

# THE DAILY REFLECTOR

Greenville, N.C.

Wednesday Afternoon, August 16, 1989

25¢



The Daily Reflector/Shannon Wolfe

## Teachers' First Day

Pattie Leary, a teacher at D.H. Conley, places a corsage on Pearl Frizzell, the school's bookkeeper, as a welcome back on the first day back for teachers today. Conley Principal Ike Baldree spoke at an assembly welcoming the teachers and staff to the upcoming school year.

## U.N. Truce Accepted In Lebanon

THE ASSOCIATED PRESS

BEIRUT, Lebanon — The leader of Lebanon's Christian forces has agreed to a U.N. call for an immediate halt in fighting with Syrian and allied Moslem troops, a spokesman said today.

The Christian army commander, Gen. Michel Aoun, said he will accept the truce called for Tuesday by the U.N. Security Council. "The general welcomes without any conditions the U.N. Security Council resolution," said an Aoun spokesman, who demanded anonymity.

Aoun's statement was issued one day after the Syrian army and allied Moslem factions vowed to join forces to defeat the Christians. Sources today reported a buildup of troops and ammunition around the embattled Christian heartland.

There was no reaction to the U.N. cease-fire demand from rival Syrian and Moslem forces. The Security Council had called for the truce during an emergency meeting ordered by Secretary-General Javier Perez de Cuellar.

The 15-nation council unanimously passed a declaration that "urgently appeals to all the parties to put an

immediate end to all operations and to all firing and all shelling on land and at sea," said Algerian Ambassador Hocine Djoudi, president of the body.

Arab League ministers also renewed their call for an end to the fighting. Arab League committee members King Hassan II of Morocco, King Fahd Bin Abdul-Aziz Saud of Saudi Arabia and Algerian President Chadli Benjedid called in a statement for "an immediate and global" cease-fire.

Police said 19 people had been killed and 104 wounded in the fighting since Tuesday, when Chris-

tian forces fought Syrian troops with tanks and artillery along the southern, eastern and northern edges of the Christian enclave north of Beirut.

Syrian gunners also pounded the 28-mile-long Christian coastline, the only escape route for the area's residents.

By police count, 760 people have been killed and 2,050 wounded since the latest round of fighting in Lebanon's civil war began March 8.

Since then, shelling day and night has largely destroyed Beirut and

(See U.N., A-3)

## Bush Says Cuba Must Do More

THE ASSOCIATED PRESS

MIAMI — President Bush today ruled out normalization of U.S. relations with Cuba unless President Fidel Castro installs "more freedom for his own people."

In remarks prepared for a fundraiser on behalf of Republican congressional candidate Ileana Ros-Lehtinen in a city long a magnet for Cuban emigres, Bush said he will look for indications that Castro will follow the moves toward openness now exhibited by his Soviet-bloc allies.

"Someday I'd like to see improved normalized relations with Cuba. But that cannot and it will not be as long as Castro violates the human rights of his own people; as long as he, almost alone in the entire world now, swims against the tide that is bringing sweeping change to closed societies around the world," he said.

"As president, I will look for signs that Castro wants to move away from subverting his neighbors and towards more openness, more freedom for his own people. But until I see such change, there will be

(See ECLIPSE, A-3)

(See BUSH, A-10)



The Associated Press

Beirut housewife examines wreckage of her home as artillery shelling abates temporarily

## Weather Holds Key To Eclipse

By Kevin Boughal  
 THE DAILY REFLECTOR

There will be no bad seats for the lunar eclipse tonight, says Dr. Rahul Mehta, assistant professor of physics at East Carolina University, as long as the weather cooperates.

Usually if you want to see a star, it is better to go away from the city lights, Mehta said today. However, as the moon is so big, observers will be able to see it from almost anywhere, he said.

He said 15 binoculars and telescopes from the ECU Physics Department will be available for public use at the River Park North picnic shelter tonight for the eclipse.

"We try to make the telescopes available to the public whenever there is something interesting to watch," Mehta said. "We will have a bunch of different telescopes at the park and we will try to photograph and videotape the eclipse. The largest telescope we will bring out is a 14-inch reflecting telescope and with the right lens, it can magnify up to 100 power. We just hope to have clear weather."

The other telescopes that will be in the park include a three-inch refracting telescope, a powerful pair of binoculars and reflecting telescopes ranging in size from four inches to

the big 14-inch one.

A lunar eclipse occurs when the earth's shadow projects on the surface of the moon. By timing and measuring the shadows on the surface of the moon, scientists measure the depth of the creaters on the moon, said Mehta.

The eclipse will begin at about 8:23 p.m. but Mehta said people

(See ECLIPSE, A-3)

## Star Drug Agent Arrested

THE ASSOCIATED PRESS

BOSTON — A decorated U.S. drug agent whose undercover work goes back to the French Connection days was himself arrested in a sting by colleagues after he allegedly walked into a setup carrying 62 pounds of cocaine.

Edward K. O'Brien devised some of the federal Drug Enforcement Administration's best undercover operations during an 18-year career, said fellow Agent John J. Coleman, who described himself as a friend of O'Brien's.

O'Brien, 44, was arrested late Monday at Logan International Airport while delivering suitcases filled with cocaine to informants, authorities said.

"This is a very sad, sad moment in drug enforcement," Coleman said Tuesday.

Coleman said he and O'Brien worked together in southern France trying to uncover heroin labs in the 1970s.

"Those were the hotbeds of activity in the French Connection days," he said.

Coleman said O'Brien's knowledge

of how sting operations worked made his arrest particularly difficult. To conduct the sting that netted O'Brien, the DEA used private citizens who cooperated with the agency, Coleman said.

"You're dealing with someone in every respect who would be knowledgeable of everything," Coleman said.

O'Brien headed the DEA's Springfield office from 1982 to 1988 and received a special citation from Gov. Michael S. Dukakis in 1984 for

(See AGENT, A-10)

## Inky Discharge Stains Sidewalk

By J. Ward Best  
 THE DAILY REFLECTOR

The same ink that sometimes turns your fingers black as you read the paper also turns the sidewalk black outside the printing room of The Daily Reflector.

Chemicals used in printing the paper, including some ink residue, are escaping from the newspaper's press room through an overflow from a drain beneath the press, blackening the sidewalk and the gutter on Reade Street. The seepage, involving five gallons or less a week, is less than two blocks from the Tar River.

The chemicals released through the plant may contain potentially hazardous materials, and the state has recommended the paper tie its drain in with the city sewer system.

According to D. Jordan Whichard III, general manager of The Daily Reflector, the discharge from the press room has occurred sporadically since the newspaper's office was renovated last fall. And when the black sidewalk came to light, the paper began to look for ways to end the discharge.

Whichard said the paper believes the discharge was mostly from a "fountain solution" used to wash printing plates and some ink residue. The discharge may also contain some cleaning solution used on the presses.

"We're pretty sure it's coming from the press," Whichard said.

The Division of Environmental Management, responding to complaints about the discolored sidewalk, took soil samples from near the drain pipe in October. Lab results of the samples, released in June, show a heavy concentration of organic chemicals in the soil.

But an analysis of the actual discharge, performed by a lab in Cary for The Daily Reflector, revealed detectable concentrations of methylene chloride.

EPA lists methylene chloride as a chronic and persistent carcinogen with environmental, developmental and reproductive toxin.

Environmental scientists disagree as to the danger of the chemical without knowing the final diluted concentration in the environment. The discharge's proximity to the Tar River, however, could be cause for concern.

"If that material in quantity were getting into the tributary, it could be bad news," said Doug Rader, senior scientist with the North Carolina Environmental Defense Fund.

The difference between the soil sample and the discharge analysis is not clear.

The concentrations of organic chemicals and alkanes such as dimethyl ethyl benzene and tetra methyl butyl phenol in the soil could have come from a cleaning solution or could have accumulated in the soil over a period of years.

From its analysis, the state concluded the discharge was not toxic, but recommended the paper connect its discharge to the city sewer system.

Whichard contacted the Greenville Utilities Commission following the state's recommendation, and the lab analysis was performed on the request of GUC.

"What we hope is that we will pay to plumb this into the sanitary sewer system," Whichard said.

(See DISCHARGE, A-3)

## Weather

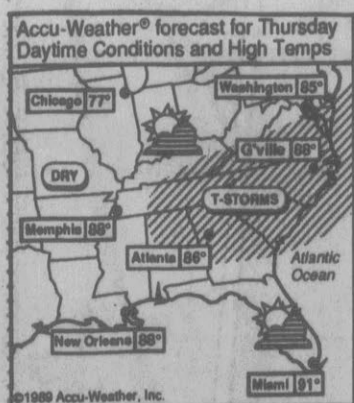

### Forecast

Chance of rain tonight and again Thursday afternoon. Low tonight near 70. High Thursday near 90.

### Looking Ahead

Partly cloudy Friday through Sunday. Highs mostly in 80s. Lows in upper 60s.

## Hospital Shows Monthly Profit

By Carol Tyer  
 THE DAILY REFLECTOR

Pitt County Memorial Hospital had more revenue than expenses in July — \$118,007. This is the first time in several months that the hospital has made more than it spent, Valerie Dixon, assistant vice president for financial services, told hospital trustees Tuesday.

Ms. Dixon said that the reversal was primarily because of having a full Medicaid rate available as of Ju-

ly 1. Also, teaching and bad debt funds were available as of July 1 from the East Carolina University School of Medicine.

Outpatient income continued to offset fewer patient days that had been budgeted, Ms. Dixon said. She said the total patient days this year were 3,781 below budget, while outpatient visits were above budget by 175.

The board voted, subject to approval by financial advisers Ernst and Young, to establish a self-insurance plan to provide employees'

medical coverage. It voted to amend the 1990 budget to allow spending of some \$200,000 to complete the funding of the self-insurance program if Ernst and Young give the go signal.

The board approved the spending of \$68,500 for auditing services of Ernst and Young. This amount is a 10 percent increase over the amount paid the same firm for auditing last year, the board was told.

Paul Jensen, vice president of

(See PCMH, A-3)

## Housing Funds Made Available

The North Carolina Department of Commerce has announced that Martin County Community Action Inc. has received an additional \$117,500 from the Commerce Department's Energy Division to weatherize homes of low-income, elderly and handicapped citizens.

The non-profit agency now has funds to weatherize 116 homes in Martin, Pitt and Beaufort counties this program year. The agency received an initial \$53,500 grant in June.

"The purpose of the weatherization program is to increase the energy efficiency of the home, thereby lowering monthly heating costs while providing more comfortable and healthful living conditions for the occupants,"

Doug Culbreth, director of the energy division, said.

The funds, part of the federal Weatherization Assistance Program administered at the state level, will be used to buy and install items like weather stripping, caulking, duct and water heater insulation, and storm windows on homes of residents whose income does not exceed 150 percent of the poverty level (\$18,150 for a family of four). On average, the grant is expected to fund about \$1,400 in energy-conserving improvements to each home weatherized.

For information on how to be considered for weatherization, call Martin County Community Action, toll-free, 1-800-682-5268.

# In The Area

## Tuesday Thefts

Eight thefts, ranging from cash and a car to flowers, were reported to Greenville police Tuesday.

Officer R.L. Smith said \$300 in cash was taken from a car parked at the intersection of 11th and Forbes streets in an incident reported at 12:16 a.m., while Officer R.C. Allbrook said a radar detector was taken from a car parked at 10A Sara Lane in an incident reported at 7:35 a.m. and a television set and video cassette recorder were taken from St. Gabriel's Catholic School at 1101 Ward St. in a break-in reported at 2:27 p.m.

Officer R.G. Mendenhall said a 1977 Datsun 280Z was taken from Plantation Apartments in an incident reported at 8:29 a.m. and a total of \$46 in cash was taken from three offices at the Pitt County Mental Health Center at 2310 Stanfordsburg Road by a 12-year-old in an incident reported at 9:34 a.m., while Officer K.M. Lang said a wallet containing \$22 in cash was taken from the Courtside Cafe at the intersection of Third and Evans streets in an incident reported at 11:31 a.m.

Officer D.R. Best said a man's diamond ring was taken from 122C Woodlawn Ave. in an incident reported at 4:54 p.m., while Officer R.S. Sawyer said 12 petunia plants were taken from a yard at 903 Douglas Ave. in an incident reported at 7:56 p.m.



Miss USA talks with Stephanie Murphy, 4, during PCMH visit

The Daily Reflector/Shannon Wolfe

## Miss USA Is Urging Kids To Keep Trying

By Amy Gavigan  
THE DAILY REFLECTOR

Gretchen Polhemus, the reigning Miss USA, wants to send a message to children to be the best they can be, no matter what the odds.

Miss Polhemus, in a visit to JC Penney at the Plaza Tuesday, said she enjoys speaking and interacting with children.

"I have a theme of 200-1," Miss Polhemus said. "When I was competing in Alabama (for Miss USA), a guy from Austin gave 200 to 1 odds (for me) to win. So, what I talk to talk to these kids about now is not sizing themselves down.

"Don't listen to somebody else," she said. "If you have the desire, go out and try. The worst thing that can happen is you didn't try hard enough."

Miss Polhemus also visited the children's ward at Pitt County Memorial Hospital Tuesday morning and was able to spend some time with the patients.

Although she knows she is not able to help cure the children, she feels a little happiness will carry them a long way.

"There was a 4-year-old little girl, going through chemotherapy," Miss

### Speaker Scheduled

The Rev. James Louis of Pleasant Park Hill will speak at Deliverance Center, Ayden, today at 8 p.m.

Polhemus said. "There wasn't anything I could do, but just to get a hug from her — little things like that — anything to make them a little happier.

"People ask a titleholder all the time: 'What can you do to save the world?' There's nothing," she said. "But, with little kids, I think it matters to them just to know that someone cares about them."

Prior to competing in the Miss USA pageant, Miss Polhemus held the title of Miss Texas USA 1989.

As Miss USA, she will represent the pageant's producer, Madison Square Garden Television Productions and its sponsors, primarily JC Penney and Procter & Gamble.

Miss Polhemus has been traveling, mainly for JC Penney, since the first of March. During her first visit to North Carolina, she has visited Wrightsville Beach and will go on to Wilson and Raleigh.

She said she was impressed with North Carolina beaches, trees and the friendly people.

"All the JC Penney stores I've been in and talk to people, they're so friendly," she said. "I kind of feel like I'm at home."

Home to Miss Polhemus is Fort Worth, Texas, where, before winning the pageant, she worked as a horse and cattle broker and real estate agent. After her reign, she plans to return to her brokerage and real estate career, according to a release by JC Penney.

## Graduate Fellowship

Linda Jean Broadbelt has received a graduate fellowship from the Phi Kappa Phi Honor Society Foundation of Baton Rouge, La., for graduate study in chemical engineering at the University of Delaware.

She was nominated by The Ohio State University Chapter of the Honor Society of Phi Kappa Phi.

Recently co-valetictorian at OSU, she was one of three seniors with a straight-A average and was the recipient of the Dow Chemical Outstanding Junior Award in chemical engineering.

Ms. Broadbelt is the daughter of Jean and Donald Broadbelt of Greenville.

## Reunion Planned

The Maury High School classes of 1928 through 1940 will hold a reunion at the Bar-B-Cue Lodge in Kinston on Aug. 26 beginning at 6:30 p.m. with dinner being served at 7 p.m.

For further information, call 747-5429 or 744-3508.

## Class Schedules

D.H. Conley students may pick up class schedules for 1989-90 in the entrance lobby of the school Monday and Tuesday from 9 a.m. to 3 p.m.

## Seminar Attended

Dr. Steven Cohen, a physician at Greenville Family Chiropractic Center, recently attended a two-week neuro-associative conditioning certification seminar in Maui, Hawaii.

## Registration Set

Ayden-Grifton High School registration for new students and those who withdrew last year will be held at the school Monday and Tuesday between 8:30 a.m. and 3:30 p.m.

## Degree Earned

William M. Foskey of Greenville has earned an associate degree through Regents College of the University of the State of New York.

## Band Camp

The Farmville Central High School Marching Band recently traveled to an annual band camp at Ferrum College, Ferrum, Va. The band will rehearse and learn its marching program. The band is directed by Craig Everett.

# Ayden Budgets Funds For Kids

By Carol Tyer  
THE DAILY REFLECTOR

AYDEN — Town Commissioners have agreed to budget \$18,000 for its Police At-Risk Kids program.

The program provides for town police officers to work with public schools in identifying and serving children who appear to be headed toward conflict with the law.

The board also voted Monday night to close an alley behind Ayden Free Will Baptist Church. This action was taken when there was no opposition from anyone present at a public hearing on the matter.

Consideration was given to requests for annexation from The Anointed One's Church and the Pitt County Group Home. Ralph Ford, town clerk, was directed to investigate the petition and see if the petitioners are owners of record. He

is to report at the commissioners' next meeting, at which time public hearings on both annexation requests probably will be set.

The board accepted the 1989 tax levy and turned the list over to Ford for collection.

There was discussion of ways to encourage owners of downtown business places to improve their buildings. It was pointed out that any building which changes purposes now has to be reinspected by the county. One of the reasons for this is that many storefronts are now being changed into places of assembly and codes for assembly places are more stringent than for retail stores.

Board member Susan Moody was congratulated by her fellow board members on being elected vice president of the Electricities organization of which Ayden is a member municipality.

## Church Service

Eldress Ella Grimes will preach at Faith Deliverance Outreach, on Second Street, Ayden, today at 8 p.m.

facilities will be closed to the public Aug. 23 for a day of in-service training for library staff.

## Church Convention

The Overcoming Faith Southern Convention will begin Thursday and continue through Sunday with services at Church of Faith, 1205B West Fifth St.

Services will be held at 7:30 p.m. each night from Thursday through Saturday. The Sunday service will be at 11 a.m.

## Surgeon Elected

Dr. James W. Carter of Greenville was recently elected president of the North Carolina Chapter of the American College of Surgeons.

Carter, a partner in Pitt Surgical, P.A., provides general, thoracic and vascular surgical services.

Carter is a member of the medical staff at Pitt County Memorial Hospital and is the vice chairman of the department of surgery. He is the director of surgical residency and a clinical associate professor of surgery at the East Carolina University School of Medicine. He received his undergraduate and medical degrees from Johns Hopkins University and completed his internship and surgical residency at Vanderbilt University.



JAMES W. CARTER

## The Daily Reflector

Incorporated  
209 Cotanche Street  
Greenville, N.C. 27834  
(919) 752-6166

108th Year No. 196

Second Class Postage Paid At Greenville, N.C.  
(USPS 145-400)

Advertising Director: Tim Holt  
Production Director: J. Tim Jones  
Circulation Director: Nelson Adams  
Director of Administration and Personnel: Barbara Jarvis

Published Monday through Friday  
afternoons and Sunday morning

Subscription Rates  
Home delivery by carrier or motor route,  
monthly \$5.00 payable in advance

Mail Rates  
Pitt and adjoining counties: \$5.00 per month  
Elsewhere in N.C.: \$5.50 per month  
Outside N.C.: \$6.50 per month

Member Associated Press  
and  
Audit Bureau of Circulation

Is your Daily Reflector not being delivered?

First - call your Independent Carrier. If you are unable to reach him... then call The Daily Reflector at 752-3952 between 6-6:30 pm, M-F and 8-9 am, Sunday.

Introducing Coco, the exciting new fragrance by Chanel now available at Brody's

The first fragrance to bear the name of the name of the woman who inspired it, Gabrielle "Coco" Chanel. A legend in her own time. A gold and warm fragrance built on a major amber chord. An asymmetry of precious flowers embellished with spices and leather. Discover Coco's distinctive allure now, at Brody's.

From the collection:  
Parfum 1/2 oz. \$125.00, EDT Pour 3.4 oz. \$90.00, 1.7 oz. \$55.00, Parfum 1/4 oz. \$72.50, 1/4 oz. spray \$75.00, EDT Pour 2.5 oz. \$37.50, EDT Spray 3.4 oz. \$55.00, EDT Spray 1.7 oz. \$35.00

Brody's

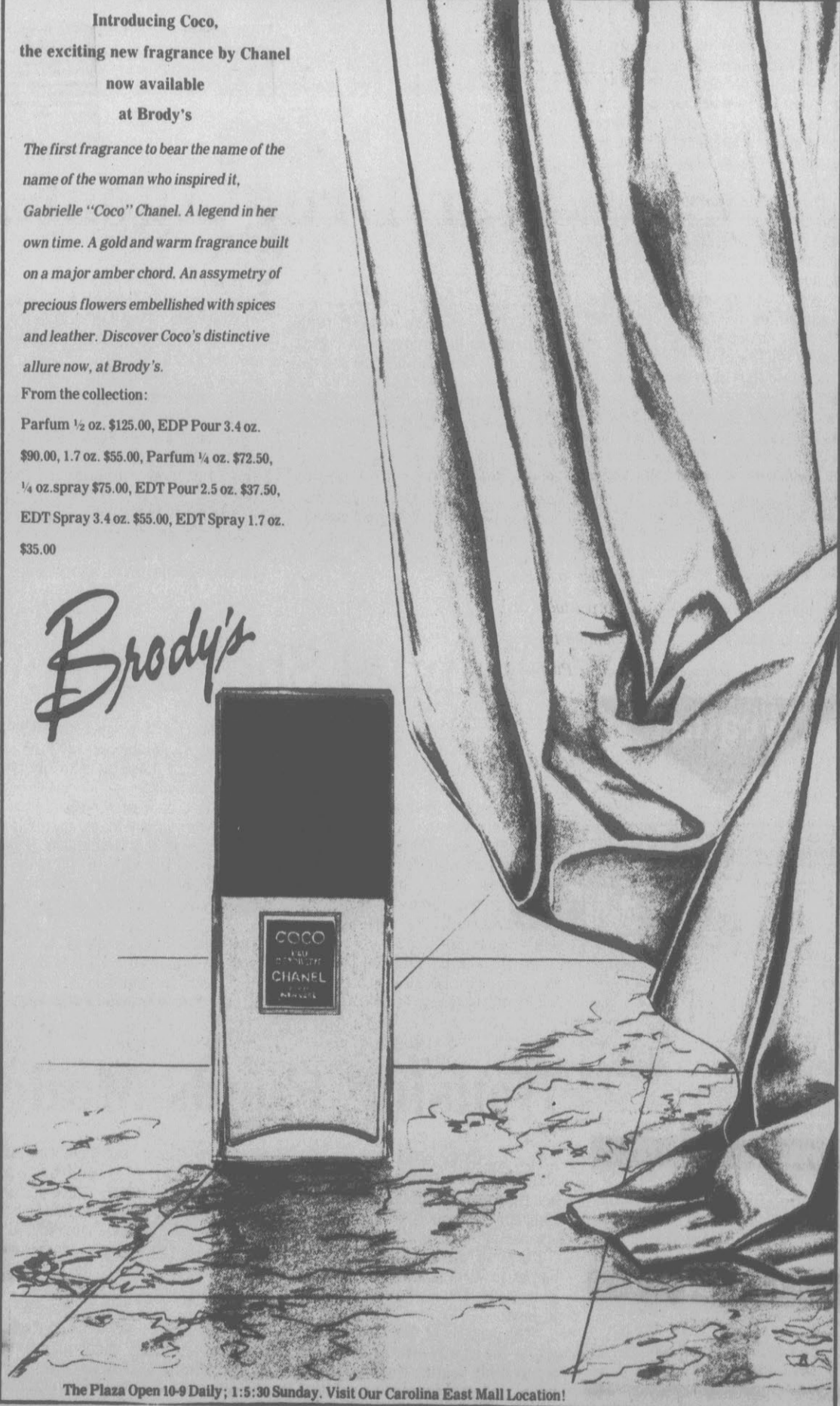

BRODY'S JUNIOR DEPARTMENT HAS TEMPORARILY RELOCATED TO THE OLD "SHOE SECRETS" LOCATION ACROSS FROM SASLOW'S JEWELERS AT THE PLAZA

COME IN AND SEE THE NEW AND EXCITING FALL JUNIOR FASHIONS WHICH ARE ARRIVING DAILY!

Brody's

SHOP 10-9 DAILY; 1-5:30 SUNDAY

The Plaza Open 10-9 Daily; 1:5-30 Sunday. Visit Our Carolina East Mall Location!

# U.N. Call For Truce Accepted

(Continued from A-1)

driven out 90 percent of the city's 1.5 million residents.

The fighting between the 20,000 mostly Christian troops under army Aoun and Syria's 40,000 soldiers slackened early today to intermittent shelling.

But Moslem security sources speaking on condition of anonymity said the Syrians were reinforcing their troops opposite Aoun's lines in Beirut, the central mountains and northern Lebanon.

One source said, "Syrian trucks were observed early in the day bringing in troops and ammunition to positions facing Aoun's lines."

He said Druse warlord Walid Jumblatt's Progressive Socialist Party and Palestinian guerrilla groups from Col. Saeed Mousa's Fatah-Uprising, bankrolled by Syria, also sent reinforcements to their positions in the wooded mountains southeast of Beirut.

The buildup began after a seven-hour meeting in Damascus of the heads of virtually all Lebanon's fractious Moslem groups.

The Syrians summoned their Moslem and leftist Lebanese militia leaders to Damascus for a council of war in what appeared to be a move to escalate the campaign against the Christians.

The leaders of 16 factions, including Iranian-backed Shiite groups and radical Palestinian guerrillas, attended. They issued a statement late Tuesday saying they would close ranks to bring down Aoun.

"The solution must be on the basis of ending the Israeli occupation, and blowing up the sectarian regime from its roots," it said. "But to bring down Aoun is the priority, as well as blowing up all the imaginary red lines."

The border of the Christian enclave is often referred to as a "red line" that would provoke international intervention if crossed by

Syrian forces because it would represent a major escalation in the fighting.

Syria has used its militia allies to do most of the ground fighting while Syrian artillery and armor provide support, giving Damascus room for diplomatic maneuvering.

International pressure was building for a cease-fire.

Pope John Paul II said Tuesday from Castelgondolfo, Italy: "In the name of God, I turn to the Syrian authorities, asking them to stop the bombardment that aims to destroy ... the whole country."

Perez de Cuellar called the emergency U.N. meeting when none of the Security Council's 15 member nations acted.

The U.N. charter allows the secretary-general to call such meetings when international security appears in serious danger.

An aide to Aoun, speaking on condition of anonymity, said the general was not seeking "merely a cease-fire" but a "package deal" that includes a schedule for the withdrawal of Syrian troops.

"Any violation of the cease-fire by the Syrians will be a challenge to the United Nations," the Aoun aide said without further elaboration.

# British Deport Pro-IRA Lawyer To United States

THE ASSOCIATED PRESS

LONDON — Pro-IRA activist Martin Galvin was deported to the United States today after violating an order barring him from British territory, the government said.

Galvin, publicity director for the New York-based Irish Northern Aid Committee, or NORAI, was flown out of Britain on a Royal Air Force flight heading to Washington, the Home Office said.

The 39-year-old New York lawyer was arrested Tuesday in Londonderry, Northern Ireland, after taking a walk through the city on the 20th anniversary of the deployment of British troops in the troubled province.

"He was flown out on a regular RAF flight to the United States," said a spokesman for the Home Office, speaking anonymously in keeping with British custom.

"It was a point that we wanted him out of the country as soon as possible and the RAF had a plane available at about 5 a.m."

Galvin has been banned from entering British territory since July 1984 when he gave a speech endorsing violence one day after a soldier was killed in Londonderry.

A month later police tried to arrest him during a public appearance in west Belfast. Galvin fled, but a young man was killed by a plastic bullet fired by police trying to break up fighting in the crowd of Irish Republican Army supporters.

Galvin has visited Northern

Ireland illegally on at least three other occasions.

He said Tuesday he had been in the province for three days before police in bullet-resistant vests arrested him. He was flown Tuesday night to Royal Air Force base Brize Norton, about 50 miles northwest of London.

During his walk, Galvin was accompanied by Martin McGuinness, vice president of Sinn Fein, the

IRA's legal political wing, and by several local IRA leaders. They openly walked past a security checkpoint on their way to the mainly Roman Catholic Bogside area of Londonderry.

Sinn Fein President Gerry Adams said Galvin was not permitted to speak to lawyers before being deported, but would be challenging the exclusion order on his return to the United States.

# PCMH Income Up

(Continued from A-1)

support and outreach services, reported that an auction of the hospital's no-longer-needed equipment will be held Oct. 6 at 10 a.m. at ABC Moving and Storage Warehouse 7.

The board approved capital requests of \$111,820. Included were \$14,000 for a manual surgical bed for labor and delivery; \$29,000 for an instrument washer for Central Services; \$19,130 for a recorder for an EKG monitor for neonatal intensive care; \$12,750 for a sterilizer and \$12,000 for bronchoscopes, both for operating rooms; \$14,950 for an EEG monitoring system for Critical Care Unit 3; and \$9,990 for a metabolic monitor for the catheterization lab. All of these but the surgical bed were

budgeted items exchanged for items of about the same price previously budgeted for.

Also approved was the spending of \$934,000 for computer expansion (\$694,000) and network expansion (\$240,000).

The total spent on capital improvements this fiscal year so far has been \$8,412,490. With a month and a half until the new fiscal year begins, the balance of the capital budget for the year is \$171,646, board members were told.

Charles Fennessy, vice president for human resources, reported that the hospital's program to combat child abuse is progressing. He said a master's-level social worker and a clinical nurse specialist to work in the program will be hired soon.

# Eclipse

(Continued from A-1)

probably will not be able to see anything until about 9:20 p.m., when the moon will begin to be covered. It will be completely covered between 10:20 p.m. and 11:56 p.m. The moon will be completely out of the shadow by 1:53 a.m. The telescopes should be in place between 8 p.m. and 9 p.m.

Because there have been no significant volcanic eruptions during the last few years, the earth's atmosphere should be clear and so the moon will appear to be copper or brick red, Mehta said. If the atmosphere was filled with dust, then the moon would just appear dark. The moon will appear red because of the way that the light is refracted in the earth's atmosphere.

Besides the lunar eclipse, observers will be able to see Saturn, Uranus and maybe Neptune in the south-southeast sky. Saturn will be visible to the naked eye but, if seen through the telescope, one will be able to see the rings and even some craters on the surface, Mehta said.

Weather forecasts call for a 30 percent chance of showers this afternoon and this evening.

# Discharge Studied

(Continued from A-1)

Since about June, Whichard said, the paper has been collecting as much of the discharge as possible and running it through the sewer system. Depending on GUC, a permanent system will be installed to connect the drainage to the city's sewer. If GUC does not accept the discharge, the waste will be collected and sent to a waste site.

Officials at GUC expect a decision by the end of this week.

Barrett Lasater, industrial services coordinator with GUC, said the amount of discharge projected to come from the paper, approximately three to five gallons a week, would not cause a problem in the city's treatment system. But he could not say definitely if the waste would be accepted.

"I would expect a definite answer by the end of this week," Lasater said.

**Lordy, Lordy "B.L.T." is 40!**

**Happy Birthday Bobby**

From: The Gang at DOC of G.

**Happy Birthday Bobby**

from A Friend At Hooker Memorial Christian Church

**Ice Cream Yogurt** COUPON

2 PrePack Quarts Only \$5

CALL 756-4477 FOR YOUR ORDER

GREENVILLE SQUARE SHOPPING CENTER

Next to K-Mart

No Limit With Coupon

Coupon Expires August 31, 1989

**GUILD OPTICIANS**

**OPEN 9:30 A.M. 'TIL 7:00 P.M.**

**MONDAY THRU FRIDAY** (LATER APPOINTMENTS BY REQUEST)

**SATURDAY 9:30 TO 3:00**

Visit The Eye Glass Professionals

**GUILD OPTICIANS**

Only 600 firms in the U.S. have qualified to display this emblem.

**FREE EYE GLASSES**

Buy A Pair Of Glasses, Get The Second Pair...FREE

Offer does not apply with any other advertised specials. \$60.00 Minimum Purchase. (NO THIRD PARTY PAYMENTS HONORED)

The Exam — We can make arrangements to have your eyes examined by an eye doctor adjacent to Clear-Vue. We fill any eye doctor's prescription.

\*By Clear-Vue Opticians

**CLEAR-VUE OPTICIANS**

WE CAN ARRANGE TO HAVE YOUR EYES EXAMINED TODAY!

2484 STANTON SQUARE GREENVILLE 752-1446

NEW HOURS MON. THRU FRI. 9:30 TO 7:00 OPEN SATURDAY 9:30 TO 3:00

WE CAN ARRANGE TO HAVE YOUR EYES EXAMINED TODAY!

\*GREENVILLE'S FIRST COMPLETE ONE HOUR SUPERLAB SINGLE VISION OR BIFOCALS IN JUST ONE HOUR (MOST PRESCRIPTIONS)

COUPON: Buy a pair of glasses at regular price and get a second pair of sunglasses or clear lenses FREE. Coupon must be presented at time of purchase. Offer includes most single vision and 28 mm flat top bifocal prescriptions. Some lens restrictions apply. Complete glasses include frames and lenses. (Choose from a select group.) Expires August 21, 1989



## Obsession and Obsession for Men

by Calvin Klein

Provocative, blending the richness of jasmine, rose and orange blossom with exotic spices and warm amber. Cologne, 1.7 oz. \$32.00. 3.4 oz. \$45.00. 3.4 oz. spray, \$47.00. Obsession for Men: 4 oz. cologne, \$39.00. 4 oz. After Shave, \$28.00, 4 oz. After Balm, \$30.00, 4 oz. Cologne Spray, \$42.00.

## Clinique

Visit our new and expanded Clinique counter. Have your skin analyzed by a Clinique consultant and learn this revolutionary approach to skin care. A success which counts as its hallmark hundreds of thousands of beautiful women the world over.

## Estee Lauder

See our Estee Lauder Specialist to discover the fine skin care and make-up products that will help you look your best. Sample the beautiful world of Knowing® fragrance. Parfum, 1 oz. \$35.00, 2 oz. \$50.00, Parfum spray, .25 oz., \$75.00

Our new cosmetic area opens tomorrow. See our new fragrances and extended treatment lines. More beautiful skin has never been more close at hand.



# A BEAUTIFUL NEW BRODY'S AWAITS YOU AT THE PLAZA

There's a whole new look at Brody's Cosmetics Department at The Plaza. We've completely remodeled our cosmetic area to bring you even better service, selection and shopping convenience.

## Erno Laszlo

Over 60 years ago, Dr. Erno Laszlo pioneered individualized skin care. Now at Brody's we can continue that tradition of success. Combining the science of dermatology with the art of cosmetology to create exacting skin care preparations that not only interact with skin, but protect, beautify and improve it.

## Poison by Christian Dior

Eau de toilette, 1.7 oz. \$42.50. Eau de cologne, 3.4 oz. \$40.00. Parfum, 1.7 oz. \$160.00. Eau de toilette splash, 1.7 oz. \$40.00.

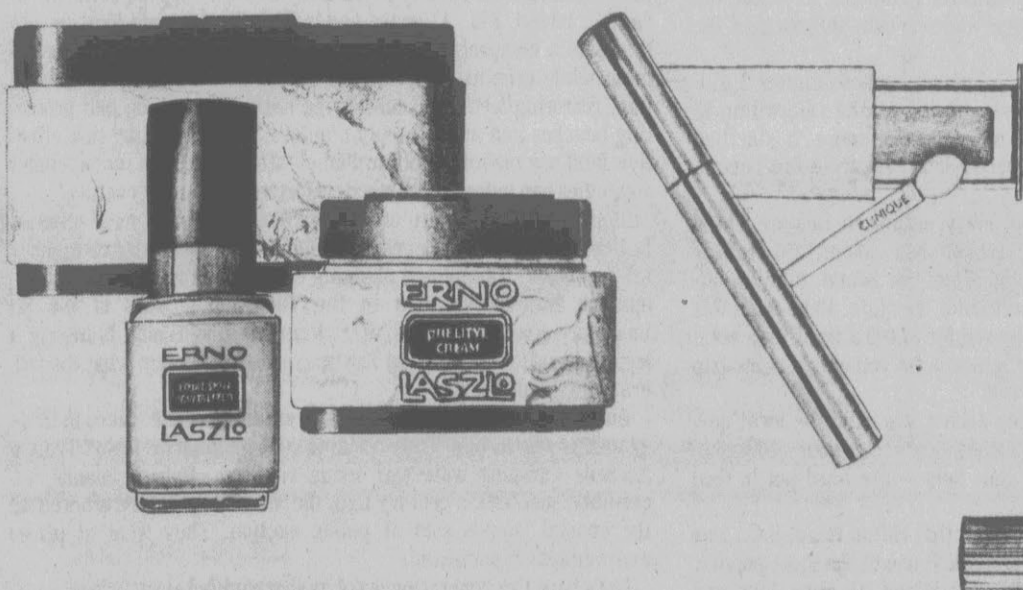

*Brody's*

# Opinion

## THE DAILY REFLECTOR

Established 1882

David Julian Whichard, Chairman of the Board

David J. Whichard II, Editor & Co-Publisher John S. Whichard, Co-Publisher  
D. Jordan Whichard III, General Manager Alvin B. Taylor, Managing Editor  
Mary C. Schulken, Editorial Page Editor

'Truth In Preference To Fiction'

## Stalemate

### Find Funds To Revitalize BEP

A step forward should be cause for pride, especially if it is a step toward better public education. But if that advance is accompanied by a step backward with the other foot, the result isn't progress, it's a stalemate.

When the 1989 General Assembly raised state teachers' salaries an average of 6 percent, North Carolina took an important step toward improving its public education system. But when lawmakers slashed funding for the Basic Education program nearly in half, that progress was negated. One step up; one step back. That amounts to a standstill.

A public school system requires excellent teachers. Attracting excellence demands good pay and good working conditions, North Carolina's teachers hadn't had a pay raise since wages were frozen early in the decade in an effort to balance the state budget. That put the state unacceptably far behind in teacher salaries — 28th in the nation. There's no way of knowing how many top quality teachers either left the profession or selected other careers because of this lag. The raise approved by lawmakers correctly addresses this issue.

But although salaries moved forward, state legislators couldn't seem to find the money to fully fund the fifth installment of the Basic Education Program, a long term effort designed to provide each school child — rural, urban, rich, poor — with an equal education. The state's public schools got a token \$69 million for the BEP instead of the \$112 million originally scheduled.

Exactly what does that cutback mean? Well, there will be 250 less counselors and school social workers available to help kids choose courses, make college plans, make decisions about sex or work out family difficulties. In addition, 1,271 lab and classroom assistants won't be giving teachers more instructional time by assuming paperwork and clerical duties. Part of the beauty of the BEP is the fact it gives teachers more time to teach. But that help is on hold — thanks to the cuts.

The BEP is a long term commitment to improving North Carolina's public school system. It is a tangible means of enabling students in poor school systems to have the same education students in wealthy systems receive. That's why its implementation should be kept on track.

This was a tough budget year for lawmakers. They struggled with shrinking revenues, woefully inadequate teachers' salaries and the need to fund massive roadbuilding.

But the state's public school system may be the most important investment North Carolina makes, and the BEP is the key to making that investment pay dividends. It should not be shortchanged.

Legislators made a significant pledge when they conceived and approved the BEP. That was no small resolution.

Their devotion to education is in serious question, however, after this year's cutbacks. When the 1990 short session of the General Assembly convenes next year it is the lawmakers' responsibility to find the funds to revitalize that commitment.

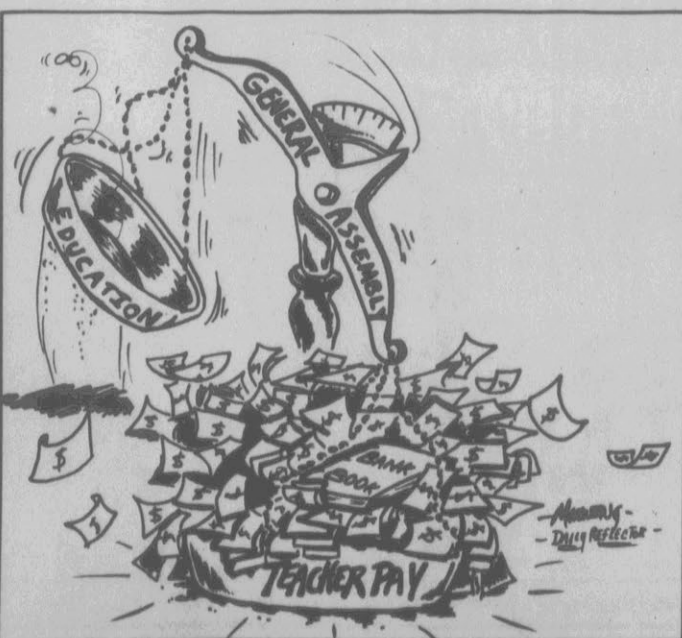

## A Legislative Report Card

### '89 General Assembly

## Bribe Somebody Else To Do It

Art Buchwald

"What on earth is going on in the Soviet Union?" I asked Sochek, my shoe repairman.

He replied, "All we are seeing is the expected. Communism doesn't work and it never has. In addition, there doesn't seem to be any way for the Communist leaders to switch to another system without losing their jobs."

"I grew up hating Communists. If they disappear, I am really going to miss them," I told him.

"The Soviet people have had it up to here," Sochek said. "Gorbachev knows this so he is hoping to change the system without toppling the entire party. One of the worst things is the corruption. No matter what is going on, someone always has his hand out demanding a bribe."

"Can Gorbachev make a difference to that situation?"

"No, but they will print his picture in the newspapers showing him in a crowd, (ital) promising (unital) that he will."

"Why did you leave Russia?" I asked.

"I was in charge of manufacturing shoes in Minsk. My responsibility was to get them made before winter set in. You have to know a lot of people to get shoes made in Russia. It was no fun, but I did it. I had only one major problem — I couldn't get any heels for my shoes."

"So, I called the Lenin Rubber Heel Works in

Pinsk. They said that they didn't have any heels at the moment and told me I should call back in two years.

*"This is why the system stinks. Even corruption doesn't work in a Communist country. The bureaucrats are too corrupt to let it work. In a democratic society if you bribe somebody, he stays bribed."*

"How much will you take under the table for the heels you don't have?" I wanted to know. "The manager told me, 'Four hundred rubles a heel. If you don't want them, the Smolensk Moccasin Cooperative will take all the heels they can get.' I paid him under the table for the rubber."

"Where did you get the money to pay him?"

"Anyone in Minsk who wanted a pair of shoes had to pay me under the table."

"Nobody could complain about that as long as they got their shoes."

"That's the problem," Sochek said. "They didn't get the shoes. Some big shot in Moscow ordered that my shoes be sent to his brother-in-law in Kiev."

"For which," I wondered aloud, "he was paid under the table?"

"This is why the system stinks. Even corruption doesn't work in a Communist country. The bureaucrats are too corrupt to let it work. In a democratic society if you bribe somebody, he stays bribed."

"Did you get into a lot of trouble because you couldn't honor your contracts for the shoes?"

"The party chief in Minsk attacked me on local television for letting Marx and Engels down. He claimed that I was part of the Brezhnev era's do-nothing managers, who deserved 20 years of hard labor in Finsk."

"That sounds serious. What did you do?"

"Just what any loyal Soviet citizen would do. I bribed someone in the Ministry of Emigration to get me out of the country."

"I'll bet you didn't mind paying that final bribe."

"It wasn't the last bribe. What makes you think that you can get on a Russian airliner for just the price of a ticket?"

"It sounds as if Gorbachev has his work cut out for him. In order to change the Communist system you have to change the people who are running the country. How do you get them out of office?"

Sochek's eyes lit up. "The only way is to bribe somebody else to do it."

(c) 1989, Los Angeles Times Syndicate

## Of Man & Islands

David Broder



BEAVER ISLAND, Mich. — Next Saturday is a big day in the history of this island at the top of Lake Michigan, west of the Straits of Mackinac. In the past 125 years, it has been a Mormon agricultural kingdom, a flourishing Irish fishing and lumbering community, a depressed area and, most recently, a growing vacation and retirement center with severely strained sewage and road facilities. Next Saturday, it may get a focus on what the next phase in its life will be.

A big turnout is expected when the final version of what is called the Wade-Trim Economic Development and Planning Report is made public by the consulting firm of that name. The firm has been retained with state funds to help chart where things stand and where they might go.

These are vital questions here. When a preliminary version of the report talked about condominium developments on the harbor, a conference center and golf course on other beaches, some people were outraged. This is a place where fist fights can break out (as happened recently) over traffic on a private dirt road.

But these are not just parochial concerns. Last month, a part-time resident of Beaver Island, William J. Schneider, was a witness at a congressional hearing on Capitol Hill. House Interior Subcommittee Chairman Peter H. Kostmayer (D-Pa.) spent a morning listening to testimony on "America's Islands — Open Space at Risk?" It was part of a series Kostmayer is holding to assess the federal role in protecting the natural and recreational assets of the nation.

Islands are an important focus, he noted, because almost 3 million of the 8 million acres of islands outside Alaska "lie within 25 miles of urban populations of 50,000 people or more, a startling statistic when...open space and recreational resources are becoming increasingly stressed."

Schneider, the president of the newly organized Beaver Island Property Owners Association, which has about 250 family members, told how that stress could affect this island, 26 miles offshore from the fastest-growing section of the state. Lake-front lots on the mainland opposite here now sell for \$4,000 a front-foot, compared to \$300 on the island. "That makes a \$45 round-trip plane trip quite a bargain," Schneider observed.

Obviously, developers are eyeing such a site. And the local governments — two separate (and sometimes contentious) township boards of busy citizens, with no staff help — are hard put to deal with the conflicting demands.

At that, Beaver Island is better fixed than Hilton Head, S.C., was when the developers moved in and made it one of the most popular resorts on the East Coast. The Barrier Island, 15 miles long and five miles wide, was home to egrets, herons and cranes; descendants of freed slaves grew rice, indigo and cotton. Then, in 1956, a

two-lane bridge was built linking it to the mainland and serious development started.

As John R. Evans, president of the Hilton Head Land Trust, testified, there was no local government on the island from 1956 until 1983. Politicians in office in Beaufort County, "one of the poorest counties in the south," could see what was happening on the island only in terms of the tax revenues it produced. By the time the island formed a city government, Evans said, three-fourths of the natural wetlands had been lost to development, marinas were polluting the oyster and clam beds, 20 golf courses were each taking 250,000 gallons of water a day from the aquifer and the average summer day saw 52,000 people crowd onto Hilton Head.

*'Incredibly, just over a century ago, the Maine legislature ordered all the coastal islands sold at public auction. They went at prices averaging \$3.25 per island. Let's hope this generation is not as shortsighted.'*

Only now is the island being protected by land-management and tree ordinances and benefiting from the two-year-old Land Trust that acquires sensitive areas like Hooping Crane Pond.

It doesn't have to be like that. Kostmayer heard Luther Propst of the Conservation Foundation describe how foresighted residents of Sanibel Island, Fla., 15 years ago halted development long enough to create a comprehensive plan "that allowed substantial development while creating a system of marsh and mangrove conservation, restoring wetlands, conserving native vegetation and protecting beaches and water supply aquifers...demonstrating that effective land-use planning and implementation of growth-management strategies can indeed reconcile development and conservation."

Similar examples were offered by developers and local officials in North Carolina and Pennsylvania, but there were also cautionary tales of weak, fragmented planning efforts endangering both development and conservation in the Thousand Islands of the St. Lawrence River and other sites. Planning and zoning is mostly a local and state function and Kostmayer is not certain what the federal role should be.

But anything that raises peoples' awareness of the stakes in these islands is worthwhile. Today, Maine is developing an Island Trail, a 325-mile camping waterway using sites on offshore islands. Incredibly, just over a century ago, the Maine legislature ordered all the coastal islands sold at public auction. They went at prices averaging \$3.25 per island.

Let's hope this generation is not as shortsighted.

(c) 1989, Washington Post Writers Group

**A RIGHT PRICE Special**



**Impulse® Deodorant Body Spray**  
**1.99** Each  
 Choice of Fragrances

**A RIGHT PRICE Special**



**Coast® Bath Soap 3-bar Pack**  
**1.79** Each  
 Regular or Sun Spray Gold

**A RIGHT PRICE Special**



**2-Liter Coke® Products**  
**99¢** Each  
 Coke, Diet Coke, Sprite, or Mello Yello

Prices Good Through Sunday, August 20, 1989

# KERR Drug Stores Back-to-School SAVINGS

**Super Low Price!**



**79.99** Each

**Sunbeam® Gas Grill with Patio Cart.** Model #3039. 24,000 BTU's. Don't miss this special price!

Limited Quantities While Supply Lasts

**Mead® Supershades™ Back-to-School Supplies**

- Two Pocket Portfolio, **SALE PRICE 2 for \$1.**
- Wirebound Notebook, Bookcovers, or RollerBall Pen, your choice, **SALE PRICE 99¢ each.**
- Scrapbook, **SALE PRICE 1.99.**

Assorted colors and designs.

**A RIGHT PRICE Special**



**Chaise Lounge #LA11412**  
**6.99** Each  
 WAS 10.99



**1.99** Each

**TRESemme® Mousse with FREE Hot Oil, or TresSpray with FREE Tres Gelee.**



**Sale Price ..... 3.29**  
**Mfr. Rebate ..... 1.00**  
**Final Cost ..... 2.29**

**Durasoft™ Colors Saline Spray or Disinfecting Solution, 8 oz.; or 1 oz. Cleaning Solution.**



**2.59** Each

**Buf-Puf® Skin Care Products.** Includes assortment of daily cleansers and facial sponges.



**4.49** Each

**One-a-Day® Within Multi-Vitamins for Women.** 100-count. Advanced formula.



**2.39** Each

**Benadryl® Allergy Medicine.** 24-count Tablets or Kapseals. Fast relief.



**12.89** Each

**Humulin® N NPH Human Insulin.** 10 ml. Non-animal derived. Save more now.



**1.99** Each

**L'eggs Summeralls® Pantyhose.** Choice of sizes and shades.



**45.95** Each

**Norelco® Triple Head Rechargeable Razor.** Model #800RXB.



**1.69** (2-pack C or D), **1.99** (2-pack AA or AAA), **1.19** (4-pack AA)

**Kodak® Batteries**  
 • 2-pack C or D, or single pack 9-volt, **SALE PRICE 1.69.**  
 • 2-pack AA or AAA, **SALE PRICE 1.19.**  
 • 4-pack AA, **SALE PRICE 1.99.**



**2.39** (200 speed), **2.19** (100 speed), **1.99** (400 speed)

**Kerr Brand 35mm Film Bonus Pack - Get 36 Exposures for the price of 24!**  
 • 100-speed film, **SALE PRICE 1.99** roll.  
 • 200 speed, **SALE 2.19.**  
 • 400 speed, **SALE 2.39.**



**19.95** Each

**Crown Craft® "Lemans" Full or Queen Size Comforter.** Buy now at this super low price!



**99¢** Each

**Papermate® Flair® Fun Pack.** Contains four assorted color Flair® felt tip pens. Save big!



**9.88** Each

**Swing Arm Architect Lamp.** Model #EA02016. Handy lamp for home, school, or office.

**Get a 2nd Set FREE!**

*A Bonus Everyday At Kerr!*

**With every film developing order get a second set of prints FREE EVERYDAY.**

C-41 process only for 110, 126, disc and 35mm full frame color print film.

*Picture the Best for Less!*

**STANTON SQUARE SHOPPING CENTER**  
 (Hwy. 264 West)

**CAROLINA EAST MALL**  
 (Hwy. 11 South)

**OVERTON'S SHOPPING CENTER**  
 (Next To Overton's Supermarket)

KERR'S POLICY: Kerr Drug Stores reserves the right to limit quantities of all items. Kerr's policy is to provide you with the item advertised at the price advertised. If, due to some unforeseeable circumstances, the item is not available, a raincheck will be issued to enable you to buy the item later when it is available.



IN THE STATE

# DOT Gives Top Priority To Paving Dirt Roads In New Highway Plan

By Dennis Patterson  
THE ASSOCIATED PRESS

RALEIGH — The state Board of Transportation has identified dirt roads as the first beneficiaries of a \$9.1 billion road construction package passed by the General Assembly.

The board has allocated nearly \$33 million from the Highway Trust

Fund to pave dirt roads across the state.

"In our county, we're really going to be glad to get those roads paved," Randolph County manager Frank Willis said Tuesday. Randolph's allocation from the trust fund is \$875,846, bringing the total for secondary road paving to \$2.5 million this year.

DOT figures show that Randolph County is second behind Wilkes

County in the number of unpaved roads.

"We never got enough money to pave roads that were unpaved," Willis said. "We got money to stabilize them, or maybe straighten out a curve, but our problem has always been unpaved roads. We've got a lot of old subdivisions that have unpaved roads in them."

The \$9.1 billion highway package approved this summer calls for paving 10,000 miles of dirt roads by 1999, with the remaining secondary roads to be paved by 2006.

Wilkes County got \$992,247 in new allocations from the trust fund Friday, the most of any county in the

state. For the year, the county leads the state with \$3.2 million scheduled for secondary road paving.

The annual allocations made so far represent about 85 percent of the total funding for the year, DOT officials said. Additional funds will be allocated if revenue projections on which the budgets are based hold true.

In addition to Wilkes and Randolph, four other counties went over \$2 million in allocations for the year with the trust fund money.

Surry County received \$791,742 in trust fund money, pushing its annual allocation to \$2.37 million. Henderson County received \$749,737 in new allocations, making its total for the year \$2.05 million. Buncombe County got \$758,106 in additional paving money, for a total of \$2.03 million. And Ashe County got \$694,485 from the trust fund, for a total of \$2.36 million.

The boost from the trust fund, when combined with increases already included in the regular highway budget, means the state will spend at least \$101.6 million on secondary road paving this year.

## Lead Discovered

ASHEVILLE (AP) — The water from nearly a fifth of the school fountains and kitchen sinks tested by a University of North Carolina at Asheville researcher exceeded a federal standard for lead contamination.

"Every school system that we've looked at has had at least some sources that were high," said Richard Maas, an environmental scientist leading the study.

Lead is a toxic metal that can be harmful even at low levels. It can damage the brain and nervous system and young children are at greatest risk, researchers say.

Nearly 20 percent of the 2,000 school fountains and kitchen sinks tested so far exceed the federal recommended standard of 10 parts per billion, said Maas.

The study, conducted by UNCA and the Clean Water Fund of North Carolina, also found that nearly 11 percent of 3,000 school fountains and home taps tested so far exceed the EPA's current standard of 20 parts per billion for school water fountains.

## Helicopter Crash

FORT BRAGG, N.C. — Army accident investigators from Alabama probed the wreckage of a helicopter and talked to witnesses as they led the probe aimed at finding the cause of a crash that killed three soldiers.

A spokesman for Fort Bragg said the OH-58A helicopter crashed about 12:10 a.m. Tuesday while on a training mission. Identification of the victims and their unit was withheld pending notification of next of kin, the spokesman said.

The four investigators were expected to concentrate on equipment, human and environmental factors, said Lt. Col. Herbert Banks, public affairs officer for the Army Safety Center at Fort Rucker, Ala.

Debris from the helicopter was scattered across the width of a tank trail in a pine and scrub forest. Practically no parts were recognizable.

## Leaky Roof

DALLAS, N.C. (AP) — The Gaston County Police Department will be forced out of its headquarters for as long as a year because of a leaky roof that could trigger problems with asbestos, officials say.

In a special meeting Tuesday, commissioners authorized up to \$110,000 to rent a minimum of 10,000-square-foot for the department for at least six months.

The move was prompted when heavy rains Monday collapsed a portion of the police department's ceiling and exposed asbestos fibers.

## Three Killed

ASHEVILLE (AP) — A Henderson County woman and her two daughters were killed Tuesday and the girls' grandmother critically injured when their car collided with a jackknifing tractor trailer on a rainy stretch of N.C. 191.

Killed in the accident were Valerie McDougal, 40, and her daughters, Kristen Beth McDougal, 15, and Lyndsay McDougal, 12, of Etowah, according to N.C. Highway Patrol Trooper Chris Phillips.

The children's paternal grandmother, Anne McDougal, 67, of Hollywood, Fla., was listed in critical condition at Memorial Mission Hospital in Asheville on Tuesday evening, according to Phillips, the investigating officer.

## Mobil Drilling

RALEIGH (AP) — The oil spill from an Exxon tanker in Alaska last spring has prompted the oil industry to improve its ability to handle large spills, said a Mobil Oil Corp. official to a state panel reviewing the company's plans to drill off the North Carolina coast.

William C. Park III, a former U.S. Coast Guard officer who works as an environmental consultant for Mobil, said the industry was caught off-guard when the Exxon Valdez hit a reef in March and spilled 10 million gallons of oil into Prince William Sound.

The oil industry reacted to that incident, he said, by creating the Petroleum Industry Response Organization (PIRO) to deal with oil spills. The new group, based in Washington, will have five regional centers for responding to major spills.

The group also plans to establish 15 coastal staging areas, including ones in Wilmington and Norfolk, Va., where it will store equipment for containing and cleaning up spills.

## Earl Ruth

SALISBURY, N.C. (AP) — Earl Baker Ruth, who served three terms in Congress and was the last appointed governor of American Samoa, died Tuesday at his home. He was 73.

Ruth, a Spencer native who grew up in Charlotte, began his political career in Salisbury, where he served three terms on the city council and was mayor pro tem in 1967-68.

In 1968, he resigned from Catawba College after 22 years with the school, changed his voter registration from Democrat to Republican and ran successfully for the 8th District congressional seat.

While in Congress, Ruth served on the House appropriations, veterans affairs, education and labor committees.

He was defeated in 1974 by Democrat Bill Hefner.

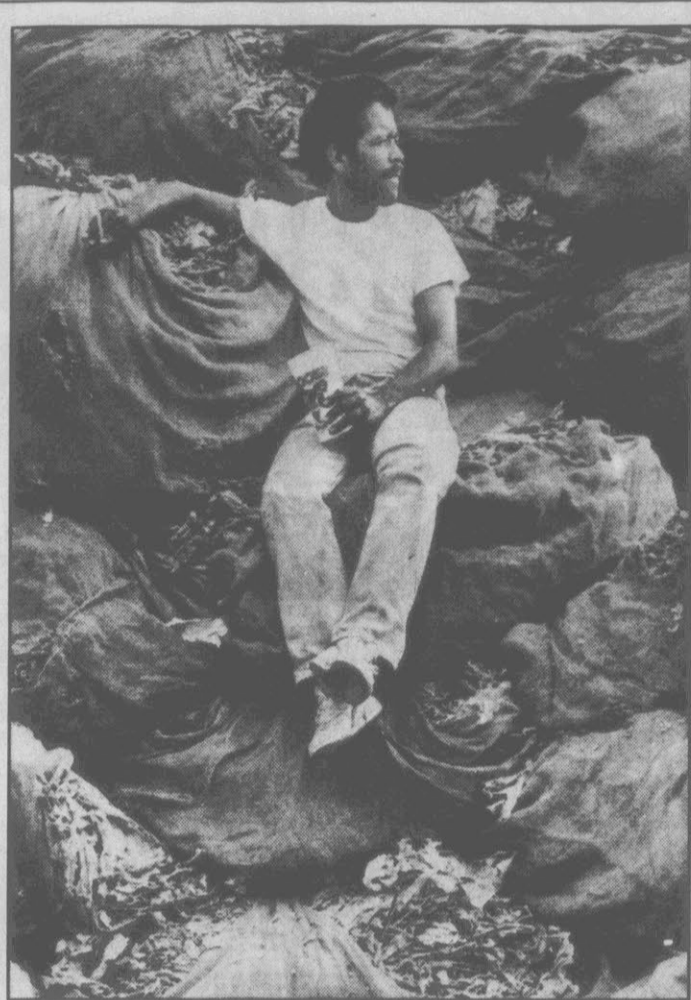

The Associated Press

## Ready For Market

Victor Sanchez takes a break on a trailer of sheeted tobacco at a farm near Hubert as he awaits the trip to market in Kinston. Flue-cured tobacco auctions opened in Kinston and other Eastern Belt markets last week.

# Spangler Meets With NCSU Leaders As Probe Broadens

By Tom Foreman Jr.  
THE ASSOCIATED PRESS

RALEIGH — University of North Carolina system president C.D. Spangler Jr. said he will use information gained from a meeting with N.C. State Chancellor Bruce Poulton and head basketball coach Jim Valvano when deciding what to do about allegations of academic abuse in the school's basketball program.

Spangler and members of a panel he set up to investigate the allegations involving the basketball program met with Poulton and Valvano on Tuesday.

"The purpose was to help answer questions that had been raised and to seek more information," Spangler said in a telephone interview. "It was information I needed to prepare my report for the board of governors."

Also present at the four-hour meeting were Raymond H. Dawson, the UNC system senior vice president for academic affairs; Samuel H. Poole, chairman of the panel that

has been investigating the basketball program; Robert L. "Roddy" Jones, chairman of the UNC Board of Governors; and N.C. State counsel Becky R. French.

Spangler would not divulge the results of the meeting, except to say a full report would be given to the board of governors at a meeting in Chapel Hill on Aug. 25.

"I will be talking to the board of governors ... to what I have determined and what solutions and recommendations I will make to the board of governors," he said.

The recommendations will be based on his conclusions and not any made by the commission, Spangler said.

"The Poole commission was not expected to make recommendations," he said. "It was to look into the matters which I asked them to look in to."

He praised the work of the commission, but said the information it presented to him in a final briefing July 17 raised "things I wanted to pursue further."

Spangler said he had read the entire book since its release.

"In many ways, it's a sad book," he said. "It's not a book that I would have read except in my responsibilities as president of the University of North Carolina, and having responsibilities in the areas of athletics and academics," he said, declining to elaborate when asked to interpret the word "sad."

## Court Blocks Insurance Order

THE ASSOCIATED PRESS

RALEIGH — The North Carolina Court of Appeals set aside a cut in automobile insurance rates, saying the state insurance commissioner had not clearly explained his basis for ordering the reduction.

The ruling on Tuesday stemmed from Insurance Commissioner James E. Long's decision in February 1988 to order a rate cut averaging 3.9 percent for autos and 2.6 percent for motorcycles. The insurance industry had sought a rate increase, and appealed the decision.

## HYPERTENSION

VOLUNTEERS NEEDED FOR THERAPEUTIC TRIALS IN HIGH BLOOD PRESSURE  
CALL MEDISPEAK  
757-0017

New 14 Kt. Gold Chains \$18 per gram  
Southern Gun & Pawn  
500 N. Greene St. • 752-2464 • Financing Available

**BACK TO SCHOOL**

headquarters for all your dancewear & exercise wear needs

Best Selection Of

- Styles
- Colors
- Sizes

In Eastern North Carolina

At Barre, Ltd.

644 Arlington Blvd., Arlington Village

Develop FINE LINES In '89...  
ALL THE WEIGHT YOU WANT TO LOSE

**\$89\***

\*Up To 60 Lbs. Medical Fee Excluded  
Offer Ends Friday, August 18, 1989

The Better Way To Diet

Call 756-2611

610 Arlington Blvd. Arlington Village (Across From Dawson's)

Photo: Frutiger

MEDICAL WEIGHT LOSS SYSTEMS

SAVE 50%

Factory Bonus Days  
1-WEEK ONLY  
August 21-28

Custom Order any Sofa, Loveseat, Chair, Ottoman, Settee or Bench in your choice of fabrics and take advantage of special "Factory Bonus Days" savings from

HICKORY CHAIR

Tyson's INTERIORS, INC.

701 Dickinson Ave.

Mon-Fri. 9:00-5:30  
Sat. 9:00-3:00

# Quayle Urges SCLC To Fight Drugs, Social Problems

By Lee May  
LAT-WP NEWS SERVICE

ATLANTA — Vice President Dan Quayle on Tuesday urged a mostly black audience to combat social problems, particularly illegal drugs, which he called "the modern equivalent of slavery."

Addressing the opening of the Southern Christian Leadership Conference's 32nd national convention, Quayle combined a spirited defense

of the Bush administration's record on civil rights with exhortations to continue the struggle for equality.

Bush "has a great sensitivity to those without hope or opportunity," Quayle told the crowd of 2,000. "He not only cares about them, he desperately wants to help them."

Quayle's appearance, following his speech to the NAACP in Detroit last month, was part of an effort by Republicans to reverse eight years of hostility between minorities and the Reagan administration.

In his 30-minute address, which was greeted with polite applause, Quayle referred to black Bush appointees and to a litany of social ills — teen-age pregnancies, school dropouts, unemployment, poverty, crime, rundown housing, drugs — in an effort to connect with the SCLC delegates and guests.

But his speech also demonstrated the difficulty that a white conservative Republican faces in making appeals to black people steeped in

years of antagonism to the party's policies.

Quayle's reference to two black Bush appointees — Louis Sullivan, secretary of health and human services, and Colin Powell, newly named chairman of the Joint Chiefs of Staff — were well received. Powell attended the lunch and at one point stood and received a standing ovation.

But later many delegates complained that Bush has lagged in ap-

pointing representative numbers of black administration officials. And during the speech, each mention of a black hero or civil rights victory, which some felt came in spite of opposition from Republicans like Quayle, caused many eyes to roll and frowns to appear.

Quayle said that "I know that there are concerns among you about the growing number of incidents of racial and religious harassment and violence around the country. And I

stand with you. There is no place for the Klan, for neo-Nazis, for Skinheads or any other such hate group in our society."

The vice president said that "family and values" would serve well in the war on social ills and that a "partnership between the government and the private organizations" is essential to victory.

Quayle thought his appearance went well.

## Woodstock Farm Draws Spirited But Light Crowd

BETHEL, N.Y. (AP) — The crowd was smaller, the musicians amateur and Saabs replaced sandals as the favored form of transportation, but hundreds of people donned tie-dyed shirts to conjure the spirit of Woodstock anyway.

Twenty years after Richie Havens opened the Woodstock festival before 400,000 people, the late Max Yasgur's old farm filled with revelers Tuesday to celebrate one of rock 'n' roll's most sacred anniversaries.

"It was a deeply spiritual experience and certainly people would want to come back," said comedian Wavy Gravy, the only one of Woodstock's original performers.

Gravy, wearing a beanie with a propeller and carrying a walking stick topped with a pig's snout, waved to festival veterans before being ushered into a forest of satellite dishes for one of dozens of interviews.

More free enterprise than free love was evident at the upstate New York meadow as tourists could choose between T-shirts emblazoned with "I survived the Woodstock Reunion" and "Was I Late?"

"I really honor the people whose spread this is for allowing this to take place," Gravy said. "It's very folksy."

It wasn't without a price. A man who said he was a relative of the field's new owners, Louis Nicky and June Gelish of New York City, asked a \$5 "field restoration" donation from each carload. Police said the owners squabbled with merchants who tried to sell their wares.

True to the spirit of the original Woodstock, when fans swarmed over fences to transform it into a free concert, some motorists just waited until the landlord looked the other way and snuck their vehicles onto the field.

Police were on hand to make sure traffic kept moving. There were no arrests, said Sgt. Charles Kulick of the Sullivan County Sheriff's Department. He estimated the crowd at about 600, the largest of a celebration that had been building for a week.

The most tension came when television reporters, nervously approaching 6 p.m. deadlines, competed for space near the commemorative plaque that is the only permanent fixture on the alfalfa field.

"I didn't really know what to expect," said Ralph Corwin, a resident of upstate New York who said he attended the original show and has returned every year since. "I'm just thankful that they let us go back. The numbers have fallen down but the spirit hasn't died."

On the same corner where Jimi Hendrix, the Who, the Jefferson Airplane and the Grateful Dead performed 20 years earlier, a makeshift stage was built for stray amateur guitarists. One singer replaced Country Joe McDonald's infamous "Gimme an 'F'" cheer with the more modest L-O-V-E spellalong.

## Alaska Files Suit Against Oil Firms

THE ASSOCIATED PRESS

JUNEAU, Alaska — In a lawsuit, Alaska accused Exxon Corp. and six other oil companies of deliberate and gross negligence in not preventing and properly cleaning up the nation's worst oil spill.

The lawsuit does not specify damages, but could amount to billions of dollars, a state official said Tuesday.

The state alleges that Exxon Corp. and Exxon Shipping Co., the subsidiary that owned the tanker Exxon Valdez, are responsible for the tanker running aground by failing to staff it adequately and supervise the crew properly.

The lawsuit, filed in state Superior Court at Anchorage, also says Alyeska Pipeline Service Co., a consortium of oil companies that runs

the trans-Alaska oil pipeline, failed to take prompt and adequate measures to contain and remove the spilled oil or prevent it from spreading into environmentally sensitive areas.

Alyeska was in charge of the initial response to the spill.

The March 24 tanker disaster left nearly 11 million gallons of crude oil in Prince William Sound.

The lawsuit names Alyeska and each of the consortium companies: Exxon Pipeline Co., an Exxon Corp. subsidiary; Arco Pipeline Co.; BP Alaska Pipelines Inc.; Mobil Alaska Pipeline Co.; Amerada Hess Pipeline Corp.; Phillips Alaska Pipeline Corp.; and Unocal Pipeline Co.

LeResche said he expected the lawsuit would take a decade to resolve.

## Democrats Pick Lawyer To Face Cuban-Born Republican In Miami

By Dan Sewell  
THE ASSOCIATED PRESS

MIAMI — In an ethnically tense battle to succeed the late Rep. Claude Pepper, a lawyer won the Democratic nomination using a theme that he's running for "an American seat."

His Cuban-born Republican opponent called his victory ominous.

The winner was Gerald Richman, a 47-year-old former Florida Bar association president making his first run for office. Richman gathered much of his strength from a heavy majority of the diverse district's white non-Hispanic voters in a 61-39 percent victory over Rosario Kennedy.

Richman moves on to an Aug. 29 special election against state Sen. Leana Ros-Lehtinen, Cuban-born as Ms. Kennedy, for the seat left vacant by Pepper's death May 30 at age 88.

"It is this community's victory," Richman said. "Now is the time for Democratic unity ... I cannot understand how being an American can possibly be divisive."

He said he will represent "all the people," not any one ethnic group.

With all of 146 precincts reporting unofficial returns, Richman had

14,411 votes to 9,226 votes for Ms. Kennedy.

Ms. Ros-Lehtinen, a seven-year state legislator, flew to Washington late Tuesday and planned to fly back to Miami today aboard Air Force One with President Bush. The president will lead a fund-raising luncheon for her today.

"I think the victory sends an ominous message that there are some voters who respond to an ethnically divisive campaign," Ms. Ros-Lehtinen said.

Republicans believe they have a strong shot at adding to their 10-8 majority in Florida's congressional delegation by winning the seat Pepper held for Democrats since its inception 27 years ago.

Ms. Kennedy, 44, in her concession speech, called on Richman "to stop this divisive campaign" and warned that an ethnic campaign "can have Claude Pepper's seat in jeopardy."

She said she would meet with Richman today to discuss the general election campaign.

Richman said, though, that he can defeat Ms. Ros-Lehtinen on issues such as abortion — she's anti-abortion, he's for abortion rights — and that he can unify the community.

"She is in the right-wing, extreme element of the Republican Party," said Richman.

"We're going to campaign by going to the people. This is a grassroots campaign," said Richman, who overcame Ms. Kennedy's support by party leaders, the AFL-CIO and The Miami Herald.

Richman said his theme was meant to unify Miami and to rebut Republican national Chairman Lee Atwater's statement that it's time to elect the first Cuban-American to Congress.

"He thinks that Lee Atwater is his opponent," Ms. Ros-Lehtinen said. "I condemned those words the moment they were uttered."

Ms. Ros-Lehtinen, 37, said she will campaign on issues such as crime and drugs and holding down taxes.

"I think voters are going to choose on issues and experience," she said. "I'm certainly proud of my heritage, but I don't campaign on that basis."

Ms. Kennedy carried Hispanic and black precincts Tuesday, but was defeated 4-to-1 in predominantly "Anglo," or non-Latin white, precincts.

Richman, Jewish and Brooklyn-born, stunned Ms. Kennedy, the Democratic front-runner, with a late-charging, 146-vote victory in the Aug. 1 primary, in which five other Democrats were eliminated.

Ms. Ros-Lehtinen, whose resignation as state legislator is effective

Aug. 29, won the four-way race for GOP nomination with 83 percent of the vote. Her campaign manager is Jeb Bush, the president's son.

Little difference on issues emerged between Ms. Kennedy and Richman in their runoff, dominated by discussion of ethnic divisiveness, qualifications and ability to defeat Ms. Ros-Lehtinen.

Democrats are concerned that an increasing number of Hispanic voters — they now make up 40 to 50 percent of those registered — will swing future elections to Republicans.

Richman supporters said he can best energize the vote in black neighborhoods and on Miami Beach to capitalize on the Democrats' continued registration advantage.

**\* GORDON'S \***  
All Ladies Apparel  
**40%-60% off**  
204 ByPass 756-1003

Classroom Presentation  
**NIE 752-6166**

# TONS O' TOYS

The World's Best Toy Store!

## Schoolltime Savings! LOWER PRICES EVERY DAY!



**ASSORTED JR. BACKPACKS \$4.99**  
No. 32081-Asst. Colors  
**ASSORTED BACKPACKS \$8.99**  
No. 32083-Asst. Colors



**LUNCH BUNCH SET**  
Set includes insulated soft lunch box, 10 oz. drink container and crush-proof divider. Asst. colors.  
ORIG. \$10.99!  
**\$4.99**

Summer Sizzler!

**\$22.99 Value!**



**JAMMIN' JETS**  
Fill the engine with water, pump it full of power and watch it fly!  
**\$8.99**



**KINDER MAT \$4.99**  
The original children's rest mat!

**CLEARANCE!**  
Selected School Supplies And Books  
Up To **50% off**

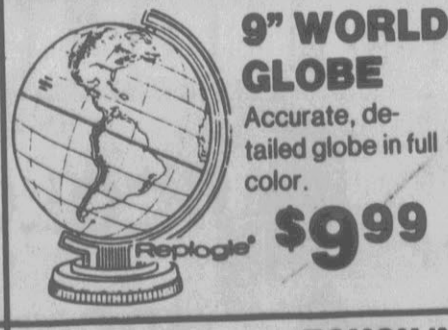

**9" WORLD GLOBE**  
Accurate, detailed globe in full color.  
**\$9.99**



**MY SIT 'N PLAY TABLE \$9.99**  
Great for coloring or snacking! Ages 2-6 yrs.



**ASST. LUNCH KITS \$5.99**  
Choose from Ghostbusters and more!



**TOUCH 'N TELL ME MATH TEACHER \$9.99**  
The right answer appears with a push of a button!

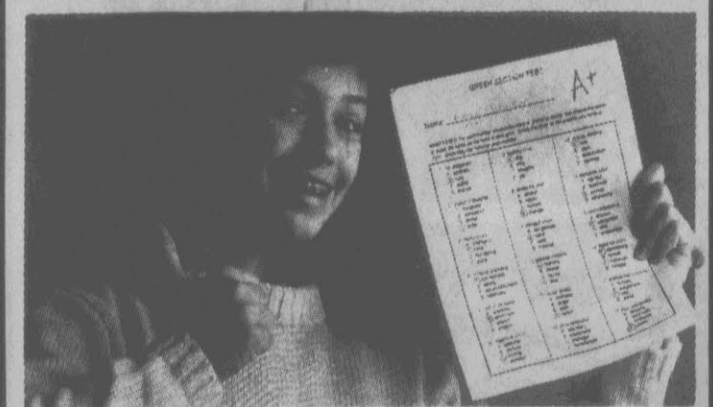

**YOU KNOW YOUR CHILD'S TRUE POTENTIAL, BUT YOU CAN'T SEEM TO BRING IT OUT.**

You're sure that with some extra attention, your child would truly blossom as a student. Sylvan Learning Centers™ are specifically designed to help your child do better in school. An individually designed program involving positive motivation, tangible rewards, friendly encouragement, an experience of success right from the start, and a certified teacher who provides personalized attention make all the difference.



Helping kids do better.™

**SYLVAN WILL. 756-9383**

© 1989 Sylvan Learning Corporation



**Layaway Now For Christmas!**

3521 Memorial Drive • Across From Carolina East Mall  
Greenville, N.C.

Some Items May Not Be Available At Some Locations / Sorry, No Rainchecks

Prices Good Thru **8-23-89**

Mon-Sat 10 am-9 pm  
Sun 1-6 pm  
Phone 355-2164

37211-00

# Search Expands For N.Y. Toddlers

THE ASSOCIATED PRESS

NEW YORK — From the same Harlem playground, at about the same time of day, on the same day of the week, two toddlers who lived in the same apartment building vanished.

Investigators now are distributing posters around the country of 2-year-old Christopher Dansby and 19-month-old Shane Walker.

Shane disappeared 5 p.m. Thursday, while Christopher was last seen 7 p.m. on Thursday, May 18.

The two never played together, but authorities say the disappearances may be linked because of the eerie similarities.

Just before they vanished, the toddlers were even playing with the same children.

The two playmates, a 10-year-old girl and her 5-year-old brother, cannot recall seeing anyone take the boys from the busy playground, police said. Authorities have questioned them extensively.

"No one that we have found yet has seen anybody with the child, taking the child by the hand, carrying it, leading it, taking it through a fence, or leaving the playground," said Deputy Chief Ronald Ferrich, head of Manhattan detectives.

He said two black men, "similar only in their dreadlock hair styles" are being sought for questioning. He declined to elaborate.

Christopher and Shane, who both lived in the Martin Luther King Jr. Towers housing project, vanished from the development's large playground.

Rosalee Glover, Shane's mother, said she and Shane went to the playground about 5 p.m. She sat on a bench as Shane played with the two children, she said.

The kidnapping "happened so fast," she said. "I turned my head away when this guy asked me a question." When she looked back, Shane was gone.

Elizabeth Manley, Christopher's grandmother, believes the two cases are connected. "In both cases, the kids were taken right under our very noses," she said.

Manley said she, too, turned her head away for a minute at the playground, "and my grandchild was gone."

The national search includes rewards for the return of the children totaling about \$30,000.

Police have searched the area's sewers, roofs, basements, and air shafts of occupied and abandoned buildings, but have found no signs of the boys.

The disappearances also have led investigators back to their files: They've reopened the cases of two other infants kidnapped in the area in the last two years. One theory they have is that Christopher and Shane were taken as part of a conspiracy to steal or sell babies.

But the heads of two private adoption agencies in the city, which place large numbers of black children with adoptive parents, discounted that thought.



## Out Of The Past

Alice Wilson, a Washington, D.C., secretary, looks through a purse that was returned to her Tuesday. The purse, stolen from her in October 1970, was found by construction workers in a now-abandoned building where she had been working. Its contents — minus \$60 in cash — were intact.

The Associated Press

# Hills Supports Saving Incentive

THE ASSOCIATED PRESS

WASHINGTON — The Bush administration, seeking ways to boost the U.S. savings rate to cure a variety of economic ills, appears to be inching closer to recommending increased tax incentives for thrifty Americans.

U.S. Trade Representative Carla Hills added her support to the idea Tuesday, saying that expanding Individual Retirement Accounts would make her job of reducing America's huge trade deficits easier.

Millions of American savers could benefit through expanded IRAs, which enjoyed great popularity earlier in the decade, but it could cost the U.S. Treasury billions of dollars in lost tax revenue.

Ms. Hills, in an interview with reporters, stressed that she was not signaling an imminent administration announcement on IRAs. However, other officials said a

proposed increase in tax incentives for IRAs is high on the list of options being studied by the administration.

Americans' personal savings rate — savings as a percentage of after-tax income — fell to a 40-year low of 3.2 percent in 1987 and increased only slightly to 4.2 percent last year.

By contrast, Japan, the country with the world's largest trade surplus, had a savings rate of 16.5 percent in 1987.

Administration officials said they are planning a fall campaign, to be led by Treasury Secretary Nicholas Brady, focusing on the country's chronic low savings rate and proposing ways to correct the problem.

The huge cost of IRAs was one reason they were greatly scaled back by the 1986 Tax Reform Act. As a result, the number of tax returns claiming IRA deductions fell from 15.5 million in 1987 to 7.4 million last year.

# SBA Alters Minority Program

THE ASSOCIATED PRESS

WASHINGTON — The Small Business Administration is overhauling its minority set-aside program in response to the Wedtech bribery and influence-peddling scandal.

The regulations, issued Tuesday and effective immediately, put into effect legislation signed nine months ago by President Reagan. They are designed to minimize political influence on the agency's 21-year-old program under which companies owned by blacks, Hispanics, Asians, Indians and economically disadvantaged women are given preference in the awarding of government contracts.

Among the changes: —The director of the program will be a career employee of the agency, rather than a political appointee. SBA Administrator Susan Engeleiter named Erlene Patrick, a former staff aide to the Senate Small Business Committee, to the post. —The person in charge will not

have to respond as much to the political pressures," Patrick said.

—Companies that misrepresent their status as minority-owned will be subject to stiffer penalties. The maximum fine was increased from \$50,000 to \$500,000 and the top jail term from five years to 10 years.

—For the first time, competitive bidding is required among minority-owned companies for manufacturing contracts over \$5 million and product and service contracts over \$3 million.

—The length of time a company may get special preference was lengthened from seven years to nine years, but companies will be expected to derive a steadily decreasing percentage of their revenues from contracts awarded under the program.

—Owners of eligible companies must have net worth of less than \$250,000, excluding equity in their home or business, when they enter the program. The old standard was \$750,000, including home or business

equity. —The agency must rule on applications within 90 days.

## Cannon Found

BRYSON CITY, N.C. (AP) — In the battle against marijuana, Swain County Sheriff's deputies found a new weapon — a homemade cannon guarding a pot patch.

The cannon was discovered last week when deputies found 157 marijuana plants on a raid. The deputies were acting on a tip, said Sheriff Ray Cline.

The officers, armed with a search warrant, found the device set up on the edge of the marijuana behind a mobile home.

# Hard Liquor Sales Hit 18-Year Low

THE ASSOCIATED PRESS

SAN FRANCISCO — Americans, who drink about a gallon and a half per capita of hard liquor a year, hit an 18-year low in average purchases of distilled spirits, according to an alcoholic beverage trade publication.

The report in the journal *Impact* cited only a few ups among the downs — principally in the sales of "white goods" that include gin, vodka, rum and tequila. Distilled goods shipments totaled 159 million cases in 1988, 4 million under the 1970 level, the report said.

Whiskies, called "brown goods," took the biggest whipping, a challenge the companies regarded as extremely grim as they plot strategy to replace over-50 U.S. whiskey drinkers — estimated as half the total.

Vodka, at 38 million cases distributed last year, was reported the biggest-selling distilled spirit in the country, far ahead of the 21 million cases sold in 1970. Gin ran a poor second with 14 million cases. Rum, with 13 million cases, advanced 7 million over 1970.

The journal blamed the 4.2 percent decline from 1987 on "the cumulative effects of federal, state and local tax increases on spirits and the continuing pressure on the entire alcoholic beverage industry from anti-alcohol forces."

Industry experts have blamed the trend on a variety of factors: growing health consciousness, the aging of baby boomers, and strong campaigns in recent years against drunken driving and drugs.

Pressured by declining sales, spirits marketers last year slashed total advertising budgets by more than \$100 million, to \$240 million, *Impact* said.

The whiskey segment, including bourbon, blends, Scotch, Canadian and Irish, declined 43 million cases, to 60 million between 1970 and 1988. Of those "brown goods," bourbon was the biggest loser, dipping 19 million cases from the 36 million figure in 1970, skidding 6.3 percent between 1988 and 1987 alone.

Although Canadian whiskey gained five million cases over 1970, the 19 million-case figure last year was 3.1 percent under the previous year's. The biggest loser between 1987 and 1988 was Scotch, dipping by 8.8 percent to 13 million cases.

Explore Your Community  
NIE 752-6166

Cargo  
is moving to  
**THE PLAZA**  
across from Brody's

Burke's House of Coins  
211 W. 14th St., Suite D  
Specializing in USA Coin Appraisal  
Paying \$250 For 1916-D Dime  
Fine Condition  
850-3951 850-9032  
Business Residence

## SEARS portrait studio



(Frame not included)

THROUGH SATURDAY ONLY!  
Good Thru August 19th

# 16.95

20-piece portrait package  
2-8x10s, 3-5x7s and 15 wallets.  
Adults & families welcome

## WE CATCH YOUR CHILD'S BEST SMILES!

Every Sears photographer is a professional, trained to bring out and catch your child's best smiles! Also available: Instant Color Passport Photos and Copy & Restoration.



Price includes \$2 deposit. Your choice of traditional, nursery, spring or fall backgrounds. White and black backgrounds, Double Feature and other Special Effects portraits not available in advertised package. Poses our selection. \$2 for each additional person in portrait. No appointment necessary. Use your Sears Credit Card or Discover Card. \*Approximate sizes

Studio hours: Sun. - Store hours (where store is open). Mon. - Sat. - Store opening until one hour prior to store closing.

SEARS  
Your money's worth and a whole lot more.

# N.Y. Phone Striker Killed In Picket Line Accident

THE ASSOCIATED PRESS

Union members mourned the death of a striker who was killed in a picket line confrontation in a New York City suburb and strikebound telephone companies in four states sought vandals who cut telephone lines.

Representatives of workers striking New York-based NYNEX and Philadelphia-based Bell Atlantic,

meanwhile, were expected to resume separate talks today.

But some union spokesmen for the four so-called Baby Bells weren't optimistic about a quick end to strikes. Pacific Bell and Bell Atlantic in Washington, D.C., had informal contract talks Tuesday, but little progress was reported.

"They offered shallow changes," CWA spokesman Bob Schlacter said of the Bell Atlantic meeting. Union officials said tense picket

lines led to the death Tuesday afternoon of Edward H. Horgan, 34, who hit his head while a non-striking worker tried to drive his car through a picket line a day before in Mount Pleasant, N.Y., a union spokesman said. No charges were filed.

Nearly 200,000 operators, clerks, technicians and other workers are on strike against four regional telephone companies in 20 states and the District of Columbia.

# PUBLIC NOTICE

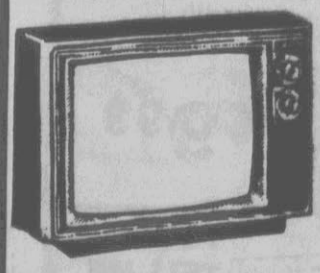

## COLOR TVs

\$99.00 TO \$159.00  
NONE HIGHER



COME EARLY FOR BEST SELECTION

ALL SIZES

These sets are repossessions, motel sets, reclaimed, etc.  
**ONE DAY ONLY**  
Thursday, Aug. 17  
10 A.M. TIL SOLD OUT  
No Checks or Credit Cards Please

**\$20 off**  
Any TV  
w/coupon  
Limit 1 per purchase  
Good 8/17/89 Only

AT THE  
**Arbogate Inn**  
3435 S. Memorial Dr.  
Across From Carolina East Mall  
Greenville

SALE CONDUCTED BY J. P. ENTERPRISES

# The Reebok® Legends.



These are the legends you've heard about down at the playground. Or around the local gym. The Reebok® Legends™ Money™ Showtime™ and Wizard™ basketball shoes. Find out what all the talk's about. Because when the new legends are made, they'll be wearing Reeboks.

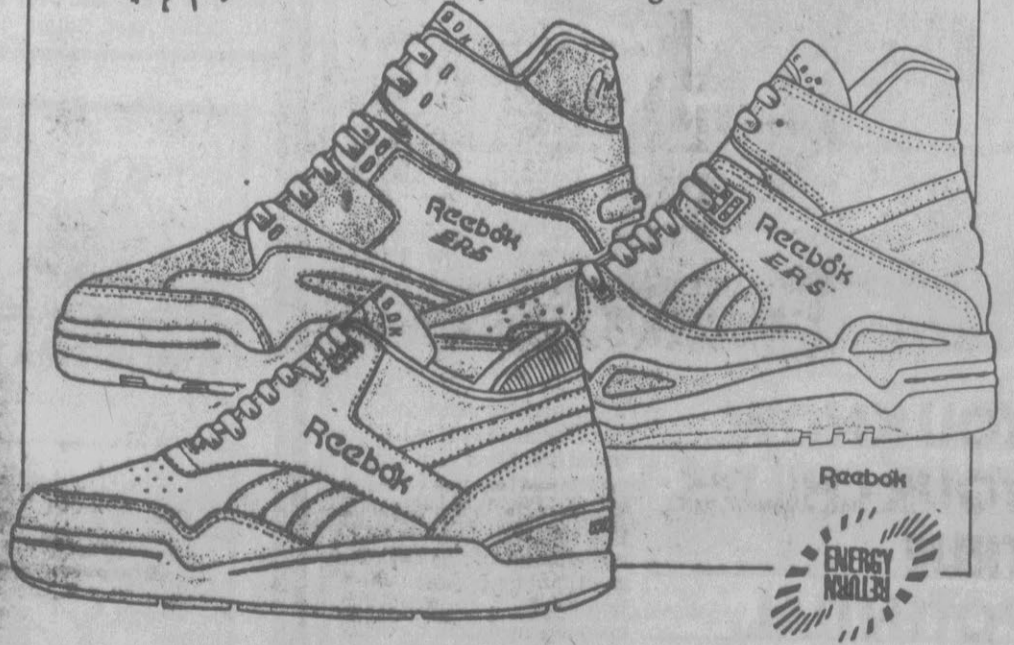

# RACK ROOM SHOES®

MOREHEAD MARKET PLACE  
4952 Arendell St.  
Morehead City, N.C.  
Phone 247-6711

BUYERS MARKET  
Memorial Drive  
Greenville, N.C.  
Phone 355-2519

TOWER MERCHANTS VILLAGE  
3523 Mattland Drive  
Raleigh, N.C.  
Phone 833-5856

# Minority Parties Back Walesa Bid

THE ASSOCIATED PRESS

WARSAW, Poland — Lawmakers of two minor parties today endorsed the idea of a coalition government led by the independent Solidarity movement, strengthening Lech Walesa's bid to create the East bloc's first non-communist government.

More than four decades of governmental leadership by the communist Polish United Workers Party appears suddenly in doubt because of the governing crisis stemming from the party's crushing losses in the most democratic elections in the country since World War II.

President Wojciech Jaruzelski on Tuesday proposed a meeting of the country's main political leaders to find "rational solutions," but there was no word today on when the meeting might take place.

In a climate of economic deterioration, a \$39 billion foreign debt and public discontent with continuing communist leadership, Solidarity has said that only an opposition-led government will have the social support needed to carry out difficult economic and political decisions.

The proposal has found sympathy with the two minor parties that hold the balance of power in parliament, the Peasants and the Democrats.

But it has alarmed the Communist Party in Poland and the Soviet Union, its superpower neighbor and communist ally, which has said the attempt to form the government could lead to destabilization of Poland and Europe and endanger the Warsaw Pact military alliance.

In a bid to ease Soviet fears, Walesa on Tuesday promised that in any Solidarity-led government, the Communist Party would be given control of the "sensitive" ministries of defense and interior that control the army and internal police.

It was possible communists could receive other ministries as well, union spokesman Janusz Onyszkiewicz said today.

Walesa reiterated his Aug. 7 proposal of a Solidarity-led coalition with the Democrats and Peasants on Tuesday, one day after communist Prime Minister Czeslaw Kiszczak announced he was ready to resign and turn over his unsuccessful attempt to form a "grand coalition" government to Peasant Party Chairman Roman Malinowski.

But Malinowski has not publicly said if he wants to be a candidate for prime minister, and his own Peasant Party legislators declared after meeting with him today that they "fully support Lech Walesa's initiative."

In a resolution, they urged party leaders to "quickly realize" the Walesa coalition plan, party spokesman Jozef Kowalczyk said.

Kowalczyk declined to say what majority the resolution was supported by the 76 Peasant lawmakers, who make up the third-largest parliamentary delegation after the communists and Solidarity. Malinowski returned to party headquarters to meet with party leaders, he said.

# Officer Says Inmates Raped, Killed Hostages

THE ASSOCIATED PRESS

MANILA, Philippines — Soldiers stormed a prison and killed convicts holding a religious group hostage after learning they had murdered male captives and raped the women, the officer in charge of the jail said today.

All 16 convicts and five of the 15 hostages died before troops recaptured the jail Tuesday in Davao City, 610 miles south of Manila.

The dead included a 9-year-old boy and Australian missionary Jacqueline Hamill, 36, of Sydney. One of the captives who was freed said Miss Hamill was raped at knifepoint the night before she was killed.

Officials said most of the hostages were slain by their captors before the assault and that none of the captives died in the military attack.

But in Canberra, Australia's foreign minister said Miss Hamill may have been killed by soldiers when the convicts tried to break out of the jail hours before troops stormed it.

President Corazon Aquino's spokesman said there was no evidence the military bungled the hostage crisis but announced an investigation into the bloody incident.

Lt. Col. Franco Calida, Davao City's police commander and jail superintendent, said civilian officials tried to negotiate with the inmates after they seized the hostages Sunday during religious services at the prison.

A few hours before the attack, the convicts had tried to escape by using hostages as shields. During an exchange of gunfire, one captive and one inmate were killed but five hostages escaped. They told police of the rapes and killings, Calida told

Manila radio station DZXL.

"When we learned that the women were raped and that male hostages were being killed, the task was given to us," Calida said. "So the negotiating team was left with no other choice, because the hostages were being killed one by one. That is what the hostages were telling the negotiating team."

The attack began at about 3 p.m. Troops rushed forward firing automatic weapons and secured the downtown jail after about 40 minutes, witnesses and officials said.

Miss Hamill's body was found dumped outside the detention center with a bullet wound in the chest. She had only been in Davao City for a month.

The Rev. Fred Castillo, one of the freed hostages, said Miss Hamill and some of the nine other women hostages were raped. Other freed hostages said they heard the women screaming on Monday night.

"Jackie told me about the incident," Castillo said Tuesday.

In Canberra, Foreign Minister Gareth Evans said it appeared Miss Hamill may have been shot by a soldier during the escape attempt.

"In the doctor's opinion, death was instantaneous and had occurred some hours previously, which would indicate she had been shot during the attempted escape incident in the morning," Evans said in a report to the Australian Senate. "Ms. Hamill was seen to slump as the group retreated back through a gateway to the inner compound."

Evans said he had asked Philippine officials to investigate her death.

# CHAIR SALE

## SAVE UP TO 50% ON 350 QUALITY CHAIRS



### Elegant Queen Anne Wing Chairs. Save Up To 50%!

- \$181 Off Rowe Blue Velvet Chairs.**  
Rich Cherry Finish Carved Legs. Only 4 To Sell. . . . **\$149**
- \$200 Off Taylorsville Queen Anne Wing Chair**  
In Rose Velvet. Tall Back. Cherry Finish Carved Legs. Expertly Tailored. . . . **\$179**
- \$131 Off Green Stripe Queen Anne Chair.**  
By Fairfield. Light Green Matched Stripe. . . **\$219**
- \$357 Off Genuine Leather Queen Anne Tufted Back Chair**  
Brown Leather. Deep Hand Tufted Back. . . **\$299**
- \$131 Off Rowe Queen Anne Wing Chair**  
In Beige Pin Dot. Shaped Legs. Woven Fabric. . . . **\$179**



### Save Up To 50% On Swivel Rocker & Glider Rocker Chairs



- \$201 Off La-Z-Boy Swivel Rocker**  
With Tufted Pillow Back. Light Green Woven Fabric. Skirted. . . . **\$179**
- \$231 Off La-Z-Boy Traditional Style Swivel Rocker**  
In 2 Colors. Shaped Back. Beige Or Blue Fabric. . . **\$239**
- \$155 Off Fairfield Glider Swivel Rocker**  
With Extra Tall Back. Light Blue Fabric. Deep Hand Tufted Back. . . **\$229**
- \$156 Off Rowe Swivel Rocker.**  
Tall Pillow Back. Beige Velvet Fabric. . . . **\$219**
- \$121 Off Rowe Traditional Style Swivel Rocker.**  
In Blue Velvet. Shaped Pillow Back. Elegant Navy Velvet Fabric. . . **\$179**
- \$256 Off La-Z-Boy Traditional Style Swivel Rocker.**  
Rose Velvet Fabric. Skirted. . . . **\$249**

### Club Chairs & Ottomans At Savings Up To 40%

- \$151 Off Rowe Pillow Back Club Chair & Ottoman**  
Mauve Pin Stripe Country Fabric. . . **\$319**
- \$270 Off Low Back Club Chair & Curved Front Ottoman**  
In Dusty Rose. By Taylorsville Hand Tufted Back. . . **\$495**
- \$246 Off Fairfield Pillow Back Club Chair & Ottoman**  
"T" Cushion Skirted. Light Rose Fabric. . . **\$379**
- \$355 Off Tall Pillow Back Light Green Chair & Ottoman**  
Bustle Barrel "T" Cushion. Lined Skirt. Rolled Arm. . . . **\$495**

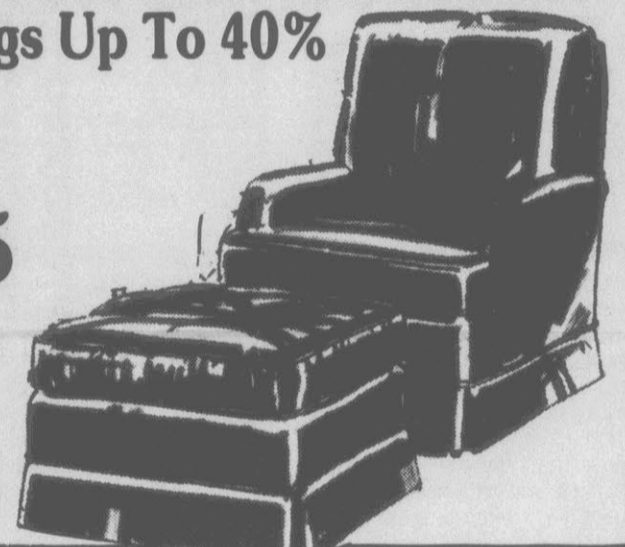

### Stately Chippendale Wing Chairs • Save Up To 40%

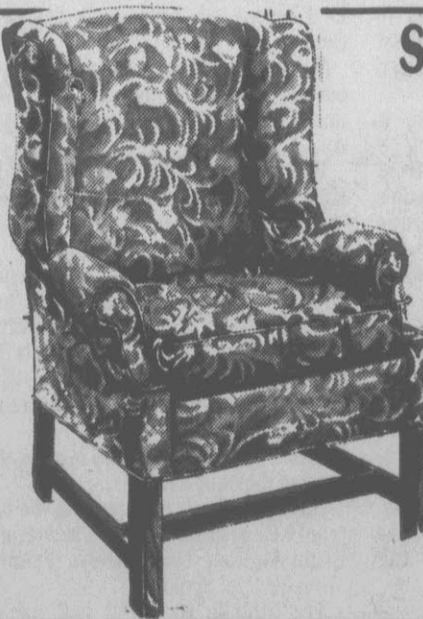

- \$161 Off Blue Chippendale Wing Chair.**  
By Fairfield. Light Blue Woven Fabric. "T" Cushion. . . . **\$199**
- \$151 Off Blue Check Chippendale Chair.**  
Tall Back. Navy & White. Blue Check Fabric. Mahogany Legs. . . . **\$295**
- \$161 Off Bustle Back Chippendale Chair.**  
Split Pillow Back In Blue & Brown Woven Fabric. . . **\$350**
- \$365 Off Rose Flame Stitch Chair.**  
By King Hickory Dark Rose Woven Flame Stitch Fabric. . . . **\$350**
- \$391 Off Leather Chippendale Chair.**  
Navy Top Grain. Leather "T" Cushion. Tall Back. Mahogany Legs. . . **\$429**
- \$441 Off Blue Leather Chippendale Chair.**  
Tall Back. Navy Top Grain Leather. Brass Nail Heads. . . . **\$579**

### Save Up to 60% On Large Elegant Office Chairs

- \$926 Off Leather Bustle Back Chair.**  
Tall Split Pillow Back Genuine Leather. . . . **\$499**
- \$110 Off Traditional Office Chair**  
Rose Woven Fabric Mahogany Trim. . . . **\$240**
- \$541 Off Blue Leather Queen Anne Wing Chair**  
Tall Back Solid Mahogany Arms. Brass Nail Trim. . . . **\$449**
- \$135 Off Low Back Office Chair.**  
Navy Woven Fabric. Swivel Base. . . . **\$295**
- \$150 Off Fairfield Tufted Back Chair**  
Gray Woven Pin Dot Fabric. Swivel Back. . . . **\$350**
- \$130 Off Fairfield Office Chair.**  
Tall Back. Blue Woven Fabric. Swivel Base. . . . **\$320**



### 18th Century Reproduction Martha Washington Or Gooseneck Chairs In Leather Or Beautiful Decorative Fabric.



- \$476 Off Blue Leather Chair.**  
Solid Mahogany Legs & Arm. Navy Top Grain Genuine Leather. . . **\$299**
- \$101 Off Low Back Chair**  
Rich Velvet Fabric. Choice Of Blue, Rose Or Beige. . . . **\$149**
- \$130 Off Rowe Low Back Chair**  
Light Green Velvet Fabric. Shaped Back. . . . **\$160**
- \$300 Off Leather Goose Neck Chair**  
Dark Red Genuine Leather. Brass Nail Trim. Carved Legs. . . . **\$494**
- \$96 Off Fairfield Tall Back Chair.**  
Beige Designed Fabric. Mahogany Finish. . . . **\$199**
- \$101 Off Rose Goose Neck Chair**  
Blue Velvet Fabric. Mahogany Finish Arms. . . . **\$149**

# CARPET CLEANED TWICE

**25% DISCOUNT**

OFF OUR REGULAR CLEANING PRICES WITH THIS COUPON

CALL NOW FOR APPOINTMENT **746-8199** NOT DELIGHTED, DON'T PAY

CARPET DYEING can be done right in your home and the results are fantastic! We will also TINT your carpet while it is being cleaned at slight additional charge. You will be amazed at the appearance!

WARRANTY - Our trained professionals will do the very best job possible in a friendly and courteous manner, or your money is refunded IN FULL; Upholstered Furniture included in this pledge.



**RAINBOW INTERNATIONAL CARPET DYEING & CLEANING CO.**

Greg & Chris Riddle (Owners and Operators)

COPYRIGHT: RAINBOW INTERNATIONAL CARPET DYEING & CLEANING CO. 1981 Service Marks Owned and Licensed by Rainbow International Carpet Dyeing & Cleaning Co.

# Stock And Market Reports

NEW YORK (AP) — The stock market opened broadly higher today, shaking off its latest doldrums. The Dow Jones average of 30 industrial stocks was up 13.28 points to 2,701.06 after a half-hour of trading at 10 a.m. EDT.

Advancing issues outpaced declines by nearly 2 to 1 on the New York Stock Exchange, with 647 issues up, 308 down and 500 unchanged.

Volume on the Big Board totaled 24.89 million shares.

Analysts said the market could break out of its recent sluggish mood after having digested interest-rate worries that helped depress bond prices lately.

A Commerce Department report this morning that new housing starts rose 0.8 percent last month had little impact on the market so far, traders said.

The NYSE's composite index of all its listed common stocks was up 0.65 to 192.73.

At the American Stock Exchange, the market value index had gained 1.06 to 380.88.

On Tuesday, the Dow Jones Industrial Average rose 9.86 points to finish at 2,687.78 in sluggish trading.

Advancing issues outnumbered declines by about 6 to 1 in nationwide trading of New York Stock Exchange-listed stocks, with 809 issues up, 689 down and 501 unchanged.

## Judgeship

CHARLOTTE (AP) — North Carolina Parole Commission Chairman Sam Wilson has been named by Gov. Jim Martin to replace retiring Mecklenburg County Superior Court Judge Frank Snapp.

Snapp, 70, is retiring after 22 years on the bench.

Wilson was Martin's legal counsel from January 1985 until August 1987, when the governor appointed him to head the parole commission. Wilson, 38, a Charlotte native, is a 1975 graduate of the University of North Carolina at Chapel Hill law school. He had practiced law in Charlotte for 10 years before becoming Martin's legal counsel.

Wilson, a former Mecklenburg County Republican Party chairman, was the GOP's candidate for state attorney general in 1988. He lost to Democratic incumbent Lacy Thornburg.

## Beached Whales

RALEIGH (AP) — A mother-and-son pair of pygmy sperm whales found beached on Bogue Banks were moved to the Duke University Marine Lab near Beaufort, where workers hope to save their lives.

Beachgoers near Pine Knoll Shores found the pair Monday and kept them wet with seawater while waiting for a team of specialists to arrive, said Gail W. Cannon, coordinator of the Dolphin Watch program at Duke University and the National Oceanic and Atmospheric Administration, also based at the marine lab.

Both whales were loaded onto stretchers and driven to the marine lab, where tanks were fashioned to hold them.

William J. Bowen, area coordinator for the Marine Mammal Stranding Network, a group of volunteers who try to rescue beached animals, said it appeared the mother had become sick and beached herself. She was followed to shore by her baby.

Big Board volume totaled 148.77 million shares, up from 142.01 million in the previous session.

NEW YORK (AP) — Midday stocks:

	High	Low	Last
AMR Corp	74 1/4	73	73 1/4
Abbott Labs	62 1/2	62 1/4	62 1/2
Alcoa	73 1/4	72 3/4	73 1/4
AmBrands	77 1/2	76 1/2	77 1/2
AmCyan	58 1/2	58 1/8	58 1/2
AmIntech	60 1/2	59 1/2	59 1/2
AmIntGrp	94 1/2	94	94 1/2
AmTFT	39 1/2	38 1/2	39 1/2
Amoco	47	46 1/2	46 1/2
BellAtlan	96 1/2	95 1/2	96 1/2
BellSouth	51 1/2	51 1/4	51 1/4
BellWest	22 1/2	21 1/2	21 1/2
Boeing	53 1/2	52 1/2	53 1/2
BoiseCased	46	45 1/2	46
Borden	71 1/2	70 1/2	70 1/2
BordenW	36 1/2	36 1/4	36 1/2
CSX Corp	35 1/2	34 1/2	35 1/2
CaroPwLT	42 1/2	42	42 1/2
Champ Int	36	35 1/2	36
ChemDyne	52 1/2	52 1/4	52 1/2
Chrysler	25 1/2	25 1/4	25 1/2
CocaCola	67 1/4	66 3/4	67 1/4
Colg Palm	58 1/2	58	58 1/2
Comw Edis	37 1/2	37 1/4	37 1/2
ConAgra	37 1/4	37	37 1/4
DeltaAirl	74 1/4	73 1/2	73 1/2
DowChem	100 1/2	99 1/4	99 1/2
dowT	117 1/2	117 1/4	117 1/2
Duke Pow	51 1/2	51 1/4	51 1/4
EstKodak	5 1/2	5 1/8	5 1/2
EatonCp	65 1/2	64 1/2	65 1/2
Exxon	45	44 1/2	45
FPL Grp	32 1/2	32 1/4	32 1/2
FstUnionCp	24 1/2	24 1/4	24 1/2
FstWachov	49 1/2	49 1/4	49 1/2
FstProgress	37 1/2	37 1/4	37 1/2
FordMotor	52	51 1/2	51 1/2
Fugua	29 1/2	29 1/4	29 1/2
GTE Corp	58 1/2	58 1/4	58 1/2
GenCorp	18 1/2	18 1/4	18 1/2
GnDynam	59 1/2	59 1/4	59 1/2
GenElt	57 1/2	57 1/4	57 1/2
GenMills	68 1/2	67 1/2	67 1/2
GenMotors	46 1/2	46 1/4	46 1/2
GnMotr E	53 1/2	53 1/4	53 1/2
GnPart	41 1/2	40 1/2	40 1/2
GaPacif	55	54 1/2	54 1/2
Goodrich	63 1/2	62 1/2	62 1/2
Goodyear	55 1/2	55	55 1/2
GraceCo	35 1/2	35 1/4	35 1/2
GnNorNek	42 1/2	41 1/2	41 1/2
Greyhound	35 1/2	35 1/4	35 1/2
HerculesInc	48 1/2	48 1/4	48 1/2
Honeywell	89 1/2	89 1/4	89 1/2
ITT Corp	62 1/2	62 1/4	62 1/2
IngRand	47 1/2	47 1/4	47 1/2
IBM	116 1/2	115 1/2	115 1/2
IntlPaper	55 1/2	55 1/4	55 1/2
IntlRect	4 1/2	4 1/4	4 1/2
JamesRivr	31 1/2	31 1/4	31 1/2
K Mart	40 1/2	40	40 1/2
KaneSvc	4 1/2	4 1/4	4 1/2
Kroger	17 1/2	17 1/4	17 1/2
Lockheed	50 1/2	50	50 1/2
LoewsCp	120 1/2	119 1/2	120 1/2
McDermInt	22 1/2	22 1/4	22 1/2
McKesson	37 1/2	37 1/4	37 1/2
MedPart	44 1/2	44 1/4	44 1/2
MercantStr	47 1/2	46 1/2	47 1/2
MinnMng	80 1/2	79 1/2	79 1/2
Mobil	53 1/2	52 1/2	52 1/2
Monsanto	118 1/2	117 1/2	117 1/2
NCNB Cp	52 1/2	52 1/4	52 1/2
Naceo	50 1/2	50 1/4	50 1/2
Navistar	5 1/2	5 1/4	5 1/2
NorSou	38 1/2	38 1/4	38 1/2
Nynex	79 1/2	78 1/2	78 1/2
OlinCp	66 1/2	65 1/2	65 1/2
PacTelesis	43	42 1/2	42 1/2
PacifiCorp	65 1/2	65 1/4	65 1/2
PepsiCo	59	57 1/2	57 1/2
Phelps Dod	72 1/2	71 1/2	71 1/2
PhillipMor	158 1/2	158	158 1/2
Phillips	23 1/2	23 1/4	23 1/2
Polaroid	46 1/2	46 1/4	46 1/2
Primerica	27 1/2	27 1/4	27 1/2
ProctGamb	126 1/2	124 1/2	124 1/2
QuakerOat	64 1/2	63 1/2	63 1/2
Quantum	43 1/2	43 1/4	43 1/2
RalstnPur	95 1/2	94 1/2	94 1/2
Rockwel	23	22 1/2	22 1/2
SFX Corp	34	33 1/2	33 1/2
ScottPapr	48 1/2	48 1/4	48 1/2
SearsRoeb	46 1/2	46 1/4	46 1/2
ShawInd	22 1/2	22 1/4	22 1/2
Skyline Cp	18 1/2	17 1/2	17 1/2
Sony Corp	62 1/2	62 1/4	62 1/2
Southern Co	27 1/2	27 1/4	27 1/2
SwtBell	55	54 1/2	54 1/2
TRW Inc	48 1/2	47 1/2	47 1/2
Texas	53 1/2	53 1/4	53 1/2
Textron	28 1/2	28 1/4	28 1/2
USX Corp	35 1/2	34 1/2	34 1/2
UnCamp	39	38 1/2	38 1/2
UnCarbde	28 1/2	28 1/4	28 1/2
US West	72 1/2	72 1/4	72 1/2
Unocal	48 1/2	48 1/4	48 1/2
WalMart	40 1/2	40 1/4	40 1/2
WestPac	55 1/2	55 1/4	55 1/2
WestghEd	69 1/2	68 1/2	68 1/2
Weyerhsr	31 1/2	31 1/4	31 1/2
WinnDix	55 1/2	55 1/4	55 1/2
Woolworth	63	62 1/2	62 1/2
Wrigley	47 1/2	47	47 1/2
Xerox Cp	67 1/2	67	67 1/2

Following are selected stock quotations as of 11:00 a.m.:

Asphalt Oil	38
Unisys	21 1/2
Fieldcrest Mills	28 1/2
Flowers Inds.	19 1/2
Hatters Inc. Securities	16 1/2
Hilton Hotel Corp.	107 1/4
Jefferson Pilot	38 1/2
John Deere	29 1/2
Lowe's Company	29 1/2
Interstate Securities	7 1/2
United Telecommunications	30 1/4
Dominion Resources	45 1/2
Piedmont Natural Gas	26 1/2
Johnson & Johnson	50 1/4
Vermont American	36 1/4
OVER THE COUNTER	
Branch Bank	21 1/4 to 22 1/4
Planters National Bank	15 1/4 to 16 1/4
Integon	5 1/2 to 5 3/4
Southern National Bank	14 1/2 to 14 3/4
Peoples Bank	15 1/4 to 16 1/4
North Carolina Natural Gas	2 1/4 to 2 1/2
Cooper LaserSonics	4 1/2 to 4 3/4
Burroughs Wellcome	7 1/2 to 8 1/4
Food Lion A	12 1/4 to 12 1/2
Food Lion B	13 to 13 1/4

# Disgruntled French Gendarmes Air Their Gripes In Public Via Papers

THE ASSOCIATED PRESS

PARIS — Newspapers are being flooded with anonymous letters from an unusual source — disgruntled gendarmes, the military corpsmen who make up almost half of France's 200,000 police officers.

Government officials have replied by saying reforms will be proposed this fall, and in the meantime the gendarmes should think about the soldier's duty not to air the military's dirty laundry in public.

National and regional newspapers have received dozens of letters, each purporting to speak for a large number of gendarmes who are unhappy about pay scales, long hours and poor living conditions in barracks.

The 90,000 gendarmes are responsible for police duties on most French highways and in rural areas, although they also sometimes patrol in cities. Special squads fight terrorism, monitor river traffic and patrol airports, among other tasks.

The line between the duties of the gendarmerie and the national police is not always clear, and leads to frequent conflict between the two bodies. It occasionally leads to arrests of gendarmes by police or vice-versa.

The gendarmerie traces its origins back centuries to the "Marchaussee," medieval soldiers called to catch bandits and highwaymen. It got its name and current status in 1791, at the height of the French Revolution.

"It's a unique organization that exists in no other country in Europe," Napoleon once said, according to a history of the gendarmes. "It's the most efficient way to maintain the tranquility of a country. ... It's a half-civil, half-military surveillance, spread over the entire territory."

Gendarmes answer to the Defense Ministry. They are trained, paid and expected to work and live like soldiers, while doing exactly the same tasks as police. Unlike police, they cannot form unions, and are not paid overtime.

Speaking out publicly means certain disciplinary action under military rules.

An anonymous letter published in the regional daily Ouest-France complained about "the 120 hours on-call each week, including 60 to 80 hours working, no overtime pay or compensatory time off and no compensation for working weekends and holidays."

Starting pay is \$1,135 monthly for the unmarried, and pay increases on a sliding scale for those with families. Several letters said that, once unpaid overtime is taken into account, gendarmes barely get the minimum wage.

A letter published by the national daily France-Soir from an anonymous gendarme's wife who signed herself "Madame X" denounced "the degradation of family life." She said the gendarmerie makes life "abominable for couples, leading many of them to divorce."

Married gendarmes live in apartments built into the barracks, with widely varying amenities.

The first anonymous letters appeared in regional newspapers in eastern France in early August and only gradually attracted national attention. Soon there was a flood, with the French news agency Agence France-Presse counting almost 20 over the weekend of Aug. 12-13.

Gerard Renon, the junior minister in the Defense Ministry, said in a television interview that the letters dealt with "problems we know about and are working on."

Other government officials said a proposal would be presented in the fall to redistribute the work force, upgrade the barracks, assure at least some free time to the gendarmes and possibly increase the number of draftees allowed to do their military service as auxiliary gendarmes.

The director-general of the gendarmerie, Regis Mourier, issued a statement saying he was aware of the problems and was working on them.

Meanwhile, he said, the gendarmes should keep quiet, "not just from respect for the obligations of the military status, but from respect for the institution, its history and its place in the nation," Mourier said.

The call to silence just unleashed more letters.

"It's not by telling us to shut up that the problems will be solved," said an anonymous letter published in the daily Le Populaire du Centre de Limoges in central France. "Watch out, general officers and elected officials, disgust and discontent is getting established in this good old Marchaussee."

## Begin Goes To Hospital

THE ASSOCIATED PRESS

JERUSALEM — Former Prime Minister Menachem Begin was hospitalized today after complaining of fatigue.

Dr. Jonathan Halevy, director general at Jerusalem's Shaarei Tzedek Hospital said Begin, who turned 76 on Saturday, will be hospitalized for "a day or two."

"He complained for the last few days about some fatigue, but nothing specific," Halevy said. He said initial tests found nothing wrong.

Begin was admitted to the same hospital in April 1987 after complaining of general weakness and was discharged after 10 days.

He suffered several heart attacks when he was prime minister from 1977 to 1983 and underwent prostate surgery in 1986.

Begin seldom speaks in public. His last public statement was July 9.

## Elvis' Fans Mark Anniversary

THE ASSOCIATED PRESS

MEMPHIS, Tenn. — Elvis Presley fans marking the 12th anniversary of his death filed solemnly past his pool-side grave in a candlelight procession early today.

The vigil, which began Tuesday night, drew 3,000 to 4,000 participants, police said. The affair is the largest single event of Elvis International Tribute Week, a nine-day lineup of concerts, memorials and fan get-togethers.

Presley died of heart disease on Aug. 16, 1977. He is buried next to the swimming pool at his white-columned estate, Graceland.

Participants in the vigil marched single file up the quarter-mile drive at Graceland, carrying tapers lighted from a torch fired from an eternal flame at Presley's graveside. Many left roses by the simple marker.

Devotees began lining up at Graceland's distinctive gates —

decorated with musical notes and a rendering of Elvis — five to six hours before the procession.

By the time the ceremony began, the highway in front of the mansion was filled with Elvis fans, more than a few with Elvis-style metallic sunglasses, spangled belts or jet-black hairdos.

Paul Campione, 6, of New York, wore a green jumpsuit with a white cape as he posed for snapshots, striking karate poses a la Elvis. "I love Elvis. He was kind and generous and I like his music," the boy said.

His mother, Angela, said her son was entered in an Elvis impersonator contest at a local nightclub.

The graveside vigil has been sponsored by the Elvis Country Fan Club for 11 years. The club has more than 1,200 members worldwide, many of

them too young to have been Presley fans when he was alive, said club president Georganna Reynolds.

"One reason for a fan club is to pass the torch, to keep the candle burning," she said.

The 7-year-old Tribute Week is organized by the managers of Graceland, which draws 650,000 visitors a year, including some 40,000 during the anniversary celebration.

Presley bought the three-story residence in 1957 when his rock 'n' roll career began to take off. It was opened to the public in 1982.

Graceland and its 36,000-square-foot souvenir shopping center across the highway take in some \$12 million a year and are run for the benefit of Presley's only child, Lisa Marie.

## Obituaries

Dail

GRIFTON — A funeral for Mr. Roy Dail will be conducted at 2 p.m. Thursday at Grifton Pentecostal Holiness Church by the Revs. Dempsey Winstead and Van Mitchell. Burial will follow in the Riverside Church Cemetery.

A member of the Grifton Pentecostal Holiness Church, Mr. Dail also served in the United States Army during World War II.

Surviving are his wife, Doris Williams Dail of the home; three sons, Charles Dail of Hookerton, Robert Dail of Boston and Jasper Dail of Fayetteville; one daughter, Annie Smith of Walsenburg; two brothers, Jessie Dail of Goldsboro and Dick Dail of Kinston; nine grandchildren and five great-grandchildren.

The family will be at the Farmville Funeral Home, Ayden, from 7 p.m. to 9 p.m. today.

Kilpatrick

FARMVILLE — James Hopton Kilpatrick, 72, of 511 E. Wilson St. died today at Pitt County Memorial Hospital. Arrangements will be announced by the Farmville Funeral Home.

## Tobacco Market

By The Associated Press

The following are gross final sales from Eastern Belt flue-cured tobacco markets for Tuesday Aug. 15 as reported by the Federal-State Market News Service:

Market	Daily Pounds	Daily Value	Daily Avg.
Ahoskie	no sale	no sale	no sale
Clinton	345,720	561,378	162.38
Dunn	325,307	502,102	154.35
Farmvl.	738,233	1,173,153	158.91
Gldsboro	402,523	646,798	160.69
Greenvl.	770,064	1,203,950	156.34
Kinston	1,074,752	1,692,298	157.46
Robrsvl.	no sale	no sale	no sale
Rocky Mt.	425,180	708,332	166.60
Smithfld.	395,754	647,394	163.58
Wallace	no sale	no sale	no sale
Wendell	no sale	no sale	no sale
Willmstn	402,035	636,369	158.29
Wilson	1,589,306	2,583,784	162.57
Windsor	355,612	558,584	157.08
Total	6,824,486	10,914,142	159.93
Season Totals	37,362,082	60,594,595	162.18

Average for the day was down \$3.07 from previous sale. Subject to revision. Averages do not reflect assessments.

**Cash Registers & Computers**

- Sales
- Rentals
- Leasing

**Century Data Systems**  
2801A S. Evans St.  
Greenville/756-2215  
**OMRON**

**SCREENING MAMMOGRAPHY**

\$50.00

For Appointment Call  
**752-2847**

**EASTERN BREAST CANCER DETECTION CENTER**  
Certified

# Dravecky Breaks His Arm

## Giants' Hurler Injures Arm Operated On Earlier

THE ASSOCIATED PRESS

It could be the worst break of all for the beleaguered San Francisco Giants pitching staff.

The Giants, who have had six starting pitchers injured during the season, received another physical blow Tuesday night when left-hander Dave Dravecky fractured his pitching arm, the same one on which he had cancer surgery 10 months ago.

Although Dravecky got credit for the Giants' 3-2 victory over the Montreal Expos, the psychological damage of his loss could be even greater than the physical one.

"It's a crying shame," first baseman Will Clark said. "Dave's first start changed the meaning of the season for us because it's not just about baseball, it's about life."

Dravecky, who won the first start of his comeback by pitching eight innings last Thursday against Cincinnati, dropped to the ground and grabbed his left arm after throwing a pitch in the sixth inning of a game the Giants were leading 3-1. He was taken from the field on a stretcher.

"It sounded like a firecracker," Expos right fielder Hubie Brooks said. "I've never seen anything like it and I hope I never see anything like it again."

Dravecky, who pitched five shutout innings before the sixth, was conscious as he left the field and was

taken to Queen Elizabeth Hospital. X-rays showed the fracture in the upper arm near the scar that marked the surgery that removed a cancerous tumor last Oct. 7.

The injury is expected to sideline him for 6-8 weeks, effectively ending his season.

"The odds are in his favor that he'll pitch again," said Dr. Robert Broderick, the Expos team doctor who examined Dravecky. "There is very little damage involving the muscles."

Matt Williams' fifth homer in six games, after a single by Will Clark, gave the Giants a 3-0 lead in the sixth.

Montreal scored its two runs off Dravecky in the bottom of the inning. Damaso Garcia led off with a homer and Andres Galarraga was hit by a pitch. Jeff Brantley relieved Dravecky and surrendered a sacrifice fly by Tim Raines.

Brantley finished with three hitless innings before Steve Bedrosian pitched the ninth for his 16th save.

### Cubs 5, Reds 2

Chicago beat Cincinnati in a game marred by a postgame brawl as Andre Dawson hit rookie Mike Roesler's 0-2 pitch for a three-run homer with two outs in the 12th inning.

Dawson, hitless in his previous five at-bats, hit his 13th homer of the season, scoring Mitch Webster and Mark Grace, who both walked with

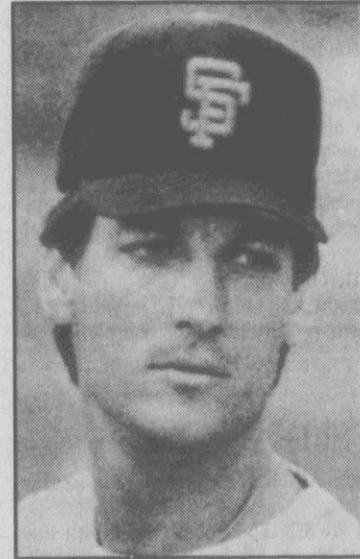

Dave Dravecky

two outs off Roesler, 0-1, the fifth Reds pitcher.

Cubs rookie Jerome Walton took advantage of the extra innings to extend his hitting streak to 25 games, the longest in baseball this year.

In his sixth at-bat, Walton singled leading off the 12th but was erased on a fielder's choice grounder by Ryne Sandberg, who then was caught stealing.

The victory went to Mitch Williams, 2-2, who pitched two hitless innings.

A postgame argument between first base umpire Joe West and Cin-

cinnati Reds second baseman Ron Oester escalated into a shoving match involving Reds manager Pete Rose, Oester and West.

Rose was suspended for 30 days and fined \$10,000 last year for shoving umpire Dave Pallone.

### Mets 3, Padres 2

New York passed Montreal for second place in the East, 3½ games behind the Cubs, when Kevin McReynolds tied San Diego with a ninth-inning homer and Kevin Elster later hit an RBI double.

New York, which won for the 12th time in 15 games, trailed 2-1 against Padres starter Ed Whitson before McReynolds homered with one out, his 15th of the season and sixth in August.

Barry Lyons singled and Keith Miller struck out before Elster doubled down the left field line. Third baseman Bip Roberts' relay throw home beat Lyons to the plate, but the ball bounced off Benito Santiago's chest.

The only run Whitson, 14-9, allowed before the ninth was Howard Johnson's 28th homer, a one-out drive in the sixth.

Chris James' home run in the seventh gave the Padres a 2-1 lead. It extended his hitting streak to 18 games.

### Astros 3, Pirates 2

Houston won its 29th one-run game when Ken Caminiti's single drove in

(See NATIONAL, B-2)



The Associated Press

Giants' Dravecky is given aid after suffering broken arm

# Sloan Resigns As 'Bama AD

THE ASSOCIATED PRESS

TUSCALOOSA, Ala. — Steve Sloan quarterbacked Alabama to the national football title in 1965 under the late Bear Bryant but his signal-calling as athletic director did not suit the school's new president.

"We had differences in management approach and style," University President Roger Sayers said in announcing the resignation of Sloan as athletic director.

Sloan assumed the post 2½ years ago at the same time Bill Curry became the Crimson Tide's second football coach since Bryant retired after the 1982 season.

Sayers said Tuesday that Sloan's departure would not affect Curry, who has been under fire by some Alabama fans since the day Sayers' predecessor, Joab Thomas, hired him in 1987.

Sayers, who succeeded Thomas in an interim capacity last year and was named president last month, said he wanted "to have in place the administrative team of my choosing."

He said that Alabama's faculty chairman of athletics, Tom Jones,

would be interim athletic director and that Sloan would stay on the payroll for six months, "working with and through" Jones to complete some projects.

Sloan, in a statement read by Sayers, said that after the six months he will seek another job, possibly a return to coaching.

In remarks Tuesday night to the Nashville Athletic Club in Nashville, Tenn., Sloan said his resignation was not due to differences with Sayers about athletic and academic priorities, but "mainly just management style."

Sloan said he met three times with Sayers.

"We just didn't really agree on the direction that we needed to take," he said. "Consequently we both agreed that he wasn't going anywhere as a CEO (chief executive officer) and, obviously, I needed to go somewhere."

Sloan said in his statement that he and Sayers agreed it was better that they not publicly discuss their differences.

Sayers said he will head a committee, to be named shortly, to seek a new athletic director and that he

will encourage applications. "We're not ruling out anyone," he said.

However, Sayers said that the jobs of athletic director and football coach will be kept separate, following "a clear trend" among the nation's colleges.

Sayers said he hopes the search committee will agree on a successor to Sloan in two months or less.

Before Ray Perkins, Bryant's successor, left to coach the NFL Tampa Bay team, Perkins held both jobs.

Perkins was one of Sloan's favorite passing targets when the 1965 team went 9-1-1, including a 39-28 Orange Bowl victory over Nebraska that gave the Crimson Tide the third of its five national championships under Bryant, something it hasn't come close to accomplishing under Perkins or Curry.

Sloan was not at Tuesday's news conference, opting instead to leave the statement, which Sayers read.

"Because of my emotional ties with the university, the staff, alumni and friends, I felt that I would be unable to properly articulate my feelings," Sloan's statement said.

Sayers said last month that he



Steve Sloan

would review all the key administrative positions.

"As part of that process, university Athletic Director Steve Sloan and I have agreed upon a course of action that we feel is in the best interest of the university," he said.

"No single event or action has precipitated this decision. We simply have a difference of opinion about the management of the program."

# Tim Richmond Is Dead At 34

THE ASSOCIATED PRESS

MIAMI — Tim Richmond's driving career held so much promise in 1980. Nine years later, the charismatic but troubled Richmond is dead at age 34.

"We had never seen anything like him before, the good and the bad," H.A. "Humpty" Wheeler, president of the Charlotte Motor Speedway, said Tuesday when informed of Richmond's death. "He was the most complex person who's ever sat behind the wheel of a stock car."

Richmond's physician, Dr. David Dodson, said the driver died on Sunday in Good Samaritan Hospital in West Palm Beach. Citing the wishes of the family and medical confidentiality, Dodson declined to give the cause of death or talk about Richmond's medical condition.

Earlier Tuesday, in an interview with the Charlotte Observer, Dodson said Richmond's thoughts at the end "were not of himself, but of his family, friends and racing fans."

Richmond, who lived in semi-seclusion in south Florida, had been hospitalized recently for injuries sustained in a motorcycle accident, Dodson confirmed. He would not say whether the motorcycle accident was related to the death.

He declined to say where or when a funeral would be held.

"The family wanted a small private ceremony," Dodson told the newspaper. "I can't say anything more than that."

Richmond burst on the racing scene in 1980, when a ninth-place finish earned him the Indy 500 rookie of the year award. He was 14th in the race in 1981, but after that abandoned Indy-car racing for stock cars.

He won 13 races in his NASCAR career, including seven in 1986, his best season.

Geoff Bodine was a teammate of Richmond's in 1986.

"We all kind of were waiting for this announcement to be made, but it's still a shock, really sad," Bodine said. "We knew he was real sick. We still don't know what he died of, or if we'll ever know. I can't say what it was, but we're all fairly confident he did have some kind of problem."

"A lot of people reached out to Tim, because he was a friend and was well-liked by many. We reached out to him, but apparently it was too late. That's the power of certain things; they can take charge of your life and there's no turning back."

"Tim obviously had talent and charisma, and it appeared to everyone that he had it made. Well, appearances fool people sometimes, and it's obvious he didn't have it made. He had some sort of situation that led him astray. What I'd like to see is the true story to come out, how his problem developed and who the people were who got Tim in this situation."

Richmond's career suffered a blow in 1987 when he contracted pneumonia, and ended when NASCAR suspended him before the

1988 season-opening Daytona 500 for failing a drug test. The test showed excessive amounts of two non-prescription drugs found in over-the-counter remedies for allergies and respiratory conditions.

Richmond passed a subsequent test and was reinstated, but he failed to get a ride in stock-car racing's biggest event.

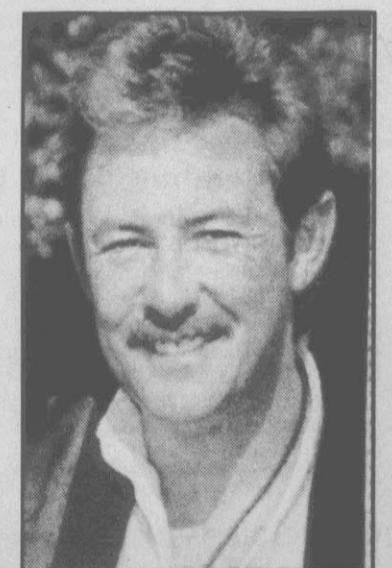

Tim Richmond

Richmond vehemently denied rumors of drug use.

"You've made mistakes in your life," Richmond said. "I've made mistakes in my life. There's been a mistake made on this drug test some way or another. I am not guilty of it."

Richmond, who won \$2,228,558 in Winston Cup racing, missed the first 11 races of the 1987 season because of illness. He won his first race back, setting off an emotional scene in the winner's circle at Pocono International Raceway. He won the next week at Riverside, Calif., his last victory.

After six more starts, he abruptly quit the team, citing his health. His last race was the Champion Spark Plug 400 at Michigan International Raceway in August 1987.

"I could find a ride, I think, without a doubt," Richmond said after being reinstated by NASCAR. "But to be honest, I don't feel comfortable or safe on a NASCAR-sanctioned track at this time. If I were to spin or crash, it would just give them more ammunition."

A few days later, shortly before the halfway point of the Daytona 500, a plane passed over the track pulling a banner that said, "Fans I miss you, Tim Richmond."

"He was a very confused young man," said Wheeler, who was one of Richmond's friends on the NASCAR circuit. "There are mental pressures on all of them. Drivers have to be everything to everyone. At times the pressure was hard for him to handle. I know, because we talked about it."

"But when the time came to perform," Wheeler said, "he could always get in the ring and perform. He had it all, and he lost it all."

# Rose, Joe West In Shoving Match

## Argument With Oester Starts Incident Between Manager, Umpire

THE ASSOCIATED PRESS

CINCINNATI — Pete Rose, already under threat of a lifetime ban for alleged gambling on baseball, could be in trouble again.

Sixteen months after his 30-day suspension for shoving umpire Dave Pallone, Rose was involved in another bumping incident Tuesday night after Cincinnati's 5-2 loss in 12 innings to the Chicago Cubs.

The Cincinnati manager and umpire Joe West shoved each other after Rose came to the defense of Reds second baseman Ron Oester, who also exchanged bumps with West.

Rose was suspended for 30 days last season by then-NL President A. Bartlett Giamatti for bumping Pallone twice and inciting the crowd.

"You saw what they did when I pushed Pallone last year," Rose said, referring to the \$10,000 fine and suspension. "Let's see what happens now."

West, who grew up in Greenville, N.C., was involved in a similar incident in 1983. The umpire was suspended for three days and fined \$300 for pushing Atlanta Braves manager Joe Torre. Torre, who was fined \$200, argued with West in the runway leading to the umpire's dressing quarters in Atlanta Stadium.

The argument started with a call on a 2-2 pitch to Mark Grace in the top of the 12th, which plate umpire Bill Hohn called a ball.

Grace walked and scored on Andre Dawson's game-winning, three-run homer.

"It started on the call on the pitch to Grace," Rose said. "Hohn warned the Reds dugout and West came over and joined in. Oester said to West, 'Just do your job.'"

In the bottom of the 12th, Oester took a 3-2 pitch and was called out by Hohn, ending the game. Shouting followed between Oester and Hohn, and again West joined in.

Words were exchanged and West pushed Oester.

Cubs manager Don Zimmer, who was on the field to congratulate his players, said, "For what reason does West have to shove Oester, not once but twice?"

Oester was restrained by teammates as he attempted to get back at West, who was leaving the field and heading toward the tunnel behind home plate.

Rose also intervened and argued with West, pushing him several times.

"We have no comment, nothing to say," crew chief Jerry Crawford said. "We will discuss it before the game tomorrow."

Rose currently is under investigation by Giamatti, now baseball commissioner, for allegedly betting on Reds game, an offense that, if proven, carries a lifetime ban. A federal court order prevents Giamatti from conducting a hearing on the charges.

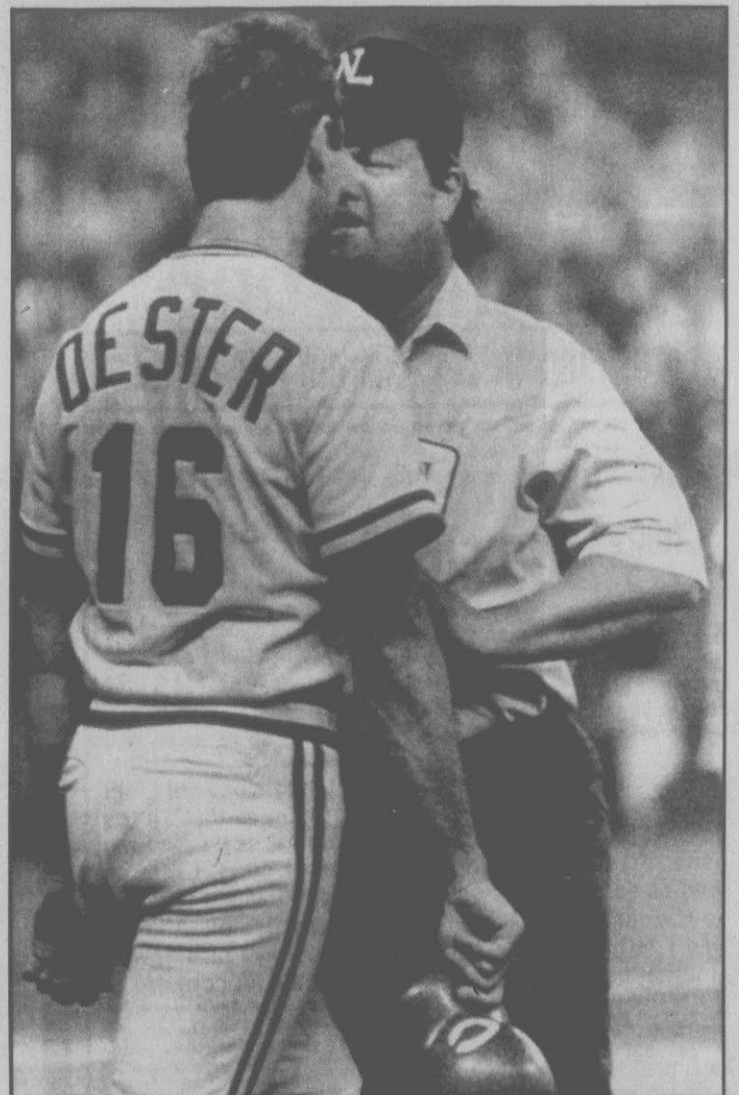

The Associated Press

Ump Joe West pushes Reds' Ron Oester during argument

# Sports Notes

## NCAA Investigates Clemson Football

ATLANTA (AP) — The NCAA is conducting a formal investigation of the Clemson University football program that could result in the "death penalty" if major rules violations are found, a newspaper reported today.

The Atlanta Journal-Constitution quoted unidentified sources close to the investigation as saying it became a formal probe after National Collegiate Athletic Association investigators found leads on recent major recruiting violations. No details were given.

Max Lennon, president of the school in Clemson, S.C., said Tuesday night he knew of the investigation.

"I'm aware of it, but I think it's extremely premature," Lennon said. "At this juncture, we simply don't know enough. Our interest is in what happened, whether or not rules have been violated. I have received several briefings from our athletic director."

Neither Athletic Director Bobby Robinson nor football Coach Danny Ford could be reached for comment Tuesday.

If a major violation were found by the NCAA between December 1982 and December 1987, Clemson football could be slapped with the "death penalty" because of repeat violations within a five-year period. The program was under a two-year probation beginning in 1982.

The "death penalty" could result in the suspension of the football program for one or two years — including elimination of all scholarships and recruiting for two years.

Lennon, however, said he did not expect that to happen.

"There, we expect to be judged as doing right, and not wrong," he said.

The sources told the newspaper there was no timetable for completion of the investigation.

## Rose Season Tickets On Sale

Rose High School will place its All-Sports Athletic Tickets on sale at the school this week.

Student tickets are \$15 and adult tickets are \$25. The tickets will admit the holder into all regular season home contests in all sports at Rose High School.

Rose will open the season on Aug. 25, hosting Tarboro.

## Pirates Begin Fall Practice Sessions

Tuesday marked East Carolina University football's first full day of practice with both its varsity and freshmen players.

First-year head coach Bill Lewis was pleased with the practice, which was the first look at his 1989 squad at work on the field since spring drills ended.

"For the first day, it was a positive experience," Lewis said. "We had pretty good awareness and intensity and I thought we worked them very hard and they gave us excellent concentration."

Preseason workouts for the Pirates will concentrate on the basic, Lewis added, as he and his staff assess the team.

"We will try to run a basic practice. We're starting at square one, at the beginning of every phase — offense, defense and kicking — and evaluating how much carry-over we've had from spring practice."

Lewis told his team that the practice was "as good a first day as I've seen and I applaud you for your work."

The Pirates will continue with preseason practice as they prepare for their season opener on Sept. 9 against Bowling Green in Ficklen Stadium.

## Wyland, Ferguson Top Qualifiers

RALEIGH (AP) — Wendy Wyland, a six-time national platform diving champion, was the top qualifier on Tuesday in the women's platform semifinal of the U.S. Diving Outdoor Championships.

Wyland, who is still recovering from viral meningitis, scored 400.95 points, to outdistance Wendy Lian Williams of Bridgeton, Mo., who finished with 360.30 points. Cokey Smith of Ann Arbor, Mich., the gold medalist at the U.S. Olympic Festival, was third with 360.27.

"I felt good today, and I've been feeling good in training," Wyland said. "The worst thing for me is that my head is throbbing and my endurance has suffered."

Wyland, of Boca Raton, Fla., took the lead on the third dive of the eight-dive competition, and was never seriously challenged. The top 12 divers advanced to the final round.

Defending U.S. champion Kent Ferguson was the top qualifier in the men's 3-meter springboard competition, finishing with 612.18 points.

Olympians Patrick Jeffrey and Mark Bradshaw, both from Columbus, Ohio, captured the next two spots with 594.57 and 592.02 points.

Competition continues Wednesday with the women's 1-meter springboard semifinal and final, and the men's platform semifinal.

## ASU's Redding, Frier Ruled Ineligible

BOONE (AP) — Appalachian State sophomore quarterback Lance Redding and junior defensive tackle Mike Frier have been ruled academically ineligible, Mountaineer coach Jerry Moore said Tuesday.

Redding, a 6-foot-3 and 208 pounder from Newport News, Va., played in 10 games in 1988. A starter in two games, Redding completed 33 of 62 passes for 543 yards and six touchdowns. In his first career start, he completed nine of 15 passes for 191 yards against Western Carolina.

Frier, 6-6, 296 pound defensive lineman from Jacksonville, N.C., ranked third in tackles for the Mountaineers last season, starting all 11 games at left defensive tackle.

## Georgia's Goff Released From Hospital

ATHENS, Ga. (AP) — Georgia Head Football Coach Ray Goff was released from St. Mary's hospital after two days of treatment for an acute stomach infection.

"He was out the door the minute the doctor arrived this morning," a St. Mary's spokesman said Sunday.

Georgia Sports Information Director Claude Felton said Goff plans to attend a Bulldog Club meeting tonight in Albany as scheduled.

The Bulldogs begin fall football practice Aug. 26.

Goff checked into the hospital Friday morning with an acute viral case of gastroenteritis, or inflammation in the stomach area.

The 34-year-old coach succeeded 25-year veteran Vince Dooley earlier this year. Goff's first game comes Sept. 16 as the Bulldogs meet Baylor.

## Hornets-Heat Proceeds To Be Donated

GREENSBORO (AP) — A portion of the proceeds from a National Basketball Association preseason game between the Charlotte Hornets and Miami Heat will be donated to a scholarship fund, it was announced Tuesday.

The Smith Barrier Scholarship Fund, endowed at the University of North Carolina at Greensboro, has been guaranteed a contribution of at least \$10,000. Barrier was a former sports editor in Greensboro for more than 40 years who died June 2.

The game will be played in the Greensboro Coliseum on Oct. 29 at 7:05 p.m. It will be the final preseason game for both teams.

The Hornets and Heat were both expansion teams during the 1988-89 season. Charlotte won 20 of 82 games and Miami 15 in their initial seasons. They split the two games they played against each other.

# Mariners Beat Odds, Rangers

THE ASSOCIATED PRESS

Maybe Charlie Hough should try pitching a no-hitter. Obviously, one-hitters don't work.

Outhit 13-1, the Seattle Mariners beat the odds and Hough on Tuesday night, defeating the Texas Rangers 2-0.

Hough has two career one-hitters and has lost both of them. The other came on June 16, 1986, in California.

"The only way it could have been worse was if I had thrown a no-hitter," Hough said.

Harold Reynolds' solid single leading off the sixth was all the Mariners got against Hough, 7-12. The Rangers got plenty of hits against Brian Holman and Mike Schooler, but no runs.

Holman, 5-5, gave up 10 hits in seven innings and Schooler got his 24th save. Texas came within one hit of tying a major league record for most hits in a shutout loss.

In other games, Milwaukee beat New York 1-0, Baltimore downed Detroit 2-0, Oakland defeated Cleveland 5-2, California topped Min-

nesota 3-2, Toronto trounced Boston 7-2 and Kansas City beat Chicago 10-6.

Hough walked five and struck out three. Reynolds scored in the sixth on a balk, a wild pitch and Jeffrey Leonard's sacrifice fly.

"Good bit of hitting by Reynolds. He's a tough out," Hough said. "I made a bad pitch to Leonard in those circumstances. He hit a knuckleball up and over the plate."

The Mariners scored in the seventh on an error by third baseman Steve Buechele.

"Our guys can't believe it. You just take this kind of win. That's baseball, I guess. This game was just unbelievable," Mariners manager Jim Lefebvre said.

**Brewers 1, Yankees 0**

Teddy Higuera again beat New York, pitching a six-hitter for his sixth straight victory as Milwaukee got above .500 for the first time since April 26.

Higuera is 12-2 lifetime against the Yankees. His .857 winning percentage is the highest for any pitcher versus New York.

Higuera, 9-4, has beaten the Yankees three times this season. He walked two and struck out five in his first shutout of the year.

Clay Parker, 3-3, gave up six hits, including Greg Brock's RBI single in the fourth inning.

**Blue Jays 7, Red Sox 2**

Lloyd Moseby led off the game with a home run and Toronto went on to win for the 14th straight time at Fenway Park.

Manny Lee and Rance Mulliniks also homered for the Blue Jays. Mookie Wilson had four hits and Fred McGriff doubled twice for Toronto, which had 15 hits.

The Blue Jays turned four double plays — in remaining unbeaten at Boston since Aug. 10, 1987.

Dave Stieb, 12-7, went five innings for the victory. Duane Ward escaped bases-loaded, one-out jams in the seventh and ninth innings for his 12th save.

Mike Smithson, 6-11, gave up four runs on eight hits and was replaced with no outs in the third inning. Moseby hit Smithson's fifth pitch for his 10th home run and Lee opened the second inning with his third homer.

run shot, his sixth homer in 25 games this season.

**Orioles 2, Tigers 0**

Rookie Bob Milacki pitched a three-hitter and Baltimore stayed undefeated in six games at Tiger Stadium this season.

Cal Ripken and Joe Orsulak homered in the Orioles' third straight victory.

Milacki, 7-10, has won all three career starts in Detroit. In those games, he has given up just one run on five hits in 25 innings.

Milacki struck out five and walked four in his second shutout. He did not allow a hit until two outs in the fifth inning.

Orsulak hit his fourth home run in the fourth inning and Ripken hit his 15th in the sixth against Doyle Alexander, 5-14.

**Angels 3, Twins 2**

Bobby Rose got his first three major-league hits and tripled home the go-ahead run in the sixth inning as California won for just the second time in six games.

Rose was recalled from Class AA on Friday after Dick Schofield fractured his hand. Rose singled home the tying run in the fourth and put the Angels in front in the sixth.

Chuck Finley, 14-8, got the victory and Bryan Harvey earned his 18th save. Mike Dyer, 1-3, was the loser.

**Royals 10, White Sox 6**

Kurt Stillwell hit two triples and drove in three runs as Kansas City won in Chicago.

Mike Macfarlane, who had three of the Royals' 15 hits, and Danny Tartabull each homered. Stillwell hit an RBI triple and scored on Jim Eisenreich's single for a 7-6 lead in the sixth inning.

Terry Leach, 3-3, got the victory. He relieved Charlie Leibbrandt after Ozzie Guillen's two-run triple in the fourth. Tom McCarthy, 1-2, took the loss.

# Ryan Shooting For 5,000th 'K'

THE ASSOCIATED PRESS

SEATTLE — Nolan Ryan is in town, which means the Seattle Mariners are flirting with another piece of baseball history.

In 1986, Roger Clemens struck out a record 20 Mariners in a 9-inning game. Today, Ryan starts for the Texas Rangers against the Mariners needing 14 strikeouts to reach 5,000 for his career.

Seattle's manager is Jim Lefebvre, one of the 1,061 major-league batters to strike out against Ryan.

"It was so long ago I don't remember facing him," Lefebvre said. "Whatever I did against him was uneventful. I'm just one of the many little guys that will put him in the Hall of Fame."

Ryan, 13-7, has 211 strikeouts in 168 1/3 innings this season, running his 23-year total to 4,986.

"I'd like to reach 5,000 but it was never a goal of mine," the 42-year-

old right-hander said. "Every player would like to reach a number like this at home, but I will approach this game like any other."

His next scheduled start will be Tuesday against Oakland at Arlington Stadium.

Fourteen isn't an unreachable figure for Ryan, who is averaging 11.3 strikeouts per nine innings this season. He struck out 15 Brewers in an 8-1 victory over Milwaukee on April 12 and 14 in only six innings against the Toronto Blue Jays on July 25.

Ryan struck out 15 Mariners on April 24, 1978 when he pitched for the California Angels. He is 1-1 against the Mariners in 1989, including a one-hit, 11-strikeout performance in the Kingdome on June 3. It is one of three near no-hitters this season by Ryan, who holds the major-league record with five no-hitters.

# National...

(Continued From B-1)

Von Hayes had a two-run homer and Dwayne Murphy hit a two-run double for the Phillies.

**Cardinals 9, Braves 1**

St. Louis routed Atlanta behind Jose DeLeon's three-hitter, Milt Thompson's four RBIs and Terry Pendleton's four hits.

DeLeon, 12-11, missed St. Louis' league-leading 16th shutout when Jeff Treadway homered with two outs in the ninth for the Braves.

The right-hander struck out 10 and walked one for his fourth complete game. He also singled home a run and took over the NL lead with 155 strikeouts, eight more than John Smoltz of Atlanta.

Thompson, who had three of St. Louis' 16 hits, had an RBI groundout in the fourth, a two-run single in the sixth and his fourth homer in the seventh, when the Cardinals scored five runs.

Pendleton homered and Tom Brunansky had three hits and two RBIs for St. Louis.

Eric Yelding from second base in the 11th inning.

Glenn Davis, who homered earlier, led off the 11th with a single off Mike Smith, 0-1, and Yelding came in to pinch run. After a sacrifice bunt by Kevin Bass moved Yelding to second, Caminiti singled to left field.

Larry Andersen, 3-3, was the winner, going one inning and giving up one hit and one walk.

The Astros are 29-17 in one-run decisions, the Pirates 13-27.

**Phillies 7, Dodgers 6**

Ricky Jordan got his 17th RBI in 15 games with his second home run of the night, leading off the bottom of the eighth against Ray Searage.

Reliever Jeff Parrett, 11-4, Philadelphia's biggest winner, pitched three scoreless innings, allowing one hit, for the victory.

The Dodgers got homers from Mike Huff and Mike Marshall in taking a 6-4 lead, but they couldn't hold it.

**NINTENDO**  
Buy - Sell - Rent  
East Coast Music & Video  
1109 Charles Blvd. • 758-4251

**GORDON'S**  
Foot-Joy. 20% OFF  
284 ByPass Golf Shoes 758-1003

**Professor O'Cool's**  
Saloon  
Eating & Drinking

**Every Thursday**  
**Thursday Night**  
**Baseball Specials**

Located Behind Ace Cleaners Near Farm Fresh 355-2946

**Back To School Special**  
**FACTORY OUTLET STORE**

**CORDURA® Back Packs** BACK-TO-SCHOOL SPECIAL  
**\$14.95** Reg. \$21.00

OFFER GOOD AUGUST 16-23 ONLY  
Also Available

Duffle bags \$15.00-\$28.00	Total bags from \$16.00-\$27.00
Briefcases \$24.50	Weekend Travel Bags \$25.50

Buy direct from factory and save  
Bring this ad and save an extra 10% off your purchases

**Hatteras Canvas Products**  
1104 Clark Street  
(Near the rear of Bostic-Sugg Furniture)  
8:00 AM - 5:00 PM

**PLAY PEPSI**

**NASCAR**

**NUMBERS**

**The winning car number**  
**at the**  
**Budweiser at the Glen**  
**in Watkins Glen, NY on**  
**Sunday, August 13, 1989 was**

**CAR #27**

If you have this number on a specially marked bottle cap or can and you also have a cap or can with Budweiser at the Glen, you've won a Free 2-liter Diet Pepsi.  
Take your winning caps or cans to your local Pontiac dealer to pick up your Free Diet Pepsi.  
While there be sure to register for a chance to win \$100,000 in cash. Drawing to be held September 3, 1989 at the Southern 500 in Darlington, South Carolina.

**Next NASCAR race is the Champion Sparkplug 400 in Brooklyn, MI on Sunday, August 20, 1989**

Make sure you, your family and friends keep collecting those specially marked caps and cans from Pepsi-Cola® products!

**For Details Call: 1-800-433-COLA**

Pepsi is a registered trademark of PepsiCo, Inc. ©1988 Geographic Marketing Group

**RAIN BIRD**

Irrigation Systems  
"FOR ALL OF YOUR IRRIGATION NEEDS"

Complete Product Inventory — Competitive Prices  
Prompt Service & Delivery — Free Estimates

**Hendrix Barnhill Co., Inc.**

919-752-4122

1819 Progress Rd. Greenville, N.C. 27835

We fix cars for keeps.

**HASTINGS FORD**

Ford, Lincoln and Mercury Owners:

Oil and Filter Change \$12.50	Tune-Up Special
Includes up to 5 quarts of oil and filter for your late model Ford or Mercury. Others slightly higher.	4 Cylinder . \$22.50
I use only genuine Ford and Motorcraft	6 Cylinder . \$25.80
When you have your Ford, Mercury, Lincoln or Ford Light Truck fixed, you pay once, and I'll guarantee that, if the covered part ever has to be fixed again, I'll fix it free. Free parts. Free labor. Covers thousands of parts. Lasts as long as you own your vehicle. No matter where or when you bought it. So take advantage of my free oil. And my free Lifetime Service Guarantee. Two ways of showing you that I care about you. Come in with your coupon!	8 Cylinder . \$31.80

This limited warranty covers vehicles in normal use. And excludes routine maintenance parts, belts, hoses, sheet metal and upholstery.

Ask us to see a copy of the Lifetime Service Guarantee

758-0114  
Toll Free  
1-800-854-3429

\*\*Lifetime\*\* is the period of ownership of the Customer's Ford, Lincoln, Mercury or Ford Light Truck.

# SCOREBOARD

## Major League Baseball

By The Associated Press  
All Times EDT  
AMERICAN LEAGUE

East Division		West Division						
W	L Pct	GB	L10 Streak Home Away					
Baltimore	62	56	.525	2-6	Won 3	34-25	28-30	
Toronto	60	59	.504	2 1/2	4-4	Won 2	28-30	31-29
Milwaukee	61	60	.504	2 1/2	2-2	Won 3	24-27	27-33
Boston	57	60	.487	4 1/2	4-6	Lost 3	29-29	28-31
Cleveland	57	62	.479	5 1/2	3-7	Lost 4	29-29	28-33
New York	55	64	.462	7 1/2	2-4	Lost 2	30-28	25-36
Detroit	43	76	.361	19 1/2	2-6	Lost 2	25-35	18-41

National League		East Division		West Division				
W	L Pct	GB	L10 Streak Home Away	W	L Pct	GB	L10 Streak Home Away	
Chicago	69	50	.580	0	2-3	Won 1	34-25	35-25
New York	65	53	.551	3 1/2	2-8	Won 3	41-19	24-34
Montreal	65	54	.546	4	2-8	Lost 3	35-25	30-29
St. Louis	63	55	.534	5 1/2	5-5	Won 3	35-28	28-29
Pittsburgh	50	68	.424	18 1/2	4-6	Lost 1	25-33	25-35
Philadelphia	48	70	.407	20 1/2	2-5	Won 2	27-31	21-39

National League		East Division		West Division				
W	L Pct	GB	L10 Streak Home Away	W	L Pct	GB	L10 Streak Home Away	
San Francisco	68	51	.571	0	2-5	Won 1	39-20	29-31
Houston	65	54	.546	3	4-6	Won 1	34-27	31-27
San Diego	59	60	.496	9	2-5	Lost 2	30-29	29-31
Cincinnati	56	62	.475	11 1/2	5-5	Lost 1	29-30	27-32
Los Angeles	56	63	.471	12	2-5	Lost 1	31-28	25-35
Atlanta	48	72	.400	20 1/2	4-6	Lost 3	25-34	23-38

**AMERICAN LEAGUE**  
Tuesday's Games  
Toronto 7, Boston 2  
Baltimore 2, Detroit 0  
Kansas City 10, Chicago 6  
Milwaukee 6, New York 0  
Oakland 5, Cleveland 2  
Seattle 2, Texas 0  
California 3, Minnesota 2  
Wednesday's Games  
New York (Yankees) 1-2 at Milwaukee (Rays) 6-6, 2:30 p.m.  
Minnesota (Rawley) 5-10 at California (M. Witt) 7-10, 4:05 p.m.  
Texas (Ryan) 18-7 at Seattle (Bankhead) 11-4, 4:35 p.m.  
Toronto (Stottelmyre) 4-5 at Boston (Clemens) 12-8, 7:35 p.m.  
Baltimore (Harmon) 2-5 at Detroit (Tanana) 9-10, 7:35 p.m.  
Kansas City (Saberhagen) 13-5 at Chicago (King) 5-4, 8:30 p.m.  
Cleveland (Black) 9-9 at Oakland (Moore) 15-6, 10:05 p.m.  
Thursday's Games  
Cleveland at Oakland, 3:15 p.m.  
Toronto at Baltimore, 7:35 p.m.  
New York at Detroit, 7:35 p.m.  
Texas at Chicago, 8:30 p.m.  
Boston at Milwaukee, 8:30 p.m.  
Kansas City at Seattle, 10:05 p.m.  
Only games scheduled

**NATIONAL LEAGUE**  
Tuesday's Games  
Chicago 5, Cincinnati 2, 12 innings  
San Francisco 3, Montreal 2  
New York 3, San Diego 2  
Philadelphia 7, Los Angeles 6  
St. Louis 9, Atlanta 1  
Houston 3, Pittsburgh 2, 11 innings  
Wednesday's Games  
San Francisco (LaCos) 7-7 at Montreal (Langston) 10-3, 7:05 p.m.  
Chicago (Bielecki) 13-5 at Cincinnati (Leary) 8-9, 7:35 p.m.  
San Diego (Rasmussen) 5-8 at New York (Daring) 10-9, 7:35 p.m.  
Los Angeles (Belcher) 8-11 at Philadelphia (Carman) 3-12, 7:35 p.m.  
Pittsburgh (Smiley) 9-7 at Houston (Rhoden) 1-4, 8:35 p.m.  
Atlanta (Clary) 2-3 at St. Louis (Power) 4-5, 8:35 p.m.  
Thursday's Games  
San Diego at New York, 1:35 p.m.  
Chicago at Cincinnati, 7:35 p.m.  
San Francisco at Montreal, 7:35 p.m.  
Los Angeles at Philadelphia, 7:35 p.m.  
Pittsburgh at Houston, 8:35 p.m.  
Only games scheduled

**League Leaders**  
By The Associated Press  
**AMERICAN LEAGUE**  
BATTING (333 at bats)—Puckett, Minnesota, .340; Boggs, Boston, .339; Lansford, Oakland, .327; A. Davis, Seattle, .334; Youn, Milwaukee, .328.  
RUNS—R. Henderson, Oakland, 87; Sierra, Texas, 76; Boggs, Boston, 75; McGriff, Toronto, 75; Youn, Milwaukee, 74.  
RBI—Sierra, Texas, 85; Franco, Texas, 84; Mattingly, New York, 81; Youn, Milwaukee, 80; Carter, Cleveland, 78.  
HITS—Puckett, Minnesota, 181; Sax, New York, 155; Boggs, Boston, 151; Youn, Milwaukee, 149; Sierra, Texas, 145.  
DOUBLES—Boggs, Boston, 39; Puckett, Minnesota, 37; Reed, Boston, 33; Youn, Milwaukee, 31; Bell, Toronto, 30; Mattingly, New York, 30; Sierra, Texas, 30.  
TRIPLES—D. White, California, 11; P. Bradley, Baltimore, 10; Sierra, Texas, 10; Boggs, Boston, 7; Guillen, Chicago, 7; Youn, Milwaukee, 7.  
HOME RUNS—McGriff, Toronto, 31; Carter, Cleveland, 25; Deer, Milwaukee, 25; Whitaker, Detroit, 25; Blackson, Kansas City, 22.  
STOLEN BASES—R. Henderson, Oakland, 54; Espy, Texas, 37; Sax, New York, 30; D. White, California, 33; Pettis, Detroit, 33.  
PITCHING (10 decisions)—Blyleven, California, 12.2, 87, 2.36; Swindell, Cleveland, 13.2, 83, 2.69; Gordon, Kansas City, 14.4, 77, 2.84; Williamson, Baltimore, 9.3, 79, 2.39; Bankhead, Seattle, 11.4, 73, 3.34.  
STRIKEOUTS—Ryan, Texas, 211; Clemens, Boston, 158; C. Finley, California, 142; Viola, Minnesota, 138; Bosio, Milwaukee, 138.  
SAVES—Plesac, Milwaukee, 28; D. Jones, Cleveland, 27; Thigpen, Chicago, 26; Russell, Texas, 25; Eckersley, Oakland, 24; Schooler, Seattle, 24.  
**NATIONAL LEAGUE**  
BATTING (333 at bats)—T. Gwynn, San Diego, .342; W. Clark, San Francisco, .339; L. Smith, Atlanta, .337; Grace, Chicago, .335; Walton, Chicago, .302.  
RUNS—H. Johnson, New York, 82; W. Clark, San Francisco, 81; Mitchell, San Francisco, 77; Coleman, St. Louis, 76; Sandberg, Chicago, 73. RBI—Mitchell, San Francisco, 102; W. Clark, San Francisco, 83; Guerrero, St. Louis, 81; E. Davis, Cincinnati, 77; G. Davis, Houston, 72; H. Johnson, New York, 72.  
HITS—T. Gwynn, San Diego, 158; W. Clark, San Francisco, 149; Guerrero, St. Louis, 126; Butler, San Francisco, 124; R. Alomar, San Diego, 124.  
DOUBLES—Wallach, Montreal, 34; H. Johnson, New York, 31; Guerrero, St. Louis, 30; Bonilla, Pittsburgh, 28; Mitchell, San Francisco, 28.  
TRIPLES—R. Thompson, San Francisco, 9; Coleman, St. Louis, 7; Roberts, San Diego, 7; Van Slyke, Pittsburgh, 7; 5 are tied with 6.  
HOME RUNS—Mitchell, San Francisco, 37; G. Davis, Houston, 28; H. Johnson, New York, 28; E. Davis, Cincinnati, 25; Strawberry, New York, 25.  
STOLEN BASES—Coleman, St. Louis, 55; T. Gwynn, San Diego, 35; Young, Houston, 33; H. Johnson, New York, 31; O. Nix, Montreal, 30.

IP	H	R	ER	BB	SO
New York	8	6	1	2	2
Parker L, 3-3	8	6	1	2	2
Milwaukee	9	6	0	0	3
Higuera W, 9-1	9	6	0	0	3
Umpires—Home, Reed, First, Johnson, Second, Phillips; Third, McCoy, T-2:27 A-38:23.					

IP	H	R	ER	BB	SO	
Cleveland	9	1	0	0	2	
Oakland	9	1	0	0	2	
Browne 2b 4 0 10	RHds 11	3	1	1	1	
Jacoby 3b 4 0 22	Lansford 3b 2 1 2					
James lf 3 0 2 0	Cassano rf 4 1 2					
Komssk of 1 0 0 0	Javier rf 0 0 0 0					
Carter cf 5 0 0 0	McGuire lf 3 4 0 0					
POBris lf 3 0 1 0	DHds of 4 1 1 0					
Snyder rf 4 0 0 0	Hassey c 2 1 1 1					
MIYong dh 2 0 0 0	Stiebch c 1 0 0 0					
Skinner c 3 0 0 0	Williams 2b 3 0 0 0					
Belle ph 1 0 0 0	Weiss ss 3 0 1 0					
Allanson c 0 0 0 0						
Fermin ss 4 2 4 0						
Totals	35	21	2	2	29	3

IP	H	R	ER	BB	SO
Cleveland	9	1	0	0	2
Oakland	9	1	0	0	2
E-Carter DP-Cleveland 2	Oakland 1				
LOB-Cleveland 11	Oakland 6				
Fermin, DHenderson, Hassey, Jacoby, HR—R. Henderson (8), Cassano (6), SB—Jacoby (2), R. Henderson (5), M. Young (1), Lansford (2), S—Browne, Phillips.					

IP	H	R	ER	BB	SO	
Seattle	8	1	2	1	5	
San Diego	9	1	0	0	2	
Hough L, 7-12	8	1	2	1	5	
Reynolds 2b 5 0 1 0	Reynolds 2b 4 1 1 0					
Phiero lf 5 0 4 0	Bryley lf 3 0 0 0					
Belle ph 4 0 2 0	Adams lf 2 0 0 0					
Sierra rf 5 0 2 0	Leard dh 3 0 0 1					
Franco 2b 4 0 0 0	Coles rf 2 0 0 0					
Incaviglia lf 4 0 1 0	Kingery lf 2 1 0 0					
Burchel 2b 4 0 0 0	Freley lf 2 0 0 0					
Sundberg c 2 0 0 0	Vale ss 2 0 0 0					
R. Leach ph 1 0 0 0	Vizquel ss 2 0 0 0					
Kreuter c 0 0 0 0	SBRly ph 1 0 0 0					
D. Shiry ph 1 0 1 0	Diaz ss 0 0 0 0					
MStanly c 0 0 0 0						
Manrqi ss 4 0 0 0						
Totals	39	13	8	2	25	11

IP	H	R	ER	BB	SO
San Diego	9	1	0	0	2
New York	9	1	0	0	2
Two outs when winning run scored.					
DP—New York 1	LOB—San Diego 2				
New York 6	H. Johnson, Templeton, Elster, HR—H. Johnson (2), James (1), McReynolds (1), SB—Samuel (2), S—Whitson, Fernandez.				

IP	H	R	ER	BB	SO	
Los Angeles	9	1	0	0	2	
Philadelphia	9	1	0	0	2	
Griffin ss 5 0 0 0	Dykstra cf 4 0 0 0					
Rodriguez 2b 3 1 0 0	Herr 2b 4 1 2 0					
Murray lf 4 2 3 0	V. Hayes rf 4 1 2 0					
Marshall rf 4 2 2 3	Kruk lf 3 1 1 0					
C. Martinez lf 3 0 1 0	Sasser c 3 0 3 0					
A. Pena p 0 0 0 0	Chavez 3b 3 1 1 0					
Gonzalez cf 3 0 0 0	Daulton c 4 0 1 0					
Huff lf 1 1 1 1	Thorn ss 3 1 1 0					
Staub ph 0 0 0 0	Jordan lf 4 2 2 3					
Shrpen ph 1 0 1 0	Cook p 2 0 0 0					
Bean lf 1 0 0 0	O'Neal p 0 0 0 0					
Sciocia c 4 0 0 1	McWilliams p 0 0 0 0					
R. Harris 2b 1 0 0 0	D. Murphy lf 1 1 2 0					
Anders ph 1 0 0 0	Parrett p 0 0 0 0					
Morgan p 0 0 0 0						
Seavage p 0 0 0 0						
L. Harris 3b 1 0 0 0						
Totals	35	8	6	2	33	17

IP	H	R	ER	BB	SO
Los Angeles	9	1	0	0	2
Philadelphia	9	1	0	0	2
DP—Los Angeles 1	LOB—Los Angeles 4				
Philadelphia 4	Marshall, D. Murphy, HR—Huff (1), Marshall (9), Jordan (2), V. Hayes (1), SB—Kruk (2).				

IP	H	R	ER	BB	SO	
Atlanta	9	1	0	0	2	
St. Louis	9	1	0	0	2	
OMcDill cf 4 0 0 0	Coleman lf 5 0 0 0					
Tredy 2b 4 1 2 0	O'Smith ss 4 0 2 0					
L. Smith lf 3 0 0 0	T. Jones ss 1 0 0 0					
Wetby lf 1 0 0 0	Ogund 2b 5 1 1 0					
D. Murphy rf 3 0 0 0	Alanta 2b 5 1 1 0					
Berra rf 0 0 0 0	Lindm lf 1 1 1 0					
Evans lf 2 0 0 0	Brandy rf 4 3 3 2					
Valdez p 0 0 0 0	P. Dittin 3b 4 2 4 2					
Blauser 3b 3 0 0 0	Wallace 2b 3 0 0 0					
D. Davis c 3 0 0 0	M. Thompson cf 4 2 3 4					
Romero ss 3 0 1 0	P. Pena c 3 0 1 0					
Lilloquist 2b 2 0 0 0	TPena p 4 0 1 1					
schrrn p 0 0 0 0						
Boeyer p 0 0 0 0						
Gregg lf 1 0 0 0						
Totals	29	13	1	2	39	16

IP	H	R	ER	BB	SO
Chicago	100	000	000-5		
Cincinnati	100	000	000-2		
LOB—Chicago 11	LOB—Cincinnati 7				
Winningham, HR—D. Smith (7), Dawson (1), S—G. Maddux.					

IP	H	R	ER	BB	SO
Kansas City	9	1	0	0	2
Milwaukee	9	1	0	0	2
Lebrndt 3b 3 8 6 6	1 2				
T. Leach W, 3-3	5	3	0	0	1
Farr 1 1 0 0 0 0					
Chicago	9	1	0	0	2
Rosenberg 2 7 5 5	1 1				
McCarthy L, 1-2	3 2 3	2	0	1	3
Fall 1 2 3	3	3	0	0	2
Hillgas 2 2 0 0	0 2				
Rosenberg pitched to 3 batters in the 3rd, Lebrndt pitched to 4 batters in the 4th.					
WP—Lebrndt.					
Umpires—Home, Voltaggio; First, Barnett; Second, Ford; Third, Hirschbeck.					
T-3:06 A-13:53.					

IP	H	R	ER	BB	SO	
New York	9	1	0	0	2	
Milwaukee	9	1	0	0	2	
Sax 2b 3 0 1 0	Mallor 3b 4 0 1 0					
Esnoz ss 4 0 3 0	Palmer 2b 3 1 1 0					
Mingly dh 4 0 0 0	Gondor 2b 1 0 1 0					
Balioni lf 3 0 0 0	Briggs lf 3 0 1 0					
Barfield lf 4 0 0 0	Yount cf 3 0 0 0					
Geran c 4 0 1 0	Brock lf 3 0 1 1					
Lawton lf 3 0 0 0	Vaughn dh 3 0 1 0					
Tollan 3b 3 0 1 0	Surhoff c 2 0 0 0					
Kelly cf 3 0 0 0	Felder rf 3 0 0 0					
Totals	31	6	6	2	30	6

## TANK McNAMARA



St. Louis W, 12-1, 9-3, 1-1, 1-1, 1-1  
Umpires—Home, Patti; First, Hirschbeck; Second, Davidson; Third, Bonn.  
T-2:35 A-39:50.

IP	H	R	ER	BB	SO
Pittsburgh	9	1	0	0	2
Houston	9	1	0	0	2
Bonds lf 4 1 1 0	Biggio cf 4 0 1 0				
Bell ss 3 0 1 0	Ramirez ss 4 0 1 0				
VanSlyk cf 4 0 0 0	Publ lf 4 1 2 1				
Bonilla 3b 4 1 2 1	G. Davis th 4 1 2 1				
C. Wilson rf 5 1 3 1	Yolding pr 1 0 1 0				
Redus lf 4 0 0 0	Bass rf 4 0 0 0				
M. Smith p 0 0 0 0	Camit 3b 5 0 2 1				
L. Villiere c 3 0 2 1	Doran 2b 3 1 0 0				
L. Young cf 4 0 2 0					
Bellard 2b 3 0 0 0	Scott p 2 0 0 0				
Distno ph 1 0 0 0	Spilman ph 1 0 0 0				
Ortiz c 1 0 0 0	Agosto p 0 0 0 0				
R. Reed p 2 0 0 0	Darwin p 0 0 0 0				
Cangels ph 1 0 0 0	Clarks ph 1 0 0 0				

**Crossword** By EUGENE SHEFFER

**ACROSS**  
 1 Indian weight  
 5 — Na-Na  
 8 Look over  
 12 Jewish month  
 13 — Days That Shook the World  
 14 All, in Avila  
 15 Unexpected loss of status  
 17 With  
 18 Kind of bullet  
 19 Shoelace tips  
 21 — mode  
 22 Berg opera  
 23 Dry, as wine  
 26 — on (urge)  
 28 Tibet's neighbor  
 31 Physi-cist's concern  
 33 Dawn goddess  
 35 Peace symbol  
 36 Mamel's "House of —"

**DOWN**  
 1 Mine great  
 11 Dozes  
 16 Take out  
 20 Rifle  
 23 Droop  
 24 Zeta  
 25 Equal  
 27 Stickum  
 29 Miss Gardner  
 30 Journey part  
 32 Mythical sea creature  
 34 Soft-shell clam  
 37 Use a straw  
 39 Weight allowance  
 42 B'way union  
 44 Playwright David and family  
 45 Obstacle  
 46 Floor covering, in England  
 48 Masculine  
 49 Sacred image  
 50 Sketch  
 53 Wood sorrel

**Solution time: 21 mins.**

REAP CHA STAR  
 ACRE LAG HULA  
 SHIPMATE LITER  
 HOD ORE SPUNK  
 SRO COS  
 CACHE BOTHERS  
 ALAI BID AGEE  
 RIPPLES SPOON  
 COT POE  
 SPRAT SOU ASP  
 IRON SHI POVER  
 NOLA EOS LINE  
 GALL AWE EDDY

Yesterday's answer 8-16

**The Family Circus**

By Bil Keane

**Horoscope**

From The Carroll Righter Institute



8-16  
 © 1989 Bil Keane, Inc.  
 Dist. by Cowles Synd. Inc.

"When you were little, Grandma, were you the only one in your class with gray hair?"

**FORECAST FOR THURSDAY Aug. 17**  
**ARIES** (March 21 to April 19): You may be torn between your own thirst for independence and your loyalty to others. Romance could show its beauty tonight.  
**TAURUS** (April 20 to May 20): Remind someone aggressive that there is a time and place for everything. Schedules run smoother, so enjoy your free time.  
**GEMINI** (May 21 to June 21): Maintain honest and sincere ties with those you love. Push ahead with your talents. Put energy into recreation and companionship.  
**MOON CHILDREN** (June 22 to July 21): You could be involved in a plan of action that has far-reaching rewards. Follow your hunches and tune into yourself.  
**LEO** (July 22 to Aug. 21): Your new money strategies are brilliant. You excel in activities that raise you to a position of authority. Remain confident.  
**VIRGO** (Aug. 22 to Sept. 22): You will have the last laugh with someone who considers you "square" because you satisfy your needs in traditional ways.  
**LIBRA** (Sept. 23 to Oct. 22): Don't charge into a social scene unless you know you belong there. You may fare best with the regular gang, even though you feel bored.  
**SCORPIO** (Oct. 23 to Nov. 21): Accept others for who they are and at their own level of proficiency. You hate inefficiency, but it is best to give others a chance.  
**SAGITTARIUS** (Nov. 22 to Dec. 21): You gain emotional satisfaction from someone who is honest and sincere. Motivate yourself to help others.  
**CAPRICORN** (Dec. 22 to Jan. 20): If tempers flare, take a backseat until the flak cools down. Romance is exciting. Enjoy tender relationships with your mate.  
**AQUARIUS** (Jan. 21 to Feb. 19): You still possess magnetism and charm. Do not be afraid to rely on your sociability to get your share of love and romance.  
**PISCES** (Feb. 20 to March 20): You are motivated to seek personal acclaim. It helps to hang out with the right people. Music comforts you when life gets tough.  
 (c) 1989, The McNaught Syndicate Inc.

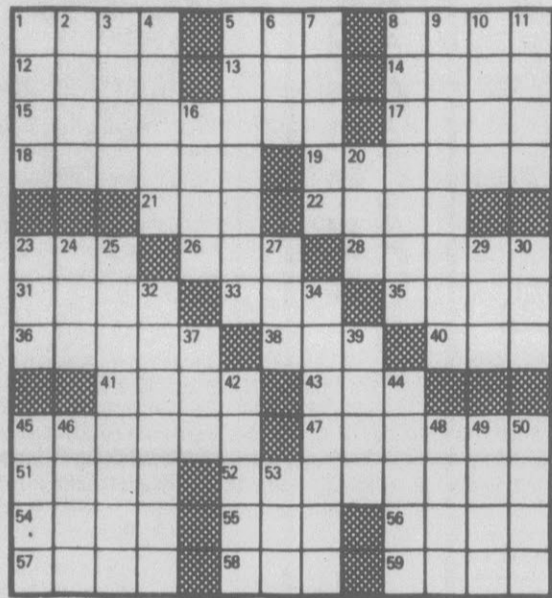

**8-16 CRYPTOQUIP**  
 NTVE I MHVISOEP PIH  
 MVEVH'A IBHBS UBXUQ PXVA  
 XRR VIHBG, OJ OA I HXXJ  
 INIQUEOEP.  
 Yesterday's Cryptiquip: COULD YOU CALL GANGS OF FIREFIGHTING DOGS DALMATIAN ARMIES?  
 Today's Cryptiquip clue: O equals I

**Bridge**

By CHARLES GOREN AND OMAR SHARIF

**READ THE LEAD**

Both vulnerable. South deals.

**NORTH**  
 ♠ K Q 6 2  
 ♥ 9 8 5 4  
 ♦ J 7  
 ♣ J 5 3

**WEST**  
 ♠ 7  
 ♥ Q J 7 6  
 ♦ K 10 8 5 2  
 ♣ Q 6 4

**EAST**  
 ♠ 10 4 3  
 ♥ 3  
 ♦ 9 6 4 3  
 ♣ A 10 8 7 2

**SOUTH**  
 ♠ A J 9 8 5  
 ♥ A K 10 2  
 ♦ A Q  
 ♣ K 9

The bidding:  
 South West North East  
 1 ♠ Pass 2 ♠ Pass  
 3 ♥ Pass 3 ♠ Pass  
 4 ♠ Pass Pass Pass  
 Opening lead: Seven of ♠  
 Positive inferences can often be drawn from an opposing bid or play. However, even more informa-

tion can sometimes be gleaned from why a player did *not* take some action. Call it "the dog that didn't bark in the night" syndrome.

South was certainly going to bid game once North raised spades. However, slam was a slight possibility if North held a magic fit, so South made a try with three hearts. When that brought no sign of interest from North, South settled for game.

West led his lone trump, won in hand with the eight. Declarer cashed the ace of hearts, then led the nine of trumps to the queen, noting West's diamond discard. Since the lead of a singleton trump could be disastrous, declarer concluded that West's holdings in the side suits looked even more unappetizing, so he elected to place West with the king of diamonds.

Declarer drew the last trump with the king, retaining the five in hand, then led a low heart, inserting the ten when East showed out. West

won, but had to do something to help declarer. He chose to exit with a club to his partner's ace. East switched to a low diamond, and the hand was at the crossroads.

Spurning the finesse and backing his card reading, declarer rose with the ace of diamonds, cashed the king of clubs and entered dummy with a trump to ruff a club. Then he exited with the queen of diamonds.

West, who had to retain two hearts to guard against declarer's holding, was forced to win the king and lead a heart into declarer's tenace to surrender the last two tricks and the contract.

For information about Charles Goren's newsletter for bridge players, write Goren Bridge Letter, P.O. Box 4426, Orlando, Fla. 32802-4426.

**Want To Buy A Home? Find It Fast In Classified**

**FUNKY WINKERBEAN**



**BC**



**PHANTOM**

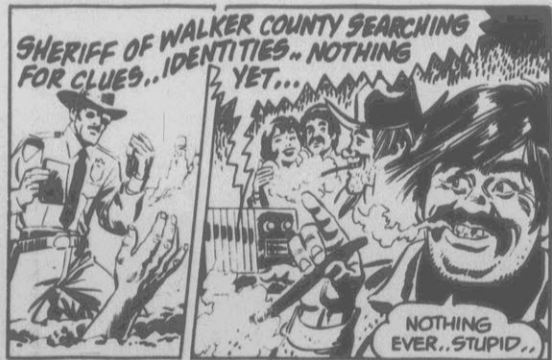

**SHOE**



**THE WIZARD OF ID**



**BLONDIE**



**PEANUTS**



**FRANK & ERNEST**



**BEETLE BAILY**



**GARFIELD**



THE DAILY REFLECTOR

Call 752-6166 To Place Your Ad

Rates Table: Transient Rates, Classified Display, Office Hours

Deadlines Table: Classified Display Deadlines, Classified Line Deadlines

Errors: Please read your ad carefully the first time it appears in the paper...

Miscellaneous: Personal, Memorial, In Memoriam, Special Notices

Wanted: Help Wanted, Administrative, Medical, Miscellaneous

Classified Index: Townhomes For Rent, Trucks For Sale, Pets

Help Wanted Clerical: CLERICAL AND secretarial positions available

Help Wanted Medical: LPN OR Medical Assistant needed for busy medical practice

Medical Coordinator: Are you a hard worker? Do you want an interesting and challenging job?

Public Notices

001 Public Notices: "Final plot plan for Horace G. Lawrence" prepared by Stroud Land Surveying Company...

ADVERTISEMENTS: The Pitt County Board of Education, pursuant to existing state law and local regulations...

ADVERTISEMENTS: Sealed bids for Wastewater Pump Station Aviden-Griffon High School...

ADVERTISEMENTS: Sealed bids for Wastewater Pump Station Aviden-Griffon High School (continued)

ADVERTISEMENTS: Sealed bids for Wastewater Pump Station Aviden-Griffon High School (continued)

ADVERTISEMENTS: Sealed bids for Wastewater Pump Station Aviden-Griffon High School (continued)

ADVERTISEMENTS: Sealed bids for Wastewater Pump Station Aviden-Griffon High School (continued)

001 Public Notices: This the 28th day of July, 1989. Ralph L. Tyson, Sheriff...

001 Public Notices: FILE NO. 89 CV D 1060 IN THE GENERAL COURT OF JUSTICE...

001 Public Notices: NOTICE OF SERVICE OF PROCESS TO: HERBERT FORREST, the above named defendant.

001 Public Notices: NOTICE OF ELECTION FOR THE TOWN OF FARMVILLE ON OCTOBER 10, 1989...

001 Public Notices: NOTICE OF SALE OF REAL PROPERTY: MERLYN WILLIAMS WHITE DUDLEY...

001 Public Notices: SANDRA FAYE HADDOCK WHITE vs. Plaintiff vs. Defendant...

001 Public Notices: NOTICE OF SALE OF REAL PROPERTY: MERLYN WILLIAMS WHITE DUDLEY (continued)

001 Public Notices: NOTICE OF SALE OF REAL PROPERTY: MERLYN WILLIAMS WHITE DUDLEY (continued)

001 Public Notices: The South side of North Carolina State Road No. 1760 and being located approximately .30 miles...

001 Public Notices: FILE NO. 89 CV D 1060 IN THE GENERAL COURT OF JUSTICE...

001 Public Notices: NOTICE OF ELECTION FOR THE TOWN OF FARMVILLE ON OCTOBER 10, 1989...

001 Public Notices: NOTICE OF SALE OF REAL PROPERTY: MERLYN WILLIAMS WHITE DUDLEY (continued)

001 Public Notices: NOTICE OF SALE OF REAL PROPERTY: MERLYN WILLIAMS WHITE DUDLEY (continued)

001 Public Notices: NOTICE OF SALE OF REAL PROPERTY: MERLYN WILLIAMS WHITE DUDLEY (continued)

001 Public Notices: NOTICE OF SALE OF REAL PROPERTY: MERLYN WILLIAMS WHITE DUDLEY (continued)

001 Public Notices: NOTICE OF SALE OF REAL PROPERTY: MERLYN WILLIAMS WHITE DUDLEY (continued)

001 Public Notices: FILE NO. 89 CV D 1060 IN THE GENERAL COURT OF JUSTICE...

001 Public Notices: NOTICE OF ELECTION FOR THE TOWN OF FARMVILLE ON OCTOBER 10, 1989...

001 Public Notices: NOTICE OF SALE OF REAL PROPERTY: MERLYN WILLIAMS WHITE DUDLEY (continued)

001 Public Notices: NOTICE OF SALE OF REAL PROPERTY: MERLYN WILLIAMS WHITE DUDLEY (continued)

001 Public Notices: NOTICE OF SALE OF REAL PROPERTY: MERLYN WILLIAMS WHITE DUDLEY (continued)

001 Public Notices: NOTICE OF SALE OF REAL PROPERTY: MERLYN WILLIAMS WHITE DUDLEY (continued)

001 Public Notices: NOTICE OF SALE OF REAL PROPERTY: MERLYN WILLIAMS WHITE DUDLEY (continued)

001 Public Notices: NOTICE OF SALE OF REAL PROPERTY: MERLYN WILLIAMS WHITE DUDLEY (continued)

001 Public Notices: FILE NO. 89 CV D 1060 IN THE GENERAL COURT OF JUSTICE...

001 Public Notices: NOTICE OF ELECTION FOR THE TOWN OF FARMVILLE ON OCTOBER 10, 1989...

001 Public Notices: NOTICE OF SALE OF REAL PROPERTY: MERLYN WILLIAMS WHITE DUDLEY (continued)

001 Public Notices: NOTICE OF SALE OF REAL PROPERTY: MERLYN WILLIAMS WHITE DUDLEY (continued)

001 Public Notices: NOTICE OF SALE OF REAL PROPERTY: MERLYN WILLIAMS WHITE DUDLEY (continued)

001 Public Notices: NOTICE OF SALE OF REAL PROPERTY: MERLYN WILLIAMS WHITE DUDLEY (continued)

001 Public Notices: NOTICE OF SALE OF REAL PROPERTY: MERLYN WILLIAMS WHITE DUDLEY (continued)

001 Public Notices: NOTICE OF SALE OF REAL PROPERTY: MERLYN WILLIAMS WHITE DUDLEY (continued)

001 Public Notices: FILE NO. 89 CV D 1060 IN THE GENERAL COURT OF JUSTICE...

001 Public Notices: NOTICE OF ELECTION FOR THE TOWN OF FARMVILLE ON OCTOBER 10, 1989...

001 Public Notices: NOTICE OF SALE OF REAL PROPERTY: MERLYN WILLIAMS WHITE DUDLEY (continued)

001 Public Notices: NOTICE OF SALE OF REAL PROPERTY: MERLYN WILLIAMS WHITE DUDLEY (continued)

001 Public Notices: NOTICE OF SALE OF REAL PROPERTY: MERLYN WILLIAMS WHITE DUDLEY (continued)

001 Public Notices: NOTICE OF SALE OF REAL PROPERTY: MERLYN WILLIAMS WHITE DUDLEY (continued)

001 Public Notices: NOTICE OF SALE OF REAL PROPERTY: MERLYN WILLIAMS WHITE DUDLEY (continued)

001 Public Notices: NOTICE OF SALE OF REAL PROPERTY: MERLYN WILLIAMS WHITE DUDLEY (continued)

001 Public Notices: FILE NO. 89 CV D 1060 IN THE GENERAL COURT OF JUSTICE...

001 Public Notices: NOTICE OF ELECTION FOR THE TOWN OF FARMVILLE ON OCTOBER 10, 1989...

001 Public Notices: NOTICE OF SALE OF REAL PROPERTY: MERLYN WILLIAMS WHITE DUDLEY (continued)

001 Public Notices: NOTICE OF SALE OF REAL PROPERTY: MERLYN WILLIAMS WHITE DUDLEY (continued)

001 Public Notices: NOTICE OF SALE OF REAL PROPERTY: MERLYN WILLIAMS WHITE DUDLEY (continued)

001 Public Notices: NOTICE OF SALE OF REAL PROPERTY: MERLYN WILLIAMS WHITE DUDLEY (continued)

001 Public Notices: NOTICE OF SALE OF REAL PROPERTY: MERLYN WILLIAMS WHITE DUDLEY (continued)

001 Public Notices: NOTICE OF SALE OF REAL PROPERTY: MERLYN WILLIAMS WHITE DUDLEY (continued)

001 Public Notices: FILE NO. 89 CV D 1060 IN THE GENERAL COURT OF JUSTICE...

001 Public Notices: NOTICE OF ELECTION FOR THE TOWN OF FARMVILLE ON OCTOBER 10, 1989...

001 Public Notices: NOTICE OF SALE OF REAL PROPERTY: MERLYN WILLIAMS WHITE DUDLEY (continued)

001 Public Notices: NOTICE OF SALE OF REAL PROPERTY: MERLYN WILLIAMS WHITE DUDLEY (continued)

001 Public Notices: NOTICE OF SALE OF REAL PROPERTY: MERLYN WILLIAMS WHITE DUDLEY (continued)

001 Public Notices: NOTICE OF SALE OF REAL PROPERTY: MERLYN WILLIAMS WHITE DUDLEY (continued)

001 Public Notices: NOTICE OF SALE OF REAL PROPERTY: MERLYN WILLIAMS WHITE DUDLEY (continued)

001 Public Notices: NOTICE OF SALE OF REAL PROPERTY: MERLYN WILLIAMS WHITE DUDLEY (continued)

001 Public Notices: FILE NO. 89 CV D 1060 IN THE GENERAL COURT OF JUSTICE...

001 Public Notices: NOTICE OF ELECTION FOR THE TOWN OF FARMVILLE ON OCTOBER 10, 1989...

001 Public Notices: NOTICE OF SALE OF REAL PROPERTY: MERLYN WILLIAMS WHITE DUDLEY (continued)

001 Public Notices: NOTICE OF SALE OF REAL PROPERTY: MERLYN WILLIAMS WHITE DUDLEY (continued)

001 Public Notices: NOTICE OF SALE OF REAL PROPERTY: MERLYN WILLIAMS WHITE DUDLEY (continued)

001 Public Notices: NOTICE OF SALE OF REAL PROPERTY: MERLYN WILLIAMS WHITE DUDLEY (continued)

001 Public Notices: NOTICE OF SALE OF REAL PROPERTY: MERLYN WILLIAMS WHITE DUDLEY (continued)

001 Public Notices: NOTICE OF SALE OF REAL PROPERTY: MERLYN WILLIAMS WHITE DUDLEY (continued)



002 Plymouth: 1978 PLYMOUTH VOLARE, 6 cylinder, owner. New tires. Clean in and out. Call 752-2326.

002 Pontiac: PONTIAC GRAND AM 1% over factory invoice. Great selection! \$1250 rebate, keep or use as down payment.

002 Foreign Cars: BMW 528e, 1980, 14,000 miles. Bronze. Call 752-6133.

002 Special Notices: WE CARRY BATTERIES (Everyday) for all types of vehicles.

002 Autos For Sale: "A GOOD PLACE TO BUY!" "CREATIVE FINANCING" We Also Sell On Consignment EASTGATE MOTORS, INC.

021 Oldsmobile: 1979 DELTA 88 ROYALE. \$950. Call 524-5704. Griffon, Conn.

021 Jeeps & Vans: 1977 DODGE Van. Rode hard and put up well for many miles but it runs. First \$950 takes it. Call 752-2873.

021 Trucks: MUST SELL-1989 F150 Lariat. 5 speed manual. All options. Make offer. 752-6472. Barn 4pm.

021 Child Care: AFTERSCHOOL PROGRAM. Snacks, games, movies, art projects and more!

021 Boats & Motors: GREENVILLE MARINE AND SPORTS. All 1989 Evinrude, Mercury and Yamaha at cost!

021 Health Care: NEED SOMEONE TO CARE for elderly lady at night. Call 746-3395 and 756-5944.

021 Dodge: 1983 DODGE Colt. Excellent condition, low mileage. \$4700. Call 890-0375.

021 Ford: 1980 THUNDERBIRD, loaded. 68,000 miles. Call 752-2909 after 5:30.

050 Pets: AKC BLACK LABS, Excellent bloodlines of Super Chief and Maple Eyes. \$150. Call Dr. Barwick.

050 Help Wanted Clerical: CLERICAL AND secretarial positions available. Washington/ Greenville area. Typing 4 words per minute.

050 Help Wanted Medical: LPN OR Medical Assistant needed for busy medical practice. Excellent benefit package.

050 Help Wanted Medical: RN/ LPN'S SIGN ON BONUS Pediatric Home Nursing Care. Flexible scheduling, excellent pay.

050 Help Wanted Medical: DIRECTOR OF NURSES. Great career opportunity for highly motivated RN. Health Force, a well-established home nursing service.

050 Help Wanted Medical: RN/ LPN'S SIGN ON BONUS Pediatric Home Nursing Care (continued)

050 Help Wanted Medical: DIRECTOR OF NURSES (continued)

050 Help Wanted Medical: RN/ LPN'S SIGN ON BONUS Pediatric Home Nursing Care (continued)

059 Help Wanted Medical: LPN OR Medical Assistant needed for busy medical practice. Excellent benefit package.

059 Help Wanted Medical: MEDICAL TRANSCRIPTIONIST Needed for Ophthalmic Surgical Practice. Must have experience.

059 Help Wanted Medical: NURSING SUPERVISOR needed for rural health clinic in Eastern NC. We are currently seeking a person to coordinate nursing assignments.

059 Help Wanted Medical: ATTENTION RNs/LPNs. Exciting part-time position now available. Do you enjoy working with people while receiving excellent pay?

059 Help Wanted Medical: ATTENTION RNs/LPNs (continued)

059 Help Wanted Medical: ATTENTION RNs/LPNs (continued)

059 Help Wanted Medical: ATTENTION RNs/LPNs (continued)

059 Help Wanted Medical: ATTENTION RNs/LPNs (continued)

059 Help Wanted Medical: LPN OR Medical Assistant needed for busy medical practice. Excellent benefit package.

059 Help Wanted Medical: MEDICAL TRANSCRIPTIONIST Needed for Ophthalmic Surgical Practice. Must have experience.

059 Help Wanted Medical: NURSING SUPERVISOR needed for rural health clinic in Eastern NC. We are currently seeking a person to coordinate nursing assignments.

059 Help Wanted Medical: ATTENTION RNs/LPNs. Exciting part-time position now available. Do you enjoy working with people while receiving excellent pay?

059 Help Wanted Medical: ATTENTION RNs/LPNs (continued)

059 Help Wanted Medical: ATTENTION RNs/LPNs (continued)

059 Help Wanted Medical: ATTENTION RNs/LPNs (continued)

059 Help Wanted Medical: ATTENTION RNs/LPNs (continued)

Wednesday Classifieds

060 Help Wanted Miscellaneous

ASSISTANT CONTROLLER. Apply Monday, August 14. Atlantic Personnel Service, 355-7931.
BRICK MASONS Wanted immediately \$12 to \$13 per hour. Qualified apprentices considered. 527-5532 after 5. Leave message.
CABLE TV Contractor/Installer Needed. 5 days training and reliable truck or van required. 755-1970.
COMPUTER SALES. Atlantic Personnel Service, 355-7931.
COOK/COOK'S ASSISTANT. Experience preferred. Call Guardian Care of Farmville, 753-5547, Monday-Friday, 8:30-4:30.
COOKS WANTED for day and night shifts. Flexible hours. Call Pizza Inn, 758-8266.
COUNTER PERSON. Industrial equipment. Career growth. \$5.00 per hour. Atlantic Personnel Service, 355-7931.
CRUISE SHIP JOBS. \$300 to \$925 per week. Call 817-662-0477 Ext. C-10.
DEPENDABLE LIVE-IN companion needed, part or full time. Driver's license and references required. Serious calls only. Call 752-7242 anytime.
DEPENDABLE DRIVERS AND Dispatchers needed. Apply at Dependable Cab, 1001 South Evans Street, 757-0268.
DESK CLERK Part-time, 32 hours. Atlantic Personnel Service, 355-7931.
DRAFTSMAN. Full or part-time. Atlantic Personnel Service, 355-7931.
DUE TO INCREASE Business, 2 part-time positions available for experienced Floral Designer. Apply in person to Fern Fresh.
DUPLICATE TRUCK DRIVER Needed. Call after 4pm, 756-0267.
DYNAMIC RESUMES GET Results. Resumes from 59 cover letters. C.R., 131 Oakmont Drive, 355-6396.
EXCELLENT WAGES For Spare Time Assembly. Easy work at home. No experience needed. Call 1-904-641-7778 extension 4604. Open 24 hours, including Sunday.
EXPERIENCED Single Applicants needed. Call 744-682.
EXPERIENCED Personal Lines Clerk for insurance office. Apply at Leon Fornes Insurance Agency, 2408 South Charles Boulevard, Greenville, NC 27858.
FOOD SERVICE MANAGER. Trained. \$220-\$260 per week. Atlantic Personnel Service, 355-7931.
FRONT DESK. Guess service representative for luxury budget motel. Must enjoy greeting public, will be in charge of front-desk operations from 7 a.m.-3 p.m., Monday-Friday, full time position. \$4.25 per hour plus benefits. Apply Cricket Inn Motel.
FULL TIME Checkers/Cashiers. Mature and dependable with references. Apply in person, Monday-Friday, 8:30am-3pm at S & S Cafeteria, Carolina East Mall. No phone calls.
FULL TIME Appliance helper/delivery man. Salary negotiable. Benefits include vacation, sick leave and hospitalization. Must be willing to work on Saturdays. Send resume to: Helper, PO Box 861, Washington NC 27889.
FULL TIME general maintenance person needed for the golf course. Experience requested but not required. Call 753-3660.
GOLF DRIVING RANGE. Highway 43 South, 1 1/2 miles past Conley High School on New Bern Highway, 355-6725.
HAIR DRESSER Wanted. Apply in person at George's Hair Designers, The Plaza. Guaranteed salary.
HAIR STYLIST AND Manicurist needed at Hair By Rytka. Both rental available. 752-4060 or 758-7425.
HAIRSTYLIST-MANICURIST With license needed for full service salon. Experience with sculptured nails desired. Call for information, Your Best Look, 355-2969.
HAND PACKERS FOR FOOD processor. Must be energetic, fast and have good coordination. Own transportation and phone in home required. Call 746-6675 for appointment.
HVAC INSTALLERS Needed immediately. Some experience necessary. Apply at Snow Hill Plumbing and Heating, Snow Hill NC.

060 Help Wanted Miscellaneous

HOT 194FM is expanding its sales force! We are looking for energetic, motivated individuals to join our team. Radio background preferred. Call 830-1110 for an appointment.
HOUSEKEEPER For cleaning and afterschool care for 11 year old. Hours are 3pm-4:30pm for 2 afternoons per week. 355-3138.
LAYOUT/PRESS OPERATOR. Atlantic Personnel Service, 355-7931.
LOOKING FOR AN enthusiastic, energetic person to fill an account manager position. Experience helpful but will train the right person. Advancement into management a possibility. Apply in person at the new Kel-Way, Farm Fresh Shopping Center, Monday-Friday, 10:30 a.m. to 5:00 p.m. No phone calls please.
LOTS OF FUN AND \$\$\$ Passing out \$1000 Drawing Cards. Inquire at Kirby Center East in Buyer's Market, 355-8280.
MAID Needed for local company. Must be a mature individual and have own car. Excellent references a must. Good company benefits. Apply in person, CopyPro, Inc., 3103 Landmark, Greenville across from Ramada Inn.
MAINTENANCE PERSON For local apartment community. General knowledge in air conditioning, heating and plumbing preferred. Must have dependable transportation and own tools. Apply in person at 214 Elm Street #5.
MAINTENANCE Supervisor. Capable of supervising approximately 10-15 employees. Consisting of mechanical, electrical, maintenance and setup men. Experience in hydraulics and pneumatics, some type of background required. Experience in purchasing materials needed. A fast growing company in the immediate area. Minimum of 10 years experience in this position. Excellent salary and benefits. Send resume to: 1108 East 4th Street, Washington, NC 27889.
MANAGER TRAINEE. College graduate, career growth. \$18,000. Atlantic Personnel Service, 355-7931.
MATURE PERSON to work in children's nursery. Phone 752-2743 between 5:30 p.m. and 7:30 p.m. only.
MECHANICAL CONTRACTOR Hiring helpers. No experience necessary. Mechanical ability helpful. Training provided. Call for appointment 758-4774.
NEEDED: SOCCER Coaches. Must be available Monday-Thursday after 2:00 p.m. Starting pay \$3.00 per hour. Call Pitt County Community Schools at 830-4240.
NEEDED Full Time Switch board operator. Apply in Person at NCB National Bank, 201 West First Street, Greenville, AA/EOE.
NEEDED IMMEDIATELY: Experienced shirt presser for dry cleaners. 355-7900.
NEEDED IMMEDIATELY: Person to do manicures and pedicures. Busy shop, excellent potential. Experience preferred. Please call 355-4596 or 756-3792.
NON-FOOD MERCHANDISER. Monday-Friday. Atlantic Personnel Service, 355-7931.
PART TIME Church Organist Position open. Position requires Bachelor's Degree in music or equivalent and professional experience in church music. Send resume with references to: Organist Search Committee, First Presbyterian Church, 1400 South Elm, Greenville NC 27858 by August 22, 1989.
PART-TIME MAINTENANCE and grounds helper and occasional weekend waitress needed. Apply at Comfort Inn, 264 By-Pass.
PASTRY CHEF, experienced with references. Apply in person, Monday-Friday, 8:30am-3pm at S & S Cafeteria, Carolina East Mall. No phone calls.
PERSONNEL COUNSELOR: Organized, self-motivated, interviewing/testing. Send resume to DR 1998, c/o The Daily Reflector, PO Box 1967, Greenville, NC 27835.
PERSONNEL, INC. Industrial and clerical jobs available now. Register with us and work for the best! Personnel, Inc. 301 West 14th Street Greenville, NC 27834 752-1811

060 Help Wanted Miscellaneous

POSITIONS AVAILABLE late August. Part time receptionist and full time kennel assistant. Applicants should be mature, responsible, neat and have good communication skills. Apply in person: Tenth Street Animal Hospital, 3192 East 10th Street.
POSTAL JOBS Start \$10.39 per hour. For exam and application information, call 219-769-6649 ext. NC119, 9:00 a.m.-7:00 p.m., 7 days.
PRODUCTION PERSONNEL For Pharmaceutical Manufacturing facility. High school education required. Send resume to Production Personnel, PO Box 147, Farmville NC 27838.
REAL ESTATE BROKERS needed for marketing larger investment properties. Call The Wingate Agency, 757-3441.
RESUMES \*Resume Composition and Typing \*Cover Letters \*Reference Sheets \*Salary History \*Typing Employment Applications \*Post-Interview Letters \*Term Papers \*General Typing \*Next Day Service Atlantic Personnel Services 209 Commerce Street, Suite B 355-7931
ROUTE SALES. Jesse Jones needs a relief driver/salesman to assist in route sales in the Northeastern NC and Southeastern Va. area. Starting salary \$15,600. Overnight travel required, need own transportation. We pay mileage and expenses. Excellent training position and good opportunity for growth. Excellent benefits. If interested see Bob Sawyer at The Holiday Inn in Williamsport, Friday, August 18, 8am-5pm or Saturday August 19, 8am-2pm. EOE
RYAN'S FAMILY STEAK House, 3427 South Memorial Drive, now accepting applications for kitchen, dishroom and salad prep positions. Experience preferred. Apply between 4-5 daily.
SALES CLERKS. New store. Atlantic Personnel Service, 355-7931.
SALES CLERK. JEWELRY. Atlantic Personnel Service, 355-7931.
SALES CLERK. Part-time. Atlantic Personnel Service, 355-7931.
SALES HELP WANTED, part or full time. Apply at The Youth Shop Boutique, Arlington Village.
EMPLOYMENT SERVICE MANAGER \$23,000 up. Company needs self-motivated to handle and organize all phases of service department! Hurry in! WORD PROCESSOR \$6,000 up. Excellent opportunity to get in with fast growing firm. Legal experience a plus! SECRETARY \$14,500 up. Put your abilities to work with local company. They need you! STORE MANAGER. Salary plus commission. Atlantic Personnel Service, 355-7931. SUPERVISOR NEEDED for local manufacturing company. Strong mechanical ability and good leadership a must. Send resume to: Supervisor, PO Box 1209, Greenville, NC 27835. TACO BELL Flexible hours, part time or full time. Apply in person. CLASSIFIED DISPLAY CLASSIFIED DISPLAY

060 Help Wanted Miscellaneous

THE WAFFLE HOUSE is now taking applications for waitresses and cooks. All shifts available. We are also accepting management applications. \$300 week to start. Hostess or host positions, part-time weekend and holidays. Am and PM, \$5 an hour. No experience necessary, will train. No phone calls. Apply in person only at 306 Greenville Boulevard, Monday-Friday, 11:00 a.m.-2:00 p.m.
VCR/TV Technician Needed. Salary negotiable based upon experience. Benefits include vacation, sick leave and hospitalization. Send resume to: Technician, PO Box 861, Farmville NC 27889.
WAIT STAFF positions available. Pay rate \$5.00-\$7.00 based on experience. Apply Kinston Country Club, 9:30 to 12:00 a.m., 6:30-9:00 p.m. Tuesday-Thursday; Saturday, 11:30-3:00.
WAITRESSES: full and part-time positions available. Apply in person between 2:00-5:00 p.m. at Three Steers Restaurant, Memorial Drive.
WANTED: Experienced roofer, laborers and sheet metal mechanics. Please apply 1314 North Greene Street.
WANTED: EXPERIENCED bartenders with dynamic personalities, willing to have fun and make money in high-energy night club. Apply in person Tuesday through Friday, Sheraton of Kinston, 1403 Richards Road.
WANTED: Banquet waiters/waitresses. Apply Greenville County Club, Tuesday-Friday, 2-4pm, 756-1227.
WANTED: Night salad person. Experience preferred but not necessary. Apply Greenville County Club, Tuesday-Friday, 2-4pm, 756-1227.
WANTED: Maintenance Repairman. Duties include painting, lawn care, general repair and overall maintenance of commercial property. Good benefits. Send resume to: PO Box 8153, Greenville, NC 27834.
WANTED IMMEDIATELY: Counter person for dry cleaners. Opportunity preferred. 355-7000.
WASHINGTON CABLE Television has an employment opportunity for part-time (Full-time January 1, 1990) for Customer Service Representative. Duties for positive, proper customer relations, phone and walk in courtesy, math skills and operation of office equipment. WE ARE ACCEPTING Applications for Counter and grill personnel. Coffee Shop open 24 hours, 7 days a week, 2nd and 3rd shift available. Good hourly wages. Pleasant working atmosphere. Apply in person to manager, The Coffee Shop, Pitt County Memorial Hospital, EOE.
WEEKEND MANAGER for women's shelter. Normal hours, Friday, 4:00 p.m.-Sunday 4:00 p.m. \$4.34/hour, salaried position with some benefits. College or experience helpful. Contact New Directions, 752-3811. Detailed job description available.
WENDY'S Currently needs ambitious, energetic individuals to join our crew at Memorial Drive location. 10 to 15 hours a week. Apply 2-4, Monday-Friday.
WOMEN-MEN, Part-time. \$200-\$300 month. Guaranteed plus commission. If you are able to work a couple of hours in the evenings call 355-3018.
061 Help Wanted Sales
ADVERTISING ACCOUNT representative. Salary plus commission. Atlantic Personnel Service, 355-7931.
ATTENTION: LICENSED Real Estate Agents. One of Greenville's most aggressive firms seeks full-time, motivated, ambitious sales agents. Excellent working conditions with a professional atmosphere. Call JANET BOWSER & ASSOCIATES, 355-7800. An Equal Opportunity Employer.
ESTABLISHED LOCAL company seeks professional salespeople who want to earn up to \$500 per week. Prefer experience. Call 752-4594 or 752-7465.
CLASSIFIED DISPLAY CLASSIFIED DISPLAY

061 Help Wanted Sales

EXPERIENCED Real Estate Agents. Join America's Largest and Full Service Real Estate Company. Complete package of marketing tools. For your confidential interview contact Elaine Coldwell Banker W.G. Blount & Associates Realtors, 756-3000 or 756-6346, 201 East Arlington Boulevard, Greenville.
MOTIVATED, Experienced Assistant Manager needed for growing junior's retail chain. Liberal benefits, personal discounts. Apply in person 10-5, Worth's Carolina East Mall.
REAL ESTATE SALES: Desk available, will consider full or part-time. 355-6258.
RETAIL OPPORTUNITIES WITH CATO This ladies retail ready-to-wear chain offers rewarding and exciting careers to those interested in retailing. CATO is currently seeking employees who enjoy public contact and who are responsible and aggressive. We have openings for Assistant Managers, Sales Associates and Cashiers, also part time positions. If you are interested in these positions please apply in person at: CATO The Plaza 714 W. Greenville Blvd. Greenville NC 27834. EOE
ROUTE SALES TRAINEE. Coca Cola of Greenville has the need for individuals who enjoy outdoor physical work with an outgoing personality. Apply between 9-4, Monday-Friday.
SALES REPRESENTATIVE. Greenville area. Salary plus commission. Call Atlantic Personnel Service, 355-7931.
SALES CLERKS. Several new stores. Atlantic Personnel Service, 355-7931.
\$25,000 FIRST YEAR Opportunity! Oakwood Homes Corp. is seeking motivated sales representatives. For career opportunity! Draw against commission, training salary, major medical, health, savings and stock purchase programs. Excellent compensation package and rapid advancement. Call 756-5631, Mr. Whitson to schedule confidential interview.
CLASSIFIED DISPLAY CLASSIFIED DISPLAY

062 Help Wanted Teachers

TEACHERS. Christian school, kindergarten and first grade. Send resume to: DR1603, c/o The Daily Reflector, PO Box 1967, Greenville, NC 27835.
ATLANTIC COAST Mechanical is now hiring Pipefitters/Helpers and Welders for New Burroughs-Wellcome project in Greenville. Excellent pay and opportunity. Call 758-6085 Tuesday through Thursday.
CONSTRUCTION PIPE Personnel. Experienced pipe layers, laborers and operators. Transportation required. Call 758-1055. EOE.
DAYCARE TEACHER for ages 2-4. Immediate opening. Good conditions. Edwin's Daycare Center, Farmville, N.C.
DRIVERS: A.T.S. of N.C. now hiring experienced OTR flatbed, dry van tractor-trailer drivers. Excellent pay and benefits package. Earnings including incentives 26.5¢ per mile. Call 71-800-457-0915.
DRIVER. Monday-Friday. Good salary plus insurance. Call 742-3302; nights, 746-2072.
EXPERIENCED PAINTERS Only. Full time work. 756-8114 between 8am-5pm.
EXPERIENCED TRUCK DRIVER. Operator. Top pay. Call 758-1191.
EXPERIENCED FOREMAN. Paid by salary. Call 355-5358.
HEATING/AIR Conditioning Mechanics for immediate opening. Salary dependent upon experience. Apply by sending resume to: HVAC Mech. Co., P.O. Box 111, Williamston, NC 27892.
TIRE/Truck Driver Needed 35 days week. Excellent pay plus insurance. Call after 6, 746-2072, 752-3502.
LOG TRUCK DRIVER. See experience. Call 758-8962.
LOGGERS HELPER needed. Some experience. Call 758-8962.
MACHINIST WANTED. Minimum 5 years lathe room experience. Must be able to work with a variety of materials. Good reading skills a must. We offer a competitive wage/benefit package. Modern air conditioned shop. Please call K.S. Smith, at 522-3333 for interview.
METAL BULBING Mechanics and helpers. Apply in person. Custom Bulb Company, East Mumfords Road. Paid benefits based on skill level. 752-4220.
NEED EXPERIENCED Metal building installer. Must be able to travel. Room and board paid. Salary based on experience. Call 355-0253 or 305-5pm.
SHEET METAL HELPER Needed for installing duct work and air conditioning duct work. Will train. Benefits offered. Apply between 8 a.m.-9 a.m. only, Larmer Mechanical, Farmville Highway.
CLASSIFIED DISPLAY CLASSIFIED DISPLAY

063 Help Wanted Technical & Trades

OSMOSE COMPANY is now accepting applications for foreman trainees. Qualified applicants must be willing to travel and relocate extensively in the Mid-Atlantic states. The position involves being the working foreman of a small crew inspecting and treating utility poles. Osmose will provide on-the-job training and transportation for year-round, outdoor job with a good wage and benefits package. To be considered for this position send a completed resume to: Osmose, PO Box 4171, Burlington NC 27215.
OTR DRIVERS. 12 months experience, 23 years of age required. Hornady Truck and Good Start 23-24¢/mile. Excellent benefits. Conventions/Covers home regularly 1-800-377-7899.
POSITIONS AVAILABLE Propane Gas Service Man AND Trainee Experience preferred. Apply in person 9am-4pm at Daughtrich Gas Company, 2102 Dickinson Highway.
SERVICE PERSON WANTED. Heating and air conditioning company. Experience required. Apply Larmer Mechanical, 8 a.m.-9 a.m., Farmville Highway.
SKILLED PAINTERS needed. Call 355-5358.
SURVEYOR. RODMAN. Apply at Siroud Engineering PA, 107-B Commerce Street, Greenville.
TEACHERS WANTED. Middle grades, speech/language therapist, school psychologist. Certification required in area(s) of interest. Contact Personnel Director, Tarboro City Schools, PO Box 370, Tarboro NC 27886. 919-823-3658.
TRUCK DRIVERS - A major truckload carrier needs experienced drivers and graduates of approved truck driver training schools. If you have no experience, we can help arrange for training. Must be a good driving record and work history. Company paid physical/drug screen. Call (919) 846-9604 or 1-800-553-9443, Dept. D-64.
WALSTON MACHINE AND Welding, Inc. needs a machinist. General machine shop work. Must read blueprints, must have own hand tools. Good pay, some fabrication and welding experience. Good benefits; paid holidays, paid vacation, Christmas bonus. For more information, call 1-822-4860 from 7:30-5:30, Monday-Friday.
CLASSIFIED DISPLAY CLASSIFIED DISPLAY

064 Work Wanted

ALL CARPENTRY And Remodeling. Room additions, sheetrock, plastering, paneling, carpents enclosed, concrete pour, plumbing and electrical work. Collect, 747-8326.
ALL PHASES OF Construction: Additions, Decks, Remodeling, Repairs of all types, Etc. Steele & Sons Home Improvements. Free Estimates. 753-2853.
ALL YOUR Lawn Maintenance needs. Free estimates. Call 757-7322.
ARE YOU IN NEED OF Quality lawn maintenance or grass cut? Free estimates. Call 757-1590.
ATTENTION: Mobile Home Residents! Let our company underpin your mobile home. All work, complete job. 1x20. Under \$450. White, beige and gray. 15 year guarantee on materials; 2 years guarantee on labor. Call 1-324-1141 for details. Leave message on machine and call will be returned.
BAB Paint and Wallpaper. Interior/Exterior. 25 years experience. Free estimates. Call 758-4837 or 758-8962.
CAROLINA TREE Service. All types done. Stump removal. Free estimates. Fully insured. 752-6420 or 757-0117.
CERAMIC Tile Installation. Bathroom renovation, kitchen floor and counter top. 31 years experience. Free estimates. Call 753-3381.
CHET, THE HANDYMAN. Interior and exterior paint and masonry carpentry repair. All work guaranteed. Call 758-2074.
CLEANING OF HOMES And Offices. R & R Cleaning Service, Bonded. Free extras and estimates. 830-9261.
COLLEGE FUND Cleaning Service. Help us through college, let us help you clean your house/business. Flexible hours, reasonable price. Call Teddy 830-3777, leave message.
CONSTRUCTION - George Webber Construction. Specializing in Remodeling, custom cabinets, painting, lawn maintenance, plumbing and all types new construction, decks and concrete work. 756-8589 anytime.
GRASS CUTTING And Lawn Maintenance. James Faulkner, 746-3721.
HANN'S ROOFING. Reasonable rates. 5 year guarantee no leaks. 1-975-6716 after 6:00 p.m.
HOME IMPROVEMENTS All home and trailer repairs, improvement, renovations, additions, floor applications, painting, etc. Large or small. Quality workmanship, at affordable prices. Call Gary at 830-6749 after 6pm, for free estimates and material discounts.
HOUSEKEEPER. Will clean houses, offices, townhouses and trailers. Call 758-1483 anytime. Have references.
CLASSIFIED DISPLAY CLASSIFIED DISPLAY

064 Work Wanted

KINSAUL CONSTRUCTION. Roofing, painting, remodeling. No job too small. Free estimates. Call 830-5316.
M & S CLEANING SERVICE. All types of cleaning services: wax floors, buff floors, wash windows, vacuum carpets, oven cleaning, bathroom cleaning, dusting of furniture. 746-4378 or 746-6760.
NEED PAINTING DONE? 18 years experience. Call 749-4891.
NEED SOME UPHOLSTERY? Who will be glad you did! 756-0910.
NEED YOUR LAWN MOWED? Reasonable rates. Call after 5:00 p.m., 752-2650.
NURSE'S ASSISTANT-Live-in. Private duty with good work reference. Call between 9am-5pm weekdays only. 758-3262, ask for Jean.
PAPERING, INTERIOR Painting and paper removal. All wall papering guaranteed in writing. Insured for your protection. Call Don English, 756-7010.
PROFESSIONAL PAINTER 10 years experience. Interior/Exterior, 2 maintenance removal. Local references. Peter, 756-5642 for free professional estimate.
RENT A HUSBAND: For a weekly affair with your overgrown garden or a maintenance job on your house. I'm good and 100% honest. 830-9597, 6-10pm.
ROBERTSON'S Tree/Yard Maintenance. Trees removed, stump grinding, lots of cleared landscaping, backhoe. Free estimates. We are insured. Call 830-1490 leave message.
ROOF LEAKS FIXED and minor repairs. 18 years experience. Work guaranteed. After 6 p.m. call 752-5906.
ROOFING SERVICE Of All Types. Call 752-5641.
SILVERTHORNE HAULING. Small loads of topsoil, sand, pine bark, yard maintenance, small clean up jobs. 758-3296.
SPECIALIZING IN Sanding and Refinishing hardwood floors. Call after 6pm 242-6457.
CLASSIFIED DISPLAY CLASSIFIED DISPLAY

062 Help Wanted Teachers

ARCHITECTURAL Drafting Technology Instructor: To start September 1, 1989. Bachelors Degree with practical work experience, teaching background and current CAD skills preferred. Applications accepted until position filled. For more information contact Jeffrey R. Olson, Dean of Occupational Education, Coastal Carolina Community College, 444 Western Blvd., Jacksonville, NC 28546 or phone (919)455-1221, extension 223. An Equal Opportunity Institution.

062 Help Wanted Teachers

CLASSIFIED DISPLAY CLASSIFIED DISPLAY

062 Help Wanted Teachers

CLASSIFIED DISPLAY CLASSIFIED DISPLAY

062 Help Wanted Teachers

CLASSIFIED DISPLAY CLASSIFIED DISPLAY

062 Help Wanted Teachers

CLASSIFIED DISPLAY CLASSIFIED DISPLAY

062 Help Wanted Teachers

CLASSIFIED DISPLAY CLASSIFIED DISPLAY

064 Work Wanted

CLASSIFIED DISPLAY CLASSIFIED DISPLAY

064 Work Wanted

CLASSIFIED DISPLAY CLASSIFIED DISPLAY

064 Work Wanted

CLASSIFIED DISPLAY CLASSIFIED DISPLAY

Personnel Department SANDHILLS CENTER P.O. Box 9 West End, N.C. 27376 An Equal Opportunity Employer
SOCIAL WORKER III Rockingham, NC \$20,004 - \$29,088
Social Worker needed to provide individual/group psychotherapy and crisis intervention to clients in an outpatient facility. Prefer a Master's degree from an accredited school of social work and 1 year of psychiatric social work experience or a Bachelor's degree from an accredited school of social work and 2 years of psychiatric social work experience. Vacation, sick leave, health, dental, life insurance and retirement paid. Resumes will be accepted until position filled.

DELIVERY SALESMAN -Excellent Benefits -Uniforms -Bonus Plan -Experience Preferred but will train right individual
W.L. ALLEN OIL CO., INC. 120 East Skinner Street 752-2345
ACCOUNT EXECUTIVE Aggressive advertising department seeking qualified person for local cable advertising sales in New Bern and Kinston area. Experienced preferred but not required. Send resume to: Diane Batts PO Box 6257 Rocky Mount, NC 27802-6257 EOE M/F

RAMADA INN We are currently seeking several talented and motivated individuals who are interested in helping us provide Greenville with an unique dining experience. We will be interviewing qualified applicants for the following positions: Banquet Staff Cocktail Staff Bartenders Wait Staff Sous Chef
We will be accepting application between the hours of 4 p.m.-6 p.m. Wednesday, Thursday and Friday. Applications will be taken in person at The Ramada, Greenville. No phone calls please.

Britt Haven Director of Nursing Must be RN with managerial experience Full Time Staff Developer/ADON Position for RN Also Available
Full Time & Part Time LPN & RN Positions Competitive Wages based on experience, Shift Differential & Benefits
Britt Haven of Washington is a special & unique nursing home. We are a small, family-like facility interested in providing quality care. Contact Kayron Carowan Mason at 946-7141 to set interview. EOE

BEVERLY ENFERMERA
NURSES WEEKEND OPTION At Greenville Villa Nursing Home \$1500/HOUR 12 Hour Shift On Saturday And Sunday
Contact: Sue Conover RN, DON 758-4121

IMMEDIATE OPENINGS! Brendle's is currently accepting applications for: JEWELRY DEPARTMENT MANAGER AT ITS GREENVILLE LOCATION
Must have experience in Diamond Sales as well as Management. Only qualified applicants need apply.
BRENDLE'S BENEFITS FOR FULL-TIME EMPLOYEES: Paid Health, Life, Dental & Disability Insurance; Paid Vacation/Holidays, Profit Sharing, Length of Service Benefit & Employee Discount Purchases.
APPLY IN PERSON 10 TO 6 MONDAY thru FRIDAY AT Customer Service Desk
3700 S. Memorial Dr. Greenville, NC 27834

WE ARE LOOKING FOR A FEW GOOD PEOPLE. We need full time Lubrication Technicians. Experience helpful but not necessary. We train you with the latest technology and information in our industry. We offer good starting wages, regular reviews, other benefits and a chance to advance in our system.
Apply in Person Only at Jiffy Lube 126 SE Greenville Blvd. Greenville, NC ASK FOR EDDIE

JOIN THE MARTIN GENERAL HOSPITAL HEALTH CARE TEAM
MARTIN GENERAL HOSPITAL is a progressive, modern facility in tune with changing times, providing primary care through a well-trained staff and high-tech equipment in a neighborhood environment. Recent additions include a CT Scanner and Eastern North Carolina's newest state-of-the-art ICU, plus renovated Emergency Department and Trauma Area.
Our NEW SALARY SCALE for RN's and LPN's is COMPETITIVE and offers specialty pay for ICU and ER, with training provided.
OPENINGS IN ICU, MED./SURG. AND OB. In addition to our neighborhood work place, MGH also offers a unique teaching environment through training associations with ECU Medical School Family Practice Residents, ECU Nursing & Physical Therapy students, and Radiology students from Pitt Community.
To Find Out More About Career Opportunities, Call Or Send A Resume To: George H. Brandt, Jr., Administrator Martin General Hospital P.O. Box 1128-Williamston, N.C. 27892 (Collect) 919-792-2186



Real Estate Classifieds

118 Business Services

CUSTOM PROGRAMMING. For the IBM PC, Compatibles, and almost-compatibles. Call 355-2797. Free consultation.

122 Business Opportunities

A BUSINESS? Buy or sell your business with C.J. Harris & Co., Inc. Financial & Marketing Consultants. Serving the Southeastern United States. Greenville, N.C. 355-7799, nights 756-8444.

AN EXCELLENT BUSINESS opportunity, set up as women's apparel store, very reasonable lease, will negotiate on the inventory. Call 752-3429.

BOOKSTORE. Washington, N.C. Newly remodeled. Inventory of books, hobby and art supplies. Call 919-946-4086 for appointment 10:5-3 daily.

CLOSE TO HOSPITAL. A very convenient store located in residential area. For more information call Parvin Khani at Century 21 Tipton, 355-7002 or 355-3144.

GROCERY AND GRILL. Best location for profitable business in an established area. For more information call Parvin Khani at Century 21 Tipton, 355-7002 or 355-3144.

JIMMY'S NEWSSTAND. Washington, N.C. Newsstand, soda fountain and sandwich bar. Call 919-946-4086 10-5 for appointment.

LOCAL BAR BUSINESS for sale. Fast return on investment. Owner selling due to health problem. After 10-m., 756-0528, for Ray. Will do some financing.

LOCAL VENDING ROUTES. For sale cheap. \$300-\$500 week potential. Call Guy, 1-800-476-3589 or nights 756-8444.

LOCATION IS IMPORTANT in business to make a profit. This shop is 3800 square feet. Adopt for any other business. Has excellent location. For more details call Parvin Khani at Century 21 Tipton, 355-7002 or 355-3144.

OWN YOUR OWN APPAREL. Or shoe store, choose from: Jean/Sportswear, ladies, men's, children's/maternity, large sizes, petite, Dancewear/Aerobic, Bridal, Lingerie or accessories store. Add color analysis. Brand names: Liz Claiborne, Healthtex, Bonnie and Bill, St. Michele, Forenza, Bugle Boy, Levi, Camp Beverly Hills, Leslie Faye, Lucia, over 2000 others.

Or \$13.99 one price designer, multi tier pricing discount or family shoe store. Retail prices unbelievable for top quality shoes normally priced from \$19. to \$60. Over 250 brands, 2600 styles. \$18.99 to \$29.99. Inventory, training, fixtures, airframe, grand opening, etc. Can open 15 days. Mr. McComb (404) 859-9229.

PARTNERSHIP INTEREST in Established local real estate company. Reply to Partnership Interest, PO Box 3168, Greenville NC 27656. All inquiries confidential.

SEAFOOD RESTAURANT for sale between Wilson and Greenville. Well established business. Avis Mooring, 237-8536 or Etheridge Associates, 291-4600.

CATCH THE SAVINGS in classified? Here's your home base for good buys!

CLASSIFIED DISPLAY

124 Professional

CHIMNEY SWEEPING And fireplace repairs. Call Gid Hoffman day or night, 753-3503 Farmville.

NEW IN YOUR AREA Carolina Bronzing. We specialize in baby shoes and other keepsakes. Call 753-4398.

132 Commercial Property

APPROXIMATELY 1200 Square Feet located in high traffic area. Commercial zoning. Contact Bobby Trippe 756-1345.

APPROXIMATELY 350 Square Feet of retail store front space in Arlington Village. Call Ken Barnes 756-3165 days, 355-6441 nights.

BRICK BUILDING, 2600 square feet, good condition. 4 miles east of city. For sale or lease. Call 756-5613.

HIGHWAY 11 NORTH. Church and mobile home for sale. Reasonable. Call Marco Anytone, 355-3045 or 758-3887.

LOOKING FOR Commercial Real Estate to lease or buy? We serve as clearing house. No fee. Commercial/Locators, 838-4759.

RETAIL SPACE Available immediately on Memorial Drive across from Carolina East Mall. High traffic area with lots of parking. Call Alice Moore Realty, 355-6712.

RETAIL SPACE in Arlington Village for rent. Steinbeck's, 756-6286 or 355-5926.

136 Condominiums For Sale

FOR SALE BY OWNER: 1300 square feet, 2 bedroom, 2 bath, loft and private courtyard. Call for appointment, 355-5654.

INVESTOR NEWS! 1 and 2 bedroom condominiums. Perfect for university interests. Excellent condition and all appliances included. Priced to sell. Contact Deborah Jones at Aldridge & Southernland, 756-3500 or nights 756-7660.

LOW INTEREST loan assumption. 2 bedroom, 2 bath condo at Willoughby Park. Many upgrades. Call 355-3740.

CALL US TODAY Results They're just a call away with a low-cost, effective classified ad. 756-6166.

139 Farms For Sale

BEAUTIFUL 20 ACRE FARM just off the County Home Road near Bell's Fork. Good road frontage and excellent owner financing. Call Kittrell & Associates, Inc., 757-1156, 752-6715.

NEW LISTING. 58 Acre farm 10 minutes north of Greenville. Call Ken at Hearshide Realty 355-3613 or 746-3255.

WATERFRONT Lake Matamoras! Beautiful lakefront 1+ acre lots, waterfront and all at its best. Owners very anxious. \$25,000 each or make offer. Call Hudgins Real Estate today, 1-800-443-8478.

144 Houses For Sale

BY OWNER, Oakdale, 4 bedrooms, corner lot, carpet, new air conditioner. \$49,500. No realtors. 756-0913.

CLASSIFIED DISPLAY

144 Houses For Sale

A COUNTRY DREAM! This Victorian has it all. Located in Woodridge II features bay-windowed dining, breakfast and master bedrooms. Large family room with french doors. Single garage. Call for details. Please ask for Nancy Dudley, Aldridge & Southernland, 756-3500 or 756-5596.

A DIGNIFIED 4 bedroom brick traditional with sunny kitchen, large breakfast area, spacious dining room, formal living room, family room. Plus bonus room, screened porch, garage, walk-up third floor attic. Call Nancy Dudley, Aldridge & Southernland, 756-3500 or 756-5596.

\*\*\*\*A FOUR STAR WINNER. That's the rating on this lovely 3 bedroom, 2 bath home in a great neighborhood. You'll get it all with a living room, dining room, family room, large deck and beautiful wooded lot. It's brick and it's great. Catch it quick at \$86,900. Please ask for Deborah Jones at Aldridge & Southernland, 756-3500 or 756-5596.

A HOME YOU WILL FALL in love with. 3 bedrooms, formal dining room, large deck and spacious kitchen. Set amidst lovely trees in this rural setting. Lots of extras. One visit and you will decide. \$54,500. Please ask for Nancy Dudley, Aldridge & Southernland 756-3500 or 756-5596.

A REAL DOLL BABY Tucker Estates. 3 bedrooms, 3 full baths, large playroom, dining and adjoining bath that could be 4th bedroom for in-law suite. Dining room with bay window, very open and airy. 2100 square feet for \$115,000. Call Deborah Jones at Aldridge & Southernland, 756-3500 or nights 756-7660.

A SPLIT RAIL Fence frames this lovely, warm, happy home. Relax in your beautifully maintained and extremely spacious brick ranch. This home features 3 bedrooms, 2 baths, formal areas, huge multipurpose room, as well as a den with fireplace. Enjoy your meals on the deck overlooking the brick patio and two lots. All this for only \$72,900. Call Allis Irwin at 355-7200 or 355-7744.

ABSOLUTELY GORGEOUS. 2 year old home in the country on 1 acre wooded lot. Room galore with 4 spacious bedrooms and loaded with closets. The master suite is down, double doors, great room with marble fireplace, hardwood foyer and dining room, chef's kitchen with granite counter, island, breakfast room. One of a kind. Call Deborah Jones at Aldridge & Southernland, 756-3500 or nights 756-7660.

ABSOLUTELY ONE OF A Kind brick home in Tucker Estates. Gorgeous wood corner lot, fresh contemporary interior, like new 3 bedrooms, 2 1/2 baths, over 2,000 square feet, custom features including expanded deck with hot tub, \$119,900. Call Deborah Jones at Aldridge & Southernland, 756-3500 or nights 756-7660.

AN EXCELLENT Opportunity awaits the discriminating buyer in this new home currently under construction. 3 bedrooms, 2 1/2 baths, formal dining room, garage, excellent location. All this and more for only \$86,900. Contact Don Mizelle at Hearshide Realty for details. 355-3613 (office) or 792-6631 (home).

AYDEN/Petite but perky, \$49,500. 3 bedrooms, 2 1/2 baths, warm. Brand new, needs finishing. Central air, paddle fans, carpeting, army built-in, eat-in kitchen, 3 bedrooms, 2 1/2 baths, patio. Fireplace. Seller will pay \$1,500 in Points or closing cost. Duffus Realty, Inc., or Better Homes and Gardens, 756-5395.

BE THE PROUD OWNER: Beautiful contemporary with 3 or 4 bedrooms, 1 1/2 baths, formal dining room and large open great room with cathedral ceiling. Many extras. \$65,000. Call Allis Irwin, CENTURY 21 J & N E T B O W S E R & ASSOCIATES, 355-7800 or 355-7744.

BETTER THAN NEW! Located in Tucker Estates, this pretty home is on a lovely wooded lot. Offers 3 bedrooms, 2 1/2 baths, great room, formal dining room, lovely eat-in kitchen, and more. Don't miss seeing this one. \$121,900. Please ask for Nancy Dudley, Aldridge & Southernland 756-3500 or 756-5596.

CHARM-STYLE WARMTH. Expect to be impressed when you enter this special home in the university area. Charming decorated throughout, it offers a living room, bay-windowed master bedroom, dining room, remodeled kitchen, 3 bedrooms, 2 baths. Plus cozy den, deck, garage. Absolutely nothing for you to do but move in. \$84,900. Please ask for Nancy Dudley, Aldridge & Southernland, 756-3500 or 756-5596.

CHARMING COTTAGE in the University area. Only one block from campus. This 1 1/2 bedroom home has had plenty of TLC and great rental history. Only \$49,900. Call Janet Bowers, CENTURY 21 JANET BOWSER & ASSOCIATES, 355-7800 or 355-8580.

CHERRY OAKS. Newly constructed Georgian offers 4 bedrooms, 2 1/2 baths, formal areas, family room. Plus unfinished bonus room and double garage. Executive quality for \$49,900. Please ask for Nancy Dudley, Aldridge & Southernland, 756-3500.

CHERRY OAKS. Stately 4 bedroom Williamsburg with 4 bedrooms, 2 1/2 baths, formal areas, lovely family room, double garage. Downstairs bedroom with full bath makes this a great house for overnight guests or in-law. \$129,900. Please ask for Nancy Dudley at Aldridge & Southernland, 756-3500 or 756-5596.

CHERRY OAKS: Traditional brick styling on the outside, and sparkling contemporary flair on the inside! Lush decorator colors, a large, airy great room with cathedral ceiling, 2 bedrooms, 2 baths, spacious closets, formal dining room, breakfast nook and many other unique features. Large deck and fenced yard. Reduced to only \$89,500. Call Janet Bowers, CENTURY 21 JANET BOWSER & ASSOCIATES, 355-7800 or 756-8580.

COUNTRY PRIVACY can be yours with this brick ranch home located 15 minutes from PCAM. 3 bedrooms, kitchen loaded with cabinet space and a big workshop/storage building out back are just some of the features. Situated on a wooded, private lot with over an acre of land, this home is a great buy at only \$48,900. Call Mike Walston, CENTURY 21 JANET BOWSER & ASSOCIATES, 355-7800 or 756-3495.

CUTE OLD BUNGALOW with 3 bedrooms and lots of potential for sale in Bethel. Good rental potential or renovate for a family. Reduced to \$20,000. Please call Kay Preston Sline, CENTURY 21 JANET BOWSER & ASSOCIATES, 355-7800 or 355-5127.

DID YOU EVER See a house sparkling? Well, I did! And you can see this immaculate 3 bedroom, 2 bath home. Features include eat-in kitchen, large living/dining area, detached garage, double carport, 2nd floor laundry, non-qualifying loan. See the difference that pride makes. \$77,900. Please call Nancy Dudley, Aldridge & Southernland 756-3500 or 756-5596.

BY OWNER-Perfect 2 bedroom starter home. All new carpet, gas heat and stove. Big front porch, 50x150 lot, \$38,000. For more details call 756-6022.

BY OWNER: NEW 3 bedroom, 2 bath, 1244 square feet heated, 1200 front porch, 196 square foot storage building, on 100'x275' lot by hospital. Call 80-3804.

BY OWNER-Perfect 2 bedroom starter home. All new carpet, gas heat and stove. Big front porch, 50x150 lot, \$38,000. For more details call 756-6022.

BY OWNER: NEW 3 bedroom, 2 bath, 1244 square feet heated, 1200 front porch, 196 square foot storage building, on 100'x275' lot by hospital. Call 80-3804.

BY OWNER-Perfect 2 bedroom starter home. All new carpet, gas heat and stove. Big front porch, 50x150 lot, \$38,000. For more details call 756-6022.

BY OWNER: NEW 3 bedroom, 2 bath, 1244 square feet heated, 1200 front porch, 196 square foot storage building, on 100'x275' lot by hospital. Call 80-3804.

BY OWNER-Perfect 2 bedroom starter home. All new carpet, gas heat and stove. Big front porch, 50x150 lot, \$38,000. For more details call 756-6022.

BY OWNER: NEW 3 bedroom, 2 bath, 1244 square feet heated, 1200 front porch, 196 square foot storage building, on 100'x275' lot by hospital. Call 80-3804.

BY OWNER-Perfect 2 bedroom starter home. All new carpet, gas heat and stove. Big front porch, 50x150 lot, \$38,000. For more details call 756-6022.

BY OWNER: NEW 3 bedroom, 2 bath, 1244 square feet heated, 1200 front porch, 196 square foot storage building, on 100'x275' lot by hospital. Call 80-3804.

BY OWNER-Perfect 2 bedroom starter home. All new carpet, gas heat and stove. Big front porch, 50x150 lot, \$38,000. For more details call 756-6022.

BY OWNER: NEW 3 bedroom, 2 bath, 1244 square feet heated, 1200 front porch, 196 square foot storage building, on 100'x275' lot by hospital. Call 80-3804.

BY OWNER-Perfect 2 bedroom starter home. All new carpet, gas heat and stove. Big front porch, 50x150 lot, \$38,000. For more details call 756-6022.

BY OWNER: NEW 3 bedroom, 2 bath, 1244 square feet heated, 1200 front porch, 196 square foot storage building, on 100'x275' lot by hospital. Call 80-3804.

BY OWNER-Perfect 2 bedroom starter home. All new carpet, gas heat and stove. Big front porch, 50x150 lot, \$38,000. For more details call 756-6022.

BY OWNER: NEW 3 bedroom, 2 bath, 1244 square feet heated, 1200 front porch, 196 square foot storage building, on 100'x275' lot by hospital. Call 80-3804.

BY OWNER-Perfect 2 bedroom starter home. All new carpet, gas heat and stove. Big front porch, 50x150 lot, \$38,000. For more details call 756-6022.

BY OWNER: NEW 3 bedroom, 2 bath, 1244 square feet heated, 1200 front porch, 196 square foot storage building, on 100'x275' lot by hospital. Call 80-3804.

BY OWNER-Perfect 2 bedroom starter home. All new carpet, gas heat and stove. Big front porch, 50x150 lot, \$38,000. For more details call 756-6022.

BY OWNER: NEW 3 bedroom, 2 bath, 1244 square feet heated, 1200 front porch, 196 square foot storage building, on 100'x275' lot by hospital. Call 80-3804.

BY OWNER-Perfect 2 bedroom starter home. All new carpet, gas heat and stove. Big front porch, 50x150 lot, \$38,000. For more details call 756-6022.

BY OWNER: NEW 3 bedroom, 2 bath, 1244 square feet heated, 1200 front porch, 196 square foot storage building, on 100'x275' lot by hospital. Call 80-3804.

BY OWNER-Perfect 2 bedroom starter home. All new carpet, gas heat and stove. Big front porch, 50x150 lot, \$38,000. For more details call 756-6022.

BY OWNER: NEW 3 bedroom, 2 bath, 1244 square feet heated, 1200 front porch, 196 square foot storage building, on 100'x275' lot by hospital. Call 80-3804.

BY OWNER-Perfect 2 bedroom starter home. All new carpet, gas heat and stove. Big front porch, 50x150 lot, \$38,000. For more details call 756-6022.

BY OWNER: NEW 3 bedroom, 2 bath, 1244 square feet heated, 1200 front porch, 196 square foot storage building, on 100'x275' lot by hospital. Call 80-3804.

BY OWNER-Perfect 2 bedroom starter home. All new carpet, gas heat and stove. Big front porch, 50x150 lot, \$38,000. For more details call 756-6022.

BY OWNER: NEW 3 bedroom, 2 bath, 1244 square feet heated, 1200 front porch, 196 square foot storage building, on 100'x275' lot by hospital. Call 80-3804.

144 Houses For Sale

EASTWOOD - Spacious Brick Ranch in this established neighborhood offers formal living room, dining, breakfast and fireplace and large playroom. Priced in the 80's. For more information call CENTURY 21 J & N E T B O W S E R & ASSOCIATES, 355-7800.

FARMVILLE, Cozy 2 bedroom home in terrific neighborhood for sale by owner. Completely remodeled, roof, siding, central heat/air only 3 years old. Foyer, living/dining, kitchen, utility, bath. Good interior storage also. \$42,000. 753-4850.

FOR SALE BY OWNER - Stately brick home in Westhaven massive suite with office and master designer master bath, double car garage and formal dining room. Lots of custom built extras. Call or contact a Buyer/Broker for an Appointment. Nights: 756-8380 or 756-8580.

FOR SALE BY OWNER, 4 bedroom, 2 bath home. Possible renovation. Call for details. Call 752-1910/830-6960.

GREAT PRICE ON 3 or 4 bedroom ranch with over 2,000 square feet in enjoy. In addition to the living room, dining room and dining room, you also have a playroom or 4th bedroom in this country home just minutes from Greenville. Totally in a nice fenced backyard, a two tier deck, and Winterville Schools. It's a steal at \$74,900. Call Janet Bowers, CENTURY 21 JANET BOWSER & ASSOCIATES, 355-7800.

LAKE ELLSWORTH: Beautiful custom contemporary-nestled among trees in the country on 1 acre. This 3 bedroom, 2 1/2 bath home features expansive great room with stone fireplace, dining room with built-in china cabinet and master bedroom on first floor. Captivating open floor plan. Reduced to \$77,900. Call Janet Bowers, CENTURY 21 JANET BOWSER & ASSOCIATES, 355-7800 or 756-8580.

LAKE ELLSWORTH: What a great find! This 3 bedroom home has it all. Totally redecorated with new carpet, wallpaper, appliances, even insulation...and the list goes on! In a quiet neighborhood, formal areas, carport and private patio. Reduced to \$69,500. Call Janet Bowers at CENTURY 21 JANET BOWSER & ASSOCIATES, 355-7800 or 756-8580.

LYNNDALE: Well-Planned brick traditional on beautiful wooded lot offers 4 bedrooms, 3 bathrooms, formal dining room, elegant dining room, inviting family room, plus rec room, and more. \$169,750. Please ask for Nancy Dudley, Aldridge & Southernland, 756-3500, or 756-5596.

MAURY-Perfect starter home in Maury just waiting for you! This brick, three bedroom, 2 bath home with cozy fireplace can be yours! Outside storage and carport. \$55,000. Call CENTURY 21 JANET BOWSER & ASSOCIATES, 355-7800 or 756-8580.

MOVING TO GREENVILLE? Call for FREE video of homes in your price range! HOMES BY VIDEO, Inc. Hignite Realtors, 1989 anytime.

NEW CONSTRUCTION! This 3 bedroom, 2 1/2 bath home in Teakwood has exceptional floor plan featuring down stairs master bedroom with walk-in closet! Call Don Mizelle at Hearshide Realty for details. 355-3613 or 792-6631.

NEW LISTING. Great Non-Qualifying loan Assumption with low washer/dryer, storage building, 758-3763 after 6pm.

OCEAN FRONT High rise condo. Emerald Isle. Completely furnished, 2 bedrooms, \$117,900. Owner 756-9989.

TIME SHARE-week of October 21-27, Maverick Resort, Ormond Beach, Florida, near Daytona. RCI exchange privileges. REDUCED to only \$5,500 or assume loan. Call Gerry Lambert, CENTURY 21 JANET BOWSER & ASSOCIATES 355-7800 or 355-7472.

TRAILER SPACES for sale in Indian Beach (Carteret County). Financing available. Call 726-1708 or 726-7933.

VERY NICE 14x70 Mobile Home. Located at Croatan in Atlantic Beach, 3 bedrooms, 2 full baths, with extra large deck. Boat access and swimming pool access. \$30,000. Call Janet Bowers, CENTURY 21 JANET BOWSER & ASSOCIATES 355-7800 days, 756-8580 nights.

WATERFRONT Lake Matamoras! Beautiful lakefront 1+ acre lots, waterfront and fishing at it's best. Owners very anxious. \$25,000 each or make offer. Call Hudgins Real Estate today, 1-800-443-8478.

157 Townhouses For Sale

MOTIVATED SELLER Desires to quickly sell luxury townhouse at Sedgfield Townes, 3 bedrooms, 2 1/2 baths, end unit with masonry fireplace. Quality construction, 5000 sq. ft. Asking low \$60's. Call owner at 355-0139 today!

SAVE YOUR Downpayment! \$46,900, 2 bedroom, 1 1/2 bath Rowntree Woods Townhome. Near hospital, pool and tennis courts. Move in today and save your downpayment. Call George Jenkins, Westminister Company, 355-3558 or ask your broker.

SAVE YOUR Downpayment! \$54,900, 3 bedroom, 2 1/2 bath Rowntree Woods Townhome. Near hospital, brick, fireplace, pool and tennis courts. Move in today and save your downpayment. Call George Jenkins, Westminister Company 355-3558 or ask your broker.

161 Apartments For Rent

A BEAUTIFUL 1 or 2 bedroom apartment on the waterfront. Total. One year lease, deposit, no pets, washer/dryer hook-up. Call Hearshide Realty Property Manager Dion, 355-2178.

A BEAUTIFUL PLACE - ALL NEW 2 BEDROOMS- UNIVERSITY APARTMENTS

2899 E. 5th Street (Ask us about our special rates to change leases, and discounts for August rentals) - Located Near ECU - ECU bus service - On-site laundry

Contact J. T. or Tommy Williams 756-7815 or 756-7428

\*AZALEA GARDENS\* CLEAN AND QUIET one bedroom furnished apartments, energy efficient, free water and sewer, optional washer, dryer, cable TV. \$225 a month, 6 month lease.

MOBILE HOME RENTALS - Apartments and mobile homes in Azalea Gardens near Brook Valley Country Club. Contact J. T. or Tommy Williams 756-7815

A CHARMING 1 bedroom \$160 or 2 bedroom \$200 located in CLEAN, QUIET 1 bedroom home \$250; 2 bedroom duplex \$235

BRAND NEW! 1 bedroom \$235 or 2 bedroom \$300 fresh paint! WON'T LAST! 3 bedroom 2 bath \$275 or huge 4 bedroom \$350.

756-7275 HOMELOCATORS Fee. Other at ECU CAMPUS, Ringgold Towers. Walk to classes and shopping. Efficiencies, 1 and 2 bedrooms. Fully furnished, carpet, security, laundry. Call Hollie Simonowich, Manager, 919-752-2865.

BROOKFIELD APARTMENTS 1 bedroom units on Evans Street, E. Greenville. August 1. Call Hearshide Realty, 355-2112.

REDUCED \$2990 1784 square foot, 3 bedroom, 2 bath home off of the Golf course in Griffin. Call Ken at Hearshide Realty 355-3613 or 746-3255.

1 BEDROOM BRICK RANCH, new roof, well, pump and furnace on SR1507 off of N.C. 30 near Whitehurst Station. \$39,900. Ben Willshire Realty, 795-4887.

99¢ FAT FREE! That's what you'll pay! Call for price on this 4 bedroom, 3 full bath brick home located on a large lot. Fresh as a daisy inside and out. Approximately 1,260 square feet in a lovely quiet neighborhood. Priced at \$88,500. Please ask for Deborah Jones at Aldridge & Southernland, 756-3500 or nights 756-7660.

148 Investment Property 3 UNIT TOWNHOUSE Condo building in excellent Greenville neighborhood. Fully occupied. Rent financed. 10% low down payment. For more information call Parvin Khani at Century 21 Tipton, 355-7002 or evenings 355-3144.

CRAFT WINDS: Winterville School District. All city services, underground utilities, curb and gutter. Offered by RAC Enterprises. Phone 355-6236; 355-7002 or 756-7660.

NEWS FLASH! 1 1/2 acre beautiful lot. Excellent neighborhood. Wintergreen school district. Contact Deborah Jones at Aldridge & Southernland, 756-3500 or nights 756-7660.

STERLING TRACE: All lots over an acre in this exclusive area just outside of Greenville. Call Hearshide Realty, 355-3613.

WATERFRONT Lake Matamoras! Beautiful lakefront 1+ acre lots, waterfront and fishing at it's best. Owners very anxious. \$25,000 each or make offer. Call Hudgins Real Estate today, 1-800-443-8478.

1.3 ACRES LOT with 14x70 mobile home with added bedroom and detached 30'x20' garage. \$37,000. Call 753-7373 after 6:00 p.m.

VACATION TIME? Take advantage of classified's clout to raise vacation cash. Call and place an ad today. 752-6166.

153 Loans & Mortgages LOANS TO \$10,000 Results guaranteed regardless of credit. 513-860-1331.

NEED A PLACE to Put Your cash? Private investor seeks investment capital for refinancing and purchases. Will give mortgage as collateral. 919-355-5444, ask for Brian.

155 Resort Property For Sale EXTRA NICE 12x60 at Indian Beach, 3 bedrooms, overhead deck, total electric, central air and heat, washer/dryer, storage building, 758-3763 after 6pm.

OCEAN FRONT High rise condo. Emerald Isle. Completely furnished,

### Wednesday Classifieds

**173 Houses For Rent**

AVAILABLE IMMEDIATELY in Popular Whitehaven, 3 bedrooms, 2 baths. \$725 per month on month-to-month basis. Call Alice Moore Realty, 355-0712.

BRICK 3 bedroom, 1 1/2 bath, attached garage, fenced-in back yard. Quiet family neighborhood. \$400 per month, deposit required. 757-3422.

FOUNTAIN - 2 and 3 bedroom houses available August 1. Central heat/air, \$225-\$275 per month, deposit required. Call 919-885-0751 Greensboro, after 6.

**HOMEOLOCATORS!**

A BEAUTY! 3 bedroom \$280 or 3 bedroom, den, two baths, \$300

HEY COUNTRY! 3 bedroom \$250 or huge 4 bedroom, den \$300

GOOD PRICE! 2 bedroom \$335 or 3 bedroom 2 bath, garage \$575

2 BEDROOM, den, fenced yard \$380 or 3 bedroom 2 bath \$625

752-1375

OTHERS TOO! 9AM-7PM FEE.

NICE QUIET 3 bedrooms, 1 1/2 baths, laundry room, carpet, appliances, central air/heat, 756-2671 or 758-9100.

2 BEDROOM HOME including living room with fireplace and screened in porch, 12 miles out on Highway 43 near Falkland. Lease and deposit required. \$400 monthly. Call Janet Frutiger at Ball & Lane, 752-9025 or 756-9239.

3 BEDROOM, executive, 2 bath, den, garage, wet bar, more \$660. 752-1375 HOMEOLOCATORS Fee.

**174 Townhouses For Rent**

NEW 2 BEDROOM. Appliances include: self-cleaning stove, refrigerator with ice maker and dishwasher. Also, ceiling fans and storage room. Central heat and air, great location. Call 355-0235, 8:30-5pm.

SHERATON VILLAGE 2 bedrooms, fireplace, dishwasher, central air, \$425 a month. Call Tom, 758-2300 days; 758-4425 nights. Available September 1st.

SHERATON VILLAGE, 2 bedroom, 1 1/2 bath, fireplace, \$440 per month. Call 756-9777 evenings.

**179 Mobile Homes For Rent**

A 2 BEDROOM only \$165 or big 3 bedroom, \$195 both furnished 752-1375 HOMEOLOCATORS Fee.

CLEAN 12 WIDE, air, \$180 + deposit, Oakwood Acres. Will rent or sell. 756-4506 after 5.

THREE BEDROOM Mobile home for rent. Call 752-7212.

TWO BEDROOMS, washer/dryer, located in good park. No pets. 756-0801 after 5:00 p.m.

TWO BEDROOM, 2 bath, 14x70 mobile home in excellent condition. Located in small park 5 minutes east of Greenville. \$240 a month. Phone 756-3517 after 6pm and weekends.

2 AND 3 BEDROOMS. Both furnished including air and washer. Lease and deposit required. 1 child okay. No pets. 758-0745.

2 BEDROOMS, furnished, clean on shady lot near Greenville. No pets. Call after 5, 746-3734.

2 BEDROOM MOBILE HOME, Colonial Trailer Park, \$160 a month plus deposit. 758-0779.

YOU'LL FIND INTERESTING items advertised everyday in classifieds. Stop and browse. 752-6166.

**179 Mobile Homes For Rent**

3 BEDROOM, Unfurnished. Washer/dryer, stove and refrigerator included. No pets. \$225 month, security deposit. References. 442-4266.

3 BEDROOM \$195 Fenced yard or 2 bedroom \$250, washer dryer hood. 752-1375 HOMEOLOCATORS Fee.

**180 Mobile Homes Lots For Rent**

COUNTRY LIVING Trailer lot, very large. Garden if you like, 200 AMP service pole and water furnished. 980, 746-6993.

FIRST MONTH FREE! Paved streets, city water, garbage pickup. Call 756-1929.

MOBILE HOME LOTS For rent. Vandermere, restrictions, cable available, garbage pick-up. Call 752-5567 or 975-6170.

**181 Office Space For Rent**

BRAND NEW DOUBLE Office Suites. (Two rooms each suite). Ground floor. Heat, air, electric, janitorial, security furnished. Private entrance. Parking at front door. Prestigious location at 313-315 Clifton, just off Arlington. Contact: J.T. Snowden, Jr. 919-355-0327.

CALL COMMERCIAL Locators for variety of office spaces. No fee. 830-4759.

EXECUTIVE OFFICE, 1,000 or 2,000 square feet, 2408 South Charles Boulevard. 355-7373 days; 756-3292 nights, ask for Leon Fornes.

EXECUTIVE OFFICES And Suites for rent on Commerce Street. Call Gaylord Builders, 756-5550.

EXECUTIVE OFFICES For rent. 3 or 4 room suite, Janitorial and utilities included. Chapin-Little Building, 3104 South Memorial Drive. 756-1234.

**OFFICE SPACE:** 1400 square feet available now for lease. 2 offices including reception area. Conveniently located off Greenville Boulevard one block from Carolina Telephone. Contact Remco East, Inc. at 756-6661 for details.

**184 Resort Property For Rent**

MYRTLE BEACH DAYS Ocean front condos. 1, 2, 3 bedrooms. Indoor pools, jacuzzis, health spas, tennis. Special \$59/night up. FREE brochure. 1-800-777-9411, Smith Rentals.

NEW 3 BEDROOM, 2 bath condo: sleeps 10, 5th floor in Summer Winds, Saffier Path, 5 pools, health club, ocean view, located on beautiful Atlantic Ocean. Call J.T. Williams, 756-7815 or 1-800-992-8545, be sure to ask for Unit 541. "Make your reservation now!"

**184 Resort Property For Rent**

ATLANTIC BEACH Prime location to ocean, beach, fishing pier and marina. This lovely 2 bedroom (2 double, 2 single) has exceptional ocean views from large porch area. Also provided are cable tv, central air conditioning and modern kitchen with microwave. Call 756-9485.

FURNISHED HOUSE on Bath Creek complete with pier. Yearly lease only. Call 1-442-3115; after 5:00 p.m., 443-1068.

**CLASSIFIED DISPLAY**

**185 Rooms For Rent**

ROOM, Furnished. Female, non-smoker, student or professional. Private entrance. Reference. Call 756-5918.

SUBLEASE ROOM SUITE Furnished, male. Available September 1st. Save Money! Call Tracy evenings, 752-8611.

ROOMS AVAILABLE. \$310 Per semester. Call 757-0313, ask for Bobby.

JUST A CALL AWAY! Call us today to place your classified ads. 752-6166.

**CLASSIFIED DISPLAY**

**192 Roommate Wanted**

FEMALE ROOMMATE Wanted (non-smoker preferred) for 3 bedroom townhouse. \$150 plus 1/2 utilities. 355-4834.

FEMALE TO SHARE 2 bedroom, 2 bath apartment. Includes facilities for tennis, booth, jacuzzi, washer/dryer. Graduate student or professional please. Call (617)834-4385.

FEMALE ROOMMATE wanted to share 2 bedroom townhouse. \$165 per month plus 1/2 utilities and cable. Need immediately. Call 752-8834.

**CLASSIFIED DISPLAY**

**192 Roommate Wanted**

MATURE FEMALE non-smoker wanted to share 3 bedroom duplex. Call Donna at 830-5274, if no answer, leave message.

FEMALE ROOMMATE Wanted to share 2 bedroom, 2 bath home. \$125 a month plus 1/2 utilities. 752-8375 after 7.

FULLY FURNISHED house, 1 1/2 baths, to share with 2. Washer/dryer, spa sized hot tub jacuzzi and all the amenities. Non-smoker. Wiley, 752-4614.

**CLASSIFIED DISPLAY**

**192 Roommate Wanted**

ROOMMATE WANTED to share 2 bedroom apartment, \$150 a month plus 1/2 utilities. Call Audrey, 752-3726 after 5:00 p.m. Monday-Friday.

ROOMMATE WANTED. \$157.50 plus utilities. Call 758-6209.

NON-SMOKING WHITE male student seeks same to share 2 bedroom Oakmont Square Apartment. \$190 covers all. 355-5703 or 783-0963 collect.

MALE ROOMMATE WANTED to share a 3 bedroom and private bath. Call 355-2527.

**CLASSIFIED DISPLAY**

**192 Roommate Wanted**

RAJAT, 1-919-493-8218, Eastbrook apartments. Need roommate to share 2 bedroom apartment, 1 1/2 baths, unfurnished. 1/2 utilities. \$160 per month. 2 miles from campus. ECU bus available. Furnished kitchen, free cable, water and sewer. Pool and laundry facilities. Available August 18.

ROOMMATE NEEDED to share 3 bedroom house, \$105 a month rent and \$105 deposit. Call 758-7809.

**CLASSIFIED DISPLAY**

**192 Roommate Wanted**

TO SHARE furnished 2 bedroom townhouse in quiet Shenandoah area. Mature, non-smoker. Rent \$177.50 per month plus 1/2 utilities. Call Mike at 756-4930.

TWO BEDROOM HOUSE Private bedroom, house being remodeled. \$125 a month. Call 752-6656 ask for Todd.

2 BEDROOM DUPLEX. Male graduate or professional student preferred. \$125 month. Ask for Braxton at 551-2324 days, 758-3751 nights.

**CLASSIFIED DISPLAY**

# We're Bending Over Cash Back-Wards!

## Get Up To A \$2,400 Rebate At Toyota East NOW!

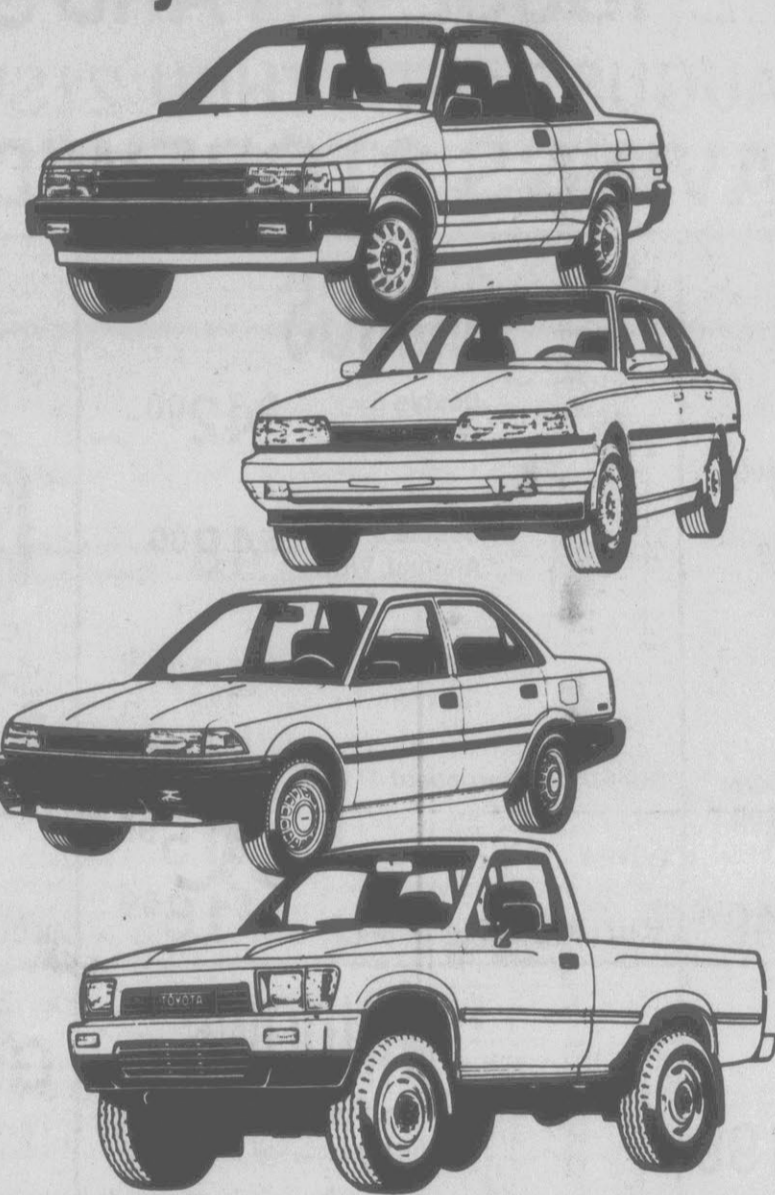

At Toyota East, we're doing whatever it takes to put you behind the wheel of a brand new Toyota. Make your best deal on a 1989 Toyota Tercel, Camry, Corolla, OR a tough Toyota truck—then get up to \$2,400 CASH BACK!

We've got a tremendous selection, but this offer will last only as long as the inventory! Here are just a few examples!

### GET \$1,200 CASH BACK

On Toyota Tercels! Make your best deal on a 1989 Toyota Tercel (Model #1302) 2-door sports coupe with automatic transmission, and get \$1,200 cash back!

### GET \$1,200 CASH BACK

On Toyota Camrys! Camry comfort, quality, and reliability—and now \$1,200 cash back! Who could ask for anything more?

### GET \$1,200 CASH BACK

On Toyota Corollas! Make your best deal on a 1989 Toyota Corolla 4-door sedan and get \$1,200 cash back. We have a huge selection priced to move NOW!

### GET \$2,400 CASH BACK

On Tough Toyota Trucks! We're making the deal twice as sweet! Get \$2,400 CASH BACK on a tough and dependable Toyota truck! Choose any new Toyota truck in stock—Xtracab, SR5, 2-wheel or 4-wheel drive. Make your best deal, and get \$2,400 cash back! (Excluding model #8503)

Cash back reflects all manufacturer and distributor incentives.

A Sigmor Company Authorized Mercedes-Benz

# TOYOTA EAST

Highway 264 Bypass Greenville  
756-3228 Toll-free: 1-800-682-5437

**MINI STORAGE UNITS FOR RENT**

Hooker Road Self Storage, now under new management! Conveniently located off Greenville Blvd. one block from Carolina Telephone. All size units available including extra large units for boats, campers, etc. Rent for three months, receive the fourth month free!

Contact Remco East, Inc. at 758-6061.

**9% Fixed Rate To Qualified Buyers**



Planter's Walk  
Lot 21 1708 Sq. Ft. \$94,900

\$3,000 Appliance Allowance  
Immediate Occupancy. Move In On Credit Approval. No Rent.

Offer Will Expire August 21, 1989

Call: George Jenkins 355-3558



**LYNNDALE**



LYNNDALE...YOU'LL FIND ALL THE RIGHT PROPORTIONS in this spacious four bedroom home in one of Greenville's finest areas. Formal areas, hardwood under carpet, corner lot. Price firm at \$110,000. Exclusively at RE/MAX PREFERRED REALTY. Please call Anita Worthington, 355-6661 or 355-5006.

LYNNDALE...SELECTIVE HOME OWNERS who prefer quality and design will find it all featured in this beautiful 4 bedroom brick home in one of Greenville's finest areas. Formal area, bonus room, and large workshop are only a few of the amenities this home offers. \$182,500. Please call Anita Worthington, 355-6661 or 355-5006.

# Premium Values.

"Premium Values" is more than a name. It's exactly what you'll find here. The finest selection of previously-owned cars and trucks, from Toyota East, so you're assured of the quality. And you're assured of the value, because each one is backed by a free 3-month/3,000 mile limited warranty. Discover the premium values at Premium Values now.

<b>1987 Honda Civic</b> 4-door, air conditioning, AM/FM cassette, AND MORE!	\$6995	\$162 <sup>33</sup> /month
<small>48 months term at 13.5% APR, with approved credit and \$1000 down, cash or trade. Tax and tags are extra.</small>		
<b>1987 Chevrolet Cavalier</b> #10290, 4-door, automatic transmission, air conditioning.	\$6495	\$154 <sup>20</sup> /month
<small>36 months term at 13.5% APR, with approved credit and \$800 down, cash or trade. Tax and tags are extra.</small>		
<b>1987 Toyota Corolla</b> 4-door with air conditioning, AM/FM stereo cassette.	\$7495	\$175 <sup>86</sup> /month
<small>48 months term at 13.5% APR, with approved credit and \$1000 down, cash or trade. Tax and tags are extra.</small>		
<b>1988 Toyota Corollas</b> Choose from an outstanding selection!	\$8995	\$198 <sup>00</sup> /month
<small>54 months term at 13.5% APR with \$1,000 down, cash or trade and approved credit. Tax and tags are extra.</small>		
<b>1988 Toyota Tercels</b> Many 2 and 4-door models in stock, with automatic transmission, air conditioning, and more!	\$7995	\$178 <sup>00</sup> /month
<small>54 months term at 13.5% APR with \$800 down, cash or trade and approved credit. Tax and tags are extra.</small>		

- 1987 Toyota 4-Runner**  
#5186B 4x4, grey, automatic transmission, cruise control, low miles, air conditioning, AM/FM cassette, power windows and more!
- 1986 Toyota 4-Runner**  
#5342A 4x4, automatic transmission, air conditioning, AM/FM cassette, blue
- 1987 Chevrolet Celebrity**  
#9882P 4-door, blue, automatic transmission, low miles
- 1988 Toyota Camry**  
#9948P 4-door, automatic transmission, good mileage
- 1987 Mitsubishi Montero**  
#10198 4x4, air conditioning, AM/FM cassette, only 20,000 miles
- 1989 Nissan 240SX**  
#10264, Automatic transmission, air, AM/FM cassette
- 1987 Nissan Maxima**  
Loaded with equipment and priced to sell now!
- 1987 Toyota Cressida**  
#9412 Automatic transmission, loaded, white
- 1986 Toyota Celica GTS**  
#10189 Red, sunroof, automatic transmission, loaded
- 1988 Pontiac Grand Am**  
We have a good selection, all fully-equipped and priced to sell!
- 1986 Honda Prelude SI**  
#10292 Black, with sunroof, automatic transmission, loaded
- 1988 Toyota 4x4** #10307 Was \$9,995, now \$8,995

**Premium Values BY TOYOTA EAST**  
Highway 264 Bypass Greenville 756-3228 Toll-free: 1-800-682-5437

# How They Voted

WASHINGTON — Here's how area lawmakers were recorded on major roll call votes in the days before Congress began its August recess.

**HOUSE**  
**TO PASS S&L BILL** — By a vote of 201 for and 175 against, the House sent to President Bush legislation (HR 1278) designed to bail the thrift industry and the federal government out of the financial calamity caused by the collapse of hundreds of savings-and-loans in the 1980s. The Senate had passed the bill on a non-record vote.

The first phase of the S&L salvage will be for the government to borrow \$50 billion primarily for padlocking or merging troubled thrifts and meeting federal reimbursement obligations to those who lost billions in U.S.-insured deposits. About \$10 billion will be incurred by Treasury borrowing and included in the fiscal 1989 budget. The remaining \$30 billion will be borrowed by a new government-chartered corporation but not counted on the budget or tallied as part of the federal debt.

Although the thrift industry will have to repay the \$50 billion principal, taxpayers will be required to pay borrowing costs. Conservative estimates are that the total bailout will cost at least \$160 billion including debt service over 30 years with the average taxpayer supplying \$1,000 of the amount. Other estimates double those projected costs.

Supporter Chalmers Wylie, R-Ohio, said: "We are not bailing out S&Ls. We are not bailing out their stockholders or their managers. We are delivering on our promise that the federal government stands behind the safety and the life savings of millions of Americans."

Opponent Sam Gibbons, D-Fla., said the rescue "should have been paid for by taxes, current taxes, a very small tax, but the president could not bring himself to say the word. So we have foisted on our children and grandchildren an unconscionable debt of perhaps \$100 to \$200 billion..."

Members voting yes supported the bill.

North Carolina members voting yes: David Price, D-4, Howard Coble, R-6, Alex McMillan, R-9, Cass Ballenger, R-10, James Clarke, D-11.

Voting no: Tim Valentine, D-2, Stephen Neal, D-5, W.G. Hefner, D-8.

Not Voting: Walter Jones, D-1, Martin Lancaster, D-3, Charles Rose, D-7.

**VIOLENCE, TELEVISION AND ANTI-TRUST** — By a vote of 399 for and 18 against, the House sent to the Senate a bill (HR 1391) providing an anti-trust exemption to enable competing television industry executives to meet to discuss ways of making their programs less violent.

Sponsor Jack Brooks, D-Tex., said the bill would "remove the perception, apparently held by many in the television industry, that the antitrust laws are a possible impediment" to less violent programming.

Opponent Don Edwards, D-Calif., said "I have never seen an exemption to the antitrust laws that worked for the benefit of the American people." Members voting yes supported the anti-trust exemption.

Voting yes: Jones, Valentine, Lancaster, Price, Neal, Coble, Rose, Hefner, McMillan, Ballenger, Clarke.

## Trident Explodes

THE ASSOCIATED PRESS

CAPE CANAVERAL, Fla. — The second explosion of a submarine-launched Trident 2 missile in five months could again delay Navy plans to send its newest, deadliest weapon on operational patrol.

The original December target was put off until March 1990 by the first failure. Now the March goal is in jeopardy.

One of the 44-foot, \$23.7 million missiles exploded Tuesday seconds after it was launched from the nuclear submarine Tennessee while it cruised submerged about 200 miles southeast of Cape Canaveral.

The Navy said the blowup caused no injuries nor did it damage the submarine or a nearby support ship.

Officials said the problem occurred shortly after the missile cleared the surface and ignited, reminiscent of the first Trident 2 submarine launch on March 21. That missile blew apart four seconds after it was launched by the crew of the Tennessee.

Investigators traced the problem in March to a mechanical linkage responsible for moving the rocket steering nozzles back and forth. The faulty part was redesigned.

On Aug. 2, the Tennessee launched a Trident 2 with the design changes on the missile's first underwater success, and Navy hopes were buoyed.

There was no immediate indication whether the two failures were related, and officials said they won't know exactly what went wrong Tuesday until they study radio telemetry tapes of the missile's behavior.

Voting no: None.  
 Not voting: None.

### SENATE

**LIABILITY FOR PLATFORM SPILLS** — By a vote of 34 for and 66 against, the Senate refused to limit oil company liability for damages and cleanup costs resulting from spills at Outer Continental Shelf (OCS) drilling platforms. The vote preserved an amendment in support of state laws that saddle the owner with unlimited liability when an offshore rig blows out. It killed a proposed \$100 million liability cap for such spills.

This occurred as the Senate sent to the House, by a unanimous vote, legislation (S 686) to help prevent oil spills or, if they occur, to cushion their impact on the environment and taxpayers.

Inspired by the Exxon Valdez

disaster, the bill sets up a \$1 billion industry-financed cleanup and compensation fund to be tapped in the event of large spills from tankers, terminals or platforms. It imposes tougher safety standards on tankers and other equipment, puts the White House in charge of the first response to a spill, creates regional clean-up teams for immediate deployment and requires alcohol-testing of key tanker personnel.

Sponsor John Breaux, D-La., said the liability cap is needed not by Exxon or Texaco but by "literally hundreds of smaller operators who never will be able to participate in OCS drilling operations if they had to face unlimited liability."

Opponent John Chafee, R-R.I., said state doctrines of unlimited liability have been "a tremendous deterrent to casualness and sloppiness" by oil companies.

Senators voting yes wanted to cap oil company liability for OCS drilling platform spills.

North Carolina Sen. Terry Sanford, D, voted yes. Sen. Jesse Helms, R, voted no.

**LIABILITY FOR TANKER SPILLS** — By a vote of 52 for and 48 against, the Senate tabled (killed) an amendment to S 686 (above) concerning owner liability when tankers spill their oil. The amendment sought unlimited liability under federal law for damages and environmental cleanup. It went beyond language in the bill allowing high but capped financial obligations on errant tanker owners and repealing legal defenses historically used by owners to insulate themselves from problems of their vessels.

Left undisturbed by the legislation are laws permitting unlimited liability

in state courts on owners of oil tankers that cause spills.

Max Baucus, D-Mont., who voted to table the amendment, said that when combined with laws of coastal states setting no cap on damages "the practical effect" of the federal bill is unlimited liability.

Amendment sponsor Slade Gorton, R-Wash., said "corporations can and will behave responsibly if they know the risks are high enough."

Senators voting yes wanted to table the amendment.

Sanford voted yes. Helms voted yes.

**TO REQUIRE DOUBLE-HULL TANKERS** — By a vote of 51 for and 48 against, the Senate tabled (killed) an amendment to require by law that oil tankers plying U.S. waters be built in the future with double bottoms and sides for added protec-

tion against spills. The amendment sought to go beyond language in the bill launching a Department of Transportation rulemaking that could require double-hull construction of many new tankers.

Ted Stevens, R-Alaska, who voted to kill the amendment, said that through the regulatory process "this bill requires double bottoms and double (sides) unless there is a better way."

Amendment sponsor Brock Adams, D-Wash., said passing a law is the only certain method of requiring double hulls on tankers, given maritime industry opposition to such a standard.

Senators voting yes wanted to kill the amendment requiring double-hull construction by law rather than regulation.

Sanford voted no. Helms voted yes.

**WICKES HAS ALL IT TAKES TO BUILD ALL YOU NEED**

Wickes Lumber

Use Your Wickes Charge Start improving the value of your home today! If you don't have a Wickes Charge ask for an application at your nearest Wickes Lumber.

# Wickes Lumber

## GIGANTIC WAREHOUSE & YARD SALE

### AUGUST 16TH THRU 21ST SAVINGS STOREWIDE

**GUARANTEE OF CUSTOMER SATISFACTION**

We guarantee your satisfaction with any product you buy at Wickes Lumber. If you are not satisfied with your purchase, simply return the item, together with proof of purchase within 30 days of purchase, and we will gladly exchange it or, if you prefer, refund your purchase price in full.

**BATH FIXTURES**

2-Pc. Tub/Shower with 1 Pc. Look White on Bone **\$269<sup>00</sup>**  
Reg. \$339.98 Sale

Acadia Toilet **\$39<sup>99</sup>**  
Reg. 54.99 Now

Alcove 3 Pc. Tub/Surround **\$129<sup>00</sup>**

Images 5 Pc. Tub/Surround **\$89<sup>00</sup>**

Peerless Tub/Shower Faucet **\$44<sup>00</sup>**  
Reg. 59.99 Now

40 Gal. Energy Saver Gas Heater **\$149<sup>00</sup>**  
Save \$40

**SIDINGS**

Double 5 White Vinyl... **\$42<sup>00</sup>** square

Double 5 Almond Vinyl... **\$48<sup>00</sup>** square

Double 5 Gray Vinyl... **\$48<sup>00</sup>** square

RUFF-X 4x8 Hardboard 4" O.C... **\$13<sup>99</sup>** pc.

RUFF-X 4x9 Hardboard 4" O.C... **\$15<sup>99</sup>** pc.

T-1-11 Pine 4x8 4", 8" or 12".... **\$16<sup>99</sup>** pc.

**ELECTRICAL**

**Save 30%** on Regular Price of Chandeliers

30" Range Hood, White or Almond Our Best Moves Air at 240 Cubic Ft. Minute **\$89<sup>99</sup>**  
Reg. 119.99 Now

All Fluorescent Light Bulbs **1/2 price**

Victorian Light Kit For Ceiling Fans **\$20**  
Reg. 26.99 Save 25%

All Other Fan Lights... **25% off**

**DOORS**

9x7 White Steel Garage Door **\$199**  
Reg. 249 Sale

8x7 White Steel Garage Door **\$195**  
Reg. \$249 Sale

6' Bronze Patio Aluminum **\$199**  
Reg. \$239 Sale

6' Crestline Swingset Door **\$389**  
Reg. \$469 Sale

1 1/4" Thick Bronze or White Storm Doors Fullview & Self Storing **\$75**  
Reg. \$95.99 Sale

1/2 H.P. Genie Opener **\$149**  
Reg. \$169 Sale

**WINDOWS**

2-0x3-2 Wood 5 gl. Glaze **\$44<sup>99</sup>**  
Reg. 59.99 Sale

2-4x3-2 Wood 5 gl. Glaze **\$44<sup>99</sup>**  
Reg. 59.99 Sale

2-8x3-2 Wood 5 gl. Glaze **\$51<sup>99</sup>**  
Reg. 64.99 Sale

3-0x3-2 Wood 5 gl. Glaze **\$54<sup>99</sup>**  
Reg. 69.99 Sale

2-8x4-6 Wood 5 gl. Glaze **\$59<sup>99</sup>**  
Reg. 74.99 Sale

Miscellaneous Skylites at Great Savings

2-Track Alum. Storm Windows... **\$21<sup>00</sup>**  
Stock Sizes

**Victorian Gingerbread Trim**

• We stock all you need to create the charming look of a Victorian porch.

Corner Brackets

Large 18" **\$21 Save 30%**  
Reg. \$29.99

Medium 12" **\$12 Save 33%**  
Reg. \$17.99

Small 6" **\$9 Save 30%**  
Reg. 12.99

48" Rail Ball or Spindle Design... **\$17.50**  
Reg. \$24.99 Now

All Interior Gingerbread... **Save 25%**

**OTHER SALE ITEMS**

Certainteed 20 Yr. Shingles **\$6.66** bd.

4 Cu. Wheelbarrow... **\$29.99**

3 1/2" x 15" R-11 Insulation **50¢ \$6.75** roll

6x15 R-19 Unfaced... **49¢ \$11.75** roll

6x15 R-19 Kraft... **49¢ \$12.25** roll

1/4x4x8 Woodgrain Pegboard... **\$8.99** pc.

1x3x8 Furring Strips... **.69¢** ea.

**FENCING**

6x8 Treated Stockade **\$19.99**  
Reg. 24.99 Sale

6x8 Treated Shadowbox **\$26.99**  
Reg. 32.99 Sale

Dog Ear 1x6x6 **\$1.39**  
Reg. 1.59 Sale

Cedar Split Rail 10' Section **\$9.99**  
Reg. 13.27 Sale

Vinyl Coated Fence 48" x 50" **\$25.00**  
Reg. 49.99 Sale

Metal Yardsaver Building 4x7 **\$119**

**CLEARANCE**

50% OFF ALL ACCESSORIES WHEN PURCHASED WITH A POWER TOOL

Wood Screen Drs. 4-Panel **\$15**  
Reg. 29.99 Now

Wood Screen Drs. 2-Panel **\$21**  
Reg. 42.99 Now

All Lawn Sprinklers... **1/2 price**

Crestline Wood Sliding Dr... **\$389**

Picnic Tables 7' Treated... **1/2 price**  
Reg. 89.99 Now

Picnic Table Hardware... **\$75**  
Reg. 39.99 Now

Mobile Home Steps & Decks (Hurry, Displays Only)

**PLUMBING**

2'x8' Treated Lattice... **\$5<sup>99</sup>** ea.

1 1/2x10' Lattice Strips... **\$1<sup>49</sup>** ea.

5-Gal. Plastic Roof Cement... **\$11<sup>99</sup>**

Armstrong #231 12" x 12" Ceiling Tile **35¢** ea.

Armstrong #942 2'x4' Ceiling Tile... **\$2<sup>50</sup>** ea.

1/2 4'x8' Sheetrock... **\$3<sup>79</sup>** ea.

**TREATED LUMBER & PLYWOOD**

	8'	10'	12'		SANDED	SHEATHING
2 x 4	2.29	2.59	3.19	3/8"	11.89	9.29
2 x 6	3.29	3.79	4.89	1/2"	15.89	9.39
4 x 4	3.99	6.49	7.35	5/8"	10.89	
5/4 x 6	3.39	3.95	5.10	3/4"	17.99	14.95

125 West Greenville Blvd.  
 Open Monday-Friday 7:30 to 7pm  
 Saturday 8 am to 5 pm  
 Sunday 1 pm to 5 pm

**756-7144**

**Wickes Lumber**

*We Deliver! Ask At Store For Details*

# A Way Of Life Goes Up In Smoke

By Jo'el Glenn Brenner  
LAT-WP NEWS SERVICE

CLINTON, Md. — Sixty years of tobacco. That's how Henry Miller describes his life. His hands, wrinkled and stained from working the fields, have known nothing else.

"I'm a tobacco farmer," Miller said, nodding his head for emphasis. "My family's been growing tobacco for 150 years." But after generations of harvesting almost 70 acres of the sweet, heavy-scented crop, Miller didn't plant a single acre this spring.

"It's all over now," he said softly. "The Millers won't be growing tobacco anymore."

Like hundreds of other Southern Maryland farmers, Miller has given up a 350-year-old Maryland tradition. Caught between faltering demand for cigarettes and the scarcity of labor needed to work the fields, the farmers have stopped growing the sotweed — once considered the backbone of the state.

But unlike many who were defeated, Miller is trying to hold on to his farm, which locals say was one of the biggest tobacco operations in the state.

This year, he replaced his tobacco crop with vegetables.

"People have to eat, but they don't have to smoke," Miller reasoned.

Only 8,500 acres of tobacco were planted in Southern Maryland in 1989, according to the U.S. Department of Agriculture. Just seven years ago, more than 24,000 acres were devoted to the crop. While thousands of acres have been sold to developers, there are still many farmers, like Miller, who are trying to make the switch to other commodities. To help ease the transition, Maryland officials have converted the little-used state tobacco warehouse in Cheltenham, near Waldorf, into a retail and wholesale produce market that gives the former tobacco farmers an outlet for their new crops.

Since opening on July 3, the Southern Maryland Regional Farmers Market has swarmed with customers eager for squash, green beans and tomatoes. Virtually all of the 28 farmers who operate the produce stands are former tobacco farmers.

Eileen Shlagel, one of the produce vendors, said the market will provide a desperately needed source of income. "Tobacco was the cash crop in Maryland," she said. "Without it, it's going to be hard to survive." Shlagel and her husband, Russell, plant more than 200 acres on a farm near Waldorf in Charles County. The farm has been in the family for more than 100 years, and until last year, tobacco was always part of the harvest.

"I'd go back to tobacco if I could," Russell Shlagel said. "When you do something like that for such a long time, it's hard to make the switch. But we're going to try."

The Shlagels' farm, once surrounded by other fields and greenery, now is bordered by subdivisions. The encroaching development has made life even more difficult, Russell Shlagel said. "I have to plan my manure spreading around the neighbors' weekend



LAT-WP NEWS SERVICE

Farmers George Shlagel, left, and son Russell check a new combine — a symbol of the change agriculture has made

cookouts," he said. "Otherwise, we get lots of complaints. That's no way to run a farm."

George B. Roche, marketing specialist with the Maryland Department of Agriculture, said houses are replacing tobacco farms at a rapid rate. "Houses are the number one crop in Southern Maryland," he said. "With all of the developers out there offering such high prices for the land, it's no wonder more farmers haven't sold out." In 1982, there were about 2,400 farms in Prince George's, Anne Arundel, St. Mary's, Charles and Calvert counties, which traditionally make up Southern Maryland's tobacco belt. By 1987, that number had dropped more than 50 percent, to 1,300 farms, according to the U.S. Agriculture Census. Roche and other agriculture experts estimate that another 200 farms have been sold in the past two years.

Gary Hodge, executive director of the Tri-County Council, a government group that represents St. Mary's, Charles and Calvert counties, said he hopes the produce market will keep more farmers from selling their land, thereby halting the rapid growth of residential and commercial development in the area.

"This isn't just a problem for the farmer," Hodge said. "Everybody's complaining about overdevelop-

ment. Unless we convince the farmers to stick around, we won't be able to control the growth."

Hodge is quick to point out that tobacco still is Maryland's third largest crop, accounting for auction sales of \$18 million this year and as much as \$57 million as recently as five years ago. But the 11.7 million pounds of tobacco that were sold in April still are a drop in the bucket when compared with national production levels.

"In North Carolina auctions, that much tobacco can be sold in one day," Hodge said. Last year, the United States produced more than 2 billion pounds of tobacco, according to the USDA. Although flue-cured and burley tobaccos account for almost all of the nation's production, Maryland tobacco, known in the industry as Type 32, holds a special niche in the marketplace. Maryland's unique variety is valued because of its ability to hold a flame, and it has been particularly popular in Europe, where unfiltered cigarettes are common.

Many packs of European cigarettes make a point to advertise that they contain Maryland-grown tobacco. Luxembourg even has a cigarette brand called Maryland.

"Most people don't realize what a specialty Maryland tobacco is," said Peter Wilby, international marketing specialist with the state

Department of Agriculture. "The state of Maryland was formed by the British to grow tobacco. Maryland tobacco was king."

But as health concerns about the effects of tobacco have grown, tobacco use has fallen. And as farmers find other crops and farms give way to suburban development, the age-old way of life in Southern Maryland is slowly and, most say, inevitably coming to an end.

Historically, much of the state's crop each year is purchased by Swiss cigarette manufacturers, although Type 32 tobacco also is used in small portions in some American cigarettes. While export demand for cigarettes is growing, domestic consumption continues to fall.

U.S. cigarette production is expected to decline 2 percent to 3 percent from the 703 billion produced last year, said Bob Miller, a tobacco specialist with the USDA.

At the same time, Europeans are smoking fewer cigarettes than ever before, Wilby said. "The Europeans liked to smoke a heavier cigarette, which got its flavor from the Maryland leaf. But they're changing to a milder blend, and they're smoking less and less," he said.

Wilby estimates that exports account for only 25 percent of Maryland tobacco sales, compared with 50 percent just 10 years ago.

Faced with the continued drop in

demand, the Maryland Department of Agriculture is sponsoring trade missions to Asia, where cigarette consumption is on the rise. This year, South Korea purchased about 300,000 pounds of Maryland tobacco, a first-ever sale for the state.

Wilby and others insist that if Maryland tobacco is to survive another decade, new markets must be found. But this year, only \$7,500 was appropriated for marketing overseas, Hodge said. "We can't do much with \$7,500," he said. "But you can't blame the state for not giving us more, given the market conditions."

The farmers say it's only a matter of time before tobacco disappears from the fields. "I think its time is over," said Mary Stach, who owns more than 400 acres on three farms but stopped growing tobacco this year. "For one thing, we won't have any land to raise it on. And with all the talk about smoking, how can we survive?" Agricultural experts, however, aren't as quick to dismiss the future of tobacco in the area. "I think we've leveled off," Roche said. "No, there won't be any more 60-acre growers. But people will keep planting a few acres each year. There will always be a demand for what Maryland has to offer."

Farmers agree that the demand, though reduced, probably will continue. Still, they say they can't af-

ford the labor to raise the crop.

Tobacco farmers have resisted mechanization more than any other crop grown in the area, Roche said. The seeds are hand-planted in carefully protected beds late in the winter, and transplanted to the fields in the spring. In the summer, the flower buds must be removed by hand.

In the late summer and fall, the plants must be cut down by hand and strung up in barns to cure and dry. After several weeks, the leaves must be stripped off the plants, graded and bundled, all by hand. The entire process takes about 14 months.

The USDA estimates that growing and harvesting an acre of tobacco takes an average of 230 worker-hours, compared with two to three worker-hours for one acre of corn. On the other hand, an acre of good tobacco can be worth \$3,000 at auction, while an acre's worth of corn may have a market value of less than \$300.

Stach said she couldn't find enough labor to harvest her crop. "It's dirty, sweaty work," she said. "When they can work in McDonald's, where it's air-conditioned, and make the same money, why would anyone want to bother working tobacco?"

So like the other farmers, Stach has stopped planting her traditional 40 acres of tobacco. She's also sold about 100 acres of her land to developers.

David Martin, agricultural extension agent for Anne Arundel County, said the recent tobacco auction proved that there's more than demand at work on the market. In April, Maryland tobacco farmers enjoyed one of their best auction seasons in nearly a decade. Top-quality tobacco sold for about \$1.60 per pound, close to the most recent peak years of 1981 and 1982. Despite the high prices, tobacco acreage continued to decline.

"If we don't stop this process now, the whole support industry is going to go under," Roche said. "It reminds me of the strawberry production on the Eastern Shore. In the 1920s, the shore had the world's biggest production of strawberries. You'd never know that now."

Roche is working furiously to see that the produce market succeeds, for in it he sees the future of the tobacco farmers. "The writing's on the wall," he said. "It's been there for 20 years. We're faced with the last hour and we've got to get these farmers to diversify."

Billy Hatfield of Huntingtown appreciates the effort. "I don't want to dump my land. I'm a farmer. That's all I know," he said.

Hatfield has replaced his 60 acres of tobacco with produce and corn. He sold cucumbers and summer squash at the wholesale market last week. "This is going to help us a lot," he said. "I've never sold wholesale before, but I guess I'll get used to it."

# South Carolina Basket Makers Weave Link To Past

By Charles Hillinger  
LAT-WP NEWS SERVICE

MOUNT PLEASANT, S.C. — Along a four-mile stretch of U.S. 17 in this Atlantic coastal town, there are 60 family-operated sweetgrass basket stands. Mazie Brown sits on a chair in the shade of Mazie's Sweetgrass Baskets, weaving her latest basket.

Behind the basket weaver are scores of baskets she has created — bread baskets, casserole baskets, fruit baskets, flower baskets, knitting baskets, cookie baskets and planter baskets. They are all made of sweetgrass, a soft pliable wild grass, gathered from sand dunes, swamps and marshes. Priced from \$25 to \$200, each one is a little different, reflecting the way Brown felt at the time she created them. She stitches in bulrush reeds, pine needles and fiber strips from palmetto trees for added color and design.

Slaves brought the art of sweetgrass basket making from the West African countries of Ivory Coast and Senegal. "This is my heritage, something my ancestors who came from Africa as far back as the 1600s gave to me. It is an art form that must never be lost, for it never lets us forget how our people came to this country in chains and shackles. It is our direct link to Africa," the 46-year-old basket maker said.

In the plantation days, the men made huge baskets for storing and winnowing grain and for shipping cotton and indigo. A few of the large 16th- and 17th-century baskets are museum pieces.

After the Civil War, the art of sweetgrass basket making died out except in Mount Pleasant, where it continued as a family tradition.

"I have been weaving sweetgrass baskets since I was 8," said the basket maker whose mother and grandmother were also named Mazie. "My mother taught me, and her mother taught her, and it goes on and on for generations in my family. My mother did this until she died two years ago when she was 72."

But now the three-century-old legacy is endangered. A year and a half ago, 100 black families, all living in Mount Pleasant, formed the Sweetgrass Basket Makers

Association to encourage younger women to take up the craft.

"We formed the association to make certain this tradition does not die," said Mary Jackson, 44, founder-president of the group.

"Most of the basket makers are older women. In many families where basket making has been a tradition, handed down (from) grandmother to mother to daughter, younger women no longer are interested in doing this."

"We are encouraging the younger women, who work at something else, to spend at least a few hours a week weaving sweetgrass baskets and to teach their daughters the art as their mothers taught them," said Jackson, a master craftsman whose baskets sell for as much as \$3,000 and are displayed in a number of museums around the country.

Then there has been the gradual disappearance of sweetgrass in Mount Pleasant, because of rapid beachfront development in recent years.

While grandmothers, mothers and daughters have made the baskets, grandfathers, fathers and sons gather sweetgrass in swamps and on dunes along the beaches where the grass grows.

But now those men have been forced to travel hundreds of miles in both directions up and down the Atlantic seashore to find enough sweetgrass to take care of their needs. Last year, they were running so short of the wild grass that the Sweetgrass Basket Makers Association held a conference in Charleston, S.C., to call public attention to the dwindling supplies.

Hearing about the search for new sources of the wild grass, Fred Marland of the Georgia Department of Natural Resources told the basket makers about a private island off the Georgia coast with an abundant supply. The Mount Pleasant basket weavers contacted the owners of Little St. Simons Island who gave them permission to harvest the grass.

"On hearing of our search for sweetgrass, Ben Gibbens, the manager of the island, said he would be delighted to have the men come out and harvest all the sweetgrass they needed," Jackson said.



LAT-WP News Service

Mazie Brown has been weaving baskets since she was 8 years old

# Vest Combines Feather And Fan Stitches

It's a dynamite combination -- the lovely feather and fan stitch and a beautiful, unusual yarn worked into a knit cardigan vest. Easy to pair with skirts or pants year-round, this vest's cap sleeves and deep V-neck make for a comfortable, easy fit.

The yarn of choice is a textured acrylic with lustrous fibers, giving the design an almost luminous look. The gauge is 4 1/4 stitches to the inch, and easy-to-follow directions are written for petite, small, medium and large sizes with finished bust measurements of 36, 38, 40 and 42 respectively.

To obtain directions for making the Feather and Fan vest, send your request for Leaflet No. Z-081389 with \$2 and a long, stamped, self-addressed envelope to: Pat Trexler

## Pat's Pointers

By PAT TREXLER

Crafts, The Daily Reflector, P.O. Box 419148, Kansas City, Mo. 64141.

Or you may order Kit No. K-081389 by sending a check or money order for \$16.95 to Pat Trexler Crafts at the same address. The kit price includes shipping charges, full instructions and yarn in your choice of the following colors: watermelon, turquoise or off-white.

From time to time, it has been my pleasure to review needlecraft books that are of particular interest to my readers. I am excited now to tell you about a brand-new book just off the

presses -- "A Collection of Afghans" from Trexler Designs, compiled and edited by Carolyn Sheffield, one of our very talented designers.

Had I been the sole author of the book, I would have found it difficult to review it, but since most of the work was done by others, I can share my delight with you.

Soon after I started writing "Pat's Pointers" 25 years ago, I learned from my readers that afghans are very precious to people -- family treasures cherished as heirlooms and used by generation after generation.

Knowing the popularity of afghans, we decided to compile this collection of our favorite afghan patterns, all shown in lovely full-color photographs. Some are from

previous columns and some are new, including an exquisite one pictured on the cover of the collection depicting a colorful cardinal on a tree branch.

Whether you choose to knit, crochet or weave an afghan, there is one for you in this book. You'll find a plaid to knit, a plaid to crochet, a traditional ripple, "granny squares," cables, diamonds, sculptured Aran knits and crochets, and lovely lace designs. Eager beginners and seasoned pros alike will find an afghan to warm the heart and the home. Each pattern is rated as easy, intermediate or advanced to help you choose one for your own skill level or comfort zone.

Although the more than 20 patterns are the highlights of the book, there's more. It begins with a brief

but fascinating history of knitting and crocheting, and then gets down to all the basic information you might need to successfully complete any of the projects.

There are chapters on needles, hooks and other accessories, and a comprehensive discussion of yarns as well as tips to help you understand terms, symbols and abbreviations, follow pattern directions, finish and block your projects -- all helpful information for the self-taught knitter or crocheter.

But suppose you don't know how to knit or crochet. "A Collection of Afghans" contains excellent, well-illustrated lessons that will enable you to teach yourself these fascinating crafts. In this "how-to" section, you'll find many helpful tips not usually found in knit or crochet instructions.

For all of you who treasure afghans, we hope this will be a book you will treasure as well. Select your favorite design and begin one of your most enjoyable and rewarding needlecraft experiences.



**Eastern Electrolysis**  
205 COMMERCE ST. GREENVILLE, NC  
PHONE 756-4034  
PERMANENT HAIR REMOVAL  
CERTIFIED THERMOLOGIST

Universal Press Syndicate

# Tension Over Boat People Coming To A Boiling Point In Hong Kong

By Dan Biers  
THE ASSOCIATED PRESS

HONG KONG -- As Hong Kong's muggy summer moves relentlessly on, long-simmering tension over the skyrocketing population of Vietnamese boat people in the British colony is coming to a boil.

Hong Kong residents are increasingly bitter about the 52,000 Vietnamese now in camps after sailing in rickety wooden boats from their communist homeland in search of a better life.

And the boat people could become increasingly difficult to control if Britain and Vietnam agree on a program that would forcibly send most of them back.

"I think the Hong Kong people in general are fed up with the problem," said Allen Lee, the senior member of the Legislative Council, which approves Hong Kong's laws. "The reason for this is the continuing influx."

More than 23,000 boat people sailed into Hong Kong from May to July, an 84 percent jump from the corresponding period a year earlier.

Resettlement of the Vietnamese asylum-seekers in third countries

has lagged far behind, creating a crisis of accommodation for the new arrivals.

Existing detention centers are overcrowded. Riots broke out in two camps late in July, one after guards tried to prevent boat people from escaping through holes cut in the fence and another after a squabble between Vietnamese women from rival groups.

"When large numbers of people are kept cooped up in camps, particularly in hot weather, there is bound to be a great deal of discomfort and frustration," Secretary of Security Geoffrey Barnes said after the first disturbance.

Meanwhile, government plans to build makeshift camps to house the flood of newcomers have met resistance from Hong Kong residents. In the most recent example, scores of villagers pitched tents on a construction site to stop work on a new detention center in rural Sai Kung.

Reports of boat people escaping, of severe staff shortages at the detention centers and alleged police brutality toward the Vietnamese have added to the crisis atmosphere.

Raymond Chung, an official who represents a Hong Kong district that has a detention center, said his con-

stituents now are more concerned about the boat people than the violent crackdown on dissent in Beijing, which has horrified this territory that returns to Chinese sovereignty in eight years.

Ironically, the hardline stance against accepting the Vietnamese comes as Hong Kong residents are demanding that Britain offer them refuge because of the Chinese communist crackdown on the mainland.

"I think the situation is completely different," Chung said. "We are claiming our rights" as British subjects.

In an effort to end the flood of boat people, Britain decided that all Vietnamese arriving after June 1988, would have to prove they fled their homeland in fear of persecution or face repatriation.

Negotiations with the Vietnamese government to set up a system of forcible repatriation of Vietnamese who fail to qualify as political refugees are under way. A Hong Kong government screening system has determined that roughly four of every five arrivals will be sent back.

The United States is among those criticizing forcible repatriation and this has irritated some Hong Kong people. They say the U.S. position, which they believe stems from a

sense of moral responsibility for its role in the Vietnam War, should be backed by promises to resettle more boat people in the United States.

What affect the U.S. opposition will have on the program is not clear, but many Hong Kong people clearly hope repatriation begins soon despite concerns of increased tension in the detention centers.

Boat people already have staged hunger strikes to protest plans for forcible repatriation and hundreds of makeshift weapons have been found during searches of the camps. The U.S. Consulate in Hong Kong received a letter from one Vietnamese who wrote in blood: "Save my soul."

While the number of boat people who have volunteered to return to Vietnam has increased in recent weeks, they still account for only a tiny fraction of the total population.

Chris Bale, the director of the relief agency Oxfam Hong Kong, sees a "potentially explosive situation" in the camps once mandatory repatriation begins.

But he believes efforts should continue on a repatriation program so long as safeguards are in place to ensure that political refugees do not have to return home and that people sent back will not face persecution.

# Insurance Benefits Can Be Taxed

By Robert B. Crenshaw  
LAT-WP NEWS SERVICE

WASHINGTON -- Life insurance enjoys many tax benefits. One of the best is that the money paid at the death of the insured person is not subject to income tax.

This benefit can be tricky to exploit, however. Life insurance proceeds are subject to estate taxes, and if the policy is found to be part of the dead person's estate, Uncle Sam is quick to arrive with his hand out.

A tried and true strategy, therefore, is to place ownership of life insurance elsewhere. One way to do this is simply to have the heirs or other beneficiaries own the policy. A more sophisticated approach, because it allows more flexibility, is to place the policy in trust for the benefit of the people you want to provide for.

Such a trust would be a taxable entity, but since the death benefit would be considered income no tax would be due on the policy's proceeds.

The key difficulty to both approaches is persuading the Internal Revenue Service that the dead person was not in fact the owner of the policy.

And there is an added twist. Policies that were owned by the dead person within three years of his demise are considered to have been transferred "in contemplation of death" and the IRS can include them in the estate for tax purposes.

This contemplation of death rule was repealed for most other assets in 1984, but Congress left it in place for insurance.

"It was one of the few exceptions," said Jack Porter of BDO Seidman, apparently because the lawmakers felt it was simply too

easy to give away a policy at the last minute.

Thus an estate must show not only that ownership of the policy lay elsewhere but also that it had been held by others for three years or more.

Over the years this issue, with slightly different sets of facts, has come before the Tax Court repeatedly, and the decisions provide guidance as to what a person should and should not do to remove a life insurance policy from his or her estate.

Last week, the court decided another such case in such a way as to add a bit of leeway for the person who uses a trust to hold life insurance.

In this case, a Tennessee lawyer named Eddie L. Headrick "skillfully drafted" an irrevocable trust that was, among other things, authorized -- but not required -- to buy insurance on Headrick and pay the premiums.

The trust documents reserved to Headrick the power to remove any trustee at will and to appoint replacements.

Headrick wanted the Cleveland Bank and Trust Co. of Cleveland, Tenn., to act as trustee. Before setting up the trust, he met with an insurance agent to price policies and then with a bank official to discuss the trust.

Headrick left the bank official with the impression that he wanted the trust to act as an insurance trust, but Headrick did not condition establishment of the trust on the bank's commitment to buy insurance.

The trust was executed and Headrick transferred \$5,900 to it. Shortly thereafter, the bank applied for a \$375,000 policy on Headrick and began paying the \$435.76 monthly premiums.

Two years later, at age 33, Headrick was killed in an automobile accident. The insurance company paid off and the proceeds were not included in Headrick's estate. The IRS said they should have been and the case ended up before the Tax Court.

The IRS conceded that the trust and not Headrick owned the policy, but argued that, in the court's words, "decendent's dominance over the trust arrangement indicates that trustee was substantively acting as decendent's agent in acquiring insurance on the decendent's life."

The service argued that Headrick indirectly paid the premiums and thus was, at least at first, the owner of the policy.

That question was the key, since if Headrick had owned the policy at any time within three years of his death -- even though he did not own it at the time of his death -- then it would be includable in his estate.

The court sided with Headrick's estate.

It noted, first, that while payment of premiums was once a definitive test of ownership, it no longer is.

Second, it drew a distinction between Headrick's case and a 1984 decision in which the proceeds were included in the estate. In that 1984 case, the trust documents said the insured person was the "initiator" of the policy and "assign(ed) to the trustees" his rights to the policy.

Further, the person in the 1984 case wrote a check to the trustee for the exact amount of the first premium.

The court said Headrick's case more closely resembled a 1987 case in which a wife bought a policy on her husband and signed the original application as owner though the husband's wholly owned corporation paid the premiums.

The court also sided with the estate in that case, finding no "incidents of ownership" such as circumstances in which the proceeds could have reverted to the insured or his estate.

Headrick also did not possess any incidents of ownership. Therefore the policy was never his so the trust did not run afoul of the three-year contemplation of death rule.

## Crime Stoppers

If you have information on any crime committed in Pitt County, call Crime Stoppers, 758-7777. You do not have to identify yourself and can be paid for the information you supply.

## PROFESSIONAL VIDEO PRODUCTIONS

Weddings, Reunions  
Parties, Sports Events

Affordable Rates  
355-7611

## Spring/Summer Sale Still Going On

Prices Cut \$32<sup>24</sup>

**FIRESIDE SHOP**

24" Model \$274 plus tax

## REAL-FYRE GAS FIREPLACE LOGS

Tar Road Antiques & Fireside Shop

•Fireplace Accessories

On the old Tar Road 1 mile south of Sunshine Garden Center - P.O. Box 913, Winterville, N.C. 28590

(919) 355-6003 • Night 756-1007

In-Home Evening Appointments Available

Monday-Friday 9-5:30 • Sat. 8-5

# UNIFORMS GALORE

COMPARE AND SAVE!!

2301 Dickinson Ave., West of Memorial Drive  
Near Buyers Market Mon.-Sat. 9:30 am-5:30 pm

756-1939

# HARRIS SUPERMARKETS

"WHERE SHOPPING IS A PLEASURE"

DISCOUNT ON EVERYTHING BUT QUALITY

We Reserve The Right To Limit Quantities  
We Accept Food Stamps and WIC Vouchers

**FLORAL DEPT.**

Bells Fork Location Only

## Carnations

Assortment of Colors

\$2.99 Dozen \$1.49 1/2 Dozen

See us for all of your floral needs - floral arrangements, corsages, boutonnieres, church altar arrangements, and balloon bouquets.

Darlene Rose Announces The Fall Opening

Of The New

# ROSE'S GYMNASTICS TRAINING CENTER

Open House and Registration  
August 20 2-4 p.m.

7200 Sq. Ft. Air Conditioned New Facility; New Equipment  
At 221 W. 10th St.

Gymnastics Instruction On All Olympic Equipment For Boys And Girls Ages 3 to 17

FOR REGISTRATION INFORMATION  
CALL DARLENE ROSE 756-3325

# Roadside Markets Cure Fever

By Delores Ballard  
THE ASSOCIATED PRESS

JACKSON, Tenn. — When the aroma of somebody's new-mowed lawn makes you think of watermelon, and the red ball of the setting sun gets you craving ripe tomatoes, you've got fresh produce fever.

Area farmers and gardeners have the cure, and they'll often oblige by setting up shop right on the roadside. In a high-traffic area, they seldom have long to wait before passing drivers start pulling over to ask, "How much you getting for your sweet corn?"

Summertime, and the eating is easy — despite the heavy rains. The Tennessee crop-reporting service rates 61 percent of the corn crop in good condition and 29 percent in excellent condition. Earlier prognoses

had said the rain would hurt the corn crop.

Most customers rate roadside produce a bargain. A dozen ears of sweet corn cost \$1.50 at most stands; you can fill your freezer for less than a \$10 bill.

Bell peppers may go for as little as 20 cents each. Cantaloupes average about a dollar, and the home-grown tomato — the unquestioned idol, the reigning king, the Elvis of fresh produce — often sells for 50 cents a pound or less.

The prices don't necessarily undersell the supermarket. Stores advertise prices like three pounds of tomatoes for 99 cents, and two cantaloupes for a dollar.

Roadside vendors aren't getting rich off vegetable stands, but many say it gives farmers, particularly retirees, a little extra income, a chance to socialize, and a way to avoid waste when a crop delivers a high yield.

Customers say the payoff is getting food home-grown and knowing it's fresh. Straight-from-the-field seems to have a psychological appeal all its own.

"This helps people out a lot. You can find fresher vegetables this way, and buying directly from them benefits the farmers, too," said customer Pauline Brown of Milan, loading up on cantaloupes and sweet corn at Robert Pope and Charles Powers' roadside market on U.S. 45 south of Milan.

Theirs is basically a tailgate operation. A quilt on the ground, a few peck baskets, an old table and a couple of pickup truck beds are their store "fixtures." But people who want field-fresh vegetables and melons don't quibble.

"We're open seven days a week," said Powers. "We don't start selling on Sunday until after church."

Fresh produce vendors aren't hard to find. They sprout up like

cornstalks along major highways, country backroads, even city streets. There's Ernest McBride selling cantaloupes and tomatoes off a truck in Jackson; a quartet of farmers who pool their vegetables under the shade trees in the first sharp eastbound curve on Mifflin Road; at least four between Medina and Milan on U.S. 45.

Their wares include everything from purple-hull peas to mouth-scorching jalapeno peppers, yellow crookneck squash and new potatoes, butterbeans and mellow cantaloupes. Some farmers even fight the thorns, wasps and chiggers to offer fresh-picked wild blackberries.

Fay and Gertrude Barr grow everything but the watermelons they sell at their stand on U.S. 45 south of Humboldt. Right now, Mrs. Barr says, customers want purple-hull peas and peaches more than anything else.

"I had one woman that said, 'I want some purple-hull peas,' and I asked her what kind, and she said, 'Purple-hull peas!'" Barr chuckled. "I never was able to make her understand I had five different kinds of purple-hull peas."

## Meeting Place

**Wednesday**  
6:30 p.m. — REAL Crisis Intervention Center meets.  
7 p.m. — Greenville-Pitt County Youth Council meets at the Greenville Recreation and Parks Department, Cedar Lane.  
8 p.m. — Narcotics Anonymous opening discussion meeting at St. Paul's Episcopal Church.

**Thursday**  
9:30 a.m. — Town and Country Senior Citizens meet at St. Paul's Episcopal Church.  
Noon — Alcoholics Anonymous meets at St. Paul's Episcopal Church.  
6:30 p.m. — Exchange Club meets.  
7 p.m. — Greenville Elks Lodge No. 1645 meets.  
7:00 p.m. — Overeaters Anonymous meets at First Presbyterian Church.  
7:30 p.m. — Duplicate bridge meets at Senior Center.  
8 p.m. — Nonsmoking Support Group for Adult Children of Alcoholics and Dysfunctional Families meets in the church parlor of First Presbyterian Church.  
8 p.m. — Coochee Council No. 60, Degree of Pocahontas meets.  
8 p.m. — VFW meets at post home.  
8 p.m. — Nonsmoking Adult Children of Alcoholics Support Group meets in the church parlor of First Presbyterian Church.  
8 p.m. — Alcoholics Anonymous closed meeting at First Presbyterian Church.  
8 p.m. — Serenity AI-Anon meets at First Presbyterian Church, room 33.  
8 p.m. — Narcotics Anonymous open discussion meeting at Arlington Street Baptist Church.

**Friday**  
Noon — Alcoholics Anonymous meets at St. Paul's Episcopal Church.  
8 p.m. — Narcotics Anonymous has open discussion at St. Paul's Episcopal Church.  
8 p.m. — Alcoholics Anonymous traditions and step (newcomers) closed meeting at AA Building, Farmville Highway.  
9:30 p.m. — Narcotics Anonymous has closed candlelight non-smoking meeting at Arlington Street Baptist Church.

**Dr. Andrew E. Haven**  
and  
**Dr. William E. Brown**  
are happy to  
announce that  
**Dr. George H. Freeman**  
has joined  
**Greenville**  
**Women's Clinic**  
for the practice  
of obstetrics  
and gynecology

2245 Stantonsburg Rd.  
(across from hospital)  
For appointments:  
Call 757-3131

# Acknowledging Gifts Is Job For Happy Couple

Dear Abby: As a devoted fan, I have admired your wisdom and solid horse sense. I am also greatly impressed with your gracious willingness to accept criticism when you goof. Well, you goofed.

An embarrassed mother wanted to know how to handle her friends who ask if her son and his bride had received their wedding gift after nearly a year had passed. You said the friends were putting the "blameless" parents on the spot — that the parents should give the friends their children's telephone number so they could ask directly. You missed the point, Abby.

The parents are not blameless! The people who sent the gift are friends of the Parents — not the free-loading children. (They may even be unknown to the newlyweds.)

Wedding invitations are issued by the parents, who are responsible for the good or bad manners of their children.

You should have advised the parents to write a formal letter of apology to the friends whose wedding gift had not been acknowledged — and send a copy to their son, along with a zinger, telling him to get his bride off the dime and acknowledge their wedding presents! — Pasadena Grandpa

Dear Grandpa: I'll take my lumps when I goof, but I stand by that answer. I hold that the parents of children who are old enough to marry are not responsible for their children's bad manners. I venture to say that most children have been taught to say "thank you" when they receive a gift, and if they are negligent or lazy, you can't blame their parents.

Dear Abby  
Abigail Van Buren

Also, you suggest that the parents should tell their son to get his bride "off the dime" and acknowledge their wedding presents!

I submit that the wedding presents are his as well as hers, and although the bride usually writes the thank-you notes, the responsibility is not necessarily hers entirely. Today, with the majority of brides working outside the home, acknowledging wedding gifts should be a shared responsibility.

Dear Abby: I am writing my will and must make some decisions. I have two large albums filled with family pictures that go back three generations. I have six children and many grandchildren.

How shall I distribute these albums? I want to be fair. — Puzzled In The Autumn Of My Life

Dear Puzzled: Please don't make the mistake most parents make and leave everything to the eldest, or only to the daughters.

Invite each one of your children — and grandchildren — to review the albums and make notes of the pictures they want. With today's technology, excellent duplicates — as good as or better than the originals — can be made. If money is a consideration, perhaps the heirs will pay for the cost of reproducing the originals.

Dear Abby: During my 10 years as a day-care provider, I have heard every excuse in the book for not

picking up a child on time. (The prize was a woman who was supposed to pick her child up at 3 p.m.; she came at 11 p.m. — saying she'd had drop-in company and couldn't get rid of them!)

While waiting for people to pick up their children, I have missed dental appointments (which I had to pay for), my daughter's piano recital, my son's no-hitter, and the funeral of a dear friend, not to mention countless meetings, hair appointments and manicures.

I have tried charging overtime, but charging is one thing, and collecting is another.

It's sad to see how upset and anxious these children are when they have to wait an hour or two for their pickups. It wouldn't be so bad if their moms would call to say they would be late but most of them never bother to call, and the kids are wondering if their mom's been in an accident, had to work late or, worse yet, just forgot them.

About money: There are women who always forget their checkbooks, and others who are "a little short this week" and will pay me on Monday. When I first went into the day-care business, I was told (by a woman who was once in the business) to get my money up front. That's a laugh! I wish I had the money some of my clients still owe me.

I could go on and on, but it's bad for my blood pressure. I really do love children, but some of their parents should have remained childless. — Also Fed Up

Universal Press Syndicate

# Couple Celebrates Anniversary



MR. AND MRS. DAIL

Mr. and Mrs. Walter A. Dail Sr. of Winterville celebrated their 50th wedding anniversary Sunday.

They were honored at a family dinner given by their children and grandchildren. Their children are Ashley Dail and Anna Bridgman, both of Winterville, Bettie Wade of Ayden and Edward Dail of Rich-

mond, Va. They also have nine grandchildren.

**Piano Lessons For Children**  
Call: 756-7821  
Sherwood Dr.

**AUDIO VISUAL SERVICE**  
Specializing In The Repair Of  
**MICROWAVE OVENS**  
and VCRs

Arlington Business Park  
400 W. Arlington Blvd., Suite 101-F  
(Next to Greenville Middle School)  
Mon.-Fri. 9-8, Sat. 9-1  
355-3506 • 355-6688

**NC Academy of Dance Arts**  
OFFICIAL SCHOOL OF DANCE ARTS THEATRE

- **OUTSTANDING CURRICULUM:** Classes in ballet, jazz, tap, modern for children and adults
- **OUTSTANDING GUEST ARTISTS:** Frank Wagner: Radio City, N.Y.C. (1981-82) Jeremy Blanton: Joffrey II, N.Y.C. (1982) Petrus van Muyden: San Francisco Ballet, NCSA (1983-84) Robert Small: N.Y.C. (1986) David Wanstreet: Univ. of Miss. (1985-88) Marcus Alford: Atlanta (1989) Joseph Carow: New Jersey Ballet (1989)
- **OUTSTANDING:** because N.C. Academy of Dance Arts cares about each student's total development

• Special Adult Classes • Tap and Jazz For Boys

For further information, call 355-2140  
P.O. Box 3777, Greenville, N.C. 27836

## WHOLESALE OUTLET

2500 CHARLES STREET EXTENSION  
756-8652

<p><b>MISS CLAIROL SHAMPOO FORMULA</b></p> <p><b>3<sup>59</sup></b></p>	<p><b>BACTINE SPRAY</b> 3 OZ.</p> <p><b>2<sup>59</sup></b></p>	<p><b>JOHNSON'S BABY POWDER</b> 14 OZ.</p>
<p><b>ATRA PLUS 5's</b> <b>ATRA CARTRIDGES 5's</b> <b>TRAC II PLUS 5's</b></p> <p><b>2<sup>09</sup></b> YOUR CHOICE</p>	<p><b>TRAC II CARTRIDGES</b> 5's</p> <p><b>2<sup>09</sup></b> YOUR CHOICE</p>	<p><b>JOHNSON'S BABY CORNSTARCH</b> 14 OZ.</p> <p><b>1<sup>79</sup></b> YOUR CHOICE</p>
<p><b>MYLANTA LIQUID</b> 5 OZ.</p> <p><b>1<sup>49</sup></b></p>	<p><b>PHILLIPS LAXCAPS</b> 24's</p> <p><b>2<sup>49</sup></b></p>	<p><b>TRENDAR MENSTRUAL PAIN TABLETS</b> 20's</p> <p><b>1<sup>79</sup></b></p>
<p><b>STRIDEX BIG PAD</b> 42's</p> <p><b>3<sup>09</sup></b></p>	<p><b>ALLEREST SINUS PAIN TABLETS 20's</b> <b>ALLEREST TABLETS 24's</b> <b>ALLEREST NO DROWSINESS TABLETS 20's</b></p> <p><b>2<sup>29</sup></b> YOUR CHOICE</p>	<p><b>WELLA SO FINE SHAMPOO MIST 3.5 OZ.</b> <b>WELLA SO FINE CONDITIONER MIST 3.5 OZ.</b></p> <p><b>1<sup>69</sup></b> YOUR CHOICE</p>
<p><b>BEN-GAY SPORTS GEL</b></p> <p><b>1<sup>49</sup></b></p>	<p><b>WART-OFF</b> 5 OZ.</p> <p><b>2<sup>69</sup></b></p>	<p><b>ORAJEL MAXIMUM STRENGTH</b> 3/16 OZ.</p> <p><b>2<sup>59</sup></b></p>
<p><b>ESOTERICA MEDICATED FADE CREAM</b> 3 OZ.</p> <p><b>3<sup>79</sup></b></p>	<p><b>PURPOSE MOISTURIZER LOTION</b> 4 OZ.</p> <p><b>6<sup>19</sup></b></p>	<p><b>STORE HOURS</b> <b>MONDAY-FRIDAY 9 AM-8 PM</b> <b>SATURDAY 9 AM-6 PM</b></p>

Prime Time Tonight

WEDNESDAY EVENING								
	7:00	7:30	8:00	8:30	9:00	9:30	10:00	10:30
2	Movie: "Florence Nightingale"						700 Club	
4	Business Rpt.	Globe Watch	National Geographic	Movie: "My Man Godfrey"		Long Ago, Far		
5	Ent. Tonight	Lose or Draw	Smothers Brothers	Jake and the Fatman		People Magazine on TV		
7	Cosby Show	Current Affair	Tender Is the Night	News				
9	Cosby Show	Night Court	Unsolved Mysteries	Night Court	Nikki	News Special: Gangs		
11	USA Today	Lose or Draw	Smothers Brothers	Jake and the Fatman		People Magazine on TV		
12	Wheel-Fortune	Jeopardy!	Gro. Pains	Head of Class	Hooperman	Coach	China Beach	
15	Bugs & Pals	Fraggle Rock	Movie: "Where the Spies Are"				Carey Tr't	
DIS	Just Around...	Dinosaurs	Sidekicks	Danger Bay	Movie: "Moon Pilot"			
ESPN	SportsCenter	Track and Field: Weltklasse		Billiards: Snooker	PBA Bowling: Senior Pro Doubles			
HBO	Movie: "The Bride"			Movie: "Dirty Dancing"				
LIFE	HeartBeat	Spenser: For Hire		Movie: "Between Two Women"				
MAX	Hitler's SS: Portrait in Evil	Movie: "Rent-A-Cop"		Movie: "Die Hard"				
SHOW	Movie: "Uncle Tom's Cabin"	Turn of the Screw		Movie: "Bad Dreams"		Super Dave		
TBS	Andy Griffith	Paris '89	Major League Baseball: Atlanta Braves at St. Louis Cardinals					
TMC	Movie: "Down Twisted"	Movie: "Stranded"		Movie: "Dirty Harry"				
USA	Miami Vice	Murder, She Wrote		Movie: "Peggy Sue Got Married"				

For complete TV programming information, consult your weekly TV SHOWTIME from Sunday's Daily Reflector.

## Television's 'People Magazine' Strives To Match The Quality

By Larry Neumeister  
THE ASSOCIATED PRESS

NEW YORK — As one editor at People magazine recalls, there was no "burst of pride" among the staff when some of their stories began appearing two years ago on a televised edition of the weekly.

But Hal Wingo, the magazine's assistant managing editor, says "People Magazine on TV" is winning over the more than 150 writers, editors, artists and production staff as it prepares to air its fifth edition on Wednesday.

"Some of them were disappointed in it in the beginning," he said of the staff's reaction. "I believe this next show is the best reflection yet of what the magazine is all about. It feels like the magazine."

The staff was concerned, he said,

because a quality TV show would stimulate sales of the magazine, which sells a majority of its copies on newsstands. Generally, no subject airs unless it already was in print.

This time, the one-hour special on CBS includes an interview with Christie Brinkley and Billy Joel in which the singer strikes back at those who claim the couple will split, and a segment about Robert Redford's fight to save an endangered Hispanic community.

It also looks at the case of a woman who has been in jail for two years because she refused to allow her daughter to visit the ex-husband she claims raped the girl.

It takes the viewer to Zambia to hear about the successful efforts of a U.S. couple who went there five years ago to teach local residents the importance of making their gov-

ernment protect wild animals being killed off by poachers.

And it includes an interview with professional tennis player Michael Chang and a first-person narrative from the mother of two 5-year-old conjoined sisters.

Wingo said the mix of celebrity interviews, features and more serious subjects is closer to what the magazine strives to publish each week.

The magazine went through the same sort of search for the best combination of stories when it started, he said.

"Nobody had ever done this before. We kind of made up the rules as we went along," Wingo said.

Duplicating the broad mix of 20 to 25 stories in the magazine was difficult on the televised special, which could only include six to eight segments, and it irritated the magazine's staff, he said.

But Ward Sylvester, supervising producer of the TV special, said he'd "like to think we've always reflected the magazine."

"Many of our stories were covers," he said. "We look at the magazine and try to think of stories that will translate well."

Sylvester said the show has improved since the arrival of KCBS-TV Los Angeles anchor Bree Walker, who was host for the first time when it aired last in April.

"I lean toward the hard news features, that's my bent," she said. "One of the things that they wanted to do was try to make 'People Magazine on TV' a more topical and newsier show. Issue-oriented features will be a bright spot of this next show."

Walker added: "We have to be a little forgiving the first time around on any new show."

## 'Parenthood' Tops Cash Flow

THE ASSOCIATED PRESS

HOLLYWOOD — "Parenthood" pleasures and the deep-water perils of "The Abyss" were box-office favorites this weekend, heading a list that included loony comedies and die-hard blockbusters.

Universal's "Parenthood," starring Steve Martin, took in \$9.7 million in its second week of release, according to figures released Monday by Exhibitor Relations Inc.

"The Abyss," with the lesser-known Ed Harris and Mary Elizabeth Mastrantonio, scored a hit with its hardware-heavy tale of close encounters in the deep ocean. The big-budget film earned \$9.3 million in its debut week. But the 2-hour and 20-minute running time cost the movie one showing per day in many theaters, contributing to an unimpressive per-screen average of \$6,079.

The return of sarcastic slasher Freddy Krueger brought "A Nightmare on Elm Street 5: The Dream Child" to third place in its first weekend of release. "Nightmare" grossed \$8.1 million, followed by the Tom Hanks-drooling dog police comedy "Turner and Hooch" in fourth with \$6.3 million.

### Watermelon Festival

KITTY HAWK — The Wacky Watermelon Festival will be held at Kitty Hawk on Friday and Saturday. Festivities include a visit from the North Carolina Watermelon Queen, Denise O'Sullivan; watermelon games such as dash races, olympic throw, bowling, carving contest, seed spitting contest and a kamikaze throw off the Rogallo Tower, and a Saturday regatta. A live remote will be on hand from noon until 3 p.m. Events begin at noon on Friday and at 10 a.m. on Saturday. The location is at the Kitty Hawk Connection at Mile Post 13 across from Jockey's Ridge. For more details call 441-4124.

### Love Warriors

BREVARD — The guitar-vocal duo of Tuck and Patti will perform in concert at 8 p.m. Friday at Brevard College. The couple's latest release "Love Warriors," currently holds a top position on Billboard's contemporary jazz chart. For more details and ticket reservations, call 704/884-2019.

### Actor Charged

FORT LAUDERDALE, Fla. (AP) — Alan Paley, an actor with television credits going back to "Surfside Six" and "Sea Hunt," faces attempted armed robbery charges after suffering a gunshot wound.

Paley, 54, who on his acting resume lists "experience with police '38," allegedly used such a weapon trying to stick up a stranger wearing a Rolex watch and gold ring in a hotel restroom last week, police say.

Fort Myers golfing executive William Donald, 55, said he wrestled the gun away and chased Paley with it, shooting him in the abdomen as he climbed into his car. "He was a pretty good actor," Donald said. "Maybe that's why he felt he could rob me."

The romantic comedy "When Harry Met Sally..." with Billy Crystal and Meg Ryan as best friends who become lovers, finished in fifth with ticket sales of \$6.2 million. "Lethal Weapon 2," the police adventure sequel with Mel Gibson and Danny Glover, was next with \$6.1 million.

Still going strong in seventh place was "Batman," collecting \$5 million. "Batman" has now sold \$223 million worth of tickets. It was trailed by the fading Sylvester Stallone prison movie "Lock Up," in eighth with \$3.34 million.

Rounding out the Top 10 were the family comedy "Honey, I Shrunk the Kids" with \$3.33 million in ninth and the withering "Young Einstein" with \$2.1 million.

Here are the top movies for the weekend as tallied by Exhibitor Relations, with distributor, weekend gross, number of theater screens, average per screen, total gross and number of weeks in release.

1. "Parenthood," Universal, \$9.7 million, 1,300 screens, \$7,440 per screen, \$30.3 million, two weeks.
2. "The Abyss," 20th Century Fox, \$9.3 million, 1,533 screens, \$6,079 per screen, \$13 million, one week.
3. "A Nightmare on Elm Street 5: The Dream Child," New Line, \$8.1 million, 1,902 screens, \$4,266 per screen, \$8.1 million, one week.

4. "Turner and Hooch," Disney, \$6.3 million, 1,880 screens, \$3,357 per screen, \$38.9 million, three weeks.

5. "When Harry Met Sally..." Columbia, \$6.2 million, 1,171 screens, \$5,292 per screen, \$45.9 million, five weeks.

6. "Lethal Weapon 2," Warner Bros. \$6.1 million, 1,830 screens, \$3,318 per screen, \$112.1 million, six weeks.

7. "Batman," Warner Bros., \$5 million, 1,770 screens, \$2,840 per screen, \$223 million, eight weeks.

8. "Lock Up," Tri-Star, \$3.34 million, 1,384 screens, \$2,415 per screen, \$12 million, two weeks.

9. "Honey, I Shrunk the Kids," Disney, \$3.33 million, 1,451 screens, \$2,293 per screen, \$108.2 million, seven weeks.

10. "Young Einstein," Warner Bros., \$2.1 million, 1,217 screens, \$1,686 per screen, \$7.1 million, two weeks.

Dark Theatre  
\$1.50 ALL TIMES  
**Karate Kid Part 3**  
Weekdays 7:00-9:10  
Sat., Sun. 2:00-4:10-7:00-9:10 -PG-

CINEPLEX ODEON THEATRES  
TENTH ANNIVERSARY  
\$3.00 BARGAIN MATINEE DAILY  
ALL SHOWS BEFORE 6:00 PM  
AT SELECTED THEATRES—CHECK SHOWTIMES  
PLITT  
Carolina East Center  
7:56-1440  
LOCK UP (M) 2:15-4:45-7:00-9:30  
SORRY NO PASSES ON COUPONS ACCEPTED  
VP ACCEPTED DURING MATINEE ONLY  
NIGHTMARE ON ELM STREET 5 (M) 8:45-10:50-7:00-9:45  
SORRY, NO PASSES ON COUPONS ACCEPTED  
LETHAL WEAPON 2 (M) 2:00-4:30-7:10-9:35  
SORRY NO PASSES ON COUPONS ACCEPTED  
VP ACCEPTED DURING MATINEE ONLY  
YOUNG EINSTEIN (PG) 2:30-4:45-7:05-9:15

Consolidated Theatres  
All Seats \$2.75 EVERY DAY  
BUCCANEER MOVIES  
1:15-4:00-7:00-9:35  
**THE ABYSS**  
No Passes PG-13  
2:10-4:40-7:10-9:40  
**PARENTHOOD**  
PG-13  
1:00-3:15-5:20-7:30-9:45  
**FRIDAY 13th Pt. 8**  
No Passes R

PLAZA CINEMA  
Plaza Mall • 756-0088  
Afternoon Shows Only \$2.75  
CARMIKE

When Harry Met Sally...  
-R- 2:00-4:15-7:00-9:15

Rude Awakening  
AARON RUSSO FILM  
CHEECH MARIN ERIC ROBERTS JULIE HAGERTY ROBERT CARRADINE  
BUCK HENRY LOUISE LASSER TONY WILLIAMS ANDREA MARTIN JEFF OF YOUNG  
"RUDE AWAKENING"  
"PAUL TRIED TO MEL BOURNE... TOM SCIEL... NEIL LEVY... RICHARD LA GRAVENSE... AARON RUSSO  
ORION  
2:05-4:10-7:05-9:10

A JOHN HUGHES FILM  
JOHN CANDY  
OH NO, IT'S...

Uncle Buck  
He's crude. He's crass.  
He's family.  
"UNCLE BUCK"  
MUSIC BY IRA NEWBORN  
DIRECTED BY JOHN HUGHES AND  
TOM JACOBSON  
WRITTEN BY JOHN HUGHES  
DIRECTED BY JOHN HUGHES  
UNIVERSAL RELEASE  
© 1989 UNIVERSAL PICTURES  
ALL RIGHTS RESERVED. MAY BE SEEN IN THEATERS IN CALIFORNIA  
GET A BUCK OFF  
Love for one dollar off  
any movie tickets  
CLIP-OUT  
Only one coupon  
redemption per purchase  
Maximum purchase may  
apply. Offer valid only on  
tickets purchased for adults.  
Offer valid through Thursday  
August 16, 1989.  
Offer valid only with full  
price admission to "Uncle Buck."  
This offer may not be  
combined with any other  
discount and is not  
redemtable for cash.

2:10-4:20-7:10-9:20

## On The Town

Here are some of the evening entertainment activities scheduled in Pitt County in the coming week:

Attila  
Wednesday: WRQR Comedy Zone.  
Friday: WRQR Comedy Zone.

Hard Times Night Club  
Wednesday: Mike El, impressionist. Doors open at 8:30 p.m.  
Friday and Saturday: Leesburg Band. Doors open at 9 p.m.  
Phone: 758-3886.

Rio! at the Greenville Hilton  
Wednesday: Muscles in motion. Fitness competition.  
Thursday: Ladies night.  
Friday: Fun Fridays; expect the unexpected. No cover charge before 8:30 p.m. Music by Dr. Doug.  
Saturday: Weekend bash; dance music and lighting by Dr. Doug. No cover before 8:30 p.m.  
Tuesday: Classic Rock and Roll. Blue jeans and tennis shoes may be worn.  
Hours: 7 p.m. to 1 a.m.

Sports Pad  
Wednesday: Wild Wednesday; Ladies night and day. Ladies play free all day, TV sports all night.  
Thursday: "Thumping" Thursday. Free balloons. Rock and roll music provided by John, Jim and Jane, disc jockeys.  
Friday: Fabulous Friday. Free popcorn and balloons. Upbeat rock and roll music. T-shirt sale.  
Saturday: Challenge billiards, air hockey, basketball. TV sports all day. Disc jockey plays requests. Free balloons and popcorn.  
Monday: Mild Monday. Free popcorn, air hockey, challenge billiards, Monday night sports on TV.  
Tuesday: Tell Tell Tuesday. Music by request with disc jockey Jim and John.  
Hours are noon to 2 a.m. daily. For information, call 757-3658.

Sharkey's  
Wednesday: Midnight Madness. Free Pizza at midnight; drink special.  
Thursday: Import Night. International party. Standing room only after 10 p.m.  
Friday: "Dress Up" party. Dancing at midnight.  
Saturday: Sharkey's dance party.  
Monday: Bartender's specials. Monday night sports in stereo on TV; snacks.  
Tuesday: Dance Party. Ladies' choice drink special; bartender's choice.

To include a club's schedule in 'On The Town,' call The Daily Reflector at 752-6166 before the close of business each Monday. There is no charge for the entertainment schedule, and those who call are asked to leave their name and telephone number so that information can be verified.

SPORTS PAD  
Family Billiards & Sports Bar  
• FREE POPCORN & BALLOONS  
• ARCADES • AIR HOCKEY  
• BASKETBALL  
Open Daily At Noon • 757-3658  
CORNER OF 5TH & COTANCHE • DOWNTOWN  
"Greenville's Plushest  
Cocktail Lounge"  
(Located Beside SPORTS PAD)  
Daily Drinks Specials  
Dancing Nightly To Your Favorite Songs  
All ABC Permits—Private Parties Booked  
Nobody has ever bet enough on the winning horse.  
Unknown

SHRIMP  
DELICIOUS  
BIG SHRIMP PLATTER  
JUST \$4.99  
■ 10 Jumbo Shrimp (lightly battered, golden fried)  
■ 5 Hush Puppies ■ French Fried Potatoes  
■ Cole Slaw ■ Choice of Tartar or Cocktail Sauce  
SMALL SHRIMP PLATTER  
5 Shrimp, JUST \$2.99 Cole Slaw, and  
3 Hush Puppies, Choice of Tartar  
French Fried Potatoes, or Cocktail Sauce.  
S&S  
cafeterias  
Carolina East Mall  
Mon.-Fri. 11 a.m.-2:15 p.m., 4:30 p.m.-8 p.m.  
Sat. 11 a.m.-8 p.m., Sunday 11 a.m.-6 p.m.



# Low Prices. And More.

Including The Best Variety Anywhere!

**Double  
Manufacturers  
Coupons**  
SEE STORE FOR  
DETAILS

COPYRIGHT 1989 - THE KROGER CO. ITEMS AND PRICES GOOD SUNDAY, AUG. 13, THROUGH SATURDAY, AUG. 19, 1989, IN

WE RESERVE THE RIGHT TO LIMIT QUANTITIES. NONE SOLD TO DEALERS.

**ADVERTISED ITEM POLICY**—Each of these advertised items is required to be readily available for sale in each Kroger Store, except as specifically noted in this ad. If we do run out of an advertised item, we will offer you your choice of a comparable item, when available, reflecting the same savings or a raincheck which will entitle you to purchase the advertised item at the advertised price within 30 days. Only one vendor coupon will be accepted per item purchased.

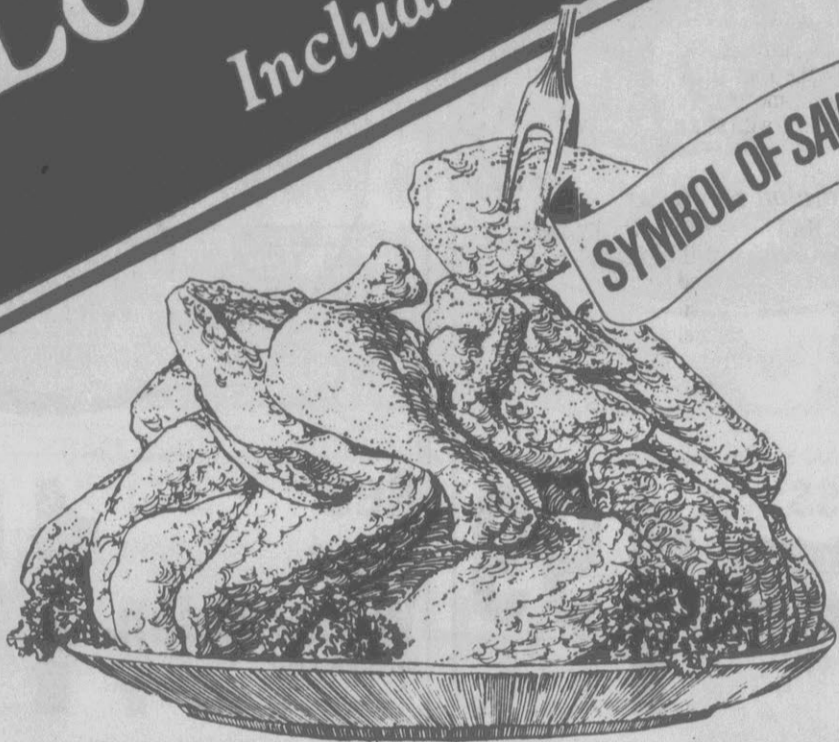

U.S. Grade A  
**Holly Farms**  
Whole Fryers lb.

**59¢**

California  
**O'Henry Peaches**  
Pound

**69¢**

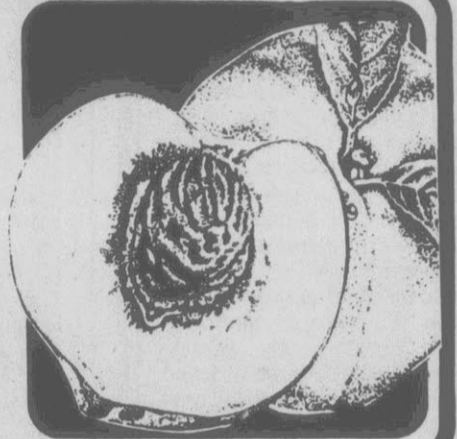

Spotlight  
**Bean Coffee**  
1-lb. Bag

**\$1.29**

3-LB. BAG . . . \$3.85  
DECAFFEINATED 1-LB. BAG . . . \$1.99



U.S. GOV'T GRADED CHOICE GRAIN  
FED BEEF "UNTRIMMED WHOLESALE CUT"  
10-12-LB. AVG.

**Whole Boneless  
Sirloin Tip**  
Pound

**\$1.59**  
SLICED  
FREE

MAPLE RIVER 7-9-LB. AVG.  
**Whole Boneless  
Smoked Ham**  
Pound

**\$1.69**

NONRETURNABLE BOTTLE, DIET COKE.  
CAFFEINE FREE DIET COKE OR

**Coca Cola  
Classic**

**89¢**

12 pk.  
**Cokes . \$2.79**



## KROGER DOLLAR DAYS

BUTTERMILK, SKIM, LIGHT 'N' LIVELY,  
HOMOGENIZED OR

**Sealtest 2%  
Lowfat Milk**  
½-Gallon

**\$1.00**

KROGER REAL SOUR CREAM DIPS  
2-8-OZ. CTNRS. . . \$1.00



FROZEN  
**Fox De Luxe  
Pizzas**  
6.8-7.6-oz.

**2 \$1**  
For

KROGER GRADE A LARGE EGGS 18-CT. . . 99¢



**Tony  
Dog Food**  
15-oz. Cans

**5 \$1**  
For



IN OIL OR WATER  
**Kroger Chunk  
Light Tuna**  
6.5-oz.

**2 \$1**  
For



(10-LBS. PLUS 2-LBS. FREE)

**Tidy  
Cat 3**  
12-lbs. Bonus Pack

**2 \$3**  
For

TIDY CAT 3 LINERS 4-CT. . . 2 FOR \$3.00



**Polar Pak  
Ice Cream**  
½-Gallon

**\$1.00**

KROGER DRY ROASTED PEANUTS  
12-OZ. . . \$2.00



# Pest-Fighting Chemicals Leave Roaches 'Forever Young'

By Malcolm Gladwell  
LAT-WP NEWS SERVICE

Ever since civilized man first turned on the kitchen light and spied a cockroach running for cover, relations between humans and the most loathed of household insects have been strained.

Cockroaches have been paralyzed, asphyxiated, doused with every conceivable poison and clubbed endlessly with blunt objects — all in an often fruitless battle to rid the world, or at least the kitchen, of roaches.

But now, in what is best described as a new spirit of roach-man rapprochement, entomologists and pest-control experts have begun to shift their strategy, moving away from extermination and toward managing roach populations at minimal levels and modifying their biology.

Behind the new roach detente are several compounds known as insect growth regulators (IGRs), which offer an environmentally friendly alternative to conventional insecticides that are widely felt to be too toxic, and in some cases too ineffective, for widespread use.

Unlike most existing poisons, IGRs don't try to kill cockroaches outright. In fact, the leading IGRs, known as juvenile hormone analogues, aren't poisons in the traditional sense. Instead, they are chemical copies of hormones that the roach uses to govern its own larval development.

Given to the insect in large enough quantities, the juvenile hormones trap the roach in the insect equivalent of pre-adolescence, leaving it as healthy and vigorous as any other juvenile cockroach, but without the sexual maturity to reproduce.

"We call it the Peter Pan syndrome," said Roger Meola, a roach expert at Texas A&M University. "They're forever young."

The appeal of insect growth regulators is their specificity. While many insecticides are broad-acting toxins poisonous not just to cockroaches, but in some cases, to any other organism they touch, juvenile hormones affect roaches and nothing else.

One hormone known as hydroprene, in fact, is so selective that it is effective only during a 5- to 18-day period just before the roach's final metamorphosis from adolescence to adulthood.

During that critical period, the IGR keeps the level of juvenile hormone in the roach artificially high, just when it is supposed to drop and be replaced by adult hormones that drive the insect's transformation to maturity.

The result is that the cockroach is crippled as its moves into adulthood, with deformed wings and inadequately formed genitalia.

Because these sterile roaches live just as long — in fact longer — than the typical four months of their untreated counterparts, IGR administration can take up to eight months, or two roach generations, to have an effect.

Other IGRs offer more immediate results. One set of compounds, for example, blocks the roach's ability to manufacture the material known as chitin, which makes up the insect's hard outer shell, or exoskeleton.

At each of the cockroach's five molting stages during development, the chitin inhibitor is potentially deadly, since once the roach sheds one skin, it cannot make another.

Unlike many other growth regulators, this one is not specific to roaches. In fact, it works on any organism that produces chitin, which

includes most other arthropods such as insects and crustaceans.

For this reason, chitin inhibitors are considered suitable only for agricultural uses that will not allow them into streams or lakes to affect shrimp and other crustaceans.

"Some of the more conventional insecticides will affect the nervous system of a cockroach and will also affect the nervous system of a mammal," said Donald Cochran, an entomologist at Virginia Polytechnic Institute and State University. "But these (juvenile hormones and chitin inhibitors) both attack systems that don't have any parallel in a human."

The big question surrounding IGRs, however, involves their effectiveness. In field trials at the University of Florida, hydroprene was

found to be 95 percent as effective as conventional pest-control methods after seven months. The chemical companies currently promoting wider use of IGRs against cockroaches claim high levels of effectiveness for their products.

The catch is that to bring down roach populations significantly, juvenile hormones have to sterilize an unusually high number of insects — more than 80 percent — because otherwise the method simply improves the survival rate and fertility of those unaffected by taking away other roaches with which they would have had to compete.

"We haven't seen the same population crashes that other researchers have," said Michael Rust, an entomologist at the University of

California at Riverside. "Juvenile hormones are a potential alternative, but they are not a panacea."

Still, several manufacturers are selling products based on IGRs. Hydroprene, for example, is sold as Gencor by Zoecon Corp. Tree companies make versions of chitin inhibitors — Larvadex by Ciba-Geigy, Baysir by Mobay Chemical, and Dimilin by Roussel Bio.

There is also some doubt about how durable IGRs will be as a form of pest control. Because of the large size of most domestic cockroach populations and their reproductive speed, some mutant roaches always will have the unusual ability to break down any toxin before it can take effect.

Those select few survive the initial

chemical onslaught and pass on their unique genetic characteristics to their offspring, creating a new and harder generation.

Even the most potent of chemicals have, over time, seen their effectiveness reduced through this process of natural selection. At first, researchers thought it was unlikely this same scenario would be repeated for juvenile hormones.

While it was understandable, after all, for an insect to have resistance to a foreign chemical, how could there be a roach that breaks down a copy of one of its own hormones?

However, recent research with fleas subjected to the same juvenile hormone techniques as cockroaches shows that resistance is possible, and that in critical stages of devel-

opment some insects have a higher tolerance for juvenile hormones, an unusually effective method for breaking the chemical down or a particularly adept way of avoiding sources of it in the environment.

"Say the insect picks up the hormone through its feet," said Ted Shapas, manger of insecticides research at American Cyanamid, maker of Combat roach poison. "Then it's not unlikely for it to develop thicker feet. That may sound facetious. But it's the type of things insects do to protect themselves."

"I don't think anything is out of the question with insects," said George Rambo, director of research at the National Pest Control Association. "Especially with cockroaches."

**SPEND 26¢ LESS**



**NORTHERN**

**Northern Bath Tissue** 4 99¢  
ASSORTED roll LIMIT ONE pkg.

**SPEND 90¢ LB. LESS**



**Boneless Rump Roast** 1 99  
USDA CHOICE BEEF  
OR BOTTOM ROUNDS U.S.D.A. CHOICE BEEF lb.

**SPEND 40¢ LESS**



**Red Ripe Watermelon** 1 59  
SWEET & JUICY 1/2 melon

**SPEND 30¢ LESS**

**DOUBLE COUPONS** SEE STORE FOR DETAILS

**California Cantaloupes** 88¢  
SWEET & JUICY

NOT THIS 18 SIZE MEDIUM BUT THIS 15 SIZE LARGE

**SPEND 20¢ LESS**

SLICE • MTN DEW • PEPSI FREE • REG & DIET

**Pepsi Cola** 1 09  
2 ltr. btl.

**SPEND 20¢ LESS**



**Apple Juice** 89¢  
64 oz. btl.

**SPEND 90¢ LB. LESS**



**Boneless Round Steaks** 1 99  
FAMILY PACK BOTTOM U.S.D.A. CHOICE BEEF lb.

**SPEND 10¢ LB. LESS**



**O'Henry Peaches** 89¢  
CALIFORNIA LARGE RIPE lb.

**SPEND 5¢ LESS**



**Pork & Beans** 3 100  
LUCK'S 15 oz. cans

**SPEND 40¢ LESS**



**Eight O'Clock Coffee** 1 99  
RICH & MELLOW 1 lb. bag

**SPEND 91¢ LB. LESS**



**Tailless T-Bone Steaks** 4 99  
U.S.D.A. CHOICE BEEF lb.

**SPEND 10¢ LB. LESS**



**California Tomatoes** 89¢  
X-LARGE VINE RIPEN lb.

**SPEND LESS VALUES**

**A&P Filler Paper** 89¢  
WIDE RULE 200 ct. pkg.

ASSORTED REG. DINNERS Budget Gourmet Dinners 3 10 500

SEALTEST Sour Cream 59¢  
8 oz. ctn.

ASSORTED Light 'N Lively Yogurt 3 89¢  
8 oz. ctns.

**SPEND 20¢ LESS**

**Turkey Breast** 3 99  
OVEN ROASTED SHAVED lb.

NEW YORKER American Cheese 2 89  
lb.

JUMBO Kaiser Rolls 99¢  
6 ct. pkg.

FRESH BAKED French Bread 79¢  
16 oz. loaf

**SPEND 20¢ LB. LESS**

**Perdue Fresh Whole Fryers** 89¢  
U.S.D.A. GRADE A lb.

FROZEN • SKINLESS Sliced Beef Liver 99¢  
lb.

NEW YORK • U.S.D.A. CHOICE BEEF Boneless Strip Steaks 5 99  
lb.

FAMILY PACK CHOPPED Fresh Beef Steak Patties 1 89  
lb.

**SPEND 20¢ LESS**

**Green Leaf Lettuce** 79¢  
CALIFORNIA CRISP ORBOSTON RED ROMAINE Lrg. Bch.

CRISP FIRM California Carrots 99¢  
2 lb. bag

RICH IN VITAMIN A Green Onions 3 100  
bchs.

LOW IN CALORIES Crisp Cucumbers 4 100  
large size

## Nags Head Dance

**NAGS HEAD** — A Raleigh orchestra is the highlight of the Big Band Preservation Society's dance at the Armada in Nags Head Thursday.

The 18-piece Casablanca Orchestra, under the direction of Mark Whitney, is part of a summer series of dances presented by the Big Band Preservation Society. The society hopes to increase interest and preserve America's big band sounds of the 1930s and 1940s.

Throughout the vacation season, the group offers name band leaders for an evening of dancing pleasure, 8:30 p.m. to 12:30 a.m.

Others scheduled are the Russ Morgan Orchestra, Sunday, Sept. 17; and the Glenn Miller Orchestra, Wednesday, Oct. 11, and a special, added attraction will be the Tommy Dorsey Orchestra Thursday, Dec. 7.

Tickets are available in several Outer Banks locations, including the Armada; or by mail from the Big Band Preservation Society, Box 219, Nags Head, 27959; telephone 441-4644.

For details, call Wally Gray at 461-4644.

Read "Yes" in Sunday's Paper  
NIE 752-6166

**When WE pay less, YOU pay less! When WE pay less, YOU pay less! When WE pay less, YOU pay less!**

WIN AT LEAST  
**\$500<sup>00</sup>**  
IN CASH  
IN OUR BIG  
MONEY JACKPOT



**\$250<sup>00</sup>** ADDED EACH WEEK  
UNTIL WE HAVE A WINNER!

REGISTER JUST ONCE AND GET YOUR CARD PUNCHED EACH WEEK AND YOU MAY WIN  
WONDERFUL CASH DOLLARS!  
NOTHING TO BUY! YOU DO NOT HAVE TO BE PRESENT TO WIN.

LAST WEEK'S WINNER                      **NO WINNER**  
GET YOUR CASH MONEY CARD PUNCHED FREE THIS WEEK!

HEAVY WESTERN BEEF  
**T-BONE STEAKS**  
**2.99**  
LB.  
SAVE \$1.60 LB.

HOUSE OF  
RAEFORD  
FRYER LEG  
QUARTERS  
SAVE 20¢ LB.  
**3.39**  
LB.

SAVE \$1.20 LB.  
**SIRLOIN STEAKS**  
HEAVY WESTERN BEEF  
**2.39**  
LB.

SAVE 10¢ LB.  
FRESH WHOLE FAMILY PACK  
**PIG FEET**  
**49¢**  
LB.

SAVE 20¢  
**LUTER'S FRANKS**  
12 OZ.  
**99¢**

SAVE 30¢ LB.  
FRESH PORK  
**BOSTON BUTTS**  
**1.29**  
LB.

SAVE 30¢ LB.  
SMITHFIELD'S  
**SLICED BACON**  
**99¢**  
LB.

SAVE 20¢  
SMITHFIELD'S  
**SLICED BOLOGNA**  
**1.09**  
12 OZ.

**KRAFT BBQ SAUCE**  
ASSORTED 18 OZ.  
**1.09**

**KRAFT PARKAY**  
1 LB.  
**59¢**

PETER PAN NO SALT, CREAMY OR CRUNCHY PEANUT BUTTER 18 OZ.  
**1.79**

**FROZEN FOODS**  
10.4 OZ. SARA LEE **POUND CAKE** 1.69  
2 PK. PET RITZ **PIE SHELLS** 89¢  
18 OZ. FREEZER QUEEN **BROCCOLI WITH CHEESE SAUCE OR 28 OZ. DINNERS** 1.59

**KELLOGG'S FROOT LOOPS**  
15 OZ.  
**2.59**

**TREET**  
12 OZ.  
**99¢**

**LIPTON FAMILY TEA BAGS**  
24 CT.  
**1.69**

**TEXAS PETE HOT DOG CHILI**  
10 OZ.  
**3/1.00**

**CATES SALAD CUBES**  
16 OZ.  
**89¢**

**SKINNER SHORT ELBOW MACARONI OR REG. SPAGHETTI**  
7 OZ.  
**3/79¢**

**TIDE REG. UNSCENTED OR BLEACH**  
42 OZ.  
**1.89**

**FRITOS CORN CHIPS**  
10 OZ.  
**1.69**

**FOODLAND BREAD**  
24 OZ.  
**2/1.00**

**PRODUCE SPECIALS**  
**SUMMER CARNIVAL OF FRUIT SPECTACULAR**

**BUDWEISER OR BUD LIGHT BEER**  
12 PK. - 12 OZ.  
**5.89**

**MAXWELL HOUSE COFFEE INSTANT DECAF**  
8 OZ.  
**3.89**

**MAXWELL HOUSE COFFEE INSTANT**  
8 OZ.  
**3.39**

**BUNCH BROCCOLI**  
**89¢**

**RED FLAME SEEDLESS OR WHITE THOMPSON GRAPES**  
DELICIOUS  
**89¢ LB.**

**VELVET ICE CREAM**  
1/2 GAL.  
**1.29**

**BOUNTY TOWELS**  
ASSORTED  
**79¢**

**AWAKE DRINK**  
64 OZ.  
**79¢**

**BAKE-RITE SHORTENING**  
42 OZ.  
**99¢**

**5LB. BAG WHITE POTATOES** 1.19  
**JUICY NECTARINES** 59¢ LB.

WE GLADLY ACCEPT ALL OTHER STORE'S COUPONS

FOODLAND GIVES YOU SAVINGS YOU CAN COUNT ON!



**PEPSI**  
2 LITER  
**99¢**

**FOODLAND**  
WE KNOW WHAT YOU LIKE.

PRICES EFFECTIVE AUGUST 17, 18, & 19, 1989  
WE RESERVE THE RIGHT TO LIMIT QUANTITIES.  
WE GLADLY ACCEPT WIC AND U.S.D.A. FOOD STAMPS.  
WE ALSO ACCEPT ALL OTHER FOOD STORE COUPONS UNDER THE SAME CONDITIONS AS THEY.

Memorial Drive-Buyers Market  
Greenville

Mon-Sat 7 a.m.-10 p.m. Sun 7:30 a.m.-7 p.m.

**DELI SPECIALS**  
**ALL YOU CAN EAT 35 ITEM SALAD BAR**  
Applies to W. 5th St., Washington #1 store only.  
**TAKE OUT 1.99 LB.**  
**EAT IN 1.99 PER PERSON**  
**CHICKEN DINNER 8 PIECE WITH 1 PINT POTATO SALAD AND 4 ROLLS 5.98**  
**DAILY LUNCHEON SPECIALS**

**When WE pay less, YOU pay less! When WE pay less, YOU pay less! When WE pay less, YOU pay less!**

# FARM FRESH

We reserve the right to limit quantities and to correct typographical errors.

**Your Super Savings Center**

Prices Good: August 16-19, 1989



**Boneless Full Cut Round Steak**

**\$1.48** Lb



**Quarter Loin Pork Chops**

**\$1.38** Lb



**Perdue Split Chicken Breast**

**\$1.58** Lb



**North Carolina Tender Green Cabbage**

**19¢** Lb



**California Red Flame Seedless Grapes**

**88¢** Lb

## Everyday Low Prices....

- Kellogg's Raisin Bran..... 25.5 Oz **\$3.16**
- Ragu Homestyle Spaghetti Sauce ..... 32 Oz **\$1.19**
- Kraft Miracle Whip..... 16 Oz **\$1.30**
- Chef Boyardee Beef Ravioli ..... 15 Oz **79¢**
- Tide \$1.50 Off Label Detergent..... 147 Oz **\$6.99**



- Scottissue 4 Roll ..... **\$2.09**
- Clorox 5¢ Off Label Bleach ..... Gallon **\$1.07**
- Blue Bonnet Margarine... Quarters **2/\$1.09**
- Eggo Regular Waffles ..... 11 Oz **\$1.09**
- Minute Maid Frozen Orange Juice..... 12 Oz **\$1.49**

**Eagle Snacks**  
Thin Chips  
BBQ Thin Chips

**89¢** 6 1/2 Oz.

WHEN YOU'RE ENJOYING THOSE SUMMER FRUITS...



Don't Forget The Apples Apple® Computers that is! With your receipts they're helping our schools to strengthen the skills of our children.

See details at the store.  
**COMPUTERS FOR KIDS**



**Miller Suitcase**  
24 12 Oz. Cans

Regular  
Lite  
Genuine Draft

**\$9.99**



**Old Fashioned Banana Splits**

**In Our Ice Cream Shop**  
**\$1.89**



**Pepsi**  
2 Liter Bottle

Regular  
Diet  
Caffeine Free

**99¢**  
12 Pack 12 Oz. Cans **\$2.99**

## Help May Be Coming

Your Food Labels May Have To List More Of What's Inside

By Robert Greene  
THE ASSOCIATED PRESS

WASHINGTON — Supermarket shoppers, unsure what distinguishes "lite" bread from regular or "high-fiber" cereals from others, may be getting some help from the federal government.

Both Congress and the Food and Drug Administration are considering massive revisions in the FDA's nutrition labeling requirements, which date from 1973, when the vitamin and mineral content of foods was consumers' prime concern.

Now, much of the focus of healthy eating has shifted to foods' cholesterol, fat and fiber content — areas untouched by the current regulations.

Even the food industry, until now a foe of compulsory labeling, appears to be going along — for a price.

Says Dr. Frank Young, the FDA commissioner:

"The public is demanding change in this area and deserves nothing less than our maximum efforts to accomplish this change."

Young, testifying before a congressional committee recently, referred to the two biggest driving forces behind the heightened interest in nutrition — the Surgeon General's Report on Nutrition and Health, which cited dietary factors in five of the 10 leading causes of death, including cardiovascular disease and cancer, and the report by the National Research Council, "Diet and Health: Implications for Reducing Chronic Disease Risk."

The FDA commissioner said both reports, issued last year, "concluded that Americans could substantially reduce their risk of heart disease, cancer and many other chronic diseases through specific changes in eating habits."

A survey of shoppers taken this year for a food industry organization found that 94 percent of the poll's participants are concerned about the nutritional content of what they eat. Thirty-eight percent said they were most concerned about cholesterol, a 16-point jump in just one year.

But the FDA and members of Congress disagree on how to give the public what it wants.

Since 1973, when the FDA imposed nutrition labeling requirements for the first time, products to which nutrients have been added or for which a nutrition claim is made:

—Must be labeled with quantitative listings of calories, carbohydrates and protein.

—Must show, by "average" or "usual" serving, the percentages of the federal government's recommended daily allowance of protein, vitamin A, vitamin C, thiamine, riboflavin, niacin, calcium and iron contained in a product.

—Must list calories, protein content, carbohydrates, fat and sodium.

But those regulations were drawn up when vitamin and mineral content was the most prevalent consumer concern.

Now, what many shoppers want most is such information as a product's fat and fiber content, its "liteness" — or lack thereof — and how "naturally" it was made.

Some in Congress contend the FDA has not moved quickly enough to address those concerns.

Rep. Henry Waxman, D-Calif., and Sen. Howard Metzenbaum, D-Ohio, have introduced the "Nutrition Labeling and Education Act of 1989." If passed by both houses, the bill's sponsors say revised labels could begin appearing within 18 months of being signed by the president.

Twenty-three groups, including the American Heart Association and American Cancer Society, have endorsed the bill.

The legislation would require that labels list the serving size and number of servings per container; total calories, and calories broken down by total and saturated fat. Also required would be amounts, broken down by serving, of total, saturated and unsaturated fat; cholesterol; sodium; complex carbohydrates; protein; dietary fiber, and other nutrients.

The bill would also require that any health claims on labels that characterize the amount or relationship of calories, fat, cholesterol, sodium, carbohydrates, sugar, protein or dietary fiber to a disease or condition use terms defined by the secretary of health and human services and that the definitions be supported by a scientific consensus.

Another bill, introduced by Sen. Orrin Hatch, R-Utah, is similar to the Waxman-Metzenbaum bill except that it would preclude state labeling regulations.

Perceptions of the two proposals vary predictably.

The FDA says congressional action isn't necessary, that it can meet shoppers' needs without legislation. The grocery industry supports the Hatch bill. Activist consumer groups say any legislation that is adopted will need to address a variety of nutrition issues not now covered.

For its part, the FDA plans to hold five hearings around the country to ask people how they would like to see the current regulations changed.

For instance, the agency wants to know how much interest there is in writing definitions for commonly used terms, such as "low salt" or "reduced fat," whether there should be requirements manufacturers must meet in claiming their products help prevent disease; if minimum standards are needed to identify certain foods, and whether the public is willing to pay the added costs that would likely accompany new labeling requirements.

From the comments at those hearings, which haven't been set, the FDA

(See LABELS, D-2)



The Daily Reflector/Thomas Forrest

A lunch from home can provide all the essential nutrients as well as good-tasting food that offers never-ending variety

## Brown-Bagging From Home Can Beat Usual Machine-Deli Lunch

By Carol Deegan  
THE ASSOCIATED PRESS

NEW YORK — Brown-bagging — it can take on a whole new meaning. You can save money — and calories — when you get your lunch from home, instead of buying it from a deli or a vending machine.

Sounds too boring? Take a break from your everyday sandwich.

You can replace the jelly in a peanut butter and jelly sandwich with fresh fruit slices or chopped dried fruit. You'll add flavor and nutrients, and save on sugar.

Mix flaked, cooked fish or water-packed tuna with fruit, bean sprouts, chopped, cooked or raw vegetables.

Combine chopped, cooked lean meat or poultry with chopped raw vegetables, moistened with plain low-fat yogurt or cottage cheese.

Use a variety of breads such as whole-wheat, rye, pumpernickel or bran; pita pockets, rolls, bagels, tortillas, English muffins and rice cakes.

If you're tired of sandwiches, try different foods.

Low-fat yogurt or cottage cheese can be mixed with chopped and drained unsweetened canned fruits, or chopped or shredded fresh fruits or vegetables.

Rice cracker mix and nuts is a combination of miniature

crackers and dried legumes with a spicy Oriental flavor, available in the dried food section of most supermarkets.

Another suggestion: pepperoni, sliced into ¼-inch pieces, and crackers.

Use an insulated lunch box instead of a paper bag when packing cold foods. Use an ice pack or a gel freezer pack to keep hard-cooked eggs, meat and milk products cold.

If lunch just isn't lunch unless it's hot, use a wide-mouth vacuum bottle for soup, chili, chowder or stew; chili or baked beans; casseroles made with pasta or rice.

Preheat the vacuum bottle by filling it with clean, hot water and letting it stand for a few minutes. Empty and promptly fill with hot food. Use a stainless-steel or glass-lined vacuum bottle rather than a plastic-lined one for hotter and safer food.

For beverages: choose low-fat or skim milk and fruit juices instead of soda. Vegetable juices supply important nutrients, but may be high in sodium, so balance these juices with low-sodium foods.

You'll save calories if you bring a naturally sweet fresh fruit such as apples, grapes and pears for snacking and dessert, instead of buying chips and candy bars from a vending machine.

A 1988 survey by MRCA Information Services says 44 percent

of all Americans carry food and/or beverages from home. The most avid brown-baggers, the survey says, are children from 6 to 12 years of age, and adults between the ages of 35 to 54. The apple is the most popular brown-bag item, followed by cookies, carbonated soft drinks and potato chips. Chinet, makers of microwave-safe, disposable tableware that is 100 percent biodegradable, recently surveyed office caterers for their tips on brown-bag and eat-in working lunches. Here are some of their ideas:

— Invest in a quality lunch box or insulated bag and a thermos.

— Bring your favorite mug from home or buy one just for the office.

— Stash a few staples in your desk drawer, including salt and pepper shakers, paper napkins and plates. (Chinet's tableware, made of hardwood pulp and individually molded, is sturdy, unbendable, and virtually cut-proof and leakproof.)

— Prepare and pack your lunch the night before, so you won't be scrambling in the morning.

— Clean up leftovers in your refrigerator by packing them for lunch. Slice leftover grilled chicken and top it with avocado, tomato and shredded cheese.

Wrap in a flour tortilla or use your favorite bread.

### CHICKEN SALAD SANDWICH

2 tbsps. mayonnaise-type salad dressing  
¼ tsp. onion powder  
¼ tsp. dried tarragon, crushed  
Dash of garlic powder  
1 cup chicken, without skin, cooked and chopped  
½ cup celery, chopped  
8 slices whole-wheat bread  
4 lettuce leaves

Mix salad dressing and seasonings in a bowl. Stir in 1 cup cooked and chopped chicken, without skin, and ½ cup chopped celery. Mix well.

Spread about 1-3rd cup of the filling on 4 whole-wheat bread slices. Top each with a leaf of lettuce and 1 slice of whole-wheat bread. Makes 4 sandwiches.  
fatty acids, 33 mg chol., 387 mg sodium.

Nutritional information per chicken sandwich: 230 cal., 6 g fat, 1 g saturated fatty acids, 33 mg chol., 387 mg sodium.

Variation: Use 1 cup chopped, cooked lean beef in place of chicken.

## Office Appliances Can Add Variety To Eat-In Lunches

THE ASSOCIATED PRESS

NEW YORK — Access to a refrigerator and a microwave can help add variety to your eat-in lunch at the office.

If you have access to a refrigerator, your lunch can include yogurt and fruit; cottage cheese and raw vegetables; tuna fish salad; brown rice salad with cubes of roast or stewed chicken; vegetables marinated in Italian or herb salad dressing; cold cooked pasta with pieces of raw or cooked vegetables.

With a microwave, you can bring leftovers from home and reheat them for lunch. Single servings of food left over from a meal, or planned leftovers, can be refrigerated and reheated. Some examples: macaroni and cheese; chop suey; pot roast and vegetables; spaghetti.

Freezing leftovers is a good way to avoid wasting larger amounts of foods. For easy reheating, store in single-serve containers that can go directly from the freezer into a microwave. For best quality, be sure to use frozen leftovers within 3 to 4 months.

No leftovers? Prepared foods include soups, hot sandwiches and frozen meals. Campbell's Souper-Combo is a line of eight, microwave-only soup and sandwich combinations including Vegetable Soup and Cheeseburger and Tomato Soup and Grilled Cheese Sandwich. Each selection can go from the freezer to the table in 7 minutes or less.

According to Liz Senior, Campbell's project director, 70 percent of all workers now have access to a microwave at their office.

"This is definitely the age of the microwave," she says. If your office has kitchen facilities, you can make your own lunch at work. For an easy minipizza, spread a bagel with spaghetti sauce, top with mozzarella cheese and then heat in the microwave. Bake a potato in the microwave, then top with shredded cheese, yogurt or leftover vegetables. Warm up a bowl of applesauce or a wedge of pie for dessert.

## Farmer's Market Source For Produce

Q: Where can I get good produce? A.C., Greenville

A: Several new faculty have asked that question. Our local Farmer's Market is always my first reply. I asked Susan Childress, a dietetic student volunteer working with us, to visit out there and share her report. Here it is:



**Kathy Kolasa**

Ph.D., ECU Dept. Family Medicine

If you were planning on having fresh fruits and vegetables this summer, but were unsuccessful with a garden, (no thanks to the weather), or you don't have garden space, you can get the "fresh" produce you crave at Farmer's Market near Bells Fork. The market is located off N.C. 43 on Old County Home Road, approximately one mile on the right.

The market is operated by Pitt County and managed by Dr. Provert Lassiter. Dr. Lassiter encourages all local farmers to come and sell their produce at the market. Tables are provided for each vendor to display his/her wares. The vendors have not only fresh produce, but also hand-crafted and homemade items.

On most Friday afternoons and Saturday mornings you can also

purchase fresh shrimp. The shrimp is purchased from fish houses in Carteret County to be sold the same or next day at the market.

You can purchase a pineapple upside down cake, crocheted items, Kentucky Wonder pole beans, Silver Queen corn, onions, peas, butter beans, lettuce, cabbage, okra, eggplant, cherry tomatoes, cucumbers, peaches, cantaloupes, watermelons, apples, berries, and all types of peppers. If you like jalapeno peppers (and you like them hot!), you can also buy them at the Farmer's Market. You can also purchase tomatoes (which are very refreshing and rich in vitamins A and C); summer collards (which are high in vitamins A, C and also calcium!), and acorn, banana, pattypan

and yellow squash (which are all rich in vitamin A). Remember, good nutrition includes eating six servings of fruits and vegetables daily.

An unusual squash, the kuta squash, is also sold at the market. The kuta squash can be eaten either raw or cooked. If you are unfamiliar with this squash, the vendor will be happy to provide some recipes!

The loofah is another member of the squash family that cannot be eaten when mature. This "vegetable sponge" is also known as the "Dishcloth Gourd." It can be used to scour your pots and pans or wash your car. Years ago, many people used the sponge while bathing to stimulate and clean the pores of their skin.

Most of the fruits and vegetables are grown here in Pitt County. The produce is generally picked the day before it is to be sold at the market. Some of the vegetables are even organically grown. This fall, weather permitting, the market will have tomatoes, peas, apples, squash, cucumbers, onions, Irish and sweet potatoes, grapes, collards and cabbage. The market is open April 30 through approximately Dec. 17; from 8 a.m. to 1 p.m. Tuesdays, Thursdays and Saturdays; and from 1 p.m. to 6 p.m. on Fridays. Go early and pick from the best!

Dear Readers: My younger sister Mary Ellen visited last week. She had a food storage trick I thought I'd pass along. She's found twist ties on food packages a problem, especially in packages she'd like her little ones to get into. So, she buys old-fashioned spring clothes pins to keep bread or cookie or pretzel packages closed. The idea is good for older folks, too.

Contact Dr. Kathy Kolasa, Department of Family Medicine or c/o The Daily Reflector.

**Basics**

**Coconuts Aren't Hard To Crack**

By Joan Drake  
LAT-WP NEWS SERVICE

Opening the inner nut of a coconut is easy with the right tools and a few pointers. To begin with, when choosing a fiber-covered nut in the market, look for one heavy for its size. Shake it to be certain there is liquid sloshing inside and check that the three dots or "eyes" at the top aren't wet or moldy.

To open the coconut, pierce the three dots with a strong ice pick, skewer, awl or screwdriver tapped in with a hammer (Step 1). Drain the coconut liquid through a coffee filter-lined strainer (Step 2) and set aside for use with other ingredients in alcoholic drinks or milk shakes. It is very perishable and must be refrigerated and used within 24 hours or else frozen.

Place the drained coconut on a jellyroll pan and bake at 325 degrees 15 minutes. Time carefully because overheating destroys the flavor of coconut.

Cool the coconut slightly, then wrap in a towel or heavy cloth to prevent shattering when you crack it open. Tap the nut briskly all over with the hammer, until it breaks into pieces (Step 3).

The white flesh may be pried from the shell with a screwdriver (Step 4). The brown peel on the back of the pieces may be pared away with a sharp knife (Step 5) or vegetable peeler, or left on to protect fingers if the coconut is going to be grated by



**STEP 1:** To use fresh coconut, pierce the three dots at the top of the coconut with strong ice pick, skewer, awl or screwdriver.



**STEP 2:** Drain the coconut liquid through a strainer, lined with a coffee filter.

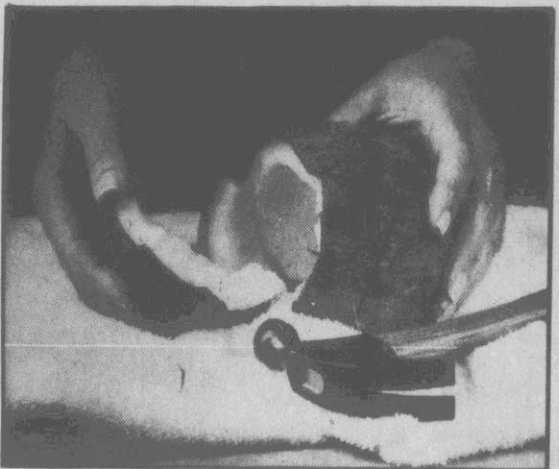

**STEP 3:** After baking the coconut, cool slightly, then wrap in a towel and crack it open by tapping briskly all over with a hammer.

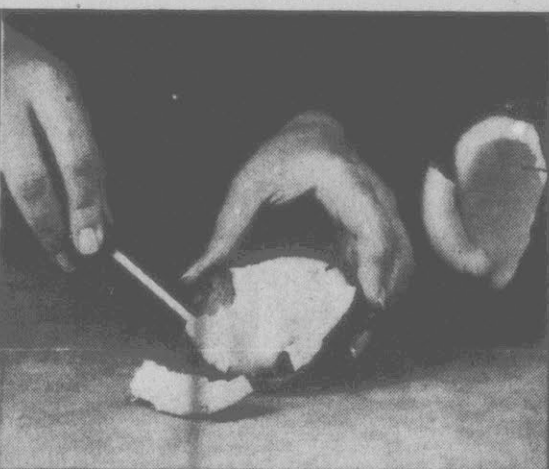

**STEP 4:** After the coconut is broken into pieces, the white flesh may be pried from the shell with a screwdriver or the end of a blunt knife.

LAT-WP NEWS SERVICE

hand. Peeled coconut may be cut into small chunks and chopped or

grated in a food processor or chopped 1/2 cup at a time in a blender.

To make coconut milk, line a bowl with cheesecloth. Add 1 cup of grated coconut and 1 cup of boiling water, cover and steep 15 to 20 minutes. Gather the ends of the cheesecloth and twist, squeezing out all the liquid. Discard the coconut. The liquid that remains is coconut milk. Coconut cream is made in the same manner, but hot milk is substituted for the boiling water.

To toast flaked or grated coconut, spread a thin layer on a baking sheet and bake at 325 degrees about 10 minutes, stirring frequently. You may also toss the coconut in an iron skillet over medium heat for three to five minutes until it browns.

Fresh coconut is more flavorful and less sweet than packaged. To substitute it for canned, shredded or flaked types, soak covered with milk six hours in the refrigerator, then drain before using. The fresh pulp may be stored, tightly covered, in the refrigerator or covered with coconut milk and frozen.

**Nelson Honor**

ATLANTA (AP) — The Federation of Southern Cooperatives will honor Willie Nelson, founder and chairman of Farm Aid Inc., Sunday for the help the entertainer has given poor and minority family farmers throughout the Southeast.

The coalition of farming cooperatives has received more than \$700,000 from Farm Aid since 1985. The money is for education, hotlines and emergency aid, such as food, medicine and heating to farmers in Alabama, Arkansas, Florida, Georgia, Kentucky, Louisiana, Missouri, Mississippi, North Carolina, South Carolina and Texas.

**Tomato Gets New Look**

LAT-WP NEWS SERVICE

The U.S. Department of Agriculture is advising consumers to alter home canning methods to accommodate the modern tomato's characteristics.

Of particular importance is that the fruit today is "fleshier," or contains more pulp than in the past. As a result, tomatoes require additional acidity and processing time in order to ensure a safe product.

The revised canning guidelines now call for two tablespoons of lemon juice per quart of home-canned tomatoes rather than only two teaspoons.

Processing time is also doubled, from 15 minutes to 30 minutes for

the hot-water bath, or when the tomatoes are sealed in jars and then placed in boiling water.

A University of California, Davis researcher, familiar with the recent recommendations, supported the changes.

"If these guidelines are followed (then) canned tomatoes will be very safe," said Kathryn Boor, UC Davis food scientist. "There's no reason to be gun-shy about home-canned tomatoes."

The precautions are necessary because tomatoes, as is true with any raw agricultural product, may contain bacteria. The pathogens, if given the proper conditions to thrive, could multiply and contaminate the food.

**PITT COUNTY FARMERS MARKET**  
Fresh Fruits And Vegetables Available:

WATERMELONS	STRING BEANS	COLLARDS
CANTALOUPE	BUTTER BEANS	PEACHES
TOMATOES	CORN	APPLES
IRISH POTATOES	PEPPERS	& OTHERS

Tuesday, Thursday & Saturday  
8 a.m. - 1 p.m.  
Friday 1 p.m. - 6 p.m.

**VALASSIS COUPON VALUES VALASSIS**

**SAVE 15¢** WHEN YOU BUY  
**Mazola® Margarine** ANY FORM

149680  
4800125015

**Labels Tell More**

(Continued from A-1)

says it will revise its regulations and that the process should be finished early in 1990.

The agency's intent is to convince Congress it need not set the FDA's standards, or at least to have revised regulations ready if Capitol Hill orders the agency to change its act.

Young told Congress: "It is unclear whether legislation is necessary to achieve most or all of our shared goals. I believe many, if not all, of the changes contemplated can be made administratively."

The food industry's primary hope appears to be getting federal legislation that eliminates state regulation.

Says Jeff Nedelman, a vice president of the Grocery Manufacturers of America: "We would support a comprehensive reform of the dietary and health information that is provided to consumers if we can come out of this process with national standards."

Seeking to avoid potentially 50 different state standards, the National Food Processors Association says regulations "appropriate for Portland, Maine, are equally applicable to Portland, Ore."

But some consumer groups say states should still have the prerogative to toughen federal standards and note that California and New York, for instance, have often taken the lead in nutrition issues.

Whatever the new regulations are, these activists say they need to reflect a range of specific consumer interests not now addressed in the FDA requirements.

One group in the forefront of the movement to toughen labeling requirements, the Center for Science in the Public Interest, says the regulations should:

—Eliminate or supplement the description of quantities as measured in "grams," a metric term, unless accompanied by defined terms such as high, low or medium.

—Eliminate thiamin, riboflavin and niacin from labels, since deficiencies in those elements are no longer a significant health threat.

—List amounts of fat, cholesterol, "cholesterol-raising" or saturated fats, sodium, starch, dietary fiber and sugar.

—Consider a diagram giving percentages of protein, sugar, complex carbohydrates, total fat and saturated fat.

—List the percentage of a product's major ingredients, such as sugar and flour.

**MEAT SPECIAL**  
Prices Good August 16 thru 19, 1989

**Pollard Trading Post**  
100 Pollard Street  
Behind Fred Webb's Grain Mill  
Greenville, North Carolina

No Limit on Purchases  
CALL IN YOUR ORDER  
It Will Be Ready

Owner and Operator  
George Whitley

Open  
MONDAY THRU SATURDAY  
8:00 A.M.—6:00 P.M.

Call in Orders For Fast Service  
All Meat Guaranteed

Food Stamp Customers Welcome  
All Beef-Western All Pork-Native

<b>T-Bone Steak</b> \$2.69 lb.	<b>Pig Feet</b> 29¢ lb.
<b>Sirloin Steak</b> \$2.59 lb.	<b>70 Lb. Box Fryers</b> \$49.95
<b>Lean Cubed Steak</b> \$1.79 lb.	<b>Pig Quarters</b> 99¢ lb. For Barbecue
<b>Smoked Slab Bacon</b> 89¢ lb.	<b>Water-melons</b> \$1.29 each

**MONEY SAVING COUPONS**  
The Sunflower Group • 10895 Lowell, Overland Park, Kansas 66210

**SAVE \$1.30**

Get the facts:  
**Absolutely no cholesterol!**

**Miracle Whip** (Cholesterol Free) and **Miracle Whip Light** (No Cholesterol)

**Save \$1.00** on your next purchase of **HUGGIES** DISPOSABLE DIAPERS 28 ct. or larger packages

MANUFACTURER COUPON / EXPIRES FEBRUARY 11, 1990

**Save 35¢** on ONE 20 oz. or 25 oz. package OR TWO 10 oz. or 15 oz. packages.

**Kellogg's FROSTED FLAKES**

5 38000 54335 2

MANUFACTURER COUPON / EXPIRES DECEMBER 31, 1989

**Save 35¢** on **Nutri-Grain® Raisin Bran** OR any other variety **Nutri-Grain**.

**Nutri-Grain Raisin Bran**

5 38000 53035 2

MANUFACTURER COUPON / EXPIRES FEBRUARY 11, 1990

**Save 35¢** on 12 or 18 oz. size OR TWO 7 oz. packages

**Kellogg's Special K**

5 38000 55135 7

**KRAFT** MAIL-IN OFFER FORM/NOT PRIVILEGE AT RETAIL STORE

**FREE Cholesterol Counter from MIRACLE WHIP Cholesterol Free Dressing**

BUY: 1-16 oz. or 32 oz. jar of MIRACLE WHIP Cholesterol Free Dressing or MIRACLE WHIP Light Reduced Calorie Salad Dressing with no cholesterol.

SEND: 1-Proof of Purchase Seal from MIRACLE WHIP Cholesterol Free Dressing or MIRACLE WHIP Light

RECIPE: A FREE Cholesterol Counter

MAIL TO: FREE Cholesterol Counter, P.O. Box 6024, Douglas, AZ 85665-6024

PLEASE SEND TO:

Name \_\_\_\_\_ Apt \_\_\_\_\_  
Address \_\_\_\_\_  
City \_\_\_\_\_ State \_\_\_\_\_ Zip \_\_\_\_\_

OFFER EXPIRES 12/31/89. REQUESTS FOR OFFER FORMS TO THIS P.O. BOX NUMBER OR KRAFT WILL NOT BE ACKNOWLEDGED. LIMIT ONE OFFER PER FAMILY OR ADDRESS. This offer good only in U.S.A. All territories and military addresses in which this offer is displayed or advertised. Void where taxed, restricted or prohibited. DUPLICATE REQUESTS WILL CONSTITUTE FRAUD. THEY OVERSICURE REPRODUCTION, SALE OR PURCHASE OF THIS COUPON IS PROHIBITED. LIMIT ONE REQUEST PER ENVELOPE. Proof of purchase and mail-in form must be forwarded in an envelope with sufficient to class postage. Mail with insufficient postage will be returned.

**KRAFT** MANUFACTURER'S COUPON EXPIRATION DATE: 11/30/89

**SAVE 30¢** when you buy one jar of **MIRACLE WHIP Cholesterol Free Dressing** or **MIRACLE WHIP Light Reduced Calorie Salad Dressing** with no cholesterol (any size)

RETAILER: Kraft, Inc. will reimburse you for the face value of this coupon plus 8¢ if submitted in compliance with Kraft's Coupon Redemption Policy, previously provided to retailer and incorporated by reference herein. Void where taxed, restricted or prohibited. Cash value 1/100¢. Mail to Kraft, Inc., 6900, GMS Bldg., #2100B, 1 Foxworth Dr., Oak Ridge, TN 37840. Offer Expires: November 30, 1989.

5 21000 42030 3

**Kimberly-Clark** Manufacturer's Coupon Expires 10/31/89

**Save \$1.00** on your next purchase of **HUGGIES** DISPOSABLE DIAPERS 28 ct. or larger packages

5 36000 11076

Over **10,000**  
**LOW PRICES**  
and clean, friendly stores!

# Plus...The lowest food bill possible!

At Winn-Dixie, our commitment to low prices is stronger than ever. We sincerely believe that our honest, everyday low prices can guarantee you the lowest food bill possible. That's our commitment today and for a long time to come.

<p><b>THE BODD PEOPLE</b></p>	<p>3-Lbs. Or More W-D Brand Fresh Pure <b>Market Style Ground Beef</b></p>	<p><b>PRIME PARTS</b> Holly Farms Chicken Leg Quarters</p>	<p>Holly Farms Grade 'A' Fresh <b>Chicken Leg Quarters</b></p>	<p><b>Sealtest</b> Vanilla Ice Cream</p>	<p>½-Gal. Ctn. <b>Sealtest Ice Cream</b> All Flavors</p>
	<b>98¢</b>	<b>48¢</b>	<b>1.10</b>	<b>189</b>	
W-D Brand 93% Lean Ground Turkey LB.	<b>88¢</b>	Holly Farms Chicken Breast Quarters ... <b>1.18</b> U.S. Choice Fully Trimmed Whole (Sliced Free Into Filet Mignons & Trimmings) Beef Tenderloins ... <b>5.98</b>	W-D Brand U.S. Choice Whole Eye Of Round Roasts ... <b>2.99</b> Golden Delight Turkey Breast ... <b>1.48</b>	Market Style Sliced Slab Bacon LB.	<b>88¢</b>

Prices Good Wed., Aug. 16th Thru Tues., Aug. 22nd!  
\*None To Dealers\*We Reserve The Right To Limit Quantities ©Copyright 1989, Winn-Dixie Stores, Inc.

SEE THE DIFFERENCE.

## Grocery Values

<p>5-Lb. Bag Pure Cane <b>Thrifty Maid Sugar</b></p>	<p><b>179</b></p>	<p>10-Oz. Bag <b>Fritos Corn Chips</b></p>	<p><b>169</b></p>	<p>12-Pak/12-Oz. Cans <b>Coors Beer</b></p>	<p><b>569</b></p>	<p>Get Two For The Price Of One!</p>	<p><b>DANO'S Gourmet COMBINATION PIZZA</b></p>		
48-Oz. Btl. Wesson Oil ...	<b>1.89</b>	18-Oz. Jar Peter Pan Creamy Or Crunchy Peanut Butter ea.	<b>1.49</b>	1-Gallon Jug Arrow Bleach ...	<b>.89</b>	8-Ct. Box Crunchy Or Original Vanilla Polar Bars Reg. \$1.99 each	<b>2199</b>	Dano's Frozen Gourmet Pizzas •21½-Oz. Combination •19-Oz. Pepperoni •18-Oz. Cheese	<b>3 \$5</b>

### Frozen & Dairy

½-Gal. Ctn. Superbrand Ice Cream Or Sherbet All Flavors

**139**

### Deli-Bakery

Save \$1.50 Per Lb.

Eat Rite Cooked Ham

**199**

LB. Sliced To Order

Herrlich German Or Beef Bologna

**299**

LB. Sliced To Order

Available In Deli-Bakery Stores Only!

### Harvest Fresh

10-Lb. Vent Vue Bag

Price Break On New Crop Harvest Fresh U.S. #1 White Potatoes

**179**

10-LBS. NET WT. POTATOES  
WHITE POTATOES

Harvest Fresh Yellow Sweet Corn **33¢** Ear

Harvest Fresh Green Cabbage **25¢** LB.

Harvest Fresh California Bartlett Pears **69¢** LB.

Ripe 'n Ready

### Health & Beauty Aids

60-Ct. Btl. Extra Strength Tylenol Tablets

**399**

250-Ct. Btl. Medic Aspirin Tablets ... **.99**

### Fisherman's Wharf

"Great On The Grill" Fresh Whole Tuna Loins

**399**

LB. Sliced Free

Fresh Tuna Steaks ... **4.99**

Available In Locations With Fisherman's Wharf Fresh Seafood Depts. Only!

You're Going To See The Difference

**WINN DIXIE**

America's Supermarket

Plus, **DOUBLE MANUFACTURERS' COUPONS!**

Good only in Richmond, Colonial Heights, Chester and Mechanicsville, Va. and Greenville and Aberdeen, N.C. stores  
\*LIMIT 10\*  
coupons doubled per customer, please. See stores for details.

# HARRIS SUPERMARKETS

**DISCOUNT** "WHERE SHOPPING IS A PLEASURE"  
ON EVERYTHING BUT QUALITY

We Reserve The Right To Limit Quantities  
We Accept Food Stamps and WIC Vouchers  
PRICES GOOD THROUGH SATURDAY

# SPECTACULAR Savings

FRESH GRADE A

**WHOLE FRYERS**  
(LIMIT 4)

**59¢** LB.

(WHOLE CUT UP FRYERS AT 79¢ LB.)

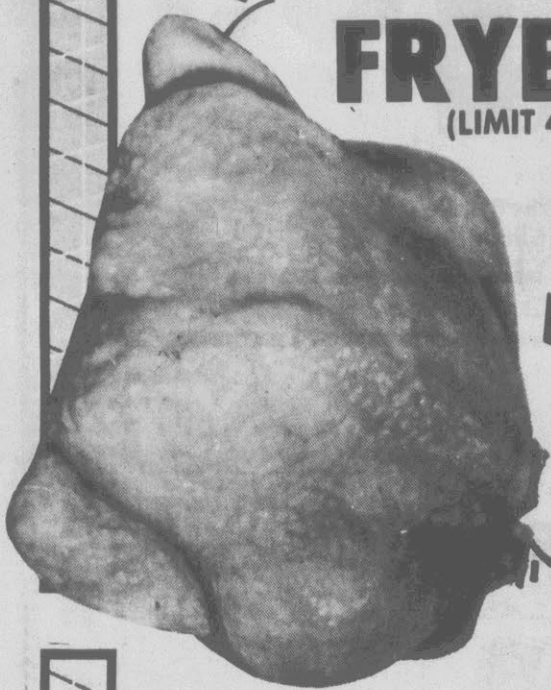

U.S.D.A. WESTERN BONELESS

**RIB EYE STEAKS**

**\$3.99** LB.



WESTERN

**ROAST**

**\$**

**\$**



U.S.D.A. WESTERN BONELESS

**SIRLOIN TIP OR RUMP ROAST** LB. **\$2.19**

**FRESH 1/4 SLICED PORK LOINS** LB. **\$1.69**

**FRESH GROUND ROUND** (GROUND FRESH DAILY) LB. **\$1.59**

LUTERS

**FRANKS** 12 OZ. **99¢**

JAMESTOWN

**SAUSAGE** 1 LB. **89¢**

SMITHFIELD 1 LB.

**BACON** **99¢**

**COCA COLA, DIET COKE**  
2 LITER

**99¢**



P & G PA

**PAMPER**

THIN OR CONVEN

**\$9**

- BUTTERBALL CHOPPED TURKEY HAM..... 8 OZ. **\$1.29**
- BUTTERBALL VARIETY PACK..... 12 OZ. **\$1.99**
- BUTTERBALL TURKEY BOLOGNA..... 8 OZ. **79¢**
- BUTTERBALL HONEY ROAST TURKEY BREAST..... 6 OZ. **\$1.29**
- BUTTERBALL SMOKED TURKEY..... 8 OZ. **\$1.79**



HARRIS' OWN FRESH LINK SAUSAGE..... LB. **\$1.89**

HARRIS' OWN AIR DRIED SAUSAGE..... LB. **\$1.99**

## FROZEN FOOD

**FREEZER QUEEN 2 LB. ENTREES** ALL VARIETIES EXCEPT BEEF OR LASAGNA..... **\$1.69**

**KRAFT SOFT PHILADELPHIA CREAM CHEESE**..... 8 OZ. **\$1.19**

**JENOS PIZZAS** ALL 7.8 OZ. VARIETIES..... **99¢**

**MARQUEZ BURRITOS** ALL 5 OZ. VARIETIES..... **3/\$1**

**PILGRIMS PRIDE MICROWAVE CHICKEN TENDERS**..... CHUNKS OR PATTIES **\$1.99**

**SEALTEST ICE CREAM**..... ALL 1/2 GAL. FLAVORS **\$1.69**



ROYAL OAK

**CHARCOAL**  
10 LB. + 2 LB. FREE!

**\$1.99**

## DAIRY

**CAROLINA DAIRIES HOMOGENIZED MILK** 1/2 GAL. CTN..... **\$1.09**

**MERICO BUTTER-ME-NOT BISCUITS** 9 OZ. 10 CT..... **2/\$1**

**TROPICANA CHILLED ORANGE JUICE** 1/2 GAL. CTN..... **\$1.59**

**TROPICANA ORANGE JUICE** 1/2 GAL. GLASS JUG..... **\$2.09**

**GRADE A GOLDEN NUGGETS**..... 1 DOZ. **85¢**

**BUDWEISER AND BUD LIGHT BEER**  
12 PK.-12 OZ. CANS

**\$5.79**



**BAKERY**  
BELLS FORK STORE ONLY  
**CARROT CAKES**  
8 INCH **\$1.99**  
ONLY **SAVE 50¢**

**HOME CARE VALUES!**

	SALE PRICE
Pledge 7 oz.	1 <sup>39</sup>
Shout 22 oz.	2 <sup>15</sup>
Favor 9 oz.	1 <sup>29</sup>
Future 27 oz.	3 <sup>39</sup>
Glade 7 oz.	99¢

KEEBLER <b>RAINBOW CHIPS</b> .....17 OZ.	<b>\$2.29</b>
KEEBLER <b>PECAN SANDIES</b> .....19 OZ.	<b>\$2.29</b>
KEEBLER <b>CHIPS DELUXE</b> .....18 OZ.	<b>\$2.29</b>
KEEBLER <b>VANILLA WAFERS</b> .....12 OZ.	<b>\$1.89</b>
KEEBLER <b>SOFT BATCH CHOCOLATE CHIP</b> .....18 OZ.	<b>\$2.19</b>
KEEBLER <b>SOFT BATCH RAISIN</b> .....18 OZ.	<b>\$2.19</b>

U.S.D.A. WESTERN FULL CUT  
**ROUND STEAK**  
**\$1.59**  
LB.

LEAN & TENDER  
**WHOLE SMOKED PICNICS**  
**79¢**  
LB.



U.S.D.A. WESTERN BONELESS  
**CUBE STEAKS**  
(5-7 LB. FAMILY PACK)  
**\$1.99**  
LB.



PAPER SALE  
**PAPER PLUS**  
OR THICK  
FACE PAKS  
**89**

P & G PAPER SALE  
**BOUNTY TOWELS**  
JUMBO ROLL  
**69¢**



CHEF-BOY-AR-DEE ZIP TOP PASTA 7 OZ. ALL VARIETIES INCLUDING SPAGHETTI & MEATBALLS.....	2/ <sup>s</sup> 1.00
GRAND GOURMET DOG FOOD..... ALL 14 OZ. VARIETIES	3/ <sup>s</sup> 1.09
JUST MY SIZE REGULAR PANTYHOSE.....	2/ <sup>s</sup> 2.49
LEGG'S REGULAR PANTYHOSE.....	2/ <sup>s</sup> 1.98
KRAFT BBQ SAUCE (ALL 18 OZ. VARIETIES).....	99¢
MAXWELL HOUSE 8 OZ. INSTANT COFFEE.....	\$3.41
MAXWELL HOUSE GROUND COFFEE..... 13 OZ. ALL GRINDS BAG	\$2.29
P&G PAPER SALE PUFFS FACIAL TISSUE (250 COUNT).....	99¢
P&G PAPER SALE PUFFS PLUS FACIAL TISSUE (150 COUNT).....	99¢
P&G PAPER SALE CHARMIN BATHROOM TISSUE..... 4 ROLL PACK	\$1.09
POST OAT FLAKES (12 OZ.).....	\$1.99

SENECA  
**APPLE JUICE**  
½ GAL.  
**\$1.19**

**GET READY FOR SCHOOL**

BACK TO SCHOOL <b>GLEEM</b> .....7 OZ.	<b>\$1.79</b>	BACK TO SCHOOL SURE 2 OZ. SOLID, 1.25 ROLL ON, 4 OZ. SPRAY 40¢ OFF LABEL.....	<b>\$2.29</b>
BACK TO SCHOOL <b>CREST TUBE</b> .....6.4 OZ.	<b>\$1.79</b>	BACK TO SCHOOL SECRET 2 OZ. SOLID, 1.25 ROLL ON, 4 OZ. SPRAY.....	<b>\$2.29</b>
BACK TO SCHOOL <b>CREST PUMP</b> .....4.6 OZ.	<b>\$1.79</b>	BACK TO SCHOOL 15 OZ. <b>HEAD &amp; SHOULDERS</b> .....	<b>\$3.49</b>
BACK TO SCHOOL <b>SCOPE</b> .....32 OZ.	<b>\$3.99</b>	BACK TO SCHOOL <b>PRELL</b> .....15 OZ.	<b>\$2.99</b>
BACK TO SCHOOL <b>PEPTO BISMOL</b> .....12 OZ.	<b>\$2.99</b>		

**PRODUCE**

FRESH <b>GREEN LETTUCE</b> .....HEAD	<b>69¢</b>	CALIFORNIA SWEET <b>BARTLETT PEARS</b> .....LB.	<b>89¢</b>
CALIFORNIA RED OR WHITE <b>SEEDLESS GRAPES</b> .....LB.	<b>79¢</b>	NEW CROP <b>WAXED RUTABAGAS</b> .....LB.	<b>39¢</b>
		MOUNTAIN GROWN <b>TOMATOES</b> .....LB.	<b>69¢</b>

IN-STORE CERTIFICATE EXPIRES 8-23-89

**FREE**  
**LOG CABIN COUNTRY KITCHEN SYRUP**  
24 OZ.

at checkout when you purchase any 3 of these items:  
PHILADELPHIA CREAM CHEESE (Regular Or Soft)  
POST OAT FLAKES  
POST RAISIN BRAN  
MAXWELL HOUSE GROUND COFFEE  
MAXWELL HOUSE INSTANT COFFEE  
LOG CABIN SYRUP (Regular Or Lite)

**\$1.89**  
Retailer Price

To the Retailer, Mail to:  
General Foods Corporation  
P.O. Box 601  
Kankakee, IL 60902

OFFER GOOD AT HARRIS SUPERMARKETS LIMIT ONE CERTIFICATE PER PURCHASE NOT TO BE USED IN CONJUNCTION WITH ANY OTHER FREE GOODS OFFER Deal #MLHM-9

# Choosing Right Cake Makes Transportation A Little Easier

By Sherrie Clinton  
LAT-WP NEWS SERVICE

There must be some law of nature that says that anyone transporting a cake to another location, such as a

## The Recipes

**CHOCOLATE PAN CAKE**  
1 cup (2 sticks) unsalted butter, cut in rough chunks  
4 tablespoons unsifted unsweetened cocoa powder  
1 cup water  
2 cups granulated sugar  
2 cups unsifted cake flour  
1 teaspoon salt  
1/2 cup buttermilk, at room temperature, blended with 1 teaspoon baking soda  
2 extra large eggs, at room temperature  
1 1/2 teaspoons pure vanilla extract

**Chocolate Fudge Frosting**  
1/2 cup (1 stick) unsalted butter, cut in chunks  
2 ounces (2 squares) unsweetened chocolate, chopped  
5 tablespoons milk, at room temperature  
1 tablespoon light cream, at room temperature  
1 box (1 pound) confectioners sugar, sifted  
1 teaspoon pure vanilla extract  
Pinch of salt  
1 cup chopped pecans

Lightly butter and flour a 9- by 13- by 2-inch cake pan; set aside. Preheat the oven to 400 degrees.

For the cake, place the butter, cocoa and water in a large saucepan, set over moderately high heat and bring to a boil. Remove from the heat. Sift together the sugar, flour and salt into the large bowl of an electric mixer. Whisk together the buttermilk, eggs and vanilla in a mixing bowl. Pour the hot butter-cocoa-water mixture over the sifted dry mixture and beat on moderate speed until thoroughly blended. Add the whisked egg mixture and continue beating on low speed until the batter is a uniform color, about 1 1/2 minutes. Pour and scrape the batter into the prepared pan.

Bake the cake on the lower third level rack of the preheated oven for 20 to 22 minutes, or until a wooden pick inserted into the center of the cake comes out clean and dry and the cake shrinks away slightly from the edges of the pan.

About 10 minutes before the cake is done, make the Chocolate Fudge Frosting. Place the butter, chocolate, milk and cream in a large saucepan, set over low heat and cook, stirring occasionally, until the chocolate has melted down completely. Remove from the heat and beat in the sugar by cupfuls with vanilla and salt. Blend in the pecans.

As soon as the cake is done, remove it from the oven to a wire cooling rack. Immediately spread the frosting evenly over the top with a flexible palette knife. Let the cake cool in the pan.

For serving, cut the cake in squares directly from the cake pan.

**FRESH PEACH CAKE**  
2 small ripe peaches  
1 tablespoon lemon juice  
1 1/2 cups unsifted cake flour  
1 1/2 teaspoons baking powder  
1/4 teaspoon salt  
1/2 teaspoon ground cinnamon  
1/2 teaspoon freshly grated nutmeg  
1/4 teaspoon ground ginger  
1/2 cup (1 stick) unsalted butter, softened at room temperature  
1/2 cup less 2 tablespoons vanilla-scented sugar (see above) or plain granulated sugar  
2 tablespoons firmly packed light brown sugar  
2 extra large egg yolks, at room temperature  
1 teaspoon pure vanilla extract  
1/4 cup milk, blended with 1/4 cup light cream, at room temperature, OR 1/2 cup Half and Half at room temperature  
Confectioners sugar for dusting, optional

Lightly butter and flour an 8-inch round springform pan, set aside. Preheat the oven to 400 degrees. Peel the peaches (dip first in simmering water, then in cold water for easier peeling); slice 3/4-inch thick. Toss with lemon juice and set aside.

Sift together the flour, baking powder, salt, cinnamon, nutmeg and ginger onto a large sheet of waxed paper. Beat the butter in the large bowl of an electric mixer on moderately high speed for 2 minutes. Beat in the granulated sugar and brown sugar; beat for 2 minutes. Beat in the egg yolks and vanilla. With the mixer on low speed, alternately add the sifted dry ingredients in 2 additions and the milk-cream blend in 1 addition, beginning and ending with the dry mixture. Spread the batter evenly into the prepared pan. Arrange the peach slices in a pattern on top of the batter.

Bake the cake on the lower third level rack of the preheated oven for about 30 minutes, or until a wooden pick inserted into the center of the cake comes out without any particles of cake batter clinging to it. The cake will pull slightly away from the sides of the pan when done.

Let cool in the pan on a wire rack for 10 minutes, then remove the hinged ring of the pan. Let cool completely (If you are transporting this cake to a picnic, leave the outer band on for traveling). Dust the top of the cake with a little confectioners sugar, if you like.

picnic or someone else's house, will encounter every pothole in the road, torrential downpours or 100 percent humidity. The fancier the occasion or cake the more likely disaster is to occur.

But there are ways to increase your chances of success. The secret is to choose the right cake because some cakes make better traveling companions than others, says Lisa Yockelson. Yockelson is the author

of "Country Cakes" (\$10.00; 1989; Harper & Row Publishers), the recently released second volume in her trilogy of country cooking.

Yockelson says that the recipes in her book are all "honest ones," using ingredients most cooks have on hand. Her only fancy recommendation is an old-fashioned one: vanilla sugar.

"This is very simple to make, it's nothing more than putting a vanilla

bean in a container of sugar," she says.

Buy a vanilla bean, slit it down the center and place in a large container. Cover vanilla bean with sugar and let sit. Keep a tightly fitting lid on the sugar.

For a picnic, Yockelson recommends her Blueberry Walnut Brown Sugar Buckle or perhaps a fresh peach or nectarine cake.

"These particular cakes enclose

fruit and cake in one dessert and for that reason they are easy to slice and easy to transport and they don't need any other embellishment," she says.

"The realm of cakedom expands somewhat," Yockelson says, if the dessert is to be served in somewhat more civilized surroundings, say at a bring-a-dish supper.

In that case, Yockelson recommends her Chocolate Pan Cake with

Chocolate Fudge Frosting.

This one-layer cake is a good traveler because it can be transported in the same pan in which it was baked in. Just cut the cake in squares and serve it from the pan.

Most "keeper cakes" that is cakes that improve on standing, also travel well, Yockelson says.

Keeper cakes are those cakes that have a fine grain yet firm texture.

Prices in this ad good thru Sunday, August 20, 1989.

Fresh Cut One Quarter  
**PORK LOINS**  
**\$1.58** Lb.

Extra Lean  
Center Cut Loin  
Or Rib  
**PORK CHOPS**  
**\$1.98** Lb.

Dinner Bell All  
Meat And All Beef  
**FRANKS**  
**\$1.19** Lb.

**USDA Choice Beef**  
**LONDON BROIL AND TOP ROUND ROAST**  
**\$1.98** Lb.

Blue Grapes/Red Or White  
**SEEDLESS GRAPES**  
**89¢** Lb.  
Jumbo Size Cantaloupes..... Each .99

Shark Or Salmon  
**STEAKS**  
**\$3.98** Lb.

Halibut Or Swordfish  
**STEAKS**  
**\$4.98** Lb.

Pepsi or Caffeine Free Pepsi  
Mountain Dew or Diet Mountain Dew **99¢**  
2 Liter

Diet Pepsi or Caffeine Free Diet Pepsi **\$1.09**  
2 Liter

Pabst  
Blue Ribbon  
**BEER**  
Pkg. of 12  
12 oz. cans  
**\$3.99**

**CARLO ROSSI WINE**  
Chablis, Rhine, Pink Chablis, Vin Rose, Burgundy, Paisano, Sangria  
**\$4.99**

Russet Baking  
**POTATOES**  
**39¢** Lb.

Fresh Green  
**CABBAGE**  
**4 Lbs. / \$1**

**EXTRA LOW PRICES...EVERYDAY!!!**

<p>16 Oz. - Assorted <b>PFEIFFER DRESSINGS</b> <b>\$1.09</b></p>	<p>46 Oz. - Mt. Olive <b>KOSHER DILLS</b> <b>\$1.39</b></p>	<p>8 Oz. - Assorted Light N' Lively <b>100 YOGURT</b> <b>3/\$1</b></p>	<p>9.5 Oz. - Reg./Bran Biscuits <b>BUTTER-ME-NOTS</b> <b>2/\$1.09</b></p>
<p>46 Oz. - Juicy Red <b>HAWAIIAN PUNCH</b> <b>79¢</b></p>	<p>46 Oz. - Fruit Punch/Lemon-Lime Orange/Lemonade <b>10K DRINK</b> <b>99¢</b></p>	<p>10 Oz. - Frozen Assorted <b>BUDGET GOURMET</b> <b>\$1.49</b></p>	<p>6 Oz. Frozen - Double Chocolate <b>CRYSTAL LIGHT BARS</b> <b>\$1.99</b></p>
<p>100 Ct. - White Facial <b>PAGE TISSUE</b> <b>3/\$1</b></p>	<p>9.75 Oz. - Old El Paso <b>TACO DINNER</b> <b>\$1.49</b></p>	<p>11 Oz. - Oat Bran <b>EGGO WAFFLES</b> <b>\$1.69</b></p>	<div style="text-align: center;"> <p><b>FOOD LION</b></p> </div>

There is a Food Lion conveniently located near you:

3136 E. TENTH STREET UNIVERSITY SQUARE SHOPPING CENTER	2430 STANTONSBURG ROAD STANTON SQUARE SHOPPING CENTER	115 E. RED BANKS ROAD SOUTH PARK SHOPPING CENTER
---	--	---



# BIRTHDAY SALE

CELEBRATING 73 YEARS OF THE ORIGINAL SELF-SERVICE SUPERMARKET.

**OPEN TO MIDNIGHT**  
**MON.-SAT.**  
**7 AM TO 9 PM SUNDAY**  
 PRICES EFFECTIVE AUG. 16-19, 1999  
 WE RESERVE THE RIGHT TO LIMIT QUANTITIES. NONE SOLD TO DEALERS OR RESTAURANTS. WE GLADLY ACCEPT U.S.D.A. FOOD STAMPS.

**U.S.D.A. SELECTED BEEF!**  
**"Trimmed The Way You Like It!"**



FULL CUT BONE IN  
**Round Steak**  
**1.59**  
 LB.



FRESH FRYER  
**Leg Qtrs.**  
**3.99**  
 LB.



SLICED BACON  
 GWALTNEY  
**BACON**  
 REGULAR OR LOW SALT  
**8.99**  
 12 OZ. PKG.



GWALTNEY  
**Meat Franks**  
**8.99**  
 12 OZ. PKG.



RUMP OR SIRLOIN TIP  
**ROAST**  
**1.89**  
 LB.

FULL CUT BONELESS ROUND STEAK	LB.	1.69	LUNDY'S QTR. LOIN	1.79
FULL CUT CUBED ROUND STEAK	LB.	1.79	<b>PORK CHOPS</b>	1.79
FAMILY PACK CUBED STEAK	LB.	1.89	LUNDY'S FAMILY PK. FRESH PORK	
FRESH GROUND ROUND	LB.	1.79	<b>NECK BONES</b>	49¢
			or PIG FEET	49¢

GWALTNEY'S GREAT DOGS	LB.	79¢
GWALTNEY'S GREAT BOLOGNA	LB.	89¢
JAMESTOWN HOT OR MILD SAUSAGE	LB.	79¢
BABY FLOUNDER FILLETS	LB.	1.89
WHITTING FILLETS	LB.	1.19

PIGGY WIGGLY'S WORLD OF **PRODUCE**  
 "FRESHEST BUYS IN TOWN"

NEW CROP WHITE  
**POTATOES**  
**1.89**  
 10 LB. BAG

**LEMONS**  
**5 FOR 1.00**

BARTLETT  
**PEARS**  
**69¢**  
 LB.

WAXED  
**Rutabagas**  
**39¢**  
 LB.

THOMPSON SEEDLESS WHITE  
**GRAPES**  
**79¢**  
 LB.

PIGGY WIGGLY BUTTERMILK  
**BISCUITS**  
**6.99**  
 4 PK.

PIGGY WIGGLY SALAD DRESSING  
 QT.  
**89¢**

PIGGY WIGGLY CHARCOAL  
 10 LB. BAG.  
**1.19**

PETER PAN PEANUT BUTTER  
 CREAMY OR CRUNCHY 18 OZ.  
**1.69**

PIGGY WIGGLY BLEACH  
 GAL.  
**79¢**

**CHARMIN**  
 BATHROOM TISSUE  
**1.09**  
 4 Roll Pkg.

SENECA Apple Juice  
 64 OZ.  
**1.29**

PIGGY WIGGLY KETCHUP  
 32 OZ.  
**79¢**

MAXWELL HOUSE COFFEE  
 8 OZ. INSTANT  
**2.99**

TROPICANA Orange Juice  
 HOMESTYLE OR PURE PREMIUM  
 64 OZ.  
**1.99**

FROZEN FOODS  
 PET NITZ PIE SHELLS  
**99¢**  
 2 PK.

**BOUNTY**  
 TOWELS  
**2.19**  
 3 ROLL PACK

FIELD TRIAL CHUNKS  
 DOG FOOD  
 40 LBS.  
**5.99**

PIGGY WIGGLY TUNA  
 IN WATER 6 OZ.  
**2.99**

TOTINO'S PIZZA  
**99¢**

AWAKE DRINK  
 64 OZ.  
**79¢**

HEALTH & BEAUTY AIDS  
 10.5 OZ. MAXZEMA SKIN CREAM **2.99**  
 50¢ OFF 4 OZ. BAN SPRAY DEODORANT **1.99**  
 9V, C&D EVEREADY BATTERIES **1.39**

**DAWN**  
 DISH LIQUID  
 40¢ OFF 22 OZ.  
**1.09**

PAMPERS ULTRA PLUS  
 60 CT. SMALL, 48 CT. THIN, 32 CT. LARGE  
**9.99**

CRUNCH & MUNCH  
**1.09**  
 3 PK.

COKE, DIET COKE OR SPRITE  
 2 LITER  
**89¢**

2105 DICKINSON AVENUE  
 Open Mon.-Sat. 7 am to Midnight  
 Open Sunday 7 am to 9 pm  
 Shop PIGGLY WIGGLY

PIGGY WIGGLY KEEPS AMERICA SHOPPING WITH EVERYDAY LOW PRICES!

RICHFOOD

1ST CUT

**TENDERIZED HAMS**

**CHUCK ROAST**

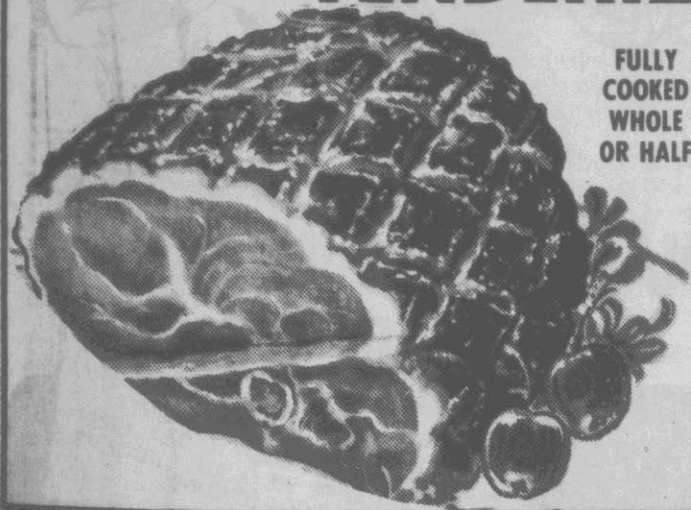

FULLY COOKED WHOLE OR HALF

**99¢**

LB.



\$

**119**

LB.

FRESH FROZEN HAMBURGER PATTIES 10 LB. PKG. **\$11.98**

HEAVY WESTERN FULL CUT ROUND STEAK LB. **\$1.69**

FAMILY PACK SPECIALS NECK BONES - PIG FEET - FAT BACK... 5-7 LB. PKG. **49¢** LB.

CENTER CUT CHUCK ROAST LB. **\$1.49**  
SHOULDER ROAST LB. **\$1.59**

FRESH GROUND BEEF 5 LBS. OR MORE **\$1.19** LB.

1/4 PORK LOIN **\$1.99** LB.  
SOUTH HAMPTON COUNTRY HAMS WHOLE OR HALF **\$1.39** LB.

FRESH FRYER CHICKEN BREAST **\$1.49** LB.

12 OZ. PKG. FROSTY MORN BACON OR FRANKS **99¢**

RICHFOOD EXTRA LARGE EGGS **79¢** DOZEN

PRICES EFFECTIVE - WEDNESDAY - AUGUST 16 THROUGH SATURDAY - AUGUST 19, 1989



PEPSI PRODUCTS **89¢** ALL 2 LITERS  
LIMIT 2 AT THIS PRICE - OTHERS 99¢

BOUNTY TOWELS GIANT ROLL **79¢**

QUANTITY RIGHTS RESERVED FOOD STAMPS WELCOME

DUKE'S MAYONNAISE QUART JAR **99¢**  
DEL MONTE KETCHUP QUART BOTTLE **99¢**

CHARMIN TISSUE 4 ROLL PKG. LIMIT 2 **99¢**

BREYER'S ALL NATURAL ICE CREAM 1/2 GAL. CARTON **\$2.89**

DUNCAN HINES YELLOW CAKE MIX 17 OZ. BOX LIMIT 2 **69¢**

KRAFT FRESH ORANGE JUICE 1/2 GAL. CARTON **\$1.19**

**COUPON: CLIP & SAVE CHEER DETERGENT WITH THIS COUPON 99¢**  
WITHOUT COUPON \$1.59  
LIMIT ONE COUPON PER PERSON PER ORDER WITH \$10.00 FOOD ORDER. COUPON EXPIRES SATURDAY - AUGUST 19, 1989.

EMBERS CHARCOAL 10 LB. BAG **\$1.59**

KRAFT MACARONI & CHEESE 7 OZ. BOX **2 FOR \$1**

GULF LITE CHARCOAL LIGHTER QUART PLASTIC BOTTLE **\$1.39**

MIAMI ICE FREEZE POPS PKG. OF 10 **99¢**

NEW CROP WHITE POTATOES 10 LB. BAG **\$1.79**

*Harvest of Savings*

FRESH FROM THE GARDEN FROZEN VEGETABLES ARE HERE. SEE OUR AD IN THE CLASSIFIED SECTION OF THE DAILY REFLECTOR.

WASHINGTON STATE RED DELICIOUS APPLES 2 LBS. FOR **\$1**

CALIFORNIA EXTRA LARGE CANTALOUPES **99¢** EACH

TENDER FRESH BROCCOLI BUNCH **99¢**

GOLDEN BANANAS **29¢** LB.

GREEN CABBAGE **10¢** LB.

SEEDLESS WHITE GRAPES **79¢** LB.

# BIG LOTS



**Buyouts! Closeouts! Liquidations!**

PRICES GOOD WED., AUG. 16  
THRU SUN., AUG. 20

**FAMOUS NAME!**

**LADES' CANVAS PANTS**  
*Proportionately Sized!*

100% cotton with yoke waist. Assorted colors. Slight irregulars.

SIZES: 8-20  
•SHORT •AVERAGE •TALL

**9<sup>99</sup>** COMP. TO \$19.99 IF PERFECT

**FAMOUS NAME!**

First Quality!  
**ROTARY WALL TELEPHONE**  
*White or Beige*

**16<sup>99</sup>**

**Scripto**

10 PK. SUPER STIC™ PENS

*Write At Any Angle... Even Upside Down!*

**39<sup>¢</sup>** Limit 6 pks.

**LOLLYTOGS**  
GIRLS' & BOYS' SHIRTS

Long sleeved, assorted styles.

COMP. TO \$10.00

**4<sup>99</sup>**

GIRLS' SIZES: 2/4, 4/6X, 7/14  
BOYS' SIZES: 2/4, 4/7, 8/10

**Judy Philippine**

COMP. TO \$8.00

**5<sup>99</sup>** GIRLS' & BOYS' DENIM JEANS

**GE**

**BEOPERLESS REMOTE ANSWERING SYSTEM**

**49<sup>99</sup>**

- 8 Beoperless Remote Functions
- Full Featured Answerer
- Uses 2 Cassettes For Full Sound and Reliability. Reconditioned by G.E.

**MEN'S & LADIES' QUARTZ SPORT WATCHES OR PEN WATCH**

**149<sup>EA.</sup>** YOUR CHOICE

**Meaddin**

**SOFT-SIDED LUNCH KITS**

**3<sup>99</sup>** Barrel bag with bottle in assorted styles and popular designs.

SPECIAL PRICE THRU SUNDAY!

**TEXAS INSTRUMENTS**

**ANYLITE™ ULTRA THIN SOLAR CALCULATOR**

**6<sup>99</sup>**

- 8-Digit LCD
- All Basic Functions Plus 3 Key Memory

T1-306

**96 CT. CRAYONS**  
Non-toxic

**149**

96 crayons

SPECIAL PRICE THRU SUNDAY!

**LEGAL PADS**

YOUR CHOICE:  
•8.5 in. x 11 in.  
•8.5 in. x 14 in.

**39<sup>¢</sup> EA.** Slight blemishes

**Guard**

**COMBINATION PADLOCK**

**99<sup>¢</sup>** Designed To Withstand Extreme Abuse!

SPECIAL PRICE THRU SUNDAY!

**UNIVERSAL** SHG

**T-120 VHS VIDEO TAPE**

Up to 6 hours of viewing time.

**199** SPECIAL PRICE THRU SUNDAY!

**Sure-Tuff**

**Sandwich Bags**

80

**399<sup>¢</sup> FOR 80 CT. SANDWICH BAGS**

SPECIAL PRICE THRU SUNDAY!

**10 CT. CREME FILLED COOKIES**

**69<sup>¢</sup>** Assorted flavors, individually wrapped. NET WT. 11.2 OZ.

SPECIAL PRICE THRU SUNDAY!

**8-10 OZ. CARAMEL CORN**

Assorted NFL Signature Series.

**99<sup>¢</sup> EA.** 18 OZ. . . . 1.49

TASTER

**Jergens**

**JERGENS® 3 OZ. BAR SOAP**

**5 \$1 FOR**

CODE 80

# Everything For Less

COMP. UP TO \$16.99

## LIFETRENDS® MEN'S & BOYS' FASHION SHIRTS

Choose from garment washed and chambray fabrics in assorted styles and colors.

**8.99** FIRST QUALITY!  
MEN'S & BOYS' SIZES: S-M-L-XL



## \$1,500,000 HUFFY® BIKE ACCESSORY BUYOUT!

We purchased a large Huffy inventory at a savings of 50% OR MORE! Items listed below are just a sample of what you might find -- so hurry in & check out our selection!



## HUFFY BIKE ACCESSORIES

- All Bike Tires . . . . . EA. 2.99 & 3.99
- All Bike Tire Tubes . . . . . EA. 1.99
- Woven Daisy Baskets . . . . . 1.69
- Deluxe Bugle Horn . . . . . 2.49
- 15" Upright Tire Pump . . . . . 2.99
- 48" Chain with Key Lock . . . . . 2.99
- 72" Cable with Combo Lock . . . . . 2.99
- Rear Seat Bag . . . . . 2.99
- 9/16" or 1/2" Reflector Pedals . . . . . PK. 3.99
- 8 Tune Musical Horn . . . . . 4.99
- Child Carrier--Holds up to 40 lbs. . . . . 6.99

COMP. TO \$9.99

## FIRST QUALITY! BOY'S FLEECE PULLOVER

Two-color tops with embroidered car insignias. Choose from Corvette®, Trans Am®, Porsche® and others.

**4.99** SIZES: 8-18  
Selection may vary by store.



COMP. UP TO \$24.99

## FIRST QUALITY! MEN'S TERRY ROBES

100% cotton terry robes in assorted styles, colors & sizes.

**10.99**  
MEN'S TERRY ROBES  
Big & Tall Sizes . . . . . **12.99**



COMP. \$7.99

## FIRST QUALITY! LADIES' 100% COTTON TURTLENECK

Assorted pastel colors.  
SIZES: S-M-L

**4.99**



COMP. TO \$4.99

## JORDACHE® LARGE NYLON TOTES

Great for school or gym! Assorted bright colors with carry straps.

**2.99** FIRST QUALITY!



COMP. TO \$19.99 IF PERFECT

## Garfield



**9.99** CHILDREN'S NOVELTY SLUMBER BAGS  
30" x 57" bags in assorted novelty prints. Slight blemishes. Selection may vary by store.

COMP. TO \$6.99

## GITANO



**2.99** EA. CHECKBOOK ORGANIZERS  
FIRST QUALITY!  
Assorted vinyl organizers.

COMP. TO \$12.99

## 50" x 60" 100% COTTON WOVEN THROWS

**7.99**

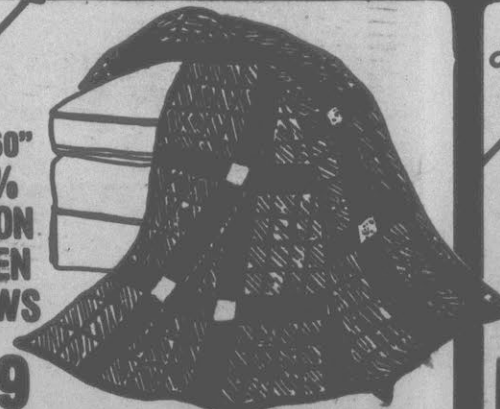

First Quality! Choose from assorted plaids with bound edges.

COMP. TO \$8.00 IF PERFECT

## BIG YANK® 3-PK. MEN'S SOCKS

Over-the-calf tube, crew tube or work crew socks. 10/13.

**2.49** PK. Slight irregulars.



COMP. TO \$1.49



**99¢** EA. FRAME-TRAY PUZZLES  
Assorted scenes.

COMP. UP TO \$3.99



**1.99** 10" x 12" PADFOLIO  
With 8-1/2" x 11" paper.  
5 1/2" x 8 1/2" PADFOLIO  
With 5" x 8" paper 1.49

COMP. TO \$1.99

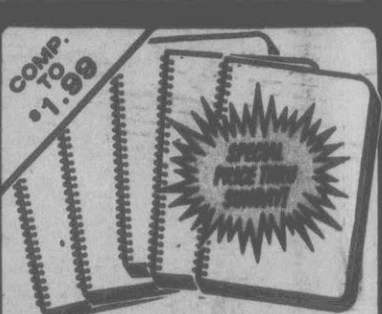

**79¢** PK. 5-PK. 3" x 5" SPIRAL BOUND MEMO PADS

# SALE BIG LOTS



**MFR'S BUYOUT! DISCONTINUED PATTERN!**

**SAVE UP TO 50%!**  
**COR-PAK® CLOSET ORGANIZERS**  
 With rugged fiberboard or padded vinyl construction.

- Storage Chest or Underbed Chest ..... EA. 1.99
- Compact Suit/Skirt Bag ..... 4.49
- Dress/Coat Bag, Suit/Skirt Bag or 12-Pr. Shoe Bag ..... EA. 4.99
- 9 Compartment Shoe Chest ..... 5.99
- 10 Shelf Accessory Bag ..... 7.99
- 4 Drawer Chest ..... 8.99

**COMP. UP TO \*18.00!**

**COMP. UP TO \*54.95**

**GUSDORF. MICROWAVE/UTILITY CART**

Oak finish microwave/utility cart featuring drawer, double doors & easy-roll casters.  
 32"H x 25"W x 19"D.

**34.99** #3515



**COMP. UP TO \*19.99**

**FIRST QUALITY! LADIES' TWILL SKIRTS**

In assorted styles and colors with elastic waistband. 25" or 27" hems.

**5.99**

SIZES: 6-20



**COMP. UP TO \*9.99**

**100% COTTON DORM SHIRTS FIRST QUALITY!**

Oversized dorm shirts with print designs in assorted bright & pastel colors. One size fits all.

**4.99**



**COMP. UP TO \*34.95**

**2 TON HYDRAULIC TROLLEY JACK**

- Lifting Height: 10"
- Lifting Range: 5"-15"
- Dimensions: 21" x 8.5" x 5.5"

**23.99**

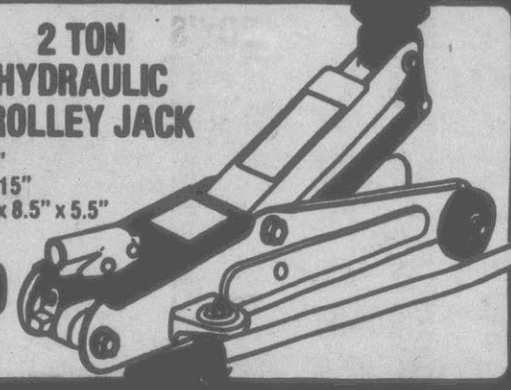

**COMP. UP TO \*18.99**

**KERO FIRE RESISTANT SECURITY CHEST**

Protects Documents From Fire or Theft. Double steel walls. Includes 2 keys.

12 1/4" L x 4" H x 8 1/4" W.

**9.99**

**COM & STAMP BOX w/2 keys..... 99¢**



**COMP. UP TO \*12.99**

**4 IN 1 COMBINATION STEREO SPEAKERS**

Includes: 2 stereo speaker boxes, headphones, earbuds & 6.3 mm adapter.

**5.99**



**COMP. UP TO \*18.99**

**SOLID OAK TOILET SEAT**

Solid brass hinges. Includes hardware.

**11.99**



**COMP. UP TO \*18.95**

**1/4" & 3/8" DRIVE 40 PC. SOCKET SET**

Includes SAE & metric sockets, 8" reversible ratchet, 3" extension bar, adaptor & more.

**3.66**



**COMP. UP TO \*1.20**

**16-OZ. CRAN-RASPBERRY SAUCE**

59¢

**14-OZ. CRAN-ORANGE RELISH 79¢**



**COMP. UP TO \*5.99**

**PARENT APPROVED CHILDREN'S VHS VIDEOS**

Assorted titles.

**2.29** EA.



**COMP. UP TO \*3.99**

**4-PK PLASTIC VHS VIDEO TAPE CASES**

**1.49** PK.



**COMP. UP TO \*1.69**

**Old Spice 2.5-OZ. AFTER SHAVE**

**99¢**



# SAVE UP TO 70%!

# EVERYTHING FOR LESS BIG LOTS®

COMP. UP TO \$19.99

**20-PC. STONEWARE DINNERWARE SET**

**12<sup>99</sup>** Includes (4 of each): Dinner plate, side plate, soup/cereal bowl, cup & saucer. Asst. patterns.

COMP. UP TO \$9.99

**TEXAS INSTRUMENTS TOUCH & DISCOVER™ LEARNING AID**

**3<sup>99</sup>** Touch & Discover uses eight, sound and touch for learning fun. Batteries not included. Factory reconditioned by T.I.

COMP. UP TO \$19.99

**NORTHWESTERN MEN'S & LADIES' GOLF CLUBS IRONS & WOODS**

**6<sup>99</sup> IRONS**  
**8<sup>99</sup> WOODS**

Choose from right & left handed clubs in assorted lengths and grips. Irons: 2-9. Woods: 1-3-5-7. Selection may vary by store.

COMP. UP TO \$99.99

**Armstrong 2-DRAWER STUDENT DESK**

Size: 41-7/8"W x 18-1/8"D x 29-5/8"H.

**34<sup>99</sup>** Oakgrain laminate. Brass finish handles.

COMP. UP TO \$19.99

**SPECIAL PRICE THRU SUNDAY!**

**QUILTED COMFORTERS**

**12<sup>88</sup> EA.** Twin, Full or Queen Poly/cotton comforters. Assorted prints.

COMP. UP TO \$19.99

**AM/FM STEREO RADIO**

**7<sup>99</sup>** With Headphones

FEATURES: Rotating tuner dial, FM stereo light & belt clip.

COMP. UP TO \$99.99 or NEW

**FAMOUS BRAND NAME! 16-GALLON WET/DRY VACUUM CLEANER**

Includes attachments. Factory reconditioned.

**49<sup>99</sup>** \*550-16

**SPECIAL PRICE THRU SUNDAY!**

**6-PK. BOYS' MULTI-COLOR BRIEFS**

100% cotton briefs with fly-front. S•M•L•XL

**2\$10** 6 PKs.

COMP. UP TO \$3.99

**STUDENT SURVIVAL KIT**

**1<sup>99</sup>** INCLUDES: Academic planner, pen, 2 two-pocket portfolios & 50-ct. typewriter paper.

COMP. UP TO 79¢

**12-PK. WOOD PENCILS**

**19¢** SPECIAL PRICE THRU SUNDAY!

COMP. UP TO \$9.99

**OXFORD NYLON TRI-PACK**

**3<sup>99</sup>** With padded shoulder straps.

COMP. UP TO \$9.99 PK.

**SPECIAL PRICE THRU SUNDAY!**

**6-PK. BOYS' MULTI-COLOR BRIEFS**

100% cotton briefs with fly-front. S•M•L•XL

**2\$10** 6 PKs.

COMP. UP TO \$6.99

**SOS 10-CT. STEEL WOOL SOAP PADS**

**69¢** Lemon Scent

COMP. UP TO \$1.99

**Velaminis 3 PK. SUGARFREE VELAMINTS®**

**79¢**

COMP. UP TO \$7.99

**SPECIAL PRICE THRU SUNDAY!**

**100 PAGE MAGNETIC PHOTO ALBUM**

**3<sup>99</sup>**

COMP. UP TO \$1.99

**SOFT & DRI® ANTI-PERSPIRANT & DEODORANT**

**99¢** EA. 4 OZ. AEROSOL 1<sup>29</sup>

\*1.5 Oz. Roll-On  
\*2 Oz. Solid

COMP. UP TO \$1.49

**HALSA 6.75 OZ. STYLING MOUSSE**

Assorted Hair Types

**69¢** EA.

OVER 325 LOCATIONS TO SERVE YOU!  
PRICES AND ITEMS GOOD AT THESE STORES ONLY!

- |  |   |  |   |                                     |   |
|--|---|--|---|-------------------------------------|---|
| ALBANY, N.C.<br>Salem Plaza  | ELKHART, N.C.<br>Elkhart Village Shop Ctr.                | KANSAS CITY, N.C.<br>407 N. Cannon Blvd. | MEMPHIS, N.C.<br>500 Plaza Dr.          | RALEIGH, N.C.<br>1000 S. Main Blvd. | WAKE FOREST, N.C.<br>1000 S. Main Blvd. |
| ASHEBORO, N.C.<br>Salem Plaza  | FAYETTEVILLE, N.C.<br>4110 Sanford Rd.                    | MEADOWS, N.C.<br>Main St.                | ROSELAND, N.C.<br>Salem Plaza           | WELLSVILLE, N.C.<br>Salem Plaza     | WILKESVILLE, N.C.<br>Salem Plaza        |
| CHARLOTTE, N.C.<br>5420 N. Tryon<br>521 Woodover Rd.<br>3317 Freedom Dr.<br>7020 Albemarle Rd. | GASTON, N.C.<br>410 W. Franklin Ave.                      | LAURENS, N.C.<br>224 E. Church St.       | SALISBURY, N.C.<br>1000 S. Main Blvd.   | WELLSVILLE, N.C.<br>Salem Plaza     | WILKESVILLE, N.C.<br>Salem Plaza        |
| CLAYTON, N.C.<br>Salem Plaza   | GREENSBORO, N.C.<br>W. Fields & S. Clayman<br>Salem Plaza | LEWIS, N.C.<br>200-A Shopping Park Blvd. | SPRINGFIELD, N.C.<br>1000 S. Main Blvd. | WELLSVILLE, N.C.<br>Salem Plaza     | WILKESVILLE, N.C.<br>Salem Plaza        |
| DURHAM, N.C.<br>Salem Plaza  | GREENVILLE, N.C.<br>Salem Plaza                           | LEWISVILLE, N.C.<br>1000 S. Main Blvd.   | WELLSVILLE, N.C.<br>Salem Plaza         | WELLSVILLE, N.C.<br>Salem Plaza     | WILKESVILLE, N.C.<br>Salem Plaza        |
| HARRISBURG, N.C.<br>Salem Plaza  | GREENVILLE, N.C.<br>Salem Plaza                           | MT. AIRY, N.C.<br>Salem Plaza            | WELLSVILLE, N.C.<br>Salem Plaza         | WELLSVILLE, N.C.<br>Salem Plaza     | WILKESVILLE, N.C.<br>Salem Plaza        |
| WELLSVILLE, N.C.<br>Salem Plaza  | GREENVILLE, N.C.<br>Salem Plaza                           | WELLSVILLE, N.C.<br>Salem Plaza          | WELLSVILLE, N.C.<br>Salem Plaza         | WELLSVILLE, N.C.<br>Salem Plaza     | WILKESVILLE, N.C.<br>Salem Plaza        |

WE'RE OPENING BECAUSE YOU LIKE US! 9 A.M. - 9 P.M. Daily '88-89. We do not accept M.C.'s Deposits.

# FAMILY DOLLAR®

Neighborhood Discount Store

# Back-to-School SALE

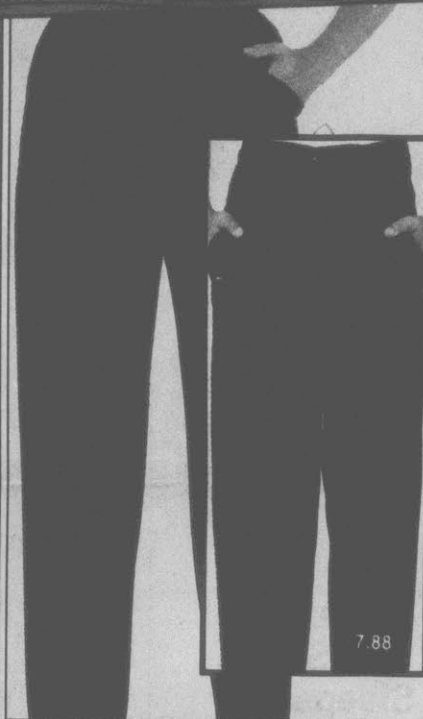

**11.99** Pr.

Students' Stonewashed Levi's Jeans Slightly Irregular

**12.99** Pr.

Men's Levi's Or Lee Jeans Slightly Irregular. Lee jeans not in all stores.

**8.88** Pair

Ladies' Asst. Jeans Or Girls' 7-14 Stonewashed Jeans  
 Girls' 4-6x Stonewashed Jeans.....7.88  
 Ladies' Denim Skirts.....11.88  
 Asst. Plus Size Jeans.....12.88



**11.88** Pr.

Ladies' Voit® Athletic Shoes

**13.88** Pr.

Ladies' Voit® Hi-Tops

**14.88** Pr.

Men's Voit® Hi-Tops

**5** rolls  
**3**  
 140 Sheet Paper Towels

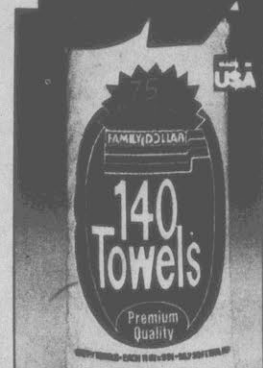

**1** Pack  
 Pk. Of 6 Rolls Bath Tissue 350 sheets per roll.



**3** for **1**  
 70 Page Spiral Notebook Limit 6.



**2** pkgs.  
**1**  
 Pkg. Of 14 Wooden Pencils

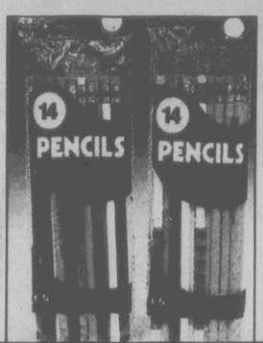

**2.99** Box  
 125 Oz. Trend Laundry Detergent Regularly 3.99



**6.99** Pkg.  
 Ultra Baby Diapers 66 ct. sm., 48 ct. med. or 32 ct. large.



**3.99** Pkg. **4.99** Pkg.  
 Pk. Of 3 Pr. Men's Briefs Boys'.....2.99  
 Pk. Of 3 Men's T-Shirts



**79¢** Jar **1.22** Jar  
 18 Oz. Apple Or Concord Grape Jelly  
 18 Oz. Crunchy Or Creamy Peanut Butter

PRICES GOOD THRU AUGUST 21ST WHILE QUANTITIES LAST! BE AN EARLY SHOPPER... LIMITED QUANTITIES ON SOME ITEMS. NO SALES TO DEALERS.



# Back-to-School SALE

**9.88**

Girls' 7-14  
Jogging Set  
4-6.....7.99 Set  
Styles vary



**7.99**  
Each  
Men's  
Fashion  
Fleece Tops

**5.99**  
Each  
Boys' 8-18  
Fashion  
Fleece Tops

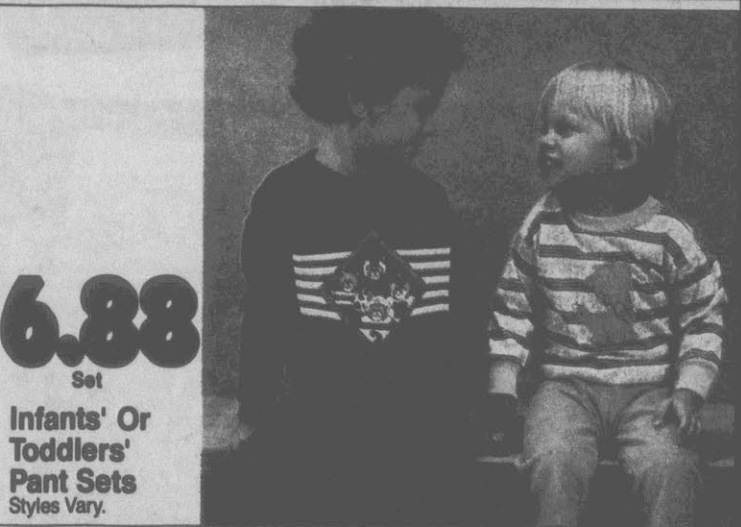

**6.88**

Set  
Infants' Or  
Toddlers'  
Pant Sets  
Styles Vary.

**4.99**

Each  
Men's Fleece  
Tops Or  
Bottoms

**3.99**

Each  
Boys' 8-18  
Fleece Tops  
Or Bottoms



**4.99**  
Each

Boys' 8-18  
Long-Sleeve  
Woven Shirts  
Belts not included.

**6.99**

Pair  
Boys' 8-16  
Casual Pants  
4-7.....4.99 Pr.  
Belts Not Included.



**7.99**

Pair  
Men's Asst.  
Casual Slacks  
Belts Not Included.



**5**  
Each  
Girls' 4-14 Fashion  
Sweaters  
Toddler.....\$4 Ea.



**4.88**  
Girls' 7-14  
Fashion Tops

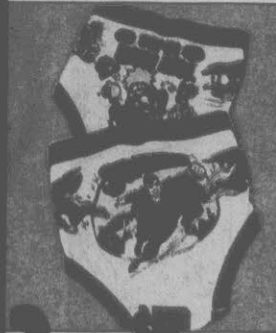

**2 pkgs \$5**  
Pk. Of 2 Pr. Boys'  
Fun Pals® Briefs  
Slightly Irregular. Styles vary.



**2 for \$4**  
Men's Fashion  
Bikini Briefs

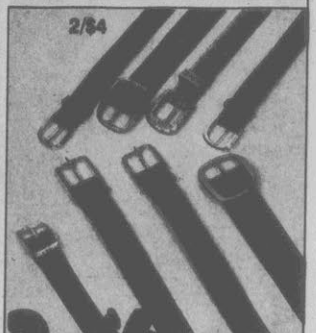

**2 for \$6**  
Men's Asst. Belts  
Boy's.....2 For \$4

**We Have Guaranteed Savings Everyday!**

# Back-to-School SALE

# 7.88

Ladies' Shoe Assortment  
Choose from heels and flats  
in casual or dress styles.

Pair

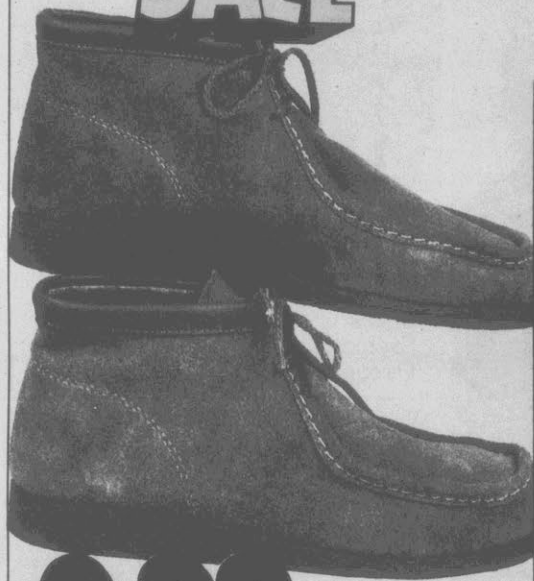

# 9.88

Pair

Men's Suede Casuals



# 8.88

Pair

Children's Hi-Tops  
Or Athletics

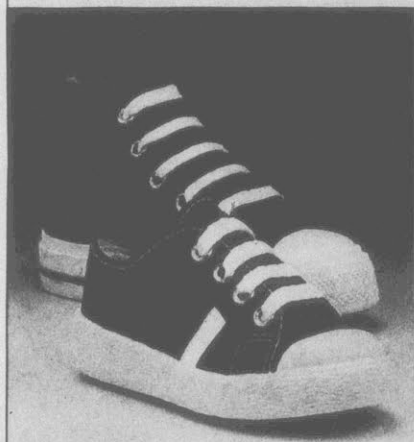

# \$4

Pr.

Children's Oxfords  
Or Hi-Tops



# \$2

Pr.

Asst. Ladies'  
Washable Scuffs



# \$4

Pr.

Ladies' Or  
Girls' Canvas  
Crissy Oxfords

Girls' Styles In White Only.



# \$3

Pack

Pk. Of 3 Pr. Ladies'  
Or Girls' Socks



# \$2 \$3

pair

Ladies' Or Girls'  
Wrangler Socks



# \$5

Pack

Pk. Of 6 Pr. Ladies'  
Or Girls' Socks



# \$5

Each

Batman Watch  
Five function. Never  
needs winding.



# \$2

Each

Men's Or Ladies'  
Asst. Watches  
Sport, dress or bangle.

# \$3

Each



# \$4

Each

Assorted Roll Bags  
Or School Bags

## Great Savings Everyday...At Family Dollar

# Back-to-School SALE



**3.99**

Each

23" x 42" Vinyl Mini Blinds

**6.99**

Each

27", 29", 31", 35" Or 36" x 64 Inch Vinyl Mini Blinds

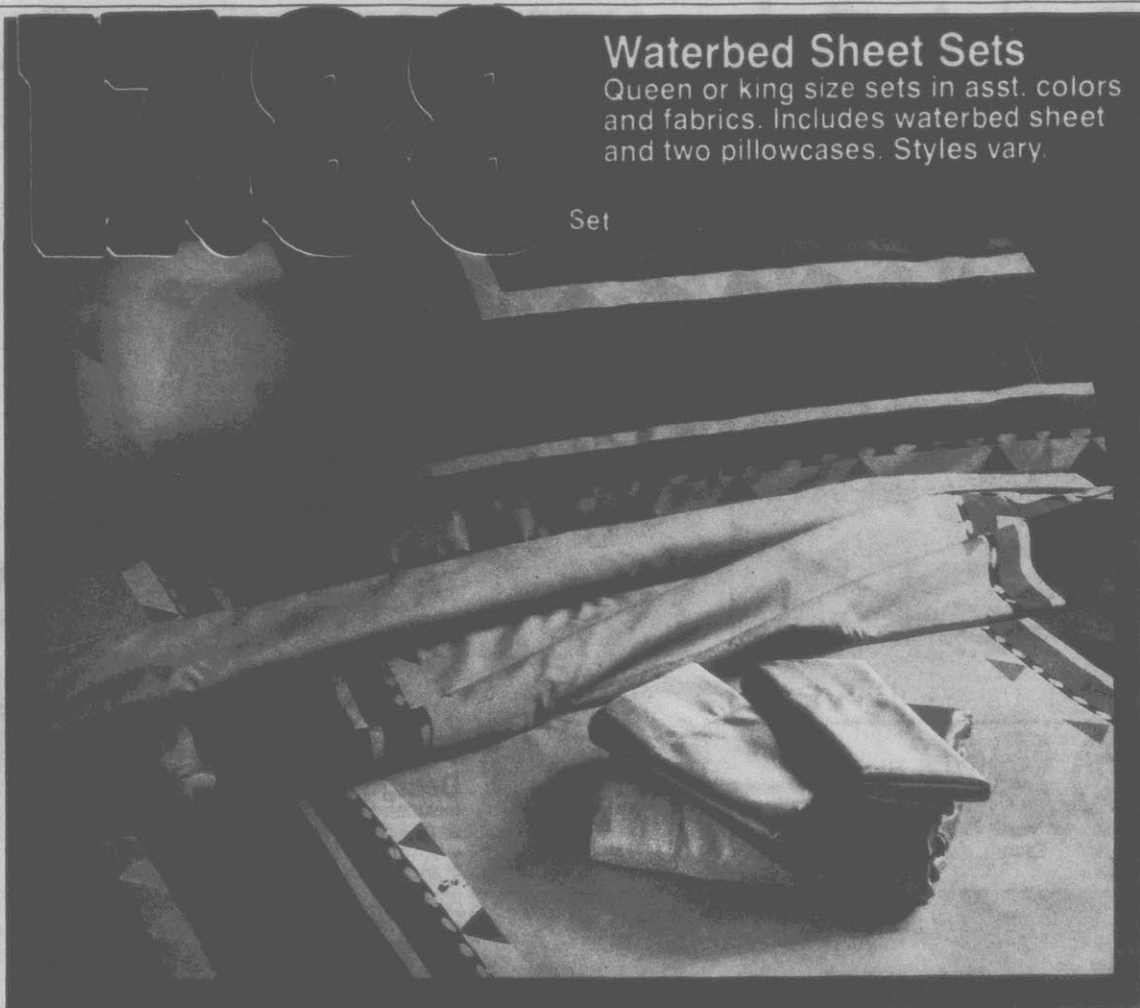

## Waterbed Sheet Sets

Queen or king size sets in asst. colors and fabrics. Includes waterbed sheet and two pillowcases. Styles vary.

Set

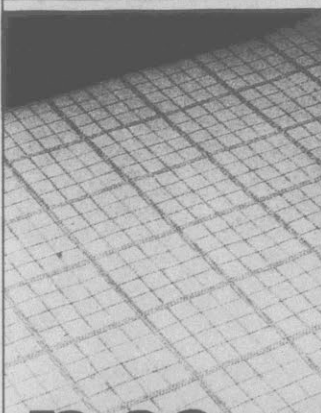

**12.88** Ea.

6'x9' Vinyl Flooring  
Asst. patterns and colors.



### Start To Sew Kit

Includes scissors, seam ripper, tailor's chalk and holder, straight pins, tracing wheel, 30 needles, tape measure, sewing gauge, thimbles and pin cushion.  
Asst. Thread.....8 For \$1



**5** Ea.

72" x 90" Solid Blankets  
102" x 90" .....6.50 Each

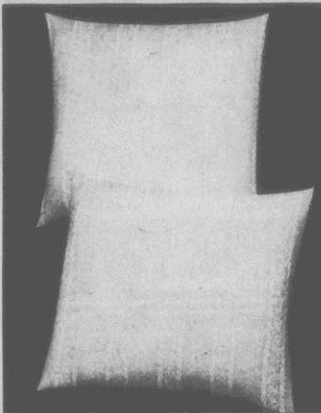

**2 for 1**

Standard Bed Pillows  
Styles vary.

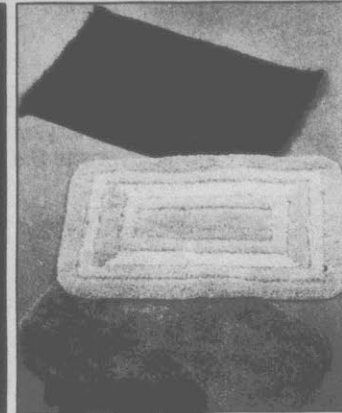

**2.88** Ea.

Asst. Scatter Rugs  
20" x 32". Asst. styles and colors. Rubber backing.

**SAVE \$10**

**29.88** Each

42" White Ceiling Fan With Light Kit  
Regularly \$40

52" Brass Ceiling Fan With Light Kit  
Not At All Stores **44.88** Ea.

**CLEARANCE!** WHILE QUANTITIES LAST!

**88¢** Pkg. Of 2 Light Bulbs

Pack

**We Have Guaranteed Savings Everyday!**

# Back-to-School SALE

# 10.88

Proctor Silex  
Steam 'N Dry Iron

Each



BISSELL



Proctor Silex

**9.88**  
Each  
Bissell  
Zoom  
Broom

**11.88**  
Set  
7 Piece Goose  
Design Cookware  
Includes 1 qt. saucepan  
w/ cover, 2 qt. saucepan  
w/cover, 4 qt. dutch oven,  
9" fry pan and cover.

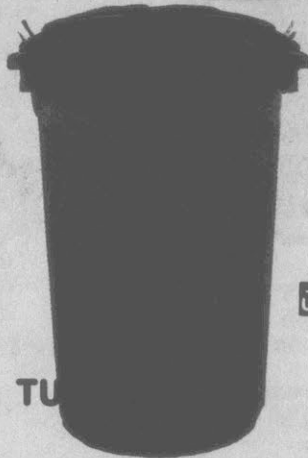

**7.88**  
Each.  
30 Gallon  
Trash Can  
With Handles

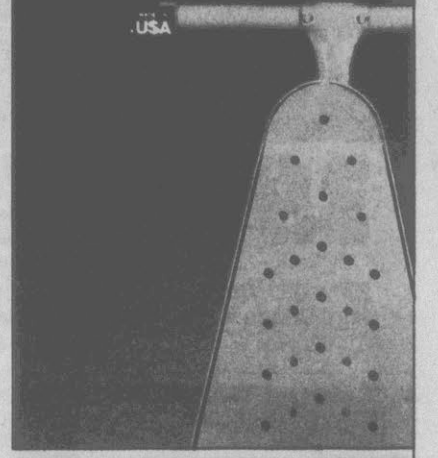

**\$5**  
Set  
12 Piece  
Sink Set



**2.99**  
Set  
12 Pc. Crystallux  
Beverage Set



Each  
14" x 50"  
Door Mirror



Each  
40 Quart  
Swingtop  
Wastebasket



**2.99**  
Each  
Handi-  
Metal  
Sponge  
Mop  
Or Corn  
Broom

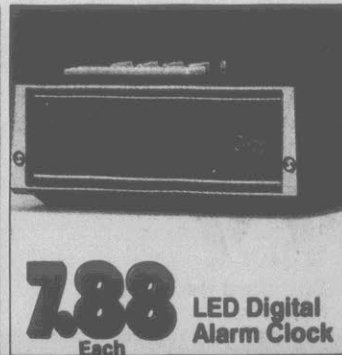

**7.88**  
Each  
LED Digital  
Alarm Clock



**2** boxes **\$3**  
Kleen Kan Trash Bags  
20 ct. 26 gal., 30 ct. 13 gal., 12 ct. 33 gal.  
or 10 ct. 39 gal.



**\$1**  
Each

- Household Needs
- 12 Oz. Spray Disinfectant
  - 22 Oz. Blue Or Green Dish Detergent
  - Honeysuckle Or Super Odor Air Freshener

## Your Neighborhood Discount Store

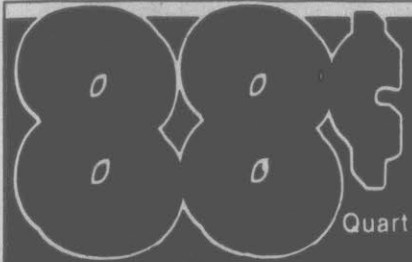

Pennzoil  
HD30  
Motor Oil  
10W30.....99c Qt.

Quart

# Back-to-School SALE



Kotex 26 Ct.  
Pantiliners  
Or 20 Ct.  
Lightdays  
Longs  
Box



1.99 Sale Price  
1.00 Mfr. Rebate

99¢

Gillette 5+ 1 Atra, Trac II  
Or Atra Plus



3.99

Latex Flat Wall Paint  
White, ceiling white or off-white.  
4" Wall Brush.....\$2 Each

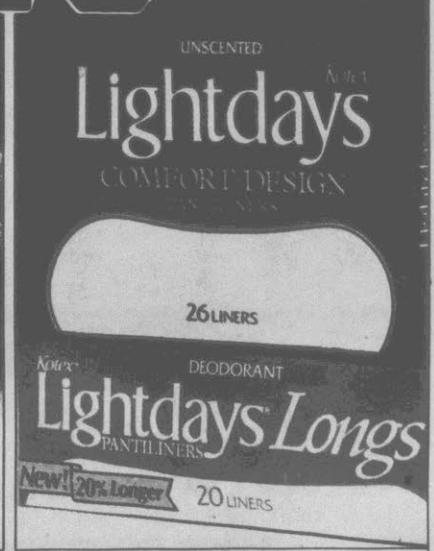

20 LINERS

20 LINERS



99¢

12 Oz. Warren  
Brake Fluid



1.99

8 Oz. Armor All  
Protectant



83¢

12 Oz. STP Gas  
Treatment Or 15 Oz.  
Oil Treatment



99¢

12 Oz. STP Power  
Steering Fluid



88¢

12 Fl. Oz. Spray Paint  
Asst. colors.



2.59

24 Ct. Security  
Tampons Or  
Profile Pads



1.84

Head & Shoulders  
Shampoo  
7 oz. normal to oily or  
normal to dry.



88¢

Snap Over Or  
Brush Rollers  
14 med. or 12 lg. brush.  
14 sm. or med., 10 lg. snap.



69¢

Super Angle  
Toothbrush And Case

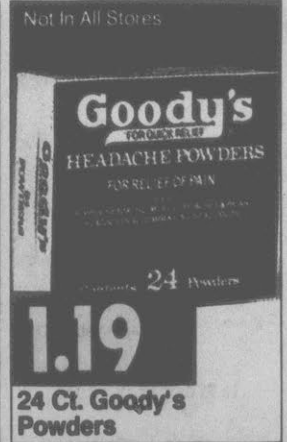

1.19

24 Ct. Goody's  
Powders

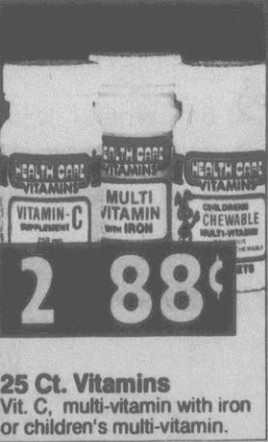

2 88¢

25 Ct. Vitamins  
Vit. C, multi-vitamin with iron  
or children's multi-vitamin.



1.19

16 Ct. Massengill  
Towelettes

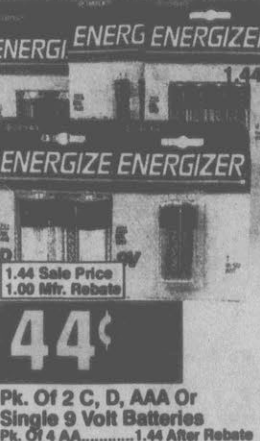

44¢

Pk. Of 2 C, D, AAA Or  
Single 9 Volt Batteries  
Pk. Of 4 AA.....1.44 After Rebate



2 \$3

Assorted Locks  
Combination lock, 1 1/2"  
laminated padlock or  
1 3/4" laminated padlock.

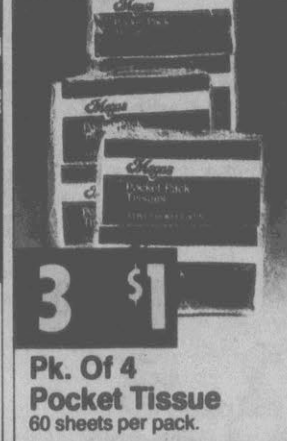

3 \$1

Pk. Of 4  
Pocket Tissue  
60 sheets per pack.



1.97

LeKair Hair Care  
16 oz. cholesterol plus  
creme or shampoo, styling  
gel or conditioning gel.



2.44

Colorsilk Hair Color  
Asst. shades.

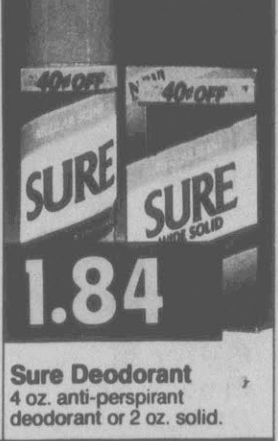

1.84

Sure Deodorant  
4 oz. anti-perspirant  
deodorant or 2 oz. solid.

## Your Neighborhood Discount Store

# FAMILY DOLLAR®

Neighborhood Discount Store

## Back-to-School SALE



**2.99** Assorted Canvas Knapsacks  
Each



**4.44** Trapper Keeper Notebooks  
Includes 2 portfolios and notepad. Design or asst. color covers.  
Each



**4.99** Nylon Teardrop Knapsacks  
Each



**99¢** Bic Writing Needs  
 • Pk. Of 10 Blue Or Black Stic Pens  
 • Pk. Of 7 Bic Pencils  
 • Pk. Of 6 Bic Hot Stic Pens  
 • Bic Clic Bonus Pack  
 Pack • Pk. Of 2 Metal Point Roller Ball Pens



**4 for 9¢**  
Asst. Bar Soaps  
5 oz. beauty, deod. or marble soap.

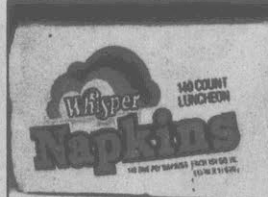

**66¢** Pkg.  
140 Ct. Paper Napkins



**77¢** gal.  
128 Ounce Clor-White Bleach



**10.88** Each  
AM/FM Clock Radio  
BATTERIES NOT INCLUDED.

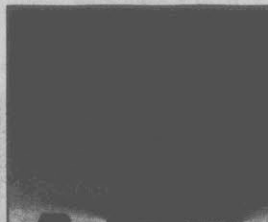

**4.44** Each  
Canon Handheld Calculator



**17.77** Each  
Canon Mini Printer Calculator



**2 for 1**  
Elmer's Glue Or Paste  
4 oz school glue or glue-all, 5 oz. paste or .22 oz. glue stick.



**59¢** Pkg.  
200 Count Filler Paper  
Limit 4.



**2 for \$3**  
Boxes  
8 Ct. Jumbo Or 24 Ct. Crayons  
64 Ct. Crayons..2 For \$3



**19.99** Each  
AM/FM Radio With Cassette Recorder



**2 pks 1**  
50 Ct. Lunch Bags Or 80 Ct. Sandwich Bags



**1.77** Pkg.  
Pk. Of 6 4 Oz. Cups Mott's Applesauce  
Reg. or cinnamon.

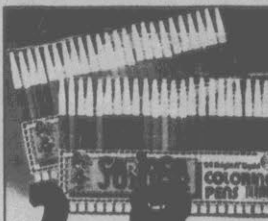

**2 pks 3**  
24 Ct. Watercolor Markers

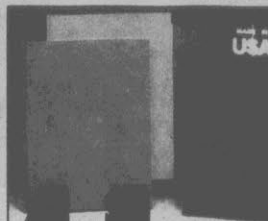

**4 for 1**  
Report Covers  
2 pocket. 3 fasteners. Asst. colors.



**66¢** Each  
2 Liter Sodas  
Cola, orange, rootbeer, grape, fruit punch or lemonade.

S

back to  
school

Save

20-35%

on many items

Belk

**A. Andrew Sport** crested oxford stripe shirt with one pocket, pure cotton. Your choice of white with cranberry/navy, pine/mustard or khaki/navy stripes, juniors' sizes S-M-L, reg. 26.00, **17.99**

**Jordache®** five pocket jeans with short zippers up the calf, ending in pert bows, in blue acid or black acid wash cotton, juniors' sizes 3-13, reg. 36.00, **26.99**

**B. Angelique®** patterned plaid shirt in navy, natural or black with brights, pure cotton, juniors' sizes S-M-L, reg. 26.00, **17.99**

**Rio®** suspended, crystal-washed cotton jeans with scalloped waist, juniors' sizes 3-13, reg. 45.00, **34.99**

**C. Red Camel®** cardigan sweater in navy, red, natural or black ramie/cotton, sizes S-M-L, reg. 24.00, **15.99**

**Jordache®** basic five-pocket jeans in blue acid or black acid finish cotton denim, sizes 3-13, reg. 25.00, **19.99**

**Save**

**20-30%**

**Junior class voted  
"most economic"**

# SCHOOL-MATES



13.99

23.99

save 25%



**A. Our Red Camel®** employs stripe force in this natural/black/khaki shirt, also in natural/olive/red or natural/navy/khaki, cotton, juniors' sizes S-M-L, reg. 22.00, **13.99**

**Our Red Camel®** button-front cotton skirt in black, loden, khaki or winter white, 3-13, reg. 28.00, **23.99**

**B. Our Adesso®** turtle has a few crimps in its neck (and on its cuffs)! The trapunto stitch cotton top comes in teal, cranberry, ochre, plum, natural or black cotton, juniors' sizes S-M-L, reg. 21.00, **14.99**

The **Red Camel®** straight skirt in khaki, navy, loden or black cotton twill, juniors' 3-13, reg. 28.00, **19.99**

**C. Our Adesso®** cotton jersey turtlenecks in black, white, navy, red, purple or jade, juniors' sizes S-M-L, reg. 8.99, **6.99**

**Lasting Impressions®** gets a check-up in black on purple, red or khaki on this pleated-all-'round skirt, rayon, in juniors' sizes 3-13, reg. 30.00, **20.99**

Not all colors in all stores

**A. Our own Red Camel®** cardigan in black, red, navy, wine, forest or natural cotton jersey, juniors' sizes S-M-L, reg. 24.00, **16.99**

How about a little mustard on your **Red Camel®** knit pants? Also in mushroom, natural or black, polyester/cotton jersey, juniors' sizes S-M-L, reg. 28.00, **19.99**

Not all colors in all stores

**B. Our Adesso®** criss-cross neck cotton jersey top in olive, plum, teal, ochre, cranberry or natural with black, in juniors' S-M-L, reg. 24.00, **15.99** Solid olive, natural, plum, teal, ochre or black, reg. 23.00, **15.99**

**Currants®** knit pants in black, navy, taupe, red or nugget polyester/cotton, S-M-L, reg. 20.00, **15.99**

**Belk** Use your credit card to build a really stylin' back-to-school wardrobe!

**Save**

**20-30%**

**on what's new in  
the state of jersey**





11.99

B

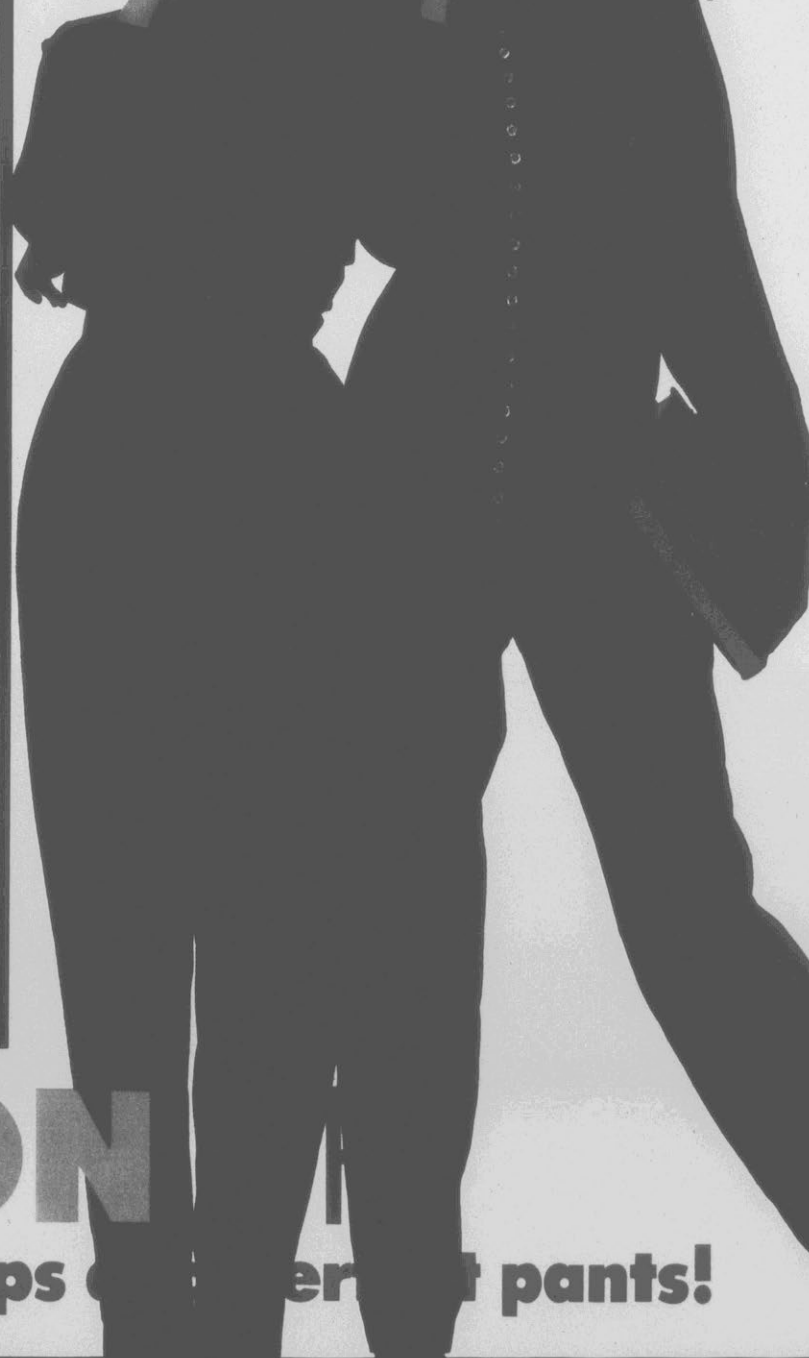

14.99

**A. Our Red Camel®** makes a 24-button salute to back-to-school in topaz, amethyst, emerald, loden, fuchsia or winter white with black stripes on ramie/cotton, juniors' S-M-L, reg. 20.99, **15.99**  
Also in solid emerald, amethyst, topaz, cranberry, navy or winter white, reg. 19.99, **14.99**

**Red Camel®** twill pants in black, navy, taupe or olive cotton, juniors' sizes 3-13, reg. 33.00, **22.99**

**B. Red Camel®** 13-button cotton jersey Henley in black, purple, navy, olive, mustard, brown, red or cream (also in stripes on black), S-M-L for juniors, reg. 16.00, **11.99**

**Airport Transport** paper-bag waist, garment-dyed cotton twill pants in olive, khaki, spice or black, sizes S-M-L, reg. 30.00, **21.99**

**C. Red Camel®** mock turtleneck in cranberry, emerald, amethyst, topaz, navy or winter white, ramie/cotton, in junior sizes 3-13, reg. 19.99, **14.99**

Also in striped brights on black, reg. 20.99, **15.99**

**Red Camel®** cotton twill "hunt" style pants: brown, blue or loden pattern, 3-13, reg. 27.00, **22.99**; solid sand, khaki, navy, black or olive cotton pants, sizes 3-13, reg. 25.00, **20.99**

Not all colors in all stores

22.99

**BUTTON**

**Multi-button tops and pants!**



**14.99**

Our Carrousel® dresses put you on the back-to-school merry-go-'round with savings on already-low prices!

**A.** She'll be a gingham girl in this checked cutie with pink buttons at the drop waist, easy-care polyester/cotton, 7-14, reg. 17.99, **14.99**

Assorted woven plaid dresses for 4-6X, reg. 15.99, **12.99**

**B.** Just for the twill of it, the solid jumper with double-tier flounce in red or black cotton, sizes 7-14, reg. 17.99, **14.99**  
4-6X, red only, reg. 15.99, **12.99**

**C.** Pleasingly plaid, the basque-waist dress in bonny reds and blues with fresh white collar, polyester/cotton, 4-6x, reg. 15.99, **12.99**  
Also, 7-14, reg. 17.99, **14.99**

**D.** The side-buttoned jumper with wrap-around pockets, in assorted plaids on cotton, 4-6X, reg. 15.99, **12.99**  
7-14, reg. 17.99, **14.99**

**12.99**

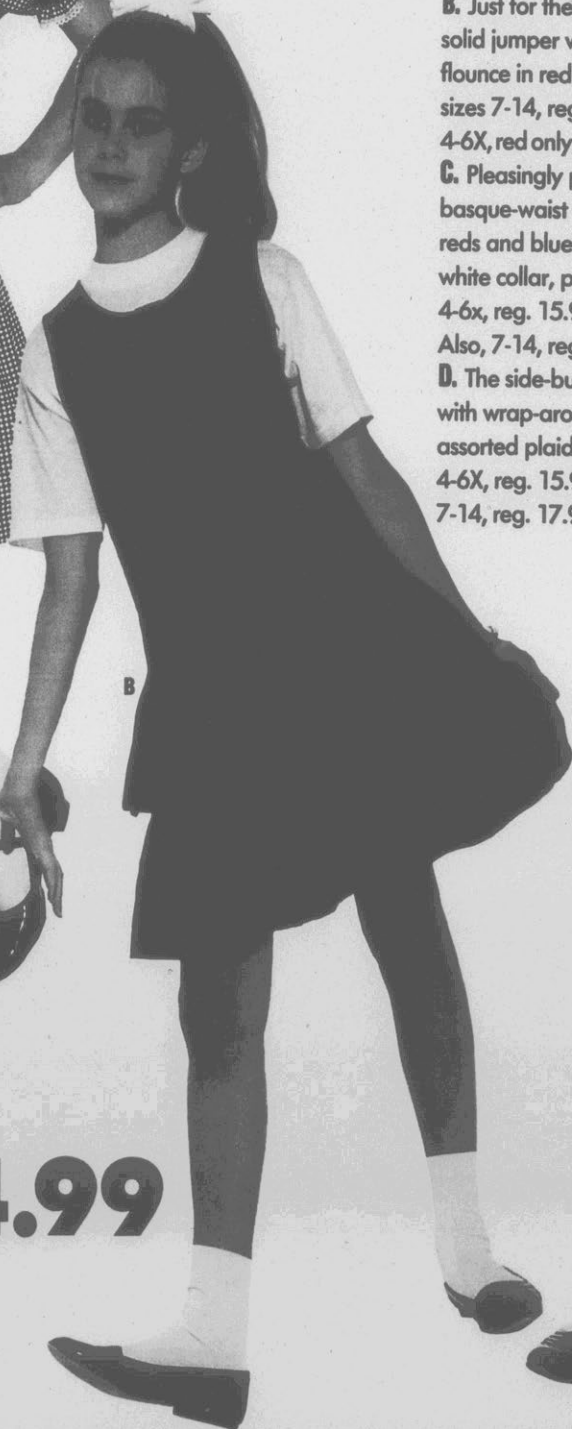

**14.99**



**12.99**

CH  
Our pr

# HARM SCHOOL

priv... ensure fashion, quality and value!



10.99

14.99

**A. Our Nouveau® girls' oversized crewneck sweaters** in red, turquoise, purple, fuchsia, white or black acrylic. Also in jacquard welt, snowflake or diamond patterns on acrylic. S-M-L for 7-14, reg. 13.99, **10.99**

4-6x in solids (not in black) or jacquard welt or snowflake patterns, reg. 12.99, **9.99**

**Red Camel® ankle-zip jeans** in blue acid wash cotton denim, girls' sizes 7-14, reg. 17.99, **14.99**

**B. Our Players Club® solid "super turtleneck"** in royal, fuchsia, purple, red, white or black cotton jersey, sizes 7-14, reg. 12.00, **8.99**

Sizes 4-6X, reg. 11.00, **7.99**

**Red Camel® plaid cotton twill trousers with leather belt** in royal check, red check, purple/green, royal/brown, or royal/green/red, sizes 7-14, reg. 18.00, **14.99**

4-6X, reg. 16.00, **12.99**

**C. Nouveau® crested cardigan sweater** in white, red or navy acrylic, S-M-L for 7-14, reg. 16.99, **13.99**  
S-M-L for girls' sizes 4-6X, reg. 14.99, **11.99**

**Cuffed, belted Red Camel® twill trousers** in navy, purple, khaki or black cotton, sizes 7-14, reg. 18.00, **14.99**  
sizes 4-6X, reg. 16.00, **12.99**



8.99

13.99

B

C

14.99

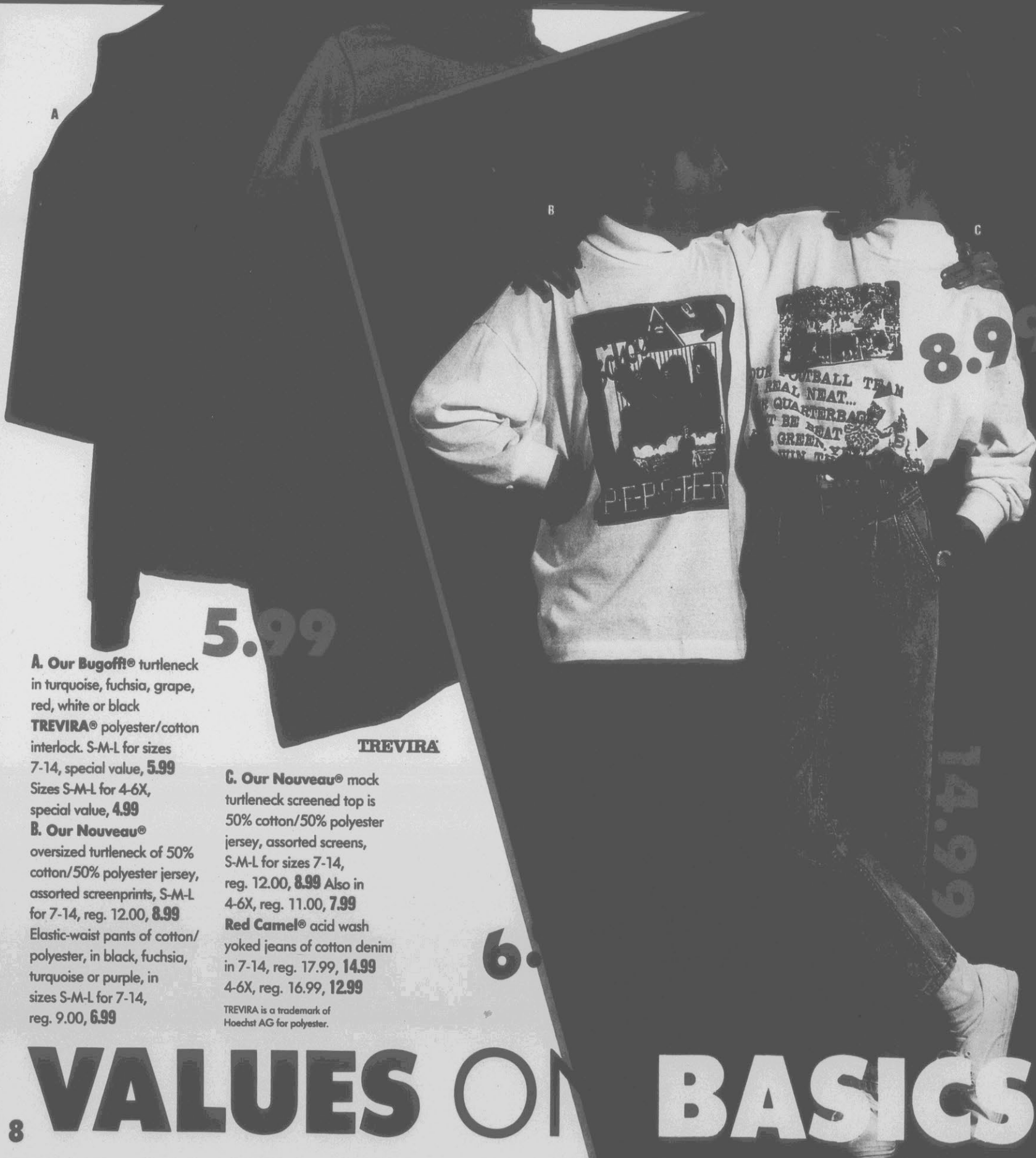

A

5.99

**A. Our Bugoff!**® turtleneck in turquoise, fuchsia, grape, red, white or black **TREVIRA**® polyester/cotton interlock. S-M-L for sizes 7-14, special value, **5.99**

Sizes S-M-L for 4-6X, special value, **4.99**

**B. Our Nouveau**® oversized turtleneck of 50% cotton/50% polyester jersey, assorted screenprints, S-M-L for 7-14, reg. 12.00, **8.99**

Elastic-waist pants of cotton/polyester, in black, fuchsia, turquoise or purple, in sizes S-M-L for 7-14, reg. 9.00, **6.99**

**TREVIRA**

**C. Our Nouveau**® mock turtleneck screened top is 50% cotton/50% polyester jersey, assorted screens, S-M-L for sizes 7-14, reg. 12.00, **8.99** Also in 4-6X, reg. 11.00, **7.99**

**Red Camel**® acid wash yoked jeans of cotton denim in 7-14, reg. 17.99, **14.99** 4-6X, reg. 16.99, **12.99**

TREVIRA is a trademark of Hoechst AG for polyester.

6.99

8.99

14.99

**VALUES ON BASICS**

Save 20-25% on our own cotton panties for girls:

**A. Bugoff® solid white briefs, 4-14, reg. 3/4.20, 3/3.29**

**B. Players Club® solid or striped panties, 4-14, reg. 1.90 each, 6/7.99**

Save 25% on our own Bugoff® girls' nylon pantyhose, sizes 7-10, 10-14.

**C. Sheer dot, white, pink or ivory, reg. 1.50, 1.12**

**D. Sheers in beige, ivory, white or pink, reg. 1.25, .93**

Save 25% on girls' Bugoff®

**E. Crew socks in white or pastel colors on cotton/nylon, reg. 3/5.00, 3/3.75**

**F. Triple roll of cotton/nylon, assorted brights, pastels or white, reg. 3/5.50, 3/4.12**

Save 30% on all of our Heiress® socks for women.

Styles shown are in brights, pastels and whites, one size 9-11:

**G. Ribbed crew sock of cotton/nylon, reg. 2.50, 1.75**

**H. Mock Shaker knit slouch of cotton/nylon, reg. 2.50, 1.75**

**J. The "boot slouch" sock of pure cotton, reg. 3.50, 2.45**

**K. The lightweight turn-cuff of 75% mercerized cotton/25% nylon, reg. 2.00, 1.40**

**L. The lightweight jersey ribbed turncuff of 75% cotton/25% nylon, reg. 2.25, 1.57**

**Women's canvas sneakers, special purchase, 4.99**

**M. Lace-up or twin gore styles in navy, red, light pink, black, white or khaki. Available in our Hosiery Department.**

# Specials and SAVINGS

on girls' and women's back-to-cool basics

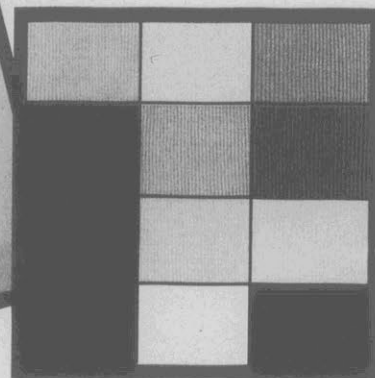

FL SCHOOL

FL

boys' 8-20

29.99  
24.99

Save 20-25% on our own Red Camel® leather-look bomber jacket! Bringing back memories of popular heroes, the intrepid flight jacket sports a fly-front with hidden zipper, printed nylon map lining and inside chest pocket for all his hidden treasure maps. Select grained leather-look black or brown polyurethane with ribbed knit cuffs and bottom, boys' sizes S-M-L-XL for 8-20, reg. 40.00, **29.99**. Also in boys' sizes 4-7, reg. 32.00, **24.99**.

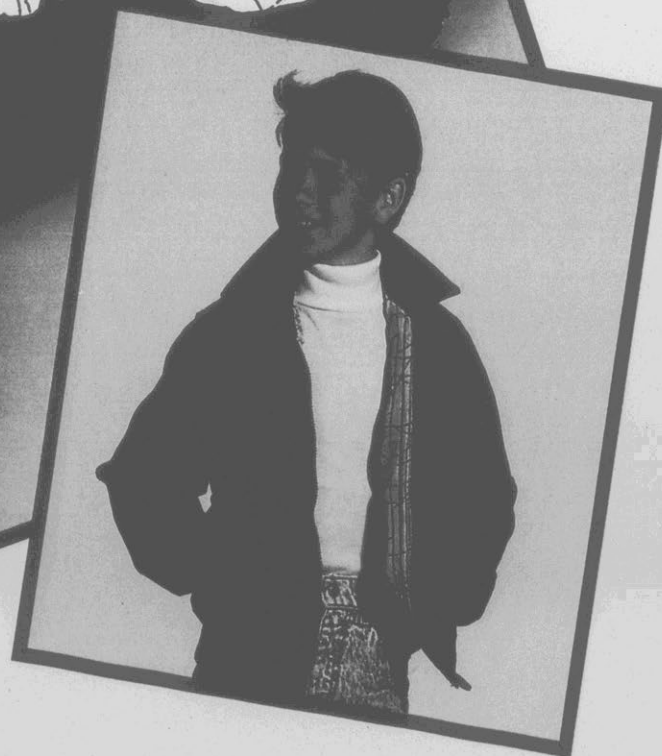



A

**A. Red Camel® knit shirt in red, royal, turquoise or purple with charcoal stripes, cotton/polyester, S-M-L-XL for 8-20, reg. 12.00, 7.80**

**Red Camel® pigment-dyed canvas pants with zippered side cargo pocket and aviator patch, in khaki, charcoal, blue or olive cotton, 8-16 regular and 8-14 slim, reg. 20.00, 13.00**

**Huskies, reg. 22.00, 14.30**

**B. Our own Red Camel® variable stripe shirt in black/white, red/indigo, red/black or royal/jade cotton/polyester, 4-7, reg. 8.00, 5.60**

**Red Camel® white-washed black cotton denim jeans elasticized at the ankles and waist, also in whitewashed indigo, 4-7, reg. 18.00, 12.60**

All items on this page are made in the USA!

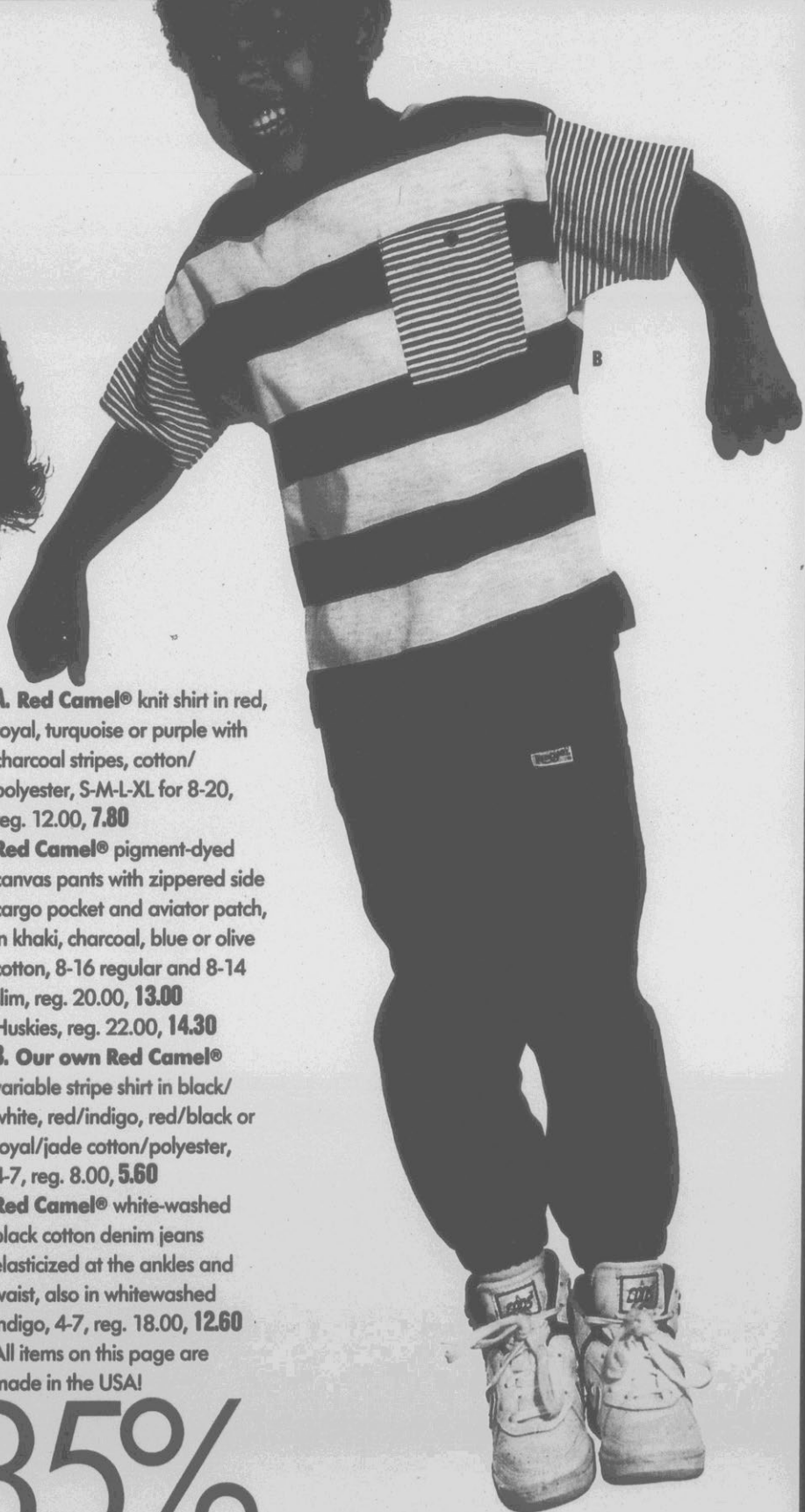

B

Save  
30-35%

our Red Camel® stripes and solids 11

Save

25-30%

Talk a blue streak about  
our Red Camel jeans!

A

**A.** Red Camel® tough stonewashed indigo jeans in classic 5-pocket style with elasticized-back waist, boys' 4-7, reg. 15.00, **10.99**

**B.** Red Camel® 5-pocket stonewashed denim jeans with metal rivets and bar tacks for extra reinforcement. Made in the U.S.A. Sizes 8-16 regular, 8-14 slim and 8-18 husky, reg. 18.00, **11.99**

**Belk** Use your credit card to stock up on Red Camel jeans!



**Our own Red Camel®** brushed oxfords in soft navy or charcoal stripes on pure cotton. Styled with button-down collar and one pencil pocket. Select from charcoal with teal blue, charcoal with helio purple, navy with strawberry red or navy with jade green. Made in the U.S.A.! Sizes S-M-L-XL for 8-20, reg. 20.00, **14.00**  
Huskies 10-20 in charcoal/teal blue or navy/strawberry red, reg. 21.00, **14.70**  
These fine quality shirts are made in the USA!

**30% OFF STRIPES**

**A.** Two striking patterns emerge in our **Red Camel®** crewneck sweater: chevron, shown, in black/gray or black/blue smoke; and a diamond pattern in black/olive or black/wine. Both are warm acrylic, made in the USA! Boys' S-M-L-XL for 8-20, reg. 22.00, **14.30**

**B.** **Lee®** Storm Rider® cotton denim jeans in the new pepper ice finish, sizes 8-14, reg. 27.00, **19.99**

Waists 26-30, reg. 30.00, **22.99**

Husky sizes, reg. 30.00, **22.99**

Also in boys' 4-7, reg. 22.00, **16.50**

A

**Save**

**20%**

**Our Red Camel crewneck sweater  
and Lee Storm Rider denim jeans**

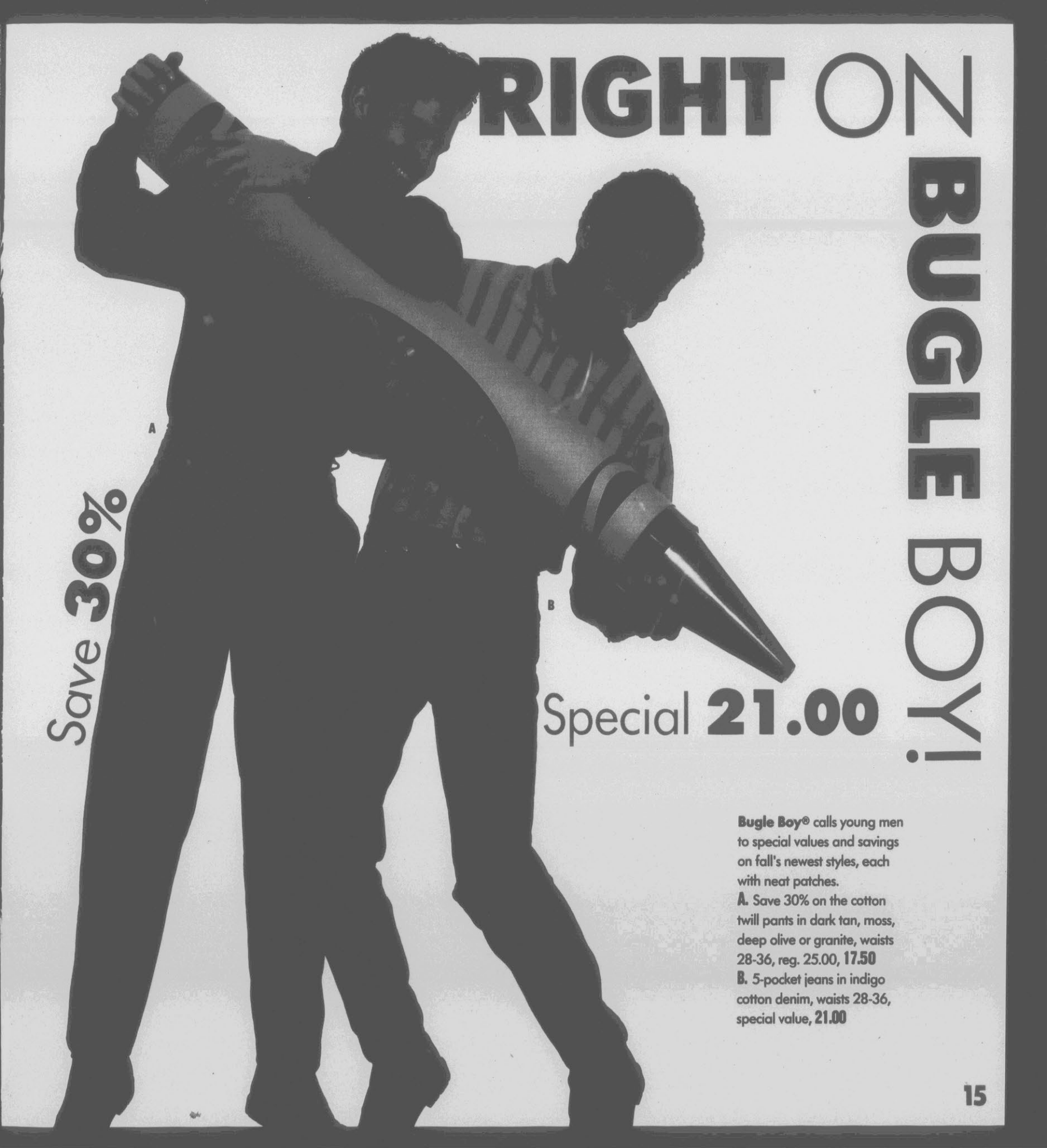

# RIGHT ON BUGGLE BOY!

Save **30%**

Special **21.00**

Bugle Boy® calls young men to special values and savings on fall's newest styles, each with neat patches.

**A.** Save 30% on the cotton twill pants in dark tan, moss, deep olive or granite, waists 28-36, reg. 25.00, **17.50**

**B.** 5-pocket jeans in indigo cotton denim, waists 28-36, special value, **21.00**

**A. Pier Connection®** striped cotton shirts in magenta, cobalt, turquoise or white with black stripes. Styled with two button-through flap chest pockets, drop back yoke and back box pleat.

S-M-L-XL for young men, reg. 22.00, **15.40**

**B. Lee® Storm Rider®** pepper ice jeans in pure cotton indigo, waists 29-42, inseams 30, 32, 34, 36, a special value, **26.99**

**C.D. Bon Homme®** long sleeve shirts in your choice of printed heather plaid in black on jade, royal or gray; or heather stripe in black on wine, sage or military blue; M-L-XL, reg. 25.00, **17.50**

**15.40**

**17.50**

**26.99**



**SALE DATES: August 17-26**

**Belk**

28, 83, 155, 192, 449, 108, 130, 90, 147



**We accept Belk Charge, American Express, MasterCard and VISA**

**OUR PROMISE TO YOU:** Sometimes due to circumstances beyond our control, advertised merchandise fails to arrive in our stores on schedule. When that occurs, we will fill your order at the earliest opportunity based on availability. However, we must receive your order within the advertised selling period. Not all items available in all stores.

**ASHOKE  
ELIZABETH CITY  
GOLDSBORO  
GREENVILLE**

**KINSTON  
ROCKY MOUNT  
TARBORO  
WASHINGTON  
WILSON**

*\*Men's & Ladies' Fashions, Accessories, Shoes, Cosmetics and Fragrances Only*

**East Main Street  
Southgate Mall  
Burlington Mall  
Carolina East Mall  
The Plaza  
Vernon Park Mall  
Golden East Crossing  
Park Hill Mall  
Washington Square Mall  
Parkwood Mall**

# SEARS

Your money's worth and a whole lot more.

# 0%

finance charge

FRIDAY, AUG. 18,  
SATURDAY, AUG. 19,  
SUNDAY, AUG. 20

**BACK-TO-SCHOOL  
BOOK COVERS**

**2-PKG. 200 CT.  
NOTEBOOK PAPER**  
TO THE FIRST 100 CUSTOMERS

Sat. August 19 only. Limit one per family.

**6-PACK PENCILS**  
TO THE FIRST 100 CUSTOMERS

Sat. August 19 only. Limit one per family.

- NO BILLING
- NO PAYMENT
- NO FINANCE CHARGE

OFFER  
EXPIRES  
AUGUST  
27

## until November

**ON QUALIFIED PURCHASES OF \$200 OR MORE  
ON SEARSCHARGE, SEARSCHARGE PLUS\* AND  
SEARSCHARGE HOME IMPROVEMENT PLAN.  
SEE SALESPERSON FOR DETAILS.**

\*SearsCharge PLUS is available on most major purchases totaling \$700 or more.

SEARS AUGUST 17 EDITION

Offer expires  
Aug. 27, 1989.  
See salesperson  
for details.

**0%**

**finance  
charge until**

**13-IN. TO 46-IN. TV's**  
Choose from our huge selection!

**LXI**

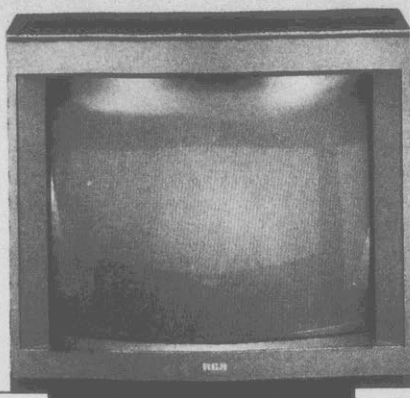

**RCA**

**SONY**

**MAGNAVOX**

**QUALITY AND VALUE VCR's**  
All the features you want!

**SEARS**

**PANASONIC**

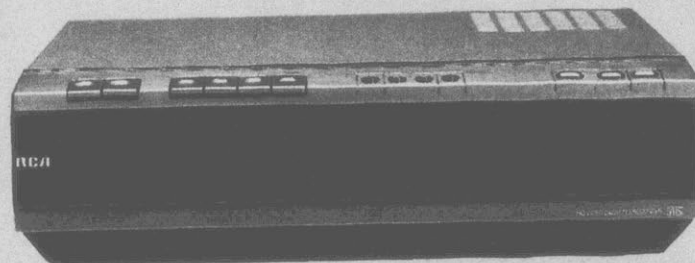

**GoldStar**

**RCA**

**THE BIGGEST NAMES**  
Stereo systems to fit your budget!

**PIONEER**

**MAGNAVOX**

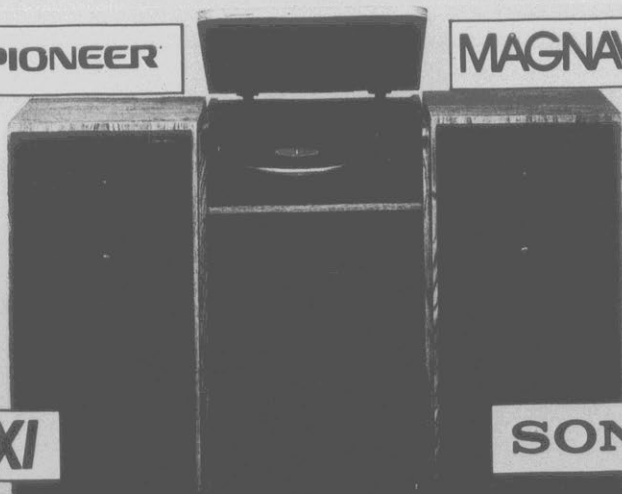

**LXI**

**SONY**

**COMPUTERS AND OFFICE AIDS**  
We have the brands that you want!

**XEROX**

**COMMODORE**



**LASER**

**brother**

**RCA**

**MAGNAVOX**

**LXI**

**PANASONIC**

**AT&T**

**SONY**

Each of these advertised items is readily available for sale as advertised.

✓ NO BILLING  
✓ NO PAYMENT

✓ NO FINANCE  
CHARGE

# November!

**ON QUALIFIED PURCHASES  
OF \$200 OR MORE ON  
SEARSCARGE, SEARSCARGE  
PLUS\* AND SEARSCARGE  
HOME IMPROVEMENT PLAN!**

18211 68211

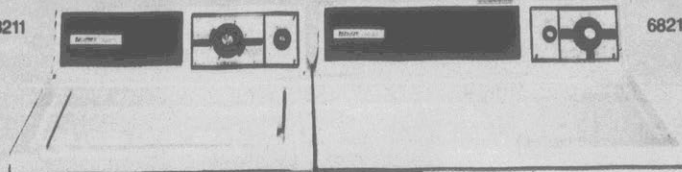

Kenmore

**\$16** PER MONTH\* FOR THE  
\$546 PAIR ON  
SEARSCARGE

## LARGE-CAPACITY LAUNDRY PAIR

6-CYCLE  
WASHER

**\$298**

4-CYCLE  
DRYER

**\$248**

Good Through August 19

Good Through August 19

Featuring 3 water temperatures and 2 water levels with permanent press cycles.

With permanent press and touch-up cycles. 2 air temperatures for versatility.

White only. Gas dryers priced higher. Dryer connectors extra.

Kenmore

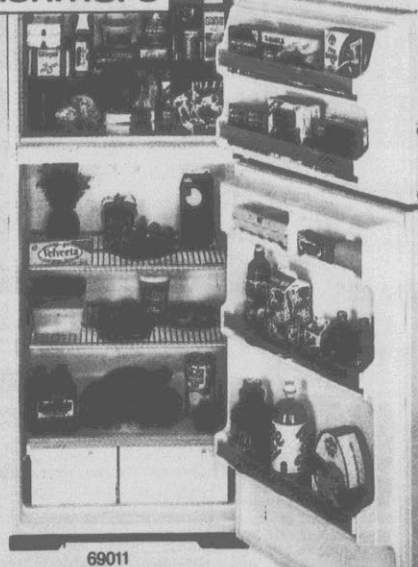

69011

**FAMILY-SIZED**  
20.6 cu. ft.\*\*  
all-frostless  
refrigerator  
with 2 crispers

**\$499**

Every Single Day!

Kenmore quality you can afford! 2 roomy shelves, plus spacious door shelves.

White only.  
\*\*Total capacity

## MULTI-LEVEL WASH

Kenmore  
dishwasher  
with Power  
Miser Control

**\$289**

Every Single Day!

**\$11** PER MONTH\* ON  
SEARSCARGE

4 washing cycles, including  
Pots/Pans cycle.

Installation extra.

Kenmore

28393

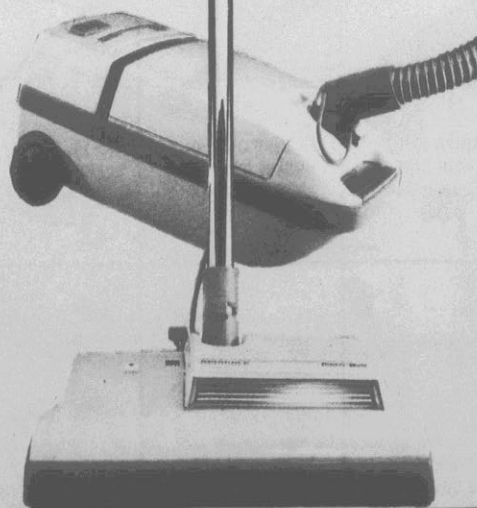

**DEEP  
CLEANING**  
Powerful  
3.9 peak HP  
Power-Mate™  
canister vac

**199<sup>87</sup>**

Every Single Day!

**\$10** PER MONTH\* ON  
SEARSCARGE

Versatile 4-level carpet height  
adjustment, plus floor tools.

\*Your actual monthly payment can vary  
depending on your account balance.



Kenmore

15385



SINGER

Amana

Kenmore



SHARP

Each of these advertised items is readily available for sale as advertised.

SEARS & CRAFTSMAN

# TOOL SPECTACULAR

**THIS WEEK ONLY!**  
OR WHILE QUANTITIES LAST

**ENERGIZER**

**8-pack** (AA batteries)

**6-pack** (C or D batteries)

Sears special  
purchase price

**3.98**

\$2.50 Mfr. rebate  
available when  
you send in  
proof of purchase

While  
Quantities  
Last

**IT'S OUR BEST VALUE OF THE YEAR**



<p>3651</p>  <p>Utility wire brush <b>96¢</b></p>	<p>9487</p>  <p>Craftsman utility knife with blades <b>1.93</b></p>	<p>3971</p>  <p>Craftsman 5-in. pocket level <b>2.96</b></p>	<p>41334</p>  <p>3/8-in. socket rack <b>3.28</b></p>	<p>39830</p>  <p>Craftsman angle finder <b>4.26</b></p>	<p>39551</p>  <p>12-in. combination square <b>4.55</b></p>	<p>58523</p>  <p>1 1/2-in. brass padlock <b>4.47</b></p>	<p>39832</p>  <p>Sears 24-in. level <b>4.96</b></p>
<p>39609</p>  <p>Craftsman 16x24-in. steel square <b>5.81</b></p>	<p>3541</p>  <p>Craftsman coping saw <b>5.94</b></p>	<p>38312</p>  <p>16-oz. nail hammer <b>6.91</b></p>	<p>3751</p>  <p>Craftsman 12-pocket work apron <b>7.16</b></p>	<p>45463</p>  <p>7-in. duck-bill tin snips <b>8.94</b></p>	<p>41772</p>  <p>Sears electronic wall stud finder <b>9.64</b></p>	<p>39007</p>  <p>100-ft. open reel tape <b>9.91</b></p>	<p>68462</p>  <p>Stapler kit, 1000 staples <b>13.87</b></p> <p>While Quantities Last</p>

## CAST-IRON TABLE

Develops  
2-HP

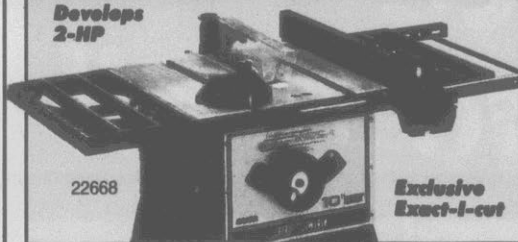

22668

Exclusive  
Exact-I-cut

Craftsman 10-in.  
direct drive table saw  
\$11 per month\* on SearsCharge

**299<sup>88</sup>**  
While  
Quantities Last

## STEEL LEG SET

48x27-in.  
worksurface

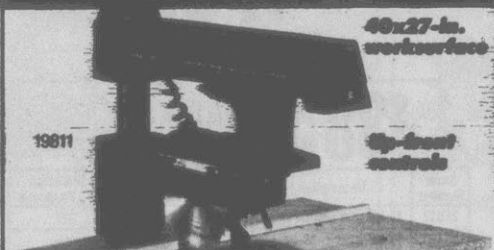

19811

Sp-front  
controls

Craftsman 10-in.  
radial arm saw  
\$12 per month\* on SearsCharge

**349<sup>88</sup>**

## 10 DRAWERS

External  
lock bars

Recessed  
handles

3-in.  
casters



Craftsman  
storage  
combination

**234<sup>92</sup>**  
BUYS  
BOTH

\$10 per month\*  
on SearsCharge

5-drawer chest, 112.46  
5-drawer cabinet, 122.46

65815  
65825

## TOOL TOWER

Side-shelf,  
accessories

Tumbler lock  
with 2 keys

Large 5-in.  
casters

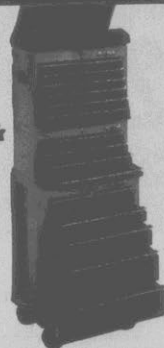

15-drawer  
professional  
combination

**469<sup>94</sup>**  
BUYS  
IT ALL

\$14 per month\*  
on SearsCharge

4-drawer chest... 129.98  
6-drawer chest... 149.98  
5-drawer cabinet, 189.98

65843  
65756  
65024

# AT A PRICE THIS LOW, THEY'LL GO FAST!

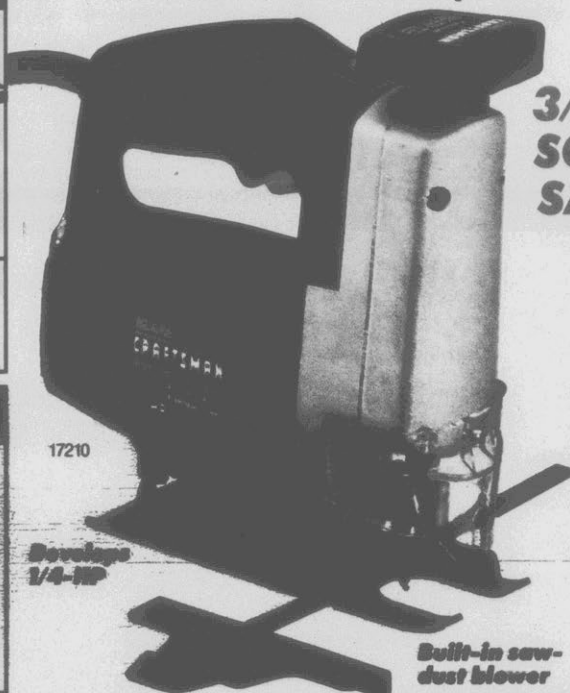

17210

Develops  
1/4-HP

Built-in saw-  
dust blower

## 3/4-IN. AUTO- SCROLLING SABRE SAW

**42<sup>88</sup>**

Only 10,000 to  
sell nationally

- Variable speed, 0-3000 SPM
- Chip shield for extra protection
- Spring detent base for setting angles

CRAFTSMAN JEEP SWEEPSTAKES

YOU  
MAY **WIN**  
A 1990 JEEP COMANCHE  
PIONEER 4WD SHORTBED



ENTER AT ANY  
SEARS HARDWARE  
DEPARTMENT

No purchase necessary. Void  
in Puerto Rico and where  
prohibited. You must be 18 to  
enter. Ohio, Michigan residents  
may enter by mail. For com-  
plete rules and chances of win-  
ning, see your Sears retail  
store by Aug. 31, 1989. Jeep  
is a registered trademark of  
Jeep/Eagle corporation.

TRY  
TO FIND  
A BETTER  
VALUE

Chain/cable  
steel driver Over 19,000  
security codes

## CRAFTSMAN 1/2-HP GARAGE DOOR OPENER

**129<sup>88</sup>**  
While  
Quantities  
Last

\$10 per month\* on SearsCharge  
Only 15,000 to sell nationally



53607

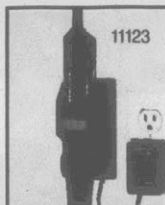

11123

Cordless  
screwdriver  
and bits

**19<sup>98</sup>**



1004

Variable  
speed,  
reversible  
3/8-in. drill

**28<sup>88</sup>**



10921

7 1/4-in.  
circular  
saw, blade

**31<sup>95</sup>**



11143

Quick-release  
cordless  
ratchet

**33<sup>33</sup>**

While  
Quantities Last

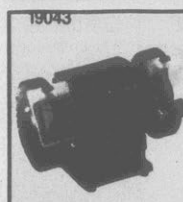

19043

Compact  
5-in. bench  
grinder

**33<sup>78</sup>**



1027

Reversible  
1/2-in. drill  
with handle

**46<sup>16</sup>**



17934

Powerful  
8-gal., 2-HP  
wet/dry vac

**69<sup>88</sup>**



15301/11

1-HP air  
compressor,  
8-gal. tank

**199<sup>83</sup>**

\*When used with optional light receivers, sold separately. Ask about Sears installation.  
\*Your actual monthly payment can vary depending on your account balance.

Offer expires Aug. 27,  
1989. See salesperson  
for details.

# 0% finance charge until

**END OF SEASON CLOSEOUT!**

10591



Kenmore 531-sq. in. gas grill, 40,000 BTUs

**176<sup>96</sup>**

- 2-pc. cooking grid
  - "H" shaped burner
- While Quantities Last  
Grills require some assembly

Kenmore

24355



**CRAFTSMAN II**  
2-YEAR WARRANTY\*

CLOSEOUT

**\$1798** Dump cart extra.

While Quantities Last  
10-cu. ft. dump cart, 139.87

All turf saver tires

44-in. floating mowing deck

5-speed transaxle

25472

**\$38 PER MONTH<sup>A</sup> ON SEARSCHARGE PLUS**

Stock Number	Description	Warranty in Years*	Cost	SearsCharge PLUS Payments
25417	10-HP rear engine rider	1	\$1048	\$22
25463	12-HP tractor, 38-in.	1	\$1098	\$23
25464	12-HP OHV, 38-in. cut	2	\$1298	\$28
25591	18-HP tractor, 44-in.	2	\$2197	\$46

Ask about our service maintenance agreements!

<sup>A</sup>Your actual monthly payment can vary depending on your account balance. SearsCharge PLUS is available for most major purchases totaling \$700 or more. \*Limited warranty for number of years specified. See store for details.



79803

Craftsman 1/2-HP, 15-in. Weedwacker®  
**49<sup>96</sup>**

79715



Craftsman 32 cc., 17-in. Weedwacker®  
**149<sup>92</sup>**

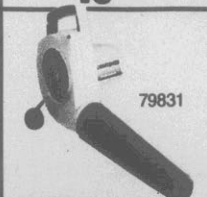

79831

Craftsman® electric blower  
Special Purchase **29<sup>98</sup>**  
While Quantities Last

87837



Craftsman 5-cu. ft. wheelbarrow  
Special Purchase **44<sup>96</sup>**  
While Quantities Last

**MORE LAWNS ARE CUT BY CRAFTSMAN THAN ANY OTHER BRAND**



20-in. cut  
1-qt. gas tank

38315

Craftsman 3.5-HP rear bagger

**199<sup>87</sup>**

Special Purchase Quantities Limited  
**\$10 PER MONTH<sup>A</sup> ON SEARSCHARGE**



22-in. cut  
2 engine speeds

37223

Craftsman 4.0-HP power propelled

**319<sup>96</sup>**

While Quantities Last  
**\$12 PER MONTH<sup>A</sup> ON SEARSCHARGE**

**INTERIOR PAINT**

Easy Living Premium flat

**10<sup>94</sup>** gal.

- 100 decorator colors
- Spot /stain resistant
- 10-year warranty\*
- Spatter resistant

**AS LOW AS 5<sup>22</sup> gal.**



**PREMIUM PAINTS FOR YOUR GREAT AMERICAN HOME!**

**1-COAT COVERAGE GUARANTEED**

**10-YR. DURABILITY**

QUESTIONS ABOUT PAINTING?



PHONE TOLL FREE

**1-800-9 PAINTS**

Get the answers from a Sears Paint Pro!

41005



Weatherbeater Premium flat

**12<sup>96</sup>** gal.

- One-coat coverage
- Mildew resistant
- Won't peel, blister, crack
- 100 colors

**AS LOW AS 6<sup>97</sup> gal.**

**EXTERIOR PAINT**

**NO BILLING NO PAYMENT  
NO FINANCE CHARGE**

# November!

**ON QUALIFIED PURCHASES  
OF \$200 OR MORE ON  
SEARSCARGE, SEARSCARGE  
PLUS\* AND SEARSCARGE  
HOME IMPROVEMENT PLAN!**

\*Searscarge PLUS is available on most major purchases totaling \$700 or more.

## EVERYTHING YOU NEED FOR HOME FIX-UP PLUS EXTRA-SPECIAL 3-DAY BUYS!

11602-22  
Ceiling fan with light **49<sup>99</sup>**

Extra Special Purchase.  
While Quantities Last

**3 DAYS  
ONLY!**

**PRICES  
LOWERED  
15%**  
on every portable &  
whole-house  
fan in stock!

64430 8032



Kenmore  
1/2-HP  
disposer  
**104<sup>31</sup>**

Closeout.  
Quantities Limited

6655

Kitchen  
faucet  
**31<sup>88</sup>**  
Easy to use  
single control.

21923



Lavatory  
faucet  
**29<sup>96</sup>**  
Solid brass.  
3 finishes.

20120

Padded  
toilet seat  
**8<sup>87</sup>**  
Comfortable,  
available in  
white.

37870



Storage  
cabinet  
**110<sup>44</sup>**  
Coordinates  
with vanities.

49110



1167-8

**3 DAYS  
ONLY!**

**FREE LIGHT**  
**19<sup>85</sup>**  
value  
With purchase of this fan

9090

### REMOTE CONTROL

Operate it from comfort of your easy chair!  
52-in. 3-speed ceiling fan in polished or antique brass  
finish. Hand-held remote, wall-mount holder.

**99<sup>81</sup>**

### ROOM AIR CONDITIONERS

**PRICES LOWERED  
15% ON ALL ROOM  
AIR CONDITIONERS  
IN STOCK**

- Most models help keep you cool with adjustable thermostat, fan speed, plus Comfort Sensor
- High efficiency, helps hold utility costs down!

<sup>4</sup>Your actual monthly payment can vary depending on your account balance.



**3 DAYS  
ONLY!**

Economical!  
Regeneration  
based on  
your water use

34280

Kenmore 80  
water softener  
Helps get laundry thor-  
oughly clean.  
Kenmore 50 softener, \$389

**\$498** Closeout  
Quantities Limited  
**\$15 PER MONTH\* ON  
SEARSCARGE**



83337

31347

Economizer 5  
water heaters  
Energy efficient! 5-yr.  
limited warranty. See  
store for details.

30-gallon gas or  
40-gallon electric  
**138<sup>67</sup>**

68377

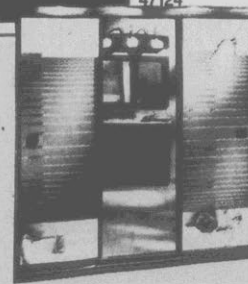

Tub door in 3 finishes  
Silver, gold or bronze  
tone. Mirrored center  
panel plus towel bar.

**139<sup>99</sup>**

Extra Special Purchase. While Quantities Last.

**DEHUMIDIFIER**  
Helps protect  
valuables  
from rust,  
mildew

**\$11** PER MONTH\* ON  
SEARSCARGE

**\$284**

Big 40-pint<sup>†</sup> capacity.  
25-pint<sup>†</sup> model ..... \$197

<sup>†</sup>Maximum  
pints of  
moisture  
removed  
daily  
based on  
AHAM Std.  
DH-1.

5540

**3 DAYS  
ONLY!**



20456

**FREE FAUCET**

**22<sup>10</sup>**  
value

With purchase of any  
wood vanity plus sink top

### DECORATOR VANITIES

24-inch

**132<sup>92</sup>**

- Vanity top, faucet extra
- Easy shopping; 50 choices, 10 styles in 5 sizes!
- Multi-step finish on exposed wood

47124

Each of these advertised items is readily available for sale as advertised.

**HURRY!**

**See us now  
and we'll pay  
for your eye exam**



See us now. It's National Eye Exam Month at Sears and that means we're doing everything to see you get the best of care. We're paying for your exam. See the coupon for details.

**Your eye exam will benefit others.**

BECAUSE YOUR EYECARE IS SO IMPORTANT TO US

**WE'LL PAY FOR  
YOUR EYE EXAM  
THIS MONTH**

It's National Eye Exam Month at Sears, and as a special reminder to take good care of your eyes we're going to see that you get your check-up. We'll pay for your exam. Just come in for an exam by one of the Independent Doctors of Optometry at Sears and we'll deduct the entire cost of your exam from any purchase of eyeglasses.\*

\*You may also redeem this coupon when buying contact lenses or with a prescription from any other doctor. (Just bring us your exam receipt dated in August.) In these cases, a maximum \$40 allowance applies.

\*Discount may not exceed 50% of your purchase price and may not be used in conjunction with any other discounts, insurance or vision care programs. Offer ends August 26, 1989. Void where prohibited. Cash value 1/20¢. Available at participating Sears retail stores. Eye exams not available at all locations.



**For each exam at Sears this month \$1 will be donated to the National Society to Prevent Blindness.**

**WE have a FREE gift for you.**

Pick up your copy of the Family Home Eye Test, an easy-to-use screening test, designed by the National Society to Prevent Blindness. While supply lasts.

8 GRE55L1 1

**SPECIAL!**

**New offer  
from Sears  
Portrait Studio**

**37 PIECE PORTRAIT PACKAGE**



**FREE  
10x13  
WALL PORTRAIT**

*Plus*  
(frame not included)

INTRODUCING

**16 Free Mini-Portraits**

17 Free Portraits \$41.90 value mini-portrait approx. size 1 1/8" x 1 5/8"

with the purchase of our 20-piece portrait package

**37 Portraits**  
2-8x10s, 3-5x7s.  
15 wallets, plus a Free  
10x13 and 16 mini-portraits\*

**16<sup>95</sup>**

\*approximate sizes.

Price includes \$2 deposit. Your choice of traditional, nursery, spring or fall background. White and black backgrounds, Double Feature and other Special Effects portraits not available in advertised package. Poses our selection. \$2 for each additional person in portrait. No appointment necessary. Use your Sears Credit Card or Discover Card. Cannot be combined with any other offer. Offer void where prohibited, taxed or licensed by law.

Cash value 1/20¢. Prices may vary in Alaska, Adults & families welcome.  
Coupon good through November 16, 1989

Studios located in Sears retail stores, including  
Alaska, Hawaii and Puerto Rico.

PRESENT COUPON AT TIME OF SITTING

#910

END OF SEASON  
**CLEARANCE**

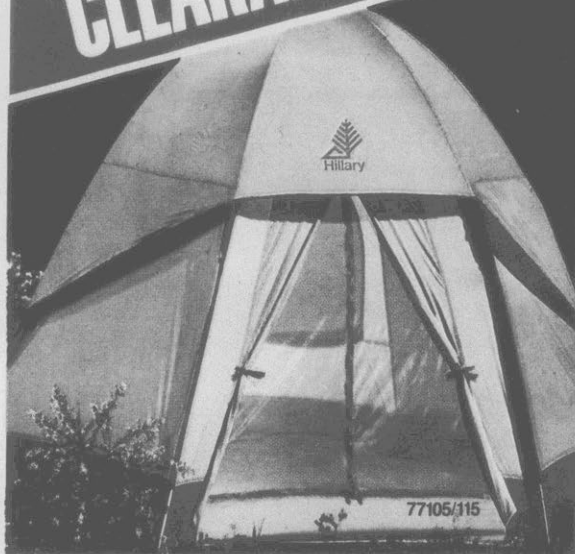

**SELECTED MODELS  
REDUCED 10-15%**

10 x 12-ft. dome, sleeps 5

- Lightweight fiberglass frame
- Zippered screen door, storm flap

**104<sup>97</sup>**  
Was \$123.78  
While Quantities Last!

**HURRY IN FOR BEST SELECTION!**



7 x 7-ft. Hillary™  
sport dome sleeps 3

- Lightweight shock-corded fiberglass frame
- Screened windows, flaps, side door

**58<sup>47</sup>**  
Was \$64.99  
While Quantities Last!

FACTORY  
**CLOSEOUT!**



**Lifestyler Ergometer Cycle**

- Electronic console measures calories burned, speed, distance, time
- Dual-action handlebars
- Cast-iron flywheel

**179<sup>83</sup>**  
Was \$198.86  
While Quantities Last!



**Lifestyler  
multi-use rower**

**99<sup>71</sup>**

Every Single Day!  
Converts to bench for squats, curls, more! Abdominal bar.

28687



**"The Bag"**

**99<sup>6</sup>**

Every Single Day!  
Backpack or 20-in. roll bag, assorted colors.

98063/4

BIKE SHOP QUALITY  
**WHY PAY MORE?**



**26-in.  
10-speed  
Tourney ATB**

**114<sup>93</sup>**

Every Single Day!

- Men's/women's strong steel-lugged frame
- Side-pull caliper brakes
- Dual-pressure tires

47426/7



24-in.  
youth  
size **114<sup>93</sup>**  
Every Single Day!

45151



**26-in.  
10-speed racer**

**78<sup>88</sup>**

Every Single Day!

- Lightweight lugged frame
- Side-pull caliper brakes, 3-pc. crank

47338



**20-in. BMX**

**74<sup>88</sup>**

Every Single Day!

- Sturdy steel frame
  - Raised crank housing, coaster brake
- Bikes require some assembly

45519

MEN'S STORE

# DRESS SHIRTS

## 995

Long sleeve solids

Every Single Day!

A wide assortment of executive solids. Easy-care polyester, cotton. Patterns, too ..... 10.95

C.R. BLUES

# DENIM JEANS

## 1094

Every Single Day!

Great for back to school! Men's frosted, all-cotton denim jeans.



MADE IN THE U.S.A.

# WORK JEANS

## 1196

Extra Special Purchase

While Quantities Last  
Heavyweight, all-cotton denim jeans for men.



FRUIT OF THE LOOM®

# MEN'S BRIEFS

Every Single Day Price (3 per pack) ..... 3.94

\$1 Manufacturer's Rebate available when you send in proof of purchase from one three-pack. The more packs you buy, the larger the rebate!  
T-shirts, 3-pack ..... 4.84





CLOSEOUT!  
**TRADER BAY  
FLEECEWEAR**

**696** EA.  
While  
Quantities  
Last

Was \$12 ea.

What a great buy on men's comfortable crew neck sweat shirts and sweat pants.



THEY'RE BACK!  
**TIE-DYED  
T-SHIRTS**

**886**  
Extra  
Special  
Purchase  
While Quantities Last

Groovy cotton tees in a spectrum of summer brights. Made in the U.S.A.



SPORTY  
**FOOTBALL  
JERSEYS**

**1393**  
Every  
Single Day!

Heavyweight jerseys have v-necks, contrasting sleeve stripes.



CASUAL  
**OXFORD  
SPORT SHIRTS**

**1263**  
Every  
Single Day!

Long sleeve styles in solids or stripes. Polyester, cotton blend.

# BIG BOYS' FLEECE SEPARATES CLOSEOUT

Was \$7.88 ea.

CREW TOP  
OR PANT  
NOW ONLY

# 588

While Quantities Last

Activewear in stay-bright colors! Shape-retentive acrylic, cotton knit. S-XL (8-20).

Styles shown are representative of Sears assortment



## MORE GREAT BUYS!

BOYS' TERRAIN  
CAMOUFLAGE PANT

NOW  
JUST

# 996

Extra Special Purchase  
With cargo pockets!  
100% cotton. 8-14.  
While Quantities Last



ICE-WASHED  
GIRLS' JEANS

NOW  
JUST

# 1292

Good Through Aug. 19  
Hot fashion look! All-  
cotton. 7-16.

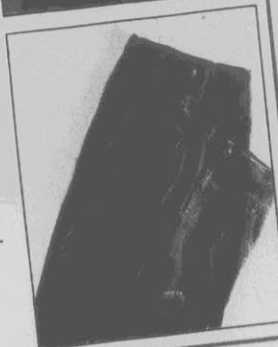

12 GRE55L1 1



NOW FOR  
BACK-TO-SCHOOL  
**KNIT'S  
THE  
WORD**

YOUR CHOICE  
BOYS' SHIRTS,  
GIRLS' SEPARATES

**796**  
Prices  
Good Through  
Aug. 19

**BOYS' KNIT SHIRTS**

A wide selection of colorful crewneck knits of polyester, cotton. Great for school or play! S-XL (8-20).

**GIRLS' SEPARATES**

A spectrum of jewel-tone fashions, all of comfortable cotton and polyester knit. Sizes S-M-L (7-16).

**Foil knit tops**

Shiny foil screen tops in brilliant color block colors!

**Knit mock cardigan**

Two tops in one! Layered look top with dramatic black stripes.

**Knit legging**

Wear with either top! With non-turning 3-needle elastic waist for comfort.

**Knit circle skirt**

A whirl of color! Wear alone or with legging to make a trendy skegging!

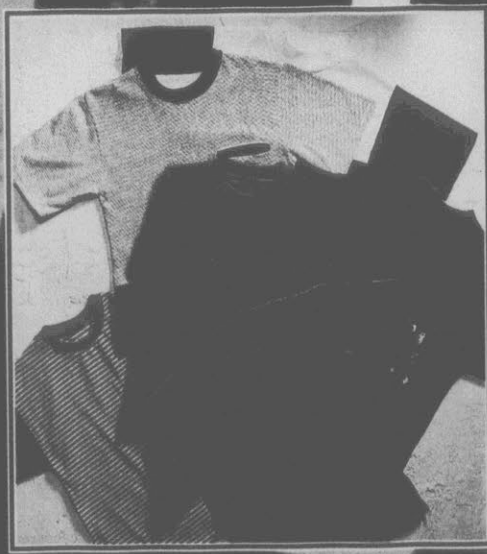

 Silver



ALSO AVAILABLE IN PRETTY PLUS AND  
HUSKY SIZES AT MOST LARGER  
SEARS STORES

# LEE® & LEVI'S®

JEANS FOR MISSES'  
AND JUNIORS

YOUR  
CHOICE

# 1794

each  
Very Special Purchase  
Quantities Limited

**FOR MISSES':** Lee® and Levi's® jeans of soft, pure cotton, with 5-pocket western styling.

White shirt of polyester and cotton ..... 9.96

Vest in fashion tapestry print ..... 19.96

Every Single Day!

**FOR JUNIORS':** The same quality Levi's® jeans for comfort and style.

Mock turtleneck top of cotton jersey, 14.94

Vest with dramatic dots; rayon acetate, 19.94

Every Single Day!

Styles and colors shown are  
representative of Sears assortment



Lee's

14 GRE55L1 1

Levi's  
LEVI STRAUSS & CO.



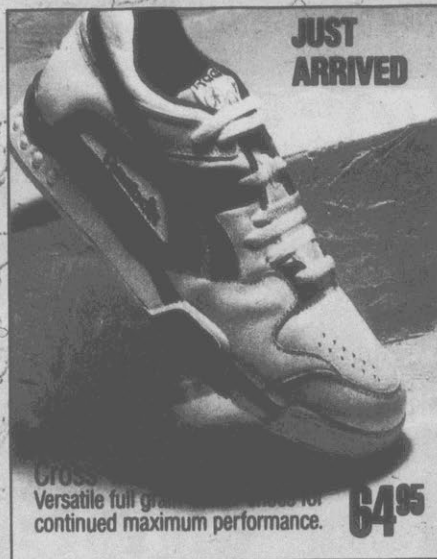

**JUST  
ARRIVED**

Cross  
Versatile full grain leather shoes for  
continued maximum performance. **64<sup>95</sup>**

All athletic  
shoes have  
RUBBER soles,  
unless other-  
wise indicated.  
Reduced prices  
in effect until  
August 26.

**MENS' Pressure Basketball  
ERS Hi-tops with ERS  
Full grain leather uppers**

**54<sup>95</sup>**  
Reg. \$64.95



**WOMENS' 4100 or AXT,  
ERS with ERS full  
grain leather oxfords**

**46<sup>95</sup>**  
Reg. \$54.95

**Reebok®**

**WE HAVE MORE  
REEBOKS  
THAN EVER, INCLUDING  
THE LATEST REEBOK  
ENERGY RETURN  
SYSTEM SHOES!**

The secret behind Energy Return System,  
specially placed tubes work to absorb  
shock and add to your performance.

**UPPERS**  
Lightweight and  
yet supportive  
full grain leather

**OUTSOLES**  
Made from  
Microcellular  
rubber and  
a DuraTech  
soft rubber.



**SOCKLINES**  
Anatomically  
molded to  
support your feet.



**ENERGY RETURN**  
Midsoles Nylon  
tubes are specially  
positioned to provide  
energy return.



Shoes with Air or Sol  
max like a pillow, cush-  
ioning your feet. Energy  
Return works like a  
spring, cushioning your  
feet and adding energy to  
your forward motion.

**FOR MEN**

**42<sup>95</sup>**  
Reg. \$49.95



**4000 Basketball Oxfords**  
Leather uppers.  
Cushioned insoles.

**47<sup>95</sup>**  
Reg. \$54.95



**4600 Basketball Hi-tops**  
Leather uppers.  
Cushioned insoles.

**44<sup>95</sup>**  
Reg. \$52.95



**Club C**  
Leather uppers.  
Padded insoles.

**29<sup>95</sup>**  
Reg. \$34.95



**CL1000**  
Nylon and suede split  
leather uppers.

**39<sup>95</sup>**  
Reg. \$46.95



**Newport Classic**  
Leather uppers.  
Terry linings.

**FOR WOMEN**

**24<sup>95</sup>**  
Reg. \$29.95



**Electra**  
Padded collars. Cushioned insoles.

**39<sup>95</sup>**  
Reg. \$47.95



**Freestyle Oxfords**  
Leather uppers.  
Cushioned insoles.

**46<sup>95</sup>**  
Reg. \$54.95



**Freestyle Hi-tops**  
Leather uppers.  
Cushioned insoles.

**29<sup>95</sup>**  
Reg. \$34.95



**CL1000**  
Nylon, suede split  
leather uppers.

**39<sup>95</sup>**  
Reg. \$46.95



**Newport Classic**  
Leather uppers.  
Cushioned insoles.

**FOR KIDS**

**36<sup>95</sup>**  
Reg. \$45.95



**4600 Jr.**  
Leather uppers.  
Cushioned insoles.

**28<sup>95</sup>**  
Reg. \$35.95



**Princess**  
Leather uppers.  
Terry linings.

**34<sup>95</sup>**  
Reg. \$41.95



**Club C**  
Leather uppers.  
Boy's and kid's.

**36<sup>95</sup>**  
Reg. \$45.95



**4600 for boys**  
Leather uppers.  
Cushioned insoles.

**35<sup>95</sup>**  
Reg. \$44.95



**AXT**  
Cross Trainer with  
leather uppers.

1 GRE55L1 15

# 0%

## finance charge

On qualified purchases of \$200 or more on SearsCharge, SearsCharge PLUS and SearsCharge Home Improvement Plan. Offer expires Aug. 27. See salesperson for details.

# NO BILLING NO PAYMENT NO FINANCE CHARGE

# until November



• Plump, reversible seat cushions

• Attractive cover is treated with Scotchgard Fabric Protector for soil and stain resistance

• Sleeper mechanism warranted for the life of the sofa

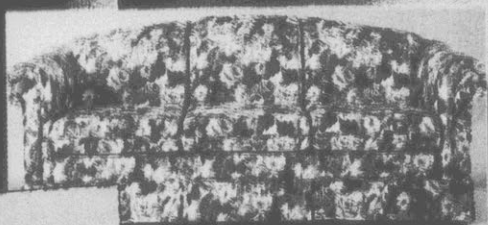

Compare for comfort—our queen sleepers give you more mattress for your money!

YOUR CHOICE

# \$499

EXTRA SPECIAL PURCHASE While Quantities Last!

Open up and say ahh...you'll find 6-in. thick innerspring mattresses for the ultimate in restful slumber. Choose from 3 styles all at one great price!

\*See store for details

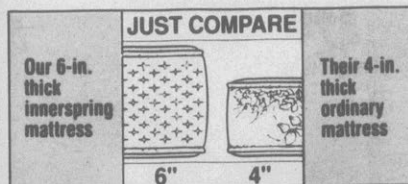

SHOP SEARS CATALOG FOR THOUSANDS OF OTHER GREAT BUYS  
**NEW! SEARS 24-HR. CATALOG HOTLINE**  
**1-800-366-3000**  
• Shop Toll-Free, Day and Night  
• Shop 24 Hours a Day, 7 Days a Week



Stampede leather recliners  
YOUR CHOICE

# \$399

Extra Special Purchase While Quantities Last! Choose from 3 colors. Sides, back are leather-matched vinyl.

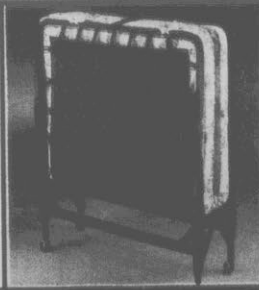

Twin size rollaway bed

# \$99

Convenient for company, student dorms, vacation homes.



Wooden barstools  
YOUR CHOICE

# \$79

ea. Extra Special Purchase While Quantities Last! Choose 24-in. or 30-in. height.

**SEARS PRICING PLEDGE:** Yes, we'll meet or beat the competition's current advertised price on the identical item! Just bring the competition's current ad to any of our Retail Stores.

This offer applies to current merchandise in our Retail Stores only. Excludes clearance, factory closeouts, Sears catalogs and special services such as eyewear and dentistry.

Merchandise in this circular available at most larger Sears stores. Delivery charges not included in selling prices of merchandise.

SEARS



Items indicated "larger stores only" are available in Barboursville, Charlotte, Charleston, S.C. (Northwoods), Charleston, W.Va., Columbia, Durham, Fayetteville, Greensboro, Raleigh, Roanoke, Wilmington and Winston-Salem. Large items such as furniture and appliances are inventoried in our distribution center and will be scheduled for pick-up or delivery. Delivery not included in prices shown.

NC: Asheboro, Burlington, Charlotte, (Eastland, Southpark), Concord, Durham, Fayetteville, Gastonia, Goldsboro, Greensboro, Greenville, Hickory, High Point, Jacksonville, Monroe, New Bern, Raleigh, Roanoke Rapids, Rocky Mount, Wilmington, Winston-Salem. SC: Charleston (Citadel, Northwoods), Columbia, Florence, Myrtle Beach, Rock Hill. VA: Christiansburg, Danville, Lynchburg, Roanoke. KY: Ashland. WV: Barboursville, Beckley, Bluefield, Charleston.

Satisfaction guaranteed or your money back

©Sears, Roebuck and Co., 1989

16 GRE55L1 1 Printed in U.S.A. 7/89 RF732A/89910

# SEARS

Your money's worth and a whole lot more.

# SEARS

TIRE AND AUTO CENTER

ONLY SEARS  
GIVES YOU  
ALL THIS  
AS LOW AS

**29.97**  
P155/80R12

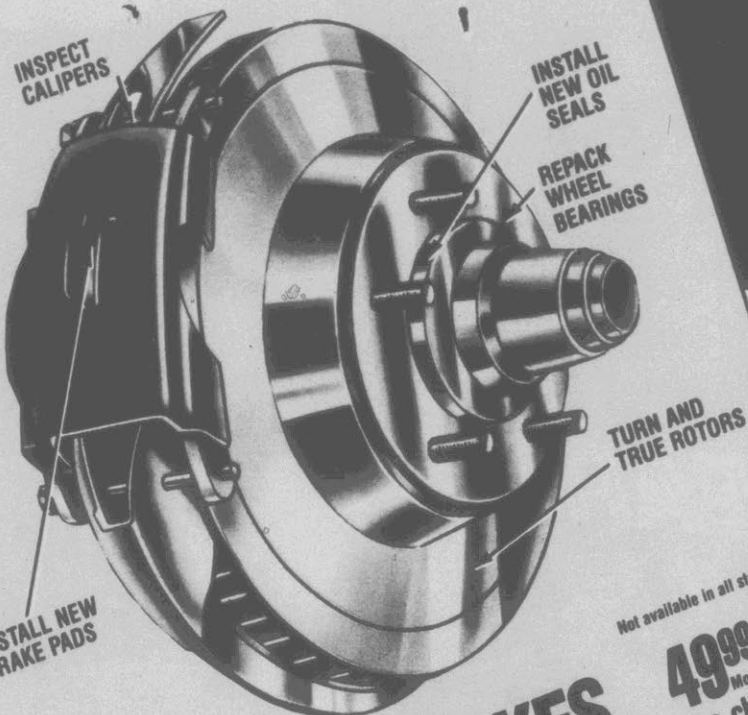

ROAD TEST  
YOUR VEHICLE

**FRONT DISC BRAKES** **49.99** Most cars  
Additional parts and services may require a substantial extra charge.

Guardsman Response  
All Season

40,000 mile wearout warranty

P155-80R12	\$29.97	P195-75R14	\$54.79
P155-80R13	29.97	P205-75R14	58.92
P165-80R13	41.80	P215-75R14	58.76
P175-80R13	48.81	P205-75R15	58.92
P185-80R13	48.76	P215-75R15	58.53
P185-70R14	58.00	P225-75R15	58.87
P185-75R14	58.00	P235-75R15	58.95

Not available in all stores

GUARDSMAN

TrailHandler

ROADHANDLER

MICHELIN

BF Goodrich

PIRELLI

SteadyRider

Tredloc

RANCHO SUSPENSION



**YOU COULD WIN A  
1989 TWIN TURBO  
CALLAWAY CORVETTE**  
in the Sears Champion Ultimate  
Power Trip Sweepstakes.

The Callaway Corvette is one of  
America's fastest production cars  
valued at over \$60,000. Get com-  
plete rules and official entry form  
at all participating Sears stores  
where you can buy Champion oil  
and air filters.

No purchase necessary. All entries must be  
received by 9:30 89. Michigan and Ohio resi-  
dents may obtain official entry form by writ-  
ing to: Ultimate Power Trip Sweepstakes,  
P.O. Box 8438, Young America, MN. 55351-  
8438. Requests must be received by 9:15 89.

Void in Puerto Rico  
and where prohibited.  
Odds of winning based  
on number of entries.

## BUDGET PRICED

**GUARDSMAN**

25,000-mile wearout warranty

Guardsman Radial	Every Single Day!
Whitewall	
P155-80R13	\$19.99
P165-80R13	33.00
P175-80R13	36.50
P185-75R14	37.99
P195-75R14	38.94
P205-75R14	39.72
P215-75R15	39.91
P225-75R15	39.99

**GUARDSMAN**

25,000-mile wearout warranty

Guardsman Performance	Every Single Day!
P175-70SR13	\$29.86
P185-70SR13	38.81
P185-70SR14	44.86
P195-70SR14	47.96
P205-70SR14	52.94
P215-65SR15	64.75
P215-60SR14	54.76
P195-60SR14	64.89
P195-60SR15	54.97

**ROADHANDLER**

50,000-mile wearout warranty

RoadHandler Response	Every Single Day!
P155-80R13	\$37.97
P165-80R13	50.86
P175-80R13	57.75
P185-80R13	59.99
P185-75R14	62.77
P195-75R14	67.79
P205-75R14	68.99
P205-75R15	69.83
P215-75R15	70.88
P225-75R15	70.88
P235-75R15	70.97

## MADE BY MICHELIN

**ROADHANDLER**

50,000-mile wearout warranty

RoadHandler SCR	Every Single Day!
145SR12	\$34.96
145SR13	44.90
155SR13	48.97
165SR13	50.08
175SR14	57.87
185SR14	58.00
185SR15	58.92
165-70SR13	60.88
175-70SR13	63.77
185-70SR13	65.72
185-70SR14	66.94
195-70SR14	67.77
205-70SR14	68.70

**ROADHANDLER**

50,000-mile wearout warranty

RoadHandler	Every Single Day!
P155-80R13	\$43.88
P165-80R13	58.73
P175-80R13	64.81
P185-80R13	68.77
P185-75R14	72.91
P195-75R14	74.91
P205-75R14	78.72
P205-75R15	81.79
P215-75R15	82.92
P225-75R15	83.79
P185-70R14	72.11
P205-70R14	77.06
P215-70R15	77.98

**ROADHANDLER**

50,000-mile wearout warranty

RoadHandler 50	Every Single Day!
P155-80R13	\$37.97
P165-80R13	50.86
P175-80R13	57.75
P185-80R13	59.99
P185-75R14	62.77
P195-75R14	67.79
P205-75R14	68.99
P205-75R15	69.84
P215-75R15	70.89
P225-75R15	70.89
P235-75R15	70.97

## PERFORMANCE

**BF Goodrich**

BF Goodrich Radial-Comp T/A

BF Goodrich Radial-Comp T/A	Every Single Day!
Radial T/A	
P175-70SR13	\$51.98
P185-70SR13	65.95
P195-70SR13	67.95
P185-70SR14	69.95
P205-70SR15	71.95
P225-70SR15	73.95
COMP T/A	
185-60HR14	\$86.95
195-60HR14	91.95
195-60HR15	94.95
205-60HR15	96.95
215-60HR15	99.95

**PIRELLI**

30,000-mile wearout warranty

Pirelli Response	Every Single Day!
P175-70TR13	\$49.97
P185-70TR13	60.74
P185-70TR14	68.81
P205-70TR14	74.99
P225-70TR15	81.70
*P195-60TR14	68.78
*P215-60TR14	76.98
*P195-60TR15	68.98
*P215-60TR15	76.76
*P225-60TR15	80.02
*Blackwall only	
P 6** Each	
185-60HR14	\$99.99
195-60HR15	114.99
205-60HR15	122.99
195-60VR15	133.99

## ROAD HAZARD WARRANTY INCLUDED

**Tredloc**

50,000-mile wearout warranty

RoadHandler Tredloc T	Every Single Day!
P175-70TR13	\$67.77
P185-70TR13	71.79
P195-70TR13	76.81
P205-70TR13	81.99
P195-70TR14	86.72
P205-70TR14	92.86
P215-70TR14	94.75
P215-70TR15	96.85
P225-70TR15	99.75
P235-70TR15	99.97

## LIGHT TRUCK, VAN

**TrailHandler**

35,000-mile wearout warranty

TrailHandler A-T Light truck	Every Single Day!
LT195-75R14	\$74.86
LT215-75R15	81.12
LT235-75R15	87.12
LT235-85R16BW	112.18
8.75R16 5BW	111.12
9.50R16 5BW	119.63
30x9 50R15	88.12
31x10 50R15	97.12
32x11 50R15	103.12
33x12 50R15	118.78

**BF Goodrich**

BF Goodrich T/A Light truck

BF Goodrich T/A Light truck	Every Single Day!
LT215-75R15C	\$92.00
LT235-75R15C	102.00
LT235-85R16E	121.00
30x9.00R15C	100.00
31x10.50R15C	112.00
32x11.50R15C	121.00

**MICHELIN**

40,000-mile wearout warranty

RoadHandler LT	Every Single Day!
LT195-75R14	\$79.88
LT215-75R15	93.67
LT235-75R15	100.17
LT235-85R16	117.63
8.00R16.5	109.70
8.75R16.5	120.44
9.50R16.5	141.73
30X9 50R15	58.25
31X10 50R15	109.92

## We're wheel alignment specialists†

**FRONT END**, check, set adjustable angles to mfr.'s specs.

**THRUST LINE**, a significant improvement over front end alignment

**TOTAL 4-WHEEL**, for cars on which all 4 wheels can be adjusted.

Additional parts and services may require a substantial extra charge.

29.99  
34.99  
49.99



## Timesaver Oil Change 19.99

Up to 5 qts. oil, oil filter, lube chassis, top off fluids: differential, transmission, power steering, brake and wiper fluids. Perform visual check.



## Tune-up NOT AVAILABLE



America's #1 Outlet FOR SHOCKS AND STRUTS

Great price for SteadyRider shock  
Reliable shock performance in any weather.  
**6.99** each

RoadHandler Performance LT Gas shocks For light trucks, vans, and 4x4's. Shock installation available.  
**19.99** each

SteadyRider gas struts For quick, even response to bumps and curves. Alignment recommended, extra.  
**2 FOR 88.88** Most cars

SEARS AUG. 17 EDITION  
Satisfaction guaranteed or your money back  
©Sears, Roebuck and Co. 1989

2 GRE55L1 1

ANCO  
Delco  
Trapper  
DieHard  
Motorcraft  
SEARS  
PIONEER  
KRACO  
JENSEN

**BRAND NAMES  
SPECIAL VALUE!**



**Spectrum, Pennzoil, Quaker State,** Oil at larger Sears stores  
 Same price for all weights carried: SAE 30, 5W30, 10W30, 10W40, 20W50  
 78¢ qt.  
 97¢ qt.  
 97¢ qt.  
 Every Single Day!

**Champion oil filter**  
 High efficiency—traps 93% of contaminants.  
 39¢ to 57¢  
 Every Single Day!



**Champion air filter**  
 At larger Sears stores  
 39¢ to 97¢  
 Every Single Day!



**Carpeted floor mats**  
 Plush dacron polyester pile on heavy duty rubber. Washable.  
 Every Single Day! 27<sup>24</sup> pair



**Nylon car covers†**  
 Includes storage bag. Sizes to fit most cars.  
 49<sup>99</sup>  
 Every Single Day!



**Turtle Wax**  
 For that new car look!  
 34<sup>9</sup> 16-oz.  
 Every Single Day!

**Armor-all Protectant†**  
 Protects and beautifies tires, vinyl tops, vinyl upholstery and more.  
 29<sup>4</sup> 8-oz.  
 Every Single Day!

†Available in most larger stores



**SEARS 45**

43321  
**DieHard**  
 Up to 650 cold cranking amps.  
 With trade-in 59<sup>97</sup>  
 Every Single Day!

43348  
**DELCO 60**  
 525 cold cranking amps.  
 With trade-in 47<sup>97</sup>  
 Every Single Day!

43160  
**Sears 60**  
 Up to 500 cold cranking amps.  
 With trade-in 39<sup>97</sup>  
 Every Single Day!

96033  
**DieHard**  
**UTILITY**  
 For lawn tractors, riding mowers.  
 With trade-in 39<sup>97</sup>  
 Every Single Day!

44353  
**DieHard**  
**MOTORCYCLE**  
 Also for watersport vehicles, ATVs, more.  
 With trade-in 16<sup>97</sup>  
 Every Single Day!

96492  
**DieHard**  
**MARINE**  
 Deep-cycle. 700 marine cranking amps.  
 With trade-in 54<sup>97</sup>  
 Every Single Day!

**Motorcraft** 43349

**TESTED TOUGH PLUS**

Replaces BCI Groups 21, 24, 25, 26, 27, 34, 85  
 PART # BX-26 COLD CRANKING AMPS 525 RESERVE CAPACITY 82  
 DIST. BY FORD MOTOR CO. DEARBORN MI 48121

**DOUBLE REBATE MOTORCRAFT**  
 Regular price 46<sup>77</sup>  
 With trade-in - \$10  
 Double \$5 rebate  
 36<sup>77</sup>  
 They cool after trade-in rebate

60 cold cranking amps for sure starts. Up to 82 minutes reserve capacity. 60-month limited warranty. See store for details.

**LAST 3 DAYS!** Get a pair of regular \$29.99 door-mounted speakers with purchase of a pair of #5041, 6x9-in. Jensen speakers.



**AUDIO SPECTACULAR**

**CAR STEREO**  
 AM/FM stereo cassette  
 Auto-stop, 2-way speaker control  
 Auto-reverse AM/FM  
 Electronic tuned, 5AM, 10FM memory  
 Pioneer Super-tuner AM/FM  
 Auto-reverse; seek, scan, 6AM, 19 FM memory  
 Sound installation available  
 39<sup>99</sup>  
 59<sup>99</sup>  
 109<sup>99</sup>

**CAR SPEAKERS**  
 Kraco 5-in. slim line, flush mount  
 5-in. woofer, 1 1/4-in. core tweeter  
 Pioneer 6 1/2-in. door mount  
 Pioneer 6 1/2-in. woofer, mid-range, tweeter  
 Jensen, 6 x 9-in. triaxial  
 6 x 9-in. woofer, mid-range, tweeter  
 See store for details on FREE Jensen offer above.

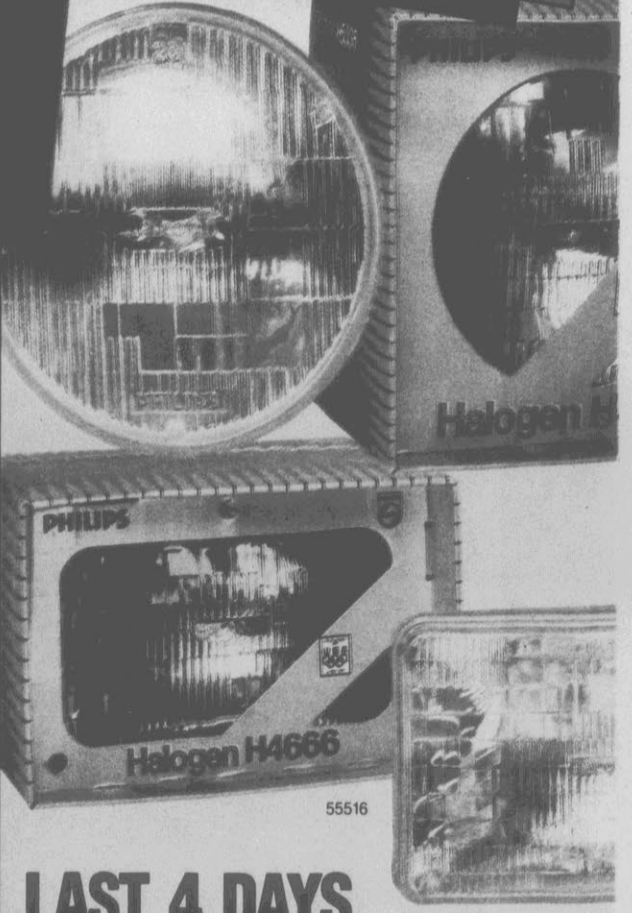

**LAST 4 DAYS  
HALOGEN  
HEADLIGHT OFFER**

4-lamp rectangular **553** each

Sears great buying power makes these low prices possible. 20% more illumination than non-halogen lights.

4-lamp rectangular	2-lamp rectangular	4-lamp round	2-lamp round	Halogen headlamp bulbs
H4651 \$5.53	H4666 \$13.96	H5001 \$5.97	H6617 \$12.71	9004 \$11.97
H4656 5.53	H6054 13.76	H5006 5.97		9005 11.97
H4701 9.96				9006 11.97
H4703 9.96				

Halogen headlamps dramatically improve visibility  
 OFFER ENDS AUG. 20

**WE INSTALL CONFIDENCE**

**SEARS**  
 Your money's worth  
 and a whole lot more.