

THE DAILY REFLECTOR

Greenville, N.C.

Wednesday Afternoon, July 19, 1989

25¢

Inflation Slows As Prices Ebb

THE ASSOCIATED PRESS

WASHINGTON — Inflation slowed in June as consumer prices rose a modest 0.2 percent, the smallest advance in 16 months, the government reported today.

The price moderation reflected the biggest drop in energy prices in more than two years and the smallest increase in food costs this year.

The 0.2 percent June rise in the Consumer Price Index, the government's primary gauge of inflation at the retail level, was just one-third the 0.6 percent increase recorded in May.

Even with the slowdown, prices at the consumer level rose at a seasonally adjusted annual rate of 5.9 percent in the first six months of 1989, the fastest pace for the first half of a year since 1982.

But the moderate June advance, the smallest increase since a similar 0.2 percent rise in February 1988, was certain to be seen as good news at the Federal Reserve Board, which has been concerned that the country might be on the verge of another inflationary spiral.

In a separate report, the Commerce Department said today that housing construction, reflecting lower interest rates, rebounded 7.0

percent in June after falling for four straight months and reaching the lowest level in May since 1982.

Fixed mortgage rates, which peaked at 11.22 percent in March before falling to 10.07 percent by the end of June, had been blamed for the recent decline in housing activity.

The Commerce Department reported that new homes and apartments in June were built at a seasonally adjusted annual rate of 1.40 million units, up from 1.31 million units in May when construction fell 2.5 percent.

Today's report on consumer prices, coupled with news last week that wholesale prices actually fell in

June, provided concrete evidence that the spurt in prices in the early part of 1989 was finally beginning to moderate.

Patrick Jackman, a Labor Department analyst, said price pressures over the next several months should moderate enough to keep consumer inflation for all of 1989 down at around 5 percent. Prices rose 4.4 percent in both 1987 and 1988.

The trouble at the beginning of the year was that energy prices, driven by the run-up in world petroleum

(See INFLATION, A-12)

Strikers Threaten Reforms

THE ASSOCIATED PRESS

MOSCOW — President Mikhail S. Gorbachev said today that thousands of striking coal miners and other workers are urging railway employees to join the work stoppage and that the unrest threatens his economic reforms.

Strikes have shut down more than 200 mines and factories in the country's two top coal-producing regions, official reports said. In a report to the Supreme Soviet, Gorbachev said they have resulted in a 1 million-ton drop in coal production.

Following Gorbachev to the podium, legislator Anatoly Saunin said each lost work day cost millions of rubles that might otherwise help improve living conditions. "You mustn't hold a knife to the throat" of the government, he told strikers.

Saunin, from the Donetsk region of the Ukraine, the country's top coal region, said the number of striking mines there increased from 20 on Tuesday to 58 today.

"Now there are reports of calls to railroad workers to join the strike as of Aug. 1," Gorbachev said during the parliamentary session, which was broadcast on television and radio.

"Such a development of events poses a threat to the implementation of plans projected by the policy of perestroika," he said, referring to his efforts to restructure the economy.

Miners began walking out July 11 in Siberia's Kuznetsk Basin coal region. Workers in other industries in the region soon followed. On Saturday, miners in the Donetsk coal basin began walking off the job.

The miners are demanding more local control over their industry as well as higher wages and better living conditions.

Gorbachev said he and Premier Nikolai I. Ryzhkov sent a telegram to miners in the Ukraine assuring them that any concessions granted to Siberian miners would apply to other mining regions as well.

Khashoggi Returns To Face Charge He Hid Marcos Assets

THE ASSOCIATED PRESS

BERN, Switzerland — Adnan Khashoggi, the Saudi financier and arms dealer, was extradited to the United States today to face charges he helped hide assets Ferdinand Marcos and his wife allegedly plundered from the Philippines.

Under the extradition agreement, the United States will drop racketeering and conspiracy charges against Khashoggi, the Justice Ministry said.

Khashoggi, escorted by two police officers, left on a plane for New York three months after he was arrested in a Bern hotel on a U.S. warrant, said ministry spokesman Joerg Kistler.

Khashoggi, the Marcoses, five other people and a California bank were indicted in October by a U.S. District Court in New York. The indictment accuses the ousted president and his wife, Imelda, of stealing more than \$100 million from the Philippine treasury to buy real estate and art in New York.

The U.S. government says Khashoggi posed as the owner of some of the assets as a cover, according to prosecutors.

Khashoggi, 53, is charged in the indictment with racketeering, conspiracy, obstruction of justice and mail fraud.

A Justice Ministry statement said extradition was denied for the racketeering and conspiracy charges and authorized only for those alleged offenses that also are punishable under Swiss law.

The statement said Swiss law does not recognize conspiracy or the U.S. Racketeer Influenced and Corrupt Organizations Act, known as RICO.

Ministry spokeswoman Ursula Riedel said this meant that he was extradited on condition that he will not be tried for racketeering and conspiracy charges.

The U.S. racketeering statute prohibits conducting an enterprise in a pattern of criminal activity, consisting of at least two specified crimes in a 10-year period. Under the statute, prosecutors can seek pretrial restraint of assets and those convicted face up to 20 years in prison.



The Associated Press

Welcome Home

President Bush is greeted by a cheerful crowd outside the White House Tuesday after returning from a 10-day trip through Europe. The president invited congressional leaders to the White House today for a report on his trip.

Pitt Memorial Increasing Rates

By Carol Tyer
 THE DAILY REFLECTOR

A 10 percent room rate increase and a 17.2 overall increase in hospital care prices is called for in the budget approved Tuesday night by the Pitt County Memorial Hospital board for the fiscal year beginning Oct. 1.

Under the new room rate schedule, the hospital's most prevalent room rate will increase from \$210 to \$230.

Kathy Barger, vice president of financial services, said the budget projects gross patient charges of approximately \$207 million. About \$152 million of the net revenue is expected to be realized because of shortfalls in payments from Medicare, Medicaid and uncollectible accounts, she said.

The revenue includes \$11.4 million in funds from the state which the hospital receives because of its affiliation with the East Carolina University School of Medicine. These funds help offset bad debt expense and other costs related to serving as eastern North Carolina's tertiary

care center, including teaching and resident costs.

Operating expenses are projected to be \$151.8 million, which is an increase from \$137.5 million in 1989. Without the rate increase, the hospital would face a \$14.3 million shortfall, Ms. Barger said.

"Financial problems are plaguing hospitals statewide," she said. "Part of the problem can be traced to the federal government's repeated cuts in the Medicare budget. This year, when a patient receives his or her hospital bill, approximately 26 cents of every dollar in that bill will be spent paying for the health care of someone else. The hospital is raising its rates to offset those anticipated losses."

In other business, the board approved a contract with Carolina Lithotripsy organization to bring a mobile lithotripsy kidney stone disintegration unit to the hospital grounds at intervals for the procedure to be available to people at PCMH. Board members said the service will become available within the next 60 to 90 days.

(See PCMH, A-3)

Carter Files For Another Term As Greenville Mayor

Greenville Mayor Ed Carter announced his bid for re-election Tuesday, saying, "I'm excited about this and ready to lead this city into the '90s."

Carter, now finishing his first term as mayor, said, "I'm confident that I am the best choice."

One challenger, Council member Nancy Jenkins, has filed to run against Carter in the Nov. 7 municipal elections.

Carter said the only issue of the campaign would be continuing progress made in all areas during his first term. "I think the record speaks for itself."

Carter said the city needs to continue long-range planning. "Greenville certainly needs orderly growth and development. Greenville must grow."

The city also needs to plan for increasing traffic congestion inside and around Greenville, he said.

The mayor called for continued efforts to solve drug problems and the housing needs of low and moderate income families. He called for

greater cooperative efforts among governments and private industries.

"We need strong leadership in the mayor's office," Carter said.

The office needs to work toward

unifying the council, according to Carter. "We need leadership that will try to build unity on the City Council," he said.

"One thing that I'm proud of above all else is that we've brought back reputation to the government of our city," Carter said.

Carter works for Burroughs Wellcome as the department head of administrative services. He is a member of several civic and governmental organizations, including the Governor's Crime Commission, the national and state League of Municipalities, and state and federal transportation committees.

He is a member of the board of directors for the Pitt-Greenville Chamber of Commerce, a member of the Mount Cavalry Masonic Lodge No. 669, a member of the local Veterans of Foreign Wars and Vietnam Veterans of America. He is a lifetime member of Alpha Phi Alpha fraternity.

Carter is married to the former Evelyn Jean Simpson, and has three daughters, Regina, Tanya and Jackie.

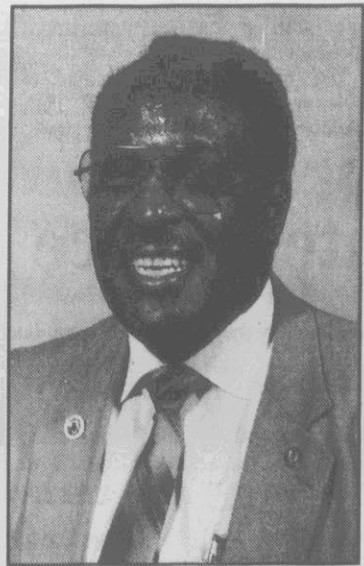

ED CARTER

Weather

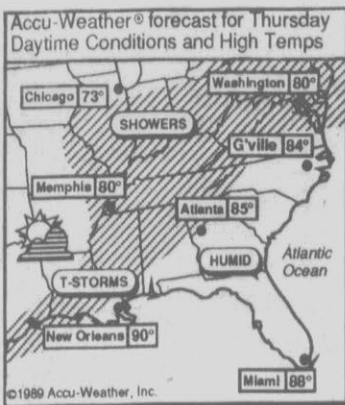

Forecast

Chance of rain through Thursday. Low tonight 70 to 75. High on Thursday 85 to 90.

Looking Ahead

Chance of rain Friday, humid Saturday and Sunday. Highs near 90. Lows in 70s.

Shinn, Brew File For City Council

The race for Greenville's City Council grew more crowded Tuesday as two more candidates filed for seats on the board.

Lorraine Shinn, incumbent council member and mayor pro-tem, and Daniel T. (Danny) Brew filed for different posts on the board.



LORRAINE SHINN

Ms. Shinn, filing for the at-large seat on the council, said the position needs a representative with an understanding of all the city, not just one district.

"The at-large seat is such a unique position that you need to have 'the big picture,'" Ms. Shinn said. She also called for responsible leadership from the council regarding financial and solid waste management plans.

"There will come a day when we have to bite the bullet and I think it will come soon," Ms. Shinn said. "You can't keep increasing taxes to fund excessive spending."

As the Washington, N.C., regional manager of the state Department of Natural Resources and Community Development, Ms. Shinn said she has the experience to properly address pollution programs in the area.

Ms. Shinn also claimed the financial experience to direct the city in budgetary matters because of her experience as a bookkeeper and office manager in the private sector.

Ms. Shinn called for an at-large representative elected by all the

voters who could speak across racial, social and economic lines.

Ms. Shinn earned a bachelor's degree in psychology from East Carolina University and also attended the governor's executive management program.

As a member of the council, Ms. Shinn is a representative to the Parks and Recreation, Planning and Zoning, Environmental Advisory and Downtown Revitalization commissions. She is also a member of the governor's commission on child victimization and the governor's commission on the family.

She is married to Stuart Shinn, an electrician and plumber, and has two daughters, Kimberly Shinn-Simpson and Gena Shinn.

Brew filed for the District 1 seat on the council, saying he is basing his election bid on "proper and orderly growth" for the city.

"I felt it would be a pleasure, a joy and an honor to represent others in the city and to be a voice in the cultivation of a better Greenville," Brew said in prepared statement. "I have always wanted to serve my community and to do what I can to see it grow and prosper."

Brew is seeking the seat held by Council member Mildred Council, representing a district that includes the northern and northwestern portions of the city. District 1 includes

(See FILINGS, A-3)

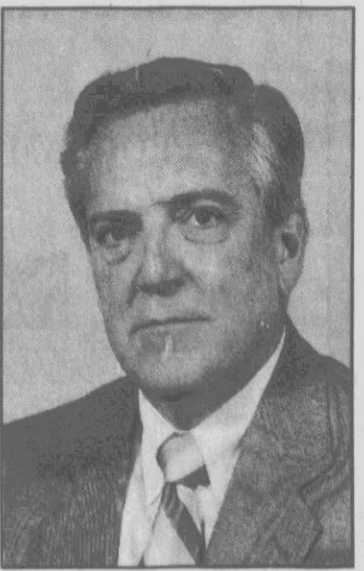

DANIEL T. BREW

Rates Change

Effective Sept. 1, The Daily Reflector will adjust its subscription rates for carrier home delivery and mail subscribers.

The basic monthly price will increase from \$5 to \$6 for daily and Sunday delivery. Sunday-only delivery will increase from \$3.25 to \$4 a month. Discounted rates for three, six and 12 months will be offered for the first time.

Although the subscription rates for home and mail delivery will go up, the daily and Sunday newsstand prices will remain at 25 cents and 75 cents respectively.

The price increase — the first change in the newspaper's subscription price since July 1987 — is being shared with the newspaper's carriers, who operate as independent contractors.

Subscription prepayments for up to 12 months from Sept. 1 will be accepted until Aug. 15 at the existing \$5 per month. Customers who wish to renew or extend their subscriptions are encouraged to do so.

In The Area

Tuesday Thefts

Investigators said four thefts were reported to Greenville police Tuesday.

Officer M.R. Benton said four rims and tires were taken from a car parked at Britt's Automotive at 1600 N. Greene St. in an incident reported at 8:57 a.m. and a gold ring was taken from 403B Summit St. in an incident reported at 1 p.m., while Officer R.L. Forrest said an answering machine was taken from 114 E. Third St. in an incident reported at 9:44 a.m.

According to Officer P.W. Worthington, a license plate was taken from a vehicle parked at Coggins Car Care on Greenville Boulevard in an incident reported at 4:04 p.m.

Larceny Charges

Greenville police arrested two people on larceny charges Monday.

Officer K.L. Hadnott said Tammy Anderson Beachum, 23, of 403 Millbrook St. was charged Monday night with larceny in connection with the theft of \$1,915 worth of jewelry from 403 Millbrook St. which was reported Monday morning.

Officer R.G. Mendenhall said Bradley Barnes, 20, of Route 4, Lumberton, was arrested on larceny charges in connection with the theft of \$11.31 from a counter at the Three Steers Restaurant on Memorial Drive at about 10:40 p.m.

Fire Call

Greenville firemen were called to the WNCN-TV studios on Evans Street Extension today shortly before 6 a.m. after smoke was reported in the television station's newsroom.

Firemen searched the area along with station employees and found an overheated motor on an air conditioning unit.

Planning Meeting

The Comprehensive Planning Committee will meet tonight at 5:30 p.m. in the conference room of the Municipal Building.

Pastor's Anniversary

Guiding Light Temple of Faith Holy Ghost Deliverance Church will celebrate the pastor's anniversary today through Saturday at 7:30 p.m. each night.

Participating today is Bishop J.R. Carney and the Noah's Ark Church family; on Thursday, Pastor Lonnie Tillery and the Christ Temple Church; Friday, Bishop James Smith and the First Born Church family, and Saturday, Lester Coward.

On Sunday at 11 a.m., Bishop Stanley McKinney and the Oasis Temple will render the service and for the closing service at 3 p.m., Eldress Gladys Underhill will render the service.

Tax Mailings

The town of Winterville mailed its 1989 tax notices today, said Town Clerk Elwood Nobles said.

The town's tax rate is 40 cents on \$100. Real property value in the town is \$44,425,150; personal property value, \$8,480,442. Both are amounting to about \$2 million more than last year.



The Daily Reflector/Shannon Wolfe

Sworn In

Pitt Clerk of Court Sandra Gaskins, far right, swears in members of the Pitt Board of Elections to new two-year terms on Tuesday. From left, Nelson B. Crisp of Greenville, H.A. "Andy" Andrews Jr. of Greenville and Myra Cain of Greenville. They were reappointed to the board last month by the state Board of Elections.

National Spinning Co. Puts Washington Plant On Block

By Jerry Raynor
THE DAILY REFLECTOR

WASHINGTON, N.C. — Officials at National Spinning Co., which includes three plants in one at its site in Washington, say the business is up for sale.

Don Barham, vice president and divisional vice president of manufacturing at the Washington plant, said, "Joe Leff of New York, primary owner of the company as well as chairman of the board and chief officer, has made a decision to put the plants, all four located in North Carolina, up for sale."

Other National Spinning facilities are also located in eastern North Carolina, at Beulaville, Warsaw and Whiteville.

National Spinning in Washington employs 1,900 workers. Most are drawn from the work force in Beaufort County, but it also employs people from Martin, Pitt and Washington counties, Barham said.

"Altogether," he said, "the four plants provide employment for more than 3,300 employees."

The Washington plant complex

Closing Extended

The N.C. Department of Transportation Bridge Maintenance Unit of Pitt County has extended the closing of N.C. 33, between SR 1415 and SR 1402 until Friday, a department spokesman said.

The section of N.C. 33, located .06 miles from SR 1415 toward SR 1402, is closed to replace an existing pipe.

dyes fabrics manufactured by the other three plants. "Our three plants constitute the largest single operation of the firm," Barham said.

National Spinning has its home office in New York City and is represented by sales offices in New York, Greensboro, the Midwest and New England.

Barham said the sale of the firm will be offered through the investment brokers firm of Goldman-Sach and CNB. "The company expects to find somebody to buy at the right price. Hopefully the buyer will have as its primary concern the goal of keeping the company operating and not only that, but to expand its growth opportunities," he said.

Citing age as the principal motivation in his decision to sell National Spinning, Leff, in a letter to company employees, said, "We need ever larger investment in new equipment to maintain market share, to improve efficiency and quality. Much of this machinery is two or three years away from installation and operation."

"It is becoming difficult to program that kind of investment as I grow older," Leff wrote. "By the end of the year, I will be 66 and realize that for National Spinning to have the future you deserve, this company must be sold to a new owner with a less limited time horizon."

Barham said his personal opinion "as well, I think, as that of all the company's employees, is gratitude that Leff has always had a close relationship with all his people."

"He has expressed his determination that whoever the new owner may be, it will be someone who is sincerely interested in the company and its workers, someone dedicated to maintaining the high quality the company is noted for."

Focus Attendance Increases Slightly

Focus 2007, a strategic regional planning group, held its second public hearing Tuesday night at Wellcome Middle School to gather comments from area citizens and to present goals and objectives of the group's strategy teams.

The second forum drew seven area citizens, slightly more than Monday's meeting when only three citizens attended the group's initial hearing at Ayden-Grifton High School.

Richard Duncan of Greenville suggested Tuesday that churches be utilized as possible support networks for prevention and rehabilitation in drug related cases, according to professional staff team leader, Janice Faulkner.

Some discussion defending or explaining some aspects of the strategic planning followed presentations by strategy team leaders, Jordan Whichard, group vice chairman, said.

"We had good comments and quality participation," said Whichard. "We hope that everyone who wants to be involved will attend the next two meetings."

A series of four meetings are being held this week to provide the public a chance to discuss and offer suggestions on the panel's aims to establish Pitt County as a "metropolitan center, pursuing excellence

in education, economic development, and cultural/social activities."

Each meeting follows a similar agenda. Strategy team leaders present the objectives and goals of their focus groups which include education, economic development, transportation, government services, crime and substance abuse, recreational and cultural activities and research and development.

The public is then encouraged to offer comments or questions.

"Any of the suggestions made will be filtered back through the process," said Ms. Faulkner, the director of the Regional Development Institute at East Carolina University.

Public hearings will be held from 7:30 to 9 p.m. today at Farmville Community Center and at the same time Thursday in the upstairs auditorium of the Pitt County Office Building

Is your Daily Reflector not being delivered?

First - call your Independent Carrier. If you are unable to reach him... then call The Daily Reflector at 752-3952 between 6-6:30 pm, M-F and 8-9 am, Sunday.

Manning Enters Race

WINTERVILLE — Keith Manning filed Tuesday for the one seat open on the Winterville Board of Aldermen.

Manning, 35, will seek the board seat now held by Alderman John G. Weathering. The incumbent has not filed for re-election.

Manning, who has been employed by Procter and Gamble of Greenville for 13 years, is a member of Immanuel Free Will Baptist Church near Winterville and serves as its treasurer and a board member. He and his wife Mary have three children.

The only person who has filed for Winterville mayor is incumbent Mayor E.C. Hines.

The deadline for filing is noon on Aug. 4.

The Daily Reflector

Incorporated
209 Cotanche Street
Greenville, N.C. 27834
(919) 752-6166

108th Year No. 172

Second Class Postage Paid At Greenville, N.C.
(USPS 145-400)

Advertising Director: Tim Holt
Production Director: J. Tim Jones
Circulation Director: Nelson Adams
Director of Administration and Personnel: Barbara Jarvis

Published Monday through Friday afternoons and Sunday morning

Subscription Rates
Home delivery by carrier or motor route, monthly \$5.00 payable in advance.

Mail Rates
Pitt and adjoining counties: \$5.00 per month
Elsewhere in N.C.: \$5.50 per month
Outside N.C.: \$6.50 per month

Member Associated Press and Audit Bureau of Circulation

VAN MODICA LOST OVER 100 LBS!

"I have had a weight problem all my life, but thanks to the help I received from the Medical Weight Loss team, my dreams have become reality. I look and feel better as well as have a new outlook on life."



SEE HOW MUCH WEIGHT YOU CAN LOSE!

8 WEEK PROGRAM **\$89⁰⁰***

*Medical Fee Excluded

Hurry... Offer Ends Friday, July 21st

The Better Way To Diet

Call 756-2611

610 Arlington Blvd. Arlington Village (Across From Dawsons)

Medical Weight Loss Systems

VISA

TAG SALE

Look for the green, yellow and red tags and take an ADDITIONAL 30, 40, or 50% OFF the already reduced prices!

30% OFF

30% OFF FOR EXAMPLE: SWIMSUITS
Originally \$19.99
Sale Price \$15.00
Take an ADDITIONAL 30% OFF
NOW JUST \$ 4.50

40% OFF

40% OFF FOR EXAMPLE: SHORTS
Originally \$ 8.99
Sale Price \$ 7.00
Take an ADDITIONAL 40% OFF
NOW JUST \$ 4.20

50% OFF

50% OFF FOR EXAMPLE: KNIT TANK TOPS
Originally \$ 7.99
Sale Price \$ 6.00
Take an ADDITIONAL 50% OFF
NOW JUST \$ 3.00

ALL MAJOR CREDIT CARDS ACCEPTED

CATO

423 Evans Mall • 758-3700 The Plaza • 756-3531 Stanton Square • 758-6723

Overton Wins Rezoning Of Bells Fork Property

By J. Ward Best
THE DAILY REFLECTOR

The slogan for a local sporting goods store reads: "Overton's has it all." And the Greenville Planning and Zoning Commission, in a split vote, recommended a request Tuesday by the owner of the firm that would allow him to build even more.

Parker Overton would not commit to relocating his business on the site he requested for rezoning but he fought for, and won, a higher-density zoning. He would not say what type of business he would build on the Bells Fork site.

Overton, the owner of Overton's Sports Center Inc., had submitted a request at the June meeting to rezone nearly 19 acres near the southern edge of town from RA-20 (residential-agricultural) to a shopping center designation. He said in June that he intended to relocate his business in the area south of Bells Fork.

Overton asked the board in June to delay a decision on the request until he could meet with adjacent property owners and the Historical Commission.

When he returned Tuesday, objections to the rezoning had vanished, and the city and county historical

societies were satisfied Overton would preserve or move an old house on the property.

But Overton also backed off of his plans to relocate his sporting goods store on the property.

The city development staff maintained the 69 acres in the rezoned Bells Fork area, which did not include Overton's property, would sufficiently handle commercial needs in that area.

Commission members split on Overton's proposal.

"It just seems logical to me that this should be commercial," Tony Lewis said of the area near Harris

Supermarket. "I have a hard time turning this down."

Board member William Roberson sided with the development staff, and said the area outlined for commercial development had been established. "If we don't do it here where do we do it at?" Roberson asked.

"I don't want to see another Greenville Boulevard anywhere in Greenville," Roberson said.

Overton supporters, including Mayor Ed Carter, argued strongly for recommendation of the proposal.

Carter said the area was not considered in the city's long-range planning, and the owner should have some say in the development of the property even after it has come in the city's extraterritorial jurisdiction.

"I told the property owners that I would not put anything in the area to hurt them if I did not put my business there," Overton told the board.

Adjacent property owners, some of them the same residents who spoke against the proposal at the June meeting, spoke in favor of the request Tuesday.

"I'd a whole lot rather see that man put a shopping center there than see a whole row of apartments

in my front yard," said Franklin "Sam" Porter.

The vote by commission members, like the debate, split with Bruce Sauter casting the deciding vote in favor of recommending that the City Council approve Overton's request. Favoring the request were Lewis, J.B. Surles, Steve Blades, Myron Brown and Sauter, while Bruce Flye, Catherine Bullock, Ruth Leggett and Roberson voted against the matter.

On a different issue, residents of Peed Drive found no satisfaction in the board's action as commission members voted to approve further subdivision development of an area over the residents' objections.

A preliminary plat for a development submitted by Leroy Cherry divided the board because of safety concerns in the area.

Residents of the existing Summerfield Gardens subdivision contended that further development and an extension of Peed Drive would greatly increase traffic on what they said is a poorly built and poorly maintained road.

"Our concern is people coming in using Peed Drive as a thoroughfare, a cut through," said area resident William Lee IV.

Peed Drive connects Tobacco Road and Memorial Drive. Extending Peed to connect with Rollins Drive, as Cherry plans, would provide a direct link between Greenville Boulevard and Memorial Drive.

The board accepted the idea that allowing continued development would also upgrade the roads in the area and make them safer. P&Z recommended approval of the plat by a five to four vote, with Sauter, Brown, Surles, Blades and Ms. Leggett favoring and Ms. Bullock, Flye, Roberson and Lewis opposing the preliminary plat.

Filings

(Continued from A-1)

3,106 voters in precincts 1, 3, 4, 6 and 8:

Brew, a resident of Greenville since 1981, owns six Burger King restaurants, three in Greenville and one each in Tarboro, Farmville and Ayden. He is a member of the Mormon Church, and served as bishop of the local congregation for two years.

The Greenville Parks and Recreation Department named Brew "Volunteer of the Year" for 1989.

Brew is a member of Burger King Corporation's Business Planning Council and serves as vice chairman of the BPC for the Richmond region.

Brew is a member of the Pitt County Board of Special Olympics and is involved with the Association for Retarded Citizens. Brew has been a member of the Pitt-Greenville Chamber of Commerce since 1981.

In his statement, Brew called for "proper and orderly growth in Greenville" through zoning, code compliance and thoroughfare planning. Brew also called for an increased recycling effort in the city to save landfill space.

"I have a concern of the 'proper and orderly' growth in Greenville," Brew said. "We need good council members to project five, 10, 15 years into the future to best cope with these situations."

Burke's House of Coins
211 W. 14th St., Suite D
Specializing in USA Coin Appraisal
We Pay \$25 for 25' 1989
No-Mint-Mark Uncirculated Quarter
830-3951 830-9032
Business Residence



Agriculture Extension Service/Mitch Smith

Tobacco Disease

Rhizoctonia leaf spot is a fungus disease that is hurting tobacco yield in Pitt and neighboring counties this season. Pitt Agriculture Extension Director Mitch Smith said the disease is a relatively rare one promoted by the high heat and humidity prevailing so far this summer. He said there is no known management to prevent or stop the spread of the disease. Applications of protectant fungicides do little or no good, he said, since this fungus is only slightly sensitive to these materials.

Pitt CAT Scores Near State Level

Recently released California Achievement Test figures show that scores for Pitt County students are near or equal to the North Carolina average. North Carolina scores were above the national norm, according to the Associated Press.

The CAT tests students in third, sixth and eighth grades on reading, language and mathematics.

Figures released by Department of Public Instruction showed that more North Carolina students scored at or above the 77th percentile than the national norm and fewer scored at or below the 23rd percentile.

Bill Brown, division director of accountability services in the Department of N.C. Public Instruction, said the 77th percentile is considered above average and the 23rd percentile is below average.

Rod Whitley, testing coordinator

for Pitt County schools, said 31 percent of Pitt County third-graders scored at or above the 77th percentile, three points below the state average. Twenty-nine percent were above the mark in sixth grade and 27 percent were above in eighth grade. Both figures were equal to the state norm.

Related Story On A-6

Nineteen percent of Pitt County third-graders scored below the 23rd percentile, three points above the state figures. Seventeen percent of sixth-graders scored below the mark, two points above the state. Nineteen percent of the eighth-graders in Pitt County scored below the 23rd percentile, two points above the state average.

Whitley said the figures were an improvement over those recorded last year.

PCMH To Boost Rates Oct. 1

(Continued from A-1)

The mobile unit will also visit other sites in eastern North Carolina. Previously, the closest place to have this procedure of breaking up kidney stones with sound energy was Fayetteville.

A resolution was adopted acknowledging the development of a section of nuclear cardiology within the hospital's department of radiology. A commitment was made to support the realm of the means of the hospital." Dr. Assad Movahed will serve as medical director of this section.

Approval was given for a 4 percent cost of living increase to hospital retirees. The action will cost the hospital \$24,000 per year.

Authorization was given for an architect to be hired for a treatment holding facility in the vicinity of the present emergency department. The project, scheduled to begin during the fiscal year beginning Oct. 1, will cost approximately \$2 million. It will provide 10 beds for people who are not considered emergencies, but who need to be observed a while before being assigned to a particular department. These people are now crowding the emergency department, so this facility will be wel-

comed by all physicians who enter patients in the hospital, Dr. Mary Raab, chief of staff, said.

A contract with the Brown & Wood law firm of New York was approved. The firm will provide counsel concerning the selling of bonds for an upcoming large addition to the hospital.

Approval was given for a number of staff classification changes, including the approval of 89 residents for reappointment in their residency training programs and for 62 resident to have house staff privileges. Neonatal nurse practitioners approved were Pamela Sue Salsbury, Lenna Sue West, Barbara B. Lilley, Barbara M. Albritton, Gail Holley, Cynthia L. Parks, Susan Tayloe, Melinda Edmundson and Victoria Bergstedt.

Dr. Ted Sunder was approved for special neurology privileges; Dr. Garrett Rogers for angiography and antioplasty privileges. Dr. Solomon Shapiro was allowed to change from active to consulting staff privileges; Dr. Joseph Wicker from active to inactive privileges.

Mrs. Barger reported that the hospital had an operating loss of \$485,026 during June. Losses during June have been experienced for the past three years and are beginning to be expected, she said. This negative trend is primarily the result of Medicaid target days and no state

reimbursement associated with bad debts and contractuals for June. She said inpatient use continued to be below budget — adults days off 837 days and newborn days off 239 days, with total year-to-date days 3,181 below budget. Year-to-date outpatient days are up 170 visits.

Equipment purchases approved amounted to \$465,651. These included a portable ultrasound unit for labor and delivery, an infant warmer for pediatric intensive care, monitors and other equipment for the neonatal intensive care unit, a power sweeper for building and grounds, computer equipment for medical records and nuclear medicine, and an echocardiograph machine for the exercise lab.

Farmville citizen David Shackelford was welcomed as a new member of the board. Board member Robert Spivey was recognized for having recently been named the News and Observer newspaper's "Tar Heel of the Week."

After the meeting, board members toured the hospital's new birthing center.

GUILD OPTICIANS

OPEN 9:30 A.M. 'TIL 7:00 P.M.
MONDAY THRU FRIDAY
(LATER APPOINTMENTS BY REQUEST)

SATURDAY
9:30 TO 3:00

Visit The Eye Glass Professionals

GUILD OPTICIANS
Only 600 firms in the U.S. have qualified to display this emblem.

FREE EYE GLASSES

Buy A Pair Of Glasses, Get The Second Pair...**FREE**

Offer does not apply with any other advertised specials. \$60.00 Minimum Purchase. (NO THIRD PARTY PAYMENTS HONORED)

The Exam - We can make arrangements to have your eyes examined by an eye doctor adjacent to Clear-Vue. We fill any eye doctor's prescription.

*By Clear-Vue Opticians

WE CAN ARRANGE TO HAVE YOUR EYES EXAMINED TODAY!

--COUPON--

FREE GLASSES

Buy a pair of glasses at regular price and get a second pair of sunglasses or clear lenses FREE. Coupon must be presented at time of purchase. Offer includes most single vision and 28 mm flat top bifocal prescriptions. Some lens restrictions apply. Complete glasses include frames and lenses. (Choose from a select group.)

EXPIRES JULY 22, 1989

CLEAR-VUE OPTICIANS

2484 STANTON SQUARE GREENVILLE 752-1446

NEW HOURS
MON. THRU FRI. 9:30 TO 7:00
OPEN SATURDAY 9:30 TO 3:00

WE CAN ARRANGE TO HAVE YOUR EYES EXAMINED TODAY!

CARPET CLEANED TWICE

25% DISCOUNT

OFF OUR REGULAR CLEANING PRICES WITH THIS COUPON

CALL NOW FOR APPOINTMENT

746-8199

NOT DELIGHTED, DON'T PAY

CARPET DYEING can be done right in your home and the results are fantastic! We will also TINT your carpet while it is being cleaned at slight additional charge. You will be amazed at the appearance!

WARRANTY - Our trained professionals will do the very best job possible in a friendly and courteous manner; or your money is refunded IN FULL; Upholstered Furniture included in this pledge.

RAINBOW INTERNATIONAL
CARPET DYEING &
CLEANING CO.

Greg & Chris Riddle
(Owners and Operators)

COPYRIGHT © RAINBOW INTERNATIONAL CARPET DYEING & CLEANING CO. 1981
Service Marks Owned and Licensed by Rainbow International Carpet Dyeing & Cleaning Co.

encore!

a continuation with a twist...

THE PLAZA

Opinion

THE DAILY REFLECTOR

Established 1882

David Julian Whichard, Chairman of the Board

David J. Whichard II, Editor & Co-Publisher

John S. Whichard, Co-Publisher

D. Jordan Whichard III, General Manager

Alvin B. Taylor, Managing Editor

Mary C. Schulken, Editorial Page Editor

'Truth In Preference To Fiction'

Smooth Summit

Events Continue To Unfold

The summit of seven democratic industrialized nations went smoothly last week ... so smoothly in fact that the world might assume there are no differences between the participants.

The leaders of the United States, France, West Germany, Japan, Britain, Italy and Canada were in accord in condemning the recent events in China, supporting more protection of the environment, encouragement of political and economic reforms in Poland and Hungary and concern about terrorism.

The leaders themselves were surprised by a letter from Soviet President Mikhail Gorbachev in a summit which otherwise lacked surprises.

Gorbachev projected economic cooperation between the democracies and the Soviet Union. He said it is "obvious that the rest

of the world can only gain by the opening to the world economy of a market such as that of the Soviet Union." He asked the nations to consider reforms now under way in the Soviet Union. While the western nations only took note of the Gorbachev letter it is clear that he was appealing for closer economic relations with the democracies.

Even with no specific action on the Gorbachev letter, it is clear that it cannot be ignored. As tensions ease there will be more trade between the Soviets and the west. It is only economic reality to expect that development.

But as the Soviet military threat recedes can we expect that future western economic summits will go as smoothly as this one? Probably not. The nations are fierce competitors and their leaders are likely to be more outspoken as security becomes less of a concern.

This one, though, went smoothly to the point of ending early, there was a friendly overture from Gorbachev and thus events continue to unfold in east-west relations that few would have expected to see in this century.

'But as the Soviet military threat recedes can we expect that future western economic summits will go as smoothly as this one? Probably not.'

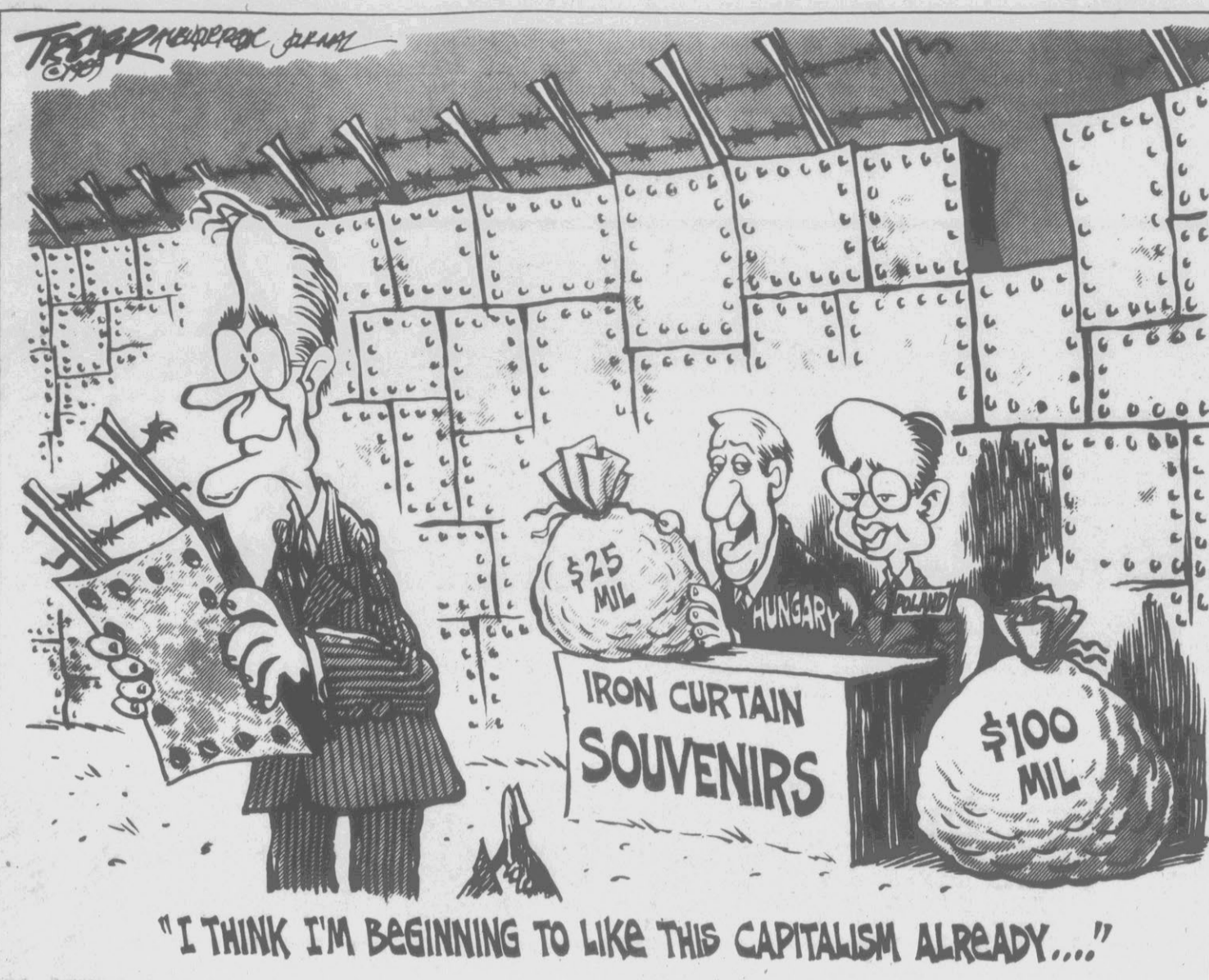

Coal Strikes: Gorbachev's 'Revolution From Below'?

David Remnick

MOSCOW — For months, Mikhail Gorbachev has been saying he wants a "revolution from below" to help accelerate his "revolution from above." Now, like it or not, the Soviet leader may have the beginnings of just that as the worst labor strikes since the 1920s continued to spread Tuesday in the coalfields of western Siberia and the Ukraine.

Ignoring appeals by their own leaders to go back to work, at least 150,000 striking miners in the Siberian Kuznetsky Basin stuck to their demands of independence from state control, staging what could prove to be the first in a series of assertive acts of independence and anger among this country's millions of dissatisfied laborers.

In the Donbass region of Ukraine, miners have now shut down 39 pits, including the Stakanov mine, the nation's largest. The Soviet news agency Tass said strikes have affected more than 160 coal, electronics and light industry businesses in western Siberia alone. Nearly half the country's coal production has been halted and Tass said "a catas-

trophe" is brewing at steel and power plants.

As concessions to workers' demands, the government has already flown into the Siberian mine region 10,000 tons of sugar, 6,000 tons of meat, 6,000 tons of soap and washing powder, and 5 million cans of condensed milk. They have raised pay for night shifts, lengthened vacations, raised by 50 percent the wholesale price of coal and said the miners would be allowed to sell for profit all the coal they produce in excess of state orders.

Nevertheless, one miner shown on the evening news program called the offer "stop-gap" and "half-baked." He said he and his fellow workers would stay out of the mines until their demands for better conditions and even greater control over their product, prices and profits were met.

In a conciliatory speech to miners in the Siberian town of Prokopyevsk, Gorbachev's emissary, Politburo member Nikolai Slyunkov, said, "people have lost patience and composure. We understand you, and we say we shall not limit ourselves to half-measures." He added that attempts at a solution so far were "just a beginning."

Analysis

In the Supreme Soviet, legislators said they were now putting "top priority" on passing a law regulating labor strikes. Although there have been nearly 100 such incidents in recent years, most of them minor, Soviet law still does not allow independent unions in the western sense.

Gorbachev, who seems to thrive on risk and finding ways to turn danger to his advantage, now faces a clear dilemma: to keep the strikes and demonstrations under control, and still allow workers and farmers to feel that Moscow's reforms can amount to more than what often seem abstract promises and parlor games for urban intellectuals.

If Gorbachev can prove he is trying to meet workers halfway, satisfying at least some of their demands for better conditions and greater independence, he may add not only to his political support, but also begin to erase some of the cynicism and complacency of tens of millions of Soviet citizens who are sick of food

shortages, cramped housing and miserable medical care.

But satisfying those demands will be extremely expensive for an already decrepit economy, especially if the strikes continue to spread. And with nationalist violence raging periodically in Abkhazia, Central Asia and elsewhere, some government leaders will not hesitate to demand that Gorbachev clamp down on all the unrest.

In Poland, contemporary change has its roots in the Solidarity movement's strike at the Lenin shipyards in Gdansk in 1980. But Gorbachev's perestroika reform program is only now sinking in at the grassroots level with popular elections and the strikes. Gorbachev has not yet been able to forge a Polish-style union of purpose between the intellectual elite and the workers.

So far, the Siberian strikers are on their own.

The unrest could not have greatly surprised Gorbachev. Although the strikes began spontaneously last

week, Gorbachev has been laying the groundwork for such a moment from the moment he succeeded Konstantin Chernenko more than four years ago.

He has at once tried to open up the country and establish new institutions, so that both demonstrators and progressive government officials are working, rockily, warily, but inevitably, toward similar goals.

In contrast to the current Chinese leaders, Gorbachev has decided that at least a measure of unrest and political independence is healthy. Despite extraordinary odds, Gorbachev has steadily, changed the vocabulary, psychology, and structure of Soviet society. The newspaper Socialist Industry even announced, with a note of approval, that miners were planning to form a "free basis for a new association of miners" — a plan that sounds somewhat like a nascent Solidarity movement.

The strikes could prove a moment of real awakening. Until now, there have been few signs that the millions of people here who are pleased to read better newspapers, but who see their everyday lives sinking further into decay were ready to put their hearts — and backs — into a

rebuilding effort that will take years, even decades, of enormous effort and sacrifice.

The leadership, which is capable of anger at nationalist demonstrations, has showed a certain sympathy for and even encouragement of the strikes in the Kuznetsky Basin. Politburo member Slyunkov in Siberia has even praised the strike committees for "high civic consciousness."

Despite their size, the strikes have not threatened the top leadership so far. The strikers have been non-violent. And the strike committees' demands have hit at Gorbachev's least favorite constituency — local Communist Party officials. Gorbachev has managed to make a political crisis work for him, allowing him to hack away at the conservative middle-level of the party.

Gorbachev used the same technique last week in Leningrad, when he engineered the firing of the unpopular regional secretary, Yuri Solovoyov, and then spent the better part of his speech telling party officials that factory workers were furious with them and they had best stop "chewing on stale gum" or face dismissal themselves.

(c) 1989, The Washington Post

PRE-SEASON SALE

30% off coats

SAVE NOW ON THE OUTERWEAR LOOKS YOU'LL WANT FOR FALL!



SALE
129.99

Reg. \$185, \$190. Save on all-wool styles that head straight into cooler weather! Choose a misses' coat with a shawl or a double-breasted reeler trimmed with leather. Or, for petites, a feminine velvet collar coat.

30% OFF ALL WOMEN'S SUITS, REGULARLY \$100 AND UP

<p>LAST WEEK WHITE SALE</p> <p>SAVE ON ALL*</p> <ul style="list-style-type: none"> • SHEETS • BLANKETS • PILLOWS • BEDSPREADS • COMFORTERS • COORDINATES <p><small>*Sale excludes JCPenney Smart Values</small></p>	<p>1/2 PRICE BONUS SALE</p> <p>SAVE ON ALL* MEN'S PAR FOUR® SHIRTS AND SLACKS</p> <p>Buy 1 item at regular price and get a 2nd of equal or lesser value at</p> <p style="font-size: 2em; font-weight: bold; text-align: center;">50% OFF</p> <p><small>*Sale excludes JCPenney Smart Values</small></p>	<p>1/2 PRICE BONUS SALE</p> <p>ALL* ALICIA® SEPARATES FOR MISSES, PETITES & WOMEN</p> <p>Buy 1 item at regular price and get a 2nd of equal or lesser value at</p> <p style="font-size: 2em; font-weight: bold; text-align: center;">50% OFF</p> <p><small>*Sale excludes JCPenney Smart Values</small></p>	<p>FINE JEWELRY SALE</p> <p>40% to 50% OFF 14K GOLD JEWELRY</p> <ul style="list-style-type: none"> • CHAINS • CHARMS • EARRINGS
--	--	--	---

You're looking smarter than ever at **JCPenney**

Shop 10AM til 9PM
Sunday 1 PM til 6 PM
Phone 756-1190
THE PLAZA

Sale prices effective through Saturday, July 29th. Percentage off represents savings on regular prices. Intermediate markdowns may have been taken on original priced merchandise. Reductions from original priced merchandise effective until stock is depleted. Sale excludes JCPenney Smart Values.

© 1989, JCPenney Company, Inc.

Legislature Stalls, But 685 Bills Go Through

By Dennis Patterson
THE ASSOCIATED PRESS

RALEIGH — With agreement over big ticket items such as highway projects and teacher salaries standing in the way of the adjournment of the General Assembly, legislators have approved 685 measures so far this year.

Out of 3,300 bills filed this session, the Legislature has passed 655 new laws and 30 resolutions, ranging from local matters like annexation or elections to nearly \$80 million in emergency spending for prison construction to settle a federal lawsuit.

In addition to the prison settlement, major issues addressed this session include environmental laws, changes in North Carolina's election regulations and a \$7 billion state operating budget that continues programs already in place.

The first bill to clear both houses of the General Assembly this session

raised the ceiling for the inmate population at the state prison system under a prison "cap" intended to alleviate overcrowding.

The changes to a 1987 measure require emergency releases of prisoners when the system has exceeded 98 percent of its 18,000-inmate capacity for 15 straight days. The original bill required the emergency releases after 15 days at 97 percent of capacity.

The new law, which was approved just three weeks after the Legislature convened Jan. 11, also gives the state Parole Commission 90 days instead of 60 to lower the prison population to 97 percent of capacity.

Prisoners eligible for immediate parole include any inmate serving a sentence of longer than six months whom the commission believes is not a danger to the community. The changes forbid any prisoner serving time for a sex offense or drug traf-

ficking to be released early.

Misdemeanor prisoners are automatically eligible to be considered for early parole, unless they were jailed for driving while impaired or any offense involving impaired driving.

In early March, legislators approved an emergency funding package of nearly \$80 million in construction and alternative sentencing funds to settle a federal lawsuit brought against the prison system for overcrowding.

The General Assembly revised its regulations on handling hazardous wastes after South Carolina Gov. Carroll Campbell banned shipments to a dump in Pinewood, S.C., from states that did not allow hazardous waste disposal sites inside their own borders.

North Carolina law had banned a hazardous waste landfill until at least one comprehensive treatment facility was operating in the state.

That restriction was lifted in a revised law on hazardous wastes that encourages a regional compact to handle wastes.

The changes give the governor the authority to negotiate with other states for a compact similar to the one used for low-level radioactive wastes.

A second major environmental bill sets up special funds to clean up environmental damage from commercial and noncommercial underground petroleum tanks.

Other environmental measures include:

- Revising appointments to the Coastal Resources Commission to ensure that members appointed from some categories do not work in construction, land development, real estate or lobbying activities.
- Allowing state officials to consider the cumulative effect of development when considering whether to issue a permit for projects in coastal areas.

- A fine of not more than \$500 for intentionally littering beaches and increasing the maximum fine for repeated non-intentional littering of \$500.
- Requiring biodegradable plastic yokes or six-pack rings for beverages sold in the state.

Black Democrats, who have pushed for years to eliminate second primaries, came close to their goal

with a new law that allows a candidate to be his party's nominee if he wins at least 40 percent of the primary vote.

The law previously allowed a second-place primary candidate to call for a runoff if the leading candidate did not get more than 50 percent of the votes cast.

Another law requires an elected official who wants to seek another elective office to resign his current position if the terms of the two offices overlap by more than 40 days.

Other new laws would:

- Grant a three-month amnesty period for back taxes and interest from Sept. 1 to Dec. 1, with tougher tax penalties to be imposed by the state beginning in 1990. Legislators say the amnesty period would raise revenues.
- Require that high schools teach the history of the founding of the United States and related documents, including the Declaration of Independence, the Constitution and its amendments.

- Make it a crime to repeatedly threaten or harass people through use of a telephone answering machine, facsimile machine or computer modem.
- Bar any eligible person who refuses to register for the draft from receiving state employment or state-supported scholarships.

- Make possession of any amount of cocaine a felony.
- Re-ratify a proposed amendment to the U.S. Constitution which allows members of Congress to approve salary increases that would take effect after the next election for the U.S. House. North Carolina first ratified the amendment in 1789, but it was not approved by the required number of states at the time.

- Require that the abortion remains be disposed of through burial, cremation or approved incineration.
- Establish scholarships for nursing programs.
- Make it a misdemeanor to use a dairy crate without the consent of the owner.

House Retains Teacher Pay Plan, Basic Education Slate

THE ASSOCIATED PRESS

RALEIGH — In an effort to clear the way for adjournment, House budget leaders agreed to stick with their plan for giving teachers a 30-step pay schedule and state employees an average 6 percent pay raise.

"I don't know about y'all, but I'm tired of coming down here," said House Appropriations Chairman David Diamont, D-Surry, a high school football coach. "Football practice starts two weeks from last night at 7 p.m., and I intend to be there."

"I want us to go ahead and get this ready so if we can get an agreement on the highway package Thursday, we can roll out an expansion budget," Diamont, D-Surry, told the panel as it began its 4½-hour meeting Tuesday.

Members of the committee voted to stick with the \$300 million salary proposal. The panel of subcommittee chairmen also agreed to back the House version of funding for the Basic Education Plan, which calls for spending \$77.4 million in fiscal year 1989-90 and \$188.6 million in 1990-91 for 1,500 new teachers, vocational teachers, teaching support staff and other expenses.

The Senate has proposed a 25-step pay plan for teachers, and spending \$60.3 million on the BEP this fiscal year and \$182.6 million next year.

A conference committee from the House and Senate is negotiating an \$8.6 billion highway funding package which includes using increased sales taxes on vehicles for the first two years of the 12-year plan to fund 6 percent pay raises.

The highway package would become part of the state expansion budget for new or increased spending.

The House pay proposal would put teachers on a 30-step plan, with teachers moving up one step and getting an automatic 2 percent pay raise each year. The only exception would be between the fourth and fifth years, when teachers would get a 5 percent pay increase.

The plan, which would be phased in over the next

three years, would add a 2.5 percent longevity pay increase beginning at the 25th step in the plan.

When fully implemented in three years, a beginning teacher would earn \$2,050 a month for the 10-month school year, while a teacher with 20 years experience would earn \$3,137 a month. A teacher with 30 years experience would get \$3,748 a month.

The pay would not include any across-the-board raises approved by the legislature or local pay supplements.

Teachers had a pay plan until 1982, when teachers were frozen at the step they then occupied. They have gotten across-the-board increases since, but no increases under the pay plan, essentially bunching teachers with several years experience at the same pay as new teachers.

The House panel, the only group meeting while many legislators were at a conference in Baltimore, agreed to accept a Senate proposal that would give the State Board of Education the equivalent of 6 percent pay increases with instructions to develop a separate pay schedule for school administrators.

The House panel also voted to stay with its proposal for the Basic Education Plan, the eight-year program approved in 1984 to guarantee that every student in the state is offered the same educational opportunities under programs funded by the state.

The House plan calls for full funding for 1,500 additional teachers, 725 teaching support positions, 300 clerical workers and 33 vocational teachers. The Senate plan does not fully fund all of those positions.

Diamont told the group the differences between the House proposal and the original schedule for the BEP amount to shifting funds around within the program.

"It's still an eight-year program," Diamont said. "We're just taking some of the money designated for the fifth year of the program (in the original plan) and moving it to the last three years of the program."

Brown Lung Award Ordered

THE ASSOCIATED PRESS

RALEIGH — The state Court of Appeals overturned a state panel decision and granted a \$48,000 award to the estate of an Alamance County man who died in 1987 of brown lung disease.

James C. Hogan, of Whitsett, had sought brown lung benefits under workman's compensation in 1976, the ruling said. Hogan had worked in the card room of a Cone Mills Corp. textile factory from 1932 to 1959, but sought other work after a doctor advised him that exposure to cotton dust was causing him breathing problems.

The state Industrial Commission dismissed his case in 1977, saying his last exposure to cotton dust had been

before 1963, the limit then set by state law.

After new laws were approved in 1980 eliminating the 1963 cutoff for brown lung claims, the Industrial Commission wrote Hogan and invited him to refile his claim, which he did. The commission approved benefits for him in 1981.

But Cone Mills and Liberty Mutual Insurance Co. appealed, saying the 1977 dismissal prevented Hogan from getting benefits. The appeals court agreed with Cone Mills and the insurance company, but the state Supreme Court said the commission could set aside its own 1977 ruling denying benefits.

The executrix of Hogan's estate, Linda Hogan, filed a motion for the commission to set aside its 1977

dismissal and grant benefits.

The commission in March 1988 refused to overrule the 1977 denial.

Judge Clifton Johnston, writing for the majority in the split decision, said the commission had asked Hogan to refile for benefits. Citing an earlier Supreme Court ruling, Johnston wrote that the court was justified in overturning the commission's 1988 decision because allowing it to stand "amounted to a substantial miscarriage of justice."

Judge Eugene Phillips agreed, but Judge Gerald Arnold dissented, saying the commission had the discretionary authority to set aside its 1977 ruling and the court should not substitute its own judgement for the commission's.

Scores Improve

THE ASSOCIATED PRESS

RALEIGH — North Carolina students continued to improve their scores on the California Achievement Tests this year, according to a report released Tuesday by the Department of Public Instruction.

North Carolina students, on average, scored higher in all subject areas on the tests than the average student in a national norm group. The tests are given each spring to students in the third, sixth and eighth grades.

Compared to the national norm group, North Carolina had a greater proportion of students scoring at or above the 77th national percentile. While the norm group had 23 percent at or above the 77th percentile, North Carolina had 34 percent score that high at grade three, 29 percent at grade six and 27 percent at grade eight.

Similarly, North Carolina had a smaller proportion of students scoring at or below the 23rd national percentile. The norm group had 23 percent scoring at or below the 23rd percentile, but North Carolina only posted 16 percent at grade three, 15 percent at grade six and 17 percent at grade eight.

State Superintendent Bob Etheridge called the test results encouraging.

The tests are a combination of scores from reading, language and mathematics.

HYPERTENSION
VOLUNTEERS NEEDED FOR THERAPEUTIC TRIALS IN HIGH BLOOD PRESSURE
CALL MEDISPEAK
757-0771

Happy Birthday Ann Marie!

Who ate the bag of Oreos under the table? ...Ain't She Sweet!
Michele Palmer Employees

WHOLESALE OUTLET
2500 CHARLES STREET EXTENSION
756-8652
STORE HOURS
Monday-Friday 9am-8pm
Saturday 9am-6pm

Johnson Baby Shampoo and Conditioner
11 oz.
\$2.09



MEDICAL PARK ASSOCIATES
TRANSFERENCE
Couples who have been in counseling for some time with one therapist sometimes suddenly decide to go elsewhere for treatment, citing a variety of complaints about how the earlier treatment was going. Upon examination, it can often be found that many of their complaints about why the counseling "wasn't working" are identical to their thoughts about why their marriage "wasn't working". It is ironic, and clinically very important, that people may try to "divorce" themselves from their counselor when the counseling begins to confront their own interpersonal problems. This is a very critical and common point in any therapy. In marital treatment, it is a sign that the couple is beginning to expose the issues which underlie their problems. In most cases, if the couple does not bolt from counseling, learning to work through issues with the counselor will have a great deal of carry-over value for their marriage. In such cases it is important to notice the similarities in issues with each other and with the counselor and to reestablish a working relationship with the counselor. The optimal choice is to divorce neither each other nor the counselor.
Presented As A Public Service By:
MEDICAL PARK ASSOCIATES
600 Medical Drive 758-6080



Help your car beat the heat!
This summer, see your Jiffy Lube® J-team® before you go on vacation or take a long trip. Regular Jiffy Lube 14-point complete service every 3,000 miles prevents engine problems brought on by long, hot driving. Before you go anywhere, spend 10 minutes at Jiffy Lube.

WE HAVE YOU READY IN MINUTES NO APPOINTMENT!

126 Greenville Blvd.
(Across from Golden Corral Steak House)
756-2579
Hours:
Monday thru Friday 8 a.m. to 6 p.m. Saturday 8 a.m. to 5 p.m.



DID YOU BUY PANASONIC OR TECHNICS PRODUCTS IN 1988?

YOU MAY BE ENTITLED TO REFUNDS IF YOU BOUGHT ANY OF THESE PRODUCTS BETWEEN MARCH 1, 1988 AND AUGUST 31, 1988:

Panasonic VCR's	Amount of Refund	Panasonic Telephones	Amount of Refund
Model PV 2800	\$19.00	Model KXT 3000	\$17.00
Model PV 2812	\$20.00	Model KXT 3880	\$17.00
Model PV 4800	\$22.00	Model KXT 2429 (answering machine & telephone)	\$18.00
Model PV 4820	\$21.00		
Model PV 4860	\$26.00		
Model PV 4862	\$19.00		
		Technics Audio	
Panasonic Camcorders		Model SA 180 (Receiver)	\$18.00
Model PV 400	\$45.00	Model SCA 830 (Rack System)	\$24.00
Model PV 420	\$38.00	Model SCA 840 (Rack System)	\$20.00
Model PV 460	\$20.00	Model SLP 600 (CD Player)	\$18.00

North Carolina Attorney General Lacy H. Thornburg and the Attorneys General of 48 other States and D.C. brought lawsuits for consumers in their states against Matsushita Electric Corporation of America (Panasonic) claiming in some instances consumers were overcharged for Panasonic and Technics products at retail stores. Under proposed voluntary settlements in those cases, you may be entitled to a refund if you bought the products listed between March 1, 1988 and August 31, 1988.

You must complete and mail in a claim form by November 2, 1989, to be eligible for any refund. On request, a claim form will be mailed to you. To receive a claim form, please write to:

Panasonic Antitrust Settlement Fund Administrator, P.O. Box 96678, Washington, D.C. 20077.
Or call 1-800-553-1739. When requesting a claim form be sure to include your return address.

The legal rights of Panasonic and Technics buyers will be affected by these settlements. If you bought Panasonic or Technics products during the time period listed above and you do not want to be bound by the settlement you must expressly exclude yourself and you will not get a refund. To exclude yourself you should contact the address shown above. To protect your legal rights, please act now.

By order of: Shirley Wohl Kram, United States District Judge, Southern District of New York.

IN THE STATE

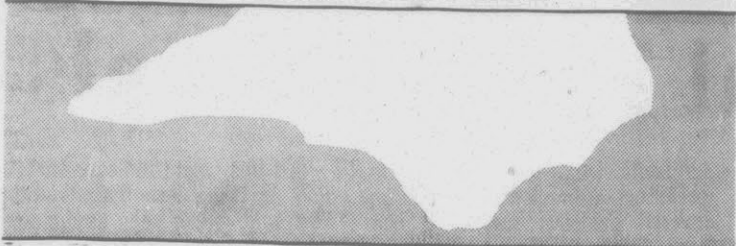

Bomb Debris

GOLDSBORO, N.C. (AP) — Retired Air Force Col. Mathew Perry, who was in charge of recovering a nuclear bomb after the crash of a Seymour Johnson AFB B-52 in January 1961, says no dangerous material was left in the ground at the crash scene.

Now a Goldsboro business man, Perry ended 28 years of public silence on the subject in a talk to Goldsboro Kiwanis Club on Monday.

He was chief of the weapons division at Eighth Air Force at the time of the crash at Musgrave's Crossroads near Goldsboro. He said digging crews recovered the "main item, the item we needed to recover" on the fourth or fifth day.

Perry did not identify the "main item" but for years speculation has been that a piece of radioactive material had been lost. Perry branded as "absolutely not true" reports that radioactive material remained in the ground.

"I assure you if there was anything left out there I would still be sitting in a little house next to that hole," Perry said.

Police Fences

CHARLOTTE (AP) — Charlotte police posing as thieves sold everything from VCRs to beer in an undercover investigation that ended with 30 arrests of neighborhood grocers, used car dealers and even convenience store clerks.

Police used \$7,500 of a \$30,000 state grant to buy the items they later sold as stolen goods to suspected fences, people who buy and sell stolen property. The rest of the money was used for equipment and other costs of the investigation, Cmdr. Bruce Treadaway said Tuesday.

The 30 people were arrested at 23 businesses on a total of 70 charges.

All were arrested on charges of attempting to receive stolen property, a misdemeanor, because police were not actually selling stolen property.

The investigation was prompted in part by a surge in store and house break-ins. Charlotte store break-ins are up 22.4 percent for the first six months of 1989, compared to the same period last year. House break-ins are up 11.4 percent, officials said.

Southern Legislators Told Prison Construction Isn't Only Solution

By Tom Stuckey
THE ASSOCIATED PRESS

BALTIMORE — New prisons fill up as quickly as they are finished and aren't the solution to prison overcrowding, but that doesn't mean states can stop building them, Southern legislators have been advised.

A federal judge, a former state attorney general and a prison administrator told lawmakers attending the annual meeting of the Southern Legislative Conference on Tuesday that new prisons must be built, but that states should also look for other ways of solving overcrowding problems.

U. S. District Judge Frank Kaufman of Baltimore said society wants offenders locked up for longer periods, and "if that's what our society wants, then as a democratic society that's what we ought to do."

Kaufman warned that states are "going to have to spend more money...if we're going to keep putting more people away for longer and longer terms."

Kaufman, Former Tennessee Attorney General Michael Cody and Daniel J. Moore, president of the Correctional Industry Association, told lawmakers that there are no easy or quick solutions to prison

overcrowding problems.

Cody said states must either divert inmates away from prison at the front end of the system or release violent offenders earlier at the other end.

He said many people charged with minor, non-violent crimes who are sent to prison simply because they can't make bail are candidates for alternative approaches such as monitored house arrest.

The N.C. General Assembly this year appropriated \$80 million for prison construction and alternative sentencing programs in response to a federal lawsuit. Legislators also enacted changes in the law that governs prison "population emergencies."

The changes to a 1987 measure require emergency releases of prisoners when the system has exceeded 98 percent of its 18,000-inmate capacity for 15 straight days. The original bill required the emergency releases after 15 days at 97 percent of capacity.

Moore, general manager of State Use Industries for the Maryland prison system, said states should put more inmates to work in prison industries.

In the early 1900s, about 60 percent of inmates worked, but today only about 10 percent of the 500,000 in-

mates in state and federal prisons are employed in prison industries, he said.

"That's very poor," Moore said. He said work programs can make money for states and also can teach skills to inmates that help them make it on the outside.

He said 22 percent of the inmates in Maryland's prison apprentice programs return to jail, a figure about half the recidivism rate for all prison inmates nationally.

Kaufman, defending the role of federal judges in demanding that states reduce inmate populations in crowded prisons, said he and other judges are aware of the problems their orders can cause and the concern they arouse in the public.

He said, however, that judges have a responsibility to balance the needs of society against "what common decency tells us in 1989 we must do" to comply with the constitutional prohibition against cruel and unusual punishment.

"Judges ... are not supposed to read the law in terms of what public opinion calls for," he said.

Kaufman told of touring an old Maryland prison, which he did not name, on a hot summer day a decade ago to view conditions and see

how inmates were affected by crowded conditions.

"We went through that day, and the place was sickening. You couldn't imagine yourself living for even an hour under those conditions," he said.

Kaufman said when he first got involved in suits filed by inmates alleging that their constitutional rights were being violated because of crowded conditions, there was a lot of stonewalling from Maryland officials.

"The attitude you got from the Maryland attorney general's office was, 'Federal court go away. Please leave us alone,'" he said.

That attitude seems to have changed in Maryland and other states, Kaufman said.

CHILDREN'S ART CLASSES

One Week Sessions:

July 24
Wearable Art \$30
Mixed Media \$45

July 31
Mixed Media \$45
Elementary Art \$35
Baskets \$45

Two Week Sessions:

July 31
Embroidery & Beading \$65
Weaving \$88

Please Call:
Anne Joyner
746-4132

Bunk Bed Headquarters

Over 20 styles available

Cargo

Down from Kmart 355-6050

Woman Charged In Arsenic Poisonings

THE ASSOCIATED PRESS

GRAHAM, N.C. — Investigators are probing additional deaths after charging an Alamance County woman with murder and assault in the poisonings of her husband and two other men.

The arrest of Blanche Taylor Moore, 56, Tuesday night came after a judge ordered the exhumation of the woman's father in a probe to see if he died from arsenic poisoning.

The Burlington Police Department charged her with first-degree murder in connection with the death of her first husband, James Taylor, in 1973. The Forsyth County Sheriff's Department also issued a warrant charging Mrs. Moore with first-degree murder in the death of Raymond Reid, a former boyfriend, who died in 1986.

In addition, the Alamance County Sheriff's Department charged Mrs. Moore with assault with a deadly weapon with intent to kill in connection with the arsenic poisoning of her current husband, the Rev. Dwight Moore.

The charges were announced hours after an Alamance Superior Court judge's order was filed Tuesday to exhume the body of the

woman's father, Parker D. Kiser Sr.

Authorities declined to say how many deaths they are investigating or to further characterize the possible victims, but they said all are from Alamance County. Officials also would not say when they will know if there are other victims.

Mrs. Moore was arrested at 6 p.m. at a residence outside Burlington, authorities said.

Ninety minutes later, the dark-haired Moore — wearing a white jacket and olive green pants and surrounded by five officers — was whisked from an unmarked police car to the Alamance County Jail, where she was held without bond.

She was scheduled to make a first appearance at 9:30 a.m. today in Alamance County Court.

At a news conference, authorities provided few details of their two-month investigations, which have enlisted at least eight officers from Alamance and Forsyth counties, Burlington and the State Bureau of Investigation.

They declined to talk about their cases against Moore or suggest a motive, and they would not say who owned the residence in which Moore was arrested, how long Moore had

stayed there, or whether she was alone when arrested.

"We're just going where the investigation leads us," said Lt. Steve Lynch of the Burlington Police Department. "This is just when the investigation merited the arrest, and the investigation will continue as scheduled."

Bond was set at \$100,000 on the assault charge. No bond has been set on the two murder charges.

"We still have some more leg work to do in our investigation. But basically, our investigation on the Rev. Dwight Moore is done at this time," Alamance County Sheriff Richard Frye said. "Any information we get, we still have some follow up to do. We'll continue that pending the trial."

Frye said there was additional evidence gathered in the case that he would not reveal prior to a trial.

Moore was taken to N.C. Memorial Hospital in Chapel Hill complaining of nausea and vomiting May 7. The arsenic was discovered within a few days after his admission.

Alamance County District Attorney Steve Balog has said investigators believe Moore might have ingested more arsenic at the hospital, but hospital officials have said they

don't believe that could have happened.

Moore's poisoning led to the exhumation of two other men. In mid-June, investigators unearthed the body of Mrs. Moore's ex-boyfriend, Raymond C. Reid Sr. Reid, a 50-year-old Kernersville grocer, died of cardiac arrest in a Winston-Salem hospital in October 1986. A subsequent autopsy revealed his heart failure was caused by arsenic poisoning, Butts said.

Reid signed a will a month before his death bequeathing equal shares of his estate to Mrs. Moore and his two sons, Steven and Raymond Jr. Mrs. Moore reported she received more than \$22,500 from Reid's \$68,000 estate.

Mrs. Moore's first husband, James N. Taylor, died of heart failure caused by arsenic poisoning, state medical examiner Dr. John Butts said. Taylor was a 45-year-old furniture refinisher when he died at home in October 1973. His body was exhumed almost two weeks ago.

Taggart's Lawyer Plans To Call Bakker To Testify In Tax Hearing

THE ASSOCIATED PRESS

CHARLOTTE — As lawyers prepared to argue over a call for testimony from PTL founder Jim Bakker, two former ministry accountants testified in the tax evasion trial of David and James Taggart they had difficulty getting documentation of expenses at the ministry.

The attorney for the Taggart brothers said he intends to follow through on his request for testimony from Bakker.

"I would never have issued the subpoena if we didn't want him to testify. Our role is not to play games," attorney Ben Cotten said in an interview outside the U.S. District courtroom Tuesday.

Cotten predicted the two sides would argue the matter today.

Bakker's attorney, Harold Bender, filed a motion last week the quash the subpoena and informed the court that Bakker will not waive his Fifth Amendment right against self-incrimination. Bakker is scheduled to be tried on fraud and conspiracy charges next month.

The Taggarts are charged with evading \$487,000 in federal income taxes while they were associated with the PTL ministry.

Two former PTL accountants who were responsible for compiling records for an ongoing IRS audit, testified Tuesday about problems they had getting expense receipts from David Taggart.

Terry Steen testified that during the years 1980-87 it was nearly impossible to convince Taggart to turn over any records.

"If you looked at the dollar amounts compared with the total (cash) advances that were due, it was very large," Steen said.

Lee Fichtner took over in 1984 as the PTL accountant responsible for providing documents to the IRS. He testified that he handled the IRS document requests pertaining to David Taggart's travel expenses covering the years 1984-85.

"Did David Taggart ever turn

those records over to you?" the prosecution asked.

"Not to my recollection," Fichtner said. "I never turned them over to the IRS."

Maxine Raudenbauch, a secretary in Bakker's office, recalled one occasion when David Taggart came into his office with a briefcase full of receipts some time in late 1986 or early 1987.

"They were all hodgepodge, in no order," she said. "There were a couple of hundred of them."

She testified that David Taggart declined her offer to help straighten them out.

"He said, 'I say every year I won't do this and I end up doing it,'" she said.

The Taggart brothers joined PTL in the late 1970s as piano players. Within a few years, David, 32, was promoted to Bakker's top personal aide and James, 35, became PTL's interior decorator.

Both were fired when Jerry Falwell took over at the television ministry following Bakker's resignation in March 1987 following revelations of the Jessica Hahn sex-and-money scandal.

William Spears, a certified public accountant who was hired by PTL to help it fight the IRS audit, testified that Taggart once showed him three binders containing travel receipts.

A WHOLE SUMMER OF BASEBALL WON'T IMPROVE HIS AVERAGE NEXT FALL.

SYLVAN WILL.

Sylvan Learning Centers are a group of neighborhood educational centers designed specifically to help your child do better in school. We test in order to pinpoint the specific areas in which your child needs help. An individually designed program, positive motivation, friendly encouragement, an experience of success right from the start, and individualized attention make all the difference.

Now is the time to enroll for this summer. Call today.

756-9383

Helping kids do better.™

Looking For A Weight Loss Plan That Is Fast While Medically Safe?

Well, look no more. With the Slim Life Weight Loss Program you can lose 3 to 5 pounds a week in the friendly surroundings of your local beauty salon or fitness spa. And the Slim Life Weight Loss Program is designed to aid dieters in not only reducing pounds but also their cholesterol and blood pressure. An exclusive feature of the Slim Life Plan is a complete health assessment by medical technicians at the beginning and end of the program. We know that the Slim Life Weight Loss Program can improve your health and we're excited about showing you. *It's your life... make it a Slim Life!*

Slim Life

Visit the Slim Life Center nearest you today!

Hair Dimensions, Branchwood Shopping Center - Jacksonville - Phone 346-3600
Inches Limited II, Henderson Drive - Jacksonville - Phone 347-7750
Mary Ann Kennedy Family Hairstyling - Richlands - Phone 324-4111

Salons and Toning Centers...

The Slim Life Weight Loss Program can add another exciting offering to your total beauty/health services. Call today about becoming a Slim Life Center! **1-800-446-1712.**

A Fast, Safe & Affordable Weight Loss Plan That Can Change Your Life!

Eastern Travelers Delayed 10 Hours

RALEIGH (AP) — About 300 New York-bound Eastern Airlines passengers were stranded here for more than 10 hours when their jet broke down and Eastern had problems finding a replacement, the Raleigh-Durham Airport Authority said.

The L-1011 jumbo jet, which left Atlanta at 9:27 a.m. with 316 passengers and a crew of 11, lost power in one engine and made a precautionary landing at 11 a.m., said Teresa Damiano, spokeswoman for the airport authority.

"I'd say it's probably par for the course," said passenger Don Eubanks of Tampa.

Passenger Norm Bass of Atlanta had said the pilot and crew planned to charter a plane back to Atlanta where they would get another L-1011 and fly to Raleigh-Durham to pick up the passengers. Eastern spokeswoman Bobbi Giordano said it would be "ludicrous" for the crew to leave the passengers in Raleigh and denied the company had chartered a flight.

However, Aero Services Inc., a Raleigh-Durham aircraft charter firm, confirmed Eastern chartered a Cessna Citation business jet and that the aircraft did depart for Atlanta.

Striking pilots union members said that while en route, the Eastern crew was told by Atlanta maintenance technicians that no airworthy widebody jets were available, the Palm Beach Post reported today.

Finally at 5:30 p.m., a jet was dispatched from Eastern's Miami headquarters to pick up the stranded passengers. Flight 102 departed for New York at 8:50 p.m. and landed at 10:02 p.m. — nearly 10½ hours after its scheduled 11:40 a.m. arrival.

Giordano said the jet ferried to the site would contain whatever ground crew would be necessary to transfer baggage from the stricken plane to the replacement.

Eastern suspended regular service at Raleigh-Durham when its mechanics went on strike. It plans to resume service at the airport Aug. 1, but so far has no ground crew there.

An Eastern employee said Tuesday night that it appeared that more than 90 percent of the passengers had to stay with Flight 102 because connections to New York are limited out of Raleigh. The travelers were served meals and drinks.

A spokeswoman from American Airlines, the dominant carrier at Raleigh-Durham, said Eastern did not contact American for help in ferrying the passengers to New York.

Paper Says 'Miracle' Pilot Faced Probe By Federal Drug Officials

THE ASSOCIATED PRESS

FORT LAUDERDALE, Fla. — Two days before pilot Thomas Root's mysterious, 800-mile unconscious flight, a special task force under federal drug czar William Bennett began investigating him on suspicion of running guns and drugs, a newspaper reported today.

The investigation of the Washington lawyer began eight days ago, after a meeting of state and federal law-enforcement officials

from the Washington, Maryland and Virginia, officials in Bennett's office told the Sun-Sentinel in Fort Lauderdale.

The task force opened its investigation after 35 guns and five gallons of ether, a chemical that can be used to process cocaine, were found during an April 24 search of the hangar where Root stored his plane, said Emile Manara, a special agent with Bennett's Office of National Drug Policy.

Task force members told the

Sun-Sentinel that the U.S. Drug Enforcement Administration has uncovered evidence suggesting that Root, who specializes in communications law, also had made unscheduled landings in remote areas.

While Manara said such behavior fits the pattern of suspected drug smugglers, he cautioned that the task force had not found any hard evidence linking Root to drug smuggling or gun running.

"We thought that this guy warranted some looking into," Manara said.

The latest disclosure came as a gun manufacturer, a police chief and a doctor who treated Root all cast doubt on his version of events.

Root, 36, who remains listed in stable condition at Memorial Hospital in Hollywood with a gunshot wound to the abdomen, has insisted that he does not remember getting shot. He was flying to Rocky Mount when his ordeal began.

He said he doesn't know why he passed out during the flight and said he was shot in the abdomen when his .32 caliber Smith & Wesson revolver, kept in the plane's glove compartment, discharged during the crash in Bahamian waters.

But Dick Bachmann, vice president of Smith & Wesson, told the Associated Press Tuesday that the gun's safety features make such accidental firings impossible. "Suggestions that it could be absolutely false," he said.

And Hollywood police chief Richard Witt told the Associated Press late Tuesday night that there was "indisputable scientific proof" that Root's bullet wound was at least four hours old when he arrived at the hospital.

"I knew from the beginning his story wasn't true," said Witt, a veteran homicide investigator.

Witt's findings supported those of U.S. Coast Guard surgeon James Rahman, who said peritonitis in the wound showed Root must have been shot at least two hours before he was rescued.

"All this would indicate that Mr. Root is being less than truthful," Witt said. "He's been saying some things that are now ludicrous. Nobody is going to know what really happened until he starts to put away those things that are implausible and starts talking about what's plausible."

The National Transportation Safety Board planned a news conference at the hospital at noon today to discuss its investigation. Spokesman Paul Miller of the FBI, which is also investigating the case, commented: "There's no question that this is an unusual case."

Manara said the task force investigation of Root has been put on hold while other agencies' inquiries into last week's flight continue.

The search of Root's hangar at the Manassas, Va., airport, also turned up cyalume chemical light sticks, which smugglers often attach to drug loads tossed out of airplanes, said Bill Kelmartin, a Prince William County, Va., police investigator.

In an interview after the hangar search, Kelmartin said, Root told him and a U.S. Customs agent that he kept the cyalume sticks in the airplane's cabin for possible "backup lighting" in the event of an electrical problem.

Kelmartin, now assigned to Bennett's 100-member regional task force, told the Sun-Sentinel Tuesday that Root's explanations were "plausible, but not all that probable."

NCNB Takeover Bid Spurs Profits

THE ASSOCIATED PRESS

ATLANTA — The stocks of seven Southeastern regional banking companies have been on a tear since late March when NCNB Corp. started its unsuccessful takeover of Citizens and Southern Corp. of Atlanta.

Unwelcome as it might have been to C&S, North Carolina-based NCNB's attempt is making money for many investors, including C&S shareholders.

NCNB's unsuccessful bid to acquire C&S brought attention to the other five super-regional banks, and falling interest rates and strong earnings for most have helped strengthen the companies' stock prices.

NCNB's 38.6 percent stock price jump leads the pack, with C&S' 27 percent increase next, but all of the seven large regional banking companies have outperformed the Dow Jones industrial average, as have bank stocks throughout the country.

"For NCNB, it is entirely the estimate of (earnings potential) from Texas," said John Mason, senior vice president at Interstate-Johnson Lane in Atlanta. "For C&S, at least half of the gain or all beyond which they would have had is due to the NCNB offer."

First Wachovia Corp. Sun-Trust Banks Inc., Barnett Banks Inc., First Union Corp. and Sovran Financial Corp. have benefited from declining interest rates and general interest in bank stocks, Mason said.

While interest in bank stocks has improved generally since lower ear-

nings in 1987, NCNB's takeover attempt was a catalyst for investor interest in the Southeast, said Jon Burke, senior vice president at Robinson-Humphrey Co. Inc. in Atlanta.

"I think people said, 'Wait a minute. There is something here,'" he said. "Their attempt did focus investor attention on small banks, as well as super-regionals."

Analysts and investors started to believe NCNB's effort signaled a possible round of consolidations in the Southeast, Burke said. There also was a feeling that other super-regionals would need to react, either as a buyer or a seller, he said.

NCNB has been the standard-bearer for super-regional stocks in recent months as investors anticipate the bank assuming 80 percent to 100 percent control of NCNB Texas National Bank and its earnings. Last week, NCNB, which owns 49 percent of the Texas bank, said \$28.8 million of its \$91.5 million second-quarter earnings from Texas.

"I don't think it hurts any of the other super-regionals to have one of their own trading for what is currently in excess of two-time stated book value," Burke said.

Drug Trial Gives Clue To Art Theft

THE ASSOCIATED PRESS

WILMINGTON, N.C. — A drug trial here has turned up clues that could lead to solving the 7-year-old mystery of who stole four 17th-century paintings from a Detroit museum.

Anna Barnes, a convicted cocaine dealer from Miami, admitted that she once kept paintings that were stolen from the Detroit Institute of Arts in 1982. The Detroit museum values the Dutch and Flemish paintings — including one attributed to Rembrandt — at \$305,000.

Ms. Barnes, testifying Tuesday in a cocaine conspiracy trial, said she gave three of the paintings back last year to the people who stole them.

She said she gave the other painting to an FBI agent in April. That agent was expected to testify today.

"We've always been hopeful to get them back," said Museum Director Sam Sachs. "I hope someone gets in touch with us."

The painting attributed to Rembrandt, "A Woman Weeping," is said to be worth \$200,000. "Laughing Boy," attributed to Frans Hals, is valued at \$60,000, but Museum Director Sam Sachs said the painting was one of the most popular at the museum and might be worth more than the one attributed to Rembrandt.

The other missing paintings are Aelbert Cuyp's "View of the Scheldt," worth \$25,000, and "St. Michael," by Lucas Franchois the Younger, worth \$20,000.

The museum offered a \$30,000 reward when the paintings were stolen May 28, 1982, and brought in a New York art investigator to track down the thieves.

But William Smith told the Detroit Free Press in 1983 that his investigation had turned up nothing.

"It's frustrating in the sense that

there are cases where you get things that entertain you; you get a lead, something to go on," Smith said. "You like to get a little encouragement. One false lead at least brings you closer to something."

Ms. Barnes dropped a lead Tuesday. One of defendant Carl Christy's lawyers, Tom McNamara of Raleigh, asked her whether she had shown the stolen paintings to Christy.

Christy, of Hollywood, Fla., faces charges of conspiracy to possess and distribute more than five kilograms of cocaine.

Ms. Barnes said she had. She said friends from Detroit had given them to her — she didn't say who — and she kept them in a safe deposit box. When the friends needed to catch up on a drug debt last year, she said, she returned three of them.

The last one she kept until after she pleaded guilty in New Bern to conspiracy to distribute cocaine on March 31, a charge for which she could get a life sentence, although she is cooperating with the government by testifying.

Ms. Barnes said she called an FBI agent and handed over the last painting because she wanted to get rid of it before it caused trouble. McNamara asked whether she didn't worry about being charged with possession of stolen property, but Ms. Barnes said she assumed her plea agreement covered all her crimes.

Museum officials said the paintings were discovered missing when an employee checked for storm damage in a storage room and saw that the paintings had been unscrewed from their frames. Officials said whoever took them must have been familiar with the museum, but added that, judging from what was taken, it had not been the work of organized art thieves.

Hatchery Attacked

HUANCAYO, Peru (AP) — About 100 Shining Path guerrillas attacked a private fish hatchery in the Andes, blowing up laboratories and incubation tanks and killing 50 tons of trout, police said.

Guerrillas in three trucks and a microbus arrived at the hatchery Monday, tied up seven employees and set dynamite charges around the facility, which is 25 miles northeast of Huancayo and 165 miles from Lima.

Authorities said the rebels made off with some arms, radio equipment and a pickup truck. Security forces left Huancayo Tuesday to pursue the rebels.

The Shining Path is a fanatical, Mao-inspired guerrilla group that has waged an armed insurgency against Peru's elected government since 1980.

The government says more than 15,000 people have died in the guerrilla war, including police, soldiers, government officials, rebels and civilians.

**SCREENING
MAMMOGRAPHY**

\$50⁰⁰

For Appointment Call
752-2847

**EASTERN BREAST CANCER
DETECTION CENTER**
Certified - Accredited

Beat The Price Increase Buy Your Yamaha Piano Before July 25!

YAMAHA INTERNATIONAL CORPORATION
6600 ORANGETHORPE AVENUE • BUENA PARK, CALIFORNIA 90620
MAIL ADDRESS: P.O. BOX 6600, BUENA PARK, CALIFORNIA 90622
PHONE: (714) 522-9011

June 20, 1989

TO OUR VALUED YAMAHA® PIANO DEALERS

This is to inform you that effective July 25, 1989, there will be a price increase on certain Yamaha® Piano models. A price list reflecting these increases will be sent to you before the end of June, 1989.

In regard to backorders, these will be billed at current prices, only on those items available in inventory and if released before July 25, 1989. All available inventory will be shipped before July 25, 1989. Unfortunately, available inventory may not be sufficient to fill all current backorders. We will continue our policy of filling all orders in the sequence we receive them, i.e., the oldest orders first. Any shipments made after July 25, 1989 regardless of the order date, will be billed at the new prices.

Thank you for your continued support and loyalty.

Sincerely,
Ronald Raup
Ronald Raup
Keyboard Division Manager
RR/lm

SEE OUR TERRIFIC SELECTION OF YAMAHA PIANOS TODAY

**YAMAHA SALE!
SAVE UP TO 40% NOW**

**YAMAHA CONSOLES
SAVE \$1,500
NO DOWN PAYMENT
NO PAYMENT 'TIL
OCTOBER 1989
@ \$75 PER MONTH**



333 Arlington Blvd.
At 264 Bypass



**Piano & Organ
DISTRIBUTORS**

355-6002
1-800-682-6911

Open Tues., Wed., Thurs., Fri., & Sat. 10-6
Monday 10-9

Price Guarantee
Purchase a piano or organ from P&O, find a lower advertised price on the same model from an authorized dealer, and we'll cheerfully refund the difference plus 10%! No one undersells P&O!

\$5 BONUS OFFER!

BUY A 24" TRIPLE HERRINGBONE CHAIN \$99

GET A MATCHING 20" CHAIN FOR JUST \$5

THURSDAY, FRIDAY AND SATURDAY ONLY.

From the Summer Fashion Collection, beautiful gold to accent a golden tan. Triple Herringbone chains. Get a matching 20" chain for only \$5 more when you purchase the 24" chain for \$99. Hurry in! Offer is valid Thursday, Friday and Saturday only. Sorry no layaways, no rainchecks during this special offer.

REEDS Jewelers

QUALITY • VALUE • SERVICE

CAROLINA EAST MALL • 756-6683
Also in Jacksonville, Rocky Mount and Wilson, NC

'My Sister Sam' Actress Killed

THE ASSOCIATED PRESS

LOS ANGELES — Police have few clues to why a man shot and killed actress Rebecca Schaeffer after waiting outside her apartment almost four hours. Her agent said she "didn't have an enemy in the world."

Police questioned a former boyfriend of the actress but said he was not a suspect. They haven't ruled out the possibility that Miss Schaeffer knew her attacker, Detective Dan Andrews said.

Authorities also found no indications of harassment against Miss Schaeffer, who starred in the old sitcom "My Sister Sam," but the possibility that the killer was a deranged fan "is a motive that we definitely have not ruled out," Andrews said.

"We have no record of her ever having called for assistance or being a victim of anything, or being harassed," he said.

Miss Schaeffer, 21, was shot once in the chest Tuesday morning by a young man who apparently rang her doorbell, Andrews said.

The attacker had been standing outside the two-story building for at least four hours, witnesses told police. The apartment is in the city's Fairfax district near West Hollywood and Beverly Hills.

"I was in the kitchen making coffee and I heard what sounded like a car backfiring," said Richard Goldman, a television screenwriter who lives across the street. "After the pop, there were two bloodcurdling screams."

"I looked out the window and I saw a guy in a yellow shirt jogging at a fair-clip ... as if it was ball four and he was running to first base."

Another neighbor, Kenneth Newell, rushed to help the fallen woman. "I felt her pulse. I couldn't feel any," Newell said.

The actress died at Cedars-Sinai Medical Center about 30 minutes after the shooting, said hospital spokeswoman Peggy Shaff.

The gunman was believed to be between 20 and 30 years old, police said.

"She didn't have an enemy in the world," said her agent, Jonathan



REBECCA SCHAEFFER

Howard. "She was a very successful young actress, on the ascent, getting job after job. I can't believe this has happened."

Miss Schaeffer co-starred on CBS' "My Sister Sam" with Pam Dawber from 1986 to 1988. She played Patti Russell, the younger sister of Miss Dawber's character, Sam.

A native of Eugene, Ore., Miss Schaeffer worked as a model in Japan in 1984, doing commercials and magazine covers. Upon her return to the United States, she took a regular role in the ABC soap opera "One Life to Live."

She also appeared in the Woody Allen film "Radio Days" and an episode of the NBC series "Amazing Stories."

She appeared most recently in the recently released movie "Scenes From the Class Struggle in Beverly Hills," playing the daughter of a character played by Jacqueline Bisset.

Miss Schaeffer had just completed a co-starring role in "One Point of View," an upcoming feature film directed by Dyan Cannon.

She had returned to Los Angeles recently from Italy, where she played a supporting role in a television miniseries about the hijacking of the Italian cruise ship Achille Lauro.

It's a great time to buy a LA-Z-BOY® recliner!



SAVE HUNDREDS OF DOLLARS NOW ON 300 LA-Z-BOY CHAIRS IN STOCK!

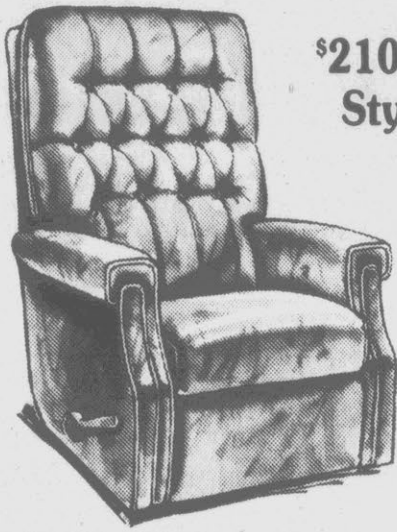

\$210 Off Retail Price
Style 10-844. Tall Back Style.

Bostic-Sugg Price
\$320
Style 10-449

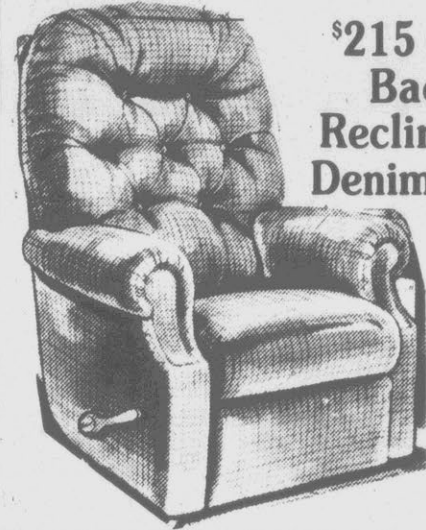

\$215 Off Big Pillow Back La-Z-Boy Recliner in Carefree Denim Velvet Fabric.

Bostic-Sugg Price
\$325
Style 10-445

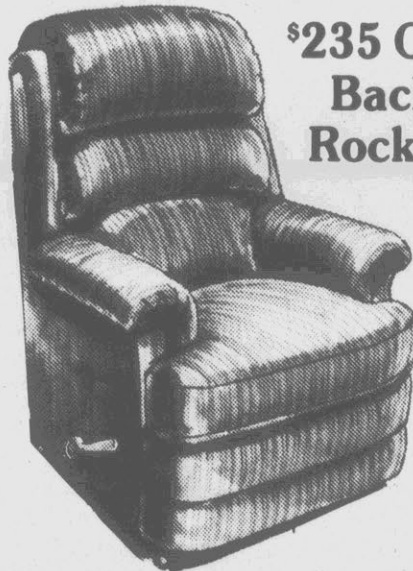

\$235 Off Big Pillow Back La-Z-Boy Rocker Recliner.

Bostic-Sugg Price
\$345
Style 10-462



\$115 Off Transitional Stripe Tall Back La-Z-Boy Rocker Recliner.

Bostic-Sugg Price
\$325
Style 10-426

UP TO 45% OFF WROUGHT IRON PATIO GROUPS



\$51.00 Off Tall Back Spring Back Rocker
Bostic-Sugg Price
\$69



\$209 Off Victorian Wrought Iron 5 Piece Patio Group With Big 48" Mesh Top Table & 4 Tall Back Chairs

Bostic-Sugg Price
\$299
Choice Of Pomp Or Blue Finish.

1/2 & MORE OFF PATIO UMBRELLAS



7 Ft. 8 Rib Vinyl Umbrella

Bostic-Sugg Price
\$49

Special Purchase of 7 Ft. & 8 Ft.

Rib Patio Umbrellas



7 Ft. 8 Rib Texoline Umbrella

Bostic-Sugg Price
\$79



\$190.00 Off 42" Round Mesh Top Table. 5 Piece Classic Style Patio Group

Choice Of Pomp Or Blue Finish. 4" Tall Back Arm Chairs & 42" Table. Bostic-Sugg Price
\$219

\$120 Off 5 Piece Group

Special Purchase Of Grosfillex Dining Group. Round Table & 4 Arm Chairs.



Bostic-Sugg Price
\$139

Grosfillex

Hurricane Veers Back To Hawaii

THE ASSOCIATED PRESS

HONOLULU — Hurricane Dalia surprised forecasters and turned north, putting it on course to pass close to Hawaii and prompting authorities to warn residents anew to stock up on emergency items.

Early Tuesday, the storm appeared to be turning away from the islands, but it shifted to a north-westerly direction and forecasters said Dalia could come closer than they expected.

"It does look like it's turning north, which makes it of a little more concern to us," said National Weather Service forecaster Hans Rosendal. "If it continues its northerly trend, it would come closer to the southern shores, but we don't know how close yet."

"It's not moving very fast, so we have plenty of time."

Hawaii Island beach parks were closed Tuesday as surf surged to more than 15 feet on the southeast coast of the southernmost island in the chain.

At 8 p.m. HST Tuesday, the hurricane was about 375 miles southeast of Hilo, on Hawaii Island, moving west-northwest at about 10 mph, the weather service said. Its maximum sustained wind speed was 75 mph; a storm is classified a hurricane when

that speed reaches 74 mph. Wind gusted to 90 mph.

By about 10 p.m. HST today it should be about 180 miles south of Hilo, the weather service said.

If the hurricane stayed on track, it would move parallel to the islands, moving south-southwest of the state, forecasters said.

A tropical storm watch remained in effect for Hawaii Island, meaning wind up to 73 mph and heavy rain were possible if Dalia moved farther north than expected.

Hawaii residents were urged to stock up on batteries, canned goods and other emergency supplies.

A high surf advisory also remained in effect for beaches along the south shore of the island, as waves reached heights of 15 feet.

"We're going to be keeping these beaches closed as a precautionary measure," said Bruce Butts, a spokesman for Hawaii County Civil Defense.

Although there were reports of waves washing up on coastal roads in some spots, Hilo police said there were no reports of injury or damage as of 10:30 p.m. HST.

Rosendal said it appeared the surf peaked Tuesday night and would subside by this morning, adding that it would surge again later today if Dalia continued to head for the island.

BANK NOTICE

Application of First-Citizens Bank & Trust Company, Raleigh, Wake County, North Carolina, for authority to change the location of its Winterville Office, 102 West Main Street, Winterville, Pitt County, North Carolina, to 115 North Mill Street, Winterville, Pitt County, North Carolina, has been filed with the Commissioner of Banks to be processed in accordance with Rule 4 NCAC 3C.0301 and the Regional Director of the Federal Deposit Insurance Corporation.

The public is invited to submit written comments on this application to the Commissioner of Banks, Post Office Box 29512, Raleigh, North Carolina 27626-0512. The comment period on this application will end 14 days from date of publication. The Commissioner of Banks will consider comments, including requests for a public meeting or formal hearing on the application, received within the comment period.

Also, any person wishing to comment on this application may file his or her comments in writing with Mr. A. David Meadows, Regional Director of the Federal Deposit Insurance Corporation at its Regional Office located at 245 Peachtree Center Avenue, N.E., Suite 1200, Atlanta, Georgia 30303, before processing the application has been completed. Processing will be completed no earlier than the 21st day following either the date of the last required publication or the date of receipt of the application by the FDIC, whichever is later. The period may be extended by the Regional Director for good cause. The nonconfidential portion of the application file is available for inspection within one day following the request for such file. It may be inspected in the Corporation's Regional Office during regular business hours. Photocopies of information in the nonconfidential portion of the application file will be made available upon request. A schedule of charges for such copies can be obtained from the Regional Office.

WILLIAM T. GRAHAM
Commissioner of Banks

Scientists Find Moon Rocks Embedded In Antarctic Glaciers

By Paul Reecer
THE ASSOCIATED PRESS

WASHINGTON — American scientists are finding rocks from the moon — and perhaps Mars — in the glaciers of Antarctica, and one expert says they may have been slung into orbit by an asteroid collision during ancient times.

"We are certain that these samples are from the moon," said William Cassidy, a University of Pittsburgh geologist.

The rocks, deposited on ancient polar show fields hundreds of thousands of years ago, match chemical characteristics of lunar samples collected by astronauts on the six Apollo lunar missions, he said. Matching the samples create what geologists call "ground truth."

"We don't know from where on the

moon they came, but we know they have to (be from places) more widespread than the four percent that we've sampled (by Apollo)," Cassidy said Tuesday at the International Geological Congress.

Cassidy said it is believed that the Antarctic moon rocks got to Earth when, in some ancient time, an asteroid smashed into the lunar surface with such great violence that chunks of the moon were slung into orbit. It would take less force to do this from the lunar surface because the moon has only one-sixth of the Earth's gravity.

Once in orbit, the moon rocks could eventually be swept up by the Earth. The lunar material would streak through the atmosphere and then crash into the Earth's surface.

Most such objects hit the oceans, where they are lost, or on land surfaces where they are weathered and eroded beyond recognition.

But in the Antarctic, time is frozen in gigantic sheets of ice that lie virtually unchanged for up to 20 million years. Moon rocks that come to rest there remain untouched and nearly pristine, awaiting collection by Cassidy and his team.

Other types of rocks from space also are found on the frozen polar plains.

Cassidy said two rare samples, called shergittes, have been found that may have originated from Mars.

"We don't really know if that's the case because we don't have ground truth (matched samples from a known source)," he said. But Cassidy said the fact that moon rocks hit Earth support the idea that other samples could be from Mars.

"The lunar samples ... lend credence to the view that you really can hit a planet with an asteroid and knock off a meteoroid and get it into

orbit," he said. "This lends credence to the idea that the shergittes could have come from Mars and are really martian samples."

Final proof, he said, will have to come from a sampling mission to Mars.

Cassidy said that about 12,000 other types of meteorites have been gathered from the ice in Antarctica. He said he and his team find the space rocks by systematically searching using snowmobiles.

"The meteorites are just lying around on the ice," he said. Most are about the size of a "large olive," but some are as large as grapefruit.

The fragments are photographed, collected in sealed bags and transported, still frozen, to the Johnson Space Center in Houston. In a special laboratory there, they are warmed and dried in a pure nitrogen atmosphere. Sections are cut from

the samples and sent for study by scientists in 17 nations.

Cassidy said when the study of Antarctic meteorites first began 20 years ago, scientists hoped to find samples that were as old as the polar ice sheets where they were found.

"We hoped we could look back 20

million years," he said. "But the oldest one we've found is only about 900,000 years old. We've found two that are 700,000 years old. The bulk have fallen over just the last 300,000 years."

And in a solar system more than four billion years old, he said, that's but a brief moment.

News Reports Link Iowa Explosion To Possible Suicide Bid By Sailor

THE ASSOCIATED PRESS

NEW YORK — A Navy investigation into the explosion that killed 47 sailors on the battleship USS Iowa in April has found strong evidence that a suicidal sailor set it off, according to two reports.

The 10-week probe, with FBI assistance, ruled out unstable gunpowder or flaws in the mechanical or electrical systems in the gun turrets where the explosion occurred, said NBC News and today's editions of The New York Times.

The network cited unidentified Navy sources Tuesday; the newspaper quoted officials in the Pentagon and Congress who spoke on condition of anonymity.

The unreleased Navy report said Gunner's Mate Clayton Hartwig, 25, may have been responsible for the

blast, according to NBC and the Times.

Navy spokesman Lt. Greg Smith told The Associated Press that the conclusion of suicide "was not based on official reports of the Navy. It is the opinion of NBC and Mr. (Fred) Francis," the network reporter.

Other Pentagon officials told the newspaper the Navy had been reluctant to issue a report, fearing it would further demoralize the ship's crew and bring on legal action, bad publicity or charges of incompetence or cover-up.

Smith said the investigation report had been submitted to the commander of surface forces for the Atlantic Fleet in Norfolk, Va., and eventually would land on the secretary of defense's desk.

The investigators based their findings on a psychological profile of

Hartwig by the FBI and 228 other exhibits, including a three-hour videotaped statement from another Iowa sailor, David Smith, NBC said.

David Smith rejected Hartwig's sexual advances the night before the explosion, he was quoted as saying in an interview with an investigator.

He also said Hartwig had discussed how to set off a bomb using a nine-volt battery and a small timer, NBC reported.

The two men talked about "explosions, that kind of stuff. How to set off the powder. All that kind of stuff," David Smith was quoted as saying.

Hartwig took him to his locker and showed him a timer, NBC reported.

"Part of me can see him doing it," David Smith was quoted as telling investigators.

In addition, a psychiatric study

done by the FBI Center for Analysis of Violent Crimes found that Hartwig was disturbed and under a lot of stress, "virtually insuring some type of reaction. In this instance, it is suicide," according to the report.

Naval investigators also pointed to the rejection of Hartwig by Gunner's Mate Kendall Truitt, who survived the explosion. Hartwig had named Truitt as the sole beneficiary of a \$50,000 double-indemnity life insurance policy.

Asked about NBC's report Tuesday night, Hartwig's father, Earl V. Hartwig of Cleveland, said there was "no way, definitely" that his son was suicidal.

FmHA Preparing Debt Notices

THE ASSOCIATED PRESS

WASHINGTON — The Farmers Home Administration is preparing for another round of notices to borrowers who missed paying loan installments by Jan. 1.

As of July 3, there were 15,704 newly delinquent borrowers, the agency said Tuesday. Notices telling them to settle their debts or face foreclosure will be mailed by early fall. Upon receipt, a delinquent borrower will have 45 days to respond.

Maryln Aycock, an FmHA spokesman, said the new wave of delinquencies is in addition to more

than 66,000 borrowers notified last fall that they would have to provide certain financial and production information to the agency if they wanted help in handling their debts.

If there is no response, or if a borrower is in such poor financial shape no alternative can be worked out, forced sale or foreclosure proceedings are authorized.

Aycock said unlike the earlier list of delinquents — many of whom were in arrears three years or more — the new batch involve farmers who are only six months or more behind.

The procedure is specified by the

Agricultural Credit Act of 1987, which requires FmHA collectors to tell delinquent borrowers of various liberalized debt-servicing options available to the borrowers.

Aycock said the 15,704 newest delinquencies represent a sharp reduction from more than 30,000 who missed the Jan. 1 deadline but made their payments later.

The FmHA, an agency of the Agriculture Department, is often called the government's farm lender of last resort. Eligible borrowers cannot qualify for loans from commercial lenders.

*** ATTENTION ***

GREENVILLE CITY COUNCIL AGENDA

Thursday, July 20, 1989 - 7:30 PM
Third Floor Council Chamber - Municipal Building

The Greenville City Council will meet at the above time, date, and location to discuss/consider the following:

- Approval of minutes for June 5, 8, 12, 19 and 27, 1989;
- Consent Agenda:
- Ordinance establishing new stop signs as required by Greenville City Code - Title 10, Chapter 2, Article H, Section 10-2-82;
- Request to prohibit trucks on Highland Avenue from Carlton Street to Greenville Boulevard;
- Request to establish a no-parking zone on Memorial Drive from Moore Street to Airport road;
- Request to convert Ames Street and a portion of Gooden Place to one way operation;
- Accept streets for permanent maintenance in Tretope, Section V, Phase I;
- Public hearing - Mayor's vote, amending City Charter to allow the Mayor a vote on all matters coming before Council;
- Public Hearings for Annexations:
 - Request by Lamont & Elizabeth Beaver to annex .40 acres (contiguous) in Bedford Subdivision, Lot 12, Block D, Section III;
 - Request by Autumnfield to annex 3.635 acres (noncontiguous) located off the western right-of-way of NCSR 1135;
- Rezoning Public Hearings:
 - Request from Ric Miller and Bryant Kittrell, agents for Bells Fort Associates, Inc. to rezone the following tracts located off the western right-of-way of NC 43, north of Bells Fort intersection: Tract 1: 28.51 acres from RA-20 to O&I; Tract 2: 1.73 acres from RA-20 to O&I; Tract 3: 24.84 acres from RA-20 to CS; Tract 4: 3.91 acres from R-6 to CS;
 - Request from Ric Miller and Bryant Kittrell, agents for Eldridge Lewis and Harvey Lewis to rezone 17.47 acres located north of NCSR 1708 from RA-20 to O&I;
 - Request from Ric Miller and Bryant Kittrell, agents for Wren Locke to rezone 5.99 acres located off the northern right-of-way of NCSR 1708 from RA-20 to O&I;
 - Request from Ric Miller and Bryant Kittrell, agents for Leon Raymond Hardee to rezone the following tracts located north and south of the proposed realignment of Fire Tower Road (NCSR 1708): Tract 1: 5.834 acres from RA-20 to O&I; Tract 2: 20.886 acres from RA-20 to O&I; Tract 3: 22.210 acres from RA-20 to R-6;
 - Request from William Dansey, Ric Miller and Bryant Kittrell agents for C.J.L. Company to rezone 36.93 acres located west of NC 43 and east of the proposed Arlington Boulevard from R-6 to O&I;
 - Request from Ralph C. Tucker, Jr. to rezone the following tracts located south of NCSR 1708 and east of NCSR 1725: Tract 1: 7.552 acres from RA-20 to O&I; Tract 2: (amended) 12.360 acres from RA-20 to CS; Tract 3: 4.186 acres from RA-20 to R-6;
 - Request from Ralph C. Tucker, Jr. to rezone 82.562 acres located north of NCSR 1708 from RA-20 to R-6;
 - Request from Ric Miller and Bryant Kittrell, agents for Helen Tucker Greene Heirs to rezone 38.91 acres located off the western right-of-way of NC 43 from RA-20 to O&I;
 - Request from Ric Miller and Bryant Kittrell, agents for Carroll and Associates and Tucker Company to rezone 42.5 acres located west of NC 43; west and east of the proposed Arlington Boulevard from RA-20 to O&I;
 - Request from Don Southard to rezone 1.811 acres located off the southern right-of-way of Hoesly Drive from CS to O&I;
 - Request from C.J. Harris, agent for Dennis I. Harris to rezone 131.53 acres located east and west of the 284 Bypass from RA-20 to I;
 - Request from Tucker Company to rezone the following tracts located off the eastern right-of-way of NC 11 across from Pitt Community College: Tract 1: 4.877 acres from O&I to O&I-I; Tract 2: 8.586 acres from O&I to CS; Tract 3: 7.563 acres from CH to CS;
 - Request from Joseph D. Spaight to rezone the following tracts located north of Pitt Community College and NCSR 1147: Tract 1: 4.54 acres from O&I to CS; Tract 2: 4.56 acres from RA-20 to O&I; Tract 3: 4.95 acres from RA-20 to CS; Tract 4 (amended): 2.707 acres from RA-20 to CS;
 - Request from Walter L. Williams to rezone 1.34 acres located on the southeast corner of NCSR 1725 and NC 43 from RA-20 to CS;
- Public Hearing to amend the Manual of Standards, Designs and Details in accordance with the adopted Subdivision Regulations; continued to August;
- Public Hearing to amend Section 32-109.2 Definitions, Subsection (k) of the Sign Regulations entitled Planned Center;
- Public Hearing - Request by Miller & Davis Associates, Inc. to amend Section 32-109.11 (c) of the Sign Regulations concerning the number of free-standing signs permitted within "planned centers";
- Public Hearing - Sale of Disposal Parcel 42-F-9A in the South Evans Community Development Project.
- Presentation to the CIA Organization.

The attachments are available in the City Clerk's office. The public is invited to attend.

PITT EAR, NOSE & THROAT HEAD & NECK SURGERY, INC.
ANNOUNCES THE ASSOCIATION OF
MARCUS S. ALBERNAZ, M.D.
FOR THE PRACTICE OF
EAR, NOSE & THROAT - HEAD & NECK SURGERY
AT
BUILDING 8 DOCTORS PARK
GREENVILLE, NORTH CAROLINA 27835-5007
TELEPHONE: (919) 752-5227 GENERAL OFFICE
(919) 752-0586 APPOINTMENTS ONLY
OFFICE HOURS BY APPOINTMENT
WILLIAM S. BOST, JR., M.D., F.A.C.S. PAUL S. CAMNITZ, M.D., F.A.C.S.
RUFUS H. KNOTT, II, M.D.

GREGORY L. JONES, MD
Announces the Opening
of the
BELHAVEN FAMILY PRACTICE CLINIC
108 Front Street
Belhaven, NC
Beginning July 17, 1989
943-6114
Appointments and Walk-ins

Meet your friends at the
Lake Ellsworth Swimming Pool
Phone 756-5374
Club House Rental Available
For Clubs, Organizations, Weddings, Church Groups, Etc.
Open Monday-Friday 9:30-1:30 p.m.

Cash Registers & Computers
• Sales
• Rentals
• Leasing
Century Data Systems
2801A S. Evans St
Greenville/756-2215
OMRON

1/2 PRICE BEDDING SALE!
NOW'S THE TIME TO SAVE A BUNDLE!
NAME BRANDS LIKE SEALY POSTUREPEDIC • SIMMONS BEAUTY REST • SLEEPWORTHY • DREAMMAKER • ON SALE NOW AT 50% OFF

SEALY **SIMMONS** **SLEEPWORTHY**

FREE
• Mattress Pad
• Bed Frame
• Pillows
Your choice with Beautyrest® or PosturePedic purchase.
• 90 Days Same As Cash
• Financing \$20.00 A Month
• Delivery And Set Up

SIMMONS SLEEP DEEP • SLEEPWORTHY RIVERA FIRM • 10 YEAR WARRANTY • INNERSPRING GREAT VALUE LIMITED TIME!!	
TWIN EA. PC. \$69	FULL EA. PC. \$79
QUEEN SETS \$199	KING SETS \$249
SEALY BODY SUPPORT • SLEEPWORTHY DREAMMAKER LUXURY FIRM • 20 YEAR WARRANTY • TOP OF THE LINE • EXTRA PADDING	
TWIN EA. PC. \$99	FULL EA. PC. \$124
QUEEN SETS \$339	KING SETS \$399

SEALY POSTUREPEDIC YOUR CHOICE... OR **SIMMONS BEAUTYREST**
MAKE YOUR CHOICE BETWEEN THE TWO BEST MATTRESS YOU CAN BUY AND SAVE 50% NOW. CHOICE EXTRA FIRM • LUXURY FIRM • PILLOW TOP • SUPER FIRM WE HAVE THEM ALL UNDER ONE ROOF AT THE GUARANTEED LOWEST PRICES!!!

TWIN EA. PC. \$129	FULL EA. PC. \$199	QUEEN EA. PC. \$275	KING EA. PC. \$325
--------------------	--------------------	---------------------	--------------------

SOFT SIDE WATERBEDS Look Like A Mattress Sleep Like A Dream!
Now you can sleep on a waterbed without changing a thing - use your headboard and footboard • your regular sheets and have no motion on the now TUBE style soft side waterbeds • on SALE NOW...

TWIN SETS \$299	FULL SETS \$399
QUEEN SETS \$499	KING SETS \$599

15 Year Warranty • Damask Cover • No Heater Needed

YOUR CHOICE \$9900

FACTORY MATTRESS & WATERBED OUTLET
355-2626 730 Greenville Blvd., Next to The Plaza 355-2626
90 Days Cash • 30 DAY LAYAWAY • Financing • Delivery • Visa & MasterCard • OPEN MON-FRI. SATURDAY 10A-6P



The Associated Press

Moi sets fire to ivory pile to back up demand for worldwide ban on illegal sale of the horns

Kenya Burns Ivory Pile Worth \$3 Million To Protest Slaughter

THE ASSOCIATED PRESS

NAIROBI, Kenya — Setting fire to 2,500 ivory tusks worth \$3 million, President Daniel arap Moi said he wanted to draw attention to a continent-wide slaughter that threatens to wipe out Africa's elephant in 10 years.

Hundreds of government officials, diplomats, journalists and conservationists watched Tuesday as Moi put a torch to the 12 tons of ivory atop a 20-foot pile of wood.

The pyre was placed on a hill in Nairobi National Park overlooking the vast Athi Plains that are home to gazelle, rhino, giraffe, zebra, lions and other wild animals.

"Actions speak louder than words," Moi said. "Kenya cannot appeal to the world to stop buying ivory if at the same time we are selling the very same commodity."

Conservationists and many nations have called for a worldwide ban on the ivory trade.

Kenya's elephant population has fallen from 65,000 in the 1970s to about 17,000. In all of Africa, poaching has cut the elephant population from an estimated 1.5 million in the 1970s to fewer than 700,000 today.

Iain Douglas-Hamilton, an elephant expert, said the burn was "immensely important" and he hoped it would help make people in ivory-consuming nations aware that if they "buy, wear or sell ivory, they're helping kill elephants."

Moi said he also will destroy 270 rhino horns Kenya confiscated from poachers, but did not say when.

Despite a rhino horn trading ban, Africa's rhino population has dwindled from 65,000 in the early 1970s to an estimated 4,000.

Conservationists say the ban has failed because the horn is still highly prized in the Far East, where it is sold in powdered form as an aphrodisiac.

Moi said his government will continue to destroy all ivory confiscated within its borders.

"I hope our action will help persuade others to appreciate the urgent need to take drastic steps to halt the wanton slaughter of elephants by declining to trade in ivory and its products both within Africa and beyond," Moi said.

The ivory burned Tuesday represented four years' worth of tusks confiscated from poachers.

More than 600 gallons of gasoline fueled the fire, since ivory only burns under intense heat. The top half of the pyre was blackened after about an hour.

Richard Leakey, Kenya's director of wildlife, said the government has increased the number of game patrols and he said poaching has fallen drastically in the past two months.

About 300 elephants were killed in the first five months of 1989.

Ivory fetches \$109 to \$154 a pound on the world market, with the higher prices going for the increasingly rare larger tusks. An average tusk weighs nearly 11 pounds, down from nearly 22 pounds a decade ago.

Kenya has joined a growing list of countries that support a worldwide ban on the ivory trade. Conservationists say the ban would likely work because the elephant tusk is used only for decorative purposes.

The EEC, Japan and the United States buy up to 75 percent of ivory on world markets. But in June, the United States, Japan, the 12-nation European Economic Community, Switzerland and Canada imposed bans on ivory imports.

The Lausanne, Switzerland-based 102-nation Convention on International Trade in Endangered Species will meet in October to consider a worldwide ban.

Zimbabwe, South Africa and Botswana oppose the ban. They say they have successfully protected their elephants while herds in other African nations have declined.

U.N. Chief Opens Talks In Namibia

THE ASSOCIATED PRESS

WINDHOEK, Namibia — U.N. Secretary General Javier Perez de Cuellar today began three days of talks aimed at resolving what he called "critical problems" in a yearlong independence plan for Namibia.

The United Nations chief met with senior U.N. officials in the territory. He was scheduled to hold talks with all major political parties and Namibia's South African administrator, Louis Pienaar.

"I want to ensure that conditions are created that will enable the holding of free and fair elections" in November, Perez de Cuellar said upon his arrival in Namibia late Tuesday night.

South Africa, which has ruled Namibia since World War I, agreed in December to carry out the U.N. independence plan under terms of a regional peace accord. Under the U.S.-brokered pact, South Africa also pledged to halt aid to guerrillas battling the Angolan government.

In exchange, the agreement stipulated that the estimated 50,000 Cuban troops supporting the Angolan government would be withdrawn.

More than 5,000 U.N. personnel are in Namibia to monitor the independence process in the territory. Perez de Cuellar indicated the independence plan is on track but said "critical problems remain."

He did not elaborate, but the remark was interpreted as a reference to mutual suspicion between Namibia's South African ad-

ministration and the South-West Africa People's Organization, or SWAPO, the group favored in the elections. SWAPO fought a 23-year guerrilla war in an effort to drive out the South Africans.

On Tuesday, SWAPO accused Pienaar of creating a "war hysteria" by claiming 1,900 SWAPO fighters were massed near the Angola-Namibia border.

SWAPO and U.N. officials said they found nothing to support the claims during a visit to northern Namibia over the weekend.

More than 1,000 armed guerrillas crossed into Namibia on April 1, the day the independence plan took effect.

Every Thursday

Thursday Night Baseball Specials

Located Behind Ace Cleaners Near Farm Fresh 355-2946

A life policy that can put you in charge.

With Allstate Universal Life, as long as you qualify, you can raise or lower your premiums and coverage as your needs change. Plus, your cash value grows using current competitive rates.

Allstate
Allstate Life Insurance Company
Certain coverage limits apply.

612 Arlington Blvd.

Leave it to The Good Hands People.

Greg Carter
Account Agent
Phone 756-0185

Chuck Humphrey
Senior Account Agent
Phone 756-0185

Nicaragua Marks 10th Year Under Rule Of Sandinistas

THE ASSOCIATED PRESS

MANAGUA, Nicaragua — The leftist Sandinista government marks a decade in power today, but many Nicaraguans have little to celebrate in a country that now ranks among the poorest in the world.

Banks, businesses and government offices closed to commemorate July 19, 1979, when the victorious Sandinista rebels marched into Managua to take power two days after dictator Anastasio Somoza fled.

The government said it expected more than 300,000 people for an anniversary rally at the Plaza of the Revolution. That would be about one-tenth Nicaragua's population and nearly one-third of the capital's.

La Voz de Nicaragua, the official radio station, took precautions. Spots broadcast Tuesday urged: "Everybody to the plaza tomorrow! And if it rains? That's no excuse. Everybody to the plaza!"

Red-and-black flags of the ruling Sandinista National Liberation Front and blue-and-white Nicaraguan flags draped the review stand, a bunker-like building built into a small hill in front of Lake Managua.

Some Managua residents predicted most of those at the rally would be Sandinista militants or public employees afraid of losing their government jobs if they failed to attend.

"Five years ago, people were still very enthusiastic about the revolution," a technician who did not want his name used said Tuesday. "People would paint and fix their houses, and neighbors would tell each other, 'Let's go to the plaza.'"

"But Managua has been deteriorating. People are now feeling the weight of the revolution."

"The people you're going to find at the rally tomorrow are the Sandinistas and those who have to go because they work for the state."

An economic report underwritten by Sweden, Nicaragua's main non-communist supporter, said last year's per capita output was \$300, making Nicaragua poorer even than Haiti, long the poorest country in

this hemisphere with a per capita gross national product of \$330.

When the Sandinistas marched into Managua 10 years ago, huge numbers of people surged through the capital to give them a joyous reception after a civil war that claimed an estimated 50,000 lives.

"When the revolution happened, people were happy because all this killing was going to stop," said Socorro, 43, a cleaning woman at a private business who asked that her last name not be used. "But these people (Sandinistas) have taken another road."

New 14 Kt. Gold Chains \$18 per gram

Southern Gun & Pawn
500 N. Greene St. • 752-2464 • Financing Available

Pitt Family Physicians PA

1402 W. 3rd Street Ayden

wishes to announce the association of

Donald A. Ribeiro, M.D.

for the practice of Family Medicine

J. Elliott Dixon, M.D.
James M. Galloway Jr., M.D.
Wilton C. Gay Jr., M.D.

Office Hours
8:30 a.m. - 5:00 p.m.
Monday-Friday
9:00 a.m. - 12 noon
Saturday

SEARS portrait studio

THROUGH SATURDAY ONLY!
Good Thru July 22

16⁹⁵

20-piece portrait package
2-8x10s, 3-5x7s and 15 wallets.

Adults & families welcome

WE CATCH YOUR CHILD'S BEST SMILES!

Every Sears photographer is a professional, trained to bring out and catch your child's best smiles! Also available: Instant Color Passport Photos and Copy & Restoration.

Price includes \$2 deposit. Your choice of traditional, nursery, spring or fall background. White and black backgrounds, Double Feature and other Special Effects portraits not available in advertised package. Posses our selection. \$2 for each additional person in portrait. No appointment necessary. Use your Sears Credit Card or Discover Card. *approximate sizes

Studio hours: Sun. - Store hours (where store is open); Mon. - Sat. - Store opening until one hour prior to store closing.

SEARS
Your money's worth and a whole lot more.

PLUMBING PROBLEMS

24 HOUR SERVICE

752-3661

Sam Pollard and Son

Plumbing • Heating • Air Conditioning
400 WEST 10TH STREET
GREENVILLE, N.C.

SUMMER SPECIALS

Specials Good Thru July 31, 1989

BRAKES \$69⁹⁵

PER AXLE MOST CARS AND LIGHT TRUCKS

- We install new guaranteed brake pads or shoes (semi-metallic pads extra)
- Resurface drums or rotors
- Inspect front grease seals
- Inspect front wheel bearings
- Road test your car

Additional parts and services may be required which are not included in this price. See warranty terms at your local Midas dealer.

Offer good with coupon only through 7/31/89 at participating Midas dealers.

4 SHOCKS OR STRUTS FOR THE PRICE OF 3

Choose from a complete line of shocks or struts. All designed for extra-quick response, improved handling and comfort, reduced in-car noise. Your car will ride better.

See warranty terms at your local Midas dealer.

Offer good with coupon only through 7/31/89 at participating Midas dealers.

15% OFF MIDAS GOLD MUFFLERS

See warranty terms at your local Midas dealer.

*Off regular price.

Offer good with coupon only through 7/31/89 at participating Midas dealers.

10% OFF COIL SPRINGS

- Midas quality installed while you wait.
- No appointment necessary.
- Famous Midas guarantee good at over 1600 Midas shops across the country.

*Off regular price.

See warranty terms at your local Midas dealer.

Offer good with coupon only through 7/31/89 at participating Midas dealers.

ECONOMIZER MUFFLER \$28⁹⁵

- 1 year guarantee
- Famous Midas quality
- See warranty terms at your local Midas dealer. (Pipes, clamps and hangers extra.)
- Fits most domestic cars

Offer good with coupon only through 7/31/89 at participating Midas dealers.

Nobody Beats Midas

3519 South Memorial Drive
Across from Carolina East Mall
Greenville
PHONE 756-9374

Bicentennial Commemorative

Only 2,500 North Carolina Bicentennial commemoratives are being minted to celebrate 200 years of statehood. All commemoratives contain one full ounce of 999 silver. Each proof quality commemorative is numbered on the rim and comes with a certificate of authenticity. Perfect for collectors and a great gift for \$32.75.

TO ORDER, call toll-free 1-800-235-6646 Ext. 377. MasterCard and Visa accepted. Or send your check to:

Bicentennial Commemorative
6040-A Six Forks Road, Suite 127
Raleigh, NC 27609

Obituaries

Batts
MAGNOLIA — Mr. Adrian Leo Batts, 49, died Tuesday.

A funeral will be conducted at 11 a.m. Thursday at Padgett Funeral Chapel in Wallace by the Rev. Dan Sellers and Mr. John A. Johnson. Burial will follow in Riverview Memorial Park near Watha.

Mr. Batts is survived by one daughter, Adriana Gay Batts of Greenville; four sisters, Evangelina Francis of Clinton, Vernell Davis of Rose Hill and Louvenia Hollingsworth and Brenda Hines, both of Wallace, and four brothers, Wendell Batts of Rose Hill, Claiborne Batts of Wallace, James Elton Batts of Augusta, Ga., and Shelton Batts of Magnolia.

The family will receive friends at the funeral home from 7 p.m. to 9 p.m. today and at other times will be at the residence of Mr. and Mrs. Shelton Batts, Route 1, Magnolia.

Bullock
CONETOE — A funeral for Mrs. Carolyn Turner Bullock will be con-

ducted Thursday at 2 p.m. in the Wilkerson Funeral Chapel by the Revs. Kenneth Harrington and Ralph Leggett. Burial will be in the Bethel Cemetery.

Mrs. Bullock, a native of Portsmouth, Va., attended the Portsmouth schools and had been a resident of the Conetoe community for the past five years. She was an employee of Farm Fresh Supermarket in Greenville and was a member of the First Pentecostal Holiness Church of Portsmouth, Va.

Mrs. Bullock is survived by her husband, L. Rowland Bullock; a daughter, Stephanie Bullock of the home; a son, William Bullock of the home; her father, Thomas Turner of Jacksonville, Fla.; seven sisters, Eunice Jones of Jacksonville, Fla., Martha Ann DeVites of Portsmouth, Va., Jeanette Hance of Conroe, Texas, Nancy Dailey of Chesapeake, Va., Mary Brewer of Fredericksburg, Va., Ruth Hanchey of Magnolia and Lynette Turner of Philadelphia, and three brothers,

Carroll Turner of Midlothian, Va., Thomas A. Turner Jr. of Tampa, Fla., and John Turner of Yukon, Okla.

The family will receive friends at the funeral home from 7 p.m. to 9 p.m. today and at other times will be at the home in Conetoe.

Carmon
Mr. Clinton Ray Carmon Jr. died Tuesday at Pitt County Memorial Hospital. Arrangements will be announced by Phillips Brothers Mortuary.

Kelsey
Mr. Clarence Mark Kelsey, 70, of 1103 N. Overlook Drive died Tuesday.

A funeral will be conducted Friday at 11 a.m. in the Wilkerson Funeral Chapel by the Rev. Billy Seate.

A retired East Carolina University professor, Mr. Kelsey was a native of Painesville, Ohio. He received a bachelor's degree from Dakota Wesleyan University, Mitchell, S.D., which he attended on a football scholarship. He received his M.Ed.

degree from Colorado State University and did doctoral study at the University of Missouri. Prior to coming to Greenville in 1962, he taught in public high schools for 10 years and taught drafting in the school of engineering at the University of Missouri for three years. For 22 years he taught industrial and technical education at East Carolina University, retiring in 1984 as associate professor.

A veteran of World War II, he served in the U.S. Army in the European Theater and was awarded

two Battle Stars. He was a member of St. James United Methodist Church and Epsilon Pi Tau honorary fraternity.

Mr. Kelsey is survived by his wife, Miriam Kelsey; two daughters, Suzanne Woxman and Carol Fornes, both of Greenville; a sister, Ruth Kelsey of Painesville, Ohio, and two grandchildren.

The family will receive friends at the funeral home from 7 p.m. to 9 p.m. Thursday and at other times at the home of Mr. and Mrs. Joe Fornes Jr., 1608 Hollybriar Lane.

Stock And Market Reports

NEW YORK (AP) — The stock market staged a broad advance today.

The Dow Jones average of 30 industrials rose 11.95 to 2,556.53 in the first half hour of trading.

Gainers outnumbered losers by more than 2 to 1 in nationwide trading of New York Stock Exchange-listed issues, with 662 up, 317 down and 510 unchanged.

Volume on the Big Board came to 26.62 million shares as of 10 a.m. on Wall Street.

Gainers among the blue chips included General Electric, up 3/4 at 55; American Telephone & Telegraph, up 1/4 at 36 3/4; McDonald's, up 1/4 at 30 3/8, and International Business Machines, up 3/8 at 115 1/8.

The NYSE's composite index of all its listed common stocks rose .81 to 185.72. At the American Stock Exchange, the market value index was up .79 at 370.96.

On Tuesday the Dow Jones industrial average fell 8.73 points to 2,544.76.

NEW YORK (AP) — Midday stocks:

High	Low	Last
AMR Corp	67 1/4	68 1/4
Abbott Labs	62 1/4	62 1/4
Alcoa	67 1/4	67 1/4
American Brands	72 1/4	72 1/4
AmCyan	54 1/4	54 1/4
Ameritech	59 1/4	58 1/4
AmIntGrp	86 1/4	86 1/4
AmerTAT	37 1/4	37 1/4
Amoco	48 1/4	48 1/4
BellAtlan	91	91
BellSouth	50 1/4	50 1/4
Beth Steel	22	21 1/4
Boeing	50 1/4	50 1/4
Boise-Casced	43 1/4	43 1/4
Borden	70 1/4	69 1/4
CSX Cp	33 1/4	33 1/4
CarrollPwL	41 1/4	41
Champ Int	34 1/4	34 1/4
Chevron	56 1/4	56 1/4
Chrysler	24 1/4	24 1/4
CocaCola	69 1/4	69 1/4
Colg Palm	54 1/4	53 1/4
Comw Edis	38 1/4	38 1/4
ComAgri	37 1/4	36 1/4
DeltaAirl	70 1/4	70
DowChem	87 1/4	87 1/4
duPont	114 1/4	114 1/4
Duke Pow	30 1/4	30 1/4
EstKodak	48 1/4	47 1/4
EatonCp	61 1/4	61 1/4
Exxon	45 1/4	45 1/4
FPL Grp	31 1/4	31 1/4
FstUnionCp	25 1/4	25 1/4
FstWachov	47 1/4	46 1/4
FlaProgress	37	36 1/4
FordMotor	49 1/4	49 1/4
Fuqua	28 1/4	28 1/4
GTE Corp	57 1/4	57 1/4
GenCorp	16 1/4	16 1/4
GenDynam	59 1/4	59 1/4
GenElet	35 1/4	34 1/4
GenMills	68 1/4	68 1/4
GenMotors	42 1/4	42 1/4
GnMotr E	53	52 1/4
GenPart	39	38 1/4
GoPaCrt	47 1/4	46 1/4
Goodrich	64 1/4	62 1/4
Goodyear	54 1/4	53 1/4
GracoCo	32 1/4	31 1/4
GTNorNek	39	38 1/4

Greyhound	34 1/4	33 1/4	34 1/4
HerculesInc	48 1/4	48 1/4	49
Honeywell	84 1/4	82 1/4	84 1/4
ITT Corp	59 1/4	59 1/4	59 1/4
IngRand	44 1/4	44 1/4	44 1/4
IBEW	115 1/4	114 1/4	115 1/4
IntlPaper	49 1/4	48 1/4	49 1/4
IntlRect	5 1/4	5	5
JamesRivr	32 1/4	32 1/4	32 1/4
K Mart	38 1/4	37 1/4	38
KaneSvcs	3	2 1/4	3
Kroger	16	15 1/4	16
Lockheed	50	49 1/4	49 1/4
LowesCp	118 1/4	117	117 1/4
McDermInt	25 1/4	25 1/4	25 1/4
McKess	36 1/4	35 1/4	36 1/4
MeadCp	41 1/4	41 1/4	41 1/4
MercantStr	45 1/4	45 1/4	45 1/4
MinnMag	73	72 1/4	73
Mobil	52 1/4	51 1/4	52
Monsanto	114 1/4	113 1/4	114 1/4
NCSB Cp	50 1/4	50 1/4	50 1/4
Nacco	46 1/4	46 1/4	46 1/4
Navistar	5	4 1/4	5
NorfolkSou	36 1/4	36 1/4	36 1/4
Nyrac	80	80	80
OlinCp	61	60 1/4	60 1/4
PacTelesis	44 1/4	43 1/4	44 1/4
PenneyJC	58 1/4	58 1/4	58 1/4
PepsiCo	55 1/4	55 1/4	55 1/4
Phelps Dod	61 1/4	61	61 1/4
PhilipMor	146 1/4	144 1/4	145 1/4
PhilipPet	23 1/4	23	23 1/4
Polaroid	41 1/4	41 1/4	41 1/4
Primerica	24 1/4	23 1/4	24 1/4
ProctGamb	115	114	115
QuakerOat	66	65	66
Quantum	40 1/4	40 1/4	40 1/4
RalstonPur	94 1/4	92 1/4	93 1/4
Rockwel	22 1/4	22 1/4	22 1/4
SPX Corp	29 1/4	28 1/4	29 1/4
ScottPaper	47 1/4	47 1/4	47 1/4
SearsRoeb	45 1/4	45	45 1/4
ShawInd	18 1/4	18	18 1/4
Skyline Cp	17 1/4	17 1/4	17 1/4
Sony Corp	55 1/4	55 1/4	55 1/4
SouthernCo	26 1/4	26 1/4	26 1/4
SwstBell	55 1/4	55	55 1/4
TRW Inc	48 1/4	47 1/4	48 1/4
Texaco	53 1/4	53 1/4	53 1/4
Trexton	27 1/4	27 1/4	27 1/4
USX Corp	35 1/4	35 1/4	35 1/4
UnCamp	37 1/4	37 1/4	37 1/4
UnCarbide	28	27 1/4	27 1/4
US West	71 1/4	71	71 1/4
Unocal	48 1/4	48	48 1/4
WalMart	40 1/4	40 1/4	40 1/4
WestingEl	66 1/4	65 1/4	66 1/4
Weyerhsr	29 1/4	29	29 1/4
WinnDix	53 1/4	52	53 1/4
Woolworth	55 1/4	55 1/4	55 1/4
Wrigley	45 1/4	44 1/4	45 1/4
Xerox Cp	66 1/4	66 1/4	66 1/4

Following are selected stock quotations as of 11:00 a.m.:

Ashland Oil	37 1/2
Unisys	23 1/4
Fieldcrest Mills	27 1/4
Flowers Inds.	19 1/4
Hatteras Inc. Securities	16
Hilton Hotel Corp.	104 1/4
Jefferson Pilot	38
John Deere	58 1/4
Lowe's Company	25 1/4
Interstate Securities	7 1/4
Southmark Corporation	9 3/4
United Telecommunications	69 1/4
Dominion Resources	45 1/2
Piedmont Natural Gas	25
Johnson & Johnson	49 1/2
Vermont American	31 1/2
OVER THE COUNTER	
Branch Bank	21 1/4 to 22 1/4
Planters National Bank	15 1/2 to 16 1/4
Integon	5 1/2 to 5 1/4
Southern National Bank	14 1/2 to 15
Peoples Bank	15 1/2 to 15 3/4
North Carolina Natural Gas	18 1/4 to 19 1/2
Cooper LaserSonic	4 1/2 to 5 1/4
Burroughs Wellcome	7 1/4 to 7 3/4
Food Lion A	10 1/4 to 11 1/4
Food Lion B	11 1/4 to 12

Inflation Slows

(Continued from A-1)
prices, shot up at an annual rate of 40.3 percent.

However, energy prices at the consumer level actually fell by 1 percent in June, the biggest decline since a 1.9 percent drop in October 1986.

Food costs, which had been climbing at the fastest pace since 1980, moderated as well in June, rising by

just 0.2 percent, reflecting a declining impact from last summer's drought.

While both food and energy prices moderated in June, other costs were held in check as well. The Consumer Price Index, excluding food and energy, rose only 0.2 percent in June, down from a 0.5 percent advance in May.

Food prices edged up just 0.2 percent in June.

SALE!

July 17-23

2 1/2 copies

2 1/2 copies

Open 24 Hours
8 1/2" X 11" 20# White Bond only, auto-fed sheets, at participating locations.

kinko's

the copy center

321 E. 10th Street
Greenville, NC
(919) 752-0875
FAX NUMBER (919) 830-4709

HURRY! 3 DAYS ONLY!

FOR THESE RADIO SHACK BARGAINS

<p>Universal Remote 6995 Cut 30% Reg. 99.95</p> <ul style="list-style-type: none"> Replaces Up to 8 Remotes Handy 7-Day/5-Event Timer Big 8-Digit LCD Display <p>#15-1901 Batteries extra</p>	<p>Stereo Color TV/Monitor Save \$120 37995 Reg. 499.95</p> <p>Remote batteries extra</p> <p>#16-252 Low As \$19 Per Month</p> <ul style="list-style-type: none"> Remote Control Sleep Timer Video/Audio Inputs/Outputs 	<p>Hi-Power Stereo Receiver Save \$150 24995 Reg. 399.95</p> <p>Low As \$15 Per Month</p> <p>#31-3007</p> <ul style="list-style-type: none"> Digital Display 12 Station Presets 																													
<p>Stereo With 'Phones Cut 30% 1388 Reg. 19.95</p> <ul style="list-style-type: none"> Enjoy FM Stereo or AM Ultra-Thin—Just 1/2" <p>#12-123 Batteries extra</p>	<p>43-Range Multitester Cut 40% 2388 Reg. 39.95</p> <p>#22-214 Batteries extra</p> <p>Great for Testing Home And Car Electronics</p>	<p>CB With Six Presets Save \$30 6995 Reg. 99.95</p> <ul style="list-style-type: none"> 40 Channels Ch. 9 Priority Switch Red LED Display 	<p>Direct-Drive Turntable Save \$50 7995 Reg. 129.95</p> <p>#42-2918</p> <ul style="list-style-type: none"> With Magnetic Stereo Cartridge Neon Strobe Damped Cueing 																												
<h1>Radio Shack SUPER SALE!</h1> <p>A DIVISION OF TANDY CORPORATION</p> <p>SAVE! GET IN ON THIS BIG EVENT!</p>																															
<p>Buy a Tandy 1000 TL and Get a Color Monitor Plus a Bonus Pack at No Extra Charge!</p>																															
<p>Tandy 1000 TL 129900 Save \$61785</p> <p>Reg. Separate Items 1916.85</p> <p>Low As \$65 Per Month</p> <ul style="list-style-type: none"> 286-Based PC-Compatible Tandy 1000 TL 640K RAM 720K Drive MS-DOS Built In DeskMate Graphical User Interface CM-5 Color Monitor DeskMate Software 2-Button Logitech Mouse MemoryMate PFS:First Publisher Quicken <p>#25-1601/1043/26-1338</p> <p>MS-DOS licensed from Microsoft Corp.</p>																															
<p>Minimus-7 Speaker System Cut 40% 2995 Each Reg. 49.95</p> <ul style="list-style-type: none"> Only 7 1/2" High Yet It Sounds Big 4" Woofer 1" Tweeter <p>Black, #40-2030. White, #40-2045</p>	<p>Versatile Personal Printer Save \$160 21995 Reg. 379.95</p> <p>#26-2814</p> <p>Low As \$15 Per Month</p> <p>IBM/Reg. TM IBM Corp.</p> <ul style="list-style-type: none"> Tandy and IBM Emulations Built-In Tractor Up to 120 cps 	<p>AM/FM Stereo Rack System Save \$100 19995 Reg. 299.95</p> <p>#13-1229</p> <p>Low As \$15 Per Month</p> <ul style="list-style-type: none"> Dual Cassettes With Synchro-Start High-Speed Dubbing AM/FM 5-Band EQ Turntable 																													
<p>Full-Featured VHS VCR Save \$6195 28800 Reg. 349.95</p> <p>Low As \$15 Per Month</p> <ul style="list-style-type: none"> On-Screen Programming Remote 14-Day/6-Event Timer HQ 	<p>Deluxe Phone Answerer Cut 25% 5995 Reg. 79.95</p> <p>#43-390</p> <ul style="list-style-type: none"> Dual Cassettes Remote Turn-On Voice Actuation 	<p>Cordless Telephone 25% Off 5995 Reg. 79.95</p> <p>#43-544</p> <ul style="list-style-type: none"> Quick One-Touch Redial Preset Security Code Low-Battery LED For Desk or Wall <p>Tone/pulse/1 dialing</p>																													
<p>RC Turbo Porsche Racer Cut 29% 4995 Reg. 69.95</p> <ul style="list-style-type: none"> Super Summer Fun Two Speeds Spring Suspension 49 MHz Recharging Jack for Ni-Cd Batteries <p>#60-4076 Batteries extra</p>	<p>AM/FM/TV-Sound Radio Cut 33% 1995 Reg. 29.95</p> <ul style="list-style-type: none"> Hear TV Soaps, Sports, News and Much More Tunes VHF-TV Channels 2-13 Audio <p>#12-613 Battery extra</p>	<p>Personal Stereo Cassette 30% Off 5995 Reg. Separate Items 85.90</p> <ul style="list-style-type: none"> Includes Headphones AM/FM Cassette Player Auto-Reverse Dolby NR <p>#14-1048/33-1000 Batteries extra</p> <p>*TM Dolby Laboratories Licensing Corp.</p>																													
<p>Alkaline Batteries 40% Off Premium Quality</p> <table border="1"> <thead> <tr><th>Type</th><th>Cat. No.</th><th>Reg.</th><th>Sale</th></tr> </thead> <tbody> <tr><td>N</td><td>23-023</td><td>Pkg. 2/1.49</td><td>.89</td></tr> <tr><td>D</td><td>23-550</td><td>Pkg. 2/2.39</td><td>1.43</td></tr> <tr><td>C</td><td>23-551</td><td>Pkg. 2/2.39</td><td>1.43</td></tr> <tr><td>AA</td><td>23-552</td><td>Pkg. 4/2.79</td><td>1.67</td></tr> <tr><td>9V</td><td>23-553</td><td>Each 1.79</td><td>1.07</td></tr> <tr><td>AAA</td><td>23-555</td><td>Pkg. 2/1.49</td><td>.89</td></tr> </tbody> </table>	Type	Cat. No.	Reg.	Sale	N	23-023	Pkg. 2/1.49	.89	D	23-550	Pkg. 2/2.39	1.43	C	23-551	Pkg. 2/2.39	1.43	AA	23-552	Pkg. 4/2.79	1.67	9V	23-553	Each 1.79	1.07	AAA	23-555	Pkg. 2/1.49	.89	<p>Personal Mini-Fone 35% Off 1295 Reg. 19.95</p> <p>Pulse dialing</p> <ul style="list-style-type: none"> "Hangs Up" On Any Flat Surface in Your Home Includes Wall Bracket Touch-Redial Mute <p>White, #43-505. Brown, #43-506</p>	<p>AM/FM Stereo Cassette Cut 29% 4995 Reg. 69.95</p> <p>#14-753 Batteries extra</p> <ul style="list-style-type: none"> Record From Radio, Built-In Mikes AM/FM Auto-Stop Tone Control 	
Type	Cat. No.	Reg.	Sale																												
N	23-023	Pkg. 2/1.49	.89																												
D	23-550	Pkg. 2/2.39	1.43																												
C	23-551	Pkg. 2/2.39	1.43																												
AA	23-552	Pkg. 4/2.79	1.67																												
9V	23-553	Each 1.79	1.07																												
AAA	23-555	Pkg. 2/1.49	.89																												
<p>Check Your Phone Book for the Radio Shack Store or Dealer Nearest You</p> <p>SWITCHABLE TOUCH-TONE/PULSE phones work on both tone and pulse lines. Therefore, in areas having only pulse (rotary dial) lines, you can still use services requiring tones, like alternative long-distance systems and computerized services. PULSE-DIALING phones work on both tone and pulse lines, but do not produce tones. FCC registered. Not for party lines. We service what we sell.</p> <p>*Radio Shack ValuePlus® revolving credit. Payment may vary depending upon your purchases. PRICES APPLY AT PARTICIPATING STORES AND DEALERS</p>																															

Talks Under Way Between Jazz, Edwards

Ex-ECU Star's Agent Confident Of Agreement Before Fall Camp

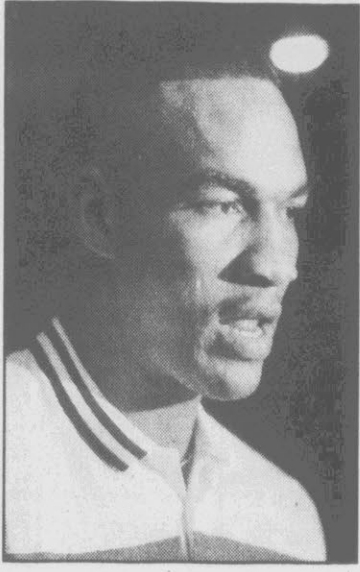

Blue Edwards

By Tom Morris
THE DAILY REFLECTOR

Blue Edwards' agent and Utah Jazz officials are talking, but the team's rookie and free agent camp is going on without Edwards for now.

"Let's just say we have a dialogue going, but it has not yet produced a contract as yet," William Pollak, Edwards' agent, said. "I'm very confident Blue will be in training camp, but I'm not sure how to categorize negotiations."

"There doesn't seem to be any obstruction. We have a view of what Blue Edwards is worth, and Utah has their view. And that's what

negotiations are all about."

Edwards was taken by the Jazz with the 21st selection July 25, but the former East Carolina University basketball star still hasn't set foot in the state of Utah.

Other draftees have also been slow to sign.

As of right now, only one of the 27 first-round selections has finalized a contract. Mookie Blaylock, the 12th overall, agreed to a deal with the New Jersey Nets that will pay him a little more than \$2 million over four years.

Utah opened its rookie/free agent camp this week. Edwards, though, won't attend without a contract. The team's regular pre-season training camp opens Oct. 8.

"I just try to stay in shape and be ready once I do sign," Edwards said. "It is a big waiting game. My agent is doing a good job of informing me about what is going on. I've got a general idea of how negotiations are going."

Utah's first pick a year ago, 6-11 center Eric Leckner, was taken with the 17th pick in the first round. He signed for \$1.1 million over three years. Centers traditionally command a bigger market value than other position players.

Pollak, of Professional Management in Washington, D.C., represents Edwards, along with fellow first-round picks Nick Anderson of Orlando (the 11th pick) and George

McCloud of Indiana (the seventh pick).

Last year, Utah's two early picks were Eric Leckner and Jose Ortiz, a 6-10 center-forward from Oregon State. Leckner signed early while Ortiz signed late after playing for Spain in the Seoul Olympics.

After the Jazz selected Edwards in the draft, Scott Layden, Utah's player personnel director and assistant coach, said it was important to Edwards' development that he attend the team's rookie/free agent camp.

"What would you expect them to say," Pollak said. "That's a company line."

One standard determinant of market value is what other relative picks sign for. In Edwards' case, what Jeff Sanders, who was taken by Chicago with the 20th pick, or

Byron Irvin, who was taken by Portland with the 22nd pick, sign for could have an impact.

"It has an effect," Pollak said. "It is a factor to put into the equation, but it alone doesn't determine anything. They drafted Blue. They didn't draft Sanders."

Phil Marantz, a Beverly Hills' lawyer who is the legal counsel for the Jazz and handles their contract negotiations, was unavailable for comment Tuesday.

Failing Career, Marital Woes Pushed Moore To Kill Himself

THE ASSOCIATED PRESS

ANAHEIM, Calif. — Tormented by the memory of one pitch and despondent over his failing career and marital troubles, former California Angels pitcher Donnie Moore shot his wife numerous times before killing himself.

"All indications are that Donnie Moore and his wife, Tonya, became involved in an argument, and during the argument, Mr. Moore produced a handgun, shot his estranged wife and then turned the gun on himself," Anaheim Police Lt. Marc Hedgpeth said.

Tonya Moore, 35, was in critical condition early today suffering from at least three gunshot wounds in the upper chest and stomach, Hedgpeth said after the shooting Tuesday afternoon at the couple's home in the affluent Peralta Hills area of Anaheim.

Their 17-year-old daughter drove her wounded mother to nearby Kaiser Permanente Hospital. The couple's two sons, ages 7 and 10, also were at the house during the shooting, but none of the children were hurt.

The 35-year-old Moore was released last month by the Kansas City Royals' minor league team in Omaha. He had been plagued by injuries during his last years in the

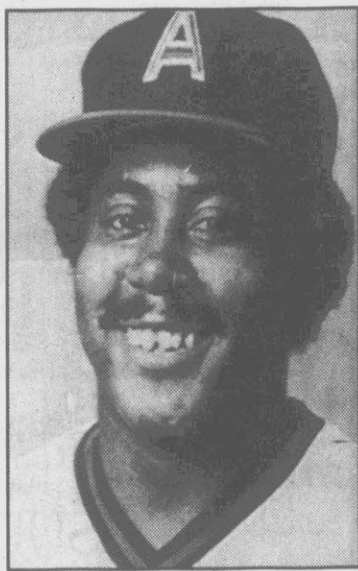

Donnie Moore

major leagues and saw yet another comeback attempt dissolve when he was released by the Royals' organization.

He also had separated from his wife of 16 years about a month ago, said Moore's New York-based agent, Dave Pinter.

Moore was released from the Angels in 1988, two years after he carried California to within one strike of the 1986 World Series, a loss that tortured him through the years.

With the Angels ahead three games to one in the best-of-seven American League playoffs, Moore, pitching with a sore right shoulder, had a 5-4 lead, with two outs and two strikes on Boston's Dave Henderson in the top of the ninth inning of Game 5. But Henderson then hit a Moore forkball for a two-run homer that gave the Red Sox a 6-5 lead.

The Angels sent the game into extra innings, and once again Henderson victimized Moore, with a sacrifice fly in the top of the 11th that lifted the Red Sox to a 7-6 victory.

The Red Sox won the next two games in Boston and moved into the World Series, which they lost to the New York Mets.

"Everything revolved around one ... pitch," California veteran Brian Downing said in a somber Angel clubhouse in Toronto, where the players heard of their former teammate's death after their 1-0 victory over the Blue Jays.

"You (to reporters) destroyed a man's life over one pitch. The guy was just not the same after that," Downing said. "I never ever saw the guy be credited for getting us to the playoffs because all you ever heard about, all you ever read about, was one pitch."

Pinter also said Moore was haunted by the pitch.

(See MOORE, B-2)

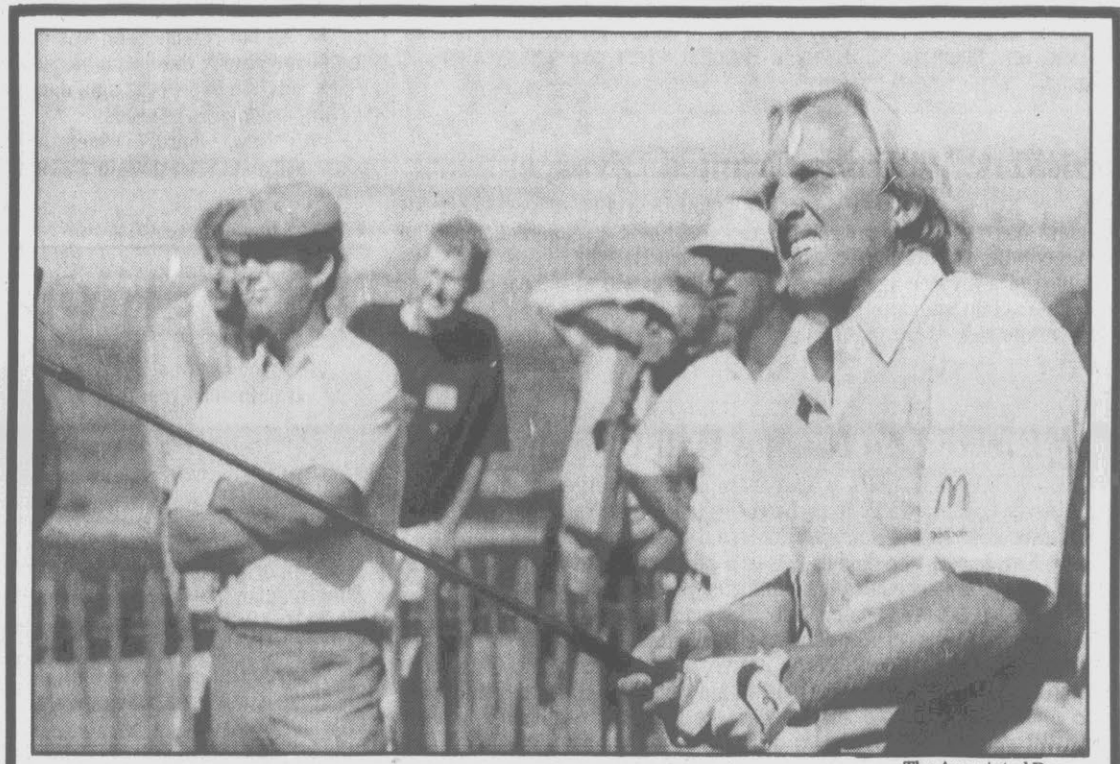

The Associated Press

Greg Norman watches a tee shot during a British Open practice round

American Hopes Doomed?

Odds makers Are Betting Against A U.S. Champion

THE ASSOCIATED PRESS

TRON, Scotland — At first, there was open-mouthed amazement and disbelief, then growing acceptance of the long odds against an American winning the 118th British Open Golf Championship.

"Get to the bookies before they change their minds," Tom Watson advised when informed that Britain's legal bookmakers have set odds of 5-2 against an American — any American — winning the oldest of the world's golf titles.

"I'm tired of hearing about how they're better than we are. They're good players, yes. Some great players. But I don't think they're any better than we are," Mark Calcavecchia said Tuesday after a practice round for the tournament that begins Thursday at Royal Troon.

"They don't make many mistakes, but I wonder if that is realistic," said Tom Kite, the year's leading money-winner on the American tour. "We're not a bunch of dogs. We can play the game a little, too, you know."

But Curtis Strange, the two-time U.S. Open champion and one of the leading contenders for the old claret jug that goes to the

winner of this ancient event, took a different view.

"Maybe," Strange suggested after some consideration, "those are the right odds."

"For one thing, the numbers work against us. There's 156 in the field and, what, 40 Americans? So the numbers are not in our favor."

And there are at least two other factors, Strange said, that work against American chances. Actually, there are three, if recent history is included. Americans, who once dominated this event, have not won the British Open since 1983.

There are five players, Strange said, generally considered to be in a group by themselves at the top of the world standings.

They include defending champion Seve Ballesteros of Spain, Masters champion Nick Faldo

(See BRITISH, B-2)



LeMond Increases His Lead

THE ASSOCIATED PRESS

BRIANCON, France — Greg LeMond, the leader of the Tour de France after 16 stages, knows the most important is No. 17.

The leader with seven stages to go, LeMond finished fourth in Tuesday's 16th stage from Gap to Briancon to increase his overall lead to 53 seconds. He said today's stage through the Alps will all but decide who will wear the yellow jersey following Sunday's final leg.

LeMond, the 1986 champion who is making a comeback following two years of misfortune and injury, says No. 17 is the toughest test in the 2,020-mile race.

"The most difficult stage of the Tour is going to be l'Alpe d'Huez," LeMond said. "It will really separate a

lot of people at the top. There are steep enough climbs you think you can't make them."

The 100-mile leg is marked by four climbs, three of which are off the scale of difficulty and steepness being rated "Out of Category."

That includes the final 6-mile climb to the 5,940-foot peak with 21 switchbacks.

But LeMond has some good memories of l'Alpe d'Huez. In 1986, his victory was assured when he climbed to the top together with five-time champion Bernard Hinault.

Since then LeMond has not returned as he missed the last two Tours. A hunting accident sprayed him with shotgun pellets in 1987 and he had an emergency appendectomy in 1988 along with leg problems.

Williams Rips Tyson

Challenger Tired Of The Champ

THE ASSOCIATED PRESS

ATLANTIC CITY, N.J. — Mike Tyson is not an ideal heavyweight champion in the eyes of challenger Carl "The Truth" Williams.

In the eyes of Home Box Office, the cable television network, however, the 23-year-old heavyweight champion is a meal ticket worth keeping.

So talks have been held concerning a lifetime contract between HBO and Tyson, who will defend the title against Williams Friday night at the Convention Center.

Williams told reporters on Tuesday that he believes the media is growing tired of Tyson.

"I know that you, like myself, would like to see him closed down," Williams said. "It's that time."

"A champion has to conduct himself like a champion. I feel that he doesn't and I'm sure you do, too."

Tyson scoffed at Williams' comments.

"Williams is talking all that garbage," Tyson said. "We'll see how he looks after he's been bashed around a little bit."

Tyson was a 12½-1 favorite to win the fifth fight in his current eight-bout, \$26.5 million deal with HBO.

"We have not discussed dollars," Seth Abraham, HBO vice president, said of the proposed lifetime deal, which he has discussed with Tyson and promoter Don King on one hand, and with Tyson's estranged manager, Bill Cayton, on the other.

"The promoter has Mike's mind, body and spirit," Abraham said. "The manager has a contract."

Abraham said it was Tyson who mentioned a lifetime contract when a meeting was held last Oct. 26 at Las Vegas in an unsuccessful attempt to solve the dispute among King, Tyson and Cayton.

"Mike was talking about loyalty," Abraham recalled. "He said HBO was loyal and I don't care if I fight for anybody other than HBO. Let's do a lifetime deal."

Under a suggested format, Abraham said, Tyson "would fight three times a year on HBO and every 18 months he would be able to do a pay-per-view fight. HBO would have the production and the delayed broadcast rights."

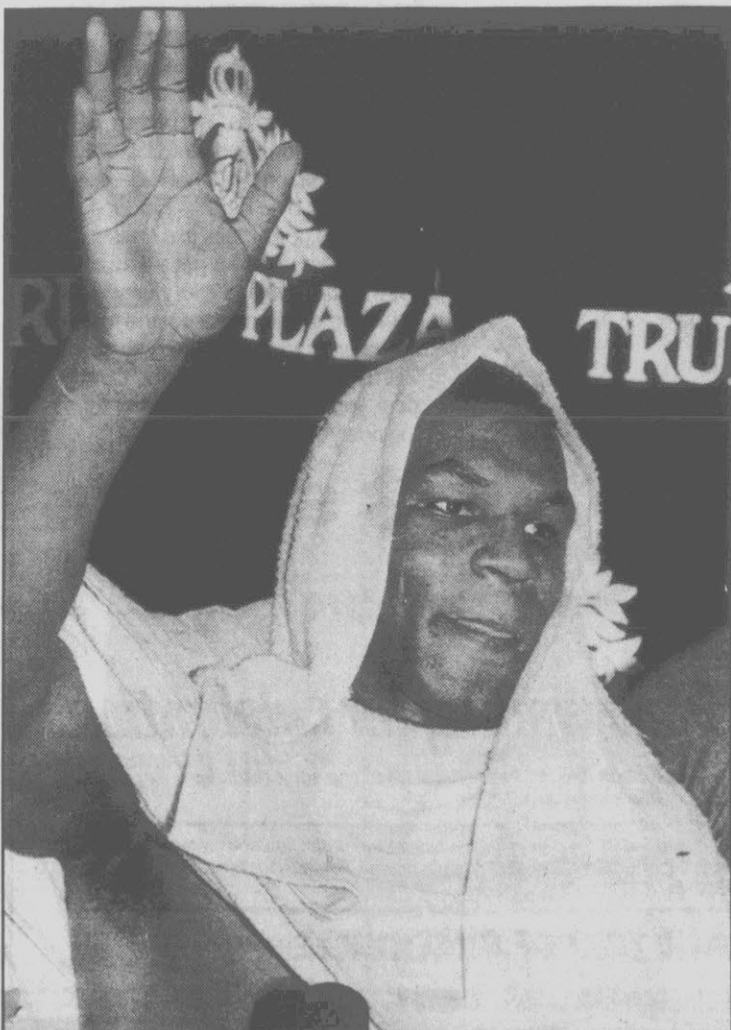

The Associated Press

Mike Tyson's next fight will be against Carl Williams

NFL Moves Slowly

Dissident Owners Still Holding Out

THE ASSOCIATED PRESS

SCHAUMBURG, Ill. — In his 29 years as commissioner, Pete Rozelle has usually been able to get the NFL owners to move on with their business.

Now that Rozelle has announced his resignation, business is moving a lot slower.

The owners met for six hours on Tuesday without reaching agreement on the creation of a new international league, although its backers seemed confident it will be approved.

Nor was any progress made in overcoming the impasse over the election of Rozelle's successor. It developed two weeks ago when 11 dissident owners kept Jim Finks from getting the 19 votes necessary to be elected commissioner.

Several of the 11, including Jerry Jones of Dallas and Patrick Bowlen of Denver, met with Rozelle on Tuesday after originally being scheduled to meet with members of the so-called "old guard" search committee that settled on Finks, the president of the New Orleans Saints.

But the dissidents weren't specific.

"We're being involved in the process," Jones said. Asked if there was any plan to work out a compromise, he replied: "There is no plan, just a real good effort to get a new commissioner. I'm confident we'll get one."

"Discussions are going on," added Mike Lynn of Minnesota, one of the leaders of the dissidents. "This will work itself out."

Rozelle was hardly more specific and said he would continue to meet with the dissidents.

"During the course of the day I had the chance to meet with some of them," he said. "I can't predict anything any more than you can. Progress? I'm still talking."

The international league proposal was to return to the table today with Tex Schramm, its commissioner, and Dan Rooney of Pittsburgh, a spokesman for the NFL's advisory committee on the league, expressing confidence it would get the 21 votes necessary for implementation.

Rooney, also a member of the commissioner search committee, said in a reference to the Finks vote: "After last week, I've learned never to anticipate what will happen in this league."

Sports Notes

Snow Hill Takes 2-1 Lead In Series

CARY — Todd Mewborn had a two-run homer in the second inning to get Snow Hill ahead early en route to a 7-5 win over Cary in the third game of the Eastern Area I American Legion Championship series Tuesday night.

The win gave Snow Hill a 2-1 edge in the best of seven series, which resumes tonight with a game at Snow Hill at 7:30 p.m.

Snow Hill scored a run in the first to go ahead early before adding three runs in the second as Ed Stanley led off with a base hit, went to second on a wild pitch, to third on a sacrifice and scored on a fielder's choice by Prentis Uzzell. Mewborn then came up and nailed his home run for a 4-0 Snow Hill edge.

Cary came back with two runs in the second, but West then came up in the fourth and added a solo home run to run Snow Hill's lead to 5-2.

Snow Hill added one run each in the fourth and the seventh. Uzzell singled in Jimmy Hardy in the fourth, while Cedric Collins scored off a bases-loaded walk in the seventh.

George Burnette, Collins, West, Jackson and Stanley had two hits apiece to lead Snow Hill.

Snow Hill.....	131	100	100-7	15	3
Cary.....	020	102	000-5	7	2

West, Mewborn (7) and McKeel; Cannon, Johnson (7) and Mauro

Green's Wife To Drop Battery Charges

TAMPA, Fla. (AP) — The wife of Hugh Green has filed a waiver to drop charges of spouse battery against the Miami Dolphins linebacker, saying news accounts about the football player's arrest were blown out of proportion.

Green, according to a police report, admitted striking his wife Saturday night. But his 21-year-old wife said she decided to drop the charges after talking with a counselor of the Hillsborough County Victim Assistance Program.

Green was arrested early Sunday and released on \$10,000 bond. He was charged with striking his wife several times in the head and chest with his fist, the police report said.

The linebacker's wife allegedly hit her head on the bed during the altercation and was taken to St. Joseph's Hospital where she was treated and released.

Redskins' Williams Granted Divorce

BATON ROUGE, La. (AP) — Washington Redskins quarterback Doug Williams has agreed to drop a forgery and theft complaint against his estranged wife, an attorney for Lisa Williams said Tuesday.

As part of a divorce agreement, Mrs. Williams will also have custody of the couple's child, said attorney Lewis Unglesby.

The settlement was to be finalized after being signed by the judge, said Unglesby.

Two Elected To Racing Hall Of Fame

DARLINGTON, S.C. (AP) — Two champions from different eras and different parts of the country have been elected to the National Motorsports Press Association Hall of Fame, officials said Tuesday.

Ralph Earnhardt, who died in 1973 of a heart attack at the age of 45, and Jerry Cook, 45, are scheduled to be inducted into the Hall of Fame on Sept. 2 at the Florence County Country Club. The induction is scheduled for the eve of the 40th annual Southern 500 at nearby Darlington Raceway.

Earnhardt, a Kannapolis, N.C., native, was the father of three-time Winston Cup champion Dale Earnhardt. He won NASCAR's national sportman division title in 1956, driving cars he built and engineered himself. Earnhardt won 32 races on 11 tracks en route to the championship.

Kinston's Lewis Leads All-Star Win

DURHAM (AP) — Kinston's Mark Lewis hit a home run in the sixth inning to give the Carolina League's Southern Division All-Stars the winning margin as they defeated the Northern Division 2-1 Tuesday night.

Durham relief pitcher Matt Turner wriggled out of a bases-loaded jam by striking out the final two batters to preserve the victory for the Southern Division.

Lewis, who was named "Star of Stars," hit his home run off Frederick pitcher Andres Constant to give the Southern Division a 2-0 lead.

The home run surprised his manager, Ken Bolek.

"He never hits home runs for me during the regular season, then he plays for (Southern Division manager) Grady (Little) and hits one out," Bolek said.

The Northern Division scored its only run in the seventh inning. John Wehner of Salem singled and moved to second on a ground ball out.

Moore ...

(Continued From B-1)

"Ever since Henderson's home run, he was extremely depressed," Pinter said. "He blamed himself for the Angels not going to the World Series."

"Even when he was told that one pitch doesn't make a season, he couldn't get over it. That home run killed him."

After the playoffs, it was determined that Moore had been pitching with a painful bone spur on his spine and he underwent surgery to correct the problem.

Neighbors said Tonya Moore had spoken with them about her husband's career and also told them of their marital problems.

"He abused her," said Betty Bailey, who lives nearby. "She said he beat her up and left bruises."

Pinter, speaking by phone from New York, said his client had not given up on his career. The agent had spoken to Moore on the phone just hours before the shooting, and said there was no indication anything was wrong.

"He seemed fine," Pinter said. "We were just going over everything in general. He was running, lifting weights, just trying to get his comeback in order. He was having domestic problems, having problems with his career."

Pinter said he had been talking with the Houston Astros about finding a place for Moore in their organization.

"Bob Watson (Houston assistant general manager) was interested and said that he would get him a AAA spot as soon as something opened up and bring him up maybe in September for the pennant race," Pinter said.

Moore had also discussed going to Puerto Rico this fall for the winter leagues.

Moore set Angel records in 1985 by recording 31 saves and finishing 57 games.

The native of Lubbock, Texas, also played for the Chicago Cubs, St. Louis Cardinals, Milwaukee Brewers and Atlanta Braves during a major league career that spanned 13 years.

Finks Holds Up Under Pressure

By Dave Goldberg
THE ASSOCIATED PRESS

SCHAUMBURG, Ill. — If he hasn't demonstrated it before, Jim Finks has now shown he has the stuff to be NFL commissioner.

Having had his life put in limbo two weeks ago by 11 owners who want a larger say in the future of the league, the president of the New Orleans Saints showed up at Tuesday's league meeting in good spirits.

He entered the session — called to discuss the new international football league — with a smile on his face, greeting a few reporters but saying nothing of substance. A couple of hours later, he came out smiling and said to the cameras that clustered around:

"A terse no comment."
Is there any other candidate with a similar sense of satire? Is there any other candidate who can retain his composure while dealing with the anarchy that has beset the NFL?

Consider what the new commissioner faces:

— A dissident "New Guard" which includes Joe Robbie, 73; Hugh Culverhouse, 70; Robert Irsay and Bud Adams, each 66, and Ken Behring, 60. All but Adams, who was absent, were among those who blocked Finks' election two weeks ago, denying him the 19 votes he needs.

— A "New Guard," which appoints as two of its negotiators Beh-

ring and Dallas' Jerry Jones, who have each been in the league less than a year. Another is Denver's Patrick Bowlen, who alienated most of the other owners by pushing through an 80-man training camp roster to save money, then making an offer to Buffalo's Bruce Smith a day later for \$7.5 million over five years.

— A dissident group whose most ambitious member, San Francisco's Edward DeBartolo Jr., shows up only for a meeting of the antis and leaves before the regular league meeting begins. Another "leader," Norman Braman of Philadelphia, considers the session so important that he is spending the time in the south of France.

In fact, the existence of the group at all is due in part to personal squabbles.

Tampa's Culverhouse, for example, was one of the most powerful owners in the league until a few months ago, when he surrendered his league chores in a huff. He is angriest at three members of the commissioner search committee — Art Modell of Cleveland, Wellington Mara of the New York Giants and Dan Rooney of Pittsburgh — because he thinks they were critical of his role as chairman of the NFL Management Council during the 1987 players strike.

British Open ...

(Continued From B-1)

England, Sandy Lyle of Scotland, Australian Greg Norman and Strange.

"There's five and there's only one American among them. So the numbers work against us there, too," Strange said.

And there are the unusually dry, hard conditions, the result of a drought and heat wave on the Ayrshire coast along the Firth of Clyde.

It was at this point that Watson, who scored the fourth of his five British Open titles here in 1982, agreed about the odds.

"These are links courses and links conditions," Watson said. "You have to play a different game, play the low shot and run the ball into the green, play the bounces."

"How often do we play these conditions? Not often. How often do the Europeans play these conditions, play links courses? A lot more than we do."

"So if there is an advantage, it has to go to people more familiar with the conditions."

Norman agreed, calling it "a home court advantage."

"We just don't play these conditions that often," Strange said. "If it favors anybody, it favors someone from over here."

He quickly added, however, that the entire situation — Americans vs. non-Americans — is one that interests the public, press and oddsmakers much more than it does the players.

"It doesn't matter," Strange said. "You don't think of it like that. If I come down to the last hole on Sunday, with one man to beat, I don't care if he's British or Australian or Spanish or American. I don't even think of that."

"I don't care who it is or where he comes from. I just see one man standing between me and the trophy and I'm going to try to beat him."

RIGGAN SHOE REPAIR SHOP
DOWNTOWN GREENVILLE
111 WEST 4TH STREET
758-0204
Open Monday-Friday 8 a.m.-6 p.m.
Owned And Operated For 17 Years

Nothin' beats nothin' down.

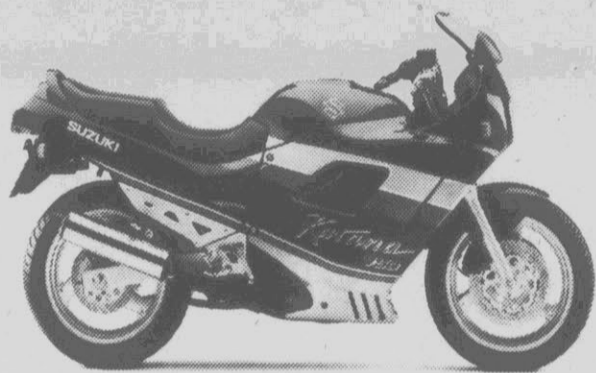

'89 Katana 750

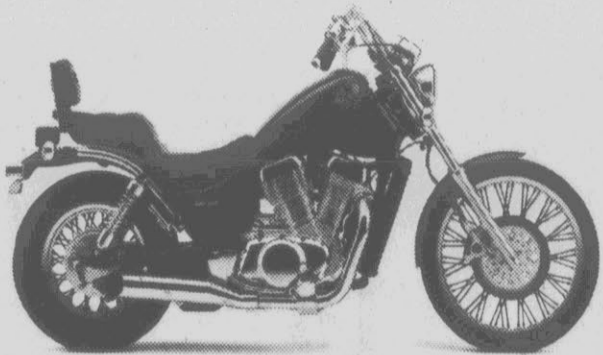

'89 Intruder 750

ZERO IN ON NEW '89 SUZUKI MOTORCYCLES NOW.

No down payment means there's no reason to wait. Today's the day to take advantage of our "Nothin' Beats Nothin' Down" deal on some hot new Suzuki motorcycles. Hop on an easy-going, fun-filled new GS500E. Or, saddle up on a rad-hot Katana 600 or cool, blue Katana 750. Or if the classic good looks of a cruiser are more your speed, get a load of the Intruder 700 and 750. Hurry down today and check out the full line of exciting Suzuki motorcycles. With the "Nothin' Beats Nothin' Down" deal, your waiting days are over for the ride you've been waiting for.



The ride you've been waiting for celebration.

*Offer good on selected models with approved credit through Suzuki Retail Financing, some restrictions may apply. Offer expires July 31, 1989.

Please ride safely. Read your owner's manual carefully. Always wear a helmet, eye protection, and protective riding apparel. Remember, riding and alcohol or drugs don't mix. Take a riding skills course. For the course nearest you call the Motorcycle Safety Foundation at 1-800-447-4700.

HONDA-SUZUKI OF GREENVILLE

1918 N. MEMORIAL DR. - HWY. 11 N.

GREENVILLE, NC 27834

PHONE 758-3084



3 Days of

SALE

Our sale represents odd groups of merchandise including discontinued colors, patterns and styles. Limited sizes and limited quantities!

Groups of:

SUITS and
SPORT COATS

25% to 50% off

A Group of
PANTS

25% off

SPORT SHIRTS

1/3 off

Short Sleeve
DRESS SHIRTS

25% off

Long Sleeve
DRESS SHIRTS

50% off

SWIM WEAR and
WALK SHORTS

25% off

A Group of PANTS

A Group of SHOES

Lightweight JACKETS

50% off



DOWNTOWN GREENVILLE
CAROLINA EAST MALL
TARRYTOWN MALL - Rocky Mount

Youth Baseball Roundup

Winterville Pee Wee

Jefferson Pilot.....11
Harris.....4
 WINTERVILLE — Jefferson Pilot handed Harris Supermarket a 11-4 defeat Tuesday in Winterville Pee Wee League baseball action.
 David Creech and Michael Page led Jefferson Pilot. Justin Little and Jeffrey Hinson led Harris.

Overtons.....17
Jaycees.....3
 WINTERVILLE — Overtons rolled past the Jaycees, 17-3, in a Winterville Pee Wee League baseball game Tuesday.
 Cliff Owens and Taylor McLawhorn led Overtons. Josh Hines and T.J. Carr led the Jaycees.

East Group.....8
Sunnyside.....4
 WINTERVILLE — East Group held off Sunnyside, 8-4, in a baseball game from the Winterville Pee Wee League Tuesday.
 Chip Brock and Ken Biggs led the East Group. Sunnyside was led by Ben Scarborough and Chris Doyle.

First Citizens.....10
Steve Evans.....1
 WINTERVILLE — First Citizens came up a 10-1 winner over Steve Evans in a baseball game from the Winterville Pee Wee League Tuesday.
 Ashley Elks and Michael Harrington led First Citizens. Steve Evans was led by Bruce Harrell and Derrick Smith.

13-15 Babe Ruth

Greenville.....2
Pitt Co.....0
 NEW HOPE — Jay Kuykendall had a two-hitter with six strikeouts and two walks Tuesday at the Greenville 13-15 Babe Ruth All-Stars defeated Pitt County, 2-0, in the Eastern North Carolina District V Tournament.
 Greenville scored its first run in the second inning as Parham Stanley had a sacrifice fly to score Matt Aldridge. In the third, Greenville made it 2-0 as Josh Potter had an RBI single to bring home Kuykendall.
 For Pitt County, Jason Congleton had a five-hitter, with five strikeouts and four walks.

Greenville advances to the finals and will have to be beaten twice to be eliminated from the tournament Tuesday.

Pitt Co.....8
Wayne Co.....4
 NEW HOPE — Jeff Simpkins and Scott Fussell combined on a six-hitter as Pitt County defeated Wayne County, 8-4, in action from the Eastern North Carolina District V 13-15 Babe Ruth Baseball Tournament Tuesday.
 Pitt scored two runs in the first and five in the second. Dean Gaskins and Jason Grant had key RBIs in the first. Fussell keyed the second with a two-out RBI single.
 Pitt later fell to Greenville, 2-0. Pitt falls into the loser's bracket and will take on the winner of the Nash County-Wayne County game at 5:30 p.m. today.

Little League

North State.....13
Roanoke Rapids.....1
 Daryl Cherry went 3-3 and Scott Briley pitched a two-hitter as the Greenville North State All-Stars took

a 13-1 win over Roanoke Rapids in second round of the District V Little League All-Star Baseball Tournament Tuesday.

North State scored four runs in the first, keyed by a double from Cherry, and three more in the second to make it 7-0. Matt Davis had a home run in the second while Matthew Dellesaga and Cherry also had base hits.

North State added one run in the third, three in the fourth and one apiece in the fifth and sixth to complete the scoring.
 Scott Burrows scored the run in the third off a solo homer.
 Briley, Dellasega and Matt Davis had two hits each for North State, which advances to play the winner of the Greenville Tar Heel-Northwest Halifax game today at 4 p.m.

Tar Heel.....9
Henderson Vance.....0
 Monte Roundtree limited Henderson Vance to one hit as the Greenville Tar Heel All-Stars rolled to a 9-0 win in first-round action from the District V Little League All-Star Baseball Tournament Tuesday.
 The Tar Heels scored two runs in the first, keyed by a single by Chris

Ball, for a 2-0 lead. The Tar Heels then added five runs in the third to put the game out of reach, keyed by a single by James Willier.

The Tar Heels added one run in the fourth and another in the sixth to complete the scoring.
 Roundtree had 14 strikeouts for the Tar Heel team, which was led in hitting by Ball with two.

Babe Ruth 13

Pitt Co.....9
Martin.....6
 NASHVILLE — Pitt County defeated Martin County, 9-6, in a loser's bracket game from the Eastern North Carolina District V 13-Year-Old Babe Ruth baseball tournament Tuesday.
 Pitt County took control in the sixth, scoring four runs off no hits and seven walks.

Greenville.....7
Pitt Co.....6
 NASHVILLE — Greenville edged past Pitt County, 7-6, in a loser's bracket game from the Eastern North Carolina District V 13-Year Old Babe Ruth League baseball tournament Tuesday.

Dante Daniels had the game-winning RBI double in the bottom of the seventh to key the win.

Greenville now advances to play Wilson tonight at 7 p.m. with the winner advancing to play Wayne County at 6 p.m. Thursday in the championship.

Babe Ruth 16-18

Coastal Plains.....9
Nash County.....6
 GOLDSBORO — The Coastal Plains All-Stars handed Nash County a 9-6 defeat in the consolation round of the Eastern North Carolina District V 16-18 Babe Ruth All-Star baseball tournament.
 Coastal Plains will now take on Wayne County at 6 p.m. today to decide the winner of the tournament. Wayne County must lose twice to be eliminated.

Ray Scharf
Swim School
 Last Session Starts July 24th
 Call Jon Rose 756-3325

W Wickes Lumber

SUMMER HOME IMPROVEMENT SALE

WICKES HAS ALL IT TAKES TO BUILD ALL YOU NEED

Wickes Builders, Wickes Furniture Emporium Lumber

MasterCard VISA

Use Your Wickes Charge
 Start improving the value of your home today! If you don't have a Wickes Charge ask for an application at your nearest Wickes Lumber.

GUARANTEE OF CUSTOMER SATISFACTION

We guarantee your satisfaction with any product you buy at Wickes Lumber. If you are not satisfied with your purchase, simply return the item, together with proof of purchase within 30 days of purchase, and we will gladly exchange it or, if you prefer, refund your purchase price in full.

Prices In Effect Through July 23, 1989



16'x20' Combo Shed
\$999⁰⁰ Also Available 20'x12' 12'x12'



24'x24' Gambrel w/Loft
 • 2-car model
 • 2, 9'x7' garage doors, gable entry
 • Loft provides plenty of usable space for a variety of uses
\$4399⁹⁹ Model 7000 Elevation E



Treated Shadowbox Fence
 • Top quality pre-assembled sections
 • Lifetime guarantee against decay
27⁹⁹ Reg. 32.99
 6'x8' Section



6'x8' No. 1 Treated Stockade Fence
 • Preassembled sections
 • Lifetime guarantee against decay
 • Double nailed pickets
18⁹⁹ Reg. 24.99
 Section



Cedar Split Rail Fence
 • Heavy duty posts & rails for durability
 • 10' section includes: 2 - 10' rails 1 - Line or end post
9⁸⁸ Reg. 13.27
 10' Section



42'x8' Treated Picket Fence
 • Full 3/4" thick top quality pickets
 • Lifetime guarantee
 • Pre-assembled sections
12⁸⁸ Reg. 14.99
 42'x8' Section

SPECIAL SAVE \$60



KELLER

Our Best Fiberglass

28' Extension Ladder
 • Type I; A rated; 300 lb. heavy duty
 • Full 3/4" non-conductive side rails
 • Heavy duty 180 swivel safety foot
 • Heavy non-slip treads
 • Meets or exceeds OSHA safety codes
\$219

2399614
 24' Fiberglass Extension Ladder.....\$199

14'.....\$44.99
 24' Type I.....\$159.99
 24' Type III.....\$109.99

Step Ladders

5' Wood.....\$16.88
 6' Aluminum.....\$36.99
 6' Fiberglass.....\$99.00



Minwax Wood Finishes
 • For any unfinished wood surface
 • Deep penetrating stain
 • Many shades
5⁸⁸ Reg. 7.99
 Quart 4757019



Dirt Fighter® Interior Latex Semi-Gloss
 • 10 year durability
 • Easy stain removal
 • Scrubbable
 • Moisture resistant
 • Easy clean up
16⁹⁹ Reg. 20.99
 Gallon



1/2' Regular Drywall Panels
 • Ideal surface for painting, wallpaper, or paneling
 • Delivery available—extra charge
10⁸⁸ Reg. 12.88
 4'x8' Sheet



2 Gallon Pail Vinyl Latex Flat Wall Paint
 • For any interior surface
 • Dries in 30 minutes
 • Soap and water clean up
 • Reusable bucket
10⁸⁸ Reg. 12.88
 Pail 4800702

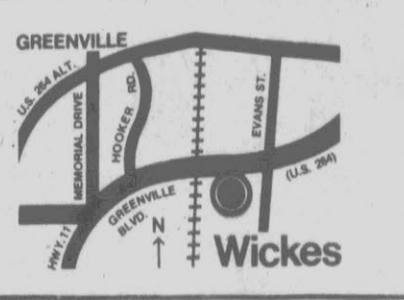

GREENVILLE
 U.S. 264
 HOOPER RD.
 EVANS ST.
 WICKES

125 West Greenville Blvd.
 Open Monday-Friday 7:30 to 7pm
 Saturday 8 am to 5 pm
 Sunday 1 pm to 5 pm
 756-7144



SCOREBOARD

Major League Baseball

By The Associated Press													
All Times EDT													
AMERICAN LEAGUE													
East Division													
W	L	Pct	GB	L10	Streak	Home	Away						
Baltimore	46	38	.582	—	6-4	Won 5	29-20-24-18						
New York	46	36	.560	7 1/2	2-5-5	Lost 1	25-22-21-24						
Toronto	46	48	.489	8 1/2	2-5-3	Lost 1	24-26-22-22						
Boston	43	46	.483	9	2-5-3	Lost 1	21-21-22-25						
Cleveland	43	48	.473	10	2-5-5	Lost 2	24-22-19-26						
Milwaukee	42	51	.452	12	2-8	Lost 6	24-22-18-29						
Detroit	33	58	.363	20	2-8	Lost 1	19-28-14-30						

West Division													
W	L	Pct	GB	L10	Streak	Home	Away						
California	54	38	.587	—	2-5-5	Won 1	30-17-24-21						
Oakland	55	39	.585	—	2-5-5	Won 1	30-16-25-23						
Kansas City	53	40	.570	1 1/2	2-7-3	Won 2	32-11-21-29						
Texas	50	42	.543	4	2-6-4	Won 2	25-17-25-25						
Seattle	45	47	.489	9	2-6-4	Lost 3	25-20-20-27						
Minnesota	45	48	.484	9 1/2	4-6	Won 4	25-23-20-25						
Chicago	37	56	.398	17 1/2	5-5	Won 5	19-28-10-28						

NATIONAL LEAGUE

East Division													
W	L	Pct	GB	L10	Streak	Home	Away						
Montreal	53	40	.570	—	2-7-3	Lost 1	26-18-27-22						
Chicago	49	43	.533	3 1/2	2-5-5	Lost 1	23-22-26-21						
New York	48	43	.527	4	2-6-4	Won 1	28-15-20-28						
St. Louis	48	43	.527	4	2-5-5	Lost 3	27-21-19-23						
Pittsburgh	38	51	.427	13	2-7-3	Lost 1	19-23-19-28						
Philadelphia	36	54	.400	15 1/2	2-6-4	Won 2	20-25-18-29						

West Division													
W	L	Pct	GB	L10	Streak	Home	Away						
San Francisco	56	37	.602	—	2-7-3	Won 4	33-15-22-22						
Houston	53	41	.564	3 1/2	5-5	Lost 1	25-22-28-19						
San Diego	46	48	.489	10 1/2	6-4	Won 1	23-21-23-27						
Cincinnati	45	48	.484	11	2-2-8	Lost 3	24-24-21-24						
Los Angeles	43	50	.462	13	4-6	Won 1	26-23-17-27						
Atlanta	39	54	.419	17	5-5	Won 1	22-27-17-27						

AMERICAN LEAGUE													
Tuesday's Games													
Oakland	7	Detroit	2										
California	1	Toronto	0										
Baltimore	4	Seattle	3										
Minnesota	5	Cleveland	4										
Milwaukee	6	Boston	9										
Kansas City	9	Milwaukee	4										
Texas	8	Boston	1										

American League

Seattle													
W	L	Pct	GB	L10	Streak	Home	Away						
Reynolds	28	52	.347	—	1-1-1	Won 1	14-10-11-10						
Cotto	14	30	.316	17	1-1-1	Won 1	10-10-10-10						
Briley	11	20	.353	24	1-1-1	Won 1	10-10-10-10						
Adavis	10	20	.333	25	1-1-1	Won 1	10-10-10-10						
Leonard	10	20	.333	25	1-1-1	Won 1	10-10-10-10						
Coles	10	20	.333	25	1-1-1	Won 1	10-10-10-10						
Griffin	10	20	.333	25	1-1-1	Won 1	10-10-10-10						
Valle	10	20	.333	25	1-1-1	Won 1	10-10-10-10						
Vizquel	10	20	.333	25	1-1-1	Won 1	10-10-10-10						
Hickley	10	20	.333	25	1-1-1	Won 1	10-10-10-10						
Sbrly	10	20	.333	25	1-1-1	Won 1	10-10-10-10						
Harris	10	20	.333	25	1-1-1	Won 1	10-10-10-10						
Orsual	10	20	.333	25	1-1-1	Won 1	10-10-10-10						
Heep	10	20	.333	25	1-1-1	Won 1	10-10-10-10						

League Leaders

By The Associated Press																													
AMERICAN LEAGUE																													
BATTING	270	(at bats)	Puckett, Minnesota, .341	Francis, Texas, .331	Lansford, Oakland, .329	Sierra, Texas, .327	Sant, New York, .326	RUNS	82	Reynolds, Oakland, 67	Sierra, Texas, 61	Tetleton, Baltimore, 61	Griffin, Toronto, 56	RJACKSON, Kansas City, 57															
RBI	Francis, Texas, 69	Sierra, Texas, 66	RJACKSON, Kansas City, 64	Leonard, Seattle, 62	McGwire, Oakland, 62	HITS	Puckett, Minnesota, 128	Sant, New York, 121	Sierra, Texas, 119	Francis, Texas, 113	Gallagher, Chicago, 110	Mattings, New York, 110	Yount, Milwaukee, 110																
DOUBLES	Puckett, Minnesota, 30	Sierra, Texas, 28	Boggs, Boston, 25	Reed, Boston, 24	Bell, Toronto, 23	TRIPLES	White, California, 9	Pridley, Baltimore, 9	Sierra, Texas, 9	Reynolds, Seattle, 6	HOME RUNS	Deer, Milwaukee, 23	RJACKSON, Kansas City, 22	McGriff, Toronto, 22	Tetleton, Baltimore, 21	McGwire, Oakland, 19	Whitaker, Detroit, 19												
STOLEN BASES	RHenderson, Oakland, 39	Exp, Texas, 30	DWhite, California, 28	Sax, New York, 27	Gullen, Chicago, 26	PITCHING	(8 decisions)	Montgomery, Kansas City, 7.1	Swindel, Cleveland, 12.2	2.64	Gordon, Kansas City, 11.2	8.6	Blyleven, California, 10.2	8.3	2.24	Henneman, Detroit, 6.2	4.38	Swiff, Minnesota, 6.2	7.50	5.86	Williams, Baltimore, 6.2	7.50	3.00	Strikeouts	Ryan, Texas, 155	Clemens, Boston, 138	Viola, Minnesota, 135	Gubucz, Kansas City, 109	Bosio, Milwaukee, 107
SAVES	DJones, Cleveland, 22	Plesac, Milwaukee, 22	Russell, Texas, 20	Schooler, Seattle, 20	Thigpen, Chicago, 17	BATTING	270	(at bats)	TGwynn, San Diego, 346	Larkin, Cincinnati, 340	WClark, San Francisco, 337	HJohnson, New York, 303	Mitchell, San Francisco, 297																
RUNS	HJohnson, New York, 64	RTompson, San Francisco, 64	Mitchell, San Francisco, 62	WClark, San Francisco, 62	Bonds, Pittsburgh, 56	Butler, San Francisco, 56	TGwynn, San Diego, 56	RBI	Mitchell, San Francisco, 84	WClark, San Francisco, 71	HJohnson, New York, 61	ONeill, Cincinnati, 60	Guerrero, StLouis, 59																
HITS	TGwynn, San Diego, 126	WClark, San Francisco, 115	Larkin, Cincinnati, 107	Butler, San Francisco, 100	RAlomar, StLouis, 98																								

Schofield														
IP	H	R	ER	BB	SO									
California	5.0	5.0	0.0	1.6	6.0									
Blyleven	W,10.2	9	5	0	1	6								
Trotter	9	5	1	0	2	6								
Key	L,7.0	9	5	1	0	2								
HBP	McGriff by Blyleven													
Umpires	Home, Coble; First, Cousins; Second, McClelland; Third, McCoy; T-2:04 A-8:27.													

CLEVELAND														
IP	H	R	ER	BB	SO									
Browne	2b 4.0	2b	0	0	1	0								
Zuvela	3b 4.0	3b	0	0	1	0								
POBIR	1b 4.0	1b	0	0	1	0								
Castillo	3b 4.1	3b	0	0	1	0								
Jacoby	dh 3.0	dh	0	0	1	0								
Belle	rf 4.0	rf	0	0	1	0								
Konask	3.0	3.0	0	0	1	0								
Skinner	c 3.0	c	0	0	1	0								
Fernin	ss 3.0	ss	0	0	1	0								
Herbek	1b 4.0	1b	0	0	1	0								
Laudner	c 3.0	c	0	0	1	0								
Luque	ss 3.0	ss	0	0	1	0								
Bisby	lf 3.0	lf	0	0	1	0								
Young	cf 3.0	cf	0	0	1	0								
Forsch	0.0	0.0	0.0	0.0	0.0	0.0								
Schirz	1.0	1.0	0.0	0.0	0.0	0.0								
Agoost	0.0	0.0	0.0	0.0	0.0	0.0								
Portugal	0.0	0.0	0.0	0.0	0.0	0.0								
Totals	32.4	6.4	0.0	2.1	35.0	15.0								

Cleveland														
IP	H	R	ER	BB	SO									
Black	7.3	8	3	1	5	0								
Orosco	13	0	0	0	0	0								
Diones	L,3.5	1	2	1	0	1								
Viola	W,9.0	9	6	4	1	11								
WP	Black 2													
Umpires	Home, Garcia; First, Reilly; Second, Scott; Third, Rose; T-2:31 A-24:06.													

MILWAUKEE														
IP	H	R	ER	BB	SO									
Felder	1.1	1.1	0.0	0.0	0.0	0.0								
Gantner	2b 4.1	2b	0	0	0	0								
Molitor	3b 4.0	3b	0	0	0	0								
Yount	cf 4.0	cf	0	0	0	0								
Deer	1.1	1.1	0.0	0.0	0.0	0.0								
Fosch	1.1	1.1	0.0	0.0	0.0	0.0								
Sorhoff	c 4.0	c	0	0	0	0								
Meyer	dh 3.0	dh	0	0	0	0								
Spiers	ss 4.1	ss	0	0	0	0								
Totals	36.9	3.3	0.0	3.2	31.0	9.0								

BOSTON														
IP	H	R	ER	BB	SO									
Boggs	3b 2.0	3b	0	0	0	0								
Reed	2b 2.0	2b	0	0	0	0								
Heep	1.0	1.0	0.0	0.0	0.0	0.0								
Grady	1.0	1.0	0.0	0.0	0.0	0.0								
Evans	rf 4.0	rf	0	0	0	0								
Kutcher	0.0	0.0	0.0	0.0	0.0	0.0								
Essay	4.0	4.0	0.0	0.0	0.0	0.0								
Romina	4.0	4.0	0.0	0.0	0.0	0.0								
Rivera	ss 3.0	ss	0	0	0	0								
Cerone	c 2.0	c	0	0	0	0								
Gedman	c 2.0	c	0	0	0	0								
Totals	28.1	2.1	0.0	3.2	31.0	8.0								

PHILADELPHIA														
IP	H	R	ER	BB	SO									
Dykstra	3.1	3.1	0.0	0.0	0.0	0.0								
Herr	2.0	2.0	0.0	0.0	0.0	0.0								
VHayes	4.1	4.1	0.0	0.0	0.0	0.0								
Jordan	1.0	1.0	0.0	0.0	0.0	0.0								
Reed	1.0	1.0	0.0	0.0	0.0	0.0								
Ford	1.0	1.0	0.0	0.0	0.0	0.0								
Ray	1.0	1.0	0.0	0.0	0.0	0.0								
Chaves	3.0	3.0	0.0	0.0	0.0	0.0								
Jeitz	3.0	3.0	0.0	0.0	0.0	0.0								
Lake	c 4.2	c	0	0	0	0								
Ruffin	p 0.0	p	0	0	0	0								
GAHarris	p 2.0	p	0	0	0	0								
Adduci	p 1.0	p	0	0	0	0								
Frutkin	p 1.0	p	0	0	0	0								
Derner	1.0	1.0	0.0	0.0	0.0	0.0								
RMcDwl	p 0.0	p	0	0	0	0								
Totals	32.6	6.6	0.0	3.4	35.5	9.0								

PHILADELPHIA														
IP	H	R	ER	BB	SO									
GAHarris	5.4	5.4	1	0	4	0								
Prohvir	1.0	1.0	0.0	0.0	0.0	0.0								
RMcDwl	3.0	3.0	0.0	0.0	0.0	0.0								
Totals	9.4	9.4	1	0	4	0								

ATLANTA														
IP	H	R	ER	BB	SO									
McDuff	3.1	3.1	0.0	0.0	0.0	0.0								
Grigg	3.0	3.0	0.0	0.0	0.0	0.0								
Acker	0.0	0.0	0.0	0.0	0.0	0.0								
Lillojil	1.0	1.0	0.0	0.0	0.0	0.0								
Boever	0.0	0.0	0.0	0.0	0.0	0.0								
Smith	1.0	1.0	0.0											

Bo's Braves Royals Past Milwaukee

Bo knows baseball. Bo knows football. Bo knows the way to the water display. Is there anything Bo doesn't know?

"I knew what he was going to throw me," Bo Jackson said of the pitch from Milwaukee's Don August that he turned into a three-run homer in the first inning Tuesday night. "I knew he was going to throw a breaking ball. I saw how he pitched the first three guys and I just looked for that pitch."

The result was a 435-foot drive that landed in the water display beyond the right-centerfield wall of Kansas City's Royals Stadium. It started the offensive fireworks for the Royals, who beat the Brewers 9-4.

Jackson, whose 22nd homer tied him for the league lead until Milwaukee's Rob Deer retook it in the next half-inning, finished with five RBIs. Jackson added an RBI single and a run-scoring grounder.

Brett had two singles and a triple and scored four runs. He had a two-run single in the seventh after the Brewers walked Seitzer to load the bases. That put the left-handed-hit-

ting Brett at the plate against southpaw reliever Tony Fossas.

Angels 1, Blue Jays 0

A five-hit shutout by Bert Blyleven and Wally Joyner's fourth homer spoiled the night for the largest crowd in Toronto history.

The shutout, before 48,717 at the SkyDome, was the second of the season and 57th of Blyleven's career, moving him past Bob Gibson and Nolan Ryan into 12th place on the all-time list. The complete game was Blyleven's fifth of the year and the 236th of his career.

Athletics 7, Tigers 2

Oakland's Dave Parker became the 55th major leaguer to drive in at least 1,300 runs with a three-run homer in the second inning as Storm Davis and three relievers throttled Detroit on four hits.

Parker's 14th homer of the season, the 299th of his career, gave him 1,302 career RBIs.

Orioles 4, Mariners 3

Craig Worthington's two-run homer in the fourth inning led to Baltimore's fifth straight victory, although the Orioles needed a little luck to hold on.

Seattle's Greg Briley was on his way home with the tying run in the

fourth and Mike Greenwell in the eighth.

NATIONAL LEAGUE

Chris James didn't get defensive about his error. He went out seeking to avenge it.

James responded with his second grand slam of the season, leading the Padres to a 17-4 victory over the Pittsburgh Pirates Tuesday night. San Diego tied its record for runs and set a season high with 22 hits.

Clark hit his 10th home run of the year in the eight-run eighth and had his first three-hit game of the season. Garry Templeton also had three hits and Benito Santiago had four hits and drove in three runs.

Bruce Hurst, 8-7, pitched a five-hitter for his fifth complete game, striking out six and walking three.

Giants 7, Cardinals 3

Kirt Manwaring drove in four runs with a two-out, bases-loaded triple in the first and an RBI single in the eighth. San Francisco won for the 22nd time in its last 27 games at Candlestick Park.

Don Robinson, 8-6, allowed six hits in 6 1-3 innings as the Giants, 19

eight inning when a drive by Darnell Coles bounced over the fence for a ground-rule double.

Briley was sent back to third and was stranded there, and the Orioles extended their winning streak to five games and their lead over the second-place New York Yankees to 7 1/2, matching their biggest lead of the season.

Twins 5, Indians 4

Frank Viola tied a career high with 11 strikeouts and pinch-hitter Jim Dwyer hit a game-winning sacrifice fly as Minnesota beat error-prone Cleveland for its fourth straight victory.

Gene Larkin's fifth single of the game started the decisive rally against Doug Jones, 3-5.

Viola, 8-10, allowed six hits in his seventh complete game.

Rangers 8, Red Sox 1

Bobby Witt pitched a two-hitter and Julio Franco doubled and tripled to drive in three runs and wrest the league RBI lead from teammate Ruben Sierra, 68-67.

Witt, 8-8, overcame a rocky first inning when he walked the first two batters. Thereafter, he allowed only singles to Kevin Romine in the

games over .500 for the first time since Sept. 10, 1978, won their fourth in a row.

Mets 9, Astros 0

Sid Fernandez, 8-3, combined with two relievers on a four-hitter and struck out six, and Howard Johnson and Kevin McReynolds homered as the Mets stopped a three-game losing streak.

New York scored two runs in the first, five in the third, one in the fourth and one in the sixth.

Expos 7, Braves 6

Lonnie Smith's two-run single capped a four-run seventh as Atlanta rallied from a 6-0 deficit in Olympic Stadium.

Dennis Martinez, who has won a club-record nine consecutive decisions, was given a six-run lead in the second but allowed three runs in the

sixth and was chased in the seventh. Steve Frey, 3-1, was the loser.

Dodgers 4, Cubs 1

Orel Hershiser, 11-7, pitched a four-hitter and struck out five at Dodger Stadium to beat Chicago for the first time since 1986. Kirk Gibson doubled in two runs for Los Angeles.

Greg Maddux, 9-8, gave up eight hits and all four runs in six innings. He had won three straight.

Phillies 6, Reds 5

Randy Ready homered off Danny Jackson, 6-10, to snap a 5-5 tie in the eighth. Cincinnati lost for the eighth time in nine games and the 24th time in its last 34.

Todd Frohwrith, 1-0, allowed three hits over three innings for the visiting Phillies and Roger McDowell pitched the ninth for his 10th save.

Daniels Hopes Trade Pays Off

receiving rookie Lenny Harris. But Daniels and Leary were the key players.

The Dodgers hope to put some punch into the league's least-productive offense with the acquisition of Daniels, a cornerstone in the Reds' rebuilding this decade. The Reds hoped to fill some injury-created holes in their starting rotation and infield with the acquisition of Leary and Duncan.

The trade will give Daniels and Leary a second chance.

Leary, 30, is 6-7 with a 3.38 earned-run average in 17 starts and two relief appearances this season. The right-hander was recently demoted to the Dodgers bullpen.

Leary was 17-11 last season in the Dodgers' World Series championship year with a 2.91 ERA in 34 starts and one relief appearance. He didn't like the move to the bullpen this season, preferring to start.

Gooden To Start Throwing

New York Mets pitcher Dwight Gooden was examined Tuesday by orthopedic specialists and given the green light to begin throwing next week.

Dr. Fiske Warren and Dr. Russell Warren reported that the right-hander had made good progress from a tear in his right shoulder muscle and could begin to throw lightly next week and "proceed as tolerated thereafter."

Stats, Streaks & Swings

Gene Larkin of the Minnesota Twins went 5-for-5 Tuesday night against Cleveland, raising his average from .235 to .250. ... The San Francisco Giants have won 22 of 28 at Candlestick Park after starting the season 11-10 at home. ... Minnesota has won four consecutive games — all in the final at-bat. ... The Milwaukee Brewers have lost six straight and five straight at Royals Stadium. ... Jack Clark of the San Diego Padres has a 13-game hitting streak, his longest streak since Sept. 15-30, 1982 when he hit in 15 straight games for the Giants. ... The Orioles won their 53rd game of the season Tuesday night. They won 54 games in 1988. ... Boston Red Sox pinch hitters have reached base 13 times in 21 plate appearances, going 8-for-16 with two homers and 10 RBIs. ... Orel Hershiser's victory over Chicago Tuesday night was the first over the Cubs for the Dodgers' right-hander since 1986. ... The Rangers' Bobby Witt beat Boston Tuesday, giving him victories over every AL club other than Texas. It was his ninth start against the Red Sox.

Bo Jackson returned to the Royals' starting lineup Tuesday after missing four games. He hit a 435-foot homer and drove in five runs.

— Disabled left-hander Dave Dravecky of the San Francisco Giants threw a 100-pitch simulated

Baseball Notes

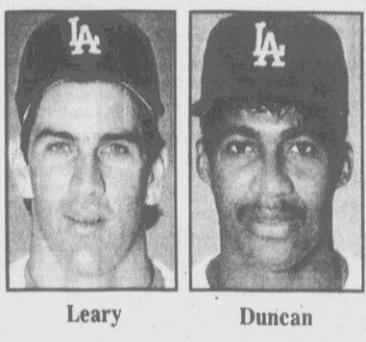

Daniels Harris Leary Duncan

Public Notices

NORTH CAROLINA PITT COUNTY
IN THE GENERAL COURT OF JUSTICE
SUPERIOR COURT DIVISION
BEFORE THE CLERK
89SP 126

NOTICE OF SALE
In the Matter of the Foreclosure of the Deed of Trust of Jay J. Fairbanks and wife, Laura S. Fairbanks

Mortgages TO
J. THOMAS KEEVER, JR.
Substitute Trustee
303 Crown Point Road
Greenville, NC 27838
Executrix of the estate of Charles Franklin Dai, deceased
July 12, 19, 1989

NOTICE
Having qualified as Executrix of the estate of Charles Franklin Dai, late of Pitt County, North Carolina, this is to notify all persons having claims against the estate of said deceased to present them to the undersigned Executrix on or before January 5, 1990. This notice is being published in accordance with the provisions of N.C.G.S. 31-12, the following and abandoned or confiscated articles of personal property have remained unclaimed by the persons to whom they may be entitled thereto for a period of 180 days or more:

1. Large 82"x36" Auto Bug Screens, 2. 10 Pack of 4 Wheel Trim Stickers, 3. 1 Pack of 2 Body Trim Stickers, 4. Truck Lock Guard, 5. Pack of 2 Door Lock Guards, 6. 7 Custom Ford License Plates, 7. 5 Chuppa Stainless Steel Butcher Knives, 8. 8 Imperial Butcher Knives, 5/8" Blade, 9. 3 Imperial Knives, 8 3/4" Blade, 10. 6 Imperial Slicer Knives, 9 3/4" Blade, 11. Set of 2 Harvard Cutlery Knives, 12. 11 Model C200 Stereo Cassette Player w/ lightweight headphones, 13. Rhapsody Clock Radio Telephone, 14. Black & White Classic Steam-Dry Iron, 15. Proctor Silex Lightweight Iron, 16. 1 Martex 100% Cotton Queen fitted sheet, gray, 17. 2 Martex 100% Cotton King fitted sheet, tan, 18. 1 Martex 100% Cotton Queen flat sheet, gray, 19. 1 Martex pack of standard pillow cases, gray, 20. 1 Martex 100% Cotton Queen fitted sheet, white, 21. 2 Martex pack of 2 pillow cases standard, tan, 22. 1 Martex 100% cotton pack of 2 King pillow cases, white, 23. 2 Martex 100% cotton King flat sheet, green, 24. 1 Martex 100% cotton King flat sheet, green, 25. 1 Martex 100% cotton King flat sheet, green, 26. 1 Martex 100% cotton King flat sheet, green, 27. 1 Martex 100% cotton queen fitted sheet, green, 28. 1 Martex 100% cotton Queen flat sheet, green, 29. 1 Martex 100% cotton King fitted sheet, green, 30. 1 Martex 100% cotton full flat sheet, green, 31. 3 Martex pack of 2 standard pillow cases, green, 32. 1 Wraps Watch-small pleate double set-4 pieces (2 pillow, flat, fitted), peach, 33. 1 Dan River 4 piece Queen set, Oriental Fantasy, 34. 1 Man's X-Large Alexander Julian dress shirt, blue, 35. 1 J.C. Penney 3-pack T-Shirts, Size 46, 36. 6 Lady's Vinyl Palm and Sack gloves, 37. Men's Hush Puppy Utility Gloves, 38. 3 Men's Vinyl gloves, 39. 3 Back Gloves, 40. 1 Women's Saguilla Shoes, Size 10, 41. 1 Men's Puma Prowler Shoes, Size 7, 42. 2 Print Scarves, 43. 4 Wraps Watch-large face, 44. 3 Aziza Polishing Pen/Automatic Nailcolor Travel Kit, 45. 6 Tri-Fold/Cologne gift set (wallet & British Sling Cologne), 46. 8 Custom fit reversible belt w/ initial buckle, 47. 1 JE Morgan Long Johns-pants size large (38-40, mens), 48. 1 JE Morgan Long Johns-shirt size medium (38-40, mens), 49. 1 JE Morgan Long Johns-shirt-size large (42-44, mens), 51. 1 Hanes Gripper Boxer Shorts, size 32, mens, 52. 5 Hanes Briefs 2-pack, size 30, mens, 53. 6 Hanes Briefs 2-pack, size 30, mens, 54. 8 Hanes Briefs 2-pack, size 30, mens, 55. 2 Hanes Showtows T-shirt, size 4, boys, 56. 2 Hanes Showtows T-shirt, size 6, boys, 57. 1 Fruit of the Loom 3-pack T-shirt, size X-large, 46-48, mens, 58. 4 Fruit of the Loom 3-pack briefs, size 38-40, 59. 9 Spams, 7 oz. cans, 60. 12 Star Kist Chunk Light Tuna, 3.25 oz. cans, 61. 12 Beach Lift small size Sardines in Soy Bean Oil, 3.75 oz. cans, 62. 5 Auto Life Copper Spark Plugs, Type 26 register 4 plug pack, 63. 3 AutoLife Copper Spark Plugs, Type 26 register 8 plug pack, 64. 3 AutoLife Copper Spark Plugs, Type 38 8 plug pack, 65. 3 AutoLife Copper Spark Plugs, Type 567 resistor 8 plug pack, 66.

Trade Pays Off

Dr. Fiske Warren and Dr. Russell Warren reported that the right-hander had made good progress from a tear in his right shoulder muscle and could begin to throw lightly next week and "proceed as tolerated thereafter."

Stats, Streaks & Swings

Gene Larkin of the Minnesota Twins went 5-for-5 Tuesday night against Cleveland, raising his average from .235 to .250. ... The San Francisco Giants have won 22 of 28 at Candlestick Park after starting the season 11-10 at home. ... Minnesota has won four consecutive games — all in the final at-bat. ... The Milwaukee Brewers have lost six straight and five straight at Royals Stadium. ... Jack Clark of the San Diego Padres has a 13-game hitting streak, his longest streak since Sept. 15-30, 1982 when he hit in 15 straight games for the Giants. ... The Orioles won their 53rd game of the season Tuesday night. They won 54 games in 1988. ... Boston Red Sox pinch hitters have reached base 13 times in 21 plate appearances, going 8-for-16 with two homers and 10 RBIs. ... Orel Hershiser's victory over Chicago Tuesday night was the first over the Cubs for the Dodgers' right-hander since 1986. ... The Rangers' Bobby Witt beat Boston Tuesday, giving him victories over every AL club other than Texas. It was his ninth start against the Red Sox.

Louisiana State pitcher Ben McDonald, who led his team into the College World Series six weeks ago, may find himself firing his 95-mph fastball and assortment of off-speed pitches in another World Series come October.

After weeks of often bitter negotiations, the Baltimore Orioles and their top draft choice are reportedly close to reaching a contract agreement.

The Washington Post said the basic elements of an agreement were worked out last week when Orioles president Lawrence Lucchino visited McDonald at his Denham Springs, La., home.

We fix cars for keeps.

LIFETIME SERVICE GUARANTEE

HASTINGS FORD

Ford, Lincoln and Mercury Owners:

Oil and Filter Change \$12.50

Tune-Up Special

4 Cylinder	\$22.50
6 Cylinder	\$25.80
8 Cylinder	\$31.80

Includes oil to 5 quarts of oil and filter for your late model Ford or Mercury. Others slightly higher.

When you have your Ford, Mercury, Lincoln or Ford Light Truck fixed, you pay once, and I'll guarantee that, if the covered part ever has to be fixed again, I'll fix it free. Free parts. Free labor. Covers thousands of parts. Lasts as long as you own your vehicle. No matter where or when you bought it. So take advantage of my free oil. And my free Lifetime Service Guarantee. Two ways of showing you that I care about you. Come in with your coupon!

This limited warranty covers vehicles in normal use. And excludes routine maintenance parts, belts, hoses, sheet metal and upholstery.

July 19, 1989

320 W. Greenville Blvd. Greenville, NC 27834-9244
758-0114
1-800-854-3429

NINTENDO
Buy - Sell - Rent
East Coast Music & Video
1109 Charles Blvd. • 758-4251

GORDON'S
All Golf Shoes
On Sale 'Til July 31
264 ByPass 756-1003

Clip & Save
Owned and Operated by the Ray Martinez Family since 1960

BAYNEZ

- Heated Pool Designed For Instruction
- Progressive Aquatic Activities
- All Levels Of Instruction/Infants Thru Adults
- Special Arrangements For Nursery School Groups
- Registered Nurse
- Private Use On Weekends And Evenings By Reservation

Class Schedule (Every Two Weeks) Sessions
July 10, 24
August 7, 21

Classes Available
10:00 a.m. Thru 6:30 p.m.
Parent/Infant Classes
5:00 p.m. - 6:30 p.m.

Call for more information
756-2667 or 756-4900

RAIN BIRD
Irrigation Systems
"FOR ALL OF YOUR IRRIGATION NEEDS"

Complete Product Inventory — Competitive Prices
Prompt Service & Delivery — Free Estimates

Hendrix Barnhill Co., Inc.

919-752-4122
1819 Progress Rd. Greenville, N.C. 27835

BRAKES TIRE SERVICES BATTERIES TUNE-UPS

BF Goodrich Super Savings Sale

on many popular sizes in Blemished XLM and XL HT Steel Belted Tires

30% to 40% off

If you need tires in the next six months, NOW is the time to buy.

	Size	Regular	Less 1/2	Our Price
Compacts	XLM 155/60R13	74 ⁹⁰	-37 ⁴⁵	\$37 ⁴⁵
	XLM 165/75R14	86 ⁹⁰	-43 ⁴⁵	\$43 ⁴⁵
Luxury Car	XLM 205/75R15	102 ⁶⁰	-51 ³⁰	\$51 ³⁰

Coupon

Front Disc Brake ReLine Including Machining Rotors \$59⁸⁸

Includes Fluid, Filter, And Gasket, Inspect Lines And Linkage. \$39⁸⁸

Coupon

Front-End Alignment and 4 Wheel Rotate And Computer Balance Set To Factory Specifications Balance And Rotate Tires \$39⁹⁵

Air Conditioner Check and Service \$24⁸⁸

Four Wheel Drive and Foreign Cars Slightly Higher

No Money Down! Financing Available!

COGGINS CAR CARE

320 W. Greenville Blvd. Greenville, N.C. 756-5244

NO MONEY DOWN! FINANCING AVAILABLE!

We accept Visa, Mastercard, Money Express, American Express, and BF Goodrich

FRONT END REPAIRS BRAKES TIRE SERVICES

Wednesday Classifieds

THE DAILY REFLECTOR Classified •Call 752-6166 To Place Your Ad

007 Special Notices DECORATED CAKES For all occasions. Reasonably priced. Call Linda, 355-4590.

011 Autos For Sale "A GOOD PLACE TO BUY!" "CREATIVE FINANCING" We Also Sell On Consignment EASTGATE MOTORS, INC

013 Buick 1973 CENTURY, 40,000 actual miles, air, power steering. AM/FM cassette. \$800. Call 355-6039 after 5:00.

015 Chevrolet 1976 CHEVROLET NOVA: 4 door, power steering, power brakes; dependable transportation; recently inspected. \$650 negotiable. 830-0737.

015 Chevrolet 1983 CAVALIER, 1 owner. Good condition. New tires. \$2500 or best offer. 752-0127 evenings.

020 Mercury 1985 MERCURY COUGAR. Fully electric, air conditioning, excellent condition. Call 752-7111.

022 Plymouth 1977 GRAND FURY, \$350. 150 gallon fuel tank, painted and ready to go. \$45. Call 756-3651 after 6pm.

024 Foreign Cars CORVETTE 25th Anniversary Edition 1978, all GM parts. Reasonable. 636-5225, New Bern.

024 Foreign Cars 1985 NISSAN SENTRA, 55,000 miles, good condition, silver. Must sell. \$4,450. Call 355-0158.

029 Auto Parts & Service USED ENGINES \$235 and up. 60 day warranty available. Call 752-6838.

032 Boats & Motors B & K MARINE Johnson, OMC, Force, Mariner, and MerCruiser Service Center.

040 Jeeps & Vans 1984 JEEP CHEROKEE Chief. Deluxe package. Excellent maintenance. \$6950 firm.

040 Jeeps & Vans 1985 GMC Pickup. Power steering, power brakes, automatic, AM/FM, chrome rims, big tires.

040 Jeeps & Vans 1984 JEEP CHEROKEE Chief. Deluxe package. Excellent maintenance. \$6950 firm.

041 Trucks F-150 4-wheel drive pick-up. Long bed, 351 V-8, 4-barrel, automatic transmission.

044 Child Care EXPERIENCED Babysitter would like to keep children in my home or yours.

047 Health Care EXPERIENCED NURSE available to anyone in need. Call 757-0287 or 746-4496 or 746-6328.

050 Pets AKC CHOW PUPS, 3 females, 12 weeks old. Good quality dogs. \$100 each. Call 523-1708.

050 Pets HUNTING DOGS: Beagles, Walker hounds and occasionally Coon Hounds. Call 792-8747.

057 Help Wanted Administrative ACCOUNT ANALYST High volume Accounts Payable Department has an opening for the individual who has at least one year experience with experience in payables.

058 Help Wanted Clerical A 9 MONTH Secretarial Course starting July 24. Greenville School of Commerce. 752-3177.

058 Help Wanted Clerical MANPOWER TEMPORARY SERVICES 757-3300 NOW!

058 Help Wanted Clerical LEGAL SECRETARY Immediate long term position with local law office.

058 Help Wanted Clerical ADMINISTRATIVE Assistant/Secretary Part-time. Excellent typing, bookkeeping, and administrative skills.

058 Help Wanted Clerical PART-TIME DESK Assistant/Secretary. Good clerical and public relations skills required.

059 Help Wanted Medical ATTENTION RNs OR LPNs. Is it possible to see day hours and no weekends or holidays in the field of nursing?

059 Help Wanted Medical EXPERIENCED TRUCK DRIVERS NEEDED! Drive Our Company Truck On Your Truck

059 Help Wanted Medical TRIAD HEALTH CARE CENTER of Greenville 120 Bed LTC Facility

059 Help Wanted Medical DENTAL HYGIENIST Needed 3-4 shifts per week. Resume to: 2406 South Charles. 355-7429.

059 Help Wanted Medical EMAT OR SIMILAR needed for medical capital equipment firm. Good driving record, mechanical and communication skills a must.

059 Help Wanted Medical NURSING ASSISTANT Needed for large practice. Experience preferred but will train. Excellent benefits package.

059 Help Wanted Medical RN/LPN'S Pediatric Home Nursing Care Flexible scheduling, excellent pay, health and dental benefits.

059 Help Wanted Medical EXPERIENCED TRUCK DRIVERS NEEDED! Drive Our Company Truck On Your Truck

059 Help Wanted Medical POSITIONS AVAILABLE For all shifts for certified Nurse's Aides. For more information, call Mary Whitchard, 752-9210.

060 Help Wanted Miscellaneous AVAILABLE NOW: permanent full-time position in hardware/paint store. Sales, stocking, and miscellaneous work.

060 Help Wanted Miscellaneous CONSTRUCTION Laborers Needed. Must have Valid driver's license and transportation. Apply in person.

060 Help Wanted Miscellaneous CONSUMER LENDING manager \$20,000.00 fee reimbursed. Atlantic Personnel Service, 355-7931.

060 Help Wanted Miscellaneous CONVENIENCE STORE clerks needed for second shift. Apply at 1110 North Memorial Drive.

060 Help Wanted Miscellaneous CAROLE MARSH Books, Bath, seeks students, teachers, mothers, retirees to write supplementary elementary educational materials 4th grade level.

060 Help Wanted Miscellaneous CONSTRUCTION Laborers Needed. Must have Valid driver's license and transportation. Apply in person.

060 Help Wanted Miscellaneous CONSUMER LENDING manager \$20,000.00 fee reimbursed. Atlantic Personnel Service, 355-7931.

060 Help Wanted Miscellaneous CONVENIENCE STORE clerks needed for second shift. Apply at 1110 North Memorial Drive.

060 Help Wanted Miscellaneous CONSTRUCTION Laborers Needed. Must have Valid driver's license and transportation. Apply in person.

CLASSIFIED DISPLAY

CLASSIFIED DISPLAY

CLASSIFIED DISPLAY

CLASSIFIED DISPLAY

CLASSIFIED DISPLAY

CLASSIFIED DISPLAY

CLASSIFIED DISPLAY

CLASSIFIED DISPLAY

Just Announced... Summer Sale Down... Pheps Chevrolet Shows It's Customers The Whole Picture Rates, Rebates & Selection! GEO CHEVROLET CARS CHEVROLET TRUCKS

Wednesday Classifieds

060 Help Wanted Miscellaneous

ACCOUNTING CLERK. Town of Farmville Finance Department. Performs general clerical duties, including data entry, typing, cash collections, record keeping, answering telephone, and related duties. Requires high school graduation and experience in bookkeeping or clerical responsibilities. Good interpersonal skills, must enjoy interaction with public. Applications may be picked up at the Farmville Town Hall Administration Office, 200 N. Main Street, Farmville, NC 27828, Monday thru Friday, 8:00 A.M.-5:00 P.M. Applications will be accepted thru August 4, 1989. The Town of Farmville is an equal opportunity employer and does not discriminate against the handicapped.



ACCOUNTING Supervisor to \$28,000. Fee Paid. Organize department for manufacturer. Cost accounting gives you the edge.

SALES REPRESENTATIVE to \$25,000. Your computer knowledge and outgoing personality wins this one!

BRANCH MANAGER \$21,000 up. Financial institution seeks credit background to take charge. Excellent benefits and incentives.

ROUTE SALES \$275 up. Kinston area organization needs self motivated to work independently. Hurry in!

OFFICE to \$250. Greet the public and take payments. Enjoy this exciting career with fast growing firm!

ACCOUNTING CLERK \$180 up. Previous cashing and experience to learn are the keys! Start today!

MANY MORE!!! 758-1393

101 W. 14th Street, Suite 203
Low Fee Personnel Service

ATTENTION!!!
THREE (3) TRAINEES

Expansion has created the need to add 3 individuals as soon as possible. We offer:

- *Training Program
- *Excellent Pay Scale
- *Management Opportunities
- *Local Positions
- *Work 9:5 Monday-Friday
- *Fast growing firm
- *Older of a young old national corporation

We require applicants to:
*Desire to learn
*Offer Their Past Experience
*Be Seeking a Career Opportunity

To arrange a personal interview please call 919-756-2792, Monday-Wednesday only, 9am-5pm, ask for Mr. Shaffer.

COMPANY EXPANDING POSITION OPENINGS ALL SHIFTS

INK MIXER First Shift. Aggressive individual with good eye for color to learn to mix plastisol ink for professional screen printing operation.

DECK MACHINE Operators. Experienced in setting up and running automatic textile presses. Mechanical abilities a plus.

LOADERS AND UNLOADERS. Fast, experienced piece loaders and unloaders. Piece goods or finished garment.

DRYER OPERATORS. Quick with hands and eyes. Good math skills.

SHIPPING/RECEIVING. First shift. Aggressive individual wanted for shipping and receiving department. Experienced in loading and unloading trucks as well as be familiar with documents.

THIRD SHIFT Machine helpers. Dependable persons to clean printing machine on a 6 hour shift, Monday-Friday. Drug screen and reference check required prior to hiring.

EXCELLENT WORKING CONDITIONS

Competitive wages and benefits. Experienced preferred for all positions, but willing train motivated, hardworking individuals. We are now accepting applications for full time employment. Apply in person to:

PRINTEX AMERICA,
405 Industrial Boulevard
Between the hours of 2-4pm

CAFETERIA CREW Leaders. \$4.75-\$5.00 per hour. Atlantic Personnel Service, 355-7931.

CLASSIFIED DISPLAY

060 Help Wanted Miscellaneous

COSMETOLOGIST
Hair stylist needed for busy salon. Guaranteed hourly pay plus commission, bonus, paid vacation, benefits and more. Experienced not required. Must have current cosmetology license. Call 1-800-476-7233.

DIRECTOR/TEACHER For Child Development Center. Skills needed in assessment and educational planning for children developmentally disabled. Supervisory and organizational skills required. Applicant must have current NC Certification and special education or childhood education. Good salary and benefits. EOE. Contact Personnel Department, Edgemore Nash, MH/MR/SAS, PO Box 4047, Rocky Mount NC 27803-0047.

DO YOU HAVE A GOOD VOICE? Do you like to talk on the phone? I have an evening job that's right for you. I pay salary plus commission. Does this sound like something you want to do? Call us at 758-1112.

DRAFT PERSON NEEDED Immediately. Greenville, 830-1115; nights, Williamston, 792-2276 days.

DRY CLEANING COUNTER/Inspector. Must be neat and personable. Must have leadership ability. Call 756-9455, 8:00-12:00 for interview, ask for Lois.

DRYWALL FRAMERS AND Hangers. Good wages, long term employment. See Bobby Ellis, The Plaza Mall, Monday-Thursday.

ELECTRONICS Technician needed. VCR and TV experience necessary. Benefits include paid vacation, sick leave and hospitalization. Salary negotiable based upon experience. Contact 946-6008 for interview.

EXCELLENT WAGES For Spare Time assembly. Easy work at home. No experience needed. Call 1-504-641-7778 extension 404. Open 24 hours, in-person Sunday.

EXPERIENCED Heating/Air conditioning installers and helpers needed. Call 758-4106 between 8-5.

EXPERIENCED Iron workers needed. Call 752-3180 days; 757-3096 evenings.

FULL TIME Checkers/Cashiers. Mature and dependable with references. Apply in person, Monday-Friday, 8:30am and 3:30pm at S & S Cafeteria, Carolina East Mall. No phone calls.

FULL TIME maintenance position available with local apartment complex. Painting experience necessary. Must be mechanically minded and have own transportation. Call 752-0277 between 3:00-5:00 p.m.

FULL TIME POSITION: Special Foods Department. Sales, inventory, sampling for highly motivated individual with personality. Apply at Jefferson's, 1720 West 5th Street.

GREAT OPPORTUNITY - Full time help starting at \$3.65 per hour. Apply Monday-Friday at Adams Auto Wash, corner of Redbanks Road and Greenville Boulevard.

GRYLY PART-TIME Income. No cash investment. Home shows. Samples provided free. Call (919)823-0810.

HAIR DRESSER Wanted. Apply in person at George's Hair Design, The Plaza. Guaranteed salary.

HAIRSTYLIST NEEDED in high traffic shop. Benefits and guaranteed hourly wage. Closing not necessary, but welcome. Please call 752-0603 or 756-3792 and leave message.

HAIRSTYLIST-MANICURIST With license needed for full service salon. Experience with sculptured nails desired. Call for information, Your Best Look, 355-2969.

HELP NEEDED in feeder pig operation. Experience needed. Call between 5:00-8:00 p.m., 753-2029.

HIGH SCHOOL Social Studies teacher and coaching position (football and baseball) at SouthWest Edgemore High School. NC teaching certificate required. Call 919-823-6151.

KITCHEN HELPERS Atlantic Personnel Service, 355-7931.

LICENSED INSURANCE Reps. Find out why A.L. Williams has become the number one producer of life insurance and mutual funds in the world. Own your own business and make the kind of money you deserve. You owe it to yourself to at least look at our program. For local confidential interview, call 355-0229 ask for David.

POSTAL JOBS Start \$10.39 per hour. For exam and application information, call 219-769-6649 ext. NC119, 9:00 a.m.-7:00 p.m., 7 days.

CLASSIFIED DISPLAY

060 Help Wanted Miscellaneous

ELDERLY COUPLE needs minimum assistance 4 hours a day. Light housework and serve meals. Own transportation required. 756-2247 after 5:30.

MAINTENANCE PERSON Wanted for local apartment community. General knowledge in air conditioning, heating and plumbing preferred. Must have dependable transportation and own tools. Apply in person at 214 Elm Street #5.

MANAGER TRAINEE. Field service. Will train. \$220-\$260 per week. Atlantic Personnel Service, 355-7931.

MERCHANTISERS WILL TRAIN

Permanent part-time position merchandising fashion jewelry in local retail stores. No experience necessary, flexible hours, good hourly wage plus expenses. Call collect between 4-6:30pm, Wednesday, the 19th, (919) 242-6760.

MOBILE HOME SERVICE MANAGER AND MOBILE HOME REPAIRMAN

2 Openings available for qualified experienced persons. Openings also available for part time and some part-time night work. Excellent benefits for the hard workers with good pay and incentive program. Nation's largest retailer LUV Homes of Wilson, 237-5391.

MOBILE HOME SERVICE Manager and Mobile Home Repair Man. Two openings available for qualified, experienced persons. Openings also available for part-time and some part-time night work. Excellent benefits for the hard workers with good pay and incentives program. Nation's largest retailer, LUV HOMES of Wilson, 237-5391.

NEED ELECTRICIANS and electrician's helpers for Greenville area. To apply, call D.L. Johnson Electrical Company Inc. 919-237-3056 for appointment. Interviews will be conducted in Greenville. We are an equal opportunity employer.

NEED SOMEONE TO Drive to the Vero Hotel. Leave Greenville 1:00pm Friday, leave Nags Head 1:00pm Sunday. Contact Rosemary, 758-0616.

NOW HIRING Full time and part time. All positions open. Apply in person, Greenville Express Car Wash, 117 Greenville Boulevard, SouthWest.

NURSES LOOKING for a career change. Busy law firm has a position available for a bright, organized, hard-working professional. No more long hours, shift work or weekends. We offer Monday-Friday, 8:30am-5:30pm. Excellent career opportunity. Send resume to: PO Box 1766, Greenville, NC 27835.

OFFICE MANAGER Needed for growing farm business publication. Successful applicant needs organizational skills, familiarity with office computer software, and ability to work with people. Job offers introduction to advertising sales and publication management. Competitive pay and benefits. Send resume to Carolina Farmer, PO Box 7344, Greenville, North Carolina 27835.

PART-TIME SALES Clerk, long hours. Atlantic Personnel Service, 355-7931.

PART-TIME INSPECTOR For properties in the Greenville Area. SMITH & SMITH Co., Inc., 1778 North Plano Road, Suite 210, Richardson, Texas 75081.

PASTRY CHEF, experienced with references. Apply in person, Monday-Friday, 8:30am and 3:40pm at S & S Cafeteria, Carolina East Mall. No phone calls.

POLICE OFFICER-Winterville. One full-time officer wanted. NC Certification required. Good benefits package. Apply Chief, PO Box 1267, 102 E. Raleigh Street, Winterville NC 28590. EOE.

RAMADA INN is now accepting applications for morning front desk clerk. Must be avid individual. We offer a competitive compensation package. Experience not required. We offer complete training program. Replies held in confidence. Reply to DR1356, c/o The Daily Reflector, PO Box 1967, Greenville, NC 27835.

PURCHASING Washington area. Manufacturer needs a team oriented individual to be assistant to the purchasing manager. Ideal candidate should be familiar with all aspects of the purchasing department. Duties include expediting, order placement, vendor research. CRT experience helpful. If qualified send resume to: 1108 East 4th Street, Washington, NC 27889.

RESUME Composition and Typing *Cover Letters *Reference Sheets *Salary History *Typing *Employment Applications *Post-Interview Letters *Term Papers *General Typing *Next Day Service

Atlantic Personnel Services
209 Commerce Street, Suite B
355-7931

RITZ CAMERA. Largest camera retail dealer in US, is seeking a career-minded full time Lab Technician. Experience helpful. Apply within, Carolina East Mall. No phone calls accepted.

RYAN'S FAMILY STEAK House seeking qualified job applicants for daytime cooks. Experienced only. Apply between 2-4 daily.

SALES CLERKS. New store. Atlantic Personnel Service, 355-7931.

SALES REPRESENTATIVE. Outside sales experience required. Hotel experience helpful. Must have a high energy level, neat appearance and work well with others under pressure. Send resume to Sales Representative, Ramada Inn, 203 West Greenville Blvd., Greenville, NC 27834. No phone calls accepted.

SIGNATURE SALOON. Has immediate openings for full or part time bartenders. Please come by to fill out job application. 2708-C East 10th Street, Greenville, 830-5597. Contact Helen or Joyce.

SMELLING & SNELLING specializes in sales, management training, accounting and clerical positions. Call 758-0541.

CLASSIFIED DISPLAY

060 Help Wanted Miscellaneous

PART TIME DISHWASHER. \$5 per hour. Apply in person only, after 5pm, Riverside Steak Bar, 315 Stantonburg Road.

PROGRAMMER/ANALYST

12 HEWLETT PACKARD Dynamic and progressive catalog distribution company is seeking several additional programmers to fill newly creative positions.

Qualifications: 2 years program experience with Hewlett Packard Series 2000 using Cobol/ Image Database experience preferred.

Full benefits package and an attractive salary based on qualifications. This position is located in Wilmington, N.C.

If you would like to work with a company that is large enough to have the latest in software and hardware, but yet small enough to provide a friendly atmosphere in which your achievements can be recognized and rewarded, please send your resume and salary requirements to: The Employment Security Commission, 717 Market Street, Wilmington, NC 28401.

PROGRESSIVE HOME Service Life Insurance Company is currently seeking aggressive, career/sales oriented individual to fill opening in our Greenville office. This is an established agency offering an excellent opportunity for the right individual. We offer a competitive compensation package. Experience not required. We offer complete training program. Replies held in confidence. Reply to DR1356, c/o The Daily Reflector, PO Box 1967, Greenville, NC 27835.

WAREHOUSE Outstanding opportunity for an individual looking for a good future. Must be energetic, hard working, enthusiastic and willing to work. Call for an appointment, 946-9636, Washington NC.

WANTED: Experienced roofers, laborers and sheet metal mechanics. Please apply 1314 North Greene Street.

WANTED: Waitress and kitchen worker. Apply in person, Bum's Restaurant in Ayden.

WANTED: Carpenter or carpenter's helper. 2 years experience. Must have own small tools and drivers license. 758-5272.

WAREHOUSE Outstanding opportunity for an individual looking for a good future. Must be energetic, hard working, enthusiastic and willing to work. Call for an appointment, 946-9636, Washington NC.

061 Help Wanted Sales

ATTENTION: LICENSED Real Estate Agents. One of Greenville's top 21 JANEY BOWSER & ASSOCIATES, 355-7900, An Equal Opportunity Employer.

DESIRE A NEW CAREER in the insurance field? Guaranteed salary of \$25,000 to start plus all company benefits. Must be licensed. Call 355-3410 or 830-5414.

ESTABLISHED Real Estate firm has an opening for a full time sales manager. Private office and excellent training. Must have North Carolina Real Estate License. Call Mavis Butts Realty, 355-7653. An Equal Opportunity Employer.

EXPERIENCED Real Estate Agents. Join America's Largest and Full Service Real Estate Company. Complete package of marketing tools. For your confidential interview contact Elaine, Coldwell Banker W.G. Blount & Associates Realtors, 756-3000 or 756-6346, 201 East Arlington Boulevard, Greenville.

FULL TIME Sales clerk needed. Apply in person at Hatch Shoes, Carolina East Mall.

HERE'S THE BOTTOM LINE. Our Company is in 4 industries with a market value in excess of \$40 billion dollars. We paid over \$20 million in commissions last year and will pay over \$50 million this year, yet virtually no one has heard of us. If you understand ground floor, market and product timing, explosive momentum growth and are willing to work hard for 12-24 months, you can join our top executives who earn in excess of \$240,000 per year. If you have you can qualify call 919-790-4008 for further information.

MATURE SALES Lady needed for Ladies Clothing store. Experience preferred. Send resume to: PO Box 45, Stokes NC 27884.

CLASSIFIED DISPLAY

061 Help Wanted Sales

PERMANENT POSITION Two openings exist now for goal oriented person in local branch of large international firm. This is an impressive opportunity for an ambitious person who wants to get ahead. To qualify you need self confidence, pleasant personality. We provide complete company benefits, major medical, dental plan, profit sharing, optional pension plan second to none. Also complete training plan. Previous experience not necessary. Income range \$20-\$30,000 depending on qualifications. Only those who sincerely want to get ahead need apply. Call Wednesday and Thursday, 9:00-5:00, 830-5414.

SUPERVISOR \$450 a week. Good benefits. Atlantic Personnel Service, 355-7931.

THE WAFFLE HOUSE is now taking applications for all positions, full and part-time. Experience preferred, but not necessary. Benefits include paid vacation after 6 months, incentive bonuses and medical dental insurance available. Must be dependable, honest, and enjoy working with the public. Apply in person only at 306 North Blvd., Monday-Friday, 11 a.m. - 2 p.m.

TRUCKS. Tobacco market opening. Need tractors to pull good trailers. Use your own trailers or pull ours. Trucks and drivers must pass our inspection. Forbes Transfer Company, Wilson, NC 27802-6272.

WANTED: Custom cabinet maker. Must have experience. Call 830-9144 days; 756-2098 nights.

WANTED: Experienced roofers, laborers and sheet metal mechanics. Please apply 1314 North Greene Street.

WANTED: Waitress and kitchen worker. Apply in person, Bum's Restaurant in Ayden.

WANTED: Carpenter or carpenter's helper. 2 years experience. Must have own small tools and drivers license. 758-5272.

WAREHOUSE Outstanding opportunity for an individual looking for a good future. Must be energetic, hard working, enthusiastic and willing to work. Call for an appointment, 946-9636, Washington NC.

061 Help Wanted Sales

ATTENTION: LICENSED Real Estate Agents. One of Greenville's top 21 JANEY BOWSER & ASSOCIATES, 355-7900, An Equal Opportunity Employer.

DESIRE A NEW CAREER in the insurance field? Guaranteed salary of \$25,000 to start plus all company benefits. Must be licensed. Call 355-3410 or 830-5414.

ESTABLISHED Real Estate firm has an opening for a full time sales manager. Private office and excellent training. Must have North Carolina Real Estate License. Call Mavis Butts Realty, 355-7653. An Equal Opportunity Employer.

EXPERIENCED Real Estate Agents. Join America's Largest and Full Service Real Estate Company. Complete package of marketing tools. For your confidential interview contact Elaine, Coldwell Banker W.G. Blount & Associates Realtors, 756-3000 or 756-6346, 201 East Arlington Boulevard, Greenville.

FULL TIME Sales clerk needed. Apply in person at Hatch Shoes, Carolina East Mall.

HERE'S THE BOTTOM LINE. Our Company is in 4 industries with a market value in excess of \$40 billion dollars. We paid over \$20 million in commissions last year and will pay over \$50 million this year, yet virtually no one has heard of us. If you understand ground floor, market and product timing, explosive momentum growth and are willing to work hard for 12-24 months, you can join our top executives who earn in excess of \$240,000 per year. If you have you can qualify call 919-790-4008 for further information.

MATURE SALES Lady needed for Ladies Clothing store. Experience preferred. Send resume to: PO Box 45, Stokes NC 27884.

CLASSIFIED DISPLAY

061 Help Wanted Sales

HAVE YOU GOT What it takes to make a lot of money? Then, we want you to come to work with us. Call today to find out how you can earn \$35,000-\$40,000 your first year selling for the fastest growing contracting company in the US. Management potential a must. Wilson, Kinston and Greenville areas. For an interview, call 1-800-444-9830.

Buying a new car or truck? Sell your old one through classifieds.

CLASSIFIED DISPLAY

061 Help Wanted Sales

SERVICE REPRESENTATIVE. Need male or female to represent United Family Life Agency is located at Wilkerson Funeral Home in Greenville. Qualifications: good personality, has a good reputation, is in good health, is ambitious, is not content with just average income. Company has a full line of fringe benefits. If interested call Carolyn Beaman at 747-5281 between 8:00am-9:00pm only.

CLASSIFIED DISPLAY

061 Help Wanted Sales

DIAGNOSTIC Prescriptive Specialist with exceptional children program. Teaching certificate in some area of exceptional children required. Contact Jane Stroud, Exceptional Children Director, Tarboro City Schools, PO Box 370, Tarboro, North Carolina 27886. Phone 823-5072.

HIGH SCHOOL Band Director. Requires certification 800. Contact Pitt County Schools Personnel Department, 1717 West 5th Street, Greenville, North Carolina 27835 or call 830-4242 for application information.

CLASSIFIED DISPLAY

G. B. Electric Inc.

ADVANCE MECHANICAL INC.

Need experienced electricians and sheet metal workers.

CALL 355-6011

HELP WANTED

Freshway Food Stores in the Farmville, Winterville, and Greenville areas has openings for full and part-time clerks. We also have possible openings for manager and assistant manager. Must have high school diploma, GED or retail experience. We will train. Good starting pay and benefits which includes: vacation, sick pay, Health and Life Insurance and Credit Union availability. Advancement opportunities available. Apply at any FRESHWAY in desired area. No Phone Calls Please.

EOE

INDUSTRIAL ELECTRICIAN/MECHANIC

Permanent Opening For A Skilled Electrician With An Industrial Background Including 2 Years Of Experience Or A Related Degree With One Year Of Industrial Experience. This Position Requires Working Rotating Shifts and Frequently On Weekends. Competitive Pay and Excellent benefits. Apply To:

PERSONNEL MANAGER
WEYERHAEUSER
FOREST PRODUCTS
P.O. BOX 787
PLYMOUTH, NC 27962

AN EQUAL OPPORTUNITY EMPLOYER M/F

1989 CLOSE-OUT

SAVE UP TO \$5,000!

Prices shown are for 5-speed front wheel drive models. Cash back rebates are available on many other models in-stock!

	4-Door Sedan #2182	Sticker Price \$11,977 ⁹⁰ Manufacturer Rebate -1,000 Sigmon Discount -1,500 Your Close-out Price \$9,477⁹⁰
	Justy GL #2171	Sticker Price \$9,428 ⁹⁰ Manufacturer Rebate -1,000 Sigmon Discount -600 Your Close-out Price \$7,828⁹⁰
	3-Door Coupe GL #AG2165	Sticker Price \$13,467 ⁹⁰ Manufacturer Rebate -1,000 Sigmon Discount -1,500 Your Close-out Price \$10,967⁹⁰
	XT GL #2117	Sticker Price \$16,905 ⁷⁰ Manufacturer Rebate -3,000 Sigmon Discount -2,000 Your Close-out Price \$11,905⁷⁰
	Station Wagon #2147	Sticker Price \$12,621 ⁷⁵ Manufacturer Rebate -1,000 Sigmon Discount -1,300 Your Close-out Price \$10,321⁷⁵

Tax and tags are not included in sale prices.

SIGMON SUBARU

Highway 264 Bypass
(next to Toyota East) Greenville
756-7644 Toll-free: 1-800-682-5437

\$25 CASH!

No purchase is necessary and there's no obligation to buy. Get \$25 cash upon the completion of a test drive at Sigmon Subaru through 7/22/89. One redemption per customer.

Sigmon Subaru
264 Bypass (next to Toyota East) Greenville 756-7644

HELP WANTED

Experienced finish carpenters, form carpenters and construction laborers.

Apply at:
J.H. Hudson Construction Co.
758-2138, Noah Buck

CAT

Wednesday Classifieds

063 Help Wanted Technical & Trades

AUTOMOTIVE TECHNICIAN needed 2 years experience required. Call 355-2258.

BUYER Experienced individual for material procurement, expediting, and vendor development. Construction buying experience a plus but not required. Salary range based on experience. Immediate opening. Send resume to: Buyer, PO Box 5004, Greenville NC 27835. EOE.

COMPUTER SERVICE TECHNICIAN

Largest computer service center east of Raleigh. Experienced person need only apply. Excellent benefits. Salary negotiable. Looking for career oriented person. Send resume to or call Service Manager at 355-6110 or write 14 Carolina East Center, Greenville, NC 27834.

CONSTRUCTION PIPE Personnel. Experienced pipe layers, laborers and operators. Transportation required. Call Carl Spencer, 758-1055. EOE.

CONSTRUCTION PIPE Personnel. Experienced pipe layers, laborers and operators. Transportation required. Call Carl Spencer, 758-1055. EOE.

DIVISION OF WESTINGHOUSE has opening for individual willing to learn tax mapping. For appointment call 830-0939. EOE.

DOZER OPERATOR Experienced only. Must have driver's license and transportation. Apply in person, Greenville Paving, Old River Road, Greenville, NC or call 752-8842. EOE/AA/M/F.

DRAFTING POSITION available: civil engineering/land surveying field. Experience helpful but not necessary. Call 753-2139 or pick up application at McDavid Associates, Inc., 120 North Main Street, Farmville, NC.

ELECTRICAL ENGINEER up to \$36,000. No Fee! Atlantic Personnel Service, 355-7931.

EXPERIENCED SHEET metal mechanics for installing heating and air conditioning duct work. Benefits. Apply between 8:00 and 9:00 a.m. only. Larmer Mechanical, Farmville Highway.

EXPERIENCED PAINTERS Only. Full time work. 756-5514 between 8am-5pm.

HEATING/AIR Conditioning Mechanic for immediate opening. Salary dependent upon experience. Reply by sending resume to HVAC Mechanic, P.O. Box 1085, Williamston, NC 27892.

LOGGERS HELPER needed. Some experience. Call 758-8962.

MECHANICAL ENGINEER up to \$24,000. No Fee! Atlantic Personnel Service, 355-7931.

CLASSIFIED DISPLAY

063 Help Wanted Technical & Trades

MECHANIC WANTED For trucks and heavy equipment. 5 years experience. Applications taken from 8-5 at Whaley Contractors, HWY 11 North, Grifton.

METAL BUILDING Mechanics and helpers. Apply in person. Custom Building Company, East Mumford Road. Pay and benefits based on skill level. 752-4220.

OPERATOR FOR Heavy Equipment. 3 years experience. Applications taken from 8-5 at Whaley Contractors, HWY 11 North, Grifton.

PLUMBER Experienced in new residential work. 3-5 years experience. References required. Must have drivers license. 746-6007 or 830-3110.

POSITIONS AVAILABLE Propane Gas Service Man AND Trainee

Experience preferred. Apply in person 9am-4pm at Daughtridge Gas Company, 2102 Dickenson Avenue.

SCRAPER PAN Operator. Experienced only. Must have driver's license and transportation. Apply in person, Greenville Paving, Old River Road, Greenville or call 752-8842. EOE/AA/M/F.

SERVICE MANAGER Electrical aptitude, good public relations skills. Will train. Excellent salary. Atlantic Personnel Service, 355-7931.

SHEET METAL MECHANICS. Modern expanding roofing and sheet metal contractor is seeking experienced Sheet Metal Mechanics. Experience in architectural sheet metal and duct work preferred. Excellent pay and benefits package. Call 758-2179. 8am-5pm.

WELDER AND IRON Worker for general construction projects. Must have NC Driver's license and be able to work with little supervision. Apply in person between 7:30am at Farrior & Sons Inc., Highway 264 West, Farmville, North Carolina. Phone 753-2005.

064 Work Wanted

A-1 QUALITY Painting, minor repairs, mildew control, we wash houses. Free estimates. Work guaranteed. 758-4136.

AIR CONDITIONING SERVICE All types central and window unit. State Licensed. #13740. Call 758-2854 for appointment.

ALL YOUR LAWN Maintenance needs. Free estimates. Call 752-7322.

CLASSIFIED DISPLAY

064 Work Wanted

ALL PHASES OF CONSTRUCTION Additions, Decks, Remodeling, Repairs of all types. Etc. Steele & Sons Home Improvements. Free Estimates. 753-2833.

ARE YOU IN NEED of Quality lawn maintenance or grass cutting? Free estimates. Call 757-1590.

B & B CONSTRUCTION Remodeling and repairs. New additions, decks, painting, roofs, concrete and brick work. Free estimates. 15 years experience. All work guaranteed. 830-9043.

B & B P A T T I A N D Wallpaper Interior/Exterior. 25 years experience. Free estimates. Call 758-6873 or 758-1548 anytime.

CAROLINA TREE Service. All types done. Slump removal. Free estimates. Fully insured. 752-6420 or 757-0117.

CERAMIC TILE Installation. Bathroom renovation, kitchen floor and counter top. 31 years experience. Free estimates. Call 753-5381.

CHET, THE HANDYMAN Interior and exterior paint and minor carpentry repair. All work guaranteed. Call 758-2074.

CLEANING PERSON for weekly duties and odd jobs. Professional worker. Reasonable rates. Call anytime. 355-4638.

CLEANING OF HOMES and offices. R & R Cleaning Service. Bonded. Free extras and estimates. 830-9261.

CONSTRUCTION - George Webber Construction, specializing in Remodeling, custom cabinets, plumbing, lawn maintenance, plumbing and all type new construction, decks and concrete work. 756-8589 anytime.

EXPERT CEMENT WORK: Carports, driveways, patios, etc. poured 20 years experience. Reasonable rates. Call Ray at 830-1318 after 5:00 p.m.

HAVE YOUR VACUUM Serviced For less at The Kirby Center East in the Buyer's Market. 355-7667.

IN NEED OF A QUALITY paint job that your wallet can afford? 15 years of experience. Call after 6pm. 752-3589 or 758-6602.

CLASSIFIED DISPLAY

064 Work Wanted

I DO GOOD WORK At reasonable prices. No job too small. Call 830-9072.

NEED A BRICK MASON? We specialize in bricks, blocks, and stones. We've been serving eastern NC for over 16 years and look forward to serving you. We do light commercial work, give free estimates, guarantee professional services to better serve you. Call today, don't delay. Call Tarheel Masonry at 758-5091 or 830-8782 anytime. Ask for James Person or leave message.

NOT JUST ANOTHER Housecleaner. Whether you need help once or on a regular basis, for dependable quality and trustworthy service, call Mrs. Black. 355-5164.

PAPERING, INTERIOR Painting and paper removal. All wall papering, mildew removal. Insured for your protection. Call Don English. 756-7010.

PROFESSIONAL PAINTER 10 years experience. Interior/Exterior. Mildew removal. Local references. Peter. 756-5642 for free professional estimate.

QUALITY Housecleaning Reasonable rates. Please call 746-2328 anytime.

RAWL'S BUILDING and Remodeling. All jobs welcomed. 11 years experience. Free estimate. Call Mike. 756-6972.

ROOF LEAKS FIXED and minor repairs. 18 years experience. Work guaranteed. After 6 p.m. call 752-5906.

ROY LEE BROCK Roofing Also do yards and paint trailer tops. Licensed. If you would like your roof done, call 830-9130.

SILVERTHORNE HAULING. Small loads of topsoil, sand, pine bark, yard maintenance, small clean up jobs. 758-3296.

SPECIALIZING in Sanding and Refinishing hardwood floors. Call after 6pm 742-6437.

TELEPHONE JACK Installation at reasonable rates. Call 756-7407 or 746-6555.

CLASSIFIED DISPLAY

069 Auctions

AUCTION!

Join us for two big sales, Friday July 21 and Sunday July 23, 1989. Friday night at 7 P.M. Sharp! We will be selling large load of antiques primitives and collectibles.

Partial List For Friday's Sale
Oak Sideboard with bevel mirror, 2 oak dressers with bevel mirrors, oak washstand with mirror, 2 oak pressback rockers, oak library table, blanket chest cedar, rope bed chestnut high back with fancy carvings, pine pie safe, oak bookcase with glass doors, chestnut dressers with mirror, oak washstand with towel bar, 4 oak dressers with mirrors, 2 oak dressers with mirrors, plus much, much more!!!

Sunday July 23, 1989 1 P.M.

Partial List For Sunday Sale
Selling for Mr. Joe Griekspeer from Bedford Pennsylvania

Very unusual North Wind pressback oak rocker, 2 Victorian walnut dressers with mirrors, walnut bed and matching dresser with mirror, Fancy oak bonnet chest with mirror, fancy oak dressers with mirrors, oak dresser with splash board, oak side board double serpentine with high back mirror, oak side board with low mirror, mahogany ladies rocker, single oak bed, oak kitchen stool, fancy mahogany side chair, walnut library table, oak Bentwood rocker, pine book case, oak prayer bench, walnut clock shelf, fancy walnut spinet desk, Chippendale Bural walnut table, oak plant stand with ball and claw feet and brass shell, 1 small oval Hepple White mahogany walnut candle stand, oak side board with fancy splash board, old mahogany Chippendale tilt table, oak lavender table, oak high chest several, fancy wooden bed, flat wall cupboard, blanket chest walnut, kitchen cupboard, oak stands, small tables, nice iron crib, walnut sewing box, fancy hanging wall mirror, small blind door corner cupboard, glass ware and brass shell, old chairs, primitive hand tools and collectibles.

Directions: Sale is located one block east of Hastings Ford off HWY 33 behind Puff Putt Golf Courses.

Greenville Auction Company
106 Riverbluff Road
Greenville NC 27834
Phone: 830-5484.

Advertise your yard sales through classified. 752-6166.

CLASSIFIED DISPLAY

069 Auctions

NORTH GREENE STREET AUCTION
Wednesday and Friday
7:30 PM
830-9262

075 Computers
IBM 386 CLONE a 20 Mhz, 40 Meg HD Monochrome. \$750. Call 355-7089.

MACINTOSH SE with 20 MB hard drive, 2.5 megs RAM, Ergotron tilt/swivel stand, Hayes modem, graphics and communication software. Like new condition. \$2,850. 758-3082.

MACINTOSH SE, Image Writer II printer, Microsoft Works, Macdraw, Macpaint, Macword, Hypercard. 1 year old. \$2500. 355-3382.

TANDY 1000 EX IBM compatible. 640K, 2 disc drives, mouse and monitor. 758-6047 after 4pm.

081 Furniture
ADOLESCENT Bedroom set with shelving. 7 piece dining set, other furniture, GE washer, auto stereo equipment. Call Dean 752-2018.

ONE YEAR OLD Sectional wrap around sofa, recliners at each end. Excellent shape. Brass coffee table, brass cocktail table and brass lamp. Asking \$1250. Call 355-3543 or 355-2840 ask for Casey.

TABLE WITH 2 Captains chairs, 4 chairs, leaf. Like new. \$500 or best offer. 355-6602.

VERY NICE. Almost new, large coffee table with storage space. Call 752-4793.

CLASSIFIED DISPLAY

GOODMAN AUTO BROKERS
Let us sell your car or truck!
(Consign-a-car plan)
Let us help you locate your next car or truck!
•Bank financing
•Factory leasing

1989 Jeep Cherokee
Automatic, 4x4, 4.0 6 cylinder, air, 6,000 miles, dark blue.

(Beside Coggins Goodrich Tire Store)
312 W. Greenville Blvd.
Greenville, N.C.
355-9196

CLASSIFIED DISPLAY

CLASSIFIED DISPLAY

Tired of rejections? Tired of feeling like a second class citizen?

DON'T BE BASHFUL!

We, at Certified Credit Consumers & Associates can help! Call 355-8337 10AM-10PM for a FREE consultation. 100% legal. Guaranteed satisfaction.

Apply in person:
601 Greenville Blvd.
3000 E. 10th Street
Greenville, NC

CLASSIFIED Ads
752-6166

CLASSIFIED DISPLAY

Quality Oil

Part-time positions available with local company. Flexible hours for the student or housewife. We offer paid vacations and insurance. Become an important part of our team today and let us help you enjoy your retirement tomorrow.

Apply in person:
601 Greenville Blvd.
3000 E. 10th Street
Greenville, NC

CLASSIFIED DISPLAY

Looking for Management Candidate

We will train you at our expense for a position with an internationally known company that is a leader in its field.

We're looking for an outgoing, confident individual with high ambition, who truly enjoys working with people.

Some sales, retail or public relations experience a plus but not necessary.

Minimum income level of \$24,000 plus bonus potential upon assuming management responsibilities.

Send resume to:
FIELD MANAGEMENT INSTITUTE
P.O. Box 2664
Rocky Mount, N.C. 27802

Equal Opportunity Company M/F

N10733-18

LOOKING FOR MANAGEMENT CANDIDATE

We will train you at our expense for a position with an internationally known company that is a leader in its field.

We're looking for an outgoing, confident individual with high ambition, who truly enjoys working with people.

Some sales, retail or public relations experience a plus but not necessary.

Minimum income level of \$24,000 plus bonus potential upon assuming management responsibilities.

Send resume to:
FIELD MANAGEMENT INSTITUTE
P.O. Box 2664
Rocky Mount, N.C. 27802

Equal Opportunity Company M/F

N10733-18

LEE MOTOR COMPANY

WILSON'S #1 VOLUME DEALER

*An Extraordinary Opportunity For Enthusiastic And Aggressive Sales Executives

*One Of The Industry's Best Salary Plans - Benefit Packages

*Flexible Work Schedule

*An Excellent Career Opportunity For Promotion With A Growth Organization. No Experience Necessary.

CONTACT RAY WOODRUFF
GEN. SALES MGR. 291-6000

LEE Motor Company
FORD · LINCOLN · MERCURY

1415 Lipscomb Road, Wilson, NC 919-291-6000
Hours Mon.-Fri. 8:30-8 Sat. 9-5 1-800-682-7906

DAYTIME OPENINGS AVAILABLE IMMEDIATELY!

Flexible hours
Excellent starting wage
Advancement opportunities
Will train

Apply now!
Little Caesar Pizza
3120 E. 10th Street or
323 Arlington Boulevard
1-4 p.m.

EOE

ZipMart CAREER OPPORTUNITIES

ZipMart has opportunities for full and part time employment. Scheduled salary \$3.50 to \$4.00, depending on experience. Scheduled salary increases based on merit. Offering paid medical, life and dental insurance, vacation, profit sharing, and other benefits. Will train good candidates. Apply in person at 700 S. Memorial Dr., see store manager from 8 AM to 4PM. No phone calls please.

EOE

Attention

The employment office for PITT COUNTY MEMORIAL HOSPITAL will be closed on Tuesday, July 18. We will reopen Wednesday, July 19 and will be located in the BB&T Building, 2000 Venture Power Drive, First Floor. Applications will be accepted:

Monday, 9 am-4 pm
Tuesday, 9 am-4 pm
Wednesday, 9 am-4 pm

For a complete listing of available positions, please call our Job Vacancy Line at 551-4900; 24/hrs day. EOE/AA.

PCMH
Patient Care Matters Here

JOB OPPORTUNITIES

SOCIAL WORKER II. Bachelor's Degree from accredited school of social work and 1 year of social work or counseling experience. Salary range: \$19,396 - \$21,372.

MENTAL HEALTH NURSE I. Graduation from state accredited school of nursing and 1 year of experience in psychiatric nursing. RN required. Salary range: \$20,358 - \$22,438.

INFORMATION COMMUNICATION Specialist II. Position available in C & E Program. Staff development, training, volunteer and student intern activity, public relations, psychoeducational workshop, agency publications and multimedia displays.

Inter-agency consultation. Graduation from 4 year college or university preferably with a major in Journalism or English and 2 years experience in communication, public relations or publicity work.

Send state of North Carolina application and resume to:
Employment Security Commission
3101 Bismarck Street
Greenville, NC 27834

SERVICE DEPARTMENT DISPATCHER

Joe Pechele Volkswagen/Audi Inc. now has an opening for a dispatcher. Hospitalization insurance, up to 4 weeks vacation, 5 day work week, paid sick days. Contact Steve Briley, in person, Monday-Friday, 10-5 pm at:

JOE PECHELE
VOLKSWAGEN/AUDI INC.

NURSING ASSISTANTS

Beaufort County Hospital is seeking Certified Nursing Assistants to be a part of our Nursing Services team. Successful candidates will be registered with the State Board of Nursing and a minimum of 2 years experience is preferred. Full and part-time positions are now available. Good pay and benefits. For further information, please contact:

Jennifer Cooner
Personnel Department
Beaufort County Hospital
628 E. 12th Street
Washington, NC 27889
(919) 975-4321

AN EQUAL OPPORTUNITY EMPLOYER

IF...

...you would like an unlimited income potential
...you are ambitious
...you can be trained
...you would like a salary while you train
...you have a desire for sales
...you would like all fringe benefits
...you would like a paid vacation
...you can take supervision
...you don't mind work

We Would Like To Talk To You!

Please apply to
EAST CAROLINA
Lincoln-Mercury-Merkur
The Big Corner

Memorial Dr. & Greenville Blvd. 355-3355
Greenville, N.C.

JOB OPPORTUNITIES

FAWN INDUSTRIES, INC., a custom injection molder of plastic parts in Rocky Mount, N.C., is accepting resumes for the following positions:

MOLDING SET-UP TECHNICIANS-2nd Shift; Experience required
SPC CO-ORDINATOR-1st Shift; Experience in SPC required
INVENTORY CONTROL CLERK-2nd Shift; Use of computer in inventory control required

These are full time, hourly positions that require:

MOTIVATED TEAM PLAYERS
CO-OPERATIVE ATTITUDE
A COMMITMENT TO EXCELLENCE

We provide:
PAID VACATIONS, HOLIDAYS, SICK LEAVE
FULLY PAID FAMILY INSURANCE
MODERN FACILITIES
A TEAM ENVIRONMENT THAT ENCOURAGES CREATIVITY AND INNOVATION

Interested individuals that meet the above requirements should send resumes or come in and complete an application.

FAWN INDUSTRIES, INC.
401 Fawn Drive (Jeffries Rd. at Hwy 301)
Rocky Mount, NC 27801

FAWN Industries
Equal Opportunity Employer No Phone Calls Please

Professional Sales People

ACURA, a division of America's Honda Motor Company Incorporated, needs Sales Professionals in their Greenville dealership.

You would be representing ACURA through the most progressive management company in the Carolinas.

The ACURA product line ranges from \$12,000 to \$32,000 and attracts the top trade-ins on the market today.

We Offer:
•Complete training program
•Guaranteed income
•Car Allowance
•Health package

•Commission range 20% to 40%
•F & I Income participation
•Incentive bonus

Experience preferred, but desire is a necessity.

Contact Dan Marlowe at
Oak Tree Acura
3325 S. Memorial Drive
Greenville, N.C.
1-800-544-8876 355-2258

BIG DEAL!

Since its introduction, the Daihatsu Charade has made a big splash in Greenville. With all these features, it's a big value:

A peppy 1.0 liter 3 cylinder S.I.C engine, 5-speed transmission, electronic fuel injection, power assisted front disc brakes, 4-wheel independent suspension, radial tires, front and rear stabilizer bars, rack and pinion steering, 2-speed intermittent wipers, fold-down rear seat, tinted glass, electronic rear window defogger, trip odometer, rear package tray, adjustable front headrest, & much more!

The Charade has been rated "the most trouble-free car in its class" by J.D. Power & Associates—that's big praise. It's backed by a 3-year/36,000 mile bumper-to-bumper warranty—that's big protection. Priced at only \$5897, the 1989 Charade is a big value at a small price. And that's a big deal!

\$5897
\$10855 per month

60 months term at 13.5% APR, with approved credit and 20% down, cash or trade. Tax and tags are additional.

Highway 264 Bypass (next to Toyota East) Greenville
756-7644 Toll-free: 1-800-682-5437

SIGMON DAIHATSU

No purchase is necessary and there's no obligation to buy. Get \$25 cash upon the completion of a test drive at Sigmon Daihatsu through 7/22/89. One redemption per customer.

\$25 CASH!

Sigmon Daihatsu
264 Bypass (next to Toyota East) Greenville 756-7644

Wednesday Classifieds

082 Garage-Yard Sales

ESTATE TAX SALE. Antiques and miscellaneous boxed items. \$2-\$10 a box. All items must go 10AM, Saturday, July 22nd at 224 Country Club Drive.

084 Heavy Equipment

FORK LIFT for sale. 1984 Teletor with extended boom. Excellent condition. Asking \$18,000. Call 355-0235.

086 Farm Equipment

TOBACCO RACKS, Bulk to back Powell and Roanoke. Call 752-2679.

089 Fruits & Vegetables

BLUEBERRIES (Late crop). Nelson's Farm, Bridgeton, NC. Phone 637-2180.

092 Livestock

HORSEBACK RIDING. Jarman Stables. 752-5237.

HORSES, FEED and Tack. Call 746-2319. Open 7 days a week.

HORSES TRAINED. Boarded and for sale. Call 753-5467 anytime.

HORSES FOR SALE. Used tack. Call 752-1408.

098 Family Action Ads

GE REFRIGERATOR, 15 cubic foot, frost-free, avocado. \$200. Call 752-2625.

099 Miscellaneous

AIR CONDITIONER for sale. 11,000 BTU. \$200 firm. 746-2316 after 4 p.m.

AIR CONDITIONING REPAIR (Window Unit). Reasonable prices. Call 757-3850 nights and weekends.

AMANDA REFRIGERATOR Bought before Christmas. Can be seen at 1208 East Wright Road. Call for appointment.

BABY CAR SEAT, \$25. Jenny Lind crib, \$75. Mattress, \$50. Playpen, \$50. Call 758-2029 for more details.

BALLY PINBALL MACHINE Kings of Steel. \$375. Call 746-2499.

BEAUTY SHOP Equipment for sale. 2 notices above excellent. Priced to go immediately. Also, set of bunkbeds. First come first serve. Call Linda at 752-7722.

BEAUTY SHOP Equipment. Many miscellaneous items. Phone 758-3181 or 756-5050.

BOSE #01 Series IV. \$400 firm. Call 830-8917.

BRANCH'S MOBILE HOME And Plumbing Supply. Located HWY 42 South near Bell's Forks. We will have Whirlpool and Hot-point washers/dryers in stock starting Monday, July 17th. Complete authorized service on all appliances. Check our prices. Phone 756-6002.

CALL CHARLES TICE, 758-3013, for small loads sand, topsoil, stone, pine bark. Also backhoe and driveway work.

CRAPSMAN 10' Table saw. Excellent condition. \$250. Call 752-7322.

DORM REFRIGERATOR and telescope. 7 month old Boxer and miscellaneous. \$24-\$614.

DROP IN STOVE, self cleaning, \$100 or best offer. 758-5031 between 11:30 a.m. and 4:30 p.m.

ENCYCLOPEDIAS. Order direct from the publisher. The New Standard and save 50%. Write 1666 Little Creek Circle, Winston-Salem NC 27103 or call 758-7867 for area representative.

F&J SALVAGE - 258 North, Kinston, NC. Cabinets, doors, windows, desk, water heaters, dishwashers, furniture, lots more. \$2-8000. Monday-Friday, 9:00-5:00, Saturday, 9:00-1:00.

FOR SALE: LARGE capacity Frigidaire refrigerator, good condition. \$250. Call 752-1201.

FOUR PIECE BEDROOM Suit. Very good condition. \$350. Call 746-4465.

GOLD AND BROWN Traditional loveseat, \$100. Upright freezer \$100. Call 756-5495.

GOOD USED VACUUM For sale starting at \$25. Located at the Kirby Center in the Buyer's Market. 355-7667.

099 Miscellaneous

GYM SET FRAME, \$80. Exercise bike, \$45. Call 355-4219.

HANDYMAN HAS RICK-UP IN PIH County. Will clean garages, sheds, utility rooms and haul away trash for reasonable rates. 752-0772.

LIMITED NUMBER OF Memberships available. Tar River Estates Swim Club. For information call 752-4225.

MAINLINE GRANITE PRESS Full array printing and copying services. \$24 for 1,000 raised letter business cards. Call 752-1402.

MUST SELL: Washer and dryer (Electric). Used, but in good condition. \$235. Call 355-0319 after 6pm.

NEW AND USED OFFICE FURNITURE Office desks, files, chairs, safes, computer furniture, folding tables and chairs, etc. 1212 North Greene Street. McBudget Office Furniture. 752-9834.

NEW 3-PIECE wood dinette suit, only \$139.95.

NEW 2-PIECE living room suit only \$189.95.

NEW 4-DRAWER chest only \$39.95.

NEW 252 COIL Mattress and foundation. Twin: \$79.95 set; Full: \$99.95 set; Queen: \$138.95 set.

Compare our prices before you buy, we will save you money. Jamie's Furniture 756-6027.

PROFESSIONAL portable phone service monitor, B&K 1050 model, brand new with manuals. \$1400. 1-892-1224 days.

RECOH COPIER AND STAND, \$400. GE Microwave, \$50. Hot point refrigerator, \$75. Or package of all 3 for \$450. Call 830-1131 between 8-5, Monday-Friday.

REFRIGERATORS For sale, in good running condition. \$150. Call 752-6778 after 6pm.

REFRIGERATOR For sale, in good running condition. \$150. Call 752-6778 after 6pm.

REFRIGERATOR Kelvinator, self defrost, 12.4 cubic foot, asking \$125. Call 752-6778 after 6pm.

SAAD'S SHOE REPAIR Quality Shoe Repairing 113 Grande Avenue Corner of Dickinson and 10th "Parking in front"

Monday-Friday 8-6 Saturday 9-2 Phone 758-1228

SEARS Washer/dryer, VCR Beta, antique Singer sewing machine. Call 355-7558.

SHAMPOO YOUR RUG! Rent shampoos and vacuums at Rental Tool Company.

SHINGLES \$8.95 square and up; 4'x8' Hardboard Sliding \$10.95; Select Plywood 4'x8' \$6.25; 4'x8' 67-46. Packed Lumber-Now on sale. Builders Bargain Center. Greenville 758-7061.

SLIDING GLASS DOOR by Atrium. Best offer. Call 355-7503.

SOFA BED: opens to queen size bed, like new, \$300. Call 756-3118 after 5:00 p.m.

STORAGE BUILDINGS Custom made or 8x12-\$750; 10x12-\$850; 10x14-\$995. Treated decks, \$5 per square foot. Call nights, 689-2381.

SURPLUS PLUMBING Supplies, Year end inventory clearance. Faucets, tub and shower valves, damaged and surplus tub and showers at cost, spas and hot tubs. Ferguson Enter. prices. 756-4101.

TRAMPOLINE WITH PAD, \$200. Go-cart, \$225. GymPac 2000, \$125. New Baldwin Keyboard, \$300. 355-0371.

USED SLATE POOL Tables. Call 1-800-627-1691.

WANTED: Several sets of sliding glass doors. \$355-3002.

WASHERS, DRYERS, refrigerators, freezers, stoves \$100 up Guaranteed. 746-6929.

WASHERS, DRYERS, stoves, refrigerators and freezers repairs. \$15 and up. Best prices in town. We buy your old appliances working or not. We make house calls 7 days a week, 6am-9pm. 752-0772.

1971 CAROLINA 64x14 2 bedroom, 1 bath, front kitchen, island range, bay window. Pay \$395 down with payments less than \$175 per month. Azalea Homes-North (across from airport) at 758-4497.

1977 HAVELOCK 70x14, 3 bedroom, 2 bath. Pay \$395 down with payments less than \$205.00 per month. Call Azalea Homes-North (across from airport) at 758-4497.

1983 OAKWOOD 14x40, 2 bedrooms, 1 bath, heat and air conditioning, partial furnished, ceiling fan, washer/dryer, 8x10 storage bay, excellent condition. Rustic Ridge Mobile Home Park. \$10,500 negotiable. Call 752-1740.

1984 MOBILE HOME At Shady Knoll Park, 14x70, 3 bedrooms, 1 1/2 baths. Furnished including washer, dryer, electric heat and stove. Available \$200 down and assume loan payments \$241 monthly. For appointment, call 756-0906 after 6pm weekdays, any time weekends.

1984 OAKWOOD 14x70, 3 bedrooms, 1 1/2 baths. 752-3818, if no answer leave message.

1984 14X54 CONNER. Has lots of extras. 2 bedroom, 1 large bath. Assume payment. 355-6197/6pm.

1985 GUERDON 12x40, 2 bedrooms, range and refrigerator, front porch, back steps and service pole. 746-2016.

1985 OAKWOOD 2 bedroom, 2 bath. Assume loan, no equity. Located in Mobile Home Park. Call 355-7189.

1984 KNOX 70X14 3 bedroom, 1 1/2 baths. Furnished including washer, dryer, electric heat and stove. Available \$200 down and assume loan payments \$241 monthly. For appointment, call 756-0906 after 6pm weekdays, any time weekends.

1987 OAKWOOD 14x70, 2 bedrooms, 2 baths, with dishwasher, deck, metal building and more. 753-5957 after 6:00.

1988 TITAN, 56x14, 2 bedroom, 1 bath, front kitchen, ceiling fan. Pay just \$395 down, payments less than \$185 per month. Azalea Homes-North (across from airport) at 758-4497.

1989 14 WIDE, payments as low as \$149.46. Greenville volume dealer. Thomas Real Estate Sales. Across from Airport. 752-6068.

1989 24x48 doublewide, 3 bedrooms, 2 baths, total electric, cathedral ceiling, fireplace. Buy this home today for less than \$225 per month. Call Azalea Homes-North (across from airport) at 758-4497.

24X60 DOUBLEWIDE, 3 bedrooms, 1 1/2 ac. rent only. \$990 or assume loan 752-0628.

4 MONTHS OLD Doublewide, 1.584 square feet, 4 bedrooms, 2 full baths, fireplace with central air. Call Parvin Khani at Century 21 Tipton & Associates, 355-7002 or 355-3144.

\$400.00 OUT OF pocket puts you in a new 1989 Oakwood, 3 bedroom, 756-5431.

105 Musical Instruments

PRE-OWNED Steinway Grand. Completely rebuilt. Save thousands. Call 355-8092.

RENT A NEW PIANO for as low as \$25 a month. Call Pearson Music Company now 355-7575.

ROGERS DRUM SET With Zildjian Cymbals. Like new. Call 752-8819 evenings.

102 Mobile Homes For Sale

EXCELLENT SELECTIONS of doublewide homes or Joe at \$19,995-\$44,900. Sale prices on many models-Hurry-Martidae Homes, Highway 301 South, Wilson. 1-800-637-1228.

FACTORY OUTLET Custom order your Horton or Mansion home. (Colors, carpets, wall boards, etc.) Save Thousands. For free literature and information call toll free 1-800-346-4847.

FOR SALE: Pre-owned mobile homes. Excellent starter homes. Payments starting under \$130 per month. Call David or Joe at 522-4111, Clayton Homes of Kinston.

FOR SALE OR RENT, 60x14 Oakwood Mobile home and 18x16 storage building on 1/2 acre lot, Winterville. 756-9591.

MOBILE HOME - Mobile Home in the country on a large lot. Features include 3 bedrooms, 1 bath, eat-in kitchen, range, refrigerator, washer, dryer and central heat and air. A real bargain at \$25,500. Call Mavis Burtis Realty, 355-7653.

MOBILE HOME PARK For Sale. 10 spaces city water. \$3000 a space. 756-2909 after 5:30PM.

MOVING, MUST SELL! 1983 Fleetwood 14x70, 3 bedroom, 2 bath, air, fireplace, underpinning, self-cleaning oven, front/back porch. Own \$12,684. Must be moved. Located between Washington and Williamston. 752-7487 or 792-3236.

MUST SELL, RELOCATING Beautiful 1985 14x60 Oakwood. 2 bedrooms, 1 bath, country decor, all GE appliances, neatly underpinned with deck. Only asking to take over payments of \$198.59. Call 758-1725.

NEW AND USED HOMES. Come by or call J.N. Hill, 756-5431 at Oakwood Homes.

OAKWOOD 1987 14x70 2 bedroom, 2 baths, central heat/air, dishwasher, washer/dryer and more. Assume loan of \$263 per month and small equity. In extra nice Mobile home park. Immaculate condition. 752-2043.

OAKWOOD QUALITY from only \$499.00 down, delivered Free! 756-5431.

THREE BEDROOM, 2 bath mobile home. Assume finances. Call 756-8634.

WHY RENT? 1988 Horton 2 bedroom, 1 bath. Pay just \$395 down with payments less than \$150 per month. Azalea Homes-North (across from airport) at 758-4497.

\$1,500.00 DOWN or less? 14 different 2 or 3 bedroom homes to choose from! 756-5431.

12X40, 2 additional rooms (12x24), 3 bedrooms, 1 bath. Must be moved from lot. \$7500. Call 752-7608 days, 746-3305 after 7pm.

14X70 3 BEDROOM trailer with 2 full baths, lot and trailer for sale. Call 757-0543 after 6, anytime weekends.

1969 RITZCRAFT 12x50, 2 bedroom, furnished, with air conditioner. Good condition. 758-5013 after 8:30pm, anytime weekends.

1971 24X40 3 bedroom, 1 1/2 bath. As is Where Is. Chocowinity, \$7900. Includes furniture. 1-469-1570 or 1-946-8827.

109 Miscellaneous

WEDDING DRESS with cathedral length train, \$250. Sleeper couch and chair, \$200. 752-5806.

10' RADIAL ARM SAW, 10' table saw, Craftsman shaver, Craftsman bandsaw. Call 756-2476.

2 MEN'S Schwinn 10 speed Bicycles, \$50 each or best offer. Call 756-8638.

20 POUND BAG of Certified centipede grass seed. Will sale to one individual for 1/2 price. Call 830-1325.

22,000 BTU WHIRLPOOL Air conditioner, \$325. 11,500 BTU Frigidaire air conditioner \$225. Both have 30 day warranty. Call 753-3978.

50 CARAT Marquis Solitaire ring on 14 carat yellow gold band. Written appraisal at \$1750. \$51-\$831 days. 758-4373 nights.

102 Mobile Homes For Sale

EXCELLENT SELECTIONS of doublewide homes or Joe at \$19,995-\$44,900. Sale prices on many models-Hurry-Martidae Homes, Highway 301 South, Wilson. 1-800-637-1228.

FACTORY OUTLET Custom order your Horton or Mansion home. (Colors, carpets, wall boards, etc.) Save Thousands. For free literature and information call toll free 1-800-346-4847.

FOR SALE: Pre-owned mobile homes. Excellent starter homes. Payments starting under \$130 per month. Call David or Joe at 522-4111, Clayton Homes of Kinston.

FOR SALE OR RENT, 60x14 Oakwood Mobile home and 18x16 storage building on 1/2 acre lot, Winterville. 756-9591.

MOBILE HOME - Mobile Home in the country on a large lot. Features include 3 bedrooms, 1 bath, eat-in kitchen, range, refrigerator, washer, dryer and central heat and air. A real bargain at \$25,500. Call Mavis Burtis Realty, 355-7653.

MOBILE HOME PARK For Sale. 10 spaces city water. \$3000 a space. 756-2909 after 5:30PM.

MOVING, MUST SELL! 1983 Fleetwood 14x70, 3 bedroom, 2 bath, air, fireplace, underpinning, self-cleaning oven, front/back porch. Own \$12,684. Must be moved. Located between Washington and Williamston. 752-7487 or 792-3236.

MUST SELL, RELOCATING Beautiful 1985 14x60 Oakwood. 2 bedrooms, 1 bath, country decor, all GE appliances, neatly underpinned with deck. Only asking to take over payments of \$198.59. Call 758-1725.

NEW AND USED HOMES. Come by or call J.N. Hill, 756-5431 at Oakwood Homes.

OAKWOOD 1987 14x70 2 bedroom, 2 baths, central heat/air, dishwasher, washer/dryer and more. Assume loan of \$263 per month and small equity. In extra nice Mobile home park. Immaculate condition. 752-2043.

OAKWOOD QUALITY from only \$499.00 down, delivered Free! 756-5431.

THREE BEDROOM, 2 bath mobile home. Assume finances. Call 756-8634.

WHY RENT? 1988 Horton 2 bedroom, 1 bath. Pay just \$395 down with payments less than \$150 per month. Azalea Homes-North (across from airport) at 758-4497.

\$1,500.00 DOWN or less? 14 different 2 or 3 bedroom homes to choose from! 756-5431.

12X40, 2 additional rooms (12x24), 3 bedrooms, 1 bath. Must be moved from lot. \$7500. Call 752-7608 days, 746-3305 after 7pm.

14X70 3 BEDROOM trailer with 2 full baths, lot and trailer for sale. Call 757-0543 after 6, anytime weekends.

1969 RITZCRAFT 12x50, 2 bedroom, furnished, with air conditioner. Good condition. 758-5013 after 8:30pm, anytime weekends.

1971 24X40 3 bedroom, 1 1/2 bath. As is Where Is. Chocowinity, \$7900. Includes furniture. 1-469-1570 or 1-946-8827.

105 Musical Instruments

PRE-OWNED Steinway Grand. Completely rebuilt. Save thousands. Call 355-8092.

RENT A NEW PIANO for as low as \$25 a month. Call Pearson Music Company now 355-7575.

ROGERS DRUM SET With Zildjian Cymbals. Like new. Call 752-8819 evenings.

122 Business Opportunities

A BUSINESS? Buy or sell your business with C.J. Harris & Co., Inc. Financial & Marketing Consultants. Serving the Southeastern United States. Greenville, N.C. 355-7799, nights 756-8444.

ESTABLISHED ROUTE For sale. Excellent opportunity in sales for someone to be own boss. Small investment. Call evenings. 830-3943.

GROWING BUSINESS For Sale. Building for lease or sale. Call 746-3900.

MINI-MART. Established retail operation with C.J. Harris & Co., Inc. Excellent opportunity for the right person. Call Parvin Khani for more details. Century 21 Tipton, 355-7002 or evenings 355-3144.

MOVING, MUST SELL. Husband being transferred. Novelty retail sales. Established 11 years. Excellent money making opportunity for aggressive male or female. Priced for quick sale. Call 830-1048.

THINKING OF STARTING Or Buying a new business? Call the Small Business Hotline 752-1000 for FREE consultation. Sponsored by the PIH County Chamber of Commerce and PCC.

122 Business Opportunities

POSTERS, BANNERS, Customized Vinyl Lettering For Trucks, Vans, Boats, Doors and Windows. Also Decals, Magnetic Signs and Bumper Stickers. GREENVILLE GRAPHICS, 1310 E. 10th Street. 752-0123.

122 Business Opportunities

ARE YOU TIRED OF...writing ads, showing property, checking credit, writing leases, handling keys, complaint calls at night or on your weekends, collecting rent, or NOT collecting your rent and going to court, doing repairs, cleaning up behind messy tenants, paying bills, KEEPING TAX RECORDS, etc., etc., etc....

Then let J.L. Harris Realty give you a REST by:

Doing ALL OF THE ABOVE AND MORE FOR YOU because with more than 20 years of property management experience, a professional staff, a property management computer maintenance staff, routine advertising, key control system, etc., etc., etc., YOU can...

LEAVE YOUR RENTAL WORRIES TO US...as we will customize a management agreement with you.

J.L. Harris Realty 200 W. 10th Street, 758-4079 Julian R. Valmwright, Property Manager

118 Business Services

TRAINING TO BE A PROFESSIONAL -SECRETARY -EXECUTIVE SEC. -WORD PROCESSOR

HOME STUDY/FREE TRAINING -FINANCIAL AID AVAIL. -JOB PLACEMENT ASSIST. 1-800-327-7728

THE HART SCHOOL A Div. of A.C.T. Corp. Hart, Indpls., Pompano Bch., FL

115 Lost & Found

LOST: White Samoyed Husky. If found please call 752-6612. Reward offered.

118 Business Services

POSTERS, BANNERS, Customized Vinyl Lettering For Trucks, Vans, Boats, Doors and Windows. Also Decals, Magnetic Signs and Bumper Stickers. GREENVILLE GRAPHICS, 1310 E. 10th Street. 752-0123.

122 Business Opportunities

ARE YOU TIRED OF...writing ads, showing property, checking credit, writing leases, handling keys, complaint calls at night or on your weekends, collecting rent, or NOT collecting your rent and going to court, doing repairs, cleaning up behind messy tenants, paying bills, KEEPING TAX RECORDS, etc., etc., etc....

Then let J.L. Harris Realty give you a REST by:

Doing ALL OF THE ABOVE AND MORE FOR YOU because with more than 20 years of property management experience, a professional staff, a property management computer maintenance staff, routine advertising, key control system, etc., etc., etc., YOU can...

LEAVE YOUR RENTAL WORRIES TO US...as we will customize a management agreement with you.

J.L. Harris Realty 200 W. 10th Street, 758-4079 Julian R. Valmwright, Property Manager

Wednesday Classifieds

132 Commercial Property

Harris Realty
COMMERCIAL INVESTMENTS LAND-FARMS
758-6079
DOUG MORGAN
Commercial Broker

LOT
45,000 square feet +/-, 300 feet of road frontage. Bethel highway just past Wellcome Middle school and HWY 101. \$25,000. Doug Morgan, listing broker. #C002

4.2+- ACRES
Approximately 195' frontage. Located 2 1/2 blocks from ECU on East 10th Street. Doug Morgan, listing broker. #C005

OFFICE-WAREHOUSE
Approximately 1000 square feet of plush office space. Large conference room, approximately 2600 square feet of warehouse space with 12 feet double doors on both sides. 3/4 acre lot. Located at intersection of CR 1711 and 1709. \$105,000. Doug Morgan, listing broker. #C004

COMMERCIAL LOT
175' x 200'. Zoned CH. Highways 11 and 13 North next to child care center. \$122,500. Doug Morgan, listing broker. #C004

LOT
\$20,000. 38,700 square feet +/-, Off Bethel HWY with access from CR 1415. Doug Morgan, listing broker. #C002

OFFICE SPACE: Over 1400 square feet available now for sale and/or lease. Located on Arlington Blvd. Call Julie White, Re/Max Properties, 355-5444.

OFFICE BUILDING with over 4000 square feet consists of 10 offices, 3 bathrooms, lots of storage, small shipping room. 2 separate front entrances, could easily be divided. Call Carolyn Erwin at 355-7878 or home 355-6016.

WAREHOUSE/OFFICE Combination for lease or sale. Units of 1500 square feet and up. Can design interior layout. 757-0248.

1200 SQUARE FEET in Tipton Annex, \$615 per month. Call for information, Ed Tipton Agency, 756-0911, nights or weekends, 756-1769.

4400' BUILDING for rent. Ficklen Street in CDF area. Owner will consider selling or option to purchase. 3000' open space and 1300' office/showroom, nicely decorated. Part could be subletted. J.L. Harris Realty, 758-6079.

6.8 ACRES on NE Greenville Boulevard at \$13,885. Over 600' road frontage. Darden Realty, 758-1983.

80'X200' Commercial Lots with water and sewer. Best buy in town! Darden Realty, 758-1983.

136 Condominiums For Sale
INVESTOR NEWS! 1 and 2 bedroom condominiums. Perfect for university interests. Excellent condition and all appliances included. Priced to sell fast. Contact Deborah Jones at Aldridge & Southerland, 756-3500 or nights 756-7660.

REDUCED! QUAIL RIDGE: 3 bedroom (master downstairs), 2 1/2 bath, cathedral ceiling. \$95,999. Call 756-0151.

140 Farms For Lease
FOR RENT: Approximately 40 acres located behind Carolina East Mall off SR134, for soy beans. Contact Dan Morgan, 756-0200.

144 Houses For Sale
A BEAUTIFUL HOME For a growing family. Excellent neighborhood and wonderful wooded lot. Three bedroom, 2 bath brick ranch, living room, dining room, family room with fireplace. \$86,500. Call Deborah Jones at Aldridge & Southerland, 756-3500 or nights 756-7660.

A BEAUTIFUL 2,000 square foot country home. Sit on a private 2.3 acre lot in The Pines of Ayrden. Home features great room, family room, spacious master suite, 2 additional bedrooms and 2 baths. Home is only 4 years old, in excellent condition and has new detached double garage. \$95,000. Call Susan Likosar at Aldridge & Southerland, 756-3500 or nights 756-7984.

A COUNTRY DREAM! This Victorian has it all. Located in Woodridge, it features bay-windowed dining, breakfast and mstr bedrooms. Large family room with french doors, single garage. Call for details. Please ask for Nancy Dudley, Aldridge & Southerland, 756-3500 or 756-5596.

A DIGNIFIED 4 bedroom brick traditional with sunny kitchen, large breakfast area, spacious dining room, formal living room, family room. Plus bonus room, screened porch, steps, walk-up third floor attic. Your American Dream at \$170,000. Please ask for Nancy Dudley, Aldridge & Southerland, 756-3500 or 756-5596.

A HOME YOU WILL FALL in love with. 3 bedrooms, formal dining room, great room, spacious kitchen. Set amidst lovely trees in this rural setting. Lots of extras. One visit and you will decide. \$54,500. Please ask for Nancy Dudley, Aldridge & Southerland, 756-3500 or 756-5596.

A REAL DOLL BABY Tucker Estates. 3 bedrooms, 3 full baths, playroom with built-ins and adjoining bath that could be 4th bedroom for in-law suite. Dining room with bay window, very open and airy plan on a super lot. Over 2300 square feet for \$115,000. Call Deborah Jones at Aldridge & Southerland, 756-3500 or nights 756-7660.

CHARACTERISTIC Old South home for sale in Griffin. Must be moved immediately. 746-6628.

HANDY-MAN SPECIAL! This 3 bedroom, 1 bath brick ranch home is just minutes away from Greenville. In need of some "tender loving care", this house is a bargain priced at \$17,000. Perfect for the investor or crafter. Don't miss this opportunity! Contact Mack Rice of CENTURY 21 JANET BOWSER & ASSOCIATES, 355-7800 or 830-8527.

UNBELIEVABLE Reduction. You must see this home to believe it! Impressive brick Williamsburg. Elegantly appointed formal areas, huge kitchen with breakfast bay, gas logs in den fireplace, screened porch. Each of large bedrooms has 2 closets or walk-in. Reduced way under market value at \$139,900. Call Sheri Carter for your private showing at Aldridge & Southerland, 756-3500 or 756-4651.

UNIVERSITY - Feel right at home in this 2 bedroom cottage only blocks away from the university. Space saving floor plan enhanced by a delightful sunroom with skylight, that could also be used as a 3rd bedroom. Many other amenities and only \$67,000. Call Alvin Irwin, CENTURY 21 JANET BOWSER & ASSOCIATES, 355-7800 or 355-7744.

CALL TODAY! 4 bedroom, 3 full bath brick ranch, desirable neighborhood on 1/2 acre lot. New carpet and paint, move in condition. Priced in the 80s. Call Deborah Jones at Aldridge & Southerland, 756-3500 or nights 756-7660.

BRIGHT AND CAREFUL 2 bath, traditional features, first floor master suite, 3 bedroom upstairs. Great room with fireplace. Located on a corner lot in quiet, friendly neighborhood. Ideal for family living and rear children. Will consider lease with option. Call Aldridge & Southerland, 756-3500 or Katherine Vinson, 752-8728.

144 Houses For Sale

ABSOLUTELY ONE of a kind brick home in Tucker Estates. Gorgeous wooded corner lot, fresh contemporary interior. Like new 3 bedrooms, 2 1/2 baths, over 2,000 square feet. Many custom features including exceptional deck with hot tub. \$179,500. Call Deborah Jones at Aldridge & Southerland, 756-3500, or nights 756-7660.

ALL YOU WANT in your first home is in this 3 bedroom, 1 1/2 bath brick ranch with carpet, new paint inside and out, new heat system, new stove and located on quiet family street. Fenced-in back yard and priced to sell. Call Deborah Jones at Aldridge & Southerland, 756-3500 or nights 756-7660.

ATTRACTIVE, BRICK Venerable home situated on a beautifully landscaped lot. Custom built, almost new-carpet, storage, deck, good looking neighborhood, neat and well planned 3 bedroom, 2 bath home. Call Lyle at Davis Realty, 355-9900 or nights 756-2904 or 756-1997 or 355-2574.

AYDEN: FOR SALE by owner. \$4,000 equity and assume 9.5% loan. 3 bedrooms, 1 bath, living room, dining room, eat-in kitchen, workshop, 603 Park Avenue. Call 756-362 after 8:00 p.m. for appointment. No realtors please.

BEAUTIFUL NEW HOME with 4 bedrooms, 2 1/2 baths, huge family room with fireplace, formal dining room and foyer with oak flooring, kitchen with lots of cabinet space, pantry and breakfast nook, double garage. Reduced from \$141,900 to \$134,500. Call Carolyn Erwin at 355-7878 or home 355-6016.

BETHEL nestled among tall pines this attractive 1 1/2 story home features great room with fireplace and insert kitchen with eat-in area, 3 bedrooms, 2 baths and a patio on a well landscaped corner lot with rail fence. For sale by owner. For appointment call 825-1035.

BETHEL - Convenient, but still in the country with plenty of room for the larger family. This brick ranch has 4 bedrooms, and 3 baths. Room for uncrowded living. The joy of home ownership could start here. \$54,900. Call Todd Ramsey at 355-7101 or Mavis Butts Realty, 355-7653.

BETTER THAN NEW! Located in Tucker Estates, this pretty home is on a lovely wooded lot. Offers 3 bedrooms, 2 1/2 baths, great room, formal dining room, lovely eat-in kitchen, and more. Don't miss seeing this one. \$121,900. Please ask for Nancy Dudley, Aldridge & Southerland, 756-3500 or 756-5596.

WESTHAVEN I. Enjoy the peaceful life in this desirable neighborhood. 3 bedroom, 2 bath and carpet make this home extra special. \$78,400. Please call Todd Ramsey, Aldridge & Southerland, 756-3500 or 752-6656 nights.

WESTHAVEN! Beautiful brick traditional home with 4 bedrooms, 2 1/2 baths, formal dining room, foyer, family room, kitchen with nook, rec room or 5th bedroom, double garage, screened porch. Call Carolyn Erwin at Erwin Realty, 355-7878 or 355-6014, C45

CHERRY OAKS. Newly constructed Georgian offers 4 bedrooms, 2 1/2 baths, formal areas, family room. Plus unfinished bonus room and double garage. Executive quality for \$149,900. Please ask for Nancy Dudley, Aldridge & Southerland, 756-3500.

CHERRY OAKS. Stately two-story Williamsburg with 4 bedrooms, 3 1/2 baths, formal areas, lovely family room, double garage. Downstairs bedroom with full bath makes this a great house for overnight guests or in-laws. \$139,900. Please ask for Nancy Dudley at Aldridge & Southerland, 756-3500 or 756-5596.

CHERRY OAKS. Immaculate two-story colonial with 3 bedrooms, 2 1/2 baths, large great room, nice deck, fenced yard, stone building, Assumable FHA loan, so well priced that you'll think it's too good to be true! Please ask for Nancy Dudley, Aldridge & Southerland, 756-3500 or 756-5596.

FROM \$39,000 to \$59,900! REDUCED \$4,000 this three bedroom rehabbed brick ranch has ceramic bath, den with fireplace and wood heater, sunken country kitchen and detached garage. Only \$39,900.

LOST IN THE COUNTRY between Greenville and Washington! Only \$1,287 down and payments under \$365 a month principal and interest. Asking \$42,900. Four bedrooms, top

NOTHING DOWN for VA and builder will pay all points and closing costs on these new three bedroom, two bath brick ranches near the industrial area, just off Highway #33. Only \$97,500.

NINE ACRES with ranch just off Mumfords Road. Priced for quick sale! \$80,000 under tax value. Only \$59,900.

HIGNITE REALTORS HOMES BY VIDEO, INC. 757-1969 ANYTIME

GREAT STARTER HOME in Ayden, only \$64,900, 3 bedroom, 2 bath brick ranch home. Large fenced yard, living room, eat-in kitchen and den, other extras. Call 756-3342 after 5:30.

CLEVEWOOD. Nestled on a wooded lot. Traditional contemporary home with 4 bedrooms, and 2 1/2 baths. Dining room, living room, gas logs, over 2200 square feet. Many other extras. \$122,500. Please call Todd Ramsey at Aldridge & Southerland, 756-3500 or 752-6688 nights.

COUNTRY - New Construction! First time buyers, now you have the opportunity to pick your own colors for this 3 bedroom, 1 1/2 bath brick home to be constructed in this country setting. Builder will pay your points and closing. \$46,000. Call Mavis Butts Realty, 355-7653.

DID YOU EVER SEE a house sparkling? Well, I did! And you can see this immaculate 3 bedroom, 2 bath home, eat-in kitchen, dining area, large living/dining area, detached garage, double carport. Ask about the excellent non-qualifying loan. See the difference that pride makes. \$77,900. Please call Nancy Dudley, Aldridge & Southerland, 756-3500 or 756-5596.

DIVORCE SALE. Planters Walk, below market. Best sell! 794 Hunter's Run, \$95,000 negotiable. Call 355-9247.

DO YOU WANT TO ASSUME the perfect yard? This immaculate brick home has 3 bedrooms, 2 baths, large open kitchen, dining combination, fenced yard, outside storage. \$59,700. Please call Todd Ramsey at Aldridge & Southerland, 756-3500 or nights, 752-6656.

EASTWOOD - Spacious brick ranch in this established neighborhood offers formal living room, family room with fireplace and large playroom. Priced in the 90s. For more information call CENTURY 21 JANET BOWSER & ASSOCIATES. Ask for Jennifer White, 355-9901, 758-7971.

ELEGANT 2 STORY HOME nestled on a beautiful corner wooded lot. Excellent neighborhood, custom and quality built, well cared for, 3 or 4 bedrooms, formal areas, deck, screened in porch, double car garage. You must see. Priced to sell \$114,900. Call Mary of Davis Realty, 355-9900 or nights 756-1997 or 756-2904 or 355-2574.

EXCELLENT INVESTMENT! Only one block from campus, this 1800 square foot home features 3 bedrooms, 2 baths, with large spacious floor plan. Great rental history! Offered at only \$54,900. Call Janet Bowser of CENTURY 21 JANET BOWSER & ASSOCIATES, 355-7800 or 355-7744.

144 Houses For Sale

GREAT PRICE on this 3 or 4 bedroom ranch with over 2,000 square feet to enjoy. In addition to a cozy den, formal living room and dining room, you also have a playroom or 4th bedroom in this country home just minutes from Greenville. Throw in a nice fenced backyard, a two tier deck, and more little extras. It's a steal at \$76,000! Call Mike Walston today for details. CENTURY 21 JANET BOWSER & ASSOCIATES, 355-7800 or 756-3495.

CLASSIFIED DISPLAY

144 Houses For Sale

FOR SALE BY OWNER. 3 bedroom, 2 bath brick ranch, 100x200 foot wooded lot in Lynndale. \$72,000. Call 355-6029 or 355-3507 evenings.

CLASSIFIED DISPLAY

144 Houses For Sale

BROOK VALLEY is the setting for this exciting 2 story that offers comfort, convenience and style. Newly decorated first floor, wonderful flowing floor plan for entertaining. This home features all the formal areas including 4 bedrooms, 2 1/2 baths and double car garage. \$1500 carpet allowance. Available immediately. \$132,900. Call Aldridge & Southerland, 756-3500 ask for Katherine Vinson 752-5778.

CLASSIFIED DISPLAY

144 Houses For Sale

CHARM-STYLE-WARMTH. Expect to be impressed when you enter this special home in the university area. Charming decorated throughout, it offers a living room, bay-windowed music room, dining room, remodeled kitchen, 3 bedrooms, 2 baths. Plus cozy den, deck, garage. Absolutely nothing for you to do but move in...\$84,900. Please ask for Nancy Dudley, Aldridge & Southerland, 756-3500 or 756-5596.

CLASSIFIED DISPLAY

144 Houses For Sale

CHERRY OAKS. Traditional brick styling on the outside, and sparkling contemporary flair on the inside! Lush decorator colors, a large, airy great room with cathedral ceiling, 3 large bedrooms, 2 baths, spicous closets, formal dining room and breakfast that make this listing so special. Large deck and fenced yard. Call Robert Dean, CENTURY 21 JANET BOWSER & ASSOCIATES, 355-7800 or 756-1147.

CLASSIFIED DISPLAY

144 Houses For Sale

ABSOLUTELY GORGEOUS. 2 year old home in the country on 1 acre wooded lot. Room galore with 4 spacious bedrooms and loaded with closets. The master suite with office and massive designer master bath, double car garage and formal dining room. Lots of custom built extras. \$186,900. Call Janet Bowser Owner/Broker for an appointment. Nights: 756-6580

CLASSIFIED DISPLAY

144 Houses For Sale

FOR SALE BY OWNER - Stately traditional. This beautiful brick home in Westhaven features 3-4 bedrooms, huge master suite with office and massive designer master bath, double car garage and formal dining room. Lots of custom built extras. \$186,900. Call Janet Bowser Owner/Broker for an appointment. Nights: 756-6580

CLASSIFIED DISPLAY

CASH BACK!

Here are a few examples of the hot summer savings:

\$2400 CASH BACK!

Tough Toyota Trucks

Choose your Toyota truck and get \$2400 cash back! Standard or long bed, Xtracab, SR5, 2-wheel or 4-wheel drive—your choice, and your savings!

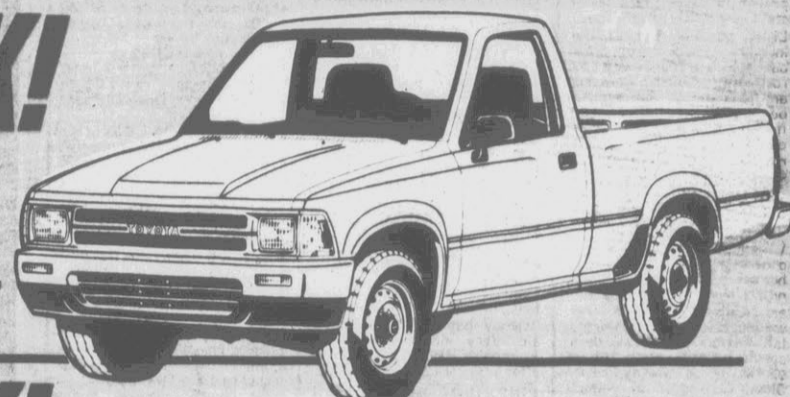

\$1400 CASH BACK!

Corolla 4-Door Sedans

We have 20 1989 Corolla 4-door sedans in stock—all with automatic transmission (model 1703) and all with \$1400 cash back!

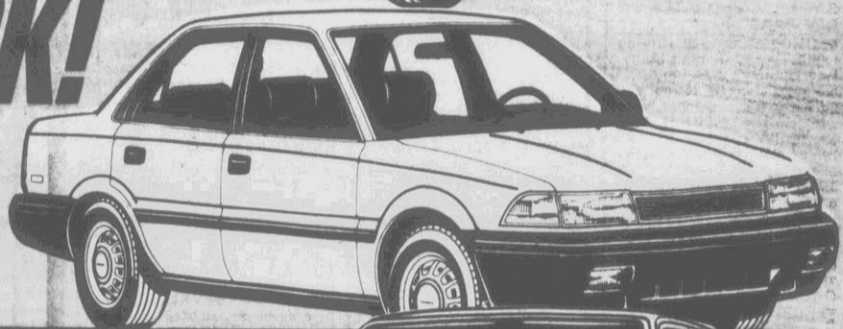

\$1000 CASH BACK!

Toyota Camrys

Camry comfort, quality, and reliability—and now \$1000 cash back! Who could ask for anything more?



TOYOTA EAST

Highway 264 Bypass Greenville
756-3228 Toll-free: 1-800-682-5437

\$25 CASH!

Get \$25 cash upon completion of a test drive at Toyota East. No purchase necessary, no obligation to buy. One redemption per customer, good through 7/22/89.

TOYOTA EAST Highway 264 Bypass Greenville 756-3228

\$25 CASH!

Test drive any brand-new 1989 Toyota car or truck at Toyota East and get \$25 cash! There's no obligation, no purchase necessary—discover Toyota quality and performance for yourself, and we'll give you \$25 for your time.

Premium Values.

"Premium Values" is more than a name. It's exactly what you'll find here. The finest selection of previously-owned cars and trucks from Toyota East, so you're assured of the quality. And you're assured of the value, because each one is backed by a free 3-month/3,000 mile limited warranty. Discover the premium values at Premium Values now.

1986 Nissan Sentra \$5495 ~~\$15600~~ /month
1004TA Fully equipped 4-door sedan with AM/FM cassette, air conditioning, cruise control, and more.
36 months term at 13.5% APR, with approved credit and \$1000 down, cash or trade. Tax and tags are extra.

1986 Isuzu I-Mark \$4995 ~~\$14611~~ /month
5254A, Air conditioned 4-door sedan.
36 months term at 13.5% APR, with approved credit and \$600 down, cash or trade. Tax and tags are extra.

1985 Nissan Sentra \$3600 ~~\$10449~~ /month
1001, Good looks and economy!
36 months term at 13.5% APR, with approved credit and \$600 down, cash or trade. Tax and tags are extra.

1986 Chevrolet Spectrum \$4495 ~~\$13500~~ /month
10061, Great car!
36 months term at 13.5% APR, with approved credit and \$600 down, cash or trade. Tax and tags are extra.

Premium Values BY TOYOTA EAST

Highway 264 Bypass Greenville 756-3228 Toll-free: 1-800-682-5437

- 1987 Toyota 4-Runner**
#5186B 4x4, grey, automatic transmission, cruise control, low miles, air conditioning, AM/FM cassette, power windows and more!
- 1986 Toyota 4-Runner**
#5342A 4x4, automatic transmission, air conditioning, AM/FM cassette, blue
- 1987 Chevrolet Celebrity**
#9882P 4-door, blue, automatic transmission, low miles
- 1988 Toyota Camry**
#9948P 4-door, automatic transmission, good mileage
- 1987 Nissan Maxima Wagon**
#10191 Automatic transmission, sunroof, loaded with equipment!
- 1987 Mitsubishi Montero**
#10198 4x4, air conditioning, AM/FM cassette, only 20,000 miles
- 1989 Toyota Camry Wagon**
#10233, Automatic transmission, low miles, excellent condition
- 1987 Nissan 200SX**
#10242 V-6, automatic transmission, sunroof, loaded with options
- 1988 Nissan 240SX**
#10264, Automatic transmission, air, AM/FM cassette
- 1985 Peugeot 505**
#10287 4-door sedan, low miles, air conditioning, automatic transmission
- 1987 Toyota Cressida**
#9412 Automatic transmission, loaded, white
- 1986 Toyota Celica GT5**
#10189 Red, sunroof, automatic transmission, loaded
- 1988 Pontiac Grand Am**
We have a good selection, all fully-equipped and priced to sell!

Wednesday Classifieds

144 Houses For Sale

SHERATON VILLAGE For sale by owner: 3 bedroom 2 1/2 bath townhouse. Assumable FHA loan. 756-8346 for appointment.

SOARING HARDWOODS And Gorgeous Azaleas grace this park-like setting! If you yearn for privacy and contemporary styling, then this fine 3 bedroom, 2 bath home with spacious deck will appeal to you. Freshly painted inside and out! \$81,000. Please call Kay Preston Stine, CENTURY 21 JANET BOWSER & ASSOCIATES, 355-7800 or 355-5127.

STATELY TWO-STORY Home in Bethel - that has charm, and quality throughout! From appealing to hardwood floors, 3 bedroom with one down, 3 baths. Lovely formal areas, paneled den with fireplace, and music room. New heat and air. Attached double garage. This home is only a few minutes from Greenville, ideal for those who want to live in a small, friendly town. See it and you will love it! \$120,000. Call Aldridge & Southernland, 756-3500 ask for Katherine Vinson 752-5778.

STATELY TRADITIONAL. This beautiful brick home in Westhaven features 3-4 bedrooms, huge master suite with office and massive designer master bath, double car garage and formal dining room. Lots of custom-built extras. \$186,900. Call Janet Bowser CENTURY 21 JANET BOWSER & ASSOCIATES, 355-800 or 756-8580.

TAKE A SECOND LOOK! This 3 bedroom, 3 1/2 bath home presents a modest face to the street, but is loaded with space. Living room with fireplace, dining room, kitchen with breakfast bay, full basement with rec room and fireplace, workshop and garage. One bedroom has built-ins for use as a study or office. Only by walking through can you appreciate so much room. Low 90's. 758-0495.

TREETOPS CONDO for sale. \$59,500. Fireplace, 2 bedrooms, 2 baths, washer, dryer, microwave. Call 355-2370.

VAULTED CEILINGS in the great room, kitchen, and 3 bedrooms, of this great contemporary make it especially airy and bright! Placed on a large wooded, corner lot, it features a loft, flexible floor plan, deck, spacious storage building. \$79,900. Please call Kay Preston Stine, CENTURY 21 JANET BOWSER & ASSOCIATES, 355-800 or 355-5127.

REDUCED! Non-Qualifying Loan assumption on this pretty traditional style home. 3 bedrooms, 2 baths, formal dining room, beautiful living room with exposed ceiling beams, fireplace, custom window treatments and more. Plus an unfinished room upstairs with 38 square feet, attached garage and big open back yard. There's more, but why read about it? You need to see this home! Priced to sell quickly at \$79,900. Call Mike Walston at CENTURY 21 JANET BOWSER & ASSOCIATES, 355-7800 or 756-3495.

REDUCED! MID 50'S Country Club Area Grillon. You don't have to be rich to own home in a well established neighborhood. Only one block to the golf course and pool. This 3 bedroom, 2 bath home is a must to see. Special features include cathedral ceiling, fireplace with woodstove, garage, and wooded lot. Call Allis Irwin at CENTURY 21 JANET BOWSER & ASSOCIATES, 355-7800 or 355-7744.

BOLLINGWOOD HOME Retirement Community. Near shopping and golfing, quiet and peaceful, 2 and 3 bedrooms uniquely designed, 1 story clustered home, affordable price. Mid \$60s. Appliances furnished. Fireplace is optional, private courtyard. Call Mary at Davis Realty, 355-2900 or nights, 756-1997 or 756-2904 or 355-2574.

SEEING IS BELIEVING Assume 8.75% loan to qualified buyer. Payments about \$405. Attractive starter home, completely redone, new roof, central heat/air, beautiful hardwood floors, tastefully decorated, 3 bedrooms, outside storage. \$56k. Call Mary at Davis Realty, 355-3900 or nights 756-1997 or 756-2904 or 355-2574.

144 Houses For Sale

LAKE ELLSWORTH: Beautiful custom contemporary nestled among the woods in Lake Ellsworth. This 3 bedroom home features expansive greatroom with stone fireplace, dining room with built-in china cabinet, and a master bedroom on the first floor. Captivating open floor plan. Offered at \$79,900. Call Janet Bowser at CENTURY 21 JANET BOWSER & ASSOCIATES, 355-7800 or 756-8580.

LET THE SUN SHINE IN! Sparkling greenhouse windows in your newly decorated kitchen looks onto a gorgeous wooded lot, complete with a beautiful deck. If you like to stay indoors, enjoy the cozy fireplace in the spacious, airy greatroom, this fine contemporary won't be available long! With 3 bedrooms, 2 baths. Call Gerry Lambert, CENTURY 21 JANET BOWSER & ASSOCIATES, 355-7800 or 355-7472.

LOVELY NEW HOME with 4 bedrooms, 2 1/2 baths, large living room, formal dining, kitchen with breakfast nook and island, laundry room and garage. Only \$119,900. Call Carolyn Erwin at 355-7878 or home 355-6016. #C26

LYNNDALE: Well-Planned brick traditional on beautiful wooded lot offers 4 bedrooms, 3 full baths, large living room, elegant dining room, inviting family room, plus rec room, and more. \$169,750. Please ask for Nancy Dudley, Aldridge & Southernland 756-3500, or 756-5596.

LYNNDALE: This elegant new home has it all! Formal areas, EXTRA LARGE den, eat-in kitchen, four bedrooms with large master area and an unfinished 3rd story. If BOWSER BUILT and affordably priced at \$159,900. Call Janet Bowser at CENTURY 21 JANET BOWSER & ASSOCIATES, 355-7800 or 756-8580.

MOVING TO GREENVILLE? Call for FREE video of homes in your price range! HOMES BY VIDEO, Inc. Hignite Realtors, 919-757-1969 Anytime.

NEW OFFERING BY Owner: Pineridge, 5 minutes to hospital, 2 bedrooms, 1 1/2 baths, fireplace, large eat-in kitchen, new high efficiency gas heat and central air. Very nice neighborhood. Assumable. \$59,900. Mornings or after 5:30. 758-6735. No Realtors.

PINERIDGE SUBDIVISION: Near hospital, 1067 square foot brick house with 16x20 shop with wiring and plumbing. Call 752-8745.

PERFECTION-Perfection-Perfection. All the nice things you want in a new home, kitchen with oak cabinetry, plus a bay window with a beautiful view. Great room features built-in and fireplace. Three bedroom with 2 1/2 baths. Single car garage. We know of nothing comparable in comfort, appearance and location. You can see it today. \$137,500. Call Aldridge & Southernland, 756-3500 ask for Katherine Vinson 752-5778.

QUAIL RIDGE - A rare find. Exceptionally nice three bedroom FLAT with spacious vaulted living room, which is warmed by lovely woodburning fireplace amidst the beauty of trees and a winding stream adding to the scenic beauty of the setting. Truly set apart in a world of its own. Occupancy within 30 days. \$71,000. Jeanette Cox Agency, 756-1322.

REDUCED TO \$119,500. Prestigious Kingsbrook. Lovely 4 bedroom, bath, brick Williamsburg ranch with all formal areas, den and double garage. New gas pack and solar water heater. Huge lot on quiet cul-de-sac. Please call Sheri Carter at Aldridge & Southernland, 756-3500 or 758-4651.

SEND YOUR KIDS TO Winterville Schools when you move into this new 3 bedroom ranch. For only \$71,500 you can own a top-quality home with spacious greatroom featuring a Cathedral Ceiling and fireplace. Don't wait to pick your favorite carpet and wallpaper. Call Gerry Lambert at CENTURY 21 JANET BOWSER & ASSOCIATES, 355-7800 or 355-7472.

144 Houses For Sale

LAKE ELLSWORTH: If you need a home, not just a house, entertain in this less than 5 year old. All formal areas, total 2,300 square feet, energy efficient. Back yard barbecue and a large storage house. 756-6768.

3 BEDROOM, 2 bath, kitchen combination with fireplace, separate laundry room, formal dining and living room, entrance foyer, 1545 square foot heated, 65 square foot attached storage room, 24x24 detached workshop. \$72,000. 756-4387 after 5pm weekdays, anytime weekends.

4-7/8% FIXED RATE Loans with initial payments as low as 4-7/8% (with no negative amortization) on this 4 bedroom home with vaunted solarium and skylights amid a splendor of lush plantings and automatic sprinkler. Don't let this opportunity pass you! Truly a home worthy of your attention. Immediate possession. Grayleigh. In the 50s. Jeannette Cox Agency, 756-1322.

150 Land For Sale

3 ACRE HOMESITE, Ready to build on, wooded, with 100% owner financing. Winterville. 1-729-0381.

152 Lots For Sale

ABOVE AVERAGE Size lot. Westhaven-Section 8. Call 355-7627.

BEAUTIFUL CORNER Wooded lot in best area in Clevevood Subdivision. For more information call Parvin Khani at Century 21 Tipton, 355-7002 or evenings 355-3144.

CRAFT WINDS, Winterville School District. All city services, underground utilities, curb and gutter. Offered by RAC Enterprises. Phone 355-6236; 756-9007.

152 Lots For Sale

NEWS FLASH! 1/2-acre building lots. Excellent neighborhood. Winterville school district. Contact Deborah Jones at Aldridge & Southernland, 756-3500 or nights 756-7660.

SPECIAL SALE PRICE - Nice 1/2 acre residential lots in the Winterville School district reduced from \$13,500 to \$12,000. Limited Time Only. Call 758-9210 days; 758-9546 nights.

APPROVED Lots 1/2 acre. 2 miles North of Wellcome Middle School. Good location. 757-1197.

152 Lots For Sale

STERLING TRACE: All lots over an acre in this exclusive area just outside of Greenville. Call Hearthside Realty, 355-3613.

WOODED ONE ACRE LOT Winterville School District. Call 756-2036 anytime.

153 Loans & Mortgages

MILLIONS TO LEND REGARDLESS OF CREDIT

48 HOUR APPROVAL SERVICE

Bill consolidation, home improvements, second mortgage refinancing, first purchase. If you have equity in your home, we can give you a loan.

1-800-759-MONY

155 Resort Property For Sale

TIME SHARE - week of October 21-27, Maverick Resort, Ormond Beach, Florida, near Daytona. RCI exchange privileges. REDUCED to only \$5,500 or assume loan. Call Gerry Lambert, CENTURY 21 JANET BOWSER & ASSOCIATES 355-7800 or 355-7472.

WATERFRONT LOT 100x180 deep well, Aurora Beach, NC. \$29,999. Call 756-4974.

"DREAMS FOR SALE"

What's The Difference Between A New

Toyota Cressida & Buick LeSabre

- They Both Have Engines
TOYOTA: 3.0 liter, DOHC, EFI, V-6 BUICK: 3.8 Liter, 3800, SFI, V-6
- They Both Have Power Driver Seats
TOYOTA: 540 BUICK: 6-way power driver's seat
- They Both Have Door Locks
- They Both Have Cruise Control
- They Both Have Transmissions
- TOYOTA: 4 speed, automatic, overdrive BUICK: 4 speed, automatic, overdrive
- They Both Have A Drive Train
TOYOTA: Rear Wheel Drive BUICK: Front Wheel Drive
- They Both Have Seating Capacity
TOYOTA: 5 BUICK: 6
- They Both Have Tires:
TOYOTA: P195/65R15 BUICK: P205/75R14
- They Both Have A Great Ride
TOYOTA CRESSIDA Cost: \$27,738 BUICK LeSABRE Cost: \$15,835

The Difference Is \$11,903!
In other words, some people will pay \$11,903 so you will have a good opinion of them. Wouldn't you really rather drive a Grant Buick and have a good opinion of yourself?

BUICK Grant

See One Of Our Professional Salesmen, Today...
Tom Dickens • Larry Fleigh • Larry Harrell • Ken Brown
Mike Laurin • Doug Rodman • Sam Lancaster • Larry Messer

603 Greenville Blvd. Greenville, N.C. **756-1877** Hours: Mon.-Fri. 8:30-8:00 P.M. Sat. 9:00-5:00

Hit The Road!

Take Your Vacation In A New Car From Sigmon—And Save!

Just in time for summer vacation, Sigmon announces tremendous savings on our tremendous inventory of 1989 models. Get year-end clearance prices now—and hit the road in style! With the money you'll save, your vacation plans just may take you a little further. Have a great summer!



BUICK



1989 Buick Skylark #2535. We have a great selection of these 4-door sedans, fully-equipped including power windows, power locks, wire wheels, cruise control, tilt steering, AM/FM cassette, and more!

SAVE UP TO \$2000!



1989 Buick Century #2531. This roomy 4-door sedan is loaded with power—a 3300 V6—and comfort: power windows and locks, electric seats, tilt steering, cruise control, delay wipers, and more!

SAVE UP TO \$3000!



1989 Buick Regal #2400. The 4-door Regal features power windows, locks, electric seats, aluminum wheels, cassette—it's loaded!

SAVE UP TO \$3200!

1989 Buick LeSabre #2556. Great selection, 4-door sedans with power windows, power locks, power seats, cassette, and more!

1989 Buick Park Avenue #2551. Fully equipped, \$3200 below MSRP!

1989 Buick Electra Limited #2545. Great equipment, great price—\$3200 below MSRP!

CHEVROLET



1989 Chevrolet Cavalier #5068, 4-door model with air conditioning, automatic transmission, body side molding, and much more!

Clearance priced from \$9495

Only **\$195**/month



1989 Chevrolet Caprice Classic #5024 4-door sedan with big V-8 power, tilt wheel, cruise control, delay wipers, and more!

Clearance priced from \$13,495

60 months term at 13.0% APR with approved credit and \$900 down, cash or trade. Tax and tags are extra.

TRUCKS



1989 Chevy Trucks



1989 GMC Trucks

Whatever you're looking for in a truck, Sigmon's got it, and we've got it for less! Let us show you: we give you more truck for your buck!

PONTIAC



1989 Pontiac 6000 LE #3253. This 4-door model features a V-6 engine, power windows, power locks, power seats, aluminum wheels, cassette, and more!

Clearance priced from \$12,289



1989 Pontiac Bonneville #3280. With power windows, power locks, power seats, cassette, aluminum wheels, loaded!

Clearance priced from \$14,495

SPECIAL PURCHASE

We've got 2 of the hottest sellers at the year's hottest prices!



1989 Buick LeSabre

A great selection of 4-door models, fully-equipped including power windows, locks, tilt wheel, cruise control, AM/FM cassette, wire wheel covers, split seats and more!

Clearance priced only \$13,995



1988 Chevrolet Sprint 10 to choose from, both 2-door and 4-door models. With air conditioning, automatic transmission/AM/FM stereo, and rear window defogger.

Clearance priced only \$5495

Only **\$123**/month

48 months term at 13.0% APR with approved credit and \$900 down, cash or trade. Tax and tags are extra.

PREVIOUSLY-OWNED

- #8317 **1987 S-10 Blazer 4x4**
With Tahoe package, alloy wheels, tilt wheel, cruise control, automatic transmission, V-6 engine, 1-owner
- #8348 **1987 Pontiac Bonneville**
4-door, automatic transmission, air conditioning, tilt wheel, cruise control, cassette, 1-owner
- #8319 **1988 Ford Mustang GT**
5-speed, air conditioning, 5.0 liter V-8, extra sharp 1-owner trade!
- #8352 **1988 Chevrolet Corsica**
4-door, automatic transmission, power steering, air conditioning, only 23,700 miles, great family sedan, only 1-owner!
- #8322 **1985 Chevrolet Caprice Classic**
V-8, loaded with equipment, 1-owner, local trade
- #8313 **1987 Pontiac Firebird**
Formula, big V-8 power, T-tops, very sporty and loaded with equipment
- #8344 **1988 Toyota Truck**
Long-bed, 5-speed, air conditioning, bedliner, only 2,800 miles, 1-owner
- #8341 **1989 Chevrolet Silverado**
4x4, 350 engine, beautiful blue and white, must see!

All sale prices include all applicable manufacturer rebates and incentives. Tax & tags are extra.



SIGMON

Chevrolet • Buick • Pontiac • GMC

Highway 264 Bypass Farmville 753-7103

\$600-\$1,200 SAVINGS!

WE DON'T HAVE HIGH-PRICED DEALER ADD-ONS!

The Drive To Farmville Is Worth The Trip!

Wednesday Classifieds

155 Resort Property For Sale

HOFFMAN BEACH at Salter Path, 5 bedroom furnished home, beautiful ocean and sound view from 4 decks, situated on 2 lots with private beach access, second row home. Real bargain at \$215,000. Call 746-6569 office; 746-3541 house.

HUNTERS' PARADISE! 477 acres, 135 clear, 14000 sq. house. Deer and turkey galore. Near Williamson and the Roanoke River, 1 mile off road. BEN WILSON REALTY 795-4687

OWN A PIECE OF THE ISLAND. Bald Head Island for sale, below market price. 756-0765.

PAMLICO RIVER. Lovely wooded lot only 30 minutes from Greenville with great view of Pamlico River. \$75,000. Call Kathy Webster, Webster & Associates Realty, 355-5712 or 757-6435.

PAMLICO RIVER. Canal lot with river view. This lot is only 30 minutes from Greenville and is wooded. Great for doublewide home. \$25,000. Call Kathy Webster, Webster & Associates Realty, 355-5712 or 757-6435.

VERY NICE 14x70 Mobile Home. Located at Croatan in Atlantic Beach. 3 bedrooms, 2 full baths, with extra large deck. Boat access and swimming pool access. \$30,000. Call Janet Bowser-Owner/Broker, CENTURY 21 JANET BOWSER & ASSOCIATES, 355-5700 days, 756-8500 nights.

157 Townhouses For Sale

JUST LIKE NEW! Owner transferred after living in unit only 3 months. Lost of extras including jacuzzi and beautiful brass fixtures. Must see to believe. Call today. Ben Strickland, CENTURY 21 JANET BOWSER & ASSOCIATES, 355-8000 or 355-3059.

LUXURIOUS TOWNHOUSE With 3 bedrooms, 2 1/2 baths, and an unfinished 3rd floor. Floor plan features a sunken living room and sunken dining room. The patio is enclosed with a privacy fence and has a storage building. With 1500 square feet this townhouse is priced at \$82,500. Please call Janet Bowser, CENTURY 21 JANET BOWSER & ASSOCIATES, 355-8000 or 756-8580.

NEW 1/2 DUPLEX. Exceptional 3 bedrooms, 2 1/2 baths, fireplace, screened in porch. Close to new Lowe's store. Selling below appraisal. Call after 6pm, 756-8961.

QUAIL RIDGE. Pick of the litter. The best end unit in the best building in the best block of Quail Ridge. 3 bedrooms, 2 1/2 baths, large living room, formal dining room. Sought after Alexander model. The lush enclosed patio becomes part of living area. \$81,500. Please ask for Nancy Dudler at Aldridge and Southernland, 756-3500 or 756-5596.

TWIN OAKS. Very low equity, non-qualifying loan assumption available on this 2 bedroom, 1 1/2 bath townhouse. Call Rod Tipton at Century 21 Tipton & Associates, 355-7002 or 355-2242.

WINDY RIDGE 3 bedrooms, 2 1/2 baths, exceptional townhouse, new carpet, freshly painted, ready to move in. \$55,800. Please call Todd Ramsey, Aldridge & Southernland, 756-3500 or nights, 752-6656.

161 Apartments For Rent

A BEAUTIFUL PLACE • ALL NEW 2 BEDROOMS • UNIVERSITY APARTMENTS 2899 E. 5th Street (Ask us about our special rates to change leases, and discounts for June rentals.) • Located Near ECU • Near Major Shopping Centers • ECU bus service • Onsite laundry • Contact J.T. or Tommy Williams 756-7815 or 758-7433

• AZALEA GARDENS • CLEAN AND QUIET one bedroom furnished apartments, energy efficient, free water and sewer, optional washers, dryers, cable TV. \$215 a month. 6 month lease. MOBILE HOME rentals. Apartments and mobile homes in Azalea Gardens near Brook Valley Country Club. Contact J.T. or Tommy Williams 756-7815

A BEAUTIFUL 1 or 2 bedroom apartment one mile from hospital. One year lease, deposit, no pets, washer/dryer hook-up. Call Heartside Realty Property Manager Division, 355-2112.

STUDENTS! ASK US! 1 bedroom \$160 or 2 bedroom \$225. Others too! DUPLEX! 1 bedroom \$200 or 3 bedroom \$485. Very nice! PETS OK! 1 bedroom \$200 or 2 bedroom \$275. Come on by! SPECIALS! 3 bedroom \$275 or 2 bedroom very close \$350. 752-1375. HOMELOCATORS Fee. Others! AFFORDABLE HOUSING

PIRATES LANDING. AFFORDABLE RENT!! Furnished room with semi-private bathroom. Microwave ovens, laundry facilities on site. Utilities included. Short term lease available also. GREAT ALTERNATIVE TO THE DORMS!!!

113-A EAST 13th STREET. Spacious 3 bedroom duplex, 1 1/2 miles in walking distance to campus. REMCO EAST, INC. (919) 758-6061

AT ECU CAMPUS Ringold Towers. Walk to classes and shopping. Efficiencies, 1 and 2 bedrooms. Fully furnished. Air, carpet, security, laundry. Call Hollie Simonowich, Manager, 919-752-2865.

BAILEY LANE Apartments. Vanceboro applications needed for 2 and 3 bedroom apartments. Full carpeting, central heat and air, refrigerator, range, drapes on site laundry, HUD subsidized rents. EHO. Phone 244-1324.

BROOKFIELD APARTMENTS New 1 and 2 bedroom units on Evans Street Extension for July 1st. Call Heartside Realty, 355-2112. CALL US! 1 bedroom \$140 or 2 bedroom duplex \$210. Hurry! 752-1375 HOMELOCATORS Fee.

Cherry Court Spacious 2 bedroom townhouse with 1 1/2 baths. Also 1 bedroom apartments available. All are carpeted, with modern kitchen appliances including compactor and dishwasher. Central heat and air. Free basic cable TV, washer/dryer hookups, carpet, hook-ups plus laundry room, pool, sauna, tennis court, club house. 752-1557

161 Apartments For Rent

DUPLEX FOR RENT Available August 1, on Huntingridge Road, 1 mile north of hospital on Highway 43. 2 bedrooms, 1 bath, washer/dryer hook-ups. Call 355-7700.

FARMVILLE, 2 bedroom, like new. Appliances furnished, patio, cable ready. Call after 5pm, 753-4750.

GreeneWay Large 2 bedroom garden apartments, all with 7 closets, carpeting, kitchen appliances including dishwasher, central heat and air. Free basic cable TV, water and sewer. Laundry rooms, spacious grounds, playground and pool, abundant parking. Pets allowed. Adjacent to Greenville Country Club. (310) 756-6869.

HAPPY DAYS! 1 bedroom \$160 or 2 bedroom \$200 Act Fast! 752-1375 HOMELOCATORS Fee.

HOUSING FOR THE PROFESSIONAL BROOK HILL 3 bedroom townhome available now. Appliances including dishwasher, washer/dryer hook-ups, patio with outside storage. Winterville School district.

SHERATON VILLAGE. 2 bedroom townhome with 1 1/2 baths. Appliances including dishwasher, washer/dryer hookups, patio.

TWIN OAKS. Spacious 3 bedroom townhome with 2 1/2 baths, fireplace, designer features, country curtains.

WILLOUGHBY PARK. 1 and 2 bedroom luxury units under construction. Preleasing now for August. Fireplaces, ceiling fans, cathedral ceilings. Also 3 bedroom apartment available now.

REMO EAST, INC. (919) 758-6061 KINGS ARMS Large 1 bedroom apartments. Carpeted, modern kitchen appliances, heat pump for energy efficient heating and cooling. Laundry facilities. 1209 Charles Boulevard, Office Apartment 104. 752-8915

KINGS ROW APARTMENTS ONE AND TWO BEDROOM Garden Apartments. Fully equipped kitchen, pool, basketball court, cable TV, 24 hour emergency maintenance and ECU bus service.

LOVE TREES? Experience the unique in apartment living with nature outside your door.

COURTNEY SQUARE APARTMENTS Quality construction, fireplaces, heat pumps, heating costs 50 percent less than comparable units, dishwasher, washer-dryer hook-ups, cable TV, wall-to-wall carpet, thermopane windows, extra insulation.

Office Open 9-5 Weekdays 9-5 Saturday 1-5 Sunday Merry Lane Off Arlington Blvd. 756-5067

NEAR UNIVERSITY, 1st floor of house. Refrigerator, stove, deposit, \$210 month plus utilities. 409 South Harding. 756-0659.

NEW 1 AND 2 BEDROOM and efficiency Apartments available. Call evenings, 758-0088/756-0603.

NEW 1 BEDROOM Apartments. Washer/dryer hookups, carpet, air conditioner. Call 756-3342.

FOR LEASE 11,400 SQ. FT. WAREHOUSE

REDUCED...REDUCED. Near downtown on 14th Street. Darden Realty - 758-1983

THOMAS MOBILE HOME SALES INC.

Across From Airport 752-6068 Just Arrived: New Line 1990 Doublewides By Redman, Mansion, Fleetwood. 14 Wide, 3 Bedroom \$12,495 All Homes Close To Cost

NEW LISTING!

IT HAS EVERYTHING...over 2200 square feet, four bedrooms, 2 1/2 baths, attached 18'x25' gameroom (or mother-in-law suite), corner lot under \$70,000! Call Roger Davenport, 524-5632, #2011.

UPSCALE RESTAURANT in eastern NC. Excellent clientele. 175 seating. Menu includes beef and seafood. 1st-rate location. C006.

161 Apartments For Rent

NEW 1 BEDROOM Apartments, 5 miles past hospital. Call 756-8996 after 6pm.

NICE QUIET 2 bedroom, carpet, air, hookups, quiet area. 756-2671 or 758-9100.

OAKMONT SQUARE APARTMENTS Two bedroom townhouse apartments. Fully equipped kitchen, pool, tennis courts, cable TV, 24 hour emergency maintenance. Very convenient to Pitt Plaza and University. Office hours 9-5:30. Monday-Friday, 1212 Redbanks Road. 756-4151

ONE AND TWO BEDROOM apartments available now. Call 752-3311.

ONE BEDROOM Duplex, Charles Boulevard, \$200. TWO BEDROOM, Washington Street, no appliances, \$225.

PERFECT FOR Four Students to share at ECU campus. Fully furnished (new furniture). Two huge bedrooms, two full baths, carpet, air, security, laundry, Ringold Towers, Call Hollie Simonowich, Manager, 752-2865.

STADIUM APARTMENTS - One bedroom, furnished, \$240. Graduate or professionals preferred. Available immediately. J.L. Harris Realty, 758-6079.

STRATFORD ARMS APARTMENTS Spacious 1,2 and 3 Bedroom Apartments \$200 Security Deposit! Required CABLE TV, TENNIS COURTS, POOL Convenient to Shopping and ECU.

FOR A LIMITED TIME NEW TENANTS ONLY Office hours 9 a.m. to 5 p.m. Monday through Friday 1 p.m. - 5 p.m. Saturday & Sunday Call us 24 hours a day at 756-4800

THREE BEDROOM, two full baths less than \$300 per month. 756-5431.

TOWNHOMES! 2 bedroom 1 1/2 bath \$345/3 bedroom 2 baths \$500 752-1375 HOMELOCATORS Fee.

TWO BEDROOMS, 2 baths, separate dining room, 2 cars, separate parking. \$399. Call Quinn Realty, 355-6258.

TWO BEDROOM, Central heat and air. In city limits. Colonial Village, \$250 and \$360. J.L. Harris Realty, 758-6079.

TWO BEDROOM, NEW CONSTRUCTION, beautiful decor, less than \$200.00 per month! 756-5431.

WE HAVE EVERYTHING BUT YOU! Greenville's affordable luxury apartments.

Fairlane Farms Apartments 1510 Bridle Circle 355-2198 EHO

WEDGEWOOD ARMS 2 bedroom, 1 1/2 bath townhouses. Excellent location. Carrier heat pumps, whirlpool kitchen, washer/dryer hookups, pool, tennis court, draperies. 355-6267.

WOOD'S EDGE Spacious two bedroom duplexes located in a quiet residential community in Heritage Village featuring: Greatroom with cathedral ceiling, fireplace, fully equipped kitchen, washer and dryer connections, energy efficient, outside storage room, private enclosed patios. 756-4151

1 AND 2 Bedroom Apartments. Carpeted, range and refrigerator hookups, carpet, heat pump for central air and heat. 752-8915.

161 Apartments For Rent

1 BEDROOM Apartment for rent. West Avenue. April. Call 746-6555.

2 BEDROOM TOWNHOUSE For rent. \$340 per month. Deposit required. 355-7071 after 6 p.m.

163 Business Rentals BEAUTY SHOP FOR RENT, East 10th Street, \$350 per month. 758-2300 days.

170 Condominiums For Rent AVAILABLE NOW! Good location. 3 bedroom, 2 bath condo in Upton Court. Kitchen appliances included. Cathedral ceiling and fireplace. Very nice unit. \$550. lease, \$550 deposit. 1 year lease preferred. Call Century 21 Tipton & Associates, 355-7002.

NEW 2 BEDROOM First floor villa in beautiful Treetops Subdivision. Living room/dining, all major appliances, fireplace, patio, pool/tennis. 756-8906.

UNIVERSITY CONDOMINIUM For rent with option to buy. \$330 a month. No pets. 2 bedrooms. Call Jeannette Cox Agency, 756-1322.

173 Houses For Rent COUNTRY! 2 bedroom \$400 or 3 bedroom 1 1/2 bath \$460 Nice! 752-1375 HOMELOCATORS Fee.

FOR RENT: 112 Fletcher Place, 3 bedrooms, 2 baths, greatroom with fireplace, dishwasher, central air conditioning, refrigerator included, ceiling fans and window treatment. No pets. \$525 per month. 753-7254.

HOMEOLOCATORS! ATTRACTIVE! 3 bedroom in country. \$375 or 3 bedroom \$425 CAMPUS AREA! 3 bedroom \$450 or larger 3 bedroom \$500 IDEAL PRICE! 2 bedroom \$210 or 3 bedroom \$350 Others! 3 BEDROOM \$295 or very big 4 bedroom 2 baths \$400 Hurry! 752-1375

OTHERS TOO! 9AM-7PM FEE. MEADOWBROOK, 2 bedrooms, 1 bath, beginning August 4. \$210. Call 758-5299.

OVER 2,000 SQUARE FEET 3 bedroom, 2 bath home in The Pines of Ayden. Detached double garage, excellent condition, immediate occupancy. No pets. Short-term lease. \$550 per month. Call Susan Likosar at Aldridge & Southernland, 756-3500 or nights, 756-9229.

THREE BEDROOM, Fleming Street, range and refrigerator. Available August 1, \$295. THREE BEDROOM, Belvoir HWY, private, room for a garden. \$290. J.L. Harris Realty, 758-6079.

UNIVERSITY AREA, Three bedroom, family only. Available August 1, \$450. J.L. Harris Realty, 758-6079.

WALK TO ECU, 3 bedroom, 1 bath. Call 752-2849 from 9:00-10:00 p.m.

WON'T Last 3 bedroom 1 1/2 bath \$375/4 bedroom 1 1/2 bath \$400 752-1375 HOMELOCATORS Fee.

2 BEDROOM HOME including living room with fireplace and screened in porch. Outside pets allowed. Lease and deposit required. \$400 monthly. Call Janet Frutiger at Ball & Lane, 752-0025 or evenings, 756-9229.

203 SOUTH MEADE Street, 3 bedrooms, 2 baths. Central air, gas heat. Available mid August. 756-7116.

3 BEDROOM HOUSE, 4 miles from Greenville on North side of Hospital. \$250 month, \$150 deposit. Call 758-2910.

MATTHEWS SEPTIC TANK CO. • NEW INSTALLATIONS • REPAIRS • PUMPING & CLEANING • PIT GROUP PERMIT #104 • 14 Years Experience • PHONE 753-4097 8 A.M. TO 9 P.M.

173 Houses For Rent

ONE BLOCK TO ECU, 5 bedroom, 2 bath. Call 752-2849 from 5:00-10:00 p.m.

7018 CHURCH STREET in Meadowbrook. 2 bedrooms, newly renovated in excellent condition. \$250. 758-5299.

174 Townhouses AVAILABLE AUGUST 1 at Brook Hill 3 bedroom, 2 1/2 bath townhouse with over 1450 square feet, refrigerator, dishwasher. Pool and tennis courts. \$525 per month. 1 year's lease. No pets. Call Clark-Branch Realtors at 355-2000.

AVAILABLE NOW 2 bedroom, 1 1/2 bath townhome in Lexington Square. Kitchen appliances included. Very nice unit. \$425 lease, \$425 deposit. 1 year lease required. Call Century 21 Tipton & Associates, 355-7002.

CANNON COURT 2 bedroom, 1 1/2 baths, dishwasher, disposal, washer/dryer hookups. \$340. J.L. Harris Realty, 758-6079.

SHERATON VILLAGE - 1 year old, 3 bedrooms, 2 1/2 baths, fireplace and patio. Available mid August. \$530 per month. One year lease and deposit. 355-3551.

SHERATON VILLAGE 2 bedroom, 1 1/2 bath, fireplace. \$440 per month. 756-9777.

TREETOPS 2 bedrooms, 2 baths, fireplace, pool and tennis. Private wooded location. Just like new. \$550, year lease. No pets. Call Brian, 355-5444.

YORKTOWN SQUARE three bedrooms, 1 1/2 baths, nestled in quiet, wooded setting, firewalls between units, extra insulation. Family or professional. Available now. \$25. J.L. Harris Realty, 758-6079.

2 BEDROOMS, 1 1/2 baths, outside storage, washer/dryer hookups. Excellent condition. No pets. \$370 a month. 757-3225.

3 BEDROOM, 1 1/2 bath, \$325 per month. Call Linda Court. Call Edgar or Ellen, 355-6666.

179 Mobile Homes For Rent AIR CONDITIONED 2 bedroom \$130/3 bedroom \$205 Hurry! 752-1375 HOMELOCATORS Fee.

BEHIND VENTER'S GRILL on Mumford Road, 2 large bedrooms, \$400 month, \$100 deposit. References required. Call Dallas, 756-4340 after 5 p.m.

FURNISHED! 3 bedroom \$200 or larger 3 bedroom \$275 Nice! 752-1375 HOMELOCATORS Fee.

MOBILE HOME, 2 bedroom, bath, air. Call 757-1542 after 7:00 p.m.

TWO BEDROOMS, washer, dryer, good condition, in good park. No pets. Call 756-0801 after 5:00 p.m.

TWO BEDROOM mobile home 2 miles east of Greenville. Call 752-6842 after 5:30 p.m.

12x40 MOBILE HOME For rent. 2 bedrooms, washer/dryer and air in nice park. Call 830-0164 after 5pm.

2 AND 3 BEDROOMS. Both furnished including air and washer. Lease and deposit required. 1 child okay. No pets. 758-0745.

2 BEDROOM MOBILE HOME. Deposit required. Call 830-9262 between 10am-6pm.

180 Mobile Homes Lots For Rent

FIRST MONTH FREE! Paved streets, city water, garbage pickup. Call 756-1929.

FIRST MONTH FREE. Large shady lots. Free garbage pickup. Cable available. \$75 per month. Call 752-6643.

MOBILE HOME LOTS For rent. Vandermere, restrictions, cable available, garbage pickup. Call 752-5567 or 975-6170.

SPACIOUS LOT south of Greenville. Paved streets. Water and garbage included in lot rent. Call 756-0461 or 355-0238.

181 Office Space For Rent ATTRACTIVE OFFICE space for rent on Arlington Boulevard. Please call 752-2000.

CALL COMMERCIAL LOCATORS for variety of office spaces. No fee. 830-4759.

EXECUTIVE OFFICE, 1,000 or 2,000 square feet, 2408 South Charles Blvd. 355-7373 days; 756-2092 nights, ask for Leon Fornes.

EXECUTIVE OFFICES And Suites for rent on Commerce Street. Call Gaylord Builders, 756-5550.

FIRST CLASS OFFICE suite at the Charles Centre, \$451 per month. Darden Realty, 758-1983.

OFFICE SPACE: 1400 square feet available now for lease. 2 offices including reception area. Conveniently located off Greenville Boulevard one block from Carolina Telephone. Contact Remco East, Inc. at 758-6061 for details. Call 752-0400.

OFFICE SPACE FOR RENT. 1306 North Greene Street. Call 752-0400.

OFFICE BUILDING, Excellent location, just off Arlington, ground level, some of the 10 offices could be sublet, plenty of parking. Call J.L. Harris Realty, 758-6079 and let us show it to you.

ONE FRONT OFFICE ROOM With Private entrance. Approximately 12x14 feet. \$150 a month. Call JANET BOWSER, CENTURY 21 JANET BOWSER & ASSOCIATES, 355-7800, 756-8580

PRESTIGIOUS OFFICE Space. 313-315 Clifton Street, just off Arlington. Will finish to suit tenants. Utilities, janitor, security furnished. VSV Properties, 355-0327.

SINGLE OFFICE, utilities included, common reception area. \$125 per month. 1902 South Charles. 355-0364.

2 OFFICE SUITES for rent/lease, bath, galley and large conference room. Only \$210 a month each. Parliament Place on Arlington Boulevard. Call Cindy at 758-8810.

184 Resort Property For Rent ATLANTIC BEACH, Salter Path. 3 bedrooms, 2 bath condo. Summerwinds, \$600 per week. Available August 5-12, August 19-26, and August 26-September 2. Call 756-3443.

EMERALD ISLE, second row, 4 bedrooms, \$550 per week. Fifth row, 3 bedrooms, \$350 per week. 1-638-5547 after 6.

184 Resort Property For Rent

MYRTLE BEACH DAYS Ocean front condos, 1, 2, 3 bedrooms. Indoor pools, jacuzzi, health spas, tennis. Special \$59/night up. FREE brochure. 1-800-777-9411, Smith Rentals.

NEW 3 BEDROOM, 2 bath condo, sleeps 10, 5th floor in Summer Winds, Salter Path. 5 pools, health club, ocean view, located on beautiful Atlantic Ocean. Call J.T. Williams, 756-7815 or 1-800-992-8545, be sure to ask for Unit 541. *Make your reservation now!*

THREE BEDROOM CONDO on the ocean, Atlanta Beach. Call 1-800-682-6866.

185 Rooms For Rent FURNISHED ROOM with utilities and refrigerator near college for male. 758-2585.

192 Roommate Wanted FEMALE TO share 2 bedroom, 2 1/2 bath. Washer/dryer. Located Upton Court. 355-7917.

FEMALE ROOMMATE Needed immediately. Nonsmoker preferred. \$150 month, 1 1/2 utilities. Will have own room, 1 1/2 miles from campus. Call anytime 758-2096.

FEMALE STUDENT or professional roommate wanted to share 3 bedroom luxury townhouse. \$200 plus utilities. Please call 752-2019, ask for Miss Harrel.

MALE, Non-smoker, serious student to share Duplex. No pets. \$150 month, 1/2 utilities. Call Hugh-757-4135 8-2pm, 355-3759 home, 752-3241 July 19-23.

MALE OR FEMALE: Own bedroom, 1/2 bath. May use stereo, microwave, cable TV. Must be working, student OK. References required. No smoking, no drinking, no drugs. Call 355-7489.

PRIVATE BATHROOM \$150 per month. Mobile home on private lot. Call 756-0144.

192 Roommate Wanted

FEMALE ROOMMATE wanted to share 3 bedroom apartment near ECU. 1/2 rent and utilities. 355-0753.

FEMALE ROOMMATE Wanted for 3 bedroom townhouse. \$150 plus 1/2 utilities. 355-4834.

ROOMMATE TO SHARE House. \$165 month, 1/2 utilities. Call 355-7089.

SEEKING FEMALE roommate to share house. Half rent, 1/2 utilities. Call Kim, 752-2435 days; 355-4685 nights.

SHARE NICE FURNISHED House minutes from Greenville. \$150 plus 1/2 utilities. Call Tom, 756-8990; nights 757-1050.

SINGLE MOTHER Would like roommate to share duplex apartment. \$125 per month plus 1/2 utilities. Call 752-7700.

TO SHARE 1/2 of 3 bedroom mobile home. Excellent location. \$150 a month. 756-0144.

192 Roommate Wanted

ROOMMATE WANTED: Share furnished 3 bedroom house. 2 decks, jacuzzi, in quiet subdivision, 4 miles ECU. Prefer professional or grad student. \$225 plus 1/2 rent. 757-3467.

194 Wanted To Buy COMMERCIAL AND Light industrial zoned parcels needed in Greenville and Winterville area. Call 757-0248.

WANT TO BUY Standing Timber, all species, timberland and Pulwood. G.R. Haddock, 746-6837 nights.

195 ETC YEARBOOK Contact Lucy Leroy Sievers, 461 Baroca, Long Beach CA 90803.

198 Wanted To Rent MATURE Female Student seeking furnished room within walking distance of campus. 758-8549.

MINI STORAGE UNITS FOR RENT Hooker Road Self Storage, now under new management! Conveniently located off Greenville Blvd. one block from Carolina Telephone. All size units available including extra large units for boats, campers, etc. Rent for three months, receive the fourth month free!

FOR SALE BY OWNER 200-43 Rollins Drive Rollinwood Cluster Homes. 1305 Square feet, two bedrooms, two full size baths, masonry fireplace, and loft. Home has all modern conveniences. Sale price \$59,500. Show by appointment. Call anytime 756-2150 or 355-5986 ask for Mike.

Arsenio Hall Fights Image As Pretender

By Donna Britt
LAT-WP NEWS SERVICE

HOLLYWOOD, Calif. — The gray-on-gray waiting room for "The Arsenio Hall Show" was icily elegant: wraparound sofas; a glossy wet bar; artful cantaloupe slices that former "Diff'rent Strokes" ingenue Dana Plato scarfed after confiding to 4 million viewers how special it was, sitting gap-legged and panty-free in a recent Playboy.

Then everybody saw the mouse. It sat, ignoring the photographer who leaped onto an ottoman, the reporter who dived for a table. Leisurely, as if it had every right to hang out among the semi-famous, the ultra-hip, the mouse glanced left, then right. It sniffed an open case of Soave wine and vanished.

Hall harrumphed in triumph. "I told you there was a mouse in this joint," he announced to his publicist. "Two weeks ago I saw it, but did you believe me when I told you?"

"Nobody around here takes me seriously." Believe that, you probably swallow the fascinated way Hall leans forward, elbows on his Armani-kneecaps, when celebs chatter about life in the fame lane. Because Hall has the best — and in this town, perhaps the only — guarantee for getting taken very, very seriously: a hit.

The Nielsens show that Hall's self-proclaimed, six-month-old "talk show for the MTV crowd" has strutted past David Letterman's and Pat Sajak's talkfests and is inching up on Johnny the Great's (three weeks ago Hall's show whipped Johnny's for the first time in New York). Stars like Anita Baker, Tony Danza and Farrah Fawcett call him to be on his show. Supermarket tabloids won't leave him alone ("ARSENIO PURSUES ROBIN GIVENS! ROARS IRON MIKE: 'LL KILL HIM!'").

Hall is hot. He just finished filming a role in "Harlem Nights," best pal Eddie Murphy's directorial debut costarring Redd Foxx, Richard Pryor and Murphy, and set for a Christmas release. Last month, he started cutting an album for MCA as "Chunky A" (short for Chunkton Arthur Hall), his own humongous, long-lost half-brother. (Hall wore a "fat suit" to introduce Chunky and his theme-phrase — "Chunky A is love, the overweight D.J. sent from above" — on a recent show.)

Hall's so hot that he says he doesn't have time to worry about being sued for \$10 million by Willis Edwards, head of the Beverly Hills-Hollywood NAACP, who claims that Hall defamed him last January by calling him an "extortionist" in a story in the Los Angeles Sentinel — an allegation Hall denies. Edwards last year accused Hall of not having enough black producers, directors or writers on the show's staff; Hall says that at least 30 percent of those staff positions are filled by blacks.

But that suit might help explain why Hall has largely traded his habit of trashing friends, foes and himself in interviews for the rudiments of a protective cover. "Why won't you tell me who you're seeing?" begs a reporter accustomed to the old Hall, who'd provided everything from insights on his sexual escapades to his mom's phone number. "Because you're trying to play me out in a national (publication) and I've got to watch myself," he responds.

These days, he has no intention of letting you know how worried he is, how angry. He'd rather you be taken in by that "see-all-my-gums?" grin; the schoolboy charm that allows him to get away with asking Brooke Shields if she's still a virgin and playing such flagrant on-air footsie with actress Emma Samms that everybody watching knew they'd had an affair.

But no matter how popular or charming he is, how distractingly naughty, one thing is clear: Hall knows that to some of his critics, he's like the waiting-room mouse — an undisputed attention-grabber who slipped into the wrong neighborhood.

And it drives him crazy. "This is my place," he says. "I invite people to my place, not necessarily to do an interview — I'm not a journalist — but to have conversations. I supply the keyhole for America to peep through and see their favorites talking."

Hall's problem is that nobody as def as he is has ever supplied the keyhole. Proof: The star actually uses the term — which in street vernacular connotes cool, great, the ultimate — on the show. ("For those

of you who are confused," he explained once after bandying the term with actor-hooper Gregory Hines, "we are not referring to the hearing-impaired.")

And some audiences and critics — older, often white, decidedly un-def — don't get it.

Some have complained that the show's frankly black sensibility — Hall consistently features African American celebs and music acts, and is more likely to joke about James Brown and Whitney Houston than about Dan Quayle or Ollie North — excludes them. They say that watching Hall's show is a bit like hanging out at a party to which they weren't invited, one where they're the least-hip people in the room.

Implicit in such complaints, says Hall, his voice going Dirty Harry soft, is the assumption that it's fine for shows like Carson's or Letterman's to consistently feature a white sensibility, and that it's okay for blacks, Hispanics and other minorities to do the adjusting.

"That mentality keeps television from expanding to higher levels, and expanding to other people," he says. Because white people who feel that way, he says, obviously can't imagine "what it's been like for us for all these years."

He wishes his critics would "sit down for a minute and try to understand my show as a huge amount of white America is doing, like I did when I watched my first Bob Hope special, my first 'Three Stooges.' ... My whole culturization requires that I understand everything that America is."

To drive the point home, Hall, who often searches pop culture for a witness, finds one in the lyrics to a song popularized by four fairly def white boys:

"I am black, offering a theory," he says. "Let's come together, right now, over me."

Now, even true believers may have some reservations about Hall's late-night love-in, syndicated six days weekly on 160 stations nationwide (that's 95 percent of U.S. markets), by Paramount Domestic Television, in association with Arsenio Hall Communications Ltd. Some decry his fidget-inducing penchant for over-complimenting guests; others feel his outrageousness occasionally backfires (guest Jesse Jackson's first reaction to Hall's gift of a bucket of chicken was to recoil, though he kept hope alive by munching his way through the appearance). Others wonder about the open-lap policy that encourages actresses like Mary Frann, Sally Kirkland and "Falcon Crest's" Ana Alicia to ogle, sit on or otherwise woman-handle the acquiescent Hall.

But to fans, none of this does much damage. Because even when Hall's at his naughtiest — cranking his arm and barking his trademark nasty-dog bark (his studio audience, TV's noisiest, also yaps, howls and cranks its approval), or explaining to females why their boyfriends are unfazed by skepticism about LaToya Jackson's cleavage ("Men don't care if she bought them"), he manages to seem, well, mischievous. Like the preschooler who suggests to your great Aunt Ida that she pass on the lemonade because "Mommy says you drink too much."

Hall's willingness to make mistakes, to be open enough to let audiences peep through the keyhole, could be his biggest weakness. It's also his greatest strength. The resulting lack of pretense, of defenses, ultimately puts guests — and many viewers — on his side.

"He's like a little kid who's about to get into some devilment," says fan La Rhonda Whitehead, a Detroit singer who was among several stars of the stage show "Don't Get God Started," who met Hall recently in Los Angeles. "Like, you can't get mad at him, you know?"

Who could get mad at a guy who, in an effort not to ego-trip ("I'm saving the clippings and tapes so I can trip later"), devised a plan to help kids stay away from drugs? "Right now I've got the ear of America's 18- to 34-year-olds, so ... when I'm not doing the show, I'm trying to figure out what else I can do to help. That's how I came up with my whole drug campaign." With Paramount's help, Hall filmed a series of stark, black-and-white commercials in which he talks with young addicts about the horrors of drug addiction. Currently, the spots are airing on MTV, VH-1 and various independent stations across the country.

How could anybody not love a guy

(See HALL, C6)



The Daily Reflector/Shannon Wolfe

Comic Chip Franklin works and audience at the Attic

Popularity Of Stand-Up On The Rise

By Lane Dunn
THE DAILY REFLECTOR

Stand-up comedy, increasingly popular nationwide, is picking up steam locally, too. Each Wednesday and Friday night, area comedy lovers stand in line at the Attic in Greenville and other clubs around the southeast to see the Comedy Zone.

Joe Tronto, manager of the Attic, says the attendance for the Comedy Zone has skyrocketed: "It's my most consistent night."

The Attic is one of 68 southeastern locations in a network of clubs associated with Creative Booking Services, a subsidiary of Creative Entertainment in Charlotte.

Tom Haines, booking agent and comic evaluator for Creative Booking and owner of the Attic, says the Comedy Zone network reaches from Maryland to Florida and from the coast to the Mississippi River.

He called comedy is the top-growth industry in the entertainment business.

"It is definitely the entertainment of the '80s," Haines said.

One reason for the growth of comedy clubs, Haines says, is stricter drinking and driving laws. Calling comedy "non-drunk oriented type of entertainment," he points out that average alcohol sales are only about two drinks per person.

"It's like going to a movie,"

Haines said of stand-up. "It has a definite beginning and ending."

Lines have gotten so long at the Attic, that the club added Wednesday night to its comedy schedule and began opening an hour earlier. When the Comedy Zone started at the Attic 2½ years ago it attracted 100 to 150 people. More than 300 attend each show now.

The Comedy Zone at the Attic was recently named Comedy Club of the Month and has also received a national honor. The audiences at the Attic generated more votes for top male and female stand-up comics than any club in the country. The Attic gained mention on the American Comedy Awards show.

The largest crowd at the Attic turned out to see Rich Schydner, a nationally known comedian. About 350 fans were brought in, Tronto said, while the club had to turn more than 100 away from the door.

The market for comedians is steadily growing. Haines says his company has more than 900 comics on its computer rolls, employing 240 every month.

Some of the big names are Kevin Hughes, Lance Montalto, Todd Yohn, Scott Shaw and Schydner. Yohn is the most popular comedian at the Attic, according to Tronto.

Whoever headlines locally, the crowds are steadily growing. And one reason, Haines says, is because comedy helps alleviate stress.

"Laughter is healthy," he says, "Everybody should pick out a night and catch a show."

Comic Is 'The Far Side' On Feet

By Lane Dunn
THE DAILY REFLECTOR

He is, The Washington Post says, "The Far Side" on feet. And after seeing a show this weekend at the Attic, Greenville-area comedy fans would probably agree.

"My brother just got a new job," says Chip Franklin. "He always wanted to work with animals ... so now he's a chef."

Not an ordinary funny man by any means, the Washington, D.C. comic says he enjoys challenging his audience. And although he was scheduled to be taped for a Showtime special during his performance at the Attic, the network's no-show didn't slow him a bit.

Franklin has a very droll, dry sense of humor. And his favorite trick seems to be catching an audience by surprise, forcing them to think about the unthinkable.

"I like to do that kind of material," he says in reference to the joke about his brother. "People

don't want to think about animals being cut up but it happens."

He loves to throw a curve. "I used to have a cat," he told the Attic crowd, "but it recently died."

The audience was sympathetic. "He had nine lives," Franklin added, "but the truck had 18 wheels."

Franklin says he doesn't like to take refuge in typical comedy material, which may be why he picked up The Washington Post nickname, but his own brand of humor seems to work well.

He has made appearances on the MTV Funny Papers, The Half-Hour Comedy Break, Showtime, The Comedy Club Network, NBC's Funny People and George Slater's Comedy Club, not to mention a bit role in the movie "Foul Play."

"I don't do that stuff like 'Why do fat people always make funny noises in elevators,'" he says. "To be good you really have to be different."

"Sex is probably 50 to 75 percent of every stand-up comic's materi-

al. But not good stand-up comics. I don't write that much about your stereotypical things."

Franklin says he would like to appear on the "Tonight Show" but thinks "Late Night with David Letterman" would be better suited to his style. He scoffs at the mention of the upstart "Arsenio Hall Show."

"The show is so sophomoric," he says. "The laughs are all cheap shots. He's still doing Rob Lowe jokes."

Phil Tagliaserri, the comedian who opened for Franklin at the Comedy Zone last week, made several remarks about the actor.

Franklin admits that his comedy doesn't go over well with everyone. "It's definitely a matter of taste," he says.

"A woman came up to me after a show and told me 'You should see a psychiatrist.' Well I'm not ashamed to say I've seen a psychiatrist. It's a good way to get to know yourself — and the court made it a condition."

Franklin says that he has depended on show business for his

income for years. He is a former rock-and-roll band member and used to play at Wrong Way Corrigan's, a local bar.

In addition to stand-up comedy Franklin has written columns for the Washington Post, several short stories and is currently working on a novel. He has also had a cartoon published in The New Yorker.

Franklin has played in cities like New York, Boston, Baltimore, Washington D.C. and Cleveland. But he says he likes to play the smaller cities, especially in the South.

"The South is a lot hipper than people think," he says. "I did a show in Rascals in New Jersey — stupidest people I've ever met. The South is a lot better, comedy audience wise, than the Northeast. Catch a Rising Star in New York City is the worst place to work. Because it's stupid people from New Jersey coming over ..."

Franklin says that music is his first love but he enjoys comedy. "In comedy you're paid to create," he says. "In music you're paid to copy."

On The Town

Here are some of the evening entertainment activities scheduled for Pitt County in the coming week:

Attic
Wednesday: WRQR Comedy Zone
Thursday: Major Record Label Showcase
Friday: WRQR Comedy Zone
Saturday: Kid Khoas
Tuesday: Summer Dance Madness Party (20 years old and under only)

Cowboys
Wednesday: Mixed doubles 8-ball tourney
Thursday: Steak night; bring your own
Friday: Ladies' 8-ball tourney
Saturday: Men's 9-ball tourney
Sunday: Party
Monday: Soup and chili night
Tuesday: Practice horse shoes
Phone: 758-6856. Taxi service available.

Hard Times Nightclub
Wednesday — Bruce Frye. Doors open at 8:30 p.m. Ladies admitted free.
Friday and Saturday, July 21 and 22, the Dalton Brothers. Doors open at 9 p.m.
758-3886.

New Deli
Wednesday: Open mike night with drink special
Friday: Bad Bob and the Rocking Horses
Saturday: The Stegmonds
Rio! at the Greenville Hilton
Wednesday: Ladies night
Thursday: Wild Thursdays; music by disc jockeys Matt Zak and Doug Young
Friday: Fun Fridays; expect the unexpected. No cover charge before 8:30 p.m. Music by disc jockeys Matt Zak and Doug Young.
Saturday: Weekend bash; dance music and lighting by Matt Zak and Doug Young. No cover charge before 8:30 p.m.

Tuesday: Classic Rock and Roll. Blue jeans and tennis shoes may be worn.
Music by Matt Zak and Kelly Long.
Hours: 7 p.m. to 1 a.m.

Sports Pad
Wednesday: Wild Wednesday; Ladies night and day. Ladies play free all day, TV sports all night.
Thursday: "Thumping" Thursday. Free balloons. Rock 'n roll music by request provided by John, Jim and Jane, disc jockeys.
Friday: Fabulous Friday. Free popcorn and balloons. Upbeat rock 'n roll music. T-shirt sale.
Saturday: Challenge billiards, air hockey, basketball. TV sports all day. Disc jockey plays requests. Free balloons and popcorn.
Monday: Mild Monday. Free popcorn, air hockey, challenge billiards, Monday night sports on TV.
Tuesday: Tell Tell Tuesday. Music by request with disc jockeys Jim and John.
Hours are noon to 2 a.m. daily.

For information, call 757-3658.
Sharky's
Wednesday: Midnight Madness. Free pizza at midnight; drink special.
Thursday: Import Night. International party. Standing room only after 10 p.m.
Friday: "Dress Up" party. Dancing at midnight.
Saturday: Sharky's dance party.
Monday: Bartender's specials. Monday night sports in stereo on TV; snacks.
Tuesday: Dance party. Ladies' choice drink special; bartender's choice.
To include a club's schedule in 'On The Town,' call The Daily Reflector at 752-6166 before the close of business each Monday. There is no charge for the entertainment schedule, and those who call are asked to leave their name and telephone numbers so that information may be verified.

Embattled Mother Should Make Time For Herself

Dear Abby: I've been reading your column for years, but when I read the letter from "Mom" about the mother of two who felt she needed a glass of wine (or two or three) at night to help her relax, I had to respond.

I am also a mother of two, and they are 13 months apart. Although they are now 7 and 8 years old, I remember those first few years quite well. They were very hectic years, and I also relaxed every night with a glass or two of wine, and I ended up being more tired than relaxed the next morning. That's

Dear Abby
Abigail Van Buren

when I decided to do something about it before things really got out of control.

A good friend suggested that I start exercising two or three times a week with her. I thought she was crazy! If I was dead tired by the evening, where would I get the energy to exercise?

Well, I tried it, and found it a

great escape for a couple of hours. I worked off all my frustrations, and I actually had more energy during the day than I had before. I slept great at night, had more patience with the kids, and improved my figure in the bargain!

You gave her good advice, Abby — she should consider going to A.A. or W.F.S. — but please tell her for me that she needs to find her own escape as I did. Whether it's exercise, crafts or social clubs, the most important thing for her to do is to get out on a regular basis and do

something for herself. — Saved By The Barbells

Dear Saved: I hope "Mom" reads this. She, too, may be saved because you cared enough to write.

Dear Abby: I am a 17-year-old girl with a rather odd problem. When I go to my best friend's house, her father likes to give me a hug, and then he kisses me on the lips. This makes me feel uncomfortable.

He also does this to some of the other girls who come to visit his daughter. I suppose he is just trying to be friendly, but I don't like it, and neither do the other girls.

We keep going there and don't say anything. What should we do? We don't want to be rude. — Kissed On The Lips (Yuck!)

Dear Kissed: Next time you see him, greet him with a smile, turn your head and say, "Not on the lips — on the cheek, please!"

Dear Abby: Is it appropriate for a gentleman to compliment a woman on her perfume, and to inquire as to what kind it is, particularly if they are strangers to one another?

Would the age of the persons involved make a difference? Occasionally I have noticed a very lovely

fragrance in a woman and I have wanted very much to know the name of it so that I could buy some for my wife, but I didn't want to appear as though I was making a pass or trying to flirt.

What do you think? And if you think it's OK, how should I ask? — Wondering In Wisconsin

Dear Wondering: I think it is very much OK to inquire, provided the question is asked discreetly and in a courteous manner.

Universal Press Syndicate

'Cat's Paw' Pattern Adds A Pretty Touch

Enjoy being a girl! This lovely, feminine, knit pullover pairs beautifully with soft summer skirts, pants or shorts, and can also be an elegant sweater for gala evenings any time of year.

A fascinating "cat's paw" pattern panel adorns the front and back of the sweater, which also features an unusual band of ribbing on the bottom and sleeves. Yet another pretty touch is a delicate picot trim on the softly rounded neckline. Both pattern stitches are fun to knit and aren't too difficult.

The gauge in stockinette stitch is five stitches to the inch, and easy-to-follow directions are written for small, medium and large sizes with finished bust measurements of 36, 38 and 40 inches respectively.

To obtain directions for making the Sugar and Spice Top, send your request for Leaflet No. Z-071689 with \$2 and a long, stamped, self-addressed envelope to: Pat Trexler Crafts, The Daily Reflector, P.O. Box 41948, Kansas City, Mo. 64141.

Or you may order Kit No. K-071689 by sending a check or money order for \$19.95 to Pat Trexler Crafts at the same address. The kit price includes shipping charges, full instructions and yarn in your choice of marine blue, magenta, gold or natural.

Dear Pat: I recently found — in a specialty boutique — a hand-knit sweater that I am wild about. It has a ribbing that looks as if it had been done in smocking. Have you ever seen such a stitch, and if so, how is it done? — Marcia M., Seattle

Dear Marcia: You're in luck, I believe the Sheaf Stitch Ribbing in today's featured sweater is just what you're looking for. To try it out, cast on a multiple of 8 stitches plus 2 (any number of stitches evenly divisible by 8 plus 2 additional stitches). For your sample swatch, cast on 26 stitches.

The odd-numbered rows are worked on the wrong side and the even-numbered ones on the right side. Rows 1, 3 and 5 are worked as follows: Step 1 — knit 2; Step 2 —

Pat's Pointers
By PAT TREXLER

purl 2; knit 2. Repeat Step 2 across to end of row.

Rows 2 and 4 are worked as follows: Step 1 — purl 2; Step 2 — knit 2, purl 2. Repeat Step 2 across to end of row.

Row 6 is a bit more involved, but you won't find it too difficult with a little practice. For this row, work as follows: Step 1 — purl 2. Step 2 — insert right needle from the front between the 6th and 7th stitches on the left needle and draw through a loop of yarn; Step 3 — slip this loop onto the left needle and knit it together with the first stitch on the left needle and knit it together with the first stitch on the left needle; Step 4 — knit 1, purl 2, knit 2, purl 2. Repeat Steps 2 through 4 across to end of row.

Rows 7, 9 and 11 are worked the same as Row 1. Rows 8 and 10 are worked the same as Row 2.

For Row 12, work as follows: Step 1 — purl 2, knit 2, purl 2. Steps 2 through 4 are worked the same as in Row 6. Repeat Steps 2 through 4 across to last 4 stitches and end with knit 2, purl 2. Work rows 1 through 12 once and then work Rows 1 through 8 once.

The "cat's paw" pattern stitch also used in today's featured sweater uses two decreases that may be unfamiliar to some readers. One of these is abbreviated as "ssk." To do this, slip the first and second stitches, one at a time, from left to right needle, inserting the right needle tip into each as if you were going to knit it. When both are on right needle, insert the left needle tip into the front of these two stitches and knit them together from this position.

The other, which is abbreviated as "sl 1, k2tog, pss0," is worked as follows: Slip 1 stitch, knit 2 stitches together, pass the slipped stitch off the right needle over the stitch left



Sugar and Spice sweater

after knitting 2 together, thus making a double decrease.

After completing the final row of your ribbing, you will need to work a decrease row to get the correct number of stitches to work the cat's paw pattern. Decrease row: Purl 2 stitches together, purl 8, place a marker on the needle, purl 7, place another marker on the needle, purl 9.

From this point on, work Row 1 and all odd-numbered rows and the stitches before and after the markers on the even-numbered rows in stockinette stitch. These stitches between markers form a panel done in the pattern stitch.

Pattern panel, Row 2: Knit 1, knit 2 together, yarnover, knit 1, yarnover, work the "ssk" decrease on the next 2 stitches, then knit 1.

Pattern panel, Row 4: knit 2 together, yarnover, knit 3, yarnover, work "ssk" on last 2 stitches. Pattern panel, Row 6: Knit 2, yarnover, "sl 1, k2tog, pss0," yarnover, knit 2. Repeat these 6 rows in sequence for desired length.

Universal Press Syndicate

Couple Wed At Sunset On Ocracoke

OCRACOKE — Corinne Lilley Underwood of Greenville and James Haywood Buck of Ayden were married at sunset July 2 overlooking the harbor of Ocracoke Island. The double-ring ceremony was performed by Lonnie Burriss of Ocracoke.

The bride is the daughter of Mr. and Mrs. Gilliam Wilson Underwood of Hertford. The bridegroom is the son of Mr. and Mrs. Paul Moore of Farmville.

The bride wore a cotton-ramie, tea-length dress trimmed in Battenburg lace and featuring a bow detail at the dropped bodice.

Attending the bride and bridegroom were Mr. and Mrs. Kelly Edwards of Winterville and Mr. and Mrs. Vincent Price of Greenville.

The bride is employed at East Carolina University School of Medicine, and the bridegroom is a residential subcontractor in the Greenville area.

The couple will make their home at Route 5, Greenville.

Eastern Electrolysis
205 COMMERCE ST. GREENVILLE, NC
PHONE 756-4034
PERMANENT HAIR REMOVAL
CERTIFIED THERMOLOGIST

UNIFORMS GALORE

COMPARE AND SAVE!!

2301 Dickinson Ave., West of Memorial Drive
Near Buyers Market Mon.-Sat. 9:30 am-5:30 pm

756-1939

Final Summer Clearance
50% To 75% Off

All Summer Clothing

Beginning Thursday, July 20th

Girls Infants to 14
Boys Infants to 10

648 E. Arlington Blvd.
Greenville, N.C.



Little

by

Little

Vicki Evans Interiors, Inc.

brings to Greenville

BEHGOOY ORIENTAL RUGS

SPECIAL

Sale

Sale Begins Tomorrow

Behgooy of Greensboro, a major wholesaler in the South and the Atlanta Mart, is now offering, direct to the public, first-quality hand-knotted rugs in Greenville.

Choose from a million dollars in inventory of a fabulous selection of antique and new rugs. All colors! All sizes!

BRING IN YOUR ROOM MEASUREMENTS INCLUDING YOUR COLOR COORDINATES

-4 DAYS ONLY!-

Thur.-Sun., July 20, 21, 22, & 23

Sponsored by

VICKI EVANS & LISA MOORE
(919) 756-1910

1805 Charles Boulevard • Greenville, North Carolina

Hours: Thur.-Sat. 9AM-7PM • Sun 1PM-6PM

DALLAS ATLANTA GREENSBORO HIGH POINT

summer Savings

Four Big Days

THURSDAY, FRIDAY, SATURDAY, SUNDAY

SAVE AN E-X-T-R-A
15-20%
ON OUR SUMMER
CLEARANCE PRICES

Further reductions have been made on most all sale merchandise and for 4 days only we are offering you an additional 15% discount on 1 pair of men's, ladies' or children's shoes or 20% on any one handbag.

RACK ROOM SHOES®

TOWER MERCHANTS VILLAGE
3523 Maitland Drive
Raleigh, N.C.
Phone 833-5856

BUYERS MARKET
MEMORIAL DRIVE
GREENVILLE, N.C.
Phone 355-2519

MOREHEAD MARKET PLACE
4952 Arendell St.
Morehead City, N.C.
Phone 247-6711

RACK ROOM COUPON #32
1 Pair MEN'S HUARACHES or SANDALS
Take an extra 15% OFF
Good July 20-23, 1989

RACK ROOM COUPON #32
1 Pair LADIES' SUMMER SALE SHOES
Take an extra 15% OFF
Good July 20-23, 1989

RACK ROOM COUPON #32
1 Pair CHILDREN'S SUMMER SALE SHOES
Take an extra 15% OFF
Good July 20-23, 1989

RACK ROOM COUPON #32
ONE HANDBAG OF YOUR CHOICE
Take an extra 20% OFF
Good July 20-23, 1989

Andrea Koppel Is No Clone Of Her Famous Dad

By Mary Corey
LAT-WP NEWS SERVICE

BALTIMORE — "Ted Koppel's daughter." For nearly as long as Andrea Koppel can remember, she has been introduced that way.

And six months at the ABC affiliate WJZ-TV here hasn't changed that, the 25-year-old reporter learned while covering a recent Chinese student rally.

"Ted Koppel's daughter?" an incredulous student asked, a tone of reverence creeping into his voice. Despite slowly carving out her own niche here, she once again had found

herself relegated to the "daughter of" status.

"It's interesting to be Ted Koppel's daughter, but that's not all I'm about," she said after the rally. "I'd like to be known as my own person."

Then, mocking a newsman's enunciated baritone, she quipped: "But they expect me to act like Ted Koppel's daughter."

And how does Ted Koppel's daughter act?

Just like everybody else, say friends and employers. They describe her as down-to-earth, enthusiastic, bright and curious. She is willing to pay her dues, they say, and wants to avoid capitalizing on a last name that spells respectability

in TV news circles. In essence, her actions seem to say: No preferential treatment required.

Sounding more like a proud father than a hard-nosed "Nightline" host, Ted Koppel says, "Quite frankly I'm a biased viewer, but I think she's coming along very well."

Natalea Brown, news director of WJZ-TV, acknowledges, however, that if Ms. Koppel's last name had been Smith, the young reporter with less than three years' experience in radio news probably wouldn't have been granted an interview.

"You do have the advantage in interviews," Ms. Koppel concedes. "But when you get the job you have to prove yourself."

Proving herself at WJZ has meant demonstrating enthusiasm and innovation more often than the non-sense style of her father.

It was during one of Ms. Koppel's first telecasts that Ms. Brown knew the former radio reporter had the affable style to make it in local television. As the season's first snowstorm loomed, she was teased by colleagues about covering the event, which inevitably would find her on the 41st Street bridge — a rite of passage for WJZ's newest reporter. But Ms. Koppel showed up on the bridge, and on the air, seated at a breakfast table she had set up, eating croissants and drinking coffee amid falling snowflakes.

"I was totally surprised," Ms. Brown recalled. "It showed a lot of creativity and humor and a lot of moxie for someone who was there only three weeks. After that I knew she was not a miniature version of her dad."

Her zeal has not kept her from making mistakes, such as missing her deadline on a news story in which a man had barricaded his dead wife and frightened neighbors in an apartment. It was supposed to open the 6 p.m. broadcast, but Ms. Koppel was three minutes late editing the segment. The delay meant the difference between getting prime placement and being buried in the newscast.

While there have been gaffes, there also have been successes. Ms. Brown lauds Ms. Koppel's coverage of a recent house fire, where she managed to convey the story through two shots: one of the mantel, where family portraits lay among the rubble, and another of the family dog, who, unharmed, wagged his tail in the charred kitchen.

If it means sitting in the Batmobile, hopping across lily pads at the zoo or befriending a dog that sits in a golf cart, she comes back to the

station with the goods. It's all in a day's work.

Her father sees these light news stories as good experience for his daughter, whom he describes as a "real rookie."

"If you can handle those dumb feature stories with any dignity, then you can handle others later on," he said.

For much of her life, she, her three younger siblings and her mother, a lawyer, followed their journalist father from New York to Egypt to points around the globe. Despite seeing the thrills of journalism firsthand, Ms. Koppel never thought of pursuing a career in television news.

"I didn't want people thinking I was just doing it because of my dad. I almost convinced myself it (wasn't) a possibility because of him."

She attended high school in Bethesda, Md., where she was the editorial page editor of the student newspaper.



MRS. HALL

Hall-Brown Pair Married

Karen Faye Brown and Timothy Jesse Hall were married at 2 p.m. Saturday in Oakmont Baptist Church.

The Rev. Greg Rogers officiated the double-ring ceremony. Wedding music was presented by organist Becky Tyndall with vocalists Anna Anderson and Clyde B. Case Jr. Lily Weaver directed the wedding.

The bride is the daughter of Mr. and Mrs. Milton R. Brown of Greenville, and the bridegroom is the son of Mr. and Mrs. A.L. Hall of Wilmington.

Given in marriage by her parents, the bride wore a floor-length gown of crystalene with beaded rachel lace over taffeta. The gown featured a Victorian neckline with an illusion

sweetheart yoke, leg o'mutton sleeves and torso waistline appliqued with rachel lace, seed pearls and iridescent sequins. The bouffant skirt extended into a cathedral train applied in a pyramid design with lace motifs, pearls and sequins. She carried a cascade bouquet of mauve and ivory silk tiger lilies, spider mums, seed pearls with white and mauve rosebuds.

Sharon Brown was maid of honor for her sister. Bridesmaids included Marcia Brown, sister of the bride, both of Greenville, Jennifer Hall of Wilmington, sister of the bridegroom, Wendy Peacock of Knightdale and Emily Brown, both cousins of the bride, and Karen Hamm, both of New Bern.

The attendants wore jade satin intermission-length gowns and carried silk tiger lilies, rosebuds and pearls.

The father of the bridegroom was best man. Ushers were David Andrew of Raleigh, Matt Hall, brother of the bridegroom, Tim Smith and Alan Nolan, all of Wilmington and Jimmy Faulkner of Greenville.

A reception was held in the church fellowship hall, and an after-rehearsal dinner was given by the parents of the bridegroom. Other parties were also given in honor of the couple.

The bride is a graduate of North Carolina State University, and the bridegroom is manager of the Footlocker in Raleigh, where the couple will live.

Births

Kittrell

Born to Mr. and Mrs. John Kittrell III, 1602 E. Fifth St., a daughter, Alexandra Gaines, on June 23, 1989, in Pitt County Memorial Hospital.

Hyman

Born to Mr. and Mrs. Rubin Hyman, 310 Lindsay Drive, a daughter, Jasmine Danielle, on June 23, 1989, in Pitt County Memorial Hospital.

Dail

Born to Mr. and Mrs. Glenn Dail, Kinston, a son, Spencer Glenn, on June 23, 1989, in Pitt County Memorial Hospital.

Wood

Born to Mr. and Mrs. Philip Wood, Walstonburg, a daughter, Tiffany Elise, on June 24, 1989, in Pitt County Memorial Hospital.

Wood

Born to the Rev. and Mrs. Philip Wood, Walstonburg, a daughter, Tiffany Elise, on June 24, 1989, in Pitt County Memorial Hospital.

Marchman

Born to Mr. and Mrs. Charles Marchman, 3412-D Evans St., a daughter, Helen Foster, on June 25, 1989, in Pitt County Memorial Hospital.

Mills

Born to Mr. and Mrs. Samuel Mills, 2815 Ellsworth Drive, a daughter Courtney Marie, on June 25, 1989, in Pitt County Memorial Hospital.

Varner

Born to Mr. and Mrs. Jimmy

Varner Jr., Grimesland, a daughter, Nina Leigh, on June 25, 1989, in Pitt County Memorial Hospital.

Kinlaw

Born to Mr. and Mrs. Kenneth Kinlaw, 102 Tanglewood Drive, a son, Madison Allan, on June 26, 1989, in Pitt County Memorial Hospital.

Jones

Born to Mr. and Mrs. Seth Jones III, Farmville, a son, Daniel Seth, on June 26, 1989, in Pitt County Memorial Hospital.

Rose

Born to Mr. and Mrs. Bert Rose, Havelock, a daughter, Caroline Cannon, on June 26, 1989, in Craven Regional Medical Center, New Bern. Mrs. Rose is the former Ramona Cannon of Greenville.

Neill

Born to Dr. and Mrs. James Neill, 112 Hearthiside Drive, a daughter, Meredith Lane, on June 26, 1989, in Pitt County Memorial Hospital.

Schneider

Born to Mr. and Mrs. Arthur Schneider, 202 River Hills Drive, a daughter, Kara Michelle, on June 26, 1989, in Pitt County Memorial Hospital.

Futrell

Born to Mr. and Mrs. Dwayne Futrell Sr., Kinston, a daughter, Barbara Nicole, on June 26, 1989, in Pitt County Memorial Hospital.

Sutton

Born to Mr. and Mrs. Joseph Sutton, Farmville, a daughter, Stacy Elizabeth, on June 27, 1989, in Pitt County Memorial Hospital.

Roberson

Born to Mr. and Mrs. Marvin E. Roberson, Shady Knoll Mobile Home Park, a son, Rashad Sentel, on June 27, 1989, in Pitt County Memorial Hospital.

Miller

Born to Mr. and Mrs. Christian P. Miller, 1726 Beaumont Drive, a son, Matthew Christian, on June 27, 1989, in Pitt County Memorial Hospital.

Deal

Born to Mr. and Mrs. Robert Deal, Stokes, a son, Justin Craig, on June 27, 1989, in Pitt County Memorial Hospital.

Laughinghouse

Born to Mr. and Mrs. Haywood Laughinghouse, Route 11, Greenville, a daughter, Melissa Marie, on June 28, 1989, in Pitt County Memorial Hospital.

Small

Born to Mr. and Mrs. Fairleigh Small, Rocky Mount, a daughter, Grace Louise, on June 28, 1989, in Pitt County Memorial Hospital.

MOM! DAD! GRANNY!

Need A Break
On Saturdays?
Call 758-7432

Ellen's Day Care

Rt. 5, Greenville, NC

Fun, Games, Balloons, Clown,
Mini-Golf And More!

GORDON'S
All Golf Shoes
On Sale Til July 31
284 By Pass 756-1003

UNIQUES
Crafts & Antiques
Vacation Sale July 19-29

Lace Window Hearts	\$2.99
Country Magnets	99¢
8" Lace Victorian Bears	\$13.95
10" With Parasol & Stand	\$23.95
Beautiful Small Oak Hall Tree	\$329

Lots Of Unadvertised Specials In Our Craft, Antique & Used Furniture Depts.
752-7023
New Hours: Mon.-Sat. 11-6
Corner Of Pitt & Chicod St.
Grimesland

Dr. Andrew E. Haven
and
Dr. William E. Brown
are happy to
announce that
Dr. George H. Freeman
is joining
Greenville
Women's Clinic
for the practice
of obstetrics
and gynecology

2245 Stantonsburg Rd.
(across from hospital)
For appointments:
Call 757-3131

There's Never
Been A Better
Time To Shop At
J.A.'s Uniform Shop
Sale Continues
1/3 Off

J.A.'s Uniform Shop
1710 W. 6th St.
Greenville, N.C.
752-2426

Belk
the plaza greenville

encore!
a continuation with a twist...

THE PLAZA

Meeting Place

Wednesday
6:30 p.m. — REAL Crisis Invention Center meets.
7 p.m. — Greenville-Pitt County Youth Council meets at the Greenville Recreation and Parks Department, Cedar Lane.
8 p.m. — Narcotics Anonymous opening discussion meeting at St. Paul's Episcopal Church.

Thursday
9:30 a.m. — Town and Country Senior Citizens meet at St. Paul's Episcopal Church.

Noon — Alcoholics Anonymous meets at St. Paul's Episcopal Church.
6:30 p.m. — Exchange Club meets.
7 p.m. — Greenville Elks Lodge No. 1645 meets.
7:00 p.m. — Overeaters Anonymous meets at First Presbyterian Church.
7:30 p.m. — Duplicate bridge meets at Senior Center.
8 p.m. — Nonsmoking Support Group for Adult Children of Alcoholics and Dysfunctional Families meets in the church parlor of First Presbyterian Church.

Summer Reductions
All Summer Merchandise Now
50% off
All Sales Final. Cash Only
C. Heber Forbes
600 Arlington Blvd. Arlington Village 756-8210

Fans Pour In To Hear The Rainmakers' Lyrics

By Len Righi
LAT-WP NEWS SERVICE

Bob Walkenhorst, front man for the Rainmakers, says lately that he has been deluged with letters from fans. What do they ask about? His favorite color? His marital status? Career advice?

"It's always the lyrics," said the 35-year-old singer-songwriter-guitarist for the Kansas City, Mo., foursome. "They tell me what they got out of them. It's the perfect completion of the circle. I have these experiences, put them into songs, people hear them and write back to me and tell me what they mean."

The Rainmakers are a fine roots rock 'n' roll band. But Walkenhorst's witty observations and provocative messages set the group apart. Which makes Walkenhorst's anger that the lyrics are not printed on the inner sleeve of the band's third Mercury-PolyGram LP, "The Good News And The Band News," understandable. "Some cheap SOB at PolyGram decided on a policy not to print lyrics (with) LPs any more. The lyrics are included with the tape and the CD. It's punishment for people who buy albums instead of tapes or CDs."

Walkenhorst said that lack of a lyric sheet will hurt the Rainmakers in countries where English is a

foreign tongue, and particularly in No way, where the band recently spent a good chunk of a six-week European tour. "We're hot stuff there for some unknown reason, always have been, right from the word go. On our first tour of Europe, people were waiting in the snow for us."

Walkenhorst said that his songwriting technique could account for the way he connects with fans. Contrary to many tunesmiths, "I don't write until we're out touring. It's all a result of direct experience. It's just the vibe of what's going on in people's lives."

He said that while he tends to write songs "about the problems of

life," they "don't come off pessimistic. It's like, 'Hey team, let's identify the problem, discuss it and see what we can do.' The bad news is, life is tough. The good news is, you can do something about it."

The band's current single "Spend It on Love," which Walkenhorst calls "a song of conscience," is a good example. Although it spotlights the way money can distort the values of people and governments, its message is essentially positive. Two other tunes echo that theme. "Dry Dry Land" tells of a wealthy man "eaten up by self-concern," while "Horn O Plenty" makes the question of the haves vs. the have-nots personal.

"Doing what I do," Walkenhorst said, "there's always the possibility I might have a lot of money. So I'm asking, if that happens, am I gonna live up to this idealistic stuff or become an elitist rich jerk?"

There isn't always light at the end of every tunnel. "Reckoning Day," Walkenhorst's impression of the 1988 presidential election, "is about a break of faith between the candidates and the people voting for them. You couldn't even vote for people you wanted to, because they knew better than to run."

And on a more personal level, "Hoo Dee Hoo" and "Battle of the Roses" are rooted in the breakup of a marriage: his own.

The new album is as direct as Walkenhorst's songs. Whereas 1987's "Tornado" LP utilized synthesizer and a fuller sound, "The Good News" has the sparseness of the band's self-titled debut. "That was very intentional," Walkenhorst said. "For a long time we hadn't been allowed to record live — record company rules. We changed producers. We tried to find someone who believed all you needed was a good band and a couple of microphones."

That someone was Jeff Glixman, whose production credits include another band of raucous rockers, the Georgia Satellites.

Band's New 'Deadheads' Bring Trouble

By J.D. Considine
LAT-WP NEWS SERVICE

From their laid-back lifestyle to the self-deprecating humor of their nickname, the Deadheads, those hard-core followers of the Grateful Dead, had always seemed a fairly benign force in the rock world. One of the last bastions of hippie gentility, Deadheads balanced an intense devotion to their favorite band with an amiable, peace-and-love attitude toward the rest of the world. If there was such a thing as mellow fanaticism, those smiley-faced, tie-dyed Deadheads embodied it.

At least, that was the legend. But there was nothing mellow about the loud and agitated crowd I found milling about outside Grateful Dead concert in Baltimore two years ago. On the way in, I had to pass an extremely angry young woman who was repeatedly screaming, "Pigs! F— pigs! You people are pigs!"

Of course, long-term Grateful Dead partisans would point out that such brazen behavior is not the stuff of which Deadheads are made. Most Grateful Dead concerts are peaceful events, populated by the sort of fan who would never yell at anyone, much less a fellow concertgoer.

Maybe so, but as its popularity has mushroomed over the past few years, the Grateful Dead has attracted almost as much trouble as new fans. For instance:

Washington, D.C., Council member Nadine P. Winter tried to introduce emergency legislation to prevent the Dead from playing RFK stadium, citing neighborhood complaints in the wake of a 1986 appearance at the stadium. "They were defecating in the area, and you could cut the odor of pot smell with a knife," she told the council. Although the band was banned from playing its hometown of San Francisco after complaints of public defecation there a few years ago, Winters' failure to give the D.C. Council 24 hours' notice ultimately quashed her motion.

Concerts, scheduled this weekend in Wyandotte County, Kan., were canceled after the local government, in response to violence in other cities, raised the show's security requirement from 20 to 140 officers.

In April, some 500 fans trying to get into an Irvine, Calif., concert without tickets began reportedly throwing rocks and bottles at police; two officers were injured and 40 people were arrested, mostly on drug-related or assault charges. A total of 79 arrests was made in the course of the band's three-day stand at the Irvine Meadows Amphitheatre.

That same month, a Cincinnati high school principal called for a ban on Grateful Dead concerts there, alleging that Deadheads sell drugs at the shows. "Our students were really hustled down there by drug dealers," complained Anderson Township High School's Mike Hall.

In Pittsburgh, 25 people were arrested when police tried to move nearly 20,000 fans without tickets off the grounds of the Civic Arena. Ten people were treated for injuries in the ensuing melee; 40 were arrested on charges ranging from drug possession to starting fires.

It has gotten to the point where even the band itself seems alarmed. "We're running out of places to play, and we're running out of ways to say the obvious," warned the group in a letter sent out to fans on the Deadhead mailing list earlier this summer. Among the advice offered in the letter were such tips as "not trashing up where you go, not using people's lawns for bathrooms, not violating local laws."

Otherwise, the band said, "the circus won't be able to travel no mo'."

How did it get to this state? Certainly, the size of the band's current audience is a factor. Although the band's audience has always been intensely loyal, it was until recently fairly small. But beginning with the band's 20th anniversary in 1985, the Grateful Dead's popularity has increased exponentially over the past few years.



Hunt's Thick Ketchup
RICH 32 OZ. BTL. **.99**



Whole Sirloin Tips
U.S.D.A. CHOICE BEEF • BONELESS
CUSTOM CUT FREE POUND **1.68**

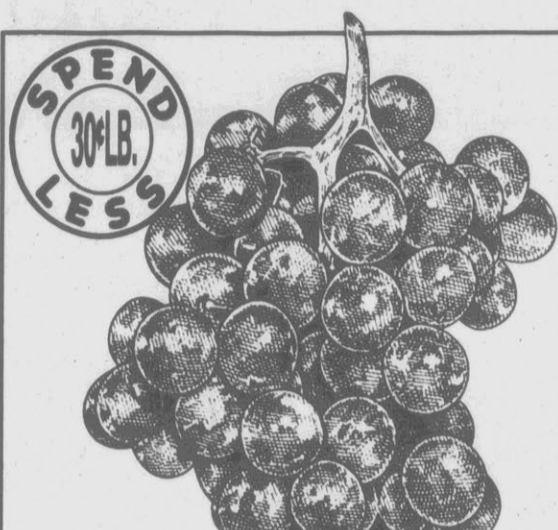

Thompson Seedless Grapes
OR RED SUPERIOR LABEL POUND **.89**

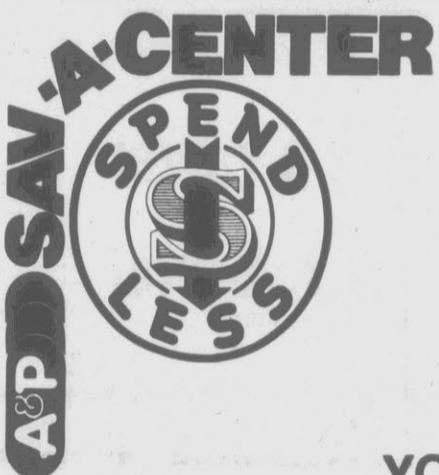

Ivory Liquid Cheer Liquid **FREE** **Ivory Liquid and Cheer**
1.99 99¢
YOUR FINAL COST FREE

Enclosed in the final source statement from one 22 oz. Ivory Liquid—ABO—the net weight statement from one 42 oz. Cheer Powder. NOTE: To remove the final source statement, seal bottle in hot, soapy water 15-20 minutes then begin removal with dull knife. Please send my \$3.00 refund to:
Name: _____
Address: _____
City: _____
State: _____ Zip Code: _____
Place in a stamped envelope and mail to:
IVORY/CHEER \$3.00 REFUND
P.O. Box 8980
Greenville, NC 27605
PLEASE NOTE THESE ADDITIONAL TERMS:
1. OFFER GOOD ONLY IN AL., AR., CA., FL., GA., HI., IL., IN., MD., MI., MN., MO., NC., OH., PA., SC., TN., VA. AND NY. ONLY IF REQUESTED FROM THESE STATES WILL BE HONORED.
2. THIS CERTIFICATE MAY NOT BE MECHANICALLY REPRODUCED AND MUST ACCOMPANY YOUR REQUEST.
3. Your offer rights may not be assigned or transferred.
4. Limit one refund per name or address.
5. Offer good from July 1, 1989 to August 17, 1989.
6. Please allow 6-8 weeks for delivery.
REGISTRATION IS THE PROPERTY OF WALKENHORST'S CASH REFUND PLAN 1/89/11

SPEND LESS
Crisco Shortening
REGULAR OR BUTTER LIMIT 1 WADDL. \$9.00 PURCHASE **3.199**

SPEND LESS 40%
Ivory Liquid
DISH DETERGENT 22 OZ. BTL. **.99**

SPEND LESS 60%
Perdue Fryer Drumsticks
OR THIGHS+WINGS U.S.D.A. GRADE A FRESH POUND **.99**

SPEND LESS 30%
Large Cantaloupe
CALIFORNIA LARGE 15 SIZE **.99**

SPEND LESS
SLICE+MTN DEW+PEPSI FREE+REG+DIET
Pepsi Cola
2 ltr. btl. **99¢**

SPEND LESS
Natural Light Beer
12-12 oz. can carton **\$5.29**

SPEND LESS \$1/LB.
Boneless Pork Loins
CENTER CUT • CUSTOM CUT FREE WHOLE • POUND **2.99**

SPEND LESS 20%
Red Delicious Apples
WASH. STATE X-FANCY POUND **.69**

SPEND LESS VALUES
Pepto Bismol ORIGINAL 8 OZ. BTL. **2.59**
MRS. FILBERT'S MARGARINE 1 lb. pkg. **.59**
LEMONADE+GRAPEADE OR FLORIDA GOLD FRUIT PUNCH 64 oz. ctn. **.89**
CHILLED+REG.+HOMESTYLE **Tropicana Orange Juice** 64 oz. ctn. **1.29**

SPEND LESS \$1/LB.
DELI BAKERY
Gourmet Turkey Breast OVEN ROASTED POUND **3.99**
CREAMY ORVAL KENT **Deli Cole Slaw** lb. **.99**
FRESH BAKED **French Hard Rolls** doz. **.99**
FRESH BAKED **Italian Bread** 16 oz. loaf **.99**

SPEND LESS 10%
MEAT
Pure Fresh Ground Chuck 3 LBS. OR MORE POUND **1.99**
ALL CHICKEN **Gwaltney Great Dogs** 1 lb. pkg. **.99**
A&P IMPORTED **Sliced Cooked Ham** lb. **3.59**
VACUUM PACKAGED **Gwaltney Sliced Bacon** 1 lb. pkg. **1.29**

SPEND LESS 20%
PRODUCE
Red Ripe Watermelon SWEET & JUICY 1/2 MELON **1.99**
LARGE RED RIPE **California Strawberries** pt. basket **1.29**
TASTY **Fresh Blueberries** pt. box **1.79**
FLORIDA **Fresh Limes** 48 size **5.100**

FARM FRESH

We reserve the right to limit quantities and to correct typographical errors.

The Big Name For Value

Prices Good July 19-22, 1989

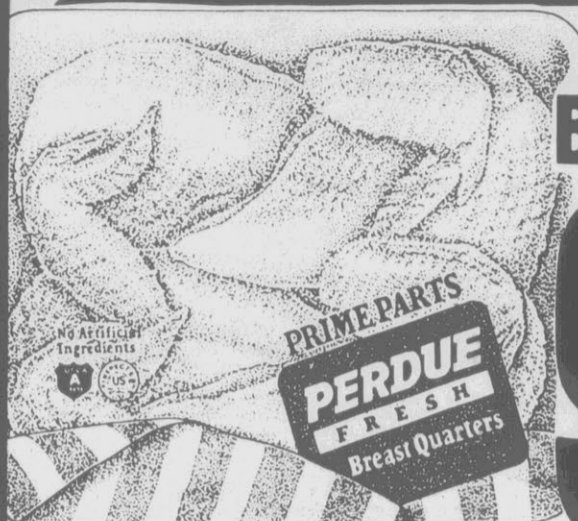

Perdue Breast Quarters

98¢ Lb



California Superior White Seedless Grapes

88¢ Lb

Boneless Chuck Roast

\$1.48 Lb



California Fresh Large Broccoli



87¢ Bunch

Full Cut Boneless Round Steak

\$1.58 Lb

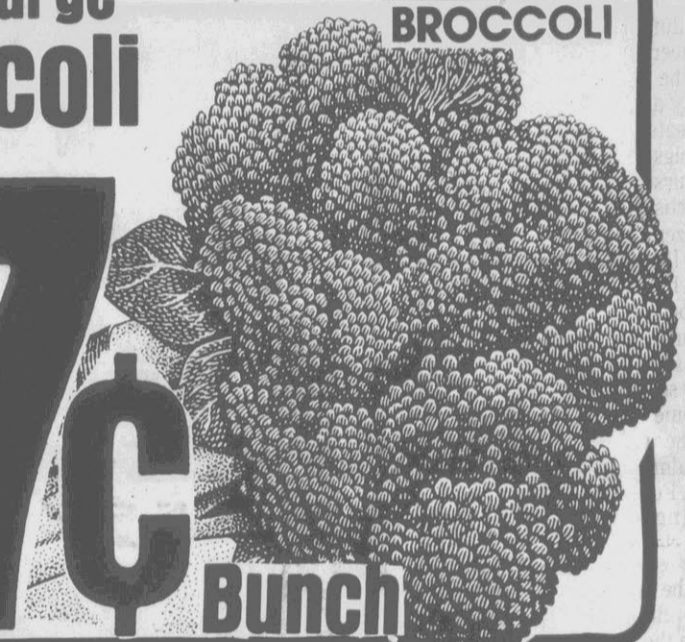
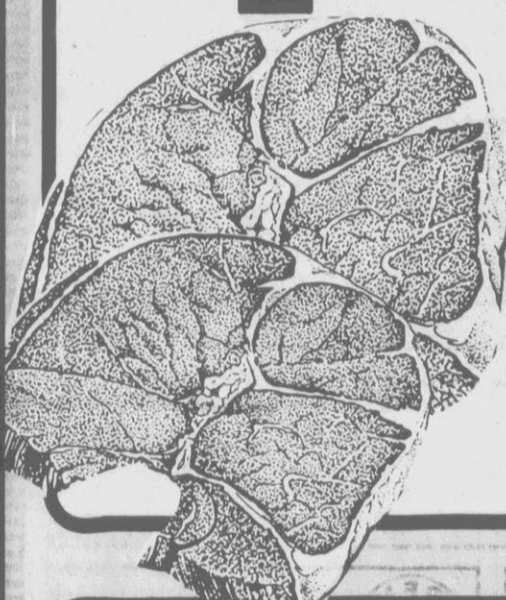

Everyday Low Prices....

- White House Applesauce 16 Oz **2/95¢**
- Kellogg's Froot Loops 11 Oz **\$2.12**
- Lipton Tea Bags 24 ct **\$1.69**
- Peter Pan Peanut Butter 16 Oz **\$1.69**
- Jell-O Gelatin Dessert 6 Oz **78¢**



- Armour Vienna Sausage 5 Oz **2/89¢**
- Tide Detergent 72 Oz **\$4.21**
- Brawny Paper Towels Roll **75¢**
- Minute Maid Orange Juice 16 Oz **\$1.79**
- Borden Cheese Singles 12 Oz **\$1.69**

IN OUR BAKERY

Glazed Donuts

Dozen Only \$1.59

WHEN YOU'RE ENJOYING THOSE SUMMER FRUITS...

DON'T FORGET THE APPLES!
Apple® Computers that is! With your receipts they're helping our schools to strengthen the skills of our children.
See details at the store.
COMPUTERS FOR KIDS

Pepsi Products
2 Liter Bottle

Regular **79¢**
\$1.09

Diet, Caffeine Free

Natural Light Beer
12 Pack, 12 Oz. Cans

\$4.99

Yolo Frozen Yogurt

½ Gallon All Flavors
Tastes Great!

\$2.49

Hall Finds His New Popularity Has Price

(Continued from C1)

who refuses to go bowling with Mr. Box Office himself, Eddie Murphy ("He calls me all the time with, 'Let's go bowling,' and I say, 'Yo, man, bowling's bull — when you're ready to not bowl, we can hook up'")? A guy who admits, "I could easily get caught up in gold chains, fur coats in the summer, sitting in a nightclub saying, 'Bring me another sloe gin fizz and tell that ho over there I'd like to meet her.' But my mom used to say, 'Idle mind, workshop of the devil.' So I stay busy."

Like, is it possible not to be captivated by a fellow who, as a Christmas present last year, moved mom Annie Hall from Cleveland to her very own Los Angeles condo? Who insists on taking out his own garbage and parking his own car? Well, sure. Because just often enough, Hall's likableness and sense of purpose are tempered by a hair-singeing display of ego. Like when he asserts, "I don't believe you can look in the archives of talk show hosts and find a guy who does it as well as I've done it in less than a hundred shows," or "When I look at the other talk show hosts around, there are no comic geniuses there; they don't do as many things as I do."

Hall is a born chameleon, just like the Cleveland kid who distanced himself from the neighborhood children but spent hours practicing magic tricks so he could wow them at self-promoted magic shows. This was a kid Annie Hall had to beg to "go play, get on a baseball team, get your ass out of the house and do something," he recalls. The only child of a Baptist preacher who died a decade ago, Hall was raised by his divorced mother, grandmother and godmother. From the beginning he was a loner who spent most of his

time at home, doing magic, listening to the Temptations and the Miracles while trying to copy their steps, and writing newspapers that nobody read.

And he was obsessed with talk shows.

His mother has said that the pre-adolescent Hall used to watch Johnny Carson and announce, "I want to do what he's doing." Even Hall's show logo — an illegibly scrawled Arsenio — is the result of hours spent in study hall copying the way Dinah Shore signed her name on her show. "I knew I was going to use it someday," he says now.

There wasn't much demand for the autograph when Hall, just graduated from Kent State University, signed on as a salesman with the Detroit company that makes Noxzema skin cream. Perhaps he was taking his cue from the college drama counselor who'd sniffed, "There are audiences and there are stars. You were meant to be in the audience." Still, he started his comedy career in Detroit, refined it in Chicago and eventually took it to L.A.

If there was one turning point in Hall's early career, it was the moment three years ago when singer Patti LaBelle, for whom he was opening, advised the young comic to ignore the "experts" who'd told him he was too "ethnic," too "up" and too "physical" and just to be himself.

And who, exactly, is that? Hall laughs, adjusting his customary off-the-air baseball cap. "If I tell you who I am, my publicist will go crazy, but I'll tell you anyway," he says. "I am an entertainer who was given many talents in many areas so I could do what I'm doing better than anybody's ever done it before. ... I feel I was born to do it."

What Hall did with it the night of the LaBelle show was to cut loose

with his own brand of cocky-humble-innocent-bawdy badness. And he got his first standing ovation for doing it.

His break into prime time was engineered by Joan Rivers, who felt Hall's insouciant, no-holds-barred style was a good match for her own. One night when she was guest-hosting for Johnny Carson, presidential daughter Patti Davis canceled her appearance and Rivers subbed Arsenio, despite Carson's lukewarm feelings about the comedian. When Rivers was fired from her own much-hyped Fox Broadcasting talk show, "The Late Show," Arsenio filled in for her, surprising everybody with a show that was loose, unpredictable — on one show, he challenged Elliott Gould to a game of one-on-one basketball, soundly spanking him — and, yes, def.

Murphy and Paramount lured Hall away from Fox with a movie contract and an offer to costar in "Coming to America." By the time the studio approached him about launching his own show last year, he knew exactly what position he required — executive producer and star. He also knew precisely who he wanted in his audience: MTV fans.

"These kids didn't have a talk show. Where do they see Duran Duran when they want to hear them talk? Where does the urban contemporary audience see Bobby Brown, the number one pop — not R&B, but pop, that means white people bought it — crossover artist in America, who could not get on a talk show?"

Not that the be-bop crowd is the only one tuning in. Hall gets letters from grandmothers who thank him for introducing them to Tiffany and Lisa Lisa and Cult Jam; from 6-year-olds miffed that their moms won't let them stay up to watch. And sacks of them from adoring women who say ...

Women. These days, they're not Hall's favorite interview subject. Because despite the show's rampant lap-hopping, despite the rumors that have paired him with everyone from Brooke Shields to Whitney Houston to Marlee Matlin (we won't even deal with Hall's favorite, which had him in a love triangle with Mike Tyson and Murphy), despite the eager groupies who've seemingly made a career of hopping from him to Michael Jordan to Murphy to Tommy Hearn, Hall has only one true love — his show.

How committed to the show is he? So committed, he jokes, that if "A Different World's" Jasmine Guy — of the taut dancer's body and witchy siren's face, who holds a lifetime spot on Hall's World Class Def list — yanked him by his 100 percent cotton collar and growled, "Marry me," he'd gasp, "No."

Is it normal, he wonders, to enjoy being alone so much? Is it smart to reject the joys of a wife and a family in lieu of, like, a TV show?

"It's one of my most agonizing thoughts," says Hall. "I'm 30 (actually, boyhood acquaintances put him closer to 34), but I guess I can always hook up with a young girl — the time factor isn't as much a consideration for men as it is for women."

"But I don't see any end in sight," he continues. "I wish I wasn't so into what I'm doing. Because you have to have a balance. Some people can do it, have careers and families. They want to do the family thing. And it scares me that I haven't had that desire."

His voice gets softer, more urgent. "Is it going to be too late when I decide? Do I want to do it and I'm too stupid and obsessed with my career? I'm totally scared about my future and when it's all going to happen."

Carolina Events

Cannon Grant To Wesleyan College

ROCKY MOUNT — North Carolina Wesleyan College has received a \$100,000 grant from the Cannon Foundation of Concord to help build an auditorium and fine arts facility.

Wesleyan, founded in 1956, is without an auditorium and there is no other facility in the Rocky Mount area for meetings of 1,500 or more persons. The college's \$8 million fund-raising campaign includes a \$2 million fund for the new facility.

Details Of Brevard Weekend Announced

BREVARD — The coming weekend at Brevard Music Center's summer festival of music opens Friday night with a concert by 18-year-old Japanese violinist Midori. Saturday's program features a concert of popular film music, and the Sunday matinee is a choral concert of works by Mozart and Dan Locklair. Locklair is Brevard's 1989 composer-in-residence. For more details and ticket reservations, call (704)884-2019.

Charity Horse Show At Blowing Rock

BLOWING ROCK — The 66th Annual Blowing Rock Charity Horse Show is Aug. 2-6 at the L.M. Tate Show Grounds. Horses and riders will compete for over \$20,000 in prize money, with more than 400 horses expected to take part.

Tickets will be on sale daily at the gates. Adult tickets are \$5; children under 12, free. For more details, call (704)295-7851.

North Carolina Is National Winner

RALEIGH — For the second consecutive year, North Carolina has received eight winning places — more than any other state — in the third national Take Pride in American awards competition sponsored by the U.S. Department of Interior.

Mrs. Dan K. Moore, chairperson of the N.C. program and three staff members will travel to Washington, D.C. on Monday to receive awards at the White House from President and Mrs. Bush, U.S. Department of Interior Secretary Manuel Lujan Jr., Education Secretary Lauro Cavazos and Agriculture Secretary Clayton Yeutter.

The Daily Reflector Classifieds
752-6166

"When You Want Results!"

BIG LOTS® SUMMERTIME SWEEPSTAKES

Win This

\$2100 Home Entertainment Package
Or one of 340 other great prizes!

ONE GRAND PRIZE

A \$2100 home entertainment package including: an \$800, 27" RCA Colortrak 2000 Stereo TV, an \$1100 Sony® Handycam 8mm Video Camera with power zoom and auto focus, and a \$200 VHS VCR with 28 function infrared wireless remote.

FIVE 1st PRIZES

A Sony® Super 8mm Handycam Video Camera with power zoom, auto focus, edit search and much more. An \$1100 value.

TEN 2nd PRIZES

An HQ VHS format Video Cassette Recorder with a 28 function infrared wireless remote, and 14 day, 6 event timer. 122 channel cable compatible. A \$200 value.

325 FIFTY DOLLAR GIFT CERTIFICATES

One gift certificate to be given away at each store! Gift certificate must be used by Sept. 13, 1989.

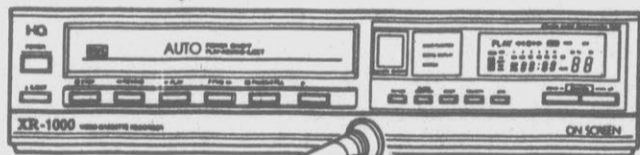

DRAWING DATE
AUGUST 16, 1989

OFFICIAL RULES

How to win: Registration forms are available in this publication or at your local Big Lots® or Odd Lots store. Deposit or mail in your entry by July 30, 1989 for an August 16, 1989 drawing. Drawing to be conducted by an independent auditing company. Winners will be contacted within one week. No purchase necessary, you need not be present to win. Employees of Consolidated Stores International Corp., their affiliates and their respective families are not eligible. Contest covers all 325 Big Lots® and Odd Lots locations. Chances of winning depend on number of entries received. You must be at least 18 years old to win. Void where prohibited by law. Winner is responsible for all taxes and fees. Official entry forms only. Contest presented by Consolidated Stores International Corp., P.O. Box 18301, 300 Phillip Rd., Columbus, Ohio 43218. All prizes will be awarded.

Enter As Often As You Like!

SUMMERTIME SWEEPSTAKES

NAME _____
ADDRESS _____
CITY _____ STATE _____ ZIP _____
AREA CODE _____ PHONE _____

COMP TO \$3.99

T-120 VHS VIDEO TAPE
Up to 6 hours of viewing time.

179 EACH

SPECIAL SALE PRICE

COMP TO \$2.99

HOT SHOT. 11 OZ. INSECT KILLERS
Assorted Formulas

99¢ EACH Limited to stock on hand.

SPECIAL SALE PRICE

COMP UP TO \$4.99

Anchor Glass 12-PACK CANNING JARS WITH LIDS

JELLY JARS OR PINT JARS ... **2.99**
QUART JARS ... **3.49**

Selection may vary by store.

SPECIAL SALE PRICE

COMP TO \$1.19

Dole 20 OZ. PINEAPPLE Tidbits or Crushed

YOUR CHOICE

49¢ EACH

SPECIAL SALE PRICE

COMP TO \$7.99

VIDAL SASSOON PROFESSIONAL CRIMPING IRON

2.99

SPECIAL SALE PRICE

COMP TO \$5.99

Tonka Pound Puppies
Lovable, Huggable

BABY POUND PUPPIES®

SIZE: 7 INCHES

99¢

SPECIAL SALE PRICE

PRICES GOOD WED., JULY 19 THRU SUN., JULY 23
STORE HOURS: 9 a.m. - 9 p.m., Sunday 'til 6 p.m.
QUANTITY RIGHTS RESERVED

VISA MasterCard

PRICES AND ITEMS GOOD ONLY AT:
COMPARATIVE PRICING BASED ON SAME OR SIMILAR ITEMS SOLD ELSEWHERE IN MARKET AREA. WE DO NOT ACCEPT MFR'S. COUPONS.

BUYERS MARKET GREENVILLE
OPEN MON.-SAT. 9-9 SUN. 12-6 **355-2991**



NC-1

Low Prices. And More.

Including The Best Variety Anywhere!

**Double
Manufacturers
Coupons**
SEE STORE FOR
DETAILS

COPYRIGHT 1989 - THE KROGER CO. ITEMS AND PRICES GOOD SUNDAY, JULY 16, THROUGH SATURDAY, JULY 22, 1989, IN

WE RESERVE THE RIGHT TO LIMIT QUANTITIES. NONE SOLD TO DEALERS.

ADVERTISED ITEM POLICY-Each of these advertised items is required to be readily available for sale in each Kroger Store, except as specifically noted in this ad. If we do run out of an advertised item, we will offer you your choice of a comparable item, when available, reflecting the same savings or a raincheck which will entitle you to purchase the advertised item at the advertised price within 30 days. Only one vendor coupon will be accepted per item purchased.



**U.S. Grade A
Holly Farms
Whole Fryers lb.**

59¢

Country Style or Cut-Up Fryers... 69¢ lb.

SYMBOL OF SAVINGS™



**Elegant Lady
Peaches**
Pound

69¢

**California Driscoll
Strawberries**
Quart

\$1.69



**California
Head Lettuce**
Each

59¢

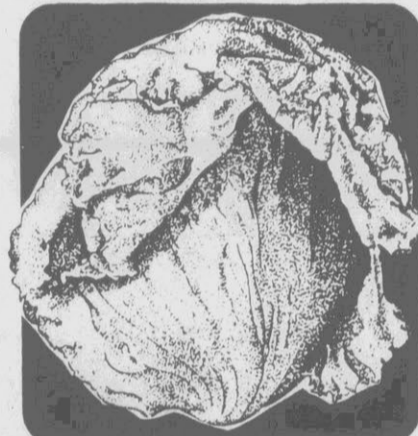

U.S. GOV'T GRADED CHOICE, GRAIN FED BEEF, "UNTRIMMED WHOLESALE CUT" CAP-ON 10-12-LB. AVG.

**Whole
Sirloin Tip**
Pound

\$1.59
SLICED FREE



FROZEN
**Morton
Fried Chicken**
28-oz.

\$1.99



U.S. INSPECTED
PRIDE OF THE FARM
**Frozen Young
Turkey Breast**
Pound

\$1.19

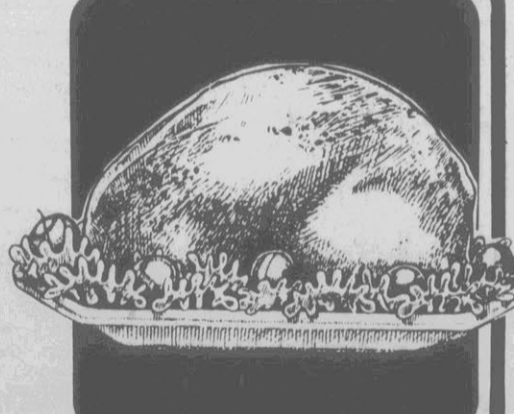

**Doritos
Tortilla Chips**
11-oz.

\$1.99
REGULARLY \$2.39

FONTOVA CHEESE SAUCE FOR NACHOS 14-OZ. CTNR. . . 2 FOR \$3



"AS ADVERTISED ON TV"
**Cheerios
Cereal**
15-oz.

\$1.99



LITE ICE MILK OR PREMIUM
**Texas Gold
Ice Cream**
½-Gallon

2 \$5
For



**Kroger 1%
Lowfat Milk**
Gallon

\$1.69

KEEBLER MAGIC MIDDLE COOKIES 11-OZ. PKG. . . \$1.99



**KROGER
Grade A
Large Eggs
18-Ct.
99¢**

NONRETURNABLE BOTTLE
**Diet Dr. Pepper
or Dr. Pepper**
2-Liter

89¢



Crossword By EUGENE SHEFFER

ACROSS
 1 Radar
 5 Kentucky bluegrass
 8 Small merganser
 12 Tip-top
 13 Fleming or Hunter
 14 Peel
 15 Dogear, sometimes
 17 TV actress Gray
 18 Oakley et al.
 19 Whipped
 21 Singer Cole
 22 Writer Bagnold
 23 See — (get mad)
 26 Went first
 28 Low-class freeman
 31 Excited
 33 Legendary bird
 35 Persuade
 36 Impersonates a werewolf
 38 Jack in cribbage

DOWN
 20 Business abbr.
 23 Arena sound
 24 Conceit
 25 Conductor's signal to start
 27 Comedian Adams
 29 — Dawn
 30 Strong cleanser
 32 Drop of liquid
 34 War actions
 37 French holy woman
 39 TV's "The Love —"
 42 Bower
 44 Rennes pen
 45 Plexus
 46 Portent
 48 Footless
 49 Pond dweller
 50 Handle
 53 Nice season

Solution time: 21 mins.

Yesterday's answer 7-19

The Family Circus By Bil Keane



7-19

©1989 Bil Keane, Inc. Dist. by Cowles Synd. Inc.

"Find out if they have a soda machine, Daddy, and a sliding board in the pool, and cable TV, and candies on the pillow..."

Horoscope From The Carroll Righter Institute

FORECAST FOR THURSDAY July 20

ARIES (March 21 to April 19): Someone is missing your signals, not ignoring them. Communicate when others need an explanation. Be honest about yourself.

TAURUS (April 20 to May 20): Warmth and sensitivity to other people's feelings are valued. A relaxed approach to love can refresh your ties.

GEMINI (May 21 to June 21): You feel less tense and pressured if you are doing what you like to do. Plan a career change that will enhance your talents.

MOON CHILDREN (June 22 to July 21): A recipe for your current emotional state—never pass up an invitation, entertain a lot, and by all means fall in love.

LEO (July 22 to Aug. 21): Emotional baggage from the past can make it difficult to make a fresh, clean, new beginning. You desire change. Go easy—plan!

VIRGO (Aug. 22 to Sept. 22): Expect a rebellion if you pinch the penny too hard. You can carry a protective attitude to extremes. Cater to others more.

LIBRA (Sept. 23 to Oct. 22): Being stylish can be uplifting, but costly. Plan a wardrobe that fits your needs and pocketbook. Impulsive buying leads to waste.

SCORPIO (Oct. 23 to Nov. 21): You will be happier if you meet more interesting and upscale types of people. Don't trust things to memory today—keep records.

SAGITTARIUS (Nov. 22 to Dec. 21): Business/career objectives are brighter. Shop for yourself and a loved one. You should be sailing smoothly today.

CAPRICORN (Dec. 22 to Jan. 20): It is hard to maintain a social life if you play "hide and then go seek." Keep contacts alive during a time when you are socially inactive.

AQUARIUS (Jan. 21 to Feb. 19): Avoid taking drastic steps if those around you are moody. Your body bulges are a concern—use it and you will lose it.

PISCES (Feb. 20 to March 20): A behind-the-scenes meeting can have a positive effect on your future. Attractiveness to the opposite sex is strong. Plan a weekend picnic.

(c) 1989, The McNaught Syndicate Inc.

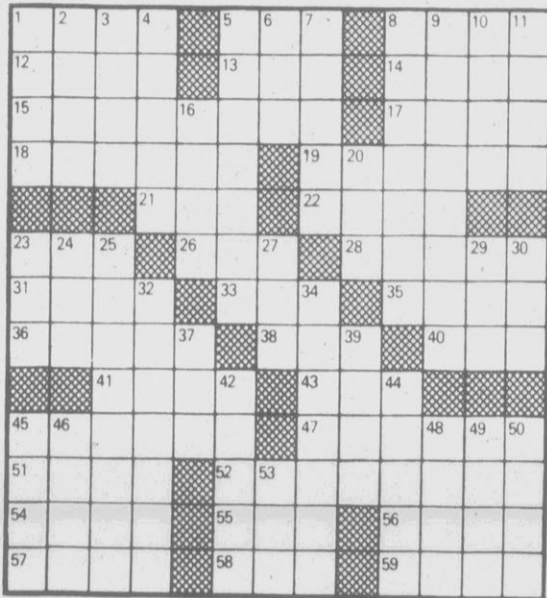

CRYPTOQUIP

7-19
 H O I G R P D D Z ' L A X R T C .
 P G H P Z R O L P D C R G D C R I D
 X D T L I

Yesterday's Cryptoquip: WHAT WE SAID TO LOUD PIANO PLAYER AS WE LEFT THE HOUSE: "HOLD THE FORTE!"

Today's Cryptoquip clue: P equals C

© 1989 King Features Syndicate, Inc.

Bridge By CHARLES GOREN AND OMAR SHARIF

ONE FOR THE PRICE OF TWO

Neither vulnerable. South deals.

NORTH
 ♠ K J 9 6
 ♥ Q 10 8 3
 ♦ A 9 2
 ♣ A 9

WEST
 ♠ 8 5 4
 ♥ 7
 ♦ Q 10 6 3
 ♣ K 8 6 4 3

EAST
 ♠ 7 3 2
 ♥ K J 9 5 2
 ♦ Q J 10
 ♣ Q J 10

SOUTH
 ♠ A Q 10
 ♥ A 6 4
 ♦ K J 8 5
 ♣ 7 5 2

The bidding:
 South West North East
 1 ♦ Pass 1 ♥ Pass
 1 NT Pass 3 NT Pass
 Pass Pass

Opening lead: Eight of ♠
 It is sometimes very difficult not to take tricks when the opportunity presents itself. On occasion,

though, it can be very costly to grab them.

The auction was routine. With a balanced hand of sound opening-bid strength facing an announced opening bid, North had an easy raise to three no trump.

West made the unusual lead of a spade (we find fourth-best of your longest and strongest to be more effective in the long run!). Declarer won in hand and, with eight fast tricks available, decided to try for the ninth in hearts. She cashed the ace and continued the suit to learn the bad news when West pitched a diamond on the second round. East won cheaply and shifted to the queen of clubs, continuing the suit when declarer held up.

Reading the hand perfectly, declarer cashed her remaining spade tricks as East discarded a heart and West a club. She returned to hand with the king of diamonds and exit-

ed with her last club. West could not resist the temptation of rising with the king of clubs to cash his remaining club. But then he had to lead away from his queen of diamonds into declarer's combined ace-jack tenace. Making three-odd.

West should never have end-played himself. If he simply plays low on the third club, East will win. Since declarer must protect against East's hearts, declarer has to discard

a diamond from the board on this trick. So East simply exits with a diamond to dummy's now bare ace and wins the last two tricks with his king-jack of hearts—down one.

For information about Charles Goren's newsletter for bridge players, write Goren Bridge Letter, P.O. Box 4426, Orlando, Fla. 32802-4426.

Want To Buy A Home? Find It Fast In Classified

FUNKY WINKERBEAN



BC

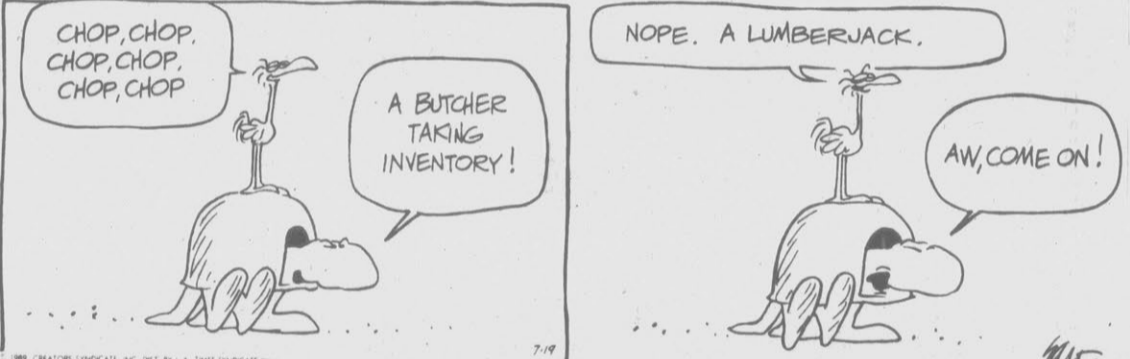

PHANTOM



SHOE



THE WIZARD OF ID



BLONDIE

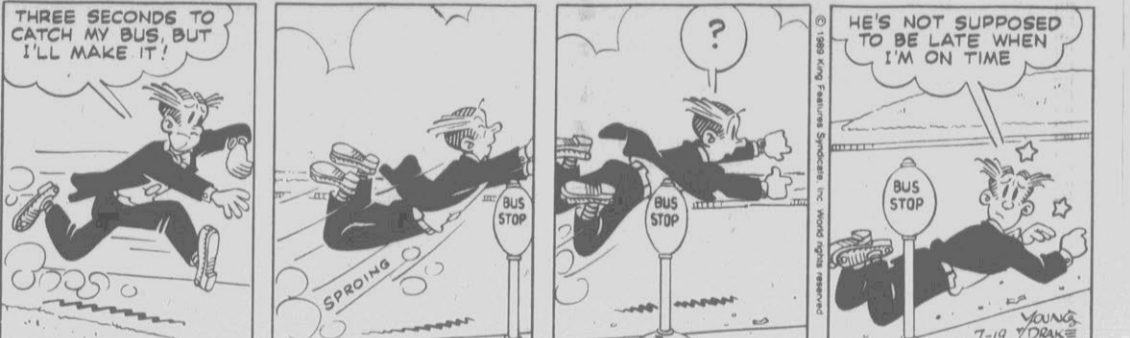

PEANUTS

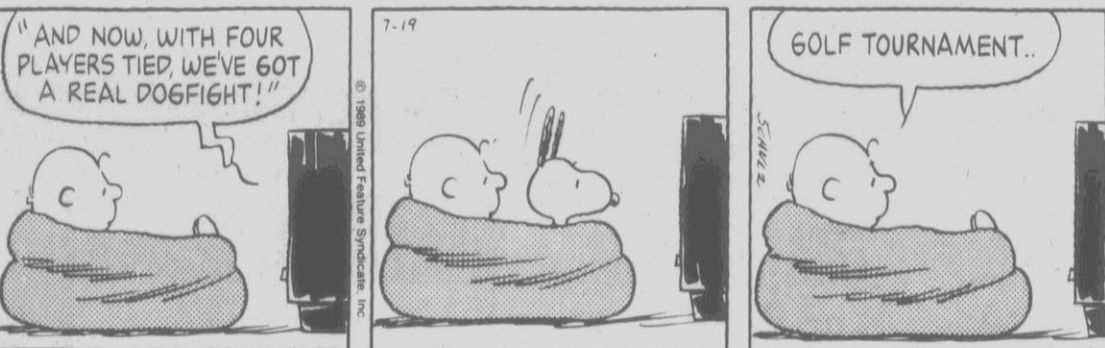

FRANK & ERNEST



BETLE DAILY



GARFIELD



Prime Time Tonight

WEDNESDAY EVENING							
	7:00	7:30	8:00	8:30	9:00	9:30	10:00 10:30
2	Father Murphy		Movie: "Norwood"				700 Club
4	Business Rpt.	Legislative	National Geographic		Movie: "On the Town"		Drive-In Blues
5	Ent. Tonight	Lose or Draw	Fresno		Jake and the Fatman		Wiseguy
7	Cosby Show	Current Affair	Movie: "Modern Problems"				News
9	Cosby Show	Night Court	Unsolved Mysteries		Night Court	Knight & Daye	Miami Vice
12	USA Today	Lose or Draw	Fresno		Jake and the Fatman		Wiseguy
15	Wheel-Fortune	Jeopardy!	Gro. Pains	Ten of Us	Hooperman	R. Guillaume	China Beach
	Bugs & Pals	Fraggle Rock	Movie: "Tarzan, the Ape Man"				Movie: "The Thing"
DIS	The Blue Bird	Splash Mount.	Sidekicks	Danger Bay	Movie: "The Karate Kid"		
ESPN	SportsCenter	Muscle Magazine		World of Sports		PBA Bowling: El Paso Open	
HBO	Movie: "Date With an Angel"		Movie: "School Daze"			Crypt Tales	Not the News
LIFE	HeartBeat		Spenser: For Hire		Movie: "Why Me?"		
MAX	Movie: "Detective Story"				Movie: "The Man from Snowy River"		
SHOW	Honky Tonk Freeway	Andrea Martin			Movie: "April Fool's Day"		Super Dave
TBS	Major League Baseball: Atlanta Braves at Montreal Expos				Movie: "Across the Wide Missouri"		
TMC	Movie: "Souvenir" Cont'd		Movie: "Jagged Edge"				Movie: "Terminal Entry"
USA	Miami Vice		Murder, She Wrote		Movie: "Murder by Night"		

For complete TV programming information, consult your weekly TV SHOWTIME from Sunday's Daily Reflector.

State's Moviemaking Industry Is Second Only To California's

By Robin P. Teater
THE ASSOCIATED PRESS

DURHAM — The stars are hanging out in North Carolina, and they're not just in the sky.

Projects featuring such movie actors as Faye Dunaway, Robert Duvall, Natasha Richardson, Debra Winger and Nick Nolte are solidifying North Carolina as a hotbed for moviemaking.

"They're major caliber people and major caliber projects. Both of those are looking at Academy Award-type situations," said Bill Arnold, director of the North Carolina Film Commission.

In the past few months, two movies with those actors have been shooting in North Carolina: "The Handmaid's Tale" in Raleigh and Durham, and "Everybody Wins" in Wilmington.

"I think we started out with major films and higher caliber pictures than had been the general rule in the South," Arnold said.

Starting with such movies as "Being There," starring Peter Sellers, in 1979 and "Brainstorm," starring Natalie Wood, in 1983, North Carolina has also made Steven Spielberg's "The Color Purple," "The Year of the Dragon" and many others.

North Carolina is one of the fastest growing moviemaking locations in the country, and is second to California in the number of sound stages and studios, Arnold said, with 18 sound stages and four studios with plans for a fifth.

"We also have the largest resident work force of crew and technical people on the East Coast, after New York," he said.

Still, even though 42 states have film offices and actively compete for business, California remains the film leader of the United States, with New York close at its heels.

Though not always cheaper, it's easier to make a movie outside California. One-stop, state-controlled film offices are preferred to California's patchwork approach, where local governments issue permits with fluctuating fees and have requirements that are 70 years old.

And the long-held belief that Hollywood could re-create anything from the Tara plantation in "Gone With the Wind" to the Las Vegas Strip in "One From the Heart" has been abandoned by filmmakers who want greater realism.

North Carolina's moderate climate and diverse landscape are attractive to Hollywood producers.

"It's the best," said Michael Stroud, location manager for "The Handmaid's Tale."

"Everyone makes it so easy for you, and the bureaucracy is nil. This really is the ideal place to film — I think the South, in general."

The movies "Bull Durham," a delightful romp about life in minor league baseball, and "Winter People," a drama about intense relations starring Kelly McGillis were both filmed in 1987.

"Winter People" is a depression-era, very cold, snowy film. "Bull Durham" is just the opposite," Arnold said. "But they were both shot in November and they both got what they want."

Since North Carolina can offer a variety of "looks," film company have fewer location moves.

"The Handmaid's Tale," which is being filmed entirely in the state, needed seasonal changes and also the look of a New England college, which it found at Duke University. Based on the acclaimed novel by Margaret Atwood, the book is a daring move into the future and tells the tale of what happens after a right-wing religious revolution has swept America, imposing a dictatorial regime and ruthlessly executing any dissenters.

'Batman' Grabs Top Spot

By John Horn
THE ASSOCIATED PRESS

HOLLYWOOD — "Batman" has passed such stellar hits as "The Exorcist," "Gremlins" and the original "Superman" to become the highest-grossing film in Warner Bros. history.

Although it finished second on the weekend box-office charts, with

receipts of \$15.1 million, "Batman" has collected \$167.6 million to date, and will almost certainly become this summer's biggest hit, surpassing "Indiana Jones and the Last Crusade."

Meanwhile, "Lethal Weapon 2" claimed the No. 1 spot for the second consecutive week, leaving the new James Bond film "Licence to Kill" reeling in its wake.

"Lethal Weapon 2," starring Mel

Gibson and Danny Glover as Los Angeles policemen out to smash a South African money laundering scheme, grossed \$17.2 million nationwide to lead all other titles, according to figures released Monday by Exhibitor Relations Co.

In third place over the weekend was the Disney comedy "Honey, I Shrank the Kids," which continues to attract waves of moviegoers. "Honey," starring Rick Moranis, sold \$8.806 million worth of tickets, topping the opening of "Licence to Kill."

The latest Bond film, starring Timothy Dalton, debuted weakly, grossing \$8.775 million to finish in fourth place. The last Bond film, "The Living Daylights," netted more than \$11 million in its opening weekend in 1987.

In fifth was Disney's re-release of the animated "Peter Pan," with sales of \$5.6 million. It was followed in sixth by Steven Spielberg's "Indiana Jones and the Last Crusade," with a gate of \$4.6 million.

The comedy sequel "Ghostbusters II," starring Bill Murray and Dan Aykroyd, was seventh on proceeds of \$4.33 million. In eighth was Robin Williams in "Dead Poets Society," which grossed \$4.26 million.

Rounding out the Top 10 were "Weekend at Bernie's," with \$3.7 million, place, and "Do the Right Thing," with \$3 million. The new romantic comedy "When Harry Met Sally..." had a strong opening in a limited release, selling \$1.1 million worth of tickets in only 41 theaters.

Here are the top movies for the weekend as tallied by Exhibitor Relations, with distributor, weekend gross, number of theater screens, average per screen, total gross and number of weeks in release.

1. "Lethal Weapon 2," Warner Bros., \$17.2 million, 1,830 screens, \$9,392 per screen, \$49.2 million, two weeks.
2. "Batman," Warner Bros., \$15.1 million, 2,201 screens, \$6,867 per screen, \$167.6 million, four weeks.
3. "Honey, I Shrank the Kids," Disney, \$8.806 million, 1,460 screens, \$6,031 per screen, \$74.8 million, four weeks.
4. "Licence to Kill," MGM-UA, \$8.775 million, 1,575 screens, \$5,571 per screen, \$8.775 million, one week.
5. "Peter Pan," Disney, \$5.6 million, 1,475 screens, \$3,805 per screen, \$5.6 million, one week.
6. "Indiana Jones and the Last Crusade," Paramount, \$4.6 million, 1,717 screens, \$2,687 per screen, \$166 million, eight weeks.
7. "Ghostbusters II," Columbia, \$4.33 million, 1,978 screens, \$2,192 per screen, \$93.2 million, five weeks.
8. "Dead Poets Society," Disney, \$4.26 million, 1,047 screens, \$4,068 per screen, \$63.9 million, seven weeks.

SPORTS PAD

Family Billiards & Sports Bar

- FREE POPCORN & BALLOONS
- ARCADES • AIR HOCKEY
- BASKETBALL

Open Daily At Noon • 757-3658

CORNER OF 5TH & COTANCHE • DOWNTOWN

"Greenville's Plushest Cocktail Lounge"
(Located Beside SPORTS PAD)
Daily Drinks Specials
Dancing Nightly To Your Favorite Songs
All ABC Permits—Private Parties Booked

Many little boys are the kind of kids their mothers tell them not to play with.
Play pool at Sports Pad.

CHICO'S

Mexican Restaurant

521 Cotanche St. • 757-1666

Late Night Special...

Mexican Pizza Grande & Nachos Grande At 1/2 Price

Served Sun.-Thurs. After 10 PM
Fri. & Sat. After 11 PM

The East Carolina SUMMER THEATRE

Presents A Great American Drama With These Shining Stars!!!



KATHLEEN NOLAN



LARRY GATES

in Susan Cooper & Hume Cronyn's
FOXFIRE

July 17-22, 8:15 pm
July 19 & 22, 2:15 pm

COME BY: McGinnis Theatre
5th and Eastern Streets
Greenville, NC 27858

FOR RESERVATIONS CALL: 757-6829
INDIVIDUAL TICKETS
Evenings \$12, Matinees \$10

WRITE: East Carolina
Summer Theatre
Greenville, NC 27858

In 1982, the science-fiction movie "Brainstorm" filmed in six different locations without leaving North Carolina.

Lake Lure in the North Carolina mountains served as the backdrop for much of the musical "Dirty Dancing," which Arnold calls one of the most successful made in the state.

"It cost them (Vestron Pictures) \$2.3 million to shoot that here," Arnold said. "They've been back here twice since. That movie has gener-

ated more than \$750 million. That's a tremendous return. That's the kind of thing that really sells the state."

North Carolina's return also has been tremendous.

PLAZA CINEMA

PLAZA MALL 756-0088

HONEY, I SHRUNK THE KIDS 2:00-4:15 7:15-9:15	INDIANA JONES AND THE LAST CRUSADE 7:30 & 9:45	PETER PAN 1:30-3:00 4:30-6:00
---	--	--

"BATMAN IS A TRIUMPH!"
— Peter Travers, ROLLING STONE

NICHOLSON KEATON

Record Bar TRACKS

BATMAN PG-13

No Discounts • No Passes
1:30-4:15-7:00-9:45

CONSOLIDATED THEATRES

All Seats Everyday 'Til 5:30 PM

BUCCANEER MOVIES

756-1307 • Greenville Square Shopping Center

2:10-4:40 7:10-9:40 LICENCE TO KILL PG	2:00-4:30-7:00-9:20 LETHAL WEAPON NO PASSES 2	1:00-3:15 5:20-7:30-9:45 GHOSTBUSTERS NO PASSES II
---	---	---

2:00-4:30-7:00-9:20 NO PASSES

LETHAL WEAPON 2

Cham Van Nguyen, Chef, of Hunan Gardens & Canton Station of Rocky Mount for 8 years has NOW OPENED

EAST CANTON STATION

Located Across From Grant Buick & Next To Toyota East - 520 W. Greenville Blvd.

Happy To Let You Sample Free

.....7 Day Buffet With A Different Menu Daily.....

\$3.95 Daily Lunch - 11 a.m.-3 p.m.
\$4.95 Daily Dinner - 5 p.m. - 10:00 p.m.

.....Special Buffet On Sundays.....

You May Also Select From Our Menu
Of Special Foods Cooked To Order Sunday-Thurs. 11 a.m.-10 p.m.
Friday & Saturday 11 a.m.-11 p.m.

RIVERSIDE STEAK BAR

315 Stantonsburg Road, Greenville, NC 752-5001
Monday-Saturday 5:30-10:00 PM

Banquet Facilities Available All ABC Permits

Extensive New Menu Plus Nightly Specials

Thursday Night:
Texas Style BBQ Beef
Baked Beans
Corn on the Cob

\$4.95

CINEPLEX ODEON THEATRES

TENTH ANNIVERSARY

\$3.00 BARGAIN MATINEE DAILY ALL SHOWS BEFORE 6:00 PM AT SELECTED THEATRES-CHECK SHOWTIMES

PLITT Carolina East Center 756-1449

"Karate Kid III" (PG) 2:15-4:30-7:00-9:15
"Great Balls of Fire" (PG-13) 2:30-4:45-7:15-9:30
"Weekend At Bernie's" (PG-13) 2:45-5:00-7:10-9:35 No Passes, No Coupons, No VIP After 4:00 P.M.
"See No Evil, Hear No Evil" (R) 2:40-4:55-7:20-9:40

RALPH MACCHIO PAT MORITA

The Karate Kid Part III

PG-13

ACADEMY PICTURES RELEASE

FRIDAY-THURSDAY 2:15-4:30-7:00-9:15
(BORRY NO PASSES OR COUPON ACCEPTED) VIP PASSES ACCEPTED DURING MATINEES ONLY

CINEPLEX ODEON
PLITT 756-1448



A RIGHT PRICE
Special

Hartz® 2 in 1 Long Lasting Flea & Tick Collar
1.99 Each
Dog, Cat, Puppy, & Large Dog
REG. to 3.98



2 FOR 1.50

Softsoap® Liquid Soap. 7.5 oz. pump container. Your choice of assorted designs.



A RIGHT PRICE
Special

Hershey® Big Block & King Size Candy Bars
2 FOR 2.88¢
Large Selection
REQ. .69 each

Prices Good Through Sunday, July 23, 1989

KERR Drug Stores



SUMMERTIME SALE

"Right Around The Corner"



1.69 **1.39**

Arrid® Extra Dry Anti-Perseptant & Deodorant
• 1.5 oz. Roll-on or Glide-on, regular or XX formula, **SALE PRICE 1.39 each.**
• 4 oz. Spray or 2 oz. Wide Solid, regular or XX; or New Designer Fragrance Spray, 4 oz., **SALE 1.69.** Choice of fresh scents.



Half Price Sale!
5.00 Each

Houbigant® Chantilly Hand & Body Lotion. 16 oz. Soothes and softens all over. Nice scent.



50% OFF OUR EVERYDAY LOW PRICE

Our Entire Stock of Soft Shadow® Fashion Sunglasses. Large selection of styles to choose from. Take advantage of this special summer offer now!



1.99 **99¢**

Save on Quality Feminine Care Products From Summer's Eve®
• Twin Pack Disposable Douche, choice of formulas, **SALE PRICE 99¢ each.**
• Feminine Wash, regular or mist, **SALE 1.99.**



1.09 Your Choice Each

Aqua Fresh® Toothpastes. 4.6 oz. Regular, 4.3 oz. Tartar Control, or 4.4 oz. Kids' formula. Great fluoride protection in a great-tasting toothpaste.



Save Big Now on These Exciting Fragrances!

1.99 Each

Impulse® All-Over Deodorant Body Spray. In your choice of exciting scents including Tres L.A., Elation, and more. 2.5 ounces.

Make Kerr Drugs Your Summer Shopping Headquarters!



2 FOR \$1

Magla® Vinyl Gloves. One size fits all. Great for doing household cleaning chores. Buy now.



3.99 Each

The Boston™ Contact Lens Cleaner, 1 oz.; or Conditioning Solution, 4 oz. Save more now.



2.79 Each

Tums® Antacid Tablets. 96-count extra strength or 150-count regular. Choice of flavors.



14.95 Each

Cigarrest™ Stop Smoking Kit. Guaranteed to work fast.



Cool Summer Savings!
14.99 Each

Holmes® 12-inch Oscillating Fan. Model #HAOF-1200. Features 3 speeds for greater comfort control. White.



1.49 Each

Royal Oak® Charcoal Lighter Fluid. 32 oz. Lights fast and burns clean. Buy now for your summer cookouts.



99¢ Each

EZ-One™ All-Purpose Sponges. Your choice of four styles including the Handler sponge and a Car Wash Sponge with FREE Armor All®. Great Value!

STANTON SQUARE SHOPPING CENTER (Hwy. 264 West)

CAROLINA EAST MALL (Hwy. 11 South)

OVERTON'S SHOPPING CENTER (Next To Overton's Supermarket)

KERR Drug Stores

Yogurt Goes Mainstream In The 1980s

By Jonathan Susskind
LAT-WP NEWS SERVICE

Hardly anything is truly new in the food world.

Kiwis were just fuzzy gooseberries and orange roughy swam in the Pacific Ocean for eons before New Zealanders began air-freighting them to America. Tomatoes dried in the sun and goat milk produced tart cheeses for centuries until trendy chefs started throwing them into everything imaginable.

But if anything ever qualified as a novelty food, it's frozen yogurt.

Twenty years ago, it was an unknown (Of course, back then yogurt itself was lumped together with granola, peace marches and communes).

Today, frozen yogurt is a national best seller, as American as ice cream, and an ideal substitute for high-fat desserts.

The cool, creamy confection that you enjoy today from the supermarket freezer case or from stores like the Lemon Tree and TCBY, the nation's largest yogurt franchise, may not be the same stuff you tasted back in the early 1970s. It was too tart for many palates, so manufacturers toned down the flavor by changing the way the milk is cultured to make yogurt.

That, coupled with the national penchant for light-but-luscious desserts and yogurt's move from the "health food" image to the mainstream, pumped up the frozen yogurt boom of the 1980s.

An estimated 5,000 retail outlets and franchises feed our frenzy for frozen yogurt, said Tracy Boyle, spokeswoman for the International Ice Cream Association. Grocery store packages are a relatively new phenomenon, but already products by Dannon, Yoplait, Edy's and Brice's are the hottest things in the freezer case, with sales of \$80 million last year, almost double 1987 sales of \$42 million, Ms. Boyle said. The association estimates that half of its more than 250 ice cream manufacturing members are getting into frozen yogurt. "It's literally growing every day," she said.

Nutritionally, frozen yogurt is rich in calcium and has protein, like ice cream, but has less fat and cholesterol, so dietitians may recommend it for those on a low-fat regimen. Moreover, people who have trouble digesting milk sugar in ice cream and ice milk may be able to eat the cultured products.

But don't fool yourself — or let a package fool you — into thinking that all commercial frozen yogurt is a dietetic treat.

True, a number of frozen yogurts are relatively low in fat and calories, especially compared to ice cream, said Bonnie Liebman, nutrition director of the Center for Science in the Public Interest, a Washington nutrition advocacy group. "The calorie savings is not as great as the fat savings, but generally speaking, frozen yogurts have fewer calories because they have less fat," she said. "The difference is pretty dramatic if you compare a premium ice cream — such as Haagen Dazs, Ben & Jerry's or Frusen Gladje — against frozen yogurt. If you switch from premium ice cream to frozen yogurt, you're getting half the fat."

Ms. Liebman said that the difference is less dramatic if your usual brand is an ordinary ice cream with half the fat of those

upscale treats. But frozen yogurt (and ice milk) also has less saturated fat and cholesterol than ice cream.

"Of course," Ms. Liebman added, "you can ruin the low-fat and low-calorie benefits by dumping on the chocolate sauce and nuts and sprinkles and Oreos cookies."

No frozen yogurt contains the same fat and calories as ice cream, but some frozen yogurts and ice milks are on a par, as the Center for Science in the Public Interest learned when rating frozen desserts for an article in the June Nutrition Action Healthletter.

For instance, Light N'Lively ice milk and Mulberry Street frozen yogurt have the same average amount of fat — 5 grams, or about 1 teaspoon, per ¾-cup serving — although the yogurt has 140 calories per serving vs. 170 for the ice milk (Five grams was the highest amount of fat in any yogurt the agency examined). And one of the TCBY frozen yogurt products weighed in at 190 calories per serving, while Jerseymaid ice milk had 145 calories; both contained about the same amount of fat — 3 grams.

But, Ms. Liebman said, "if you look carefully (at frozen yogurt labels) you could get zero fat rather than 5 grams." Colombo Lite Frozen Yogurt has no fat and only 140 calories per ¾-cup serving, for example.

You can't buy a non-fat ice milk because government standards say a product must contain a minimum amount of butterfat — between 2 percent and 7 percent by weight — to be legally called ice milk. Ice cream manufacturers have petitioned the Food and Drug Administration to create a standards category for low-fat ice cream, containing 7 percent to 10 percent fat. Currently, some of these products are labeled "frozen dairy desserts."

Meanwhile, the International Ice Cream Association has asked the FDA to set definitions of frozen regular, low-fat and non-fat yogurts, with fat content ranging from no less than 3.25 percent to less than 0.5 percent.

There could be a decision on those petitions later this year or early next year. Meanwhile, when you read labels or ask clerks, be sure to note the serving size of the product in relation to its fat or calories. The numbers may sound low but are for a 3-ounce serving; do you eat that little? Ms. Liebman said her comparisons were based on a 6-ounce or ¾-cup serving because that is closer to the government's measure of an average serving.

Here lies the beauty of making your own frozen yogurt at home. You control portion sizes and the fat and sugar content by using low-fat or non-fat yogurt, flavorings and sweeteners (including artificial sweeteners) to taste. Any ice-cream freezer can make frozen yogurt. Check your machine's instruction booklet for recipes and ideas. You can also make frozen yogurt in the freezer compartment of your refrigerator, although the texture may be somewhat grainier this way.

Freeze the yogurt mixture in shallow metal trays with the freezer set at the coldest temperature. When a hard border about an inch wide has formed around the edge, scrape out the contents of the tray and beat thoroughly with a hand-held elec-

(See YOGURT, D8)



Recreate the magic of a country inn weekend at home with a brunch featuring Spring Vegetable Timbales

In Pursuit Of Romance

A survey of country inn advocates proved what insiders had long suspected: the decision to stay at a country inn is made most often by a woman... a woman in pursuit of romance.

According to the survey sponsored by Great Inns of America, a national marketing association representing established inns throughout the United States, a substantially greater number of women than men reported that it was their idea to stay in an inn, and most men indicated the choice of an inn was their wife's idea.

So just what are women looking for in a country inn?

Overall, the most frequent reason given for choosing a country inn was its location near historic or scenic attractions. But women were twice as likely as men to choose an inn because they perceived it as offering a setting for a romantic weekend.

Moreover, women listed "atmosphere" as the primary reason for choosing an inn over a chain hotel. The description of types of atmosphere most frequently desired were: homey, charming, quiet, comfortable and private.

Other items high on the women's list of things they looked for in an inn were cleanliness, a private bath, a queen-sized bed, personalized service and one-of-a-kind rooms decorated in antique or period furniture.

A good dining room was also important, with breakfast considered the most necessary meal.

It's fairly easy to create a country-inn type menu at home. Spring Vegetable Timbales, for instance could provide a focal point for a romantic brunch. A mixture of carrots, peas, onions, eggs and chicken with rice soup mix is baked in celery-leaf lined custard cups. Serve on a bed of lettuce with salad, hot rolls and orange juice...or champagne.

Another brunch option, Skillet Sausage 'n' Cheese Potato Pancakes, is an easy-to-prepare, one-dish meal. The "pancakes" are assembled in three layers: potatoes on the bottom, Swiss cheese and sausage in the middle, and an egg and milk mixture on top. Serve with fresh fruit and individual French brioche from your favorite bakery.

A European-style sandwich, Baked Monte Cristo Sandwiches, provides a way to add foreign flair to a romantic "getaway" at home. Turkey and Swiss cheese sandwiches are dipped in an egg mixture and baked until golden brown. A

Brunch Recalls Atmosphere Of Country Inn

spicy Dijon Dipping Sauce adds extra zesty flavor to the dish.

Round out the meal with a tossed salad and beverage to dine, "inn style" in your own home.

SPRING VEGETABLES TIMBALES

- 6 celery leaves
- 1 pouch dry chicken with rice soup and recipe mix
- 1 cup water
- ½ cup finely chopped celery
- ½ cup shredded carrot
- ½ cup frozen peas, thawed
- 2 green onions, sliced
- 3 eggs
- 1½ cups half-and-half
- Generous dash ground red pepper

Grease six 6-ounce custard cups and place one celery leaf in the bottom of each. Set aside. In two-quart saucepan over high heat, heat soup mix, water, celery, carrot, peas and green onions to boiling. Reduce heat to low, cover and simmer five minutes. Cool. In a large bowl, beat eggs, half-and-half and pepper until well blended. Stir in soup mixture. Pour into prepared custard cups. Set custard cups in shallow baking pan; place on oven rack. Pour hot water around cups to reach halfway up the sides of cups. Bake at 350° for 30 minutes or until knife inserted in center comes out clean. Let stand five minutes. Unmold onto serving plate. Serve on lettuce if desired. Makes six servings.

SKILLET SAUSAGE 'N' CHEESE POTATO PANCAKE

- ½ lb. bulk pork sausage
- 3 cups peeled, sliced potatoes

- 2 slices Swiss cheese (2 oz.)
- 5 eggs
- ½ cup milk
- 1 pouch dry onion soup mix

Stirring to separate meat, cook sausage until browned in 10-inch, nonstick skillet over medium heat. Remove to paper towels to drain. Spoon off all but one tablespoon of the drippings. In skillet over low heat, in hot drippings, stir potatoes. Cover; simmer 10 minutes. With spatula, carefully turn potatoes. Cover and cook eight minutes or until golden brown. Arrange potatoes in even layer in skillet. Top with sausage and cheese. In a large bowl, beat eggs, milk and soup mix together until well blended. Gradually pour into skillet. Cover. Over medium heat, cook 10 minutes or until eggs are set and potatoes are tender. Remove from heat. Let stand, covered, three minutes. Loosen edge with spatula and invert into serving plate. Cut into wedges. Makes six servings.

BAKED MONTE CRISTO SANDWICHES

- 4 slices Swiss cheese (4 oz.)
- 4 oz. sliced cooked turkey
- 8 slices firm white bread
- 3 eggs
- ½ cup milk
- 1 pouch onion soup mix
- 3 tbsps. butter or margarine
- Dijon Dipping Sauce (recipe follows)

To prepare sandwiches, place on slice of cheese and one ounce of turkey on each of the four bread slices. Top with remaining bread slices. In pie plate, beat eggs, milk and soup mix until well blended. Preheat oven to 450°. Dip each sandwich into egg mixture, spooning onion pieces onto bread, making sure all egg mixture is used. Place butter in 15-by-10-inch jelly-roll pan; place in oven for about three minutes to melt butter. Arrange sandwiches in pan. Bake five minutes. Turn sandwiches; bake five minutes more or until golden brown. Serve with Dijon Dipping Sauce. Makes four servings.

Dijon Dipping Sauce:

- ½ cup sour cream
- 2 tbsps. milk
- 1 tbsp. Dijon-style mustard

In a small bowl, stir together all ingredients. Cover; refrigerate until serving time. Makes ¾ cup.

Lower Cholesterol By Making Changes In Your Diet

Dear Readers: Last month the Department of Family Medicine cooperated with the Pitt County Agricultural Extension Service to conduct a cholesterol screening and dietary assessment in Bethel. We asked 200 people who had their diet analyzed if they could select five changes in their diet to improve health that they could try from the following list:

- Change to skim milk
- Change to a low fat milk
- Change from butter to margarine
- Change from hard margarine to a soft (tub) margarine

- Use less fat spreads (butter, margarine)
- Use vegetable oil in cooking instead of "Crisco type shortenings" or lard when possible
- Use a low fat cheese instead of regular cheese
- Use fewer gravies and sauces that are made with fat drippings
- Eat sausage, bacon and luncheon meats less often
- Remove skin from chicken before eating
- Trim and remove fat from meats before eating
- Cook meats so fat drips away from meat during cooking



Kathy Kolasa

Ph.D., ECU Dept. Family Medicine

- Eat smaller portions of meat
- Use less butter, lard or meat drippings to season vegetables
- Eat fewer sweet pastries like doughnuts, fried pies
- Cut down on salty snack foods like crackers and potato chips
- Eat more foods with a dietary fiber (i.e., oatmeal, fruits, vegetables)

- Eat less food (fewer calories)
- Eat less fried food

We went to Farmville this month to screen for blood cholesterol and also present nutrition information to another 180 folks. Many people were surprised how high their blood cholesterol were. Other people who had learned earlier this year that their blood cholesterol were high and have made changes in what they ate were very pleased to see their blood cholesterol had come down.

If you participated in either of these events, you'll be getting a let-

ter asking how you did in making the food changes you said you would try. We sure would appreciate your filling out the form and sending it back to us.

We're trying to learn what typed of teaching techniques will help make changes that will improve your heart health. Remember that any small change can make a difference. Thanks, it was good to meet many of you.

Contact Dr. Kolasa, Department of Family Medicine or c/o The Daily Reflector.

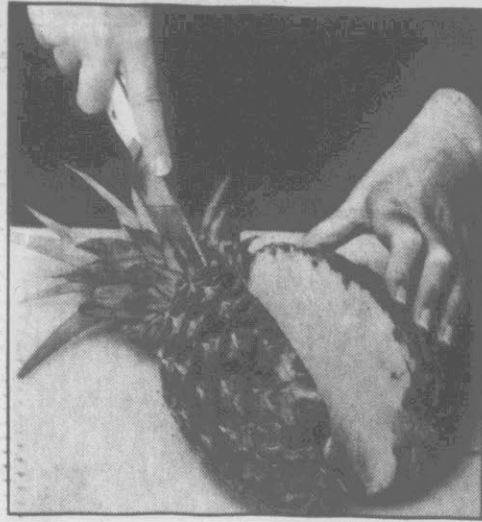

STEP 1: Using a long, sharp knife, cut pineapple in half lengthwise, then in quarters

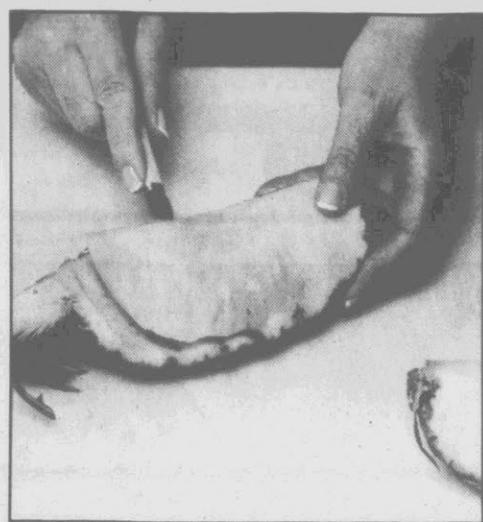

STEP 2: A curved pineapple knife is ideal for cutting the fruit from the shell, but any serrated knife may be used

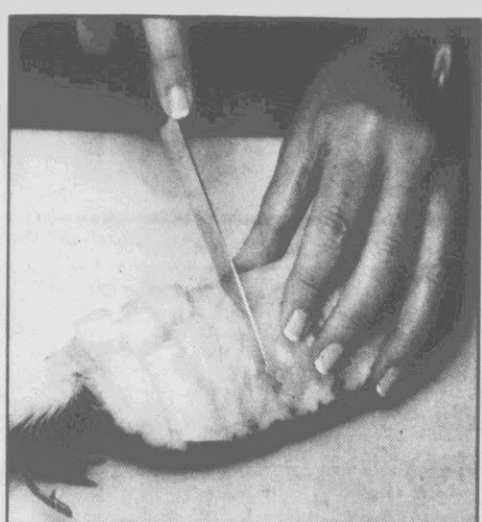

STEP 3: After cutting the fruit into bite-size chunks, either remove it or leave it decoratively in the shell

LAT-WP News Service

How To Prepare Fresh Pineapple

By Joan Drake
LAT-WP NEWS SERVICE

Basics

When choosing a fresh pineapple, select fruit that is plump and firm with fresh green leaves in the crown. The pineapple should have a sweet aroma, and no mold or soft spots.

Shell color is not a good sign of maturity — some pineapple varieties remain green even when they are fully ripe. And forget pulling leaves out of the crown; ease of extraction is not an indication of either ripeness or quality.

Once a pineapple is harvested

from the plant, it will not ripen any further. It will change color, get soft and the leaves will fall out, but these are signs of old age, not ripeness. The fruit should be used as soon as possible after purchase but may be wrapped in plastic and refrigerated three to five days.

There are numerous ways to prepare fresh pineapple. The following method is an easy way of cutting chunks, spears and wedges.

Step 1. Using a long, sharp knife, cut the pineapple in half lengthwise from the bottom through the crown. Repeat, cutting pineapple into quarters.

Step 2. Trim the strip of hard core from the top of each quarter. Then cut the fruit away from the shell. A curved pineapple knife is ideal for this step but a sturdy grapefruit knife or standard serrated knife may be used.

Step 3. Cut the fruit into chunks, wedges or spears. Remove the fruit or use the shell as a serving container.

A reminder: Fresh pineapple contains the enzyme bromelin, which breaks down protein. Used in marinades it helps tenderize meats, but it also prevents gelatin from setting. The enzyme is destroyed by cooking, so canned pineapple may be used in gelatin salads and desserts.

Suggestions for column topics may be sent to Back to Basics, Food section, Los Angeles Times, Times Mirror Square, Los Angeles, Calif. 90053.

Try Various Types Of Oriental Noodles

By Rose Dosti
LAT-WP NEWS SERVICE

Today, many varieties of Oriental noodles are manufactured in the United States and are available in fresh and dry forms. However, some noodles, particularly rice and mung bean noodles, are imported from Thailand, China, Japan and Korea, giving the buyer an opportunity to test the various types.

Rice-based noodles, generally called "rice sticks," are probably the most common and come in a variety of shapes, sizes, colors and thicknesses. But there also are noodles made from wheat, buckwheat, mung bean, egg and even green tea, with credit given to China as the inspiration for all noodles (mein).

Noodles may be found wrapped like folded ribbons or packaged like stick spaghetti in various widths and in flat or round shapes. They may be opaque and white — as are those that puff to several times their volume when fried for use in Chinese chicken salad — or thin like vermicelli for adding to stir-fried chow mein dishes. Cellophane noodles — somewhat transparent, translucent noodles made from mung beans — are prized in soups and stir-fry dishes.

Japanese noodles also come in numerous colors, shapes and sizes, from white wheat to gray buckwheat or green tea.

Imported varieties of Thai rice sticks ("sen mee") used in stir-fried

dishes and soups, as well as the famous "mee krob," which requires deep frying, generally are soaked before using. "Gwaytio" noodles, the wide fresh noodles used as the first meal of a Thai day, are commercially available as pancakes in vacuum packets.

Noodles also are a staple of Korean cuisine. Among the most popular are very thin white wheat or buckwheat noodles and thin transparent cellophane noodles. If Oriental noodles are not available for Korean cooking, substitute regular pasta noodles of varying sizes, from very thin vermicelli to fat macaroni.

Here is a description and suggested method of cooking for some of the Oriental noodles used in our recipes, commonly found in supermarkets and Oriental food stores.

Bean threads — Also called cellophane noodles or silver threads and are like rice sticks, but slightly thinner and translucent. Made from starchy liquid leached from pureed mung beans, the tough threads require soaking to soften. Soak in warm water 20 minutes, then cook in boiling water three minutes. Drain and rinse in cold water. Use in soups, stir-fry dishes or deep fried to add as toppings to salads and stir-fry dishes.

Rice sticks — Used throughout the Orient. Specific names for these noodles vary depending on their size and shape and place of origin. They can be used as you would spaghetti or spaghetti or cappellini (angel-hair pasta), cooking thin ones quick-

ly in boiling, salted water for three to four minutes, depending on the thickness of the pasta. The thicker varieties require longer cooking. Most always they are rinsed in cold water to remove excess starch before using.

Another variety of rice sticks, called "banh pho" in Vietnamese and "mei fun" in Chinese, are white, dry opaque noodles. The stringlike noodles are bundled in see-through packages and expand to double their volume when fried or cooked. They are used in Chinese chicken salad and soups and with barbecued meats. In Thai cuisine they are used to make "mee krob" — sweet, deep fried noodles. To use, soak in cold water 20 minutes. Cut, if necessary, and cook two to three minutes to use in soups and stir-fry dishes. Noodles can be crisp-fried by dropping them from the package into hot oil until they puff to several times their original volume. Use in salads or as crushed toppings for stir-fry dishes or salads.

Bon Mein ("bun" in Vietnamese) — Wheat flour egg noodles used like vermicelli in stir-fry or pan-fried chow mein and braised lo mein noodle dishes as well as soups.

Udon — Fat, white wheat noodles sold fresh (vacuum-packed) or dried. The most popular Japanese noodle, chiefly used for soups. Fresh noodles are now available vacuum-packed in most supermarket dairy counters. They may be prepared ahead ready to add to soups. Cook in boiling water until just tender and

rinse in cold water. Sprinkle with oil and cover with cloth until ready to add to soups. Avoid overcooking.

Kishimen — Flat fettuccine-type noodle, a variation of Japanese udon used in place of rice in sukiyaki dishes. Cook with other foods in broth or water until done, then lift out of cooking liquid and eat with dipping sauces or natural juices from stewed foods.

Soba — Thick or thin and caramel-colored from buckwheat flour. Eaten like udon, hot and wet, cold and slightly dry, or on ice for summer salads. Cook in boiling water one minute, then drain in colander and rinse in cold water. Place ice cubes over noodles if cold summer noodles are desired. Serve dipped in dipping sauce or soy sauce.

Somen — Thinnest Japanese noodle made from wheat flour and prepared like soba or rice sticks. Cook in boiling water one minute, then drain in colander and rinse in cold water. Cover noodles with damp cloth if not using immediately.

Spaghetti noodles — Egg noodles resembling Italian spaghetti used like spaghetti with sauces and other toppings. Cook as you would spaghetti, but avoid overcooking for best results. **Ramen** — Same as Chinese egg noodles (bon mein). Plunge into boiling broth to use as main ingredient in soup with or without desired toppings.

Farmers Of Parma Join To Protect Integrity Of Cheese

By Anita I. Mizner
THE ASSOCIATED PRESS

NEW YORK — Descriptions of the Parma region in Italy conjure up its sweet green meadows and hills, meandering rivers, clean air, and painterly, beflowered countryside.

And historic Parma reveals one harmonious scene after another. It's such a delight to stroll the ancient, narrow streets and discover its treasures: the glorious Pink Baptistery, the Cathedral, the wooden Farnese Theater, the Opera House. And Parma's food.

Restaurants, cafe-confectioneries (the Torino is a must), and salumerias are filled to the rafters with Parma's famed succulent hams and sausages, pastas, breads, tomatoes, cheeses and other specialties.

Parma's butter is deluxe. But the masterpiece of Parmesan gastronomy is grana, the incomparable formaggio Parmigiano-Reggiano or genuine Parmesan cheese.

Parmigiano-Reggiano can only be made in Parma and the delimited "zona tipica" — Bologna, Mantua and Modena, all provinces of Reggio-Emilia.

In and around Parma, about 1,200 small cheese-making firms have banded together into an official consortium that represents 60,000 dairy farmers. A prime goal of the consortium is to safeguard the established character and quality of Parmigiano-Reggiano cheese.

The Parma cheese consortium says that although cheeses made elsewhere are called Parmesan, they aren't the same. What makes the difference, the consortium says, is the "superior milk" from cows specially bred in a clean-air environment and fed only on grasses and fodder grown in very fertile soil.

Parmigiano-Reggiano's special character and superiority are due to certain other factors, the experts say, including the hand-making of the cheese according to an old for-

mula; the absence of any artificial additives; the completely natural method of maturation under the strictest of supervision and controls to produce flavor, texture and nutritional value.

Parma's cheese is high in calcium, phosphorus, other minerals and vitamins, and is easy to digest. Parma's cheese is entirely edible; the rind can be used in cooking.

Some 2-3 million wheels of cheese are produced annually. Each wheel weighs about 80 pounds and is worth about \$363 wholesale.

Parma's cheese-makers debate whether their cheese is best at 18 months or 2 years; some say 3 and 4 years. Cheese made in mid-summer is deeper-colored, a bit moister (due to cows feeding on fresh green grass), and has the edge over winter cheese, which is slightly lighter in color and flavor. But only slightly.

During the aging process, cheeses are constantly tested for possible imperfections of texture, and for aroma and degree of maturation. Only perfect cheeses, stamped with the identifying Parmigiano-Reggiano name, are sold.

Parmigiano-Reggiano doesn't deteriorate quickly. Wrap small portions in plastic wrap or foil and store in the refrigerator cheese tray. If you need pre-grated Parmesan, buy a wedge and have the clerk grate it for you; that way you'll know what you're getting.

There are about 450 calories in one-quarter pound of Parmigiano-Reggiano cheese.

Crime Stoppers

If you have information on any crime committed in Pitt County, call Crime Stoppers, 758-7777. You do not have to identify yourself and can be paid for the information you supply.



MEAT SPECIAL

Prices Good July 19-22

Pollard Trading Post

100 Pollard Street
Behind Fred Webb's Grain Mill
Greenville, North Carolina

No Limit on Purchases
CALL IN YOUR ORDER
It Will Be Ready

Owner and Operator
George Whitley

Call in Orders For Fast Service
All Meat Guaranteed

Food Stamp Customers Welcome
All Beef-Western All Pork-Native

Phone 758-2277

Open
MONDAY THRU SATURDAY
8:00 A.M.—6:00 P.M.

RIBEYE STEAK \$3 ⁹⁹ lb.	BONE-IN CHUCK ROAST \$1 ²⁹ lb.
COUNTRY CURED HAM HOCKS 59¢ lb.	COUNTRY STYLE CORNED BACK BONE \$1 ³⁹ lb.
PORK NECK BONES 39¢ lb.	PIG LIVER 19¢ lb.
WHOLE SMOKED SLAB BACON 79¢ lb.	TEA 1 GALLON \$1 ⁰⁹ PEPSI 2 LITER 99¢

Keep Your Cool With No-Cook Meals

THE ASSOCIATED PRESS

NEW YORK — Who wants to "bake" in the kitchen this summer? When the mercury soars, you can keep your cool with simple, no-cook meals.

Use prepared cuts of meat and slices of cheese for supersize summer sandwiches — an easy way to feed your family — and backyard guests.

Fresh vegetables make quick and tasty salads. Buy fresh or refrigerated pasta salads and toss with crisp vegetables, lean meats and light seasonings.

1 medium red onion, sliced and separated into rings
2 cups shredded iceberg lettuce
Salt and pepper to taste

On bottom half of bread, arrange meats and cheese in layers. Top with crumbled bacon, tomato, onion and lettuce. Sprinkle with salt and pepper, or use grainy mustard, mayonnaise or pickle relish. Makes 4 servings.

PEPPERED HAM IN TORTILLA CONES

1 lb. extra lean ham, cut into ten 1/4-inch slices
1/2 cup bottled light Italian salad dressing
1 tsp. coarsely cracked black pepper
3 red, green or yellow sweet peppers, or 1 pepper of each color
Five 8- to 10-inch flour tortillas
10 leaf or romaine lettuce leaves
10 green onion tops, halved lengthwise and blanched, optional
Cut ham lengthwise into quarters.

In an 11-by-7-by-2-inch shallow baking dish, combine salad dressing and black pepper. Place ham strips in bottom of dish; stir to blend. Set aside. Cut each pepper into 24 strips. Halve tortillas.

To assemble, top each tortilla half with one lettuce leaf, 7 pepper strips and 1/2 cup ham mixture. Roll up gently to form cone. Repeat with remaining ingredients. Tie one green onion top around each tortilla cone, if desired. Makes 5 servings (2 cones per serving).

SUMMER SALAD

2 1/2 oz. Saga Blue cheese
3 to 4 tbsps. salad oil
1 tbsp. wine vinegar
Dash of salt
1 to 2 bunches radishes, sliced
1/2 gherkin, cubed
Chives

Mash blue cheese with wooden spoon. Add oil to cheese, gradually blending in along with vinegar and salt. Add radishes and gherkin. Sprinkle with chives. Serves 4.

VALASSIS COUPON VALUES VALASSIS

FREE

4 OZ TRIAL SIZE



KRAFT

Cheez Whiz

PROCESS CHEESE SPREAD

ZAP-A-PACK™

MICROWAVE CUP

FREE

4 oz.

trial size or 69¢ OFF

4-pack CHEEZ WHIZ®

Pasteurized Process Cheese Spread in Zap-A-Pack™ microwave cups

RETAILER: Kraft, Inc. will reimburse you for the face value of this coupon plus 6¢ if submitted in compliance with Kraft's Coupon Redemption Policy, previously provided to retailer and incorporated by reference herein. Void where taxed, restricted or prohibited. Cash value 1/100¢. Mail to Kraft, Inc. (P.F.O.), CMS Dept. #21000, 1 Fawcett Dr., Del Rio, TX 78840. Offer Expires: October 18, 1989

ONE COUPON PER ITEM PURCHASED • REDEEM PROMPTLY

© 1989 Kraft, Inc. 21000 28856 NF9-21

FREE

30¢

SAVE 30¢

when you buy 16 oz.

VELVEETA Slices Pasteurized Process Cheese Spread



RETAILER: Kraft, Inc. will reimburse you for the face value of this coupon plus 6¢ if submitted in compliance with Kraft's Coupon Redemption Policy, previously provided to retailer and incorporated by reference herein. Void where taxed, restricted or prohibited. Cash value 1/100¢. Mail to Kraft, Inc. (P.F.O.), CMS Dept. #21000, 1 Fawcett Dr., Del Rio, TX 78840. Offer Expires: October 31, 1989.

ONE COUPON PER ITEM PURCHASED • REDEEM PROMPTLY

© 1989 Kraft, Inc.

MONEY SAVING COUPONS the Sunflower Group

50¢

EXPIRATION DATE: OCTOBER 31, 1989

SAVE 50¢ on WISK

LAUNDRY DETERGENT

Good on two 16 oz. or 32 oz. or one any larger size.



RETAILER: Lever will reimburse you for the face value of this coupon, plus 6¢ if submitted in compliance with Lever's Redemption Policy. Valid if redeemed by retail distributors of our merchandise or those authorized by Lever. Cash value 1/100th of 1¢. Lever Brothers Household Dept. #1111, 1 Fawcett Drive, Del Rio, TX 78840. Limit one coupon per purchase. Good only on Wisk Liquid Detergent. Any other use constitutes fraud.

© 1989 Lever Brothers Company

5 11111 27050 8

GRADE A WHOLE FRYERS

HEAVY WESTERN SIRLOIN STEAKS

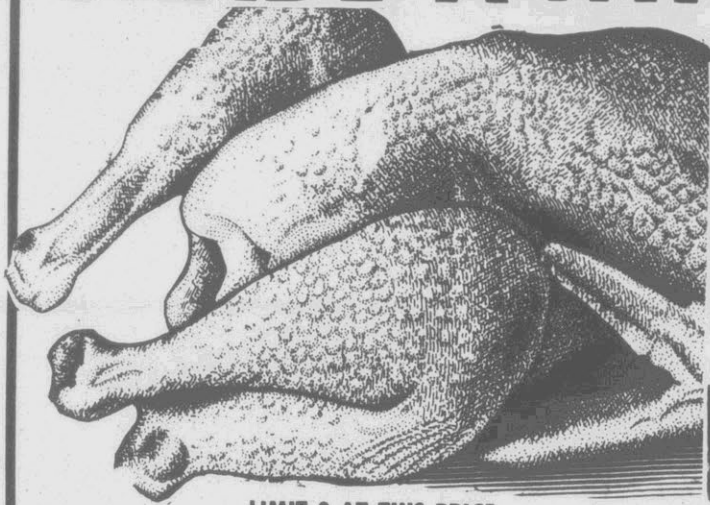

LIMIT 2 AT THIS PRICE

59¢

LB.

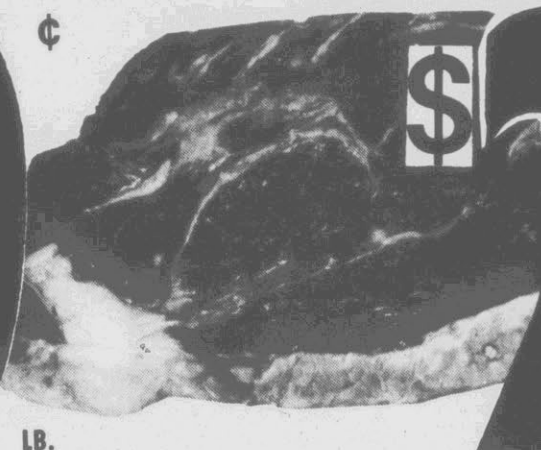

\$2.29

LB.

DELI SPECIALS:
COOKED HAM
AMERICAN CHEESE (YELLOW OR WHITE) LB. **\$2.99**

FAMILY PACK SPECIALS
NECK BONES,
FAT BACK, PIG FEET 5-7 LB. PKG. **49¢** LB.

FULL CUT
ROUND STEAK LB. **\$1.79**

HEAVY WESTERN
PORTERHOUSE STEAKS LB. **\$2.49**
T-BONE STEAKS . . . LB. **\$2.59**



FRESH WHOLE
CHICKEN BREAST
\$1.39 LB.

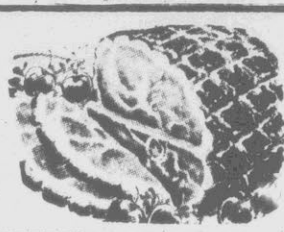

BEALE VIRGINIA
COUNTRY HAMS
\$1.39 WHOLE OR HALF LB. **\$1.49** SLICED LB.

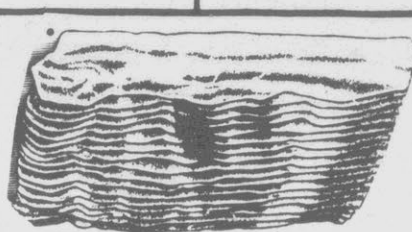

FROSTY MORN
BACON OR
FRANKS
99¢ 12 OZ. PKG.

LIBBY'S
VIENNA SAUSAGE 5 OZ. CAN **2 \$1** FOR

STORE HOURS:
OPEN SUNDAYS - 1 P.M.-6 P.M.
MONDAY - SATURDAY 8 A.M.-8 P.M.

PRICES EFFECTIVE WEDNESDAY, JULY 19
THROUGH SATURDAY, JULY 22, 1989

GIBB'S
PORK-N-BEANS 16 OZ. CAN **3 \$1.19** FOR

FAB DETERGENT

GIANT 42 OZ. BOX
LIMIT ONE WITH \$10.00
FOOD ORDER EXCLUDING
ADVERTISED SPECIALS.



99¢



VISA, AMERICAN EXPRESS
FOOD STAMPS, MASTERCARD WELCOME

PAGE TOILET TISSUE

4 ROLL PKG.



79¢

SAUER'S
MUSTARD 32 OZ. JAR **2 \$1.19** FOR

FRESH FROM THE GARDEN FROZEN
VEGETABLES ARE HERE. CALL 752-5025
FOR MORE INFORMATION.

THANK-YOU
APPLE OR CHERRY
PIE FILLING 20 OZ. CAN **79¢**

VINTAGE
SELTZER WATER, GINGER
ALE, TONIC WATER 1 LITER **3 \$1** FOR

BREYER'S
ALL NATURAL
ICE CREAM 1/2 GAL. CARTON **\$2.79**

WELCH'S
GRAPE JAM 2 LB. JAR **99¢**

PAGE PAPER TOWELS
GIANT ROLL **39¢**



MIAMI ICE
FREEZE POPS PKG. OF 10 **\$1.39**

RICHFOOD
HOMOGENIZED
MILK 1/2 GAL. PAPER CARTON **99¢**

BRIGHT & EARLY
JUICE 1/2 GAL. CARTON **99¢**

PARKAY
MARGARINE LB. PKG. **2 \$1** FOR

PEPSI PRODUCTS ALL 2 LITERS
LIMIT 6 **99¢**



EMBERS
CHARCOAL 10 LB. BAG **\$1.59**

RICHFOOD
VINEGAR GALLON JUG **\$2.49**

Harvest of Savings

GOLDEN
BANANAS **3 LBS. FOR \$1**



WASHINGTON STATE,
EXTRA FANCY
RED DELICIOUS
APPLES 2 LBS. **\$1**

FRESH LIMES 2 LB. BAG **99¢**

NEW CROP
WHITE
POTATOES 3 LBS. **\$1**



SOUTH CAROLINA
TREE RIPENED
PEACHES 2 LBS. FOR **\$1**

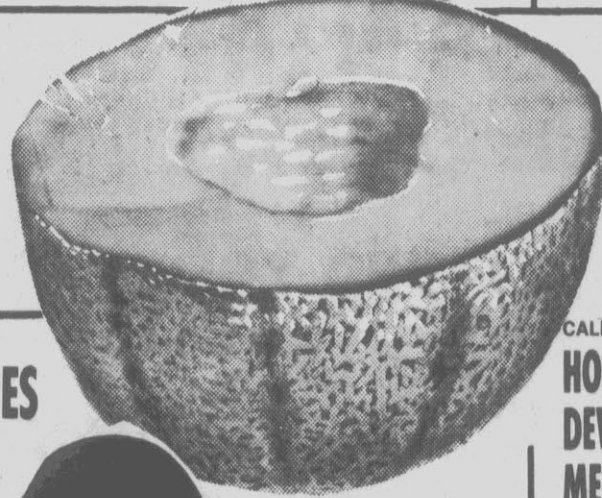

CALIFORNIA EXTRA LARGE
CANTALOUPE **99¢** EACH

FRESH TENDER
BROCCOLI **99¢** BUNCH

SEEDLESS
WHITE GRAPES **99¢**



GREEN CABBAGE **4 LBS. FOR \$1**



CALIFORNIA SWEET
HONEY
DEW
MELONS EA. **\$1.19**

WATERMELON 1/8 SLICE **99¢**

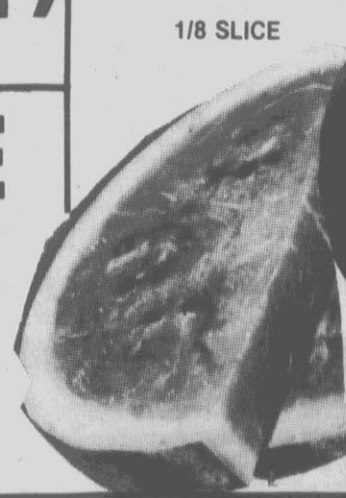

HARRIS SUPERMARKETS

DISCOUNT "WHERE SHOPPING IS A PLEASURE"
ON EVERYTHING BUT QUALITY

We Reserve The Right To Limit Quantities
We Accept Food Stamps and WIC Vouchers

PRICES GOOD THROUGH SATURDAY

it's BARBECUE



U.S.D.A. WESTERN BONELESS

CHUCK ROAST

\$1.49 LB.



U.S.D.A. WESTERN BONELESS

SIRLOIN STEAKS

\$2.69 LB.

FRESH FRYER LEG 1/4's

49¢

LB.



- FRESH GRADE A FRYER BREAST 1/4's LB. **99¢**
- U.S.D.A. WESTERN BONELESS CHUCK STEAKS LB. **\$1.69**
- U.S.D.A. WESTERN BONELESS SHOULDER ROAST LB. **\$1.69**
- U.S.D.A. WESTERN BONELESS STEW BEEF LB. **\$1.69**
- (GROUND FRESH DAILY) FRESH GROUND CHUCK LB. **\$1.59**
- FRESH 1/4 SLICED PORK LOINS LB. **\$1.69**
- JESSE JONES FRANKS 12 OZ. **\$1.19**
- JESSE JONES BOLOGNA 12 OZ. **\$1.19**
- JESSE JONES SAUSAGE 14 OZ. **\$1.49**
- CARL BUDDIG WAFER THIN MEATS 2.5 OZ. **49¢**
- SMITHFIELD BACON 1 LB. **\$1.19**
- HARRIS' OWN FRESH LINK SAUSAGE LB. **\$1.89**
- HARRIS' OWN GENUINE OLD FASHION COUNTRY HAM 1/5TH SLICES LB. **\$2.99**

DR. PEPPER OR DIET DR. PEPPER

2 LITER

89¢



JOY DISHWASHING LIQUID

12 OZ.

69¢



PRODUCE



3 IN 1 NORTH CAROLINA WHITE POTATOES

\$1.59

5 LB. BAG



LARGE CAROLINA SWEET PEACHES

2 \$1

LBS. FOR

WASHINGTON STATE EXTRA FANCY RED DELICIOUS APPLES 2 LBS. **\$1** FOR

RED FLAME SEEDLESS GRAPES LB. **99¢**

LITTLE HUG FRUIT FLAVORED DRINKS 8 OZ. SIZE ALL FLAVORS **6 FOR \$1**

FROZEN FOOD

EDWARDS **CONDENSED PIES** **\$1.99**

22 OZ. LEMON, CHOCOLATE OR COCONUT

LA CHOY **FRESH 'N LITE ENTREES** **\$1.99**

SHRIMP OR PORK EGG ROLLS

LA CHOY **FRESH 'N LITE ENTREES** **\$1.99**

IMPERIAL CHICKEN, SWEET & SOUR CHICKEN BEEF & BROCCOLI, BEEF TERIYAKI, PEPPER STEAK

PET WHIP **WHIPPED TOPPING** 8 OZ. **59¢**



SARA LEE **POUND CAKE** 10 OZ. **\$1.69**

TOTINOS **PARTY PIZZAS** ALL 10 OZ. VARIETIES **99¢**

- CRIS**
- KRAFT RANCHER**
- MURRAY GOLDI**
- PARADE CHA**
- SURF LAUND**
- WHITE HO VINE**

DEAL TIME

KEEBLER
 E.L. FUDGE 16 OZ. DOUBLE
 FUDGE CREME,
 PEANUT BUTTER **\$1.99**
 CREME, VANILLA CREME
 OR FUDGE FUDGE CREME
 KEEBLER HONEY
 GRAHAM, PLAIN **\$1.89**
 GRAHAM OR
 CINNAMON CRISP .16 OZ.
 KEEBLER
 WHEATABLE 12 OZ. **\$1.49**

DELI
 (BELLS FORK STORE ONLY)
ROAST BEEF LB. **\$3.99**
MUENSTER CHEESE LB. **\$2.89**
MACARONI SALAD LB. **89¢**

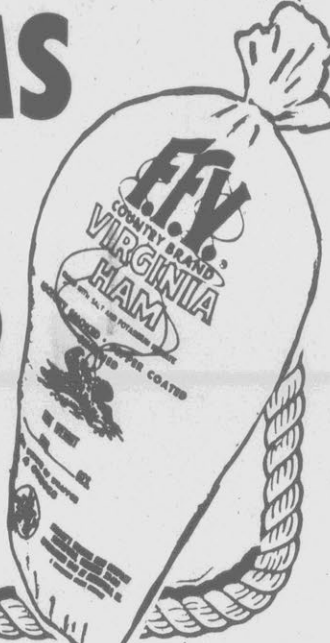
PEANUT CITY WHOLE
COUNTRY HAMS

\$1.29 LB.

ANGEL SOFT BATHROOM TISSUE
 4 ROLL PAK
99¢

DELMONTE CATSUP
 32 OZ.
89¢

PEPSI, DIET PEPSI, 7-UP OR MT. DEW
 2 LITER
99¢

PURINA BEEF COMPLETE DOG FOOD
 20 LB.
\$5.99

SPARKLE TOWELS
 JUMBO ROLL
59¢

SCOO OIL 48 OZ. **\$1.89**
RS CHOICE DRESSING REGULAR OR REDUCED CALORIE 16 OZ. **99¢**
Y'S HONEY BEARS 10 OZ. **99¢**
ARCOAL 10 LB. **99¢**
DRY DETERGENT 40¢ OFF LABEL 42 OZ. **\$1.69**
HOUSE VEGAR GALLON SIZE **\$2.49**

DAIRY
 BRIGHT 'N EARLY CHILLED
ORANGE JUICE DRINK 1/2 GAL. CARTON **79¢**

 CAROLINA DAIRIES
HOMOGENZIED MILK 1/2 GAL. CARTON **99¢**
 MERICO
BUTTER-ME-NOT BISCUITS 9.5 OZ. **2/89¢**

 SHEDD'S SPREAD
MARGARINE 1 LB. 1/4's **3/\$1**

Old Good Housekeeping Recipes Stir Memories

By Carleton Jones
LAT-WP NEWS SERVICE

Conceivably there are billions of citizens on the planet who have never heard of elbow macaroni. And perhaps as many countless millions have never delved into ham baking, preferring their piggie tinned, sliced, barbecued or not at all.

I prefer both, together, prepared in a manner just as corny as the combination. They are simple, but that is no reason why they cannot become things of legend.

There is a story that goes along with these prejudices and the saga goes like this:

In early 1947, Good Housekeeping magazine revved up its busy test kitchens and produced another specimen of middle American goodies. On page 118 of the March issue, splang in the middle of an article called "There's Plenty of Cheese," they unveiled the formula for "Baked Macaroni Loaf de Luxe," accompanied by a full-color photo, something of a treat in that period of recipe publishing. It rated the title of deluxe only because it included chopped parsley and pimiento — two ingredients that were hardly household words in kitchens that scorned the fancy or the new-fangled. "Delightfully different is this golden-brown, molded macaroni-and-cheese loaf served with mushroom sauce," read the color photo's captioned hype.

In this instance, the caption did not lie. Baked mac caught on big just about the time the serve-them-a-buffet-supper movement got rolling after World War II, in my house and in thousands of others.

The green parsley and the red pimiento gave the dish a luxurious, party sort of look in the days when few American family cooks gave much priority to how food looked. Of course cheese macaronies had been served (more or less indifferently) for generations as a side dish. But the Good Housekeeping formula brought it into the big time, fast.

We had the Good Housekeeping type baked in deep earthenware crocks that fitted into bamboo stands for porch and patio parties. We had it done in huge round Pyrex casseroles (doubling the recipe for big dinners indoors). With its ham combination (see below) it made a great meal for guests and you would lather the slices of baked mac, or reheated grilled macaroni, with a mushroom cream sauce. For family affairs we just used big flat 14-by-9-inch glass pans for a loaf that was a snap to slice after cooling. We also did it in the conventional loaf pan method described below.

Then one day disaster struck. It was a sort of lifetime formula for making sure you read a recipe carefully.

My associate cook and I assembled the ingredients for a dinner party for 10. Then, while my back was turned, the first step — cooking the pasta — was completed by my partner. We forged ahead with the rest of the macaroni and I let my assistant take over the seasoning, assembly and stirring. Then, luckily before baking, I tasted the result. It was roarily salty and inedible.

Instead of putting 4 teaspoons of salt into the pasta water and then throwing the liquid away, 80 percent of the salt and an additional teaspoon had all been dumped into the prepared macaroni — 5 teaspoons in all.

What to do? There was only one way out. We had to throw out everything — or make four more complete recipes to thin out our inedible, salty batch. There was a riotous trip to the grocery store to get more supplies, including three more boxes of macaroni, two dozen eggs, three quarts of milk, 12 cups of grated cheese, etc.

It took every pot in the house to boil the pasta and hours to get this giant batch in the oven. We had to

bake it all immediately because of the egg content of the mix. And then the only solution to getting rid of it all was to throw another party, the week after the disaster, and saute the rest of the giant batch for lunches. I figure it fed in the vicinity of 35 or 40 people, with lots of calls for seconds.

In the original article, Good Housekeeping did not provide a recipe for mushroom sauce, but it was recommended as an escort for the macaroni. The mushroom sauce below is from the 1953 edition of the "Good Housekeeping Cookbook" and true to the era of the original master pasta recipe.

With the pasta, the family traditionally served "the ham what am." It was normally a Georgia or a North Carolina-type smoked country ham (not a Smithfield and not as expensive as one) that had been through the soaking and slow-bake ordeal that produces the perfect Dixie pig.

"If it isn't smoked, it isn't ham to me. And country ham is really the only ham what am," says Miriam Ungerer, who hails from South Carolina, who is wife of the distinguished author Wilfred Sheed in private life. Her newly published *Summertime Food* (Random House; \$19.95), is an authoritative roundup of ways to treat midsummer garden bounty and prepare such regional treats as shrimp perloo and Georgia peaches with white chocolate sauce. Ham what am a la Ungerer (see below) is the classic treatment of smoked, down-home type hams, as opposed to the lighter and less complex flavored supermarket varieties of cured (not smoked) hams or the sublime and overpowering Smithfields.

So there it is — its own tacky but irresistible self, a dinner formula that is the enemy of every diet since World War II. Conceivably it could make you flunk your metabolism test or your next blood pressure reading. It is likely, though, that if you spring it unannounced on your family or guests, it may be rated, as many good old boys and girls already have at buffets well south of the Potomac or east of the Pecos, "the best thang we ever had."

Note: Lovely accompaniments for this dinner dish are spiced, glazed apples, spiced apple rings or green tomato pickles served with yeast rolls and butter. Or all three. Enjoy.

Some comments on the recipe: This stellar recipe is beginning to show its age. "Fortified margarine" is a World War II shortage term indicating color additions. Butter will deliver more flavor — and more calories to say nothing of the cholesterol. Also, processed Cheddar is an out-of-date term. Many Cheddars today are naturally ripened affairs. A real nutty, buttery Wisconsin Cheddar, moist but sliceable, is nevertheless perfect for this dish. Avoid the crumbly, sweet New York variety here. You can also slice your leftovers for sauteing only half an inch thick. Also, I occasionally add about a half-teaspoon of dry mustard to the mix of the main recipe. I think it accents the cheese flavor.

BAKED MACARONI LOAF DE LUXE

- 1 1/2 cups uncooked elbow macaroni
- 3 qts. of boiling water
- 5 tps. of salt
- 3 cups of milk
- 1/2 cup of butter or fortified margarine
- 2 cups of soft bread crumbs
- 1/3 cup of chopped pimiento
- 3 cups of grated, processed American Cheddar cheese
- 1/2 cup minced parsley
- 1/4 cup minced onion
- 1/4 tsp. pepper
- 6 eggs, beaten

Cook macaroni in boiling water to which 4 teaspoons of salt have been added — about 9 minutes — or until macaroni is tender. Drain;

rinse with boiling water. Combine milk and butter; then scald. Pour over bread crumbs; then add all remaining ingredients except eggs. Next add eggs and macaroni, stirring until blended. Pour mixture into greased 10- by 5- by 3-inch oven glass loaf pan. Bake in moderate oven, 325° for 1 hour 10 minutes or until knife inserted in center comes out clean. Cool for 10 minutes; unmold and serve with mushroom sauce. Serves eight.

Note: Any leftover loaf is delicious after being chilled in the refrigerator, sliced 3/4-inch thick then sauteed in butter.

For a diet version of this dish, try boiling the mac in salt-free water and omit all salt with the mix. Use low-cal bread in preparing bread crumbs. Substitute mozzarella or Muenster cheese for the Cheddar. Use the least salty and lowest calorie margarine you can find. Cut back from standard milk to skim. And use only two whole eggs and four egg whites.

GOOD HOUSEKEEPING MUSHROOM SAUCE

- 2 tbsps. butter or margarine
- 1/2 lb. chopped mushrooms
- 3 tbsps. flour
- 1/2 tsp. salt
- Speck pepper
- 2 cups milk or chicken broth
- Snipped parsley

In hot butter in saucepan, saute mushrooms, 3 to 4 minutes. Stir in flour, salt, pepper, then milk or broth; cook, stirring, until thickened. Add parsley. Serves eight.

MIRIAM UNGERER'S HAM WHAT AM

Scrub smoked country ham with a stiff brush under tepid running water. Get off all the pepper or mold or ashes and put the ham in a large roaster or a big plastic container. Cover it completely with cold water and let it soak 12 hours. Change the water and soak a further 12 hours. I have a deep sink in my greenhouse that I use for this purpose — or you might commandeere a bathtub overnight.

The beautiful copper boilers of the 19th century kitchen have become plant cachepots in country houses, and nothing has come along to replace them. However, you can make do with one of the old-fashioned, blue speckled graniteware roasters still sold in hardware and dime stores. Huge foil roasting pans can be found in similar stores. As they aren't very strong, buy two and place them one inside the other on a heavy baking sheet.

Put the ham in whatever vessel you've got, cover it with cold water, cover with foil if there is no top, and put it in a cold oven. Turn the thermostat to 325° and bake 4 hours for a whole ham, turning it once midway in the cooking. Pierce it with tines to be sure it is tender.

Remove the ham to the top of the stove and let it cool in its liquid (now called likker) to tepid. Remove the rind carefully and let the fat solidify. Pare the fat evenly — this is easier than soap carving — leaving about a half-inch layer. This helps to preserve the ham's freshness and moisture — a completely scalped ham will dry out. Wrap the ham in heavy foil and refrigerate it overnight.

Carving, not cooking, is the bete noir of country hams. Problems in the procedure are caused either by undercooking, undersoaking, removing the ham before it has cooled in its cooking liquid, or, maddeningly, overcooking until all the flavor and texture have been boiled away. So stick to the age-old traditional routine and let no one persuade you to "try something new" with a valuable, aged country ham. Even after you have successfully cooked, cooled and carved a ham, dryness is still to be guarded against. Cover the sliced ham with airtight plastic wrap until serving (or arranging) time.

Turkey-Noodle Casserole Is Low Fat All The Way

By Nancy Byal
BETTER HOMES AND GARDENS

Look for the new wave of lower-fat dairy products in your supermarket's dairy case. They've won raves from our food editors and home economists in samplings in our Test Kitchen. These products taste great and cut fat and calories by about one-third. In this dish we used low-fat cream cheese, cottage cheese and yogurt to help us hit our target — no more than 30 percent of calories from fat.

TURKEY-NOODLE CASSEROLE

- 12 oz. ground raw turkey
- 1/4 cup chopped onion
- 1/4 cup chopped green pepper

- One 8-oz. can tomato sauce
- 1/4 tsp. salt
- 1/8 tsp. pepper
- 1/2 of an 8-oz. package wide noodles
- 1/2 of an 8-oz. package low-fat cream cheese, cubed
- 1/2 cup low-fat cottage cheese
- 1/4 cup plain low-fat yogurt
- 1 1/2 tps. poppy seed

In a skillet cook turkey, onion and green pepper until meat is no longer pink and vegetables are tender. Drain off liquid. Stir in tomato sauce, salt and pepper.

Meanwhile, cook noodles according to package directions, except omit salt; drain. In a small mixing bowl combine cheeses, yogurt and poppy seed; toss cheese mixture with hot noodles.

Layer 1/3 of the noodle mixture in a

9- by 9- by 2-inch baking dish. Spoon meat mixture over noodles, leaving a 1- to 2-inch border of uncovered noodles. Layer remaining noodle mixture over meat mixture, leaving a 1- to 2-inch border.

Bake, covered, in a 375-degree F oven for 30 minutes. Uncover the casserole. Bake 10 to 15 minutes more or until casserole is heated through. Makes 4 servings.

Nutrition information per serving: 348 cal., 31 g pro., 29 g carb., 11.5 g fat (30 percent of calories from fat), 73 mg chol., 741 mg sodium. U.S. RDA: 18 percent vit. A, 18 percent vit. C, 24 percent thiamine, 23 percent riboflavin, 30 percent niacin, 12 percent calcium, 15 percent iron.

WHOLESALE OUTLET

2500 CHARLES STREET EXT.

756-8652

STORE HOURS

MONDAY-FRIDAY 9am-8pm

SATURDAY 9am-6pm

SHOWER TO SHOWER POWDER 8 Oz.  \$1.59	TRONOLANE CREAM 1 Oz.  \$2.39	EXTRA STRENGTH GAS-X TABLETS 18's  \$1.79
SOFT & DRI ANTI-PERSPIRANT DEODORANT SPRAY 5.2 Oz. BONUS  \$1.99	MENNEN SKIN BRACER 5 Oz. REGULAR OR SPORT TALC  \$2.39	"GEE YOUR HAIR SMELLS TERRIFIC" SHAMPOO AND CONDITIONER 12 Oz.  \$1.69
DAISY PLUS 10's  \$2.09	CONCEPTROL CONTRACEPTIVES GEL 10 PREFILLED APPLICATOR  \$6.39	CLAIROL LOVING CARE MOUSSE HAIR COLOR  \$3.89
MIDOL 200 TABLETS 32's  \$2.69	MIDOL PMS TABLETS 32's  \$3.49	NEET WIDE ROLL-ON HAIR REMOVER 5 Oz.  \$2.89
CHILDREN'S PANADOL TABLETS 30's CHILDREN'S PANADOL LIQUID 2 Oz.  \$1.99 YOUR CHOICE	OLD SPICE DRY STICK 2 Oz.  \$1.79	
COLGATE MOUTH RINSE 24 Oz. PEPPERMINT OR COOL MINT  \$2.59	NOXZEMA ANTISEPTIC SKIN CLEANSER 8 Oz.  \$1.99	RAVE HAIRSPRAY 7 Oz.  79¢
AOSEPT DISINFECTION AND NEUTRALIZATION SOLUTION 12 Oz.  \$4.39	NEO-SYNERGIC NOSE SPRAY .5 Oz.  \$2.19	CHAPSTICK LIP BALM .15 Oz.  39¢

Meatballs Take 15 Minutes

By Nancy Byal
BETTER HOMES AND GARDENS

Savory cheese-and-beer sauced meatballs in just 15 minutes? Yes, it's possible when you cook both meatballs and sauce in your microwave. For fast shaping and for uniform meatballs, important for even cooking in the microwave, pat the meat mixture to a 6-inch square on waxed paper. Cut into 1-inch squares and shape into balls. Look for the tiny dumplings called spaetzle in the freezer case of your supermarket.

BEER-SAUCE MEATBALLS

1 beaten egg

- One 10 3/4-oz. can condensed Cheddar cheese soup
- 1 cup soft bread crumbs (1 and 1/3rd slices)
- 1/4 tsp. salt
- 1 lb. ground beef
- 1 medium onion, thinly sliced and separated into rings
- 1/2 cup beer
- 1/2 tsp. dried oregano, crushed
- Dash pepper
- Hot cooked spaetzle, noodles or rice

In a small bowl combine egg and 1/4 cup of soup. Stir in bread crumbs and salt. Add ground beef. Mix well. Shape into 36 meatballs. Set aside.

Place onion rings in a 12- by 7 1/2- by 2-inch microwave-safe baking dish. Cover with waxed paper. Cook

on 100 percent power (high) 2 to 3 minutes or until onion is just tender. Arrange meatballs over onion. Cook, covered, on high 8 to 10 minutes or until no pink remains, rearranging twice. Drain.

Combine remaining soup, beer, oregano and pepper. Pour soup mixture over meatballs. Cook, covered, on high 5 to 8 minutes or until heated through, stirring twice. Serve over hot cooked spaetzle, noodles or rice. Makes 6 servings.

Nutrition information per serving: 451 cal., 23 g pro., 47 g carb., 18 g fat, 174 mg chol., 544 mg sodium. U.S. RDA: 11 percent vit. A, 21 percent thiamine, 19 percent riboflavin, 27 percent niacin, 21 percent iron.



piggly wiggly

"When You See This Face, You're at the Right Place!"

PRICES EFFECTIVE JULY 19-22, 1989
WE RESERVE THE RIGHT TO LIMIT QUANTITIES.
NONE SOLD TO DEALERS OR RESTAURANTS.
WE GLADLY ACCEPT U.S.D.A. FOOD STAMPS.

EARN EXTRA MONEY
for your church or civic group

Your organization can earn a substantial sum by saving the labels on all Piggly Wiggly products. Just follow the rules below:

- 1 Send in the portion of the label that reads "Distributed by Piggly Wiggly Corporation, Memphis, TN" in packets of 200. Each label is worth 2c.
- 2 Be sure to include the label count for the total amount of the labels.
- 3 Include the name of your organization on each package of labels, as well as the name and mailing address of the person responsible for the labels.
- 4 Wrap labels in a strong package and mail or deliver to Piggly Wiggly Labels, 3030 Poplar Avenue, Memphis, TN 38111.

Individuals are not eligible. Offer is open only to religious, charitable, civic or fraternal organizations.

U.S.D.A. SELECTED BEEF! "Trimmed The Way You Like It"



FULL CUT BONE IN
Round Steak
159
LB.

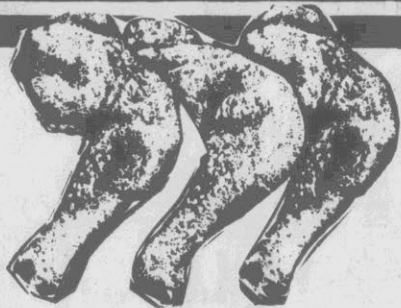

FRESH FRYER
Leg Qtrs.
399
LB.



LUTER'S OLD FASHIONED
Meat Franks
899
12 OZ. PKG.



PEANUT CITY
HAMS
129
LB.
SLICED FREE!

RUMP OR SIRLOIN
TIP ROAST . **189** LB.
FAMILY PACK
CUBE STEAK LB. **1.89**
FRESH
GROUND ROUND LB. **1.79**

RIB EYE STEAKS **399** LB.
LUNDY'S QTR. LOIN PORK CHOPS LB. **1.79**
LUNDY'S FAMILY PK.
FRESH PORK
NECKBONES **499** LB.
or **PIG FEET** LB.

SMITHFIELD
BACON 1 LB. PKG. **119**
SMITHFIELD
GRILL-READY
CHICKEN FRANKS 1 LB. PKG. **899**

PIGGLY WIGGLY'S WORLD OF PRODUCE "Freshest Buys In Town"

CHERRY TOMATOES
999 PT.

WHITE SEEDLESS GRAPES
999 LB.

SLICING CUCUMBERS
3/999 FOR

WESTERN CHERRIES
999 LB.

SAV-SUM
TEA BAGS
100 COUNT
899

PIGGLY WIGGLY BUTTER-ME-NOT
BISCUITS
10 COUNT
2/999

BANQUET
FROZEN DINNERS
CHICKEN, TURKEY, SALISBURY STEAK
119
10 OZ.

DUKE'S
MAYONNAISE
899 QT.
LIMIT 1 WITH THIS COUPON AND A \$10 OR MORE FOOD ORDER. EXPIRES JULY 22, 1989. PLU-10

Light 'n Lively
Cottage Cheese
24 OZ. **1.69**
Light 'n Lively
YOGURT
8 OZ. ALL FLAVORS **3/100**

PIGGLY WIGGLY
KETCHUP
799
32 OZ.

PIGGLY WIGGLY
CHARCOAL
20 LB. BAG
249

JENO'S
PIZZA
ALL FLAVORS
889
8 OZ.

Tropicana
ORANGE JUICE 64 OZ. CTN. **149**
HOMESTYLE OR PURE PREMIUM 64 OZ. CTN. **229**

CHARMIN
BATHROOM TISSUE
WHITE, YELLOW/BLUE
899 4 ROLL PKG.
LIMIT 1 WITH THIS COUPON AND A \$10 OR MORE FOOD ORDER. EXPIRES JULY 22, 1989. PLU-11

KRAFT Four-on-the floor SALE!

TWIN PET
DOG FOOD
15 OZ.
5 for 100

ScotTowels
JUMBO ROLLS
699 PER ROLL

HEALTH & BEAUTY AIDS
BENADRYL ELIXIR . . . 4 OZ. **3.29**
4.6 OZ. AQUA-FRESH PUMP TOOTH PASTE. **159**
40 CT. TABLETS EFFERDENT . **2.49**
BIC BUTANE LIGHTERS . **2/100**

SAV-SUM
SHORTENING
699 42 OZ.
LIMIT 1 WITH THIS COUPON AND A \$10 OR MORE FOOD ORDER. EXPIRES JULY 22, 1989. PLU-12

FRENCH, THOUSAND ISLAND, CATALINA OR COLE SLAW
KRAFT DRESSING . . . 8 OZ. **999**
KRAFT DELUXE MACARONI & CHEESE DINNERS 14 OZ. **1.39**
KRAFT MIRACLE WHIP 32 OZ. **1.99**
KRAFT PARKAY MARGARINE 1 LB. **599**
KRAFT SLICED AMERICAN CHEESE SINGLES 16 OZ. **2.29**

CHATHAM
CHUNX
DOG FOOD
40 LB. BAG
599

TOP POP
DRINKS
3 LITER
999

COKE, DIET COKE
2 LITER
999

2105 DICKINSON AVENUE
Open Mon.-Sat. 7 am to Midnight
Open Sunday 7 am to 9 pm
Shop PIGGLY WIGGLY

PIGGLY WIGGLY KEEPS AMERICA SHOPPING WITH EVERYDAY LOW PRICES!

Yogurt, Once A Health Food, Becomes A Mainstream Treat

(Continued from D1)

tric mixer to break up the frozen parts and incorporate air. Return to the tray and freeze. Beat the mixture again when it firms in 20-60 minutes. If the mixture freezes too hard between beatings, place in the refrigerator until softened. Repeat at least twice, then freeze until firm.

In some of the recipes that follow, gelatin or whipped egg whites added to the yogurt mixture help it freeze smoothly with fewer ice crystals. (In commercial yogurt products, vegetable gums are used to produce the smooth, creamy "mouthfeel" that ordinarily would be provided by fat in ice cream and ice milk). Egg whites also lighten the texture.

Some recipes below call for superfine sugar, also called dessert or bar sugar, which is made to dissolve quickly in cold liquids.

FAST FROZEN YOGURT

1 10-oz. package loose-pack frozen strawberries, raspberries, blueberries, peaches, apricots, cherries or other fruit (or about 1 1/4 cups fresh fruit, cleaned, sliced and frozen solid)

1 cup plain or vanilla yogurt
Superfine or confectioner's sugar, to taste
Lemon juice, to taste

About a half-hour before you plan to serve, place the yogurt and serving dishes in the freezer. Do not thaw the fruit.

Finely chop the fruit in the processor (You may wish to do this in batches in a small machine). Spoon yogurt over fruit and process just until mixed. Taste and add sugar or lemon juice as needed; remember that vanilla yogurt is sweetened. Serve at once in chilled dishes.

If desired, freeze the yogurt in a loaf pan, covered with plastic wrap. Remove from freezer about 10 minutes before serving or chop it into large chunks and process until smooth again. However, this dessert is better fresh or no more than a few hours old. Serves four to six.

Variation: Use frozen banana chunks, about 4 large or 8 small ripe bananas. Add freshly grated nutmeg and 2 teaspoons vanilla.

IRISH COFFEE FROZEN YOGURT

3 cups plain yogurt
1/2 cup superfine sugar
3 to 4 tbsps. freeze-dried coffee
2 tbsps. Irish whiskey

Combine all ingredients and mix well. Taste for sweetness and add more coffee or sugar if necessary. Chill thoroughly. Freeze according to ice-cream machine directions.
Note: The brand of coffee we used did not dissolve in the yogurt well and had to be thoroughly stirred; small bits still remained. Mixing the whiskey with the coffee before adding to the yogurt and sugar may solve this.
Makes about 1 quart.

PEACH DAIQUIRI FROZEN YOGURT

1 large peach, peeled and quartered
1/2 cup light corn syrup
1/4 cup sugar
1 tsp. grated lime zest
1 tsp. lime juice
2 tbsps. dark rum
1 pint plain yogurt

Combine peach, corn syrup, sugar, lime zest, lime juice and rum in blender and process until smooth. Add yogurt and blend just until mixed. Chill thoroughly. Freeze according to ice-cream machine directions.
Makes about 1 1/2 pints.

FROZEN YOGURT POPS

1 pint strawberries
1 tsp. unflavored gelatin
2 tbsps. cold water
1/4 cup sugar
1 cup plain yogurt
2 tbsps. lemon juice

Place strawberries in food processor or blender and process to about 1/4 cups puree. Combine gelatin and water in saucepan and stir over low heat until dissolved. Add sugar and stir to dissolve. Remove from heat and set aside.

Combine yogurt, strawberry puree and lemon juice in small bowl. Thoroughly mix in warm gelatin mixture until smooth. Pour into pop stick or bar molds and freeze until firm. To remove pops from molds, run hot tap water around outside just until loosened. Makes 8 pops.

GRAPEFRUIT YOGURT ICE

2 large grapefruit
1/2 cup sugar
3/4 cup water
1 cup plain yogurt
8 oz. low-fat cream cheese, beaten

1 tbsp. finely chopped fresh mint

1 egg white
Grapefruit sections and mint leaves for garnish

Peel the grapefruit, divide into segments, and cut the flesh away from the membranes. Chop the flesh, reserving any juice.

In a heavy saucepan, dissolve the sugar in the water. Bring to a boil and boil until temperature

reaches 234 degrees. Set aside to cool.

Stir the grapefruit flesh and reserved juice into the syrup. Blend the yogurt and cheese together until smooth, then mix in the grapefruit mixture and mint.

Freeze the mixture until slushy. Mix well in a bowl.

Whip the egg white in a small bowl until stiff but not dry. Fold

into the grapefruit-yogurt mixture. Cover and return to the freezer (If you like, the dessert may be spooned into serving dishes now and frozen).

Transfer the dessert to the refrigerator 20 to 30 minutes before serving to soften. Decorate dishes with grapefruit segments and mint leaves. Makes about one quart.

PEAR-HAZELNUT YOGURT ICE
2 8 1/2-oz. cans of Bartlett pears in natural juice
2 tbsps. honey
1 tbsp. lemon juice
1 cup plain yogurt
1/4 cup chopped hazelnuts
Lemon balm leaves, for decoration

Drain the pears, reserving

juice. Chop the pears finely and set aside. Pour the juice into a saucepan. Add the honey and lemon juice and heat gently, stirring, until evenly mixed. Cool. Stir in the yogurt and chill for about 30 minutes.

Freeze mixture until slushy. Fold in the chopped pears and nuts. Continue freezing until firm. Serve decorated with lemon balm leaves. Makes about 1 pint.

**All Beef Or All Meat
GWALTNEY BIG
8 FRANKS
99¢ Lb.**



**Chicken Breast
FILLETS &
Breast
TENDERS
\$2.99 Lb.**

**LEG QUARTERS
49¢ Lb.**

**USDA Choice Beef
UNTRIMMED WHOLE
SIRLOIN TIPS
12-14 Lbs. Avg.
Sliced FREE!**

\$1.58 Lb.

USDA CHOICE

**BLUE GRAPES/
Red Or White
SEEDLESS
GRAPES
99¢ Lb.**

PLUM CRAZY SALE!!

"Your Choice" - California Red Rosa, Nubiana, Laroda, El Dorado, Black Amber & Purple Frontier Plums Or CALIFORNIA PEACHES/NECTARINES
79¢ Lb. "Your Choice"

60-80 Ct.
SHRIMP..... Lb. **2.99**

Salmon Or
SHARK STEAK..... Lb. **3.98**

Halibut And
SWORDFISH STEAK... Lb. **4.98**

Washington State
**RED DELICIOUS
APPLES
49¢ Lb.**

Sweet
**NORTHWEST
CHERRIES
99¢ Lb.**

EXTRA LOW PRICES...EVERYDAY!!!

Pepsi, Caffeine Free Pepsi, Mountain Dew, Diet Mountain Dew, Diet Pepsi, Caffeine Free, Diet Pepsi

**PEPSI
99¢**
2 Liter

Pkg. of 24
12 Oz. Cans

**OLD MILWAUKEE
\$7.99**
Reg/Lt.

3.0 Gallo Chablis Blanc, Rhine, Pink Chablis, R. Rose, Vin Rose, Burgundy, Premium Blush

**GALLO
\$5.79**

32 Ounce

**DEL MONTE CATSUP
89¢**

7 Oz. - Elbow Macaroni/Long Or Thin Spaghetti

**CREAMETTES PASTA
3/99¢**

64 Oz. Carton - Old South

**ORANGE JUICE
\$1.39**

Roll - 2 Ply Mardi Gras

**PAPER TOWELS
65¢**

40 Lb. - Ration

**CHATHAM DOG FOOD
\$6.39**

42 Oz. - 40¢ Off

**SURF DETERGENT
\$1.69**

There is a Food Lion conveniently located near you:

2430 STANTONSBURG ROAD 115 E. RED BANKS ROAD 3136 E. TENTH STREET
STANTON SQUARE SHOPPING CENTER SOUTH PARK SHOPPING CENTER UNIVERSITY SQUARE SHOPPING CENTER



**Assorted Sizes
And Flavors**

GENERAL FOODS INTERNATIONAL COFFEES

REGULAR **\$2.50** SUGARFREE **\$2.66**

MANUFACTURER'S COUPON EXPIRES 7/31/89
REDEEM AT CHECKOUT

Save \$1.00 on Ice Cream or Sherbet
when you buy one package of any General Foods' International Coffees
Limit - One coupon per purchase

No reproductions or facsimiles will be accepted.

ML 799 0 4



5 43000 30076 8

This coupon good only on purchase of product and only other use constitutes fraud. COUPON NOT TRANSFERABLE. LIMIT - ONE COUPON PER PURCHASE. To the retailer, GFC will reimburse you for the full value of this coupon plus 8¢. It is submitted in compliance with GFC Redemption Policy. C. incorporated herein by reference. Void only if determined by retail distributor of our merchandise or anyone specifically authorized by GFC. Cash value .001¢. Mail to: General Foods Corporation, P.O. Box 103, Kansas City, MO 64102. GENERAL FOODS CORPORATION



FOOD LION

But Wolf
Winn-Dixie's,
Food And
Good Health
Expert

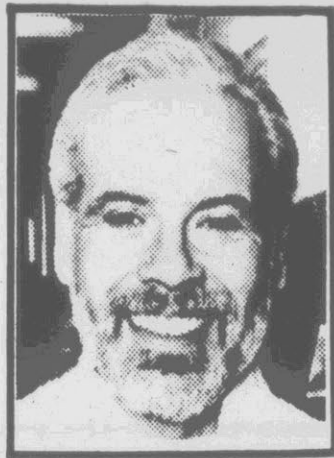

Winn-Dixie's pledge to you...

Over **10,000** **LOW**
PRICES Plus, clean
friendly stores!



U.S. Choice
Western Grain Fed
Whole Bone-In
**New York
Strips**
2.99
LB. Sliced Free
Into Steaks
& Trimmings.

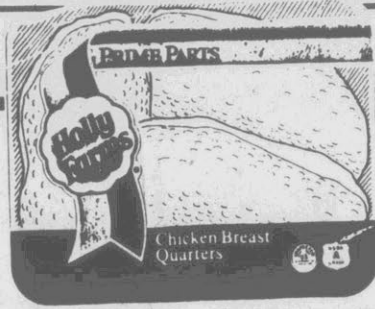

Holly Farms Grade "A"
**Chicken
Breast
Quarters**
99¢
LB. Holly Farms Grade "A"
Leg Quarters LB. .49



1/2-Gal. Carton
Superbrand Sherbet,
**Ice Milk
Or
Ice Cream**
All Flavors
99¢
EA.

All prices in this ad
effective 7-full days.

SUN	MON	TUE	WED	THU	FRI	SAT
			19	20	21	22
23	24	25				



Fresh Pure
**Ground
Chuck** LB. **1.69**

W-D Brand U.S. Choice
Boneless Aged
Sirloin Steaks ... LB. 3.99
Whole Cry-O Vac Select Lean
Pork Tenderloins . LB. 3.99

8-oz. Cup Light 'N Lively
Assorted Varieties
Yogurt 3 for \$1
1-Gallon
Superbrand Tea99

*Prices Good Wed., July 19th Thru Tues., July 25th
*None To Dealers *We Reserve The Right To Limit Quantities
©Copyright 1989, Winn-Dixie Stores, Inc.

W-D Brand
Select Lean Fresh
**Whole
Pork Picnics**
89¢
LB.

W-D Brand U.S. Choice
Western Grain Fed
1/4-In. Trimmed
**Tail-less
T-Bone Steaks**
4.99
LB.

5¢ Off Label
1-Gal. Jug
Regular
**Clorox
Bleach**
79¢
Limit 1, Please



Harvest Fresh
**Red Or White
Seedless
Grapes**
88¢
LB.

20-Oz. Pkg.
W-D Brand Breakfast
Link Sausage
2.49

12-Oz. Pkg.
Pinky Pig Thin
**Sliced
Bacon**
99¢

10-Lb. Bag
**Embers
Charcoal**
1.69
Limit 1, Please

10-Lb. Vent Vue Bag
Harvest Fresh
White Potatoes 2.79
Harvest Fresh Washington State
Cherries LB. 1.29
Harvest Fresh Washington State
**Red Delicious
Apples** LB. .59

1-Lb. Roll Mild Or Hot Jamestown
Pork Sausage79
3-Lb. Box W-D Brand
Beef Patties 2.99

7-Oz. Bag Crackin Good
Potato Chips79
3-Lb. Jar Welch's Grape
Jam Or Jelly 1.49

11-Oz. Bag
**Doritos
Tortilla Chips**
*Corn *Nacho
*Cool Ranch *Salsa Rio
1.99
EA.

**Medium
Headless Shrimp**
4.99
LB.
"Ready To Cook"
**Fresh
Whole Catfish**
1.99
LB.
Available In Locations With Fisherman's
Wharf Fresh Seafood Depts. Only!

DELI-BAKERY
Save **70¢**
Per Lb.
"Deli Fresh"
**Virginia
Brand Ham**
3.59
LB. Sliced To
Order
Available In Deli Bakery Stores Only!

2-Ltr. Btl.
**Coca-Cola
Classic**
*Diet Coke
*Caffeine Free Diet Coke
1.09
12-Pak/12-Oz. Cans
**Old
Milwaukee
Beer**
*Regular *Light
3.99



18-Oz. Box
Combination
**Dano's
Pizzas**
1.59

WINN DIXIE
America's Supermarket®

Plus,
**DOUBLE
MANUFACTURERS'
COUPONS!**
Good only in Richmond,
Colonial Heights, Chester
and Mechanicsville, Va.
and Greenville and
Aberdeen, N.C. stores
LIMIT 10
coupons doubled per
customer, please. See
stores for details.

When WE pay less, YOU pay less! When WE pay less, YOU pay less! When WE pay less, YOU pay less!

WIN AT LEAST
\$500⁰⁰
IN CASH
IN OUR BIG
MONEY JACKPOT



\$250⁰⁰ ADDED EACH WEEK
UNTIL WE HAVE A WINNER!
REGISTER JUST ONCE AND GET YOUR CARD PUNCHED EACH WEEK AND YOU MAY WIN
WONDERFUL CASH DOLLARS!
NOTHING TO BUY! YOU DO NOT HAVE TO BE PRESENT TO WIN.

LAST WEEK'S WINNER Sandra Bryant
GET YOUR CASH MONEY CARD PUNCHED FREE THIS WEEK!

**WHOLE
SMOKED
PICNICS**
69¢
LB.

**FRESH
LEAN
GROUND
CHUCK**
1.59
LB.

**HOUSE OF
RAEFORD
FRYER
LEG
QUARTERS**
39¢
LB.

**HEAVY
WESTERN BEEF!**
**RIBEYE
STEAKS**
3.99
LB.

**BROOKWOOD
SLICED BACON** 12 OZ. PKG. **99¢**
**BIG TOP
BOLOGNA** 1 LB. PIKG. **79¢**
**BIG TOP
FRANKS** 12 OZ. PKG. **59¢**

**SYCAMORE
LINKS**
**SMOKED
SAUSAGE**
1.99
2 LB. PKG.

**HEAVY
WESTERN BEEF!**
**END CUT
PORK
CHOPS**
1.09
JUMBO
PACK LB.

**FREEZER QUEEN
DINNERS**
1.59
28 - 32 OZ.
ASSORTED

**OZARK VALLEY
POT PIES**
7 OZ.
3/89¢

**HUNT'S
KETCHUP**
32 OZ.
1.19

**FOODLAND
EVAPORATED
MILK**
13 OZ.
39¢

46 OZ. DEL MONTE
PINEAPPLE JUICE **1.29**
46 OZ. DEL MONTE
TOMATO JUICE **89¢**
46 OZ. ASSORTED
HAWAIIAN PUNCH **79¢**
15.4 OZ. ASSORTED DEL MONTE
PINEAPPLE **59¢**
20 OZ. ASSORTED
PINEAPPLE **89¢**

**MAXWELL HOUSE
COFFEE**
8 OZ. INSTANT
3.39

**TROPICANA
ORANGE JUICE**
64 OZ.
1.69

**FOODLAND
BREAD**
24 OZ.
2/1.00

**SOUTHERN BISCUIT
BUTTERY
BISCUIT MIX**
3 FOR
1.00
7.5 OZ.

HUNT 4 PK. ASSORTED
SNAK PAK **1.19**
10.5 OZ. ASS'T MICROWAVE
ORVILLE REDENBACHER'S
POPCORN **1.69**

**KRAFT MACARONI &
CHEESE
DINNER**
2 FOR
1.09
7 1/4 OZ.

**SKINNER REG. OR THIN SPA-
GHETTI OR LARGE ELBOW
MACARONI**
69¢
16 OZ.

KEEBLER
16 OZ. E.L. FUDGE
COOKIES-ALL FLAVORS **1.89**
16 OZ. TOWNHOUSE
CRACKERS **1.99**
9 1/2 OZ. SUNCHEROS
RANCH, NACHO OR SALSA **1.59**

NESTEA
3 OZ.
2.59

**FINE FARE
CHARCOAL**
10 LBS.
1.19

**HOT SHOT
FLYING INSECT
SPRAY**
16 OZ.
BONUS
1.99

CHEER
42 OZ.
1.79

**CHATHAM CHUNX
DOG FOOD**
40 LBS.
5.99

**SEALTEST
POLAR BARS**
8 PK.
1.99

**FRITO'S
CORN CHIPS**
10 OZ.
1.69

6.4 OZ. AIM
TOOTHPASTE **1.39**
2.5 OZ. MENNEN SPEED STICK
DEODORANT **1.69**

**VELVET
ICE
CREAM** **1.29**
1/2 GAL.

**WESSON
OIL**
48 OZ.
REG. OR
CORN
1.99

**FOODLAND
MARGARINE
QUARTERS**
3 FOR
1.00
1 LB.

**GIBBS
PORK N'
BEANS**
3 FOR
1.00
16 OZ.

**CHARMIN
TISSUE**
4 ROLL
WHITE OR
YELLOW/
BLUE
1.19

DELI SPECIALS
THURSDAY - FRIED CHICKEN \$2.95
FRIDAY - BARBECUE CHICKEN \$2.95
SATURDAY - SPAGHETTI \$1.99
♦ VIRGINIA HAM \$3.00 LB.
♦ BOLOGNA \$2.69 LB.
♦ PEPPERONI \$2.99 LB.

**PRODUCE
SPECIALS**

**YELLOW
SQUASH** LB. **39¢**
**RED FLAME SEEDLESS
GRAPES** LB. **69¢**
**SNAP
BEANS** LB. **79¢**
**GOLDEN RIPE
BANANAS** 3 LBS. **1.00**

PEACHES
3 LBS. FOR
1.00

*Summer
CLEAN SWEEP SALE!*
ALL THIS WEEK AT...
PEPSI
2 LITER
99¢

FOODLAND
WE KNOW WHAT YOU LIKE.
Memorial Drive-Buyers Market
Greenville

PRICES EFFECTIVE JULY 20, 21 & 22, 1989
WE RESERVE THE RIGHT TO LIMIT QUANTITIES.
WE GLADLY ACCEPT WIC AND U.S.D.A. FOOD STAMPS.
Mon-Sat 7 a.m.-10 p.m. Sun 7:30 a.m.-7 p.m.

When WE pay less, YOU pay less! When WE pay less, YOU pay less! When WE pay less, YOU pay less!

When WE pay less, YOU pay less! When WE pay less, YOU pay less! When WE pay less, YOU pay less!

When WE pay less, YOU pay less! When WE pay less, YOU pay less!

DISCOVER THE NEW LOWE'S®

© 1989 Lowe's Companies, Inc.



America's Largest Lumber & Building Materials Store!

4 DAYS ONLY!

JULY 20 - 23



See More Mowers On Page 11

\$94⁸³

3½ HP 20" Cut Mower

Powerful 3½ HP engine for tough cutting jobs, and 3 position height adjustment to allow for different mowing conditions. #95104

Grass Catcher #95164 \$24.99



See More Pressure Treated Products On Page 2

\$2⁶⁹

8' Treated Landscape Timber

Treated pine resists insects and decay. Border walkways, build planters, etc. Attractive landscaping accent. #04574



YOUR CHOICE! \$7⁷⁷
2 Gallon

Interior Flat Classic White Or Exterior Flat White House Paint

Interior in classic white. Exterior is white. Both are colorfast and quick-drying. Easy soap and water clean-up. #49922.31

See More Paint On Pages 6 & 7

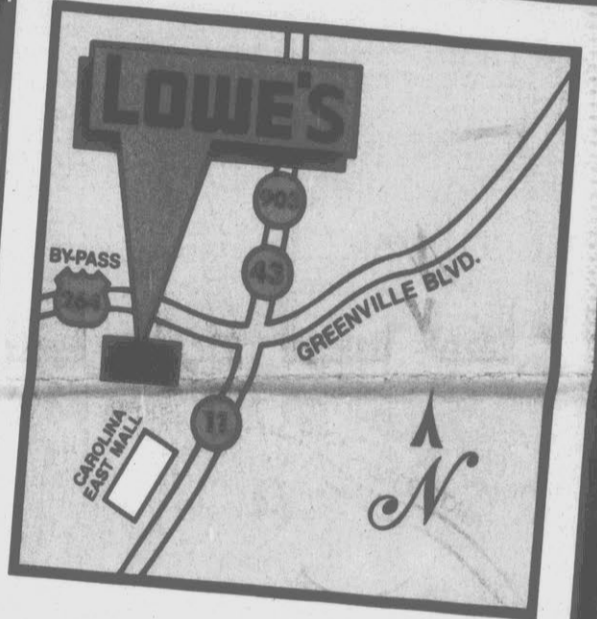

Lowe's of GREENVILLE

1055 S.W. Greenville Blvd. Greenville, NC 27834 (919) 756-6560

STORE HOURS:

Mon. - Sat.: 8:00 AM - 9:00 PM
Sunday: 1:00 PM - 6:00 PM



\$5⁹⁹

5 Gallon Driveway Sealer

Seals and protects from gas, oil, acid, water, frost, etc. Improves driveway's appearance by drying to deep black. Easy to apply. Our most economically priced sealer. #10272

See More Building Products On Page 4

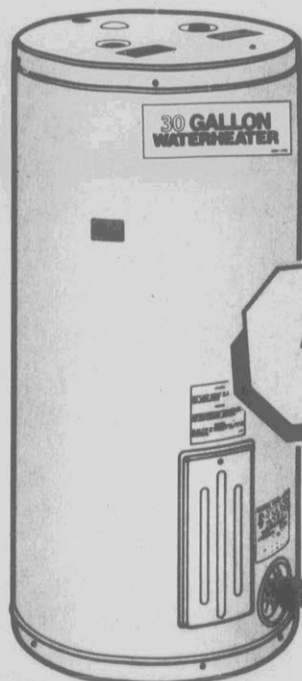

See More Plumbing Products On Page 8

\$97

30 Gallon Energy Efficient Electric Water Heater

Heavy duty insulation. Porcelain glass-lined tank. Single heating element. One year limited warranty. #26294

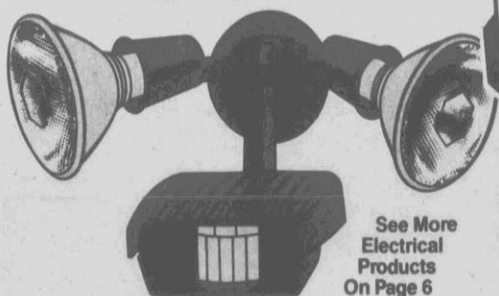

\$19

Motion Sensor Security Light

Motion activated — turns on automatically to welcome you home or startle intruders. Great security measure. Hands-free operation is ideal for home, barn, garage. #72082

See More Electrical Products On Page 6

When You Shop At Lowe's You'll Be Sure Of...

Over 300 Store Buying Power Saving You Money!

Everyday Low Prices... GUARANTEED!

Friendly, Helpful And Knowledgeable Salespeople!

Choosing From Several Easy And Convenient Payment Plans!

Your Complete Satisfaction ... IS GUARANTEED!



You Could Win A

\$1000

Shopping Spree!

Full Details On Back Page!

LOWE'S®
Guaranteed Low Prices

GRAND OPENING 4 DAYS ONLY! JULY 20 - 23

Lowe's 300 Store Buying Power Saves You Money!

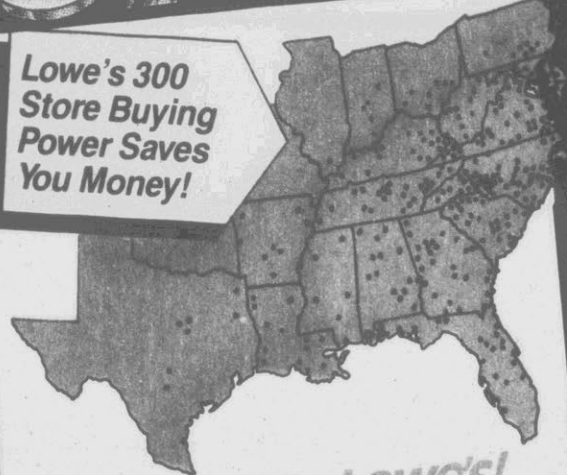

Welcome To Lowe's!

Lowe's has been serving the people of the southeast for over forty years. Since 1946 Lowe's has supplied quality building materials, as well as the expertise needed to use them wisely, to millions of satisfied customers. With over 300 stores in 20 states, Lowe's is the leading home improvement store in the nation, and now that Lowe's has come to your area, we hope that you'll come in and see what makes Lowe's so special.



America's Largest Treated Lumber Store!

DECK PACKAGES AVAILABLE!



Lowe's Commitment To You...

10% LOW PRICE GUARANTEE

Lowe's guarantees our everyday low prices. If you find an identical advertised item at any retail competitor currently priced lower than ours, simply bring us written proof of that price, and we'll match it, PLUS give you an additional savings of 10% of the difference between the two prices when you buy from us. (Must be an identical in-stock item. Closeout, discontinued and other clearance type sale items are excluded from this offer.)

SATISFACTION GUARANTEE

Lowe's guarantees that you will be satisfied with your purchase. If you are not completely happy with your purchase, simply return it along with your original sales receipt to any Lowe's store. We'll repair it, replace it or refund your money.

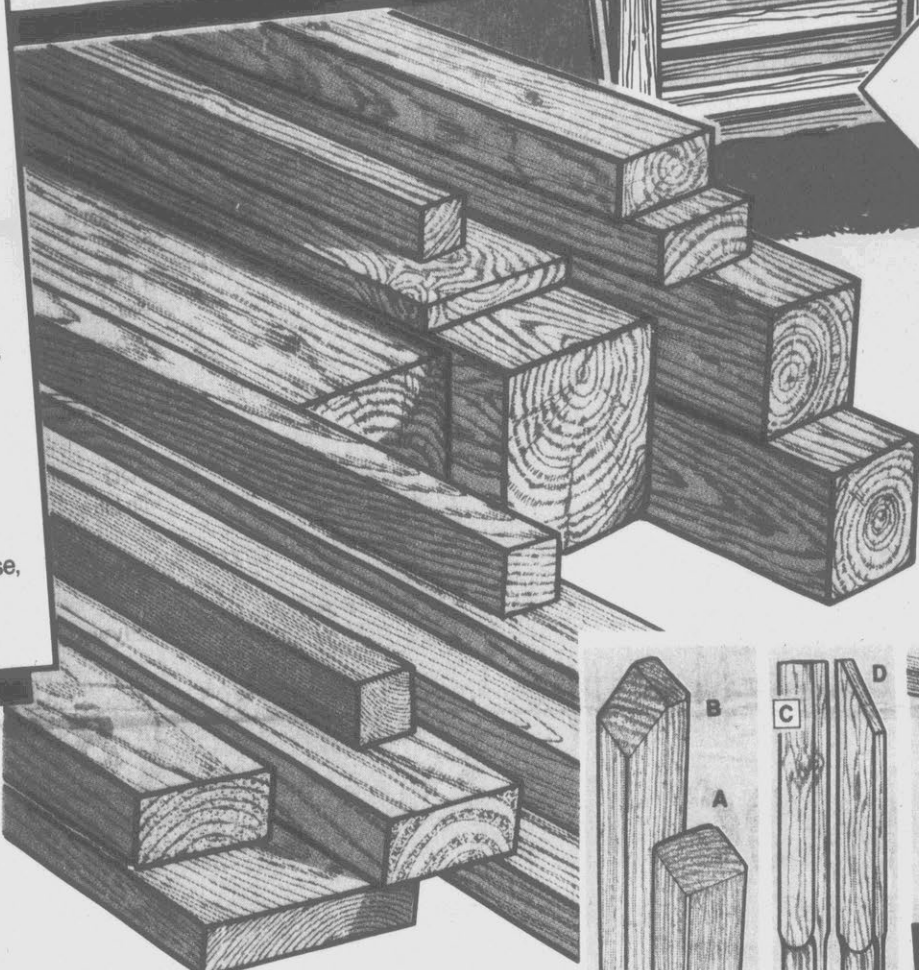

Why Use Pressure Treated Wood?
Because this lumber is treated to resist insects and decay, so it's perfect for any outdoor project. Left unpainted, it weathers to a beautiful gray and it's covered by a 30 year limited warranty. And Lowe's is the natural choice when durability and dependability matter most. We offer outstanding selection, everyday low prices and knowledgeable salespeople.

Treated Deck And Project Lumber

	6'	8'	10'	12'
1 1/2 x 6	—	\$2.49	\$2.95	\$3.84
2 x 4	\$1.29	\$1.59	\$2.15	\$2.57
2 x 6	—	\$2.69	\$3.23	\$4.33
4 x 4	\$2.69	\$3.49	\$5.77	\$6.77

	8'	10'	12'	14'	16'
2 x 6	—	—	—	—	—
Round Edge	\$3.19	\$3.44	\$4.67	\$5.22	\$6.44

2 x 2 x 8' Treated Strip #04680 98¢
6 x 6 x 8' Lowe's Best Timber #05470 ... \$11.88
1 x 6 x 6' Treated Boards #05542 \$1.28
1 1/2 x 4 x 6' Treated Decking #05426 99¢



Now Accepting Lowe's Credit Payments At Any Lowe's Store
For your convenience, you can make payments on your Lowe's credit card or Lowe's low payment plan in any Lowe's store.



Up To \$1,000 Instant Credit
Your Visa, American Express, MasterCard or Sears Card may qualify you for up to \$1,000 instant credit on a new Lowe's card. Ask a Lowe's salesperson and how it can make details on our credit card program and how it can make shopping Lowe's easier than ever!

90 DAYS SAME AS CASH!
FREE of Any Down Payment
FREE Of Any Monthly Payment
FREE Of Any Finance Charges
On Any Lawn Mower, Riding Mower, Tiller, Steel Storage Building, Air Conditioner, Freezer, Refrigerator Or Kitchen Cabinet Purchase Of \$250 Or More.

Just pay off the full purchase price within 90 days from the date of purchase. That is it. There's no down payment, no monthly payment and no finance charge. This special offer is available to all qualified applicants. (See Lowe's Low Monthly Payment Credit Terms On This Page). Ask your Lowe's salesperson for complete details.

LOW MONTHLY PAYMENT PLAN

Our Low Payment Plan offers you an easier way to make those major home improvements and larger purchases. It's designed to let you finance purchases of \$250 to \$5,000 for up to five years at competitive rates. The result is a very low monthly payment that fits comfortably into your family budget, and brings important home additions from a new refrigerator to a new roof, within easy reach. So apply today, and let us show you just how easy and affordable making that special improvement to your home can actually be.

Lowe's Low Payment Plan — Terms Of Repayment:

Your credit must be satisfactory. No down payment required. The monthly payment includes sales tax of 5% and finance charges. If sales tax differs in your area, the monthly payment may vary slightly. The monthly payment has been estimated and may vary depending upon state laws and charges. The APR is as follows:

Number of Monthly Payments	APR	
	NC	3
36	18.00	
30	18.00	
24	18.00	

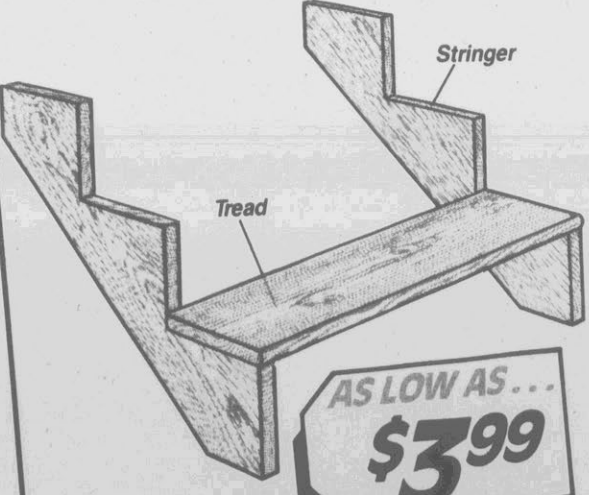

AS LOW AS... \$3.99

Treated Stair Tread and Stringer

Lowe's has a complete assortment of stairway treads & stringers for both new construction & replacement.

36" Stair Tread #04582 \$3.99 Each
42" Stair Tread #04583 \$4.49 Each
3 Step Stair Stringer #04578 \$5.99 Each
4 Step Stair Stringer #04579 \$6.99 Each
5 Step Stair Stringer #04580 \$8.99 Each



Deck Remodeling Made Easy!

Treated Deck Components

Customize your deck — decorate it in style! Add lattice, railing, benches, a gazebo... the possibilities are endless! Make your deck the focal point of your home... an ideal place to entertain. No one gives you the same quality and selection as Lowe's!

Pickets And Spindles

A. 2x2x42" Square End	#04504	69¢
B. 2x2x42" Mitred End	#04505	69¢
C. 2x2x42" Decorative Square End	#04506	99¢
D. 2x2x42" Decorative Mitred End	#04507	99¢
E. 1 1/2 x 1 1/2 x 36" Turned Spindle	#07869	\$1.79
F. 1 1/2 x 1 1/2 x 36" Turned Spindle	#07870	\$2.49

Posts And Rails

G. 4' Deck Post (2 Styles)	#04502.3	\$3.49
H. 8' Deck Post (Not Shown)	#07861	\$5.49
H. 8' Top/Bottom Rail, 1 1/2" Plow	#04501	\$3.99
I. 54" Turned Post	#07860	\$8.99
J. 4x4x5' Deck Lamp Post	#07572	\$9.99
K. 32"x44" Lattice Deck Rail Panel	#07879	\$11.99
L. 8' Decorative Rail, 2" Plow	#07876	\$5.49

Decorative Accents

M. Decorative Ball Post Top	#07866	\$2.99
N. Acorn Post Top	#07865	\$2.99
O. 4x4 Post Cap	#07864	99¢
P. Deck Bench Support	#07863	\$4.29



AS LOW AS... \$5.25

4'x8' Treated Lattice Panel

Has a 20 year limited manufacturer warranty. Sturdy construction. #98884 \$7.88

1/2" x 4' x 8' Premium Treated Lattice Panel \$13.77

Pressure treated for exterior use. Has a 40 year limited factory warranty. Stapled & glued every joint. #98892

1" x 4' x 8' Heavy Duty Treated Lattice Panel \$24.99

Premium grade panel. A full one inch thick at joints. Has rust-free staples. Resists insects and decay. #98890

2'x8' Pressure Treated Lattice Panel \$5.25

High quality. Ideal for decorative enclosure of decks, etc. Panel is weather resistant. #98886

8' Cap Moulding For 1/2" Lattice Panel \$1.99

A decorative accent for lattice panel. And it's treated to resist decay and insects. #98898

8' Cap Moulding For 1" Lattice Panel \$2.99

A decorative accent for lattice panel. This moulding is also resistant to decay and insects. #98897



Pre-Assembled \$10.99

Pressure Treated Clothesline Post \$12.99
Treated to resist decay and insects. #04483

4x4 Treated Mailbox Post
Treated to resist decay and insects. #04484

LOW PRICES SINCE 1946!

DISCOVER THE NEW

LOWE'S

America's Largest Lumber Store!

Top Quality Lumber

Lowe's knows lumber. For over 40 years our reputation has been built on supplying our customers with the best lumber available with the widest selection and lowest prices. Our friendly, knowledgeable salespeople can give you expert advice whether you're building a doghouse, a deck or adding onto your house.

Framing Lumber

	8'	10'	12'
2x4	\$1.47	\$1.86	\$2.26
2x6	\$2.27	\$2.44	\$3.29
2x8	\$2.88	\$3.47	\$4.92
2x10	\$3.76	\$4.67	\$7.96

88¢

2x4 Economy Studs #07002

Lowe's Best 2x4 Studs

West Coast	#06007	\$1.55
------------	--------	--------

Furring Strips

1x2x8'	#04511	39¢
1x3x8'	#04512	69¢
2x2x8'	#04513	89¢

Lengths may vary 92 1/2" to 96".



4'x8' Building Panels

Lowe's has just the building panel you need for your special project, whether it's remodeling, repair or new construction!

AS LOW AS... \$3.95 1/4"x4'x8'

1/4"x4'x8' Waferboard \$3.95 Durable utility building panel. Versatile. #12206

7/16"x4'x8' Waferboard #12212 \$5.66

5/8"x4'x8' Particleboard Underlayment \$6.99 For carpet underlayment, shelving, etc. #12259

3/8"x4'x8' Sheathing Plywood \$6.19 For roofs, etc. Agency approved. #12246

1/4"x4'x8' Lauan Plywood \$7.88 Multi-purpose plywood for interior projects. #12201

3/8"x4'x8' BC Pine Plywood \$8.34 1 1/2" actual thickness. #12231

3/4"x4'x8' Birch Plywood \$27.00 7 ply real wood construction with birch veneer. #12271

1/2"x4'x8' Pressure Treated Plywood \$12.29 1 1/2" actual thickness. #12197

3/4"x4'x8' Pressure Treated Plywood \$17.69 2 1/2" actual thickness. #12193

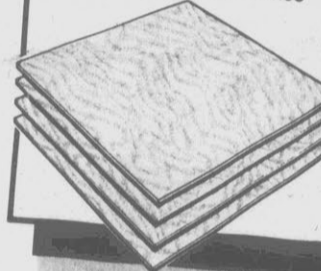

87¢

1/4"x2'x2' Exterior Plywood #07701

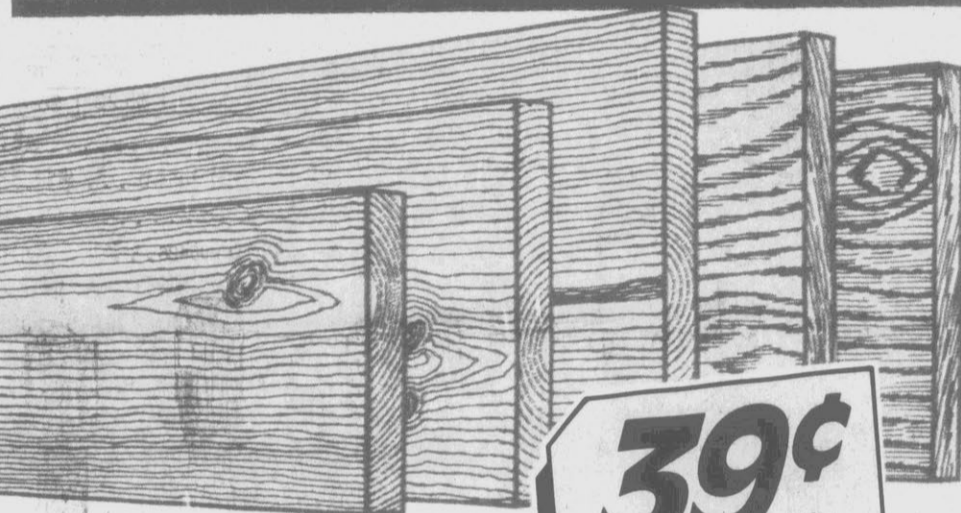

1x12 #3 Ponderosa Pine Shelving

Available in lengths up to 16'. Features 4 smooth surfaces. Can be painted or stained. #01350

Particleboard Shelving

5/8"x12x4'	#01385	88¢
3/4"x12x8'	#01386	\$1.96
3/4"x12x8' Oak Print	#01387	\$4.22

Rocky Mountain Spruce Boards

	4'	6'	8'
1x4	88¢	\$1.53	\$1.97
1x6	\$1.56	\$2.34	\$3.27
1x8	\$1.88	\$2.82	\$3.76
1x10	\$2.56	\$3.84	\$4.97
1x12	\$3.88	\$5.82	\$7.76

#2 And Better Grade. Sizes Above Also Available In #3 Ponderosa Pine And Select White Pine.

Solid Pine Panels #00994-01012

	3'	4'	6'
1x14	\$4.98	\$6.84	\$9.96
1x18	\$5.97	\$7.96	\$11.94
1x24	\$8.97	\$11.96	\$17.94

Also available in 5/8" thickness.

Furniture Grade Hardwoods #01036-01092

	Red Oak		Poplar	
	4'	6'	4'	6'
1x2	\$2.28	\$3.75	\$1.48	\$2.23
1x4	\$4.63	\$6.97	\$2.91	\$4.37
1x6	\$7.52	\$11.28	\$4.48	\$6.72

Many Other Lengths And Widths Available. Decorative Edging Also In Stock.

When You Shop At Lowe's You'll Be Sure To Get ...

Quality And Selection ...

Lowe's has top quality items with a wide selection of values in everything from lumber to electronics, and if there's something special needed, we'll order it.

Low, Low Prices ...

Lowe's has more than great sales and close out values, we have everyday low prices that you won't believe! All backed by a 10% low price guarantee.

And Helpful Salespeople.

Do-it-yourself doesn't mean doing it alone when you shop at Lowe's. Our friendly, knowledgeable salespeople are there to help you do the job quickly and easily!



Lowe's Nails

Lowe's is the place to go when you need nails for what ever project you may be working on.

AS LOW AS... 58¢ One Lb. Box

Coated Sinker Nails

General construction nails in a variety of sizes.

One Lb. Box #69000	58¢
5 Lb. Box #69000	\$2.98
25 Lb. Box #69000	\$9.98



Do-It-Yourself Kits

Lowe's has a wide variety of kits that make do-it-yourself projects easier than ever. Add to the beauty of your home with a new deck or gazebo, or build a new workbench, picnic table or park bench. Easy to assemble with full, step-by-step instructions.

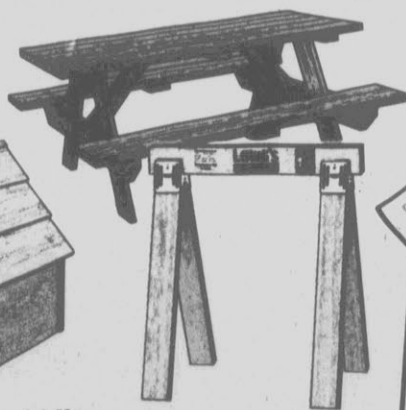

Pressure Treated Kits

8x10 Deck	#04471	\$273.00
6' Park Bench	#04478	\$38.00
6' Gazebo	#04621	\$447.00
6' Picnic Table	#04481	\$48.00
Trash Can Rack	#04475	\$29.00
4x8 Mobile Home Deck	#04498	\$177.00

Other Wood Kits

6' Workbench	#04489	\$38.00
Sawhorse	#04490	\$4.97
2'x2' Doghouse	#04626	\$24.00
4'x6' Storage Cabinet	#04493	\$87.00
Tool Box	#04641	\$6.47



YOUR CHOICE! \$1.99 #96888.9

Lowe's Has A Plan For Your Dream Home!

Lowe's Home Designs Portfolio Or Dream Homes House Plan Catalog

Lowe's Home Designs Portfolio and Dream Homes Catalog together offer floor plans for over 105 contemporary & traditional homes, from 800 to 3,800 sq. ft. Blueprints & materials available through Lowe's.

TO GET YOUR CATALOG CALL 1-800-334-1148*

In NC Call 1-800-672-1148 *Or Fill Out This Coupon

Lowe's Direct Marketing Department P.O. Box 1111, N. Wilkesboro, NC 28656

Name _____
Address _____
City _____ State _____ Zip _____
Telephone _____

(50¢ Handling Fee For Phone Or Direct Mail Order)

Stop By Lowe's And Pick Up Your Homestead Catalog Or Mail This Coupon To ...

GRAND OPENING

4 DAYS ONLY! JULY 20 - 23

America's Largest Lumber & Building Materials Store!



26" x 8' Steel Roofing/Siding
Features 2 1/2" corrugation. 22" coverage when panels are overlapped. Galvanized coating. Economical and durable. Ideal for new construction or replacement. Use with leadhead or galvanized nails with washers. #12473

\$4.66

26" x 10' Panel #12474 **\$5.86**
26" x 12' Panel #12475 **\$6.93**



3' x 36' Roll Roofing
Most affordable roofing available. For barns, sheds, etc. Assorted colors. #10285,90

\$10.99

\$6.23 Bundle

Re-Roof With Lowe's Quality Asphalt Roofing Shingles
Come to Lowe's for brand name roofing shingles. The sun-activated, self-sealing tabs seal out wind and weather to protect your home & family. Available in beautiful colors to match your home. Class A fire and wind rating. #14808-28
4 Square Roofing Felt #10306 \$7.99



\$2.78 Gallon

Roof Cement
Stops leaks around skylights, chimneys, vent pipes, foundation joints. #12005,7

Gallon Aluminum Roof Coating . . . \$5.49
Reflects heat, keeping building cooler in summer. #12028,30

5 Gallon Roof Coating . . . \$9.99
Resaturates dried, cracked roofs and protects from further cracking. #12021,3

5 Gallon Aluminum Roof Coating . . . \$25.99
Reflects heat. Ideal for mobile home roofs. #12029,31

10' Section White Or Brown Vinyl Gutter
Maintenance-free, never needs painting. Will not rust. Lightweight but sturdy. #12066,12084

\$3.49

10' Section White Or Brown Aluminum Gutter
Complete line of accessories available. Protects foundations. #11551,11585

\$3.90

4' Section Iron Rail
One inch wide top and bottom rails. Pre-primed, and ready to paint. #14251
Deluxe 4' Section #14252 . . . \$6.66

\$3.33

Woodsman Lap Siding
The look & feel of rough-sawn cedar. Pattern doesn't repeat itself in any one piece. 25 and 5 year limited warranties. 7/16" x 8 x 16'. #15626

\$4.99 Piece

4' x 8' Panel Knotty Barnside Siding
Unprimed. 25 year limited warranty. Overlapping edges, barnboard graining, random grooving and hardboard base. 7/16" thick. #15601

\$9.97 Panel

Rough Sawn 4' x 8' Pine Siding Panel
3/4" panel grooved 4" on center. Rough sawn for dramatic effect. Gives warm look to interior or exterior. Paint or stain to highlight. Lightweight. Strong & durable. Overlapping edges. #19345

\$9.88 Panel

Double 5" White Vinyl Siding
Limited lifetime factory warranty. Never needs painting. Won't decay, chip, peel or flake. Has wood texture. Post-formed for durability. Easy to install. 10 pieces per square. 10" x 12" pieces. #02599,17419

\$39.99 Square

99¢ 1/2" x 2' x 4' Perforated Hardboard
Ideal for organizing work area, garage, kitchen, etc. Easy to handle size. Won't crack, split, flake or peel. 1/8" thickness. #15498
1/4" x 4' x 4' #15495 **\$4.99**

60 Lb. Bag Blacktop Patch \$4.95
Asphalt mix requires no heating or mixing. Pour from bag. #10394

40 Lb. Bag Vinyl Concrete Patch . . . \$8.95
Patch or resurface concrete floors, steps, sidewalks, etc. #10397

10' x 100' Convenience Poly Pack
Comes in dispenser box with free cutting tool. Black or natural. #16902,3

3' x 50' Mulch Film . . . 99¢
Ideal weed barrier because black color blocks out sunlight. #16907

28" x 60" Galvanized Mobile Home Skirting
Attractive rock face design. Creates storage space, helps stop drafts. #60762

13" x 12' Vinyl Mobile Home Skirting . . . \$7.99
White, beige, or brown. Matching installation/trim kit extra. #60774-76

\$3.44 Piece

3 1/2" Thick x 15' Kraft Faced R-11 Insulation
Use in walls, floors or ceilings when remodeling or adding a room. Lower energy bills. 50 sq. ft. #13574
Insulation Safety Kit #12349 . . . \$5.99

\$5.76 Bundle

6" Thick x 15' Faced R-19 Insulation
Adding insulation increases the value of your home by making it more energy efficient. Insulation pays for itself over time through heating and cooling savings. Facing forms a vapor barrier. 48.96 sq. ft. bundles. #13581

\$9.88 Bundle

40 Lb. Bag Quikrete Concrete Mix
Easy to use. Just add water. Pour slabs, steps, set fence posts, etc. #10388
80 Lb. Bag #10385 . . . \$2.57

Concrete Blocks
4x8x16 Concrete Block . . . **69¢**
Sturdy, all-purpose building block. Use for a variety of projects. Build foundations, retaining walls, bookshelves. #10382

8x8x16 Block #10383 . . . **88¢**
4x8x16 Solid Cap Block #10335 . . . **92¢**
Red Clay Brick #10359 . . . **22¢ Each**

60 Lb. Bag Quikrete Mortar Mix
Just add water. Lay brick, block, stone, or repair cracked or loose mortar. Strong bonding. #10391

\$2.88

5 Gallon E-Z Stir Driveway Sealer
Outlasts & outperforms all other driveway sealers Lowe's carries. Rubberized for greater durability. Get a free driveway brush greater durability. Get a free driveway brush greater durability. Get a free driveway brush greater durability. #10276

Gallon Crack Filler #10273 . . . \$3.99

\$10

26" x 8' Fiberglass Building Panels
Comes in white, green or clear. Use as a siding, roofing or privacy panel. Panels diffuse sunlight. #12550,6,9

26" x 8' Heavy Duty Panel #12568,9,70 . . . **\$7.99**
26" x 10' Heavy Duty Panel #12571,2,4 . . . **\$9.99**
26" x 12' Heavy Duty Panel #12573,5,6 . . . **\$11.99**

\$3.49

1/2" x 4' x 8' Gypsum Wall Board
Use to finish walls or ceilings. Non-warping and crack resistant. Easy to paint. Accents wallpaper or decoration. #11730

62 Lb. Pail Joint Compound
Ready-to-use. For smooth, high quality finishing of gypsum panel joints. Easy to use. #11768

\$7.25

\$3.99

GUARANTEED SATISFACTION!

DISCOVER THE NEW LOWE'S

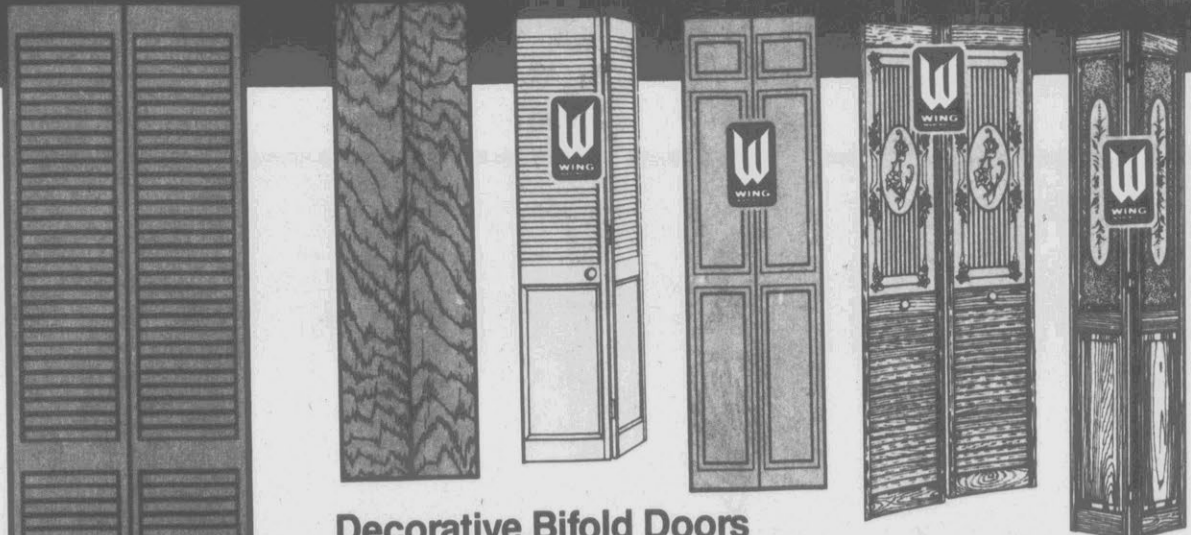

Decorative Bifold Doors

Lowe's has a wide selection of bifold doors, from economical luan to beautiful glass panel doors that will look great in any decor. Come in today and see our complete line, because when it comes to great selection, Lowe's delivers!

STYLE	24"	30"	32"	36"
A. 7/8" Pine Louver Bifold #10640-2	\$15.65	\$18.25	—	\$20.75
B. Luan Flush Bifold #10712-5	\$19.99	\$21.99	\$23.99	\$24.99
C. Pine Louver/Panel Bifold #10544.52.3	\$32.99	\$35.99	—	\$42.99
D. Wood Colonial Bifold #10880-3	\$42.99	\$53.99	\$57.99	\$61.99
E. Orleans Decorative Bifold #11987-9	\$54.99	\$59.99	—	\$64.99
F. Courtney Deco Glass Bifold #12288-90	\$72.99	\$86.99	—	\$95.99



Storm Doors

- A. 32" Or 36" Aluminum Door **\$38⁷⁷**
Has self-storing safety glass and a pushbutton latch with anti-lockout. With 3 nylon hinges, standard. #11131-4
- B. 32" Or 36" Fullview Door **\$79⁸⁴**
Protects your front door without hiding it. Heavy duty hinges, pushbutton latch, removable glass. Bronze or white. #15678-85
Screen For Door Above #15659-82 \$13.99
- C. 32" Or 36" Mid-View Wood Core Storm Door **\$99⁴⁶**
Has solid wood core for strength, a seamless exterior surface, self-storing safety glass, 4 rugged hinges. Brown or white. #15861-4
- D. 32" Or 36" Micromesh Door **\$163**
Champagne or white finish. With heavy duty hardware and dead-bolt. Grille & brass hardware shown are extra. #15867.8;15976.8
Brass Hardware #15872 \$29.99
32" or 36" Grille #15871.4;15977.9 \$44.99



32" 6-Panel Steel Entrance Door Unit

Steel entrance doors won't warp, crack, or split. #16786.7

36" 6-Panel Steel Entrance Door Unit

#16788.9 **\$99**

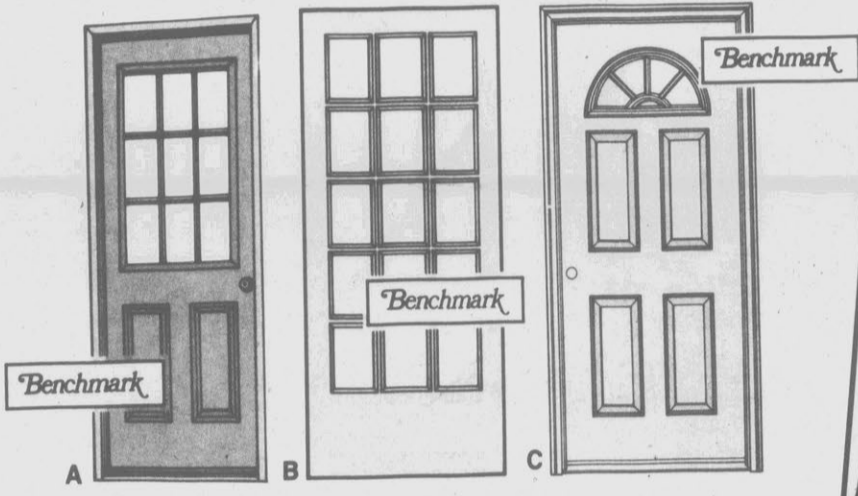

Lowe's Carries A Full Line Of Entrance Doors
Lowe's has a variety of styles to fit your needs and tastes. You can find everything from beautiful Royal Mahogany doors to attractive and durable steel doors. Lowe's has the perfect door for your home!

- A. 32" 9-Lite Steel Door **\$149**
Has insulating glass lites, polyurethane core. 36" door is \$5 more. #14056.7
- B. 32" 15-Lite Steel Door **\$189**
Insulating glass, polyurethane core. 36" door \$5 more. #14064.5
- C. 36" Sunburst Door **\$239**
Insulating glass, polyurethane core, weatherstripping. #35796.7



\$19⁹⁹

36" Replacement Patio Screen

Has heavy duty nylon rollers for easy operation. Can be installed for left or right hand operation. Height is adjustable for sure fit & fingertip control. #13000



\$15⁰¹
Per Month For 30 Months*

6' Woodstock Hinged Patio Door

\$339
Stain grade Ponderosa Pine. Fully assembled in a primed frame with 5/8" thick insulated safety glass. Has adjustable oak threshold. Screen, hardware & grille extra. #79786.7

- 15 Lite Patio Grille **\$24⁹⁹**
3" grille adds a decorative touch to your patio door. #18024
- Replacement Screen **\$32⁹⁹**
3" screen. Available in bronze or white. #12999,13039



AS LOW AS 19¢ Lft.

- A. 7/8"x1 1/8" Shoe Moulding #03358-68 **19¢ Lft.**
- B. 1 1/4" Colonial Stop Moulding #03292-302 **39¢ Lft.**
- C. 2 1/4" Colonial Case Moulding #03144-54 **69¢ Lft.**
- D. 2 1/4" Crown Moulding #03015-25 **79¢ Lft.**
- E. 2 3/4" Chair Rail Moulding #03468-78 **89¢ Lft.**
- F. 3 1/4" Colonial Base Moulding #03204-14 **99¢ Lft.**

- 30"x76" Fiberglass Screen Wire **\$2²⁹**
Easy to handle. Replace torn screens in storm doors, windows, etc. Rustproof. #14432
- 30"x76" Aluminum Screen #14426 **\$4.29**

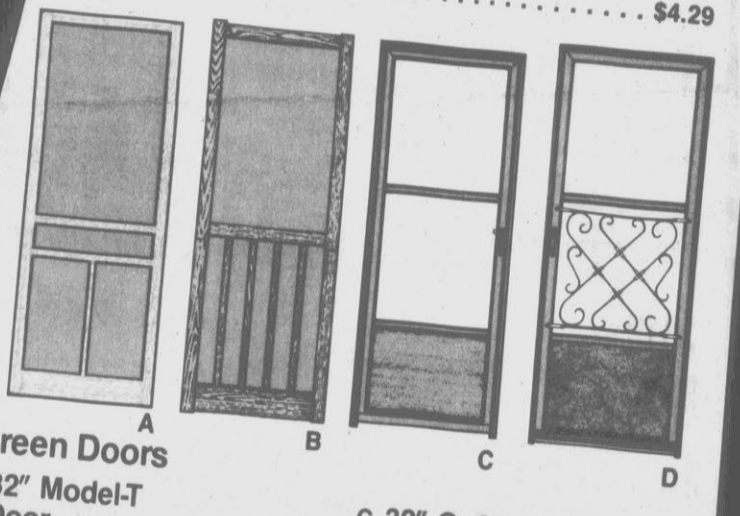

Screen Doors

- A. 32" Model-T Door **\$18.49**
Kiln-dried Western wood for lasting beauty. #11192
- B. 32" Sandhill Door **\$28.99**
Reinforced built-in grille. Glare-reducing screen. #11190
- C. 32" Or 36" Mill Finish Door **\$29.13**
Pre-hung. Heavy duty hinges, 1" aluminum frame. #11182-5
- D. 32" Or 36" Bronze Door **\$43.61**
Front grille for strength. Heavy duty hinges. #11196-9

Special Orders
If we don't have an item in stock, we'll be glad to order it for you at no extra charge.



36"x36" Garden Window

\$193
Bronze finish. Insulated glass. Screen mesh over vent sash. #19440

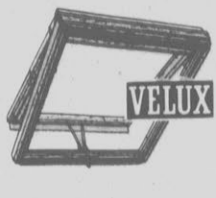

10% Off All Velux Skylight Orders

Now you can get 10% off quality Velux skylights, plus get guaranteed 3-5 days delivery! See store for details.

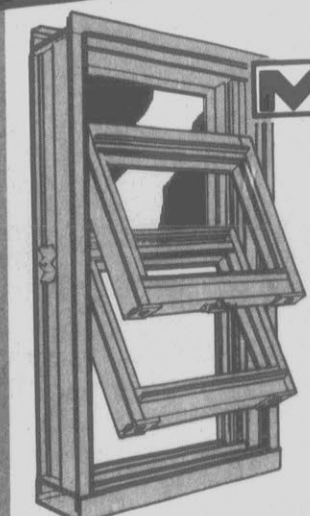

Heat Lock Vinyl Replacement Windows

With maintenance-free vinyl-clad aluminum frame and 1/2" insulated glass. Includes half screen. Calculate united inches by adding width & height of window opening together. Windows over 101" also available. Allow 3-4 weeks for delivery.



39" Polystyrene Louvered Shutters

\$11⁹⁹ Pair
Black or white. Maintenance free. Will not chip, peel or warp. Can be painted. #12852.60



Octagon Wood Window

Stationary. 21"x21". For small spaces and adding extra light. Insulated glass. #18249
Leaded Bevel Glass Insert #18243 \$54.99



8' Mill Finish Ridge Vent

Has a built-in wind baffle to draw moisture out of attic while keeping bad weather out. One-piece aluminum construction. #17131

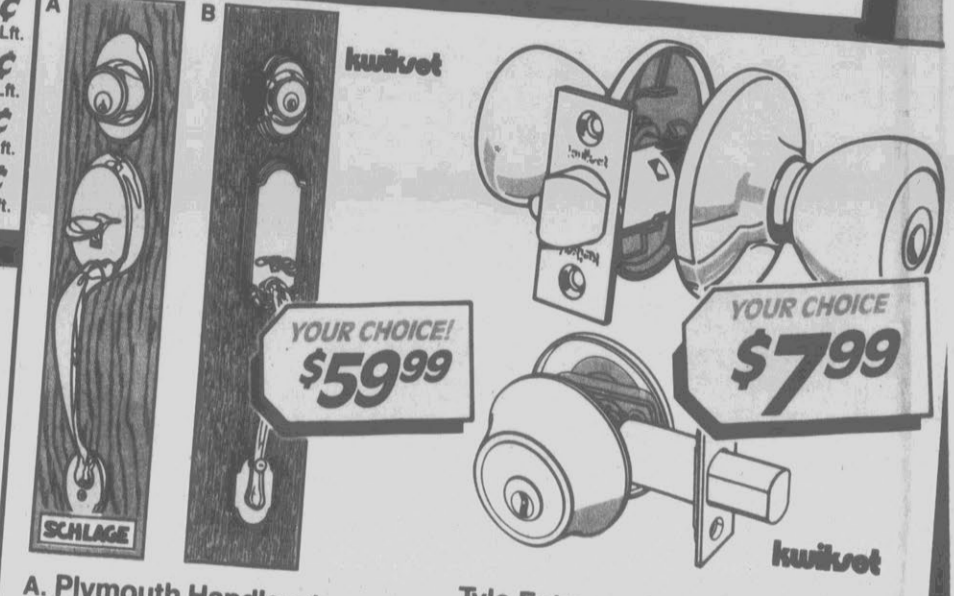

- A. Plymouth Handleset
Add a touch of elegance to any entry way. Attractive polished brass is perfect for any decor. #60177
- B. Barkley Handleset
Dress up your doorways and add security to your home. Beautiful polished brass. #61330

Tylo Entrance Lock
Form follows function in this economical design. Has an attractive polished brass finish. #61391

Single Cylinder Deadbolt
Has a beautiful polished brass finish. Locks with key from the exterior, turnpiece from the interior. #61318



8"x34" Solid Brass Kickplate
Adds beauty and elegance to any door. Also protects against scuffs. #61817



Stainless Steel Entrance Lock
Attractive design matches any decor. Very easy to install. #65504

Polished Brass Entry Lock #65524 **\$5⁹⁹**

Style/United Inches	Up To 72"	73" To 82"	83" To 92"	93" To 101"
Double Hung	\$127	\$147	\$157	\$177
2 Lite Slider	\$133	\$153	\$163	\$183
3 Lite Slider	\$139	\$159	\$169	\$189
Casement	\$136	\$146	\$166	\$186

Above windows are white. Beige and brown available 10% more.

GRAND OPENING

4 DAYS ONLY! JULY 20 - 23

The Last Paint You'll Need in The Enterprise One brand paints are durable - so either of these have to paint again & Only. Severe you'll need in the

Do a 10'x12' ceiling for less than \$35 with these styles!

27¢ Sq. Ft.

Armstrong

12"x12" Or 2'x4' Impressions Or 2'x4' Fashiontone Ceiling Panel

Choose from 2 styles. Armstrong has a ceiling for every room in your home! Fashiontone is fire-resistant. Sold by carton. #12596,12312,25,29,33

2'x4' Clear Cracked Ice Light Panel **\$2.29**

Acts as a diffuser for recessed fluorescent ceiling fixtures. #18425

Bruce Everbond LP Adhesive

79¢ Sq. Ft.

Armstrong

12"x12" Solid Oak Floor Tile

Durable urethane finish for long-lasting beauty. Choose from chestnut, mellow or desert tones . . . one is just right for your home color decor. #00454,58

\$1.99

Clean 'N Strip For Parquet Floor

Removes wax and cleans wood parquet floor tiles in one easy step. #00464

\$3.99 Quart

Everbond LP Mastic

Floor adhesive for a bond that lasts. For wood floor installation. #00461

\$15.99 Gallon

Once 'N Done Floor Cleaner

Easy cleaning of no-wax floor surface in one easy step! #16469

\$3.99 Quart

20' Self-Adhesive Vinyl Cove Base

Sturdy vinyl strip protects walls and cabinets from scuffing. #16390-5

\$9.49 Roll

12' Wide Green Carpet Indoor/Outdoor Turf

Has the look and feel of grass. Ideal for patio, porch, or around pool. Hoses clean and it's mildew resistant. Great for the laundry area or basement. #15282

\$1.89 Sq. Yd. #15282

\$3.99 Sq. Yd.

Armstrong
12' Accotone Vinyl Flooring

Available in many patterns. Has a touch no-wax, vinyl wear surface that resists scuffs and scratches. Easy to install. In 12 foot seam-saving width. #15903,4,5,10,16042,179,182,191

Do-it-Yourself Sheet Floor Adhesive

Now you can install your own flooring . . . the quick and easy way! #16208

\$9.59 Gallon

Trim 'N Fit Kit

Do-it-yourself floor installation that looks like it was done by a pro! #16468

\$5.49

12' Wide Blue Or Brown Carpet Turf . . . **\$2.29** Sq. Yd.

Indoor or outdoor use. Hoses clean and resists mildew. #10317,15252

12' Wide Green Carpet Turf **\$3.69** Sq. Yd.

Deluxe indoor/outdoor carpet turf is durable, natural looking. #15283

HALF PRICE!

12-Year Warranty Interior One Latex Flat Wall

\$6.49 Gallon

LOWE'S DELUXE

12-Year Warranty Exterior One Coat Latex Flat House Paint

\$7.49 Gallon

12 Year Exterior Flat House Paint **\$7.49** Gallon

Covers in one coat, resists blistering, peeling, staining & chalking. Available in white, colors, custom colors. Reg. \$14.99. #47401-10,431-4

12 Year House & Trim Paint **\$12.99** Gallon

Durable, stain resistant. In white, colors, custom colors. #47551-74

Interior Flat Latex Wall Paint **\$6.49** Gallon

Great price — reg. \$12.99! Warranted 12 years. Offers superior stain resistance and durability. Washable. In white, colors & custom colors. #47301-11,47331-34

Interior Semi-Gloss Enamel **\$10.99** Gallon

Warranted 12 years. Is stain resistant and scrubbable. Available in white, colors and custom colors. #47351-84

No One Outperforms Lowe's Quality Paint!

PAINT THINNER

KRYLON

WOOD FINISH MINWAX

Interior Wood Enamel Spray Paint Thinner

CLOSET MAID

\$11.99

Vinyl Coated Closet Organizer

Kit includes three 12" wide shelves, one pole support, hardware, and instructions. Vinyl coated steel resists rust, never needs painting. Fits closets up to 58" wide. #62108

58" To 82" Organizer **\$17.99**

Made of steel. Template included. #62109

12"x6" Or 12"x12" Shelf #62121,50 **83¢** L.t.

4,000 Watt Generator

With reliable Briggs & Stratton engine, four 120/240V outlets, 4 quart fuel tank, and rubber feet to lessen vibration and minimize "crawling." Great for construction sites, home standby in case of severe weather, etc. #72013

\$419

\$16.07 Per Month For 36 Months*

200 Amp 20 Space Panel Box

Includes main breaker. Provision for up to 40 branch circuits. Flush mount design. #71776

\$66

12/2 W/Ground Copper Cable

For interior rough electrical applications. #70111

\$29.79 250' Roll

Electrical Hardware & Accessories

AS LOW AS . . . **18¢**

100' 100' outdoor/indoor extension cord

A. 16 Cu. In. PVC Electrical Wall Box	#70991	18¢
B. Brown, Grounded Outlet	#70500	39¢
Ivory, Grounded Outlet	#70685	39¢
C. Brown, Grounded Switch	#70623	45¢
Ivory, Grounded Switch	#70624	45¢
D. Metal Box With Clips	#70940	77¢
E. Porcelain Socket	#71140	95¢
F. Ivory, Grounded Adaptor	#71318	\$1.88

Brown, Grounded Adaptor	#71320	\$1.88
White, Grounded Adaptor	#71385	\$1.88
G. 15 Amp Single Pole Breaker	#71922	\$2.77
20 Amp Single Pole Breaker	#71924	\$2.77
30 Amp Single Pole Breaker	#71926	\$2.77
H. Ground Fault Interrupter Outlet	#71915	\$8.88
I. 6 Outlet Surge Protector	#71177	\$9.88
J. 16/3 100' Extension Cord	#70372	\$10.88

REGENT LIGHTING

\$24.50

Dusk-To-Dawn Outdoor Security Light

Automatically comes on at dusk, goes off at dawn. 175 watt mercury vapor lamp is brighter than four 150 watt par floodlights. #74011

REGENT LIGHTING

\$9.88

Quartz Security Light

With bronze finish, adjustable swivel mount. 300 watt bulb included. Use around pool, in backyard, etc. #74010

REGENT LIGHTING

\$12.88

Fluorescent Entrance Light

Lasts an average of 10 times longer than a 60 watt incandescent bulb. Energy efficient. Designed for cold weather operation. #74002

\$18

A. Black Outdoor Lantern

Has a black finish, beveled glass, and an attractive coach lantern style. #79271

B. Black And Brass Wall Lantern

Has a black finish with brass trim, and beveled glass. Coach design. #79272

\$29

C. Solid Brass Wall Lantern

Features attractive old-world styling in beautiful polished brass finish. #79264

\$39

THOMAS

\$1.99

A. 75 Or 100 Watt Flood Lamp

Designed for long life. #75229,31

B. Outdoor Porch Light . . . **\$3.57**

Has a weatherproof, rustproof black base. #78546

DISCOVER THE NEW LOWE'S

FRIENDLY HELPFUL SALESPEOPLE!

Paint You'll Love This Century!
 One & Only and Severe Weather are warranted for 15 years. So if you paint your home with these paints in 1989, you won't have to repaint until the year 2004! One & Only and Severe Weather — the last paint you'll need in this century!



Clear, Solid, Or Semi-Transparent Oil Stain & Preservative
 Preserves the life of wood against rot and decay. Is mildew resistant and helps wood resist warping and cracking. For exterior use only. #49956-85

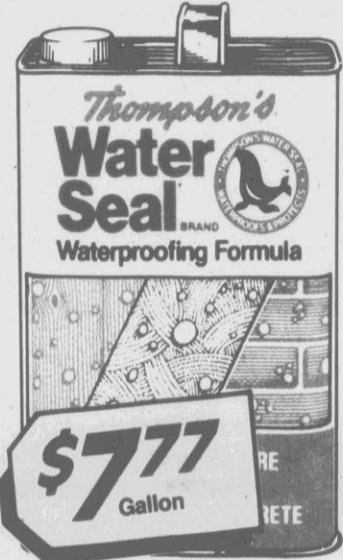

Thompson's Waterproofing
 Seals basement walls, floors and other masonry against moisture that can lead to water damage. #46097

15 Year Interior Flat Latex Wall Paint \$8.99 Gallon

Warranted 15 years durability. Is scrubbable and stain and fade resistant. Covers in just one coat. Premium quality interior paint. Available in white, colors and custom colors. #47581-89

15 Year Interior Semi-Gloss Enamel \$12.99 Gallon

Covers in one coat over primed surfaces. Scrubbable, colorfast, stain resistant and durable. In white & custom colors. #47491-8

15 Year Exterior Latex House Paint \$10.99 Gallon

Covers in just one coat. Fade, stain and mildew resistant. Warranted 15 year durability. Ideal for new work and repainting. White, colors, custom colors. Premium quality. #47511-22

15 Year Exterior House & Trim Paint \$12.99 Gallon

Semi-gloss paint. Covers in one coat. Is stain, fade and chalk resistant. Non-yellowing and washable. #47531-40

YOUR CHOICE!
88¢ Each

#41175 10.5 Oz. Liquid Nails
 #41012 3 Pack Tape
 #43505 10.5 Oz. Acrylic Latex Caulk

3 Pack Masking Tape, Acrylic Latex Caulk Or Liquid Nails Adhesive



Pre-Finished Mouldings Available In Colonial And Ranch Styles

AS LOW AS \$388

4'x8' Interior Paneling

5/32" Autumn Oak
 An attractive medium brown wood grain simulated on a particle-board base. #13867

- 5/32" Colortone Lauan \$7.97
 Simulated on a lauan plywood base. #13866
- 5/32" Modern Oak \$8.88
 Simulated on a lauan plywood base. #13875
- 5/32" Clear Birch \$9.87
 Simulated on a lauan plywood base. #13956
- 5/32" Cinnamon Birch (Not Shown) \$9.99
 Simulated on a lauan plywood base. #13905
- 1/4" European Oak (Not Shown) \$11.97
 Simulated on a lauan plywood base. #13925
- 1/4" Oyster Pearl \$13.47
 Simulated on a lauan plywood base. #13901
- Trim & Save Panel \$5.97
 Sold per 14 sq. ft. bundle. #13790
- Pine Edge Center Bead Lumber Panel \$8.87
 Sold per 14 sq. ft. bundle. #13787



Buy One Single Roll Get One FREE!

Stock Wallpaper Sale! \$8.49

Single Roll AS LOW AS
 All first-quality up-to-date patterns! Lowe's has the perfect wallcovering for your new or remodeled rooms, from distinctive patterns for living room & bedroom to Teflon® coated for the kitchen & laundry area. Sold in double roll bolts. #42009-492

White Or Almond Vinyl Mini-Blinds
 Control sunlight and privacy with just the turn of a control wand. Other sizes, see below. #63761,63790

Choose From 8 Widths \$6.69
 64" long x 23", 27", 29", 30", 31", 32", 35", and 36". #63767-778,796-807

Mini-Blind Duster/Cleaner #63834 \$1.99



\$88

8 Light Brass And Glass Chandelier
 Has a beautiful polished brass finish, beveled glass panels, and an attractive 3 tier chain hung design. 22" high, 18 1/2" diameter. #79189



\$28

3 Light Brass And Glass Ceiling Fixture
 A 10" round ceiling fixture with polished brass finish and clear beveled glass. Has a closemount design. #79177



\$77

5 Light Glass Chandelier
 Has a polished brass finish, clear strip glass shade, and chain hung design. #79187



\$38

4 Light Cut Glass And Brass Ceiling Fixture
 12" round fixture with a polished brass finish and 24% lead crystal glass shade. Closemount. #79180



\$44

5 Light Chandelier
 With polished brass finish and amber glass panels. Attractive chain hung design. #79190



\$357

Ceiling Light
 12" square fixture with beautiful white glass shade. #77621



\$12

3 Bulb Bar Bath Light
 Choice of finishes. #73400,07,15



\$1.87

60 Or 100W Soft White Light Bulbs
 6 Pack #75218,9

A. 52" Ceiling Fan With Light \$49.99
 5 cane insert blades, 4-light fixture and polished brass finish. 3 speed reversible motor for year-round use. #31778

B. 36" White And Brass Ceiling Fan With Light \$24.99
 4 white blades. Polished brass finish. Schoolhouse light. 3 speed motor with pull chain control. #31709

C. 42" Ceiling Fan With Light — 2 Styles \$34.99
 Both 4-blade fans have polished brass finish. Choose bell-shaped or tulip-shaped light style. 3-speed reversible motor. #31719,20

D. 16" Oscillating Pedestal Fan \$27.99
 Adjustable fan height and tilt. 3 speed fan control. Oscillation can be shut off. #39589

E. 6" Portable Personal Fan \$6.99
 For desk top, small spaces, etc. #39586

30" Whole House Attic Fan \$89.99
 Simple to install — no joists to cut. With pre-wired motor and control and built-in overload protection. Has a direct drive 2 speed motor and heavy gauge galvanized steel construction. #31285

Roof Mount Power Attic Vent \$33
 Cuts air conditioning costs by helping cool attic. Designed for attics up to 2,000 sq. ft. With adjustable thermostat. #30985

GRAND OPENING

4 DAYS ONLY! JULY 20 - 23



TRIPac
American Woodmark Corporation

90 DAYS Same As Cash!
See Pg. 2 For Details



\$169

60" Century Or Brookfield Kitchen Starter Set
These cabinets feature self-closing hinges, adjustable shelves and smooth rolling drawers. Flat panel doors provide an easy-to-clean cabinet, and the finish is resistant to most household chemicals. Additional cabinet sizes are available in both styles. In-stock and pre-assembled. Sink, countertop and valance are available extra. #56500,59100
Lowe's Has Over 16 Styles Of Kitchen Cabinets To Choose From!

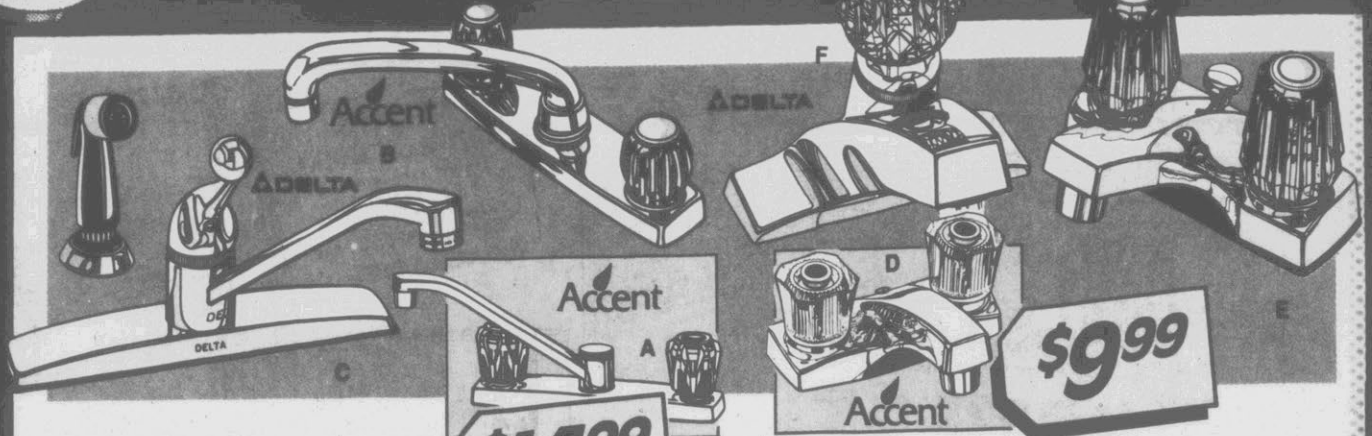

A. Chrome Kitchen Faucet
Washerless design has a 10 year limited drip-free warranty. #24810

\$14⁹⁹

B. Washerless Kitchen Faucet **\$39⁹⁹**
Features a beautiful chrome finish, trouble-free brass construction, and attractive acrylic handles. Has a 10 year limited drip-free warranty. #24809

C. Single Control Kitchen Faucet With Spray **\$59**
Has a beautiful chrome finish, reliable washerless design, and handy spray attachment. With copper tube inlets. #25401

D. Chrome Bath Faucet Non-metallic washerless construction has a 10 year limited drip-free warranty. #24913

\$9⁹⁹

E. Bath Faucet With Pop-Up **\$24⁹⁹**
Beautiful chrome finish and washerless design assure years of maintenance-free use. Features twin acrylic handles and aerator. #24901

F. Decorative Bath Faucet **\$49**
Features a beautiful chrome finish, metal pop-up drain, reliable washerless design, aerator and stylish handle. #25430



BANNER

\$26⁹⁹

33"x 22" Stainless Steel Sink
Comes pre-drilled for easy faucet installation (available extra). Self-rimming design for easy, do-it-yourself installation. #26145
7" Deep Deluxe Stainless Sink #26150 **\$49**
Lowe's Best 8" Deep Sink #26152 **\$69**



\$89⁹⁹

5' Acrylic Faced White Tub
Available in left or right hand styles. PVC is warm to the touch & is easy to clean. Lowe's has a complete line of bath tubs & accessories in stock. #20430,1
White Tub Surround #20310 **\$21⁹⁹**

Chrome Tub Enclosure **\$39⁹⁹**
Easy-to-clean, self-draining track. Anodized aluminum finish. Safety glass. #26731



\$9⁹⁹

White Bath Cabinet
Polystyrene cabinet. Surface mount design. #23669



\$24⁹⁹

Stainless Steel Bath Cabinet
Recess or surface mount. Has a steel cabinet with protective enamel finish. #23672,74

Faucets for all vanities are available at Lowe's low prices.



\$29⁹⁹

Oak Vanity With Top **\$59⁹⁹**
Features an oak front and frame. Ready-to-assemble design. With easy-to-clean cultured marble top. #21075

White Bath Vanity With Marble Top
Comes ready-to-assemble. Roomy interior. White with in-laid gold accent. Easy-to-clean cultured marble top. #21071

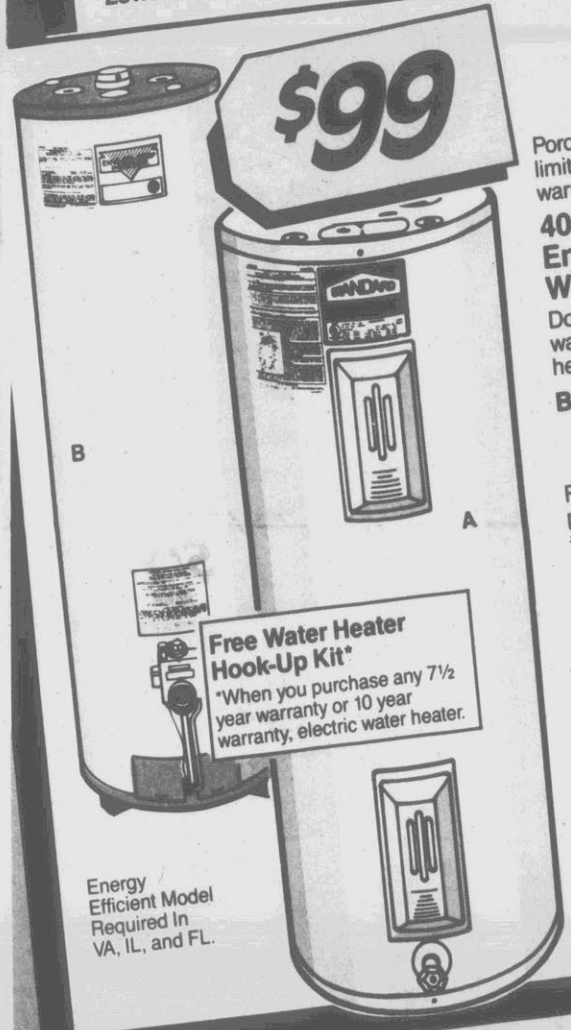

\$99

A. 40 Gallon Electric Water Heater
Porcelain glass-lined tank. Has a 5 year limited tank warranty. One year limited parts warranty. #26322

40 Gallon Electric Energy Efficient Water Heater **\$129**
Double element design. Has a 5 year tank warranty and one year parts warranty. Dual heating elements. #26302

B. 40 Gallon Natural Gas Energy Saver Water Heater **\$149**
Features a 5 year tank warranty & one year parts warranty. High density foam insulation. #26314

50 Gallon Electric Energy Efficient Water Heater **\$199**
Deluxe water heater. Has a 7 1/2 year limited tank warranty. 5 year limited parts warranty. Porcelain glass-lined tank. Stainless steel dual heating elements. #26305

50 Gallon Electric Energy Efficient Water Heater **\$229**
Lowe's best electric water heater! Has a 10 year tank warranty and a 5 year parts warranty. Stainless steel dual heating elements. #26307

Free Water Heater Hook-Up Kit*
*When you purchase any 7 1/2 year warranty or 10 year warranty, electric water heater.

Energy Efficient Model Required In VA, IL, and FL.



AS LOW AS **\$3⁹⁹**

\$129

PVC DWV Pipe

PVC won't rust or corrode. For use in drain, waste or vent systems.

1 1/2" x 10' #23830 **\$3.99**
2" x 10' #23832 **\$5.79**
3" x 10' #23834 **\$12.50**
4" x 10' #23838 **\$15.99**
4" x 10' Corrugated Drain Pipe **\$2.77**

Solid or slotted with coupling. #24134,38

1/2 HP Shallow Well Jet Pump

Lowe's stocks a full line of jet pumps. #25701

1/2 HP Deep Well #25702 **\$129**

1 HP Convertible #25703 **\$199**

20 Gallon Vertical Or Horizontal Well Tank #25674 **\$99**



\$39⁹⁹

White Watersaver Commode

This model uses only 1 1/2 gallons of water per flush. Features a white vitreous china bowl. Seat is not included but available extra. #20457,58

Crete Commode Seat available extra. #20460,1 **\$49⁹⁹**



\$59⁹⁹

White Kohler Commode **\$89⁹⁹**

Siphon-jet action flushing. Watersaver model. Seat is available extra. #21280,1

Almond, Blue Or Rose Commode **\$109**
Almond, heron blue or wild rose. #21282,36,7,21294,5

White Commode
Has a sleek, streamlined design. Seat available extra. #20551,2
Crete Or Blue Commode #20555,56,59,60 **\$69⁹⁹**

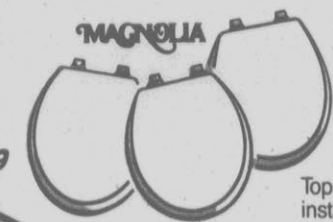

Cushioned White Commode Seat **\$788**

Top mount hinges for do-it-yourself installation. #20660

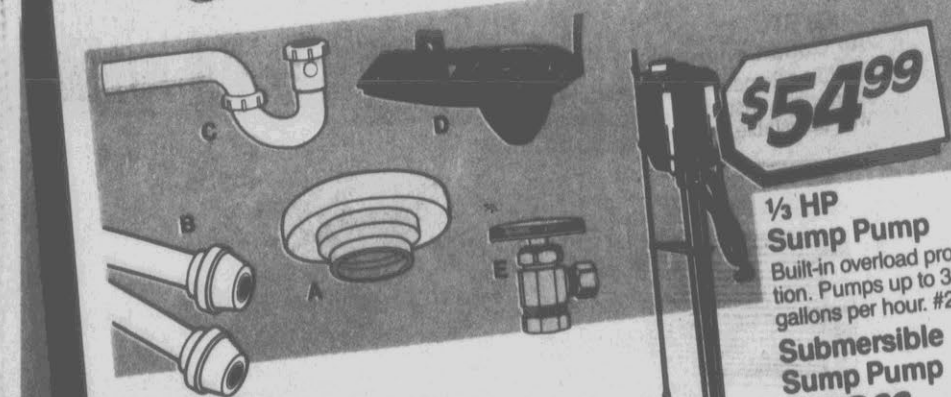

\$54⁹⁹

1/2 HP Sump Pump

Built-in overload protection. Pumps up to 3,600 gallons per hour. #25778

Submersible Sump Pump **\$79⁹⁹**

Has a capacity to pump up to 2,400 gallons per hour. Built-in overload. Not shown. #25779

Plumbing Accessories

A. Wax Bowl Ring #24391 **69c**
B. 3/4" x 12" Poly Supply Line #24969,71 **79c**
C. 1 1/2" x 1 1/4" PVC P-Trap #24650 **99c**
D. Flapper Tank Ball #24462 **99c**
E. Supply Valve #24945,7 **\$2.99**



\$9⁹⁹

A. Ceiling Bath Fan

Has a lifetime lubricated, plug-in motor. For bathrooms up to 45 square feet. Quiet operation. #25502

B. Fan And Light Combination . . . **\$29.99**
Fan & light can work together or separately. #25504

Fan, Light And Heater Combination **\$59⁹⁹**
Features a 2 motor system for dependability. #25506

FAMOUS NAMES AT LOWE'S LOW PRICES!

DISCOVER THE NEW

LOWE'S



HOTPOINT Frost Free Refrigerator \$458

21.6 Cu. Ft. Refrigerator With In-The-Door Crushed Ice And Water Dispenser
Has 2 see-thru produce dispensers. Textured doors hide fingerprints and smudges. Rolls out on wheels. #53635
Icemaker Installation Kit #53755,56 **\$699**

Energy efficient foam insulation. Energy saver switch. Full width produce crisper. Built-in door stops. 14.2 cu. ft. Icemaker extra. #53600
Icemaker Kit #53761 **\$89.99**



HOTPOINT Compact Refrigerator \$97
With ice storage. #53812

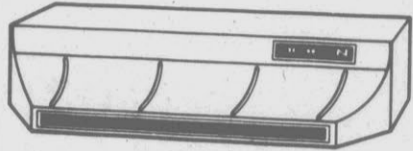

Range Hood \$3388 Nautilus
Your choice, vented or non-vented. Has a powerful 2 speed mixed-flow fan. Baked-on enamel finish. 30" wide. #53401-13

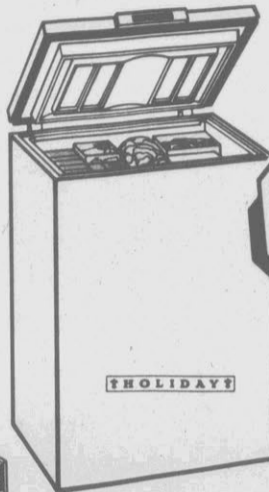

\$197

6.1 Cu. Ft. Chest Freezer
Has textured steel lid and cabinet, foam insulation and adjustable temperature control. #50810



Deluxe Range \$499
Electric. Removable black glass door and lift-up cooktop for easy cleaning. #52909,29

Electric Range \$279
Lift-off oven door. One 8" and three 6" surface units. Storage drawer. #52803



5 Cycle Dishwasher \$269
Has heavy sound insulation. Built-in soft food disposer. Rinse & hold cycle. #51024



Compact Microwave \$77
Has 15 minute timer and up to 450 watt cooking power. Compact design with .3 cu. ft. oven. #51819

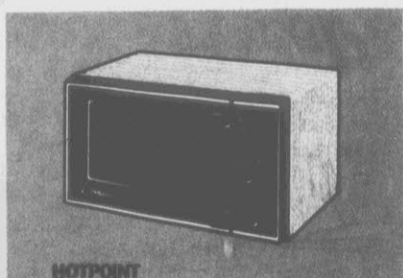

500 Watt Microwave \$98
Compact. Has 2 power levels, defrost setting and 35 minute timer. Convenient lighted cooking compartment. #51755



1/3 HP Disposer \$3388
Continuous feed operation. Has overload switch & cast aluminum grind chamber. #50306



Ask About Service Protection Plus . . . A Quality Service Plan Backed By G.E.

HOTPOINT 4 Cycle Washer \$359
Per Month For 30 Months*

Has 3 wash and rinse temperature selections and 3 water levels. Top to bottom agitator. #51226



HOTPOINT Clothes Washer \$299
Extra large capacity. Offers the simplicity of one regular wash cycle and temperature. Top-to-bottom agitator. #51210



\$1435
Per Month For 24 Months*

4 Cycle Dryer \$269
Has up to 70 minutes of timed drying with Sensi-Dry™ feature. Cool down care for perm press fabrics. #51421

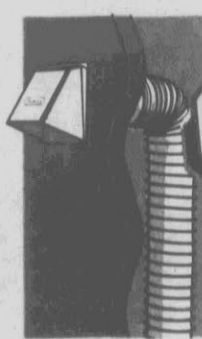

\$499
Dryer Vent Kit
Vent opens and closes automatically to seal out wind and weather. #51606



\$1588
Per Month For 30 Months*

Remotable 25" Color Console TV \$359

Remote control ready. Up to 178 channels with programmable scan tuning. On-screen displays and electronic volume control. (A) Contemporary, (B) Traditional or (C) Early American cabinet style. 100% solid state chassis. #54786-8

Optional Remote Control \$34.86
Random access tuning, sleep timer and more! #54789



\$188

19" Color TV
100% solid state chassis. Rapid-on picture and sound. Up to 82 channels. #54491



13" Color TV \$156
Auto color. Rapid-on picture & sound. #54488



\$3392
Per Month For 36 Months*

VHS Camcorder \$888

Has a high speed 6:1 power zoom lens that's ideal for low light recording. Electronic high-speed shutter. Date generator. #54887
Carrying Case \$4699
Makes camcorder carrying easy. #54888



Remote Control VHS VCR \$216

Has "HQ" circuitry for a better picture, cable-compatible tuning. 14 day/4 event programming and slimline design. #54975



Cordless Telephone \$3997
Lowe's Price Factory Rebate After Rebate
Tone/pulse switchable. Has an extended range. Wall or desk mount. Last number redial. Rebate expires 7/30/89. #55387



\$276
6 Hour Blank VHS VCR Tape \$4699
#54957

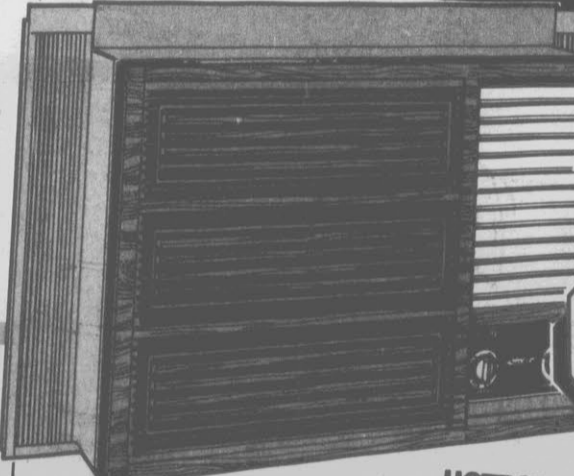

17,600 BTU High Efficiency Air Conditioner \$499
Features a 2-speed fan and an 8-position thermostat. Power Saver switch and slide-out chassis. #50181

90 DAYS Same As Cash
On All Air Conditioners Priced \$250 Or More See Page 2 For Details

\$1912
Per Month For 36 Months*

23,500 BTU Air Conditioner \$669
#50182

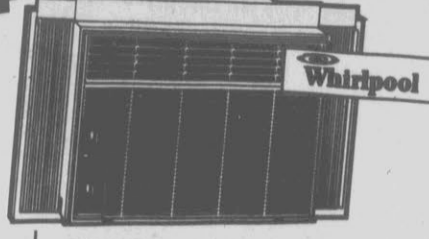

5,000 BTU, 115 Volt Air Conditioner \$199
Features 2-speed fan and adjustable thermostat. Insta-Mount™ installation with adjustable side panels. #50020

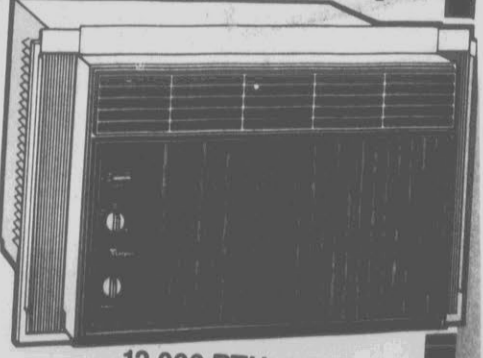

12,000 BTU, 115 Volt Air Conditioner \$497

High efficiency 3-speed fan and adjustable thermostat. Insta-Mount™ installation. #50027
18,000/17,800 BTU High Efficiency Air Conditioner #50028 **\$599**

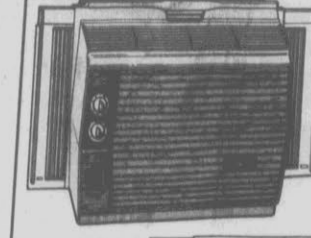

4,200 BTU, 115 Volt Air Conditioner \$169
Adjustable thermostat. 2-speed fan. #50149

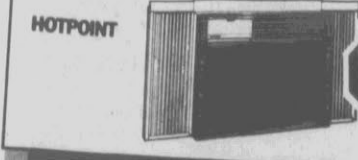

\$368

7,800 BTU, 115 Volt Air Conditioner \$497
High efficiency. Power saver switch. 8 position thermostat. Slide-out chassis. #50169

GRAND OPENING

4 DAYS ONLY! JULY 20 - 23

All Your Hardware Needs!

Locks & Latches

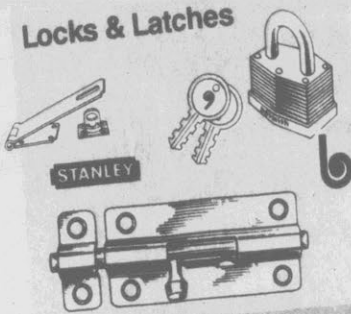

- \$129** 1 9/16" Padlock
With 2 keys. For maximum security. #60051
- 3 1/2" Safety Hasp #64004 \$1.79
- 2 1/2" Barrel Bolt #64732 \$1.29
- 2" Padlock #60083 \$6.99

Cabinet Hardware

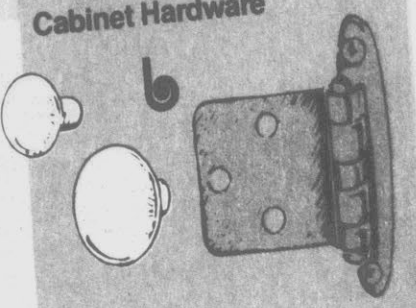

- \$129** Pair Self-Closing Cabinet Hinge
Antique brass. Offset or flush. Convenient and attractive. #602478
- Polished Brass #66242.3 \$1.49 Pair
- 1 1/4" White Porcelain Knob **89¢**
- Enhance the beauty of your kitchen with attractive cabinet knobs. #60220
- Almond Knob #66138 \$1.10

Strap & T Hinges

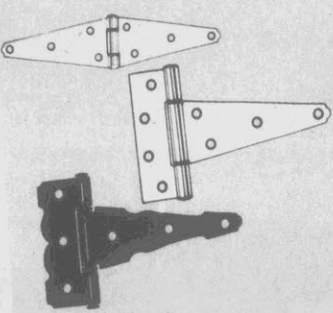

- 99¢** 4" Heavy Strap Hinge
Sturdy design. #64167
- 6" #64168 \$1.49
- \$129** 4" Heavy T Hinge
Use on gates for gardens, patios, etc. #64171
- 6" T Hinge #64172 \$1.89
- \$299** 6" Decorative T Hinge
Heavy & durable for long wearing service. #64737
- 8" #64738 \$3.99

27 Drawer Organizer Cabinet \$999

Durable, non-coloring plastic. Stackable. Easy to hang. #67445

\$399

BUSH LAKE

6 Pack Bin Organizer \$399

Red or yellow. 2 wall mounts. #67443

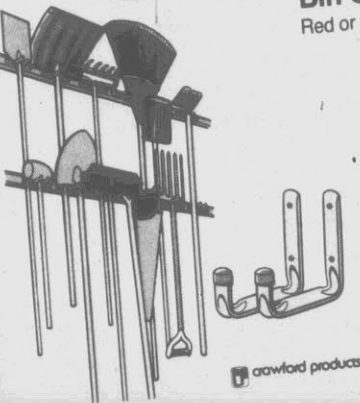

Storage Hangers Or Tool Organizer \$399 Each

2 great ways to straighten up a basement, garage or workroom. #61726.8

Peerless

\$699

43 Piece Peghook Kit \$699

Organize tools and more. #61977

\$129 Pair

Vinyl Coated Hooks \$129

#64909-12

Water Level \$927

Provides accurate measurements. For decks, floors, etc. Made of durable impact-resistant plastic. #99498

\$199

Propane Cylinder \$199

Disposable 14.1 ounce propane fuel cylinder. #91313

16 Oz. Hammer \$193

Wood handle. #99861

\$899

1" x 25' Tape \$899

Locks into place. Built-in belt clip. #99930

\$1191

Staple Gun \$1191

All steel construction. Chrome finish. Holds 85 staples. #91426



10x8 Steel Storage Building \$14999

All painted parts are 100% galvanized steel. Double roof beams at ridge for extra support. Base: 118 1/4" x 90" x 69 3/4". #92733

10x8 Storage Building Foundation Kit #92726 \$39.99

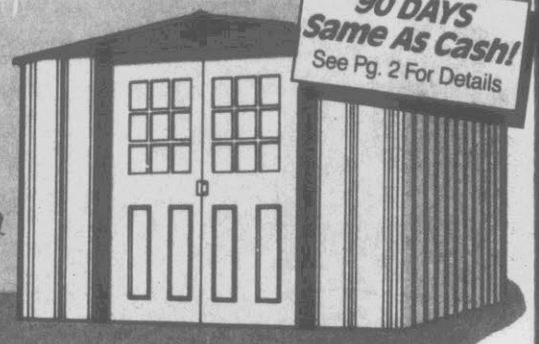

10x14 Steel Storage Building \$28999

Frame is hot-dipped galvanized. All painted parts are 100% galvanized. Double roof beams at ridge. Mid-wall brace. Has a 3 year limited factory warranty. Base dimensions: 118 1/4" x 157 1/2" x 74 3/4". #92736

Foundation Kit For Above #92728 \$59.99

90 DAYS Same As Cash! See Pg. 2 For Details



~~\$3693~~ **\$3393** After Rebate

5 Gallon Wet Or Dry Vacuum \$3393

Includes a 1 1/4" x 6' flexible hose 2 extension wands & squeegee. Stores easily. Rebate ends 12/31/89. #98687



\$4499

6 Gallon Wet/Dry Vac \$4499

Ideal for larger clean-up jobs. Flexible hose, extension wands & more. 1.1 HP. #98688

10 Gallon Wet/Dry Vac \$6877

Heavy duty, large capacity model for bulk pick up. 1.5 HP. #98695

16 Gallon Vac #98698 \$7999

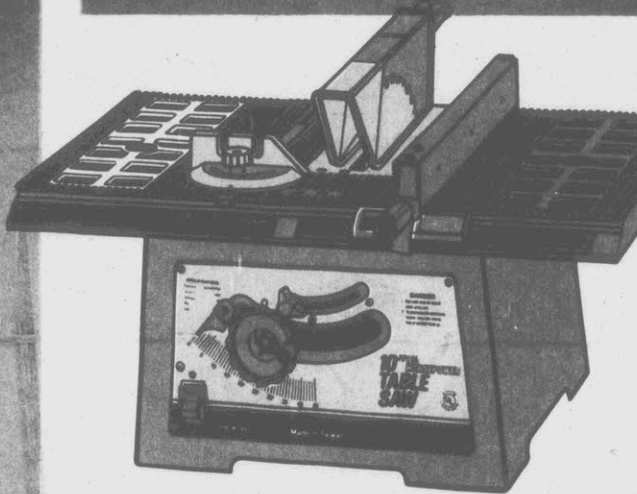

\$8996

10" Bench Table Saw \$8996

Has a reinforced aluminum table. Adjustable rip fence locks front and rear with one knob. Blade adjusts from 0° to 45°. Has a steel cabinet. Anti-kickback device. See through blade safety guard. #91182

Delta™ 10" Table Saw With Stand (Not Shown) \$299

Features a metal miter gauge. Rip fence has a "jet-lock" control, aligns and locks fence to front and rear rails. #91984



10" Power Miter Saw \$139

Has a calibrated miter scale. Cuts up to 45° right or left. Has positive stops at 90° and 45°. #91798



\$5494

4" Angle Grinder Kit \$5494

Includes wheel guard, grinding wheel, 2 sanding discs, rubber back pad and case. #90171



\$2294

3/8" Drill \$2294

Ideal general purpose drill. Has a full 2 year home-use warranty. 6' cord. #91702

3/8" 2-Speed Cordless Drill \$2888

Recharges in only 3 hours. With recharging base. Built-in chuck holder. Double gear reduction for high torque driving. #91708

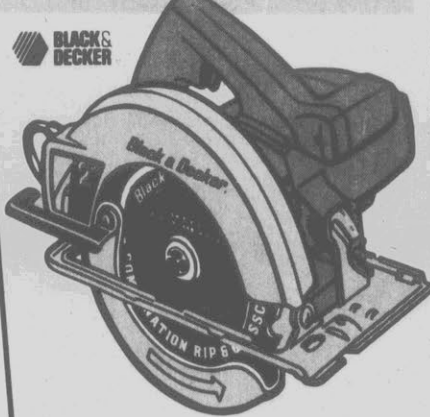

\$3797

7 1/4" Circular Saw \$3797

2 1/2 HP motor output. Steel wraparound shoe. #91802



2 1/2 HP Air Compressor \$319

Has a 20 gallon tank capacity. Oilless, with 6 valve design. Has a one piece, easy-change filter. Has 25% more power delivery than ordinary 2 HP motors. Rebate ends 12/31/89, limit one rebate. #90930

~~\$319~~ **\$299** After Rebate

1/2" Air Ratchet #90971 \$24.99



~~\$497~~ **\$467** After Rebate

5 HP Air Compressor \$467

60 gallon tank. Has a 230-volt single phase motor. Single stage compressor. Includes flow control valve and tank pressure gauge. Enclosed reusable intake filter. Stainless steel valves. Rebate ends 12/31/89, limit one. #90934

\$2797

6 Gallon Air Tank \$2797

Includes air chuck, pressure gauge, brass manifold and safety valve. Inflate tires, basketballs, etc. #97719

LOWEST PRICES EVERYDAY... GUARANTEED

DISCOVER THE NEW

LOWE'S



\$22⁹²
Per Month For 36 Months*

5 HP, 26" Cut Riding Mower \$599

Briggs & Stratton engine, full-floating deck, 3 speed transaxle with reverse, air cushion tires, adjustable seat. #95172

90 DAYS Same As Cash
On All Mowers & Tractors Priced \$250 Or More.
See Details On Page 2.



\$33⁴⁹
Per Month For 36 Months*

12 HP, 38" Cut Lawn Tractor \$888

12 HP engine tackles any cutting job. With 6 speed Transmatic® transaxle, high vacuum deck, electric start with alternator. #95185
Twin Bag Grass Catcher #95340 **\$188**

12 HP, 39" Cut Lawn Tractor \$999

Has a Briggs & Stratton Industrial-Commercial engine with cast iron cylinder sleeve, full-floating extra-wide 39" deck, 7 speed transaxle. Large 20" rear tires. #95191
Twin Bag Grass Catcher #95332 **\$188**

All Lowe's Riding Mowers Come Fully Assembled & Serviced... Ready To Mow!



\$19

6'x8' Stockade Fence Panel
6' high x 8' wide pre-assembled panel. 3 back rails for strength and stability. #99051
Treated Stockade Fence Panel... \$25
Pressure treated pine resists insects & decay. 6' high x 8' wide pre-assembled panel. #99002
Shadowbox Fence Panel... \$28
Pressure treated pine resists insects & decay. 6' high x 8' wide pre-assembled panel. #99003

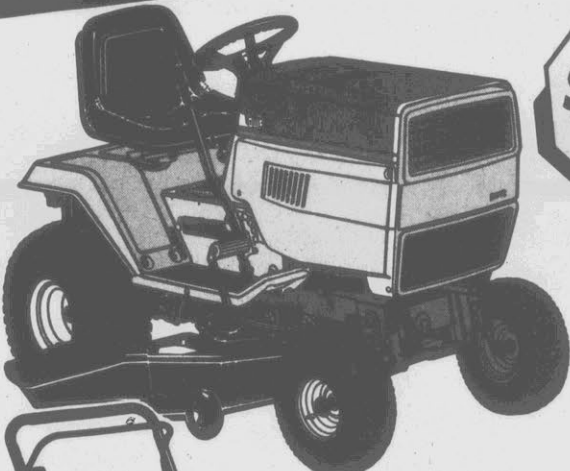

\$1544

18 HP, 46" Cut Lawn & Garden Tractor

Briggs & Stratton twin cylinder engine with cast iron cylinder sleeve, 46" deck with special vacuum lift action, anti-scalp deck wheels, heavy duty 5 speed transaxle, and extra-large cushioned seat. #95198
Triple Bag Grass Catcher #95337 **\$249**



\$117

3 1/2 HP, 22" Cut Lawn Mower

Solid state electronic ignition, adjustable cutting heights, handle mounted throttle. #95116



\$179

3 1/2 HP, 22" Cut Lawn Mower

Has Briggs & Stratton engine, dual handle controls, fingertip height adjustment from 1" to 3", solid state ignition. #95152
Grass Catcher #95156 **\$24.99**



\$14²⁵
Per Month For 24 Months*

4 HP, 21" Cut Self-Propelled Mower \$267

Rear bag mower with Briggs & Stratton MAX engine, deep tunnel deck to assure excellent cutting & bagging. Easy-dump nylon bag. Built-in discharge chute allows you to use mower without rear bag. #95137



\$69⁶⁶

15" Gas String Trimmer

Has a 21.2 cc engine, an electronic engine, Delta handle, and debris shield with built-in cutter head. 2 year warranty. #91578

17" Brushcutter \$179
Not shown. Has shoulder harness. 21.2cc engine. #91574



\$337 Each
#99755,6,8

\$15⁵⁰

Post Hole Digger
#99762

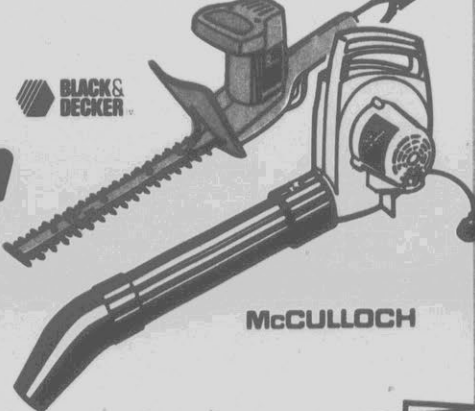

\$27⁹⁶

13" Electric Hedge Trimmer

Has double edged blades and sturdy up-front grip handle. With safety switch. #91556

Electric Yard Blower \$27⁸⁶

Has a 1/3 HP universal motor, 30° concentrator nozzle, and is double insulated. #91551

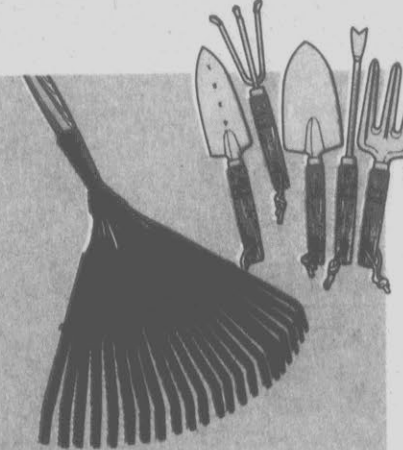

YOUR CHOICE! \$177

Leaf Rake Or Garden Tool Set

Tool set includes a trowel, transplanter, cultivator, digger, and fork. Built for years of use. #99742,50



\$18⁸⁸

8" Electric String Trimmer

Designed for easy, one-hand operation, this trimmer weighs only 3.2 lbs. and is perfect for trimming grass and light weeds around walks, driveways, foundations, etc. #96571

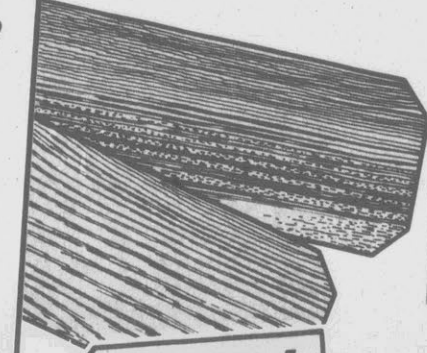

96¢

3 1/2" x 6' Treated Dog-Ear Fence Board

Pressure treated pine. Rough sawn surface. #98903

5 1/2" x 6' #98901 **\$1.27**

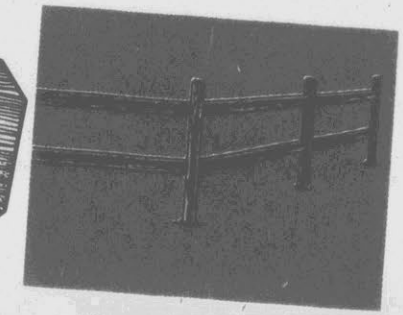

Treated Post And Rail Fence \$11

8' Section
Includes two 8' rails & one line post. Stain or let weather. #98941,2

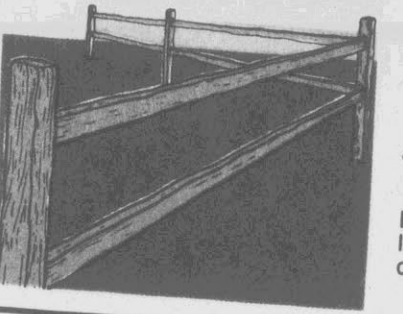

10' Section Split Rail Cedar Fence \$12⁶⁶

Includes 2 rails & one line post. Resists decay, insects. #98921,2

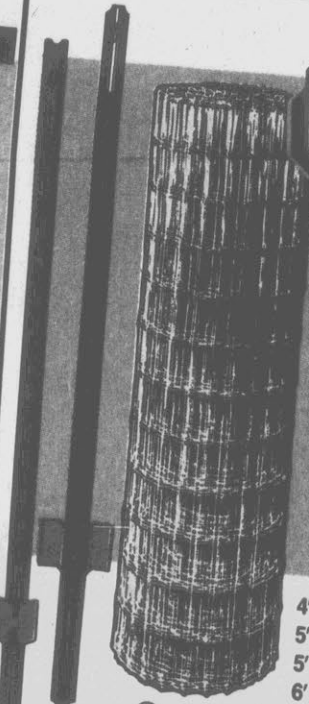

\$14⁹⁹

3'x50' Sturdy 14 Gauge Utility Welded Fence

4"x2" mesh. Galvanized wire resists rust. For a variety of projects. #92256
4'x50' Fence **\$19.95**
14 gauge. 4"x2" mesh. Galvanized. #92257
5'x50' Fence **\$24.95**
14 gauge utility welded fence. #92258
4'x50', 12 1/2 Gauge Fence **\$28.95**
2"x4" mesh. Galvanized. Welded. #92288
4'x100', 12 1/2 Gauge Fence **\$56.95**
2"x4" mesh. Galvanized. Welded. #92280
5'x100', 12 1/2 Gauge Fence **\$69.95**
2"x4" mesh. Welded. #92285
4' Steel Fence Post #92063 **\$1.44**
5' Steel Fence Post #92064 **\$1.98**
5' Heavy Duty Fence Post #92065 ... **\$2.44**
6' Heavy Duty Fence Post #92060 ... **\$2.98**

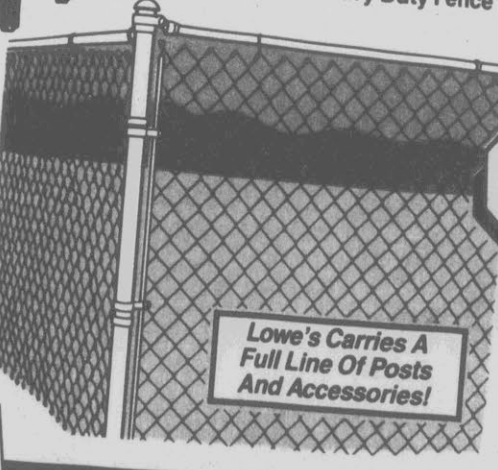

59¢ Lt.

4'x50' Chain Link Fence Fabric

12 1/2 gauge. Galvanized after weaving to protect against rust & corrosion. #92149

Extra 33 Feet Per Roll



\$82⁸⁸

47'x363', 12 1/2 Gauge Field Fence

Quality Red Brand® fencing with 10 cross wires. Made in the USA. #92656

6' Studded T-Post With 3 Clips \$198

#92070,69



\$19⁹⁵

3'x50' Vinyl-Coated Lawn Fence

2"x3" mesh. For enclosing yards, pools, flower beds. #92253

4'x50' **\$26.95**

16-gauge wire. 2"x3" mesh. #92254



\$20⁷⁷

15 1/2 Gauge 4 Point Barbed Wire

High tensile. 1/4 mile roll. Barbs spaced 5" apart. Reverse twist strands resist sagging. #92050

12 1/2 Gauge Barbed Wire \$34.88
1/4 mile roll. 4 point. American made. #92055

GRAND OPENING 4 DAYS ONLY! JULY 20 - 23

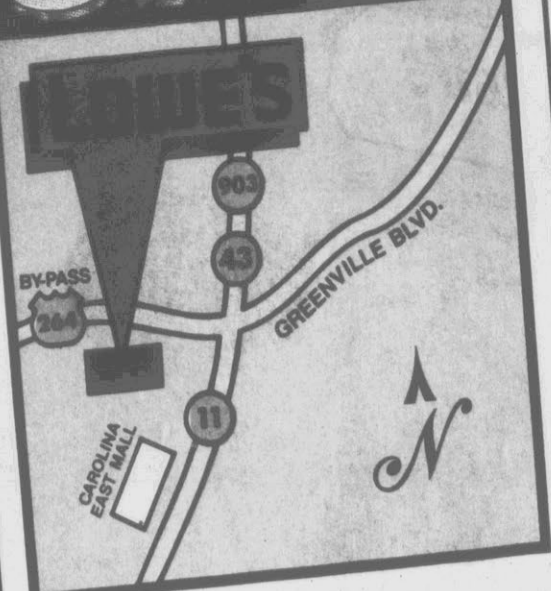

Lowe's of GREENVILLE

1055 S.W. Greenville Blvd.
Greenville, NC 27834
(919) 756-6560
STORE HOURS:
Mon-Sat: 8:00 AM - 9:00 PM
Sunday: 1:00 PM - 6:00 PM

YOUR CHOICE \$179
Gallon Pot

\$788
Tropical Houseplants
Lowe's has a wide variety of plants available. Come and see our complete selection. #93406

\$499
Hanging Plant
Lowe's has a large selection of 10" foliage & flowering plants available. #93398

Assorted Evergreens
Use as an accent, border, background, screen, foundation, etc. Beautiful variety! #93209-16,23-47,63-9,78-81
3 Gallon #94860-92 \$7.83

LOWE'S GARDEN CENTER . . .
Lowe's offers a wide variety of beautiful plants to brighten your lawn, garden and home. Everything from flowering bulbs, to fruit trees, to evergreens, & more. An almost endless selection of types, colors, textures and sizes to fit your needs.

Red Tip Photina \$179
Gallon
Grows to over 6'. Has bright red foliage. #93217

Marble Chips, River Rock Or Pea Gravel \$269
50 lb. bag. #92421;92125,30

Pine Bark Mulch \$188
2 Cu. Ft.
Helps soil retain moisture. #92118

Top Soil Or Peat Humus \$169
40 Lb. Bag
Organic, weed-free. For planting or patching. #92432,5

Roundup® Weed Killer \$347
24 Oz.
Ready-to-use weed & grass killer. #94608

Sevin Dust \$177
4 lb. bag. Kills garden pests, fleas, etc. #93046

Thinsset Paver Brick 29¢
3" W x 7" L x 1 1/4" D. #19210

4 Cu. Ft. Wheelbarrow \$2199
Has 4 cu. ft. heaped capacity, 21 gauge steel. #92854

10'x10' Brick Patio Package \$188
480 thinsset bricks, 12 packs of grid trays, basket weave design, four 60 lb. bags of sand mix. Easy-to-follow instructions. #00044

\$149.95
5 Piece Patio Group
Set includes 40" round Werzalit table and 4 comfortable strap chairs. Chaise lounge, umbrella, and umbrella stand shown are sold separately. #96525,26

Resin Stack Chair \$9
All resin construction. Stack to store. #96517

Adirondack Chair \$49.99
Great for lounging around your deck, pool, porch, etc. Solid oak. #96521

6"x3' Treated Lawn Edging \$377
Flexible design. Pre-assembled. 30 year limited warranty. #04608

6"x10' Cedar Lawn Edging \$577
Flexible design. Pre-assembled. Decay and insect resistant. #04609

2'x2' Treated Patio Square \$377
#04607

18" Round Or Square Pebble Surface Stepping Stone \$3.99 Each
A decorative design stone that's great for walkways, garden paths, etc. #19225,6

- Strap Chair #96525 \$27.49
- 40" Round Werzalit Table #96526 \$39.99
- 7 1/2' 8-Rib Umbrella #96527 \$69.99
- Strap Chaise Lounge #96528 \$79.99
- Umbrella Base #96814 \$7.99

2' Concrete Lawn Edger 99¢
Ideal for lawn edging, patio border, etc. #19196

12" Concrete Square 89¢
Convenient size for patio, walkway, etc. #19183

6' Picnic Table \$34.99
Made of redwood-stained whitewood. Has a 7 board top and comes with matching 3 board benches. #96806

22" Round Charcoal Grill \$39.99
Has a chrome plated cooking grid, an ash catcher and a vented bottom. With heat resistant handles. #97297

15 Watt Bug Killer \$19.99
Has rustproof top and cage. #73009

40 Watt Bug Killer \$29.99
Has a one acre luring range. #73014

24,000 BTU Gas Grill \$89
Has tubular steel patio cart frame, 2 redwood side tables and a Lite-A-Matic™ pushbutton ignition system for safety. #97273
Grill Cover . . . \$9.99
Fits grill above. #97308

10 Qt. Cooler \$8.99
Great for picnics, cook-outs, etc. #95852
34 Qt. Cooler \$14.99
Big enough to hold 2 & 3 liter bottles. #95857

Hose Reel Cart \$19.99
Holds up to 150' of 3/4" hose. Has 4' leader hose, non-rusting water system. #92349
5/8" x 50' Reinforced Hose \$7.97
Strong reinforced vinyl. #92359

1/2" x 50' Vinyl Hose \$2.93
100% vinyl brass couplings. #92351

Oscillating Or Spike Lawn Sprinkler \$4.97
Oscillating sprinkler can water up to 2800 sq. ft. Spike sprinkler can water up to 5300 sq. ft. #93024,8

LOWE'S Guaranteed Low Prices



See Page 2 For Credit Details

You Could Win A **\$1000 Shopping Spree!**

As part of our big Grand Opening celebration, we're giving away a \$1000 shopping spree in our new store. If you win, you'll be able to choose from thousands of quality products. You must be 18 or over to enter. No purchase is necessary. You do not have to be present to win. Lowe's employees and their families are ineligible. Prizes are not redeemable for cash. Drawing will be held Sunday, July 23, 1989 at 5:00 PM.

SEARS

Your money's worth and a whole lot more!

NATIONAL HOME APPLIANCE AND ELECTRONICS

SPECTACULAR



ONLY \$21

PER MONTH* ON SEARS- CHARGE PLUS

YOUR CHOICE

999⁸⁷

White. Color extra.
Good Through July 29

KENMORE— AMERICA'S #1 CHOICE* ONLY AT SEARS

*Reflects the combined market shares of 11 different product lines.
*Your actual monthly payment can vary depending on your account balance.
SearsCharge PLUS is available for most major purchases totaling \$700 or more.
2 GRE55L1 1A

21.7 CU. FT. TOTAL CAPACITY!

3 GLASS SHELVES, 4 DOOR SHELVES

HUGE CAPACITY—25.1 CU. FT.!

ADJUSTABLE GLASS SHELVES

JULY 19 EDITION

**SATISFACTION
GUARANTEED OR
YOUR MONEY BACK!**

FAMOUS BRAND NAMES YOU WANT!

**GREAT LOW PRICES
EVERY SINGLE DAY
GUARANTEED!**

Each of these advertised items is readily available for sale as advertised

NATIONWIDE DELIVERY

We'll deliver to accommodate your schedule—including Saturdays, when possible.

NATIONAL HOME APPLI SPECTA

**WHERE ELSE
COULD YOU
FIND A
REFRIGERATOR
THIS SIZE
AT SUCH A
LOW PRICE?
18-CU. FT.* KENMORE**

\$449

White only

Good Through July 22

**\$14 PER MONTH* ON
SEARSCARGE**

- Convenient all-frostless design
- Handy twin crispers help keep your fruits and vegetables fresh and crisp!
- Freezer shelf keeps frozen goods organized
- Easy-to-clean textured steel door

*Your actual monthly payment can vary depending on your account balance.

*Total capacity

FOR A FEW DAYS ONLY!



Kenmore®

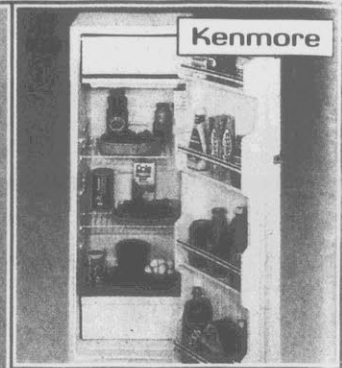

Kenmore

9.5 cu. ft.* manual defrost refrigerator

\$269
Every Single Day!
White only.

\$11
Per month* on
SearsCharge



Kenmore

18.2 cu. ft.* with crispers, meat drawer

\$599⁸⁷
Good Thru July 29
White. Color extra.

\$17
Per month* on
SearsCharge

**FACTORY
INSTALLED
ICEMAKER
ONLY
\$80 MORE!**



Kenmore

Family-size 21.7 cu. ft.* capacity!

\$650
Good Through July
White. Color extra.

\$19
Per month* on
SearsCharge

**FACTORY
INSTALLED
ICEMAKER
ONLY
\$80 MORE!**

5 cu. ft.* upright or chest freezer

YOUR CHOICE

\$198

Every Single Day!
Almond only.

\$10 Per month* on
SearsCharge

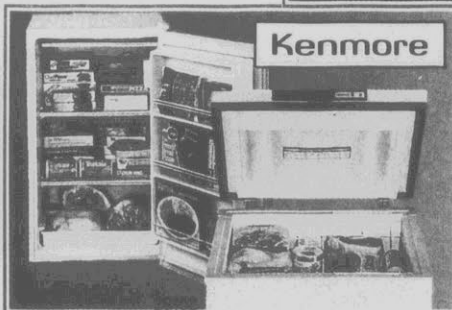

Kenmore

15.2 cu. ft.* upright or chest freezer

YOUR CHOICE

\$298

Every Single Day!
White only.

\$11 Per month* on
SearsCharge



Kenmore

Each of these advertised items is readily available for sale as advertised.

ANCE AND ELECTRONICS ACULAR

NATIONWIDE SERVICE

Your purchase is backed by America's largest service organization—with over 14,000 trucks and 18,000 trained service technicians!

Kenmore

20-ft. cord reel
lets you move easily
from room to room

Motor overload
protection prevents
motor burnout

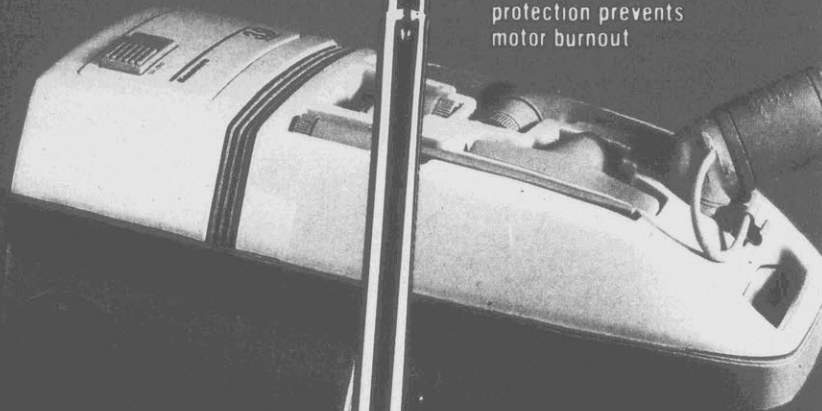

**WE'VE PACKED OUR
3.9-HP KENMORE
VAC WITH QUALITY
FEATURES—BUT
KEPT THE PRICE
SO LOW!**

1.6-HP portable
canister vac
Compact
design!

4987

Every Single Day!

Kenmore

Kenmore®

Active brush edge
clean makes vacuuming
walls, baseboards a snap!

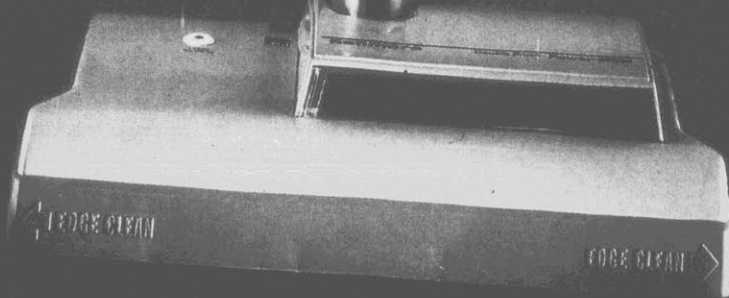

19987

Good Through July 29

**\$10 PER MONTH* ON
SEARSCARGE**

Compact Power-Mate™
canister vacuum
2-HP motor.

\$99

Every Single Day!

Kenmore



5.5-AMP upright
vacuum
Dual edge
cleaning!

\$84

Every Single Day!

Kenmore

Drytech
carpet cleaner

19999

Every Single Day!

\$10 Per month* on
SearsCharge



Kenmore

6-AMP self-
propelled vac

\$149

Every Single Day!

\$10 Per month* on
SearsCharge

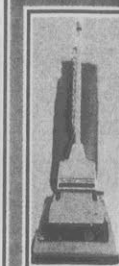

Each of these advertised items is readily available for sale as advertised.

**1 OUT OF EVERY
2 AMERICAN FAMILIES
OWNS A KENMORE!**

**NATIONAL HOME APPLIANCE
SPECTACULAR**

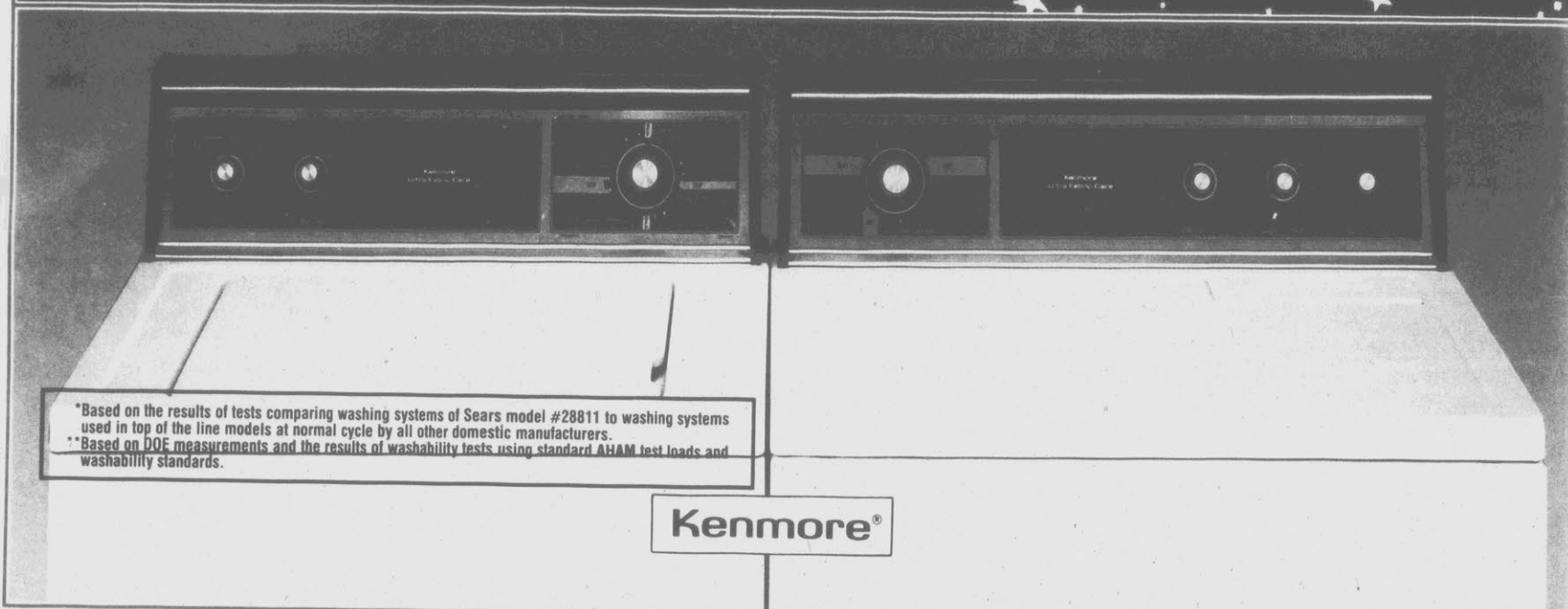

*Based on the results of tests comparing washing systems of Sears model #28811 to washing systems used in top of the line models at normal cycle by all other domestic manufacturers.
**Based on DOE measurements and the results of washability tests using standard AHAM test loads and washability standards.

Kenmore®

ONLY SEARS HAS AMERICA'S BEST WASHING SYSTEM—NO OTHER CAN COMPARE!

\$14 PER MONTH* ON SEARSCHARGE

- The largest usable washing capacity** in the industry lets you wash more clothes!
- Sears exclusive dual-action agitator
- Electronic temperature control automatically gives you optimum water temperature!

*Your actual monthly payment can vary depending on your account balance.

10-cycle washer

\$439

Good through July 29
White. Color extra

\$12 PER MONTH* ON SEARSCHARGE

- Solid-state sensors actually "feel" when your clothes are dry and shuts off dryer!
- Wrinkle-Guard and Soft Heat controls help protect your clothing investment
- Convenient Easy-Loader door

Gas dryers priced higher. Dryer connectors extra.

10-cycle electric dryer

\$349

Good through July 29
White. Color extra

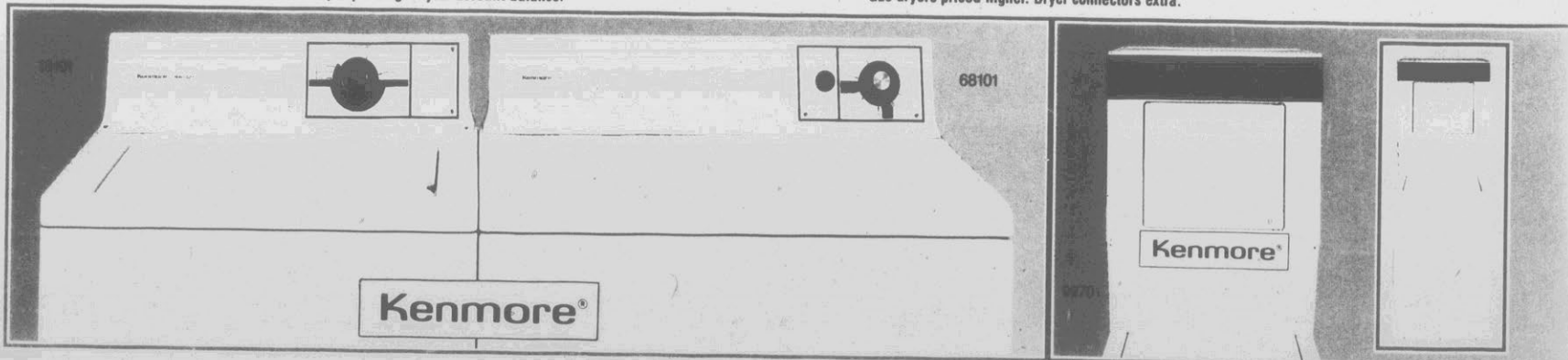

Kenmore®

LARGE CAPACITY LAUNDRY PAIR TACKLES YOUR TOUGH LOADS!

3-cycle washer

\$11 PER MONTH* ON SEARSCHARGE

\$258

Good through July 22
White only

2-cycle dryer

\$10 PER MONTH* ON SEARSCHARGE

\$218

Good through July 22
White only

CONVENIENT ALL-IN-ONE LAUNDRY SYSTEM

\$18 PER MONTH* ON SEARSCHARGE

\$619

Every Single Day!
White. Color extra

Each of these advertised items is readily available for sale as advertised.

ANCE AND ELECTRONICS ACULAR

**NO PAYMENTS
UNTIL NEXT YEAR**
No monthly payment until Jan. 1990 on Sears
Deferred Credit Plan. There will be a finance
charge for the deferral period.

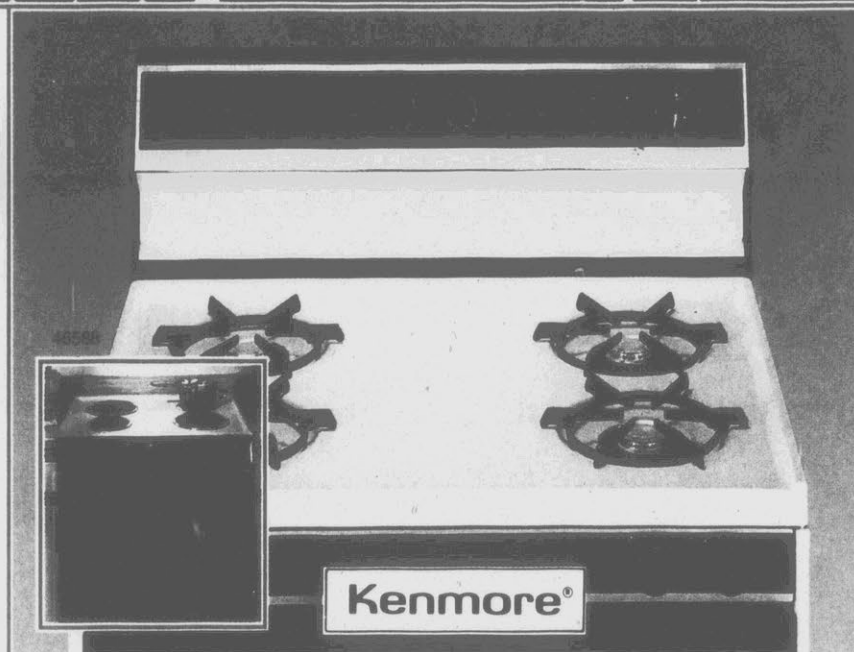

Kenmore®

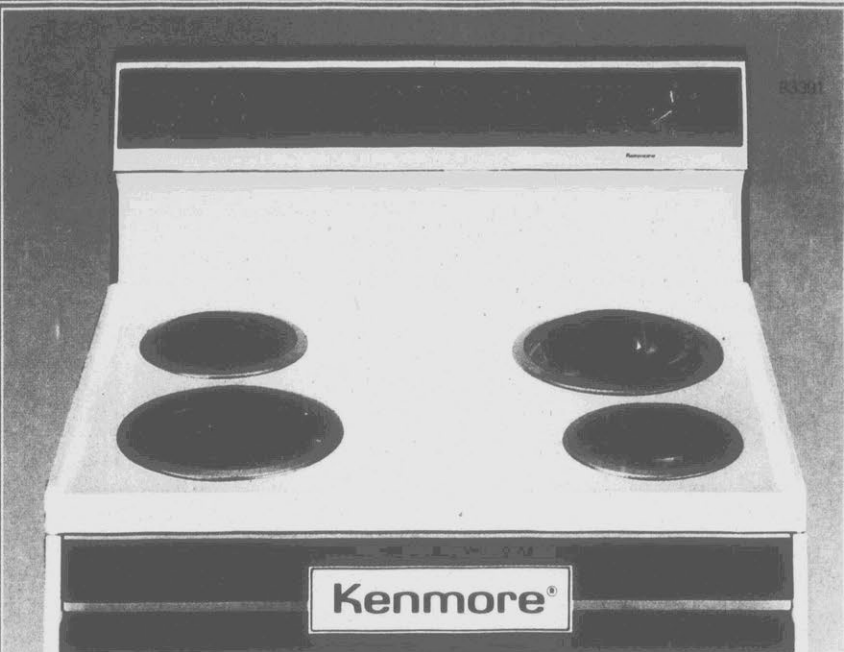

Kenmore®

KENMORE—AMERICA'S #1 CHOICE IN APPLIANCES*

Featuring gas and electric ranges loaded with quality features!

*Reflects the combined market shares of 11 different product lines

**\$16 PER MONTH* ON
SEARSCHARGE**

- Convenient self-cleaning oven
 - Porcelain enamel cooktop lifts up for quick and easy cleaning!
 - Easy-clean black glass oven door
- Inset: Self-cleaning slide-in electric range \$656 Every Single Day!

30-in. gas range
\$559
Good Through July 22

**\$14 PER MONTH* ON
SEARSCHARGE**

- Self-cleaning fully-automatic oven with chrome-plated racks
 - Deluxe porcelain broiler pan
 - Easy-to-clean porcelain enameled non-drip cooktop with porcelain sub top
- Slide-in gas range \$767

30-in. electric range
\$449
Good Through July 22



SHARP®

Sharp 400-watt compact microwave oven
Convenient size at a great low price! With rotating carousel and 15-minute timer.
99¢87
Every Single Day!



PANASONIC

99616

Panasonic 500-watt compact microwave
Featuring the convenience and versatility of 6 power levels, plus automatic defrost, reheat.
\$147
Every Single Day!



Kenmore®

Electric cooktop with solid burner elements
With easy-to-clean black surface. Gives your counter a sleek, contemporary look!
\$298
Every Single Day!

*Your actual monthly payment can vary depending on your account balance.
Each of these advertised items is readily available for sale as advertised.

**BIG BRAND NAMES
BACKED BY
TRUSTED SERVICE**

NATIONAL HOME APPLIANCE SPECTACULAR

**ALL NEW CAMCORDER
OUTFIT—EVEN MORE
ADVANCED THAN OUR
BESTSELLER—AT THE
SAME GREAT PRICE!**

**\$21 PER MONTH[▲] ON
SEARSCARGE PLUS**

99996
Good Through
July 22

- Auto-focus and balance for easy-to-shoot sharp images
- Full size camcorder records on ready-to-play VHS tape
- 3 LUX rating for clear low light shots
- Hi-tech flying erasehead for smoother, virtually seamless editing

[▲] Your actual monthly payment can vary depending on your account balance. SearsCharge PLUS is available for most major purchases totaling \$700 or more.

TV sizes on page are measured diagonally.



RECORDS EVEN
IN CANDLELIGHT
CCD imaging sensor
with 3 LUX rating
captures great low
light shots



PLUS!
Outfit includes
1.5X tele-
photo lens

SEARS

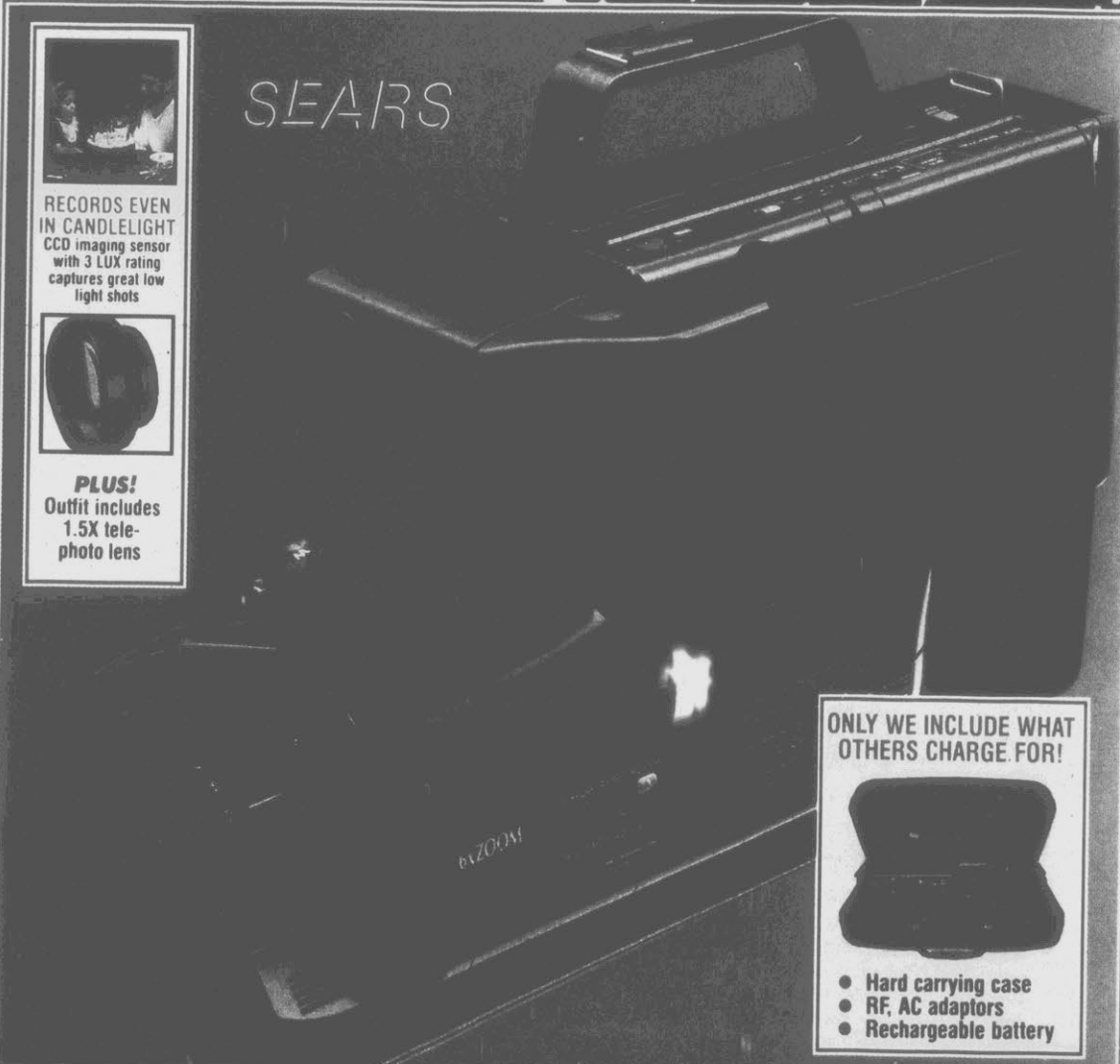

**ONLY WE INCLUDE WHAT
OTHERS CHARGE FOR!**



- Hard carrying case
- RF, AC adaptors
- Rechargeable battery

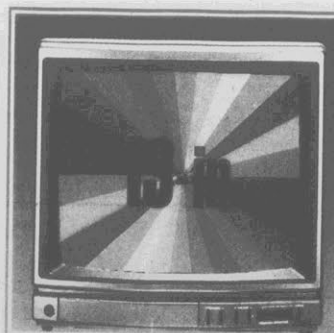

**Come in and check out
our great selection
of 13-in. TVs—from
Sears, RCA, Sony, more!**



Color TV with
off-timer, on-screen menu

319⁹⁷

Good Through July 29



Colortrack console TV with
4 hour sleep timer, remote

499⁷⁴

Good Through July 22



VCR with unified TV/VCR
27 function remote

299⁹⁷

Good Through July 22



4 head VCR with variable
slow motion, MTS stereo

352⁰⁴

Good Through July 29

Each of these advertised items is readily available for sale as advertised.

ANCE AND ELECTRONICS ACULAR

**NO PAYMENTS
UNTIL NEXT YEAR**
No monthly payment until Jan. 1990 on Sears
Deferred Credit Plan. There will be a finance
charge for the deferral period.

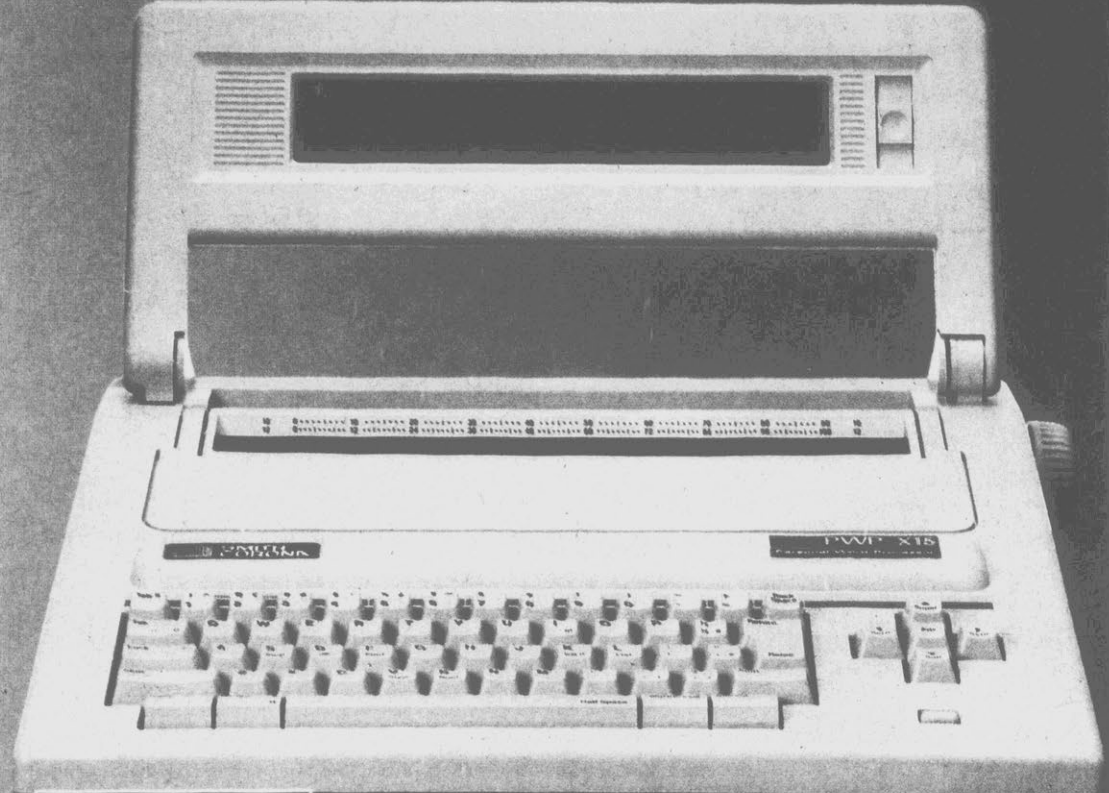

100,000 character memory
diskettes and correctable/
multi-strike ribbon cassettes
also available at Sears!

THE AFFORDABLE PORTABLE WORD PROCESSOR WITH LETTER QUALITY PRINTING

\$17 PER MONTH* ON
SEARSCARGE

59882
Every Single Day!

- Built-in disk drive for unlimited text storage
- Spell-Rite™ 75,000 word dictionary corrects typos
- Built-in electronic thesaurus
- 16-line LCD display with adjustable contrast
- 50,000 character built-in editable text memory

Not available in Asheboro, Ashland, Burlington, Christiansburg, Concord, Danville, High Point, Gastonia, Monroe, New Bern, Rock Hill, Rocky Mount, Roanoke Rapids, Shelby.

WE HAVE TYPEWRITERS FROM AS LOW AS 128.77

*Your actual monthly payment can vary according to your account balance. SearsCharge PLUS is available on most major purchases totaling \$700 or more.



Ultra-light portable stereo with auto-reverse

Batteries not included
41²¹
Every Single Day!

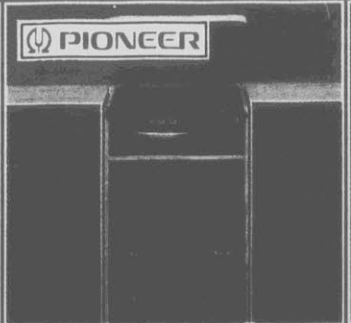

125-watt stereo rack with CD changer, dual tape

125 watts per channel at 8 ohms from 20 Hz-20 kHz with 0.09% THD.
999⁷⁴
Good Through July 29



Compact IBM PC/XT compatible computer with 512K RAM memory

Monitor extra in larger stores only.
548⁷⁷
Every Single Day!



AT&T 4310 cordless phone with page, last number redial

Not in all stores. See list on right.
79⁹⁹
Every Single Day!



Electronic word-processing typewriter with dictionary

Not available in Asheboro, Ashland, Christiansburg, Monroe, New Bern, Roanoke Rapids, Shelby.
189⁸⁷
Every Single Day!

Each of these advertised items is readily available for sale as advertised.

WEATHERBEATER AND EASY LIVING PAINTS—

WEATHERBEATER®

OLYMPIC®

RUST-OLEUM®

RED DEVIL®

20505

Acrylic latex

Thick film formula

Easy clean-up

HOUSE PAINT

ONE GALLON

Terrific buy! Sears economical latex exterior flat goes on easy, cleans up with soap and water.

666 gal. Every Single Day!

28005

Acrylic latex

5-year warranty

Mildew resistant

HOUSE SHIELD

EXTERIOR

Acrylic Latex House and Trim Paint

Low Luster Satin

House shield low luster satin—50 colors cover over similar colors in just one coat!

984 gal. Every Single Day!

41005

SEARS WEATHERBEATER PREMIUM

10 YEAR DURABILITY SATISFACTION WARRANTED* EXTERIOR ONE COAT COVERAGE

Acrylic Latex House and Trim Paint

Flat

THE MOST DURABLE EXTERIOR PAINT WE'VE EVER SOLD!

Weatherbeater premium flat—superior protection!

1278 gal. Every Single Day!

- 100 designer colors, all backed by our 10-yr. warranty!*
- Climate formulated to resist blistering and peeling.
- Soft, no-sheen look helps hide surface defects.

Weatherbeater premium satin—new and improved!

1483 gal. Every Single Day!

- Our most popular multi-purpose finish repels dirt build-up.
- Superior mildew resistance, anti-blistering, anti-peeling formula.
- 100 custom designed colors to choose from, 10-yr. warranty.*

UP TO 300 COLORS MIXED FREE

47005

SEARS WEATHERBEATER PREMIUM

10 YEAR DURABILITY SATISFACTION WARRANTED* EXTERIOR ONE COAT COVERAGE

Acrylic Latex House and Trim Paint

Satin

For one-coat results, all Sears one-coat paints must be applied as directed. *Limited warranty for years specified. See stores for details.

54305

Porch, Floor and Deck Latex Paint

25 one-coat colors! Non-yellowing.

1383 gal. Every Single Day!

8T GRE55L1 2

Premium driveway coating

NOT AVAILABLE

Sears Best driveway coating

NOT AVAILABLE

OLYMPIC STAINS

Solid or semi-transparent Weather Screen™

Sears price 15.88
Less mail-in rebate - \$2
Your cost after rebate 13.88

Wood preservative 10.88 gal.

Multi-Master™ 7-ft. ladder

NOT AVAILABLE

13174

Masking tape 66¢ 3/4" x 60 yds.

44732

Drop cloth

Sears Price, 2 for 4.99
Less mail-in rebate - \$1
Your cost after rebate . . . for 2

FREE Laundry lingerie washing bag with purchase of any economy size. While Quantities Last.

93351

PLUS Laundry Detergent

Sears Plus 40-lb. box 19.99

3-gal. liquid 24.99

Concentrated—so you use only half as much as the leading brand!

93551

ONE COAT COVERAGE GUARANTEED

EASY HIDE

MINWAX

EASY LIVING

WAGNER

HOMAX

EASY LIVING—100 COLORS, 10-YEAR DURABILITY!

Easy Living flat—
top quality, low price!

10⁹⁴
gal. Every
Single
Day!

- Choose from 100 decorator colors—ideal for living, dining and bedrooms.
 - Backed by a 10-year warranty!
 - Tough, durable finish resists chipping, peeling, stains.
- Easy Living ceiling paint... 10.94

Easy Living low luster
semi-gloss enamel

12⁸³
gal. Every
Single
Day!

- Low luster finish perfect for kitchens, baths, doors, woodwork.
- 100 custom designed one-coat colors, 10-year warranty!
- Washable, scrubbable formula helps you wipe away stubborn dirt.

For one-coat results, all Sears one-coat paints must be applied as directed.
†Warranty limited for years specified.
See store for details.

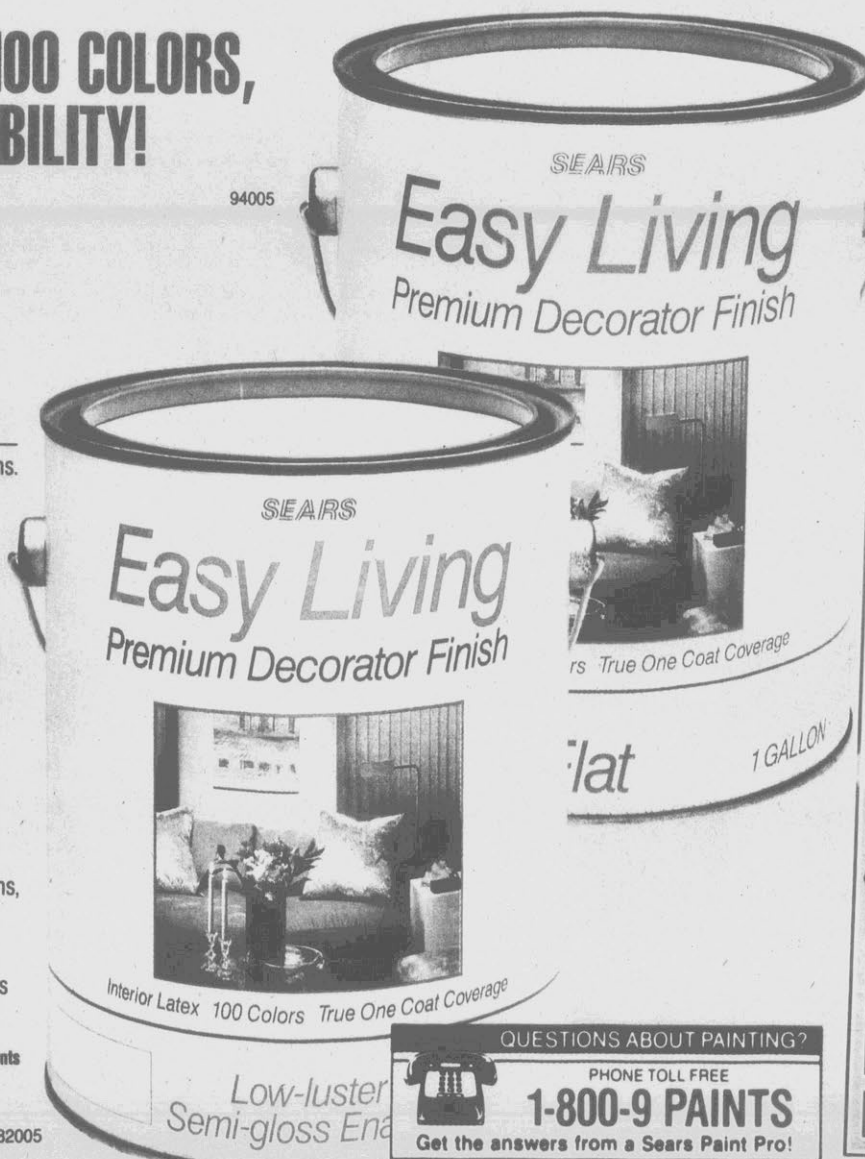

QUESTIONS ABOUT PAINTING?
PHONE TOLL FREE
1-800-9 PAINTS
Get the answers from a Sears Paint Pro!

80855

Flat Interior

Sears budget interior flat

5²²
gal. Every Single Day!

SEARS Our Budget Quality Latex

Fast drying

Easy clean-up

Value-priced!

85005

Easy Hide flat latex

7⁹¹
gal. Every Single Day!

SEARS Easy Hide Interior Latex Paint

5-yr. warranty †

Good hiding

Easy to apply

Easy Hide semi-gloss

9⁹¹
gal. Every Single Day!

SEARS Easy Hide Interior Latex Paint

5-yr. warranty †

Medium sheen

Quality economy!

75005

40114



4-foot wood stepladder
Economical household duty ladder. **14⁷³**
Every Single Day!

11858



Paint stick roller set
Makes painting fast, easy, neat! **21⁷³**
Every Single Day!



Minwax Wood Finish stain **5⁸²**
qt. One-step.

Red Devil enamel **7⁰⁴**
Polyurethane.

Rust-Oleum rust reformer **4⁸³**
qt. Durable.

67906

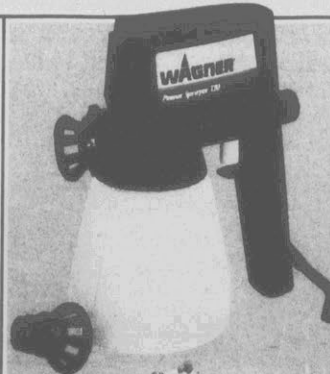

Wagner 120 airless sprayer
NOT AVAILABLE

BIG SELECTION

Wallcoverings **8⁸⁸ TO 19⁹¹** Borders **6⁸⁸ TO 8⁸⁸**
Double rolls
Every Single Day!
In larger stores only



1 GRES5L1 9

CRAFTSMAN, KENMORE—FAMOUS

SUNBEAM®

TECUMSEH®

CRAFTSMAN®

BRIGGS & STRATTON®

SOLID STATE IGNITION

2 adjustable handle heights

Briggs & Stratton engine

38013

1-qt. gas tank

Quick height adjustment

COMPANION

3.5-RP†, 20-in. push mower

Only \$10 per month* on Sears-Charge

168⁹⁴
Every Single Day!

Rear bag push mower..... 199.83
Rear bag power propelled mower..... 317.96

*Limited warranty for years specified. See store for details. †RP means reserve power.

COUNTER BALANCED

Cushioned seat

25463/24940

Rear turf saver tires for traction

4-speed transaxle

38-in. floating deck mows without scalping!

CRAFTSMAN

Craftsman 12-HP tractor

Only \$21 per month* on Sears-Charge PLUS

\$998
Every Single Day!

Bagger..... 249.96

GREAT LOW PRICES

1/4 HP, adjustable handle

Semi-auto line feed

79662

42 blade teeth

79602

2.4 amp UL listed motor

CRAFTSMAN

Bushwacker® or Weedwacker®

34⁸⁷

16-inch trimmer 3000 cutting strokes/minute

36⁹⁷

13-inch line trimmer with adjustable handle

See thru window

402-SQ. IN. COOK SPACE

Porcelain cooking grid

Redwood shelves

10291

13261

Kenmore

Kenmore 28,000 BTU gas grill

Gas grills start as low as... 98.87
LP tank included, assembly required.

139⁹⁷
Every Single Day!

Grill rotisserie **19⁹¹**
Every Single Day!

CLOSEOUT!

CRAFTSMAN

35506

Craftsman 16-inch gas chain saw
2.3 CID, automatic chain oiling, lo-kick bar, lightweight!

189⁸⁶

While Quantities Last

CRAFTSMAN

79638

1-HP blower and vac attachment

Every Single Day! **59⁸⁸**

CRAFTSMAN

3415

2-HP, 14-in. electric chain saw

Every Single Day! **69⁸⁵**

CRAFTSMAN

79642

1-HP electric lawn edger

Every Single Day! **73⁸¹**

CRAFTSMAN

79710

22cc, 15-in. gas Weedwacker®

Every Single Day! **89⁸⁸**

CRAFTSMAN

79712

26cc, 16-in. gas Weedwacker®

Every Single Day! **109⁹³**

CRAFTSMAN

79796

22cc gas power blower

Every Single Day! **98⁸⁷**

CRAFTSMAN

79652

3-RP† gas edger edges to 2¾-in.

Every Single Day! **198⁸⁷**

SEARS EXCLUSIVE!

Protects up to 1 acre

14043

40-watt programmable Bugwacker®
Built-in programmable photocell and timer. High-powered transformer.

41⁷⁶

While Quantities Last

10V GRE55L1 2

CRAFTSMAN

69102

Rubber/vinyl hose, 50-ft.

Every Single Day! **11⁹⁴**

CRAFTSMAN

79217

Pulsating sprinkler

Every Single Day! **10⁷¹**

CRAFTSMAN

69057

Pistol grip hose nozzle

Every Single Day! **3⁵⁷**

CRAFTSMAN

69620

Wall mount hose reel

Every Single Day! **25¹⁸**

Larger stores only

CRAFTSMAN

15725

2-gal. plastic sprayer

Every Single Day! **13⁸⁸**

12430

32-gal. mobile trash can

Every Single Day! **13⁶⁷**

Trash bags 33-gal., 80-ct.

NOT AVAILABLE

*Your actual monthly payment can vary depending on your account balance. SearsCharge PLUS is available on most major purchases totaling \$700 or more.

NAME BRANDS YOU TRUST AT SEARS

BLACK & DECKER®

KENMORE®

PHILIPS®

3M

EVEREADY®



2 1/4-HP wet/dry vac

- Swivel casters
- 5 accessories
- Rust proof tank
- 16-ft. cord

\$10 per month* on SearsCharge

9977

Every Single Day!



20-gal. air compressor

- Cast iron sleeves
- Full needle gauges
- Includes air chuck
- 15-ft. air hose

\$13 per month* on SearsCharge

39993

Every Single Day!



1/2-HP garage door opener

- Operate indoor/outdoor house lights from inside your car*
- Over 19,000 codes

\$10 per month* on SearsCharge

14996

While Quantities Last

*Your actual monthly payment can vary depending on your account balance.

1 GRE55L1 11

 38143	 39426	 39832	 7799	 93194	 17832	 17912	 17932	 17932
Sears durable 16 oz. hammer Every Single Day! 388	1-in. x 25-ft. tape measure While Quantities Last 696	Sears 24-in. level Every Single Day! 496	100-ft. 16/3 extension cord Every Single Day! 1298	Rechargeable flashlight Every Single Day! 998	8-light path set While Quantities Last 4995	Powerful cordless vac Every Single Day! 1996	Compact 6-gal. wet/dry vac Every Single Day! 3993	1 1/2-HP, 8-gal. wet/dry vac Every Single Day! 5983
 15027	 1530141	 1540242	 1532333	 19047	 1220	 2134	 71857	 1254
3/4-HP compact air compressor Every Single Day! 10991	1-HP, 8-gal. air compressor Every Single Day! 19983	2-HP, 12-gal. air compressor Every Single Day! 29986	3-HP, 20-gal. air compressor Every Single Day! 34993	1/3-HP variable speed grinder Every Single Day! 5965	Steel 2500-lb. car ramps Every Single Day! 1988	Craftsman timing light Every Single Day! 3687	10/2 dual amp battery charger Every Single Day! 3982	2-ton jack with case Every Single Day! 4774

CRAFTSMAN—AMERICA'S NUMBER

FAMOUS NAMES! SEE THESE AND MORE: CRAFTSMAN® PHILLIPS® EVEREADY®



Cordless drill

34⁷¹

Every Single Day!
With 5-cell battery pack.
Recharges in 3 hours. 3/8-in.



Circular saw

43³³

Every Single Day!
Includes blade and wrench.
Wrench stores in base.

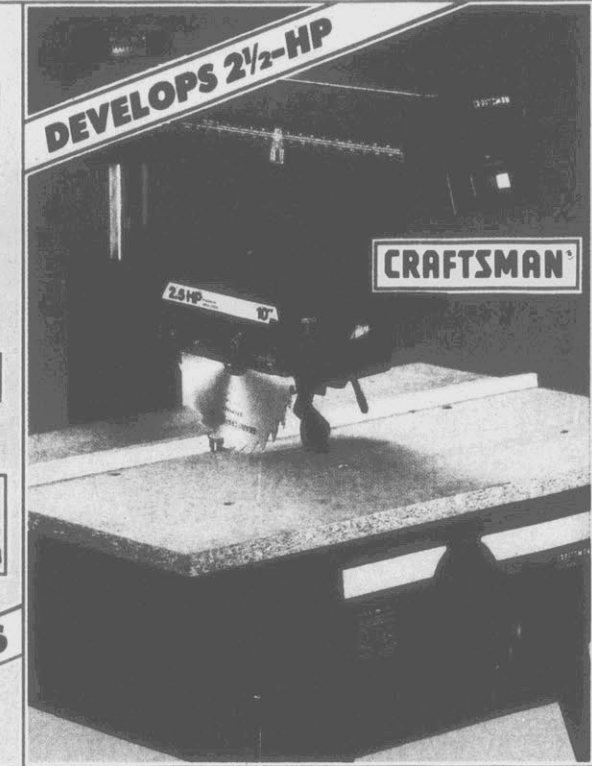

Radial arm saw with legs

Only \$12 per month* on Sears-Charge

349⁸⁸

Every Single Day!
Up-front controls. Includes miter, bevel, in and out rip scales. 40-in. x 27-in. workspace. 1 GRE55L1 12

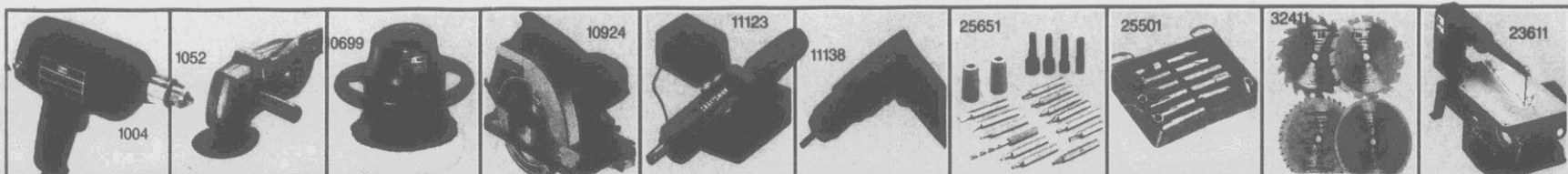

3/8-in variable speed drill

28⁸⁸

Every Single Day!

6-in. sander/polisher

46⁵³

Every Single Day!

9-in. buffer/polisher

61⁹⁸

Every Single Day!

2 1/4-HP circular saw

55⁷⁷

Every Single Day!

Cordless screwdriver

15⁸⁸

Every Single Day!

Cordless screwdriver kit

42⁴³

While Quantities Last

Screwdriver bit set—19-pc.

9⁸⁷

While Quantities Last

16-piece router bit set

19⁹⁶

While Quantities Last

7 1/4-in. saw blade pack

29⁹³

While Quantities Last

16-in. bench top scroll saw

129⁸⁸

Every Single Day!

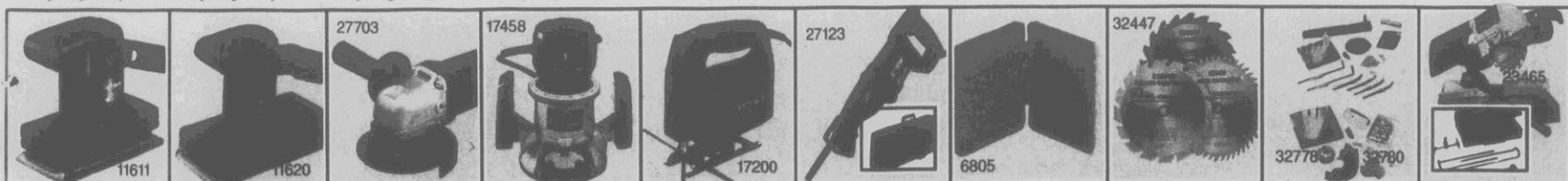

Orbital pad sander

24⁹⁸

Every Single Day!

Dual motion pad sander, sheets

47⁹⁵

While Quantities Last

Industrial 4 1/2-in. grinder/sander

59⁶⁶

Every Single Day!

1-HP router, freehand base

45⁶³

While Quantities Last

Sabre saw with blades

31³³

While Quantities Last

Industrial reciprocating saw

99⁹⁸

While Quantities Last

10-pc. drill bit set

9⁸⁷

Every Single Day!

Saw blade pack

39⁹⁴

While Quantities Last

Table or radial saw kits

69⁹⁶

Every Single Day!

Contractor's miter saw

249⁸⁸

Every Single Day!

ONE NAME IN TOOLS!

3M

WEBER®

SUNBEAM®

WD40®

KENMORE®

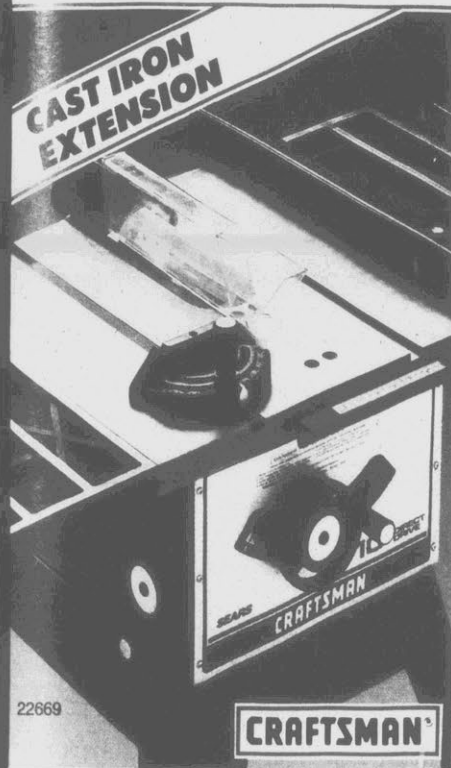

22669

CRAFTSMAN



65817
65824

CRAFTSMAN

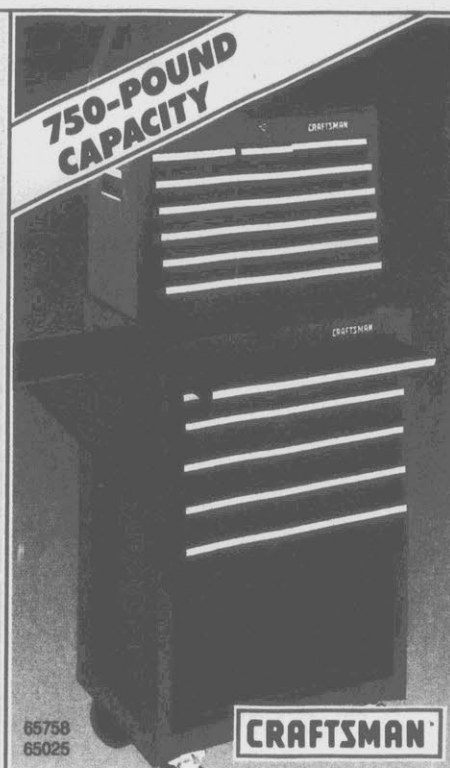

65758
65025

CRAFTSMAN

10-in. cast iron table saw

Only \$12 per month* on Sears-Charge

349⁸⁸

Every Single Day!

1 HP develops 2-HP. 40-in. x 20-in. workspace. Reliable direct drive. Casters for mobility.

9-drawer storage combination

Only \$10 per month* on Sears-Charge

189⁹⁶

Every Single Day!

6-dr. chest with recessed handles . . . 89.98
3-dr. roll-a-way cabinet with casters . . . 99.98

13-drawer storage combination

Only \$13 per month* on Sears-Charge

399⁹²

Every Single Day!

8-dr. chest with recessed handles . . . 169.98
5-dr. cabinet with 5-in. casters . . . 229.94

*Your actual monthly payment can vary according to your account balance.



24451

18-in. bench top band saw

129⁸⁸

Every Single Day!



24744

Electronic band saw

349⁸⁸

While Quantities Last

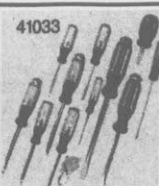

41033

12-pc. screwdriver set

19⁹⁸

While Quantities Last



44676

Adjustable wrench set

29⁹⁶

While Quantities Last



65081

Craftsman 16-in. tool box

9⁸⁸

Every Single Day!



6500

Craftsman 18-in. tool box

19⁹⁸

Every Single Day!



65514

2-drawer workbench

59⁹⁶

unassembled
Every Single Day!



Router/planer outfit

359⁸⁸

Every Single Day!



Planer/molder

359⁸⁸

Every Single Day!



45292

Craftsman 5-pc. pliers set

29⁹⁶

While Quantities Last



45344

3-pc. locking pliers set

17⁸⁸

While Quantities Last



6513

Sears Best tool box

29⁸⁴

Every Single Day!



65337

3-drawer tool chest

44⁹⁶

Every Single Day!



65453

3-drawer storage unit

59⁹⁸

While Quantities Last

All 3 pieces—15 drawers!

469⁹⁴

Every Single Day!
4-dr. chest, 129.98
6-dr. chest, 149.98
5-dr. cabinet, 189.98

**TRUSTED
QUALITY
FOR OVER
60 YEARS
PLUS
SO MUCH
MORE!**

Quality

To us, quality is the will to design tools that work better and last longer than they already do.

Commitment to innovation

We develop and perfect innovations in the industry to make our tools better and better.

Lab Tested

Every tool designed is tested in Sears Lab—the largest of its kind in American business.

Warranted forever

If any Craftsman hand tool ever fails to give complete satisfaction, return it for free replacement.

**CRAFTSMAN
AMERICA'S
FAVORITE
BRAND OF
TOOLS**

BUY AMERICAN—BUY SEARS!

SPALDING[®]

GAMEFISHER[®]

RUBBERMAID[®]

HILLARY[™]

TRY TO FIND A BETTER
10-SPEED VALUE ANYWHERE!
**HUGE FAMILY
SELECTION**
MEN'S 10-SPEED TOURNEY ATB

11184

Every Single Day!

- Strong, 26-in. steel-lugged frame
- Side-pull caliper brakes
- Three-piece cottered crank
- Dual-pressure gumwall tires

Bikes, exercise equipment
require some assembly.

Items on this page not available in Ashland,
Monroe, New Bern, Roanoke Rapids, Shelby.



EASY SET-UP, STURDY
DESIGN HILLARY TENTS
**SEARS
EXCLUSIVE!**
FAMILY DOME WITH FLY

9994

Every Single Day!

- 8½ x 10-ft. base sleeps 4
- Lightweight shock-corded fiberglass frame
- Inside zip screen door, rear screened window with storm flap

ENJOY SUMMER
FUN NOW!

**NO PAYMENTS*
TILL NEXT YEAR**
ON THIS 3-PIECE RIG

**\$31 PER MONTH* ON
SEARSCHARGE PLUS**

\$1455
Every Single Day!

INCLUDES:

- Gamefisher 10-ft. aluminum semi-vee boat
- Gamefisher 3.0-HP gas motor
- 600-lb. capacity trailer**

*No monthly payments until January 1990
on Sears Deferred Credit Plan. There will
be a finance charge for the deferral period.

**Your actual monthly payment can vary
depending on your account balance.

SearsCharge PLUS is available for most
major purchases totaling \$700 or more.

**Trailer unassembled



Gamefisher 10-ft. **\$457**
jon boat Every Single Day!



26-inch 10-speed
racer
Every
Single Day! **6893**



Women's/Men's
tourer
Every
Single Day! **9994**



20-inch hi-rise bike
Every
Single Day! **6893**



20-inch BMX bike
Every
Single Day! **6893**



8 x 10-ft. cabin tent
Every
Single Day! **7996**



Pak-A-Potti II
Every
Single Day! **5363**



Rubbermaid[®] 48-qt.
ice chest, jug
Special
Purchase! **1996**



3-lb. Hollofil[®]
sleeping bag
Special
Purchase! **2293**



Lifestyler
exercise cycle
Every
Single Day! **\$98**



Lifestyler
i-beam rower
Every
Single Day! **7986**



Weight bench
Every
Single Day! **5782**
110-lb. cast iron wts. 49.96



Calorie monitor
treadmill
Every
Single Day! **39986**

NO PAYMENTS TILL NEXT YEAR!

No monthly payment until January, 1990 on Sears Deferred Credit Plan. There will be a finance charge for the deferral period.

SEARS-O-PEDIC

STRATFORD[®]

SPRING AIR[®]

SEALY[®]

WHAT A SELECTION!

2 PC. LIVING ROOM GROUPS

YOUR CHOICE

\$699

Every Single Day!



Holiday. Contemporary style with attached back and 2 extra pillows. Sofa and loveseat.

Carmel Tables \$159



Whisper. Comfort and style with this contemporary style sofa and loveseat.

Upton tables \$139



Image. Beautiful fabric is enhanced by wood trim. Includes sofa and loveseat.

Centerra tables \$99



Lexington. Country style sofa and loveseat. Cushions reverse for longer wear.

Brocroft tables \$99

Not in all stores. See page 16

3 COMFORT OPTIONS
CHOOSE SEARS INNERSPRING, SEALY INNERSPRING OR FOAM



SEARS BEDDING PROMISE: SLEEP ON IT FOR 30 NIGHTS— NOT HAPPY? WE'LL BUY IT BACK!

Sleep on your Sears bedding set for 30 nights. If you're not completely satisfied, Sears will buy it back! And, of course, at Sears, it's always satisfaction guaranteed or your money back!

King and queen sold only in sets. King requires two foundations. Sealy foam is polyurethane. *See store for details.



Sears Deluxe and Sealy Comfort Guard Deluxe

Twin ea. pc.

\$79

Every Single Day!

Full ea. pc. \$129
Queen 2-pc. set \$299
King 3-pc. set \$399
5 yr. warranty*

Sears Elegance Prestige and Sealy PostureCrest Extrordinaire

Twin ea. pc.

\$129

Every Single Day!

Full ea. pc. \$199
Queen 2-pc. set \$499
King 3-pc. set \$599
15 yr. warranty*

Sears-O-Pedic Imperial Paramount and Sealy Posturepedic Iris

Twin ea. pc.

\$199

Every Single Day!

Full ea. pc. \$269
Queen 2-pc. set \$699
King 3-pc. set \$899
15-18 yr. warranties*

Sears Elegance Classic and Sealy PostureCrest

Twin ea. pc.

\$99

Every Single Day!

Full ea. pc. \$159
Queen 2-pc. set \$399
King 3-pc. set \$499
10 yr. warranty*

Sears-O-Pedic Imperial Superba and Sealy Posturepedic Violet

Twin ea. pc.

\$159

Every Single Day!

Full ea. pc. \$229
Queen 2-pc. set \$599
King 3-pc. set \$799
15 yr. warranty*

Sears-O-Pedic Imperial Regal and Sealy Posturepedic Emerald

Twin ea. pc.

\$249

Every Single Day!

Full ea. pc. \$349
Queen 2-pc. set \$799
King 3-pc. set \$1199
15-20 yr. warranties*

McKids is throwing a party at Sears. Be sure to bring your noisemaker.

It's our birthday! McKids® is two years old this week. And like any other two-year-old, we wanted a giant birthday party. So from July 16-22, McKids is having a week-long, balloon-filled, fun-packed party at Sears.



birthday party.*

Best of all, you can shop at this party, too.

There will be free toy gliders, paper dolls and ID tags, and a sweepstakes where you could win a Lifesaver Game,™ \$30 worth of terrific McKids outfits, or the grand prize—a McDonald's®

You'll find great-looking McKids play clothes for infants and toddlers through sizes 6x and 7. They're well-made, well-priced, and come in lots of mix and match colors and styles.



So come to McKids Days at Sears and help us celebrate our birthday. For you, it will be a great time to shop.

For your kids, it will just be a great time.

McKIDS

At Sears.



McKids Days at Sears July 16-July 22.

© Sears, Roebuck and Co. 1989 © 1989 McDonald's Corporation. McKids is a registered trademark of McDonald's Corporation. Residents of Michigan and Ohio only may enter by mailing an entry blank to their nearest Sears store to be received by July 19, 1989. Attention: Children's Apparel Department. Void where prohibited. No purchase necessary to enter. Sweepstakes ends July 22, 1989. See store for complete rules. †While quantities last. *Prize award is \$50 worth of McDonald's gift certificates redeemable for any product at participating McDonald's Restaurants.



SEARS PRICING PLEDGE Yes, we'll meet or beat the competition's current advertised price on the identical item! Just bring the competition's current ad to any of our retail stores. This offer applies to current merchandise stocked in our retail stores only. Excludes Clearance, Closeouts and Catalogs.

Items indicated "larger stores only" are available in Barboursville, Charlotte, Charleston, S.C. (Northwoods), Charleston, W.Va., Columbia, Durham, Fayetteville, Greensboro, Raleigh, Roanoke, Wilmington and Winston-Salem. Large items such as furniture and appliances are inventoried in our distribution center and will be scheduled for pick-up or delivery. Delivery not included in prices shown. Furniture and bedding are not available in Asheboro, Ashland, Beckley, Bluefield, Burlington, Christiansburg, Concord, Danville, Florence, Gastonia, Goldsboro, Greenville, Hickory, High Point, Myrtle Beach, Roanoke Rapids, Rock Hill, Rocky Mount, Shelby, and Williamson.

NC: Asheboro, Burlington, Charlotte, (Eastland, Southpark), Concord, Durham, Fayetteville, Gastonia, Goldsboro, Greensboro, Greenville, Hickory, High Point, Jacksonville, Monroe, New Bern, Raleigh, Roanoke Rapids, Rocky Mount, Wilmington, Winston-Salem. SC: Charleston (Citadel, Northwoods), Columbia, Florence, Myrtle Beach, Rock Hill. VA: Christiansburg, Danville, Lynchburg, Roanoke. KY: Ashland. WV: Barboursville, Beckley, Bluefield, Charleston.

Satisfaction guaranteed
or your money back
©Sears, Roebuck and Co. 1989

SEARS
Your money's worth
and a whole lot more.