

**My Lai Spectre**

A Drifter Shot To Death Over A Bottle Of  
Vodka Was Haunted By The My Lai Massacre  
Story on A-9

**Quilted Heritage**

Quilting As Folk-Art May Reach Spectacular  
Height As Tarboro Show Demonstrates  
Story on C-1

**Kicking Jet**

ECU Punter John Jett Doing  
The Job For Pirates  
Story on B-1

# THE DAILY REFLECTOR

Greenville, N.C.

Wednesday Afternoon, September 14, 1988

25¢



**CAMPAIGN DIALOGUE** — Gov. Jim Martin, left, discusses his proposals to improve education in North Carolina with Doug Story and his daughter, Amber, at a campaign rally Tuesday. Approximately 300 people attended the Republican event at the Greenville Moose Lodge. (Reflector Photo by Shannon Wolfe)

## Martin Employs Pitt Rally As Forum To Attack Jordan

By GREG LAUDICK  
Reflector Staff Writer

After spending most of Tuesday unveiling details of his new 70-county "Democrats for Martin" organization, Gov. Jim Martin told approximately 300 people gathered at the Moose Lodge that his administration represents the party of "better schools, better roads and better jobs."

Martin, who is seeking re-election against Democrat Lt. Gov. Robert B. Jordan III, was one of several Republicans, including Bill Dansey, Howard Moye, Judge Robert Orr and DOT official Randy Doub, speaking at the rally.

At a stop earlier in the day at the Greenville Airport, Martin announced former Mayor Les Garner would be the chairman of the Pitt

County "Democrats for Martin" campaign.

Garner was also among the approximately 300 people in attendance at Tuesday's campaign rally, as Martin and the mostly Republican following partook of eastern North Carolina barbecue and Republican rhetoric.

Martin elaborated on his campaign theme of "better schools, better roads and better jobs" and gave his Democrat opponent Jordan a verbal lashing for his proposal to eliminate the N.C. Department of Commerce.

"Now talk about dumb ideas, that's one of them. It's the most effective machine for generating jobs in the country and he wants to abolish it," Martin said.

The governor also took the opportunity to tell those in attendance

about his "Democrats For Martin" organization.

He described the organization as community leaders in 70 counties throughout the state working to recruit Democratic voters to support Martin's re-election campaign.

Martin said in the 1984 election, he carried 46 to 47 percent of Pitt County and he envisions the organization will enable him to have much stronger support this year.

"We've got a much stronger organization in the eastern communities and I just feel good about it," Martin said. "Not only does that seem to be the case in Pitt County but it seems to be the case in many neighboring counties as well."

Following the rally, Martin commented he was proud of the reception he received at the Moose Lodge.

"It was just a tremendous crowd, it almost filled up the place. I thought it was a great crowd and enthusiastic. The response was very good," he said.

Meanwhile, Garner said he is looking forward to the challenges ahead in this year's gubernatorial campaign.

"I'm happy to serve because I think he's a good governor and he deserves to serve another four years. I'm going to do everything I can to get him all the votes I can in Pitt County," Garner said.

Related story on A-2.

## Possibly Tainted Blood Released By Mistake

By CHERIE EVANS  
Reflector Staff Writer

After a nationwide review of its 56 Blood Services regions, the American Red Cross today reported that blood products — including some possibly contaminated with AIDS or hepatitis B — have been dispersed by mistake.

The Tidewater region, which includes Greenville, is one of four regions where the bulk of the mistakes have occurred.

Red Cross officials said early retesting of donors has failed to turn up anyone with a positive reaction to either illness.

After a review of regional operations and procedures, the Red Cross found that 576,426 products were adequately quarantined and/or destroyed out of more than 6 million total products, while 2,420 were mistakenly released for use, according to Victor W. Schmitt, vice president of the national Blood Services.

"Most mistakes involved donations that test negative for AIDS, but for various reasons were not in compliance with Red Cross or FDA (Food and Drug Administration) directives that require such donations to be quarantined and/or destroyed," he said in a news release.

For example, if a donor who was previously found to have "false-positive" test results gives blood

(See BLOOD, A-12)

## Gilbert Slams Cozumel With Winds Of 175 MPH

By CHRIS ANGELO  
Associated Press Writer

MERIDA, Mexico (AP) — Hurricane Gilbert slammed into the resort island of Cozumel with 175 mph winds today, and thousands of people on the nearby Yucatan Peninsula fled coastal areas for the interior.

Residents along the gulf coast of Texas, 560 miles to the north, stockpiled food and supplies and prepared to evacuate. The hurricane, one of the strongest in history, is "extremely dangerous," the U.S. National Weather Service said.

Oil companies evacuated thousands of workers from rigs in the Gulf of Mexico, according to reports from New Orleans.

The National Weather Service in Miami said the eye of the storm was near the island, 12 miles off the Yucatan coast, at 9 a.m. EDT. Gilbert was reported at latitude 20.4 north and longitude 86.6 west moving west northwest at 15 mph. Gilbert pounded the Dominican Republic, Jamaica and the low-lying Cayman Islands Sunday,

Monday and Tuesday. At least 11 people were reported killed, and at least 60,000 were left homeless in Jamaica. Rescue teams worked desperately to restore utilities and communications in the shattered areas.

In a telephone call early today, receptionist Pablo Torres of the Carrillos Hotel in the Yucatan resort of Cancun said about 150 people, most of them tourists, were crowded in the lobby on sofas and chairs.

"We are full, and there is not one tourist now in the beach hotel zone," he said. "The sound of the wind outside is horrible. You couldn't leave even if you wanted to."

He said the winds felled utility poles and trees and that sheets of rain were hitting the city.

Telephone lines from Mexico City to Cozumel and Cancun later were cut. Cancun is 175 miles east of Merida.

Gilbert was expected to pass over the northern portion of Cozumel and hit the peninsula near the sparsely popu-

(See STORM, A-12)

## Bentsen To Hold Courthouse Rally

Sen. Lloyd Bentsen of Texas, the Democratic vice presidential nominee, will make his first official campaign appearance in North Carolina with a campaign rally at the courthouse in Greenville on Friday.

The 12:30 p.m. event, billed as an "old fashion Democratic rally" by Pitt County Democratic Chairman J.B. Spillman, will include a speech by Bentsen and a barbecue dinner.

Spillman said at a morning news conference today that Bentsen will be joined at the rally by U.S. Sen. Al Gore of Tennessee, Lt. Gov. Bob Jordon, state Agriculture Commissioner Jim Graham, and other state and local officials.

A Bentsen campaign worker, who said the candidate will be in Greenville about 90 minutes, said the rally will last about 45 minutes.

State Sen. Tom Taft, who also spoke at the news conference, said, "I encourage everybody in Pitt County — Democrats and Republicans — to come out to this event (and) see history in the making."

Bentsen was a U.S. Congressman from 1949 to 1954 and has served in the U.S. Senate since 1970.

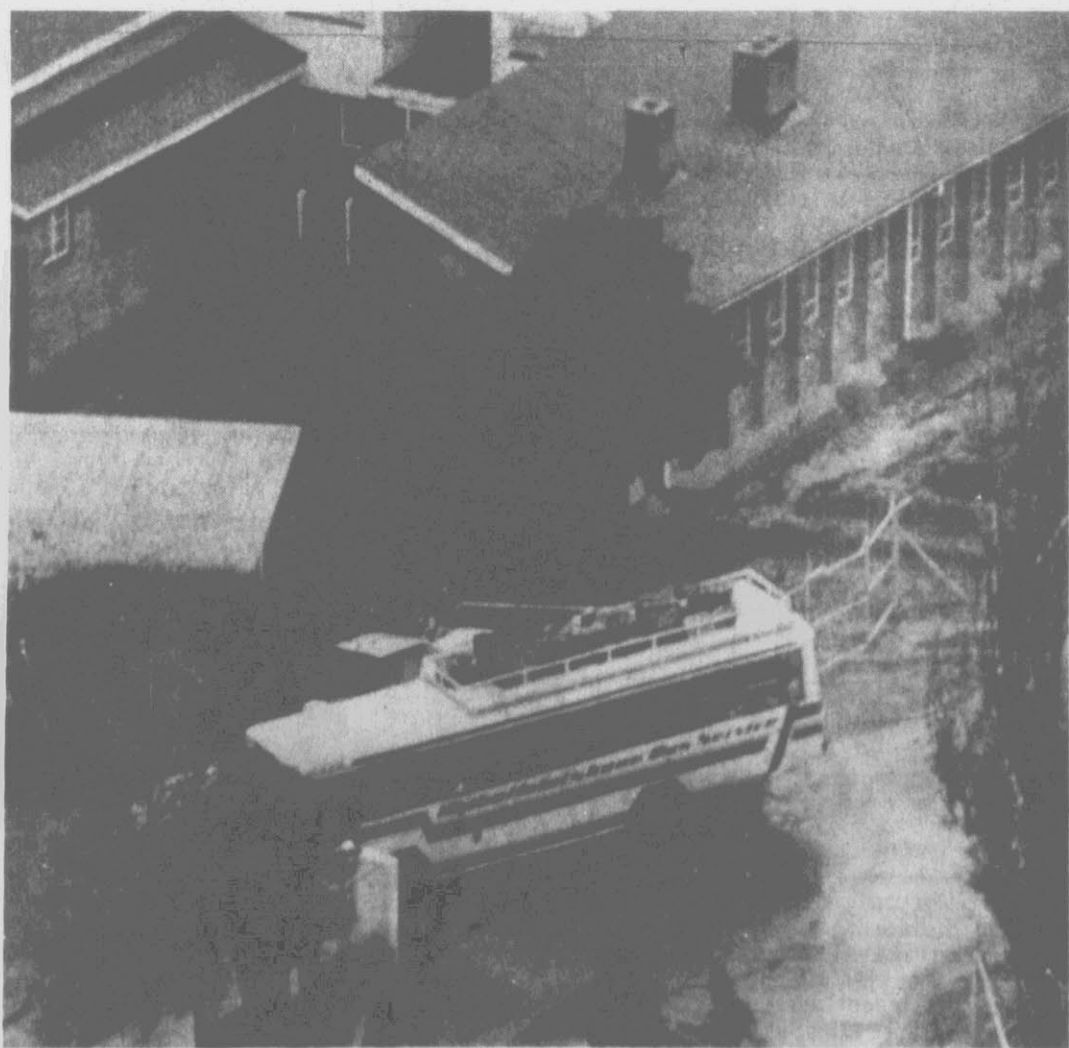

**HIJACKED BUS** — Gunmen believed to be members of the exiled Lesotho Liberation Army seized this bus Tuesday, holding pilgrims en route to Pope John Paul's scheduled visit to Lesotho this week. Some of the hostages reportedly were freed today. (AP Laserphoto)

## Rebels Seize Bus As Papal Visit Nears

MASERU, Lesotho (AP) — Guerrillas held nuns, schoolgirls and other papal pilgrims on a hijacked bus in this kingdom that Pope John Paul II was scheduled to visit as part of a tour of southern Africa. A nun said some captives were released.

Official Lesotho Radio said a group of "fanatics" had taken over the bus of papal pilgrims Tuesday. Diplomats said the guerrillas were believed to be members of the dissident Lesotho Liberation Army.

Sister Therese Labrecque, a nun helping to arrange the papal visit scheduled to start today, said some of the original 60 hostages were released this morning from the bus surrounded by Lesotho security forces outside the British High Commission, or embassy, in Maseru. She said she did not know how many were freed.

The plane carrying the pope from Botswana to Lesotho, meanwhile, was diverted to South Africa because

of bad weather. South African officials said the plane would land at Johannesburg to refuel, and Foreign Minister R.F. Botha would go to the airport to meet the pontiff.

South Africa had been omitted from the pope's five-nation southern Africa tour after South African bishops said it was not an appropriate time for a visit. The pope has spoken out against apartheid, the system of racial segregation in South Africa.

As an army helicopter flew overhead, about 100 armed soldiers and police set up roadblocks with armored cars and kept spectators at least four blocks from where the hijacked bus could be seen parked on the grass outside the embassy.

A spokesman for Botha said the Lesotho government had asked for security help and that "units have moved in on a standby basis."

The commission is on a hill in the center of Maseru, next to police

headquarters in a district of government offices.

Witnesses said guerrillas took over the bus at Mazenod, outside Maseru. They said police surrounded the bus but later moved back and let it proceed to Maseru.

The Lesotho Liberation Army is fighting the nation's military rulers. The rebels took up arms after a coup in January 1986 deposed leftist Prime Minister Leabua Jonathan, who died of natural causes in April 1987. The guerrillas have been holed up in South Africa.

Jervis Chavase, deputy high commissioner at the British Embassy, said he learned of the hijacking when the bus drove up and stopped in front of the diplomatic compound.

"A bus is parked outside the commission and I believe the police have the situation in control," Chavase said at 1 a.m. (7 p.m. EDT Tuesday). He said the hijackers have "asked to

come into the compound and we have refused to let them."

He said the bus arrived about 6 p.m. Tuesday.

A nun at the Papal Visit Office, Sister Rita Brassard, said the bus had come from the town of Quacha's Nek, a remote area in the south of this nation completely surrounded by South Africa.

She said the bus was carrying eight nuns, seven teen-age schoolgirls, six teachers and other pilgrims who had been picked up on the way to Maseru, the capital.

The bus was to have dropped the nuns at a convent outside the capital but the vehicle never arrived, she said.

Police and soldiers put up roadblocks on streets leading to the British commission.

Police have refused comment.

(See REBELS, A-12)

### The Weather

Forecast

Fair tonight, Low in mid 60s. Mostly sunny Thursday, High in mid 80s.

Looking Ahead

Fair Friday, cloudy Saturday, chance of rain Sunday, Highs near 80. Lows in 60s.

Inside Today

- A-2 — Local news
- A-4 — Editorials
- A-6 — State news
- A-10 — Lifestyle
- A-12 — Obituaries
- C-6 — Crossword

Accu-Weather® forecast for Thursday  
Daytime Conditions and High Temps

©1988 Accu-Weather, Inc.

# In The Area

## Vehicles Entered

Police said two thefts — both involving items from vehicles — were reported to the Greenville department Tuesday.

Officer K.L. Jones said an equalizer was taken from a car parked at Carolina East Mall in an incident reported at 9:23 a.m., while Officer R.L. Vandiford said a radar detector was taken from a car parked at the Western Steer restaurant on 10th Street in an incident reported at 9:44 p.m.

## Concealment Charge

Deanne Antenette Jackson, 19, of Winterville was arrested by Greenville police Tuesday on a concealment of property charge.

Officer K.M. Smeltzer said the charge resulted from a 9:28 a.m. incident at Harris Super Market on South Memorial Drive.

## MS Support Group

The Down East Multiple Sclerosis Support Group will hold a discussion meeting at 2 p.m. Sunday in a conference room of St. James United Methodist Church, 2000 E. Sixth St.

For information call Pat Cannon, 752-9864, or Shirley Taylor, 758-2975.

## Pitt Health Board

The Pitt County Board of Health will meet Thursday at 7 p.m. in the conference room of the health department building, 1825 W. Sixth St.

## Adjusters To Gather

Affiliates of the North Carolina Adjusters Association will open their annual convention Thursday at the Hilton Inn in Greenville.

About 350 insurance adjusters are expected to attend, according to Al Nichols, executive director of the Pitt-Greenville Convention and Visitors Bureau, who said the two-and-a-half-day conference is expected to generate nearly \$100,000 in revenue for Pitt County.

Harry E. Munn Jr., assistant professor of speech communication at North Carolina State University, will be the first featured speaker Friday. Munn, a member of the public relations staff of General Motors, will discuss ways to improve communication.

W.B. O'Neal, a special agent with the Insurance Crime Prevention Institute, is also scheduled to speak Friday. He is to discuss insurance fraud.

The Greenville Claims Association, the Rocky Mount Claims Association and the Neuse Adjusters Association are hosting the event.

## Special Olympics

The North Carolina Special Olympics was honored by the Association for Retarded Citizens/North Carolina at its second annual "Celebration of Caring," marking the Special Olympic's 20th year.

Attending from Pitt County were Lorraine, Kenneth and Gary McGowan, Clara and Chris Richards, and Dr. Bill Martin.

## ECU Will Host '89 Student Conference

ECU News Bureau  
More than 700 students representing 150 colleges and universities in the United States and Canada are expected at East Carolina University a year from now when the Ambassadors, a student service organization, hosts the 1989 national convention of the Student Alumni Association-Student Foundations.

The ECU Ambassadors won the right to host the 1989 conference last week while attending the 1988 national conference in Maine, said Scott Allen, Ambassador adviser and assistant director of alumni affairs.

In addition to networking sessions when students share ideas that have proven successful at their schools, several "just for fun" activities have been planned including a pizza party, pig picking, and a banquet.

"We have already confirmed Kay Yow, an ECU graduate and coach of



**VOLUNTEER AWARDS** — Pitt honorees at the governor's volunteer recognition ceremony Tuesday at Hendrix Theater, East Carolina University, gather on stage with Gov. Jim Martin, extreme right. The recipients are, left to right, Raymond L. Denson, Dr. Jasper L. Lewis Jr., Jean Weaver and Wadie Tucker, representing the D.H. Conley High School JROTC. (Reflector Photo by Shannon Wolfe)

## Martin Honors Volunteers From 35 Eastern Counties

By JERRY RAYNOR  
Reflector Staff Writer

"You show us the ways people come together in North Carolina to make our communities places that are indeed community," Gov. Jim Martin told an assembly of volunteers gathered in Hendrix Theater at East Carolina University to receive 1988 governor's volunteer recognition awards.

"We are here today celebrating and giving thanks to all those who have helped us through extra commitment to others," the governor said Tuesday afternoon to 120 individuals and recipients representing agencies from 35 eastern North

Carolina counties being honored in the ceremony.

Three individuals from Pitt County and one organization were 1988 honorees — Raymond L. Denson, Dr. Jasper L. Lewis Jr. and Jean Weaver, and the Junior ROTC group from D.H. Conley High School.

Each of the 35 counties had a selection committee whose members reviewed the achievements of volunteers in all fields of endeavor. From this large list, they named persons and/or agencies whom they felt had been exceptionally helpful through volunteer efforts during the past year.

From neighboring counties, those

honored were: Greene County — Annie Ruth Jones, Audrey Jones, Julia Ormond and Ruth Paige, and Martin County — Barbara James, Caroline Stalls, William James Wallace, and the Williamston Rotary Club.

Martin told the audience that the forthcoming Sept. 19 issue of Business Week had "named North Carolina as the best state in the U.S. for the location of businesses. Being cited as the best can be attributed to many factors, not the least of which is the reputation the state enjoys as one where caring people such as you help each other, help your communities."

"And we are proud, too, of our reputation for support to the arts. In fact, we are known as the state of the arts," Martin said.

"What you volunteers have achieved makes North Carolina the state of the hearts, loving, caring, giving hearts. You as volunteers being awarded today are but a small representation of many who give of their time and talents to making our state the state of North Carolina."

## Garner In Group Backing Martin

By CAROL TYER  
Reflector Staff Writer

Former Greenville Mayor Les Garner appeared Tuesday with Gov. Jim Martin at a Pitt-Greenville Airport news conference to unveil the governor's statewide "Democrats for Martin" organization.

Martin and several supporters flew across the state holding five conferences in five cities in one day to unveil his 70-county "Democrats for Martin" organization. He said he believes that conservative Democrats like his record, are angry at the General Assembly and consider their party's ticket too liberal.

Martin, who is seeking re-election against Democratic Lt. Gov. Bob Jordan, released lists of registered Democrats in each of the 70 counties who have agreed to assume leading roles in Martin's campaign.

Among those present at the Pitt-Greenville news conference other

than Garner were Red L. Cratch of Beaufort County, Glenn Jarvis of Hyde County and Sue Adams of Wilson County. Others from the east he mentioned by name included Kerry Ippock of Craven County, B.R. Burgwyn of Northampton County, Sam Stell of Carteret County and Taylor Slade of Martin County.

Martin strategists believe at least half the votes he received in 1984, when he defeated Rufus Edmisten 54 percent to 46 percent, came from Democrats. Strong support from the majority party is a must for any successful Republican candidate in a statewide race, since the GOP is outnumbered in North Carolina 2½ to 1.

"We've made some progress in getting people to switch (to the GOP) — slow, steady progress," Martin said. "But we still need Democratic support."

He said he is confident that his Democratic support will be at least as strong as it was four years ago, when he was "Jim Who" in many parts of the state — particularly in eastern North Carolina, a Democratic Party bastion.

"We've got 70 counties organized this year, more people working as volunteers," he said. "In 1984, we only had 45 — and we won," he said.

Albert O. McCauley of Fayetteville and Joe I. Marshall of Madison, both of whom are businessmen, will be co-chairmen of the organization, Martin said. The two accompanied Martin on his tour of the state.

Martin fielded a question about publicly accepting support from a former Greenville mayor, who many believe was voted out of office largely because of what was perceived as a racist joke, by saying that he has been impressed with the way Garner, who is white, and current Greenville Mayor Ed Carter, who is black, have worked together. "They aren't having problems with each other, so why should anyone else have problems with something that's long in the past?" he said.

## Music Workshop

Judith Thomas and Gary Ritcher will present a music education workshop, "Orff-Schulwerk: Meeting the Classroom Goals," on Sept. 23 and Sept. 24.

The workshop will be held on the University of North Carolina at Chapel Hill campus in Room 107 of Hill Hall. Workshop sessions will meet from 5:30 p.m. to 9:30 p.m. Friday and from 9 a.m. to 4 p.m. Saturday.

The workshop is being sponsored by the Central Carolina Chapter of the American Orff-Schulwerk Association and the music department at UNC-CH.

For more information contact 942-7719 in Chapel Hill, 544-7182 in Durham or 782-2453 in Raleigh.

## WOW Meeting Set

Lodge 218, Woodmen of the World Life Insurance Society, will have a Dutch dinner meeting Thursday at 6 p.m. at Tar Landing Seafood.

## DAV Fund Drive

Greenville Post 37 of the Disabled American Veterans will hold its annual fund-raising "forget-me-not" drive Friday and Saturday in various locations in the city.

The drive is the only fund-raising effort of the DAV. Proceeds are used to help disabled veterans in need.

## Revival Speaker

Dr. West Shields will preach revival services tonight at the Price of Peace Holiness Church in Portsmouth, Va.

## Services Planned

The Church of God of Prophecy, 1206 Mumford Road, will have

## CORRECTION

On page 8 of our "Price Blast" section in today's paper for September 14-17, the model #53263 shows incorrect illustration and states that it's a "VCR". It is actually a "VCP", Video Cassette Player, #53263.

We are sorry for any inconvenience this may have caused you.

**SEARS**

Sears, Roebuck and Co.

revival services Friday, Saturday and Sunday.

Evangelist David Wakins, the Wings of Faith singers and Pastor Vernon Morris will be present at each night's service beginning at 7:30.

## UP-LIFT Session

UP-LIFT, the United Pastors Ladies Intercessory Fellowship Time, will meet Saturday at 4 p.m. at Victory Deliverance Center on 14th Street in Greenville.

The Rev. Sudie Woodard of Chesapeake, Va., will be the guest speaker.

For more information call 757-3119.

## Dean's List Honors

Three area students — John D. Drum of Greenville, Lois F. Owens of Fountain and Lorenzo F. Barfield of Snow Hill — have been named to the dean's list for the summer 1988 quarter at Wilson County Technical College.

WCTC said 64 full-time students achieved a quality point average of 3.5 or better on a minimum of 12 quarter credit hours with no grade below B. In addition, 51 students enrolled on a part time basis were eligible for the dean's list as the result of their achievements.

## Playhouse Tickets

The East Carolina Playhouse will sell season tickets for the 1988-89 season Saturday from 11 a.m. to 3 p.m. in the jewelry department at Belk in the Carolina East Mall.

(See IN, A-3)

**FERGUSON**  
Bath Gallery  
KOHLER Plumbing Products  
3108 South Memorial Drive  
(Across From Parker's BBQ)  
756-6101  
Visit Our REGISTERED Showroom

# YOU KNOW YOU NEED TO LOSE WEIGHT



## ...Let's Follow Doctors Orders.

**A Proven and Successful Way To Lose Weight Safely**

- Medical Supervision
- No Injections
- No Starvation Diets
- Continuous Support Programs

Losing Together  
Winning Together

Offer Expires  
Fri. Sept. 16th



**Medical Weight Loss Systems**

Arlington Village (Across from Dawson's) • 756-2611

## REFLECTOR HOTLINE

Hotline gets things done. Write and tell us about the problem or issue into which you'd like for Hotline to look. Enclose photostatic copies of any pertinent information. Our address is The Daily Reflector, Box 1967, Greenville, N.C. 27835. Because of the large numbers received, Hotline cannot answer or publish every item we receive, but we deal with all of those for which we have staff time. Names must be given, but only initials will be published.

## READING CLINIC

The East Carolina University afternoon reading clinic needs students in grades two through 10 to participate in its program.

The clinic meets from 3:30 p.m. to 4:30 p.m. Tuesdays and Thursdays at ECU. After a thorough diagnosis, each student will be tutored one-to-one. For information, call 757-6833.

## The Daily Reflector

Incorporated  
209 Colaniche Street  
Greenville, N.C. 27834  
(919) 752-6166

107th Year No. 217

Second Class Postage Paid At Greenville, N.C.  
(USPS 145-400)

Production Director: J. Tim Jones  
Circulation Director: Nelson Adams  
Director of Administration and Personnel: Barbara Jarvis

Published Monday through Friday  
afternoons and Sunday morning

Subscription Rates  
Home delivery by carrier or motor route,  
monthly \$5.00

Mail Rates  
Pitt and adjoining counties: \$5.00 per month  
Elsewhere in N.C.: \$5.50 per month  
Outside N.C.: \$6.50 per month

Member Associated Press  
and  
Audit Bureau of Circulation

**In The Area**

**Achievement Award**

The United States Achievement Academy recently announced that Jamie Batten has been named a United States Award winner in mathematics.

A student at East Wake High School in Wendell, he is the son of Don and Trillis Batten of Wendell and the grandson of Mr. and Mrs. J.L. Padley of Ayden and E. Frank House of Greenville.

Batten's award and special recognition will appear in the United States Achievement Academy official yearbook, published nationally.

**Bus Safety Talk**

Rodney Bullock, transportation director of the Pitt County schools, spoke recently to seventh-graders at Wellcome Middle School about bus safety.

He said Pitt County transports about 7,467 elementary and 3,000 high school students daily and emphasized bus regulations for safety and well-being.

Bus safety instructions have begun with Walter B. Harris, Thomas Council and Monty G. Frizzell as instructors.

**Bethel School**

Bethel Elementary School cheerleaders for this year are Julie Lewis, Julianna Whitehurst, SuSu Hunnicutt, Angel Taylor, Shalana Williams, Kim Davenport, Sarah Stancil and Babs House. Chiefs are Latonya Purvis, Marty Smith, Lynn White and Denise Roberson. Alternates are Shani Nicholson and Niya Brown.

A cheerleading clinic was held recently with Kim Bowen, chief of the East Carolina University squad, as the instructor.

Officers elected to the Student Council Association this year are Denise Roberson, president; Leighton Blount, vice president; Bo Carson, secretary-treasurer, and Latonya Purvis, Nathan Barnhill, Shani Nicholson, Leslie Skipper, Rhonda Barnes and Kiona Andrews, representatives.

The school is having a fund-raising drive which consists of taking orders from companies for food items to raise money for computers and supplies. Students will compete for prizes through their orders, which must be returned to the school by Sept. 26.

**Nursing Workshop**

"Nursing as a Career," a workshop for career exploration teachers of the Pitt County schools, will be conducted Friday at the Brody Health Sciences building at the East Carolina University School of Medicine.

The program is intended to increase the awareness of career exploration teachers and their students about career opportunities in the nursing profession, according to Dr. Emilie D. Henning, dean of the ECU School of Nursing. Dr. Henning chairs the Co-Adventure project.

The project is a cooperative venture of the Eastern Area Health Education Center, ECU, Pitt Community College and Pitt County Memorial Hospital in recognition of the increasing demand for nurses, Henning said.

Presentations beginning at 9:15 a.m. will include educational preparation, hospital tours, skills lab demonstration, video display and discussions and resource identification.

**Annual Registration**

Greenville area Girl Scouts will kick off their annual registration Saturday from 10 a.m. to noon on the Town Common.

Jeff Diamond from WRQR-FM will conduct a live radio show from the site. Other activities will include face painting, relays, parachute games.

# GUC Expands Beat-The-Peak Program

By STUART SAVAGE  
Reflector Staff Writer

An expansion of the Greenville Utilities Commission's load management program — which saved \$195,462 in wholesale power costs during the month of August — was approved by the GUC board Tuesday night.

The expansion of the Beat-the-Peak program, which allows the GUC to control residential air conditioners and water heaters through a radio-controlled switch, will allow control of supplemental electric heat strips on heat pumps.

Since the Beat-the-Peak program began in 1977, the GUC load management program has expanded to include voltage adjustment, operation of existing standby generators and control of wells on the GUC water system.

Roger Jones, who heads the GUC Electric Department, told board

members Tuesday that the \$195,462 savings in power costs resulted from load management program operations on Aug. 18, between 4 p.m. and 5 p.m., the time of Carolina Power & Light Company's coincident system peak.

The savings, Jones said, included: \$68,422 through voltage adjustments; \$80,875 from control of air conditioners; and \$7,218 through operation of generators at the GUC water plant and Procter & Gamble Paper Products Co.

Malcolm Green, GUC's general manager, said an electric rate increase last month was "100 percent demand-oriented," which "further encourages" expansion of the utility's load management efforts.

Based on a pilot supplemental heat strip control program last winter involving 50 GUC customers, Green estimated the average savings per

customer at \$210 over the five-month period from November through March. With an estimated 10,000 of the commission's 27,000 residential customers heating with heat pumps, total savings in wholesale power costs through heat strip control could approach \$210,000.

As approved Tuesday, the heat strip program will be available to the current backlog of customers now awaiting installation of Beat-the-Peak switches and new applicants. Present Beat-the-Peak customers wishing to participate in the expanded program will have to wait until next summer or fall for inclusion in the heat strip program.

As part of the project, Beat-the-Peak heat strip customers will receive a \$10 per month credit for three winter months for their participation.

Present Beat-the-Peak participants now receive a \$5 per month credit for water heater switches and \$5 for air conditioner switches — for a maximum credit of \$40 — over the

period June through September.

Most heat pumps start relying on strip heat backup when outside temperatures drop below 30 degrees, Green said. The heat strips use about three times more electricity to produce one British Thermal Unit of heat than regular heat pump operations.

At the end of August there were

8,842 load management switches installed on water heaters throughout the GUC system and 9,177 switches installed on air conditioners, and a backlog of 342 applicants waiting for switches.

Since January 1985, the load management program has saved more than \$5.83 million in wholesale power costs.

**RADIO ANTENNA TOWER SPACE FOR LEASE**  
Heights Up to 450 feet  
Location: 2 miles Southeast of Washington  
Contact J.E. Hodges: 122 Riverside Dr. Washington Park, N.C. 27889  
638-5807 Day • 946-4313 Night

## Republican Judge Says Race Different

By GREG LAUDICK  
Reflector Staff Writer

The last time a registered Republican was elected to a statewide judgeship was 1896.

But Judge Robert F. Orr hopes that after all the votes are tabulated, 1988 will be different than those previous 92 years.

Orr, who is a Republican, is running for a seat on the N.C. Court of Appeals. His opponent in the upcoming election is retired Superior Court Judge John Friday, a Democrat.

Orr, 41, says he faces an uphill challenge, but he believes the circumstances this year might help him in November.

"A lot of things are taking place which haven't happened in the same time before," he said in an interview Tuesday. "It's a presidential year, we have a popular Republican governor in Jim Martin heading the ticket, and a strong lieutenant governor candidate in Jim Gardner," Orr said. But, like the majority of Republicans running for office in the state this year, Orr believes for a registered Republican to win, he needs to attract a large number of registered Democrat voters.

Martin named Orr to the Court of Appeals in 1986 to serve until this fall, when a judge will be elected to serve the next four years.

"I've served on the Court of Appeals for over two years now," Orr says of his experience. "I have voted on over 600 cases and written opinions in over 200 cases and I have established a record of work on the court that I feel justifies the voters of this state, be they Democrat, Republican or independent."

A native of Hendersonville, Orr studied law at the University of



ROBERT F. ORR

North Carolina at Chapel Hill, receiving a juris doctor degree in 1975. He also served in the U.S. Army for three years from 1968-1971.

**Resignation**

CHARLOTTE (AP) — Iredell County's Emergency Medical Services director resigned on Tuesday in the wake of reports he supervised at a wreck where cargo was taken.

John Fleming, director since 1976, was suspended without pay on Saturday. He resigned shortly before a 9 a.m. news conference scheduled by Joel Mashburn, the Iredell County manager.

Fleming, 50, is one of 14 county rescue squad and EMS officials who responded to a Sept. 4 tractor-trailer accident on Interstate-77 that broke up a Consolidated Freightways Inc. truck and threw truck cargo across the interstate.

**Lawyer Arrested**

RALEIGH (AP) — An attorney for Farmworkers Legal Services, a federally funded legal advocacy program that has represented migrant workers, was arrested Tuesday on charges that he deliberately struck a Johnston County farmer with his car, authorities say.

shoesPLash

**Presents**

THE UNIQUE SHOES OF 1989.

For The Contemporary Woman

ARLINGTON VILLAGE SHOPS  
GREENVILLE 355-3069

PELLETIER HARBOR SHOPS  
MOREHEAD CITY 726-7882  
HOURS: 10-6 MON.-SAT.

JACQUES VERT  
AMANO  
AMERICAN EAGLE  
CONCORDIA  
ONEX  
JASMIN  
CHINESE LAUNDRY  
GOLO

**SPECIAL! ADAMS PRODUCTS COMPANY**  
309 Hooker Rd., Greenville  
355-7258

Sale Ends: Sept. 16, 1988  
WHILE SUPPLIES LAST

**W. ROSE TROWELS**  
ONLY \$16.48

MUST PRESENT COUPON TO REDEEM

Good For One W. Rose Trowel Special \$16.48

Name \_\_\_\_\_  
Address \_\_\_\_\_  
Phone \_\_\_\_\_  
9/16/88

**GREENVILLE'S BEST BACK TO SCHOOL EYEGLASS SPECIALS!**

**CLEAR-VUE OPTICIANS EYEGLASSES**

**1 HOUR**

• GLASS • PLASTIC • SINGLE VISION • BIFOCAL • TRIFOCAL 1 DAY

**20% SENIOR CITIZEN DISCOUNT**

We Can Make Arrangements To Have Your Eyes Examined By The Doctor Of Your Choice

**COUPON**  
NON-PRESCRIPTION RAY-BAN WAY-FARER PLASTIC FRAMES & LENSES \$32.95 EXPIRES 9/16/88

**COUPON**  
NON-PRESCRIPTION RAY-BAN METAL FRAMES & LENSES \$36.95 EXPIRES 9/16/88

**COUPON**  
SINGLE VISION LENSES No Frame Purchase Necessary Plus or minus 3.00 sphere 2 Cyl. \$12.95 EXPIRES 9/16/88

**COUPON**  
LINE BIFOCAL LENSES No Frame Purchase Necessary Plus or minus 3.00 sphere 2 Cyl. \$36.95 EXPIRES 9/16/88

**COUPON**  
PROGRESSIVE BIFOCAL LENSES Plus or minus 3.00 sphere 2 Cyl. \$78.95 EXPIRES 9/16/88

**COUPON**  
BUDGET DEPARTMENT FRAMES Starting at \$12.95 EXPIRES 9/16/88

**COUPON**  
MEN'S or LADIES SINGLE VISION LENSES w/PLASTIC FRAMES (Also Available in Sunglasses) Plus or minus 3.00 sphere 2 Cyl. \$26.95 EXPIRES 9/16/88

**COUPON**  
MEN'S METAL RIMLESS FRAMES w/ Single Vision Plastic Lenses Plus or minus 3.00 sphere 2 Cyl. \$59.95 EXPIRES 9/16/88

**COUPON**  
MEN'S or LADIES BIFOCAL LENSES w/PLASTIC FRAMES (Also Available in Sunglasses) Plus or minus 3.00 sphere 2 Cyl. \$46.95 EXPIRES 9/16/88

**COUPON**  
LADIES' METAL RIMLESS FRAMES w/ Single Vision Plastic Lenses Plus or minus 3.00 sphere 2 Cyl. \$59.95 EXPIRES 9/16/88

**COUPON**  
MEN'S or LADIES' BIFOCAL LENSES AND RIMLESS FRAMES Plus or minus 3.00 sphere 2 Cyl. \$79.95 EXPIRES 9/16/88

**COUPON**  
OUR PREP GLASSES \$36.95 (Plus \$10.00 for 1.50 sphere to 2.00 sphere) EXPIRES 9/16/88

54 Eye and Above. Overize Charge for 54 Eye and Above. Tints Extra! Example: Single Vision Gray \$19.95

Opinion

# The Daily Reflector

Established 1882

David Julian Whichard, Chairman of the Board

David J. Whichard II, Editor & Co-Publisher John S. Whichard, Co-Publisher

D. Jordan Whichard III, General Manager Alvin B. Taylor, Managing Editor

Mary C. Schulken, Editorial Page Editor

'Truth In Preference To Fiction'

## Stop Overflow

### Temporary Jail Only Solution

Pitt County has nothing less than a crisis on its hands with a jail that is spilling over with inmates.

And right now, the only viable solution is to find suitable temporary quarters for the overflow and house inmates there until a more modern jail can be built. The county should not turn inmates away and allow lawbreakers to go free.

The problem is well-documented. The jail was built to house up to 83 inmates and it is averaging 25 over capacity regularly. The facility, built in the 1960s, is pitifully inadequate to handle the needs of a growing community.

Although the county is studying plans for construction of new jail facilities in master planning for other county office space needs, new facilities are still years away.

Superior Court Judge David Reid suggested in a meeting with the commissioners that identifying non-violent criminals and housing them in a temporary facility might be a way out. However, he said, with inmates who are a danger to themselves or others "you just can't turn them out."

The notion of not jailing even non-violent proven lawbreakers is a slap in the face of a strong justice system. Incarceration is the foundation of a punishment system. It protects the public and acts as a deterrent for criminals.

Since a new facility is not in sight temporary quarters must be provided. The most dangerous criminals necessarily must be housed in high security quarters. Others will have to be placed elsewhere.

Pitt County's predicament proves neither the county nor the state can allow construction of jail facilities to lag in the future. Without facilities inappropriate decisions are forced upon a county — decisions about who will serve the time and who will not. In that kind of situation justice is thwarted.

## Care Crisis

### Not Enough Family Physicians

Dr. Harry L. Metcalf, president of the American Academy of Family Physicians, sees a crisis in medical education and primary health care in the United States.

Metcalf, speaking here last week, said there is a dwindling supply of persons applying to medical schools in this country and those who graduate are too concentrated in medical and surgical subspecialties.

This will create future problems. If the drop in applicants continues some schools may have to be closed to maintain the physician quality. And while there are still too few family and other primary care physicians the subspecialties are becoming overcrowded. The answer to that may be reducing the residency positions for the subspecialties.

For whatever reason it is obvious that the family physician supply is not being replenished as older physicians retire. That was the reason for the establishment of the East Carolina University School of Medicine. There are still not enough family physicians and that is particularly true in eastern North Carolina where large areas often have no doctors.

It would seem that if medical school applicants are declining, incentives could be offered to entice qualified young people into family medicine. What comes to mind is forgiveness of tuition if the new doctors practice family medicine in rural areas for a set number of years.

There must be other ways to increase the supply of family doctors. It is the challenge of the next decade for the nation's health delivery system.



## Public Forum

To the editor:

Your Sunday editorial comment titled "Vigilance" may have been an accurate assessment given from the point of view of a non-participating third party. But the idea at the Pitt County Board of Elections monitoring itself isn't practical from the standpoint of those of us who worked hard to win an election only to have its results nullified by sloppy and careless administrative procedures. Federal observers during the Oct. 11 runoff would ensure some degree of added trust in the process. What harm could that do? And, besides, why should voters put their total trust in our board after all that has been revealed about its handling of the previous election?

The comments in the editorial which discount the possibility of racial bias as a factor in the electoral process are predictable and difficult to refute. Racial bias, by its very nature is extremely hard to prove, even when clearly recognized.

In your previous editorials, support for a new election was made clear. I would have thought that any measures intended to ensure fairness in the new election, including federal observers, would attract your support as well. From the perspective of a participant, believe me, if ever federal observers were needed to help restore faith in local balloting, now is the time.

Michael Garrett, campaign manager  
Committee to Elect D.D. Garrett County Commissioner

To the editor:

This is not meant to take anything away from Dr. William Laupus and the great job he has done for and with the East Carolina University Med School. I just think the facts should be set straight. In last week's article, Dr. Laupus was presented as the first dean of the med school, when in fact there were two deans prior to Dr. Laupus.

Dr. Wallace R. Wooles, presently chairman of the Department of Pharmacology, was the first dean, coming to ECU in 1970. After the legislature

made ECU a four-year med school, Dr. Wooles stepped down as dean and Dr. Hal Wiggers served as dean until the coming of Dr. Laupus.

All these men, and many others, shared in the building of what the ECU Medical School is today.

Mary W. Roscoe  
Greenville

To the editor:

Recently I read with great interest an article in your paper concerning a former New Jersey nun who fought for equal funding of all students in the public educational system. She fought the injustices and prejudices against the poorer schools and the less gifted students for seven long years and won!

As a part of the special educational system of Pitt County schools, I think it is time that we as educators, parents and concerned citizens took a deeper look at the educational needs of the exceptional child.

The programs that have been developed for these children look great on paper. However, in actual practicality, I.E.P.'s (individualized educational plans) are tailored to fit the needs and schedules of teachers and administrators, certainly not the child. These I.E.P.'s are frequently filed away, overlooked or in some cases, blatantly disregarded for a number of reasons.

Teachers in this area are often hired, not on the basis of knowledge, degree or experience, but on the basis of availability. A figurehead in the classroom; a name on a list, a vacancy filled!

Parents, if you have an exceptional child, find out all you can about the teacher's experience and the program's success-failure rate. You owe it to your child to make sure his/her educational needs are being met.

Darlene Davenport

Submissions to the Public Forum should consist of no more than 300 words and should deal with public issues. The editor reserves the right to cut longer letters. Signatures and phone numbers should be included on all letters.

— Ellen Goodman —

## Not Remedial, Just Plain Dumb

BOSTON — I grew up in an era when the most profound political thought was: "I Like Ike." So I never expected a presidential campaign to be like a graduate class in good government.

But after the back-to-school week of the 1988 campaign, I know how teachers feel when they get some new and simpler set of textbooks. What we are witnessing is the "dumbing down" of politics.

Forgive me if I reject the polite school jargon. This campaign isn't "special," nor is it "remedial." Even simpleminded is too kind a word. It has become just plain dumb.

Consider what we've been taught so far. That civics is solely a matter of pledging allegiance to the flag. That history is a matter of opinion: One side can blame every problem on the Seventies, the other on the Eighties. That math is something to be manipulated: You can add to the budget and subtract from the deficit.

The Bush campaign has had a heavier hand in the dumbing down process. In Bush's class you don't have to be the brightest boy to be the

teacher's pet. Danny Quayle was already proof of that. But now Bush, who cannot parse a sentence, and Quayle, who speaks in Germanic word order — "it is an issue that I have not spent thus far a great deal of time on" — are trying to reduce the campaign to a patriotic pop quiz.

As for history, the Vice President misplaces more than Pearl Harbor Day. His geography class has maps that put Brookline, Mass., in the Soviet Union and that cover up Iran. His best English compositions are by speechwriter Peggy Noonan.

This man wants to be the education President?

Dukakis for his part looks shell-shocked by this streak of silliness. But he, too, has been warned against sounding professorial. Instead he has sounded elementary: leading drills in the American dream and refrains about "good jobs at good wages."

In this long-term dumbing-down process, all the pictures get bigger while the texts get smaller. The 1988 presidential campaign is a cross between a comic strip and a video. Bush goes to Disney World; Dukakis

to Ellis Island. Balloons abound. The analysts grade campaigns as if they were MTV awards: One point for Concept, another for Special Effects, a third for Choreography and the ultimate for Viewer's Choice.

Is there anyone to blame for such political sliding? Surely Reagan had a role. It was more than a slip of the tongue, when he told the GOP convention that "facts are stupid things." Reagan's campaigns convinced a generation of handlers that the most successful candidate is the one who says the least of substance.

Few of us thought that elections would (or could) actually deteriorate in the post-Gipper era. But this year, it is considered brave and downright risky when a candidate "goes specific."

In one way or another, everyone has played a part in the downward spiral. The media do not go into a "feeding flurry" over economics or disarmament. We do not dog the candidates in their driveways until they sweatily explain how they would reduce the deficit. The networks, geared to the attention span of

Sesame Street viewers, are easily manipulated, even as they report on their manipulation.

As for the voters, we are told that the legions of advisers do not go broke underestimating them. Negative advertising works. If voters find it hard to sort out messages, they choose an image.

My hope is that this campaign has bottomed out. Surely, if the public were to raise hands, the question we would ask is: "how." How would the next President lower the deficit, live in peace, manage families and work, secure the future? Please give us more than a "sound bite" or a hint.

I wish I had more faith that an hour-long debate, or two of them, will answer these questions, satisfy the longing for real knowledge. But candidates care less about what we learn than how we rank them.

The next set of grades will be out in November. The most important news may not be which man passed and which failed, but how many more voters, once and for all, dropped out.

(c) 1988, The Boston Globe Newspaper Company-Washington Post Writers Group

— Paul O'Connor —

## A Few N.C. AIDS Facts

RALEIGH — To this point, about 600 cases of AIDS have been reported in North Carolina. A year from today, that figure will probably be twice as high, and two years from today, four times as high.

The state's population of AIDS victims is doubling about every 13 months, according to statistics released by the state Division of Health Services. By Aug. 8, 1988, the latest date on which a count was conducted, there had been 598 cases reported in North Carolina.

Dr. Ron Levine, state health director, says that the most respected forecasts of the growth in the AIDS population call for a doubling every year for at least the next three or four years. The most optimistic projections say that at some point in the early 1990s, the number of AIDS patients will begin to level off. But the leveling off will occur at a number which may be eight or 16 or 32 times as great as today's figures.

Of the 598 cases reported before Aug. 8, 325 of the patients had already died. That's 54 percent.

Levine said that the profile of the North Carolina AIDS population mirrors the national population to a great extent, with one exception. Because blacks comprise a larger percentage of North Carolina's population than of the national population, the percentage of black AIDS patients in the state is well above that of the national average.

In North Carolina, 44 percent of the reported AIDS cases have been black. Nationally, Levine said, about one-fifth have been black.

Dr. Rebecca Merriwether, Levine's assistant, said North Carolina's AIDS population is also adapting another aspect of the national AIDS population. The percentage of intravenous drug users is growing rapidly.

Six months ago, she said, only 13 percent of North Carolina's AIDS cases could be traced back to IV drug users. By August, the percentage was up to 18. This is a national trend.

Characteristics of the AIDS population in North Carolina, according to a state report given to a legislative study commission, showed that 90 percent are male and that 87 percent of the afflicted range in age from 20 to 49 years. Of the 598 cases, 14, or slightly more than two percent, were children.

The adults in the state AIDS population were overwhelmingly homosexual or bisexual — 60 percent. This percentage is dropping, however, because the number of IV drug users is growing so rapidly. Levine hopes that the growth in the number of gays contracting AIDS will level off, as it has in San Francisco.

The rest of the state's AIDS cases have been comprised of hemophiliacs, four percent, heterosexual persons having sexual contact with other high risk people, five percent, and those receiving AIDS from a transfusion, four percent. The cause of three percent of the cases could not be determined.



— Neil Schram —

# AZT Subsidy Only Solution

## Analysis

The definition of AIDS prevention is changing. In the past it referred only to efforts to slow the spread of the human immunodeficiency virus. Now, however, it also means slowing the progression of disease in people who are already infected with the virus. Like so many other parts of the epidemic, this, too, will be expensive. As recent experience with the drug AZT has shown, government has not yet made the decision that it must play a major role in prolonging quality life for many people who are ill in their most productive years.

Treatment to prevent AIDS in those who are already infected will involve at least three types of drugs: those (like AZT) that suppress the virus, others that will boost the immune system and those that prevent infections occurring in people with a severely compromised immune system. Hundreds of millions or even billions of dollars will be spent over the next several years on research to develop all three types of medication. Once they are developed, it is likely that patients will need all three for the rest of their lives.

If current assumptions are correct that most people who are infected will eventually develop a severely depressed immune system, then society will need to provide medications eventually to a million or more Americans. This need will be particularly critical because no other life-threatening disease affects so

many people in their 20s, 30s and 40s.

The example of AZT, which is the only drug approved by the Food and Drug Administration as effective in prolonging life and relieving symptoms, demonstrates government's difficulty in grappling with the cost of AIDS drugs. President Reagan signed a one-time appropriation of \$30 million in 1987 to subsidize the costs of AZT for people who could not afford it. The program applies to people who make too much money to be on Medicaid or who do not have health insurance that pays for the drug. It was made clear that this was a stopgap measure that would end Sept. 30, 1988.

However, since the bill was signed, neither Congress nor the states have made provisions to continue AZT for the 5,800 people nationwide who are receiving the drugs from this program. No provision has been made for the thousands more who will need it in the next year and the year after, although AZT will continue to be available for those who are eligible for Medicaid.

Both the states and the federal government appear to be waiting for the other to provide a long-term solution. It is likely to be far too expen-

sive for the states to do more than provide a short extension of the current program. Long-term solutions must lie with the federal government.

Although the cost of AZT has been reduced in the past year, the cost at a typical pharmacy is still about \$2.30 per pill, or about \$10,000 per year per person. One drug that is being used to replace half the dose of AZT turns out to be just as expensive.

Since AZT prolongs life and helps people feel better, it might be considered the equivalent of insulin for diabetics. A better analogy would be to equate AIDS drugs with dialysis machines for people with kidney failure. In the 1970s the federal government recognized that chronic hemodialysis, which cost about \$25,000 per year, was too expensive for most Americans. Thus it was decided to cover dialysis costs under Medicare — even for people with health insurance that would have paid for it. A similar decision for AIDS must be made because the problem of AZT is likely to be repeated and magnified as newer and better (and possibly more expensive) drugs become available.

It is widely recognized that no cure

for AIDS is likely in this century. Nor is a vaccine likely to help those who are already infected. Thus AIDS, or more probably HIV infection, will need to be seen as a chronic, expensive disease. People with health insurance and coverage for drugs will be provided for, as will those who are or who will become impoverished. However, an estimated 37 million Americans have no health insurance, and millions of others have no drug coverage to make the cost of AIDS medications affordable should they become ill.

Thus we must solve two urgent problems: continuing the AZT program for those who are already enrolled and for the additional patients who will need it. Equally important is the need for a long-term solution, which will require federal government funding. Like the epidemic, the problem will not just go away.

If government does not accept this responsibility in funding AIDS drugs, we will be left with the availability of medication to keep people feeling well enough to work; the only way in which many will be able to obtain that medication would be to stop work, go on disability and become impoverished.

Neil Schram, an internist, is a member of the Los Angeles County Medical Association AIDS Committee.

— Mark Green —

# The Label-Mongering Of George Bush

Vice President George Bush's major strategy is apparent: He's running against 1972 presidential candidate George McGovern. Massachusetts Gov. Michael S. Dukakis, he says, is "on the very very far liberal fringe."

While Bush's furious label-mongering has certainly produced short-term gains, can this tactic work? Especially after hearing Yalie Bush attack Dukakis for Harvard liberalism, I'd have to say that this bulldog won't hunt, for several reasons:

• McGovern wasn't the radical that Republicans claimed he was. It wasn't easy selling a bomber pilot and father of five from a conservative Midwestern state as an advocate of "acid, amnesty and abortion," but Republicans in 1972 had the advantages of the Tom Eagleton vice presidential fiasco, a divided Democratic Party, post-Vietnam angst and an incumbent President. In 1988,

**'Especially after hearing Yalie Bush attack Dukakis for Harvard liberalism, I'd have to say that this bulldog won't hunt, for several reasons ...'**

however, Republicans not only lack any comparable fiasco and angst, they are also opposed by an Eagle Scout who never marched on the Pentagon. It won't be easy for them to radicalize someone as culturally straight as Mr. Rogers.

• Bush periodically himself is campaigning as a semi-liberal. He has campaigned as a champion of child care, the environment, education, civil rights and ethics — a "Democratic" posture that discombobulates conservative columnist Bob Novak. Indeed, Bush's \$1,000 tax rebate or federal check to families for child care is positively, well, McGovernish. How long can Bush get away with running down what he's running on?

• If Dukakis is for "big government and big spending," what can you say about Reagan-Bush? A new definition of chutzpah is for Bush to attack a budget-balancer like Dukakis when federal spending as a percentage of the gross national product rose from Jimmy Carter to Reagan-Bush and when the latter accumulated more red ink in eight years than all their predecessors combined in two centuries. Nor was this the fault of a Democratic Congress, since Reagan-Bush's proposed budgets exceeded those that Congress passed.

Nor does Dukakis propose statist, expensive solutions. His constant advocacy of public-private partnerships reveals an activist who wants government to do more and be less — as in be more efficient.

Also, at the important level of imagery, how do you sell the frugal owner of a 25-year-old snow blower as the last of the big-time spenders?

• Where are the "special interests" that Bush says are holding Dukakis captive? Dukakis accepted no special-interest money from political-action committees. So the governor can persuasively argue that he captured the nomination with no strings attached. (Recall who did promise to name a Latino to the Cabinet and who has never told an audience what it didn't want to hear. Hint: Reagan's vice president.)

• Is Dukakis "unpatriotic" because he vetoed a compulsory Pledge of Allegiance measure? A nominee who served two years in Korea need not feel defensive about patriotism. Eventually, perhaps during their scheduled debates, the vice president will have to answer a question: "Would you pledge allegiance to the Constitution, which the U.S. Supreme Court says forbids government from making any American say something contrary to his religious beliefs?"

• If Dukakis is "soft on crime," why is there less of it in Massachusetts? The Republicans have been and will be running against Willie Horton, the furloughed murderer who didn't come back. But since exactly 99.6 percent did come back, and since furloughed prisoners have half the recidivist rate of others when finally released, Dukakis' furlough program clearly resulted in less crime. Indeed, crime in Massachusetts fell 13.4 percent in the last four years while the national rate has gone up.

• Is Dukakis another "gloom and doom" Democrat? Not according to one-time GOP presidential candidate Rep. Jack Kemp, R-N.Y. After listening to Dukakis' relentless speeches about economic growth and opportunity, Kemp acknowledged that "Michael Dukakis doesn't sound at all like Jimmy Carter. He talks about an economic miracle, not economic malaise."

• Is he a "unilateral disarmament"? It's true that Dukakis believes in complying with international treaties and advocates greater collaboration with our allies. What a relief after Lt. Col. Oliver L. North's and Assistant Secretary of State Elliott Abrams' cowboy recklessness!

Eventually it should not be difficult for Dukakis to observe that wasting money on weapons that don't work (the B-1, SDI) is itself a form of unilateral disarmament, while the weapons that he advocates (the Trident D-5 missile, the stealth bomber) strengthen America's national security.

I can understand the frustrations of a Pat Buchanan, a prominent conservative commentator and liberal-baiter, that Dukakis doesn't use, and doesn't get tainted by, "the L word." Pat and his party have worked overtime for the past eight years to create a liberal bogymen-strawman bearing no resemblance to reality, and now they're angry that the Democratic nominee won't accept their caricature.

Watching Bush is like listening to an aging soprano reach for the high notes that are no longer there. "We're going to spend all our energies trying to make Dukakis out to be another George McGovern," confided one Bush adviser in a not-for-attribution comment to Business Week. "The trouble is, he isn't."

Mark Green is the president of the Democracy Project, a policy institute in New York City, and a Cable News Network political commentator.



## PROFESSIONAL BODY WORKS

"Pitt County's Largest Body Repair Facility"



### The NEW Professional Body Works!

We offer you the highest quality and upmost professional service of any bodyshop in town. We can give you the following things other body shops can't:

1. Computer wheel and frame alignment.
2. State of the art equipment.
3. A self-contained, environmentally controlled paint room, which will result in even paint flow and a smoother finish.
4. Baked on painting environment.
5. Shorter Repair Times.
6. In-house paint mixing system to ensure better color matching.
7. We employ ASE Certified Technicians.
8. 24-hour wrecker service.

**We're not just talk - we back our work with a three-year/36,000 mile warranty!**

# PROFESSIONAL BODY WORKS

## 756-3471

400 Greenville Blvd., (Across from Nichols)      Night Wrecker Service 830-1306

**Don't Put Off Till Tomorrow What You Can Sell Today**  
Call Classified  
752-6166

B.M.I. 12-String Pedal Steel Guitar	\$699 <sup>95</sup>
Tomos 2-Sp. Automatic Moped	\$279 <sup>95</sup>
5-Pc. Set Ludwig Drums	\$299 <sup>95</sup>
Toshiba 4-Head VHS Remote Control	\$229 <sup>95</sup>
Curtis Mathes 19 Inch Color TV	\$149 <sup>95</sup>
"New" Ladies 14K Nugget Watch	\$459 <sup>95</sup>
Ruger Redhawk .44 Mag 8 Inch W/Holster	\$359 <sup>95</sup>
Remington 1100 12 Ga. Auto Shotgun	\$189 <sup>95</sup>
Remington 870 12 Ga. Pump Shotgun	\$179 <sup>95</sup>
Springfield O3/A3 Bolt 30.06 W/ Sniper Scope	\$379 <sup>95</sup>

**East Carolina Coins & Pawn**  
CORNER OF TENTH & DICKINSON STS  
We buy, sell, trade, and make loans on all types of firearms.  
"WE MAKE INSTANT LOANS ON ITEMS OF VALUE"  
WE BUY GOLD & SILVER      PHONE 752-0322      90 DAY LAYAWAY  
Mon - Fri 9 to 6, Sat 9 to 5

\*\*\*\*\*

7th ANNUAL  
**Winterville Rescue Squad**  
Sponsors  
**"RESCUE DAY"**  
— All Day Events —  
★ Lunch Served  
★ Family Entertainment  
★ Rescue Competition  
★ Special Shows  
★ Auction  
★ Parade  
**September 16 & 17, 1988**

**FRIDAY, SEPTEMBER 16th**

Pancake and Sausage  
Supper ..... 5:00 pm-8:00 pm  
Auction ..... 6:00 pm-Until  
Little Miss Winterville  
Rescue Contest ..... 7:00 pm

**SATURDAY, SEPTEMBER 17th**

Parade ..... 9:00 am-10:00 am  
East Care  
Helicopter ..... 11:00 am-11:30 am  
Rescue Competition ..... 11:30 am-2:30 pm  
Hot Dog Wagon ..... 10:00 am-Until  
Craft Exhibits ..... 10:00 am-4:00 pm  
Military Exhibits ..... 10:00 am-Until  
Talent Contest ..... 11:30 am-1:30 pm  
Road Race ..... 10:30 am-Until  
Bike Race ..... 11:00 am-Until  
Blood Pressure  
Check ..... 10:00 am-4:00 pm  
Children's Games ..... 10:00 am-4:00 pm

\*\*\*\*\*

## Free From Eureka.. How to Beat Housework!

A \$19.95 value. Hardcover book. Yours at no additional cost when you purchase a Eureka cleaner for \$80.00 or more.

**EUREKA UPRIGHT With Bonus Tool Kit**  
**\$20 off**



**\$79<sup>95</sup>**

**4.0 Amp Motor**

- 4 Position Dial-A-Nap\*
- Power Driven Beater Bar Brush Roll
- Dual Edge Kleener\*
- Brilliant Dirt Seeking Headlight
- Top Loading Large Capacity Disposable Dust Bag
- Adapts Easily To 6-Piece Bonus Tool Kit

**6.5 Amp Motor**

- Extra Suction Power Motor
- 6 Position Dial-A-Nap\*

**\$139<sup>95</sup>**

**Eureka Upright With Vibra-Groomer II<sup>®</sup> Model 1945**  
**\$50 off**



**5.5 Amp High Performance Motor**

- 6 Position Dial-A-Nap\*
- Dual Edge Kleener\*

**\$99<sup>95</sup>**

**Eureka Two Motor Power Team**  
**\$90 off**



**3.2 Peak H.P. Motor**

- Automatic Carpet Height Adjustment
- Roto-Matic<sup>™</sup> Powerhead With Power Driven Beater Bar Brush Roll
- Cordaway\*

**\$199<sup>95</sup>**

**Eureka will sweep you off your feet<sup>®</sup>**  
**EUREKA VACUUM CLEANERS**

\* 1987 The Eureka Company, division of National Union Electric Corporation, Bloomington, IL 61701  
**V.A. Merritt & Sons**  
"Electrical Appliances since 1928"  
"WE KEEP OUR PRICES LOW AND SERVICE WHAT WE SELL"  
YOUR REPLACEMENT PARTS CENTER      Convenient Back Entrance  
FACTORY TRAINED SERVICE      90 DAY CASH PLAN      EASY FINANCING  
DOWNTOWN GREENVILLE 752-3736  
8:30 a.m. - 5:30 p.m. Monday-Friday  
9:00 a.m. - 1:00 p.m. Saturday



**CITY OF GREENVILLE**  
NORTH CAROLINA  
27835-7207

OFFICE OF MAYOR

My Fellow Citizens:

This represents a real opportunity for you to join an organized effort against those factors which adversely affect the quality of life in our city.

I am appealing to each of you to register to join our Community Improvement Association (C.I.A.) in combating drug abuse, illiteracy, poor housing and all other factors which degrade the quality of life in our city.

With your help, we shall win over the forces of evil and destruction. Please fill out the questionnaire below and mail to:

C.I.A.  
City of Greenville  
P.O. Box 7207  
Greenville, N.C. 27835-7207

For additional information, please contact the Mayor's Office at the above address.

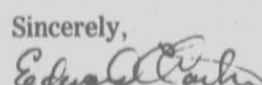
Sincerely,  
  
Edward E. Carter, Mayor

Name \_\_\_\_\_  
Birth Date \_\_\_\_\_ Place of Birth \_\_\_\_\_  
Home Address \_\_\_\_\_ Tel \_\_\_\_\_  
Business Address \_\_\_\_\_ Tel \_\_\_\_\_

# Faithful Wait, And Wait Again, For Rapture To Come

By ROBIN P. TEATER  
Associated Press Writer  
RALEIGH, N.C. (AP) — The prediction of the "Rapture," or prelude to the second coming of Christ, was half right and half wrong, some Pentacostalists and fundamentalists say.

While a Biblical scholar predicted that believers would not rethink their trust in the theory, the believers proved him right. They conceded that the time was wrong, but said the Rapture still would occur — and could happen at any time.

"We believe in the rapture, but the Bible says no man knoweth the day nor the hour," Bill Raby said Tuesday night while swaying to the gospel music at the Crusade on the Green in

Asheville. The three-day event was not planned for the Rapture, Raby said.

More than 100 people were listening to the preaching and singing about an hour after sundown. Mention of the Rapture brought smiles, some of skepticism and some of joy.

The Rapture was predicted by Edgar Whisenant, a 56-year-old Little Rock, Ark. resident, retired NASA rocket engineer and self-taught Bible student who had said Jesus would "rapture the church" — take the faithful to heaven — by sunset Tuesday.

He changed his prediction Tuesday, setting the final hour for 9:55 a.m. CDT today. Whisenant's original predictions were made in his

book "88 Reasons Why The Rapture Will Be In 1988."

About 1 million copies of the copyrighted book have been circulated throughout the nation, two-thirds sold for \$2, the rest given away, said the Rev. Bob Doom, who runs a Christian bookstore in Asheville and is pastor of Grace Fellowship Baptist Church, a "Bible-believing fundamentalist church."

"Why copyright the book if you won't be here to get the royalties?" Doom asked.

Doom, who also does some publishing, said the book was printed on poor quality paper with a low-cost cover. Publishing costs must have been low — maybe a dime or 15 cents.

"Most folks who have some sort of

thorough knowledge of the Scripture just sort of laughed at the thing," he said. Whisenant's premise is "interesting," he said, "but he's got a mixture of truth and error."

A Duke University theologian said even if the event doesn't happen soon, believers won't give up.

"I don't expect it to go away. Every time they predict and it doesn't come to pass... they don't get embarrassed by that. They just reload. And they say 'We miscalculated,'" said James Efirid, professor of biblical interpretation at Duke's Divinity School.

"In other words, a true believer doesn't give up just because there's been a disappointment, and these people, I fearlessly predict, will go on

predicting," Efirid said.

Efirid said predictions pinpointing the time of the Rapture cause a stir every couple of years.

"They've all come to naught. Most of these predictions are based on a system of interpretation based on faulty presuppositions," Efirid said.

He said the system used by Whisenant and others dates back to 1829,

when Irish minister John Nelson Darby began predicting the end of the world.

"A lot of people are turned off from Christianity and biblical study and responsible religion because of these kind of sensational predictions... It keeps people away from studying the Bible," he said.

## Rapture Wait Prompts 30-Hour Standoff

GIBSONVILLE, N.C. (AP) — An armed Guilford County man who had barricaded himself in a house for more than 30 hours after being told that the world was coming to an end was apprehended without incident early today, officials said.

Ricky Odell Chavis, 27, was apprehended after negotiators from the State Bureau of Investigation got him to step outside the back door of the house shortly after 2 a.m. today, said Gibsonville police dispatcher Susan Garinger.

Officers from the Guilford County sheriff's department then threw concussion grenades at Chavis, stunning him, Ms. Garinger said.

"No one was hurt," said Sgt. David Powell of the Guilford Coun-

ty sheriff's department. "(Chavis) had fired one shot (Tuesday night), in the house, but not at our officers."

Chavis was charged with two counts of assault on a police officer with a deadly weapon and with one county of going armed to the terror of the public, Powell said.

The standoff began about 6 p.m. Monday. On Tuesday, police snipers were posted on the roof of a nearby building and behind the wall of an adjacent car wash, and surrounding businesses were evacuated. Almost every street in downtown Gibsonville was blocked, at least partially, with dozens of neighbors watching from their por-

"He was messed up real bad on religion," said Chavis' aunt, Joy Cassell, one of dozens of on lookers following the marathon standoff from a vantage point about 200 yards from Chavis' house.

Ms. Cassell said two door-to-door missionaries for the Jehovah's Witness sect apparently convinced her nephew he needed to "get right" because Tuesday would be the day that God called all the righteous to heaven and left the secular world to warring non-believers.

Edgar Whisenant, an Arkansas evangelist, predicted that the faithful would be called to heaven on Tuesday in his book, "88 Reasons Why The Rapture Will Be In 1988."

On Tuesday, he changed his prediction to 10:55 a.m. today.

The standoff began shortly after Chavis reportedly entered a food store adjacent to his home and took a 12-pack of beer without paying for it. He fired a handgun several times in the air as he exited the store.

Morris McPherson, Gibsonville's police chief, said Chavis fled to a nearby wooded area, firing more shots before making it back to his house.

When McPherson and a colleague, Elon College Police Chief Dan Ingle, tried to apprehend Chavis, he fired on them and passing motorists from the house, McPherson said.

### PUBLIC NOTICE AUCTION

DATE: SEPTEMBER 17, 1988  
TIME: 10:00 AM  
LOCATION: PITT COUNTY SCHOOL BUS GARAGE-264 BYPASS

Pursuant to North Carolina G.S. 160A-270, the Pitt County Board of Commissioners has authorized the County Manager to dispose of the following surplus vehicles and equipment by public auction.

#### AUTOMOBILES

(1) 1984 Citation	(2) 1983 Crown Victorias
(2) 1983 Reliants	(2) 1984 Impalas
(2) 1979 Volares	(3) 1985 Impalas
(4) 1981 Chevettes	(2) 1982 Impalas
(1) 1982 Chevette	(1) 1980 Chrysler

#### OFFICE FURNITURE AND EQUIPMENT

(3) Projectors	(2) Calculators
(4) Folding Chairs	(3) Side Chairs
(1) Typing Stand	(1) Secretarial Chair
(1) Student Chair	(1) Lanier Recorder/Transcriber
(1) Mis. Table	(3) Adding Machines
(1) Sofa	(2) Electric Typewriters
(1) Copier	(1) Generator-3 Phase (60KW)
(1) Desk	

INSPECTION: 1 HOUR PRIOR TO SALE  
TERMS: STRICTLY CASH OR GOOD CHECK

Everything sold "As is, where is", with no expressed or implied warranties. The County reserves the right to add to or delete from this list. Title for the vehicles sold will be available on site. Other terms and conditions will be announced prior to sale. All bidders must register prior to sale time with name, address, and N.C. driver's license. Sale conducted by Charles E. Mayo, NCAL #3296. The Pitt County Board of Commissioners reserves the right to reject any and all bids. Call Ward Parker at 830-6306 for any questions.

## IRS Auditor Says No Business Basis Found For PTL Spending

COLUMBIA, S.C. (AP) — An IRS agent says he could find no documentation to prove a legitimate business purpose for a personal 300-foot water slide, two Rolls Royce automobiles and hundreds of thousands of dollars that Jim and Tammy Bakker and a key aide got through PTL accounts.

Larry Howlett, an auditor of tax-exempt organizations, was the second witness Tuesday in the trial of PTL's \$52 million claim against the Bakkers and former PTL aide David Taggart. The trial began Monday in U.S. Bankruptcy Court.

PTL attorneys are seeking to force the Bakkers and Taggart to repay the money they say was lost through through mismanagement of funds that included cash advances on PTL credit cards and unjustified compensation and benefits.

Howlett listed among the expenditures with no legitimate business purpose a 300-foot water slide at Bakker's Lake Wylie home, which has since been sold, and \$32,000 worth of luggage.

Howlett also said the IRS could find no documentation to support the

business purpose of some \$300,000 in cash advances made to Bakker and Taggart between 1984 and 1986.

"There was no back-up documentation for any of the cash advances, none of them," Howlett said.

"We tried to evaluate the business nature of these items, but we could not determine any business purpose," Howlett said.

Howlett also testified that records show neither Bakker nor Taggart attempted to reimburse the ministry for money taken from three executive accounts.

The PTL television ministry and Heritage USA theme park at Fort Mill filed for reorganization in bankruptcy court in June 1987, three months after Bakker left the ministry amid a sex and money scandal involving church secretary Jessica Hahn.

Earlier Tuesday, a former PTL accountant said he was frustrated that Bakker and other top ministry executives continually ignored his memos warning that the ministry financially was facing "real emergencies."

Peter Bailey, who was an accountant and financial director at PTL from June 1979 through July 1987, also testified that top executives received bonuses in anticipation of money coming into the ministry's coffers, but that there was often no money in the bank to cover those bonuses.

**Mobile Home Lots for Rent**  
**VILLAGE RESOURCES, INC.**  
P.O. Box 2122  
Greenville Greenville Ayden  
753-3003 758-5591 748-2425  
Ph. 919-752-7148  
Greenville, N.C. 27858

**Bunk Bed Headquarters**  
Over 20 styles available  
**Eargo**  
FURNITURE USA  
Down from Kmart 355-6050

## THE WHOLESALE OUTLET

### SOUTHPARK SHOPPING CENTER

756-8652

<p><b>VASELINE INTENSIVE CARE FOAM BATH</b> 8.5 Oz.</p> <p><b>VASELINE INTENSIVE CARE BATH BEADS</b> 15 Oz.</p> <p>YOUR CHOICE <b>89¢</b></p>	<p><b>CRAYOLA COLORWORKS COLOR STICKS</b> Pastel 12 Count</p> <p><b>2.19</b></p>	
<p><b>TRUST DEODORANT SPRAY</b> 4 Oz.</p> <p><b>TRUST OVAL SOLID DEODORANT</b> 2 Oz.</p> <p><b>TRUST ROLL ON DEODORANT</b> 1.5 Oz.</p> <p>YOUR CHOICE <b>89¢</b></p>	<p><b>AQUAMARINE SHAMPOO AND CONDITIONER</b> Shampoo Conditioner 15 Oz.</p> <p><b>89¢</b></p>	
<p><b>TYLENOL EXTRA STRENGTH GELCAPS</b> 24's</p> <p><b>1.89</b></p>	<p><b>JOHNSON'S BABY POWDER</b> 14 Oz.</p> <p><b>JOHNSON'S BABY POWDER CORNSTARCH</b> 14 Oz.</p> <p>YOUR CHOICE <b>1.89</b></p>	
<p><b>SCHICK SUPER II PLUS</b> 5's</p> <p><b>1.89</b></p>	<p><b>STRIDEX PADS</b> Regular 42's</p> <p><b>1.49</b></p>	<p><b>GAVISCON ANTACID LIQUID</b> 6 Oz.</p> <p><b>2.39</b></p>
<p><b>BENADRYL ANTI-ITCH SPRAY</b> 2 Oz.</p> <p><b>3.09</b></p>	<p><b>SEA BREEZE ANTISEPTIC</b> Regular and Sensitive 4 Oz.</p> <p><b>1.19</b></p>	<p><b>ANUSOL SUPPOSITORIES</b> 12's</p> <p><b>2.59</b></p>
<p><b>PLAYTEX LIVING GLOVES</b> Small, Medium and Large</p> <p><b>1.39</b></p>	<p><b>STORE HOURS</b> <b>MONDAY-FRIDAY</b> 9 AM - 8 PM <b>SATURDAY</b> 9 AM - 6 PM</p>	

**"OOPS! I HOPE IT'S AN ANSO Worry-FREE CARPET!"**

Even robots have their human moments—like spilling red wine all over the carpet. That's why you should get the advanced stain barrier protection of Anso Worry-Free™ carpet.

The stain barrier is so effective, most spills and foods—if cleaned up promptly—can be removed without a trace. And right now, we have a magnificent selection of luxurious colors and styles from which to choose.

Come see our Anso Worry-Free stain barrier carpets today. After all, nobody's perfect—not even robots.

**Anso Worry-Free CARPET**  
So stain resistant, it's Worry-Free.

Anso Worry-Free carpet has full protection:

- Built-in stain resistance barrier
- Built-in soil resistance
- Static control
- Wear resistance
- Full 5-year warranty\*

\*For details see Allied's SmartCare® for Carpet manual available at your carpet dealer or call 1-800-992-9014.

## Waters Carpet Center, Inc.

22 Years In The Carpet Business  
"Where Quality Installation Counts"  
Phone 756-2341  
Winterville, N.C. 28590  
S.J. Waters Mike Waters Buddy Waters  
"Pitt County's Original Carpet Specialty Business"

# Radon Threat Minimal In N.C.

CHARLOTTE (AP) — About 10 percent of North Carolina homes may have excessive levels of radon, a radioactive gas that can cause cancer, state officials say.

The highest percentage occurs in the mountains, where granite that contains uranium-producing radon lies near the surface of the ground.

The state's top radiation official, Dayne Brown, said about 25 percent of the homes sampled in the mountains exceeded the federal health standard of 4 picocuries per liter. Brown said the highest reading he recalled was between 45 and 50 picocuries.

The U.S. Environmental Protection Agency reported Monday that 29 percent of the 15 million homes surveyed last winter in seven states and on Indian land in two more states exceeded the agency's acceptable standard of 4 picocuries per liter.

But the Radiation Protection Section in the N.C. Department of Human Resources conducted a survey of 500 homes in the state last year and found the radon problem does not appear to be as severe as in other parts of the country, said Mel Fry, deputy chief of the Radiation Protection Section of the N.C. Department of Human Resources.

Brown, who is chief of the N.C. radiation protection section in Raleigh, said surveys have shown that high radon levels are associated with houses that have a basement, have baseboard heating that doesn't

allow for air exchanges and are well-insulated.

He said homeowners can lower radon levels in their houses by opening windows on mild days and by sealing cracks in concrete and holes around pipes with a special caulk.

Meanwhile, officials at the EPA in Research Triangle Park said they were inundated Tuesday with telephone calls from North Carolina residents concerned about radon.

"We've been swamped. The phone has not stopped," said Deborah

Janes, an EPA spokeswoman in the Research Triangle Park.

Ms. Janes said the EPA is recommending that homeowners test their homes for radon with an inexpensive testing device. If elevated levels are found, more comprehensive followup tests that measure the average annual radon exposure should be done before expensive remedial measures are taken, she said.

The gas, which can't be seen, felt or smelled, occurs naturally by the breakdown of uranium, which is radioactive.

While the federal government determines the danger of radon gas mostly on studies of uranium miners rather than homeowners, officials are convinced that the problem is serious.



NUCLEAR PROTEST — Members of the Shearon Harris Action Group stage a symbolic protest near the Harris Nuclear Power plant at Newhill, southwest of Raleigh, on Tuesday. The group wants the plant closed, contending it was rushed to completion and that emergency planning has been insufficient. (AP Laserphoto)

## Grand Jury Studies Hatcher's Absence

By The Associated Press  
A federal grand jury in Fayetteville is investigating the whereabouts of Eddie Hatcher, who failed to surrender two weeks ago after a federal appeals court repealed his bail on hostage-taking charges, officials say.

"It's my understanding that the grand jury is investigating anyone with knowledge of Mr. Hatcher and his whereabouts," said Marshal Bill Berryhill. "It's pretty much an investigative grand jury looking into Mr. Hatcher's status as a fugitive and how it came about."

Dale McKinley, a student activist at the University of North Carolina at Chapel Hill, said he and three Robeson County residents were questioned Tuesday before the grand jury. McKinley, who met with Hatcher on the UNC-Chapel Hill campus before Hatcher disappeared, said he and the others did not know where Hatcher was.

"I think the whole exercise that the grand jury did today (Tuesday) was basically based on hearsay," McKinley told the News and Observer of Raleigh. "In all four of our situations, it was ridiculous to put us through what they did."

McKinley said FBI agents and federal marshals had staked out his house and had followed him in a car earlier this month.

McKinley said he had been questioned before the grand jury by Assistant U.S. Attorney John Stuart Bruce, who is prosecuting Hatcher and Jacobs. Bruce declined to discuss the grand jury proceedings.

Hatcher, 30, and Timothy Bryan Jacobs, 20, are charged with taking up to 20 hostages at The Robesonian newspaper in Lumberton Feb. 1. Both men also face federal weapons charges. Jacobs surrendered Aug. 31 and is scheduled to go on trial Sept. 26.

Hatcher and Jacobs were ordered to surrender after the 4th U.S. Circuit

Court of Appeals in Richmond, Va., reinstated a lower court order requiring them to be held without bail until the appeals court decides whether they were detained properly in the first place. They had been jailed without bail after the hostage siege until they were released July 5.

U.S. District Judge Terrence Boyle, who is scheduled to preside at the trial, denied a motion Tuesday by Jacobs' lawyers for Jacobs' release pending trial.

Berryhill said he thought Hatcher was being "hidden away someplace."

"We continue to feel that Mr. Hatcher is being purposefully hidden until some decision is made as to when it would behoove him to reappear with appropriate fanfare," Berryhill said.

"I don't consider that he is in flight, as you would think the normal textbook fugitive is," he said. "In normal fugitive cases there are sightings. There is a constant flow of information into law enforcement from informants, from people who have had contact with him, from attempts to buy or steal transportation."

"In this day and time, it is very, very difficult for a human being to disappear off the face of the Earth without some assistance, and that is literally what Mr. Hatcher has done," Berryhill said.

Meanwhile, a 28-year-old construction worker from Robeson County said he was detained early Saturday by gun-wielding officers who mistook him for Hatcher.

Lesley Manuel Dial, 28, said he was driving his father's Cadillac with a friend at 2 a.m. when he was stopped by officers in the Prospect community.

"They said, 'All right, Eddie Hatcher, pull over. Get out of the car with your hands up. You're under arrest,'" Dial told The Fayetteville Times on Tuesday.

Health Supplies of America

We're your headquarters for ostomy supplies, bladder control products & diabetics supplies. See us for your home health needs.

BUYERS MARKET, MEMORIAL DRIVE

355-7997

REAL-FYRE Gas Logs



With Glowing Embers They Look Real!

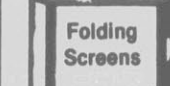

Folding Screens



Grates

See Our Burning Display

Wide Selection Of Good Used Fireplace Inserts From \$199. Get Them While They Last!

Schaefer Fireplace

GLASS DOORS

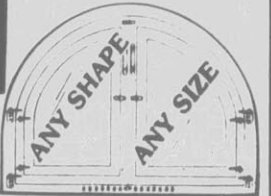

Tar Road Antiques & Fireside Shop

• Fireplace Accessories • Chimney Sweeping

• Furniture Stripping & Refinishing

On the old Tar Road 1 mile south of Sunshine Garden Center-P.O. Box 913, Winterville, N.C. 28590

(919) 355-6003 • Night 756-1007

Hours: 8-3 Saturday; 10-6 Mon.-Fri. • In-Home Evening Appointments Available



## THE OPENING CEREMONIES OF MARY FRANCES CENTER

Saturday, September 17

Ribbon Cutting Ceremony with Governor James G. Martin  
1:00 p.m.-2:30 p.m.  
Open House 2:30 p.m.-5:00 p.m.

Sunday, September 18

Open House 1:00 p.m.-5:00 p.m.

The Board of Directors of Mary Frances Center, B. Mayo Boddie, Sr., Chairman, Rocky Mount; R.E. Barnhill, Jr., Tarboro; Nicholas B. Boddie, Rocky Mount; William G. Clark, III, Tarboro; Vinton Fountain, Jr., Tarboro; Jack A. Laughery, Rocky Mount; Ben C. Mayo, II, Tarboro; C.W. Mayo, III, Tarboro; Thomas Urquhart, Raleigh and Tom O. Palmer, Tarboro, cordially invite you to the opening ceremonies. This will be your opportunity to see North Carolina's newest, and most complete, alcoholism and chemical dependency treatment facility prior to its official opening on Monday, September 19, 1988.



1212 Recovery Road, Tarboro, NC 27886  
For more information, please call (919) 641-1111  
1-800-999-4TLC



mary frances center

WE'RE CAUGHT WITH TOO MUCH MERCHANDISE

**FRANCINE'S BOUTIQUE**  
107 W. Main Downtown Washington

Every Single Item In Our Store Is Reduced Including New Fall Arrivals

**OUT GOES the SURPLUS STOCK**

IN MANY CASES

**1/2 PRICE** And much LESS

Mon.-Sat. 9:30 a.m.-5:30 p.m.

# Wet, Calm Weather Brings Relief For Firefighters

By JONATHAN W. OATIS  
Associated Press Writer

Firefighters battling Western blazes got a helping hand from weather so cool and wet that a crew was pulled out of a wilderness near Yellowstone National Park for fear they'd be trapped by snow.

"Things are real calm," said park spokesman Greg Kroll. "We've had some pretty good precipitation."

Fires also burned in California, Utah, Oregon, Idaho, Montana, Alaska and Washington state as the worst fire season in 30 years continued.

Calmer 5-7 mph winds, lower temperatures and higher humidity were a blessing to California's Gold Rush country, where a fire that has burned 52 square miles since Sunday has destroyed 97 homes and 60 other buildings.

The thousands of residents evacuated Sunday or Monday were allowed to return to their homes.

"As far as I know, we have allowed everyone who wants to return home to do so," state Department of Forestry spokesman Steve Iverson said Tuesday.

But some of the 8,000 residents evacuated had little or nothing to return to in the charred foothills of the Sierra Nevada northeast of Sacramento.

Preliminary damage estimates were set at about \$9 million, but authorities expected the figure to climb.

Officials also prepared today to begin relieving some of the 2,800 firefighters who have battled the fire, which consumed more than 52 square miles of timber and brush or 33,500 acres since it was started Sunday.

"If it holds through the night, we'll consider releasing some people," said Iverson, the planning chief for the firefighting force.

About 30,000 firefighters were battling 32 fires in eight Western states, said White House spokesman Marlin Fitzwater. President Reagan received a briefing Tuesday from a Cabinet-level team that toured Yellowstone.

As of Tuesday, wildfires had charred 4,104,000 acres, an area larger than Connecticut, according to the Boise Interagency Fire Center, which coordinates firefighting in the West.

At Yellowstone, officials kept an eye on the weather. Rain continued falling Tuesday in parts of the oldest national park. Today's forecast held a slight chance of showers, but called for a return of summer temperatures and more wind, said Kroll.

"The fires are still a threat, we are not out of it yet," said fire informa-



tion officer Sonya Capek.

Firefighters used the break to strengthen lines. Meanwhile, about 550 Marines from Camp Pendleton, Calif., the first of 1,200 sent to reinforce the 7,200 firefighters in the park, arrived in West Yellowstone, Mont.

The weather was so cool officials began distributing cold-weather gear donated by residents of Wyoming communities. Few firefighters had been prepared for the cold and wet.

In the Bridger-Teton National Forest southeast of the park, a 38,507-acre fire was declared contained and a 225,500-acre complex of fires was 85 percent contained with full containment expected by Thursday.

North of the park, a 93,000-acre fire that threatened Cooke City and Silver Gate was declared 90 percent contained with complete containment expected by Saturday.

A crew was pulled out of the Absaroka-Beartooth Wilderness north of the park, said fire information officer Ted Coffman.

"We were afraid if we put a crew in there we might not be able to get them out if it snowed," Coffman said.

At Glacier National Park in Montana near the Canadian border, 1,300 firefighters joined by a Canadian "hot-shot" crew had a 31,500-acre blaze 30 percent contained. The fire has destroyed 21 homes, killed one firefighter and injured six others.

"We're working maximum effort and the next couple of days are important to us," said fire information officer Ted Coffman.

Fires have blackened 939,270 acres of the 2.2 million-acre park. Blazes in national forests and parks surrounding Yellowstone in Wyoming, Montana and Idaho bring the total to 1.4 million acres.

officer Jim Payne.

Firefighters were to be joined today by 1,400 Army soldiers from Fort Lewis, Wash.

Elsewhere in Montana, 1,100 firefighters attacked a 247,000-acre fire north of Helena, crews demobilized from a fire in the far northwest part of the state and rehabilitation work began near Cooke City and Silver Gate north of Yellowstone.

Controversy has surrounded the Yellowstone fires because of the

Park Service policy of not fighting most naturally-caused blazes.

Reagan said Tuesday he had not been aware of the policy, but said Interior Secretary Donald Hodel told him it was being withdrawn.

Colorado Gov. Roy Romer said Democratic presidential candidate Michael Dukakis would join him, Wyoming Gov. Mike Sullivan, Montana Gov. Ted Schwinden and Idaho Gov. Cecil Andrus on Thursday to survey fire damage in Yellowstone and discuss policy.

## House To Vote On Pesticide Bill

WASHINGTON (AP) — Farm lawmakers are moving to impose an eight-year deadline for the completion of safety research on hundreds of chemicals that are used to protect crops from damaging pests.

The plan, aimed at toughening federal regulation because of growing concern about potential health hazards, won House Agriculture Committee approval Tuesday on a voice vote and now heads to the House floor.

Under the legislation, the Environmental Protection Agency would have eight years to complete its safety reviews of hundreds of pesticides.

The agency, working under no deadline, has been finishing reviews of about two dozen chemicals a year since the mid-1970s when it took over the job from the Agriculture Department.

The legislation also would largely end government payments to chemical companies to buy up supplies of recalled pesticides. Such payments have totaled \$20 million so far.

## Group Says Teacher Supply Good

WASHINGTON (AP) — An independent education group says its survey of American schools and education officials indicates there is no shortage of qualified teachers despite frequent talk to the contrary.

"The facts are that there is no teacher shortage," C. Emily Feistritz of the National Center for Education Information said Tuesday.

She said the group's "Teacher Supply and Demand Surveys 1988"

report shows that not only is the alleged teacher shortage unsubstantiated, the teaching market was glutted, with some school districts maintaining large applicant lists.

The center's surveys, conducted June 28-Aug. 28, were directed at teacher certification and education offices across the nation, 75 school districts, and more than 1,000 individuals who had been seeking teaching jobs.

The National Education Association disputed the results, with NEA spokesman Howard Carroll saying past NEA surveys indicated that vacancies reported during the summer months usually were not filled by new full-time hires in September.

"These school districts say they hired temporaries, or substitutes, reassigned teachers' aides, misassigned teachers, eliminate or reduce course offerings," he said. "We generally find that 20 percent of the schools will increase class size."

"This is merely a smokescreen to mask the hiring of temporaries and uncertified teachers," he said.

Feistritz said the state boards maintained that all their teachers were certified and noted that many had a policy of placing all new hires on a probationary or temporary status.

She acknowledged that the surveys found a shortage in bilingual and special education teachers, but ascribed the outcry over a teacher shortage partly to political considerations.

## NBC Will Carry Presidential Debate Live

NEW YORK (AP) — NBC will carry the first presidential debate live, reversing an earlier decision and taking a potential \$8 million loss when it interrupts its prime-time coverage of the Summer Olympics.

NBC President Robert C. Wright said Tuesday the change was made because "there is no more important news story than selecting the 40th president of the United States."

ABC and CBS have already said they would carry the Sept. 25 debate live.

NBC had said last week when the date of the first debate between Vice President George Bush and Massachusetts Gov. Michael Dukakis was announced that it would carry the debate on a tape-delayed basis rather than interrupt the Olympics.

On Tuesday, Wright issued a statement saying NBC would interrupt the Olympics for 90 minutes for the debate, then return to Seoul, bringing viewers up to date and resume live coverage of the Olympics.



**FALL SALE**  
**SAVE OVER**  
**50%**

IFI Knit Dresses	\$29 <sup>99</sup>
DEPT. STORE \$52	
Two Piece Knit Skirt Sets	\$29 <sup>99</sup>
DEPT. STORE \$56	
IN GROUP Challis Skirts	\$18 <sup>99</sup>
DEPT. STORE \$38	
BRIGGS Lined Gab Skirts	\$19 <sup>99</sup>
DEPT. STORE \$32	
ERIKA Fine Gauge Sweaters	\$16 <sup>99</sup>
DEPT. STORE \$30	
RAFAELLA Linen Sweaters	\$16 <sup>99</sup>
DEPT. STORE \$48	

# HELP SUPPORT CRIME STOPPERS



## ELETHON

### CABLE TV 7 & 9

Call 756-5677  
1-11 pm Sat, 1-7 pm Sun  
**SEPT. 17-18, 1988**

CABLE TV SITE ARLINGTON BLVD.  
GREENVILLE, N.C.

★ LIVE ENTERTAINMENT ★ D.J.'S ★  
REFRESHMENTS ★ BALLOONS ★ PRIZES ★ ETC.

★ SPONSORED BY ★  
PITT-GREENVILLE CHAMBER OF COMMERCE  
COMMUNITY SAFETY COMMITTEE  
AND PITT-GREENVILLE CRIME STOPPERS, INC.

*Arlington Hall*

**Our New Address**  
**690 Ashley Way**  
**in Arlington Village**  
**Opening Exhibit**  
**Sept. 13th**  
**355-2426**  
**Hours: Mon.-Fri. 10 to 5**  
**Sat. 11 to 4**

**RAISE S.A.T. SCORES!**

- Ideal For Juniors And 11/5/88 S.A.T.
- 7 Week Comprehensive Course
- Two Full Practice Tests
- Give Your Student A Huge Advantage
- Only 5 Openings - Call Today!
- Starts 9/19/88

**756-7766 After 7 p.m.**  
For Information

**"BELLY" DANCE LESSONS**

An ancient folk dance that has become a modern exercise.

For women of all ages who want to stretch and tone, to learn relaxation techniques and stress release. To release energy you never knew you had!

Registration-Call Donna Whitley  
**355-5150**

Class begins first week of October

For All Her  
**Back-To-School**  
**Dancewear Needs!**



*At Barre, Ltd.*

644 Arlington Blvd., Arlington Village

# DRESS BARN

**Famous Fashion Labels... Always 20-50% Off!**

GREENVILLE BUYERS MARKET—Memorial Dr.

ALWAYS 20-50% OFF DEPARTMENT STORE PRICES. NO SALE IS EVER FINAL!  
OPEN 7 DAYS, 6 NIGHTS. MAJOR CREDIT CARDS ACCEPTED.

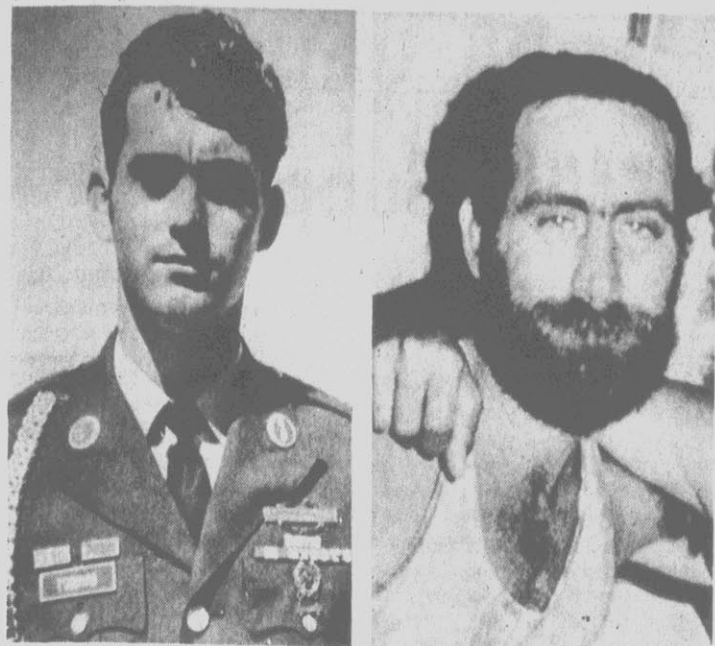

**HAUNTED** — Police Robert W. T'Souvas, shown at right in 1987, died as a bum, a 39-year-old drifter killed in a spat over vodka. His family says he started downhill after the Army charged him with killing two children at My Lai. The photo at left shows him after his return from Vietnam in 1970. (AP Laserphoto)

## Drifter Was Haunted By My Lai Massacre

PITTSBURGH (AP) — A drifter found dead 1½ weeks ago following an argument with his girlfriend over a bottle of vodka was haunted by his role in the My Lai massacre during the Vietnam War, relatives say.

"He actually was a casualty of the war," said Rebecca T'Souvas, estranged wife of Robert W. T'Souvas. "He had such problems from what was wrong in Vietnam. Nothing was ever right for him."

"He was just a weak person," she said. "I'm sure it was because of Vietnam and because of what he had to endure there. But he was a gentle man and a very good person when he was not under the influence."

Robert T'Souvas, 39, was shot to death Sept. 3 beneath the Smithfield Street Bridge in downtown Pittsburgh.

His girlfriend, Kathlynn T'Souvas, 36, who took his last name even though he never divorced Rebecca T'Souvas, has been charged with criminal homicide and is being held without bail at the Allegheny County Jail. A coroner's inquest is scheduled for Thursday.

Army Spec. 4 T'Souvas, then 19 and a high school dropout in San Jose, was a member of one of three platoons that entered the village of My Lai on March 16, 1968, where, he told an Army hearing in 1970, he saw about 30 bodies, "old men, women and children."

"On the way out, T'Souvas saw two small children lying in the road with their intestines hanging out," said his attorney, George T. Davis of Mauna Lani, Hawaii. "In an emotional reaction, he took his M-16 and killed both to put them out of their misery."

The Army charged T'Souvas with premeditated murder of two unidentified Vietnamese with a machine gun. He was one of nine enlisted men charged in the massacre, in which more than 100 civilians were killed.

After two soldiers were acquitted at courts-martial, charges against T'Souvas and the six others were dropped. All were given honorable discharges.

Army Lt. William Calley was convicted of killing at least 22 civilians at My Lai. President Richard Nixon reduced Calley's life prison sentence to 20 years. Calley served three years under house arrest at Fort Benning, Ga. He was released when his conviction was overturned by a federal district judge, and he was not returned to house arrest when an appeals court reinstated the conviction.

While awaiting trial at Fort McPherson, Ga., T'Souvas lived in an Atlanta hippie commune, where he met his wife, according to family members. Both later spent time in jail on marijuana charges before they moved to California, the relatives said.

They raised two children and T'Souvas worked in a bakery and at various jobs before their marriage broke up, Lynn T'Souvas, an aunt, said.

About four years ago, he met Kathlynn, a carnival worker. "She liked alcohol and was his drinking companion," said his father, William T'Souvas, of San Jose, Calif.

Police said the couple's trailer burned down and they left California in August 1987 for Pittsburgh, where T'Souvas hoped for a construction job.

Police said Kathlynn's diary showed they lived in the van, often parking it near Three Rivers Stadium, as they fished in the rivers, sold their blood for money and worked part-time in a food kitchen for the unemployed and the homeless.

After the van broke down this summer, they built a makeshift shelter on the banks of the Monongahela River, police said.

On Sept. 3, police said, the T'Souvases and another homeless man, David Bozic, 42, spent the day drinking, fishing and using Bozic's .22-caliber pistol to shoot rats and cans under the bridge.

While Bozic went to get food, police said the couple argued over a bottle of vodka T'Souvas held between his legs. Police said the woman took Bozic's gun and shot T'Souvas once in the head.

William T'Souvas said he last talked to his son a few days before the shooting.

"I just tried to tell him to put it together and come home," he said. "I sent him some money, but he never came."

## Reagan Says Strong Economy Continuing

CAPE GIRARDEAU, Mo. (AP) — President Reagan, on a political trip for his vice president George Bush, declared today that the national economy is strong and "what we have seen in the last eight years is only the beginning."

"We intend to ensure this kind of economic prosperity right through the '90s and into the next century by guaranteeing the federal government can never again spend and tax the American people into another economic nightmare," Reagan said.

The president's remarks were prepared for delivery at a Republican rally at Southeast Missouri State University in this Mississippi River shipping center.

He was to speak later in the day to an expected crowd of 1,000 at a \$250-a-plate GOP fund-raising dinner in St. Louis.

In his Cape Girardeau speech, Reagan said children born today "will know the brightest future the world has ever seen."

"That bright future is also yours," he told his audience. "It is your birthright as Americans, and what we have seen in the last eight years is only the beginning."

The national economy has been expanding for more than five years following the steep recession that marked Reagan's first two years in office.

"Ultimately, the choice before the American people is the choice between two visions," he said. "It is the choice between the policies of liberalism or the policies of America's po-

litical mainstream."

The president, a former Democrat, said that party's "liberal leadership ... has turned a once proud party of hope and affirmation into one dominated by strident liberalism and negativism."

"The truth is that when you take a walk down our opposition's memory lane, it starts to look like a 'Nightmare on Elm Street.' If you want to remember how things really were just a few years back, think of the year 1979," he said.

"In that one year, Iran, Nicaragua and Grenada were all lost. That was the year 1979. Don't we have the right to ask the American people: If the liberals return to power, what happens in 1989?"

Spokesman Marlin Fitzwater said in advance of the trip that Reagan would be giving "traditional political speeches" trying to win support for the Republican ticket of Bush and Dan Quayle.

**WALLCOVERINGS**  
30-50% OFF  
Family Operated • In the business for over 15 years!

9 a.m. to 5 p.m. E.S.T. Mon.-Sat.  
Shop & call with book name and pattern no.  
BUY IN THE SOUTH FROM SOUTHERNERS  
TOLL FREE 800-848-7283  
Kinaton, N.C. 28501

## Tomorrow's Heirlooms At Today's Sale Prices 40% Off Cresent Solid Honduras Mahogany 18th Century Bedroom Collection



40% Off Retail Prices On All Cresent Mahogany Bedrooms



Each Piece Hand Crafted With 18 Step Hand Rubbed Finish. Solid Oak Drawer Sides & Backs. Hand Fitted Drawers. Solid Wood Drawer Guides. Recessed Back Panel. Wood Rails With All Beds.

\$426 Off Double Dresser & Landscape Mirror

9 Drawers. 54" Double Dresser. Beveled Landscape Plate Glass Mirror

SALE PRICE **\$649**

\$501 Off 60" Triple Dresser & Pediment Mirror

60 Inch 9 Drawer Dresser With Pediment Crown Beveled Plate Glass Mirror

SALE PRICE **\$749**

\$216 Off Twin Or Full Size Low Poster Bed. Wood Rails

SALE PRICE **\$339**

\$300 Off Full Size Tall Post Tester Bed. Wood Rails

SALE PRICE **\$450**

\$371 Off Chest On Chest Solid Honduras Mahogany. 7 Drawers

SALE PRICE **\$549**

\$295 Off Solid Honduras Mahogany Chest Of Drawers 45" Tall

SALE PRICE **\$425**

\$325 Off Queen Size Poster Bed Solid Honduras Mahogany

SALE PRICE **\$475**

\$355 Off Queen Size Pencil Post Bed. Solid Honduras Mahogany

SALE PRICE **\$495**

\$120 Off Queen Anne Nite Stand. 1 Drawer. Solid Mahogany

SALE PRICE **\$175**

\$146 Off 3 Drawer Nite Chest Solid Honduras Mahogany

SALE PRICE **\$219**

## SAVE \$646 TO \$845 ON 5 OR 7 PIECE SOLID CHERRY DINING ROOM



Solid Pennsylvania Cherry 18th Century Queen Anne 5 Piece Dining Room Group

SALE PRICE **\$969**

44" X 60" Oval Queen Anne Table. Extends To 90 Inches. 2 Arm & 2 Side Queen Anne Chairs.

\$845 Off 7 Piece Solid Cherry Queen Anne Dining Group

CRESENT

Oval Table & Two Arm & 4 Side Queen Anne Chairs

SALE PRICE **\$1249**

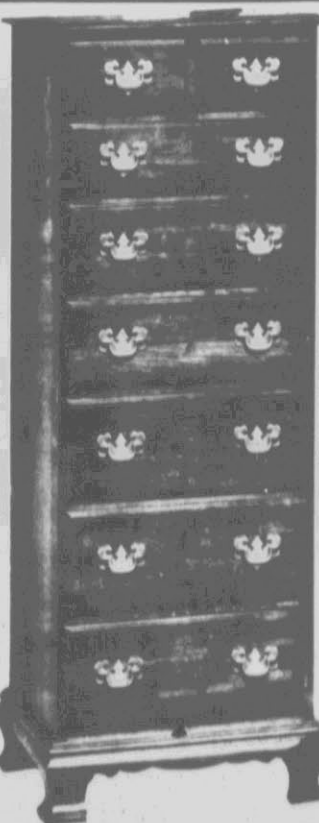

\$220 Off Cresent Solid Pennsylvania Cherry Seven Drawer Queen Anne Lingerie Chest

SALE PRICE **\$320**

Hand Rubbed Finish. Solid Oak Drawers, Sides & Back.

Save \$56 To \$150 On Solid Pennsylvania Cherry Headboards & Complete Beds

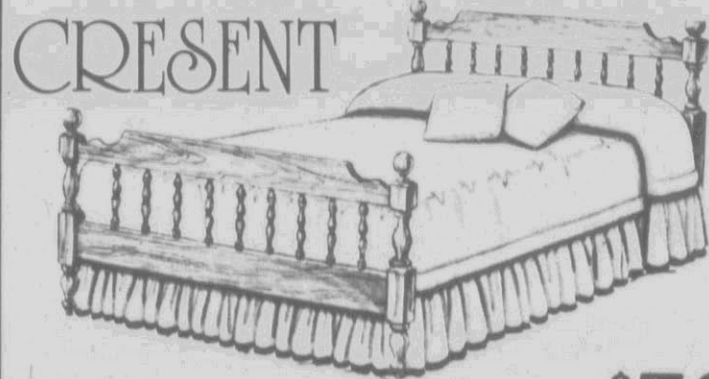

\$56 Off Twin Size Solid Pennsylvania Cherry Headboard

SALE PRICE **\$79**

\$71 Off Full-Queen Solid Pennsylvania Cherry Headboard

SALE PRICE **\$99**

\$150 Off Twin-Full Or Queen Spindle Bed

Your Choice Of All 3 Sizes Hand Rubbed Finish. Complete With Matching Wood Rails

SALE PRICE **\$225**

Lifestyle

# Cancer Society Names Officers

Harvey Sharp Wooten was installed as president of the Pitt County Unit of the American Cancer Society Tuesday night.

Other officers installed during the annual awards meeting were Dr. Albert Wiley, first vice president, John West, second vice president, Jeannette Waters, treasurer, and Ernestine Haselrig, secretary. Installing officers were Barbara and Jim Woods.

Keith Norwood, crusade chairman for the Beaufort County Unit of the ACS, was keynote speaker. He told of positives and negatives, goal setting and motivation for crusades.

Highlights of the evening were the presentation of awards. Frances Young of Bethel received the Silver Bowl Award while the Sword of Hope Award went to Betty Sue Forest. Quality of Life Awards were presented to Craig Bruno and Nancy Smith. A new award, Life Saves Award, was given to Melissa Minter.

Rose Richards, director of the Pitt County unit, presented the Volunteer of the Year Award to Ms. Wooten and Ms. Young, co-winners.

Special recognition was given to Mrs. Richards for her work with the American Cancer Society.

A reception was held honoring the outgoing and incoming officers.

Providing crusade reports were: Judy Pollard, Arthur; Susan Wilson, Ayden; Eugene and Pat James, Belvoir; Ms. Young, Bethel; Sally Glisson, Carolina; Hazel Edwards, Chicod; Joyce Peaden, Falkland; Roger and Anna Barefoot, Farmville; Marie Gardner, Fountain; Ed and Hazel Bright, Grifton; Joanne Miller, Grimesland; Millie Tripp,

Pactolus; Jenny Louy Strickland, Swift Creek; Joan Hooks, Winterville, and Jo Saunders, Greenville.



HARVEY S. WOOTEN

**MEATS WITH FAT**  
NEW YORK (AP) — Americans are cutting away more fat from their red meats.

In 1979, says the Reebok Aerobic Information Bureau, the average American household cut away about 3.5 grams of fat a day. In 1985, that figure rose to 7.5 grams.

# Orchids To Hubbies For Wife Support

**DEAR ABBY:** Three cheers for Wayne Gretzky, the world's No. 1 hockey star! He left the Edmonton Oilers to join the Los Angeles Kings because his bride's movie career would be jeopardized if she left Hollywood for Canada.

Gretzky's move has special significance for me because my husband did the same thing for me 16 years ago, when I was an energetic young executive employed by a large national organization with offices in every major city in the country. I was offered a once-in-a-lifetime opportunity that would necessitate moving from Los Angeles to New York. My husband was doing well at the time with a California law firm. I didn't even have to ask him. He offered to move to New York to further my business career! The word "wimp" was not even in the language then, but he was called "weak," and a few other things that are not printable.

As it turned out, it was a great move for both of us. I'm sure this is not so unusual today, but 16 years ago, it took a real man to subordinate his career to his wife's. — MARILYN IN N.Y.C.

**DEAR MARILYN:** Orchids to your husband. Coincidentally, 16 years ago another young lawyer, James Schroeder, uprooted himself (from Denver) to follow his wife to Washington, D.C., when she was elected to the U.S. House of Representatives. It also turned out to be a great move for both of them. I agree, it takes a strong, unselfish man to put his wife's career ahead of his own. Lucky Patricia Schroeder!

## Dear Abby

Abigail Van Buren

**DEAR ABBY:** I am a widow (age 70) living alone in a remote part of Florida. I recently made a trip to Germany, my native country, after many years. Naturally, I visited relatives and friends. I stayed one week with a close girlhood friend — the mother of three grown children. She was very good to me and knows that she is welcome here at any time.

Well, she has written to tell me that her 25-year-old unmarried son, whom I met for just a few minutes, is coming to America to stay for several months. She informed me that she had given him my address and phone number, and I should "expect" him.

Abby, I know that he was well-raised, but I am old-fashioned and the thought of having this young man as a guest for several months is not pleasing to me.

What shall I do? — OLD-FASHIONED

**DEAR OLD-FASHIONED:** I think you should write to this "close girlhood friend" and tell her quite honestly what you have told me, that you would not be comfortable having her son stay with you for several months. Offer to put him up for a week until he can make other arrangements.

**DEAR ABBY:** My husband is a business executive, but every once in a while he will make a grammatical error, so I correct him. He blows up

like you wouldn't believe and doesn't speak to me until the next day.

Should I just let it go when he makes mistakes in grammar? I only want to help him and he knows it, but he can't take any kind of criticism. Please tell me how to handle this. — MEANS WELL

**DEAR MEANS WELL:** I hope you do not correct him in the presence of others. If you do, he can't be blamed for reacting in a hostile manner.

When he's in a good mood, have a heart-to-heart talk with him. Tell him

you love him and ask him if he wants to be corrected (privately, of course) when he makes a mistake in grammar. If he doesn't, bite your tongue and let it go.

Is your social life in a slump? Get Abby's booklet, "How to Be Popular" — for people of all ages. To order, send your name and address, plus check or money order for \$2.89 (\$3.39 in Canada) to: Dear Abby, Popularity Booklet, P.O. Box 447, Mount Morris, Ill. 61054.

## State President Is Key Speaker

The Patient Circle of the International Order of the Kings Daughters and Sons held its meeting last week. Margaret Highfill, state president, was keynote speaker.

She told of the international convention which was held in Savannah, Ga. She commended the order on accomplishments in various departments. The circle continues to assist young people in the departments of student ministry and health careers.

Mrs. Highfill announced the N.C. branch convention will be held in Greenville Oct. 1.

A devotional on righteous living was presented by the Rev. Dan Earnhardt.

Kemp Baldwin and Frances Riddick were guests for the meeting. Dr. Lois Staton, local circle president, recognized Phoebe Owens, Carmen Albea and Edie Baker as new members.

The meeting hostess was Mrs. Luther Moore.

## ENROLL NOW

### Touch of Class

Modeling School

Corner of First & Pitt Sts., Greenville

**752-0509**

Guys & Girls 5 & up

- Low Monthly Rates
- Modeling in the Community
- Exciting Regional USA Modeling Conventions
- Gain Poise, Confidence & Self Esteem
- Finishing Course

Access To National & International Modeling & Casting Agencies-Film & TV

Registration At The School  
Mon. 6:15-9:15 p.m.  
Wed. 6:15-9:15 p.m.

Other Information after 6 pm  
736-7665

## Area Births

### Edwards

Born to Mr. and Mrs. David Earl Edwards, 1309 S. Greene St., a daughter, Danisha Dacole, on Aug. 24, 1988, in Pitt County Memorial Hospital.

### Ball

Born to Mr. and Mrs. Arthur Lewis Ball Jr., Washington, N.C., a daughter, Mallory Nicole, on Aug. 24, 1988, in Pitt County Memorial Hospital.

### Symons

Born to Mr. and Mrs. Dennis Martin Symons, 1104 Kent Drive, a daughter, Meredith Grace, on Aug. 24, 1988, in Pitt County Memorial Hospital.

### Irvin

Born to Mr. and Mrs. Howard Van Irvin, Fountain, a son, Russell Eliot, on Aug. 25, 1988, in Pitt County Memorial Hospital.

### Sawyer

Born to Mr. and Mrs. Edgar Thornton Sawyer III, Route 2, Greenville, a daughter, Ashley Danielle, on Aug. 25, 1988, in Pitt County Memorial Hospital.

### Sloan

Born to Mr. and Mrs. Vonne Lee Sloan, Williamston, a son, Lucas Ray, on Aug. 25, 1988, in Pitt County Memorial Hospital.

### Holmes

Born to Mr. and Mrs. Mark Alan Holmes, Fountain, a daughter, Brandy Michelle, on Aug. 26, 1988, in Pitt County Memorial Hospital.

### Perry

Born to Mr. and Mrs. Marvin

Albert Perry, Jamesville, a daughter, Allison Lorraine, on Aug. 26, 1988, in Pitt County Memorial Hospital.

### Prayer

Born to Mr. and Mrs. Gregory Prayer, Walstonburg, a daughter, Ashley Nicole, on Aug. 27, 1988, in Pitt County Memorial Hospital.

## Bridge Games Are Played

Duplicate bridge games were played Thursday and Saturday nights at the Senior Center.

North-South winners Thursday included, Mrs. Wiley Corbett and Lee Hastings, first with .65 percent; Mr. and Mrs. Rick Johnson, second, and Sam Taylor and Masao Kishore, third.

East-West winners were Ned Kinsey and Phil Lewis, first with .60 percent; Mr. and Mrs. Everett Pittman, second, and Dave Proctor and Graham Davis, third.

Mrs. Mel Wright and Mrs. A.L. Roque were first place North-South winners with .66 percent Saturday. Others placing were Mrs. Wiley Corbett and Lee Hastings, second; Mr. and Mrs. Jeff McAllister, third, and Mrs. William McConnell and Lewis Newsome, fourth.

East-West winners included, Marjorie Crisp and Lynda Land, first with .62 percent; Mr. and Mrs. Everett Pittman, second; Maggie Gentile and Mrs. W.R. Harris, third, and Dave Proctor and Dr. Charles Duffy, fourth.

curtain call  
draperies, bedspreads & accessories  
WE ARE NOW LOCATED AT  
1010 SOUTH EVANS STREET  
752-9736

For Information About Fall Registration Call  
down east dance  
2500 Trent Road, Suite 2  
New Bern, N.C.  
636-1760  
419 Evans Mall  
Greenville, NC 27834  
830-9284

FACTS YOU SHOULD KNOW

1 out of 11 women will develop breast cancer at some time in their lives.

8 out of 10 breast lumps are benign (noncancerous)

9 out of 10 breast tumors are found by women themselves.

9½ out of 10 women treated for early breast cancer will be alive five years later.

Breast Screening Mammography  
EASTERN BREAST CANCER DETECTION CENTER, INC.  
CHARLES CENTRE  
2404 S. Charles St., Suite A  
Greenville, NC 27858  
(Charles Street near Red Banks Road next door to Fire Station)  
APPOINTMENTS NOW AVAILABLE 752-2847

"Brides Beautiful"  
Summer Clearance  
20 to 50% off our entire stock of summer wedding gowns & prom dresses thru September

Also...  
Come see our new lines of wedding gowns, mothers dresses & bridesmaid dresses in exciting fall & winter colors, as well as sparkling party dresses for that Christmas party coming up.

For a complete line of formal wear for women and, of course, tuxedo rentals for men, shop...

"Brides Beautiful"  
"We make those memorable moments perfect for you."  
Open Mon.-Fri. 10-6, Sat. 10-4  
109 Arlington Blvd., Greenville Phone 756-1744

Final Sale  
50% to 60% Off  
Now Take An Extra 20% Off  
Spring and Summer Merchandise  
Summer Scarves  
Values to \$18.00 Now \$4.00  
the Snooty Fox  
698 E. Arlington Blvd., Arlington Village  
355-5080 Open Monday-Saturday 10-6

THE Linen Tree  
The Plaza, Greenville, 756-7872  
Country Ruffles  
Elegant Single or Double Ruffled Country Curtains  
Sale  
Quality Country Ruffles for any decor. High headers, beautifully pre-tied bows & beautifully stitched fabric with matching bedspread & accessories. Classic Ruffles in natural, smoke & rose.  
29<sup>88</sup> Comp. \$65 (100x84)  
curtain pictured in natural, blue, rose & white.

Comp.	Our Price	Comp.	Our Price
100x84	65	200x63	100
100x63	60	Valance	26
200x84	110	Swag	46

Lots of other styles & sizes available  
Double ruffles in blue or rose ruffle attached on natural ruffle.  
Matching bedspreads available for special orders.  
NEW ITEMS ARRIVING DAILY  
The Plaza • Greenville • 756-7872  
Hours: Mon.-Sat. 10 to 9 • Sun 1 to 5  
North Ridge Shopping Center • Raleigh • 1-876-3600

# Jealousy May Be Positive, If Kept In Check

By LARRY ROSENTHAL  
Associated Press Writer

NEW HAVEN, Conn. (AP) — Getting in touch with your feelings and thinking positively about yourself are fine, but the best way to stave off the pangs of jealousy are to just get on with your life, two psychologists say.

A positive attitude about yourself, or self-boasting, seems to be the best way to prevent the depression that could follow jealousy, but doesn't do much to much to keep away envy or jealousy itself, the researchers say.

"We like to think getting in touch with your feelings is a good thing, that exploring how you feel will make you feel better," said Peter Salovey, a Yale University assistant professor of psychology. "But we found that strategy actually made you feel worse in jealousy-producing situations."

Those who are jealous of others' success may long to curl up with a bowl of ice cream while recalling every word of praise ever uttered by family, friends and acquaintances, but that doesn't help, said Salovey, who has studied jealousy for five years with Yale professor Judith Rodin.

"Ignoring your feelings and getting on with your daily work and striving even harder ... for what you want works better," Salovey said.

A third coping strategy, selective ignoring, works in the short run by invoking the attitude, "it's not so important to me anymore," he said. "But I suppose there is a limit to how many times you can do that. Nothing is going to be important to you ... if you employ it all the time."

Salovey and Rodin asked 95 Yale undergraduates in 1986-87 to rate the frequency of jealousy-provoking situations involving school, family, friends and romance, how jealous they felt and how they coped. Their research will be published in the fall issue of the Journal of Social and Clinical Psychology.

Jealousy is the worry that something you have will be lost to someone, and envy is wanting something someone else has. "To the extent they do not run your life, they may be healthy and helpful," Salovey said.

"They are negative in what people is often a lot of anger, sadness and occasionally fear. But in the sense they can also help enrich our lives by letting us now what is important to us, that's not so negative."

# Lacy Pattern Offers Sweater Or Vest

This lovely knit is ideal for welcoming fall. The softness of the fluffy acrylic yarn is enhanced by the easy leaf stitch. A versatile pattern offers directions for a vest or a sweater, with approximate finished bust measurements of 35, 40 and 45 for small, medium and large respectively.

To obtain directions for making the Lacy Impression Sweater Pattern, send your request for Leaflet No. Z-091188 with \$2 and a long self-addressed envelope to: Pat Trexler Crafts, The Daily Reflector, P.O. Box 419148, Kansas City, Mo., 64141.

Or you may order Kit No. K-091188 by sending check or money order for \$18.95 for the sweater and \$11.95 for the vest to Pat Trexler at the same address. Kit price includes shipping charges, full instructions and yarn in your choice of violet, magenta or teal.

Dear Readers: A couple of months ago, I gave directions for making knit or crochet pincushions. Soon mail began to arrive with patterns from readers. Some were too involved to use in the column, but the following ones will, I think, appeal to many of you.

Dorothy Zahn of Brick, N.J., makes jiffy-quick knitted pincushions from the following directions. She uses Size 7 needles with worsted yarn. Four separate pieces are made, and each can be a dif-

ferent color. This not only adds visual appeal, but also is a great way to use up leftover yarns!

For each piece, cast on 15 stitches and work in garter stitch (knit every row.) After binding off on each piece, leave about 5 or 6 inches or yarn to use for sewing the ends together. For the first piece, with color A, knit until you have 7 ridges; knit one more row and bind off. For the second piece, with color B, knit until you have 12 ridges; knit one more row and bind off.

For the third piece, with color C, knit until you have 23 ridges; knit one more row and bind off. For the fourth piece, with color D, knit until you have 30 ridges and bind off.

Treating each piece separately, sew the cast-on and bound-off edges together forming a tube. Next, fold each piece so that the edges of each are together. When all four circles are completed, put one inside the other with the smallest on the inside and the largest on the outside, and — presto! — you have a decorative pincushion.

Mildred Irwin, from the Rocky Mountain area of Colorado, sent a crocheted pincushion that looks like

an old-fashioned garden party hat worked in lavender and white.

To make one with worsted-weight yarn, start with a chain of 85 stitches. Work one row single crochet, one row double crochet and one row single crochet.



LACY CREATION

Before working the next row, mark a stitch approximately 8 inches from the end. For the brim, along this 8-inch edge, work a row of single crochet, increasing one in every other stitch. Work back across the brim edge with a row of double crochet, again increasing one in every other stitch. With a contrasting color, single crochet around all edges of strip and brim. Fasten off.

Starting at the narrow strip end, roll the strip until the two edges of the brim meet. Now you can finally see the hat take shape, complete with a crown and a brim. Thread a tapestry needle with a strand of each yarn and make a row of long stitches between the crown and the brim. Leave about 6 inches of yarn free at each end.

Pull up slightly on the ends of yarn and tie a saucy bow. Use the crown of the hat.

**Eastern Electrolysis**  
205 COMMERCE ST. GREENVILLE, NC  
PHONE 756-4034  
PERMANENT HAIR REMOVAL  
CERTIFIED THERMOLOGIST

## Meeting Place

### WEDNESDAY

7 p.m. — Greenville Toastmasters meet at Western Sizzlin. Dinner at 6 p.m.  
7:30 p.m. — Family Violence Center's Women's Support Group meets. Call 752-3811 for more information.  
7:30 p.m. — Winterville Jaycees meets at Jaycee Hut.  
8 p.m. — Greenville White Shrine meets at Masonic Temple.  
8 p.m. — John Ivey Smith Council No. 6600, Knights of Columbus, meets at St. Peter's Catholic Church.  
8 p.m. — Narcotics Anonymous opening meeting at St. Paul's Episcopal Church.  
8 p.m. — New Beginning Womens Alcoholic Anonymous meets at St. Paul's Episcopal Church.

### THURSDAY

9:30 a.m. — Town and Country Senior Citizens meet at St. Paul's Episcopal Church.  
6:30 p.m. — Exchange Club meets.  
7 p.m. — Greenville Elks Lodge No. 1645 meets.  
7:30 p.m. — Overeaters Anonymous meets at First Presbyterian Church.  
7:30 p.m. — Duplicate bridge meets at Senior Center.  
8 p.m. — Coochee Council No. 60, Degree of Pocahontas meets.  
8 p.m. — VFW meets at post home.  
8 p.m. — Alateen meets in room 32 of

### First Presbyterian Church.

8 p.m. — Alcoholics Anonymous closed meeting at First Presbyterian Church.  
8 p.m. — Serenity Al-Anon meets at First Presbyterian Church, room 33.  
8 p.m. — Narcotics Anonymous open meeting at Arlington Street Baptist Church.

### FRIDAY

Noon — Full Gospel Businessmen Fellowship meets at Tar Landing Seafood.  
Noon — Alcoholics Anonymous meets at St. Paul's Episcopal Church.  
8 p.m. — Narcotics Anonymous has open discussion at St. Paul's Episcopal Church.  
8 p.m. — Alcoholics Anonymous traditions and step (newcomers) closed meeting at AA Building, Farmville Highway.

### SATURDAY

9:30 a.m. — Overeaters Anonymous Big Book meeting at First Presbyterian Church, Harvey-Webb room, Elm Street.  
Noon — Narcotics Anonymous open discussion at St. Paul Episcopal Church.  
1:30 p.m. — Duplicate bridge meets at Senior Center.  
8 p.m. — Alcoholics Anonymous open discussion group meets at St. Paul's Episcopal Church.  
8 p.m. — Narcotics Anonymous closed candlelight meeting at Arlington Street Baptist Church.

## Yearly Plans Told At Meet

FARMVILLE — Plans for the year were outlined at the meeting of the Major Benjamin May chapter, Daughters of the American Revolution Saturday.

Mrs. Charles Carr, regent, said plans include preparation of a downtown window for Constitution Week, assisting the CAR with a yard sale and consideration of a spring bridge benefit.

Elizabeth Lang reported on Tamasee School, which is sponsored by DAR. The school dining hall was destroyed by fire and the chapter will contribute to the replacement.

Ann Holland gave the national defense report and the devotional was given by Mrs. E.P. Bass.

Meeting hostesses were Mrs. Leroy Bass, Miss Lang and Mrs. Jack Spain.

## Engagement Announced

Bishop and Mrs. W.H. Mitchell of Winterville announce the engagement of their daughter, Mary Elizabeth, to Ronnie Finch, son of Ruth Finch of Kenly. The wedding will take place Oct. 1.

Susan's  
CUSTOM FRAMING  
AND  
ART GALLERY

Fall Hours

10:00 - 5:30, Mon. - Fri.  
10:00 - 3:00, Sat.

Prints • Prints • Prints

Come see our new selection!

Get Stitchin'! Christmas framing sale begins October 15th!

1413 S. Evans Street

752-9594

**Belk**  
carolina east mall  
greenville

HORIZON

Fashion Headlines—Fall '88  
A Contemporary Fashion Show  
presented by

**Belk**  
and The American Cancer Society

Wednesday, October 5, 1988  
8:15 p.m.—Wright Auditorium, ECU

Tickets: Patron \$20.00\*  
Gen. Admission \$15.00  
Students \$7.00  
Reservations: Belk 756-2355  
ACS 752-2574  
Mrs. Hall 756-0262

Ladies'  
Timberland Shoes  
Trunk Showing

by Keith Myers

Saturday, September 17  
12 Noon 'Til 3:00 P.M.

Receive a FREE TIMBERLAND T-SHIRT (while supply lasts) with each Timberland shoe purchase.



\$70 - \$90

Hailing a cab, cheering on the home team, or meeting friends for lunch, Timberland® dress and casual shoes enhance your lifestyle. Durable features like patented tap soles, and water-proof leathers, combine with clean lines to give you a classic look for any occasion. "Lauren" penny loafer available in tan; "Britt" penny loafer in black/brown trim; "Canoe Moccasin" in tan or chocolate; "Camp Moccasin" in burgundy. Ladies' sizes.

**Belk**  
carolina east mall  
greenville

**Hush Puppies**  
BRAND SHOES

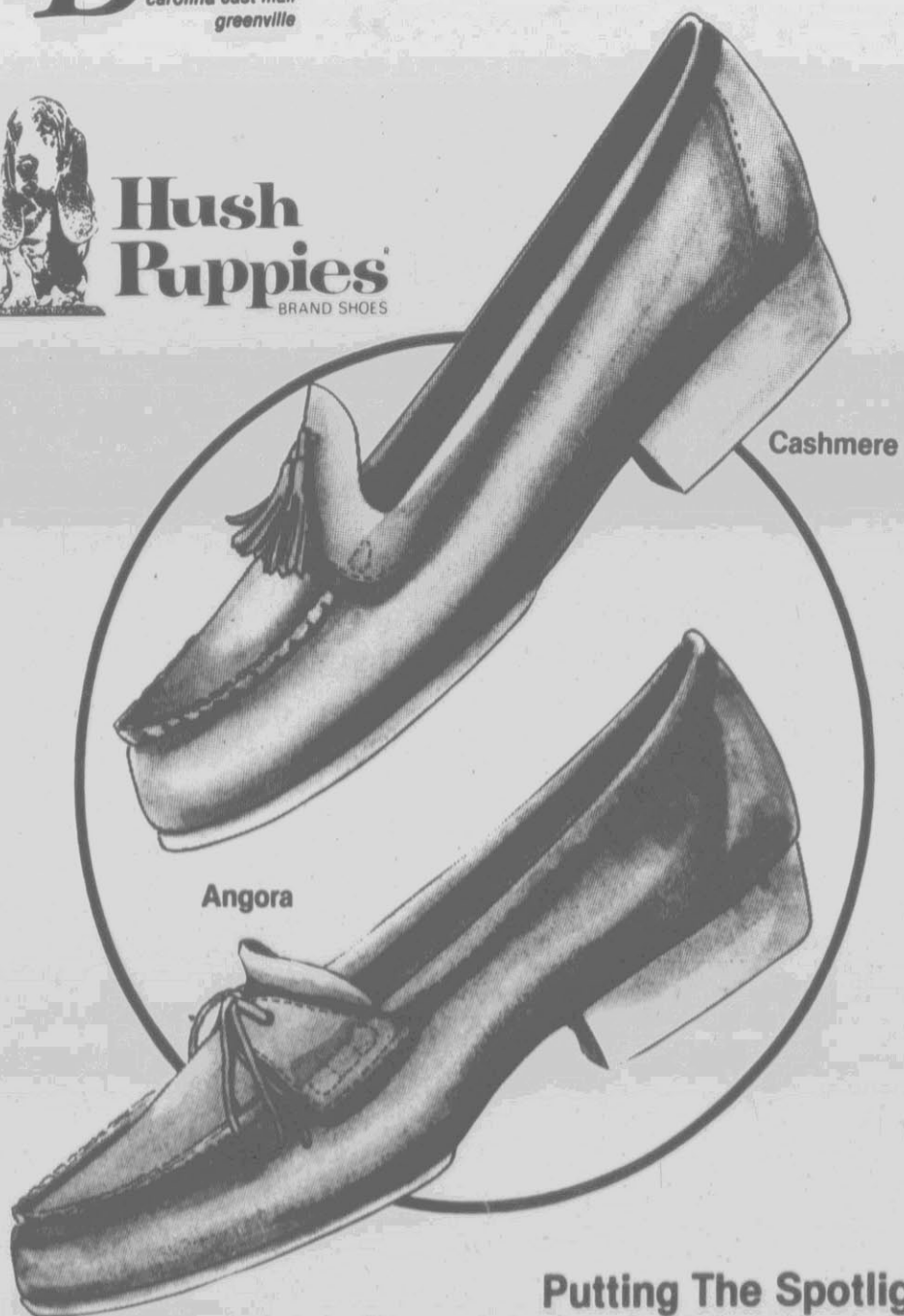

Putting The Spotlight  
On Comfort And Career Appeal

The best way to dress for success is to start from the ground up . . . in these attractive Hush Puppies® shoes. They're made to look great and feel great, too, with the deep down comfort Hush Puppies® shoes are famous for. "Cashmere" available in wine or navy; "Angora" in black or tan. Ladies' sizes 6-10. . . . \$49

Shop Carolina East Mall, Greenville, Monday Through Saturday 10 a.m. Until 9 p.m., Sunday 1:30 p.m.-5:30 p.m. — Phone 756-B-E-L-K (756-2355)

100  
You're the reason

100  
You're the reason

Shop Carolina East Mall, Greenville, Monday Through Saturday 10 a.m. Until 9 p.m., Sunday 1:30 p.m. to 5:30 p.m. Phone 756-B-E-L-K (756-2355)

# Stock And Market Reports

NEW YORK (AP) — The stock market rolled up a broad gain today, responding to better-than-expected news on international trade.

The Dow Jones average of 30 industrial stocks climbed 12.27 to 2,095.31 in the first half hour of trading.

Gainers outnumbered losers by about 7 to 2 in nationwide trading of New York Stock Exchange-listed issues, with 774 up, 217 down and 446 unchanged.

Volume on the Big Board came to 32.10 million shares as of 10 a.m. on Wall Street.

The Commerce Department reported this morning that the nation's trade deficit shrank to \$9.53 billion in July from a revised gap of \$13.22 billion the month before.

The dollar rose in foreign exchange following the trade report, and interest rates fell in the credit markets.

Among actively traded blue chips, Merck rose 3/8 to 58 1/8; Exxon 1/4 to 45 1/8; Philip Morris 7/8 to 97 3/4; Coca-Cola 1/2 to 42 3/8, and General Electric 1/8 to 42 1/2.

The NYSE's composite index of all its listed common stocks gained .72 to 151.87. At the American Stock Exchange, the market value index was up 1.44 to 298.23.

On Tuesday the Dow Jones industrial average ended 10.67 points higher at 2,083.04.

Advancing issues narrowly outnumbered declines in nationwide trading of NYSE-listed stocks, with 705 issues up, 681 down and 545 unchanged.

Volume on the floor of the NYSE totaled 162.49 million shares, up from 114.88 million in Monday's session.

NEW YORK (AP) — Midday stocks:

High	Low	Last	
AMR Corp	45 1/2	45 1/2	45 1/2
Alcoa	48 1/2	48 1/2	48 1/2
AmGen	9 1/2	9 1/2	9 1/2
AmInt	50 1/2	50 1/2	50 1/2
AmRad	48 1/2	48 1/2	48 1/2
AmT	48 1/2	48 1/2	48 1/2
AmTech	48 1/2	48 1/2	48 1/2
AmIntGrp	64 1/2	63 1/2	63 1/2
AmerT&T	25 1/2	25 1/2	25 1/2
Amoco	74 1/2	73 1/2	73 1/2
BellAtl	71 1/2	70 1/2	70 1/2
BellSouth	40 1/2	40 1/2	40 1/2
BethSteel	21 1/2	21 1/2	21 1/2
Boeing	62 1/2	62 1/2	62 1/2

## Destroyed

HILLSBOROUGH, N.C. (AP) — Orange County Sheriff's deputies on Tuesday destroyed about 600 marijuana plants with an estimated street value of \$800,000 which were found growing in rural Orange County.

"It was a good size plot," said Orange County Sheriff Lindy Pendergrass. The plants ranged in height from six to 18 feet.

No arrests were made and there are no suspects, Pendergrass said the investigation is continuing.

## Correction

The Daily Reflector incorrectly reported Tuesday that only pollworkers are allowed to assist voters during an election.

Election rules state that any voter may request assistance from a near relative, and any blind, disabled or illiterate voter may be assisted by any person the voter chooses, other than his employer, an officer of his union, or an agent of either one.

BoiseCascade	43 1/2	43 1/2	43 1/2
Borden	54	53 1/2	53 1/2
CNSX Cp	27 1/2	26 1/2	27
Carroll	147 1/2	147 1/2	147 1/2
Champ Int	32 1/2	32 1/2	32 1/2
Chevron	44 1/2	44 1/2	44 1/2
Chrysler	23 1/2	23 1/2	23 1/2
CocaCola	42 1/2	42 1/2	42 1/2
Colg Palm	46 1/4	45 1/2	45 1/2
Com Edis	30 1/2	30 1/2	30 1/2
ConAgra	31 1/2	31 1/2	31 1/2
DeltaAirl	48 1/2	48 1/2	48 1/2
DowChem	87 1/2	86 1/2	87
duPont	81 1/2	81 1/2	81 1/2
Duke Pow	44 1/2	44 1/2	44 1/2
EstKodak	45	44 1/2	44 1/2
EatonCp	75 1/2	75 1/2	75 1/2
Exxon	45 1/2	45	45
FPL Grp	30 1/2	30 1/2	30 1/2
FstUnionCp	22 1/2	22 1/2	22 1/2
FstWachov	39 1/2	39 1/2	39 1/2
FlaProgress	34 1/2	34 1/2	34 1/2
FordMtr	47 1/2	47 1/2	47 1/2
Fuqua	29 1/2	29 1/2	29 1/2
GTE Corp	43 1/2	42 1/2	42 1/2
GenCorp	21 1/2	21 1/2	21 1/2
GenDynam	51 1/2	51 1/2	51 1/2
GenElec	42 1/2	42 1/2	42 1/2
GenMills	51 1/2	50 1/2	50 1/2
GenMotors	75	74 1/2	74 1/2
GenMotE	40 1/2	40 1/2	40 1/2
GenPart	35 1/2	35 1/2	35 1/2
GenPacif	38 1/2	37 1/2	38
Goodrich	53 1/2	53 1/2	53 1/2
Goodyear	59 1/2	59 1/2	59 1/2
GraceCo	25 1/2	24 1/2	25 1/2
GrainCo	41 1/2	40 1/2	40 1/2
Greyhound	31 1/2	31	31 1/2
Hercules	46 1/2	45 1/2	45 1/2
Honeywell	62	61 1/2	61 1/2
HCA	36 1/2	36 1/2	36 1/2
ITT Corp	49 1/2	49 1/2	49 1/2
IntLand	36 1/2	36 1/2	36 1/2
IBM	115 1/2	114 1/2	114 1/2
IntPaper	45 1/2	44 1/2	45 1/2
IntRect	57 1/2	57 1/2	57 1/2
JamesRiver	27 1/2	27 1/2	27 1/2
K Mart	36 1/2	35 1/2	35 1/2
Kaiser	18 1/2	18 1/2	18 1/2
KanebSve	21 1/2	21	21 1/2
Kroger	31 1/2	31 1/2	31 1/2
Lockheed	40 1/2	40	40 1/2
LoewstP	73 1/2	73 1/2	73 1/2
McDermInt	18 1/2	18 1/2	18 1/2
McKess	34 1/2	34 1/2	34 1/2
MeadCp	44 1/2	44 1/2	44 1/2
MercantStr	39 1/2	39 1/2	39 1/2
MinnMng	63	62 1/2	62 1/2
Mobil	46 1/2	45 1/2	45 1/2
Monsanto	76 1/2	76 1/2	76 1/2
NCNB Cp	28 1/2	27 1/2	28
Nacco	28 1/2	28 1/2	28 1/2
Nation	51 1/2	51 1/2	51 1/2
NorfolkSou	29 1/2	29 1/2	29 1/2
Nynex	65 1/2	64 1/2	65
OlinCp	46 1/2	46 1/2	46 1/2
PacTel	29 1/2	29 1/2	29 1/2
PenneyJc	48 1/2	48 1/2	48 1/2
PepsiCo	37 1/2	37 1/2	37 1/2
Phelps Dod	38 1/2	37 1/2	38 1/2
PhilMor	97 1/2	97 1/2	97 1/2
Phillipet	17 1/2	17 1/2	17 1/2
Polard	42 1/2	41 1/2	42
Primerica	28 1/2	28 1/2	28 1/2
ProctGamb	89 1/2	79 1/2	79 1/2
Quaker	53 1/2	53 1/2	53 1/2
Quantum	96 1/2	95 1/2	96 1/2
RJR Nab	54 1/2	54 1/2	54 1/2
Realtor	79 1/2	78 1/2	78 1/2
Rockwell	20 1/2	20 1/2	20 1/2
SPX Corp	34	34	34
ScottPap	37 1/2	37 1/2	37 1/2
SearsRoeb	36 1/2	36 1/2	36 1/2
ShawInd	22 1/2	22 1/2	22 1/2
Skyline Cp	13 1/2	13 1/2	13 1/2
Sony Corp	50 1/2	50 1/2	50 1/2
SpartanCo	20 1/2	20 1/2	20 1/2
SwestBell	39 1/2	39 1/2	39 1/2
TRW Inc	43 1/2	42 1/2	43 1/2
TRW	43 1/2	44 1/2	45 1/2
Texaco	25 1/2	25 1/2	25 1/2
TextEast	25 1/2	24 1/2	25 1/2
Textron	25 1/2	24 1/2	25 1/2
USX Corp	28 1/2	27 1/2	27 1/2
UnCamp	33 1/2	33 1/2	33 1/2
UnCarbide	22 1/2	22 1/2	22 1/2
US West	55 1/2	55 1/2	55 1/2
Unocal	35 1/2	35 1/2	35 1/2
WalMart	31 1/2	31 1/2	31 1/2
WalP&P	34 1/2	33 1/2	33 1/2
WestghE	52 1/2	51 1/2	51 1/2
WeyerHsr	25 1/2	25 1/2	25 1/2
WinnDix	43 1/2	43	43 1/2
WorWor	53 1/2	52	52 1/2
Wrigley	34 1/2	34 1/2	34 1/2
Xerox Cp	55 1/2	54 1/2	54 1/2

Following are selected stock quotations as of 11:00 a.m.:

Ashland Oil	35 1/2
Unisys	32 1/2
Fieldcrest Mills	23 1/2
Flowers Inds	18 1/2
Hatteras Inc. Securities	16 1/2
Hilton Hotel Corp	44 1/2
Jefferson Pilot	35 1/2
John Deere	43 1/2
Lowe's Company	20 1/2
Interstate Securities	16 1/2
Wickes	13 1/2
Southmark Corporation	2 1/2
United Telecommunications	39 1/2
Dominion Resources	42 1/2
Piedmont Natural Gas	22 1/2
ER THE COUNTER	
Branch Bank	15 1/2 to 15 1/2
Planters National Bank	13 1/2 to 14
Vermont American	21 1/2 to 21 1/2
Integon	57 to 6
Southern National Bank	16 1/2 to 17 1/2
Peoples Bank	13 1/2 to 14
North Carolina Natural Gas	16 1/2 to 17
Cooper LaserSonic	10 to 10 1/2
Farm Fresh	12 1/2 to 12 1/2
Burroughs Wellcome	8 to 8 1/2
Johnson & Johnson	83 1/2 to 84
Food Lion A	10 1/2 to 10 1/2
Food Lion B	10 1/2 to 11

# Tobacco Market

By The Associated Press

The following are the final gross figures for the Eastern Belt flue-cured tobacco markets for Monday, Sept. 12, 1988, as reported by the Federal-State Market News Service.

	Daily Pounds	Daily Value	Daily Avg.
Clinton	350,002	593,209	169.49
Dunn	355,555	591,563	166.38
Farmvl	362,086	641,559	177.18
Gldsboro	754,404	1,317,445	174.63
Greenvl	1,132,003	1,974,936	174.46
Kinston	903,328	1,599,453	177.06
Robrsvl	346,063	606,474	175.25
Rocky mt	756,479	1,300,177	171.87
Smithfld	434,887	738,496	169.81
Wallace			no sale
Wendell			no sale
Willmstn			no sale
Wilson	1,762,632	3,063,284	173.79
Windsor	405,015	694,843	171.56
Total	7,562,454	13,121,439	173.51
Season Totals	153,733,679	237,576,013	154.54

Average for the day was up \$4.23 from previous sale. Subject to revision. Averages do not reflect assessments.

## THE LAW FIRM OF

JAMES T. CHEATHAM, P.A.

IS PLEASED TO ANNOUNCE THAT

SHARON A. WOODARD

HAS BECOME ASSOCIATED WITH THE FIRM

SUITE C  
202 E. Arlington Blvd.  
Greenville, North Carolina 27834  
(919) 355-5400

August 1988

# Obituaries

**Aaron**  
BURLINGTON — Mr. Hoyt Shoaf Aaron, 70, of 711 Lexington Ave. died Tuesday in Clapps Nursing Center in Asheboro.

His funeral will be conducted Thursday at 2 p.m. in the First Baptist Church of Burlington by Dr. Dale Steele. Burial will be in Pine Hill Cemetery.

Mr. Aaron was a native of Davidson County and was a field representative for Blue Ridge Crafts in Greensboro. He was a former manager of the Burlington Bus Station for 30 years. He was a member of the First Baptist Church where he served as a senior deacon and Sunday school teacher. He was a charter member of the Burlington Gem and Mineral Club and a paratrooper in World War II.

Surviving are his wife, Peggy Wilson Aaron of the home; two daughters, Ann Newman of Burlington and Jane Carmichael of Winston-Salem; a son, Jeff Wilson Aaron of Greenville; four sisters, Lila Reed and Julia Hege, both of Lexington, Glenna Hart of Easley, S.C., and Alma Efid of Charlotte; five grandchildren, and three great-grandchildren.

The family will receive friends at the Rich & Thompson Mortuary in Burlington from 7 p.m. to 9 p.m. today.

## Grimes

WASHINGTON, D.C. — Mr. Joe Eddie Grimes, formerly of Greenville, died Tuesday in Washington, D.C. Arrangements are incomplete.

## Hall

A funeral for Mrs. Lethia Washington Hall will be conducted at 2 p.m. Friday in the chapel of Joyner's Mortuary in Farmville by Elder George Wiggins. Burial will be in Sunset Memorial Park.

A former resident of Greene County, Mrs. Hall had lived in Greenville for several years. She was a member of Warren Chapel Free Will Baptist Church.

Surviving are two sons, James Hall of Orange, N.J., and Joe Lewis Hall of Newark, N.J.; three daughters, Willie Mae Holland of Stantonsburg, Minnie L. Carney of East Orange, N.J., and Letha C. Cobb of Newark, N.J.; three brothers, Dave Washington and John H. Washington, both of Greenville, and Leon Washington of Baltimore; a sister,

Lossie J. Brimage of Farmville; 19 grandchildren, and 13 great-grandchildren.

The family will receive friends in Joyner's Memorial Chapel Thursday from 8 p.m. to 9 p.m. and at other times will be at the home of Joe Hall near Castoria in Greene County.

## Mills

Mr. Franklin D. Mills, 55, of Route 3, Box 300, Greenville, died Tuesday in Pitt County Memorial Hospital.

His graveside funeral will be conducted at 11 a.m. Thursday in the Mills Family Cemetery near Black Jack.

A native of the Chicod area, Mr. Mills spent most of his life in the Black Jack community and was a farmer.

Surviving are three brothers, L.C. Mills of Grimesland, Alton Lee Mills of Greenville and Truman Mills of Grimesland, and three sisters, Clara Mills Manning of Grifton, Vera Mills Smith of Kinston and Permillie Whaley of Fayetteville.

The family will receive friends at the Wilkerson Funeral Home from 7 p.m. to 9 p.m. today.

## Stocks

WINTERVILLE — A funeral for Mrs. Irene Windham Stocks, 76, of 116 Ange St. will be conducted at 3:30 p.m. Thursday in the Wilkerson Funeral Chapel by the Revs. Douglas Skinner and Ed Taylor. Burial will be in Reedy Branch Baptist Church Cemetery.

Mrs. Stocks was a lifelong resident of the Winterville community. She was a member of Winterville Free Will Baptist Church.

Surviving are a son, Ben L. Stocks of Ayden; a daughter, Faye Thomas of Goldsboro; two sisters, Margaret Joyner of Farmville and Ruth Rourk of Leland; eight grandchildren, and six great-grandchildren.

The family will receive friends at the funeral home from 7 p.m. to 9 p.m. today and at other times will be at the home of Mr. and Mrs. Ben L. Stocks, 307 Country Club Drive, Ayden.

## Wallace

EVERETTS — Mrs. Annie R. Wallace, Staton Street, Everetts, died Tuesday in Beaufort County Memorial Hospital. Arrangements will be announced by Congleton Funeral Home, Robersonville.

# Blood

(Continued from A-1)

again, the Food and Drug Administration and the Red Cross require that any subsequent donations be quarantined and/or destroyed even when they test negative for AIDS or hepatitis B.

The Tidewater region was one of the regions which failed to correctly categorize subsequent donations as suitable for transfusion.

Between March 1985 and July 1988, out of a total of over 440,000 pints collected from volunteer donors in the Tidewater Region and ultimately produced into over 1 million blood components, 821 blood components were released that should not have been," regional director Dr. Andrew Heaton said. "To date, however, we've retested two-thirds of the donors in question" and none have tested positive for viral infections.

According to David Parsons, an administrator for blood services in the Tidewater Region, the first unit of blood tested had indeterminate results — neither positive nor negative, he said. "In a subsequent test, it was negative all the way through."

The problem comes with the procedure in which the blood was handled, Parsons said. The first units of blood tested were destroyed and are not part of the donor deferral register.

Even though the subsequent tests were negative, according to FDA and Red Cross procedures, the donations should have been quarantined and destroyed.

"If the person had made the second donation anywhere else, there would never be a question," he said. But since the first and subsequent donations were made within the same region, the proper samples and records should have been kept.

"It's a procedural violation," Parsons said.

The Tidewater region will establish a new compliance license office and other provisions as a means to correct its errors.

# Storm Smashes Island Off Mexico

(Continued from A-1)

lated area of Puerto Morelos, 30 miles south of the resort area of Cancun, at about 2 p.m. EDT. Merida is 175 miles west of Cancun.

The storm was maintaining its west-northwest course and had slowed down a little from its 15 mph speed, but retained its intensity.

The entire seaside hotel zone in Cancun was evacuated to inland hotels, said Jennie Valdez, a representative of the U.S. Consul. She said Cancun had been experiencing heavy wind gusts and sporadic rain.

Ms. Valdez said she did not know how many tourists were in Cancun, but that government figures estimate between 40,000 and 65,000 a month. Cancun has a population of about 100,000 to 150,000, she said.

High winds also were reported in Valladolid, a city of 80,000 located 80 miles southwest of Cancun, said Jose Joaquin Martil, local Red Cross president.

Jamaican Prime Minister Edward Seaga said late Tuesday that at least six people were killed, and an estimated 60,000 were left homeless in "the worst natural disaster in the modern history of Jamaica."

"Everything is a disaster," said Grace Morris of Kingston. "We have to build a complete new Jamaica."

Civil defense officials in the Dominican Republic, side-swiped Sunday by the storm, reported five people were known dead.

The U.S. National Weather Service said today that "People in the warned areas should have completed all possible preparations for this extremely dangerous hurricane."

# Rebels

(Continued from A-1)

Lesotho, a nation of about 1.6 million people about the size of Maryland, is officially a constitutional monarchy but is ruled by a

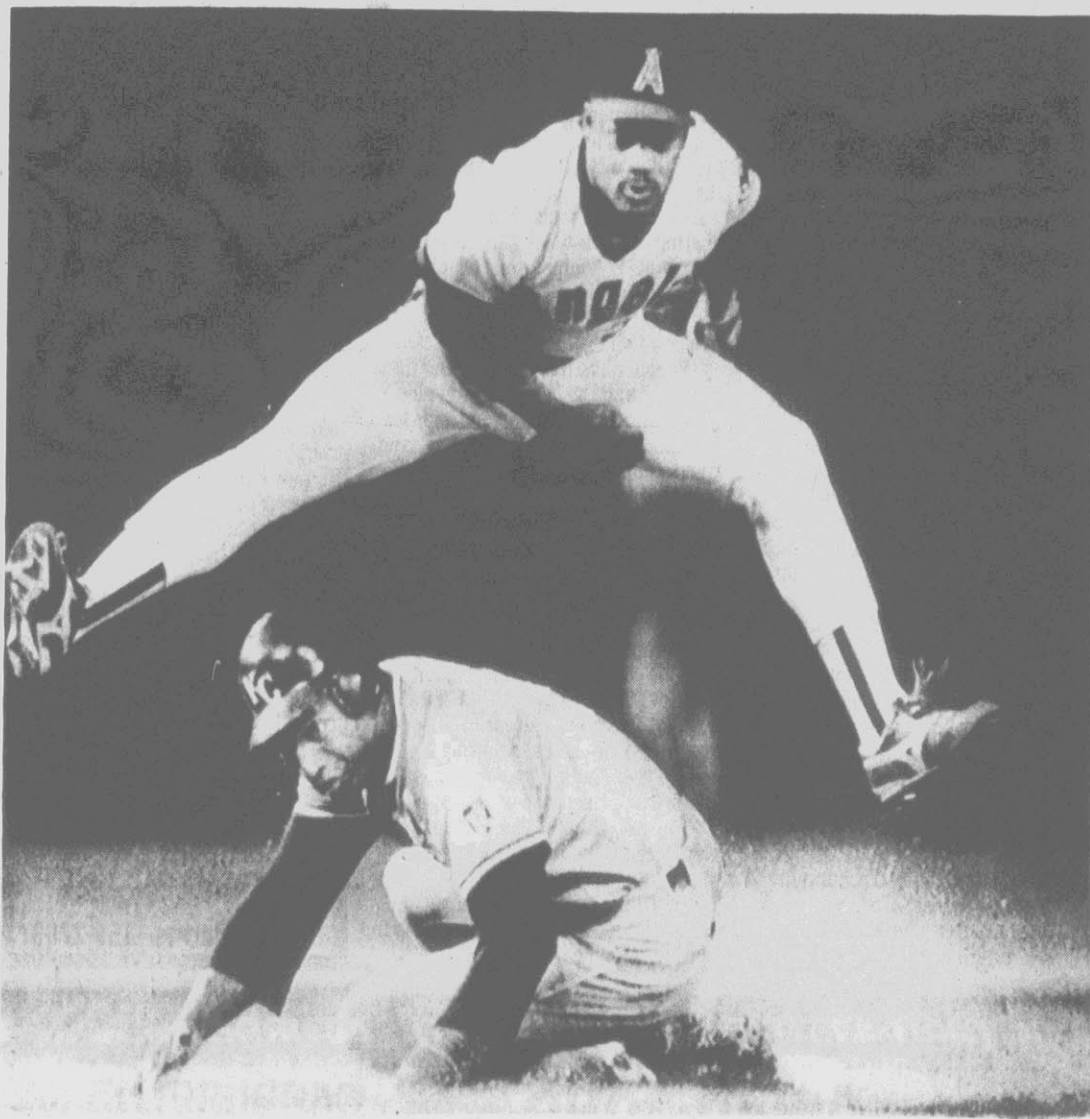

Angels' Johnny Ray leaps to avoid sliding Royal Bo Jackson in double play.

## Dodgers Record 19th Shutout With 2-0 Victory Over Braves

By The Associated Press  
Shutout for shutout, the Los Angeles Dodgers almost match up with the New York Mets.

While the Mets have grabbed all the attention with their 22 shutouts, the Dodgers quietly have compiled their own impressive total. They beat the Atlanta Braves 2-0 Tuesday night for shutout No. 19.

"We're not really concerned with the pennant race," Mike Scioscia said after hitting a two-run homer that proved decisive.

The victory, coupled with Houston's 5-2 loss to Cincinnati, increased the Dodgers' lead in the National League West to 6½ games over the Houston Astros.

John Tudor, Ramon Martinez and Jay Howell combined on a two-hitter for the Dodgers.

"We're just going out there every game and playing good baseball," Scioscia said. "We're confident we're going to win, but we haven't painted ourselves into a corner and put pressure on ourselves."

In other games, Pittsburgh beat New York 1-0, Montreal beat St. Louis 7-1, Chicago beat Philadelphia 9-2 and San Francisco beat San Diego 4-1.

Tudor, 9-8, held the Braves to a first-inning leadoff single by Ron Gant and a two-out single in the fourth by Andres Thomas. Both Martinez and Howell pitched two innings of hitless relief, with Howell gaining his 19th save.

(See NATIONAL, B-2)

## Chargers Set For Another Big Test At Washington

By TIM CHANDLER  
Reflector Sports Writer

Ayden-Grifton's final non-conference test before jumping into the Eastern Plains race comes Friday on the road against unbeaten 3-A Washington.

The 2-A Chargers are heading into

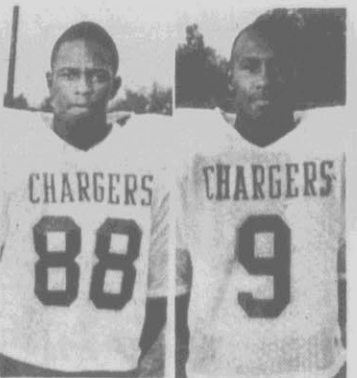

Kelvin Ellison Darryl Moye

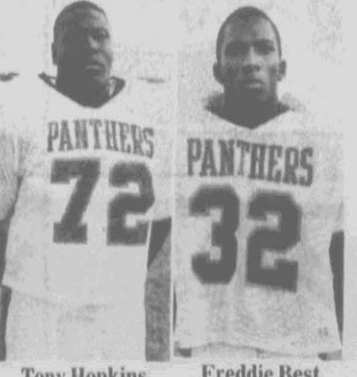

Tony Hopkins Freddie Best

the game with a 2-1 mark and a full head of steam after shutting out 4-A Kinston Monday night on the road, 19-0.

"We did a good job of executing offensively and defensively in the second half of the Kinston game," Ayden-Grifton head coach B.T. Chappell said. "We made some adjustments to our game plan at halftime and they (Kinston) made a few mistakes that helped us to take control of the game."

The win, although an impressive one for the Chargers, has not changed the way Chappell looks at Friday's matchup against the 3-0 Pam Pack.

"We know we've got our work cut out for us," Chappell said. "They've beaten Belhaven, Pamlico County and Plymouth. And last week Plymouth beat Farmville (Central)."

One of the keys to controlling the Pam Pack is stopping wide receiver Joe Randolph, according to Chappell. "In the Pamlico County game, he caught passes for about 100 yards and rushed for over 100 more," Chappell said. "He had one reverse play that went for about 75-80 yards and another that went for about 40. He's very quick and hard to handle."

Washington's 6-0, 180-pound quarterback Bryan Jones could also pose some problems for the Chargers, according to Chappell.

"He's got good size and he does a good job of getting the ball where they want it to be."

Following the battle with the Pam Pack, the Chargers will jump into the

heat of the conference race against Pamlico County.

"It's (the Washington game) gonna be a tough road game," Chappell said. "But we're gonna have some tough ones once we get into the conference play also, so it'll be interesting to see how we'll do down there."

### North Pitt

North Pitt head football coach Stuart Innis' answer to what his team could do to rebound from a 13-6 loss Monday at the hands of D.H. Conley was simple: "I don't know."

The Panthers next foe will be Roanoke, which is coming off a 26-6 win last Friday over Jamesville. North Pitt will carry a 1-2 record into the game, while the Redskins stand at 1-1 for the year.

"After looking at the film, they (Conley) did a real good job on our offensive line," Innis said. "They continually got people past our linemen and into our offensive backfield."

Another problem Innis sees in having to battle the Redskins Friday is they will have had a full week to get ready for the game. Roanoke's game with Jamesville wasn't rained out last Friday.

"It always makes it tough when you have to move a game to Monday and then turn around and play again on Friday," Innis said. "They (Roanoke) should be better prepared from that respect."

In Roanoke, North Pitt will find a team which is not big in size or numbers, but one that is extremely quick both offensively and defensively.

"I think we can compete with them speed-wise if we do a good job of blocking them," Innis said. "They're coming off a big win though, so we definitely have our work cut out for us."

Following their battle with Roanoke, the Panthers will have a week off before beginning play in the Eastern Plains Conference.

"I just want to come out of this game in good shape," Innis said. "Once this game is behind us, we'll have a week to heal and get ready for a tough conference race. The race in the conference will be extremely difficult so I don't think the off week could have come at any better time."

## Rice's Grand Slam Lifts Boston Past Baltimore; Yankees Defeat Cleveland

By BEN WALKER  
AP Baseball Writer

Even in a season of discontent, Jim Rice still finds moments of solace. Enough of them might make him and the Boston Red Sox very happy.

Rice, relegated to a role as part-time designated hitter, connected for his eighth career grand slam Tuesday night as the Red Sox beat Baltimore 6-4 and increased their lead in the American League East.

"I'm ready to play any day, but if I'm not in the lineup I can't do anything about it," Rice said after starting for just the fourth time in 14 games. "My attitude has been the same for 14 years. I'm not going to change."

"When I'm called upon, I want to go up there and do my job. If I'm not called upon, I don't have anything to worry about."

Rice, suspended earlier this season after a run-in with Manager Joe Morgan, is batting .270 with 12 home runs and 61 runs batted in.

The Red Sox moved 4½ games ahead of Detroit, which lost to Toronto 9-1. New York also is 4½ behind after beating Cleveland 5-4. Milwaukee stayed 5½ back by defeating Chicago 4-0.

In other AL games, Oakland held off Texas 2-1, Minnesota rallied past Seattle 2-1 and Kansas City downed California 4-3.

Rice spoiled the major league debut of Pete Harnisch, who was drafted by the Orioles in June 1987.

Harnisch struck out Rice on three pitches in the second inning, but Rice got his revenge when he came to the plate with the bases loaded in the fourth.

Rice sent a 2-2 pitch high off the light tower above the wall in left-center field for his 376th career home run.

"I watched it go the whole way," Harnisch said. "I turned around because when I give those up I don't mind watching them. If it hadn't hit halfway up the light tower, it might still be going somewhere."

Rice later singled as the Red Sox won for the seventh time in nine games.

Morgan said Rice would be in the starting lineup tonight against Baltimore. The Yankees begin a four-game series at Fenway Park on Thursday night.

"That was one of his old time shots," Morgan said. "He hit good the last time I took him out for a few days. He returned in time to blast one."

Mike Smithson, 8-5, was the winner and Lee Smith got four outs for his 25th save.

Yankees 5, Indians 4  
Pinch hitter Luis Aguayo's two-run

homer in the eighth inning rallied New York over host Cleveland for its fifth victory in six games.

Dave Winfield opened the eighth with a single for his third hit. One out later, Aguayo greeted Scott Bailes, 8-13, with his third home run of the season for the Yankees and second in two nights.

Neil Allen, 5-2, pitched 3 1-3 shutout innings for the victory and Dave Righetti got his 21st save in 30 opportunities.

Joe Carter hit a two-run homer, his 27th, and rookie Luis Medina hit his fourth home run, all against New York.

Blue Jays 9, Tigers 1

Jesse Barfield hit a grand slam and Ernie Whitt added a two-run shot as host Toronto trounced slumping Detroit.

The Tigers, who led the division by four games on Aug. 12, have lost 18 of 22.

Dave Stieb, 13-8, allowed six hits in seven innings. Ted Power, 5-7, gave up five runs in 2 1-3 innings.

Barfield's second slam of the season and third of his career came in the seventh. It was his 17th home run this year and came against Paul Gibson.

Whitt hit his 13th homer during a four-run third.

Detroit shortstop Alan Trammell left the game after being hit by a pitch in the first inning. He had a severe bruise on his right forearm and his status is day-to-day.

Brewers 4, White Sox 0

Juan Nieves pitched a three-hitter and Paul Molitor and Robin Yount homered in the first inning to send Milwaukee over Chicago.

The visiting Brewers won for the 10th time in 13 games.

Nieves, 6-5, won in his first start since July 14. He struck out four and walked two in his only complete game this season.

Molitor led off the first inning with a home run for the 23rd time in his career. Two outs later, Yount hit the Brewers' first inside-the-park homer since he did it in June 1982. Ken Patterson, 0-2, was the loser.

Athletics 2, Rangers 1

Jose Canseco hit his 39th home run and Dennis Eckersley got his 40th save as host Oakland cut its magic number for winning the AL West to seven.

Canseco, leading the majors in home runs and with 115 RBI, hit a two-run shot in the sixth inning. He also stole his 37th base, moving closer to becoming the first player to hit 40 homers and steal 40 bases in the same year.

Twins 2, Mariners 1

Jim Dwyer singled home the tying run and Tom Herr had an RBI grounder as Minnesota rallied for two runs in the ninth inning and won at Seattle.

The Twins, shut out by five pitchers for eight innings, came back as singles by Randy Bush, Gary Gaetti and Dwyer tied it at 1-1. Herr's bases-loaded groundout scored pinch runner Al Newman.

Royals 4, Angels 3

Bret Saberhagen evened his record at 14-14 as Kansas City won at California.

Saberhagen gave up two runs on six hits in seven innings. He struck out nine, matching his season high. Steve Farr got his 19th save.

Chuck Finley, 9-14, took the loss. The Angels were mathematically eliminated in the AL West.

## Sports Calendar

Editor's Note: Schedules are supplied by schools or sponsoring agencies and are subject to change without notice.

Today's Sports

Volleyball  
Campbell at East Carolina (7 p.m.)  
Soccer  
East Carolina at Christopher Newport (3 p.m.)  
Tennis  
Washington at Williamston (4 p.m.)

Thursday's Sports

Volleyball  
North Pitt at Conley (5 p.m.)  
West Craven at Farmville Central (4 p.m.)  
Rose at Hunt (4:30 p.m.)  
Falls Road at Greenville Christian (4 p.m.)

Tennis

Rocky Mount at Rose  
Williamston at Roanoke (4 p.m.)  
Greene Central at James Kenan  
East Duplin at Conley

Soccer  
Rocky Mount at Rose  
Falls Road at Greenville Christian (4 p.m.)

Cross Country

Rose at New Bern (4 p.m.)

Football

Washington at Ayden-Grifton JV (7 p.m.)

Farmville Central at Conley JV (7 p.m.)

Rose at Eastern Wayne JV (7 p.m.)

Greene Central at Williamston JV

Softball

Family Practice vs. 427 Auto (E1 - 7 p.m.)

Piland vs. Conger Plumbing (E2 - 7 p.m.)

Sub Station II vs. Aldridge & Southerland (E1 - 8 p.m.)

Cherry's vs. Jim's Tires (E2 - 8 p.m.)

Bridal Boutique vs. TCBY (E1 - 9 p.m.)

Holiday Shell vs. Winterville Machine

## Jett Happy To Get In His Few Minutes On Field

By TOM MORRIS  
Reflector Sports Writer

While most football players are concerned about how many minutes they get to play, East Carolina punter John Jett is more concerned with a few precious seconds.

That's because for Jett, the short time from when the ball is snapped from center to when he kicks it away to the other team is often the difference between success and failure.

"When the ball is snapped, it has to leave your foot in two seconds," he said. "I don't notice anything. You don't have time for anything to be on your mind. I just know my job is to get the ball off."

A redshirt freshman from Reedsville, Va., Jett has stepped in to fill a void for ECU this fall. With incumbent starter Craig Losito slowed by illness in the preseason, Jett took full advantage of his opportunities to earn the number-one punting spot.

"I had a real good spring game and (this fall) I was more relaxed," he said. "I knew how the program was going. I also worked on my techniques all summer, fine tuning them."

Jett, who is presently averaging 38.2 yards a kick, is a two-and-a-half step punter who relies on self-visualization to help his kicking.

"It's more of a mental game," he said. "You have to see what you do before you do it. Dropping the ball is the main thing. As long as you see the ball drop on your foot you are okay."

Jett was a four-year varsity player in high school, playing



John Jett

quarterback and defensive back while also punting. He also played baseball and considered pursuing that avenue following graduation. He looked into playing for Mississippi Delta Junior College or even the Naval Academy. But in the end, he decided to come to ECU after talking with the Pirate coaches about walking on.

When he got here, Losito was back after starting the previous year, so Jett redshirted.

"It's tough," he said. "You second guess yourself a lot because you know you can't play but you have to out and try as hard as you can. You have to dig down deep and see if you really want to play college football. I love football and all sports."

But the wait ended this fall and Jett was punter when the Pirates

took on Tennessee Tech in the season opener.

"Before I got out there, I had butterflies, but everybody told me that when you got out there it was just like practice," he said. "Matt McLaughlin, our snapper, calmed me down. He told me it was just like practice and he was right. You don't believe it until it happens."

In the course of a 27-16 loss to Virginia Tech last weekend, Jett encountered his first case of potential stress, college style, when McLaughlin left the game with an injury.

"We had to change long snappers during the course of the game," said coach Art Baker. "Matt hurt his elbow and Brian Walsh came in and in his first snap in a college ball game, he didn't get it all the way back."

"They had a full rush on. John got the ball off the ground and got the kick off. He averaged 39 yards a kick for us and had two inside the 15-yard line."

But Jett said the situation wasn't as tough as it was made out to be.

"Brian was in a tough spot, but I knew he could handle it," he said. "I've worked with him a lot (in practice)."

Division I college football is a long way from 1-A high school football in Virginia, but Jett said he's learned two unique things about big-time college athletics.

"It's a lot more (of a) business, but it also a lot more fun as well," he said. "I went to a small high school and we worked hard for nothing. Here you get benefits. You have more fans here. You are showing what you can do."

**Roanoke-North Pitt**

- The Site: Bethel.
- The Time: 8 p.m.
- Records: Roanoke 1-1; North Pitt 1-2.
- Significance: North Pitt is coming off a disappointing 13-6 loss at the hands of D.H. Conley Monday night, marking the second straight difficult loss for the Panthers.
- Last Time: Roanoke won the 1987 meeting 31-12.
- Players To Watch: Roanoke — TB-DB Pender Locke, FB-OLB Bernard Hudgins, QB-DB Jimmy Brown; North Pitt — RB-LB Michael Blow, QB-DB Billy Hardison, RB-LB Freddie Best.

**Ayden-Grifton-Washington**

- The Site: Washington.
- The Time: 8 p.m.
- Records: Ayden-Grifton 2-1; Washington 3-0.
- Significance: Both teams are looking to continue successful seasons. For Ayden-Grifton, it is another chance to see how the team can perform on the road in a difficult game.
- Last Time: Ayden-Grifton won the 1987 meeting 34-14.
- Players To Watch: Ayden-Grifton — HB Tony Reaves, E-FB Ronnell Peterson, E Kelvin Ellison; Washington — WR Joe Randolph, QB Brian Jones, OG Greg Smith.

# Redshirting Is Dirty Word At Notre Dame

By **HERSCHEL NISSENSON**  
AP Football Writer

"Redshirting," like "Miami," is a dirty word at Notre Dame. The Notre Dame roster for 1988 includes only three redshirts — fifth-year seniors Flash Gordon, Wes

Pritchett and Frank Stams, all linebackers.

Gordon was granted an extra year of eligibility after a series of injuries prevented him from playing in 1984. Pritchett was not in school during the spring of 1986 and needs this

semester to complete his degree requirements. A nagging thigh problem limited Stams to 16 seconds of action in 1986 — ergo, an extra year. Coach Lou Holtz may not be thrilled with the Notre Dame athletic board's policy of granting a fifth year

only for medical or personal reasons — many coaches automatically redshirt as many true freshmen as possible to build depth for the future — but says he agrees with it.

"Eleven times a year — 12 times, hopefully — I wish we redshirted," Holtz says. "But it doesn't blend in with Notre Dame's philosophy or with its purpose."

"We're the only school in America that doesn't redshirt, and I don't think there's any doubt that that has hurt us drastically on a Saturday afternoon."

"But I concur with Notre Dame's philosophy and belief. You have to understand why Notre Dame doesn't redshirt."

"Notre Dame says you come in here as a freshman and your schedule's set for you. You're going to take 'X' amount of hours. You have your choice what language you want to take or what science you want to take."

"At the end of your freshman year, if you're not even with your class for graduation — athletes, non-athletes — you go to summer school and you start out your sophomore year even with your class. Same thing at the end of your sophomore and junior years. So you start your senior year, you're on line for graduation."

"Now the NCAA says to be eligible you basically have to be pursuing a worthwhile degree. But you've already graduated. Do we give somebody a position in graduate school

and deny a worthy candidate a position just so he can play one semester of football? Or do we start playing games and stretching out their career and change everything about Notre Dame?"

How important is redshirting? Holtz says it has "changed the game more than any other thing in the last 25 years."

Like most schools, Notre Dame is hurting depth-wise. In Saturday night's 19-17 victory over Michigan, the Irish unveiled a brand-new offensive line, three new receivers and two new kickers.

"People have five classes, and they mature and grow and develop," Holtz said. "We have four classes. You need three classes to win, and when people redshirt they have five classes to draw three."

Over the years, even the Gerry Faust years, Notre Dame generally was ranked near the top in recruiting by the so-called experts. Where have all those great players gone?

"Number one, I don't believe who had the best recruiting year in the country," Holtz says. "That goes according to who had great high school years. It's never based on who's going to get better, who's going to mature and the reasons why."

"But I do think if you will go check the recruiting list three and four years ago, you will not find Notre Dame in the top 10. And consequently, our junior-senior class from top to bottom is not real strong."

"When I first came here (1986), we were predominantly a freshman-junior-senior football team. Last year, we were predominantly a freshman-sophomore-senior football team. This year, we're predominantly a freshman-sophomore-junior football team without very many seniors on the first two teams."

But if any school in the country can survive the rigors of major-college football without redshirting, it would have to be Notre Dame. It won't be easy, though.

"We've got to," Holtz says. "We can and we will."

At Newark, Del., Dave Nelson probably has a big smile on his face. His new rule permitting the defense to score 2 points on a botched conversion try actually has decided a football game.

Nelson, former head coach and athletic director of the University of Delaware, has been secretary-editor of the NCAA Rules Committee, it seems, since Walter Camp's days, probably because he's one of the few who understands them.

**STIHL**  
THE WORLD'S LARGEST CHAIN SAW  
Sales & Service  
Billy's Marine 355-2793

## National...

(Continued From B-1)

John Smoltz, 2-5, gave up five hits, struck out five and walked three in 5 1-3 innings. He has lost five of his six starts since winning his major league debut on July 23.

**Pirates 1, Mets 0**

Bob Walk won for the first time since beating San Diego July 20 and Bobby Bonilla hit a run-scoring double, snapping the Mets' five-game winning streak. New York leads Pittsburgh by 10 games in the National League East.

Walk, 12-10, had lost six consecutive decisions. He allowed five hits, walked two and struck out two in eight innings before Jim Gott finished for his 29th save.

Dwight Gooden, 17-7, lost to Pittsburgh for the third time this season. He allowed five hits and struck out seven in seven innings.

**Expos 7, Cardinals 1**

Hubie Brooks hit a grand slam and drove in five runs and Pascual Perez pitched a seven-hitter.

Brooks hit his fifth career grand slam and 17th home run of the season in the fifth inning off Larry McWilliams, 5-7, giving Montreal a 6-0 lead.

Perez, 11-6, walked four and struck out one in his third complete game as he won his third consecutive decision.

McWilliams, 5-7, gave up eight hits and six runs in six innings.

**Cubs 9, Phillies 2**

Greg Maddux won his first game since Aug. 10 and Damon Berryhill hit his first career grand slam as

## Pack Takes 9-0 Victory

WASHINGTON — Washington High School rolled up a 9-0 victory over D.H. Conley in a tennis match Tuesday.

Conley's less-experienced team won only 13 games in the singles, and never more than three in a set.

The loss was the second in as many matches for the Valkyries, who play host to East Duplin on Thursday.

Summary:

Rene Manning (W) d. Nichole Bookworth, 6-0, 6-0.

Lisa Manning (W) d. Celeste Charlton, 6-1, 6-0.

Ann Archie (W) d. Brandy Scudder, 6-0, 6-0.

Megan Tayloe (W) d. Mary Beth McLeod, 6-1, 6-3.

Anna Champion (W) d. Vanessa Small, 6-2, 6-0.

Dodi Darrow (W) d. Gail Lilley, 6-3, 6-3.

Melissa Harris-Archie (W) d. Bloodworth-Charlton, 8-4.

Champion-Tayloe (W) d. Scudder-McLeod, 8-0.

Darrow-Ann Taylor (W) d. Small-Lilley, 8-2.

**James Kenan.....6**

**Greene Central.....1**

WARSAW — James Kenan High School captured a 6-1 tennis victory over Greene Central Tuesday in the opening match of the season for both teams.

Greene Central's only victory came in the number one singles where Jennifer Roberts took a 6-4, 6-1 win over Brittney Hasty.

Greene Central opens its home schedule on Thursday, hosting Rosewood.

Summary:

Jennifer Roberts (GC) d. Brittney Hasty, 6-4, 6-1.

Beth Pope (JK) d. Carmen Sugg, 6-3, 6-1.

Dawn Guy (JK) d. Megan Wyatt, 6-4, 6-2.

Leigh Ann Carlton (JK) d. Kim Pridgen, 6-0, 6-0.

Rosemary Futrell (JK) d. Lisa Cullipher, 6-0, 6-0.

Pope-Carlton (JK) d. Roberts-Sugg, 8-3.

Hasty-Futrell (JK) d. Stacy Morgan-Pridgen, 8-1.

Exhibition: Shane Hutchins (JK) d. Cullipher, 8-4; Vanessa Mills (JK) d. Bridget Williamson, 6-3, 6-0; Kristy Kornegay (JK) d. Morgan, 6-0, 6-1.

**Roanoke.....6**

**Currituck.....3**

CURRITUCK — Roanoke High School spotted Currituck the first three singles matches, then came back to defeat the Lady Knights, 6-3, in a non-conference tennis match Tuesday.

After Currituck took the number one, two and three singles, Roanoke did not lose again in boosting its record to 4-1 on the season.

Roanoke plays at home to Northeastern Conference foe Williamston on Thursday.

Summary:

Jennie Chavers (C) d. Amy Stegal, 6-1, 6-4.

Beth Snowden (C) d. Dawn Briley, 6-4, 6-4.

Emily Ansell (C) d. Amy Oakley, 6-4, 6-3.

Rhonda Bailey (R) d. Meredith Davies, 6-2, 6-2.

Michelle Roberson (R) d. Jennifer Beasley, 6-1, 6-3.

Cindy Powell (R) d. Brook Taylor, 6-0, 6-3.

Stegal-Roberson (R) d. Chavers-Snowden, 8-6.

Briley-Oakley (R) d. Ansell-Davies, 8-1.

Bailey-Kristi Ayers (R) d. Beasley-Taylor, 8-1.

Chicago snapped a five-game losing streak.

Maddux, 17-7 after going 15-3 in the first half, allowed six hits in seven innings, struck out six and walked none.

Kevin Gross, 11-14, lost his sixth consecutive decision since Aug. 12, giving up four runs and six hits 3 2-3 innings.

Steve Jeltz was 0-for-2 and now has one hit in his last 52 at-bats.

**Reds 5, Astros 2**

Jose Rijo allowed three hits in seven innings and Dave Collins' pinch-hit single ignited a three-run seventh inning.

Cincinnati built a 2-0 lead as Eric Davis singled home a first-inning run and Jeff Reed hit a solo homer in the second off Mike Scott, 13-7, who hasn't won since Aug. 13. A throwing

error by reliever Larry Andersen set up run-scoring singles in the seventh by Collins, Barry Larkin and Kal Daniels.

Rijo, 13-8, allowed just three singles in his second start since coming off the disabled list Sept. 8. John Franco got four outs for his 33rd save.

**Giants 4, Padres 1**

Robby Thompson and Candy Maldonado hit solo home runs and Rick Reuschel gained his 18th victory as San Francisco passed San Diego and went back into fourth place in the NL West.

Reuschel, 18-8, gave up seven hits, struck out one and walked none in seven innings. Craig Lefferts finished with one-hit relief for his eighth save.

Ed Whitson, 12-10, gave up seven hits and four runs in five innings.

## SALE GOOD SEPTEMBER 15TH THRU 17TH THURSDAY THRU SATURDAY

We are your small truck headquarters for parts and accessories.

**CRAZY JOE'S**  
DO-IT-YOURSELF  
AUTO PARTS

We reserve the right to limit quantities. Actual products may differ slightly in appearance from line drawings. All sale items may not be available at all store locations.

**10W30\*10W40\*30HD** **PENNZOIL**  
YOUR CHOICE!  
LIMIT 12 QUARTS  
PRICE PER QUART  
**99¢**

**CARBURETOR and FUEL SYSTEM CLEANER**  
GUMOUT  
7518  
LIMIT 2  
**179**

Just add to gas. Cleans the carburetor, improves fuel economy, helps reduce stalling and rough idling. Helps keep PCV Valve and system clean. Helps protect against rust and corrosion of fuel systems and engine intake systems. Use it regularly.

**Arnie's "Caddy" Giveaway!**  
Registration Form on Every Bottle

**TRANSMISSION FILTERS**  
REG. 5.89 TO 6.99  
**4.99** LIMIT 2

**SPARK PLUG WIRE SETS**  
VALUES TO 13.99  
**11.99** LIMIT 2

\$2.00 OFF OTHER FRAM & AUTOLITE WIRE SETS & TRANS. FILTERS

CJ52  
**WON'T DIE 52**  
MAINTENANCE FREE  
**39.99** W/EXCH

CRAZY JOE'S  
WON'T DIE 52 MONTH BATTERY  
VALUES TO 49.99

**PREMIUM REBUILT ALTERNATOR**  
REG. 39.95  
**34.99** W/EXCH

\$5.00 OFF OTHER PREMIUM & REG. DOMESTIC REBUILT ALTERNATORS

**AC Spark Plugs**  
STANDARD LIMIT 8  
**34¢** AFTER REBATE

**RESISTOR** LIMIT 8  
**54¢** AFTER REBATE

**AC OIL FILTERS**  
VALUES TO 4.29  
**1.19** AFTER REBATE

\$1.00 OFF OTHER AC OIL FILTERS

**ROL**  
**2.99** LIMIT 2

VALVE COVER GASKET SETS  
REG. 3.22 TO 5.79  
\$1.00 OFF ALL OTHERS

**BENDIX RIVETED BRAKE SHOES**  
VALUES TO 14.99  
**9.99** W/EXCH  
4 TO A SET  
LIMIT 2

**LIVEEDGE**  
wiper blades and refills  
ONE BLADE OR A PAIR OF REFILLS  
REG. 3.39  
**2.99** LIMIT 2

**MEQUIAR'S**  
M1214  
M1216  
MEQUIAR'S PASTE OR LIQUID CLEANER/WAX  
LIMIT 2  
**2.49** AFTER REBATE

SALE PRICE LESS MFR'S REBATE ..... 4.49  
..... 2.00

**A Fashion Look and a Magic Fit**  
Fashion Magic  
GOLD MEDAL SHEEPSKIN HI-LO BACK BUCKET  
**49.99** 2011-2-55

Genuine sheepskin installs easily without tools.

**PERFORMANCE CORNER** 48000 Series  
**SONIC TURBO**  
Stainless Steel  
**37.95** EACH

Offer expires September 30, 1988

**Greenville, N.C.**  
Memorial Drive, Across From Wendy's Near Hospital  
**752-1123**

VISA  
MasterCard

# SCOREBOARD

## Major League Baseball

By The Associated Press  
All Times EDT

### AMERICAN LEAGUE

W	L	Pct	GB	L10	Streak	Home	Away
Boston	81	63	.563	-	7-3	Won 2	49-24 32-39
New York	65	67	.493	4 1/2	6-4	Won 1	42-32 34-35
Detroit	77	68	.531	2 1/2	2-8	Lost 1	43-29 34-39
Milwaukee	77	70	.523	5 1/2	2-7	Won 1	44-32 33-38
Toronto	73	72	.503	8 1/2	2-6-4	Won 1	36-34 37-38
Cleveland	70	74	.486	11	2-5-5	Lost 2	38-32 32-42
Baltimore	51	92	.357	29 1/2	4-6	Lost 1	32-40 19-52

### NATIONAL LEAGUE

W	L	Pct	GB	L10	Streak	Home	Away
Oakland	92	53	.634	-	2-8-2	Won 2	46-24 46-29
Minnesota	80	64	.556	1 1/2	2-5-5	Won 1	40-31 40-33
Kansas City	76	68	.528	15 1/2	5-5	Won 1	41-33 35-35
California	73	72	.503	19	4-6	Lost 3	33-36 40-36
Texas	63	80	.441	28	3-7	Lost 1	36-39 27-41
Chicago	62	81	.434	29	4-6	Lost 1	36-38 29-43
Seattle	59	86	.407	33	2-5-5	Lost 1	31-39 28-47

### NATIONAL LEAGUE

W	L	Pct	GB	L10	Streak	Home	Away
New York	86	57	.601	-	2-7-3	Lost 1	45-24 41-33
Pittsburgh	76	67	.531	10	5-5	Won 1	41-34 35-33
Montreal	73	71	.507	13 1/2	2-4-6	Won 1	41-33 34-38
St. Louis	70	75	.483	17	7-3	Lost 2	40-35 30-40
Chicago	69	75	.479	17 1/2	2-3-7	Won 1	35-37 34-38
Philadelphia	58	86	.403	28 1/2	4-6	Lost 1	33-36 25-50

Detroit	IP	H	R	ER	BB	SO
Power L-57	213	7	5	5	2	3
Henke	223	2	1	3	3	4
Gibson	2	1	3	3	4	0

MILWAUKEE	CHICAGO
abrbhi	abrbhi
Molitor 3b 5 111 Gallgr cf 4 0 0 0	Gantner 2b 4 110 KWilliams rf 0 0 0 0
Yount cf 4 2 3 1 Lyons rf 4 0 0 0	Deer rf 3 0 1 0 Baines dh 3 0 1 0
Felder lf 0 0 0 0 Fisk c 4 0 0 0	Leonard lf 4 0 1 1 MIDX lf 3 0 1 0
Bruck lf 4 0 0 0 Morman lf 0 0 0 0	Meyer dh 4 0 0 0 CMRtz 3b 3 0 1 0
Surhoff c 4 0 1 0 Guillen ss 3 0 0 0	Sheffild ss 4 0 2 0 Manrig 2b 2 0 0 0
Totals	35 412 3 Totals

### AMERICAN LEAGUE

Tuesday's Games

Boston 6, Baltimore 4  
New York 5, Cleveland 4  
Toronto 9, Detroit 1  
Milwaukee 4, Chicago 0  
Kansas City 4, California 2  
Minnesota 2, Seattle 1

Wednesday's Games

Baltimore (Baustista 6-13) at Boston (Boddicker 11-9), 7:35 p.m.  
New York (Dotson 9-9) at Cleveland (Yett 8-5), 7:35 p.m.  
Detroit (Terrell 7-13) at Toronto (Clancy 9-13), 7:35 p.m.  
Milwaukee (Wegman 11-11) at Chicago (Long 7-10), 8:30 p.m.  
Kansas City (Banister 10-12) at California (Witt 13-12), 10:05 p.m.  
Minnesota (Toliver 7-3) at Seattle (Langston 11-11), 10:05 p.m.  
Texas (Krohn 8-10) at Oakland (Stewart 18-11), 10:35 p.m.

Thursday's Games

Texas at Oakland, 7:35 p.m.  
New York at Boston, 7:35 p.m.  
Cleveland at Toronto, 7:35 p.m.  
Chicago at Minnesota, 8:05 p.m.  
Kansas City at California, 10:05 p.m.

Only games scheduled

### NATIONAL LEAGUE

Tuesday's Games

Cincinnati 5, Houston 2  
Montreal 7, St. Louis 1  
Pittsburgh 1, New York 0  
Chicago 5, Philadelphia 2  
San Francisco 4, San Diego 1  
Los Angeles 2, Atlanta 0

Wednesday's Games

Houston (Ryan 11-11) at Cincinnati (Jackson 21-6), 7:35 p.m.  
Pittsburgh (Dunne 7-11) at Montreal (Folman 3-7), 7:35 p.m.  
Chicago (Schiraldi 9-1) at New York (Hernandez 8-10), 7:35 p.m.  
St. Louis (Mathews 4-5) at Philadelphia (Sebra 9-2), 7:35 p.m.  
San Francisco (Robinson 6-6) at San Diego (Jones 9-12), 10:05 p.m.  
Atlanta (Mahler 9-14) at Los Angeles (Hershiser 20-8), 10:35 p.m.

Thursday's Games

Chicago at New York, 1:35 p.m.  
St. Louis at Philadelphia, 5 p.m.  
San Francisco at Cincinnati, 7:35 p.m.  
Pittsburgh at Montreal, 7:35 p.m.

Only games scheduled

### AMERICAN LEAGUE

BALTIMORE	BOSTON
abrbhi	abrbhi
Orsualk rf 5 110 Borrett 2b 3 1 2 1	Bandsk cf 4 0 0 0 Barrett 2b 3 0 0 0
Ripken ss 4 0 0 0 DeJesus rf 4 0 0 0	Murray lf 3 2 3 1 Greenw lf 3 1 0 0
Sheets lf 3 1 2 1 Burks cf 2 2 0 0	EDAVIS lf 0 0 0 0 Rice dh 4 1 2 4
Traber dh 3 0 0 0 Parrish dh 3 0 1 0	Schu 2b 4 0 1 0 Bzngr lf 1 0 0 0
Bripan 2b 2 0 0 0 JokReed ss 4 1 3 1	Dwyer dh 1 0 0 0 Gorman cf 3 0 0 0
Gonzals 2b 0 0 0 0 Romine ph 1 0 0 0	Stanick ph 1 0 0 0
Totals	34 184 Totals

### AMERICAN LEAGUE

BALTIMORE	BOSTON
abrbhi	abrbhi
Harnisch L-91	7 6 5 3 3 5
Wilson	23 2 1 1 1 0
Thurmond	13 0 0 0 0 0
Boston	
Smithson W-85	5 2 3 4 2 2 2 2
Stanley	2 4 2 2 0 2 2
LeMay S-25	113 0 0 0 1 1

### AMERICAN LEAGUE

NEW YORK	CLEVELAND
abrbhi	abrbhi
Rhinds lf 3 111 Franco 2b 5 1 2 0	Whelan cf 5 0 1 0 Williams lf 3 1 2 1
Mingly lf 5 0 0 0 Hall lf 1 0 1 0	Winfield rf 3 1 3 0 Carter cf 4 1 1 2
JKClark dh 4 0 0 0 Snyder rf 4 0 2 0	Kelly pr 1 0 1 0 Ballew lf 3 0 0 0
PgRulo 3b 2 0 0 0 DCIark ph 1 0 0 0	Aguiro 3b 1 1 1 2 Jacoby 2b 4 0 0 0
Rndph 2b 4 0 1 1 Medina lf 4 1 2 1	Slaughter c 4 0 0 0 Allison c 3 0 0 0
Santana ss 4 1 2 0 CCastill ph 1 0 0 0	JBell ss 3 0 0 0
Kittle ph 1 0 1 0	Zavella pr 0 0 0 0
Totals	35 5 9 1 Totals

### AMERICAN LEAGUE

NEW YORK	CLEVELAND
abrbhi	abrbhi
Gudry 4 2 3 6 4 4 0 2	Allen W-52
Righth 5-21	1 2 0 0 0 0 1
Cleveland	
RNichols	6 6 3 2 3 2
Gordon	11 3 2 1 1 0 1
Bailes L-84	1 2 1 1 1 1 1

### AMERICAN LEAGUE

NEW YORK	CLEVELAND
abrbhi	abrbhi
Guay 4 2 3 6 4 4 0 2	Allen W-52
Righth 5-21	1 2 0 0 0 0 1
Cleveland	
RNichols	6 6 3 2 3 2
Gordon	11 3 2 1 1 0 1
Bailes L-84	1 2 1 1 1 1 1

### AMERICAN LEAGUE

NEW YORK	CLEVELAND
abrbhi	abrbhi
Guay 4 2 3 6 4 4 0 2	Allen W-52
Righth 5-21	1 2 0 0 0 0 1
Cleveland	
RNichols	6 6 3 2 3 2
Gordon	11 3 2 1 1 0 1
Bailes L-84	1 2 1 1 1 1 1

### AMERICAN LEAGUE

NEW YORK	CLEVELAND
abrbhi	abrbhi
Guay 4 2 3 6 4 4 0 2	Allen W-52
Righth 5-21	1 2 0 0 0 0 1
Cleveland	
RNichols	6 6 3 2 3 2
Gordon	11 3 2 1 1 0 1
Bailes L-84	1 2 1 1 1 1 1

### AMERICAN LEAGUE

NEW YORK	CLEVELAND
abrbhi	abrbhi
Guay 4 2 3 6 4 4 0 2	Allen W-52
Righth 5-21	1 2 0 0 0 0 1
Cleveland	
RNichols	6 6 3 2 3 2
Gordon	11 3 2 1 1 0 1
Bailes L-84	1 2 1 1 1 1 1

### AMERICAN LEAGUE

NEW YORK	CLEVELAND
abrbhi	abrbhi
Guay 4 2 3 6 4 4 0 2	Allen W-52
Righth 5-21	1 2 0 0 0 0 1
Cleveland	
RNichols	6 6 3 2 3 2
Gordon	11 3 2 1 1 0 1
Bailes L-84	1 2 1 1 1 1 1

### AMERICAN LEAGUE

NEW YORK	CLEVELAND
abrbhi	abrbhi
Guay 4 2 3 6 4 4 0 2	Allen W-52
Righth 5-21	1 2 0 0 0 0 1
Cleveland	
RNichols	6 6 3 2 3 2
Gordon	11 3 2 1 1 0 1
Bailes L-84	1 2 1 1 1 1 1

### AMERICAN LEAGUE

NEW YORK	CLEVELAND
abrbhi	abrbhi
Guay 4 2 3 6 4 4 0 2	Allen W-52
Righth 5-21	1 2 0 0 0 0 1
Cleveland	
RNichols	6 6 3 2 3 2
Gordon	11 3 2 1 1 0 1
Bailes L-84	1 2 1 1 1 1 1

### AMERICAN LEAGUE

NEW YORK	CLEVELAND
abrbhi	abrbhi
Guay 4 2 3 6 4 4 0 2	Allen W-52
Righth 5-21	1 2 0 0 0 0 1
Cleveland	
RNichols	6 6 3 2 3 2
Gordon	11 3 2 1 1 0 1
Bailes L-84	1 2 1 1 1 1 1

### AMERICAN LEAGUE

NEW YORK	CLEVELAND
abrbhi	abrbhi
Guay 4 2 3 6 4 4 0 2	Allen W-52
Righth 5-21	1 2 0 0 0 0 1
Cleveland	
RNichols	6 6 3 2 3 2
Gordon	11 3 2 1 1 0 1
Bailes L-84	1 2 1 1 1 1 1

### AMERICAN LEAGUE

NEW YORK	CLEVELAND
abrbhi	abrbhi
Guay 4 2 3 6 4 4 0 2	Allen W-52
Righth 5-21	1 2 0 0 0 0 1
Cleveland	
RNichols	6 6 3 2 3 2
Gordon	11 3 2 1 1 0 1
Bailes L-84	1 2 1 1 1 1 1

### AMERICAN LEAGUE

NEW YORK	CLEVELAND
abrbhi	abrbhi
Guay 4 2 3 6 4 4 0 2	Allen W-52
Righth 5-21	1 2 0 0 0 0 1
Cleveland	
RNichols	6 6 3 2 3 2
Gordon	11 3 2 1 1 0 1
Bailes L-84	1 2 1 1 1 1 1

### AMERICAN LEAGUE

NEW YORK	CLEVELAND
abrbhi	abrbhi
Guay 4 2 3 6 4 4 0 2	Allen W-52
Righth 5-21	1 2 0 0 0 0 1
Cleveland	
RNichols	6 6 3 2 3 2
Gordon	11 3 2 1 1 0 1
Bailes L-84	1 2 1 1 1 1 1

### AMERICAN LEAGUE

NEW YORK	CLEVELAND
abrbhi	abrbhi
Guay 4 2 3 6 4 4 0 2	Allen W-52
Righth 5-21	1 2 0 0 0 0 1
Cleveland	
RNichols	6 6 3 2 3 2
Gordon	11 3 2 1 1 0 1
Bailes L-84	1 2 1 1 1 1 1

### AMERICAN LEAGUE

NEW YORK	CLEVELAND
abrbhi	abrbhi
Guay 4 2 3 6 4 4 0 2	Allen W-52
Righth 5-21	1 2 0 0 0 0 1
Cleveland	
RNichols	6 6 3 2 3 2
Gordon	11 3 2 1 1 0 1
Bailes L-84	1 2 1 1 1 1 1

### AMERICAN LEAGUE

NEW YORK	CLEVELAND
abrbhi	abrbhi
Guay 4 2 3 6 4 4 0 2	Allen W-52
Righth 5-21	1 2 0 0 0 0 1
Cleveland	
RNichols	6 6 3 2 3 2
Gordon	11 3 2 1 1 0 1
Bailes L-84	1 2 1 1 1 1 1

## TANK McNAMARA



### HOUSTON

abrbhi	abrbhi
Young cf 5 0 1 0 Larkin ss 4 0 2 1	Doran 2b 5 0 1 0 Sabo 2b 3 1 1 0
Bass rf 1 2 1 1 LHarri 3b 0 0 0 0	GDavis lf 5 0 1 1 Daniels lf 4 0 1 1
Bell 3b 3 0 2 0 EDavis cf 4 0 2 1	Bigstla pr 0 0 0 0 RMRphy p 0 0 0 0
Blatche lf 0 0 0 0 Easaky lf 3 0 0 0	Pauli lf 2 0 0 0 O'Neill rf 4 0 1 0
Asby c 3 0 0 0 Reed c 3 2 1 1	Cammit 3b 1 0 0 0 Oester 2b 3 1 0 0
Ramirez ss 4 1 2 0 Rijo p 2 0 0 0	Scott p 1 0 0 0 Collins ph 1 1 1 1
Spiln ph 1 0 0 0 Wingham cf 1 0 0 0	Anderson p 0 0 0 0
Meads p 0 0 0 0	Meyer p 0 0 0 0
Totals	38 2 9 2 Totals

### HOUSTON

abrbhi	abrbhi
Young cf 5 0 1 0 Larkin ss 4 0 2 1	Doran 2b 5 0 1 0 Sabo 2b 3 1 1 0
Bass rf 1 2 1 1 LHarri 3b 0 0 0 0	GDavis lf 5 0 1 1 Daniels lf 4 0 1 1
Bell 3b 3 0 2 0 EDavis cf 4 0 2 1	Bigstla pr 0 0 0 0 RMRphy p 0 0 0 0
Blatche lf 0 0 0 0 Easaky lf 3 0 0 0	Pauli lf 2 0 0 0 O'Neill rf 4 0 1 0
Asby c 3 0 0 0 Reed c 3 2 1 1	Cammit 3b 1 0 0 0 Oester 2b 3 1 0 0
Ramirez ss 4 1 2 0 Rijo p 2 0 0 0	Scott p 1 0 0 0 Collins ph 1 1 1 1
Spiln ph 1 0 0 0 Wingham cf 1 0 0 0	Anderson p 0 0 0 0
Meads p 0 0 0 0	Meyer p 0 0 0 0
Totals	38 2 9 2 Totals

### HOUSTON

abrbhi	abrbhi
Young cf 5 0 1 0 Larkin ss 4 0 2 1	Doran 2b 5 0 1 0 Sabo 2b 3 1 1 0
Bass rf 1 2 1 1 LHarri 3b 0 0 0 0	GDavis lf 5 0 1 1 Daniels lf 4 0 1 1
Bell 3b 3 0 2 0 EDavis cf 4 0 2 1	Bigstla pr 0 0 0 0 RMRphy p 0 0 0 0
Blatche lf 0 0 0 0 Easaky lf 3 0 0 0	Pauli lf 2 0 0 0 O'Neill rf 4 0 1 0
Asby c 3 0 0 0 Reed c 3 2 1 1	Cammit 3b 1 0 0 0 Oester 2b 3 1 0 0
Ramirez ss 4 1 2 0 Rijo p 2 0 0 0	Scott p 1 0 0 0 Collins ph 1 1 1 1
Spiln ph 1 0 0 0 Wingham cf 1 0 0 0	Anderson p 0 0 0 0
Meads p 0 0 0 0	Meyer p 0 0 0 0
Totals	38 2 9



# Tim Chandler

## Wednesday Notebook

### Time To Regroup

East Carolina, coming off a tough 27-16 loss at the hands of Virginia Tech last Saturday, has a tough test awaiting Saturday as it travels to Columbia, S.C., to battle the nationally-ranked Gamecocks.

Overall, the Gamecocks hold a 5-0 advantage in the series after scoring a 34-12 victory over the Pirates last season in Columbia. South Carolina quarterback Todd Ellis set a Gamecock passing record in that contest as he hurled for 425 yards through the air.

### ECU Coaches Set For Another Reunion

A pair of ECU coaches will be experiencing a Homecoming of sorts when the Pirates invade Williams-Brice Stadium Saturday. Pirate defensive coordinator Richard Bell served as head coach of the Gamecocks during the 1982 season, posting a 4-7 mark before departing to take over the defensive coordinator position at Duke. Before serving as head coach, Bell had served at the school as an assistant under former coach Jim Carlen for seven years.

ECU outside linebacker coach Clyde Christensen will be hoping for a repeat performance of what his 1979 North Carolina team accomplished in Williams-Brice. Christensen was a quarterback for the Tar Heel team that shutout the Gamecocks 28-0. The loss was one of only three by South Carolina the entire season.

### Pirate Players Heading Home

Six ECU players will be heading to their home state Saturday when the Pirates take on the Gamecocks. They include junior defensive lineman Carl Carney (Columbia), senior fullback Tim James (Hartsville), sophomore offensive lineman Bill Maxwell (Ware Shoals), junior linebacker Compton McCurry (Summerville), freshman defensive lineman Mark Weatherford (Charleston) and sophomore wide receiver Al Whitting (Dalzell).

The Gamecocks list of North Carolinians on their roster totals 23.

### Hunter Continues To Challenge Records

ECU junior quarterback Travis Hunter continues his assault on the Pirate all-time passing marks. Hunter currently needs only 327 yards of total offense to move into the top 10 of the ECU career total offense list. He now has 2,404 yards, while 10th-place Theodore Sutton's mark stands at 2,730.

Hunter needs only 153 yards to take over fifth place on the Pirate career passing yardage list. He now stands in the sixth spot with 1,824 yards, while former signal caller Kevin Ingram is in fifth with 1,976.

After three more pass completions, Hunter will take over the sixth position on the all-time Pirate completions list. Hunter currently stands at 131, while Leander Green completed 133 from 1976-79.

### Duke Turning Heads In The ACC

After stunning Tennessee last Saturday, 31-26, Duke pushed its record to 2-0 and is sending out a warning to the rest of the Atlantic Coast Conference that it doesn't plan to be the doormat of the league this year.

One of the reasons for all of the success experienced by the Blue Devils this season has been the connection between quarterback Anthony Dilweg and wide receiver Clarkston Hines.

Saturday against Tennessee, the two teamed up for three touchdowns as Duke built up a 31-7 lead in the game.

Dilweg has thrown for over 300 yards in his last three starts, while Hines has a streak of five straight 100-yard receiving contests. In all, Hines hauled in eight passes Saturday for 145 yards, running his season total, after only a pair of games, to 16 receptions for 276 yards and four touchdowns. Dilweg, on the other hand, has completed 50 of 72 passes this season for 664 yards and five TD's.

## Sports Notes

### Kobe Named Master Swim Coach

East Carolina University head swimming coach Rick Kobe has been awarded the title of Master Swim Coach by the American Swimming Coaches Association. Kobe was given the award during the recent World Swim Clinic held in San Francisco.

According to the A.S.C.A., Kobe is one of the youngest coaches to ever receive the title of Master Swim Coach. Approximately 20 percent of coaches on the collegiate level hold the honor.

Kobe has been the head swimming coach at ECU since the 1982 season and has compiled a 97-46 record in dual meets. Prior to that, he served as an assistant for two years under former coach Ray Scharf.

### Rose Rallies Past Northern Nash

RED OAK — Rose High School came from a 1-0 deficit to take a 4-1 soccer victory over Northern Nash Tuesday in the opening Big East Conference match for the Rampants.

Northern Nash scored at the 11 minute mark of the first half when Chris Peacock stole a pass and scored.

But Rose came back on a pair of Jason Bizzaro goals in less than two minutes, both off penalty kicks. Patrick Joyner and Michael Thompson were credited with assists on the goals.

David Leisten, who also scored twice, game Rose a 3-1 lead with a goal at 35:54, assisted by Toure Claibourne. Leisten's other goal came at 23:23 of the second half, with an assist by Joyner.

"What pleased me most about this game," said coach Charlie Harvey, "was that we came from behind to win."

He cited the defensive play of John Bolen and goalie Scott Thomas. Rose outshot Northern, 17-9, for the game.

Rose, now 2-3 overall and 1-0 in the Big East, is at home to Rocky Mount on Thursday at 4 p.m.

### Sheridan Remembers Trench Battle

RALEIGH (AP) — North Carolina State coach Dick Sheridan didn't care much for the Wolfpack's 21-3 loss to Wake Forest last year, but he really didn't like the way his team was beaten up front by the Demon Deacons.

"A year ago they just dominated us, on both sides of the football," Sheridan said at his weekly press conference on Monday. "They took the ball and stuck it right at us on offense."

"On defense, they completely stymied us. They won those key battles up front."

Sheridan hopes his team remembers last year's game as it prepares for Saturday's game with the Deacons, who are 2-0 after victories over Villanova and Illinois State. N.C. State, which was idle last Saturday, is 1-0.

"I'm anxious to see if we've improved up front on both sides of the ball," Sheridan said. "I think we're quicker. I'm anxious to see if we're stronger."

The Wolfpack will start two freshman and four sophomores on defense against a team that averaged 447 yards in its first two games.

"We are very concerned about that," Sheridan said. "I think Wake Forest offensively is ... very versatile. I think they've got a great blend of running the football at you, optioning the ball and throwing it."

## Pack Takes 9-0 Victory

WASHINGTON — Washington High School rolled up a 9-0 victory over D.H. Conley in a tennis match Tuesday.

Conley's less-experienced team won only 13 games in the singles, and never more than three in a set.

The loss was the second in as many matches for the Valkyries, who play host to East Duplin on Thursday.

Summary:

Rene Manning (W) d. Nichole Blookworth, 6-0, 6-0.

Lisa Manning (W) d. Celeste Charlton, 6-1, 6-0.

Ann Archie (W) d. Brandy Scudder, 6-0, 6-0.

Megan Tayloe (W) d. Mary Beth McLeod, 6-1, 6-3.

Anna Champion (W) d. Vanessa Small, 6-2, 6-0.

Dodi Darrow (W) d. Gail Lilley, 6-3, 6-3.

Melissa Harris-Archie (W) d. Bloodworth-Charlton, 8-4.

Champion-Tayloe (W) d. Scudder-McLeod, 8-0.

Darrow-Ann Taylor (W) d. Small-Lilley, 8-2.

### James Kenan.....6 Greene Central.....1

WARSAW — James Kenan High School captured a 6-1 tennis victory over Greene Central Tuesday in the opening match of the season for both teams.

Greene Central's only victory came in the number one singles where Jennifer Roberts took a 6-4, 6-1 win over Brittney Hasty.

Greene Central opens its home schedule on Thursday, hosting Rosewood.

Summary:

Jennifer Roberts (GC) d. Brittney Hasty, 6-4, 6-1.

Beth Pope (JK) d. Carmen Sugg, 6-3, 6-1.

Dawn Guy (JK) d. Megan Wyatt, 6-4, 6-2.

Leigh Ann Carlton (JK) d. Kim Pridden, 6-0, 6-0.

Rosemary Futrell (JK) d. Lisa Cullipher, 6-0, 6-0.

Pope-Carlton (JK) d. Roberts-Sugg, 8-3.

Hasty-Futrell (JK) d. Stacy Morgan-Pridden, 8-1.

Exhibition: Shane Hutchins (JK) d. Cullipher, 8-4; Vanessa Mills (JK) d. Bridget Williamson, 6-3, 6-0; Kristy Kornegay (JK) d. Morgan, 6-0, 6-1.

### Roanoke.....6 Currituck.....3

CURRITUCK — Roanoke High School spotted Currituck the first three singles matches, then came back to defeat the Lady Knights, 6-3, in a non-conference tennis match Tuesday.

After Currituck took the number one, two and three singles, Roanoke did not lose again in boosting its record to 4-1 on the season.

Summary:

Jennifer Roberts (GC) d. Brittney Hasty, 6-4, 6-1.

Beth Pope (JK) d. Carmen Sugg, 6-3, 6-1.

Dawn Guy (JK) d. Megan Wyatt, 6-4, 6-2.

Leigh Ann Carlton (JK) d. Kim Pridden, 6-0, 6-0.

Rosemary Futrell (JK) d. Lisa Cullipher, 6-0, 6-0.

Pope-Carlton (JK) d. Roberts-Sugg, 8-3.

Hasty-Futrell (JK) d. Stacy Morgan-Pridden, 8-1.

Exhibition: Shane Hutchins (JK) d. Cullipher, 8-4; Vanessa Mills (JK) d. Bridget Williamson, 6-3, 6-0; Kristy Kornegay (JK) d. Morgan, 6-0, 6-1.

### CL Adds Two Teams

NEW YORK (AP) — Army and Fordham will join the six-member Colonial League in 1990 when the league expands to include competition in other intercollegiate sports, league officials announced Tuesday.

The Colonial League, entering its third season of football competition, requires that its members award financial aid on a need basis and does not permit athletic scholarships except under special circumstances, said league spokesman Todd Newcomb.

The founding members of the league are Bucknell, Colgate, Davidson, Holy Cross, Lafayette and Lehigh, all NCAA Division I-AA football schools.

Newcomb said only Holy Cross is permitted to award football scholarships, but that practice will end in 1991.

Army will remain in Division I-A football and continue to play baseball in the Eastern Intercollegiate Baseball League, Newcomb said.

Fordham will move up from Division III in football. The school will continue to award basketball scholarships for men and women until the class of 1992 enters, he said.

Roanoke plays at home to Northeastern Conference foe Williamston on Thursday.

Summary:

Jennie Chavers (C) d. Amy Stegal, 6-1, 6-4.

Beth Snowden (C) d. Dawn Briley, 6-4, 6-4.

Emily Ansell (C) d. Amy Oakley, 6-4, 6-3.

Rhonda Bailey (R) d. Meredith Davies, 6-2, 6-2.

Michelle Roberson (R) d. Jennifer Beasley, 6-1, 6-3.

Cindy Powell (R) d. Brook Taylor, 6-0, 6-3.

Stegal-Roberson (R) d. Chavers-Snowden, 8-6.

Briley-Oakley (R) d. Ansell-Davies, 8-1.

Bailey-Kristi Ayers (R) d. Beasley-Taylor, 8-1.

SAVE 65¢ on Kellogg's products  
DISCOUNT COUPONS, Valassis Black and White, Wilton, CT 06897

MANUFACTURER COUPON / EXPIRES DECEMBER 31, 1988

**Save 35¢**  
on one 20.3 oz. or two 14 oz. packages

CONSUMER: Offer good on all sizes EXCEPT single serving size packages and is limited to one coupon per package purchased.  
RETAILER: KELLOGG SALES COMPANY will redeem this coupon in accordance with our redemption policy copies available upon request. Cash value 1/100¢. Void where prohibited, taxed or restricted by law. Mail coupons to DEPT. K, P.O. Box 870087, EL PASO, TX 75287-0087.  
Kellogg Company 1988 Kellogg Company

5 38000 52535 8

MANUFACTURER COUPON / EXPIRES DECEMBER 4, 1988

**Save 30¢**  
Good on any one 12-count or any two 6-count packages Good on any one 6-count or 12-count Pop-Tart brand toaster pastries.

CONSUMER: Offer limited to one coupon per 6-count or 12-count package purchase.  
RETAILER: KELLOGG SALES COMPANY will redeem this coupon in accordance with our redemption policy copies available upon request. Cash value 1/100¢. Void where prohibited, taxed or restricted by law. Mail coupons to DEPT. K, P.O. Box 870087, EL PASO, TX 75287-0087.  
Kellogg Company 1988 Kellogg Company

5 38000 81000 3

# FREE COLD CUTS!

**BUY ONE PACKAGE OF BRYAN® COLD CUTS AND GET A SECOND PACKAGE FREE.**

**Bryan**  
The FLAVOR of the SOUTH!™

REDEEM THIS COUPON TODAY AT YOUR LOCAL STORE

**FREE COLD CUTS**  
BUY ONE PACKAGE OF BRYAN® COLD CUTS AND GET A SECOND PACKAGE FREE.

Customer Signature \_\_\_\_\_ Date \_\_\_\_\_  
Retail Price \_\_\_\_\_ (Customer must sign and fill in for redemption.)  
CONSUMER: Limit one coupon per purchase. Void if reproduced or restricted by law.  
RETAILER: Your redemption signifies compliance with Bryan Foods coupon redemption policy. Copy available upon request. Cash value \$ .002. To receive face value plus 7¢ handling, send coupons to Bryan Foods, P.O. Box 870028, El Paso, TX 88567-0028. Proof of purchase must be submitted on request. Expires 11/12/88.

53400 128582

## DISCOUNT COUPON

VALASSIS BLACK AND WHITE Wilton, CT 06897

**Belk**  
carolina east mall  
greenville

Belk and 1928 Jewelry  
presents  
"Theatre Nights"  
Coming Soon...Saturday  
Sept. 17, 1988

AT LAST! FROM THE **MUPPET TEST KITCHENS** OF THE **SWEDISH CHEF™**

Delicious Cinnamon Toast Flavor!  
Nutritiously Wholesome!!  
Marvelous Muppetry Fun!!

**Post**  
**CROONCHY STARS**  
CEREAL

LIVE! FROM THE MUPPET TEST KITCHENS

NO BUTTERIES MESSY!!

SWEDISH CHEF™

MANUFACTURER'S COUPON EXPIRES JAN 31, 1989

**SAVE \$1.00**

ON YOUR NEXT PURCHASE OF **Post** **CROONCHY STARS™**

GENERAL FOODS CORPORATION

HENSON ASSOCIATES, INC. 1988 THE SWEDISH CHEF™ AND MUPPET™ ARE TRADEMARKS OF HENSON ASSOCIATES, INC.

5 43000 16176 5

This coupon good only on purchase of product indicated. Any other use constitutes fraud. COUPON NOT TRANSFERABLE. LIMIT — ONE COUPON PER PURCHASE.  
To the retailer: GFC will reimburse you for the face value of this coupon plus 8¢ if submitted in compliance with GFC Redemption Policy C-1, incorporated herein by reference. Void only if redeemed by retail distributors of our merchandise or anyone specifically authorized by GFC. Cash value 1/20¢. Mail to: General Foods Corporation, P.O. Box 103, Kalamazoo, MI 49002.

SG0REV0810

0 1

# Ex-Hostage Goes Into Seclusion For Reunion With Wife, Sons

BONN, West Germany (AP) — West German Rudolf Cordes, home after 20 months of captivity in the hands of pro-Iranian kidnapers in Beirut, was flown to an undisclosed location to rest and enjoy a reunion with his wife and two sons.

Reporters were given no chance to talk to the 55-year-old Frankfurt businessman upon his arrival at Cologne-Bonn airport Tuesday night.

West German officials, including Foreign Minister Hans-Dietrich Genscher, have denied making any payments for Cordes' freedom. He was released by his pro-Iranian Shiite Moslem kidnapers late Monday night.

But the mass-circulation Bild newspaper of Hamburg said "a sum of millions is believed to have been paid to kidnapers for the release." Bild cited unidentified security sources.

The newspaper also quoted a source identified only as a "security expert" as saying that at least 40 mil-

lion marks (\$22.2 million) were paid for Cordes' release. Bild is known to have good sources within the government.

A high-ranking government official described Cordes' long captivity, the isolation he endured, and his constant uncertainty over his fate.

The Los Angeles Times said today Iran apparently arranged for Cordes to be transferred from captors linked to Mohammed Ali Hamadi, who is being tried in Germany for hijacking a TWA jet, to the group that freed the West German.

Iran apparently arranged the release to regain favor with West Germany, a vital trading partner and the Western nation with which it has the closest ties, the Times said, citing unidentified sources.

Cordes was abducted in West Beirut in January 1987, three days before a West German engineer, Alfred Schmidt, was kidnapped. Schmidt was freed Sept. 7, 1987. The Hamadi clan was believed to have

abducted both men.

Cordes and his wife, Marlene, touched down at 10:20 p.m. aboard a twin-engine West German military jet after a five-hour flight from Syria.

The federal minister for chancellery affairs, Wolfgang Schauble, was aboard the same plane.

Schauble later told West German television that Cordes was "feeling better than he had expected."

"But naturally he's very weak. He's probably feeling better now because of the initial excitement that he will be tomorrow or the day after tomorrow," the official said.

"He's been flown to a place where he can find privacy for a time. He desperately needs quiet, to recover, to work through the experience.

"I don't know where he's going and even if I knew I wouldn't say," the official said.

Schauble said Cordes told him his kidnapers "treated him humanely, but the conditions were hard, he was



RUDOLPH CORDES

always isolated and was always chained."

Hans Neusel, a state secretary in the federal Interior Ministry, told reporters at the airport Cordes said there were signs he was about to be released before it happened.

"His hopes increased when he was given new clothes three days before he was freed," said Neusel, who also was on the plane with Cordes.

# Iran-Iraq Talks Shifting To N.Y.

GENEVA (AP) — Iran and Iraq agreed to recess their stalled peace talks and resume them in New York, according to a U.N. mediator, but Baghdad balked at a proposed meeting date this month.

A U.N. mediator said he hoped to come up with a meeting date today.

U.N. Secretary-General Javier Perez de Cuellar proposed the temporary move to New York in the hope of unblocking the U.N.-mediated negotiations which opened in Geneva almost three weeks ago.

The agreement to pick up talks "shortly" in New York was announced Tuesday by U.N. mediator Jan Eliasson, appointed by Perez de Cuellar last week to oversee the talks in his absence.

The U.N. chief invited the foreign ministers of the two nations to meet at U.N. headquarters in New York on Sept. 22, but the Iraqi delegation announced that Foreign Minister Tariq Aziz could not be in New York before the first week of October.

The Iraqis also said they agreed to attend one meeting in New York only if, before leaving Geneva, a firm date was fixed for returning.

The Iraqis' hardline stance was spelled out in a press statement Tuesday night.

Eliasson sought to play down the problem, calling the question of dates a "technical, secondary issue." He told journalists it could be solved in a "smooth, undramatic manner" and indicated he hoped this could be done by today.

"The main thing is the acceptance (by both sides) of a meeting in New York shortly ... and of the subsequent continuation of the talks in Geneva," he said.

He told a news conference earlier that both sides "seem committed to keep the peace process going." He said they also pledged to continue to observe the cease-fire, which went into effect Aug. 20 after eight years of fighting and an estimated 1 million dead.

THE DAILY REFLECTOR CLASSIFIED 752-6166

# classified

**rates**

**TRANSIENT RATES**  
Minimum 3 Lines  
1 Day, ... 90¢ per line per day  
2-3 Days, ... 68¢ per line per day  
4-6 Days, ... 61¢ per line per day  
7-14 Days, ... 55¢ per line per day

**CLASSIFIED DISPLAY**  
\$4.15 Per Col. Inch  
Contract Rates Available

**office hours:**  
Monday thru Friday  
8:30 a.m. - 5:00 p.m.

THE DAILY REFLECTOR reserves the right to edit or reject any advertisement submitted.

**errors**

Please read your ad carefully the first time it appears in the paper. If it needs a correction as a result of our error, please call us before 9:30 a.m. and we will correct it for you. The Daily Reflector cannot make allowances for errors after the 1st day of publication.

**cancellations**

If you wish to cancel an ad, please call before 9:30 a.m. on the day that is scheduled to run and we will remove it. We cannot cancel ads after 9:30 a.m.

**deadlines**

**Classified Display Deadlines**  
Mon. .... Fri. Noon  
Tues. .... Fri. 4 p.m.  
Wed. .... Mon. 4 p.m.  
Thurs. .... Tues. 4 p.m.  
Fri. .... Wed. Noon  
Sun. .... Wed. 3 p.m.

**Classified Line Deadlines**  
Mon. .... Fri. 4 p.m.  
Tues. .... Mon. 3 p.m.  
Wed. .... Tues. 3 p.m.  
Thurs. .... Wed. 3 p.m.  
Fri. .... Thurs. 3 p.m.  
Sun. .... Thurs. 5 p.m.

**MISCELLANEOUS**

Personals	002
In Memoriam	003
Card Of Thanks	005
Special Notices	007
Travel & Tours	009
Automotive	010
Child Care	044
Day Nursery	045
Health Care	047
Employment	055
For Sale	067
Instruction	114
Lost And Found	115
Business Services	118

**WANTED**

Help Wanted	056
Administrative	057
Clerical	058
Medical	059
Miscellaneous	060
Sales	061

**RENT/LEASE**

Apartment For Rent	161
Business Rentals	163
Campers For Rent	167
Condominiums For Rent	170
Farms For Lease	140

**SALE**

Autos For Sale	011 029
Bicycles For Sale	030
Boats And Motors	032
Camping Equipment	034
Cycles For Sale	036

**classified index**

Houses For Rent	173
Trucks For Sale	175
Merchandise Rentals	177
Mobile Homes For Rent	179
Mobile Home Lots For Rent	180
Office Space For Rent	181
Resort Property For Rent	184
Rooms For Rent	186

**classified index**

Jeeps And Vans	040
Mobile Home Insurance	103
Musical Instruments	105
Sporting Goods	109
Antiques	069
Woodstoves	112
Commercial Property	132
Condominiums For Sale	136
Farms For Sale	139
Houses For Sale	144
Business Investment Property	147
Investment Property	148
Land For Sale	150
Farm Products	088
Mobile Home Lots For Sale	151
Lots For Sale	152
Resort Property For Sale	155
Timberland & Timber	156
Townhouses For Sale	157

**Public Notices**

This is the 12th day of September, 1988.

**NELSON B. CRISP, CHAIRMAN**  
**PITT COUNTY BOARD OF ELECTIONS**  
September 14, 1988

**EXECUTOR NOTICE**  
**NORTH CAROLINA**  
**PITT COUNTY**

The undersigned Executor of the Estate of Elizabeth Speir Davenport, gives notice that all claims against said decedent are to be presented to the undersigned on or before February 24, 1989 or this notice will be pleaded in bar of the recovery. All persons indebted to said estate, please make immediate payment.

This notice is given pursuant to the provisions of G.S. 28A-14.1.

This 15th day of August, 1988.  
Roy Edward Davenport, Jr., Executor  
Post Office Box 66  
Farmville, NC 27828  
ROSE, JONES, RAND & ORCUTT, P.A.  
Attorneys  
Post Office Drawer 2367  
Wilson, NC 27894 2367  
Telephone: (919) 291-3848  
August 24, 31; Sept. 7, 14, 1988

**001 Public Notices**

Sealed Bid proposals will be received by the Pitt Greenville Airport Authority, at the office of the Airport Manager until 2:00 PM on September 27, 1988, at which time and place all proposals received will be opened and read aloud for constructing the site for Glideslope equipment at the Pitt Greenville Airport.

Specifications and contract documents are available for prospective bidders and shall be distributed to bidders requesting said documents.

Bidders are invited to submit proposals for this work on the proposal forms provided. Other proposal forms will not be accepted.

Each bidder shall present his proposal in a sealed envelope marked at the lower left hand corner "Proposal for Glideslope Site Preparation, Pitt-Greenville Airport".

September 14, 1988

**001 Public Notices**

STATE OF NORTH CAROLINA COUNTY OF PITT

FILE NO.: 88-SP-163  
FILM NO.: 88-44-752

**NOTICE OF SALE**  
IN THE GENERAL COURT  
OF JUSTICE  
SUPERIOR COURT DIVISION  
BEFORE THE CLERK  
IN THE MATTER OF THE  
FORFEITURE OF THE  
DEED OF TRUST OF JAMES  
R. PAYTON AND LINDSAY D.

CLASSIFIED DISPLAY

**001 Public Notices**

PAYTON, Mortgagees Grantors TO  
**EUGENE RUSS TAYLOR**, (Substitute) Trustee and STATE EMPLOYEES CREDIT UNION, Noteholder.

Under and by virtue of an Order of Sale issued by the Clerk of Superior Court of Pitt County on the 9th day of August, 1988, the undersigned will, on the 28th day of September, 1988 at 12:00 a.m., at the door of the courthouse of Pitt County, Greenville, North Carolina, offer for sale to the highest bidder for cash subject to the confirmation of the Court, that certain property described as follows:

BEGINNING at a stake on the East side of N.C. Highway #11, being the Cora Roundtree Southwest corner, and runs thence along the Roundtree line, South 59.35 East 57.2 feet to a stake; thence South 65.50 East 167 feet to a stake, intersection of a ditch; thence along said intersecting ditch and along the Ruth Farmer line, South 31.30

CLASSIFIED DISPLAY

**001 Public Notices**

West 172 feet to a stake, another ditch; thence along said other ditch and the Pete Jones line, North 59.45 West 218 feet to the Eastern right of way of said Highway #11; thence along the eastern right of way of said Highway #11, North 29.35 East 150.5 feet to the point of beginning according to a plan of the lot surveyed for James R. Payton of Ayden, North Carolina by W. B. Duke, P.S., on March 1, 1961. Reference is made to James R. Payton and Lindsay D. Payton deed dated December 10, 1960.

Said real estate shall be sold as is without express or implied warranties subject to Pitt County Ad Valorem Taxes and assessments, all liens and encumbrances whatsoever; that the highest bidder at said sale

CLASSIFIED DISPLAY

**001 Public Notices**

shall be required to deposit five percent (5%) of his bid plus \$50.00 as evidence of good faith, and that said undersigned shall report said sale to the Court for confirmation.

This the 29th day of August, 1988  
Eugene Russ Taylor, Trustee  
300 West 1st Street  
Greenville, NC 27834  
Aug. 31; Sept. 7, 14, 23, 1988

CLASSIFIED DISPLAY

**001 Public Notices**

**HELP IS HERE!**  
Call classified.  
752-6166

CLASSIFIED DISPLAY

**007 Special Notices**

**WE CARRY BATTERIES** (Eveready) for all makes of watches! Floyd G. Robinson Jewelers, Downtown Evans Mall, Greenville, 758-2452

CLASSIFIED DISPLAY

**001 Public Notices**

**DELIVER TELEPHONE BOOKS**

Men or Women 18 years old or older with vehicles (must have liability insurance) to deliver telephone directories in Greenville, Ayden, Bethel, Farmville, Fountain, Snow Hill, Winterville-also rural areas in Pitt and Greene Counties. Must be able to work 5 or more daylight hours. Call 830-9421 between 9:00 a.m.-3:00 p.m., Monday-Friday. Delivery starts September 16th.

**001 Public Notices**

**TIRED OF OVER THE ROAD AND OUT OF THE POCKET EXPENSES?**

**NEEDED: Tractor Trailer Drivers**

Home every night, heavy lifting, Class A License and security check required. Call Joyce Foods, 756-6412 from 1-5.

EOE

**001 Public Notices**

**ADVANCE MECHANICAL**

Needs persons experienced in sheetmetal and duct installing.

**355-6011**

**001 Public Notices**

**REMODELING**

The Waffle House located at 306 Greenville Blvd., will be closed for remodeling September 6 and scheduled for reopening approximately September 12. We will be reopening under new management. Applications will be accepted for all positions both full and part-time.

Apply in person only between 7 a.m. and 3 p.m. Must be dependable neat, pleasant, and enjoy working with the public. Benefits include incentive bonus, 1 week paid vacation after 6 months and medical/dental insurance available.

Management applicants please submit resume and salary expectations.

**The Waffle House**  
306 Greenville Blvd  
Greenville, NC 27834  
Attn: Division Manager

**001 Public Notices**

**RN/PA NEEDED**

For a challenging career in organ procurement in the Greenville area. Must possess excellent interpersonal skills. Excellent benefits, which include employer-paid life, disability, hospitalization, and pension. Salary commensurate with experience. Send current resume to: Carolina Organ Procurement Agency, Attention: Executive Director, 702 Johns Hopkins Drive, Greenville, NC 27834. No phone calls please. EOE.

**001 Public Notices**

**PITT COUNTY GOVERNMENT EMPLOYMENT OPPORTUNITY PUBLIC HEALTH EDUCATOR II**

Hiring Range \$20,358-\$22,438

Responsibilities include developing, implementing and evaluating health promotion activities throughout the county, including a Wellness Program for Pitt County Employees. A master's degree in public education or in public health with a major in public health education; or graduation from a four-year college or university with a major in health education and two years experience in public health education or a related field; or graduation from a four-year college or university and three years experience in public health education; or an equivalent combination of training and experience. A valid N.C. driver's license and proof of Rubella immunity is required.

Apply: Employment Security Commission  
3101 Bismarck Drive  
Greenville, NC 27834

Deadline for applications is Friday, September 23, 1988.

AN AFFIRMATIVE ACTION/EQUAL OPPORTUNITY EMPLOYER

**001 Public Notices**

**Bob Barbour Honda invites you to Come Grow With Us!**

We are currently interviewing to increase our sales staff to meet the tremendous public acceptance of our product.

**The Ideal Candidate Would Be:**

- Aggressive
- Possess Some Sales Experience (not necessarily automobiles)
- Committed To Earning In Excess Of \$35,000 Per Year
- Well Groomed

**If You Are Selected, We Offer:**

- An Excellent Pay Plan
- An Opportunity For A Car Allowance
- Excellent Training
- The Opportunity For Rapid Advancement
- A Positive Work Environment
- Excellent Benefit Package

Both men and women may apply.

To take advantage of this rare opportunity apply in person to Hayden Butts,

**Bob Barbour Honda**  
3300 S. Memorial Dr.  
Greenville, N.C.

**001 Public Notices**

**PITT COUNTY GOVERNMENT EMPLOYMENT OPPORTUNITY SOCIAL WORKER II**

Hiring Range \$19,396-21,372

Responsibilities of this position are to coordinate day care services for eligible children of Pitt County and to also to conduct investigations of cases of child abuse and neglect.

Minimum Training and Experience Requirements: Bachelor's degree from an accredited school of social work and one year of social work or counseling experience; or a four year degree in a human service field or related curriculum including at least 15 semester hours in courses related to social work or counseling and two years of social work or counseling experience; or graduation from a four-year college or university and three years of experience in rehabilitation counseling, pastoral counseling, or a related human service field providing experience in the techniques of casework, group work, or community organization; or an equivalent combination of training and experience.

PD-107 State Applications and college transcripts are required.

Apply: Employment Security Commission  
3101 Bismarck Drive  
Greenville, N.C. 27834

Deadline for applications is September 23, 1988

AN AFFIRMATIVE ACTION/EQUAL OPPORTUNITY EMPLOYER

**001 Public Notices**

**LITTLE CAESAR'S PIZZA**

Now taking applications for management trainees. Previous management experience required.

Apply at Little Caesar's Pizza, 3120 E. 10th Street.  
Call 757-1212 For Appointment

**001 Public Notices**

**BUILDING SUPPLY COMPANY**

is opening a new branch in the Greenville area and has openings for the following positions:

- Dispatcher/Warehouse Manager
- Truck Drivers - Class A License preferred
- Fork Lift Operators
- Material Handlers

Top pay and benefits for qualified individuals. Send resume and salary requirements to:

PO Box 3156  
Greenville, NC 27836

**001 Public Notices**

**TELEPHONE SALES CLASSIFIED ADVERTISING**

The Daily Reflector has an immediate opening in its Classified Advertising Department for a full-time telephone salesperson.

Responsibilities will include assisting customers in placing ads both by the phone and over-the-counter, telephone sales, proofreading, typing and general clerical duties.

If you have good typing and spelling skills, a pleasant telephone personality, and are interested in entering the field of advertising sales, please send resume to:

**Barbara Jarvis**  
**THE DAILY REFLECTOR**  
PO Box 1967  
Greenville, NC 27835  
NO PHONE CALLS

**001 Public Notices**

**NOTICE**

Pursuant to G.S. 163-230(31a) and resolution duly adopted on August 30, 1988, the Pitt County Board of Elections will hold public meetings at the Elections Office, 201 East Second Street, Greenville, N.C., to pass upon the validity of all applications for absentee ballots received by the county for the general election to be held on November 8, 1988.

During the period commencing 50 days before the general election to be held on Tuesday, November 8, 1988, and until 30 days before said election, the Pitt County Board of Elections shall hold one or more public meetings at 4:30 p.m. on Wednesday of each week for the purpose of action on applications for absentee ballots. During the period opening 30 days before said election to be held on November 8, 1988, and closing at 5:00 p.m. on the Tuesday day before the election, the Pitt County Board of Elections shall hold public meetings at 4:30 p.m. on Tuesday and Friday of each week, and shall also hold public meetings at 4:30 p.m. on the eighth, sixth, fourth and first days immediately preceding election day. These meetings will be held at the Elections Office, 201 East Second Street, Greenville, N.C., for the purpose of passing upon applications for absentee ballots.

**001 Public Notices**

**NOTICE TO CREDITORS**

The undersigned, having qualified as Executor of the Estate of EDWARD FREDERICK SWITZER, deceased, late of Pitt County, North Carolina, this is to notify all persons having claims against the estate to present them to the undersigned on or before the 24th day of February, 1989, or this notice will be pleaded in bar of the recovery. All persons indebted to said estate will please make immediate payment to the undersigned.

This the 24th day of August, 1988.

Thelma Cherry Switzer  
Executrix OF THE ESTATE OF EDWARD FREDERICK SWITZER  
P.O. Box 404  
Greenville, N.C. 27834  
OWENS, ROUSE & NELSON ATTORNEYS AT LAW  
P.O. Box 88  
Farmville, N.C. 27828  
August 24, 31; Sept. 7, 14, 1988

**001 Public Notices**

**NOTICE**

Having this day qualified as Executor of the Estate of Adrian E. Brown, deceased, late of Pitt County, North Carolina, this is to notify all persons having claims against said estate to present them to the undersigned Executor on or before the 14th day of March, 1989, or this notice will be pleaded in bar of their recovery. All persons indebted to said estate will please make immediate settlement.

This the 9th day of September, 1988.

William J. Woolen, Jr., Executor  
111 W. Third Street  
P.O. Box 451  
Greenville, N.C. 27835 0451  
Telephone: 758-2111  
Sept. 14, 21, 28, Oct. 5, 1988

**001 Public Notices**

**NOTICE**

The undersigned, having qualified as Executor of the Estate of EDWARD FREDERICK SWITZER, deceased, late of Pitt County, North Carolina, this is to notify all persons having claims against the estate to present them to the undersigned Executor on or before the 14th day of March, 1989, or this notice will be pleaded in bar of their recovery. All persons indebted to said estate will please make immediate settlement.

This the 9th day of September, 1988.

William J. Woolen, Jr., Executor  
111 W. Third Street  
P.O. Box 451  
Greenville, N.C. 27835 0451  
Telephone: 758-2111  
Sept. 14, 21, 28, Oct. 5, 1988

**001 Public Notices**

**NOTICE**

The undersigned, having qualified as Executor of the Estate of EDWARD FREDERICK SWITZER, deceased, late of Pitt County, North Carolina, this is to notify all persons having claims against the estate to present them to the undersigned Executor on or before the 14th day of March, 1989, or this notice will be pleaded in bar of their recovery. All persons indebted to said estate will please make immediate settlement.

This the 9th day of September, 1988.

William J. Woolen, Jr., Executor  
111 W. Third Street  
P.O. Box 451  
Greenville, N.C. 27835 0451  
Telephone: 758-2111  
Sept. 14, 21, 28, Oct. 5, 1988

**011 Autos For Sale**  
**"A GOOD PLACE TO BUY!"**  
**"CREATIVE FINANCING"**  
**EASTGATE MOTORS, INC.**  
 130 East Greenville Blvd.  
 Greenville, 355-2193

**1986 MONTE CARLO**, wrecked, engine and transmission runs good. 752-9324 after 5:00 p.m.

**014 Cadillac**  
**1978 CADILLAC** Coupe de ville. Carolina blue. 5 excellent Firestone 721 tires. New battery. Reconditioned air conditioner. 746-4517. Call after 3 p.m.

**1982 CADILLAC FLEETWOOD** Brougham - charcoal gray with gray leather interior. 56,000 miles. Local car. Call Eastgate Motors at 355-2193.

**015 Chevrolet**  
**1986 CHEVROLET** Impala. 4 door, new tires. Call after 6, 1-747-3805.

**1979 MONTE CARLO**, excellent condition. Call 756-9137 after 6:00 p.m.

**1981 CHEVROLET** Citation. Below average miles, needs work. \$1200. 830-9504.

**1982 CHEVETTE** power steering, air, automatic transmission, AM/FM cassette player, new tires, shocks, front and rear brakes, 4 door, good gas mile age. \$1,000. Call 756-1670 after 6:00 p.m.

**1983 CAMARO** Wrecked, 5 speed, air, \$500 or best offer. 757-0229 after 6 p.m.

**1984 CHEVROLET** Corvette, 66,000 miles, white with red interior, fully loaded, \$14,500 or best offer. Call Vicki at 756-8830. 746-3491 after 7:30 p.m.

**017 Dodge**  
**1978 DODGE** Omni. 4 speed, air, AM/FM cassette, 129K miles, new carburetor, under 25K miles on transmission, clutch, etc. \$700. 758-7438 weekends.

**1982 DODGE** Diplomat 4 door, excellent condition, AM/FM stereo, tilt wheel and air. \$3000. 756-6169.

**018 Ford**  
**1986 FORD ESCORT** - beige with tan cloth interior, 4 speed, AM/FM radio, 16,000 miles. Call Eastgate Motors at 355-2193.

**1984 MUSTANG LX** white with red cloth interior, automatic, air, power steering, power brakes, cruise, stereo with cassette. Call Eastgate Motors at 355-2193.

**019 Lincoln**  
**1984 TOWN CAR** Signature Series, mint condition. 355-5406.

**021 Oldsmobile**  
**1987 OLDSMOBILE 98** Regency Brougham. 4 door, 9,000 miles, all power equipment, blue exterior and interior. \$14,995. Call 756-3209 after 5 p.m.

**023 Pontiac**  
**1979 PONTIAC** Stationwagon. \$400 negotiable. Call 752-5650 or 752-1654 leave message.

**1980 LEMANS** Station wagon. Good condition. \$1,500. 355-5859.

**1983 PONTIAC** 6000. Clean and in good condition. 753-3830.

**1987 BONNEVILLE**, white, loaded, excellent condition. \$10,400 negotiable. 757-1392 or 756-3000, ask for Kenny.

**024 Foreign Cars**  
**NISSAN MAXIMA**, 1986, excellent condition, black with fog lights, moon roof, fully loaded. Call 355-3339.

**1952 MG-TD** Replica. Almost new. \$7,500. 355-7408 or 324-4848.

**1973 MGB** AM/FM with cassette, royal blue. 757-1134.

**1979 DATSUN** B210. \$800 or best offer. Must sell. 756-6691.

**1977 DATSUN** 280Z Silver. Good condition. Call 830-9381.

**1979 HONDA CIVIC** 4 speed, air. Call Eastgate Motors at 355-2193.

**1979 TOYOTA** COROLLA. Half ch-back. 5 speed, air. \$850. Call 752-9249.

**1979 VOLKSWAGEN** Diesel Rabbit, stick shift, clean. Excellent mechanically. 1-946-0271.

**1980 TOYOTA SUPRA**, excellent condition. \$3600 negotiable. Call 830-1255.

**1980 VOLVO** DL for sale. Call 830-3551 after 6:00 p.m.

**1981 HONDA** Civic. 1500. Half ch-back. Good condition. New rear tires. \$1,600. Call 752-7396.

**1981 VOLVO** DL station wagon. 79K miles. \$4700. 756-5666.

**1984 HONDA CRX** Excellent condition. Call 946-6812 or 830-6905.

**1984 MAZDA RX7** GL. Low mileage, sunroof. \$7800. 756-9271 or 757-3536.

**1984 NISSAN** 2005X. Silver with gray cloth trim. loaded. Call Eastgate Motors at 355-2193.

**1984 RED** 300 Z. Xatsun. 5 speed. 2+2. T-top. Digital. Leather. Loaded. \$10,300. 355-7488.

**1984 SAAB** 900 TURBO. Excellent condition. Must sell. \$7,000 or best offer. 756-3980.

**1985 HONDA CIVIC** 4 door, AM/FM stereo, air, new tires, excellent condition. \$4800. Call 830-5497.

**1986 VW Jetta** GL. Must sell. Take up payments. Air, automatic, white. 752-1031, leave message.

**1987 HONDA ACCORD LXI**, 4 door, automatic, power sunroof, \$12,200. 752-1357. 3 p.m. 5 p.m.

**1987 VW GOLF**, 21,000 miles, loaded. \$8,000. Call 752-6859 after 5:30 p.m.

**024 Foreign Cars**  
**1988 HONDA ACCORD LX**, loaded, 4 door, 5 speed, like new. 12,000 miles. Call 756-8582.

**1988 9245 PORSCHE**, low miles, still under warranty. Asking \$21,800. Midnight blue. A must see. Call 756-8172 after 6:00 p.m.

**029 Auto Parts & Service**  
**CRAZY JOE'S** now has a three year warranty on starters, alternators, water pumps, and etc. Call 752-1123.

**032 Boats & Motors**  
**B & K MARINE**  
 Evinrude, Omc, Mariner and MerCruiser service center. All Evinrude and Mariner motors and Cox trailers at clearance prices.

1205 Dickinson Avenue, Greenville. 752-2882.

**GALAXY 20'**, 190 OMC inboard/outboard, extras. \$5000. 746-6394.

**GREENVILLE MARINE AND SPORTS**  
 Pitt County's oldest marine dealership. We sell everything at wholesale prices year round. 764 Bypass N.E., Greenville. 758-5938.

**ONE MAN BASS TRACKER** Boat. Price negotiable. Call 752-3409.

**14' BASS BOAT** 35 horsepower Evinrude, depth finder, foot control trolling motor and live wells. \$1800. 757-3956.

**16' BAY BOAT**, center console, 35 horsepower, tilt and trim, galvanized trailer, excellent condition. \$4500. Call Harry. 756-8356 9 p.m.

**1971 SPORTS CRAFT** 18', open bow, 85 horsepower Evinrude outboard motor, Deep V with equipment. In good condition. \$1695. Call 752-3537.

**1975 23' PENYAN**, Hard top with 225 Chrysler with trailer. 756-3344 days. 756-6358 nights.

**1984 19' SEA LION** Center console, 115 horsepower, float on, perfect for fall fishing. \$6,900. 758-6925.

**1986 WINCHESTER**, center console, 1986 Cox galvanized drive on trailer, 135 horsepower Evinrude, Johnson 28 pound thrust trolling motor, lots of extras. \$5,000. Call 746-3687.

**1987 COBIA BOAT** 20' galvanized trailer, 90 horsepower Evinrude, center console, built in ice chest, tackle box and live wells. \$7900. 830-1124. 355-6462.

**1988 BAYLINER** 19 footer. Call 752-2867 after 5 p.m.

**WHEN SOMEONE IS** ready to buy, they turn to the Classified Ads. Place your Ad today for quick results.

**036 Cycles For Sale**  
**HONDA** 250 Elita Scooter, 1985. Low mileage, AM/FM stereo, good condition. Must sell. 746-4456 or 757-1278.

**1983 HONDA SABRE** V45 748 C.C., burgandy, \$1300 firm. 2 helmets and a cold weather suit. Evenings. 756-3269.

**1983 KAWASAKI** Spectra with trailer. \$2100. 757-1367 ask for Matt.

**1988 HONDA** Helix \$2000 or best offer. \$30. 1308 ask for Chris.

**71 TRIUMPH** 650. Good original shape. Runs good. \$650. Sacrifice/good investment. 758-3417.

**041 Trucks**  
**IRS AUCTION** 1979 Ford F700 Van with 22 foot box. Tuesday, 9:20-88, 10:00 a.m. Pitt County School Bus Garage. 752-4605.

**1953 FORD TRUCK** Excellent condition. Call Eastgate Motors at 355-2193.

**1967 CHEVROLET** pick up. \$550. 756-4027.

**1973 CHEVROLET TRUCK**. Good condition. Nights. 758-8413.

**1981 WHITE EL CAMINO** V.6, auto, air, high mileage, for sale or trade for car. 355-2340.

**1985 ISUZU**, excellent condition, 47,000 miles. \$3500 or best offer. Call 757-1834.

**1985 5-10 4x4 BLAZER**, Red with white stripes, excellent condition, requesting pay off amount. Call 756-2119.

**1984 MAZDA B2000**, 14,000 miles, 4 speed, air, AM/FM, camper top, bed liner. \$6195. Call 756-8876 any time.

**1987 MAZDA** 2600 LX, loaded, new condition, 14,000 miles, full warranty. Lists for \$11,600, pay off loan at \$7800. 746-2761.

**044 Child Care**  
**BABYSITTER REQUIRED**. Full time post in my home. Monday-Friday. References required. 355-7779, 1 p.m. every day.

**ESTABLISHED HOME** playschool has 3 openings for newborn to 3 years old. Full learning experience. 830-1009.

**EXPERIENCED** Babysitter will keep children in my home in Oakdale community, from age 3 months to 4 years old. Please call anytime. 756-5668.

**INTERESTED IN KEEPING** children in my home, reasonable rates. 758-5605.

**WILL CARE FOR CHILD** or infant in my home, Monday-Friday. Fenced play area. 752-1517.

**WILL KEEP** children in my home. Monday-Friday. Prefer ages 2, 3 and 4. Call 756-0608.

**YOU CAN SAVE** money by shopping for bargains in the Classified Ads.

**047 Health Care**  
**HEALTH INSURANCE** rates outrageous??? Call Wade Wilson at Leon Furnes Insurance. A+ companies; individual or groups. Phone 355-7557.

**034 Camping Equipment**  
**1984 SCOTTIE**, 22', double bed, full bath with shower, awnings, air conditioning, fully contained, sleeps 4. 752-0738 or 746-6433.

**050 Pets**  
**AKC BLACK CHOW** female puppy, 4 months old, had all shots, \$125. 752-0606.

**AKC BOXER** 6 months old. Ears cropped, all shots, and wormed. \$250. Call 752-2991.

**AKC COCKER SPANIELS**, wormed and shots, 7 weeks old. Buff, black and red. \$100 each. 927-4870 after 8:00 p.m.

**AKC GERMAN SHEPHERD** Female puppy. Black and tan, 4 months. Large bone quality dog. \$250. Wormed and shots. Dr. Charles Boyette, Belhaven, 943-2550.

**AKC LAB** puppies. Bred from excellent hunting and field trial. Yellow and black. 355-4831.

**AKC LONG HAired** miniature dachshund puppy, male; beautiful and lovable. \$150. Please call 757-0311.

**AKC REGISTERED** Shelties or Miniature Collies, 3 males, \$225 each. 752-5419 after 4 p.m.

**BLUE CROWN** Conure with cage \$90. Call 752-3647 or 757-0133.

**DARLING GRAY TABBY** kitten, loving with people, fearless with dogs. Litter trained, but accustomed to being outside. One male, one female. Free to good home or homes. Carol Tyler. 758-2232.

**FOR SALE** German Shepherd puppies. Championship bloodline. 792-3568 after 5 p.m. Jamesville, N.C.

**FOR SALE** AKC Registered Bassett hound puppies. Call after 5 p.m., 946-1907.

**FOR SALE**; Springer spaniel puppies, 6 weeks old. AKC registered. \$150. 753-4022.

**FREE!! MIXED LAB** retriever puppies. 7 weeks old. Females only. 758-8358 evenings.

**FREE MIXED LAB** puppies to a good home with responsible family. Ready to go. 756-8768.

**FREE**: 4 kittens. 3 males, litter trained. 2 long haired all black. 1 short haired black, 1 grey tiger white paws. Phone 355-2848.

**HAPPY JACK** Skin Balm. For scratching and gnawing dogs or cats. Soothes irritated skin. Contains no synthetic pyrethroids! Southern States Coop, corner of Line/Chestnut, Greenville, N.C.

**LOIS'S PAMPERED PETS**. Small dog grooming. \$12.00. Call 355-5754.

**PEKINGESE** pups: 3/4 Pekingese, 1/4 Shih Tzu 7 week old pups. Call 756-8664 after 7:00 p.m. weekdays.

**SIX WALKER HOUNDS** for sale. 752-8703 or 752-9123.

**050 Pets**  
**WALKER DEER HOUND** for sale. Guaranteed with trial. 752-6029 or 756-7315.

**3 ADORABLE KITTENS** free to good homes. Call 752-6314.

**057 Help Wanted Administrative**  
**CITY OF GOLDSBORO JOB OPPORTUNITIES**  
**CHIEF OF POLICE** City of Goldsboro, North Carolina. Population 36,000. Manages a 95 member force involved in enforcing laws and ordinances and the prevention of crime and protection of life and property. Position requires extensive knowledge of police administration and police methods; demonstrated ability to lead and direct the activities of police personnel. Must have the ability to establish and maintain effective working relationships with all private and public agencies, organizations and individuals. Requires a Bachelor's degree with major course work in law enforcement or police administration including or supplemented by course work in law enforcement or police administration including or supplemented by course work in police management and extensive progressively responsible experience in police work, including at least 5 years experience in an administrative or command capacity; or any equivalent combination of education, training, and experience which provides the required knowledge, skills and abilities. Salary range: \$36,129.60-\$50,856.00. Apply to: City of Goldsboro, Personnel Office, PO Drawer A, Goldsboro, NC 27530.

The City of Goldsboro complies with the Immigration Reform and Control Act of 1986. All employees must provide documentation to verify identity and employment eligibility within the first three days of employment with the City. The City does not discriminate against employees on the basis of race, sex, age, religion, ethnic origin or handicapped status.

**058 Help Wanted Clerical**  
**ARE YOU A MATURE** hardworking self motivated individual, then we have the perfect job for you. Office setting, salary plus commission. Call 756-1195 for application information. Equal Opportunity Employer.

**IT'S NEARING THE END** of summer making this a good time to shop for a good buy in boats and marine equipment. Find them in Classified.

**058 Help Wanted Clerical**  
**PERMANENT FULL-TIME** Secretary to work in local engineering/surveying firm. Career opportunity. Experience preferred. Excellent fringe benefits, including retirement plan. Reply to: Olsen Associates, Inc., PO Box 93, Greenville, NC 27835. 919-752-1137.

**PROGRAMMER ANALYST**. Benefit Manufacturing Corp., one of the world's most famous and respected names in casual wear, located in Rocky Mount, NC. Benefit's largest plant in the US, has a career growth opportunity for a programmer analyst. Qualified individuals must possess a minimum of 2 years experience on an IBM System 38 using RPG III. Successful candidate can look forward to an excellent starting salary, opportunities for advancement, and a comprehensive benefit package. Interested applicants should call or send resume to: Director of Human Resources, Benefit Manufacturing Corp., 501 English Road, Rocky Mount, NC 27866, 919-937-6883. EOE.

**SECRETARY/BOOKKEEPER** needed for local general contractor. Experience with PC computers, general bookkeeping and word processors a must. Good organization and communication skills are desired. Send resume to: Bookkeeper, 905 Box 2593, Greenville, NC 27836.

**PUT EXTRA CASH** in your pocket today. Sell your "don't need" with an inexpensive Classified Ad.

**059 Help Wanted Medical**  
**COME JOIN OUR TEAM**. Explore the unique nursing opportunities of hi-tech home care. Must be registered with no less than 2 years of experience. Top salary, car allowance, flexible hours, paid medical benefits and more. Pick your location in NC, part time and full time positions. Baylor positions available. Career oriented respond to: Nursing Personnel Department, PO Box 30485, Raleigh, NC 27622-0485.

**DENTAL ASSISTANT** needed, full time, 4 1/2 days per week, previous experience preferred. Excellent salary and benefits. Contact Dr. Billy Williams, 752-2838.

**DON'T THROW IT AWAY!** Sell it for cash with a fast-action Classified Ad!

**CLASSIFIED DISPLAY**

**CLASSIFIED DISPLAY**

**CLASSIFIED DISPLAY**

**CLASSIFIED DISPLAY** **CLASSIFIED DISPLAY**



**CLASSIFIED UNLOCKS OPPORTUNITIES!**

If you are looking for work, tell the right people with classified.

Whether you spot your ideal position in the "Help Wanted" section, or place your own ad, classified can help you reach the people who are looking for you!

**752-6166**

**CLASSIFIED ADVERTISING DEPARTMENT**

**The Daily Reflector**

**SECRETARY**

Full time position available for a Secretary/Cashier to work in the outpatient Department. Hours are 3:30 p.m.-12 a.m. Applicant must be available to work every other weekend. Competitive salary based on experience plus 60¢ per hour 2nd shift differential and 75¢ per hour weekend differential. Excellent position for take charge individual interested in opportunity for personal and professional development. Responsibilities includes admitting patients, collections, and filing insurance. Applicant must be people oriented with above average communication skills. 45 wpm typing and minimum of 12 months previous secretarial or collections experience required. Medical terminology and knowledge of medical insurance a plus. Heritage Hospital is an employee owned facility offering an excellent benefits package including company paid retirement, flexible paid days off plan, education tuition reimbursement and much more. Applications will be taken in the Personnel Department, Heritage Hospital, 111 Hospital Drive, Tarboro, N.C., 9 a.m.-4 p.m., Thursday, September 8th through Friday, September 16, 1988. EEO/AAF Employer M/F.

**Get There Any Way You Can**



**\$600 down**

**1988 Isuzu TF-Truck**  
**\$142.91/month Selling Price \$6888**  
 12.95 APR; 60 months with approved credit; plus tax and tags  
 5 speed transmission; double wall cargo bed; 1680 pounds; halogen headlamps; 2.3 liter engine; dual sport mirrors; steel belted radial tires



**\$600 down**

**1988 Isuzu XS-Mark**  
**\$199.73/month Selling Price \$9388**  
 12.95 APR; 60 months with approved credit; plus tax and tags  
 Automatic transmission; AM-FM stereo cassette; air conditioning; intermittent wipers; tilt steering; electric outside mirrors; rear window defogger; power steering; locking gas door; steel belted radial tires; aluminum wheels

**BROWN & WOOD**  
 PONTIAC • CADILLAC • ISUZU  
 Greenville Blvd. 355-6080

At Barbour Honda...

**Absolute Final Clearance**

Every '88 Honda In Stock Has Been Drastically Reduced!

**On Every '88 Honda In Stock**

'88 Honda Civic DX  
**\$8,888**  
 4 door, 5 speed, independent double wishbone suspension, rear window defogger, power brakes, intermittent wipers, 16 valve engine, fuel injection.

'88 Honda Accord DX  
 Discounted Up To **\$3,700**  
 Was \$15,699.80 is **\$11,988\***  
 2 door, automatic, AM-FM stereo/cassette, power steering, power brakes, independent double wishbone suspension, rear window defogger, intermittent wipers.

**NOTICE**  
 Great value means getting the vehicle you want at a price you can afford. There's no better time all year to buy the one you've always wanted. Get it now at the lowest price, possible. But hurry while the selection lasts.

**Hurry! 'Til 5 P.M. Saturday!**

Only At...

**Bob Barbour HONDA**  
 355-2500  
 3300 South Memorial Drive  
 Greenville, N.C.

\*Prices do not include tax, tags and any additional dealer options. With approved credit.

# 1000

## CLOSE-OUT WEEK

This week and this week only, our '88 cars and trucks have dramatically reduced prices! Our 1989 models are coming in, so we've priced everything to **move!**

Beat the 1989 price increase. **Buy smart!** Come to Sigmon and **buy now!**

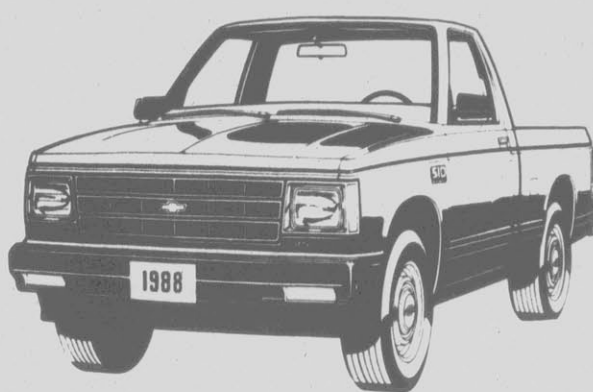

**1988 Chevrolet S-10 Pick-Up**  
Cool off in this versatile, air conditioned pick-up! Hard-working and dependable, it's got the comfort and power you've been looking for!

From Just ~~\$7,699~~  
**\$14879**

Only **per month!**  
60 months term at 11.9% APR with approved credit and \$995 down cash or trade. Tax and tags are extra.



**1988 Pontiac Grand Am**  
Styling and performance at an affordable price are what you'll find in this attention-getting Grand Am.

**\$10,599**

From Just  
Tax and tags are extra.



**1988 Buick Regal #2322**

This strikingly stylish coupe could be the start of your love affair with the open road.

**\$12,399**

From Just  
Tax and tags are extra.

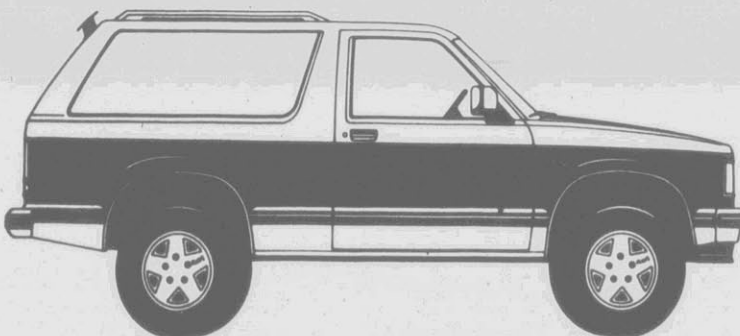

**1988 GMC Jimmy #4166**

Ideal for off-road or on, this 2-wheel drive Jimmy takes you and your friends wherever you want—stylishly, comfortably and affordably.

**\$12,999**

From Just  
Tax and tags are extra.

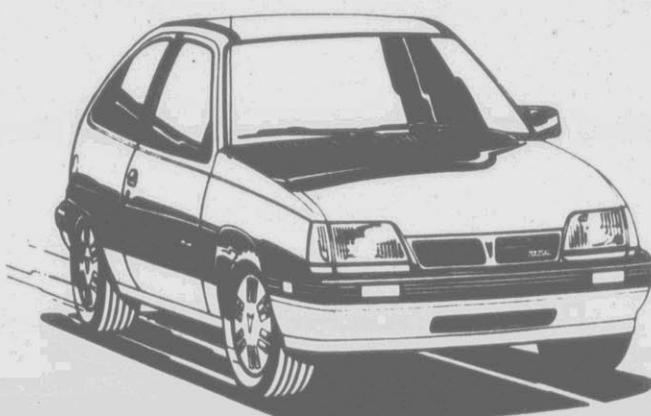

**1988 Pontiac LeMans #3188**

Perfectly practical and wonderfully equipped, this dependable LeMans comes with lots of open-road excitement—for less!

From Just ~~\$8,899~~  
**\$17542**

Only **per month!**  
60 months term at 11.9% APR with approved credit and \$995 down, cash or trade. Tax and tags are extra.

Sale prices reflect manufacturer's rebates where applicable.

### Our Best Selection Of Previously-Owned Models Ever!

Stock #	Year Make/Model	Description	Stock #	Year Make/Model	Description
2094A	1986 Nissan Sentra	2-door, local, one-owner, 36,000 miles.	8189	1983 Buick LeSabre Custom	4-door, very nice, 58,000 miles.
8181A	1986 Chrysler Fifth Avenue	Local, one-owner, leather, like new, only 34,000 miles.	2335A	1984 Pontiac 6000 LE	Local one owner, very clean, 35,000 miles.
8183	1986 Chevrolet Celebrity	4-door, white with red interior, 44,000 miles.	8167	1984 Olds Cutlass Supreme	4-door, full power, 49,000 miles.
8188	1986 Chevrolet Caprice Classic	V-8, full power, new tires, 40,000 miles.	8184	1984 Pontiac Sunbird	Automatic, air conditioning, 4-door, 56,000 miles.
8116	1987 Oldsmobile Firenza	Air conditioning, automatic, 2-door, 10,000 miles.	8187	1984 Buick LeSabre Limited	4-door, full power, 36,000 miles.
7009	1987 Pontiac Sunbird GT	Local, one-owner, automatic, air conditioning, 16,000 miles.	8154	1985 Chevrolet Cavalier	Automatic, air conditioning, 4-door, 50,000 miles.
8152	1987 Chevrolet Astro Van	8 passenger, CL model, 19,000 miles.	2206A1	1985 Buick LeSabre Limited	Local one owner, 58,000 miles, very nice.
8185	1987 Oldsmobile Cutlass Ciera	2-door, loaded, 24,000 miles.	8161	1985 Oldsmobile Calais Supreme	2-door, automatic, air conditioning, loaded, 46,000 miles.
5009A	1987 GMC Jimmy	2-wheel drive, local, one owner, loaded, only 29,000 miles.	3204A	1985 Mercury Lynx	Local one owner, 58,000 miles, very nice.
8191	1987 Chevrolet Nova	Automatic, air conditioning, very clean, 27,000 miles.	8182	1985 Chevrolet Camaro	Sporty, t-tops, loaded, 43,000 miles.
8179	1987 Pontiac 6000	4-door, automatic, tilt steering, cruise, 26,000 miles.	8186	1985 Buick Century	6 cylinder, 4-door, automatic, air conditioning, 50,000 miles.
8151	1987 Chevrolet Corsica	Tilt steering, cruise, 4 door, only 13,000 miles.	8192	1985 Honda CRX	One owner, automatic, air conditioning, 34,000 miles.
8156	1987 Chevrolet Cavalier Z-24	6 cylinder, automatic, air conditioning, 18,000 miles, super sharp.	8193	1985 Chevrolet Monte Carlo SS	T-tops, loaded, very fast, 54,000 miles.
8162	1987 Oldsmobile Calais	2-door, automatic, air conditioning, 29,000 miles.	8115	1986 Oldsmobile Cutlass	Loaded, 4-door, only 23,000 miles.
8175	1987 Chevrolet Blazer	2-wheel drive, 6 cylinder, automatic.	8124A	1986 Buick Century Limited	Local, 4-door, loaded, only 41,000 miles.
8176	1988 Cadillac Sedan de Ville	Full power, all leather, like new.	8158	1986 Pontiac Grand Am	Automatic, air conditioning, 4-door, only 20,000 miles.
			8169	1986 Oldsmobile Calais	Local, one-owner, full power, 29,000 miles.

# SIGMON

Chevrolet • Buick • Pontiac • GMC Truck

Highway 264 Bypass, Farmville 753-7103



# TOYOTA EAST'S 1988 CLOSE-OUT TENT EVENT!

It's our intent to save you money! This Thursday, Friday and Saturday you can shop 'til 9pm during our 1988 Close-Out Tent Event. We have the best deals **anywhere** on new or used

used cars and trucks and the service that keeps 'em running! And our brand-new Toyotas are backed by a 3 year/36,000 mile warranty. All at incredible all-out '88 close-out prices!

## Choose From Our Great '88 Toyota Selection!

- 1988 Toyota Celicas
- 1988 Toyota Camrys
- 1988 Toyota Corolla 4-Doors
- 1988 Toyota SR5  
2-Door Coupes
- 1988 Toyota Tercels
- 1988 Toyota Tercel EZs
- 1988 Toyota MR2s
- 1988 Toyota Vans
- Toyota 2WD Trucks
- Toyota 4WD Trucks

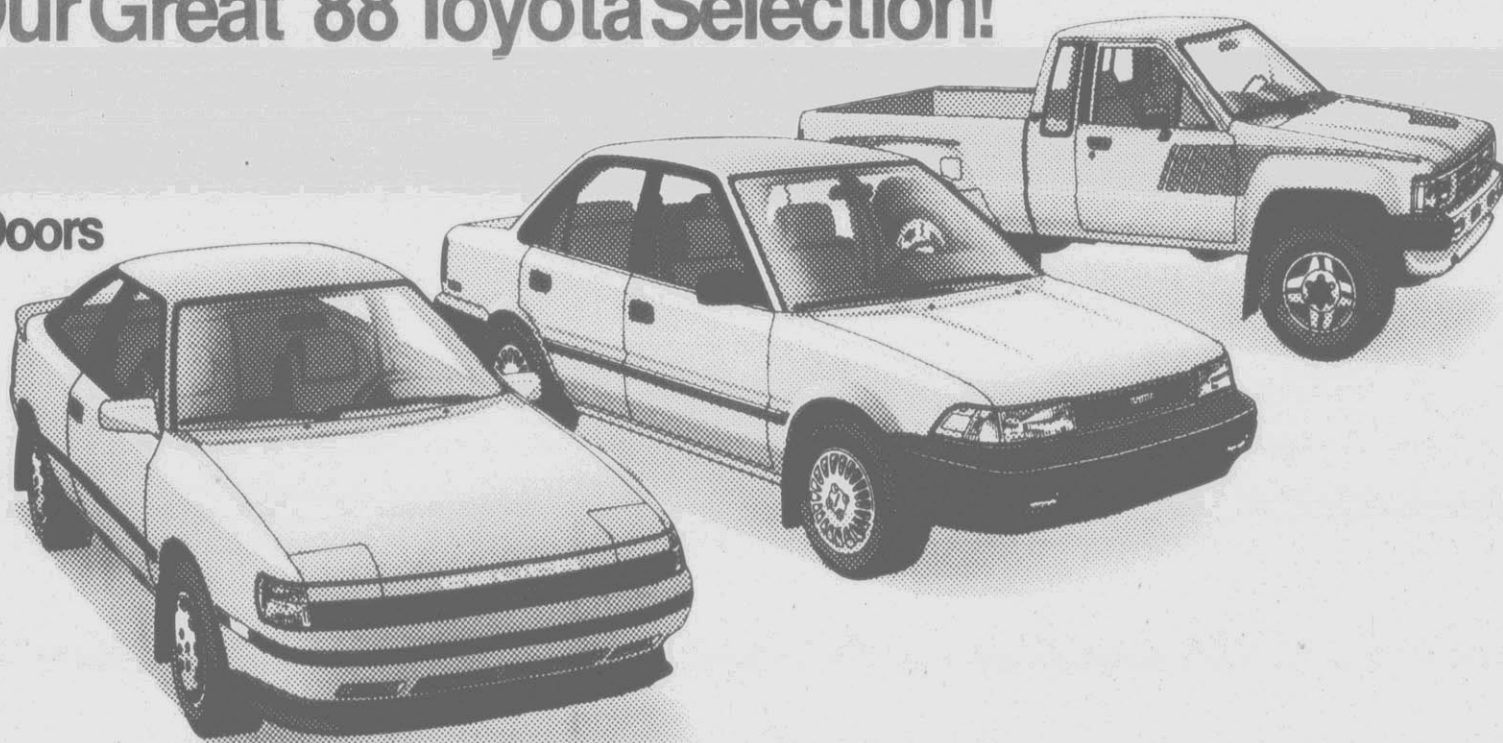

### 1988 Suzuki Samurai



**\$155<sup>65</sup>**  
Only per month!

#P9750  
Just  
**\$8,099**

We Have 17 To Choose From!

Try this fun, 4-wheel drive vehicle once and you'll never want to drive anything else! Completely equipped with a punchy 1.3 liter engine, chrome wheels and more, this sporty Samurai gets you into all kinds of places...and gets you out! This new Samurai is being sold as "used" at a low, used car price!  
60 months term at 11.99% APR with approved credit and \$1,100 down, cash or trade. Tax and tags are extra.

### 1988 Chevrolet Cavalier



**\$176<sup>00</sup>**  
Only per month!

Just  
**\$8,450**

We Have 20 To Choose From!

This easy-to-drive, low mileage compact comes equipped with automatic transmission, air conditioning, radial tires, power steering, AM/FM stereo plus a 5 year, unlimited mileage warranty!  
60 months term at 11.99% APR with approved credit and \$1,100 down, cash or trade. Tax and tags are extra.

## SUPER SERVICE SAVINGS!

Express Lane Oil Change

**\$16<sup>88</sup>**

Just

No appointment necessary! Takes only 20 minutes! Includes 5 quarts of oil and a genuine Toyota double-filtering oil filter!

Minor Tune-Up

**\$29<sup>88</sup>**

Just

Includes genuine Toyota spark plugs plus timing and idle adjustment! (6 cylinder and other special plugs will cost a bit more.)

## From Our Premier Selection Of Previously-Owned Models!

Because our new car sales have been so successful, we've got an over-stock of late model, low-mileage trade-ins! Shop now for the best selection and save!

Year	Make/Model	Stock #	Description
1984	Honda Prelude	4456A	Blue, 5-speed, air conditioning, AM/FM stereo.
1986	Dodge Colt	4463A	Blue, 4-speed, low mileage.
1983	Toyota Corolla	4484A	Blue, 4-speed, AM/FM stereo.
1988	Toyota Tercel	4487A	Blue, 5-speed, air conditioning, AM/FM stereo, low mileage.
1986	Toyota Corolla SR5	4512A	White, 5-speed, air conditioning, AM/FM stereo, sunroof.
1984	Buick Regal	4512F	Blue, automatic, air conditioning, loaded.
1985	Toyota Camry	P7601	Silver, automatic, air conditioning, AM/FM stereo.
1983	Olds Cutlass Sierra	P7604A	White, automatic, air conditioning, AM/FM stereo.
1985	Ford Bronco II 4x4	P9456B	Blue/White, automatic, air conditioning, AM/FM stereo cassette.
1985	Olds Delta 88 Royale	P9487	Gray, low mileage, power windows, locks and seats, loaded.
1987	Pontiac Grand Am	P9502	Silver, power windows and locks, tilt wheel, low mileage.
1984	Chevy Blazer Tahoe 4x4	P9515	Black, automatic, air conditioning, loaded.
1987	Chevy Corsica	P9708	Gold, automatic, air conditioning, AM/FM stereo.
1987	Chevy Beretta	P9709	Blue, automatic, air conditioning, AM/FM stereo.

Year	Make/Model	Stock #	Description
1986	Buick Regal Limited	P9783	White, automatic, air conditioning, AM/FM stereo, loaded.
1984	Olds Delta 88 Royale	P9784	Brougham, White, automatic, air conditioning, loaded.
1987	Pontiac 6000LE	P9785	Burgundy, automatic, air conditioning, AM/FM stereo.
1982	Pontiac Bonneville	P9826	Dove gray, automatic, air conditioning, loaded.
1987	Toyota Celica GT	P9840	Convertible, white, automatic, air conditioning, loaded.
1986	Hyundai Excel	P9865	Gold, 5 speed, air conditioning, AM/FM stereo.
1984	Toyota Camry LE	P9866	Black, automatic, air conditioning, sunroof, loaded.
1987	Nissan Sentra	P9868	Bronze, 5 speed, air conditioning, AM/FM stereo, low mileage.
1986	Ford Taurus	P9871	Gray, automatic, air conditioning, loaded.
1986	Ford Tempo	P9872	White, automatic, air conditioning, AM/FM stereo.
1988	Nissan Sentra	P9875	Red, 5 speed, air conditioning, AM/FM stereo cassette.
1986	Toyota Elegante Van	P9876	Bronze, automatic, air conditioning, AM/FM stereo.
1986	Mazda RX7	P9881	Gray, automatic, air, AM/FM stereo, sunroof.
1987	Chevy Celebrity	P9882	Light blue, automatic, air conditioning, AM/FM stereo.

Thursday, Friday & Saturday:

**SHOP 'til 9!**

A Sigmon Company

# TOYOTA EAST

Authorized Mercedes-Benz Dealer

109 Trade Street Greenville 756-3228 Call Us Toll Free 1-800-682-5437

063 Help Wanted Technical & Trades

Immediate Openings For Industrial Positions

Heavy lifting, material handling, machine operators and related positions immediately available. Must have industrial experience, phone and transportation. A better opportunity with excellent benefits. Apply in person at...

ANNE'S TEMPORARIES

Flowers Office Complex 1410 South Evans Street (Use Evans Street Entrance) M. H. HOE

INDUSTRIAL ENGINEER Degree in Industrial Engineering with 23 years experience in manufacturing systems. Primary responsibility includes the development and maintenance of labor and assembly standards for an internationally recognized power boat manufacturer. Experience with IBM S/36 Macips environment and marine industry experience are highly desirable. Excellent starting salary and benefits. For confidential interview forward resume complete with salary history to: Personnel, PO Box 457, Washington, North Carolina 27889.

LOCKS WITH MECHANIC needed. Light weight mechanical work. Must have good appearance, clean record and bondable. Good personality. Salary and hours negotiable. Call 757-0075 anytime.

LOGGERS HELPER needed. Some experience. Call 758-8962.

MECHANICS and truck drivers needed. 25 years or older. Experience only. Minimum 2 years over the road, good driving record. Insurance and uniforms are available after 90 days. Call 823-2182.

SURVEY INSTRUMENT man 1 year experience required. Call Donna or Bo with McDevitt & Frost Company, 830-4700.

SWIMMING POOL service technician needed. Willing to train. Recent graduate. Mechanical aptitude necessary. Training period with excellent opportunity for advancement. Phone 355-7121, ask for Lonnie.

WANTED ROOFERS sheet metal mechanics and laborers. Apply in person, 1314 N. Greene Street. No phone calls please.

WANTED CARPENTERS and helpers. Call 756-0063.

WANTED EXPERIENCED burglar alarm/sound system installers. Must be bondable. No criminal record. Phone 758-4544 for an interview appointment.

064 Work Wanted

A-1 QUALITY Painting, minor repairs, milder, clean up, wash houses. Free estimates. Work guaranteed. 758-4136.

ADDITIONS, DECKS, FENCE, garages, improvements, repair. Haddock Construction, 758-7884.

CAROLINA Tree Service. All types done. Stump removal. Free estimates. Fully insured. 752-6420 or 757-0117.

D & T FIBERGLASS Repair. 759-3881.

DAVENPORT WOOD Services. Landscaping, tree clearing, free service, lops/sid, Bull dozer, backhoe and dumptrucks for hire. 756-1339.

EXPERT LAWN CARE AND LANDSCAPING. Call 756-8200.

GRASS CUTTING AND YARD Maintenance. Quality work, reasonable prices. Call James Falkner, 746-3721.

HOME REPAIRS. Additions, renovations, garages, storage buildings, or any home improvement. We specialize in saving you money. For free estimate, call Gary at 758-3215 or 756-1788.

HOUSE CLEANING. Reasonable rates. References. Call 746-2682.

INTERIOR AND EXTERIOR painting, general carpentry, guttering and roof repair. 99 years experience. Free estimates. 752-4171.

J. McNEILL & SONS. Roofing, carpentry and sheet metal. All work guaranteed. 830-9001.

JOSEPH PADLEY Paint Company. Highest quality work, dependable, thorough, neat. Customer satisfaction is our goal. References gladly provided. Call 758-8584 or 830-9001.

LANDSCAPING AND lawn renovation. Seeding and weed control. Call 757-1590.

LAWN MAINTENANCE. Grass cutting, including lots plus shrubbery and tree trimming. Call 757-1590.

MANNING'S REMODELING. Interior trim, decks, cabinets and counter tops. 746-4849.

NEW OPENING. Carpets by Anderson, 708 Mumford Road. Now installing Dupont carpet as little as \$12.95 per yard. Vinyl no wax flooring, as low as \$8.95 per yard. Installed Carpet and vinyl repairs. 830-9238.

PAINT WORK wanted inside and out. Roof top, advancement tops, trailer bodies. Call anytime after 6. 752-5448.

PAINTING professional work. Reasonable rates. References. 756-0627.

PAINTING. 25 years of customer satisfaction. Honesty is my goal. 524-3396.

PAINTING. NEW work or repairs. Interior and exterior. No job too big or too small. Free estimates. Call Mike Cassidy, 355-2111 or Bill Vandlingham at 830-4960 after 5:00.

PAPERING, INTERIOR Painting and paper removal. All wall papering guaranteed in writing. Insured for your protection. Call Don English, 756-7010.

CLASSIFIED DISPLAY

Train to be a TRAVEL AGENT TOUR GUIDE AIRLINE RESERVATIONIST

Start locally, full time/part time, train on live airline computers. Home study and residential training. Financial aid available. Job placement assistance. National Headquarters, Pompano Beach, Florida.

A.C.T. TRAVEL SCHOOL 1-800-327-7728 Accredited member N.I.C.E.C.

064 Work Wanted

PRIVATE NURSING. Nursing Assistant/EMT for the elderly in home, hospital, nursing home or live-in. 10 years experience. Call 760-9903.

PROFESSIONAL Office Cleaning. Reasonable rates. Call James at 752-4599 after 3 p.m.

REPAIR WORK of all kinds. Pickett fences, additions, garages. Turn key job. Call 753-3869.

RICHARD'S WALLPAPERING and Painting new number 825-7748.

ROOF LEAKS FIXED and minor repairs. 18 years experience. Work guaranteed. After 6 p.m. call 752-5906.

SHALLOW WELLS drilled 1st 25' \$160. Includes pipe and point. Call 830-6655.

SILVERTHORNE HAULING. Small loads of top soil, fill sand, pine bark and small clean up jobs. Mowing, planting shrubbery. 758-3296.

WILL KEEP ELDERLY in my home. 795-5156 or 795-3034 immediate.

WINDOW WASHING Commercial and residential. Call Sunday, Thursday, 5 p.m. 757-0609.

WORK WANTED: Pressure treated decks and fences. Male. 746-815 or installation. Lifetime warranty. Guaranteed low prices for quality work. Call for free information or estimate. 752-2766 or 1-800-682-6555.

WOULD LIKE TO CLEAN your home. Quality work, reasonable rates. Call 524-5820 anytime.

068 Antiques

ANTIQUES BOUGHT and sold daily. Woodside Antiques, Allen Road. Please call 758-9929.

075 Computers

APPLE IIe, Monitor, 80 column card, 1 drive. Almost new. \$700. Call 756-716 after 5.

ATARI 100K, disk drive, printer, plotter, 19" color tv and over \$700 worth of software. \$450. 752-2766 or 1-800-682-6555.

TANDY 100K EX computer, 640K ram, second disk, 19" monitor, printer and software. Value \$2000 plus. Will sell at \$1500. Call 756-1168.

080 Fuel, Wood, Coal

FIREWOOD FOR SALE. Call 758-1559 after 5:30.

GAS LOGS. Largest selection in Eastern NC of fireplace items. Glass doors, grates, top sets, chimney pipe, reconditioned woodstoves from \$199 and up. Chimney sweeping, Tar Road Antiques & Fireside Shop, 1 mile south of Sunshine Garden Center, Winterville, 355-6003.

FOR SALE: Lane living room suite. Sofa, loveseat, and chair. Exposed dark. Raffan wood frame, deep peach floral print. Good condition. Excellent for sun porch or vacation home. \$800. 756-5410.

FOR SALE: Solid pine dining room table and 4 chairs. Very good condition. \$225. 746-6838.

FURNITURE STRIPPING. Paint and varnish removed from wood and metal. All items returned within 7 days. Tar Road Antiques & Fireside Shop, 1 mile south of Sunshine Garden Center, Winterville, 355-6003.

KING SIZE WATERBED. mirrored, bookcase headboard, drawer space and cabinets all around bottom, great condition. \$300 firm. 758-4136 or 758-5719.

MOVING: selling 40' round pine table with Lazy Susan, appraised at \$225, for \$125. Country style drop leaf table, seats 6, appraised at \$399 for \$240. 752-5255.

ONE 90" SOFA and matching chair. Clean and in good condition. \$250. (Gold) 1 antique office chair. \$30. Chester drawers. \$30 negotiable. Can be seen at Middlefield Subdivision at 200 Fred Drive. Call before coming. 752-6884. Will deliver in town.

REFRIGERATOR \$75. Sofa and recliner \$50. 746-2719, after 5.

8-PIECE LIVING ROOM set, pine with cushions, \$200 firm. Must sell 830-5393.

CLASSIFIED DISPLAY

MATTHEWS SEPTIC TANK CO.

NEW INSTALLATIONS REPAIRS PUMPING & CLEANING. P.M. County Permit #184. 14 Years Experience. PHONE 753-4097 9 A.M. TO 9 P.M.

Rent A NEW CAR

As Low As \$18.00 Per Day Sharpest Fleet In Town RENT WAY AUTO RENT Downtown 752-2892

NEED A LOAN?

OWN A HOME? HOME EQUITY LOANS \$1,000 to No Limit Mortgage Past Due O.K. Credit Problems Understood Various Rates & Terms Cash For Any Purpose

WHEN YOUR BANK SAYS NO...

WE SAY YES!!! FAST SERVICE Midstate Financial Services Apply By Phone 1-800-777-3701 M-F 8 am-10 pm, Sat. 9 am-5 pm

IMMEDIATE OPENINGS

FOR OUR QUALIFIED GRADUATE TRUCK DRIVERS! NOW TRAINING MEN & WOMEN

• OCCIDENTAL AREA • FULL PART-TIME CLASSES • 24 HOUR SERVICE • ASSISTANCE

BLANTON'S JUNIOR COLLEGE TRACTOR TRAILER TRAINING CENTER

Location: N.C. 1460 W. 12th Street, Wilson, N.C. 27894 (919) 281-4144

082 Garage-Yard Sales

LADY FROM ALAMANCE County will be at Tiche Field Market on Saturday, September 17 with socks. Special sale.

086 Farm Equipment

HEALTH INSURANCE rates outrageous?? Call Wade Wilson at Leon Fortes Insurance. A+ companies; individual or groups. Phone 355-7557.

SAVE MONEY this winter... Shop and use the Classified Ads every day!

092 Livestock

APPALOSA HORSE and a month old stud. Both for \$800. Can be seen anytime. 830-9238 or 756-9557.

COASTAL BERMDA HAY 758-8454 after dark.

HORSEBACK RIDING. Jarman Stables, 752-5237.

099 Miscellaneous

AIR CONDITIONERS \$3,200. \$150-\$550. Also have central units. Gas or electric. Dryers, washers, ranges and refrigerators. Freezers, wall ovens, commercial hot dog rollers and bun warmer. Scotsman ice machine, chest drink box, 4 door sliding glass cooler, 2 egg coolers, gondola shelving all rebuilt like new and guaranteed. Call B.J. Mills at Black Jack, 746-2446, nights 753-2878.

AYDEN HOUSING Authority modernization project has used water heaters, refrigerators and kitchen cabinets for sale. If interested contact Ayden Housing Authority Field Office, 905 Liberty Street, Ayden, NC 746-2129.

BOAT 35 HORSE MOTOR and trailer, \$1150. 756-7680 days; 756-3778 after 5.

CALL CHARLES TICE, 758-3013, for small loads sand, top soil, stone, pine bark and backhoe and driveway work.

WHEN SOMEONE IS ready to buy, they turn to the Classified Ads. Place your Ad today for quick results.

CASH for glass and other recyclables. Glisson Enterprises, phone 758-2548 and Greenville Recycling Project, phone 752-7151.

CASIO KEYBOARD cover and over \$60 worth of music. \$165. 746-6412 after 7:00 p.m.

CENTRAL AIR, 3 ton. Call after 5:30 weekdays and anytime weekends. 752-9899.

DECK LUMBERS 5/4x6: 20c per foot. Reject Plywood: (1 1/2" \$6.60), (1 3/4" \$6.20), (1 3/4" \$6.90). Pine Lumber 2x4x8 \$4.98. Down East Lumber, 6 miles east of Kingston 522-2400 or 1-800-522-2400.

DON'T GIVE YOUR SILVER away when you can get top dollar. Call 746-3550.

F & J SALVAGE. 258 North, Kingston, N.C. New and used items arriving daily. Hundreds of cabinets, doors, windows, water heaters. Lots more. 222 0806 Monday-Friday, 9:00-5:00, Saturday, 9:00-1:00.

FOR SALE: Guns, jewelry, stereos, TVs. Great savings! Coastal Jewelry & Pawn, 758-9976. (Next door to Pull-Tuff Golf).

FOR SALE: Complete TIE Electronic telephone system with 36 phones, 12 trunk line capability, power supply and cards with control panel. Purchased new from Carolina Telephone. Perfect for small business. \$3,000. Please telephone Steve Grant, 756-2228.

FOR SALE: large dog house; playhouse; toddler car seat; Lee Wood burning insert with blower, \$300. Red barn storage building, 8x12, \$800. you move. Call 756-3897.

CLASSIFIED DISPLAY

CLASSIFIED DISPLAY

ATTENTION CAT OWNERS

Pet Portraits will be taken Saturday, September 17. Package will consist of 1-8x10; 2-5x7; 8-wallets for \$29.95. \$10 deposit required.

Contact Everlasting Memories Studio & Gallery, 355-6862 day or night. Special effect photos also available.

099 Miscellaneous

FAIRFIELD OCEANFRONT Condo; Atlantic Beach. No money down. Take up payments. 757-3693 after 6:00 p.m. FRIDGE FOR SALE. Rebuilt. Brown, \$150. Call after 5 p.m., 752-2594.

GAS STOVE good condition, \$100. Gas heater, 5000 BTU's, in good condition, \$200. Call 758-0185 after 5 p.m.

GU DUFFEL BAGS, backpacks, canteens, mess kits, tents, sleeping bags, hammocks, map cases, compasses, lanterns, flashlights, coils, 200 different items. HENRY'S ARM & NAV, E. 1501 S. Evans Street.

GUN/repair. Expert Gunsmith. Guns Unlimited of Ayden. Buy, Sell, Trade, Pawn, Repair. Call 752-2464.

GUNS

LOANS ON BUY, SELL and Trade. Southern Gun & Pawn Inc., 752-2464.

INSTANT CASH

LOANS ON BUYING GUNS, TV's, gold and silver jewelry, coins, most anything of value. Southern Gun & Pawn Inc., 752-2464.

LANDSCAPING TIMBERS: \$2.69 each, 4x8 Lattice: \$8.25. Down East Lumber, 522-2400 or 1-800-522-2400.

MAG TAG WASHER and Kenmore dryer. Like new. Washer 5 years old, dryer 2 years old. Used very little. Both for \$600. 756-9000 ask for Don.

MATCHING SOFA and recliner. Brown plaid, best offer. Call 355-2627 after 5:00 p.m.

MATERIAL CLOTHING for sale size 8. Good condition. Reasonable. 752-2690.

MOBILE HOME STEPS, 3 steps with landing and railing, all steel, freshly painted. \$150. 12' double edge hedge trimmer, Black & Decker, \$15.45. Sunbeam 12' single edge hedge trimmer, \$12. Both in good shape. 752-3951.

NEW BROYHILL Couch and loveseat and coffee table. \$300. Call 756-8692.

NEW SLATE POOL TABLES. Over 200 in stock. \$895 and up. Game World Leisure Time Equipment, 919-821-3488.

NEW 2-PIECE living room suit, \$189.95.

NEW 4-DRAWER Chest for only \$39.95.

NEW 252 COIL Mattress and foundation. Twin \$89.95 set. Full \$99.95 set. Queen \$138.95 set. Compare our prices before you buy. We'll save you money. Jamie's Furniture 756-6027.

ONE GLASS TOP Coffee table \$50. Magnavox console stereo \$100. 756-1944.

PLANTS Cabbage collards and cauliflower. Wholesale or retail. Call Roy White, 1-527-1707.

PORTABLE WOOD GRAIN Cabinet on brass wheels. Cabinet underneath has lots of storage for books and records. Can be used as microwave stand, bar or tv stand. \$40. price negotiable. Call 758-1450 anytime.

SEARS WASHER and dryer. Decade green, both in good working condition. \$125. Call 746-6901.

SECRETARIAL DESK 30x60 with left return 20x40. Nature oak finish, 4 drawers include file drawer. Like new condition. \$800. 355-5464 or 355-7530.

SHAMPOO YOUR RUG! Rent shampooers and vacuums at Rental Tool Company.

SHINGLES \$9.95 square and up, 15 pound Flat \$4.95. Reject Plywood 5/8" \$6.25, 3/4" \$6.95. 8'x16' Hardboard siding \$2.89. Builders Bargain Center, Greenville, 758-7061.

STORAGE BUILDINGS constructed out of wood. 8x8 \$500. 8x12 \$725. 10x12 \$850. 10x14 \$925. 12x16 \$1400. Treated decks 8x12 \$500. Other items out of wood. 689-2381 nights.

CLASSIFIED DISPLAY

CLASSIFIED DISPLAY

099 Miscellaneous

STORE FIXTURES Glass cases, counters, and shelf units. Price negotiable. 756-3344 days. 756-4538 nights.

THEATER SEATS for sale, cheap. Call 757-3119 anytime.

WASHERS, DRYERS, refrigerators, freezers, stoves \$100 up guaranteed. 746-6929.

WINDOW AIR conditioner, 22,500 BTU's, \$165. 2 burner gas grill, \$50. Side by side refrigerator with icemaker, \$275. GE washer, \$100. 752-2625.

WOULD LIKE TO BUY used window and central air conditioners that need repair. Call 746-2446 or nights, 753-2878.

1.35 KARAT Diamond Solitaire engagement ring, 14K yellow gold, 4 prong setting. Graded G for cut, 4 for color, and 6 for clarity. Stones of this quality rare. Appraisable. Call 756-5410 for appointment.

10' UNIDEN SATELLITE dish with receiver, 200' connecting wire \$700. You move. Call 752-2540 or 355-0364.

10 SPEED BIKE, like new \$50. 3 speed bike with baby sit \$15. 756-6444.

200 GALLONS at \$2.00 per gallon. Pittsburg 2 burner gas grill surplus. Can be used on roofs, barns, wood or metal. A.B. Whitley, Inc. 1-497-8377 after 5 p.m.

WE AT LUV HOMES have sold large amounts of double wide. Need to move nice used homes. We look in on trade. Good selection. Come early and get the best pick. Luv Homes, Greenville, NC.

WHAT IS IT? Maintenance free, superior construction, cozy and comfortable, quality builder, money saver. The answer: a Clayton Mobile Home only at Luv Homes, Greenville, NC.

WHY PAY RENT! \$2505, excellent condition, 16500, well maintained partial financing. 1-975-6639.

14X70 FLEETWOOD, stereo, washer, dryer, air conditioning, loaded. Only \$18,041.25. 3 bedrooms, 2 baths. See at Luv Homes, Greenville, NC.

1970 CONNER MOBILE home, furnished, \$5,000 firm. Call 752-3295, 756-9256 or 752-3349.

1979 MARSFIELD 24x52. Loaded with lots of extras. Call 752-0356 after 6:00 p.m.

1983 OAKWOOD 14x60, 2 bedrooms, central air, assume payments. 746-4715.

1986 OAKWOOD Briarcliff 14x76, 3 bedrooms, 2 baths, like new, new heat pump, unfurnished, kitchen appliances with dishwasher, walk in utility, deck and patio, large wooded rental lot in Santree. Equity with loan assumption. Shown by appointment. 758-7711.

1988 14 WIDE, payments as low as \$141.86. Greenville volume dealer, Thomas' Mobile Home Sales, Across from Airport, 752-6068.

1988 14X70 COTTONWOOD, 2 bedrooms, 2 baths, central air, dishwasher, stereo, completely furnished. Still at dealer's. Never lived in. One year warranty with dealer. Move and take it! Let me help you. Buy your own nice mobile home at fixed rate and maximize the tax breaks while enjoying your brand new mobile home. Luv Homes, Greenville, NC.

DOUBLE-WIDE SHOPPERS! July is the best month to buy your new home from Martindale Homes. Inventory is disappearing fast. Save \$1000's like hundreds of our happy customers have. Martindale Homes, Highway 301 South, Wilson, NC. 1-800-637-1228.

DOUBLEWIDE SPECIAL 3 bedrooms and 2 full baths. Completely furnished for only \$19,995.00. Call Bill Jackson at 756-4687, Johnny's Mobile Homes, 316 W. Greenville Blvd., Greenville.

CLASSIFIED DISPLAY

CLASSIFIED DISPLAY

102 Mobile Homes For Sale

BRAND NEW 1989 NORRIS double wide now on display. Hardwood floors, loaded with extras. The leader in quality homes. See at Luv Homes, Greenville, NC.

FACTORY OUTLET Custom order your Horton or Mansion home. (Colors, carpets, boards etc) Save Thousands. For free literature and information call toll free 1-800-346-4847.

YOU'LL BE WELL satisfied with the service our classified staffers provide. Try us!

ONE OF A KIND 1989 Clayton 1480 square feet, 2 bedrooms, utility with wash basin, loaded with all extras. Duke Power Pac insulation. Probably the most beautiful home you have ever seen. See it! Luv Homes, Greenville, NC.

SACRIFICE 1985 14 wide, 2 bedrooms, 1 bath, like brand new. Large deck, skirting, and central air. Assume payments of \$157.30 per month. Call 1-828-5495 days, 1-870-0936 nights.

THREE BEDROOM trailer, 1981, 1 bath, very good condition. Need to move nice used homes. We look in on trade. Good selection. Come early and get the best pick. Luv Homes, Greenville, NC.

WHAT IS IT? Maintenance free, superior construction, cozy and comfortable, quality builder, money saver. The answer: a Clayton Mobile Home only at Luv Homes, Greenville, NC.

102 Mobile Homes For Sale

A CLEAN 12X45, center kitchen, 2 bedrooms. Only \$395.00 down and payments under \$138.00 per month set up on your lot. Call Bill Jackson at 756-4687, Johnny's Mobile Homes, 316 W. Greenville Blvd., Greenville.

"A HOME YOU CAN LIVE WITH" a 1989 Fleetwood 70x14, 2 or 3 bedrooms for an incredible price of \$13,500. Includes deluxe refrigerator, sheetrock walls, cathedral ceilings, storm wind down and much more. Delivery set up free! Martindale Homes, Highway 301 South, Wilson, N.C. 1-800-637-1228.

A 1989 14X80 FLEETWOOD home with 3 bedrooms and 2 full baths, cathedral ceiling, frost free refrigerator, stereo, totally electric, and fully furnished for only

144 Houses For Sale

BEAUTIFUL Williamsburg home at a reasonable price in a terrific neighborhood! Brick ranch, 3 bedrooms, 2 baths, carpet over hardwood. Wood storage house, gorgeous, walled yard. All for \$71,500. Call Sheri Carter 756-3500 or 758-4651.

CANTERBURY. Winterville city limits, city water and sewer, curb and gutter streets. New 3 bedroom, 2 bath ranch; formal dining, Mid 80's. Call for details. Jack Gordon, The Evans Company, 752-2814 or 355-5494.

CHERRY OAKS. A proven area deserves attention. New custom built farmhouse design. Three large bedrooms with master bedroom downstairs. Formal dining, double garage with unfinished area overhead. 100's. Call Jack Gordon, The Evans Company, 752-2814 or 355-5494.

CHERRY OAKS. By Owner. 4 bedroom ranch, 2 full baths, approximately 3 years old, 1900 square feet, formal dining room (11'9" x 16'8"). Call for details. School, double garage, \$172,900. Call 355-6908.

COMFORTABLE CHARM. Live comfortably in this Charm Line 1 1/2 story, 3 bedroom, 2 1/2 bath Williamsburg. Single car garage. Great family area, central air, paddle fans, French doors, crown moulding. Ceramic tile floor in kitchen, old brick fireplace. \$112,500. Duffus Realty, Inc., 756-5295.

CRAFT-BUILT HOMES. Custom home builder. We build to your plans. Little or no down payment. No closing cost. Your plans or ours. Call 937-6186 or 350-942-3211 anytime.

EASTBURY Off highway 43 South. New starter home. Three bedrooms, 1 bath, plus heat pump. On wooded lot. \$49,500. Call Jack Gordon, The Evans Company, 752-2814 or 355-5494.

FOUR BEDROOMS? No Problem! We have two four bedroom homes in Cherry Oaks with 2 1/2 baths. One area with den with fireplace, and double garages. Call for details and appointment. Hignite Realtors, 757-1969 anytime.

GREAT BEGINNER! Don't throw away money! Invest in this very affordable three bedroom, 2 bath brick ranch. Assumable VA loan. Call Aldridge & Sutherland, 756-3500, ask for Katherine Vinson, or 752-5778.

HARDEE ACRES. Beautiful full view glass door accents the entrance to this 3 bedroom, 2 1/2 bath brick home. This home has brand new carpeting, new wallpaper, new floor covering, new central heat and air, garage and a fenced in yard. Excellent value at \$49,900. Owner Broker. Please call Winnie Evans, The Evans Company, 752-2814 or 355-5494.

HARDEE ACRES; 3 bedrooms, 1 1/2 baths; 3 1/4 acres, \$52,900. 758-1914.

IF YOU LOVE COUNTRY, you'll love this home, situated on a nicely landscaped acreage outside of Farmville. Inside there is over 2000 square feet of living space, and outside, there is a double carport, a detached garage workshop. For details, call Susan Likosar, at Aldridge & Sutherland at 756-3500 or 756-7984.

LARGE COUNTRY ESTATE under \$100,000. This unique ranch offers over 2,400 square feet with cathedral ceilings, exposed beams, skylights, huge fireplace, double carport, screened porch, split rail and chain link fence, and storage galore. All this combined with 3 bedrooms, 2 baths, a pool, and much more. All for \$95,000. Call Sheri Carter at Aldridge & Sutherland 756-3500 or 758-4651.

LOW, LOW LAND ASSUMPTION! On a nice starter home in a nice neighborhood in Ayden. Priced in the low 40's. It won't last long. Call Ben Singleton, CENTURY 21 JANET BOWSER & ASSOCIATES, 355-7800.

LYNNDALE. This elegant new home has it all! Formal areas, Extra Large den, eat-in kitchen, four bedrooms with large master area, 2 1/2 baths, 3rd story. It's BOWSER BUILT and affordably priced at \$137,500. Call Janet Bowser at CENTURY 21 JANET BOWSER & ASSOCIATES, 355-7800.

NEAR GREENFIELD Terrace. Break the rent limit! Invest your money in your pocket. Move up to the comforts of owning your own home. Enjoy this spacious living room, 3 spacious bedrooms, and a very nice kitchen with lots of custom built cabinets, plus a spacious dining area. NC Housing money available at 8.75% fixed rate. Please call Winnie Evans, The Evans Company, 752-2814 or 752-4224.

NEW CONSTRUCTION, custom built cabinets, masonry fireplace, 3 bedrooms, 2 1/2 baths. High 80's. Betty Hardesty, Realty, 746-3788.

NEW HOME IN SUMMERFIELD. Comfort and style! That's what you'll find in this new 3 bedroom home. Formal dining, large eat-in kitchen, great room with fireplace are just a few of it's features. And you know it's quality construction because it's BOWSER BUILT. Builder will pay up to \$2,000 in closing costs. See us now. CENTURY 21 JANET BOWSER & ASSOCIATES, 355-7800 or 756-8580.

NON-QUALIFYING FHA loan assumption next to Athletic Club. 2 bedroom, 1 1/2 bath townhome, great kitchen, all appliances included. Min. condition. \$54,000. Century 21 Tipton & Associates, 355-7002, nights 756-2421.

ONE ROOM WITH Private entrance, front office. \$200 month. Call Janet Bowser, CENTURY 21 Janet Bowser & Associates, 355-7800 or 756-8580.

OPEN THE DOOR and walk into a quality custom built home you can feel proud to own. In beautiful Cherry Oaks, this 3 bedroom, 2 1/2 bath home features large great room with built-ins, wet bar, formal dinner master suite on main floor and unfinished room for work or play area. \$110,000. Please call Janet Bowser, CENTURY 21, JANET BOWSER & ASSOCIATES, 355-7800 or 752-2690.

144 Houses For Sale

NEWLY PLANNED community near Winterville and Ayden includes large (1.3 acre) lots ranging from \$8,900-\$26,000. \$7201. Call DeDe for directions and details. 752/MAX/PRO PERTIES, 355-5444 or 757-3759.

PINE BROOK. New in the city, but under \$50,000. Three bedrooms, 2 full baths, heat pump, central air, Jack Gordon, The Evans Company, 752-2814 or 355-5494.

QUALITY AND ELEGANCE can be found throughout this exquisite "Beverly Hills" home. Master bedroom with walk-in closet, stairs and spacious bedrooms upstairs, large den, office area, playroom and formal area. Over 2600 square feet of beauty in prestigious "1 1/2 to 2 acre lots. We also give estimates on your plan. Call Carolyn Erwin Realty, 355-7878 or at home, 355-6016.

BEAUTIFUL WOODED LOT in prime Lyndale subdivision. Will not last long! Call Pragna Mehra for more information at CENTURY 21, JANET BOWSER, 355-7800 or 355-6054.

HALF ACRE LOTS available at Frog Level off 264 By Pass, Call 946-0017 days 756-4017 nights.

HAMS CROSSROADS. State Road 1780. 100 x 200 on Eastern Pines water. \$5,500.

STOKES. On State Road 1588. 1/2 acre lot. Owner financing with \$500 down payment. Payments as low as \$80.57 a month. THE EVANS CO. 752-2814.

Jack Gordon, Broker, 355-5494 Winnie Evans, Broker, 752-4224

LARGE WOODED and cleared lots. Water and sewer included. For sale or rent. In Pitt County, 4 miles to Washington Square Mall. Owner financing. 756-9400 Days: 758-0218 nights.

RIVERFRONT LOT. 210 square feet of water frontage on Tar River, 9 miles west of Greenville. Private and sparsely wooded. Call Don Mizelle, Hearshide Realty 355-3613.

SANDSTONE SUBDIVISION. Lots with water and septic. Financing terms available. No down payment required. Call 758-5103.

STATONSBURG ESTATES. Quiet cul-de-sac, starting at \$11,900. Call Linda Gaddis, Hearshide Realty 355-3613 or 756-3291.

WATERFRONT PROPERTY. Holly Point Shores. 2.22 acres with 3 bedroom mobile home on water. Can subdivide once. A great buy at \$45,000 or purchase half of land with mobile home for just \$35,000. See Janet Bowser, CENTURY 21, JANET BOWSER, 355-7800 or 756-8580.

WESTHAVEN. Fully wooded. Developing area. 1 1/2 acre. Offered at \$28,500.

WOODS SUBDIVISION. 100' lot. Wooded. \$8,500.

4 ACRES NEAR Simpson. Wooded surroundings. On paved road. Call for details.

CLEARED LOTS east of Greenville. 100'x250'. \$9,000 each. CLARK BRANCH REALTORS 355-2000.

WINDSOR. Nice corner lot in second phase of Windsor. \$180,500. 756-9726.

WOODED LOTS for sale. Winterville. Biggest residential lots, 100'x300'. city water, septic permits in place. Price includes lot clearing. Ready to build. \$13,500. 758-9210 days; 758-9546 nights.

2.84 ACRE Homesite, Winterville, owner will assist in building a home. 1-729-0381.

153 Loans & Mortgages

NEED MONEY? Loans on or buy anything of value. Guns Unlicensed of Ayden. Buy, sell, trade, pawn, repair.

155 Resort Property For Sale

LARGE WATER FRONT LOT located on Bath Creek at Pecan Grove. Priced in the 60's. Call 756-0046.

OWN YOUR ACRE LOT on one of North Carolina largest lakes. \$250 weekend get away. Contract purchase with only \$95 down. Complete financing with low payments. Call for details. 758-1389.

157 Townhouses For Sale

ATHLETIC CLUB FANS; nice end unit at Lexington Square. 3 bedrooms, 1 1/2 baths, washer and dryer connection, refrigerator, bay window and private patio. \$45,000. Call Delia Liff at Jeannette Cox Agency, 756-1322 or 756-1976.

150 Land For Sale

NEAR HOSPITAL Exclusive privacy with small creek and shade trees, sloping terrain. 1 1/2 acres. \$14,500. All Clark Branch Realtors at 355-2000 or John Moye, Jr., 756-0604.

UNLIMITED POTENTIAL - 18+ acres on Tarboro and Williams on Highway 44, in zoned, rail, county water available. \$160,000. Owner/financing negotiable. Call Nags Head Realty, 919-441-4311.

152 Lots For Sale

BEAUTIFUL WOODED LOTS with 1700' minimum building restrictions. Conveniently located, very reasonably priced. 1 1/2 to 2 acre lots. We also give estimates on your plan. Call Carolyn Erwin Realty, 355-7878 or at home, 355-6016.

BEAUTIFUL WOODED LOT in prime Lyndale subdivision. Will not last long! Call Pragna Mehra for more information at CENTURY 21, JANET BOWSER, 355-7800 or 355-6054.

HALF ACRE LOTS available at Frog Level off 264 By Pass, Call 946-0017 days 756-4017 nights.

HAMS CROSSROADS. State Road 1780. 100 x 200 on Eastern Pines water. \$5,500.

STOKES. On State Road 1588. 1/2 acre lot. Owner financing with \$500 down payment. Payments as low as \$80.57 a month. THE EVANS CO. 752-2814.

Jack Gordon, Broker, 355-5494 Winnie Evans, Broker, 752-4224

LARGE WOODED and cleared lots. Water and sewer included. For sale or rent. In Pitt County, 4 miles to Washington Square Mall. Owner financing. 756-9400 Days: 758-0218 nights.

RIVERFRONT LOT. 210 square feet of water frontage on Tar River, 9 miles west of Greenville. Private and sparsely wooded. Call Don Mizelle, Hearshide Realty 355-3613.

SANDSTONE SUBDIVISION. Lots with water and septic. Financing terms available. No down payment required. Call 758-5103.

STATONSBURG ESTATES. Quiet cul-de-sac, starting at \$11,900. Call Linda Gaddis, Hearshide Realty 355-3613 or 756-3291.

WATERFRONT PROPERTY. Holly Point Shores. 2.22 acres with 3 bedroom mobile home on water. Can subdivide once. A great buy at \$45,000 or purchase half of land with mobile home for just \$35,000. See Janet Bowser, CENTURY 21, JANET BOWSER, 355-7800 or 756-8580.

WESTHAVEN. Fully wooded. Developing area. 1 1/2 acre. Offered at \$28,500.

WOODS SUBDIVISION. 100' lot. Wooded. \$8,500.

4 ACRES NEAR Simpson. Wooded surroundings. On paved road. Call for details.

CLEARED LOTS east of Greenville. 100'x250'. \$9,000 each. CLARK BRANCH REALTORS 355-2000.

WINDSOR. Nice corner lot in second phase of Windsor. \$180,500. 756-9726.

WOODED LOTS for sale. Winterville. Biggest residential lots, 100'x300'. city water, septic permits in place. Price includes lot clearing. Ready to build. \$13,500. 758-9210 days; 758-9546 nights.

2.84 ACRE Homesite, Winterville, owner will assist in building a home. 1-729-0381.

153 Loans & Mortgages

NEED MONEY? Loans on or buy anything of value. Guns Unlicensed of Ayden. Buy, sell, trade, pawn, repair.

155 Resort Property For Sale

LARGE WATER FRONT LOT located on Bath Creek at Pecan Grove. Priced in the 60's. Call 756-0046.

OWN YOUR ACRE LOT on one of North Carolina largest lakes. \$250 weekend get away. Contract purchase with only \$95 down. Complete financing with low payments. Call for details. 758-1389.

161 Apartments For Rent

A BEAUTIFUL 1 or 2 bedroom apartment one mile from hospital. One year lease, deposit, no pets, washer/dryer hook up. Call Hearshide Realty Property Manager Division, 355-2112.

A BEAUTIFUL PLACE ALL NEW 2 BEDROOMS UNIVERSITY APARTMENTS 2899 E. 5th Street \*Located Near ECU \*Near Major Shopping Centers Contact J.T. or Tommy Williams 756-7815 or 830-1937

AZALEA GARDENS CLEAN AND QUIET one bedroom furnished apartments energy efficient, free water and sewer, optional washers, dryers, cable TV. Couples or singles on ly. \$205 a month. Adjacent to MOBILE HOME RENTALS. Couples or singles. Apartments are mobile homes. Azalea Gardens near Brook Valley Country Club. Contact J.T. or Tommy Williams 752-8915

AN AIR CONDITIONED single bedroom apartment with appliances. \$210 a month. Located at 426 W. 5th Street. 756-7285.

ATTENTION STUDENTS 2 bedrooms, walk, ride bike or ECU bus to campus. College View Apartments. No kids. \$220 J.L. Harris & Sons, Realtors 758-4711.

ATTRACTIVE 2 bedroom townhouse, 1 1/2 baths, quiet area, energy efficient, 355-75480.

AYDEN, large 1 bedroom apartment. Snow Hill Street. \$170 per month. 758-5177.

BAILEY LANE Apartments, Van Hook one bedroom vacancy available for elderly, handicapped, disabled. Need 2-3 bedroom applications. Hud sub \$1200. Private patio, range, refrigerator, central heat and air, cable TV available. EHO 744-1324.

BEAUTIFUL New luxury apartments now leasing in medical park area. Classy, spacious and balconies. All 1 bedrooms have additional dens and 1 1/2 baths. Call 830-8661.

TREYBROOK APARTMENTS

BRYTON HILLS, 2 bedrooms, deck, \$275. Call 752-4131 after 5 p.m.

Cherry Court Spacious 2 bedroom townhouse with 1 1/2 baths, 1 bedroom apartments available. All are carpeted, with modern kitchen appliances including compactor dishwasher, central heat and air. Free basic cable TV, water and sewer. Washer/dryer hook-ups plus laundry room, pool, tennis court, club house. 752-1557.

COZY 2 BEDROOM duplex near Simpson. 756-1889 or 752-4200.

DELIGHTFUL 1 bedroom \$235 or Big 2 bedroom townhouse \$320 752-1375 HOMELOCATORS Fee.

DUPLEX 2 BEDROOM, 1 bath, washer and dryer hook ups, \$280 a month. Deposit required. Call 355-5248 after 5:00 p.m.

EASTBROOK AND VILLAGE GREEN APARTMENTS

One, two and three bedroom apartments, featuring cable TV, modern appliances, clean laundry facilities, swimming pools, fully carpeted.

Office: 204 Eastbrook Drive 752-5100

FARMVILLE, 2 bedroom apartment, appliances included. Patio, cable hook-up, central air, \$250 a month. Call 753-4750.

FURNISHED 2, 3, or 4 room apartment. 752-7212 or 756-0176.

FURNISHED ONE bedroom apartment, 1 1/2 blocks from ECU. Call 758-2683 anytime.

FURNISHED 1 bedroom water paid \$200/1 bedroom heated \$245 752-1375 HOMELOCATORS Fee.

HOUSING FOR THE PROFESSIONAL

BROOKHILL. Three bedroom townhome available. 2 1/2 baths, all energy efficient appliances, fireplace, outside storage/private patio.

AYDEN. Two bedroom duplexes available on 2nd Street. Dishwasher, range, and frost free refrigerator. Pets under 20 pounds.

SHENANDOAH VILLAGE. 309-C Tobacco Road. Two bedroom townhome available October. 1 1/2 baths, washer/dryer hook ups, and outside storage.

WILLIAMSBURG MANOR. Two bedroom townhome available October. Fireplace, appliances, washer/dryer hook ups. 1 1/2 baths, and outside storage. Professional area.

161 Apartments For Rent

GreeneWay Large 2 bedroom garden apartments, all with 7 closets, carpeting, kitchen appliances including dishwasher, central heat and air. Free basic cable TV, water and sewer. Laundry rooms, spacious grounds, playground and pool, abundant parking. Pets allowed. Adjacent to Greenville Country Club. (330) 756-6869.

KINGS ARMS Large 1 bedroom apartments. Carpeted, modern kitchen appliances, heat pump, for energy efficient heating and cooling. Laundry facilities, 1209 Charles Boulevard, Office Apartment 104. Furnished Apartments Available. Also Renting For Fall.

752-8915 KINGS ROW APARTMENTS

ONE AND TWO BEDROOM Garden Apartments. All appliances included plus walk in washer, carpeting, basic cable, water, sewage, on site laundry, 24 hour emergency maintenance, swimming pool and 2 basketball courts.

LOVE TREES? Experience the unique in apartment living with nature outside your door.

COURTNEY SQUARE APARTMENTS

Quality construction, fireplaces, heat pumps (heating costs 50 percent less than comparable units), dishwasher, washer/dryer hook ups, cable TV, walk-in closet, carpet, thermopane windows, extra insulation.

Office Open 9-5 Weekdays 9-5 Saturday 1-5 Sunday Merry Lane Off Arlington Blvd. 756-5067

NEAT CRIB! 1 bedroom \$220 or 2 bedroom \$270 near hospital 752-1375 HOMELOCATORS Fee.

NEW 1 BEDROOM apartments. Washer/dryer, cable TV, carpet, electric heat, air conditioning, appliances. 756-3342.

NICE QUIET 1 bedroom duplex, carpet, appliances, hookups. \$250 a month. 756-2071, 758-9100.

OAKMONT SQUARE APARTMENTS

Two bedroom townhouse apartments. Fully equipped kitchen, pool, tennis courts, cable TV, 24 hour emergency maintenance. Very convenient to Pitt Plaza and University. Now leasing for September and October.

Office hours 9-5:30, Monday-Friday, 1212 Redbanks Road. 756-4151

ONE AND TWO bedroom apartments for rent. Smith Insurance and Realty, 752-2754.

ONE BEDROOM apartment. Heat, hot and cold water, septic included, \$250 monthly. 201 N. Woodlawn. 756-0545 or 758-0635.

ONE BEDROOM furnished apartment 3 blocks from university. Heat, hot and cold water, furnished. No pets. Call 758-3781 or 758-0889.

ONE BEDROOM, S. Evans Street. No kitchen, water and electric included. \$175.

TWO BEDROOM, Forbes Street, \$175.

TWO BEDROOM duplex, central heat and air. Colonial Village, 1212 Redbanks Road, J.L. Harris & Sons, Realtors, 758-4711.

ONE LARGE 1 bedroom apartment, completely furnished. The bath, carpet, drapes, all furniture. Available October 1 or sooner. 311 Lewis Street, half a block from campus. 752-2691.

STUDENT HOUSING

PIRATES LANDING. LIMITED OFFER: SIGN ONE YEAR LEASE BY OCTOBER 1, AND RECEIVE FIRST MONTH FREE!! Furnished room with semi private bathroom. Microwave oven, laundry facilities. Utilities included. Short term lease available.

CAPTAINS QUARTERS. One bedroom apartment available October. Dishwasher, range, and refrigerator. Water and sewer included. Close to campus.

REGENCY HOUSE. Two bedroom condos available October. Completely furnished. Hot/cold water, sewer included. Corner of 5th and Reade Streets. Walk across street to campus.

REMCO EAST, INC. (919) 758-6061 Ask for Patli

161 Apartments For Rent

ONE AND TWO BEDROOM apartments available now. Call 752-3311.

STRATFORD ARMS APARTMENTS

Spacious 1,2 and 3 Bedroom Apartments \$200 Security Deposit Required CABLE TV, TENNIS COURTS, POOL Convenient to Shopping and ECU

Office hours 9 a.m. to 5 p.m. Monday through Friday Call us 74 hours a day at 756-4800

TWO BEDROOM Apartment for rent. Hospital area. Contact F.L. Garner, Owner/Broker, 757-1445.

UTILITIES included 1 bedroom \$205/2 bedroom \$295 Campus 752-1375 HOMELOCATORS Fee.

WEDGEWOOD ARMS 2 bedroom, 1 1/2 bath townhouse. Excellent location. Carport heat pumps, whirlpool kitchen, washer/dryer hookups, pool, tennis court, draperies. 355-6302.

WOOD'S EDGE Brand new spacious two bedroom duplexes located in a quiet residential community in Heritage Village featuring: Greatroom with cathedral ceiling, microwave, extra nice, full kitchen, washer and dryer connections, energy efficient, outside storage room, private enclosed patio. 756-4151

1 Bedroom \$175 Near downtown 2 bedroom townhouse \$315 752-1375 HOMELOCATORS Fee.

1068 SHILOH DRIVE. Shenandoah Townhomes, 2 bedroom, 2 1/2 baths, washer/dryer hook ups, outside storage. Assume short term lease with low rent. Contact Remco East, 758-6061.

2 BEDROOM, bath and 1/2 apartment for rent. Call 355-2474 or 355-6016 after 6:00 p.m.

170 Condominiums For Rent

AVAILABLE in September: 3 bedroom, 2 bath flat with 1300 square feet. Fireplace, stove, fireplace, fully equipped kitchen and disposal, pool and tennis courts. 1 year lease and deposit required. No pets. Call Clark Branch Realtors, 355-2000.

SHERATON VILLAGE: 2 bedroom townhouse, 1 1/2 baths, No fireplace, washer, dryer. \$450. Call 756-6223.

TWO BEDROOMS, 2 baths, flat, Upton Court, washer and dryer, microwave, extra nice. \$475 per month. Call 756-8085.

YORKTOWN SQUARE, 3 bedrooms, 1 1/2 bath, available after September 21. \$460 per month. One year lease required. Please call Al Bridg and Sutherland, 756-3500.

173 Houses For Rent

ARE YOU LOST, CONFUSED? Let us help! We have affordable, private, unadvertised rentals. Available October 1. Call 758-0801 after 6:00 p.m.

AVAILABLE IMMEDIATELY in Pineridge Subdivision, 3 bedroom, 1 1/2 bath home with stove and dishwasher. Approximately 1400 square feet, \$500 before 5 or \$300 after 5.

WELL KEPT 2 bedroom \$200 or 3 bedroom \$225. Washer/dryer hook ups. Call 756-6223.

WHY PAY RENT! 12x55, owner will consider partial financing. 1-975-6639.

173 Houses For Rent

3 BEDROOM HOUSE in Ayden. Days, 830 1124; nights, 355-6462.

174 Townhouses For Rent

LEXINGTON SQUARE Townhome 3 bedroom townhome available for \$525 a month. Please call Janet Bowser at CENTURY 21 JANET BOWSER & ASSOCIATES, 355-7800 or 756-8580.

TWIN OAKS, 2 bedrooms, 1 1/2 baths, range, refrigerator, dishwasher, spacious floor plan, \$335. 756-7480.

YORKTOWN SQUARE 3 bedrooms, 1 1/2 baths, living room with washer/dryer, furnished, central air and heat, undersliding privacy fence on private lot in country. No pets. 756-3329, 756-8195 or 524-4687.

# With The Armed Services



Navy Lt. George P. Davis has received a Master of Science degree from the Naval Postgraduate School in Monterey, Calif. He also is a graduate of the U.S. Naval Academy, Annapolis, Md., and Ayden-Grifton High School.

Marine Sgt. Gregory Prayer has been promoted to his present rank while serving 3rd Force Service Support Group on Okinawa. He is the son of Fannie L. Prayer of Ayden.

Marine Cpl. Clyde H. Shaeffer has reenlisted for four years while serving with 3rd Marine Division on Okinawa. He is the son of Walldine Shaeffer of Greenville.

Marine 1st Lt. Durward W. Walker recently reported for duty with 2nd Marine Aircraft Wing, Marine Corps Air Station New River, Jacksonville. He is the son of Shelby J. Bailey of Greenville.

Marine Cpl. Jimmy R. Daughtery reported for duty with 3rd Marine Aircraft Wing, Marine Corps Air Station Camp Pendleton, Calif. He is the son of Dora D. Daughtery of Greenville.

Navy Midshipman Douglas C. Frelke was one of many U.S. Navy Midshipmen who recently participated in a summer training cruise aboard the repair ship USS Vulcan, homeported in Norfolk, Va. He is a resident of Greenville.

Senior Master Sgt. Ervin Yarrell has graduated from the Air Force noncommissioned officer leadership school and a Wing Supply Division superintendent with the 507th Tactical Air Control Wing at Shaw Air Force Base, S.C. He is the son of Retha M. Yarrell of Greenville and is a graduate of Bethel Union High School.

Army Reserve Pfc. Jackie C. Clark has completed an Army administration course at Fort Jackson, S.C. She is the daughter of Bertha M. and Willie H. Clark of Hookerton. She also is a graduate of Greene Central High School, Snow Hill, and East Carolina University.

Marine Lance Cpl. Jeffrey L. Wright has been awarded a Meritorious Mast while serving with 2nd Marine Aircraft Wing, Marine Corps Air Station, Cherry Point. He is the son of Estella T. Wright of Greenville.

Marine Lance Cpl. Jeffrey L. Wright has been awarded a Meritorious Mast while serving with 2nd Marine Aircraft Wing, Marine Corps Air Station, Cherry Point. He is the son of Estella T. Wright of Greenville.

Marine Pfc. Derrick A. Boyd has completed recruit training at Marine Corps Recruit Depot, Parris Island, S.C. He is a resident of Robersonville

and a graduate of Roanoke High School.

Marine Gunnery Sgt. Monnie E. Belcher recently reported for duty with 4th Marine Division, Marine Corps Logistics Base, Albany, Ga. He is the son of Raymond T. and Joann Belcher of Snow Hill.

Marine Pvt. James D. Jones recently reported for duty with 2nd Marine Aircraft Wing, Marine Corps Air Station, Cherry Point. He is the son of Marie Jones of Greenville.

Pfc. Edward G. Andrews has completed basic training at Fort Leonard Wood, Mo. He is the son of Roy R. Andrews of Bethel.

Army Sgt. James T. Joyner has arrived for duty at Fort Benning, Ga. He is the son of James Joyner of Farmville.

Airman 1st Class Brian D. Jernigen has graduated from the U.S. Air Force course for information systems specialist at Keesler Air Force Base, Miss. He is the son of Elton and Claire Jernigan of Greenville.

Coast Guard Seaman Apprentice Charles K. Baker recently was graduated from Coast Guard recruit training at the Coast Guard Recruit Training Center, Cape May, N.J. He is the son of Gene P. and Judy B. Baker of Greenville.

Navy Seaman Recruit James P. Thomas has completed recruit training at Recruit Training Center, Great

Lakes, Ill. He is the son of James A. and Julia C. Thomas of Snow Hill.

Marine Staff Sgt. Gregory L. Roberts has reenlisted for four years while serving with 2nd Marine Aircraft Wing, Marine Corps Air Station New River, Jacksonville. He is the son of Willie B. and Alice M. Roberts of Williamston.

1st Lt. Sara E. Baker of the 909th Air Refueling Squadron, Kadena Air Base, Okinawa Japan, recently was named Navigator of the Quarter in her squadron. She is the daughter of Simon and Rosalie Baker of Greenville and is a graduate of J.H. Rose High School and North Carolina State University.



SARA E. BAKER

Marine Sgt. Christopher E. Candler recently reported for duty at Marine Corps Air Station, Cherry Point. He is a resident of Greenville.

Coast Guard Seaman Apprentice Jeffrey M. Haddock was recently graduated from Coast Guard Recruit Training at the Coast Guard Training Center, Cape May, N.J. He is the son of Walter M. and Jean B. Haddock of Greenville.

Navy Seaman Recruit Christopher A. Clemons has completed recruit training at Recruit Training Center, San Diego. He is the son of Edward and Nina M. Hooks of Greenville.

Marine Pfc. Curtis D. Dickerson has completed the School of Infantry at Marine Corps Base, Camp Lejeune. He is the son of Charles J. and Rosalee Taft of Greenville.

Navy Petty Officer 1st Class Gene R. Carr recently made port visits in Nouakchott, Mauritania, Abidjan, Ivory Coast, Tema-Accra and Ghana, Africa. He is a graduate of J.H. Rose High School.

Marine Lance Cpl. William H. Holbert recently completed the Enlisted Supply Basic Course conducted at Marine Corps Service Support Schools, Marine Corps Base, Camp Lejeune. He is a resident of Greenville.

Marine Pfc. Clifton E. Clemons recently reported for duty with 2nd Force Service Support Group, Camp Lejeune. He is the son of Clifton E. and Ann L. Clemons of Grimesland.

Marine Pvt. James D. Jones recently reported for duty with 2nd Marine Aircraft Wing, Marine Corps Air Station, Cherry Point. He is the son of Marie Jones of Greenville.

Army Reserve Pvt. Michael D. Benson has completed the chaplain assistant course at the U.S. Army Chaplain Center and School, Fort Monmouth, N.J. He is the son of Jimmy A. Benson of Grifton and Dan B. Benson of Kinston.

Air Force Capt. James T. Manning III has arrived for duty at Columbus Air Force Base, Miss. He is the son of Mr. and Mrs. James T. Manning Jr. of Greenville.

Spec. Tracy R. Cherry has been decorated with the Army Achievement Medal in West Germany as a petroleum supply specialist with the 94th Field Artillery. He is the son of Letha Cherry of Bethel.

Pfc. Timothy E. Rogerson has completed basic training at Fort Jackson, S.C. He is the son of Norman E. Rogerson of Greenville and is a graduate of J.H. Rose High School and East Carolina University.

Army Specialist Anthony M. Rodgers, son of Tonasia F. and James E. Rodgers of Williamston, was awarded the Good Conduct Medal in West Germany. The award was presented for exemplary conduct while in the active service of the United States. Rodgers is a missile crewmember with the 9th Field Artillery.

## Military Doubling Explosives Experts To Combat Terrorism

By BILL KACZOR  
Associated Press Writer  
EGLIN AIR FORCE BASE, Fla. (AP) — The American military is almost doubling the number of its explosives specialists in response to growing international terrorism and other factors, says the head of a new Navy training school.

Explosive ordnance demolition technicians most recently have been involved in clearing and recovering mines from the Persian Gulf, said Navy Lt. Cmdr. H.F. Mixer, officer in charge of the new \$18.6 million EOD school at this base in the Florida Panhandle.

The Eglin school, one of only two of its kind in the U.S. military, opened June 24 and trains Army, Air Force, Marine and some foreign military students, as well as Navy personnel.

Defense officials began planning for additional training and the new school three years ago when a survey showed an 89 percent increase in EOD technicians would be required by the four services between 1985 and 1990, Mixer said in a recent interview.

"I think you can attribute it (in part) to the growing threat of international terrorism," Mixer said.

"We are the bomb squad of the military," he said. "We are locating, identifying, evaluating, rendering safe and then removing and/or disposing of explosive ordnance of all types: domestic and foreign, surface and underwater."

The types of explosives range from improvised explosives of the "mad bomber" kind, to the most sophisticated military weapons, conventional and nuclear, he said.

"The world's weaponry is far more sophisticated than it used to be," another factor contributing to the need for more EOD technicians, Mixer said.

Changes in battlefield strategies also have caused a need for more

bomb squad technicians, Mixer said, but he declined to get any more specific, saying that information was classified.

All he would say is that the military has adopted a different way of doing business, changing its view of war from the "Vietnam mentality."

Although operated by the Navy, the school was built at an Air Force installation because Eglin, the free world's largest air base at 724 square miles, had enough space to accommodate the school, existing support facilities including test ranges where explosives can be set off and temperate weather that permits year-round outdoor activities.

Another factor is that of the few bases meeting those criteria, it is the closest to the Naval Explosive Ordnance Disposal School at Indian Head, Md., the military's only other facility for bomb-squad training.

The Eglin facility, although the larger of the two, has been designated as a detachment of the Indian Head school.

The new school has a staff of 23 officers and 160 enlisted personnel, also drawn from all four services. An average of 45 officers and 280 enlisted people are in training at any one time with approximately 20 percent women. About 1,200 students are expected to graduate each year. The Navy accounts for 30 to 40 percent of the students.

Mixer said the common training for all branches, relatively rare in the U.S. military, pays off when EOD technicians from different services work together in the field.

"Regardless of the service, you know that he knows what you know," Mixer said.

The new school includes a 29,272-square-foot classroom building, a nearby dormitory for 366 staffers and students, and three air-conditioned and heated concrete bunkers which can double as classrooms at test ranges.

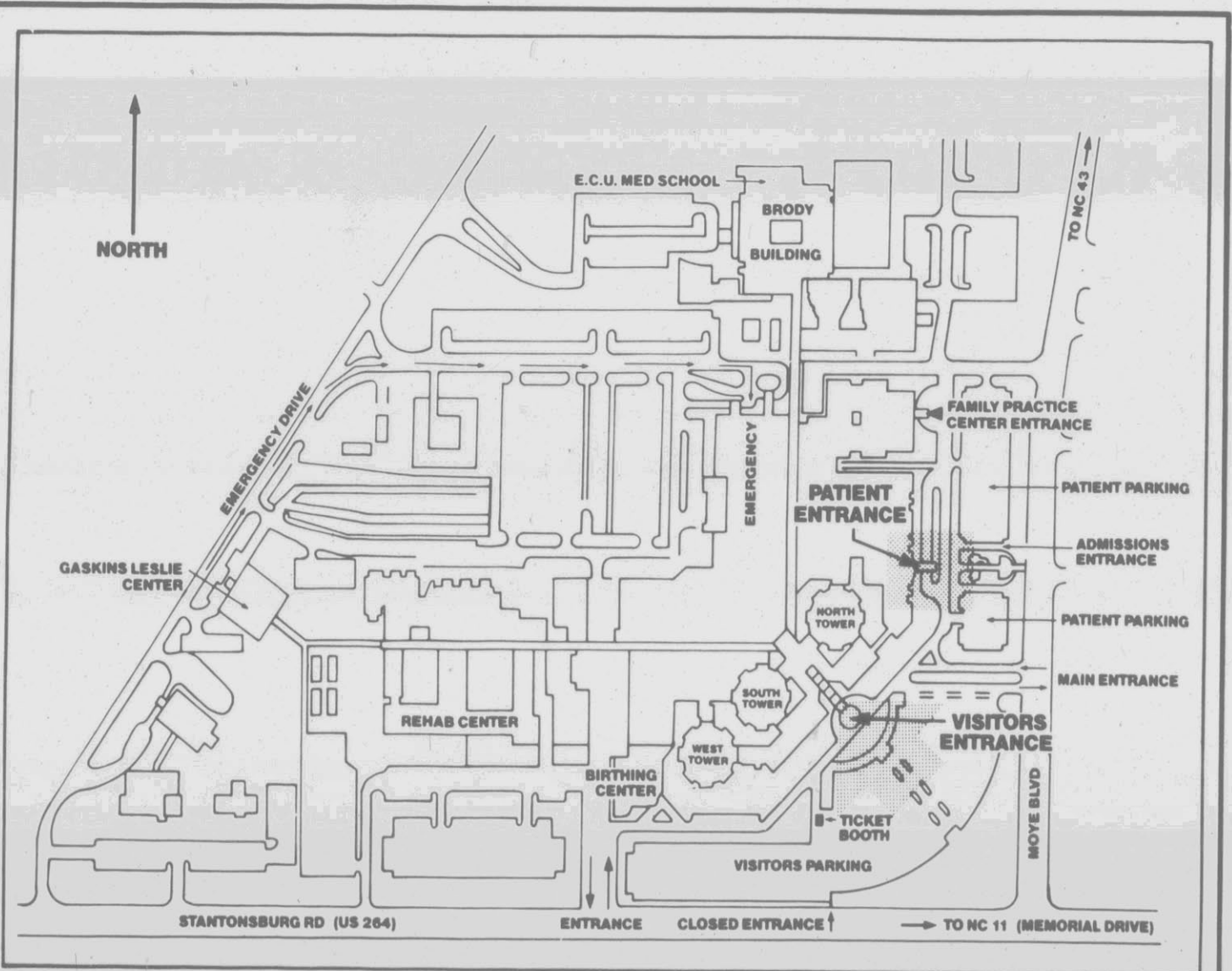

## We've Opened New Doors for Healthcare in Eastern North Carolina

September 15, 1988 marks the opening of a new admission entrance to Pitt County Memorial Hospital. All inpatients and outpatients will use the new entrance, and will have easy access to the facility with ample parking adjacent to the building. Visitors will continue to use the existing main entrance.

The new admissions area is located more conveniently to the areas where many patients receive diagnostic tests during the admitting procedures. Also included in the expansion is a new Laboratory Medicine Department and a new Medical Records Department.

The emergency entrance to Pitt County Memorial Hospital will remain in its previous location on Emergency Drive off of Stantonburg Road. Emergency patients, obstetrical patients and patients with appointments at the Magnetic Resonance Imaging Center will continue to use the emergency entrance.

This project is a part of the multi-phase development at Pitt County Memorial Hospital which represents the mission of the hospital as an academic medical teaching center.

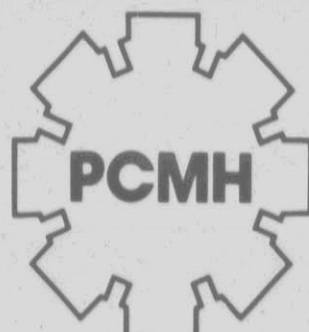

People Care More Here  
**PITT COUNTY MEMORIAL HOSPITAL**  
200 Stantonburg Road • P.O. Box 6028 • Greenville, NC 27835 • (919) 551-4100

### THIS CAN BE THE BEST YEAR YOUR CHILD EVER HAD IN SCHOOL!

Let Sylvan improve your child's learning skills dramatically. Call today for a free, no obligation consultation.

**The Sylvan Guarantee**

When enrolled in our basic reading or math program, your child will improve at least one full grade equivalent score after the first 36 hours of instruction, or we will provide up to 12 additional hours of instruction, at no further cost.

- Sylvan's basic Reading and Math programs improve skills 1-12 grade.
- Sylvan's Algebra program will give your child a head start.
- Sylvan's Study Skills program will develop positive study habits.
- Sylvan develops confidence, motivation and self-esteem.



**Sylvan Learning Center**  
We help children master the basics of learning.

200 Arlington Blvd., Suite D

756-9383

## Key West Business Mogul Just Learns From His Mistakes

By CATHERINE WILSON  
Associated Press Writer

KEY WEST, Fla. (AP) — Ed Swift acknowledges \$1.8 million worth of failures.

Photographs of his money-losing business ventures and their dollar losses fill a bulletin board in his company's employee training room just a few steps off Key West's restored Duval Street.

"Unfortunately, I've got a few more to add," concedes Swift, 41. "Each of these I cried about."

But there's a lesson to learn from the \$125,000 loss on the floating restaurant that caused seasickness, the \$103,000 loss on the Florida City welcome center that was planned 10 years too soon, the failed car and boat rental businesses.

"Everyone has the right to fail," the bulletin board slogan says. "No one has the right not to try."

Swift has been trying since he inherited his father's Key West photo shop in his late teens when both parents died within two years. In addition to his failures, he has a string of successes to his credit.

With two partners, Swift and their Old Town Key West Development Ltd. restored 26 deteriorating storefronts and houses and founded Old Town Trolley and Conch Tour Train Inc. of Key West.

As president of Key West Hand Print Fabrics, he reopened a fabric printing factory. His help rehabilitating the 54-year-old Key West Aquarium produced a home for indigenous marine life that now draws 175,000 visitors a year.

Old Town Trolley, a narrated sightseeing tour service aboard classic-styled trolley buses, also runs in Washington, D.C., and Boston and will begin running soon in Miami, San Diego and Cambridge, Mass.

The company also will be operating information services at Boston's Quincy Market and Washington's Union Station.

Swift companies will employ close to 400 by the end of the year.

"The thing that really amazes me is I never had any aspiration of doing any of this," Swift says, resplendent in a cotton Hawaiian shirt with yellow bananas and green leaves on a sky-blue background, one of the fabric shop's new products.

His rise to prominence in this tourist mecca began in the early 1970s when Key West was in one of its perennial slumps. The Navy had come and gone, just like sponge harvesting, the hemp factory and cigar industry.

"I don't know if you can fully appreciate how depressing this street really was," Swift said of Duval Street, now lined with upscale boutiques, trendy restaurants, restored lodges and open-air bars.

The Strand Theater had been running "Deep Throat" for nine straight years and "For Rent" signs abounded.

Swift and barber Gerald "Moe" Mosher, who came to Key West with the Navy in 1951, called a meeting on a downtown cleanup, but hardly anybody showed up.

"We used to discuss Duval Street in the barber shop, and we finally decided everything was moving to the shopping centers," Mosher recalled.

With 90 percent of the storefronts empty in the early 1970s, owners were anxious to unload them.

Swift, Mosher and Wharton economics major Christopher Belland, who moved south from Miami, invested in their first storefront, gutted it themselves and tried to bring back the historic conch style evident in other Key West buildings.

In a 1950s building with a concrete facade, the partners embellished the front to add some island charm. Other buildings had to be moved. Some even lost their front walls. In their place came bay windows, fresh paint and period signs.

But with no bank financing for such an untested venture, the partners were on their financial knees.

"We were 180 days behind in our payments. You talk about broke," sighed Swift, who went on to serve a four-year term on the Monroe County Commission. "We went to give one building back, but the woman said, 'Don't you dare.'"

The restoration idea caught on, and the southernmost city in the continental United States now boasts a 100-block historic district.

The storefronts bought for \$50,000 in the days of decline now sell for \$300,000, \$350,000 and up.

"When the Navy pulled out, the plan for Key West tourism had been on the back burner since the aquarium was built in 1936," said Swift, sipping diet cola and munching unbuttered popcorn before lunch in his office. "We've rebuilt our whole economy around tourism since '73-'74."

Sensing the turnaround, Swift and partners tried a sightseeing trolley in 1979 but failed. British Leyland double-decker buses were on their last legs, and no replacement parts were obtainable.

But three years later, Belland saw a trolley he liked at a Rose Bowl parade. The partners are now ready to start building their own, in Key West of course, with their own designs.



EDGECOMBE QUILTS — Beatrice Jordan of Edgecombe County shows off one of her quilts at her home. This quilt, along with 17 other domestic-type quilts made in Edgecombe County, will go on view Sunday at the Blount-

Bridgers House, 130 Bridgers St. in Tarboro. A reception to honor the quiltmakers, free and open to the public, will be held from 4 p.m. to 6 p.m. Sunday.

## Edgecombe Women Exhibit Quilts

TARBORO — Quilting is a folk-art that has a large and devoted following across the United States, an art born of necessity that often reaches spectacular heights.

In an effort to shed more light on this domestic art on a local level, the Edgecombe County Cultural Arts Council with the Tarboro Ebonette Club, in cooperation with the Folklife Section of the North Carolina Arts Council, is presenting an exhibit of 18 quilts made by residents of Edgecombe County.

The show of quilts will be held at the Hobson Pitman Memorial Gallery of the Blount-Bridgers House, 130 Bridgers St., Tarboro, to be on view through Oct. 23.

A reception honoring the quilters will be held from 4 p.m. to 6 p.m. Sunday at the gallery. Gallery hours for viewing the exhibition are from 10 a.m. to 4 p.m. weekdays, and from 2 to 4 p.m. on Sundays. Admission is free.

The exhibit compares certain features of these quilts — most of them made by black Edgecombe County women born in the early part of the 20th century — to authentic African textiles.

The exhibit was curated by Mary Ann McDonald and intern Jillian Friedman of the N.C. Folklife Section, with the assistance of members of Tarboro's Ebonette Club. Ebonette Club members made inquiries throughout the county, locating residents who were known for their skills as quilters.

The quilters were visited in their homes, interviewed on tape, photographed with their quilts, and their permission secured to borrow certain quilts. Members of the Ebonette Club selected the quilts being shown.

County quilting residents who have loaned quilts for the show are Henrietta McNeil, Bettie Cofield,

Josephine Randolph, Rosaie Dozier, Blanche Vines Shaw, Mabel Dancy, Hattie Ransome, Beatrice Jordan, Geneva Knight and Maggie Peele.

Also included in this exhibit will be authentic Kente cloth weavings from the collection of Matye Reed, recently retired from the African Heritage Center at North Carolina A&T University, Greensboro.

These enormous brilliantly colored weavings were designed to be worn by tribal kings. Made of raw silk and dating from the first half of the 10th century, they display many of the elements of contrasting color, bold vertical stripes and prominent borders that appear in the quilts made by the Edgecombe County residents of African descent.

For more information about the exhibit and the Blount-Bridgers House, call 823-4159.

## Carolina Events

### Macclesfield To Hold Fall Festival

Macclesfield's 11th annual Fall Festival will be held Oct. 1 at the mini-park on Railroad Street.

The day-long event will feature music by local talent, the Southwest Edgecombe Choir, the Little Rock Band and gospel music groups. There will be a street dance in the evening with music by New Breed and cheerleaders from Southwest Edgecombe and South Edgecombe high schools will perform in the morning.

A variety of foods, such as Brunswick stew, ham biscuits, hot dogs and barbecue chicken, and arts and crafts will be on sale throughout the day.

For more information about booth rental for food or crafts, call Elizabeth Ellis at 827-5572 or write Fall Festival, P.O. Box 283, Macclesfield, N.C. 27552.

### Rocky Mount Fair Opens Friday

ROCKY MOUNT — The 1988 Rocky Mount Agricultural Fair opens Friday and runs for nine days through Sept. 24. Gate Admission is \$3 for adults and \$2 for children. Senior citizens day is Sunday, with exhibit judging being held Monday. Marching band units will perform Monday through Sept. 22, with horse show night on Sept. 23. Attractions will include Stunt World performances, truck shows, muppet shows, racing pigs, carnival rides and games.

### Mountain Heritage Day Set

CULLOWHEE — Western Carolina University's 14th annual Mountain Heritage Day will be held Sept. 24 at the Mountain Heritage Center on the university's campus. The traditional music, foods, dance, crafts and skills of the mountain region will be celebrated.

Mountain Heritage Day activities will begin at 8 a.m. and continue until 5 p.m. If it rains, the events will be moved into the Liston B. Ramsey Regional Activity Center. There is no admission charge.

For more information call Doug Davis at (704) 227-7234, or write to him at Room 460, Robison Administration Building, Western Carolina University, Cullowhee, N.C. 28723.

### Senior ECU Student Recital Friday

Jerry G. Lilly of New Bern, a student of Harold Jones in the school of music at East Carolina University, will present his senior percussion recital at 7 p.m. Friday in the A.J. Fletcher Recital Hall on the ECU campus.

For his program, he will be accompanied by Alisa Wetherington, piano. Selections he will perform include compositions by Darius Milhaud, Keiko Abe, Anthony Cirone, Christopher Deane and Ruud Wiener.

The recital is free and open to the public.  
(See CAROLINA, C-2)



MARSH AREA BEAUTY — These lovely morning glories, of a shade of lavender with a touch of cerise, are at their finest in coastal eastern North Carolina during the month of September. This particular species of morning glories is common to marsh areas of North Carolina. The blossoms shown here were photographed in the marsh area just across the bridge at Leecheville along the eastern banks of the Pungo River in Hyde County. (Reflector Color-photo by Jerry Raynor)

## Diver Earns Living With Golf Balls

By SHERRI BERRY  
The Beaufort Gazette  
BEAUFORT, S.C. (AP) — A golfer without a ball retriever is Bob Glenn's best friend, and winter and alligators are his worst enemies. Glenn is the owner of Hazard Divers in Charleston and earns a living diving in ponds for golf balls.

"Snakes, alligators and winters are the cons of my job," Glenn said,

"and I wouldn't rank them in that order. Winters bother me more than snakes and alligators."

In the quest for misdirected golf balls, Glenn has been battling cold water and reptiles full time for four years.

The 30-year-old Charleston resident began diving of and on for balls eight years ago after a friend suggested it as a way to make extra

money. Upon realizing he could make a living doing it full time, he made golf ball diving his occupation. There are about four other golf ball divers in the state, according to Glenn. "There are guys in the business in Florida and Myrtle Beach who make up to \$200,000 a year," Glenn said. But shaking his head and grinning, quickly added that he doesn't make that kind of money.

Throughout the summer, Glenn, said he works five to six days — about 40 to 75 hours — a week. He works no more than 30 to 35 hours a week during the winter.

Glenn contracts to dive at three courses in the Beaufort area and at about 70 throughout the state, traveling 500 to 1,000 miles a week.

(See DIVER, C-3)

## On The Town

Here are some of the evening entertainment activities scheduled for Pitt County in the coming week:

### Attic

Wednesday: Comedy zone.

Thursday-Friday: Sidewinders will perform.

Saturday: Amateurs will perform rock and reggae music.

### Calico Club

Saturday: Concessions, pool room and gift shop available, and there is live country music and dancing. Open 7:30 p.m. to 11:30 p.m.

### Corrigan's

Thursday: Rick Cornfield will perform.

### Fox Trap

Friday: No cover charge. Shurestep is the disc jockey. Doops open at 10 p.m.

Saturday: Ladies admitted free until 11:30 p.m. Free hors d'ouvres. Doors open at 10 p.m.

Sunday: Reduced prices on beverages. Ladies' night with D.J. Shurestep with Sugarman Disco and hosts the Mills Brothers.

The club is located on the Stokes highway, 903 North. For more information, call 758-9375.

### New Deli

Wednesday: Open Mic night.

Thursday: Deadhead jam will perform.

Friday: Blues Defenders will perform.

Saturday: Liquid Sound will perform.

### Ollies

Thursday: Ladies' night out.

Friday-Saturday: Randy Lee and the Black Bart Band will perform at 9:30 p.m. Saturday: open pool competition.

Sunday: Horseshow throwing.

Monday: Taven opens at 1 p.m. each day.

Tuesday: Softball Players' special.

For more information, call 758-0058.

### Rio! at the Greenville Hilton

Wednesday: Ladies night will be held. Music by Doug Young. Club is open 7 p.m. to 1 p.m.

Thursday: Wild Thursdays. Music by disc jockeys Scott McLogan and Doug Young.

Friday: Fun Fridays; expect the unexpected. No cover charge before 8:30 p.m. Music by disc jockeys Scott McLogan and Doug Young.

Saturday: A weekend bash will be held from 7 p.m. to 1 p.m. Dance music and lighting will be provided by Scott McLogan and Doug Young. No cover charge before 8:30 p.m.

Tuesday: Classic Rock and Roll. Blue jeans and tennis shoes may be worn. The club will open from 7 p.m. to 1 a.m. Music by Scott McLogan and Kelly Long.

### Sports Pad

Wednesday: Ladies play billiards free.

Sunday-Saturday: Disc jockey will entertain with rock and roll music.

Tuesday: Eight-ball tournament begins at 8 p.m.

For information, call 757-3658.

Prime Time Tonight

WEDNESDAY EVENING							
	7:00	7:30	8:00	8:30	9:00	9:30	10:00 10:30
2	Remington Steele		Movie: "Helltown Goes Bananas"				700 Club
4	Business Rpt.	Innovation	Who Cares for the Children?	Moyers/Secret Gov'l/Constitution			Fall Preview
5	CBS News	Lose or Draw	Live! Dick Clark Presents	Equalizer			Wiseguy
5	3's Company	Current Affair	Movie: "Youngblood"				News
7	Jeffersons	Benson	Unsolved Mysteries	Night Court	To Be Announced		
9	USA Today	Lose or Draw	Live! Dick Clark Presents	Equalizer			Wiseguy
12	Wheel-Fortune	Jeopardy!	Gro. Pains	Head of Class	Hooperman	Slap Maxwell	China Beach
DIS	Show Off At	Mouseterp.	Ashford & Simpson	Movie: "Sounder"			
ESPN	SportsCenter	Scholastic	Horse Racing: Del Mar	Billiards	Bowling: Showdown to Seoul		
HBO	Raise Street-Smart Child		Women of the Night		Vietnam War		Hitchhiker
LIFE	E/R	Easy Street	Cagney & Lacey	Surviving a Heart Attack	Seoul Women		KnowsBest
MAX	Movie: "Revenge of the Nerds II: Nerds in Paradise"			Movie: "The Squeeze"			
SHOW	Something for a Lonely Man	Brothers	Super Dave	Movie: "An Officer and a Gentleman"			
TMC	The Garbage Pail Kids Movie	Movie: "Malone"		Movie: "Kelly's Heroes"			
USA	Airwolf		Tales of the Gold Monkey	Movie: "Rollover"			
WTBS	9 to 5	Sanford	Movie: "Legend of the Lost"				Baseball

For complete TV programming information, consult your weekly TV SHOWTIME from Sunday's Daily Reflector.

# Writer Takes His 'History Of White People' To Films

By KATHRYN BAKER  
AP Television Writer  
BEVERLY HILLS, Calif. (AP) — Martin Mull is delighted. He has found a parking place right in front of the Beverly Hills restaurant. But, of course — his car is white.

Blond-haired, blue-eyed Mull has become a white person by profession since 1985, due to the success of an innocuous notion he and fellow white writer Allen Rucker had one day — "The History of White People in America."

"Based on my experiences in Ohio and his in Oklahoma, we figured we had the Grain Belt pretty well in hand," Mull said over lunch, a salad with a lot of white stuff in it.

"We started describing what makes a person white by our standards. And in this case, the standards were liberal enough they could include black people; there are certain Caucasians who do not qualify, as well."

A friend at a movie studio told the two they should send the idea to the cable television people, Mull recalled. "We said send what? We don't have anything other than the title. He said, that doesn't matter."

Mull and Rucker produced a two-part Cinemax special, "Martin Mull Presents the History of White People in America," instructing viewers on

the identification of the white person: habitat, the Midwest; its clothing, polyester; its food, tuna noodle casseroles and Cheezits. We were informed the specials were sponsored by the Institute for White Studies in Zanesville, Ohio, and funded through a grant from Tastee-Freeze.

The specials were among the most successful Cinemax had aired, and they spawned two best-selling books. In 1986, Mull and Rucker followed up with a four-part series on white religion, crime, stress and politics.

The series has since been packaged for home video.

Mull, the on-camera host of the series, took viewers right into the lair of the white people, Hawkins Falls, Ohio, and introduced them to quintessential white couple Hal and Joyce (Fred Willard and Mary Kay Place) and their offspring, Debbie and Tommy, students at Dinah Shore High School.

Now Cinemax presents White People: The Movie. "Martin Mull in Portrait of a White Marriage" premiered on the cable channel last week and is being played Thursday and on Sept. 17, 20, 23 and 28. The two-hour movie takes characters from the instructional series and sets them up for a psycho-cultural crisis — even as the day of the Hawkins

Falls Founder's Day parade approaches.

"White People" was often viciously satirical. In "White Marriage," Mull and Rucker have softened up. The laughs are more mainstream, and the movie is a virtual homage to old-fashioned values in the face of Hollywood starshine.

For his part, Mull is now proud father of a 3-year-old daughter. His wife, Wendy, a composer, wrote the score for "White Marriage" and has a bit part — as an ex-con trying to start a diaper service.

In the movie, Mull plays the slick host of "Ask Martin," a "Donahue"-like talk show. When he can't fill a studio in Pittsburgh, he goes to Hawkins Falls in a pathetic effort to keep the show afloat, intending to lure starstruck housewives into a gymnasium to talk about such subjects as "women who have lost parts of their bodies through household accidents."

He enlists Joyce as his unpaid assistant and falls in love with her. It seems the big Hollywood star actually longs for the comforts of a Midwestern home. Meanwhile, Hal becomes jealous and embarks on an affair with the minister's wife (Julie Payne).

Michael McKean plays the minister, Harry Shearer, who directed the movie, plays Mull's producer. Robin Williams makes a cameo appearance as Bill Loman, a salesman who is rooming at the same motel as Mull.

Since completing the movie, Mull has moved on from "White People" to black comedy. He's written a feature film, scheduled to go before the cameras this fall, about two homeless men in New York, Eddie Wood and Mr. Nickles, called "Wood n' Nickles."

A new movie for Cinemax, "Change of Heart," will mark his directing debut. "I think the word 'terror' is overused, but apt," he said. "Change of Heart" is a "somber comedy," Mull said, about a heart transplant that raises the philosophical questions implied by the figurative meanings of the word "heart."

### Eastwood Gift

MIDDLETOWN, Conn. (AP) — Clint Eastwood made their day at Wesleyan University when he agreed to donate films and documents relating to his career to the Clint Eastwood Cinema Collection.

# Aykroyd Will Return Elwood Blues

LOS ANGELES (AP) — Dan Aykroyd is bringing back Elwood Blues, for only the second time since the death of John Belushi, who played the other Blues Brother.

Elwood Blues will perform as the Elwood Blues Review, with veteran bluesmen Sam Moore and Booker T. Jones during NBC's "Coca-Cola presents: Live, The Hard Rock," to be

broadcast Tuesday to raise money for the homeless.

"It will just be a sample of what the Elwood Blues Review could give the world if we could get some bookings," said Aykroyd, who with Belushi created Jake and Elwood Blues on "NBC's Saturday Night Live."

Since Belushi's death, Aykroyd has performed as Elwood only at the

Atlantic Records anniversary concert earlier this year.

Tuesday night's show also features musicians Paul Simon and John Cougar-Mellencamp, comedians John Candy and Jon Lovitz and "Saturday Night" alumni Laraine Newman and producer Lorne Michaels.

"It's great that we have the old team back together again," Aykroyd said.

"It's the best!" Newman said. "It feels comfortable. It feels nice."

# Maria Says Life 'Boringly Normal'

NEW YORK (AP) — Maria Shriver, a member of the Kennedy family, a television anchorwoman and the wife of a movie star, says her life is "boringly normal."

Ms. Shriver insists in an interview with McCall's magazine that her goals are pretty much the same as everybody else's: a satisfying career, a happy home life, "some inner peace."

"I just want to survive and hang in there and do good work," said Ms.

Shriver, a niece of President John F. Kennedy and the daughter of Eunice Kennedy and Sargent Shriver. Ms. Shriver works for NBC News in New York and shares a home with actor Arnold Schwarzenegger in Los Angeles.

In her current job, she said, she's "the happiest I've ever been" professionally. Her low point was when CBS canceled its "Morning News," which she co-anchored.

CONSOLIDATED THEATRES All Seats \$2.50 (EVENING TIL 9:30 PM)

**BUCCANEER MOVIES**  
In Theatres at Greenville Super Shopping Center

1:00-3:05-5:10-7:15-9:20  
**YOUNG GUNS** -R-

1:00-3:05-5:10-7:15-9:20  
**COMING TO AMERICA** -R-

1:00-3:00-5:00-7:00-9:00  
**THE GREAT OUTDOORS** -PG-

# Loni Happy To Let Burt Rule

NEW YORK (AP) — Actress Loni Anderson says letting her husband, Burt Reynolds, control their marriage is fine with her.

"I don't want to be No. 1 in this marriage," she said in an interview in the October issue of McCall's magazine.

"For most of my career I was a driven woman, then three years ago my mother died of cancer at a comparatively young age and I sat down to do some serious thinking," she said.

"Did I want to end up an old lady

living alone and surrounded by statues, scrapbooks and memories? Or is it more important to have some fine man with whom to share a life, as Mother did? I opted for the latter."

Anderson, who recently finished two television movies, said she and Reynolds plan to raise their recently adopted son in Jupiter, Fla., where Reynolds runs a dinner theater.

"I'll get as many parts as I can that can be filmed in Florida, maybe even another sitcom, but Burt's work comes first," Anderson said.

# Carolina Events

(Continued from C-1)

### Gospel Program In Kinston Sunday

KINSTON — The Gospel Music Superstar National Tour group will present a program of gospel music in Kinston on Sunday. The program will begin at 3 p.m. at Grainger Stadium.

Admission to the 2.5-hour program is \$8, with tickets to be available at the stadium box office prior to performance time.

Performers will include the Williams Brothers' Luther Barnes and the Red Barn Choir; Jerome Williams and the Ever-Readies; the Christianaires; evangelist Mary White and the St. John Gosepelles; the Dixieland Gospel Singers; the Trenton All-Stars and the Gardner Brothers.

### Planet Mars Show Scheduled In Charlotte

CHARLOTTE — To mark the rotation route of the planet Mars that brings it the nearest to the earth in 17 years, the Discovery Place-Nature Museum in Charlotte is offering a special "Mars Show."

The show will be presented at the Kelly Planetarium each Saturday and Sunday throughout September, with showings at 2 and 4 p.m., with evening shows at 7:30 p.m. on the evenings of Sept. 21 and Sept. 22. Following the evening shows, those attending will be invited to walk to nearby Freedom Park where members of the Charlotte Amateur Astronomers Club will have telescopes aimed at the planet.

For more details on this event and other events at Discovery Place-Nature Museum at 301 N. Tryon St. in Charlotte, call 704-372-6261.

**CINPLEX ODEON AND PLITT THEATRES**

\$3.00 BARGAIN MATINEE  
ALL SHOWS BEFORE 6 PM  
AT SELECTED THEATRES CHECK SHOWTIMES

MOON OVER PARADOR (PG-13) 7:15 & 9:20  
BIG (PG) 7:20 & 9:25

WHO FRAMED ROGER RABBIT (PG) 7:05 & 9:30  
DIE HARD (R) 7:00 & 9:30

**Expressions Page**  
Share your talents with other young people each Wednesday during the school year.  
The Daily Reflector  
Newspaper In Education  
752-6166

**PLAZA CINEMA**  
PLAZA SHOPPING CTR. 756-0088

STEALING HOME -PG13-  
NIGHTLY SHOWS 7:00 & 9:10

COCKTAIL -R-  
NIGHTLY SHOWS 7:10 & 9:20

A NIGHTMARE  
ON ELM STREET 4 -R-  
NIGHTLY SHOWS 7:05 & 9:20

**PARK**  
\$1.50 ALL TIMES  
ARTHUR 2  
ON THE ROCKS -PG-  
WEEKNIGHTS 7:00 & 9:00

**MONEY SAVING COUPONS**  
The Sunflower Group • 10895 Lowell, Overland Park, Kansas 66210

**SAVE \$1.25**

**50¢ MANUFACTURER COUPON / EXPIRES DECEMBER 31, 1988**

**SAVE 50¢**  
ON SURF® DETERGENT LIQUID OR POWDER  
Good on any size.

811813

RETAILER: Lever will reimburse you for the face value of this coupon plus 8¢ if submitted in compliance with Lever's Redemption Policy. Valid if redeemed by retail distributors of our merchandise or those authorized by Lever. Cash value 1/1000th of 1¢. Lever Brothers Co., P.O. Box 870094, El Paso, TX 78867-0094. Limit one coupon per purchase. Good only on Surf Liquid or Powder Detergent. Any other use constitutes fraud.  
© 1988 Lever Brothers Company 5 11111 14850 0

**25¢ MANUFACTURER COUPON / EXPIRATION DATE 3/31/89**

**Save 25¢** on Mrs. Butterworth's Pancake Mix  
GOOD ON ANY FORM

805894

RETAILER: We will reimburse you for the face value of this coupon plus 8¢ if submitted in compliance with Lever Brothers' Redemption Policy. Valid if redeemed by retail distributors of our merchandise or those authorized by us. Cash value 1/1000th of 1¢. Foods Division, P.O. Box 870097, El Paso, TX 78867-0097. Limit one coupon per purchase. Good only on Mrs. Butterworth's Pancake Mix. Any other use constitutes fraud. Expires 3/31/89. 5 11115 13025 9

**GET TWO 75¢ COUPONS BY MAIL FOR MAXITHINS® PADS AND PANTY SHIELDS**

Send this certificate together with the UPC symbol (proof of purchase) from any box of MAXITHINS® pads (26 or larger) or panty shields and dated cash register receipt with the purchase price circled to receive two 75¢ coupons each good on any package of MAXITHINS® pads (26 or larger) or two panty shields. Only one offer per household, group or organization. Offer good only in U.S.A. and void where prohibited, restricted or taxed. Reproductions of UPC symbol is prohibited. Allow 8-10 weeks delivery time. Offer Expires March 31, 1989.

Mail To: MAXITHINS® PADS OR PANTY SHIELDS COUPON OFFER  
P.O. Box 8693  
North Suburban, IL 60169-8693

Name \_\_\_\_\_  
Street \_\_\_\_\_  
City \_\_\_\_\_ State \_\_\_\_\_ Zip \_\_\_\_\_

**50¢ MANUFACTURER COUPON / EXPIRES MARCH 31, 1989**

**SAVE 50¢** on MAXITHINS® PADS AND PANTY SHIELDS  
COUPON GOOD ON  
One MAXITHINS® PADS or  
Two MAXITHINS® PANTY SHIELDS

105242

MAXITHINS is the registered trademark of Sarnibonds Inc. - Lane Success, NY 11042 - 1988 Sarnibonds Inc. 5 73010 21050 4

# Smugglers' Contraband May Include 'More Than Drugs'

By LARRY LOPEZ  
Associated Press Writer  
PHOENIX, Ariz. (AP) — Cocaine and marijuana are still the major targets, but spiders and snakes are showing up in some contraband searches.

So are iguanas, desert tortoises and just about anything else that creeps or crawls, officials say. Federal and state officials who patrol Arizona's borders don't keep tabs on their living hauls the way they keep a count of kilos and bales they seize, but consider the numbers in two recent cases:

— On July 28, 1987, the U.S. Border Patrol seized 3,000 iguanas and several hundred tarantulas that were being smuggled into the United States through Nogales, Mexico.

— On March 23, the U.S. Customs Service confiscated 1,600 tarantulas and 500 iguanas from a pickup truck as it tried to cross the border.

"We're not seeing a vast amount cross the border," says Tom McDermott, agent in charge for the customs office in Tucson. "It's just in the course of our normal customs-type of exams."

But Assistant U.S. Attorney Reese Bostwick, who is prosecuting Jorge Manuel Martinez-Quintero in the March 23 incident, says there is "a real market" out there for almost anything that is rare, even when it would make most people's flesh crawl.

Bostwick, who handled wildlife cases for the Pima County attorney's office before switching to the federal

prosecutor's office, recalls trailer home bedrooms where walls were lined with reptile cases and closets held "canvas bags full of poisonous snakes."

"To me, it's not normal to sleep in your bedroom with all kinds of reptiles," he said.

"There's big bucks involved," Bostwick added, saying tarantulas go for \$1.25 each while Gila monsters can sell for \$50 to \$75 apiece and the endangered twin-spotted rattlesnake

fetches \$100 to \$150.

Although traffic in endangered or protected species such as 18 types of iguanas is a special focus of such agencies as the U.S. Fish and Wildlife Service, even a common species can draw the attention of customs agents.

That's because federal smuggling laws require importers to declare their goods and pay tax, whether or not the goods are legal.

"Anytime you conceal something

and bring it across the border and don't declare it, you are violating a general smuggling statute," McDermott says. That's true even when the item is duty-free, he added, citing laws on declaring currency and jewels.

Smuggling of endangered species and their pelts was a bigger concern in the 1970s, but drugs provide a bigger margin of profit and "it's going to take you just as much room to smuggle in a tarantula" as a more-

profitable amount of cocaine, he adds.

Over the years, customs agents "run across every type of commodity conceivable," from pre-Columbian artifacts to bull semen, McDermott says. Still, officers tend to "jump back a few feet" when they open a box that looks as though it could contain drugs but find a boa constrictor, says Assistant Chief Ron Moser of the U.S. Border Patrol's Tucson sector.

Hunting a protected species not only devastates the population but often also ruins the only habitat in which the species can live, Bostwick said.

And while the squeamish may think of a world with fewer spiders and snakes as a better place to live, other animals have provided useful medicines as scientists learned more about them, Bostwick added.

"What if they find out venom from the two-spotted rattler is the only known cure for AIDS?" he said.

## Diver

(Continued from C-1)  
"I get a lot of strange looks when people find out what I do," he said. "And I'd just as soon keep it that way."

Glenn explained that he'd prefer not to have any added competition.

Usually Glenn can be found with a tank on his back and mask over his face entering a water hole, but if the water is shallow enough, Glenn goes in with only his wetsuit, scanning the bottom with his hands and feet.

In raking through the mud and weeds, Glenn often grabs onto objects that are not round, solid and covered with indentations.

"But after you do it long enough, you learn what they are," he said. Glenn was bitten by a non-poisonous snake after he surprised it by grabbing its tail. Snakes can pose problems, but catfish cause the most discomfort, he said.

"During cold weather catfish burrow in the mud. They won't move so you end up reaching in the mud and getting stuck fingers by their sharp spines. It's terrible in the fall and winter."

On occasion, Glenn hooks a snapping turtle — a 35-pounder was his biggest catch.

"I took him out of the pond and put him in a place where he couldn't get back in."

Glenn considers alligators just another hazard.

"I went into a pond one time that had four large gators in it," he said. "I came up and saw they were following me around."

"I went back under and began thinking about it. I got heartburn and decided they could have the hole. It wasn't that great anyway."

As long as the alligator is above water and can be seen, Glenn said he will dive. But once the gator goes under, Glenn comes out.

"Once I was working near the edge with a lot of weeds, and I accidentally grabbed one," he said. "That scared him, and he came after me. That was the end of that day. As a matter of fact, I didn't work for the next two days."

Glenn finds up to 20,000 balls a day, diving as frequently as every two weeks on some courses. On others he may find as few as 2,000 to 4,000 "which is not real great," he said.

Glenn works some courses bi-weekly and others only a few times a year. It all depends on the potential of the ponds to supply him which a large find.

Glenn is either paid for the balls, or he pays for the rights to the balls. If he keeps the balls, he washes them, separates them into categories depending on their condition and sells them.

Often Glenn gets offers for balls from passing golfers. And, at times, golfers just ask Glenn to replace a ball for them because they hit one into the pond where he is diving.

About a week ago, when Glenn was diving in a pond on a Beaufort course, he stood in the water as three female golfers each hit their tee shots into the pond.

As one drove by in her cart, she yelled, "I should have just thrown you my ball."

Aside from surprised animals and balls, Glenn finds other objects such as golf shoes and clubs — from disgruntled or discouraged golfers, no doubt.

"I've got kind of a collection of them at home," he said. "About 200 to 300."

But Glenn doesn't find all of these treasures alone. He often has help.

Abbie Moore, 16, of Charleston, and Edwin Smoak, 19, of Spartanburg have worked for Glenn during the summer.

Both are paid by the ball. Glenn plans to keep diving as long as he enjoys it and stays busy.

Extra Lean  
BONELESS  
**PORK CHOPS**  
**\$2.98**  
Lb.

Swift - Sliced FREE!  
**HOSTESS  
HAMS** — **\$6.98**  
4 Lb. Can

Prices in this ad good thru Sunday, September 18, 1988.

USDA Choice Boneless  
**SIRLOIN STEAK**  
**\$2.98**  
Lb.

**Smithfield BACON**  
**99¢**  
Lb.

**SEEDLESS GRAPES**  
Thompson  
**79¢**  
Lb.

Coke, Diet Coke, CF Coke  
CF Diet Coke, Cherry Coke,  
Classic Coke  
**99¢**  
2 Liter

Sprite, Diet Sprite **1.09**  
2 Liter

3.0 Gallo Chab Blan,  
Rhine, Pink Chab, Red Rose  
Vin Rose, Burg., Prem Blush,  
**5.49**

**Wise Regular/  
Natural Ridgie  
POTATO CHIPS**  
**\$1.99**  
15 Oz.

**BUDWEISER**  
12 pack/12 oz.  
Regular and Light Cans  
**5.79**

Jumbo Western  
**CANTALOUPE**  
**99¢** Each  
California Peaches . . Lb. .49

3 Lb. Bag  
North Carolina "New Crop"  
**RED/GOLDEN APPLES**  
**\$1.39**

**EXTRA LOW PRICES...EVERYDAY!!!**

<p>64 Oz. - Tree Top <b>APPLE JUICE</b> <b>99¢</b></p>	<p>3 Oz. - Chicken/Beef/ Mushroom - Ramen Pride <b>NOODLES</b> <b>5/89¢</b></p>	<p>10 Oz. - Frozen Cheese/ Vegetable/Sausage/Hamburger/ Pepperoni/Sausage &amp; Pepperoni <b>CHEF BOY-AR-DEE PIZZAS</b> <b>89¢</b></p>	<p>Pillsbury 11.5 Oz. - Frozen Apple- Spice/Cherry/Strawberry/Blueberry <b>TOASTER STRUDEL</b> <b>99¢</b></p>
<p>16 Oz. - Assorted <b>PFEIFFER DRESSINGS</b> <b>99¢</b></p>	<p>32 Ounce <b>DEL MONTE CATSUP</b> <b>89¢</b></p>	<p>20 Oz. - Frozen Shoestring <b>INTERSTATE POTATOES</b> <b>3/\$1</b></p>	<p>8 Oz. - Merico <b>CRESCENT ROLLS/</b> 9.5 Oz. - Merico <b>CINNAMON ROLLS</b> <b>89¢</b></p>
<p>64 Oz. - Detergent <b>YES LIQUID</b> <b>\$1.99</b></p>	<p>22 Oz. - Dish Detergent <b>DOVE LIQUID</b> <b>79¢</b></p>	<p>Roll - Paper Towels <b>SO-DRI</b> <b>2/\$1</b></p>	 <p><b>FOOD LION</b></p>

There is a Food Lion conveniently located near you:

3136 EAST TENTH STREET UNIVERSITY SQUARE SHOPPING CENTER	2430 STANTONSBURG ROAD STANTON SQUARE SHOPPING CENTER	115 E. RED BANKS ROAD SOUTH PARK SHOPPING CENTER
---	--	---

# The Absolute

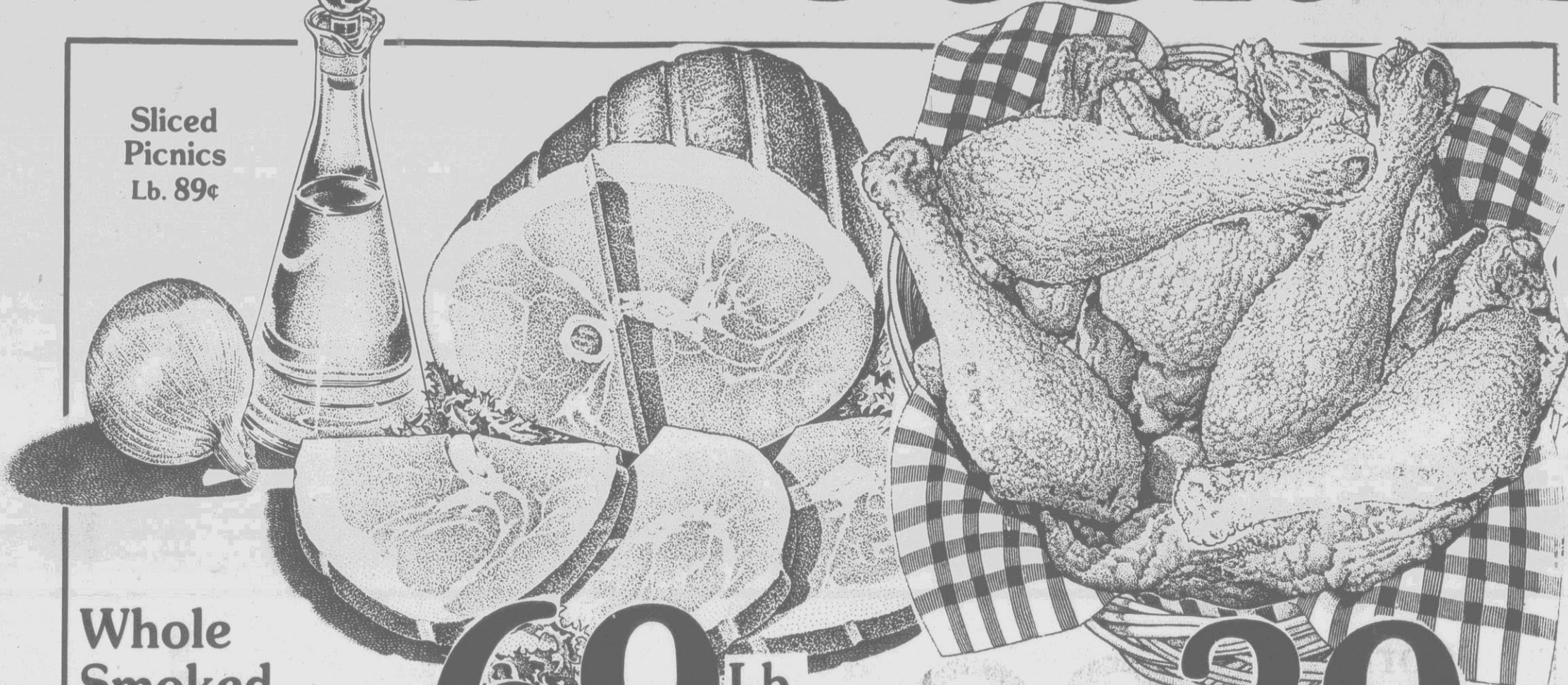

Sliced Picnics  
Lb. 89¢

Whole Smoked Picnics

69¢ Lb.

Carolina Fresh Leg

39¢ Lb.

Boneless Sirloin Steaks..... Lb. \$2.49  
 Old Hickory Pork Barbeque ..... Lb. \$1.59  
 Lundy Mild Roll Sausage ..... Lb. \$1.39

Quarters Lb.  
 Gwaltney Meat/Beef Franks ..... Lb. 89¢  
 Gwaltney Sliced Bacon ..... Lb. \$1.19

## Seafood Sale

Flounder Fillets..... **\$1.99** Lb.  
 Medium Gulf 51/60 Count Shrimp ... **\$3.99** Lb.  
 Sea Leg Supreme Lb. **\$3.79**

## The New FARM FRESH

White House Apple Juice  
**89¢**  
 64 Oz. Limit 2  
**Absolute Best Price**

## The New FARM FRESH

The pizza to fall in love with.

**Tony's PIZZA**  
 WITH ITALIAN STYLE PASTRY CRUST  
**Absolute Best Price**

Bartles & Jaymes Wine Coolers  
**\$2.79**  
 4 Pack.....

Miller  
 Reg., Lite Genuine D  
 12/12 Oz. C

Herr's Potato Chips  
 6 Oz. Bag  
**Buy One, Get One FREE!**

Garden Fresh Salad Bar  
 Eat-In Or Take-Out  
**\$1.99** Lb.

Gourmet Cheese Shop  
 6 Inch Personal Pizza **99¢**  
 Made Fresh Daily

Two  
 Sept  
 We reserve the right to correct

# Best Prices...

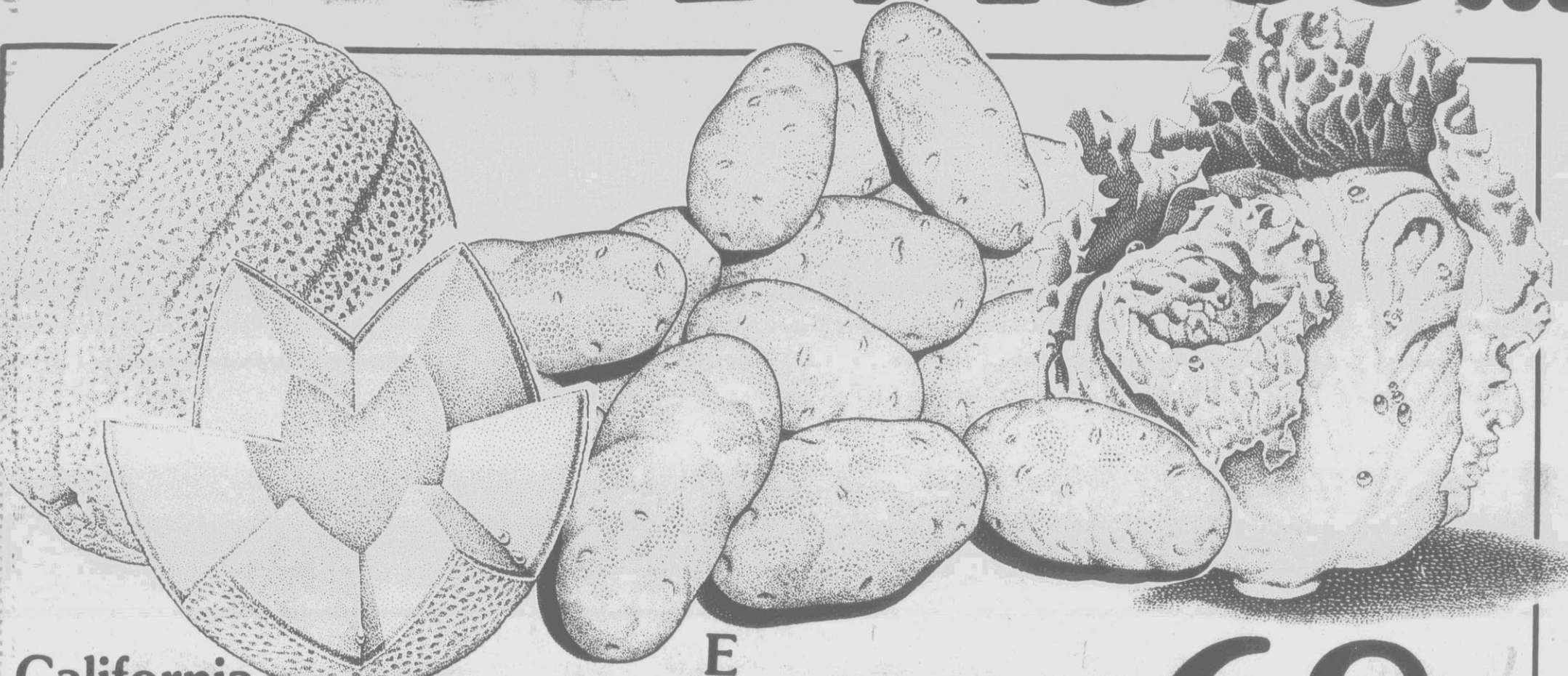

California <b>Cante- Loupes</b>	<b>99¢</b>	Each	California Sweet Juicy Nectarines	<b>68¢</b>	Lb.
California Cello Lettuce	<b>59¢</b>	Head	Wisconsin Russet Potatoes	<b>33¢</b>	Lb.

**FRESH**

**Pony's Pizza**  
Pepperoni  
Extra Cheese  
Sausage & Pepperoni  
Supreme

3 For **\$5.00**

**Best Price**

**The New FARM FRESH**

**Pepsi & Pepsi Products**

6 Pack 12 Oz. Cans

**\$1.39**

**Absolute Best Price**

**Deli**

**CORNER BUTCHER**  
Corner Butcher  
Cooked Salami **\$1.99** Lb.

Corner Butcher  
Cooked Ham **\$2.89** Lb.

Corner Butcher  
German Recipe Bologna **\$1.59** Lb.

New Yorker  
Domestic Swiss **\$2.99** Lb.

Mrs. Giles  
Tuna Salad ... **\$1.87** Lb.

Mrs. Giles Carrot &  
Raisin Salad **\$1.19** Lb.

**Palmolive Automatic Dishwashing Liquid**

**\$5.39**

**\$1.99**

50 Oz. (Prepriced 2.29)

**The New FARM FRESH**

**The Absolute Best Deal In Town!**

Corner Of Arlington & Greenville Boulevard

Good: 9-14-20, 1988  
Subject to limit quantities and to geographical errors.

**Crossword** By EUGENE SHEFFER

**ACROSS**  
 1 Actress Moreno  
 5 Biblical pronoun  
 8 News king  
 12 Amalekite  
 13 Vintage car  
 14 Ibsen's "doll"  
 15 Hunter's dog  
 17 Tools for woodsmen  
 18 Groups of three  
 19 Engraves with acid  
 21 Toper  
 22 Apollo's mother  
 23 Switch position  
 26 Capitol VIP  
 28 Purposive  
 31 Whistle's short blast  
 33 Corn unit  
 35 Food shop  
 36 Dallas native  
 38 Morning moisture

**DOWN**  
 1 Float of logs  
 2 Stravinsky  
 3 TV series  
 4 Turkish officials  
 5 School board member  
 6 Farm layer  
 7 Alpine song  
 8 Made into law  
 9 GI shelters  
 10 It grows in Brooklyn  
 11 Impudent talk  
 16 Skunk's defense  
 20 Asian festival  
 23 Baseball great  
 24 Enemy  
 25 Harmless reptile  
 27 Cushion  
 29 River in Asia  
 30 Spanish hero  
 32 Snarled  
 34 Took a breather  
 37 New: prefix  
 39 House addition  
 42 Fairy-like  
 44 Block-heads  
 45 Red planet  
 46 Kind of exam  
 48 French painter  
 49 Old revelers' cry  
 50 Defeats at bridge  
 53 Rio de

**Solution time: 24 mins.**  
 RAFT ODA TSAR  
 OHIO FEN ANNA  
 TARTUFFE RAIL  
 ABE RET APPLE  
 TAR LEA  
 LOYAL RESUMES  
 AVER AAR LARA  
 BANNERS TIPSY  
 ILK TON  
 MESSY CAM PAS  
 AMAH TARBOOSH  
 MIRE UFO ALOE  
 ARID BET TERM

Yesterday's answer 9-14

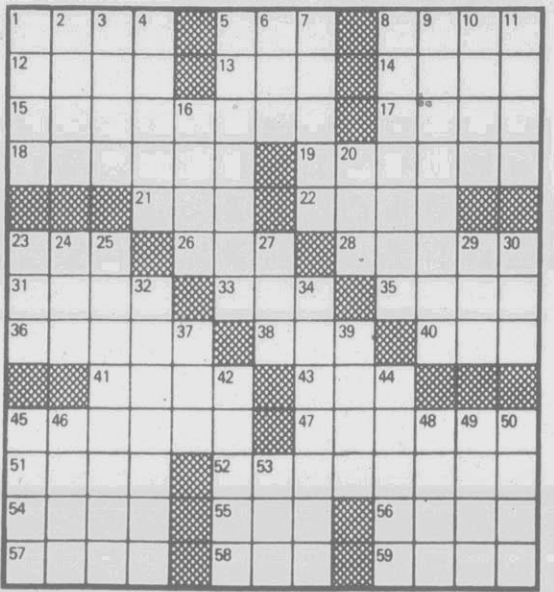

**CRYPTOQUIP**  
 9-14  
 E Z W J N X C L H A E W H A D  
 B W V F H E K W D E X E R H W X V H R  
 K R E A R D F Y D W L X Y W E E W H  
 Z F B F J N C Y A D W  
 Yesterday's Cryptiquip: IF BEEKEEPER TALKED  
 AWHILE, HE PREFERRED TO USE BUZZ WORDS.  
 Today's Cryptiquip clue: H equals R  
 © 1988 King Features Syndicate, Inc.

**The Family Circus** By Bil Keane



9-14  
 Copyright 1988  
 Cowles Syndicate, Inc.

"But Claire's mommy let her get her ears punched out for earrings."

**Horoscope** From The Carroll Righter Institute

**FORECAST FOR THURSDAY Sept. 15**  
**ARIES** (March 21 to April 19): A former teacher becomes an ally in a plan that you have wanted to set in motion for some time. Set your priorities now for future success.  
**TAURUS** (April 20 to May 20): You see clearer sailing today at your place of work, and the plans you have formulated are starting to take shape and gel.  
**GEMINI** (May 21 to June 21): Your partners will waste your time today, and you cannot do much to avoid them. The best you can do is just deal with your own duties.  
**MOON CHILDREN** (June 22 to July 21): Emotional associates could get you excited today about situations which you have no control over. Keep this in mind.  
**LEO** (July 22 to Aug. 21): Your spending urge needs to be put under wraps for now. It is important to shop for and purchase only the essentials at this time.  
**VIRGO** (Aug. 22 to Sept. 22): Now that you have everything in order and just the way you want it, enjoy the gathering that you have been looking forward to.  
**LIBRA** (Sept. 23 to Oct. 22): Today is a good day to look the other way and be mindfully tolerant of troubling situations. Don't get involved in other people's business.  
**SCORPIO** (Oct. 23 to Nov. 21): Further investigation of existing concerns today will pay big dividends and give you new piece of mind later.  
**SAGITTARIUS** (Nov. 22 to Dec. 21): Do not try to cover too much territory in one leap today, and enjoy the company of close friends tonight. You deserve it.  
**CAPRICORN** (Dec. 22 to Jan. 20): With the gains which you made earlier this week and the positive aspects you are enjoying today, all is a plus.  
**AQUARIUS** (Jan. 21 to Feb. 19): You may be concerned with the purchase of a home or automobile now, either for yourself or a close friend. Everything works out as it should.  
**PISCES** (Feb. 20 to March 20): Glamour and intrigue continue to figure into your daily plans and activities. You should have a terrific day and an exciting evening.  
 (c) 1988, The McNaught Syndicate Inc.

**Bridge** By CHARLES GOREN AND OMAR SHARIF

**A FRIENDLY BAD BREAK**  
 Neither vulnerable. South deals.  
**NORTH**  
 ♠ J 10 9 5  
 ♥ A 4 3  
 ♦ K 2  
 ♣ A Q 10 7  
**WEST**  
 ♠ A 4 3  
 ♥ 6 5  
 ♦ A Q J 9 8 7 6 5  
 ♣ Void  
**EAST**  
 ♠ 8 6 2  
 ♥ Q J 8  
 ♦ 10 4  
 ♣ K J 9 6 2  
**SOUTH**  
 ♠ K Q 7  
 ♥ K 10 9 7 2  
 ♦ 3  
 ♣ 8 5 4 3

The bidding:  
 South West North East  
 Pass 1 ♦ Dbl Pass Pass  
 2 ♥ 4 ♦ Pass Pass  
 4 ♥ Pass Pass Pass

Opening lead: Ace of ♦  
 We have often heard bridge players say: "Those who can, play; those who can't, write!" A danger-

club suit. In that event, it was quite likely that the major suits were going to split favorably.  
 Declarer captured the spade in hand, cashed the ace-king of hearts and then continued with a spade. East refused to ruff the fourth spade, since he would be endplayed, but it did not help. Declarer discarded another club from hand and then threw East in with a trump. That defender's forced club return into the table's major tenace allowed South to escape with losing nary a club trick! Making four-odd.  
 Available for a limited time as a special offer is a two-for-one package of **DOUBLES** booklets. For your copies send \$3 to "GOREN DOUBLES," care this newspaper, P.O. Box 4426, Orlando, Fla. 32802-4426. Make checks payable to "Newspaperbooks."

**Want To Buy A Home? Find It Fast In Classified**

**FUNKY WINKERBEAN**



**BC**



**PHANTOM**



**SHOE**

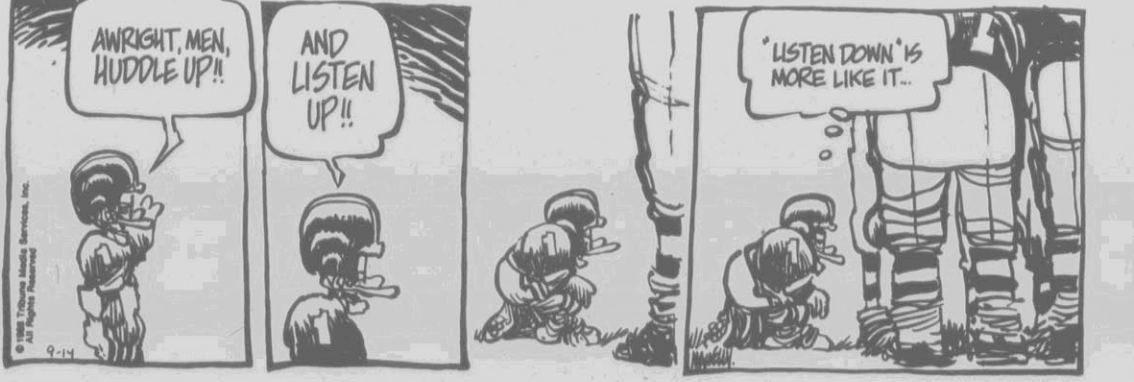

**THE WIZARD OF ID**



**BLONDIE**



**PEANUTS**

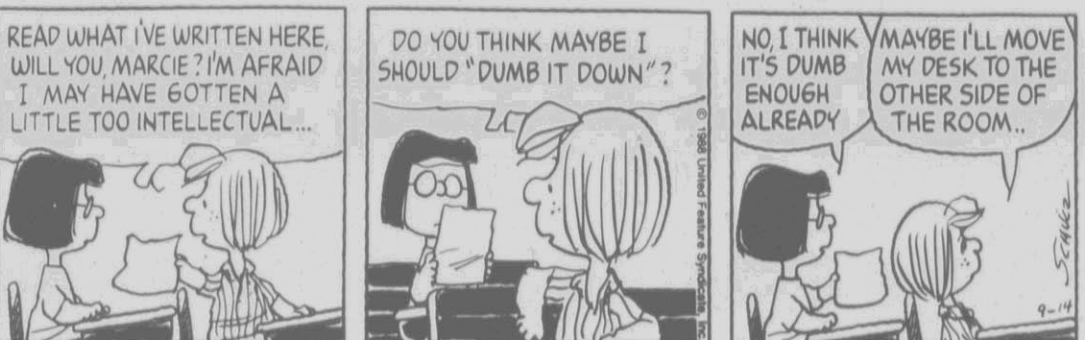

**FRANK & ERNEST**



**BEETLE BAILEY**



**GARFIELD**





# EXPRESSIONS

a page for our young readers

Edited By DIANE WILLIAMS — Reflector NIE Coordinator

- essays
- art
- games



Andy Roebuck, 7 a student at Stokes Elementary School wins this week's drawing contest.

## Fall

By Gail Marie Goers

Fall is a beautiful time of year when leaves turn beautiful colors. It is like a rainbow. The leaves fly down and leave the trees bare. In the mountains, it is a splended sight to see. Some leaves are red;

some are yellow; some are orange; and some are brown. It is fun to sit and watch them fall to the ground. Some trees die at this time of year, but the evergreen trees keep their color. Sometimes

I like to make a pile of leaves and jump in them and be buried in them. It is fun just to sit in them. Parks are pretty this time of year and so are the ponds, because they have leaves around and on them. To me, fall is the very best

time of the year and the leaves make it fun.

Gail Marie Goers, 10 a student at St. Peter's School wins this week's writing contest.

## Bubbles

By Damita Kerwin

Blowing bubbles can be fun. First open the bottle. Take the seal off. Then take out the wand. Dip the wand in the liquid, and blow your bubbles. When you get through, put the

bubbles up. Bubbles look different in many different ways. They can be in big shapes or little shapes. They can be different colors, too. They can be pink,

purple, red, blue, and other colors. My two best colors are pink and purple. Bubbles do many things. They can float up. They can pop, too. Some bubbles fly up

in the air without bursting.

Damita Kerwin, 10, a student at Belvoir Elementary School receives special mention.

## Trip To Plant And See

By Rick Clay

On our trip to Plant and See, we learned that fertilizer was black, blue and white. Sometimes if you touch it, it will burn you. I liked the fern

best. Ferns are very sensitive. If you touch, sometimes they will turn brown right in the spot. The fuschia plant was shipped in from

California. They took good care of them. Fuschias can't grow in hot weather. It will kill the plant.

Rick Clay, 7, a student at Sadie Saulter School receives special mention.

## The Storm

By Steve Brown

As the rain pours upon my house. I sit inside as quiet as a mouse.

The clapping of the thunder. The flashing of lightning.

The feeling I get is oh so frightning

As the thunder roars on, The lightning flashes until the rain is gone.

Inside my house I sit so

warm, When just outside there was a storm.

Steve Brown, 16, a student at D.H. Conley High School receives special mention.

## Why I Love America

By Monica Williams

I love America because I was born in America, and my family was born here. Some of our people fought the civil wars. I love it because we have freedom. Also we can make many choices. America is clean and beautiful. We have most of our needs met.

We have clothes, food, shelter, and education. We also have teachers and schools to attend. We have hospitals and doctors. Everyone helps each other. We love each other. We have freedom and worship with provided protection while we

sleep. I am proud to be in America.

Monica Williams, 10, a student at Ayden Elementary School receives special mention.

## Why I Love America

By Jennifer Brick

I love America because each person has a vote that counts. All our officials are elected to serve people by the people's vote.

Every person has a choice where they would like to live. They can choose the city and state that they like best. I love America because

there are policemen to protect you. We have firemen who risk their lives to help us in case of fire. We have doctors, hospitals and rescue squads to help us when we are sick.

We have freedom of choice to attend churches. One of our most important freedoms is to learn. Every one has the right to go to school.

When I see people of other countries on television, I realize how much we have and how fortunate I am to live in America. I see them with so little and I have so much. That's why I love America!

Jennifer Brick, 11, a student at Ayden Elementary receives special mention.

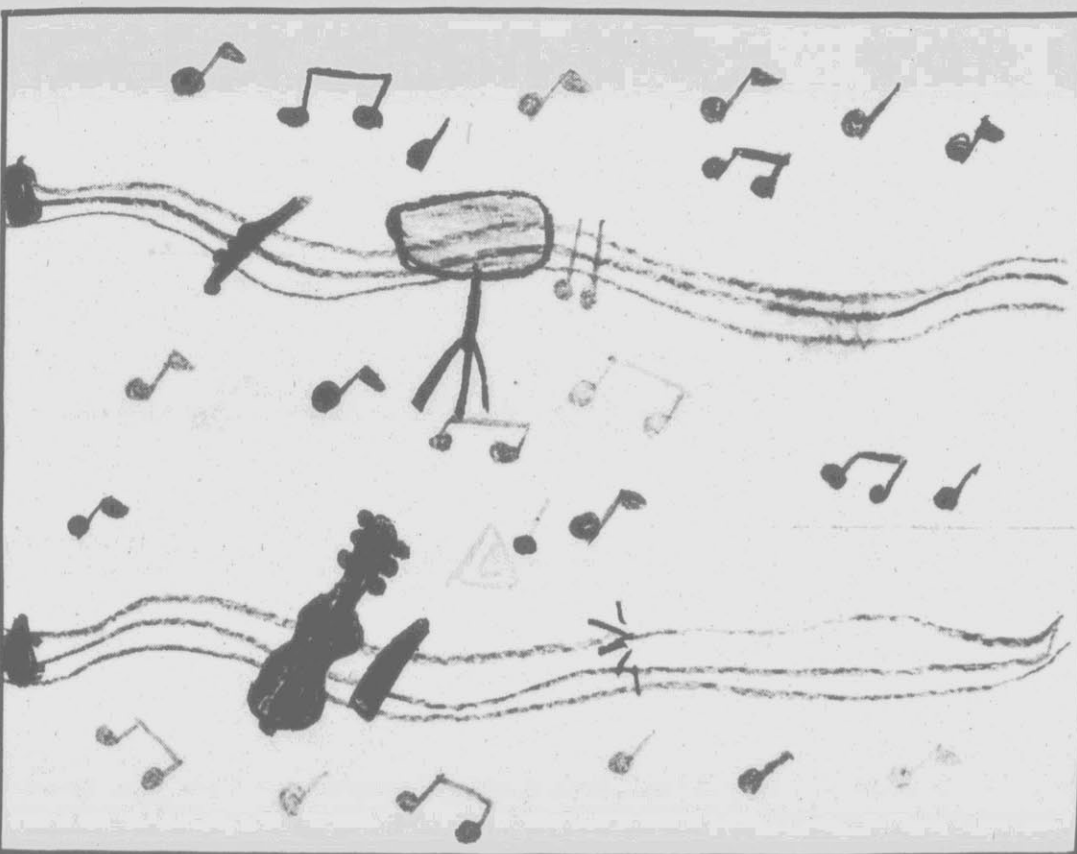

Jennifer Waguespack, 9, a student at Belvoir Elementary School receives special mention.

## PUZZLE CORNER



September is National Cat Health Month. Egypians had the first tamed cats who were used to keep mice and rats out of the grain storehouses. Cats were gods to the Egyptians. Mummified cats along with mummified mice and saucers of milk were buried together in cat cemeteries.

Cats are some of the smartest animals and are friendly and independent. Sailors believe cats bring good luck to a ship. In the Middle Ages, people thought that cats spoke English and talked to witches. Many people quote common sayings about cats such as, "Don't walk across the path of a black cat" or "Curiosity killed the cat". Using the key below, decode another saying about cats.

### KEY

A-26	E-22	I-18	M-14	Q-10	U-6	Y-2
B-25	F-21	J-17	N-13	R-9	V-5	Z-1
C-24	G-20	K-16	O-12	S-8	W-4	
D-23	H-19	L-15	P-11	T-7	X-3	

"19 12 13 22 8 7 26 8 26 24 26 7 4 19 22 13

7 19 22 24 9 22 26 14 18 8 12 6 7 12 21

9 22 26 24 19."

## Send In Your Entries To Expressions

The Daily Reflector is looking for elementary, middle, and high school students to draw pictures, write stories, essays and poems. Each week we will publish the best writing and drawing. The winner of each will receive \$2. We will publish stories and art work we feel should receive special mention.

Entries must be original. Drawings must be in ink, crayon, markers or paint on thick colored paper. Please no pencil. Entries will be held for a period of ninety days and will be considered for that period of time. Entries will be returned if a self-addressed, stamped envelope is included.

Parents or teachers who sign the entry form should monitor for good taste and plagiarism.

Fill out the form and attach it to your entry.

Expressions  
The Daily Reflector  
P.O. Box 1967  
Greenville, N.C. 27835-1967  
(Please Print)

Student's Name \_\_\_\_\_ Age \_\_\_\_\_ Birthdate \_\_\_\_\_

School \_\_\_\_\_ Parent's Name \_\_\_\_\_

Entrant's complete address—street or box number \_\_\_\_\_

City \_\_\_\_\_ State \_\_\_\_\_ Zip Code \_\_\_\_\_

I verify this to be original work.

Parent's or Teacher's signature \_\_\_\_\_

## The Moon

By Jason Powers

We see a moon. It shines at night and the moon is white. I like the moon. It gives light in the night.

Jason Powers, 6, a student at Eastern Elementary receives special mention.

## Federal Facts

### Bill Of Rights

When the United States Constitution was being written, many of the men working on the document desired a Bill of Rights. These were to list to the people the rights which are guaranteed to them. The United States had been ruled by a king and a Parliament which had taken away rights. Therefore some of the writers of the new U.S. Constitution wanted rights of the people to be listed as part of the new government. Other people felt this was not necessary.

The Constitution was ratified or accepted in 1788 but the Bill of Rights were not ratified until December 15, 1791. These are the first ten amendments to the Constitution. These guarantee the right of freedom of the press, right of the people to gather

or assemble together peacefully and the right to bear arms or weapons. Included are the right of a speedy trial, the right of a trial by a jury and no excessive or extreme bail to be established. Included in the Bill of Rights is the statement that no one can be required to testify against him/herself in court. These are only a part of the guarantees in the first 10 amendments.

James Madison who is called "The Father of the Constitution" suggested 15 changes or amendments, but the states finally ratified or accepted 10. Ideas for these rights came from various places. Some were from the Bible and others came from laws of ancient Greece and Rome as well as the 1689 English Bill of Rights.

# Answer Remains Elusive: 'Who Killed The Red Baron'

By JOHN PLATERO  
Associated Press Writer

HOLLYWOOD, Fla. (AP) — A misty rain and low overcast allowed Capt. Manfred von Richthofen to sleep late Sunday, April 21, 1918, but when the German ace climbed into his bright red triplane to hunt for enemy aircraft along the Somme River in France, it would be his last flight.

Richthofen was shot down before noon and the question of who killed the "Red Baron" would become a timeless controversy for World War I and aviation history buffs.

Jim Butler, a veteran airman, built a duplicate of the Fokker DR-1 the German ace flew as leader of his Flying Circus Squadron and provides part of the answer.

"Richthofen was supposed to be the best. I wanted to see for myself," explained the 45-year-old Butler, owner of an aerial sign company based at North Perry Airport.

The son of a German army major, Richthofen was a cavalry officer when, at 23, a pilot friend taught him to fly. He soloed Oct. 10, 1915, but crashed making his first landing.

When he was killed 2½ years later, he had shot down 80 planes — more

than any other pilot in World War I.

Butler soloed at 16 in Manchester, N.H., and moved here in 1953 when his father, an aviator, began a banner-towing service. Over the years, Butler has accumulated 17,000 hours in the air in more than 120 makes and models of small aircraft.

Like Richthofen, Butler has more interest in being in the cockpit than dealing with the mechanical side of flying.

However, Butler and aviation mechanic Ned Ames began constructing the famed triplane in 1977 from copies of plans by its Dutch designer, Anthony Fokker.

Thirteen months and almost \$30,000 later, Butler flew his Fokker for the first time Aug. 28, 1978.

"The plane has no inherent stability and it is nowhere near what the Germans said it was," said Butler.

"We duplicated the weight and balance, but I wouldn't put it into a spin. If I did, I think I'd have to jump out."

With its three wings, a pilot could hold the aircraft steady, said Butler, and use it as a "platform" for two Spandau machine guns mounted in front of the open cockpit.

"As long as a diligent person is at the controls, it flies well," added Butler.

As Richthofen led his squadron that fateful morning, 24-year-old Capt. Roy Brown, a Toronto, Canada, native in the Royal Air Force, took off in his Sopwith fighter from an airfield in Bertangles, France, 25 miles to the west.

Brown had learned to fly in Dayton, Ohio, and suffered from stomach ulcers. Richthofen endured recurrent headaches from a head wound.

The two squadrons met and Australian ground troops watched as a "dogfight" ensued overhead between 12 German and eight British planes.

When Brown saw a bright red "tripe," as triplanes were called, chase 2nd Lt. Wilfred May, who was on his first combat sortie, he pushed his fighter into a dive and went to his friend's aid.

The three planes, lined one behind the other, dropped to below 100 feet of the ground. Richthofen fired at the

fleeing Sopwith, but was distracted when Brown shot at him from behind.

Brown got closer, opened fire again, saw bullets hit the Fokker DR-1 and watched the pilot slump forward. The aircraft continued, skimming the deck for an estimated one or two miles.

On the ground, troops saw an opportunity and opened fire at the enemy aircraft.

Sgt. C.B. Popkin and gunners R.F. Weston, W.J. Evans and R. Buie watched their bullets tear into the plane. Sgt. Alfred Franklyn of an anti-aircraft battery and dozens of riflemen nearby fired their weapons.

The plane crashed, and Germany's great hero was dead. When Allied troops examined the wreckage and

learned the pilot's identity, the plane was stripped for souvenirs.

There were many individual claims for shooting down the German ace, and the controversy caused political tension between Great Britain and Australia.

Brown was given credit for his 11th and last enemy plane shot down. He died of a heart attack on a Stouffville, Ont., farm March 9, 1944.

"There is no way that plane will fly one or two miles without someone fully at the controls," emphasized Butler. "It wouldn't fly that far at 20,000 feet without spiraling."

Butler is often asked the final question: Who killed the Red Baron?

"Not Capt. Roy Brown," he replies.

## Loggers Tell Of Their Life In Big Woods

By MIKE THOEL  
The Register-Guard

EUGENE, Ore. (AP) — Screaming saws, crashing trees and roaring trucks they can handle. But that's nothing compared with what they can do with acoustic guitars and mellow voices.

For years, Craig Jenkins and Terry McKinnis of Deadwood, Ore., have been self-taught, "aw-shucks" musicians. The kind of guys who'd duck their heads, grin sheepish grins and strum another tune every time someone suggested they should do something with the original material that was flowing out of their heads and off their fingertips.

So now they've gone and done it. Cut an album that's a polished mix of deft picking, smooth singing and graceful lyrics that capture the loggers' life. And — no surprise to those who've been listening to the two guitar-playing, songwriting buddies for years — the thing is selling.

But Jenkins and McKinnis aren't certain they want the world to beat a path to their door. This furor is enough to make a man want to pick up his saw and retreat to the safety of the woods.

"We've never thought of ourselves as professional musicians," says Jenkins, 35. "We don't read music. We have to memorize everything we write. We just work on something until it sounds good. We do it for our enjoyment and for the people around us."

Their cassette-tape album, "The Snag Fallers Ball," is a mostly light-hearted collection of songs about logging in Oregon and Alaska.

Jenkins wrote nine of the 11 songs on the album and co-authored two others with Don Beck, a friend who also is a logger and musician. Jenkins and McKinnis do the singing on the album, with Jenkins' animated, Burl Ives-like voice dominant.

The two partners are assisted in the guitar work by Doug Daniels, who owns the Eugene recording studio where the album was cut.

The material on the album deals with such woods scenarios as the foibles of family-owned logging operations and the logger's propensity to quit any job that doesn't suit him.

The songs are laced with the jargon of the woods. Loggers who've heard the album give it high marks for clarity.

McKinnis, 34, met Jenkins' sister, Kim, and married her in 1977. The two men have been playing guitar together ever since.

Over the past 10 years, the two have dabbled in creating lyrics and melodies of their own. Jenkins characterizes much of that work as a diversion and describes most of the songs as pieces that were done for one-time special occasions.

"I was writing a few tunes, and we were playing at some places and packing them in," he says. "We started getting a few offers from outfits like the Roadway Inns. I figured it was time to make a decision. So I did. I went with a logging company up in Alaska."

But friends kept making it tough for them to edge away from the idea that songs about logging was intriguing. Last fall, they committed themselves to doing it.

The recording business was a strange new world for them, as foreign as a Coast Range logging operation might be for a studio musician.

After a false start or two, they found Doug Daniels Productions in Eugene, Daniels, a folk musician who established his studio a year ago, made more than one contribution to the album.

"It was like two cultures meeting when we found him," Jenkins says. "We were just a couple of loggers with some music, and we didn't know if he was going to laugh at us or what. He took us seriously."

your **FOOD \$** SHOP EZE

# FOODLAND

 MARKETS *produces more here!*

PRICES EFFECTIVE SEPT. 15-16-17, 1988  
WE RESERVE THE RIGHT TO LIMIT QUANTITIES.  
WE GLADLY ACCEPT U.S.D.A FOOD STAMPS.

BUYERS MARKET-MEMORIAL DRIVE  
Mon.-Thurs. 7:00 a.m.-9:00 p.m., Friday 7:00 a.m.-10:00 p.m.  
Saturday 7:00 a.m.-9:00 p.m., Sunday 7:30 a.m.-6:00 p.m.  
WE INVITE PRICE COMPARISON ANY TIME IN OUR STORES. FRESH PRODUCE - LOW PRICES

WE ACCEPT USDA FOOD STAMPS, WIC VOUCHERS & ALL OTHER FOOD STORE COUPONS

Flower Shop Now Open. We Deliver to PLMHA Twice A Day. Call For Your Flower Needs!

## Foodland's Grade "A" Meats!

HEAVY WESTERN BEEF!

<b>BONELESS BEEF RUMP ROAST</b> 12 OZ. PKG. <b>89¢</b>	<b>FROSTY MORN FRANKS</b> 12 OZ. PKG. <b>89¢</b>	<b>LEAN, TENDER CUBE STEAK</b> LB. <b>1.99</b>	<b>LEAN, FRESH PORK SMOKED SPARERIBS</b> LB. <b>1.49</b>
<b>GWALTNEY CHITTERLINGS</b> FROZEN 10 LB. PAIL <b>3.79</b>	<b>FULL CUT ROUND STEAK</b> LB. <b>1.59</b>	<b>SIRLOIN TIP ROAST</b> LEAN, BONELESS LB. <b>1.89</b>	<b>JIMMY DEAN'S SMOKED MEAT OR BEEF MESQUITE SAUSAGE</b> . . . 1 LB. <b>1.89</b>
<b>JIMMY DEAN'S SAUSAGE, CHICKEN, STEAK BISCUITS</b> . . . 8 OZ. <b>1.59</b>	<b>JIMMY DEAN'S SAUSAGE, HAM &amp; CHEESE MUFFINS</b> . . . 8 OZ. <b>1.59</b>	<b>JIMMY DEAN'S ROLL SAUSAGE</b> HOT, MILD, SAGE 1 LB. ROLL <b>1.59</b>	<b>JIMMY DEAN'S CHILI MIX</b> 4 OZ. <b>1.49</b>

**FRYER LEG QUARTERS** HOUSE OF RAEFORD **39¢ LB.**

<b>Pillsbury Buttermilk BISCUITS</b> 4 PK. 8 OZ. <b>99¢</b>	<b>Jif Peanut Butter</b> CREAMY OR CRUNCHY 18 OZ. <b>1.69</b>	<b>DUNCAN HINES CAKE MIX</b> 18 & 19 OZ. YELLOW, BUTTER GOLDEN & LEMON SUPREME YOUR CHOICE <b>79¢</b>	<b>CHARMIN TISSUE</b> 4 ROLL PK. WHITE AND YELLOW/BLUE <b>99¢</b>
<b>TROPICANA ORANGE JUICE</b> 64 OZ. GLASS <b>1.99</b>	<b>MAXWELL HOUSE MASTERBLEND</b> 13 OZ. VACUUM BAG REG. EP & ABC <b>1.59</b>	<b>SENECA APPLE JUICE</b> 64 OZ. <b>1.09</b>	<b>FOODLAND APPLE SAUCE</b> 303 SIZE <b>3/1.00</b>
<b>COMET RICE</b> LONG GRAIN 28 OZ. <b>99¢</b>	<b>SANKA</b> 8 OZ. INSTANT <b>4.39</b> 13 OZ. VACUUM BAG AUTO. DRIP <b>2.99</b>	<b>FOODLAND VEGETABLES</b> CUT GREEN BEANS, W/ K CORN, SWEET PEAS & MIXED VEGG. 303 AND 16 OZ. <b>3/1.19</b>	<b>FOODLAND BROWN &amp; SERVE ROLLS</b> 12 PK. <b>2/99¢</b>
<b>JIFFY CORN MUFFIN MIX</b> 8.8 OZ. <b>4/89¢</b>	<b>Health &amp; Beauty Aids</b> <b>LISTERINE ANTISEPTIC</b> 32 OZ. <b>3.89</b>	<b>FROZEN FOODS</b> <b>ORANGE JUICE</b> . . . . . 12 OZ. <b>1.19</b> <b>COOL WHIP</b> . . . . . 12 OZ. <b>1.19</b> <b>JENO'S PIZZA</b> . . . . . <b>99¢</b> 10.1 OZ. CHEESE, 10.5 OZ. SAUSAGE, PEPPERONI & HAMBURGER	<b>FOODLAND ICE MILK</b> 1/2 GAL. <b>89¢</b>

WIN AT LEAST **\$500.00 Cash** IN OUR BIG MONEY **JACK POT** **\$750**

**\$250.00 ADDED EACH WEEK UNTIL WE HAVE A WINNER!**  
REGISTER JUST ONCE. GET YOUR CARD PUNCHED EACH WEEK AND YOU MAY WIN **WONDERFUL CASH DOLLARS!**  
NOTHING TO BUY! YOU DO NOT HAVE TO BE PRESENT TO WIN.

LAST WEEK'S WINNER  
GET YOUR CASH MONEY CARD PUNCHED FREE THIS WEEK!

**COCA COLA** 2 LITER **99¢**

**KRAFT JELLY**  
Good Grief! The Glass is FREE!  
18 OZ. GRAPE **89¢**  
STRAWBERRY JAM 18 OZ. **1.39**

**TAILGATE USA**

**KRAFT VELVEETA SHREDDED CHEESE**  
ORIGINAL, HOT OR MILD 8 OZ. **1.49**

**KRAFT CHEEZ WHIZ**  
16 OZ. **2.69**

**KRAFT SINGLES**  
12 OZ. **1.49**

**KRAFT PHILADELPHIA CREAM CHEESE**  
**PHILADELPHIA Cream Cheese**  
8 OZ. **1.09**

**CARROLL SHELBY'S CHILI MIX**  
4 OZ. **1.49**

### Foodland's Great Produce Buys!

EASTERN RED OR GOLDEN DELICIOUS  
**Apples** 3 LB. BAG **99¢**

**YELLOW ONIONS** 3 LB. BAG **79¢**

**CELERY** STALK **59¢**

**CARROTS** 1 LB. **39¢**

**BROCCOLI** BCH. **79¢**

**CAULIFLOWER** HD. **99¢**

**COCA COLA** 6 PK. 12 OZ. CANS **1.39**

**POLAR BARS** 8 PK. **1.99**

**NATURAL LIGHT BEER** 6 PK. 12 OZ. CANS **2.49**

**NABISCO**  
Chocolate, Honey or Cinnamon Teddy GRAHAMS 10 OZ. **1.69**  
Regular, Chewy and Striped CHIPS AHOY 18 OZ. **2.29**  
Honey & Cinnamon GRAHAMS 16 OZ. **1.79**

### Deli Specials!

**THURS.-FRIED CHICKEN**  
**FRI.-BBQ CHICKEN**  
**SAT.-SPAGHETTI**

**\$2.75**

ALL SPECIALS SERVED WITH 1 MEAT, 2 VEGETABLES & ROLLS.  
TRY OUR DELICIOUS HOMEMADE CAKES FOR YOUR PARTIES, BIRTHDAYS AND OTHER OCCASIONS.



SAVORY MEAL IN A MUFFIN — Flavorful muffins are perfect fare for breakfast or dinner. Serve them freshly baked for a light breakfast or as a perfect accompaniment for a chicken or ham dinner.

## Muffins Are Good Choice For Breakfast Or Dinner

One simple recipe is the perfect answer to at least three different serving occasions.

"Savory Meal In A Muffin" makes a wonderfully light breakfast when baked fresh. Refrigerate what's left and you have a week's worth of "one minute breakfasts" for re-heating in the microwave -- perfect for working couples. This muffin is also the perfect accompaniment for a chicken or ham dinner. If you make them for dinner, you'll have them for breakfast.

The flavor of these muffins is both, "eggy" and light. The lightness comes from sour cream and self-rising flour. "Self-rising" means that the leavening and salt is already added so you save measuring and mixing steps. But the secret ingredient must be the honey mustard. This

adds a sweet-savory highlight that wakes up the natural goodness of ham and cheese.

The recipe makes a dozen muffins. Serve them with juice or fresh fruit for perfectly balanced nutrition. The dairy products are a good source of vitamin D and calcium. Enriched self-rising flour provides you ample amounts of the B-vitamins, thiamine, riboflavin and niacin -- plus the minerals, iron and calcium.

**SAVORY MEAL IN A MUFFIN**  
(makes 12 muffins)  
2 eggs  
1 tablespoons sugar  
1 cup sour cream  
2 tablespoons margarine, melted  
2 teaspoons honey mustard  
1 1/4 cup enriched self-rising flour  
1/2 cup chopped ham

1/2 cup shredded Cheddar cheese  
Beat eggs with sugar until fluffy. Stir in sour cream, margarine and mustard. Add remaining ingredients; stir just until moistened, do not overmix. Fill greased muffin cups 3/4 full. Bake at 400 degree F. 20 minutes.

By Karen Collins  
American Institute  
For Cancer Research

It hardly seems fair. The most important meal of the day comes when many people are still half asleep. It's breakfast, of course, a meal that should send you and your family off in the morning with 1/4 to 1/3 of your daily nutrition requirements.

Each member of your family needs a well-balancing meal to start the day. And with the busy, erratic schedules of active families -- late nights at the office, evening basket-

## Olympic Menu Planners Must Always Think Big

What does it take to satisfy the nutritional needs of the world's finest athletes competing in the Summer Olympics in Seoul, Korea, from Saturday to Oct. 2?

For starters, it takes a gigantic shopping list that includes: 272,000 pounds of meat; 600,000 pounds of vegetables; 274,000 pounds of fresh fruit; 70,000 pounds of fresh fish; 40,000 pounds of rice; and one million fresh eggs.

It also takes 900 pounds of horseradish, 4,200 pounds of ketchup and 2,400 quarts of soy sauce to add the necessary spiciness that these athletes demand.

The Herculean task of helping a consortium of Korean food service operators fill that epic shopping list while creating a nutritionally complete--and tasty--menu belongs to ARA Services, which is celebrating its 20th anniversary of managing the food service for the Olympic games.

ARA's role in Seoul involves overseeing menu planning, staffing, sanitation measures and other related aspects of serving the 17,000 athletes, coaches and support staff attending the largest Olympic event in history. ARA is also sharing its considerable expertise in terms of Olympic kitchen and dining area planning and design.

ARA's Olympic history dates back to the 1968 Summer

Olympics in Mexico City and includes the 1984 Summer Olympic Games in Los Angeles, the 1987 Pan-Am Games in Indianapolis, and the 1988 Winter Olympics in Calgary, Canada.

According to John Scanlan, ARA's vice-president for the Olympic project, the solution to satisfying the divergent needs of athletes--who range in size from 90-pound gymnasts to 250-pound weight-lifters--lies in offering a menu varied enough to meet each individual's particular needs, while also factoring in ethnic, cultural and religious considerations.

Based on previous Olympic experiences, the menu was designed to provide the average athlete with about 6,000 calories per day which is more than twice the caloric consumption rate of an average adult.

A typical breakfast menu includes three juices, yogurt, four fresh fruits, five cereal (two hot), two soups, four egg entrees, five meat and fish entrees, one each from the complex carbohydrate-rich potato/rice/pasta families, eight baked goods, pancakes, french toast, cold cuts, and a 25-item salad bar.

Typical dinner entree selections will include such pro-

(See OLYMPIC, D-3)

## A Little Citrus Packs Big Punch For Lunch Boxes

Forty percent of America's almost 20 million mothers working outside the home have children under the age of 18, many of whom bag their school lunches. To avoid the "Back-to-School Brown Bag Blues," busy moms face the daily challenge of creating lunch-time meals that are fun, inexpensive and nutritious.

A kid's idea of "fun food" usually includes a candy bar, soft drink or cookies for lunch, but smart moms will pack a fun food with a lot of nutritional punch--a fresh orange. An abundant supply from California and Arizona make oranges one of the best and most nutritious bargains mothers can find in the supermarket today.

Twenty million cartons of Valencia oranges will be shipped this year from California and Arizona to domestic and overseas markets, enough to fill over 20,000 train cars with the nutritious "gold" of the citrus industry. This juicy, sweet fruit will be in excellent supply this fall at grocery produce departments. Economical prices, with fruit sizes running a bit smaller than last season, make oranges the perfect

"kid-sized" snack for the lunch bag or box.

An orange has a high concentration of natural sugars, including sucrose, fructose and glucose, which provide children with a quick and safe pick-me-up on the playground, school bus, or athletic field.

"Today's bountiful supply of oranges isn't the only citrus crop in

abundance this fall," says Dawn Gray, sales operation manager for Sunkist Growers. "Choice large sizes of lemons grown in California will be available in ample supply. The crop quality is rated very good this year, with the lemons especially heavy and juicy, making them favorites of lemonade fans."

(See ORANGES, D-3)

## Eat To Live

Our diets are killing us, according to the Surgeon General of the United States, who called for major dietary reform in a recent report.

Surgeon General Dr. C. Everett Koop said that two-thirds of Americans die of diseases linked to diet. The excess dietary fat in a typical American diet contributes to heart disease, obesity--which affects 25 percent of adults, some types of cancer and other disorders. He also cited salt for its link to high blood pressure.

Changing long-established habits is never easy. However, responding to the Surgeon General's 1964 report on smoking, millions of Americans chose to kick the habit. Health experts hope that the response to this new report on diet will be at least as strong.

Thanks to modern food technology, eating right is easier for Americans than ever before, and sacrificing favorite food flavors is a thing of the past. For example, butter and

(See DIETS, D-6)

## Breakfast: A Big Deal Meal

petities with wholesome, nutritious breakfasts:

These whole grain muffins are a sweet, moist breakfast treat. Bake on the weekend and freeze; then just defrost and reheat briefly for a quick, warm and nutritious weekday breakfast. The whole grain provides healthful fiber and the carrots are a great source of beta-carotene, a form of Vitamin A that helps lower your risk of many cancers.

**CARROT BRAN MUFFINS**  
1 cup bran flakes cereal, crushed  
1 1/4 cups whole wheat flour

1/4 cup packed brown sugar  
2 tsp. baking powder  
1/2 tsp. baking soda  
1 tsp. cinnamon  
1/2 tsp. nutmeg  
1 1/4 cup skim milk  
1 egg  
3 tbs. oil  
1 1/2 cups carrots, grated, (about 1/2 lb.)  
1/4 cup raisins (optional)  
Thoroughly combine cereal, flour, sugar, baking soda, baking powder and spices in large bowl. In small

(See BREAKFAST, D-6)



### Kathy Kolasa

Ph.D., ECU Dept. Family Medicine

Q. Our 11-year-old daughter is now too heavy to plot on the weight charts. We've tried to help her diet without luck. Is there something we can do? Concerned Parents, Greenville.

A. Congratulations for monitoring your daughter's growth with her height and weight. If you've talked with your family doctor and he or she agrees that weight loss is appropriate, a new group program in Greenville offered by the East Carolina University Department of Pediatrics may be right for your daughter. I've asked Nancy Gray, nutritionist in that program, to tell us about it. Her description of Life Changes follows.

As a nutritionist in pediatrics, many overweight teen-agers have been referred to me. Teens need more than orders to lose weight. They need to decide they are ready to work on it. Also, teens need more than just a diet to follow. They need the support of friends and family, help with self confidence and a focal point of commitment.

So, we created the "Lifechange: Weight Control Program for Teenagers." Our program is designed for teen-agers 11 to 16 who are at least 15 pounds over their expected weight for height. First, we measure the amount of calories each needs to hold his or her weight. We figure out a good calorie goal for weight loss. We measure how much of their weight comes from fat so we can see if they lost fat or muscle. We measure blood cholesterol and triglyceride levels, blood pressure, blood sugar and a sound wave of the heart to be sure there aren't any hidden problems. Then we put the teens to work together in our nutrition and exercise classes.

The classes focus on good nutrition without excess calories, thin but healthy eating habits, exercise and activity to help with weight loss and self confidence. The teens keep track of everything they eat and make slow weekly changes to improve their eating and exercise habits. They are encouraged to eat balanced meals and to make changes only if they can continue them for the rest of their lives.

An important part of the program is the parent sessions. Parents are given suggestions about food preparation and buying, healthy eating and exercise habits for the family, and what to say to a teen who is trying to lose weight. We try to ease some of the stress that surrounds this touchy time. After the classes are over, the teens are seen by us on an individual basis for a year to reinforce and revitalize. Change takes time.

If your teen-ager thinks we could help him or her, please give me, Nancy Gray, a call at 551-2513 for details and changes. Adults interested in weight control classes should watch for announcements of Winding Your Weigh Down offered by the Department of Family Medicine.

Contact Dr. Kolasa, Department of Family Medicine or c/o The Daily Reflector.

## Treat The Family To A Hearty Salad

When the football game is over, treat the whole family to a Marinated Beef and Walnut Salad. It's cool, refreshing and satisfying. Best of all, it's easy on the cook.

Tender, cooked beef strips, sliced strips are steeped in a mildly-sliced fresh mushrooms, and pimiento strips are steeped in a mildly-spicy marinade and heaped onto plates of crisp, shredded lettuce. A generous sprinkling of toasted, seasoned walnuts adds the final touch of superb flavor and texture.

Having a portable feast? Pack the salad greens, beef mixture and walnut topping in separate containers and place in the picnic cooler. When you arrive, simply build the salad into pocket or pita bread. Finish with your favorite dessert, and it will be an occasion to remember.

Toasted, seasoned walnuts are also delicious toppers for other salads. Try them in mixed greens, chicken or seafood for added crunch and nutrition. And, as snacks, these walnut nibbles are hard to resist.

Make an extra batch and store in an airtight container in the refrigerator. The walnuts will keep

for several weeks, if you can resist temptation that long!

**MARINATED BEEF AND WALNUT SALAD**

1 cup large pieces walnuts  
1 teaspoon salad oil  
1/2 teaspoon marjoram, crumbled  
1/3 cup chili sauce  
1/4 cup garlic flavor red wine vinegar

1 teaspoon Dijon mustard  
1 cup (4 oz.) thinly sliced cooked beef strips

1 cup sliced fresh mushrooms  
2 tablespoons pimiento strips  
1 head iceberg lettuce  
horseradish cream

Spread walnuts in shallow pan. Bake in 350 degrees F. oven about 10 minutes, stirring several times. Toss with oil, marjoram and seasoned salt; set aside to cool. Combine chili sauce with vinegar and mustard; mix well. Pour over beef, mushrooms and pimiento strips; refrigerate up to 2 hours.

At serving time, line individual serving plates with lettuce leaves. Shred remaining lettuce and arrange

(See SALAD, D-3)



TASTY SALAD — The whole family will enjoy a Marinated Beef and Walnut Salad after the ballgame.

# Homemakers Can Cut Salad Dressing Calories

By Betsy Balsley  
L.A. Times-Washington Post  
News Service

With all of the emphasis on the need to follow a healthful diet these days, it is not surprising that the market for low-calorie and low-fat salad dressings is alive and well. Salads have always been popular in America — the bigger and fresher, the better.

But in spite of their popularity, until about five years ago, most diners thought nothing of slathering favorite salads with a thick, creamy — and highly caloric — blue-cheese dressing.

Have things changed? Absolutely. Thin is in. And so is good nutrition. No longer do most of us, with a clear conscience, top a crisp fresh salad with 400 calories worth of salad dressing. Just walk into the nearest supermarket and survey the increasing number of reduced-calorie commercial dressings on display and you will quickly realize that it is definitely a dieter's world today. The array is mind-boggling.

There are thick dressings, thin dressings, spicy sweet-and-sour dressings, low-calorie blue-cheese dressings — all geared to add flavor to salads and other foods without adding unwanted calories and fats.

The only problem with many commercial dressings is that although they have taken out the calories, the manufacturers have, of necessity, left in stabilizers, preservatives and other additives that those watching their nutritional intake may prefer to avoid. Even good label readers often can be misled. All-encompassing terms such as "vegetable oils," for instance, can conceal the fact that the oils used may be vegetable oils high saturated fats such as coconut or palm oils.

Granted, these dressings are convenient, and many are, indeed, nutritionally worth their cost. However, the one sure way to know exactly what is in the salad dressing is to make it yourself. And that is much easier and much less time-consuming than one might think.

It all depends on the type of salad dressing you prefer.

If you like a light vinaigrette-type dressing, it is a simple matter to reduce the calorie content by replacing part of the oil with tomato pulp or some other pureed fruit or vegetable to cut the sharpness of the vinegar used.

Unflavored gelatin is another ingredient that will provide body in an oil-free dressing, while low-fat cottage cheese and buttermilk, when combined, make an acceptable substitute for sour cream in a cream-style dressing.

A somewhat more unusual choice as a stabilizer-thickener for a salad dressing is plain old rice. That's right — rice.

To create a rice-based dressing, cook a small amount of white rice in a large amount of water until the grains burst and become supersoft. This will take about 45 minutes, but once the rice is soft enough to puree, you can make a whole variety of dressings in a blender.

If you only want to make a small amount of dressing, the excess rice base will keep nicely in the refrigerator for five to seven days. If it solidifies as it chills, just throw it back into the blender or bring to room temperature and whisk vigorously to reliquefy it.

Because it is a very bland food, the

cooked-rice base acts as a stabilizer and natural filler rather than as a flavoring agent. Thus it can be mixed with almost any other ingredients to create the type of dressing you want.

Although the following recipes include one for the rice base and two suggestions for how to use it, a small amount of experimentation will show how easy it is to substitute this almost flavorless base for all or most of the oil in other dressings. And there is still another plus for this oil-less base.

**Rice Dressing base**  
4 cups water  
1/2 cup rice  
Bring water and rice to boil over medium heat, stirring occasionally. Reduce heat and simmer mixture 45 minutes or until rice grains split and are very soft. Remove from heat and place mixture in blender container. Makes 2 1/2 cups, about 9 calories per tablespoon.

**HONEY-LIME RICE DRESSING**  
1 1/3 cups Rice Dressing Base  
3 to 4 tablespoons honey  
1 tablespoon Dijon mustard  
1/4 teaspoon grated ginger root  
2 teaspoons lime juice  
1/4 teaspoon lime zest  
Place rice base, honey, mustard, ginger and lime juice in blender container and blend until creamy. Stir in lime zest. Refrigerate until 1 hour before serving. Serve at room temperature. Makes 1 1/2 cups, about 17 calories per tablespoon.

**HERBED TOMATO-RICE DRESSING**  
1/2 cup Rice Dressing Base  
1/4 cup water  
1 medium tomato, peeled, seeded and quartered  
1 clove garlic, peeled  
1 tablespoon balsamic vinegar  
2 tablespoons lemon juice  
2 tablespoons minced fresh basil or tarragon leaves  
Salt  
Combine rice dressing base, water, tomato, garlic, balsamic vinegar and lemon juice in blender container and blend until creamy. Stir in basil and season to taste with salt. Makes 1 1/2 cups, about 5 calories per tablespoon.

**ITALIAN MUSHROOM SOUP**  
12 ounces fresh mushrooms  
4 tablespoons butter or margarine  
1/2 cup chopped onion  
1/2 teaspoon minced garlic  
2 tablespoons flour  
2 cups half and half or light cream  
1/2 cup chicken broth  
3 tablespoons dry marsala  
1 teaspoon salt  
1/8 teaspoon ground nutmeg  
1/8 teaspoon ground black pepper  
Chopped parsley  
Rinse, pat dry and slice mushrooms (makes about 4 cups); set aside. In a medium saucepan melt butter. Add onion and garlic; saute until tender, about 3 minutes. Add reserved mushrooms; saute until golden, about 4 minutes. Add flour; cook and stir, until a smooth paste is formed, 1 minute. Add cream, chicken broth, marsala, salt, nutmeg and black pepper. Cook until thickened, about 5 minutes. Garnish with chopped parsley.

Note: If a thinner, less rich soup is desired, substitute an additional 1/2 cup of chicken broth for 1/2 cup of the half and half.

**LOW-CALORIE LEMON FRENCH DRESSING**  
1/2 teaspoon unflavored gelatin  
1/4 cup cold water  
1/2 cup boiling water  
1/4 cup lemon juice  
Sugar substitute to equal 1 tablespoon sugar  
1 teaspoon minced onion  
1/4 teaspoon curry powder  
1/4 teaspoon paprika  
Few strips lemon zest, optional  
In jar with tight-fitting lid soften gelatin in cold water. Add boiling water. Cover and shake to dissolve gelatin. Add lemon juice, sugar substitute, onion, curry powder and paprika. Shake well.

Chill about 1 1/4 hours or until dressing begins to thicken. Shake well. Add lemon zest for garnish, if serving separately. Serve with crisp green salad. Makes 1 cup, about 5 calories per tablespoon.

**LOW-CALORIE BLUE CHEESE DRESSING**  
1 cup low-fat cottage cheese  
1 tablespoon lemon juice  
1/4 teaspoon salt  
1/3 cup water  
2 ounces blue cheese  
White pepper  
Garlic powder  
Onion powder  
Combine cottage cheese, lemon juice, salt and water in blender or food processor container and blend until smooth and creamy. Add blue cheese and blend until nearly smooth. Season to taste with white pepper, garlic powder and onion powder. Store covered, in refrigerator. Will keep up to 5 days.

Makes 1 1/2 cups, about 15 calories per tablespoon.  
**LOW-CALORIE TOMATO DRESSING**  
1/2 teaspoon dry mustard  
1 (6-ounce) can tomato juice  
1 clove garlic, minced  
3 tablespoons oil  
2 tablespoons lemon juice  
Dash pepper  
Chopped green onion  
1 tablespoon Worcestershire sauce  
Salt  
Blend mustard with a little tomato juice and let stand 5 minutes. Add garlic, remaining tomato juice, oil, lemon juice, pepper, 1 tablespoon chopped green onion and Worcestershire and beat well. Season to taste with salt. Store in covered jar and chill.

separately, sprinkle with additional chopped green onion before serving. Serve with greens or avocado halves. Makes 1 cup, about 26 calories per tablespoon.

**CENTURY PLAZA LOW-CALORIE BUTTERMILK DRESSING**  
1 1/2 cups low-fat cottage cheese  
3/4 cup low-fat buttermilk, about 1 cup  
1/4 teaspoon white pepper  
1/2 teaspoon salt  
1 tablespoon minced green onion  
1 tablespoon chopped parsley  
Place cottage cheese, buttermilk, lemon juice, white pepper and salt in blender container. Blend until smooth. If too thick, add more buttermilk. Stir in green onions and parsley. Makes 2 1/3 cups, about 10 calories per tablespoon.

## DISCOUNT COUPONS

VALASSIS BLACK AND WHITE  
Wilton, CT 06897

20¢ MFG COUPON EXPIRES 12/31/88 20¢

### SAVE 20¢ WHEN YOU BUY

**Mazola Light**  
CORN OIL SPREAD

CONSUMER: Limit one coupon per purchase and you must pay all applicable sales taxes. Void where prohibited, taxed or otherwise restricted. Cash value 1/100¢. RETAILER: Best Foods will reimburse you the face value of this coupon plus 8¢ if submitted in full compliance with the Best Foods Redemption Policy. Send coupons for redemption to: Best Foods, Box 870025, El Paso, Texas 88587-0025.

48001 140432

### Introducing the most natural baby wipe you can buy

**Natural Touch**  
Baby Wipes

No Alcohol • Milder Than Soap And Water

Moistened with All Natural Ingredients Plus a Mild Fragrance

© 1988 James River Corporation

25¢ MANUFACTURER COUPON — EXPIRES MARCH 15, 1989 25¢

### Save 25¢ on New Natural Touch Baby Washcloths

TO CONSUMER: Coupon limited to purchase of specified product and size. Void if used otherwise. Cash value 1/20 of one cent.

TO DEALER: For each coupon you redeem as our agent, we will reimburse you the face value of this coupon plus 8¢ for handling, provided it was used in accordance with our consumer offer. Invoices proving purchase of sufficient stock to cover coupons presented must be shown on request. Void where taxed, prohibited or restricted, or if not presented by retailers or others specifically authorized. Consumer pays sales tax. Coupon not transferable. Mail properly redeemed coupons to: James River Corporation, P.O. Box 870070, El Paso, TX 88587-0070. Offer good only in U.S.A. and Puerto Rico. LIMIT ONE COUPON PER PURCHASE.

If you can't use this coupon, pass on to a friend.

GOOD ON 80-WASHCLOTH TUB ONLY 42000 310799

## Start the SAVINGS SEASON

### SAVE UP TO \$2.35

### FREE PHILLY INSTANTLY!

WHEN YOU BUY ANY FOUR DIFFERENT PRODUCTS SHOWN AT RIGHT. →

Nothing to mail in!

FREE IN-STORE

### FREE 8 oz. PHILLY

WHEN YOU BUY ANY FOUR DIFFERENT PRODUCTS LISTED AT LEFT. (PLEASE CHECK)

RETAILER: Kraft, Inc. will reimburse you the retail price of the free goods, plus 8¢ if submitted in compliance with Kraft's Coupon Redemption Policy, previously provided to retailer and incorporated by reference herein. Void where taxed, restricted or prohibited. Cash value 1/100¢. Mail to Kraft, Inc. (RFG), CMS Dept. #21000, 1 Fawcett Dr., Del Rio, TX 78840. Offer Expires: 12/31/88. ONE COUPON PER FOUR ITEMS PURCHASED. REDEEM PROMPTLY.

CASHER PLEASE FILL IN RETAIL PRICE: 21000 26402

KRAFT MANUFACTURER'S COUPON EXPIRATION DATE: 12/31/88 20¢

### SAVE 20¢

When you buy any size or variety CASINO Natural Cheese

RETAILER: Kraft, Inc. will reimburse you for the face value of this coupon plus 8¢ if submitted in compliance with Kraft's Coupon Redemption Policy, previously provided to retailer and incorporated by reference herein. Void where taxed, restricted or prohibited. Cash value 1/100¢. Mail to Kraft, Inc. (RFG), CMS Dept. #21000, 1 Fawcett Dr., Del Rio, TX 78840. Offer Expires: 12/31/88. ONE COUPON PER ITEM PURCHASED. REDEEM PROMPTLY.

27152

5 21000 29020

KRAFT MANUFACTURER'S COUPON EXPIRATION DATE: 12/31/88 25¢

### SAVE 25¢

When you buy any size or variety CRACKER BARREL Natural Cheese

RETAILER: Kraft, Inc. will reimburse you for the face value of this coupon plus 8¢ if submitted in compliance with Kraft's Coupon Redemption Policy, previously provided to retailer and incorporated by reference herein. Void where taxed, restricted or prohibited. Cash value 1/100¢. Mail to Kraft, Inc. (RFG), CMS Dept. #21000, 1 Fawcett Dr., Del Rio, TX 78840. Offer Expires: 12/31/88. ONE COUPON PER ITEM PURCHASED. REDEEM PROMPTLY.

26127

5 21000 25025

KRAFT MANUFACTURER'S COUPON EXPIRATION DATE: 12/31/88 20¢

### SAVE 20¢

When you buy any variety VELVEETA Shredded pasteurized process cheese food

RETAILER: Kraft, Inc. will reimburse you for the face value of this coupon plus 8¢ if submitted in compliance with Kraft's Coupon Redemption Policy, previously provided to retailer and incorporated by reference herein. Void where taxed, restricted or prohibited. Cash value 1/100¢. Mail to Kraft, Inc. (RFG), CMS Dept. #21000, 1 Fawcett Dr., Del Rio, TX 78840. Offer Expires: 12/31/88. ONE COUPON PER ITEM PURCHASED. REDEEM PROMPTLY.

NE8-12

21000 27048

KRAFT MANUFACTURER'S COUPON EXPIRATION DATE: 12/31/88 20¢

### SAVE 20¢

When you buy CARROLL SHELBY'S ORIGINAL TEXAS BRAND Chili Mix

RETAILER: Ridg's Finer Foods will reimburse you for the face value of this coupon plus 8¢ if submitted in compliance with the Coupon Redemption Policy, applicable to Ridg's Finer Foods previously provided to retailer and incorporated by reference herein. Void where taxed, restricted or prohibited. Cash value 1/100¢. Mail to Ridg's Finer Foods (RFG), CMS Dept. #21000, 1 Fawcett Dr., Del Rio, TX 78840. Offer Expires 12/31/88. ONE COUPON PER ITEM PURCHASED. REDEEM PROMPTLY.

CS8-15

72396 65152

### Save up to 45¢ on Chicken Applause!® from KRAFT

4 Ways to Fabulous Chicken.

KRAFT MANUFACTURER'S COUPON EXPIRATION DATE: 12/31/88 50¢

### SAVE 50¢

When you buy any size or variety CHEEZ WHIZ Pasteurized Process Cheese Spread

RETAILER: Kraft, Inc. will reimburse you for the face value of this coupon plus 8¢ if submitted in compliance with Kraft's Coupon Redemption Policy, previously provided to retailer and incorporated by reference herein. Void where taxed, restricted or prohibited. Cash value 1/100¢. Mail to Kraft, Inc. (RFG), CMS Dept. #21000, 1 Fawcett Dr., Del Rio, TX 78840. Offer Expires 12/31/88. ONE COUPON PER ITEM PURCHASED. REDEEM PROMPTLY.

NB8-20 A

21000 14150

KRAFT MANUFACTURER'S COUPON HURRY COUPON EXPIRES: 10/31/88 25¢

### Save 25¢

when you buy CHICKEN APPLAUSE!® Oven-Bake dinner from KRAFT (any variety)

RETAILER: Kraft, Inc. will reimburse you for the face value of this coupon plus 8¢ if submitted in compliance with Kraft's Coupon Redemption Policy, previously provided to retailer and incorporated by reference herein. Void where taxed, restricted or prohibited. Cash value 1/100¢. Mail to Kraft, Inc. (RFG), CMS Dept. #21000, 1 Fawcett Dr., Del Rio, TX 78840. Offer Expires: October 31, 1988.

21000 69405

LCB-11

ONE COUPON PER ITEM PURCHASED REDEEM PROMPTLY

KRAFT MANUFACTURER'S COUPON EXPIRATION DATE: 11/30/88 20¢

### Save 20¢

when you buy CHICKEN APPLAUSE!® Oven-Bake dinner from KRAFT (any variety)

RETAILER: Kraft, Inc. will reimburse you for the face value of this coupon plus 8¢ if submitted in compliance with Kraft's Coupon Redemption Policy, previously provided to retailer and incorporated by reference herein. Void where taxed, restricted or prohibited. Cash value 1/100¢. Mail to Kraft, Inc. (RFG), CMS Dept. #21000, 1 Fawcett Dr., Del Rio, TX 78840. Offer Expires: November 30, 1988.

21000 69417

LCB-13

ONE COUPON PER ITEM PURCHASED REDEEM PROMPTLY

## Pollard's Trading Post

100 Pollard St.  
Behind Fred Webb's Grain Mill  
North Greene St., Greenville, N.C.  
758-2277  
Under New Management-George Whitley  
Open 8:00 A.M.-6:00 P.M. Monday-Saturday

Round-Up Sliced Bacon 6 12 Oz. Pkgs. \$5.99	Sirloin Steaks 10 Lb. \$20.90
Round Steak \$1.79 Lb.	Rib Stew Beef 10 Lb. \$11.90
Beef Ribs For Barbecue \$1.59 Lb.	Fresh Link Sausage 10 Lb. Box \$13.50
Smoked Ham Bones 10 Lb. \$8.90	Slab Bacon (Whole) \$1.04 Lb.
<b>A-Pack</b> 10 Lbs. T-Bone Steak 10 Lbs. Pork Chops 10 Lbs. Whole Fryers 10 Lbs. Ground Beef 59 <sup>95</sup>	<b>B-Pack</b> 10 Lbs. Sirloin Steak 10 Lbs. Fryer Parts 10 Lbs. Grd. Beef Patties 10 Lbs. Smoked Sausage 49 <sup>95</sup>
<b>C-Pack</b> 10 Lbs. Rib Steaks 10 Lbs. BBQ Beef Ribs 10 Lbs. Chicken Leg 1/4s 10 Lbs. Hot Dogs 45 <sup>95</sup>	<b>D-Pack</b> 10 Lbs. Pork Spareribs 10 Lbs. Pork Sausage 10 Lbs. Chicken Wings 10 Lbs. Chitterlings 35 <sup>95</sup>

# Olympic Menus Are Big Items

(Continued from D-1)

tein-rich fare as: Fillet of Beef Steak, Chicken Cacciatore, Braised Pork with Green Peppers, Salmon Steak and Broiled Beef Bul-Gal-Bi, a traditional Korean dish containing marinated beef, garlic and red pepper. Kimchi, a peppery hot mixture of pickled cabbage and other vegetables, is another popular Korean dish which also will be well represented.

In addition to directing the food service for the athletes, ARA also is providing 24-hour food service for some 1,400 NBC News and Sports employees, including technicians and on-air personalities.

Operations, which began in early August, employ mobile units to transport meals daily to crews at various events. Catering trucks, featuring ARA-designed equipment, offer continental breakfasts daily.

ARA also is working with a local Coca-Cola bottler to operate about 115 food and refreshment concession stands at 20 venues throughout Seoul and Pusan. A total of 780 ARA-trained employees will serve five million spectators such interesting and unusual fare as walnut balls, squid, and rice-wrapped in seaweed.

For those not traveling to Seoul for the games—here is a recipe for sampling Olympic-style nutrition at home. This pasta dish is from a cookbook which ARA Services' dietitians compiled using recipes from its previous Olympic experiences.

## VEGETABLE LASAGNA

- 1 cup chopped onion
- 3/4 cup chopped celery
- 1/3 cup chopped green pepper
- 3 tablespoons butter or margerine
- 1 can (28 ounces) crushed tomatoes
- 1 cup water
- 1 1/2 teaspoons oregano leaves, crushed
- 1 teaspoon sugar
- 1/2 teaspoon salt
- 1/2 teaspoon garlic powder
- 1/2 teaspoon Worstershire sauce
- 1/8 teaspoon pepper
- 1 1/4 cups shredded mozzarella cheese
- 9 lasagna noodles, uncooked
- 2 cups thinly sliced zucchini

In 2-quart saucepan cook onion, celery and green pepper in butter or margerine until tender. Add tomatoes, water and seasonings. Bring to boil. Reduce heat; simmer over low heat, uncovered, 30 minutes. Add 3/4 cup mozzarella cheese, stir until smooth. To assemble; preheat oven to 350 degrees F. In 12 x 8 x 2-inch baking dish, spread 1 cup sauce. Top with 3 noodles, 1 cup zucchini and 1 cup sauce. Repeat layers of noodles, zucchini, sauce, noodles and sauce. Sprinkle with remaining 1/2 cup cheese. Cover tightly with aluminum foil. Bake 45 minutes. Remove foil; cook 15 minutes longer. Remove from oven. Let stand 15 minutes before serving. Makes 8 servings.

# Oranges Wake Up Lunches

(Continued from D-1)

"Grapefruit, a breakfast favorite on many tables, harvested primarily in Riverside and Ventura counties in southern California during the summer months, will be smaller in size than usual, with the Ruby variety displaying a nice exterior blush on the fruit, and a bright interior color," adds Gray.

To add a nutritious punch to today's lunch, here are some tips to beat "Back-to-School Brown Bag Blues":

— Give children a good variety of foods, selecting one item from each food group. Include such high protein foods as eggs, peanut butter, meat, poultry, fish and cheese; a whole grain bread of complex carbohydrate such as pasta or rice; milk or other dairy products for calcium; a raw or cooked vegetable, and a raw fruit for dessert.

— Keep the meal "eye-appealing" and "feel-appealing" with a rainbow of colors and a variety of food textures and shapes. Raw carrots and celery sticks, green peppers and red pepper strips, raw broccoli and cauliflower flowerettes are all "kid-pleasers," but make them more interesting with a cheese, yogurt, or peanut butter dip.

— Make sandwiches creative by stuffing your sandwich fillings into such white bread alternatives as whole wheat pita pockets, croissants and sourdough rolls.

— Give meals crunch and high fiber by adding chopped nuts or apples to sandwich fillings, or sliced almonds or non-buttered popcorn as a side snack.

— Keep cartons of fruit juice cold by freezing the night before, then wrapping in plastic wrap. The juice will thaw out in time for lunch and keep other items in the bag cool.

— Add nutritional citrus 'gold' to the meal with a fresh Sunkist Valencia orange, cut into "smiles" for easy eating. Just cut the orange in half crosswise; place cut-side-up. Cut three to four wedges from each half and place in a plastic bag. To pick the perfect orange in the fall, don't reject fruit that is green on the stem end. This greenish tinge is actually a natural "regreening" process that occurs during warm weather when the orange's skin reabsorbs chlorophyll from the tree. It's actually a sign that the orange is fully ripe, sweet and delicious.

Some kids find school fun, some find it's a bore and to some, it's a totally new experience. Keep the fun alive and the "bored" surprised by introducing some creative crunchy appeal to bag lunches. Here's some sandwich and snack recipes that pack a creative nutritious punch.

## CHICKEN SALAD IN POCKET BREAD

- 1 can (about 5 to 6 ounces) chunk white chicken, drained
  - 1 small unpeeled red apple, cut in bite-size pieces
  - 1/4 cup chopped celery
  - 1/4 cup mayonaise or salad dressing
  - 2 tablespoons coarsely chopped walnuts
  - Grated peel of 1/2 fresh lemon
  - 1 teaspoon fresh squeezed lemon juice
  - 1/2 teaspoon prepared mustard
  - 1/4 teaspoon ground cinnamon
  - 2 (6-inch) loaves pocket bread, cut in half
- In bowl, combine all ingredients except pocket bread. Spoon 1/4 chicken mixture into pocket of each bread half. Makes 2 sandwiches.

## ORANGE GRANOLA NUT SPREAD

- 1 teaspoon fresh grated orange peel
  - 1 orange, peeled, cut in bite-size pieces
  - 1 cup granola
  - 1/2 cup chunky peanut butter
  - 2-4 tablespoons honey
- In bowl, combine all ingredients, adding enough honey for a spreadable consistency. Makes about 2 cups filling for 6 sandwiches.

## ORANGE POPCORN BALLS

- 4 quarts popped popcorn
- 1 cup coarsely chopped nuts
- 2 cups sugar
- 1/2 cup fresh squeezed orange juice

- 1/2 cup half&half
- 1 tablespoon butter or margerine
- Grated peel of 1 orange

In large pan, combine popcorn and nuts; set aside. In saucepan, combine sugar, orange juice and cream; cook over low heat, stirring constantly until sugar dissolves. Cover; boil 1 minute to dissolve sugar off sides of pan. Increase heat slightly; cook to hard ball stage (260 degrees F.) on candy thermometer, stirring occasionally. Remove from heat; stir in butter and orange. Slowly pour the hot syrup over popcorn and nuts; toss until evenly coated. Shape popcorn mixture into balls with buttered hands. (Mixture is hot and sets quickly—so work fast.) Cool on waxed paper. Makes 18 to 20 small popcorn balls, 2 inches in diameter.

This recipe works best with two people—one to pour, the other to stir, and both to quickly form balls.

## Crimestoppers

If you have information on any crime committed in Pitt County, call Crimestoppers, 758-7777. You do not have to identify yourself and can be paid for the information you supply.

# Salad

(Continued from D-1)

over leaves. Portion beef mixture over lettuce. Sprinkle with seasoned walnuts. Serve with horseradish cream, if desired. Makes 4 servings.

Horseradish cream: Combine 1/2 cup dairy sour cream and 1 tablespoon prepared horseradish; mix well and chill.

# Don't try it just because it's new. Try it because it's EXTRA.

All the goodness of Quaker Oatmeal PLUS All the EXTRA goodness of 10 vitamins and iron.

Each delicious bowl of Quaker EXTRA is fortified with a whole day's worth of 10 vitamins and iron.

Choose one of three great flavors, or sample them all in our Variety Pack.

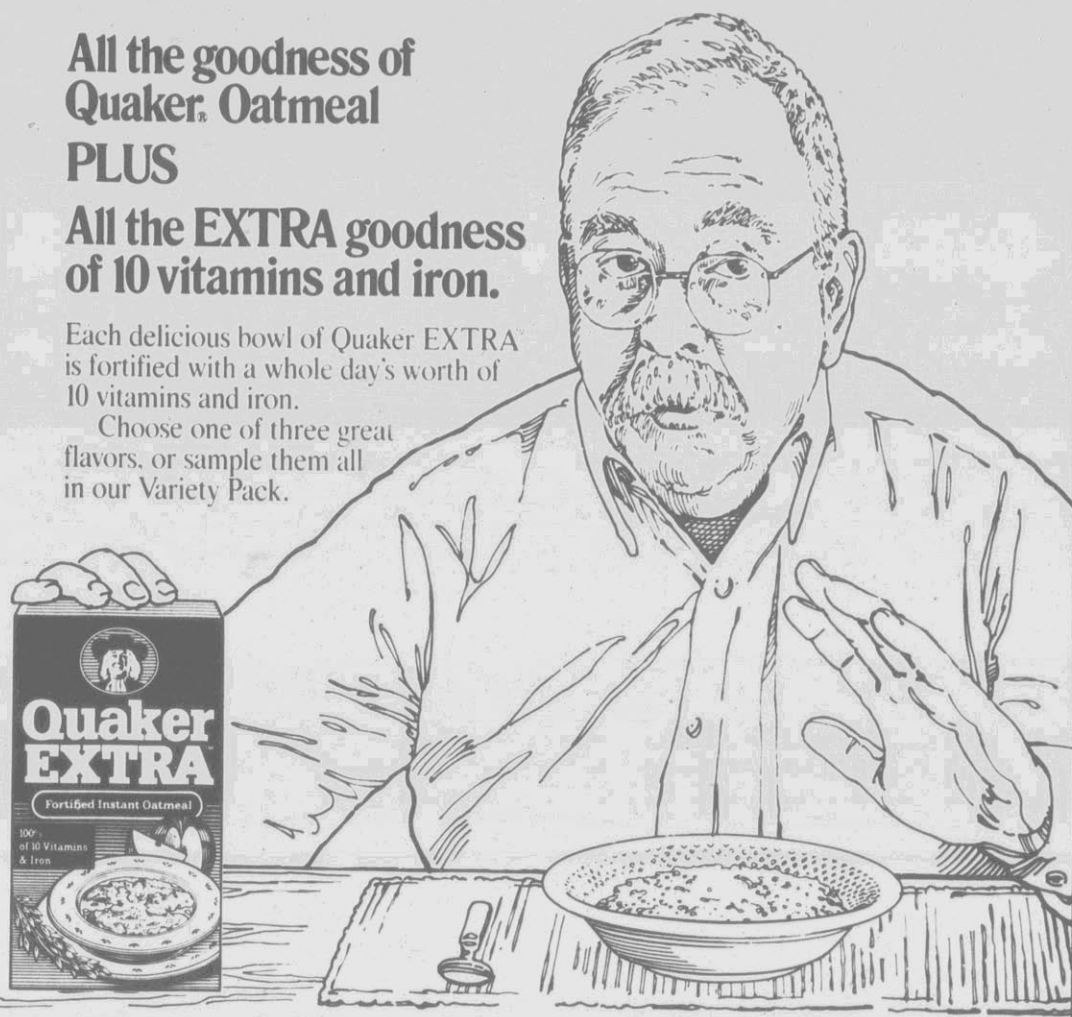

Quaker Oats. It's The Right Thing To Do!

MANUFACTURER COUPON EXPIRES OCT. 31, 1988

**60¢** OFF ANY Quaker EXTRA Fortified Instant Oatmeal

10657/RO9

RETAILER: Quaker will reimburse you for the face value of this coupon plus 5¢ when accepted in accordance with our redemption policy (copy available upon request). Retailers & authorized clearing houses send to: Quaker Oats, 800 Springer Drive, Lombard, IL 60148. LIMIT 1 COUPON PER TRANSACTION. Void if transferred or copied. Good only in U.S.A. Void where taxed or prohibited by law. Cash value .001¢. ©1988 Quaker Oats Company. EXPIRES OCT. 31, 1988.

5 30000 12460 9

**GAINES INVITES YOU TO**

**MICKEY'S BIRTHDAYLAND**

Walt Disney World.

**SWEEPSTAKES**

**1st Prize:** Win one of 50 trips for a family of four to the Walt Disney World Vacation Kingdom with V.I.P. activities at Mickey's Birthdayland

**2nd Prize:** Win one of 1,000 authentic Mickey Mouse watches

**3rd Prize:** Win one of 15,000 limited edition Mickey's Birthdayland posters available only from Gaines

© 1988 The Walt Disney Company      © 1988 Gaines Pet Foods Corp.

**CARNATION AND CONTADINA INVITE YOU TO EAT-AT-HOME AND SAVE.**

**1988 Eat At Home and Save.**

<p><b>25¢</b> MANUFACTURER COUPON EXPIRES 3/31/88</p> <p><b>SAVE 25¢</b> on any variety of Carnation® Breakfast Bars.</p> <p>50000/182456</p>	<p><b>15¢</b> MANUFACTURER COUPON EXPIRES 12/31/88</p> <p><b>SAVE 15¢</b> on any three Contadina® canned tomato products.</p> <p>50000/182423</p>
<p><b>25¢</b> MANUFACTURER COUPON EXPIRES 12/31/88</p> <p><b>SAVE 25¢</b> on any size or variety of Carnation® Instant Breakfast.</p> <p>50000/182449</p>	<p><b>50¢</b> MANUFACTURER COUPON EXPIRES 4/30/89</p> <p><b>SAVE 50¢</b> on one 16-oz. or larger size Coffee-mate® non-dairy creamer.</p> <p>50000/182431</p>

<p>MANUFACTURER COUPON EXPIRES NOV. 30, 1988</p> <p><b>\$100 OFF</b> ANY SIZE BAG</p> <p><b>GAINES® GRAVY TRAIN®</b></p> <p>10683/RO9</p>	<p>MANUFACTURER COUPON EXPIRES NOV. 30, 1988</p> <p><b>\$100 OFF</b> ANY ONE 72oz. OR TWO 36oz. PACKAGES</p> <p><b>GAINES® TopChoice®</b> OR <b>GAINES-burgers®</b></p> <p>10682/RO9</p>	<p>MANUFACTURER COUPON EXPIRES NOV. 30, 1988</p> <p><b>25¢ OFF</b> ANY FLAVOR</p> <p><b>PUSHA-BOOTS® Pounce®</b></p> <p>TREATS FOR CATS</p> <p>TRY NEW TUNA FLAVOR</p> <p>10679/RO9</p>	<p>MANUFACTURER COUPON EXPIRES NOV. 30, 1988</p> <p><b>75¢ OFF</b> ANY SIZE BAG</p> <p><b>GAINES® CYCLE®</b></p> <p>10667/RO9</p>
---	--	---	---

# HARRIS SUPERMARKETS

**DISCOUNT** "WHERE SHOPPING IS A PLEASURE"  
ON EVERYTHING BUT QUALITY  
We Reserve The Right To Limit Quantities  
We Accept Food Stamps and WIC Vouchers  
**PRICES GOOD THRU SATURDAY!**

## DELI

(BELLS FORK STORE ONLY)

**BOILED HAM** .. **\$1.99** LB.

**HOOP CHEDDAR, CORNED BEEF OR PASTRAMI** **\$3.49** LB.

## PRODUCE

LARGE CALIFORNIA SWEET **CANTALOUPE** EACH **99¢**

TENDER YELLOW **SQUASH** ..... LB. **49¢**

WAXED **RUTABAGAS** ..... LB. **25¢**

FRESH GRADE A **FRYER LEG QUARTERS**

**45¢** LB.

FRESH **GROUND BEEF**  
(3 LBS. OR MORE. GROUND FRESH DAILY)

**99¢** LB.

U.S.D.A. WESTERN **SIRLOIN STEAKS**

**\$2.19** LB.

JIMMY DEAN **ROLL SAUSAGE** ..... 1 LB. **\$1.49**  
(REG., HOT OR SAGE)

JIMMY DEAN **BISCUITS** ..... 8 OZ. **\$1.59**  
(SAUSAGE, STEAK OR CHICKEN)

JIMMY DEAN **MUFFINS** ..... 8 OZ. **\$1.59**  
(SAUSAGE, OR HAM AND CHEESE)

OSCAR MAYER **WEINERS** ..... 1 LB. **99¢**

OSCAR MAYER **BOLOGNA** (REG., THICK OR THIN) . 12 OZ. **\$1.49**

OSCAR MAYER **BACON** ..... 1 LB. **\$1.89**

OSCAR MAYER **COOKED HAM** ..... 6 OZ. **\$1.69**

U.S.D.A. WESTERN **T-BONE STEAKS** .... LB. **\$2.49**

HARRIS' OWN **FRESH LINK SAUSAGE** ..... LB. **\$1.89**

HARRIS' OWN GENUINE **HICKORY SMOKED SAUSAGE** LB. **\$1.99**

LEAN AND TENDER **FRESH PORK SPARERIBS**  
(3 DOWN SIZE)

**\$1.39** LB.

## PILLSBURY SALE

PILLSBURY **CAKE MIX** ALL 18 OZ. VARIETIES **59¢**

PILLSBURY **READY-TO-SPREAD FROSTING** ALL FLAVORS **\$1.39**

PILLSBURY **SELF-RISING FLOUR** ..... 5 LB. **\$1.09**

SANKA **COFFEE**  
13 OZ. VACUUM BAGS **\$3.19**

SANKA **INSTANT COFFEE**  
8 OZ. **\$4.29**

**COCA COLA, DIET COKE OR MELLO YELLO**  
2 LITER

**99¢**

**DR. PEPPER OR DIET DR. PEPPER**  
2 LITER

**89¢**

**KAL KAN DOG FOOD**  
ALL 14 OZ. FLAVORS

**3/\$1**

## HUNT-WESSON SALE

HUNT'S **TOMATO SAUCE** ... 8 OZ. **3/\$1**

WESSON OIL ... 64 OZ. 1/2 GALLON **\$2.99**

HUNT'S **SPAGHETTI SAUCE** . 27.5 OZ. **99¢**

HUNT'S **KETCHUP** ... 32 OZ. **99¢**

HUNT'S **TOMATO PASTE** ..... **3/\$1**

NABISCO **CHIPS AHOY, CHEWY CHIPS AHOY OR STRIPED CHIPS AHOY** ..... 18 OZ. **\$2.19**

NABISCO **FUDGE OREOS** ..... 14 OZ. **\$2.49**

NABISCO **PARTY GRAHAMS** ..... 10 OZ. **\$1.29**

NABISCO **RITZ BITS** ..... **\$1.49**

REGULAR (10 OZ.), LOW SALT (10 OZ.), OR CHEESE (11 OZ.)

NABISCO **STRIPED SHORTBREAD** ..... 10 OZ. **\$1.29**

NABISCO **STRIPED SUGAR WAFER** ..... 9 OZ. **\$1.29**

NABISCO **TEDDY GRAHAMS CHOCOLATE, HONEY OR CINNAMON** ..... 10 OZ. **\$1.39**

**NATURAL LIGHT** 6 PAK 12 OZ. CANS **\$2.59**

## SEALTEST POLAR BAR



8 PAK **BUY ONE, GET ONE FREE!**

**2/\$2.49**

## FALL CLEANING FAVORITES

STOCK UP ON THESE VALUES



COMET CLEANSER 14 OZ. YOU PAY ONLY <b>2/\$1.00</b> 8¢ OFF	MR. CLEAN LIQUID 28 OZ. YOU PAY ONLY <b>\$1.89</b> 25¢ OFF
SPIC and SPAN POWDER 8 OZ. YOU PAY ONLY <b>79¢</b> 20¢ OFF	SPIC and SPAN PINE 28 OZ. YOU PAY ONLY <b>\$1.99</b>
TOP JOB LIQUID 28 OZ. YOU PAY ONLY <b>\$1.89</b> 25¢ OFF	

# HARRIS SUPERMARKETS

**DISCOUNT** "WHERE SHOPPING IS A PLEASURE"  
ON EVERYTHING BUT QUALITY

We Reserve The Right To Limit Quantities  
We Accept Food Stamps and WIC Vouchers

**PRICES GOOD THRU SATURDAY!**



**HELP KIDS LEAD A  
DRUG FREE LIFE**  
Just say no  
**SAVE MONEY**

• Redeem P&G Coupons Here

## WHITE CLOUD TISSUE



4 ROLL PAK  
**\$1.19**

## LUVS DIAPERS



ALL SIZE  
CONVENIENCE PAKS  
**\$8.99**



## PUFFS FACIAL TISSUE

175 CT.  
**99¢**

## JOY DISHWASHING LIQUID



**\$1.09**  
40¢ OFF



## FOLGERS INSTANT COFFEE

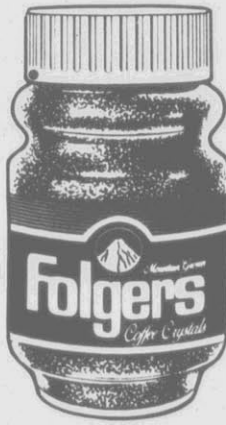

8 OZ.  
**\$3.69**

## FOLGERS COFFEE



13 OZ. VACUUM BAGS  
**\$3.19**

## DOWNY FABRIC SOFTENER



96 OZ.  
**\$3.39**  
60¢ OFF LABEL

## TIDE LAUNDRY DETERGENT



42 OZ. REGULAR  
OR UNSCENTED  
**\$1.79**

## DUNCAN HINES TIARA DESSERTS



ALL  
VARIETIES  
**\$2.99**

### DAIRY PRODUCTS



TROPICANA  
**ORANGE JUICE** ½ GALLON  
GLASS JUG **\$1.99**



TROPICANA PURE PREMIUM  
FRESH SQUEEZED  
**ORANGE JUICE** ½ GALLON  
CARTON **\$1.99**

### FROZEN FOODS



ALL 11 OZ. VARIETIES  
EXCEPT BEEF  
**BANQUET DINNERS** **99¢**



ANNE'S OLD FASHIONED  
**PASTRY FOR CHICKEN** 24 OZ. **\$1.69**



COUNTRY FRESH  
**ICE CREAM** ALL ½ GALLON  
FLAVORS **\$1.19**



PET RITZ DEEP-DISH  
**PIE SHELLS** 2 PAK **99¢**

# The '50s: When Well-Rounded Meals Were Square

By Irene Sax  
L.A. Times-Washington Post  
News Service

Forget chocolate truffles and Scotch salmon. When I am hungry and needy, I want my mother's icebox cake.

Of course, it was not exactly my mother's. You might say it was Nabisco's.

To make it, she bought a package of dark-chocolate wafers. She stuck them together with whipped cream, spread more cream over the top and sprinkled on a lot of chocolate-wafer crumbs. When the cake had ripened in the icebox, she cut it on the diagonal into zebra-striped slices of black biscuit and white cream. Delicious.

I am not alone in my nostalgia for the unfashionable dishes made with processed foods that were popular in the 1950s. Many of my friends admit to similar passions: if not for icebox cake, then for California dip; if not for tuna noodle casserole, then for green beans and canned onion rings baked in Campbell's cream of mushroom soup.

"People desperately want to eat something familiar," said Jane Stern, co-author with her husband Michael of "Square Meals" (Knopf). "Even though we're now grand and sophisticated, it's hard to feel cozy about Famous Young Chefs, ditsy portions and squid pasta. In an age of anxiety, the middle-class soul food we grew up with reminds us of safer times."

The style that the Sterns call "vernacular cooking" or "populist cooking" or "things made from other things" blossomed from the end of World War II until the 1960s.

A lot of '50s food was good, better than we are willing to admit in this decade of fresh goat cheese, baby vegetables and undercooked fowl (One of the hallmarks of a '50s casserole is that even though all the ingredients are precooked, it is still baked in a 350-degree oven for an hour).

As a style, populist cooking has been fiercely in and out of favor. At first, everyone loved it. Such culinary sophisticates as James Beard included brand names in cookbooks and invented new ways for food corporations to use their products. In the

'50s, Beard worked for Pillsbury, Nestle and Green Giant, said his biographer Evan Jones, and was the one responsible for adding butter sauce to vegetables-in-a-pouch.

But when food fashion turned away from hamburger pies and cake-mix cakes, home cooks remained faithful. You have only to look at the hundreds of dishes made with Bisquick and Jell-O in spiral-bound charity cookbooks to see how faithful they are.

"Are people still cooking this way?" Stern asked. "You bet they are. It really tickles me that Michael and I are credited with bringing back a style, when in 99 percent of the country, it simply never went away." Now the fashionable food world is

paying attention again. Fifties food is coming back, along with '50s harlequin glasses, pedal pushers, kidney-shaped coffee tables and linoleum.

The '50s were certainly a time of optimism. The war, which introduced GIs to croissants and pizza, also convinced them that there was no place like home. The women who had been filling in for them at work covered their typewriters, put down their riveting guns and went back to the kitchen. The birthrate went up. The move to the suburbs began.

Nothing, it seems, could be less like our own decade of two-career families, workaholics and restaurant mania. But that is just why the nostalgia makes sense.

A recipe does more than tell us how

to cook: It also communicates a set of values. The nostalgia we feel for English-muffin pizza and Ginger-Ale salad echoes our nostalgia for what seems a simpler time: for Lucy, Ozzie and Harriet, Beaver, Dobie Gillis and The Honeymooners; for a time before technology got out of hand, when Mom was in the kitchen and all was right with the world.

Maybe we are not so different from the people of the '50s as we think. We are still in love with technology, although now our toys are microwave ovens instead of home freezers.

We still care about speed and convenience. How much difference is there between 1988's frozen dinner and 1955's canned sausage, corn,

lima bean and cheese-soup casserole?

We still like portable and snack foods. Much of '50s food was designed to be eaten on a patio or while watching Milton Berle on the new television set. Thirty years later, the catchword is grazing, and we are eating while walking on the street or sitting in front of the VCR.

And if predictions are right, we are also going to be spending more time at home. Kraft Inc. does a study of consumer trends every year. What it found this year, said Velveta spokeswoman Kim Burson, is that we are not going to restaurants as much as we did. We are getting married, having babies and enjoying home-bound activities such as watching the VCR.

## Breakfast

(Continued from D-1)

bowl, mix together milk, egg and oil. Stir into dry ingredients; mix well but do not overstir. Add carrots and raisins. Spoon batter into lightly greased muffin pans.

Bake at 400 degrees about 15 minutes, or until toothpick inserted in middle comes out clean.

This will yield 12 muffins, with about 4 grams of fat each, and about 130 calories each.

Oatmeal adds an interesting new flavor to a traditional breakfast favorite. This recipe is designed to be low in fat, so don't add extra butter or margarine at the table. Instead, top with fresh fruit, applesauce or syrup.

### OATMEAL PANCAKES

1 1/2 cups quick cooking oatmeal  
3/4 cup unsifted whole wheat flour  
1 tbs. sugar  
1 tsp. baking soda  
2 tbs. oil  
2 cups buttermilk (or 2 cups skim milk plus 2 tsp. lemon juice)

1 egg  
optional flavorings:  
1 tsp. vanilla  
cinnamon or nutmeg to taste  
Combine oatmeal, flour, sugar, and baking soda in bowl. Add oil, milk, egg, and any optional flavorings desired. Stir vigorously until thoroughly mixed. Let batter stand at room temperature for 30 minutes.

Drop mixture from spoon onto preheated griddle or skillet. Bake until bubbles form, then turn and bake on other side. Serve and top with favorite syrup or fruit topping.

This will give you about 8 pancakes, 4 inches in diameter, of about 170 calories and 6 grams of fat each.

## Diets

(Continued from D-1)

margarine, both high in fat and "weighing in" at 100 calories per tablespoon, are "off limits" on low-fat diets. However, now their rich flavors may still be enjoyed.

A new alternative, Molly McButter All Natural Butter Flavor Sprinkles, provide real rich butter taste with virtually no fat, no cholesterol and only four calories per half-teaspoon serving. Praised as a "better butter" by the Center for Science in the Public Interest, it may be sprinkled onto or stirred into hot, steaming foods such as vegetables, baked potatoes, fish, chicken and pasta to provide rich butter taste with virtually no fat or cholesterol and only four calories per half-teaspoon serving. In addition, it is low in sodium.

The Surgeon General's report recommended that the use of salt be limited both at the table and in food preparation. Since salt is an acquired taste, the salt habit can be kicked when salt and salt substitutes are eliminated from the diet. Unmasked by salt, natural food flavors can be surprisingly good.

Those who would like to reduce salt consumption but who yearn for flavor can turn to natural herbs and spices to enhance the taste appeal of foods. Created to add great flavor to foods without salt, all-natural Mrs. Dash is a balanced blend of 14 herbs and spices. Available in four varieties, it provides an easy way to start shaking the salt habit.

For two free brochures full of tips on how to add fabulous flavor to foods without salt and without the fat, cholesterol and calories of butter or margarine, send your name and address to: Molly McButter, Mrs. Dash; Dept. Health; 2525 Armitage Avenue; Melrose Park, IL 60160.

## Sale Starts Sunday, Sept. 11th.

PRICES EFFECTIVE THRU SATURDAY, SEPTEMBER 17, 1988.  
QUANTITY RIGHTS RESERVED. NOT RESPONSIBLE FOR TYPOGRAPHICAL ERRORS.  
DELI/BAKERY ITEMS AVAILABLE ONLY IN STORES WITH THOSE DEPARTMENTS.



SUPER STAR SAVINGS GUIDE

SAVE-AGENTER

SAVE 110<sup>lb.</sup>

U.S.D.A. CHOICE GRAIN FED

### Boneless Beef Chuck Roast

# 139

lb.

### PANTRY PICKS

SLICE\*MTN. DEW\*PEPSI FREE

Regular or Diet Pepsi Cola **99¢** (2 lb. bot.)

Sparkle Towels **3100** (single rolls)

Crisco Shortening **188** (3 lb. can)

Ruffles Potato Chips **99¢** (8.5 oz. bag)

Miller Beer **12519** (12 oz. cans)

Del Monte Squeeze Catsup **89¢** (28 oz. bot.)

### BUTCHER BLOCK

FIELDALE GRADE 'A' Fresh Pick of the Chix **129** (lb.)

SMITHFIELD\*SPECIAL TRIM Fresh Pork Picnic **99¢** (lb.)

FRESH ITALIAN SAUSAGE **199** (lb.)

HICKORY HOLLOW BONELESS Turkey Buffet Ham **119** (lb.)

### BETTER LIVING

PUMP\*REG. OR FOR KIDS Aqua Fresh Toothpaste **149** (4.3 oz. pump)

### CATCH OF THE DAY

FRESH Special Crabmeat **599** (1 lb. cont.)

SAVE 60¢ LB. Fresh Perch Fillet **339** (lb.)

### DELI DELIGHTS

U.S.D.A. CHOICE Deli Roast Beef **459** (lb.)

NEW YORKER WHITE OR YELLOW American Cheese **269** (lb.)

DELI FRESH Macaroni Salad **69¢** (lb.)

### COUNTRY DAIRY

LIMIT ONE WITH MINIMUM \$10 PURCHASE Old South Orange Juice **98¢** (64 oz. ctn.)

ALL FLAVORS Light N'Lively Yogurt **3100** (8 oz. pkg.)

### FARMERS MARKET

RED OR GOLDEN\*NEW CROP Delicious Apples **119** (3 lb. bag)

CALIFORNIA GOLDEN Bartlett Pears **79¢** (lb.)

FRESH\*NORTH CAROLINA U.S.1 New Crop Yams **100** (3 lbs.)

### DEEP FREEZE

ALL FLAVORS Sealtest Ice Cream **229** (1/2 gal. ctn.)

GLAZED CHICKEN\*CHICKEN ALAORANGE\*CHICKEN MARSALA Lean Cuisine Entrees **2500** (8-8.5 oz. pkg.)

ALL FLAVORS Pet Ritz Cream Pie **88¢** (14 oz. pie)

CHEESE\*DELUXE\*SAUSAGE & PEPPERONI Stouffer's Pizza **199** (10.3-12.5 oz. pkg.)

NOW AVAILABLE! AMERICAN EXPRESS  AT U.S. POST OFFICE PRICES 

## Money Orders Postage Stamps

# DOUBLE COUPONS!

MANUFACTURERS'  
Good only in Richmond, Colonial Hts.,  
Chester and Mechanicsville, Va. and  
Greenville and Aberdeen stores only.  
★Limit 10★  
coupons doubled per customer, please.  
See stores for details.

and lowest prices!

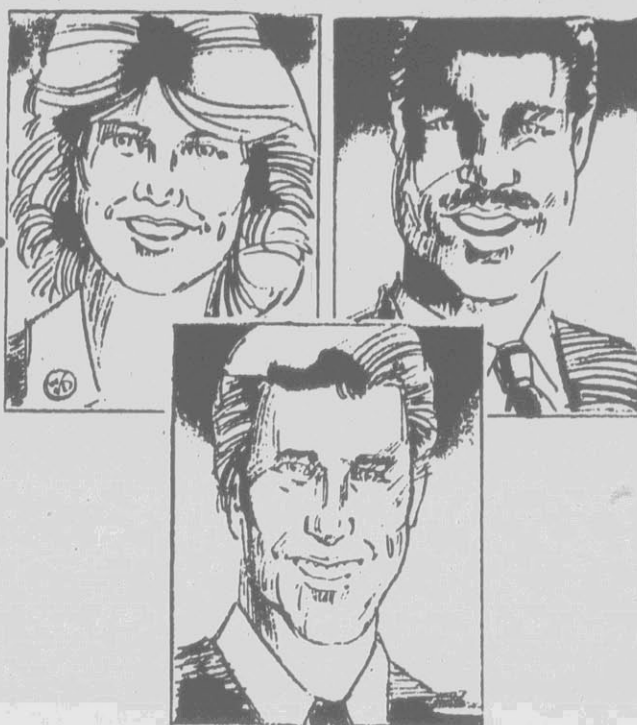

The lowest food bill possible...

That's Winn-Dixie's commitment to you. Not just for today, but for a long time to come! Plus, the quality, variety and service you deserve in a food store. Winn-Dixie's got it!



2-LTR. BTL. COCA-COLA

- COCA-COLA CLASSIC
- CHERRY COKE•DIET COKE
- CAFFEINE FREE COKE
- CAFFEINE FREE DIET COKE

999¢



HOLLY FARMS GRADE 'A' WHOLE FRYING CHICKENS

59¢ LB.

HOLLY FARMS GRADE 'A' WHOLE CUT UP CHICKEN ..... LB. .69



HARVEST FRESH THOMPSON WHITE SEEDLESS GRAPES

68¢ LB.

## ✓ Your Choice for Quality Meats



W-D BRAND U.S. CHOICE WESTERN GRAIN FED BONELESS SIRLOIN STEAKS

399¢ LB.

W-D BRAND U.S. CHOICE BONELESS BOTTOM ROUND STEAKS ..... LB. 2.69



W-D BRAND SELECT LEAN SMALL TENDER PORK SPARERIBS

149¢ LB.

W-D BRAND SELECT LEAN ECONOMY CUT PORK CHOPS .... LB. 1.49



5-LB. BOX W-D BRAND BEEF PATTIES

399

W-D BRAND FRESH PURE ALL AMERICAN GROUND BEEF ... LB. 1.39



Beef. Real Food for Real People.

## ✓ Your Choice for Quality in our Deli-Bakery

"CHICKEN PICKER'S" 12-PC. SATCHEL SOUTHERN STYLE FRIED CHICKEN DINNER

- 12 PCL. FRIED CHICKEN•1 LB. POTATO SALAD
- 1 LB. COLE SLAW•1 DOZ. DINNER ROLLS

1149 ALL FOR

We call our fried chicken "Chicken Picker's" because it's the chicken you'd pick if you weren't going to cook it yourself!



BUTTERBALL TURKEY BREAST 488¢ LB. SUICED TO ORDER

AVAILABLE IN DELI-BAKERY STORES ONLY!

## ✓ Your Choice for Savings on Health & Beauty Needs

50-CT. BTL. NUPRIN TABLETS 408

- 1.25-OZ. ROLL-ON POWDER OR UNSCENTED SURE DEODORANT .... 1.86
- 2-OZ. SOLID POWDER, REGULAR OR UNSCENTED SURE DEODORANT .... 2.57
- 4-OZ. SPRAY SPICE, REGULAR OR UNSCENTED SURE DEODORANT .... 2.37
- 3.9-OZ. SIZE FOR DRY SKIN POND'S COLD CREAM . 3.03

## ✓ Your Choice for Grocery Values



5-LB. BAG THRIFTY MAID PURE CANE SUGAR

139

WITH 10.00 OR MORE ORDER (LIMIT 1)



12-PAK 12-OZ. CANS MILLER BEER

- REG. •LITE •GENUINE DRAFT

519



24-OZ. LOAF DIXIE DARLING SANDWICH BREAD

2119 FOR



13-OZ. BAG MAXWELL HOUSE COFFEE ALL GRINDS

179



16-OZ. BOX MUELLER'S SPAGHETTI

- REG. •THIN

69¢



40¢ OFF LABEL 22-OZ. BTL. JOY DISH-WASHING LIQUID

109



18½-OZ. BOX DUNCAN HINES CAKE MIXES ALL FLAVORS EXCEPT ANGEL FOOD

79¢



32-OZ. JAR RAGU HOMESTYLE SPAGHETTI SAUCE ALL VARIETIES

119



64-OZ. BTL. WISK DETERGENT

299

## ✓ Your Choice for Harvest Fresh Fruits and Vegetables



HARVEST FRESH TENDER GREEN BROCCOLI

89¢ EA.

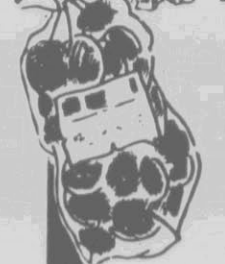

4-LB. BAG HARVEST FRESH RED DELICIOUS APPLES

149

## ✓ Your Choice for Variety in our Dairy & Frozen Food



½-GAL. JUG SUPERBRAND 100% PURE FLORIDA ORANGE JUICE

139



2-LB. BOX FREEZER QUEEN SUPPERS ALL VARIETIES

149

16-OZ. BOX TASTE O' SEA PERCH FILLETS 169

# WINN-DIXIE

America's Supermarket

## YOUR CHOICE FOR LOW PRICES

HELP YOUR KIDS MAKE THE RIGHT CHOICE ABOUT DRUGS.



Take home WINN-DIXIE'S videotape promoting a drug-free lifestyle.

## FREE RENTAL

This video can help you teach your children and their friends to lead drug-free lives. It has been written and produced by WINN-DIXIE in conjunction with the F.B.I. and is suggested for ages 9-12. Rental tapes are available at all WINN-DIXIE stores. Reserve one today. VHS format.

\*PRICES GOOD WED., SEPT. 14TH THRU TUES., SEPT. 20TH \*NONE TO DEALERS \*WE RESERVE THE RIGHT TO LIMIT QUANTITIES ©COPYRIGHT 1988, WINN-DIXIE STORES, INC.

# Overtton's has the Best Meats & Finest Produce in Greenville!

PLUS SUPER FAST SERVICE-AND LOW, LOW PRICES

**FRESH FRYER LEG QUARTERS**

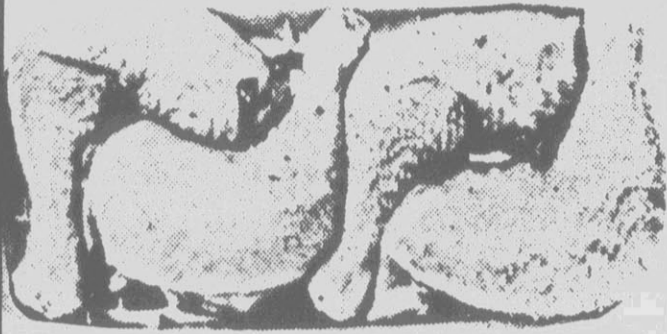

LIMIT 2 BAGS PER CUSTOMER PER ORDER WITH \$10.00 FOOD ORDER

**FRESH WHOLE PICNICS**

SLICED...LB.



**38¢** **69¢**

GROUND FRESH SEVERAL TIMES DAILY  
**GROUND BEEF** 5 LBS. OR MORE LB. **99¢**

**TURKEY WINGS** 10 LB. PKG. **\$2.99**  
**PORK NECK BONES** 10 LB. PKG. **\$2.99**

**LOIN END PORK ROAST** LB. **99¢**  
SLICED FREE

LUTER'S SMITHFIELD **BACON** REGULAR THIN OR THICK LB. **\$1.19**

**FAMILY PACK SPECIAL END CUT PORK CHOPS** 5 LB. PKG OR MORE **99¢** LB.

**TENDER FRESH CUBED STEAK** **\$1.99** LB.

**FROZEN FOOD SALE**

PRICES EFFECTIVE WEDNESDAY, SEPTEMBER 14-SATURDAY, SEPTEMBER 17, 1988



211 JARVIS STREET  
"HOME OF GREENVILLE'S BEST MEATS"  
QUANTITY RIGHTS RESERVED

STORE HOURS: OPEN SUNDAYS 1 P.M.-6 P.M.  
MONDAYS-SATURDAYS, 8 A.M.-8 P.M.

*Supermarket Inc*

QUANTITY RIGHTS RESERVED

**FROZEN FOOD SALE**

GREEN GIANT FROZEN  
**ONE SERVING MICROWAVE VEGETABLE WITH BUTTER SAUCE**

- CORN ON THE COB..... YOUR CHOICE
- NIBLETS CORN..... 4.5 OZ. 69¢
- LESUEUR PEAS..... 4.5 OZ.
- CUT BROCCOLI..... 4.5 OZ.
- CAULIFLOWER WITH CHEESE..... 5.5 OZ.
- BROCCOLI WITH CHEESE..... 5.0 OZ.
- WELCH'S GRAPE JUICE..... 12 OZ. CAN **79¢**
- HAMILTON ICE CREAM SANDWICHES..... 15 OZ. PKG. OF 6 **99¢**
- JUICESICLES..... 12 COUNT **79¢**
- TOTINO'S PIZZAS..... ALL VARIETIES 12 OZ. **79¢**
- FLAV-O-RITE FROZEN ORANGE JUICE..... 6 OZ. CAN **3 FOR \$1.00**
- FARMER'S CHOICE FROZEN FRENCH FRIES..... 2 LB. BAG **2 FOR \$1.00**

**DELI SPECIALS:**

- BOILED HAM..... LB. **\$2.99**
- AMERICAN CHEESE..... LB. **\$1.99**
- SWISS CHEESE..... LB. **\$2.99**
- VIRGINIA BAKED HAM..... LB. **\$2.99**

FRESH FROZEN **SPARERIBS** LB. **\$1.29**

**FREE**  
BUY ONE GET ONE FREE!



**PAPER TOWELS**

GIANT ROLL  
LIMIT 3 WITH \$10.00 FOOD ORDER EXCLUDING ADVERTISED SPECIALS.

**29**

**FAB DETERGENT**  
GIANT 42 OZ. BOX



LIMIT ONE BOX PER CUSTOMER PER ORDER WITH A \$10.00 FOOD ORDER EXCLUDING ADVERTISED SPECIALS.

**99**

KINGSFORD **CHARCOAL** 10 LB. BAG **\$2.49**

CHIQUITA POPS..... 16 OZ. PKG. 8 COUNT **\$1.99**

**PEPSI COLA** ALL 2 LITER PRODUCTS **99¢**

CAMPBELL'S **TOMATO SOUP**



**28**

PENOBSCOT STUFFED POTATOES 10 OZ. PKG. **79¢** VALUE  
WITH CHEESE OR WITH SOUR CREAM

TIDY CAT CAT LITTER 5 LB. BAG **99¢** VALUE

JACK RABBIT POPCORN..... 2 LB. BAG **79¢** VALUE

DUDLEY FARMS APPLE JUICE..... GALLON JUG **\$1.99** VALUE



OSCAR MAYER **ALL MEAT WIENERS** LB. PKG. **\$2.29**  
BUY ONE, GET ONE FREE



**DUNCAN HINES CAKE MIX** YELLOW, BUTTER GOLDEN, DEVILS FOOD ONLY 17 OZ. BOX  
LIMIT 2 PER CUSTOMER PER ORDER

**69**

LOOSE-YOU BAG 'EM **FRESH RED POTATOES** 5 LBS. FOR **\$1**

FRESH FROM THE GARDEN **FROZEN VEGETABLES** 6-8 LB. AVERAGE LB. **99¢**  
MOST ALL ITEMS AVAILABLE. PACKED AND CONVENIENT FAMILY PACKS.

**FRESH BAKING POTATOES** MEDIUM SIZE PKG. OF 5 **99¢**

**SEEDLESS WHITE GRAPES** LB.

**YELLOW ONIONS** 3 LB. BAG

**TENDER FRESH BROCCOLI** A BUNCH



**69**



**79**



**99**

# SEARS

Sale ends Saturday, Sept. 17

## VALUES HAVE NEVER BEEN SO GREAT!

Most items at reduced prices

### NO MONTHLY PAYMENTS UNTIL NEXT YEAR!

No payments until January 1989 on Sears Deferred Credit Plan. There will be a finance charge for the deferral period.

Sears  
Kenmore  
Birthday  
Sale

## SAVE \$240 on pair

### THE LARGEST USABLE CAPACITY IN THE INDUSTRY\*

**399<sup>98</sup>**  
Reg. \$529.99  
Washer

**299<sup>98</sup>**  
Reg. \$409.99  
Dryer

ONLY \$22 per month<sup>a</sup> on SearsCharge<sup>®</sup> for this \$639.98 pair

Exclusive Dual Action<sup>®</sup> agitator in washer

- 10 washing cycles including knit
- 5 water temps. and 3 water levels
- Self-cleaning lint filter

Gas dryers \$40 more.

White. Colors extra. Dryer connectors extra.

Auto Fabric Master in dryer

- 8 drying cycles including delicate
- 4 temperatures for total fabric care
- Huge Easy Loader door

<sup>a</sup>Your actual monthly payment can vary depending on your account balance.

\*Based on DOE measurements and the results of washability tests using standard AHAM test loads and washability standards.



18101

Large capacity pair

**\$289** **\$239**

Washer.  
3 cycles.

Dryer.  
2 cycles

White only.

28731

68731

Each of these advertised items is readily available for sale as advertised

ALL STORES NOW OPEN SATURDAY MORNING AT 9 AM

Satisfaction guaranteed  
or your money back

©Sears, Roebuck and Co., 1988

Items indicated "larger stores only" are available in Barboursville, Charleston, SC (Northwoods), Charleston, WV, Charlotte, Columbia, Durham, Fayetteville, Greensboro, Raleigh, Roanoke, Wilmington and Winston-Salem.

"Sears Pricing Policy: All reductions are from Sears regular prices unless otherwise stated. If an item is not described as reduced or a special purchase, it is at its regular price. A special purchase, though not reduced, is an exceptional value."

Large items such as furniture and appliances are inventoried in our distribution center and will be scheduled for pick-up or delivery. Delivery is not included in selling prices.

# SEARS

2C4 9/14/88

Sears  
Kenmore  
Birthday  
Sale

# PICK YOUR POWER! ONLY SEARS HAS KENMORE VACS

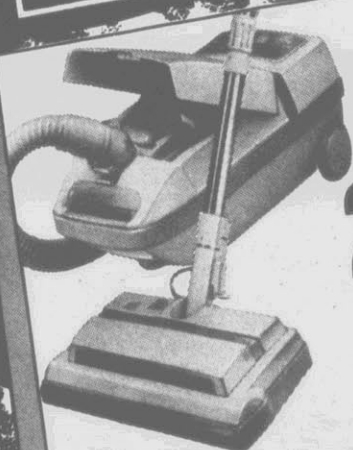

26450

**\$130 OFF!**  
**299<sup>99</sup>**

Reg. \$429.99

**4.5 peak HP**  
Vac with powerful suction (1.30 HP VCMA). Motor has 3 speeds.  
While quantities last



26320

**SAVE \$70**  
**169<sup>99</sup>**

Reg. \$239.99

**3.9 peak HP**  
Heavy-duty motor (.95 HP VCMA) and brush edge clean.

**SAVE \$60**  
**159<sup>99</sup>**

Reg. \$219.99

**2-speed upright**  
Active edge cleaner. Powerful floor light.



35502



28430

**SAVE \$100**  
**299<sup>99</sup>**

Reg. \$399.99

**4.3 peak HP**  
Big power (1.1 HP VCMA). Active edge cleaner.

**1/2 PRICE**  
**99<sup>99</sup>**

Cat. price \$199.99

**2-speed upright**  
Double beater bar/brush. 8 pile heights. Floor light.



37602



28393

**SAVE \$80**  
**219<sup>99</sup>**

Reg. \$299.99

**3.9 peak HP**  
Brush edge clean, suction power control (.95 HP VCMA).

**GREAT BUY!**  
**59<sup>99</sup>**

Sears Everyday Low Price  
**Upright vacuum**  
Twin motor fans for deep cleaning. Bright floor light.



32402

Each of these advertised items is readily available for sale as advertised

# KENMORE: #1 IN AMERICA'S KITCHENS EXCLUSIVELY AT SEARS!



84171

**SAVE \$20**  
A great sale price! Oak laminate microwave cart with cabinet doors.

**39<sup>99</sup>** Reg. \$59.99

**ALL WALL OVENS ON SALE**



40188

**SAVE \$60**  
Electronic clock and timer. Delay cook. Visi-Bake oven door.

**389<sup>98</sup>** Reg. \$449.99  
Other wall ovens also on sale

**ALL COOKTOPS ON SALE**



43573

**SAVE \$110**  
European style. 4 elements on tempered black glass.

**289<sup>98</sup>** Reg. \$399.99  
Other cooktops on sale

**YOU CAN'T  
BEAT  
SELECTION AND SAVINGS!**



91481

**SAVE \$100**  
Electronic clock and timer. Solid black glass door.

**369<sup>98</sup>** Reg. \$469.99  
White. Colors extra



51861  
92861

**SAVE \$100**  
Continuous Cleaning\* oven. Electronic clock. Rangehood . . . **69.99**

**399<sup>98</sup>** Reg. \$499.99  
White. Colors extra  
Helps clean spatters at baking temperatures.



83481

**SAVE \$180**  
Self-cleaning oven. Electronic clock and timer.

**499<sup>98</sup>** Reg. \$679.99  
White. Colors extra

Each of these advertised items is readily available for sale as advertised

Sears  
Kenmore  
Birthday  
Sale

# KENMORE FREEZERS ONLY AT SEARS!

**KENMORE—BACKED  
BY 60 YEARS OF  
DEPENDABILITY**

**SAVE \$40**

**6.0 cu. ft. upright freezer**

- Security lock protects your investment
  - Adjustable cold control
  - Textured steel door hides smudges
- Reg. \$269.99

**SAVE \$20**

**6.0 cu. ft. chest freezer**

- Power signal light and security lock
  - Durable security lock
  - 1 lift-out Spacemaster basket
- Reg. \$249.99 Almond color.

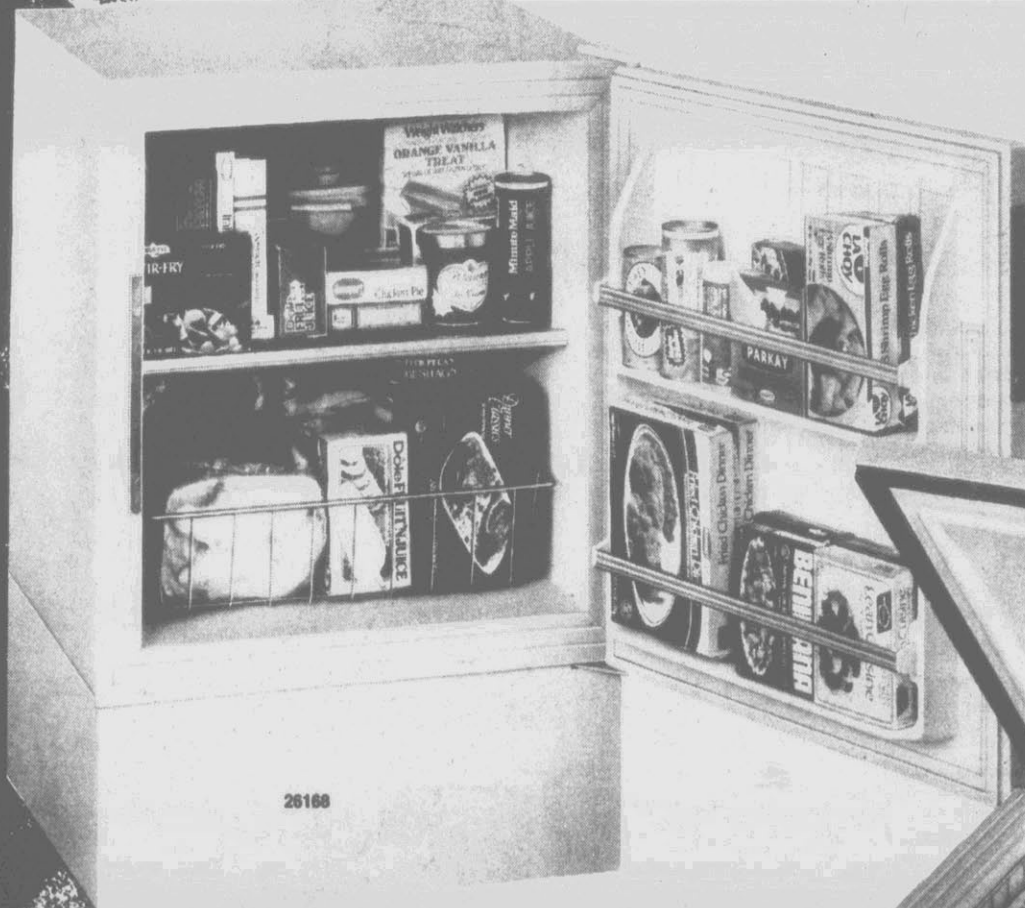

**YOUR  
CHOICE** **229<sup>98</sup>** each

**ONLY \*10 per month\* on SearsCharge**  
\*Your actual monthly payment can vary  
depending upon your account balance.

Each of these advertised items is readily available for sale as advertised

**SPACE A PROBLEM? THIS HUGE  
18.0 CU. FT. IS ONLY 29<sup>3</sup>/<sub>4</sub> in. WIDE!**

*Sears  
Roebuck  
Birthday  
Sale*

**EMERGENCY  
DELIVERY OF  
REFRIGERATORS  
IN MOST AREAS**

Delivery not included in  
selling price of all major  
home appliances



**NEVER DEFROST  
AGAIN!  
SAVE \$150-\$170  
599<sup>98</sup>**

Reg.  
\$749.99

**ONLY \$19 per month\* on SearsCharge  
ALL-FROSTLESS**

- 18.0 cu. ft. total capacity
- Quality glass shelving
- Meat pan, crisper, and Nice 'N Fresh for food storage
- Textured steel door
- Adjustable rollers for easy moving

White. Colors extra. Icemaker hookup extra.

**WITH ICEMAKER  
ONLY \$80 MORE**

Reg. \$849.99 ..... 679.99

\*Your actual monthly payment can vary depending upon your account balance.



**SAVE \$100  
BIG BUY!  
\$399**

15.1 cu. ft.  
capacity  
Manual defrost.  
Crisper. White.  
Reg. \$499



**SAVE \$100  
FROSTLESS!  
599<sup>98</sup>**

Reg.  
\$699.99

19.8 cu. ft.  
capacity  
Meat pan for  
storage. White.



**SAVE \$200  
799<sup>98</sup>**

Reg.  
\$999.99

Ice thru  
the door  
19.8 cu. ft. total  
capacity.  
White. Colors extra

Each of these advertised items is readily available for sale as advertised

# 19-INCH TV WITH MTS STEREO AT A PRICE YOU'LL FIND HARD TO TOP

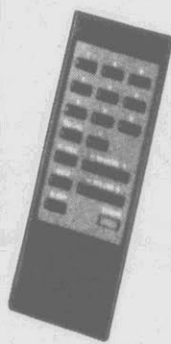

42305

**SAVE \$100**

**299<sup>99</sup>**

Catalog price \$399.99

- 18-key remote with channel scan, more
- Reliable electronic quartz tuning
- Cable-compatible—up to 139 channels
- On-screen time and channel display

ONLY \$13 a month\* on SearsCharge

\*Your actual monthly payment can vary depending on your account balance.

97551

**SAVE \$30**  
LXI CD player  
with remote,  
track memory

**189<sup>99</sup>**  
Reg. \$219.99

9550

**SAVE \$200**  
PIONEER  
stereo with  
CD player

**799<sup>99</sup>**  
Reg. \$999.99

92811

**SAVE \$80**  
Rack stereo  
system with  
dual cassettes.

**319<sup>99</sup>**  
Reg. \$399.99

40453

**SAVE \$60**  
13-in. color  
TV with remote,  
cable-compatible

**219<sup>99</sup>**  
Reg. \$279.99

48208

**SAVE \$150**  
25-in. color  
console with  
MTS stereo

**499<sup>99</sup>**  
Reg. \$649.99

42881

**SAVE \$150**  
RCA 26-in. color  
TV/monitor,  
MTS stereo

**499<sup>99</sup>**  
Reg. \$649.99

42912

**SAVE \$50**  
SONY 27-in.  
color TV/monitor,  
MTS stereo

**699<sup>99</sup>**  
Reg. \$749.99

48727

**SAVE \$200**  
RCA 26-in.  
color  
MTS stereo  
console

**699<sup>99</sup>**  
Reg. \$899.99

54711

**SAVE \$500**  
31-in. MTS  
stereo giant  
screen,  
bi-fold doors

**1999<sup>99</sup>**  
Reg. \$2499.99

TV picture sizes on page measured diagonally

Each of these advertised items is readily available for sale as advertised

NO BRIGHTER OR SHARPER PICTURE AT THIS PRICE—NO FINER WARRANTY ANYWHERE!

GIANT SCREEN  
**TV**

LAST 4 DAYS:  
NO LOWER PRICE  
IN 1988!

SAVE \$800  
**\$1999**

Reg.  
\$2799.99

54461

ONLY \$50 a month\* on SearsCharge PLUS<sup>†</sup>

- Bi-fold doors
- 160° wide-angle viewing
- 70% brighter than last year
- Universal remote for cable, TV, and VCR
- On-screen menu displays TV functions, controls
- A/V jack with surround sound
- Reliable quartz tuning with MTS stereo surround sound
- Programmable timer
- Picture within a picture: see 2 programs at once
- Beautiful furniture styling fits nearly every decor
- Easy-gliding castors

46-in

NO SSSSSS  
**PAYMENTS**  
TIL NEXT YEAR

No monthly payments until January 1989 on Sears Deferred Credit plan. There will be a finance charge for the deferral period. Your actual monthly payment can vary depending on your account balance.

**STEREO**  
MTS



24085

SAVE \$60  
AT&T® 5300  
cordless  
phone

**159<sup>99</sup>**  
Reg. \$219.99

Not available in Ashland, Christ-  
iansburg, Monroe, New Bern,  
Roanoke Rapids, Shelby and  
Williamson.



53002

Not available in  
Ashland, Christ-  
iansburg, Monroe,  
New Bern, Roanoke  
Rapids, Shelby and  
Williamson.

SAVE \$60  
Electronic  
typewriter  
with daisy wheel

**159<sup>99</sup>**  
Reg. \$219.99



21108

SAVE 25%  
Personal  
stereo  
cassette

**11<sup>99</sup>**  
Reg. \$15.99

Reg. \$24.99 re-  
corder . . . . 19.99

\*SearsCharge PLUS is available for most major purchases totaling \$700 or more.

TV picture sizes on page measured diagonally

Each of these advertised items is readily available for sale as advertised

# SEARS

# VALUES HAVE NEVER BEEN SO GREAT!

AMERICA'S BEST-SELLING  
CAMCORDER OUTFIT NOW  
INCLUDES \$149 TELEPHOTO  
LENS—FREE\*!

SAVE \$300  
**999<sup>99</sup>**

Reg.  
\$1299.99

ONLY \$25 a month\*\* on  
SearsCharge PLUS\*

- 7 lux rating for low light use
  - Solid-state MOS element
  - 6X power zoom magnification
- SAVE \$20 tripod. Reg. \$79.99. .59.99  
SAVE 20% Video tape. Reg.  
\$4.99 ..... 3.99



We include accessories many  
others usually charge extra for!

**FREE**  
Telephoto lens  
\*with purchase  
Reg. \$149.99  
While quantities last.

53742

SAVE \$40  
Goldstar VCR  
with auto-rewind

**179<sup>99</sup>**  
Reg.  
\$219.99

SAVE \$70  
VCR with  
on-screen  
display, remote

**279<sup>99</sup>**  
Reg.  
\$349.99

SAVE \$100  
VCR with on-  
screen display,  
MTS, remote

**319<sup>99</sup>**  
Reg.  
\$419.99

\*SearsCharge PLUS is available for most  
major purchases totaling \$700 or more.

Each of these advertised items is readily available for sale as advertised.  
Your actual monthly payment can vary depending on your account balance.

SEARS

DISCOVER

Satisfaction guaranteed  
or your money back

©Sears, Roebuck and Co., 1988

ALL STORES NOW OPEN SATURDAY MORNINGS AT 9 AM

NC: Burlington, Charlotte (Eastland, Southpark), Concord, Durham, Fayetteville,  
Gastonia, Goldsboro, Greensboro, Greenville, Hickory, High Point, Jacksonville,  
Raleigh, Rocky Mount, Wilmington, Winston-Salem

SC: Charleston (Citadel, Northwoods), Columbia, Florence, Myrtle Beach, Rock Hill

VA: Danville, Lynchburg, Roanoke

WV: Barboursville, Beckley, Bluefield, Charleston

KY: Ashland

# SEARS

# SEARS SALE OF CHAMPIONS

Saluting athletes of the world with super fitness buys like this!

Most items at reduced prices

ON SALE	W	T	F	S
SEPT. 14-17	14	15	16	17

Items indicated "larger stores only" are available in Barboursville, Charleston, SC (Northwoods), Charleston, WV, Charlotte, Columbia, Durham, Fayetteville, Greensboro, Raleigh, Roanoke, Wilmington and Winston-Salem.

MORE GREAT VALUES!



## SAVE \$300

### ONLY AT SEARS! THE BEST TREADMILL VALUE IN AMERICA!

#### NEW! Lifestyler™ ergometer treadmill

As the #1 exercise equipment outlet in America, we demand the latest innovations and highest quality for our Lifestyler™ equipment. We believe the exclusive combination of features and price, backed by nationwide warranty and parts and service availability, make this the best treadmill value in America.

SAVE \$300 **399<sup>99</sup>**  
Reg. \$699.99 in 1988 Fall General Catalog

One week only or while quantities last

Digital ergometer computer monitors your workout AND MEASURES CALORIES BURNED!



**5-FUNCTION MONITOR**  
 • CALORIES • SPEED  
 • PULSE • DISTANCE  
 • TIME

- Vary your walking or jogging speed from 1.75 to 5.0 MPH
- Removable siderails for convenience
- Simulate running conditions with 0 to 15 degree incline adjustment
- Spacious 13x48-in. jogging surface with dismount footpads
- Lockout safety switch feature helps prevent accidental startups
- ½ H.P. General Electric motor



29622  
**STORES EASILY! REMOVE SIDERAILS, FOLD, AND ROLL AWAY!**

**NO \$\$\$\$\$\$ PAYMENTS 'TIL NEXT YEAR**  
No monthly payments until January 1989 on Sears Deferred Credit plan. There will be a finance charge for the deferral period. Your actual monthly payment can vary depending on your account balance.

**13<sup>99</sup> each**  
**PRO WEIGHT® SWEATS**  
 Oversized separates for men/women in many colors. Available in larger stores only.

**SAVE \$160**  
 Ergometer cycle  
 Lifestyler 575-dual action with locking handlebar feature. 7-function electronic console.  
**199<sup>99</sup>**  
Reg. \$359.99

**SAVE \$80**  
 132-lb. wt. set/bench. DP\* bench with 700-lb. capacity (user plus weights).  
**119<sup>98</sup>**  
Reg. separate prices total \$199.98

**YOUR CHOICE**  
 12-speed racer: Men's/women's 27-in. Caliper brakes. **99<sup>99</sup> each**  
 Boys' 20-in. BMX: Caliper brakes.

**SAVE \$101**  
 Table tennis combo. Includes 12 official olympic balls.  
**179<sup>99</sup>**  
Reg. separate prices total \$281.98

**SAVE \$40**  
 Electronic I-Beam rower  
 Electronic rower has console that features countdown timer.  
**129<sup>99</sup>**  
Reg. \$169.99

**Sport roll bag.** Water repellent 420 denier nylon. Web straps. **7<sup>88</sup>**  
Reg. \$9.99  
**Duffel bag.** Water repellent 420 denier nylon. End pocket. **17<sup>88</sup>**  
Reg. \$19.99  
 Available in larger stores only.

**12-speed touring.** Men's/women's 26-in. **109<sup>99</sup> each**  
Reg. \$169.99\*  
**YOUR CHOICE**  
 All-terrain bike. Men's/women's 10-speed. **109<sup>99</sup> each**  
\*In 1988 Annual Catalog. Quantities limited

**A SEARS EXCLUSIVE: LOBO III**  
 Radio control truck. Rechargeable battery pack. Fast 1-hour charger.  
**49<sup>99</sup>**  
19<sup>99</sup> 24<sup>99</sup>  
 Available in larger stores only.

Sears Pricing Policy: All reductions are from Sears regular prices unless otherwise stated. If an item is not described as reduced or a special purchase, it is at its regular price. A special purchase, though not reduced, is an exceptional value.

Bikes, exercise equipment require some assembly and are not available in Ashland, Shelby and Williamson.

SEARS



# FROM BASICS TO JACKETS SEARS FOR SCHOOL-TIME SAVINGS 20% OFF ALL KIDS' APPAREL

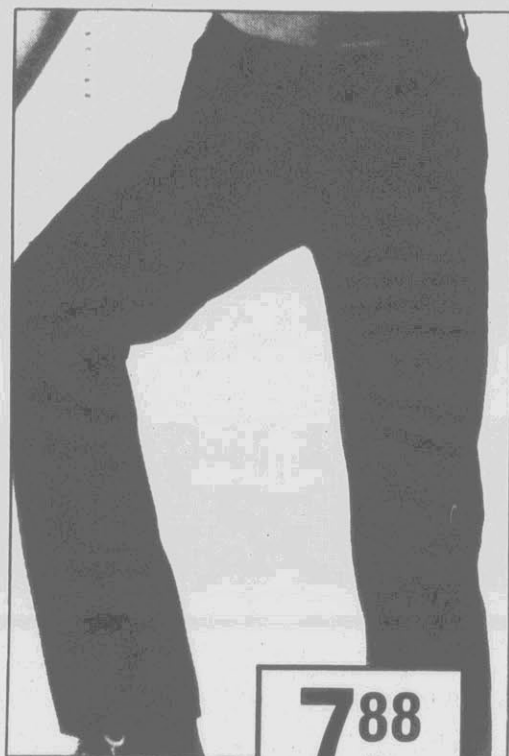

**7<sup>88</sup>**  
Reg. \$12.99

**BOYS' ORIGINAL TOUGHSKIN'S®**

Jeans of durable Dacron® polyester, Dupont 420® nylon, cotton. 8-14. 4-7 and Husky sizes, reg. \$11.99, \$15.99 . . . . . 7.88, 10.88



**9<sup>88</sup>**  
Reg. \$16.99

**25% OFF ALL OTHER BOYS' AND GIRLS' SWEATERS BOYS' AND GIRLS' COLORFUL SWEATERS**

Boys' jacquard sweater is of easy-care 100% acrylic. Sizes 8-20. Girls' crop sweater comes in solid or stripes. 100% acrylic. 7-16. Boys' long-sleeve twill woven shirt, reg. \$14.99. . . . . 9.88

**7<sup>88</sup>**  
Reg. \$12.88



**34<sup>88</sup>**  
Reg. \$49.99

**GIRLS' PADDED DENIM JACKET**

Of 100% cotton. Lined with snap front and fur collar! Sizes 7-16. 30% OFF ALL OTHER GIRLS' OUTERWEAR



**13<sup>88</sup>**  
Reg. \$19.99

**BOYS' PLEATED TWILL PANTS**

Tiger Bay pants of 100% cotton. Prewashed for comfort! Assorted colors. 8-20. 30% OFF ALL OTHER TIGER BAY CASUAL PANTS

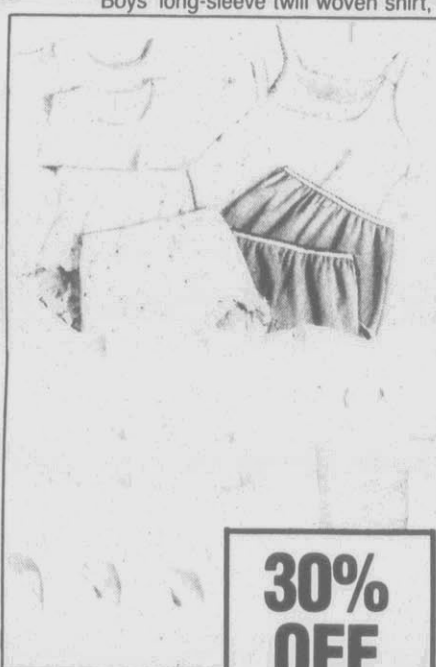

**30% OFF**

**BOYS' GIRLS' UNDERWEAR**

Selected boys' styles, sizes 4-20. All girls' styles, 4-14. Infants' one piece, S, M, L.

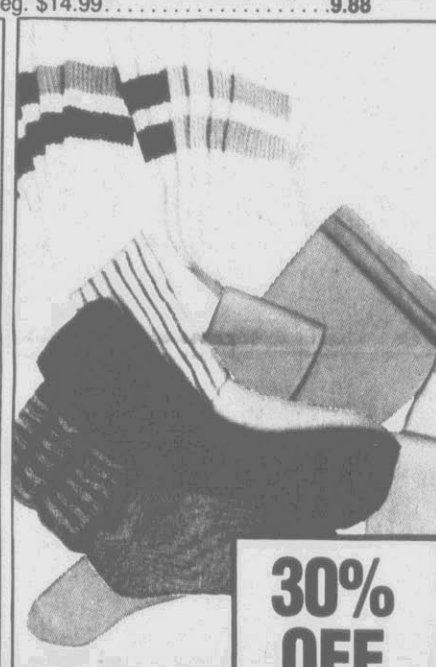

**30% OFF**

**BOYS' GIRLS' AND TODDLERS' HOSIERY**

In assorted styles and colors. Boys' S, M, L, XL. Girls' M, L. Toddlers' dress tights, 2T-4T.



**9<sup>88</sup>**  
Reg. \$12.99

**GIRLS' 100% COTTON SHIRT**

In stripes, checks or solids! Great match with jeans. Sizes 7-16.



## EVERYTHING FOR BABY NOW ON SALE!



©Walt Disney Productions

**1/3 OFF**

**All Winnie-the-Pooh nightwear**  
Shown: \$10.99 grow sleeper, 1T-4T . . . . . 7.29  
\$12.99 blanket sleeper, 1T-4T . . . . . 8.59  
Other Winnie-the-Pooh nightwear at similar sale prices

**YOUR CHOICE!**

**2 for 2<sup>88</sup>**  
Reg. \$2.19-\$2.69

**Pacifier, mirror, booties, other nursery needs**

**YOUR CHOICE!**

**88¢**  
ea.  
Save 40% to over 50%

**Spoon, bib and more**  
Rattles and diaper pins . . . 2 for 88¢

**YOUR CHOICE**

**69<sup>99</sup>**  
Reg. \$89.99-\$99.99

**Way-to-Go® stroller, maple color crib and GT-2000 car seat**  
All strollers, cribs and car seats on sale.

**4<sup>99</sup>**  
EACH  
Reg. \$6.99-\$7.99 ea.

**SAVE \*2-\*3 on bath tub and bath cushion**  
All baths and diaper pails now on sale.

**8<sup>99</sup>**  
EACH  
Reg. \$10.99-\$11.99 ea.

**SAVE \*2-\*3 on training seat or booster seat**  
25% off all cloth diapers and waterproof pants.

**9<sup>99</sup>**  
EACH  
Reg. \$15.99

**SAVE \*6 Washable diaper bag in asst. prints**  
1/3 off all diaper bags.

**19<sup>99</sup>**  
Reg. \$29.99

**SAVE \*10 Inflatable walker, heavy-duty vinyl**  
All walkers now on sale.

# 15 OF OUR BEST-SELLING BASICS



COME SEE THESE ESSENTIALS AND MANY, MANY MORE ALL ON SALE NOW!

YOUR CHOICE **4<sup>88</sup>**

YOUR CHOICE **6<sup>88</sup>**

YOUR CHOICE **8<sup>88</sup>**



**Simple Sizing bra**  
Beautifully feminine bra of all-stretch floral lace with front closure and comfortable, stretch straps. **4<sup>88</sup>**  
Reg. \$7

**Lace Crossover bra**  
Elastic inserts cross between cups for a great fit. Lace cups are lined with cotton for comfort. **6<sup>88</sup>**  
Reg. \$9.50

**Pretty Comfort Ah-h Bra<sup>®</sup>**  
Sears Best bra with quilted side panels for extra comfort and support. Pretty seamed lace cups. **8<sup>88</sup>**  
Reg. \$12

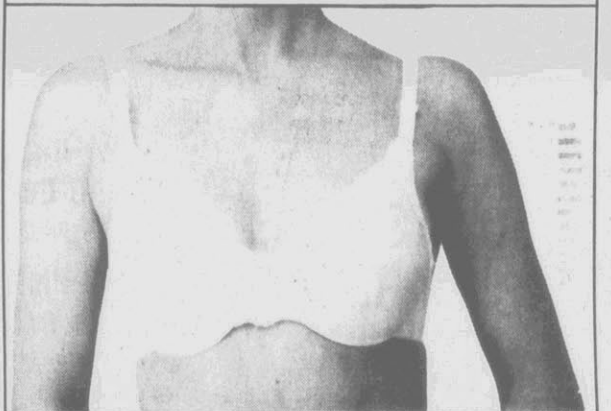
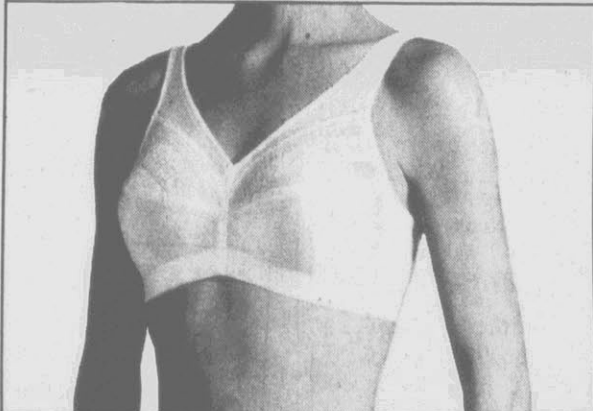

**Support, control top pantyhose**  
Choose styles from Sears exclusive sheer hosiery brands: Hug-alon<sup>®</sup>, Cling-alon<sup>®</sup> and Nice Touch<sup>™</sup>. **4<sup>88</sup>**  
2 pr. Hug-alon shown  
Reg. \$3.49 pr.  
Not available in Myrtle Beach.

**Full figure bra**  
Nylon tricot and lace cups lift and support. Stretch bottom band for comfort. Longline bras also on sale. **6<sup>88</sup>**  
Reg. \$9.50

**Lite 'N Lacey Ah-h Bra<sup>®</sup>**  
Seamless polyester tricot underwire cups and adjustable stretch straps give comfortable support. Cushioned back elastic sides. **8<sup>88</sup>**  
Reg. \$13.50

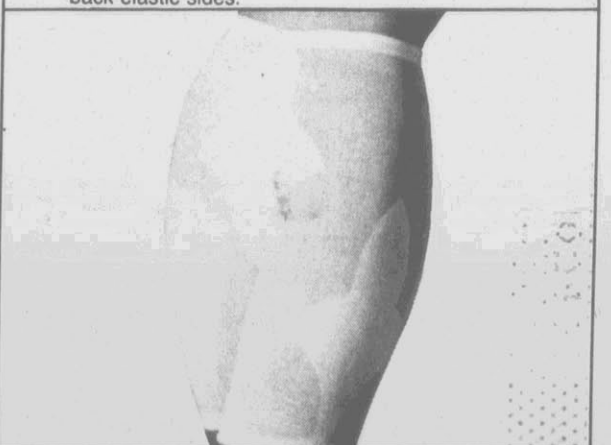
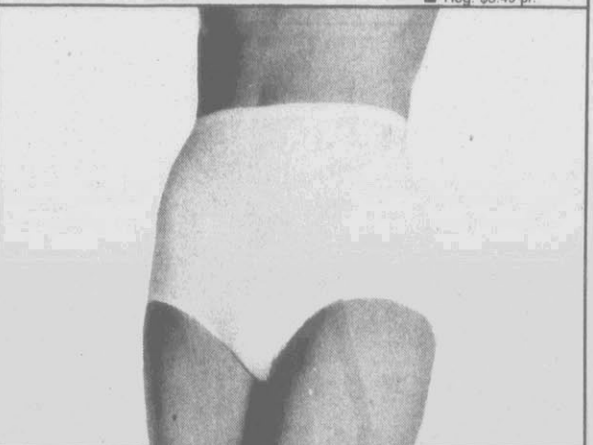

**Combed Cotton panties**  
Of soft 100% shrinkage-controlled combed cotton. Choose hipgiggers, hi-leg briefs or briefs. **4<sup>88</sup>**  
Pkg. of 3  
Reg. \$7

**T-back sports bra**  
With adjustable non-stretch straps, smooth seamless cups and a convenient front closure. **6<sup>88</sup>**  
Reg. \$11

**Tulip shaper**  
Lightweight fabric with tulip-shaped panels that give comfortable, moderate control and a smooth look. **8<sup>88</sup>**  
Reg. \$12

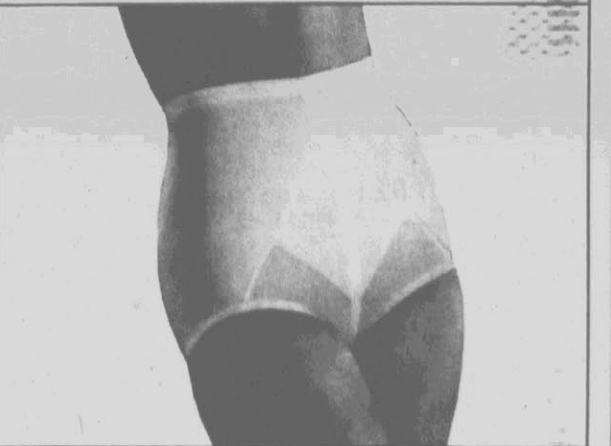
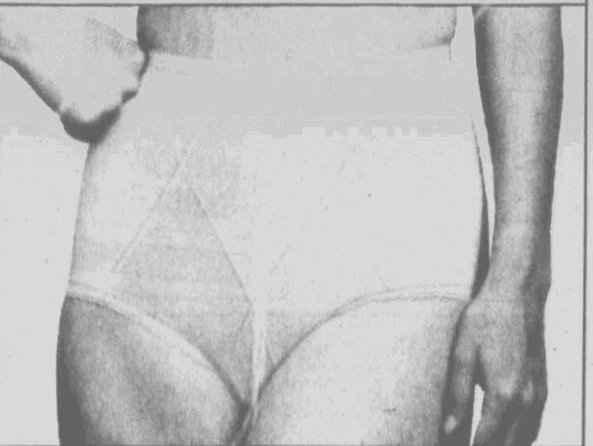
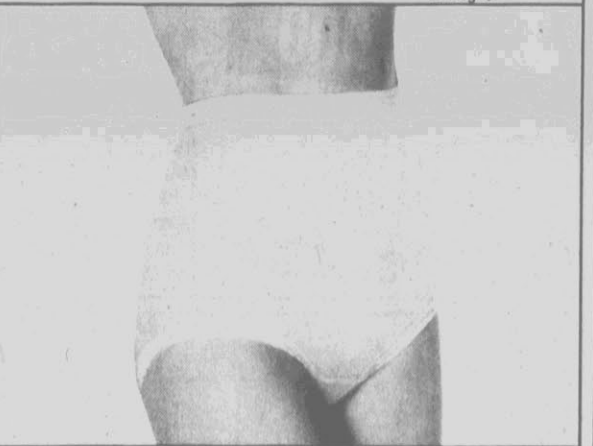

**The Doesn't Panty<sup>™</sup>**  
With seams that won't show through your clingiest clothes. Bikinis, briefs and hipgiggers. **4<sup>88</sup>**  
2 pr.  
Reg. \$3.25 pr.

**Soft Shape Ultra Fit brief**  
Provides smooth, comfortable control with a little sparkle! Available in Misses' and plus sizes. **6<sup>88</sup>**  
Reg. \$9

**Diet Trim shaper**  
Comfortably adapts 2 sizes with weight changes. Inside panels provide firm control and shaping. **8<sup>88</sup>**  
Reg. \$14

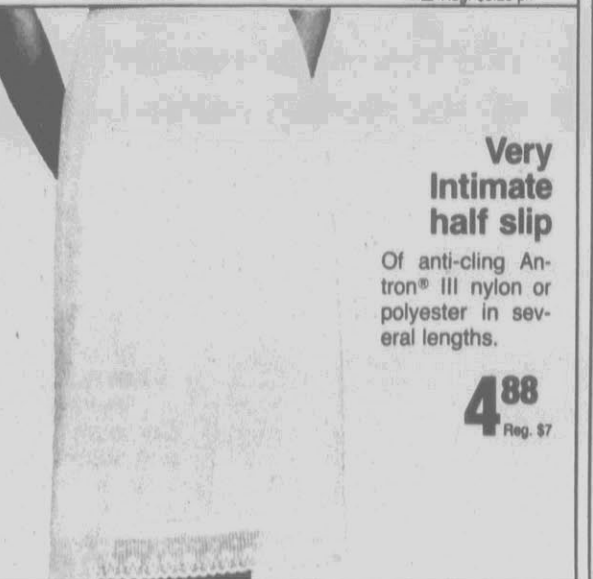

**Very Intimate half slip**  
Of anti-cling Antron<sup>®</sup> III nylon or polyester in several lengths. **4<sup>88</sup>**  
Reg. \$7

**Clip-it half slip**  
Shortens 2 or 4 inches without sewing! Clean, classic lines. **6<sup>88</sup>**  
Reg. \$9

**Shadow Panel full slip**  
Of anti-cling Antron<sup>®</sup> III nylon with seam-to-seam front panel for no show-thru. **8<sup>88</sup>**  
Reg. \$11.50



YOUR CHOICE  
**49<sup>99</sup>**

**CRAFTSMAN  
PORTABLE  
POWER  
TOOLS**

- 2 1/2-inch belt sander with belts and case  
3/8-HP motor. With flush sanding.
- 7 1/4-inch circular saw with extra blade  
Powerful 2-HP motor. 5000 RPM.
- Rechargeable cordless drill with fasteners  
2-speed. Features pistol grip handle.  
Special purchase. Quantities limited.

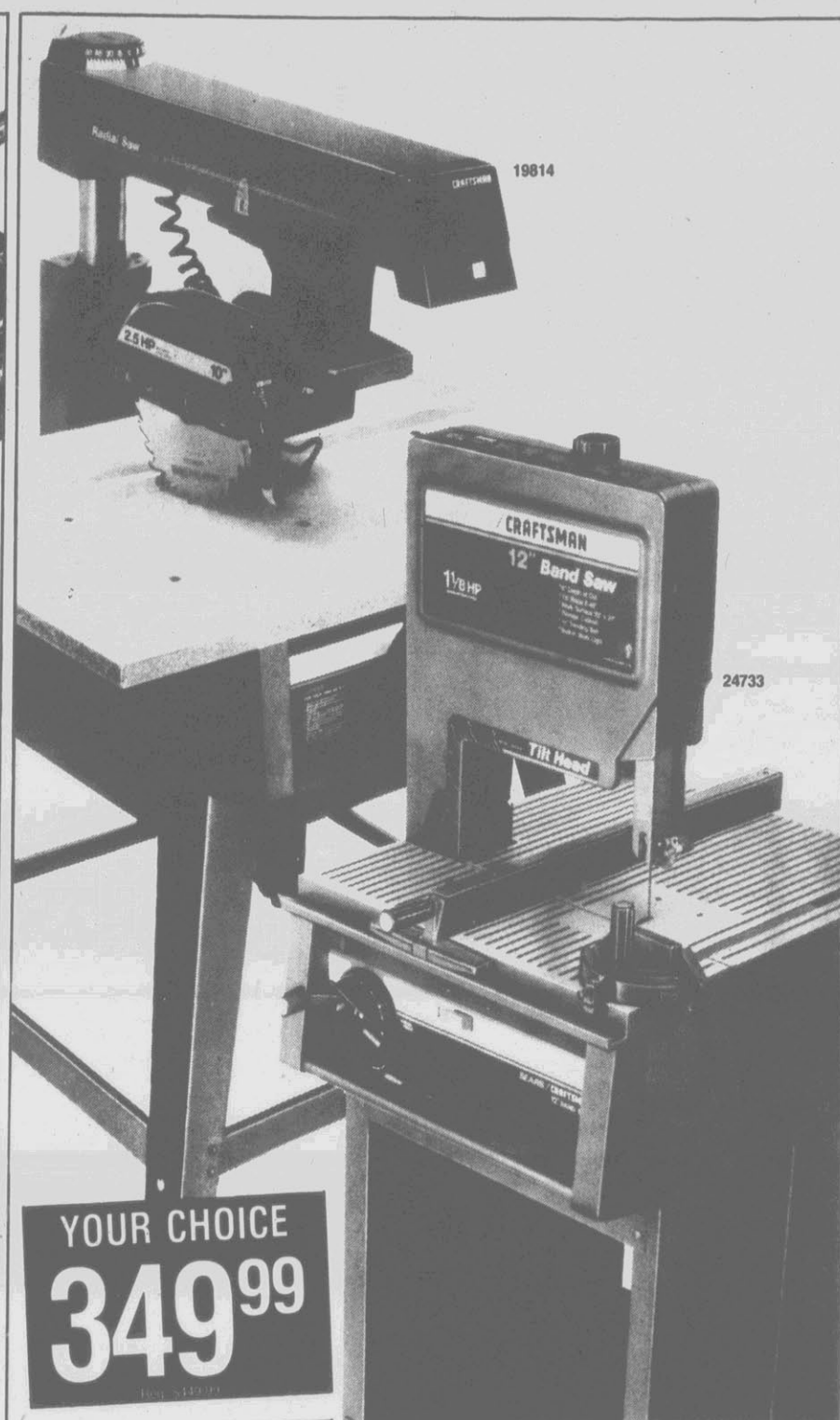

YOUR CHOICE  
**349<sup>99</sup>**

**CRAFTSMAN  
POWER  
SAWS**

- A. 10-inch radial saw  
• 1 1/2-HP motor develops 2 1/2-HP  
• 40x27-inch 3-piece worktable
- B. 12-inch band saw  
• 3/4-HP develops 1 1/2-HP  
• Cabinet with storage shelf  
Special purchases. Quantities limited.

SAVE \$100 on 10-in. radial saw, Reg. 499.99, 399.99



SAVE  
**25%**

**29<sup>99</sup>**  
Reg. \$39.99

**VARIABLE  
SPEED  
3/8-IN. DRILL**

- Includes 6-piece bit set
- Reversible
- 1/4-HP motor
- No load speed to 1200 RPM

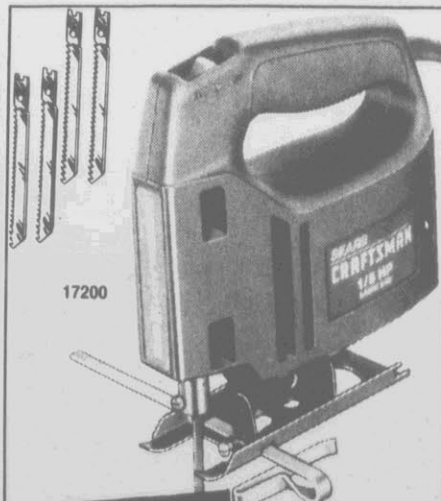

SAVE  
**25%**

**29<sup>99</sup>**  
Reg. \$39.99

**CRAFTSMAN  
1/5-HP SABRE  
SAW**

- Includes 4 extra blades
- 1/2-inch stroke
- Sawdust blower
- With edge guide
- Base tilts 0-45°



SAVE  
**40%**

**29<sup>99</sup>**  
Reg. \$49.99

**DUAL  
MOTION  
SANDER**

- With slide action motion selector
- Develops 1/2-HP
- 3/16-inch stroke
- 1/2-inch sheet
- Save now



SAVE  
**\$100**

**399<sup>99</sup>**  
Reg. \$499.99

**10-INCH  
TABLE  
SAW**

- Includes quick release rip fence
- 1-HP motor develops 2-HP
- Cast iron table included



SAVE  
**25%**

**59<sup>99</sup>**  
Reg. \$79.99

**REVERSIBLE  
1/2-INCH  
DRILL**

- Includes auxiliary grip handle
- Develops 3/4-HP
- Variable speed
- Adjustable speed dial

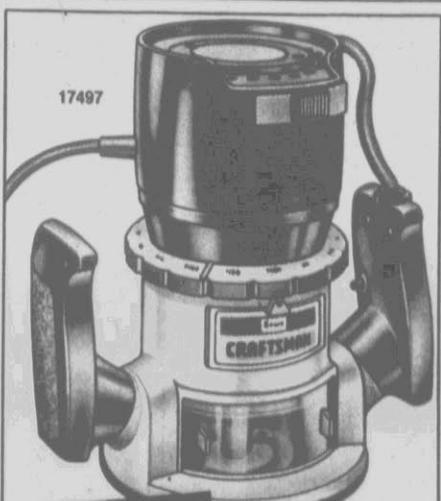

SAVE  
**25%**

**59<sup>99</sup>**  
Reg. \$79.99

**CRAFTSMAN  
1/2-HP  
ROUTER**

- Includes carrying case
- Heavy-duty motor
- Built-in worklight
- Auto shaft lock for easy bit changes

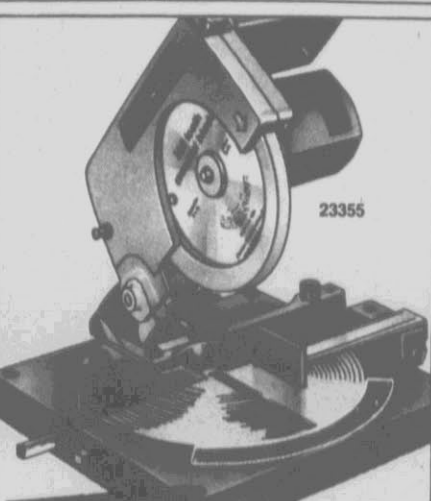

SAVE  
**\$30**

**129<sup>99</sup>**  
Reg. \$159.99

**8 1/4-INCH  
MITER  
SAW**

- With direct drive motor
- Cuts through even heavy stock
- Motor develops 1 1/4-HP

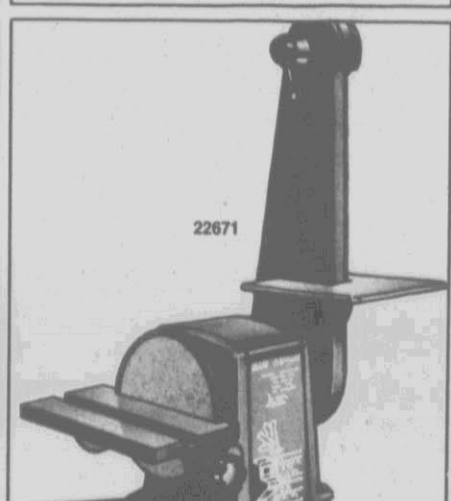

SAVE  
**\$30**

**129<sup>99</sup>**  
Reg. \$159.99

**BELT/  
DISC  
SANDER**

- Contours and sharpens
- 1/4-HP motor
- 1x42-inch belt
- 6-inch disc
- Versatile

# OUR MOST VERSATILE BENCHTOP TOOL!

INCLUDES  
7 BLADES

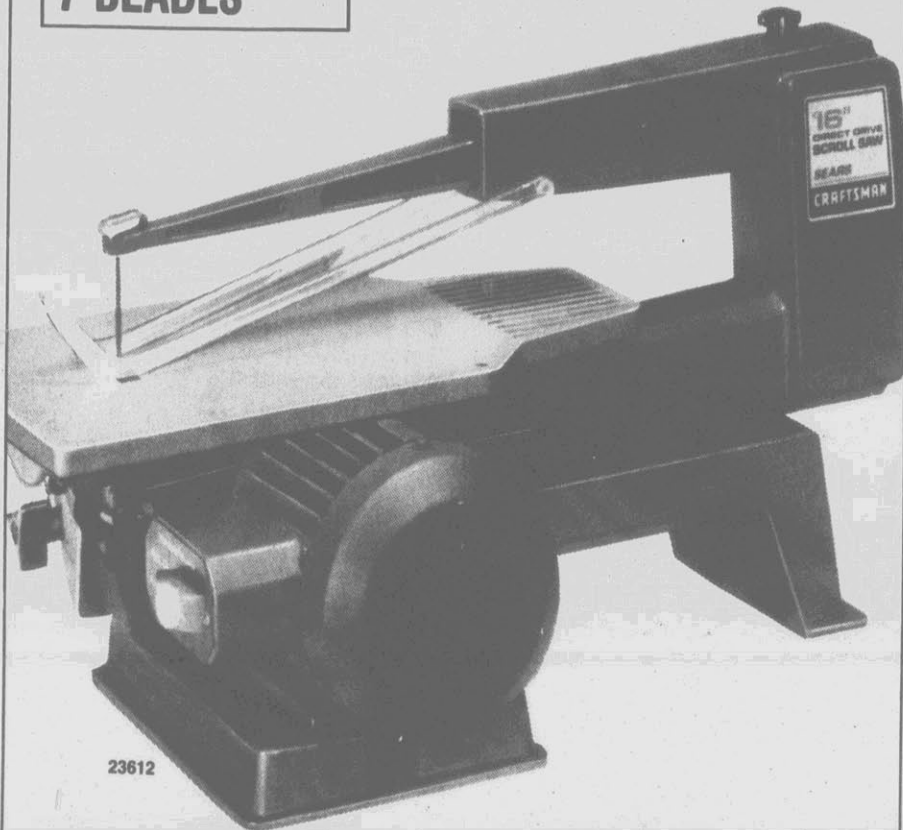

23612

**129<sup>99</sup>**

**CRAFTSMAN  
16-INCH  
SCROLL SAW**

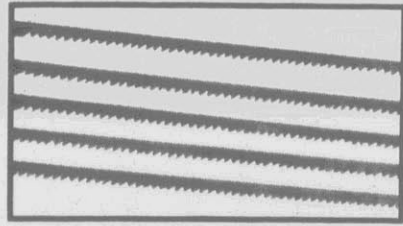

Featuring tilting table—  
Tilts up to 45° left

- 16-inch depth of throat; 3/4-inch stroke
- 2-inch depth of cut at 90°
- Clear plastic to view workplace

SEARS  
DISCOVER POWER!

TWICE THE BUYING  
POWER!

Storage pouch  
for both wall  
hanging and toting!

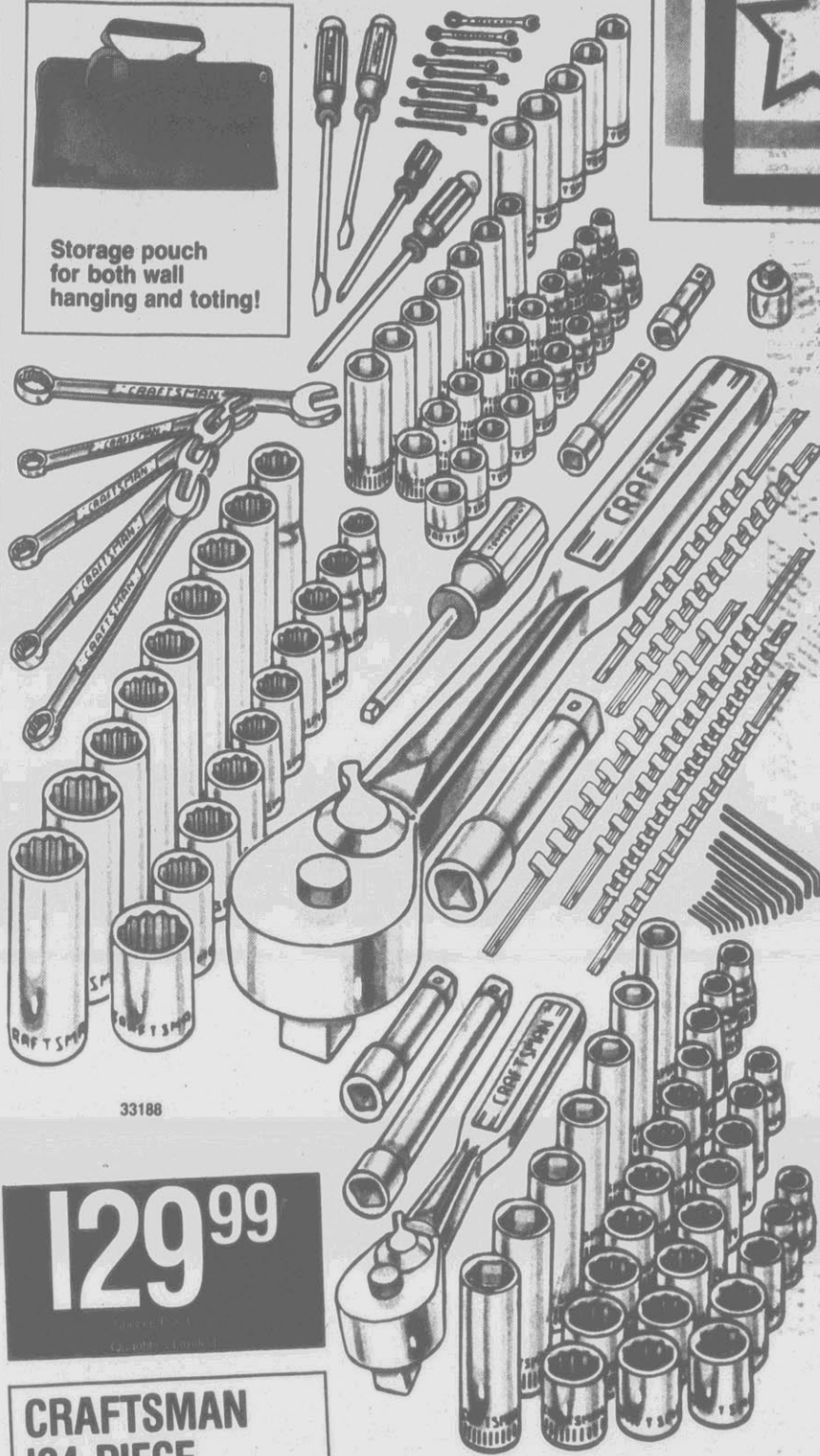

33188

**129<sup>99</sup>**

**CRAFTSMAN  
124-PIECE  
TOOL SET**

Warranted forever\*  
Standard and metric sizes

Craftsman Hand Tool  
Full Unlimited Warranty  
\*If any Craftsman hand tool ever fails to give  
complete satisfaction, return it for a free replacement.



17938

**99<sup>99</sup>**

**2.25 PEAK  
HP-WET/  
DRY VAC**

- Includes 5 accessories!
- More powerful than most similar vacs
  - 16-gallon tank

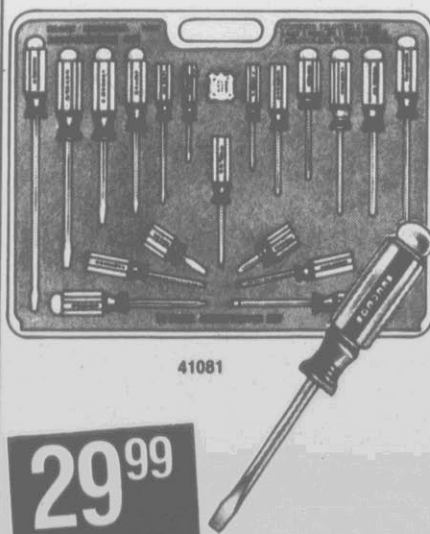

41081

**29<sup>99</sup>**

**SCREW-  
DRIVER  
SET**

- Warranted forever\*!
- Craftsman quality
  - Includes Torx, Phillips, Slotted and more

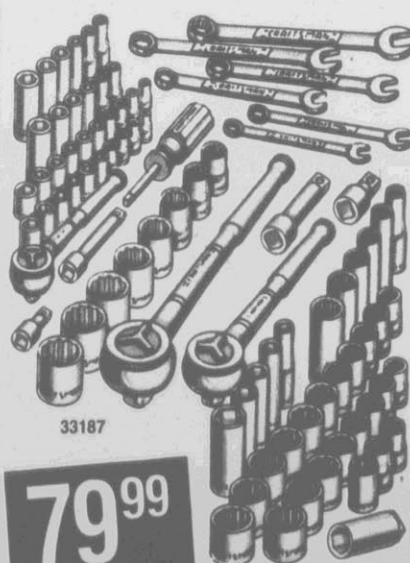

33187

**79<sup>99</sup>**

**88-PIECE  
TOOL  
SET**

- Warranted forever\*!
- 1/4, 3/8, 1/2-inch drive tools, sockets
  - Standard and metric sizes

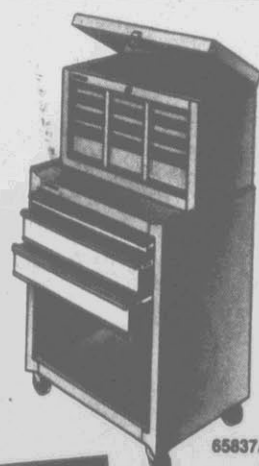

65837/38

**179<sup>99</sup>**

**9-DRAWER  
STORAGE  
UNIT**

- One price buys both!
- 6-dr. chest
  - Full length drawer pulls
  - 3-dr. roll-a-way lower compartment



17673

**SAVE  
\$150**

**349<sup>99</sup>**

- Reg. \$499.99
- Large 20-gallon tank**
- Standard current
  - 100 PSI max. delivery
  - With hose, chuck

**3-HP  
AIR  
COMPRESSOR**



15028

**SAVE  
\$30**

**129<sup>99</sup>**

**COMPACT  
1-HP AIR  
COMPRESSOR**

- Reg. \$159.99
- With adjustable pressure valve
  - Operates small air tools

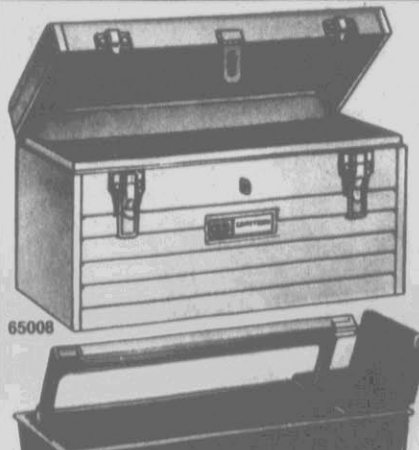

65008

**19<sup>99</sup>**

**18-INCH  
TOOL  
BOX**

- Durable plastic tool shuttle
- Rugged steel box
  - Shuttle has 3 compartments
  - Fold down handle

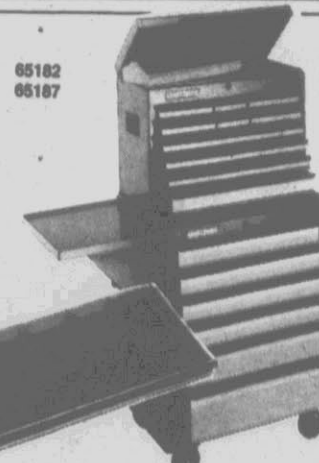

65182  
65187

**SPECIAL  
PURCHASE**  
Limited Quantities

**16-DRAWER  
CHEST  
CABINET**

**299<sup>98</sup>**

- Reg. separate prices total \$469.98
- 10-drawer chest
  - Drawer locks
  - Professional use
  - 6-dr. roll-a-way
  - Welded steel
  - 4 3-in. casters





\*No payments until Jan. 1st., 1989 on Sears Deferred Credit Plan for all riding equipment. There will be a finance charge for the deferral period.

NO PAYMENTS UNTIL NEXT YEAR! \*\*

POWER-PACKED!



24939

25423

1099<sup>99</sup> SAVE \$400  
Reg. \$1499.99  
Catcher extra

ONLY \$28 per month\* on SearsCharge PLUS

CRAFTSMAN II-HP LAWN TRACTOR

Time saving 38 inch twin blade mowing deck 5 speed transaxle drive plus reverse. Turf saver tires for soft, secure traction  
\*Your actual monthly payment can vary depending on your account balance

Permanex® grass catcher, Reg. \$279.99 ..... NOW 249.99

SAVE \$500 Craftsman 16 HP yard tractor. Reg. \$2199.99 .... NOW 1699.99

SAVE \$240

KENMORE 70 WATER SOFTENER



34270

SOFT WATER CAN MAKE SUCH A DIFFERENCE



Laundry cleans bright, white



Dishes, glass-ware shine



Soap lathers richly



459<sup>99</sup>  
Reg. \$699.99

ONLY \$17 per month\* on SearsCharge

4 SALT-SAVER SETTINGS, GREAT ECONOMY

Six-day dial lets you pick the regeneration cycle that suits you best; convenient guest and vacation cycles give you extra flexibility. For hardness to 70 grains per gallon.

Full 1-year warranty on the entire softener; limited 10-year warranty on both brine and resin tanks. See your nearest Sears store for complete details.

\*Your actual monthly payment can vary depending on your account balance.

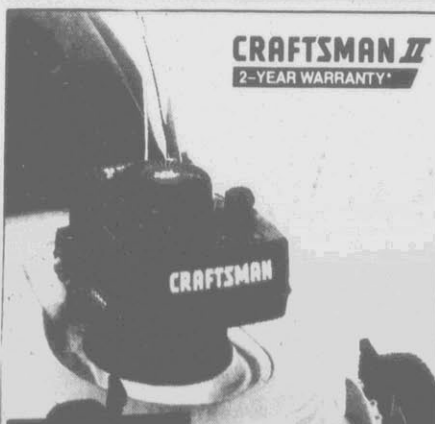

CRAFTSMAN II 2-YEAR WARRANTY\*

SAVE \$60

3.5/20

38332

CRAFTSMAN PUSH REAR-BAGGER

259<sup>99</sup>  
Reg. \$319.99

Only \$12 monthly\* on SearsCharge 3.5 RP†, Permanex® catcher included. Below-deck muffler. †RP means reserve power

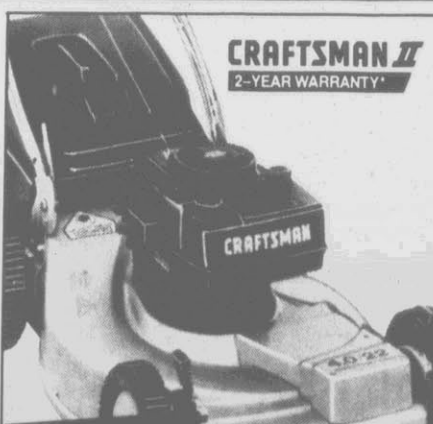

CRAFTSMAN II 2-YEAR WARRANTY\*

SAVE \$90

37234

CRAFTSMAN PROPELLED MOWER

329<sup>99</sup>  
Reg. \$419.99

Only \$14 monthly\* on SearsCharge 4.0 RP†, 22 in. cut, Exclusive Super Pull-Lite® starter.



SAVE \$9

87005

EASY LIVING® VELVET FLAT

10<sup>99</sup>  
gal. Reg. \$19.99

The most durable flat paint we sell. 200 decorator colors. Scrubbable. 12-year warranty. See store for details.



SAVE \$9

36005

WEATHER-BEATER® LOW-LUSTER SATIN

10<sup>99</sup>  
Reg. \$19.99

Mildew resistant. 50 one-coat colors. Limited warranty for years specified. See store for details. For one-coat results all Sears one-coat paints must be applied as directed.

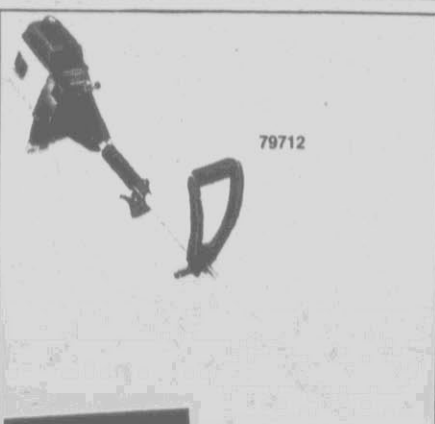

79712

SAVE \$30

CRAFTSMAN GAS TRIMMER

99<sup>99</sup>  
Reg. \$129.99

Only \$10 monthly\* on SearsCharge Gas rear mount engine provides great balance. 16-in. cut.



35718

SPECIAL PURCHASE

CRAFTSMAN GAS CHAIN SAW

179<sup>88</sup>  
Quantities limited

Only \$10 monthly\* on SearsCharge 2.3 CID, with 18 inch sprocket nose guide bar.

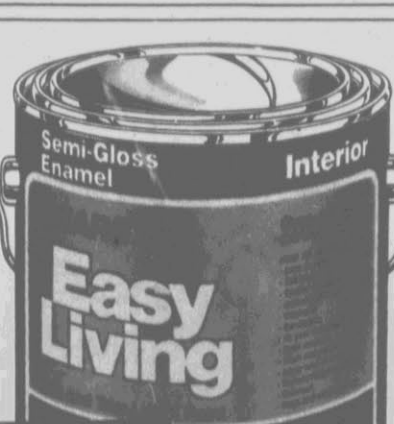

SAVE \$7

71005

EASY LIVING® SEMI-GLOSS

12<sup>99</sup>  
Reg. \$19.99

Easy to apply, one-coat coverage. Scrubbable, washable and 12-year durability. See store for details.

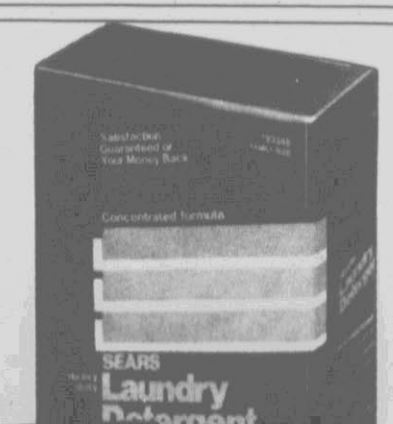

SPECIAL PURCHASE

48

93348

POWDER DETERGENT

19<sup>98</sup>  
Quantities limited

48-lb. bonus size • 10\* per washload • Over 5 month supply\* \*Based on 10 loads per week, 1/2 cup per load

# SEARS SALE OF CHAMPIONS

## NEW <sup>60</sup> PLUS BATTERY



**POWER** Up to 530 amps of cold cranking power for reliable all-weather starts

**RESERVE SIZES** 100 minute reserve capacity. Power when you need it most

**WARRANTY** Fitment for over 90% of cars, vans, light trucks—imported or domestic

Service nationwide at over 800 Sears Tire and Auto centers

**OUR BEST VALUE EVER FOR A BATTERY THIS POWERFUL!**

- More power than the standard 60 month battery at a lower price!
- With Sears car batteries installation is always fast, professional and **FREE!**
- Computer designed grids allow for maximum output of power

# 48<sup>99</sup>

with trade-in

Limited warranty for period specified! See store for details.

## SAVE 30%

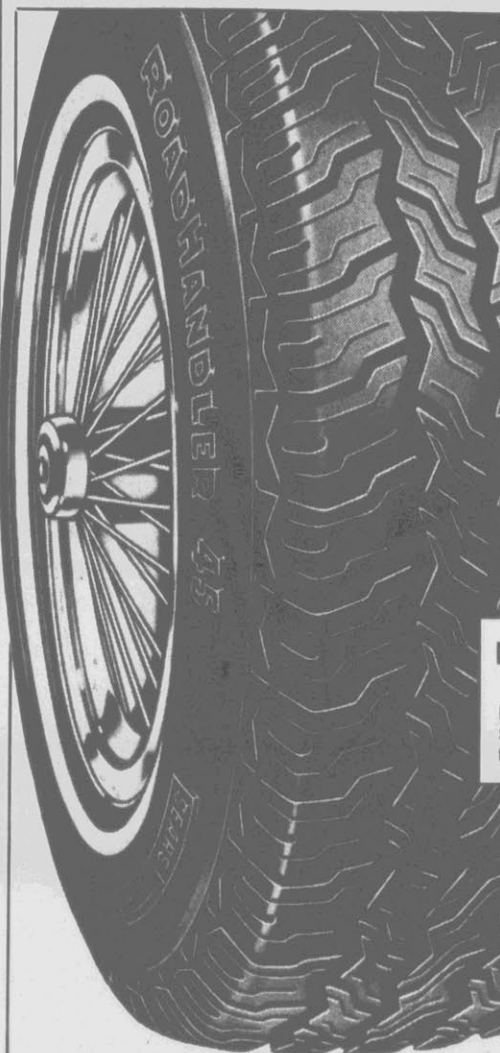

### 5 REASONS TO BUY YOUR TIRES AT SEARS

- Free tire inspection
- Tire installation included
- Tire rotation every 5000 miles included
- Nationwide service and warranty at over 800 Auto Centers
- Choose tires for most cars: American-made and import; compact, mid-size and full-size, light trucks and vans

### NO PAYMENTS ON TIRES UNTIL NEXT YEAR

No monthly payments until Jan. 1989 on Sears Deferred Credit Plan. There will be a finance charge for the deferral period.

#### 45,000-mile wearout warranty

RoadHandler 45	Reg. price each	SALE price each
P155-80R13	\$67.99	\$44.99
P165-80R13	74.99	49.99
P175-80R13	82.99	57.99
P185-80R13	92.99	64.99
P185-75R14	94.99	65.99
P195-75R14	99.99	69.99
P205-75R14	107.99	74.99
P205-75R15	109.99	76.99
P215-75R15	114.99	79.99
P225-75R15	118.99	82.99
P235-75R15	119.99	83.99

QUALITY-BUILT BY

# MICHELIN

BACKED FOR OVER 800 SEARS AUTO CENTERS

- 2 rugged steel belts for strength and durability
- All-weather tread great traction in all seasons on all kinds of roads
- Smooth-riding plus exceptional handling

# 44<sup>99</sup>

P155/80R13

Limited tire wearout warranty for miles specified. See store for details.



PERFORMANCE

#### 30,000-mile wearout warranty

Response High Performance	May be Substituted for	Each
P185-70TR13	P185-80R13	58.99
P195-70TR14	P175-80R13	61.99
P185-70TR14	P175-75R14	64.99
P195-70TR14	P185-75R14	68.99
P205-70TR14	P185-75R14	72.99
P215-70TR15	P205-75R15	75.99
P225-70TR15	P215-75R15	79.99
P235-70TR15	P225-75R15	84.99
P215-65TR15		74.99
P195-60TR14		64.99
P215-60TR14	P185-76R14	74.99
P195-60TR15		64.99
P205-60TR15		69.99
P225-60TR15	P185-75R15	79.99
P215-60TR15		74.99
P235-60TR15		84.99

**60, 65, 70 series**

- Kevlar® aramid over steel belts
- All-season tread
- Raised white letters

# 49<sup>99</sup>



SAVE 30%

## LIGHT TRUCK

All-terrain, on-off road radial

- Strong steel belts (except RV sizes)
- Raised white outline letters

# 55<sup>99</sup>

#### 35,000-mile wearout warranty

TrailHandler A-T	Reg. price	Sale price each
LT195-75R14	\$79.99	\$55.99
LT215-75R15	89.99	62.99
LT235-75R15	104.99	72.99
30x9 50R15	109.99	76.99
31x10 50R15	114.99	79.99
LT215-85R16	114.99	79.99

Other sizes available



### LOOK AT ALL WE DO:

- Install up to 5 qts. motor oil
- Replace oil filter
- Lube chassis
- Check and fill: Brake fluid, differential fluid, transmission fluid, power steering fluid and windshield wiper fluid.
- Perform visual check

ONLY **19<sup>99</sup>**

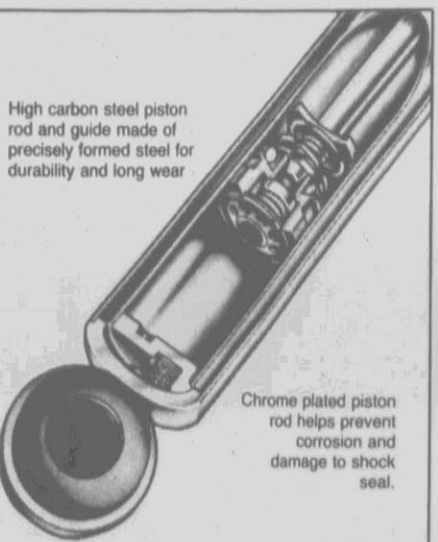

High carbon steel piston rod and guide made of precisely formed steel for durability and long wear

Chrome plated piston rod helps prevent corrosion and damage to shock seal.

**SPECIAL PURCHASE**

Roadhandler Gas: all the features of our \$25.99 shock for \$12 less

# 13<sup>99</sup>

Installation available. A special purchase, though not reduced, is an exceptional value. While quantities last.

### TRY TO FIND A PROFESSIONAL QUALITY JACK AT A PRICE THIS LOW

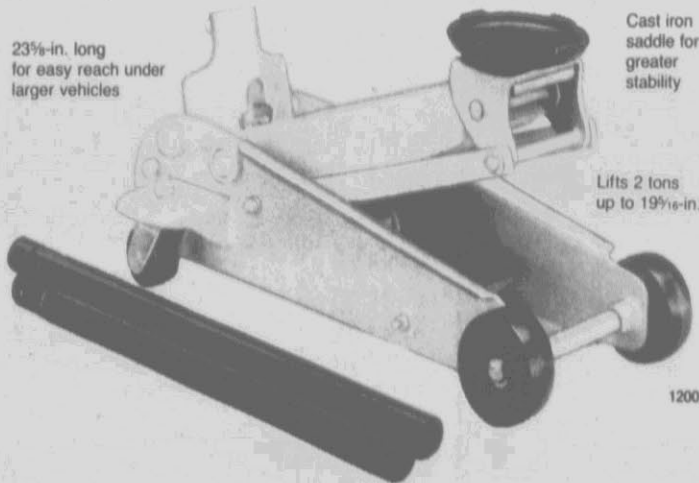

23½-in. long for easy reach under larger vehicles

Cast iron saddle for greater stability

Lifts 2 tons up to 19½-in.

1200

#### SPECIAL PURCHASE!

Heavy duty floor jack—perfect for frequent use and demanding jobs. Thick all-steel frame, rear swivel wheels for mobility plus wide stance for increased stability.

# 98<sup>88</sup>

### INSTALLED!

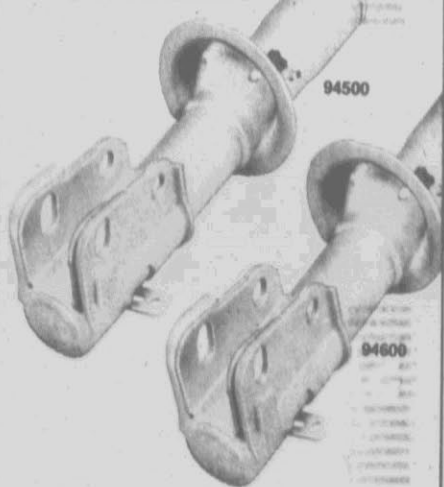

#### MacPherson Gas struts

Parts and installation warranted for as long as you own your car. For imports and domestics.

Cartridges available at ..... 99.99 Alignment recommended, extra.

AS LOW AS **139<sup>99</sup>**

# SEARS SALE OF CHAMPIONS



Buy any bedding, recliner  
or carpet on this page—  
**MAKE NO PAYMENTS  
TILL NEXT YEAR!**

No monthly payments until Jan., 1989 on Sears Deferred Credit plan. There will be a finance charge for the deferral period.

**40%-50% OFF SEALY OR  
SEARS-O-PEDIC  
BEDDING**

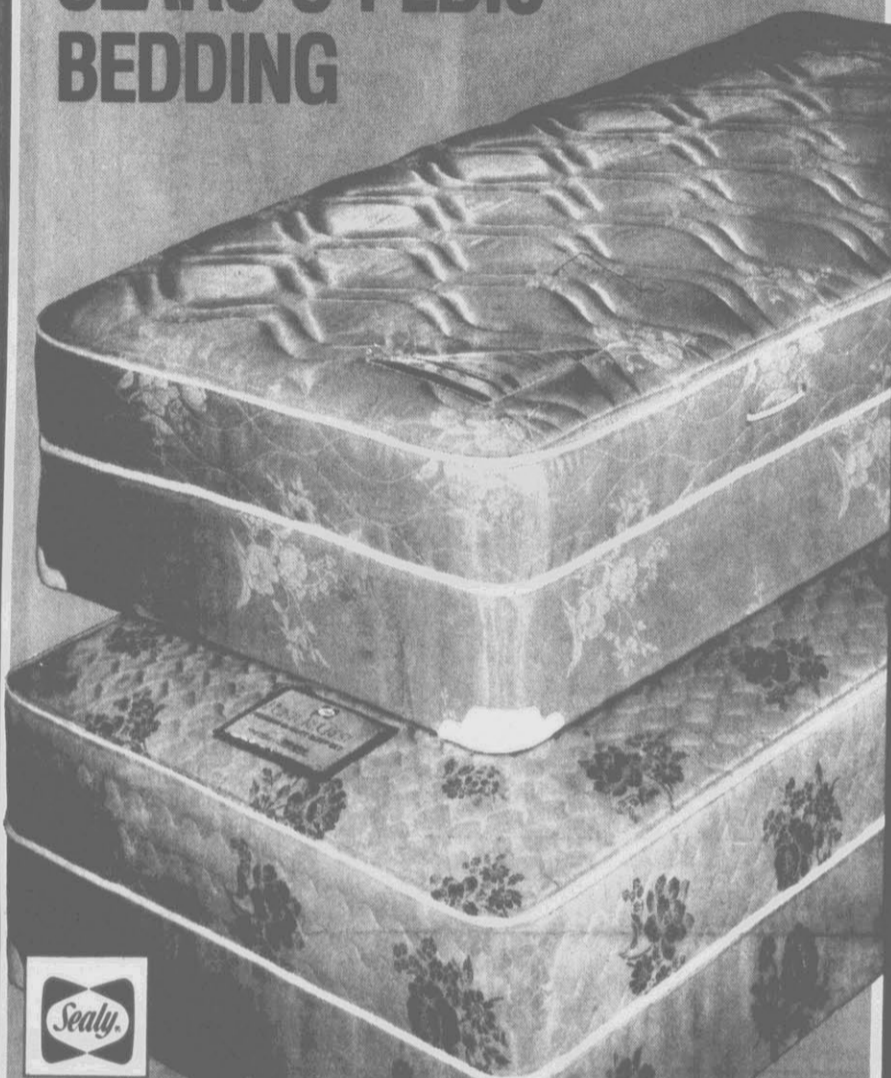

Extra-firm Sears-O-Pedic  
Elegance Classic or  
Sealy PostureCrest

Twin,  
ea. pc. **99<sup>99</sup>**  
Reg. \$199.99

Super-firm Sears-O-Pedic  
Elegance Prestige or extra-firm  
Sealy PostureCrest Elite Century  
not shown

Twin,  
ea. pc. **129<sup>99</sup>**  
Reg. \$259.99

Full, ea. pc., reg. \$299.99 ..... **179.99**  
2-pc. queen set, reg. \$699.99 ... **419.99**  
3-pc. king set, reg. \$999.99 ..... **599.99**

Full, ea. pc., reg. \$299.99 ..... **215.99**  
2-pc. queen set, reg. \$899.99 ... **539.99**  
3-pc. king set, reg. \$1199.99 ..... **719.99**

Furniture and bedding are not available in Ashland, Beckley, Bluefield, Burlington, Concord, Danville, Florence, Gastonia, Goldsboro, Greenville, Hickory, High Point, Rock Hill, Rocky Mount, Shelby and Williamson.

Queen and king sold only in sets.  
King requires two foundations.

**SAVE 25-40%  
ON SELECTED RECLINERS**



BRAWNY  
RECLINERS

**299<sup>99</sup>**

TRIPLE SOFT  
RECLINERS

**349<sup>99</sup>**

CELEBRATION  
RECLINERS

**399<sup>99</sup>**

All Sears upholstery  
fabrics



**COMFY RECLINERS WITH MORE!**

- A. **2-WAY WALLHUGGER. Brawny.** Heavy-duty and big on comfort too! Rich 100% nylon velvet with Scotchgard® Brand Fabric Protector.
- B. **3-WAY WALLHUGGER. Triple Soft.** Reclines close to wall for free and easy movement. Plush cover of 100% olefin fabric.
- C. **3-WAY SWIVEL GLIDER. Celebration.** 3-way mechanism enables the back to move independently of the seat. 100% Acrilan® by Monsanto. Two-year Wear-Dated® warranty by Milliken.

OTHER STYLES AVAILABLE AT SIMILAR SAVINGS



**SEARS  
GREAT  
WINDOW  
COVER-  
UP  
SALE!**

**SAVE  
20-40%**

Reg. \$29.99  
50x84-in. pr. **17<sup>99</sup>**

**ALL READY-  
MADE & MADE-  
TO-MEASURE  
DRAPERIES**

Michelle case-  
ment draperies  
come self-lined.  
Also on sale: Caribou tex-  
tured draperies, 48x84-in.  
pr. Reg. \$29.99 ... **17.99**

Home fashions are not available in  
Ashland, Shelby and Williamson.

**SAVE  
20-40%**

Reg. \$29.99  
96x81-in. pr. **19<sup>99</sup>**

**ALL PANELS,  
PRISCILLAS,  
SHORT CURTAINS**

Inheritance III  
priscillas with at-  
tached valance.  
Also on sale: matching  
Cape Cods, 84x24-in. pr.  
Reg. \$9.99 ..... **6.99**

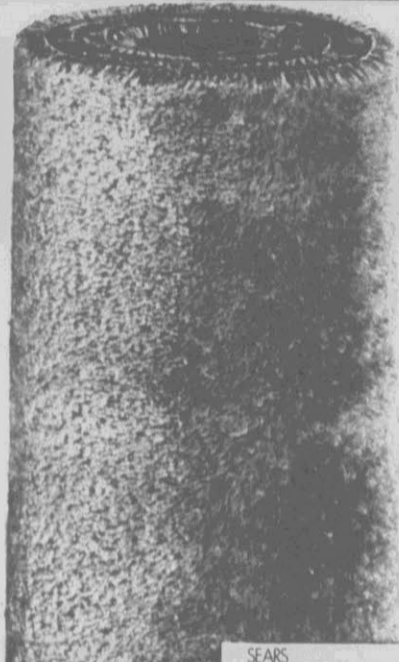

**SAVE  
\$5 sq. yd.**

**36 OZ. BASIC  
PRIORITY  
POLYESTER PILE  
PLUSH CARPET**



Reg. \$15.99  
sq. yd. **10<sup>99</sup>**  
sq. yd.

Beautiful, affor-  
dable carpet in 8 col-  
ors. Treated with  
Scotchgard®  
Brand Carpet Pro-  
tector.

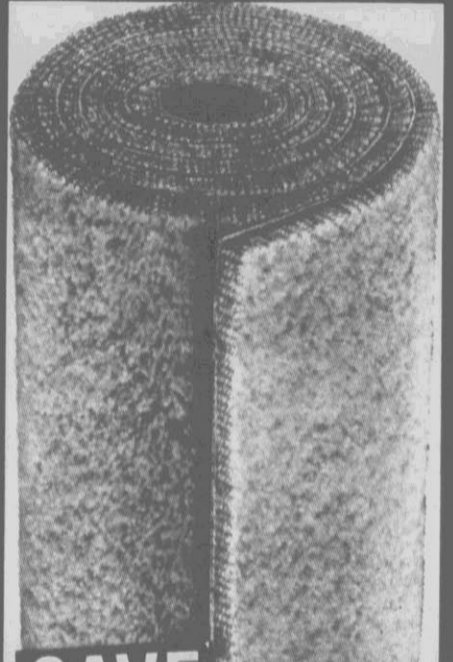

**SAVE  
\$5 sq. yd.**

**25 OZ. RUSTIC  
SHADOWS  
NYLON PILE  
PLUSH CARPET**

Reg. \$14.99  
sq. yd. **9<sup>99</sup>**  
sq. yd.

Choose from 5 vi-  
brant shades of  
this lovely carpet  
treated with  
Scotchgard® Car-  
pet Protector.  
Cushion, installation extra  
for all carpets

Carpet is not available in Ashland, Concord, Dan-  
ville, Gastonia, Greenville, Hickory, High Point,  
Myrtle Beach, Rock Hill, Shelby and Williamson.



Satisfaction guaranteed  
or your money back

©Sears, Roebuck and Co., 1988

ALL STORES NOW OPEN SATURDAY MORNINGS AT 9 AM

NC: Burlington, Charlotte (Eastland, Southpark), Concord, Durham, Fayetteville,  
Gastonia, Goldsboro, Greensboro, Greenville, Hickory, High Point, Jacksonville,  
Raleigh, Rocky Mount, Wilmington, Winston-Salem  
SC: Charleston (Citadel, Northwoods), Columbia, Florence, Myrtle Beach, Rock Hill  
VA: Danville, Lynchburg, Roanoke KY: Ashland  
WV: Barboursville, Beckley, Bluefield, Charleston

Large items such as furniture and ap-  
pliances are inventoried in our distribu-  
tion center and will be scheduled for  
pick-up or delivery. Delivery is not in-  
cluded in selling prices.

**SEARS**

America's largest installed home improver.

# SEARS FALL FIX-UP

## HOME IMPROVEMENT

# TIME



SALE  
ENDS

SEPT.  
17

unless otherwise  
indicated

Our policy is  
Satisfaction  
Guaranteed  
or your  
money  
back!

NO PAYMENT  
UNTIL  
JANUARY 1

ON SEARS DEFERRED  
CREDIT PLAN

There will be a finance charge  
for the deferred period



FREE IN-HOME PLANNING  
AND ESTIMATING  
COMPLETE INSTALLATION BY SEARS  
AUTHORIZED CONTRACTORS  
3 WAY INSURANCE PROTECTION  
COVERS COMPLETE JOB & LIABILITY & WORKMAN'S COMPENSATION  
1 YEAR LABOR WARRANTY  
SEE STORE FOR DETAILS

CREDIT  
PLAN  
TO SUIT  
MOST  
ANY  
NEED

# 45% OFF

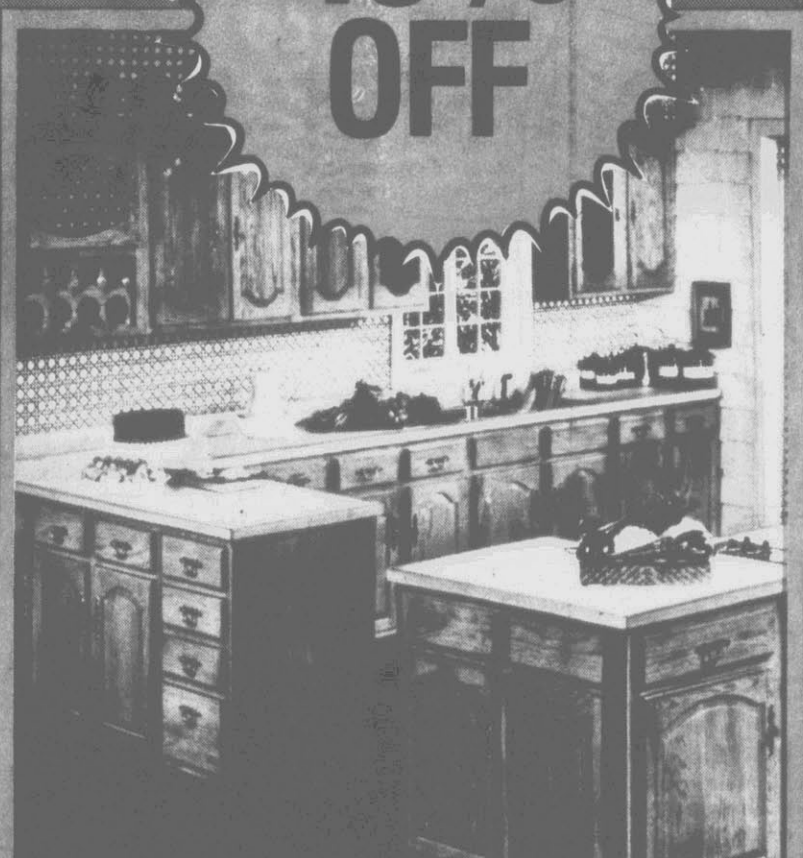

## 45% OFF PRESTIGE®

Greatest savings this year through the end of September.  
Quality crafted wood kitchen cabinets

Now it's easy to have the kitchen of your dreams and save money too! Choose from our wide selection of contemporary and traditional style cabinets while they're sale priced. Then let Sears specialists show you how to custom design your kitchen for the work and entertainment space you need.

### FREE PLANNING

Sears specialists will help you custom design your kitchen and select the materials.

### FREE ESTIMATE

After the plan is complete, we will give you a free estimate of the total cost including materials and labor.

## 10% OFF Custom Countertops



OUR GOAL IS TO MAKE YOUR NEXT INSTALLED HOME IMPROVEMENT A NO-RISK, HAPPY EXPERIENCE.

Satisfaction guaranteed  
or your money back

©Sears, Roebuck and Co., 1988

\*Sears Pricing Policy: All reductions are from Sears regular prices unless otherwise stated. If an item is not described as reduced or a special purchase, it is at its regular price. A special purchase, though not reduced, is an exceptional value.

# SEARS

Let Sears  
trained  
specialists  
help solve  
your  
problems.

Call us  
today for a  
FREE in-home  
estimate.

Appointments  
at your  
convenience



# 15% OFF

**continuous guttering with overhang and trim**

Fabricated on the job, our enameled aluminum guttering goes corner to corner without a seam. Matching overhang and trim gives finished look.

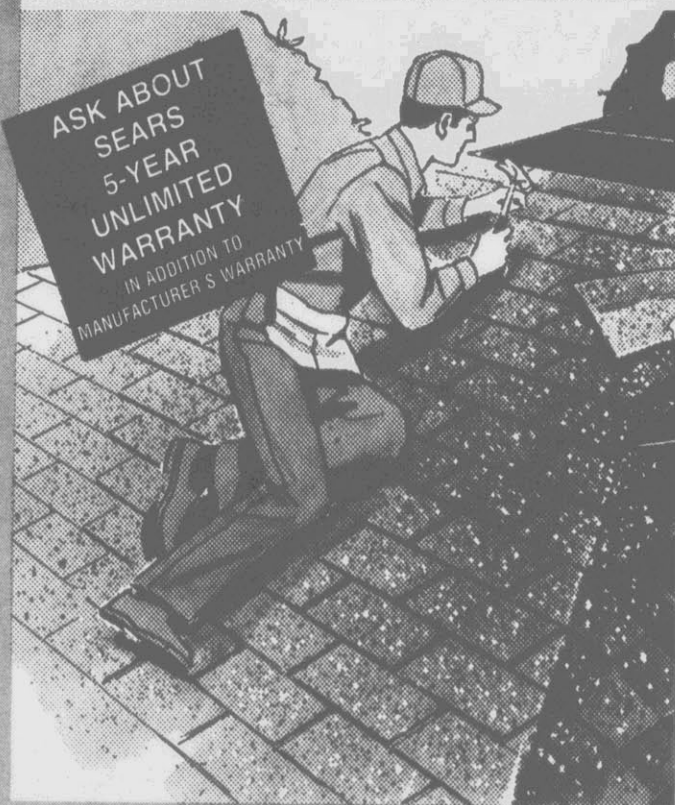

# 15% OFF

**Our 25 year fiberglass roofing shingles installed**

Our shingles have glass fiber mat base, covered with asphalt, then sprinkled with ceramic granules for a handsome appearance and long life. UL Class A fire-resistant, each shingle has a sun activated stick-down strip that seals it to the roof and resists blow-offs, even in gale force winds.

# 10% OFF



### Insulated mobile home roofer

Aluminum panels that go right over your mobile home's present roof not only stops leaks but helps cut down on energy costs. Reduces roof rumble and rain drumming, too. Baked-on enamel finish, plus overhang and trim.

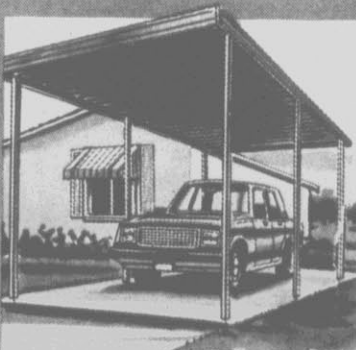

# 15% OFF

**patio covers or carports**

Sturdy aluminum construction free-standing or attached, to add to your living or storage space.

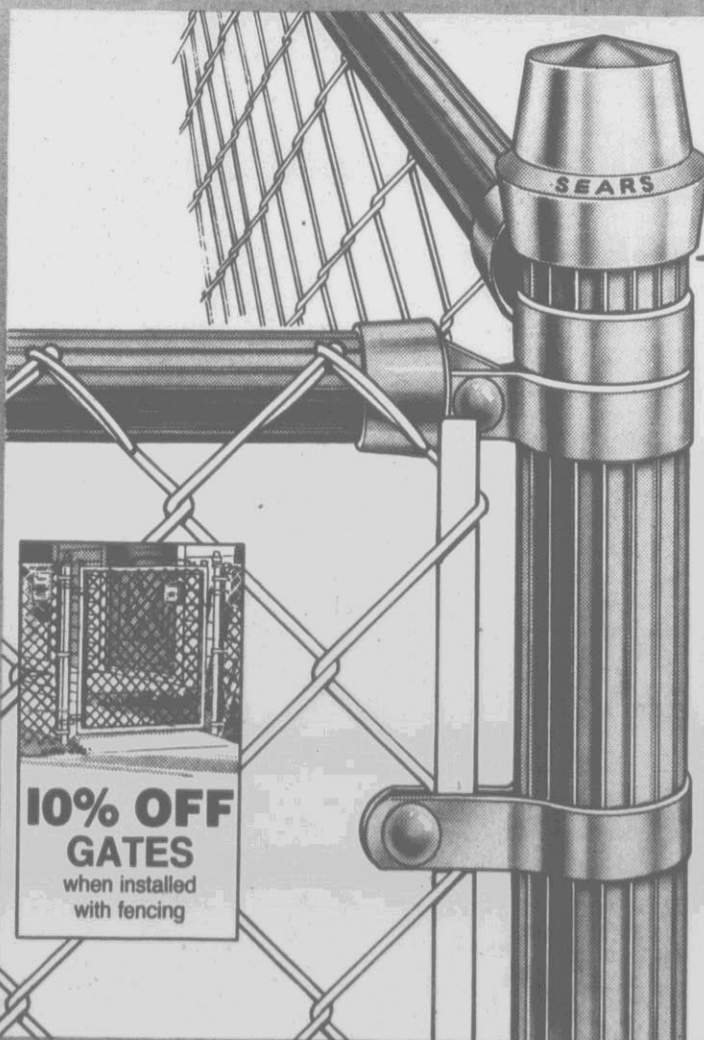

# 40% OFF

**Sears Premium 11½ gauge chain link fencing fabric when installed by Sears**

Save now when we arrange installation of our most popular gauge fencing fabric in your choice of heights. Get added privacy and protection in the bargain. Sears fencing features Armadillo X posts and top rails that are ribbed for extra strength, and have 50% more zinc than is applied by leading manufacturers.

**FREE ON SITE ESTIMATES**

**10% OFF GATES**  
when installed with fencing

# Sears...Your Heating and Cooling Headquarters

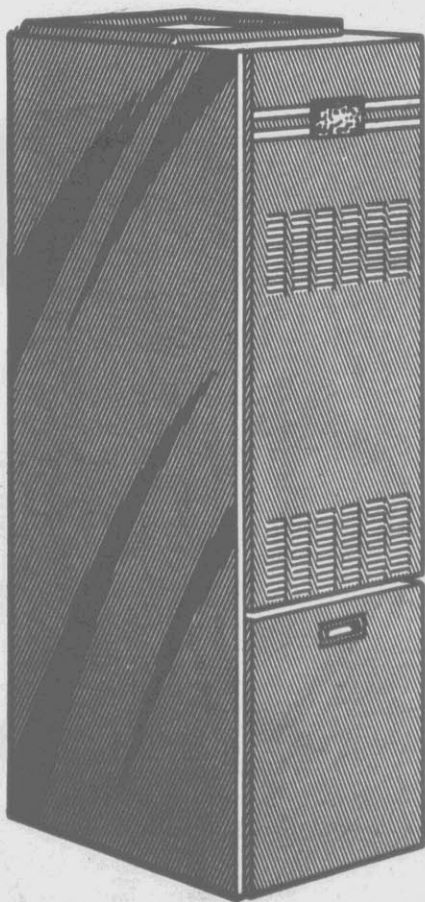

**SAVE  
\$100**  
Kenmore®  
80

PowerMiser gas furnace could cut  
your heating costs by up to 32%\*

**\$699**

80,000 BTU  
Upflow Reg. \$799

This compact size furnace is an easy and efficient replacement for almost any furnace. Ask a salesperson for details of the 20 year limited warranty on the heat exchanger.

Larger sizes also on sale.

\*Based on a properly sized Sears Kenmore® High Efficiency gas furnace compared with the least efficient gas furnace in the same size range as determined by the Dept. of energy test procedures. Other size furnaces have similar savings. Actual savings may vary.

**CALL FOR  
FREE IN HOME  
ESTIMATES!**

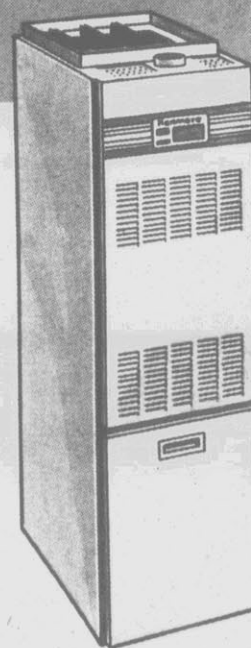

**SAVE  
\$100**

Kenmore 80 Spacesaver  
upflow oil furnace

**\$949**

105,000 BTU  
Reg. \$1049.00

Our most solid value in an oil furnace, gives you a high-pressure flame retention burner that's 83.9% efficient with clean, hot-firing. 10 year limited warranty on heat exchanger. Ask for details in stores. Save on other sizes too!

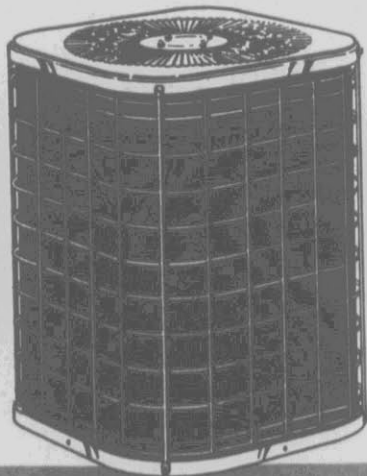

## End-of-Season Sale! Central Air Conditioning

**\*150 OFF!** Kenmore 9 central air conditioning  
system designed to help save on cooling costs

Kenmore state of the art air conditioning system designed to help save on cooling costs.

Larger sizes also on sale!

18,000 BTU, Reg. \$899.00

**\$749**

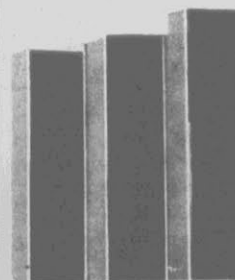

**\*50 OFF**

Entire stock  
Wall Furnaces

Very efficient heating for  
single rooms or small  
areas.

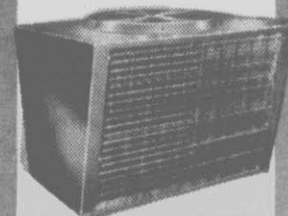

**\*150 OFF**

Single package  
heat pump

24,000 BTU heat,  
25,000 BTU cool.

Reg.  
\$1749.00

**\$1599**

# YOU CAN TRUST YOUR HOME TO SEARS FOR EXPERT IMPROVEMENTS AND SAVINGS



## Sears vinyl replacement windows that are almost maintenance free!

They never need painting or scraping, won't rot or crack, and they're available in a wide variety of great-looking styles. Made to your measurements, these custom windows are designed for easy cleaning. Some have self storing vinyl screens.

# 20% OFF

## Sears Best custom made aluminum storm screen windows

Add these windows to your home for more efficient control of heating and air conditioning. Aluminum frame windows with felt insulation are custom made to your measurements. Low maintenance finish in a choice of colors.



## Decorative security storm doors

Steel frames and decorative bars give added protection at your entrance that looks great! Tempered glass panels interchange with screen panels.



## Steel entry doors look like wood

You can choose from several handsome styles with steel exterior and foam core that adds insulation as well as protection. Magnetic seal and threshold included.

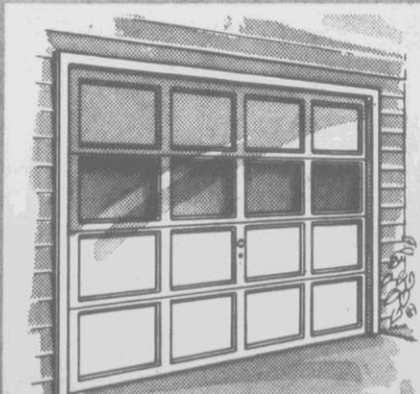

## Garage doors with hardware

Choose a style that complements your home and fits your budget. Sturdy construction in single or double door models, ready to stain or paint.

**Satisfaction guaranteed  
or your money back**

©Sears, Roebuck and Co., 1998

### ALL STORES NOW OPEN SATURDAY MORNINGS AT 9 AM

NC: Burlington, Charlotte (Eastland, Southpark), Concord, Durham, Fayetteville, Gastonia, Goldsboro, Greensboro, Greenville, Hickory, High Point, Jacksonville, Raleigh, Rocky Mount, Wilmington, Winston-Salem  
 SC: Charleston (Citadel, Northwoods), Columbia, Florence, Myrtle Beach, Rock Hill  
 VA: Danville, Lynchburg, Roanoke KY: Ashland  
 WV: Barboursville, Beckley, Bluefield, Charleston

Let Sears  
trained  
specialists  
help solve  
your  
problems.

Call us  
today for a  
FREE in-home  
estimate.

Appointments  
at your  
convenience

# SEARS

# FAMILY DOLLAR

Neighborhood Discount Store

# Dollar Days Sale

Low Prices ... Our Policy



Shop And Compare

**2 \$12**  
FOR  
Ladies' Or  
Men's Fleece  
Tops Or  
Bottoms

**\$5** Ea.  
Boys' 8-16 Or  
Girls' 7-14  
Fleece Tops  
Or Bottoms  
Girls' 4-6x \$4 Ea.



**\$5** Ea.  
Printed  
Blankets  
72" x 90"

**5 \$2**  
FOR  
Dial Bar Soap  
5 ounce. Limit 5.

**\$1** Box  
Laundry Detergent  
38 oz. Rinso,  
36 oz. Ajax  
or 64 oz. Arm  
& Hammer.  
Each brand  
not at all  
stores.

**3 \$2**  
FOR  
Clo-White Bleach  
Reg. 89¢ Ea. 128 ounce.

**3 \$1**  
FOR  
Paper  
Towels  
Reg. 2 For \$1  
90 sheets.  
Limit 3

**\$1** Ea.  
Dish  
Washing  
Detergent  
22 ounce Lux  
or Dove.

**\$7** Pk.  
Disposable  
Ultra Thin  
Diapers  
Regularly 7.99.  
66 ct. small, 48  
ct. med. or 32  
ct. large.

FREE  
After  
Rebate  
**0**  
Twin  
Pack  
Douche  
Assorted  
fragrances.

**2 \$3**  
PKS  
8 Roll  
Pack Bath  
Tissue  
Regularly 1.99.

**5 \$3**  
FOR  
2 Liter  
Soda  
Reg. 79¢ Ea.  
Cola, orange,  
root beer or  
grape flavor.

**2 \$3**  
PKS  
Pack Of 6  
Candy  
Bars  
Asst. Hershey,  
M&M, Nestle  
or Peter Paul  
candies.

**2 \$1**  
FOR  
Boxed Envelopes  
50 count legal or 100  
count letter size.

Half Off  
After  
Rebate  
**50¢**  
Trash Bags  
15 ct. 13 gal., 10 ct.  
26 gal or 7 ct. 33 gal.

Only 25¢  
Per Package  
After Rebate  
**4 \$1**  
PKS  
After 4 Pack  
Rebate  
Pack Of 2  
Light Bulbs  
40, 60, 75 or 100 Watt.  
Limit 4 pks.

**2 \$1.50**  
PKS  
After 2 pkg.  
Rebate  
Alkaline  
Batteries  
Pk. of 2 C, D or AAA or  
single 9 volt.  
Pk. Of 4 AA Sale \$2  
After Rebate... 1.25

**5 \$2.50**  
FOR  
After 5 Qt. Rebate  
Mobil  
Motor Oil  
10W30 or  
10W40. Limit  
12 qts.

**4.99** Sale Price  
**1.50** Mfr. Rebate  
**4.49** Gal.  
After Rebate  
Texaco  
Anti-Freeze  
Coolant  
Texaco  
Anti-Freeze  
Coolant  
1 gallon.  
Limit 2.

NO SALES TO DEALERS. PRICES GOOD THRU MONDAY SEPTEMBER 19TH WHILE QUANTITIES LAST QUANTITIES LIMITED ON SOME ITEMS.

# Guaranteed Low Prices

**TRUST** \$4.99 Ea.  
**Just Wonder** \$4.99 Ea.  
**TRUST** \$4.99 Ea.  
**TRUST** \$4.99 Ea.

**Your Choice**

- Hair Spray-9 oz.
- Natural care aloe vera lotion or shampoo-18 oz.
- Trust anti perspirant deodorant solids or sprays-2 or 4 oz.
- Roll-on deodorant-2.5 oz.

**LANDER** \$4.99 Ea.  
**LANDER** \$4.99 Ea.  
**LANDER** \$4.99 Ea.  
**LANDER** \$4.99 Ea.  
**LANDER** \$4.99 Ea.

**2 FOR \$4.99**

**Lander Products**

- Baby oil, lotion or powder-4 oz.
- Baby shampoo, cocoa butter lotion, skin lotion or extra soft skin lotion-12 oz.
- Roll-on deodorant-1.05 oz.
- Stick deodorant-2.25 oz.

**Plax** \$2.99 FOR 3  
 8 Oz. Plax Dental Rinse Original or mint.

**Vaseline** \$1.50 After Rebate With Purchase Of 2  
 7.5 ounce.

**TYLENOL** \$1.50 Mfr. Rebate  
 Extra Strength Tylenol Gels 24 count.

**Carefree** \$2.99 FOR 5  
 8 Oz. moisturizer, activator or restorer.

**Color Mates** \$1.49 Pk.  
 Asst. Giftwrap Reg. 1.49. Pk. of 8 sheets or combo with bow, ribbon & card.

**Fine Bond** \$2.99 FOR 1  
 Reg. 79¢. 100 sheets. Ruled or unruled.

**Windex** \$1.30 After Rebate  
 32 ounce.

**Behold** \$1.30 After Rebate  
 9 ounce.

**Rust-Free SCRUBBER** \$2.99 FOR 1  
 7 types.

**Liquid Drano** \$1.30 Ea.  
 32 ounce.

**Lysol** \$1.49 Ea.  
 Cleaners Lysol 22 Oz. direct multi purpose, 16 oz. toilet bowl cleaner, 16 oz. Murphy oil soap, 5 oz. Lysol liquid or 22 oz. Faultless spray starch.

**40 Qt. Swing Top Waste Basket** \$5.99 Ea.  
 Regularly 6.50.

**30 Gallon Trash Can** \$8.99 Ea.  
 Regularly \$10.

**Heavy Duty Laundry Basket** \$4.99 Ea.  
 Regularly \$5.

**60 Quart Laundry Hamper** \$6.99 Ea.  
 Regularly \$8.

**Baking Dishes** \$5.99 Ea.  
 2 quart casserole with cover or 3 piece mixing bowl set.

**5"x9" Loaf Pan** \$3.99 Ea.  
 2 Qt. Baking Dish \$4.99, 3 Qt. Dish \$5.99.

**Pack Of 4 Glasses** \$2.99 PKS  
 16 oz. Three designer patterns.

**CASIO Mini Printer Calculator** \$16.99 Ea.  
 Regularly \$20. Paper and batteries included.

**Childrens' Tape And Book** \$4.99 ea.  
 Jumbo Color And Activity Book... 2 For \$3, Jumbo Joke And Activity Book... \$2

**Walkie Talkies** \$10.99 Set.  
 Regularly \$11.99. Volume control and Morse set code button.

**Rechargeable Lantern** \$3.99 Ea.  
 Cordless.

**Interior Latex Semi Gloss Paint** \$6.99 Gal.  
 Regularly \$9. 4" Wall Brush \$2.99

**Rechargeable Folding Screwdriver** \$9.99 Ea.  
 After Rebate

**Turtle Wax** \$3.99 Ea.  
 Paste Wax 16 ounce. Liquid 18 Oz. Car Wash \$2.99

**Power Steering Or Brake Fluid** \$1.99 Ea.  
 12 ounce.

**Fix-A-Flat** \$4.99 FOR 3  
 12 ounce.

**Armor All Protectant** \$4.99 Ea.  
 16 ounce.

**Brown Jersey Or Cotton Canvas Gloves** \$1.99  
 Rubberized Or Hobnob \$2.99, Leather Safety \$3.99, Suede Leather \$5.99

# ...Family Dollar's Policy

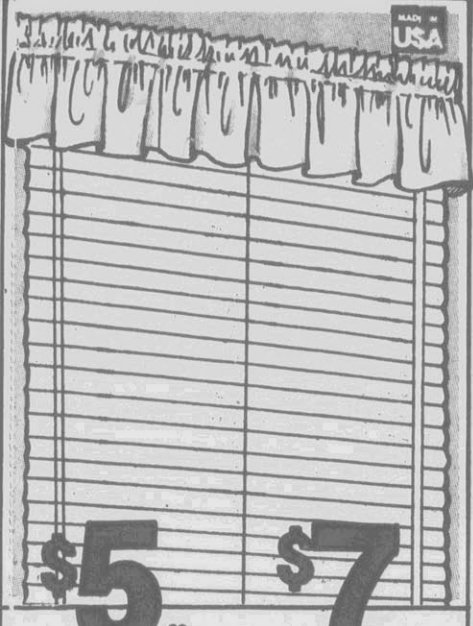

**\$5** ea. **\$7** Ea.  
**23" x 42" Vinyl Mini Blinds**  
 Regularly \$6  
 Pouf Valance \$7

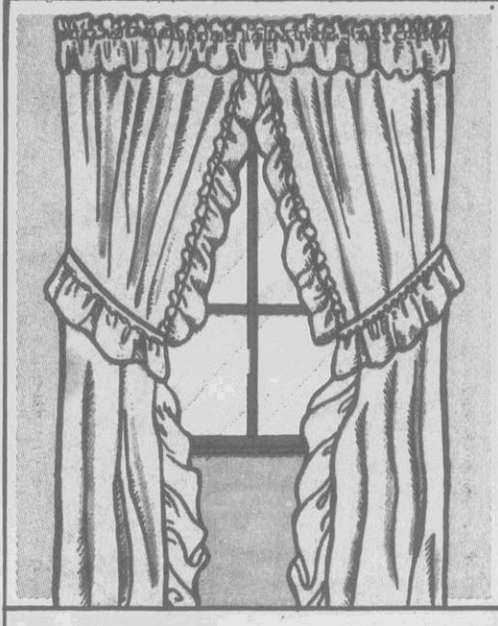

**\$10** Pr  
**Priscilla Curtains**  
 63" or 81" length

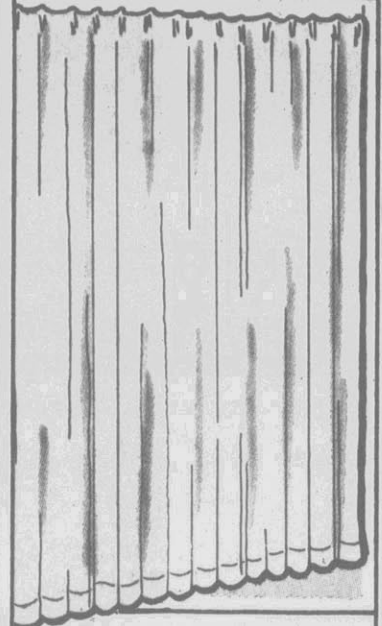

**\$3** Ea.  
**Curtain Panels**  
 Regularly \$4. 40" x 63" or 40" x 81". Available in white, beige or blue.



**\$8** Set  
**3 Piece Bath Mat Set**  
 Lid cover, contour mat and bath mat. Assorted colors.



**3 \$5 FOR**  
**Print Terry Bath Towels**  
 Reg. \$2 Ea. Assorted patterns and colors  
 Pk. Of 12 Washcloths \$3 pkg.



**\$23**  
**8' x 10' Room Size Rug**  
 Reg. \$30.



**\$11**  
**Tufted Bedspread**  
 Reg. \$13. Twin or full size.



**\$6** Ea. Queer Size. \$8 Full Size. \$10  
**Twin Size Mattress Pad**  
 Full Size... \$8 Ea. Queer Size. \$10

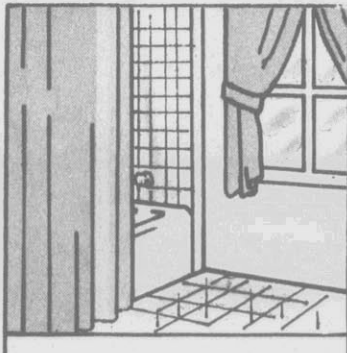

**\$5** Set  
**6 Pc. Shower Curtain Set**  
 Reg. \$6. Shower curtain & rings, 2 window panels with tie backs.



**\$6** Ea.  
**Carpet Runner**  
 2' x 6' Asst colors.

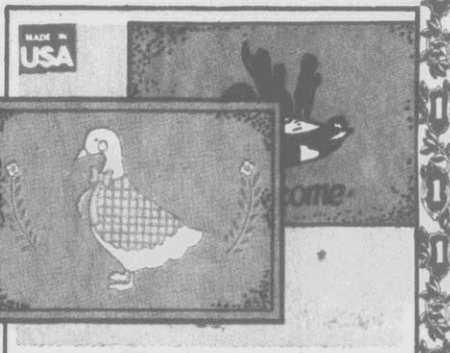

**\$4** Ea.  
**Novelty Rugs Or Door Mats**  
 19" x 27", 18" x 30" or 18" x 27"

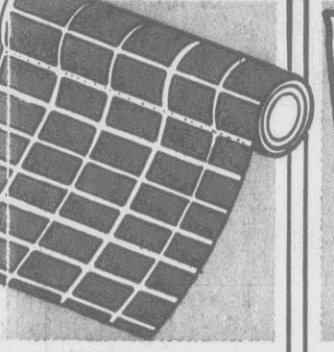

**\$15** Ea.  
**6' x 9' Vinyl Rug**  
 Easy to install.



**\$1** Bag  
**Polyester Stuffing**  
 12 ounce. Not Available At All Stores

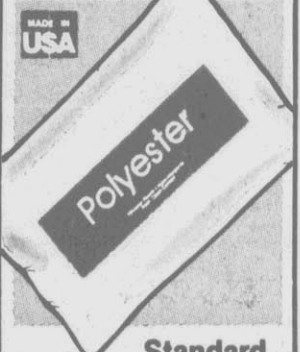

**\$3** Ea.  
**Standard Size Bed Pillow**  
 Regularly \$4. Polyester filled.

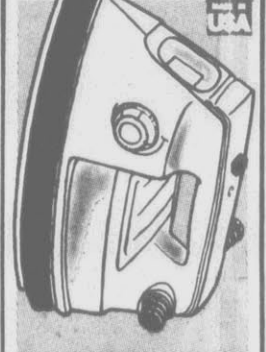

**\$10** Ea.  
**Steam & Dry Iron**



**\$10** Ea. Cover \$2.50  
**Ironing Board**  
 Reg. \$13. Pad And Ea. Cover \$2.50



**\$10** Ea.  
**Carpet Sweeper**  
 Regularly \$12.

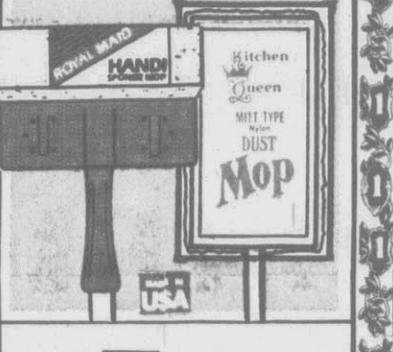

**2 \$5 FOR**  
**Dust Mop Or Metal Sponge Mop**



**\$3** Each After Rebate  
**Wring-A-Matic Floor Mop**



**2 \$3 FOR**  
**8 Oz. String Mop Or Wax Applier**

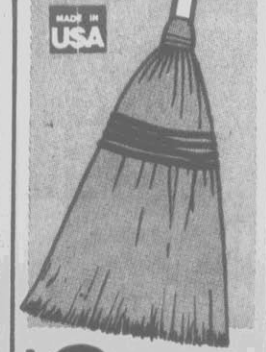

**\$3** Ea.  
**Corn Broom**  
 Regularly \$4.



**\$8** ea.  
**Assorted Lamps**  
 Ceramic Lamps (Slightly Irregular) Regularly \$15



**150** Each After Rebate  
**Contact Paper**  
 3 yard roll.



**50c** Each After Rebate  
**Shelf Liner**  
 10 sq. ft.



**\$3** Ea.  
**Autumn Harvest Center Piece**  
 Silk flowers with earthenware container. Silk Flower Bush \$1 Ea.

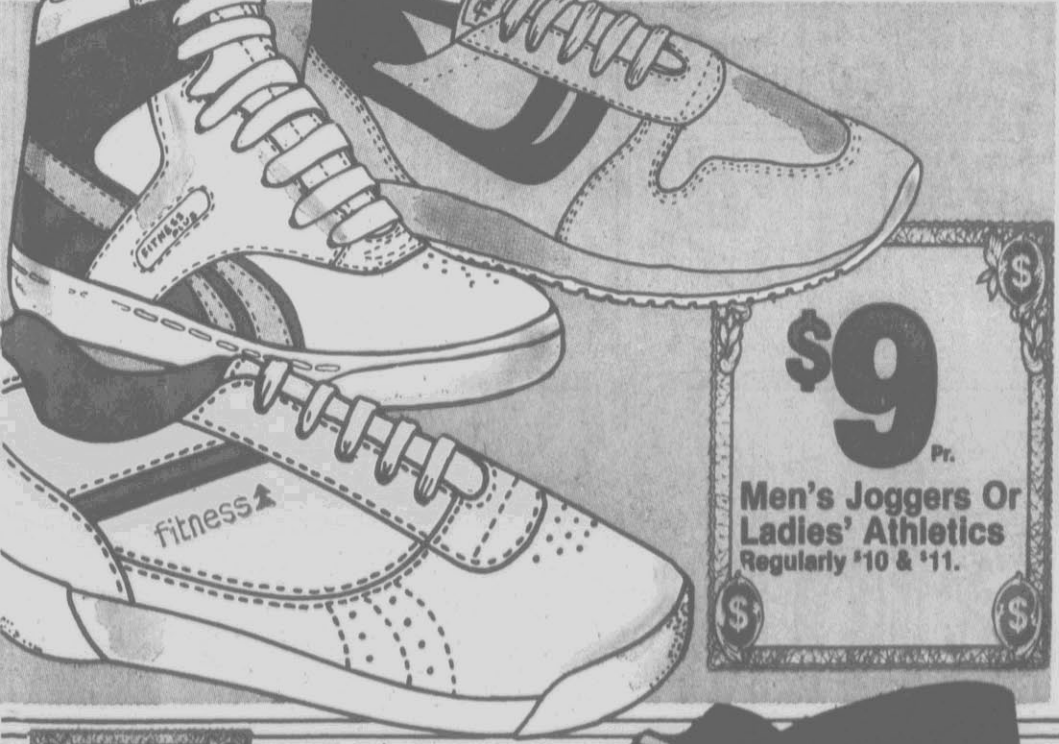

**\$8** Pr.  
**Ladies' Camp Moccasins**



**\$10** Pr.  
**Men's Court Shoes**  
 Regularly \$13.

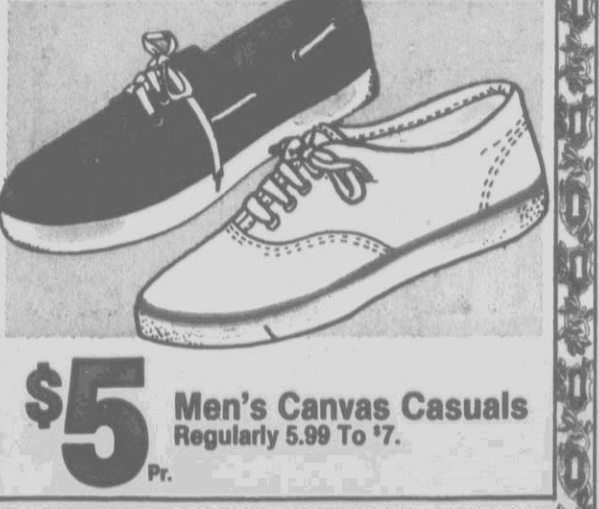

**\$5** Pr.  
**Men's Canvas Casuals**  
 Regularly 5.99 To \$7.

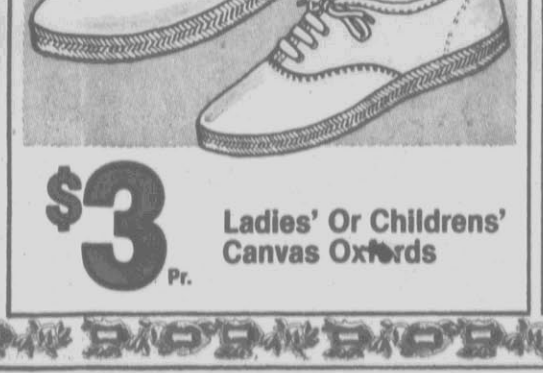

**\$3** Pr.  
**Ladies' Or Childrens' Canvas Oxfords**



**\$2** Pr.  
**Ladies' Washable Scuffs**

## Dollar Days Sale

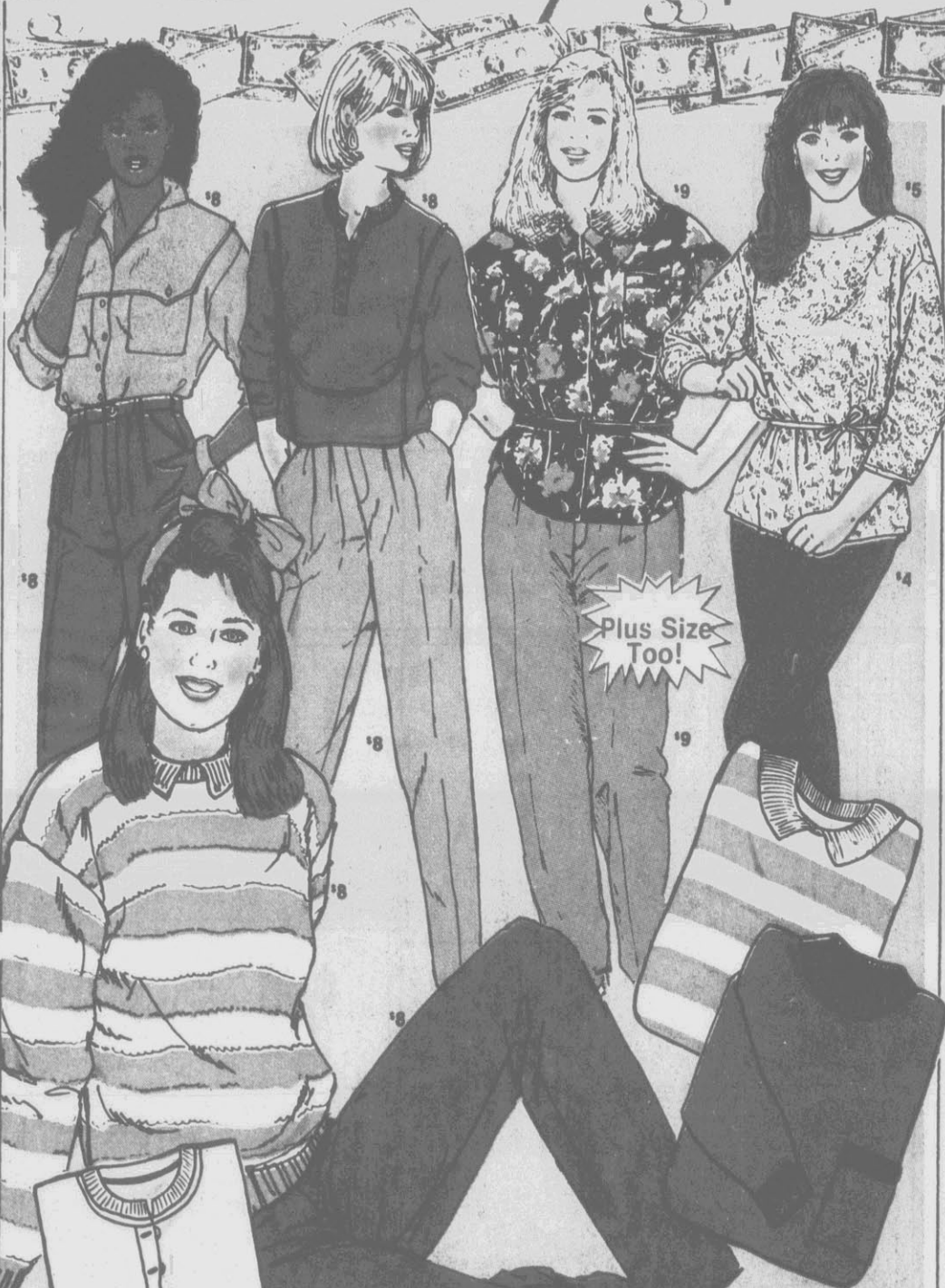

Plus Size Too!



SAVE \$2

**\$8** Ea.  
Asst. Ladies' Tops, Sweaters, Pants Or Skirts  
Plus Size Skirts, Tops Or Sweaters \$9  
Plus Size Fleece Tops \$10

**\$4** Pr.  
Ladies' Polyester Pull-On Pants Tunic Blouses \$5  
Plus Size Pants \$5  
Plus Size Blouses \$6

**\$5** Ea.  
Boys' 8-16 Long Sleeve Knit Shirts Regularly \$7  
**\$7** Pr.  
Boys' 8-16 Casual Slacks Sizes 4-7 Reg. \$7 \$5

**\$6** Ea.  
Men's Long Sleeve Knit Shirts Regularly \$8  
**\$9** Pr.  
Men's Casual Slacks Regularly \$11

**\$2** Ea.  
Ladies' Criss-Cross Bras with or without cap.  
**\$3**  
Ladies' Pk. Of 3 Acetate Panties

**2 \$7 FOR**  
Ladies' Bra And Bikini Sets

**\$4** Ea.  
Ladies' Full Figure Bras  
**2 \$3 PRS**  
Ladies' Wrangler Socks



SAVE \$2  
**\$7** Ea.  
Men's Long Sleeve Sport Shirts Regularly \$9.



**2 \$4 FOR**  
Men's Pocket Tee Shirts Regularly 2.50 Ea.

**\$5** Pk.  
Pack Of 6 Pr. Men's Socks  
**\$4** Pk.  
Pk. Of 6 Pr. Socks Ladies', boys', girls' or toddlers'

**\$8** Ea.  
Assorted Ladies' Handbags



**\$6** Ea.  
Girls' 7-14 Fashion Shirts Regularly \$7  
4-6x Reg. \$6 \$5

**\$8** Pr.  
Girls' 7-14 Sheeting Pants Regularly \$10.  
4-6x Reg. \$8 \$7



SAVE \$2

**\$10** Ea.  
Girls' 7-14 Printed Jog Suits Regularly \$12. Assorted screened prints. 4-6x Reg. \$10 \$8



**\$7** Ea.  
Toddlers' Printed Jog Suits Infants \$5



**\$4** Ea.  
Infant Boys' Or Girls' Pajamas Regularly \$5.

PRICES GOOD  
WED., SEPT. 14 THRU  
SUN., SEPT. 18

# BIG LOTS

# BARGAINS

TRY US FIRST!



## Summer's end

**SOUND DESIGN®**  
4.5" TUBE  
PORTABLE  
BLACK & WHITE  
TELEVISION  
WITH AM/FM CLOCK RADIO



#3943  
**53<sup>99</sup>**  
COMP. TO  
~~99.99~~

FEATURES: Powerful 3" speaker, UHF/VHF TV band, L.E.D. clock with alarm, snooze and sleep-to-music. Headphone jack and telescopic antenna. Operates on AC/Battery operation or car adapter (not included).



**12 NUMBER  
MEMORY  
PHONE**



#2-9260  
**16<sup>99</sup>**  
COMP. TO  
~~34.95~~

Tone/pulse switchable, 12 number memory, one-touch redial, desk or wall mountable. Assorted colors.

COMP. TO  
~~5.49~~  
**MJB**  
12 OZ.  
INSTANT COFFEE  
Made by one of the leading  
Coffee Manufacturers in the U.S.



**3<sup>99</sup>**

COMP. TO  
~~1.49~~  
**SYLVANIA**  
2-PACK  
SOFT WHITE  
ENERGY PINCHER  
LIGHT BULBS



**79¢** PK. YOUR CHOICE: 55, 70 or 95 Watts

COMP. TO  
~~89¢ EA.~~  
**Fiddle Faddle**  
**GLAZED  
POPCORN  
SNACKS**



**49¢** EA. YOUR CHOICE: •Fiddle Faddle® •Screaming Yellow Zonkers® NET WT. 5.5 OZ.

COMP. TO  
~~1.29~~  
**Hormel**  
**BEEF  
STICKS**  
**Hormel**  
6 COUNT  
MEAT  
STICKS



**69¢** YOUR CHOICE: •Beef •Salami •Pepperoni NET WT. 3 OZ.

COMP. TO  
~~3.99~~  
**FINESSE**  
32 OZ.  
SHAMPOO OR  
CONDITIONER



**2<sup>99</sup>** EA.

COMP. TO  
~~89¢~~  
**Scotties**  
**KACHOOS™**  
200-CT.  
FACIAL  
TISSUES

**59¢**

COMP. TO  
~~6.95~~  
**Accu-Edge**  
**CARBIDE** 7-7/8"  
TIP  
7-7/8"  
24 TOOTH  
CARBIDE TIP  
SAW BLADE



**2<sup>99</sup>** #11-104 Fits all portable electric saws.

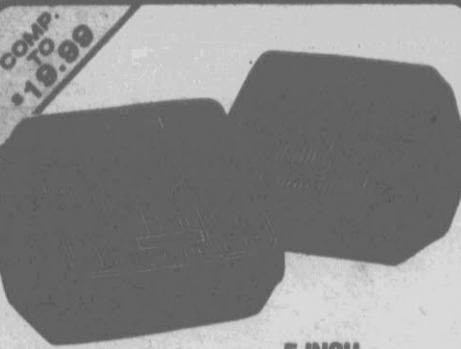

**KRACO**  
5 INCH  
DUAL CONE  
CAR SPEAKERS

**12<sup>99</sup>** PR. FEATURES: Surface or flush mount, 5.3 oz. magnet and 10 watts handling capability. •KS-275F

COMP. TO  
~~59.95~~  
**KRACO**  
INDASH AM/FM STEREO  
CAR CASSETTE PLAYER  
WITH AUTO-REVERSE

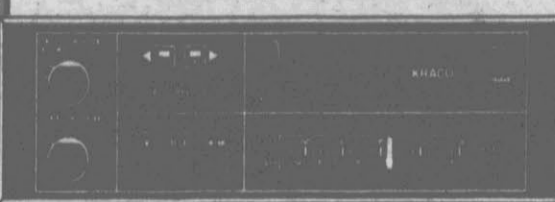

**39<sup>99</sup>** FEATURES: Fast forward and eject, stereo/mono switch, analog dial scale, tone and balance controls and much more! Fits late model cars. •KF-1103

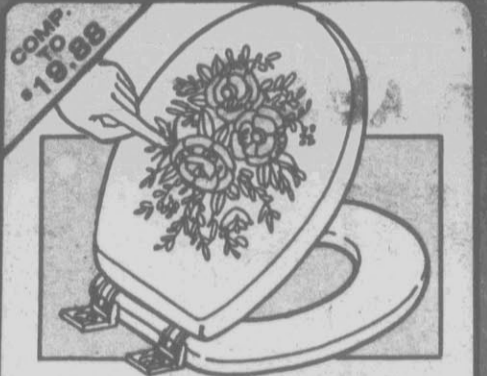

**9<sup>99</sup>** FIRST QUALITY EMBROIDERED/CUSHIONED TOILET SEATS Easy clean vinyl with adjustable top mount hinge. Assorted designs and colors.

CODE 80

# EVERYTHING FOR LESS AT BIG LOTS®

SHOP US FIRST FOR *Savings*

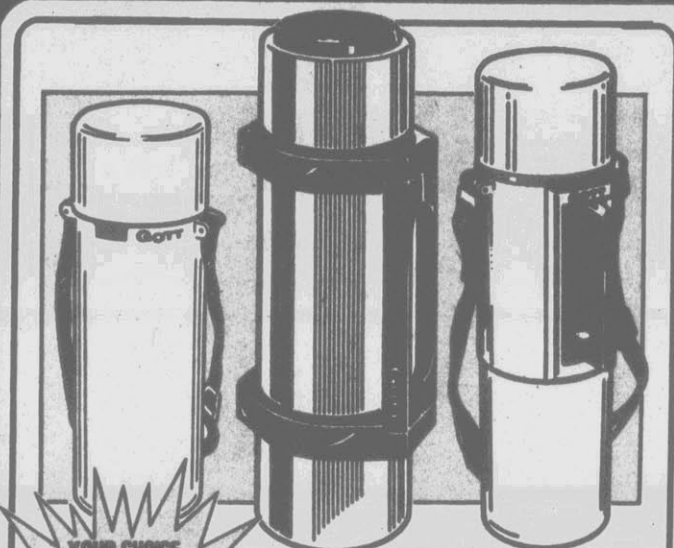

COMP. UP TO \$19.99

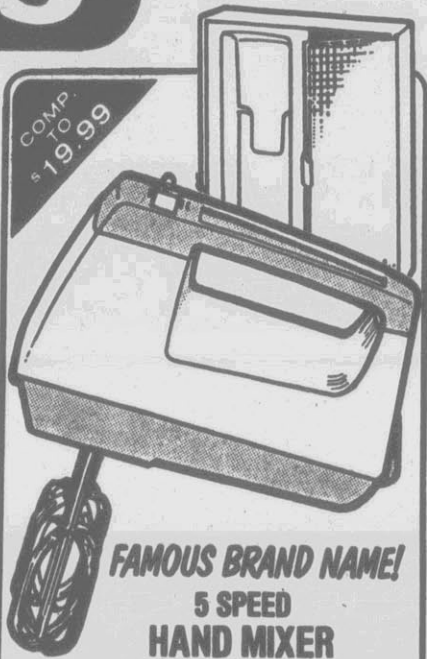

**FAMOUS BRAND NAME!**  
**5 SPEED HAND MIXER**  
WITH WALL MOUNT STORAGE CABINET

**12<sup>99</sup>** Features: Fingertip Speed Control, Top Beater Ejector Button and Non-Splash Beaters.

## BARGAIN PRICES ON EVERYDAY ITEMS

COMP. UP TO \$1.89

**empress STUFFED OLIVES**  
IN DECORATIVE GLASS



**99¢** NET WT. 5 OZ.

COMP. UP TO \$1.79

**Shultz 1 LB. HARD PRETZELS**



**88¢**

COMP. UP TO 79¢

**SINGLE SERVING CHICKEN & DUMPLINGS**  
NET WT. 7.5 OZ.



**39¢**

COMP. UP TO \$1.19

**vlastic HOT JALAPENO PEPPERS**



**69¢** NET WT. 10 OZ.

COMP. UP TO 40¢ EA

**Betty Crocker PUDDING ROLL-UPS**  
MILK CHOCOLATE

**5 \$1** FOR SINGLE SERVING CHOCOLATE PUDDING ROLL-UPS™ NET WT. .75 OZ.



COMP. UP TO \$2.98 EA

**READ-ALONG ADVENTURE STORIES**  
Wide assortment of stories adapted from famous movies. For young readers.

**7" BOOK WITH RECORD \$10 \$1**  
FOR  
•7" BOOK w. CASSETTE  
•12" BOOK w. RECORD  
•12" BOOK w. CASSETTE  
COMP. UP TO \$7.98  
**39¢-99¢ EA.**

COMP. UP TO \$89.95



**THE NATIONAL ENCYCLOPEDIA**  
**19<sup>99</sup>** 13 VOLUME SET  
Thousands of illustrations, photos and much more.



**NORMAN ROCKWELL 10 OZ. MUGS**  
**99¢** EA. Assorted famous reproductions.

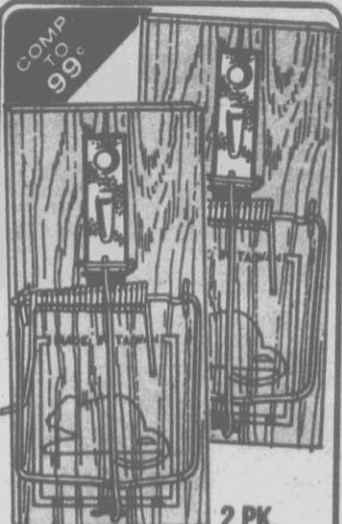

**39¢** 2 PK. WOOD MOUSE TRAPS



**5" GUMBALL MACHINE COIN BANK**  
**3<sup>99</sup>** YOUR CHOICE  
Complete with gumballs, lock & key. Assorted styles.

Summer's end  
**BARGAINS!**

EVERYTHING FOR LESS AT  
**BIG LOTS®**

COMP. TO  
UP TO  
\$1.69

**EASY-OFF®  
GLASS CLEANER**  
NET WT. 32 FL. OZ.



**99¢**

COMP. TO  
UP TO  
\$1.69

**PUREX®  
32 OZ. LIQUID  
LAUNDRY  
DETERGENT  
WITH FABRIC SOFTENER**



**1.19**

COMP. TO  
UP TO  
\$1.69

**Aqua-fresh**



6 OZ.  
**FLUORIDE  
TOOTHPASTE**  
Special kids' flavor.

**1.29**

COMP. TO  
UP TO  
\$3.49

**100 CT.  
DISPOSABLE  
CUPS**

12 OZ. SIZE  
In assorted designs.



**1.79** 100 CT.  
HOT CUPS  
8.25 OZ. ... **1.29**  
or 9 OZ. ...

COMP. TO  
UP TO  
\$2.69

**Purina®  
SPECIAL  
DINNERS®  
CAT FOOD**  
NET WT. 2 LBS.



**1.79**

COMP. TO  
UP TO  
\$4.99

**18" BAMBOO  
RAKE**

31 tine rake  
with 48 inch  
hardwood  
handle.



**1.49** 24" BAMBOO  
RAKE  
With 26 tines... **2.99**



**3 TON  
CAST ALLOY  
JACK STAND  
SET**

Heavy duty - designed for professional shop use. Provides maximum stability.

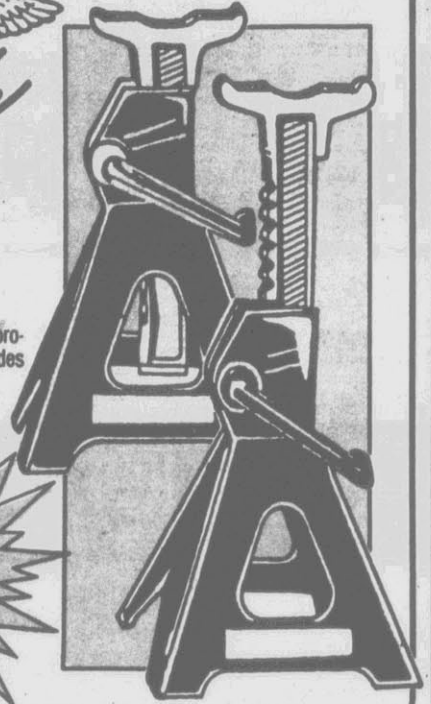

**19.88**

SET  
COMP. TO  
\$39.99

**Coleman®**

**CLASSIC  
SACK  
BACKPACK**

Large-capacity heavy-duty nylon with suede bottom, front pocket, hang loop, straps and waistbelt. Two-toned silver. 12" x 18" x 6".

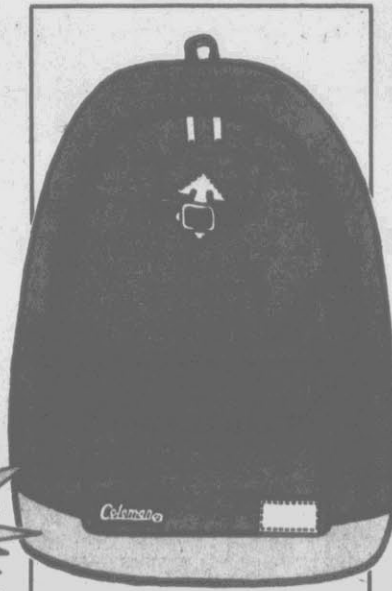

**9.99**

COMP. TO  
\$22.99

COMP. TO  
UP TO  
\$7.95



**WHITE FLAT LATEX  
HOUSE PAINT**

**3.99**  
GAL.

Vinyl acrylic paint for interior or exterior use. Easy clean-up.

COMP. TO  
UP TO  
\$3.99

**25 WATT  
ELECTRIC  
SOLDERING  
IRON**

With Stand  
And 71" Cord



**2.69**

COMP. TO  
UP TO  
\$3.99

**11 QT.  
GALVANIZED  
DRAIN PAN**

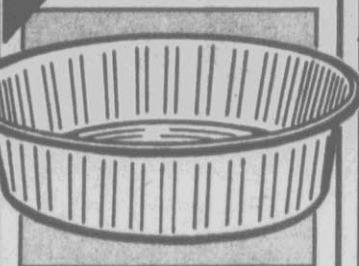

**1.69** Wide lip,  
easy pour.

COMP. TO  
UP TO  
\$2.99

**LINED  
HUNTING  
GLOVES**



**1.39** Lined jersey gloves in camouflage or hunter's orange. Assorted styles.

# EVERYTHING FOR LESS AT BIG LOTS®

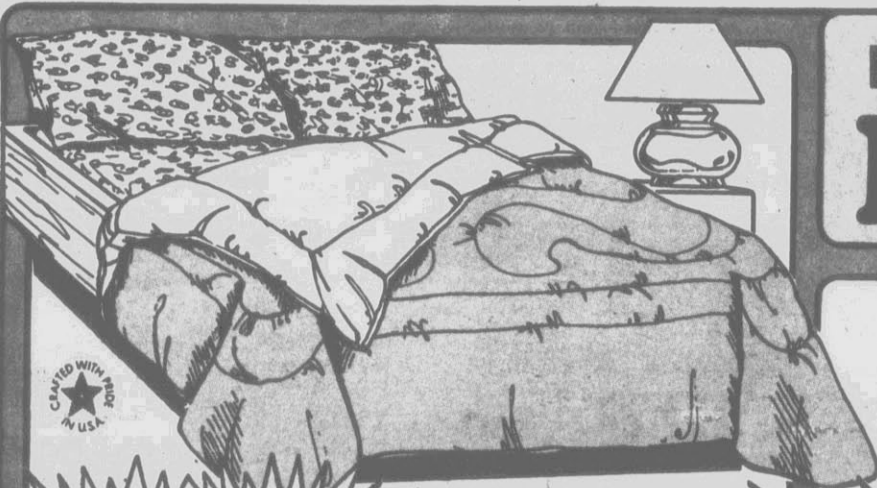

MADE WITH 100%  
COTTON  
IN U.S.A.

## SATIN WATERBED SHEET SETS

Polyester/satin sheet sets in solids or prints. King, Queen or Super Single Sizes.

**19<sup>99</sup>**  
SET  
COMP. TO \*29.99

eastern

## REVERSIBLE SATIN WATERBED COMFORTER

Polyester/satin quilted comforter in assorted colors. Fits King or Queen.

**30<sup>99</sup>**  
COMP. TO \*49.99

## GENERATION ONE® MEN'S FLANNEL-LINED DENIM JACKETS

First Quality!

100% cotton blue denim jean jackets with plaid flannel lining.

**19<sup>99</sup>**

COMP. TO \*29.99

SIZES:  
S•M•L•XL



## LADIES' CAMISOLES & HALF SLIPS

Choose from assorted colors, fabrics and styles with lace trim. SIZES: XS•S•M•L PLUS SIZES: 1X•2X•3X

**2<sup>99</sup>**  
EA.



## Lovable® FIRM CONTROL BODY BRIEFER

Self-fabric reinforced tummy panel. 100% cotton lined hook & eye crotch. Adjustable straps. Assorted sizes.

**7<sup>99</sup>**



## LADIES' NYLON GOWNS

Choose from assorted soft colors with lace trim. Wide sweep.

**4<sup>99</sup>**



## BOYS' & GIRLS' INFANT WARM-UP SETS

INFANT SIZES: 12-24 MOS. Fleece tops with coordinating pants in a variety of fabrics. Ass't. colors.

**3<sup>99</sup>**  
COMP. TO \*8.99



## LADIES' LACE UNDERWEAR

Choose from assorted styles and colors with lace trim. SIZES: 5•6•7

**2\$3**  
FOR

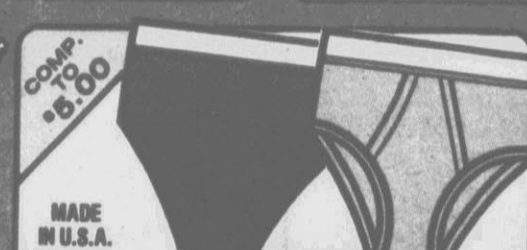

## MEN'S FASHION BRIEFS

Choose from low rise or mesh briefs in assorted colors. SIZES: S•M•L

**1<sup>99</sup>**  
EA.



## MEN'S ORLON CREW SOCKS

In assorted colors. SIZE: 10-13 Slight Irregulars.

**99¢**



## 17" X 17" DECORATOR PILLOWS

Polyester filled. Assorted colors. 27" x 27" FLOOR PILLOWS ..... 6<sup>99</sup>

**3<sup>99</sup>**



## MEN'S & LADIES' THERMAL UNDERWEAR

Choose from long sleeve crew neck tops or ankle length pants. Assorted colors & sizes. Poly/cotton blend. MADE IN U.S.A.

**2<sup>99</sup>**  
EA.



## QUILTED BEDSPREADS

Polyester/cotton with tricot back. Assorted solids and prints. •TWIN •FULL •QUEEN •KING YOUR CHOICE

**19<sup>99</sup>**  
EA. Slight Irregulars.

- Atlanta, GA: 1000 Peachtree St. N.E.
- Baltimore, MD: 1000 N. E. Street
- Birmingham, AL: 1000 N. E. Street
- Charlotte, NC: 1000 N. E. Street
- Cincinnati, OH: 1000 N. E. Street
- Columbus, GA: 1000 N. E. Street
- Dallas, TX: 1000 N. E. Street
- Dayton, OH: 1000 N. E. Street
- Denver, CO: 1000 N. E. Street
- Des Moines, IA: 1000 N. E. Street
- Detroit, MI: 1000 N. E. Street
- Fort Worth, TX: 1000 N. E. Street
- Houston, TX: 1000 N. E. Street
- Indianapolis, IN: 1000 N. E. Street
- Jacksonville, FL: 1000 N. E. Street
- Kansas City, MO: 1000 N. E. Street
- Las Vegas, NV: 1000 N. E. Street
- Little Rock, AR: 1000 N. E. Street
- Los Angeles, CA: 1000 N. E. Street
- Memphis, TN: 1000 N. E. Street
- Minneapolis, MN: 1000 N. E. Street
- Miami, FL: 1000 N. E. Street
- Mobile, AL: 1000 N. E. Street
- Montgomery, AL: 1000 N. E. Street
- New York, NY: 1000 N. E. Street
- Oak Ridge, TN: 1000 N. E. Street
- Oklahoma City, OK: 1000 N. E. Street
- Omaha, NE: 1000 N. E. Street
- Orlando, FL: 1000 N. E. Street
- Philadelphia, PA: 1000 N. E. Street
- Pittsburgh, PA: 1000 N. E. Street
- Raleigh, NC: 1000 N. E. Street
- Richmond, VA: 1000 N. E. Street
- Riverside, CA: 1000 N. E. Street
- Salt Lake City, UT: 1000 N. E. Street
- San Antonio, TX: 1000 N. E. Street
- San Diego, CA: 1000 N. E. Street
- San Francisco, CA: 1000 N. E. Street
- Seattle, WA: 1000 N. E. Street
- St. Louis, MO: 1000 N. E. Street
- Tampa, FL: 1000 N. E. Street
- Tucson, AZ: 1000 N. E. Street
- Wichita, KS: 1000 N. E. Street

WE'RE HAVING FUN LIKE YOU ARE! WE STAY OPEN: 10:00 a.m. - 8:00 p.m. 7 days a week. Due to the nature of our business, Big Lots, Great Deals, Special Buys, we must limit our stock to what is on hand.

What Matters Most Is You.

# KERR Drug Stores



**1.00**  
Each

Crest® Toothpaste. 4.6 oz. tube. Your choice of regular, mint, gel, tartar control, tartar control gel, or super cool gel for kids. Don't miss these special savings.

# Dollar Days



**4 FOR \$1**

Bubble Yum® Bubblegum. Regular or sugarless. Your choice of fun flavors.

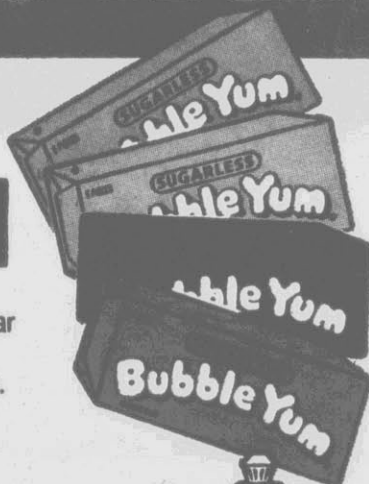

**4 FOR \$1**

Life Savers® Fruit Juicers. Strawberry, citrus, mixed berry, or fruit punch flavors.



**2.00**

**1.50**

**Special Value on Sure® Anti-Perspirant!**

Sure® Dry Roll-On, or Super Dry Spray, your choice, **SALE PRICE 1.50.**

Sure® Wide Solid, **SALE PRICE 2.00.**

Choice of fresh scents.

**1.00**  
Each

Dawn® Dish-washing Detergent. 22 ounces. Your choice of regular or Mountain Spring scent.



Save Big with 40¢-Off Label!

**2.00**  
Each

Tide® Detergent. Big 42 ounce box. Gets even the toughest dirt out of clothes to leave them clean and fresh.

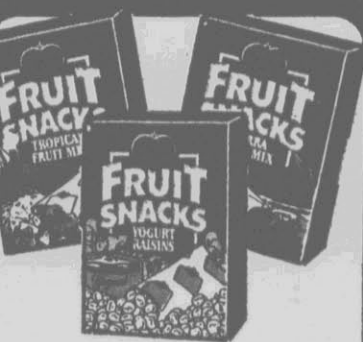
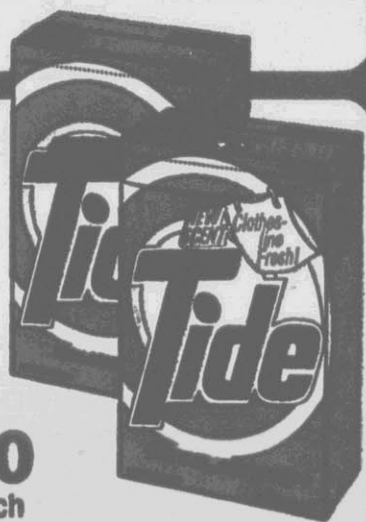

**2 FOR \$3**

Del Monte® Fruit Snacks. Nine ounce package. Choice of delicious flavors.



**2 FOR \$3**

Planters® Microwave Popcorn. Three packages per box. Natural or Butter flavors. Great taste.



**99¢**  
Each

Del Monte® Raisins. 9 oz. box. Delicious and nutritious snack. Buy now for the whole family.

Pharmacist House  
Call Video Library  
**FREE VIDEO RENTAL**  
Only at... **KERR**  
Drug Stores

**CHIP**  
C. LISTENERS' HEALTH INFORMATION LAN

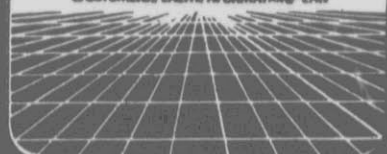

# Nature Made



Save Big Now On Nature Made® Vitamins!

Potassium Gluconate Tablets, 550 mg, 100 count, SALE PRICE 1.99.  
 Vitamin C, 1000 mg, 100 count, SALE PRICE 2.99.  
 Vitamin E 400 IU Di-Alpha Caps, 100 count, SALE PRICE 2.99.  
 Oyster Shell Calcium, 500 mg, 100 + 30 FREE, SALE PRICE 3.99.  
 Super B Complex Tablets, 100 count SALE PRICE 3.99.

HELENE CURTIS  
**SALON SELECTIVES**



**1.69**  
 Each

Salon Selectives® Hair Care. Shampoo, Conditioner, Hair Spray, Volumizing Spray, Spritz, or Styling or Sculpting Gel. Choose the level that's right for your type of hair.

What Matters Most Is You.

**KERR**  
 Drug Stores

## Look and Feel Your Best

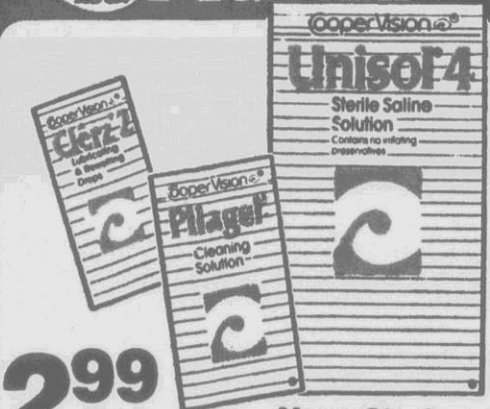

**2.99**  
 Each

Your Choice

Unisol® 4 Saline Solution, 3-pk. of 4 oz. bottles; Pilagel® Cleaning Solution, 25 ml; or Clerz® 2 Rewetting Drops, 15 ml.



**2.99**  
 Each

40¢-Off Label!

Playtex® Tampons. 28 count. Regular, Super, or Super Plus. Your choice of deodorant or non-deodorant.



**3.49**  
 Each

Alcon® Opti-Clean or Opti-Clean II, 20 ml; or Flex-Care, 12 oz.  
 36 Opti-Zyme Enzymatic Tablets, SALE 7.99.



Stiff Stuff® Styling Products  
 Super Hold Non-Aerosol Styling Mist, 8 oz.; or Styling Gel, 4 oz., SALE PRICE 1.99.  
 Light or Finishing Spray, 7 oz., your choice, SALE PRICE 2.49.



Special Value on Proline® Soft & Beautiful Hair Care  
 Your Choice: Creme Moisturizer, Holding Spray, Oil Sheen, or Perm Repair, SALE PRICE 1.99.  
 Creme Relaxer Kit, SALE 4.99.



Theragran-M® Multivitamin.  
 Bonus Pack of 100 plus 30 FREE. SALE PRICE 6.49.  
 Theragran Jr.® Children's Chewable Vitamins. With extra Vitamin C. 75 tablets. SALE PRICE 3.99.



**2.19**  
 Each

Sudafed® Tablets, 24 count; 12-Hour Capsules, 10 ct.; or Cough Syrup, 4 oz.

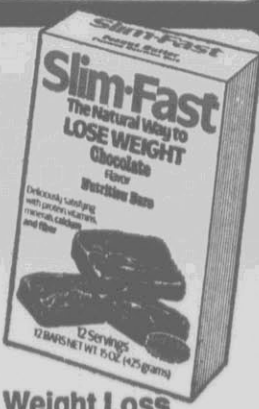

Save Now on Safe & Effective Weight Loss  
 Maximum Strength Dexatrim® Appetite Suppressant, capsules or caplets, 20 count, Caffeine-free or Vitamin C formula, SALE PRICE 3.29 less \$1.00 Mfr. Rebate. Final Cost 2.29.  
 Slim Fast® Chocolate or Chocolate Malt Powder, 15 oz.; or Chocolate Bars, 12 ct., SALE PRICE 4.49 each.



**4.99**  
 Each

Dental Pik Plaque Remover. Helps get rid of plaque for better dental health.



**1.99**  
 Each

Nivea® Skin Lotion, regular or extra enriched formula, 8 oz.; Creme, 4 oz. jar; or Oil, 8 oz.



**30% OFF** Our Everyday Low Price

All Sally Hansen® Nail Enamel and Nail Care Products. Large selection. Buy now for more beautiful nails.

**MAX FACTOR**

**30% OFF** Our Everyday Low Price

Our Entire Selection of Max Factor® Cosmetics. Includes face and eye makeup, lipstick, nail enamel and more. Save now and look your best for less.

**KERR**  
Drug Stores

Beauty Is Always On Sale



**4.99** Each **\$1.00 OFF!**

Your Choice: Pavlon® Beautyzone Eye Gel or Nailzone Nail Gel. Revive and renew your sensitive eye and nail areas.



**40% OFF** Our Everyday Low Price

Our Entire Selection of Earrings. Many to choose from in gold, silver, and fashion colors. Buy several pairs now and save big.

PARFUMS de COEUR

**\$3.00 Value FREE!**

**8.00** Each

Your Choice of Parfums de Coeur® Fragrances. Includes 1 oz. cologne and FREE Body Spray. Save on these special scents.



**8.95** Each **Great Value!**

Jean Nate® After Bath Splash Special. Get 32 ounces for the 16 oz. price - 100% more FREE!

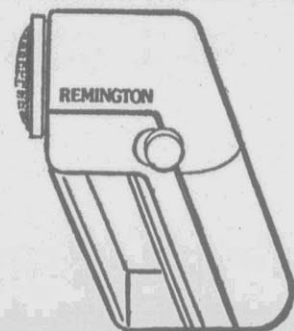

**6.99** Each

Remington® Fuzzaway Garment Shaver. #RCS-1. Removes unsightly lint and fuzz from clothes.

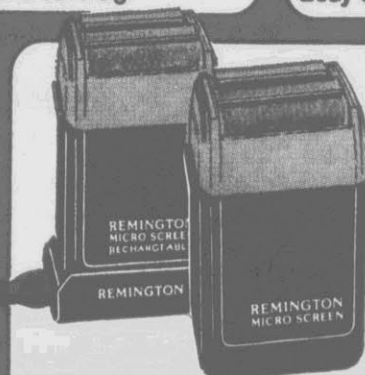

Save Big Now on Remington® Razors Micro Screen Razor, model #XLR-800, SALE PRICE 24.95. Rechargeable Micro Screen Razor, #XLR-920, SALE 34.95.

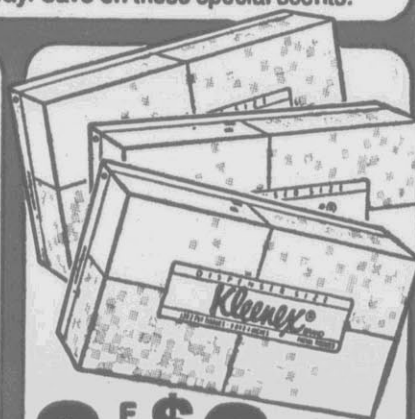

**3 FOR \$2** Limit 3

Kleenex® Dispenser Size Facial Tissues. Box of 130 2-ply tissues. Soft and thick.



**2.00** Each

Cotton Ball and Swab Holder. Made of durable plastic. Handy cosmetic accessory.



**99¢** Pack **Buy One, Get One FREE!**

Kerr Brand Small Emery Boards. Strong and long-lasting. For great-looking nails.



**20% OFF** Our Everyday Low Price

Our Entire Selection of No Nonsense® Sheer Indulgence® Hosiery. Come in today and try this new premium quality Department Store pantyhose. Assorted styles and shades in sizes 1, 2, and 3.

**NEW!**



**2 FOR \$1**

**Great Buy!**

Assorted Bathroom Accessories. Your choice of Tube Squeezer, Soap Holder, Soap Dish, or Hooks. Many handy uses. Buy several now at this great price for a neater bathroom.



**1.39**  
Each

Nabisco® Milk Bone Large Dog Biscuits. 26 oz. box. Cleans and strengthens your dog's teeth. Great-tasting, too.

What Matters Most Is You.

**KERR**  
Drug Stores

Great

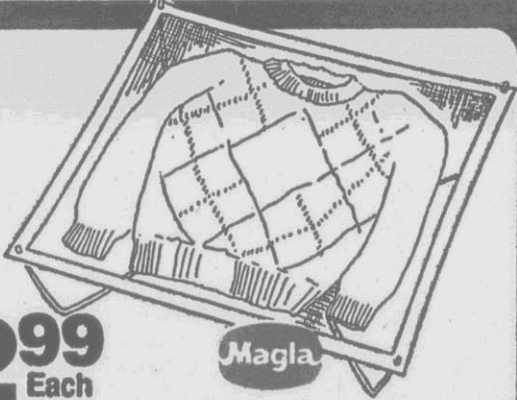

**2.99**  
Each

Magla

Magla Sweater Dryer. Sturdy wire frame. Convenient way to dry your delicate sweaters, lingerie, etc. Buy now and save big.

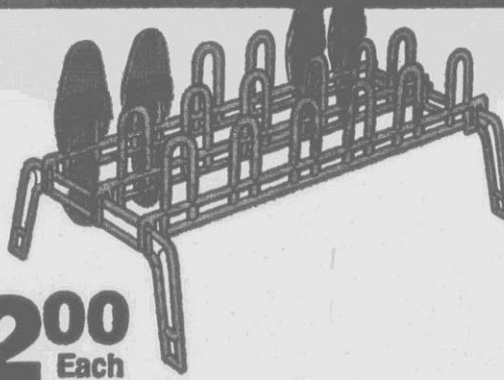

**2.00**  
Each

Low Boy KD Shoe Rack. Your choice of pretty fashion colors. Neat way to store and organize your shoes. Save more now.

**Do**  
**\$ Da**

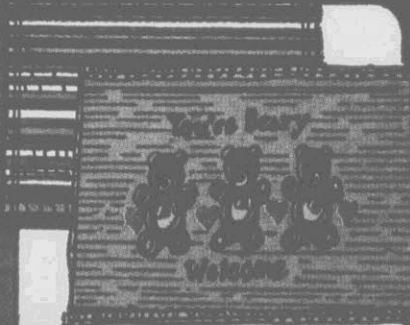

Big Savings On Quality Rugs for the Home  
Bolo Rug, #100, 19 x 33 inches, SALE PRICE 1.00. Mud Rug Welcome Mat, assorted styles, 22 x 34 inches, SALE PRICE 2.00.

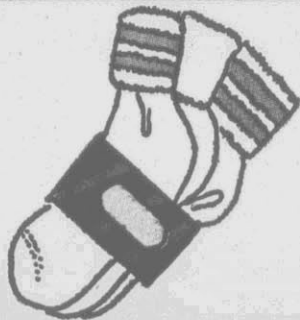

**2 FOR \$3**

Ladies' Sport Socks. Comfortable and durable. Great for sport or casual wear.

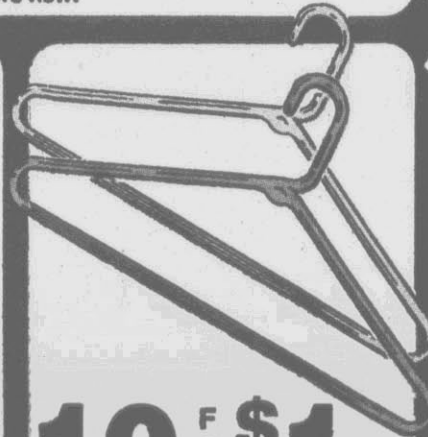

**10 FOR \$1**

Tubular Clothes Hangers. Your choice of assorted colors. Sturdy and durable for long use.

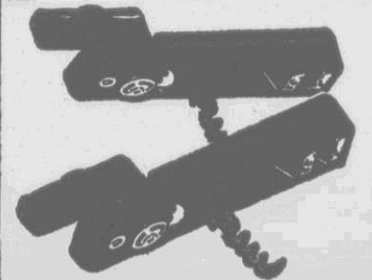

**2.00**  
Each

3 in 1 Quick Lift Can Opener. Handy can and bottle opener, and corkscrew in one easy to use tool.

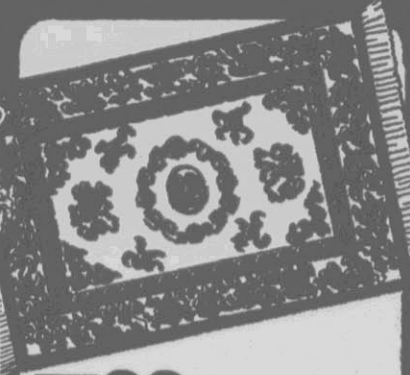

**7.99**  
Each

Attractive Oriental Design Rug. Measures 30 x 50". Adds a nice decorative touch to your home.



**1.00** Each  
Your Choice

Assorted Clothes Hanger Sets. Selection includes skirt, dress, suit, drip dry, and add-on hangers.



**2.19**  
Each

Penn® Tennis Balls. Can of three. Orange or yellow Regular or Heavy Duty style.

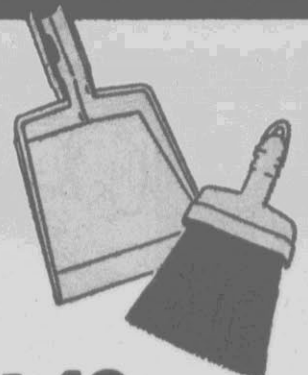

**1.49**  
Each

Dust Pan with Brush. Pan measures 9 1/2"; brush is 10 inches long. Handy for small cleanups.

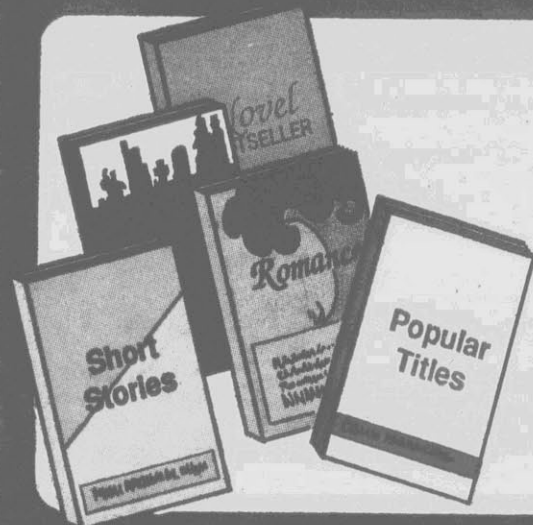

**Special Promotion!**

**99¢ Each**

Your Choice of Selected Paperback Books. Assortment of popular titles and subjects. Buy several now.



**1.00 Each**

Your Choice

Handy Kitchen Accessories. Selection includes Plastic Dish & Sink Brush, 4-piece Rubber Scraper set, 7" 2 in 1 Peeler with Brush, 2 Steel Wire Egg Beaters, 6" Peeler with iron plate handle, or Vegetable Strainer.

**Savings Everyday**

**Clearance**  
**Yes \$\$\$**



**99¢ Each**

Assorted Snack Bag Closures. Your choice of Snack Savers, Cereal Clips, Magnetic Bread Clips, or Bag Lockers.

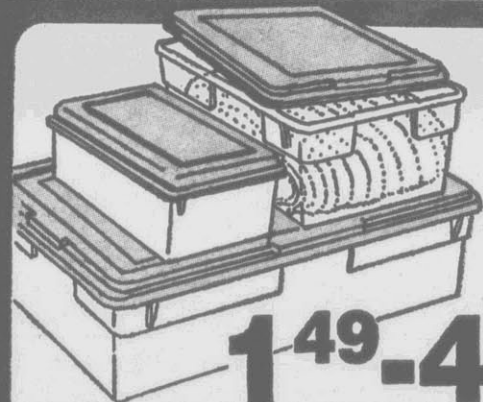

**1.49 - 4.99 Each**

Save on Sterilite Storage Boxes. Slate blue. Regular Size, SALE PRICE 1.49. Large, SALE PRICE 2.99. Jumbo Size, SALE PRICE 4.99.



**99¢ Each**

Assorted Plastic Family Combs. Package of ten. Sturdy and long-lasting.



**2.99 - 3.99 Each**

Children's Ponchos. Up to Size 8, SALE PRICE 2.99. Size 8 to 14, SALE PRICE 3.99.



**2 FOR 1.49**

Kiwi® Shoe Paste Polish. Choice of colors. Easy to apply. Helps keep your shoes looking new.



**3.00 Each**

Magic Butler Ashtray. Your choice of assorted colors. Save more now.

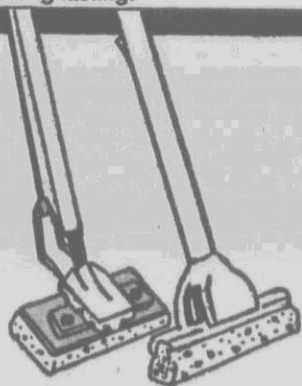

**Empire Mops & Refills**  
Ergo- or Swivel Matic Sponge Mop, SALE PRICE 4.99 each. Swivel Mop Refill, SALE 1.69; Ergo Refill, SALE PRICE 2.99.

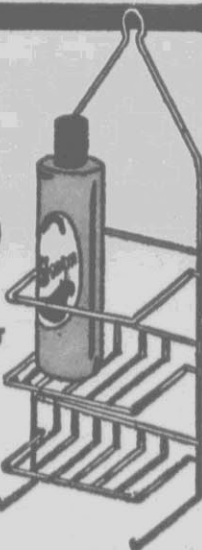

**1.99 Each**

Selfix Shower Organizer. Neat way to store your shower and bath accessories. #2151.



**1.49 Each**

Selfix Deluxe Shampoo Sprayer. #C441. Attaches quickly to your faucet for easy shampooing.



**4.99 Your Choice**

Miller Studios Country Cut-Outs. Several styles including duck trio, ABC Bear, Horse, and more.

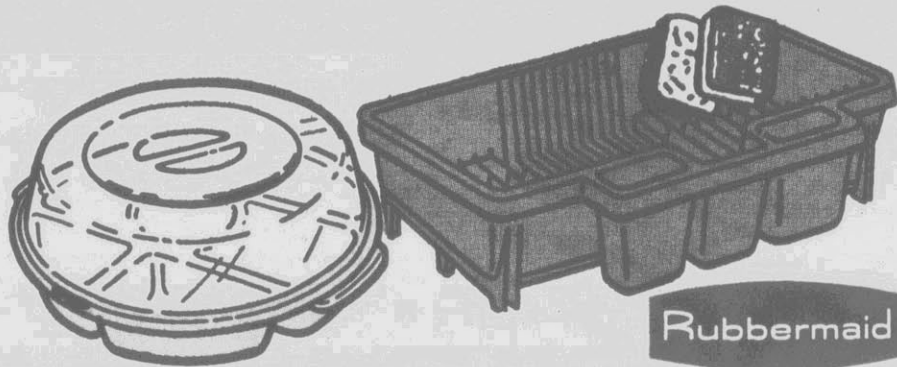

Rubbermaid

**5.00**  
Each

Your Choice: Rubbermaid® Space Saver Sink Drainer Set, almond or slate blue color; or Servin' Saver Sectional Dip 'n Snack Tray. Save big now on these great kitchen accessories.

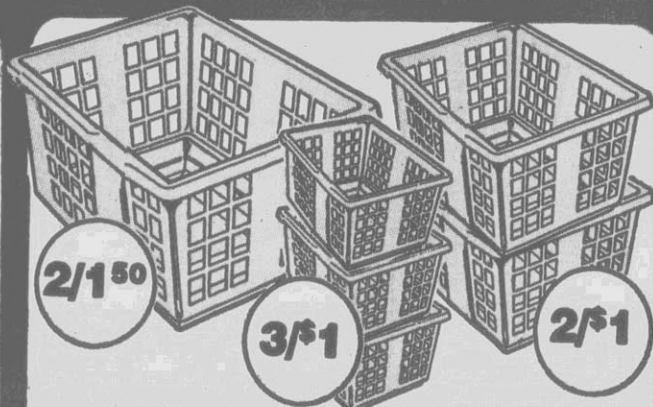

**2/1.50**

**3/1**

**2/1.50**

**Tucker Storage Baskets**

Mini Storage Basket, SALE PRICE 3 for \$1. Medium Size Stack & Storage Basket, SALE PRICE 2 for \$1. Large Stack & Storage Basket, SALE 2 for \$1.50.

What Matters Most Is You.

**KERR**  
Drug Stores

# Top Quality Housewares

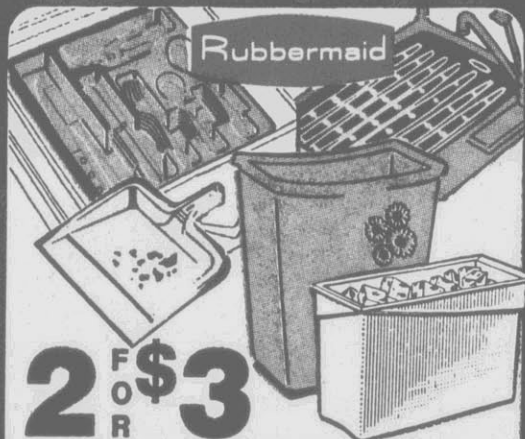

Rubbermaid

**2 FOR \$3**

Rubbermaid® 6 qt. Vanity Wastebasket, Sink Mat, Dustpan, Twin Sink Mat, Cutlery Tray, or Ice Cube Bin. Choice of colors.

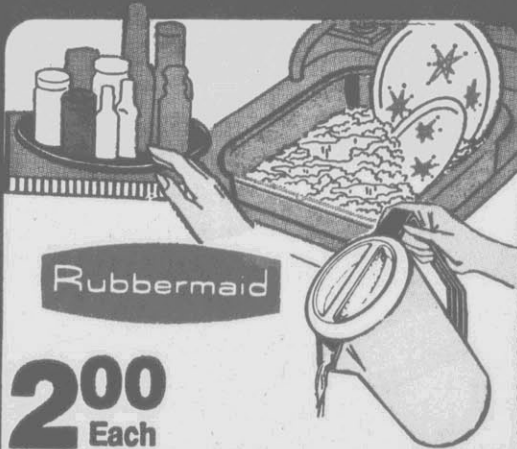

Rubbermaid

**2.00**  
Each

Your Choice: Rubbermaid® 2 1/4-qt. Covered Pitcher, Dishpan, or Single Turntable. Your choice of almond or slate blue colors.



**2 FOR \$5**

Rubbermaid

Rubbermaid® Shower Caddy, Neat 'n Tidy Bucket, or Drainer Tray. Your choice of colors. Buy now and save.



**2 FOR \$1**

Magla® Easy Wipes. Package of 8 wipes. Strong and reusable. For easy household cleanups.



Rubbermaid

**4.00**  
Each

Rubbermaid® Laundry Basket, Bath Mat, Twin Sink Drainer, or Wrap & Bag Organizer.



Rubbermaid

Your Choice

**3 FOR \$2**

Rubbermaid® Soap Dish, choice of colors; or Drawer Organizer, 9 x 3 x 2 or 12 x 3 x 2 inches.

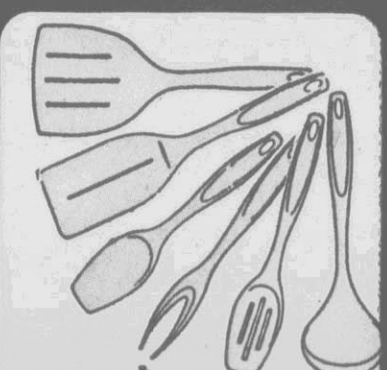

**2 FOR \$1**

Your Choice

Foley® Nylon Utensils. Spoon, fork, slotted spoon, spatula, or hamburger turner. Almond color.



**1.99**

**8.99**

**6.99**

**Neat Ideas Storage Accessories**

Attractive Geese Collection style. Storage or Underbed Box, SALE PRICE 1.99. Shoe/Accessory Organizer, SALE PRICE 6.99. Four Drawer Chest, SALE PRICE 8.99.

Geese Collection Pattern Not Shown

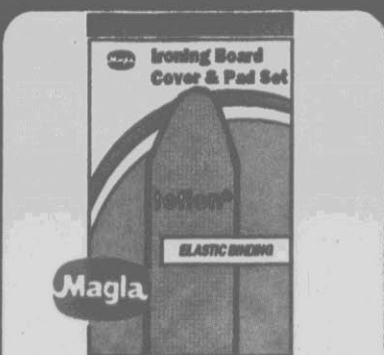

Magla

**1.99**  
Each

Magla Press Queen Ironing Board Cover. Style #6336. Durable Teflon construction.



**2 FOR \$1**

Kerr Brand Latex Gloves. Flock lined. Small, medium, or large size. Great for household chores.



Save Now on Kodak® Supralife Alkaline Batteries. Long-lasting. Size AAA, 2-pk., SALE PRICE 1.59. C or D 2-pk., or single pack 9-volt, SALE PRICE 1.19. 4-pk. AA, SALE PRICE 1.99.

Super Savings!

**3.99** Each

3-M Scotch® Standard EG Videocassette Tapes. Your choice of T-120 VHS or L-750 Beta. High quality recording and playback. Buy now at this great price.

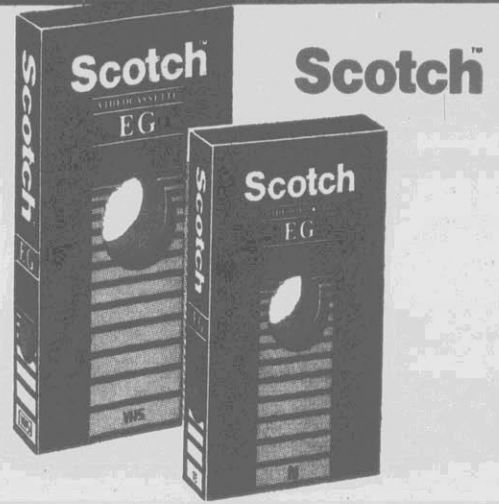

What Matters Most Is You.

**KERR** Drug Stores

**Name Brand Electronics**



179<sup>99</sup>

139<sup>99</sup>

Great Savings on Top Quality Smith Corona® Typewriters For Home, Office, Or School  
Model #SL500, SALE PRICE 139.99.  
Model #SL600, with Spell Right Dictionary, SALE PRICE 179.99.



Sale Price .....15.99  
Mfr. Rebate.....- 3.00  
Your Cost **12.99**  
After Rebate  
Polaroid® Time Zero or 600 HI Speed Color Film. Twin pack. Save big with rebate.



**CONAIR®**

**14.99** Each

Conair® Desk or Wall Phone. Interchangeable tone and pulse dialing. Model #SW204. Your choice of colors.



**4.99** Each

Your Choice: Conair® Curling Iron, #CD11; or Mini Curls Curling Iron, #CD14A.



5.99

**SHARP**

22<sup>99</sup>

Quality Sharp® Calculators  
Solar Power Calculator, model #EL-376AB, SALE PRICE 5.99.  
10-Digit Hand Held Calculator Printer, model #EL-1611S, SALE PRICE 22.99.

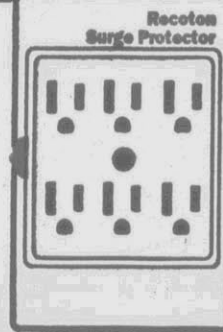

**9.99** Each

Recoton® Surge Protector. With six handy electrical outlets. Model #C1955CD.



**4.99** Each

Westclox® Sassy Time Key-wound Alarm Clock. Your choice of assorted colors.



**9.99** Each

Golden State "Whitewash Collection" Collage Frame. Great way to display photos.

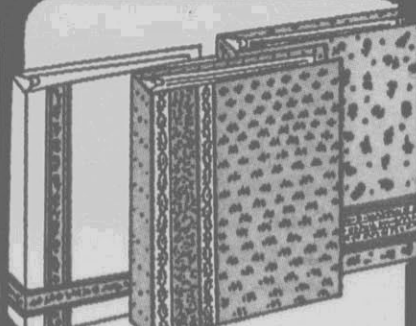

**5.99** Each

Kleer-Vu Magnetic Photo Album. Attractive country styling. 100 pages.

2nd Set of **COLOR PRINTS FREE!**

OFFER GOOD EVERY DAY

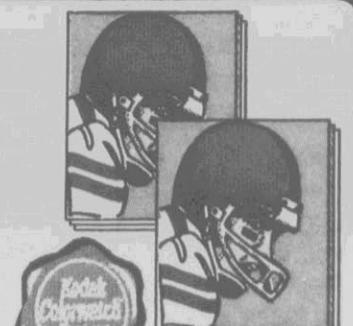

plus...

**COLOR ENLARGEMENTS**  
**5X7 1.19** Made from your 110, 126, 35mm & disc color print negatives. Offer expires 9/18/88.  
**8X10 1.99**

What Matters Most Is You.

**KERR** Drug Stores

**Dollar Days Specials**



**Great Price!**

**89¢** Each

Crush® Soft Drink. In 2-liter plastic bottles. Your choice of refreshing flavors. A great thirst quencher.

**8¢-Off Label!**

**40¢** Can

Comet® Cleanser. 14 oz. can. Scours away even the toughest food stains without scratching surfaces.



**99¢** Pack

White Cloud® Bathroom Tissue. Four rolls per pack. Soft and thick. Buy now and take advantage of the savings.

**79¢** Each

Your Choice: Planters® Corn Chips, 7.5 oz.; Cheez Curls, 6.5 oz.; or Cheez Balls, 5 oz. In convenient stay-fresh canisters. Delicious snacks.



**89¢** Each

Solo® Party Cups. Twenty 16 oz. cups per package. Your choice of colors.



**3 FOR \$1**

Fluted Coffee Filters. Package of 100. Don't miss this special price!



**89¢** Each **Your Choice**

Handi-Bag Trash Bags. Tall Kitchen bags, 20 ct.; Trash Bags, 15 ct.; or Lawn Bags, 10 ct.

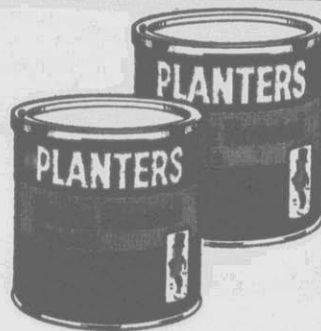

**1.59** Can

Planters® Honey Roasted Peanuts. 12 oz. can. Fresh-tasting. Buy now and save.

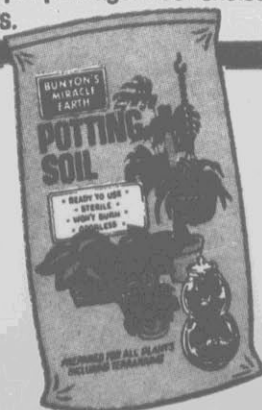

**3 FOR \$1**

Potting Soil. Four quart bag. PS-4. Save now on this gardening essential.



**99¢** Each **Your Choice**

Jobe's® Liquid Sunsplash Plant Care. 8 ounces. Houseplant or African Violet formula.



**1.59** Can

STP® Oil Treatment. 15 oz. can. Extra protection to keep your car in top shape.



**79¢** Limit 6 Quart

Texaco Havoline® 30 HD Motor Oil. Saves gas and keeps your engine running smoothly.

What Matters Most Is You. **KERR** Drug Stores



**COST CUTTER  
LOW PRICES**

PLUS **DOUBLE MFG  
COUPONS**

**SEE  
DETAILS  
ON PAGE  
THREE**

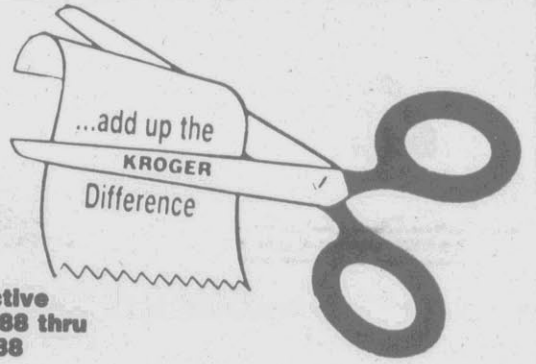

Items and Prices Effective  
Sun. September 11, 1988 thru  
Sat. September 17, 1988



USDA CHOICE GRAIN FED  
BEEF KROGER

**Boneless  
Round Steak**

**\$ 1 69**

Lb.

**KROGER  
GRADE 'A'  
Large  
Eggs**

Doz. **69¢**

**KROGER CHILLED  
Orange  
Juice**

1/2 Gal. Ctn **\$ 1 19**

**ADVERTISED ITEM POLICY**  
Each of these advertised items is required to be readily available for sale in each Kroger Sav-on, except as specifically noted in this ad. If we do run out of an item we will offer you your choice of a comparable item when available, reflecting the same savings or a raincheck which will entitle you to purchase the advertised item at the advertised price within 30 days. Only one vendor coupon will be accepted per item.

**OPEN 24 HOURS EVERYDAY  
600 Greenville Blvd. - Greenville**

**Kroger Sav-on**

Copyright 1988  
Kroger Sav-On  
Quantity Rights Reserved  
Name Sold To Dealers

# Kroger Sav-on

PLUS

# DOUBLE

MFGR'S



KROGER

**Pork 'n Beans**

**4 \$1**  
16 Oz. Cans



KROGER GROUND OR

**Spotlight Bean Coffee**

**\$1.88**  
1 Lb. Bag



KROGER NATURAL FLAVOR

**Deluxe Ice Cream**

**\$1.88**  
1/2 Gal. Ctn



KROGER REGULAR OR LITE

**Sour Cream**

**79¢**  
16 Oz. Cup



KROGER DAIRY FRESH

**Apple Juice**

**88¢**  
1/2 Gal. Ctn



ASSORTED FLAVORS

**Big K Soft Drinks**

**69¢**  
2 Ltr. Btl



KROGER REGULAR OR RESTAURANT STYLE

**Tortilla Chips**

**99¢**  
12 Oz. Bag



COST CUTTER

**Dog Food**

**\$3.49**  
25 Lb. Bag



KROGER **Corned Beef**

**99¢**  
12 Oz. Can



KROGER GRATED

**Parmesan Cheese**

**\$1.99**  
8 Oz. Can



KROGER

**Family Napkins**

**\$1.19**  
300 Ct. Pkg



COST CUTTER **Peanut Butter**

**99¢**  
18 Oz. Jar



KROGER **Pimento Cheese**

**\$1.19**  
14 Oz. Cup



BIG VALUE **Apple or Fig Bars**

**\$1.69**  
24-32 Oz. Pkg



KROGER **Black Pepper**

**\$1.39**  
4 Oz. Can

# COUPONS

ALL WEEK, WE WILL REDEEM UP TO 5 MFGS' COUPONS FOR DOUBLE THEIR VALUE (MAXIMUM REDEMPTION \$1.00) WITH EVERY \$10 PURCHASE. SEE COMPLETE DETAILS IN STORE.

MANUFACTURERS COUPON	MFG. CENTS OFF	YOU SAVE AT KROGER
Coupon A	20¢	40¢
Coupon B	39¢	78¢
Coupon C	50¢	\$1.00
Coupon D	75¢	\$1.00



COORS, COORS EXTRA GOLD OR

**Coors Light Beer**

24 **\$9.99**  
12-Oz. Cans



ASSORTED DINNERS

**Stouffer's Lean Cuisine**

2 **\$5**  
8½ Oz. Boxes



KROGER ½%

**Lowfat Milk**

**\$1.69**  
Gal. Jug

MILLER, MILLER GENUINE DRAFT OR

**Miller Lite Beer**

12 **\$5.69**  
12-Oz. Cans



DORITOS CORN Tortilla Chips

**\$1.99**  
11 Oz. Bag



ASSORTED FLAVORS Breyer's Yogurt

3 **\$1.19**  
8 Oz. Cups



KROGER CHILLED Orange Juice

**\$1.19**  
½ Gal. Ctn

KROGER CHUNKY VEGETABLE BEEF OR **Chicken Noodle Soup**

19 Oz. Can **99¢**



KROGER PEACHES OR **Fruit Cocktail**

16 Oz. Can **66¢**



KROGER **Graham Crackers**

1 Lb. Pkg **99¢**



DIET COKE, CAFFEINE FREE COKE OR **Coke Classic**

2 Ltr. Btl **99¢**

DEL MONTE PEAS, **Corn or Green Beans**

2 **\$8.99**  
16 Oz. Cans



KROGER MILD CHEDDAR WEDGE OR **Mozzarella Chunk Cheese**

1 Lb. **\$2.79**

KROGER HOMESTYLE **Spaghetti Sauce**

32 Oz. Jar **\$1.29**

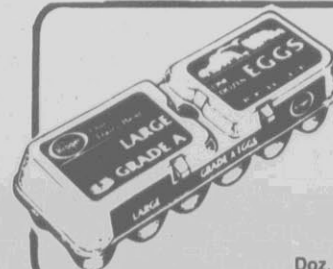

KROGER GRADE 'A' **Large Eggs**

Doz. **69¢**

KROGER REGULAR OR **Lite Mayonnaise**

32 Oz. Jar **88¢**



KROGER **Instant Coffee**

8 Oz. Jar **\$1.99**



**Parkay Margarine**

3 Lb. Tub **\$1.09**



# Kroger Sav-on Variety Frozen



KROGER  
**Orange Juice**

12 Oz. Can  
**99¢**



KROGER ASSORTED  
**Premium Dinners**

10-11 Oz. Boxes  
**2 \$5**



ASSORTED  
**Kroger Pot Pies**

7 Oz. Boxes  
**3 \$1**

KROGER  
**Apple Juice**



12 Oz. Can  
**79¢**

KROGER  
**Grape Juice**



16 Oz. Can  
**79¢**

FROZEN  
**Kroger Limeade**

6 Oz. Can  
**39¢**

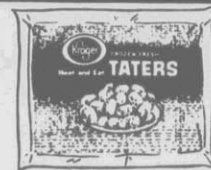

KROGER  
**Tater Rounds**

24 Oz. Pkg  
**99¢**

KROGER MIXED VEGETABLES, PEAS,  
**Corn or Green Beans**



9-10 Oz. Boxes  
**4 \$2**

KROGER  
**Sliced Strawberries**



16 Oz. Pkg  
**99¢**

KROGER  
**Shoestring Potatoes**

48 Oz. Bag  
**\$1.49**



KROGER JELLY DONUTS OR  
**Honey Buns**

10-11 Oz. Pkg  
**99¢**



KROGER  
**Pie Shells**

5 Ct. Pkg  
**\$1.49**

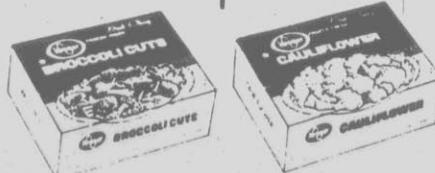

KROGER CAULIFLOWER, BROCCOLI CUTS, LIMAS,

**Broccoli Spears or Okra . . . . . 3 10 Oz. Boxes \$2**

KROGER CHOPPED OR LEAF SPINACH, MUSTARD

**Turnip or Collard Greens 4 10 Oz. Boxes \$2**

KROGER  
**Garden Blend Vegetables . . . 18 Oz. Bag \$1.19**

KROGER BLACKEYE OR  
**Crowder Peas . . . . . 3 10 Oz. Boxes \$2**



BIRD'S EYE  
**Cool Whip**

8 Oz. Cup  
**99¢**



KROGER  
**Deep Dish Pie Shells**

10 Oz. Pkg  
**89¢**



PET RITZ  
**Pie Shells**

10 Oz. Pkg  
**79¢**

# Foods at Cost Cutter Prices!



KROGER  
**Whipped Topping**  
**99¢**

16 Oz. Ctn

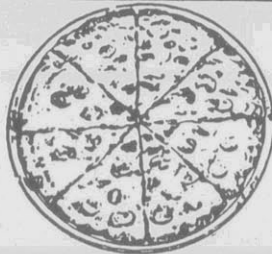

ASSORTED TOPPINGS

**Kroger Pizza**  
**69¢**

12 Oz. Box



FROZEN

**Avondale French Fries**  
**\$1.19**

5 Lb. Bag

KROGER  
**Pie Shells**



**69¢**

2 Ct. Pkg

FROZEN  
**Kroger Lemonade**

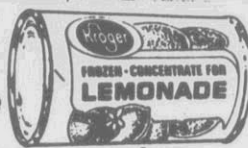

**39¢**

12 Oz. Can

FROZEN  
**Kroger Croissants**



**\$1.39**

6 Oz. Box

KROGER  
**Corn on The Cob**

**2 \$3**

4 Ct. Pkgs

KROGER  
**Bread Dough**



**5 \$1.49**

1 Lb. Lvs.

KROGER  
**Onion Rings**



**79¢**

16 Oz. Bag

SARA LEE  
PLAIN OR  
**Cinnamon & Raisin Bagels**



**75¢**

12 Oz. Pkg

SARA LEE  
**Snack Cakes**

**\$1.99**

14 Oz. Pkg



FROZEN  
**Kroger Bagels**

**2 \$1.19**

12 Oz. Pkgs



ASSORTED CONCENTRATED  
**Welch's Juices** . . . . .

11 1/2 Oz. Can **99¢**

CORN ON THE COB

**Bird's Eye Little Ears** . . .

12 Ct. Pkg **\$1.79**



BIRD'S EYE  
**Custom Cuisine Vegetables**

**\$1.69**

14 Oz. Pkg



FROZEN  
**Downyflake Waffles**

**\$1.39**

19-20 Oz. Box

FROZEN

**Bird's Eye Strawberries** .

10 Oz. Pkg **\$1.19**

STOUFFER'S LEAN CUISINE  
CHICKEN LA ORANGE,  
CHICKEN MARSALA OR

**Glazed Chicken** . . . . . **2 \$5**

8 1/2 Oz. Boxes



LA CREME  
**Whipped Topping**

**99¢**

8 Oz. Cup

# Kroger Sav-on Quality, Variety



**Kellogg's  
Bran Flakes**

**\$1.79**

16  
Oz.  
Box



BRIGHT

**Gallon  
Bleach**

**69¢**

Gal.  
Jug



ASSORTED FLAVORS

**Big K  
Soft Drinks**

**\$1.99**

12-Pk  
12-Oz.  
Cans

EVERYDAY  
COST CUTTER  
LOW PRICES

EVERYDAY  
COST CUTTER  
LOW PRICES



ASSORTED  
**Purina 100  
Cat Food**

**5.1**

6  
Oz.  
Cans



JIFFY  
**Corn  
Muffin Mix**

**4.89**

8 1/2  
Oz.  
Boxes



VELVET  
**Paper  
Towels**

**39¢**

Jumbo  
Roll

EVERYDAY  
COST CUTTER

EVERYDAY  
COST CUTTER

**BUY ONE, GET ONE FREE!** (M)

- Buy Any Variety Of **COUNTRY INN™** Brand Rice Dishes 10 Minute Recipes
- Present This Coupon To The Cashier Along With Purchase
- Receive One Box Of **COUNTRY INN™** Brand Rice Dishes 10 Minute Recipes FREE!



FROM **Uncle Ben's, Inc.**

Limit 1 coupon per purchase; good only on product indicated. Customer pays any sales tax. Any other use is fraud. Void if altered, transferred or copied. RETAILER: To obtain face value plus 8¢ (maximum value \$1.29) submit this coupon to Uncle Ben's, Inc., Box 870152, Ft. Paso, TX 88587-0152. Invoices proving purchase of sufficient stock within the past 90 days to cover coupons presented for redemption must be shown upon request. Cash value .01¢. Void outside USA and where prohibited or taxed.

**Good Week of Sept. 11-17, 1988  
Only at Kroger Sav-on**

RETAIL PRICE



SPRINGDALE  
**Drinking  
Water**

**2.1**

Gal.  
Jugs



HAMBURGER DILLS,  
BREAD 'N BUTTER  
CHUNKS OR  
**Kroger Sweet  
Salad Cubes**

**89¢**

22-24  
Oz.  
Jar



KROGER  
APPLE OR  
**Grape  
Jelly**

**89¢**

32  
Oz.  
Jar

IN AD COUPON



**BUY ONE, GET ONE  
FREE**

**BUY:** Any one (1) box of Quaker Chewy® Granola Bars or Quaker Granola Dipps® Bars.  
**PRESENT:** This coupon to the cashier along with your purchase.  
**GET:** Any one (1) box of Quaker Chewy® Granola Bars or Quaker Granola Dipps® Bars FREE.

RETAILER MAIL TO: Quaker Oats Company  
848 Springer Drive, Lombard, Illinois 60148  
Cash value .001¢ - 1988 QOC

**Good Week of Sept. 11-17, 1988  
Only at Kroger Sav-on**

\$ \_\_\_\_\_

RETAIL PRICE



5 30000 51000 6

C-0152

C-0152

# and Cost Cutter Low Prices!

**NEW!**



# Lite



NO  
SUGAR  
ADDED



## For Yogurt Lovers Everywhere.

Non-Fat Yogurt With Only 1/2 the Calories of Regular Yogurt.



**In 6 Delicious Flavors:**

Strawberry, Raspberry,  
Strawberry-Banana, Blueberry,  
Peach and Cherry-Vanilla

**5** <sup>8</sup> **\$2**  
Oz.  
Cups

NutraSweet and the NutraSweet symbol are registered trademarks of The NutraSweet Company

ANY QUESTIONS  
OR COMMENTS  
ABOUT KROGER MEAT

Call Our Toll Free

USDA CHOICE GRAIN FED  
BEEF KROGER

**Boneless Round Steak** Lb. **\$1.69**

JUMBO PACK FRESH

**Fryer Breast** Lb. **\$1.69**



USDA CHOICE GRAIN FED  
BEEF EXCEL OR KROGER  
BONELESS

**Regal Rump Roast**

**\$2.49**

Lb.

QUARTER PORK LOIN  
CUT INTO

**Pork Chops**

**\$1.69**

Lb.

OSCAR MAYER

**All Meat Wieners**

**\$1.89**

1 Lb. Pkg

USDA CHOICE GRAIN FED  
BEEF EXCEL OR KROGER

**Boneless Top Sirloin Steak**

**\$3.99**

Lb.

RIB OR LOIN  
END CUT

**Pork Chops**

**\$1.79**

Lb.

LOUIS RICH SLICED  
TURKEY

**Variety Pack**

**\$1.99**

12 Oz. Pkg

EXCEL OR KROGER  
BONELESS BEEF

**Cube Steak**

**\$2.99**

Lb.

FRESH MILK FED  
PLUME DE VEAU

**Veal for Scallopini**

**\$8.99**

Lb.

GWALTNEY

**Great Dogs**

**89¢**

1 Lb. Pkg

USDA GOV'T INSPECTED  
GENUINE

**Ground Round**

**\$1.89**

Lb.

FRESH DOMESTIC GROVE

**Whole Lamb Shoulder**

**\$1.59**

Lb.

CUT UP AND WRAPPED FREE

GWALTNEY

**Sliced Bacon**

**\$1.29**

1 Lb. Pkg

**Meatline 1-800-632-6900**

3-LBS. OR MORE PKG.  
CENTER CUT

**Rib Pork Chops . . . Lb. \$ 1 99**

WASH'S 4-6 LBS. AVG. WGT.  
SHANK PORTION

**Smoked Ham . . . Lb. 99¢**



HILLSHIRE FARMS  
REGULAR OR POLISH  
**Smoked Sausage**  
**\$ 1 99**  
Lb.

HILLSHIRE FARMS  
BEEF OR BEEF POLSKA  
**Smoked Sausage . . . Lb. \$ 2 19**

OLD VILLAGE  
HOT OR MILD  
**Pork Sausage . . . Lb. \$ 1 49**

SWIFT 8-OZ. PKG.  
ALL VARIETIES  
**Brown 'n Serve  
Breakfast  
Links**  
**BUY-ONE GET-ONE FREE**

**SAVE \$1.79**

**PIER FRESH SEAFOOD**

PREVIOUSLY FROZEN  
50 - 70 CT. HEADLESS

**Medium Shrimp**

**\$ 3 99**  
Lb.

PREVIOUSLY FROZEN  
26 - 35 CT. HEADLESS

**Jumbo Shrimp**

**\$ 5 99**  
Lb.

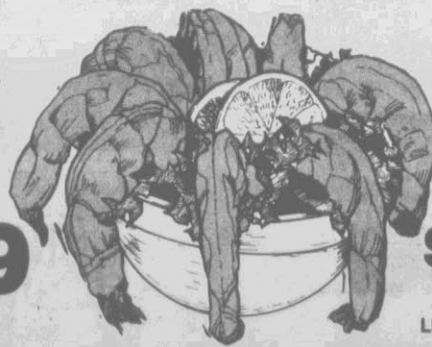

NEVER FROZEN  
FRESH

**Catfish Fillets . . . . . Lb.**

**\$ 4 29**

NEVER FROZEN  
FRESH

**Shark Fillets . . . . . Lb.**

**\$ 3 99**

NEW ENGLAND  
**Cooked Salad Shrimp . . . . . 1 Lb. Pkg**

**\$ 4 99**

COST CUTTER  
FROZEN

**Breaded Fish Portions . . . . . 20 Oz. Pkg**

**\$ 1 99**

FRE-SHORE FROZEN

**Perch Fillets . . . . . 1 Lb. Pkg**

**\$ 2 49**

FROZEN

**Turbot Fillets . . . . . Lb.**

**\$ 2 99**

# Kroger Sav-on National Brands

## GENERAL & MILLS Salute to Savings



**BETTY CROCKER Super Moist Cake Mixes** .. 18 Oz. Box **69¢**

**BETTY CROCKER Hamburger Helper** ..... 7.75 Oz. Box **\$1.19**

**BETTY CROCKER Specialty Potatoes** .... 5.5 Oz. Box **79¢**

**REGULAR OR SELF-RISING Gold Medal Flour** ..... 5 Lb. Bag **89¢**



**READY TO SPREAD Betty Crocker Frosting** .... 16 Oz. Cup **\$1.35**

**REGULAR OR SELF-RISING Red Band Flour** ..... 5 Lb. Bag **89¢**

**BUTTERMILK Bisquick Baking Mix** .. 60 Oz. Box **\$2.45**



**BETTY CROCKER READY TO SPREAD Mini Morsels Frosting** .... 16 Oz. Cup **\$1.49**

**GENERAL MILLS Cheerios Cereal** ..... 15 Oz. Box **\$2.19**

**GENERAL MILLS Total Cereal** ..... 12 Oz. Box **\$2.35**

**GENERAL MILLS Honey Nut Cheerios** .... 14 Oz. Box **\$2.29**

**BEEF FLAVORED Gaines Burgers**



**\$2.89**  
72 Oz. Box

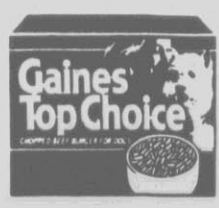

**CHOPPED BEEF FLAVORED Gaines Top Choice**

**\$2.89**  
72 Oz. Box



**PUSS 'N BOOTS Pounce Cat Treats** .. 4 Oz. Can **66¢**

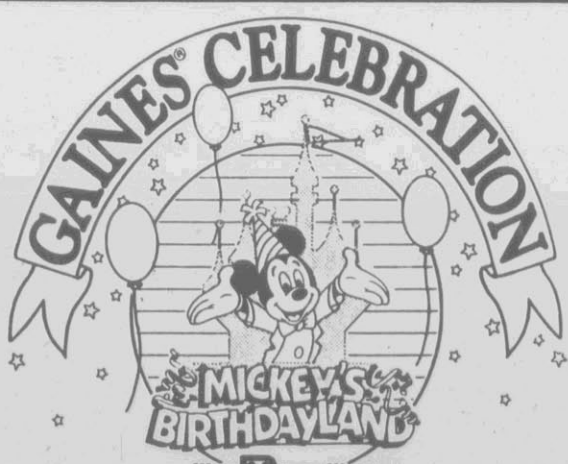

**FALL SAVINGS SPECTACULAR**

Win a Free Trip for Four to Mickey's Birthdayland at the Walt Disney World Vacation Kingdom - See Details In-Store -



**GAINES BEEF FLAVORED Puppy Choice**

**\$1.55**  
36 Oz. Box



**ASSORTED Cycle Dog Food**

**3 \$1**  
14 Oz. Cans

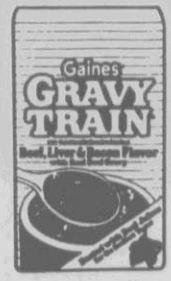

**BEEF/LIVER/BACON OR BEEF FLAVORED Gravy Train Dog Food** ... 25 Lb. Bag **\$8.99**

**ASSORTED Cycle Dog Foods** .. 5 Lb. Bag **\$2.67**

# and Cost Cutter Low Prices!

Kroger is asking our customers to join in the fight against drugs by participating in the....



**to Drugs  
Pledge  
Program**

OFF LABEL  
DOWNY

**Fabric Softener** .. 2 <sup>96 Oz. Blts</sup> \$5

LAUNDRY

**Gain Detergent** 42 Oz. Box \$1.79

(6.4 OZ. PUMP TARTAR CONTROL REGULAR OR GEL OR FOR KIDS) TARTAR CONTROL REGULAR OR GEL, OR REGULAR OR GEL

**Crest Toothpaste** 8.2 Oz. Tube \$1.89



BATH TISSUE

**White Cloud** ... 4 Roll Pkg \$1.09

PAPER

**Bounty Towels** .. Jumbo Roll 79¢

FACIAL TISSUES

**Puffs Plus** .... 150 Ct. Box \$1.39

DISHWASHING

**Ivory Detergent** 32 Oz. Btl \$1.69

OFF LABEL  
POWDER

**Tide Detergent** 42 Oz. Box \$1.59

LIQUID

**Tide Detergent** 64 Oz. Btl \$3.49



(48 CT. MEDIUM OR 32 CT. LARGE BLUE RIBBON) 66 CT. SMALL, 48 CT. MEDIUM, 32 CT. LARGE OR 28 CT. EXTRA LARGE

**Pampers Ultra Plus** Ea. \$9.89



VACUUM

**Folger's Coffee** .. 36 Oz. Can \$6.69

FOLGER'S

**Instant Coffee** .. 8 Oz. Jar \$3.29

CITRUS HILL

**Orange Juice** ... 96 Oz. Jug \$3.19



ASSORTED VARIETIES

**Pert Shampoo** 15 Oz. Btl \$2.99

ASSORTED VARIETIES  
CONDITIONER OR

**Ivory Shampoo** 15 Oz. Btl \$1.79

ASSORTED (2-OZ. SOLID DEODORANT OR 4-OZ. ANTI-PERSPIRANT, \$1.99) OR

**Sure Roll-On** ..... 2 <sup>1.25 Oz. Pkgs</sup> \$3



Official Pledge  
Collection Point

**Just say no PLEDGE**

I pledge to lead a drug-free life. I want to be healthy and happy.  
I will say no to harmful drugs.  
I will help my friends say No.  
I pledge to stand up for what I know is right.

Name \_\_\_\_\_

Address \_\_\_\_\_

City \_\_\_\_\_ State \_\_\_\_\_ Zip \_\_\_\_\_

Signature \_\_\_\_\_

My School is \_\_\_\_\_

# Super DOLLAR DAYS\*



**A.** Pkg. of 3 Soft White Light Bulbs 40, 60, 75 or 100 Watt  
**B.** Pkg. of 4, 7-Watt Night Light Bulbs  
**C.** 3-Way Inside Frost Bulb 50/100/150 Watt

**\$1** pkg.



**A.** Mini Handy Basket ... **2** \$1  
**B.** Small Pet Dish ... **\$1**  
**C.** Pkg. of 2 Ice Cube Trays ... **\$1**  
**D.** Bowl Brush & Holder Set ... **2** \$3  
**E.** 7x9x2 1/2" Handy Box ... **2** \$3  
**F.** Red Pet Dish ... **2** \$3



**Assorted Metal Photo Frames**

**\$1** ea.



**A.** 12-Pc. Felt Pen Set **\$1**  
**B.** 30-Pc. Felt Pen Set **\$3**

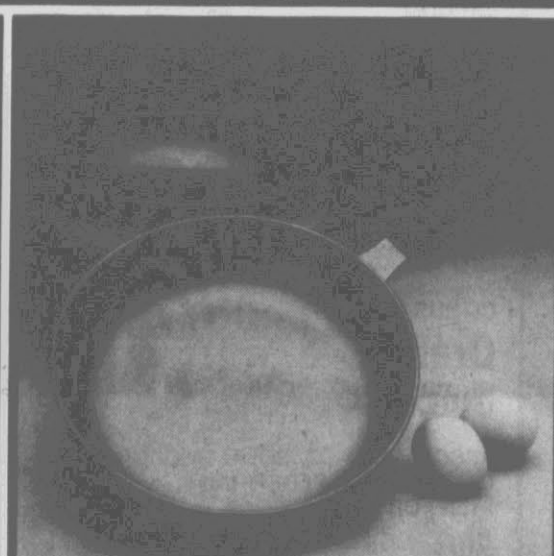

**9 3/4-Inch Non-Stick Fry Pan**

**\$3** ea.



8-Ounce Stoneware Mug **\$1** ea.

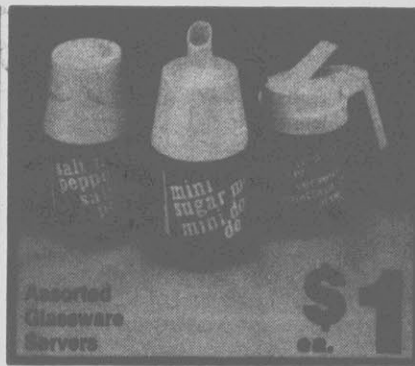

Assorted Glassware Servers **\$1** ea.

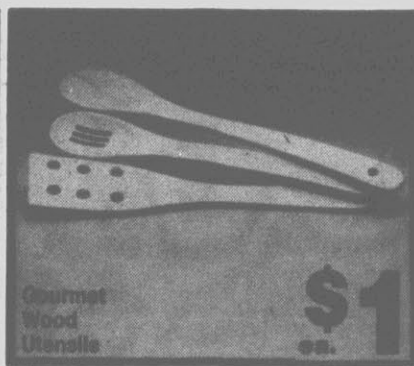

Gourmet Wood Utensils **\$1** ea.

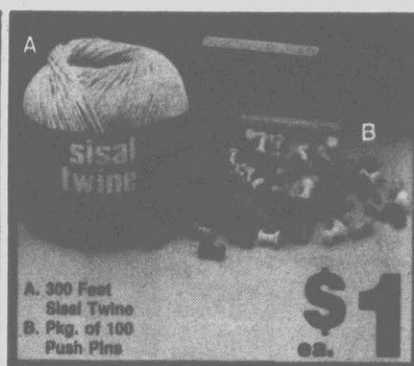

A. 300 Feet Sisal Twine  
B. Pkg. of 100 Push Pins **\$1** ea.

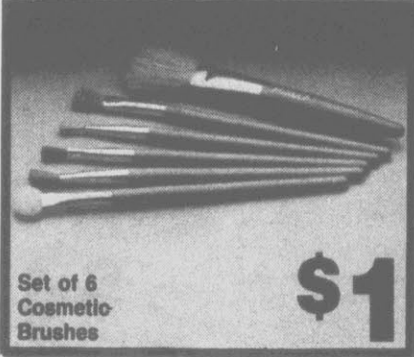

Set of 6 Cosmetic Brushes **\$1**



Assorted Decorative Boxes **\$1** ea.



1-Ounce Pkg. Simmer & Scent Potpourri **\$1** pkg.



A. Assorted Stoneware Ashtrays  
B. Hand-Crafted Miyako Vases **\$1** ea.

# Kroger Sav-on

**"Blue Geese" Coordinates**

A. 10-Ounce Glass Mug	<b>\$1</b>	D. 2-Liter Glass Storage Jar	<b>2 for \$5</b>
B. 1-Liter Glass Storage Jar	<b>\$2</b>	E. 3-Liter Glass Storage Jar	<b>\$3</b>
C. 1½-Liter Glass Storage Jar	<b>4 for \$9</b>	F. Decorative Trivets	<b>\$3</b>

**\$1-\$3** ea.



A. ½" x 800" Cello Tape  
B. ½" x 450" Invisible Tape **2 \$1** for

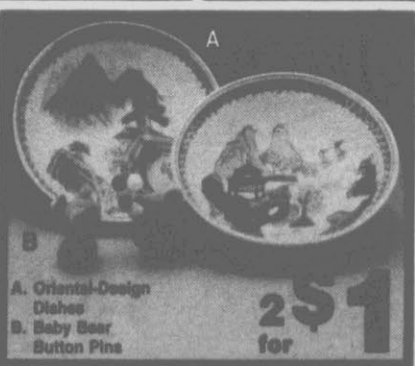

A. Oriental-Design Dishes  
B. Baby Bear Button Pins **2 \$1** for



Assorted Pet Chews **2 \$1** for



Vinyl/Wire Space Savers **4 \$5** for



7-Inch "Diamond" Ashtray **\$3**



Wooden Cutting Board **\$3** ea.



A. 28-Piece Animal Domino Set  
B. Dial-Style Telephone Index **\$3** ea.



Set of 3 Decorative Tins **\$3**

# \$1

12-inch Square Woven Rush Mats **\$1** ea.

Assorted Appliance Covers **\$1** ea.

A. 5 1/2-inch Tricolored Bowl  
B. 11-Ounce Tricolored Mug **\$1** ea.

**COUPON SAVER**  
Coupon Saver **\$1**

A. 8 1/2 x 11" Theme Book  
B. 6 x 9 1/2" 3-Subject Notebook **\$1** ea.

Card Holder/Address Book **\$1** ea.

A. Webster's Paperback Dictionary  
B. Brag Book Photo Album **\$1** ea.

A. 17-Oz. Container... 4 for \$3  
B. 2-Qt. Water Bottle... \$1  
C. 1-Gal. Refrigerator Bottle... \$2  
D. Assorted Food Keepers... 2 pkgs. \$5  
E. 6-Piece Food Keeper Set... \$3

**4 \$3 - \$3**

# Kroger Sav-on

## MORE GREAT VALUES

A. 12-Ounce Tumbler... 5 for \$1  
B. 20-Ounce Tumbler... 3 for \$1

26 Ounce Plastic Bowl **3 \$1** for

A. 55-Count Flexible Straws  
B. 5-Ounce See-Thru Plastic Container **2 \$1** for

Assorted Personal Spoonrests  
Assorted Hand-Cut Glass Yeasts **2 \$3** for

3-in-1 Clothes Brush **\$2**

Frog Scouring Pad Holder **\$2**

A. 114-Page Note Book  
B. 9-inch General Purpose Shears **\$2** ea.



- |   |   |   |
|---|---|---|
| A. Sponge/Scrubber ... 3 for \$1                | D. 20-Ounce Spray Bottle ..... \$1      | H. Long-Handled Mesh Squeegee ..... 2 for \$3 |
| B. Pkg. of 4 Cleaning Pads ..... \$1            | E. Pkg. of 20 Asst'd. Sponges ..... \$1 | J. Deluxe Corn Whisk Broom ..... 2 for \$3    |
| C. Feather Duster with 19-inch Handle ..... \$1 | F. Dustpan with Insert ..... \$1        | K. Dustpan & Brush Set ..... \$2              |
|   | G. 20 Rust-Proof Clothespins ..... \$1  |   |

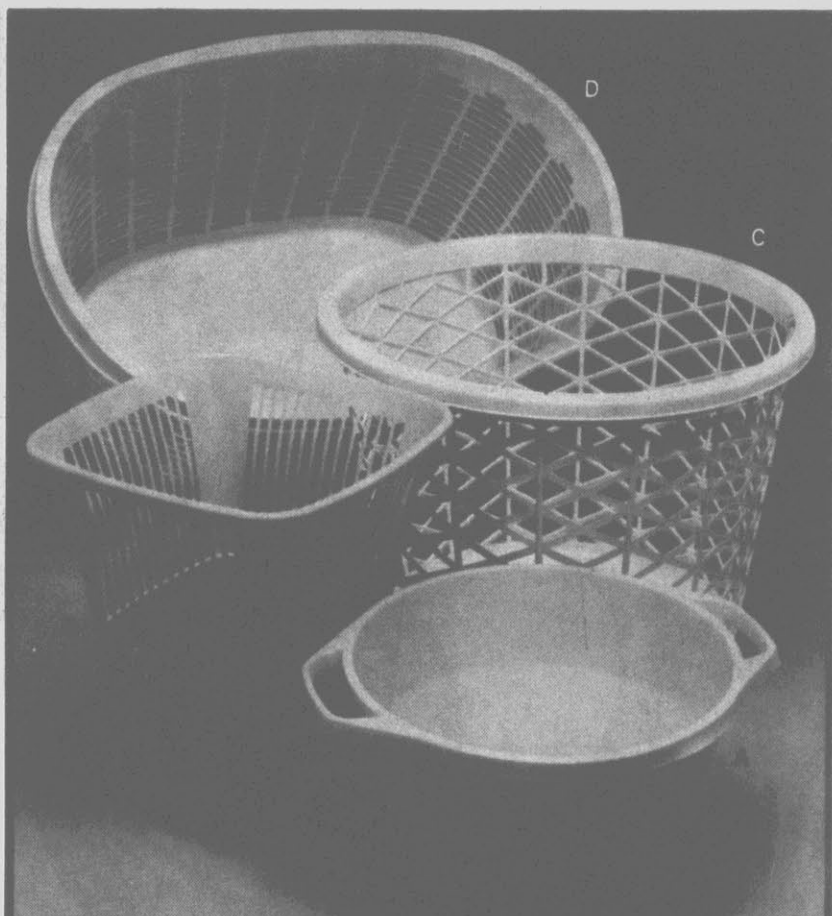

- |                                     |  |
|-------------------------------------|--|
| A. 9-Quart Handi Tub ..... \$2      | C. Round Laundry Basket ..... \$3          |
| B. Gallery Wastebasket... 2 for \$5 | D. 1½-Bushel Oval Laundry Basket ..... \$4 |

# Super DOLLAR DAYS

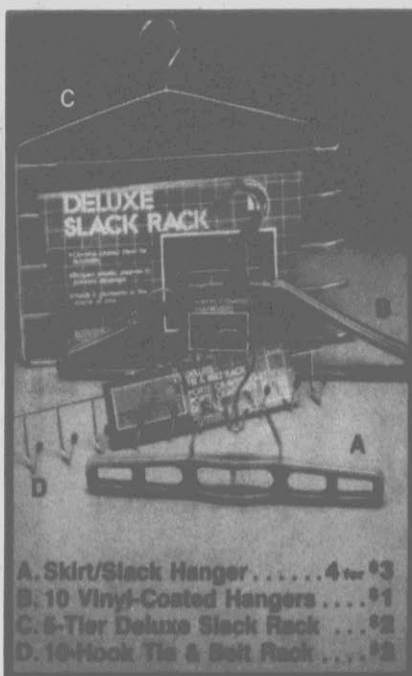

- |                                       |
|---------------------------------------|
| A. Skirt/Slack Hanger ..... 4 for \$3 |
| B. 10 Vinyl-Coated Hangers ..... \$1  |
| C. 5-Tier Deluxe Slack Rack ..... \$2 |
| D. 10-Hook Tie & Belt Rack ..... \$2  |



- |   |
|---|
| A. Plumber's Force Cup ..... \$1        |
| B. Electric Tape on Dispenser ..... \$1 |
| C. 10-Piece Screwdriver Set ..... \$2   |
| D. 10-Piece Pliers Set ..... \$2        |
| E. Saw ..... \$2                        |

# It's Harvest Time

IN THE KROGER GARDEN

NEW CROP EASTERN GOLD OR

## Red Delicious Apples

3 Lb. Bag \$1.28

ALL PURPOSE

White Potatoes . 10 Lb. Bag \$1.48

SNOW WHITE JUMBO

California Cauliflower Ea. \$1.58

SUPER SWEET

Jumbo Honeydews Ea. \$1.88

CALIFORNIA Red Leaf Lettuce . . Hd. 68¢

MEDIUM Yellow Onions . . . 3 Lb. Bag \$1.18

RED, WHITE OR Pink Carnations Doz. \$3.99

Colorful Azaleas . 5" Pot \$5.99

### Italian CREMINI MUSHROOMS

Think of us as the mushrooms with a tan.

That's right. Italian Cremini mushrooms are like white mushrooms but have a unique outer color—a tan if you will. That's why we're nicknamed California Browns or Golden Creams. It's just like when you get a tan—unchanged on the inside with a healthy color outside.

And healthy is a key word. Today's nutrition-conscious consumers love us. Creminis are rich in protein, vitamins and minerals (especially potassium). Also we're low in fat, calories and sodium.

And we've got class, too.

Indeed. Italian Creminis have true clout over more ordinary white mushrooms. We have more flavor and flair with a distinctive, intense taste which makes us a gourmet's choice. Creminis have a reduced water content making us great for stuffing. We shrink less during cooking so we offer the consumer more servings per pound than white mushrooms.

We stay longer in your refrigerator

Although we won't stay around long on your produce shelves, we could. Creminis have an extended shelf life of approximately ten days. Also we don't bruise easily.

12 Oz. \$1.29



## Delicatessen

ALL VARIETIES TOUFAYAN 12-OZ.

Pita Bread

BUY ONE GET ONE FREE

SAVE \$1.19

AMERICAN OR MUSTARD Potato Salad

Lb. 99¢

Imported Ham . . . . . Lb. \$2.99

CUDDY Turkey Breast . . . Lb. \$4.49



FINLANDIA Swiss Cheese

Lb. \$3.99

FINNISH Havarti Cheese

Lb. \$3.99

FINLANDIA Lappi Cheese

Lb. \$3.99

T O T A L



FALL '88

ROSCOE  
**GRiffin**  
SHOES

# WHEN EVERY *DETAIL* COUNTS...

Here are the pumps you can count on to polish your style. A touch of texture here and a lovely swirl there are all you need to put your prettiest foot forward.

**3** Life Stride's VANESSA in black or winter white smooth, plus black and sand suede.

**\$40**

**4** 9 West's ROSALYN in black patent or navy leather uppers.

**\$52**

## **ON THE COVER:**

Snake Charmer: Fall finds this tempting texture in curvy form to wow everything in your wardrobe. Add the matching bag and you have total style that's totally irresistible!

**1** Impo's CHA CHA in black, chestnut brown, red or winter white snakeskin uppers.

**SALE \$49<sup>99</sup>**

Regularly \$67.

**2** Matching handbag in black, chestnut brown, red or winter white snakeskin.

**SALE \$24<sup>99</sup>**

Regularly \$35.

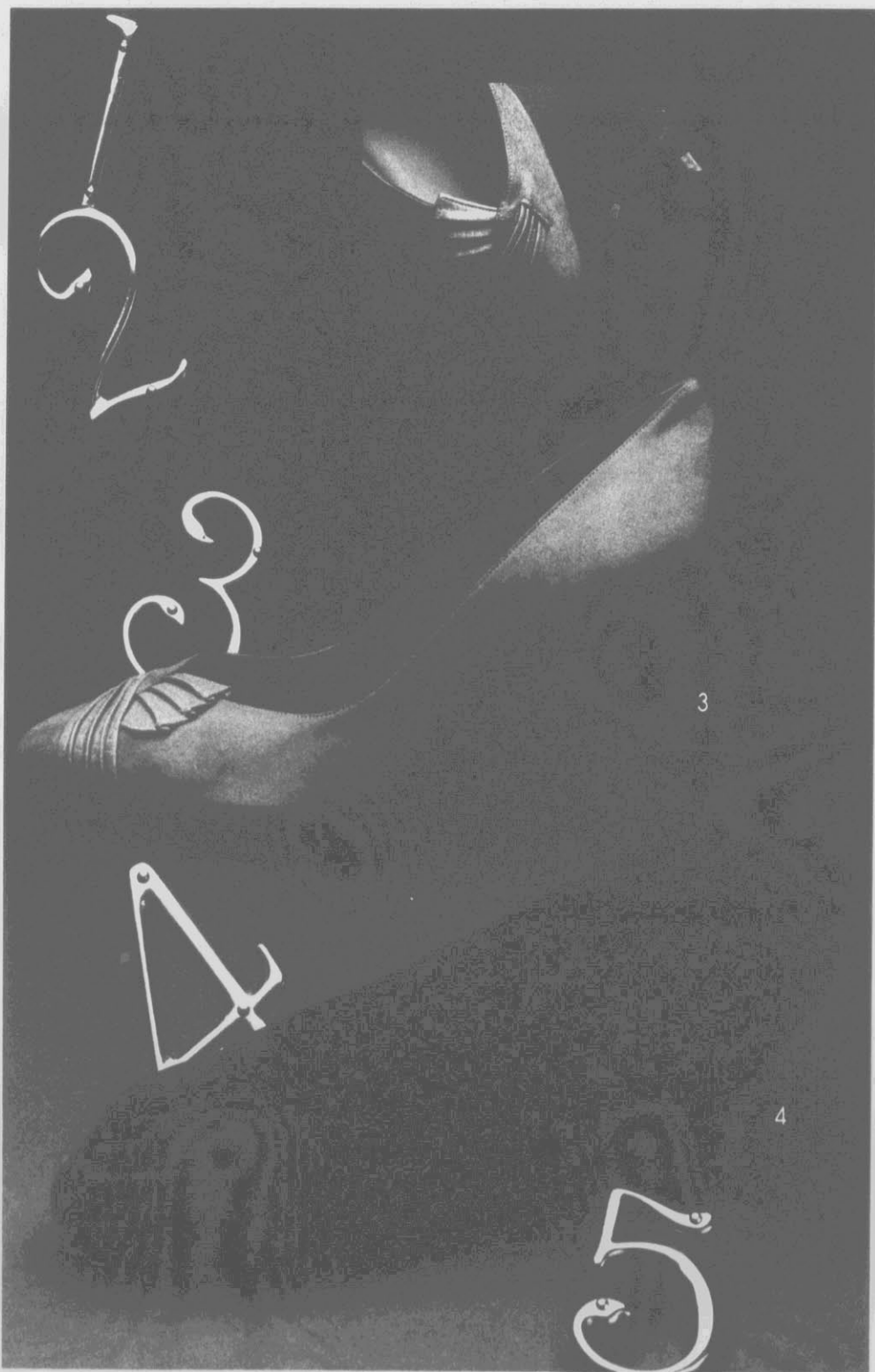

# CONNIE—INCREDIBLE,

## CONNECTION FASHION

Connie brings you the newest silhouettes on the freshest heights of fashion, all tagged with one value-packed price. It's just like Connie to give you so much for so little—and just like you to take advantage of it!

**LEATHER  
PUMPS,  
YOUR  
CHOICE  
\$39<sup>99</sup>**

**5** SHARP in black, navy or grey leather uppers. Regularly \$46.

**6** BEST in red, black, black patent, winter white or navy leather uppers. Regularly \$46.

**7** ACCLAIM in black patent, navy, red or winter white leather uppers. Regularly \$46.

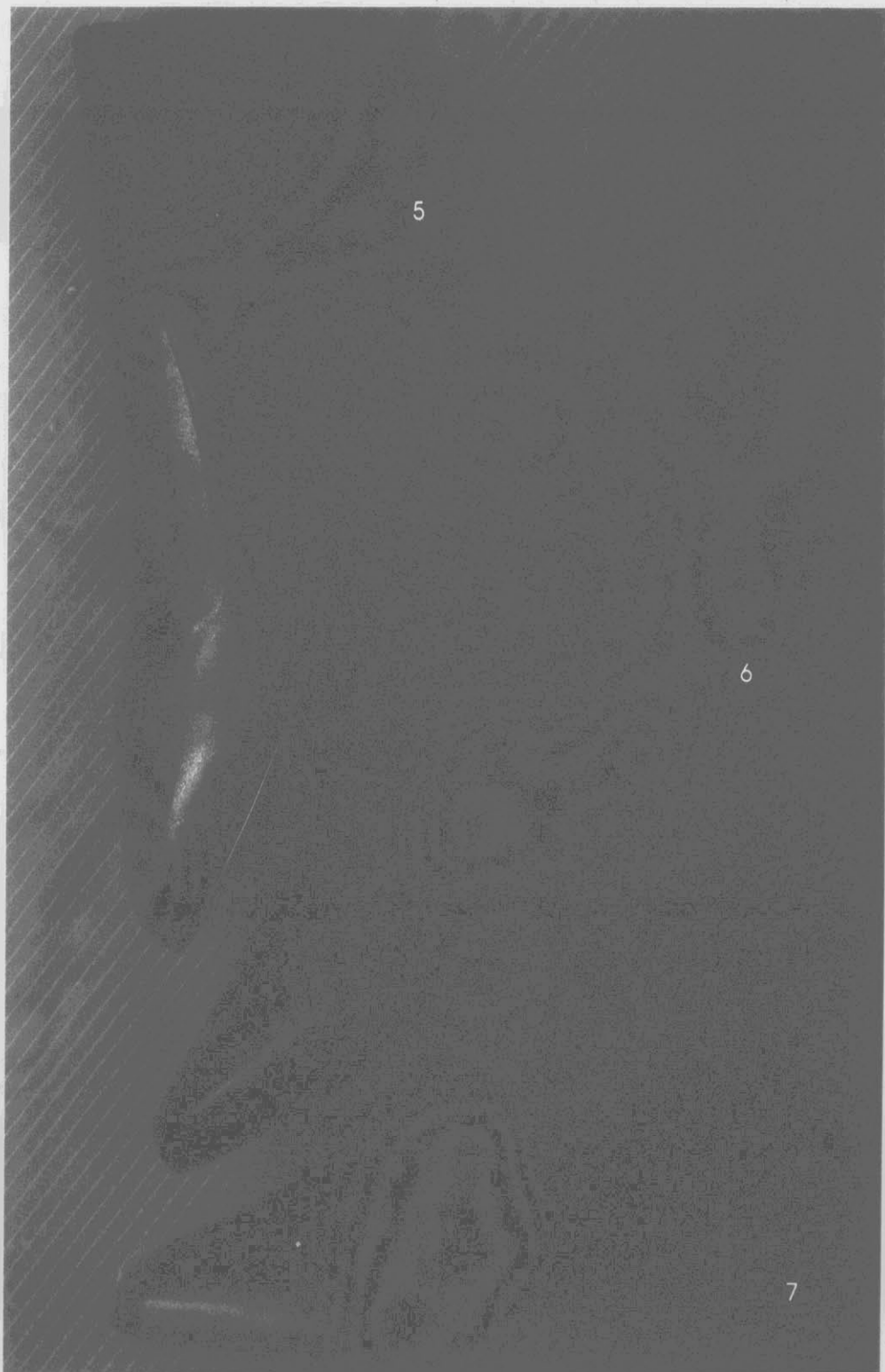

5

6

7

# NATURALIZER—A PERFECT BLEND OF *FASHION* AND *COMFORT*

Leave it to Naturalizer to cook up comfort that satisfies your taste for fashion. The ingredients? Ultra-flexible soles lavished with extra-cushy padding then topped with some of the most stylish looks around. Now that's what you call scrumptious!

**8** BERMUDA in black, navy or camel leather uppers.  
**\$45**

**9** TONYA in black multi or taupe multi.  
**\$39**

**10** TRANCE in black or taupe ultra-soft plonge leather uppers.  
**\$45**



# LIFE STRIDE—TRUE BLUE VALUES

Of course fashion is important, but money matters, too. Lucky you, you can have your fair share of both with Life Stride. Life Stride features first-class styling and now first-class comfort, thanks to their new Flexibles construction. At \$32.99 each, these shoes are true-blue values—and honest-to-goodness great buys!

**VALUE  
PRICE  
\$32.99  
each**

**11** SHELA in black or beige snakeskin print.

**12** SHELA in black shiny, black, navy, taupe, green or red.

**13** UPTOWN in black, taupe or navy.



# TALK ABOUT



Underscore your wardrobe with the signature look of today's tailored footwear. Pair these with pants, skirts or dresses; they'll punctuate your fall fashions with absolute style.

**14** West's BRIT in wine, navy or taupe leather uppers.  
**\$50**

**15** West's RENEE in taupe leather uppers.  
**\$48**

**16** Dominique's TOE TOE in black, navy or beige leather uppers.

**SALE \$34<sup>99</sup>**  
Regularly \$45.

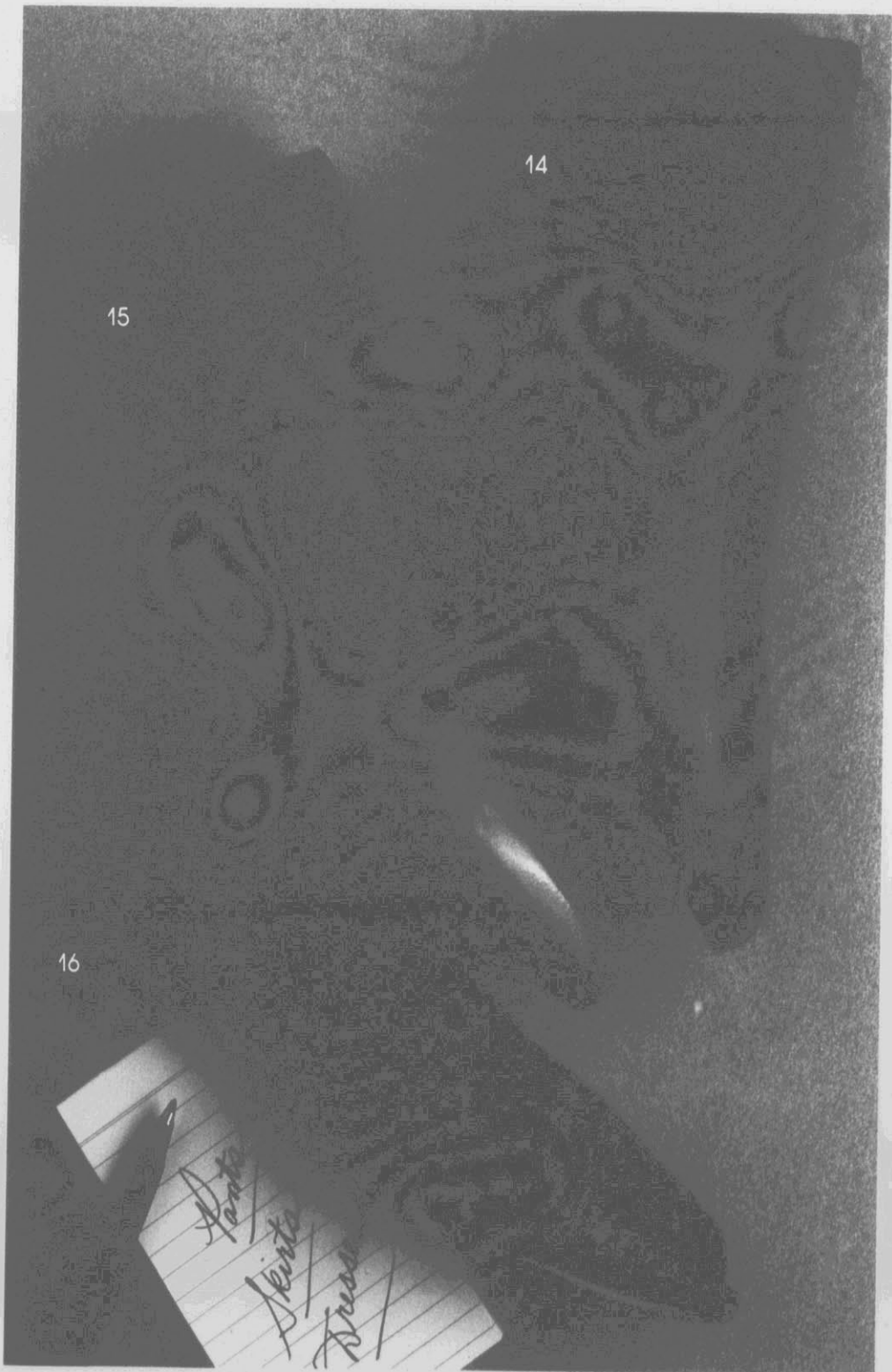

# SNAPPY *FLATS*

Walk to the latest beat in these noteworthy flats. Their sleek styling is right in tune with fall's newest fashions, and their low price won't leave you singing the blues!

**NOW  
ONLY  
\$29<sup>99</sup>  
each**

**17** Mia's SIDE DIP in black, red or winter white leather uppers. Regularly \$40.

**18** Diesse's CREST in black or tan leather uppers. Regularly \$38.

**19** Bellini's SALLY in black, navy, red or tan leather uppers. Regularly \$38.



# AT YOUR LEISURE

Sit back and relax, Buskens will take care of your spare-time style. Just slip on this moc, and you're ready for whatever the weekend brings you!

**20** Buskens' TWIST & SHOUT in navy, grey, red or taupe leather uppers.

**SALE \$24<sup>99</sup>**  
Regularly \$32.

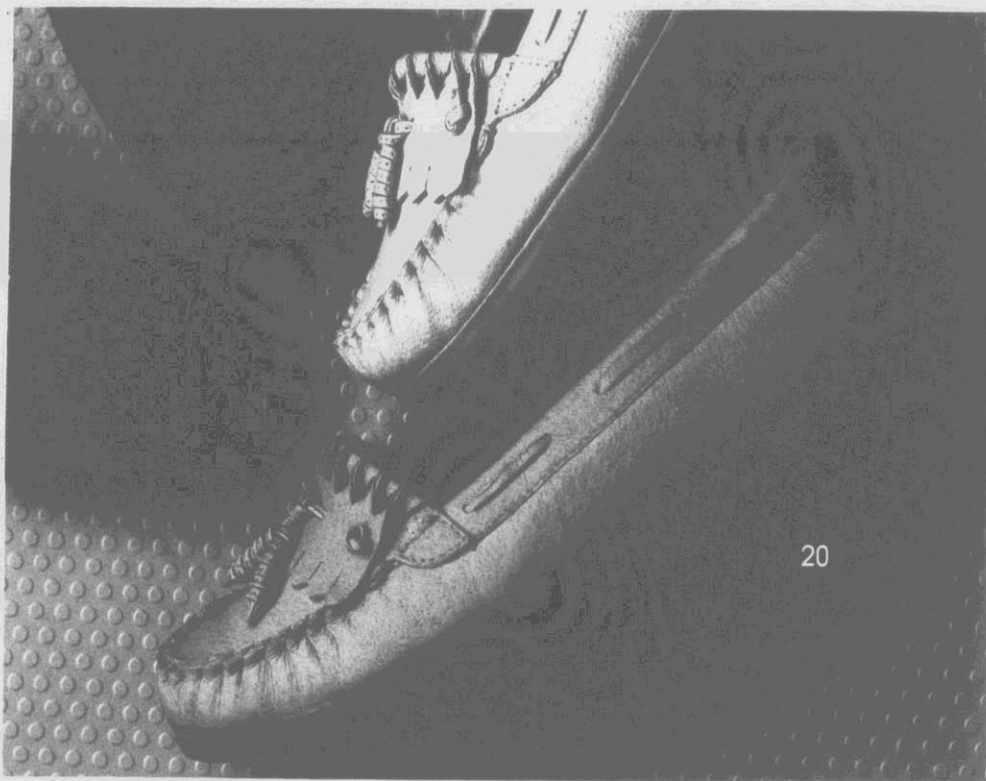

20

To order by mail, complete the order form below and mail it to:

Roscoe Griffin Shoes  
P.O. Box 12427  
Raleigh, NC 27605-2427

Name \_\_\_\_\_

Address \_\_\_\_\_

City \_\_\_\_\_ State \_\_\_\_\_ Zip Code \_\_\_\_\_

Mastercard    Discover    Visa    American Express

Card # \_\_\_\_\_ Exp. Date \_\_\_\_\_

Signature \_\_\_\_\_ Amt. Enclosed \$ \_\_\_\_\_

Check or Money Order  
Sorry No C.O.D.'s

\*Add State and Local Taxes where applicable

\*Add Handling Charges  
1 item-\$2.00 2 items-\$2.50  
3 items-\$3.00 4 items-\$3.25  
5 or More items-\$3.50

\*Most shoes available in sizes 5½-9, 10 medium and 7½-9 narrow

Life Stride and Naturalizer available in more sizes and widths by special order. Not all styles available in all colors and sizes at every location

Upper constructions as noted. VANESSA, TONYA, SHELA, UPIOWN and ROYAL composed of man-made materials

Shoe Number	Color	Size/Width	Quantity	Price

Total price of above items \_\_\_\_\_  
Handling/delivery charge \_\_\_\_\_  
State sales tax \_\_\_\_\_  
TOTAL \_\_\_\_\_

To place an order by phone,  
call collect (919) 834-7978 or 834-7981

# STREET *CHIC*

Traveling city sidewalks or easing down country roads, you'll make fashion progress in these street neat shoes. Wear them to flaunt your adventurous sense of style.

**21** Buskens' JUNGLE in dark brown leather uppers.

**SALE \$49<sup>99</sup>**

Regularly \$65.

**22** Buskens' TRIBAL in dark brown leather uppers.

**SALE \$49<sup>99</sup>**

Regularly \$65.

**23** Dominique's CRUNCH in black or tan leather uppers.

**SALE \$34<sup>99</sup>**

Regularly \$45.

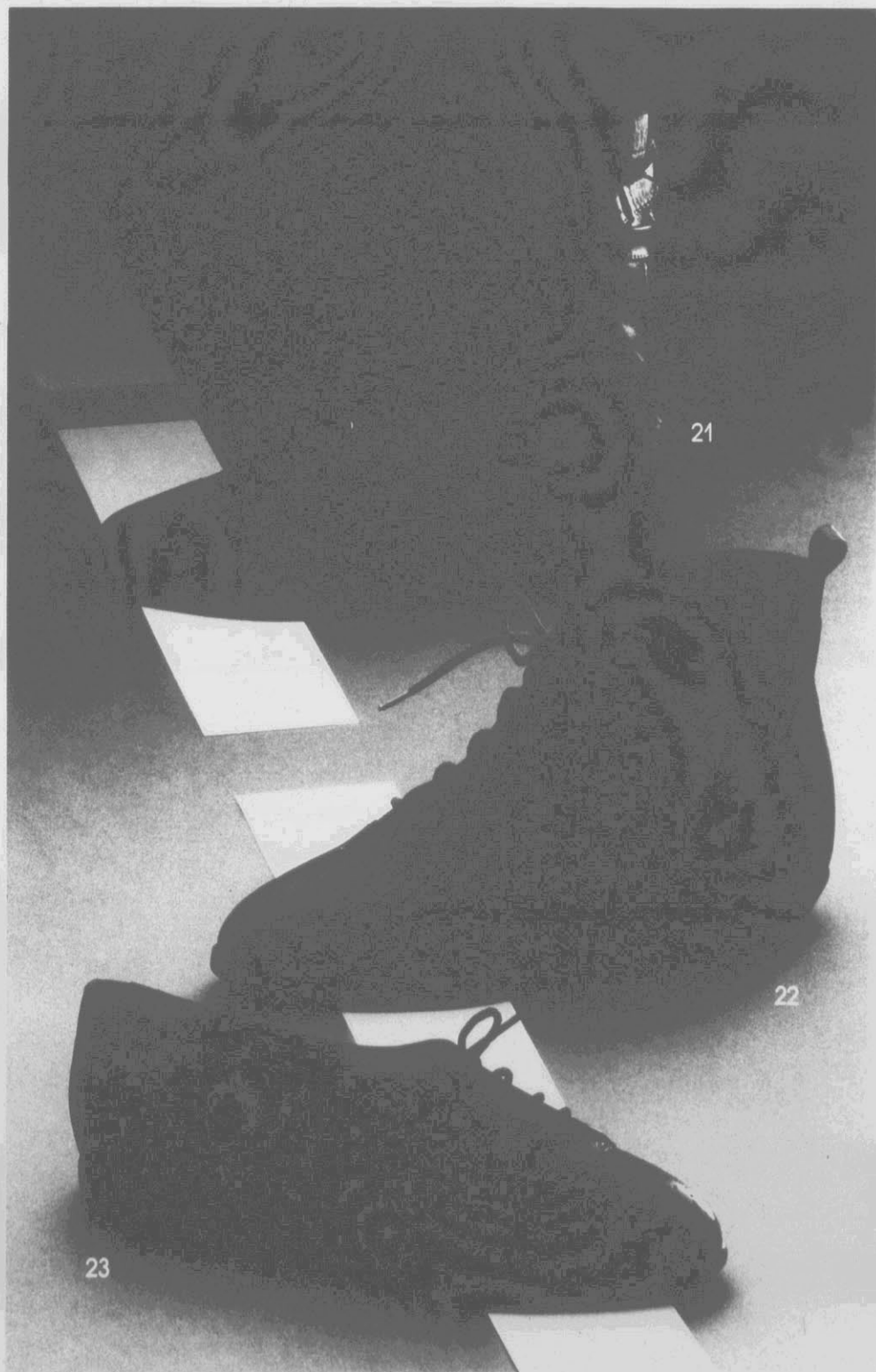

# DEXTER — ALL-AMERICAN

## FOR WOMEN

Just like baseball and apple pie, these shoes have become American traditions. With classic styling that always looks right. With all-American construction you know you can trust.

**24** POW WOW in burgundy leather uppers.

**25** HIAWATHA in burgundy leather uppers.

**VALUE  
PRICE**  
**\$39<sup>99</sup>**  
**each**

**26** TOTEM in tan leather uppers.  
**\$45**

**27** TUMBLEWEED in tan leather uppers.  
**\$48**



# LADIES, TAKE A WALK WITH **ROCKPORT**

The proper footwear can make all the difference to your active feet! Rockport's walking shoes are constructed to keep your feet *extra-comfortable*. Choose from several looks for all your walks in life!

**28** PRO WALKER in sport white leather uppers.  
**\$78**

**29** SKIMMER in black, navy or taupe leather uppers.  
**\$56**

**30** KILTIE MOC in navy or taupe leather uppers.  
**\$68**



# REEBOK—GREAT SPORTS, NOW AT GREAT **SAVINGS**

Want the winning edge?  
You're right on track with  
Reebok.

## 20% OFF ENTIRE STOCK!

**31** Women's FITNESS  
WALKER in white or  
white/light blue leather  
uppers.

**32** Men's FITNESS  
WALKER in white/royal  
leather uppers.

**SALE \$47<sup>20</sup> each**  
Regularly \$59.

**33** Women's CL 1000 in  
white nylon uppers.

**34** Men's CL 1000 in  
white/royal or white/red  
nylon uppers.

**SALE \$28 each**  
Regularly \$35.

**35** Women's NEWPORT  
in white leather uppers.

**36** Men's NEWPORT in  
white leather uppers.

**SALE \$38<sup>40</sup> each**  
Regularly \$48.

**37** Women's CLUB  
CLASSIC in white/rose  
leather uppers.

**38** Men's CLUB  
CHAMPION in white/  
royal leather uppers.

**SALE \$40 each**  
Regularly \$50.

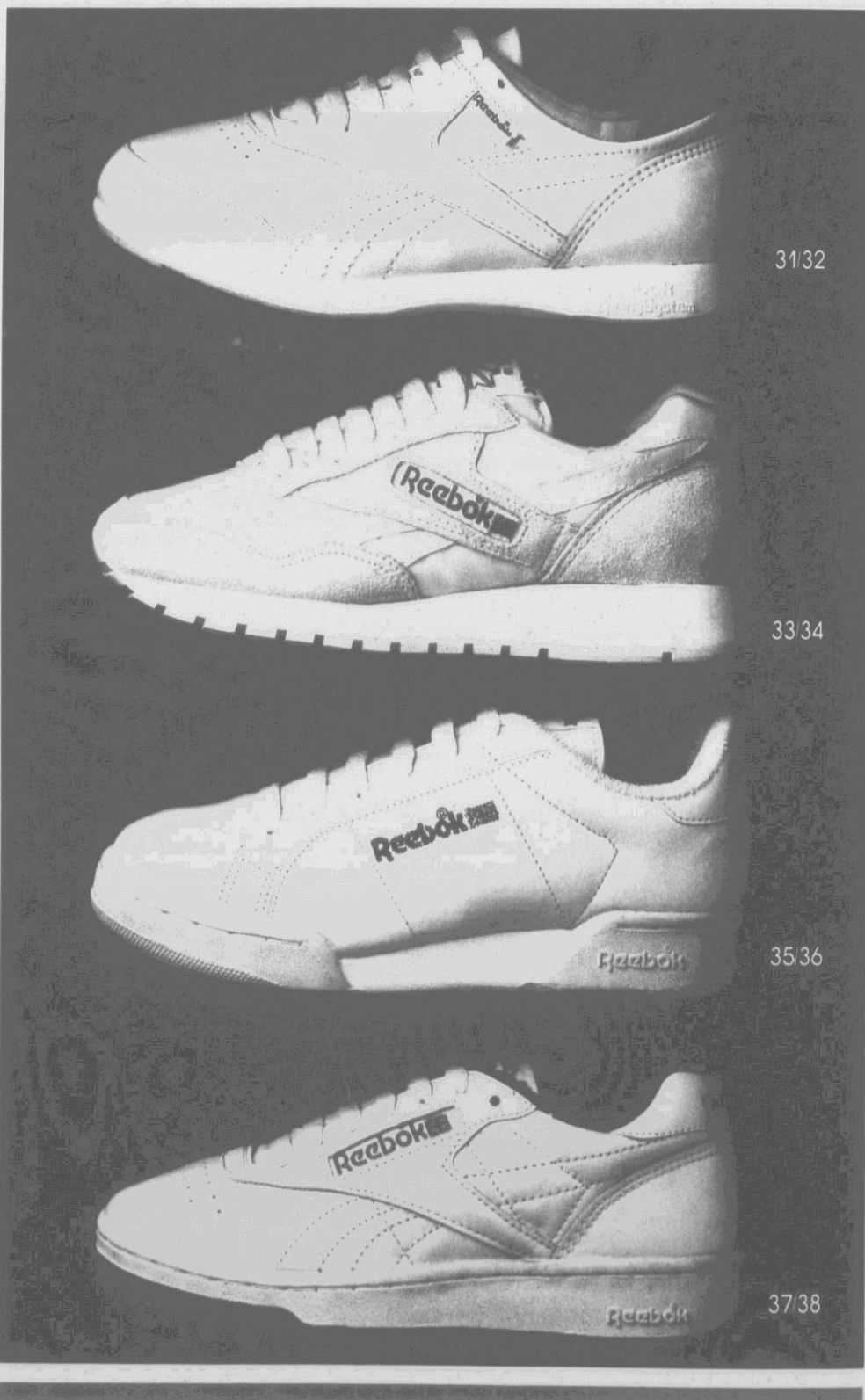

# HEY GUYS—STEP UP THE PACE WITH *ROCKPORT*

Whether you're taking steps toward good health, or covering more ground than ever—Rockport can help! Cushioned linings, flexible soles and breathable leather uppers keep your feet comfortable no matter what the pace.

**39** PRO WALKER in sport white leather uppers.  
**\$95**

**40** PENNY LOAFER in black or burgundy leather uppers.  
**\$85**

**41** DRESSPORT WING in black or burgundy leather uppers.  
**42** Also available with plain toe in black or burgundy leather uppers.  
**\$99**

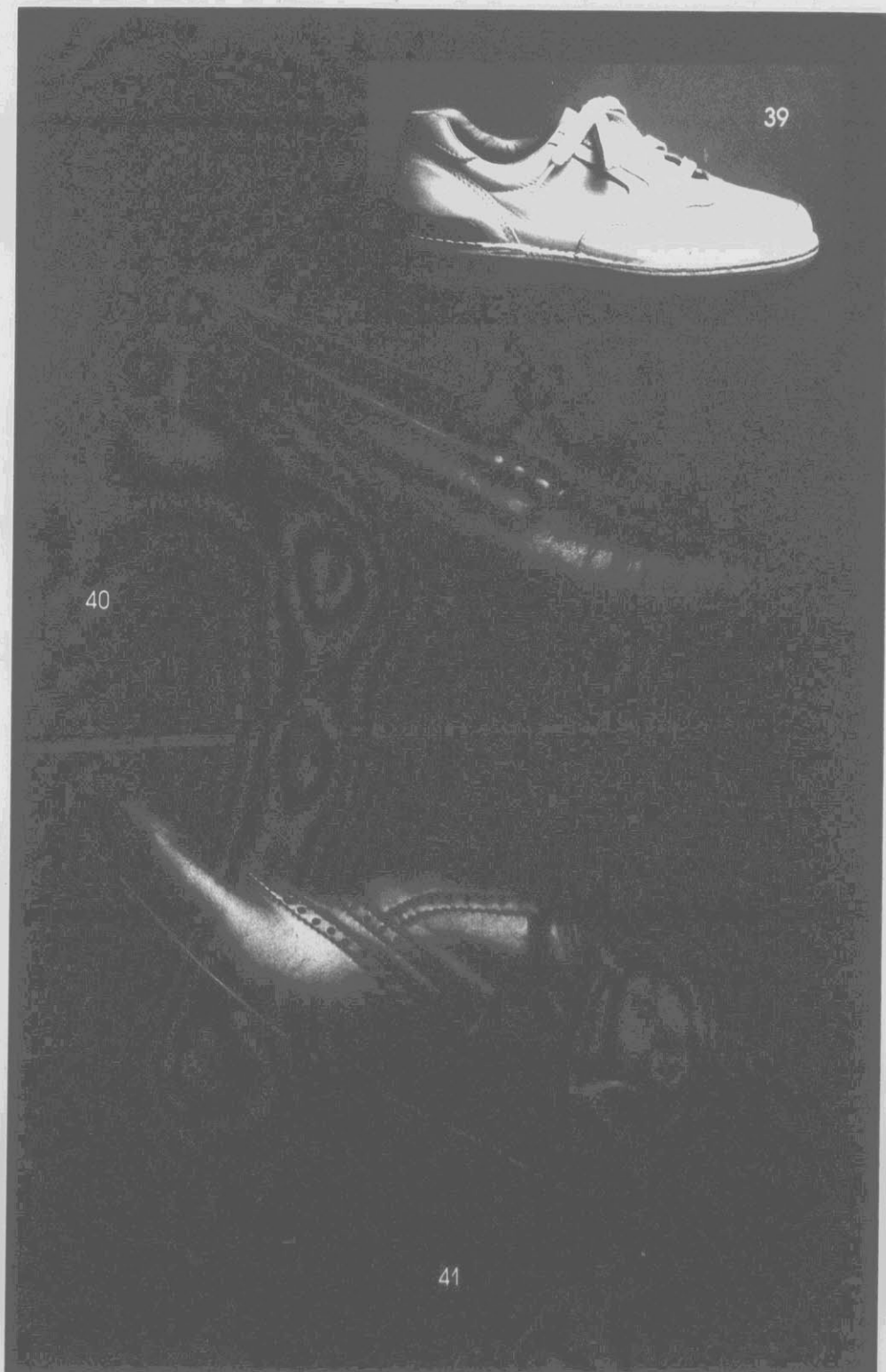

# FLORSHEIM—THESE SHOES MEAN **BUSINESS**

A sharp professional image doesn't just happen. It requires groundwork and keen attention to detail. For example, what shoes you wear. Florsheim shoes are handsomely crafted for that look of success. And of course, they're styled in the Florsheim tradition of superb quality, fit and comfort. Go ahead, put a pair to work for you!

**43** PACER in black or burgundy kidskin leather uppers. Leather soles.

**\$70**

**44** RIVA in black or burgundy nappa kidskin leather uppers. Cushioned unit bottom for extra comfort.

**\$75**

**45** NEVADA tassel in black or burgundy kidskin leather uppers. Leather soles.

**46** Also available with self-ornament.

**\$75**



Here's a hot tip: Don't take stock in just any shoe. Invest in a brand you can feel good about, like Dexter. The dividends? Quality craftsmanship, classic styling and even some capital left over, thanks to Dexter's low prices. Ahhh, don't you wish all purchases took such little speculation?

**47** LENOX in black or burgundy leather uppers. Leather soles.

**48** ASCOT in black or burgundy leather uppers. Leather soles.

**VALUE PRICE**

**\$59<sup>99</sup>**

**each**

**49** DURHAM in burgundy leather uppers.

**50** RALEIGH in burgundy leather uppers.

**VALUE PRICE**

**\$44<sup>99</sup>**

**each**

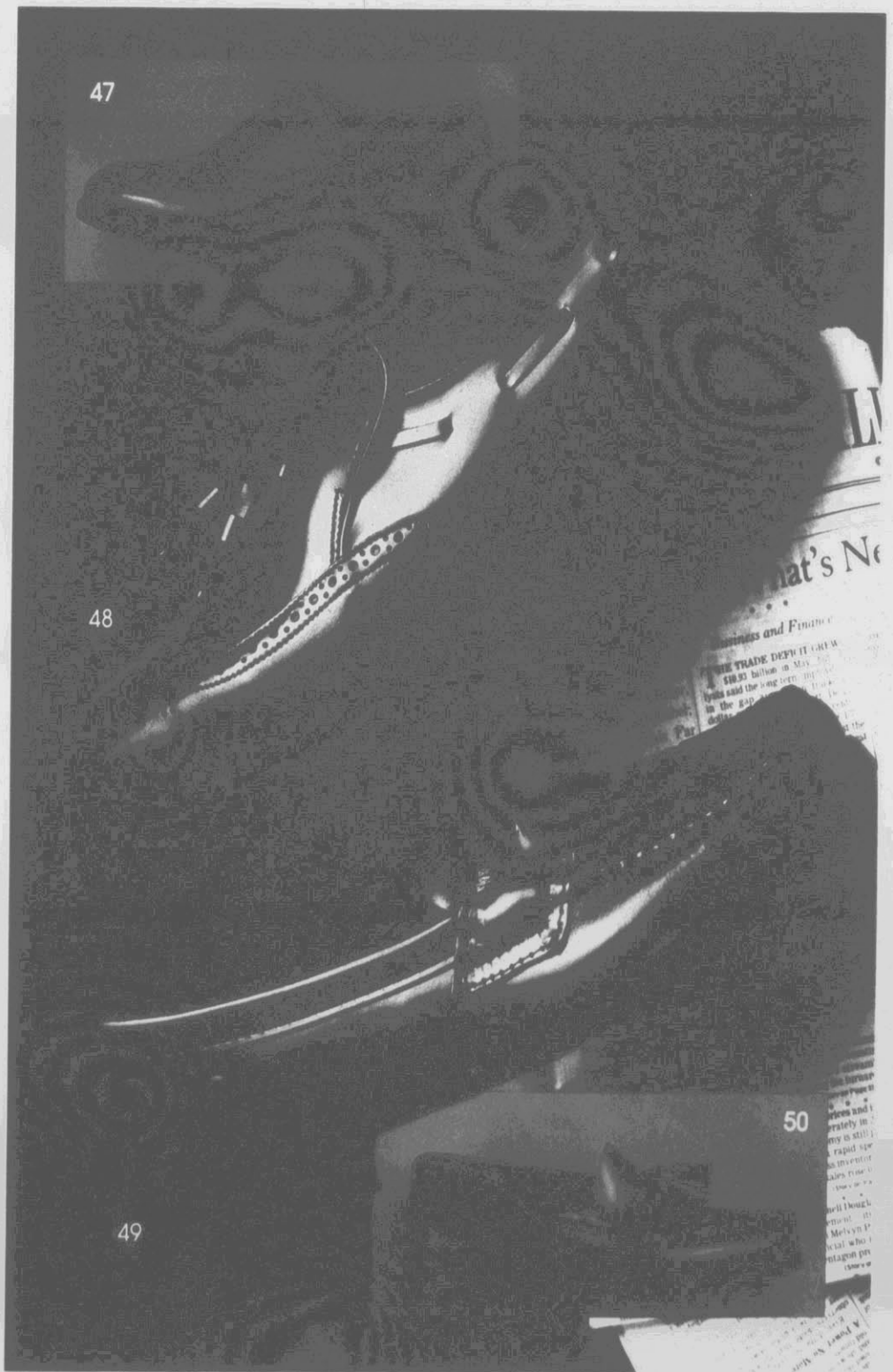

50

49

47

48

# A GO-WITH-EVERYTHING WEDGE

## SAVE \$5

It looks super with skirts, just as pleasing with pants. There's no end to what works with this versatile wedge... and no end to its deep-down Naturalizer comfort.

**51** ROYAL in black shiny, black, navy, red or taupe.

**52** ROYAL II in black or taupe reptile print.

**SALE \$33<sup>99</sup>**  
each

Regularly \$39.

S	N	M	W
7-9	6½-10	5-10	7-9

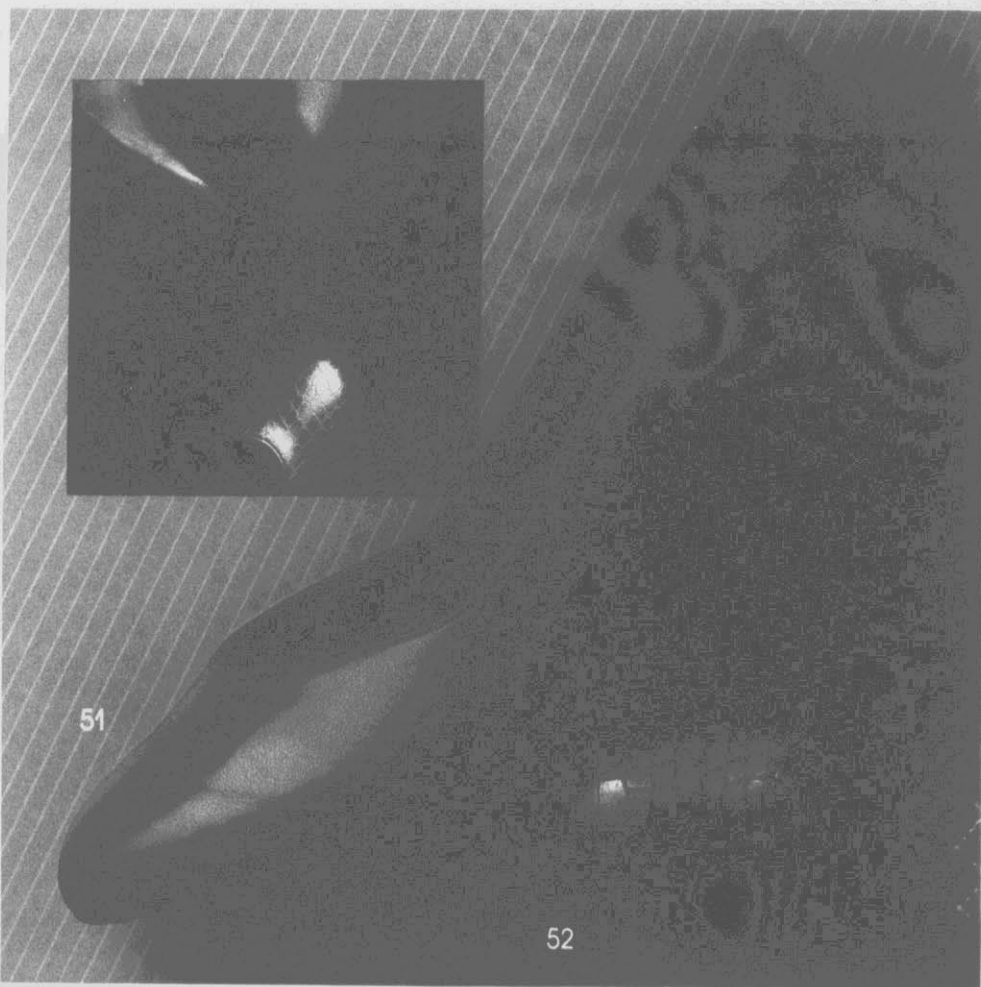

ROSCOE  
**Griffin**  
SHOES

Roscoe Griffin Shoes  
P.O. Box 12427  
Raleigh, NC 27605-2427  
(919) 834-7978, 834-7981

LOCATIONS:

North Hills Mall  
Raleigh, NC 27609

Cameron Village  
Raleigh, NC 27605

Northgate Mall  
Durham, NC 27701

South Square Mall  
Durham, NC 27707

Berkeley Mall  
Goldsboro, NC 27530

Crabtree Valley Mall  
Raleigh, NC 27612

University Mall  
Chapel Hill, NC 27514

Washington Square Mall  
Washington, NC 27889

Carolina East Mall  
Greenville, NC 27834

The Plaza  
Greenville, NC 27834

Golden East Crossing  
Rocky Mount, NC 27801

Tarrytown Mall  
Rocky Mount, NC 27801

Parkwood Mall  
Wilson, NC 27893

Becker Village Mall  
Roanoke Rapids, NC 27870

Piedmont Mall  
Danville, VA 24540

# TODAY

fall fashion  
**SALE**



**50%  
OFF**

*You're the reason*

OUR NEW  
FINDS: HIDE  
'N SLEEK!

▶ 50% OFF

A. Going soft in the nicest way...a tie neck sweater of plush lambswool/angora by FENN WRIGHT & MANSON®. Cranberry, ivory or black, misses' sizes S-M-L, orig. 72.00, **36.00**

▶ 50% OFF

B. Almost per-sueded? Then say yes to our G III LEATHER FASHIONS 30" pig suede skirt! With v-yoke and snapped back slit. Evergreen or tan, misses' 4-16, orig. 120.00, **60.00**  
Also, 29" length skirt for petites' sizes 4-14.

▶ 50% OFF

C. Leather takes a decidedly feminine turn in this G III LEATHER FASHIONS form-fitter. 25" skirt with slit, black or brown, misses' 4-16, orig. 170.00, **85.00**  
Also, 23" length skirt for petites' sizes 4-14.

TOUCH-AND-GO FASHIONS!

100

*You're the reason*

Since 1888, it has been our goal to bring you quality...in selection, style, and customer service. Now as we celebrate our 100th anniversary, our commitment to these aims is stronger than ever, as is our appreciation for your valued and loyal patronage.



Piedmont Airlines is the official airlines for our 100th anniversary celebration.



50% off

**BUSINESS PARTNERS**

**YOUR MOST  
RELIABLE  
CO-WORKERS**

**50% OFF** ◀

A. CHAUS partners in prime Acrylic/cotton crewneck sweater with embroidery detail. Choose red, sapphire or gold with paisley detail, navy or red with foulard detail, misses' sizes S-M-L, orig. 65.00, **32.50**

Softly pleated skirt of rayon challis. Choose red/multi or sapphire/multi paisley, navy/multi foulard, misses' 6-16, orig. 63.00, **31.50**



LITHE SPIRIT:  
SEPARATES GO  
LONG & LEAN

► 50% OFF

A. This SML SPORT® duo easily goes from the front office to the tailgate picnic. Ramie/cotton/ rayon in wine, natural, black, spruce or blue, misses' sizes S-M-L. Cardigan with 3 pockets, orig. 48.00, **24.00**

Short sleeve shell with shoulder pads, orig. 36.00, **18.00**

NORTON McNAUGHTON tri-pleated pants of rayon/ polyester. Black/white houndstooth check, misses' 6-16, orig. 40.00, **20.00**

Also available in plaid or houndstooth stripe patterns.

► 50% OFF

B. Suitably impressive: our own SWEETBRIAR® rayon separates. Black, navy or taupe, misses' 8-18. Fully lined one-button jacket, orig. 68.00, **34.00**  
Fully lined dirndl skirt, orig. 42.00, **21.00**

FASHION TAILORED TO YOUR NEEDS





SCOTLAND YARDS

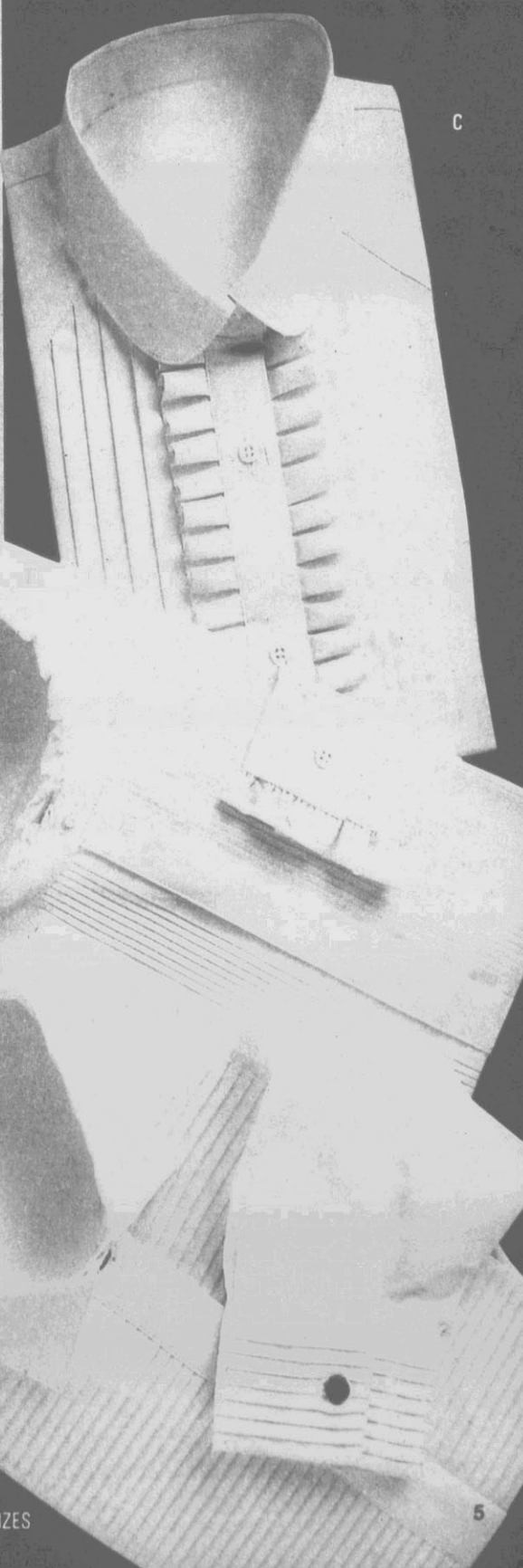

50% OFF  
BRIGHTS AND  
TARTANS

16.00 ea. ◀

A. Straight up with a twist!  
EL & EL NOVELTY cable  
cardigan in red, navy, hunter  
or creme. Acrylic, misses'  
sizes S-M-L, orig. 32.00  
PARSON'S PLACE pleated  
tartan skirt of polyester/wool.  
Navy/red, navy/hunter, white  
plaid or red plaid, misses'  
sizes 8-18, orig. 32.00

19.00 ◀

B. Team me up, Scottie.  
This D.H.I. red tartan sweater  
just begs to be paired with  
all your favorite skirts and  
slacks. Acrylic, misses'  
sizes S-M-L, orig. 38.00

17.00 your choice ▶

C. Tucks and ruffles add a touch of  
femininity to our own crisp white shirts  
by SADDLEBRED® Polyester/cotton,  
misses' 6-16. Also in petites' 4-14.  
Tuxedo shirt with pleated yoke, orig. 34.00  
Tucked shirt with band collar, orig. 34.00  
Tucked shirt with ruffled front, orig. 34.00

50% off

ALSO IN PETITE SIZES

**50% OFF  
FALL'S PEAK  
COLORS!**

▶ **18.00**

A. HONEY has harvested this wool challis scarf in so many colors, you must come picking! 36" self-fringed square in florals, tapestries, and paisleys, orig. 36.00

▶ **19.00 ea.**

B. Our own SWEETBRIAR™ rayon twosome is as soft and easy as it is detailed. Wine, black or blue, misses' 8-18. Saddle shoulder blouse with concealed button placket and front yoke, orig. 38.00. Softly pleated, button front skirt with two pockets and back button tab (belt not included), orig. 38.00

**THE HUES AND CRY OF AUTUMN!**

**100**

*You're the reason*

TEXTURES & TWILLS

HALF SOFT,  
HALF CRISP,  
HALF OFF!

50% OFF ▲

A. REGATTA SPORT pure cottons are a boon to all your autumn weekends.

Sweater in red, regal, natural or olive, misses' S-M-L, orig. 44.00, **22.00**

Twill trouser skirt has concealed button placket. Olive, sand or luggage, misses' sizes 6-16, orig. 52.00, **26.00**

50% OFF ▲

B. IZOD™ WOMENSWEAR takes texture to the nth degree in this ramie/cotton cardigan. Choose steel blue, winter white or rosewood, misses' sizes

S-M-L, orig. 64.00, **32.00**

CALVIN KLEIN SPORT™ cotton twill cuffed pants in khaki or navy, misses' sizes 4-14, orig. 48.00, **24.00**

50% off

FALL'S FLORA AND FINERY



A



B



C

PRETTY  
DRESSES  
IN FULL  
BLOOM,  
50% OFF

44.00 set

A. Designed exclusively for us by ANDREA GAYLE®, cotton/ramie sweater with hand-embroidered floral yoke, polyester jacquard pleated skirt and matching scarf. Black/multi, misses' sizes S-M-L, orig. 88.00  
Also in petites' sizes S-M-L

38.00

B. Designed exclusively for us by PERIWINKLE, a floral sweep skirt dress of rayon faille. With single-button fly front and patent belt (rose pin not included) Jade/black, misses' 10-18, orig. 76.00

34.00

C. STUART ALAN sweetens this tapestry floral dress with a pretty crochet collar, smocked waist and cuffed three-quarter sleeves. Rayon challis in royal/fuchsia, misses' 8-18, orig. 68.00

50% off



A

ALSO IN PETITE SIZES

**CAREER  
LOOKS TO  
FALL FOR**

**50% OFF** ◀

A. This two-tone classic from LESLIE FAY® has real pick-up and go! With soutache trim and faux snake belt. Polyester doveskin in cream/navy, misses' sizes 8-18, orig. 100.00, **50.00**. Also in petites' sizes 8-16



B

**50% OFF** ◀

B. The rich facade of this REO ORIGINALS dress is just a cover-up for its easy care, easy wear! Blouson bodice with border hip yoke and soft skirt. Rayon challis in navy/multi, misses' sizes 6-16, orig. 108.00, **54.00**

**50% OFF** ◀

C. DARA JEFFRIES styles a floral rayon challis dress with a flirty peplum and all the right lines, plus a lace hankie for good measure! Black/multi floral print, misses' 6-16, orig. 108.00, **54.00**

**FOR SUCCESS CLIMBS OR SOCIAL CLIMES**



C



**70.00**

**A. MAGGY LONDON BY  
JEANNENE BOOHER**  
takes you from morning  
coffee to evening cocktails  
with our exclusive silk  
jacquard dress in a vivid  
floral. With set-in waist  
and softly knotted belt,  
turquoise/multi, misses'  
6-16, orig. 140.00



DEF

**80.00**

B. A detachable linen jabot and cuffs with hand-crocheted lace romance this rayon challis dress designed just for us by NJ, A DIVISION OF NANCY JOHNSON. With button front and v-waist. Bluegrass, misses' 4-14, orig. 160.00

**74.00**

C. Rich jewel hues on silky polyester jacquard make this FAMOUS MAKER dress look and feel expensive...only you'll know the difference! Blouson bodice with crushed turtleneck and contrast cummerbund, purple/turquoise, misses' 4-14, orig. 148.00

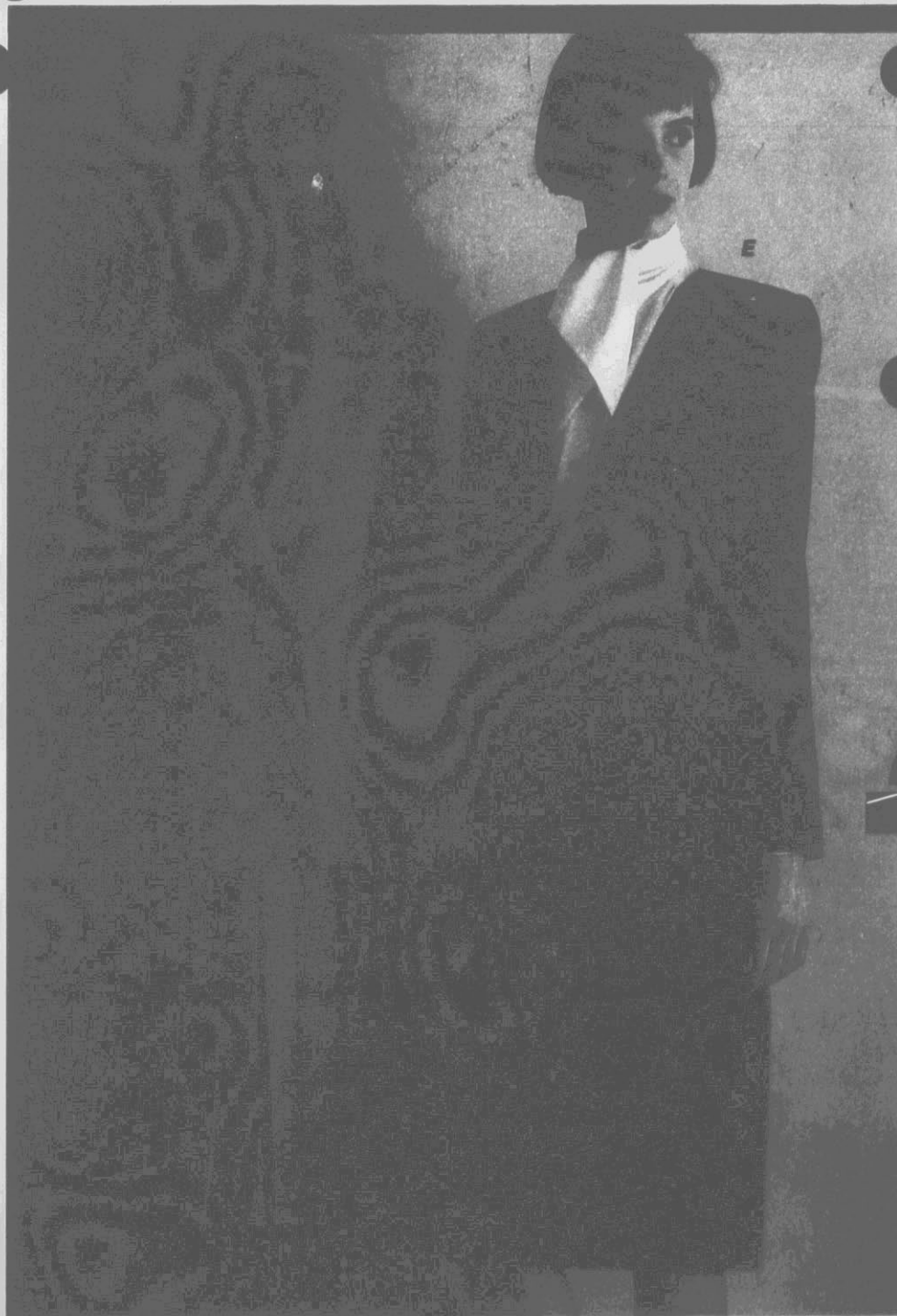

**69.00**

D. Investment-minded women can't help but notice the blue chip potential of this RAOUL glen plaid suit. Two-button double breasted jacket and panel pleated skirt in viscose polyester. Black/white, misses' sizes 6-16, orig. 138.00

**74.00**

E. A menswear plaid is the perfect foil for the feminine lines of this suit by CROSS COUNTRY. One-button cardigan and dirndl skirt with besom pockets in polyester/wool. Gray/multi, misses' sizes 8-18, orig. 148.00

100

You're the reason

EFINED

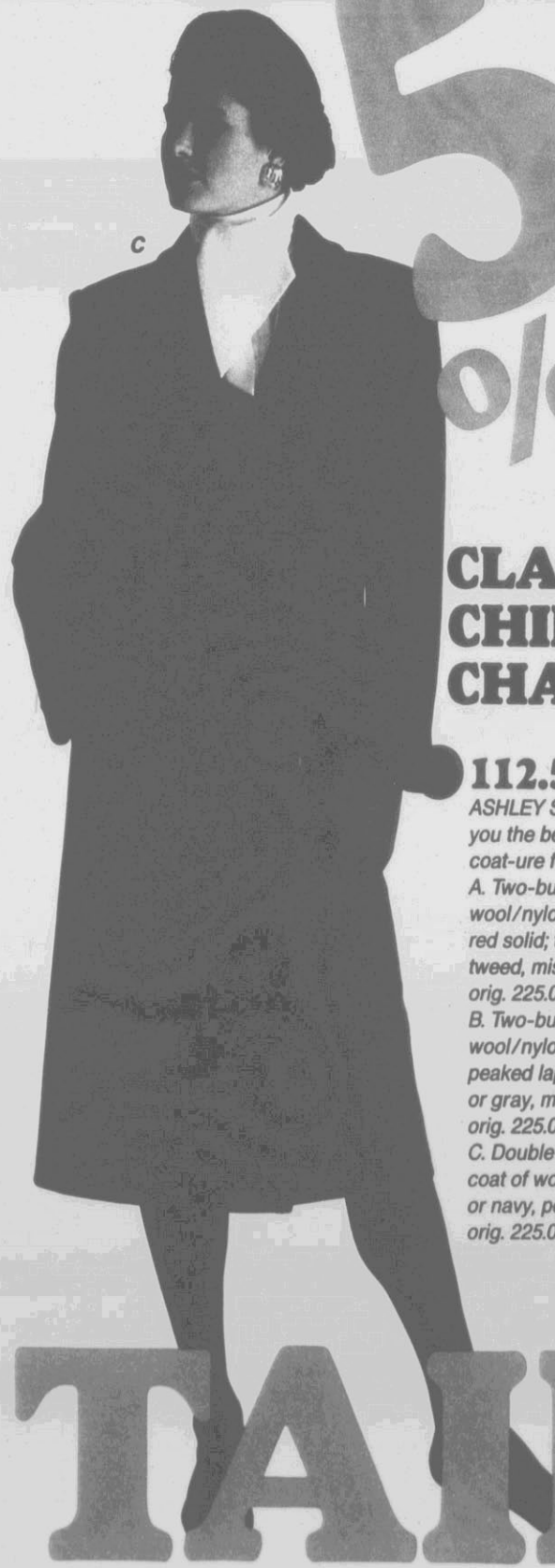

50% OFF

## CLASSIC CHILL CHASERS

**112.50** *your choice*

ASHLEY SCOTT brings you the best of haute coat-ure for '88.

A. Two-button reefer of wool/nylon. Cobalt or red solid; tan/gray tweed, misses' 8-20, orig. 225.00

B. Two-button coat of wool/nylon with peaked lapels. Tan or gray, misses' 6-16, orig. 225.00

C. Double-breasted coat of wool/nylon. Red or navy, petites' 6-16, orig. 225.00

TAIL

# TODAY'S LOOKS FOR TODAY'S WOMAN, 50% OFF

**44.00**

A. SCHRADER SPORT® renders a pen and ink effect on our exclusive polyester crepe dress. Button tab front with self belt, detachable flip tie. Navy/cream, sizes 14W-24W, orig. 88.00

Not all sizes in all stores.

**34.00-50.00**

B. Flattering separates from COMPLEX® INDUSTRIES CORP. Checked twill jacket, polyester/rayon in brown/black, sizes 16W-24W, orig. 100.00, 50.00  
Pleated pants with side elastic waist, polyester/rayon crepe in black or brown, sizes 16W-24W, orig. 68.00, 34.00

Not all colors in all stores

**25.00-28.00**

C. Easy acrylic jersey knits by YOUNG STUFF® in white, jade or black. Soutache trimmed top for large sizes 36-46, orig. 56.00, 28.00  
Gored skirt with elastic waist, sizes 30-40, orig. 50.00, 25.00

Not all colors in all stores.

**Belk** Acquire the latest in full-figured fashions by using your credit card.

# ORED



50% OFF

**15.00-17.00**

*A. Check and checkmate. KIKOMO rayon separates for juniors' S-M-L. Checked camp shirt in white/black, turquoise/black or red/black (pin not included), orig. 30.00, 15.00 Paperbag waist pants in black, turquoise or red (belt not included), orig. 34.00, 17.00*

**15.00 ea.**

*B. As easy going as you are, our own ADESSO™ cotton jersey knits with details aplenty! Choose berry, black or forest, juniors' sizes S-M-L. Cropped top with new shawl crewneck collar, orig. 30.00 12-pleat pants have elastic back waist for easy fit, orig. 30.00*

JR.

# THE BAGGIES, ALL GATHERED TOGETHER!

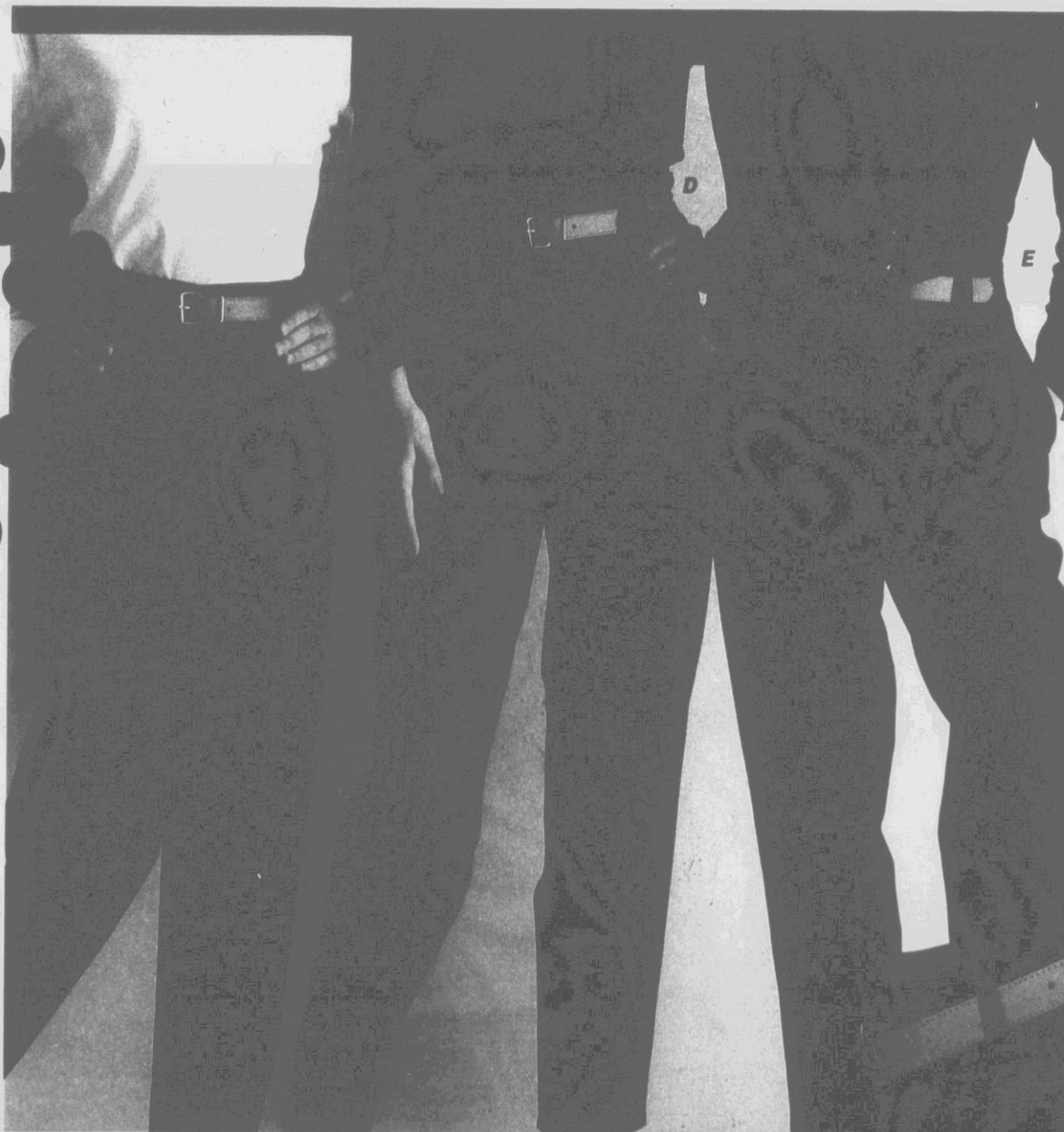

**17.00** your choice

*Details, details, details!  
C'EST JOLI pays attention  
to special touches in  
cotton twill pants for  
juniors' 3-11.*

*C. Belted, pleated pants  
with side tabs and slash  
pockets, navy, black, red  
or oyster, orig. 34.00*

*D. Belted paperbag waist  
pants in olive drab, black,  
bordeaux or tobacco,  
orig. 34.00*

*E. Belted pants with fold-  
over waist and pleats,  
black, new red, oyster or  
navy, orig. 34.00*

# JAM!

**SAVE ON ENTIRE STOCK OF BALI®**



**50% OFF**



**A.** All Bali® bras and something Else® for Heiress® bottoms. Shown: Pretty Bali™ underwire bra of nylon/polyester/Lycra® spandex. 34-36B, 34-38C, reg. 17.00, **8.50**  
34-36D, reg. 18.00, **9.00**  
Pretty Bali™ for Heiress® lace leg brief of nylon/Lycra® spandex. Sizes S-M-L-XL, reg. 9.00, **4.50**

Not all styles, sizes or colors available in all stores. Lycra® is a registered trademark of DuPont.

**50% OFF**

**B.** WARNER'S® goes to any lengths to please you! Perfect Measure™ A-line petti of Antron® III anti-cling nylon in 23", 25", 27", 29" or 31" lengths. White or beige, S-M-L-XL, reg. 9.50, **4.75**

Not all sizes, colors or lengths available in all stores. Antron® III is a registered trademark of DuPont.

**50% OFF**

The stuff dreams are made of, courtesy of JAYRE®!  
**C.** Polyester/cotton knit pajamas with multi-color buttons and merrow stitching. Red or royal, P-S-M-L, reg. 40.00, **20.00**  
**D.** Satiny jacquard nightshirt with front placket. Blue or pink polyester, P-S-M-L, reg. 36.00, **18.00**

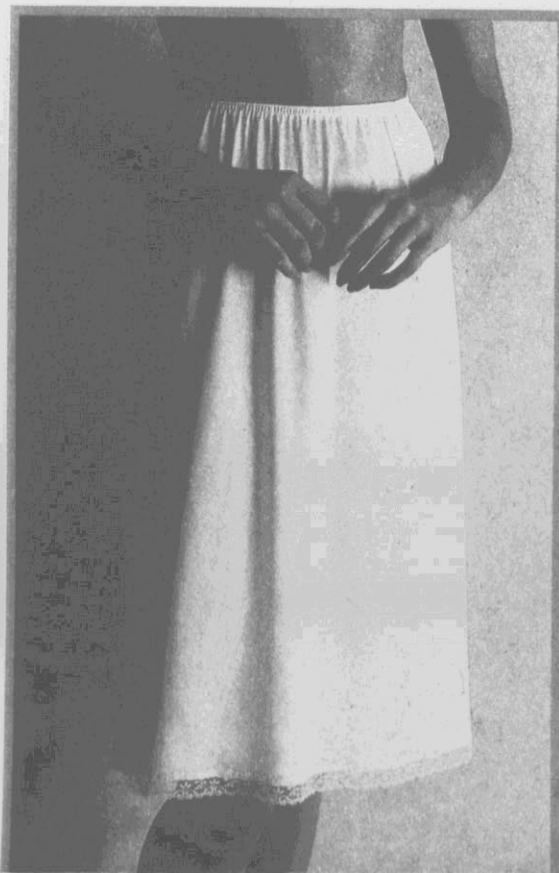

# AUTUMN ADORNMENTS, 50% OFF

**6.50-21.00**

A. MONET® has some wonderful ways to string you along...with a lustrous collection of faux pearl! Choose from a treasure trove of pierced or clip earrings in drop or button styles, plus versatile lengths of graduated or pink/pearl strands, reg. 13.00-42.00

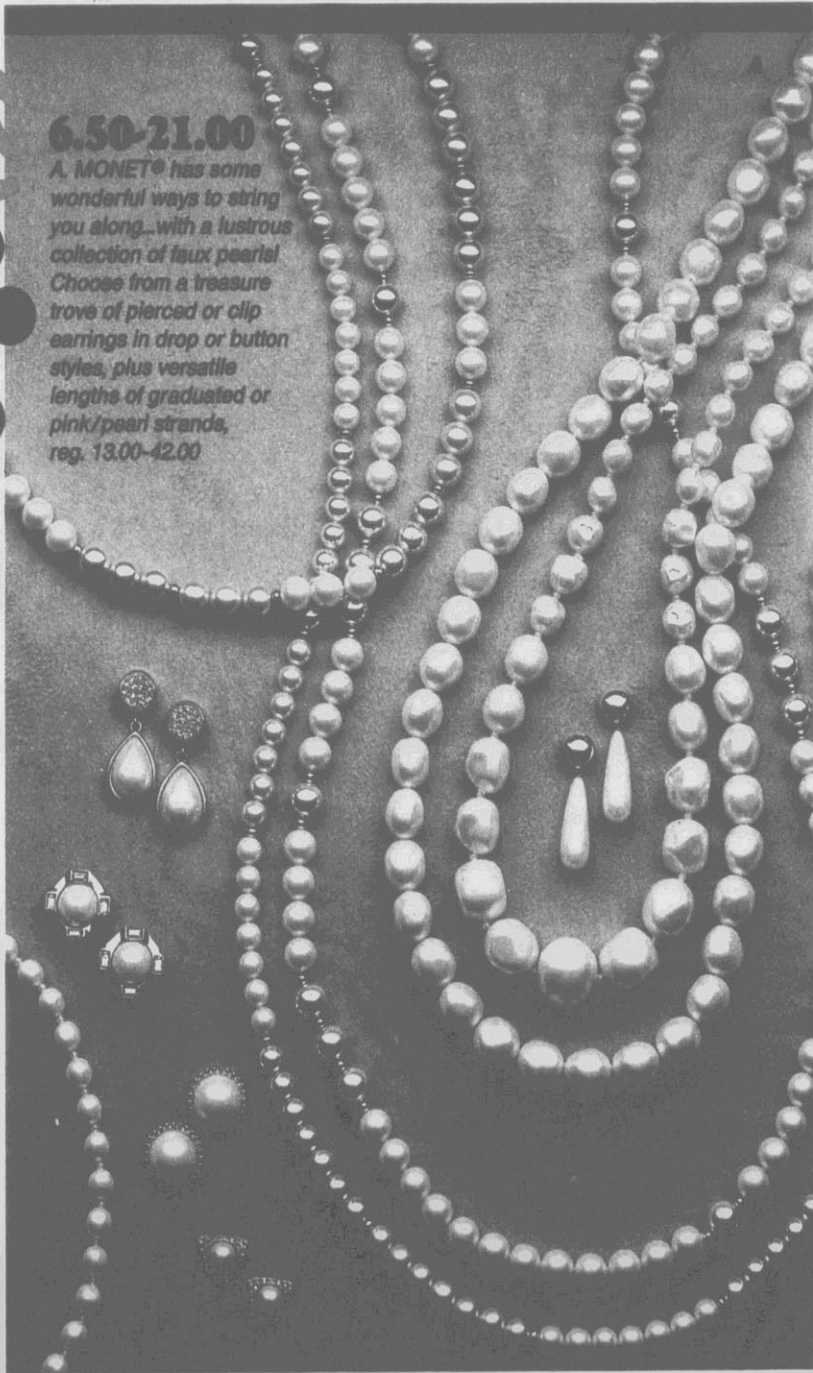

**15.00** your choice

B. State of the art-deco. CAROL DAUPLAISE brings you ultra-modern shapes and glittering stones in a collection of pins and earrings for fall. Choose assorted styles with faux ruby, emerald, sapphire or amethyst accents, reg. 30.00

# BAUBLES



%

## BURNISHED AUTUMN ACCENTS

**35.00-55.00**

A. UNISA® takes fashion firmly in hand with handbags of fine pebble grain leather. Choose whiskey, black, navy or red. Shown:  
"North" satchel, orig. 110.00, **55.00**  
"Richmond" fishing creel, orig. 70.00, **35.00**  
"Pony" small drawstring, orig. 82.00, **41.00**  
Not shown:  
"Harry" large drawstring, orig. 110.00, **55.00**  
"Alamo" large binocular, orig. 88.00, **44.00**

Not all styles in all colors.

**10.00-28.00**

B. We're predicting a new gold rush when you discover this ANNE KLEIN® collection at 50% savings! Choose from elegant goldtone snake chains, pins, and earrings in clip or pierced styles, orig. 20.00-56.00

B

## INDIAN SUMMER TONES

### 50% OFF

A. Your kind of DAME®...a tailored 1½" wide belt of aniline leather joined by a gold/silver tone interlock buckle. Red, dark green, British tan, navy, black, ivory or eggplant, orig. 20.00, **10.00**

### 50% OFF

B. TREASURES DE PARADISE presents a collection of lobe lovelies in semi-precious stones. Pierced or clip styles in button, drop, doorknocker designs, orig. 22.00-26.00, **11.00-13.00**

### 50% OFF

C. New waist sights from a "wiz" of a designer! Aniline leather belt with a sculptured gold/silver tone buckle. Red, navy, fuchsia, emerald, black, winter white or luggage, orig. 27.00, **13.50**

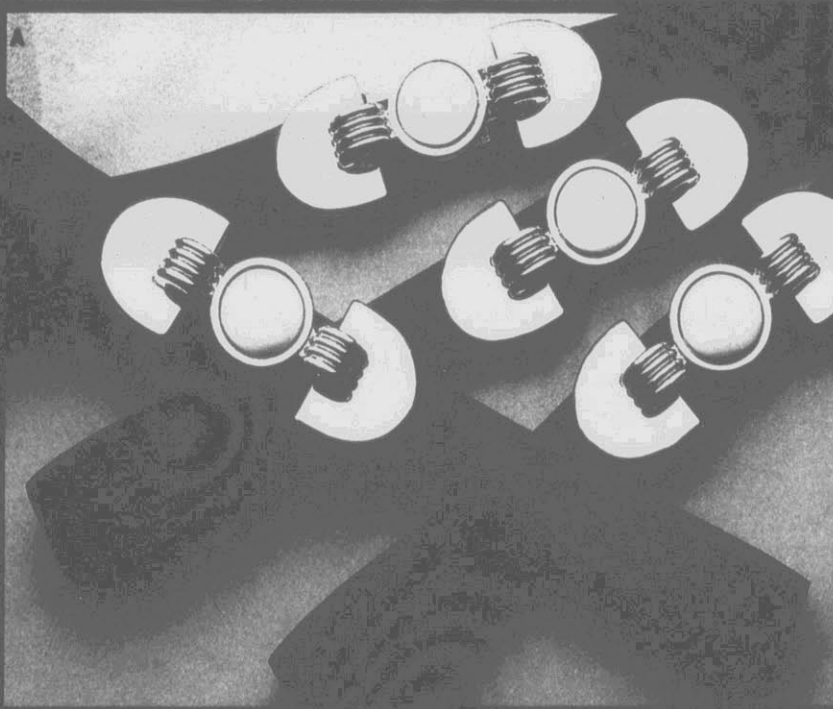

50%

50%

OFF

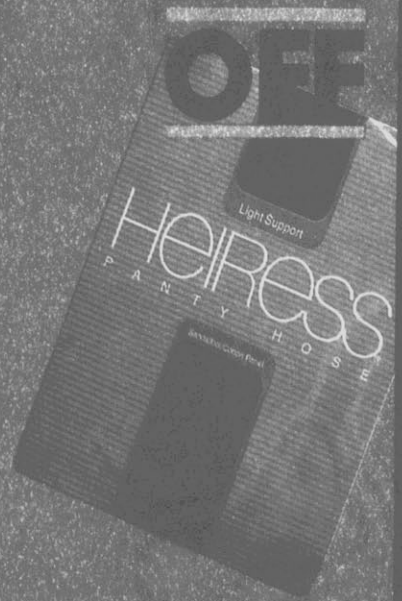

ENTIRE  
STOCK OF  
HEIRESS®

.50-3.00

A. Enjoy 100th anniversary savings on our own Heiress® sheer hosiery! Choose from Heiress® basic or fashion styles, Silky Sensations, and all Heiress® Full Figure pantyhose. Assorted neutrals and fashion colors, reg. 1.00-6.00  
Not all colors in all stores.

100

*You're the reason*



# SAVE ON A BUMPER CROP OF COLORFUL SOCKS BY HEIRESS®

1.00-1.50

HEIRESS® takes the pain out of footing the bill with 50% savings on women's socks. Choose anklets, turncuffs and crews in a bevy of colors, sizes 9-11.

- A. Ribbed turncuff socks, reg. 2.25, **1.12**
- B. Flat knit socks, reg. 2.00, **1.00**
- C. Mini slouch socks, reg. 2.75, **1.37**
- D. Gray marl turncuff socks, reg. 3.00, **1.50**
- E. Cable crew socks of cotton/nylon/flax, reg. 3.00, **1.50**

Not all colors and styles in all stores.

Save 50% on the socks of your choice. See the sign in store to see the sock styles.



## A TRIO OF SNAKE CHARMERS

### 50% OFF

A. Our own ADESSO™ walks away with the fashion honors this fall for "Skin" snake skimmers. Black or taupe, women's sizes, reg. 64.00, **31.99**

### 50% OFF

B. "Zoe" by IMPO can be a snake in the grass, but it's sophisticated enough for city pavement, too! Navy or taupe on wedge, women's sizes, reg. 60.00, **29.99**

### 50% OFF

C. JASMIN™ proves you can be well heeled without being rich. "Jiffy" offers polished good looks in a high heeled snakeskin pump of brown, taupe or black, women's sizes, reg. 60.00, **30.00**

# PUMPED UP...

AND READY TO GO FOR FALL DAYS AHEAD!

## 50% OFF

A. Our exclusive SWEETBRIAR® classic leather pumps are the perfect footnotes to all the chapters in your life.

"Jillian" in wine, taupe, black or navy, women's sizes, reg. 39.00, **19.50**

## 50% OFF

B. Weave your way through a busy day wearing "Chariot" by TOPAZIO, texture-rich urethane pumps in navy, black or taupe, women's sizes, reg. 34.00, **17.00**



4

%  
OFF

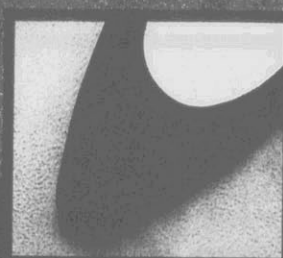
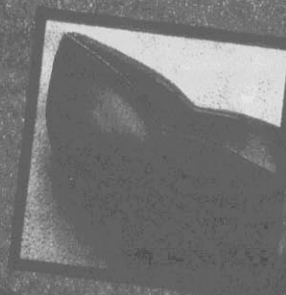
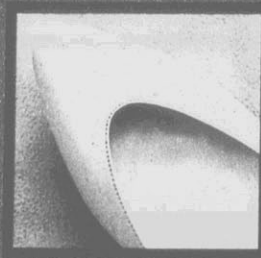
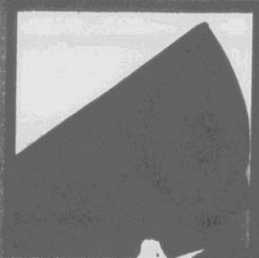

100

A

B

*You're the reason*

## CITY SLICKERS WITH COLORFUL PERSONALITIES!

### 50% OFF

A. Here with the lowdown on fall footwear trends, "Skim" by SRO. Have this delightful leather charmer in red, navy, cream or black, women's sizes, reg. 48.00, **24.00**

### 50% OFF

B. SWEETBRIAR® goes a step further and adds pretty sculpting detail to the traditional leather pump. Have "Carolyn" in black patent, taupe or navy, women's sizes, reg. 37.00, **18.50**

**50% OFF**

A. BEES BY BEACON® leather moccasins offer all the fringe benefits... comfort, classic styling and value! Taupe or wine, women's sizes, reg. 39.00, **19.50**



**50% OFF**

B. Town-and-country versatility makes "Pepper" by UNISA® a must-have for fall. Soft leather with hand stitched vamp, brown or navy, women's sizes, reg. 59.00, **29.50**

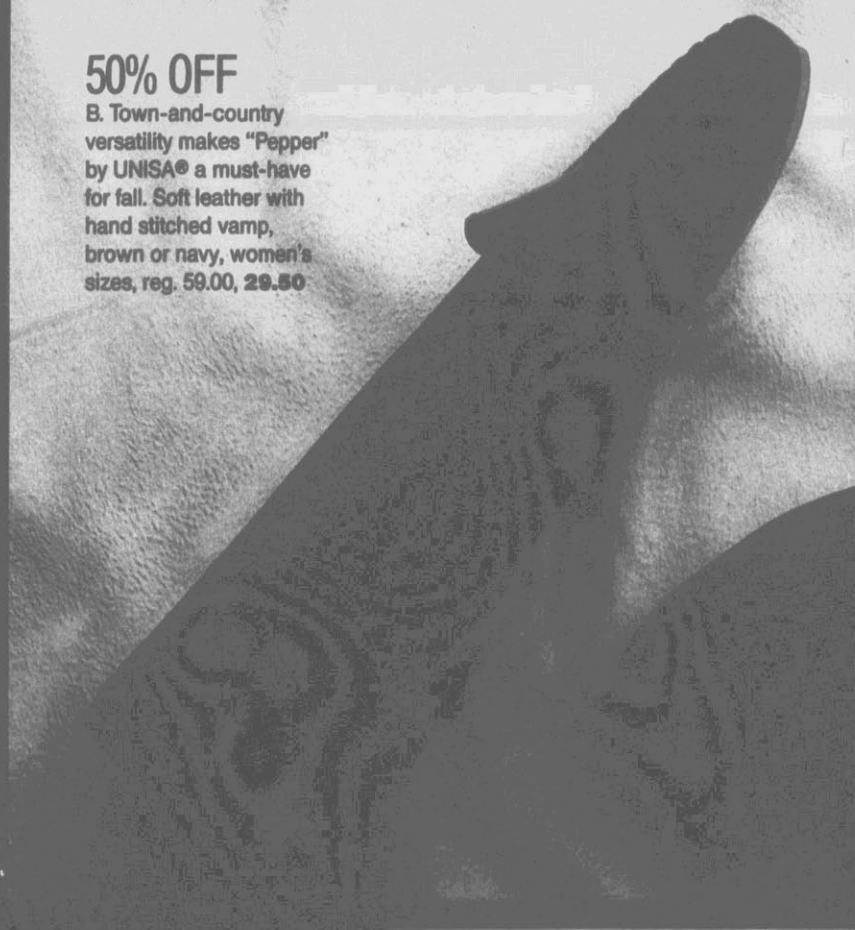

**50% OFF**

C. Go 9-WEST™, young woman, and discover the new frontier styling of "Emily" lace-up leather high tops. French Polish or black, women's sizes, reg. 75.00, **37.50**

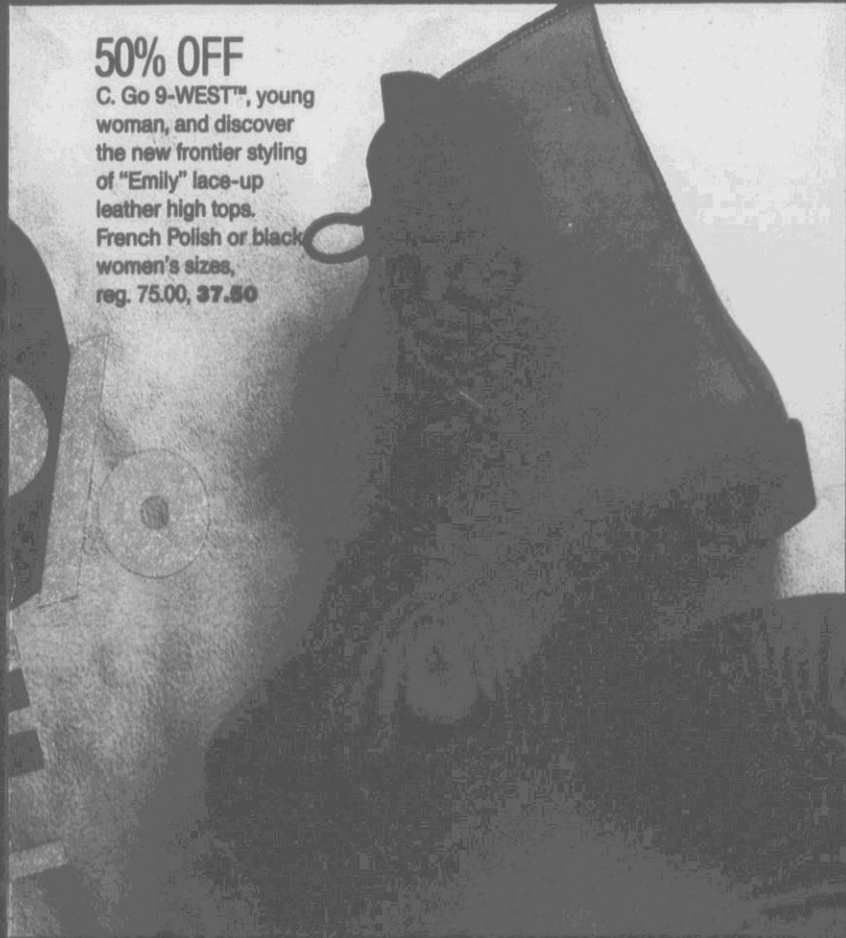

**50% OFF**

D. 9-WEST™ "Charlotte" will have everyone watching your step this fall! With woven leather vamp, parchment, black or navy, women's sizes, reg. 35.00, **17.50**



## 50% OFF

A. STACY ADAMS® walks all over notions of what's traditional in a tasseled slip-on and livens things up a bit with woven detail. Black or brown leather, men's sizes, reg. 58.00, 29.00

# stop

## keeping pace with style

## 50% OFF

B. If you're leaning toward a more traditional stance, our RED CAMEL® suede dirty bucks are a step in the right direction. Tan suede on crepe soles, men's sizes, reg. 44.00, 22.00

100  
*You're the reason*

**50% OFF**

A. Move over, James Dean. The leather jacket takes on a whole new cosmopolitan aura, but still retains its rugged nonchalance. This tailored version from a FAMOUS MAKER has a zip front and snap-through flap pockets. Khaki, men's sizes 36-46, orig. 310.00, 155.00

**50% OFF**

B. Prime rib...served up by a colorful FAMOUS MAKER and cut in half! Pleated corduroy slacks of pure cotton in mallard, gray, black, blue, tan or plum, men's waist sizes 32-40, orig. 40.00, 19.99

SAVE  
50%  
%



**just look  
at these  
photo  
finishes!**

**6.99-14.99**

**A. BURNES® OF BOSTON**  
backs your favorite photographs  
into the nicest corners possible!  
Matted or unmatted styles in  
wood, oak, silverplate or polished  
brass, sizes ranging from 3 x 5" to  
8 x 10", orig. 14.00-30.00

**6.99** your choice

**B.** We're cutting albums and  
they're yours for a song!  
Save on **HOLSON Buksyn®**  
vinyl photograph albums in three  
styles: 100-page magnetic, 3 x 5"  
pocket slip-in or 4 x 6" pocket  
slip-in, orig. 15.00 ea.

**8.99-11.99**

**C.** Picture your loved ones in  
contemporary frames from  
**BARLOW.** Choose beveled glass  
with brass frame in 5 x 7" or  
8 x 10" sizes, orig. 18.00-24.00

**Belk** It's a picture-perfect time  
to use your credit card.



**SAVE  
50%**

## 50% OFF

A. The inn crowd chooses GAUCHO® BY ATLANTIC® for handsome styling in a water-resistant tweed of acrylic/nylon/polyester. 4-piece set, reg. 420.00, **210.00**  
Shoulder tote, reg. 50.00, **25.00**  
Cargo duffie, reg. 90.00, **45.00**  
26" pullman, reg. 140.00, **70.00**  
Garment bag, reg. 140.00, **70.00**

## 39.99

B. The JORDACHE® super carrier offers jet-age styling with water-resistant interior, organizer pockets and sturdy nylon construction. Royal or gray, reg. 100.00



## 50% OFF

A. ANDHURST® puts the 'dash' in haberdashery with our exclusive sportcoat of wool/lambswool in the season's newest windowpane plaid. Brown, men's 38-46 reg. or 40-46 long, orig. 140.00, 70.00  
See page 32 for slacks information.

## 50% OFF

B. Our own ANDHURST® mid-weight contender...a year-round suit of 65% polyester/35% wool in windowpanes, glen plaids or multi-stripes, men's 38-46 reg. or 40-46 long, orig. 150.00, 75.00

## 50% OFF

C. Lead off with your strong suit. PALM BEACH® distinctive charcoal plaid suit of 55% Dacron® polyester/45% worsted wool. Single-breasted jacket with center vented, pleated trousers, men's 38-46 reg. or 40-46 long, orig. 295.00, 145.00

\*Dacron® is a registered trademark of DuPont.

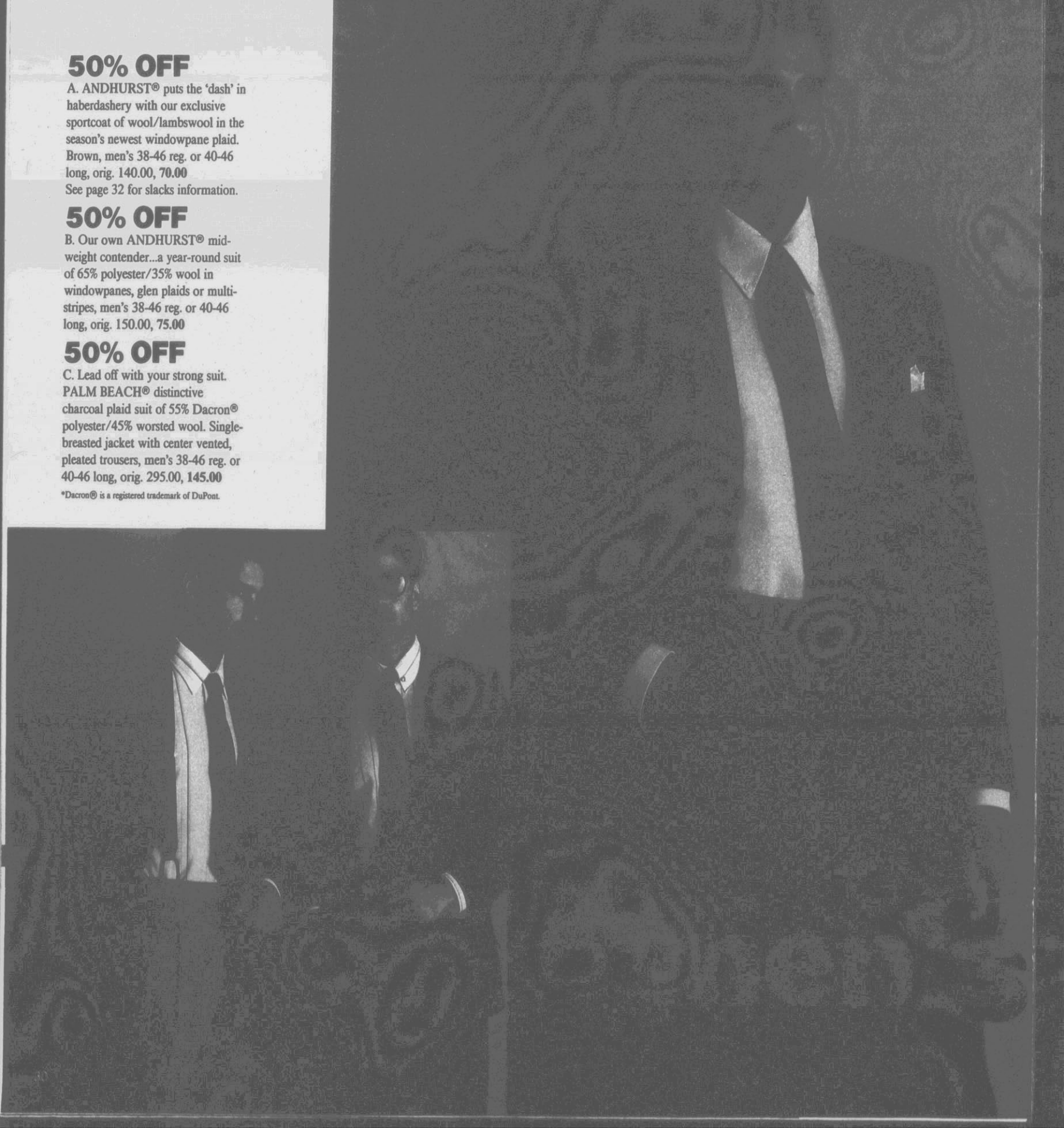

SAVE

%

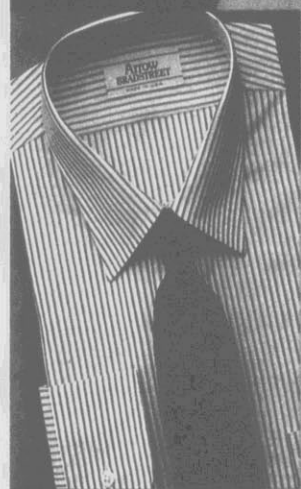

ARROW  
BRADSTREET  
MADE IN U.S.A.

## 12.00-13.50

A. ARROW® goes right to the heart of what a man wants in a dress shirt. Choose "Dover" or "Bradstreet" styles in solids or stripes, button down or regular collars, all of cotton/polyester. Necks 14½-17½, sleeves 32/33-34/35, orig. 24.00-27.00

## 7.50

B. Impeccable silk ties from WEMBLEY® make sticking your neck out at the office a little less risky. Paisleys or neats in a range of colors, orig. 15.00

## 6.25-9.00

C. Enhance your image in our own ANDHURST® fashions. Polyester/cotton broadcloth dress shirt in stripes or solids, necks 15-17½, sleeve lengths 32-35, orig. 18.00, 9.00  
Pure silk ties in neats, paisleys, medallions or persian patterns, orig. 12.50, 6.25  
See page 32 for slacks.



Chubb

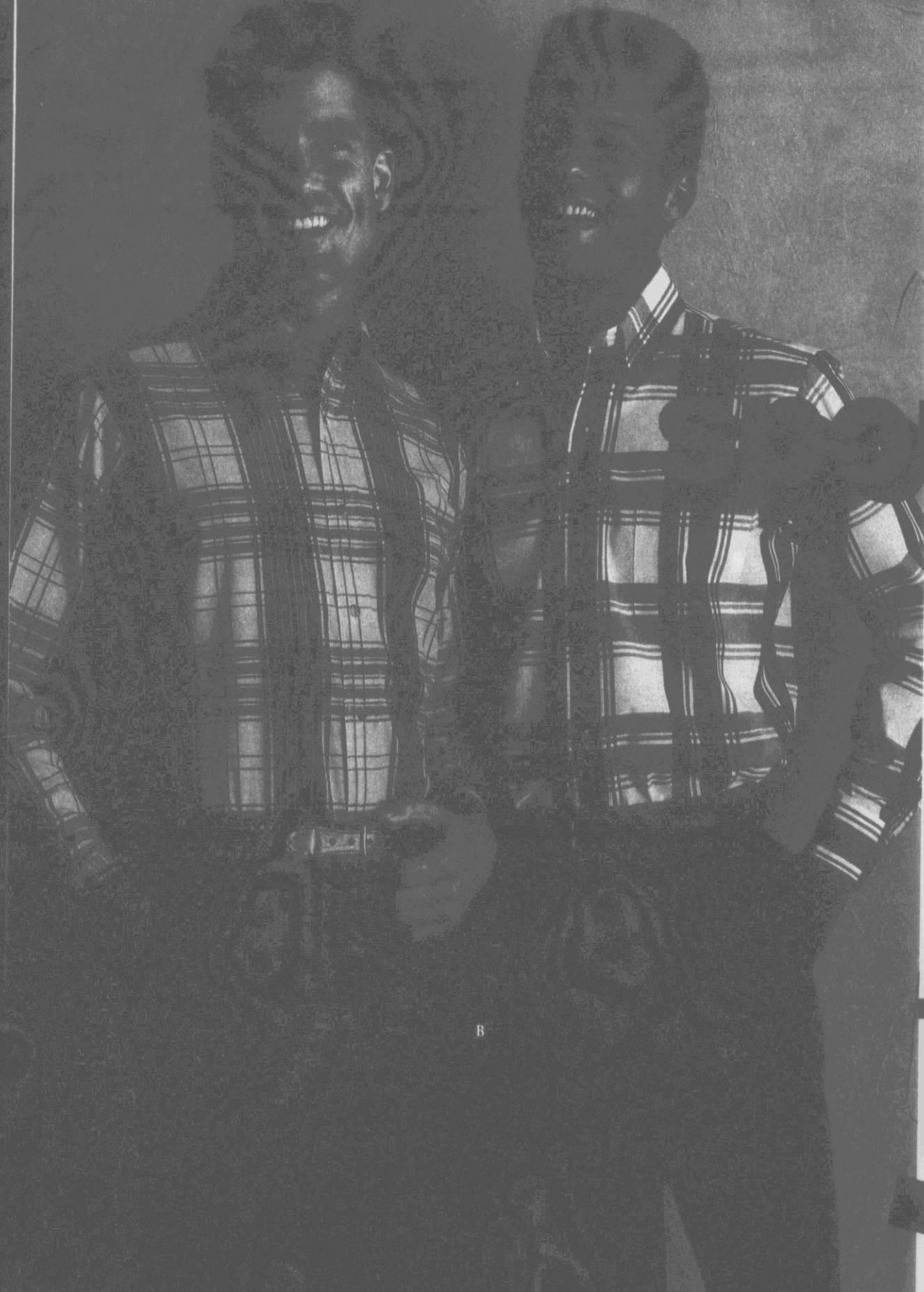

**8.00**

A. Let others go with fads, you'll take plaids! Our ANDHURST® yarn-dyed woven sport shirts of easy-care polyester/cotton. Regular or button-down styles, men's S-M-L-XL, orig. 16.00

**16.99**

B. Versatile enough to pull dress or casual duty, ANDHURST® pleated slacks of polyester/wool gabardine. Blue, rose, fawn, navy or black, men's sizes 32-42 regular or long, orig. 34.00

**Andhurst!**

**our own  
Andhurst®,  
Saddlebred®  
score big  
points!**

**SAVE  
50%**

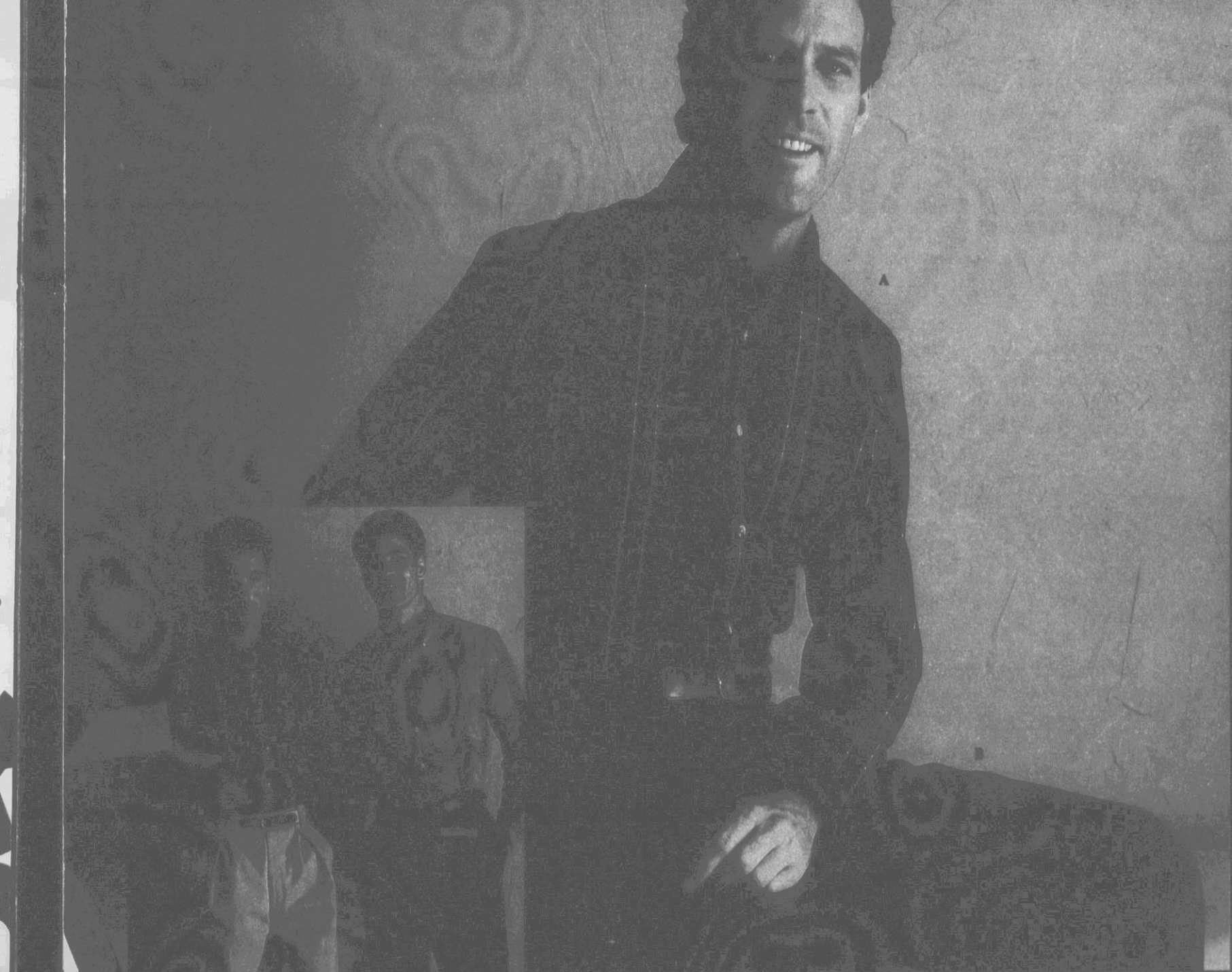

**11.00**

A. Execute the pattern play. Our own SADDLEBRED® button-down shirts kick off the season in colorful plaids. Cotton/polyester, men's S-M-L-XL, orig. 22.00

**14.99**

B. Providing the color commentary, our own SADDLEBRED® brushed twill slacks of pure cotton. Inverted double pleats, hemmed bottoms, green, khaki, navy or plum, men's 32-40, orig. 30.00

**Belk** Use your credit card to select fall weekend casuals.



**29.99**

A. Tactile maneuvers. Your fashion strategy for fall should include this cable sweater from a FAMOUS MAKER. Claret, bone or green, men's M-L-XL, orig. 60.00

18.00-22.00

18.00-22.50

13.00-13.50

• Soft, warm, casual crew  
 neck, 100% acrylic.  
 Available in 100% acrylic. Young men's  
 sizes 22-24, reg. 43.00, 22.00  
 • Soft, warm, casual crew  
 neck, 100% acrylic. Young men's  
 sizes 22-24, reg. 43.00, 22.00

• Our own 100% wool  
 pullover of pure wool. Available  
 color, young men's 22-24, reg.  
 25.00, 23.00  
**SHIRTS** • 100% cotton, 100%  
 cotton shirt. Olive, black, or white.  
 Young men's 22-24, reg. 27.00, 25.00  
 For all other items see



SAVE  
**50**  
%

**cool  
fronts of  
autumn**

**18.99-23.99**

CACHAREL takes a refreshing departure from fall's warm hues.

A. Cotton dobby windowpane sport shirt, men's sizes

M-L-XL, orig. 40.00, **19.99**

Pleated cotton twill pants, men's sizes 30-38, orig. 38.00, **18.99**

B. Ramie/cotton marl crewneck sweater, men's sizes M-L-XL, orig. 48.00, **23.99**

Melange plaid, cotton marl sport shirt, men's sizes M-L-XL, orig. 40.00, **19.99**



We accept Belk Charge, American Express, MasterCard, VISA

**OUR PROMISE TO YOU:**

Sometimes due to circumstances beyond our control, advertised merchandise fails to arrive in our stores on schedule. When that occurs, we will fill your order at the earliest opportunity based on availability. However, we must receive your order within the advertised selling period. Not all items available in all stores.



Our special thanks to Piedmont Airlines, the official airlines for our 100th anniversary celebration.

Receive a coupon for discounts of \$25-\$100 off a Piedmont ticket purchase with a Belk charge purchase of \$100 or more during our Fall Fashion Sale. While supplies last. Visit your participating Belk for details.

**Belk**

ROCKY MOUNT Golden East Crossing  
GOLDSBORO Berkeley Mall  
GREENVILLE Carolina East Mall  
WILSON Parkwood Mall  
KINSTON Vernon Park Mall

100

*You're the reason*

**SALE DATES: Sept. 15-17**

28, 83, 155, 192, 449

# Fall Wardrobe Sale

JCPenney



II  
*Worthington*

A COLLECTION  
OF SEPARATES  
FOR MISSES

\$6 to  
\$22 off

Details on page 2

JCPenney

SALE 24.99 TO 36.99

WORTHINGTON™  
GO-TOGETHER FASHIONS

Reg. \$32 to \$48. Misses welcome Autumn with wardrobe makers from Worthington™. Skirt, cardigan or shell of warm acrylic/wool; blouse or skirt of polyester. Traditional Sportswear Dept.

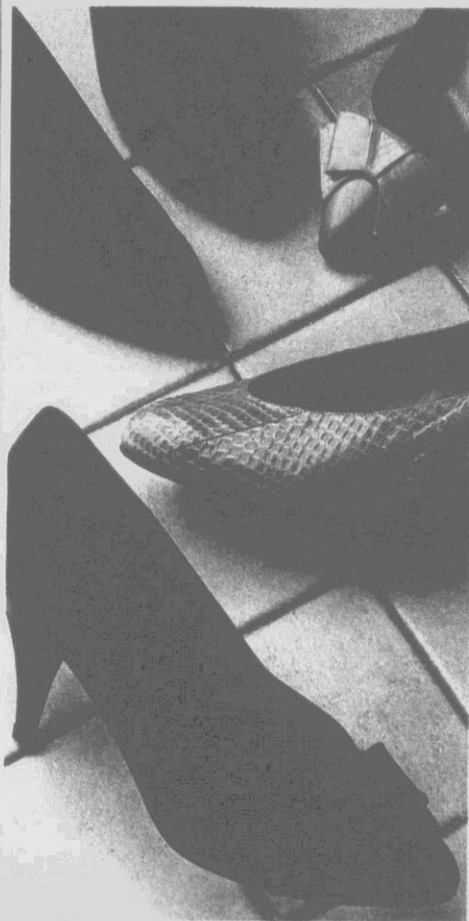

SALE 29.99

ALL WORTHINGTON™ DRESS SHOES  
Reg. \$42. Luscious dress shoe with leather uppers in the styles you love best. We show smooth mid-heel pumps in fashion colors, and snake-finish favorites, too. Choose from all these and many more!

ON THE COVER:

Worthington™ Tartan separates for Misses.

	Reg.	Sale
Cardigan sweater	\$40	29.99
White blouse in ruffle or button-front styles	\$28	21.99
Plaid pleated skirt	\$38	27.99
Plaid jacket	\$72	49.99
Blouse with detachable trim	\$28	21.99
Solid color slim skirt	\$34	24.99



Sale prices on regular priced merchandise shown throughout this circular effective through Saturday, September 17th unless otherwise noted. Intermediate markdowns may have been taken on original priced merchandise. Reductions from original priced merchandise effective until stock is depleted. Sale does not include those items designated in our stores as JCPenney Smart Values.

SALE **19.99, 23.99** OUR BEST-SELLING BLOUSES

**Sale 23.99** Reg. \$28. Worthington™ print blouse with notch collar and long sleeves. Polyester. Sizes 6-18.

**Sale 19.99** Reg. \$24, \$26. Take your pick of styles by Shapely® and LaBlouse®. Polyester. Misses' and petites' sizes.

Fall Wardrobe  
**SALE**



**COMPLETE THE LOOK**

Fall Wardrobe Offer: with any women's fashion and/or jewelry purchase totaling \$50 or more, receive a coupon good for 20% off any regular priced service in the JCPenney Styling Salon.

Offer expires October 1st.

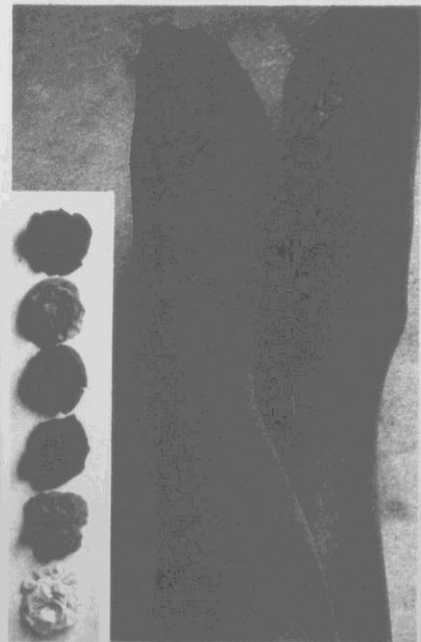

**20% OFF**

**Sale \$2** Reg. 2.50. Sheer swiss-dot textured pantyhose. In fashion colors.

**Sale 2.20** Reg. 2.75. Sheer Caress™ sheer pantyhose with cotton panel. Sandalfoot.

JCPenney

SALE

19.99-44.99

WORTHINGTON™ SEPARATES

Sale 24.99 Reg. \$32. Your choice: Blouse with lace-touched collar. Or, polyester/rayon gabardine skirt. Women's sizes.

Sale 19.99 Reg. \$25. Mock turtleneck sweater for petites.

Sale 44.99 Reg. \$60. Petites' single-button blazer.

Sale 24.99 Reg. \$32. Menswear plaid skirt. For petites.



# 25%-30% OFF ALL RAFFERTY® FOR JUNIORS

**Sale 42.99** Reg. \$60. Double-breasted polyester/rayon blazer.

**Sale 13.99** Reg. \$20. Mock turtleneck with zip back. S,M,L.

**Sale 24.99** Reg. \$36. Pleated skirt of polyester/rayon. 3-13.

**Sale 17.99** Reg. \$26. All-cotton fitted white shirt. Sizes S-M-L.

**Sale 24.99** Reg. \$36. Knee-grazer skirt in menswear check. 3-13.

Sale prices effective through Saturday, October 8th.

Fall Wardrobe  
**SALE**

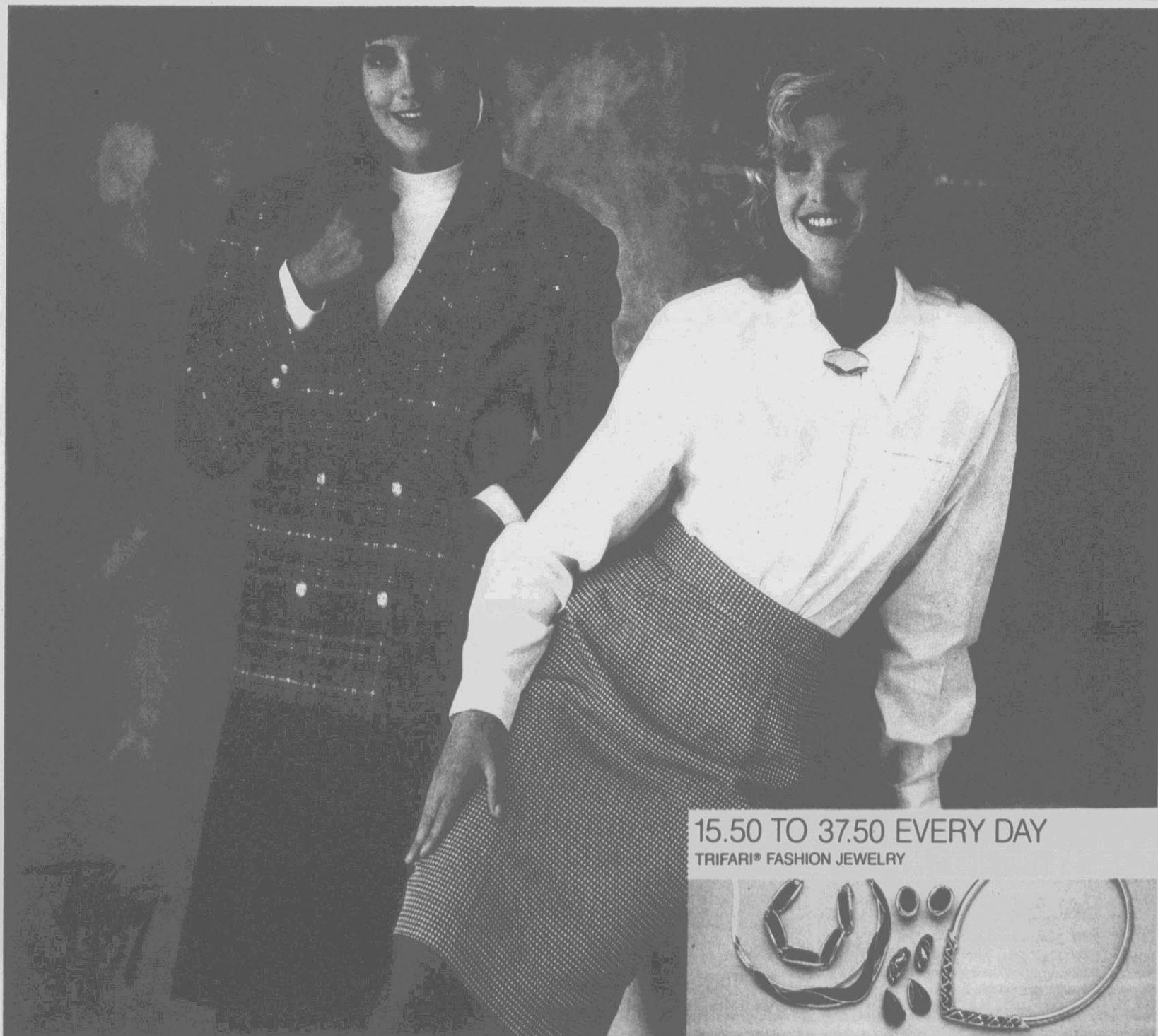

15.50 TO 37.50 EVERY DAY

TRIFARI® FASHION JEWELRY



JCPenney

**25% OFF** DRESSES, \$50 AND UP, SUITS \$100 & UP

Save on a terrific selection of dresses and suits that take you off to work or out to play. We show two styles here; find lots more in store!

Glenbrooke® twill suit with windowpane jacket and slim skirt,

**Sale 99.99** Reg. \$135

**Sale 69.99** Reg. \$94, Classic dress is a fashion staple for Fall wardrobes.

Sale prices on suits effective through Saturday, October 1st.



**SALE 23.99**

**Reg. \$30.** From La Blouse®, a pretty pleated topping, even nicer with face-flattering neckline detailing. In white. Misses' sizes 8-18.

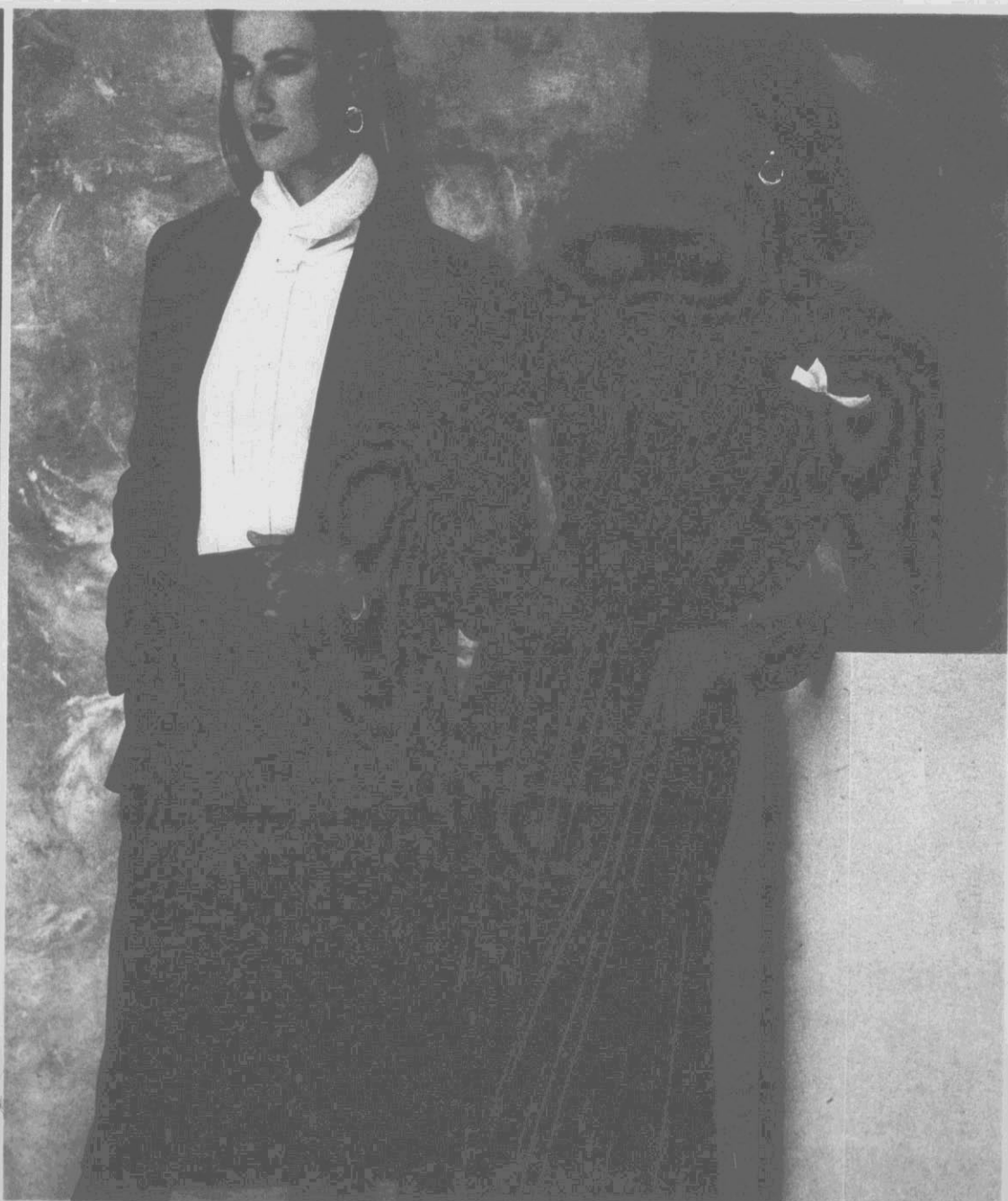

NILANI® • MICHAEL BLAIR® • DANNY & NICOLE® • ALEXIS® • POSITIVE INFLUENCE® • CHELSEA® • MCII®  
JONATHAN MARTIN® • PELLINI® • S.L. FASHIONS® • DAWN JOY® • SCARLETT® • BLONDIE & ME®  
ALL THAT JAZZ® • MY MICHELLE® • NINA PICCALINO® • RHODES® • BETSY'S THINGS®

# 25%-40% OFF FINE JEWELRY

## 40% OFF DIAMONDS

STYLES FOR WOMEN, STYLES FOR MEN  
BRIDAL SETS • COCKTAIL RINGS • SOLITAIRES • AND MORE

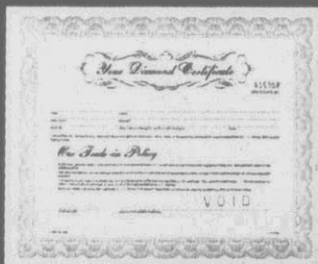

### TRADE-IN CERTIFICATE

When you present this certificate, you can trade in your JCPenney diamond and get full credit for its purchase price when you trade up to a newer, more expensive diamond.

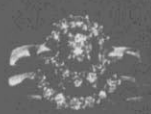

Sale \$399  
Reg. \$665  
.25 Ct. T.W.



Sale \$399  
Reg. \$665  
.25 Ct. T.W.



Sale \$399  
Reg. \$665  
.25 Ct. T.W.



Sale \$649  
Reg. \$1085  
.50 Ct. T.W.

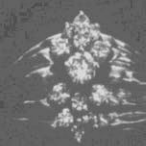

Sale \$649  
Reg. \$1085  
.50 Ct. T.W.

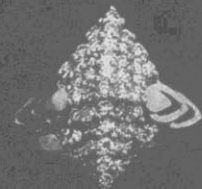

Sale \$999  
Reg. \$1665  
1.0 Ct. T.W.

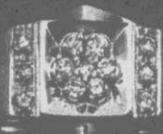

Sale \$649  
Reg. \$1085  
.50 Ct. T.W.

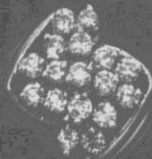

Sale \$999  
Reg. \$1665  
1.0 Ct. T.W.



Sale \$999  
Reg. \$1665  
1.0 Ct. T.W.

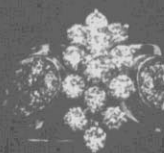

Sale \$1699  
Reg. \$2850  
1.50 Ct. T.W.

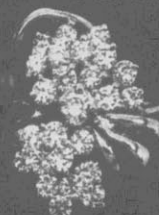

Sale \$1699  
Reg. \$2850  
1.50 Ct. T.W.

## 25%-40% OFF STONE JEWELRY

RINGS • PENDANTS • EARRINGS

### RUBIES

Sale \$267  
Reg. \$445

Sale \$108  
Reg. \$180

Sale \$371.25  
Reg. \$495

Sale \$423.75  
Reg. \$565

Sale \$281.25  
Reg. \$375

Sale \$318  
Reg. \$530

### EMERALDS

Sale \$156  
Reg. \$260

Sale \$129  
Reg. \$215

Sale \$147  
Reg. \$245

Sale \$131.25  
Reg. \$175

Sale \$138.75  
Reg. \$185

Sale \$221.25  
Reg. \$295

### SAPPHIRES

Sale \$112.50  
Reg. \$150

Sale \$246  
Reg. \$410

Sale \$221.25  
Reg. \$295

Sale \$138  
Reg. \$230

Sale \$180  
Reg. \$300

40% OFF PEARLS

30% OFF GOLD PLATE OVER SILVER

30% OFF STERLING SILVER

Diamonds shown are representative of our collection. Actual styles vary by store. Percentages off represent savings on regular prices. Photos may be enlarged to show detail. Available only at JCPenney stores with Fine Jewelry departments. Sales does not include jewelry designated as Everyday Values. Sale prices on Total Weight diamond collection and stone-and-diamond rings effective through Saturday, September 24th; on other jewelry through Saturday, September 17th.

JCPenney

# 25% OFF ALL LEATHER HANDBAGS \$30 AND UP

Our just in-time-for-Autumn sale of better leather handbags. Wonderful supple shapes with full fabric linings, zippered compartments and room to spare. Choice of many styles. Shown: Worthington™ soft leather hobos. Reg. \$40 Sale \$30

Does not include Special Buys or JCPenney Smart Value Items. Percentages off represent savings on regular prices.



## SPECIAL BUY 59.99

Here's a handsome group of leather bags: hobos, satchels, flap and camera styles. All beautiful buys!



## SPECIAL BUY 49.99

Saddle River knows how you like a leather bag. Multi-compartmented, dome-topped or hobo styled. Pricey looks, at a very low price.



SALE **25.99**

## BUGLE BOY® PANTS FOR GUYS

**Reg. \$32.** Lightweight twill pants of polyester/cotton. With patch pockets in back, modified cargos in front. Young men's sizes.

**Sale 27.99** Reg. \$35. Bugle Boy® aviator-style cotton fleece shirt.

**Sale 27.99** Reg. \$36. Bugle Boy® heavy-weight polyester/cotton twill pullover.

Fall Wardrobe  
**SALE**

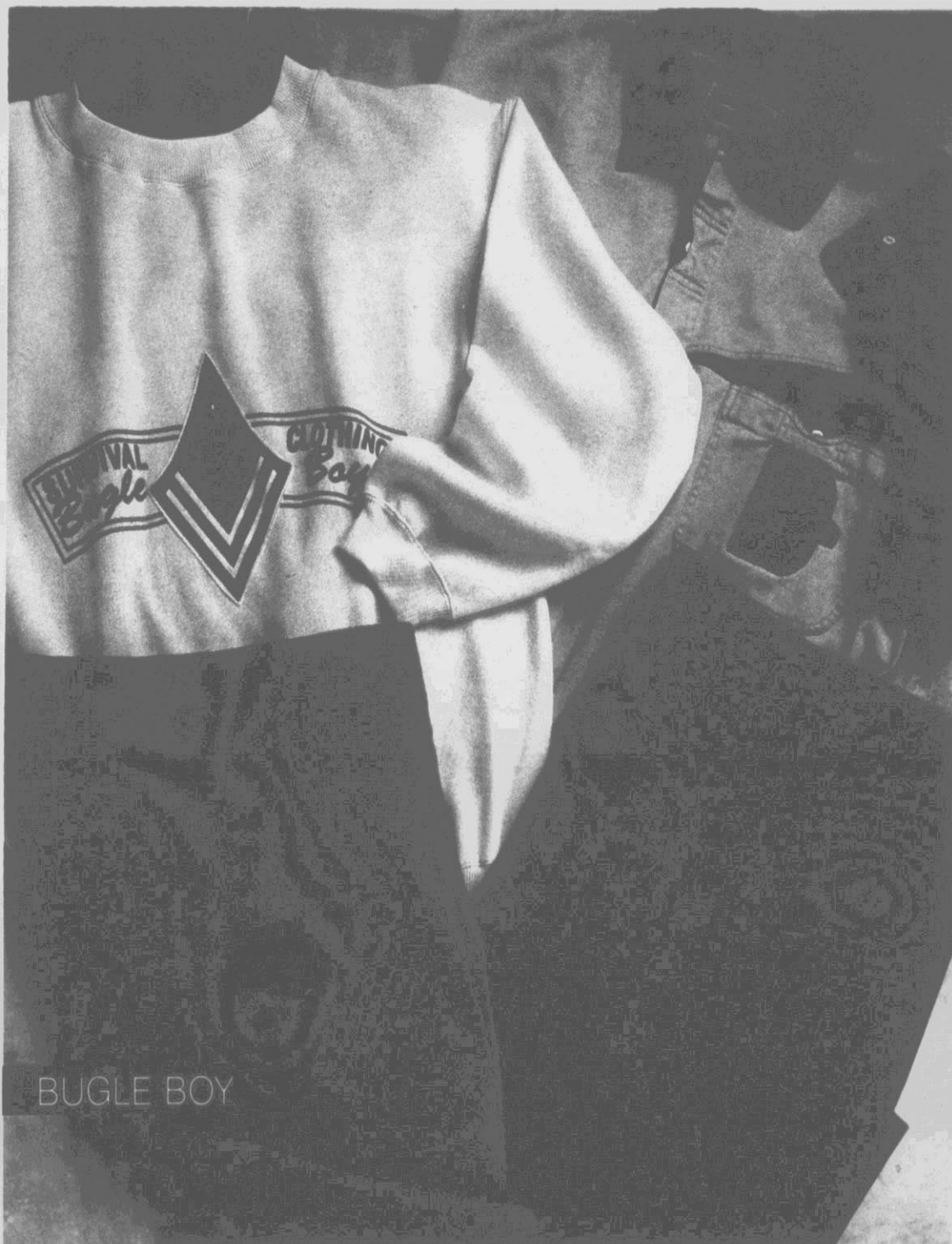

BUGLE BOY



THE FOX

PAR FOUR

SALE 15.99

**Reg. \$20.** Par Four® oxford-cloth shirt of polyester/cotton. Men's S-XL.

**Reg. \$21.** The Fox® polyester/cotton sportshirt.



PAR FOUR

THE FOX

SAVE \$5-\$7

**Sale 19.99** Reg. \$25. Par Four® crew-neck sweater. Acrylic. Men's S-XL.

**Sale 22.99** Reg. \$30. The Fox® cotton sweater.

SAVE ON ALL SWEATERS REG. \$25 AND UP

JCPenney

# STAFFORD® & GENTRY®

## SALE 74.99

**Reg. \$100.** Stafford® blazer. Tailored in Dacron® polyester/worsted wool for a luxurious feel and neat looks. Available in Regular, Short and Long sizes.

## SALE 32.99

**Reg. \$45.** Stafford® dress slacks of Dacron® polyester/worsted wool. Styled with french fly, 1/4 top pockets, more. Available in Regular, Short and Long sizes.

## SALE 74.99

**Reg. \$100.** Stafford® any-weather trench coat. Polyester/cotton with Zepel® finish and nylon lining. Cozy zip-out acrylic pile liner. Available in Regular, Short, and Long sizes.



## 20% OFF

**Sale \$40** Reg. \$50. Classic wing tips of full-grain leather with leather sole.

**Sale \$44** Reg. \$55. Tube moc slip-on of soft kidskin with leather sole.

Sale prices effective through Saturday, September 24th.



Portly, Athletic Cut,  
Extra Long and Big sizes  
available by special order  
at similar savings.

25% OFF

ALL STAFFORD® & GENTRY®  
DRESS SHIRTS FOR MEN

■ Sale 14.99 Reg. \$20. Stafford® Performance Plus solid color dress shirt.

■ Sale 16.49 Reg. \$22. Stafford® long sleeve dress shirt.

■ Sale 11.99 Reg. \$16. Gentry® shirt of polyester/cotton broadcloth.

■ Sale 14.99 Reg. \$20. Gentry® long sleeve dress shirt.

Sale prices effective through Saturday, September 24th. Excludes JCPenney Smart Values.

Fall Wardrobe  
SALE



STAFFORD

GENTRY

JCPenney

SMART VALUE \$ **24-\$28**

**PORSHA® & COTLER® FOR BOYS**

Your boys will love this pieced french terry top from Porsha®. Polyester/cotton in assorted colors. For sizes 8-16. **\$24 Every Day.**

■ Cotler® pant in cotton pigment canvas. Sizes 8-14. **\$25 Every Day.**  
Cotler® belted all-cotton pant for prep boys, **\$28 Every Day.**



### SAVE 25%

**Sale \$12.** Reg. \$16. Striped acrylic tee. 7-14.

**Sale 16.50** Reg. \$22. Acrylic jumper. 7-14.

**Sale 8.25** Reg. \$11. Cotton/polyester turtleneck top. Sizes 4-6X.

**Sale 14.25** Reg. \$19. Suspender skirt. Polyester/cotton 4-6X.

### The JCPenney Catalog

Stop by your nearest JCPenney Catalog Dept. and find uniforms and accessories for Boy Scouts, Girl Scouts and their leaders in our Scouting Catalog. Convenient home delivery available.

COTLER

PORSHA

# BABY-YOUR-BABY SALE

Fall Wardrobe  
**SALE**



**20% OFF**

All-cotton and polyester/cotton crib coordinates with a Disney® print. Plus a jumbo changer bag. Reg. \$8-\$24  
**Sale 6.40-19.20**



**20% OFF**

- ALL TOPS, BOTTOMS
- ALL DRESSES, SETS
- ALL SESAME STREET® APPAREL

**SALE 12.80**

**Reg. \$16.** Sesame Street® toddler sets for boys and girls feature pants or skirts with fashion tops of polyester/acrylic fleece. Long sleeve polyester/cotton polo shirt for infants' and toddler sizes.  
Reg. 6.50 **Sale 5.20**

**SALE 12.80**

**Reg. \$16.** Handstands® acrylic fleece sets for toddler girls. 2T-4T. Stonewashed all-cotton overalls. Infant and toddler sizes. Reg. \$12. **Sale 9.60**  
Nana's Pet® dresses of polyester/cotton for toddler girls, Reg. \$20 **Sale \$16.**

Sesame Street® is a trademark of The Children's Television Workshop.



**20% OFF**

All Toddletime® gowns, sleepers, plus JCBear. Reg. 4.49-10.99 **Sale 3.59-8.79**  
Sale does not include those items designated as JCPenney Smart Values.



**20% OFF**

Our entire line of socks and underwear. Cozy pilucho, Reg. 3.99 **Sale 3.19**  
Sport socks, Reg. 3/2.29 **Sale 3/1.83**



**15% OFF**

Save on selected strollers, carseats, playpens and highchairs. Toddletime® stroller, Reg. 79.99 **Sale 67.99**  
Sale prices effective through Saturday, September 24th.

JCPenney

SMARTVALUE **3.99**  
SOLID  
BATH

## OUR LUXURY BATH TOWEL

- Surround yourself in luxury with soft, sumptuous towels of cotton/polyester. Choose from an array of rich solids.
  - Hand towel, **Smart Value 2.99 Every Day**
  - Wash cloth, **Smart Value 1.99 Every Day**
- Stripes and florals available at similar smart values.

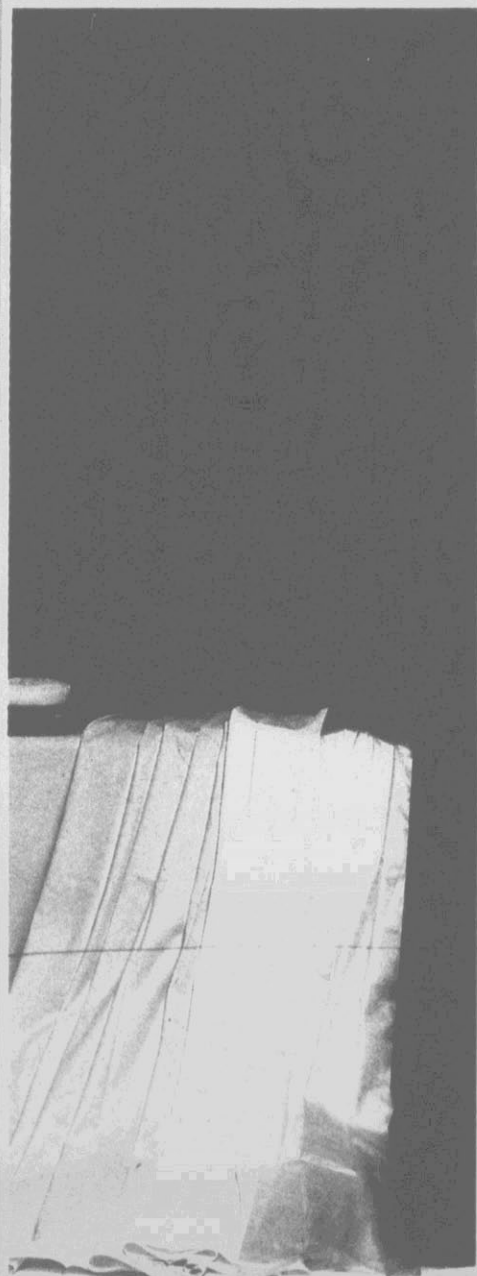

**\$5 EVERY DAY**

■ Durable vinyl shower curtain cleverly doubles as a liner. Available in colors to enhance any decor.



# 25% OFF SUPREME® DRAPERIES

Luxurious antique satin draperies of rayon/acetate, lined with polyester/cotton.

Supreme® solid color	Reg.	Sale	Supreme® English floral print	Reg.	Sale
■ 50"x84" pair	\$40	30.00	48"x84" pair	\$40	30.00
■ 75" Swag, Cascade Valance	\$82	61.50	82"x30" Pouf Valance	\$29	21.75

Other sizes also on sale.

■ Sale 12.80 Reg. \$16. Sheer polyester voile panel 60"x84". Other sizes also on sale.

Fall Wardrobe  
**SALE**

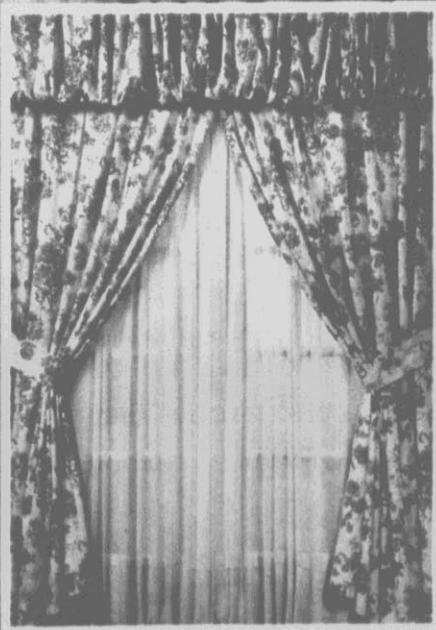
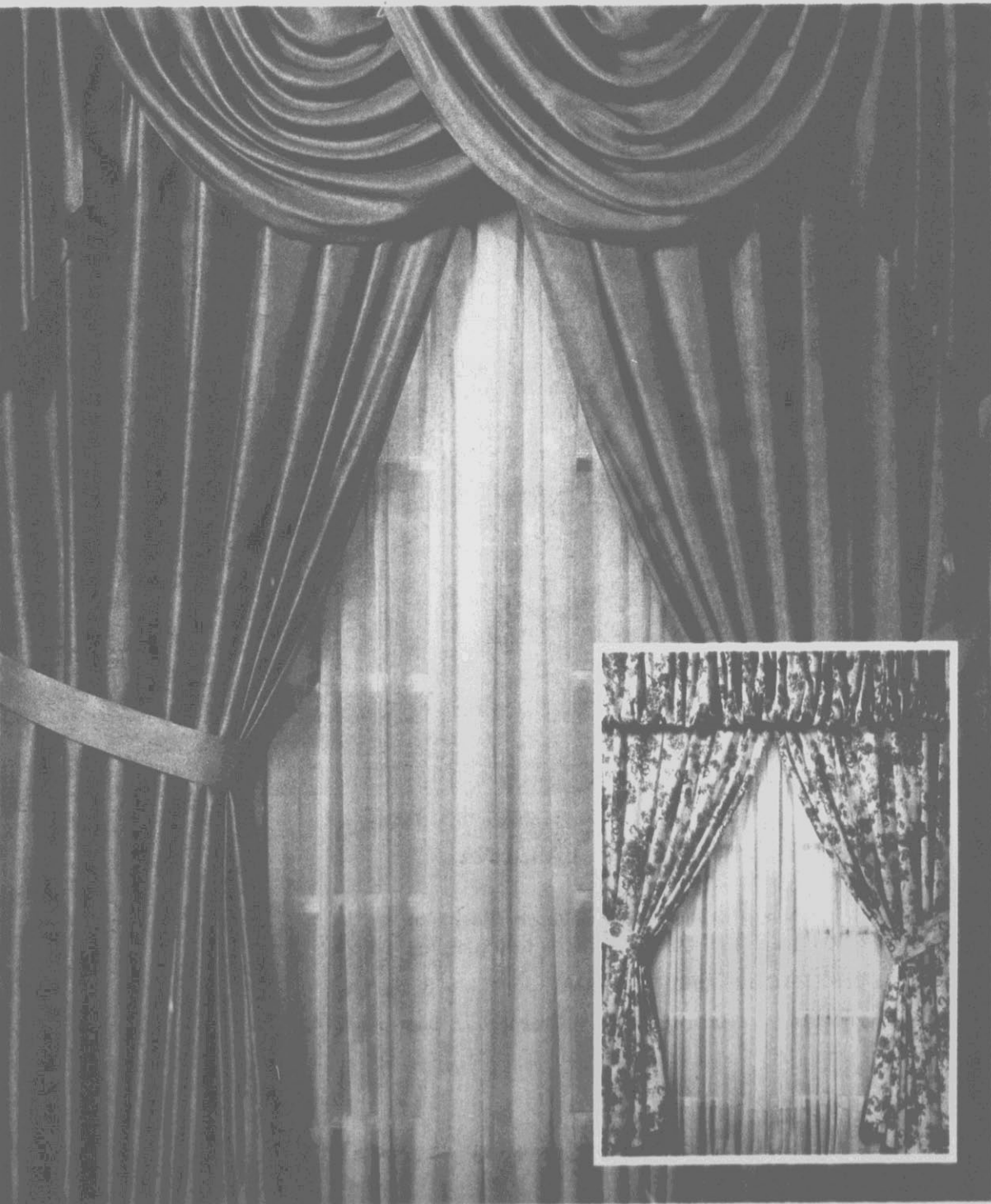

## 40% OFF

- BALI® MICRO BLINDS
- BALI® 1" MINI BLINDS
- BALI® ½" ULTRA BLINDS
- BALI® 1" ULTRA BLINDS
- JCPENNEY BY KIRSCH® VERTICALS
- BALI® VERTICALS

Percentage off represents savings on regular prices.

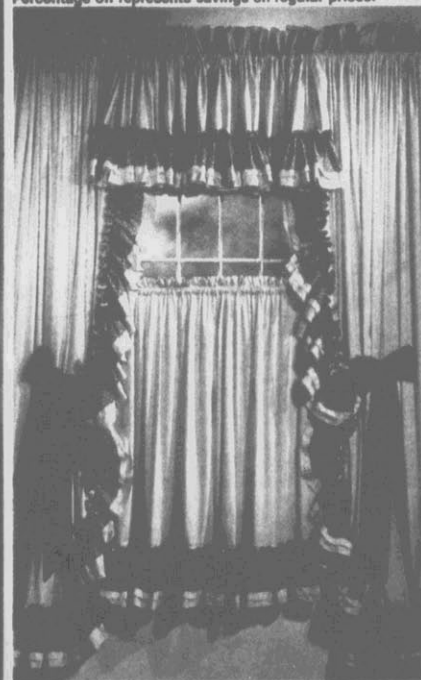

## 20% OFF

Charleston extra-wide priscilla curtains. Made of cotton/Kodel® polyester for easy care.

- 150"x84" pair, Reg. \$135 Sale \$108
- 82"x45" tiers, Reg. \$35 Sale \$28
- 132"x20" valance, Reg. \$45 Sale \$36

Other sizes also on sale.

JCPenney

# 25% OFF ALL ANY-WEATHER AND TRENCH COATS

Save on chill-chasers in juniors', misses' and women's sizes. Shown here:

**Sale \$54.99 Reg. \$79.** Flyfront twill raincoat features a cozy plaid button-out liner of cotton/polyester/wool and smart-looking sleeve and back details. Shell of cotton/polyester, nylon lining. Sizes 8-16.

**25% off all wool coats, too. Come see our fabulous selection of all-wool coats in juniors', misses' and women's sizes.**

Sale does not include JCPenney Smart Value items.

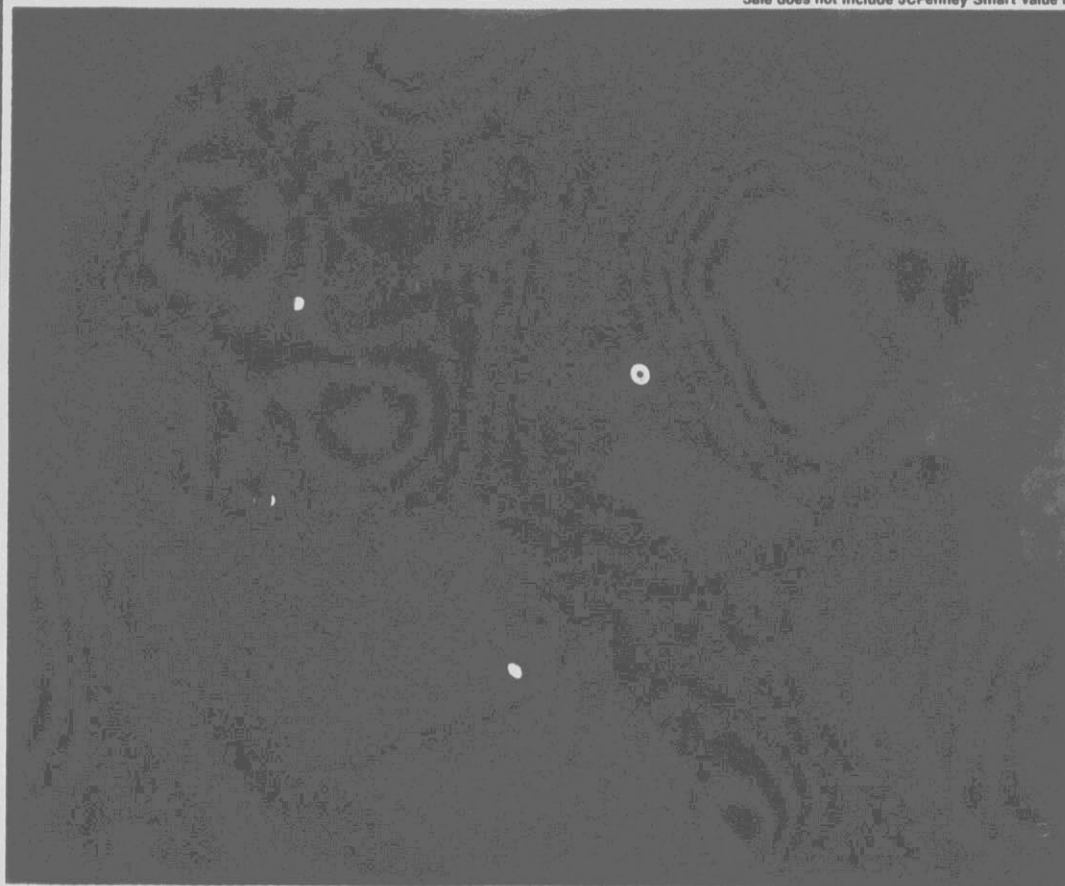

Discover



*You're looking smarter than ever at JCPenney.*

**EVENT STARTS WEDNESDAY, SEPTEMBER 14, 1988**

**GREENVILLE, NORTH CAROLINA**

**THE PLAZA**

**Store Phone 756-1190 Catalog Phone 756-2145**

**Open Daily 10:00 a.m. to 9:00 p.m. Sunday 1:00 p.m. to 6:00 p.m.**

**SALE PRICES EFFECTIVE THRU' SATURDAY, SEPTEMBER 17, 1988**

**Advertising Supplement to the DAILY REFLECTOR, Wednesday, September 14, 1988**

1900-0/01

Your satisfaction is our goal. To serve the public as nearly as we can to its satisfaction. That's the Penney idea. If you're not satisfied with your purchase after a reasonable time, let us know, and we'll try to satisfy you completely.