

PTL Feud

Jimmy Swaggart Says He Complained But Didn't Try To Take Over PTL Ministry
Story on A-8

Security

Burroughs Wellcome Plans Tight Security At Greenville Plant To Protect AZT Shipments
Story on B-8

Tom Chapman

Tom Chapman May Be The New ECU Basketball Coach
Story on B-1

THE DAILY REFLECTOR

TRUTH IN PREFERENCE TO FICTION

106th YEAR

NO. 72

GREENVILLE, N.C.

WEDNESDAY AFTERNOON, MARCH 25, 1987

44 PAGES

PRICE 25 CENTS



WATCHING THE GAME — Phyllis Sides of Goldsboro, mother of East Carolina second baseman Steve Sides, holds granddaughter Leslie Sugg, 2, during Tuesday's baseball game between ECU and Rider College. Leslie cheered on Uncle Steve as the Pirates won the doubleheader 6-5, 7-5. (Reflector Photo by Tommy Forrest)

To Counter Sex Bias In Work

Court Rules Boss May Bypass Male

WASHINGTON (AP) — The Supreme Court, ruling in its first affirmative action case involving alleged sex discrimination, said today an employer may promote a woman over a more-qualified man to help get women into higher ranking jobs.

By a 6-3 vote, the justices ruled against a man who was denied promotion to road dispatcher by the Santa Clara County Transportation Agency in California.

The court said employers need not admit past discrimination against women to adopt such preferential

treatment. The promotion of more women is a legitimate effort to overcome "a conspicuous imbalance in traditionally segregated job categories," the court said.

"Voluntary employer action can play a crucial role in ... eliminating the effects of discrimination in the workplace," Justice William J. Brennan wrote for the court.

The decision was based on the court's interpretation of a 1964 civil rights law banning on-the-job discrimination.

The court today did not decide whether Santa Clara's affirmative

action plan might violate the Constitution's equal-protection guarantees. Constitutional issues were not raised in the case.

Today's ruling marked the second defeat this year for the Reagan administration in key high court rulings on affirmative action.

The court last month upheld the constitutionality of a court-ordered plan requiring promotion of equal numbers of black and white Alabama state police troopers.

The Justice Department called the

(See BIAS, A-14)

Pitt Republicans Name Smith County Chairman

By STUART SAVAGE
Reflector Staff Writer

Pitt County Republicans, apparently split between supporters of Jack Hawke and Barry McCarty for state party chairman, elected McCarty-supporter Carlton Smith of Greenville as county chairman at the county convention Tuesday night.

Elected on the same slate with Smith was Mary Lou Sugg as vice chairman, Cindy Story as secretary and Chip Laughinghouse as treasurer.

The McCarty supporters won by a vote of 115-104 over a slate of officers nominated by Hawke supporters that proposed Ed Griffith as chairman, Gladys Strauss as vice chairman, Ms. Story as secretary and Laughinghouse as treasurer.

The McCarty faction was also successful in electing its slate of nominees for membership on the county executive committee and for the county's 76 state convention delegates.

McCarty is supported in his bid for

the state party chairmanship by the National Congressional Club, Sen. Jesse Helm's Raleigh-based political organization.

Hawke, now serving as interim party chairman, is Gov. Jim Martin's choice as state chairman.

Smith, a former precinct chairman, in a nominating speech, said he would "work for stability and growth of the Pitt County Republican Party" and strive to "build a strong grassroots organization."

(See SMITH, A-14)

Driver Charged

An 18-year-old driver of a Pitt County school bus involved in a collision that injured six people in Farmville Tuesday afternoon has been charged with a safe movement violation, Farmville police said today.

The driver, Jesse Ray Vandiford Jr., of 201 North Jefferson St., Fountain, was treated at Pitt County Memorial Hospital and later released, according to Sgt. W.R. Stokes of the Farmville Police Department.

Talea Hunter of Toddy, a passenger on the bus and a fourth-grade student from H.B. Sugg Grammar

School, was also taken to the hospital and later released, school officials said.

Stokes said the bus, which was carrying 22 students from Sugg and Sam D. Bundy Primary School, was attempting a left turn off Wallace Street when it collided with a car driven by Alice Haddock Dail, 31, of Route 1, Box 260, Greenville, in the incident reported at 3:13 p.m.

Mrs. Dail and three passengers were transported to the hospital and later released.

Warren Praises Occupancy Tax As Innovative Concept

By DON REUTER
Reflector Staff Writer

RALEIGH — Pitt County's decision to levy a 3 percent motel and hotel occupancy tax to promote travel, tourism and conventions is an innovative concept, says Rep. Ed Warren, D-Pitt.

"I think this is one of the most progressive things the county has ever done," Warren told members of the Greenville City Council at a luncheon meeting at the Capital City Club Tuesday.

The proposed bill, which is to be forwarded to the county's delegation in Raleigh for passage by the General Assembly, was approved by the City Council on March 16.

Warren said lawmakers will begin work on the legislation as soon as they receive the draft from the Pitt

County Board of Commissioners.

Revenue from the tax, which is estimated at \$200,000 per year, would be used for "promotion, activities and programs aiding and encouraging travel, tourism and conventions," the act said.

The ordinance would establish an 11-member Pitt-Greenville Convention and Visitors Authority to be comprised of a board of directors consisting of five appointments from both the city and county and one from the Pitt-Greenville Chamber of Commerce.

Members of the Greenville City Council met with the Pitt County delegation to discuss the occupancy tax, the repeal of portions of the Law Enforcement Officers Bill, retirement benefits for firemen, annexation, transportation issues, a manufac-

tured housing bill, and a clean water detergent bill.

"It's always to our benefit to know the thinking of the leaders of Greenville and the county," Rep. Walter B. Jones Jr., D-Pitt, told council members. "I can assure you that we will think carefully when we deliberate on these matters."

Council members Ed Carter, Janice Buck, Bill Hadden and Lorraine Shinn traveled to Raleigh along with Mayor Les Garner to meet with the Pitt delegation, which included Sen. Bob Martin of Bethel. Malcolm Green, general manager of the Greenville Utilities Commission, also attended the annual luncheon.

Sen. Tom Taft, D-Pitt, and council members Nancy Jenkins and Inez Fridley were unable to attend the meeting.



RURAL CONFERENCE — Dr. Robert C. Wells, left, associate director for North Carolina State University's Agricultural Extension Service, talks with Eddie Miller, a conference planning committee member, and Dr. Ed Bishop of the University of North Carolina at Chapel Hill, the first speaker at today's conference on the rural economy. The forum, held at the Sheraton, focused on the economic impact of changes in rural communities and encouraged rural economic development. (Reflector Photo by Cliff Hollis)

Economist Notes Rural Changes

By CHERIE EVANS
Reflector Staff Writer

Powerful structural changes in rural America have caused it to lose its ability to employ its people, an economist said today.

Dr. C.E. Bishop, special assistant to the provost at the University of North Carolina at Chapel Hill, spoke to local municipal leaders during a Rural Economic Development Conference at the Sheraton today.

Structural changes that have impacted rural America include standardization, simplification and computerization of production and com-

ponent manufacturing, he said.

"These forces, taken together, have the capacity to affect the United States and the world," Bishop said.

Those structural changes, for example, helped create institutional land grants to build schools to educate sons and daughters of farmers and mechanics, he said.

They also created the American Country Life Commission to strengthen rural sociology and to create institutions such as the Agricultural Extension Service, Bishop said.

"Farmers have to have some cred-

it; farmers have to have some capital," he said.

With these structural changes, "the system hit the key elements" with education, extending knowledge and providing capital, he said.

"That set in motion technology that's unbelievable," Bishop said. "It increased production capacity and changed the way we do things. We've substituted capital for labor."

"We lost our capacity to employ our people," he said. But, "you're not going to solve that problem by looking at agriculture" alone.

"Rural America must survive; farming must survive," Bishop said.

But, "there are no general solutions to the problems" such as a vast increase in production.

"We must keep our economy dynamic; new technology is essential," he said. To accomplish that, "we must educate our people, maintain and improve our infrastructure, cultivate local entrepreneurship and support the local industry we have."

The conference, sponsored by several state agencies, was to continue today with presentations by Claude Pope, secretary of the state Department of Commerce, and other local and state economists.

The Weather

Forecast
Rain likely tonight. Low in upper 40s. Chance of rain Thursday. High in mid 60s.

Looking Ahead
Partly cloudy Friday and Saturday, fair Sunday. Highs in 60s. Lows in 40s.

Inside Today
A-2 — Local news
A-4 — Editorials
A-6 — State news
A-14 — Obituaries
B-1 — Sports
C-6 — Crossword

In The Area

Thefts Reported

Three thefts were reported to Greenville police Tuesday.

Officer B.M. Highland said a 100-foot tape measure valued at \$25 was taken from a truck parked at Doc Moore & Sons Pest Control on Dickinson Avenue in an incident reported at 11:37 a.m., while Officer S.A. Person said a boat propeller assembly valued at \$220, a spotlight and a pair of pliers were taken from 1206 S. Overlook Drive in an incident reported at 11:41 a.m.

According to Officer J.M. Jones, several items, including an equalizer, amplifier, four wheel spinners and a set of Corvette emblems were taken from a vehicle parked at the Sheraton on Greenville Boulevard in an incident reported at 1 p.m.

Stolen Property

Ralph Christopher Langley, 24, of 603B Church St. was arrested by Greenville police Tuesday on a charge of possession of stolen property.

Officer B.W. Lewis said Langley was charged after a motorized bicycle, taken from 203 S. Elm St. in November 1986, was found in his possession.

Rape Charge

Greenville police arrested Lavern Frank, 34, of Route 1, Greenville, on a second degree rape charge Tuesday.

Detective J.E. Harris said Frank was arrested about 8:24 a.m. by Officer E.E. Laughinghouse in connection with a rape reported at 7:57 a.m.

Harris said a 66-year-old woman told officers she was assaulted at a home in the Cherry View area.

Marijuana Counts

Greenville police arrested two people early Sunday on charges of possession with intent to sell and distribute marijuana.

Officers C.M. Credle and B.M. Highland said Michael Dodd Stanley, 20, and Johnny Ray Stanley, 22, both of 915 Cortland Road, were arrested about 1 a.m. in an alley off Cotanche Street between Fourth and Fifth streets.

The officers said 10 small bags of marijuana and \$625 in cash were confiscated at the time the two men were taken into custody.

Program On AIDS

The Learning Channel on cable television will air a call-in show

about AIDS Friday from 7 p.m. to 8 p.m. as part of a series called "State-to-State."

Three doctors from across the country will participate in the program. Taking part will be Dr. J.N. McCormack, state epidemiologist for North Carolina; Dr. Donald Lyman, director of the California Department of Health Services Office of AIDS, and Dr. Peter Selwyn, medical director for the Drug Abuse Treatment Program at Montefiore Hospital in the Bronx, New York, and assistant professor in the department of epidemiology and social medicine at Albert Einstein College of Medicine in New York City.

The telephone number for the live program will be 733-6342. Collect calls will be accepted.

"State-to-State" is a production of the North Carolina Agency for Public Telecommunications in Raleigh.

Nature Presentation

Jerry Everhart, nature science coordinator for the Pitt County schools, taught first- and second-grade students at Falkland Elementary School recently to identify various animal tracks.

Everhart showed the students several types of tracks and discussed the information which could be obtained from them. The students used models to make their own tracks.

Expo 87 Broadcast

Television station WITN, Channel 7, Washington, N.C., will take part in Eastern Expo 87 at the Raynor Warehouse in Rocky Mount Thursday, Friday and Saturday.

Dick Jones will broadcast live from Expo 87 on the news hour at 6 p.m. each day. Jones will also be the WITN-7 booth. Other WITN-7 personnel appearing at Expo 87 will be Ken Brady, Gail Paschall and David Crabtree.

High Score On Exam

Mike Shafer, a senior at Ayden-Grifton High School, earned the 10th highest score in the state on the recent annual high school mathematics examination. Over 10,000 North Carolina students took the test.

Shafer is one of 65 North Carolina students who qualified to take the recent American Invitational Mathematics Examination.

He will receive a gold medal for earning the top school score for three consecutive years.

Society Membership

Rena L. Meteye has been named to the North Carolina State University

chapter of Tau Beta Pi, the highest national engineering honor society.

She is the daughter of Gladys T. Meteye of Greenville.

Art Media Discussion

Eleanor Ruffin, an art docent from the Greenville Museum of Art, recently discussed art media with fifth-grade students at Falkland Elementary School.

Troupe To Perform

East Carolina University's sign language troupe Fantasy will perform "Hands of Time" Saturday at 8 p.m. in the auditorium of the Jenkins Fine Arts Center.

Fantasy performs sign language to music.

All proceeds will go to the Sign Language Club to provide funds for future performances at Carowinds and in Chattanooga, Tenn.

Committee Member

Charles A. Waller of Greenville has been named a member of the executive committee of the North Carolina Society to Prevent Blindness.

The appointment was made during a recent annual meet of the society in Raleigh.

Orchestra Selections

Four students chosen recently to perform in the Eastern Regional Honors Orchestra are from Rose High School.

The four, selected at the Honors Orchestra competition Sunday at Atlantic Christian College, are Lillian Gordley, first violin; Kendra Harris, second violin, and Susan Sayette and Marissa Teleki, viola.

The Honors Orchestra is sponsored each year by the North Carolina Music Educators Association Orchestra Section.

This year, several hundred music students from public and private schools in North Carolina competed for selection to appear with the orchestra.

The program, coordinated jointly by the music department of Atlantic Christian College and the Wilson Symphony Orchestra, was guest conducted by Allen Moineux of the Wilson Symphony.

Compositions performed at the Sunday concert included Offenbach's "Overture to Orpheus in the Underworld"; the Mussorgsky/Stokowski "Entr'acte to Khovanschina"; Massenet's "Le Cid Ballet Suite," and Tchaikovsky's "March Slav."

Eno Hikes Planned

The Eno River Association is sponsoring wildflower hikes on the Eno River, Durham, each Sunday through May 10.

A naturalist familiar with plants and wildflowers that bloom in the Eno River State Park will conduct the hikes.

Each hike is limited to 20 people. Those planning to take part must reserve a space.

For making a hike reservation, call 544-1506 or write to: Hike Coordinator, 3639 Alston Ave., Durham, 27713.

Juried Art Show

Works of art selected for Goldsboro's eighth annual Juried Art Show are on display through April 17 in the Community Arts Council Gallery, 901-C East Ash St., Goldsboro.

The works, which consists of 94 pieces, were chosen from 352 entries representing artists from 20 states.

Gallery hours are 9 a.m. to 5 p.m. weekdays and 2 p.m. to 5 p.m. Sundays. There is no charge to view the show.

For more details call 736-3300.

The local Youth Services Advisory Committee has identified the following needed juvenile justice services in Pitt County: parent training, substance abuse-in-patient services, expansion of after-school program for latchkey children, adult bus supervision, support group for parents, and redirection for long-term suspension for juvenile alcohol and substance abusers.

Preapplication forms may be secured from Patrice Alexander, Pitt County Mental Health Center, 306 Stantonsburg Road.

Applicants must be prepared to present their requests at the 3 p.m. April 13 meeting of the CBA Task Force in the Pitt County Office Building.

Funds Available

The North Carolina Department of Human Resources, Division of Youth Services, has announced the availability of \$128,484 in community-based alternative funds for fiscal year 1987-88.

The river otters habitat will be part of the Streamside habitat cluster at the zoo's planned North American region. The society is conducting a campaign to raise \$6 million in private funds for the \$30 million North America project.

The river otters will be exhibited in an outdoor pool at the cluster when North America is complete. Visitors will be able to see the otters from outdoors or from inside for underwater views.

At the Streamside habitat cluster, visitors will be able to follow a small, fast-moving stream to a quiet beaver pond, into a net-covered, 10,000 square-foot flight cage and then into the Streamside building.

Within the building, visitors will have closeup underwater views of otters, muskrats, trout, water snakes, turtles and other wildlife. A simulated beaver dam will form the backdrop to the NCNB-sponsored otter habitat.

Ground for North America will be broken this spring, with the grand opening scheduled for late 1991.

Zoo Gets Donation

The Accreditation Council for Services for Developmentally Disabled People will hold a public hearing April 14 at 7:30 p.m. in the Caswell Center Chapel in Kinston.

People who receive services or have other contact with Caswell have been invited to make comments at the meeting. Those who cannot attend may send written comments to ACDD, Caswell Center, Kinston, 28501.

The meeting is part of the process of determining if the quality of services at the state facility has been maintained at a level worthy of continued public acknowledgement.

People who receive services or have other contact with Caswell have been invited to make comments at the meeting. Those who cannot attend may send written comments to ACDD, Caswell Center, Kinston, 28501.

The meeting is part of the process of determining if the quality of services at the state facility has been maintained at a level worthy of continued public acknowledgement.

ACSD Public Hearing

People who receive services or have other contact with Caswell have been invited to make comments at the meeting. Those who cannot attend may send written comments to ACDD, Caswell Center, Kinston, 28501.

The meeting is part of the process of determining if the quality of services at the state facility has been maintained at a level worthy of continued public acknowledgement.

Music Scholarship

Mary Elizabeth Beckman has been selected to receive the Benjamin C.

Dunford Music Scholarship at Salem College.

A senior at Arendell Parrott Academy in Kinston, she is the daughter of Mr. and Mrs. Ed Beckman. She has studied violin for 10 years under Joanne Bath of Greenville.

Convention Speaker

State Insurance Commissioner Jim Long will deliver the keynote address at the Pitt County Democratic Party's biannual convention April 4 at 1 p.m. in the Pitt County Courthouse.

Long was elected insurance commissioner in 1984 after serving four years as counsel to House Speaker Liston Ramsey. Long is a former chairman of the N.C. Property Tax Commission and served as chief deputy insurance commissioner in 1975 and 1976. He represented Alamance County in the N.C. House of Representatives from 1971 until 1975.

Voting delegates to the convention were elected at precinct meetings March 5. Pitt chairman is J.B. Spilman Jr. of Greenville and Betty Lewis of Farmville is first vice chairman. Other officers are D.D. Garrett of Greenville, second vice chairman; Betsy Leech of Greenville, third vice chairman; Wayne Harris of Winterville, secretary, and John Ball of Greenville, treasurer.

(See IN, A-3)

Science Fair Winners

Thirty-three junior and senior high school students won top honors at the recent Northeast Region Science Fair at East Carolina University.

The fair drew 136 student exhibitors from a 15-county region. They competed in junior and senior level divisions of biological, physical and earth sciences.

Those receiving first place awards in each category became eligible to compete in state-level competition April 10 in Greensboro.

In addition to regular science fair awards, other awards were presented by the American Nuclear Society, the American Society for Microbiology, the ECU Geology Department, the Greenville Utilities Commission, the ECU Home Economics Society, and the U. S. Air Force, Army and Navy.

The fair was sponsored by the Department of Science Education and the Science and Mathematics Education Center at ECU, the Northeast Regional Education Center and Elizabeth City State University. It was coordinated by Wende Allen, science coordinator for the

Northeast Regional Education Center.

WASHINGTON, N.C. — P.S. Jones Junior High School: Kevin Woolard, third place.

WILLIAMSTON — Williamston Junior High School: Katherine Ann Daniel, second place.

BETHEL — Bethel Elementary School: James Rodney Whitley Jr., Marine Corps Award.

GREENVILLE — Greenville Middle School: Charles Will Stanley, third place, and Jeffrey Li, third place;

Greenville Christian Academy: Gina Renee Bullock, third place, and Joseph Clint Parker, third place, first-place Army Award and second-place Navy Award;

J.H. Rose High School: Jonathon Li, third place; Anjali Kataria, second place, ECU Home Economics Alumni Award and U.S. Navy Award, and Michael Stone, first place; Jonathan Paul Carson, first place.

FARMVILLE — Farmville Middle School: Carrie Hale, first place.

REFLECTOR HOTLINE

Hotline gets things done. Write and tell us about the problem or issue into which you'd like for Hotline to look. Enclose photostatic copies of any pertinent information. Our address is The Daily Reflector, Box 1967, Greenville, N.C., 27835. Because of the large numbers received, Hotline cannot answer or publish every item we receive, but we deal with all of those for which we have staff time. Names must be given, but only initials will be published.

FEEDBACK

In response to the appeal for a support group for people who are widowed, we have not yet heard from any group that is especially for widows and widowers. However, a spokesperson for the Greenville Christian Singles Clubs says that much of its membership is widows and widowers and its members invite participation by anyone not currently married.

One group meets each fourth Saturday at 7 p.m.; the other each second and fourth Friday at 7:30 p.m.

For information on either group, call 355-2940 after 5 p.m.

Our Fabulous SIT & SLEEP SALE

3 Days Only!

Thursday • Friday • Saturday • March 26, 27, 28 Only!

<p>Solid Colors 100% Cotton Duck Flip Chairs</p> <p>39.99</p> <p>\$100 value Opens up to a Single Sleeper.</p>	<p>Solid Colors or Designer Prints Full-Size Foutons</p> <p>\$200 value</p> <p>\$89</p> <p>Frames Sold Separately</p>	<p>Black • Almond • Mauve • Grey Galleria Chairs</p> <p>\$200 value</p> <p>\$99</p> <p>New Soft Touch Fabric with Leather Look & Feel. Solid Foam Construction. Matching Ottomans Available</p>
<p>Trump Style Sofa Sleepers</p> <p>\$400 value</p> <p>\$129</p> <p>Wood & Foam Construction Opens up to a Full-Size Sleeper</p>	<p>New Style in Designer Fabrics Pillow Talk Sofa Sleepers</p> <p>\$800 value</p> <p>\$359</p> <p>Matching Chair & Ottoman Available Opens up to a Queen Size Sleeper</p>	<p>Sofa Sleepers Solid Cotton Duck</p> <p>\$350 value</p> <p>\$179</p> <p>Designer Prints \$375 value Wood & Foam Construction Opens up to a Full-Size Sleeper</p>

Plus Much Much More!

galleria

Open Nightly & Sundays • Except Cameron Village

RALEIGH • Cameron Village & North Ridge DURHAM • Northgate Mall
GREENVILLE • The Plaza FAYETTEVILLE • The Marketplace

Ask about our Layaway Plan Financing Available

VISA • MasterCard • Choice Instant Credit

Belk

carolina east mall
greenville

Shop Thursday, Friday & Saturday!



S2087



U4423

Hoover® Vacuums

Convertible™ Upright

99.99

\$150 Value

Powerful 5.0 amp motor, 15-qt. top-fill bag, 4-position rug adjustment, positive agitation, fulltime edge cleaning. #U4423



S3289

Spirit™ Canister

69.99

\$120 Value

Portable canister vacuum features: dual edge cleaning, 7½-qt. disposable bag, 16-foot cord, built-in carrying handle, multi-purpose brush and crevice tool included. #S3289.

Three-Speed Quik-Broom™

49.99

\$70 Value

With "Quiet Series" motor muffler, selective edge cleaning, cassette bag changer and storage rack. #S2087.

Shop Carolina East Mall, Greenville, Monday Through Saturday 10 a.m. Until 9 p.m. - Phone 756-B-E-L-K (756-2355)

In The Area

(Continued from A-2)

New Board Member

Linda Whitehurst of Greenville has been installed as North Carolina's representative on the board of the National Rural Electric Women's Association.

She is a member of the Women's Committee of Edgecombe-Martin County Electric Membership Corp., Tarboro.

Unemployment Rate

North Carolina's 1986 annual average unemployment rate showed a decrease of one-tenth of a percent over the previous year, according to the Employment Security Commission of North Carolina.

The 1986 figures, released by the ESC, show the state's annual average rate was 5.3 percent, down from the 1985 rate of 5.4 percent.

North Carolina's unemployment rate is the lowest among the southeastern region states, the ESC reported.

Christian Singles

Christian Singles, a non-denominational fellowship, will meet Saturday at 6:30 p.m. for a pot luck meal and recreational activity in the fellowship hall of Trinity Free Will Baptist Church.

For more information call Jon or Susan at 757-3888, Jewell at 756-4883 or Penny at 758-1760.

Adjustment Board

The Greenville Board of Adjustment will meet on Thursday at 7 p.m. in the Council Chambers of the Municipal Building, located on the corner of Fifth and Washington streets.

Deliverance Services

Deliverance Back To God Revival Temple will have services Thursday and Friday at 7:30 p.m. Evangelist Josie Goddard of The Friendly Church, Robersonville, will be the speaker.

Toastmasters Club

The Greenville Toastmasters Club will meet today at 7 p.m. at the Western Sizzlin' on East 10th Street. Dinner will start at 6:30 p.m.

EANC Chapter Meets

The Coastal Plains chapter of the Epilepsy Association of North Carolina will meet Thursday at 7:30 p.m. in the Pitt County Mental Health Center.

Marine Arrested

WASHINGTON (AP) — A second former Marine guard at the U.S. Embassy in Moscow is in custody at a Virginia Marine base on suspicion of espionage, a corps spokesman says.

Cpl. Arnold Bracy, 21, of Woodside Queens, New York City, was transferred from the Marine base at Twentynine Palms, Calif., to Quantico late Tuesday, said spokesman Lt. Col. John Shotwell.

"He has not been formally charged as yet," Shotwell said. "But he is

Guest speaker Cheryl Johnson, EANC's eastern field representative, will show a new video about epilepsy.

The leadership training workshop to be held in Goldsboro April 4 will be discussed, along with the parent-to-parent workshop attended last week.

For information about epilepsy or for transportation to the meeting call Cathy at 758-6487 or Scott at 752-7151 (days).

Doctor Visited Class

Dr. Randy Renegar of the East Carolina University School of Medicine recently spoke to Carol Whitaker's class at Stokes Elementary School in conjunction with the students' study of parts of the body.

Renegar discussed the human skeleton, brain, heart and lungs, and showed the students models of each.

Fellowship Services

A series of fellowship services will be held at Popular Hill Free Will Baptist Church, Ayden, Friday through Sunday.

Friday's service will be conducted by the Rev. Hoyt Hammond and the Allen Chapel choir at 7:30 p.m. The service Saturday at 7:30 p.m. will be led by the Rev. J.C. Mercey and the junior choir of Popular Hill F.W.B. Church.

The Sunday worship service at 11 a.m. will feature the Rev. Jasper Tyson and the Popular Hill senior choir and ushers, and the Sunday evening service will be conducted by the Rev. Jimmie Swinson and the choir and ushers of Mills Chapel F.W.B. Church, Black Jack.

District Union

The Eastern Middle District Union meeting will take place at Simpson Chapel Free Will Baptist Church this weekend.

A Bible workshop will be held at 7:30 p.m. Friday. A business meeting will be held Saturday at 5 p.m., followed by a 6 p.m. service featuring Eldress Vickie Dixon and Simpson Chapel.

Worship services will be held Sunday at 11:30 a.m. and 2:30 p.m.

Fire 'Suspicious'

WILSON, N.C. (AP) — Investigators say a March 12 fire that leveled an entire city block was "of a suspicious origin."

Investigators plowed through brick and soot last week searching for clues to what started the blaze, which caused an estimated \$1.5 million to four businesses, including two warehouses.

suspected of espionage and related charges. He will appear before a military magistrate who will determine whether his continued confinement is justified."

Shotwell said Bracy was arrested as a result of investigation into the case of Sgt. Clayton J. Lonetree, 25, currently held at Quantico. On Jan. 30, the Marine Corps announced it was asking a military lawyer to approve the start of court martial proceedings against Lonetree on 19 charges, including espionage.

Overturned Trailer Rig Spills Toxic Chemical Near Saluda

SALUDA, N.C. (AP) — About 100 people were evacuated from Saluda early today when a tractor-trailer carrying a poisonous chemical overturned on Interstate 26 and the chemical combined with rain to form a toxic cloud.

"The cloud doesn't seem to be moving right now," said a dispatcher with the Polk County Sheriff's Department who would not give her name. "It just seems to be hanging over the Saluda exit right at the interstate."

Chrystal Stowe of the state Department of Crime Control and Public Safety said the truck, reported by the sheriff's department to be owned by Welland Chemical Co. of Ontario, Canada, was carrying aluminum chloride anhydrous. It is a granular chemical that is poisonous

if inhaled and can cause severe burns to skin and eyes.

Polk County emergency management coordinator Jim Cochran said the truck was carrying eight aluminum chloride containers totaling 36,000 pounds. It wrecked at the 29-mile marker, forcing eastbound trucks to divert to Spartanburg, S.C., 40 miles to the south.

Polk County sheriff's deputy Dennis Bishop was among the first law enforcement officers on the scene. He said he noticed a burning sensation in his chest, followed by a headache.

"I was completely engulfed in it at one time before I knew what it was," Bishop said. "When I found out what we were dealing with, I got out of there."

A statement released by the sheriff's department this morning

said the driver, identified as Joseph Such, 56, was transported to St. Luke's Hospital in Columbus where he was treated for minor lacerations and released, according to hospital spokesman Tom Kelly.

The dispatcher said residents within a mile radius of the interchange had been evacuated to the Saluda Fire Department and the gymnasium of a school at Saluda.

"A lot of people went to the firehouse," said a secretary at Saluda Elementary School who asked that her name not be used.

"We prepared breakfast for them and took it over there. There are a few here who came in around 6 or 7 o'clock."

J.D. Gilbert, a Saluda fireman, said there were about 40 evacuees at the station. He said he thinks other people may have either gone to work

or traveled to neighbors, while the people in the firehouse were fairly calm.

"There's a lot of anxiety because people want to go home, but that's about all right now," Gilbert said.

A section of I-26 around the wreck site was closed and was expected to remain closed all day, the dispatcher said.

She said rain was continuing to fall before dawn, but emergency crews from the state Emergency Management Division, Department of Transportation and the local fire department were trying to clean up the spill. Rain was still falling at mid-morning.

"Saluda is not alerted yet," said mayor Nolan Pace. "But if the wind changes, we will be and could be evacuated. I think that we're safe here in Saluda, but maybe not."

Congress Told Private Pension Plans Often Aren't Available When Needed

By MATT YANCEY

AP Labor Writer

WASHINGTON (AP) — Since 1980, U.S. businesses have stripped 1,338 pension plans of nearly \$16 billion in so-called surplus assets, often to finance or fight corporate takeovers.

In that same period, other companies have foisted upon the government 734 pension plans with more than \$3.7 billion in promised but unfunded pension obligations.

The phenomena result from pension fund terminations either by corporations in order to lay claim to the surplus assets of overfunded plans or by government insurers to protect the benefits of workers in insolvent plans.

In both cases, hundreds of thousands of current and future retirees are being hurt, Congress was told

Tuesday, with warnings that what has happened in the past seven years is just the tip of the iceberg.

If what Labor Secretary William E. Brock called the "two disturbing trends" continue, millions of retirees can anticipate losing one-third to one-half of the benefits they had expected would protect them in their old age, according to a study by his department.

Testimony of more than a dozen witnesses Tuesday before House and Senate labor subcommittees indicated those trends will continue unless Congress changes the law to force underfunded plans to improve their solvency and then addresses who should enjoy the excess assets of the overfunded plans.

"The situation cries out for reform," said Sen. Howard Metzen-

baum, D-Ohio. "Millions believed the pension promises made by their employers. They assumed there were laws to protect them. Sadly, they were wrong."

To understand the enormity of what is at stake requires only a cursory glance at the number of people and amount of money involved:

—A total of 38 million workers plus their spouses, or roughly one-fourth of the nation's population, look to 110,000 private and voluntary defined-benefit pension plans to help take care of them in retirement.

—Assets in those individual pension plans to finance those benefits total nearly \$2 trillion, an amount approximating the total federal debt and equal to half the annual U.S. gross national product.

The Labor Department says

surplus assets in overfunded plans total \$263 billion, making them a lucrative target for both corporate raiders and entrenched managements in defending themselves against takeovers.

"Companies have turned their pension plans into corporate piggy banks," Metzenbaum said. "And in the process, workers have lost retirement security."

By terminating overfunded plans, companies can capture the excess assets for their own coffers. "Without a cushion of assets, plan sponsors will be less likely to increase benefits or grant cost-of-living increases to retirees," Brock said.

"The problem is awesome and I don't know that any of us have the answer," Brock said.

RESOLUTION NO. 1003
RESOLUTION OF THE CITY COUNCIL OF
THE CITY OF GREENVILLE DECLARING ITS
INTENT TO CLOSE A PORTION OF
THE 300 BLOCK OF HILL TOP AVENUE

WHEREAS, the City Council has received a petition that a portion of Hill Top Avenue be closed; and

WHEREAS, the City Council intends to close the portion of Hill Top Avenue in accordance with the provisions of G.S. 160A-299;

NOW, THEREFORE, BE IT RESOLVED BY THE CITY COUNCIL that it is the intent of the City Council to close the following described portion of Hill Top Avenue a distance of 150 feet, said portion being more particularly described as follows:

To Wit: Hill Top Avenue, a portion

Location: Greenville Township, Pitt County, North Carolina. Bound on the north by Hill Top Avenue, unopened on the east by Lillah W. Heath, on the south by East Fourth Street and on the west by Lillah W. Heath. Lying within the city limits of Greenville, NC containing .241 acres.

BEGINNING at a point in the northern right-of-way line of East Fourth Street where said right-of-way line intersects the western right-of-way line of Hill Top Avenue; thence as the western right-of-way line of Hill Top Avenue, N 02-24 E 150 feet to a point in the northern boundary line of Green Springs Development as recorded in Map Book 4, Page 102, of the Pitt County Registry; thence as the aforesaid boundary line, S 87-36 E 70 feet to a point in the eastern right-of-way line of Hill Top Avenue; thence as the eastern right-of-way line of Hill Top Avenue S 02-24 W 150 feet to a point in the northern right-of-way line of East Fourth Street; thence N 87-36 W 70 feet to the point of beginning.

BE IT FURTHER RESOLVED that a public hearing will be held in the Council Chamber, Municipal Building, Greenville, North Carolina, on April 9, 1987 at 7:30 p.m., to consider the advisability of closing the aforesaid portion of Hill Top Avenue. At such public hearing, all objections and suggestions will be duly considered.

BE IT FURTHER RESOLVED that a copy of this resolution be published once a week for four (4) successive weeks in The Daily Reflector; that a copy of this resolution be sent by certified mail to the owners of property adjoining the aforesaid portion of Hill Top Avenue as shown on the County tax records; and that a copy of this resolution be prominently posted in at least two (2) places along the aforesaid portion of Hill Top Avenue.

Duly adopted this 12th day of March, 1987.

LESLIE H. GARNER, MAYOR
 ATTEST:
 LOIS D. WORTHINGTON, CITY CLERK

March 25, April 1, 1987

Shop Carolina East Mall, Greenville, Monday Through Saturday 10 a.m. Until 9 p.m. -- Phone 756-B-E-L-K (756-2355)

— Donald M. Rothberg —

Editorials

Professional Search

By no means should the Greenville City Council's search for a new city manager be conducted in the same manner in which the dismissal of Gail Meeks occurred.

Instead, the City Council should use the search as an opportunity to develop a new unity and professional image that will be an asset to progress.

The council's goal of new direction for the city via a new city manager is worthy of support but it is an objective marred by the haphazard way the board fired Mrs. Meeks. The public watched with dismay as a widely-divided council axed the 5-year city manager with no discussion, no negotiation and no heed to the consequences of the action.

The council can work to improve its impaired image, however, and take solid steps toward dissolving disorganization by carefully devising and agreeing upon a sound plan of action for selecting the city's new top executive.

Seeking the expertise of Woody Underwood, services director for the N.C. League of Municipalities, was an important first step. It would be a responsible move, however, for council members to promptly schedule a meeting to set mutually agreed upon standards for the search. The board should state, in writing, its goals, procedures and qualifications for filling the position. It should make sure these requirements are objectives of the entire council — not just one faction.

The search should be conducted only under the most professional circumstances. The priority of the council should be unity — oneness in purpose dedicated to the best interest of the city.

The standards for a new city manager must be the highest attainable. Education, experience, expertise, financial acuity and vision — those are the characteristics the board should choose.

The firing of Gail Meeks was a decision made by a divided board. Consequently, it was an irresponsible move made under the poorest of circumstances. By pulling together in the search for a new manager, the council can retract itself from the quagmire of that questionable choice.

Even though the intent may have been correct, the council blew it by firing Mrs. Meeks so abruptly. Now, with the search for her replacement, the board has a second chance to accomplish what it was elected to do — govern Greenville in a responsible, professional manner with careful attention to progress.

Possible Source

A possible source of money to be used in a program to compensate crime victims has finally emerged in the fee convicted criminals must pay for their probation or parole supervision.

It sounds like a winner and it comes at a time when (a) pressures for providing money for the crime victims' fund is growing and (b) when numbers of prisoners who are going to be freed from durance vile are rising because of the new cap on the state's prison population result in more criminals being freed from prison and given probation or parole supervision.

As it now stands, convicted criminals pay \$10 a month for their parole supervision (or probation). Raising that monthly fee to \$15 would generate about \$1.5 million a year, or more than enough to offset the \$2 million appropriation the program is said to need for openers.

Revenue from the fee increase would go into the state budget's general fund and could not be earmarked for the victim compensation program, but it would furnish the money the legislature has to see before approving an appropriation for victim's compensation.

General Assembly members are wrestling with budgetary items and awareness has penetrated deep into the ranks that money-shortage versus money-needs is a recurring story.

There are details to be ironed out.

For instance, avoidance of an alternative "home-owners insurance program"; whether to put a cap on benefits per case and, if so, how much. Most agree some limits are necessary and, too, there's the matter of making sure that victims of crime are not also victims of the criminal justice system.

The Legislature's Fair Treatment for Victims and Witnesses Act includes a victims' bill of rights and funds to ensure victim-witness coordinators are provided in all 35 of the state prosecutorial districts. The coordinators help victims compile reports on how crimes affected them and give judges some guidance in sentencing criminals and ordering restitution.

It is all coming to a head at a time when the crackdown on crowded prisons is under way and the Parole Commission begins wielding its authority to reduce that prison population to the 17,280 limit.

Everything is fitting into place.

Today's Thought

Congress's 65 mph speed limit legislation certainly won't be accelerating with President Reagan's veto looming ahead.

Haig Running Against The Odds

NEW YORK (AP) — By traditional political standards, the presidential bid of Alexander M. Haig Jr. is a quixotic venture given no chance of success.

Yet Haig was outwardly buoyant Tuesday when he launched his campaign for the 1988 Republican presidential nomination with a news conference at the Waldorf-Astoria Hotel and the obligatory quick trip to New Hampshire.

Obviously, the retired general with an impressive resume hopes to turn conventional political wisdom on its

ear and upset the likes of George Bush, Bob Dole and Jack Kemp.

With his entry into the race, Haig joined former Gov. Pete du Pont of Delaware as the only declared candidates on the Republican side.

Both are long shots. But du Pont is regarded as a dark horse with a chance of surprising his better known rivals. He has won elections to the House of Representatives and to two terms as governor of his state.

By contrast, at 62, Haig has never held elective office, has never run for anything. He can argue that neither

had Dwight D. Eisenhower, another retired general who entered electoral politics at the presidential level.

But Eisenhower emerged from World War II as one of the most, if not the most popular man in America. He was the architect of the Normandy invasion, the commander of the Allied forces that defeated Germany.

Haig lacks the celebrity and the persona of Eisenhower. What Haig doesn't lack is a resume that has placed him at the side of the men who

held power during much of his professional life.

He worked for Henry A. Kissinger, was Richard M. Nixon's chief of staff and Ronald Reagan's secretary of state.

William E. McCann pointed out with pride that Haig was the only White House chief of staff "who ever oversaw the resignation of a vice president (Spiro T. Agnew) and the resignation of a president (Richard M. Nixon)."

Maybe voters will come to agree with McCann that service at the center of that dark moment in American history is more to be admired than forgotten.

Haig rarely misses reminding audiences that "I've served seven presidents."

But is a resume enough for a man with no discernable political base?

"I think I have a very substantial constituency and that's the American people," he told reporters at his announcement news conference.

Haig must count on more than the shortcomings of his rivals.

So far he is pushing his resume and telling voters, "What I offer is leadership."

More consistently than any of his Republican rivals, Haig indirectly attacks Reagan policies at the same time he urges audiences to rally around the president.

For example, he said he opposed covert aid to the Contra forces fighting the Sandinista government of Nicaragua but then adds that "now that we are there I support aid to the Contras."

He refused to rule out a tax increase to help balance the budget but ruled out "going immediately to a tax increase."

These are the kind of positions that could strike voters as an effort to have it both ways.

Donald M. Rothberg is the chief political writer of The Associated Press.



Public Forum

To the editor:

I have been reading about all the heat our City Council is taking over the recent request for City Manager Gail Meeks' resignation. In contrast to these opinions, I feel Council members Ed Carter, Lorraine Shinn, and Janice Buck, along with Mayor Garner, should be applauded for their vote.

A city manager whose income is between \$50,000 and \$60,000 per year should be a creative, resourceful person. Ms. Meeks has not been. It should be easy for anyone to bring a budget out of the red by proposing a tax increase at every opportunity or charging citizens extra for garbage collection. Methods such as these are not creative or imaginative. A sharp manager would be able to use things such as our various Parks and Recreation facilities to generate funds.

If our new city manager can only propose taxes or collection fees to answer our budget problems, then replace him or her, whether a professional or someone who rose through the ranks. Call me — for \$50,000 per year, I'll come up with some great ideas.

Robert Moseley
Greenville

To the editor:

I wish to praise the wise decision of the City Council to ask Ms. Meeks to resign. Most people against this action cite Ms. Meeks as being a capable leader. How can this be?

If you look around at the town of similar size to Greenville, all city managers must have at least a college degree related to the job or higher. Ms. Meeks' education ended with a high school diploma. As a city manager, a college degree is a must in order to have an adequate understanding and ability to perform as a professional. Ms. Meeks was never qualified for this job and I think that became more evident within her five years as city manager.

The council took a brave action that had to be done. Perhaps now a city manager can be brought in that is ready for the job, instead of training someone on the job as in Ms. Meeks' case. Greenville citizens expect Greenville to be the best in the East — it's time we select individuals with the background capable of making us the best!

Leslie Smith
Greenville

— James Kilpatrick —

The High Cost Of Running

WASHINGTON — Back in 1958, Robert Byrd and Jennings Randolph pooled their efforts to run for the Senate in West Virginia. Their combined war chest amounted to \$50,000. In 1962, running alone, Byrd had to raise \$2 million. That is a fair measure of what is happening to congressional elections. The costs have soared out of sight.

Byrd was one of eight senators who testified last week before the Senate Rules Committee on the wide-ranging field of election reform. The eight agreed on only one point: Something has to be done to curb campaign spending and to restore public confidence in the electoral process. Beyond that consensus each of the witnesses had some different ideas.

Let us crunch numbers. As recently as 1976, total spending on Senate general election campaigns amounted to \$38 million. In 1986 candidates reported comparable spending of \$182 million. In 1988 the average Senate race will cost a candidate more than \$3 million. Ten

years hence, if present trends continue, the average candidate will have to raise \$15 million.

In last year's congressional elections, about 23 percent of campaign receipts came from PACs (political action committees) and 9 percent from political parties. The balance came from individuals, from the candidates themselves, and from independent sources. The PACs contributed \$8.5 million to House and Senate general election campaigns in 1972. By 1980 PAC funding had grown to \$51.9 million. Last year the PACs gave \$127.7 million.

The perception grows, in Mark Twain's cynical observation, that we have the best Congress that money can buy.

One after one the Senate witnesses testified to the strain of raising money, money, money. "Today candidates campaign for funds, not for votes," said California's Alan Cranston. "Rightly or wrongly," said Oregon's Robert Packwood, "the public perceives that elections are being 'bought and sold.'" Edward

Kennedy of Massachusetts asserted that "Congress is awash in a sea of special interest contributions, and it's time to drain the swamp."

The stark reality, said Byrd of West Virginia, is that "we are all trapped by a system which forces us to make fund raising a major priority." The senator had done some figuring: In order to raise \$2 million for an election campaign, a candidate "must raise \$2,739 every day of every week for two straight years, Saturdays and Sundays included." This obsession with fund raising inevitably pulls incumbents away from their primary responsibilities.

The principal reform bill before the Senate is S.2, sponsored by Byrd and David Boren of Oklahoma. Its key provisions would provide public financing for senatorial candidates, if they choose to accept it, in general election campaigns. To be eligible for public funds, a candidate first would have to raise \$250,000 from individual contributions; 80 percent of these would have to come from individuals

residing in the candidate's state.

The Boren-Byrd bill would limit PAC contributions to no more than \$175,000 in small states, \$750,000 in large states. It would lower the limit on individual PAC contributions from \$5,000 to \$3,000. Overall, a candidate in a general election could spend no more than \$600,000, plus 25 cents for every person of voting age in his state.

For my own part, I doubt that the time has come for public financing of congressional elections. Such a step would lay the heavy hand of federal regulation upon one more area of public life. It would diminish individual and party involvement. Neither can I accept Boren's unwritten premise that political action committees are inherently evil. Often they represent positive good. Yet I willingly concur in the feeling that the present system cries out for reform. The incessant pursuit of money, money, money has to be curbed.

Copyright 1987 Universal Press Syndicate

— Elisha Douglas —

Strength For Today

Over the past decades the gypsy moth has done considerable damage to woodlands in many parts of the country. How the gypsy moth arrived here is an instructive story.

Many years ago an American traveling in China conceived the idea that he might be able to spin a new kind of silk from the cocoons of the gypsy moth. He brought back some of the insects with which to experiment. Some escaped, began to multiply and in a short

time were playing havoc with trees.

Like the gypsy moths, there are a few little sins in life which, while we are not looking, can grow into a devastating burden. The little white lie, for instance, is the progenitor of a vast number of lies, not little and not white, the little words uttered in anger which cause mounting division in families — these are examples of how little pests grow into great afflictions.

THE DAILY REFLECTOR

INCORPORATED
209 Cotanche Street,
Greenville, N.C. 27834

Established 1882

Published Monday Through Friday Afternoon and Sunday Morning

DAVID JULIAN WHICHARD, Chairman of the Board

JOHN S. WHICHARD — DAVID J. WHICHARD, Publishers

Second Class Postage Paid At Greenville, N.C.

(USPS 145-400)

SUBSCRIPTION RATES

Payable in Advance

Home Delivery By Carrier or Motor Route Monthly \$4.50

MAIL RATES

(Prices include tax where applicable)

Pitt And Adjoining Counties \$4.50 Per Month

Elsewhere in North Carolina \$5.00 Per Month

Outside North Carolina \$8.00 Per Month

MEMBER OF
ASSOCIATED PRESS

The Associated Press is exclusively entitled to use for publication all news dispatches credited to it or not otherwise credited to this paper and also the local news published herein. All rights of publications of special dispatches here are also reserved.

Advertising rates and deadlines available upon request.
Member Audit Bureau of Circulation.

Analysis

— Eugene J. Carroll Jr. —

Missile Proposal Essentially The Same

A RAY OF SUNSHINE?



— Rowland Evans & Robert Novak —

Playing His Game

WASHINGTON — Under reform-minded Mikhail Gorbachev, the Soviet Union is conducting unprecedented jamming of Munich-based Radio Liberty in a move that coincides with his campaign for major political change. That demonstrates Kremlin concern over internal publicity of the reform program, perhaps because of political delicacy or inopportune timing.

Gorbachev's unwitting ally in the high-intensity jamming of Russian-language broadcasts may be none other than the U.S. Congress. Worried by Gramm-Rudman budget ceilings, Congress is not rushing to give Radio Liberty and its partner, Radio Free Europe, the piddling millions they need just to compensate for the 30 percent decline of the dollar.

The result could cripple Radio Liberty at the peak of its impact as the West's only reporter of news inside the Soviet Union to the Soviet Union. Radio Liberty's broadcasts have always been jammed, but never at today's level of intensity.

The impact of the Radio today must be substantial, judging from the Soviet efforts to prevent the signal from getting through to millions of radio receivers in cities, towns and farms. When the Soviets stopped jamming Britain's BBC at the end of January for the first time in almost 10 years, 12 of the nearly 20 large jamming transmitters used to block the BBC's signal were redirected against Radio Liberty.

But why on earth would Gorbachev fear Radio Liberty's reports back to his own people when he is making so large a world case out of his political, economic and other efforts to reform the Soviet system? "Because," a White House adviser told us, "he wants to be in charge of timing and of how his people react to *Glasnost*, and he doesn't want his critics to have the means of articulation" — Radio Liberty.

That answer explains worry in the Kremlin about Radio Liberty (and Radio Free Europe, which broadcasts to Eastern Europe). Using sources of information from hundreds of different places inside the Soviet Union, Liberty's broadcasts tell Soviet listeners infinitely more about what is happening in their country than they get from Tass, Pravda or any other media.

The disaster at the Chernobyl nuclear reactor, withheld for days by government censors, was not withheld by Radio Liberty. Gory details were aired as they were discovered.

Last December, when major political riots in Alma Ata greeted the dismissal of D.A. Kunayev as boss of the Kazakhstan Communist Party, Radio Liberty broadcast far more about the size and intensity of the riots than came out of Moscow — and more about Kunayev's corrupt past than Gorbachev may have wished.

These subtleties are not entirely lost on Capitol Hill, but they play a secondary role to the questionable politics of budget deficits and Gramm-Rudman. That helps explain why, with the dramatic drop in the dollar, both Radios are in serious financial trouble. Converting dollars into West German marks, the currency for almost all spending by the

Will we soon have a nuclear arms-control agreement with the Soviet Union? Early agreement would seem highly likely in light of President Reagan's optimistic appraisal of Soviet leader Mikhail S. Gorbachev's proposal to eliminate all intermediate-range missiles in Europe. In fact, proponents of arms reductions suggest that such an agreement is possible in three or four months.

But some key players are not equally optimistic. Before he fell ill, Max M. Kampelman, the senior U.S. negotiator in Geneva, said that he hopes to reach a useful agreement by spring 1988. Other authoritative voices in, or close to, the administration are raising doubts, citing three principal concerns about the wisdom of removing U.S. missiles, the difficulty of negotiating an equitable agreement with the Soviets, and the ability to verify compliance with the agreement to prevent Soviet cheating in the future.

The first concern is based on the assertion that the Soviet Union has overwhelming conventional military power that can be countered only by U.S. nuclear strength. That assertion is made so often that it is commonly accepted without question even though there is considerable evidence that it is a myth. For example, the conservative International Institute for Strategic Studies of London says in a recent analysis that the conventional balance of NATO and Warsaw Pact military forces in Europe "is still such as to make general military aggression a highly risky undertaking for either side ...

there would still appear to be insufficient overall strength on either side to guarantee victory."

There is another reason to question any argument that 316 intermediate-range U.S. nuclear missiles are critical to nuclear deterrence or the defense of Europe. Even after all 316 are gone, the United States will still have aircraft and submarine-based missiles assigned to NATO that are capable of delivering approximately 1,200 nuclear warheads and bombs on the Soviet Union from European bases and waters.

The second reservation about obtaining an equitable arms-reduction agreement reflects a mistaken belief that devious Soviet negotiators always hornswoogle their innocent American counterparts. Former Secretary of State Henry A. Kissinger recently explained the problem this way: "Wherever the Soviets are numerically inferior they demand equal numbers; in whatever categories they are ahead they ask for equal reductions that improve their proportionate advantage."

The record shows that the American negotiators have more than held their own. SALT II numbers are a good example. In that treaty the Soviets agreed to surrender their overall numerical advantage in strategic nuclear delivery vehicles (2,504 Soviet to 2,284 U.S.) by coming down to equal limits of 2,250 missile launchers and bombers when the treaty was ratified. The United States was not required to surrender its 2 to 1 advantage in deliverable strategic bombs and warheads (9,808

U.S. to 5,764 Soviet). Not a bad bargain!

In the present Soviet proposal the numbers favor the United States even more. Both sides would remove all intermediate-range missiles from the European theater. The Soviets would retain 100 warheads on 33 missiles in Eastern Russia while we would retain 100 warheads on 100 missiles in the United States. To reduce to equal numbers of warheads, the Soviets would have to dismantle 520 missiles and inactivate 1,336 warheads while the United States would dismantle 216 missiles, each with one warhead. Numbers never tell the whole story of an arms-control agreement, but it is fair to say that the Soviets are offering up a lot more than we are.

Finally, the issue of verification is raised by many who oppose any arms agreement with the Soviets. Perhaps the most straightforward evidence that we can verify missile levels with great confidence is provided by the Department of Defense in its publication, "Soviet Military Power." The 1986 edition lists exactly 112 SS-4 and 41 SS-20 missiles deployed in the Soviet Union. Previous editions have carefully reported the inactivation since 1978 of 485 SS-4 and 90 SS-5 missiles as the SS-20s increased from zero to 41. All of this information was available without any special verification arrangements. If we have been able to track their intermediate-range missiles one-by-one since 1978, we certainly have the ability to keep track of them today. Furthermore, the Soviets are proposing

new measures of on-site inspection in each country that would increase confidence even more that no significant cheating was possible.

Reagan has promised new "hands-on" leadership in the White House, and it appears that his personal political interests would be well served by a breakthrough on arms control after six years of no progress.

For his own reasons Gorbachev has chosen to offer an agreement that is almost exactly the same "zero-option" that Reagan originally proposed for intermediate-range missiles in November 1981. In effect, Reagan is being asked to accept "yes" for an answer to his own proposal. If the president is really back in command, that should not be hard to do.

Eugene J. Carroll Jr., a retired rear admiral, is deputy director of the Center for Defense Information in Washington.

PLUMBING PROBLEMS
24 HOUR SERVICE
752-3661

Sam Pollard and Son
400 WEST 10TH STREET
GREENVILLE, N.C.

We'll Put Our Home Equity Line Of Credit Up Against Anybody's.

NCNB LineOne Equity.

1. No closing costs.
2. No appraisal fee.
3. No title search fee.
4. No points.
5. No recording fee.
6. No origination fee.
7. Interest-only repayment.
8. Fast closing-10 to 15 business days.
9. Rate based on NCNB Prime.
10. May qualify for up to 100% of the equity in your home.

(Put anybody else's home equity loan features here for a side-by-side comparison.)

As you can see by the chart, feature for feature, we're not going to let anyone, anywhere, offer you a better home equity line of credit. What's more, there are none of the drawbacks that you might find in the fine print of some home equity loan ads. So, to take full advantage of the interest deductions allowed under the new tax law, come see us about LineOne Equity. Or you can just call Phone-A-Loan at 1-800-342-9701 (in Greensboro, call us at 855-NCNB). And you'll find out how a bank works to be the best in the neighborhood.

Interest and principal due at maturity. NCNB's Prime Rate is the rate announced from time to time as its Prime Rate. Although the Annual Percentage Rate may vary, on March 16, 1987, the Annual Percentage Rate was 9 3/4%. An optional lower rate is available if you choose to pay closing costs, appraisal and title search fees.

NCNB

Member FDIC

Happy Jack
HAPPY JACK HI-ENERGY DOG FOOD
... specifically formulated for hunting dogs and growing pups. Expanded chunks enhance taste and go twice as far as ordinary brands. 26% Protein - 10% Fat!
available at
HARRIS SUPER MARKETS

Equal Housing Lender

House Democrats Back Special School Tax

By JOHN FLESHER
Associated Press Writer
RALEIGH (AP) — A four-year sales tax increase of 1 cent per dollar is the best way to generate more than \$2 billion needed for school construction in North Carolina, House Democratic leaders say.

A spokesman for Gov. Jim Martin, however, says the governor's plan to issue \$1.5 billion in bonds is a better idea.

"It's an innovative and creative way to finance school needs and build them now, without any additional taxes," Phil Kirk, Martin's chief of staff, said Tuesday. "I'm sure there's some consternation among the Democratic leadership in the House that they didn't think of it first."

Kirk called raising taxes "the typical Democratic approach." But House Speaker Liston Ramsey, D-Madison, said Martin's plan would triple the state's indebtedness and force many local governments to boost property taxes.

"My position is that (raising taxes) is better than borrowing the money," Ramsey said. "Borrowing the money, that's the way the federal government's doing — and look at them."

Ramsey said he supported the tax increase bill, sponsored by his chief ally, Rep. Billy Watkins, D-Granville. But Ramsey said he would not campaign vigorously on its behalf.

Martin issued a statement opposing the tax increase and Lt. Gov. Bob

Jordan, a Democrat who is expected to challenge Martin's re-election in 1988, reacted coolly.

"We do not need another major tax increase at this time," Martin said. "I hope that the General Assembly will support my proposal for a bond issue to build the schools we need."

Jordan told reporters, "I'm not sure this is the appropriate time for another sales tax (increase). ... It will not be an easy year to raise taxes."

The state sales tax is 3 percent, but all 100 counties levy a 2 percent local option tax. Thus, Watkins' bill would boost the sales tax North Carolinians pay to 6 percent.

Under the bill, the state tax would rise to 4 percent for four years, beginning July 1. The tax would

revert to 3 percent July 1, 1991, unless a future Legislature voted by a two-thirds majority to keep it at 4 percent.

The four-year increase would generate about \$1.8 billion, all of which would be earmarked for school construction. The money would be deposited in a special fund that would generate enough interest to push it above \$2 billion, Watkins said.

The revenue would be distributed to local school boards under a population-based formula that benefits smaller, rural counties.

Reporting on a recent survey of the state's 140 school boards, the Department of Public Instruction said March 4 that North Carolina needed \$3.2 billion to construct and renovate school buildings.

Watkins and Ramsey said that figure probably was inflated and that the proposed tax increase would generate most if not all of the money needed.

The Watkins bill drew quick endorsements from the public instruction department and the North Carolina Association of School Boards, both of which support the Martin plan.

"We've talked about construction needs of school for the last 20 years, and they've been documented and documented and documented," said Gene Causby of the school board association. "This is the first bill that ... attacks the problem directly with a specific amount of money over a set period of time."

Superintendent of Public Instruction Craig Phillips could not be reached. But his senior associate superintendent, William W. Peek, said Phillips supported a sales tax increase for school construction.

Under the Martin plan, unveiled last fall, the state would issue up to \$1.5 billion in bonds to create a pool from which local governments could borrow to fund school capital projects.

Local officials could take advantage of the state's AAA bond rating to borrow the money at low interest rates and could pay off the loans over 20 years using revenue from half-cent, local-option sales tax increases authorized in 1983 and 1986.



WAITING — The Rev. J.C. Pinkham, a Washington, N.C., radio evangelist, took steps to keep the curious from his auto after vandals broke the glass out of the back window and the two back doors. "I painted the signs so that people will know that the car is being investigated by the sheriff's people for criminal damages," Pinkham said. (Reflector Photo by Jerry Raynor)

Legislature Approves Paid State Holiday Honoring Martin L. King

RALEIGH (AP) — A law establishing a paid state holiday in honor of Martin Luther King Jr. takes effect today, showing the nation that North Carolina supports the cause for which he died, the measure's sponsor says.

"It sends a signal of commitment to the principles we all claim to support — peace, justice, freedom, and equality," Rep. Dan Blue, D-Wake, said. North Carolina is the 40th state to give its employees a day off in honor of the slain civil rights leader.

The House took final action on the bill Tuesday, approving 114-0 a Senate amendment to Blue's bill. Lt. Gov. Bob Jordan and House Speaker Liston Ramsey were to sign the measure into law today.

Under the bill, the holiday will be the third Monday in January — the same date as the federal King holiday. North Carolina has designated King's birthday, Jan. 15, as an unpaid holiday since 1983.

North Carolina was the only Southern state without a paid King holiday.

The bill drew bipartisan support, although most Republicans in both

chambers voted against it and Sen. Donald Kincaid, R-Caldwell, charged that King was unworthy of the honor because he allegedly associated with communists.

"The day he died ... he had become as polarizing, as divisive, as negative a force as we've had in the United

States in many years," Kincaid said during Senate debate last week.

Gov. Jim Martin, a Republican, opposed the measure but did not lobby against it.

The only significant opposition came from the 50,000-member State Employees Association of North

Carolina Inc., which fought a provision under which the King holiday will replace one of the 11 paid holidays observed in 1986.

Durwood "Butch" Gunnells, executive director of SEANC, said he regretted that his organization found itself working against the King bill.

House Wants Separate Public Hearings For Board Nominees

RALEIGH (AP) — A House committee has refused to participate in a public hearing with its Senate counterpart on Gov. Jim Martin's three nominations for State Board of Education seats, insisting on separate sessions to guard against "rubber stamp" approval.

The House Education Committee voted to conduct its own hearing next Tuesday and to make no decision on whether to recommend confirmation of the nominations until after April 1, the day the State Board of Education

had planned to swear in its new members if the nominations were approved.

That means the 13-member board apparently will have to meet with three of its slots unfilled, since the incumbents' terms expire March 31.

Martin's nominees are Howard Haworth of Morganton, former state commerce secretary; William C. Meekins Jr. of Elizabeth City, and Patricia H. Neal of Durham.

Members of the House panel complained that Martin only recently had

submitted his nominations and that lawmakers weren't being given enough time to study them.

"It does appear that they expect us to rubber-stamp these nominations," Rep. George Brannan, D-Johnston, said Tuesday.

They also said their decision was a demonstration of unhappiness with the way the Senate Commerce Committee handled a joint hearing this month on Martin's nomination of Ben Tison as state banking commissioner.



EXPO '87

NEW GREENVILLE WAREHOUSE
THURSDAY-SATURDAY • APRIL 2-4

"Pitt County is Promoting Business"

Pitt County's third trade show, featuring exhibits of business, industry, education, home & garden plus live entertainment daily, refreshments and much more.

Thursday, April 2 10 AM - 9 PM

Friday, April 3 10 AM - 9 PM

Saturday, April 4 10 AM - 6 PM

at the NEW GREENVILLE WAREHOUSE
Pactolus Highway, Greenville
Admission: \$2.00 Adults, \$1.00 under 12



Friday, April 3
5:30 - 6:30 p.m.
7:00 - 8:00 p.m.
SUPER GRIT COWBOY BAND



Thursday, April 2
5:30 - 6:30 p.m.
7:00 - 8:00 p.m.
THE EMBERS



Saturday, April 4
1:00 - 2:00 p.m.
3:00 - 4:00 p.m.
ATLANTIS

FOR MORE INFORMATION, CALL 752-4101

Sponsored by Pitt-Greenville Chamber of Commerce, 302 S. Greene Street, Greenville, North 27834

1964  1987

ARENDELL PARROTT ACADEMY

P.O. Box 1314 (Dobbs Farm Road) Kinston, NC 28501
Now enrolling for the 1987-88 academic year.

A College Preparatory Day School

GRADES KINDERGARTEN THROUGH GRADE 12

Interested parents are invited to attend a slide presentation on the Academy at Pitt Community College, Room 221, Whichard Building At 7:30 P.M. On Wednesday, March 25.

Transportation available from Greenville and Farmville.
Does not discriminate on basis of race, creed or national origin.

FIGHT HUNGER IN 1987

While you lose up to a pound a day
You don't have to starve yourself to lose weight. At Nutri/System, you can reduce while enjoying three delicious, satisfying meals a day.

Call 355-2470



I LOST 169 LBS.!

-Richard Bowers
Richard Says, "Come to Nutri/System! I feel this is the best reward you could give yourself, I've never felt better in my life."

1/2 Price

Program Cost And
1st Week's Food

FREE

Expires March 28, 1987

I AM 12 YEARS OLD AND I LOST 31 LBS.!

-Susan Bowers
Susan says, "I had been overweight off & on during most of my life, then I found Nutri/System and lost 31 pounds. Come join us today!"



CALL TODAY FOR FREE NO OBLIGATION CONSULTATION

355-2470

210 Arlington Blvd. Greenville



nutri/system

weight loss medical centers

Mon.-Thurs. 9 To 7
Friday 9 To 6
Saturday 9 To 1

IN THE STATE



Appointment

RALEIGH (AP) — Gov. Jim Martin has appointed a Carolina Power & Light Co. foreman to the state Industrial Commission, possibly avoiding attempts to limit his appointment powers.

Martin announced Tuesday that Harold Davis of Raleigh, plant services foreman at CP&L's Shearon Harris Nuclear Plant, to replace Charles Clay on the commission. He will join another Martin appointee, commission chairman David Brooks, and William Stephenson on the commission.

Chris Scott, president of the state AFL-CIO, said both Davis and Brooks, a former workers' compensation defense lawyer, appeared to represent employers on the three-member panel. He said current law allows no more than one representative of employers and no more than one supporter of labor.

Manager

CHADBOURN, N.C. (AP) — An attorney representing former Chadbourne Town Manager Steve Wyatt says he will ask the town council to reinstate his client or face a lawsuit charging his dismissal was a violation of his civil rights.

Wyatt was suspended last week just hours before he intended to swear in the town's first black police chief. Two days later, he was fired.

"The law is clear that to discriminate against an employee because that employee lawfully causes or encourages the employment of a black applicant is a violation of the law," said Robert P. Joyce, a lawyer from Pittsboro, citing the Civil Rights Act of 1964. "The termination of Mr. Wyatt's employment was such a violation."

The three white council members who supported Wyatt's suspension and firing said the termination was not racially motivated but stemmed from Wyatt's failure to adequately consult them on major hiring decisions. After firing Wyatt, they voted to swear in the black police chief, Kelly Rogers.

Student Killed

LELAND, N.C. (AP) — A Brunswick County college student was killed and two other people were injured when a 15-year-old boy, angry after an argument, rammed a pickup truck through a duplex apartment.

The body of William Guy Bondurant II, 21, a junior at the University of North Carolina at Wilmington, was found among the debris inside the apartment early Tuesday.

The crash apparently followed a disagreement earlier in the evening between the 15-year-old and one or more of the people in the duplex apartment.

No formal charge had been filed.

Ford Visit

CHAPEL HILL, N.C. (AP) — The National Security Council was intended to be a think-tank of highly qualified analysts who could advise the president, not an agency for running covert operations, former President Gerald Ford says.

Ford, at a news conference before a speech at the University of North Carolina, said he does not fault the U.S. government for trying to establish relations with Iran, but said the operations posed high risks.

"The NSC was never intended as a field operation organization," Ford said. "When you undertake a high-risk operation, you better supervise. Nobody did."

NCAE Director

RALEIGH (AP) — Thomas Husted, a director of business affairs and research for the Utah Education Association, will become executive director of the N.C. Association of Educators on April 6.

The NCAE board of directors chose Husted, 42, as its staff chief following a two-month national search. Husted will succeed K.Z. Chavis, who died in a car accident in November.

The 45,000-member NCAE, an affiliate of the National Education Association, is the state's largest teacher association. Elected officials in the NCAE have been trying to exercise more leadership and to bring the staff into a subordinate role.

Hall Of Fame

CHAPEL HILL, N.C. (AP) — Six North Carolinians will be inducted into the N.C. Journalism Hall of Fame at the University of North Carolina at Chapel Hill on April 12, the UNC-CH School of Journalism has announced.

The Hall of Fame honors journalists who have made significant contributions in the state and native North Carolinians who have attained journalistic distinction elsewhere.

Honored will be Claude Sitton, editor of The News and Observer of Raleigh; Margaret Harper, former editor of the State Port Pilot in Southport; Neil Luxon, dean emeritus of the school of journalism; Robert Mason, former editor of the Norfolk Virginian-Pilot; Sam Summerlin, president of The New York Times Syndication Sales Corp., and the late Henry Belk, former editor of the Goldsboro News-Argus.

The inductees will be honored during the Hall of Fame banquet at The Carolina Inn. A reception will begin at 6 p.m. in the UNC ballroom.

Military Awards

WASHINGTON (AP) — Defense Secretary Caspar W. Weinberger on Tuesday cited four military bases as recipients of the annual Commander-in-Chief's Award for Installation Excellence.

Established in 1984 by President Reagan, the award is presented to bases that have done the most to "increase productivity of the workforce and enhance the quality of life for personnel."

The four winners include the Army's Mainz Military Community in West Germany; the Marine Corps' Camp Lejeune, N.C.; the San Diego, Calif., Naval Station, and Beale Air Force Base, Calif.

Drug Charge

MONROE, N.C. (AP) — A 41-year-old Waxhaw man has been charged by Monroe and Union County officers with 30 counts of obtaining a prescription drug illegally.

John Sheldon was arrested by the Monroe Public Safety Office and charged with 17 counts of obtaining a controlled substance by forgery and one count of obtaining a controlled substance by fraud, according to Capt. Reid Helms.

"The drug he was charged with obtaining is a Schedule II drug called Dilaudid," Helms said. Sheldon was charged with seven counts of prescription forgery and five counts of obtaining prescription drug through fraud.

Search Ends

WILMINGTON, N.C. (AP) — The Coast Guard has called off its search for a Wilmington man missing since Saturday, said Coast Guard spokesman Peter Virock in Portsmouth, Va.

John Good was among four men aboard on a fishing boat that sank last weekend. One man, Doug Sherwood of Wilmington, survived by climbing inside a four-foot cooler. He drifted 19 hours before his rescue, officials said.

Two others who had been aboard the boat drowned.

Willis Maid Service, Inc.
752-4043

Federal Judge Will Allow State More Time To Improve Prisons

GREENSBORO (AP) — A federal judge has ruled that the state has not complied with a two-year-old consent decree to improve facilities at 14 prisons, but has declined to intervene in the prison system until he sees how much money the General Assembly puts into prison improvements.

State officials say the ruling earlier this month by U.S. District Court Judge James B. McMillan is a reprieve that gives them more time to avoid a federal takeover of North Carolina's prison system.

"We won the first battle," Deputy Correction Secretary John Higgins told the Greensboro News and Record Tuesday. "Not the war, but the battle. We are very pleased."

McMillan, in his ruling, said the state had failed to meet all the requirements of the consent decree, but was making progress.

"The Legislature is now addressing the budget, and it will be some months before it will be known how far they have gone toward funding the goals of education, employment and rehabilitation which the consent decree embraces," McMillan said in his decision.

"The defendants are complimented upon the progress achieved to date."

McMillan could have held the state in contempt, fining officials until they complied with his order. He could have closed some units or ordered prison officials to release inmates.

In a hearing in Charlotte on March 9, lawyers for prison inmates argued the state had violated the 1985 consent judgment and should be forced to comply immediately.

The judgment settled a 1980 law suit brought by four prisoners at Union County's state prison unit. McMillan later certified the litigation as a class-action lawsuit involving about 2,000 inmates.

The lawsuit, one of the first of many attacking conditions in the state's prisons, charged that the prisons are unfit for human habitation.

The judgment McMillan signed in September 1985 requires the state to spend \$12 million to improve physical conditions at the prisons, provide better medical care and improve recreational, vocational and educational programs.

McMillan's deadline for improving vocational, educational and rehabilitation programs expired late last year, and lawyers for the inmates asked the judge to intervene.

McMillan, however, said his court "will not put in its oar" until prison officials know how much money they will have to spend.

The General Assembly approved a \$29 million emergency bill March 12 to provide space for some 3,000 additional beds in the system.

At the same time, lawmakers enacted emergency legislation requiring prison officials to place a cap on the rapidly increasing inmate population.

On Thursday, parole officials will begin releasing hundreds of inmates convicted of misdemeanor crimes, in addition to those criminals who ordinarily would be paroled.

The special releases will continue until the prison population, now at more than 18,000, falls to 17,280 — 96 percent of 18,000 — as required by the emergency bill.

Lawmakers and prison officials hope these moves will avert a federal takeover of the system.

Higgins said he was heartened by McMillan's language in his decision, particularly a phrase in which the judge says any action by the court should come after the Legislature "has read-dressed the questions of money, and after the Department of Correction has had a reasonable time to make use of a new set of appropriations...."

"Reasonable time." Those words warm us very much," Higgins said.

Mavretic Suggests Union Of States Opposed To Regional Waste Sites

RALEIGH (AP) — North Carolina should trade its membership in a Southeast compact for low-level radioactive waste for a new pact with states that agree to take care of their own, a state representative says.

Rep. Joe Mavretic, D-Edgecombe, said Tuesday that if North Carolina leaves the eight-state compact that chose it to host a waste site in 1992, it could create a domino effect that will force Congress to re-examine the whole idea.

"It might be North Carolina's largest contribution to the whole issue," Mavretic told the Joint Select Committee on Low-Level Radioactive Waste.

Mavretic asked the staff of the committee to consult with Texas about forming a compact that would let each state handle its own wastes without violating laws governing interstate commerce.

He said North Carolina was chosen by "lottery" as the regional host and should have no qualms about leaving the compact.

Linda Little, director of the Governor's Waste Management Board, said the idea was unworkable.

"The costs are going to be absolutely prohibitive," she said. "No matter where you look, you're talking about big money."

Ms. Little estimated it would take

250,000 cubic feet of radioactive waste a year to make a facility cost effective, while North Carolina generates about 80,000 cubic feet.

Mavretic, however, said the cost figures were suspect because they came from utilities.

"If you were Duke Power or Carolina Power & Light ... and you certainly did not want to be the first power companies in America to handle your own wastes, would you set your prices very high?" he said.

Rep. George Miller, D-Durham, one of two North Carolina members on the 16-member compact commission, said he doubted Congress would go along with the idea.

"We don't have the convenience of moving in and out and in and out (of compacts)," he said.

UNCONTESTED DIVORCE
\$150 Plus Court Costs
POPKIN & ASSOCIATES
Attorneys At Law
752-0753

Belk

HOSIERY 25% OFF

KEEP THEM LOOKING: OUR SEMI-ANNUAL SALE!

- Heiress® sheer fashion socks.
- Classic and fashion styles.
- Regular, tall, extra tall.
- 1.00 - .75-3.00
- Silky Sensations in day control top and fashion sizes as above.
- 1.00-3.50, 2.25-2.62
- Heiress® Full Figure in ultra sheer, day sheer, control top.
- Sheer support and fashion texture. Sizes A, B, C, D, E and 1.
- 2 and 3/4. 1.50-5.25, 1.89-
- 1.00-3.00. Anklets, sport socks and crews. Made in the USA. Reg. 1.25-4.00. .94-3.00

Shop Carolina East Mall, Greenville, Monday Through Saturday 10 a.m. Until 9 p.m. -- Phone 756-B-E-L-K (756-2355)

Carlson's
Riverside Shopping Center

Northern Italian Restaurant
757-1757

THURSDAY LUNCH SPECIAL

Fettucini Carbonara \$3.75

Large pasta noodles served with bacon, mushrooms, and onions in a parmigiana cheese sauce.

Now Under New Ownership
An Eats, Inc. Restaurant

Lunch Mon.-Fri. 11:30 a.m.-2:00 p.m.
Dinner Sun.-Thurs. 5 p.m.-9:30 p.m.
Fri. & Sat. 5 p.m.-10:30 p.m.

Swaggart Denies He Planned Takeover

By MARTIN STEINBERG
Associated Press Writer

Jimmy Swaggart, rejecting accusations he masterminded a "diabolical plot" to seize the \$172 million PTL empire from Jim Bakker, suggested the evangelist was a "cancer" that needed to be excised from the body of Christ.

In TV interviews Tuesday night, Swaggart repeated denials he was behind any attempt to take over the 500,000-member PTL television ministry by revealing that Bakker had had an extramarital affair.

He also criticized Bakker ally Oral Roberts for his \$8 million, do-or-die fund drive, and denied he forced a

fellow Pentecostal minister in Louisiana to resign by spreading sexual misconduct allegations.

Bakker resigned last week from the South Carolina-based TV ministry, admitting he had an affair with a woman seven years ago and saying he had been blackmailed. On Monday, he said he quit to thwart a "diabolical plot" to take over PTL, which stands for Praise the Lord or People That Love.

Bakker's attorney, Roy Grutman, on Tuesday identified Swaggart as being behind the takeover plot.

In an interview with the WBRZ-TV of Baton Rouge, La., Swaggart said the charges were a "smokescreen"

to cover Bakker's "nefarious" activities.

On "The Larry King Show" Tuesday night on the Cable News Network, Swaggart said: "In one sense of the word, it's a sad day for the church of the Lord Jesus Christ."

"And in another sense of the word it's a very glad day, because this cancer has been excised that I feel has caused the body of Christ untold reproach...."

And on ABC's "Nightline," in an interview that Swaggart said would be his last on the subject, he asserted that Bakker's resignation was "a very painful experience, but it's something that needed to be done."

Asked about Roberts' fund drive, he said, "I think it's very inappropriate.... I think that this terrible situation in Tulsa and this situation going on in South Carolina is bringing terrible reproach to the Kingdom of God."

Roberts has said God told him to raise \$8 million by March 31 or he would be "called home."

In New York, Grutman told a news conference Swaggart had gone to prominent believers and at least one newspaper with "exaggerated and distorted" information about Bakker's sexual liaison of seven years ago.

"It was part of a plan that would

have accomplished the ouster of Jim Bakker and if that had occurred, would have enabled Jimmy Swaggart to take over PTL," Grutman said.

He said Swaggart's feud with Bakker stemmed from the latter's decision to remove Swaggart's show from the PTL network because Swaggart's "condemnatory, un-Christianlike, personal attacks on other churches which are not in keeping with the message of PTL."

Swaggart was not involved in blackmailing Bakker for \$115,000, but found out about it and tried to use the information against Bakker, Grutman said.



JIMMY SWAGGART

Secretary Says She's Sincere 'Churchwoman'

By GERALDINE BAUM
L.A. Times-Washington Post News Service

Jessica Hahn, a secretary whose sexual liaison with evangelist Jim Bakker figured in his decision last week to give up his multimillion-dollar PTL empire, defended herself this week as a sincere churchwoman who spent most of her adult life working for a Long Island faith healer and his congregation.

"I've spent my life in the church," Ms. Hahn said. "I was in at nights and working in the office during the day. My first job was cleaning toilets. Nobody asked me to. I just did it."

Last Thursday, Bakker revealed that he had paid money in "blackmail" over the 1980 sexual encounter and resigned as president and chairman of the board of PTL, which stands for both "Praise the Lord" and "People That Love."

But Monday, appearing with his wife, Tammy, in Palm Springs, Calif., on a taped segment of the PTL cable television show, Bakker said a takeover attempt of his empire was the underlying reason he turned his 500,000-member charismatic ministry over to Moral Majority leader Jerry Falwell, a Baptist fundamentalist. The revelation of the sexual encounter was the first step in that plot, he said.

Ms. Hahn, 27, said that from the time she graduated from Massapequa (N.Y.) High School until recently, she worked full-time at the Massapequa Tabernacle Church for Gene Profeta, a charismatic minister who started preaching to a few in a tent in 1970 and now attracts thousands to a brand-new brick church.

It was there that Ms. Hahn met John Wesley Fletcher, a traveling evangelist who in the 1970s occasionally set up his tent to preach next to Massapequa Tabernacle. Ms. Hahn confirmed a report that Fletcher would later set up the Dec. 6, 1980, encounter between Ms. Hahn and Jim Bakker in a hotel room in Clearwater Beach, Fla.

Ms. Hahn confirmed the 1980 encounter with Bakker and said she later received "a few dollars" of the \$115,000 that PTL reportedly paid after Ms. Hahn complained. She insisted there was "no blackmail" but refused to give a detailed account of her part in Bakker's downfall.

Of Fletcher, Ms. Hahn said she used to babysit for his children on occasion but did not consider him a friend. Profeta, she said, was a trusted friend who knew nothing of her meeting with Bakker.

Ms. Hahn, who said she was hiding from the media in her South Shore apartment, complained that her family was being harassed. "I just want this whole thing to blow over and for my family to be left alone," she said, stroking her black dog, Missy. A thin woman with flowing hair, Ms. Hahn wore black jeans, a black top and heavy gold jewelry.

"I didn't come forward in the first place," she said. "There were other people who used the information. But I didn't want to hurt anybody. I didn't want to hurt Jim." She refused to elaborate.



CONFIRMATION — Jessica Hahn, shown in West Babylon, N.Y., on Monday, has confirmed she had a sexual encounter with evangelist Jim Bakker in 1980. Ms. Hahn, 27, denied that she had tried to blackmail Bakker although she admitted some of the money paid by PTL to settle her complaints did go to her. (AP Laser-photo)

Future Of Bakkers' Real Estate Still Uncertain

FORT MILL, S.C. (AP) — PTL evangelist Jim Bakker and his wife, Tammy, amassed at least \$700,000 worth of real estate and cars in recent years, but it's uncertain what holdings they will keep now that Bakker has resigned from the PTL ministry.

The figures on the Bakkers' holdings were compiled from previous stories by The Associated Press on PTL and the couple.

The 47-year-old evangelist resigned as PTL president and turned the ministry over to the Rev. Jerry Falwell last week, saying he had been blackmailed after a sexual encounter with a New York secretary seven years ago. In a videotaped statement aired Monday, Bakker said the sex scandal was just the beginning of a "diabolical plot" to take over the ministry which reported \$129 million in revenues last year.

Bakker attorney Norman Roy Grutman on Tuesday said the takeover plot was hatched by television evangelist Jimmy Swaggart, with whom Bakker has feuded. Swaggart denied the charge.

Bakker has not said how his departure will affect his assets, and repeated calls to PTL's vice president for public relations, Neil Eskelin, were not returned Tuesday.

Since his resignation, Bakker and his wife, Tammy, have been in seclusion in Palm Springs, Calif.

The Bakkers are in the process of selling a house they bought in Palm Springs in 1984 and buying another one there, The Charlotte (N.C.) Observer reported. The transactions have not been finalized, but the Bakkers have been in the new home since February, the newspaper said. The

value of the new home could not be learned Tuesday.

In addition, the Bakkers own a mountainside house overlooking Gatlinburg, Tenn. The PTL ministry also provided homes for the evangelists near PTL headquarters in Fort Mill and a Florida condominium.

The Bakkers bought the first Palm Springs home for \$449,000, saying they used their own money. The same year, Bakker bought a new Mercedes-Benz for \$45,000 and a 1953 Rolls Royce for \$55,000

IRRIGATION SPECIALIST

RESIDENTIAL—COMMERCIAL—RECREATIONAL—FARM
FREE ESTIMATES

OVER 40 YEARS CUSTOMER SATISFACTION

HENDRIX-BARNHILL CO.

GREENVILLE, N.C.

919-752-4122

EXPO 87

TOP ENTERTAINMENT
WITELY

Special Guests
"THE BELLAMY BROS."
Sat. March 28th 7:30 p.m.

"THE SHAKERS"
Thurs. March 26,
7:30 p.m.

"THE COULTERS"
Fri. March 27, 7:30 p.m.

DON'T MISS IT!

See over 200 exhibitions displaying home and office furnishings, autos, jewelry, log and mobile homes, antiques, arts, crafts, computers and more!

SEE ...

- ★ Face Painters ★
- ★ Clowns ★ Sparky ★
- ★ Smokey the Bear ★
- ★ McGruff ★

Food Prepared by

The 7th Annual EASTERN FARM/HOME TRADE EXPO '87

March 26, 27 and 28

1441 South Church St. Raynor (formerly Works) Whse. Rocky Mount, N.C.

REGISTER MAIN DOOR PRIZE

New Orleans/Louisiana Vacation For Two

▲ Delta Gets You There
Compliments of Delta Air lines

ALSO MANY OTHER FREE PRIZES

FREE SHUTTLE BUS SERVICE

5:30-10:00 p.m. Thursday and Friday

11:00-10:00 p.m. Saturday

TRAVEL BY BUS

EXPO '87 ADMISSIONS \$1.00
Children Under 6 FREE With Parents

EXPO '87 HOURS

Thursday and Friday 3:00-10:00 p.m.

Saturday 11:00 a.m.-10:00 p.m.

Bakker May Return To Active Ministry

DUNN, N.C. (AP) — PTL founder Jim Bakker could be preaching again as an Assembly of God minister within two years if he accepts an invitation to stay in the denomination, the North Carolina district superintendent for the church says.

Bakker resigned from the Assemblies of God as well as his PTL television ministry last Thursday. But district superintendent Charles Cookman said Tuesday the door is open for Bakker to return.

"Jim Bakker is one of ours. There is an open door of restoration avail-

able to him through his church, the Assemblies of God," Cookman said.

"According to church documents, there is a restoration-rehabilitation process that is open to all Assemblies of God ministers and Jim Bakker will not be an exception to that," Cookman said.

Cookman said a board must decide on the punishment to be meted out to Bakker, but he said whatever action is taken will be based on what occurred according to Bakker's admission as well as Bakker's standing with the church.

Swaggart Faces Suit

NEW ORLEANS (AP) — An attorney for Jimmy Swaggart says there is no foundation to a \$90 million lawsuit filed by evangelist Marvin Gorman, which accuses Swaggart of trying to bankrupt Gorman's television ministry by spreading tales of sexual misconduct.

"I've read his complaint. It's totally unfounded and full of nontruths," said Swaggart's attorney, William Treeby, a codefendant in the lawsuit

filed Tuesday by Gorman in state district court in New Orleans.

Gorman said in the lawsuit that he had committed "an immoral act" with a woman in 1979. But he said he repented and felt he was forgiven by God.

He said in the lawsuit that he resigned in July as pastor of the First Assembly of God Church in New Orleans after Swaggart joined church's officials in a conspiracy to defame him.

TOO MUCH DEBT?

The U.S. Bankruptcy Code Allows For Individuals To Get Relief From Debt By Two Plans: Chapter 7, Straight Bankruptcy or Chapter 13, Wage Earner. These Plans Allow A Relief From Debt And A Fresh Start.

Call
Popkin & Associates
752-0753

Some Still Manage To Avoid Paying Income Taxes

By JIM LUTHER
AP Tax Writer
WASHINGTON (AP) — High-income Americans are finding it more difficult to escape the federal income tax, but 325 well-heeled citizens still managed to put together enough big deductions to pay nothing, the Treasury Department says.

Another 3,605 couples and individuals with incomes above \$200,000 paid a tax of less than 10 percent — less than that paid by a typical two-earner, four-member \$40,000-a-year family.

But the percentage of over-\$200,000 earners paying no tax on 1985 returns dropped to the second-lowest level since Congress began requiring the annual reports in 1976. About one of every 1,000 top earners got off scot-free on returns filed in 1985, less than half the figure of a year earlier, when 579 paid no tax.

The Treasury offered no explanation for the decline, saying it had not had time to analyze the figures. A former congressional analyst, Joseph Minarik of the Urban Institute, suggested that several tax changes that took effect in 1984 were responsible.

He mentioned a less-advantageous depreciation deduction for buildings, several accounting changes and a

crackdown on tax-shelter arrangements that the Internal Revenue Service defines as abusive. While those changes affected relatively few people, they "are the kind of thing that could affect you if you were making over \$200,000 a year and trying to pay zero tax," Minarik said.

Analysts say there is even less chance for the wealthy to escape taxes under the landmark tax overhaul enacted last year. It includes a major revision of the "minimum tax" rules aimed at ensuring

that high-income earners and profitable corporations pay some tax, regardless of how many legitimate deductions they have.

The latest figures reflect income earned in 1984 and filed on returns in 1985.

The number of upper-income people who paid no tax or less than that paid by more-typical wage-earners dropped slightly, to 3,930, or about 13 of every 1,000 people at that income level. A year earlier, 4,134 of the 249,319 with incomes over \$200,000

(about 17 per 1,000) paid less than 10 percent of their earnings in federal income tax.

A two-earner family of four with \$40,000 income and average deductions paid 12 percent to the government on returns filed in 1985, as did a typical single person earning \$30,000. A one-earner, four-member family with \$20,000 income paid about 8 percent.

Most wealthy people pay a substantial tax, the report shows. Sixty-four percent of the 310,042 peo-

ple with incomes over \$200,000 paid between 20 cents and 50 cents of each dollar to the government. Treasury said 566 paid more than 50 cents on the dollar; 11 of them paid a tax of over 80 percent.

Thirty-seven percent of the 310,042 high earners used deductions to avoid tax on at least half their income. That was up from 34 percent of 249,319 the previous year.

Interest paid was the biggest tax-saving device for most of the 325 upper-income non-taxpayers. Next in line was the foreign tax credit, which eliminates \$1 of U.S. tax liability for every \$1 paid to a foreign country. The third-most-popular was the 10

percent credit for investment in business equipment, which was repealed last year.

The over-\$200,000 non-taxpayers reported wages averaging in excess of \$260,000 and taxable capital gains of more than \$362,000. Their interest income averaged more than \$144,000. Most of them reported large losses from businesses, partnerships or farming.

Their average itemized deductions doubled from a year earlier, to more than \$562,000. The biggest average deduction, claimed by 32 of the group, was the \$583,000 for casualty or theft losses.

How They Avoided The Tax

WASHINGTON (AP) — Here, according to a Treasury Department report, are some of the ways 325 couples and individuals making more than \$200,000 earned their money and managed to pay no federal income tax on returns filed in 1985:

- 204 claimed interest deductions averaging \$366,000, more than double the average of a year earlier.
- 218 itemized deductions, at an average of \$562,018, again up by more than 100 percent.
- 14 claimed medical deductions, averaging \$135,500.
- 193 made contributions to charity, averaging \$63,000.
- 32 took a writeoff for a casualty or theft loss, averaging \$583,000.

On the income side:

- 190 reported wages or salaries, averaging \$260,616, double the previous year.
- 300 received interest, averaging \$144,633.
- 227 reported dividends, averaging \$64,203.
- 61 had net business income, averaging \$160,410.
- 64 reported business losses, averaging \$458,203.
- 4 had a farm profit, averaging \$163,500.
- 38 claimed farm losses, averaging \$189,895.
- 166 had partnership losses, a favorite tax-shelter device; they averaged \$459,663.
- 74 reported partnership gains, averaging \$374,797.
- 194 had net taxable capital gains, or profits from the sale of stocks and other assets. They averaged \$362,650. The 60 percent of capital gains that was not subject to tax averaged \$430,835.

Domenici Says Budget 'A Joke'

By ROBERT A. ROSENBLATT
and DEBRA WHITEFIELD
L.A. Times-Washington Post
News Service

WASHINGTON — Sen. Pete V. Domenici, R-N.M., throwing a cloud over Congress' ability to write a federal budget for next year, said Tuesday that the annual budget-writing process was "a joke" and called for Congress to prepare two-year spending plans with strict deficit controls.

Domenici, the top-ranking Republican on the Senate Budget Committee, said that Senate Republicans would not cooperate in preparing a fiscal 1988 budget unless they were convinced that Democrats would agree to legislation reforming the budget process.

Budget Committee Chairman Lawton Chiles, D-Fla., said that Democrats intended to go ahead and issue their own budget soon for fiscal 1988, which begins on Oct. 1.

Meanwhile, partisan wangling also intensified in the House, where Republican leader Robert H. Michel of Illinois insisted that Democrats should say what programs they plan to cut and what taxes they plan to raise. House Republicans, he said, will continue to boycott the budget-writing sessions until Democrats offer a spending program.

House Budget Committee Chairman William H. Gray Jr. responded angrily: "Here we go again. We expected a legislative process, not a diplomatic negotiation. Instead, we have another delay and another excuse for the president to lambaste the Democrats."

The partisanship could leave Congress unable to write a budget. Although Democrats control both houses of Congress, it is unlikely that all Democrats in both the House and the Senate could unite around a

single package of spending cuts and tax increases.

Their goal is a combination of expenditure reductions and new revenues totaling \$36 billion to enable Congress to reduce the 1988 deficit to \$108 billion, the goal of the Gramm-Rudman deficit reduction law.

So far, the House Budget Committee has made virtually no progress in writing a budget. In the Senate Budget Committee, Democrats have been meeting privately to devise a plan.

Domenici, who ran the Senate committee for six years until the Democrats won control of the Senate in November, complained in an interview that Congress often ignored its own budget when it passed individual spending bills. "What we've got now is a joke," he said.

In addition to recommending that Congress adopt budgets and spending bills that cover two-year periods instead of just one, Domenici called for automatic spending reductions if the deficit exceeded congressionally established targets.

The Supreme Court ruled the automatic spending cuts of the Gramm-Rudman act unconstitutional because the General Accounting Office, an arm of Congress, participated in executing the law. Domenici would delete the GAO's role.

"We need to see some willingness to reform the process," Domenici said.

Chiles said that the Democrats would proceed with the process anyway.

Domenici "is my friend and sincere in wanting to make some changes," Chiles said in an interview. But he added, "There's a little bit of hypocrisy to say another process, a two-year budget, will take care of the problem," said Domenici.

Weekend Specials
\$24.90

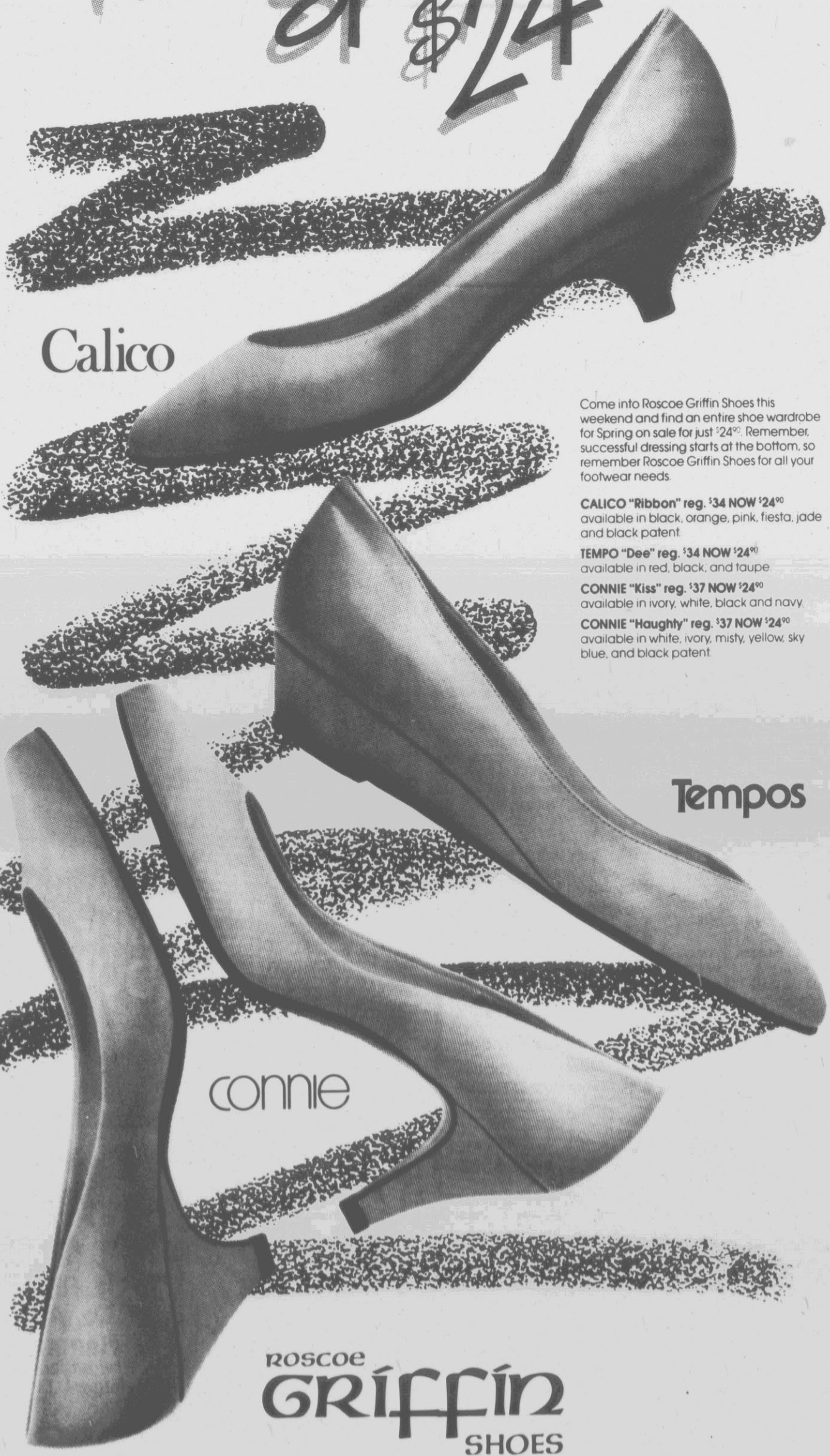

Come into Roscoe Griffin Shoes this weekend and find an entire shoe wardrobe for Spring on sale for just \$24.90. Remember, successful dressing starts at the bottom, so remember Roscoe Griffin Shoes for all your footwear needs.

CALICO "Ribbon" reg. '34 NOW '24.90
available in black, orange, pink, fiesta, jade and black patent.

TEMPO "Dee" reg. '34 NOW '24.90
available in red, black, and taupe.

CONNIE "Kiss" reg. '37 NOW '24.90
available in ivory, white, black and navy.

CONNIE "Haughty" reg. '37 NOW '24.90
available in white, ivory, misty, yellow, sky blue, and black patent.

art & camera
Frame Shop
& Gallery

Come in and see our new limited edition prints by Nancy Stonington & Herb Jones, our new group of Charleston prints and our original silk screens by Michael Helton.



20% OFF
your next complete
frame order.
Expires April 30, 1987

520 S. Cotanche Street
Greenville

Parking in rear on
Evans Street

752-4620

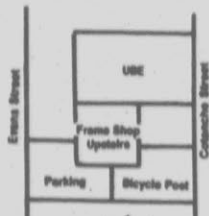

ROSCOE
GRiffin
SHOES

Raleigh, Durham, Chapel Hill, Rocky Mount, Goldsboro, Wilson, Roanoke Rapids, Washington, Greenville & Danville, VA

Haig Begins Candidacy With Visit To Tiny Dixville Notch

By WENDY MITMAN
Associated Press Writer
DIXVILLE NOTCH, N.H. (AP) — Newly announced presidential contender Alexander Haig opened his campaign by courting the nation's first voters — all 35 of them — as if they were a vast constituency.

"As Dixville goes, so goes America," the former GOP secretary of state told supporters, voters and reporters Tuesday at a small room at The Balsams resort ringed with photographs of candidates past.

The citizens of Dixville Notch, most of them employees of the resort, traditionally cast the first votes in New Hampshire's leadoff primary every four years, although their record for picking winners is poor.

On Election Day, Dixville Notch's polls open before dawn — earlier than anywhere else in the country — and the town's voters go in front of TV cameras to be the first in the na-

tion to cast their ballots for president.

Haig, 62, announced his intentions in the morning in New York and opened his New Hampshire headquarters in Manchester in the afternoon, complimenting the state's voters as smart people who don't buy packaging, labeling or imagery.

The retired Army general then boarded a helicopter for Dixville Notch with his wife, Patricia, and daughter, Barbara.

There he told voters that the GOP has faced tough times for the past several months, including the failed Iceland summit and "this Iranian brouhaha."

The 1988 election will let voters decide whether the "renaissance of spirit" brought about under President Reagan will "carry us successfully through the turn of the 21st century or be a brief — although very happy — footnote" in U.S. history, Haig said.

Haig said he opposes apartheid in South Africa but said economic sanctions against the country and pulling American companies out will only hurt the black majority. He also said he opposed sending covert aid to rebels in Nicaragua.

For Haig, Dixville Notch was one of many stops on a tour that was to lead him next to Iowa. For Dixville Notch residents, it was another in a series of whirlwind candidate visits.

"They're working to get the vote," said Linda Tillotson, who seemed unimpressed by the candidate and press entourage. "It's just like getting a bunch of mail from one candidate ... if you read his mail, he's in your brain more often."

Rick Tillotson said living in Dixville Notch affords the "rare opportunity ... to have people take the time to let us know them personally."

While in Manchester, Haig called

New Hampshire residents "the essence of America."

New Hampshire is a state "where the electorate looks at the candidates," Haig said. "This is not a state that's sold a bill of goods by propaganda or a media blitz but

which eyeballs each candidate and looks for the qualities that each candidate brings."

"I think in 1988 that leadership, experience and competence are going to be at the centerpiece of the American electorate," he said.

Voters will "wonder who is sitting across the table from who is clearly the most adept, capable — and perhaps for that the most dangerous — leader of the Soviet Union since the days of Marxist-Leninism," Haig said.

There Are Some Who Chose Not To Run For Presidency

By HARRY F. ROSENTHAL
Associated Press Writer
WASHINGTON (AP) — Two more people announced this week they are not running for president. That brings the total of prominently announced noncandidates to 10.

More than 240 million other Americans also can truthfully say they are not running.

But, because the refusniks were at least on someone's list of possible candidates, their declarations of noncandidacy made news.

So did the announcements of the four who have so far declared themselves candidates for an election still two baseball seasons in the future.

Latest to join the presidential race is Alexander Haig, the former secretary of state, former White House chief of staff and former NATO commander. He is in the company of former Delaware Gov. Pete duPont on the Republican side and former Arizona Gov. Bruce Babbitt and Rep. Richard Gephardt of Missouri on the Democratic.

The reason most cited by those who have dropped out is family responsibilities.

The evening before Haig's Tuesday announcement, former U.N. ambassador Jeane Kirkpatrick, a Republican, and Sen. Albert Gore, D-Tenn., made statements that they were not running.

First to bow out was Democratic Sen. Edward M. Kennedy. He bought time on Boston television on Dec. 19, 1985 — yes, that's nearly three years before the election — to announce he would not be a presidential candidate in 1988.

"I know that this decision means that I may never be president," said

the senior senator from Massachusetts. The reason: his children deserved more of his time than campaigning.

Mario Cuomo, the governor of New York, started Democratic pulses racing in 1984 with his keynote speech at the San Francisco convention. But he took himself out for 1988 saying he couldn't perform adequately as both governor and candidate. And besides, he said, it was a family decision. "We'd all have to go to Iowa and do this thing. It would be a strain on everybody."

Sen. Dale Bumpers, D-Ark., a favorite of his peers in Congress, decided against running in 1984 after toying with the idea and did it again last week. "A campaign means a total disruption of one's life and the life of his family," he said. "It would mean a total disruption of the closeness my family has cherished."

In January, Colorado's Sen. Bill Armstrong issued a statement that "if there were an overriding reason to do so, I would run for president; but I do not think this is the case." There were plenty of other outstanding Republican leaders, he said.

Two months later, Gov. James R. Thompson of Illinois, also a Republican, said he needed to stay home to advance his programs and to spend time with his family. "I can't be an absentee governor," he said.

During two days in late February, two Democrats announced they would not run. Sen. Paul Simon of Illinois said "there was a fair amount of interest but I would be fooling you if I said there was a large draft out there." And former Gov. Charles Robb of Virginia said "I have retired from elective politics and I hope to stay there."

Howard Baker, the former senator from Tennessee, left the presidential scene when he became President Reagan's chief of staff last month, although there is still some speculation he or another noncandidate could be drafted at the GOP convention in August.

Gore added his name to the presidential non-runner list, saying: "I'm not running for anything but the job I have." Gore said that "every once in a while someone mentions it. But it hasn't affected my thinking on it. I just want to be the best senator for Tennessee I can."

Kirkpatrick said — for the thousandth time — that she is not a candidate for anything and she said it is "not necessarily" time to have a woman on a Republican ticket.

For just \$97.34* a month, you can have \$3,000 today.

At Commercial Credit, we tell you right up front how low your monthly payments will be. And along with your low payments, we give you plenty of time to repay, and we don't ask for one bit of collateral. We'll even take your application right over the phone. And give you an answer fast, usually in just 24 hours. That's the way we are at Commercial Credit. Up front, fair, plain talking. So call Commercial Credit. Get the money you need today, without getting payments you'll regret tomorrow.

AMOUNT	TERM	MONTHLY PAYMENT
\$3,000	48 month	\$ 97.34*
\$4,000	48 month	\$126.94**
\$5,000	48 month	\$156.45***

Other amounts and terms also available.

Commercial Credit
a Commercial Credit Company

*23.72% Annual Percentage Rate
22.42% Annual Percentage Rate *21.60% Annual Percentage Rate

Greenville: 3201 South Memorial Dr., S.W., 756-2195.

Pentagon To Chart Airspace Policies

By NORMAN BLACK
AP Military Writer
WASHINGTON (AP) — The Pentagon may not be able to resolve rural residents' complaints of being "bombed" and "strafed" by warplanes, but it has decided it's got to bring some order to the process of setting aside airspace for military training.

The Defense Department, in a Feb. 24 letter to the General Accounting Office, officially concurred with a new audit's conclusion that the Navy and Air Force have been approaching airspace management in a haphazard fashion.

Because it has "not been a high priority in the Department of Defense," the military services have not attempted to forecast or coordinate their requests to restrict airspace, said the GAO, the congressional watchdog agency.

The result, the agency added, has been the deployment of high-speed fighters to bases that don't have sufficient restricted airspace for training purposes, and which have little prospect of obtaining rights to such airspace without touching off bitter fights with residents and the civilian aviation community.

While offering a few caveats, the Pentagon agreed it was time to cen-

tralize planning and better define its needs for airspace.

"By July 1987, the Department of Defense plans to develop a directive that will require the services to develop and maintain airspace plans, use these plans to help make aircraft basing and mission decisions and share these plans with the Federal Aviation Administration and affected states," the Pentagon wrote the GAO.

The 27-page audit by the GAO, initiated on its own authority last year, was published Monday.

WE GUARANTEE LOW PRICES EVERY DAY...

FAMILY DOLLAR

Will Not Be Undersold

IF OUR SALE PRICE DOESN'T ALREADY BEAT IT...WE'LL MEET IT!

Bring in any current local competitor's ad. If on an identical item, our price isn't lower or as low as their advertised price... **FAMILY DOLLAR WILL IMMEDIATELY MATCH IT!**

We Must Exclude Clearance Items, Damaged Or Irregular Merchandise, Percent Off Sales, Gimmick Promotions, Double And Triple Coupons And 2 For 1 Sales

Everett Fence Builders
Spring Sale
Chain Link Fences
FREE Gate With Purchase of 125' or More of Fencing.
Free Estimates
756-6388

27th Annual Barbecue
Staton House Fire Dept.
Friday, March 27, 1987
11 A.M. - 7 P.M.
At The Fire Station
Hwy. 11 & 13 North, Greenville
\$3 A Plate 752-3879

2⁹⁹ Each Ladies' Ribbed Tank Tops Assorted colors.	97¢ Each 38 Oz. Rinso Or 65 Oz. Arm & Hammer Powder laundry detergent. Limit 2.	88¢ Ea. Disposable Bic Razors Or Lighters Twin pack lighters, 10 or 12 pack razors.	84¢ Qt. Quaker State Super Blend 10W30 Oil Limit 5 qts.
--	--	--	--

FAMILY DOLLAR
SATISFACTION GUARANTEED

Prices Good At All Family Dollar Stores Through This Weekend. Quantities Limited On Some Items. No Sales To Dealers.

HARRIS SHOPPING CTR., SOUTH MEMORIAL DRIVE, GREENVILLE, NORTH GREENVILLE SHOPPING CTR., GREENVILLE

Reports Say Casey Masterminded Contra Aid

WASHINGTON (AP) — Congressional investigators believe former CIA Director William J. Casey got former White House aide Oliver L. North to organize a military supply operation to the Nicaraguan Contras that would hide CIA involvement, a published report says today.

The New York Times quoted two unidentified senators and a representative on the special committees investigating the Iran-Contra affair as saying they have clear indications that Casey, who is hospitalized with a brain tumor, masterminded the Contra aid effort.

The newspaper quoted other lawmakers and legislative aides as saying Casey turned to North to mask CIA's involvement and to avoid having to report the matter to Congress. From 1984 to 1986, Congress banned military aid to the Contra rebels fighting the leftist Nicaraguan government.

"Casey's fingerprints are everywhere," one lawmaker told the Times. Another said, "North surely needed the expertise and help of the CIA to do all the things he did in Central America."

The lawmakers did not say what specific evidence they had to indicate Casey's involvement, said the Times, adding that Casey may have told North that the president wanted him to do it.

They said they did not know whether Casey was involved in channeling to the Contras profits from the secret sales of weapons to Iran.

Meanwhile, the Senate votes today for the third time on whether to cut off a filibuster that is blocking action on a proposed freeze of U.S. military aid to the Nicaraguan rebels that Congress approved last year.

But even before the vote, Democratic leaders said their real goal

was to demonstrate they can muster the 51 votes needed to kill the aid program completely later in the year. The Reagan administration is seeking to give the Contras \$105 million in aid for the fiscal year beginning Oct. 1.

On Tuesday, the Senate split 50-50 on the question of whether the filibuster should be ended. On Monday, the vote was 46-45. It takes 60 votes — three fifths of the 100 senators — to choke off debate.

A CIA spokeswoman, asked late Tuesday about the Times report, denied any involvement of senior CIA officials, including Casey, in any private military aid to the Contras.

"The CIA had a longstanding policy, which it reiterated to employees twice, of avoiding agency involvement with the Contras' private benefactors. There is no basis for stating that senior agency officials authorized any activities contrary to

that policy," said spokeswoman Kathy Pherson.

The commission headed by former Texas Sen. John Tower, in its report on the sale of arms to Iran and the purported diversion of funds to the Contras, concluded there was evidence that North assumed "a direct operation role" in sending privately purchased arms to the Contras when aid was banned by Congress.

Casey, before he resigned to undergo brain surgery, had acknowledged the CIA helped North transfer U.S. arms to Iran. He said he did not learn of any diversion of funds to the Contras until last November.

But members of the Senate Intelligence Committee have complained that Casey's testimony to them was misleading and that he did not pass on suspicions brought to him in October by a senior CIA analyst and a New York businessman that

the profits might have been diverted to the Contras.

A Republican lawmaker was quoted as saying Casey's involvement would explain how a relatively low-ranking Marine officer such as North, who was unlikely to have acted without orders, could have directed such an important foreign policy operation. It also would explain why North believed he had the authority to use money from the arms sales to help the Contras, the lawmaker said.

In other developments: —The Justice Department repeated denials Tuesday that Attorney General Edwin Meese III intervened at the request of former National Security Adviser John M. Poindexter to block indictments of smugglers shipping guns to the Contras. The latest denial came after the Village Voice on Tuesday, quoting unidentified White House and Justice

Department sources, said Meese blocked the indictments after responding to a request from Poindexter that the investigation could imperil the Contras' efforts against Nicaragua's government.

—Independent counsel Lawrence E. Walsh asked Bandar bin Sultan, Saudi Arabia's ambassador to the United States, to answer questions about the Iran-Contra affair, according to unidentified sources cited in today's Washington Post. Former National Security Adviser Robert McFarlane has said the ambassador arranged for millions of dollars in contributions to the Contras that began at a rate of \$1 million per month in 1984. The ambassador has denied personal or Saudi involvement in funding the Contras. Walsh and Frederick G. Dutton, the Saudi government's attorney, declined to comment on the Post report.



YANKEE DOODLE DISSENTER — Air Force security policemen drag the Rev. Roy Bourgeois, a roman Catholic missionary from Ossining, N.Y., from the gate of Hurlburt Field, Fla., Tuesday. Bourgeois had knelt and spilled blood at the gate to protest reported training of Nicaraguan Contra rebels at the base. (AP Laserphoto)

Moslems Cite Heavy Toll By Soviets

ISLAMABAD, Pakistan (AP) — Soviet air attacks and commando raids killed hundreds of civilians and Moslem guerrillas in northern Afghanistan in retaliation for a guerrilla rocket attack on Soviet territory, guerrilla officials said today.

A Pakistan newspaper, meanwhile, reported that the toll from a series of Afghan bombing attacks on Pakistani border villages Monday was 147 dead and 176 injured. Government officials in Islamabad on Tuesday put the losses at 85 dead and 13 wounded.

Jamiat-i-Islami, the dominant guerrilla group in northern Afghanistan, said new reports described massive destruction in Afghanistan's Kunduz province along the Soviet border, with waves

of Soviet jets and helicopters bombing villages and towns.

The group quoted guerrilla reports from Kunduz as saying hundreds of people were killed.

"Many people have been killed, many villages have been destroyed and the Soviets are everywhere," said a guerrilla officer, who spoke on condition of anonymity.

Soviets forces launched their air attacks and commando raids five days after guerrillas bombarded Soviet territory across the Amu Daryu River with 107mm rockets on March 9, the guerrillas said.

Guerrilla officials said Tuesday that up to 12 Soviets were killed by the rockets and Western diplomats based in Islamabad said they also had received reports of the rocket attack.

Helicopter gunships and jet fighter-bombers from bases in the Soviet Union began bombing villages in the Imam Sahib district of Kunduz province March 14, the guerrillas said. Elite commando units then were dropped from helicopters, surrounding villages and guerrilla posts, they said.

Many guerrillas were trapped and

killed in the attacks and others were surrounded by attacking Soviet troops, the officials said. No specific casualty figures have been received on guerrilla losses, but it is unusual for the insurgents to admit any serious losses.

Western journalists are rarely allowed into Afghanistan and reports often cannot be checked.

People's Congress Opens In Beijing

BEIJING (AP) — Premier Zhao Ziyang today opened the annual session of the National People's Congress with a pledge to continue economic reform, but said 1987 would be a year of austerity and grappling with low productivity.

China's second major goal, Zhao said, would be to oppose "bourgeois liberalization," the current phrase for favoring Westernization and capitalism over socialism.

"Immense efforts must be made to eliminate the pernicious influence of this erroneous ideological trend," Zhao said.

The opening session of the 16-day meeting of China's legislature was attended by 2,719 delegates, including former Communist Party General Secretary Hu Yaobang.

It was Hu's first public appearance since he was ousted as party chief Jan. 16 for failing to crack down on student pro-democracy demonstrations in December and January and stop the trend of bourgeois liberalization. There was brief, scattered applause as he entered the auditorium.

Hu waved after sitting down in the second row on the rostrum two seats from Zhao, who has been acting Communist Party general secretary.

Zhao said China has been successful in curbing bourgeois liberalization, which he blamed on "weak and lax" leadership and said resulted in the student unrest.

He said if allowed to spread unchecked, Western liberal ideas would

"plunge our country and society into turmoil."

But, he said: "Under no circumstances is it permissible to stifle democracy on the pretext of opposing bourgeois liberalization."

The National People's Congress is constitutionally the highest state organ with sole authority to enact laws and amend the constitution, but long has been regarded as a rubberstamp body. In recent years it has taken a more decisive role in putting final touches on government policies, but ultimate power remains in the grip of the Communist Party.



Spring Dress-Up Days
Spectacular Savings!

- Draperies
- Top Treatments
- Bedspreads
- Mini and Micro Blinds
- Balloon and Roman Shades
- and more!

Country Drapery & Fabric Shop
Rt. 3, Box 375-C, Greenville
Phone 756-2876



Spring

Fashion Bonanza

Ameritogs/Alison Roberts Warehouse Sale

"3 Big Days"

•Expanded Floor Space, Dressing Rooms & Check-outs
For Your Shopping Convenience•

FANTASTIC VALUES

50-75% Discounts On

- ★ LADIES SPORTSWEAR, BLOUSES
- ★ PANTS, LINED BLAZERS, SKIRTS
- ★ SHIRTS, SWEATERS

Misses, Junior, Petite, Some Irregulars

Thursday, March 26th 5:00 P.M. To 9:00 P.M.

Friday, March 27th 5:00 P.M. To 9:00 P.M.

Saturday, March 28th 9:30 A.M. To 4:00 P.M.

CASH AND PERSONAL CHECKS ONLY - NO CREDIT CARDS

801 WEST CHURCH STREET
FARMVILLE, N.C.



"The tax deadline is looming. H&R Block is never too busy to help you."

—Henry Block



H&R Block's tax preparers are working every day and evening through April 15th. We're pledged to find you the biggest refund you're entitled to. This year get back everything you've got coming.

H&R BLOCK
THE INCOME TAX PEOPLE

WHERE MORE AMERICANS FIND A BIGGER REFUND.

Also in most major SEARS during regular store hours

MasterCard, Visa, and Discover accepted at most area locations.

Buyers Market

(Formerly West End)

756-1209

Greenville Square

756-9365

Lifestyle

Williams-Fisher Vows Exchanged

KITTRELL — Oak Ridge Baptist Church was the setting Saturday at 4 p.m. for the marriage of Julene Faye Fisher and Larry Brooks Williams. Dr. Roger Crook officiated at the double ring ceremony.

Parents of the bride are Mr. and Mrs. Gene Fisher of Rt. 1, Kittrell. She graduated from Vance Senior High School and East Carolina University. She is employed by the New Bern-Craven County school system.

The bridegroom is the son of Bernard Thomas Williams and Frances Williams. He is a graduate of William Edloe High School, Hardbargers Business School and served in the U.S. Army. He is presently employed by the U.S. Postal Service in Raleigh.

Nancy Shearin was pianist for the ceremony. Mary Nell Hight sang "It Seems I've Always Loved You," "Evergreen" and "The Lord's Prayer."

Given in marriage by her father, the bride was attired in a white gown of chiffon over taffeta with silk Venise lace and schiffli embroidery. The fitted bodice, which featured a Victorian neckline over a sheer English net yoke trimmed with a deep schiffli embroidered ruffle, was accented with designs of silk Venise lace and schiffli embroidery. The long, full chiffon sleeves extended to English net cuffs trimmed with silk Venise lace. The flared chiffon skirt featured a pyramid of lace at the center front that extended around the skirt and chapel train. Her organza covered cap was accented with seed pearls and had a back organza pouf flowing into a double layer fingertip veil with pencil edging. She carried a

cascade bouquet of pixie carnations and snowdrift mums tied with white satin ribbon and streamers.

Linda Susan Roberson, cousin of the bride, was matron of honor and wore a blue satin gown with fitted bodice, sweetheart neckline and double cap sleeves trimmed with bows. A matching spray of baby's breath adorned her hair. She carried a long-stemmed mum with greenery and blue satin bow.

Bridesmaids were Shannon Williams of Garner and Eva Blackburn of Greenville. Their gowns and flowers were designed identical to that of the honor attendant. Natalie C. Hight was flower girl and wore a formal blue gown of sheer polyester lined in taffeta with a jewel neckline. The gown had a raised waist with satin bow trim. The skirt had a lace flounced hemline. She carried a white basket with flowers tied with blue satin bow and streamers.

The bridegroom's brother was best man. Other groomsmen were Steven Fisher, brother of the bride, Donald Williams, brother of the bridegroom, and Bobby Bourne of Raleigh. Brooks Williams was ring bearer. Tammy Hight directed the wedding.

The bride's parents and brother entertained at a reception in the fellowship hall of the church. Guests were greeted by Mr. and Mrs. Joe Hight of Henderson.

The couple will live in Raleigh after a wedding trip.

A dinner party was held at Middleburg Steak House after the rehearsal Friday night. The bride-elect was also honored at a miscellaneous shower.



MRS. WILLIAMS

Bridal Policy

A black and white glossy five by seven photograph is requested for engagement announcements in The Daily Reflector. For publication in a Sunday edition, the information must be submitted by 12 noon on the preceding Wednesday. Engagement pictures must be released at least three weeks prior to the wedding date. After three weeks, only an announcement will be printed.

Wedding write-ups will be printed through the first week with a one column picture. During the second week, a one column picture will be used with a write-up giving less description and after the second week, just as an announcement.

Wedding forms and pictures should be returned to The Daily Reflector one week prior to the date of the wedding. All information should be typed or written neatly.

CLARIFICATION

An article in Sunday's Lifestyle section failed to note that Patricia Wilkes is director of the Cornerstone Baptist Church's "Taking Charge" physical fitness program.

Since 1960, Pitt County's population has increased from 69,942 to approximately 95,000.

Love Was In The Cards

Dear Abby
Abigail Van Buren

DEAR ABBY: Last year when I was a freshman at Tulane University, I read in your column (The Times-Picayune) that the Marines at Guantanamo Bay, Cuba, were "lonely" and wanted mail, so I wrote a friendly letter to a Marine (any Marine) telling him all about myself. Much to my surprise, I received a wonderful five-page letter from Lance Cpl. Mark Dennis — a native New Yorker. I answered immediately and enclosed my picture. He wrote again and sent me his picture. (He's very handsome!) Soon we were often exchanging letters and there were hour-long long-distance telephone calls!

Mark was promoted to corporal and transferred to a base in Florida. The best news is that we have fallen in love through the mail. Mark flew to New Orleans and we met for the first time when I picked him up at the airport on a rainy Thursday night in December. Our weekend was like a fairy tale!

We exchange letters and phone calls almost daily now. From pen pals we became sweethearts dreaming of the future. I flew to Florida to spend Valentine's Day weekend with Mark, and it's like a dream come true.

How can I thank you, Dear Abby, for giving fate a hand by publishing that address in your column last April? — VANESSA McMILLAN

DEAR VANESSA: Don't thank me, and don't thank fate. You reached out to cheer up a lonely Marine, and in so doing, you caught the gold ring. Congratulations and all the best to both of you!

DEAR ABBY: Some young relatives of mine are getting married. Bonnie is 19 and Chuck is 20. The other evening a friend (not a relative) was over and the kids were here. This friend congratulated the bride, then asked her what she wanted for a wedding present. Then Bonnie said, "How much did you want to spend?"

I nearly fainted! The friend was obviously taken aback, but she hemmed and hawed and never did give Bonnie a direct answer. I got in to it, and saved the situation by telling the friend that Bonnie was registered at such and such a store downtown.

Later I got into an argument with Bonnie's mother. She thought Bonnie's response was perfectly OK. What do you think? — IN THE MIDDLE

DEAR IN: Bonnie's response was frank and forthright — although somewhat startling. The answer you provided in the interest of "saving the situation" was the one Bonnie should have used.

DEAR ABBY: A very bright, single and absolutely beautiful young woman recently came to work in our office, and I would like to ask her for a date. There's only one problem. She wears a very strong perfume, and too much of it.

Meeting Place

WEDNESDAY

6:30 p.m. — REAL Crisis Intervention Center meets
7:00 p.m. — Greenville/Pitt County Youth Council meets at the Greenville Recreation and Parks Department, Cedar Lane.

7:00 p.m. — Greenville Toastmasters meet at Western Sizzlin. Dinner at 6 p.m.

8:00 p.m. — John Ivey Smith Council No. 6600, Knights of Columbus, meets at St. Peter's Catholic Church

8:00 p.m. — Narcotics Anonymous mid-week open meeting meets at St. Paul's Episcopal Church

8 p.m. — New Beginning Womens Alcohol Anonymous meets at Saint Paul's Episcopal Church.

THURSDAY

6:30 p.m. — Jaycees meet at Rotary Building

6:30 p.m. — Exchange Club meets

7:00 p.m. — Pitt County Arthritis Support Group meets at the Gaskin Leslie Building.

7:00 p.m. — Greenville Civitan Club meets at Three Steers

7:30 p.m. — Overeaters Anonymous meets at First Presbyterian Church

7:30 p.m. — Duplicate bridge meets at Senior Center

8:00 p.m. — Chapter 1308 of the Women of the Moose meets

8:00 p.m. — VFW Auxiliary meets at Post Home

7:30 p.m. — Epilepsy Association of North Carolina, Coastal Plains Chapter, meets at Pitt County Mental Health Center.

8:00 p.m. — Alateen, a meeting for children of alcoholics will meet in room 32 of First Presbyterian Church.

8:00 p.m. — Alcoholics Anonymous closed meeting at First Presbyterian Church

8:00 p.m. — Serenity Al-Anon meets at First Presbyterian Church, room 33

8:00 p.m. — Freedom Group of Narcotics Anonymous open meeting, St. Paul's Episcopal Church

FRIDAY

12 noon — Alcoholics Anonymous meets at St. Paul's Episcopal Church

8:00 p.m. — Serenity Group of Narcotics



OUT FOR ANOTHER SET — 2-year-old Kyle Nash of Myrtle Beach appears to be headed for another set at the Myrtle Beach Tennis Club when in reality he would put the ball on the ground and use the racquet as a golf club — much to his and others amusement. (AP Laserphoto)

Bridge Games Winners Named

A team-of-four bridge game was played Thursday night at the Senior Center. Placing were Mr. and Mrs. Jeff McAllister, first; tied for second were Effie Williams and Bertha Jones, V. Srinivasan and George Martin with Anne Lathan and R.B. Keusch.

North-South winners in the Saturday afternoon game included Beulah Eagles and Dave Proctor, first with 67 percent; Mrs. Mel Wright and Mrs. A.L. Roque, second; Mrs. Roy Gunderson and Mrs. Robert Blenk, third.

East-West: Effie Williams and Mrs. Zeb Cummings, first with 58 percent; Mrs. Harold Forbes and Emma Warren, second; Mr. and Mrs. Everett Pittman, third.

SAPPHIRES, EMERALDS, RUBIES, PEARLS, DIAMONDS
LAUTARES JEWELERS
Est. 1912
Specialists In Precious Gems



An Evening of Dance featuring Peter and the Wolf

April 9, 10, 11
Evening Performances 7:30
April 11th Matinee 3:00

D.H. Conley High School

Box Office: 355-2140
Children: \$4.00 Adults: \$5.00

performed Nutcracker with N.C. Symphony

CAROLINA CLOTHING

LUCIA
For Spring
Suits
Skirts
Slacks
Sweaters
Blouses

\$23⁹⁷

\$54

to

HWY 164 BY-PASS GREENVILLE ACROSS FROM NICHOLS OPEN MON-SAT. 9:30-5:30

Dr. Andrew E. Haven and Dr. William E. Brown
announce the opening of
GREENVILLE WOMEN'S CLINIC

on April 1, 1987,
specializing in obstetrics
and gynecology.

Hospital Professional Center
2245 Stantonsburg Road
(across from hospital)
Telephone 757-3131
for appointments.



We're in the new building, facing Kroger, in the Parking Lot. We've Moved!

Grand Award Perm Special
(Haircut included) Reg. \$19.50 Now **\$16.50**
With Coupon
Expires Wednesday, April 1, 1987

Lustra Curl
(\$60.00 Value) Reg. \$39.50 Now **\$32.50**
With Coupon
Expires Wednesday, April 1, 1987

Everyday Low Prices • Haircuts \$4
Shampoo & Set \$4, Shampoo & Blow Dry \$5

All services performed exclusively by students. No appointment necessary.
Nexxus • Nationally accredited. Long hair slightly higher.

Mitchell's

HAIR STYLING

Academy

426 Arlington Blvd. 756-3050
Monday 9 to 5:00
Tues-Fri. 10 to 9
Saturday 8 to 4:30

Geometric Shapes Add Appeal To Vest

Pat's Pointers
Pat Trexler

You won't often create so much drama with so little effort. Eye appeal of this knit sweater vest is guaranteed by the interplay of geometric shapes and two contrasting shades of yarn.

There is virtually no shaping involved in this intriguingly designed garment. It's worked quickly with double strands of yarn on size 10 needles in two rectangles that are simply seamed up the sides, front and back. The lightweight, silky acrylic yarn used in the pattern can be machine-washed and dried.

Easy-to-follow directions are written for small, medium and large sizes, with finished bust measurements of 36, 38 and 40 inches respectively. The gauge on large needles is four stitches per inch.

To obtain directions for making Two Easy Pieces, send your request for Leaflet No. Z-032287 with \$2 and a long, stamped, self-addressed envelope to: Pat Trexler Crafts, The Daily Reflector, P.O. Box 419148, Kansas City, Mo. 64141.

Or you may order Kit No. K-032287 by sending check or money order for \$14.95 for small or medium or \$15.95 for large to Pat Trexler Crafts at the same address. The kit price includes shipping charges, full instructions and yarn in your choice of peach with flamingo, ruby with silver, taupe with natural, or Ming blue with white.

One of the joys of working with plastic canvas is the ease of

finishing. There is no blocking to worry about and assembly is truly beginner easy.

When you want to join two pieces together, the easiest — and often most effective — way is with the basic overcasting stitch, also known as whipped edging or the lacing stitch.

Simply hold the two pieces together with right sides out and wrong sides facing each other, and with the holes of each piece lined up over one another. Then just whip or lace them together. To do this, bring the threaded needle up through one matching pair of holes; carry it over the edge and bring it up in the adjoining pair of holes; carry it over the edge and bring it up in the adjoining pair of holes. Continue along the edge or edges to be joined, taking an extra stitch or two in the corners, as needed, for good coverage.

In starting or finishing a yarn strand, always secure the ends under previously worked stitches or — if there are no stitches near the edge — start by working over the yarn "tail" for the first inch or so.

For ease in securing the yarn, I recommend that you always work toward the open end of any boxlike shape. Here is the preferred working order for joining the pieces of such a shape. First, join all side pieces to the bottom piece. Then join each of the sides to the adjoining piece, starting at the bottom and working to the top.

The same overcast, whipped or laced stitch can be used to cover any raw edges that are not to be joined to any other edge. You might want to try a couple of more advanced edging and joining stitches, however.

To work either the picot or binding stitch described below, it helps to mentally number the holes along one edge. For the picot stitch, bring the needle up in hole 1; take it to back of work and bring it up in hole 3. Now,

back up and bring it up in hole 2, which you skipped over in working the second stitch. Skip hole 4 and bring needle up in hole 5; back up and bring it up in hole 4. Continue in this manner all around. Often when working this stitch, I make no special effort to completely cover the corners as the stitch itself has a rather airy look.

By way of contrast, the binding stitch is a very solid stitch, giving the best coverage of any finishing stitch. It is also a little more involved. To avoid a lot of repetition, I will just

give you the sequence of hole numbers and you will know that I mean for the needle to be brought up in each hole in the order given. The sequence is as follows: 1, 4, 2, 5, 3, 6, 4, 7, 5, 8, and so on in this manner. This is not quite as complicated as it may seem from reading this, so practice it on a scrap of canvas. It's a really beautiful finishing stitch and well worth the effort on some projects. I should add that it is really a "yarn-eater," though, taking about two and a half times as much yarn as the overcasting stitch.



KNIT SWEATER VEST — Geometric shapes and two contrasting shades of yarn are used in sweater vest.

Little University Preschool
• Certified Kindergarten
• Lippincott Program
• Class Taught Age 2 and Up
• School Transport AM/PM
Greenville Farmville
752-7148 753-5681

GORDON'S
Ladies' Spring Apparel
284 ByPass 758-1003

Dance!
Register Now, Classes Start April 1
Designed for the woman who wants to stretch and tone, to learn relaxation techniques and diet control. To have fun! A Great Stress Release. Call Donna Whitley, 756-0574.

JUST HAIR
Happy 1st Anniversary
We Would Like To Thank Our Customers For Their Patronage Over The Past Year.
Carol Fulford, Terry Carraway, Susie Adams, Enid Smith, Joyce Harper, Frances Tripp
756-8802 Bells Fork Square
Mon.-Thurs. 9-8 • Friday 9-6 • Saturday 8-1
Walk Ins Welcome Family Haircare

Best Kind Of Friend Gives At All Times

By REDBOOK
A Hearst Magazine

The proverbial friend in need may not be a friend indeed — that kind of good friend may be bad for you.

"We operate on the belief a friend in need is a true friend," clinical psychologist Mervin R. Smucker said in an article in the March issue of Redbook, but the article points out that the best kind of friend sees you through good times as well as bad.

"The need for fair weather friends is often grossly underrated because we have the mistaken idea that a real friend is a friend in need and that other friendships aren't nearly as important," said Smucker, formerly director of clinical education at the Center for Cognitive Therapy at the University of Pennsylvania in Philadelphia.

Some friends seem almost gratified by our troubles but indifferent or even hostile to good news.

"Some friends want confirmation of their particular negative world view," said New York City psychotherapist JoAnn Magdoff.

Smucker said this "misery loves company" type "depends on other people's misery to mitigate her own."

Other foul weather friends rush to your aid to avoid facing their own problems or to spice up dull lives with your misery.

Joan Odes, a Millburn, N.J., psychotherapist and marriage counselor, said, "Many people fantasize about being very powerful, and thrive on having needy people around them."

Smucker said foul-weather friends could have a profoundly negative effect by reinforcing miseries.

"Fair weather friends don't reinforce you for being a complainer or being miserable, so they may prompt you to bounce back quickly," he said.

How can you spot the foul weather friends in your life? Here are some signs to watch for.

Do you "bite your tongue" in front

of your friend when you are feeling happy and funny?

Do you hesitate before phoning her with good news, or feel guilty when you do?

Do you feel your good news isn't so good once she's done with it?

Do you have the feeling she is taking your problems a lot harder than you are?

Old Photos?

We Can Copy And Restore Your Old Photos.

- Cracks Removed
- Stains Removed
- Missing Parts Restored
- Color Added
- People Removed From Groups
- Clothing Changed

Complete Photographic Services
Portraits, Weddings, Commercial, Aerials
Frames, Albums, Invitations

Rudy's Photography
1025 Evans St. Greenville, N.C.
752-5167
MasterCard and Visa Accepted



SAVE UP TO 50% ONE WEEK ONLY!

- JACK MULQUEEN SILK T-SHIRTS**
DEPT. STORE \$28 EA. **2/\$25**
 - DANIELLE B. LINEN PRINT SKIRTS**
DEPT. STORE \$34. **\$19.99**
 - RUMOURS LINEN BLAZER**
DEPT. STORE \$32. **\$19.99**
 - PRINT DRESSES BY JONATHAN MARTIN, BILLY JACK, SCARLETT**
DEPT. STORE \$62. **\$29.99**
 - DAVID MATHEW DRESSY BLOUSES**
DEPT. STORE \$36. **\$19.99**
 - COORDINATE BLAZER**
DEPT. STORE \$70. **\$34.99**
 - COORDINATE SKIRT**
DEPT. STORE \$44. **\$24.99**
- AND MUCH, MUCH MORE!

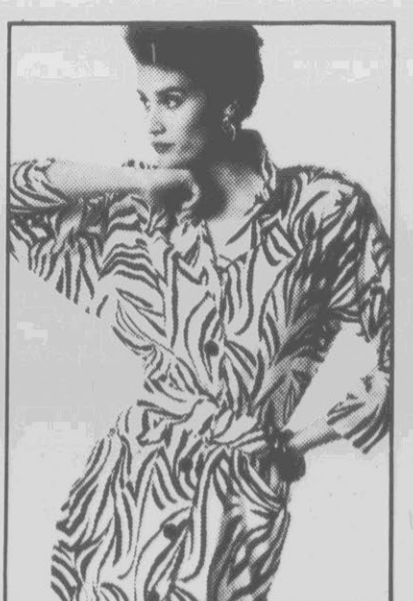

A SALE LIKE THIS ONLY COMES ONCE IN 25 YEARS



DRESS BARN
WHERE SMART WORKING WOMEN PAY LESS FOR FASHION.

• GREENVILLE BUYERS MARKET, Memorial Dr

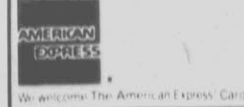

ALWAYS 20-50% OFF DEPARTMENT STORE PRICES. NO SALE IS EVER FINAL! OPEN 7 DAYS, 6 NIGHTS. MAJOR CREDIT CARDS ACCEPTED.

SEARS PORTRAIT STUDIO

Trust Your Baby's Smiles to Sears!

Only Sears Portrait Studio has the exclusive Video-Vision camera system. It frees our professional photographers to work closely with your baby... so we capture the cutest smiles! No appointment necessary. Use your Sears Credit Card or Discover Card!

14-piece portrait package \$12.95 plus 95c sitting fee

2-8x10s, 2-5x7s and 10 wallets
on your choice of a traditional, nursery, spring or fall background

Adults & families welcome. Each additional person, 95c. Pose our selection. White and Black Backgrounds and Double Feature Portraits available in addition to this offer. Also available: Instant Color Passport Photos and Copy & Restoration. *Approximate size

OFFER FOR PORTRAITS TAKEN THRU MARCH 28

Studio hours: Sun. Store hours (where store is open): Mon. & Tue.: Store opening until 5 pm; Wed.-Sat.: Store opening until one hour prior to store closing.

There's more for your life at SEARS
Celebrating Our New Century

Stock And Market Reports

NEW YORK (AP) — The stock market declined slightly today, meeting with more resistance from profit-takers after Tuesday's mixed session.

The Dow Jones average of 30 industrial stocks slipped 3.55 to 2,365.63 in the first half hour of trading.

Losers outnumbered gainers by 5 to 4 in the overall tally of New York Stock Exchange-listed issues, with 481 up, 602 down and 499 unchanged.

Volume on the Big Board came to 28.75 million shares as of 10 a.m. on Wall Street.

Analysts said several seasonal forces continued to work in the market's favor.

For one thing, they said, money managers at investing institutions appeared still to be doing some last-minute buying as they prepared their portfolios for first-quarter reports to clients.

For another, equity mutual funds are presumed to be receiving a steady stream of new money from investors making individual retirement account contributions for 1986 before the April 15 deadline.

But brokers said many traders looking past those temporary influences found the temptation strong to cash in some of their gains after the market's runaway rise since the start of the year.

Losers among the blue chips included General Electric, down 7/8 at 110 1/2; International Business Machines, down 1/4 at 152 1/2; and International Paper, down 1/4 at 105 1/2.

The NYSE's composite index of all its listed common stocks dropped .34 to 170.74. On the American Stock Exchange, the market value index was up .17 at 339.48.

On Tuesday the Dow Jones industrial average rose 5.40 to 2,369.18, marking its sixth consecutive record close.

But declining issues outnumbered advances by about 8 to 7 on the NYSE, with 738 up, 850 down and 402 unchanged. Big Board volume totaled 189.85 million shares, against 189.07 million in the previous session.

NEW YORK (AP) — Midday stocks:			
	High	Low	Last
AMR Corp	55 1/2	54 3/4	55
AbbottLab	66 3/4	65 3/4	65 3/4
Allis Chalm	29 1/4	29 1/4	29 1/4
Alcoa	46 1/4	45 1/2	45 1/2
AmBrands	49 1/4	48 1/2	48 1/2
AmCan	52 1/2	51 1/2	51 1/2
Am Cyan	97 1/2	97 1/4	97 1/4
Ameritech	91 1/4	91 1/4	91 1/4
AmIntGp	79 1/2	78 1/4	78 1/4
AmMotors	4 1/4	4 1/4	4 1/4
AmStand	41 1/2	40 3/4	41 1/2
Amer T&T	24 3/4	24 1/2	24 1/2
Amoco	83 1/4	82 1/4	82 1/4
BellAtlan	70 3/4	70 3/4	70 3/4
BellSouth	41 3/4	40 3/4	41 1/2
Beth Steel	8 3/4	7 3/4	7 3/4
Boeing	52 3/4	52 1/4	52 1/4
Boise Casced	84 1/2	82 1/2	82 1/2
Borden	59 1/2	58 1/2	59 1/2
Burlingt Ind	47 3/4	47 1/4	47 1/4
CSX Cp	35 1/4	34 1/4	34 1/4
CaroP&L	40 3/4	40 1/2	40 1/2
Champ Int	58 1/2	57 1/2	57 1/2
Cherron	58 1/2	57 3/4	57 3/4
Chrysler	56 1/2	55 1/2	55 1/2
Chrysler w	38 3/8	38 3/8	38 3/8
CocaCola	47 1/2	47 1/4	47 1/4
Colg Palm	47 3/4	47 1/2	47 1/2
Comw Edis	36 1/4	36 1/4	36 1/4
ConAgra s	32 1/2	32 1/2	32 1/2
DeltaAir	58 5/8	57 3/4	57 3/4
DowChem	84 1/2	83 3/4	83 3/4
dupont	117 1/2	116 1/2	116 1/2
Duke Pow	47 1/4	47 1/4	47 1/4
EastKodak	79 3/4	78 3/4	78 3/4
EastCorp	81 1/2	80 3/4	80 3/4
Exxon	88 1/2	87 3/4	87 3/4
FPL Grp	32 3/4	32 1/2	32 1/2
Firestone	37 1/2	37 1/4	37 1/4
FluWachov	44 1/2	44 1/4	44 1/4
FluProgress	39 1/4	38 3/4	39 1/4
FordMot	81 3/4	81 1/4	81 1/4
Fugua	34 3/4	34 1/2	34 1/2
GenCorp	113 1/4	112 3/4	112 3/4
GenCorp	113 1/4	112 3/4	112 3/4
GenDynam	73 1/2	73 1/4	73 1/4
GenElec	110 1/2	109 3/4	109 3/4
Gen Mills	53 1/2	53 1/4	53 1/4
Gen Motors	79 1/2	79 1/4	79 1/4
GenMotr E	35 1/2	35 1/4	35 1/4
GenuPart	53 1/2	53 1/4	53 1/4

UNC Petition

CHAPEL HILL, N.C. (AP) — A student group at the University of North Carolina at Chapel Hill is soliciting signatures from campus faculty members in an effort to force a meeting of the UNC endowment board April 7.

Members of Action Against Apartheid, a campus anti-apartheid group, began circulating petitions among faculty Monday, said Dale McKinley, a leader of the group.

The faculty petitions will be sent along with a letter to each of the seven members of the UNC endowment board, McKinley said. The letter urges the members to appear at a special board meeting on the steps of UNC's South Building at noon April 7.

The April 7 date marks the anniversary of campus workers tearing down shanties erected in March 1986 in front of South Building, the campus administrative building.

MASONIC NOTICE
There will be a stated communication of Crown Point Lodge 708 Thursday at 7:30 p.m.

SHOP-EZE
Greenville Buyer's Market
Phone 355-2373

WOODLAND
Thursday Special
Spaghetti \$2.50
Special served with 2 fresh vegetables & rolls.

Try Our Salad Bar
We have homemade cakes.

GalPact	52	51 1/4	51 1/4
Goodrich	56 1/2	56 1/2	56 1/2
Goodyear	54 1/2	54 1/2	54 1/2
Grace Co	63	62 1/2	62 1/2
GTNorNek	94 1/4	94 1/4	94 1/4
Greyhound	37	36 1/2	36 1/2
HerculesInc	60 1/2	59 1/4	59 1/4
Honeywell	73 1/2	73	73 1/4
HCA	35 1/2	35 1/2	35 1/2
ITT Corp	64 1/4	63 3/4	64
Ing Rand	83	82 1/2	83
Intl Paper	152 1/2	152 1/2	152 1/2
IntRel	106 1/2	105 1/2	105 1/2
IntRel	9 1/2	9 1/2	9 1/2
JamesRvr	43 1/4	42 1/2	42 1/2
K mart	65 1/2	65	65 1/4
KaiserAlum	18 1/4	18 1/4	18 1/4
KaneSvc	2 1/4	2 1/4	2 1/4
Kroger	36 1/4	35 3/4	36
Lockheed	51 1/2	50 3/4	50 3/4
Lovemy	71 1/4	70 3/4	70 3/4
McDermInt	29 1/2	28 1/2	28 1/2
McKesson	36 1/2	36 1/4	36 1/4
MeatCorp	71 1/2	71	71
Mercant	121	120	120 1/2
MinMM	132 1/2	131 1/2	132 1/2
Mobil	49 1/2	49 1/2	49 1/2
Monsanto	80	79 3/4	79 3/4
NorNB	25 1/2	25 1/2	25 1/2
Nat Distill	66 1/2	66	66
Navistar	6 1/2	6 1/4	6 1/4
NorflSou	98 1/4	97 3/4	98 1/4
NorflSou w	32 1/2	32 1/2	32 1/2
Nynex	67 1/2	67 1/2	67 1/2
OlinCo	52 1/4	52	52 1/2
PacTel	27 1/4	27 1/2	27 1/2
Painey JC	98 1/2	98 1/4	98 1/4
PepsiCo	35 1/4	34 3/4	34 3/4
Phelps Dod	31 1/2	31 1/2	31 1/2
PhilipMor	85 1/4	85 1/4	85 1/4
Polarmet	15 1/4	15	15
Polarmet	88 1/2	88 1/2	88 1/2
ProctGamb	94 1/4	93 3/4	94
QuakerOats	48 1/2	47 3/4	47 3/4
RJR Nab	56 1/2	56 1/2	56 1/2
Rohm&Co	81 1/2	81 1/2	81 1/2
Rockwell	58 1/2	58 1/2	58 1/2
Scott Paper	82 1/2	81 1/2	81 1/2
SealedPwr	34	33 3/4	33 3/4
SealedPwr	104 1/2	103 1/2	103 1/2
Shaklee	23 1/4	23 1/4	23 1/4
Skyline Cp	17 1/2	17 1/2	17 1/2
Sony Corp	20 1/2	20 1/2	20 1/2
Sony Corp	27	27	27
Stamps	118 1/2	118	118 1/2
StdOil	66 1/2	65 3/4	65 3/4
Stevens JP	42 1/2	42	42 1/2
T&W In	104 1/2	103 1/2	103 1/2
Texaco Inc	37 1/2	36 3/4	36 3/4
TexEastn	36 1/2	35 3/4	36 1/4
USX Corp	28 1/2	28	28 1/2
Unicom	69 1/2	69 1/2	69 1/2
UnCarbide	29 1/4	28 1/2	28 1/2
USWest s	56	55 1/2	56
Unocal	37	36 1/2	36 1/2
Walkm	59 1/2	59 1/2	59 1/2
WestPIPep	62 1/2	61 1/2	61 1/2
WestgEl	65 1/2	65 1/2	65 1/2
Weyerhae	57 1/2	56 1/2	56 1/2
WinnDix	49 1/2	49 1/2	49 1/2
Woolworth	50 1/2	49 1/2	49 1/2
Wrigley	50 1/2	50	50
Xerox Cp	76 1/4	75 3/4	75 3/4

Following are selected stock quotations as of 11:00 a.m.:

Ashland Oil	63 1/4
Unisys	102 3/4
Conner Homes	6 1/4
Fieldcrest Mills	34 3/4
Flowers Inds	26 1/2
Hatteras Inc. Securities	20 1/2
Hilton Hotel Corp	89 1/2
Jefferson Pilot	33 1/2
John Deere	27 1/2
Low's Company	30 1/2
Interstate Securities	30 1/2
Wickes	4 1/4
Piedmont Aviation	67 1/2
Southmark Corporation	10 1/2
United Telecommunications	29 1/2
Dominion Resources	45 1/2
Piedmont Natural Gas	23 1/2

OVER THE COUNTER

Branch Bank	38 3/4 to 39 1/4
Planters National Bank	17 1/2 to 18
Vermont American	21 1/4 to 22
Chemlawn	36 1/2 to 36 3/4
Southern National Bank	27 to 27 1/2
Peoples Bank	15 1/4 to 15 1/2
North Carolina Natural Gas	19 1/2 to 20 3/4
Cooper LaserSonics	2 1/16 to 2 3/16
Farm Fresh	15 1/4 to 15 1/2

Bias

(Continued from A-1)

Santa Clara plan "casual social engineering heedless of individual rights."

The plan was challenged by Paul E. Johnson, who was denied promotion in 1980 when the job of road dispatcher went to Diane Joyce. Both had considerable experience working as road yard clerks with the transportation agency.

Johnson said he was more qualified because he scored two points higher than Ms. Joyce on an oral examination for the dispatcher job. Also, the examiners who conducted the test unanimously recommended Johnson for the promotion.

The agency adopted a voluntary affirmative action plan in 1978 aimed at promoting women, minorities and the handicapped. At the time, not one of the agency's 238 skilled craft positions was held by a woman.

The affirmative action plan has a long-range goal of assigning 36 percent of the agency's jobs to women, minorities and the handicapped.

MASONIC NOTICE

The 10th Masonic District Male Chorus will rehearse Thursday at 7 p.m. at the home of Jasper Peyton, 701 Wymat St.

Obituaries

Bryant

A funeral for Mr. Johnnie Wilson (Bug) Bryant Jr., 25, of Route 3, Grifton, will be conducted at 2:30 p.m. Thursday in Grifton Chapel Church of Christ, Disciples of Christ, Church by Bishop Ben Sutton. Burial will be in the Ayden Cemetery.

A native and lifelong resident of the Grifton community of Lenoir County, he was employed by Arthur Glass Co. of Kinston. He was a member of Grifton Chapel Church.

Surviving are a son, Derrick Maurice Bryant of Grifton; his parents, Johnnie Bryant Sr. of Fort Barnwell and Mrs. Maggie Lee Bryant of Grifton, and his paternal grandmother, Mrs. Pearl Bryant of Fort Barnwell.

The body will be at Grifton Chapel Church of Christ from 6 p.m. to 8 p.m. today and at Norcott Memorial Chapel in Ayden from 10 a.m. until one hour before the funeral. The family will receive friends at the church from 7 p.m. to 8 p.m. today, and at other times will be at the home of Ms. Rittia Willis in Grifton.

Caine

Mr. Gary Lamont Caine, 21, died Sunday in Heritage Hospital, Tarboro, as a result of injuries received in an automobile accident.

His funeral will be conducted at 1 p.m. Thursday at Bethlehem Baptist Church near Leggett by the Rev. Wayne Hines. Burial will be in Pine View Cemetery, Rocky Mount.

Mr. Caine was a 1983 graduate of North Edgecombe High School.

He is survived by a son, Antwan Bell of Tarboro; his mother, Mrs. Delores Deans of Rocky Mount; his father, Linwood Caine of Norfolk, Va.; a sister, Angela Caine of the home; his paternal grandparents, Leslie and Betty Caine of Norfolk, Va.; his stepfather, McCray Deans of Rocky Mount; his step-grandmother, Mrs. Dizahiba Rogers of Greenville; two step-sisters, Lisa Dunn and Beatrice Dunn, both of Spring Hope, and his step-grandfather, James Dean of Rocky Mount.

The family will receive friends from 7 p.m. to 8 p.m. today at Hemby-Wiloughby Mortuary, Tarboro, and at other times will be at 807 Pender St., Rocky Mount.

Dunn

A funeral for Mrs. Mary King Dunn of the Haddock's Crossroads community on Route 2, Ayden, will be conducted at 2 p.m. Friday at Zion Chapel Free Will Baptist Church by Elder Stephen Jones. Burial will be in the Ayden Cemetery.

Born and reared in the Shelmerdine community of Pitt County, she had made her home near Ayden for the past 55 years. She was a member of Zion Chapel F.W.B. Church, the Church Home Mission, and Morning Star Christian Aid Lodge No. 12 of Ayden.

Surviving are her husband, Willie Dunn of the home; a son, Willie

(Jack) Dunn Jr. of the home; a daughter, Mrs. Everlean Tyson of New Haven, Conn.; two brothers, Charlie King of Ayden and Theodore (Thea) King of Route 1, Grifton; two sisters, Mrs. Bessie King Hardy of Route 1, Grifton, and Mrs. Martha Jane Knight of Erwin; four grandchildren, and five great-grandchildren.

The body will be at Norcott Memorial Chapel in Ayden from 6 p.m. Thursday until one hour before the funeral. The family will receive friends at the chapel from 7 p.m. to 8 p.m. Thursday, and at other times will be at the home on Route 2, Ayden.

McBean

WASHINGTON — Mrs. Helen Marie McBean, formerly of Wayne County, N.C., died Tuesday. Arrangements will be announced by Mitchell's Funeral Home, Winterville, N.C.

Raines

BETHEL — Mrs. Clara Estelle Raines, 73, died Tuesday.

Her funeral will be conducted Friday at 2 p.m. in Living Water Free Will Baptist Church by the Rev. Gordon Hart. Burial will be in the Bethel City Cemetery.

Mrs. Raines is survived by two sisters, Mrs. Nell Herman of Northville, Mich., and Mrs. Harriet Lee of Charlotte, and one brother, George A. James of Robersonville.

Family visitation will be from 7 p.m. until 9 p.m. Thursday in the Ayres-Gray Funeral Home.

Warren

ROBERSONVILLE — Mrs. Violet Rodgers Warren, 77, died Tuesday.

Her funeral will be conducted at 3:30 p.m. Thursday at Biggs Funeral Chapel by the Rev. Bob Wallace. Burial will be in the Robersonville Cemetery.

Surviving are one son, Eli Anderson Warren of Greenville; one sister, Mrs. Marjorie Matthews of Robersonville, and two grandchildren.

The family will be at the funeral home from 7 p.m. to 8:30 p.m. today. Memorials may be made to the Robersonville First Christian Church.

Williams

OAK CITY — Mr. Robert Lee Williams, 58, died Tuesday.

His funeral will be conducted at 1:30 p.m. Thursday at Biggs Funeral Chapel in Robersonville by the Rev. Gary Dillensnyder. Burial will be in Oak City Cemetery.

Surviving are eight brothers, Jasper Williams of California, Melvin Williams of Belflower, Calif., Wallace Williams of Fremont, Ervin Williams, Kenneth Williams and Dalton Williams, all of Chesapeake, Va., Lee Williams of Robersonville and Vernon Williams of Goldsboro, and three sisters, Mrs. Sally Edmondson and Mrs. Estelle Martin, both of Williamston, and Mrs. Velma Peaks of Everetts.

The family will be at the funeral home from 7 p.m. to 8:30 p.m. today.

Smith

(Continued from A-1)

But Randy Doub, in a nominating speech for the Martin-Hawke slate, said Griffith has been far more active in the party than Smith, and said Griffith would support Martin's choice for state party chairman.

Smith, Doub said, has "loyalty to the Congressional Club and Helms. Support the governor ... stand behind him" by electing Griffith, Doub urged.

Doub, a member of the state board of transportation, was Martin's campaign manager in Pitt County.

One Republican, active in local and state politics, said following the convention that the Helms-McCarty faction had "registered 65 people in the past two weeks" in an effort to gain control at the county convention. He asked not to be identified.

Another active party member, who asked not to be identified, said "it's unfortunate that the party has been taken over by the extremes. We've worked so hard over the past few years to build credibility."

There were 257 delegates present at the convention, held at the Willis Building at the intersection of First and Reade streets.

In a farewell speech, Tom Herndon, the outgoing party chairman, said the Republican presence in Pitt County had increased during his term of office and said that the party is "becoming a force to be reckoned with in eastern North Carolina."

Herndon said when he took office "a little over a year ago," that there was "internal dissension" and he promised to work toward "unification" of the party.

"There is still some dissension within our ranks," Herndon said, but "we care about differences as we care about similarities. I am confident we can join together" to elect Republican candidates in the next election.

Suit Settled

CHARLOTTE (AP) — Collier Cobb and Associates, a Charlotte-based insurance broker, has reached an out-of-court settlement in a sex-discrimination lawsuit filed 15 months ago by the U.S. Equal Employment Opportunity Commission.

Indian Wins Suit Over Oil Rights

MUSKOGEE, Okla. (AP) — A U.S. district judge has awarded \$685,000 to a Cherokee Indian who was penniless and living in a car before he learned oil and gas was being pumped from his land.

Austin Walker, 47, sued the government after learning that in 1983 he had signed away leasing rights to property he owned in Creek County for \$4,000 even though substantial gas and oil had already been pumped from his land.

Judge H. Dale Cook said in his ruling, issued Thursday, that the legal process had broken down when the Bureau of Indian Affairs allowed an attorney who represented the oil company, Bristow Resources Inc., to also serve as Walker's attorney.

Court records show Walker was penniless in 1983 when he went to the Bureau of Indian Affairs office in Muskogee to ask if he had a check for a grazing lease on the Creek County land he inherited from his grandmother.

When Walker told a clerk he knew nothing about a lease he allegedly signed with Bristow for oil and gas production on his land, he was sent to Rex Herren of the bureau's Office of the Solicitor, which provides legal advice to Indians.

The oil and gas drilling agreement had apparently been signed by someone else who had falsely represented himself as owner of the land, court records indicate.

Cook said Herren notified court officials and the oil company lawyers about the erroneous drilling lease. He said an employee of Bristow Resources contacted Walker and offered him money to sign a new leasing agreement.

McGraw, Smith Lead ECU Sweep

By WOODY PEELE
Reflector Sports Editor

Since it was a double dipper, East Carolina's Pirates came up with a double solution — Jay McGraw and Gary Smith.

McGraw came up with the game winning runs batted in in both games against Rider College, 6-5 in the first

and 7-5 in the second. The latter came on a two-run homer in the bottom of the seventh inning.

Smith, who came on in relief in the first game to pick up his fourth win, came back in the second to notch number five against one loss this year.

First Game		Second Game	
ab	r h rb	ab	r h rb
Rider	3 0 0	E. Carolina	3 1 0
Sosa, dh	3 0 0	Adams, lf	3 1 0
Coddington, ss	4 2 2	Sides, 2b	2 0 1
Larkin, cf	3 1 0	Sullivan, dh	4 1 1
Kremer, lb	2 2 1	McGraw, rf	3 1 2
Kuehner, 2b	3 0 1	Brown, lb	3 0 1
Vallorosi, 3b	3 0 0	Cable, c	2 0 1
Beck, rf	3 0 0	Thomas, cf	3 0 1
Wandling, c	3 0 2	Andrews, ss	2 1 0
Remprey, lf	3 0 0	Ritchie, 3b	2 1 1
Totals	27 5 6	Totals	24 6 8

Rider.....301 009 1-5
East Carolina.....111 102 x-6

Game winning RBI—McGraw
E—Brown; DP—East Carolina; LOB—RC 4; ECU 8; 2B—Wandling, Brown; HR—Coddington 2; Kramer; SB—McGraw, Thomas, Ritchie; S—Ritchie.

Pitching	ip	h	r	er	bb	so
Rider						
Walker (L, 0-1)	5½	7	6	6	6	1
Dey	½	1	0	0	1	2
East Carolina						
Peterson	1½	3	3	3	1	2
Smith (W, 3-1)	5½	3	2	1	1	2

Pitching	ip	h	r	er	bb	so
Rider						
Deutsh (L, 0-1)	6½	6	7	7	5	3
East Carolina						
Berkman	4	8	5	4	2	3
Smith (W, 5-1)	3	0	0	2	1	

HBP—by Peterson (Larkin); WP—Walker 3.

WP—Berkman 2.

“(Rider) didn't seem to handle (Smith) well,” ECU coach Gary Overton said. “They have no left-handers and they haven't seen a left-hander this year. Too, they had a lot of left-handed hitters.”

“Gary felt he could throw three or four more innings, but I don't think he could have gone much longer. We were ready to relieve him if it had gone further,” Overton added.

The games featured hits in each by second baseman Steve Sides, who has now hit safely in his last 16 games, including four going into last season. “Sides is doing an excellent job for us,” Overton said. “Not only is he swinging the bat well, he's getting important hits for us.”

As for McGraw, who has been struggling this spring thus far, Overton pointed out that that has been the rightfielder's custom — a slow start and a fast finish.

For the Pirates, it represented another come-from-behind effort. In their 12 games thus far, they had recorded two shutouts. In the remaining 10 games, they have trailed in all but one — and rallied to win in all but two.

Rider, a strong hitting team, used the home run rout in both games. Chet Coddington hit two in the first game while Ken Kuehner added one. That accounted for all but one of the runs in that game.

In the second game, Kuehner and Nick Vallorosi each homered, picking up four of the five Bronc runs.

Rider jumped into the lead with three first inning runs in the opener. Coddington got the first on a solo homer with one away. Pat Larkin was hit by pitcher Jim Peterson, making his second start after coming off arm problems. Kremer then followed with a second shot out of the

park in left for the 3-0 lead.

East Carolina came back with one in the bottom of the first. With two away, Mike Sullivan singled and McGraw walked, as did Calvin Brown, loading the bases. A walk to Chris Cauble brought in Sullivan.

A second run scored in the second. Mike Andrews singled and moved up on a wild pitch. Two ground outs, the latter by John Adams scored Andrews.

Rider added one in the third for a 4-2 edge. Kremer reached on a two-base error and took third on a single by Kuehner. Vallorosi then grounded out, scoring Kremer.

East Carolina got a third run in the bottom of the frame. McGraw singled and stole second. A wild pitch moved him to third and he scored on Thomas' single.

The Pirate tied it up in the fourth with still another single run. David

Ritchie singled and stole second. He moved up on an out and scored on Sides' single to left.

In the sixth, the Pirates struck for two more to take a 6-4 lead. Andrews walked and was sacrificed up. Adams walked as did Sides, loading the bases. With two away, McGraw delivered a single to left, scoring both Andrews and Adams.

Rider closed to within one in the seventh as Coddington again homered, but the rally was ended there.

McGraw had two hits for the Pirates in the game while Coddington and Dave Wandling each had two for Rider.

Rider again went up with two runs in the first inning of the second game. Coddington walked and Kuehner

(See MCGRAW, B-3)



No Double This Time

East Carolina's Steve Sides slides into second base too late to avoid the tag by Rider's Jim Kuehner in the fourth inning of Tuesday's doubleheader. Sides hit sharply down the left field line to score David Ritchie but was thrown out trying to stretch the hit. He has hit safely in the last 16 ECU games. (Reflector Photo by Tommy Forrest)

Chapman Appears To Be ECU Choice

East Carolina University has apparently offered the head basketball coaching position to Tom Chapman, head coach of Gannon College.

Gannon was the national runner-up for NCAA Division II honors this season.

Chapman was on campus this morning, and ECU had, Tuesday night, notified the media of a 10 a.m. press conference.

However, Bob Roller, Sports Information Director at the school, called media members back this morning, and said that the press conference had been postponed. No new time for it was scheduled. Roller later said that there would likely be no official word today.

Late this morning, Chapman and Dr. Ken Karr, ECU director of athletics, were meeting Karr's office. John Ruby, Chapman's chief assistant at Gannon, told the

Erie, Pa., newspaper that the hangup was the length of contract offered. ECU was offering a three-year pact, while Chapman was asking for a four-year contract, Ruby related.

Chapman emerged as the top candidate for the job vacated by Charlie Harrison after a tenure of five years. Ironically, he was a finalist when Harrison was hired in 1981.

At least four other head coaches had been mentioned as candidates. They include Mike Steele of Division III DePauw, Bobby Hussey of Davidson, Bob Huggins of Akron and Mike Stewart of Middle Tennessee State.

Stewart was reportedly offered the job last week, but turned it down. Huggins was apparently dropped as a candidate following his interview, one source said.

Jaguar Thinclads Sweep Tri-Meet

FARMVILLE — Farmville Central won every individual event, led by four wins by Rodney Gorham as the Jaguars romped to an easy victory in a three-way track meet Tuesday.

Gorham captured the high jump, triple jump and both of the hurdle races to lead the way for the Jaguars. Marty Baker added three wins, in the mile, 800 and two-mile, while Anthony Carmon won the 220 and the long jump.

Farmville finished the day with 108 points while D.H. Conley was a distant second with 47. Southern Wayne finished with just nine points.

Conley won only two events, taking two of the three relays.

Farmville is now 2-0 and hosts Greene Central and Pamlico on Thursday. Conley returns to action on Thursday at North Lenoir.

Summary:

Shot put: Kei. Barrett (FC) 45-5; White (FC) 40-9; Kev. Barrett (FC) 38-8½; M. Streeter (FC) 38-5.
Discus: White (FC) 129-6; Kev. Barrett (FC) 116-7; Southerwind (SW) 110-3; Kei. Barrett (FC) 103-8.

High jump: R. Gorham (FC) 5-8; Green (C) 4-10; Middleton (C) 4-8; Mallison (C) 4-6.

Pole vault: D. Barrett (FC) 9-6.
Long jump: Carmon (FC) 21-6; Harper (C) 18-4; Jones (C) 15-10½; Simmons (C) 15-10.

Triple jump: R. Gorham (FC) 37-4½; Daniels (C) 36-11¼; Mallison (C) 26-11½.
120 high hurdles: R. Gorham (FC) 16.7; V. Gorham (FC) 18.7.

100: Blue (FC) 10.25; Dickerson (SW) 10.55; Jones (C) 10.85; Harper (C) 11.34.
Mile: Baker (FC) 5:02.8; D. Streeter (FC) 5:23; Middleton (C) 5:41; Mallison (C) 5:47.3.

440: McFee (FC) 58.7; Darden (FC) 59.3; Saunders (FC) 1:01.8; Green (C) 1:04.6.

330 intermediate hurdles: R. Gorham (FC) 44.9; Mercer (FC) 48.4; Morgan (SW) 49.0; Middleton (C) 52.1.

880: Baker (FC) 2:23.1; V. Gorham (FC) 2:26; Daniels (C) 2:41.4; Robinson (SW) 2:54.4.

220: Carmon (FC) 23.6; Jones (C) 25.5; Harper (C) 26.2; Jordan (FC) 26.8.

2-mile: Baker (FC) 11:40.9; D. Streeter (FC) 12:42; Mallison (C) 13:10; Stacy (SW) 13:12.

880 relay: Conley (Daniels, Green, Jones, Harper) 1:42.9.

440 relay: Conley (Daniels, Green, Jones, Harper) 48.6; Farmville Central 49.3.

Mile relay: Farmville Central (Mercer, McFee, Kei. Barrett, Carmon) 4:07; Conley 4:15.7.

Southern Miss, LaSalle Win

NEW YORK (AP) — One team's poison might be another team's candy.

That could be the lesson for Southern Mississippi Coach M.K. Turk, who put his team in a zone defense during a decisive stretch of its 82-75 victory over Nebraska in the National Invitation Tournament semifinals Tuesday night.

But Turk might think twice about doing the same thing against La Salle in the final on Thursday.

La Salle took advantage of Arkansas-Little Rock's zone defense in the other semifinal, hitting eight of its

first 12 shots from 3-point range to build an 18-point lead late in the first half. When UALR went man-to-man in the second half, the Explorers took only one 3-point shot, but went on to a 92-73 victory.

“I was happy to see the zone,” La Salle Coach Bill “Speedy” Morris said. “Making our first four 3-point shots got us off good and relaxed us.”

La Salle, 20-12 will play Southern Mississippi, 22-11, in Thursday night's 50th NIT championship game.

Randolph Keys had 24 points and nine rebounds and combined with John White to score all of Southern

Mississippi's points during a 15-2 second-half spurt that broke open a close game.

Nebraska led 60-58 before White, who had 19 points, started the streak with a 3-point goal, giving the Golden Eagles a 61-60 lead with 7:17 left.

At that juncture, Turk went to a zone defense.

“We had defensive problems early and in the second half we struggled until we went to the zone when we got ahead 61-60,” Turk said. “Man-to-man pressure is our usual defense, but we had to use the zone when we got ahead because their fast break was hurting us.”

With White scoring eight points and Keys seven, the spurt ended with the Golden Eagles ahead 73-62 with 2:58 left, and Nebraska got no closer than the final score.

Southern Miss made only two of its first 15 shots and fell behind 18-5 in the first six minutes of the game. After making 54.2 percent of their field-goal attempts in three previous NIT victories, the Golden Eagles hit just 43.9 percent against the Cornhuskers, 20-12.

“It was not a pretty win, but it was a great win,” Turk said. “We aren't beautiful to watch to anyone but our wives and girlfriends.”

The Golden Eagles got back in the game with a 14-0 spurt late in the first half, giving them their first lead at 30-28. After that, the game at 12 more lead changes until Southern Miss grabbed the lead for good at 61-60.

In the first game, Tim Legler had 26 points, Rich Tarr 23 and freshman star Lionel Simmons 21 for La Salle against UALR, 26-10.

Guards Legler and Tarr had three 3-pointers each during the Explorers' first-half bomb fest when they collected all but one of their nine 3-point goals.

“No team in the country can play us like they tried to,” Legler said. “Temple played a zone against us and we were up 20 at the half. I think they didn't know we were such good shooters.”

Legler said La Salle's game plan was to establish an outside game to open up the inside game for Simmons, the team's leading scorer with 19.8 points per game.

“It just happened that we tried three pointers because they extended the zone out that far,” the 6-foot-4 guard said.

UALR switched to a man-to-man defense after La Salle led 43-25, and the Trojans cut the deficit to 45-34 at halftime. In the second half, the Explorers abandoned the outside game and went inside to Simmons, who had

nine points during a 21-13 streak that rebuilt La Salle's advantage to 66-47 with 10:26 left.

“We just didn't miss in the first half,” Simmons said, “and when they went man-to-man, that freed me up. I knew the ball would come in to me.”

Arkansas-Little Rock got 19 points from James Dawn, 15 of them in the first half, and Paul Springer had 12.

Trojans Coach Mike Newell said a lack of depth forced him to use a zone defense.

“We don't have the depth to match them, only seven players,” Newell said.

Keys, Southern Mississippi's leading scorer, was scoreless in the first 14 minutes of the second half, but had 11 points the rest of the way.

“He's a money player for them and when he got going, that won the game for them,” Nebraska co-captain Brian Carr said.

Carr, who scored the last eight points during an early 11-0 Nebraska run, finished with 12. Derrick Vick led the Cornhuskers with 19 points, and Bernard Day and Anthony Bailous had 14 each.

“They outplayed us during the spurt and made some 3-pointers,” Nebraska Coach Danny Nee said. “We just couldn't come back. I think the two beat teams will be playing for the championship.”

ARKANSAS-LITTLE ROCK (73)
Hoges 4-11 1-9, Kidd 3-11 1-2, Cummings 2-4 0-4, Brown 4-12 0-11, Springer 5-9 2-2, Dawn 8-14 2-4, Powell 3-10 0-0, Smith 1-3 0-2, Totals 30-74 6-97.

LA SALLE (92)
Koretz 5-11 0-0, Simmons 6-8 9-10, Conlin 1-1 0-2, Legler 8-22 6-7, Tarr 5-7 10-12, Barnes 2-3 2-3, Polczewski 0-0 0-0, Johnson 1-1 0-0, Jones 0-0 0-0, Totals 28-53 27-92.

Half-time—La Salle 45, Ark.-Little Rock 34. 3-point goals—Ark.-Little Rock 7-14 (Brown 3-5, Powell 3-7, Dawn 1-2), La Salle 9-15 (Legler 4-8, Tarr 3-4, Koretz 2-3).

Fouled out—Springer. Rebounds—Ark.-Little Rock 43 (Dawn 11), La Salle 30 (Legler 9). Assists—Ark.-Little Rock 19 (Springer 8), La Salle 22 (Tarr 12). Total fouls—Ark.-Little Rock 22, La Salle 10. Technical—Arkansas bench.

NEBRASKA (75)
Jackman 3-7 1-7, Vic 8-9 3-4, Day 4-9 6-9, Buchanan 3-10 0-0, Carr 5-14 1-1, Bailous 5-12 2-3, Fisher 2-5 0-6, Siler 2-7 0-1, van Poelgeest 0-0 0-0, Rokeweg 0-1 0-0, Totals 29-66 13-75.

SOUTHERN MISSISSIPPI (82)
Hailton 4-13 3-4, White 5-12 6-7, Keys 10-18 4-24, Fisher 2-5 0-6, Siler 2-7 0-1, Brown 2-0 0-0, Pettus 3-7 0-1, Hinton 4-5 2-3, Smith 0-0 0-0, Totals 30-69 15-20.

Half-time—S. Mississippi 43, Nebraska 42. 3-point goals—Nebraska 4-9 (Bailous 2-3, Buchanan 1-2, Carr 1-4), S. Mississippi 7-14 (White 3-5, Fisher 2-4, Pettus 2-4, Siler 0-1). Fouled out—None. Rebounds—Nebraska 38 (Jackman 9), S. Mississippi 46 (Keys 9). Assists—Nebraska 16 (Carr 7), S. Mississippi 22 (Pettus 8). Total fouls—Nebraska 22, S. Mississippi 18. A—7,965.

Sports Calendar

Editor's Note: Schedules are supplied by schools or sponsoring agencies and are subject to change without notice.

- Today's Sports**
Swimming
Senior Nationals
Tennis
Campbell at East Carolina (3 p.m.)
Bertie at Farmville Central (3:30 p.m.)
Softball
Virginia Commonwealth at East Carolina — 3 (2 p.m.)
Chocowinity at Jamesville
Track
Ahooskie, Roanoke Rapids at Roanoke
Williamston at Edenton
Thursday's Sports
Swimming
Senior Nationals
Tennis
St. Mary's at East Carolina women (3 p.m.)
Southern Nash at Farmville Central (3:30 p.m.)
Conley at Greene Central (3:30 p.m.)
Rose at North Lenoir (3:30 p.m.)
Golf

- Ayden-Grifton, Eastern Wayne at Rose (2 p.m.)
Southern Wayne, Zebulon, Conley at Farmville Central (2 p.m.)
Track
Conley at North Lenoir (3:30 p.m.)
C.B. Aycock, Pamlico at Farmville Central (3:30 p.m.)
Ayden-Grifton, Greene Central at South Lenoir (3:30 p.m.)
Conley at North Lenoir girls (3:30 p.m.)
Rocky Mount at Rose (3:30 p.m.)
Baseball
Creswell at Chocowinity (3:30 p.m.)
Jamesville at Belhaven
Mattamuskeet at Bear Grass (4 p.m.)
Greene Central at C.B. Aycock JV (4 p.m.)
C.B. Aycock at Greene Central (4 p.m.)
Softball
Creswell at Chocowinity
Jamesville at Belhaven
Eastern Wayne at Rose
Mattamuskeet at Bear Grass (4 p.m.)
Greene Central at C.B. Aycock (4 p.m.)



Tough Luck

Casey Fisher (10) of the University of Southern Mississippi has his shot blocked by Anthony Bailous (14) of Nebraska Tuesday night in New York's Madison Square Garden during NIT semifinal action. Southern Miss won to advance to the finals. (AP Laserphoto)

Vikings Rip Farmville, 13-2

By TOM MORRIS
Reflector Sports Writer
FARMVILLE — It may have been the first baseball game of the year for Bronswell Patrick and Sherwood Wilder, both of whom had been busy helping the Vikings' basketball team win the state title, but the two appeared to be in midseason form as they helped the Vikings roll over Farmville, 13-2, in high school baseball action Tuesday.

With only Monday's practice session under their belts, Patrick and Wilder helped Conley rap out 11 hits and also combined with starter Brian Bullock to hold the Jaguars to four hits.
 "I wanted all of them to throw," Conley coach Allan Wilson said of his team's latecomers. "But, I didn't want to throw them too much. I also wanted them to hit the ball. That's what we've been missing."

Bullock pitched the first four innings, giving up three hits and two runs while striking out seven. Patrick came on in the fifth and pitched two scoreless innings with four strikeouts. Wilder then came on for the final inning and struck out the last batter to end the game.
 "Bronswell and Sherwood have thrown some," Wilson said. (But) that's the first live hitting they've faced."

Patrick also collected three hits and drove in a run while Bullock had two hits and two RBIs for the Vikings. Brian Joyner also hit a two-run homer in the five-run sixth inning.
 Conley went ahead early and never trailed.
 In the third inning, Bullock opened with a double, went to second on an error and moved to third on a single by Karl McLawhorn. Bullock then scored on Butch Mills' ground out to make it 1-0.
 The Vikings added three runs in the fourth. Joyner reached on an error on the third baseman and went to second on a wild pitch. Kervin Vines walked and Bullock followed that with an RBI single that scored Joyner.
 Vines later came home on an error by the second baseman before Robbie Nichols doubled home Bullock to make it 4-0.
 The Jaguars made their first and only attempt at a rally in the bottom of the fourth.
 With one out, Mike Vandiford walked before Chris Ross ripped a homer to make it 4-2. That was as close as the Jaguars would get.

Conley added three runs in the fifth.
 Patrick singled then moved home on consecutive errors. Joyner reached on one of the errors and moved to third on the other one. Wilder also reached on the first error, then stole second. Joyner then stole home to make it 6-2. Wilder also came home that inning, on a ground out by Jim Faulkner.
 The Vikings added five more runs in the sixth, with Joyner's two-run homer highlighting the scoring.
 Farmville had a chance to rally again in the fifth. Patrick had replaced Bullock on the mound and had given up a single and two walks to load the bases with one out.
 Nichols then caught Shea Terrell's pop fly and Patrick struck out Vandiford to end the threat.

"We're still not swinging the bats well," said Jaguar coach Bill Davis. "We've just got to keep our heads up, keep working hard and hopefully things will jell."
 Ironically, Farmville was not able to use pitcher Alexander Daniels, who like Patrick and Wilder, had missed the early part of the season while Farmville's basketball team advanced to the state finals.
 "He hadn't worked enough to pitch," Davis said.
 Conley improves to 2-1 on the year while Farmville drops to 1-2.
 "It was a close game to start with," Wilson said. "We started hitting the ball. They started making mistakes."

Facing A Known Team No Consolation For Syracuse

By The Associated Press
 For the Syracuse Orangemen, familiarity breeds caution.
 The Orangemen, winners of the NCAA Tournament's East Regional, will face a team they know well in the Final Four at New Orleans on Saturday. That opponent, Providence, has been the surprise team of yet another wild college basketball championship tournament.

He dismissed the fact Syracuse, 30-6, has won 15 straight games against Providence, which was fourth in the conference this year. The Orangemen tied with Georgetown and Pittsburgh for first place and then lost the conference tourney final to the Hoyas.
 "They're the hottest team in the tournament," Boeheim said. "Everyone else has had to struggle. All the regional finals and semifinals came down to the last shot or the last play, except theirs. They're playing the best of anybody at this stage."

to try to push the pace with us. It's going to be a very fast game."
 Probably not as fast as the nightcap, however. The top-ranked Runnin' Rebels of Nevada-Las Vegas, in the Final Four for the first time in 10 years, won't do much walking. Neither will Indiana, which built its 28-4 record on solid defense — a trademark of all Bobby Knight teams — and a high-powered attack led by All-America guard Steve Alford.
 "It will be a real physical game," said Jerry Tarkanian, coach of the Rebels, 37-1. "Bobby's teams always play that way. If we play a real good ball game, I think we have a chance. I hope we are a team of destiny."

East Carolina's Lady Pirate tennis team rolled up a 9-0 victory over Mt. Olive College Tuesday.
 The Lady Pirates were never contested in the match, losing only 13 games throughout the whole afternoon.
 The victory boosts East Carolina to 11-8 on the year. The Lady Pirates play host to St. Mary's on Thursday.
 Summary:
 Amy Ziemer (EC) d. Michele Brown, 6-0, 6-1.
 Maria Swaim (EC) d. Jennifer Williams, 6-0, 6-0.
 Ty Myers (EC) d. Donna Best, 6-0, 6-1.
 Susan Montjoy (EC) d. Kyan Kramer, 6-2, 6-0.
 Holly Murray (EC) d. Leigh Culbreth, 6-1, 6-1.
 Kim Bergen (EC) d. Melinda Joyner, 6-0, 6-0.
 Jeannie Jones-Swaim (EC) d. Brown-Kramer, 6-0, 6-1.
 Montjoy-Myers (EC) d. Williams-Best, 6-4, 6-1.
 Murray-Ziemer (EC) d. Culbreth-Joyner, 6-0, 6-1.

Conley	ab	r	h	rb	Farmville	ab	r	h	rb
McLawnhorn	3	0	1	0	Huber	3	0	2	0
Mills	5	1	1	1	Wooten	2	0	0	0
Patrick	5	2	3	1	Baker	3	0	1	0
Joyner	4	3	1	2	Terrell	3	0	0	0
Wilder	4	2	1	0	Vandiford	2	1	0	0
Vines	2	2	0	0	Collins	2	0	0	0
Faulkner	3	0	1	0	Ross	3	1	1	1
Bullock	3	2	2	2	Little	3	0	1	0
Nichols	3	0	1	1	Barnhill	2	0	0	0
LeGrand	0	2	0	0					
Hoffner	2	1	1	0					
Totals	34	13	11	8	Totals	23	2	4	1

Tarboro Tops Jags

TARBORO — Tarboro High School eased past Farmville Central in a nine-hole golf match held at the Tarboro Country Club Tuesday.
 Tarboro finished the afternoon with a team total of 160 while Farmville Central came in with a 178 total.
 Steve Brewer led Tarboro with a 35 while Lee Edmondson had 40, Jim Stocks had 42 and Will Aycock had 43.
 Farmville Central was paced by Mark Williams with a 39, while Lance Parker and Gary Joyner each had 46 and Parker Ledbetter had 47.
 The loss drops the Jaguars to 1-3 on the year. They return to action on Thursday, hosting Conley, Zebulon and Southern Wayne at the Farmville Golf and Country Club.

"They're not the same team we beat twice," Syracuse guard Sherman Douglas said. "They've raised their game a notch. They're using the 3-pointers more. They're more aggressive. The two games we played them, we had to come from behind, which showed us they can beat us."
 Providence's 88-73 win over Georgetown, which had routed the Friars 84-66 in the Big East tournament earlier this month, proved there are no favorites in postseason.
 "Anyone that's overconfident at this stage shouldn't be in college," Syracuse Coach Jim Boeheim said.

"It would be understating it to say it is a shock," Providence Coach Rick Pitino said of being 25-8 and in the Final Four. "The biggest shock is the way we have done it."
 "We played on Alabama-Birmingham's home court and that didn't bother us. One of the toughest defensive teams we faced all year was Austin Peay. Then we played the SEC (Southeastern Conference) champions and the Big East champions and executed very well."
 Pitino, who once was an assistant at Syracuse under Boeheim, said he doesn't look for a repeat in style of last Saturday's Georgetown game. The Hoyas shut down the Friars' vaunted outside game but, while guards Billy Donovan and Delray Brooks struggled, Providence dominated the inside.
 "We're going to react to what they give us," Pitino said. "We're going to try to push the pace and they're going

"I think we've really improved, but at times we play really immature, run the offense too quick," forward Daryl Thomas said. "That leads to a bad defensive conversion. ... The other team gets it out and runs it up."

Lady Bucs Take Win

East Carolina's Lady Pirate tennis team rolled up a 9-0 victory over Mt. Olive College Tuesday.
 The Lady Pirates were never contested in the match, losing only 13 games throughout the whole afternoon.
 The victory boosts East Carolina to 11-8 on the year. The Lady Pirates play host to St. Mary's on Thursday.
 Summary:
 Amy Ziemer (EC) d. Michele Brown, 6-0, 6-1.
 Maria Swaim (EC) d. Jennifer Williams, 6-0, 6-0.
 Ty Myers (EC) d. Donna Best, 6-0, 6-1.
 Susan Montjoy (EC) d. Kyan Kramer, 6-2, 6-0.
 Holly Murray (EC) d. Leigh Culbreth, 6-1, 6-1.
 Kim Bergen (EC) d. Melinda Joyner, 6-0, 6-0.
 Jeannie Jones-Swaim (EC) d. Brown-Kramer, 6-0, 6-1.
 Montjoy-Myers (EC) d. Williams-Best, 6-4, 6-1.
 Murray-Ziemer (EC) d. Culbreth-Joyner, 6-0, 6-1.

D.H. Conley	ab	r	h	rb	Farmville	ab	r	h	rb
McLawnhorn	3	0	1	0	Huber	3	0	2	0
Mills	5	1	1	1	Wooten	2	0	0	0
Patrick	5	2	3	1	Baker	3	0	1	0
Joyner	4	3	1	2	Terrell	3	0	0	0
Wilder	4	2	1	0	Vandiford	2	1	0	0
Vines	2	2	0	0	Collins	2	0	0	0
Faulkner	3	0	1	0	Ross	3	1	1	1
Bullock	3	2	2	2	Little	3	0	1	0
Nichols	3	0	1	1	Barnhill	2	0	0	0
LeGrand	0	2	0	0					
Hoffner	2	1	1	0					
Totals	34	13	11	8	Totals	23	2	4	1

Rec Tennis Gets Win

The Greenville Recreation and Parks Department's junior boys tennis team opened its season Tuesday with a 15-2 win over Kinston.
 The team travels to Goldsboro for its next match on April 1 to face Wayne Country Day.
 Summary:
 Derrick Hines (G) d. Prashant Demon, 8-5.
 Chris Bland (G) d. Mike Walters, 8-0.
 Joseph Taft (G) d. Kyle Lewelyn, 8-1.
 Mike West (K) Stephen Simpson, 8-4.
 Kieth Corbett (G) d. Danny Summerlin, 8-1.
 Jeff Pittman (G) d. Rob Worthington, 8-0.
 Ray Randall (K) d. Joel Metzger, 9-7.
 Heath Nisbet (G) d. Joe Deveav, 8-6.
 Devon Wilkins (G) d. Jimmy Landry, 8-1.
 Hank Thompson (G) d. John Skinner, 8-3.
 Mark Honeycutt (G) d. Wesley Collins, 8-4.
 Joel Metzger (G) d. Kevin Worthington, 6-0.
 Hines-Bland (G) d. Demon-Walters, 8-1.
 Taft-Simpson (G) d. Lewelyn-West, 8-1.
 Corbett-Pittman (G) d. Summerlin-Worthington, 8-1.
 Wilkins-Nisbet (G) d. Caps-Collins, 6-3.
 Honeycutt-Thompson (G) d. Skinner-Landry, 6-0.

Rose Girls Win Opener

Lisa Leisten scored the only goal of the game as the Rose girl's soccer team won its opening match of the year, 1-0, over the Eastern North Carolina School For the Deaf Tuesday.
 The game was scoreless in the first half before Leisten scored on a break away with four minutes left in the game.
 Rose took seven shots at the goal while NCSDF took only four. Senior goalie Adrienne Harrington had her first shutout of the year and had five saves.
 Rose improves to 1-0 and 1-0 in the Big East Conference.
 The Rampettes next game is Friday at Rocky Mount.

"We're going to react to what they give us," Pitino said. "We're going to try to push the pace and they're going

Pre-Season SALE DAYS

Sale Ends **March 31, 1987**

	Reg. \$1229⁹⁵
	Less Trade - 100⁰⁰
<p style="font-size: 1.2em; font-weight: bold;">\$1000.00</p> <p style="font-weight: bold;">Instant Credit</p>	Your Cost \$1129⁹⁵

90 Days Same As Cash

TORO

Sutton's Service Center

1105 Dickinson Ave. 752-6121
 Open Mon.-Fri. 7:00-5:30 Sat. 7:00-1:30

Used Tires - All Sizes

Priced As Low As

4 For \$36

13", 14", & 15"

(Mount & Balance extra)
 We fix flats—\$2 each

Washington St. Behind Evans Seafood

SALE ON STEEL

Steel Belted Radials — Some Of Goodyear's Most Popular Tires — Now Sale Priced To Fit Your Budget!

Sale Ends Sat., March 28

Custom Polysteel Radial

Whitewall Size	SALE PRICE No trade needed.	Whitewall Size	SALE PRICE No trade needed.
P175/80R13	\$43.95	P215/75R14	\$55.95
P185/80R13	\$45.95	P225/75R14	\$59.95
P175/75R14	\$46.95	P205/75R15	\$56.95
P185/75R14	\$49.95	P215/75R15	\$58.95
P195/75R14	\$52.95	P225/75R15	\$61.95
P205/75R14	\$54.95	P235/75R15	\$65.95

\$29⁹⁵

P155/80R13 Whitewall. No Trade Needed.

Tread Designed For Traction Even In The Rain*

*NOTE: Rib count and sidewall styling may vary with size.

Steel Belts For Strength And Durability

Polyester cord body, radial construction for smooth ride and gas-saving performance.

Disc Brake Service

\$59

New front disc pads, repack wheel bearings, resurface front rotors. Conventional rear wheel drive vehicles. Prices vary for front wheel drive. Caliper overhaul \$22.50 each if needed. Hydraulic service will be recommended if needed for safe operation.
Warranted 12 months or 12,000 miles, whichever comes first

Engine Tune-Up

For most cars with Electronic Ignition Systems.

\$32 4-cyl \$39 6-cyl \$46 8-cyl

Includes computerized engine performance analysis. Check battery, starting, charging, combustion systems. Install new spark plugs. Set timing. Adjust carburetor, where applicable. Extra charge if removal is necessary.
Warranted 6 months or 6,000 miles, whichever comes first

Oil Filter, Chassis Lube, And Oil Change

\$14⁸⁸

Lubricate chassis, drain oil and refill with up to five quarts of major brand motor oil, and install a new oil filter. Note: special diesel oil and filter type may result in extra charges.
Oil brands may vary by location

David Harris
Store Manager
Buyers Market

Phill Trull
Store Manager
Downtown Store

Goodyear Take Me Home

"Service With A Smile"

We employ technicians certified by the National Institute for Automotive Service Excellence

GOODYEAR

TIRE CENTER

729 Dickinson Ave. Open 7:30-6, Sat. 'til 5:00

752-4417

Greenville Buyers Market Open 7:30-6, Sat. 'til 5:00

756-9371

GOODYEAR AUTO SERVICE IS AVAILABLE ONLY AT GOODYEAR AUTO SERVICE CENTERS AND FRANCHISEES' PRICES LIMITED WARRANTY. CREDIT TERMS AND AUTO SERVICE OFFERS SHOWN HEREIN ARE BY GOODYEAR AUTO SERVICE CENTERS. SEE ANY OF THE BELOW LISTED INDEPENDENT DEALERS FOR THEIR COMPLETE LISTING. WARRANTY, CREDIT TERMS AND AUTO SERVICE OFFERS NOT AVAILABLE AT STATIONED LOCATIONS.

SCOREBOARD

NHL Standings

By The Associated Press
All Times EST

WALESE CONFERENCE

Team	W	L	T	Pts	GF	GA
x-Philadelphia	33	10	7	73	257	225
NV Islanders	33	10	7	73	261	264
NV Rangers	32	8	7	72	287	286
Pittsburgh	28	12	6	62	279	271
Washington	26	11	6	58	283	337

Adams Division

Team	W	L	T	Pts	GF	GA
x-Hartford	40	7	7	87	365	245
x-Montreal	35	10	6	76	253	222
x-Boston	32	7	7	72	278	256
Quebec	27	10	6	64	291	309
Vancouver	27	9	7	61	257	283

CAMPBELL CONFERENCE

Team	W	L	T	Pts	GF	GA
Detroit	33	10	7	74	248	258
St. Louis	28	11	7	63	254	272
Los Angeles	28	12	6	62	286	294
Minnesota	26	9	7	67	276	289
Toronto	26	9	6	58	287	299

NBA Standings

By The Associated Press
All Times EST

EASTERN CONFERENCE

Team	W	L	Pct.	GB
x-Boston	51	18	.739	-
Philadelphia	39	31	.551	13
Washington	35	33	.515	15½
New York	31	48	.394	30
New Jersey	27	59	.320	31

Central Division

Team	W	L	Pct.	GB
x-Detroit	47	22	.681	-
x-Milwaukee	43	25	.626	5
Chicago	33	34	.497	12
Indiana	33	35	.485	13½
Cleveland	26	44	.371	21½

WESTERN CONFERENCE

Team	W	L	Pct.	GB
x-Utah	46	23	.667	-
x-Houston	38	30	.559	7½
Denver	36	34	.514	10½
San Antonio	26	43	.377	28
Sacramento	21	48	.304	35

Pacific Division

Team	W	L	Pct.	GB
x-L.A. Lakers	54	15	.783	-
x-Portland	42	27	.609	12

MISL Standings

By The Associated Press
All Times EST

Eastern Division

Team	W	L	Pct.	GB
Baltimore	26	12	.684	-
Cleveland	24	14	.632	2
Dallas	24	17	.585	3½
Minnesota	22	18	.550	5
Chicago	19	20	.487	7½

Western Division

Team	W	L	Pct.	GB
Tacoma	24	14	.632	-
Kansas City	22	17	.564	2½
San Diego	20	17	.541	3½
Wichita	20	19	.513	4½
St. Louis	14	27	.341	11½

NCAA Tournament

By The Associated Press
All Times EST

AMERICAN LEAGUE

Team	W	L	Pct.
New York	12	8	.600
Boston	11	10	.524
Minnesota	9	7	.563
Toronto	8	7	.500
Oakland	7	9	.438

NATIONAL LEAGUE

Team	W	L	Pct.
St. Louis	14	5	.727
St. Louis	13	4	.675
Chicago	13	8	.619

NIT Schedule

By The Associated Press

At New York

Team	W	L	Pct.
Syracuse	20-4	vs. Providence	25-8
Indiana	25-4	vs. Nevada-Las Vegas	37-1

At Miami, Fla.

Team	W	L	Pct.
Toronto	vs. Kansas City	ced., rain	
Baltimore	(as) vs. Montreal	ced., rain	
Philadelphia	vs. Cincinnati	0	
Pittsburgh	vs. St. Louis	1	

At Kansas City

Team	W	L	Pct.
Chicago	vs. New York	7:30 p.m.	
Boston	vs. Washington	7:30 p.m.	
Dallas	vs. Atlanta	7:30 p.m.	
Portland	vs. Houston	8:30 p.m.	
Seattle	vs. Denver	9:30 p.m.	
San Antonio	vs. Dallas	10:30 p.m.	
Phoenix	vs. Sacramento	10:30 p.m.	

At Sacramento

Team	W	L	Pct.
Los Angeles	vs. Cincinnati	at Tampa, Fla., 1 p.m.	
Toronto	vs. St. Louis	at St. Petersburg, Fla., 1 p.m.	
Chicago	vs. New York	(as) vs. Houston (as) at Kissimmee, Fla., 1:05 p.m.	
Philadelphia	vs. Chicago	White Sox (as) at Sarasota, Fla., 1:30 p.m.	
Kansas City	vs. Detroit	at Lakeland, Fla., 1:30 p.m.	
New York	vs. Minnesota	at Orlando, Fla., 1:30 p.m.	
Atlanta	vs. Montreal	at West Palm Beach, Fla., 1:30 p.m.	
Houston	(as) vs. Pittsburgh	at Bradenton, Fla., 1:30 p.m.	
Los Angeles	vs. Milwaukee	at Chandler, Ariz., 3 p.m.	
Seattle	vs. Oakland	at Phoenix, Ariz., 3 p.m.	
Chicago	vs. San Diego	at Yuma, Ariz., 3 p.m.	
San Francisco	vs. California	at Palm Springs, Calif., 4 p.m.	
Boston	vs. New York	Yankees at Fort Lauderdale, Fla., 7:30 p.m.	
Baltimore	vs. Texas	at Port Charlotte, Fla., 7:35 p.m.	

Transactions

By The Associated Press

BASEBALL

BALTIMORE ORIOLES—Placed Mike Young, outfielder, and Rex Hudler, infielder, on the 21-day disabled list. Optioned Billy Ripken, second baseman, D.L. Smith, shortstop, Carl Nichols, catcher, John Habyan, pitcher, and Chris Fagde, first baseman-outfielder, to Rochester of the International League. Outrighted Ricky Jones, outfielder, to Rochester. Optioned Greg Talamantez, pitcher, to Charlotte of the Southern League. Sent Donnie Scott and Jeff Tackett, catchers, Pete Stanick, second baseman, Craig Worthington, third baseman, Mike Hart, outfielder, and Rick Ownby and Jeff Ballard, pitchers, to their minor-league camp for reassignment.

FOOTBALL

ATLANTA BRAVES—Named Bruce Belton, pitching coach. Named Johnny Sain, pitching coach, pitching consultant.

BASEBALL

PITTSBURGH PIRATES—Optioned Jose Lind, infielder, and Tim Drummond, Hippoto Pena and Martin Hernandez, pitchers, to Vancouver of the Pacific Coast League. Signed Jose Lind, infielder, and Ed Rodriguez, infielder, Shawn Abner, outfielder, and Rusty Ford, Ray Hayward, Todd Simmons and Ed Volberg, pitchers, to their minor-league camp.

FOOTBALL

CHICAGO BEARS—Signed Jim Covert, tackle, to a series of one-year contracts.

Golf Scores

By The Associated Press

ATLANTA BRIVES

Player	Score
Jamesville	103 62-12
Bear Grass	100 01-1

ATLANTA BRIVES

Player	Score
Jamesville	103 62-12
Bear Grass	100 01-1

ATLANTA BRIVES

Player	Score
Jamesville	103 62-12
Bear Grass	100 01-1

ATLANTA BRIVES

Player	Score
Jamesville	103 62-12
Bear Grass	100 01-1

Transactions

By The Associated Press

BASEBALL

BALTIMORE ORIOLES—Placed Mike Young, outfielder, and Rex Hudler, infielder, on the 21-day disabled list. Optioned Billy Ripken, second baseman, D.L. Smith, shortstop, Carl Nichols, catcher, John Habyan, pitcher, and Chris Fagde, first baseman-outfielder, to Rochester of the International League. Outrighted Ricky Jones, outfielder, to Rochester. Optioned Greg Talamantez, pitcher, to Charlotte of the Southern League. Sent Donnie Scott and Jeff Tackett, catchers, Pete Stanick, second baseman, Craig Worthington, third baseman, Mike Hart, outfielder, and Rick Ownby and Jeff Ballard, pitchers, to their minor-league camp for reassignment.

FOOTBALL

ATLANTA BRAVES—Named Bruce Belton, pitching coach. Named Johnny Sain, pitching coach, pitching consultant.

BASEBALL

PITTSBURGH PIRATES—Optioned Jose Lind, infielder, and Tim Drummond, Hippoto Pena and Martin Hernandez, pitchers, to Vancouver of the Pacific Coast League. Signed Jose Lind, infielder, and Ed Rodriguez, infielder, Shawn Abner, outfielder, and Rusty Ford, Ray Hayward, Todd Simmons and Ed Volberg, pitchers, to their minor-league camp.

FOOTBALL

CHICAGO BEARS—Signed Jim Covert, tackle, to a series of one-year contracts.

Transactions

By The Associated Press

BASEBALL

BALTIMORE ORIOLES—Placed Mike Young, outfielder, and Rex Hudler, infielder, on the 21-day disabled list. Optioned Billy Ripken, second baseman, D.L. Smith, shortstop, Carl Nichols, catcher, John Habyan, pitcher, and Chris Fagde, first baseman-outfielder, to Rochester of the International League. Outrighted Ricky Jones, outfielder, to Rochester. Optioned Greg Talamantez, pitcher, to Charlotte of the Southern League. Sent Donnie Scott and Jeff Tackett, catchers, Pete Stanick, second baseman, Craig Worthington, third baseman, Mike Hart, outfielder, and Rick Ownby and Jeff Ballard, pitchers, to their minor-league camp for reassignment.

FOOTBALL

ATLANTA BRAVES—Named Bruce Belton, pitching coach. Named Johnny Sain, pitching coach, pitching consultant.

BASEBALL

PITTSBURGH PIRATES—Optioned Jose Lind, infielder, and Tim Drummond, Hippoto Pena and Martin Hernandez, pitchers, to Vancouver of the Pacific Coast League. Signed Jose Lind, infielder, and Ed Rodriguez, infielder, Shawn Abner, outfielder, and Rusty Ford, Ray Hayward, Todd Simmons and Ed Volberg, pitchers, to their minor-league camp.

FOOTBALL

CHICAGO BEARS—Signed Jim Covert, tackle, to a series of one-year contracts.

TANK McNAMARA by Jeff Millar & Bill Hinds

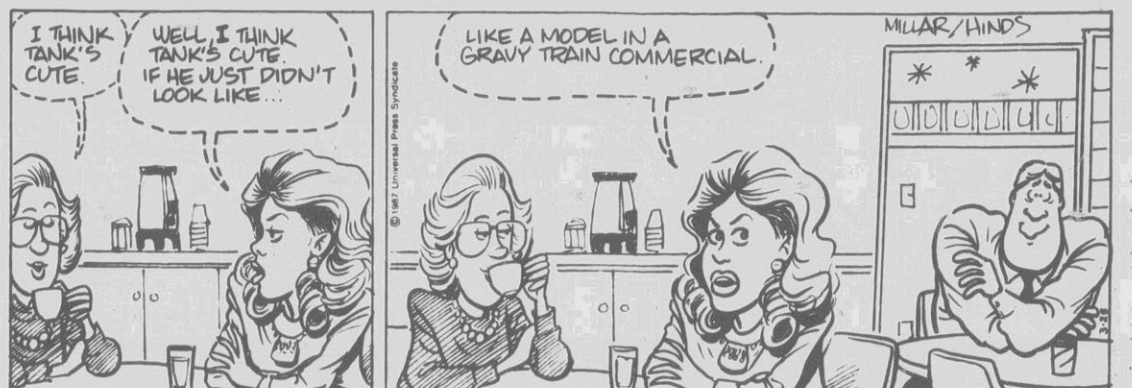

ALACHUA, Fla. (AP) — Second-round scores Tuesday in the Futures Golf Tour's \$200,000 Turkey Creek Classic at the 6,190-yard, par-72 Turkey Creek Country Club (a-grades amateur):

76-71-147	Denise King	76-74-150	Rhonda Reilly	77-75-152
76-71-147	Anne Heuschneider	77-73-150	Cathy Tatum	82-70-152
72-75-147	Sharon Smith	71-79-150	Jennifer Cole	79-74-152
79-69-146	Debbie Rhodes	75-75-150	Carol Hogan	79-73-152
74-75-149	Lu Smart	77-74-151	Debbie Zahand	77-75-152
77-72-149	Robin Abare	77-74-151	Shelly Rule	80-73-153
75-74-149	Jane Kleiman	77-74-151	Janine Kullman	74-79-153
73-76-149	Janet Robbins	75-76-151	Cara Andreoli	78-75-153
76-74-150	Jennifer MacCarrach	73-78-151	Lisa Grimes	74-80-154

Cindy Schreyer
Marilyn Lovander
Jennifer Steiner
Jenny Ludback
Debbie Cum
Donna Fiedorowicz
LuLung Radler
a-Brenda Corne
Wendy Ver Brugge

Boyd Leads Valkyries Past Lady Jaguars, 9-4

FARMVILLE — Trellan Boyd went 3-4 as D.H. Conley's girl's softball team defeated Farmville Central, 9-4, Tuesday.

The Valkyries went ahead 4-0 in the third inning and never looked back. Conley loaded the bases with Miriam Fulford, Boyd and Tabitha Dalton. Three runs then scored on an error on the shortstop.

Gail Cash got the win for Conley, which improves to 4-0. Farmville drops to 1-2.

Chocowinity.....15

COLUMBIA.....9

COLUMBIA — Chocowinity rallied from a 9-0 deficit to gain a 15-9 softball victory over Columbia Tuesday in Tobacco Belt Conference action.

Columbia took the lead with two runs in the first then added seven in the third for the 9-0 lead.

But Chocowinity came back with three in the fourth, then scored six in the fifth, three on a homer by Christie Bradley, tying it at 9-9.

In the fifth, Chocowinity scored four more times for a 13-9 lead. Corinna Paszt reached on an error and

scored on a triple by Bradley. Susan Elks singled in Bradley and Dawn Mayo reached on an error. Tracy Dixon hit a sacrifice fly to score Elks and Cheryl Wiggins doubled in Mayo.

The Lady Tribe added three more in the seventh to wrap it up.

Bradley led Chocowinity's hitting by hitting for the cycle. Wendy Dixon, Susan Elks and Vickie Elks each added two. Elizabeth Tarkington had two for Columbia.

Now 2-2, Chocowinity plays host to Creswell on Thursday.

Chocowinity.....200 364 2-15 16 7
Columbia.....207 300 0-9 8 12
WP — Vickie Elks.

Jamesville.....12

Bear Grass.....1

JAMESVILLE — Jennifer Getchel singled home two runs in the first two innings as Jamesville rolled to a 12-1 win over Bear Grass in high school softball action Tuesday.

In the first inning, Carolyn Price doubled and then came home on a single by Getchel. In the third inning, Michelle Peele reached on a fielder's choice. Price then singled to score Peele. Getchel then singled home Price before Val Clark brought home Getchel with a base hit to make it 4-0.

Jamesville improves to 4-1 overall and 2-1 in the conference. The Bullets return to action next Thursday at Behaven.

Jamesville.....103 62-12
Bear Grass.....100 01-1
WP — Jennifer Getchel.

Thanks...

Your patience and understanding are appreciated, as we were unable to repair stereos this past year. We now have a specialist in Stereo - VCR - CD Player - Monitors - and Big Screen TV Repair. Call us for any repair needed on these electronic items listed above.

Where Did We Go? In The Brick House Next To Our Old Building. Coming Soon: The LARGEST, MOST MODERN RCA DEALERSHIP IN TOWN!

Cox Electronics

Owned & Operated by Rudy Cox
2313 South Memorial Drive, Greenville, N.C.
Factory Trained Technicians • No Money Down With Approved Credit
Hours: Monday Through Saturday 8:30-5:30
Other Times By Appointment

McGraw, Smith Lead...

(Continued From B-1)

slapped still another Bronco homer for a 2-0 edge.

The Pirates used the long ball themselves in the second to take a 4-2 lead, however. Andrews walked and Ritchie beat out a bunt single. Adams singled to drive in Andrews and Sides followed with his fourth homer of the year, scoring all three runs.

Rider pulled back into a tie in the third. With one out, Kremer walked and Vallorosi homered to left, knotting it at 4-4.

Rider then took the lead in the

fourth with one. Larkin beat out an infield hit and stole second. He took third on a wild pitch and scored when Coddington reached on an error.

The Pirates tied it again with one in the bottom of the fourth. Thomas singled and was sacrificed up. He scored on Adams' single.

It stayed tied until the seventh when McGraw struck. Adams led off with a walk but went down on Sides' infield grounder. Then, after a popup made two away, McGraw crushed the ball to left.

"The only question when it left the bat was whether it would be fair or

foul," Overton said. "I couldn't tell, but when I saw their pitcher walk off the mound, I knew."

Adams had two hits to lead ECU while Rider was paced by Larkin and Joe Lacagnina with two each.

The loss drops Rider to 1-8 on the year, having lost eight in a row after an initial win.

The Pirates are now 10-2 and return to action on Saturday at Williamsburg, Va., facing Colonial Athletic Association rival William & Mary in a single game. The two play a doubleheader on Sunday.

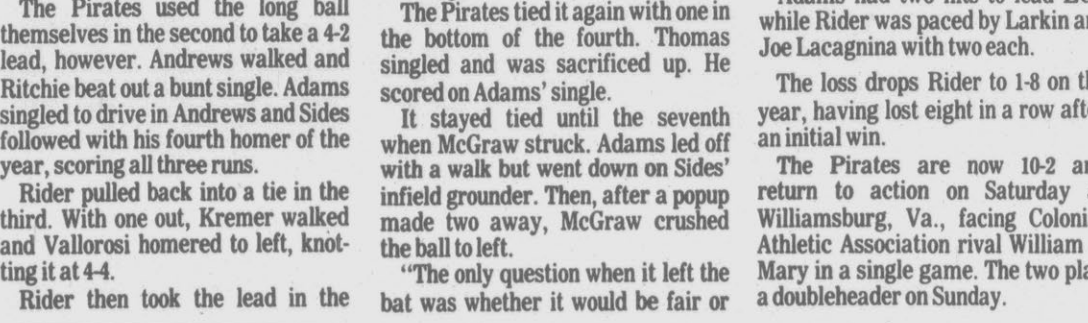

SHOP THURSDAY, FRIDAY AND SATURDAY!

Belk carolina east mall greenville

SPECIAL PURCHASE

99.99 Sport-Table
34.99 Sport-Umbrella

Sport-Table is literally a go-anywhere table with seating for up to four adults. It is self-contained and folds into a very slim, lightweight, easy-to-carry case. Add the Sport-Umbrella and Sport-Table becomes a portable, shaded picnic or recreation table for any outdoor setting. No assembly is required.

Shop Carolina East Mall, Greenville, Monday Through Saturday 10 a.m. Until 9 p.m. Phone 756-B-E-L-K (756-2355)

The Bank Said Yes!

Your Choice

\$289 Per Month*



Now you can drive a fine European road car for less than what many people pay for an ordinary car.

Due to a special arrangement with the bank, for 3 Days Only. Your choice BMW or Volvo... Just \$289 per month.

Three Days Only... Two Great Cars... One Low Payment.

Bob Barbour
BMW • Volvo
3303 S. Memorial Dr. GREENVILLE 355-7200

*Actual payment \$289.49, 60 month closed end lease, plus 1st payment, registration, security deposit and \$1424 down on Volvo. Residual Value on BMW \$10917, Volvo \$8696.

Peterson Goes The Distance As Chargers Rout Havelock

HAVELOCK — Ayden-Grifton scored seven times in the first inning and went on to romp to a 15-1 baseball victory over Havelock High School Tuesday.

Ronnell Peterson hurled the victory, going the distance in his first-ever start. He struck out five and walked five as he scattered only three hits.

The first inning put the game away. Billy Miller led off with a walk and moved up on a wild pitch, scoring when Ty Little reached on an error. Gary Eubanks singled and Tony McLawhorn's hit scored Little. Courtesy runner James Woodard stole second and Aaron Harper walked to load the bases. Steven Tucker's grounder got Eubanks at the plate, but Stacy Cole walked to force in Woodard. Peterson singled in Harper and Tucker, and Miller doubled to drive in Cole and Peterson.

Ayden-Grifton added four in the second inning, then scored three times on a homer by Stacy Cole in the fourth. The final run came over in the sixth.

Havelock's only run scored in the fifth.

Miller led Ayden-Grifton's hitting with three while Eubanks, Peterson and Cole each had two, one of Cole's a triple. Andy Amidon had two of the three hits for Havelock.

The Chargers are now 2-3 on the year and play host to North Pitt.

Ayden-Grifton.....740 301 0-15 12 3
Havelock.....000 010 0-1 3 6
Peterson and McLawhorn; Amidon, Sikes (2), Duncan (4), Seaton (5) and Franks, Kelly (5).

**Greene Central.....6
West Craven.....0**

VANCEBORO — Greene Central rolled up a 6-0 baseball victory over West Craven Tuesday behind the shutout pitching of Eddie Honrine.

The game was scoreless until the sixth inning when the Rams scored four times to take the lead. T.J. Johnson singled and stole second. Gary Ginn singled and both runners were sacrificed up. Tommy Eason

Hoosier Stations To Play By Rules

BLOOMINGTON, Ind. (AP) — Because they don't want to see Steve Alford warming the bench during the Final Four in New Orleans this weekend, three Indiana radio stations say they will stop playing "Stevie Shoot a Three-Pointer" and the "Bobby Knight Bop."

Indiana University sports promotion director Chuck Crabb said WEAG-FM and WENS-FM in Indianapolis, and WTTS-FM in Bloomington, stopped playing the songs when they learned the NCAA had warned that any player named in a song on a commercial broadcast could be ineligible to play in remaining games.

"Three of the four radio stations I've had to contact about playing the songs have all agreed to comply with the request to discontinue the songs," Crabb said.

"They said the last thing they wanted was for any player's eligibility to be in question going into the Final Four."

Crabb said the fourth station, WSTO in Owensboro, Kentucky, is unwilling to stop playing "Stevie Shoot a Three-Pointer," which was written by a WSTO employee.

"Barry Witherspoon, the program director there, says they don't see the song as being sold as a commercial product," Crabb said. "They say they want to study the matter further."

Crabb said the problem began when he heard "Stevie Shoot a Three-Pointer" on WTTS.

Alford received a one-game NCAA suspension in the 1985-86 season because he posed for a calendar made by an I.U. sorority to benefit charity.

"I heard the song, and a note of alarm went off in my brain," Crabb said. "So I contacted our associate athletic director, who talked with the Big Ten, which then sent a request for interpretation to the NCAA."

reached on a fielder's choice that left the bases loaded. A wild pitch brought in Johnson, and Barry Ginn followed with a three-run homer.

The Rams added two more in the seventh.

The Ganns each had two hits, Gary adding a double. West Craven was led by David Boyd and John Taylor, each of whom doubled.

The victory boosts the Rams to 6-2 on the year. They return to action on Thursday, opening Eastern Plains Conference action against C.B. Aycock.

Greene Central.....000 004 2-6 8 0
West Craven.....000 000 0-0 6 1
Honrine and Eason; Woolard, Nobles (7) and Boyd.

**Columbia.....2
Chocowinity.....1**

COLUMBIA — Columbia High School pushed across a run in the bottom of the fifth inning to nip Chocowinity, 2-1, in a Tobacco Belt Conference baseball game Tuesday.

Columbia had taken the lead in the first with one run. Then, in the top of the fifth, Chocowinity rallied to tie it up.

Brian Badeau opened the fifth with a single but was forced on Jamie Stokes' grounder. Stokes stole up and scored on Brad Tyson's double to tie it at 1-1.

In the bottom of the inning, however, Columbia came back with a run to win it. Pledger walked and after two outs, stole second. Liverman then singled him in.

Badeau led Chocowinity's hitting with three while Liverman had two for Columbia.

Chocowinity, now 2-3 in the league and 2-4 overall, plays host to Creswell on Thursday.

Chocowinity.....000 010 0-1 8 2
Columbia.....100 010 x-2 3 4
Hawley and Vick; F. Creech, J. Creech (6) and Kirkman.

**Jamesville.....16
Bear Grass.....9**

JAMESVILLE — Jamesville High School took advantage of 17 walks to rout Bear Grass, 16-9, in Tobacco Belt Conference baseball Tuesday.

Both teams scored single runs in the first inning with the Bullets adding two in the second. Bear Grass came back with three in the third for a 4-3 lead, then added three more in the fourth. Jamesville rallied for five in the bottom of the inning, but the Bears added another in the top of the fifth for a 9-8 tie.

The Bullets then scored three times in the bottom of the fifth to take the lead for good. Ernie Coltrain and Ernie Gardner both walked. Eric Spruill singled to score Coltrain. Spruill moved up on the relay and both he and Gardner scored on Jeff Phelps singled for an 11-8 lead.

The Bullets added five more in the sixth while Bear Grass got one in the seventh.

Tommy Mobley and Jake Scott each had two hits for Bear Grass while no one had more than one for Jamesville.

Jamesville is now 3-3 overall and 3-1 in the league. The Bullets travel to Belhaven on Thursday.

Bear Grass.....103 310 1-9 6 7
Jamesville.....120 535 x-16 6 4
Whitley, Stalls (4), Whitley (5), Wynn (5), Stalls (6) and Rawls; Gardner and Dickerson.

**Ahoskie.....9
Williamston.....1**

WILLIAMSTON — Ahoskie rolled to a 9-1 win over Williamston in Northeastern 2-A baseball action Tuesday.

The Cougars pushed across two runs in the second inning and four more in the sixth as Ahoskie got ahead early and never was threatened.

In the second, Leary reached on a passed ball. Russell singled to score Leary before White singled Russell.

In the sixth, Anthony and Lassiter singled. Brown doubled home Anthony. Leary singled home Lassiter and Brown. Russell then singled home Leary.

Anthony had two hits and Leary had three. Williamston was led by Doug Manseau with two hits.

Williamston.....000 100 0-1
Ahoskie.....020 004 3-9
Spruill, James (6) and Manseau; Brown and Lassiter.

**Roanoke Rapids.....9
Roanoke.....0**

ROANOKE — Roanoke Rapids pushed across eight runs in the fifth inning to break open a scoreless game as the Yellow Jackets went on to take a 9-0 win over the Redskins in high baseball action Tuesday.

Roanoke went through four pitchers and suffered through eight errors.

In the decisive fifth inning, four straight walks and two straight errors allowed seven runs to score.

J. Allen opened the fifth with a walk. R. Allen sacrificed J. Allen to second. Collins reached on an error.

Oliver walked. Jackson, Rogerson and Story walked, bringing in R. Allen, Collins and Oliver to make it 3-0. An error on the catcher scored Jackson and Rogerson to make it 5-0.

An error on the second baseman allowed two more runs to score to make it 7-0. Roanoke Rapids scored one more run in the inning to make it 8-0.

Roanoke falls to 3-2 and returns to action Friday at Ahoskie.

Roanoke.....000 000 0-0 1 8
Roanoke Rapids.....000 081 0-9 5 2
Whitfield, Mason (4), James (4), Little (6) and Nicholson; Jean and Ellis.

Three DHC Players Named All-Stars

HOLLYWOOD — Three D.H. Conley basketball players, two from the boys' team and one from the girls' were selected to the Coastal All-Conference team announced last night.

Trellaney Boyd was named to the girls' first team while Rhonda Jackson received honorable mention.

From Washington, Angie Holley and Tonya Holley were both named to the second team.

On the boys' honor list, Troy Ebron and Ricky Farrow were both named to the first team while Phil Medlin was selected on the second team. Jonathan Bonner was given honorable mention.

From Washington, Frankie Warren was selected to the first time while Ryan Dixon was listed on the second team. Franz Holscher was named to the honorable mention list.

EXTRAVAGANZZA!

NINE TOPPINGS FOR THE PRICE OF FOUR



Call Domino's Pizza for the ExtravaganZZa™, our pizza with nine toppings for the price of four. We make every pizza by hand, using only the finest ingredients, like 100% Real cheese. And Domino's Pizza Delivers® the ExtravaganZZa™ hot and extra-delicious, in less than 30 minutes.

Call Domino's Pizza for the ExtravaganZZa™, our pizza with nine toppings for the price of four. We make every pizza by hand, using only the finest ingredients, like 100% Real cheese. And Domino's Pizza Delivers® the ExtravaganZZa™ hot and extra-delicious, in less than 30 minutes.

Serving East Greenville
Rivergate Shopping Center

752-6996

Serving West Greenville and ECU Campus

1201 Charles Blvd
758-6660

Serving West Greenville

2405 West Dickinson Ave. NE
756-9998

HOURS

11AM - 1AM Sun - Thurs
11AM - 2AM Fri & Sat

Limited Delivery Areas
Drivers carry less than \$20.00

DOMINO'S PIZZA DELIVERS FREE.

©1987 Domino's Pizza, Inc.

\$8.99 Special!

Get a small 12" ExtravaganZZa and 2 cans of Coke* for only \$8.99 (including tax).

One coupon per pizza. Offer good thru 4/13/87. Not valid with any other offer.

Please provide name, address, phone on coupon BEFORE driver arrives.

Name _____ Phone _____

Address _____

Southern States
Farm • Home • Garden

SPRING Sale Celebration

NOW thru March 28

3 hp. Briggs & Stratton Engine Statesman Front Tine Tiller

269⁹⁵
Reg. 299.95

14 ga. 100-ft. roll. Galvanized Welded Mesh 48 in. height

27⁴⁹
Reg. 41.95

Motto High-Tensile Barbed Wire
Easy handling. Long last ing. 80-rod roll.

20⁹⁵
Reg. 24.99

TRUE TEMPER Wheelbarrow

25⁹⁵
Reg. 40.95

AMES Post Hole Digger

6⁹⁹
Reg. 9.49

Liquid Fruit Tree Spray

4⁹⁹ pt.
Reg. 7.99

Round Point Shovel Welded Bow Rake Garden Hoe Metal Leaf Rake

AMES Your Choice

(Reg. 6.29) (Reg. 6.29) (Reg. 4.99) (Reg. 5.69)

3⁹⁹

Corner of Line Ave. & Chestnut St.
Phone 758-3173 or 758-3174

Quality for Everyone

COMING MARCH 27th & 28th

See Thursday's edition of THE DAILY REFLECTOR for more details!

7.5% APR OR CASH BACK

On quality built FORD lawn and garden tractors.

DON'T MISS THIS SALE!

TARHEEL FORD TRACTORS, INC.

Hwy 11 South • Ayden, N.C. • 746-6345
Open Daily 7:30-5:30, Saturday 7:30 to Noon

Big Decision Awaits Robinson

By HAL BOCK
AP Sports Writer

The decision weighs heavily on the broad shoulders of Midshipman 1st Class David Robinson, who continues to sweep college basketball's Player of the Year awards.

Does he become a part-time NBA player while completing his two-year Navy commitment? Or does he hang onto his amateur standing and play in this summer's Pan American Games and next year's Olympics?

For Robinson, who won the Eastman Award on Tuesday, his final days at the U.S. Naval Academy, where he set 33 school records, are clouded by the dilemma. "I am confident I'll be successful no matter which way I go," he said. "But I think one way might be better. The question is, which one?"

Robinson thoroughly enjoyed last summer's world championships and suspects the Pan Am-Olympic amateur perfecta would be just as rewarding an experience. He is almost certain, however, to be a lottery pick in the NBA draft and the right Navy assignment would permit him to start his pro career immediately.

There are other factors involved for the 7-foot-1 Robinson, whose size disqualifies him from sea and air duty and reduced his military obligation from five years to two. One is which NBA team drafts him. Another is the experience of his friend, Ensign Napoleon McCallum.

McCallum, a record-setting running back at the Naval Academy, was drafted by the NFL Los Angeles Raiders. He has combined his Monday-through-Friday Navy duty with a pro football career on Sundays.

"We talk a lot," Robinson said. "For Napoleon, it has been real hard. Practicing all the time, working in the Navy, putting the two together have been real tough for him. He told me he knows the money I'll be offered will be attractive but that I

should be careful and live day to day. There will always be a need (in the pros) for a big man. I'll still be seven feet tall in two years."

When he graduates May 20, Robinson will be commissioned in the civil engineer corps on a restricted-list billet, which limits his duty because of his size. When he enrolled at Annapolis, he was 6-7. He just kept growing beyond the limits that planes and ships can accommodate.

"I went to the Academy because I wanted a great education," he said. "Basketball was secondary to me. I felt I had more (academic) potential than I showed in high school. I felt I needed a little discipline."

"With the emphasis on academics and the military, the Academy is a tough place to develop your game. It's easy to get distracted from basketball. If you're not a great player with great potential, you might figure, 'Why waste my time?' When I came to the Academy, I was not a great player and it was not a great program. We had trouble getting 1,000 fans to a game. As I grew, the program grew. That was to my advantage."

Not to mention the Academy's. Now, Robinson thinks Navy is a viable option for high school players interested in getting a quality education in a program that is not a total stranger to the Top 20.

"I think a lot of guys want the education," he said. "That's real important today with the emphasis on academics. I think scholar-athletes will go that route, especially shooting guards or small forwards. If they are realistic about their pro potential and remember the small percentage of players who make it to the pros, they'll take a chance."

"Big men who are pro prospects will still go to the other schools."

Or, perhaps, they'll remember David Robinson and sign on, too.

Solid Cherry!! Solid Savings!! Solid Values!!



Save Up To 40% On Solid Cherry Bedrooms

**Show Room Hours
8 AM To 5:30 PM
Monday Thru Saturday
& Open 'Til 9 Friday Nites**

**Save \$745 Retail \$1740 Special Purchase
Four Piece Solid Pennsylvania Cherry Group**

60 Inch 9 Drawer Triple Dresser And Beveled Plate Glass Mirror, 7 Drawer Chest On Chest And Full-Queen Piedmont Headboard. . . **SALE PRICE \$995**

Open Stock Group...Buy Any Piece You Desire!

**Retail \$1680. Save \$695
Four Piece Solid Pennsylvania Cherry 18th Century Group**

- Double Dresser
- Landscape Mirror
- 6 Drawer Chest
- Spindle Headboard

SALE PRICE \$985

Crescent Solid Cherry Bedroom Exclusively At Bostic-Sugg!!

Retail \$2745. Save \$1105!! 5 Piece Solid Pennsylvania Cherry Master Bedroom Group With Door Pieces

72" Tall Triple Dresser-1 Drawer With Two Crown Beveled Mirrors
Armoire Chest With 7 Drawers
And Queen Size Tall Post Tester Bed **SALE PRICE \$1640**

Save \$280. Retail \$675. Queen Size Pencil Post Bed In Solid Cherry Hand Rubbed Finish

Wood Rails Includes 84" Tall Post. Tomorrow's Heirloom At Today's Prices. **SALE PRICE \$399**

Save \$95 To \$110 On Solid Cherry Nite Stands

Retail \$220.00
One Drawer 1 Shelf Nite Stand **SALE PRICE \$125**

Nite-Chest 3 Drawer **SALE PRICE \$165**
Retail \$275. PRICE

Wyoming Coach Moves West

SAN DIEGO (AP) — In the battle for Jim Brandenburg's heart, Wyoming more than matched San Diego State dollar for dollar but ended up losing its veteran basketball coach to the allure of Southern California.

At a Tuesday news conference to announce his appointment as San Diego State's new basketball coach, Brandenburg said he relished the challenge of rebuilding an Aztec program that sagged to new lows in 1986-87. He also said he was attracted to the job by the quality of life the city offers.

"I think this is a tremendous community, and I think there is unlimited potential. It's an opportunity I just couldn't afford to turn down," Brandenburg said.

Wyoming Athletic Director Paul Roach, who failed in an 11th-hour bid to change Brandenburg's mind, said he hopes to name a new basketball coach within 10 days.

Roach said he offered to raise Brandenburg's annual pay but could not convince the coach to stay.

"I know the issue wasn't money," he said.

Brandenburg left a Wyoming club that won the Western Athletic Conference tournament and advanced to the Round of 16 in the NCAA tournament before being eliminated last Friday by Nevada-Las Vegas. Last season, the Cowboys were 24-12 and advanced to the finals of the NIT tournament, where they lost to Ohio State.

All five starters from this season's 24-10 Cowboys team are returning next year.

At San Diego State, Brandenburg, 51, takes the reins of a team that suffered through a school record 17-game losing streak en route to a 5-25 record, the worst in the school's history.

He replaced David "Smokey" Gaines, who resigned Feb. 6 but stayed on to coach through the end of the season, when he became San Diego State's assistant athletic director for marketing and promotions.

Brandenburg is no stranger to rebuilding projects. In 1978, he took over a Wyoming program that in the previous eight years had only one winning season.

Fred Miller, San Diego State's athletic director, said Brandenburg was signed to a five-year contract with a base pay of \$57,000 a year plus other economic benefits that are being negotiated.

San Diego State and Wyoming are both members of the WAC, and Brandenburg's defection is likely to heat up the schools' rivalry.

Havelock Tops AG

LITTLEFIELD — Havelock High School's junior varsity baseball team downed Ayden-Grifton, 9-5, Tuesday.

Gene Stancil led the Charger Colt attack with a 3-4 afternoon. He also suffered the loss in the game.

Ayden-Grifton, now 2-2, plays at North Pitt on Friday.

**D.H. Conley.....8
North Pitt.....2**

HOLLYWOOD — Andy Fasfet went 3-3 to lead the D.H. Conley JV baseball team to a 8-2 win over North Pitt Tuesday.

Kendal Hardee took the win and combined with two other pitchers to hold the Panthers to two hits.

Conley improves to 4-1 and returns to action Friday at home against Kinston.

EAST CAROLINA INSURANCE AGENCY, INC.

"The Insurance Center"



For all your insurance needs.

Business, Homeowners, Auto, Boats, Group Life and Hospitalization and Individual Pensions, Bonds, Mobile Homes.

Representing

Aetna Life and Casualty, The Travelers Companies, The Harleyville Companies, North American Life, First of Georgia, The Royal Insurance Company.

2739 E. 10th Street (P.O. Box 3785)
Greenville, N.C. 27836



Carolyn V. Bowen
(Office Manager)
Angela C. Bowen
Linda S. Davenport
Frank B. Nelson

919-752-4323

Lakers Lose Magic Touch

By The Associated Press
 For one night, the Los Angeles Lakers — the team with the best record in the NBA — looked more like The Gang That Couldn't Shoot Straight.
 The Lakers lost Magic Johnson early in the game with a bruised calf muscle and then had their 10-game winning streak snapped by the Phoenix Suns 108-93 Tuesday night.
 Along the way, the Lakers made only two of 24 shots in the second quarter — the fewest field goals in one period ever in the Arizona Veterans Memorial Coliseum — as they were outscored 28-12 and fell behind 57-42 at halftime.
 "There's not a better team in the NBA to beat outside of the Lakers to come out of a slump," said Larry Nance, who scored 32 points as the Suns snapped a seven-game losing streak.
 "It was our very, very poor game combined with their great game," Los Angeles Coach Pat Riley said after his club fell to 54-15. "It was our mental slippage more than anything else. They were aggressive, they got all the loose balls and second shots. They dominated the boards."

Despite their cold shooting, the Lakers were warmer than Washington's Jeff Malone, a 22.3-point scorer. In what he conceded was "probably my worst shooting night," Malone missed his first 13 shots and scored only six points, getting his only field goal of the game with five seconds remaining as the Bulls lost to Atlanta 96-87.
 Meanwhile, at the other end of the thermometer:
 —Michael Jordan scored 56 points and sparked a 12-point burst in the fourth quarter as the Chicago Bulls held off the Philadelphia 76ers 93-91.
 —Larry Bird made 13 of 16 shots, including his last 10, and added nine assists and eight rebounds as the Boston Celtics rolled to a 111-88 victory over the Cleveland Cavaliers.
 —Mark Aguirre, who became involved in controversy after being ejected from a game on Saturday, scored a season-high 43 points and tied the pro scoring record for the Byrnie Meadowlands Arena as the Dallas Mavericks defeated the New Jersey Nets 119-107.
 —The Milwaukee Bucks set season highs of 78 points in the first half and

135 points in a game in routing the New York Knicks 135-96.
 Elsewhere, it was San Antonio 103, Houston 97; Denver 128, Los Angeles Clippers 119; Sacramento 128, Portland 116.
 Phoenix's Nance scored eight points during the lopsided second period. The Suns also scored the last seven points of the first quarter to trigger a 35-12 burst.
 The Lakers got within 73-65 late in the third quarter but six points from Nance, who had 11 in the period, put Phoenix ahead 83-70 and the Suns led by as many as 20 in the fourth quarter. James Worthy paced Los Angeles with 23 points.
 The Lakers were outrebounded 48-43 and had four shots blocked by the spirited Suns, who had lost 14 of 16 games against Los Angeles dating back to November, 1984.
 The victory was only the third in 11 games for Phoenix interim Coach Dick Van Arsdale, who took over for the fired John MacLeod on Feb. 26.
 "It was a great win, Magic or no Magic," Van Arsdale said. "We lost the last two games against the Lakers and they didn't have Magic in

the lineup, either. We were just ready to play tonight."
 Riley said the loss of Johnson may have been a factor in the outcome.
 "There's always a shock when one of your great ones goes down, and you could feel it on the bench," he said. "Magic got kicked in the back of the calf and we'll have to wait and see, but he should be okay. It's the same thing as a charley horse."
Hawks 96, Bulls 87
 Dominique Wilkins took six stitches above the left eye when he caught a stray elbow in the first quarter, but came back to score 31 points as Atlanta moved one game ahead of idle Detroit in the Central Division.
 Atlanta shot 39 percent and Washington 25 percent in a first half that included Wilkins' injury, a near-fight between Atlanta's Spud Webb and Washington's Michael Adams and the automatic ejection of Bulls Coach Kevin Loughery, who picked up two technical fouls for arguing a call.
Bulls 93, 76ers 91
 Jordan scored 56 points and sparked a 12-point burst in the fourth quarter. Jordan tied the game 71-71 with 9:50 left, then stole the ball and scored on a slam dunk 27 seconds later. After a three-point play by Gene Banks, Jordan added a free throw and two more baskets to give the Bulls an 81-71 lead with 5:14 left.
 Philadelphia, led by Steve Colter's season-high 21 points, pulled within 93-91 on Colter's steal and layup with 14 seconds left.
Celtics 111, Cavaliers 88
 Kevin McHale had all his 22 points and Bird had all but two of his 32 in the first three quarters as the Celtics built a 20-point lead and substituted freely in the final period.
 Brad Daugherty had 16 points for the Cavaliers, who scored only 76 points in a weekend loss to Indiana.

Boston held high-scoring rookie Ron Harper, who leads Cleveland with 23 points per game, to just eight, the first time all season he failed to score in double figures.
Mavericks 119, Nets 107
 Aguirre scored 18 points in the first quarter and 17 in the fourth period when Dallas came from behind for its sixth straight victory. New Jersey, which led by nine points in the third period, was ahead 88-84 early in the final quarter. Then Aguirre took over, scoring all of Dallas' points in a 13-4 spurt that put the Mavericks in front for good.
 The spurt put Dallas in control and the Mavericks went on to their 14th victory in the last 18 games. They lead second-place Utah by 7½ games in the Midwest Division. Orlando Woolridge led the Nets with 29 points.
Bucks 135, Knicks 96
 Craig Hodges scored 27 points and Milwaukee opened a 44-30 first-period lead in snapping a three-game losing streak. Ricky Pierce added 24 points for Milwaukee. Trent Tucker scored 19 for the Knicks, who lost for the seventh time in the past eight games. New York played without three injured 7-footers — Patrick Ewing, Bill Cartwright and Jawann Oldham.
 "This game is just what the doctor ordered," Milwaukee Coach Don Nelson said. "It was just a pleasure to let the game come to us for a change. It's the first one we've had like this in a long, long time."
Spurs 103, Rockets 97
 Artis Gilmore scored 24 points as San Antonio avenged a string of five straight losses to Houston. The Spurs had four other players in double figures — Walter Berry with 22, Jon Sundvold 18 and Johnny Moore 17 while David Greenwood had 14 points, 10 assists and 15 rebounds. Houston was led by Akeem Olajuwon with 22 points.

Hunt Tops Rampants In High School Tennis Action

Wilson Hunt gained a 6-3 victory over the Rose High School tennis team in its first match of the spring Tuesday.
 Rose's only victories came in the number one and number six singles where David Ruiz and Neal Creech came away with wins, and in the number two doubles where Ruiz teamed with Josh Hickman.
 The Rampants travel to Elizabeth City on Thursday to face Northeastern High School.
Summary:

David Ruiz (R) d. Mike Diemer, 6-1, 6-1.
 Hunter Gallimore (H) d. Ben Harrison, 6-4, 6-0.
 Jeff Daniels (H) d. Jim Metzger, 6-3, 6-4.
 Mark Atterhold (H) d. Brian Marlowe, 6-2, 6-3.
 Chris Bolt (H) d. Luiz Maestre, 7-6, 6-2.
 Neal Creech (R) d. Brian Ellis, 6-4, 6-1.
 Gallimore-Diemer (H) d. Harrison-Maestre, 8-4.
 Ruiz-Josh Hickman (R) d. Atterhold-Bolt, 8-0.
 Wayne Graham-Monton Hausen (H) d. Metzger-Jason Dohm, 9-8 (7-5).
 Exhibition: Mike Bradshaw (H) d. Ron Dunn, 8-4; Rex Vick (H) d. Sean Frelke, 8-4.

Conley.....5
Ayden-Grifton.....4
Farmville C.....9
Southern Nash.....0
STANHOPE — Farmville Central romped to a 9-0 tennis victory over Southern Nash Tuesday.
 The Jaguars had little trouble with the win, losing no more than four games in any one set.
 The victory boosts the Jaguars to 3-2 on the year while Southern is now 0-2. Farmville plays host to Bertie today.
Summary:

Eric Shine (FC) d. Darren Hales, 6-1, 6-0.
 Al Hedgepeth (FC) d. Steven Reams, 6-2, 6-1.
 Jay Morris (FC) d. Carol Overman, 6-0, 6-0.
 Troy Barnes (FC) d. Andy Tyson, 6-1, 6-1.
 Chris Wade (FC) d. Jake Allen, 6-1, 6-1.
 Danny Morris (FC) d. Curtis Walston, 6-3, 6-4.
 Shine-Hedgepeth (FC) d. Hales-Reams, 8-4.
 J. Morris-Wade (FC) d. Overman-Tyson, 8-1.
 Wes Craft-Barnes (FC) d. Kevin Measley-Kanawha Perry, 8-1.
 Exhibition: Matt Mills-Jeff Mazingo (FC) d. Bud Holly-David Pandoria, 8-2.

GORDON'S
 Sea Island
 Cotton Sweaters
 264 By-Pass 756-1003

Back Saver
SPECIAL
 Reg. 549⁹⁵
Now \$499⁹⁵

90 DAYS SAME AS CASH

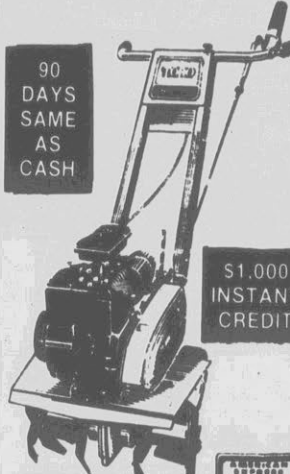

\$1,000 INSTANT CREDIT

Model 58007
 3.5 H.P.
 Belt Drive

FRONT TINE TILLER
 ALL OTHER MOWERS AT PRE-SEASON PRICE!

Haven't you done without a Toro long enough?
TORO

Sutton's Service Center
 1105 Dickinson Ave. 752-6121
 Open Mon.-Fri. 7:00-5:30 Sat. 7:00-1:30

It's Vegetable Garden Time Again!

THE BEST SEEDS PRODUCE THE BEST RESULTS.

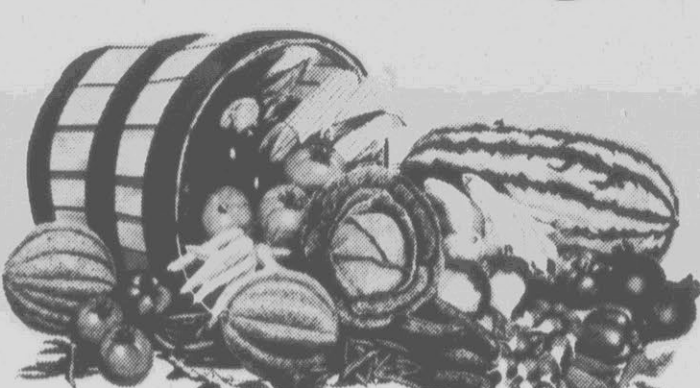

Wyatt-Quarles
 TESTED-ADAPTED SEEDS
 since 1881

When you choose Wyatt-Quarles seeds for your vegetable garden you choose the best! - Seeds grown by specialists in scientifically controlled conditions. Seeds selected as the best for growing conditions in the Carolinas and Virginia. Seeds that are weed-free, disease-free, worry-free.
 The Best Seeds.
 It's the only way to get the best results.

AVAILABLE AT:

Greenville Kittrell's Greenhouse Van's Hardware Sutton's Hardware & Mobile Home Supplies Greenville True Value Hardware	Falkland W.D. Little's General Store
Ayden McCurry Hardware & Garden Supplies Ayden Nitrogen	Farmville Farmville Hardware Farmville Garden Center
Winterville A.W. Ange Plant & See Nursery	Fountain F.C. Owens General Store
Grifton Grifton Ace Hardware	Walstonburg Farmers Gin & Milling Co.
Stokes Stokes & Congleton	Maury Redwood Garden Center Stokes Supply Co.
	Snow Hill Harrell-Holden Hardware

Ready Every Thirty Minutes.

Headline News Now On Channel 6



Events that rock and shape our world happen every minute of every day. But whatever, wherever, and whenever news happens, you'll know about it instantly—if you're watching Headline News.
 Turn to the only American news service that keeps you up to date by taking you completely around the world every thirty minutes. 48 times a day.
 Turn to Headline News.

HEADLINE NEWS
 AROUND THE WORLD EVERY 30 MINUTES

Greenville Cable TV
 517 Arlington Blvd.
PHONE 756-5677

What Matters Most Is You.

Prices Good Through Sun., March 29

KERR Drug Stores

LOWEST PRICES

On Baby Milk and Formula In The Carolinas... If you find a lower price anywhere, we'll match it!! No dealers, please.



ANGEL SOFT

99¢ Pack

Angel Soft® Bath Tissue. Four rolls per pack. White. Two layers. Regular price is 1.27. Save 28¢ now!



5.99 Each

Marsh Allan® 18 Inch Bar-B-Que Grill. 25 inches high. Great for those spring cookouts. Regular 7.99. Save 2.00.



1.49 Bag

Embers® Charcoal Briquets. Ten pound bag. Easy lighting. Long burning. Regular price 1.99. Save 50¢.



Coke 1.09 Each

Your Choice: Coca-Cola, Mello Yello Or Diet Coke



Cadbury® 99¢ Pack

Cadbury® Creme Eggs. Milk Chocolate with soft creme center. 3 per pk. Reg. 1.19.



3.49 Each Reg. 4.95

Adidas® Cologne by Jovan. .85 ounces. A fresh masculine fragrance. Great buy!



3.29 Each 25% MORE FREE

Bufferin®. Fast pain relief tablets. 125 tablets for the price of 100. Regular 4.39.



3.79 Each Your Choice

Gillette® Trac II or Atra Cartridges. 10 plus 2 FREE. Regular price 4.99.



1.09 Each 75% off label!

Gillette® Foamy Shave Cream. Reg. menthol, lemon-lime, or sensitive skin. 11 oz.



1.99 Each Reg. 2.83

Johnson's® Baby Shampoo, Gentle Condition Formula or Conditioner. 11 ounces.



2.59 Each

Scope® Mouthwash and Gargle. Regular or New Peppermint. 24 oz. Reg. 3.99.



1.89 Each

Maximum Strength Anacin-3 Tablets, 30 ct; or Caplets, 24 count. Regular to 2.99.



79¢ Each

Wet 'N Wild® Nail Enamel Hardener. Many shades to choose from. Regular 99¢.



ANY 2 for \$5 Your Choice!

Kerr Vitamins. Thera-Kerr M 100's, StressForm 600's, Stress 600 with Iron 60's, Stress 600 with Zinc 60's, B-Complex 50's, Calcium 600 mg 60's, or Calcium 600 mg with Vitamin D 60's.



99¢ Each

Dr. Scholl's® Air Pillo Double Comfort Insoles. Absorbs perspiration. Regular 1.49.



Sale Price 1.00
Mfg. Rebate -1.00
Your Cost After Rebate **FREE**

Eveready® General Purpose Batteries. AA, C, or D, 4 pk.



5.99 Each

Eveready® Energizer Flashlight with 2 "D" batteries. Regular 10.79



1.99 Each

Regal® Ten Inch Non-Stick Frying Pan. Heat-resistant handles. Regular 3.99.



6.99 Each Reg. 9.99

Gott® Tote 6 Cooler with refreeze bottle under the lid. Almond/brown. Model #18055.



3.99 Pack

TDK® Better Quality Blank Cassette Tapes. 90 minute. 2 per pack. Regular 4.99.



2.99 Each

Kodak® Kodacolor VR-G100 CA135 Film. 24 exposures. Regular 3.49. Save 50¢.



14.99 Each

Deluxe Folding Patio Chair. Vinyl straps. Regular price is 19.99. Save 5.00 now.



1.49 Each 50¢ off label

Right Guard® Bronze, 5 oz.; Spray or Powder, 4 oz. Several scents available.



1.59 Each

STP® Oil Treatment. 15 ounce. Keeps engine cleaner. Regular 2.19. Save 60¢.

EASTER COLORING CONTEST

Three prizes to be given away in each store. Special bonus for the first 300 entrants. Open to all children age 10 and under. Ask any Kerr Drugs employee for rules and coloring pages.

CHIP CUSTOMER HEALTH INFORMATION PLAN

Takes Care Of Your Children From Birth To Pre-School With Special 10% Discounts. Only at **KERR Drug Stores**



4 for \$1

Kudos® New Granola Snack. Assorted flavors. Regular price 40¢ each. Stock up and save.



69¢ Box

Crunch 'N Munch. Maple Walnut, Toffee, Caramel, or Molasses. 5 oz.

Kerr's Policy. Kerr Drugs reserves the right to limit quantities of all items. Kerr's policy is to provide you with the item advertised at the price advertised. If due to some unforeseeable circumstances the item is not available, a raincheck will be issued to enable you to buy the item later when available.

Carolina East Mall
756-0031
Open 9-9 Daily, Sunday 1-6

Overton's Shopping Center
Next to Overton's Supermarket
758-6305
Open 9-9 Daily, Sunday 1-6

Stanton Square Shopping Center
758-5188
Open 9-9 Daily, Sunday 1-6

What Matters Most Is You. **KERR Drug Stores**

Science And Medicine

AIDS in Europe

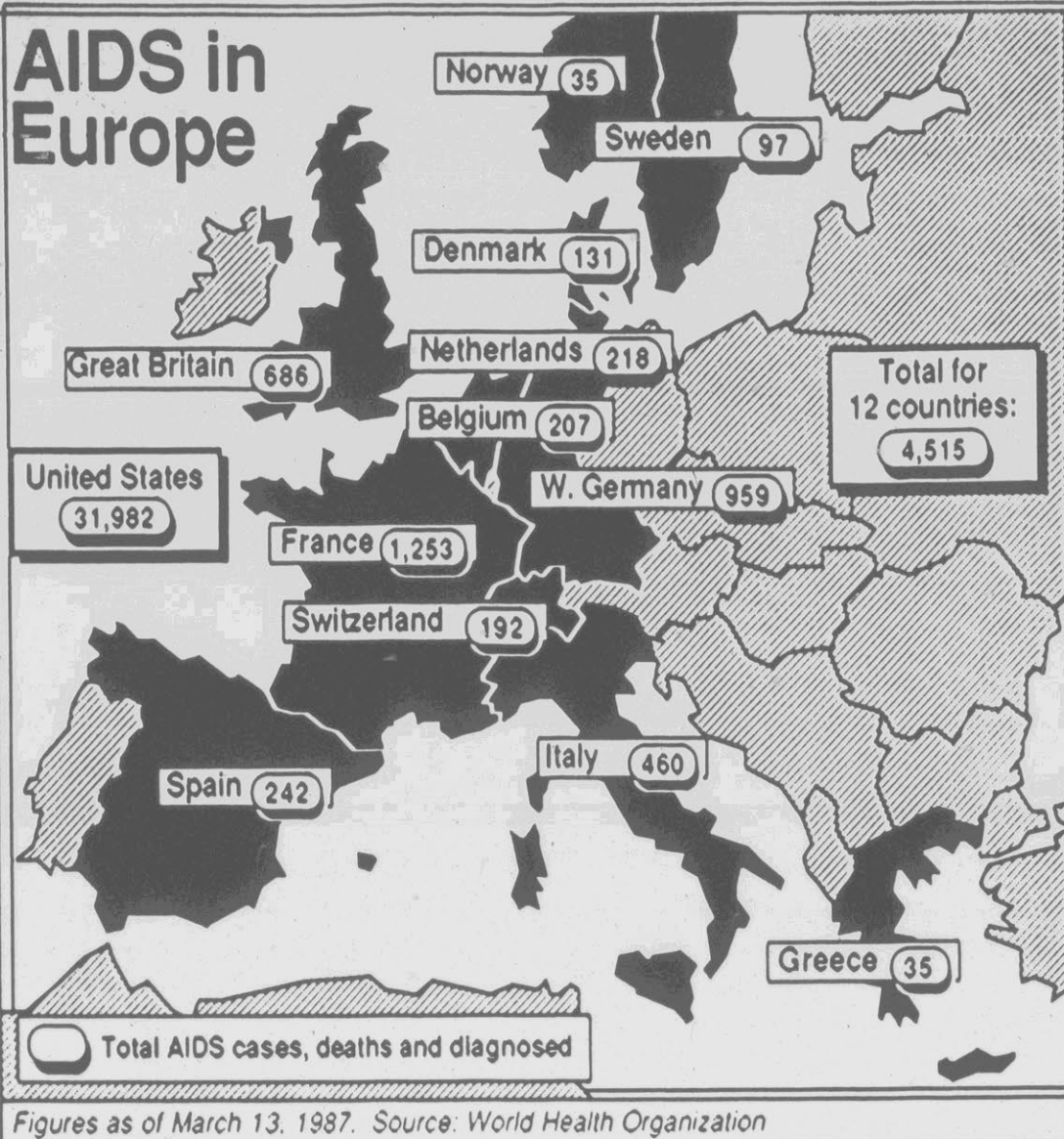

AIDS IN EUROPE — The number of AIDS cases in Europe reported to the World Health Organization has nearly tripled in the past 18 months. This map gives the total number of AIDS cases in each of 12 European countries.

As the disease spreads, more and more European countries are turning to some form of selective screening for high-risk groups to detect the AIDS virus. (AP Laserphoto)

Europe Tends To Favor Selective Screening Of High-Risk Groups To Find AIDS Carriers

By ROBERT GLASS
Associated Press Writer

LONDON (AP) — Some European countries have begun or plan selective medical screening of high-risk groups for AIDS, prompting complaints of discrimination and invasion of privacy.

Proponents say selective blood tests are needed to halt the rapid spread of the acquired immune deficiency syndrome, but civil liberties groups say it violates the rights of homosexuals, prostitutes, drug abusers and foreigners.

A survey by Associated Press bureaus in Europe indicates that most governments have rejected mass screening in favor of health-education campaigns. Nationwide screening programs are confined mainly to voluntary tests for antibodies to the AIDS virus in donated blood and transplant organs.

Nevertheless, some authorities have opted for selective and, in some cases, compulsory testing.

The West German state of Bavaria has adopted sweeping measures requiring compulsory screening of all homosexuals, prostitutes, inmates, applicants for public-service jobs and foreigners from outside the European Economic Community from seeking residency.

Belgium has announced it will require foreign students, most of them from central Africa, to submit to annual blood tests for AIDS. Finland has similar plans, and Finns who study abroad would also be tested for AIDS on their return.

Turkey has ordered AIDS screening of all prostitutes and homosexuals, and officials say at least 5,000 have been tested in Istanbul alone since December.

Austria also has included tests for AIDS in regular health checkups given licensed prostitutes.

The French Health Ministry has said it will soon require AIDS screening for applicants for marriage licenses to protect unborn children.

The number of AIDS cases in Europe reported to the World Health Organization has nearly tripled in the past 18 months: from 1,573 through September 1985 to 4,647 as of March 13.

Twenty-six European countries now have reported AIDS, up from 21 in 1985.

Compared with the United States, where as of March 6 there had been 31,982 reported AIDS cases, including 18,462 deaths, the figures from Europe are small. But the disease is following the U.S. pattern in Western Europe, with a doubling of cases every nine to 11 months, and experts are forecasting a European epidemic.

AIDS cripples the immune system, leaving victims vulnerable to infections and cancers. It is invariably fatal and is spread through sexual contact or exchange of blood, as can occur when drug addicts share needles. Male homosexuals, prostitutes and intravenous drug users are most at risk.

With no cure or vaccine expected for at least five years, large-scale screening has been proposed by some as the only possible way to protect the uninfected population.

A Harris poll published by London's Observer newspaper in November found 63 percent of the public favored compulsory nationwide AIDS screening. Eighty-two percent of the 1,050 people surveyed said all visitors to Britain should be tested.

Britain's chief medical officer, Dr. Donald Acheson, told a parliamentary committee that the government is considering screening visitors from high-risk countries, presumably central Africa, where the disease is widespread.

He also said officials were considering anonymous tests for the AIDS virus among hospital patients to determine trends and prevalence of

the disease. Under the proposal, patients would not be told the results of the tests.

Marie Staunton, legal officer for Britain's National Council for Civil Liberties, said in an interview that her group opposed any screening that could involve coercion or invasion of privacy.

"The problem with compulsory screening is that it is impracticable to screen everybody, so to screen targeted groups would further expose groups that already suffer from prejudice, such as gay men, to further prejudice," Ms. Staunton said.

AIDS experts convened in March by the World Health Organization in Geneva rejected screening international travelers. They said it would be too costly, impractical and possibly counterproductive.

Dr. Jonathan Mann, the American director of the organization's special program on AIDS, said it can take weeks, or even months, for antibodies to the AIDS virus to show up in the blood after a person is infected. A negative result might be meaningless and could lead to the abandonment of sexual precautions, he said.

But the Belgium government says it will go ahead with plans to require all foreign students on state scholarships, as well as their spouses and partners, to submit to annual blood tests for AIDS.

Of the 207 AIDS cases reported in Belgium, more than half — 113 — have been among nationals from the former Belgian colonies of Zaire, Rwanda and Burundi in central Africa.

Eighty-five percent of 1,262 foreign students studying in Belgium are from central Africa.

Pierre Herbecq, spokesman for the Belgium's Human Rights League, denounced the program as racially discriminatory because it primarily affects black students.

Burroughs Wellcome Keeps Tight Security On AZT Drug

RESEARCH TRIANGLE PARK, N.C. (AP) — Burroughs Wellcome Co. officials say tight security at its Greenville plant and an unusual distribution system should keep its much-sought-after AIDS drug off the black market.

"The security measures from the very beginning for this drug were the very same... (as) for narcotics," said S. Winston Singleton, vice president of medical affairs for the company, which is based in Research Triangle Park.

The drug AZT — being sold under the brand name Retrovir — was approved Friday for sale in the United States. It is the only AIDS treatment available by prescription and is expected to remain in short supply for months.

Singleton said the drug is kept under lock and key at the

Greenville plant and will be shipped in small orders to pharmacies all over the country. The small shipments will limit the amount that could fall into the wrong hands.

AIDS sufferers will get the drug only after they are approved by a panel of doctors in Maryland and assigned a special identification number. They will be able to get only a month's supply of the drug at a time from pharmacists.

An estimated 15,000 AIDS patients live in the United States, not including people with AIDS-related complex, a condition that is similar to and sometimes precedes the full-blown disease. Another 19,000 have died.

Retrovir prolongs the lives of AIDS sufferers but is not a cure for the disease, which cripples the immune system.

Public Ranks AIDS No. 2

NEW YORK (AP) — AIDS has replaced heart disease in the public mind as the second-most serious health problem in the country, ranking behind cancer, according to a nationwide survey.

The poll, conducted in December for the American Association of Blood Banks, showed that 35 percent of the respondents ranked AIDS as the No. 1 health problem, while 29 percent viewed heart disease as the major threat.

The majority, 52 percent, feared cancer most.

A 1985 poll showed 35 percent of the respondents ranked heart disease as the main health threat, with 27 percent naming AIDS. Fifty-four percent of those questioned in the

previous survey viewed cancer as the most serious health problem.

Blood bank officials, reporting the results at a news conference Tuesday, said the poll showed public confusion and "irrational fear" over contracting the deadly AIDS from blood transfusions.

They said 55 percent of those polled believed it was likely that a person could become infected with the AIDS virus from a blood transfusion. These fears were unfounded, they said, since the development of a screening test that has been applied to all donated blood since April 1985.

However, officials at the federal Centers for Disease Control are encouraging the nation's doctors to recommend the AIDS test for some

patients who received transfusions between 1978 and 1985.

Many people also had unfounded fears about donating blood, said Dr. Edwin A. Steane, the association's president. He said 27 percent of those polled believed it was likely that a person could get AIDS that way, even though there was no risk whatsoever from donating blood.

The telephone poll interviewed 1,000 randomly selected Americans age 18 and older. Conducted Dec. 12-16 by Hamilton, Frederick & Schneiders of Washington, the poll had a margin of sampling error of plus or minus three percentage points.

New Therapy Offers Hope After Tumor

By DANIEL Q. HANEY
AP Science Writer

SAN DIEGO (AP) — A new form of therapy is providing "some hope" for the first time for victims of the most common form of brain cancer, which until now has been quickly and relentlessly fatal, a researcher says.

Among the 60 patients who have received the experimental therapy so far is Dick Hower, who resigned as manager of the Kansas City Royals baseball team this team after attempting a comeback following surgery.

Doctors are unsure whether they have cured anyone with the new approach, but some of their patients are still alive long after such victims usually die.

The patients were treated at an advanced stage of their disease, when the expected survival is 14 weeks. But some are apparently free of disease more than two years later.

The therapy uses a newly developed technique to rally the body's own immune defenses to fight cancer. In this case, it's being used to attack brain tumors called gliomas. About 15,000 new cases of malignant brain tumors occur in the United States each year, and 70 percent of them are gliomas.

Dr. Deane Brunton Jacques and colleagues began administering the treatment in February 1985 at the Huntington Medical Research Institutes in Pasadena, Calif. He described his results at a meeting of the American Cancer Society under way this week.

"It's not a panacea," he said. "It's highly experimental. But in a disease that's heretofore been 100 percent fatal, at least for the first time there's some hope for these people."

The approach, called adoptive immunotherapy, uses the patient's own white blood cells as the primary assault against cancer. The white cells are separated from the blood and grown for 10 days in interleukin-2, one of the body's natural chemical weapons against disease. This seems to stimulate the white cells to fight the cancer.

All of the patients so far have failed to respond to surgery and radiation. When their cancers recur, surgeons remove as much of the tumors as they can, then fill up the resulting cavity with a mixture of the activated white cells and blood plasma.

Jacques said several of the patients have continued to improve long after the treatment. On CAT scans, a standard diagnostic test, there is often no sign of their cancer.

However, this does not mean they are cured.

"I don't know what the natural history of this disease is, since people don't live this long" with this form of cancer, Jacques said. "One young man recurred over two years later, when I thought he was over the hump."

Of the 60 patients treated, 16 have died. He said everyone else is alive and well with followup times ranging from a week to 26 months.

Typically people with gliomas live just under a year from the time their disease is first spotted. And they survive 14 weeks from the time of recurrence of their disease, which was when these people were treated.

Koop Says AIDS Testing Needed Before Pregnancy

WASHINGTON (AP) — Surgeon General C. Everett Koop and a national blood bank official are urging women to have themselves tested for AIDS before becoming pregnant.

That advice, which came separately Tuesday from Koop and Edwin A. Steane, president of the American Association of Blood Banks, is based on the high probability that a pregnant woman with the virus will pass it to her infant and that the child runs a substantial risk of developing the fatal disease.

Dr. James Curran, AIDS project director at the Centers for Disease Control in Atlanta, echoed the recommendation today.

"We've recommended now for the past year that all women with any increased risk of infection with the AIDS virus be tested before contemplating pregnancy," Curran said in an interview on NBC-TV's "Today" show. "This is an entirely preventable condition — the perinatal transmission of the AIDS virus."

Although Koop, Steane and Curran did not cite statistics, some researchers say 30 percent to 70 percent of infected mothers will transmit the

AIDS virus to their babies either prior to or at birth.

Moreover, AIDS experts are finding that children infected with the virus seem to develop the disease itself, acquired immune deficiency syndrome, more readily than infected adults.

Koop, a pediatric surgeon who specializes in treating newborns with life-threatening defects before becoming surgeon general, is holding a conference on AIDS in children next month in Philadelphia.

He made his statements regarding pregnant women during a question-and-answer session at the National Press Club in which he was asked about mandatory AIDS testing for people applying for marriage licenses.

"I can't understand why it is so controversial," he said. "I would think anybody who is getting married today would want to be tested and would want to know" whether his or her intended spouse had the AIDS virus.

"One of the things I think is most important about this... is my great concern for the babies who are born to... positive mothers," he said. "I

think no woman should contemplate a pregnancy without voluntarily wanting to be tested for the AIDS virus."

Koop, a strong opponent of abortion, picked his words carefully when asked whether abortion is an option for a woman who discovers she has the AIDS virus after becoming pregnant.

"If you wanted to give her all the possibilities that were available to her, you would have to mention abortion," he said.

"It is my understanding that in major obstetrical clinics on the East Coast... where the population has a high incidence of... the AIDS virus, that women who are pregnant under 13 weeks are being advised to have abortions and about 50 percent of those, I understand, are indeed having abortions."

Koop told reporters later that his personal opposition to abortion has not changed.

Steane, at a briefing on the state of the nation's blood supply, said there is no compelling reason for most people who received a transfusion before blood donations were routinely screened for AIDS in 1985 to get the test.



KOOP CAUTIONS — Surgeon General C. Everett Koop draws a hand across his brow Tuesday during a question-answer session at the National Press Club in Washington. Koop urged women who want to become pregnant to have their blood tested for AIDS before pregnancy occurs. He said their is a high probability that a pregnant woman with the virus will pass it to her infant. (AP Laserphoto)

059 Help Wanted Medical

LPN NEEDED in local doctors office. Excellent fringe benefits. For more information write to P.O. Box 396, Greenville, NC 27835-0296.

MEDICAL

Seeking LPN or equivalent to fill our full time position Monday-Friday in Medical Records/Central Supply. Independence and organizational skills a plus in a progressive 120 bed skilled, intermediate care facility. Computer background, medical terminology, and nursing experience required.

If you're interested in a challenging position in a positive environment apply at:

University Nursing Center
Route 1, Box 21
Greenville, NC 27834

Or contact:
Sharon Huston, RN
Director of Nursing Services
Monday-Friday 9 a.m.-3 p.m.
AT 758-7100
EEO/H

ADMINISTRATOR

Complete management of Home Health agency including planning, budgeting, marketing and operations. Must have broad experience or degree in healthcare administration. Home Health background a plus.

Good salary and benefits and exceptional opportunities for future advancement.

ADMINISTRATOR

Send resume to:
P.O. Box 1967
Greenville, NC 27835

ADMINISTRATOR

Equal Opportunity Employer M/F
Nursing Assistant needed for private duty, Monday-Friday 8-4. Call Apple Nursing Services, Inc. 355-7119.

OPTOMETRIC NURSE

position available with growing optometric group practice. Experience preferred. Excellent opportunities for growth and advancement for assistant with desire to excel. Send resume and 2 references to Ophthalmic Nurse, P.O. Box 1967, Greenville, NC 27835.

PART TIME medical office

assistant for weekends and evenings. Experienced only. Send resume to: P.O. Box 2276, Greenville, NC 27835.

POSITIONS AVAILABLE RN's

needed immediately for long term care facility in Washington, N.C. Starting salary up to \$20,000 per year. Blue Cross/Blue Shield group insurance, retirement plan, 7 paid holidays included in fringe benefits package. For further information contact Bridget Miller, 946-9570.

RECEPTIONIST needed for

ophthalmology practice. Competitive salary with good benefits. Send resume to Ophthalmic Receptionist, P.O. Box 1967, Greenville, NC 27835.

CLASSIFIED DISPLAY

059 Help Wanted Medical

REGISTERED NURSES Considering a change? We are looking for RNs interested in a challenging nursing opportunity. Full and part-time positions with flexible hours. Must have a NC License. We offer competitive salary and benefit package. Apply to Director of Nursing, Our Community Hospital, Inc., P.O. Box 405, Scotland Neck, NC 27874.

WANTED

Registered Nurses for 3-11, 11-7, and full-time supervisor position. Must have the following skills: Physical assessment, IV therapy, phlebotomy, tube feeding, leadership.

Contact Phyllis Jarrett, Director of Nursing at 823-0401 Monday thru Friday from 9:00 a.m.-5:00 p.m. or apply at Beverly Health Care P.O. Box 7008, Tarboro, N.C. 27860. EQUAL OPPORTUNITY EMPLOYER M/F/H/V/I-14c

060 Help Wanted Miscellaneous

AAA EMPLOYMENT

MANAGER TRAINER: 11K up

Financial background a must. Advance. MECHANIC: to \$300 Work on vans, computers, heavy equipment. Good benefits. ROUTE SALES: Career in Greenville and surrounding areas. RECEPTIONIST: \$200 Light typing Fast paced Music public contact Medical background helpful. SALES: Successful store Gem of a job. 101 West 14th Street Suite 203 758-1392

Low Fee Personnel Service

AGES 16-21 out of school. Free

job training through Job Corps. Also G.E.D. Social Services, Greenville, Wednesday, 12 noon-2 p.m.

ASSISTANT MANAGER TRAINER:

Person wanted who wants to learn the restaurant business. Involves limited traveling and must be willing to relocate. Experience helpful but not necessary. 756-7454 for appointment.

AUTO MECHANIC needed.

Tools and 5 years experience. Contact M.E. Porter-Regional Auto Parts, Inc. Highway #264 West, Greenville, NC 27810.

AUTO PARTS counter person

needed. Contact M.E. Porter-Regional Auto Parts, Inc. Highway #264 West, Greenville, NC 27810.

CABLE INSTALLERS needed

to install cable services. Must have late model truck or van. Please call 756-9515 Monday-Friday, from 8-5 p.m.

CASHIERS needed full and

part time. Call Atlantic Personnel, 355-7921.

CLERK/CASHIER 30-40 hours

weekly, evening and weekend plus included in fringe benefits. Location with great customers, good work history and references required. Apply Short Stop Food Mart, 1928 East Greenville Boulevard between 7 a.m. and 2 p.m. Good benefit package for full time employees. Will train.

LUNCH TIME position available

Monday thru Friday. Apply in person, Beef Barn between 10:00 a.m.-11:00 a.m.

CLASSIFIED DISPLAY

060 Help Wanted Miscellaneous

MANAGER NEEDED. If you have management ability and knowledge of automobiles and would like to work into part ownership of a profitable business contact M.E. Porter-Regional Auto Parts, Inc. Highway #264 West, Greenville, NC 27810.

MANAGER TRAINER in family

style restaurant. Start 15K-20K. Call Atlantic Personnel, 355-7921.

NEEDED for light delivery

work. Must have own car and know Greenville and surrounding areas well. Good pay and car allowance. Call 756-1115, extension 138.

NOW TAKING applications for

work experience preferred. hours 7 a.m. to 2 p.m. Apply in person at Tom's Restaurant, Maxwell Street (next to Buyers Mart Shopping Center). 756-1012.

OPPORTUNITY in image im-

provement with large color company in America. Comprehensive training in color analysis, seasonally coded fashions, cosmetics and accessories. Professional status in the fashion and beauty industry. Expect \$10,000 per year part-time. You deserve a rewarding career. For interview, call M.S. Stout, 919-776-7025.

PART TIME cook for local

daycare. Apply Monday-Friday 9:30-11:30 at 313 East 10th Street.

PART-TIME PHONE solicitors

needed immediately. Good hourly rate plus bonuses 2 shifts. 10-3 Monday-Thursday or 5-9, Sunday-Thursday. Call for interview. 756-1317.

POLICE OFFICERS. Must be

high school graduate, be at least 21 years of age, be able to withstand a background investigation, and be of good moral character. Must be willing to work rotating shifts, weekends, and holidays. Experience preferred but not required. Applications may be picked up at the town Administrative offices located at 124 North Main Street, Farmville, N.C., Monday thru Friday, 8:30 a.m.-5:00 p.m. Applications will be accepted through March 30, 1987. The Town of Farmville is an Equal Opportunity Employer and does not discriminate against the handicapped.

PROFESSIONAL RESUME

composition. Atlantic Personnel Services, 355-7921.

QUALITY RESUMES. free

cover letter with resume. C.R. Writing Services, 355-4390.

REPAIRMAN needed with

experience in repairing mobile homes. Apply in person between 9 and 11 a.m. Monday-Friday. No phone calls. Contact: Express, 616 West Greenville Boulevard, Greenville.

SWITCHBOARD OPERATOR

Requirements: *Ability to get along well with co-workers. *Excellent dictation with ability to pronounce international names. *Excellent/accurate handwriting and spelling. *Must be trusted with confidential information. *Ability to work under customer pressure and pressure involving emergency medical situations. *Ability to follow and carry out directions. *Must be reliable, dependable and prompt worker. *Must be community spirited. *Written/verbal tests will be given.

CAREER OF THE 80's

Color, fashion, and glamour! Join me in a fascinating career offering color analysis, fashion, and color coordinated cosmetics. All of this and more when you represent the fastest growing color company in America. For more information call Mrs. Waring 919-736-1162.

SALES. Salaried position. Start-

ing 14K. Good people skills. Call Atlantic Personnel, 355-7921.

TELEPHONE SALES

Part-time work, full time pay. Entertainment field. Experience preferred, but will train. \$3.50 per hour. Apply 123 West 3rd Street, upstairs or phone 830-0109 between 10 a.m. and 12 and 5:30 p.m. and 8:30 p.m. for appointment.

CLASSIFIED DISPLAY

060 Help Wanted Miscellaneous

PERSON WITH experience in automobile titles, contracts, and bookkeeping work. Send Resume to Title Clerk, P.O. Box 1967, Greenville, N.C. 27835.

SERVICE MAN for up keep

of mobile homes and mobile home park. Apply 313 East 10th Street.

SNELLING & SNELLING

specializes in sales, management training, accounting and clerical positions. Call 758-0541.

SUMMER EMPLOYMENT.

Camp Hardee. Looking for waterfront staff (Red Cross Certified) and unit leaders. Call Coastal Carolina Girl Scout Office. 1-800-558-9297.

WANTED: Variety store

manager for regional chain. Good salary plus bonuses, vacation, insurance program, etcetera. Experience helpful. Apply to Variety Store Manager, P.O. Box 1967, Greenville, NC 27835.

WANTED: Experienced

screen printing personnel. Apply in person 309 Anderson Avenue, Farmville, Monday-Friday, 8-4.

WEST AVENUE Productions, a

new professional screen printing firm will be opening soon in Ayden, NC. We are now hiring personnel for all departments. Call 746-3417 for an interview.

061 Help Wanted Sales

ATTENTION Real Estate

Agents. We presently have an opening for one full time agent with a North Carolina real estate license. Full time. Must plan to work 40 hours per week. Leads and sales aids available. For your confidential interview, call Ann Bass, CENTURY 21 Bass Realty, 756-6666.

ATTENTION: Due to expansion

in our new and used sales volume we are in need of a salesperson. If you enjoy communicating with the public and have the ability to follow directions this could be an excellent opportunity to join a winning team. Excellent training program, guaranteed salary and benefits including paid vacation, hospitalization insurance and demo program. No experience needed. Quick advancement for the right individual. Contact: Leon Kremzant at 756-1153 for an interview.

AUTO SALES. Knowledge im-

portant. Experience not required. Call Atlantic Personnel, 355-7921.

BUYER FOR

WOMEN'S CLOTHING Retail store is seeking an assistant buyer for women's clothing. This entry level position will train you on the job. If you are bored with your work and want an exciting change this is the job for you. Person must demonstrate fashion merchandising skills, paperwork ability and be willing to travel to New York and regional markets. Retail or buying experience preferred. Send resumes to: Buyer, P.O. Box 741, Winterville, NC 28590.

RENTAL ESTATE AGENTS

needed. For more confidential information, call Jean Hopper at University Realty, 355-8866.

REPS NEEDED

for business accounts. Full time: \$60,000-\$80,000. Part-time: \$12,000-\$18,000. No selling, repeat business. Set your own hours. Training provided. Call C-112-988-670. Monday-Friday 8 a.m.-5 p.m. (Central Standard Time)

SALES representative-contract

carrier/property broker seeks experienced sales person, full or part-time. Person must demonstrate sales ability. P.O. Box 6066, Statesville, NC 28677.

SALES Representative for

jewelry accounts in your area. Earn extra income. Call Cathy after 6 p.m. 919-442-7670.

WANTED: Salesperson for

medical equipment company in Greenville. Good salary and benefits plus car allowance. Sales experience required. Send resume to P.O. Box 1781, Greenville, N.C. 27835. Attention: SALES.

\$20,000 PLUS first year. Salary

plus commission. Opportunity to move into management within one year. Company benefits provided. No travel. Nation's largest mobile home dealer. Apply in person. Conner Homes, 710 Southwest Greenville Boulevard.

CLASSIFIED DISPLAY

061 Help Wanted Sales

CUSTOMER SERVICE Agent. Full-time position with Piedmont Computer. Contact station manager Larry Dufton for interview. Call 758-1457.

EARN 40% PROFIT selling

computer supplies. Local territory. Call 778-5644 for further details.

IF YOU ARE a go-getter

and like making money, then we may have a position for you in retail sales. Come by Joe Culliphan's Subaru, Monday-Friday between 10 and 2 p.m.

IMMEDIATE OPENING for

ambitious real estate agent. Private office and training available. Must have NC Real Estate License. Call Mavis Butts at Mavis Butts Realty for confidential interview. 355-7453.

LOOKING FOR ambitious,

motivated real estate agents to work in a sales office. Must have real estate license. Call for your interview today. Contact: Janet Bower & Associates, 355-7800.

MAKE A FRESH start with us.

1 agent needed. Call ERA Carson & Tyler Realty, 756-8666.

NEED Full time Salesperson

and assistant manager. Experience preferred. Good benefits and working conditions. Apply in person only. Baldwin's, The Plaza. Room for advancement.

****NOW HIRING****

Sales and delivery persons needed at Factory Maltress and Waterbed Outlet. Confidential application available. Apply now at 730 Greenville Boulevard near The Plaza. No phone calls please.

PART TIME Salesperson

needed. Experience preferred but not necessary. Experience in handling field or retail sales helpful. Send resume and salary history to Locksmith, NC P.O. Box 1967, Greenville, NC 27835.

MECHANIC for service and

body work. Must have 3 years experience in foreign and domestic cars. Knowledge of automatic transmissions. Must furnish own tools. Call 757-1960.

PASTE-UP ARTIST wanted

for part time work. Apply in person 2 p.m. daily. Williams & Simpson, Inc. 223 West 10th Street, Suite 113.

PROJECT MANAGER capable

of estimating and managing projects up to two million dollars. Projects consist of mechanical, electrical, and civil construction. Please send resume and three references to The Roberts Company, P.O. Box 499, Winterville, N.C. 28590.

TRACTOR trailer drivers. High

pay, new equipment. 2 years experience required. Call 1-800-682-6574.

064 Work Wanted

CALL QUALITY LAWN Care.

Free estimate. Mowing. 758-4584.

CAROLINA TREE Service.

All types done. Free estimates. Fully insured. 752-6420 or 757-0117.

CARPENTER. Remodeling,

repairs, decks, fences and utility buildings. 355-5700.

CARPENTRY, repair work,

remodeling and additions from the ground up. Your one stop home improvement specialist. Call 756-5285.

COMPLETE TREE SERVICE

Landscape, lawn care, tractor, loader and driveway work. Fully insured. Call 756-1339.

DO YOU NEED a storage room,

playhouse, fence or your closet lined with tongue-and-groove ceiling? Call John after 6 at 756-9957.

EXPERT FLOOR refinishing.

No job too large or small. Call 756-8335.

CLASSIFIED DISPLAY

061 Help Wanted Sales

WANTED INDEPENDENT Sales Representative. THE CLEARCROCK COMPANY is seeking aggressive, self-motivating sales rep to promote and sell its State-of-the-Arts Water Treatment unit. Developed with space age technology, The Clearbrook Water Treatment unit is the most technically advanced method of making the water you drink and cook with clear, palatable and pure and at an unbelievable cost of less than 3¢ per gallon. Excellent income and benefits. 80% of demonstrations result in sales. Full time or part-time. Ideal opportunity for college students, housewives, and other persons desiring to supplement their incomes. Call 757-3040 or 758-2047 for appointment for interview.

063 Help Wanted Technical & Trades

CABINET MAKER 5 years

experience. Must be dependable. Work in a clean, modern environment. Call Lilie Construction, 757-0588 or 756-2119.

EXPERIENCED Acoustical

ceiling help needed. Call 752-1154, 9:30-5 p.m. for interview.

EXPERIENCED MECHANIC

wanted to repair and rebuild engines. Call Bob 752-1370.

FIRST CLASS PAINTERS.

Apply R.N. Rouse job site trailer, ECU classroom building, Tuesday morning. Ask for Carl King.

LICENSED Cosmetologist.

Preferably clientele. Commissions and bonuses. Call for an appointment. 756-3705.

LOCKSMITH wanted to do

showup work, outside service calls. Minimum 3 years experience. Must have valid NC driver's license, be bondable. Send resume and salary history to Locksmith, NC P.O. Box 1967, Greenville, NC 27835.

MECHANIC for service and

body work. Must have 3 years experience in foreign and domestic cars. Knowledge of automatic transmissions. Must furnish own tools. Call 757-1960.

PASTE-UP ARTIST wanted

for part time work. Apply in person 2 p.m. daily. Williams & Simpson, Inc. 223 West 10th Street, Suite 113.

PROJECT MANAGER capable

of estimating and managing projects up to two million dollars. Projects consist of mechanical, electrical, and civil construction. Please send resume and three references to The Roberts Company, P.O. Box 499, Winterville, N.C. 28590.

TRACTOR trailer drivers. High

pay, new equipment. 2 years experience required. Call 1-800-682-6574.

064 Work Wanted

CALL QUALITY LAWN Care.

Free estimate. Mowing. 758-4584.

CAROLINA TREE Service.

All types done. Free estimates. Fully insured. 752-6420 or 757-0117.

CARPENTER. Remodeling,

repairs, decks, fences and utility buildings. 355-5700.

CARPENTRY, repair work,

remodeling and additions from the ground up. Your one stop home improvement specialist. Call 756-5285.

COMPLETE TREE SERVICE

Landscape, lawn care, tractor, loader and driveway work. Fully insured. Call 756-1339.

DO YOU NEED a storage room,

playhouse, fence or your closet lined with tongue-and-groove ceiling? Call John after 6 at 756-9957.

EXPERT FLOOR refinishing.

No job too large or small. Call 7

099 Miscellaneous

BUILDING for sale. 26x60. Highway 33 East. 758-0431.
CALL CHARLES TICE, 758-3013, for small loads sand, topsoil, stone, pine bark. Also backhoe and driveway work.
COMPLETE BAND equipment. 2-BF-1A speakers, 2-BF-1A outfront monitors. 1 Boss drum monitor with stand. 1 Traylor power amp. 1 Yamaha 8 channel mixing board. All cords included. Excellent condition. used less than 1 year, \$1400 negotiable. Call 746-4120 after 6 p.m.

CUSTOM SCREEN printed t-shirts. Studio 86, located in Ayden, NC specializes in custom screen printed t-shirts for clubs, organizations, and firms for advertisement. Professional artist available. Call 919-746-3417.

ELECTROLUX Repositioning. Limited models available. Full warranty. Contact dealer at 105 Trade Street, 756-6719.

FHA CARPET \$4.95/square yard. Congoleum and Mannitol no wax vinyl, \$2.49/square yard. Grass carpet, \$1.99/square yard. Thick sculptured Aulon, \$6.95/square yard. 1/2" Excelon tile, \$27.95/carton. 9/16" Rebound cushion, \$1.75/square yard. The Carpet Bargain Center, Greenville, 758-0857. Now open Saturday until 5 p.m.

FORMAL GOWNS, almost new. Sizes 8-10. Call 756-5461.

GE WASHING machine, \$250; electric stove, \$100; living room suite, \$25; couch, \$50; dining room suite, \$50; what-not shelf, \$15; chairs, \$15 a piece; encyclopedias, \$35; baby clothes, 756-2665.

GRAIN FED bees for sale. Call 946-1402.

GUNS
LOANS ON BUY, SELL and trade. Southern Gun & Pawn Inc., 752-2464.
HEAVY DUTY Washing Machine for sale. Good condition. Best offer. Call 758-9381.

INSTANT CASH
LOANS ON & BUYING Guns. TV's, gold and silver jewelry, coins, most anything of value. Southern Gun & Pawn Inc., 752-2464.

KENMORE MODEL 1785 sewing machine with attachments, case. Does decorative stitching. 6 years old. Good condition. Trading up. \$200. Call 355-2742.

KENMORE ELECTRIC range, portable sewing machine, dinette table, bookcase, and many extras. Call 752-4824.

KITRELL'S GREENHOUSES
VIDALIA ONIONS
ASPARAGUS BROCCOLI
CALLIFLOWER
CABBAGE
LETTUCE
COLLARDS

Garden Seeds For All Your Needs
 2531 Dickinson Avenue Ext. 756-7173
 We specialize in your garden!

MOVING, MUST SELL. Refrigerator, coffee machine and other household furniture. Call 752-0626 after 6 p.m.

MUST SELL 19" Sharp remote control color television. One year old. \$175. 758-7367, anytime. 355-2650.

NORDIC TRACK exercise equipment, \$275 or best offer. 355-2650.

POOL TABLE, new 8' slate bed, \$895. Delivered, installed, with choice of felt colors. Wood rails, heavy frame construction. Game World, Inc. 1-21-3468.

PROM DRESSES sizes 8, 10, & 12. \$25 each. Apple IIE Printer \$75. 1972 Super Beetle \$1500. Call 756-2012.

CLASSIFIED DISPLAY
WE REPAIR SCREENS & DOORS
 C.L. Lupton Co.
 752-6116

MATTHEWS SEPTIC TANK CO.
 NEW INSTALLATIONS • REPAIRS
 • PUMPING & CLEANING
 Pin County Permit #104
 14 Years Experience
 PHONE 753-4097
 8 A.M. To 9 P.M.

Rent A NEW CAR
 As Low As \$18.00
 Per Day
 Sharpest Fleet In Town
RENT WAY AUTO RENT
 Brown & Wood
 Downtown
 752-2882

School Instruction
 Train to be a TRAVEL AGENT
TOUR GUIDE
 AIRLINE
RESERVATIONIST
 Start locally, full time/part time, train on live airline computers. Home study and resident training. Financial aid available. Job placement assistance. National Headquarters - Lighthouse Point, FL.
 A.C.T. TRAVEL SCHOOL
 1-800-327-7728
 Accredited Member NHSC

WE WANT TO BUILD YOUR SUNDECK!
 -choose from our two high quality reasonably priced packages or
 -let us custom design and build the deck of your dreams
 Call 747-8439

HEARDLAND BUILDERS INC.
 DESIGN & CONSTRUCTION

099 Miscellaneous

SEA QUEST Sea Jacket V BC, Schwinn Varsity 10 speed, MKP windsurfer (only used twice). Call after 6. 756-9730.
SHAMPOO YOUR RUG! Rent shampooers and vacuums at Rental Tool Company.
SINGLES, (Desert Wood) \$10.00 square, 8'X 16' Hardboard siding, \$2.89. Replied Plywood by Unit 1/2" \$4.75, 3/4" \$5.75, 1/2" \$6.75. Builders Bargain Center, 758-7061.
SKILLED COMPANION to assist in use of ventilator. 5 days a week, 12 hours per day, in my home. 758-2956.
THREE PIECE Bedroom suite: Double bed, dresser with mirror, and chest of drawers. Good condition. \$125. Call after 6:00 p.m. 825-1922.
TOPSOIL, fill dirt, pinebark. Call 756-4472 after 6 p.m.
WANTED TO BUY GE, Kenmore, and Whirlpool washers and dryers that don't work. Call 756-2479.
WASHERS, dryers, color TV's, refrigerators and stoves. \$100 up. Guaranteed. 746-6929.
WEDDING DRESS size 5. Good condition. \$125. 825-4871 after 5:30 p.m.
WIDE WEDDING Band. Diamond cluster ring. Pearl heart ring. Men's wedding band. Prices negotiable. Call 355-6763.
ZENITH 25 inch console TV. Remote control. \$250. 756-2211 after 4 p.m.
5 HORSEPOWER Murray riding lawn mower. \$350. Call 752-9527.
8x8 LEONARD storage building, reasonable. 752-3228. After 6, 756-8219.

102 Mobile Homes For Sale
ASSUME LOAN with no equity. 1981 14x70. 756-9191.
DOUBLEWIDE setup in exclusive mobile home park in Greenville area. Less than \$1,000 down for this 3 bedroom, 2 bath beautiful home. Call Quinn, 756-0323.
FOR SALE: Trailer, 12x60, 3 bedrooms, 1 bath, 2 air conditioner units. Call 524-6111.
MOBILE HOME PLUS additions including 2 rooms, approximately 1400 sq ft. in all. On private lot. Above ground swimming pool and deck. 12 x 16 block workshop. 16 x 24 two car carport. Chain link fenced yard. 255,000 or best offer. Contact after 5:30 p.m. 746-3949.
MOBILE HOME on double lot in Shady Knoll. 830-0878 nights.

NEW HOMES: Singlewide and doublewide. No money down to qualified buyers.
NEW 1987 doublewide. Payments less than \$179 per month.
USED HOME SALE as low as \$350 down. Payments under \$110 per month.
OVERSTOCKED 14 wide with washer/dryer, air conditioning as low as \$148 per month.
 Call or come by Tri County Homes Greenville 756-0131
NEW 1987 CORNER, 2 bedrooms, 1 1/2 wide with beautiful front kitchen and garden tub. Delivered and setup for only \$143.48 per month. Free 5 year warranty. Call J.Q. at 756-7138 immediately.
PERFECT STARTER home. 1975 12x60 2 bedroom, 1 bath. Must be moved. Make offer. Call 355-7449.

102 Mobile Homes For Sale
1981 14x70 mobile home, 2 bedrooms, 2 baths, central heat and air, plus extras. Call 919-643 after 6 p.m. and weekends.
1984 14' X 60' MOBILE home. A-roof, garden tub, ceiling fan, central heat and air, plus extras. Call 919-643 after 6 p.m. and weekends.
1984 14X60 mobile home. 8x12 front deck, underpinned, 45x backporch, 2 bedroom, 2 baths, 2 car port. Open inside with storm door set up on semi-private lot in Eastern Pines. Call 756-0479 after 5:30 p.m.
1986 CHAMPION 14x50, 2 bedroom set up in park, assume \$9,500. 355-7576 evenings.

102 Mobile Homes For Sale
1980 48x14, 2 bedroom, setup anywhere within 100 miles of Greenville, NC for only \$261.06 down and assume old loan for less than 12 years. Call J.Q. 756-7490.
1986 FLEETWOOD 14x70 mobile home. \$201 monthly. Call 757-3555 after 5 p.m.
1984 14 WIDE, payments as low as \$141.86. Greenville volume dealer. Thomas' Mobile Home Sales. Across from Airport. 752-6068.
1987 FLEETWOOD, 24x64, 3 bedrooms, 2 baths, fireplace, sliding glass door, Frost free, ceiling fans, home type furnace, 2 ceiling fans, central air, 8x8 storage building. Excellent price. Call 756-8328.
14x70 1983 Fleetwood, 3 bedrooms, 2 baths, central air, fireplace, new carpet, deck, underpinning, shed and fenced yard. Mortgage assumable, low monthly payment. 758-7728.
14x70 1985 Rockford. Assume loan \$223.56/month. Negotiable down payment. Call 756-3419.
14x70 OAKWOOD, 3 bedrooms, 2 full baths, central heat/air. Assume loan, no equity. Call 355-8854.
1987 COMMODORE 10x50, partially furnished. One bedroom. Great for single. Also good for beach trailer. \$200. Call 746-2540 after 6 p.m.
1972 12x55 Havelock home. Deck, storage building, washer/dryer, underpinning. Good condition. Set up in local park. \$4800. 237-8400 after 5 p.m.
1972 12X60 mobile home, 2 bedroom, 1 1/2 bath, extra clean, central heat and air, new carpet and underpinned, \$6,200 negotiable. Call 756-9027 after 7 p.m.
1973 RITZCRAFT, 12x65. Nice clean used home. Some equity and assume payments. Call Calvary Mobile Homes of Greenville at 756-5114.
1975 TITAN, 2 bedrooms, bath. Good condition. \$5500. Call nights, 752-1285.
1975 12x60 2 bedroom, 1 bath, new gas furnace. One bedroom. Great for single. Also good for beach trailer. \$200. Call 746-2540 after 6 p.m.
1979 14x70, 3 bedrooms, 1 1/2 baths. Must see to believe. Some equity and assume payments. Call Calvary Mobile Homes of Greenville at 756-5114.
1979 48x14, completely furnished. \$450 down, \$167 per month. This includes all set up and delivery. Ask for Mr. Meeks at 756-7490.
1981 CONNOR 2-Bedroom, spacious floor plan. Good condition. Equity \$1500 negotiable, assume payments. Call 555-6466.
1981 FLEETWOOD 14x70, 3 bedrooms, 2 full baths. Must sell-moving in new home. Call 757-1879 after 4:30 p.m. or anytime on weekends.
1981 78x14, 3 bedrooms, 2 baths. Extra nice. Free up and delivery. Completely furnished. \$495 down, \$241 per month. Call 756-0333, ask for Mr. Meeks.
1983 14' X 60' Oakwood Mobile Home. Take over payments of \$194.56 per month. Negotiable down payment. Call Earl, 756-3640.
1984 14x76 mobile home, 3 bedrooms, 2 full baths, cathedral ceiling. Call from 8-572-6178, Randy.
1984 14' X 60' MOBILE home. A-roof, garden tub, ceiling fan, central heat and air, plus extras. Call 919-643 after 6 p.m. and weekends.
1984 14X60 mobile home. 8x12 front deck, underpinned, 45x backporch, 2 bedroom, 2 baths, 2 car port. Open inside with storm door set up on semi-private lot in Eastern Pines. Call 756-0479 after 5:30 p.m.
1986 CHAMPION 14x50, 2 bedroom set up in park, assume \$9,500. 355-7576 evenings.

105 Musical Instruments
MUSICAL AND PA equipment. We install church PA, buy, sell, trade and rent all types of musical instruments including PEAVEY, Mac Stewart Music, 2700 East Ash Street, Goldsboro, 751-0120.
SILVER BACH stradivarius cornet, excellent tone, beautiful horn, masonite sliding shingle roof. \$699, only \$35 per month. 355-6402.
SPINET PIANO, excellent condition, \$850 negotiable. 792-6209.
THOMAS transistor organ, double keyboard, four pedals, phone jack, and books. 752-3558.
WE BUY, sell, trade and rent all types. All major lines including Peavey, New Bern Music, 1409 Tatum Drive, 636-5640.

112 Woodstoves
CRAFT WOODSTOVE, used 6 years, \$200. Call after 5:30 p.m. 355-2759.

115 Lost & Found
LOST: black and white female dog. Call Grayson Coward. Reward offered.

118 Business Services
BRANCH BROOK Marine Construction specializing in piers, bulkheads and jetties. All work guaranteed. Free estimates. Call 946-1748, ask for David.

122 Business Opportunities
A BUSINESS? Buy or sell your business with C.J. Harris & Co., Inc. Financial & Marketing Consultants. Serving the Southeastern United States. Greenville, N.C. 355-7799, nights 756-8444.
CONVENIENT STORE with fully equipped grill for sale. Excellent location in Portersport. For more information call 355-6645.
ESTABLISHED full-line service station for sale. Excellent location. Call Richard Allen at The Real Estate Center. 355-6666.

122 Business Opportunities
DRYCLEANERS and laundromat for sale. Call 756-4001.
KITCHEN FOR LEASE. Large facility, heavy traffic. Great opportunity. Contact George at 757-3658 or 355-6560.
OWN YOUR OWN Jean-Sportswear, Ladies Apparel, Children's/Maternity, Large Sizes, Pettie, Dancewear/Aerobic or Accessories store. Jorjache, Chic, Lee, Levi, Izod, Gilano, Mens, Calvin Klein, Sergio Valente, Evan Picone, Liz Claiborne, Members Only, Gasoline, Healthtex, over 1000 others. \$14,800 to \$26,900 inventory, training, fixtures, grand opening, etc. Can open 15 days. Mr. Keenan (305) 678-3639.

124 Professional
CHIMNEY SWEEPING. Gid Holloman. North Carolina's original chimney sweep. 30 years experience working with chimneys and fireplaces. Fireplace repair, chimney caps installed, screens for chimney tops. Call day or night, 753-3503, Farmville, NC.

132 Commercial Property
FOR SALE: Warehouse at 307 Skinner Street. 4200 square feet, 2 baths and office. Can be made into apartments or used for business. Call 756-0416.
OLD SHONEYS for sale or lease. Greenville Boulevard. Call Mike Darden Realty, 758-1983; nights and weekends, 355-6558.
WAREHOUSE-Farmville-6200 square feet with offices. 1.6 acres, lease or sell. 1-322-5171.
WASHINGTON INDUSTRIAL Park: 48 acre lot of prime property suitable for commercial or industrial location. Road frontage on U.S. 17 and S.R. 1536. Call Mike Darden Realty, 758-1983; nights and weekends, 355-6558.
100'x400' LOT, Greenville's newest and hottest spot!!! On Greenville Boulevard. Call Carl Darden Realty, 758-1983; nights and weekends, 355-6558.
400' ROAD FRONTAGE available on North Greene Street. Excellent location for commercial development with high traffic count. Priced in low \$20's. Call Mike Davis with Century 21, Janet Bowser & Associates at 355-7800 or 355-6777.

136 Condominiums For Sale
WESTHILLS, 2 bedrooms, 2 baths, new hospital, 1 1/2 years old. Call 757-1691.
139 Farms For Sale
83 ACRE PITTS COUNTY farm with tobacco allotment located on paved road. \$79,900. Call Real Estate Center 355-6666.
140 Farms For Lease
WANTED: Tobacco shops (Pitt County). Call Jack Sharp, 795-4578.
144 Houses For Sale
AS LOW AS \$200 per month, \$0 down! Brick, 3 bedrooms, 1 1/2 baths. Home Realty, 355-4663.
AYDEN: Payments less than \$400 a month can be found in this 3 bedroom brick ranch boasting fenced backyard, screened porch, garage and wood lot. Convenient location and great neighbors make this an exceptional buy. Priced to sell at \$45,500. Call Century 21 Tipton and Associates, 355-7002. Nights, DeDe Carney, 757-3759.
AYDEN: The Pines - quiet luxury in a beautiful 2 story brick Colonial home. Has 4 bedrooms, 3 1/2 baths, formal area, family room and a large solarium. Call Century 21 Tipton and Associates, 355-7002 and nights John Carpenter, 355-5618.
AYDEN: Attractive brick ranch with 3 bedrooms, 1 bath and carport. Air conditioning and area yard. Contact Rhonda Bailey at CENTURY 21 Janet Bowser & Associates, 355-7800 or 756-8003, 841,900.
BAYTREE: Beautiful wooded area, 3 bedroom, 2 bath, fenced yard, deck, central air. \$78,500. Owner, George. Call 757-3658 or 355-6560.
BEAUTIFUL MANTELS... this house has seven. Offers living room, dining room, den and 3 or 4 bedrooms to accommodate your needs. This could be your special showplace. \$58,000. Call Century 21 Bass Realty, 756-6666 or 355-BASS. 8654.
BELVOIR: Great starter home, that features 3 bedrooms, appliances and heat pump. \$20's. Call J.L. Harris & Sons, 758-4711 or Don Lee, 752-1910.
BILTMORE: Mid \$30's will put you right at home in this newly listed 4 bedroom in-town location. Call and find out how you could have payments less than \$300 a month. Call Century 21 Tipton and Associates, 355-7002. Nights, DeDe Carney, 757-3759.
BRITANNY RIDGE: New Listing. New Construction, excellent floor plan on this 3 bedroom 2 bath Traditional on large corner lot. Call now and pick out your colors. Call Century 21 Tipton and Associates, 355-7002.
BROOK VALLEY: Reduced to \$169,900. Contemporary elegance in exquisite private setting. A truly unique custom built home featuring impressive 2 story, great room, balconied staircase, large deck overlooking creek off master bedroom and many more fine details. Call Janet Bowser, CENTURY 21, Janet Bowser & Associates, 355-7800 or 756-8580.
BY OWNER: \$2500 down, assume 9 1/2% FHA loan on 2 bedroom, 1 1/2 bath townhouse. Many extras. 756-2950 after 5:30 or weekends.

144 Houses For Sale
BY OWNER on 1100 square feet 3 bedroom, 2 bath, with fireplace and patio. 752-7607.
BY OWNER: 3 bedrooms, 1 1/2 baths, living room, kitchen and dining area combination, fully carpeted over hardwood floors, central heat and air, carport, lot approximately 100x150. Monday-Friday, 355-2461, 756-0652 after 5.
BY OWNER brick home in Cherry Oaks, good assumption. Call 355-2634.
CAMELOT: Brick ranch. Corner lot, double carport, nice closets and extras. Priced to sell. 355-8255.
CAROLINA HEIGHTS: Shady, wooded lot provides natural setting for this 3 bedroom, 1 1/2 bath starter home. You'll love the hardwood floors and pine paneled walls. Call to see this great buy in the \$40's. Call Century 21 Tipton and Associates, 355-7002. Nights, DeDe Carney, 757-3759.
CLUB PINES: This 4 bedroom traditional, located in one of Greenville's most desirable areas features living room, separate dining room, family room with fireplace. This charming neighborhood offers the warmth, beauty and convenience every family needs. \$96,500. Call Century 21 Tipton and Associates, 355-7002 and nights John Carpenter, 355-5618.
CLUB PINES... Lovely 3 bedroom contemporary home featuring large greatroom with wet bar, dining room and kitchen with Jenn Aire range and microwave oven. Other extras include an attached efficiency apartment, double carport and fenced in yard. Offered at \$132,500. \$637. Call Century 21 Bass Realty, 756-6666 or 355-BASS. 8649.
COLONIAL HEIGHTS: Country quiet pervades this 3 bedroom, 2 bath brick ranch. Has a den and a fireplace in the living room. Affordably priced in low \$30's. Call Century 21 Tipton and Associates, 355-7002 and nights John Carpenter, 355-5618.
COUNTRY SQUIRE: Farmers Home Assumption. 3 bedrooms brick ranch on a corner lot. Call Century 21 Tipton and Associates, 355-7002 and nights John Carpenter, 355-5618.
CUSTOM HOME BUILDER. Craft-Bilt Homes builds and finances on your lot - completely finished home. Call 1-800-942-5211 anytime.
FOR RENT in Griffon. 2000 square foot brick home, 4 bedrooms, 2 bathrooms, living room/dining room combination den/kitchen combination with fireplace, garage, air conditioning. Exclusive area. 15 minutes from Greenville. \$475 per month. Call George Saleeby Realty, 524-4191; nights, 524-4088.
FORT SUMNER: New construction in Lyncdale. This Bowers Bull home features 2750 square feet of finest workmanship. There's 4 bedrooms, 2 car garage and an unfinished 3rd floor. Call Janet Bowser, CENTURY 21 Janet Bowser & Associates, 355-7800 or 756-8580. \$168,900.
GET A BETTER interest rate! Seller will pay up to three points or take \$2000 off price of \$64,900, for this well maintained 3 bedroom brick ranch at 1603 South Elm Street. Leave message with babysitter or call after 6 p.m. 756-5772.

144 Houses For Sale
CUSTOM FEATURES Abundant in this 3 year old home just on the edge of town. 3 bedrooms, 2 full baths, garage and fireplace. Excellent financing available. Come and see the difference for yourself. \$57,500. \$604. Call CENTURY 21 Bass Realty, 756-6666 or 355-BASS.
DO YOU WANT A PLACE of your own? This clean 2 or 3 bedroom mobile home with its own private lot may be the answer. Owner will help with points and closing costs. Call J.L. Harris & Sons, 758-4711 or Don Lee, 752-1910.
EASTWOOD/PACKED With Values. \$68,000. Bright ranch with nice floor plan. Quiet street, great family area, heat pump, dryer, family room, eat in kitchen, 3 bedrooms, 2 baths, fencing, easy-care landscaping, shutters. Fireplace, garage. Duffus Realty, Inc. 756-5395.
FAIRFIELD: Price has been reduced on this 3 bedroom, 2 bath brick ranch with garage, fireplace in den. \$56,500. Call Century 21 Tipton and Associates, 355-7002 and nights Rod Twigwell, 355-7224.
FARMVILLE: This 2 or 3 bedroom, 1 1/2 bath brick ranch comes with a complete application, double carport and fenced backyard. Priced in the low \$40's. Call Century 21 Tipton and Associates, 355-7002 and nights John Carpenter, 355-5618.
FARMVILLE: 3 bedroom ranch with carport. Priced in \$50's. Call Century 21 Tipton and Associates, 355-7002 and nights Rod Twigwell, 355-7224.
FARMVILLE: This house is fresh on the market. This 4 bedroom brick home, located on a nice sized lot on South Barrett Street, can be yours for less than \$55,000. Call Century 21 Janet Bowser and Associates, 355-7800 or Seth Jones, 753-5576.
FINALLY AN affordable house payment that could be as low as \$314. 3 bedrooms, family room, dining room, brick, on wooded lot, 1400 square feet, good area. Very small down payment. Home Realty, 355-4663.
LYNNDALE BY Owner, 115 Asbury Road, 4 bedroom Williamsburg farmhouse on wooded lot. Call 355-2102 for appointment.
NEAR SCHOOLS... This 4 bedroom ranch in Colonial Heights is a must see! Recently remodeled with 3 baths, whirlpool, 2 fireplaces and many more extras. Price has been reduced to \$63,900. Call CENTURY 21 Bass Realty, 756-6666 or 355-BASS. 8649.
NEED A LIVING ROOM and den with fireplace for less than \$70,000! Now available only \$59,900! 3 bedrooms, 2 full baths, fenced backyard and located in the Winterville School District. Hignite Realtors, 757-1969.
NEW HOME ON MILLBROOK Street with 3 bedrooms, 1 1/2 baths, living room, large eat-in kitchen, Heatpump for heating and cooling foot! Only \$49,000. Builder will pay closing costs! Hignite Realtors, 757-1969.
NEW LISTING in the country with a country kitchen and great big dining area with ceiling fan. You will all love the spaciousness of 3 large bedrooms and nice yard for the kids to play. Seller must sell! \$64,000. Offered for only \$49,000. Call CENTURY 21 Bass Realty, 756-6666 or 355-BASS. 8654.

144 Houses For Sale
GRIFTON AREA: A charming traditional 2 story home offering 4 bedrooms, 2 1/2 baths. Formal areas with 2 fireplaces plus woodstove in large family room. Many extras in the 2400 square feet. Must see to appreciate. \$88,900. Call Century 21 Tipton and Associates, 355-7002 and nights Joan Crane 756-5408.
GRIMESLAND: Spacious 3 bedroom, 1 1/2 bath, brick ranch, carport, storage building. Great location. Call Century 21 Tipton and Associates, 355-7002 and nights Annette Parker-Butler 355-7009.
HARDEE ACRES: Marvelous starter home. Outside of city, but convenient. Offering 3 bedrooms, wired workshop, nice yard. \$55,900. Call Aldridge and Southlander, 756-3500; ask for Katherine Vinson, 752-5778.
HARDEE ACRES: This brick ranch home features 3 bedrooms, 1 1/2 baths, family room with woodstove, fenced backyard and garage. Newly decorated. 50's. Call Rhonda Bailey, Century 21 Janet Bowser & Associates, 756-8003 or 355-7800.
HOUSE FOR SALE by owner. Near Eastern Elementary School. Call 758-3265.
IMPERIAL ESTATES: Farmers Home Assumption near Bowers Home Welcome - includes extra large lot with 3 bedrooms listed at only \$36,800. See how low your payment can go by calling Century 21 Tipton and Associates, 355-7002. Nights, DeDe Carney, 757-3759.
KEARNEY PARK: Great buy on this 3 bedroom brick ranch located on large corner lot with fenced backyard, and sunny disposition. Priced in low \$40's, see it soon by calling Century 21 Tipton and Associates, 355-7002. Nights, DeDe Carney, 757-3759.
KEARNEY PARK: Large sunny kitchen makes this home just right for the cook who needs lots of cabinets and rooms to move about. 3 bedrooms, ceramic tile bath, convenient to city bus line. \$42,900. Call Century 21 Tipton and Associates, 355-7002. Nights, DeDe Carney, 757-3759.
LYNNDALE: Quality Tipton Construction in this outstanding neighborhood. 2 homes now under construction. Call today and pick out your colors. Call Century 21 Tipton and Associates, 355-7002.
UNIVERSITY AREA. 3 bedrooms, 2 baths, central air, new gas heat and new roof. \$59's. 752-0991. Owner/Broker. 803-873-1629.
UNIVERSITY AREA: Classic! This 3 bedroom brick beauty is indeed a site to behold with its ornate columns, wood floors, screened porch and large yard. Won't last long in this well-liked location. Call right away to make an appointment to see this one. Call Century 21 Tipton and Associates, 355-7002. Nights, DeDe Carney, 757-3759.
ROCK SPRINGS: Executive home near ECU featuring 5 bedrooms, 2 1/2 baths and over 3000 square feet. Priced to sell in low \$100's. Call Century 21 Tipton and Associates, 355-7002. Nights, DeDe Carney, 757-3759.

144 Houses For Sale
GRIFTON AREA: A charming traditional 2 story home offering 4 bedrooms, 2 1/2 baths. Formal areas with 2 fireplaces plus woodstove in large family room. Many extras in the 2400 square feet. Must see to appreciate. \$88,900. Call Century 21 Tipton and Associates, 355-7002 and nights Joan Crane 756-5408.
GRIMESLAND: Spacious 3 bedroom, 1 1/2 bath, brick ranch, carport, storage building. Great location. Call Century 21 Tipton and Associates, 355-7002 and nights Annette Parker-Butler 355-7009.
HARDEE ACRES: Marvelous starter home. Outside of city, but convenient. Offering 3 bedrooms, wired workshop, nice yard. \$55,900. Call Aldridge and Southlander, 756-3500; ask for Katherine Vinson, 752-5778.
HARDEE ACRES: This brick ranch home features 3 bedrooms, 1 1/2 baths, family room with woodstove, fenced backyard and garage. Newly decorated. 50's. Call Rhonda Bailey, Century 21 Janet Bowser & Associates, 756-8003 or 355-7800.
HOUSE FOR SALE by owner. Near Eastern Elementary School. Call 758-3265.
IMPERIAL ESTATES: Farmers Home Assumption near Bowers Home Welcome - includes extra large lot with 3 bedrooms listed at only \$36,800. See how low your payment can go by calling Century 21 Tipton and Associates, 355-7002. Nights, DeDe Carney, 757-3759.
KEARNEY PARK: Great buy on this 3 bedroom brick ranch located on large corner lot with fenced backyard, and sunny disposition. Priced in low \$40's, see it soon by calling Century 21 Tipton and Associates, 355-7002. Nights, DeDe Carney, 757-3759.
KEARNEY PARK: Large sunny kitchen makes this home just right for the cook who needs lots of cabinets and rooms to move about. 3 bedrooms, ceramic tile bath, convenient to city bus line. \$42,900. Call Century 21 Tipton and Associates, 355-7002. Nights, DeDe Carney, 757-3759.
LYNNDALE: Quality Tipton Construction in this outstanding neighborhood. 2 homes now under construction. Call today and pick out your colors. Call Century 21 Tipton and Associates, 355-7002.
UNIVERSITY AREA. 3 bedrooms, 2 baths, central air, new gas heat and new roof. \$59's. 752-0991. Owner/Broker. 803-873-1629.
UNIVERSITY AREA: Classic! This 3 bedroom brick beauty is indeed a site to behold with its ornate columns, wood floors, screened porch and large yard. Won't last long in this well-liked location. Call right away to make an appointment to see this one. Call Century 21 Tipton and Associates, 355-7002. Nights, DeDe Carney, 757-3759.
ROCK SPRINGS: Executive home near ECU featuring 5 bedrooms, 2 1/2 baths and over 3000 square feet. Priced to sell in low \$100's. Call Century 21 Tipton and Associates, 355-7002. Nights, DeDe Carney, 757-3759.

144 Houses For Sale
GRIFTON AREA: A charming traditional 2 story home offering 4 bedrooms, 2 1/2 baths. Formal areas with 2 fireplaces plus woodstove in large family room. Many extras in the 2400 square feet. Must see to appreciate. \$88,900. Call Century 21 Tipton and Associates, 355-7002 and nights Joan Crane 756-5408.
GRIMESLAND: Spacious 3 bedroom, 1 1/2 bath, brick ranch, carport, storage building. Great location. Call Century 21 Tipton and Associates, 355-7002

144 Houses For Sale

PRICE REDUCED \$2000. Country living can be yours now with this 3 bedroom, 2 bath home with over 1700 square feet located just 5 miles from Greenville. Built-in bookcases, wood stove, ceiling fans and microwave are just a few of the extra's that can be yours now. Owner anxious to sell so make an offer before this beauty is gone! Call Mike Davis at CENTURY 21 Janet Bowser and Associates, 355-7800 or 355-6777.

144 Houses For Sale

RIVERDALE: Unbelievable! Payments approximately \$300/month on this centrally located home featuring fenced backyard, carport, central heat and air located only minutes from hospital. Buyer's loss can be your gain. Call today to take advantage of this deal for real! Reduced to \$36,000. Call Century 21 Tipton and Associates, 355-7802. Nights, DeDe Carney, 757-3759.

144 Houses For Sale

ROLLING MEADOWS: New construction. We have a brand new house in one of Greenville's hottest new neighborhoods. Priced in the \$50's and perfect for the first time home buyer. Call today! Century 21 Tipton and Associates, 355-7802.

THIS MAY SHOCK YOU! 3 bedroom brick bungalow in the mid 20's. Home is well constructed and sound, needs only painting and is an excellent investment opportunity for your first home. Features include hardwood floors, large living room with fireplace, oversized kitchen with eat in area and more. Listed for \$25,000. #647. CENTURY 21 Bass Realty, 756-6666 or 355-BASS.

144 Houses For Sale

UNIVERSITY AREA: 3 bedroom brick ranch at the corner of Woodlawn and Willow. Priced at \$54,500. Call Century 21 Tipton and Associates, 355-7802 and nights Rod Tugwell, 355-7224.

UNIVERSITY: Spacious and sunny creates a relaxing livable atmosphere in this traditional 2 story, 4 bedroom brick home. See it today. \$73,900. Call Aldridge and Southernland, 756-3500; ask for Katherine Vinson, 352-5778.

144 Houses For Sale

VALUE AND AFFORDABLE: 3 bedroom brick home with new carpet, paint and wallpaper. Ceiling fans in the living room and dining area along with new range add to this home's appeal. \$42,500. #568. Call CENTURY 21 Bass Realty, 756-6666 or 355-BASS.

VETS! SELLER WILL PAY: points and closing costs for VA or FHA loan! 3 bedroom brick ranch for only \$46,900. Hignite Realtors, 757-1969 anytime.

150 Land For Sale

DEVELOPER! Your opportunity to develop a fantastic subdivision midway between the rail and the hospital has arrived. 71 acres with water and sewer nearby. Call Richard to day for more information. The Real Estate Center, 355-6666.

AYDEN, NC: 8 acre subdivision for 20 lots, all utilities available. Call 746-6116.

AYDEN: 2 adjacent residential lots behind 499 King Street. Both for \$5500. Call Century 21 Tipton and Associates, 355-7802 and nights Joan Crane 756-5408.

152 Lots For Sale

1/2 ACRE LOTS AND UP: located in Simpson with community water and cable available. Call Worley Warren at Aldridge & Southernland 756-3500. Nights 757-3222.

CHERRY OAKS: Williams Street. Wooded. Call 513-298-7340 collect.

152 Lots For Sale

LARGE LOTS: may include septic tank, well, 200 amp meter pole. No down payment. 100% owner financing. Call 752-5677.

LOTS - DOWNTOWN AREA: 3 lots for sale. Located Downtown Greenville area in older residential section. All border on Tar River. Call Mike Davis with CENTURY 21 Janet Bowser & Associates, 355-7800 or 355-6777.

161 Apartments For Rent

A PERFECT PLACE to live. 1 bedroom apartments, \$225. 2 bedroom apartments, \$275. Water included. Brand new washer/dryer hookups, no pets. Security appliances required. Approximately 1 mile from hospital. Call 756-1454.

A QUIET PLACE! WILLIAMSBURG MANOR Super decor, outside and attic storage. E300 energy rating. Young professionals. No pets. \$354.50 after 6 p.m. 3545.

CLASSIFIED DISPLAY

River Bluff

"Spacious Affordable Luxury Apartments"
• 2 bedroom townhouse temporarily reduced for new move ins only.
• 1 bedroom garden apt. temporarily reduced to \$220 mo.
• Large pool • Cable TV • ECU Bus Service

Phone: 758-4015

CLASSIFIED DISPLAY

CLASSIFIED DISPLAY

CLASSIFIED DISPLAY

CLASSIFIED DISPLAY

CLASSIFIED DISPLAY

CLASSIFIED DISPLAY

CLASSIFIED DISPLAY

OUTSTANDING VALUE



SAVE \$2000**

\$600
CUSTOMER CASH BACK
USE THIS \$600 AS YOUR
DOWN PAYMENT!

**1987 TOPAZ GS SPORT
WITH MANUAL
TRANSMISSION**

15 CARS IN STOCK **PRICED TO MOVE AT \$209* PER MONTH**

6 YEAR/60,000 MILE WARRANTY

THESE CARS ARE LOADED!

Just Look at What You Get For This Price

- Clearcoat paint
- Interval wipers
- Digital clock
- Light group
- Tilt wheel
- Rear window defroster
- Front wheel drive
- Electronic fuel injection
- 48 amp-hour maintenance free battery
- Power rack and pinion steering
- All-season steel belted radial tires
- Power front disc/rear drum brakes
- Air conditioning

- Nitrogen gas-filled struts
- Tinted glass
- Rear door child proof locks
- 5 MPH bumper
- Bright moldings
- Color-keyed dual power remote mirrors
- Wheel covers
- Tachometer
- Trip odometer
- AM-FM stereo cassette radio with dual front and rear speakers
- Side window demisters

- Individual reclining low back front seats
- Color-keyed seat belts with tension relievers
- Performance suspension package
- Cast aluminum wheels
- Charcoal decklid luggage rack
- Black leather-wrapped steering wheel
- Sport bucket seats
- Fold-down vinyl covered front seat armrest
- Speed control

151 Mobile Home Lots For Sale

LARGE LOTS for mobile homes in the country. Excellent location. Easy financing. Call Winnie, 752-4224; days at 752-2814.

MOBILE HOME lots for sale; Low down payment, easy financing. Located on Old River Road and Eastwoods Country Estates. Call Benny Eastwood, 752-1802, anytime.

152 Mobile Home Lots For Sale

SAVE MONEY this winter shop and use the Classified Ads every day!

WINTERVILLE SCHOOL District: 100x160 corner lot, city water, state maintained road, FHA/VA approved. Can build to suit. Call Century 21 Tipton and Associates, 355-7802 and nights Annette Parker-Butler 355-7009.

155 Resort Property For Sale

ATLANTIC BEACH oceanfront 24 ft camper/trailer, fully equipped with deck and central air, 1983 model in excellent condition. Call 758-6599 days; 355-7977 evenings. Ask for Ms. Harris.

CRYSTAL BEACH on the Pamlico River, 4 bedrooms, 2 baths, wooded lot, beautiful view along with extras. \$50,000 with terms. Speight Realty 752-2136 or 758-3253.

157 Townhouses For Sale

FOR SALE BY OWNER: 2 Bedroom townhome at Lexington Square beside Greenville Athletic Club. \$45,900. 752-8747.

GREAT INVESTMENT! This spacious unit featuring 2 bedrooms each with a bath and 1/2 bath downstairs, great room/dining room combination can be yours with just \$2,095 down. Monthly payments of only \$395.51 (P/I) based on a FHA 8 1/2% 30 year fixed rate, loan amount of \$51,697.59 including \$1,992.59 (P/M). Builder will pay closing costs and up to 3 points. \$51,900. Call Linda Gaddis at CENTURY 21 Janet Bowser & Associates, 355-7800 or 756-2291.

HUD OWNED: 2 bedroom townhouse next to Greenville Athletic Club. Asking \$43,300. Only \$500 down. Hignite Realtors, 757-1969 anytime.

AROUND TOWN
People are Talking

- One, Two & Three Bedrooms Available
- Private Patios, Clubhouse and Pool
- A community of families professionals & students
- 24-Hour Maintenance
- Minutes from ECU and Medical Center

752-4225
1400 Willow St.
Hours 9-6 Monday-Friday, 1-5 Saturday
Professionally Managed by US Shelter



Tar River ESTATES

remco east, inc.

(919) 758-6061. Call for appointment. NO Fees.

REAL ESTATE MANAGEMENT

2088 ALICE DRIVE. Two bedroom, 1 1/2 bath townhouse on end of quiet street. All appliances and washer/dryer hook-ups. Outside storage.

302A ALICE DRIVE. Two bedroom, 1 1/2 bath garden apartment. Includes cathedral ceilings, outside storage and large yard.

AYDEN DUPLEX. Two bedroom with range, refrigerator, dishwasher, washer/dryer hook-ups included. Available now.

CAPTAINS QUARTERS. East Twelfth St. Spacious one bedrooms near ECU. Dishwasher, refrigerator, range and washer hook-up.

CEDAR COURT. Two bedroom, 1 1/2 bath townhouse with patio and energy efficient appliances, washer/dryer hook-ups.

COLLEGE VIEW. Only one apartment left. Two bedroom with hardwood floors. Close to university.

700-8 COTANCHE STREET. One bedroom apartment with water, sewer and heat. Walk to the campus from this convenient location.

CYPRESS GARDENS. Spacious one bedroom apartment with washer/dryer hook-ups. Water and BASIC CABLE included.

JOHNSTON STREET. One bedroom apartments only two blocks from campus. Convenient to grocery stores and laundry.

RIVER OAK. One bedroom efficiency overlooking the river. We furnish hot water. Laundry on site.

LANGSTON PARK. Special. One month rent free! Two bedroom apartment by the river. Energy efficient appliances, washer/dryer hook-ups. Water and cable included in \$300 rent.

PIRATES LANDING. Private furnished rooms for rent. Utilities included. Share bath and kitchen. Laundry on site.

REGENCY HOUSE. Corner of 5th and Reade. Two bedroom, one bath next to campus and downtown. New appliances - completely renovated.

EDGEFIELD TOWNES. Lovely three bedroom, 2 1/2 bath townhome with large patio and privacy fence. Garbage disposal, refrigerator with ice maker, dishwasher range and lots of storage space.

WEST HILLS TOWNHOMES. Two bedroom, 2 1/2 bath townhome and two bedroom, 2 bath garden apartment near PCMH. Fully equipped with energy efficient appliances, storage, washer/dryer hook-ups.

WOODSIDE. 98 Brookwood Dr. for the young professional - one bedrooms with energy efficient appliances. Quiet surroundings.

WILLIAMSBURG MANOR. 102D Concord Dr. Short Term lease available. Large 2 bedroom, 1 1/2 bath townhome in professional area. Appliances with washer/dryer hook-ups. Private patio. Immediate occupancy.

**EXCEPTIONALLY EQUIPPED
EXCEPTIONALLY PRICED**



1987 COUGAR LS

\$279.83* PER MONTH

THIS IS YOUR PRICE YOU SAVE OVER **\$2700**
With Value Option Package

6 YEAR/60,000 MILE WARRANTY

LOOK AT ALL THE EQUIPMENT THAT'S INCLUDED:

- Interval Windshield Wipers
- Electronic Digital Clock
- Tilt Steering Wheel
- Fingerprint Speed Control
- Electric Rear Window Defroster
- Electronic AM/FM Stereo
- Cassette Radio
- Power Side Windows
- Light Group
- Power Lock Group

- Front Carpet Floor Mats
- Leather-Wrapped Steering Wheel
- 6-Way Power Driver's Seat
- Polycast Wheels
- Dual Illuminated Visor Vanity Mirrors
- 3.8-Liter V-6 Engine
- Electronic Fuel Injection
- EEC-IV Electronic Engine Controls

- Variable-Ratio Power Rack-and-Pinion Steering
- Aero Halogen Headlamps
- Doors with Flush Side Glass
- Manual Air Conditioner
- Tinted Glass
- Side Window Demisters
- Reclining Twin Comfort Lounge Seats
- Carpeted Luggage Compartment

* Based on 10.9% A.P.R. Total payments \$16,789.80. \$1000 down payment plus tax and N.C. license, selling price \$13,900. 60 monthly payments, with approved credit.

EAST CAROLINA
LINCOLN-MERCURY-GMC TRUCK-MERKUR



West End Circle
756-4267

Greenville, N.C.



THE "BEST" JUST KEEPS GETTING BETTER!

Come See The New Two Bedroom, Two Bath Garden Apartments At

COURTNEY SQUARE

Office Open 9-5 Weekdays
9-5 Saturday 1-5 Sunday

Merry Lane Off
Arlington Blvd.
756-5067



Cherry Court

Spacious 2 bedroom townhouse with 1 1/2 baths. Also 1 bedroom apartments available. All are carpeted, with modern kitchen appliances including compactor and dishwasher. Central heat and air. Free basic cable TV, water and sewer. Washer/dryer hook-ups plus laundry room, pool, sauna, tennis court, club house. 752-1557.

DELIGHTFUL 2 bedroom \$250 or 3 bedroom 1 1/2 baths \$350
Homeowners Fee 752-1375.

EASTBROOK AND VILLAGE GREEN APARTMENTS

One, two and three bedroom apartments, featuring cable TV, energy efficient, free water and sewer, optional washers, dryers, cable TV. Couples or singles only. \$195 month. 6 month lease.

MOBILE HOME RENTALS
Couples or singles. Apartments and mobile homes in Azalea Gardens near Brook Valley Country Club.
Contact J.T. or Tommy Williams 756-7815

BROOKSIDE APARTMENTS

1 bedroom, fully carpeted, all appliances, washer/dryer hook-ups, water and sewer furnished. Cable available. \$230 per month. 752-4295 or 756-6199.

CARRIAGE HOUSE Apartments, Highway 43 South, just past the plaza. 2 bedroom townhouses, all electric, fully carpeted, pool and laundry room. Call 756-3450 after 5 p.m.

Office: 204 Eastbrook Drive 752-5100

ELM VILLA Apartments. 208 South Elm Street. 3 bedrooms. Fully furnished. Heat, air and water furnished. Call 752-3376.

FAIRLANE FARMS APARTMENTS

1,2 & 3 BEDROOMS
With Fireplace & Ceiling Fans
• \$95 Security Deposit + \$12 Month Leases
• Washer/Dryer Connections
• Pets Conditional
• Two Full Baths in two & three bedrooms.
• New apartments available

**MONDAY-FRIDAY 10-6
SATURDAY 9-1
1510 Bridle Circle
355-2198**

Located off Hooker Road on Horseshoe Drive.
Equal Housing Opportunity

GreeneWay

Large 2 bedroom garden apartments, all with 7 closets, carpeting, kitchen appliances including dishwasher, central heat and air. Free basic cable TV, water and sewer. Laundry rooms, spacious grounds, playground and pool, abundant parking. Pets allowed. Adjacent to Greenville Country Club. (\$295) 756-6869.

HIGHLAND APARTMENTS
1 & 2 bedroom garden apartments with wall to wall carpeting, drapes, washer/dryer connections, dishwasher, disposal, swimming pool, private deck and much more.
Call 919-946-4794
or 800-843-1096
or write:
P.O. Box 425
Washington, NC 27889
EHO

IDEAL! 1 bedroom \$175 campus or 2 bedroom \$265 washer/dryer hookups
Homeowners Fee 752-1375.

IN WINTERVILLE 3 bedroom apartment, appliances and water furnished, no children or pets, deposit/lease, \$245/month. Call 756-5007.

KINGS ARMS

Large 1 bedroom apartments. Carpeted, modern appliances, efficient heat pump for energy efficient heating and cooling. Laundry facilities. 1209 Charles Boulevard, Office Apartment 104. Also Available Furnished Apartments.

752-8915

KINGS ROW APARTMENTS

• 1 & 2 Bedroom Garden Apartments • Appliances furnished, carpet • Central heat and air • Free Cable TV • Pool and laundry facilities • 24 hour emergency maintenance.
Located off East 10th Street behind Huddle's and Western Steer. Office Hours: 9:00-5:30, Monday-Friday.

752-3519

LOVE TREES?
Experience the unique in apartment living with nature outside your door.

COURTNEY SQUARE APARTMENTS

Quality construction, fireplaces, heat pumps (heating costs 50 percent less than comparable units), dishwasher, washer-dryer hook-ups, cable TV, wall-to-wall carpet, thermopane windows, extra insulation!

Office Open 9-5 Weekdays
9-5 Saturday 1-5 Sunday

Merry Lane Off Arlington Blvd.
756-5067

MEDICAL OAKS
Apartments... Brand New, 2 bedrooms, Walking Distance to Hospital, Washer-Dryer Hook-ups, Outside Storage, Fully Carpeted, Super Insulated... \$285.00 per month plus deposit and year's lease - Call Davis Realty 752-3000 or 756-2904 or 355-2574 or 752-9072.

NEAR HOSPITAL, 2 bedroom townhouse, Quiet neighborhood. Call 757-0671 after 5 p.m.

161 Apartments For Rent

NEAR HOSPITAL. 2 Bedroom, 2 bath duplex. Very clean. \$350 month. 355-6666. 830-0878 nights. No pets. 758-6004.

NEW ENERGY efficient 1 bedroom. Near Twin Oaks. \$245. No pets. 758-6004.

NEW 1 BEDROOM apartment. Washer/dryer, cable TV, carpet, electric heat, air conditioning, appliances. 758-3342.

OAKMONT SQUARE APARTMENTS
Two bedroom townhouse apartments. Fully equipped kitchen, pool, tennis courts, cable TV. Very convenient to Pitt Plaza and University. Also some furnished apartments available. Sign 1 year's lease. Move in March. March rent free. 1212 Redbanks Road. (758-4151)

161 Apartments For Rent

STUDENTS. 2 bedroom apartment. Cindy Court. \$290 per month. Heat and water furnished. No pets. 758-3561 after 4 p.m.

SUMMER SEMESTER! We have temporary rentals now furnished/unfurnished. Hurry Call HomeLocators 752-1375.

SUPER LOCATION and nice 1 bedroom. washer/dryer hook-ups. Water furnished. \$225 per month. 757-1626.

THREE BEDROOM. 2 1/2 bath condo for rent. 1500 square feet. Call 355-6934 after 4 p.m.

TOWNHOUSE FOR RENT. 2 bedrooms, 1 1/2 baths, all appliances. 355-6016 after 6 p.m.

TWIN OAKS-2 bedroom. 1 1/2 bath, dishwasher, washer/dryer hook-up. Call Allen 8 a.m.-5 p.m., Monday thru Friday 758-3191.

TWO BEDROOMS. 1 1/2 baths, nice quiet area. Ridge Place. \$325 month. 355-2256.

TWO BEDROOM duplex with fireplace, garage with electric doors, no pets. 1 child. 5 miles from hospital on Stantonsburg Road. 355-6960 and 757-0272.

TWO BEDROOM townhome near hospital area. 752-7101 from 9-5 Monday through Friday.

TWO BEDROOM townhouse. quiet neighborhood. Call 355-7071.

TWO BEDROOM unfurnished apartment on River Bluff Road. Call between 8 a.m. and 5 p.m. 758-1277

TWO BEDROOM apartment for rent. Hospital area. 757-1445.

TWO BEDROOM apartment. near university. Wilkey Realty, Atlantic Beach, 247-5848.

TWO BEDROOM upstairs apartment. 1 block from ECU. Washer/Dryer hook up \$300 per month. Call Allen 8-5. Monday-Friday, 758-3191.

TWO BEDROOM townhome. excellent condition. \$320 month. No pets. Call Geep Johnson, 355-2000.

TWO BEDROOM duplex on one acre lot at Frog Level. No pets. \$280-\$300. Call 756-4624 before 5 p.m. or 756-8076 after 5 p.m.

TWO BEDROOM. renovated bath, kitchen, new flooring, etcetera. 1505 Halifax. \$235. lease. 752-2615-95.

WEDGEWOOD ARMS
2 bedroom, 1 1/2 bath townhouses. Excellent location. Carrier heat pumps. Whirlpool kitchen, washer-dryer hookups, pool, tennis court. 355-6302.

WESTHILLS Townhouse. 1 mile from hospital. Like new, 2 bedrooms, 2 1/2 baths, cable hook-up, professional neighbors. Immediate occupancy. No pets. \$350/month. 355-6002 or 756-7541.

WHY PAY \$350 rent for a 2 bedroom apartment when you can own your own brand new 3 bedroom, 2 bath, 1500 square foot home for \$340.45 per month? This includes taxes, insurance, 5 year warranty, the works! Call the housing expert, John Quinn at 756-0333.

161 Apartments For Rent

1 AND 2 BEDROOMS available. Cypress Gardens. Nice, wooded setting. Good for young professional or couple. Call 355-2025.

1 BEDROOM Duplex \$185 per month ok or 3 bedroom \$245 Others too. HomeLocators Fee 752-1375.

1200 sq. ft. apartment one block from campus. \$200. Call 355-5721 between 8 a.m. and 12 noon or after 9 p.m.

173 Houses For Rent

ECU AREA! 2 bedroom \$275 or Big 3 bedroom \$360 fenced yard. HomeLocators Fee 752-1375.

FOR THE EXECUTIVE and family. large brick, 4 bedrooms, 3 full baths, newly remodeled kitchen with new Jenn-air stove, big den, living room and formal dining. Located on exclusive wooded lot in Bethel adjacent to park. \$550 a month. Absolutely no pets. Security deposit, year's lease required. 825-8511, 6-9 p.m. or weekends.

FOUR BEDROOM. 2 bath Cape Cod in Farmville. Shop and privacy fence. 3375 a month. Call Ray Holoman. 355-2000 or 757-1877.

FOUR BEDROOM house near downtown and campus. \$400 per month. Call owner. 757-1308.

FOUR ROOM house. wall to wall carpet, gas heat, private lot. 1 or 2 people. \$160/month. No children or pets. 752-7140.

HOLLYBRIAR: Beautiful woody location. 3 bedroom, 2 bath. 757-0473 or 355-6560, George.

Large Two Story house-3 bedrooms. 109 Columbia Avenue. \$315 month. Call Allen 8 a.m.-5 p.m., Monday thru Friday 758-3191.

NEED A HOME FAST? We have 250-300 confirmed vacancies listed daily! Kids, pets HomeLocators 752-1375 Fee.

THREE BEDROOMS. 1 1/2 baths. heat pump, garagesil required. No pets. \$320. 204 East 12th Street. Call after 6:00 p.m., 756-0489 or 756-6382.

UNIVERSITY AREA 3 bedroom for rent. Call 756-1160.

3 BEDROOM 2 baths \$315 Big yard or 5 bedroom \$460 2 baths HomeLocators Fee 752-1375.

179 Mobile Homes For Rent

BEHIND VENTER'S Grill. 3 bedroom, 1 1/2 wide, 2 baths, \$210-\$225. 3 bedrooms, 1 bath, \$190. All partially furnished. 756-4982.

CLEAN TWO BEDROOM. fully furnished, central air. Located in Shady Knoll Park. No pets or children. 758-4244.

PRIVATE LOT 3 bedroom. washer/dryer and appliances included. Very nice. garbage pick-up and grass cut. \$245. 758-5253.

THE BEST MOBILES are here today, gone tomorrow! So don't miss them. Hurry, call us today HomeLocators 752-1375 Fee.

TWO BEDROOM. \$200 plus deposit. Call 752-4577 after 6 p.m.

TWO BEDROOM. Furnished. No children. No pets. Call 758-6679.

UNFURNISHED 12x65. 2 bedrooms, central air. No pets. Near Judson's crossroads. Call 758-2992.

UNFURNISHED 12x60. 2 bedroom, nice kitchen, \$225 month. Deposit required. Call 756-4189 days; 756-2098 nights.

1 AND 2 bedroom Mobile homes. \$130 and up. Also Mobile home lot for rent. No pets and no children. 758-0745.

2 BEDROOMS. unfurnished, 1 mile from Greenville in Belvoir Estates. \$150 per month. Call 830-1672 or 752-0978.

2 BEDROOMS. washer/dryer, furnished or unfurnished, good condition, good park, no children or pets. 756-0601.

2 BEDROOM \$150 pets ok or 3 bedroom \$225 washer/dryer kids HomeLocators Fee 752-1375.

181 Office Space For Rent

ATTRACTIVE COMPLEX near Court House (between Coffmans and First Citizens Bank). Three offices, individually or together. Telephone answering and reception services available. 752-6888.

FOR RENT executive office space. Evans Street directly across from courthouse. 1000 to 3400 square feet. Call 756-7648 evenings.

FREESTANDING OFFICE building 1360 square feet. Newly redecorated, excellent location, optional new phone system. Call 354-4451.

181 Office Space For Rent

NICE OFFICE AVAILABLE immediately on Memorial Drive. Utilities and Janitorial services included in rent. Contact Keith Warren at 752-3850 for more information.

OFFICE OR retail space available. 1500, 2000, 3500 square feet available. \$4.00 per square foot. 757-0123 or 756-0765.

PRIME OFFICE Space for rent located on Greenville Boulevard. Please call 756-9404.

185 Rooms For Rent

PIRATES LANDING 200 W. Eighth Street
Private furnished rooms for rent. Utilities included. Share bath and kitchen. REMCO EAST, 758-6061.

192 Roommate Wanted
ROOMMATE WANTED to share 2 bedroom 2 bath new mobile home. \$160 plus 1/2 utilities. Private lot in country. Call Kim days. 757-1727; after 6, 756-8670.

194 Wanted To Buy

TRAILER FOR tractor needed, also a 48" cut self-propelled lawn mower. 355-5338.

WANT TO BUY pine and hardwood timber. Pamlico Timber Company, Inc. 756-9615, nights.

WINNER CHEVROLET
Highway 11 Bypass, Ayden We buy used cars and trucks 746-4032

MOVING AWAY? Make the trip lighter by selling those unneeded items with a fast action Classified ad. Call 752-4166.

Attention First-Time Car Buyers

- Just out of college?
- Just landed a new job?
- Just married and need a dependable car?

YOUR CHOICE! REBATES FROM \$350 TO \$1200 ARE AVAILABLE ON ALL NEW PONTIACS OR 3.9% APR NOW THRU APRIL 30TH

CLARK-BRANCH, REALTORS 355-2000

WE BUILD EXCITEMENT...

Attention First-Time Car Buyers



YOUR CHOICE! REBATES FROM \$350 TO \$1200 ARE AVAILABLE ON ALL NEW PONTIACS OR 3.9% APR NOW THRU APRIL 30TH



WE BUILD EXCITEMENT...

The Real Estate Corner

REDUCED \$6,500 To \$109,500

104 Windermere



Call now and see this beautiful custom-built Williamsburg home with over 2,100 square feet. Features 3 bedrooms, 2 1/2 baths, formal areas, large eat-in kitchen and den with fireplace. Many extras like double car garage, wooded lot and deck. Contact Rhonda Bailey at 756-8003 or 355-7800. #151.

HOUSE FOR SALE By Owner

Three bedrooms, 1 1/2 baths, living room with fireplace, dining room, kitchen, carport, fenced back yard, carpet, like new. Near Pitt Community College and Carolina East Mall, Fairfield Subdivision. \$46,500. Call 756-1795 after 5 p.m.

REAL ESTATE SALESPERSON

Join us and experience what it is like to be part of the #1 leader in selling homes.

Call Devonshire Square 756-8485 or 636-2588

CHERRY OAKS

212 Sumrell Street

Owners will pay closing costs and points up to \$3,000. 1675 square feet contemporary ranch features extra large greatroom with cathedral ceiling and woodburning stove, breakfast room, 3 bedrooms (12x20 master bedroom with large walk-in closet), 2 full baths, and attic storage. Great yard for children, close to pool and tennis courts, and in the new school district. \$82,500. Call 756-7865

JANET BOWSER & ASSOCIATES

355-7800

221 Commerce St., Suite A

Thinking About A New Home?

Please call me for personal and CONFIDENTIAL service at your convenience.

DON EDMONSON
CLARK-BRANCH, REALTORS
355-2000 / 756-7583

The Evans Company
Of Greenville, Inc. 752-2814



NORTH HILLS in Ayden is the location of this newly built 3 bedroom home featuring a large kitchen and dining combination. The perfect home for the buyer looking under \$50,000.

CAMELOT - This lovely 3 bedroom, 2 bath home is in Nantucket. Blue siding and features a mantled fireplace in the greatroom. It has a dressing area, as well as, a mirrored vanity which complements the large master bedroom. A super home in a super location!

Excellent FHA/VA and conventional rates available.

Winnie Evans Realtor-GRI 752-4224

Century 21 BASS REALTY 756-6666

WESTMINSTER HOMES A Weyerhaeuser Company

Check it out from **\$49,400**

1 1/4% below market rate financing. Seller pays closing costs.

When you work 70 hours a week, you don't want to come home to one of these.

Rownetree Woods

WINNER CHEVROLET

24 HOUR WRECKER SERVICE 746-4032

"THE COUNTRY DEALERSHIP - BE A WINNER"

3 DAY SALE—MARCH 26, 27 & 28, 1987

NEW USED

1986 Cavalier Stationwagon ... \$189.45 Mo.	1985 Mercury Merkur ... \$12,450
Was \$10,659, Sale \$9632 Stock #366, Rebate \$750, Total Payments \$11,367, 60 Months, 9.99% A.P.R., NO DOWN PAYMENT!!	Was \$13,995 Stock #1002
1987 Spectrum ... \$159.04 Mo.	1987 Honda Accord ... \$13,995
Was \$7962, Sale \$6944.64 Stock #455, Total Payments \$8067.60, 60 Months, 9.99% A.P.R., Down Payment \$500.	Stock #1001, 4 door, automatic loaded
1987 Sprint ... \$137.46 Mo.	1986 Pontiac Sunbird ... \$176.26 Mo.
Was \$7962, Sale \$6944.64 Stock #455, Total Payments \$8067.60, 60 Months, 9.99% A.P.R., Down Payment \$500.	Was \$8595, Sale \$7722 Stock #460A, Total Payments \$8460.48, 10.95% A.P.R., Down Payment \$1200, 48 Months
1987 Nova ... \$164.75 Mo.	1987 Corsica ... \$206.22 Mo.
Was \$10,122, Sale \$9023.97 Stock #471, Rebate \$500, 60 Months, 9.99% A.P.R., Down Payment \$800, Total Payments \$9885.	Was \$12,400, Sale \$10,565 Stock #1003, Total Payments \$12,373.20, 10.45% A.P.R., Down Payment \$1500, 36 Months
1987 S-10 Pickup ... \$135.97 Mo.	1983 Chevrolet S-10 4 X 4 ... \$143.29 Mo.
Was \$9093, Sale \$7374.79 Stock #452, Rebate \$500, 60 Months, 9.99% A.P.R., Down Payment \$500, Total Payment \$8158.20	Was \$5995, Sale \$5105 Stock #439A, Total Payments \$5,158.44, 12.99% A.P.R., Down Payment \$1000, 36 Months

(Plus Tax, N.C. Registration And Approved Credit!)

Come Meet The Ayden-Grifton High School Men's And Women's Basketball Teams & Cheerleaders! March 26th, 1987 • 11:00 a.m. - 1:00 p.m.

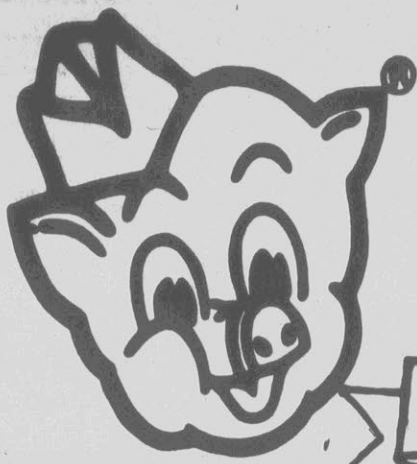

piggly wiggly

PRICES EFFECTIVE MAR. 25-28, 1987
WE RESERVE THE RIGHT TO LIMIT QUANTITIES.
NONE SOLD TO DEALERS OR RESTAURANTS.
WE GLADLY ACCEPT U.S.D.A. FOOD STAMPS.

EARN EXTRA MONEY FOR YOUR CHURCH OR CIVIC ORGANIZATION

Your organization can earn a substantial sum by saving the labels on all Piggly Wiggly products. Just follow these rules:

1. Send in the portion of each label that reads "Distributed by Piggly Wiggly Corporation, Memphis, TN" in packets of 200. Each label is worth 1¢.
2. Be sure to include the label count.
3. Include the name of your organization on each package of labels as well as the name and mailing address of the person responsible for the labels.
4. Wrap labels in a strong package and mail or deliver to: Piggly Wiggly Labels, Malone & Hyde, Inc. 3030 Poplar Avenue, Memphis, TN 38111

INDIVIDUALS ARE NOT ELIGIBLE. OFFER IS OPEN ONLY TO RELIGIOUS, CHARITABLE, CIVIC OR FRATERNAL ORGANIZATIONS.

U.S.D.A. SELECTED BEEF! TRIMMED THE WAY YOU LIKE IT!

WHOLE RIB EYES
2.99 LB.
9-12 LB. AVG.

U.S.D.A. HEAVY WESTERN BEEF

LUNDY'S WHOLE SMOKED PICNICS
69¢ LB.

PIGGLY WIGGLY WORLD OF **PRODUCE**
"Freshest Buys In Town"

WASHINGTON STATE RED DELICIOUS **APPLES**
39¢ LB.

GREEN CABBAGE
15¢ LB.

Rib Eye Steaks
3.99 LB.

ALL CENTERS BEEF LIVER
89¢ LB.

BALL PARK MEAT FRANKS & KNOCKWURST
1.69 LB.

SUPER SAVERS!
PRICED LOWER THAN OUR EVERY DAY LOW PRICES!

GOLDEN BEST PEACHES 29 OZ. **69¢**

PIGGLY WIGGLY MARGARINE
4/1.00 1 LB.

LIMIT 4 WITH THIS COUPON AND A \$10 OR MORE FOOD ORDER. EXPIRES MAR. 28, 1987

ALPHIN BROS. BEEF PATTIES
5 LB. BOX **3.69**

WHOLE PORK LOIN
1.29 LB.

BALL PARK BEEF FRANKS
1.79 LB.

SUPER SAVERS!
PRICED LOWER THAN OUR EVERY DAY LOW PRICES!

KRAFT BARBECUE SAUCES 18 OZ. **88¢**

PIGGLY WIGGLY BLEACH
39¢ GAL.

LIMIT 1 WITH THIS COUPON AND A \$10 OR MORE FOOD ORDER. EXPIRES MAR. 28, 1987

LUNDY BACON
1 LB. PKG. **1.39**

QUARTER LOIN Pork Chops
1.59 LB.

PIGGLY WIGGLY SAUSAGE HOT OR MILD LB. **99¢**

SUPER SAVERS!
PRICED LOWER THAN OUR EVERY DAY LOW PRICES!

SURF DETERGENT 42 OZ. **1.69**

PIGGLY WIGGLY TUNA
3/1.00 6.5 OZ.

LIMIT 3 WITH THIS COUPON AND A \$10 OR MORE FOOD ORDER. EXPIRES MAR. 28, 1987

FRESH FRYER LEG QTRS.
89¢ LB.

FAMILY PACK FRYER THIGHS LB. **99¢**

FAMILY PACK FRYER DRUMSTICKS LB. **99¢**

Family Pack Sale!
FRESH PORK NECKBONES,
FRESH PORK PIG FEET,
FRESH PORK PIG LIVER

49¢ LB.

YOUR CHOICE

FROZEN FOODS

WEIGHT WATCHERS Spaghetti 10 oz. **1.59**

WEIGHT WATCHERS ITALIAN Lasagna 10 oz. **1.59**

WEIGHT WATCHERS PIE & CAKE 1.35

APPLE PIE, GERMAN CHOCOLATE CAKE, CANNON CAKE & STRAWBERRY SHORTCAKE

HI-DRI TOWELS
JUMBO ROLLS
2 for **99¢**

SANI-FLUSH 20 OZ. **89¢**

WOLITE LIQUID 16 OZ. **1.99**

BRIGHT & EARLY BREAKFAST BEVERAGE
64 OZ. CTN. **69¢**

CRISP CRUST Party Pizza

TOTINO'S PIZZA EA. **99¢**

GOLDEN BEST FRENCH FRIED POTATOES
5 LBS. **99¢**

GOLDEN BEST JELLY APPLE, GRAPE 2 LBS. **79¢**

DOVE LIQUID 22 OZ. **69¢**

TOP POP DRINKS
3 LITER **39¢**

LIMIT 1 WITH THIS COUPON AND A \$10 OR MORE FOOD ORDER. EXPIRES MAR. 28, 1987

PIGGLY WIGGLY SALT
26 OZ. BOXES **4 \$1**

ROLLER CHAMPION OR CREAM
5 LB. BAG **89¢**

GOLDEN BEST MACARONI & CHEESE DINNERS 7 1/2 OZ. **4 for 1.00**

QUAKER QUICK GRITS
35¢ OFF 5 LBS. **99¢**

CHATHAM CHUNX DOG FOOD
20 LB. BAG **2.79**

Decorated matching accessory pieces in beautiful new shapes...and at money-saving low prices!

THIS WEEK'S FEATURE SAUCERS
79¢

12" Round Chop Plate \$1.99
Covered Sugar \$1.99
Creamer \$1.99
9" Rd. Vegetable Bowl \$1.99
Salt & Pepper \$1.99
Gravy Boat with Tray \$1.99
Coffee/Tea Pot \$1.99
Covered Casserole \$1.99
2 Soup Bowls \$1.99
Set of 2 Mugs \$1.99
12" Oval Platter \$1.99
10" Oval Baker \$1.99

Crisco Oil 30¢ OFF 48 OZ. **1.79**

PIGGLY WIGGLY KETCHUP 32 OZ. **69¢**

PIGGLY WIGGLY BATHROOM TISSUE 4 PK. **69¢**

HEALTH & BEAUTY AIDS

PIGGLY WIGGLY NIGHTTIME COLD MEDICINE **2.29**

PIGGLY WIGGLY GEL TOOTH PASTE 4.5 OZ. **1.29**

Decorated matching accessory pieces in beautiful new shapes...and at money-saving low prices!

2105 DICKINSON AVENUE
OPEN 7 A.M. TO 12 A.M.
SEVEN DAYS A WEEK

MAXWELL HOUSE COFFEE 12 OZ. INSTANT **4.99**

Cascade 35 OZ. POWDER **1.99**

40 OZ. LIQUID **2.09**

PEPSI, MOUNTAIN DEW OR DIET PEPSI OR PEPSI PRODUCTS
TWO LITER **1.09**

PIGGLY WIGGLY KEEPS AMERICA SHOPPING WITH EVERYDAY LOW PRICES!

Vicksburg's 'Attic' Is A Treasure Of Memories

By STRAT DOUTHAT
Associated Press Writer

VICKSBURG, Miss. (AP) — At a time when Dixie Democrats are dreaming about having a Southerner in the White House again, Gordon Cotton would much rather talk about the presidency of Jefferson Davis.

You remember Davis, of course. He was a local boy who made good back in 1861, when he was chosen to lead the Confederate States of America in its bid to leave the Union.

That might seem like a long time to some folks, but Cotton, a lanky, gray-bearded son of Mississippi, can make it sound like only yesterday.

"The bell on top of this building rang for four solid hours the day Davis was sworn in over at Montgomery, Ala.," he said the other day.

Cotton's remark came as he stood next to a set of 30-foot Ionic columns on the portico of a two-story stone edifice overlooking the Mississippi River.

The building, once the Warren County courthouse, now is the home of the Old Court House Museum. As such it is a repository of Mississippi

memorabilia and a storehouse for some of the Old South's most sacred totems, including part of the inauguration outfit worn that day by Davis, who owned a nearby plantation.

"Jefferson Davis made his first political speeches on these grounds when he was a young man," Cotton says. "His family came to Vicksburg from Kentucky when he was just 2. He grew up in Warren County."

As director of the museum, Cotton spends a lot of his time ruminating over Davis and the role of Vicksburg in the Civil War, referred to locally as the "War of Yankee Aggression."

"Take this building for example," he says. "It took only one direct hit during the 47-day siege of Vicksburg. That was because the Confederates let the word out that they were keeping Yankee prisoners in the courtroom on the second floor."

Cotton's grin made it clear what he thought of this Southern stratagem.

Vicksburg, where Cotton was raised, surrendered to the Union troops on July 4, 1863. Newspaper accounts of the siege are displayed in the museum.

"This is the famous wallpaper edi-

tion of the old Vicksburg Daily Citizen," he says, pointing to a yellowed page dated July 2, 1863. "They started printing on wallpaper after they ran out of newsprint during the last days of the siege."

The siege and surrender made such a vivid impression on Vicksburgers that they refused to observe Independence Day for more than a century, Cotton notes.

"We started observing it again in 1976, the bicentennial year," he says. "Immediately following World War II there were three celebrations that coincided with the Fourth of July, but they called them Confederacy Day."

In addition to his museum job, Cotton pursues his penchant for the past in a weekly historical column for the Vicksburg Evening Post, the local newspaper. He gets much of his information from the museum's research library.

"Several books have been researched in our research library," he says. "The building itself is a national historic landmark. It was built by slave labor in 1858."

Cotton proceeded to conduct a brief tour of the building, which was aban-

doned as a courthouse in 1939 and reopened as a museum nine years later.

Heading upstairs he says, "See this iron staircase? It was made in Cincinnati and shipped down the river by steamboat. Legend has it that when the Yankees first entered the building one of them saw the staircase and said, 'The damned rebels think they can win a war when they can't even build their own steps.'"

Cotton sighs and adds, "That pretty well summed up the problem."

The museum's second floor is dominated by a large courtroom with a cast-iron judge's platform and a 23-foot-high ceiling.

"Jeff Davis went to court here in this room and fought to get his plantation back following the war," Cotton says. "A carpetbagger court ruled against him but he appealed to the state Supreme Court and got it back."

The museum displays include slavery and black history exhibits and collections of Confederate ballots, stamps and money. A tattered flag commands a place of honor on the first floor.

"It belonged to the 21st Mississippi. We call it the flag that never surrendered," Cotton says. "John Collier, a local boy, brought it home wrapped around his body, beneath his clothing. Like a lot of the other Confederate soldiers, he walked the entire way."

Cotton stops in front of a case containing a 2-foot-high, starched Ku Klux Klan hood with finely stitched eye slits.

"That was my great-grandfather's Klan hood," he says. "My aunt gave it to me after I promised I would never show it to anybody."

He scratched his beard and looked at the hood for a long moment.

"You know," he says, "the Klan eventually wound up in the wrong hands, but for a while there, in its early years, it was about the only

protection we had. Things were so bad during the period of Reconstruction following the war that you even had to get permission to put flowers on a relative's grave."

Cotton says some people who come to the museum, such as a recent visitor from France, get the wrong idea when they see some of the exhibits.

"The Frenchman told me he got the impression we Southerners wish we'd won the war. Well, I told him that ought to be obvious, even though we know now that things turned out for the better."

"Personally, I feel you can honor your past without wanting to go back to it. I see this museum as a way of honoring our rich heritage. Many of the local residents call us 'Vicksburg's attic.'"

Creek-Cherokee Has Public Radio News For Indians

By DAVID FOSTER
Associated Press Writer

ANCHORAGE, Alaska (AP) — His long, black hair hangs freely. A wide leather belt and beaded buckle depicting the Minneapolis skyline secure a pair of faded jeans. Gary Fife, managing editor of the first national daily news show on Indian issues, does not bend to convention.

"I've worked in the business for a long time. I don't have to conform to anybody's standards," he said. "What's an Indian journalist supposed to look like?"

Fife, a 36-year-old Creek-Cherokee raised in Tulsa, Okla., is one of the few American Indian journalists with national experience. He worked 11 years for native news and advocacy groups in Washington, then spent four years in Minnesota free-lancing and running a weekly radio show on Indian issues.

Diane Kaplan, director of the Alaska Public Radio Network, started looking for someone to run a native news show last spring.

"Gary was the logical person," said Kaplan, who had the idea for the program and obtained \$60,000 in seed money from the Corporation for Public Broadcasting.

The National Native News hit the airwaves Jan. 5. It is available free five days a week via satellite or telephone to any public radio station.

The 10-minute program, four minutes of news followed by a longer feature, is designed to fit into a variety of formats. A musical lead-in and Fife's smooth delivery make it sound like public radio anywhere, but the stories are purely native:

—The Mohawk Nation in upstate New York negotiates with state officials for 14,000 acres it claims were taken illegally.

—Aleuts in Alaska's Pribilof Islands worry that proposed federal rule changes could further reduce their harvest of fur seals.

—Residents of Santa Cruz, Calif., raise money to send an ambulance to the Oglala Sioux living on South Dakota's Pine Ridge reservation.

"We're trying to personalize native issues — bring them out of the romantic savage or drunken Indian image," Fife said in a recent interview. "We live, we die, we get in trouble. And we get in arguments with the rest of the world from time to time."

Indian news shows already exist, including a weekly feature program broadcast from Minneapolis and a weekly wire service in Washington, but Fife said his was the first such daily program.

He said his service filled a void, reminding listeners daily that native Americans — 1.5 million at last count — are out there. The show also aims to link the country's often disjointed tribes.

"We have to fight a lot of the same battles," he said.

Fife and two assistants augment their coverage with reports from stringers scattered across the country and items from other news services.

About 45 public radio stations, mostly in the West, use the program regularly. Others lift segments for their shows.

Subscribers' initial reactions are encouraging, Fife said, but the program's success depends on financial backing as much as on popularity. Kaplan is seeking additional grants to keep the program alive.

Fife is proud of his Indian heritage but said he struggles to keep bias out of his work, and that it is important to report objectively.

"I'm a full blood myself, and I'd love to see natives progress. But we need to know when mistakes happen, when something goes wrong or situations backfire."



NATIVE NEWSMAN — Gary Fife, 35, is managing editor of the National Native News Service, the first daily news program on native issues to be broadcast nationally. Fife is hoping the program will help erase stereotypes about native American culture. (AP Laserphoto)



FINISHING TOUCH — Earl Peaden and Dennis Thomas of the Staton House Fire Department give a finishing wipe to a new equipment truck members of the fire department built. The used auto parts truck was painted and equipped by the department members, taking about 1,000 hours to complete.

Money to build the truck is being obtained through fund-raisers held each year. This year's fund-raising barbecue will be held Friday. According to department officials, about \$12,000 is expected to be raised. (Reflector Photo by Tommy Forrest)

On The Town

Here are some of the evening entertainment activities scheduled for Greenville in the coming week:

Beau's

Wednesday, March 25: Ladies' Zoo Night will be held. Disc jockey Bill Cozart will play Top 40 and dance music.

Friday, March 27: All ages will be admitted for Teen Night. Doors open at 8 p.m.

Saturday, March 28: Disc jockey John Moore will play Top 40, beach and dance music.

Country Junction

Wednesday, March 25: A juke box dance will be held, with doors opening at 8 p.m. Two-step dance lessons will be held from 8:30 p.m. until 9:30 p.m.

Friday, March 27 — Saturday, March 28: Country rock music will be performed by The Gales Creek Band from 9 p.m. until 1 a.m.

Sunday, March 29: Three bands will be featured during a Super Sunday concert. Music will be provided by Rockin' Horse, The Dalton Brothers and the Bitter Creek Band. Doors will open at 3 p.m. and the concert will be from 4 p.m. until 10 p.m.

New Deli

Thursday, March 26: Music will be played by Mike Edwards and Rick Lawson.

Saturday, March 28: Soul Train and Flat Stanley will perform.

Off the Cuff Lounge at the Sheraton-Greenville

Wednesday, March 25: Music will be provided by a disc jockey.

Thursday, March 26: Ladies' Night will feature dance music by a disc jockey.

Friday, March 27 — Monday, March 30: Music will be provided by disc jockey.

Tuesday, March 31: Beach night will be held, with beach music played by a disc jockey.

Ollie's

Saturday, March 28: The Fifth Wheel Band will perform rock and oldies music beginning at 9 p.m.

Rio! The Club at the Greenville Hilton

Friday, March 27: The nightclub, located adjacent to the hotel, will open to the public at 10 p.m.

Silver Bullet

Wednesday, March 25: A disc jockey will play country and oldies music. Doors open at 8 p.m.

Friday, March 27: Country Ways Band will play country and country rock music. Doors open at 8 p.m. and the band will perform from 9 p.m. until 1 a.m.

Saturday, March 28: Top 40 and country music will be performed by Take Five from 9 p.m. until 1 a.m. Doors open at 8 p.m.

The Attic

Wednesday, March 25: Comedians Murle Hobbs and Ted Norkey will be featured in the Comedy Zone.

Thursday, March 26: Rock music will be played by Painter.

Friday, March 27: The Band of Oz will perform beach music.

Saturday, March 28: Ice Water Mansion will play power rock.

Tuesday, March 31: The Pika Best Chest Contest and Beer Olympics will be held.

Speed Reading Isn't All You Might Believe

By MARCIA DUNN
Associated Press Writer

PITTSBURGH (AP) — Back in the '60s, when speed reading was the rage, comedian Woody Allen quipped: "I read 'War and Peace' in 15 minutes. It's about Russia."

That's overdrawn, but speed readers don't comprehend more than the gist of a text unless it deals with familiar subjects, two researchers say.

"You don't want your lawyer speed reading," says Marcel Just, a psychology professor at Pittsburgh's Carnegie Mellon University.

Speed reading has its uses and "we don't mean to debunk speed reading," says Just. "But some claims are not accurate."

"One hears, almost anecdotally, about people reading 2,000 words a minute or something fantastic like 10,000 words a minute. Yet, there's seldom, perhaps never, a test of comprehension," he said.

Some people do read fast — even really, really fast — to race through mounds of material, but there's nothing magical or supernatural about that, Just says.

"Many intellectual feats are like that," he adds, citing championship chess as an example. While they are still very impressive, "it's when you analyze them that they get demystified."

By monitoring eye movement with a computerized tracker, Just and Patricia Carpenter, his research partner and wife, have found that speed readers pick out about every

third word regardless of size or importance.

The result, they say, is a "grab bag" of information and a vague understanding, but within its limitations there's a time and place for speed reading, depending on the reader's purpose and material, according to the psychologists.

The couple's speed reading study is one of the first of its kind dealing with that skill. The study is reported in their new textbook, "The Psychology of Reading and Language Comprehension."

Speed reading was popularized through Evelyn Wood, a former Utah school teacher who opened her first Reading Dynamics Institute in 1959.

She taught readers to guide their eyes down a page with a rhythmic hand movement and to take in groups of words at a time. She cautioned readers against "saying" the words in their heads, a habit she said slowed them down.

"A person who speed reads and does it correctly can read with better comprehension. I'm sure of it," says Mrs. Wood, who is now 78.

"We've had too many hundreds of thousands of people who could do it."

Since 1959, more than 2 million people have passed through the Evelyn Wood Reading Dynamics program, now owned and operated by American Learning Corp., a subsidiary of Encyclopedia Britannica Inc. The roll included the staff of President John Kennedy and President Jimmy Carter and his family.

(See READING, C-8)

Prime Time Tonight

WEDNESDAY EVENING								
	7:00	7:30	8:00	8:30	9:00	9:30	10:00	10:30
2	Hardcastle And McCormick	Bring 'Em Back Alive	700 Club		Snapshots			
4	Business Rpt.	Legislative	Soldiers	Hollywood's Favorite Heavy		In Performance		
5	CBS News	PM Magazine	New Mike Hammer	Magnum, P.I.		Houston Knights		
5	Taxi	M*A*S*H	Movie: "A Rumor Of War"		News			
7	Facts Of Life	Benson	Down & Out Donald Duck	Night Court	The Tortellis	Bronx Zoo		
9	Newlyweds	Ent. Tonight	New Mike Hammer	Magnum, P.I.		Houston Knights		
12	Fortune	Jeopardy	P. Strangers	Harry	Dynasty		The Colbys	
DIS	Movie	Theater	Edison Twins	Danger Bay	Movie: "The Great Muppet Caper"		DTV	
ESPN	SportsCenter	Baseball	Horse Racing	'80 Final 4	Boxing: Frankie Randall vs. Shelton LeBlanc			
HBO	Movie: "Breakin'"	Movie: "Return Of The Jedi"		"Jaws"				
LIFE	Marcus Welby, M.D.	Call To Glory		Regis Philbin Show		Dr. Ruth Show		
MAX	"Police Academy 3"	Movie: "To Sir With Love"		Movie: "Target"				
SHOW	Movie: "2010"	Movie: "Conan The Barbarian"						Movie
TMC	Movie: "Prizzi's Honor"	Movie: "East Of Eden"						
USA	Airwolf	Riptide		Movie: "Crazy Mama"				
WTBS	Sanford	H'mooners	Movie: "Standing Tall"		Movie: "The Sea Hawk"			

For complete TV programming information, consult your weekly TV SHOWTIME from Sunday's Daily Reflector.

Nominees For Supporting Actor Include Top Names

By BOB THOMAS
Associated Press Writer
LOS ANGELES (AP) — The Academy Award nominees for supporting actor include four well-established performers and one who evoked the question: "Who's Willem Dafoe?"

The well-known actors are: Tom Berenger, "Platoon"; Michael Caine, "Hannah and Her Sisters"; Denholm Elliott, "A Room With a View"; and Dennis Hopper, "Hoosiers."

But Willem Dafoe? Those who had seen his riveting performance as the good-guy sergeant in "Platoon" didn't need to be told who he was. And, like most of the principal figures involved in the landmark film of the Vietnam War, he is likely to become familiar to the general public.

Despite the foreign-sounding name, Willem — a childhood phoneticism for William — Dafoe is a 31-year-old Wisconsin native who seemed destined for a career of sadistic heavies. "It's a matter of physiognomy, I guess — my face and the way I move," he said.

In his film debut he played a biker gang leader in "The Loveless," and his career in crime continued with "The Hunger," "Streets of Fire" and "Roadhouse." Oliver Stone chose him for the role of Sgt. Elias after seeing Dafoe as another insidious villain in "To Live and Die in L.A." Elias, a humane soldier, plays opposite to Berenger's sadistic Barnes. Both, however, are highly skilled killers.

Dafoe, along with other members

of the "Platoon" cast, was surprised by the pre-production training in the Philippines.

"It was half-survival training and half-jungle warfare," he said.

"We were totally unprepared for it. They just dropped us off in the jungle and issued us gear. There was no explanation at all. ... We were always asked to do what we weren't prepared to do, and I think that paralleled the experience of a lot of grunts in Vietnam.

"It was unorthodox, but I think it paid off. It really helped to make all the soldierly tasks we had to do become second nature. I developed such a relationship with my weapon that once when I didn't need to draw it from the armory, I was anxious all day."

Berenger, the scarred, demonic Staff Sgt. Barnes, lost 20 pounds during the training period, couldn't sleep and became "cranky, tired and mean" — a perfect condition for his role. Chicago-born, he started acting in "Who's Afraid of Virginia Woolf?" at the University of Missouri, studied in New York and worked off-Broadway.

Berenger is the only well-known actor in "Platoon," which has been nominated for eight Oscars. He began in films as the psycho who murdered Diane Keaton in "Looking for Mr. Goodbar." His television credits include "Butch and Sundance: The Early Days," "Flesh and Blood" and "If Tomorrow Comes." He also is remembered for his portrait of the TV star in "The Big Chill."

For his "Platoon" role Berenger obliterated his good looks with unsightly scars. His main concern was not loss of glamour, but of sleep: "I worried about how long it would take to get into the makeup in the morning. It could have been up to two hours, and our call was already a sleep-robbing 5 a.m." Fortunately, the makeup man came up with a new kind of glue that allowed the scars to be applied in 25 minutes.

The Oscar nomination culminates a remarkable comeback by Hopper, a folk figure of the 1960s with his "Easy Rider." After 20 years in a career limbo, Hopper kicked alcohol and drugs and proved himself employable by appearing in 10 movies in three years. Now he is directing a major film, "SMASH," starring Sean Penn and Robert Duvall.

Hopper was mentioned as a nomination possibility for both "Hoosiers" and "Blue Velvet." As the town drunk in "Hoosiers," he feels he has a better chance of winning — "only because it parallels my life a lot; I'm a recovering alcoholic."

Two veteran British actors round out the nominees. Denholm Elliott, the outspoken Mr. Emerson of "A Room With a View," has been on the London stage since 1945 and in films since 1949. He already holds the British Academy award for "Trading Places" and "A Private Function." Caine, who plays the errant husband in "Hannah and Her Sisters," won his fourth nomination — the first as supporting actor. He was in contention as best actor for "Alfie" (1966), "Sleuth" (1972) and "Educating Rita" (1983).

After his "Educating Rita" nomination, he said: "The last time I won an award was for 'most promising newcomer.' I was beginning to feel I let down the people who gave it to me."

Caine has played university professors and business magnates, but he has never forgotten his cockney birth as Maurice Joseph Micklewhite. During most of his London youth his father was unemployed and his mother worked as a charwoman.

He once explained why he continued to speak with a cockney accent: "I want people who are stuck in a bloody caste system to know they can make it without changing their accent. You can force people to accept you the way you are."

'Max Headroom' Goes Prime Time

By KATHRYN BAKER
AP Television Writer
NEW YORK (AP) — Fans of irreverent cable TV denizen Max Headroom must have heaved a collective, weary sigh when they learned he was moving into the uptight world of network prime time. Sellout time, right?

Not Max. The wisecracking computer concept's futuristic action series on ABC, premiering Tuesday, March 31, is wicked, fast, funny and sophisticated. In the pilot, an evil television network covers up a lethal side effect of subliminal commercials — they cause viewers to explode.

"Max Headroom" is the first new idea network television has had since "Moonlighting," and, in fact, Max is getting a prime tryout spot following ABC's hit detective series on Tuesday nights.

Matt Frewer stars in a dual role as Max and his human counterpart, television reporter Edison Carter.

The look of the show resembles Ridley Scott's movie "Blade Runner," with its grimy, rain-and-neon street scenes and high-tech interiors furnished with circa-1930s antiques. All the cars are Studebakers. There's also a touch of Sidney Lumet's cynical 1976 film "Network," written by Paddy Chayevsky.

"The show revolves around the media, the manipulation of the media and the power of television," said producer Peter Wagg in a telephone interview from Los Angeles.

Wagg developed the Headroom character for British television, and Max soon was a hit in America on cable television and in commercials. Frewer, an American, had moved to England to study acting.

Headroom's fictional genesis is the subject of the series pilot, described by Wagg as "set 20 minutes into the future."

Star television reporter Carter is hot on the trail of a story, the mysterious death of a John Q. Citizen. Carter takes his camera to the scene, guided by a computer "controller" back in the newsroom where "real-time" ratings are projected on a chart and fluctuate by the second.

At a crucial moment, Carter's controller is ordered, by the network, to pull Carter off the story.

Furious, Carter demands a new controller and is assigned Theora Jones, played by Amanda Pays.

With Jones at the computer, the two use the building's security camera to eavesdrop on executives standing at urinals.

It seems the killer commercials are "blipverts," high-speed ads designed to keep viewers from switching channels. The network knows blipverts are dangerous, but will lose its biggest sponsor if it takes them off the air.

Guided by Jones, Carter scours the network for clues and stumbles on

the secret whiz kid who created blipverts, Bryce, played by Chris Young.

Security chases Carter. He roars off on a motorcycle, only to run head-on into a low barricade labeled with a warning about "Max(imum). Headroom."

At the behest of the network's evil boss Grossberg, played by Charles Rocket, Bryce copies the dying reporter's memory into the computer so they can find out how much he knows. Carter is carted off to a body bank, and a smart-mouth, talking head is born. His first words are the last thing Carter saw — "M-m-m-max Headroom."

"Welcome to Network 23," chirps Max, "the network where two's company and three's an audience."

Jones locates Carter, still alive, at a body bank where body parts are sold. "Any particular piece in mind, honey?" the proprietress inquires. (Carter is saved. He and his video alter ego will team up to solve crime in future episodes.)

Max knows about the blipverts, and Grossberg orders his memory erased. Max escapes into the network's computer system and puts himself on television. The ratings go up.

According to the last decennial census, 45.5 percent of Pitt County's labor force was composed of females; roughly 12 percent of workers belonged to minority groups.

plitt THEATRES PLITT CAROLINA THEATRE CENTER 705 S.W. 10th St.

CROCODILE DUNDEE PG-13
WEEKNIGHTS 7:00-9:00

HEAT R
WEEKNIGHTS 9:30 ONLY

OUTRAGEOUS FORTUNE R
WEEKNIGHTS 7:30-9:30

LETHAL WEAPON R
WEEKNIGHTS 7:00-9:15

Winners Take All PG-13
WEEKNIGHTS 7:15 ONLY

A first rate comedy about a second story woman.

Plaza cinema 1-2-3 756-0088
PLAZA SHOPPING CENTER

MONSTER IN THE CLOSET PG
WEEKDAYS 7:15-9:00

HOOSIERS PG
WEEKDAYS 7:00-9:00

PARK UPTOWN GREENVILLE \$1.50 ALL TIMES

WHOPI GOLDBERG BURGLAR WEEKDAYS PG 7:00-9:00

THE THREE AMIGOS PG WEEKDAYS 7:00-9:15

We Are Now Open
Sunday 5 P.M.-9:30 P.M.

Carlsos
Rivergate Shopping Center

Northern Italian Restaurant
757-1757

WEDNESDAY NIGHT SPECIAL

Lasagna \$5.95
Baked to perfection. Served with salad and bread.

THURSDAY NIGHT SPECIAL

Linguine \$6.50
Served with red or white clam sauce, salad and bread.

Now Under New Ownership
An Eats, Inc. Restaurant

Lunch Mon.-Fri. 11:30 a.m.-2:00 p.m.
Dinner Sun.-Thurs. 5 p.m.-9:30 p.m.
Fri. & Sat. 5 p.m.-10:30 p.m.

Disney Contract Signed

PARIS (AP) — Premier Jacques Chirac today signed a contract for creation of a EuroDisneyland east of Paris, saying the link with the Walt Disney Co. was "a guarantee of success."

The \$2 billion project is to be built on a 4,400-acre site in Marne-la-Vallée, about 25 miles from the capital, with opening day set for 1992.

National and local governments are pledged to spend \$333 million, much of it on road improvements and extending an urban transit rail line to the park, which has become known as "Mickey-sur-Marne."

Michael D. Eisner, president of Walt Disney Co., said in French at the signing ceremony that Walt Disney, the creator of Mickey Mouse, was "a citizen of the world who knew

how to talk to the entire world through his cartoons."

The French government said it won guarantees from Disney, in negotiations lasting more than a year, that the park would incorporate themes from French and European culture, rather than simply copying the formulas of Disneyland in California and Walt Disney World in Florida.

A statement issued by the Culture Ministry less than 24 hours before the signing also said the Disney company had agreed to guarantee the primacy of the French language on the site "in the name of a certain cultural idea of France."

EuroDisneyland is projected to draw 10 million visitors a year and create at least 30,000 jobs, government officials say.

New Lounge Open

\$1.50 Highballs Friday Night

Grilled Pork Chops With A Garlic Clam Sauce \$9.95

British Whiskey Ribeye \$10.95

All Dinners Include Salad Bar, Choice Of Potato Or Vegetable, Rolls & Butter

•Live Piano Music Every Night •Banquets, Rehearsal Dinners And Business Meetings

•Reservations available. Accepted from 4:00 P.M.-10:00 P.M. •All Credit Cards Accepted.

THE NEW King and Queen

103 Eastbrook Drive Off 264 ByPass
Monday-Saturday 8:00 to 10:00 758-8883

Man Chow

CHINESE RESTAURANT

FREE DELIVERY 5:00-9:00 p.m.

Luncheon Buffet
All you can eat Only \$3.69 from 11:30-3:00 p.m. (Children under 5 eat free, ages 6-10 \$2.75) Luncheon Special Menu Available

Evening Dinner Special
Combo Plate Only \$4.89

Shrimp Dinner Buffet \$5.29
Steamed Shrimp, Spareribs, Shrimp & Chicken Delight, Shrimp Fried Rice, Shrimp Lo Mein, Egg Roll, Sweet & Sour Pork and Chicken, Soup, Ice Cream, Pineapple, Fortune Cookies

2217 S. Memorial Drive, Greenville (Located Corner of Dickinson Ave. & Memorial Drive at West End Circle) Open 7 Days A Week 11:30 a.m.-10:00 p.m. 756-9687

All ABC Permits-Take Outs Welcome Cantonese & Szechuan Cuisine

our salad bar lasts a long, long time

IT'S GREAT BIG AND IT IS SCRUMPTIOUS.

FEATURING DAILY:

1 MEAT - Chicken Pastry, Baked Chicken, Chicken Livers, or Chicken Wings.

6 HOT VEGETABLES

GARDEN FRESH FRUITS & VEGETABLES

HOT ROLLS OR HUSHPUPPIES

4 DESSERTS - Chocolate eclair cake, pudding cake, banana pudding, bread pudding or hot cobblers.

LOWEST FOOD BAR PRICES IN TOWN

With Meal \$1.99

Without Meal \$3.49

Western Sizzlin

2903 E. 10th Street 758-2712

Banquet facilities available

Kroger
Sav-on

Copyright 1987
 Kroger Sav-On
 Quantity Rights Reserved
 None Sold To Dealers

Items and Prices
 Effective thru Sat.
 March 28, 1987.

ADVERTISED ITEM POLICY
 Each of these advertised items is required to be readily available for sale in each Kroger Sav-On. Except as specifically noted in this ad, if we do run out of an item we will offer you your choice of a comparable item when available. Reflecting the same savings or a raincheck which will entitle you to purchase the advertised item at the advertised price within 30 days. On 19 one vendor coupon will be accepted per item.

Go Krogering for...

COST CUTTER PRICES

EVERYDAY LOW PRICES
 WEEKLY SPECIALS
 COMPARE ANYWHERE!



SAVE \$1.50 Lb.

USDA CHOICE HEAVY WESTERN GRAIN FED BEEF BONELESS

Round Steak

\$1.49
Lb.



SAVE 20¢

IN OIL OR WATER

Double Q Tuna

39¢
6 1/2 Oz. Can
LIMIT 2 WITH \$10 ADD'L PURCHASE



SAVE 40¢

FRESH RED, RIPE

Strawberries

\$1.58
Qt.

DOUBLE MFG COUPONS

UP TO 50¢ FACE VALUE. SEE DETAILS IN STORE
 5 WITH \$10 OR MORE PURCHASE

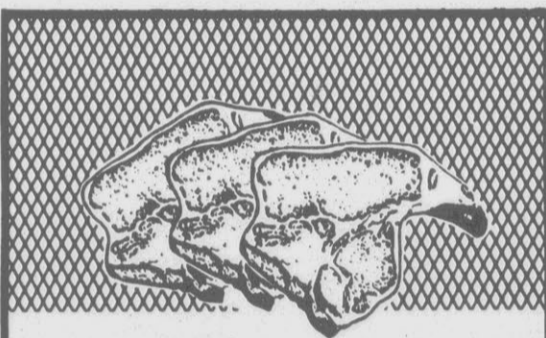

ASSORTED CENTER AND END CUT

Pork Chops

\$1.28
Lb. 8 LBS. OR MORE



USDA CHOICE HEAVY WESTERN GRAIN FED BEEF BONELESS

Top Sirloin Steak

\$2.99
Lb.

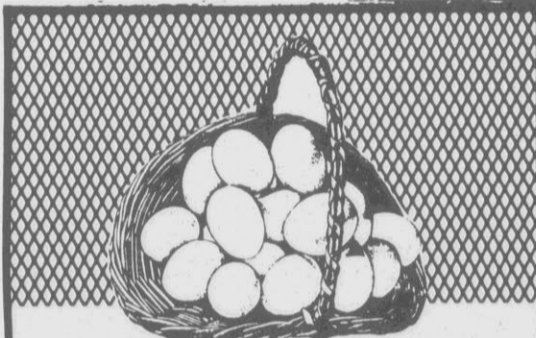

KROGER GRADE 'A'

Large Eggs

89¢
18 Ct.



NEW CROP SPRING FRESH

Green Beans

49¢
Lb.

SILVER PLATTER CENTER CUT

Rib Pork Chops

\$1.99
Lb. 3 LB. OR MORE PACKAGE

QUARTERS

Imperial Margarine

2.89¢
1 Lb. Qtrs.

KROGER

2% Lowfat Milk

\$1.79
Gal. Jug

PEPSI FREE, REGULAR OR DIET

Pepsi Cola

\$1.09
2 Ltr. NRB

HOLLY FARMS FRESH FRYER

Combo Pack

99¢
Lb.

INCLUDES:
 ✓ 3 BREASTS
 ✓ 3 THIGHS
 ✓ 3 DRUMSTICKS

AVANTI VHS

Video Tapes

\$2.99
Ea.

SUNNY DELIGHT

Citrus Punch

89¢
1/2 Gal. Ctn.

REGULAR OR LIGHT

Old Milwaukee

\$3.89
12 12-Oz. Cans

SEAFOOD SHOPPE

PREVIOUSLY FROZEN 36-50 CT. LARGE

Headless Shrimp

\$5.99
Lb.

FLORAL SHOPPE

BEAUTIFUL

Long Stem Roses

\$12.99
Doz. FREE GIFT BOX

SANDWICH FIXIN'S

Hormel Salami

\$3.99
Lb.

✓ HARD SALAMI
 ✓ GENOA SALAMI
 ✓ SANDWICH PEPPERONI

PHARMACY

Turumo Syringe

COMFORT DESIGNED ULTRA THIN WALL NEEDLE
 EASY TO READ SCALE FOR ACCURATE DOSAGE

1CC Turumo Syringe . Box \$9.99
 100 Ct. Box

Shop Kroger for all Your Diabetic Needs.
 EFFECTIVE THRU SAT. APRIL 11, 1987
 *SUBJECT TO STATE AND LOCAL ORDINANCES

NONE SOLD TO DEALERS **OPEN 24 HOURS EVERYDAY** 600 Greenville Blvd. - Greenville 756-7031

Carolina Events

Program Returns

Open/net, North Carolina's Open Public Events Network, returns to cable television on six Tuesday nights from 8 to 10 p.m., featuring topics such as economic development, juvenile delinquency and prisons.

Each program features one hour of footage of a state government meeting or conference, followed by a one hour call-in program with leaders from the meeting or conference.

Upcoming topics include: March 24 - Winning in the Global Economy, March 31 - Preventing Juvenile Delinquency, April 7 - Prison Alternatives, April 14 - Alcoholism Research, April 21 - Public Education, April 28 - Constitution Bicentennial.

Lecturer

Christopher French of New York, a visiting critic at East Carolina University, will present a lecture at 7:30 p.m. Thursday in Jenkins Auditorium on the ECU campus.

The lecture is free and open to the public.

A contributing editor to Artweek magazine, French has written more than 50 reviews of artist's exhibitions in the San Francisco Bay area. He has lectured on art at the University of California, in Davis and at Sacramento, and is himself a practicing artist.

'Good Old Days'

FREMONT - On Friday, the Aycock Birthplace State Historic Site will host its first "Good Old Days" living history program. The program will be held in conjunction with Fremont's Annual Daffodil Festival.

Both the Aycock old days and the Fremont festival are open to the public without charge.

Interpreters dressed in period attire will perform activities such as quilting, open-hearth cooking, spinning, natural dyeing, washing clothes and corn grinding.

These activities will represent some of the typical farm and domestic chores performed on a mid-19th century modest farm home such as the birthplace and early years home of Governor Aycock.

"Good Old Days" will begin at 10 a.m. and continue until 4 p.m. The site is located nine miles north of Goldsboro between Pikeville and Fremont, one-half mile off U.S. 117.

For more details, call 242-5581. From Greenville, the shortest route to Fremont is via Farmville, then take a left on N.C. 222 at Saratoga. Distance, about 42 miles.

Iraqis To Unveil Restored Babylon

By JOHN RICE
Associated Press Writer
BABYLON, Iraq (AP) - This ancient "fairest of the kingdoms" is rising again on the Euphrates plain in an Iraqi restoration program, 2,500 years after the Hebrews fled from exile with curses upon it that echo across history.

Babylon, 60 miles south of Baghdad, was the place of the Tower of Babel, whose foundations are still visible; the stories of the three men

in the fiery furnace, Daniel in the lion's den, and the handwriting on the wall.

It also is the place of one of the Seven Wonders of the World, the Hanging Gardens, but an Iraqi researcher says he doubts they ever existed as such.

From Genesis to the last chapters of Revelations, Babylon was a byword for splendor and sin to the biblical authors, whose views were colored by the Hebrews' forced exile

here under King Nebuchadnezzar II, the last great Babylonian king.

"Never again shall she be inhabited," wrote the prophet Isaiah in chapter 13 of the Old Testament's Book of Isaiah, after the Hebrews were conquered. "No man shall dwell in her through all the ages. There no Arab shall pitch his tent, nor shepherds fold their flocks. ... Jackals shall occupy her mansions and wolves her gorgeous places."

But to modern Iraqis, Babylon is a monument to the region's history as the birthplace of writing and law, and they have begun a task likely to take many years to restore the city that dates from around 2000 B.C. Officials have set no time limit nor do they give any idea how much it will cost.

Iraq itself is considered by many historians to be the cradle of civilization dating as far back as 6,000 years to the time of the Sumerians whose city states flourished as early as 3500 B.C.

The Iraqis have begun rebuilding several major structures from Nebuchadnezzar's time and plan to unveil them this summer in an international culture festival.

The government considers the project so important it has exempted some Iraqis from military duty in the war against Iran to work on it, said site director Donny George Yokhana.

The ancient Temple of Ishtar has been rebricked, replastered and whitewashed. A new 4,000-seat Greek theater is rising on the site of the old.

Workers on scaffolds are topping the ancient bricks of Nebuchadnezzar's palace with blocks from the government brick works.

The bitumen mentioned as mortar in the biblical story of Babel is still visible between the old baked mud bricks.

In Nebuchadnezzar's time in the 6th century B.C., Babylon was a sprawling city of perhaps a million people, one of the most powerful and cultured places in the world.

The city had been pillaged, destroyed and rebuilt several times before the Hebrews conquered by Nebuchadnezzar were brought there from Palestine in the late 6th century.

It survived some 400 years after they left in 538 B.C., until the descendants of Alexander the Great, who conquered Babylon and died there, moved their capital north to Selucia in 274 B.C.

Babylon's most famed early king was Hammurabi, who codified its laws 3,700 years ago and some 1,200 years before Nebuchadnezzar II.

Hammurabi's city today lies below the ground water level, Yokhana said.

To reach it, he said, archaeologists would have to lower the water level, perhaps by diverting the Euphrates.

Most of Babylon's brown-brick ruins rest below the level of the ground, dotted with clumps of yellow grass and palm trees.

But most of the exposed brick was hauled away over the centuries by the modern city of Hilla a few miles south, Yokhana said.

The European excavators who first explored the site also carried treasures away.

One of Babylon's great monu-

ments, the Ishtar Gate, stands today in an East German museum. Only the foundations of the gate, some 120 feet across, are now visible in Babylon.

Carved into the bricks are reliefs of oxen and a mythical beast called the mushrushu, with the head of a serpent, body of a fish, front legs of a lion and back legs of an eagle.

Some carvings have been scarred by graffiti that stand out over the occasional, original cuneiform inscriptions on a few old bricks.

The Hebrew tribes were both awed and appalled by Babylon.

"Babylon has been a gold cup in the Lord's hand," wrote Jeremiah. He also called it "a land of idols that glories in its dreadful gods."

"Babylon the great, the mother of whores and every obscenity on earth," said the author of Revelations.

But said Moaiyad Saeed Dimugi, head of Iraq's Antiquities and Heritage Organization, "Babylon has been misunderstood."

He maintained that many stories in the Bible and elsewhere "are mixed up," noting that biblical writers sometimes confused the reigns of Babylonian kings.

Dimugi directs the restoration work at Babylon, where he did research that led him to doubt the Hanging Gardens.

"I believe there were no Hanging Gardens at all," he said.

He suggested that ancient visitors may have been confused by the Babylonian practice of decorating their towers with trees and plants once a year during a festival.

San Quentin May Have Own Museum

By TRACEY KAPLAN
L.A. Times-Washington Post
News Service

SAN QUENTIN, Calif. - Prison officials here are planning to open a small museum that would depict 134 years of life inside San Quentin, home to some of California's most notorious criminals.

The plans include the construction of model jail cells and a gas chamber similar to the real one that was installed in 1938, after then-Warden James Holohan succeeded in having hanging banned.

Also included would be artifacts dating from the days when inmates were whipped for misbehavior.

"There should be some way of preserving the history of this grand old place," said Associate Warden Richard A. Nelson of the penal complex perched on a rocky outcropping overlooking the bay about 20 miles north of San Francisco.

"Right now, there are just volumes of historical material scattered all over the state," he said.

Officials also intend to renovate the prison cemetery, which is no longer in use. The graves of 694 people are located high on a hill in a eucalyptus grove, far enough away from the watchful eye of guards so that vandals over the years have stolen the original wooden markers and disinterred several of the plots.

The cemetery, like the prison itself, is off limits to tourists and would remain so after its renovation. Until the museum is installed in the small, mint green, stucco building that once housed the inmates' mail room, visitors will have to be content with purchasing inmate-made handicrafts such as desk accessories in the hobby shop just outside the prison gates, and with peering in at the 432-acre complex.

If the museum opens by January

1988, as planned, it would be the first glimpse the public would get of the maximum-security institution since it stopped conducting public tours in 1976 when the state began sending all disruptive or violent inmates from its 11 other major institutions to San Quentin, said prison spokesman John W. Reid.

The prison houses 3,429 convicted rapists, killers, thieves and other assorted felons, about 1,700 of them under high-security conditions. Isolated on death row are 203 men.

The prison contains so many dangerous criminals that the few law enforcement officers, judges and journalists who tour it are given a stern warning, delivered with a dash of humor:

"Are you aware of the state's no-hostage policy?" each person is asked in a standard speech given by the guards. "If you are taken hostage, the state will do everything in its power to negotiate your release. However, no exchanges will be made."

To satisfy public curiosity about the 134-year-old institution, Nelson and a group of citizens and employees, including Warden Dan Vasquez, formed the San Quentin Museum Association, which has collected about \$3,400 so far in its efforts to raise the \$200,000 needed for the museum. Nelson, who is the group's president, said several corporations and trusts have expressed interest in donating funds.

"There is just a tremendous fascination with this place's macabre history," said Nelson, 49, a short rotund man with silver hair. "Everyday, we turn away people at the gate asking for tours."

The old and dilapidated penitentiary is currently undergoing a \$36.9 million renovation to comply with court-ordered improvements in living conditions.

THE WHOLESALÉ OUTLET

OF
GARNER WHOLESALÉ MERCHANDISERS, INC.
LOCATED NEAR FOOD LION AT SOUTHPARK SHOPPING CENTER
OFF GREENVILLE BLVD.
756-8652
STORE HOURS MONDAY-FRIDAY 10 AM-8 PM SATURDAY 10 AM-6 PM

MISER™ Light Bulbs
GE MISER LIGHT BULBS-4 PACK
55, 70 AND 95 WATT
2⁹⁰
GE MISER THREE WAY BULBS
15/150 AND 50/185
2¹⁸

BIC STIC VALUE PACK
(2 MEDIUM POINT STICS, 1 ROLLER PEN)
3/\$1

BIC PENCILS, 5 PACK POUCH
BIC BIRO PENS, 10 PACK
YOUR CHOICE
2/1⁴⁹

BIC SENSITIVE SHAVER, 10 PACK
BIC LADY SHAVER, 10 PACK
YOUR CHOICE
2/1⁴⁹

SUAVE STYLING SPRAY, 8 OZ.
SUAVE STYLING GEL, 8 OZ.
YOUR CHOICE
1⁰⁹

FINISS SHAMPOO AND CONDITIONER
11 OZ.
1⁸⁹

ALBERTO MOUSSE 5.5 OZ.
ALBERTO GEELE 4 OZ.
ALBERTO STYLING HAIRSPRAY 7 OZ.
AEROSOL AND NON-AEROSOL
YOUR CHOICE
2⁰⁹

PHISODERM 5 OZ., REGULAR OR OILY
1⁸⁹

DIAL ANTI-PERSPIRANT/DEODORANT SOLID 2 OZ.
1²⁹

CURITY COTTON BALLS 65's
69¢

SOLTICE QUICK RUB 1.33 OZ.
1³⁹

FIBRE TRIM TABLETS 100's
2⁸⁹

WET PRUF TAPE 1/2" x 5 YDS.
59¢

AFRIN NASAL SPRAY 1 OZ.
3⁴⁹

NEO-SYNEPHRINE SPRAY .5 OZ.
2⁰⁹

CURITY STRETCH GAUZE BANDAGES 2" x 5 YDS.
79¢

Hello Savings.

Say hello to the great taste of Taco Bell® at great savings.

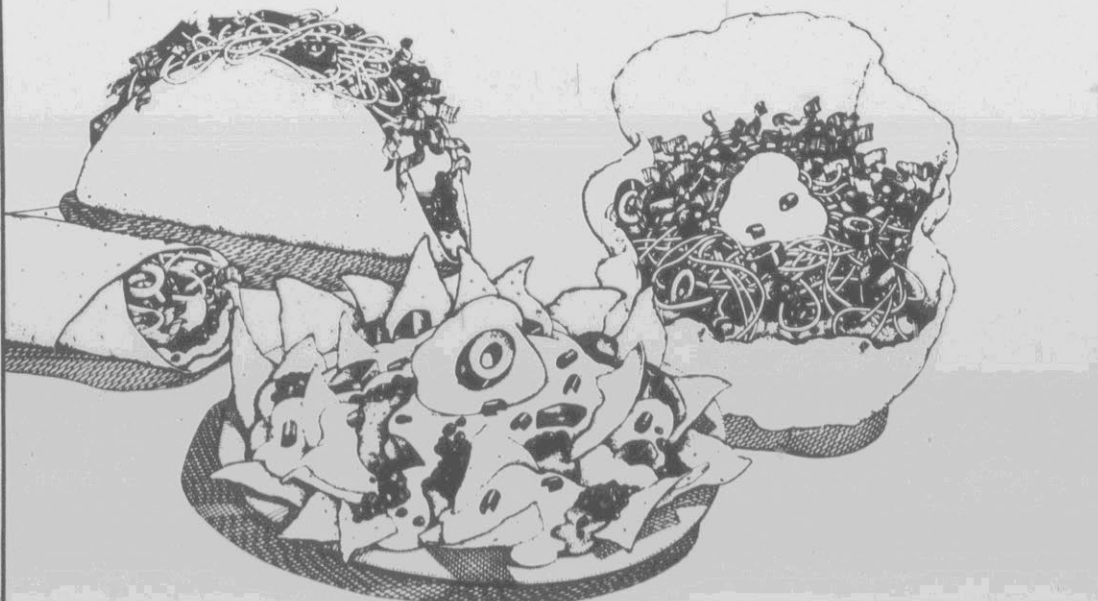

Hello Taco Bell

Burrito Supreme
for just **99¢**

Please present this coupon when ordering. Limit: One coupon per person per visit. Not good with any other offer. Cash redemption value is 1/20th cent. Good only at participating Taco Bell® restaurants. Tax not included. Offer expires 4/25/87.

Kids Fiesta Meal
with \$1.50 purchase **99¢**

Please present this coupon when ordering. Limit: One coupon per person per visit. Not good with any other offer. Cash redemption value is 1/20th cent. Good only at participating Taco Bell® restaurants. Tax not included. Offer expires 4/25/87.

Taco Bell Grande
or **Taco Light** **99¢**

Please present this coupon when ordering. Limit: One coupon per person per visit. Not good with any other offer. Cash redemption value is 1/20th cent. Good only at participating Taco Bell® restaurants. Tax not included. Offer expires 4/25/87.

Reg Taco & Lg Pepsi
for just **99¢**

Please present this coupon when ordering. Limit: One coupon per person per visit. Not good with any other offer. Cash redemption value is 1/20th cent. Good only at participating Taco Bell® restaurants. Tax not included. Offer expires 4/25/87.



FARM FRESH

SUPERMARKETS AND SUPER SAVING CENTERS

PRICES EFFECTIVE THROUGH MAR. 28, 1987
QUANTITY RIGHTS RESERVED

DOUBLE COUPONS

ON MANUFACTURER'S CENTS OFF COUPONS
EVERYDAY OF THE WEEK!

See Store For Details



USDA CHOICE WHOLE
SIRLOIN TIPS
(Cut to Order FREE!)

\$1.29
lb.

USDA CHOICE
SIRLOIN TIP ROAST ... \$1.87 lb.

USDA CHOICE WHOLE
BOTTOM ROUNDS .. \$1.29 lb.

FRESH
GROUND ROUND ... \$1.78 lb.

SMITHFIELD GRILL READY
FRANKS 68¢ lb. pkg.

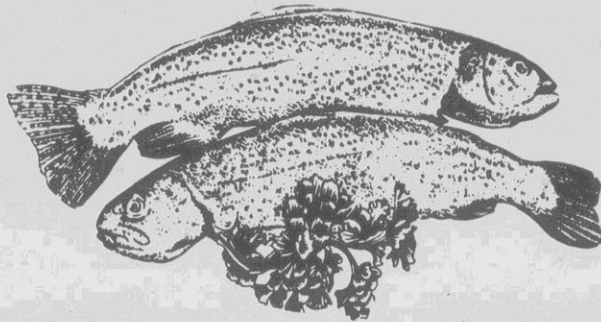

LIVE MAINE
LOBSTER ... \$5.99 lb.
SEA LEGS
SUPREME \$3.49 lb.
FRESH
BLUEFISH 89¢ lb.

**Family Pack
Fryer Parts Sale
Our Everyday Low Price!**

LEG QUARTERS 38¢ lb.

BREASTS \$1.38 lb.

THIGHS 78¢ lb.

DRUMSTICKS 68¢ lb.

WINGS 68¢ lb.

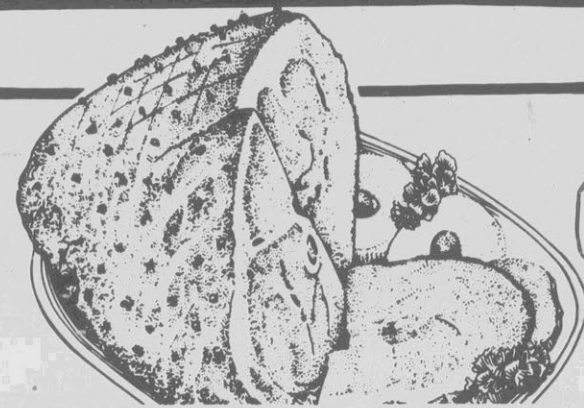

SMITHFIELD WHOLE
SMOKED PICNICS

59¢
lb.

COUNTRY STYLE
PORK RIBS \$1.58 lb.

SMITHFIELD
SLICED BACON .. \$1.68 lb. pkg.

SMITHFIELD MEAT or BEEF
FRANKS 88¢ 12oz. pkg.

SMITHFIELD PORK
BARBEQUE \$1.28 12oz. cup

PENNZOIL
MOTOR OIL
HD30,
10W30 & 10W40

99¢
Quart Bottles

MAXITHIN'S
Unscented
Reg. or Super

30
Count **\$3.99**

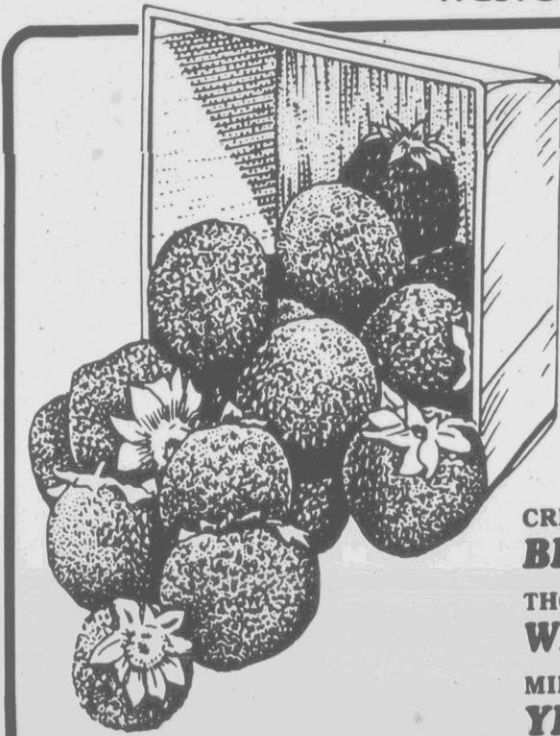

RED, RIPE AND SWEET
STRAWBERRIES

69¢
pint

CRISP, GREEN
BROCCOLI 69¢ bunch

THOMPSON SEEDLESS
WHITE GRAPES 79¢ lb.

MILD MEDIUM
YELLOW ONIONS 99¢ 3lb. bag

DELICATESSEN

CUDDY DELI
HAM

\$1.99 lb.

NEW YORKER
MOZZARELLA or
PROVOLONE \$2.98 lb.
CHEESE ...

FRESH
CHICKEN
SALAD \$3.99 lb.



ARMOUR TREET
Luncheon MEAT

99¢
12oz. can



WISE REGULAR OR RIDGIES
POTATO CHIPS

89¢
6.5oz. bag

(Puffed or Crunchy)
CHEEZ DOODLES 8oz. bag 89¢



MAXWELL HOUSE
COFFEE
(Reg., Ep and ADC)

\$2.49
1lb. bag

SCOTT
PAPER TOWELS

59¢
single roll



SURF LAUNDRY
DETERGENT

(40¢ Off Label) **\$1.59**
42oz. Box



MINUTE MAID
ORANGE JUICE

Regular and
COUNTRY STYLE **99¢**
64oz. carton



NABISCO (Regular or Double Stuff)
OREO COOKIES 20oz. pkg. **\$1.99**

KEEBLER SOFT BATCH
COOKIES 18oz. pkg. **\$1.69**

PEPPERIDGE FARMS (Assorted Varieties)
SNACK STICKS 7.5oz. pkg. **99¢**

**PEPSI, DIET PEPSI,
PEPSI FREE and
MT. DEW** 2 Liter **\$1.09**
(REGULAR AND DIET)

7 UP 2 Liter **89¢**

DR. PEPPER, SUGAR FREE DR. PEPPER 2 Liter **99¢**

REGULAR or LIGHT
Milwaukee's Best BEER .. 6-12oz. cans **\$1.79**

LIGHT or DARK
HEINEKEN BEER ... 6-12oz. btls. **\$4.19**

SEAGRAM'S
WINE COOLERS 4 pk. btls. **\$2.79**

COUPON COUPON

1411 RICHFOOD OR FOODCLUB
SUGAR

5lb. bag **99¢**

LIMIT 1 WITH ADDITIONAL \$7.50 PURCHASE!
Void after Sat. Mar. 28, 1987

FARM FRESH

COUPON COUPON

1412 DUKES
MAYONNAISE

32oz. jar **69¢**

LIMIT 1 WITH ADDITIONAL \$7.50 PURCHASE!
Void after Sat. Mar. 28, 1987

FARM FRESH

COUPON COUPON

1413 SUNLIGHT
DISH LIQUID
(35¢ Off Label)

22oz. btl. **79¢**

LIMIT 1 WITH ADDITIONAL \$7.50 PURCHASE!
Void after Sat. Mar. 28, 1987

FARM FRESH

COUPON COUPON

1414 WALDORF
BATH TISSUE

4 roll pk. **59¢**

LIMIT 1 WITH ADDITIONAL \$7.50 PURCHASE!
Void after Sat. Mar. 28, 1987

FARM FRESH

Crossword By EUGENE SHEFFER

- ACROSS**
 1 Membrane
 5 Jo's sister
 8 Street sign
 12 Isles off Ireland
 13 Creek for Petula Clark
 14 Finish line need
 15 Impudent answer
 17 Essayist
 18 Stone pillar
 19 Gamblers need them
 21 Theater sign
 24 German river
 25 Army meal
 28 Island country
 30 Old crone
 33 Anglo-Saxon letter
 34 Traveler's haven
 35 Eggs
 36 Card game
 37 Presently
 38 Exchange
 39 It might be civil
- DOWN**
 11 Banquet vegetables
 16 Overstrain
 20 Duck or color
 22 Sacred image
 23 Instructor
 25 Blanc or Ferrer
 26 Tokyo, once
 27 "High Noon" confrontation
 29 Part of n.b.
 31 Miss Gardner
 32 Breach
 34 Artist
 38 Sofa
 40 Cousins' moms
 42 Heflin or Johnson
 43 Ladder round
 44 Fencing sword
 45 Icelandic tale
 47 Tree snake
 48 Pointed tools
 49 Dagger
 52 "Miss Brooks"
 53 One type of blanket?
- Solution time: 24 mins.**
 ACROSS: 1 MEMBRANE, 5 JO'S, 8 STREET, 12 ISLES OFF IRELAND, 13 CREEK, 14 FINISH, 15 LINE, 17 ESSAYIST, 18 STONE, 19 GAMBLERS, 21 THEATER, 24 GERMAN, 25 ARMY, 28 ISLAND, 30 OLD, 33 ANGLO-SAXON, 34 TRAVELER'S, 35 EGGS, 36 CARDS, 37 PRESENTLY, 38 EXCHANGE, 39 CIVIL.
 DOWN: 11 BANQUET, 16 OVERSTRAIN, 20 DUCK, 22 SACRED, 23 INSTRUCTOR, 25 BLANC, 26 TOKYO, 27 HIGH NOON, 29 PART, 31 MISS, 32 BREACH, 34 ARTIST, 38 SOFA, 40 COUSINS, 42 HEFLIN, 43 LADDER, 44 FENCING, 45 ISLANDIC, 47 TREE, 48 POINTED, 49 DAGGER, 52 MISS, 53 BLANKET.

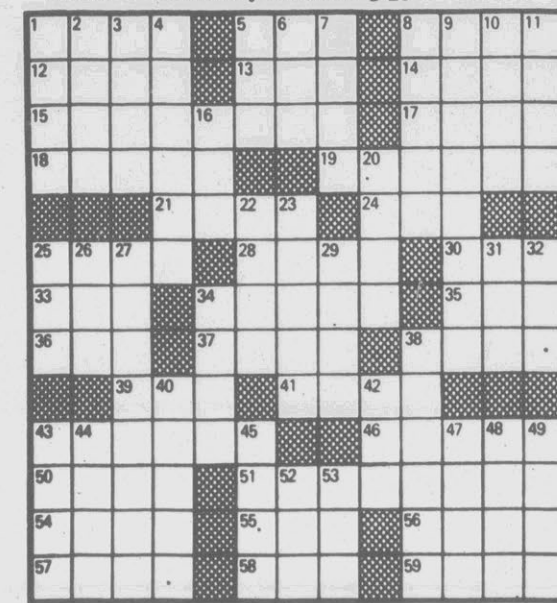

CRYPTOQUIP
 3-25
 YNI BY N EBINI ABZPU
 CUJB AUEPNJUA XNJWPZ.
 "CBPWUL SL XCUJU QCU
 CUNJQ SL."
 Yesterday's Cryptiquip: SAID ONE CONGENIAL
 BAT TO ANOTHER: "CARE TO HANG AROUND A BIT,
 AS USUAL?"
 Today's Cryptiquip clue: C equals H

FOCUS

Taxing Tomatoes
 Trade legislation now before Congress could raise prices for many imported goods. About 100 years ago, a tariff on tomatoes imported from the West Indies led to a major Supreme Court battle. Under the Tariff Act of 1883, only fruits could be imported duty-free. Because tomatoes are a technically a fruit of the vine, importer John Nix challenged the duty on tomatoes. The Supreme Court ruled the tomato a vegetable on the grounds that it is served for dinner, not dessert.
DO YOU KNOW — What nation is our country's number-one trading partner?
TUESDAY'S ANSWER — Houdini died on Halloween.
 3-25-87 Knowledge Unlimited, Inc. 1987

Horoscope From The Carroll Righter Institute

FORECAST FOR THURSDAY March 26
GENERAL TENDENCIES: One of the best days you could have to put into motion a new inspiration that is unique and original and which involves persons who are quite extraordinary.
ARIES (March 21 to April 19): Some ideas you have may seem odd, but later you realize that they are dynamic and can bring you the right results.
TAURUS (April 20 to May 20): Be more enthused when dealing with the public and you can get your points across more successfully.
GEMINI (May 21 to June 21): Any communications, either written or oral, are the best means through which you can get your new plans across.
MOON CHILDREN (June 22 to July 21): Use more advanced systems that can help you to produce more during the daytime.
LEO (July 22 to August 21): Plan a new course during the day with an associate. Take time to do some civic duty and gain more prestige.
VIRGO (August 22 to September 22): You can gain all the data you need now that will help you in furthering your ambitious activities.
LIBRA (September 23 to October 22): Make romantic and recreational arrangements for the evening. Work on ideas that are lucrative.
SCORPIO (October 23 to November 21): You are highly enthused at home with your kin and can get much done. Have guests in and enjoy amusements.
SAGITTARIUS (November 22 to December 21): Find the right words in any communications with others. Be sure to dress nicely today.
CAPRICORN (December 22 to January 20): Plan on making new additions to your home. Your education in finances can be most helpful to you now.
AQUARIUS (January 21 to February 19): You are cheery and can help others to come out of any depression. Get into new outlets with the one you love.
PISCES (February 20 to March 20): You have privately been thinking along modern lines and can use such ideas in a profitable way now.
IF YOUR CHILD IS BORN TODAY ... he or she will be quite dramatic in actions, but don't try to change your progeny since the best success can come from this very difference. Do teach your New Age progeny to value the conventional things in life. Give as many courses as possible in school.

"The Stars impel; they do not compel." What you make of your life is largely up to you!
 (c)1987, The McNaught Syndicate Inc.

Bridge

By CHARLES GOREN AND OMAR SHARIF

THE NUMBER IS THE KEY
 North-South vulnerable. South deals.
NORTH
 ♠ 73
 ♥ J52
 ♦ K72
 ♣ A Q J 5 2
WEST
 ♠ 10 8 6 4 2
 ♥ K 8 7 4
 ♦ Q 9
 ♣ 8 4
EAST
 ♠ Q 9 5
 ♥ Q 10
 ♦ J 10 8 3
 ♣ K 10 9 6
SOUTH
 ♠ A K J
 ♥ A 9 6 3
 ♦ A 6 5 4
 ♣ 7 3

The bidding:
 South West North East
 1 NT Pass 3 NT Pass
 Pass Pass

Opening lead: Four of ♣
 We are always wary about giving an answer when someone asks us about the right way to play a particular suit combination. We were burned many years ago when we were given the club holding that appears in the diagram and we replied that we would finesse the jack. Considered in isolation, that reply was undoubtedly correct. In the context of the whole hand, however, we could not have been further from the truth!
 With a combined 27 high-card points, it might seem the hand should present no problem. Certainly, that is the way declarer approached his task after West led a spade against three no trump. He captured East's queen of spades with the king and led a club to the jack. Despite the fact he had two stoppers in the suit, East made a farsighted play when he held up the king. Declarer was a dead duck. With only one side entry to dummy, there was no way he could make more than two club tricks for a grand total of eight tricks.
 Our advice, and declarer's play of

Need A Car? Find It Fast In Classified

FUNKY WINKERBEAN

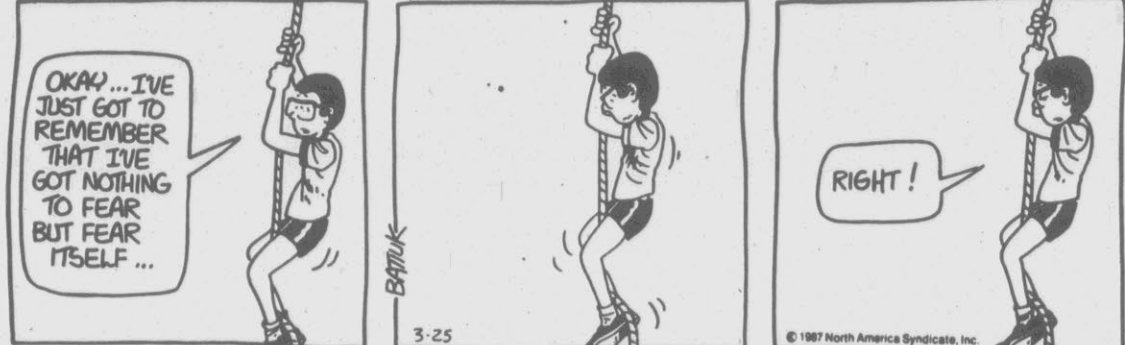

BC



PHANTOM



SHOE



MUBBIN



BLONDIE



PEANUTS



FRANK & ERNEST



BEETLE BAILEY



GARFIELD





EXPRESSIONS

a page for our young readers

Edited By DIANE WILLIAMS — Reflector NIE Coordinator

- essays
- art
- games

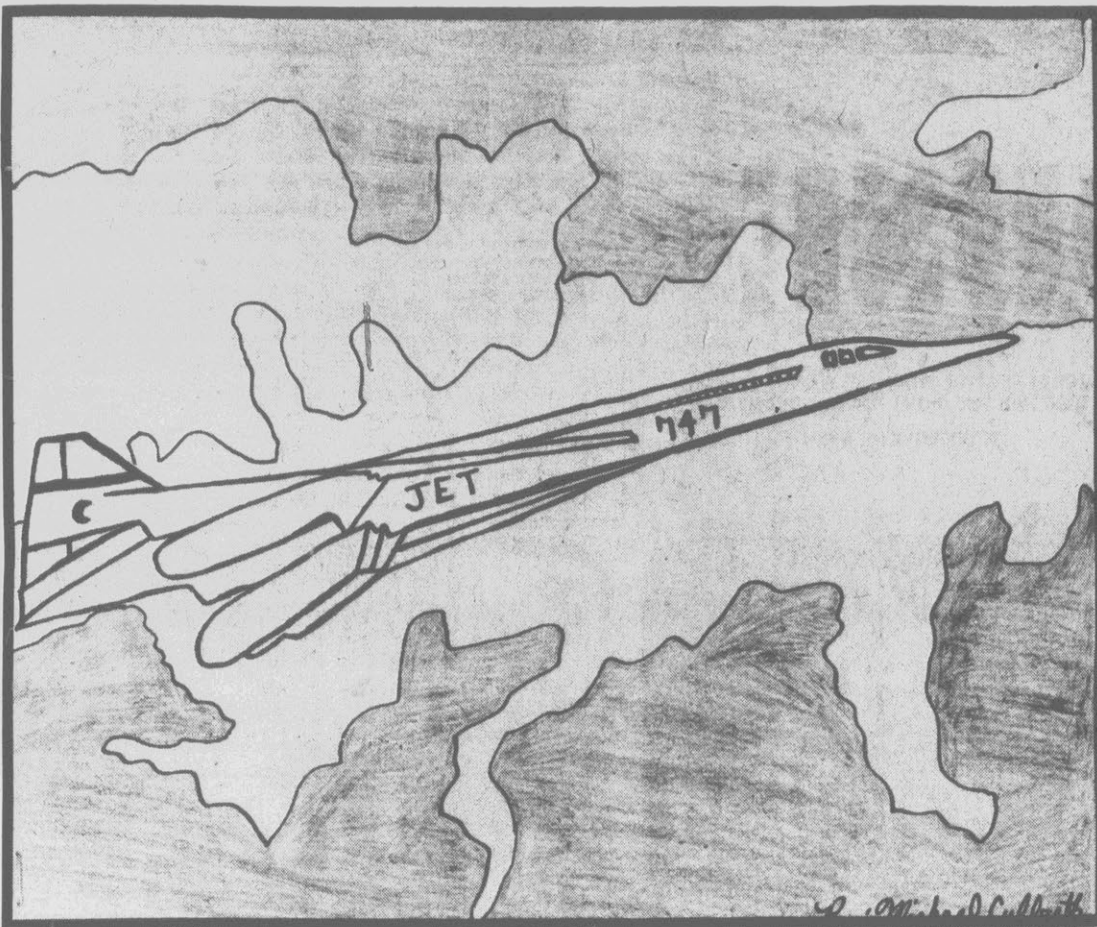

Michael Culbreth, 14, a student at Bethel Elementary School wins this week's drawing contest.

Leisure

By Jay Perry

Reflections in the river
As I sit and reminisce
My thoughts linger carelessly
Nothing wanting to resist
The trees climb over my face
And I look into their eyes
They tell of lost stories
of the dinosaurs rise

A sliding breeze passes through
And I stare into the sky
The emotion towers within me
And my eyes begin to cry
Rolling down the river
My thoughts, my hopes, my

dreams
My life finally opening up
Unraveling at the seams

Jay Perry, 16, a student at Tarboro High School receives special mention contest.

Nature

By Angela Guion

Nature is special among all things.
Beauty is what Nature brings,
A rain cloud rising in the sky
or
A flower blooming early in

the spring.
Nature is the small things
that not everyone has seen.

Angela Guion, 15, a student at D.H. Conley High School receives special mention.

Excuses, Excuses

By Christie Collins

I can't clean up the yard today,
said little Christie right away.

I have a fever of one hundred three,
I have a sore right on my knee.

My hand is broke, my finger too,
I have no socks, I can't find my shoes!

What is that I heard you say,
I can do it some other day?

I think I have the chicken pox,
my hands are filled with little dots.

Thank you mother, that made my day,
now I am going out and play!

I am sick I have a cold,
Or maybe I'm just getting too old.

Christie Collins, 11, a student at Bethel Elementary School receives special mention.

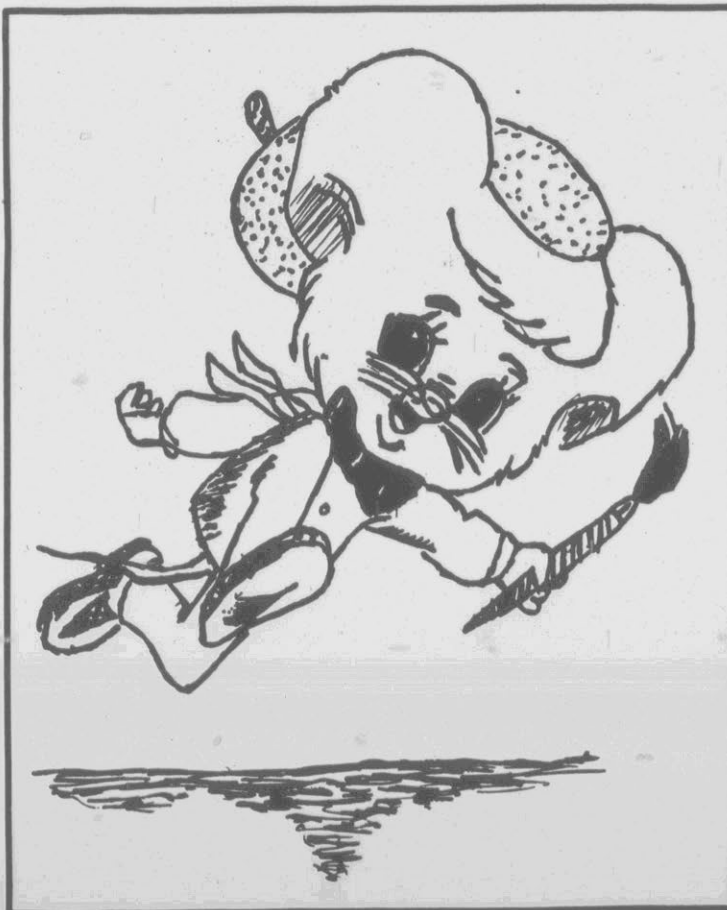

Lenwood Mercer, 16, a student at Farmville Central High School receives special mention.

Over The Rainbow

By Sarah Lewis

On a day that was both rainy and sunny, I saw a rainbow come out. It was beautiful! The colors were red, yellow, blue, purple, pink and a mixed color.

I wondered where that big rainbow ended. It was so big, it covered the whole town. "I wish I could find the gold at the end," I said to myself.

Then all of a sudden, I thought of something! I would find it! I was going to the end of the rainbow.

So I ran and ran and ran until I got so tired I laid down. But it was strange, something

was lifting me but I could see nothing.

The next morning I stood up and a bright-rainbow was under me! No wonder I was so tired, I was running up a rainbow!

Well was I ever surprised! Now I knew what I was going to do. So down I went sliding right into a pot of gold! From then on whenever I saw a rainbow, I'd remember this time.

Sarah Lewis, 8, a student at Sam D. Bundy School receives special mention.

What I Wanted

By Jodie Stackhous

I loved you but you didn't love me,
I wanted you but you didn't want me,
I needed you but you just tore me down,
Even though you had a special kind of way that made me feel good everyday.

The kind of way only I could see.
I loved you, I wanted you, I needed you, but you weren't there for me.

Jodie Stackhous, 13, a student at Wellcome Middle School receives special mention.

Margo

By Teresa Lambe

"Look, Margo, you've got to decide!"

"Mom please, you know how hard this is for me," Margo replied.

"I know. But, honey, don't you realize that you've either got to accept the dance scholarship or the science scholarship. You can't choose both!" her mother pointed out.

"But—" she began, only to be interrupted by her father.

"C'mon, Margo. The train to your Dance Expo is leaving soon," he yelled from the front door.

Margo stared out of the train window, eyes unfocused, not really looking past the glass. Thoughts flew around her head.

"What if I take the dance scholarship? But maybe I'm not good enough, then what will I do?"

"In that case, I should take the science and GIVE UP DANCE?"

The words in her mind stood out in capitals — GIVE UP DANCE.

She arrived at the expo, dance bag in hand and big dreams in heart. This was the day she had always dreamed of; the day she would go to the Dance Expo. Dancers from all over the world were here for the two day seminar.

Margo ran lightly up the heavy concrete steps.

"Name, please?" the registrar at the door asked.

"Margo, Margo Dickenson. I'm from Dreyfus Connecticut."

"OK, Margo, go right in."

Everywhere dancers. They stood, they stretched, they sat. Their taut bodies seemed to flow from position to position. No one ever sat perfectly still, always moving extending their limbs.

Margo stood in the midst of all this, a rock among swirling dust. Finally she began to stretch, too — to move her body, tune it in the same way a musician tunes his instruments or a writer sharpens his work.

"All right people! To the barre!" the instructor rapped out.

Margo chose her spot and stood ready at graceful attention. The class did not begin right away, as the instructor had to take a phone call.

Margo glanced at the other dancers. They seemed much more experienced than her, not at all like the girls back home. They all looked haughty and bored, as if they knew they were better than everyone else.

She walked up to one of them. "Hi," Margo ventured shyly. The girl just nodded. "Small room isn't it?" Margo tried again.

"We're always in a small room," the girl said. "Last year, we had a real studio to work in. Now we're here bumping legs." Her tone was mean and sarcastic.

"Oh," was all Margo said as she stepped back into place. "Are these the kind of people I want to work with?" she thought.

After several hours of class, Margo collapsed onto her hotel bed.

"Ugh," she groaned. "I've never worked so hard in my

life!" she complained to nobody.

But it was time now to sleep. Tomorrow would be a long day in the study class at 7:30 a.m. Yawn.

"Push, push, straighten that leg! You call that a pirouette? What's wrong with you? Keep your back up!" the teacher yelled.

"How much longer can he keep that up?" Margo thought. "I'd be hoarse by now!"

Suddenly a cry from the corner of the room. A small girl with red hair and freckles lay sobbing on the ground, clutching her knee.

"Help! I think I broke my leg!" she cried.

Everyone rushed around, someone called an ambulance. The dancers stood in huddles, whispering among themselves. Only Margo stood alone.

"How bad is she?" the teacher asked the ambulance attendant.

"Well, I don't think she'll dance again," he answered unemotionally.

NOT DANCE.

NOT DANCE.

"What would she do? She had already graduated with a major in dance. Now what?"

Margo thought.

"But I don't have to be like that. I'll always have dance, but will dance have me? THEN WHAT?"

"I can't. I can't. Dance, it's my life, but I can't live with it," Margo told herself.

She walked up to the registrar at the top of the steps.

"Name, please?"

"Margo, Margo Dickenson."

"What course?"

"Chemistry II," Margo said.

Teresa Lambe, 13, a student at E.B. Aycock School wins this week's writing contest.

PUZZLE CORNER

Now that Spring is here, it is important to follow certain rules. Use the code below to figure out one rule that is very important.

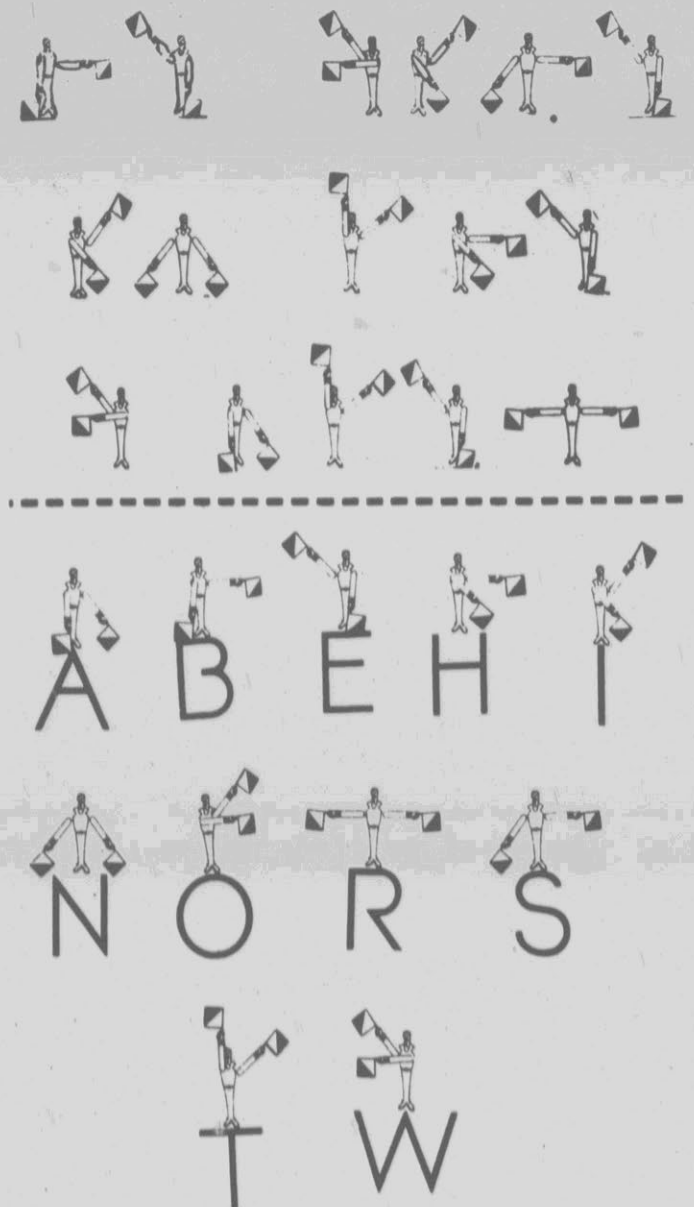

Send In Your Entries To Expressions

The Daily Reflector is looking for elementary, middle, and high school students to draw pictures, write stories, essays and poems. Each week we will publish the best writing and drawing. The winner of each will receive \$2. We will publish stories and art work we feel should receive special mention.

Entries must be original. Drawings must be in ink, crayon, markers or paint on thick colored paper. Please no pencil. Entries will be held for a period of ninety days and will be considered for that period of time. Entries will be returned if a self-addressed, stamped envelope is included.

Parents or teachers who sign the entry form should monitor for good taste and plagiarism.

Fill out the form and attach it to your entry.

Expressions
The Daily Reflector
P.O. Box 1967
Greenville, N.C. 27835-1967

Name _____ Age _____
School _____ Parents _____
Entrant's home address _____
Parent's or Teacher's signature _____

Reading

(Continued from C-1)

In addition, 46 major U.S. corporations such as IBM Corp. and General Motors Corp. have offered the course for employees, according to Claire Carlyle, director of speed reading for American Learning Corp.

"The average person who takes this course is usually a professional looking to improve his reading skills to try to clear the paperwork off his desk or get through journals quicker," Ms. Carlyle said.

Although still popular, speed reading no longer attracts as much attention from educators as it did during the 1960s and 1970s, says Alan Farstrup, director of research and development for the International Reading Association.

As to speed reading, he says, "It allows you to plow through the material and find those places where you really need to read with care. You just have to be realistic about what it does for you."

Long intrigued by the mental processes of reading and why some people are better readers than others, Just and Carpenter decided to study speed reading when a subject in one of their adult reading tests proved to be an extraordinarily rapid reader.

Their opportunity came in late 1979 when an Evelyn Wood course was offered at Carnegie Mellon.

Of the students and university staff members enrolled in the seven-week program, 11 agreed to take part in the professors' experiment. Three were tested before and after the course, while others were studied immediately afterward.

"We studied people as they stepped out of the course" as opposed to those with years of practice, Just said.

Just, Carpenter and research associate Michael Masson compared the 11 speed readers, who clocked in at about 700 words a minute, to 25 university-affiliated people who had never studied speed reading. Half the untrained readers were asked to read at a normal rate, or about 200 to 250 words a minute. The other half, instructed to skim, zipped along at about 600 words a minute.

The 36 subjects were given relatively easy excerpts from Reader's Digest on familiar topics, such as the adventures of a 19th century American frontiersman, as well as technical articles from Scientific American.

The texts, 1,500 to 2,000 words each, were presented on a video monitor. One by one, day by day for several weeks, the subjects read the articles as instructed, using a long pointer to pace themselves while moving through the text.

The computer recorded the duration of the readers' gaze on each word, indicating exactly what was being looked at and what was being missed.

Just and Carpenter found that the normal readers looked at 64 percent of the words, compared to 33 percent for the Evelyn Wood students and 40 percent for the untrained skimmers.

In addition, the normal readers spent an average 330 milliseconds on each word, or about a third of a second, compared to 233 milliseconds for the Evelyn Wood students and 221 milliseconds for the untrained skimmers, the researchers said.

The researchers regularly questioned the subjects to test comprehension and asked them to summarize what they had read. In nearly every case the normal readers fared much better than their quicker counterparts. The three readers studied both before and after the Evelyn Woods course comprehended more when they proceeded at a normal rate.

Unsurprisingly, all readers comprehended more from Reader's Digest than from Scientific American. They also responded more accurately to questions about main ideas rather than details.

The Evelyn Wood students were better at grasping simple, familiar passages than the untrained rapid readers, such as the Reader's Digest text dealing with an Indian attack on a group of fur traders.

There was no evidence that the speed readers forgot any more, or any less, than the untrained rapid readers.

Speed reading courses offer effective retention techniques, Just says: for example, asking oneself why he is reading a piece and what information he wants from it, and afterward making an outline of what was read.

"There are occasions when people are needlessly slow on certain kinds of information," Carpenter says. "They don't know how to be flexible readers. Speed reading courses tend to teach people that."

Show Returns

NEW YORK (AP) — CBS is putting its "West 57th" newsmagazine show back on the air in April.

The show will get a four-week test run in the time period now occupied by "Cagney & Lacey," Monday at 10 p.m. EST, where it will have a lead-in from CBS' strong comedy lineup. But in May, it will move to 8 p.m. EST Tuesday, up against top-rated shows on both ABC and NBC.

"I think it will get very good ratings," CBS News President Howard Stringer said Monday. "I think it will succeed, and I don't think the network can ever afford to put it on hiatus again."

SAV-A-CENTER FOOD MARKET

The supermarket with WAREHOUSE PRICES

PRICES EFFECTIVE THRU SAT., MARCH 28, 1987
WE RESERVE THE RIGHT TO LIMIT QUANTITIES.
IN GREENVILLE, N.C.

DOUBLE COUPON SAVINGS!

WE WILL REDEEM UP TO FIVE MANUFACTURER'S COUPONS WITH EACH \$10.00 ORDER FOR DOUBLE THEIR VALUE UP TO THE RETAIL PRICE

WITH EACH PURCHASE OF \$10.00 OR MORE ANY COUPON EXCEEDING 50¢ WILL BE REDEEMED AT ITS FACE VALUE ONLY

SEE EXAMPLES BELOW

COUPON	ITEM	RETAIL	SAVINGS	AMOUNT
Coupon A	60¢	20¢	20¢	40¢
Coupon B	60¢	40¢	20¢	80¢
Coupon C	\$1.29	50¢	50¢	\$1.00
Coupon D	\$1.29	75¢	—	75¢
Coupon E	\$2.79	\$1.00	—	\$1.00
Coupon F	40¢	FREE	—	40¢

EXCLUDING CIGARETTES, BEER, WINE, FOOD, RETAILERS' COUPONS

SAVE 30¢

PURE CANE

A&P Sugar

5 lb. bag

98¢

LIMIT ONE WITH AN ADDITIONAL \$10.00 OR MORE PURCHASE.

SAVE 20¢

REGULAR OR BUTTER

Crisco Shortening

3 lb. can

1.68

LIMIT ONE OF YOUR CHOICE WITH AN ADDITIONAL \$10.00 OR MORE PURCHASE.

SAVE 30¢ lb.

YOUNG 'N TENDER

Fresh Whole Fryers

1 lb.

48¢

LIMIT FOUR

SAVE 31¢

DUKE'S

Mayonnaise

32 oz. jar

78¢

LIMIT ONE WITH AN ADDITIONAL \$10.00 OR MORE PURCHASE.

SAVE 41¢

A&P LIQUID

Laundry Bleach

gal. jug

48¢

LIMIT ONE WITH AN ADDITIONAL \$10.00 OR MORE PURCHASE.

SAVE 60¢ lb.

FRESH CUT GRAIN FED BEEF WHOLE

Bottom Rounds

20-26 LB. AVG. CUT FREE

1.39

lb.

SAVE 41¢

DELICIOUS

Hunt's Ketchup

32 oz. btl.

68¢

LIMIT ONE WITH AN ADDITIONAL \$10.00 OR MORE PURCHASE.

SAVE 25¢

P&Q

Paper Towels

big roll

38¢

LIMIT ONE WITH AN ADDITIONAL \$10.00 OR MORE PURCHASE.

SAVE 15¢ lb.

THIN TRIM GRAIN FED BEEF TAILLESS

T-Bone Steaks

1 lb.

2.98

COLD POWER

Laundry Detergent

36 oz. 1.49

CREAMY • CRUNCHY

Jif Peanut Butter

18 oz. jar 1.99

ASSORTED

Special Dinners

18 oz. pkg. 99¢

ARMOUR

Vienna Sausage

15 oz. cans 99¢

50¢ OFF REGULAR LEMON/LIME

Palmolive Liquid

32 oz. btl. 1.49

HUNT'S

Tomato Sauce

15 oz. cans 1.00

ASSORTED

Hi-C Drinks

46 oz. can 79¢

GENERAL MILLS CEREAL

Crispy

12 oz. pkg. 1.39

THIN TRIM GRAIN FED BEEF

Boneless Rump Roast

1 lb. 1.99

YOUNG 'N TENDER • FRESH

Breast Quarters

1 lb. 99¢

THIN TRIM GRAIN FED BEEF BOTTOM BONELESS

Round Steaks

1 lb. 1.99

SUPER TRIM SHANK PORTION

Smoked Ham

1 lb. 1.19

THIN TRIM GRAIN FED BEEF TOP • BONELESS

Sirloin Steaks

1 lb. 2.89

LEAN 'N MEATY • COUNTRY STYLE

Pork Ribs

1 lb. 1.69

THIN TRIM GRAIN FED BEEF • BONELESS

N.Y. Strip Steaks

1 lb. 3.99

HOLLY FARMS

Sunday Best Roasters

1 lb. 89¢

SAVE 80¢

REGULAR • LITE SALAD DRESSING

Kraft Miracle Whip

qt. jar

99¢

LIMIT ONE WITH AN ADDITIONAL \$10.00 OR MORE PURCHASE.

SAVE 10¢

ASSORTED DUNCAN HINES

Layer Cake Mixes

18.5 oz. pkg. 79¢

SAVE 90¢ lb.

FRESH

Tender Asparagus

1 lb.

99¢

SAVE 10¢

CHUNK LIGHT • IN OIL OR WATER

Starkist Tuna

2 6.5 oz. cans

88¢

LIMIT TWO WITH AN ADDITIONAL \$10.00 OR MORE PURCHASE.

SEALTEST

Cottage Cheese

24 oz. pkg. 1.39

ASSORTED

Lender's Bagels

12 oz. pkg. 69¢

BUTTERMILK

Hungry Jack Biscuits

5 oz. cans 69¢

DEAN'S FRENCH

Onion Dip

16 oz. ctn. 79¢

ASSORTED

Banquet Dinners

17-19 oz. pkg. 1.99

PET RITZ

Pie Shells

12 oz. pkg. 99¢

BORDEN

Cheese Slices

12 oz. pkg. 1.59

A&P

Whip Topping

8 oz. ctn. 59¢

JUICY RED • BLACK • WHITE

Seedless Grapes

1 lb. 99¢

JUMBO GOLDEN RIPE

Pineapples

ea. 99¢

FRESH FROM FLA. SUNSHINE TREE

Grapefruit

3 for 99¢

FRESH

Spinach

10 oz. pkg. 99¢

AMERICAN EXPRESS

Money Orders

ea. 25¢

SAVE 30¢

ALL VARIETIES

Coca-Cola

2 lt. DTI.

1.09

6 PK. 12 OZ. CANS 1.99

SAVE 50¢

LIGHT OR REGULAR

Taylor California Cellars

Old Milwaukee

12 pack 12 oz. cans

3.89

SAVE 90¢

FAMILY PACK

Red Ripe Tomatoes

26 oz. pkg.

99¢

Sensational Savings

Premium Quality Porcelain on Steel

COOKWARE

AVAILABLE IN RED • WHITE • BLUE

8" Open Frypan

5.99

each with a 15 minute purchase

PRICES GOOD AT SAV-A-CENTER

703 Greenville Boulevard
Open 24 Hours—Open Mon. 7 a.m., Closed Sat. 11 p.m., Open Sun. 7 a.m.-11 p.m.



WOK COOKING — The wok is traditionally used for Chinese cooking such as with this dish of sweet and sour chicken with rice. But, the wok can extend beyond ethnic cooking and be used for most modern, Western cooking

techniques such as frying and stir-frying, braising and steaming. Try the accompanying recipes. (Reflector Photo by Cliff Hollis).

Wok Cooking Is Quick, Has Nutritious Results

By **CHERIE EVANS**
Reflector Staff Writer

Not only is wok cooking fast and easy, but the food preparatory process also has nutritional value, said a local cardiovascular nurse specialist at Pitt County Memorial Hospital.

Using a wok to cook usually decreases the amount of oil needed to prepare foods, said Cindy Mayo. "You can wok without oil and use the natural juices of food."

"You are usually cooking vegetables for less time" when using a wok, she said, therefore the vegetables maintain some of its nutritive value. "You lose nutrients when you boil food because you're cooking for a longer period of time," Ms. Mayo said.

The shape of the wok contributes to its ability to cook foods with less oil, said Linda Walker, a nutritionist at Eastern Carolina Family Practice Center.

"It seems to be you can use less fat and keep it from sticking," she said. "In a flat pan, you tend to use more."

The wok is a thin, curved metal pan that originally was beaten out of tempered steel, which heated quickly and curved to fit over the flames of a Chinese brazier — a pan in which charcoal is burned, according to "Cooking With A Wok" by Bridget Jones.

The wok is traditionally used for Chinese cooking and may be used for frying, stir-frying, braising and steaming.

Try the wok recipes below from Jones' book.

SIMPLE CHOP SUEY

- 1 small onion
- 2 carrots
- 1 can bamboo shoots
- 12 ounce bean sprouts
- 1 tablespoon sunflower oil
- 1 small clove garlic
- 3 to 4 tablespoons soy sauce

Halve the onion, then cut it into very thin slices and separate the slices into strips. Trim the carrots and cut them into very fine strips, and do the same with the drained bamboo shoots. Pick over the bean sprouts, removing any which are slightly brown and as many of the green pods as possible.

Heat the oil in the wok and crush the garlic into it, then add the onion and carrots. Stir-fry for a few minutes, or until the onion has softened slightly. Stir in the bamboo shoots and cook for a minute, then add the bean sprouts and stir-fry for another minute before adding soy sauce to taste. Serve immediately — the bean sprouts should be very crunchy and overcooking will destroy their texture. Serves 4.

SHRIMP FRIED RICE

- 1 onion
- 3 tablespoons oil
- 1 clove garlic
- 1 cup long-grain rice
- salt and freshly ground black pepper
- 2 1/2 cups chicken stock
- 2 cups frozen peas
- 8 ounces peeled cooked shrimp

Chop the onion. Heat the oil in the wok and crush the garlic into it. Add the onion and cook until softened but not browned. Add rice and stir-fry until the grains are transparent and lightly browned. Add seasoning to taste and carefully pour in the stock — take care because a cloud of steam will rise from the wok and this may burn your hand or arm if it is in the way. Bring to a boil, reduce the heat and put the lid on the wok, then simmer gently for 15 minutes.

When the rice has absorbed most of the stock, stir in the peas and shrimp and continue cooking for a further 5 minutes; make sure that the rice does not overcook and burn at this stage. Serve straight from the wok or spoon the fried rice into a heated serving bowl.

CRISPY NOODLES WITH MUSHROOMS AND HAM

- salt and freshly ground pepper
- 12 ounces lo mein noodles (thin Chinese egg noodles)
- 6 large dried Chinese mushrooms
- 8 ounces cooked ham
- 1 bunch spring onions
- 2 tablespoons oil
- 4 tablespoons butter

Pour 5 cups water into the wok and add a little salt, then bring to a boil and add the noodles. Put the lid on the wok and simmer for about 5 minutes; when cooked the noodles should be tender but not sticky. Drain the noodles and place them on a plate, patting them into a round shape.

Place the mushrooms in a basin and pour in enough boiling water to cover them completely, then leave to soak for 15 minutes. Drain and slice. Cut the ham into shreds and trim and shred the spring onions.

Heat the oil and butter together in the wok and add the mushrooms, ham and spring onions. Cook for a few minutes, then remove with a slotted spoon and set aside. Slide the noodles into the wok and cook over a high heat until they are golden and crisp underneath, then turn them over and cook the second side in the same way. Sprinkle the ham mixture over the noodles and serve immediately. Serves 4.

(See WOK, D-2)

Sweet Onions Are Just Right For Light Entrees

A triple dip of sweetness is available in the onion bin or your local market. For good cooks and health enthusiasts throughout the nation, fresh red, white and yellow onions herald the advent of spring.

Known for their juiciness and natu-

ral sweetness, spring and summer onions boast a mellow flavor which has started a new eating trend. An onion connoisseur even knows them by name and will diligently shop for Texas 1015Y Super Sweet, Imperial Sweet from California, Carzalia

Sweets from New Mexico, Vidalias from Georgia, and Walla Wallas from Washington.

These "gourmet" onions have been developed especially for their specific areas and take advantage of their special climates and soil condi-

tions to produce large, thin skinned onions which are extremely mild.

A healthy choice, an average onion provides 20 percent of the U.S. Recommended Daily Allowance for Vitamin C and has 2.8 grams of dietary fiber. A good source of potas-

sium, they possess no fat or cholesterol and retain their healthful properties whether cooked or eaten raw. Studies also indicate that onions help lower blood pressure and reduce cholesterol levels.

The sweet onion's crisp fresh wholesomeness is especially suited to the light summer entrees and salads that lend themselves to our summer lifestyle. When selecting fresh onions, choose those that are well-cured and have tight, dry, necks. Avoid exterior blemishes or cuts. Store onions with a high water content in a cool, dry, well-ventilated area, in a single layer if possible. Store cut onions in an airtight container in the refrigerator.

Here are some delightfully adaptable recipes that utilize the appealing characteristics of the spring and summer sweet onions available in your markets from March to August.

Pepper to taste

- 1 dash vinegar (optional)
- Slice onions and separate into rings. Pour boiling water over onions and let stand for 1 minute. Drain and chill in covered container till cold. Combine the rest of the ingredients and toss with chilled onions. Parsley and cucumber may be added for variety.

CARZALIA SWEET SALAD

- 1 sweet Carzalia onion (jumbo size)
- 2 large vine-ripened tomatoes
- 1 avocado
- Cut the onion into 1/2-inch wedges. Wedge the tomatoes and chunk the avocado. Salt and pepper, toss lightly with vinegar and oil or Italian dressing. Serve on a bed of crisp lettuce. 4 servings.

TERRIFIC TEXAS SWEET ONION-POTATO BAKE

- Per serving:
- 1 medium Texas sweet onion
- 1 medium potato
- 1 tablespoon parmesan cheese
- Peel onion and slice into five equal slices. Scrub potato well and cut into

(See ONIONS, D-3)

Fun Meals Bridge Gap Between Seasons

It's that in-between time of year — post-holiday and pre-barbecue — when meal preparation becomes particularly perplexing. Yet, satisfying meals can really bolster sagging March spirits.

Here are two super menus you can whip up in a mere half hour or less, a big benefit since time, for many, is always in short supply. Each is elegant enough for entertaining but quick and easy enough for everyday. The secret to these magical menus is condensed soup, that most versatile of ingredients, which adds flavor and convenience to a variety of recipes.

The first menu typifies the lighter style of eating so popular today. Instead of the traditional tossed salad, try Marinated Vegetable Kebobs, a colorful medley of artichoke hearts and crisp vegetables, marinated in a

flavorful mixture made with condensed zesty tomato soup/sauce. This attractive appetizer or salad course can easily be made in advance and chilled until serving time.

A fitting follow-up is Cheddar Baked Fish, a delicious dish which tastes robust without being filling. Start with a can of condensed cheddar cheese soup/dip and any light-tasting but meaty "steak" fish such as halibut, cod or swordfish. The fish is baked over rice that's blended with cheddar cheese soup and a touch of sherry. A fruit dessert would certainly make an apt finale to this appealing meal.

Menu two has the exotic taste of the Far East beginning with Oriental Garden Soup, a clear broth enhanced with tofu cubes, mushrooms, leeks and lemon peel. Condensed chicken

broth is the time-saving solution, supplying a richly-seasoned flavor base to perfectly enhance the delicate ingredients. Follow the soup with Beef Stir-Fry in Creamy Peanut Sauce. Whether you stir-fry in a skillet or wok, this dish is fun to prepare, particularly when you can count on such tasty shortcuts as canned soup and frozen vegetables. For best results, have all of the ingredients measured, mixed and ready, because the cooking goes fast!

Armed with such special — yet easy — recipes, you'll find that March may very well fly by. Before you know it, you'll uncover the picnic table and dust off the barbecue for warm weather meals.

(See FUN, D-6)

Munchy, Crunchy Specialty Vegetables Help Slim Down

LOS ANGELES — Swimsuit season is fast approaching. So, start thinking "slimline" eating with munchy, crunchy, svelte specialty vegetables.

Unlike a boring carrot-and-celery-stick regime, noshing on exotic, enticing produce like jicama, spaghetti, squash, Belgian endive, bamboo shoots, sunchokes and other wonderful vegetables can melt extra pounds away with little effort and no guilt.

"Nothing is better for staying slim than making natural, fiber-rich, low-cal, high-nutrition veggies part of your daily diet," says Karen Caplan, president of a specialty produce firm in Los Angeles.

A close inspection of slimline vegetables from the firm reveals the very foods jet setters and celebrities make their daily sustenance. The world's most exclusive spas feature "spa cuisine" made with select veggies such as fresh herbs, baby vegetables, watercress, alfalfa sprouts, sno peas, fresh chiles and more.

Specialty produce is especially

well-suited to diets, including calorie-restricted, low-salt, diabetic or low-fat, because they offer variety, new flavors and satisfying textures. Recipes help spark up restricted menus with flavor ranges from delicate to snappy.

"Entertaining is one of my favorite things to do," says Ms. Caplan. "And I like all my guests, especially dieters to enjoy my cooking. Endive Hors D'Oeuvres, a simple appetizer of Belgian endive leaves stuffed with ricotta cheese and fresh herbs, make entertaining a lot easier and lighter."

Vegetables are excellent fare for weight-control, yet it's important to remember that a healthy portion of nutrients our bodies derive from vegetables also depends upon how to prepare them. To keep from cooking out all that's good within, consider eating produce raw or simply steaming, boiling, broiling, baking, microwaving or lightly stir-frying.

One light and low-calorie dish is Quick Shrimp Chop Suey with fresh shrimp, ginger root and Chop Suey Mix by Frieda. Stir-frying in chicken broth rather than oil really saves on

calories while using fresh pre-chopped chop suey vegetables, made with celery, napa (Chinese) cabbage, bok choy and onions, saves on time.

For a Sunday brunch fit for any "beautiful" person, try a Peasant Omelet made with sunchokes — knobby brown tubers with a nutty skin and white flesh tasting of a brown artichoke. This recipe adds sophistication to a simple omelet.

Grow fresh potted herbs on your windowsill and you can enjoy their aroma and spunk in any dish while avoiding the saltshaker. Vegetable-Stuffed Finnish Potatoes blend fresh snipped herbs with broccoli, red bell pepper and shredded cheese for the hottest trend in main dishes — stuffed potatoes.

ENDIVE HORS D'OEUVRES

- 3/4 cup ricotta or drained cottage cheese
- 1/4 cup grated carrot
- 1 green onion, chopped
- 2 tablespoon chopped fresh herbs such as sage, basil, chives, dill, sorrel or watercress

(See MUNCHY, D-3)

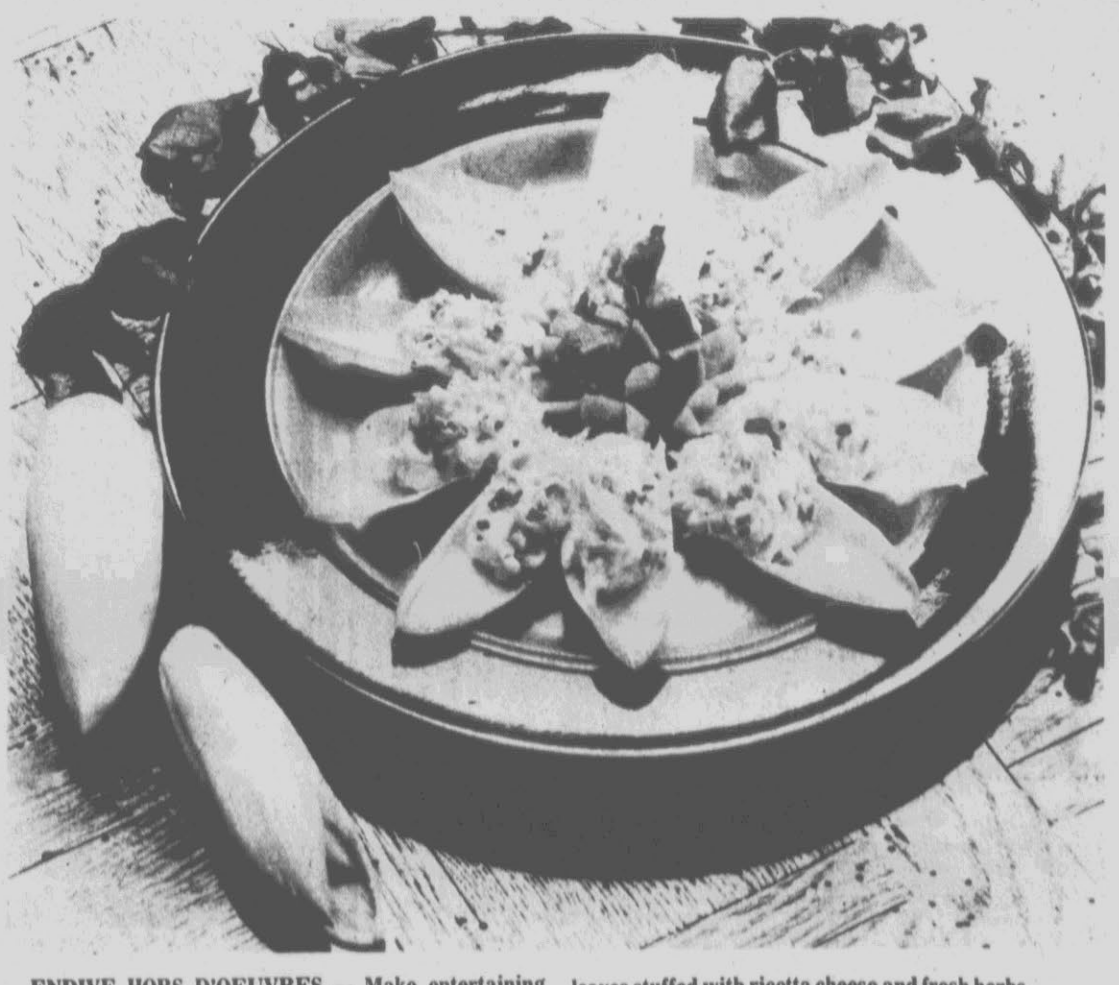

ENDIVE HORS D'OEUVRES — Make entertaining easy and light with a simple appetizer of Belgian endive leaves stuffed with ricotta cheese and fresh herbs.

Wok Cooking Is Not Only Fast, But The Results Are Nutritious

(Continued from D-1)

UPSIDE-DOWN PUDDING

- 4 canned pineapple rings
- 6 glace cherries
- 1/2 cup butter
- 2/3 cup sugar
- grated rind of 1 large orange
- 2 eggs
- 3/4 cup self-rising flour

Arrange three of the pineapple rings in the base of a buttered 6-inch soufflé dish. Cut the remaining pineapple ring into thirds and arrange the pieces between the rings in the dish. Place the cherries in any gaps between the rings and place one in the center.

Cream the butter with the sugar and orange rind until pale and soft. Gradually beat in the eggs with a little of the flour, then use a metal spoon to fold in the remaining flour. Spoon the mixture into the dish, taking care not to disturb the arrangement of the fruit in the base. Wrap the dish completely in foil, making sure that it is securely folded to prevent any steam from entering. Stand the dish on the steaming rack in the wok and pour in enough water to come up to the base of the dish. Put the lid on the wok and bring the water to a boil, then boil steadily for 1 1/2 hours. Check to make sure that the wok does not boil dry during cooking and add more boiling water if necessary.

When cooked, carefully lift the dish from the wok and remove the foil wrapping, then turn the pudding out onto a heated serving plate and serve hot. Serve with a custard cream or whipped cream. Serves 6.

CARAMELIZED PINEAPPLE

- 1 large pineapple
- 4 tablespoons butter
- 4 tablespoons brown sugar
- 4 tablespoons kirsch
- 2 tablespoons chopped pistachio nuts
- 2 tablespoons chopped maraschino cherries

Trim the leaves off the pineapple and cut off the stalk end. Using a sharp knife, cut off all the peel and remove the spines. Slice the fruit fairly thickly and remove the hard core from each slice.

Melt the butter in the wok and add the pineapple slices, frying both sides for a few seconds. Sprinkle the sugar over and turn the slices of fruit, then cook until the sugar caramelizes, turning the fruit once again. As soon as the sugar is lightly browned, turn off the heat and pour in the kirsch. Sprinkle on the nuts and cherries and serve with whipped cream or vanilla ice cream.

RICH CHICKEN STOCK

- 2 chicken legs and thighs
- 8 ounces lean boneless pork
- 1 large onion
- large bay leaf
- 6 peppercorns
- about 6 cups of water

Place the chicken in the wok. Cut the pork into cubes and cut the onion into chunks, then place both in the wok with the chicken. Add the bay leaf and peppercorns and pour in the water, adding a little extra, if necessary, just to cover the meats. Bring to a boil and skim off any scum which rises to the surface. Put the lid on the wok and reduce heat so that the stock simmers steadily. Cook for one hour.

Lift the chicken joints out of the stock and cut all the meat off. Chop this and reserve for use in the soup, or for another purpose. Remove and discard the onion, pork and bay leaf, then strain the stock through a piece of fine cheesecloth or a coffee filter paper. If the stock looks greasy, then chill it thoroughly and skim off the fat. The stock is now ready for use, but remember it is not seasoned.

A simple chicken soup can be prepared by returning the chopped chicken to the stock and adding seasoning to taste. Heat through and sprinkle some chopped parsley into the light broth.

EGG DROP SOUP

- 3/4 cups Rich Chicken Stock and reserved chicken meat, chopped (above)
- 6 spring onions
- 2 tablespoons chopped fresh coriander leaves
- 4 tablespoons soy sauce
- salt and freshly ground black pepper
- 2 teaspoons cornstarch
- 1 tablespoon cold water
- 2 eggs

Prepare the stock according to the recipe above, straining it and removing any excess fat if necessary. Stir in the chopped chicken meat. Finely chop the spring onions and mix them with the coriander.

Pour the stock into the wok and heat through, then stir in the soy sauce, tasting the soup as you do so, and add seasoning to taste. The soup will need some pepper but, depending on the strength of the soy sauce, it may not need any salt. Blend the cornstarch with the water and stir into the hot soup, then bring to a boil to thicken slightly.

Beat the eggs thoroughly without allowing them to become frothy — the idea is to combine the yolks and whites evenly. Stir the spring onion mixture into the soup, bring to a rapid boil and stir the soup so that it swirls around vigorously in the wok. Immediately turn off the heat and pour in the egg in a slow thin stream. It should

set in the swirling soup to give thin strips. Serve immediately. Serves 4.

STEAMED FLOUNDER

- 2 whole flounder, heads removed and cleaned
- 4 slices fresh ginger
- 2 large stalks lemon grass
- 3 tablespoons soy sauce
- Garnish: 1 lemon
- 1/4 cucumber, sliced

Rinse and dry the fish, then make a neat slit down the center of the backbone and cut between the bone and the flesh, working outward to make a large pocket on each side. Place the ginger slices and lemon grass in the pockets, allowing two slices of ginger and a piece of lemon grass for each fish.

Lay the fish on a large plate and sprinkle over the soy sauce. Alternatively, wrap the soy sauce-coated fish in greased foil. Place on the steaming rack in the wok and add water to come up to the edge of the rack. Bring to a boil and put the lid on the wok, then steam for 15 to 20 minutes, or until the fish is cooked through.

Garnish the cooked fish with sliced lemon and cucumber and serve immediately. Serves 4. (Lemon grass is sold in oriental groceries).

TROUT WITH ZUCCHINI

- 4 tablespoons butter
- 2 trout, cleaned
- 4 small zucchini
- 2 tablespoons chopped dill
- salt and freshly ground pepper
- Garnish: lemon wedges
- dill sprigs

Melt the butter in the wok and add the trout. Cook until browned on the underside, then carefully turn the fish over and cook until browned on the second side. Meanwhile, slice the zucchini.

Sprinkle the zucchini over the fish in the pan. Allow as many of the slices as possible to sit beside the fish in the wok, then sprinkle the chopped dill over and add a little seasoning. Put the lid on the wok and cook gently for 20 minutes, turning the fish over after 10 minutes cooking time.

Serve immediately on a warmed serving platter, with the zucchini arranged around the fish, garnished with lemon wedges and dill sprigs. Serves 2.

CHICKEN IN A WOK

- 1 (3 1/2 pound) oven-ready chicken
- 6 carrots
- 1 pound potatoes
- 2 large onions
- 2 cups green beans
- 4 tablespoons butter
- bay leaf
- 3 sprigs parsley
- 2 sprigs thyme
- spring of sage
- pared rind of 1/2 lemon
- salt and freshly ground black pepper
- 3/4 cups dry white wine or chicken stock

Trim the ends of the wings and legs from the chicken. Cut the carrots into chunks and cut the potatoes in half, or quarters if they are very large. Slice the onions fairly thickly and separate the slices into rings. Trim the green beans if they are fresh. Melt the butter in the wok and add the chicken. Fry, turning frequently, until well browned all over. Add the onion rings and cook for a few minutes. While the chicken is browning tie the bay leaf and the other herbs into a small bunch with the lemon rind.

Sprinkle a little seasoning over the chicken — add this sparingly at this stage if you are going to use ready-seasoned stock. Add the bouquet garni and pour in the wine or stock. Bring to a boil and put the lid on the wok. Reduce the heat so that the liquid simmers steadily and cook for 30 minutes. Open the wok and add the carrots and potatoes, then bring the liquid back to a boil, regulate the heat so that it simmers again and put the lid back on the wok. Simmer for a further 30 minutes. Add the green beans and cook for 10 minutes, then serve straight from the wok. Serves 4.

ORIENTAL DUCK WITH PINEAPPLE

- 1 oven-ready duck
- 5 cups water
- 3 tablespoons rich soy sauce
- 1 fresh pineapple
- 1 can water chestnuts
- 1 bunch spring onions
- 2 green chilies
- sesame oil
- 1 large clove garlic

Cut the duck in half lengthways, using a meat cleaver and poultry scissors. Place the halves in the wok and pour in the water, then add 1 tablespoon of the soy sauce. Put the lid on the wok and bring to a boil. Reduce heat so that the liquid simmers steadily and cook for an hour.

While the duck is cooking prepare the remaining ingredients.

Trim the leaves off the pineapple and cut off the stalk end. Cut off the peel and cut out all the spines, then slice the spring onions diagonally. Cut the stalks off the chilies and remove all their seeds, then slice the green part thinly.

At the end of the simmering time remove the duck from the stock and set it aside. Pour the stock out of the wok (this should be chilled and the fat skimmed off, then the stock can be used in oriental soups and stews) and wipe

out the pan. Grease it with a little sesame oil. When the duck is cool enough to handle cut all the meat off the bones and slice it into pieces. Heat the wok and add the chilies, crush the garlic into the pan and add the duck. Stir-fry until lightly browned, then add the water chestnuts and pineapple and cook for a few minutes. Stir in the remaining soy sauce and any juice from the fruit, and sprinkle over the spring onions. Cook for a minute before serving straight from the wok. Serves 4.



HARRIS
SUPER MARKETS, INC.
"Where Shopping Is A Pleasure"

DISCOUNT
to help you save

We Reserve The Right To Limit Quantities. We Accept Food Stamps And WIC Vouchers.

PRICES GOOD THRU SATURDAY

DELI

BELLS FORK SQUARE STORE ONLY

OUR DELI AND CHEESE SHOP OFFERS A FULL VARIETY OF DELI MEATS AND CHEESE, BOTH DOMESTIC AND IMPORTED, SLICED TO ORDER, ALL AT AN AFFORDABLE PRICE. COMPARE AND SAVE!

LORRAINE SWISS .. \$4.59 Lb.

TURKEY BREAST . \$3.99 Lb.

LIVER/WURST . \$1.09

GERMAN BOLOGNA . 99¢ Lb.



Order Your Deli Trays For The NCAA Final Four

Custom Made Cheese Balls And Cheese & Meat Deli Trays Available In All Our Stores Call Bonita 756-6105

SPRING SPECIAL FROM

THE DIETERS CLUBSM

OPTI-LOSS MEDICAL SYSTEMTM

QUESTION/ANSWER CORNER

Q. Why is your weight loss program different?

Q. Do I have to take shots?

Q. Is your program medically safe?

Q. Sounds great but aren't they all alike?

Thanks...Greenville...Now get into shape for spring.

Spring Special

(FIRST VISIT ONLY PLEASE)

50% OFF

PROGRAM COST

CALL...

756-2611

610 ARLINGTON BLVD.
GREENVILLE, NC
ACROSS FROM DAWSONS

(ANSWERS)

A. There is no starvation. The Diet is totally unique in its ability to leave you full but losing weight. Weight loss is more permanent that way.

A. Shots are not necessary. Our program provides all the nutrition and vitamins you need...orally.

A. Our staff includes a doctor and a nurse that monitor your diet the whole way.

A. We are unique...Call us and set up a no charge appointment and see.

MONEY SAVING COUPON

The Sunflower Group • 10409 L. West Overland Park, Kansas 66210



Save 20¢ on

NEW 12 oz.

100% Natural



Sharp Cheddar

MANUFACTURER'S COUPON

EXPIRATION DATE: 6/30/87

20¢



Save 20¢

when you buy NEW 12 oz.

100% Natural KRAFT

Sharp Cheddar Shredded

cheese or any 12 oz. or larger variety

23736

RETAILER: Kraft, Inc. will reimburse you for the face value of this coupon plus 8¢ if submitted in compliance with Kraft's Coupon Redemption Policy, previously provided to retailer and incorporated by reference herein. Void where taxed, restricted or prohibited. Cash value 1/100¢. Mail to: Kraft, Inc. (980), 2285 West, #21800, 1 Foxworth Dr., Oak Brook, IL 60455. Offer Expires: 6/30/87.

21000 26320

SC7-49

20¢

ONE COUPON PER ITEM PURCHASED - REDEEM PROMPTLY



DISCOUNT COUPONS

Newspaper Co-Op Couponing Westport, Connecticut 06880

SEAFOOD SPECIAL



SAVE UP TO \$1.35

[MAIL-IN OFFER FORM] [NOT PAYABLE AT RETAIL STORE]

SAUCEWORKS Sauces and SUCCESS RICE®

\$1.00 FISH REFUND

Buy: One 6-oz. or larger jar of SAUCEWORKS Sauces (any flavor), one box of SUCCESS RICE® and any fresh or frozen fish/seafood.

Send: The UPC code () from SAUCEWORKS and SUCCESS RICE and the cash register receipt with the purchase price of fish circled along with this completed offer form.

Receive: \$1.00 cash refund and free fish recipe leaflet.

Mail to: SAUCEWORKS SAUCES AND SUCCESS RICE, \$1.00 FISH REFUND, SR 7474, El Paso, TX 79975

Please send my refund to:

Name _____

Address _____

City _____ State _____ Zip _____

OFFER EXPIRES 12/31/87. REQUESTS FOR OFFER FORMS TO THIS P.O. BOX NUMBER WILL NOT BE ACKNOWLEDGED. LIMIT ONE OFFER PER FAMILY OR ADDRESS. This offer good only in U.S.A. An error and misprint address in which this offer is displayed in advertisement, void where taxed, restricted or prohibited. DUPLICATE REQUESTS WILL CONSTITUTE FRAUD. THEFT, DIVERSION, REPRODUCTION, SALE OR PURCHASE OF THIS FORM IS PROHIBITED. LIMIT ONE REQUEST PER FAMILY OFFER. Proof of purchase submitted by clubs or organizations will not be honored. Proof of purchase and mail in form must be forwarded in an envelope with sufficient postage will be returned.

(Allow 4-6 weeks for delivery)

20¢

MANUFACTURER'S COUPON

NO EXPIRATION DATE

SAVE 20¢

on 7-oz., 14-oz., or 21-oz.

SUCCESS RICE

Boil-In-Bags

791679

20¢

MANUFACTURER'S COUPON

EXPIRATION DATE: 12/31/87

SAVE 15¢

when you buy one 6-oz. or larger size jar of SAUCEWORKS Sauces (any flavor)

791679

20¢

Great in the microwave

15¢

21000 63530

21000 44315

Munchy, Crunchy Specialty Vegetables Can Help To Slim Down

(Continued from D-1)

2 to 3 tablespoons milk
Few drops bottled hot pepper sauce
Salt and pepper to taste
2 heads Belgian endive
Watercress sprigs for garnish
For filling, combine the ricotta or cottage cheese with carrot, green onion, chopped herbs and enough milk to make a smooth consistency. Add pepper sauce and salt and pepper to taste. Separate endive leaves, reserving the tiny leaves for another time. In larger leaves, spoon about 1 tablespoon filling carefully into each leaf. Garnish each with a sprig of watercress. Cover and chill until serving time. Makes about 16 appetizers. About 22 calories each.

QUICK SHRIMP CHOP SUEY
2 tablespoons cooking sherry
2 tablespoons low-sodium soy sauce
1 tablespoon hoisin sauce
1/2 cup chicken broth
2 teaspoons cornstarch
About 1/4 cup chicken broth
1 pound medium or large shrimp, shelled and deveined
1 tablespoon minced fresh ginger root
1 red or green bell pepper, seeded and cut into 1-inch squares
1 1-pound package chop suey mix
1/2 cup peanut halves
For sauce, stir together sherry, soy, hoisin sauce, 1/2 cup chicken broth and cornstarch until well blended. Set aside. Heat about 2 tablespoons chicken broth in a wok or large skillet until very hot. Add shrimp and ginger root, stir-frying until shrimp turn pink. Remove from wok.
Add more chicken broth; stir-fry bell pepper about 2 minutes. Remove from wok. Stir sauce; pour into wok. Cook and stir sauce about 1 minute or until bubbly. Add shrimp, chop suey mix and peanuts to wok; toss to combine with sauce. Cover and steam 2 minutes or until heated through; serve at once. Makes 4 servings; 200 calories/serving.

PEASANT OMELET
1 tablespoon cooking oil
3/4 cup chopped sunchoke
1 medium zucchini, halved

ONIONS

(Continued from D-1)

six equal crosswise slices. Dredge the onions in the cheese and roll the sides of the potato through the cheese.
Reassemble the potato with a slice of onion between each slice of potato and place in a piece of foil that has a thin pat of butter on it. Seal the foil and bake at 375 degrees for 45 minutes. May also be done on the middle rack of the grill.
WALLA WALLA SWEETS & SALMON
8 slices Walla Walla Sweet Onion, 3/8-inch thick
4 6-ounce salmon fillets, boneless
4 teaspoons butter, divided
4 tablespoons parmesan cheese
Dried dill weed
Fresh parsley, chopped
In a heat-proof dish, for each serving, layer one slice Walla Walla Sweet Onion, a salmon fillet, a sprinkle of dill, another onion slice and 1 teaspoon of butter. Bake, uncovered, for 20 minutes at 450 degrees.
Uncover, sprinkle 1 tablespoon parmesan cheese over each serving broiling briefly until cheese is melted and lightly browned. Garnish with chopped fresh parsley. 4 servings.

VELVETY VIDALIA SWEET SALAD
1/2 cup sliced almonds
3 tablespoons sugar
1/2 head iceberg lettuce
1/2 head romaine lettuce
1 cup chopped celery
1 Vidalia Sweet Onion
1 11-ounce can mandarin oranges, drained
Dressing:
1/2 teaspoon salt
Dash of pepper
1/4 cup vegetable oil
1 tablespoon chopped parsley
2 tablespoons sugar
2 tablespoons vinegar
Dash Tabasco sauce
In a small pan over medium heat, cook almonds and sugar, stirring constantly until almonds and sugar dissolve. Watch carefully as they will burn easily. Cool and store in airtight container. Mix all dressing ingredients and chill.
Slice the Vidalia Sweet Onion and separate into rings. Mix lettuce, celery and onions. Just before serving add almonds and oranges. Toss with dressing. 4-6 servings.

crosswise and thinly sliced
1 small tomato, chopped
2 shallots, thinly sliced
1 tablespoon chopped fresh herbs such as rosemary, basil, oregano, chervil or chives
1/4 teaspoon pepper
1 tablespoon oil or butter
3 eggs
1 tablespoon water
Dash of salt
Heat oil in a small skillet. Sauté

sunchoke, zucchini, tomato and shallots for 3 minutes or until vegetables are crisp-tender. Stir in fresh herbs and pepper. Cover and keep warm. In another small skillet, heat oil or butter. Whip together eggs, water and salt lightly; pour into hot skillet. Stir mixture for a few seconds; then allow to cook for 1 minute.
Use a spatula to lift egg mixture, allowing uncooked portion to flow

underneath. When omelet is cooked, spoon the vegetable mixture over top half of omelet; fold bottom half of omelet over filling. Turn out into platter. Makes 2 servings, 275 calories/serving.

VEGETABLE-STUFFED FINNISH POTATOES
3 to 4 yellow finnish potatoes, scrubbed
1 cup broccoli florets

Half of a red bell pepper, chopped
1 leek, sliced (white part only)
1 tablespoon chopped fresh herbs such as basil, chives, rosemary or thyme
1/8 teaspoon pepper
3/4 cup shredded cheddar, Monterey Jack or Swiss cheese
Pierce potatoes several times with fork. Bake potatoes in a 350-degree oven for about 50 minutes, or until tender. (Or, cook potatoes in a

microwave about 5 minutes; let stand 5 minutes.) Meanwhile, steam broccoli and bell pepper about 5 minutes.
Add leeks; steam 2 minutes more. Cover and keep warm. Split potatoes; place on a heat-proof platter. Heap vegetables over potatoes. Sprinkle on fresh herbs, pepper and shredded cheese. Return to oven until cheese melts. Makes 4 servings, about 160 calories/serving.

EXTRA LOW PRICES!



Holly Farms



Grade A

WHOLE FRYERS

We Reserve The Right To Limit Quantities.
Prices in this ad good thru Sunday, March 29, 1987.

49¢ Lb.

BONELESS ROUND STEAK
\$1.98 Lb.
USDA Choice Beef Round - Full Cut

Large Exotic KIWI FRUIT 3/\$1

RED RIPE STRAWBERRIES
\$1.59
Pint..... .89 Quart

USDA Choice Beef Chuck
BONELESS CHUCK ROAST
\$1.68 Lb.
USDA CHOICE

"Seedless" Thompson
OR RED GRAPES
99¢ Lb.



Snow
WHITE CAULIFLOWER
99¢ Head

Wise Regular & Ridgie
POTATO CHIPS
99¢ 6.5 Oz.
Wise Nacho Triangles..... 12 Oz. 1.59

Pepsi Cola
\$1.09
2 Liter - Pepsi-Free, Diet Pepsi, Diet Pepsi-Free

Milwaukee's Best
\$1.89
Pkg. of 6 - 12 Oz. Cans - Reg. & Lt.

Coors Beer
\$2.69
Pkg. of 6 - 12 Oz. Cans - Reg. & Lt.

EXTRA LOW PRICES ... Everyday

Duke's Mayonnaise
99¢
32 Ounce



Broccoli Spears
2/\$1
10 Oz. - Frozen Pictsweet

Corn-On-The-Cob
89¢
6 Ct. - Frozen Niblets Green Giant

Orange Juice
\$1.09
64 Oz. - Old South



Mueller's Elbow Macaroni/Spaghetti
3/\$1
8 Oz.



French's Mustard
69¢
28 Oz. - Bonus

Blue Bonnet Oleo
49¢
1 Lb. - Quarters

Buttermilk Biscuits
4/\$1
12 Oz. - 10 Ct. Merico Texas Style

Pink Salmon
\$1.49
15.5 Oz. - Libby's



Snuggle Fabric Softener
\$1.39
64 Oz. - 45¢ Off



Dawn Liquid
\$1.49
32 Oz. - 50¢ Off



Twin Pet Cat Food
5/\$1
15 Oz. - Fish Or Fish/Beef



Crimestoppers

If you have information on any crime committed in Pitt County, call Crimestoppers, 758-7777. You do not have to identify yourself and can be paid for the information you supply.

115 E. Red Banks Road
South Park Shopping Center

2430 Stantonsburg Road
Stanton Square Shopping Center

SHOP ALL OF OUR CONVENIENT HARRIS SUPER MARKETS, INC.

HARRIS
 SUPER MARKETS, INC.
 "Where Shopping Is A Pleasure"

DISCOUNT
 ON EVERYTHING BUT QUALITY

We Reserve The Right To Limit Quantities.
 We Accept Food Stamps And WIC Vouchers.
PRICES GOOD THRU SATURDAY!

*Sweet Days
 of Spring*

GRADE A
WHOLE FRYERS

47^c



U.S.D.A. WESTERN BEEF

BBQ RIBS . . . 99^c LB.

U.S.D.A. WESTERN BONELESS

STEW BEEF . . . \$1.69 LB.

U.S.D.A. WESTERN BONELESS

SHOULDER ROAST . . . \$1.47 LB.

U.S.D.A. WESTERN BONELESS

SHOULDER STEAKS \$1.67 LB.



HOUSE OF RAEFORD
 GRADE A JUMBO PACK

FRYER THIGHS . . . 79^c LB.

HOUSE OF RAEFORD
 GRADE A JUMBO PACK

FRYER DRUMSTICKS . 89^c LB.

FRESH 1/4 SLICED
PORK LOINS

\$1.39 LB.



U.S.D.A. WESTERN BONELESS

CHUCK ROAST

\$1.27 LB.



FRESH
PORK PICNICS (LEAN AND TENDER) 79^c LB.

FRESH
GROUND CHUCK (GROUND FRESH DAILY) \$1.39 LB.

U.S.D.A. WESTERN BONELESS
CUBE STEAKS \$2.19 LB.

CIRCLE A
BEEF PATTIES 5 LB. \$3.99

HARRIS OWN GENUINE HICKORY
SMOKED SAUSAGE (PURE PORK. NO FILLERS ADDED) \$1.99 LB.

LUTERS
FRANKS 12 OZ. 99^c

(LUTERS BEEF FRANKS \$1.09)
 JAMESTOWN
SAUSAGE 1 LB. 79^c

U.S.D.A. WESTERN BONELESS

CHUCK STEAKS . \$1.47 LB.

GWALTNEY GREAT DOGS OR GREAT BOLOGNA 1 LB. 89^c

GWALTNEY MEAT OR BEEF BOLOGNA 8 OZ. 99^c

GWALTNEY BIG 8 MEAT OR BEEF FRANKS 1 LB. \$1.49

GWALTNEY BACON 12 OZ. \$1.29

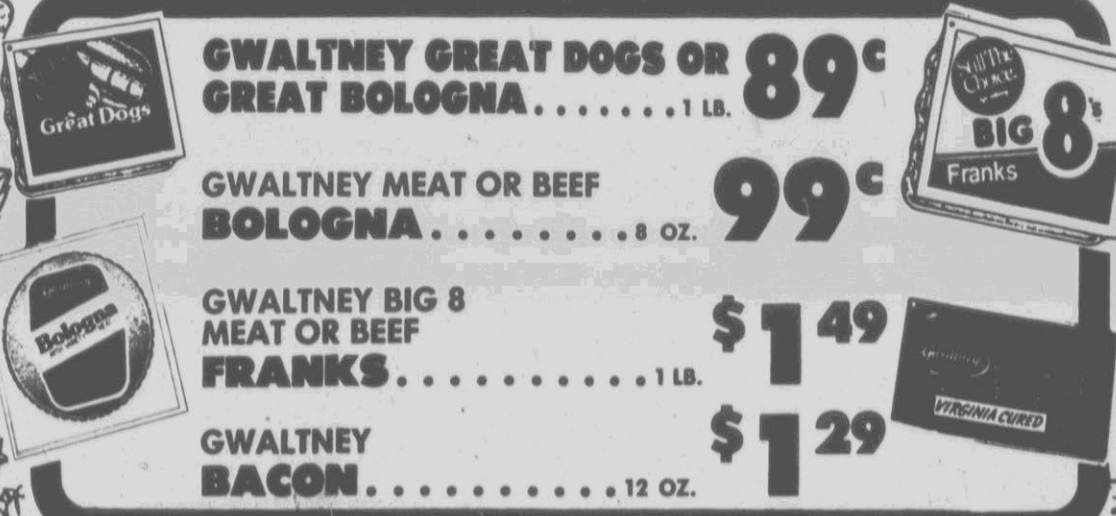

Add A Touch Of Charm To Your Kitchen With

Crowning Touch

HARVEST BLOSSOM PATTERN

PORCELAIN ENAMEL COOKWARE

Now you can add a bright, cheerful note to your kitchen with Crowning Touch...the decorator cookware that looks as great as it cooks.

Crowning Touch's striking porcelain finish, pattern designs and unique ball shape make it a beautiful alternative to the drab aluminum and stainless steel cookware used in many kitchens today. And because of its core of carbon steel and many cooking features it will enable you to cook your every meal to sheer perfection.

Now for a limited time only, you can acquire a full set of this beautiful cookware at savings of over 40% on our convenient tape saver plan. Here's how our plan works: Shop at our store regularly and save your register tapes. Once you have collected \$50.00 in tapes, you can purchase any one of 10 exciting Crowning Touch Cookware pieces at our special discount price, which is \$5.00 less than our regular store price without qualifying register tapes. Also, every Crowning Touch item is carried in open stock so you can add or replace pieces long after the promotion has ended.

Featuring the NEW **SPEED SKILLET** with Magic Touch Nonstick Interior. The only skillet that combines:

- The superior cooking qualities of carbon steel cookware.
- The charm and beauty of the Crowning Touch porcelain finish and decorative pattern designs.
- And the cooking and cleaning ease of the new Magic Touch, quick to heat nonstick finish.

Start Your Set With an Oval Baking Pan, Specially Priced at Only **\$3.99** with \$50.00 in Register Tapes



SUPERMARKET LOCATIONS AND SAVE MONEY!

PRODUCE

LARGE JUICY FLORIDA

ORANGES

5 LB. BAG

\$1.39

FRESH TENDER

BROCCOLI . . . 14 CT.

79¢ BUNCH

SNO WHITE

CAULIFLOWER .

89¢ HEAD

NEW CROP

RED POTATOES .

\$1.69 10 LB. BAG

SWEET FLORIDA
STRAWBERRIES

PINT

69¢

DR. PEPPER OR DIET DR. PEPPER
\$1.09
2 LITER

NABISCO SALE
NILLA WAFERS 12 OZ. **\$1.49**
OREO CREME COOKIES 20 OZ. **\$2.09**
ALMOST HOME COOKIES . . . ALL 12 OZ. VARIETIES **\$1.25**

ALL FLAVORS
TOP POP DRINKS
99¢
3 LITER

HI-C
FRUIT DRINKS
8 OZ. ASEPTIC PAKS
39¢

DIXIE CRYSTALS
5 LB. GRANULATED
SUGAR
LIMIT 1
\$1.19

MILWAUKEES BEST
REG. OR LIGHT BEER
6 PACK 12 OZ. CANS
\$1.99

PEPSI, DIET PEPSI OR MOUNTAIN DEW
2 LITER
\$1.09

Your Purchase of Scott Products Will Help Raise \$1,000,000 For



SCOTT
NAPKINS . 140 CT. **69¢**
PP-79¢

BABY FRESH WIPES . 40 CT. **\$1.29**
15¢ OFF LABEL

SCOTTOWEL . JUMBO ROLL **59¢**

ROLLER CHAMPION, FAMO OR MARTHA WHITE
FLOUR
SELF-RISING 5 LB. **69¢**

PREGO AL FRESCO
SPAGHETTI SAUCE
ALL 30 OZ. VARIETIES **\$1.49**

CHEF-BOY-AR-DEE
SPAGHETTI DINNER WITH MEAT
19 OZ. **\$1.29**

7-FARMS
SHORTENING
42 OZ. **99¢**

PREMIUM PARTNERS
FREE!
WITH PROOFS OF PURCHASE
Campbell's & PREMIUM
SOUP CRACKERS
89¢
SEE STORE DISPLAYS FOR DETAILS

ARM & HAMMER
DEODORIZER SPRAYS
8 OZ. **\$1.29**

ARM & HAMMER
CARPET DEODORIZER
FLORAL OR LIGHT SCENT
21 OZ. **\$1.39**

ARM & HAMMER
BAKING SODA
16 OZ. **2/89¢**

ARM & HAMMER
HEAVY DUTY LIQUID DETERGENT
40¢ OFF LABEL
64 OZ. **\$2.19**

FOLGERS
INSTANT COFFEE . . . 9 OZ. BONUS PAK **\$3.99**

FOLGERS
FLAKE COFFEE 11.5 OZ. **\$2.09**

KELLOGGS
FROOT LOOPS 15 OZ. **\$1.99**

JACK AND THE BEANSTALK
SMALL WHOLE GREEN BEANS . . #303 CANS **59¢**

JIF
PEANUT BUTTER . CREAMY OR CRUNCHY 18 OZ. **\$1.89**

PURINA 100
CAT FOOD ALL 6 OZ. FLAVORS **5/\$1**

SURF
LAUNDRY DETERGENT . 42 OZ. 40¢ OFF LABEL **\$1.69**

JACK AND THE BEANSTALK
CUT GREEN BEANS . #303 CANS **2/\$1**

DAIRY

FROZEN FOODS

CAROLINA DAIRIES
BUTTERMILK . 1/2 GALLON **99¢**

CAROLINA DAIRIES CHILLED
ORANGE JUICE . 1/2 GALLON **99¢**

KRAFT PARKAY
MARGARINE . 1 LB. 1/4" **2/\$1**

MERICO TEXAS STYLE OR TEXAS BUTTERY
BISCUITS . . 12 OZ. **4/\$1**

CAROLINA DAIRIES PREMIUM
ICE CREAM . ALL ROUND PLASTIC 1/2 GALLONS **\$1.99**

CAROLINA DAIRIES
NUTTY BUTTY . . 6 PAK **99¢**

TOTINO PARTY
PIZZAS ALL VARIETIES 12 OZ. **99¢**

CRINKLE CUT
FRENCH FRIES . . 2 LB. **2/\$1**

PARADE
BROCCOLI SPEARS . 10 OZ. **2/\$1**

Fun Meals Aid In Planning Menus For In-Between Time Of Year

(Continued from D-1)

MARINATED VEGETABLE KEBOBS

- 1 jar (6 ounces) marinated artichoke hearts, undrained
- 1 can (11 ounces) condensed zesty tomato soup/sauce
- 1/4 cup water
- 3 tablespoons wine vinegar
- 4 large cauliflowerets
- 4 pitted ripe olives
- 4 pimento strips, cut 1-inch wide
- Salad greens

To make dressing: Drain artichokes, reserving 1/4 cup marinade. In covered jar or shaker, combine reserved marinade, soup, water and vinegar.

To make kebobs: On four 6-inch bamboo skewers, alternately thread artichoke hearts, cauliflowerets, olives and pimento. Serve on salad greens with dressing.

Makes 1 1/2 cups dressing or 4 servings. Calories per serving: 171.

CHEDDAR BAKED FISH

- 1 can (11 ounces) condensed cheddar cheese soup/dip
- 1/4 cup sour cream
- 2 teaspoons dry sherry
- 1/8 teaspoon cayenne pepper
- 2 cups cooked rice
- 1/4 cup sliced green onions
- 4 cod, halibut or swordfish steaks, about 1/2 inch thick (about 2 pounds)
- Sliced green onion for garnish

Preheat oven to 375 degrees F. In a small bowl, stir soup, sour cream, sherry and cayenne. Set aside.

In medium bowl, stir rice, onions and 1/2 cup of the soup mixture. In each of four buttered 8-ounce ramekins, place 1/2 cup of the rice mixture. Top with a fish steak; cover with foil.

Bake 30 minutes or until fish flakes easily with fork. Heat remaining soup mixture; serve with fish. Garnish with additional green onions.

For microwave cooking: Stir soup, sour cream, sherry and cayenne in

small bowl and set aside. In medium bowl stir rice, onions and 1/2 cup of the soup mixture. Place 1/2 cup of the rice mixture in each of four buttered 8-ounce ramekins and cover with fish.

Arrange ramekins in microwave oven. Cover with waxed paper.

Microwave on High 10 minutes or until fish flakes easily with fork. Rearrange ramekins twice during cooking. Remove ramekins from oven; let stand, covered.

Meanwhile, in 2-cup glass measure, microwave remaining soup

mixture 1 1/2 minutes or until hot. Serve with fish. Makes four servings. Calories per serving: 421.

ORIENTAL GARDEN SOUP

- 1 cup (10 3/4 ounces) condensed chicken broth
- 1 soup can water
- 1/2 cup cubed tofu
- 1/2 cup sliced mushrooms
- Dash Chinese 5-spice powder
- 2 tablespoons thinly sliced leeks or green onions
- 1/4 teaspoon slivered lemon peel

In 2-quart saucepan, combine broth, water, tofu, mushrooms and

5-spice powder. Over high heat, heat to boiling. Reduce heat to low. Cover; simmer 5 minutes.

To serve: Divide leeks and lemon peel evenly among four soup bowls. Ladle soup into bowls.

NOTE: Substitute a sprinkle each of ground cinnamon, cloves and paprika for dash of Chinese 5-spice powder.

For microwave cooking: In 2-quart microwave-safe casserole, combine broth, water, tofu, mushrooms and Chinese 5-spice powder. Cover. Microwave on High for 6 minutes or until hot. Serve as directed above.

Makes about 3 1/2 cups or 4 servings. Calories per serving: 48.

MAGIC WANDS

- 1/2 cup chunky peanut butter
- 1 cup sifted powdered sugar
- 1 cup shredded coconut
- 1 cup raisins
- 1 to 1 1/2 tablespoons milk
- 1 to 1 1/2 cups crushed Do-si-dos
- Blend well, peanut butter, powdered sugar, coconut and raisins. Add enough milk to make firm mixture. Form into thin fingers and roll each in cookie crumbs. Chill.

Peanuts Maintain Popularity

March is National Peanut Month so lets take a look at this great tasting celebrity.

Peanuts were first brought to America from Africa. They were raised in the South mostly as food for the poor (sole food). During the War-Between-the-States, this crop was eaten by soldiers on both sides.

Union soldiers spread the popularity of our celebrity (the peanut) by taking him home and sharing him with friends and family. History shows that the production of peanuts increased rapidly after the Civil War.

Peanut "pastry", known better to us as peanut butter, was developed in 1890 by a St. Louis doctor who was looking for a nutritious, easily-digested food to prescribe to his patients. Today peanut butter is a staple found in everyone's cupboard across our country.

At present there are more than 300 by-products made from peanuts. These products include; cheese, oil, flour, livestock food, face powder, face cream, soap, paint, dyes and axle grease, just to name a few.

In North Carolina peanuts are grown in the eastern section of the state, with most of the production being in the northeast area. An average of 275,000 tons of peanuts were harvested this past year, grossing \$150 million of income to North Carolina farmers.

PEANUT INFLATION CORN-BREAD

- 1/2 cup peanut butter
- 1 pound ground beef (saute/drain off fat)
- 1 onion finely chopped
- 1/2 pound grated cheddar cheese
- 3 chopped Jalapeno peppers (optional)
- 12-ounce jar pimentos, chopped
- Mix Together:
 - 1 cup corn meal
 - 1/2 teaspoon baking soda
 - 3/4 teaspoon salt
 - 2 eggs, well beaten
 - 1 cup buttermilk
 - 1/2 cup peanut oil
 - 1 can (303) cream style corn

Preheat oven to 350 degrees F. Stir peanut butter into cooked ground beef. Pour 1/2 of corn meal batter into greased large iron skillet (or 9 1/2" casserole dish). Spread in meat and peanut butter mixture. For next layer, put in onions, peppers, cheese and pimentos. Pour remaining batter on top. Bake uncovered for 50-60 minutes. Serves 6-8.

A DATE WITH PEANUTS

- 20 pitted dates (prunes)
 - 20 whole salted peanuts
 - 20 uncooked bacon strips (approximately 2 1/2 inches long)
 - 20 toothpicks
- Stuff dates with peanuts. Wrap with bacon strips, secure with toothpicks. Bake for 20 minutes at 350 degrees. Cool before serving.

FUDGY PEANUT PIE

- 9" regular pie shell
- 1 stick (1/2 cup) margarine; melted
- 1/4 cup cocoa
- 1/4 cup all-purpose flour
- 1 cup sugar
- 1/2 teaspoon vanilla
- 2 eggs, slightly beaten
- 3/4 cup salted peanuts, chopped
- Mix all ingredients together and pour into unbaked pie shell. Bake in a 350 degree oven for 25 minutes. Serve warm with whipped topping. Makes a 9" pie.

SHOP EZE FOODLAND

BUYERS MARKET-MEMORIAL DRIVE
QUANTITY RIGHTS RESERVED. NONE SOLD TO DEALERS.
HOURS: MON.-SAT. 7:00 A.M.-9:00 P.M.
SUNDAY 7:30 A.M.-6:00 P.M.

WE ACCEPT USDA FOOD STAMPS, WIC VOUCHERS & ALL OTHER FOOD STORE COUPONS.

THESE PRICES ARE EFFECTIVE MARCH 25-28, 1987 WEDNESDAY THRU SATURDAY

DOUBLE COUPONS EVERY WED. & SUN. SEE STORE-FOR DETAILS

Congratulations to E.S. Asby who won \$500 dollars in our 21st Anniversary give-a-way!!

FOR THE BEST FRESH COOKED COLLARDS IN TOWN VISIT OUR DELI ON TUESDAY & FRIDAY

Flower Shop Now Open. We Deliver To PCMA Twice A Day. Call Virginia Perkins For Your Flower Needs!

 <p>SWIFT PREMIUM, BLADE CUT CHUCK ROAST</p> <p>99¢ LB.</p>	 <p>SHANK HALF SMOKED HAMS</p> <p>79¢ LB.</p>	 <p>INDIAN RIVER GRAPEFRUIT</p> <p>36 SIZE</p> <p>29¢ EACH</p>
<p>SWIFT PREMIUM, CENTER CUT CHUCK ROAST \$1.19</p> <p>SWIFT PREMIUM, BONE-IN SHOULDER ROAST . . . \$1.29</p> <p>SWIFT PREMIUM, BONELESS STEWING BEEF \$1.69</p> <p>SWIFT PREMIUM GROUND CHUCK . . . \$1.49</p>	<p>BUTT HALF SMOKED HAMS 89¢</p> <p>WHOLE SMOKED HAMS 85¢</p> <p>CENTER SLICES SMOKED HAMS . . . \$1.19</p> <p>PORK PIG FEET JUMBO PACK LB. 39¢</p>	<p>RED POTATOES 5 LB. BAG 99¢</p> <p>FRESH, GREEN CUCUMBERS 39¢</p> <p>FRESH RIPE PEACHES 89¢</p> <p>RED RIPE STRAWBERRIES PINT 89¢</p>
 <p>GWALTNEY REGULAR OR THICK SLICED BACON</p> <p>1 LB. PKG.</p> <p>\$1.49</p>	 <p>GWALTNEY FRANKS</p> <p>12 OZ. PKG.</p> <p>89¢</p>	 <p>TENDER & FRESH BROCCOLI</p> <p>69¢ BUNCH</p>
<p>GWALTNEY HOT OR MILD SAUSAGE 1 LB. \$1.39</p> <p>GWALTNEY-BONED & TENDER BUFFET HAMS \$2.29</p> <p>GWALTNEY-TURKEY BUFFET HAMS \$1.89</p> <p>GWALTNEY-BEEF OR MEAT BOLOGNA, SALAMI OR SLICED LUNCHEON MEAT 8 OZ. 99¢</p>	<p>GWALTNEY-COOKED, PRESSED OR SMOKED HAM 6 OZ. PKG. \$1.59</p> <p>GWALTNEY GREAT BOLOGNA 1 LB. PKG. 89¢</p> <p>GWALTNEY BOLOGNA 1 LB. \$1.39</p> <p>GWALTNEY-BIG & BEEF OR MEAT FRANKS 1 LB. \$1.29</p> <p>GWALTNEY GREAT DOGS 1 LB. 79¢</p>	<p>MRS. PAUL'S-CRISPY CRUNCHY FISH FILLETS 15 OZ. \$2.49</p> <p>GORTON FISH STICKS 2 LB. \$3.79</p> <p>DULANY CUT OKRA 10 OZ. PKG. 69¢</p> <p>FIVE ALIVE ORIGINAL OR BERRY/CITRUS 12 OZ. 99¢</p> <p>PET RITZ CREAM PIES 14 OZ. 99¢</p>
 <p>CAMPBELL'S VEGETABLE SOUP</p> <p>10 3/4 OZ. CAN</p> <p>3/\$1</p>	 <p>KRAFT MAYONNAISE</p> <p>32 OZ. JAR</p> <p>99¢</p> <p>LIMIT 1 WITH \$10.00 FOOD ORDER.</p>	 <p>MERICO BUTTER-ME-NOT BISCUITS</p> <p>9 OZ. CAN</p> <p>3/\$1</p>
<p>GREER APPLESAUCE 303 CAN 3/\$1</p> <p>AUNT JEMIMA BUTTERMILK-COMplete PANCAKE MIX 25' OFF 2 LB. \$1.17</p> <p>JELL-O GELATIN 3 OZ. 37¢</p>	<p>FOODLAND HAMBURGER OR HOT DOG BUNS PKG. OF 8 2/99¢</p> <p>JIFFY POP-MICROWAVE POPCORN PLAIN OR BUTTER 4 1/2 OZ. 99¢</p> <p>KEEDLER-OATMEAL RAISIN OR CHOC. CHIP SOFT BATCH COOKIES 18 OZ. PKG. \$1.69</p>	<p>MAOLA 1/2% LOWFAT MILK 1 GAL. \$1.69</p> <p>SEALTEST SOUR CREAM 16 OZ. 99¢</p> <p>MILWAUKEE'S BEST BEER 6 PACK-12 OZ. CANS \$1.69</p>
 <p>KELLOGG'S SPECIAL K CEREAL</p> <p>12 OZ. BOX</p> <p>\$1.79</p>	 <p>COKE, NEW COKE OR DIET COKE</p> <p>2 LIT. BOTTLE</p> <p>\$1.09</p>	 <p>BOUNTY TOWELS</p> <p>69¢</p>
 <p>DI-BITE SUGAR</p> <p>5 LB. BAG</p> <p>99¢</p> <p>LIMIT 1 WITH \$10.00 FOOD ORDER. EXPIRES 3/28/87.</p>	 <p>STAR-KIST CHUNK LIGHT TUNA</p> <p>6 1/2 OZ. CAN</p> <p>39¢</p> <p>IN OIL OR WATER LIMIT 1 WITH \$10.00 FOOD ORDER. EXPIRES 3/28/87.</p>	 <p>RED GLO TOMATOES</p> <p>300 CAN</p> <p>15¢</p> <p>LIMIT 2 WITH \$10.00 FOOD ORDER. EXPIRES 3/28/87.</p>

Holly Farms® guarantees the highest standards of quality and freshness in the world.

And you can taste it.

Holly Farms guarantees The Taste of First Day Freshness.™

There's fresh. And there's Holly Farms fresh. Because every one of Holly Farms' ten thousand employees is committed to

assuring you of absolutely the freshest chicken possible. And that's why Holly Farms guarantees you The Taste of First Day Freshness every time. That's not just an idle promise. That's a full money-back guarantee.

We demand far more inspections than the Federal Government.

We're continuously checking our chickens' freshness from before hatching until after they're in the store. Every Holly Farms plant has its own laboratories to closely monitor every aspect of quality and freshness from feed ingredients to final product freshness. And we don't leave it there either. We send our own highly trained inspectors right into the food stores to check on meat case temperatures and climate conditions.

The fresher the feed, the fresher your food.

Our chickens dine on a



natural blend of corn and soybeans delivered by our own computerized feed mills. The result is the freshest food for our chickens. And that means the freshest food for you.

To be really fresh, you've got to be fast.

When it comes to freshness, speed is of the essence. Every Holly Farms chicken is processed, packaged and ready to deliver in less than three hours. Then it's shipped out fast. In most cases Holly Farms chicken arrives at the market less than twelve hours after leaving the plant. And that plays no small part in how we deliver The Taste of First Day Freshness.

Real freshness requires the right refrigeration.

Temperature is a vital ingredient to freshness. At Holly Farms we've pioneered our own chilling process to maintain a perfect freshness-preserving temperature. Then, to ensure that our chicken arrives at the store with The Taste of First Day Freshness, we send it in our own fleet of refrigerated trucks—the largest in the industry.

FreshGuard™ packaging keeps freshness all wrapped up.

Every Holly Farms chicken comes in a special package that's not only tear-resistant. It's air-resistant. Every package is heat-sealed to keep the freshness in. FreshGuard packaging. It's another reason we can guarantee The Taste of First Day Freshness.

We never stop looking for fresh ideas.

Fresh thinking is what keeps Holly Farms products at their freshest. Every person at Holly Farms is encouraged to develop fresh ideas for feeding, raising, processing, packaging, distributing, inspecting. Because at Holly Farms we're not just living up to the highest standards of quality and freshness. We're setting them.

What the highest standards mean for you.

It's this simple. Every time you purchase a Holly Farms product, you can be sure you are getting the freshest, highest-quality food a company can deliver. We guarantee it. And you can taste it.



QUALITY FOODS

priced right here!

OVERTON'S

OPEN 8 AM-8 PM
MONDAY-SATURDAY
SUNDAY 1 PM-6 PM

NEW! POTATO BAR!

LARGE, STEAMING, IDAHO BAKED POTATOES JUST WAITING TO BE TOPPED WITH YOUR CHOICE OF CHEESE, BROCCOLI, WHIPPED MARGARINE, CHILI & BEANS, SOUR CREAM & BACON BITS.
SPECIAL INTRODUCTORY OFFER 99¢
Regular \$1.39 Value. Take-Out Only.



FRESHLY BAKED
FRUIT & CUSTARD PIES..... 24 OZ. \$1.99
FRESHLY BAKED SAN FRANCISCO
SOURDOUGH FRENCH BREAD..... 89¢
FRESHLY BAKED
APPLE TURNOVERS..... PKG. OF 4 \$1.49

211 JARVIS STREET

Supermarket Inc.

"HOME OF GREENVILLE'S BEST MEATS"
WE RESERVE THE RIGHT TO LIMIT QUANTITIES.

PRICES EFFECTIVE
WEDNESDAY-SATURDAY,
MARCH 25-28

SWIFT PREMIUM WHOLE

RIB EYES

CUT FREE!

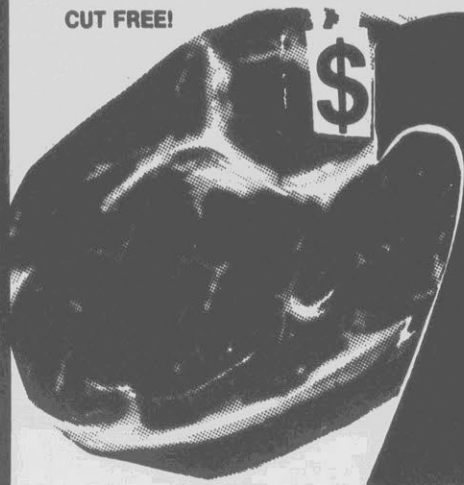

2.89 LB.

SMOKED WHOLE OR HALF

TENDERIZED HAMS

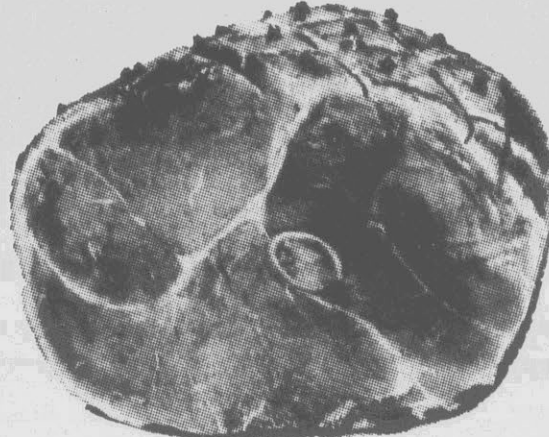

99¢ LB.

GREENVILLE'S LOWEST PRICE!
GWALTNEY

PORK CHITTERLINS



10 LB. PKG. \$3.79

FAMILY PAK SPECIALS

PORK NECK BONES..... 5-7 LB. PKG. LB. 49¢

FIRST CUT PORK CHOPS..... 5-7 LB. PKG. LB. 99¢

FROSTY MORN

FRANKS..... 12 OZ. PKG. 99¢

BACON..... 12 OZ. PKG. \$1.29

PORK TENDERLOINS..... 5 LB. PKG. \$9.49

GWALTNEY GREAT BOLOGNY & GREAT DOGS..... 1 LB. PKG. 99¢

GRADE "A" YOUNG TURKEYS
10 LBS. & UP



5.99 LB.

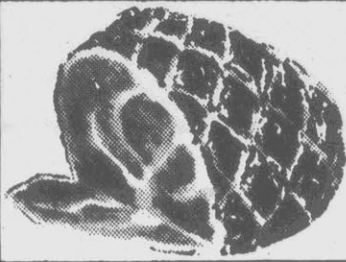

SOUTHAMPTON SMOKED WHOLE OR HALF COUNTRY HAM

\$1.29 LB.

NEW FROM ALPO ALAMO CHUNKY DOG FOOD... 14 OZ. CAN 3/\$1



REGULAR & DIET SUN-DROP SOFT DRINK
6 PACK-12 OZ. CANS

99¢

GRADE "A" FRYER LEG QUARTERS



BREAST QUARTERS... LB. 79¢

3.37 LB.

KRAFT MAYONNAISE..... QUART JAR \$1.39

WHITE HOUSE APPLE JUICE..... 64 OZ. JUG 99¢

IMPERIAL CHARCOAL..... 20 LB. BAG \$1.99

CHARMIN TOILET TISSUE

4 ROLL PKG.



9.99

REGULAR & DIET PEPSI COLA & DR. PEPPER
2 LITER BOTTLE



\$1.09

RICHFOOD ORANGE, GRAPE, GINGER ALE & COLA
SOFT DRINKS
2 LITER BOTTLE



59¢

ALL FLAVORS RUFFLES POTATO CHIPS
6 1/2 OZ. BAG 99¢



BUDWEISER & BUD LIGHT
8 PACK 7 OZ. BOTTLES \$1.99



COUNTRY CANE SUGAR

5 LB. BAG LIMIT ONE



9.99

PINE GLEAM PINE OIL CLEANER..... 28 OZ. BOTTLE 2/\$1

SARA LEE FROZEN ORIGINAL POUND CAKE... 10.75 OZ. GREAT WITH STRAWBERRIES! \$1.49



DUNCAN HINES YELLOW CAKE MIX..... 18 OZ. BOX 79¢

BOUNTY PAPER TOWELS

GIANT ROLL



6.99

ADAM'S 100% PURE FLORIDA SUPER BUY! ORANGE JUICE..... 12 OZ. CAN 59¢

SPECIALS FROM BIRD'S EYE
COOL WHIP 8 OZ. CUP CUT CORN, GREEN PEAS & MIXED VEGETABLES 16 OZ. POLY BAG
YOUR CHOICE 79¢



FRESH JUICY STRAWBERRIES..... PINT 99¢



SNOW WHITE CAULIFLOWER HEAD 99¢

RUTABAGAS OR GREEN CABBAGE 5 LBS. \$1

FAB DETERGENT

42 OZ. BOX



9.99

KLEENEX SOFTIQUE FACIAL TISSUES..... 150 CT. PKG. 69¢

ALL PURPOSE WHITE POTATOES

10 LB. BAG LIMIT ONE

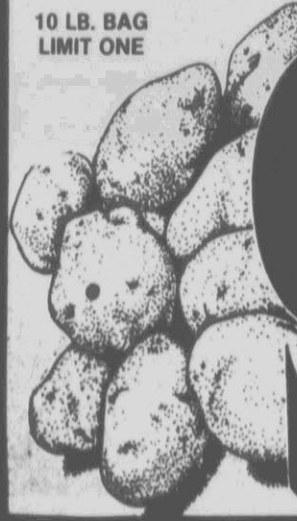

9.99

FRESH BROCCOLI BUNCH



7.99

GOLDEN RIPE BANANAS

LB.

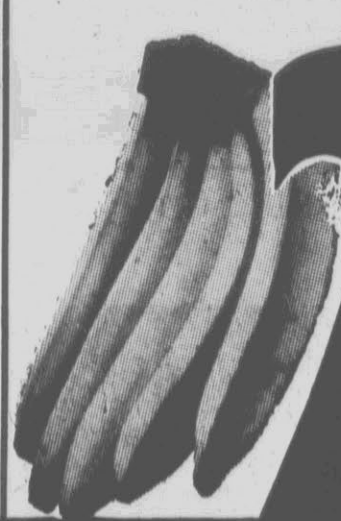

2.29

Belk

SHOP MARCH 20th THROUGH 22nd
IN ROCKY MOUNT, GOLDSBORO, ELIZABETH CITY,
WILSON, GREENVILLE, KINSTON, HOOKLET,
TARBORO AND WASHINGTON

LAST
THREE
DAYS!

SPRING FASHION SALE

OUR PROMISE TO YOU:
Sometimes due to circumstances beyond our control, advertised merchandise fails to arrive in all quantities. When that occurs, we will fill your order at the earliest opportunity based on availability. However, we must receive your order within the advertised selling period.



Select Group Of Infant Blankets

7.99

Reg. \$11 to 11.50

Acrylic baby blankets, in white or maize solids and plaid patterns. Hurry... limited quantities available!



Terry Coveralls For Infants

4.99

Regular 6.50

"Way-To-Go" Stroller

59.99

Reg. \$79

Full lie-back and multi-recline positions, adjustable canopy, easy compact fold, plus numerous other features. By Century®.



Girls' Leggings From BugOff!®

6.99

and

7.99

Reg. \$9 and \$11

Elastic waist rib leggings of 50% polyester/50% cotton. Choose from solids of black, strawberry and turquoise, sizes 4-6X and 7-14. Limited quantities!

BugOff!® Briefs For Girls-Save!

6 Pair 4.99

Reg. 6/5.44

Pastel-colored briefs, in a convenient package of six pair. For girls size 7-14. Limited quantities available at this fantastic, low price!



Girls' Camp Shirt With Tank Top

9.99

Regular \$14

BugOff! short-sleeve camp shirt, in tropical print, novelty print, or multi-stripped pattern, with coordinating solid ribbed tank top. Sizes 7 to 14. You save \$4!



Select Group Of Girls' Handbags!

Regular \$8. **20% OFF**

Canvas handbags, in blue, gray, and just the right brights! Select from notebook bags, organizers, zipper bags and more. Limited quantities.

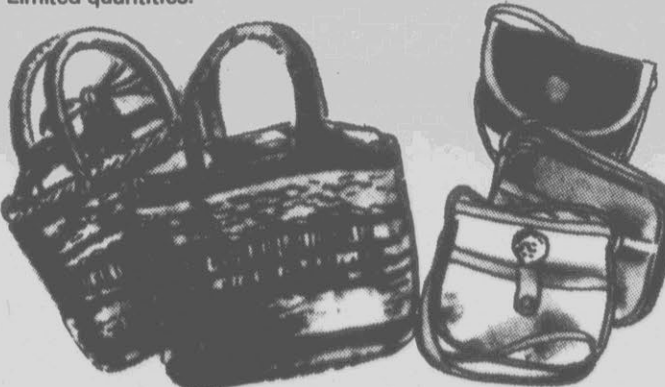

Girls' Cotton Anklets On Sale!

3 Pair 2.99

Reg. 3/3.75

Nursery Rhyme® 100% cotton anklets with lace trim, in white and fresh pastels. Limited quantities available in sizes 3-3 1/2 to 6-6 1/2.



Boys' Andhurst® Sport Socks-The More You Buy, The More You Save!

Regular 1.50 **20% OFF**

Cotton/nylon, quarter top sport sock with cushion sole, in white, sizes 9-11. Limited quantities!



Tuf-N-Ruf® Boat Shoes For Boys

Regular \$29 **24.99**

"Sloop" leather boat shoe, tan with white boat sole. Limited quantities available in sizes 3 1/2-7. Shop early!

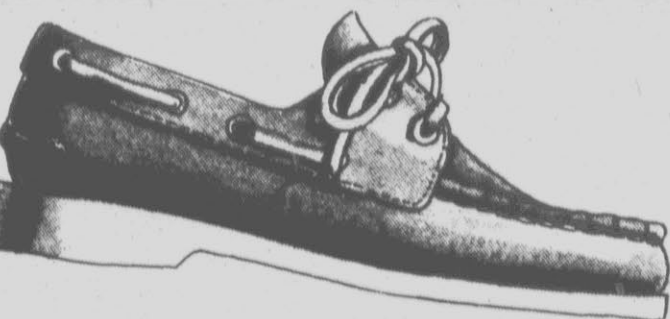

Save on Boys' Plaid Shirts!

7.49

and

9.49

Reg. \$9 and \$12

Short-sleeve, button-down collar sport shirts, in woven plaid patterns for boys' size 4-7. Similar style for boys size 8-20, in yarn dyed plaids of 60% cotton/40% polyester.



Saddlebred 

Duck Head Slacks For Boys

12.99

to

16.99

Reg. \$15 to \$21

Boys' polyester/cotton Duck Head® pant, in khaki and navy, sizes 8-14 Regular and Slim, Student sizes 25-30. Juvenile twill pant, in khaki, navy and gray, sizes 4-7 Regular and Slim. Limited quantities!

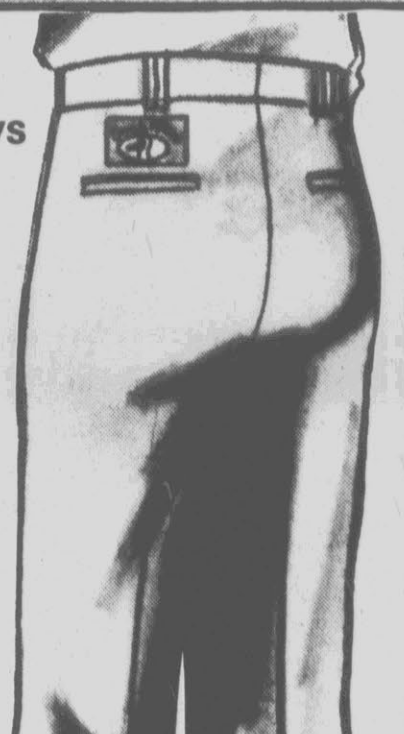

Belk

INFANT FURNITURE AND CHILDREN'S ITEMS SPECIALLY PRICED! SHOP AND SAVE! LAST THREE DAYS!



Select Group Of Diaper Bags, Now At Terrific Savings!

20% OFF

Regular Prices

Solid color and printed vinyl diaper bags. Carrying all of baby's needs couldn't be easier, or more colorful!

Select Group Of Infant And Girls' Dresses-Big Reduction!

20% OFF

Regular Prices

A variety of colors and simply adorable styles, including some with smocking and embroidery trim. Sizes 3 to 24 months and 2-3-4 years. Come early for best possible selection!

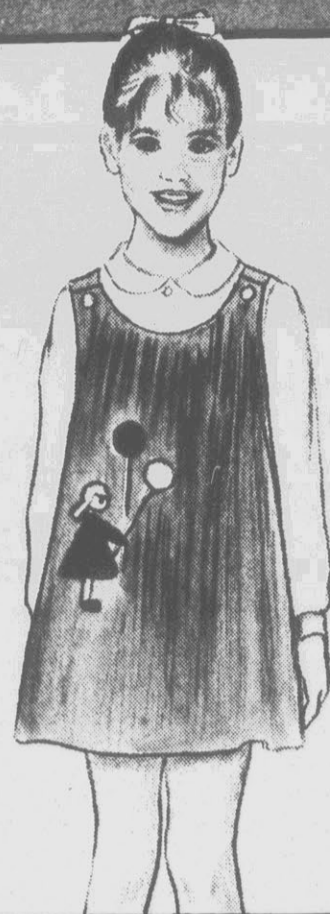

Select Group Of Infant Coveralls By Nursery Rhyme®

20% OFF

Regular Prices

One-piece knit coveralls in gift box sets. Buy now and set some aside for giving!

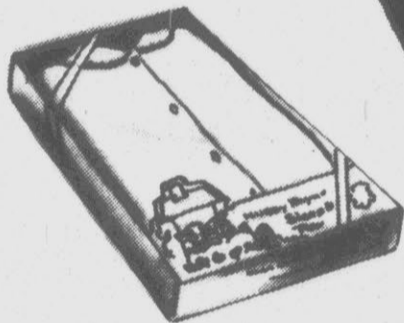

Nursery Rhyme® Shortall Sets For Infant Boys, Low-Priced!

9.99

Regular \$11

Two-piece builtup shortall sets in polyester/cotton blends with grippers and back tabs. Fully lined. Choose from blue, yellow and white solids with assorted applique trims. Solid polyester/cotton short-sleeve shirt included. Sizes 12/18/24 months and 2-3-4 toddler.



Your Baby Will Sleep Sweetly With Our Nursery Rhyme® Jenny Lind Crib, Mattress And Coordinate Bedding

149.99

Regular \$229

Our exclusive Nursery Rhyme® wooden Jenny Lind crib with single drop side, 4-position spring, double action stabilizer bar, clear plastic teething rails and Lucite® casters. In white or maple finish. 54" x 30" size.

20% OFF

Regular Prices

Our Nursery Rhyme® 150 coil mattress features treated fiber insulation, non-allergenic foam wrap, 4-vent ventilation, 9 gauge border rod and a pearlized, electronically quilted cover. In white morning glory. Also save 20% on "Beartyme" bear print crib ensembles and bedding! Select from headboard bumper, dust ruffle, sheets, pillowcases, diaper bags, or sham and comforter.

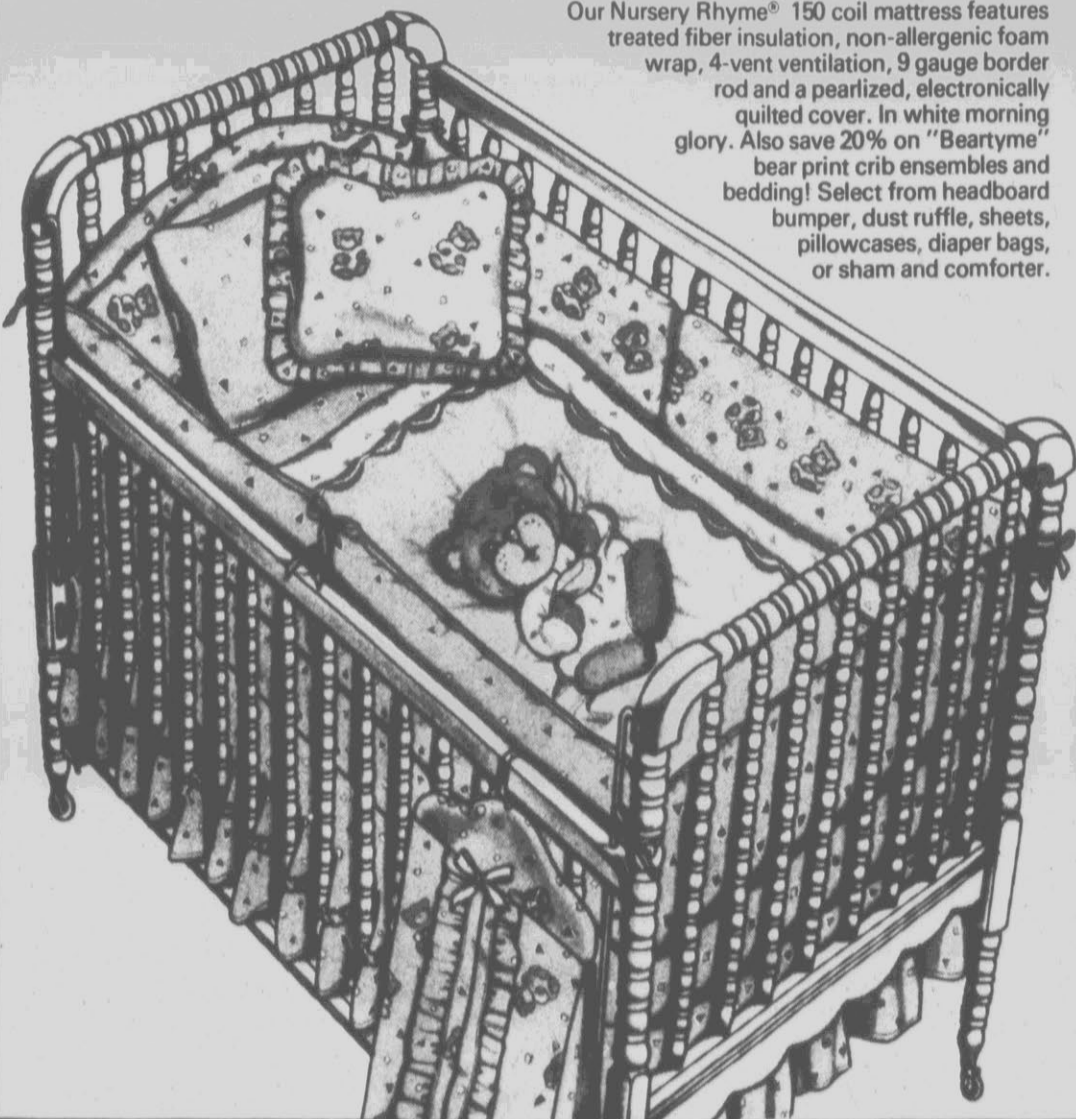

Century® Products For Your Baby, Specially Priced!

19.99

Regular \$22

Kangaroo Rock-A-Roo® rocking carrier with unique removeable pouch, wrap-over padded vinyl cushion and safety belt, adjustable carrying handle.

29.99

Regular \$38

Infant Super Swing® with quiet wind-up action and two-position posture molded seat that reclines for napping.

59.99

Regular \$79

Safety car seat for infants and toddlers features one-handed restraint system and a padded two-position shield for comfort and growth. Available in tan.

59.99

Reg. \$79

The "Way-To-Go" stroller/carriage features convertible handle, multiple positions for baby's comfort and swivel wheels for easier maneuverability.





CLOTHING, SHOES AND ACCESSORIES
FOR BOYS OF ALL AGES, ON SALE
NOW AT BELK!



Working to
Serve You
Better

SPRING FASHION SALE

Boys' Andhurst® Dress Socks

Regular 1.19 and 1.39 Pr. **99¢** Pair

Ribbed crew socks of 75% Orlon® /25% nylon, in black and navy. The more you buy, the more you save!

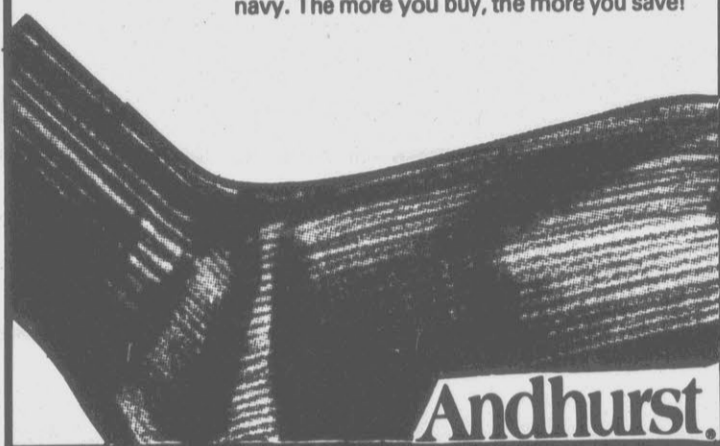

Andhurst.

Boys' Tuf-N-Ruf® Casual Shoes

Regular \$25 **17.99**

"Wiggins" lace-up leather oxford, in wine color, sizes 3 1/2 to 7. At a savings of \$7!



Boys' Reebok® "CLT" Tennis Shoe

Regular \$35 **26.99**

Leather upper, lace-up oxford styling, available in white only. Sizes 10 to 6.

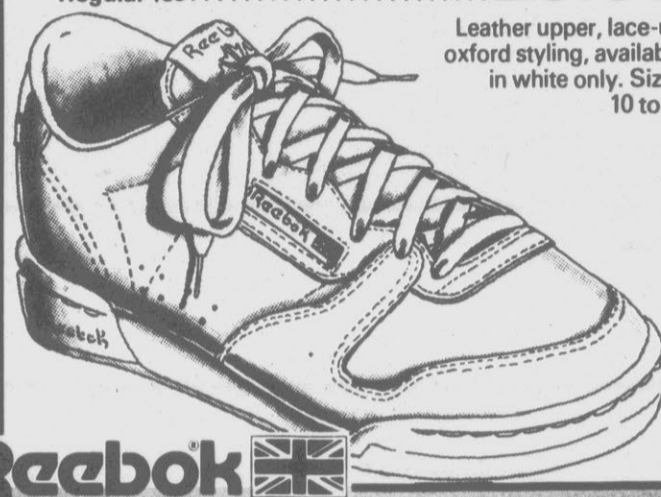

Reebok Because life is not a spectator sport.™

Boys' Underwear

Regular Prices **25% OFF**

Polyester/cotton briefs and t-shirts, 8-20. Package of three.

Andhurst.



Boys' Reebok® Basketball Shoe

Regular \$39 **29.99**

Leather hi-top, in white with royal blue trim. Lace-up styling. Sizes 10 to 6. More than a gym shoe...a vital part of "the look" for school!



Reebok Because life is not a spectator sport.™

Clip-On Suspenders For Boys

Regular \$7 **5.99**

Adjustable 38" sizes, in prints and just the right brights! Come early for best possible selection!



Lee® Jeans For Boys

14.99

and **16.99**

Special Value

Five-pocket, western style jeans of 100% cotton pre-washed denim, sizes 8 to 14 and 25 to 30 waist.



Boys' Andhurst® Knit Shirts

4.99 and **5.99**

Regular \$6 and \$7
50% polyester/50% cotton short-sleeve shirt, in assorted stripes or solids of white, red, royal, green, yellow, more. Sizes 4 to 7 and 8 to 20.



Andhurst.

Save On Boys' LEVI'S® Jeans!

14.99

Special Value
Five-pocket, straight leg jeans of 100% cotton. Pre-washed for soft comfort and sure fit. Sizes 8 to 14.



Boys' Selected Suits & Jackets

20% OFF

Regular Prices

Select group of Spring suits and sportcoats, for boys size 8 to 20. The very things you wished would go on sale!



Select Group Of Boys' Andhurst® Belts

25% OFF

Regular 4.00 to 7.50

Select group of vinyl and leather belts, in brown, tan, black and wine colors. Sizes 18 to 22, and 24 to 30 waist.

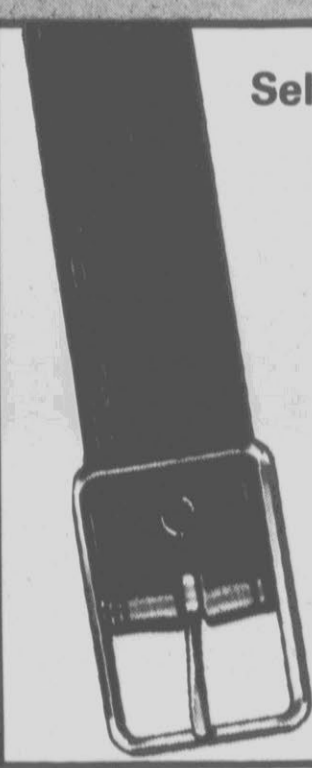

Andhurst.

Boys' Oxford Dress Shirts

5.99 and

6.99

Reg. \$7 and \$8

Short-sleeve, polyester/cotton blends, in solid colors. Button-down collar styling. For boys size 4-7 and 8-20.



Andhurst.

Belk



Working to
Serve You
Better

**GIRLS WILL LOVE OUR GREAT SHAPES
AND NEW COLORS FOR SPRING AND SUMMER!
HURRY FOR THREE DAYS OF FANTASTIC LOW
PRICES!**

Girls' Lace Anklet By BugOff!®

Regular 1.25 Pr. **99¢** Pair
Nylon anklet with double row of lace, in white and pastels, sizes 6-7½ and 7½-9. The more you buy, the more you save!

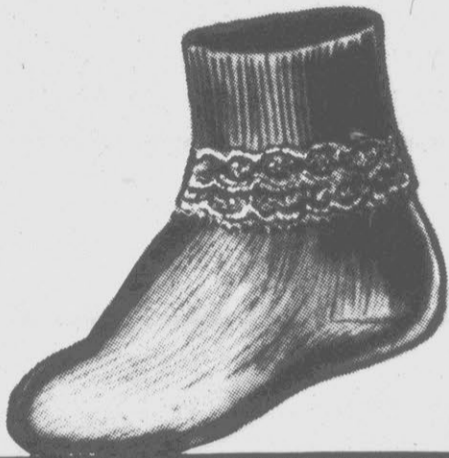

**Children's Athletic
Shoes-Save!**

Regular Prices **20% OFF**
StrideRite® "Zips"-for hard playing, fast moving children! Choose from canvas or nylon uppers, with lace-up styling or easy Velcro® closure. Boys' and girls' sizes, in white, navy and pink.



**BugOff!® Dorm
Shirt For Girls**

5.99

Reg. 7.99
Lines worth repeating...on our comfy, oversized rugby striped sleep shirt. With scoop neck and shirrtail hem, sizes 4-6X and 7-14.



**Girls' BugOff!®
Crewneck T-Shirt**

5.99

Regular \$8
50% polyester/50% cotton interlock crewneck t-shirt, with chest pocket. In just the right brights for Spring and Summer! Strawberry, turquoise, yellow, white, red, light pink, light turquoise and light lilac, sizes 7-14. From our own BugOff!®.



**Low-Priced Rugby
Tops For Girls!**

9.99

Reg. 12.50
Players Club® short-sleeve sport tops, in white with royal, red or yellow rugby stripes. 50% polyester/50% cotton interlock, sizes 7-14.



**Girls' Knit
Shirts-Save!**

8.99

Reg. \$11
Polyester/cotton knit, oversized short-sleeve shirt with pique design placket. In your color choice of white, pink, yellow or peach, sizes 7-14.



Saddlebred

Girls' BugOff!® Surfer Short

Regular \$7 **4.99**

Print surfer short with elastic waist, string-tie trim and back pocket, in colors meant to be seen! Sizes 7-14.

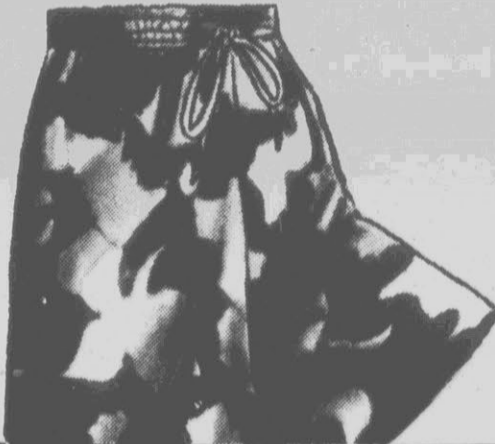

Girls' BugOff!® Twill Short

Regular \$9 **5.99**

100% cotton twill short with elastic waist, side vent and tie trim, sizes 7-14. Choose red, white, royal, or bright pink, yellow or turquoise.



**Girls' Knit
Tops-Save!**

6.99

Reg. \$9
Players Club® 50% polyester/50% cotton short-sleeve oversized knit top. Johnny collar styling. Strawberry, turquoise, light pink, yellow and white, sizes 7-14.



**Girls' Tank
Tops-A Value!**

3.99

Reg. 5.00 and 5.50
50% polyester/50% cotton action back tank top, sizes 7-14, in strawberry, turquoise, yellow, red, white, light pink, light turquoise, light lilac or choose white with strawberry, black, turquoise, red or light pink rugby stripes.



**Girls' Knit
Shirts**

7.99

Reg. \$10
BugOff!® short-sleeve, placket collar shirt of 50% polyester/50% cotton interlock, in white, lollipop yellow, strawberry, turquoise, red and royal, sizes 7-14.



**Girls' Selected
Spring Dresses**

20% OFF

Regular Prices
Just in time for Easter! Lovely pastel colors, with smocking trim, sizes 7-14.



THREE DAYS LEFT TO SHOP BELKS IN ROCKY MOUNT,
GOLDSBORO, ELIZABETH CITY, WILSON, WASHINGTON,
GREENVILLE, KINSTON, AHOSKIE AND TARBORO!

SPRING FASHION SALE

Bass® Men's Penny Loafers!

\$69 Value **52.99**

Bass® classic leather upper penny loafer, in handsewn construction, with leather heel and sole. In antiqued brown.

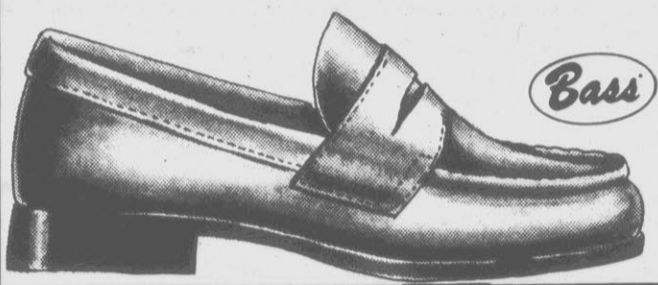

Sperry®/Top-Sider® Boat Shoes!

Reg. \$66 **52.99**

The "Sperry Cup" boat shoe, with leather upper, non-skid sole and comfort the boaters know and love. In tan, gray, sizes 8 to 12.

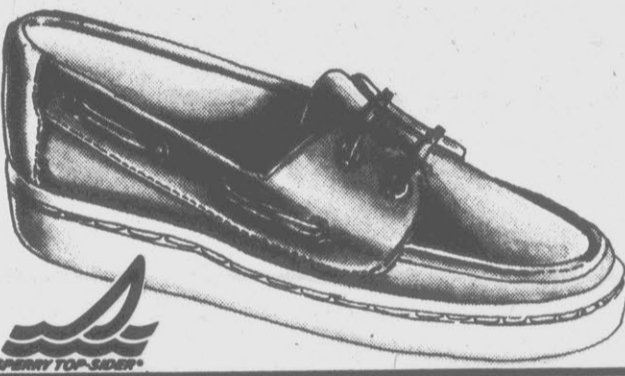

Sperry®/Top-Sider® "Seamate"!

Regular 30.00 **24.99**

Men's "Seamate" for any boating adventure. With canvas double cushion arch with adjustable lace tie and non-skid white boat sole. In natural color for sizes 6 to 12. For expecting summers.

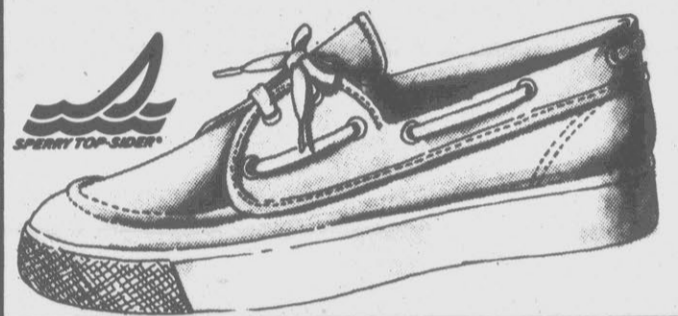

Rockport® Men's Shoes \$15 Off!

Regular 68.00 **52.99**

Rockport® leather upper lace-up oxford with famous Rockport® Morflex® Vibram® sole, known for its lightweight comfort features, in sizes 8 to 12 and tan and cordovan colors.

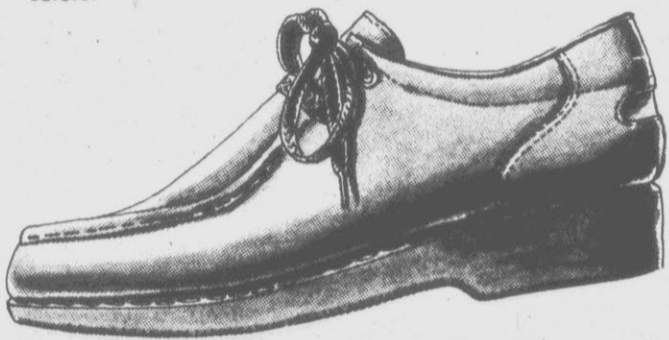

Jockey® Men's Underwear!

Brief **3/10.00**
Reg. 3/12.00

T-shirt **3/12.00**
Reg. 3/15.00

Lo-Rise Brief **4.00**
Reg. \$5

Select from his favorites in Jockey®. White classic brief, sizes 28 to 44, white classic T-shirts, Trophy Lo-Rise brief in assorted colors, sizes 30 to 38, all 100% cotton.



Famous Maker Knit Shirts At A Savings Of \$7 Now!

24.99

Regular 32.50

Short sleeve knit shirts, with fashion collar, banded sleeves, button placket front, made of 100% cotton, in white, red, tan, yellow, navy, green, and more. For men's sizes S, M, L, XL.



Andhurst® Men's Slacks \$5 Off!

18.99

Regular 24.00

60% cotton/40% polyester cotton-rich canvas, VISA® treated for soil release, plain front, beltloop model, in khaki, royal, creme, navy, rose, white, gray, yellow, sizes 29 to 42.



Andhurst.

Men's Duckhead® Pants At A Special Value

19.99

100% cotton twill fabric pants with plain front, beltloop style, in khaki and navy colors, mens sizes. Great casual pants for summer fun.

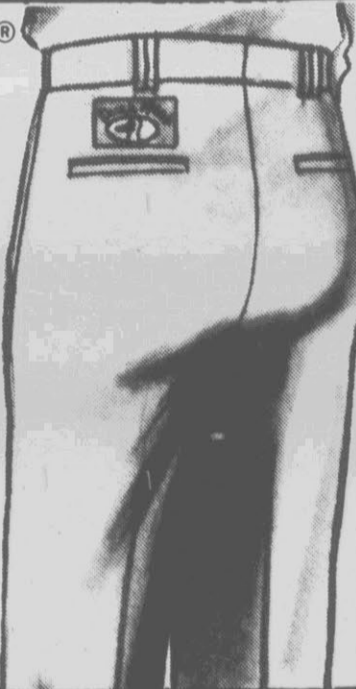

Andhurst® Men's Blazers Low-Priced!

69.99

Special Value

55% polyester/45% wool hopsack fabric blazers, with center vent, two button front, notched lapel, in navy, tan, men's sizes. Save now!



Andhurst.

Haggar® Men's Casual Slacks \$7 Off Now!

22.50

Regular 30.00

Men's Haggar® "Expando-matic" waistband with two button side tab waist treatment "Tourney" model; 65% Dacron® polyester/35% cotton twill fabric. With two reece back hip pockets with button through left hip pocket. In natural, slate blue, pewter, navy, khaki, sizes 32-42 waists.

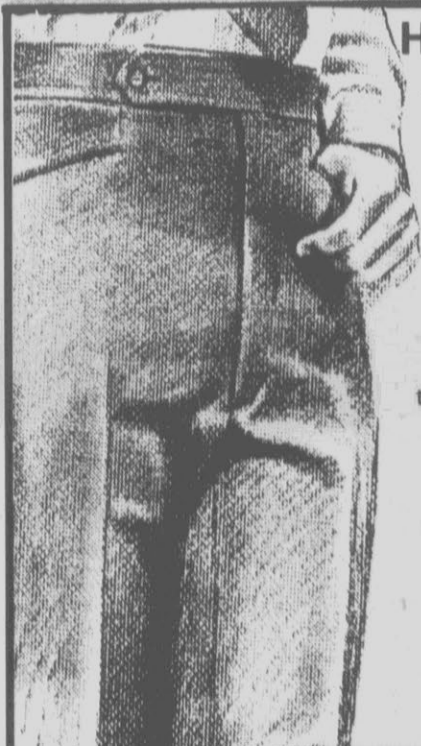

HAGGAR.

Arrow

Arrow® Men's Dress Shirts!

20% OFF

Regular Prices

Choose from our select group of men's Arrow® dress shirts, in men's sizes.

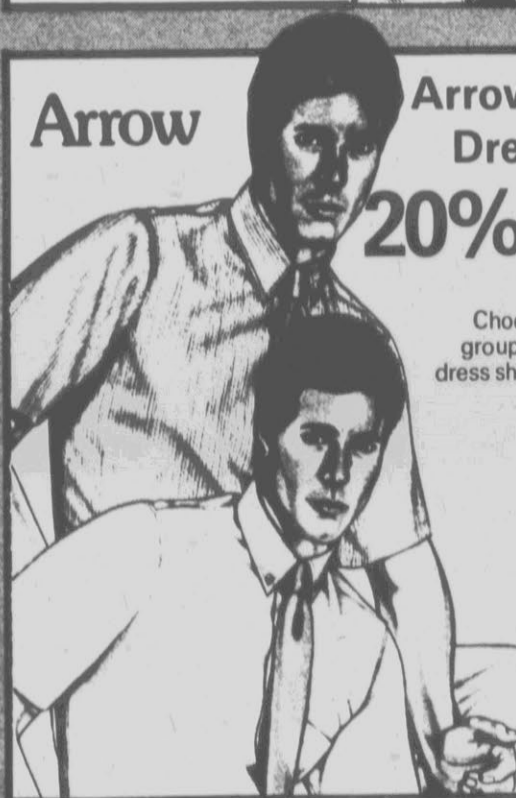

Andhurst® Men's Sport Shirts At A \$4 Savings!

10.99

Regular 15.00

Andhurst® men's sportshirts with short sleeves, button down and regular collar models. Men's sizes.



A·N·D·H·U·R·S·T.

Belk



APPLY TODAY FOR A BELK CHARGE! Phone us toll free at 1-800-432-6690 ext. 392 during business hours and our interviewers will take your application information. Outside North Carolina call 1-800-436-4062 ext. 392.
CHARGE IT 4 WAYS: Belk Charge, Visa, MasterCard, American Express

LAST
THREE
DAYS!

SPRING FASHION SALE

SHOP AND SAVE ON SPECIALLY PRICED LADIES' ITEMS!

Melini® Chains

2.99 to 9.99

Reg. \$6 to \$20

Fine quality fashion chains that are suitable for both women and men. Choose from 16" to 36" lengths, in French rope, beveled herringbone, cobra and other styles. Finish resists tarnishing, in gold or silver color.

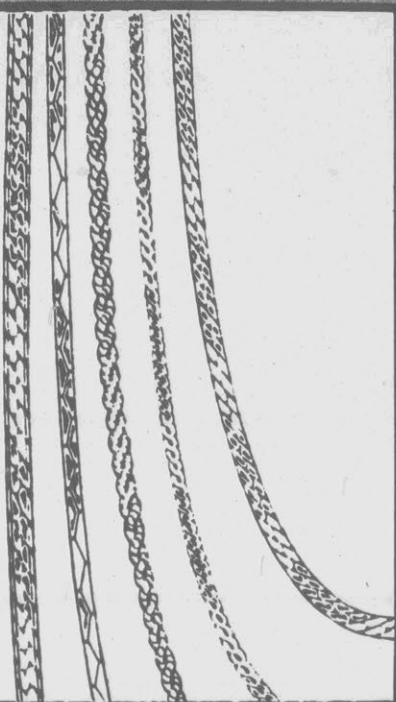

Ladies' Heiress® Hosiery

1.50 to 2.62

Regular 2.00 to 3.50

Semi-Annual Sale! Save 25%! Silky Sensations Lycra Day Sheer and Control Top Ultra Sheer, Day Sheer and Ultra Sheer pantyhose, in addition to crewsocks, tear drop anklets and cuffed crewsocks...all in just the right colors for Spring.

Ladies' Playtex® Bras On Sale!

20% OFF

Regular Prices

Made For Me® seamless soft cup bra with Playflex® under-shapers of nylon/Lycra® spandex, in white or beige, And the Support Can Be Beautiful® seamless under-wire bra.



Ladies' Sweetbriar Pump, At A Savings Of \$7!

Regular \$32 24.99

"Fan" mid-heel pump with soft, urethane upper, elevates comfort to high fashion. Your color choice of black, navy, bone or cashew, sizes 6 to 10.

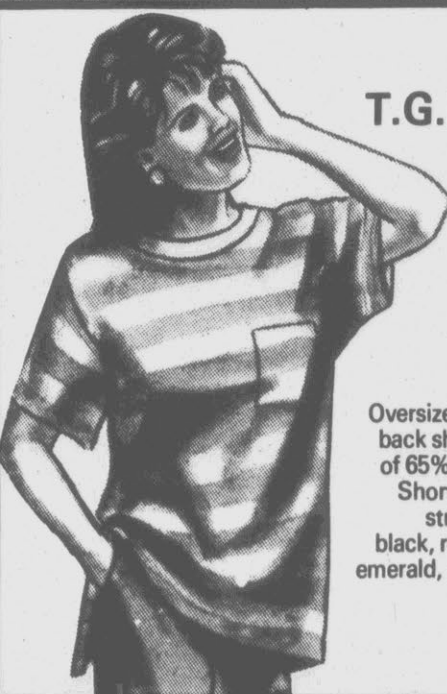

T.G.I.F.® Junior T-Shirts

10.99

Regular 12.99

Oversized crewneck t-shirt with back shirttail and front pocket, of 65% polyester/35% cotton. Short-sleeve styling. Choose stripes or solids, including black, red, navy, yellow, green, emerald, royal, yellow and white. One size fits all.



Knit Shirts For Ladies

8.40

Regular \$12

Short-sleeve, polyester/cotton interlock knit shirt with two-button placket and collar. White, pink, jade, red, royal and yellow, sizes S-M-L. By Sweetbriar.

T.G.I.F.® Knit Shirts For Juniors

Regular \$12 8.40

Save 30%! Short-sleeve, polyester/cotton interlock knit with two-button placket and collar. Choose white, pink, yellow, lilac, navy, red or black, sizes S-M-L.



Casual Cotton Jackets For Ladies

19.99

Regular \$27

Item Eyes® crinkle cotton jacket with cuffed sleeves. Your color choice of white, jade, yellow or fuchsia, sizes 10 to 18.

Jeans For Juniors

17.99

\$40 Value

Palmetto's® White Lightning™ jeans, in slim fit five-pocket, zip-bottom five-pocket, and multi-pleated baggy styles. 100% cotton with acid-washed finish, sizes 5 to 13.



Bermuda Shorts For Ladies

16.80

Regular \$24

Polyester/cotton twill, pleated shorts with criss-cross waistband. Sizes 8 to 18, in white, khaki, jade, pink and yellow. By Sweetbriar.



Sweater Tops For Ladies

15.99

\$24 Value

Select group of Knit Maven® cotton and cotton blend sweater tops. Cap and short-sleeve styles, in brights and pastels, sizes S-M-L.



Ladies Misty Harbor® Raincoats

50% OFF

Regular Prices

Famous Misty Harbor® long raincoats in several updated styles and colors. Hurry for best possible selection.



DOUBLE MANUFACTURERS' COUPONS!

Good in Richmond, Hopewell,
Chester, Mechanicsville and Colonial
Heights, Va. and Greenville, Wilson,
Southport, Williamston, Oxford,
Henderson & Wilmington, N.C. only.
See Stores for Details.

PLUS A WHOLE LOT MORE. Like our W-D Brand U.S. Choice beef and Harvest Fresh pick-your-own produce. And complete delicatessens and bakeries in most stores. All this, plus the quality, variety and service you deserve in a food store. That's an unbeatable combination other food stores can't match!



**YOUR BEST TIP
ON SAVINGS
IS A WHOLE
SIRLOIN TIP!**

Take a tip from The Beef People and buy a Whole Sirloin Tip for your freezer. It's U.S. Choice... naturally tender and full of the hearty satisfying flavor of good beef.

And it's economical, because it gives you the beginnings of many delicious meals...savory roast, country-fried steaks, rich brown stews and of course, great ground round for burgers or casseroles!

So take a tip on a great buy - a Whole Sirloin Tip!

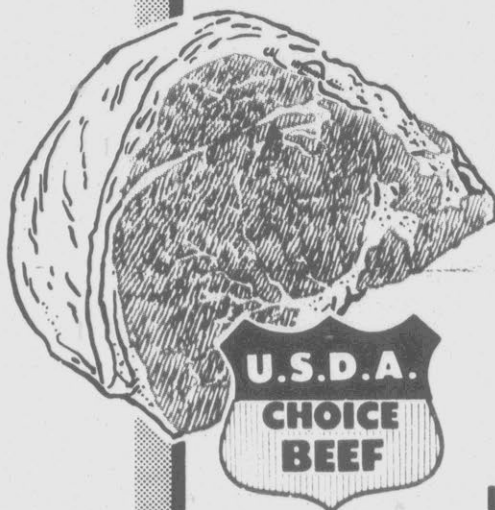

9/11-LB. AVG.
U.S. CHOICE
WESTERN GRAIN FED
UNTRIMMED
**WHOLE
BONELESS
SIRLOIN TIPS**

149
LB. SLICED FREE INTO
STEAKS, ROASTS
& TRIMMINGS



Plus,
**WE BRING YOU
THE BEST OF
THE FRESH!**

If you're looking for the freshest produce around, you don't have to look any further than WINN-DIXIE's produce department!

From the moment of delivery, we're working, carefully sorting all our fruits and vegetables. We check for color, firmness and ripeness. And we choose only the finest for display.

So you have your pick of the very best of the fresh. Harvest Fresh from WINN-DIXIE.

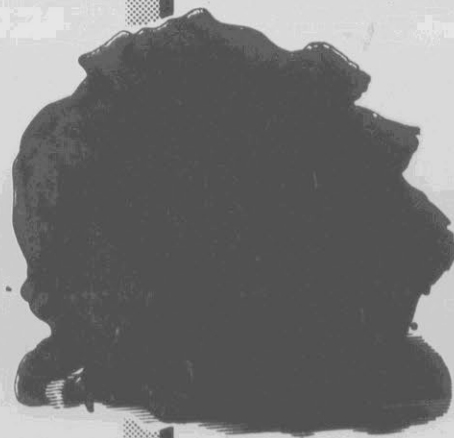

HARVEST FRESH
**CRISPY
ICEBERG
LETTUCE**

49
HEAD

Variety for today's lifestyle?... Winn-Dixie's got it!



America's Supermarket™

YOUR CHOICE FOR LOW PRICES

WINN DIXIE

America's Supermarket T.M.

PRICES GOOD WED., MARCH 25TH
THRU TUES., MARCH 31ST!

SUN	MON	TUE	WED	THU	FRI	SAT
			25	26	27	28
29	30	31				

*NONE TO DEALERS *WE RESERVE THE RIGHT TO LIMIT QUANTITIES © COPYRIGHT 1987, WINN-DIXIE STORES, INC.

With Over

10,000



1-LB. BAG
**ASTOR
COFFEE**

*REC. *A.D.C. *ELECTRO PERK

189

WITH 10.00 OR MORE ORDER (LIMIT 1)



5-LB. BAG
PURE CANE
**DIXIE CRYSTALS
SUGAR**

139

WITH 10.00 OR MORE ORDER (LIMIT 1)



2-LTR. BTL.
COCA-COLA

- *CLASSIC COKE
- *CHERRY COKE
- *DIET COKE
- *CAFFEINE FREE COKE
- *CAFFEINE FREE DIET COKE

109

Made in America



Look for this symbol for quality and savings!

It takes a lot of pride and confidence to put "Made in America" on a product. And at WINN-DIXIE, we know the products wearing this symbol are the best. The best quality at the best price possible. And one hundred percent guaranteed.

So for real American value, look for the "Made in America" symbol, only at WINN-DIXIE, the store with 10,000 everyday low prices.



32-OZ. BTL.
**LILAC
DETERGENT**

69¢



32-OZ. JAR
**TROPICAL
GRAPE JELLY**

99¢



18-OZ. JAR
**DEEP SOUTH
PEANUT BUTTER**
*SMOOTH*CRUNCHY

99¢



48-OZ. BTL.
**ASTOR
VEGETABLE OIL**

139



32-OZ. JAR
**DEEP SOUTH
SALAD DRESSING**

79¢



1-LB. CUP
**PALMETTO FARM
PIMENTO CHEESE**

149

...Made With Pride.
Only at Winn-Dixie.

Grocery Values



12-PAK/12-OZ. CANS
**OLD
MILWAUKEE
BEER**

389



5-LB. BAG
PLAIN OR SELF RISING
**MARTHA WHITE
FLOUR**

59¢

WITH 10.00 OR MORE ORDER (LIMIT 1)



6-OZ. SIZE
**DIXIE DARLING
CINNAMON
ROLLS**

4 FOR \$1



24-OZ. BTL.
**THRIFTY MAID
TOMATO CATSUP**

2 FOR \$1



10-LB. BAG
**KITTY PLEASE
CAT LITTER**

79¢

Health & Beauty Aids



4.6-OZ. TUBE
**CREST
TOOTHPASTE**

- *REGULAR
- *MINT
- *GEL
- *TARTAR CONTROL
- *GEL TARTAR CONTROL

111



12-OZ. BTL.
**LIQUID
MAALOX
PLUS
ANTACID**

299



75-CT. BTL.
**ROLAIDS
ANTACID
TABLETS**

- *REGULAR
- *SPEARMINT
- *CHERRY

170



32-OZ. BTL.
**LISTERINE
MOUTHWASH**

329



**SKILLCRAFT
SEDFIELD
KITCHEN
BROOM**

399



32-GAL. GOTT
**RUBBERMAID
WHEELED
TRASH
CONTAINER**

1300

Walt Disney FUN-TO-LEARN LIBRARY

This week's feature
VOLUME 9
Our Wonderful Earth
\$2.79

SPECIAL INTRODUCTORY OFFER!
Volume 1
99c

BANTAM BOOKS.

CLIP & SAVE
ON
SOUTHAMPTON
BAKEWARE

Week **9** **WINN W/D DIXIE** **SAVE \$3.18 WITH THIS COUPON!**

Southampton Collection Bake, Serve 'n Store Bakeware

THIS WEEK ONLY!

Reg Price: 16.99
2 1/2-Quart COVERED CASSEROLE
14.99

WITH THIS COUPON & \$10.00 OR MORE ORDER

and get
TWO
6 1/2-OZ. CANS
OIL OR WATER
STAR-KIST TUNA FREE

Coupon Valid Wed., March 25 thru Tues., March 31, 1987.

LOW PRICES!

THE BEST PEOPLE

W-D BRAND FRESH PURE
ALL AMERICAN GROUND ROUND
1.69
LB.

100% LEAN BEEF FOR SHISH KEBAB OR STIR FRY
2.99
LB.

INSPECTED BY U.S. DEPARTMENT OF AGRICULTURE

U.S.D.A. INSPECTED
FRESH FRYER LEG QUARTERS
3.99
LB.

Harvest Fresh

HARVEST FRESH
RED OR THOMPSON WHITE
SEEDLESS GRAPES
8.89
LB.

Quality Meats

W-D BRAND U.S. CHOICE WESTERN GRAIN FED SIRLOIN TIP ROASTS
1.79
LB.

12-OZ. PKG. PINKY PIG THIN SLICED BACON
1.19

HICKORY SWEET BONELESS BUFFET HAMS
1.79
LB.

U.S. CHOICE CUBED SIRLOIN TIP STEAK LB. 1.99
OCEAN PERCH FILLETS LB. 1.99
1-LB. PKG. BALL PARK FRANKS 1.99
12-OZ. PKG. SWIFT SIZZLEAN 1.49

W-D BRAND SELECT LEAN PORK STEAK ... LB. 1.49
12-OZ. PKG. W-D BRAND ALL MEAT FRANKS99
1-LB. PKG. W-D BRAND ALL MEAT BOLOGNA 1.29
8-OZ. CUP PALMETTO FARM PIMENTO CHEESE79

Harvest Fresh

HARVEST FRESH CALIFORNIA NAVEL ORANGES
5 \$1 FOR 1

HARVEST FRESH ASPARAGUS
1.49
LB.

5-STEM SWEETHEART ROSE BOUQUET
4.99
EA.

Deli-Bakery

GOURMET QUALITY TURKEY BREAST
3.98
LB. SLICED TO ORDER

1-DOZEN JUMBO HONEY GLAZED DONUTS
1.88

GENOA OR HARD SALAMI
3.98
LB. SLICED TO ORDER

HOMESTYLE EGG POTATO SALAD
99c
LB.

18-OZ. SIZE HAM & CHEESE SUBMARINE SANDWICHES
1.99

QUARTER SHEET YELLOW LAYER COCONUT BUTTERCREAM CAKES
5.99
EA.

AVAILABLE IN DELI-BAKERY STORES ONLY.

Frozen & Dairy

1/2-GAL. CARTON ALL NATURAL PRESTIGE ICE CREAM ALL FLAVORS
2.49

VINNIE'S 10 1/2-OZ. BOX PIZZAS
•COMBO
•SAUSAGE
•PEPPERONI
89c

20-OZ. BAG FARMERS SHOESTRING POTATOES
2.89
FOR

1-LB. PKG. IN QTRS. MRS. FILBERTS MARGARINE
2.89c

1-GAL. JUG CHOCO-CHARM CHOCOLATE DRINK
99c

1/2-GAL. CARTON SUPERBRAND NONFAT BUTTERMILK
99c

Fisherman's Wharf

41-50 CT. FRESH WHITE MEDIUM SHRIMP
4.99
LB.

FRESH GROUPE FILLETS
3.99
LB.

IMITATION CRAB MEAT
2.99
LB.

AVAILABLE IN LOCATIONS WITH FISHERMAN'S WHARF FRESH SEAFOOD DEPTS. ONLY!

WINN DIXIE

America's Supermarket™

All prices in this ad effective 7-full days.

SUN	MON	TUE	WED	THU	FRI	SAT
		25	26	27	28	
29	30	31				

MILUTO RICE
14-OZ. BOX MINUTE RICE
95¢

Duke's MAYONNAISE
32-OZ. JAR
99¢

Wisk
50¢ OFF 32-OZ. BTL. WISK DETERGENT . **1.51**

all
84-OZ. BOX ALL DETERGENT... **3.59**

LUX
4-PAK BATH SIZE LUX SOAP **.99**

Rinso
38-OZ. BOX RINSO DETERGENT .. **.99**

CERTS
.63-OZ. SIZE CERTS ALL FLAVORS
40¢

TRASPAS
10-OZ. CAN TEXAS PETE HOT DOG CHILI
3\$1

Wild Blueberry Muffin Mix
13-OZ. BOX BETTY CROCKER WILD BLUEBERRY MUFFIN MIX
1.26

OLIVE OIL
6-OZ. CAN 9 LIVES CAT FOOD
3 CANS FOR 89¢

SPAM
12-OZ. CAN REG. OR NO SALT SPAM
1.55

Lipton
3-OZ. JAR LIPTON INSTANT DECAFFEINATED TEA **3.39**

3.3-OZ. JAR LIPTON w/NUTRA SWEET DECAFFEINATED TEA **3.29**

3.3-OZ. JAR LIPTON w/NUTRA SWEET INSTANT TEA . **3.06**

4.9-OZ. JAR LIPTON w/NUTRA SWEET INSTANT TEA . **4.32**

6-OZ. JAR LIPTON LOW CALORIE INSTANT TEA . **3.10**

24-OZ. JAR LIPTON w/LEMON TEA MIX **2.34**

32-OZ. JAR LIPTON TEA MIX **3.06**

3-OZ. JAR LIPTON INSTANT TEA . **2.94**

White House Apple Sauce
25-OZ. JAR WHITE HOUSE REG. OR NATURAL PLUS APPLE SAUCE . **.59**

48-OZ. BTL. WHITE HOUSE REG. OR NATURAL PLUS APPLE JUICE . **1.09**

CASCADE LIQUID DETERGENT
80-OZ. BTL.
3.69

SUN-SWEET
12-OZ. BOX SUN-SWEET PITTED PRUNES **1.39**

15-OZ. BOX SUNMAID SEEDLESS RAISINS **1.09**

WELCH'S
32-OZ. JAR WELCH'S CONCORD GRAPE JELLY OR JAM
99¢

MORFOND
8-LB. BAG PURINA MOIST 'N CHUNKY DOG FOOD
3.79

Kibbles 'n Bits
8-LB. BAG PURINA KIBBLES AND CHUNKS DOG FOOD
4.27

Meow Mix
8-LB. BAG PURINA MEOW MIX CAT FOOD
4.76

Happy Cat
3-LB. BAG PURINA HAPPY CAT CAT FOOD
2.89

COOKIE-CRISP
16-OZ. BOX RALSTON CHOCOLATE CHIP COOKIE-CRISP CEREAL
2.47

Sun Flakes
15-OZ. BOX RALSTON SUN FLAKES CEREAL
1.90

KEEBLER
6-OZ. SIZE KEEBLER READY-CRUST GRAHAM CRACKER PIE CRUST
91¢

Betty Crocker Frosting
16-OZ. SIZE BETTY CROCKER READY TO SPREAD w/ MORSELS FROSTING **1.45**

16 1/2-OZ. SIZE BETTY CROCKER READY TO SPREAD FROSTINGS ... **1.29**

Aunt Jemima
2-LB. BAG AUNT JEMIMA WHITE CORN MEAL MIX
49¢

Kellogg's Apple Raisin Crisp
13-OZ. BOX KELLOGG'S APPLE RAISIN CRISP CEREAL
1.97

Post Cereal
18-OZ. BOX POST SUPER GOLDEN CRISP CEREAL **2.02**

15-OZ. BOX POST ALPHA-BITS CEREAL . **1.94**

14-OZ. BOX POST HONEY-COMB CEREAL **2.01**

9 Lives
3 1/2-LB. BAG REGULAR OR CRUNCHY MEALS 9 LIVES CAT FOOD
2.27

JFG
11-OZ. BAG JFG BONUS BLEND COFFEE **1.99**

32-OZ. JAR JFG MAYONNAISE **.89**

32-OZ. JAR JFG SALAD DRESSING **.99**

Kibbles 'n Bits
\$1.00 OFF LABEL 20-LB. BAG KIBBLES 'N BITS 'N BITS DOG FOOD
7.99

Ruffles
6 1/2-OZ. BAG RUFFLES POTATO CHIPS
99¢

- BARBECUE
- SOUR CREAM & ONION
- BACON & SOUR CREAM
- CHEDDAR & SOUR CREAM
- CAJUN

Saran Wrap
100-FT. ROLL SARAN WRAP PLASTIC WRAP
1.99

ALPO
14-OZ. CAN ALPO DOG FOOD
3\$1

Sure & Natural
30-CT. BOX SURE & NATURAL MAXISHIELDS
3.78

Glad
10-CT. BOX GLAD LAWN BAGS
1.49

Mazola
64-OZ. BTL. 100% PURE MAZOLA CORN OIL
3.30

SOLO
20-CT. 16-OZ. SIZE SOLO PARTY CUPS ... **.89**

15-CT. 9-IN. SOLO PARTY PLATES **1.15**

Party Plates
20-CT. 16-OZ. SIZE SOLO PARTY CUPS ... **.89**

15-CT. 9-IN. SOLO PARTY PLATES **1.15**

10,000 LOW PRICES

Plus, Winn-Dixie's **Wise Buys!**

SCOPE
24-OZ. BTL. SCOPE MOUTHWASH *REG.-PEPPERMINT
2.97

Chlor-Trimeton
Allergy Sinus Congestion Tablets
For congested allergy/sinus conditions

FASTEETH
EXTRA HOLD DENTURE ADHESIVE FOR LOWERS
Fixodent
POWDER FOR DENTURE ADHESIVE

speed stick
DEODORANT

Baby Magic
BABY OIL

Skin Bracer
AFTER SHAVE

TYLENOL
EXTRA-STRENGTH CAPLETS
extra pain relief... contains no aspirin
Caplets - 500 mg each

TYLENOL SINUS
MAXIMUM-STRENGTH TABLETS

Metamucil
A Natural-Fiber Laxative

14-OZ. BTL. METAMUCIL REGULAR OR ORANGE OR 7.5-OZ. BTL. SUGAR FREE METAMUCIL LAXATIVE
6.42

Tinactin
ANTIFUNGAL CREAM
3.89

Chlor-Trimeton
ALLERGY TABLETS 4mg
For hay fever/allergy symptoms

24-CT. PKG. CHLOR-TRIMETON ALLERGY TABLETS **2.58**

24-CT. PKG. CHLOR-TRIMETON DECONGESTANT ALLERGY SINUS CONGESTION TABLETS **3.30**

3-OZ. SIZE FASTEETH POWDER DENTURE ADHESIVE **2.89**

1.6-OZ. SIZE FASTEETH EXTRA HOLD POWDER DENTURE ADHESIVE **2.35**

1.5-OZ. TUBE FIXODENT DENTURE ADHESIVE CREAM **2.09**

2.25-OZ. STICK MENNEN MUSK OR FRESH SCENT SPEED STICK ANTI-PERSPIRANT DEODORANT . **2.14**

5-OZ. BTL. MENNEN SKIN BRACER AFTER SHAVE **2.56**

9-OZ. BTL. MENNEN BABY MAGIC RICH N'CREAMY BABY OIL **2.32**

50-CT. BTL. TYLENOL EXTRA-STRENGTH CAPLETS **3.78**

24-CT. BTL. TYLENOL MAXIMUM-STRENGTH SINUS TABLETS **3.65**

24-CT. BTL. TYLENOL EXTRA-STRENGTH CAPLETS **3.64**

K mart ADVERTISED MERCHANDISE POLICY
Our item selection is to have every advertised item in stock on our shelves. If an advertised item is not available for purchase due to any unforeseen reasons, it must not exceed a 10% Check on request for the merchandise. Some items or comparable family quantity to be purchased at the same price whenever available or we will give a comparable quality item at a comparable reduction in price.



America's Favorite Store
Kmart
the Saving Place

ON SALE
WED., MAR. 25
THRU
SAT., MAR. 28

50% OFF

EVERY ITEM
ON THIS PAGE



~~13⁹⁷~~ ~~6⁹⁸~~

Misses' proportioned **Gitano** pants of carefree polyester/cotton twill with all-around elastic waistband. Various flattering styles in petite, average and tall sizes 6-18.



~~97¢~~ ~~48¢~~

Your Choice. Pr. of men's crew socks of acrylic/nylon. Fit 10-13.



~~1⁶⁸~~ ~~84¢~~

Your Choice. Misses' panty hose fit S/M, M/T. Our 1.98, Queen Size, 99¢



~~4⁷⁷~~ ~~2³⁸~~

Std.-size sleep pillow. Odorless, nonallergenic polyester fill; cotton tick. Mfr. may vary



~~3²⁷~~ ~~1⁶³~~

Your Choice. 1½-bushel laundry basket of durable plastic in colors.



~~4⁹⁷~~ ~~2⁴⁸~~

Handy broom features natural corn bristles and sturdy wooden handle.

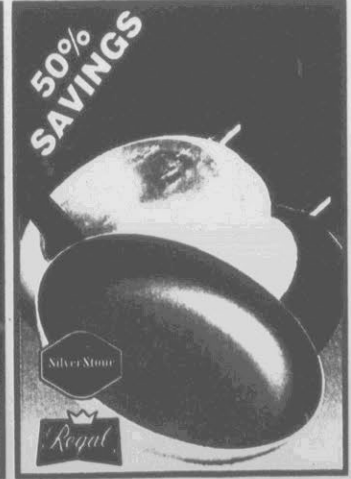

~~6⁹⁶~~ ~~3⁴⁹~~

10" gourmet pan of even-heating aluminum with SilverStone® interior. *Du Pont Reg. TM

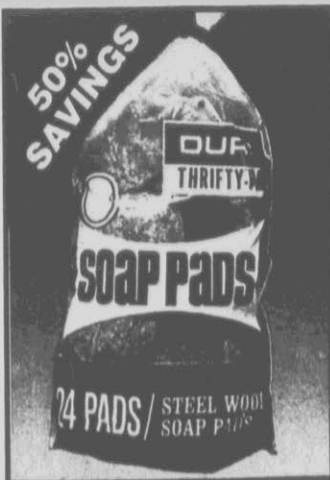

~~1⁵⁵~~ ~~76¢~~

Pkg. of 24 soap pads for dishwashing. Ideal for scrubbing pots 'n pans.



~~1⁶⁸~~ ~~84¢~~

Pkg. of 50 cold drink cups of sturdy translucent plastic. 14-oz. size. Mfr. may vary. Limit 3 pkgs.



~~1⁸⁷~~ ~~78¢~~

Your Choice. Pkg. of 10 hangers; plastic. Colors. Our 1.87, 10-pack Kids', 93¢ Mfr. may vary



~~19⁹⁷~~ ~~9⁹⁸~~

4-pc. carpeted car mat set. Full size, original-equipment type. Colors.



~~8⁹⁷~~ ~~4⁴⁸~~

Your Choice. Roll bag of lightweight nylon in choice of popular colors. Sold in Sporting Goods Dept.

Springtime Fashion Savings

25% OFF
Our Reg. Low Prices

SPORTSWEAR SEPARATES

5⁹⁷ To 10⁴⁷

Quality-constructed casual wear in wide variety of fashion-right styles. Selection includes oversize tops, novelty tops, tropical-print shirts, shorts or pull-on pants. All of carefree fabrics for washing ease. S-M-L.
Our 7.97-11.97, Short-sleeved Tops in Oversize Styles And More 5.97-8.97
Our 8.97-12.97, Novelty Tops With Screen Prints, Other Fashion Detailing 6.72-9.72
Our 9.97, Tropical-print Shirts Of Rayon In Button-front Styles 7.47
Our 8.97-13.97, Pull-on Pants Or Shorts In Array Of Fashion Colors 6.72-10.47
Styles shown are representative of group and may vary by store

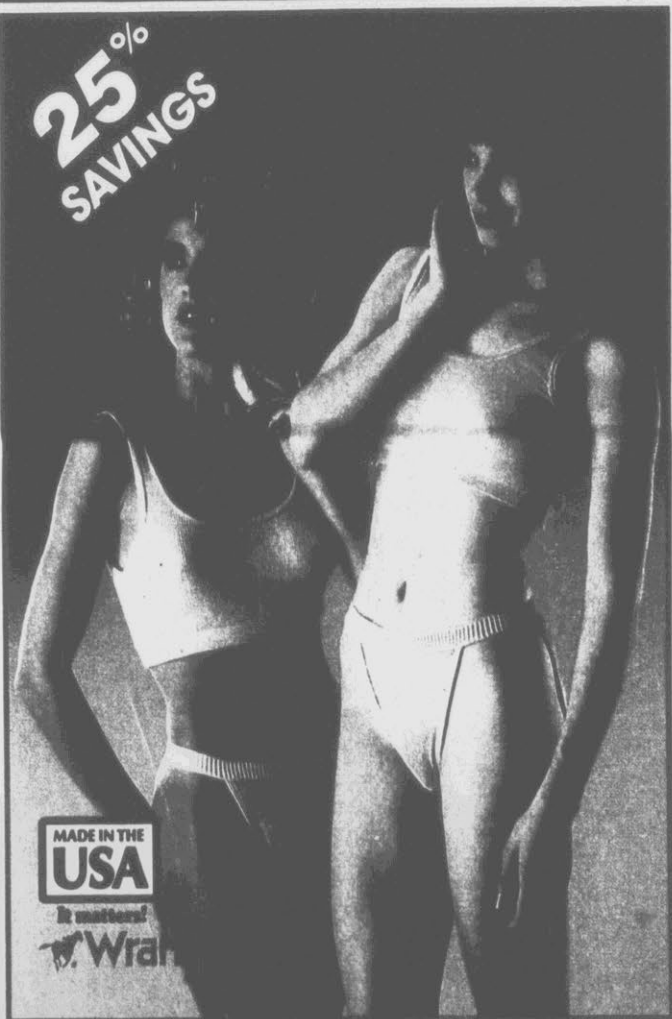

MADE IN THE USA
It matters!
Wrangler

1⁸⁸ To 3⁹⁷

Wrangler vests or panties of rib-knit cotton. Vests in sizes S-M-L-XL; panties in string or bikini styles, misses' 5-7 or women's 8-10. Choose pretty colors.

1⁴¹ To 2⁹⁷



25% SAVINGS

6⁹⁷ To 10⁹⁷

Our 6.97-7.97, Girls' Tops Or Skirts* 5.22-5.97
Our 7.97-9.97, Girls' Rompers, Sizes 4-6X, 7-14, 5.97-7.47
Our 8.97-10.97, Girls' Shorts Sets** 6.72-8.22
*Sizes 4-6X **Sizes 7-14

5²² To 8²²



25% SAVINGS

13⁹⁷ To 10⁴⁷

Girls' dresses in choice of styles. Sizes 7-14.
Our 12.97, Sizes 4-6X, 9.72



50% SAVINGS

7⁹⁷ To 8⁹⁷ 3⁹⁸ To 4⁴⁸

Fashion bags of textured weaves; some with popular shoulder or drawstring.



35% SAVINGS

5⁹⁷ 3⁸⁸

Fashion totes of nylon. Choice of styles, some with removable shoulder strap.



50% SAVINGS

2⁹⁷ To 4⁹⁷ 1⁴⁸ To 2⁴⁸

Organizers. Many styles to choose including wallets, totes, clutches and more.



30% SAVINGS

8⁹⁷ To 14⁹⁷ 6²⁷ To 10⁴⁷

Dressy spring hats in choice of styles and colors. One size fits all.

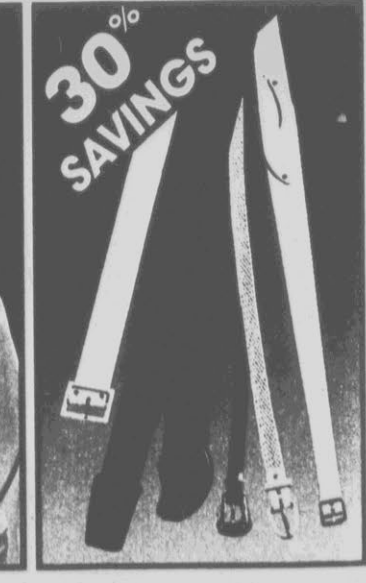

30% SAVINGS

1⁷⁸ To 5⁹⁷ 1²⁴ To 4¹⁷

Selection of in-stock belts. Choice of fashion styles; variety of sizes.

All former prices on this page are our reg. low prices

On Quality Apparel From K mart



SAVE NOW!

~~5⁹⁷~~ ~~4⁹⁷~~
Men's Islander T-shirts with pocket, crew-neck styling.

Islander™



Our Reg. Low Prices

MEN'S SHIRTS
~~10⁹⁷~~ ~~7⁶⁷~~ Ea.

Islander Hawaiian shirts in a selection of fashion prints and solid colors. All of easy-care rayon. Shop today!

MEN'S SHORTS
9⁹⁷ To 14⁹⁷
~~6⁹⁷~~ To ~~10⁴⁷~~ Ea.

Men's handsome shorts in fashionable longer or short-length style. Choose solids, prints or pierced looks. Varied fabrics. Also available, popular cotton canvas shorts with cargo pockets. Save. All former prices on this page are our reg. low prices



24% SAVINGS

RUSTLER
BRAND FROM THE MAKERS OF Wrangler

~~12⁹⁷~~ ~~9⁷⁷~~
Men's Rustler twill jeans with popular 4-pocket styling. Constructed of rugged polyester/cotton, looks great wash after wash.



30% SAVINGS

~~8⁹⁷~~ ~~5⁹⁷~~
Men's short-sleeved camp shirts of carefree polyester/rayon; with 1-pocket styling. Warm-weather favorite in smart-looking solid colors.



25% SAVINGS

~~9⁹⁷~~ TO ~~23⁹⁷~~ ~~7⁴⁷~~ TO ~~17⁹⁷~~
Our entire stock of little girls' spring dresses. Infants' sizes 9-24 mos., toddlers' sizes 2-4. Our 3.97, Infant Or Toddler Girls' Bonnets, Ea., 2.97
Styles and colors may vary by store



33% SAVINGS



29% SAVINGS

IdleTime

~~8⁹⁷~~ ~~5⁹⁷~~ ~~12⁹⁷~~ ~~9⁰⁷~~
Men's IdleTime sport shirts with 2 pockets. Colors. Men's IdleTime linen-look shirts of polyester/cotton.



30% SAVINGS

Botany 500

MADE IN THE USA
DUPONT DACRON POLYESTER

~~19⁹⁶~~ ~~13⁹⁷~~
Men's Botany 500 belted slacks of Dacron® polyester or cotton/Dacron® polyester to help retain shape, look great wash after wash. *DuPont Reg. TM



30% SAVINGS

~~5⁹⁷~~ TO ~~11⁹⁷~~ ~~4¹⁷~~ TO ~~8³⁷~~
Boys' or girls' shorts sets; some with appliques, embroidery accents. Choice of solid colors or prints. Infants' sizes 12-24 mos., toddlers' 2-4. Styles shown are representative of group

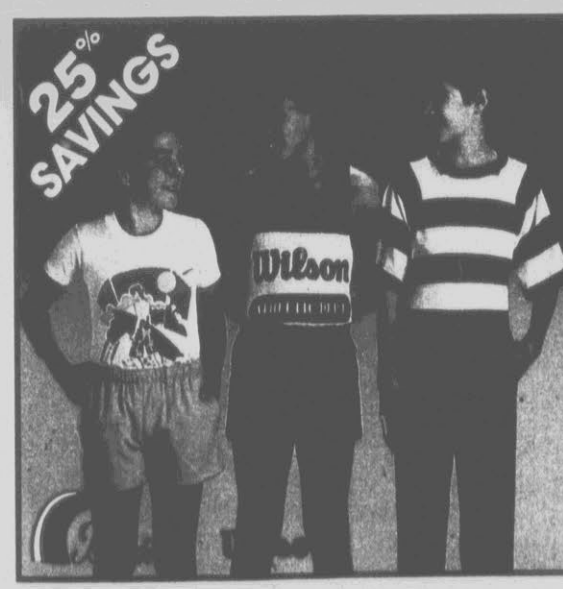

25% SAVINGS

~~4⁵⁷~~ TO ~~9⁹⁷~~ ~~3⁴²~~ TO ~~7⁴⁷~~
Boys' quality separates. Screen-print T-shirts, crew-neck jerseys, tank tops, shorts, elastic-back pants and more. Varied styles, colors.



25% SAVINGS

~~3⁹⁷~~ TO ~~8⁹⁷~~ ~~2⁹⁷~~ TO ~~6⁷²~~
Jr. boys' casualwear of high-quality fabrics. Screen-print T-shirts, 2-pc. shorts sets, or twill jeans with 1/2 elastic waistband. Jr. boys' sizes 4-7. All former prices on this page are our reg. low prices



24% SAVINGS

~~7⁹⁷~~ \$6
Toddler boys' short sleeve oxford-cloth dress shirts of carefree polyester/rayon in choice of smart solid colors. 1-pocket styling. Sizes 2-4.

High Quality From America's Favorite Store

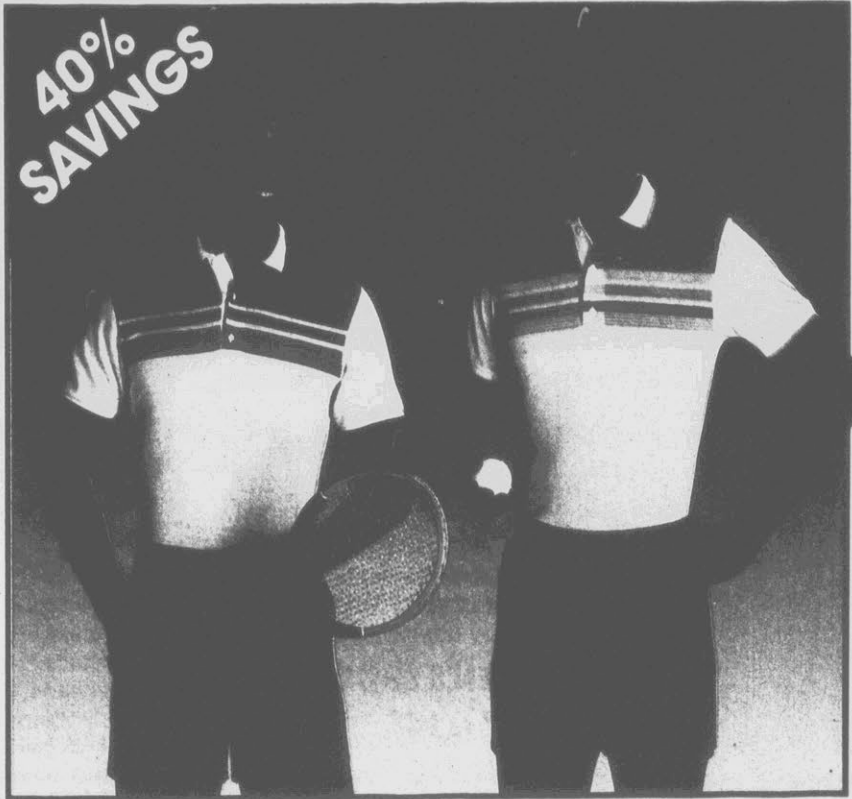

40% SAVINGS

~~13⁹⁷~~ ~~8³⁸~~ Ea.

Men's Travis Cup coordinated tennis separates. Choose from wide variety of machine-washable polyester/cotton shirts and shorts in stripes and colors. Mix and match for many different winning looks!

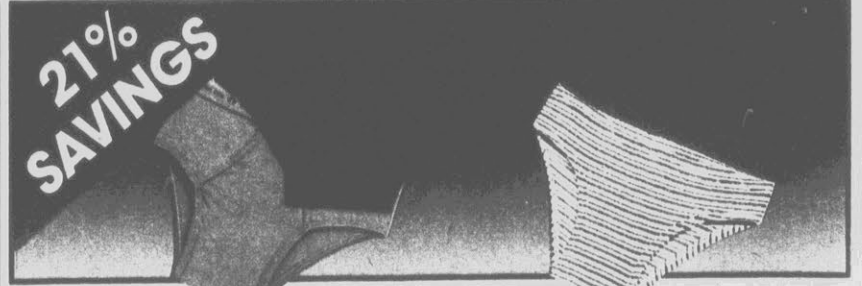

21% SAVINGS

~~2⁹⁷~~ ~~2³³~~ Ea. *Hang Ten* **MADE IN THE USA** It matters!

Men's Hang Ten fashion briefs of shape-retaining cotton in choice of hip or fly-front styles. Choose from wide variety of fashion colors. High quality, style and comfort at an excellent K mart value price!

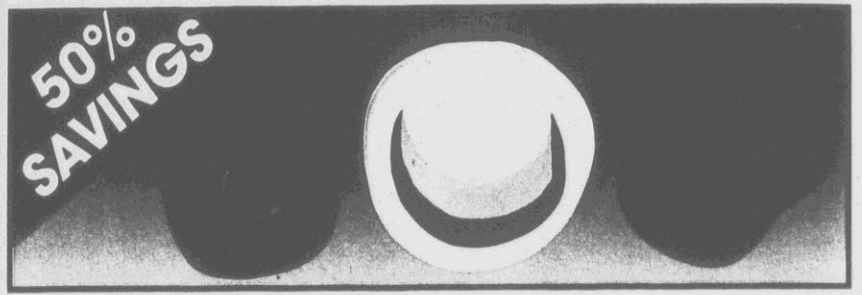

50% SAVINGS

~~2⁷⁷~~ To ~~5⁹⁷~~ ~~1³⁸~~ To ~~2⁹⁸~~

Choice of men's hats. Selection includes sporty baseball cap of breathable nylon mesh, cotton roll-up hat with contrasting accents, Ivy League style cap with snap-front brim. In colors.



YOUR CHOICE

~~\$4~~ Ea.

Fashion sunglasses in large selection of updated styles and colors. Metal or plastic frames, some mirrored lenses; all with durable optical hinges. Help protect your eyes from the sun's harsh rays.

While quantities last



50% SAVINGS

~~19⁹⁷~~ ~~9⁹⁸~~ Jheri Redding II

Jheri Redding II hair dryer, curling iron set. 1250-W dryer with 2 heat settings; iron with 5/8" barrel, cool tip, more. Hot colors!

JRK2634/pink JRK2633/peach JRK2632/lavender While quantities last Minimum 6 per color available in each store

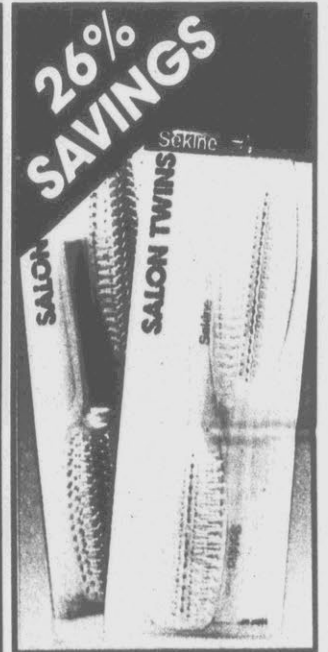

26% SAVINGS

~~2⁶⁷~~ ~~1⁹⁷~~

Set of 2 brushes. One large, great for styling; one purse-size to take along.



30% TO 46% SAVINGS

~~9⁹⁰~~ ~~6⁹⁰~~ Pr. **Your Choice**

Aerobic workout shoes for men or women. Quality-constructed footwear with comfort-cushioned tongue, collar and insole, soft and absorbent nylon tricot lining. Gear up for action in style!

~~8⁹⁷~~ ~~10⁹⁷~~ ~~5⁹⁰~~ Pr. **Your Choice**

Children's aerobic shoes. Choice of supportive high-top style with convenient hook-and-loop closures, soft nylon tricot lining, long-wearing sole; or low-cut aerobic shoes. Sizes 6-12. A K mart value.

All former prices on this page are our regular low prices

Use Our Layaway And Save Now

QUALITY PATIO OR LAWN FURNITURE

9⁹⁷ TO 24⁹⁷
6⁹⁷ TO 17⁹⁷

Our quality-crafted patio furniture will help make your summer even more enjoyable. Whether you're entertaining or just relaxing, do it in comfort and style with any of these handsome pieces. Perfect for a cookout or lounging in the sun.

- Our 9.97, Woven Web Lawn Chair 6.97
 - Our 19.97, Rocking Lawn Chair 16.97
 - Our 19.97, 5-position Back Lounge 14.88
 - Our 24.97, Deluxe Chaise Lounge 17.97
 - Our 12.97, Deluxe Web Lawn Chair 9.97
 - Our 19.97, 2-tier Serving Cart 16.97
- Style and mfr. may vary

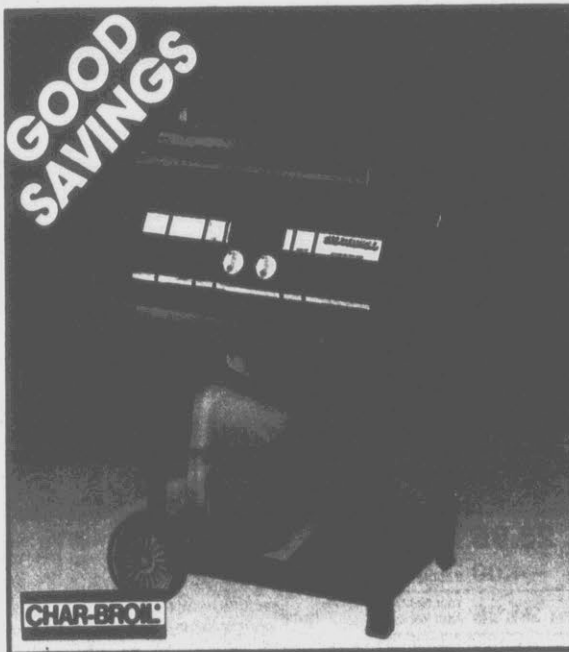

~~\$217~~ \$189

Cart-style portable gas grill with 328-sq.-in. cooking area, 34,000 BTU dual burners with push-button ignition and heat indicator.

GG7734 Fuel not included Unassembled in carton

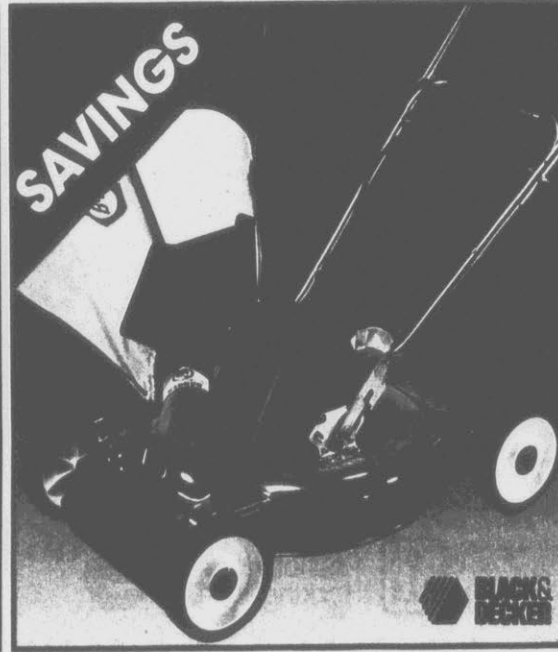

~~137⁸⁸~~ 118⁸⁸

18" electric lawn mower with flip-over handle, height adjusters and easy-rolling 7" wheels.

Our 28.88, Grass Catcher With Frame, Bag . . 24.88
Grass catcher sold separately (8018) Complies with A.N.S.I. and C.P.S.C. safety standards

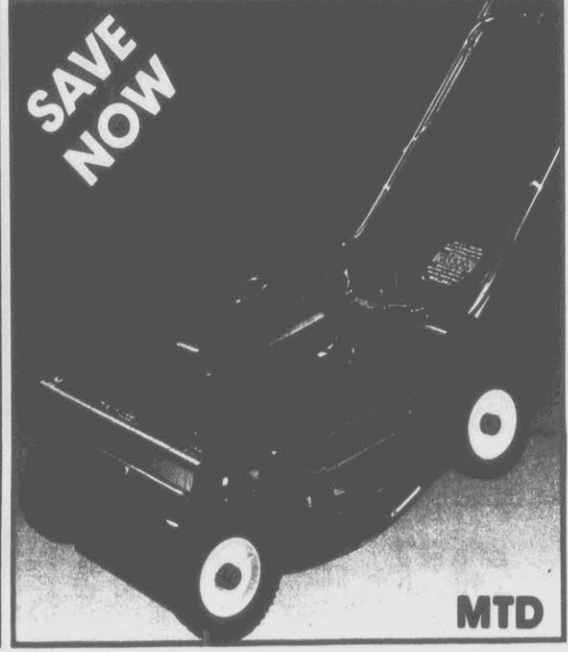

~~249⁸⁸~~ 217⁷⁷

21" self-propelled rear-bag mower with 3.5-HP Briggs and Stratton engine, electronic ignition.

20-fl.-oz. Briggs & Stratton 4-cycle Engine Oil, 99¢
(7007) Mfr. may vary Bag included Complies with A.N.S.I. and C.P.S.C. safety standards



~~21⁹⁷~~ 12⁸⁸

16" Big Wheel with action handle, safety-styled handlebars, wide-track wheels.

For ages 3-8 yrs.



~~27⁹⁷~~ 18⁸⁸

12" tricycle with chrome handlebars, decorative seat, whitewall tires and more.



~~26⁹⁷~~ 18⁸⁸

Heavy-duty wagon with easy-turn steering assembly. Semi-pneumatic rubber wheels.



~~4⁹⁷~~ 2⁸⁸

Grass seed mixture. Quick-growing annual/perennial ryegrass seed. 5-lb.* bag.

*Net wt.



~~39.88~~ 34.88

14" bump feed string trimmer. Our 5.88, Trim Line Dispenser, 1-lb.* .065" Or .80" Dia., 4.44

*Net wt. Rebate limited to mfr.'s stipulation



~~6⁹⁷~~ 3⁹⁹

Attractive planters. 10½x10" full depth* or 12x10½" ceramic-look** planter; with saucer.

*3770 **3242



~~23⁹⁷~~ 15⁵⁸

Decorative floor-standing bird cage in attractive brass finish. K mart value!

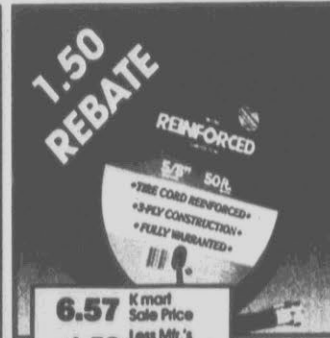

6.57 K mart Sale Price
-1.50 Less Mfr.'s Rebate
5.07 Your Net Cost After Rebate

50' garden hose with solid brass couplings, nylon reinforcement. ½" interior dia.

Mfr. may vary Rebate limited to mfr.'s stipulation



~~8⁹⁷~~ 5⁸⁸

Impulse sprinkler evenly waters up to 5300-sq.-ft. area. Our 6.97, Trigger Nozzle . . . 4.77

P55/sprinkler T10C/nozzle

All Former Prices On This Page
Are Our Regular Low Prices

Reap The Rewards Of Sa



SAVE 50% ON ANCHOR HOCKING

Our Reg. 97¢-12.77 Ea.

48¢ To 6³⁸

Anchor Hocking vases will enhance the decor of many rooms in your home. Great for displaying fresh-cut flowers, dried flower arrangements, much more.

- Our 97¢, 9" Bud Vases In Choice Of Prescut Or Wexford Crystal-clear Patterns Ea., 48¢
- Our 7.77, 9 1/4" Vases In Choice Of Fashion Colors Or Patterns Ea., 3.88
- Our 9.77, 12 1/4" Vases In Choice Of Fashion Colors Or Patterns Ea., 4.88
- Our 10.77, 9 1/4" Vases In Choice Of "Spider Mum" Or "Nightingale" Patterns . . . Ea., 5.38
- Our 12.77, 12 1/4" Vases In Choice Of "Spider Mum" Or "Nightingale" Patterns . . . Ea., 6.38

*Approximate size



2.59 CAFETERIA SPECIAL
Fried fish dinner served with tartar sauce, French fries, coleslaw, roll and butter.
Available only in stores with Cafeteria
Thurs., Fri., Sat. only

50% SAVINGS



3⁹⁷ To 5⁵⁴ 1⁹⁸ To 2⁷⁷ Anchor Hocking

Anchor Hocking "Canfield" kitchenware is quality constructed of crystal-clear glass, designed for versatile use. Take advantage of the savings!
Our 3.97, 10 1/2" Bowl 1.98 Our 4.97, 12" Platter 2.48
Our 4.97, 12" Divided Dish 2.48 Our 5.54, 4, 5 1/2" Bowls 2.77

\$4 REBATE

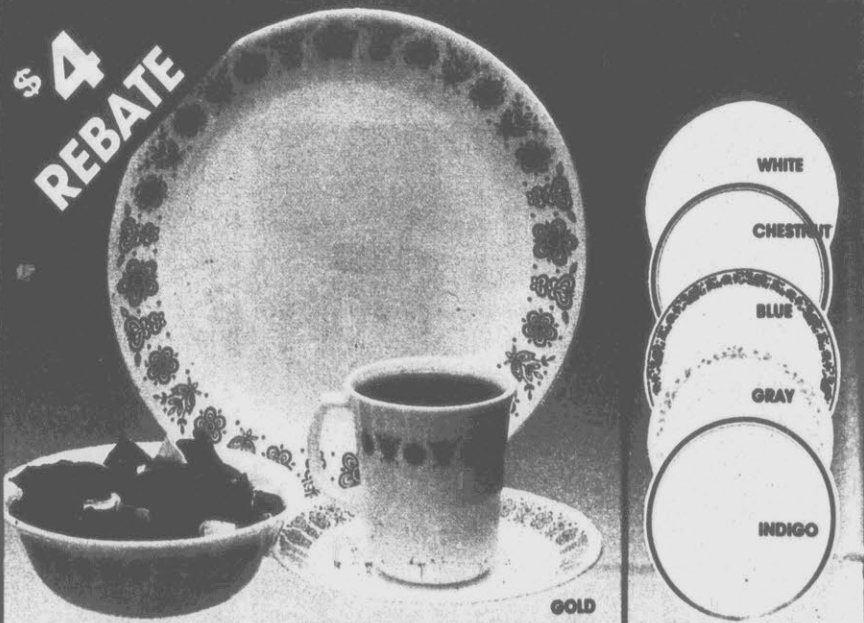

39⁵⁶

28.96 K mart Sale Price
- 4.00 Less Mfr.'s Rebate
Set **24.96** Your Net Cost After Rebate



Quality Corelle 32-pc. Livingware set includes 8 ea.: dinner plates, soup/salad bowls, bread/butter plates, mugs. Choose from varied decorator colors to match the color scheme in your kitchen or dining room. Durable to use everyday, elegant for entertaining guests.

Rebate limited to mfr.'s stipulations



50% SAVINGS
3²¹ Ea. Anchor Hocking
Choice of baking dishes. 1 1/2- or 2-qt. covered casseroles or 2-qt. dish.



40% to 41% SAVINGS
2²⁰ Anchor Hocking
Kitchenware choice. Set of 4, 6-oz. custard cups, 1 1/2-qt. loaf dish or 1-qt. batter bowl.



50% SAVINGS
2⁸⁸ 1⁴⁴ Ea. Anchor Hocking
Baking needs. Choose from 9" pie plate or 16-oz. measuring cup. Save now!



50% SAVINGS
5³⁴ 2⁶⁷ Anchor Hocking
8"-square baking dish of high-quality durable glass. Meets many baking needs.



40% to 48% SAVINGS
2⁹⁷ To 1⁷⁸ Ea. Anchor Hocking
Decorative storage jars in handy 1-, 1 1/2- or 2-liter sizes. Durable, many uses.



50% SAVINGS
9²⁸ 4⁶⁴ Anchor Hocking
Set of 4 "Courtney" wine glasses. Choose from 8-oz. glasses or 10.5-oz. goblets.



45% SAVINGS
10⁹⁷ 5⁹⁷ Anchor Hocking
24-pc. tumbler set. 6 ea.: 10-oz. rocks, 12-oz. beverage, 16.5-oz. tea glasses.



50% to 53% SAVINGS
4⁹⁷ 2⁴⁸ Anchor Hocking
Pkg. of 4 glasses. 9.5-oz. rocks, 12-oz. beverage or 15-oz. iced tea glasses.



41% SAVINGS
11⁹⁷ 6⁹⁷ Anchor Hocking
Cake plate. 12" footed serving plate, 11 1/4" dome. Helps keep cakes fresh!



40% SAVINGS
3⁹⁷ 2³⁸ Anchor Hocking
Pkg. of 4 glasses. 9.5-oz. rocks, 12-oz. beverage, or 16-oz. iced tea glasses.

Savings On Name Brand Kitchenware

SAVE 39%-40% ON RUBBERMAID

Our Reg. 1.93-13.83

1¹⁵ To 8³⁰ *Less Mir's \$2 Rebate

Quality Rubbermaid products are constructed of long-lasting materials.

- Our 1.93, Vanipan Wastebasket In Choice of Colors . . . 1.15
- Our 2.97, Vanity Wastebasket 1.78
- Our 3.14, 11-qt. Dishpan In Colors 1.88
- Our 3.97, 3-gal. Mini Tote With Handles . . . 2.38
- Our 4.78, 12 1/2 x 18 1/2 x 8 3/4" Storage Basket . 2.87
- Our 5.48, 30-qt. Wastebasket In Colors . . . 3.29
- Our 7.87, 12 1/2 x 15 1/2 x 9 1/4" Step Stool . . . 4.72
- Our 7.97, 42-qt. Self-closing Wastebasket, 4.78
- Our 8.97, 8-gal. Tote With Handles 5.38
- Our 10.97, 30-qt. Step-on Wastebasket . . 6.58*
- Our 12.97, 16-gal. Footlocker Tote 7.78
- Our 13.83, 56-qt. Covered Wastebasket, 8.30*

Rubbermaid®

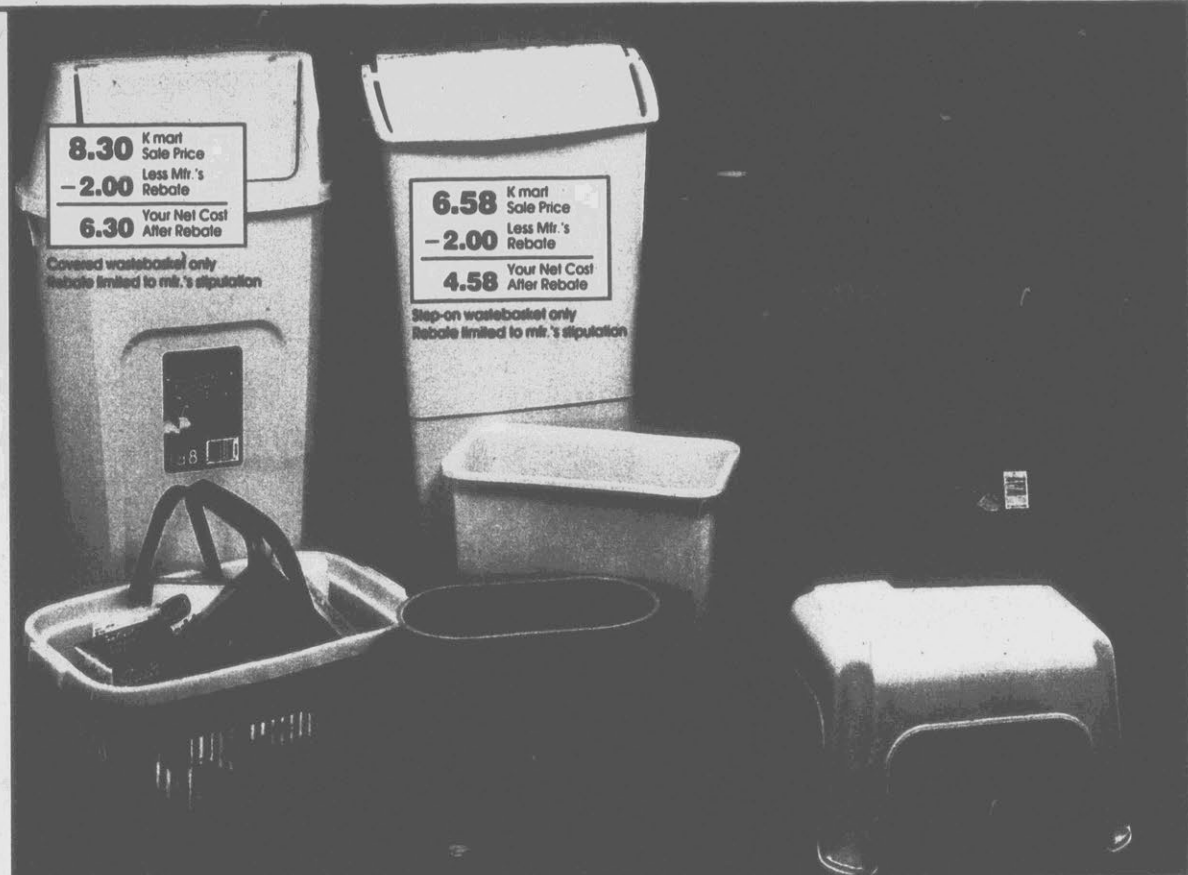

1⁴⁸ To 11⁶⁷

Household items of durable plastic. Our 1.48, 10-qt. Wastebasket 88¢
Our 1.78, 10-qt. Wastebasket 1.06
Our 1.87, 1-bushel Basket 1.12

Our 2.17, Utility Stacking Bin 1.30
Our 6.73, 14x14x13 1/2" Crate 4.03
Our 9.97, 60-qt. Hamper In Colors, 5.98
Our 11.67, 76-qt. Hamper In Colors, \$7

88¢ To \$7



14⁹⁶ 10⁹⁶ Litton

Litton 6-pc. Cook 'n Serve set includes 1-qt. and 1 1/2-qt. covered casserole dishes, 2-cup bowl with lid. Durable pieces are great for use in microwave or conventional ovens, dishwasher safe for faster, easier cleanup. High quality you love at a K mart value you expect!



4⁹⁷ 2⁹⁹

Kitchen sink set. Drainer and tray, soap dish, dish sponge*, silverware cup.



4⁵⁸ 3²⁰

12-qt. Roughneck bucket of durable plastic. Many indoor, outdoor uses.



2⁵⁸ 1²⁹

Multipurpose 20-qt. utility tub in choice of colors. High quality, long lasting.



16⁹⁷ 12⁹⁷

50-pc. flatware set. Service for 8 plus 8 extra teaspoons, butter knife, sugar shell.



5⁴⁷ 3⁹⁷

2-qt. whistling teakettle of heat-resistant glass; cool handle. Dishwasher safe.



14⁹⁷ 8⁸⁸

10-cup percolator of durable polypropylene. Lock-tight lid, removable cord.



16⁸⁸ 12⁶⁶

5-speed hand-held mixer with Power Surge. Lightweight, easy to handle.



1³⁸ 66¢

Pr. of rubber gloves in varied sizes. Helps protect hands, keep them soft.



3⁹⁷ 2³⁸

Clean-up kit. 5-qt. pail, 3 sponges*, 2 scrubbers, 1 dish mop, cheese cloth.



2¹⁷ 1³⁰ Ea.

Soil and stain remover in 32-oz. bottle; with easy-to-use trigger sprayer.

*1 polyester, 2 Estracell

VALUE-PRICED HOUSEHOLD ITEMS

**SAVE
30%**

CONVENIENT AND STYLISH VINYL BLINDS

2⁷⁷ TO 9⁴⁹

Decorative roll-up blinds of durable vinyl construction, available in fruitwood or white to help accent any decor. Perfect window treatment for porch, sunroom, kitchen, den or any room you want to highlight.

Our 3.97, 2½x4' Blind 2.77
 Our 6.88, 3x6' Blind 4.81
 Our 9.37, 4x6' Blind 6.55
 Our 11.57, 5x6' Blind 8.09
 Our 13.57, 6x6' Blind 9.49
 Mr. may vary

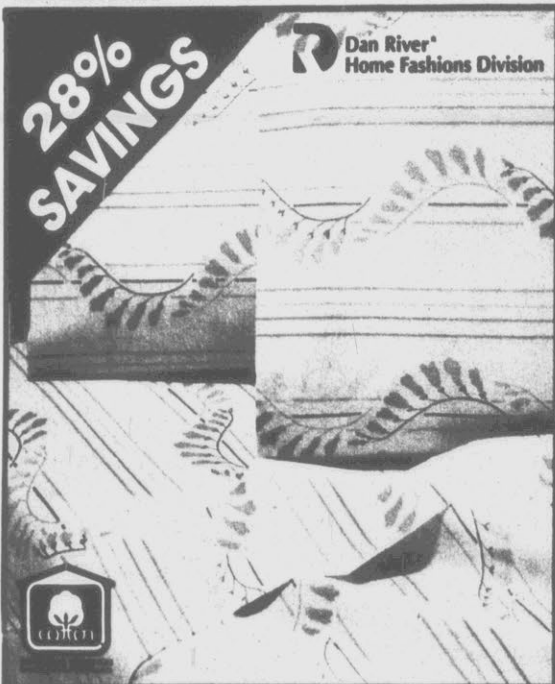

**28%
SAVINGS**

Dan River®
Home Fashions Division

13⁹⁷ 9⁹⁶

MADE IN THE
USA
It matters!

Twin-size luxury percale sheet set* of no-iron 50% Fortrel® polyester/50% cotton.
 Our 19.97, Full-size Sheet Set** 14.96
 Our 26.97, Queen-size Sheet Set** 19.96
 Our 29.97, King-size Sheet Set** 21.96

*Fortrel is a Reg. TM of Celanese Corp.
 *Includes 1 flat, 1 fitted sheet, 1 pillowcase
 **Includes 1 flat, 1 fitted sheet, 2 pillowcases

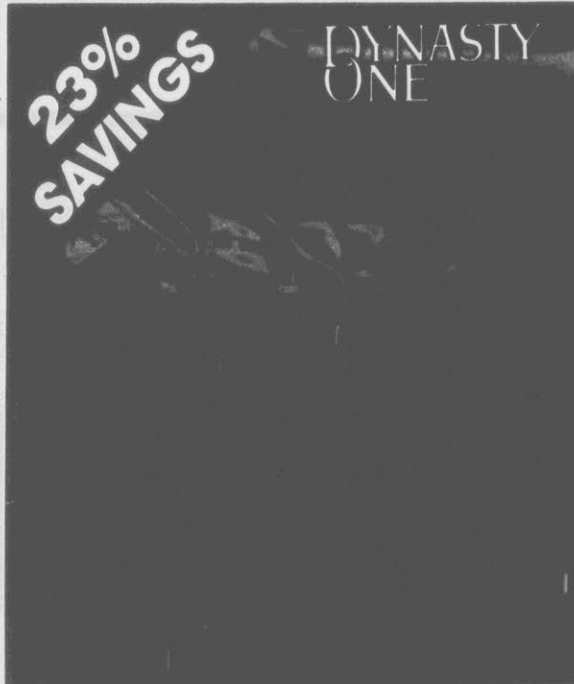

**23%
SAVINGS**

DYNASTY
ONE

29⁹⁷ 22⁹⁷

MADE IN THE
USA
It matters!

Dynasty One queen- or king-size waterbed sheet set* of no-iron polyester satin; with specially fitted corners.
 Our 49.97, Queen/King Reversible Waterbed Comforter Of Luxurious Polyester Satin . . 34.97

*Includes 1 top sheet attached to bottom sheet, 2 matching pillowcases

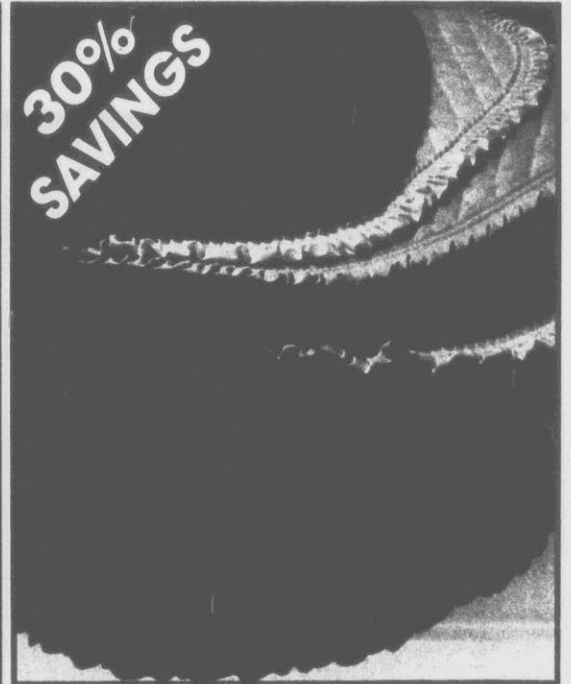

**30%
SAVINGS**

1⁹⁷ 1³⁷ Ea.

Solid-color place mats of quilted polyester/cotton in choice of attractive colors to help accent home decor. 14x20" size.
 Our 2.97, 12½x18¼" Obliquely Pleated Place Mats In Variety Of Popular Colors . . . Ea., 1.97



**23%
SAVINGS**

69⁸⁶ 53⁵⁷

27" Victorian-style table lamp of hand-blown glass with floral decal on base. 3-way lighting, built-in night light. Boxed.
 3-way bulb not included



**UP TO 33%
SAVINGS**

MADE IN THE
USA
It matters!

4⁹⁷ 5⁹⁷ 3⁹⁷ Ea.

Shower curtain liner of wipe-clean vinyl. Choice of clear or decorative colors.



**38%
SAVINGS**

2⁵⁷ 1⁵⁷

Pkg. of 12 shower curtain rings constructed of durable plastic. Choice of colors.

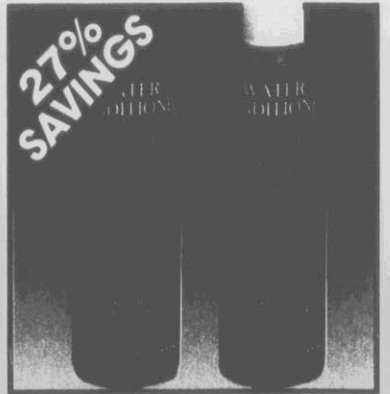

**27%
SAVINGS**

3⁹⁷ 2⁸⁸ Ea.

Waterbed water conditioner helps keep water clean and fresh. 16 fl. oz.
 Mr. may vary



**50%
SAVINGS**

15⁹⁴ 7⁹⁷

Pkg. of 2 daisy Astroturf outdoor mats. 1, 19x33" mat and 1, 17x23" mat. Green.



**50%
SAVINGS**

5⁹⁷ 2⁹⁸ Ea.

Attractive area rugs in choice of 24x40" or 24x42" sizes. For high-traffic areas.



**49%
SAVINGS**

5⁹⁷ 2⁹⁹ Ea.

Solid-oak picture frames in choice of shapes. 3½x5".
 Our 6.97, 5x7" Frames, Ea., 3.48
 All former prices on this page are our regular low prices

Savings On Products That Organize



Save 19%-29%
Our Reg. 2⁹⁹ To 69⁹⁹
2³⁷ To 48⁹²

Handy organizers help straighten your closet and keep it uncluttered, neatly integrate sweaters, shoes, belts, accessories, more.

- A. Organizer Fits 8-10' Closets 48.92
- B. Organizer Fits Up To 5' Closets 20.92
- C. Organizer Fits 5-8' Closets 34.92
- D. 2' Organizer Shelf Of Vinyl-coated Steel, 5.57
- E. 3' Organizer Shelf For Many Uses 6.37
- F. 4' Organizer Shelf Adds Storage Space .. 7.17
- G. 8-Shelf Organizer Rack; 18x72" 19.90
- H. Add-a-Basket For Sweaters, Accessories, 5.57
- I. Tie And Belt Rack 2.37
- J. 2-shelf 12x10" Organizer Rack 3.97

Hardware Included



Save 23%-46%



SAVE 22%-36%

~~1⁴⁴~~ To ~~17⁴⁴~~ **77¢** To ~~10⁴⁶~~

Closet organizers or moth deterrents. Organizers increase storage space, are great for closets, laundry area, workshop. Moth products kill moths, eggs, larvae; help protect sweaters, blankets. 1-lb.-net-wt. Moth Balls 77¢ 30x12x11½" Organizer 10.46 1-lb.-net-wt. Nuggets, Crystals, 1.35 11½x31x11½" Organizer 10.46 Shoes, towels not included Organizers unassembled in carton

~~2⁹⁷~~ To ~~12⁸⁸~~ **1⁹⁰** To ~~9⁹²~~

"Country Charm" accessories for storing, protecting, organizing. 24x13x11" Storage Box 1.90 42x20x14½" Vinyl Suit Bag ... 5.96 31x16x5" Under-bed Box 1.90 54½x20x14½" Dress Bag ... 5.96 18-section Hanging Shoe File, 5.50 26½x15x13" 4-Drawer Chest .. 8.98 26½x15x13" Organizer 5.96 10-shelf Sweater Bag 9.92



78¢ 59¢
Clear tape in money-saving value pack. ½x1000"; many uses.



4⁹⁷ 2⁴⁸
25' telephone coil cord with modular plugs; in choice of basic colors. TA65



37⁹⁷ 29⁹⁷
Printing calculator with 10-digit 2-color printout, memory, one-touch key. EL-1626 Batteries are included

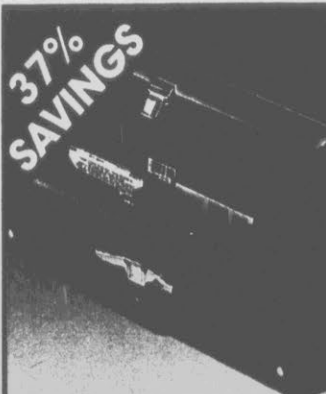

7⁹⁷ 4⁹⁷
Cassette carrying case holds 24 tapes. Of durable vinyl in color display. Tapes not included

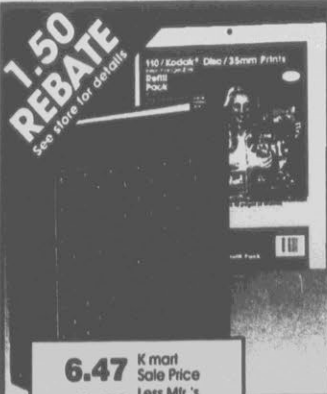

6.47 K mart Sale Price
-1.50 Less Mfr.'s Rebate
Ea. **4.97** Your Net Cost After Rebate
Photo album displays up to 500, 35mm prints. Pkg. Of 5 Refill Pages, 1.88 Sold in Camera Dept. Rebate limited to mfr.'s stipulation



11⁸⁸ 5⁹⁴
UHF/VHF indoor antenna with solid brass dipoles, 6-position rotary switch. KM200



\$39 29⁵⁰
Microwave stand with 2.2-cu.-ft. storage space, casters, durable finish. 3620 Unassembled in carton



17⁹⁷ 12⁴⁸
The tall can opener with knife sharpener, magnetic lid grabber, auto-shutoff. 0208



22⁸⁸ 17¹⁶
12-speed blender. 48-oz. durable plastic container, stainless steel blades. 03-0905



44⁸⁸ 33⁶⁶
8x40mm ZWCF binoculars feature quick focus, wide-angle viewing, more. Case and strap included All former prices on this page are our regular low prices

Get A Jump On Summer Savings!

25% SAVINGS



MacGregor
Our 5.97, Youths' Batting Glove ... Ea., 4.47

SALE PRICE



25% SAVINGS

Our 27.97, Canyon 21.97
Our 29.97, Pullman 22.97
Our 39.97, Garment Bag 29.97

19⁹⁷ 14⁹⁷

"Holiday" expandable tote bag is light-weight and durable for short or long trips. Soft-sided nylon with fashion styling. Sold in Sporting Goods Dept.

50% SAVINGS

Our 24.97, 23" Weekender 14.97
Our 29.97, 25" Pullman 19.97
Our 34.97, 27" Pullman 24.97

19⁹⁷ 14⁹⁷

Youths' Leaguer baseball glove of top-grain cowhide for better strength and flexibility. Our 11.97, Peewee Ball Glove 8.97

5⁹⁷ 4⁹⁷ Ea. MacGregor

Women's "Sport Coordinates" or men's "Summer Sweats". Choose muscle shirts, tank tops or shorts in colors. Comfortable sports gear.

19⁹⁷ 9⁹⁷

"Giordano" 21-inch suitcase of durable nylon with pleated front pocket, designer styling. In classic gray. Save now! Sold in Sporting Goods Dept.

SALE PRICE



Palmer

SALE PRICE



NORTHWESTERN

SAVE 25%-33%



ERICOTT JOHNSON

26⁹⁷ - 29⁹⁷ 19⁹⁷

Your Choice. Pair golf shoes in choice of Nancy Lopez or Ray Floyd models with rubber spikes. Available in most stores

SALE PRICE



GOTT

9⁹⁷ 7⁹⁷

6-qt. cooler with refreezable bottle. Holds up to 6 cans. Great for travel, picnics and more! Sold in Sporting Goods Dept.

29⁹⁷ 24⁹⁷

Your Choice. Arnold Palmer golf bag. Lightweight for carrying ease. Padded strap. Colors.

119⁹⁷ 99⁹⁷

Men's Pro-Bilt golf set includes 3 woods, 7 irons and pitching wedge. Right hand model.

SALE PRICE



NORTHWESTERN

59⁹⁷ 49⁹⁷

Youths' golf set complete with three irons, driving wood, putter and golf bag. Save.

30% SAVINGS



Maxfli BLUE MAX DUNLOP

12⁹⁷ 8⁹⁷

1-dozen Blue Max golf balls with Surlyn cover. Durable Dunlop quality. Value! Limit 2 dozen

SALE PRICE



Wilson

VALUE PRICE



Sportfisher

14⁹⁷ 12⁹⁷

Michael Jordan basketball* with wide channel, deep pebbling. Protective Knee Pads Pr., 3.97
*Official size, weight Sold in Sporting Goods Dept.

7⁹⁷ 7⁹⁷ ZEBCO

Your Choice. Fishing reels. Spinning, spincast or mini-cast models for most fishing needs.

SALE PRICE



Sportfisher garcia

14⁹⁷ 7⁹⁷ SUMMIT

Your Choice. Fishing rods. Select top brand rods in choice of styles and actions. Great value!

VALUE PRICE



Sportfisher

\$1 Slabspoon Sportfisher

Your Choice. Fishing needs; hooks, split shot, leaders, bobbers, snap swivels or mono line.

SALE PRICE



fenwick 1050

37% SAVINGS



SEARS

8⁹⁷ 6⁹⁷ ACTION

Two-tray tackle box is compact, lockable for safety. Complete with 15 compartments. 1050

7⁹⁷ 4⁹⁷

Fillet board features rust-resistant clamp and grooves. 6" Fillet Knife/Sheath* 6.97
*DF60

SALE PRICE



bagley's

5⁹⁷ 4⁷⁷

2 1/4-oz. Killer B II lure helps catch more fish with realistic movement and color. Save now.

36% SAVINGS



ACTION

13⁹⁷ 8⁹⁷ ACTION

Swivel boat seat of tough, molded polypropylene plastic in choice of complementary colors.

Great Auto Values At Spring Savings

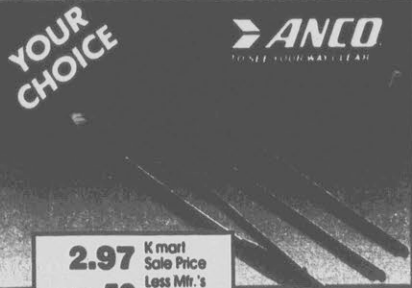

YOUR CHOICE

ANCO
TO SET YOUR WAY CLEAR

25% SAVINGS

2.97 K mart Sale Price
Less Mfr.'s Rebate
- .50
Pkg. 2.47 Your Net Cost After Rebate

Your Choice. 1 wiper blade or 2 refills in sizes to fit many U.S. cars and light trucks.
Rebate limited to mfr.'s stipulations

39⁹⁷ 29⁹⁷

Pkg. of soft velour seat cover; comfort padding. High-or low-back bucket styles; colors.



26% SAVINGS

49⁹⁷ 39⁹⁷
6/12-V battery charger. 10-amp automatic/manual or deep cycle for autos or RV's.



32% SAVINGS

4⁹⁷ 3³⁷
22-pc. socket set. SAE or metric; 1/4"- and 3/8"-drive combo. For home, car or shop.
Sold in Auto Dept.

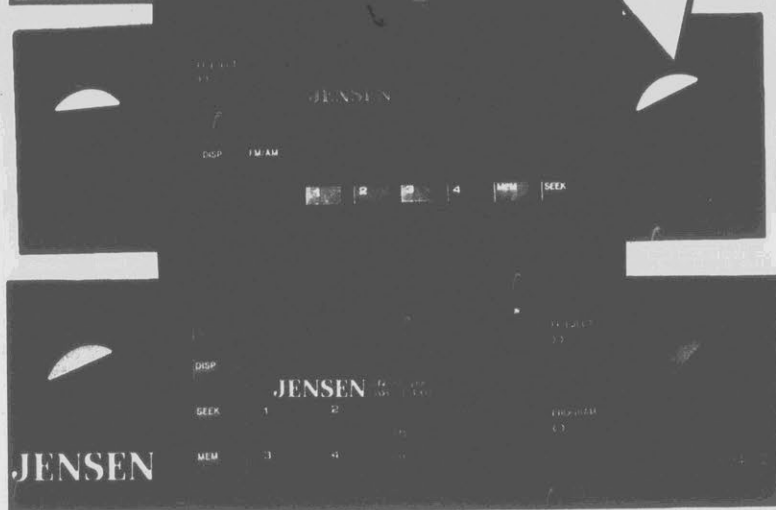
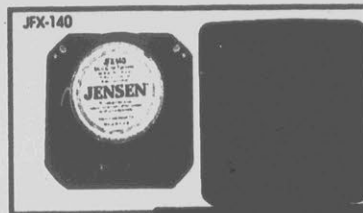

SAVE 20% TO 30%

129⁹⁷ 89⁹⁷
AM/FM cassette stereo with electronic tuning, seek, preset. Our 24.97, 4" Stereo Speakers, Pr. 19.97

149⁹⁷ 119⁹⁷
AM/FM cassette with auto-reverse, auto-seek, clock.

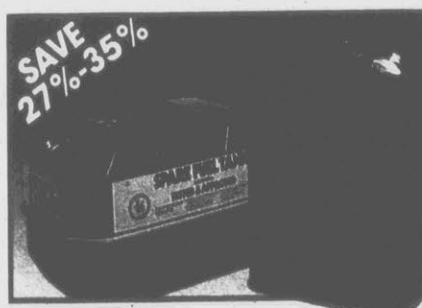

SAVE 27%-35%

13⁷⁷ 9⁹⁷
Ea. Gas cans. Choose 2 1/2-gal. can with pouring spout or 5-gal. can of 20-gauge steel.



46% SAVINGS

2⁹⁶ 1⁵⁹ Ea.
Air filters in sizes to fit many U.S. and foreign cars. Quality meets mfrs.' specifications.
Mfr. may vary



54% SAVINGS

10⁹⁷ 4⁹⁷
Mechanical water temperature gauge with indicator. Our 17.97, Triple Gauge, 14.97



SAVE 28%-54%

6⁹⁷ 4⁹⁷
Your Choice. Gauges. Mechanical oil pressure gauge or ammeter gauge. Save now.



SAVE 25%-41%

16⁹⁷ 9⁹⁷
Each. Carryout. Mono-Matic shocks. Heavy-duty; popular sizes for many U.S., import cars.



15⁹⁷ 11⁹⁷
Each. Carryout. Van and truck shocks. Performance shock built for many trucks and vans.



37% SAVINGS

7⁹⁷ 4⁹⁷
Lever-action grease gun holds std. cartridge; 3-way load. 14-oz.* Grease Cartridge . . . 88¢
*Net wt. Mfr. may vary



SALE PRICE

1⁸⁹ 88¢
Qt. transmission fluid. Type F or Dexron type in handy bottle. Our 1.57, Set Of 3 Funnels . . . 97¢



30% SAVINGS

78⁸⁸ 54⁹⁷
With Exchange. Motorvator 650 battery with 650 CCA's. For many U.S., import cars, lt. trucks.
See store for details 72-mo. Limited Warranty



21% SAVINGS

69⁹⁷ 54⁹⁷
2-wheel drum or disc brake service special for many U.S. cars. Great spring savings!



34% SAVINGS

28⁸⁸ 18⁹⁷
Arrestor Plus muffler installed. Sizes for many cars and light trucks. Heavy-duty, aluminized.
Additional parts and services extra. Single unit (welded systems) excluded. *Limited Warranty - Details in Store

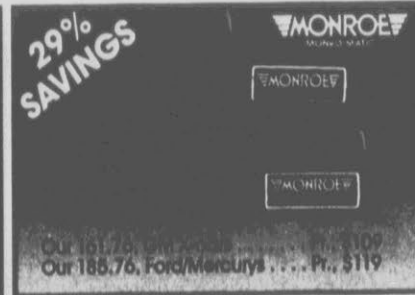

29% SAVINGS

139⁷⁶ \$99
Pair of Monroe Super Struts installed. For Omni, Horizon, and K-Cars. Spring Special
Additional parts and services are extra Alignment recommended on many cars with strut replacement

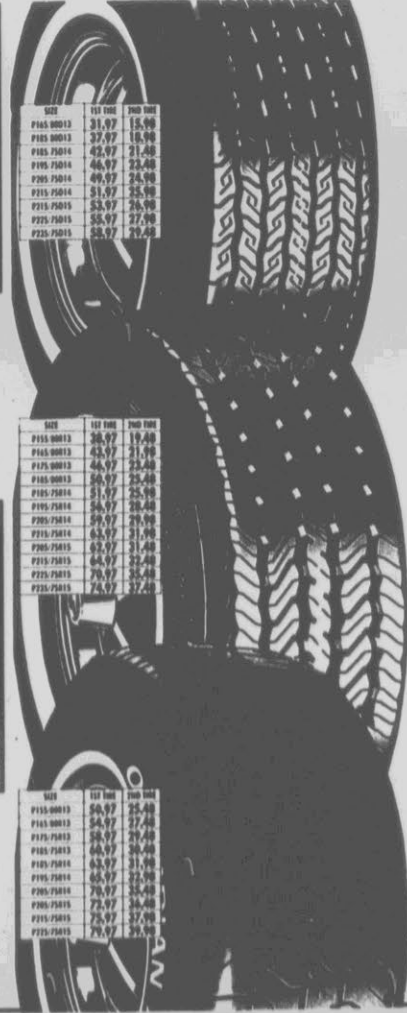

SIZE	1ST TIRE	2ND TIRE
P145-80D12	31.97	18.99
P145-80D13	37.97	18.99
P145-70D14	42.97	21.49
P145-70D14	46.97	23.49
P145-70D14	49.97	25.99
P215-70D14	51.97	25.99
P215-70D15	53.97	26.99
P215-70D15	55.97	27.99
P215-70D15	57.97	27.99

SIZE	1ST TIRE	2ND TIRE
P145-80D12	34.97	19.49
P145-80D13	40.97	21.49
P145-70D14	45.97	23.49
P145-70D14	49.97	25.49
P215-70D14	51.97	25.99
P215-70D15	53.97	26.99
P215-70D15	55.97	27.99
P215-70D15	57.97	27.99

BUY 1ST TIRE AT OUR REG. PRICE. GET 2ND TIRE AT 1/2 PRICE!

MEDALLION® 78 BIAS-PLY WHITEWALL
● 7 Multisiped Tread Ribs
● Quality Plus Economy
25,000-mile Warranty*
*Limited tread wearout warranty. Details in store

avant 225 radial STEEL BELTED RADIAL
● Radial Tire Mileage, Traction
● 5-rib Highway Tread
35,000-mile Warranty*
*Limited tread wearout warranty. Details in store

OLYMPIAN XT STEEL BELTED RADIAL
● "Our Best" Radial Tire
● Radial Tire Mileage, Traction
55,000-mile Warranty*
*Limited tread wearout warranty. Details in store

Mounting included - No trade-in required Alignment available. Tires and service available only in stores with Service Dept.

America's Favorite Store

Kmart
The Saving Place



**TRUCKLOAD PAINT
SALE & SWEEPSTAKES**

Paint On Sale Thru April 11

7⁹⁹

Sale Price Gal. Latex paint or primer/sealer. Flat wall paint in white or colors, ceiling white or interior primer/sealer.

10⁸⁷

Sale Price Gal. Paint or primer. Choose interior semi-gloss, exterior flat or gloss paint in white and colors; oil-base primer.



**ONE OF 10 1987
DODGE DAKOTAS**

No Purchase Necessary. Ten (10) Grand Prizes... each a Dodge 1987 Dakota pickup truck. All are standard equipped which includes: power disc brakes, 2.2-liter 4-cylinder engine, tinted glass, message center lights, rack and pinion steering, 5-speed overdrive manual transmission and many other standard features.

To enter, visit your local K mart store to obtain an Official Entry Form and rules. Deposit your entry blank in the Official Entry Box provided at the Glidden Paint Sale Headquarters in K mart. Sweepstakes entries must be deposited by April 11, 1987. Sweepstakes open to U.S. residents who are 18 years or older and who are not employees of Glidden or K mart and their immediate families. Void where prohibited by law. "Best built" based on survey of owner problems with '86 light trucks designed & built in No. America and sold Oct.-Nov. '85 (5 mos. avg. usage). See 5/50 limited warranty on powertrain & outer body rust-through at dealer. Excludes imports. Restrictions apply.

See Store For Details



Vehicle shown may vary in equipment from actual grand prize. See official rules and regulations for complete description.



AMERICA'S BEST BACKED TRUCKS ARE RAM TOUGH*

DIVISION OF CHRYSLER MOTORS

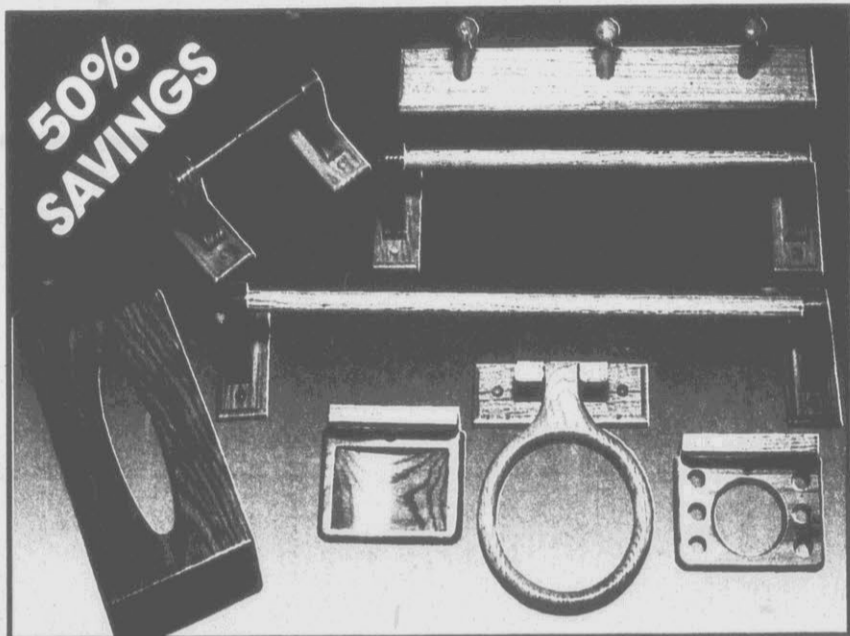

50% SAVINGS

6²⁷ To 10⁹⁷
Toothbrush/Tumbler Holder .. 3.13
Soap Dish Of Solid Oak 3.33
Oak Toilet Paper Holder 3.63
18" Solid-oak Towel Bar 3.84



SAVE 24%-50%

BEARCAT
Package* Of Bolts, Screws, Washers, Or Nuts 94¢
32-gal. Roughneck Can 9.78*

1⁸⁸ To 12⁹⁷
*Less mfr.'s \$2 rebate. Price after rebate, 7.78
*Pkg. of 50-100 depending on item

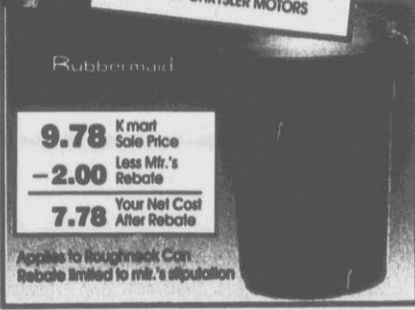

9.78 K mart Sale Price
- **2.00** Less Mfr.'s Rebate
7.78 Your Net Cost After Rebate
Applies to Roughneck Can. Rebate limited to mfr.'s stipulation

94¢ To 9⁷⁸
25"x4" Power Tape Measure 3.98
27-drawer Parts Cabinet 5.98*
Tool Caddy; 8 Locking Drawers... 5.38
U-20 Plastic Toolbox With Lift-out Tray; 12"x6 1/2"x5 1/4" Size 1.78
*Not shown



25% SAVINGS

24⁸⁸ 18⁶⁶
Solid-oak toilet seat with sculptured design, solid-brass hinge.



34% SAVINGS

9²⁸ \$6
Wall/hand-held shower. Rubber adaptor fits most tub faucets.



43% SAVINGS

10⁴⁸ 5⁸⁷ GE
65-W floodlight and fixture with nonrust plastic holder, 4' cord.



50% SAVINGS

4⁹⁸ 2⁴⁸ UL
Clamp-on work light with 8 1/2" aluminum reflector, 6' cord.



29% SAVINGS

29⁸⁸ 20⁹²
Outdoor clothes dryer with 30, 73" lines. Folds for storage.



55% SAVINGS

8⁸⁸ 3⁹⁸
5-pc. paint brush set. 1" trim, 1 1/2" sash, 2", 2 1/2", 3" sizes.



37% SAVINGS

18⁹⁷ 11⁸⁸
Roller unit with cover, paint reservoir, 2-position handle.

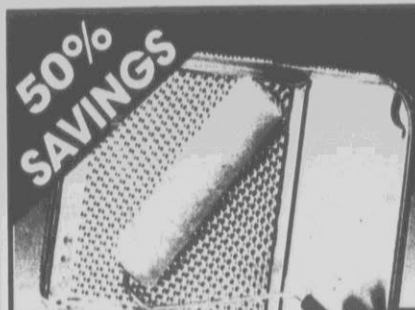

50% SAVINGS

3⁹⁷ 1⁹⁸
Quality paint roller set includes tray, roller, frame. Mfr. may vary

TRAVEL ANYWHERE AND GET A BONUS!
EARN K MART BONUS GIFT CERTIFICATES GOOD FOR MERCHANDISE & SERVICES

1-800-872-0096

JUST CALL: 1-800-872-0096* FOR YOUR TRAVEL AND LODGING

Thrifty Car Rental National Car Rental TWA OR BOOK THRU ANY INTERNATIONAL TOURS TRAVEL AGENCY

EASTERN AIRLINES CONTINENTAL AIRLINES TRANS WORLD AIRLINES FLORAFAX Worldwide Family Of Professional Florists 1-800-932-3223*

EXAMPLE:
A TYPICAL ONE WEEK VACATION FOR THREE CAN EARN UP TO \$59 IN GIFT CERTIFICATES!

- 7-day Car Rental \$7.00
- Average Airfare for 3 people at \$230 each \$34.50
- 6 Night's Lodging at \$15.00
- Send Flowers** when traveling on vacation or business \$2.50

**Applies to \$30 flower arrangement

TOTAL CERTIFICATES EARNED \$59.00

Pick up an envelope with details at the service desk at any K mart store. *To qualify, you must use the toll-free 800-872-0096 number except for FLORAFAX use 1-800-932-3223.

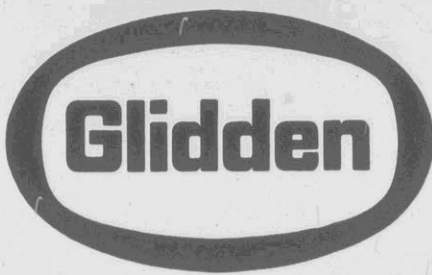

FOR THE HOMEOWNER

FOR THE PROFESSIONAL

THE FIRST LATEX PAINT IS STILL THE BEST!



**Best Scrubbing
Paint of
the Top
10 Sellers!***

*Based on results from
the world's leading
paint testing laboratory

**Glidden's
FAMOUS Latex
Wall Paint!**

SALE
\$ 999
Gal.
REG. \$15.99

Glidden's BEST Latex Semi-Gloss Enamel!

SALE
\$ **12.99**
Gal.
REG. \$19.99



Glidden's BEST Alkyd Semi-Gloss Enamel!

SALE
\$ **15.99**
Gal.
REG. \$24.99

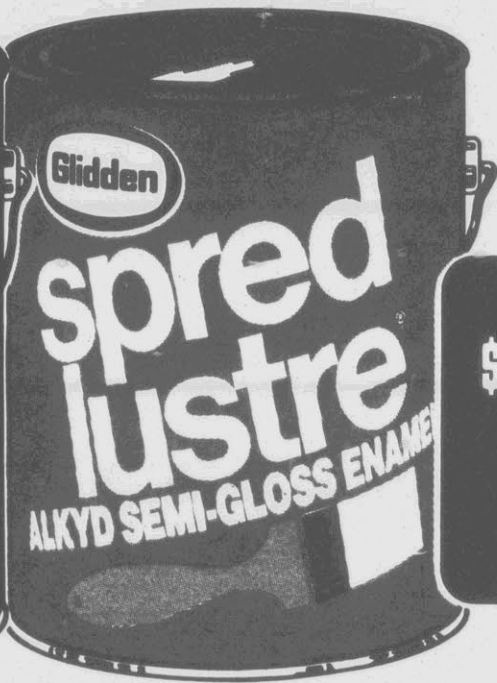

SAVE ON THE ENDURING QUALITY OF ENDURANCE

\$ **9.99**
Gal.

For Rich Wood Beauty, Naturally!
reg. \$15.99



Water Repellent Stain Protects and Preserves Wood!
reg. \$15.99



All The Convenience of Latex, For All The Beauty of Wood!
reg. \$15.99



Goes On Easily Over Paint OR Stain!
reg. \$17.99



Glidden's BEST Latex Flat House Paint!

SALE
\$ **11.99**
Gal.
REG. \$19.99

Glidden's BEST Latex Gloss House Paint!

SALE
\$ **12.99**
Gal.
REG. \$20.99

Glidden's MOST DURABLE Satin Finish House Paint!

SALE
\$ **12.99**
Gal.
REG. \$20.99

One-Coat Gloss Alkyd House Paint!

SALE
\$ **15.99**
Gal.
REG. \$24.99

Glidden's BEST Masonry & Stucco Finish!

SALE
\$ **11.99**
Gal.
REG. \$19.99

FOR THE HOMEOWNER

FOR THE PROFESSIONAL



Vin-Dotco REALLY WORKS!
Waterless Citrus Hand Cleaner
\$2.25 16 oz. can
reg. \$3.35
• One step cleaning: wipe it on, wipe or wash off



simple green All-Purpose Cleaner & Degreaser
\$13.99 Gal.
reg. \$16.15
\$5.99 24 oz. reg. \$7.45
• Removes stains from concrete



EMPIRE BUBBLESTICK™
\$4.99
reg. \$6.45
• 48'' straightedge, ruler or level



Glidden PLASTIC DROP CLOTH
99¢
reg. \$1.35
• 9' x 12'
• 1 mil thickness

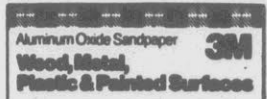

3M SANDPAPER
\$1.75
reg. \$2.75
GET \$3 BACK from 3M. Buy 3 pkgs. of 3M sandpaper and 1 Gal. paint remover (details in store).

50% OFF
BRUSHES,
ROLLER COVERS
and
ROLLER KITS
Come in and see our great assortment!

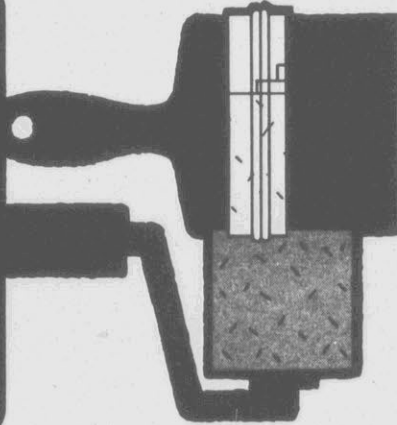

Glidden WHITE KNIT RAGS
\$5.95 5 lb. box
reg. \$10.75
• Lightweight, highly absorbent



ULTRA-HIDE Professional Latex Caulk
95¢ 10.5 oz. cartridge
reg. \$2.05
• Paint over in 30 minutes with any type paint

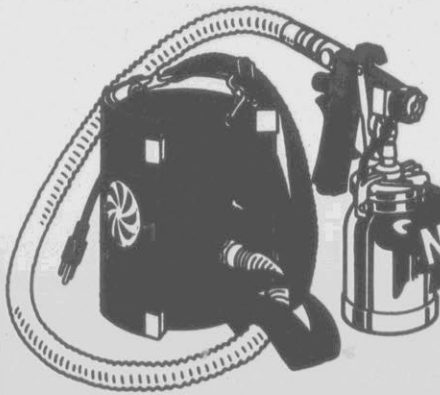

Glidden TURBINE 1000
\$399.00
reg. \$447.99
NEW!
• SAVE TIME—SAVE MONEY!
• Puts paint where it belongs; not in the air, on the floor or all over you!



2 1/2'' Angular Sash PREMIUM PRO Ultra Brushes 3'' Angular Sash
\$6.39 **\$7.75**
reg. \$11.89 reg. \$14.75



UGL Spackling Paste 222
\$8.95 Gal. reg. \$13.25
\$2.95 Qt. reg. \$4.25



KILZ Primer-Sealer
\$9.95 Gal. reg. \$16.48
\$1.95 13.5 oz. aerosol reg. \$3.39



KLEAN STRIP Paint Thinner
\$2.75 Gal. reg. \$3.55
\$6.95 2 1/2 Gal. reg. \$8.55



Flood PENETROL Paint Conditioner
\$11.50 Gal. reg. \$16.75

**We're Rolling Down Our
Prices on Glidden's
Designer Collections**

50% OFF*

*mfg. sugg.
retail price

- Collage • Hatley Square • Silk Flowers • Best Sellers
- Past and Present • Strings & Grasscloths
- Hundreds of patterns to choose from

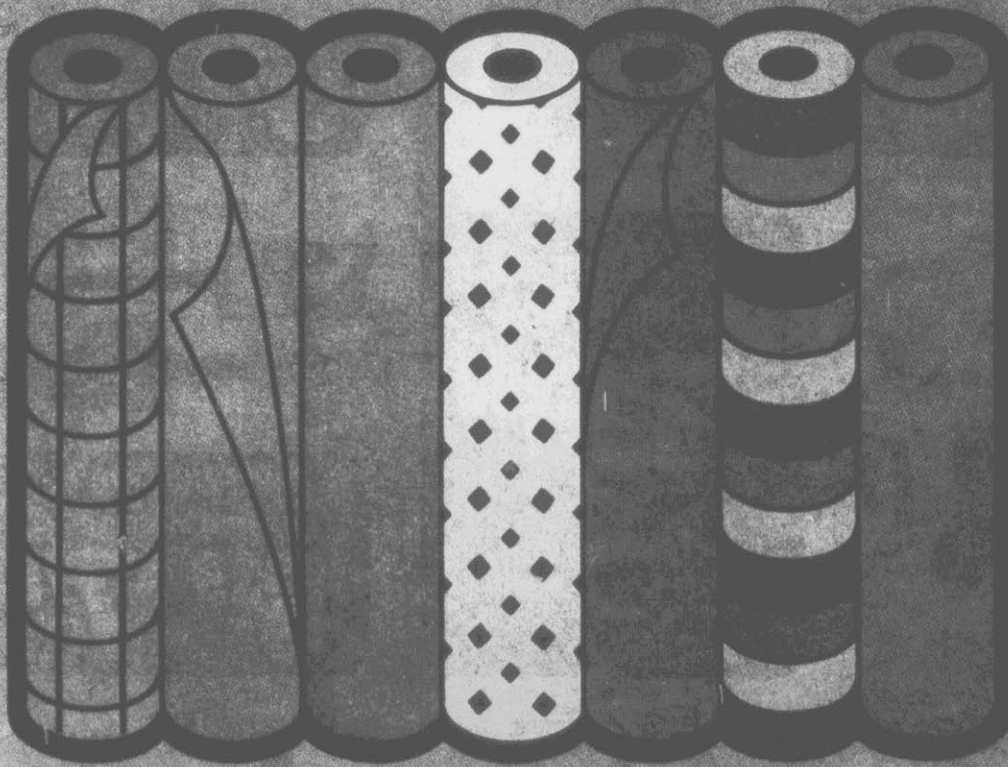

del mar

**Custom
WINDOW TREATMENTS**

**60%
OFF***

*suggested retail price.

- 1" Mini Blinds • 1/2" Micro Mini Blinds
- Vertical Blinds • Pleated Shades
- 1" & 2" Wood Blinds • Woven Wood Shades



Greenville

300 Plaza Drive
756-1833



Sale ends May 16, 1987.

SEARS SUPER SALE

4 DAY

SALE STARTS
WED., MARCH 25
ENDS SAT. MARCH 28
unless otherwise stated

Big cushioned seat with springs.

Auto-type steering.

Large turf-saver tires.

38-inch mower deck.

6 forward speeds. 1 reverse.

Dual headlights
Electric start

SAVE \$300
12-HP LAWN TRACTOR
1299⁹⁹
Regular \$1599.99

SAVE \$300!
16-HP Lawn Tractor
1899⁹⁹
Regular \$2199.99

SAVE \$600!
18-HP Tractor
2399⁹⁹
Regular \$2999.99

• Electric start, alternator charged battery
• Large turf saver tires
• 44-in. heavy-duty trans-

• Twin cylinder engine
• 6 forward speeds and 2 reverse
• 44-in. mower
• Electric start alternator charged battery

SAVE \$200!

25412

5-HP RIDING MOWER

599⁹⁹
Reg. \$799.99

3-speed. Easy pull recoil start. 25-in. mower deck.

SAVE \$300!

25413

8-HP RIDING MOWER

899⁹⁹
Reg. \$1199.99

30-in. mower. Electric-start. speed.

SAVE \$300!

25414

10-HP RIDING MOWER

999⁹⁹
Reg. \$1299.99

6-speed "shift on the fly" transmission. 30-in. mower. Electric-start.

SAVE \$40!

24355

DUMP CART

129⁹⁹
Reg. \$169.99

10.0 cu. ft. capacity. Loads up to 1000 lbs.

Satisfaction guaranteed or your money back

©Sears, Roebuck and Co., 1987

Items indicated "larger stores only" are available in Barboursville, Charleston, SC (Northwoods), Charleston, WV, Charlotte, Columbia, Durham, Fayetteville, Greensboro, Raleigh, Roanoke, Wilmington and Winston-Salem.

Large items such as furniture and appliances are inventoried in our distribution center and will be scheduled for pick-up or delivery. Delivery is not included in selling prices.

There's more for your life at
SEARS

4G4 3/25/87

SAVE \$10-\$70!



119⁹⁹ Reg. \$129.99
\$20 OFF 3.0-RP side discharge
 Pressurized lubrication.
 20-inch cut.
 90-day warranty*

38001



199⁹⁹ Reg. \$269.99
\$70 OFF 3.5-RP side discharge
 5-quick set cutting heights.
 20-inch cut.
 2-yr. warranty*

38031



259⁹⁹ Reg. \$319.99
\$60 OFF 3.5-RP rear bagger
 Cast iron cylinder liner.
 Permanex® catcher. 20-in.
 2-yr. warranty*

38331



319⁹⁹ Reg. \$369.99
\$50 OFF 4.0-RP power propelled
 Super Pull-Lite starter.
 Gear drive. 22-inch cut.
 2-yr. warranty*

37825



349⁹⁹ Reg. \$419.99
\$70 OFF 4.0-RP power propelled
 Cast iron cylinder liner.
 Permanex® catcher. 22-in.
 2-yr. warranty*

37233

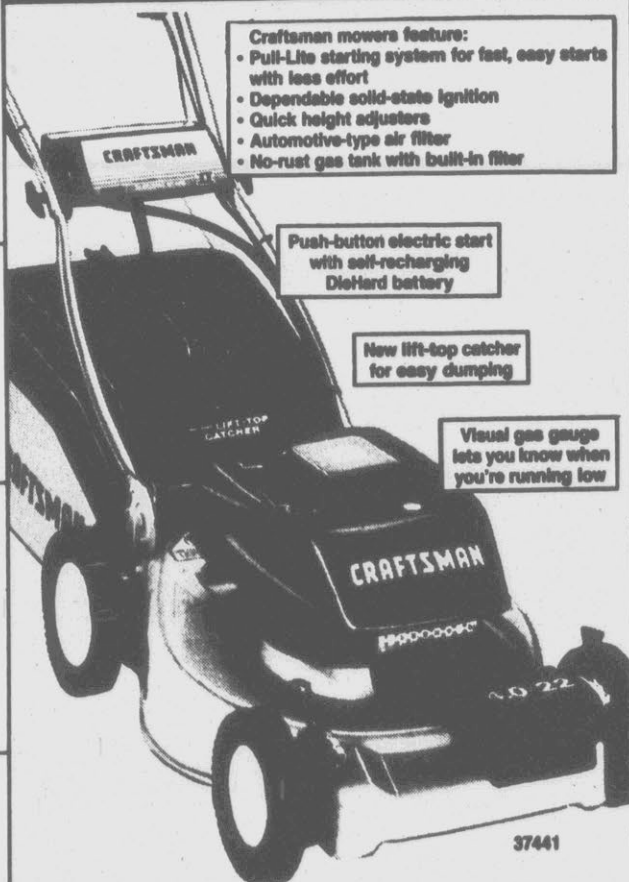

Craftsman mowers feature:

- Pull-Lite starting system for fast, easy starts with less effort
- Dependable solid-state ignition
- Quick height adjusters
- Automotive-type air filter
- No-rust gas tank with built-in filter

Push-button electric start with self-recharging DieHard battery

New lift-top catcher for easy dumping

Visual gas gauge lets you know when you're running low

37441

449⁹⁹ Reg. \$499.99
\$50 OFF 4.0-RP power propelled mower

Sears Best rear bagger has all the deluxe features that you're looking for. Maneuverable front wheel gear drive. Cast iron cylinder liner for long engine life. Wide range quick height set adjusts from 1 to 4 inches. 3 walking speeds. 22-inch cut.

2-yr. warranty*

*Limited warranty for period specified. See store for details.
 RP means reserve power



12410

6101/2

SAVE 2-4!

Garbarg can, 32-gal.
 Permanex®, Reg. \$8.99..... **4.99**
Trash bags, reg. \$4.99.2.99

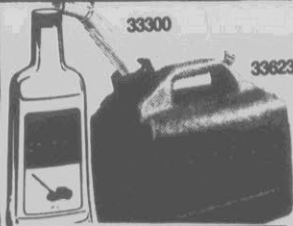

33300

33623

SAVE 50-74!

Gas can, 2½-gal. Reg. \$8.99..... **4.99**
Power mower oil,
 20-oz. Reg. \$1.49 **99¢**



33301/02

SAVE 5!

Chute deflector

Clippings chute deflector for rear-bag mowers. 20,22-in. Reg. \$14.99 **9⁹⁹**



33071/77

SAVE 5!

Grass catcher

Cloth grass catcher for side-discharge mowers. Reg. \$24.99 **19⁸⁸**

**SAVE UP
TO \$40!**

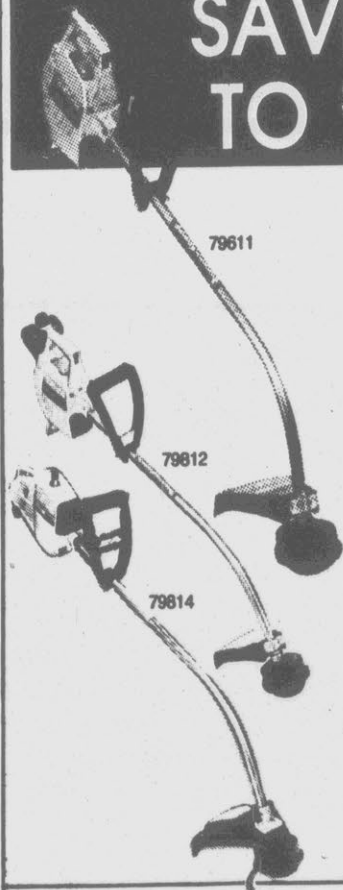

89⁸⁸
Reg. \$99.99

**\$5 OFF Gas
Weedwacker®**
22.2-cc line trimmer. 14-in.
cutting swath. Solid-state igni-
tion.

109⁸⁸
Reg. \$129.99

**\$20 OFF Gas
Weedwacker®**
26.2-cc line trimmer. 14-in.
cutting swath. Solid-state. 15-
in. cut.

159⁸⁸
Reg. \$199.99

**\$40 OFF Gas
Weedwacker®**
28.0 cc line trimmer. 18-in. cut-
ting swath. Uses .080 dia-
meter line.

**SAVE UP
TO \$35!**

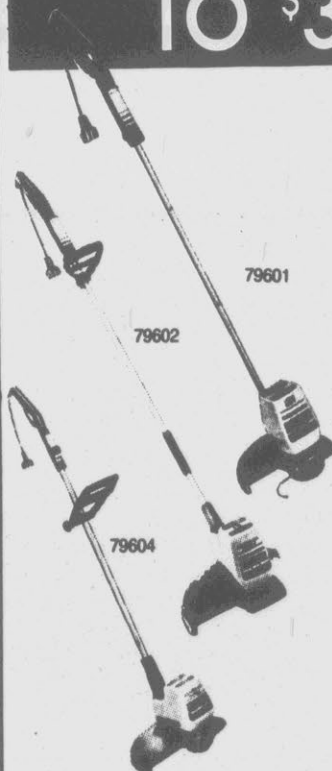

24⁸⁸

**VALUE! Electric
Weedwacker®**
1/5-HP, 10-in. cutting swath.
Semi-auto line feed. Uses
.051 diameter nylon line.

34⁸⁸

**\$15 OFF Electric
Weedwacker®**
1/4-HP, 13-in. cutting swath.
Semi-auto line feed.

54⁸⁸

**\$35 OFF Electric
Weedwacker®**
3/4-HP line trimmer with Power
Miser switch. 10-position adj.
handle. 17-in. cut.

SAVE \$2-\$5 Craftsman tools!

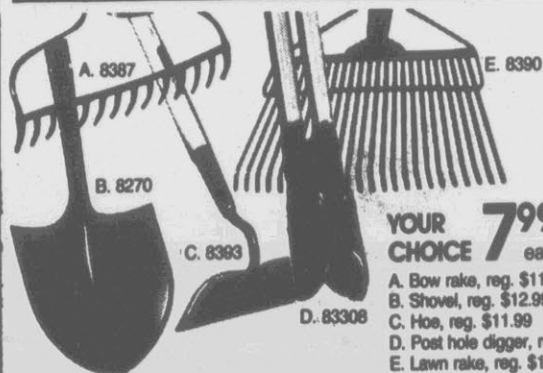

**YOUR
CHOICE 7⁹⁹** each

- A. Bow rake, reg. \$11.99
- B. Shovel, reg. \$12.99
- C. Hoe, reg. \$11.99
- D. Post hole digger, reg. \$9.99
- E. Lawn rake, reg. \$11.99

THESE TOOLS ARE WARRANTED FOREVER!
If any Craftsman hand tool ever fails to give complete
satisfaction, return it for a free replacement.



SAVE \$13!

26⁸⁸
Reg. \$39.99
**Craftsman 4-cu.
ft. wheelbarrow**

Contractor's type. Seam-
less tray. 14x4-in. tire.

**SAVE UP
TO \$70!**

59⁹⁸ Reg. separate
prices \$129.98

**\$70 OFF Electric
blower/vac**
1-HP blower with versa-tile vac
attachment.

99⁹⁹ Reg. \$129.99

**\$30 OFF Gas
blower**
Lightweight, powerful.

129⁹⁹ Reg. \$179.99

**\$50 OFF Gas
blower**
28.0-cc solid-state engine.
Powerful!

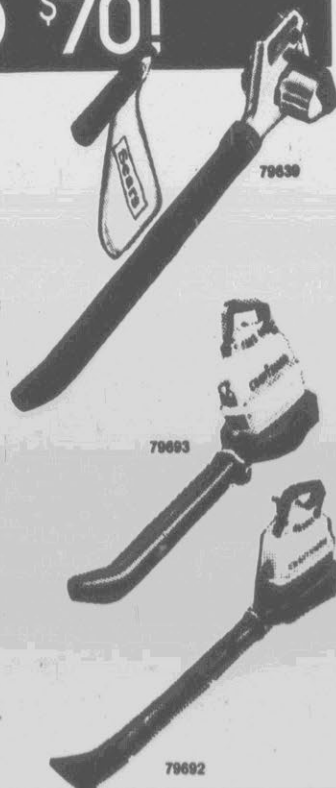

SAVE \$100-\$200

Craftsman tillers!

29813

SAVE \$100
3-HP front-tine

Reg. \$379.99

279⁹⁹

Solid-state ignition, dual chain drive. 11, 15 and 17-in. path widths.

29814

SAVE \$120
5-HP front-tine

Reg. \$449.99

329⁹⁹

Efficient dual-chain drive. Dependable solid-state ignition. 12, 22 and 24-in. path widths.

29861

SAVE \$100
5-HP front-tine

Reg. \$499.99

399⁹⁹

Heavy-duty model with 3-chain drive. Has power reverse.

29923

SAVE \$200
3½-HP rear-tine

Reg. \$699.99

499⁹⁹

Dual-chain drive, power reverse, counter rotating tines for more efficient tilling.

29925

SAVE \$200
5-HP rear-tine

Reg. \$799.99

599⁹⁹

Efficient dual-chain drive, power reverse. 17-in. tine path width. Counter rotating tines.

All tiller require some assembly, extra.

SAVE \$20-\$40

Kenmore gas grills!

10161

SAVE \$20
22,000 Btuh/Hr.

99⁹⁹

Reg. \$119.99

225-sq. in. total cooking area. Chrome grid, dual up-front controls. 1 wood side shelf, 1 steel bottom shelf.

10361

SAVE \$40
24,000 Btuh/Hr.

149⁹⁹

Reg. \$189.99

399-sq. in. total cooking area. 2-pc. porcelain grid, 2 wood side shelves, 1 steel bottom shelf.

10461

SAVE \$50
32,000 Btuh/Hr.

169⁹⁹

Reg. \$219.99

399-sq. in. total cooking area. 2-pc. porcelain grid. Match-free ignition, dual up-front controls. 2 side, 1 front, 1 bottom shelf, all wood. See-thru window in hood.

10871

SAVE \$20
44,000 Btuh/Hr.

299⁹⁹

Reg. \$319.99

667-sq. in. total cooking area. Match-free ignition see-thru window in lid, fold-down front shelf. Heat indicator, fuel indicator. More.

All grills come unassembled.

SAVE \$100-\$200

Kenmore air conditioners!



PRE-SEASON SALE

SAVE \$100 6,000 Btuh/Hr. small capacity room size model. 3-speed fan. Reg. \$399.99 **299⁹⁹**

SAVE \$100 14,000 Btuh/Hr. cools 795-sq. ft. 3-speed fan, 4-way air flow. Reg. \$699.99 **599⁹⁹**

SAVE \$200 21,000 Btuh/Hr. cools 1345-sq. ft. 3-speed fan, 4-way air flow. Reg. \$899.99 **699⁹⁹**



SAVE \$5 turbine ventilator
12-in. diameter.
Adj. pitch base. **24⁹⁹**
Reg. \$29.99



SAVE \$40 whole-house fan
30-in. motor with variable speed. **149⁹⁹**
Reg. \$189.99

SAVE \$20!
Ceiling fan
59⁸⁸
Reg. \$79.99
4-speeds, 52-in. with reversing switch. Brass, ant. brass.

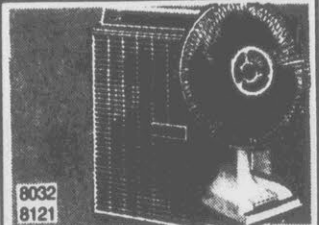

SAVE \$3-\$8 box or oscillating fan
12-in., 3-speed oscillating, reg. \$29.99
20-in. boxfan, reg. \$34.99 **26⁹⁹**
YOUR CHOICE

SAVE \$10-\$70!



A. SAVE \$40 1/3-HP
Quick-mount collar, jam resistant. Reg. \$59.99 **49⁹⁹**

B. SAVE \$40 1/2-HP
Resists corrosion, jam resistant. Reg. \$129.99 **89⁹⁹**

C. SAVE \$70 3/4-HP
Heavy-duty model. Auto reverse action. Reg. \$199.99 **129⁹⁹**

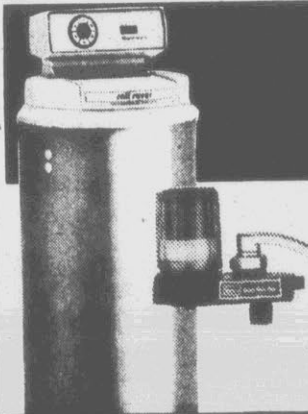

20% OFF!

ALL WATER SOFTENERS AND FILTERS NOW ON SALE!

Help increase cleaning power and protect water appliances with a Kenmore water softener.

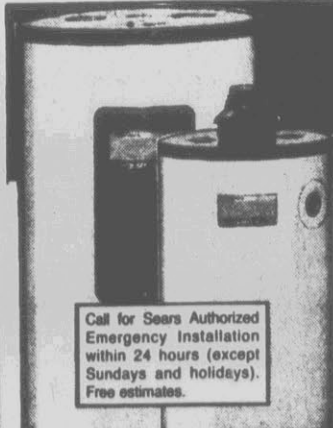

15% OFF

ALL WATER HEATERS IN STOCK NOW ON SALE!

Choose from gas or electric, standard, low-boys, table-tops, more!

Call for Sears Authorized Emergency Installation within 24 hours (except Sundays and holidays). Free estimates.

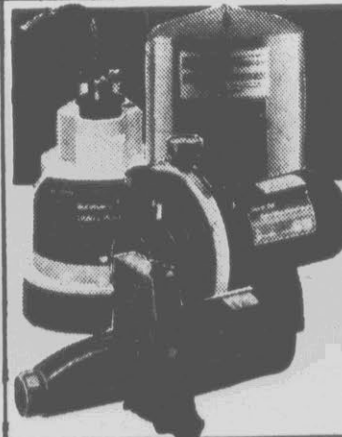

10% OFF!

ALL PUMPS IN STOCK NOW ON SALE!

Choose from well pumps, specialty pumps and captive air tanks!

Each of these advertised items is readily available for sale as advertised.

YOUR CHOICE... **29⁹⁹**

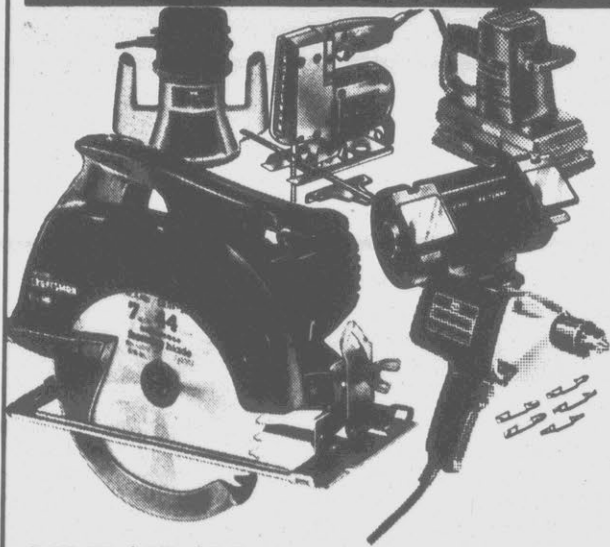

SAVE \$10-\$35 on these Craftsman portable power tools!

- Reg. \$59.99 7-in., 1½-HP circular saw. Trigger switch.
- Reg. \$49.99 ¾-HP light-duty router. Uses ¼-in. shank bits.
- Reg. \$59.99 ¼-HP variable speed sabre saw. Locking switch.
- Reg. \$59.99 ¾-HP dual motion pad sander. 4,000 orbits/strokes.
- Reg. \$39.99 5-in., 2-wheel grinder. Permanent magnet motor.
- \$64.98* ½-HP VSR drill. Includes 4-pc. drill bit set.

*Reg. separate prices total

YOUR CHOICE... **59⁹⁹**



SAVE \$10-\$60 on these Craftsman portable power tools!

- \$109.98* 1-HP belt sander with case. Auto belt tracking.
- \$119.98* 1½-HP heavy-duty router with Permanex® case.
- \$119.98* 7¼-in., 2¼-HP circular saw with case.
- Reg. \$69.99 9-in. buffer/polisher. Random orbital motion.
- \$99.98* ½-HP variable speed sabre saw with carry case.
- Reg. \$109.99 ½-HP variable speed grinder. 6x¼-in. wheels.

Not shown: \$94.99* ½-in. electronic drill. ¾-HP motor.

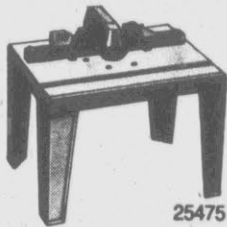

25475

SAVE \$10!

Router table

Reg. \$39.99
Aluminum top, structural foam legs and fences.
Hinged guard.

29⁹⁹

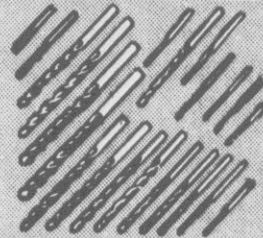

67020

SAVE OVER 50%!

Drill bit set

*Reg. separate prices \$40.38
Craftsman high-speed drill bits in 22 sizes.

19⁹⁹

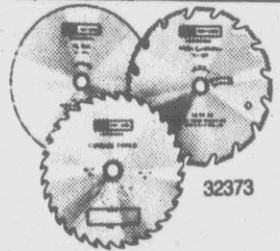

32373

SAVE \$7!

Saw blade pack

Reg. separate prices \$26.97
3-pc. Craftsman saw blade kit. For 7¼-in. circular saws.

19⁹⁹



25654

SAVE \$5!

Screwdriver bit set

Reg. \$24.99
30-pc. set contains most common sizes.

19⁹⁹

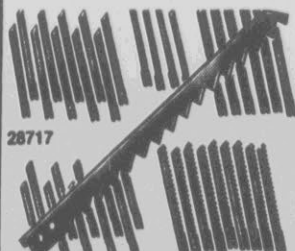

28717

SAVE OVER 50%!

Sabre saw blades

*Reg. separate prices \$47.80
40 high carbon steel blades. Fits most sabre scroll saws.

19⁹⁹

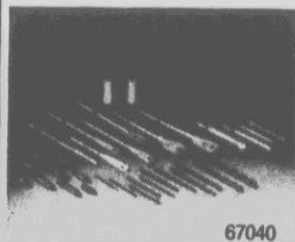

67040

SAVE \$20!

Drill bit set

*Reg. separate prices \$50.56
Versatile Craftsman 40-pc. drill bit set. Masonry, woodboring, more.

29⁹⁹

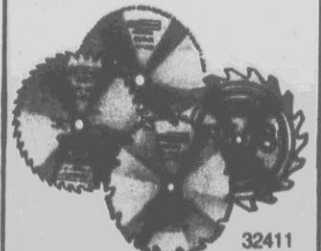

32411

SAVE \$18!

Saw blade pack

Reg. separate prices \$47.96
4-pc. set Craftsman circular saw blades. Fits 7¼-in. saw.

29⁹⁹

YOUR CHOICE... **399⁹⁹**

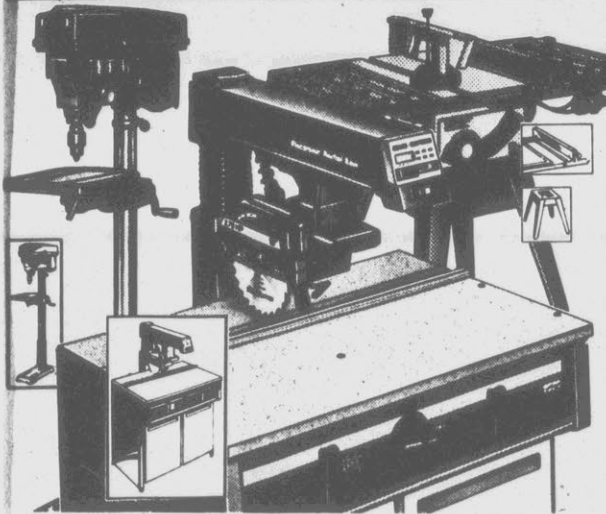

SAVE \$100-\$200 on these Craftsman power bench tools!

Reg. \$499.99 10-in. radial arm saw with maximum 2 $\frac{1}{4$ -HP motor has 44x27-in. worktable and full storage shelf, 2 doors.
 Reg. \$599.99 17-in. Craftsman heavy-duty drill press outfit boasts 16-speeds and a hefty $\frac{3}{4}$ -HP motor.
 Reg. \$599.99 10-in. flex drive Craftsman table saw has 44x27-in. work surface. Includes 2 $\frac{1}{2$ -HP motor, leg stand, more.
 Bench power tools require some assembly, extra.

INCLUDES TWO 3-FUNCTION TRANSMITTERS

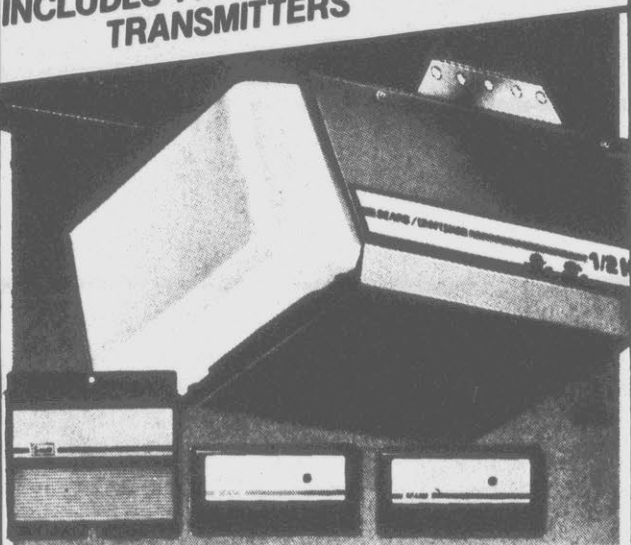

SPECIAL PURCHASE!
Craftsman garage door opener

Extra security is what you get with this dependable cable/chain drive garage door opener. Powerful $\frac{1}{2}$ -HP motor, wall mount indoor control, two 3-function transmitters.

159⁸⁸
 While quantities last!

Ask about Sears Authorized Installation

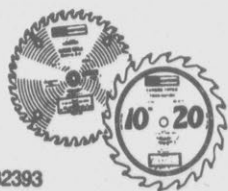

32393

SAVE OVER 50%!*

Saw blade pack

*Reg. separate prices \$74.98
29⁹⁹
 Rugged 2-pc. Craftsman saw blade set. Fits 10-in. table saws.

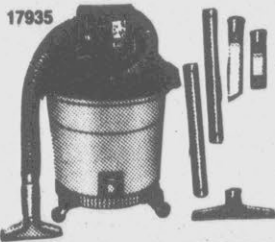

17935

SAVE \$85!

Craftsman wet/dry vac

Reg. separate prices \$184.95
99⁹⁹
 2-HP vac has 16-gal. tank. Includes accessories.

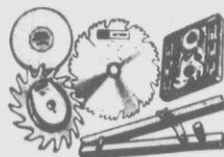

32773/6

SAVE \$20!

Saw accessory kit

Reg. \$99.99
79⁹⁹
 Table saw or radial arm saw accessory kit. Craftsman.

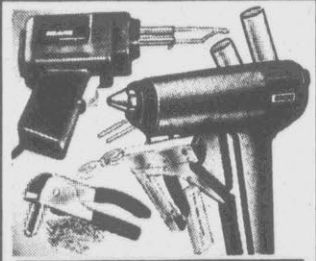

SAVE \$5-\$6!

\$14.99 100-watt soldering gun, extra tip.
 • Solid-state glue gun, 2 glue sticks
 \$16.98* heavy-duty riveter with rivets.
 \$16.58* chrome-plated stapler with staples.
 *Reg. separate prices

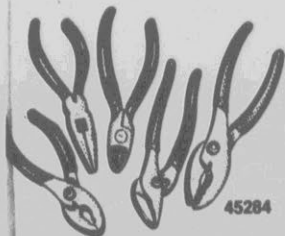

45284

SAVE OVER 50%!*

Craftsman plier set

*Reg. separate prices \$44.95
19⁹⁹
 5-pc. Craftsman pliers set includes long-nose, slip-joint pliers, more.



17834

SAVE \$10!

Craftsman cordless vac

Reg. \$39.99
29⁹⁹
 Recharges when not in use. For wet and dry spills.



15563

SAVE \$100!

Craftsman air compressor

Reg. \$649.99
549⁹⁹
 3-HP compressor with large 20-gal. air tank. Includes 15-ft. air hose.



15665

SAVE \$100!

Craftsman air compressor

Reg. \$749.99
649⁹⁹
 5-HP compressor with a giant 30-gal. air tank. Includes 15-ft. air hose.

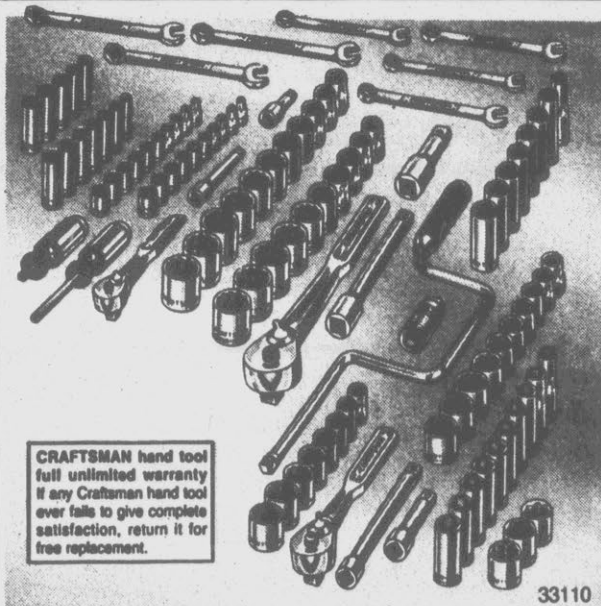

CRAFTSMAN hand tool full unlimited warranty
If any Craftsman hand tool ever fails to give complete satisfaction, return it for free replacement.

33110

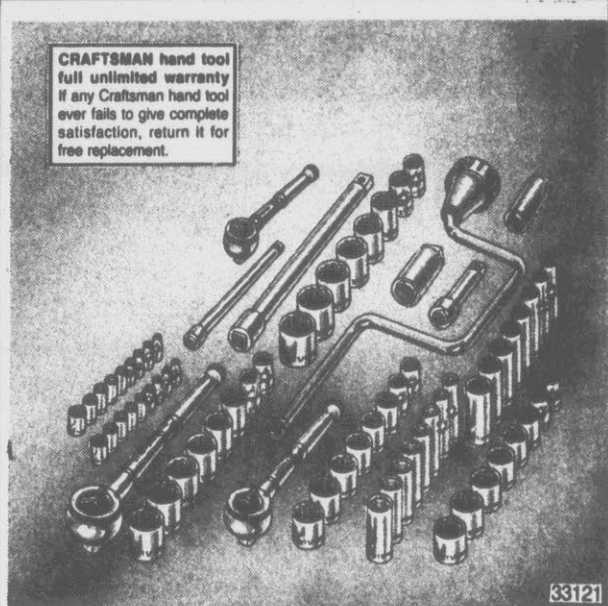

CRAFTSMAN hand tool full unlimited warranty
If any Craftsman hand tool ever fails to give complete satisfaction, return it for free replacement.

33121

SAVE OVER 50%!*

Craftsman's 112-piece mechanics' hand tool set

At this price the set comes to less than \$1 per tool!
Includes 1/4, 3/8 and 1/2-in. drive tools, regular and deep sockets in standard, metric. More.
99⁹⁹

*Savings based on regular separate prices in '86-'87 Tool Specialog

SAVE OVER 50%!*

Craftsman's 75-piece mechanics' hand tool set

Even at this low price you get famous Craftsman quality and dependability! 1/4, 3/8 and 1/2-in. drive tools, regular and deep sockets, more!
59⁹⁹

*Savings based on regular separate prices in '86-'87 Tool Specialog



65008

SAVE \$8!

Craftsman tool box

\$27.99 in '86-'87 Tool Specialog
19⁹⁹
Holds tools up to 17-in. long. Includes plastic tool shuttle.



65338

SAVE \$20!

Craftsman tool chest

\$59.99 in '86-'87 Tool Specialog
39⁹⁹
3 full-length locking drawers provide 1403-sq. in. storage space.

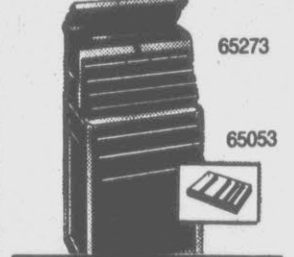

65273

65053

SAVE \$170 WHEN YOU BUY BOTH!

Tool chest and cabinet

BUY BOTH FOR.....239⁹⁸
\$179.99* 6-dr. chest119.99
\$189.99* 3-dr. cabinet119.99
*Reg. separate prices

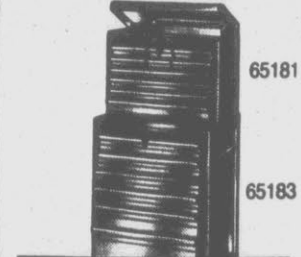

65181

65183

SAVE \$140 WHEN YOU BUY BOTH!

Tool chest and cabinet 10

BUY BOTH FOR.....299⁹⁸
\$222* 10-dr. chest139.99
\$219.99* 6-dr. cabinet159.99
*Reg. separate prices

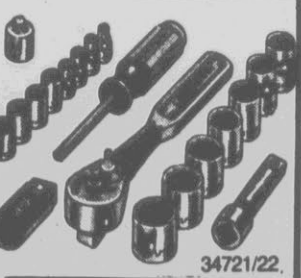

34721/22

SAVE OVER 50%!*

Socket wrench set

*Reg. separate prices \$92.90
19⁹⁹
Craftsman 20-pc. 1/4 and 3/8-in. drive socket wrench set. STD or MET.



41063

SAVE OVER 50%!*

Screwdriver set

*Reg. separate prices \$57.24
19⁹⁹
Craftsman 16-pc. screwdriver set. Includes slotted, Phillips, more.

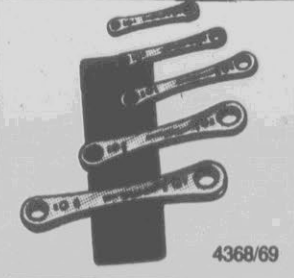

4368/69

SAVE \$5!

Craftsman wrench set

Reg. \$24.99
19⁹⁹
Craftsman 5-piece ratcheting box-end set in standard or metric.



4971/72

SAVE OVER 50%!*

Craftsman wrench set

*Reg. separate prices \$74.88
19⁹⁹
Craftsman 12-piece combination wrench set. Standard or metric.



30005R

SAVE \$8!

Weatherbeater 10-flat exterior latex paint

Provides easy one-coat coverage in a variety of 40-rich colors! Dries to a washable finish that resists cracking, peeling, mildew and color-fading. Reg. \$17.99

9⁹⁹
GAL.



92005R
92955

SAVE \$8!

Easy Living 10-satin flat interior latex paint

Colorful decorator delights are available in Easy Living 10-satin flat! Cleans up easy with soap and water. Fast drying, excellent leveling. Reg. \$17.99.

9⁹⁹
GAL.



20505

BIG BUY!

Exterior latex paint

SEARS LOW PRICE
Acrylic latex paint goes on smooth. Soap, water clean-up.

4⁹⁹
GAL.

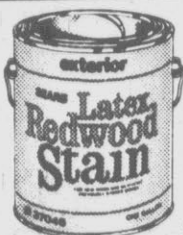

37045

SAVE \$2!

Latex redwood stain

Reg. \$5.99
Covers new wood and also weathered or previously stained finished wood.

3⁹⁹
GAL.



80855

VALUE!

Interior wall paint

SEARS LOW PRICE
Choice of pastels and white. Acrylic latex flat finish, for ceilings too.

3⁹⁹
GAL.



76005R

SAVE \$8!

Easy Living 10-semi gloss

Reg. \$19.99
Comes in 50 decorator colors. Scrubbable finish. 10-yr. warr.

11⁹⁹
GAL.



35005

SAVE \$7!

Weatherbeater 10-semi gloss

Reg. \$19.99
Available in a rainbow of colors. One-coat coverage. 10-yr. warr.

12⁹⁹
GAL.

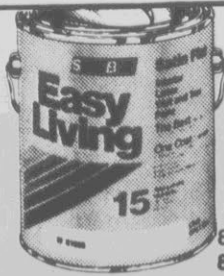

81005
81955

SAVE \$8!

Easy Living 15-satin flat

Reg. \$22.99
200 one-coat decorator colors. Stain resistant. Also bright white ceiling.

14⁹⁹
GAL.



81005
81955

SAVE \$8!

Easy Living 15-semi gloss

Reg. \$24.99
200 one-coat decorator colors. Soap, water clean-up. Scrubbable. 15-yr. warr.

16⁹⁹
GAL.



93340
93840

GREAT BUY!

Sears laundry detergents

YOUR CHOICE
Choose concentrated 1/2-cup formula or triple action with fabric softener.

19⁹⁹



SHOP AND COMPARE

**SAVE
20%**

**There's no better
Replacement
value than Sears
vinyl windows**

It's the most maintenance-free window we sell. No painting ever. Won't pit or corrode! Double-hung windows tilt in for safe and easy cleaning. Self-storing screens included. Installation by Sears Authorized installers.

**SAVE
\$40**



**Insulating
storm doors**

Reg. \$169.99

139⁹⁹

Choice of 3 styles, with baked enamel finish and thick weather-stripping on sturdy aluminum frames.

**LOWEST PRICE
OF THE YEAR**

**25%
OFF**



**Storm
Windows**

**INSTALLED
BY SEARS**

Create an insulating barrier with sturdy aluminum frame insulated and weather-stripped windows. Choice of finished, with screens.

40% OFF

FABRIC WHEN YOU PURCHASE TOP RAIL POSTS & GATES INSTALLED AT REGULAR PRICE

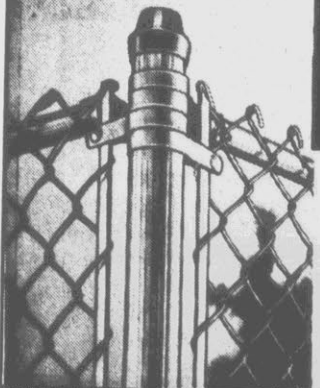

**When you buy this
chain link fence at
our regular low prices**

11-gauge fencing fabric installed on ArmadilloV line posts, rails, end posts and gates...all ribbed for added strength. 50% more zinc than applied by leading manufacturer.

**15%
OFF**



**Stockade or
posted rail
wood fence
INSTALLED**

Classical style for privacy and protection, plus good looks! Can be stained or painted, or you can just let it weather. Installation by Sears Authorized Installers.

**SAVE
\$150**

**Kenmore Premium
Air Conditioning**

18,100-Btuh, Reg. \$799.00

\$649

Economical central system could cut your cooling costs by 30%. Great replacement system, with 5-year warranty. See store for details. Installation available, extra.

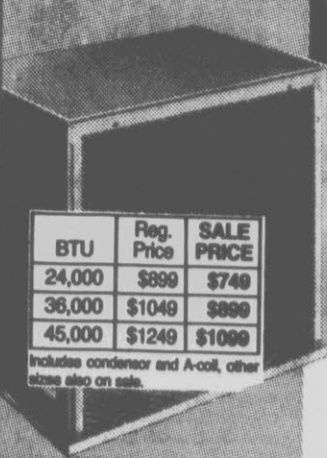

BTU	Reg. Price	SALE PRICE
24,000	\$899	\$749
36,000	\$1049	\$899
45,000	\$1249	\$1099

Includes condenser and A-coil, other sizes also on sale.

**SAVE
\$150**

**Split System
heat pump**

Reg. \$1599.00

\$1449

A cost-effective replacement for your old heating and cooling systems. 20,500-Btuh heating, 19,700 btuh cooling. Call for FREE Home Estimate.

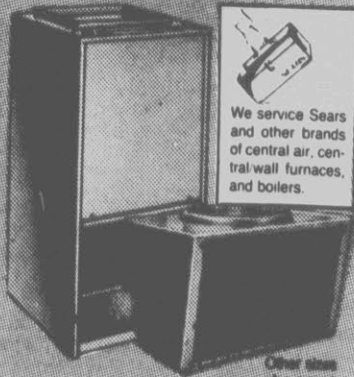

We service Sears and other brands of central air, central-wall furnaces, and boilers.

Other items also on sale

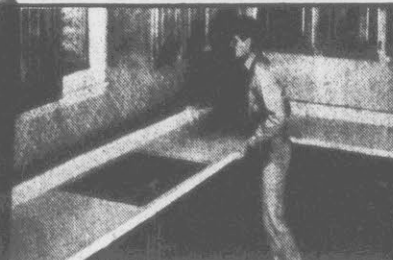

20% OFF Installed Custom-made countertops

Let us create a beautiful, durable work surface in your choice of many colors and textures.



SAVE 40%

Wood kitchen cabinets

So many ways to revamp your kitchen—from the rich traditional look of solid wood to the sleek elegance of laminates. Sears offers FREE professional planning to assist you with creative design ideas for redecorating on a budget. Come to Sears for everything to make your kitchen beautiful—and depend on our Authorized Installers to get it installed right!

CALL SEARS FOR YOUR FREE HOME ESTIMATE!



Authorized Installers
TRUST SEARS TO GET IT INSTALLED RIGHT!
Free Estimates



20% OFF

Steel Entry Doors

Looks like wood! Fully-insulated and weather-stripped heavy gauge steel in many styles. Available with deadbolt and key locks. Sears authorized installation available.

Some samples available at greater savings (not in all stores)

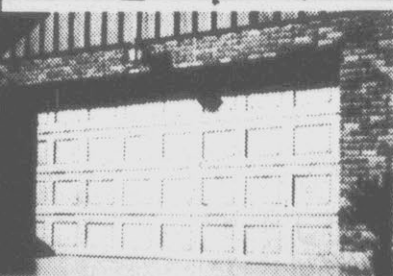

15% OFF INSTALLED wood garage doors

Styles that compliment your home and your budget. Sturdy and long-lasting construction in single or double door models. Installation includes hardware.

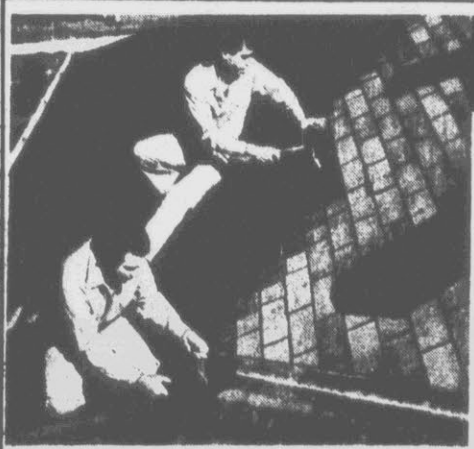

15% OFF

Sears "30" glass fiber roofing shingles

When Sears arranges installation Fiber mat shingles covered with asphalt and ceramic granules in a choice of colors. Sun-activated self-adhesive tabs, UL Class A fire resistant. 30-year pro-rated warranty.



20% OFF

INSTALLED Security storm doors

Handsome doors have steel protective frame and bars plus tempered glass and screen. Choice of styles in black finish. Can be custom-made to your measurements.



FREE ESTIMATES ON VINYL OR ALUMINUM SIDING



20% OFF

Aluminum overhang and trim

Save when Sears authorized professional install low-maintenance enameled trim. Ends need for frequent painting. For siding or brick homes.

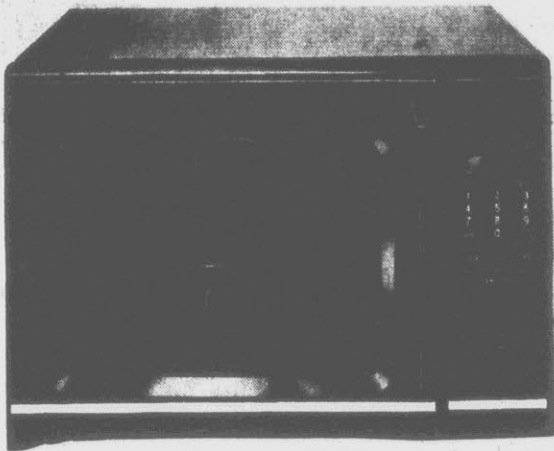

87448

SAVE \$160!

KENMORE 1.4 CU. FT. MICROWAVE

Regular \$459.99

- 5 stage memory
- 80 recipes • 12 hour delay to start
- Probe for temperature cooking • whole-meal cooking • 750 watts

299⁹⁸



87425

SAVE \$120!

KENMORE 0.8 CU. FT. MICROWAVE

Regular \$319.99

- 650 watts • Two stage memory
- 100 minute delay start
- Electronic digital display • 100 minute timer • mount under cabinet or on wall

199⁹⁸

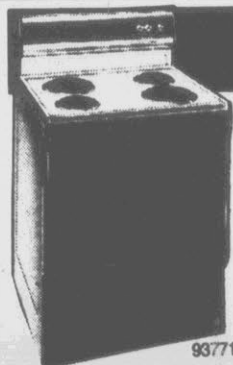

93771

\$190 OFF!

KENMORE SELF-CLEANING OVER

499⁹⁸ Regular \$689.99

- 30-inch model
- Automatic oven
- Black glass door

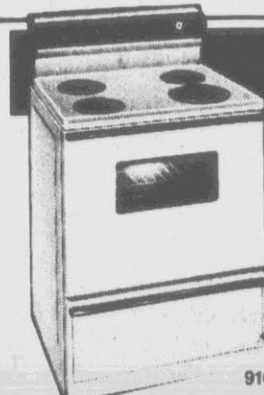

91671

\$110 OFF!

KENMORE ELECTRIC RANGE

359⁹⁸ Regular \$469.99

- 30-inch model
- Visi-lock oven door
- Storage drawer



42158

SAVE \$70!

KENMORE BUILT-IN WALL OVEN

379⁹⁸ Reg. \$449.99

- Visi-bake oven door
- Has clock/timer

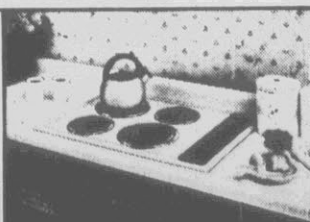

43463R

BIG BUY!

KENMORE BUILT-IN COOKTOP

179⁹⁵

- Convenient slide control
- 4 heating elements

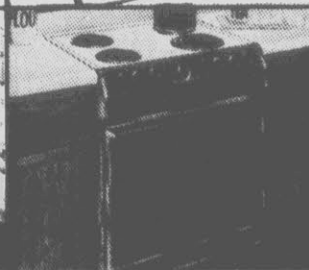

45261

VALUE!

KENMORE DROP-IN ELECTRIC RANGE

399⁹⁵

- Black glass oven door
- 4 elements • Clock/timer

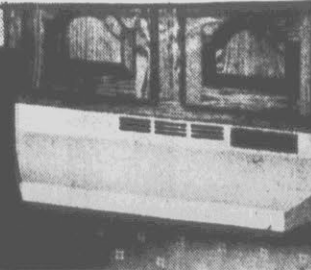

51001

FANTASTIC BUY!

KENMORE OVERHEAD RANGE HOOD

29⁹⁹

- Has electric fan and light.

Each of these advertised items is readily available for sale as advertised.

Installation on built-ins, extra

YOU SAVE \$230!

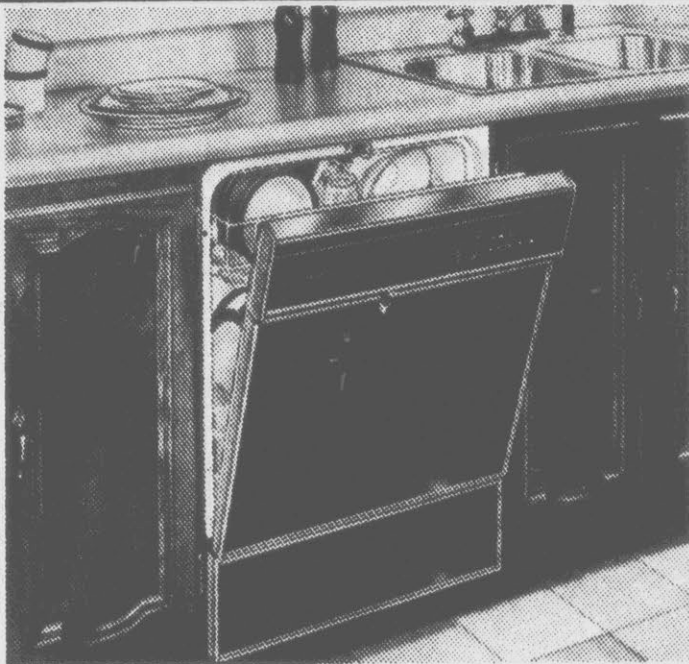

14875

KENMORE PREMIUM ELECTRONIC DISHWASHER

399⁹⁸

Reg. \$629.99

- Features 18 cycle/option combinations
- Water heat option
- Water Miser cycle

Professional installation available for dishwashers and compactors, extra.



\$40 OFF

KENMORE 24-IN. DISHWASHER

259⁹⁸

Regular \$299.99

- Lightwash plus rinse hold
- Power Miser option to help save energy

15175

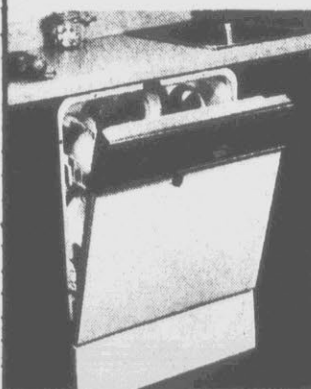

BIG VALUE!

OUR LOWEST PRICED DISHWASHER

\$229

- Power Miser control uses 1/3 the electrical energy of normal cycle

15071

SAVE \$120!

KENMORE BUILT-IN COMPACTOR

229⁹⁸

Regular \$349.99

- Safety key lock start/stop switch
- 1/2 HP motor
- Automatic contain lock

13365



SAVE \$150!

SEARS BEST COMPACTOR

249⁹⁸

Regular \$399.99

- Get rid of that unsightly kitchen waste basket.
- Built-in deodorizer

13065



Each of these advertised items is readily available for sale as advertised

**\$240
OFF**

WHEN YOU
BUY BOTH!

**LARGE-CAPACITY
8-CYCLE WASHER**

359⁹⁸

Regular \$489.99
•Dual-Action™ agitator to get
clothes really clean •Self-
cleaning lint filter •3 water
levels

**LARGE-CAPACITY
FABRIC MASTER
DRYER**

279⁹⁸

Regular \$389.99
•Automatically shuts dryer off
at dryness level selected
•End-of-cycle signal

All Washer and Dryer
installation is extra

Dryers require
connector, extra

16641
66631

\$80 OFF!

ON THIS ECONOMICAL
KENMORE LAUNDRY PAIR

KENMORE 6-CYCLE WASHER

299⁹⁸ LARGE-CAPACITY

Regular \$349.99
•3 pre-set water temperatures
•2 water levels •Heavy-duty motor

KENMORE ELECTRIC DRYER

249⁹⁸ LARGE-CAPACITY

Regular \$279.99
•2 temperature controls •Top-mounted
lint screen •Air-only option

16211/66211

Each of these advertised items is readily available for sale as advertised

SAVE \$190!

ICEMAKER CONVENIENCE! KENMORE REFRIGERATOR

559⁹⁸

Regular
\$749.99

- 16.3 cu. ft. capacity
- Frostless, no more messy defrosting chores
- Power Miser to help save energy
- Twin crispers and 3 full-width adjustable shelves
- Icemaker hook-up to water, extra



67631/8440

\$90 OFF!

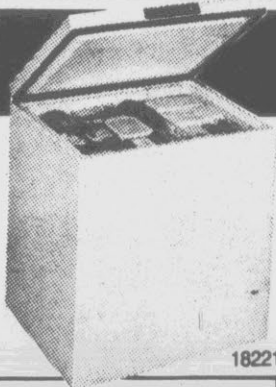

**KENMORE 12.0
CU. FT. CHEST
FREEZER**

299⁹⁸

Reg. \$389.99

- Has lift-out basket
- Power signal lights
- Adjustable cold control

18221

66111



VALUE!

**KENMORE 11.0 CU. FT.
REFRIGERATOR**

\$299

2 cantilevered half shelves. 4 door shelves.

\$100 OFF!



**KENMORE 11.0
CU. FT. UPRIGHT
FREEZER**

299⁹⁸

Reg. \$399.99

- 3 interior shelves
- Bottom storage trivet
- Magnetic door gasket

26221

16058



COMPACT!

**KENMORE 5.1 CU. FT.
CHEST FREEZER**

\$199

Has adjustable cold control. Magnetic gasket.

66501



BIG BUY!

**KENMORE 15.1 CU. FT.
REFRIGERATOR**

\$399

Wide crisper, 2 full-width adjustable shelves.

26168

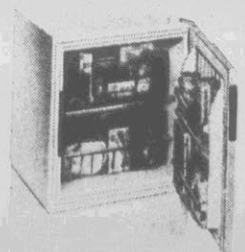

COMPACT!

**KENMORE 6.0 CU. FT.
UPRIGHT FREEZER**

259⁹⁹

Has basket and 2 door shelves.

Each of these advertised items is readily available for sale as advertised.



\$80 OFF!

**REMOTE CONTROL
TABLETOP COLOR TV**

42151

369⁹⁹

Reg. \$449.99

- 19-inch diag. meas. picture
- 19-key remote control
- On-screen display •Quartz tuning
- Stereo adapter jack

\$50 OFF!

14-DAY/2 PROGRAM VHS/VCR

299⁹⁹

Regular \$349.99

- 9-function wireless remote control
- High quality picture •82-channel tuning
- 2 Head design.

Simulated TV reception on all sets shown

53292



40451

SAVE \$50

**PERSONAL-SIZE
COLOR TV**

229

Reg. \$279.99

- 13-in. diag. meas. picture
- 5-key remote control
- Electronic tuning •Super Chronix black matrix picture tube

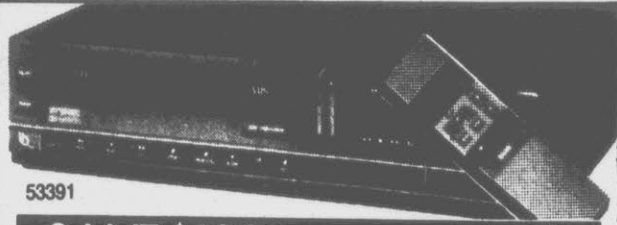

53391

SAVE \$120!

14-DAY/4 PROGRAM VHS/VCR, STEREO!

- 107 channel tuning •25-cunition wireless remote
- Dolby® stereo play and record •HQ picture

379⁹⁹

Reg. \$499.99



48011

SAVE \$50!

**REMOTE CONTROL
CONSOLE COLOR TV**

449⁹⁹

Reg. \$499.99

- 25-in. diag. meas. screen
- 3 button remote control
- One button color

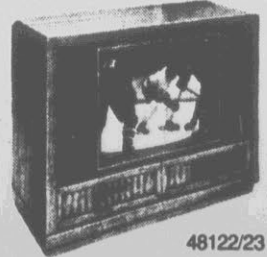

48122/23

SAVE \$100!

**STEREO! REMOTE
CONTROL CONSOLE**

599⁹⁹

Reg. \$679.99

- 25-in. diag. meas. screen
- 18-button remote •One-button color.

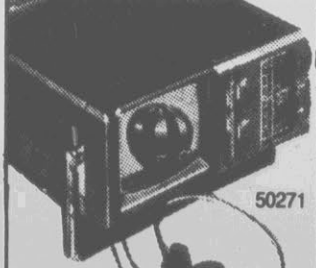

50271

SAVE \$20!

**BLACK/WHITE
"GO-ANYWHERE" TV**

79⁹⁹

Reg. \$99.99

- AM/FM/FM stereo radio
- 5-in. diag. meas. picture
- With earphones

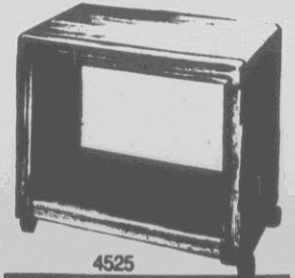

4525

SAVE \$10!

**BEAUTIFUL TV/VCR
STAND ON CASTERS**

69⁹⁹

Reg. \$79.99

- 2 shelves •Open storage area
- Easy-roll casters

Each of these advertised items is readily available for sale as advertised

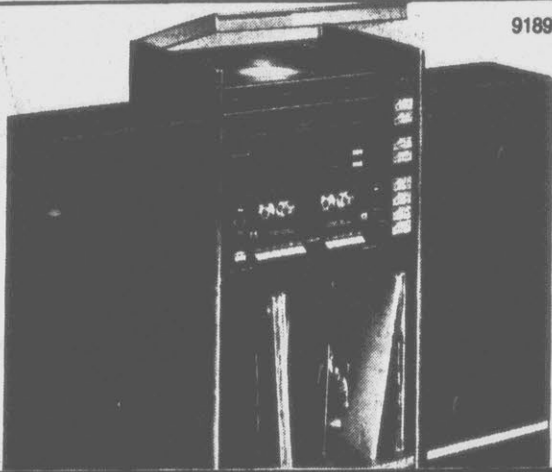

91898

SAVE \$80

20-WATT RACK STEREO SYSTEM

219⁹⁹

Reg. \$299.99

•AM/FM stereo with digital green LED display •5-band graphic equalizer
•High speed synchronous dual cassette •Turntable and 2 speakers.

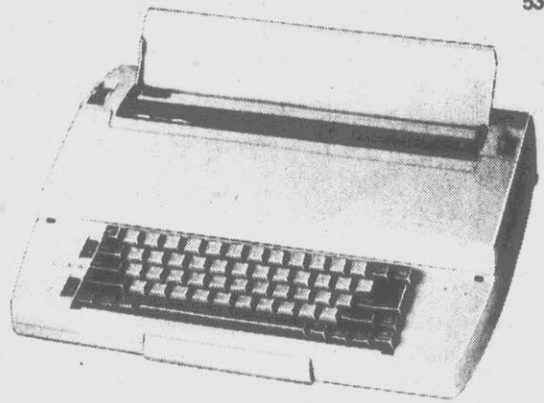

53025

SAVE \$80!

ELECTRONIC TYPEWRITER

219⁹⁹

Regular \$299.99

Full-line lift-off correction memory, daisy-wheel printing system, auto centering. Not available in Ashland.



\$60 OFF

STEREO RACK SYSTEM

169⁹⁹

Reg. \$229.99

•AM/FM stereo
•Dual cassette tapes
•Belt drive turntable
•2 speakers and storage rack

91863



\$20 OFF!

SEARS 20-NUMBER MEMORY PHONE

29⁹⁹

Reg. \$49.99

•Last number redial
•Pause function
•Full modular
•Desk or wall mountable

34751



21363

SAVE \$20!

AM/FM STEREO WITH DUAL CASSETTES

79⁹⁹

Reg. \$99.99

•Detachable speakers •FM stereo
LED •Carrying handle

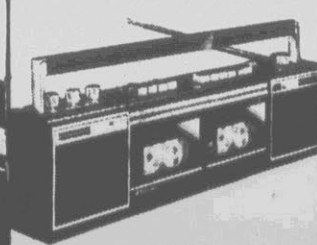

21442

SAVE \$10!

AM/FM STEREO WITH DUAL CASSETTES

59⁹⁹

Reg. \$69.99

•Dual cassettes for high speed dubbing •AC cord included.

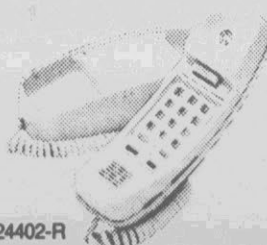

24402-R

SAVE \$15!

AT & T® TRIMLINE 100 TELEPHONE

44⁹⁹

Reg. \$60.99

•Mute •Last number redial •Desk/wall convertible

Typewriter, phones are not available in Ashland.



60101-R

SAVE \$30!

22-INCH, 2-DRAWER STEEL FILE CABINET

49⁹⁹

Reg. \$79.99

•Rugged steel construction •In an assortment of colors

Not available in Ashland.

Each of these advertised items is readily available for sale as advertised

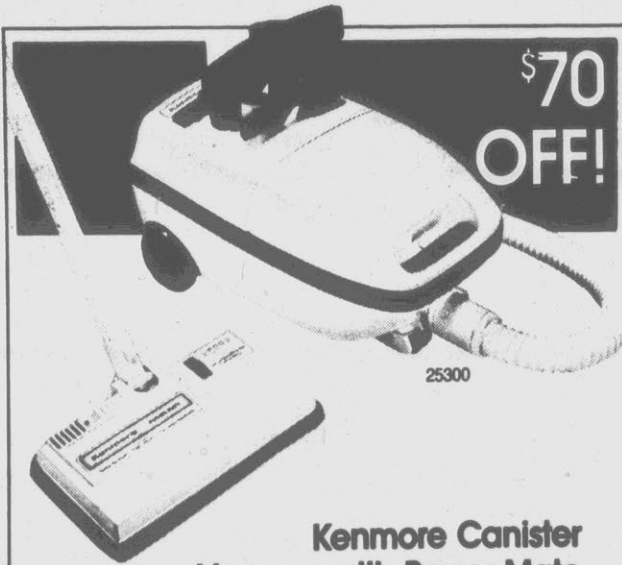

\$70 OFF!

25300

Kenmore Canister Vacuum with Power-Mate

149⁹⁹ Regular \$219.99

Has Power-Mate with edge-cleaning and adjustable carpet heights. Tools store conveniently on top. Automatic cord reel.



SAVE \$70!

Powerful Kenmore Upright Vacuum ONLY

99⁹⁹ Reg. \$169.99

Powerful 2-speed motor. Has floor light to help you see what your vacuuming. Active edge-clean. Reusable dust bag. Adjustable floor height.

Thru March 31

35401



\$100 OFF!

Deluxe Power-Mate Vacuum

199⁹⁹

Reg. \$299.99
Active edge cleaning to get close to walls and corners. Tools store on top.

Thru March 31

26355



SAVE \$60!

Kenmore Free-Arm Sewing Head

169⁹⁹ Reg. \$229.99

5-Utility and 5 stretch stitches. Built-in button-holer. Converts easily to flat bed.

12621

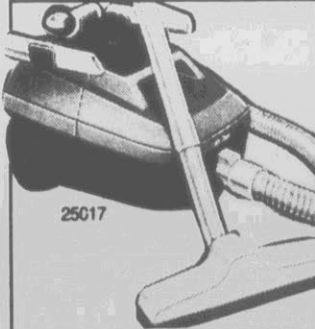

25017

SAVE \$40!

Kenmore Canister Vacuum

59⁹⁹

Reg. \$99.99

Includes cleaning tools that store on top.

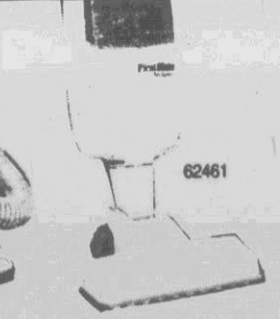

62461

SAVE \$20!

First Mate Lightweight Vacuum

59⁹⁹

Reg. \$79.99

2-speed vacuum. Great for small jobs. Thru March 31

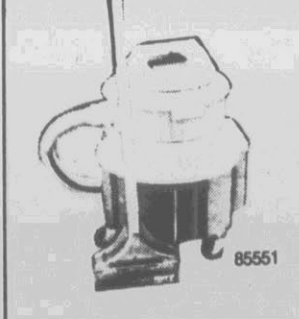

85551

SAVE \$70!

Power Spray Carpet Cleaner

159⁹⁹

Reg. \$229.99

Sprays hot solution, then vacuums it up. Thru March 31

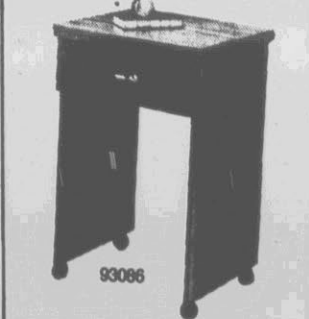

93086

SAVE \$50!

Console-style Sewing Cabinet

\$110

Reg. \$160

Has storage drawer on casters for convenience. Thru March 31

Each of these advertised items is readily available for sale as advertised.

SEARS SERVICE CENTER

COAST TO COAST

WE SERVICE

WHAT WE SELL

Count on Sears for maintenance and repair

SERVICE WHILE YOU WAIT



Many Sears carry-in appliances can be repaired while you wait at one of our Service Centers. Avoid long repair delays. Receive expert Sears Service. See us today!

EXPRESS PARTS PICK-UP



Sears makes buying parts even easier. Just call in the needed part number ahead of time. When you arrive, your part will be waiting for you! It's fast and easy!

MAINTENANCE AGREEMENTS



Get tomorrow's repair service at today's prices. Protect your appliance investments with a maintenance agreement from Sears. Don't wait! Call today for more information.

MOST BRANDS SERVICING



In addition to Sears brands, we now service most other brands of heating and cooling equipment including water heaters, furnaces, and central air units, and most brands of window air conditioners. One call does it all!

LAWN MOWER CHECK-UP



Summer's just around the corner. A preventative maintenance check-up can help add to the life of your lawn mower. Don't put it off! Call the experts. Call Sears Service.

EXTENDED SERVICE HOURS



Sears Service Centers are now open longer for you!

BRING IN YOUR REPAIR WORK AT 7:30 A.M. AND PICK IT UP WHEN YOU GET OFF WORK.

You'll find a Sears Service Center near you



*Cheryl
Tiegs™*

SAVE \$7-\$11

on Cheryl Tiegs
spring-brightened
separates for misses

14⁹⁹ YOUR CHOICE

Shirt, Reg. \$22; Pants, Reg. \$24; Skirt, Reg. \$26

Extended ¾ sleeved shirts and button-front or pull-on skirts in plaid and stripes. Versatile solid pants - get a free belt with purchase! All of easy-care cotton and polyestr. Misses' sizes.

**25% OFF All
Cheryl Tiegs Blue Star
Sportswear**

*Shopping's easy with your
Sears Charge Card!*





Trader Bay

SAVE \$2-\$5 New for you!
 Trader Bay color-coordinated
 separated add zip to your spring!

Camp shirt, Reg. \$11.99; Sport top, Reg. \$12.99

Pants or skirts, Reg. \$15.99

9⁹⁹
 each

12⁹⁹
 each

Start with crisp twill button-front shirts and zip-front pants with pockets and elastic waist. Add camp shirts, placket-front jersey sport tops, short-sleeved sweaters. Sweaters of all cotton; everything else of polyester and cotton. Brights and stripes, plus white. Misses' sizes.



SAVE \$5 Henley tops
 Polyester and
 cotton knit tops in
 coordinating
 colors.

Reg. \$14.99

9⁹⁹

CAREER BOUND?

Sears has polished looks
at great prices!

SPECIAL PURCHASE

Classic suits are
our successful
combinations

49⁹⁹

While quantities last
Our combinations for success: the 2-piece suit,
updated in this season's favorite styles and col-
ors. Choose from an outstanding assortment in
misses' and petite sizes.

25% OFF

Our entire stock of
jacket dresses
for career-minded
misses

29⁹⁹

Style shown:
Reg. \$40 each

The polished look of a suit with all the wearing
ease of a dress! Choose from an exciting
selection of styles in solids, stripes, prints and
combinations. Misses', petites and half sizes.

Use your Sears credit card!

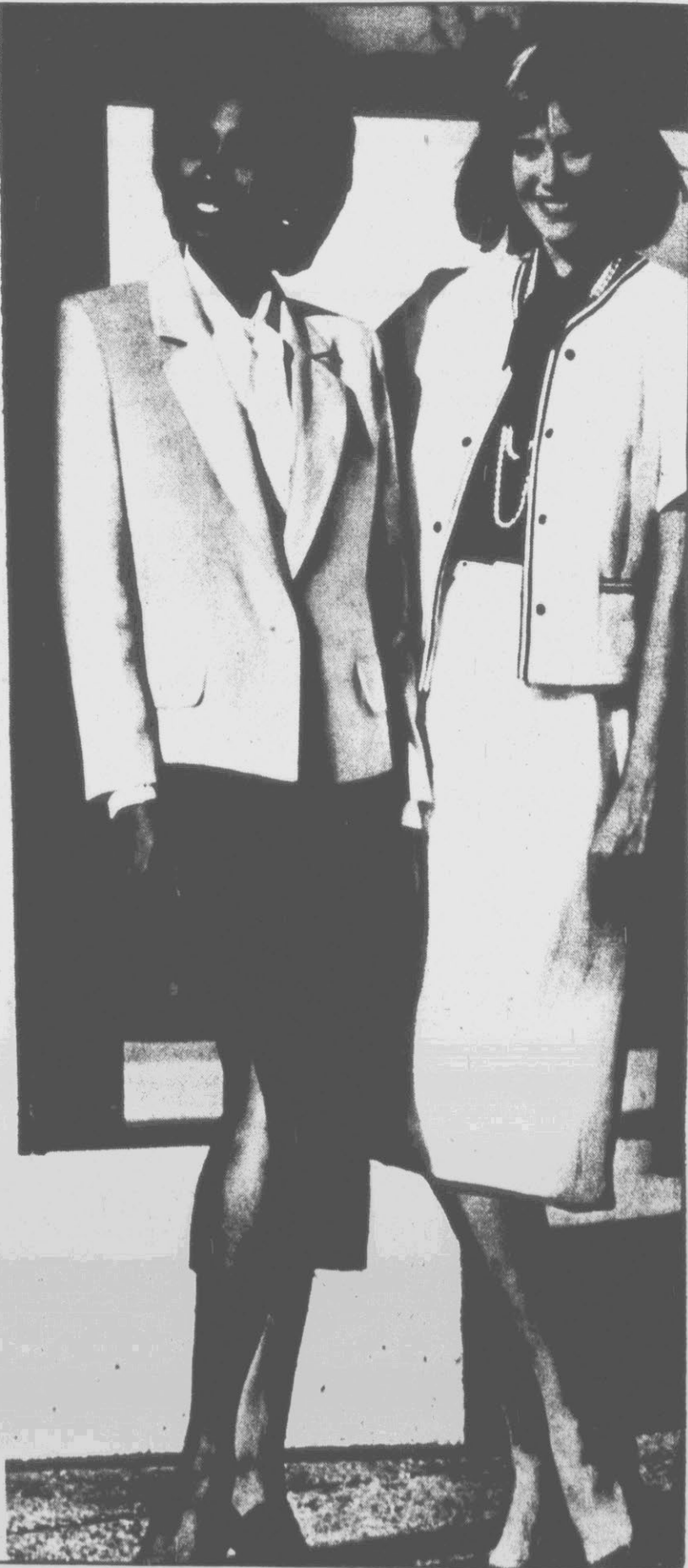



20% OFF Double-Double knit, Lace Expressions and Beautiful Advantage™ bras

7⁹⁹

YOUR CHOICE
Reg. \$10-\$10.50

- A. Lace Expressions stretch contour, natural or underwire cups. Lace trimmed.
- B. Double-Double knit. Natural and contour cups with extra shaping support.
- C. Beautiful Advantage™ knit cups with unique Secret Stay Shaper® for support.

Contour and underwire cups priced higher

20% OFF
Selected knit and woven knitwear

Pajamas

12⁷⁹

Reg. \$16

Short gown

11¹⁹

Reg. \$14

Knit pajamas of nylon tricot have dainty embroidery and lace trim. Elegant short gown of woven fabric comes in your choice of prints and solids.



25%-33% OFF
Entire stock of Cling-alon® hosiery

1⁹⁹

Pantyhose, Reg. \$2.99

SAVE on control and support pantyhose, Thi-Top®, knee-highs and more.

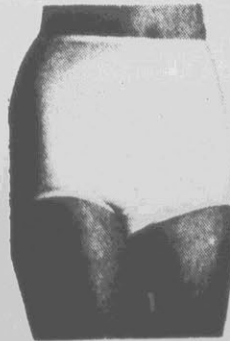

25% OFF
Very Impressive Panties

5⁵⁹ Reg. \$7.50
PKG. OF 3

Nylon briefs, bikinis or hipbudders, all on sale!

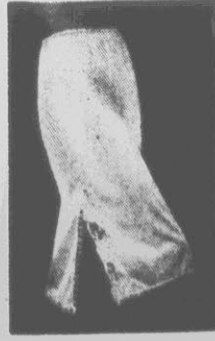

25% OFF
Very Intimate half-slips

5¹⁹ Reg. \$7

Sleek anti-cling Antron® III nylon half slip.

25% OFF

Sears Best men's matched work clothes

Shirts, Reg. \$14.99

Pants, Reg. \$16.99

11²⁴

12⁷⁴

Perma-Prest® polyester and cotton shirts and pants feature a Scotch-Release® Fabric Treatment for easy care. Men's sizes.

SAVE \$5
Men's cotton
blend bibs

17⁹⁹

Reg. \$22.99

Cotton and polyester blue denim bib overalls have triple-stitched main seams and thread bartacking at all stress points.

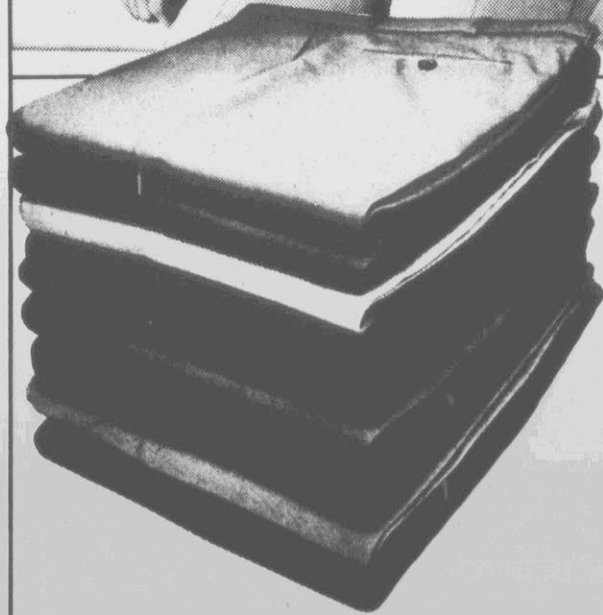
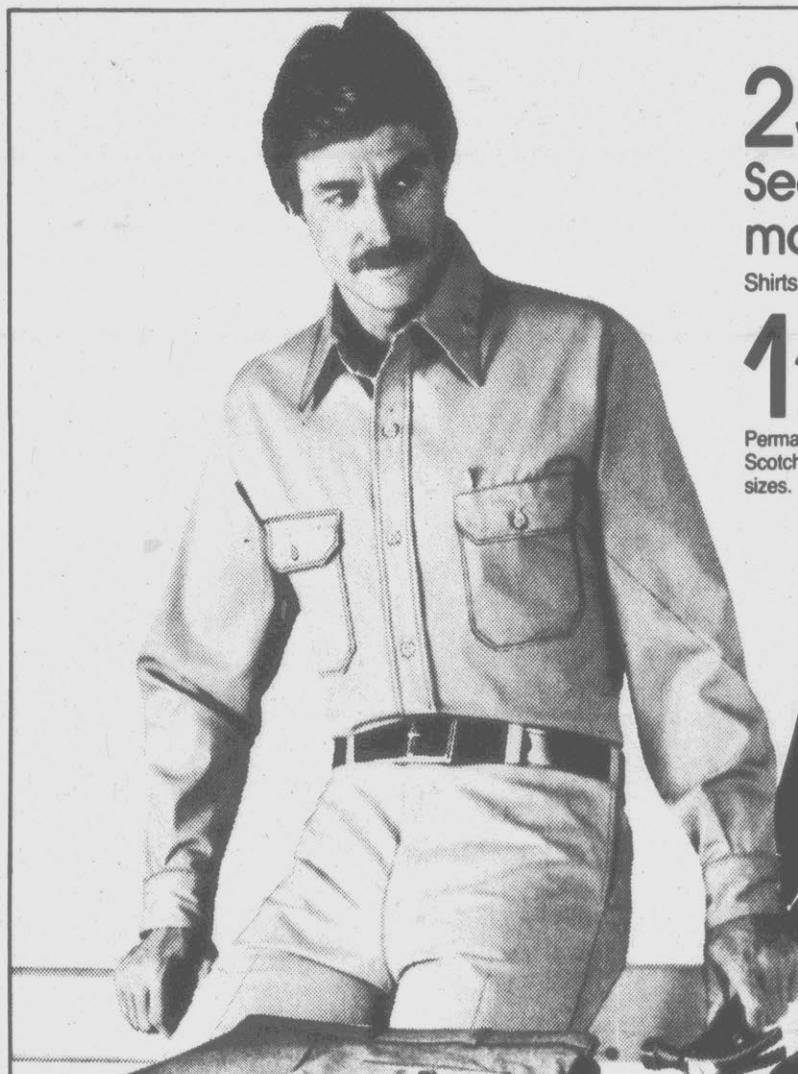

SAVE \$8 Men's Flexslax

Perma-Prest® slacks mean no ironing with tumble dried. Stretch Ban-Rol® waistband, 2-way stretch woven polyester gabardine slacks in regular and full fit sizes. Sale ends Saturday.

Reg. \$25

16⁹⁹

SAVE \$3 Oakton sportshirts

Plaid shirt, Reg. \$14.99

Solid, knit shirt, Reg. \$10.99

11⁹⁹

7⁹⁹

Woven polyester, cotton plaid shirt. Knit shirt is polyester, cotton.
\$12.99 stripe knit shirt **9.99**

Arnie-suits are available in Barboursville, Charleston (North Woods), Charleston, WV, Charlotte, Columbia, Durham, Fayetteville, Greensboro, Raleigh, Roanoke, Wilmington and Winston-Salem.



SAVE \$60

Arnie-Life™ 2-pc. suit for a crisp, cool business look

\$110

Reg. \$170

Your search for a premium blend suit that's an undeniable value is over! Coat and pants are of lightweight polyester and wool, in distinctive solids and patterns. Men's sizes.

\$7 to \$25 OFF

Men's Classic Collection separates

54⁹⁹

Blazer
Reg. \$80

For the man on the move! Blazer is designed with action stretch panels in the shoulder area. Tailored of wrinkle resistant polyester.

\$27 Vest..... 19.99
\$30 Slacks..... 21.99

Stripe separates at similar savings

\$3 OFF Sears Best men's underwear

T-shirts, briefs of polyester and pima cotton. PKG. OF 3.

9⁹⁹
Reg. \$12.99

\$3 OFF Men's casual hosiery

Orion® acrylic, nylon.
\$6.99 Tube socks 2 PKG. \$10

2 PR. \$3

PICK A PACK OF SEARS VALUES

388

YOUR CHOICE

- A. Infant's sleep'n playsuit, NB-3B, reg. \$6.99
Also in size TNB to fit infants up to 7 lb. and to 18-in.
- B. Infant's 1-pc. underwear, S-M-L, reg. \$4.99
- C. Bath tub or bath pad, reg. \$6.99 each
- D. Handy diaper bag, reg. \$7.99

788

YOUR CHOICE

- E. Infant girl's dress, S-M-L, reg. \$11.99
- F. Infant boy's pant set, S-M-L. Special purchase
Quantities limited
- G. Toddler's dress, 2T-4T, reg. \$11.99
- H. Toddler boy's set, 2T-4T, reg. \$8.99

1388

YOUR CHOICE

- J. Carri cradle, reg. \$19.99
- K. Commander™ toddler car seat, reg. \$19.99
- L. Adjustable gate, reg. \$14.99
- M. Hi & Mitey™ high chair, reg. \$19.99

4988

YOUR CHOICE

- N. Portable crib in maple, reg. \$69.99
- P. Century 2500 STE™ car seat, reg. \$69.99
- Q. Baby-go stroller, reg. \$69.99
- R. I Love Elephants playpen, reg. \$59.99

Apply today for
America's favorite
department store
credit card



1/3 OFF DISCONTINUED NURSERY FURNITURE

While quantities last



\$1 to \$5 OFF Boys' safari-style separates

Pants
Sizes 4-7 **8⁹⁹** Reg. \$11.99

100% cotton pants with easy-fitting elastic waists. Woven tops and knit pocket T's are polyester and cotton.

Pants
Sizes 8-20 **9⁹⁹** Reg. \$14.99

\$4.99, Pocket T's, 4-20..... 3.99
\$6.99, Shirts, 4-7 4.99
\$9.99, Shirts, 8-20 7.99

\$1 to \$3 OFF Girls' 2-part shirt sets and sheeting pants

Pants or tops, 4-6X **6⁹⁹**

Tops. Sizes 4-14, oversized shirt or knit top with knit tank, Reg. \$9.99-\$10.99. Sizes 7-16, 2-pc. top set, Reg. \$10.99. All polyester and cotton.

Pants. Sizes 4-6X, Reg. \$7.99; sizes 7-14 and Pretty Plus sizes, Reg. \$10.99. 100% cotton or polyester and cotton.

Pants or tops, 7-14 **8⁹⁹**

NAME YOUR SPORT - THEN PICK YOUR BRAND AT SEARS

winner™



\$7 OFF Winner™ men's jogging shoe

A. Nylon and suede split leather uppers. Cushioned arch, removable insoles. Rubber soles. Men's sizes.

12⁹⁹
Reg. \$19.99

\$6 OFF Winner™ aerobic shoes

B. Women's aerobic shoes have soft leather uppers, rubber soles. Heel and toe wraps for stability. Women's sizes. Larger stores only.

19⁹⁹
Reg. \$29.99



\$5 OFF Reebok® Newport Classic

C. Men's and women's classic tennis shoes have leather uppers and rubber soles. Men's and women's sizes.

34⁹⁵
Reg. \$39.95

\$5 OFF Ladies' Reebok® aerobic shoes

D. Princess shoes have full grain soft leather uppers and rubber soles. Women's sizes.

29⁹⁵
Reg. \$34.95



\$5 OFF Nike® jogging shoes

E. Nylon and suede split collar and tongue. Rubber soles. Women's sizes.

17⁹⁵
Reg. \$22.95

Use Your Sears Charge!



Reebok

NIKE

PORTRAIT STUDIO

**FREE
10x13
mini-poster
of Fievel
the Mouse,
star of
"An
American Tail",
with your
portrait
purchase!**

Trust Your Baby's Smiles to Sears!

Only Sears Portrait Studio has the exclusive VideoVision camera system. It frees our professional photographers to work closely with your baby . . . so we capture the cutest smiles! No appointment necessary. Use your Sears Credit Card or Discover Card!

14-piece portrait package

12⁹⁵

plus 95¢ sitting fee

2-8x10s, 2-5x7s* and 10 wallets
on your choice of a traditional, nursery,
spring or fall background

Adults & families welcome. Each additional person, 95¢. Poses our selection. White and Black Backgrounds and Double Feature Portraits available in addition to this offer. **Also available: Instant Color Passport Photos and Copy & Restoration.** *Approximate size

**OFFER FOR PORTRAITS
TAKEN THRU MARCH 28**

Studio hours: Sun: Store hours (where store is open); Mon. & Tue.: Store opening until 5pm; Wed.-Sat.: Store opening until one hour prior to store closing.

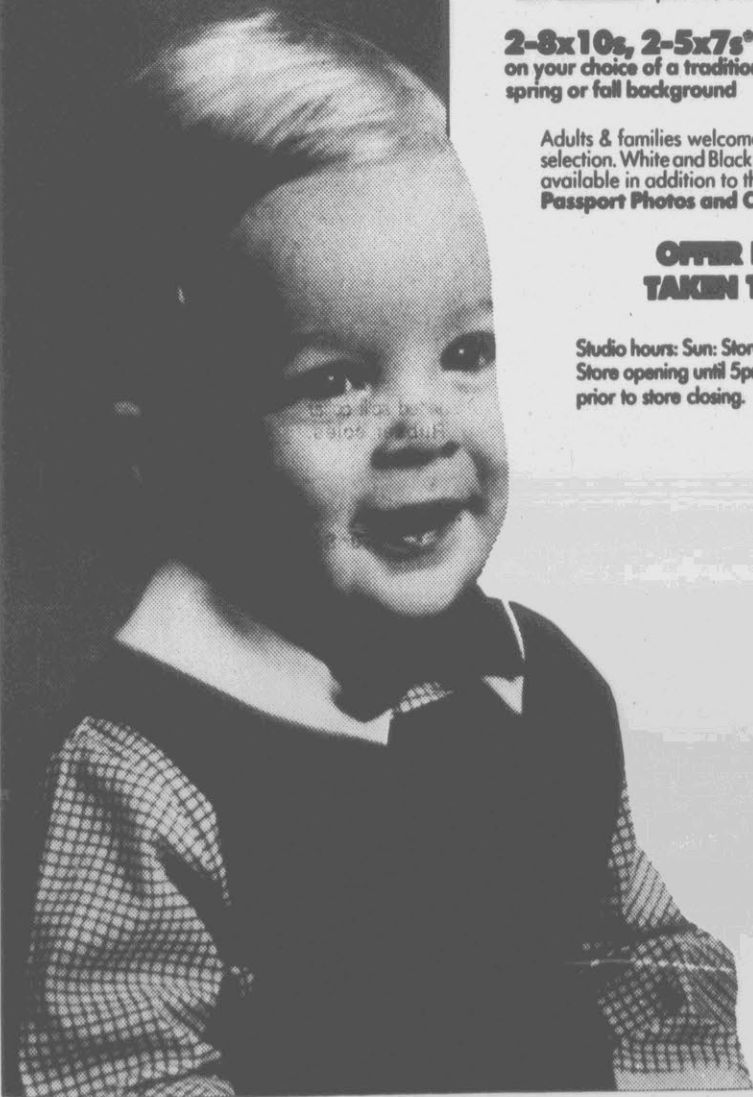

The Optical Department at **SEARS**

All Frames 50% Off

with purchase of prescription lenses at regular price.



Offer ends May 2, 1987. Not applicable in conjunction with other offers or to prior orders.

Complete Contact Lens Selection

Bausch & Lomb Sofspin™ Daily Wear Soft Contact Lenses.....	\$39
Bausch & Lomb O Series Soft Extended Wear Lenses.....	\$59
Tinted Soft Daily Wear Lenses.....	\$69

Eye examinations, lenses for astigmatism and lens care kits extra. Many people leave with their lenses the same day.
Bring in your prescription and we'll fill it just as your doctor ordered.



GREENSBORO, NC
3200 W. Friendly Ave.
Phone: 294-6800

WINSTON-SALEM, NC
Hanes Mall
Phone: 768-9100

CHARLOTTE, NC
Eastland Mall
Phone: 588-9100

* Southpark Mall
Phone: 364-7550

CONCORD, NC
Carolina Mall
Phone: 786-6111

HICKORY, NC
Valley Hills Mall
Phone: 328-2851

* **GREENVILLE/NEW BERN, NC**
JACKSONVILLE, NC
Jacksonville Mall
Phone: 353-2223

RALEIGH, NC
Crafbree Valley Shopping Center
Phone: 782-6800

DURHAM, NC
1620 Guess Road
Phone: 286-2951

FAYETTEVILLE, NC
Cross Creek Mall
Phone: 864-2671

* **GOLDSBORO, NC**
Berkley Mall
Phone: 778-0200

WILMINGTON, NC
Independence Mall
Phone: 799-9100

CHARLESTON, SC
Citadel Mall
Phone: 556-1077

CHARLESTON HTS., SC
Northwood Mall
Phone: 797-2100

* **COLUMBIA, SC**
Columbia Mall
Phone: 788-9121

* **FLORENCE, SC**
Myrtle Square Mall
Phone: 448-1731

BECKLEY/BLUEFIELD, WV
MT. HOPE, WV
Crossroads Mall
Phone: 253-7000

CHARLESTON, WV
Town Center Mall
Phone: 357-7211

BARBOURSVILLE, WV
Huntington Mall
Phone: 733-0582

ROANOKE, VA
Valley View Mall
Phone: 563-3838

LYNCHBURG, VA
River Ridge Mall
Phone: 237-6761

* Contact lenses not available at these locations.

We are a participating provider in most major Vision Care Plans. Available at participating Sears stores.

SAVE \$50-\$80!



47285/6

47437/8

Choose 12-speed
racer or touring
bike

YOUR CHOICE

99⁹⁹

While quantities last!

Sovereign 12.27-in. men's
and women's 12-speed
racer, side-pull caliper
brakes. \$149.99 in '87
Annual Catalog.

Brittany 12.26 26-in. men's
and women's 12-speed
touring bike. \$179.99 in '87
Annual Catalog.

Bikes require assembly and are
not available in Ashland, Shel-
by and Williamson.

SAVE \$110!



Exercise equipment requires
some assembly and is not avail-
able in Ashland, Shelby and Wil-
lamson.

28680

OUR LOWEST PRICE EVER!

The Lifestyler™ 1000
multi-purpose gym

89⁹⁹

Includes butterfly arm attachment and bench
attachment. Firm and tone your body by doing
leg lifts, bench and shoulder presses, curls,
butterfly exercises and more! Folds for easy
storage.

\$199.99 in '86
Spring/Summer Cat.



45173

SAVE \$40!

FS 500 BMX bike

\$129.99 in '87
Annual Catalog

20-in. boy's bike. Front/rear caliper
brakes.

89⁹⁹



47395

SAVE \$60!

All-terrain bike

Reg. \$179.99

26-in., 10-speed Dynasty all-
terrain bike. Thumb-shifters.

119⁹⁹



29122

50% OFF

Ergometer Cycle

Was \$299.99
Fall '86
Gen. Catalog

Allows you to set the resistance to
suit your workout.

149⁹⁹

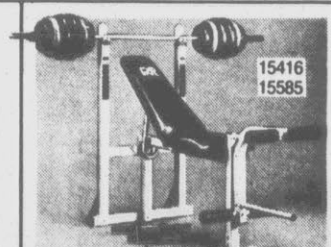

15416
15585

SAVE \$40-\$60!

Reg. \$89.99 151-lb.
weight set

54⁹⁹

Reg. \$179.99 weight
bench with leg lift

124⁹⁹



77436

Camping equipment is not
available in Ashland, Shelby
and Williamson.

\$60 OFF!

Dome sport tent

\$119.99 in '87
Annual Catalog

7x10-ft. square dome tent with fly.
Center height is 4-ft. 2-in.

59⁹⁹

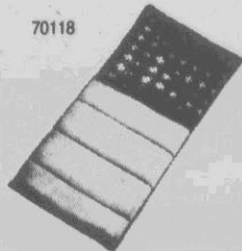

70118

\$20 OFF!

Sleeping bag

\$39.99 in '87
RV Specialog

3-lbs. polyester insulation. 33x75.
Nylon taffeta outer shell.

19⁹⁹

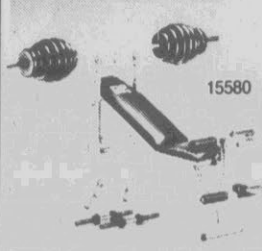

15580

SAVE \$100!

Weight set/bench combo

Reg. separate
prices \$199.98

132-lb. weight set and incline
bench with leg lift.

99⁹⁸



97580

SAVE \$4!

Wilson shirts, shorts

Reg. \$13.99 each
in larger stores only

Wilson shirt and shorts in assorted
colors. Men's, women's sizes.

9⁹⁹
ea.

SAVE \$100-\$130!

SAVE \$40!

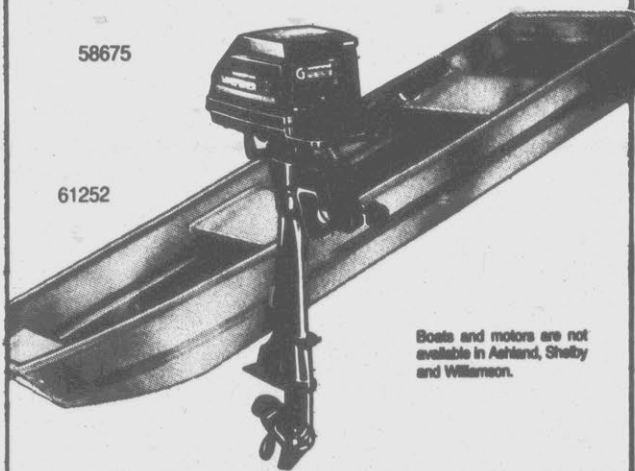

58675

61252

Boats and motors are not available in Ashland, Shelby and Williamson.

Save on 11 1/2-ft. aluminum Jon boat and 7.5-HP boat motor

Aluminum jon boat provides greater stability to make it easier to keep your balance while hunting. Gets into shallow waters. Reg. \$469.99. 7.5-HP Gamefisher® gas motor. Powerful single-cylinder motor. Automatic rewind starter. Reg. \$799.99.

**359⁹⁹
659⁹⁹**

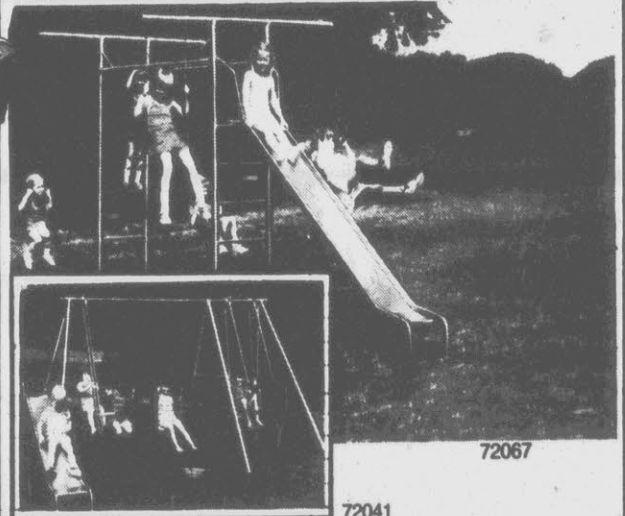

72067

72041

Armadillo 10 gymsets! Choose "Big T" or 6-leg styles

Gym sets have 2-in. diameter tubular steel headbar and legs. Acrylic-sealed galvanized steel tubing for superior rust resistance. Limited warranty for years specified on tubular steel portion. See store for details.

YOUR CHOICE
139⁹⁹ ea.
Reg. \$179.99 each

34423/31

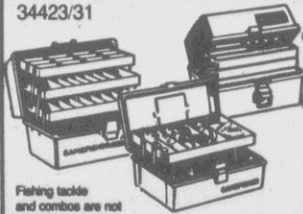

Fishing tackle and combos are not available in Ashland, Shelby and Williamson.

SAVE \$5-\$6!

Tackle boxes

Plano tackle box, reg. \$15.99
Flambeau tackle box, reg. \$16.99

9⁹⁹ each

33306/214



SAVE 3!

Fishing combos

YOUR CHOICE Reg. \$12.99
Save on these rod/reel combinations!

9⁹⁹ ea.

87858

Available by special order in smaller stores.



SAVE 25!

Sidewalk bikes

YOUR CHOICE Reg. \$99.99
Boys' Street Rod BMX and girls' Miami Miss riders. 16-in.

74⁹⁹

17702

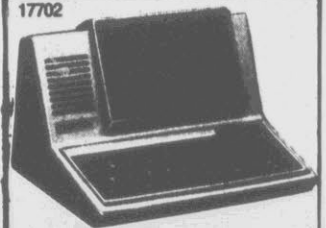

GREAT BUY!

Comptron

Available in larger stores only
Sears Price Programmed for 10 challenging games. Photon.....~~39.99~~

32⁹⁹

63131/23

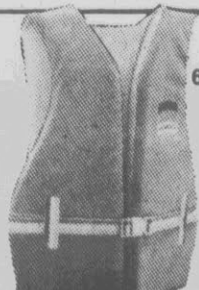

SAVE \$6!

Buoyancy vest

Reg. \$15.99
Be prepared with extra protection! Adult or child's medium or small sizes.

9⁹⁹



Buoyancy vest and scooter are available in larger stores only.

SAVE 10!

Strada scooter

Reg. \$69.99
Rugged BMX-style handlebar, rear caliper brake. Unassembled.

59⁹⁹

18719
18762
18772
1830



SAVE \$50!

Backboard and pole

Laminated backboard, steel pole. Reg. sep. prices \$129.98
Reg. \$16.99 goal with net..... 9.99
Reg. \$21.99 basketball..... 14.99

79⁹⁸

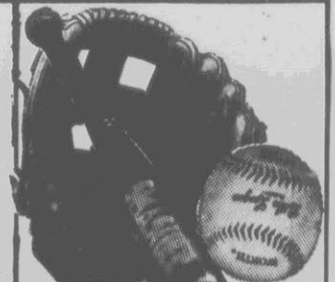

20% OFF!

ALL BASEBALL EQUIPMENT NOW ON SALE!

Choose from baseball gloves, bats and balls. Basketball and baseball equipment are not available in Ashland, Shelby and Williamson.

ALL DIEHARD BATTERIES
NOW ON SALE!

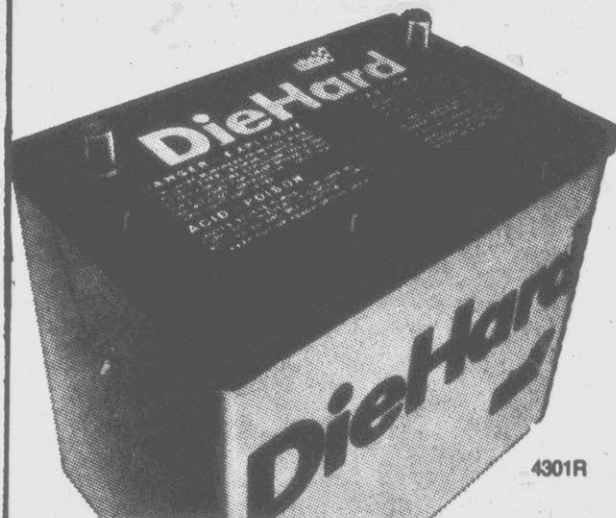

4301R

\$16 OFF DieHard car battery

The power of 550-cold cranking amps* for sure fast starts — from the hottest days of summer to the coldest days of winter! NO CHARGE FOR INSTALLATION!

- \$5 OFF DieHard utility battery, reg. \$49.99 **44.99**
- \$16 OFF DieHard marine batteries, reg. \$75.99 **59.99**
- \$14 OFF DieHard Mercedes batteries, reg. \$99.99 **85.99**

20% OFF DieHard cycle batteries

*In Groups, 24, 24F and 74

59⁹⁹
Reg. \$75.99
with exchange

1/2 PRICE!

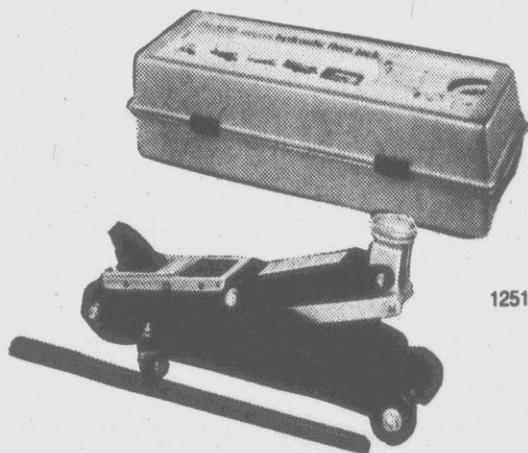

1251

50% OFF Sears compact floor jack with storage case

This compact floor jack is not only small enough to fit into most trunks, but is big enough to lift up to 1½-tons! Durable storage case is included.

34⁹⁹
\$69.99 in '86
Fall Gen. Cat.



2197

1/2 PRICE!

Advance timing light

\$79.99 in '86
Fall Gen. Cat.
Diagnoses problems of vacuum, centrifugal or electronic distributor advance.

39⁹⁹

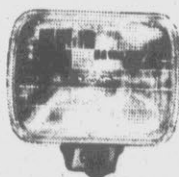

55810

SAVE \$5!

Drive light kit

Reg. \$29.99
Chrome-plated halogen driving light kit. Includes 2 lights.

24⁹⁹



71835

SAVE \$20!

Battery charger

Reg. \$69.99
Recharges 6 or 12-volt batteries in as little as 2½-hrs! 50-amp starter.

49⁹⁹



74561

SAVE \$20!

Car cover

Reg. \$69.99
Polyester/cotton cover protects finish. 12-ft. 11-in. to 14-ft. 7-in.

49⁹⁹

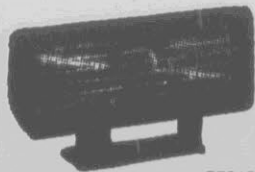

55012

SAVE 6!

Brake light

Reg. \$19.99
Rear-window brake light kit. Hardware, instructions included.

13⁸⁸

SAVE

7043

Limit 12 qts per customer



7044

SAVE OVER 50%!

Quaker State motor oil

Sears reg. price **1.29**
SALE PRICE **79¢**
Less mail-in rebate **20¢**
Your cost after rebate **59¢**



68127
68141

SAVE \$2!

Rain Dance car wax

YOUR CHOICE
Reg. \$6.99 ea. **4⁹⁹** ea.
Choose liquid or paste. Provides excellent protection for car's finish.

SAVE \$1!
KIT
CAR WAX

YOUR CHOICE **1⁹⁹** ea

Choose paste or liquid. Both are easy to apply and remove. Provides great year-round protection for your car's finish. Reg. \$2.99 each.

SEARS BIG SUSPENSION SALE!

**INSTALLED
PRICE!**

SteadyRider Gas MacPherson

SteadyRider gas replacement cartridges for most cars with MacPherson suspension systems. Reg. installed price \$119.99 per pair.

99⁹⁹
per pair
-INSTALLED

SteadyRider gas struts for modern cars with advanced MacPherson suspension systems. Reg. installed price \$159.99 per pair.

139⁹⁹
per pair
-INSTALLED!



Regular shocks, MacPherson equipment, cargo coils, air adjustable shocks and booster shocks are available in sizes to fit most cars.

\$5 OFF!

Heavy-duty gas shocks

Heavy-duty gas shocks for greater comfort, better handling and greater stability than most non-gas shocks. Installation is available, extra.

9⁹⁹
each
Reg. \$14.99

\$10 OFF!

SteadyRider RT shocks

Radial-tuned for exceptional handling, stability and control. Temperature compensated for a smooth ride in any temperature. Installation extra.

12⁹⁹
each
Reg. \$22.99

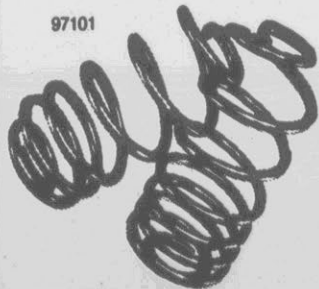

97101

**SAVE
\$30!**

INSTALLED! Cargo coils

79⁹⁹
per pair
-INSTALLED!
Heavy-duty suspension for big loads. Reg. \$109.99 pr.

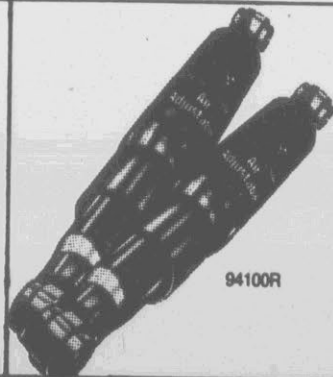

94100R

**SAVE
\$30!**

INSTALLED!
Air shocks

69⁹⁹
per pair
-INSTALLED!
Adjusts for loads up to 1,000-lbs.
Rear only. Reg. \$99.99 pr.



FRONT-END SERVICES

Sears Auto Centers offers front-end services on most foreign and domestic cars for ball joints, tie rod ends, CV joints and boots.

Let us inspect your car without any obligation!

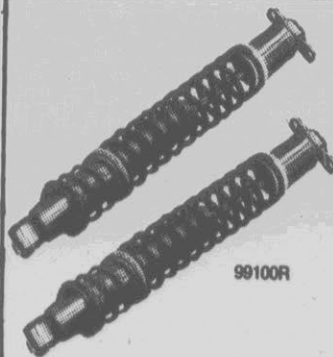

99100R

**SAVE
\$15!**

INSTALLED!
Booster shocks

49⁹⁹
per pair
-INSTALLED!
Adds carrying capacity...up to
500-lbs. in rear, 300-lbs. in front.
Reg. \$64.99 pr.

4 good reasons to buy your tires at Sears

1. Great selection of tires for popular American cars, compacts, imports and light trucks.
2. Tire installation included.
3. Tire rotation every 5,000 miles included.
4. Mileage wearout warranty on every tire and backed by every Sears Auto Center nationwide.

25008R

OUR BEST RADIAL FOR COMPACTS AND IMPORTS!

RoadHandler SCR

155SR12 **36⁹⁹**

- Great handling radial
- "S" speed rated
- All-season traction

50,000-mile wearout warranty

RoadHandler SCR	EACH	RoadHandler SCR	EACH
155SR12	\$36.99	165/70SR13	\$58.99
145SR13	41.99	175/70SR13	59.99
155SR13	47.99	185/70SR13	61.99
165SR13	51.99	195/70SR13	64.99
175SR14	58.99	185/70SR14	66.99
185SR14	62.99	195/70SR14	69.99
165SR15	61.99	205/70SR14	72.99

OUR BEST-SELLING PERFORMANCE RADIAL!

Response High Performance

P175/70TR13 **49⁹⁹**

- All-season traction
- 70 and 60 series
- "T" speed rated
- Raised white or black outline letters.

30,000-mile wearout warranty

Response High Performance	May be Substituted for	Each
P185/70TR13	P165/80R13	\$68.99
P195/70TR13	P175/80R13	69.99
P185/70TR14	P175/75R14	62.99
P205/70TR14	P195/75R14	66.99
P215/70TR15	P205/75R15	73.99
P215/60TR14	P185/75R14	72.99

Other sizes available

Open a SearsCharge account today

83008R

SAVE 30%-40%! OUR BEST HIGHWAY RADIAL!

MADE BY MICHELIN-BACKED BY SEARS

RoadHandler

P155/80R13 **49⁹⁹** Reg. \$84.99

- 2 steel belts for strength and durability
- Great all-season traction

50,000-mile wearout warranty

RoadHandler	Reg. ea	Sale ea.
P155/80R13	\$84.99	\$49.99
P165/80R13	94.99	59.99
P185/75R14	109.99	76.99
P195/75R14	115.99	80.99
P205/75R15	127.99	82.99
P215/75R15	132.99	84.99
P225/75R15	137.99	86.99
P235/75R15	139.99	89.99

Other sizes available

SAVE 10%! LIGHT TRUCK TIRE

MADE BY MICHELIN-BACKED BY SEARS

RoadHandler Rib light truck tire

LT195/75R14 **76⁴⁹** Reg. \$84.99

- All-season radial traction
- 2 long-wearing steel belts

40,000-mile wearout warranty

RoadHandler Rib	Regular price	Sale price each
LT195/75R14	\$ 84.99	\$ 76.49
LT235/75R15	104.99	94.49
31x10.50R15	114.99	103.49
32x11.50R15	129.99	116.99

Other sizes available

Made by Michelin Backed by Sears

77700R

65200R

15%-40% OFF

All Percale Sheets and Coordinates

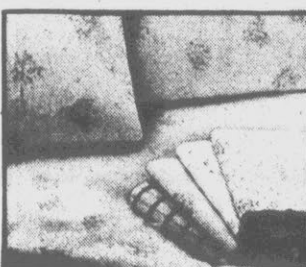

Perma-Prest Muslin sheets Special!

Flat or fitted. Easy-care sheets in a choice of prints.

Twin size **2²²**



1/6 OFF percale print sheet sets

Sets include flat Twin, Reg. \$19.99 sheets, fitted sheet and pillow cases. All sizes on sale!

13⁹⁹

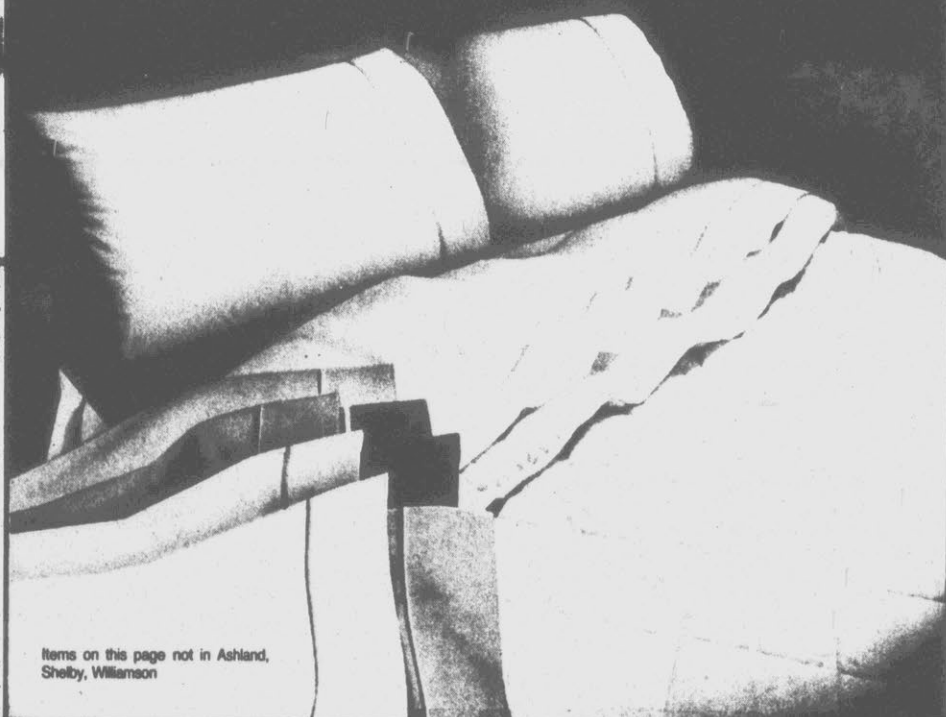

Items on this page not in Ashland, Shelby, Williamson



1/5 OFF Living Home bedroom ensemble

Twin set with one flat, one fitted sheet, case. All sizes on sale! ~~\$69.99~~ comforter, 44.99

Reg. \$19.99 **14⁹⁹** Twin

Colormate Perma-prest flat or fitted sheets . . . and matching comforters

Smooth comfortable feel and a wide choice of light and dark colors, all accented with contrasting border trim. Time to stock up at Terrific Savings!

\$12.99 Full, 8.99, \$19.99 Queen **14.99**
\$22.99 King..... **16.99**

Twin flat or fitted
Reg. \$9.99

5⁹⁹

SAVE 1/5! Matching colormate comforters
All sizes on sale!
Reg. \$49.99 Twin size **34⁹⁹**

SAVE on a wide selection of Colormate window treatments, too!

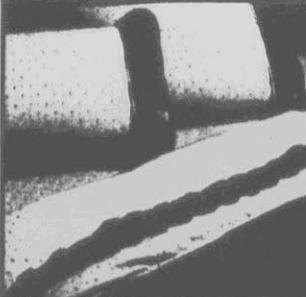

1/5 OFF Open Home bedroom coordinates

3-pc. twin set with flat and fitted sheet, one case.

Reg. \$29.99 **24⁹⁹**

~~\$69.99~~ Twin Comforter **54.99**



1/10 OFF! Floral Ribbons Matchmate bedspread

Quilted bedspread. ~~\$39.99~~ Twin **29⁹⁹**
Quilted pastel throw. Other sizes also on sale.



ALL PADS & PILLOWS ON SALE

Polyester pillow shown

Standard size
Reg. \$5.99

3⁹⁹

Fitted mattress pad

Twin size
Reg. \$9.99

6⁹⁹

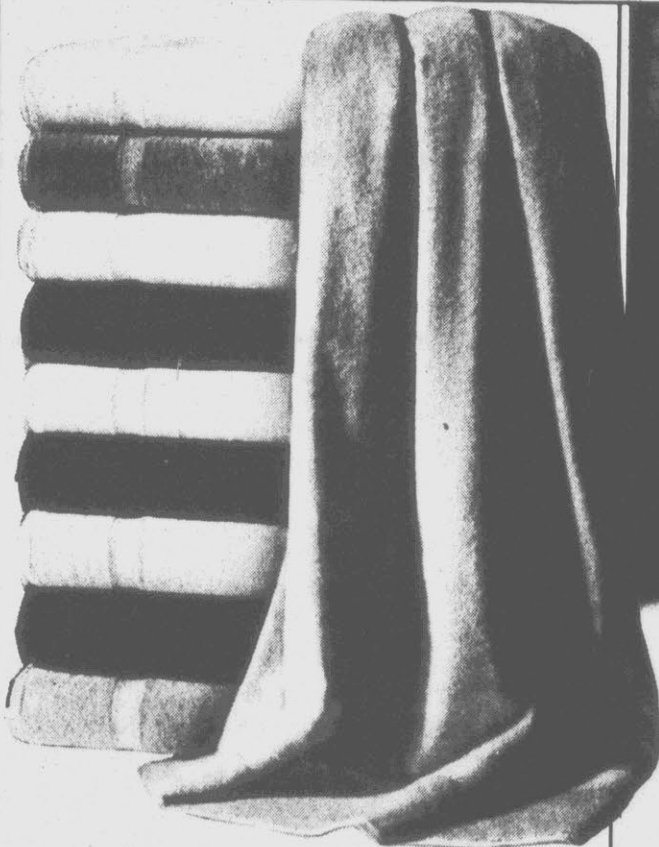

SAVE 50%

Matchmate bath towels

Soft cotton velour on one side, thirsty loops on the other! Big choice of colors! super savings.
 \$3.99 Hand towel..... 2.29
 \$2.99 washcloth..... 1.99

2⁹⁹
 Reg. \$5.99
 Bath Towel

SAVE 25%

Cotton bath towel

Good quality cotton terry at a real bargain price! Stock up now and SAVE!
 \$1.99 Hand Towel 1.49
 \$1.19 Washcloth 99*

2²²
 Reg. \$2.99
 Bath Towel

Items on this page not in Ashland, Shelby, Williamson

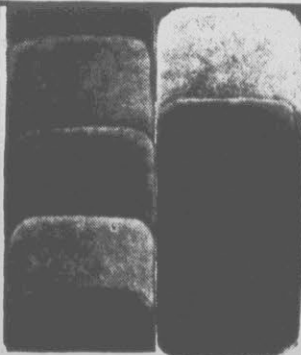

SAVE \$2
 Matchmate rug
5⁹⁹
 Reg. \$7.99

21x36-in. oblong, 100% Dupont nylon. Deep pile with skid-resistant back!



SAVE 24%
 Colormate shower hooks
1⁸⁸
 Reg. \$2.49

Pack of 12. in your choice of 30 colors! Holds both curtain and liner. SAVE!

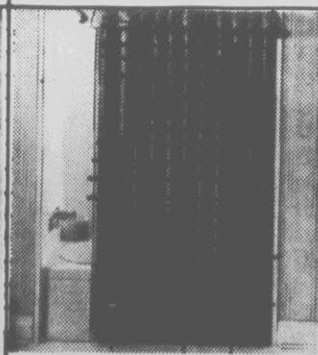

SAVE 25%
 Matchmate shower curtain
14⁹⁹
 Reg. \$19.99

Wicker-look openweave curtain shower liner. Colors to coordinate with towels.

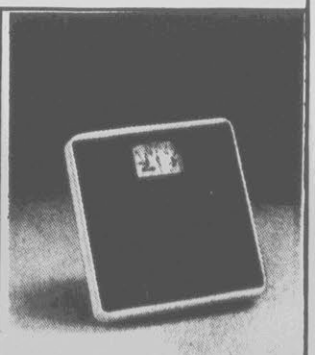

SAVE 30%
 Matchmate bath scales
13⁹⁹
 Reg. \$19.99

Wicker-look mechanical scale in blue, brown, white or wheat! Super buy!

SAVE 40% TO OVER 50%

**SUPER
FIRM**

**EXTRA
FIRM**

**ULTRA
FIRM**



*on bedding
by Sealy including
Posturepedic*

POSTURE CREST

\$299.99 Full, ea., pc., Twin, ea., pc.
\$179.99, 2-pc. queen set,
SAVE OVER 50%, 449.99
\$999.99 3-pc. king set, **499.99**

99⁹⁹

SAVE OVER 50%

POSTUREPEDIC ELITE VIOLET

\$429.99 Full, ea. pc., **249.99** Twin, ea., pc.
\$379.99 Full, ea. pc., **219.99**
\$899.99 2-pc. queen set, **549.99**

149⁹⁹

Reg. \$299.99

POSTUREPEDIC ELITE IRIS

\$429.99 Full, ea., pc., **239.99** Twin, ea., pc.
\$1199.99 Two-piece queen
set **599.99**
\$1499.99 Three-piece king
set **649.99**

179⁹⁹

Reg. \$349.99

Foam bedding is of polyurethane. Queen and king
sold only in sets. King requires two foundations.

Furniture and bedding are not available in Aehlend, Concord, Danville,
Goldboro, Greenville, High Point, Rock Hill, Rocky Mount, Shelby and
Williamson.

**The Best Full
Carpet Warranty
in the Industry!
10 YEARS**

**OUR
LOWEST
PRICE EVER FOR
Super Plush**

ONLY 16⁹⁹
sq. yd.

Magni V nylon fiber pile that looks great, lasts for years under normal wear, and resists soil and odor-causing bacteria. 12 great colors. 40-oz. per square yard.

Carpet is not available in Aehlend, Concord,
Danville, Gastonia, Goldboro, Greenville,
High Point, Rock Hill, Shelby and Williamson.

FEEL RIGHT AT HOME AT SEARS



Furniture and bedding are not available in Ashland, Concord, Danville, Goldsboro, Greenville, High Point, Rock Hill, Rocky Mount, Shelby and Williamson.

SAVE
\$450
TO
\$550

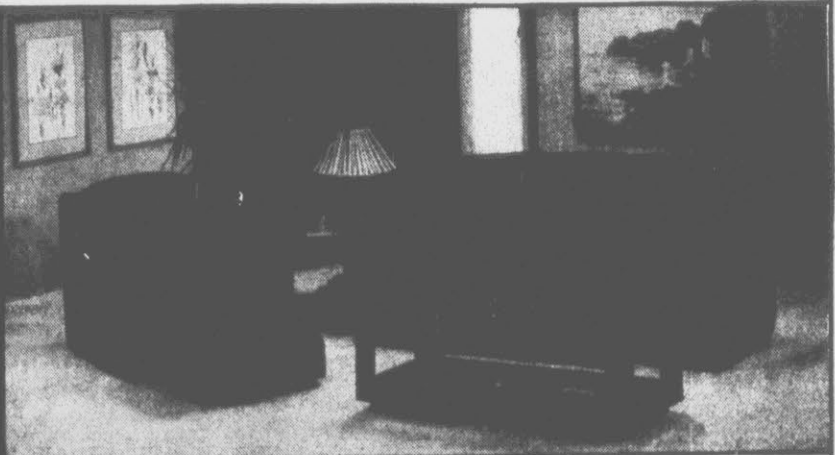

Super Savings on 2-piece sofa groups ...no money down on SearsCharge

Saratoga. Country colonial charm in a button-tufted sofa and matching chair..plus a big soft ottoman! All are covered in a traditional blue print cotton fabric, and accented with deep, full ruffles. Two matching pillows included.

Landmark. Contemporary looks and classic comfort, in this deep-padded group, covered in rich antron nylon. Both sofa and chair have padded arms and sides, too!

Reg. \$1149.98 to \$1249.98

699⁹⁹

\$899.99 matching queen sleeper sofas.....549.99

HURRY! LAST 4 DAYS OUR LOWEST PRICE EVER

on vinyl mini-blinds



**Skyline vinyl blinds
...quality construction
in fashionable colors**

488

23x42 in.
Reg. \$9.99

Our lowest price ever applies to stocked sizes only.
Special order sizes are available at 25%-40% OFF.

- EASY TO INSTALL!
- EASY TO CLEAN!
- WE SELL MORE BLINDS THAN ANYONE ELSE IN AMERICA

Other ready-made sizes available at sale prices. Just a few listed here.

\$12.99 29x42-in., 7.88	\$18.99 31x64-in., 9.88
\$16.99 23x64-in., 8.88	\$19.99 34x64-in., 9.88
\$16.99 29x64-in., 8.88	\$19.99 35x64-in., 9.88

SAVE 40% MATCHING MADE-TO-MEASURE SIZES

Just bring in your window measurements for blinds that fit problem size windows beautifully.

Made-to-measure sizes are in larger stores only, except not in Durham.

Ask about Sears credit plans

**Satisfaction guaranteed
or your money back**

©Sears, Roebuck and Co., 1987

ALL STORES NOW OPEN SATURDAY MORNINGS AT 9 AM

NC: Burlington, Charlotte (Eastland, Southpark), Concord, Durham, Fayetteville, Gastonia, Goldsboro, Greensboro, Greenville, Hickory, High Point, Jacksonville, Raleigh, Rocky Mount, Wilmington, Winston-Salem
SC: Charleston (Glades, Northwoods), Columbia, Florence, Myrtle Beach, Rock Hill
VA: Danville, Lynchburg, Roanoke KY: Ashland
WV: Barboursville, Beckley, Bluefield, Charleston

There's more for your life at
SEARS

JCPenney Days Sale

AND OTHER GREAT VALUES

OUR BIGGEST AND BEST SALE CONTINUES!

S·A·L·E

12.99

Reg. \$16. Marled Shaker sweater in
ramie/cotton. For misses and petites.

Women's cotton shaker knit. Reg. \$20 Sale 15.99

**Save on all cotton and cotton blend
sweaters regularly \$16 and up. For
misses, juniors, petites and women.**

S · A · L · E

14.99

Reg. \$20. Our perfect little blouse takes a shine to spring. In Silk-Alike® polyester. And a choice of such vivacious colors! Misses' sizes.

Women's sizes. Reg. \$21 Sale 15.99

Sale prices on regularly priced merchandise effective through Saturday, March 28th, unless noted otherwise. Intermediate markdowns may have been taken on originally priced merchandise shown throughout this circular. Reductions from originally priced merchandise effective until stock is depleted.



The Oscar will be awarded to the year's most outstanding motion pictures and stars in The 57th Annual Academy Awards Presentation on Monday, March 25th, starting at 9 p.m. on ABC Television.

© A.M.P.A.S.



INTRODUCTORY
S • A • L • E

12.99

■ Will be \$16 to \$18. The Motion Pant[®], new in DuPont Dacron[®] polyester/cotton. In misses', petites' and women's sizes.

Introductory sale price effective through March 28th.

Sale 16.99 to 19.99 Reg. \$22 to \$26. Polyester or polyester/cotton blouses. For misses and women.

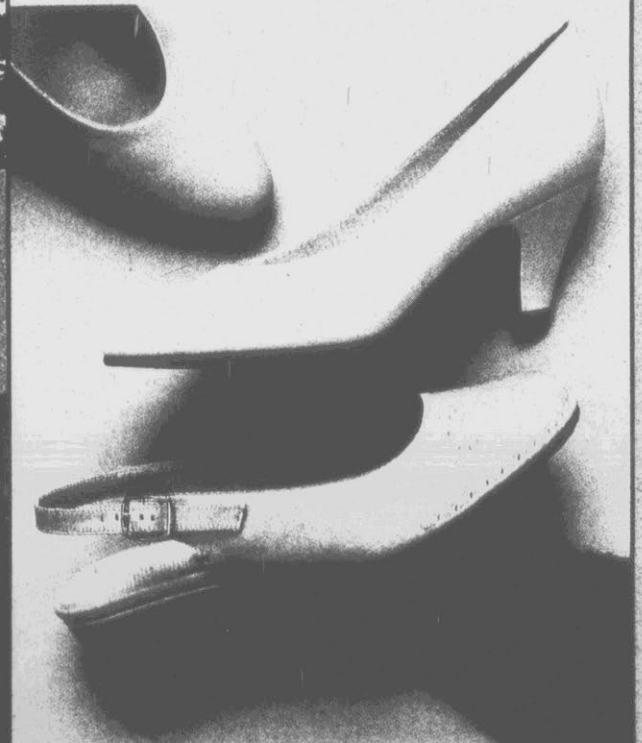

YOUR CHOICE, 14.99
ANNADALE[™] SHOES

Reg. \$20 and \$22. Classics fit for any occasion, these leather-like urethane shoes in pump, sling and wedge styles. All with comfortable padded insoles.



PAR FOUR®
S · A · L · E

10.99

Save on all our Par Four separates.

A. Sale 10.99, Reg. \$14. The slightly
oversize shirt in cotton/polyester;
misses' and petite sizes.

Women's size shirt, Reg. \$15 **Sale 11.99**

B. Misses' polyester/cotton shorts;
Reg. \$15 **Sale 10.99**

*C. Misses' cotton polo sweater; Reg. \$22 **Sale 16.99***
*Women's size short sleeve polo; Reg. \$25 **Sale 18.99***

D. Misses' and petites' polyester/cotton plaid shirt;
*Reg. \$18 **Sale 13.99***

E. Misses' all-cotton pants; Reg. \$25 **Sale 18.99**



S · A · L · E

11.99

Reg. \$14 to \$16. Sun-bright camp shirts in pure cotton. To mix with our easy Hunt Club® pants below. All for juniors. Cotton/polyester striped jeans. Reg. \$22 Sale 16.99
Washed cotton twill jeans. Reg. \$25 Sale 18.99
All cotton tank top. 5.99 every day

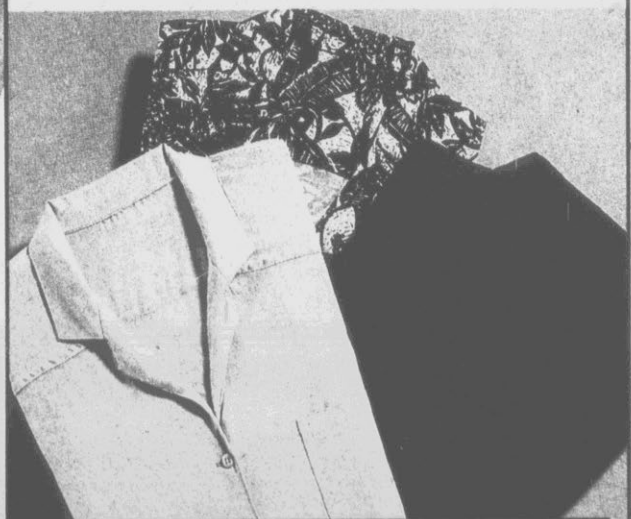

SALE 11.99

Reg. \$16 and Orig. \$18. More camp shirts in the spirit of spring! Pretty prints or vivid solids of rayon or cotton. Junior sizes.

YOUR CHOICE

\$35^{every day}

Eye-catching casual sophistication. See the big look of a full, full skirt, dropped shoulders, and easy rolled sleeves on an American shirtdress that goes anywhere, in style. Polyester/cotton solids, stripes, plaids and prints in misses' and petites' sizes.



25% off
all vinyl handbags
reg. \$10 and up

When you must carry everything. Our multi-compartment organizer bags are here in an assortment of styles.

Shown: Reg. \$16 Sale 11.99



SPECIAL BUY, 9.99

Choose the right bag for your particular taste from this special collection of multi-compartment vinyl handbags.



7.99 and 8.99^{every day}

Here's a real value! Fashionable vinyl handbag collection; from stylish compact clutches to double-zipper hobo.

S · A · L · E

25% OFF

Selected bras of nylon, polyester, more.

	Reg.	Sale
A. De-Lite-Fully Fitting™ lacy underwire bra	12.00	9.00
B. Fashion Plus Comfort™ bra	9.50	7.12
C. Padded plunge-front bra	10.50	7.87
D. Lacy underwire bra	8.00	6.00
E. JCPenney contour bra	8.50	6.37

Comparable savings on D or DD cups, where available.

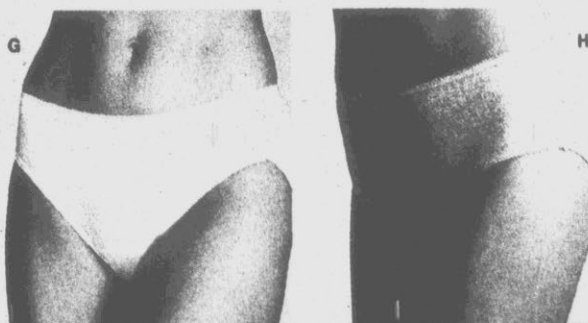

20% OFF ALL BIKINIS \$1 UP

	Reg.	Sale
F. Nylon hip hugger	2.25	1.80
G. Tailored cotton bikini	1.79	1.43
H. Sani-Terry® bikini of stretch nylon with cotton panel	2.25	1.80

Sale excludes those items designated in our stores as JCPenney Smart Values.



20% OFF SHEER CARESS®

Control top nylon sheer pantihose with Lycra® spandex, Reg. \$3 Sale 2.40

Not shown:	Reg.	Sale
Conventional sandalfoot with cotton panel	2.50	2.00
Sheer-to-waist or Ultra-sheer sandalfoot	2.75	2.20

Queen sizes, where available, at comparable savings.



HOBIE®
S · A · L · E

\$8

Ride the wave to great savings with Hobie sun and sport fashions. For example; feel breezy in an all-cotton short-sleeve t-shirt. S-XL. Reg. \$10, **Sale \$8**. Or sail away in polyester/cotton/nylon swim trunks. Sizes 28-38. Reg. \$24, **Sale 19.20**
20% off all men's swimwear.



ST JOHN'S BAY®
SALE 11.99 ea.

Reg. \$16 and \$18. Wear our oversized cotton camp shirt with the greatest of ease. Under the big top, safari-style cotton shorts; men's sizes S-XL.



20% OFF

Sale 10.40 and 11.20, Reg. \$13 and \$14. Here comes the sun! Our beach combing all-cotton shorts include fully lined Bermudas or fancy printed square-leg boxers. S-XL.

Not shown: All-cotton oversized, fashion T-shirt. Reg \$11 Sale 8.99



JEANS • SALE

17.99

■ **A. Reg. \$24.** Our justly famous Plain Pockets® jeans of soft bleached cotton denim. Young men's sizes.

■ **Not shown:** Plain Pockets® pre-washed jeans, Reg. \$20 **Sale 15.99**

■ **B. Lee®** pre-washed cotton jeans, **Now 18.99**

SALE 13.99

■ **Reg. \$18.** Stalk your prey in LeTigre® striped shirts of Dacron® polyester/cotton. Young men's sizes.

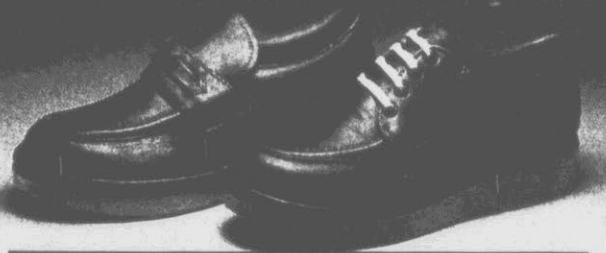

SALE 44.99_{pr.}

■ **Reg. \$55.** Streetcars® shoes of rugged leather with thick, comfortable rubber soles. Sealion slip-on or Dolphin oxford; men's sizes.

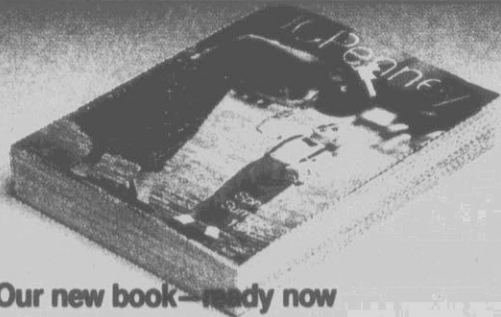

Our new book—ready now

From kidswear to cookware. Lighting to lingerie. You'll find thousands of values in our new 1200-page Spring and Summer '87 Catalog. Plus a coupon for \$5 off any catalog order. Get it all today for only \$4, at your nearest JCPenney Catalog Department.

The JCPenney Catalog

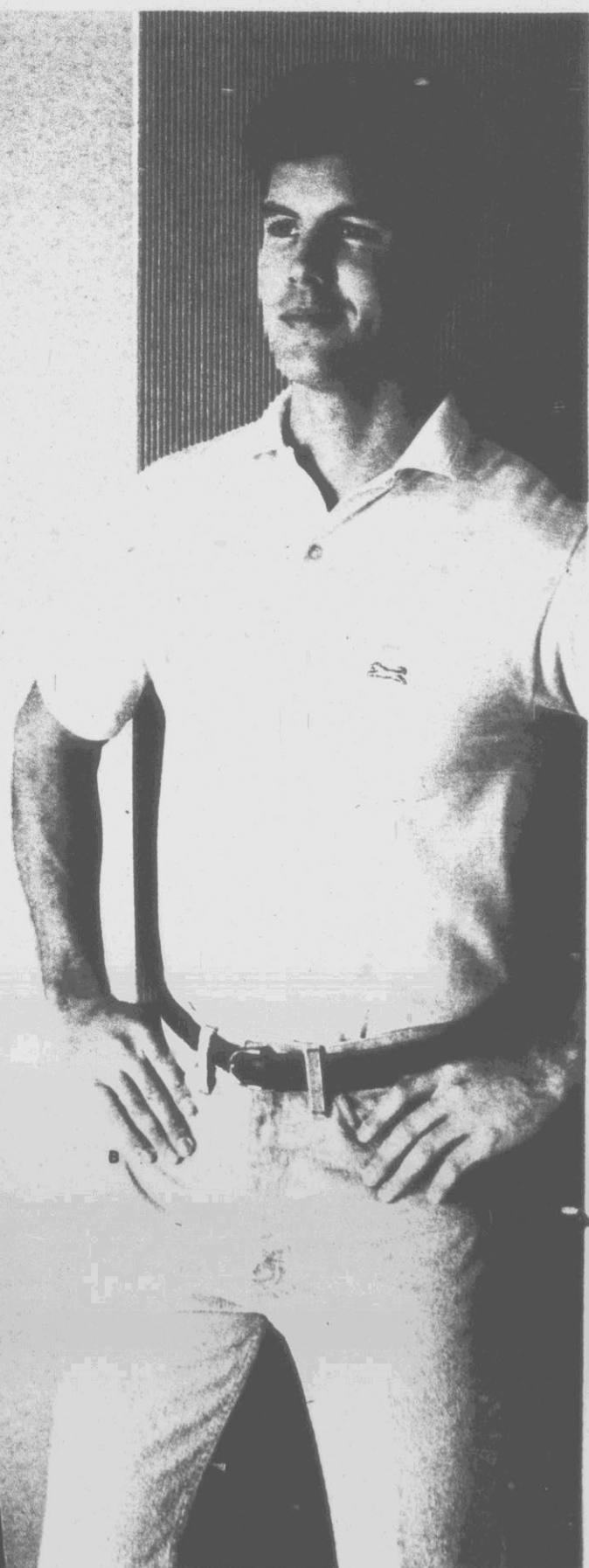



STAFFORD™
S • A • L • E

11.99

Orig. \$18. Solid color dress shirts, so low priced you can wear a different color every day of the week.

Polyester/cotton or cotton/polyester; men's sizes.

Sale 8.99 Orig. \$15. Selected silk ties.

Not shown:

Stafford™ solid color short-sleeve, Orig. \$16 Sale 11.99

Gentry® long sleeve fancy, Orig. \$20 Sale 11.99

SMART VALUE

66.98 every day

Edgeworth™ suited separates: a handsome twosome of easy-care polyester.

Sportcoat, **Smart Value 49.99 every day**

Slacks, **Smart Value 16.99 every day**

■ *Not shown: Austin Manor™ 3-pc. polyester/worsted wool suit, Smart Value 119.99 every day*



SALE 44.99

Reg. \$55. Classic comfort in a leather kiltie slip-on shoe with tassel. From Conte di Roma®.

S · A · L · E

4.99

■ A. Reg. 5.99. Bold solid-color T-shirt of polyester/cotton. In big boys' sizes.

	Reg.	Sale
■ B. Splashes of color on cotton shorts	8.00	5.99
■ C. Bright knee-buster cotton shorts . .	12.00	8.99
Not shown:		
■ Little boys' cotton/polyester T-shirt . . .	4.99	3.99
Little boys' vivid print cotton shorts . . .	7.00	4.99



SALE 6.99

Reg. \$9. Big girls' polyester/cotton oversized T-shirt. Polyester/cotton kneeknockers, Reg. 6.99 Sale 4.99



SALE 3.99 ea.

Reg. \$5. Little girls' shorts or Handstands™ shirt; of polyester/cotton.



LAST WEEK OF OUR NATIONAL BABY EVENT!

20% OFF

All Toddletime® and Sesame Street® tops, bottoms and selected sets.

A. Sale 3.99 Reg. \$6. Colorful camp shirt has bright prints on woven polyester/cotton. For toddler girls.

B. Sale 3.99 Reg. \$6. Coordinating rib knit pants in solids and prints. Polyester/cotton; sizes 2T,3T,4T.

C. Sale 3.99 Reg. 5.99. Their favorite Sesame Street® characters live up these popular polyester/cotton short sets. In styles for toddler boys and girls.

D. Sale 8.99 Reg. \$12. Action themes show up on short sets. Knit tops and twill shorts of polyester/cotton. In toddler boys' sizes.

Sesame Street® is the trademark of Children's Television Workshop®



SMART VALUE,
8.99 every day

She'll be the star of every occasion in this darling dress and pinafore of polyester/cotton. Sizes. 1/2-2.



Your choice,
3.99

SAVE ON SESAME STREET® TODDLETIME®

3.99

5.99

Your choice.
1.77

20% OFF

All Toddletime® underwear and sleepwear. All Sesame Street® underwear 20% off, too.

Sale 3.99 Reg. 5.50. Seersucker-look pajamas and gowns for boys and girls; in polyester.

Sale 5.99 Reg. 7.99. Polyester terry sleep 'n play garment; for boys and girls.

Sale 1.77 ea. Reg. 2.25 and 2.50. Infants' all-cotton print undershirt or training pants.

20% off reg. prices of all car seats and strollers.

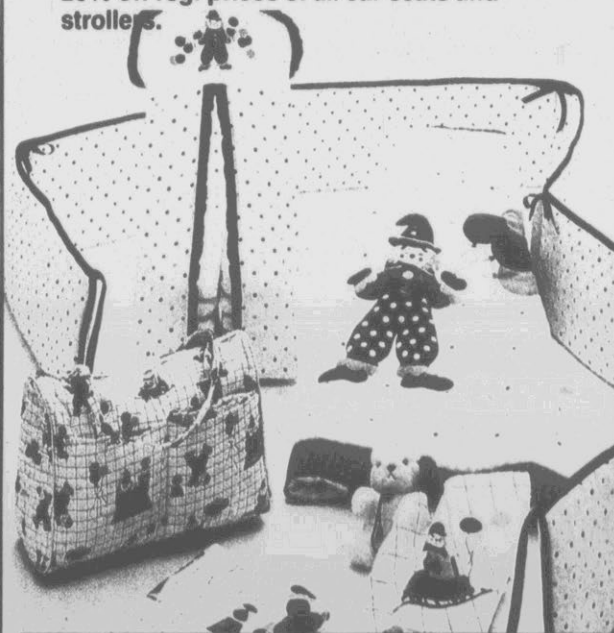

25% OFF

All Toddletime and Sesame Street bedding. Shown: Toddletime Fun Clown print on all cotton or polyester/cotton.

	Reg.	Sale
Crib sheet or receiving blanket	7.00 ea.	5.25
Comforter or bumper pad	22.00 ea.	16.50
Diaper stacker	7.50	5.63
Quilted diaper bag	14.00	10.50

NIKE®
S · A · L · E

16.99

■ **A. Reg. 22.99.** Stay in step with the durable Nike® Bravo jogger. With lightweight nylon and suede upper. In men's and women's sizes.

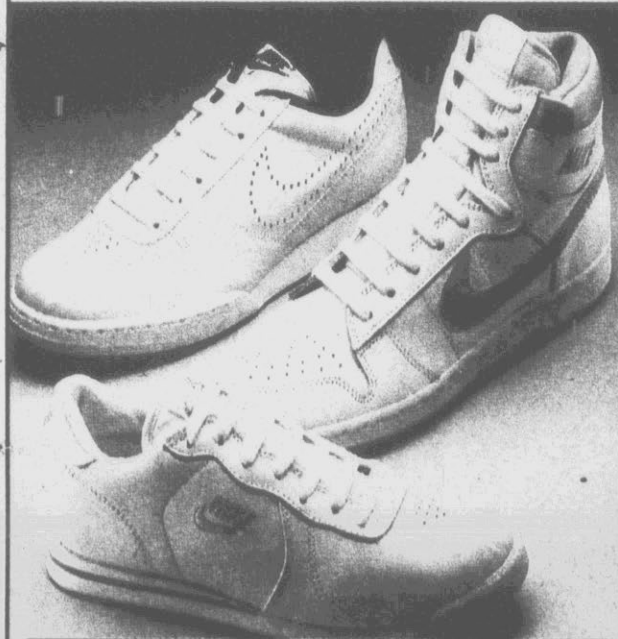

SALE 34.99

■ **Reg. 41.99.** Nike® Volcano II high-top all leather basketball shoe. Men's sizes.

■ **Not shown: Sale 26.99** Orig. 32.99. Men's Nike® Volcano II low-cut.

Sale 33.99 Reg. 39.99. Men's Nike® Volcano II mid-high.

SALE 24.99

■ **Reg. 34.99.** Get the perfect workout with the Nike® Workforce of lightweight garment leather. Men's sizes.

SALE 22.99

■ **Orig. 32.99.** Women, jump into the Nike® Radius aerobic shoe. Made of soft garment leather.

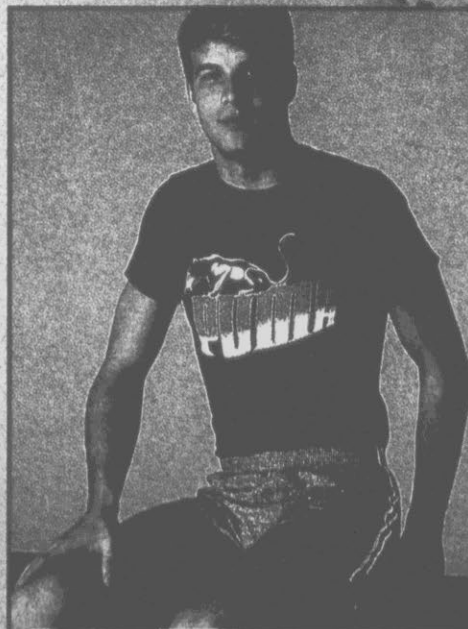

25% OFF

Top name polyester/cotton T-shirts. Choose from Nike®, Puma®, adidas®, Reebok® and more.

4.99 every day

Workout shorts at a no-sweat price. Choose from polyester/cotton or all polyester.



5.99 every day

Crop-top polyester/cotton exercise T-shirt. In women's styles and sizes.

4.99 every day

Coordinating polyester/cotton twill shorts. With easy-wear elastic waist.



JEWEL-TEX S • A • L • E

20% TO 40% OFF

Textured draperies of cotton/polyester/rayon;
cotton/acrylic backing. 50x84", Reg. \$30
Sale 23.99 pr. Additional sizes plus patio
panels, tiebacks and valances also on sale.
Semi-sheer polyester panel, 7.99 ea. every day

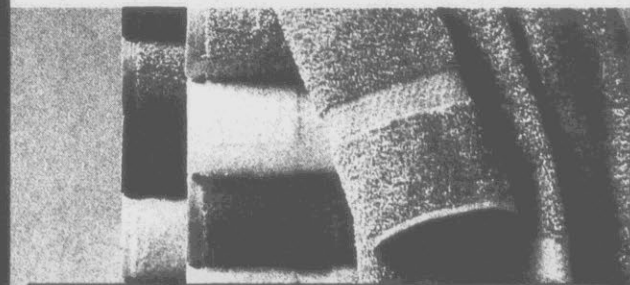

SALE 4.99 bath

Reg. 5.99. Pamper yourself with pima cotton towels.
Hand towels and washcloths at comparable savings.



**DU PONT
DACRON®
POLYESTER**

20% OFF

A. 24x42" Dacron® polyester rug,
Reg. \$17 Sale 13.60

B. 24x42" polyester accent rug, Reg. \$15 Sale \$12

Other sizes are also on sale.

Sale prices effective through Saturday, April 4th for towels and rugs on this
page; through Saturday, April 11th for Jewel-TEX draperies.

On Board



S · A · L · E

24.99 ea.

Reg. 29.99 to 34.99. On Board™ nylon multi-pak, carry-on, or cargo bag.

<i>Not shown:</i>	<i>Reg.</i>	<i>Sale</i>
<i>Sport duffle bag</i>	19.99	14.99
<i>Satchel</i>	24.99	19.99
<i>Deluxe multi-pak</i>	49.99	39.99
<i>International pak</i>	59.99	47.99

CLOSEOUT \$88 SET

Orig. \$134. Jaguar™ 5000 vinyl luggage set:

	<i>Orig.</i>	<i>Sale</i>		<i>Orig.</i>	<i>Sale</i>
<i>Tote bag</i>	\$12	5.99	<i>25" pullman</i>	\$35	22.99
<i>Garment bag</i>	\$20	14.99	<i>27" pullman</i>	\$45	29.04
<i>22" carry-on</i>	\$22	14.99			

SALE 169.99 SET

Reg. \$230. Samsonite Tiempo® nylon luggage set:

	<i>Reg.</i>	<i>Sale</i>		<i>Reg.</i>	<i>Sale</i>
<i>Tote bag</i>	\$25	18.49	<i>22" pullman</i>	\$45	33.75
<i>Garment bag</i>	\$60	48.00	<i>26" pullman</i>	\$65	48.75
<i>Tempo pack</i>	\$35	21.00			

Jaguar 5000

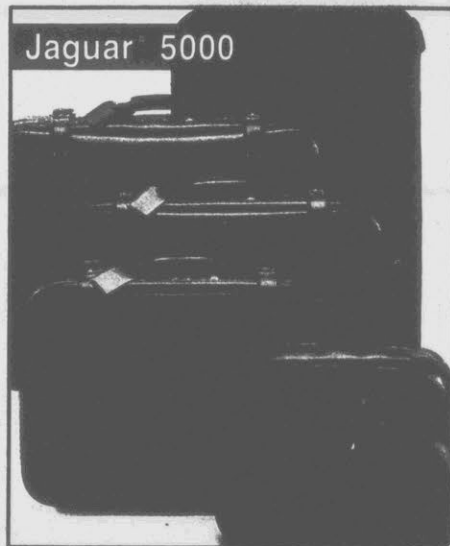

Samsonite Tiempo



You're looking smarter than ever.™ JCPenney



EVENT STARTS SUNDAY, MARCH 22, 1987

GREENVILLE, NORTH CAROLINA

Store Phone 756-1190 Catalog Phone 756-2145

Open Monday thru Saturday 10:00 a.m. to 9:00 p.m. Sunday 1:00 p.m. to 6:00 p.m.

SALE PRICES EFFECTIVE THRU SATURDAY, MARCH 28, 1987

Advertising Supplement to the DAILY REFLECTOR, Wednesday, March 25, 1987