

**APOLOGY**

Gary Dotson met the woman who accused him of rape six years ago and told her on TV that he accepted her apology. See page 6.

**ARRESTS**

Authorities have arrested four people following the slaying of a Highway Patrol trooper Tuesday in Halifax County. Page 10.

**ECAC TOURNEY**

The ECAC-Southern Division Baseball Tournament will get underway Thursday with East Carolina seeded first in the field. Page 15.

# THE DAILY REFLECTOR

TRUTH IN PREFERENCE TO FICTION

104th YEAR NO. 116

GREENVILLE, N.C.

WEDNESDAY AFTERNOON, MAY 15, 1985

38 PAGES PRICE 25 CENTS



**BODY TAKEN FROM MOVE SITE** — Workers remove a body from the rubble at the site of the former MOVE house Tuesday in Philadelphia. Fire swept through many homes in the neighborhood of the house occupied by MOVE, a radical group, following a siege and aerial bombing of the house Monday. (AP Laserphoto)

## Mayor Defends Bomb Use

# Police Probe Rubble For Victims Of Fire

By LEE LINDER  
Associated Press Writer

PHILADELPHIA (AP) — Police using a huge crane today dug through the charred ruins of a radical group's house, seeking more bodies after a daylong siege by police and a fire that also set the neighborhood ablaze.

All or parts of six charred bodies, two of them the remains of children, were removed Tuesday from the ruins of the house formerly occupied by the group MOVE.

Meanwhile, the mayor defended a decision to drop a bomb on the house as appropriate although it "did not turn out as intended," while critics said police overreacted and should have been aware of the danger of fire.

And the city's police commissioner said officials now believe the MOVE members who had been barricaded in the house had a hand in starting the fire, and said members apparently had spread flammable material around their compound.

Representatives of the health department, fire department, medical examiner's office and mayor's office

joined police in the search for bodies.

"I imagine it's going to be an all-day thing," said police Detective Jerry Whartenby.

Fire Commissioner William Richmond described the unidentified remains found Tuesday "as two male adults, one female adult, parts of another adult, one female child, and multiple parts of at least one other child."

Some reports had said as many as 12 adults and 10 children had been holed up in the house before the police tried to clear them out. Other reports about the squalid fortress said that MOVE members had dug a labyrinth of tunnels from the basement, and police were looking for signs of escape routes.

The fire that damaged or destroyed dozens of homes in the middle-class neighborhood broke out after police dropped a bomb on the roof of MOVE headquarters.

Mayor W. Wilson Goode, who denounced MOVE as a group "dedicated to the destruction of our way of life," said he accepted responsibility for the fire, though he said it

was not known who started it. He promised the estimated 225 neighborhood residents who were displaced by the fire that the city would pay to rebuild their houses. Damage is estimated at at least \$5 million.

Police Commissioner Gregore Sambor, interviewed today on the "CBS Morning News," said, "We did not create any fire."

"The fire did start inside the house," said Sambor, who ordered the bomb dropped. He said police had tested the bomb on wood-and-tar paper structures without starting any fires.

"To the best of our knowledge, the MOVE members had spread flammable material in their compound and in neighboring areas," he said, in explaining why the fire burned so hot and spread so quickly.

MOVE members had said they were "prepared to die," he said. MOVE follows a philosophy espoused by its founder, Vincent Leaphart, who later took the name John Africa. Its members, who use the surname Africa, eschewed con-

(Please turn to page 14)

# Lawyer Says Board Failure Was 'Technicality'

By JERRY RAYNOR  
Reflector Staff Writer

School board attorney Phillip R. Dixon says he wants the public to understand that recent concern over failure to secure Justice Department preclearance in a 1977 change in the method of city school board selections "in no way invalidates the legality of actions taken by the city school boards since that time."

"I wish to emphasize," he added, "that the only concern of the Justice Department is that any change in the election structure of a school board does not result in a negative impact on minority representation."

Dixon further notes that the 1977 election change was in fact submitted to the Justice Department in the summer of 1977. The U.S. Justice Department in October, 1977 responded to an August, 1977 letter from Louis Singleton, then serving as the school board's attorney.

The reply letter to Singleton,

referring to the change in method of selection of the Greenville City Board of Education, states: "The Attorney General does not interpose any objection to the change in question. However, we feel a responsibility to point out that Section 5 of the Voting Right Acts expressly provides that the failure of the Attorney General to object does not bar any subsequent judicial action to enjoin the enforcement of such change." This letter was signed by Drew S. Days, III, Assistant Attorney General, Civil Rights Division.

Until the question of preclearance was raised in April by the Concerned Citizens for Justice, a minority group that wants more representation on local boards, there has been no action, nor questioning of the legal status of school board members and their actions as members. "I believe that those raising questions recently, not understanding the situation, may have

panicked a little," Dixon said. Essentially, "the failure of the Greenville City Board of Education to obtain such preclearance was a mere technicality," he added.

Had there been any serious doubts on the part of the Justice Department about the legality of the 1977 Greenville city schools election change, or any possible negative

impact on minority representation, Dixon said he feels sure the Justice Department would have immediately posed objections to the plan and directed the board to revise the plan to meet the mandates of the Voting Rights Act.

In a Texas court case which was the subject of a suit before the U.S. District Court for the Northern

District of Texas and bears similarity to the Greenville situation, the ruling by the reviewing court was that "no past actions (on the part of the board) are proscribed," Dixon said.

Asked about the method of elections and procedures proposed for a merged Greenville-Pitt County School Board, Dixon said "the pro-

posed merger act, including the method of electing school board members, has been studied by North Carolina legal officials. Once the proposal is approved, action will be taken to submit the procedures to the U.S. Justice Department for their determination of its validity before any voting action takes place."

# Utilities Commission Told Of Savings Realized By Load Management Strategy

By STUART SAVAGE  
Reflector Staff Writer

Members of the Greenville Utilities Commission were told Tuesday night that load management operations for the month of April saved around \$122,824, approved the write-off of some \$100,856 in bad debts from the 1983-84 fiscal year and presented Margaret Wirth with a plaque for her service as a commission member.

Malcolm Green, superintendent of GUC's electric system, reported that of the \$125,202 gross savings realized through load management operations during April, \$78,474 resulted from operation of load management switches on water heaters, while \$44,588 came from voltage adjustments and \$2,140 came from supplemental generation at the water treatment plant.

But Green said a \$2,378 minimum billing ratchet resulting from a peak demand set last summer resulted in the \$122,824 net billing reduction.

Although commissioners approved the write-off of \$100,856 in bad debts from the fiscal year which ended June 30, 1984, GUC Director Charles Horne said "we continue to monitor these accounts and if a customer moves back onto our system, we require that full payment be made before a new service application is accepted."

Officials noted that the bad debts figure represented 19 percent of total billings during the 1983-84 fiscal year and is \$7,000 less than the write-off for the 1982-1983 fiscal year.

possible ... hearing all sides ... not trying to dictate..."

The city council last month appointed Annie L. Graham to replace Mrs. Wirth, who was named to the commission in March 1980.

Wadie Lewis, superintendent of GUC's water and sewer departments, reported that the new waste water treatment plant is now "totally operational" and said the city's old plant will be "closed down in 10 days to 2 weeks."

There was no public comment on a proposed amendment to sanitary sewer use regulations at a public hearing and commission members scheduled action on the amendment in June.

The new regulation would require owners of improved property within 150 feet of a city sewer installed after July 1, 1985, to connect to the public sewer within 90 days after receiving official notice to do so.

Owners of improved property within 150 feet of a city sewer installed before July 1, 1985 would be required to connect to the public sewer on or before July 1, 1987, and pay half the fees and charges applicable at the time application is made for sewer service.

The proposed amendment to the regulations also provides for a \$50 per day penalty for violations.

In other business, the commission approved an agreement with Southern Railway to locate a transmission line from the Eastside Substation to Simpson along the railroad right-of-way; approved a pole attachment agreement with Red's TV & Cable Company of Farmville (\$5 per pole per year), for extending cable television service along N.C. 33 and in the Simpson area; approved a refund of \$20 to Mr. and Mrs. Benjamin Braswell, who complained that their electric service was cut off after they paid their bill, and rejected a request for relief from a high water-sewer bill

for use in construction of the transmission line from the Eastside substation to the Simpson substation to Rigby Electric Supply Co. for \$118,239.

Commissioners also awarded a bid for the purchase of 39 concrete poles

## REFLECTOR HOTLINE

Hotline gets things done. Write and tell us about the problem or issue into which you'd like for Hotline to look. Enclose photostatic copies of any pertinent information. Our address is The Daily Reflector, Box 1967, Greenville, N.C., 27835. Because of the large numbers received, Hotline cannot answer or publish every item we receive, but we deal with all of those for which we have staff time. Names must be given, but only initials will be published.

### ASSISTED IN EMERGENCY

I am grateful to and have no way to know the identities of two young ladies who assisted in the parking lot of the Farm Fresh Store here recently. A soft drink bottle exploded, cutting an artery in my arm. I was taken away by the Rescue Squad and these ladies put all my groceries in my car and locked the doors. I appreciate them more than they'll ever know. G.B.



### Inside Today

Partly cloudy tonight, Thursday with 30 percent rain chance. Lows mid 60s, highs upper 80s.

### Looking Ahead

Friday through Sunday, partly cloudy with chance of showers each day. Highs Friday in 80s, then 70s to 80s rest of weekend. Lows in 50s.

### Forecast

Page 4 — Editorials  
Page 10 — State news  
Page 14 — Obituaries  
Page 15 — Sports  
Page 19 — Local news  
Page 30 — Crossword

# Engagements Announced



**CYNTHIA MARIE PACY**...is the daughter of Mr. and Mrs. Robert C. Pacy of Stoneham, Mass., who announce her engagement to Michael M. Wooles, son of Dr. and Mrs. Wallace R. Wooles of Greenville. An Aug. 18 wedding is being planned.



**MARY ANN MORRISON**...is the daughter of Dr. and Mrs. Hugh Maxwell Morrison Jr. of Southern Pines, who announce her engagement to Carlton David Johnson, son of Dr. Thomas Hatcher Johnson of Greenville and the late Nancy Adams Johnson. The wedding will take place June 15.

## Dear Abby

By Abigail Van Buren  
1983 by Universal Press Syndicate



(Every teen-ager should know the truth about drugs, sex and how to be happy. For Abby's booklet, send your name and address clearly printed with a check or money order for \$2.50 (this includes postage) to: Abby, Teen Booklet, P.O. Box 38923, Hollywood, Calif. 90038.)

## Should Stores Sell Bottled 'Fresh Air'

**DEAR ABBY:** Thanks for running the letter from "All Choked Up," complaining about people who practically bathe in cologne and perfume. I have a close friend who really needs to read that letter (I clipped it), but I don't know how to get that message to her without hurting her feelings. She may have read it, but most people never see themselves in your letters.

I've been trying for a long time to think of a diplomatic way to tell her that her cologne is killing me! When we're in a restaurant, I try to sit on the other side of the table. When we talk, I try not to get too close, but when I'm riding in a car with her, I'm trapped. If I open the car window, she says, "The air conditioner is on." Then she rolls the window up!

I wish perfume counters sold bottles of "Fresh Air."  
**SUFFOCATED BY SCENTS**

**DEAR SUFFOCATED:** What's wrong with the direct approach? No friend worth having would intentionally offend. It would be a kindness to tell her.

**DEAR ANONYMOUS:** For openers, you shouldn't have asked Joe if he had ever been to bed with Joyce. (It's none of your business.) And Joe shouldn't have told you. You are childish and unfair to refuse to socialize with Joyce, thus breaking up the foursome.

The solution would be to take a more realistic and mature attitude about something that happened before you were even in the picture, then bury the hatchet. But not in Joyce's back.

## Wedding Invitation

Mary Ella Joyner requests the honor of your presence at the marriage of her daughter, La'Senna, to Charles Wesley Hardy, on Saturday at 5 p.m. at the home of the bride's mother, 111 Foree Circle in Farmville.



**DIENER'S BAKERY**

"Greenville's finest bakery for 63 years."

815 Dickinson Ave.

### Cakes For All Occasions

752-5251

## At Wits End

By Erma Bombeck



All of my life I've been a social wimp.

I laugh at jokes that aren't funny. I rave about yellow food. I compromise my own views.

If I had seen the emperor naked, I would have said, "Love that color on you. You're a Spring, aren't you?"

I'm a wimp because basically I am insecure and need to be loved.

Recently, I read where Christopher Welles, a prominent hair stylist, named Tina Turner as having the best hair style in America today. He described it as "innovative and fresh."

Croissants are fresh. Fat

cheerleaders are innovative.

Tina's hair is what happens to a 45-year-old woman who has just been told by her obstetrician she is about to become a mother.

It's what happens when you clean the toaster without unplugging it.

It's what happens to Shirley MacLaine's hair in "Terms of Endearment" after a ride in a convertible with Jack Nicholson.

It's what happens when you crawl out of bed in the morning and want to die.

There's a lot of things to admire about Tina Turner. Her legs, for example. They're going to go on dancing for a good 20 years after she's gone. She sings a good song, seems like a nice lady and has endured. But somehow I don't see the women of America worshipping at the shrine of space shuttle hair.

What is really amazing to me is the double standard our kids use. Recently my son came for a visit. Something had happened to my hair. I had slept funny on it and already used enough foam on it to land a crippled 747.

"What's wrong with your hair?" he asked.

"What's it doing?"

"It's sticking up all over your head. Jeez, Mom, you ought to do something with it. It looks strange."

"I look strange," I said. "You talk to me about my hair when you can watch Cyndi Lauper without adjusting the color on the TV set?"

"You could watch the Grammys and not try to crawl into the set with a brush and comb? And as for Tina Turner's hair..."

"What's wrong with Tina Turner's hair?" he said defensively.

"It looks like she's just been on a trip with Toto and Dorothy."

"I always thought you were too insecure and had to be loved to say things like that."

I shrugged. "So maybe she has a cowlick. I'll give her that."

## Births

### Wilson

Born to Mr. and Mrs. Henry Roosevelt Wilson, Parmele, a son, Joshua Devon, on May 8, 1985, in Pitt County Memorial Hospital.

### Mabe

Born to Mr. and Mrs. Michael Joseph Mabe, Ayden, a daughter, Andrea Renee, on May 8, 1985, in Pitt County Memorial Hospital.

### Haynes

Born to Mr. and Mrs. Charles David Haynes Jr., 1003 E. Wright Road, a son, Wesley Scott, on May 8, 1985, in Pitt County Memorial Hospital.

### Bridges

Born to Mr. and Mrs. Paul Bridges Jr., Lot 20 Oakwood Acres, a daughter, Paulette Renee, on May 8, 1985, in Pitt County Memorial Hospital.

### Nichols

Born to Mr. and Mrs. David Webster Nichols Jr., 105 Jay Circle, a son, Brandon Webster, on May 9, 1985, in Pitt County Memorial Hospital.

### Barr

Born to Mr. and Mrs. James Edward Barr, Williamston, a son, Brian Edward, on May 9, 1985, in Pitt County Memorial Hospital.

### Matheron

Born to Mr. and Mrs. Christian Matheron, Wilson, Wyo., a daughter, Catherine Therese, on May 9, 1985. Mrs. Matheron is the former Lynn Cargile of Greenville.

### Bridgers

Born to Mr. and Mrs. Daniel Simon Bridgers, Ahsokie, a son, Nicholas Daniel, on May 10, 1985, in Pitt County Memorial Hospital.

## Mrs. Williams Gives Talk

Mrs. R.T. Williams, state organizing secretary of DAR and a member of the Major Benjamin May Chapter, spoke at the chapter meeting Saturday. She reported on the Continental Congress held in April in Washington.

She encouraged members to become involved in the national society elections and attend the congress in 1986.

Mrs. E.P. Bass presented a memorial to Bertha Lang Darden. The national defense report was given by Mrs. Russell Britt, regent.

Mrs. Rodney Carlson and Mrs. John C. House were named as new members.

Officers of the chapter were meeting hostesses.

**Community Watch** - neighbors helping neighbors! Inquire about starting a community watch program in your neighborhood. Contact Sgt. Doug Jackson at the Police Department, 752-3342.

## Give him a memory for Father's Day and SAVE up to 25%



This Father's Day, begin a tradition by having those adorable baby shoes preserved in bronze. Choose from our five most popular styles...at up to 25% savings

- 62 Miniature Oval Picture Frame
- 51 Unmounted shoe
- 50 Bookends
- 32 Walnut Base
- 31 Walnut Base

Any of these distinctive styles will be available in six different finishes: bright bronze, antique bronze, pewter, silver, gold, and porcelainizing a beautiful china-like finish available in three lovely pastel tones. For only 25c a letter, we will engrave baby's name and birthday. We can even add birthstones and zodiac signs for a minimal cost. It's a perfect finishing touch. Remember...up to 25% savings during our Father's Day Sale. The perfect way to start a tradition. Sale ends May 25.

Style 51 Unmounted Shoe Bright Bronze Reg \$16.50 **NOW ONLY \$12.38**

Style 31 Walnut Base 1 Shoe Bright Bronze Reg \$26.95 **NOW \$23.64**

Style 32 Walnut Base 2 Shoes Bright Bronze Reg \$44.95 **NOW \$34.99**



**Brody's**  
The Plaza

Enjoy the convenience of a Brody Charge Account. Open one today!

## Belk Tyler

carolina east mall greenville



### COMMITMENT TO VALUE

#### Shell/Cord and Metal! Cord Spring Belts!

Special Purchase **15.99**

All Natural abalone shell with an array of pastel cords, white, beige, more. Sharp accessory item!



Shop Thursday, Friday and Saturday!

Shop Monday Through Saturday 10 a.m. Until 9 p.m. —Phone 756-B-E-L-K (756-2355)

### TWICE IS NICE!

1726 W. 5th Street  
752-1722  
M.T.Th.F.: 9:30 - 4:30  
Wed. 9:30-6 Sat. 10-4

Come See Our Newly Expanded MATERNITY Department And New 25% Off Sale Room!

Ease Of Shopping Guaranteed.

"Nearly New" Children's Clothing, Shoes, Furniture, Maternity, Toys, on Consignment.

### 30% off

Flexalum 1" Blinds  
Flexalum 1/2" Micro Blinds  
Louverdrape Verticals Blinds (Both 3 1/2 and 2" Louvers)  
Nanik Wood Blinds

Timberline Wood Blinds  
Woodland Blinds  
Verosal Pleated Shades  
Sunpleat Shades

Country Drapery & Fabric Shop

Rt. 3, Box 376-C, Greenville, N.C. Don & Lois Braxton Phone 756-2876 Monday-Friday 10 to 4

## VERY IMPORTANT SAVINGS

Save \$5.00 on Etienne Aigner Sandals. Reg. \$28.00

**\$22.99**

Enjoy the summer in comfort and style with Aigner Sandals. (Thong Sandal also available.) White or sig.



Etienne Aigner

Save \$5.00 on Candies Espadrille. Reg. \$20.00

**\$14.99**

Classic French Espadrille available in all the fashion colors—Light blue/white, Beige multi, Pink/White.



Candie's

Enjoy the convenience of a Brody charge account. Open one today!

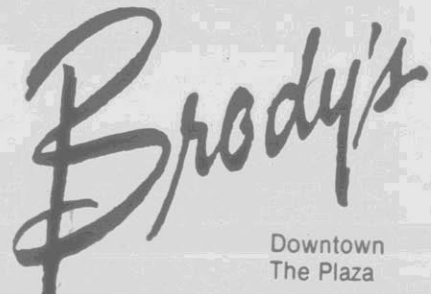

**Brody's**  
Downtown The Plaza

# Service League Names New Members

Ten provisional members of the Greenville Service League have been welcomed into full membership and have completed five months of

volunteer activities. Working in the Pitt County Memorial Hospital gift shop, visiting patients with the shop cart, chapel care, sewing layettes for newborns, tray favors for hospital patients, Red Cross Bloodmobile, Operation Santa Claus, Christmas food baskets for the needy and working for the Ronald McDonald house have been included in their activities.

The welcome was given by President Mrs. Edward C. Smith Jr. to: Mrs. Allen Adams, who has lived in Greenville for many years. She attended East Carolina University and has been involved in many volunteer positions including Jaycettes and city schools. The Adams attend Jarvis Memorial United Methodist Church and they have three daughters.

Mrs. William C. Baggett has lived in Greenville for two years. Her husband is senior vice president with Wachovia Bank and they have three sons. She has a B.S. in special education from ECU and has taught school. She has been active in the Presbyterian church and PTA.

Mrs. McDonald Carr, who has lived in Greenville for many years, is a retired business teacher at Rose High School. She has both B.S. and M.A. degrees in business education from ECU. She has been active in Business and Professional Women's Club and Delta Kappa Gamma.

Mrs. Warren Charlton was a previous resident of Ahsokie and attended Radford College. Her husband is a department head with Burroughs Wellcome. The couple has three children. She is president

of the St. James United Methodist Women and is a former Sunday School teacher. Mrs. Bill Clark is originally from Weldon and came to Greenville as a student. She graduated from ECU with a degree in education. Her husband is a realtor and owner of Bill Clark Construction Co. The couple has three sons and are members of St. Peter's Catholic Church.

Mrs. Michael Dragoon is a graduate of the University of New Hampshire and has lived in Greenville for three years. Her husband is an industrial engineer with Procter and Gamble. Prior to moving to Greenville she was involved in the Woman's Club and chairman of the Hospital Auxiliary in Tunnhannock, Pa.

Mrs. Malcolm Howard has been a resident of Greenville for 12 years and her husband is an attorney. She attended the University of Hawaii, Coker University, University of Virginia and ECU. Her activities include being involved in the Museum of Art, a member of the Fidelis Book Club and a board member of Kennedy Children's Home.

Mrs. Bill Queen has a degree in English from the University of North Carolina and has been actively involved in various activities during her years of living in Greenville. She has been coordinator for the Tobacco Festival as well as serving on the board of directors of the Greenville Museum of Art.

Mrs. Thomas L. Scoopmire, a native of Greenville, graduated from ECU. She taught physical education

at Rose High School and works in the family business, Carawan Oil Co., of which her husband is president. The couple has a son and the family attends Jarvis Memorial United Methodist Church. Mrs. William R. Wright is a past recipient of the Civitan Award for Volunteer Service and has lectured in the city schools on historical costuming. Her husband is vice president and general manager of B. Wright Associates Marketing firm and they have three children. Mrs. Wright graduated with a B.S. degree in art education and B.S.A. in drama from ECU.

At the April 1-2 visits at Mendenhall, Alice Clark reported 41 league members worked 132 hours and collected 235 units of blood. Ann Lewis reported that a local florist

donated Easter lilies for the hospital chapel and Mrs. Donald McGlohon reminded members of the annual league luncheon on May 22 at 11 a.m. at the Greenville Country Club.

Linda Seykora reported on the hospital gift shop. Twenty memorials were received by Dottie Nisbet for the Laughinghouse Hospital Fund and 11 calls for service were answered.

May Harvey, layette chairman, had a call and Marcia Tingelstad

reported three calls and four returns of lending chest equipment. Mary Wesley Harvey reminded members that June 12 is the last day of the spring term.

**Little University Preschool**

- Certified Kindergarten
- Lippincott Program
- Class Taught Age 2 and Up
- School Transport AM/PM

Greenville 752-7148      Farmville 753-5681

## Births

**Beaman**  
Born to Mr. and Mrs. Mack Waddell Beaman, Route 2, Greenville, a son, Victor Mackenzie, on May 6, 1985, in Pitt County Memorial Hospital.

**Webb**  
Born to Mr. and Mrs. Steven Lawrence Webb, Williamston, a daughter, Jamie Joan, on May 6, 1985, in Pitt County Memorial Hospital.

**Mozingo**  
Born to Mr. and Mrs. Willie Thomas Mazingo Jr., Farmville, a daughter, Ashley Megan, on May 6, 1985, in Pitt County Memorial Hospital.

**Smith**  
Born to Mr. and Mrs. Hurtford Smith Jr., Tarboro, a son, Hurtford III, on May 7, 1985, in Pitt County Memorial Hospital.

**Manning**  
Born to Mr. and Mrs. Lewis Keith Manning, Winterville, a son, Justin Keith, on May 7, 1985, in Pitt County Memorial Hospital.

**Tracy**  
Born to Mr. and Mrs. Preston Thomas Tracy, 110 Ripley Drive, a son, David Preston, on May 7, 1985, in Pitt County Memorial Hospital.

**Dennis**  
Born to Mr. and Mrs. Allen Lee Dennis, Ayden, a son, James Allen, on May 7, 1985, in Pitt County Memorial Hospital.

**Linton**  
Born to Mr. and Mrs. William Keith Linton, Walstonburg, a son, Norman Andrew, on May 8, 1985, in Pitt County Memorial Hospital.

## Marriage Announced

Mr. and Mrs. Edward E. Corey of Greenville announce the marriage of their daughter, Faye Michelle, to Curtis Ray Reddick, son of Robert Reddick and Clara Corey, both of Greenville. The ceremony was held at the home of the mother of the bridegroom Sunday at 5 p.m.

**THE OUTSIDE COUNTS**  
WINSTON-SALEM, N.C. (AP) — There's no such thing these days as a simple package.

Several years of research often go into developing many of the materials used to package hundreds of familiar products on supermarket and drug store shelves.

The time and care given to perfecting a single package is well spent, though, contends RJR Archer Inc., a packaging producer. It says, "Rigorous testing of product packaging helps assure consumers that the items they buy are in top condition."

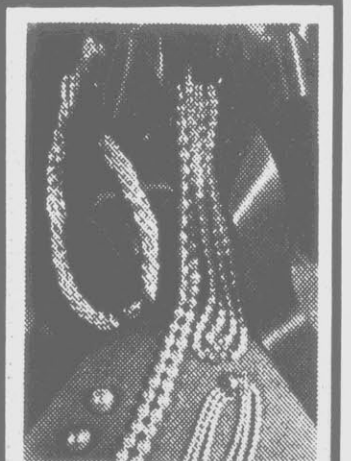

## The Versatile Pearl

Short and long, classic or jazzy, white or pastel, alone or in groups, Pearls, whether natural or cultured, are the jewelry fashion leader. One strand may be worn as a long necklace, a choker or a bracelet with just a twist here and a clasp there. A pearl stud earring may make a simple statement or scream for attention in a fancy earring jacket.

The versatile pearl. A must for the well-dressed woman.

**LAUTARES JEWELERS**  
Registered Jewelers  
Certified Gemologists  
414 Evans Street



# Belk Tyler

carolina east mall    greenville



# CROSCILL WEEK

### "Chelsea" Bedroom Ensembles Up to \$35 Off!

"Chelsea" comforter, pillow shams, dust ruffles and more by Croscill® 100% cotton face. Regular \$12 to \$140

25% OFF

### Amanda Comforter Set

Comforters, matching dust ruffle & shams. Regular \$26.00-\$112.00

25% OFF

### Country Ruffle Kitchen Curtain

Ruffled style with tiebacks. Natural color only. 150x45, 50% polyester, 50% cotton. Regular \$75.00. (Machine washable)

25% OFF

### Carolina Ruffle Curtain

Ruffle style curtain (150x84). Natural only. 50% Kodol polyester, 50% cotton. Regular \$65.00

30% OFF

### Crossroads Set.

Choose from twin, full, queen comforters. Colors, royal or adobe. Twin \$4.00, Full \$8.00, Queen \$106.00. Curtain \$60.00

20% OFF

### Nose Gay Comforter Set.

Dust ruffle, shams, priscilla curtains. Floral printed. Regular \$23.00-\$120.00

25% OFF

### Laurel Comforter Set.

Dust ruffle, shams, priscilla curtains. Floral design with pewter binding and lace. Regular \$26.00-\$127.00

25% OFF

SPECIAL ORDERS AVAILABLE IN ALL ITEMS

### by Croscill® for You

### Somerset Bedroom Ensemble.

#6822 Comforter Set. Reversible. Full or queen. \$104.00 and \$126.00.

30% OFF

Priscillas with jib tiebacks, sham and dust ruffles. 50% Kodol polyester, 50% cotton. Regular \$26.00-\$126.00

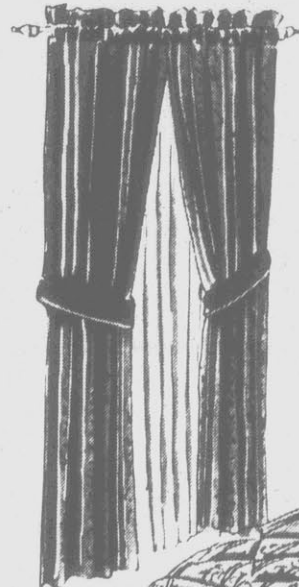
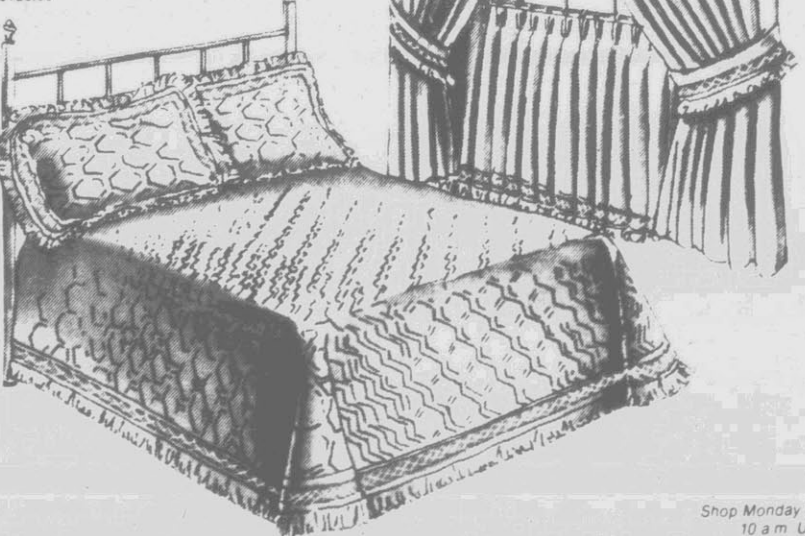

### Chestnut Hill Bedroom Ensemble

Mauve floral print comforter, Priscillas, dust ruffles, sham, and more. Regular \$26.00-\$120.00.

Sale 30% OFF



### Country Ruffle Bedspread Ensemble

Choose from bedspreads, shams, priscilla curtains and tier curtains. Lovely Queen Anne style quilted bedspread (White, natural) Regular \$26.00-\$150.00.

30% OFF



Shop Monday Through Saturday 10 a.m. Until 9 p.m. Phone 756-BELK (756-2355)

# Editorials

## Conference

The ideology of hunger transcended political and social differences last week in Greenville.

Phosphorite, a mineral resource found in chemical fertilizer, prompted scientists from 42 nations to meet in Greenville. The substance spurred them to set aside political differences, roll up their sleeves and join hands in the fight against world hunger.

The mineral has international significance because of its ability to increase food production. Since it is an abundant eastern North Carolina resource, it also has local significance. Phosphorite, the source of phosphates, is mined in nearby Aurora.

The East Carolina University conference, sponsored by the International Geological Correlation Program, was designed to develop and share information on the mineral. Speakers and participants included representatives of underdeveloped nations in Africa and Central America as well as the United States and Soviet Union.

The "summit" meeting was the eighth in a series aimed at helping other nations discover and develop their supplies of phosphates. This research is vital, according to conference co-director Stanley Riggs of ECU, because fertilizer will be needed to feed the world's growing population.

"It is a solid science," Riggs said of phosphate research. "It is also a science on which the future well-being of mankind, the whole human race, may depend."

Preserving the earth's environment is also a science on which the future of humanity is hinged. We hope both the research and the conference put emphasis on how to remove and utilize the valuable resource of phosphate without damage to the environment. The condition of the environment directly affects the ability of the earth's inhabitants to feed themselves, phosphates or no phosphates. For this reason, utilizing phosphorite resources must go hand in hand with ecology. Both causes are ones the world's nations should set political difference aside to champion.

## Barbs

The exchange of barbs and criticism between President Reagan and Mikhail Gorbachev produces attention-getting stories in the news media but accomplishes nothing and only makes any real communication between their two countries more difficult.

Surely Mr. Reagan is not so unthinking as to believe his repeated pointing to threats of Soviet aggression will modify the Kremlin's policy on shooting-to-kill a foreign national who walks too closely to "no trespass" zones; nor statements of regret over the deliberate slaying of an American Army officer.

Gorbachev's frequent viewing-with-alarm a "re-surgency" of Nazism in the United States does not help him accomplish any kind of detente or anything else he says he would like to see. Both leaders play to their own captive audiences.

Someday there very well could be an occasion when meaningful communication between the rivals would be most helpful; and the people who are supposed to do the speaking for both sides may have forgotten the words, by then, and an opportunity fades away.

Somehow we can't see a whole lot of such opportunities coming our way.

—Arnold Sawislak—

## Confrontation For Reconciliation

WASHINGTON (UPI) — Just over a week ago, President Reagan delivered what may have been the most eloquent speech of his life at the site of the Bergen-Belsen concentration camp in Germany.

Here are some of the more striking excerpts:

"For year after year, until that man (Hitler) and his evil were destroyed, Hell yawned forth its awful contents. People were brought here for no other purpose but to suffer and die."

"Here death ruled. But we have

learned something, as well. Because of what happened, we found that that death cannot rule forever."

"We are here today to confirm that the horror cannot outlast hope — and that from the worst of all things, the best may come forward."

"Everywhere here are memories — pulling us, touching us, making us understand that they can never be erased. Such memories take us where God intended his children to go — toward learning, toward healing and above all, toward redemption."

Presidents are known and judged by their public utterances and it is a pity that this speech, overshadowed by other events on May 5, may not be remembered.

What will be remembered of that day, at least during the rest of Reagan's public life, is that he laid a wreath in a German army cemetery that contained the graves of soldiers who were members of Hitler's elite SS Waffen.

No more need be said about the reasons Reagan went to Bitburg. What may be worth examination is why the episode may haunt the president for the next three and a half years.

Even before the trip to Germany, Jack Germond, the canny political columnist, summed up the president's situation with words to the effect that he who lives by media symbols dies by media symbols.

That doesn't mean the Reagan presidency will or should be judged to any great extent on the basis of this incident. Reagan has made profound changes in the national government and its relationship to its citizens. He stemmed, perhaps ended, the trend toward federal activism that began more than half a century ago with Franklin D. Roosevelt. That will be the record on which the Reagan presidency will be judged by history.

But in rallying support for his substantive programs, Reagan has manipulated symbols to help his cause like the Wizard of Oz used flashing lights and puffs of smoke to terrify his visitors.

Who was it that produced Lennie Skutnik, the hero of Washington's Air Florida crash, to sit next to the first lady at a State of the Union speech? And who came back to the same occasion this year with the young Vietnamese woman who is attending West Point? Who, at the drop of a speaking opportunity, repeatedly quotes Democrats FDR and John Kennedy in an effort to wrap himself in the humanitarian heritage of the New Deal and the questing spirit of the New Frontier?

In all of this, he really has been a great communicator, managing with his words and public actions, by the places and settings he chose for his appearances to touch chords that the country liked.

But in Germany he communicated something he didn't intend. He was trying to project reconciliation and got confrontation.

Certainly Reagan is far from being the first president to engage in symbol-mongering. But until Bitburg, he did it better and profited more than most who have tried, and it may be a kind of wry justice that has him suffering for it now.

— Art Buchwald —

## Columnist's Views Are Sought

People are constantly asking me if the Reagan administration ever comes to me for personal advice. Up until last week the answer was "no." But, lo and behold, the other day I received a letter which was in the form of a poll. It said the president wanted to know where I stood on the controversial issues of the day. I was urged to answer the list of unbiased questions which were enclosed.

Some of them weren't easy, such as, "In the 1970s funds were cut off for development of the MX missile, causing our strategic defenses to

become dangerously obsolete while the Soviets escalated their weapons buildup. Do you support continued U.S. efforts to modernize our strategic defenses by funding this weapons system?" I was instructed to check off one of three boxes: "yes," "no" or "undecided."

I had no problem with that one. But the next one was a mind-bender. "Should the U.S. continue research and development of a space-based missile defense system to give the United States protection we do not now have against a Soviet nuclear

attack?" I took a gamble and said "yes." The question that followed also required tremendous concentration. "Do you agree with the Democrats who say the Soviet/Cuban efforts to topple pro-West governments in Central America pose no direct threat to U.S. security?"

I tried to figure out what answer the president would want to hear, and on a hunch said "no."

By this time I was perspiring. Ideological tests always get me nervous.

"Should the United States continue providing support to people in Central America who are fighting for their independence from Soviet-backed Marxists?"

I put a big black X in the "yes" box so the president wouldn't miss it. Then came the question which made me think the president might be considering me for the job as his secretary of the Navy. "The Soviets have amassed the largest naval force in the world and have increased the number of submarines patrolling the U.S. coast. Should the U.S. Navy receive more funding to replace our aging sea force and build more Trident nuclear submarines?"

I called up a friend who works at the Pentagon for advice on how to answer the question. "Oh," he said. "You got one of those Republican fund-raising letters too."

"What do you mean fund-raising? It says the president wants to personally know where I stand on the issues of the day. He probably wants to make me the new U.S. ambassador to Germany."

"If you read the letter closely you'll see it was sent out by the Republican Party and you're supposed to enclose your check with the answers."

"Are you trying to tell me the president isn't interested in my opinion?"

"He probably doesn't even know you were sent the letter. And he may never know unless you send the Republican a whopping check."

"I was hoping he was considering me for his new budget director," I admitted, "and the questions were just to see if I was a team player. Why did they write to me?"

"The Republicans probably bought your name for 5 cents from a credit card company."

"It's not fair to make someone answer a bunch of tough questions on national defense and then ask for money for the party."

He said, "It was either P.T. Barnum or Richard Viguerie who said, 'There's a sucker born every minute.'"

"Just in case you're wrong and the president wants me to be national security adviser after Pat Buchanan pushes Robert McFarlane out the window, what should I answer to the question on our need to replace aging subs with Trident nuclear submarines?"

He said, "The answer is 'yes' but that's still a secret. So for heaven's sake don't tell anyone you spoke to me."

—Elisha Douglas—

## Strength For Today

Every time we test the air pressure of the spare tire we are impressed with the debilitating effect of idleness.

Four tires which are in constant use will maintain their air pressure for a long time, while the spare loses it very quickly. Take the spare out and submit it to the rough use of everyday driving, and it will maintain its pressure as well as the other tires. But put it again back on the rack, and again it becomes flabby.

Many people dream of the happiness which would be theirs if they could be relieved of all responsibility. What fun it would be if one did not have to work at all! Yet the number of tragedies among the people who have this "advantage" is greater than to scratch to make a living.

It's hard to keep happiness at high pressure if we ride through life as a spare. Don't long for the spare rack.

POLITICAL FAUNA:

The Potomac Jellyfish (Budgetis Reelectus)

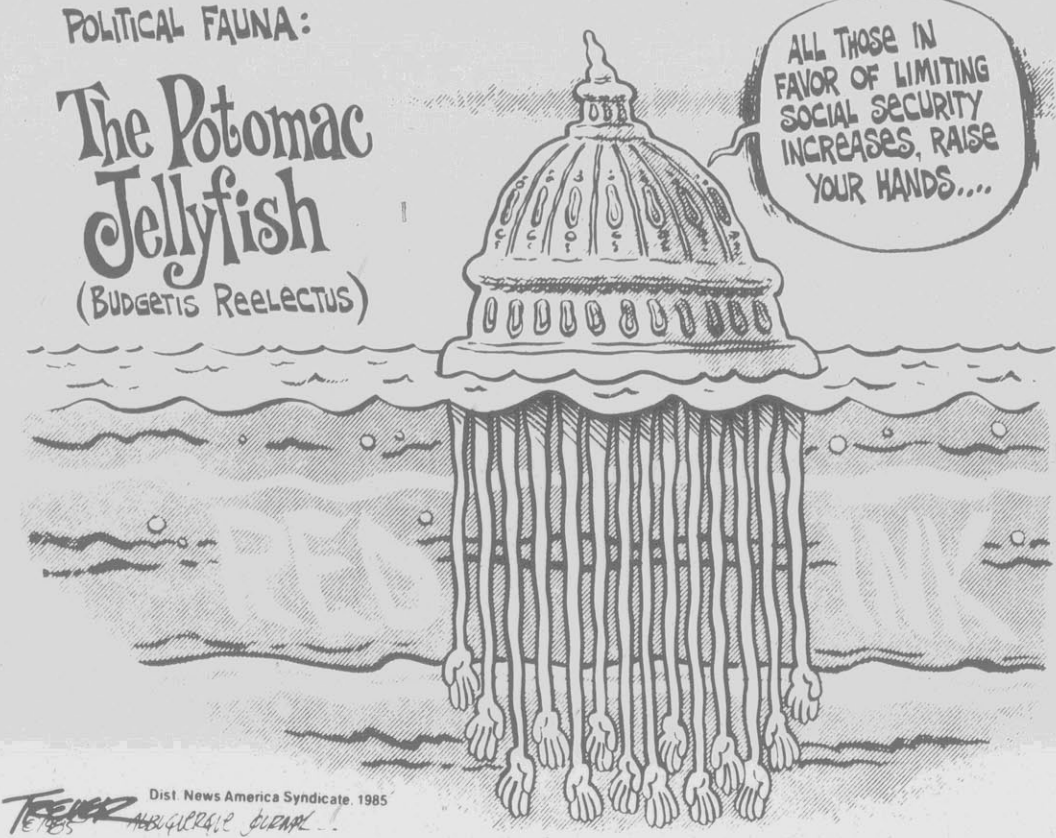

—Rowland Evans and Robert Novak—

## Chemical Weapons May Return

WASHINGTON — After 16 years of U.S. abstinence, a hesitant Congress is getting ready to move this country back into the chemical weapons business thanks to new evidence that the Kremlin has totally ignored the unilateral American freeze and is far ahead in this deadly field.

A high-powered presidential commission's report on the extent of Moscow's chemical war plans hit Congress recently, just as the Soviet Union is charged in a new book with using human guinea pigs to test deadly chemical weaponry. Coincidental timing of the two events may well persuade Congress to approve a new \$1.3 billion chemical weapons program, the first since 1970.

The commission, headed by retired diplomat Walter Stoessel and including former Reagan Secretary of State Alexander Haig and former Carter national security adviser Zbigniew Brzezinski, issues a grim warning. Failure to modernize chemical weapons, it says, will confront the U.S. with either "quick defeat" or "early escalation to a nuclear exchange" as the only response to Soviet chemical-war tactics being perfected in Afghanistan.

The time for an American program is none too soon. The high place of chemical warfare in Soviet

strategic planning is manifest in the brutal way new weapons are believed to be tested: against human beings, probably political prisoners under death sentence.

A book just off the presses, "Soviet Military Supremacy" by hard-line military experts David S. Sullivan and Quentin Crommelin Jr., makes the charge. Shortly after the invasion of Afghanistan, they write, "the Soviets conducted lethal chemical and biological tests against men and women tied to stakes in target areas at the gigantic Chikhany Chemical Test Range."

No Soviet specialist in this or past administrations that we asked dismissed the Sullivan-Crommelin contention as either implausible or untrue. What gives the charge special interest is Sullivan's former career as a top Soviet analyst for the Central Intelligence Agency (CIA), from which he resigned in 1978 after allegedly leaking a document to the late Sen. Henry M. Jackson. He is now national security aide to several conservative Republican senators; Crommelin is a former Senate aide.

One part of their book dealing with the dangers of Soviet chemical warfare was specifically verified for us by the intelligence community. They wrote that the Soviets have 14 chemical weapons production facilities "operating at full capacity"

(and eight biological warfare plants). The U.S. has none of either. "These horrifying weapons," says Sullivan and Crommelin, can be delivered globally by 150 special intercontinental ballistic missiles developed for that purpose.

Their book, a project of the Defense and Strategic Studies Program of the University of Southern California, could influence Congress on the chemical warfare issue. But likely to be more significant in moving the lawmakers is the Stoessel Commission report, which shows that the long freeze on U.S. chemical weaponry imposed by President Richard M. Nixon had no impact on the roaring Soviet program. The commission's stern warnings could prevent a recurrence of the last three years.

In both 1982 and 1983, it took a tie-breaking vote of Vice President George Bush to break a deadlock in the Republican Senate and end the long U.S. abstinence on chemical weaponry, but President Reagan's proposal to start catching up with the Russians fell in the Democratic House. In 1984, fearful that election-year politics would produce lopsided votes in both Houses against ending the freeze, the administration did not press the issue.

But 1985 looks different. Even before the Stoessel Commission report, the Senate Armed Services Committee approved the Reagan program by a record 15-to-3 vote. That suggests a much stronger Senate vote and at least a fighting chance to move the president's chemical weapons program through the House to replace useless stockpiles from World War II — and to develop new defenses against chemical war.

Whether the congressmen choose to ignore the human guinea pig charges, they cannot avoid clear evidence that Moscow has taken maximum advantage of the honorable American invitation to freeze chemical weapons. That has implications that reach beyond chemical warfare and go to the heart of the nuclear freeze movement and the belief that fear of the U.S. getting ahead is what drives Soviet weapons programs.

## Public Forum

To the editor:

As a fervent admirer of our beautiful state's bountiful natural resources, I wish to call attention to the upcoming "Hikes in State Parks" to be held May 19 in North Carolina's state parks. This event, scheduled for 2 p.m. throughout the state, is in recognition of the value of our state parks, as well as to enlist support for much-needed preservation efforts to maintain provisions of the park system.

North Carolina's state parks have so much to offer, but are in constant danger of encroachment by developers as well as the loss of already-meager funding due to federal budget cuts.

Please show your support for our state parks this weekend. We unfortunately tend to take such assets for granted until we no longer have them.

Nancy Ruppert  
Greenville

## The Daily Reflector

INCORPORATED  
209 Cotanche Street,  
Greenville, N.C. 27834

Established 1882

Published Monday Through Friday Afternoon and Sunday Morning

DAVID JULIAN WHICHARD, Chairman of the Board  
JOHN S. WHICHARD — DAVID J. WHICHARD, Publishers  
Second Class Postage Paid At Greenville, N.C.  
(USPS 145-400)

SUBSCRIPTION RATES

Payable in Advance

Home Delivery By Carrier or Motor Route Monthly \$4.00

MAIL RATES

(Prices include tax where applicable)

Pitt And Adjoining Counties \$4.00 Per Month  
Elsewhere in North Carolina \$4.35 Per Month  
Outside North Carolina \$5.50 Per Month

MEMBER OF  
ASSOCIATED PRESS

The Associated Press is exclusively entitled to use for publication all news dispatches credited to it or not otherwise credited to this paper and also the local news published herein. All rights of publications of special dispatches here are also reserved.

UNITED PRESS INTERNATIONAL

Advertising rates and deadlines available upon request  
Member Audit Bureau of Circulation

## Plans Noted For Project To Create New Center

By GILES HUDSON  
Associated Press Writer  
ST. PAUL, Minn. (AP) — Gov. Rudy Perpich announced today the formation of a non-profit corporation to build the nation's first center to treat worldwide victims of torture, and said he will spearhead fundraising efforts.

A task force Perpich appointed in January recommended the center be established in Minnesota because "there is no such center in the United States nor is there likely to be one in the near future."

Amnesty International, the worldwide human rights organization, estimates that 96 countries practice some form of torture on political prisoners and other "prisoners of conscience."

"Our feeling is that the number of people needing this service is so enormous that other states will see the need," said Robert Stein, dean of the University of Minnesota Law School and a co-chairman of the task force.

The torture center should be located in the Minneapolis-St. Paul Twin Cities metropolitan area, the task force recommended in its report. Other torture centers are located in Toronto and Copenhagen, Denmark.

"I cannot help but feel that our immigrant roots, our fine medical and legal facilities, our strong religious communities, and our strong caring for others make this an ideal place...for such a center," Perpich said at a morning news conference.

"It's highly appropriate for Minnesota to join in the struggle (for human rights)."

Thomas McCarthy, chief of the liaison office of the United Nation's Human Rights Center, said the center could help meet many of the needs facing torture victims worldwide.

"An institution like yours is most welcome and can provide essential help," he said.

Task force members say they will seek between \$10 million and \$12 million for a private endowment to operate the facility, an independent, non-profit corporation affiliated with one or more medical and educational institutions.

Stein said the center will not seek funds from the U.S. government or the United Nations. "We think it's important to stay as non-political as possible," he said.

A task force committee said

establishing the center in Minnesota will meet a need "that is not now being met anywhere else in the United States."

"Minnesota has a worldwide reputation for excellence in medical, legal and social services," the preliminary report said.



**READY FOR A RESCUE** — Crew members of the 41-foot U.S. Coast Guard rescue boat No. 41450, stationed at Coinjock, are shown at dock in Elizabeth City preparing for a rescue demonstration. The activity was one of many water events of Elizabeth City's annual River Spree festival last weekend. (Reflector Photo by Jerry Raynor)

## Dedication Planned For Maritime Museum

BEAUFORT — The dedication of the new North Carolina Maritime Museum building will be held at 10 a.m. Saturday with North Carolina Governor James Martin and N.C. Agriculture Commissioner Jim Graham as the speakers.

The 18,000 square foot facility, located at 315 Front Street, Beaufort, was designed by Robert Winston Carr, Inc. Associated Architects, Durham. The style of the all-wood building reflects a blend of 19th century Beaufort architecture and that of the early U.S. Lifesaving Service buildings, forerunner of the U.S. Coast Guard.

Architectural features come directly from old photos of these North Carolina stations. The interior is like the hold of a large wooden ship. Laminated, exposed, heavy beam construction is used.

Wood used in construction is North Carolina yellow pine, treated with a

fire retardant. The overall size of the museum has been increased from 4,000 square feet of the old building to 18,000 square feet in the new facility.

Funded by the N.C. Department of Agriculture, the North Carolina Maritime Museum, under the directorship of Charles R. McNeill, the facility is considered one of the best maritime museums in the country.

The dedication ceremony includes music by the U.S. Marine Corps 2nd Marine Aircraft Wing Band from Cherry Point. The official opening event, "Casting Off," is scheduled for noon. An open house will continue until 3 p.m.

Special opening exhibits include coastal scenes by Bob Dance in the R.J. Reynolds Tobacco Company auditorium, and a display of historic waterfowl decoys from the James F. Lewis, Jr. collection in the main exhibit hall.

**VAN KAMPEN MERRITT  
U.S. GOVERNMENT FUND  
INC.**

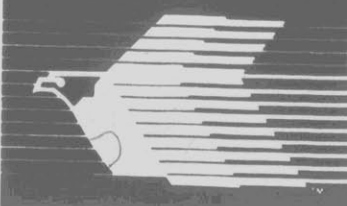

OFFERED BY  
**Wheat  
First Securities** 200 West  
3rd Street  
(919) 758-6850 Greenville, N.C.

**12.41%**\*

Plus the safety of U.S. government and agency securities, monthly dividends, dividend reinvestment at no charge, and low investment minimums. Plus an exceptional feature concerning quality.

Call 800-682-6576  
We'll rush a prospectus which includes information about charges and expenses. Read it carefully before you invest or send money.

\*Current return is determined by annualizing the monthly distributions paid per share for the 3 months ending April 15, 1985 and dividing the result by the average maximum public offering price for the same period. This will vary because of changes in the Fund's distributions and offering price. Shares may be redeemed at more or less than the cost.

Ideal for IRAs



EXCLUSIVE APPAREL FOR WOMEN

C. HEBER FORBES

419 EVANS STREET DOWNTOWN MALL 752-3468

**CORRECTION**  
In The Sears May Value Days Sale Section That Many Of You Received In The Mail On Page 18 The Incorrect Price Was Printed On The Timesaver Oil Change. The Correct Copy Is: Timesaver Oil Change \$49.99. On Page 26, The Art Illustration On The #8121 And #8120 Floor Fans Has Been Transposed. Prices Are Correct. On Page 36, The Men's Spaulding Hi-Top Court Shoes And The Women's Reebok Aerobic Shoes Are Not Available. On Page 39, The Braggin Dragon Knit Top, Regular \$6.99, On Sale For \$5.24 And The Braggin Dragon Shorts, Regular \$10.00, On Sale For \$7.50; On Page 41, The Toddler's Summer Separates Are Not Available. On Page 48, The Ladies Espadrilles, Regular Price \$15.99, On Sale For \$9.99 Are Available In Tan Only. We Regret Any Inconvenience That This May Cause.  
Sears, Roebuck & Co.  
Greenville, N.C.

**Belk Tyler**  
carolina east mall greenville



SHOP  
THURSDAY,  
FRIDAY,  
AND  
SATURDAY

**HAGGAR**



**MAY  
MENS  
SALE**

Haggar® Men's Slacks at An  
Incredible Savings of Up to 8.00  
for Spring and Summer Comfort!

**19.99**

Regular \$26 and \$28

Designed to fit any man's spring and summer wardrobe, in cotton and polyester blend. Belt loop and beltless styling. Some with matching belts. Solids, plaid and pincord colors for your selection! A great buy for two great seasons. Buy now for best selection and savings while supply lasts!

Shop Monday Through Saturday 10 a.m. Until 9 p.m.—Phone 756-B-E-L-K (756-2355)

# Dotson Tells Webb Apology Is Accepted

By RAYNER PIKE  
Associated Press Writer  
NEW YORK (AP) — Gary Dotson, face-to-face with the woman whose rape accusations sent him to prison six years ago, told a national television audience today he had accepted her apology and they "shook hands."  
"I more or less had to get some things out and meet the person," said Dotson during an interview on NBC's "Today" show with Cathleen Crowell Webb, who has recanted her assertions that Dotson raped her.  
"She's a different person today than eight years ago, and I just had to meet her."  
Both said they had talked Tuesday night in a meeting arranged by their lawyers prior to their television appearance.  
"Well, it was a mutual meeting, mutual agreement," Mrs. Webb said. "I, of course, apologized for what I don't think I could apologize

enough. It was a friendly meeting." Asked if he accepted her apology, Dotson replied, "Oh, yeah. We shook hands."  
"She paid me back by coming forward," Dotson said, commenting on Mrs. Webb's earlier statement that she wished she had a million dollars to give him.  
Mrs. Webb said despite Gov. James R. Thompson's refusal to clear Dotson's rape conviction, "I believe the people of America know Gary Dotson is innocent... He's not a rapist. He doesn't have the character of a rapist."  
The meeting followed high-level jockeying by the NBC and ABC television networks for the first interview with the two side by side, with "Today" winning a battle over ABC's "Good Morning America." Interviews on both ABC and CBS followed.  
Arrangements for the meeting

were made after Thompson on Sunday commuted Dotson's 25- to 50-year sentence to the six years already served.  
Mrs. Webb, now 23 and the mother of two children, has lobbied for Dotson's freedom in recent months — telling a judge, the governor and nationwide television audiences that she lied when she said he raped her in 1977.  
She said she fabricated a rape story because she feared she was pregnant after having sex with a teen-age boy.  
Dotson's lawyer, Warren Lupel, said Mrs. Webb and her husband, David, agreed to be available any time Dotson may need them in the future.  
"I don't think my obligation to him is at an end," Mrs. Webb said.  
Later, Dotson said he expected their friendship would continue.  
"I'm sure I'll drop her a dime

occasionally," he said, meaning he would telephone, "just to see how she and her husband are doing. I'm sure the whole thing's been pretty rough on them."  
He said he and Mrs. Webb's husband got on well when they met late Tuesday. "He's a very nice person."  
Mrs. Webb and Dotson came onto the NBC set with tight nervous smiles and sat stiffly beside each other on a sofa, awaiting their cue. With a few seconds to go, Mrs. Webb leaned over and whispered to Dotson, then sat back and relaxed.  
Though Dotson is now a free man, he is seeking a new trial to clear his name. As a convicted felon he can neither vote nor hold public office, and a state law might prevent him from realizing profits from dozens of offers to sell his story.  
On Tuesday, the government filed a motion to dismiss Dotson's petition for a new trial, saying he "has failed to raise a single issue of constitutional scope sufficient to justify granting a hearing in this case."  
J. Scott Arthur, assistant Cook County state's attorney, also said the government needs more time to gather additional testimony to support its case.  
Circuit Judge Richard Fitzgerald continued the case until June 4.

Unless he clears his name, Illinois law says Dotson would have to put any money he earns from movie, television or book rights into an escrow account and the alleged victim would have two years to sue to claim that money.  
But Mark Rotert, an assistant Illinois attorney general, said Mrs. Webb "doesn't claim to be a crime victim, so I don't know about her standing. She'd be entitled to sue, but it (recantation) would be good grounds for a motion to dismiss."  
Lupel said Dotson has received 41

offers from producers interested in turning Dotson's story into a television movie.

**Personal Dentist**  
Do You Need A Caring, Professional Dentist?  
• Cleaning done by the Doctor  
• Comfortable restorative dentistry  
**Dr. Robert Cargill**  
608 E. 10th St., Greenville, N.C.  
Phone 758-4927

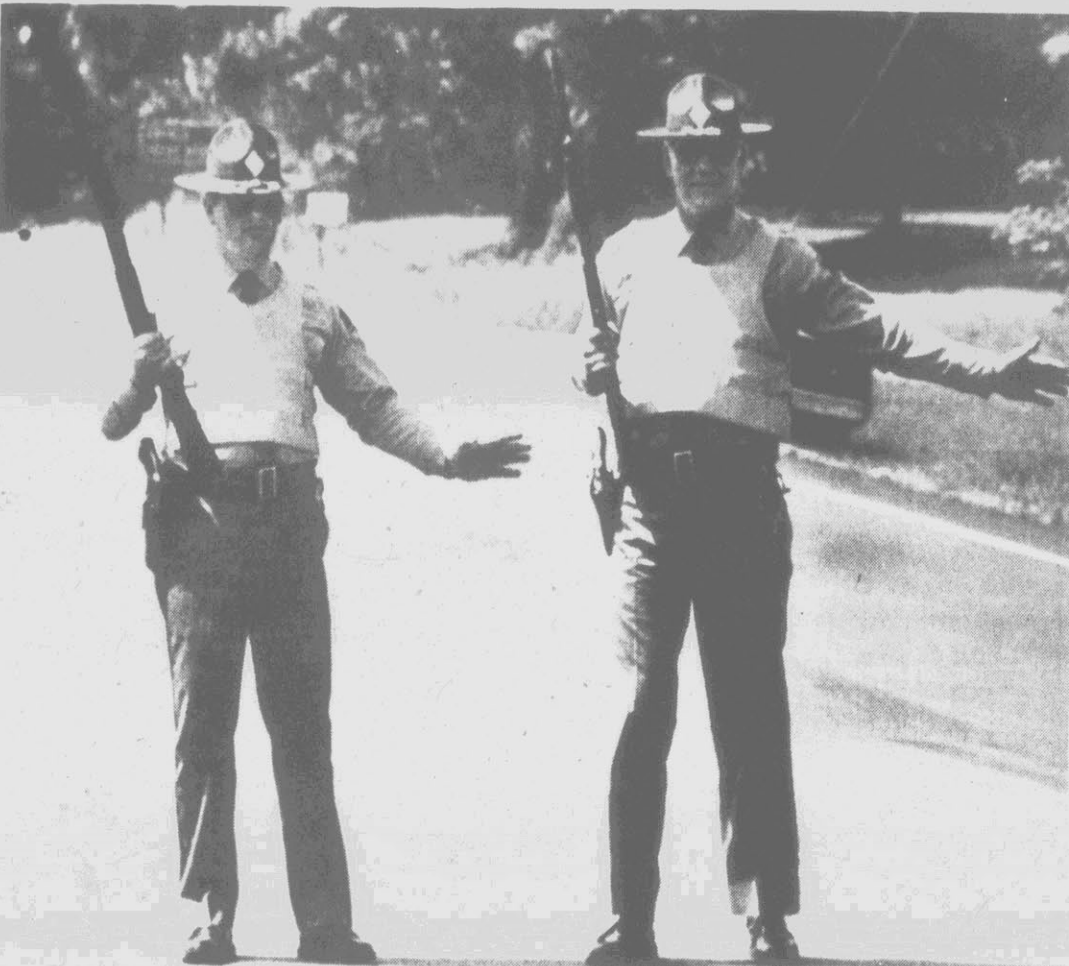

**STOPPING TRAFFIC** — North Carolina State Troopers Jerry Maxwell, left, and John Andrews stop traffic on U.S. 301 between Enfield and Halifax Tuesday after fellow Trooper Raymond Worley was shot and killed on Interstate 95 after stopping two vans. Four have been arrested in connection with the slaying. (AP Laserphoto)

## Jet Crash Kills Pilot

LOS ANGELES (AP) — One of only two prototypes of the F-20 Tigershark military jet crashed during a practice flight in Canada, killing the test pilot, according to a spokesman for Northrop Corp., which made the single-engine fighter.  
The cause of the crash Tuesday in Goose Bay, Labrador, was unknown, said Tony Cantifo.  
He said the pilot, 40-year-old David Barnes, of Palmdale, was practicing routines for the Paris Air Show when the plane went down. Barnes joined Northrop in 1982 as an engineer-test pilot, Cantifo said.  
It was the second fatal crash of an F-20 in seven months. Pilot error was blamed for the first F-20 crash, which killed Northrop's chief test pilot, Darrell Cornell, during a demonstration near Seoul, South Korea, last October.  
Northrop still has an F-20 undergoing flight tests at Edwards Air Force Base and another prototype in production at its Hawthorne aircraft plant.  
The company, which spent five years and \$800,000 developing the aircraft, has tried to sell the plane in the export market as an alternative to the Air Force's F-16 fighter. However, foreign governments have balked at buying a jet not used by the U.S. military.



Coupon Must Be Presented  
**Grand Award Perm Special**  
(Haircut included) Reg. \$19.00 Now **\$16.50!**  
Expires Wednesday, May 22, 1985  
Coupon Must Be Presented  
**Lustre Curl**  
Especially for Black Hair  
(\$60.00 Value) Reg. \$39.50 Now **\$32.50!**  
Expires Wednesday, May 22, 1985  
All Services Performed Exclusively By Students  
No Appointment Necessary  
*Mitchell's*  
HAIR STYLING  
*Academy*  
Monday 9 to 5:30  
Tues.-Fri. 10 to 9  
Saturday 8 to 4:30  
The Plaza Nexxus 756-3050

## Space Weapon Development Is Reported

NEW YORK (AP) — Scientists developing an X-ray laser space weapon powered by a nuclear bomb have increased the brightness and power of the device by focusing its rays. The New York Times reported today.  
The so-called "Super Excalibur" is being developed at the Lawrence Livermore National Laboratory in California, and was tested in an

underground explosion in Nevada on March 23, the Times said. The test was generally positive, although it was ambiguous in certain areas, the Times said. The newspaper did not elaborate.

MINORITIES INTERESTED IN MAKING APPLICATION FOR CONSIDERATION AS AN APPOINTEE TO THE CONSOLIDATED PITT COUNTY BOARD OF EDUCATION SHOULD CONTACT, NO LATER THAN MAY 20, 1985, THE OFFICE OF THE SUPERINTENDENT.  
1717 WEST FIFTH STREET  
GREENVILLE, NC 27834  
752-6106

# FAMILY DOLLAR SPECTACULAR \$1,400,000 NIKE CLOSE-OUT!

**6.88** COMPARE AT 20.00  
SPECIAL PURCHASE! NIKE CASUALS  
Boys' & girls' court shoes or ladies' casual oxfords. Limited quantities.

*Coming* Victory Day At Black Jack F.W.B. Church & You Are Invited!

Rev. Robert (Bob) Rudd Will Be The Guest Speaker At 11:00 A.M.

Gospel Singing by **The Anchormen**

We Are Looking For 400 In Sunday School!

PLACE: Black Jack F.W.B. Church  
TIME: 2:00 - 8:00 P.M. (Supper Served At 5:00 P.M.)  
DATE: Sunday, May 19, 1985

Stacy Carter, Youth Pastor

Aquafresh Noxzema TUSNY <b>99¢</b> HEALTH AND BEAUTY AIDS 4.6 oz. Aquafresh pump, 2.5 oz. Noxzema, 2 pk. Refresh & more.	<b>\$1</b> 42 OUNCE RINSO Regularly 1.49 Box. Limit 2.	<b>84¢</b> VALVOLINE MOTOR OIL Regularly To 1.19. 10W40 motor oil. Limit 5 qts.
Camay <b>2 FOR 288¢</b> 5 OUNCE CAMAY Regularly 2 Bars \$1. Limit 4 bars.	HERSHEY'S 6 PACK Kit Kat, Mr. Goodbar, Reese's and more. <b>1.69</b>	Marcal <b>2 FOR 288¢</b> PAPER TOWELS Reg. 63¢ Each. 100 2 ply towels. Limit 2.
		24 LARGE 36 MEDIUM ELASTIC LEG Disposable Diapers <b>4.99</b>

Prices Good At All Family Dollar Stores Through This Weekend. Quantities Limited On Some Items. No Sales To Dealers.  
Harris Shopping Ctr. South Memorial Drive, Greenville 1401 Ayden Plaza, Ayden North Greenville Shopping Ctr., Greenville

# Shultz Plugs For East-West Cooperation

By BARRY SCHWEID  
AP Diplomatic Writer

VIENNA, Austria (AP) — U.S. Secretary of State George P. Shultz today stressed the importance of U.S.-Soviet cooperation, recalling the "victory for reason and peace" that resulted from the creation of a free and neutral Austria after World War II.

Shultz and Soviet Foreign Minister Andrei A. Gromyko attended ceremonies marking the 30th anniversary of postwar Austria a day after airing "a lot of differences" during a six-hour meeting.

In a speech prepared for delivery at ceremonies in Vienna, Shultz said the nine years of U.S.-Soviet negotiations over Austria may provide a lesson for current talks in Geneva on nuclear weapons and in Vienna on troop reductions.

Shultz said East and West, working in a spirit of cooperation and goodwill, "can find ways to work together for the benefit of all concerned." He called the agreement on Austria a victory for neither side, "but a victory for all — a victory for reason and peace."

Earlier today, Shultz met over breakfast with the foreign ministers of West Germany, France, Italy and Great Britain. Officials would not say what they discussed, but Shultz's session with Gromyko was a likely topic. Shultz had said he would discuss with the allies the possibility of another meeting with Gromyko in August.

The Shultz-Gromyko meeting Tuesday lasted twice as long as scheduled, and Shultz told reporters afterwards that: "We spent a heavy proportion of our time on the subject of arms control."

Soviet spokesman Vladimir Lomeiko said Gromyko told Shultz there could be no progress on arms control talks in Geneva unless there was "strict adherence" to an agreement between the two men that led to the start of the talks.

Shultz and Gromyko agreed to reopen arms control negotiations on the basis that both offensive weapons and space-based defenses would be discussed. The Soviets have accused the United States of refusing to bargain on the space weapons issue during the first round

of talks, but U.S. officials have denied that.

The Soviets said in a statement that Gromyko had renewed Soviet leader Mikhail S. Gorbachev's Easter Sunday call for a moratorium on design, testing and deployment of space weapons. The Soviet news agency Tass said Gromyko expressed concern over "the nonconstructive stand" of U.S. negotiators in Geneva.

Spokesman for both sides refused to discuss the possibility of a summit meeting between President Reagan and Gorbachev.

However, they freely pointed out issues on which Shultz and Gromyko had clashed. There also was some evidence the two men wanted to improve relations.

Shultz said he and Gromyko discussed issues "where some progress can be made and we discussed many matters of mutual interest in various regions of the world." He did not identify the issues.

Lomeiko, speaking for Gromyko, recalled that the United States and Soviet Union cooperated during World War II to defeat Nazi

Germany despite their different political systems. "Both sides emphasized their intention to do all possible to strengthen the structure of bilateral relations," he said.

But reports on the meeting generally were negative.

"There were a lot of differences between the two sides on a variety of issues," said a U.S. official designated to brief reporters. He spoke on condition he not be identified.

He said Shultz condemned the shooting of Maj. Arthur D. Nicholson, an American reconnaissance officer, by a Soviet sentry in East Germany in March. The official said Shultz demanded an apology, compensation to the slain major's family, and assurances the incident would not recur.

Lomeiko blamed "certain circles" — an apparent allusion to the United States — for stirring up unrest and raising tensions in the Middle East, Central America and Africa.

He stiffly dismissed as an "internal" matter that the Soviets discussed with nobody, the condition of Soviet dissident Andrei Sakharov, and other dissidents.

Shultz had promised to take up anti-Semitism and emigration restrictions with Gromyko and brought a list of human rights cases with him.

He and other U.S. officials gave no indication the Reagan administration's determination to proceed with research on anti-missile defenses would ease when the arms negotiations resume May 30 in Geneva.

Shultz urged Gromyko to consider proposals to reduce mistrust between the two countries made by



KITTENS REVIVED — Sedwick County Sheriff's Deputy Larry Palmer administers artificial resuscitation Tuesday to a kitten suffering from smoke inhalation after a smoky house fire in Park City, a Wichita, Kan., suburb. Palmer and an animal control officer revived five kittens found in the house, which sustained more than \$10,000 damage. (AP Laserphoto)

suburb. Palmer and an animal control officer revived five kittens found in the house, which sustained more than \$10,000 damage. (AP Laserphoto)

## Feminists Say Pill Data Needed

WASHINGTON (AP) — Two leading feminists marked the 25th anniversary of the birth control pill by telling doctors that patients need better information about such drugs and researchers need to look into male contraception.

The pill was "the technological underpinning of the modern feminist movement," author Betty Friedan told physicians attending the annual convention of the American College of Obstetricians and Gynecologists.

But she added, "I'm not sure (the

researchers) were right in not giving men any role at all in birth control. Was it really right to say, 'You don't have to worry anymore'?"

"Men have a responsibility for contraception as well," activist-writer Gloria Steinem told the overflow crowd at the Washington Convention Center on Tuesday. "This has been more realized by individual sensitive men than it has by medical research funds."

Ms. Steinem said patient information packets that accompany the pill

should be safeguarded and contraceptive advertising should be allowed. She also urged doctors to be more specific in giving information to their patients.

"We need to know about the pluses and minuses (of new types of birth control pills). Yet the dialogue is as if it were all the same pill," she said.

Ms. Steinem noted that the women's health movement started 20 years ago as a response to research that found problems with the pill.

Reagan last week in a speech in Strasbourg, France, U.S. officials said.

The steps include an exchange of observers at military exercises, regular contacts between American and Soviet military leaders, and a direct link between ranking U.S. and Soviet commanders.

### Joseph's

Fast Service-90% Of All Service Calls Have Been Taken In 4 Business Hours. Specializing In Repairing IBM Typewriters. 355-2723  
cut and place ad on typewriter

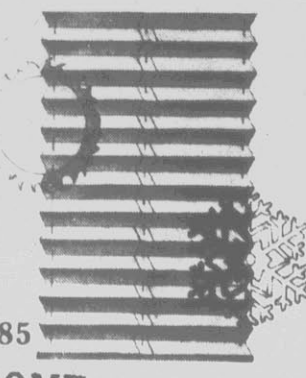

**verosol**  
PLEATED SHADES

- Energy efficient—summer and winter.
- Designer colors.
- Opaque and translucent fabrics.
- Easy cleaning—easy installation.

**40% OFF TIL JUNE 28, 1985**

**HOME IMPROVEMENT UNLIMITED**

West End Shopping Center  
Phone 355-2250

## Carnival Of Values

**20% OFF**  
A GREAT GROUP OF  
**Dresses**

Store No. 178 423 Evans Mall Downtown Greenville 758-3700

Apply for Cato Credit or use our Layaway Plan

**CATO**

Hours: Mon. - Sat. 10:00 - 5:30 Fri. 10:00 - 6:00

### Lawyer Paroled

PEKING (AP) — China said today it has paroled a Hong Kong-born, Harvard-trained lawyer jailed for spying two years ago in a celebrated case that focused attention on arbitrary arrests and secret detentions in the Chinese justice system.

The official news agency Xinhua said parole for Hanson Huang, 34, was based on his "prison behavior and willingness to serve Chinese modernization."

Huang, who once worked for a U.S. law firm, disappeared in 1981 during a visit to Peking. The government did not admit until last February that he had been arrested, tried as a spy and sentenced to 15 years at an undisclosed prison.

The Xinhua announcement said Huang was paroled by an unidentified judge of the Peking Intermediate People's Court. The announcement did not disclose Huang's present whereabouts or explain whether he is allowed to leave the country.

## '85 Better Home and Garden Show

Thursday, Friday, Saturday  
May 16, 17, 18



**Greenville-Pitt Co. Home Builders Association presents**  
**Hundreds of Home Improvement Ideas**



**CAROLINA EAST CENTRE**  
264 By-Pass on Hwy 11, Greenville

**WE'VE DECLARED WAR ON HIGH PRICES!**



**Amana Radarange**  
SIMPLY SOPHISTICATED

- Dialed settings appear in the easy-to-read lighted display. Eliminates guesswork, lines and pointers.
- Just dial in the time or temperature and push START. It's that easy! •Full 700 watts of cooking power. •Patented Rotawave Cooking System.
- Cook by time or to temperature. •Time-of-Day clock. •Strong 10-year limited warranty.

**10 GOOD REASONS TO BUY FROM US**

1. Bob's TV has two stores to serve you.
2. Bob's TV has a reputation for reliability.
3. Bob's TV sells top-quality, well known brands.
4. Bob's TV has a wide selection in every line.
5. Bob's TV purchases products in large lots, earns quantity discounts, and passes the savings on to you.
6. Bob's TV has qualified delivery personnel.
7. Bob's TV has sales personnel who are well trained and courteous.
8. Bob's TV has factory-trained servicemen.
9. Bob's TV has radio dispatched service & delivery trucks.
10. Bob's TV has 90 days cash, easy monthly terms and accepts Mastercard & Visa

**TV & APPLIANCE**  
3205 South Memorial Dr. Greenville, N.C.  
Telephone 756-8830

**BOB'S TV'S INC.**

108 East Second St., Ayden, N.C.  
Telephone 746-4021

**SALES & SERVICE**

*"Your Something Special Store"*

# Store Clerk Murderer Executed In Texas



JESSE DE LA ROSA

By MICHAEL L. GRACZYK  
Associated Press Writer  
HUNTSVILLE, Texas (AP) — Jesse de la Rosa, professing love for his stepmother and asking forgiveness for his sins, was executed by injection early today for killing a convenience store clerk over six cans of beer in 1979.

De la Rosa, 24, was pronounced dead at 12:17 a.m., four minutes after a lethal dose of chemicals was injected into both arms. He was the 11th person executed in the nation this year and the 43rd put to death since the U.S. Supreme Court

reinstated capital punishment in 1976.

De la Rosa was executed for the death of Masoud Ghazali, a former Iranian Air Force captain who was shot twice in the head during a robbery of a San Antonio 7-11 store that netted only a six-pack of beer.

He made his final statement staring at the ceiling, telling his stepmother, Carmen, who was in the death chamber with him, "I love you."

"God forgive my brothers and sisters for sins I have committed," de la Rosa said in Spanish.

De la Rosa's stepmother, who was accompanied by the condemned man's father, Luciano, replied in English, "You'll never die because you'll always be in my memories."

His father added in Spanish, "God forgive my son."

De la Rosa then added, "God, I give my life for my brothers and sisters."

When he gasped and his stomach buckled, his stepmother began sobbing. She was comforted by his father, who also was in tears. The couple left the prison without further comment.

De la Rosa's execution, the third carried out this year by the Texas Department of Corrections, came after two days of unsuccessful appeals by his attorneys.

Late Tuesday, the U.S. Supreme Court voted 7-2 to deny him new hearings. Then Gov. Mark White, as he has in previous death sentences, refused to grant a 30-day reprieve.

On Monday, de la Rosa was turned down by a federal appeals court and the Texas Board of Pardons and Paroles.

After a steak dinner for his final meal, he spoke by telephone for about 20 minutes to a longtime friend, Margie Garcia of San Antonio, and shortly after 8 p.m. he received communion from a prison priest, the Rev. Stephen Walsh.

It was the second death date for de la Rosa, who said in an interview a week ago that he was coerced into confessing to the slaying of Ghazali. He refused, however, to identify the triggerman.

A store clerk shot earlier the same night in a \$40 robbery identified de la Rosa, who was 18 at the time. De la Rosa has said he had been drinking and smoking marijuana that night, but was at a friend's house when Ghazali was walked to the back of the store to a cooler and shot twice in the head.

Asked if the execution relieved her, Ghazali's wife Gloria replied: "It does," then hung up the telephone.

A second man involved with de la Rosa in the crime spree, Alejandro Alcorta Garcia, 28, is serving a life sentence for aggravated robbery.

## Police Use High Powered Weapons To Fight Crime

By LAWRENCE KILMAN  
Associated Press Writer  
NEW YORK (AP) — From powerful water cannons to a bomb that set 60 homes ablaze, Philadelphia police used a wide range of weapons in their attempt to roust members of the radical group MOVE from a fortified row house.

The old six-shooter is still standard issue for the cop on the beat. But departments confronted with more and more situations like that involving MOVE have resorted to new kinds of weapons, both lethal and non-lethal.

Drug dealers, terrorists and other criminals are armed to the teeth, and some police departments have responded with special forces that carry machine guns, assault rifles and automatic firearms.

Los Angeles police even have a tank, which they use as a battering ram against criminals' fortified hideouts.

"It shows that police have become more anti-riot oriented, anti-terrorist oriented," said Leslie Dees, president of the Police Marksman Association.

The search for more firepower has many police departments replacing their .38-caliber, six-shot revolver with semiautomatic weapons that fire more shots, reload quickly and are more powerful.

New weapons are not adopted simply because they are available or because officers are intrigued by high technology. There has to be a reason, and the reasons are many.

In New Jersey, the 1981 slaying of state trooper Philip Lamomaco in a gun battle led the department to replace 2,500 .357-caliber Smith & Wesson six-shooters with Heckler and Koch 9mm semiautomatic weapons. The new weapons carry nine bullets and reload three times as quickly as the old ones, said Capt. Joseph Kobus, a spokesman for the department.

In Chicago, the Hostage Barricade and Terrorist Incident Team was having a tough time maneuvering their 12-gauge shotguns and 30-06 rifles in narrow hallways, said John Gavin, an officer in the Uniform Equipment Standards section.

"We looked for an intermediate assault weapon for going up small stairways in crowded apartment houses," he said. They chose a .223-caliber rifle with a collapsible stock.

In New York, where police killed an emotionally disturbed woman in an eviction proceeding last year, the search is on for new non-lethal

weapons. The Emergency Services squad has purchased several stun guns called tasers and is experimenting with a type that attaches to poles, said Inspector Raymond Abruzzi, commanding officer of the squad.

Tasers shoot electrically charged darts that cause a loss of muscle control. Stun guns are similar in effect, but the pocket-size weapons must be touched directly to the person.

Five police officers have been indicted in New York on charges of using stun guns to torture suspects, but stun guns were not issued to them from the department. They were not members of Abruzzi's squad.

In Bowie, Texas, a town of 6,000 between Forth Worth and Wichita Falls, Chief Jim Wade originally resisted younger officers' requests for semiautomatic weapons.

"I have 20 years in law enforcement. My training and background has been totally toward the six-shot revolver," he said. But a distributor sent a Beretta 9mm to the department for a trial, and 15 officers fired 1,000 rounds from it. "We found it to be totally acceptable," Wade said.

And in Philadelphia, where the 2,000-gallon-a-minute water cannons failed to breach a steel plated rooftop bunker, officials turned to a more powerful weapon — an explosive charge dropped from a helicopter.

The bomb, two pounds of blasting material called Tovex, which is similar to dynamite and used in mining, destroyed the bunker, but the resulting fire also claimed the neighborhood.

## Arafat Seeks Endorsement

WASHINGTON (AP) — Palestine Liberation Organization leader Yasser Arafat, in a possible bid to improve chances for discussions between the PLO and the United States, says he would recognize Israel's right to exist if the Reagan administration endorsed Palestinian "self-determination," according to published reports.

Since 1975, the United States has refused to have official contacts with Palestinian leaders until they accept United Nations Security Council resolution 242, which affirms Israel's right to exist.

"We are not refusing 242 because it is a resolution," Arafat said in an interview Tuesday in Amman, Jordan, with reporters from The Washington Post and the Los Angeles Times. "We are refusing 242 because it does not treat us as people."

Asked if he would accept the resolution by name if the United States explicitly endorsed Palestinian "self-determination," Arafat answered, "Absolutely," the Post said in today's editions.

Would he accept Israel's right to exist?

"I would accept all the international legality. It is very clear what I am saying. Simple and clear. We are not against this resolution. It is simple and clear," he said.

State Department spokeswoman Kathleen Lang said early today the department had no immediate comment on Arafat's remarks.

Arab officials said Arafat's statements were not a direct contradiction of the most recent public declaration on the subject by the PLO's executive committee. On Feb. 19, the committee rejected Resolution 242, which besides recognizing Israel, also calls for the Israelis to return lands occupied in the 1967 Arab-Israeli war.

Companies like Beretta and Heckler and Koch are challenging Colt and Smith & Wesson, the fabled names of police lore.

In the nation's largest police departments, however, the six-shooter is still standard equipment. It is generally the smaller of the nation's 19,000 police and sheriffs departments that are on the cutting edge of new weaponry, said Dees.

"Your average police departments are 20- and 30-man departments. That's where change can happen," he said. Fewer weapons mean a switch is less costly, but there is another reason, too. "These are the ones where the Green Beret goes back and becomes the man in charge of the police department

because he's the expert," said Dees.

"We see that: The guys who were in Vietnam are much more concerned about their weapons than older officers," said Robert Haas, a spokesman for Smith & Wesson.

Philadelphia Managing Director Leo A. Brooks, the man who coordinated the day-long siege against the MOVE stronghold, is a 52-year-old retired major general who saw two tours of duty in Vietnam.

weapons. The Emergency Services squad has purchased several stun guns called tasers and is experimenting with a type that attaches to poles, said Inspector Raymond Abruzzi, commanding officer of the squad.

Tasers shoot electrically charged darts that cause a loss of muscle control. Stun guns are similar in effect, but the pocket-size weapons must be touched directly to the person.

Five police officers have been indicted in New York on charges of using stun guns to torture suspects, but stun guns were not issued to them from the department. They were not members of Abruzzi's squad.

In Bowie, Texas, a town of 6,000 between Forth Worth and Wichita Falls, Chief Jim Wade originally resisted younger officers' requests for semiautomatic weapons.

"I have 20 years in law enforcement. My training and background has been totally toward the six-shot revolver," he said. But a distributor sent a Beretta 9mm to the department for a trial, and 15 officers fired 1,000 rounds from it. "We found it to be totally acceptable," Wade said.

And in Philadelphia, where the 2,000-gallon-a-minute water cannons failed to breach a steel plated rooftop bunker, officials turned to a more powerful weapon — an explosive charge dropped from a helicopter.

The bomb, two pounds of blasting material called Tovex, which is similar to dynamite and used in mining, destroyed the bunker, but the resulting fire also claimed the neighborhood.

reconciliation period, a family spokesman said.

Ms. Osmond, 25, asked \$1 per year alimony, reasonable child support and custody of the couple's son, 2-year-old Stephen James Craig. The action filed Tuesday claimed she had been treated "cruelly, causing her great mental distress."

Ms. Osmond and Craig, 28, a former Brigham Young University basketball player, were married in June 26, 1982, in a highly publicized ceremony in the Salt Lake Temple of the Mormon Church.

The 1 1/2-page divorce complaint, filed in 4th District Court in Provo, also asked the court to decide how the couple's property should be divided if Ms. Osmond and Craig can't reach an agreement.

The document did not elaborate on the reason for the divorce. Osmond family spokesman Ron Clark said he had been asked by both Craig and Ms. Osmond not to discuss their problems. He said no statement from either party would be forthcoming.

"They won't talk," he said. "I talk about it more than they do. Everything I ask them is 'no comment,'" he said.

## Marie Osmond Wants A Divorce From Hubby

PROVO, Utah (AP) — Claiming she had been treated cruelly, singer Marie Osmond has filed for divorce from Steve Craig six months after the couple separated and began a reconciliation period, a family spokesman said.

Ms. Osmond, 25, asked \$1 per year alimony, reasonable child support and custody of the couple's son, 2-year-old Stephen James Craig. The action filed Tuesday claimed she had been treated "cruelly, causing her great mental distress."

Ms. Osmond and Craig, 28, a former Brigham Young University basketball player, were married in June 26, 1982, in a highly publicized ceremony in the Salt Lake Temple of the Mormon Church.

The 1 1/2-page divorce complaint, filed in 4th District Court in Provo, also asked the court to decide how the couple's property should be divided if Ms. Osmond and Craig can't reach an agreement.

The document did not elaborate on the reason for the divorce. Osmond family spokesman Ron Clark said he had been asked by both Craig and Ms. Osmond not to discuss their problems. He said no statement from either party would be forthcoming.

"They won't talk," he said. "I talk about it more than they do. Everything I ask them is 'no comment,'" he said.

The couple made their home in Los Angeles after their wedding. Clark said Ms. Osmond has been living in the Provo area with her son since the separation.

At the time of her marriage, Ms. Osmond said, "It feels wonderful; I got the best."

Following the temple wedding rites, which Mormons believe bind couples together for eternity, the couple celebrated with a reception attended by 4,000 guests.

**CLARK GALLERY**

646 Arlington Blvd.

**Custom & Do It Yourself Picture Framing**

Posters  
Prints Of All Types  
Original Lithographs  
Serigraphs

**-GALLERY HOURS-**  
Mon - Sat 9:30-5:30  
Mon & Wed Nights  
Til 9 P.M.

**NOW**

**VACATION SALE**

**Entire Spring-Summer Stock REDUCED 1/3 to 40%**

coats·suits·dresses  
sportswear·swimwear  
accessories

New Fall Merchandise Not Included

**sidney's**

Sidney's Invites Your Charge Account

Carolina East Mall  
Open 10 A.M. to 9 P.M. Monday-Saturday

**Shear Hair Designs**

**Keith Hollowell**  
(formerly of Great Expectations)

Is Now Associated With

**Shear Hair Designs**  
514 E. 14th St.

Walk-Ins Welcome Or Call 752-9706

For Appointment  
Free Consultation

Keith Invites All His Friends & Customers  
To Come By & See Him.

**Belvoir Factory Outlet**

Located In Old Belvoir Schoolhouse Hwy 33  
Thurs. & Fri. 9:30-5

Shop Our Outlet Store Nearest You

**Tom & Togo INC**  
SPORTSWEAR & PLAY WEAR

Located Between Bethel & Tarboro on Hwy. 54  
Hours 9:5 Mon - Sat We Accept Visa & Mastercard

We Also Wholesale

**luff logs**  
Factory Outlet

Located In Old Grimesland School House on Hwy 33  
Hours: Wed - Fri 9:30 - 5 Sat 9:30 - 3

**Panama Jack Originals**

Coordinates in first quality also good irregulars

New Spring Merchandise Now In Stock

**Heads Up Safety Collar**  
Reversible, assorted colors and designs

Reg. \$8.99

Our Price **\$4.99**

**Baby Week**

Designer Infant Sleepers & Creepers

Reg. \$8.99

Select Irregs. 2 for **\$4**

Extra Large  
**Infant Sleepers**  
Reg. \$9.99

Our Price **\$3.99**

**AT LAST, A BOAT SHOE THAT PERFORMS AS WELL AS YOUR BOAT.**

The Timberland® boat shoe has a long-wearing, non-slip, squeegee design, white Vibram® sole; silicone-impregnated waterproof leather uppers that stay soft and supple; solid brass eyelets that won't rust, and tough nylon stitching. It's built to give you maximum performance.

You expect the most from your boat; don't settle for anything less from your boat shoes.

enter the Timberland "Perfect Summer Sweepstakes."

Roscoe Griffin  
Got Your Shoe!

**ROS COE GRIFFIN SHOES**

Raleigh, Durham, Chapel Hill, Rocky Mount, Goldsboro, Wilson, Roanoke Rapids, Fayetteville, Washington, & Greenville

Prices good through Sun., May 19, 1985

**What Matters Most Is You.**

# KERR

Drug Stores

We bring you...  
**the best of everything**  
 ...including price!

**OUTDOOR FURNITURE**

**5.99** Ea  
 80% COTTON  
 20% POLY  
 Terry Cloth Multi-position lounge cover. Asst. colors. Reg. 7.99

Terry Cloth Chair Cover. Reg. 6.99. Sale 4.99

**8.88** Ea  
 Outdoor Folding Chair with Textilene seat. Reg. 12.88. While they last.

**SUNTAN LOTIONS**

**2.59** Each  
 Regular \$3.59  
 Your Choice! SEA & SKI Suntan Oil or Lotion. 4 ounce. 6 formulas for all skin types.

**RECREATIONAL ITEMS**

**6.99** Ea  
 Highback Vinyl Tubed Outdoor Chair. Asst. pastel colors. Reg. 8.99

**HIBACHI**

**9.99** Ea  
 Pot Belly Cast Iron Hibachi Grill. #861036. Reg. 14.99

**HEALTH AND BEAUTY AIDS**

**2.99** Box  
 Efferdent® Denture Cleanser. 96 ct. extra strength. Regular 4.15

**2.19** Ea  
 50% OFF Label! Scope® Mouthwash & Gargle. 24 ounce. Plastic Bottle.

**99¢** Each  
 CLOSE-UP® Toothpaste. Regular flavor. 6.4 oz. Get Closer! Regular 1.87

**GOTT® Cooler.**  
 30 quart blue/white.  
 Reg. \$24.88

**16.88** Each

**DIET AIDS**

**2.99** Box  
 Your Choice! ACUTRIM® Appetite Suppressant. 20 ct. or Acutrim II, 20 ct. Reg. 5.23

**1.79** Ea  
 Old Spice® Solid Anti-perspirant. 2 oz. Regular, Musk or Fresh Scent. Reg. 2.37

**1.89** Ea  
 Dimension® Shampoo. Normal, Oily or Dry Formulas 11 oz. Reg. 2.93

**HOUSEHOLD PRODUCTS**

**1.99** Ea  
 Mood Magic® Lipstick. Newest in lipstick. Changes with your body chemistry. Reg. 3.50

**2 \$1** PAIRS  
 Men's, ladies', and children's rubber zorries. Asst. colors. Regular 99¢ ea.

**99¢** Each  
 Nigara® Spray Starch. 22 ounce. No Clogging, flaking or scorching. Regular 1.19

**AUTOMOTIVE NEEDS**

**79¢** Quart  
 Regular \$1.29  
 Limit 12 qts.  
 Havoline Supreme® motor oil 10W30. Buy now at this low price. While supplies last.

**FOOD & BEVERAGES**

**4 BARS \$1**  
 Nestle's Chocolate Candy Bars. Your choice of 4 flavors. Reg. 35¢ ea.

**89¢** Bag  
 COMBOS® Snacks. 8 oz. Cheddar, Nacho or Pizza flavors. Regular 1.39

**7.49** Ea  
 Igloo Explorer® 6 Cooler. 5.4 quart. #4607. Regular 9.99

**GARDEN SUPPLIES**

**1.99** Ea  
 Folding Wire Fence. 8 inches x 8 ft. Easy to install. Regular 2.29

**99¢** Each  
 Fletcherwire® Tomato Cage. 3 ring. Reg. 1.29. While supplies last.

**2 ROLLS \$1**  
 Bulk Masking Tape. 3/4 x 60. Regular 99¢ ea.

**SHOP AND COMPARE!**

**2.99** Each  
 Regular \$3.99  
 Vinyl Garden Hose. 1/2 inch x 50 feet. #765. Durable vinyl made to last.

**PHOTO COUPON SPECIAL**

**KERR Film Developing**  
**Print 1**  
**Print 2**  
 It's up to you

**\$1 OFF** Regular Price  
 SAVE on single and Double Prints of 12, 24 or 36 exposure film for C-110, 126 and 135 type film. Offer applies to film brought in during this sale. Expires 5/22/85

**CHIP**  
 CUSTOMER HEALTH INFORMATION PLAN  
 Only at  
**KERR** Drug Stores

Provides A Link Between Doctor, Patient And Pharmacy

# Four Arrested In Trooper's Death; Authorities Search For A Motive

By TOM FOREMAN Jr.  
Associated Press Writer  
ENFIELD, N.C. (AP) — Authorities say they have no motive in the death of a 23-year veteran of the state Highway Patrol who was shot while still in his patrol car, but suspects were rounded up within hours of the shooting.

Timothy Lanier Allen, 30, of Washington, D.C. was charged Tuesday with the first-degree murder of Trooper Raymond E. Worley, 44, said Halifax County District Attorney David Beard.

Worley "was a very dedicated trooper and had been with us for many years," said Trooper Glenn Swanson, operations sergeant at Highway Patrol Troop A in Greenville. "He was at one time involved in a very serious accident. He fought back his disabilities and came back into uniform. A normal person would not have come back."

Allen's brother, Alex Allen, 34, along with Antonio Maurice Worrell, 28, and Mack Eugene Green, 27, all of Washington, were charged with accessory after the fact to murder.

A first court appearance is scheduled for today in Halifax County District Court, Beard said.

All four men also were charged

with two counts each of possession of stolen property, felonious possession of stolen property and two counts of possession of property in connection with the breaking and entering at a Pender County grocery store.

Halifax County sheriff's detective E.C. Warren said the men were wanted for questioning in the Washington area in connection with other charges.

Worley was shot three times in the head and left hand Tuesday morning after he stopped two vans on Interstate 95, authorities said.

Maj. Robert A. Clark said the investigators thought Worley was shot from the back seat of his car. He said the trooper's service revolver was still in his holster when he was found.

"This trooper was on the Interstate 95 patrol which we run all night long and he stopped two vans headed in a northerly direction," Swanson said.

"Then there was no further contact and some license and theft personnel who manned the weigh station were sent out to check him to find out what was wrong. They found him seated in his patrol car...."

The suspects were in custody by 9 a.m., four hours after Worley had

radioed that he was stopping two vans on the highway at milepost 163.

One suspect was captured on U.S. 301 by a state trooper who was backing up from his driveway to join the search. Three others were captured after a farmer checking his corn crop saw a van he hadn't seen before parked on his property.

A search of the two vans turned up beer and cigarettes believed to have been taken from a Pender County grocery store.

Clark said officers will search luggage found in one of the vans and hoped what was found would establish a motive for the shooting.

A .38-caliber pistol and a .22-caliber pistol were recovered from the vans, which were believed to be stolen, Clark said. Warren said the weapons were reported missing in the Pender County break-in.

The slaying was the second of a state trooper in little over a month. Trooper Giles A. Harmon, 26, of Arden, was shot to death April 9 when he stopped a speeding car on a detour near a rockslide-blocked Interstate 40 in Haywood County. A Lexington, Ky., man was indicted on murder charges in connection with the slaying.

Funeral services for Worley have been scheduled for 11 a.m. Thursday

at Zion United Methodist Church in Conway. Burial will follow at the family cemetery at the home.

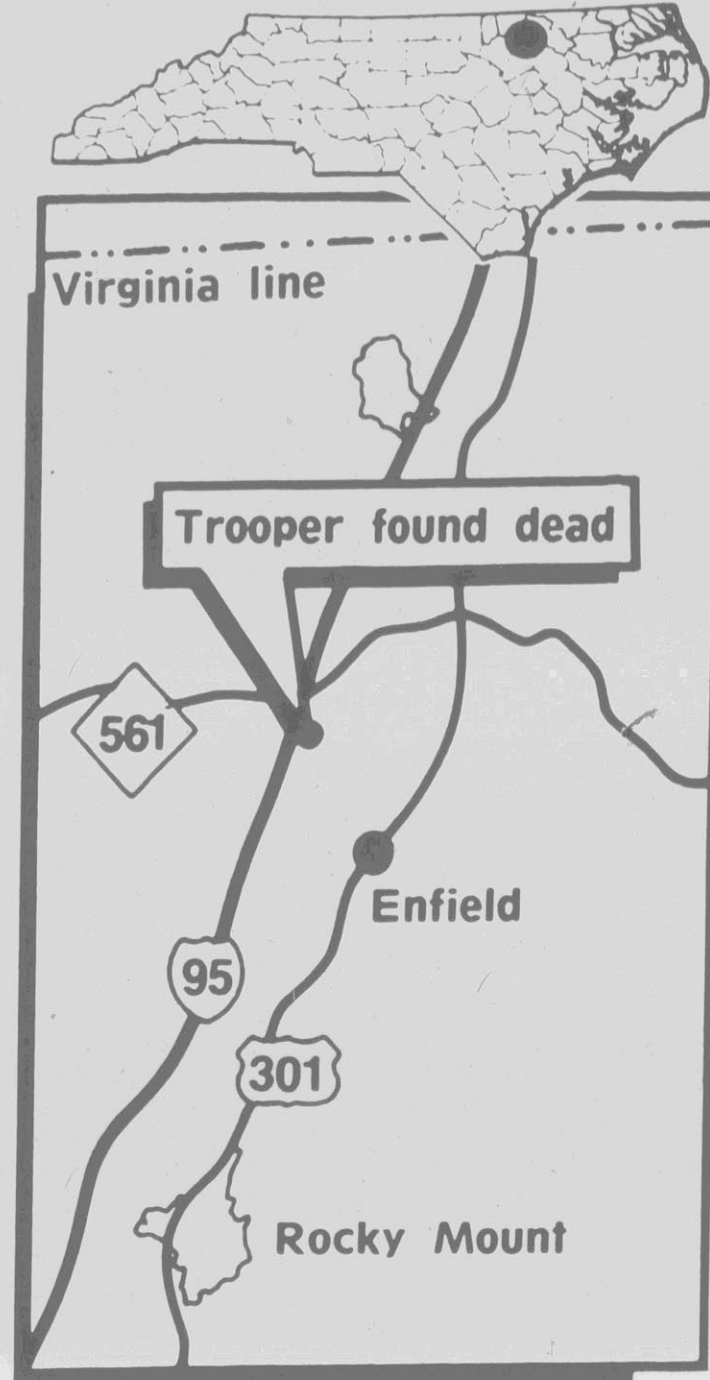

TROOPER SLAIN — This map locates the scene where North Carolina State Trooper Raymond E. Worley was shot to death on Interstate 95 after he stopped two vans. (AP Laserphoto)

## Hatteras Canvas Products "The Dry Dock"

Custom Work & Design for Marine, Auto, and Home.

- Quality Custom Work
- Reasonable Prices
- Trained Marine Canvas Expert on Staff



sail covers • boat covers and tops • boat upholstery and cushions • porch enclosures • awnings • outdoor furniture covers • auto upholstery • auto covers • equipment covers • all canvas repairs • binnies • dodgers

"The Dry Dock"

1104 Clark Street, Greenville, N.C. 752-4351

## IN THE STATE

# Officers Seek Clues In Triple Slayings

By TOM MINEHART  
Associated Press Writer  
FAYETTEVILLE, N.C. (AP) — Detectives are working 24 hours a day on the slayings of the wife of an Air Force captain and their two children, but still have no motive or suspect in the case, authorities said.

"They're mad, shocked, disgusted and now they're determined," Cumberland County Sheriff's Department spokesman Harold Little said of the investigators Tuesday. "The fact that it's hard just makes them more determined."

Air Force Capt. Gary Eastburn returned to his house Tuesday to help detectives find out who raped and stabbed his wife, Kathryn, to death and killed their two daughters, Kara, 5, and Erin, 3.

"We took him to the house and let him walk around for a while to see if he could help us find out anything," said Major C.D. Smith, chief of detectives for the Cumberland

County Sheriff's Department. Smith said Eastburn was at the house for two hours, but he declined to comment on what he said or his emotional condition. Eastburn was in seclusion at Pope Air Force Base and could not be reached for comment.

The bodies were found Sunday in the Eastburn's comfortable, one-story brick home after neighbors heard the cries of another daughter, 18-month-old Jana. She was unhurt. Authorities said the victims had been dead three days.

The Eastburns were "real nice people, pleasant to be around," Little said. "Why would anybody want to do this to (Mrs. Eastburn)? There were no bad spots in her background. ... It's not like some guys we get in drugs or who hang around with shady characters."

Four detectives are working around the clock on the case, Little

said, adding that all the department's 33 detectives were helping by checking their own sources.

Also helping was a seven-member investigative team from the State Bureau of Investigation, including two lab chemists checking physical evidence.

Little said the Eastburns spent a lot of time with their children and kept pretty much to themselves.

"All these things make our job tougher," he said.

Smith said detectives used a chemical and light technique Tuesday to highlight blood around the house. Little said fingerprints were found but he declined to say what any of the evidence means so far.

"If he (the killer) left so much as a hair, we're going to find it," he said. "It's hard to do that much damage without leaving a part of yourself."

Little said Mrs. Eastburn's nude body was found with Erin's in the

master bedroom, Kara's body was found in another bedroom and Jana was in a crib in a third room.

Autopsy reports showed the three died from multiple stab wounds and slit throats and that Mrs. Eastburn had been sexually assaulted. The living room showed signs of struggle but the furniture was not in disarray, he said.

"We assume it was a spontaneous-type thing," Little said. Eastburn, chief of air traffic control at Pope Air Force Base, next to Fort Bragg, was attending an eight-week training course in Alabama at the time of the slayings.

"He's definitely been ruled out as a suspect," Little said.

Fort Bragg was the scene in 1970 of the slayings of the wife and two daughters of former Green Beret physician Jeffrey MacDonald, who was convicted of murder despite his claims that a band of drug-crazed hippies killed his family and wounded him.

Little said detectives are taking "extra precautions" to preserve evidence in this case. Military investigators accidentally destroyed some evidence in the MacDonald case, leading to delays in his conviction.

"We're certainly not going to make that mistake again," Little said.

# Privette Eyes Legislation Banning Ads For Alcohol

By DENNIS PATTERSON  
Associated Press Writer  
RALEIGH (AP) — Advertising by the beer and wine industry is aimed at convincing young people to drink and should be banned, a state legislator says, but a spokesman for beer wholesalers says the ads are not seeking new customers.

Rep. Coy Privette, R-Cabarrus, said Tuesday his bill banning alcoholic beverage ads in all print and broadcast media is necessary "because of the irresponsible behavior of the alcohol industry in

purposely pushing its product to alcoholics, young people and new users."

But Chris A. Valauri, executive vice president of the North Carolina Beer Wholesalers Association, denied that beer producers aim their advertising at the young.

"We are not trying to recruit a new generation of beer drinkers," he said. "Beer advertisements are designed to influence brand selection. They're not saying to the consumer, 'You should go out and have six or

seven of these.'"

Privette said he would introduce legislation today that would prohibit all advertising of alcoholic beverages in newspapers, pamphlets, billboards, television, radio and other mass media.

George Diaz, president of the North Carolina Association of Broadcasters, said his organization opposes the bill.

"The people of North Carolina won't be fooled by this bill," Diaz said.

## "Bank with the double advantage."

At Home Federal Savings, you'll find a full range of financial services, plus the personal attention you deserve.

Come see us to open a checking account or for your next investment, or loan. You'll like the double advantage.

**HOME FEDERAL SAVINGS**  
AND LOAN ASSOCIATION  
OF EASTERN NORTH CAROLINA

DOWNTOWN GREENVILLE 758-3421

Other Greenville Office: Arlington Boulevard 756-2772



Roscoe L. King  
Vice President, Branch Development

# • AUCTION •

OFFICE EQUIPMENT, STEREO EQUIPMENT, & TOOLS

**FORMER CENTRAL LEASING CO.**

**AND OTHER LIQUIDATIONS, BANKRUPTCIES**

**NATIONAL GUARD ARMORY**

**801 E. Highland Ave., Kinston, N.C.**

**WED. MAY 15th, 11:00 AM**

**ALSO INCLUDING: Manufacturer's over runs, overstocks, etc.**

**OFFICE FURNITURE:** Brand new wooden desks in traditional and contemporary styles including executive and "L" shaped by HI-Tech and DMI and others in cartons. Chairs including secretary, steno, judges, executive, side stack, folding, and more. These chairs are new and in cartons. Files both letter and legal sizes with heavy duty suspensions in two, four, and five drawer sizes, assorted colors and depths. Lateral files, bookcases and more.

**OFFICE MACHINES:** IBM Selectric I, II, and III with balls, new and factory renewed, some with self correcting features. Other typewriters include new SCM, Remington, Olympia, TCA, and others. Electronic calculators with displays and tapes from Olivetti, Victor, Sharp, Sunstrand, and others.

**ELECTRONIC CASH REGISTERS:** by Casio, TCA, and others. Two and four total available.

**STEREO EQUIPMENT:** New component stereo systems by Sanyo, tape recording units, portable stereos, digital clocks, digital clock phones, t.v. band radios.

**COPIERS:** Canon PC-home and office, legal and letter.

**TOOLS:** Pipe wrench sets, wrench sets, vice grips, socket sets, screw drivers, mechanics socket sets, drill presses, bench grinders, and other hand tools.

**OPEN TO THE PUBLIC**

**MANY MORE ITEMS TOO NUMEROUS TO MENTION**

Duration of auction approx. 2 hrs.

Terms: Inspection 9 a.m. morning of sale, same day removal.

**CASH OR CERTIFIED CHECKS**

**EDWARD ZEDD AUCTIONEERS**

795 Monticello Ave., Norfolk, Virginia 23510  
(804) 623-4999 N.C. Lic #2625

## Reader Files Are Private, Say Officials

By JOHN FLESHER  
Associated Press Writer

RALEIGH (AP) — Libraries should be able to keep confidential the records of borrowers or lists of readers for certain books because readers have a right to privacy, library officials say.

"Questions concerning the rights of library users go back to the McCarthy era, usually in the form of a request to view the records of a particular library borrower, or to see the names of all the persons who read a certain kind of book," Gene Lanier, an East Carolina University professor and chairman of the Intellectual Freedom Committee of the North Carolina Library Association told the House Judiciary I Committee.

"When the time comes in any society that people seek information as to what people are reading, it must be presumed that they expect to use these records as evidence of

dangerous thinking," Lanier said Tuesday.

The panel discussed, but did not vote on, a bill sponsored by Rep. George Miller, D-Durham, that would keep records identifying library users private.

The bill would grant exceptions when open records are needed for "reasonable" library operations such as keeping circulation statistics; when the user agrees in writing; and when the records are subpoenaed for a law enforcement probe.

Critics pointed out that under the bill, a teacher no longer could check to see whether a student checked out a book for a report as assigned.

Lanier said police once sought the names of everyone who used a particular study area during an evening when a woman lost a purse there. "That's not due process," he said.

But Rep. George Robinson, R-Caldwell, said he saw nothing wrong with such an effort.

"I don't see why this bill is needed," said Robinson. "I have a little problem with trying to deter these folks (police) from apprehending someone who's broken the law."

## Senate Ready For Last Vote On Day Care

RALEIGH (AP) — A disgruntled Senate committee chairman, weary of futile attempts to please everyone with a bill to reorganize child day care, successfully fought off concessions to religious groups and hopes to have similar success with Republicans.

"You haven't seen me like this very often," said Sen. Charles Hipps, D-Haywood, after the Senate voted 39-8 Tuesday to tentatively approve a bill to move all day-care operations to the Department of Human Resources.

"I've tried to get a consensus. I tried right up until this morning to address their concerns," he said. "Now we all have to share this responsibility."

Hipps helped shoot down an amendment backed by Gov. Jim Martin to let church-run day care be regulated in the governor's office while everything else went to the Division of Facility Services. And he

vowed to fight attempts to give the governor a majority of appointees to a newly created, 15-member Day Care Commission.

Hipps said religious groups once satisfied with being exempted from new standards governing education and programming in day care resurfaced to back exclusion from reorganization.

"They agreed to be bound by ... health, safety and sanitation and

that's what we're dealing with here," he said.

Hipps said he tried unsuccessfully to compromise by giving the governor nine members on the commission in exchange for religious support. Now the deal is off, he added.

The bill is designed to eliminate duplication with the Department of Administration at a savings of \$4.7 million over the next two years.

Hipps said.

"I'm reassured that the Senate realizes the compelling urgency to consolidate these different departments," he added.

The only amendment backed by the Senate Tuesday was one to give the 1,600 for-profit day-care facilities a 4-3 advantage over the 500 nonprofit facilities on the commission.

**Peak Of The Season!**

a berry special place...

# DEWS BERRY PATCH

## Strawberries!

—Pick Your Own—

Open 7 A.M.—7 P.M., Mon.-Fri.  
7 A.M.—4 P.M., Sat. & 2 P.M.—4 P.M., Sun.

756-7116

N.C. 903 South  
Turn Right Past Waller Tractor Co.  
3 Miles From Winterville



SAVE 30%...40%...& UP TO 50% NOW AT BOSTIC-SUGG...QUALITY HOME FURNISHINGS AT FANTASTIC SAVINGS. NOW NAME BRAND HOME FURNISHINGS AT HUGE SAVINGS. BROWSE THRU OUR BOSTIC-SUGG'S 22,000 SQUARE FOOT SHOWROOM & SEE QUALITY HOME FURNISHINGS AT DISCOUNTS YOU NEVER THOUGHT POSSIBLE.



**Bostic-Sugg**  
FURNITURE INC.

401 W. 10TH STREET GREENVILLE, N.C.  
PHONE 758-2513

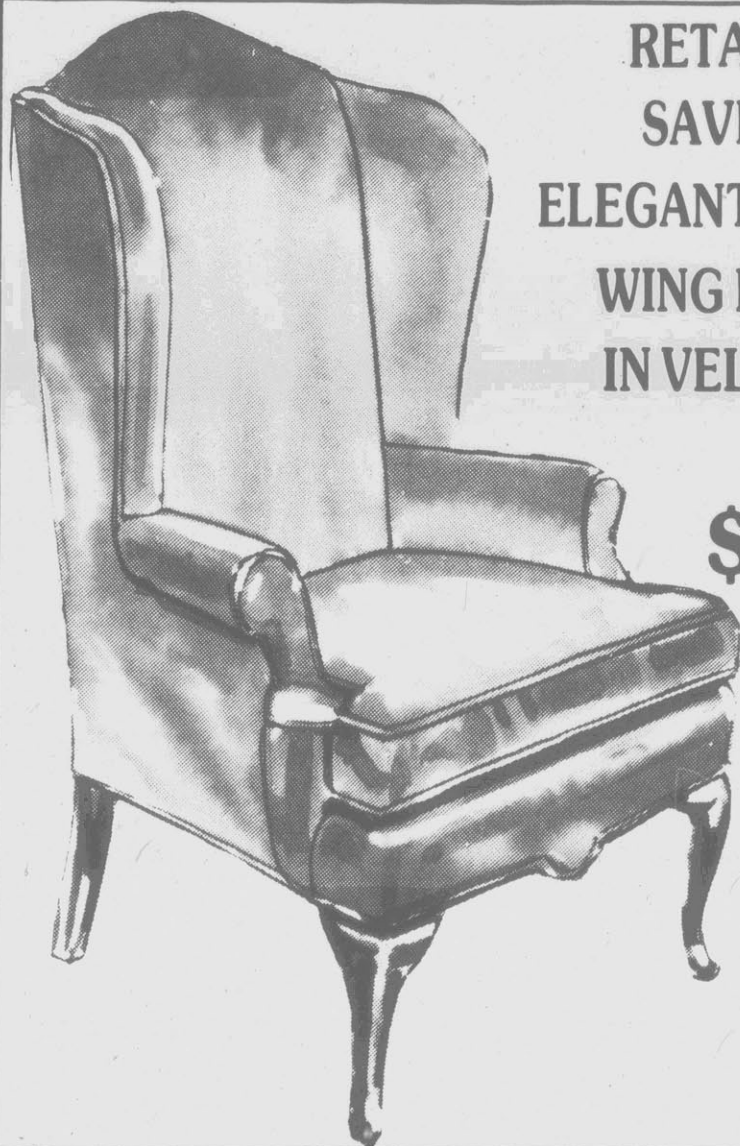

RETAIL \$390.00  
SAVE \$171.00.

ELEGANT QUEEN ANNE  
WING BACK CHAIR  
IN VELVET FABRIC.

SALE PRICE

**\$219**

SELECT FROM 4  
COLORS. TEAL,  
MAUVE, ROSE OR  
MINT. BEAUTIFUL  
VELVET FABRICS.  
CARVED QUEEN ANNE  
LEGS IN RICH  
CHERRY FINISH.

## LA-Z-BOY® RECLINER SALE



150 LA-Z-BOY  
CHAIRS IN STOCK  
RETAIL \$380.00.  
STYLE 302  
CONTEMPORARY  
LA-Z-BOY

SALE PRICE  
**\$189<sup>00</sup>**

LA-Z-BOY® ROCKS AND RECLINES  
HERCULON TWEED

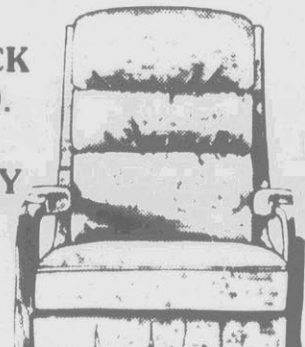

RETAIL  
\$430.00  
STYLE 334  
CONTEMPORARY  
LA-Z-BOY

SALE PRICE  
**\$280<sup>00</sup>**

ROCKS AND  
RECLINES  
PILLOW BACK

**35% TO 50% OFF**



RETAIL \$485.00.  
STYLE 684  
TRADITIONAL  
LA-Z-BOY

SALE PRICE  
**\$315<sup>00</sup>**

LA-Z-BOY® ROCKS AND RECLINES  
BEAUTIFUL FABRIC



RETAIL \$460.00.  
STYLE 849  
TALL BACK  
LA-Z-BOY

SALE PRICE  
**\$300**

ROCKS AND  
RECLINES  
CHOICE OF  
COLORS

**1/2 OFF** AMERICAN-DREW  
18TH CENTURY  
ACCENT



CHERRY GROVE  
CHIPPENDALE  
DECORATIVE  
MIRROR

RETAIL PRICE  
\$265

SALE PRICE  
**\$129**

FRAME SIZE: 30" X 50" PLATE  
MIRROR SIZE: 22" X 32"

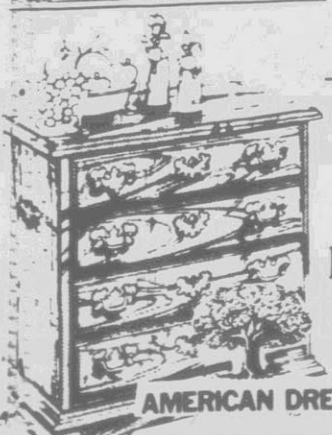

RETAIL \$360.00.  
4 DRAWER  
AMERICAN DREW  
BACHELOR CHEST

SALE PRICE  
**\$169**

BOSTIC-SUGG SHOWROOM HOURS 8 A.M. TO 5:30 P.M. MONDAY  
THRU SATURDAY AND OPEN TIL 9 P.M. ON FRIDAY NITES.

**1/2 PRICE AMERICAN-DREW CLOSE OUT**



AMERICAN DREW

SAVE \$1005.00. RETAIL PRICE \$1800  
AMERICAN-DREW  
5 PIECE OAK BEDROOM GROUP.

TRIPLE DRESSER VERTICAL MIRROR  
CHEST ON CHEST, NITE CHEST & QUEEN-FULL SIZE HEADBOARD

SALE PRICE  
**\$795**

AMERICAN DREW

# USDA Snubs Stabilization Buy-Out Plan

WASHINGTON (AP) — The U.S. Department of Agriculture, saying reduced sales of tobacco this year could simply replace the surplus eliminated by a proposed buy-out, has balked at a plan proposed by Stabilization and offered a plan of its own.

In the USDA's proposal, a support price rollback — a key company demand for a buy-out — would hinge on minimum purchases of tobacco this year by the companies.

"The policy people (in USDA) would like assurances that the Flue-Cured Tobacco Cooperative Stabilization Corp. would not be just taking it out of one pocket and putting it another pocket," said James Davis, director of the tobacco division of the Agriculture Stabilization and Conservation Service.

said. "It was left open for discussion."

The USDA rejected a plan proposed by Stabilization for a buy-out of tobacco surpluses by cigarette manufacturing companies, officials said Tuesday.

While negotiations are continuing to try to satisfy USDA concerns, the reluctance of the federal officials to approve Stabilization's plan has raised another problem for the proposed buy-out of some 800 million pounds of surplus leaf.

The department has demanded assurances that a buy-out at significant losses to taxpayers would not be canceled out by reduced purchases of tobacco in this year's tobacco markets.

Fred Bond, manager of the Raleigh-based cooperative, said he was working on another offer to

USDA, but he was unsure what would satisfy the officials.

"It certainly is a problem that is going to have to be resolved if we proceed with an administrative program (for a buy-out this year)," Bond said.

The failure of an administrative plan could mean that growers this year would pay a 25-cent-per-pound fee to support the tobacco program without a cut in the price support level to prevent further buildup of tobacco stocks.

The projected price support is now set at \$1.70 per pound, although that level is expected to be reduced to \$1.65 per pound through discretionary powers of the USDA.

The proposed buy-out is not only intended to eliminate large portions of existing stocks held by stabilization, but also to reduce a buildup this year by further reducing the price

support to \$1.40 per pound.

The cooperative has asked USDA to approve converting the 25-cent assessment to support the program into a rebate to buyers as the effective way to cut the price support.

**the eye site**  
affordable fashion eyewear & contact lenses  
grand opening  
save up to 30%  
the plaza 756-9771

## Tax Gets Tentative Approval

By JOHN FLESHER  
Associated Press Writer

RALEIGH (AP) — Rejecting warnings of "cutthroat" competition, the Senate tentatively approved a proposed constitutional amendment that would let each county decide whether to keep the inventory tax.

"The inventory tax is a county tax, a city tax, a local tax," Sen. R.P. "Bo" Thomas, sponsor of the proposed amendment, said Tuesday. "It's not a state tax."

But Sen. Melvin Watt, D-Mecklenburg, said that when counties "start to get cutthroat with each other in competing for business ... we are heading for trouble."

The measure was passed 31-15, with most of the opposition coming from Republicans who prefer Gov. Jim Martin's plan to repeal the tax statewide. A final vote was scheduled for Monday.

If approved by three-fifths House and Senate votes, a statewide referendum on the amendment would be scheduled for November 1986. A similar bill has been endorsed by the House Finance Committee and awaits floor action.

Thomas said his bill would benefit small, poor counties that get little inventory tax revenue because they have few industries. By doing away with the tax, they might lure new businesses and create jobs, Thomas said. But wealthier counties that collect substantial amounts of

money from the tax could keep it. Sen. Bob Somers, R-Rowan, charged that no one seriously wanting to lift the inventory tax would support the amendment.

"In my opinion this bill is nothing but a ruse, introduced ... solely for the purpose of ensuring that (Martin's) inventory tax bill ... never sees the light of day," Somers said.

Sen. Cass Ballenger, R-Catawba, said, "I think that basically we're all being pretty chicken about this — not biting the bullet and dealing with this and passing it on down to the county commissioners instead."

But Sen. Dennis Winner, D-Buncombe, responded, "This is not passing the buck. It is not a state tax." North Carolina counties already compete with each other for industry, he added.

Watt said he was afraid local officials wouldn't withstand pressure to lift the tax even if doing so would "jeopardize their own financial well-being."

Sen. Jim McDuffie, R-Mecklenburg, broke party ranks to support the amendment, saying it was "half a loaf" but would let local officials "determine their own destiny."

A subcommittee of the Senate Finance Committee is expected to vote this week on an omnibus tax-relief package. The co-chairmen, Thomas and Sen. Marshall Rauch, D-Gaston, say

they're compiling a "skeleton" proposal for the subcommittee.

Committee members predict the package will include a partial reduction of the inventory tax.

Complete Lawn Care Programs

- Fertilization
- Weed Control
- Insect Control

FOR YOUR FREE LAWN SURVEY AND FIRM PRICE QUOTATION  
CALL 758-3161

AMERICA'S LEADER IN PROFESSIONAL LAWN CARE  
AN INDEPENDENTLY OWNED FRANCHISE

**CHEMLAWN**<sup>®</sup>

\*1985 ChemLawn Services Corporation. ChemLawn<sup>®</sup>, ChemLawn Guarantees<sup>®</sup>, ChemLawn Tree & Shrub Care<sup>®</sup>, ChemLawn Carpet Clean<sup>®</sup> and ChemLawn Pest Free<sup>®</sup> are marks used by ChemLawn Services Corporation and are registered in the United States Patent and Trademark Office. ChemLawn Commercial Services is a mark used by ChemLawn Services Corporation.

**SAVE UP TO \$1.30**

Try Great Tasting Sugar Free **ORANGE CRUSH**

100% **NUTRASWEET**<sup>®</sup> BRAND SWEETENER

**SAVE 30¢** with this coupon and Up to **\$1.00** with coupons by mail.

**HERE'S HOW:** Redeem the coupon below and try Sugar Free Crush.

**Challenge Refund Offer Certificate**  
(Cash redemption value 1/20 of 1¢)

Enclosed is the cash register receipt with the purchase price of one Crush 2 liter bottle or one multi-pack of cans or bottles circled and the UPC code written on the receipt. (Please Check One):

I prefer the Great Taste of Sugar Free Orange Crush. Please send me four 25¢ coupons, each good toward the purchase of one Crush 2-liter or multi-pack of cans or bottles.

Please send 50¢.

Name \_\_\_\_\_  
Street \_\_\_\_\_  
(Please print clearly — proper delivery depends on a complete and correct address)  
City \_\_\_\_\_  
State \_\_\_\_\_ Zip Code \_\_\_\_\_

Offer expires August 1, 1985  
Place in a stamped envelope and send to:  
**Sugar Free Crush Challenge**  
P.O. Box PM 043  
El Paso, Texas 79966

PLEASE NOTE THESE ADDITIONAL TERMS: 1. Offer good in U.S.A. only. 2. THE ATTACHED CERTIFICATE MAY NOT BE MECHANICALLY REPRODUCED AND MUST ACCOMPANY YOUR REQUEST. 3. Your offer rights may not be assigned or transferred. 4. Limit one refund per name and address. 5. Please allow six to eight weeks for delivery. 6. Offer expires August 1, 1985.

MANUFACTURER COUPON Expiration Date July 27, 1985

**crush** **SAVE 30¢** **crush**

WHEN YOU BUY ANY MULTI-PACK OR ONE 2-LITER BOTTLE OF REGULAR OR SUGAR FREE CRUSH

OFFER GOOD ONLY IN AREAS SERVED BY: Coca-Cola Bottling Co., Greenville, Goldsboro, and Kinston, N.C.

30¢

LIMIT ONE COUPON PER PURCHASE.  
NOTE TO DEALER  
This coupon will be redeemed by our salesman. Invoices showing your purchase of sufficient stock to cover all coupons must be shown upon request. Void if prohibited, taxed, or restricted. Your customers must pay any required bottle deposit and sales tax. Cash value 1/20 of 1 cent. Coupons sent to Coca-Cola Bottling Co., P.O. Box 24, Goldsboro, N.C. 27530 will be redeemed according to our normal coupon redemption policy.

ONLY ONE COUPON PER REQUIRED PURCHASE

30¢

**Save 30¢**

**Barg's**<sup>®</sup> ROOT BEER

in 6-Pack 12 oz. Cans, 2-Liter Bottles and 6-Pack 16 oz. Non-returns

Offer Expires July 31, 1985

LIMIT ONE COUPON PER PURCHASE.  
NOTE TO DEALER  
This coupon will be redeemed by our salesman. Invoices showing your purchase of sufficient stock to cover all coupons must be shown upon request. Void if prohibited, taxed, or restricted. Your customers must pay any required bottle deposit and sales tax. Cash value 1/20 of 1 cent. Coupons sent to Coca-Cola Bottling Co., P.O. Box 24, Goldsboro, N.C. 27530 will be redeemed according to our normal coupon redemption policy.

Offer good in territories served by Coca-Cola Bottling Cos. of Greenville, Goldsboro and Kinston, N.C.



MODERN DAY TARZAN — Burlington tree surgeon J.D. Norton uses an elaborate rope system to swing through a tree he's trimming at a residence in the Alamance County city. The ropes made him appear to be something of a modern day Tarzan. (AP Laserphoto)

**Briley's Strawberries**  
*Pick Your Own*

264 E. Pactolus Hwy., 3 Miles From 264 Bypass Stoplight

Hours: Mon.-Fri. 7:30 a.m.-7 p.m.  
Sat. 7:30 a.m.-5 p.m.  
Sun. 1:30-5 p.m.

Call After 8 p.m.  
758-2996 758-3976

# Breath-Taking CELEBRATION

You Are Invited To A Breath-Taking  
**OPEN HOUSE CANDLE LIGHT CELEBRATION**  
**FRIDAY, MAY 17, 1985 at 7:30 PM**  
**UNDER THE NEW DOME SANCTUARY**  
**FAITH ASSEMBLY OF GOD**  
**HOOKER ROAD, GREENVILLE**

This will be a special Thanksgiving Celebration unto the Lord for our 80% Construction Phase Completion  
No Offering Will Be Taken During This Thanksgiving Celebration

**Schedule of Events**

**GOSPEL SINGING**

Featuring THE GOSPEL ECHOES and other groups

**GUEST SPEAKERS**

**REV. MARSHALL HOWELL**  
Former Faith Assembly Pastor

**REV. STEPHEN JONES**  
Former Faith Assembly Pastor

**BISHOP SMITH**  
First Born Holy Church, Pastor

**REV. BILL HARRELSON**  
Pastor, Lighthouse Church of God

**FRED ALCOTT**  
Owner, East Carolina Insurance

**FRED DANIELS**  
Insurance Executive

**MARTHA CARPENTER**  
Arapahoe, N.C.

**CARL KNOTT**  
C & K Enterprises

**TOM JARMAN**  
Craven Electric Supply

Rev. David Moulton will preside and also deliver a Thanksgiving Message

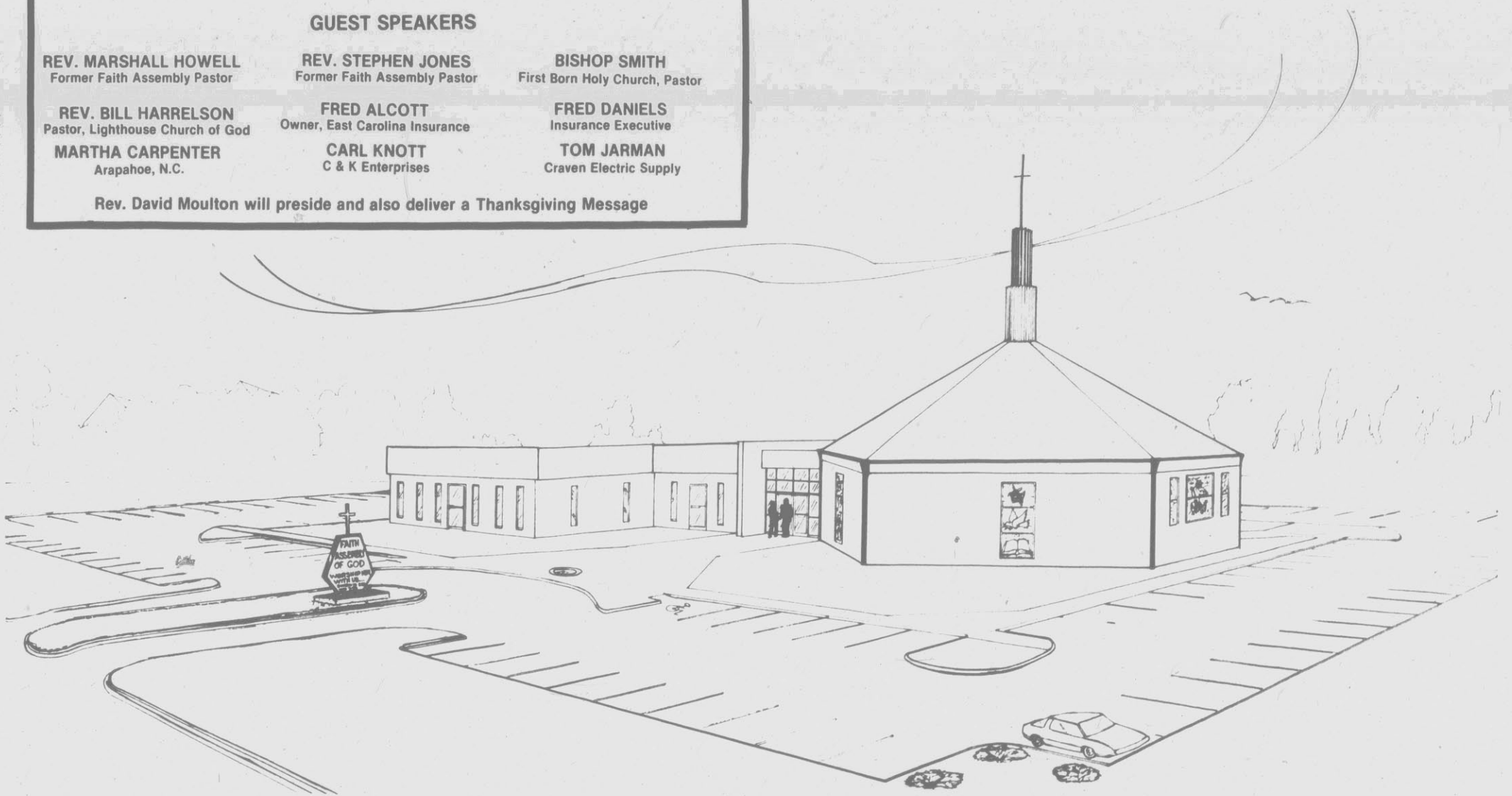

Plan To Arrive Early And View The Beautiful Leaded Cut Glass Windows  
A Community Church With Family And Evangelistic Emphasis  
Positive, Encouraging and Challenging

Do you remember  
the joy you felt  
when you first  
experienced the  
good news of  
Jesus Christ?  
IMAGINE THAT  
JOY RETURNING!

It Would Be  
A Joy To Have  
You Stop By  
And Celebrate  
With Us!

**WEEKLY SERVICES**

Sunday School 9:45 AM  
Morning Worship 10:45 AM  
Sunday Evening 7:00 PM  
Wednesday Evening 7:30 PM

Royal Raugers  
Wednesday 7:30 PM  
Missionettes  
Wednesday 7:30 PM

Come join the choir and orchestra  
Friday Night Youth Service



R. David Moulton  
Pastor, Faith Assembly of God

Come And Receive A Life-Changing Experience And Be An Encourager

# Stock And Market Reports

**NEW YORK (AP)** — The stock market opened mixed today as new signs emerged of sluggish economic growth.

The Dow Jones average of 30 industrials rose 1.77 points to 1,275.07 in the first half hour of trading today. But more stocks fell in price than rose in the early going on the New York Stock Exchange.

Hopes for renewed economic strength have been dampened by a series of disappointing figures released by the government and private industry.

The Federal Reserve Board said today that industrial production fell 0.2 percent in April, the first decline in six months. On Tuesday, the nation's automakers said sales fell 8.6 percent in the first 10 days of May from a year earlier.

The slowing of economic growth, however, has touched off a rally in the bond market, with interest rates falling in anticipation that the Federal Reserve will accommodate lower rates to prevent a recession.

Analysts also said it is likely the Fed will encourage lower interest rates to ensure liquidity and calm in the banking system following an order by Maryland's governor to limit withdrawals at the state's privately insured savings and loan associations following a run by depositors at some of the institutions.

Analysts said the situation in Maryland appeared to be under control, but that the latest problems would be a factor dampening investor enthusiasm.

Some selling also was attributed to traders who were cashing in on the stock market's recent rally.

In early trading today, American Telephone & Telegraph was up 1/4 at 22 3/4; Perkin-Elmer was unchanged at 23 1/4. General Motors rose 3/4 to 67 1/2. Unocal was unchanged at 45 3/4, and Mobil was unchanged at 30 1/2.

On Tuesday the Dow Jones industrial average dropped 4.20 to 1,273.30.

Declines outpaced advances by about 8 to 7 on the NYSE.

Big Board volume rose to 97.36 million shares from 85.83 million Monday.

The NYSE's composite index lost 37 to 106.48. At the American Stock Exchange, the market value index was down .63 at 227.76.

**NEW YORK (AP) — Midday stocks:**

Company	High	Low	Last
AMR Corp	43 1/2	43 1/2	43 1/2
AshLabs	52 1/2	52 1/2	52 1/2
Alis Chalm	6 1/2	6 1/2	6 1/2

## The Meeting Place

- WEDNESDAY**
- 6:30 p.m. — REAL Crisis Intervention
  - 7:30 p.m. — Winterville Jaycees meet at Jaycee Hut
  - 8:00 p.m. — N.A. midweek open meeting at St. Paul Episcopal Church
- THURSDAY**
- 9:30 a.m. — Town and Country Senior Citizens meet at St. Paul Episcopal Church
  - 6:30 p.m. — Exchange Club meets
  - 7:00 p.m. — Greenville Elks Lodge No. 1645 meets
  - 7:30 p.m. — Overeaters Anonymous meets at First Presbyterian Church
  - 8:00 p.m. — Cochee Council No. 60, Degree of Pochabontas
  - 8:00 p.m. — VFW meets at Post Home
  - 8:00 p.m. — AA closed meeting at First Presbyterian Church

**BRICK SUTTON COMPANY**

Complete Line of Brick and Accessories

- Roofing Shingles
- Prompt Delivery
- Slate & Stone

Come By Our Showroom At 369 Hooker Road

756-5951

8-5 Monday-Friday

**East Carolina Coins & Pawn**  
CORNER OF TENTH & DICKINSON STS.

Pawn	12" Black & White T.V.s	Your choice	44.95
Shop	Kirby Classic III Vacuum		139.95
Specials	Yamaha Acoustic FG-375S Guitar (like new)		239.95
	Washburn Force III Electric Guitar W/Case		299.95
	Electrolux Super J Vacuum Cleaner		99.95
	Bentwood Rocker		49.95
	2-man inflatable boat		49.95
	Gibson 6000 BTU A.C.		129.95
	Gibson 8000 BTU A.C.		139.95
	1913 2 1/2 dollar Indian U.S. gold (Au)		225.00
	1900 5 dollar Liberty U.S. gold (Au)		225.00
	All Bicycles		25% off

"WE MAKE INSTANT LOANS ON ITEMS OF VALUE"

WE BUY GOLD & SILVER      PHONE 752-0322      WE BUY CASSETTE TAPES  
Mon. - Fri. 9 to 6, Sat. 9 to 5

## Fire ...

(Continued from page 1)

tact with bureaucracy and kept scores of dogs and welcomed rats into their home as part of their back-to-nature outlook.

Some residents said the police overreacted and should not have used a helicopter to bomb the house, which authorities believed contained explosives.

Police surrounded the MOVE rowhouse in a neat, working-class neighborhood Sunday night and evacuated 200 homes. When they tried to evict MOVE members Monday on charges including possession of explosives and harassment of neighbors, MOVE refused and a gunbattle ensued.

Police in a helicopter dropped a bomb on the house Monday night to destroy a rooftop bunker and a fire started, eventually spreading to 61 houses.

Two MOVE members escaped their blazing fortress with minor burns — 9-year-old Birdie Africa and Ramona Africa, who had been sought by police on various charges and is being held in \$3 million bail.

Goode said during Monday's fire that "at least three others were on the loose," but on Tuesday he told reporters "I don't know" if any MOVE members got away.

"The fire was accidental and unexpected," Goode said at a news

conference, adding that the bomb plan "did not turn out as intended."

"But it was the right decision," said the mayor in accepting full responsibility for the operation that burned down more houses than any other fire in the history of America's fifth-largest city.

Burton Caine, president of the Philadelphia Chapter of the American Civil Liberties Union, called the bombing "totally unjustified."

"Trained public safety officials should have known that the dropping of a bomb onto a row home full of ammunition and other explosives, in a tightly compacted area, is like lighting a match in a room full of gas," Caine said.

Ruth Willis, whose home was damaged, said "we wanted them to get the problem settled, but not with a fire. For it to end up like this, it's just horrible."

Goode, visiting some of the homeless at a temporary church shelter on Tuesday, said, "we believe we owe it to you to make you whole again (and) we will rebuild those blocks with city funds."

Sambor said the rubble at the MOVE house was being excavated by a five-story crane. The house, he said, was "the most heavily fortified of any building I have ever seen in 35 years of police work."

"The inside of the home was fortified with trees," he said. "Tree trunks with the bark still on, and through which fireports were cut so they could shoot outside."

## Industrial Production Sees April Decrease

By MARTIN CRUTSINGER  
Associated Press Writer

**WASHINGTON (AP)** — U.S. industrial production fell 0.2 percent in April, the first decline in six months, as the industrial sector of the economy continued to suffer from America's weak trading performance, the government reported today.

The Federal Reserve Board said its index of total output at the nation's factories, mines and utilities fell for the first time since a 0.4 percent decline last October.

The latest setback left the index at 165.4 percent of its 1967 base. The highpoint reached during the current recovery was 166 percent back in August. Since that time, the set-backs have outweighed the gains as the country's industrial sector has struggled against a worsening trading performance.

The inability of U.S. industry to compete against foreign products was cited as the main reason overall economic growth slumped to an anemic 1.3 percent during the first three months of this year, the slowest pace since the end of the 1981-82 recession.

Reflecting this slow growth, the employment rate has been stuck at 7.3 percent of the civilian workforce for the past three months.

Analysts believe the weak trading performance will depress economic growth the entire year with many predicting the gross national product will advance by only 3.1 percent this year, down sharply from the 6.8 percent growth in 1984.

Worries have also begun rising about a recession, perhaps starting next year and some analysts have warned that the United States is already in a growth recession, a period when economic growth is so sluggish that the unemployment rate rises.

Today's report by the Fed showed that output at manufacturing companies was down 0.2 percent with the biggest drop occurring in industries making durable goods, items expected to last three or more years. These industries suffered a 0.4 percent while the nondurable goods segment dipped 0.1 percent.

Automobiles were assembled at an annual rate of 8.1 million units in April, down from the March rate of 8.3 million units.

Production of business equipment fell by 0.3 percent in April, the fourth consecutive decrease for this industry.

About the only industrial segment showing strength was the defense and space industry, which posted a 0.7 percent increase in April following an even larger 1.3 percent March gain.

Output at the nation's mines fell a sharp 1.5 percent in April following a 1 percent increase in March.

Utility output was up 0.3 percent, reversing a 0.3 percent March decline.

The strong dollar is blamed for much of the country's trading woes. A strong dollar makes imports cheaper and thus more attractive to U.S. consumers while making American products more expensive and thus harder to sell overseas.

While the dollar has declined somewhat from the highs it reached in mid-February it has still risen in value by more than 50 percent against other foreign currencies since late 1980.

## Pickle Packers Pick President

**CHICAGO (AP)** — Pickle Packers International has named President Reagan Pickle Person of the Year because he "has gotten into a lot of pickles this year, but he has gotten out of them, too."

Bill Moore, executive vice president of Pickle Packers International, said Tuesday the president's pickles included "a number of hotly contested appointments," as well as the furor over a joking comment Reagan made about bombing the Soviet Union before a radio broadcast last year.

As a symbol of the honor, Moore said the president would receive a three-foot inflatable plastic pickle May 23, which is the first day of International Pickle Week.

Moore said the pickle awards have gone to other presidents, including Richard Nixon, who won one during the Watergate period.

Did you know that you can get a free library card at Sheppard Memorial Library? Discover the wonderful world of reading at your public library. For more information call 752-4711.

## Obituaries

Carraway

**WASHINGTON** — Mr. Marvin McDonald Carraway, 70, of Route 1, Washington, died today at his residence.

His funeral will be conducted at 3 p.m. Thursday at Paul Funeral Chapel of Washington with Lewis Styons and Thelbert Leggett officiating. Burial will be at the Oakdale Cemetery with Masonic graveside rites.

Mr. Carraway was the retired owner and operator of Marvin's Service Station located in the Old Ford Community of Washington.

Surviving are his wife, Mrs. Arah

Bell Gautier Carraway; one daughter, Mrs. Jane C. Lawrence of Washington N.C.; four sisters, Mrs. Pearl Cratt of Greenville, Mrs. Irene Taylor of Williamston, Mrs. Ruth Taylor of Washington, Mrs. Martha Mae Moore of Pensacola, Fla., and one grandson.

The family will receive friends from 7:30-8:30 p.m. today at Paul Funeral Home of Washington.

Ellis

Mr. James (Steel) Ellis died Tuesday in Pitt County Memorial Hospital. Funeral arrangements will be announced by Joyner's Mortuary of Farmville.

Johnson

Mrs. Elizabeth (Penny) Johnson died at her home, 122-A Howard Street, Saturday.

Her funeral will be conducted at 2:30 p.m. Thursday at English Chapel Free Will Baptist Church by Rev. David Hammond. Burial will be in Greenwood Cemetery.

Mrs. Johnson was a member of English Chapel Free Will Baptist Church, where she served as chaplain of the Mother Board, president and chaplain of the Senior Choir Club, and as a member of the Home Mission.

Surviving are a daughter, Mrs. Doris M. Johnson of the home; a stepdaughter, Mrs. Louise Wesley of Newark, N.J.; two foster daughters, Mrs. Clydia Austin of Ayden and Evangelist Eva J. Forbes of Philadelphia; a grandchild and a great-grandchild.

The family will be at Phillips Brothers Mortuary from 9:15 to 10:15 p.m. today and at other times will be at the home, 122-A Howard Circle.

Joyner

**FARMVILLE** — The Rev. Lonnie Joyner, a resident of Farmville, died Tuesday in Pitt County Memorial Hospital. Funeral arrangements will be announced by Joyner's Mortuary.

Moore

**FARMVILLE** — Mr. William (Bill) Larkin Moore, 62, died Tuesday at his home.

His funeral will be conducted at 3:30 p.m. Thursday from the Church Street Chapel of the Farmville Funeral Home by the Revs. Dewey Tyson and Clyde Dunn. Burial will follow at Forest Hills Cemetery, Farmville.

A member of Farmville United Methodist Church, Mr. Moore was a World War II veteran and an auto salesman.

He is survived by his wife, Mrs. Mary Elizabeth Carr Moore of the home; his mother, Mrs. Octavia Moore of Selma; and two sisters, Mrs. Dorothy M. Castleberry of Garner and Mrs. Annie Gray Powell of Raleigh.

The family will receive friends from 7-9 p.m. today at the Farmville Funeral Home.

## A Card of Thanks

We, the family of the late Bette Dickens Mitchell, with heartfelt gratitude, thank each and every individual and organization responding to the grievous loss of our mother, grandmother and aunt. A special thanks goes out to the pastors and members of Sycamore Hill Missionary Baptist, First Missionary Baptist (New Bern), and York Memorial Baptist Churches.

Charles Mack Dickens  
Mary L. Pinkett  
Athena C. Johns  
Doris Dickens Hansley  
Georgina Harris Best

The Greenville Recreation & Parks Department provides individualized programs for Special Populations Citizens. Call 752-4137, Ext. 201, for more information.

**CASH REGISTERS \$299 and up!**

756-2215 Greenville  
2801 S. Evans St.  
Century Data Systems  
We cannot afford a single dissatisfied customer.



## Follmer Financial Services Advisory Presents A Real Estate Investment Seminar

"Investing in All Cash (Unleveraged) Real Estate"

This unique investment is designed to take advantage of inflation, deflation and taxes.

When	Where
Thursday, May 23 7:30 to 9:00 p.m.	Sheraton Greenville Greenville Blvd.

**With Guest Speaker**  
Leo Wells  
President and Director  
Wells Capital, Inc.  
Atlanta, Ga.

**Who should attend?**  
-The income real estate investor  
-Persons seeking a pension investment  
The seminar is free  
Space is limited to 50, so registration is requested.

To reserve seats  
**Call Follmer Financial Services Advisory today!**  
355-2836

**TOTALLY COVERED** presents  
carpets & interiors

**marrington**

**FLOOR THE NATION**

**20% OFF SALE**  
til May 18

BOCA™ COLLECTION • ARISTOCON® • LUSTRECON®

604 Arlington Blvd. Greenville 756-6082  
Open 9-5 Mon.-Fri. 9-1 Sat.

# ECAC Tourney Opens Thursday

The 1985 ECAC-Southern Division Baseball Tournament, making its first appearance in Greenville, will get underway Thursday at 2 p.m. at Harrington Field.

Second seeded New York Tech, winners of the New York/New Jersey Conference, will take on Iona, the champion of the Atlantic Metro Conference, seeded third in the tournament field in the opening game of the double elimination tournament.

Thursday at 7 p.m., hosting East Carolina, the ECAC-South champ and the top seed in the tournament, takes on George Mason, also of the ECAC-South, the fourth seeded and at-large pick in the field.

New York Tech brings a 32-13-1 record into the tournament, and it is the first appearance in the Southern Division tournament for the Bears. Tech's 32 victories set a new school record, one better than the old mark of 31. They have broken eight other school records during the year and are on the verge of setting three more.

Tech comes into the tournament hitting .350 as a team,

and is led by junior third baseman Fred Leone, hitting .461 through 45 games. He stands eighth among all ECAC hitters. Leone has also set school record for homers in a second and is second in runs batted in. Senior first baseman Mike Frustaci set that latter mark with 65 through 45 games, standing fourth in the ECAC. He is hitting at a .437 clip.

Frustaci is also tied for seventh in the ECAC in doubles with 17, and tied for tenth in homers with 12. Ray Karczewski is tied for third in ECAC triples with six, while Leone is seventh in runs batted in with 61.

The Bears have averaged better than seven runs a game in the year, hitting more than 50 homers, 90 doubles and 20 triples, all school records.

Al Silverstein is 14th in strikeouts in the ECAC with 63 while Mike Conklin is second in saves with five.

The Iona Gaels come in with a 23-12-1 mark, the most wins in the school's history and their first 20-game victory season.

It is the first time that the Gaels have ever made post-season play also.

Catcher Glen McElroy, who set a school record for hits with 62, leads the way for the Gaels with a .492 average in a year that saw six of the ten Metro Atlantic top hitters come from Iona. The Gaels hit .380 as a team for the season.

McElroy stands fifth in the ECAC in hitting, while Joe Staraci is 16th at .439 and Mark Casey is 26th at .419. McElroy is fifth in the league in doubles with 19, and tied for ninth in triples with five.

Chris Hansen is the leader on the mound for Iona, which won the league championship for the second straight year. Hansen is 3-3 with a 5.06 ERA, but was impressive in his last two outings, beating nationally-ranked Seton Hall and LaSalle for the conference championship.

George Mason posted a 35-21 record this year and was third in the final ECAC-South standings with an 11-7 mark. They will be making their first post-season appearance since moving up to Division I in 1976.

Senior first baseman Kevin Burke, who hit .434 during the season, and who is 21st among ECAC hitters, leads

the Patriots. He hit 17 homers and 72 runs batted in, both second in the ECAC to East Carolina's Winfred Johnson.

Danny Atcheson, 7-3, is the pitching leader. He beat the Pirates 7-2 on April 20 in Fairfax, Va. Steve Kann is the leading reliever with five saves, tied for second in the ECAC.

Burke also leads the ECAC in doubles, triple and hits with 89 in 56 games.

Following Thursday's first round games, two games are planned for Friday and Saturday, also at 2 and 7 p.m. The Friday afternoon game will send the losers of the Thursday games against each other, with the loser eliminated from the field. The two winners collide in the Friday night game.

Saturday afternoon, the losers' bracket finals will reduce the field to two, and the championship game will be played Saturday night. Should it take two games to decide the title, a final game will be played on Sunday at 2 p.m.

The winner of the tournament advances to the NCAA regionals next week, the site still to be determined.

# Rose Rallies To Top Hunt, 6-3

By WOODY PEELE  
Reflector Sports Editor

Steve Wall recovered from a shaky start in the first inning when he allowed three runs to pitch Rose High School to a 6-3 Big East baseball victory over Wilson Hunt last night.

Tagged for three runs and five hits in the opening frame, Wall rebounded to hold the Warriors scoreless the rest of the way on just four more hits. He walked two and struck out nine along the way.

"Steve threw a very good game tonight after he got past the first inning," Coach Ronald Vincent said.

It wasn't the most perfect game played as five of the six runs scored by the Rampants were unearned through five Hunt errors. Rose got only six hits, but used them to good advantage. "We got some good two-out hits," Vincent said. "Overall, I think we played pretty well tonight."

Vincent was also pleased with the play of two of his defenders. "Doyle Kirkland continues to be a very steady performer. He plays a solid second base. And Mike Wooten made a heck of a catch to end the game for us."

Wooten, inserted for the last inn-

ing for defensive purposes, came up with a diving, rolling catch of a ball hit off the bat of Jay Lassiter in the

Hunt	ab	r	h	rb	Rose	ab	r	h	rb
Bass,dh	4	1	2	0	Kirkland,2b	3	1	1	0
Boykin,lf	3	0	1	0	Jarman,1b	2	1	0	1
Farmer,2b	4	0	0	0	Scott,1b	1	0	0	0
Smith,c	4	1	2	0	Alston,dh	4	0	1	0
Lassiter,ss	4	1	1	0	Wall,p	3	0	0	0
Chatman,cf	2	0	2	1	Ehrmann,cf	3	1	1	1
Parker,p	3	0	1	1	Davis,ss	2	0	0	0
Barnes,cf	0	0	0	0	Matthews,c	3	0	1	1
Wood,rf	2	0	0	0	King,cr	0	1	0	0
Jump,3b	0	0	0	0	Emory,lf	2	1	1	1
Massey,1b	3	0	0	0	Wooten,lf	0	0	0	0
Caddell,3b	0	0	0	0	Hallow,3b	3	1	1	0
White,rf	0	0	0	0	Taylor,rf	0	0	0	0
Totals	29	3	9	2	Totals	26	6	6	4

Hunt	ab	r	h	rb	Rose	ab	r	h	rb
Rose	200	0	0	0	3	211	110	5	6
Game Winning RBI—Matthews.									
E—Wood, Farmer, Caddell 2, Davis, Lassiter, DP—Hunt, Rose; LOB—HHS 8, RHS 6, 2B—Bass 2, Emory, SB—Barnes, King 2, Ehrmann, Chatman, Alston, Boykin, SF—Jarman.									

Pitching	ip	r	h	er	bb	so
Hunt	6	6	6	1	2	2
Parker (L,4-4)	7	3	3	2	9	
Rose	7	3	3	2	9	
Wall (W,9-3)	7	3	3	2	9	

HBP—by Parker (Emory), by Wall (Chatman); WP—Wall, Parker 2; PB—Matthews 2, Smith.

seven with two out and two on. The 3-2 shot would have scored two runs had it fallen in.

Hunt took the initial lead, scoring all three of its runs in the top of the first. Robbie Bass led off with a double down the left field line. He moved to third on a wild pitch and scored off a passed ball. With two away, Jerry Smith singled to center and Jay Lassiter reached on an infield hit. William Chatman singled to center, scoring Smith and Lassiter came home on a hit to right by Mark Parker.

That was to be it for Hunt, thanks to some fine pitching by Wall and some fine defense behind him.

Hunt's biggest threat came in the fifth. Bass again opened with a double and James Boykin singled, then stole second. With one out, Smith lifted a fly to short center that Kirkland went back to catch. He then fired home to double up Bass,

tagging up after the catch.

In the sixth, Hunt used a hit batsman and a walk to put runners on, and advanced them on a passed ball before a popup ended the inning.

Rose got back in the game with a pair of runs in the bottom of the first. Kirkland opened with a single to right, moving up on an error on the play. Eric Jarman reached on an error, scoring Kirkland all the way from second. Jarman advanced on a wild pitch and scored on a two-out single by Robbie Ehrmann.

The tying run came over in the second. With one away, Battle Emory was hit by a pitch and Joey Hallow singled. Both advanced on a wild pitch and Emory scored when Jarman was again safe on an error.

Rose took the lead in the third with another run. Ehrmann reached on a fielder's choice and stole second. James Matthews then singled him in for a 4-3 lead.

The first of two insurance runs came over in the fourth. Hallow went all the way to second when his grounder was errored. A passed ball put him on third. After Kirkland walked, Jarman lofted a fly ball to right. After the catch, Hallow tagged and scored, but Kirkland, who had broken on the pitch, was thrown out trying to get back to first.

In the fifth, Matthews reached on a fielder's choice and courtesy runner Travis King stole second, scoring on a double to left by Emory. Bass, Smith and Chatman each had two hits for Hunt, while no one had more than one hit for Rose.

The Rampants climb to 13-8 on the season, 7-6 in league play. Hunt falls to 5-15, 2-11.

Rose will wind up its season on Thursday, traveling to Elizabeth City Northeastern.

## Sports Calendar

Editor's Note: Schedules are supplied by schools or sponsoring agencies and are subject to change without notice.

### Today's Sports

**Tennis**  
Regionals  
Downeast League  
Greenville Nets at Tarboro Busters  
Kinston Centerstraps at Greenville Aces

**Baseball**  
Roanoke at North Pitt JV (4 p.m.)  
Little League  
Union Carbide vs. Coca-Cola (ES - 6 p.m.)

Exchange vs. Pepsi-Cola (GS - 6 p.m.)  
Babe Ruth League  
Computerland vs. Pepsi-Cola (7 p.m.)

**Softball**  
North Pitt at Conley (4 p.m.)  
Rec Leagues

**Women's League**  
Ms. C's vs. Copper Kettle (6:30 p.m.)  
ECPTA vs. Prep Shirt (7:30 p.m.)  
Pellers vs. Overton (8:30 p.m.)

**Industrial League**  
Dixie Supply vs. Enforcers (E1 - 6:30 p.m.)

East Carolina #1 vs. East Carolina #2 (E2 - 6:30 p.m.)  
D.O.T. vs. Burroughs Wellcome #1 (E1 - 7:30 p.m.)

Fire Fighters vs. Yale (E2 - 7:30 p.m.)  
Pitt Memorial vs. Empire Brushes #2 (E1 - 8:30 p.m.)

Grady-White vs. TRW (E2 - 8:30 p.m.)  
Toyota East vs. Fieldcrest (E1 - 9:30 p.m.)

Ajax vs. Greenville Utilities (E2 - 9:30 p.m.)

**City League**  
Mr. C's Lounge vs. Elbo Room (WM - 6:30 p.m.)  
White's vs. Airborne (WM - 7:30 p.m.)  
Sunnyside Eggs vs. Continental (WM - 8:30 p.m.)  
Carolina Window & Door vs. Taylor's (WM - 9:30 p.m.)

**Thursday's Sports**  
**Baseball**  
Belhaven at Chocowinity (8 p.m.)  
Aurora at Jamesville (8 p.m.)  
Columbia at Bear Grass (8 p.m.)  
Williamston at Edenton (7:30 p.m.)  
Rose at Northeastern (4 p.m.)  
ECAC-Southern Tournament  
New York Tech vs. Iona (2 p.m.)  
East Carolina vs. George Mason (7 p.m.)

**Little League**  
Lions vs. Sportsworld (ES - 6 p.m.)  
Jarman's Auto vs. Wellcome (GS - 6 p.m.)

**Softball**  
Belhaven at Chocowinity (5:30 p.m.)  
Aurora at Jamesville (6 p.m.)  
Columbia at Bear Grass  
Williamston at Edenton  
Rose at Northeastern (5 p.m.)

**Rec Leagues**  
**Church League**  
Arlington vs. 1st Presbyterian (E1 - 6:30 p.m.)  
1st Free Will vs. St. Paul (E2 - 6:30 p.m.)

Black Jack vs. Immanuel (E1 - 7:30 p.m.)  
1st Christian vs. 1st Pentecostal (E2 - 7:30 p.m.)  
Faith & Victory vs. Jarvis (E1 - 8:30 p.m.)

Mt. Pleasant vs. Peoples (E2 - 8:30 p.m.)  
Grace vs. Oakmont (E1 - 9:30 p.m.)  
St. James vs. Memorial (E2 - 9:30 p.m.)

**Industrial League**  
Enforcers vs. Carolina Leaf (WM - 6:30 p.m.)  
Yale vs. Wachovia Bank (WM - 7:30 p.m.)

Union Carbide vs. Empire Brushes #2 (WM - 8:30 p.m.)  
Burroughs Wellcome #1 vs. Empire Brushes #1 (WM - 9:30 p.m.)

**City League**  
Stop & Shop vs. Jimmy's 66 (JC - 6:30 p.m.)  
Elbo Room vs. Pair Electronics (JC - 7:30 p.m.)  
State Credit vs. Airborne (JC - 8:30 p.m.)  
Mr. C's Lounge vs. White's (JC - 9:30 p.m.)

**Track**  
Girls Regionals at Fike  
Tennis

**Regionals**

## ECU Hosts



**Southern Baseball Tournament**  
May 16 thru 19  
2 pm & 7 pm  
Harrington Field  
Phone 757-6500  
For Information

CHARLOTTESVILLE, Va. (AP) — University of Virginia Athletic Director Dick Shultz has branded as "sour grapes" North Carolina football Coach Dick Crum's claim that Virginia is accepting student-athletes with lower academic credentials.

Crum, meanwhile, said he was quoted "totally out of context" and that his remarks were meant as praise for Virginia's recruiting success during the reign of Coach George Welsh.

"It's really a good case of the old foot-in-the-mouth disease," Shultz said Tuesday, reacting to a report of Crum's remarks at a meeting of North Carolina alumni in Richmond. "The fact is that George Welsh and his staff have practically shut off North Carolina recruiting in the Richmond area...that's what Crum is saying we've been able to do."

"And Crum saying that is proba-

bly a good sign because you know you're really getting to them when they resort to saying things like this," Shultz said.

Crum contended in the article that recently relaxed academic entrance requirements at Virginia make it more attractive and easier for student-athletes with marginal academic records to attend school in

Virginia rather than be wooed southward.

**Riggin Shoe Repair Shop**  
113 W. 4th Street  
Downtown Greenville  
Parking in Front & Rear  
758-0204  
Open: Mon-Fri. 8 A.M. 'til 6 P.M.  
Saturday 9 A.M. 'til 3 P.M.

**SPECIAL PRICES ON MICHELIN STEEL BELTED RADIALS. XZX \$43.49**  
P155-80R13XZX  
MICHELIN  
Because so much is riding on your tires  
Quality Remanufactured Tires

**4 for \$60.00**  
Carry out. Add \$2.00 per tire for whitewalls. \$3.00 per tire for mounting.  
A78-13 B78-13 D78-13 C78-14 D78-14 E78-14 560-15 600-15

**LEGENDARY STEEL BELTED DUNLOP WHITE WALLS TRUCKLOAD SPECIALS**

SIZE	SALE
155/80R13	29.50
175/80R13	31.50
185/80R13	33.50
185/80R14	34.50
195/75R14	36.50
205/75R14	38.50
215/75R14	40.50
225/75R14	42.50
215/75R15	44.50
225/75R15	46.50

**WHITE'S THE SERVICE SINCE 1961**  
3012 Memorial Dr.  
Near Parker's Barbecue  
Phone 355-2400

**SNAPPER TRUCKLOAD SALE Buy Now And Save**

Examples—  
21" Hi-Vac Snapper 3 1/2 HP Push With Bag Suggested Retail \$335.00 - MAY SALE **\$289.95**  
21" Hi-Vac Snapper 4 HP Self Propelled With Bag Suggested Retail \$480.00 - MAY SALE **\$395.00**  
30" 11 HP Electric Start With Bag Suggested Retail \$1600.00 - MAY SALE **\$1300.00**  
33" 11 HP Hi-Vac With Bag Suggested Retail \$1650.00 - MAY SALE **\$1375.00** Plus Tax On All

**2 Year Limited Warranty On All Snappers**  
These Prices Good Only On Mowers In Stock

It's a snap with **SNAPPER**  
A division of Fuqua Industries

**Ayden Sport Shop**  
746-6790 Ayden, N.C. 746-2598

**DISCOUNT PRICES BFGoodrich**  
Pick A Size To Fit Your Car

ECONOMY GLASS BELT	CLASSY WHITE LETTER	FOR ALL COMPACTS
<b>\$29.95</b> 15580R12 CLM <b>\$47.95</b> 1857013 TA Belted <b>\$37.95</b> GT 200	<b>\$39.95</b> 16580R13 XLIII <b>\$37.95</b> 155SR12 GT-4 <b>\$44.90</b> 15580R13 XLM	
DOUBLE STEEL	ALL WEATHER STEEL	HIGH MILEAGE STEEL
<b>\$47.95</b> 1858013 <b>\$49.90</b> 1758013 <b>\$42.90</b> 1857013 <b>\$45.50</b> 2057014 <b>\$49.80</b> 2157014 <b>\$51.10</b> 2257015 <b>\$54.40</b> 2456014 <b>\$58.30</b> 2356015	<b>\$42.80</b> 1858013 <b>\$45.20</b> 1858013 <b>\$48.20</b> 1857514 <b>\$49.60</b> 1957514 <b>\$55.60</b> 1957514 <b>\$57.80</b> 2057515 <b>\$59.80</b> 2157515	<b>\$52.95</b> 1858013 <b>\$53.60</b> 1858013 <b>\$54.80</b> 1757514 <b>\$56.70</b> 1957514 <b>\$58.80</b> 2057514 <b>\$55.62</b> 1957515 <b>\$59.95</b> 2057515 <b>\$62.90</b> 2157515

**WITH COUPON ALIGN SPECIAL \$15.88**  
**WITH COUPON OIL, FILTER, LUBE \$12.88**

**Coggins Car Care**  
320 W. Greenville Boulevard  
Greenville, N.C.  
756-5244

BFGoodrich Tires and Service  
WE OFFER BFGoodrich NATIONAL FLEET SERVICE  
MasterCard VISA

# Chargers Rip Panthers; Gain 3-A Playoff Berth

By JIMMY DuPREE  
Reflector Sports Writer

**BETHEL** — Shannon Peede fired a one-hitter and blasted a solo homer to lead the Chargers of Ayden-Grifton to a 6-0 shutout over North Pitt Tuesday in Eastern Carolina 3-A baseball.

But the biggest news for the Chargers was Farmville Central's 6-3 upset victory over Southern Nash which insured Ayden-Grifton of the other ECC playoff berth. C.B. Aycock had already wrapped up the conference title.

Peede recorded eight strikeouts as the Chargers raised their record to 9-3 in the ECC and 12-9 overall. Ayden-Grifton maintained a share of second place in the league with the victory.

"Shannon Peede did a real good job for us," Ayden-Grifton Coach Chris Ross said. "He hadn't started in a while, and he got a little tired in the seventh inning. And he was three-for-four at the plate."

Frank Mills went to third on a three-base error after one out in the third, and Jackie Conway singled him in with the game-winning RBI.

After one out in the fourth, Peede ripped a shot over the fence in left field for a 2-0 Charger lead.

The Chargers plated three more runs in the sixth to put the game out of reach. Gene Johnson reached first on an error, went to second on a single by Peede and scored on hit by Curt Tucker. Tony McLawhorn lofted sacrifice fly to drive in

courtesy runner Jesse Hooker, and Tucker scored on an RBI single by Ty Little.

Ayden-Grifton plated its final run in the seventh, as Wesley Hardee walked, stole second and scored on a fielder's choice by Eddie Brown.

"Their pitcher (Alfred Braxton) did a good job of keeping our boys off stride," Ross said. "We had the one big inning that put us over the hump."

North Pitt, meanwhile, left runners in scoring position in both the first and second innings. Jarvis Massenburg was hit by Peede with the first pitch of the game. Lee Eakes drew a base on balls, and both

runners advanced when McLawhorn attempted to pick Massenburg off second. After one out, Scott Rawls lofted a fly ball to center, but Massenburg left third before the catch to give the Chargers an inning-ending double play.

After two out in the second, Alfred Braxton struck out but reached first on a passed ball. Chuck Doak singled, and both runners took an extra base when Hardee bobbled the ball in center. But Peede settled down to strike out Billy Warren to end the rally.

In the seventh, Peede recorded two strikeouts but then walked Doak and Warren. Johnson went to the mound and got Massenburg to ground out to end the game.

"Braxton did a good job pitching," North Pitt Coach Doug Warren said. "We just didn't do the job at the plate. We had men on second and third and didn't get them in."

The Panthers slipped to 1-10 in the conference and 4-14 overall.

Ayden-Grif	ab	r	h	rb	North Pitt	ab	r	h	rb
Mills,3b	4	1	0	0	Massenburg,cf	1	0	0	0
Hardee,cf	3	1	0	0	Eakes,ss	2	0	0	0
Conway,ss	4	0	1	1	Everett,1b	3	0	0	0
Brown,lf	4	0	1	1	Rawls,c	3	0	0	0
Johnson,1b-p	3	1	0	0	Wright,dh	3	0	0	0
Peede,p-1b	4	1	3	1	Grimes,3b	3	0	0	0
Hooker,cr	0	1	0	0	Braxton,p	2	0	0	0
Tucker,rf	2	1	1	1	Hobbs,p	1	0	0	0
McLawhorn,c	2	0	1	1	Doak,lf	2	0	1	0
Little,2b	3	0	1	1	Warren,rf	2	0	0	0
					Lloyd,2b	0	0	0	0
Totals	29	6	6	6	Totals	182	11	4	4

Ayden-Grifton	ip	r	er	bb	so
Ayden-Grifton	6.0	0	0	0	8
Peede (W)	6.0	1	0	0	8
Johnson	0.0	0	0	0	0
North Pitt	6.0	6	6	4	4
Braxton (L)	6.0	6	6	4	4
Hobbs	0.0	0	0	0	0

HBP—by Peede (Massenburg); PB—McLawhorn.



## Heart Fund Winners

The team of Jack Mann, Greg House, Jerry Lee and Don Sweeting captured first place in the annual Pitt County Heart Association Golf Tournament held yesterday at Brook Valley with an amazing 21 under par score of

51. They, along with three other teams qualified for the state tournament. From left to right are Mann, House and Lee. Sweeting was not present for the picture. (Reflector Photo)

# Quartet Captures Heart Fund Tourney With Amazing Score

The team of Jack Mann, Greg House, Jerry Lee and Don Sweeting powered their way around the Brook Valley Country Club course yesterday with an amazing 21 under par round to win the annual Pitt County Heart Association Golf Tournament.

Their net score easily won their the tournament and advanced them, along with three other teams into the state tournament, to be held August 9-11 at Mid-Pines Resort.

In the Superball format, the four college students birdied 15 holes and recorded eagles on the remaining three — the 2nd, 13th and 17th holes, all par fives. Only on the sixth hole, the remaining par five, did they fail to record an eagle, missing a 30-foot putt for the gem.

The rest of the way, they made all their putts, the

longest of which was also about 30 feet, on the second hole.

Second place in the gross division went to the team of Billy Clark, Tommy Boone, Ron Carpenter and Joe Jenkins. They carded a 56.

Third place was taken by the team of John Finch, Jim Ward, Cleve Branch and Larry Picard with a 58. They tied with the team of Jimmy Hillard, Charlie Berkey, Craig Davies and Austin Britt, and won on card playoff.

The low net division was taken by the team of Walker Allen, Joe Long, Tommie Little and Randy Smith, who carded a 49 with handicap. They also won on the basis of a playoff.

Closest to the pin contests were won by the following: #5 Mark McDaniel; #8 Dave Myles; #12 Lee Moore; and #18 Tommy Davis.

# Williamston Clinches Title

**WILLIAMSTON** — Williamston High School romped to a 12-3 victory over Washington High School yesterday in softball and wrapped up the 1985 Northeastern Conference championship.

The Lady Tigers are now 14-0 on the season, with two games remaining to be played. Everyone else in the league has lost at least four games.

Williamston took the lead with three runs in the first inning and then put it away with two more in the second. They ran the lead to 11-0 with six more big runs in the third. Their final run came over in the sixth. All three Washington runs scored in the fourth.

Williamston got only eight hits, two of them by Myra Brown. One of her's was a triple. They also took advantage of ten Washington errors.

The Lady Tigers play a makeup game at Roanoke today and close out the season Friday at Edenton.

Washington.....000 300 0- 3 5 10  
Williamston.....326 001 x-12 8 3  
WP — Angie Gainer.

**Havelock.....3  
Conley.....2**

**HAVELOCK** — The Lady Rams of Havelock plated a run in the bottom of the 10th inning to defeat D.H. Conley 3-2 Tuesday in Coastal 3-A softball action.

Karen Johnson paced Havelock with three hits in four trips to the plate, while Olkowska added a 2-4 effort.

Conley evened the score in the top of the seventh when Lisa Mills and Janelle Gaylor both reached first on errors, and Michelle Waters' grounder got past the infield to drive in Mills for a 2-2 tie.

In the 10th, C. Genvender reached first on an error and later scored on a sacrifice fly for the game-winning run.

D.H. Conley, now 14-8 overall and

7-3 in the Coastal standings, must play North Lenoir Thursday to determine second place in the league. North Lenoir lost to West Carteret Tuesday.

D.H. Conley.....010 000 100 0-2 7 2  
Havelock.....001 100 000 1-3 9 3  
WP — Wilson

**Greene Central.....21  
SW Edgecombe.....3**

**PINETOPS** — Greene Central completed its swing through the Eastern Carolina Conference softball ranks yesterday with a 21-3 romp past SouthWest Edgecombe.

The win boosted the Lady Rams to 12-0 in the league and 20-1 overall. They have already been informed that they have received a bye in the first round of the state 3A/4A playoffs, and will face the winner of the Havelock-Wilmington Hoggard game by midweek next week.

The Lady Rams will serve as the host team for that game. The time of the contest will be determined whenever the winner of the first round game emerges.

Greene Central jumped ahead early, scoring a run in the first on a solo homer by Denise Warren. Five more runs crossed in the second to put it away.

SouthWest didn't score until the fourth when it was hopelessly behind.

Trenette Daniels and Antionette Wilkes each had three hits for Greene Central, while Warren had two. Dalen Herring added a two-run homer in the fifth inning for Greene Central, while Wilkes had a solo shot in the sixth.

Phyllis Gorham led SouthWest's hitting with two, while Pam Gorham had a solo homer in the sixth.

Greene Central.....153 041 7-21 16 5  
SW Edgecombe.....000 201 0-3 7 6  
WP — Dalen Herring.

**Southern Nash.....26  
Farmville C.....4**

**FARMVILLE** — Southern Nash plated 10 runs in the second inning to pave the way to a 26-4 victory over Farmville Central's Lady Jaguars Tuesday in Eastern Carolina 3-A softball.

The Lady Jaguars finished the season 2-16 overall and 2-10 in the conference. Southern Nash finished in a tie for second with C.B. Aycock at 9-3.

Southern Nash.....2(10)5 36-26 21 3  
Farmville Central.....030 10-4 7 5  
WP — Richardson

**Jamesville.....19  
Mattamuskeet.....0**

**JAMESVILLE** — The Lady Bullets of Jamesville pounded Mattamuskeet 19-0 Tuesday in Tobacco Belt 1-A girls' softball action.

Jamesville, now 15-1 in the Tobacco Belt, closes the season Thursday at home against Aurora.

# Barrise Resigns ECU Post For Fairfield Position

East Carolina University assistant basketball Coach Tom Barrise resigned his position with the Pirates effective immediately, head Coach Charlie Harrison announced Wednesday.

Barrise, who just completed his fourth season with the Pirates and the third under Harrison, has accepted an assistant coaching position with Fairfield University of the ECAC Metro Atlantic Athletic Conference. ECU is a member of the ECAC-South.

# EBA Girls Rip Hunt

E.B. Aycock rolled up a 17-4 softball victory over Wilson Hunt yesterday in a game that was forfeited to Aycock in the second inning.

Kathy Clark got the win. Poghie Maxon, Becky Stoneham, Cammie Smith, Scharles Cox, Clark and Tiffany Murray each had two hits. Maxon and Stoneham both homered, while Smith and Cox both collected doubles.

Aycock ends its year with a 5-5 record.

**SERVICE AND SOLUTIONS.**

Rachel Wahlen

As a Life of Virginia representative, my job is to stay abreast of economic trends and changes in the law that could affect a client's financial future. Then, by analyzing needs and available resources, I can make specific recommendations that will meet my client's objectives.

Besides personal protection and retirement needs, my service may include comprehensive estate planning and solutions to business needs such as group insurance, buy-sell agreements, profit-sharing, executive compensation and favorable tax positioning. My clients expect professional service and solutions to their financial problems. And that's what they get from me.

Rachel Wahlen  
Eastern Carolina Pittman Agency  
400 Eastbrook Dr.  
Greenville, N.C.  
752-6747

**Tom's Restaurant**  
Maxwell Street West End Circle Area  
(Behind Phelps Chevrolet)

- ★ Home Style Cooking At Reasonable Prices
- ★ Friendly Atmosphere
- ★ Space Available For Meetings
- ★ Eat In Or Take Out

**Seafood**—including Shrimp, Scallops & Fish Available.

Phone: 756-1012  
Hours: Mon.-Fri., 6 a.m.-3 p.m. Saturday, 6 a.m.-1:30 p.m.

**WE DISCOUNT**  
MICHELIN-BRIDGESTONE & OTHER MAJOR BRANDS

Whitewall Retreads	Double Steel Radial Whitewalls	Dayton Steel Radial For Compacts	Dayton Sport Outline White Letters	Dayton Steel Radial Whitewalls	Bridgestone RD212 Steel Radial White
A78-13 19.95	155/80R13 34.95	155SR12 33.95	A70-13 39.95	155/80R13 39.95	165/75R13 47.95
B78-13 19.95	165/80R13 36.95	155SR13 37.95	E70-14 46.95	165/80R13 43.95	185/75R13 57.95
D78-14 23.95	175/80R13 38.95	165SR13 39.95	F70-14 47.95	175/80R13 44.95	185/75R14 59.95
E78-14 23.95	185/80R13 40.95	175SR14 42.95	G70-14 49.95	185/80R13 47.95	195/75R14 63.95
F78-14 23.95	185/75R14 42.95	175/70SR13 43.95	G70-15 50.95	185/75R14 49.95	205/75R14 66.95
G78-14 25.95	195/75R14 44.95	185/70SR13 45.95	H70-15 52.95	195/75R14 52.95	215/75R14 70.95
H78-14 25.95	205/75R14 46.95	185/70SR14 47.95	G60-14 53.95	205/75R14 55.95	225/75R14 74.95
G78-15 25.95	215/75R14 48.95	195/70SR14 51.95	G60-15 55.95	205/75R15 56.95	205/75R15 69.95
H78-15 25.95	205/75R15 48.95		L60-15 62.95	215/75R15 60.95	215/75R15 71.95
L78-15 25.95	215/75R15 50.95			225/75R15 62.95	225/75R15 73.95
New Tire Guarantee	225/75R15 52.95			235/75R15 65.95	235/75R15 77.95
	235/75R15 54.95				

Save 5% Off Any Purchase All Day Tuesday With This Coupon

**Brake Reline 44.95** With Coupon

Senior Citizens 65 yrs. or older Save An Extra 5% On Any Purchase Every Day With This Coupon

**FREE FRONT END CHECK**

**—CHARGE 'EM—**

**FREE FRONT END CHECK**

Dayton 12 Volt Batteries Any Size 44 Mo. 36.95	Foreign Size Tires 600-12 560-15 600-15 27.95 Any Size	German Radials 29.95 Any 13" Size	Tune up 4 Cyl. 24.95	Road Hazard Available Free Mounting Free Rotation	Dayton Charge Southern Charge Plan
---	---	--------------------------------------	-------------------------	---	------------------------------------

**MONEY BACK GUARANTEE IF UNDERSOLD**

**WE DO NOT SELL SECONDS OR BLEMS**

**SOUTHERN TIRE BROKERS**  
OPEN MONDAY - FRIDAY 8:00 TIL 5:30; SATURDAY 8:00 TIL 1:00  
Greenville Blvd. & Charles Next To Pitt Plaza 756-5823

**INSTANT CREDIT**  
when you buy Dayton tires or car service on Dayton revolving charge

**Credit established in minutes**

— Also —  
5th & Market  
Washington, N.C.  
946-9400

**Holiday Shell**

724 S. Memorial Dr.  
Greenville 752-0334

**Now Has**

- Hot Popcorn - Fountain Drinks
- Milk - Bread - Eggs - Ice Cream
- Cigarettes By Carton
- Plus Many More New Items
- Plus We Still Have -
- Tune-ups - Brake Work - Wash Jobs
- Road Service - Wrecker Service
- Oil Changes - Oil Filter - Lube Jobs
- Plus Pickup And Delivery Service

# Patrick's Three-Hitter Powers Conley

**HAVELOCK** — Freshman Bronswell Patrick struck out 10 and hurled a three-hitter as the Vikings of D.H. Conley claimed a playoff berth with a 4-2 victory over Havelock Tuesday in Coastal 3-A baseball action.

D.H. Conley improved its record to 6-4 in the Coastal Conference and 18-5 overall. North Lenoir, meanwhile, defeated West Carteret to give the Vikings sole possession of second place.

Paul Hill ripped his fourth homer of the season, a two-run shot in the fifth, to claim the game-winning RBI.

Havelock jumped out to a 2-0 lead in the first, but Patrick settled down to claim his eighth victory in nine decisions.

Conley trimmed the margin in the fourth when Todd Cochran singled, took second and third on passed balls and scored on a wild pitch.

In the fifth, Jody Vines walked before Hill blasted the ball over the fence in left field for a 3-2 Conley lead.

Patrick pitched out of trouble

twice in the late stages of the game. In the fourth, errors by Shane Adams and Vines put runners on first and second with no outs. Eric Panknin grounded into a double play, and Patrick recorded the third out on a pop fly.

Then in the fifth, Jamie Franks reached first on another error by Vines, and Arnold Rivenbark bunted a single past the infield to move Franks to third. Rivenbark stole second, and the Rams sent the top of their lineup to the plate. Patrick struck out leadoff hitter Jeff Peay on three pitches, then retired Pete Johnson on four tosses. David Currie popped out to end the threat.

The Vikings added an insurance run in the seventh when Ken Hadnott singled after one out, pinch runner Amzie Hoffner went to third on a pickoff attempt and Steve Mills ripped an RBI single.

D.H. Conley.....000 120 1-4 5 3  
Havelock.....200 000 0-2 3 3  
Patrick and R. Mills; Carter and Larraway

Farmville.....6  
Southern Nash.....3

**FARMVILLE** — Farmville Central closed out its 1985 baseball season yesterday with a 6-3 upset of Southern Nash, ousting the Firebirds from a chance at the playoffs.

Farmville winds up the season with a 5-7 Eastern Carolina Conference record and was 6-15 overall.

Southern Nash took the initial lead in the third inning, scoring a single run. Tony Bissette singled and with two outs scored when B. Marlowe was safe on an error.

Farmville got back into the fight with two runs in the bottom of the fourth. Brian Huber reached on an error and Randy Daniels singled. Greg May also got a hit and when the ball got past the fielder, both Huber and Daniels came around to score.

After Southern tied it up with one in the top of the fifth on a solo homer

by Bissette, Farmville pushed over four more for a 6-2 lead.

Dennis Tripp led off, reaching on an error. Shea Terrell doubled and Gary Baker walked to load the bases. Hugh Moore singled in Tripp and Huber walked, forcing in Terrell. Successive walks to Daniels and Brian Windham brought home Baker and Moore.

Southern added one more in the sixth. Bissette was the game's only hitter with as many as two.

Southern Nash.....001 011 0-3 5 3  
Farmville C.....000 240 x-6 5 3  
May, Bryant (5) and Webb; Huber and Terrell

Greene Central.....7  
SW Edgecombe.....6

SNOW HILL — James Hill reached first on an error and later

scored on another error in the ninth inning as the Rams of Greene Central closed the season with a 7-6 victory over SouthWest Edgecombe Tuesday in Eastern Carolina 3-A baseball.

Gary Ginn paced the Rams with four hits in five trips to the plate, while Ken Wade went 3-5. Ervin Collins and James Hill added two hits each.

SouthWest held a 5-4 lead in the fifth, but Greene Central evened the score in the bottom of the fifth and took the lead in the sixth.

Roger Sutton walked, and Collins and Ginn followed with singles. Sutton was thrown out at the plate on Ginn's hit, but Wade drove in Collins with a single for a 6-5 Greene Central edge.

In the top of the seventh, Larry Gulley walked, went to second on a

passed ball and scored on a single by Tony Nichols to send the game to extra innings.

But in the ninth, Hill stole second after reaching first on an error. SouthWest recorded two outs before throwing away an infield grounder to allow Hill to score the game-winning run.

"We played pretty good ball the last part of the season," Greene Central Coach James Fulghum said. "We've got a group of kids coming back that should make us more experienced next season; it's a good opportunity."

Gulley and David Randolph paced SouthWest with two hits each.

Greene Central finished the season 5-7 in the ECC and 6-16-1 overall.

SW Edgecombe.....100 310 100-6 9 4  
Greene Central.....102 111 001-7 15 3  
Braswell and Owens; Honrine, Smith (4) and Lang, Brown (6)

Jamesville.....4  
Mattamuskeet.....0

**JAMESVILLE** — The Jamesville Bullets remained undefeated in the Tobacco Belt 1-A standings with a 4-0 victory over Mattamuskeet Tuesday.

The Bullets are now 15-0 in the conference and close the regular season Thursday hosting Aurora.

Further details of the game were not available.

**PARROTT CANVAS CO., INC.**  
• Marine Canvas  
• Auto Upholstery  
• Sail Repair  
West End Circle 756-4011

## Youth Baseball

### South Pitt Bambino

McKenzie.....6  
Hornets.....5

**CHICOD** — Alton Hardee slapped four hits and Eric Ruffin added a homer as McKenzie defeated the Hornets 6-5 Tuesday in South Pitt Bambino League baseball.

Derrick Rodgers picked up the victory on the mound for McKenzie.

Hardee had three singles and a double, while Ruffin added a single to his homer.

Ashley Summerlin rapped a double and two singles for the Hornets, while Nikki Adams had two hits.

### Little League

Optimists.....2  
Kiwanis.....1

Michael Polard hit a double in the fifth inning to drive in a run and give the Optimists a 2-1 victory over the Kiwanis in the North State Little League yesterday.

The Kiwanis had taken the lead in the first inning on a single run. It stayed that way until the fourth when the Optimists tied it up with a run.

In the fifth, Steve Nobles reached on a fielder's choice that erased an earlier runner. Two wild pitches moved him to third and he scored on Polard's double with what proved to be the winning run.

The Optimists got only two hits off the pitching of Jason Bizzaro, while Mitch Jones held the Kiwanis to only one hit.

## Brook Valley Women Win

Several Brook Valley women were among the winners at the Carolina League finals held at the Greenville Country Club.

In the championship flight, Sue Hallow won low putt.

In the first flight, Maxine Hawley took first low net.

In the third flight, Jan Kanetzke took first low gross, Miriam Martin took second low gross, Missy Decker had second low net and the longest drive on the first day of competition.

In the fourth flight, Ellen Fleming won first low net.

Brook Valley also won the traveling cup for having the low net for the two day event.

True Value.....13  
Moose.....8

Witt Thomas banged out three hits and Gamal Hunter had a three-run homer as True Value Hardware rolled up a 13-8 victory over the Moose in the Tar Heel Little League yesterday.

True Value took the lead with two runs in the first and added five more, including Hunter's three-run homer, in the second. The Moose got things started with two in the third, but True Value added an eighth run in the bottom of the frame.

In the fourth, True Value scored three more to put the game away. Hunt led off with a walk and with one away, Thomas singled. Chris Langley singled in Hunter and Craig Brannon walked. Henry Clark hit into a fielder's choice that got Thomas, but a single by Matthew Cagle brought in Langley. Ryan Walker walked to force in Brannon with the 11th Hardware run.

True Value added two more in the fifth. The Moose picked up two in the fifth and four in the sixth.

Terrell Phillips led the Moose with four hits while Brad Carter added two.

### Prep League

Hendrix & Dail.....9  
Garris-Evans.....7

Despite getting only three hits, Hendrix & Dail pushed over five runs in the seventh inning to take a 9-7 win over Garris-Evans in the Prep League last night.

Garris-Evans led off with a run in the first and added two in the second. Three more crossed in the third for a 6-0 lead. Hendrix & Dail started its rally with one in the fifth and three in the sixth.

In the seventh, Alfonza Freeman led off for H&D with a double and Chris Hill walked. With one away, Travis Williamson walked to load the bases. Then, with two outs, Walter Gatlin walked to force in Freeman. Hill scored on a wild pitch and Eric Nelson singled in Williamson. Derrick Clark reached on an error, driving in the other two runs.

Garris-Evans came back with one run in the bottom of the seventh, but fell two short.

No one on either team had more than one hit.

## Royals Break Slump

By The Associated Press  
Sooner or later, the Kansas City Royals were bound to break out of it. They finally did.

Frank White, George Brett and Jim Sundberg hit home runs in the fourth inning Tuesday night to carry the Royals over the Baltimore Orioles 5-3. Kansas City scored all five of its runs in the fourth, the team's biggest inning of the season.

"We're starting to hit, starting to get the long ball and also getting good pitching," Kansas City Manager Dick Howser said. "We're a better hitting club than we've shown. We finally got some production from our home run guys, and I hope we can keep it up."

The Royals had been mired in a season-long slump until they met the Orioles. The victim of the long-ball assault was Baltimore starter Scott McGregor, who slipped to 1-4.

"My biggest concern right now is the starting pitching," Orioles Manager Joe Altobelli said after the visiting Royals swept the two-game series. "Our bullpen seems to be doing a pretty good job, but we need a lift from our starters."

In other American League games, Seattle blanked Boston 5-0, Toronto tripped California 6-3, Detroit beat Texas 4-1, New York popped Minnesota 10-7, Chicago nipped Cleveland 2-1 and Oakland downed Milwaukee 6-3.

White hit his sixth home run of the season to lead off the fourth. Brett then followed with his fourth homer. Steve Balboni and Darryl Motley rapped one-out singles before Sundberg drilled his second home run.

Mark Gubicza, 1-2, went six innings before leaving when his left leg stiffened up. He was hit in the left thigh by Rich Dauer's line drive in the second inning.

Dan Quisenberry got the final three outs for his fifth save.

The Orioles scored in the first inning on a sacrifice fly by Cal Ripken and closed the gap to 5-3 in the fifth on a two-run double by Eddie Murray.

Mariners 5, Red Sox 0  
Mike Moore scattered seven hits for his fourth career shutout, and first since August 1983.

Visiting Seattle staked Moore, 4-3, to a 4-0 lead after two innings. Alvin

Davis and Steve Henderson had RBI singles in the first, and Phil Bradley had a run-scoring single and Al Cowens delivered an RBI double in the second.

The Mariners chased Boston starter Dennis "Oil Can" Boyd, 4-2, in the third inning. Bradley and Spike Owen each had three singles as the Mariners finished with 14 hits.

Blue Jays 6, Angels 3  
Damaso Garcia, the leadoff batter in Toronto's lineup, continued to look

See KANSAS CITY page 18

**Congratulations Adrian Adams On Winning The Expo '85 Black & Decker Band Saw.**



**GARRIS EVANS Lumber Co., Inc.**  
701 West 14th Street  
Open Weekdays 8 to 5  
Saturday 8 to Noon  
752-2106

# GREAT GOODYEAR GETAWAY SALE!

Get your car ready for some great driving days ahead with new tires you won't have to worry about. Some of our most popular tires are on sale now!

**Sale Ends June 1**

## STEEL BELTED

**\$48** Custom Polysteel Radial\*  
\* Gas-saving radial ply construction  
\* The strength and durability of steel cord belts  
\* Smooth riding body plies of polyester cord  
\* Rib count and tread design vary with tire size

## EAGLE PERFORMANCE RADIAL SALE!

**\$64.90** Eagle ST Radial\*  
\* Competition style raised white letters - a look borrowed from Goodyear's racing Eagles.  
\* Low profile, wide tread, big footprint - all designed for traction.  
\* Still belts, under the tread for traction and long-term wear.  
\* Rib count varies with tire size.

Whitewall Size	SALE PRICE	Whitewall Size	SALE PRICE
P175/80R13	\$53.75	P215/75R14	\$69.30
P185/80R13	\$54.45	P225/75R14	\$72.75
P175/75R14	\$54.70	P205/75R15	\$68.15
P185/75R14	\$60.70	P215/75R15	\$71.20
P195/75R14	\$61.95	P225/75R15	\$74.30
P205/75R14	\$65.70	P235/75R15	\$77.80

**SPECIAL SUMMER VALUE!**

Whitewall Size	SALE PRICE	Whitewall Size	SALE PRICE
R78 13	\$29.90	H78 14	\$41.65
G78 14	\$32.00	F78 15	\$35.25
D78 14	\$33.10	F78 15	\$37.40
E78 14	\$33.85	G78 15	\$40.25
F78 14	\$36.00	H78 15	\$42.30
G78 14	\$39.15	L78 15	\$44.45

**GOODYEAR BIAS BELTED**

Whitewall Size	Everyday Low Price With old tire	Whitewall Size	Everyday Low Price With old tire
D78 14	\$39.50	H78 14	\$49.95
E78 14	\$40.65	G78 15	\$48.35
F78 14	\$44.20	H78 15	\$50.65
G78 14	\$47.65	L78 15	\$52.95

**LIGHT TRUCK FAVORITE!**

Wrangler Radial RV  
**\$89.95**

Outline White Letter Size	Load Range	SALE PRICE	FEET
9R15	B	\$100.95	5' 18"
10R15	B	\$114.25	5' 6"
31-1150R15	B	\$121.45	5' 6"
33-1250R15	B	\$134.05	5' 9"

**SIZZLING HOT SUMMER SERVICE SPECIALS**

<b>DISC BRAKE SERVICE</b> New front disc pads, repack front wheel bearings, resurface front rotors. Conventional rear-wheel drive vehicles. Prices vary for front wheel drive. Caliper overhaul \$19 each. If needed. Hydraulic service will be performed if needed for safe vehicle operation. <b>\$59.00</b>	<b>Electronic Ignition</b> <b>ENGINE TUNE-UPS</b> 4-cyl. .... \$29.88 6-cyl. .... \$34.88 8-cyl. .... \$38.88	<b>WHEEL ALIGNMENT</b> <b>\$16.88</b> Set front or rear wheel-caster, camber, and toe on cars with adjustable suspension. Chevrolet's, light trucks, and cars requiring MacPherson Strut correction extra.
--	---	--

**GOODYEAR TIRE CENTER**  
Owned & Operated by Wayne L. Trull, Inc.

•Greenville West End Shopping Center Phone 756-9371	•Rocky Mount Corner Thomas & Franklin St. Phone 977-2045	•Tarboro Fairview Shopping Center Phone 623-5191	•Greenville 729 Dickinson Ave. Phone 752-4417
---	--	--	---

NO. 1 IN EASTERN NORTH CAROLINA

**WE SERVICE NATIONAL ACCOUNTS**  
**OFFICIAL NORTH CAROLINA INSPECTION STATION**

# SCOREBOARD

## Rec Softball

Church League		
Peoples	303	400 0-10
Memorial	200	200 0-4
Leading hitters: P — Nat Sutton 2-4, Dan Heinz 3-4		
Arlington St.	004	024-12
St. James	401	900-14
Leading hitters: AS — Kenny Grojny 4-4, Bill Woodard 2-4, JJ Bubba Pinner 3-4, Chuck Seely 4-4		
Mt. Pleasant	114	122 1-12
1st Christian	100	100 0-2
Leading hitters: FC — David Jester 3-3, Billy West 2-3, MP — Sam Jarman 3-4, Bob Cotton 3-4		
St. Paul	430	202 0-11
1st Pentecostal	220	001 1-10
Leading hitters: SP — Jeff Wilkins 2-4, Brent Stokes 2-4, FP — Ray Bullock 4-4, H.L. Austin 2-4		
Unity	310	004 0-8
Peace	112	001 0-5
Leading hitters: U — Eddie Walker 2-3, Danny Tucker 2-3, P — Marc Sasser 2-3		
Jarvis	000	370 1-11
Grace	112	001 0-5
Leading hitters: J — Roy Selby 3-4, John Conway 2-4, G — Keith Jones 3-4, Tony Godley 3-3		
Faith & Victory	432	010 0-10
Immanuel	230	051 1-3
Leading hitters: EV — Mark Kemp 4-4, Wade Cox 3-4, I — Greg Britt 2-4, Tony Dove 2-2		
Oakmont	550	46 20-1
1st Free Will	101	00 0-2
Leading hitters: O — Don Brinkley 4-4, Ashley Ferrell 3-3		
Co-Ed League		
Yale	320	005-11
Kroger's	012	000-3
Leading scorers: V — Shirley Brown 4-4, Ben Wilson 3-4, K — Steve Bajtko 2-2		
Tapscott	132	240 1-13
Bill's Goodies	200	001 0-3
Leading scorers: T — Lori Garish 2-4, Marty Radford 3-4, BG — Carlton Parker 2-3, Billy Savage 2-3		
Grady White	010	000 0-13
Ready Mix	041	401 8-13
Leading hitters: EV — Sully Cogdell 2-3, Jimmy Gurganus 2-4, RM — Worth Albee 3-4, Stan Joyner 2-2		
Sheraton	200	00 0-2
Immanuel	613	106 2x-27
Leading hitters: I — Bob		

## Baseball Standings

Williams 3-3, Marty Varnes 3-3

By The Associated Press  
AMERICAN LEAGUE

East Division				
	W	L	Pct.	GB
Toronto	20	11	.645	—
Detroit	18	11	.621	1
Baltimore	18	12	.600	1 1/2
Boston	15	16	.484	5
New York	14	15	.483	5
Milwaukee	12	18	.409	7 1/2
Cleveland	12	19	.387	8
West Division				
	W	L	Pct.	GB
California	19	13	.594	—
Chicago	16	12	.571	1
Minnesota	16	15	.516	2 1/2
Kansas City	15	15	.500	3
Oakland	15	17	.469	4
Seattle	14	18	.438	5
Texas	9	21	.300	9

Houston 10, Montreal 0  
San Diego 6, St. Louis 2  
Chicago 9, Los Angeles 3

Wednesday's Games  
Pittsburgh (Rhoden 2-4) at San Francisco (Hammer 0-3)  
Cincinnati (Soto 5-3) at Montreal (Smith 5-0) (n)  
Philadelphia (Carlton 0-3) at Atlanta (Betrosian 0-2) (n)  
New York (Gooden 5-1) at Houston (Niekro 2-3) (n)  
St. Louis (Andujar 5-1) at San Diego (Thurmond 1-2) (n)  
Chicago (Sanderson 1-1) at Los Angeles (Honeycutt 2-2) (n)  
Cruz, Houston, 20; Herr, St. Louis, 20

Thursday's Games  
Cincinnati at Montreal (n)  
Philadelphia at Atlanta (n)  
New York at Houston (n)  
Only games scheduled

## League Leaders

By The Associated Press  
AMERICAN LEAGUE

**BATTING** (65 at bats) — 6 5 a t  
Whitaker, Detroit, .366;  
Bochte, Oakland, .361; Salas, Minnesota, .353; Baines, Chicago, .330;  
Brunansky, Minnesota, .330;  
Cleveland 1

Wednesday's Games  
Oakland — Krueger 3-3; at Milwaukee — Huguera 1-1  
Seattle — Langston 3-3; at St. Louis — Nipper 1-1; (n)  
California — Romanick 4-1; at Toronto — Leal 2-2; (n)  
Kansas City — LeGrandt 3-2; at Cleveland — Schulze 2-1; (n)  
Texas — Mason 2-4; at New York — Guidry 3-1; (n)  
Baltimore — Martinez 2-2; at Chicago — Seaver 3-1; (n)  
Detroit — Terrell 4-0; at Minnesota — Butler 3-1; (n)

Thursday's Games  
Texas at New York  
Detroit at Minnesota  
Kansas City at Cleveland  
Baltimore at Chicago  
Only games scheduled

NATIONAL LEAGUE  
East Division

	W	L	Pct.	GB
New York	20	9	.690	—
Chicago	18	11	.621	2
Montreal	19	12	.613	2
Philadelphia	11	19	.367	9 1/2
Pittsburgh	9	21	.300	11 1/2

West Division

	W	L	Pct.	GB
San Diego	18	12	.600	—
Houston	17	14	.548	1 1/2
Los Angeles	17	16	.515	2 1/2
Cincinnati	15	16	.484	3 1/2
San Francisco	13	18	.419	5 1/2
Atlanta	12	18	.400	6

Tuesday's Games  
Philadelphia 7, Cincinnati 1  
San Francisco 3, Pittsburgh 1  
New York 3, Atlanta 1

## TANK McNAMARA

by Jeff Millar & Bill Hinds



W L Pct GB

Winston-Salem 16 16 .500 —  
Peninsula 16 18 .471 1  
Durham 15 19 .441 2  
Kinston 11 23 .324 6

By The Associated Press  
Conference Finals  
EASTERN CONFERENCE  
Boston vs. Philadelphia  
Tuesday, May 14

Boston 106, Philadelphia 98.  
Boston leads series 2-0  
Saturday, May 18  
Boston at Philadelphia  
Sunday, May 19  
Boston at Philadelphia  
Wednesday, May 22  
Philadelphia at Boston, if necessary  
Friday, May 24  
Boston at Philadelphia, if necessary  
Sunday, May 26  
Philadelphia at Boston, if necessary

## NHL Playoffs

By The Associated Press  
Conference Finals  
(Best-of-Seven)

Wales Conference  
Tuesday, May 14  
Philadelphia 2, Quebec 1.  
Philadelphia leads series 3-2  
Thursday, May 16  
Quebec at Philadelphia  
Sunday, May 19  
Philadelphia at Quebec, if necessary

Campbell Conference  
Tuesday, May 14  
Edmonton 10, Chicago 5.  
Edmonton leads series 3-2  
Thursday, May 16  
Edmonton at Chicago  
Saturday, May 18  
Chicago at Edmonton, if necessary

## USFL Standings

By The Associated Press  
EASTERN CONFERENCE

	W	L	T	Pct.	PF	PA
Tampa Bay	9	3	0	.750	309	238
Birmingham	8	4	0	.667	280	218
New Jersey	8	4	0	.667	281	246
Memphis	7	5	0	.583	259	244
Jacksonville	6	6	0	.500	288	283
Baltimore	5	6	1	.458	203	183
Orlando	3	9	0	.250	189	310

WESTERN CONFERENCE

	W	L	T	Pct.	PF	PA
Oakland	8	3	1	.708	294	224
Denver	8	4	0	.667	323	236
Houston	8	4	0	.667	276	251
Arizona	4	8	0	.333	236	271
Los Angeles	3	9	0	.250	185	296
Portland	3	9	0	.250	154	278
San Antonio	2	9	0	.250	189	292

Friday's Game  
Baltimore at Orlando  
Saturday's Games  
Memphis at Tampa Bay  
Oakland at San Antonio  
San Antonio vs. Houston  
New Jersey at Denver  
Arizona at Portland  
Birmingham at Los Angeles  
Monday's Game  
Jacksonville at Houston

## Transactions

By The Associated Press  
American League

MILWAUKEE BREWERS—Recalled Earnie Riles, shortstop, from Vancouver of the Pacific Coast League. Optioned Doug Loman, outfielder, to Vancouver.

SEATTLE MARINERS—Optioned Harold Reynolds, second baseman, to Calgary of the Pacific Coast League. Recalled Darnell Coles, third baseman, from Calgary.

NATIONAL LEAGUE  
CINCINNATI REDS—Sent Dann Biliardello, catcher, and Carl Willis, pitcher, to Denver of the American Association. Recalled Alan Kneely, catcher, and Ron Robinson, pitcher, from Denver.

HOUSTON ASTROS—Recalled Mark Ross, pitcher, from Tucson of the Pacific Coast League. Sent Julio Solano, pitcher, to Tucson.

BASKETBALL  
National Basketball Association  
HOUSTON ROCKETS—Signed Eric Turner, guard, to a two-year contract.

## N.C. Scoreboard

By The Associated Press  
Men's Professional Baseball

Carolina League  
Kinston 3, Prince William 0  
Lynchburg 7, Durham 4  
Salem 9, Winston-Salem 8

Southern League  
Columbus 3, Charlotte 1

# Bowa's Hits Save Job, Lead Cubs' Win

By The Associated Press  
And the new starting shortstop for the Chicago Cubs is...the old starting shortstop, Larry Bowa.

The 39-year-old veteran has won, for now, his fight with 22-year-old Shawon Dunston for the regular role. Bowa had two hits and drove in two runs as the Cubs defeated the Los Angeles Dodgers 8-3 Tuesday night.

After the game, the Cubs announced that Dunston, struggling with a .194 average and nine errors in the field, had been demoted to their AAA farm club in Des Moines.

"I was just happy to play and contribute," said Bowa, who raised his average to .286 (6-for-21). "I got an opportunity tonight and came through."

"Shawon has had a lot of instruction while he has been here. Unfortunately, we might have jammed too much at him," said Cubs president and general manager Dallas Green. "We just felt it was time for him to go down and play and have fun and get his offense together."

"Anytime you make a decision like that, you hope it works out and

lasts forever. But we're baseball people, and we recognize a 21-year-old can't recognize game situations that a seasoned veteran can."

In other National League games, San Diego stopped St. Louis 6-2, New York edged Atlanta 3-1, San Francisco topped Pittsburgh 3-1, Philadelphia beat Cincinnati 7-1, and Houston romped over Montreal 10-0.

Trailing 2-1, Chicago sent 10 men to the plate in the second inning against Fernando Valenzuela, 3-4,

Valenzuela, who had wild-pitched Gary Matthews home from third in the first inning, issued bases-loaded walks to Ryne Sandberg and Keith Moreland after Chicago starter Rick Sutcliffe's RBI single.

An error by Dodger shortstop Mariano Duncan brought the fourth run home.

Moreland, who also had two hits, felt the Cubs' offense was overdue. "We've been winning games with pitching. The guys are just starting

to have fun again offensively," he said.

Sutcliffe, 5-3, gave up six hits and four walks, striking out five, in his fourth complete-game victory of the season.

"I'm happier with the way I swung the bat than I am with my pitching," Sutcliffe said.

Padres 6, Cardinals 2  
"I'm not as good as that 7-0 record," said Andy Hawkins after pitching five innings to gain the victory. "I'm not making many good pitches. I'm very hittable but I've got guys back there who can make the plays."

Hawkins gave up five hits, including homers to Andy Van Slyke and Darrell Porter, before departing in the sixth. Mark Thurmond earned his first save with four innings of two-hit relief.

Hawkins benefited from a three-run homer by Kevin McReynolds. After getting off to a slow start this year, McReynolds has hit in nine consecutive games, driving in 10 runs over that stretch.

Mets 3, Braves 1  
Roger McDowell was perfect in relief, pitching 4 2-3 innings and combining with Calvin Schiraldi on a three-hitter as New York won for the seventh time in eight games.

McDowell, 3-1, replaced Schiraldi after Claudell Washington's homer. Schiraldi left with pain in his right

foot, which was struck by Washington's infield single in the first inning. The Mets, winners of 11 of their last 15 games, learned after the game that Schiraldi's toe had been broken by the smash.

The Braves lost their sixth game in seven while Rick Mahler lost his second straight game after a 7-0 start. And Dale Murphy lost his hitting streak of 15 games. He went 0-for-4, and struck out twice.

Washington's second homer of the year — both against the Mets — provided the Braves with only their second run in 53 innings.

Giants 3, Pirates 1  
Mike Krukow tossed a five-hitter, clubbed two doubles and drove in two runs to lead the Giants. Krukow, 3-2, lowered his earned run average to 1.45 in pitching his third complete game of the season.

Their pitchers have four RBIs in the Giants' last two games. Jim Gott hit two homers Sunday.

Pittsburgh Manager Chuck Tanner expressed concern over Larry McWilliams, 3-3, who hit two batters in a three-run second inning. "His arm felt a little stiff. He thought it would go away, but it didn't. We're going to have him checked out when we get home," Tanner said.

The Pirates had been shut out in three of their last four games but scored Tuesday on Lee Mazzilli's

first homer of the year.

Phillies 7, Reds 1  
Charles Hudson gave up just one hit over eight innings, but left for a pinch hitter in the top of the ninth with Philadelphia ahead 4-0. "Anytime you've got a shutout going — not only me, but any pitcher would be upset," Hudson said. "But I'm not going to cause any bad vibes. I'll just leave it at that."

It was Hudson's first start of the season after 12 relief appearances. Don Carman finished, allowing two hits and a run.

Juan Samuel, who drove in five runs, and Mike Schmidt belted home runs, helping Philadelphia end a seven-game losing streak. Samuel's was a three-run homer in the fifth; Schmidt led off the sixth with his second homer in two games.

Astros 10, Expos 0  
Seventeen hits — four by Craig Reynolds and three each by Jerry Mumphrey and Bill Doran — eight walks, and three Montreal errors buried the Expos. Mumphrey drove in three runs, while Reynolds knocked in two.

Rookie Ron Mathis combined with Mark Ross, who had been called up from the Pacific Coast League earlier in the day, to seven-hit the Expos and help the Astros to their fourth straight victory. The Astros are second in the NL West, 1 1/2 games behind the Padres.

## Presbyterian Tops Putt

Farmville Presbyterian defeated previously unbeaten Immanuel Baptist and Jarvis Memorial edged First Wesleyan in Church League Putt-Putt action Tuesday.

Farmville, 2-1, was led by Thomas Lewis with a 65 and Gary Joyner with a 66. Medalist Sandy Williams, who shot an 11-under 61, was the top for Immanuel.

Jarvis, 1-2, beat First Wesleyan by five strokes. Mark Eakes, Robbie Moye, Jerry Jolley and Jon Jolley all shot two-under 70s for Jarvis. David Crane at 65 and Phil Martin at 67 were the leaders for Wesleyan.

## Kansas City Wins...

Continued from page 17

more like a cleanup hitter. Garcia, who went 8-for-13 with seven runs batted in during a weekend sweep of Seattle, cracked a two-run single with two outs in the sixth to break a 3-3 tie.

Jesse Barfield hit his sixth home run for the Blue Jays, while Lloyd Moseby snapped an 0-for-19 slump with a two-run triple.

Doyle Alexander, 5-1, pitched 6 2-3 innings for the victory. Bill Caudill worked the ninth for his seventh save.

Rod Carew and Bobby Grich homered for visiting California. It was Carew's first homer since May 22 of last season.

Tigers 4, Rangers 1  
Lou Whitaker raised his AL-leading average to .366 by going 3-for-4, including his second home run in two games.

Whitaker singled in the first inning, went to second on a balk by Charlie Hough, 3-2, and scored on a single by Lance Parrish. Whitaker drilled a two-run homer in the second.

Milt Wilcox, 1-1, went five innings for the victory. Willie Hernandez pitched the ninth for his ninth save in nine opportunities this season.

Texas stranded 12 runners at Tiger Stadium.

Yankees 10, Twins 7  
Ken Griffey's grand-slam home run capped a six-run rally in the seventh inning that again led New York over visiting Minnesota.

The Yankees trailed 7-3 going into the seventh, but relievers Pete Filson, Rick Lysander and Curt Wardle walked four straight batters in losing the lead and the game.

A one-out single by Willie Randolph and walks to Don Mattingly and Dave Winfield loaded the bases against Filson, and Lysander walked Don Baylor to force home a run. Wardle, 0-2, walked Butch Wynegar to force in another and Griffey then hit the first pitch into the right-field seats for his third homer of the season.

Reliever Brian Fisher worked 3 2-3 innings to win his first major-league decision.

On Monday night, Mattingly had hit a three-run homer with two outs in the bottom of the ninth to give New York a 9-8 triumph over the Twins, who had led 8-0.

White Sox 2, Indians 1  
Greg Walker's two-out single in the eighth inning drove home Ozzie Guillen from second base to lead host Chicago to victory.

## Special Purchase!

# NIKE

athletic shoes

	<b>\$9.97</b>	Children's
	<b>\$12.97</b>	Boys'
	<b>\$13.97</b>	Men's

**Pick 'n' Pay Shoes**  
Limited quantities. Styles may vary from store to store.

**Greenville Blvd. on 264 By Pass  
Greenville, N.C.**

Sale prices good thru Sat. MasterCard, Visa or choice. Open evenings

# OVERSTOCKED

WE HAVE TO CUT OUR PRICES ON ALL DYNAMARK MOWERS AND ROBIN BRUSHCUTTERS TO RELIEVE OUR SPRING INVENTORY

THESE SPECIAL SAVINGS WILL END SATURDAY, MAY 18TH AT 5:00

 Reg. \$129.00 <b>Sale \$119.00</b> 20" Cut 3 HP Briggs & Stratton	 Reg. \$169.00 <b>Sale \$149.00</b> 22" Cut 3.5 HP Briggs & Stratton Adjustable Wheels
<b>Robin Brushcutter</b> 22.5 CC Engine Auto Centrifugal clutch Comes with Nylon Stringhead, Four Star Blade, Tool Kit And Shoulder Strap. <b>\$189.00</b>	<b>Robin Brushcutter</b> 22.5 CC Engine Auto Centrifugal Clutch Comes With 9" Sawblade, Nylon Stringhead, Tool Kit And Shoulder Strap. On Sale For <b>\$279.00</b>

## GOOD YEAR TIRE CENTER

Owned & Operated by Wayne L. Trull, Inc.

•Greenville West End Shopping Center 756-9371	•Rocky Mount Corner Thomas & Franklin St. Phone 977 2045	•Tarboro Fairview Shopping Center Phone 823-5191	•Greenville 729 Dickinson Ave. 752-4417
---	--	--	---

# In The Area

## Thefts Investigated

Greenville police are continuing their investigation of five thefts reported to the department on Tuesday.

Officer S.A. Person said a lawnmower, chain saw and three fishing rods were taken from 108 Pinehurst Drive in an incident reported at 11:38 a.m., while Officer E.M. Haddock said \$50 in cash and a gold bracelet were taken from a purse at a Library Street residence in an incident reported at 4:19 p.m.

Officer T.G. Shane said a \$2 in change was taken from a purse at Pitt County Memorial Hospital's emergency department in an incident reported at 6:27 p.m. and a purse containing \$7 in cash taken from a parked car at the Town Commons in an incident reported at 8:26 p.m., while Officer J.A. Bartlett said a radar detector valued at \$250 was taken from a truck parked at the Camelot Inn in an incident reported at 11:24 p.m.



**MOTORCYCLE CLUB DONATES...**The Down East Gold Wings Road Riders have given \$6,140 to the Ronald McDonald House project. Club members presenting a check to Mrs. Barbara Woods, a member of the Ronald McDonald House board of directors, were (left to right) Thurman James, Johnnie Rouse and Thomas Fisher. The money was raised through various projects conducted by the club, including a dance. (Reflector Staff Photo)

## Fire Report

The rural fire departments of Pitt County answered 133 alarms in April and attended 122 wrecks and fires, according to the Pitt County Fire Marshal's Office.

There 11 house fires reported; eight mobile homes fires; four building fires; 41 grass and woods fires; 11 dumpster blazes; nine motor vehicle fires and 22 other fires. In addition, 15 wreck calls were answered including one false alarm and 11 mutual aid calls.

Pitt County Fire Marshal Bobby Joyner said there was \$601,200 property involved in fires. The Station House Fire Department answered 26 fire calls, the highest number in the county.

## La Leche League

The evening group of La Leche League will begin a series of discussions at 7 p.m. Thursday.

"The Advantages of Breastfeeding to Mother and Baby" will be discussed at the meeting, which is open to both mothers and babies. For more information call 756-6951 or 746-3412.

## Successful Festival

Ayden Middle School's May Festival raised over \$2,000 for the school, according to members of the school's Parent-Teacher Association, sponsors of the event.

The festival featured a prom and a May king and queen competition with the following winners: fifth and sixth grade division May kings were Brad Allen and Johnny Martin; May queens in this division were Antoinette Locust and Stacey Bowen; seventh and eighth grade division May kings were Kelvin Ellison and Scott Cannon; May queens in this division were Lisa Jones and Nikki Tucker.

The candidates who raised the most money during the three-week festival period were the ones crowned king and queen.

## District Meeting

The first district meeting of District 5 of the North Carolina Retired Governmental Employees' Association Inc. will be held at the Sheraton Hotel Thursday.

Dr. John C. Rice, executive director, will speak at the 9:30 a.m.-noon meeting and O.E. Dowd of Greenville, a director of the association, will speak at a noon luncheon.

Other guests include Cindy Godwin, director of the EDS Health Care Insurance Program; Del Mills, field representative of the North Carolina Retirement System, and Russ Taylor, an officer of the State Employees' Credit Union.

## Spring Canoe Trip

The Pamlico-Tar River Foundation will hold its spring canoe trip beginning at 10:30 a.m. Saturday on the Tar River in Edgecombe County.

The trip will begin at the Tarboro boat ramp near the U.S. highway 64 business bridge between Tarboro and Princeville. The trip is scheduled to end by mid-afternoon at Old Sparta. Transportation back to Tarboro is available.

Persons using their own canoes need not register. Canoes are also available for a fee. For more information on the planned trip, call 946-1840 or 758-0579.

## Wheelchair Games

The Veterans Administration and Paralyzed Veterans of America will hold the fifth national Veterans Wheelchair Games Aug. 8-10 at the University of Maryland campus near Washington, D.C.

The games are open to all military service veterans who are wheelchair-bound due to spinal cord injuries, neurological problems and amputations. Included are competitions in track and field events, archery, bowling, basketball, billiards, swimming and weightlifting. Those interested in competing may write the VA central office, Recreation Service (11K), 810 Vermont Ave. NW, Washington, D.C. 20420.

## New PCMH Program

The Duke Endowment has announced a contribution of \$25,000 to support a new clinical pastoral education program expected to begin in January 1986 at Pitt County Memorial Hospital.

The program will offer basic in-hospital training for ministers in the holistic care of patients, said Lewis Lint, hospital chaplain. The program will benefit the hospital's staff and patients by providing additional ministerial staff in the department of pastoral care, which will administer the program.

Lint said he is applying for accreditation to the Association for Clinical Pastoral Education and is planning in the next few years to create a residency program to train ministers who want to be hospital chaplains.

Duke Endowment officials have said they plan to provide an additional \$15,000 in 1986 and \$10,000 in 1987. The fund has contributed \$1,967,709 to Pitt Memorial since 1951.

## Two Selected

Mrs. James G. Martin, wife of North Carolina Governor Jim Martin, along with Patric Dorsey, North Carolina's Secretary of Cultural Resources, are scheduled to attend a reception Saturday at Kensington Palace, the London home of the Prince and Princess of Wales.

The two were chosen to represent North Carolina in conjunction with Operation Raleigh, a four-year around-the-world expedition and youth leadership development project involving around 5,000 youth in scientific and community service projects.

## Marijuana Charges

Joe Ray Harper, 44, of Route 3, Ayden, was arrested Monday by Pitt County deputies and Ayden police on marijuana charges following a raid at his home, according to Sheriff Ralph Tyson.

The sheriff said Harper was charged with possession of marijuana, possession of drug paraphernalia, and with manufacturing and selling marijuana.

Tyson said officers confiscated 44 four-inch tall marijuana plants, drug paraphernalia, and \$75 in cash from Harper's residence.

Bond was set at \$5,000, Tyson said.

## Meeting Scheduled

Pitt County Shrinettes will meet at 7 p.m. Thursday at Western Sizzlin' Steakhouse on Tenth Street.

## Prizes Awarded

TEL AVIV, Israel (AP) — President Chaim Herzog awarded six \$100,000 prizes to be shared by eight recipients of the Wolf Foundation prize for achievements in the sciences and arts. Among the winners were five American scientists.

The annual prizes were awarded Sunday at the parliament in Jerusalem.

The five American recipients were Donald Steiner of the University of Chicago, for medicine; Robert Burris of the University of Wisconsin, for agriculture; Rudolf Marcus of the California Institute of Technology, for chemistry; Conyers Herring of Stanford University, for physics; and Hans Lewy of the University of California at Berkeley, for mathematics.

## Toastmasters

The Unicorn Toastmasters Club No. 5058 will meet at 6:30 p.m. Thursday at Burroughs Wellcome Co. in the executive conference room. Toastmaster for the evening will be Trudy Briley and table topics master will be Olin Davis. Scheduled speakers include Linda Cochran and Clint Elbert.

For more information about Unicorn Toastmasters call Kirk Marness at Burroughs Wellcome. 758-3436, extension 2440.

## Bible Lesson

Eldress Irene G. Epps, pastor of Morning Glory Holiness Church, will teach a Bible lesson at 7:30 p.m. today at Deliverance Mission Outreach, 416 S. Main St., Farmville.

## Accountants Meet

The Eastern Carolina Chapter of the National Association of Accountants will meet at 6:15 p.m. today at the Greenville Country Club.

"Capital Budgeting Techniques" will be the topic presented by Bruce N. Wardrop, chairman of the Department of Finance of East Carolina University. He holds bachelors and doctorate degrees in finance and real estate from Georgia State University and is a consultant in strategic profit-planning, asset liability management, financial analysis and hedging of interest rate risk.

For information call Diane Hurley, 752-4126.

## Services Scheduled

New Covenant Temple Bible School in Grifton will hold its seventh annual school-closing services Thursday-Saturday.

Thursday at 8 p.m. crusade night will be celebrated with the Rev. Dexter Wingfield, assistant pastor of Faith and Victory Church of Greenville, speaking.

At 8 p.m. Friday commencement will be held, with the Rev. Clifton Buckram of Raleigh as the guest speaker. At 7 p.m. Saturday a fellowship dinner will be held at King's Restaurant in Kinston with Evangelist Linda Isler of Kinston speaking.

## New Restaurant

A new steak house — Quincy's — is under construction off Greenville Boulevard in the parking lot in front of the Farm Fresh store.

A spokesman for Spartan Food Systems Inc. of Spartanburg, S.C., the owners and builders of Quincy's, said today that completion of the 7,400 square foot, \$280,000 restaurant, which will seat 280 people, is scheduled for Aug. 28, with opening of the restaurant scheduled for Sept. 4.

Presently there are over 200 Quincy's steak houses in the Southeast, from Mississippi and Kentucky to the east coast, including Florida.

## Oak Grove Services

Oak Grove Free Will Baptist Church will hold services at 7:30 p.m. today through Sunday.

Today the Rev. Delores Corbett will preach and on Thursday the Rev. Bobby Holloway will be the speaker. On Friday, Eldress Ida Edwards will be guest speaker and Saturday Evangelist George Hawkins will speak. On Sunday the Rock Islands Singers of Fountain will sing.

At 3 p.m. Sunday a fellowship service will be held featuring the Oak Grove Choir.

## North Pitt Play

The Shubert Fendrich-George M. Cohan musical, "Give My Regards To Broadway," will be presented by members of the North Pitt High School Drama Class in two performances scheduled this week.

Performances will be at 8 p.m. Thursday and 3 p.m. Sunday in the school auditorium.

Danny Dial will direct the performance and Gail Haney will serve as artistic director. John Relford is lighting director.

Principal cast members include Alfred Braxton as Dick Foster, the director; Curtis Moore as Eddie Cowles, the pianist; Jackie Ross as Betty, the leading chorus girl; Sandi Braxton as the aspiring actress, Mary Collins, and Jarrett Wynne as Legs Ruby, the bookie.

Tickets will be available at the door or from members of the drama class.

Store Hours  
8-6 Mon-Fri  
8-5 Sat

**Thursday Through Saturday**

# WEEKEND SPECIALS

**PEAT MOSS**  
Bale contains 4 cu. ft. 335-013  
Reg. \$6.99

**Sale \$4.97**

**ADS 4-INCH PLASTIC DRAIN PIPE** Lightweight pipe to drain your field for less compaction, less alkali build-up, and more workable soil. Many home and farm uses, such as downspout drainage. 10' plain or perforated sections. Available in 100' & 250' coils. 534-560 and 534-511. Reg. 25¢ per ft.

**Sale 20¢ per ft.**

**UNIVERSAL CO-OP 1-HP ELECTRIC AIR COMPRESSOR**  
14-gal. tank and hose operating pressure gauges. Use for inflating tires, operating sprayer, paint guns or air tools. Single-cylinder. Model 64A100-14. 685-543. Reg. \$349.95

**Sale \$279.95**

**HAPPY JACK 3-X TICK AND FLEA COLLAR**  
Kills fleas for 11 months, ticks for 7 months and also removes mange mites. 495-200. Reg. \$4.99

**Sale \$3.99 each**

**AIR COMPRESSOR OIL**  
All air compressors are shipped with break-in oil. This should be changed after eight running hours. Regular air compressor oil should be changed every 50 running hours. 685-102.

**\$2.65 Per Qt.**

**FCX LIQUID SEVIN**  
Controls over 160 pests, including Japanese beetle, bagworms, moths, ants, fleas and ticks. 446-141. Reg. \$3.89 pt.

**Sale \$3.19 per pt.**

**1/2 IMPACT WRENCH** 685-110. **\$49.95**

**3/8" VARIABLE SPEED DRILL** 685-116. **\$51.49**

**VARIABLE SPEED SANDER** 685-113. **\$28.95**

**PAINT SPRAYER** Model 010-0331. 685-033. **\$49.55**

**BROWN DUCK**  
Liberty's brown duck overall patented bib pocket elasticized suspenders triple-stitched felled seams reinforced at points of strain full fitting graduated rises long wearing. Great for work or play.  
190-Reg. #476-261  
191-X-Lg. #476-262  
Reg. \$24.95

**Sale \$22.95**

**BLUE DENIM**  
Authentic Liberty high-back overall patented bib pocket swing front pockets patch back pockets hammer loop ruler pocket triple-stitched felled seams reinforced at points of strain full fitting graduated rises.  
180-Reg. #476-259  
181-X-Lg. #476-260  
Reg. \$18.95

**Sale \$16.95**

\*Most popular sizes available

\*Buy 3 pairs of overalls and receive a \$9.00 Rebate Check from George "Goober" Lindsay. Offer good through the month of May.

**WE NOW ACCEPT MASTERCARD AND VISA**

**FARM & GARDEN**  
Corner of Line Avenue & Chestnut Street  
758-3173

WE RESERVE THE RIGHT TO LIMIT QUANTITIES. HANDCHECKS WILL BE ISSUED IF SUPPLIES RUN OUT.

**SMART MONEY**

**COUPON**

# SAVE 20¢

with coupon below

# SAVE 20¢

when you buy one Puritan Oil any size

8702PO

48885

48885

CONSUMER INFORMATION: This coupon is valid only on one purchase of Puritan Oil. It cannot be used on other brands of oil. It is not valid on bulk purchases. It is not valid on other products. It is not valid on other brands of oil. It is not valid on other products. It is not valid on other brands of oil. It is not valid on other products.

DEALER: PROCTER & GAMBLE

GAMBLE

PROCTER & GAMBLE

343250

3700032220

**THE NEW**

**A&P**

**THE SUPER**

**WAREHOUSE**

**WALL TO WALL PRICES**  
On the items you

PRICES EFFECTIVE SUNDAY, MAY 12 THROUGH SAT., MAY 18 AT A&P IN GREENVILLE. ITEMS OFFERED FOR SALE NOT AVAILABLE TO OTHER RETAILERS OR WHOLESALERS. WE RESERVE THE RIGHT TO LIMIT QUANTITIES.

WAREHOUSE PRICES

KRAFT

**Miracle Whip**

**99¢**

32 oz. jar

SAVE UP TO 70¢

LIMIT ONE WITH ADDITIONAL 10.00 OR MORE ORDER

WAREHOUSE PRICES

PARKAY

**Margarine Qtrs.**

**2100**

1 lb. pkgs.

SAVE UP TO 38¢ ON TWO

LIMIT TWO WITH ADDITIONAL 10.00 OR MORE ORDER

WAREHOUSE PRICES

PRIDE OF THE FARM

**Canned Tomatoes**

**3100**

14 1/2 oz. cans

SAVE UP TO 20¢ ON 3

WAREHOUSE PRICES

HUNT'S

**Ketchup**

**68¢**

32 oz. btl.

SAVE UP TO 31¢

LIMIT ONE WITH ADDITIONAL 10.00 OR MORE ORDER

WAREHOUSE PRICES

20¢ OFF LABEL

**Wesson Oil**

**88¢**

24 oz. btl.

SAVE UP TO 61¢

LIMIT ONE WITH ADDITIONAL 10.00 OR MORE ORDER

WAREHOUSE PRICES

WINE

**Paul Masson**

**399**

1 ltr. btl.

WAREHOUSE PRICES

HUNT'S

**B-B-Q Sauce**

**129**

18 oz. btl.

SAVE UP TO 24¢

WAREHOUSE PRICES

SMUCKER'S GRAPE JAM OR

**Grape Jelly**

**99¢**

2 lb. jar

SAVE UP TO 50¢

WAREHOUSE PRICES

ASST. FLAVORS

**Kraft Dressing**

**149**

16 oz. btl.

SAVE UP TO 30¢

WAREHOUSE PRICES

WHITE • ASSORTED

**Scottissue**

**189**

4 roll pkg.

SAVE UP TO 30¢

- VAN CAMPS **Pork & Beans** 3 16 oz. cans **100** SAVE UP TO 17¢ ON 3
- CRISCO **Shortening** 3 lb. can **245** SAVE UP TO 20¢
- Tomato Paste** 2 6 oz. cans **79¢** SAVE UP TO 15¢ ON 2
- PURE VEGETABLE **Wesson Oil** 64 oz. btl. **362** SAVE UP TO 37¢
- ALL VARIETIES **Pillsbury Cake Mixes** 18 1/2 oz. pkg. **69¢** SAVE UP TO 20¢
- MAXWELL HOUSE **Master Blend Coffee** 13 oz. bag **209** SAVE UP TO 20¢
- KELLOGG'S **Honey Smacks** 13 oz. pkg. **147** SAVE UP TO 22¢
- DESSERTS **Royal Gelatins** 5 3 oz. pkgs. **100** SAVE UP TO 25¢ ON 5
- FRUIT **Hi-C Drinks** 49 oz. can **79¢** SAVE UP TO 10¢
- JIFFY **Corn Muffin Mix** 8 1/2 oz. pkgs. **89¢** SAVE UP TO 19¢ ON 4

- HUNT'S **Manwich Sauce** 15 1/2 oz. can **89¢** SAVE UP TO 10¢
- DEL MONTE **Catsup** 32 oz. btl. **79¢** SAVE UP TO 20¢
- LONG GRAIN **Comet Rice** 1 lb. pkg. **36¢** SAVE UP TO 13¢
- KINGSFORD **Charcoal** 10 lb. bag **289** SAVE UP TO 30¢
- ALL VARIETIES **French's Potatoes** 5 1/2 oz. pkg. **69¢** SAVE UP TO 14¢
- CANNED **Alpo Dog Food** 3 14 oz. cans **100** SAVE UP TO 50¢ ON 3
- SPRAY **409 Cleaner** 22 oz. btl. **137** SAVE UP TO 28¢
- LEMON SPRAY **Favor Polish** 14 oz. can **185** SAVE UP TO 34¢
- FABRIC SOFTENER **Snuggle** 33 oz. btl. **117** SAVE UP TO 22¢
- FOR YOUR BATH **Safeguard Soap** 4 5 oz. bars **177** SAVE UP TO 42¢ ON 4

- KRAFT DELUXE **Macaroni & Cheese** 14 oz. pkg. **109** SAVE UP TO 16¢
- SPAM **Luncheon Meat** 12 oz. can **129** SAVE UP TO 15¢
- CASTLEBERRY **Beef Stew** 24 oz. can **99¢** SAVE UP TO 40¢
- PACKETS **Sweet N' Low** 250 ct. pkg. **279** SAVE UP TO 40¢
- HUNT'S **Tomato Paste** 6 oz. can **38¢** SAVE UP TO 11¢
- QUAKER (35¢ OFF LABEL) **Quick Grits** 5 lb. pkg. **99¢** SAVE UP TO 70¢
- FRANCO AMERICAN **Spaghetti** 14 1/2 oz. cans **41¢** SAVE UP TO 10¢ ON 3
- CARNATION **Coffeemate** 11 oz. jar **149** SAVE UP TO 40¢
- SMUCKERS **Strawberry Jam** 32 oz. jar **199** SAVE UP TO 50¢
- PETER PAN **Peanut Butter** 12 oz. jar **116** SAVE UP TO 10¢

- 40¢ OFF LABEL **Liquid Wisk** 32 oz. jar **149** SAVE UP TO 62¢
- LAUNDRY DETERGENT **Rinso** 42 oz. box **119** SAVE UP TO 16¢
- DISH DETERGENT **Dove Liquid** 22 oz. btl. **99¢** SAVE UP TO 52¢
- DIXIE EVERYDAY **Paper Plates** 100 ct. pkg. **109** SAVE UP TO 21¢
- ALL SCENTS **Glade Aerosol** 7 oz. can **119** SAVE UP TO 30¢
- GLADE **Fabric Fresh** 4 1/2 oz. size **119** SAVE UP TO 30¢
- A&P **Trash Bags** 8 ct. pkg. **169** SAVE UP TO 30¢
- SHOUT IT OUT **Shout Liquid** 22 oz. btl. **159** SAVE UP TO 20¢
- WOOD SCENT • LEMON **Pledge** 14 oz. car **229** SAVE UP TO 50¢
- RATION DOG FOOD **Field Trial** 20 lb. bag **269** SAVE UP TO 50¢

- KRAFT **Amo**
- KRAFT **Cra**
- KRAFT **Squ**
- KRAFT **Cre**
- CH **Ch**
- IN QU **She**
- PACKE **Pot**
- MRS S **App**
- BIRDS **App**
- COO **Co**
- A&P FR **Or**
- JUI **Jui**

# MARKET WITH

# SALE PRICES

## PRICE REDUCTIONS

you want most! Plus Double Coupons!

703 GREENVILLE BLVD.  
OPEN 24 HOURS  
OPEN MONDAYS AT 7AM - CLOSE SATURDAYS AT 12 MIDNIGHT  
OPEN SUNDAYS 8AM TIL 10PM

SEE DETAILS AT GREENVILLE A&P STORE

DIET COKE • SPRITE • TAB

**Coca Cola**  
**105**  
2 ltr. btl.  
SAVE UP TO 54¢

WAREHOUSE PRICES

COUNTRY PRIDE

COUNTRY PRIDE FRESH  
**Fryer Leg Qtrs.**  
**35¢**  
lb.  
Whole Fryers Limit 4 39¢ lb.

WAREHOUSE PRICES

FRESH CUT GRAIN FED BEEF BONELESS

**Rib Eye Steak**  
**389**  
lb.  
SAVE UP TO 180 LB.

REGULAR • LIGHT

**Coors Beer**  
**239**  
ctn. of 6 12 oz. cans  
SAVE UP TO 50¢

WAREHOUSE PRICES

GOLDEN RIPE

**Bananas**  
**4100**  
lbs. only  
SAVE UP TO 16¢ LB.

WAREHOUSE PRICES

FRESH CUT GRAIN FED BEEF

**Cubed Beef Steak**  
**189**  
lb.  
SAVE UP TO 110 LB.

WAREHOUSE PRICES

BUTTER-ME-NOT

**A&P Biscuits**  
**89¢**  
4 5 ct. 5 oz. cans

Produce Specials

RED RIPE FLORIDA

**Watermelon**  
**129**  
half each  
SAVE UP TO 100

DELI SPECIALS

BUY ONE POUND OF BAKED

**Virginia Ham** lb. **299**  
GET A LOAF OF **French Bread Free!**

WAREHOUSE PRICES

QUARTER SLICED

**Pork Loin**  
**129**  
lb.  
SAVE UP TO 80¢ LB.

**American Singles** 6 oz. pkg. **99¢** SAVE UP TO 20¢  
**Cracker Barrel** 10 oz. pkg. **199** SAVE UP TO 30¢  
**Squeeze Parkay** 1 lb. btl. **99¢** SAVE UP TO 20¢

FRESH FLORIDA **Yellow Corn** 6 ears only **99¢** SAVE UP TO 8¢ EA  
BROCCOLI OR **Cauliflower** each only **99¢** SAVE UP TO 50¢  
FRESH **Cucumbers** 5 for only **100** SAVE UP TO 8¢ EA

12 PIECE BOX W 2-LBS. SLAW WITH 6 ROLLS **Fried Chicken** each box **949** SAVE 50¢  
HOT **Pepper Cheese** lb. **358** SAVE 40¢  
FRESH **French Bread** each loaf **79¢** SAVE 20¢

FRESH GRAIN FED BEEF WHOLE-BONELESS **Sirloin Tip** lb. **159** SAVE UP TO 60¢ LB.

WAREHOUSE PRICES

**cream cheese** 8 oz. pkg. **109** SAVE UP TO 24¢  
**chedd's Spread** 1 lb. pkg. **39¢** SAVE UP TO 10¢  
**potatoes** 5 lb. bag **129** SAVE UP TO 100  
**Apple Pie** 26 oz. pkg. **189** SAVE UP TO 30¢  
**ool Whip** 8 oz. pkg. **79¢** SAVE UP TO 20¢  
**range Juice** 12 oz. can **99¢** SAVE UP TO 30¢

WAREHOUSE PRICES

DELUXE **Fox Pizza** 10 oz. pkg. **59¢** SAVE UP TO 40¢  
HOT N' BUTTERY **Downyflake Waffles** 13 oz. pkg. **89¢** SAVE UP TO 16¢  
PET RITZ REGULAR **Pie Shells** 2 ct. pkg. **79¢** SAVE UP TO 20¢  
BIRDS EYE **Corn on Cob** 12 ears only **199** SAVE UP TO 30¢  
FROZEN **Morton Dinner** 2 lb. pkg. **189** SAVE UP TO 30¢  
FROZEN **Morton Pot Pies** 3 8 oz. pkgs. **100** SAVE UP TO 65¢

WAREHOUSE PRICES

REGULAR • MINT • GEL **Crest Toothpaste** 4.6 oz. tube **99¢** SAVE UP TO 50¢  
50% OFF **Scope Mouthwash** 24 oz. btl. **199** SAVE UP TO 14¢  
SOLID **Secret Deodorant** 2 oz. size **219** SAVE UP TO 50¢  
ROLL-ON **Secret Deodorant** 1.25 oz. size **159** SAVE UP TO 50¢  
ANTI-PERSPIRANT **Secret Deodorant** 4 oz. size **199** SAVE UP TO 50¢  
MEN'S DISPOSABLE **Bic Shavers** 8 ct. pkg. **100**

WAREHOUSE PRICES

BONELESS **Sirloin Tip Roast** lb. **189** SAVE UP TO 100  
A&P **Meat Franks** 12 oz. pkg. **88¢** SAVE UP TO 41¢  
A&P **Meat Bologna** 1 lb. pkg. **148** SAVE UP TO 31¢  
A&P HOT OR MILD **Sausage** 1 lb. pkg. **88¢** SAVE UP TO 31¢  
ANN PAGE **Sliced Bacon** 1 lb. pkg. **159** SAVE UP TO 30¢  
CHOPPED 81% LEAN **Beef Steak Patties** lb. **159** SAVE UP TO 80¢

**Prime Time Tonight**

WEDNESDAY EVENING								
	7:00	7:30	8:00	8:30	9:00	9:30	10:00 10:30	
CBN	2 Theater	Cisco Kid	Flipper	Flipper	700 Club			
WYAY	3 Fortune	3's Company	Fall Guy		Dynasty		Hotel	
WRAL	5 ABC News	P.M. Mag	Fall Guy		Dynasty		Hotel	
WTTG	5 3's Company	M*A*S*H	P.M. Mag	Movie: "Dressed To Kill"			News	
WECT	6 Jeffersons	M*A*S*H	Highway To Heaven		Facts Of Life		Censored Bloopers	
WITN	7 Jeffersons	Family Feud	Highway To Heaven		Facts Of Life		Censored Bloopers	
WNCN	9 M*A*S*H	Sale Of Cent	Double Dare		Movie: "Blade In Hong Kong"			
WTVB	11 Jeopardy	Fortune	Double Dare		Movie: "Blade In Hong Kong"			
WCTI	12 Fortune	3's Company	Fall Guy		Dynasty		Hotel	
WTBS	17 Sanford	Baseball: Philadelphia Phillies at Atlanta Braves						Basketball
FNN	23 Mike Evans	Gary Mtrik	Camp Meeting U.S.A.		Jim Bakker		W. Cantelon J. Ankerberg	
WUNK	25 Business Rpt	Legislative	Spaceflight		National Geographic		Woody Guthrie	
SPN	Maker	Franchise	Am. Baby	Travelvision	Heartbeat Of The Pacific		Discover Australia	
SHOW	"Ladybug, Ladybug"		Movie: "Psycho II"				"House Of Long Shadows"	
ESPN	SportsCenter	PGA Tour	World Cup Soccer U.S. vs. Trinidad				Auto Racing: Hulman Classic	
HBO	Movie	Video	Movie: "Spring Break"				Acts Of Violence	
NICK	Do That	Dangermouse	Escape: Hijack To Mogadishu	Get Out	Freud			
USA	Radio 1990	Dragnet	Wrestling				Toma	

For complete TV programming information, consult your weekly TV SHOWTIME from Sunday's Daily Reflector.

# 'Cosby Show' Leads Nielsen Ratings; 'Dallas' Is Second

**By FRED ROTHENBERG**  
AP Television Writer  
NEW YORK (AP) — CBS found some reassurance for its move creating a "Saturday Night Movie" slot next season in the success of a rival network's rare Saturday film and the failure of its own Wednesday feature.

ABC's Saturday movie, "Letting Go," starring John Ritter, performed respectably in the A.C. Nielsen Co. ratings released Tuesday, finishing 26th and prompting Michael Eisenberg, CBS' director of audience measurement, to say: "this portends well for the future."

However, the recent past belonged to NBC, which won the ratings race last week with its "Cosby Show," once again topping the Nielsen charts. CBS was second and ABC third.

Next season, CBS moves its low-rated Wednesday night movie to Saturday night. This past season, network viewing on Saturday fell off more than any other night, a decline network officials attribute to the popularity of movie rentals for videocassette recorders.

Last week, another sports-oriented film failed on Wednesday. CBS' "Going for the Gold: The Bill Johnson Story," about America's Olympic gold-medal skier, ranked 61st. The week before, boxer Boom Boom Mancini's "Heart of a Champion" finished 52nd.

"Sports movies are not usually successful," said Eisenberg. But the genre may work better on Saturday night next season. CBS has said it will try to capture male viewers with

more action-oriented films, most of which will be TV movies.

CBS announced recently that it would burn off its inventory of theatrical films and not purchase any new titles because previous cable exposure has limited their effectiveness on network TV.

"Why spend money on a product that millions of viewers have seen already?" said Eisenberg.

On a selective basis, however, theatrical films can be successful, as the networks found out with NBC's "First Blood," starring Sylvester Stallone. CBS researchers had forecast "First Blood" to come in third in its timeslot, but, instead, it beat CBS' "Malice in Wonderland," with Elizabeth Taylor, and the first part of "Death in California," starring Cheryl Ladd, Sunday night.

"First Blood," making its network debut after an extensive cable run, ranked fifth for the week of May 6-12 and served as successful counter-programming.

"The (female) audience was split, and, consequently, the odd man out was the male-appeal movie that won," said Eisenberg.

With the unexpected boost from Stallone and the predictable No. 1 showing of "The Cosby Show," NBC won its third consecutive week since the end of the regular season, closing the gap with CBS for the 52-week September-through-September season.

NBC finished the week with a 14.6 rating to CBS' 13.8 and ABC's 13.0. When the 30-week prime-time season ended April 21, CBS had averaged a

16.9 rating to NBC's 16.2 and ABC's 15.4. Three weeks later, CBS leads with a 16.6 to NBC's 16.1 and ABC's 15.2.

A rating measures the percentage, on average, of the nation's 84.9 million TV homes tuned to a given minute of programming.

NBC is leading the May sweeps, the period when ratings for local stations are measured and used to set advertising rates for the next few months.

The rest of the Top 10 was predictable, led by NBC's comedies and the popular prime-time series on CBS and ABC.

"The Cosby Show," with its final original episode this season, had a 24.1 rating, followed by 22.6 for CBS' "Dallas," a 21.9 for ABC's "Dynasty" and 20.9 for NBC's "Family Ties."

"First Blood" was fifth, NBC's "Remington Steele," sixth, CBS' "Knots Landing, seventh, CBS' "Falcon Crest," eighth, ABC's "Hotel," ninth, and "Malice in Wonderland," 10th.

The two lowest-rated shows were NBC's Sunday night kids entry, which is returning next season, "Silver Spoons," 69th, and "Punky Brewster," 68th. The warm weather affects most adversely the earliest hour of prime time. Even CBS' popular "60 Minutes," dropped to 22nd on Sunday, Mother's Day.

The rest of the bottom five included canceled series, NBC's "Best Times," ABC's "Street Hawk" and ABC's "Me and Mom" — all tied for 65th.

## Charleston Author Wins Annual Award For Novel

NEW YORK (AP) — Josephine Humphreys has received an award from the writers' group PEN for her "Dreams of Sleep," chosen as the best first novel published in 1984.

The author from Charleston, S.C., was given the \$7,500 Ernest Hemingway Foundation Award at a reception Monday night.

The judges also awarded special citations to Kent Haruf of Yuma, Colo., for "The Tie that Binds," and Douglas Unger of Syracuse for "Leaving the Land."

The awards, presented by the American branch of PEN, the world organization of writers, are for excellence in fiction and translation.

Other winners were:

Translation medal — Richard Howard, for a career in which he translated more than 100 volumes of French fiction, poetry, philosophy, criticism and history.

Poetry translation — Seamus Heaney, for "Sweeney Astray."

Prose translation — Helen R. Lane, for Mario Vargas Llosa's "The War at the End of the World."

Renato Poggioli award for translation from Italian — Ann Snodgrass of Salt Lake City, for "Fifteen Poems of Vittorio Sereni."

# Armstrong Refuses To Grant Interview For 'Spaceflight'

**By FRED ROTHENBERG**  
AP Television Writer  
NEW YORK (AP) — "Spaceflight" had about as much success interviewing the man in the moon as it did interviewing the man on the moon.

Neil Armstrong, he of "one small step for a man, one giant leap for mankind" fame, declined to be interviewed for public television's four-part "Spaceflight" that continues with the second installment tonight.

"The irony is that the first human to walk on another celestial body was such a recluse," said Blaine Baggett, producer-writer for this magnificent series. "He's the reincarnation of Charles Lindbergh. He always was."

In trying to land Armstrong, Baggett spoke to him and they exchanged letters — but to no avail. "He says he doesn't like the interview process," Baggett said. "He didn't want to be another interview."

Baggett said money was never an issue with Armstrong, just privacy. In fact, nobody was paid for on-camera appearances, the producer said.

The other space-program participant who turned camera-shy was James Webb, NASA's former chief administrator who helped engineer the public relations campaign that turned the original Mercury astronauts into larger-than-life heroes. "He's happy with his place in history," said Baggett. "His attitude was, 'Why should I upset the applecart?'"

Of all the astronauts who were interviewed — and that group included John Glenn, Alan Shepard and Sally Ride — Baggett was most impressed with Pete Conrad.

"He'd be the one I'd most want to go into space with," he said. "You really get a sense of his competence." Conrad repaired Skylab and helped pilot an ailing Apollo 12 — it was struck by lightning — to the moon and back.

Conrad also comes across as one of the most engaging personalities. In the first episode, he used the term "head shrinkers" to describe the psychological probers who helped select the original seven astronauts.

"I don't think these guys knew a stick from a rudder or space from a submarine," Conrad said. "And I began to play games with them. So that end result was that I was not one of the chosen seven."

Since the 1960s, Americans have had a hot-and-cold love affair with space. Many turned off to the NASA program after the moon landings, and the dramatic re-creations, "The

Right Stuff" movie and the "Space" miniseries, fizzled, even with massive promotional campaigns.

Despite that poor track record, "Spaceflight," which began production three years ago, actually fills a void. "The Right Stuff" ended with the Mercury astronauts; James Michener's "Space" was fiction.

"Is the glass half empty or half full?" Baggett asked about being the third stage of the space projects. "They'll either have whet the appetites, or people will say they've had enough."

As public TV's former creative director, Baggett put together the show "A Dream Called Public Television," which renewed his desire to return to TV production full time. For his first venture, he wanted "something that was popular, memorable, important — and could be done cheaply."

He remembered loving Tom Wolfe's book, "The Right Stuff," and thought the subject was ripe for a thorough TV investigation. He discovered that NASA's footage was plentiful and spectacular, "and when I realized it was available for the cost of duplication, I said 'Eureka!'"

As always, financing was harder to find.

WYES, the public TV station in New Orleans, provided a \$5,000 grant and PBS matched it. The money was supposed to go for a 30-page proposal, but Baggett used it instead to shoot some interviews.

"I thought a sample reel would gain momentum and wouldn't just collect dust," he said. Eventually,

Du Pont financed the project. Baggett estimates the production cost \$600,000. (CBS' 13-part "Space" cost \$32 million.)

Baggett obtained the footage from various sources. Film of Robert Goddard's 1926 rocket launch was in the National Archives in Washington. World War II color footage of the Germans' V-2 rocket launches was growing musty with other German military film at the Norton Air Force Base in San Bernardino, Calif.

Baggett also badgered NASA officials into declassifying some NASA footage just for the program. Soviet film, never seen on American TV, came from a Russian contact at the Soviet Embassy in Washington.

As narrator, Martin Sheen helps pull everything together with a authoritative, yet understated reading. Baggett remembered him for his voice-over on "Apocalypse Now."

"Sheen worked out real well," said Baggett. "He's a little mystical himself. He has a real cosmic view of life."

**PLITT THEATRES**  
CAROLINA EAST CENTER 750-1488

CHECK TIMES DAILY  
"RUSTLERS RHAPSODY"  
7:30-9:15-PG

"GIRLS JUST WANT TO HAVE FUN"  
7:30-9:25-PG

"GYMKATA"  
7:15-9:00-R

"GOTCHA"  
7:30-9:20-PG-13

**Plaza 756-0088**  
cinema 1-2-3  
PLAZA SHOPPING CENTER

ENDS THUR!  
"JUST ONE OF THE GUYS"  
3:00-7:05-9:00 PG-13

ENDS THUR!  
**STICK** (R)  
3:00-7:10-9:00

ALL SEATS PLAZA  
\$2.00 3:00 PM SHOW ONLY!

ENDS THUR  
"MISSING IN ACTION I & II" R  
3:00 & 7:15

**PARK** PARK ONLY  
UPTOWN GREENVILLE 757-7444  
ALL SEATS \$1.00 ALL TIMES

ENDS THURS!  
**WITNESS**  
7:00-9:00

**264 Fish Fry**  
Rt. 2, Walstonburg 753-5828

Tuesday Special	KING CRAB LEGS & SOFT SHELL CRABS All You Can Eat	\$9 <sup>95</sup>
Wednesday Special	STEAMED SHRIMP & SCALLOPS All You Can Eat	\$6 <sup>95</sup>
Thursday Special	STEAMED SHRIMP All You Can Eat	\$5 <sup>95</sup>

**Peppi's Pizza den**  
421 Greenville Blvd.  
Phone 756-0825

**COUPON** 2 For 1 Pizza Special

Buy One Pizza At Regular Price And Get Another Of Same Value Or Less Free.

COUPON EXPIRES MAY 15-26  
(Not Good With Any Other Specials)

TDR

**264 PLAYHOUSE**  
INDOOR THEATRE  
6 Miles West Of Greenville  
On U.S. 264 (Farmville Hwy.)

ENDS TONIGHT  
AT YOUR ADULT ENTERTAINMENT CENTER

"Good Girl Bad Girl"

756-0848  
Showtime 6:00 Rated X Doors Open 5:45

**ATTENTION**  
Greenville Cable TV  
Subscribers

Only 6 Days Left Before We Switch To Our New Channel Lineup. HBO & Showtime Will No Longer Be Viewed On Channel 14 & 20. The New Channels For HBO & Showtime Will Be Channel 17 & 21. Please Call Our Office At 756-3384 From 9 A.M. To 9 P.M. If You Have Not Had Your New Equipment Installed. We Will Be Switching To Our New Channel Lineup Tuesday, May 21st.

Phone 756-3384

**Greenville Cable TV**  
517 Arlington Blvd. Phone 756-3384

**BUCCANEER MOVIES**  
756-2287 Greenville Square Shopping Center

1-3-5-7-9  
"CODE OF SILENCE"  
RATED - R -

1-3-5-7-9  
"RAPPIN"  
RATED-PG

1:15-3:15-5:15-7:15-9:15  
"PRIVATE RESORT"-R

**BEEF BARN**

Lunch  
Fast & Delicious  
With Great Atmosphere

Feeding Time 11:30 'Til 2 P.M. Phone 756-1161

**What does a Tax Cut and a Cold Cut have in common?**

WE THINK THE EXECUTIVE IS LOOKING FOR BOTH.

Ramada Inn Presents THE EXECUTIVE SANDWICH BUFFET In The New Veranda Lounge

All for just \$3.95 Monday-Friday 11:30 a.m. - 2:00 p.m.

**VERANDA** 501 Greenville Blvd. Greenville, N.C. 27834 (919) 756-2792

**RAMADA INN** Operated by PLAZA HOTEL MANAGEMENT INC.

PEANUTS

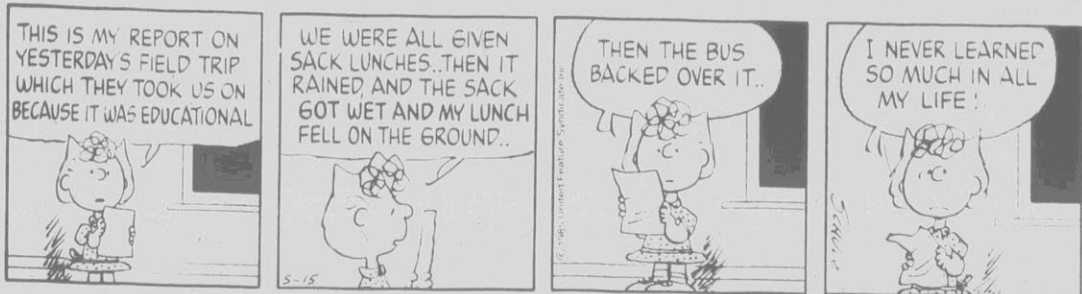

B.C.



NUBBIN

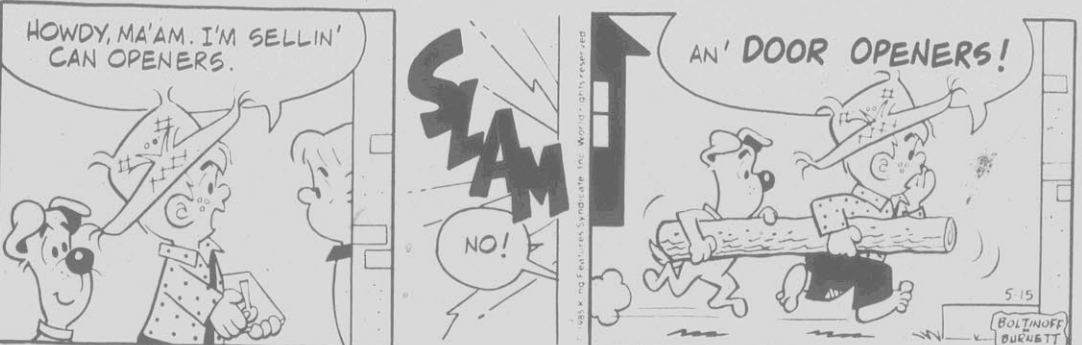

BLONDIE



BEETLE BAILEY



PHANTOM



FRANK & ERNEST

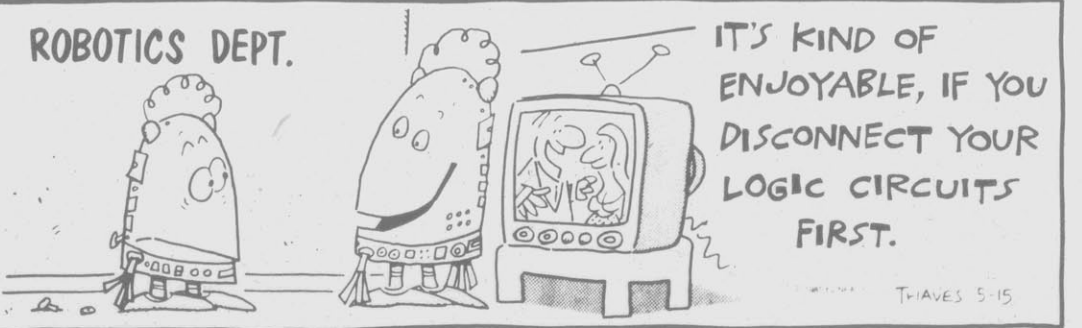

FUNKY WINKERBEAN



SHOE



Public Notices

CO-ADMINISTRATORS' NOTICE

STATE OF NORTH CAROLINA  
PITTSBOROUGH COUNTY  
IN THE GENERAL COURT OF JUSTICE  
SUPERIOR COURT DIVISION  
Having qualified as Co-Administrators in the estate of Jarvis Russell Worthington of Pitt County, North Carolina, this is to notify all persons having claims against the estate of said Jarvis Russell Worthington to present them to the undersigned on or before October 25, 1985, which date is six months from the date of the first date of publication of this notice, excluding the first publication or same will be pleaded in bar of their recovery. All persons indebted to said estate please make immediate payment.

This 19th day of April 1985.  
Arnold Russell Worthington  
Heber Francis Worthington  
2715 Darden Road  
Greensboro, North Carolina 27407  
Co-Administrators of Estate of Jarvis Russell Worthington  
Edward J. Harper, II  
Everett Everett  
Warren & Harper  
Attorneys at Law  
Post Office Box 1220  
Greenville, NC 27835-1220  
April 24, May 1, 8, 15, 1985

NOTICE  
Having qualified as Administrator of the estate of Raymond T. Rogerson late of Pitt County, North Carolina, this is to notify all persons having claims against the estate of said deceased to present them to the undersigned Administrator on or before October 24, 1985, or this notice or same will be pleaded in bar of their recovery. All persons indebted to said estate please make immediate payment.

This 22nd day of April, 1985.  
Russell T. Rogerson  
1805 E. Fourth Street  
Greenville, N.C. 27834  
Administrator of the estate of Raymond T. Rogerson, deceased.  
April 24, May 1, 8, 15, 1985

NOTICE  
Having qualified as Co-Executors of the estate of Leonard Benjamin Manning late of Pitt County, North Carolina, this is to notify all persons having claims against the estate of said deceased to present them to the undersigned Co-Executors on or before November 1, 1985, or this notice or same will be pleaded in bar of their recovery. All persons indebted to said estate please make immediate payment.

This 26th day of April, 1985.  
Christine M. Barefoot  
Rt. 2, Box 62E  
Benson, N.C. 27504  
Rubielle Harper Manning  
P.O. Box 232  
Fountain, N.C. 27829  
Co-Executors of the estate of Leonard Benjamin Manning, deceased.  
May 1, 8, 15, 22, 1985

NOTICE  
IN THE GENERAL COURT OF JUSTICE  
SUPERIOR COURT DIVISION  
BEFORE THE CLERK  
NORTH CAROLINA  
PITTSBOROUGH COUNTY  
The undersigned having this day qualified as Administrator of the Estate of Rosevelt Highsmith, deceased, this is to notify all persons, firms, and corporations having claims against said estate to present them to the undersigned or her attorneys on or before the 15 day of November, 1985, or this notice will be pleaded in bar of their recovery. All persons indebted to said estate will please make immediate payment to the undersigned.

This 10th day of May, 1985.  
Alice G. Highsmith  
P.O. Box 191  
Bethel, N.C. 27812  
Everett Everett, Warren & Harper, Attorneys  
P.O. Box 609  
Bethel, N.C. 27812  
Telephone: 919-825-5691  
May 15, 22, 29, June 5, 1985

NOTICE OF SALE TO SATISFY LIENS PROVIDED UNDER G.S. 44B-2  
Hall Oldsmobile, 101 Hooker Road, Greenville, N.C. will offer for sale at public auction on Wednesday, May 29, 1985 at 12 Noon the following vehicles to satisfy mechanical & storage liens:  
1978 Fiat Convertible Serial # 124C51013666  
1972 Oldsmobile 4 dr. Serial # 3V397E129887  
1973 Toyota Serial # TE5167127  
1967 Oldsmobile 4 dr. Serial # 366697M389265  
May 15, 22, 1985

NOTICE TO PROSPECTIVE BIDDERS  
INSTALLATION OF FOUNDATIONS FOR THE SIMPSON SUBSTATION FOR THE GREENVILLE UTILITIES COMMISSION GREENVILLE, NORTH CAROLINA  
Sealed proposals for the installation of foundations for the Simpson Substation, including the necessary labor, tools, and equipment will be received by the Greenville Utilities Commission, Attention: Malcolm A. Green, The outside of the envelope must be marked 'Proposal for Installation of Foundations for the Simpson Substation' and the Bidder's name, bid opening date and time shall be shown thereon. All proposals must be made on the blank forms provided in the specifications.  
Each proposal shall be accompanied by cash or a certified check drawn on a bank insured with the FDIC payable to the Greenville Utilities Commission, North Carolina, in an amount not less than four percent (5%) of the total bid, as a guarantee that a contract if awarded will be entered into and that satisfactory contract bond will be executed. In lieu thereof, a bid bond which conforms to the provisions of GS 44-22 as amended by Chapter 104 of the Public Law, 1981, may be submitted by the bidder.  
Plans and specifications will be on file and may be examined at the Engineering Office of the Greenville Utilities Commission, Greenville, North Carolina, and in the office of Booth & Associates, Inc., Consulting Engineers, 161 Schaub Drive, Raleigh, North Carolina 27608, or may be obtained from the Consulting Engineers by those qualified and who will make a bid.  
The right is reserved to reject any or all bids and to hold any or all bids for a period of thirty (30) days from the date of opening thereof.

GREENVILLE UTILITIES COMMISSION  
Greenville, North Carolina  
May 15, 1985

•023 Pontiac

1979 PONTIAC Trans AM, good condition, AM-FM stereo, sunroof, \$1900 758-2996, ask for Marvin

1981 PHOENIX PONTIAC Good condition \$2700 757-0626

024 Foreign

MG MIDGET convertible 1978, 1 owner, superior condition, 40,000 miles, \$3,000 756-9507

1968 VOLKSWAGEN BEETLE good mileage \$475 Call 756-1047

1971 504 PEUGEOT Gas, new engine and tires \$700 Call 756-8247

1974 HONDA Civic AM-FM, 4 speed \$750 746-2047 after 7 p.m.

1974 TOYOTA Automatic, air, AM-FM, excellent, low mile age \$1,200 756-6449

1975 RABBIT AM-FM cassette, air, great shape \$1500 Call 756-6787

1977 VOLKSWAGEN Scirocco for sale, excellent condition information call 756-9577

1979 MG Midget, good condition, mechanical, great transportation Best offer 758-7557

1979 TOYOTA COROLLA 4 speed, color, AM-FM, AM-FM radio, excellent condition, Call 758-7217

1979 VOLKSWAGEN SCIROCCO 5 speed AM-FM cassette, stereo, Kamin spoiler, new battery, clean, good condition \$3650 Call 541-5703 10:30 days 752-3843 nights

1981 DASHER stationwagon, 40 miles, gas, gallon 756-9400 nights 758-8218

1982 MAZDA RXJ GS fully loaded, excellent running condition, sunroof, AM-FM tape deck, aluminum wheels, air etc \$8300 756-2008

1982 TOYOTA TERCEL 4 door, automatic, air conditioning, AM-FM Stereo \$4800 or best offer Call 752-0860 after 5 p.m.

1983 COROLLA hatchback SR 5, 5 speed, air, AM-FM cassette, 758-9982, after 6 p.m.

1983 HONDA CIVIC wagon, Air, AM-FM stereo, low mileage, must sell \$55,791, after 6 p.m.

1983 VOLKSWAGEN Vanagon Excellent condition Asking \$9900 or best offer 756-2345

1984 PEUGEOT 505 STI Loaded, immaculate condition, low mileage, Call 756-9025 anytime.

030 Bicycles For Sale

BOY'S 10 SPEED bicycle for sale \$65 Call 758-0721

032 Boats And Motors

14' SPORTSMAN 65 horse power Johnson motor and trailer \$1500 756-2674

14' TURBO Hobie Cat Excellent condition, well equipped 756-1122

15 FOOT FIBERGLASS boat, complete, inboard motor, Johnson motor \$1200 negotiable One owner Call 758-0396

17' BOW RIDER, cathedral hull, 80 horsepower Mercury and Long Trailer \$2,000 Call 758-4815

19' GALAXY (1977), inboard outboard OMC 190 engine with stern drive canopy, depth finder, CB, Cox Till Trailer \$4500 Call 746-1704

1967 151' WELLCRAFT, 40 horsepower Johnson motor, Cox till trailer 756-9400, nights 758-6218

1970 21' AIRCRAFT, 1976 Chevy engine, 6 cylinder, 160 horse power, in and outboard, 258 0028 days or 758-1750 after 5:30

1972 16' BONITO 65 horsepower Johnson motor, galvanized trailer, 756-1189 after 6 p.m.

1976 JOHNSON outboard motor, complete, inboard, including new pistons and water pump, 5625 Day 1792 7355, night 1792 7144

1980 GRADY WHITE 19' Tarpaulin with Cox tandem trailer and all extras, including top, depth finder, compass, etc. Like new. Perfect condition. Call 756-2609

1981 HOBBE 18 Call 756-1582

1983 NACRA 5 1/2 Sailboat Call 756-2150, after 5:30 756-2047

1984 14' SAILBOAT Like new, reduced for quick sale \$2400 756-5126 after 5 p.m.

034 Campers For Sale

CAMPER TRAILERS for rent. Late model, clean, Coleman folding trailers. Call for details 756-1189 after 6 p.m. Kingston Tractor Inc. 527-1036

LOWLINER with 8x10 add a room, \$750 or best offer Call 756-8689

TRUCK COVERS All sizes, colors, Levi Fiberglass, and Superman tops, 240 units, in stock O'Brian's, Raleigh, N.C. 814-2774

15' SCOTTIE CAMPER, sleeps 4, good condition \$800 Call 752-8189 after 6 p.m.

1973 DODGE MOTOR home 28' 51,000 miles, air conditioner, Call 758-0026 days or 758-3750 after 5:30

1976 HOLIDAY RAMBLER, 22' travel trailer, full bath across back, fully cert. contained, sleeps 6, air, new awning, \$1250 firm, raise hatch with Swagbars, \$150 758-3867

1976 COACHMAN, 25 foot, burrhouse, air and awning, loaded Call 756-1510 or 746-4953

1975 PROWLER 27' travel trailer, sleeps 8, lots of extras, excellent condition \$6500 Call 756-4195

036 Cycles For Sale

ENDURO YAMAHA 250, 1978 Must sell \$425 Call David 756-8040

HONDA 750K 1978, with Wind jammer, cruise control, lug gage, compartment, good shape. Asking \$995 or best offer 756-8686

LARGE SELECTION of Premium Brand tires at quantity prices. Check our prices before you buy. Stan's Cycle Center, 102 We are Excellent!! 757-0292

1978 HONDA 400 HAWK, excellent condition, full late helmet \$650 Call 758-2363 after 6 p.m.

1981 CM400 motorcycle, 850 cc, 1978, \$1995, Day 1792 7155, night 1792 7144

1981 SUZUKI GS 550 4 cylinder, 2,800 miles, 48 mpg, 1981 Suzuki RMZ 125, motorcycles, Call 758-7862

1982 HONDA 750, Black, 8850, negotiable, 756-8238 evenings

039 Trucks For Sale

1950 FORD F-2 mini running condition, body needs repair. Call 757-5520

1963 INTERNATIONAL 2 ton wrecker with Holmes 220 electric unit, good condition, asks \$4500. Air and axles, body separate, good truck, if desired Call 756-5097 or 752-1232

1969 CHEVROLET 1 ton pickup, best offer 758-7557

1972 FORD automatic 302 engine, 3.95, \$1748 0202

1973 INTERNATIONAL garbage pumper, good condition. Will sell for \$4,000 negotiable. Call 752-0840 758-6602 after 12:30

1974 CHEVROLET C30 good condition, \$550 757-3019

1975 CHEVROLET, 150 engine, automatic, 48,000 actual miles, \$2195 Call 758-0503

1975 FORD RANGER Rebuilt engine, \$1595 752-7636 Dealer #10292

1976 FORD F100 good condition, \$4,400 757-3019

1977 DODGE CUSTOMIZED Van Air, captain seats, great stereo system. Call 752-8855 or 756-8690

MONEY In Your Pocket!

When you need money, cash in on the items that are laying around the house - items that you no longer use.

Our Family Rates  
3 Lines  
4 Days  
\$4.00

Family Want Ads Must Be Placed By An Individual To Run Under The Miscellaneous For Sale Classification Limit One Item Per Ad With Sale Value Of \$200 Or Less. Commercial Ads Excluded All Ads Cash With Order No Refund For Early Cancellation

Use Your VISA or MASTER CARD THE DAILY REFLECTOR Classified Ads 752-6166





**109 Houses For Sale**

**AYDEN.** Housing money available on this immaculate 3 bedroom brick ranch featuring 1 1/2 baths, living room, kitchen with eat in area and garage \$41,500. Call Louise Moseley Realty 746-2166.

**BRENTWOOD.** Immaculate contemporary home features great room with cathedral ceiling, lots of storage and a huge deck for summer outings \$64,900. Call Jeff Aldridge, Aldridge and Southerland, 756-3500 or 756-8278.

**BRICK RANCH.** 2070 square feet, 3 bedrooms, 2 baths, of tile, 660 square foot den, living room, wood stove, paved drive with patio shed. 65 acre lot. \$69,000. Open House May 19 from 2 to 4 pm. Lynda Mann 756-6666 or 753-4409.

**BRICK VENEER RANCH** with over 2000 square feet, 4 bedrooms, 5.5 baths, 1.5 car garage, convenient to shopping and schools, low \$50's. Call Davis Realty 752-3000, 756-2904, 756-1997, 752-2438, 756-2477 or 355-2574.

**BRICK VENEER.** Home assume FmHA loan, payment could be \$200 or less to qualified buyer. 6 1/2 miles from Pitt Plaza, 3 bedrooms, 1 1/2 baths, country kitchen and breakfast area, large back yard, \$42,900. Call Davis Realty 752-3000, 756-2904, 756-1997, 752-2438, 756-2477 or 355-2574.

**BY OWNER:** Must sell, 3 bedroom, 2 bath ranch, \$58,900. owner will pay \$3200 closing cost. 752-3339.

**CHERRY OAKS** This 6 bedroom home with over 3500 square feet of living area is custom built with many special features. With all formal areas, family room, den, large kitchen and double car garage and a pretty wooded lot, it's perfect for a family who likes a spacious home. \$127,800. For more information, call Alita Carroll, Aldridge and Southerland, 756-3500 or 756-8278.

**CLOSE TO EVERYTHING!** This 2 story, 1800 square foot home offers much for the money. Popular neighborhood, 2 full baths, all formal areas, garage. Located on quiet dead end street. \$66,500. Call Nancy Dudley, Aldridge and Southerland, 756-3500 or 756-5596 nights.

**CLUB PINES** Belvedere. By owner. Cape cod on Crestline Boulevard. Approximately 1750 square feet. L shaped living and dining room with fireplace, large family room with stairs down stairs bedroom with bath, 2 bedrooms and storage up stairs, workshop/garage in back, 20x24 feet. Upper \$70's, 355-2221.

**COLONIAL HEIGHTS** 3 bedroom white brick ranch with carpet, hardwood floors and fireplace. Living room, separate dining room, high sunny kitchen, laundry room, custom blinds. Beautiful, shaded back yard resort with 30' pool and deck totally enclosed by 7 foot weathered fence, centrally located for school. 756-1855. By owner, \$57,800.

**COUNTRY,** Winterville area. This lovely home on nearly four acres of land has all the charm of country living, but is just minutes from Greenville. With three bedrooms, two baths, large great room with fireplace, kitchen with built in microwave, it's custom built with many special features. \$83,500. To see this spacious home, call Alita Carroll, Aldridge and Southerland, 756-3500 or 756-8278.

**DALEBROOK,** one of Greenville's most desirable locations. This 4 bedroom, 2 bath home with living room, kitchen, family room and sewing/laundry room has been freshly painted, inside and out and completely recarpeted. It's immaculate and ready for immediate occupancy. \$99,500. Call Alita Carroll, Aldridge and Southerland, 756-3500 or 756-8278.

**109 Houses For Sale**

**CAN'T KEEP UP** with the kids? Need to worry this lovely fenced back yard will keep them in site. 3 bedrooms, 2 baths, den and living room. Quinn Realty Inc. 355-6258.

**CANDLEWICK ESTATES** Bright and airy contemporary home offers outstanding energy efficiency, a large private yard and assumable loan. \$69,000. Call Jeff Aldridge, Aldridge and Southerland, 756-3500, nights 355-6700.

**DRASTICALLY REDUCED!** This home located at 1900 East 6th Street offers a living room with a fireplace, 3 bedrooms, in cozy den and a screened in porch. Below market value \$59,900. Owner will consider renting with an option to buy #830. CENTURY 21 Bass Realty, 756-6666 or 756-0604.

**DUPLEX with FHA loan** assumption! 2 bedrooms, 1 1/2 baths, heat pump on each side. Almost new, only minutes from medical school. See it today \$50's +186. CENTURY 21 Bass Realty, 756-6666.

**EIGHTIES-NINETIES**

Forest Hills Circle	\$87,500
Blounts Creek	\$87,500
West Acres	\$89,900
Westhaven III	\$89,900
Club Pines	\$98,000
Moore's Beach	\$98,500
Blounts Creek	\$98,500
Cherry Oaks	\$98,500
Baywood	\$99,500

**109 Houses For Sale**

**FARMERS HOME** Assumable Loan. This 2 bedroom home offers a spacious living room and a country kitchen with lots of cabinet space. Separate utility room has space for a freezer. Reduced to \$42,900 +150. CENTURY 21 Bass Realty, 756-6666 or 756-0604.

**GRIMESLAND** This modular home on wooded lot has 3 bedrooms, 2 baths, living room, den and kitchen dining combo. All appliances furnished. A must see at \$36,900. Call Sue Dunn at Aldridge and Southerland, 756-3500, nights, 355-2588.

**HOME (\$15,000 to be moved)** Buyer must have cash, lot and own movers, estimated cost to move \$22,000. 1 1/2 story home, masonry, 4 bedrooms, 2 baths, family room with fireplace, living room, modern kitchen and utility area. Call for details. 756-2904, 756-1997, 752-2438, 756-2477 or 355-2574.

**IF YOU ARE an outdoor person** this home is a must to see at \$61,900. Large lot with garden already started, privacy patio, well landscaped. Home has 3 bedrooms, 2 baths, greatroom with fireplace. Convenient to hospital. Assumable loan. Call Sue Dunn at Aldridge and Southerland, 756-3500, nights, 355-2588.

**IN THE COUNTRY,** but minutes from town. Charming ranch with 3 spacious bedrooms, 2 full baths. Like new. On a private wooded lot. Mid \$50's. Owners have been transferred and are anxious to sell! Call Nancy Dudley, Aldridge and Southerland, 756-3500 or 756-5596 nights.

**JUST LISTED** and like new! Call now about this 3 bedroom, 1 1/2 bath brick ranch. Central air, lovely landscaping and extra storage. Many more extras. All for \$47,900. Perfect for NC Housing Money. Call Sue Dunn at Aldridge & Southerland, 756-3500 or 756-5596 nights.

**JUST THE FLOOR plan** you've been looking for. This new construction features the master bedroom and bath down stairs and 2 large bedrooms and bath up. Large kitchen with nook area, and priced at just \$74,500. #29. CENTURY 21, Bass Realty, 756-6666.

**KING-SIZE BARGAIN.** Over 3,000 square feet including 3 bedrooms, all formal areas, sun room and recreation room. On a huge lot. All for only \$91,500. Call Call Nancy Dudley, Aldridge and Southerland, 756-3500 or 756-5596 nights.

**LAKE ELLSWORTH.** Contemporary lovers. Here's your chance to indulge. Lott area with wet bar for entertaining, jacuzzi in master bath for relaxing and deck for grilling, wooded setting. \$60,000. Ask for Sue Dunn at Aldridge and Southerland, 756-3500, nights, 355-2588.

**109 Houses For Sale**

**NEW LISTING.** "The Pines" Ayden. This 2 story brick home is quality built with 4 bedrooms, 2 baths, formal living room, dining room, den with wood stove insert, central vacuum, intercom and many other extras. \$84,500. Louise Moseley Realty, 746-2166.

**NORTH EASTERN** street 4 blocks from campus. 2 bedrooms, 1 bath, recently renovated. \$30,000. 752-3256 or 1-443-0897.

**NOW IS THE TIME TO INVEST** in a place on the Pamlico River. A beautiful waterfront lot with 280 Cypress pier and dock. Fully furnished cottage. Large screened porch. A great place for a get away. \$38,500. Call Carol H. Morgan at Aldridge and Southerland for more information. 756-3500 or nights, 746-2019.

**ONLY \$3000 DOWN** and assume FHA 235 loan if qualified. 3 year old, 2 bedroom brick ranch. Possible rent with option. Call 752-0458.

**QUAIL RIDGE** Possible loan assumption on the 3 bedroom, 2 1/2 bath condominium. Plan features large greatroom with fireplace, dining room with bay window, kitchen with all appliances furnished. Immaculate! Call Sue Dunn today at Aldridge and Southerland, 756-3500, nights, 355-2588.

**RECENTLY REMODELED** this home has a new 1/2 bath, new paint and wallpaper, 3 bedrooms, 1 1/2 baths, large kitchen, dining room, fenced in yard. And best of all! Affordable at \$41,900. Call Sue Dunn at Aldridge and Southerland, 756-3500, nights, 355-2588.

**REDUCED!** Beautiful contemporary 4 bedroom, living room, dining room, kitchen with breakfast nook, large den with fireplace, sunroom with jacuzzi, wet bar, deck, fenced yard, work shop, walk to golf course or yacht club. \$89,500. Washington 1-946-8021. The Rich Company.

**REDUCED HOME** (\$59,000). Country, good looking neighborhood, extra large lot, less than 1 year old, excellent condition, brick veneer. Traditional ranch with some siding, front porch with swing, deck in back, about 1589 square feet of quality construction, tastefully decorated, heat pump, insulation, super insulated, possible NC housing financing to qualified buyers. Fixed financing, (9.95% possible) Call for details. \$59,900. Call Davis Realty 752-3000, 756-2904, 756-1997, 752-2438, 756-2477 or 355-2574.

**109 Houses For Sale**

**NO MONEY DOWN!** FmHA loan. Payments could be as low as \$150. 3 bedroom, 1 1/2 bath. Heath Realty Company, 355-7335.

**ROWNETREE WOODS**  
Greenville's newest townhome community is now under construction. Affordable two and three bedroom townhomes with 95% financing available. Call today for details. Jane Warren at 758-6050 or 830-1459 (Greenville, NC) and Wil Reid at 758-6050 or 756-0446.

**COLLICE C. MOORE & ASSOCIATES**  
110 South Evans  
Greenville, NC  
758-6050

**STARTER HOME.** Doll House. Country, near Hospital, vinyl siding on outside, newly painted inside. 3 bedrooms, \$38,900. Call Davis Realty 752-3000, 756-2904, 756-1997, 752-2438, 756-2477 or 355-2574.

**THE EVANS COMPANY**  
752-2814  
Faye Bowen 756-5258  
Winnie Evans, 752-4224

**SINGLETREE.** New 3 bedroom, 1 1/2 bath brick home almost finished. Low \$50's. Seller pays points and closing costs.

**CHERRY OAKS.** 3 bedroom brick home, 2 baths, large great room, lots of space, over 1700 square feet \$70's.

**NEAR WELCOME.** Middle School 3 bedroom brick ranch with carport. FmHA loan assumption available. \$37,500.

**FHA 235 LOAN.** Assumption in North River Estates. Attractively decorated 3 bedroom, 1 1/2 bath home. \$43,000.

**109 Houses For Sale**

**SEE FOR YOURSELF** this exceptionally nice ranch in Edwards Acres. Great room features lovely fireplace and decorative ceiling. Traditional decor will complement your country collectibles. Mid \$50's. Call Nancy Dudley, Aldridge and Southerland, 756-3500 or 756-5596 nights.

**SPACIOUS AND CUSTOM** built! 3 bedrooms with 3 baths are just the beginning. Large great room with stone fireplace and eat in country kitchen. Workshop with 1 1/2 bath and double garage. Many more extras for \$94,900. Call Sue Dunn at Aldridge and Southerland, 756-3500, nights, 355-2588.

**THIS ORCHARD HILLS** home is conveniently located and cute as can be. With 3 bedrooms, 2 baths, living room with fireplace and nice eat in kitchen, it has a finished garage that can easily make a 4th bedroom or family room. \$53,900. For more information call Alita Carroll, Aldridge and Southerland, 756-3500 or 756-8278.

**THIS RUSTIC RANCH** on a beautiful tree lot in Cherry Oaks has 2200 square feet of comfortable living space. 4 bedrooms, fireplace in the master bedroom, plenty of built-ins, beamed ceilings and a warm entry foyer. This is a one of a kind and offered at \$98,900. #903. CENTURY 21 Bass Realty, 756-6666.

**WAITING FOR A BARGAIN?** This lovely home has just been reduced over \$4,000 to \$69,000! Features include great room with fireplace, 2 full baths, screened porch, double garage. On a beautiful lot in Lake Glenwood. Call Nancy Dudley, Aldridge and Southerland, 756-3500 or 756-5596 nights.

**109 Houses For Sale**

**NICELY DECORATED,** 3 bedroom, 2 bath brick ranch in Red Oak. Included den with fireplace, deck, fenced yard. Workshop and heat pump. Priced in the \$60's. Will qualify for NC low interest for 1st home owners. 756-6923.

**WESTHAVEN V.** New construction, you'll love relaxing in the huge 25 foot greatroom. This home features 3 bedrooms, 2 1/2 baths and a kitchen to delight any woman. Built by Bowser Construction Company and priced at just \$103,900. #143. CENTURY 21 Bass Realty, 756-6666.

**WINTERVILLE.** This 3 bedroom, 1 1/2 bath home in Shamrock Terrace features a huge fenced backyard with plenty of room for kids to play and garden space. \$48,900. For more information call Alita Carroll, Aldridge and Southerland, 756-3500 or 756-8278.

**109 Houses For Sale**

**\$500 DOWN PAYMENT** is all you need to buy this 3 bedroom, 1 1/2 bath located in the country. Call Heath Realty Company, 355-7335.

**\$57,900** university area. Charming with a capital 'C' describes this lovely home on Elm street. Featuring living room with hardwood floors and fireplace, dining room, kitchen, remodeled kitchen, it's loaded with extras. To see this lovely home, call Alita Carroll, Aldridge and Southerland, 756-3500 or 756-8278.

**109 Houses For Sale**

**4 BEDROOM.** A frame rustic charmer, situated in Country, almost 2 acres of beautiful wooded lot, detached garage for workshop or etc., recently carpeted upstairs in beautiful beige carpet, new floor tile in kitchen, neat utility area, over 2100 square feet, possibility of third floor for office or etc., delightfully different, you must see! High \$70,000. Call Davis Realty, 752-3000, 756-2904, 756-1997, 752-2438, 756-2477 or 355-2574.

**109 Houses For Sale**

**BRICK VENEER RANCH** with over 2000 square feet, 4 bedrooms, 5.5 baths, 1.5 car garage, convenient to shopping and schools, low \$50's. Call Davis Realty 752-3000, 756-2904, 756-1997, 752-2438, 756-2477 or 355-2574.

**BRICK VENEER.** Home assume FmHA loan, payment could be \$200 or less to qualified buyer. 6 1/2 miles from Pitt Plaza, 3 bedrooms, 1 1/2 baths, country kitchen and breakfast area, large back yard, \$42,900. Call Davis Realty 752-3000, 756-2904, 756-1997, 752-2438, 756-2477 or 355-2574.

**BY OWNER:** Must sell, 3 bedroom, 2 bath ranch, \$58,900. owner will pay \$3200 closing cost. 752-3339.

**CHERRY OAKS** This 6 bedroom home with over 3500 square feet of living area is custom built with many special features. With all formal areas, family room, den, large kitchen and double car garage and a pretty wooded lot, it's perfect for a family who likes a spacious home. \$127,800. For more information, call Alita Carroll, Aldridge and Southerland, 756-3500 or 756-8278.

**CLOSE TO EVERYTHING!** This 2 story, 1800 square foot home offers much for the money. Popular neighborhood, 2 full baths, all formal areas, garage. Located on quiet dead end street. \$66,500. Call Nancy Dudley, Aldridge and Southerland, 756-3500 or 756-5596 nights.

**CLUB PINES** Belvedere. By owner. Cape cod on Crestline Boulevard. Approximately 1750 square feet. L shaped living and dining room with fireplace, large family room with stairs down stairs bedroom with bath, 2 bedrooms and storage up stairs, workshop/garage in back, 20x24 feet. Upper \$70's, 355-2221.

**COLONIAL HEIGHTS** 3 bedroom white brick ranch with carpet, hardwood floors and fireplace. Living room, separate dining room, high sunny kitchen, laundry room, custom blinds. Beautiful, shaded back yard resort with 30' pool and deck totally enclosed by 7 foot weathered fence, centrally located for school. 756-1855. By owner, \$57,800.

**COUNTRY,** Winterville area. This lovely home on nearly four acres of land has all the charm of country living, but is just minutes from Greenville. With three bedrooms, two baths, large great room with fireplace, kitchen with built in microwave, it's custom built with many special features. \$83,500. To see this spacious home, call Alita Carroll, Aldridge and Southerland, 756-3500 or 756-8278.

**DALEBROOK,** one of Greenville's most desirable locations. This 4 bedroom, 2 bath home with living room, kitchen, family room and sewing/laundry room has been freshly painted, inside and out and completely recarpeted. It's immaculate and ready for immediate occupancy. \$99,500. Call Alita Carroll, Aldridge and Southerland, 756-3500 or 756-8278.

**109 Houses For Sale**

**CAN'T KEEP UP** with the kids? Need to worry this lovely fenced back yard will keep them in site. 3 bedrooms, 2 baths, den and living room. Quinn Realty Inc. 355-6258.

**CANDLEWICK ESTATES** Bright and airy contemporary home offers outstanding energy efficiency, a large private yard and assumable loan. \$69,000. Call Jeff Aldridge, Aldridge and Southerland, 756-3500, nights 355-6700.

**DRASTICALLY REDUCED!** This home located at 1900 East 6th Street offers a living room with a fireplace, 3 bedrooms, in cozy den and a screened in porch. Below market value \$59,900. Owner will consider renting with an option to buy #830. CENTURY 21 Bass Realty, 756-6666 or 756-0604.

**DUPLEX with FHA loan** assumption! 2 bedrooms, 1 1/2 baths, heat pump on each side. Almost new, only minutes from medical school. See it today \$50's +186. CENTURY 21 Bass Realty, 756-6666.

**EIGHTIES-NINETIES**

Forest Hills Circle	\$87,500
Blounts Creek	\$87,500
West Acres	\$89,900
Westhaven III	\$89,900
Club Pines	\$98,000
Moore's Beach	\$98,500
Blounts Creek	\$98,500
Cherry Oaks	\$98,500
Baywood	\$99,500

**109 Houses For Sale**

**FARMERS HOME** Assumable Loan. This 2 bedroom home offers a spacious living room and a country kitchen with lots of cabinet space. Separate utility room has space for a freezer. Reduced to \$42,900 +150. CENTURY 21 Bass Realty, 756-6666 or 756-0604.

**GRIMESLAND** This modular home on wooded lot has 3 bedrooms, 2 baths, living room, den and kitchen dining combo. All appliances furnished. A must see at \$36,900. Call Sue Dunn at Aldridge and Southerland, 756-3500, nights, 355-2588.

**HOME (\$15,000 to be moved)** Buyer must have cash, lot and own movers, estimated cost to move \$22,000. 1 1/2 story home, masonry, 4 bedrooms, 2 baths, family room with fireplace, living room, modern kitchen and utility area. Call for details. 756-2904, 756-1997, 752-2438, 756-2477 or 355-2574.

**IF YOU ARE an outdoor person** this home is a must to see at \$61,900. Large lot with garden already started, privacy patio, well landscaped. Home has 3 bedrooms, 2 baths, greatroom with fireplace. Convenient to hospital. Assumable loan. Call Sue Dunn at Aldridge and Southerland, 756-3500, nights, 355-2588.

**IN THE COUNTRY,** but minutes from town. Charming ranch with 3 spacious bedrooms, 2 full baths. Like new. On a private wooded lot. Mid \$50's. Owners have been transferred and are anxious to sell! Call Nancy Dudley, Aldridge and Southerland, 756-3500 or 756-5596 nights.

**JUST LISTED** and like new! Call now about this 3 bedroom, 1 1/2 bath brick ranch. Central air, lovely landscaping and extra storage. Many more extras. All for \$47,900. Perfect for NC Housing Money. Call Sue Dunn at Aldridge & Southerland, 756-3500 or 756-5596 nights.

**JUST THE FLOOR plan** you've been looking for. This new construction features the master bedroom and bath down stairs and 2 large bedrooms and bath up. Large kitchen with nook area, and priced at just \$74,500. #29. CENTURY 21, Bass Realty, 756-6666.

**KING-SIZE BARGAIN.** Over 3,000 square feet including 3 bedrooms, all formal areas, sun room and recreation room. On a huge lot. All for only \$91,500. Call Call Nancy Dudley, Aldridge and Southerland, 756-3500 or 756-5596 nights.

**LAKE ELLSWORTH.** Contemporary lovers. Here's your chance to indulge. Lott area with wet bar for entertaining, jacuzzi in master bath for relaxing and deck for grilling, wooded setting. \$60,000. Ask for Sue Dunn at Aldridge and Southerland, 756-3500, nights, 355-2588.

**109 Houses For Sale**

**NEW LISTING.** "The Pines" Ayden. This 2 story brick home is quality built with 4 bedrooms, 2 baths, formal living room, dining room, den with wood stove insert, central vacuum, intercom and many other extras. \$84,500. Louise Moseley Realty, 746-2166.

**NORTH EASTERN** street 4 blocks from campus. 2 bedrooms, 1 bath, recently renovated. \$30,000. 752-3256 or 1-443-0897.

**NOW IS THE TIME TO INVEST** in a place on the Pamlico River. A beautiful waterfront lot with 280 Cypress pier and dock. Fully furnished cottage. Large screened porch. A great place for a get away. \$38,500. Call Carol H. Morgan at Aldridge and Southerland for more information. 756-3500 or nights, 746-2019.

**ONLY \$3000 DOWN** and assume FHA 235 loan if qualified. 3 year old, 2 bedroom brick ranch. Possible rent with option. Call 752-0458.

**QUAIL RIDGE** Possible loan assumption on the 3 bedroom, 2 1/2 bath condominium. Plan features large greatroom with fireplace, dining room with bay window, kitchen with all appliances furnished. Immaculate! Call Sue Dunn today at Aldridge and Southerland, 756-3500, nights, 355-2588.

**RECENTLY REMODELED** this home has a new 1/2 bath, new paint and wallpaper, 3 bedrooms, 1 1/2 baths, large kitchen, dining room, fenced in yard. And best of all! Affordable at \$41,900. Call Sue Dunn at Aldridge and Southerland, 756-3500, nights, 355-2588.

**REDUCED!** Beautiful contemporary 4 bedroom, living room, dining room, kitchen with breakfast nook, large den with fireplace, sunroom with jacuzzi, wet bar, deck, fenced yard, work shop, walk to golf course or yacht club. \$89,500. Washington 1-946-8021. The Rich Company.

**REDUCED HOME** (\$59,000). Country, good looking neighborhood, extra large lot, less than 1 year old, excellent condition, brick veneer. Traditional ranch with some siding, front porch with swing, deck in back, about 1589 square feet of quality construction, tastefully decorated, heat pump, insulation, super insulated, possible NC housing financing to qualified buyers. Fixed financing, (9.95% possible) Call for details. \$59,900. Call Davis Realty 752-3000, 756-2904, 756-1997, 752-2438, 756-2477 or 355-2574.

**109 Houses For Sale**

**NO MONEY DOWN!** FmHA loan. Payments could be as low as \$150. 3 bedroom, 1 1/2 bath. Heath Realty Company, 355-7335.

**ROWNETREE WOODS**  
Greenville's newest townhome community is now under construction. Affordable two and three bedroom townhomes with 95% financing available. Call today for details. Jane Warren at 758-6050 or 830-1459 (Greenville, NC) and Wil Reid at 758-6050 or 756-0446.

**COLLICE C. MOORE & ASSOCIATES**  
110 South Evans  
Greenville, NC  
758-6050

**STARTER HOME.** Doll House. Country, near Hospital, vinyl siding on outside, newly painted inside. 3 bedrooms, \$38,900. Call Davis Realty 752-3000, 756-2904, 756-1997, 752-2438, 756-2477 or 355-2574.

**THE EVANS COMPANY**  
752-2814  
Faye Bowen 756-5258  
Winnie Evans, 752-4224

**SINGLETREE.** New 3 bedroom, 1 1/2 bath brick home almost finished. Low \$50's. Seller pays points and closing costs.

**CHERRY OAKS.** 3 bedroom brick home, 2 baths, large great room, lots of space, over 1700 square feet \$70's.

**NEAR WELCOME.** Middle School 3 bedroom brick ranch with carport. FmHA loan assumption available. \$37,500.

**FHA 235 LOAN.** Assumption in North River Estates. Attractively decorated 3 bedroom, 1 1/2 bath home. \$43,000.

**109 Houses For Sale**

**SEE FOR YOURSELF** this exceptionally nice ranch in Edwards Acres. Great room features lovely fireplace and decorative ceiling. Traditional decor will complement your country collectibles. Mid \$50's. Call Nancy Dudley, Aldridge and Southerland, 756-3500 or 756-5596 nights.

**SPACIOUS AND CUSTOM** built! 3 bedrooms with 3 baths are just the beginning. Large great room with stone fireplace and eat in country kitchen. Workshop with 1 1/2 bath and double garage. Many more extras for \$94,900. Call Sue Dunn at Aldridge and Southerland, 756-3500, nights, 355-2588.

**THIS ORCHARD HILLS** home is conveniently located and cute as can be. With 3 bedrooms, 2 baths, living room with fireplace and nice eat in kitchen, it has a finished garage that can easily make a 4th bedroom or family room. \$53,900. For more information call Alita Carroll, Aldridge and Southerland, 756-3500 or 756-8278.

**THIS RUSTIC RANCH** on a beautiful tree lot in Cherry Oaks has 2200 square feet of comfortable living space. 4 bedrooms, fireplace in the master bedroom, plenty of built-ins, beamed ceilings and a warm entry foyer. This is a one of a kind and offered at \$98,900. #903. CENTURY 21 Bass Realty, 756-6666.

**WAITING FOR A BARGAIN?** This lovely home has just been reduced over \$4,000 to \$69,000! Features include great room with fireplace, 2 full baths, screened porch, double garage. On a beautiful lot in Lake Glenwood. Call Nancy Dudley, Aldridge and Southerland, 756-3500 or 756-5596 nights.

**109 Houses For Sale**

**NICELY DECORATED,** 3 bedroom, 2 bath brick ranch in Red Oak. Included den with fireplace, deck, fenced yard. Workshop and heat pump. Priced in the \$60's. Will qualify for NC low interest for 1st home owners. 756-6923.

**WESTHAVEN V.** New construction, you'll love relaxing in the huge 25 foot greatroom. This home features 3 bedrooms, 2 1/2 baths and a kitchen to delight any woman. Built by Bowser Construction Company and priced at just \$103,900. #143. CENTURY 21 Bass Realty, 756-6666.

**WINTERVILLE.** This 3 bedroom, 1 1/2 bath home in Shamrock Terrace features a huge fenced backyard with plenty of room for kids to play and garden space. \$48,900. For more information call Alita Carroll, Aldridge and Southerland, 756-3500 or 756-8278.

**109 Houses For Sale**

**\$500 DOWN PAYMENT** is all you need to buy this 3 bedroom, 1 1/2 bath located in the country. Call Heath Realty Company, 355-7335.

**\$57,900** university area. Charming with a capital 'C' describes this lovely home on Elm street. Featuring living room with hardwood floors and fireplace, dining room, kitchen, remodeled kitchen, it's loaded with extras. To see this lovely home, call Alita Carroll, Aldridge and Southerland, 756-3500 or 756-8278.

**109 Houses For Sale**

**4 BEDROOM.** A frame rustic charmer, situated in Country, almost 2 acres of beautiful wooded lot, detached garage for workshop or etc., recently carpeted upstairs in beautiful beige carpet, new floor tile in kitchen, neat utility area, over 2100 square feet, possibility of third floor for office or etc., delightfully different, you must see! High \$70,000. Call Davis Realty, 752-3000, 756-2904, 756-1997, 752-2438, 756-2477 or 355-2574.

**109 Houses For Sale**

**BRICK VENEER RANCH** with over 2000 square feet, 4 bedrooms, 5.5 baths, 1.5 car garage, convenient to shopping and schools, low \$50's. Call Davis Realty 752-3000, 756-2904, 756-1997, 752-2438, 756-2477 or 355-2574.

**BRICK VENEER.** Home assume FmHA loan, payment could be \$200 or less to qualified buyer. 6 1/2 miles from Pitt Plaza, 3 bedrooms, 1 1/2 baths, country kitchen and breakfast area, large back yard, \$42,900. Call Davis Realty 752-3000, 756-2904, 756-1997, 752-2438, 756-2477 or 355-2574.

**BY OWNER:** Must sell, 3 bedroom, 2 bath ranch, \$58,900. owner will pay \$3200 closing cost. 752-3339.

**CHERRY OAKS** This 6 bedroom home with over 3500 square feet of living area is custom built with many special features. With all formal areas, family room, den, large kitchen and double car garage and a pretty wooded lot, it's perfect for a family who likes a spacious home. \$127,800. For more information, call Alita Carroll, Aldridge and Southerland, 756-3500 or 756-8278.

**CLOSE TO EVERYTHING!** This 2 story, 1800 square foot home offers much for the money. Popular neighborhood, 2 full baths, all formal areas, garage. Located on quiet dead end street. \$66,500. Call Nancy Dudley, Aldridge and Southerland, 756-3500 or 756-5596 nights.

**CLUB PINES** Belvedere. By owner. Cape cod on Crestline Boulevard. Approximately 1750 square feet. L shaped living and dining room with fireplace, large family room with stairs down stairs bedroom with bath, 2 bedrooms and storage up stairs, workshop/garage in back, 20x24 feet. Upper \$70's, 355-2221.

**COLONIAL HEIGHTS** 3 bedroom white brick ranch with carpet, hardwood floors and fireplace. Living room, separate dining room, high sunny kitchen, laundry room, custom blinds. Beautiful, shaded back yard resort with 30' pool and deck totally enclosed by 7 foot weathered fence, centrally located for school. 756-1855. By owner, \$57,800.

**COUNTRY,** Winterville area. This lovely home on nearly four acres of land has all the charm of country living, but is just minutes from Greenville. With three bedrooms, two baths, large great room with fireplace, kitchen with built in microwave, it's custom built with many special features. \$83,500. To see this spacious home, call Alita Carroll, Aldridge and Southerland, 756-3500 or 756-8278.

**DALEBROOK,** one of Greenville's most desirable locations. This 4 bedroom, 2 bath home with living room, kitchen, family room and sewing/laundry room has been freshly painted, inside and out and completely recarpeted. It's immaculate and ready for immediate occupancy. \$99,500. Call Alita Carroll, Aldridge and Southerland, 756-3500 or 756-8278.

**109 Houses For Sale**

**CAN'T KEEP UP** with the kids? Need to worry this lovely fenced back yard will keep them in site. 3 bedrooms, 2 baths, den and living room. Quinn Realty Inc. 355-6258.

**CANDLEWICK ESTATES** Bright and airy contemporary home offers outstanding energy efficiency, a large private yard and assumable loan. \$69,000. Call Jeff Aldridge, Aldridge and Southerland, 756-3500, nights 355-6700.

**DRASTICALLY REDUCED!**

**109 Houses For Sale**  
**109 Houses For Sale**

**109 Houses For Sale**  
**109 Houses For Sale**

**113 Land For Sale**  
**115 Lots For Sale**

**117 Resort Property For Sale**  
**121 Apartments For Rent**

**121 Apartments For Rent**  
**121 Apartments For Rent**

## RIVER BLUFF

"Spacious Affordable Luxury Apartments"

Your Choice Of A Microwave Oven or 13" Color TV If You Sign A 12 Month's Lease. Limited Time Only!!! Offer For New Residents only. Present Residents Not Eligible For Offer.

- Professional Management and Maintenance
- 2 Bedroom Townhouses & 1 Bedroom Garden Apartments
- Kitchens Feature Dishwashers & Disposals
- Fully Carpeted
- Private Laundry Facilities
- Large Pools
- Cable T.V. Included
- Private Balconies
- Convenient To Shopping Centers & Restaurants
- ECU Bus Service
- Security Deposits Negotiable

Directions: 10th Street Extension To River Bluff Road Next To Rivergate Shopping Center.

**PHONE 758-4015**

**EXPERIENCED HEAVY EQUIPMENT MECHANIC**

Experience in Drott equipment helpful opening new facility in Greenville area. Excellent fringe benefits, good pay.

Please Contact  
 George Tucker at  
 1-522-0922 days  
 or 756-7104 nights for interview EOE.

**115 Lots For Sale**

BEAUTIFUL LOTS. Located near Burroughs Wellcome. We also have other lots available. Financing available. Low down payments. Call 355-7486.

**BUILDERS OR INVESTORS.** 2 duplex lots or possible 4 townhouse units on both. By owner 756 3611 or 756 3936.

**LARGE LOTS** for sale close to Greenville. Call 757-1365, nights and weekends, 1-975-3240.

**AFFORDABILITY**

Callice C. Moore and Associates offers affordable two and three bedroom townhomes at four locations in the Greenville area. Why pay rent? You can own your townhome with payments comparable to or lower than rent. Call today. Will Reid at 758-0500/756-0446 or Jane Warren at 758-0500/830-1459 (Greenville, NC).

**APARTMENT FOR RENT.** 2 bedroom, 1 bath. By The Wingate Agency 757-3441.

**CLASSIFIED DISPLAY**

# HERE WE GO AGAIN BY POPULAR DEMAND

## HOLT OLDS—NISSAN'S SPRING "BIG TOP" SALE

AT **The Plaza**

On 264 By-Pass — Greenville  
 Wednesday Thru Saturday, May 15 Thru 18

Holt Olds-Nissan And The Plaza (The Winning Combination) Join Forces To Bring You The First Big Top Sale In 1985. We Have A Line-Up Of New Oldsmobiles, Nissan Cars And Trucks And Value Rated Used Cars Like You've Never Seen Before.

**Balloons For The Kids** | **Free Soft Drinks**

- Price:** I Make The Best Deal. Ask One Of My Customers.
- Quality:** I Deliver Quality Merchandise.
- Service:** I Back My Deals With Solid Dependable Service.
- Fixed Prices — No Haggling:** Sale Prices Are Posted On Every Vehicle. You Don't have To Ask For My Bottom Line—I Give It To You Up Front.

Over 150 Vehicles On Display Ready For Delivery. Come Early And Take Your Pick. We Have GMAC And Local Banks Available For Immediate, On The Spot Financing. Trade-Ins Are Welcome And Will Be Appraised At Their Actual Cash Value. Bring The Title To Your Trade Or Know The Loan Pay-Off—Be Prepared To Buy—We Are Prepared To Make Immediate Delivery.

**4 Good Reasons To Join Me Under THE BIG TOP**

**4. Fixed Prices — No Haggling:** Sale Prices Are Posted On Every Vehicle. You Don't have To Ask For My Bottom Line—I Give It To You Up Front.

**3. Service:** I Back My Deals With Solid Dependable Service.

**2. Quality:** I Deliver Quality Merchandise.

**1. Price:** I Make The Best Deal. Ask One Of My Customers.

**Fixed Prices—No Haggling**  
 Whatever It Takes!  
 Holt Olds-Nissan Wants To Be YOUR Car Dealer

**8.8% APR** NO TRICKS! NO GIMMICKS!  
 On All New Nissan Trucks And Olds Calais—48 Months Financing  
 Just More For Your Money

**1. Price:** I Make The Best Deal. Ask One Of My Customers.

**2. Quality:** I Deliver Quality Merchandise.

**3. Service:** I Back My Deals With Solid Dependable Service.

**4. Fixed Prices — No Haggling:** Sale Prices Are Posted On Every Vehicle. You Don't have To Ask For My Bottom Line—I Give It To You Up Front.

Over 150 Vehicles On Display Ready For Delivery. Come Early And Take Your Pick. We Have GMAC And Local Banks Available For Immediate, On The Spot Financing. Trade-Ins Are Welcome And Will Be Appraised At Their Actual Cash Value. Bring The Title To Your Trade Or Know The Loan Pay-Off—Be Prepared To Buy—We Are Prepared To Make Immediate Delivery.

**Come Early Don't Be Late And Disappointed. Drive Home In Your New Car Today!**

**If You Really Want A New Car, Visit Holt's Big Top**

**New Oldsmobiles**

Stock #	Model	Retail	Save	ONLY
6078	85 Toronado Brougham	\$22,645.95	\$3096.95	\$19,549
6211 (Demo)	85 98 Regency Brougham	\$18,731.00	\$2300.00	\$16,431
5711 (Demo)	85 98 Regency	\$18,288.00	\$2127.00	\$16,161
6181 (Demo)	85 Cutlass Salon	\$15,760.00	\$1860.00	\$13,900
6272	85 Cutlass Ciera Brougham	\$15,093.00	\$1839.00	\$13,254
6224 (Demo)	85 Calais Supreme	\$12,295.00	\$1384.00	\$10,911
6252	85 Calais	\$11,721.00	\$1099.00	\$10,622
6255	85 Firenza Sedan	\$11,240.00	\$1270.00	\$9,970

**New Nissan Trucks**

Stock #	Model	Retail	Save	ONLY
5498	84 Cab & Chassis (1 Ton)	\$9,290.00	\$2199.00	\$7,091
5916	85 King Cab	\$10,695.95	\$1533.95	\$9,162
6101	85 King Cab 4 X 4	\$13,295.00	\$2100.00	\$11,195
6311	85 Standard Truck	\$6,698.90	\$359.00	\$6,339

**Meet Francesca Adler**  
 Miss North Carolina 1984

Under The Big Top  
 Wednesday, May 15, 1985  
 From 2-6 P.M.

**Value Rated Used Cars**

Stock #	Model	Retail	Save	ONLY
6154-A	79 Olds Custom Cruiser	\$4795.00	\$995.00	\$3800.00
5877-A	79 Toyota Celica Liftback	\$5495.00	\$938.00	\$4557.00
R6119	80 Toyota Celica GT	\$5495.00	\$620.00	\$4875.00
5299-A	81 Chevrolet Citation	\$4695.00	\$730.00	\$3965.00
6297-A	81 Dodge Mirada	\$5895.00	\$735.00	\$5160.00
6268-A	81 Buick Century	\$5495.00	\$730.00	\$4765.00
5903-B	81 Datsun 280Z Plus 2	\$9695.00	\$700.00	\$8995.00
5880-A	82 Honda Accord 2 Door	\$7295.00	\$845.00	\$6450.00
6010-A	82 Mazda GLC	\$4995.00	\$635.00	\$4360.00
6048-A	83 AMC Jeep CJ-7	\$8995.00	\$1100.00	\$7895.00
R-6187	85 Datsun 4 X 4 Pickup	\$10495.00	\$1230.00	\$9265.00
6166-A	80 Ford Pinto	\$2995.00	\$810.00	\$2185.00

**12.75%**

APR Variable Rate Financing Available To Qualified Buyers With Approved Down Payment On All New Cars

**HOLT OLDS-NISSAN**  
 101 Hooker Rd., Greenville  
 (919) 756-3115

- Highest Trades In Eastern N.C.
- Finance Specialist Available To Assure You The Best Deal Possible
- Eastern Carolina's Largest Olds-Nissan Dealer

**ECU**  
 East Carolina University

Tar River offers more comfort for your money, a variety of floorplans, and lots of fun things to do.

- One-bedroom garden apartments
- Two- or three-bedroom townhouses.

Call us today.

Office Hours: M-F 9-6 p.m.  
 Sat. & Sun. 1-5 p.m.

**Tar River ESTATES**  
 752-4225  
 1400 Willow St.  
 Managed by U.S. Shelter Corporation

**CLASSIFIED DISPLAY**

**LOVE TREES?**  
 Experience the unique in apartment living with nature outside your door.

**COURTNEY SQUARE APARTMENTS**  
 Quality construction, fireplace, heat pumps (heating costs 50 percent less than comparable units), dishwasher, washer-dryer hook-ups, cable TV, walk-in closets, air conditioning, thermopane windows, extra insulation.

Office Open 9-5 Weekdays  
 9:5 Saturday 1-5 Sunday

Merry Lane Off Arlington Blvd.  
 756-5067

**NEW TOWNHOUSE** for rent, 2 bedrooms, 1 1/2 baths, heat pump, outside storage, all appliances, private patio, many extras, great location, no pets, deposit required. Call weekdays after 5 p.m. 753-5449 and weekends.

**OAKMONT SQUARE APARTMENTS**  
 Two bedroom townhouse apartments 1212 Red Oaks Road. Dishwasher, refrigerator, range, disposal included. We also have Cable TV. Very convenient to Pitt Plaza and University. Also some furnished apartments available.

756-4151

**ON THE RIVER!**  
 WE HAVE SEVERAL freshly remodeled one bedroom apartments bordering the Tar River. Each apartment has refrigerator, range, central heat and air conditioning, hot water. Call today for an appointment to see these efficiency minded apartments. Professional management by Remco East. 758-6061.

**PUBLIC AUCTION**  
**ABSOLUTE AUCTION**  
 Estate of Bobby Phillips  
 Farm Equipment  
 MACCLEFIELD, N.C.  
 10 A.M. Sat., May 18, 1985

**TRACTOR, TRUCKS, TRAILERS & CAMPER**

1972 International 986 Diesel Tractor	1982 Datsun King Cab Diesel Pickup
New Tires. Motor rebuilt approx. 1000 hrs. Good condition	AM, FM Stereo, 5 Speed, A.C., 47,888 Miles
1975 International 574 Diesel Tractor	
New Tires	
1972 Farmall Super A with Cultivator	5x15 Dual Axle Utility Trailer
6x12 Dual Equipment Trailer	1972 Custom 10 Chev. Pickup 350 V8, Tool Box
6'x8' Camper, Refrigerator, Stove,	

**BULK BARN**  
 2 Barns: 128 Rack Gas Fired Bulk Barns  
 1 Gastobac 152 Rack Gas Fired Barn

**EQUIPMENT**

Webb 4 Row Pull Type Bulk Tobacco Harvester	4 Bulk Trailers
John Deere 14 Spout Grain Drill (3) pull type tobacco sprayers (1-300 gal. (2-200 gal.)	Holland 2 row Tobacco Transplanter with gantry box and harrow
Lullston 2 row rolling cultivator with fert. attach	Rhin-Jax blade
Harde Side Boy Ditch Bank Cutter	Lullston 2 row peanut harrow
4'x8' Rotary Cutter	Burch 2 row bedder with chemical attachment
King 4'x8' Disc Harrow	32 1/2" pull type Disc Harrow
Plant Bed Irrigation Unit (Sprinkling, hose pump and meter)	Old Breaking Plow (2 bottom)
Several Tobacco Trucks	2 The Master Forty Tobacco Looper Tobacco Sheets
Rackling Table	8 Body Camper Shell
Gas Tank and Pump	Several Drums
500-gal. Fiberglass Tank	Emerson Air Compressor
Small Box	Many other farm-related items
Wizard 230 AMP Welder	

**TERMS:** Cash or good check day of sale.  
**NOTE:** This is an absolute auction for the Estate of Bobby Phillips. Come bid your judgment on this field-ready equipment. Lunch will be served.

**DIRECTIONS:** Macclefield turn west on Railroad St. Go beyond the city limits sign. Sale is on right.

**TUGWELL & WARREN AUCTION & REALTY CO.**  
 P.O. BOX 134  
 ROCKY MOUNT N.C. 27801

John Tugwell  
 Rocky Mount, NC  
 919-446-0514

Glenn Warren  
 Tarboro, NC  
 919-823-8101  
 919-823-1774

Auction: The Sound That Sells  
 N.C.A.#3492  
 N.C.R.#2487

### 121 Apartments For Rent

**NEAR HOSPITAL**, new condo, 2 bedrooms, 2 baths, great floor plan, professional neighbors, no pets. \$350. 355-6002 or 756-7541.

**NEAR HOSPITAL**, new condo, 2 1/2 baths, 2 bedrooms, central air, cable, professional neighbors, no pets. \$350. 355-6002 or 756-7541.

**NEW BRICK DUPLEX**, two bedrooms near hospital, not B's Barbecue area. Call 756-5488, 758-8241.

**ONE AND TWO** bedroom apartments. Carpeted, kitchen appliances, heat pump. Call 752-8915.

**ONE BEDROOM** unfurnished garden apartment. Security deposit required. Call Between 8-5-756-1277.

**ONE BEDROOM** small efficiency apartment, \$275, utilities included. 756-8785.

**ONE STORY** 2 bedroom apartment available March 1. Located in Shenandoah 1 bath, stove, refrigerator, dishwasher, patio and heat pump. \$300 per month. Call Clark Branch Realtors, 355-2000.

**RENT WITH OPTION** to buy. Quiet location, carpet, hookups, all extras, 2 baths, near Pitt Plaza and University. 756-2671 or 758-1543.

**SHENANDOAH VILLAGE** 2 bedroom townhouse, 1 1/2 baths with fireplace. Available March 1 at \$350 per month. Call Clark Branch Management 355-2000.

**SINGLE BEDROOM** apartment, carpeted, appliances. Available June 1. 426 West Fifth Street. \$200 per month. 756-7285.

**STADIUM APARTMENTS**, 1 bedroom, nicely furnished, quiet, near university, professional or graduate student preferred. \$230 plus deposit. Grier Rental Agency, 1100 Charles Boulevard, 752-5700.

### STRATFORD ARMS APARTMENTS

Spacious 1, 2 and 3 bedroom Apartments. Cable TV, Tennis Courts, Pool. Convenient to Shopping and ECU.

One bedroom now available. Office hours 9 a.m. to 5 p.m. Monday through Friday. Call us 24 hours a day at 756-4800.

**TWO BEDROOM** Apartment, Tenth St. \$265 per month. 758-0491 or 756-7809 before 9pm.

**TWO BEDROOMS**, 1 block from campus on 10th Street, \$175. Days 752-7148; nights 752-0978.

**TWO BEDROOM DUPLEX**, 14th Street Extension. 756-5203.

**TWO BEDROOM**, duplex, carpeted, appliances, washer, dryer hook-ups, fireplace, Riverbluff. 756-2879.

**TWO BEDROOM** apartment for rent across from campus at 405 East 5th Street. Includes range and refrigerator. Heating and air conditioner are included in rent. \$290 per month plus deposit. 756-5155 for appointment.

**WEDGEWOOD ARMS** 2 bedroom, 1 1/2 bath townhouses. Excellent location. Carrier heat pumps, whirlpool kitchen, washer-dryer hookups, pool, tennis court. Immediate occupancy. 756-0987.

**WILSON ACRES APARTMENTS** 1806 East First Street. **TWO AND THREE** Bedrooms, hookups, dish, washer, heat pump, tennis, pool, sauna, self cleaning oven, frost-free refrigerator, drapes, laundry mat, water and sewage furnished. 3 blocks from ECU. Call 752-0277 day or night. Equal Housing Opportunity.

**ONE AND TWO** bedroom apartments available, for rent. 752-3311.

**TO PLACE YOUR** Classified Ad, just call 52-6166 and let a friendly Ad-Visor help you word your Ad.

**CLASSIFIED DISPLAY**

### 121 Apartments For Rent

**TWO BEDROOM**, 1 1/2 bath, fireplace, equipped kitchen, washer-dryer hookups. 116 Riverbluff Road. \$295. Call 756-3666.

**1 AND 2 BEDROOM** apartment on River Bluff Road. Smith Insurance & Realty. 752-2754.

**1118 BROOKWOOD** Drive, River Bluff, 2 bedroom, living room, dinette, kitchen, carpet. Available May 1st. Call after 6 p.m. 752-2887.

**2 BEDROOM TOWNHOUSE** at Yorktown Square with 1450 square feet, fireplace, sun room, garbage disposal, dishwasher, stove and refrigerator. Extra nice. Available Now. No pets allowed. \$400 per month. Call Clark Branch at 355-2000.

**2 BEDROOM**, carpeted, dishwasher, refrigerator, oven, washer-dryer hookups, central heat, 5 blocks from campus. 757-3883, 752-0180, 756-2766.

**2 BEDROOM DUPLEX** at Frog Level, heat pump, dishwasher, no pets. \$255/monthly. Call 756-4024, before 5 p.m. or 756-8076, after 5 p.m.

**2 BEDROOMS**, 1 1/2 baths, living room, dining room, kitchen, located in Greeridge subdivision by B's B-BQ. Call 752-1383 after 4:30, weekdays.

**2 BEDROOM**, near University, available June 1st. Day call 752-5126 or 752-7753, after 5 p.m.

**2 BEDROOM**, 2 1/2 bath townhouse available for month to month or short term lease. Call Jeff Aldridge, Aldridge and Clark, 756-3500. Nights 355-6700.

**3 BEDROOM DUPLEX** near ECU, range, refrigerator, hookups, central air and heat. \$285. 756-7480.

### 122 Business Rentals

**BUILDING FOR RENT**... Over 2500 square feet, high traffic area located in shopping center in Ayden between Harris Supermarket and Super Dollar. Plenty parking spaces. Rear loading dock. Perfect as is, or you may remodel inside to fit your needs. \$500 per month, first year; re-negotiate each year thereafter. 1-975-3386 or 746-6986.

**LARGE BUILDING** for rent. Over 3300 square feet, desirable for business use. Next to John's Hardware. Call 756-1050.

**125 Condominiums For Rent**

**EXTREMELY nice** 2 bedroom townhouse at Upton Court. Condos, prefer married or mature singles. \$360. Ask for John Taylor at 752-3850.

**LEXINGTON SQUARE**, 2 bedroom unit available June. J. R. York Construction. 355-2286.

**QUAIL RIDGE** - 2 bedrooms, 1 1/2 baths, 1172 square feet, available June 1 at \$425 per month. Call Clark Branch Management 355-2000.

**TWO BEDROOM** condominium for rent. Collindale Court. Call 757-1365, nights, 975-3240.

### 127 Houses For Rent

**AYDEN** - 3 bedrooms, 2 baths, heat pump, large yard. \$400/month. Deposit required. Available June 1st, 746-2134, after 6 p.m.

**COUNTRY PLACE** - new home available immediately. 2 bedrooms, 1 bath, 960 square feet. \$428 per month. Call Clark Branch Management 355-2000.

**EXECUTIVE HOME**, 3 bedrooms, 2 baths, all formal areas with garage. \$525/month. Lily Richardson Realty, 355-2260.

**CLASSIFIED DISPLAY**

### ROOFING STORM WINDOWS DOORS & AWNINGS

**C.L. Lupton Co.** 752-6116

### 127 Houses For Rent

**FIVE ROOM HOUSE** for rent with bath, 1 1/2 miles south of D.H. Conley High School on Highway 43. 746-6741.

**HOMES FOR RENT** in Griffon. \$250-\$350 monthly. Call Max Waters at Unily Inc. 524-4147 day; 524-4007 night.

**HOUSE FOR RENT**, 3 miles outside Greenville. Heat and air conditioning, 2 bedrooms, living room, kitchen, glassed in front porch, brick veneer. \$250 month 12' wide, nice trailer on private lot, no furniture other than stove, \$150 month. 758-2635, David Mayo.

**HOUSES AND APARTMENT** in Greenville. Call 746-3284 or 1-524-3180.

**IN AYDEN**, 2.3 bedroom house, carpeted, heat pump. \$310 per month. 752-5167, 746-6394.

**IN AYDEN**, 3 bedroom house, new carpet, living room, kitchen, 2 bedrooms, living room, kitchen, glassed in front porch, brick veneer. \$250 month 12' wide, nice trailer on private lot, no furniture other than stove, \$150 month. 758-2635, David Mayo.

**MEADOWBROOK AREA**, 2 bedroom house. Excellent condition. \$225 a month. 757-1204.

**NEAR UNIVERSITY**, 112 East 12th Street, 3 bedrooms, dining room, living room, kitchen with appliances, screened porch, available immediately. \$275. 756-0765.

**NEAR UNIVERSITY**, 3 bedroom, available immediately. Day call 752-5126 or 752-7753, after 5 p.m.

**ONE BLOCK** from campus and town, 4 bedrooms, 2 baths. \$440. Lease and deposit. 758-0174.

**ONE STORY** 3 or 4 bedroom house with central heat, wall to wall carpet and blinds. 1 mile from Farmville schools. Rent: \$275. Call days, 753-3101, nights 753-4785.

**THREE BEDROOMS**, 1 1/2 baths, 106 North Warren Street. Nice neighborhood. \$325 month. Speight Realty 756-5217, 756-0489 or 756-9784.

**TWO BEDROOM HOUSE** located at 326 Clairmont Circle, fenced in backyard. Rent \$310 month. Call 756-5217, 756-0489 or 756-9784.

**TWO BEDROOMS**, full bath, great room, kitchen, dining area, carport. \$350 per month. Call Mavis Butts Realty, 355-7653.

**3 BEDROOM** ranch with garage. \$395. Available August 1st. Call 757-0001, or nights 753-4015 or 756-9006.

**7 BEDROOMS** to be renovated. Near University. 305 East 14th Street. Short term or long term rental. \$350. 756-5299.

### 129 Lots For Rent

**LARGE MOBILE HOME** lot in mobile home court on Highway 33 East. No children and no pets. Call 758-0745.

### CLASSIFIED DISPLAY

### Greenbriar Village

746-2020

Charming 1 story Colonial, fully carpeted, with appliances furnished, washer-dryer connections, energy efficient heat pump, and outside storage. Well maintained grounds and playground for the tots.

1 Bedroom Units Starting At \$185  
2 Bedroom Units Starting At \$200

OFFICE HOURS: Mon., Tues., Thurs., Fri. from 9 to 2

### 129 Lots For Rent

**MOBILE HOME LOTS**, Birchwood Sand section "A". Wooded lots, city water, swimming pool, cablevision. Phone 756-6953 or 752-6643.

**NEW MOBILE HOME** park, paved streets, concrete parking spaces for 3 cars, patios, wooded lots, cable TV, garbage pickup and lawn maintenance provided, VA approved. Only a few lots available. A quality environment for people who want a nice place to live. 756-9784 or 746-6339.

### 131 Merchandise Rentals

**RENTAL** New Curtis Mathes Color TV for as little as \$1.00 a day. Order by phone 756-9311.

### 133 Mobile Homes For Rent

**CLEAN, COMPLETELY** furnished with air, washer and dryer, 1 1/2 bath trailer, located in Shady Knoll Park. No pets or children. Call 758-4249.

**OAKWOOD TRAILER** Park, 2 bedroom, partly furnished. 756-9089.

**THREE BEDROOM**, 2 bath, 12x70, central heat and air, carpeted, nice lot. \$200 month. 6 miles from Greenville. Call 746-6394 or 752-5167.

**UNFURNISHED** 3 bedroom, 2 full bath doublewide, central heat and air. Located on 1/2 acre lot one mile outside of Winterville. Yard already landscaped. Call 756-4706, after 4, ask for Janice.

**12x70**, 3 bedroom, 2 bath, located Ormondsville. \$200 per month. 752-5167, 746-6394.

**2 BEDROOM** furnished, \$160, unfurnished, \$140; 3 bedrooms furnished \$165; unfurnished, \$145; 1 bedroom furnished, \$135, unfurnished, \$120. No pets; no children. 758-0745.

### CLASSIFIED DISPLAY

### PLASTIC SLIP COVERS

Custom fitted in home. Heavy clear plastic. Protects furniture from smoke, dust, staining.

SOFA & CHAIR COVERED in 90 minutes or Less \$110

**AUSBY PLASTIC COVERS** 536-4793 • WELDON

### CLASSIFIED DISPLAY

### 133 Mobile Homes For Rent

**2 BEDROOM**, furnished or unfurnished, washer/dryer, air, excellent condition, good park, no children, no pets. 756-0801, after 5 p.m.

### 135 Office Space For Rent

**COLONIAL HEIGHTS** - Private, all utilities furnished. \$85 per month. 756-7417.

**EXECUTIVE OFFICES** and suites for rent on Commerce Street. Gaylord Builders, 756-5550.

**FOR RENT**: 7500 square foot Warehouse with 2 offices and rest rooms available with 60 days notice. \$800 per month. West 9th Street, Greenville. Call 752-1232 days or 756-5097 nights.

**NEED OFFICE SPACE?** All sizes. From \$6.00 to \$9.00 per square foot. Several locations. Call Connally Branch at Realty World, Clark Branch Realtors. 355-2000.

**NEW EXECUTIVE OFFICE** space on Commerce Street. Available June. Extra services available to tenants: phone answering, copy machine, computer time (IBM AT), reception room, conference room, secretary assistance, word processing, bookkeeping, etc. 752-4080.

### CLASSIFIED DISPLAY

### CLASSIFIED DISPLAY

### 135 Office Space For Rent

**OFFICE FOR RENT**, University Professional Centre, 602 East 10th Street. Call 752-4405.

**OFFICE/RETAIL** very reasonable overhead. 758-2127, 10-5.

**THREE ROOM** downtown office suite, 440 square feet. Joyner Lanier Building, 219 Colaniche Street. Utilities, janitor and parking furnished. Call Jim Lanier at 752-5505.

### 137 Resort Property For Rent

**HILTON HEAD** 2 bedroom, 2 bath condo. Tennis, pools, beach. \$395/week. 404-868-5537.

**NEED A REASONABLE** place to vacation? Trailer at Satter Path. Call 756-4189.

### 138 Rooms For Rent

**QUIET ROOM** for rent. East 5th Street near campus. \$150 or free in exchange for painting and/or carpentry work. Call 752-1905.

### 142 Roommate Wanted

**FEMALE ROOMMATE** wanted for townhouse apartment. \$140 rent plus 1/2 utilities. Call 758-1263 after 6 p.m.

### CLASSIFIED DISPLAY

### CLASSIFIED DISPLAY

### 142 Roommate Wanted

**FEMALE ROOMMATE** to share house near P.H. Community College. \$125 plus 1/3 utilities. Call 355-6713.

**ONE OR 2** Female Roommates needed to share 2 bedroom apartment from May to August with the option to stay longer. \$150/month plus 50% utilities. Call between 5-11 p.m. 758-5297.

### 144 Wanted To Buy

**WANTED TO BUY** pine and hardwood timber. Pamlico Timber Company, Inc. 756-8415, nights.

### 148 Wanted To Rent

**PROFESSIONAL MALE** would like to rent condominium, preferably furnished. Call 752-3659 from 8 to 5.

**WANTS TO RENT** 3 bedroom, 2 bath home for responsible family. Will sign lease. Call 355-5225 nights.

### CLASSIFIED DISPLAY

### CLASSIFIED DISPLAY

### CLASSIFIED DISPLAY

### CLASSIFIED DISPLAY

### CLASSIFIED DISPLAY

### CLASSIFIED DISPLAY

### CLASSIFIED DISPLAY

### CLASSIFIED DISPLAY

### CLASSIFIED DISPLAY

### CLASSIFIED DISPLAY

### CLASSIFIED DISPLAY

### CLASSIFIED DISPLAY

### CLASSIFIED DISPLAY

### CLASSIFIED DISPLAY

### CLASSIFIED DISPLAY

### CLASSIFIED DISPLAY

### CLASSIFIED DISPLAY

### CLASSIFIED DISPLAY

### CLASSIFIED DISPLAY

### CLASSIFIED DISPLAY

### CLASSIFIED DISPLAY

### CLASSIFIED DISPLAY

### CLASSIFIED DISPLAY

### CLASSIFIED DISPLAY

### CLASSIFIED DISPLAY

### CLASSIFIED DISPLAY

### CLASSIFIED DISPLAY

### CLASSIFIED DISPLAY

### CLASSIFIED DISPLAY

### CLASSIFIED DISPLAY

### CLASSIFIED DISPLAY

### CLASSIFIED DISPLAY

### CLASSIFIED DISPLAY

### CLASSIFIED DISPLAY

### CLASSIFIED DISPLAY

### CLASSIFIED DISPLAY

### CLASSIFIED DISPLAY

### CLASSIFIED DISPLAY

### CLASSIFIED DISPLAY

### CLASSIFIED DISPLAY

### CLASSIFIED DISPLAY

### CLASSIFIED DISPLAY

### CLASSIFIED DISPLAY

### CLASSIFIED DISPLAY

### CLASSIFIED DISPLAY

### 142 Roommate Wanted

**ROOMMATE WANTED** - 2 bedroom duplex, close to campus and Overtons, half rent and half utilities. Call Pam 758-6722.

**WANTED**: Female roommate, \$135 per month and half utilities. Available now. Call 758-7345.

**WANTED**: Female graduate student, neat, clean, non-smoker. Must be responsible, academically inclined and considerate. Own room and complete bath. \$125 month plus 1/2 utilities. Call 758-5633.

### CLASSIFIED DISPLAY

### CLASSIFIED DISPLAY

### CLASSIFIED DISPLAY

### CLASSIFIED DISPLAY

### CLASSIFIED DISPLAY

### CLASSIFIED DISPLAY

### CLASSIFIED DISPLAY

### CLASSIFIED DISPLAY

### CLASSIFIED DISPLAY

### CLASSIFIED DISPLAY

### CLASSIFIED DISPLAY

### CLASSIFIED DISPLAY

### CLASSIFIED DISPLAY

### CLASSIFIED DISPLAY

### CLASSIFIED DISPLAY

### CLASSIFIED DISPLAY

### CLASSIFIED DISPLAY

### CLASSIFIED DISPLAY

### CLASSIFIED DISPLAY

## Census Notes Smaller Family Sizes In U.S.

By RANDOLPHE SCHMID  
Associated Press Writer

WASHINGTON (AP) — The average American household contained fewer people than ever last year, while families with children increasingly were headed by a single parent, the Census Bureau says.

The decline in the size of the household, from an average 2.73 persons in 1983 to 2.71 in 1984, resumes a trend which had been strongly under way since the 1960s.

Also reflecting a dramatic post-1960s phenomenon, more than one in four families with children last year were headed by one parent, the Census Bureau said Tuesday.

The maturing of the post-World War II Baby Boom generation helped spur the decline in overall family size, with many young people setting up households on their own and young couples postponing children to pursue education and careers.

At the same time, more and more elderly people continue to maintain households on their own rather than moving in with their children, a trend that also helps lower the average size of households.

Nonetheless, after falling from 2.76 in 1980 to 2.73 in 1981, the per-household average held steady until last year's drop.

Some sociologists speculated that family size had evened out because weak economic conditions discouraged the formation of new households. Thus improvements in the economy and increased public confidence may have led to the resumed decline found in the new study.

While household size has declined most steadily since the 1960s, the trend has been a way of life throughout the nation's history.

The first census in 1790 found an average of 5.79 persons per household. That slipped below five persons by 1890 and below four in 1940, after which it leveled off, fluctuating only slightly until the average reached 3.34 in 1961 and then began falling steadily.

But as household size has fallen, the number of one-parent situations has shot upward. Single-parent family groups constitute 25.7 percent of

all family situations, up from 21 percent in 1980 and only 12.9 percent in 1970, the bureau reported.

Prime reasons for this change were cited as premarital birth separation and divorce.

While the increase occurred among both black and white families, blacks reported a considerably higher ratio of one-parent situations totaling nearly three out of five families in 1984, Census officials said.

The new study found 59.2 percent

## Reagan Moves On With Tax Package

By W. DALE NELSON  
Associated Press Writer

WASHINGTON (AP) — President Reagan is continuing to work on a tax overhaul plan to be presented to Congress next week, despite a suggestion by Senate Majority Leader Robert J. Dole that he wait until the House has approved a budget plan for 1986.

Reagan huddled with Secretary of the Treasury James A. Baker III and their aides Tuesday, but Albert R. Brashear, a deputy White House press secretary, said no decisions were made. Brashear said the meetings would continue today.

White House spokesman Larry Speakes said that after an overhaul plan is agreed upon, it will take three or four days for the Treasury Department to prepare the papers for use in presenting the plan to Congress and the public.

Speakes has said the president is aiming for an announcement next week.

"A number of options and opportunities are under consideration," he said. "A speech is certainly an option, either on television or to a group."

But Dole, speaking to reporters on Capitol Hill, urged a delay in the presentation, saying, "Once the tax thing is out, all the focus is going to shift" and "it will take the pressure off" reducing spending as a means to cut the deficit. The House is working on a 1986 federal budget blueprint this week and leaders were hoping for a full floor debate by next week.

Dole also said, however, "I think if the president makes an all-out campaign, it will have a chance (of passage this year) if we stay in through December," Dole said. "This would put it in the possible category... not impossible."

Reagan's plan is expected to be patterned on the recommendations made by the Treasury Department

last November, when the agency was headed by Donald T. Regan, now the White House chief of staff.

That plan would reduce tax rates and boost the personal exemption while taking away or limiting many deductions. For business, the November plan would mean lower rates but loss of two major investment incentives: generous depreciation allowances and the investment tax credit.

The president has approved a plan that would double the personal income tax exemption to \$2,000, lower individual tax rates and eliminate many popular deductions and tax breaks, The Washington Post reported in today's editions. The Reagan-backed proposal includes a three-tiered individual income tax rate structure and a minimum tax for corporations, it said.

Reagan will launch his tax plan with a nationally televised address on Monday, the newspaper said.

Regan has said the main changes from the November plan to Reagan's proposal would be in the areas of capital gains, charitable contributions and business depreciation. The November plan would repeal the preferential tax rate for capital gains, allow itemizers to deduct only the portion of contributions that exceed 2 percent of income and end the special charitable deduction for people who do not itemize deductions.

Congressional sources have said the new administration plan also would back away from the proposal to repeal special tax breaks for the oil industry. Rep. Dan Rostenkowski, D-Ill., whose Ways and Means Committee must originate tax legislation in Congress, told reporters "if what I read in the papers is true, he (Reagan) is going to lose some votes" by allowing those and similar tax breaks to remain in the law.

## Phony Report Cards Done On Home Computer

GONZALES, La. (AP) — Two 11th-graders who used a home computer to produce fake report cards probably were planning to go into business selling the phony documents, their high school principal said.

"They copied the exact form and then changed the grades," East Ascension High School principal Joel Meredith said Tuesday. "On their computer, they could do that," he said.

Aside from the elevated grades and a slight difference in the color of the ink on the home printer, the forgeries were identical, he said.

"In my opinion, they were not selling them. But I think they were getting ready to start," Meredith said. "If they did sell them, they only sold two or three."

### Demonstration

BONN, West Germany (AP) — Police arrested 29 people, including four members of the European Parliament, for demonstrating in front of the South African Embassy, authorities said.

Police said the demonstrators were taken into custody Monday after they refused to disperse, and were released after identification checks.

The demonstrators tried unsuccessfully to deliver a petition to the South African ambassador expressing support for 16 leaders of the United Democratic Front who are facing trial in South Africa, police said. The front is a multi-racial coalition opposed to the apartheid policies of South Africa's white-minority government.

### Copeland Praised

LONDON (AP) — Violinist Isaac Stern, performing at Britain's first American Festival of the arts, praised the music of Brooklyn-born Aaron Copeland, whom he called "the most American of American composers."

"There was a time a few years ago in a festival of contemporary music when you couldn't tell if the work came from Germany, Japan, the United States, France, or Lower Slavonia," Stern, 64, said during a rehearsal break.

But the Russian-born musician said, "You can smell the earth of America" in music by Copeland, whose violin sonata he performed Monday night.

BE

WHAT

AT FOODLAND  
SPECIALS FOR  
LION, AND V  
PAPER ADS  
AND MONEY  
CIALS. SHO  
FOODLAND  
MORE SPECI

WH

SMOKED

5

GR

"M  
EVERY SUN

DELTA  
TOWELS  
PP-59

DEL MONTE  
CATSUP  
32 OZ. BOTTLE

ARMOUR  
TREET  
12 OZ. CAN

SHENANDOAH  
APPLESAUCE

PET RITZ  
DEEP DISH  
PIE SH  
PKG. OF 2

MAOLA  
ICE  
CREAM . . .  
1/2 GALLON

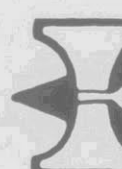

1212 N. Green  
Mon.-Wed. 8 A  
Thurs.-Sat. 8

# piggly wiggly

PRICES EFFECTIVE MAY 15-18  
WE RESERVE THE RIGHT TO LIMIT QUANTITIES.  
NONE SOLD TO DEALERS OR RESTAURANTS.  
WE GLADLY ACCEPT U.S.A. FOOD STAMPS.



**U.S.D.A. CHOICE GRADE BEEF**

**WHOLE SIRLOIN TIPS**

**149** LB.

**WHOLE BONELESS STRIPS**

**298** LB.

**BONELESS STRIP STEAK**

**398** LB.

**SMALL, LEAN SMOKED PICNICS**

**59¢** LB.

**PRICE BLITZ!**

**COCA-COLA, TAB SPRITE, DIETS**

**CAFFEINE & SUGAR FREE**

**99¢**

TWO LITER BOTTLE  
LIMIT 2 PLEASE!  
ADDITIONAL \$1.09 EACH

**PRICE BLITZ!**

**BRAWNY TOWELS**

**JUMBO ROLLS**

**2/100**

**PRICE BLITZ!**

**TOTINO'S PIZZA**

**98¢** 10.5 OZ.

**FRESH GROUND BEEF**

(3-LBS. OR MORE)

**89¢** LB.

**HOUSE OF RAEFORD FRESH WHOLE FRYERS**

**38¢** LB.

LIMIT 4, PLEASE!

**BROOKWOOD FARMS OR PEANUT CITY COUNTRY HAMS**

**128** LB.

SLICED FREE!

**MAXWELL HOUSE INSTANT COFFEE**

**359** 8 OZ.

**Wexford** by ANCHOR HOCKING

**20% OFF** FEATURED ITEMS!

**THIS WEEK'S FEATURE ITEM:**

**Beverage Glass**

**79¢** EACH

With Each \$5.00 Purchase Matching Accessories Also Available. See Store Display For Complete Details.  
Regular Retail 99¢

**FROSTY MORN WEINERS**

12-OZ. PKG.

**79¢**

**FROSTY MORN SLICED BACON**

12-OZ. PKG.

**99¢**

**CHITTERLINGS**

10-LB. BUCKET

**399**

**PIGGLY WIGGLY SALT**

26-OZ.

**4/100**

**MAZOLA CORN OIL**

25¢ OFF

**159** 32 OZ.

**DR. PEPPER, 7-UP SUGAR FREE & DIETS**

**99¢**

TWO LITER BOTTLE

**STAR'S PIMENTO CHEESE SPREAD**

15-OZ. CUP

**1.29**

**OSCAR MAYER COOKED HAM**

12 OZ.

**299**

**PIGGLY WIGGLY HOT OR MILD ROLL SAUSAGE**

1 LB.

**97¢**

**KRAFT PARKAY**

1 LB.

**2/109**

**KRAFT DELUXE MACARONI & CHEESE DINNERS**

14 OZ.

**99¢**

**GOLDEN BEST TOMATOES**

4 FOR **100**

16 OZ. LIMIT 4

**PIGGLY WIGGLY WORLD OF PRODUCE**

"Freshest Buys In Town"

**WHITE POTATOES**

**169** 20-LB. BAG

**EXTRA LARGE TOMATOES** LB. **39¢**

**CELERY** 3 STALKS FOR **100**

<b>FRESH OKRA</b> LB. <b>89¢</b>	<b>GREEN PEPPERS</b> PODS <b>6/100</b>	<b>WESTERN D'ANJOU PEARS</b> LB. <b>59¢</b>	<b>FRESH CAULIFLOWER</b> <b>119</b>
----------------------------------	--	---	-------------------------------------

**PLANTER'S COCKTAIL PEANUTS**

REGULAR, UNSALTED, SPANISH

**189** 12 OZ.

**PIGGLY WIGGLY 1/2% LO-FAT MILK**

GAL. **159**

**GOLDEN BEST SLICED AMERICAN CHEESE SINGLES**

**99¢** 12 OZ.

**PIGGLY WIGGLY VITAMIN "D" MILK**

GALLON JUG **189**

<b>SEALTEST CULTURED OR NUGGET BUTTERMILK</b> QT. SIZE <b>2/100</b>	<b>PIGGLY WIGGLY 1 1/2% LOW FAT MILK</b> GALLON JUG <b>179</b>
---	--

**MERICO BIG TEXAS BUTTERY FLAVORED BISCUITS**

12-OZ. CAN **3/100**

**COUPON**

**GENERIC BATHROOM TISSUE**

4-ROLL PKG. **49¢**

LIMIT ONE WITH THIS COUPON AND A \$7.50 FOOD ORDER. COUPON EXPIRES 5/18/85

PLU-26

**COUPON**

**PIGGLY WIGGLY CANNED DRINKS**

12-OZ. **FREE!**

LIMIT ONE WITH THIS COUPON AND A \$7.50 FOOD ORDER. COUPON EXPIRES 5/18/85

PLU-27

**COUPON**

**GRADE "A" EXTRA LARGE EGGS**

DOZEN **29¢**

LIMIT ONE WITH THIS COUPON AND A \$7.50 FOOD ORDER. COUPON EXPIRES 5/18/85

PLU-28

**Open**

**7 AM to Midnight**

**Seven Days A Week**

**Shop PIGGLY WIGGLY**

**COUPON**

**DUNCAN HINES CAKE MIX**

18-OZ. SIZE **49¢**

LIMIT TWO

LIMIT ONE WITH THIS COUPON AND A \$7.50 FOOD ORDER. COUPON EXPIRES 5/18/85

PLU-29

**COUPON**

**TREND LAUNDRY DETERGENT**

42-OZ. SIZE **59¢**

LIMIT ONE WITH THIS COUPON AND A \$7.50 FOOD ORDER. COUPON EXPIRES 5/18/85

PLU-30

**COUPON**

**SUNSET GOLD ICE MILK**

HALF GALLON **89¢**

LIMIT ONE WITH THIS COUPON AND A \$7.50 FOOD ORDER. COUPON EXPIRES 5/18/85

PLU-31

**PIGGLY WIGGLY KEEPS AMERICA SHOPPING WITH EVERYDAY LOW PRICES!**

**Crossword By Eugene Sheffer**

- ACROSS**
- 1 Balloon fill
  - 4 Ice cream holder
  - 8 "The Man in Black"
  - 12 Fib
  - 13 War god
  - 14 Table spread
  - 15 Greek peak
  - 16 Blowhard
  - 18 African tribe
  - 20 Soak
  - 21 Spoken
  - 24 Frozen
  - 28 Lunch container
  - 32 Hindu queen
  - 33 Conger
  - 34 Takes the part of
  - 36 Many secs.
  - 37 A Biblical people
  - 39 Doctor's trademark
  - 41 Roundup
  - 43 French verb
  - 44 Large cask
  - 46 Follow
  - 50 Trifle
- 55 Endeavor**
- 56 Inland sea**
- 57 Levantine ketch**
- 58 Mature**
- 59 Haunches**
- 60 Son of Adam**
- 61 Garden plot**
- DOWN**
- 1 Fluent
  - 2 Verdi
  - 3 Author
  - 4 Actors
  - James and Charles
  - 11 Mortar
  - 17 Haze
  - 19 Haul
  - 22 Ancient
  - 23 Soup
  - 25 Mary's pet
  - 26 Dolphin
  - 27 — dong
  - 28 Tavern
  - 29 San —
  - 30 Fetid
  - 31 Hole in a casting mold
  - 35 Shriek
  - 38 Gold
  - 40 Author
  - 42 Empire's call
  - 45 Monster's loch
  - 47 Rash
  - 48 Strong
  - 49 Ogled
  - 50 Ebenezer's remark
  - 51 Onassis
  - 52 Breach
  - 53 New
  - 54 Illumined
- Avg. solution time: 22 min.**
- 5-15**

EPER ERNE THY  
LIAR NAIL YEA  
FERROTYPE PAM  
ARE MEETS  
BUTTE PELT  
ANYA STANDARD  
TIP COAST CUE  
STEWARDS BENE  
WINE POSED  
CARTA PERT  
OBI PROTOTYPE  
RUT EARN LEARN  
ETE GETA ENDS

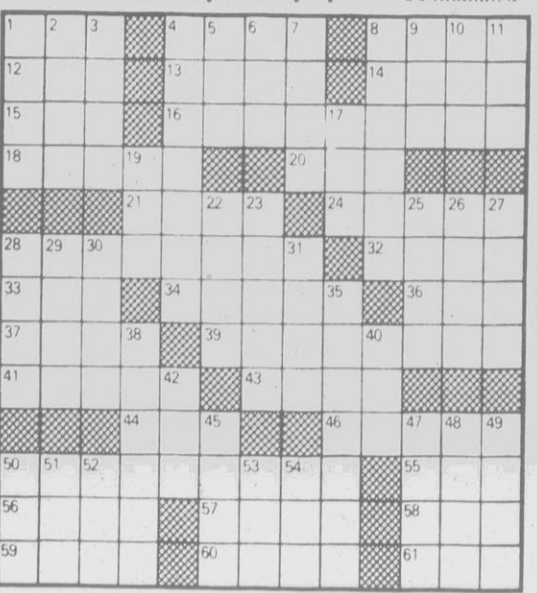

Ans. to yesterday's puzzle. 54 Illumined

**CRYPTOQUIP**

5-15

G N L L U H B B A I M K E G H K Z M S J I K

X N E E I X L N A A U B N C Z M S J K M M C X

Yesterday's Cryptiquip: FINE, SKILLFUL SAUNA WORKER WANTS TO THROW IN THE TOWEL.

Today's Cryptiquip clue: A equals L

The Cryptiquip is a simple substitution cipher in which each letter used stands for another. If you think that X equals O, it will equal O throughout the puzzle. Single letters, short words, and words using an apostrophe can give you clues to locating vowels. Solution is accomplished by trial and error.

**More American Babies Are 'Wanted'**

WASHINGTON (AP) — An increasing share of babies born in this country are the result of "wanted" pregnancies, although parents continue to have problems scheduling the new arrivals, a new government report indicates.

The proportion of births to married women "that resulted from unwanted pregnancies declined significantly and, of course, the proportion of births that were wanted rose correspondingly" between 1973 and 1982, the National Center for Health Statistics reported Monday.

The center said unwanted pregnancies led to 10 percent of births to married or formerly married women in 1982, down from 14 percent in the earlier study.

Wanted births rose correspondingly from 86 percent to 90 percent, the study said. However, during the same period the share of wanted but mistimed births climbed slightly, from 26 percent to 28 percent, the agency said.

The agency, a part of the Department of Health and Human Services, defined a "wanted" birth as one in which the mother intended to have a child at some point, although not necessarily at the time the conception occurred.

"It is important to emphasize that an 'unwanted birth' is not necessarily an 'unwanted child,' many children whose conceptions were not wanted nonetheless become cherished members of their families," noted the study by William F. Pratt and Marjorie C. Horn.

The 1982 study showed that the proportion of unwanted births increased as women aged. For example, in the 20-to-34 age groups unwanted children made up 6 percent to 8 percent of all pregnancies.

However, they constituted 10 percent of births to women aged 35-to-39 and 13 percent in the 40-to-44 age group.

"The notably higher proportions of unwanted and mistimed births to formerly married women suggest the possibility that unplanned childbearing is a factor in the instability of some marriages," the study suggested.

While the study did not seek to ascribe reasons for the increasing share of "wanted" births, the change has occurred at a time when sterilization has moved into first place as a method of birth control.

Since sterilization is virtually 100 percent effective, it removes the possibility of unwanted births for couples who want no more children.

However, those merely postponing families cannot choose sterilization because it is irreversible, and must make do with other methods.

Fears about side effects of the birth control pill and intrauterine devices have led to a decline in the use of those more effective methods by many people in recent years.

Thus, the study by Pratt and Ms. Horn commented, the increase in mistimed births "may be due in large measure to the trend toward greater use of barrier methods of contraception which are generally less effective than the pill or IUD."

**Radio Shack®**

Watch the Seventh Van Cliburn International Piano Competition Tuesday, June 4 at 9 p.m. EDT on Your Local PBS Channel  
Broadcast Made Possible by Grants from Tandy Corporation/Radio Shack and Mobil Oil Corporation

**3-DAY ELECTRONICS SALE!**

<p><b>Clock Radio and Cordless Phone</b> Chronofone™ ET-380 by Radio Shack</p> <p><b>Save \$90</b> <b>5995</b> Reg. 149.95</p> <p>■ Cuts Nightstand Clutter ■ AM/FM Radio Mutes When You Pick Up Handset</p> <p>60% off! Phone lets you make and take calls room-to-room. Battery backup if AC fails. Pulse dialing. #43-274 Backup battery extra. FCC registered.</p>	<p><b>Video Color Processor</b> By Archer®</p> <p><b>HALF PRICE</b> <b>4995</b> Reg. 99.95</p> <p>Puts you in control of your VCR! Improves color from prerecorded tapes, off-the-air recordings and video cameras #15-1275.</p>	<p><b>Under-Dash Cassette</b> By Realistic®</p> <p><b>Save \$30</b> <b>6995</b> Reg. 99.95</p> <p>Dolby™ B NR Cuts Hiss</p> <p>Auto-reverse plays both sides of tapes. Auto-Search. 24-watts output power. #12-1982 TM Dolby Laboratories Licensing Corp.</p>
<p><b>AM/FM LED Clock Radio</b> Chromatic®-230 by Realistic</p> <p><b>Cut 42%</b> <b>2788</b> Reg. 47.95</p> <p>Battery Backup</p> <p>Wakes you on-time, every time! Battery backup operates alarm if AC fails. Snooze-bar, sleep function. #12-1537 Backup battery extra.</p>	<p><b>Versatile Multitester</b> By Micronta®</p> <p><b>43% Off</b> <b>2288</b> Reg. 39.95</p> <p>For household and auto electronics. Measures AC and DC volts, DC amps and resistance. With test probes, manual. #22-204 Batteries extra.</p>	

**FORECAST FOR THURSDAY, MAY 16, 1985**

**YOUR DAILY Horoscope**  
from the Carroll Righter Institute

**GENERAL TENDENCIES:** A good day to start putting into motion new plans or courses of action that appeal to you, and the more up-to-date they are in nature the better.

**ARIES (Mar. 21 to Apr. 19)** Early get some new course started that is inspiring in some new direction not tried before.

**TAURUS (Apr. 20 to May 20)** Confer with experts confidentially and gain the information you require. Then make plans that are important.

**GEMINI (May 21 to June 21)** Contact those you have met recently and turn them into valuable friends. Entertain them charmingly.

**MOON CHILDREN (June 22 to Jul. 21)** A good day to get into more modern methods of operating so that you become more successful in your career.

**LEO (Jul. 22 to Aug. 21)** You are inspired how to gain greater knowledge and development and should waste no time in carrying through with your ideas.

**VIRGO (Aug. 22 to Sept. 22)** Find the right system under which to operate so that your business will fare much better. Gain valuable suggestions.

**LIBRA (Sept. 23 to Oct. 22)** Listen carefully to the suggestions which a clever associate gives you and utilize them to your advantage.

**SCORPIO (Oct. 23 to Nov. 21)** Use a new system that can make your work easier yet productive of greater benefits. A co-worker could give you a fine idea.

**SAGITTARIUS (Nov. 22 to Dec. 21)** Plan the entertainment with congenials early so that all will go well. Then get busy handling practical affairs efficiently.

**CAPRICORN (Dec. 22 to Jan. 20)** Doing something now that will bring in greater security is wise, so figure out how this can be accomplished.

**AQUARIUS (Jan. 21 to Feb. 19)** Become more cognizant of modern ways to operate and you can produce far more in daily routines.

**PISCES (Feb. 20 to Mar. 20)** Try to see experts you know and they will give you invaluable information you need. Get your possessions improved.

**IF YOUR CHILD IS BORN TODAY ...** he or she will be interested in the ultra-modern and will frequent places and do things you had never even heard about, but don't let this bother you too much, since your progeny is mapping out a future that can bring a good deal of success, provided you teach to finish whatever is started.

"The Stars impel; they do not compel." What you make of your life is largely up to you!  
© 1985, The McNaught Syndicate, Inc.

**Hurry—Last Days to Save on These Items!**

<p><b>LCD B&amp;W Pocket TV Slashed 30%</b> PocketVision™ by Realistic</p> <p><b>Save \$60</b> <b>13995</b> Reg. 199.95</p> <p>Low As \$20 Per Month on CitiLine®</p> <p>2.7" screen flips up for easy viewing. 15/16 x 5 9/16 x 3". #16-151 Batteries extra. For dim light, backlight hood available on special order.</p>	<p><b>CB With Ch.9/19 Priority Switch</b> TRC-414 by Realistic</p> <p><b>HALF PRICE</b> <b>5995</b> Reg. 119.95</p> <p>Priority Switch Gives You Emergency Ch.9 or Highway Ch.19 Instantly</p> <p>Add the safety, convenience and just plain fun of CB to your car now and save! LED channel display. #21-1508</p>
<p><b>Car Cassette With 3-Way Speakers</b> By Realistic</p> <p><b>Save \$60</b> <b>14990</b> Reg. Separate Items 209.90</p> <p>Low As \$20 Per Month on CitiLine®</p> <p>DIN-size in-dash cassette with auto-reverse. Dolby B NR. Flush-mount 5 1/4" speakers with 20-oz. magnets. #12-1913/1856</p>	<p><b>24K Model 100 Portable Computer</b> By Radio Shack</p> <p><b>HALF PRICE</b> <b>49900</b></p> <p>Low As \$23 Per Month on CitiLine®</p> <p>Originally 999.00 in 1984 Cat. RSC-11 (interim markdowns taken)</p> <p>Built-in word processor, address/phone directory, appointment scheduler. BASIC. #26-3802 Batteries extra</p>

<p><b>Portable Cassette</b> STEREO-MATE™ SCP-12 by Realistic</p> <p><b>38% Off</b> <b>4995</b> Reg. 79.95</p> <p>Headphones, batteries extra. Enjoy stereo tapes anywhere! Auto-reverse. #14-1026</p>	<p><b>Classic-Style Phone</b> Fashion-Fone™ by Radio Shack</p> <p><b>Cut 29%</b> <b>4995</b> Reg. 69.95</p> <p>Adds a Nice Touch to Any Desk</p> <p>Switchable Touch-Tone/pulse dialing. #43-330 FCC registered</p>	<p><b>Desk/Wall Telephone</b> By Radio Shack</p> <p><b>33% Off</b> <b>2995</b> Reg. 44.95</p> <p>Switchable Touch-Tone/pulse dialing. #43-513 FCC registered</p>	<p><b>LCD Alarm Clock</b> By Micronta</p> <p><b>Cut 33%</b> <b>1195</b> Reg. 17.95</p> <p>Folds to 5/8" Thin</p> <p>Backlight, snooze control. #63-705</p>
<p><b>Fold-Up Headphones</b> Nova™-52 by Realistic</p> <p><b>HALF PRICE</b> <b>995</b> Reg. 19.95</p> <p>Feathery light, with adjustable headband. #33-979</p>	<p><b>Electronics Lab Kit</b> By Science Fair®</p> <p><b>35% Off</b> <b>1295</b> Reg. 19.95</p> <p>Build 50 projects. Coil-spring assembly. #28-227 Batteries extra</p>	<p><b>Smoke Detector/Alarm</b> By SAFE HOUSE®</p> <p><b>36% Off</b> <b>1088</b> Reg. 16.95</p> <p>For Wall Or Ceiling</p> <p>Protect your home and family! With battery. #49-455</p>	<p><b>Chrono-Alarm Watch</b> By Micronta</p> <p><b>Cut 40%</b> <b>1188</b> Reg. 19.95</p> <p>A clock, stopwatch and calendar. With battery. #63-5057</p>

Check Your Phone Book for the Radio Shack Store or Dealer Nearest You

\*CitiLine revolving credit from Citibank. Payment may vary depending upon balance.

A DIVISION OF TANDY CORPORATION

PRICES APPLY AT PARTICIPATING STORES AND DEALERS

VISA, MasterCard, Discover, CitiLine

CHARGE IT (MOST STORES)

**Soviet Republic Gets Cold Snap**

MOSCOW (AP) — A cold snap in Kazakhstan that sent temperatures plunging as much as 70 degrees over a few hours has blanketed the southern republic with snow and damaged cattle, grain and vegetable crops, Soviet media reported.

The official news agency Tass on Monday issued a brief account of the sudden change in weather on its Russian language service, and the evening news program Time showed fields of tomato plants poking through the snow cover.

Tass said as much as 4 inches of snow fell in places and that nearly the entire republic was hit by the mass of cold air that dropped temperatures from 81 degrees to 10 degrees in just a few hours.

Masses of cold air swept south from the Kara Sea were responsible for the cold snap, Tass said.

# FOCUS



**That's Stretching It**

On this day in 1940, the first nylon stockings were put on sale. The first nylon fibers were made of chemicals distilled from coal, air and water. Nylon was considered a revolutionary material because it was strong, tough and elastic. During World War II, the United States Army replaced its silk parachutes with ones made of nylon. Today nylon is found in products ranging from dresses, underwear, carpets and upholstery to brushes, surgical thread, machine parts, and fishing line.

**DO YOU KNOW** — What major chemical company was the first to produce nylon commercially?

**TUESDAY'S ANSWER** — Sacajawea served as Lewis and Clark's interpreter and guide.

5-15-85

Knowledge Unlimited, Inc. 1985

## How They Voted

WASHINGTON — Here's how area members of Congress were recorded on major roll call votes May 2-8.

### House

**THE RECORD** — The House voted, 245 for and 184 against, in favor of the softer of two proposed investigations of the accuracy of the Congressional Record, the publication that is supposed to chronicle all that happens on the House and Senate floors.

Democrats prevailed as the vote referred the matter to the Administration Committee, rather than to the Rule Committee as House Republicans has requested.

If a member does not deliver a speech but inserts written comments into the Record, his remarks are supposed to be typographically distinguished from words actually uttered.

Partly at issue on this vote was the fact that written material recently inserted by two Democratic members was incorrectly identified as speeches actually delivered.

Republicans wanted the Rules Committee to look into that discrepancy as well as into the overall integrity of the Congressional Record.

Thomas Foley, D-Wash., who favored sending the matter to the Administration Committee for a less-exhaustive probe, attributed the misidentification of the Democrats' written comments to clerical error.

Charles Pashayan, R-Calif., said the Record must be made a more accurate chronicle of floor proceedings because judges and historians rely on it to determine legislative intent.

Members voting no favored the tougher of two proposed investigations of the Congressional Record.

North Carolina representatives voting yes were Walter Jones, D-1; Tim Valentine, D-2; Charles Whitley, D-3; Stephen Neal, D-5; Charles Rose, D-7, and W.G. Hefner, D-8.

Those voting no were William Cobey, R-4; Howard Coble, R-6; Alex McMillan, R-9; James Broyhill, R-10, and Bill Hendon, R-11.

### Senate

**PAY CUT** — By a tie vote of 49-49, the Senate rejected an amendment to slash the salaries of senators and House members by ten percent. The proposed \$7,510 cut would have lowered lawmakers' pay to \$67,590.

Members of Congress in January received a 3.5 percent pay hike, following a 1984 increase of four percent.

This amendment was offered to the congressional budget blueprint (S Con Res 32) for fiscal years 1986-88. The measure, which remained under debate, sets spending priorities and limitations but stops short of releasing federal outlays.

Congress later in the year will implement the blueprint when it

### Siege Ends

ATHENS, Greece (AP) — About 30 young anarchists have ended a five-day takeover of Athens University's chemistry school after 16 of their supporters were released from custody.

An Athens district attorney ordered the release of 16 people detained on charges of causing injuries and damaging property in clashes with police last week.

Anarchists occupied the chemistry building Thursday after police banned a planned anti-government march. They barricaded the street in front of the building with filing cabinets and desks, threatened to blow up the five-story building, and hurled fire bombs and stones at police riot officers.

Police said more than 40 officers were injured during the occupation.

takes up authorization and appropriation bills.

Jesse Helms, R-N.C., who sponsored the pay cut, said "I hear constantly in this chamber and across the country that the burden of reducing the federal deficit must be shared by all."

Opponent Carl Levin, D-Mich., said: "The goal of shared sacrifice is to be fair, not punitive, and should not be exploited for political or partisan gain."

Senators voting no were opposed to cutting congressional salaries by ten percent.

North Carolina Sen. Jesse Helms voted yes. Sen. John East did not vote.

**DEFENSE** — By a vote of 48 for and 51 against, the Senate refused to kill an amendment in behalf of lower defense spending than President Reagan wants in fiscal 1986-88. This occurred during debate on the congressional budget blueprint (above).

The vote sustained a proposal that defense outlays be allowed to rise only to keep pace with inflation. By contrast, Reagan has recommended a 1986 defense hike equivalent to the inflation rate plus three percent, down from the six percent "real growth" hike he originally requested.

The vote would permit 1986 defense outlays of \$273.1 billion.

Strom Thurmond, R-S.C., who voted to kill the amendment, said senators should "have the courage and have the wisdom not to cut the defense budget below a three percent growth. We need that growth to keep this country free."

Disagreeing, Mark Hatfield, R-Ore., said "any nation that is a debtor nation, carrying a \$200 billion budget deficit and a \$140 billion trade deficit, is not a secure nation in any sense of the word."

Senators voting no favored the lesser of two proposed hikes in defense spending.

North Carolina Sen. Jesse Helms voted yes. Sen. John East did not vote.

**HIKES** — The Senate voted, 80 for and 18 against, to permit full cost-of-living adjustments (COLAs) in fiscal 1986-88 for retired civil service and congressional employees, military retirees, recipients of black lung and veterans compensation benefits, and all other federal pensioners.

The vote is expected to increase deficit spending by \$11 billion over three years. It occurred during debate on the congressional budget blueprint (above).

President Reagan had requested lower COLAs — of about two percent — for Social Security recipients and all other federal pensioners. In a previous vote, the Senate restored full Social Security COLAs, at a projected cost of \$22 billion over three years.

Senators voting yes favored full cost-of-living adjustments for federal pensioners.

North Carolina Sen. Helms voted no. Sen. East did not vote.

**LABELING** — The Senate rejected, 27 for and 68 against, an amendment requiring that artificially sweetened soft drinks be labeled to tell consumers how much aspartame, or NutraSweet, they might contain.

The vote occurred during debate on S 484, which was later passed and sent to the House.

Sponsor Howard Metzenbaum, D-Ohio, said: "I am just saying tell the people how much (aspartame) is in the can. What is so terrible about that and why so much lobbying is taking place against it is beyond my comprehension."

Opponent Orrin Hatch, R-Utah, said it is up to the Food and Drug Administration, not the Congress, to set labeling requirements for products containing aspartame.

Senators voting yes favored labeling to show the quantity of aspartame contained in soft drinks.

North Carolina Sen. Helms voted no. Sen. East did not vote.

# Coal Industry Pollutants Kill Forests

By LARRY GERBER  
Associated Press Writer  
MOST, Czechoslovakia (AP) — The view from the hill is one of a whole town razed for an open-pit mine, a huge factory belching smoke as it converts coal to chemicals, and on the horizon a dead forest — an environmentalist's nightmare.

Movie makers come to Most from around the world when they need scenes of devastation.

Coal, which has been Czechoslovakia's prime energy source for centuries, has killed the woods and polluted the air of northern Bohemia.

The hilltop view takes in a dilemma that confronts not only this region, but the rest of Europe and North America, where coal-fired power plants and other industries are believed to cause acid rain, dirty air and foul water.

The destruction and subsequent protests have prompted Czechoslovakia's communist authorities to rethink their energy policy, and to plan on replacing coal by nuclear and other power sources. But much of the damage will not be repaired.

This town of 60,000, about 45 miles northwest of Prague, was torn down so strip miners could get at the veins of soft coal beneath the picturesque buildings. A dozen of them still stand, used by miners or deserted.

Over the past 20 years, its people have been moved into gray apartment blocks across the highway. Ten years ago the 16th-century Gothic church, a 12,000-ton architectural treasure, was rolled nearly a half-mile away. It now sits on the edge of the coal pit, still on its moving frame, unused.

Down the road, the Chemopetrol factory turns the coal into

chemicals, rubber and other products. Germany started construction of the plant during its occupation of the region in World War II, and for years the plant's stacks have spewed smoke into the sky.

Just a 20-minute drive away, where the Krusne Hory (Ore Mountains) rise to the East German border, fir trees are skeletons on the slopes.

A people who prize their woods and mountain cottages are alarmed.

The Charter 77 dissident group in 1983 warned of "an ecological catastrophe" and cited an unpublished report by the Academy of Sciences predicting that 45 percent to 60 percent of the forests in this thickly wooded country would be dead or damaged by the end of the century.

But officially sanctioned groups also have been calling for action,

and hardly a day passes without an environmental horror tale in the state-run press.

A group called Brontosaurus is probably the nation's most influential environmentalist movement.

It is affiliated with the 1.5 million-member Socialist Youth Union and its influence is steadily increasing.

The name comes from the group's motto: "Brontosaurus wouldn't have survived it," a warning that people may go the way of the dinosaurs if they don't clean up the environment.

Dr. Zdenek Badura wrote in the newspaper Ostrava Vecernik that the deteriorating environment could be affecting people's health.

"New viral illnesses are emerging," he said. "The activity of viruses has grown, and they are assuming new forms unknown to us."



**SAVE \$1.50**

**MONEY SAVING COUPONS**

The Sunflower Group, 15481 West 110th Street, Lenexa KS 66219 (913) 492-2021

MANUFACTURER'S COUPON NO EXPIRATION DATE **10c**



**Save 10¢ when you buy any size or flavor of KRAFT Jams, Jellies, or Preserves.**

RETAILER: Kraft, Inc. will reimburse you for the face value of this coupon plus 8¢ if submitted in compliance with Kraft's Coupon Redemption Policy, previously provided to retailer and incorporated by reference herein. Void where taxed, restricted or prohibited. Cash value 1/100¢. Mail to Kraft, Inc., Dept. 5949, El Paso, TX 79966

**ONE COUPON PER ITEM PURCHASED REDEEM PROMPTLY**

B5-4 **10c**

21000 601100 



## TRY DARK ROAST FROM BRIM®

Decaffeinated Coffee

For a coffee that separates the extraordinary from the ordinary, try **Dark Roast** from **Brim®**. It has a taste that's hearty and robust.

For a smooth, rich taste, try **Brim® Regular Roast** or **Freeze Dried**. Either way, you fill your cup to the rim with the great taste of Brim.

**40c** Save 40¢ when you buy **brim** Dark Roast and Regular Roast available in Auto-Drip® and Percolator grinds.

NOT GOOD ON 07 OZ. OR TRIAL SIZE  
SG017196



43000 33040

MANUFACTURER'S COUPON COUPON EXPIRES SEPTEMBER 30, 1985

**40c** Save 40¢ when you buy **brim** DECAFFEINATED COFFEE

10 This coupon good only on purchase of product indicated. Any other use constitutes fraud. COUPON NOT TRANSFERABLE. LIMIT — ONE COUPON PER PURCHASE

To the retailer: GFC will reimburse you for the face value of this coupon plus 8¢ if submitted in compliance with GFC Redemption Policy 1.1 incorporated herein by reference. Valid only if redeemed by retail distributors of our merchandise or anyone specifically authorized by GFC. Cash value 1/20¢. Mail to: General Foods Corporation, P.O. Box 103, Kansas City, MO 64102

GENERAL FOODS CORPORATION **40c**

Your child may

## Win a \$1000 Toy Shopping Spree

from **Post** and **TOYS 'R' US**





Now your child may instantly win all the toys he can haul (max. \$1000), or a Huffly® Bike in the Post® Cereals Toys 'R' Us® Shopping Spree Game®. To enter, look for specially marked boxes of the Post® Cereals shown above. No purchase necessary.



This coupon good only on purchase of product at store indicated. Any other use constitutes fraud. COUPON NOT TRANSFERABLE. LIMIT — ONE COUPON PER PURCHASE

**Save 25¢** when you buy **PEBBLES** Cereal

SG0B0446



43000 11625

This coupon good only on purchase of product at store indicated. Any other use constitutes fraud. COUPON NOT TRANSFERABLE. LIMIT — ONE COUPON PER PURCHASE

**Save 25¢** when you buy **Super Golden GIPS** Cereal

SG0B0446



43000 11425

This coupon good only on purchase of product at store indicated. Any other use constitutes fraud. COUPON NOT TRANSFERABLE. LIMIT — ONE COUPON PER PURCHASE

**Save 25¢** when you buy **ALPHA-BITS** Cereal

SG0B0456



43000 11525

This coupon good only on purchase of product at store indicated. Any other use constitutes fraud. COUPON NOT TRANSFERABLE. LIMIT — ONE COUPON PER PURCHASE

**Save 25¢** when you buy **HONEY-COMB** Cereal

SG0B0416



43000 11225

This coupon good only on purchase of product at store indicated. Any other use constitutes fraud. COUPON NOT TRANSFERABLE. LIMIT — ONE COUPON PER PURCHASE

**Save 25¢** when you buy **ALPHA-BITS** Cereal

SG0B0456



43000 11525

**HARRIS**  
SUPER MARKETS, INC.  
"Where Shopping Is A Pleasure"

**DISCOUNT**  
ON EVERYTHING BUT QUALITY

We Reserve The Right To Limit Quantities  
We Accept Food Stamps And WIC Vouchers  
PRICES GOOD THRU SATURDAY

Hear Ye!  
Hear Ye!  
Hear Ye!

We Officially  
The 2nd  
Procter & Gamble Ap  
At Harris Su

GRADE A  
**FRYER LEG**  
1/4s  
**39<sup>c</sup>**  
LB.

FRESH PORK  
**SHOULDER PICNICS ... 69<sup>c</sup>**  
LB.

USDA WESTERN BONELESS  
**SHOULDER ROAST**

**\$1<sup>19</sup>**  
LB.

USDA WESTERN BONELESS  
**SHOULDER STEAKS**

**\$1<sup>39</sup>**  
LB.

FRESH PORK  
**NECKBONES OR FEET**  
(5-7 LB. FAMILY PACKS)

**39<sup>c</sup>**  
LB.

FROZEN  
**PORK CHITTERLINGS**

10 LB. PAIL  
**\$3<sup>99</sup>**

FRESH CENTER CUT  
**PORK CHOPS**

**\$1<sup>59</sup>**  
LB.

**LUTERS FRANKS**

12 OZ. **99<sup>c</sup>**

**SMITHFIELD BOLOGNA**

12 OZ. **99<sup>c</sup>**

**JAMESTOWN SAUSAGE**

1 LB. **89<sup>c</sup>**

**SMITHFIELD BACON**

1 LB. **\$1<sup>39</sup>**

USDA WESTERN BONELESS

**CHUCK STEAKS**

**\$1<sup>19</sup>**  
LB.

USDA WESTERN BONELESS

**CHUCK ROAST**

**99<sup>c</sup>**  
LB.

Get up to an **\$8.00 REFUND**  
BY MAIL ON THESE PROCTER & GAMBLE PRODUCTS



PROCTER & GAMBLE PRODUCT  
**LILT SHAMPOO**

CONDITIONER DEEP  
CONDITIONER 11 OZ. **\$2<sup>69</sup>**

PROCTER & GAMBLE PRODUCT  
**PRELL SHAMPOO** 16 OZ. **\$2<sup>39</sup>**

PROCTER & GAMBLE PRODUCT  
**SECRET** 2 OZ. SOLID 1.25 OZ. ROLL-ON 4 OZ. SPRAY **\$1<sup>99</sup>**

PROCTER & GAMBLE PRODUCT  
**HEAD & SHOULDERS** 7 OZ. REGULAR 7 OZ. CONDITIONER **\$1<sup>99</sup>**

PROCTER & GAMBLE PRODUCT  
**WONDRA HAND LOTION** 10 OZ. REG. 10 OZ. UNSCENTED **\$1<sup>99</sup>**

**MILLER LITE BEER**  
6 PAK 12 OZ. CANS

**\$2<sup>49</sup>**

**COORS OR COORS LIGHT**  
6 PAK 12 OZ. CANS

**\$2<sup>49</sup>**



FRESH  
**GROUND BEEF**  
GROUND FRESH DAILY  
**99<sup>c</sup>**  
LB.

FRESH  
**GROUND CHUCK** GROUND FRESH DAILY **\$1<sup>29</sup>**  
LB.

USDA WESTERN WHOLE BONELESS  
**RIB EYES**  
**\$2<sup>99</sup>**  
LB.

USDA WESTERN BONELESS  
**RIB EYE STEAKS** **\$3<sup>89</sup>**  
LB.

Procter & Gamble began as a s  
eration more than 140 years ago  
andle business nor just in the lau  
ness. Growth has taken place into  
goods, coffee, food, and industri  
Greenville facility which produce  
Always mini and maxi sanitary n  
& Gamble's first of two North Car

Procter & Gamble's Greenville p  
1975. The site is located on Old C  
Greenville. Twenty-six of their 33

Procter & Gamble paid out ap  
North Carolina/Greenville area ec  
included over \$10 million in sala  
and over \$115 million for purchas

Most of the approximately 50  
locally.

We would like to honor them for  
minded friend in our community, s  
ing sale items all made by divi  
Company.

Thanks a

DETAILS OF THE MISS USA REFUND OFFER IN OUR STORES

# Proclaim This Annual Appreciation Week Supermarkets

small candle and soapmaking op-  
e. Today they are no longer in the  
laundry and cleaning products busi-  
to household paper products, toilet  
rial and institutional products. The  
ces Attends incontinent briefs, and  
napkins and pantliners, is Procter  
Carolina plants.

plant began operations in August,  
Creek Road just north of the City of  
334 acres are under roof.

approximately \$125 million to the  
economy during the past year. This  
aries paid at the Greenville Plant  
ases of goods and services.

500 plant employees were hired

or being a good neighbor and civic  
so we proudly feature the follow-  
visions of the Procter & Gamble

gain P&G!

**PRODUCE \$2.49**

RED RIPE FLORIDA  
**WATERMELONS**  
EACH

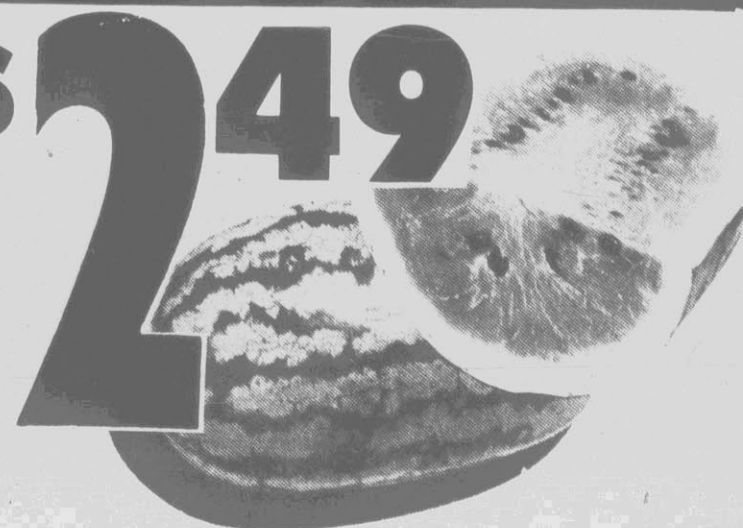

EASTERN  
RED DELICIOUS  
**APPLES**  
3 LB. BAG **89¢**

FRESH GREEN  
**BROCCOLI**  
HEAD **69¢**

CALIFORNIA  
**NAVEL ORANGES**  
4 LB. BAG **\$1.49**

WAXED  
**RUTABAGAS**  
LB. **19¢**

LARGE  
VINE RIPENED  
**TOMATOES**

**39¢**



PROCTER & GAMBLE PRODUCT  
CHARMIN  
**BATHROOM TISSUE**  
4 ROLL PAK **\$1.19**



PROCTER & GAMBLE PRODUCT  
**BOUNTY TOWELS**  
JUMBO ROLL **79¢**



PROCTER & GAMBLE PRODUCT  
**IVORY SOAP**  
4 BAR PERSONAL SIZE 15¢ OFF LABEL **99¢**

PROCTER & GAMBLE PRODUCT  
**PUFFS FACIAL TISSUE**  
250 CT. **\$1.09**



PROCTER & GAMBLE PRODUCT  
DOWNY TRIPLE CONCENTRATED  
**FABRIC SOFTENER**  
21.5 OZ. 45¢ OFF LABEL **99¢**



PROCTER & GAMBLE PRODUCT  
**CRISCO OIL**  
48 OZ. **\$2.49**



PROCTER & GAMBLE PRODUCT  
**DUNCAN HINES CAKE MIX**  
YELLOW, BUTTER RECIPE OR LEMON  
18 OZ. **68¢**



PROCTER & GAMBLE PRODUCT  
**TIDE LAUNDRY DETERGENT**  
GIANT SIZE **\$1.99**



PROCTER & GAMBLE PRODUCT  
**JOY DISHWASHING LIQUID**  
32 OZ. **\$1.59**  
30¢ OFF



PROCTER & GAMBLE PRODUCT  
**CRUSH, ORANGE, GRAPE OR SUGAR-FREE ORANGE**  
2 LITER **89¢**

Look for 30¢ coupon on page 12 in today's Reflector.

PROCTER & GAMBLE PRODUCT  
**SCOPE MOUTHWASH**  
24 OZ. **\$2.79**



PROCTER & GAMBLE PRODUCT  
PRINGLE  
**POTATO CHIPS**  
ALL VARIETIES **99¢**



PROCTER & GAMBLE PRODUCT  
FOLGERS  
**COFFEE**  
13 OZ. FLAKED VACUUM BAG **\$1.99**



PROCTER & GAMBLE PRODUCT  
**DUKE'S MAYONNAISE**  
OT. JAR **99¢**



**PEPSI, DIET PEPSI, MT. DEW**  
2 LITER **\$1.09**



PROCTER & GAMBLE PRODUCT  
DUNCAN HINES  
**FUDGE BROWNIE MIX**  
23 OZ. FAMILY SIZE 20¢ OFF LABEL **\$1.19**

PROCTER & GAMBLE PRODUCT  
**JIF PEANUT BUTTER**  
18 OZ. CREAMY & CRUNCHY **\$1.49**

**IMPERIAL CHARCOAL**  
10 LB. **\$1.39**

## FROZEN FOODS

MR. P'S  
**PIZZAS** . ALL FLAVORS **59¢**

CRINKLE CUT  
**FRENCH FRIES** . 2 LB. **2/\$1.00**

PARADE  
**PIE SHELLS** . . . . . 2 PAK **59¢**

PARADE  
**WHIPPED TOPPING** . . . . . 8 OZ. **59¢**

COUNTRY FRESH  
**ICE MILK** . . . . . 1/2 GAL. ALL FLAVORS **\$1.19**

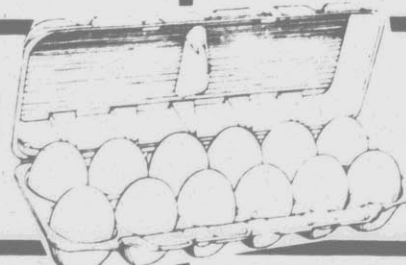

COUNTRY FRESH  
**LARGE EGGS** . 2 DOZEN **\$1.00**

CAROLINA & SEALTEST  
**SKIM MILK** . . . . . 1/2 GAL. **99¢**

COUNTRY FRESH  
**HOMOGENIZED MILK** . . . 1/2 GAL. **99¢**

BORDEN SLICED  
**AMERICAN CHEESE SINGLES** . . 12 OZ. **\$1.39**

PARADE CHILLED  
**ORANGE JUICE** . . . . . 1/2 GAL. CTN. **\$1.19**

PILLSBURY HUNGRY JACK  
**BUTTERMILK BISCUITS** . 10 OZ. **2/89¢**



# Superior Court

Judge Fred Williams disposed of the following cases during the April 1, 1985, term of Superior Court in Pitt County.

John Edward Cotton Jr., Raleigh, careless and reckless driving, 6 months jail suspended on payment of fine and costs.  
Odell Sharpless, Kinston, driving while license revoked, called and failed, bond forfeiture.  
William Arthur Gouras, East Third Street, driving while impaired, order for remand to comply with district court judgment.  
Gregory Wayne Forrest, Shady Knoll Trailer Park, driving while impaired, order for remand to comply with district court judgment.  
Donald Lee Moye, Kinston, driving while license suspended, financial responsibility violation, order for remand to comply with district court judgment.  
John Jeffrey Stamatt, East 12 Street, larceny, 90 days jail suspended on payment of fine, costs, restitution and probation supervision fee, 2 years probation.

Lisa Lane Steen, East 12th Street, larceny, 90 days jail suspended on payment of fine, costs, restitution and probation supervision, 2 years probation.  
Chrissie W. Haddock, Ayden, public assistance fraud, food stamp fraud, 2 years jail.  
George Watson Hamill, Homestead Trailer Park, driving while impaired, 6 months jail suspended, surrender operator's license, remit costs, 30 days jail, 2 years probation.  
Arthur Lee Tyson, Route 1, possession of stolen goods, order for remand to comply with district court judgment.  
Frank Edward Northern, Contentnea Street, driving while license revoked, no liability insurance, order for remand to comply with district court judgment.  
Lynn Bryan Jourden, Fayetteville, driving while impaired, order for remand to comply with district court judgment.  
Janice McLamb Radford, Route 13, driving while impaired, order for remand to comply with district court judgment.  
Isaac Cornelius Smith, Line Avenue, possession of stolen property, 15 months jail pay restitution.  
Joseph Wallace, Route 2, simple assault, 30 days jail suspended on payment of fine, costs, restitution and probation supervision fee, 1 year probation.  
Marvin Earl Wooten, Ayden, driving while impaired, 10 days jail, surrender operator's license, 1 year unsupervised probation.  
Russell Petteway, Bethel, no operator's license, voluntary dismissal.  
Brenda Chaney, Ayden, worthless check, jury verdict - guilty, 21 days jail.  
James Wooten, Hopkins Drive, public assistance fraud, 6 months jail suspended on payment of costs and restitution, 2 years probation.

Lonnie Ray Cherry, Ford Street, unauthorized use of a motor vehicle, 2 years jail suspended on payment of fine and costs, 60 days jail, 2 years probation.  
Curtis Whitaker, Ayden, driving while impaired, 160 days jail, driving while impaired, 160 days jail.  
Michael Ray Lewis, Grifton, driving while impaired, prayer for judgment continued until May.  
Jimmy Anderson, Ford Street, assault on a female, voluntary dismissal.  
Zeno Burnett, Arthur Street, larceny from employer, 3 years jail suspended on payment of fine, costs and restitution, 3 years probation.  
George Cox, Darden Drive, simple assault, 30 days jail.  
Judge Napoleon Barefoot disposed of the following cases during the March 25, 1985, term of Superior Court in Pitt County.  
Danny Taft, Smith Trailer Park, worthless check (5 counts), fail to return hired property, 6 months jail suspended on payment of costs, restitution and probation supervision fee, 2 years probation.  
Billy Ray Mazingo, Farmville, damage to real property, called and failed, bond forfeiture.  
Patty Burrus, Jackson Trailer Court, worthless check, 30 days jail suspended on payment of costs and restitution.  
Edward Lee Godley, Williamston, abandonment and non-support, called and failed, bond forfeiture.  
Jeffrey Wayne Williams, Route 6, shoplifting, 60 days jail.  
Raymond Scott Braddy, Country Paradise Estates, larceny, 60 days jail suspended on payment of costs and fine.  
Jasper Earl Grimes, Winterville, worthless check, order for remand to comply with district court judgment.  
Terry Carroll Hollowell, Hillside Drive, driving while impaired, 12 months jail suspended on payment of fine and costs, 7 days jail, perform 72 hours community service and pay fee.  
Fitzhugh Mills, Hollister, speeding 75/50, called and failed, bond forfeiture.  
Dana Darrell Phillips, Hooker Road, breaking, entering, larceny and possession of stolen goods, called and failed, bond forfeiture.  
Ruby Ann Blount, Norcott Circle, worthless check, 60 days jail suspended on payment of costs and restitution.  
Jimmy Lee Harris, Darden Drive, larceny and possession of stolen goods, 4 years jail, pay restitution and attorney fees.  
Bernice Allen, Cross Street, worthless check (14 counts), called and failed, bond forfeiture.  
Danon Phillips, Paige Drive, possession of stolen goods, called and failed, bond forfeiture.  
Harold Kinston Vines, Route 1, burglary, called and failed, bond forfeiture.  
Curtis Ray Tyson, Darden Drive, breaking, entering and larceny, called and failed, bond forfeiture.  
Clinton Ray Sharpe, Hopkins Drive, shoplifting, called and failed, bond forfeiture.  
Simon David Boone, Greenway Apartments, harassing telephone calls, jury verdict - guilty, 2 years jail, harassing telephone calls (2 counts), 2 years jail, harassing telephone calls (4 counts), 2 years jail, appeal to N.C. Court of Appeals.  
Cecil Gordon Jones, Bethel, assault with a deadly weapon, 30 days jail.  
Herbert Isaac Williams, State Department of Corrections, breaking and entering, 10 years jail, breaking, entering and larceny (2 counts), voluntary dismissal.  
Tracy Elaine Hardee, Cooper Lane, possession of stolen goods, 12 months jail suspended on payment of costs, restitution and probation supervision fee, 2 weekends jail, perform 25 hours community service and pay fee, 2 years probation.  
Melvin Rudolph Smith, Washington, simple assault, 30 days jail suspended on payment of fine and costs.  
William T. Winslow, 10th Street, worthless check (4 counts), order for remand to comply with district court judgment.  
Johnny Morgan, Rocky Mount, larceny from person, 3 years jail, pay restitution.  
Danny Garris, Ayden, sale of marijuana, 2 years jail, maintain vehicle for purpose of keeping marijuana, 12 months jail suspended on payment of fine, costs, probation supervision fee and restitution, perform 50 hours community service and pay fee, 2 years probation; possession with intent to sell and deliver marijuana and possession of marijuana, voluntary dismissal.  
Melvin Williams, Ayden, larceny, 6 months jail suspended on payment of fine, costs and restitution, 1 year probation.  
David May, Bell Arthur, take indecent liberties with a minor, 10 years jail, sexual offense (2 counts), voluntary dismissal.  
Reginald Peterson, Cherry Street, simple assault, 10 days jail.  
Harold Stevenson, West 12th Street, possession of stolen goods, uttering a forged check (7 counts), 4 years jail, pay restitution.  
Mary A. Williams, Raleigh, public assistance fraud, 3 years jail suspended on payment of costs and restitution, 3 years probation.

# Deeds

City of Greenville TO Ollie A. Harrington al -  
Wade H. Lewis al TO Wade H. Lewis al -  
Charles A. Lewis Jr. al TO Clyn W. Barber Jr. al 45.00  
Charlie Mack Long al TO Charles C. Watts Jr. 11.50  
U.S.-FmHA TO Donna J. Phillippe - Preferred Properties of Greenville Inc. TO Chapin & Assoc. Inc. -  
Rollins Clustered Homes TC McKenny White Egerton II 57.00  
Don Redden Warren Sr. al TO Dept. of Trans. 76.50  
Michael L. Aldridge al TO Upton Ct., Homeowners Assoc. of Greenville -  
NCNB TO Elmer L. Rook Jr. al 99.00  
Bowser B. Bradshaw TO Brenda B. Martin -  
Eleanor A. Burnette TO Richard A. Langley al 10.00  
James S. Carroll al TO Thomas S. Coltrain al -  
Anthony Myles Cartrette al TO John Thomas Woodley al 52.50  
Chapin & Assoc. Inc. TO Sheldon L. Miller al 43.50  
Dixie Supply Co. of Greenville Inc. TO Stanley Peaden Bldrs. Inc. 31.50  
H. Oscar Edwards al TO Michael W. Purser al 60.50  
City of Greenville TO General Heating Inc. -  
Carrie Bell Harris TO Seymour Smith -  
Alma Stokes Johnson TO Jack Riddick Crawford al -  
Kensington Develop. Corp. TO Micael L. Aldridge al -  
James A. Nelson Sr. Com'r TO Seymour Smith 15.00  
Stanley Peaden Bldrs. Inc. TO Gary Walter Bush al 142.50  
Alyra Ray Taylor al TO A.T. Leary Jr. 54.00  
U.S.-FmHA TO Regina M. Carmon  
Mary D. Ward TO Charles H. Duke al 57.00  
Vernon E. White al TO Garfield Carmon al -  
Leroy Wilson al TO Robert Lee Moore al -  
Cartrette Const. Co. TO Eugene Scott Lewis al 51.00  
Bill Clark Const. Co. TO Bernice Sylvant Ward 67.00  
Anthony Ray Evans al TO Hubert L. Newell al 6.00  
The Evans Co. of Grvl. TO Jody A. Wylam 53.00  
Graham Farmer al TO Ford McGowan Jr. al 22.00  
Liberty Financial Planning Inc. TO Jarvis J. Mills al 5.00  
Leonard D. Lilley Jr. al TO Kenneth Vanderburg al 21.00  
Richard A.J. McKinney al TO Juan Carlos Divergillis al 46.00  
Thomas J. Morris al TO Lawrence V. Behr 80.00  
Gloria Jane Niles TO Nancy P. Garner 10.00  
A.J. Speight al TO William Leland Bagley al 8.50  
FmHA TO Carol D. Parker -  
Vanrack Inc. TO Janet V. Robinson 42.00  
George Madison Venters al TO Jackie Ann Venters 4.50  
Ed N. Warren al TO Kathy W. Carnes 15.00  
Ed N. Warren al TO Wibedi Inc. 15.00  
Michael L. Aldridge al TO Larry Edward Drinnon 44.00  
Michael L. Aldridge al TO Hilda S. Patterson al 55.00  
William R. Bonar al TO Joseph B. Smith al 71.50  
Cartrette Const. Co. Inc. TO Raymond B. Minard 112.50  
Bill Clark Const. Co. Inc. TO David Barnette Joyner al 64.00  
Fenner Samuel Corbett al TO Kunk Soon Park al 23.00  
Diversified Fin. Serv. TO Ceco Contractors Inc. 13.50  
The Evans Co. of Grvl. TO Julian Lloyd Nelson al 62.00  
Greenbrier Realty Co. Inc. TO Gaylord Bldrs. Inc. 18.50  
Shirley S. Hollingsworth TO Arthur J. Dellano al 16.50  
Thomas L. Lamb al TO John R. Eads al 73.00  
Audrey Worthington Lynn al TO Floyd G. Harris al 76.50  
Nancy M. Manning al TO Lennie Darrell Harrington -  
R. Guy Mayo Jr. al TO Rebecca

Parker 10.00  
Thomas E. Moore al TO Kemp Robert Lee al 50.00  
James A. Nelson Jr. Com'r TO George Sutton Jr. al 14.00  
Mary W. Newton TO Tyrone Newton  
D.G. Nichols al TO Collice C. Moore 9.50  
Pollard Const. Co. Inc. TO David Ryhanych al 14.00  
Rollins Clustered Homes Inc. TO Vivian Lee Pierce 62.50  
Haldane Brooks Smith TO Herbet W. Wheelless al 54.50  
Joseph B. Smith al TO Michael Ashley Brown al 12.00  
Elbert R. Stokes al TO Ulys Smith al 18.00  
Tipton Bldrs. Inc. TO Bryan J. Connors al 108.50  
Mamie Velma Williams al TO Michael W. Mills -  
Hazel O. Wooten al TO Stuart Hardy 5.00  
Sally A. Barnaby TO Brian A. O'Doherty al 59.50  
Bill Clark Const. Co. Inc. TO Harry G. Walker Jr. al 70.00  
Arthur John Dellano al TO Haywood M. Collier al 7.50  
Derek P. Dunn al TO Home Builders & Supply 64.50  
Home Builders & Supply TO Harris Johnson Const. Co. Inc. 18.00  
Hosea D. Lambert Jr. TO John D. Lambert al -  
Willie L. Manning al TO William White -  
Johnnie E. May al TO Charles Carson 220.00  
The Mercer Group Inc. TO Morgan Fertz. Co. 163.50  
The Mercer Group Inc. TO Parker Grain Co. Inc. 175.00  
Merrill Lynch Relocation Management Inc. TO Joseph E. Warren al 47.00  
P.S. Prasad al TO Kirit C. Pate al 25.00  
Charlie R. Speight al TO Arthur John Dellano al -  
Joseph D. Speight al TO Rufus V. Keel III al 240.00  
Asa G. Warren al TO Ronald Gray Mills al 4.00  
Linda W. Westbrook TO Merrill Lynch Relocation Mgmt. Inc. 23.00  
Westmont Develop. Co. TO Bowen-Pollard Const. Co. 8.00  
Westmont Develop. Co. TO Vanrack Inc. 32.00

# Researchers Say Genes Borrow Some Functions

By WARREN E. LEARY  
AP Science Writer  
WASHINGTON (AP) — The genes that govern the structure and function of all cells may be able to make evolutionary shortcuts in developing new functions by borrowing parts of other genes, according to reports published today.  
Researchers say they have found evidence supporting a theory that nature allows genes to adopt entire segments from other genes and assemble the fragments in different order so the combination performs new functions.  
The work by Texas scientists, reported in the journal Science, appears to support a proposal by Nobel Laureate Walter Gilbert that gene segments triggering specific functions shuttle about when needed for new tasks.

part, such as a human being.  
A decade ago, scientists discovered that functional segments of DNA code within genes were separated by long chains of genetic material that had no apparent function, so-called "nonsense DNA."  
Gilbert proposed that when genes break, either naturally or accidentally, they snap in the nonsense part, leaving the functional segments intact. These segments, then, are ready to be scooped up and spliced into other genes when needed.  
But proof that genes could acquire such segments in that way instead of having them custom-made over time has been lacking until now.  
Researchers at the University of Texas Health Science Center in Dallas said in two reports that they

had such evidence in the form of a gene that makes a protein receptor that resides on the surface of some cells.  
This surface protein is the binding point for another one called low-density lipoprotein (LDL), a substance that carries cholesterol in the blood in a form that makes it a major factor in heart disease.  
Thomas C. Sudhof, Joseph L. Goldstein, Michael S. Brown and David W. Russell found that the LDL receptor gene was a mosaic of code segments originally found in other functionally unrelated genes. These other genes include one responsible for making a blood-clotting factor and another that makes a basic component of a cell growth promoter.

Borrowing these segments to make new genes would significantly shorten the time needed for new sets of genes to evolve when compared with the traditional belief that this evolution results from many tiny mutations accumulating over many years.  
Genes are segments of deoxyribonucleic acid, or DNA, the basic material of heredity, strung in a chain. The "links" in these chains, known as bases, are arranged in a code that determines the production of the protein molecules that govern the nature of living things.  
Residing in the nuclei of cells, these genes trigger the production of thousands of different proteins that serve many functions in the cell and the larger organism of which it is a

## ECU DAY CAMP

**Supervised Instruction And Play  
For Children Ages 6-12**

**VARIETY OF ACTIVITIES  
WEEKLY CAMPS CONDUCTED**

**JUNE 17- JULY 12**

**For Information and Registration  
Call Imogene Turner  
757-6441**

## GET A \$2.00 REFUND BY MAIL

When you buy Charmin or Bounty and a pair of Sunglasses or Suntan Lotion.

# CHARMIN & BOUNTY FUN 'N SUN REFUND OFFER



**NEW! STRONGER THAN EVER!**  
Squeezably Soft  
**Charmin**  
THE FAMILY PACK  
Bounty

**MAIL IN CERTIFICATE (Not Payable at the Retail Store)**  
**CHARMIN/BOUNTY FUN 'N SUN REFUND OFFER**  
Enclosed are the Universal Product Code (UPC) Symbols from four Charmin packages (any size) and four Bounty packages (any size) and my cash register receipt with my suntan lotion or sunglasses purchase price circled. Please send my \$2.00 refund to:

NAME \_\_\_\_\_  
ADDRESS \_\_\_\_\_  
CITY \_\_\_\_\_  
STATE \_\_\_\_\_ ZIP CODE \_\_\_\_\_

Offer expires June 27, 1985  
Place in a stamped envelope and mail to: Charmin/Bounty Fun 'N Sun Refund Offer  
P.O. Box PM251  
El Paso, Texas 79966  
Charmin/Bounty Fun 'N Sun Refund Offer Certificate (cash redemption value 1.20 of \$1)

**Please Note These Additional Terms:**

1. Offer good only in the U.S.A.
2. The attached certificate may not be mechanically reproduced and must accompany your request.
3. Your offer rights may not be assigned or transferred.
4. Limit one refund per name or address.
5. Offer expires June 27, 1985.
6. Please allow 6-8 weeks for delivery.

## DISCOUNT COUPONS DISCOUNT COUPONS

Newspaper Co-Op Couponing, Westport, Connecticut 06880

### GOT ROACHES? GET NEW COMBAT!

- No aerosol mess, odor or contamination worry.
- Unique patented ingredient.
- More powerful than leading sprays and foggers.
- Keeps killing for 3 whole months... Guaranteed!



**NEW COMBAT**  
Roach Control System

**HERE'S HOW COMBAT WORKS:**  
Simply place COMBAT bait trays anywhere you've seen roaches, even where you wouldn't dare spray. Roaches enter the tray through the openings provided, eat the bait inside the tray, then crawl away to die!

Contains 12 Childproof Bait Trays  
Kills roaches for three months

### New Cheddar Browns

From Ore-Ida  
Great-Tasting Hash Browns With Real Cheddar Cheese  
Wholesome Combination!



### SAVE 50¢ on COMBAT

STORE COUPON 50¢



**NEW COMBAT**  
Roach Control System

**50¢** EXPIRES MARCH 31, 1986 **50¢**

### SAVE 20¢

Manufacturer's Coupon Expires November 30, 1985



**Ore-Ida**

**On your next purchase of ORE-IDA Cheddar Browns™**

CONSUMER: Please redeem this coupon only upon making the required purchase. Only one coupon redeemed per purchase. Any other use constitutes fraud. RETAILER: Ore-Ida Foods, Inc. will reimburse you the face value of this coupon plus 8¢ handling, provided you and the consumer comply with the terms of this coupon. Sales tax must be paid by consumer. Void where prohibited, taxed or restricted. Cash value 1/100¢. Redeemable only on ORE-IDA Cheddar Browns™. Mail to: Ore-Ida Foods, Inc., Redemption Center, P.O. Box 20333, El Paso, TX 79998.  
© 1985 Ore-Ida Foods, Inc.

# New Research Says Eating Fish Is Good For The Heart

By DANIEL Q. HANEY  
AP Science Writer

BOSTON (AP) — Mothers tell children that fish is brain food, but new research suggests that it's actually heart food, a part of the diet that may help protect people from the nation's No. 1 killer.

A Dutch study found that the more fish people eat, the less likely they are to die from coronary heart disease.

"It seems justifiable to include a recommendation for one or two fish dishes a week in dietary guidelines for the prevention of coronary heart disease," the researchers wrote in today's New England Journal of Medicine.

In the United States, coronary heart disease is responsible for more than 550,000 deaths each year, more than all forms of cancer combined. The disease is due to atherosclerosis, a buildup of fatty deposits in the arteries that feed the heart.

The disease is less common in some cultures, and this has bolstered the suspicion that fish may play a role in warding off heart trouble. For instance, heart disease is rare among the Eskimos of Greenland, who eat about 14 ounces of fish a day, and in Japan, where people average about 3½ ounces of fish daily.

The latest study was conducted in the town of Zutphen by Dr. Daan Kromhout and colleagues from the University of Leiden.

They followed the health of 852 middle-aged men. About 20 percent of them ate no fish at all when the study began in 1960, and the average consumption was just over half an ounce a day.

After 20 years, 78 men had died of heart disease. Their risk seemed to be related to how much fish they ate. Those who averaged at least an

ounce of fish daily were less than half as likely to die of heart disease than were those who never consumed fish.

Obesity, cigarette smoking, high blood pressure, high cholesterol levels and physical inactivity are among conditions and habits that are associated with heart trouble. However, the researchers found that none of these could explain the link they found between fish and health.

In an editorial in the journal, Dr. John A. Glomset of the University of Washington cautioned: "The study remains to be completed, however, because an important question that has yet to be answered is whether the consumption of fish also correlated, perhaps unfavorably, with mortality from cancer and other diseases."

No one knows exactly how fish could help the heart. But experts

speculate that the key ingredient is fish oil, which may make blood clot more slowly and reduce fat levels in the blood.

Both fish oil and vegetable oil are polyunsaturated fatty acids, but they are not identical. A second study in the journal showed that supplements of fish oil were far more effective than vegetable oil in reducing the abnormally high blood fat levels of people with a condition known as

hypertriglyceridemia.

This study was conducted at the Oregon Health Sciences University, where doctors have also shown that fish oil can reduce cholesterol levels in normal people.

The doctors said fish oil supplements must still be considered experimental, although people should try to substitute fish for meat in their diets.

"The problem of coronary heart

disease is a very complex one, and the role of diet needs to be considered in its entirety, not just from the point of view of one food," said Dr. William E. Connor, one of the Oregon researchers. "One of the best diets for prevention of heart disease is low in cholesterol and saturated fat, and now I think the evidence is that such a diet can contain reasonable quantities of fish."



Jumbo Pack

Chicken Breast 98¢ Lb.

These prices good thru Sunday, May 19, 1985

49¢ Lb.

Holly Farms - Grade A

Whole Fryers

\$1.78 Lb.

USDA Choice - Family Pack

Cube Steak

We reserve the right to limit quantities.

88¢ Lb.

Lean And Tender

Boston Butt Roast

## Cystic Fibrosis Links Traced By UNC Study

CHAPEL HILL, N.C. (AP) — Abnormalities responsible for cell damage in people with cystic fibrosis lie within the cells themselves and are not the result of bacterial infections or other outside influences, as some scientists had thought, a physician says.

"This may resolve a long debate over where the abnormality lies and at the same time enable our group and others to focus more closely on the real biochemical problem," said Dr. James R. Yankaskas, research assistant professor of medicine at the University of North Carolina at Chapel Hill.

Yankaskas published a report on his work in the April 27 issue of The Lancet, a major British medical journal, and UNC released the study findings Thursday.

Yankaskas said his cultured cystic fibrosis cells exhibit the same irregular characteristics they would have in a patient with the disorder.

"That's important because you obviously can't test drugs in humans that might turn out to be toxic, and you don't have access in humans to the back side of cells lining the airways," he said. "If the cell didn't behave the same as they do in patients, they wouldn't be of much use to us."

In 1981, UNC scientists Michael R. Knowles, John Gatzky and Richard Boucher discovered that the respiratory tracts of patients with cystic fibrosis have a natural electrical activity that is more than twice as high as in healthy people and respond abnormally to certain drugs.

Yankaskas now has shown that isolated cystic fibrosis cells continue to display this unusual activity weeks after they have been removed from patients.

"Because the abnormalities have been preserved, we believe they are contained within the cells and are not caused by infection, inflammation or unknown factors circulating in the blood," he said.

About one in every 20 white Americans are carriers of cystic fibrosis, Yankaskas said. Until the early 1950s, infants born with cystic fibrosis had a median life expectancy of two years.

Life expectancy increased to about 24 years with the discovery that digestive enzymes from cow pancreases could be used to replace the digestive enzymes the children were unable to produce on their own.

Victims of the condition continue to die, however, from infections caused by another symptom of the disorder — overly thick and sticky mucus that clogs the lungs, trapping bacteria and viruses.

## Bullfight

VALENCIA, Spain (AP) — A bullfight in this eastern port city ended in an exchange of blows between two matadors.

Vicente Ruiz and Jose Maria Manzanares engaged in a fistfight while fighting the last of the six bulls killed during the performance.

The scuffle began when Manzanares, without being asked, joined in fighting a bull assigned to Ruiz. The two traded punches, and their assistants joined in the fight before it ended.

Red Ripe California Strawberries

Strawberries ..... Pint .59

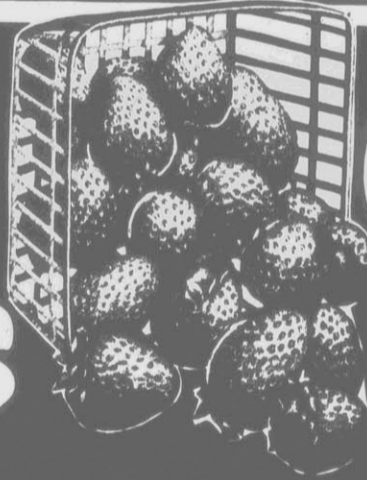

99¢ Full Quart

3 Lbs. 99¢ Golden Ripe Bananas

5 Ears/99¢ Tender Yellow Corn

4 Lbs. \$1 Fresh Green Cabbage

Wise Snacks  
Wise Nacho Bravos ..... 8 Oz. 1.09  
Wise Picante Dip ..... 10.5 Oz. .89  
Wise Bean Dip ..... 10.5 Oz. .89

\$2.79  
1.5 Liter - Chablis, Rhine, Pink Chablis, V. Rose, Burgundy, Pinot, Lt. Chianti, Sangria  
Carlo Rossi

\$1.99  
Pkg. of 6 - 12 Oz. Cans  
Meister Brau

\$1.09  
2 Liter - Diet Coke/Caffeine Free Diet Coke/Caffeine Free Coke  
Coca Cola

99¢ 64 Oz. - Carolina Gold Apple Juice

85¢ Large Roll - Designer Bounty Towels

\$1.19 4 Pack - Toilet Tissue Cottonelle

6800 EVERYDAY LOW PRICES

# Micronesia Is Haven For Ex-Volunteers

By CHARLES J. HANLEY  
Associated Press Writer  
POHNPEI, Micronesia (AP) — As a straw-haired schoolgirl back home in Teutopolis, Ill., Marialice Burford had a dream.  
"I was going to be a Chicago Cubs sportswriter someday," she recalled.  
Then she found her South Sea island. "And my dreams all went away." There was a heaven beyond Wrigley Field after all.  
For a generation now, the ageless allure of the Pacific — the jewel-like waters, the lush little islands, the languid, laughing people — has been

luring Peace Corps volunteers like Marialice Burford into sinking new roots in remote old societies.  
Dozens of volunteers have stayed behind after their tours of duty ended, becoming part of island life, operating businesses and practicing law, keeping taverns and advising governments, studying anthropology and writing novels.  
Some liken themselves to old beachcombers, those 19th-century adventurers who counseled island chiefs on the ways of the outside world.  
Today, 394 Peace Corps volunteers are assigned to the Pacific islands, 94 of them in Pohnpei, the Marshall Islands and other places in Micronesia, a U.S.-administered territory 5,000 miles from the American mainland. They work on agricultural projects, as teachers, as advisers to businesses.

ried a Bikinian, settled down on impoverished Kili, fished, harvested coconut and began long-distance lobbying of the U.S. government to get radioactive Bikini decontaminated so that its people could return home.  
"Before coming out here, I wasn't aware of how my government had taken advantage of these people," said the burly Waltz.  
His fight continues. He and his shy, slim wife, Heity, live in Majuro with two of their children. Two older

children are at a U.S. high school.  
The transplanted Americans say they miss the excitement of big cities, good bookstores and hardware stores.  
"I miss McDonald's hamburgers and french fries," Marialice Eperiam, nee Burford, said with a grin.  
A 29-year-old University of Missouri journalism graduate, the onetime aspirant to the baseball press box now works for the Pohnpei Congress, and she and her

Pohnpeian husband have opened a liquor business.  
She laughed at how she has adapted in the eight years since she arrived as a volunteer.  
"I remember being amazed at all these naked kids waving at us in the bus," she said. "Now it's my two kids who are running around naked."  
Whatever yearnings they have for old roots, these ex-volunteers are hooked on islands and island people.  
"Out here," said Waltz, "it's

people that are important. And I liked the people immediately. They're honest, sensitive to each other's feelings."  
The 42-year-old Waltz does plan to move on someday — but farther out over the horizon, to distant Bikini, if it is made habitable again. He made a brief visit there once, and the vision won't leave this island-lover's mind.  
"A lagoon full of lobster. Fantastic fishing," he said. "The most beautiful island I've ever seen."

## Boat People Still Mow

MOBILE, Ala. (AP) — People who live on their boats have a word for those who don't.  
They are "townies," defined as "anybody who lives in square boxes that don't move," according to Braz Webb, whose idea of housecleaning is swabbing the deck of his 37-foot sailboat.  
Webb is a "non-townie," one who lives on a boat full time. He hasn't escaped lawn mowing entirely, though. He mows the grass around the marina picnic table near his dock.  
"Most of the people who live on their boats are very individualistic," said Webb, 43, who lives with his wife, Barbara, at a marina on Dog River, south of Mobile.

On a warm spring weekend, Webb and his neighbors find consolation in a strong wind that takes their home to an island or anyplace the weather permits.  
During the week, however, the neighbors relax from work and party as though they lived on a city block.

"Maybe we party a little too hard, but we pay our taxes," said Webb, who moved onto the sailboat in January after his house burned.

Brad Eklund, a neighbor, has been living on sailboats for 11 years.

"Day in, day out," said Eklund, 37, who teaches metal shop and drafting at Williamson High School. "When it gets cold, we just plug in an extra heater. Nobody sleeps as well as I do."

One thing that disturbs the tranquility of boat living, however, is the "townies" who sometimes hotrod around the dock with their powerboats.

"You wouldn't believe the wake created when a 37-foot powerboat comes by at 28-30 knots," said Eklund, lamenting the lack of marine police protection.

But they said that was one of the few drawbacks to permanent boat living.

No one knows just how many of their predecessors have settled in the islands. But on Majuro atoll, a slender ring of palm-fringed islets that is the capital of the Marshall group, "ex-vols" turn up everywhere.

One runs the coconut-oil factory. Another manages the big store. A third owns a handful of small businesses. But none has plunged more deeply into atoll life than Jerry Knight.

A Chicagoan who arrived as a volunteer in 1967, Knight later decided to stay on and "get inside the culture."

First, he worked as a Majuro fisherman for two years, perfecting his knowledge of the musical Marshallese language. Then he cast off into the unknown — sailing 400 miles up to isolated Rongelap atoll, where he lived for four years among the 150 Rongelapese, an ocean away from Western civilization.

In his lagoon retreat, the self-taught anthropologist took down the oral histories told by a traditional island narrator. He later published a book of the stories.

"I was planning to stay there till I died," said the wiry, mustached Knight, 37. But he finally was recalled to Majuro for overstaying his visa in the Marshalls. Later he re-established himself in Majuro, and as curator of the local museum continues recording Marshallese tales and music.

Down the Majuro road, ex-volunteer Ralph Waltz has plunged into community action, on behalf of a historically special community — the people of Bikini atoll.

The former college linebacker from Menomonee Falls, Wis., arrived in the Marshalls 18 years ago to work as a Peace Corps teacher on Kili island, exile home for people evacuated from Bikini in 1946 for U.S. atomic weapons tests. The assignment changed his life.

After his two-year tour, he mar-

## Island People

Today 394 Peace Corps volunteers are assigned to the Pacific islands. No one knows just how many of their predecessors have settled in the islands but "ex-vols" turn up everywhere. Jerry Knight, left, a Chicagoan, is curator of the local museum on the Marshall Islands. Ex-volunteer Ralph Waltz, his wife and their children, formerly of Wisconsin, has established his family in the islands. (AP Laserphoto)

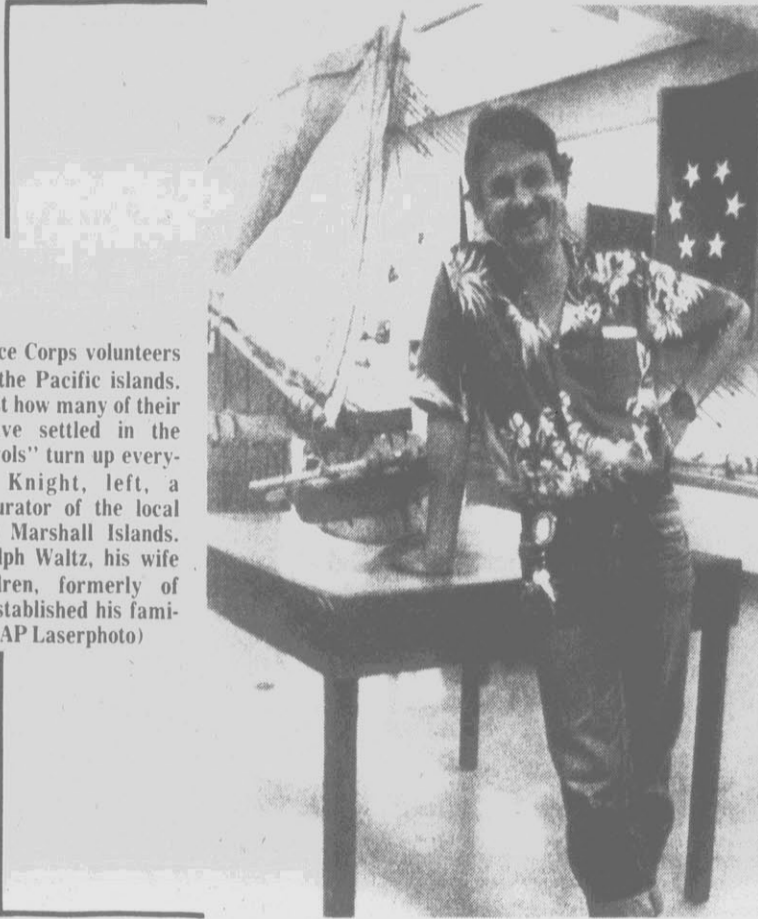

## Americans Take To Roads Again

WASHINGTON (AP) — Summertime, while no longer synonymous with vacationtime, will see Americans take 126 million pleasure trips from June through August and spend \$85 billion doing so, a travel industry study forecasts.

That would mark a 5 percent jump from the 120 million vacations taken a year ago, when pleasure travelers spent just under \$80 billion, the U.S. Travel Data Center said in its annual outlook Thursday.

The center, a research arm of the nation's travel and tourism industry, based its projections on monthly telephone surveys of 1,500 adults. No percentage-of-error figure was given.

While two decades ago, more than half of all vacations were taken during the summer months, only 40 percent are done so now, the center's director, Douglas C. Frechtling, told a news conference.

This has occurred "particularly as winter vacation destinations have grown up — not only the Caribbean for sun, but also the ski resorts that have been developed for winter recreation," he said.

Changes in the population, including increasing numbers of single adults and childless couples whose vacation schedules bound from the modest increases of 2 percent last year and 1 percent in 1983 and an 11 percent plunge in 1982, when Americans were struggling out of an economic recession.

Frechtling, an economist, said the recovery for the leisure industry was slower than expected because Americans spent their extra money on cars and household goods, especially entertainment products such as video cassette recorders.

"This (buying) explosion drained away \$100 billion more in discretionary spending power that could

have financed a vacation travel boom but instead went to buy these items," he said.

"We believe that this pent-up demand is completely satisfied and that now consumers are free to spend their extra money on vacation travel in the coming summer months," he said.

As to where travelers are going, an ocean beach is the top intended destination. It was chosen by 37 percent of the respondents, up from 29 percent in last year's survey.

## Have You Missed Your Daily Reflector?

First Call Your Independent Carrier. If You Are Unable To Reach Him Call The Daily Reflector.

**752-3952**

Between 6:00 P.M. And 6:30 P.M. Weekdays And 8 A.M. 'Til 9 A.M. On Sundays.

## On The Town

Here are some of the evening entertainment activities scheduled in Greenville in the coming week:

### Tarheel II

Friday, May 17 — Saturday, May 18: Cross Fire will perform country music.

### The Attic

Thursday, April 16: Heart Throb will perform.  
Friday, April 17 — Saturday, April 18: Music will be provided by Trezor Rex.

### The Veranda at the Ramada Inn

Wednesday, April 15 — Saturday, April 18: Top 40 music will be played by TNT.

Sunday, April 19: Disc jockey Trashman will provide music.

### The Unlimited Touch

Thursday, April 16: Music will be provided by disc jockey Tito the Party-Rican.

### T.W.'s Nitelife

Wednesday, May 15: Beach music will be played by The Entertainers.  
Thursday, May 16: Top 40 and funk music will be provided by Power Play.  
Friday, May 17: Tightrope will play Top 40 music and the shag contest will be held.  
Saturday, May 18: Blue Grass music will be played by the Seldom Scene, along with the Silverliners.

### The Sportsman's Lounge

Friday, May 17 — Saturday May 18: Music will be performed by the Carolina Outlaw Country Band beginning at 9 p.m.

# SMART MONEY

# COUPON

# SAVE 15¢

with coupon below



**save 15¢**  
when you buy one package any size, any flavor

**PRINGLES**

CONSUMER: Don't forget to ask your dealer to redeem this coupon ONLY by purchasing the product in which it is used. It is the value indicated from the retail selling price. Coupon is not to be reproduced, void if transferred to any person, firm or group prior to its redemption. No cash value. No expiration date. Any other use constitutes fraud. LIMIT: 15¢ PER PURCHASE.

DEALER: Your redemption requires compliance with P&G Coupon Rules. Redeem 10/1/85. Free copy available by writing to PROCTER & GAMBLE, 2360 Summit Drive, Cincinnati, Ohio 45221. Send coupon redeemed coupons to same address. Cash value: 10¢ of 10.

PROCTER & GAMBLE 34325C

37000 36115

# NEW 450 of America's Favorite Napkin in one convenient pack!



Try this new convenient 450 count Family Pack. 450 soft, strong Scott napkins... so you won't run out of America's Favorite as often!

# SAVE 25¢

ON ONE PACKAGE OF NEW Scott FAMILY PACK NAPKINS (GOOD ON 450 CT. ONLY)



25¢

RETAILER: If you receive this coupon in part payment on the retail sale of one package of Scott napkins 450 ct. to a consumer and if upon request you submit evidence thereof satisfactory to Scott Paper Company we will reimburse you for the face value of the coupon plus 8¢ for handling. Mail properly received and handled coupon to SCOTT PAPER COMPANY, BOX 5000, CHESTER, PA 19380. Cash value: 1/2¢. Coupon may not be assigned or transferred. Void where prohibited, taxed or restricted by law. Good only in U.S.A. and all U.S.A. government installations. Consumer must pay sales tax.

THE USE, REDEMPTION OR HANDLING OF COUPON NOT ACCORDING TO ITS TERMS CONSTITUTES FRAUD. ONLY ONE COUPON PER ONE PACKAGE PURCHASED. MECHANICAL REPRODUCTION OF COUPON PROHIBITED.

R-493 54000 13525

**FARM FRESH**  
 SUPER SAVING CENTER  
 609 E. GREENVILLE BOULEVARD  
 GREENVILLE, N.C.



IT'S OUR **BIRTHDAY!**  
 AND WE ARE GIVING AWAY  
**\$500<sup>00</sup> IN FREE GROCERIES EVERY WEEK**  
 ON SUNDAY, MAY 19  
 JUST COME IN AND REGISTER PLUS A GRAND PRIZE...  
**5 MINUTE GROCERY SHOPPING SPREE**  
 TO BE GIVEN AWAY ON MAY 28TH  
 LIVE ON THE "CAROLINA TODAY" SHOW  
 NO PURCHASE NECESSARY. NEED NOT BE PRESENT TO WIN.  
 LISTEN TO WNCT CHANNEL 9 AND FM 108 FOR DETAILS AND WINNERS' NAMES

**BUY 1, GET 1 FREE!**

- SAN GIORGIO SPAGHETTI  
 • REG. AND THIN • 1 LB. BOX
- PINE GLO CLEANER  
 28 OUNCE BOTTLE
- SUNSHINE COOKIES  
 HYDROX AND VIENNA FINGERS • 17 OZ. PKG.
- STAR PIMENTO SALAD  
 8 OZ. CUP

PRICES EFFECTIVE  
 THRU 5-18-65  
 QUANTITY RIGHTS RESERVED.

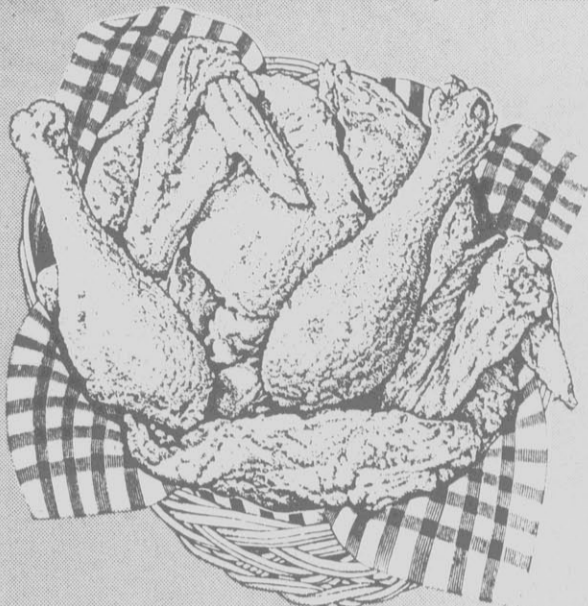

**WHOLE FRESH FRYERS**

LIMIT 4 PLEASE

**38¢** LB.

SWIFT'S PREMIUM (10 LBS. & UP)  
**BUTTERBALL TURKEYS**  
**79¢** LB.  
 HOUSE OF RAEFORD  
**TURKEY BREASTS**  
**1<sup>29</sup>** LB.  
**FROSTY MORN FRANKS**  
 12 OZ. PKG. **89¢**

USDA CHOICE BLADE-CUT

**CHUCK ROAST . 79¢** LB.

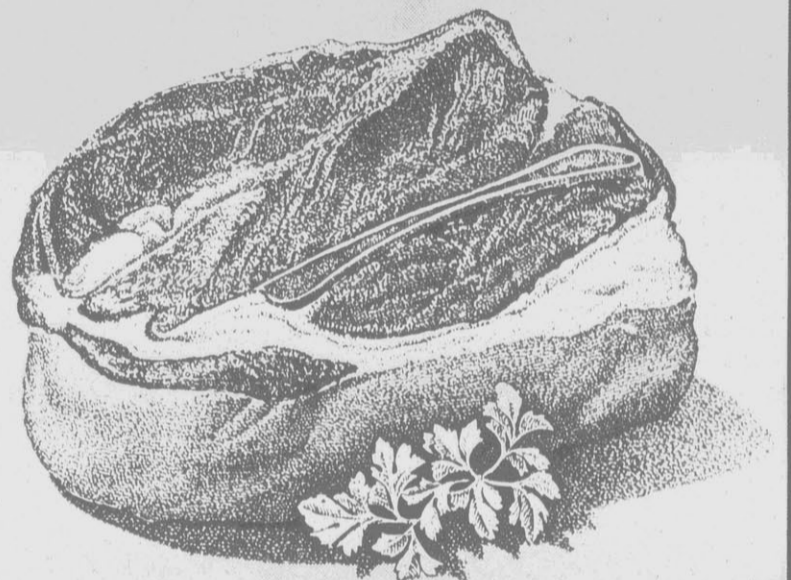

- 7-BONE CHUCK ROAST . . . 99¢ LB.
- ROUND BONE SHOULDER ROAST . 1.19 LB.

**COUNTRY HAMS.** SLICED FREE UPON REQUEST **1<sup>29</sup>** LB.



YELLOW SWEET  
**CORN ON THE COB**  
**6 EARS FOR 1<sup>00</sup>**

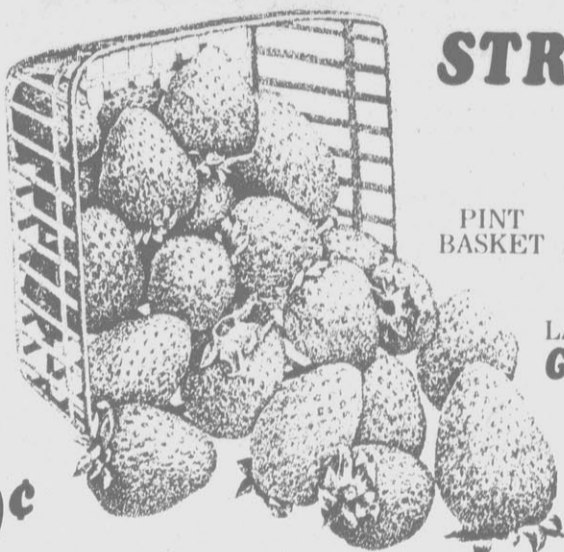

RED, RIPE & SWEET  
**STRAWBERRIES**

**49¢**  
 PINT BASKET

- RED RIPE **TOMATOES . . . 1<sup>00</sup>** 3 LBS.
- YOUNG N' TENDER **SNAP BEANS . . . 39¢** LB.

LARGE FLORIDA **GREEN PEPPERS . 5 FOR 1<sup>00</sup>**

YELLOW **SQUASH . . . 29¢** LB.

**DAIRY SPECIALS**

- TROPICANA GOLD 'N PURE **ORANGE JUICE . . . . . 1<sup>29</sup>** 64 OZ. CARTON
- BREYER'S **ICE CREAM . . . . . 2<sup>29</sup>** 1/2 GAL.
- BLUE BONNET **MARGARINE . . . . . 59¢** 1 LB. CARTON

**DELICATESSEN SPECIALS**

- PETER'S BEST **ROAST BEEF CORNED BEEF OR PASTRAMI . . . . . 1<sup>89</sup>** 1/2 LB.
- DELSACO SOUTHERN **POTATO SALAD . . . . . 79¢** LB.

**SEAFOOD SPECIALS**

- 36-42 COUNT **LARGE SHRIMP . . . . . 3<sup>99</sup>** LB.
- ALASKAN **SNOW CRAB LEGS . . . . . 2<sup>69</sup>** LB.
- THE CRABMEAT ALTERNATIVE **SEA LEGS SUPREME . . . . . 3<sup>99</sup>** LB.

**STAR-KIST TUNA**  
 IN WATER OR OIL  
**59¢**  
 6 1/2 OZ. CAN

**KRAFT MAYONNAISE**  
**1<sup>59</sup>**  
 32 OZ. JAR

**PURINA DOG CHOW**  
**6<sup>99</sup>**  
 30 LB. BAG

**OODLES OF NOODLES**  
**5/\$1**  
 3 OZ. PKG.

**COKE PRODUCTS**  
 2 LITER BOTTLES  
**99¢**  
 6 12 OZ. CANS 1<sup>69</sup>

**STROH'S BEER**  
 REG. OR LITE  
**2<sup>25</sup>**  
 6-12 OZ. CANS

**WISE POTATO CHIPS**  
 REG. OR RIDGIE  
**99¢**  
 6 1/2 OZ. BAG

**KELLOGG'S CORN FLAKES**  
**1<sup>09</sup>**  
 18 OZ. BOX

**RICHFOOD MACARONI & CHEESE**  
**5 1<sup>00</sup>**  
 FOR 7 1/4 OZ. BOX

**RED-GLO TOMATOES**  
**3/\$1**  
 14 1/2 OZ. CAN

**PUNCH DETERGENT**  
**3<sup>69</sup>**  
 147 OZ. BOX

**COUPON-COUPON**  
**PURE CANE SUGAR**  
 REG. 1.59  
**99¢**  
 5 LB. BAG  
 LIMIT 1 WITH PURCHASE OF \$7.50 OR MORE.  
 VOID AFTER 5-18-65  
 FARM FRESH

**COUPON-COUPON**  
**FARM FRESH SANDWICH BREAD**  
 REG. 1.09  
**2/89¢**  
 LIMIT 1 WITH PURCHASE OF \$7.50 OR MORE.  
 VOID AFTER 5-18-65  
 FARM FRESH

**COUPON-COUPON**  
**EXTRA LARGE EGGS**  
 REG. 69¢  
**29¢**  
 GRADE "A" DOZEN  
 LIMIT 1 WITH PURCHASE OF \$7.50 OR MORE.  
 VOID AFTER 5-18-65  
 FARM FRESH

**GOREN BRIDGE**  
By CHARLES GOREN AND OMAR SHARIF  
1983 Tribune Company Syndicate, Inc.

**DUPLICATE vs. RUBBER**

North-South vulnerable. South deals.

- NORTH**  
♦ AKQ1086  
♥ A854  
♦ 3  
♦ 64
- WEST**  
♦ J742  
♥ 9  
♦ K6  
♦ QJ9732
- EAST**  
♦ 9  
♥ J10762  
♦ Q9872  
♦ K10
- SOUTH**  
♦ 53  
♥ KQ3  
♦ AJ1054  
♦ A85

The bidding:  
South West North East  
1-♦ Pass 1-♥ Pass  
1-NT Pass 3-♥ Pass  
3-NT Pass Pass Pass  
Opening lead: Queen of ♠.

"Your hands are all well and good," we often hear from our readers, "but they never turn up in real life." Wrong! That's precisely where we get most of our material. This example is from the recent Spring North American Championships held in Montreal.

North showed touching faith in his partner's judgment when he elected to pass three no trump. Obviously, he was hoping his side could make as many tricks in no trump as they could in spades, in which case he would receive an excellent score.

Naturally, South received a club lead against three no trump. East correctly overtook the queen with the king and returned the suit as declarer held off winning the ace until the second round. What now?

At duplicate, you can see that declarer has a chance to make 12 tricks with favorable breaks in the major suits. Therefore, your best chance for a reasonable result is to try to run spades and hope that your rivals can't outscore you at a spade contract. However, the spades turn out to be 4-1 and, to make it worse, West has the long spade, so you can no longer set up the suit by conceding a trick to the safe hand—when West wins the spade he can take more than enough club tricks to defeat you. There is no way for you to make your contract.

At rubber bridge, you should surely play the hand in four spades, especially since you get the honor bonus. However, if you did land in no trump, you should adopt a totally different line to safeguard your contract. First, duck two rounds of clubs. Then cash a spade honor, cross back to your hand with a high heart, and lead a spade to the ten. Even if the finesse loses you have ten tricks, and you protect against the distribution that exists. East can do you no harm if he wins the jack of spades.

**Former Guide Turns Priest**

PORT ST. LUCIE, Fla. (AP) — The Rev. Ernesto Rios uses himself as an example that God works in mysterious ways.

Staunchly religious since his childhood days in the Bronx, N.Y., Rios took the path to priesthood after spending 14 years guiding pilots and their passengers safely through the skies.

The former air traffic controller also says he is the only Puerto Rican priest in the Orthodox Church in America which has an estimated 1 million members. The Orthodox Church, however, consists of a federation of Christian churches found primarily in Greece, Russia, Eastern Europe and Western Asia.

"That's how God works," says the jovial priest.

When Rios arrived here in 1980 several months after he was ordained, he helped finish construction of the St. James Orthodox Church across from the city hall of this growing retirement city. He is not discouraged that his basic congregation consists of only 21 parishioners.

"The land and church are already paid for," he boasts as he explains where he plans to build a church hall and a dozen condominium units for retired members of the Orthodox Church.

"This will be the nucleus of a living orthodox community — a magnet that will draw people to church," he says enthusiastically.

The only sadness Rios shows is when he talks about his father, who died two years ago.

"Papa prayed every day of his life. He took people into his house, fed them and clothed them," he adds.

Rios also remembers his father's mixed emotions when he converted from a Roman Catholic to the Orthodox Church. His conversion began in the early 1970s when he encountered the Byzantine Rites while still a Roman Catholic. The attraction, he admits, was the liturgy, which has remained almost unchanged since the early centuries of Christianity.

# OVERTON'S

211 JARVIS STREET  
"HOME OF GREENVILLE'S BEST MEATS"  
QUANTITY RIGHTS RESERVED.

*Supermarket* Inc.

PRICES EFFECTIVE THURSDAY - SATURDAY  
OPEN 8 AM - 8 PM MONDAY - SATURDAY  
SUNDAY 1 PM - 6 PM

**COUPON** \$

CLIP THIS COUPON

**RICHFOOD SUGAR**

5 LB. BAG **99¢**

With this coupon and \$10.00 food order excluding advertised items. Without coupon \$1.79. Limit one per customer. Expires 5-16-85.

## OVERTON'S FINEST HEAVY WESTERN SIRLOIN STEAKS



# 2.39



T-BONE STEAKS... LB. \$2.59

<p>LUTER'S JAMESTOWN</p> <p><b>SAUSAGE</b> . LB. ROLL <b>89¢</b></p> <p>SLICED 7-9 CHOPS</p> <p><b>1/4 PORK LOIN</b> . LB. <b>\$1.29</b></p>	<p>FAMILY PAK SPECIALS</p> <p>PORK NECK BONES... 5-7 LB. PKG. LB. <b>49¢</b></p> <p>PIG FEET... 5-7 LB. PKG. LB. <b>49¢</b></p> <p>EDGEMONT</p> <p>LINK SAUSAGE... 10 LB. PKG. <b>\$13.90</b></p>	<p>GWALTNEY FRANKS</p> <p>MORRELL BOLOGNA... 12 OZ. PKG. EACH <b>99¢</b></p> <p>MORRELL BACON... 12 OZ. PKG. <b>\$1.19</b></p>	<p>IN OUR DELI</p> <p>ROAST BEEF... 1/2 LB. <b>\$1.99</b></p> <p>TURKEY BREAST... 1/2 LB. <b>\$1.79</b></p>
--	---	--	---

<p>GRADE "A" PITT COUNTY BROWN</p> <h1 style="font-size: 3em;">LARGE EGGS</h1> <p>DOZEN <b>59¢</b></p> 	<p>LUTER SMOKED WHOLE OR SHANK PORTION</p> <h1 style="font-size: 3em;">TENDERIZED HAMS</h1> <p>LB. <b>69¢</b></p> 
--	--

<p>GREEN GIANT FROZEN</p> <p>NIBLETS CORN OR BROCCOLI CUTS... 16 OZ. PKG. <b>99¢</b></p>	<p>RICHFOOD FROZEN</p> <p>TWIN POPS... 12 CT. PKG. <b>99¢</b></p>	<p>BLUE BONNET</p> <p>MARGARINE... LB. PKG. <b>59¢</b></p>	<p>STOKELY</p> <p>CUT GREEN BEANS</p> <p>YOUR CHOICE</p> <p>CREAM OR WHOLE KERNEL CORN 303 CANS <b>38¢</b></p> <p>WHITE HOUSE APPLE SAUCE 303 CAN</p> <p>GREEN GIANT NIBLETS CORN 12 OZ. CAN EACH</p>
<p>FABRIC SOFTENER</p> <p>RICHFOOD</p> <p>FUDGE BROWNIE MIX... 21 OZ. BOX <b>99¢</b></p> <p>FAB DETERGENT... BIG 84 OZ. BOX <b>\$1.99</b></p> <p><small>LIMIT ONE WITH \$10.00 OR MORE FOOD ORDER. NO RAIN-CHECKS!</small></p>	<p>SEALTEST LIMITED FLAVORS</p> <p>ICE CREAM... 1/2 GALLON CARTON <b>\$1.99</b></p> <p>SEALTEST ALL VARIETIES</p> <p>POLAR BARS... PKG. OF 6 <b>\$1.59</b></p>		

<p>JOY OR SUNLIGHT</p> <p><b>DISHWASHING LIQUID</b></p> <p>22 OZ. BOTTLE <b>99¢</b></p> 	<p>DEL MONTE CATSUP</p> <p>32 OZ. BOTTLE <b>79¢</b></p> <p>LIMIT ONE</p> <p>QUART BOTTLE</p> 
---	--

<p>BOUNTY</p> <p>PAPER TOWELS... GIANT ROLL <b>78¢</b></p>	<p>PURINA DOG CHOW... 30 LB. BAG <b>\$6.99</b></p> <p><small>LIMIT ONE WITH \$10.00 OR MORE FOOD ORDER.</small></p>	<p>IMPERIAL</p> <p>CHARCOAL... 10 LB. BAG <b>\$1.79</b></p>	<p>PEPSI, DIET PEPSI, MOUNTAIN DEW</p> <p>2 LITER BOTTLE <b>99¢</b></p> <p>LIMIT 2 OF YOUR CHOICE WITH \$10.00 OR MORE FOOD ORDER. ADDITIONAL PEPSI'S \$1.09.</p> 
<p>CHARMIN TOILET TISSUE</p> <p>4 ROLL PKG. <b>99¢</b></p> <p><small>LIMIT ONE WITH \$10.00 OR MORE FOOD ORDER.</small></p> 			

<p>TENDER NEW CROP</p> <p>YELLOW CORN... 5 EARS <b>\$1</b></p>	<p>SALAD SIZE VINE-RIPENED</p> <p>TOMATOES <b>3 \$1.00</b></p> 	<p>TENDER FRESH</p> <p>BROCCOLI... BUNCH <b>79¢</b></p>
--	---	---

<p>CALIFORNIA CRISP</p> <p>ICEBERG LETTUCE... 2 HEADS <b>\$1</b></p>	<p>LOOSE-U BAG 'EM</p> <h1 style="font-size: 3em;">WHITE POTATOES</h1> <p>10 LBS. <b>99¢</b></p> 	<p>TENDER FRESH</p> <h1 style="font-size: 3em;">YELLOW SQUASH POLE BEANS</h1> <p>LB. <b>39¢</b></p> 
--	--	---

Regular Prices May Vary  
At Some Stores Due To  
Local Competition

# dollar days

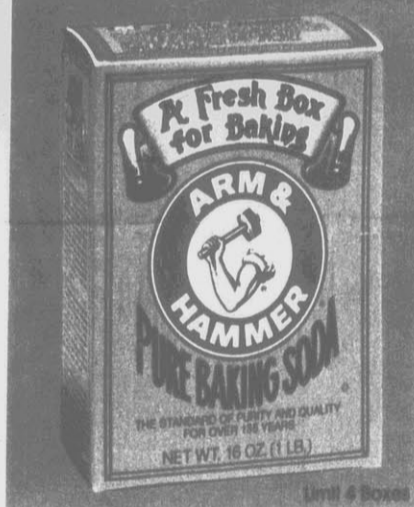

Limit 4 Boxes

**4** **\$1** Sale Price. 1-lb.\* baking soda for baking, cleaning, and many other household uses.  
Boxes

\*Net wt.

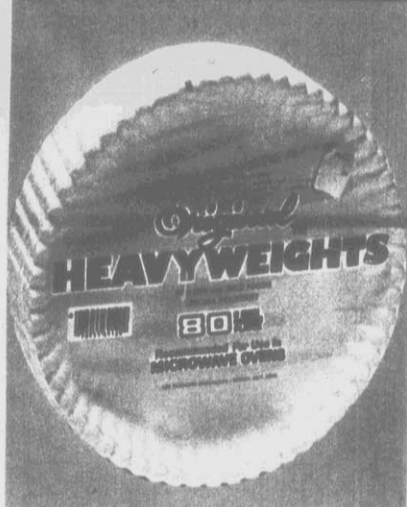

**\$1** Sale Price. Pkg. 80, 9" heavyweight paper plates. Grease resistant. For hot, cold food.  
Mfr. may vary



**\$2** Sale Price Box. 49-oz.\* Tide® laundry detergent. Scented or unscented formulas.  
Special Purchase While Quantities Last

\*Net wt.

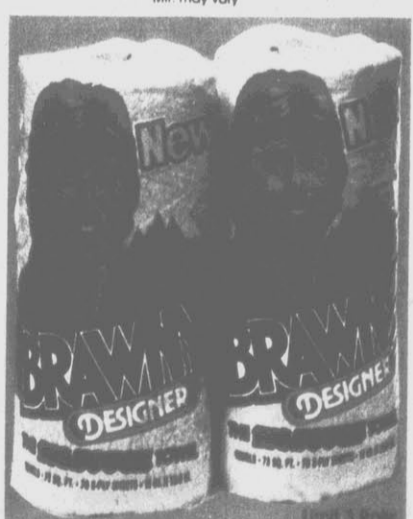

Limit 3 Rolls

**3** **\$2** Sale Price Roll. 70, 2-ply Brawny® paper towels each 11x13.8". Soft colors.

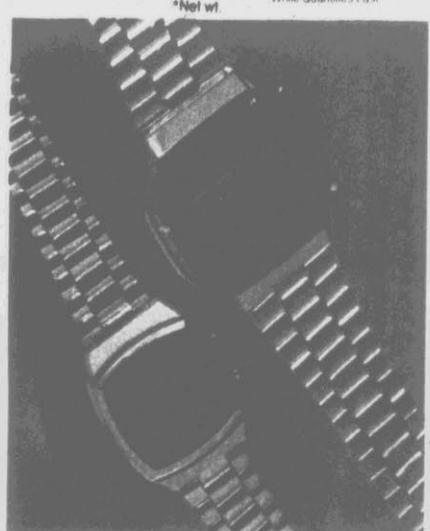

**\$3** Save 39%. Our 4.97 Ea. 5-function watches for men and women. Silver- or gold-tone band and case.  
Mfr. may vary



**\$9** Sale Price Box. Pampers® disposable diapers with refastenable tapes are absorbent and fit snugly.

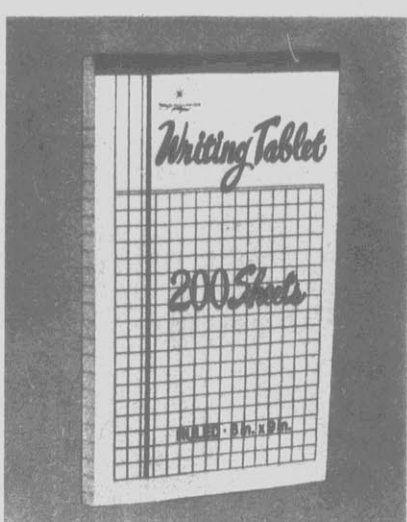

**2 Pkgs. \$1** Sale Price. Pkg. 5 Schick® disposable blades for a close shave time after time.

**\$1** Save 32%. Our 1.48 Ea. 6x9" white bond writing tablet. Choice of ruled or plain paper. 200 sheets.



**\$1** Save 39%. Our 1.64 Set 17-oz. or 25-oz. ice tea tumblers in "Swirl Gold" or "Swirl Crystal" pattern.

**\$1** Sale Price Roll. Focal® color print film with ISO 100. Your choice of 110/12, 135/12 or 126/12 film.

# Our Most Popular Sales Event EVER!

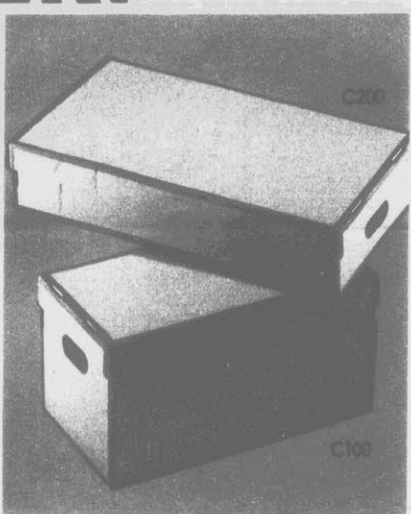
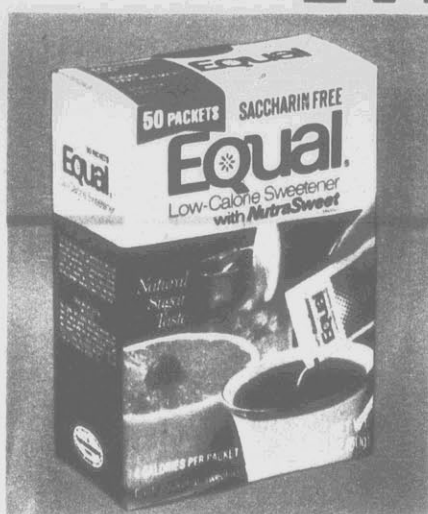

**\$2** Sale Price Box. Equal® sweetener. Super sugar substitute for coffee, tea, more. 50 packets.

**\$2** Save 22%. Our 2.57 Ea. 24x13x11" storage or 31x16x6" underbed box. Corrugated cardboard.

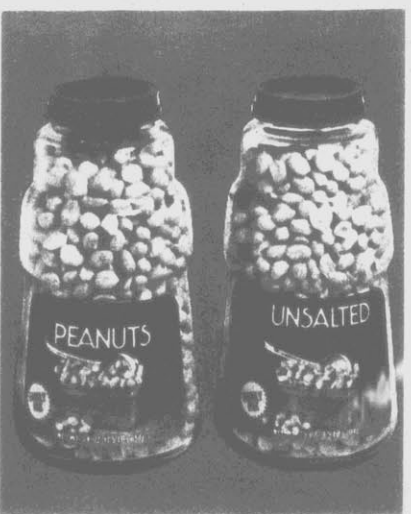

**\$2** Save 32%. Our 2.97 Ea. Plastic 5x7" picture frames. Our 1.97 Ea., 3½x5" .2 For \$3 Our 1.57, 2½x3½" . . . Ea. \$1

**\$2** Sale Price Jar. Dry-roasted peanuts. Great for snacks. 24-oz.\* salted; 25-oz.\* unsalted peanuts. \*Net wt.

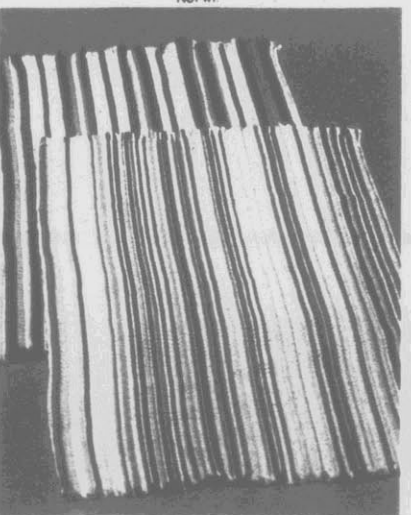
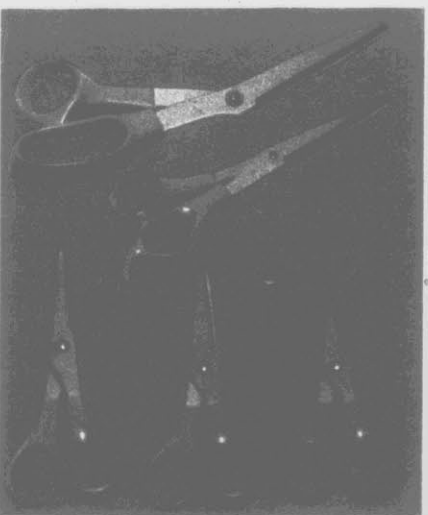

**2 For \$3** Save 39%-62%. Our 2.47-3.97 Ea. 4½" to 8" scissors of stainless steel.

**2 For \$3** Save 36%. Our 2.38 Ea. Multicolor 24x45" reversible rugs to protect your floors.



**4 \$1** Sale Price. Your favorite candy for any-time snacking. 1 1/2-oz.\* to 2.1-oz.\* sizes.  
\*Net wt

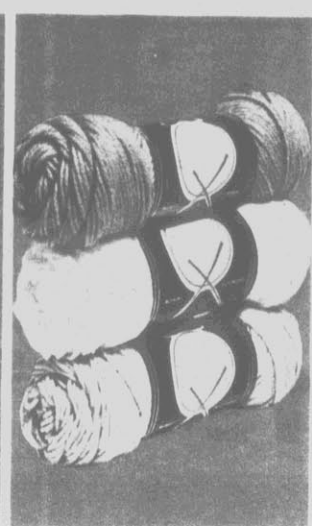

**2 \$1** Save 35%. Our 77¢ Skein. Acrylic knitting yarn in a choice of solid colors. 3-oz.\* skein.  
\*Net wt



**2 \$1** Save 42%. Our 87¢. Jobe's® houseplant spikes. Easy way to feed your plants. Pkg. of 18.



**3 \$1** Sale Price. Comet® cleanser in convenient 14-oz.\* size. Gets tubs, sinks and white walls clean.  
\*Net wt



**2 \$1** Save 48%. Our 97¢ Pr. Men's crew socks of acrylic/stretch nylon in color choice. Size 10-13.



**3 \$1** Save 57%. Our 78¢ Pr. Comfort-top knee highs. Nylon/spandex in basic shades. Size 9-11\*.  
\*Misses' or queen

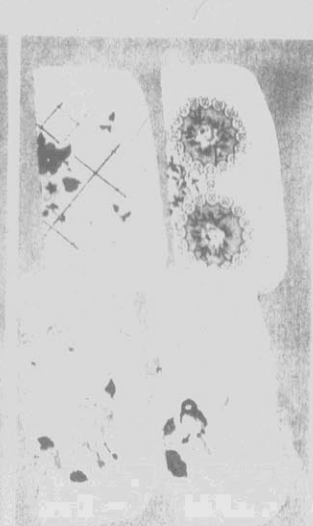

**3 \$1** Our 38¢. Wash cloths of cotton/polyester terry. Bath-brightening prints, in 12x12" size.



**\$1** Sale Price Pkg. 300 luncheon napkins. 1 ply, 13x12 1/4". The easy way to entertain... they're disposable.



**\$1** Sale Price Pkg. Palmolive® complexion bars, 3.25-oz.\* per bar. 4-bar pkg. includes one bonus bar.  
\*Net wt



**\$1** Save 49%. Our 1.97 Ea. Kitchen towels of absorbent cotton. In choice of prints. 16x27".

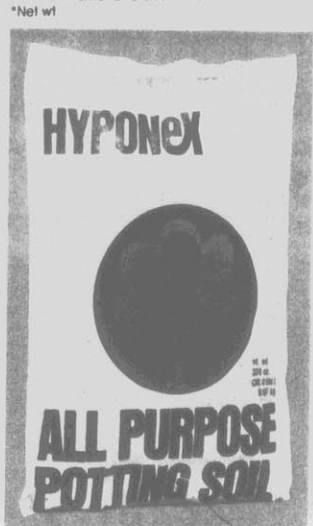

**\$1** Save 57%. Our 2.37. All-purpose potting soil in 20-lb.\* bag. Odorless, non-burning, ready to use.  
\*Net wt



**\$1** Save 46%. Our 1.87. Bushel laundry basket of sturdy plastic in a choice of colors.

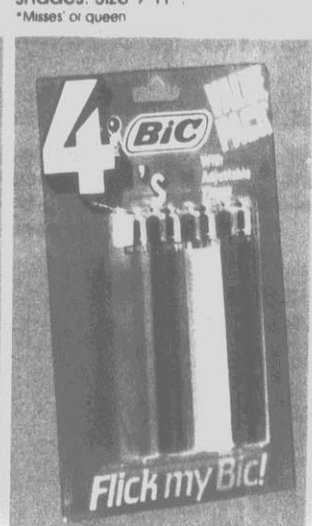

**4 \$1** K mart® Sale Price Less Factory Rebate  
**\$1** Your Net Cost After Rebate  
Rebate limited to mfr's stipulation  
Bic® disposable lighters in pack of 4. Color choice.

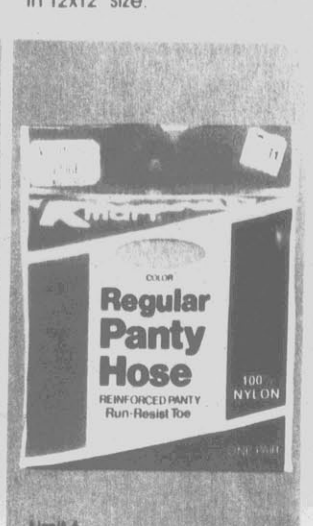

**3 \$2** Save 31%. Our 97¢. Panty hose. Stretch nylon with reinforced panty. Misses' S/M, M/L.



**K mart® ADVERTISED MERCHANDISE POLICY**  
Our firm intention is to have every advertised item in stock on our shelves. If an advertised item is not available for purchase due to any unforeseen reason, K mart will issue a Rain Check on request for the merchandise (one item or reasonable family quantity) to be purchased at the sale price whenever available or will sell you a comparable quality item at a comparable reduction in price.

## Stock Up And Save At Kmart® During Our Most Popular Event Wed., May 15 Through Sat., May 18



**\$2** Sale Price Ea. Krylon® interior/exterior spray paint in white and colors. 12 oz.\*  
\*Net wt

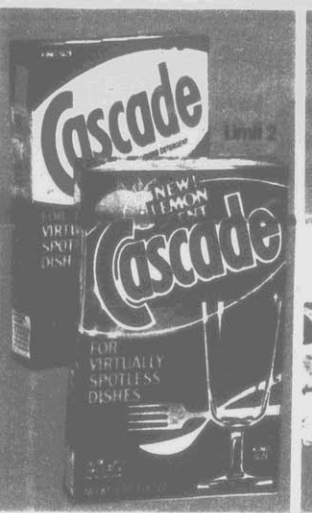

**\$2** Sale Price Ea. 50-oz.\* Cascade® dish detergent for automatic dishwashers. Regular, lemon scent.  
\*Net wt



**\$2** Save 32%. Our 2.97 Ea. Bath towel. Cotton/polyester terry or velour. Solid colors, prints. 22x42".



**\$3** Save 32%. Our 4.47 Ea. Infant boys' short sets of cotton. Top has screen print. Sizes 9-18 months.

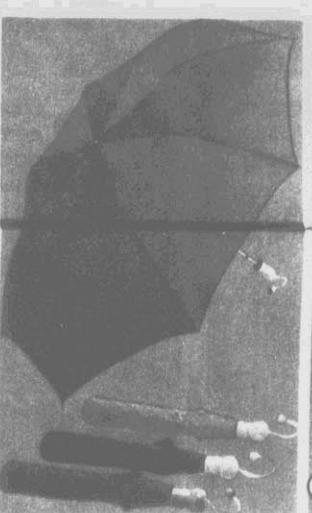

**\$2** Save 59%. Our 4.97 Ea. Women's folding umbrella of nylon. In colors to brighten rainy days.



**2 \$5** Save 21%. Our 3.17 Ea. Men's pocket t-shirts of comfortable cotton in color choice.

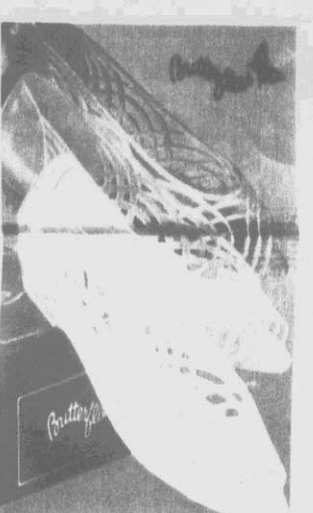

**\$2** Save 49%. Our 3.97 Pr. Women's or girls' pumps. Lattice design. Latest spring colors: Girls' 9-4.\*  
\*White, pink only

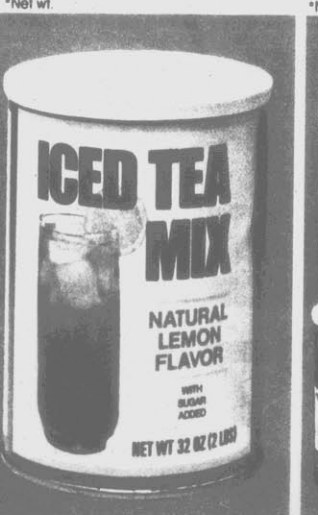

**2 \$3** Save 41%. Our 2.57. 32-oz.\* iced tea mix to help you cool off when the weather gets warm.  
\*Net wt

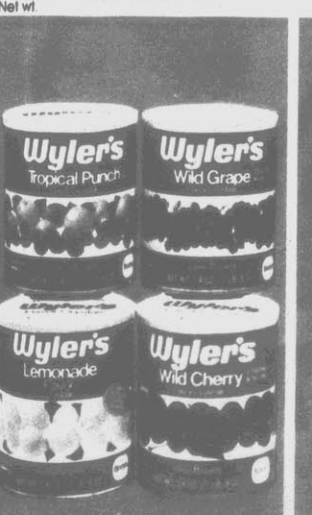

**2 \$3** Save 23%. Our 1.97 Ea. 24-oz.\* Wylers'® drink mixes. Lemonade, grape, cherry or fruit punch.  
\*Net wt



**2 For \$3** K mart® Sale Price  
**-\$2** Less Factory Rebate  
**2 For \$1** Your Net Cost After Rebate  
Rebate limited to mfr's stipulation  
Ivory® shampoo or conditioner. 15 oz.\* each.  
\*Fl. oz.



**2 \$3** Save 41%. Our 2.58. Pkg. of 20 trash bags. 30x36"x1.5-mil size fits 20-30 gal. containers.



**4 \$3** Special Purchase.\* Nylon or cotton briefs or bikinis in misses' 5-7, 8-10. Solid colors or prints.  
\*Limited quantities available



**2 \$5** Brushes or combs in the latest colors, to super-style your hair! Of plastic.



**2 \$7** Save Up To 37%. Our 4.27-5.58. Ovenware. 1- or 1 1/2-qt. covered casserole, 8" sq pan, 1 1/2-qt. dish

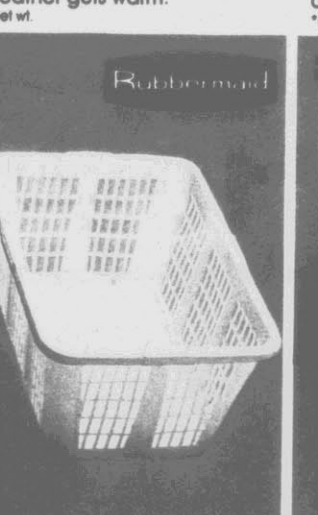

**\$5** Sale Price. 1 1/4-bushel laundry basket in stylish colors. Of durable plastic.



**\$5** A. Our 6.97. Life vest. Polyester shell with foam fill.  
B. Our 8.97. Boat Cushion, \$7



**\$6** Save 29%. Our 8.47. 50' garden hose. Nylon reinforced for longer life. 3/4" inside dia.

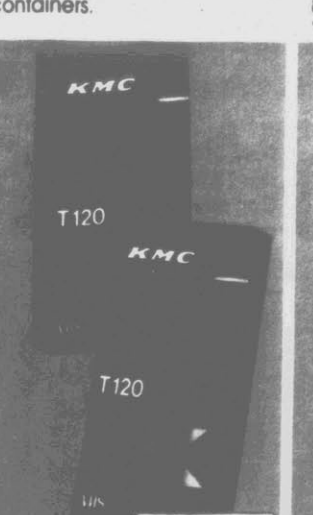

**2 \$9** Save 24%. Our 5.97 Ea. VHS blank video tape. 2-, 4-, 6-ht. recording. With cover.

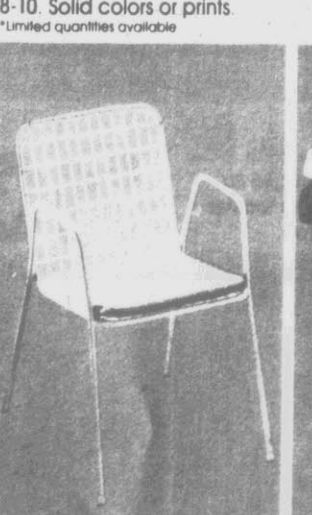

**2 \$11** Save 44%. Our 9.97 Ea. Stackable steel chairs, 22x29", with mesh seat, back.

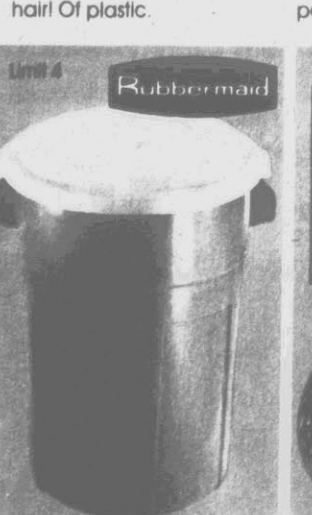

**\$12** Ea. K mart® Sale Price  
**-\$2** Less Factory Rebate  
**\$10** Ea. Your Net Cost After Rebate  
Rebate limited to mfr's stipulation  
"Roughneck" 32-gal. trash can of rugged plastic



**\$3** Ea. K mart® Sale Price  
**-\$3** Ea. Less Factory Rebate  
**\$2** Ea. Your Net Cost After Rebate  
Rebate limited to mfr's stipulation  
C. Car wax. 14 oz \* paste or 16-oz \*\* liquid  
\*Net wt \*\*Fl. oz

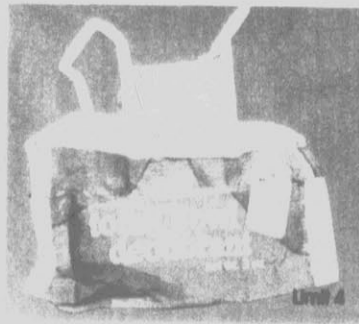

**4\$1** For **1** Sale Price Ea. 3-oz<sup>+</sup> toilet bowl deodorizer is pleasantly scented. \*Net wt.

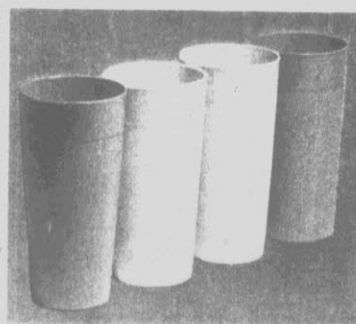

**4\$1** For **1** Sale Price. Plastic tumbler in 30-oz. size. Choice of colors.

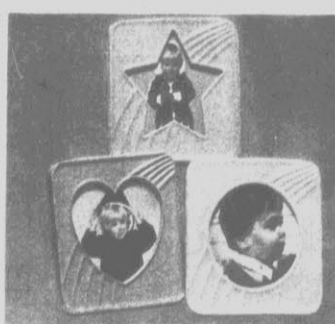

**3\$1** For **1** Save 29%. Our 47¢ Ea. 3x3" magnetic frames in choice of shapes, colors.



**2\$1** For **1** Save 21%. Our 64¢ Ea. Food-saver jar of durable plastic. 9 oz.

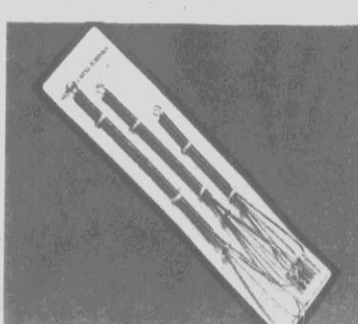

**2\$1** For **1** Sale Price. Set of 3 mini whisks. Set contains 3 different sizes.



**\$1** Save 36%. Our 1.57. Handy 2-qt. bottle; clear plastic for household uses.



**\$1** For **1** Sale Price Ea. 32-oz<sup>+</sup> RealLemon<sup>®</sup> concentrate or 16-oz<sup>+</sup> cold-slaw dressing. \*Fl. oz.

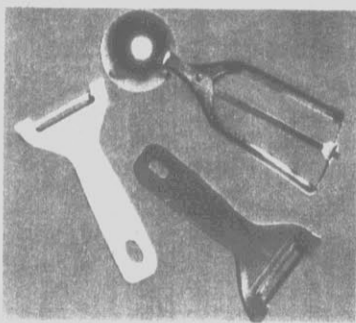

**\$1** For **1** Sale Price Ea. Ice cream scoop or floating-blade vegetable peeler.



**\$1** For **1** Sale Price Ea. Simmer ring for ranges or set of 2 corn-cob skewers.



**\$1** For **1** Sale Price Ea. 12-oz<sup>+</sup> luncheon meat or 48-oz<sup>+</sup> Polish or kosher dills. \*Net wt.

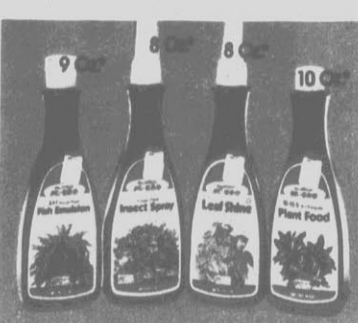

**\$1** For **1** Save 21%-40%. Our 1.27-1.67 Ea. Fish emulsion, insecticide, leaf shine, plant food. \*Fl. oz.



**\$2** For **1** Sale Price. 6-qt. vanity wastebasket of durable plastic. Colors.

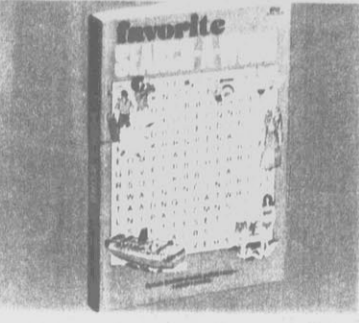

**\$2** For **1** Save 32%. Our 2.96 Ea. Choice of 430-pg. puzzle books. 8 1/2 x 10 1/2"

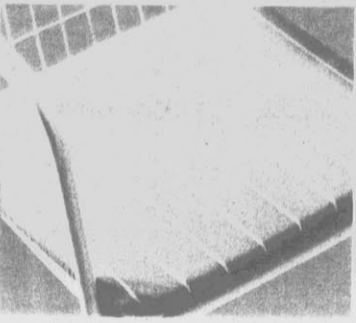

**\$2** For **1** Save 30%. Our 2.88. 16x17x1" rayon chair pad; polyurethane fill.



**\$2** For **1** Save 38%. Our 3.27. Cassette head cleaner Non-abrasive.

# Super Savings Spree

# dollar



**3\$2** For **2** Sale Price. 3-in-1 love stories; paperback.



**3\$2** For **2** Save 31%. Our 97¢ Ea. 32-oz. food saver.

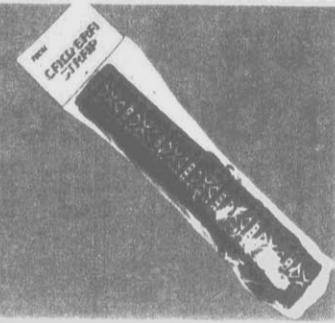

**\$3** For **1** Sale Price. 48" camera strap is adjustable. Pattern choice.



**\$3** For **1** Save 29%. Our 4.27. 30-tape cassette case of durable plastic.



**\$3** For **1** Save 24%. Our 3.97 Ea. 40x63" or 40x81" polyester panel.



**\$3** For **1** Sale Price Pkg. Efferdent<sup>®</sup> denture cleaner. Pkg. of 96 tablets. Limit 2 Pkgs.



**\$3** For **1** Sale Price. Our 4.97. Foot pump with gauge for inflatables.



**\$4** For **1** Sale Price. 4-oz<sup>+</sup> Coppertone<sup>®</sup> Super Shade<sup>®</sup> 15 sunblocking lotion. \*Fl. oz.



**\$4** For **1** Sale Price Set. 1 1/2-, 3-, 5-cup stainless-steel containers, covers.

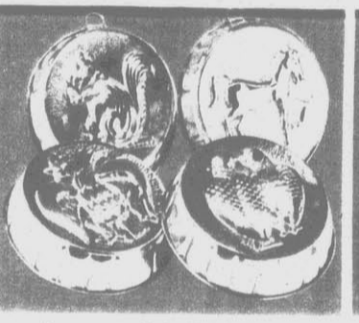

**\$4** For **1** Sale Price Ea. copper mold in choice of 4 animal styles.



**\$4** For **1** Save 28%-42%. Our 5.97-7.57 Ea. 11x8 1/2", 11x8 1/2", 10x10" plastic planters.

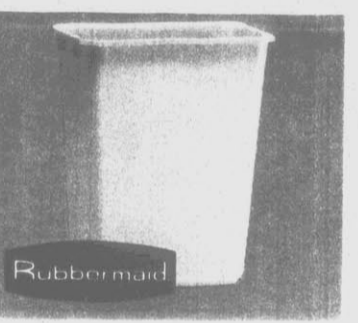

**\$4** For **1** Sale Price. 30-qt. wastebasket of sturdy plastic in choice of colors.



**\$5** For **1** Sale Price. Cellulose-sponge mop. Cellulose-sponge Refill . . . . . 2 For \$5

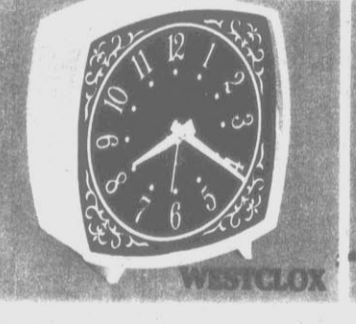

**\$6** For **1** Our 7.47. Hand-wind alarm clock with luminous dial, 36-hr. movement.

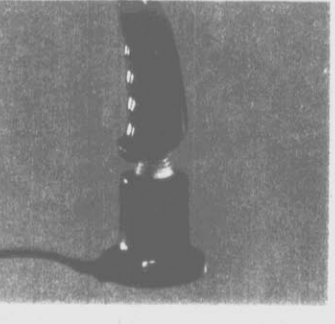

**\$6** For **1** Save 33%. Our 8.97. Video controller with pistol grip.

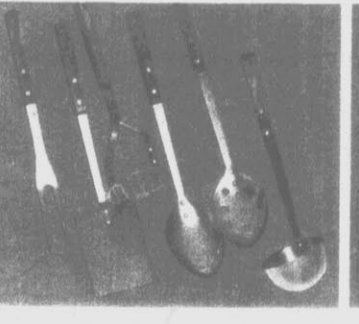

**\$7** For **1** Sale Price Set. 6-pc. kitchen tool set of stainless steel.

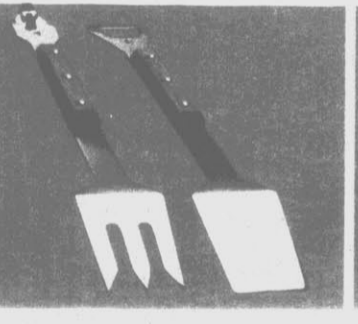

**\$7** For **1** Sale Price Set. 2-pc. barbecue tong set. Stainless steel, wooden handles.

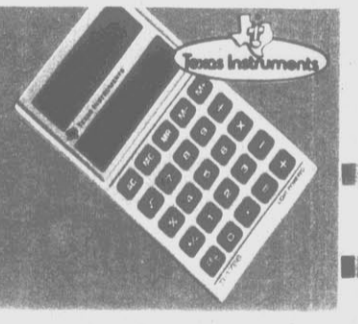

**\$7** For **1** Save 29%. Our 9.97. Solar calculator with 8-digit L.C.D.

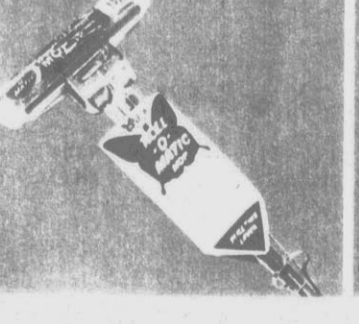

**\$7** For **1** Sale Price. Roll-O-Matic<sup>®</sup> polyurethane-sponge mop for cleaning.

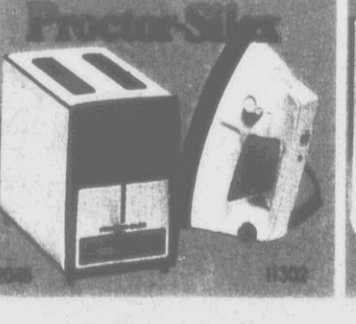

**\$10** For **1** Save 26%. Our 13.66 Ea. 2-slice toaster or iron.

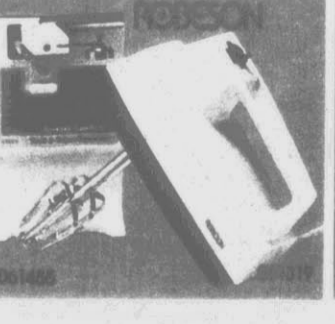

**\$10** For **1** Save 26%. Our 13.55 Ea. Can opener or hand mixer.



**\$10** For **1** Save 28%. Our 13.97. 3 1/2-qt. slow cooker.



**\$10** For **1** Our 11.97-12.97 Ea. 6-cup hot pot or 8-cup coffee pot.

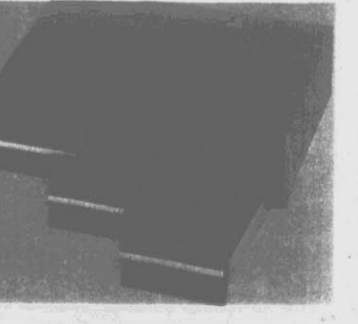

**\$10** For **1** Save 30%. Our 14.47. 36-tape storage case.

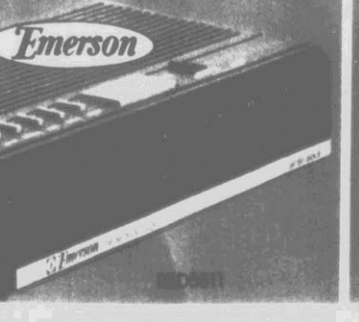

**\$16** For **1** Our 19.88. Emerson<sup>®</sup> AM/FM digital clock radio.



**\$16** For **1** Our 19.97. Desktop calculator; 8-digit solar powered.

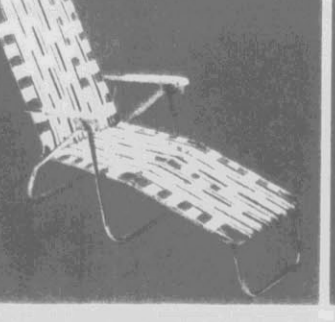

**\$16** For **1** Sale Price. 5/position lawn chase. Mr. may vary

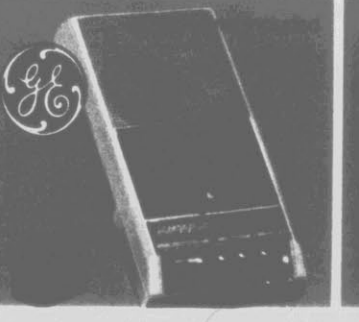

**\$20** For **1** Sale Price. AC/DC<sup>®</sup> cassette recorder. \*Batteries are extra



**\$20** For **1** Sale Price. 2X teleconverter for cameras.



**\$19** For **1** Sale Price. 7x35mm ZWCF binoculars; wide angle.



**\$1** Sale Price Ea. Household cleaners. 32-oz.\* Fantastik® or 48-oz.\*\* Vanish® crystals. \*Fl. oz. \*\*Net wt.



**\$1** Sale Price Ea. 17 oz.\* bathroom cleaner or 33-oz.\*\* Fabric softener. \*\*Fl. oz. \*Net wt.



**\$1** Sale Price Pkg. 36 wooden clothes pins with springs for hanging laundry.



**\$1** Sale Price Pkg. 80 bandages in choice of 2 styles for minor cuts, burns.



**\$1** Sale Price. Krazy Nails® glue pen for repairing broken nails, attaching new ones. .07 oz.\* \*Fl. oz.



**\$1** Sale Price Ea. 8-oz.\* Style® hair spray in choice of formulas; scented; unscented. \*Net wt.



**\$2** Sale Price Set. 3 utility knives in 3 sizes. Stainless-steel blades.

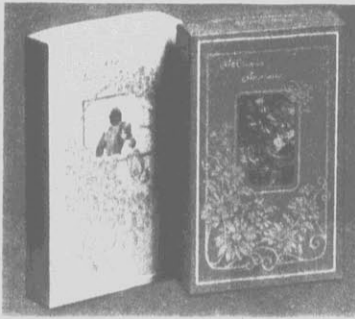

**\$2** Sale Price Box. 14 cards with envelopes for everyday use.

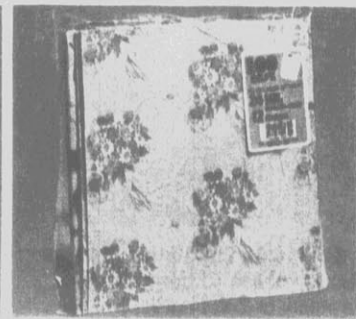

**\$2** Sale Price Pkg. 24, 20x30" sheets wrapping paper. 12 designs.



**\$2** Sale Price Kit. Krazy Nails® nail tip kit for more attractive hands.



**\$2** Sale Price Pkg. 150 Diaparene® baby washcloths for cleaning.



**2\$3** For Sale Price. 28-oz.\* Mr. Clean® all-purpose household cleaner. \*Fl. oz.

# At Your Local K mart® days

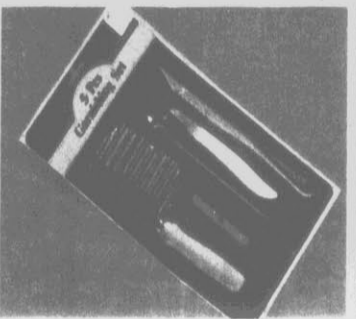

**\$2** Sale Price. 5-pc. set garnishing tools of stainless steel.



**\$2** Sale Price. 5 1/2" steamer basket of stainless steel. Fits most pots.



**2\$3** For Sale Price. 1-gal. decanter for water, juices, other beverages.

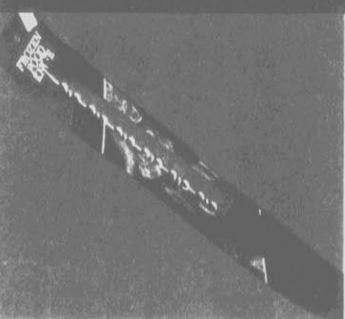

**\$3** Sale Price. Frozen-food knife with stainless-steel blade.



**\$3** K mart® Sale Price — **\$3** Less Factory Rebate  
\*Your Net Cost After Rebate. Rebate limited to mfr.'s stipulation.  
**60 Excedrin®** tablets. Extra strength.



**2\$3** For Our 1.86 Ea. Pocket trivia games. Choice of subjects.



**2\$3** For Sale Price. 12-oz.\* saline solution for contact lenses. \*Fl. oz.



**2\$3** For Sale Price. Children's hardcover story books for young readers.



**2\$3** For Sale Price. 2-lb.\* jar strawberry jam. Delicious on toast, sandwiches. \*Net wt.



**\$2** Sale Price. 24-oz.\* Spray 'n Vac® rug cleaner. Easy, convenient. \*Net wt.



**\$5** Sale Price. 24" push broom for indoor, outdoor use.

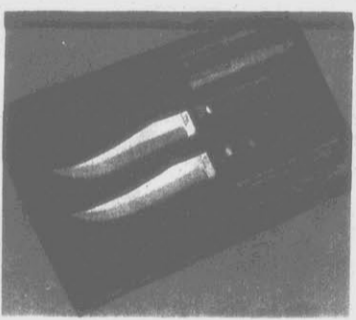

**\$5** Sale Price Set. 6-pc. steak knife set boxed for gift giving.

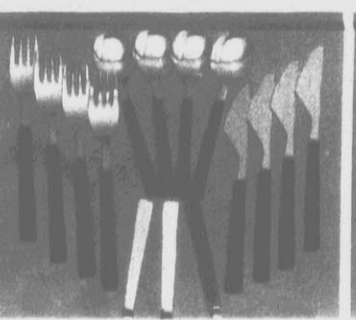

**\$5** Sale Price Set. 12-pc. flatware set with colorful plastic handles.

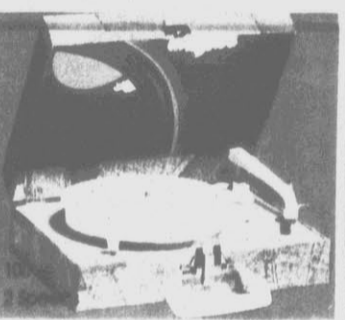

**\$16** Our 19.97. children's record player; manual.



**\$6** Save 49%. Our 11.97 Ea. Posters are in 16x20" frame.

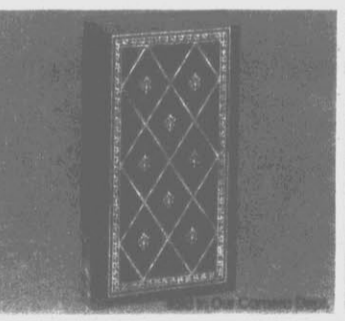

**\$7** Sale Price. 3-ring photo album for storing precious moments.

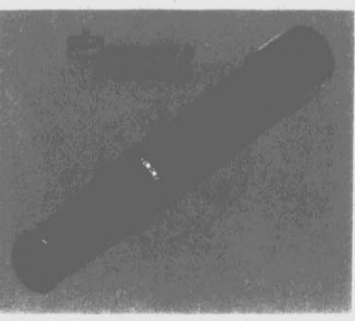

**\$8** Sale Price. 30x30mm telescope is hand-held for convenience.

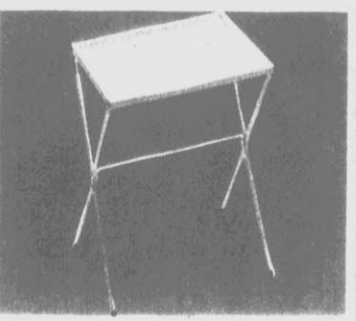

**\$8** Save 27%. Our 10.97 Ea. 12x16" or 16"-dia. patio table. Metal, colors. Mfr. may vary.

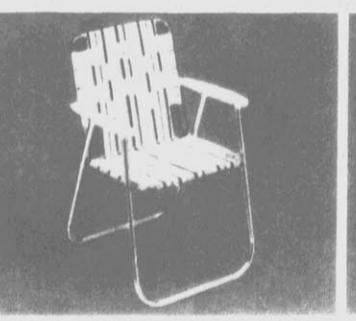

**\$7** Sale Price. Folding aluminum chair; plastic webbing. Mfr. may vary.



**\$8** Save 26%. Our 10.88 Pkg. 12 hanging folders; frame, inserts, tabs.

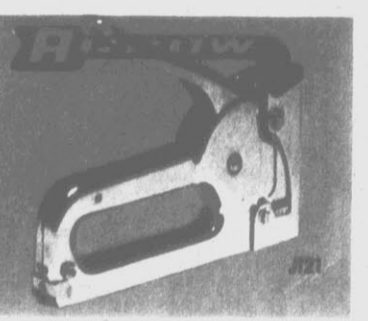

**\$8** Our 988 Staple gun for household use. Durable; chrome finish.



**\$12** Sale Price. Camera shock bag of nylon, vinyl trim.

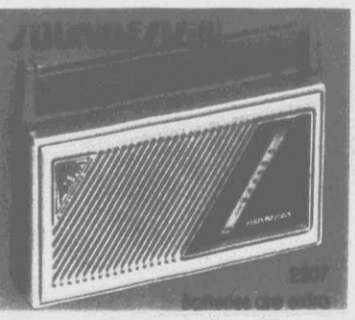

**\$13** Save 22%. Our 16.77. AM/FM, AC/DC portable radio. Style and model may vary.



**\$14** Our 17.47. AM/FM stereo receiver with headphones.



**\$15** Save 24%. Our 19.97 Box. 10 floppy disks; single side.



**\$14** Sale Price. 16" black and silver big wheel.

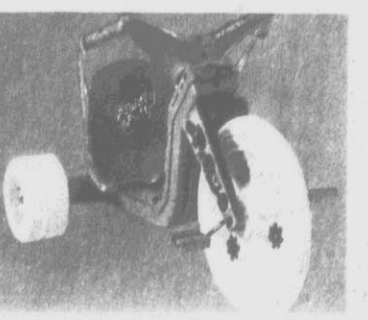

**\$14** Sale Price. 16" big wheels for girls. Mfr. may vary.

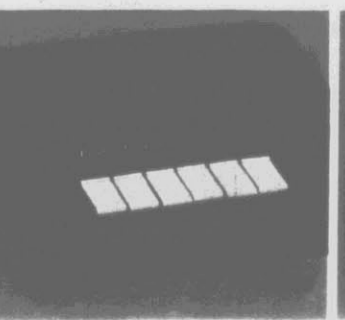

**\$22** Save 26%. Our 29.97. Data cassette for Commodore®.

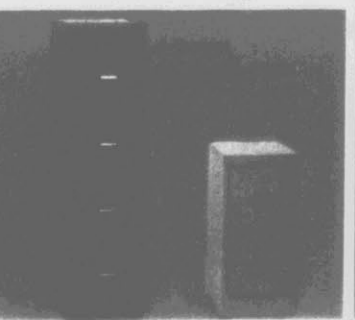

**\$39** Sale Price. 2-drawer file cabinet; lockable. Mfr. may vary.



**\$59** Sale Price. AM/FM, AC/DC\* radio with cassette recorder. \*Batteries are extra.

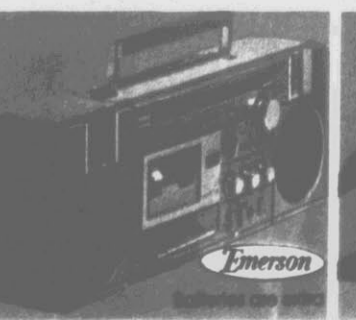

**\$69** Sale Price. AM/FM, AC/DC "home and go" system. Style and model may vary.



**\$99** Sale Price. 35mm Freedom II® camera; auto focus.

**PRO VALUE FILM DEVELOPING SPECIALS**

Double-inspected glossy color prints from 35mm film.

12 Exposures **\$3**

24 Exposures **\$5**

36 Exposures **\$7**

Scale Ends May 18

AT YOUR K MART® CAMERA DEPT.



**2 FOR \$7**

Save 29%-41%. Our 4.97-5.97 Ea. Fashion shorts or tank tops. Choice of styles and colors. All of easy-care fabrics. Sizes S-M-L.



**\$12**

Save 27%. Our 16.66 Ea. Junior dresses in casual and dressy styles. Choose from a variety of summery colors. Sizes 3-13. Our 16.66, Women's Dresses, Sizes 16½-24½, \$12 Styles are representative of group



**2 FOR \$9**

Special Purchase\* Playtex® bras in a variety of styles including Cross Your Heart® seamless styles and more. Popular sizes. \*Limited quantities available

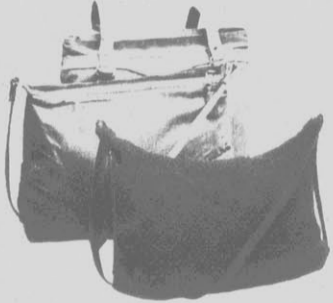

**\$3** Save 49%-86%. Our 5.97-6.97 Ea. Summer bags; nylon or cotton/nylon mesh.



**\$4** Save 32%. Our 5.97 Ea. Oversize crop tops. Many styles. S-M-L.



**\$5** Save 37%. Our 7.97 Ea. Terry rompers. Cotton/nylon. Misses' sizes S-M-L.

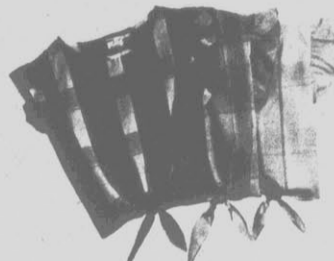

**\$7** Save 21%. Our 8.97 Ea. Cropped tops of polyester/cotton. S-M-L.

Lovable



Exquisite Form



**\$3** Special Purchase\* Ea. Lovable® bras; many styles, sizes. \*Limited quantities available

**\$3** Special Purchase\* Ea. Exquisite Form® bras; many styles, sizes. \*Limited quantities available

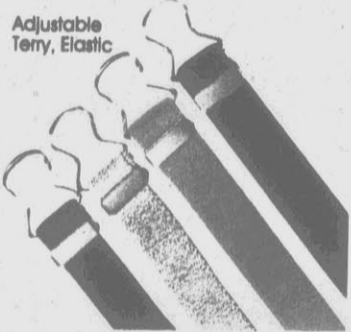

**4 \$3 FOR** Save 57%. Our 1.78 Ea. Women's elastic belts. Fashion Colors

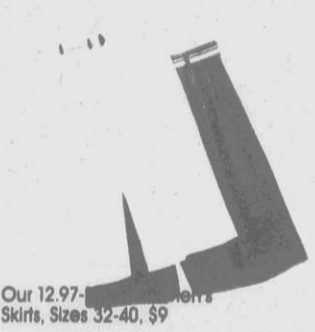

**\$9** Save 24%-30%. Our 11.96-12.96 Ea. Twill skirts; jr. misses' 7/8-17/18. \*Polyester/cotton



**\$9** Save Up To 24%. Our 9.97-11.97 Ea. Swimsuits; jr. misses' 7/8-13/14



**\$9** Save 30%-38%. Our 12.97-14.97 Ea. Beach cover-ups. Sizes S-M-L.



**\$1** Save 27%. Our 1.37 Ea. Double-back panties. Sizes 7-10.



**\$5** Save 20%. Our 6.27 Ea. Girls' baby-doll pajamas. Sizes 4-14.



**4 \$3 FOR** Our 97¢ Ea. Women's print bandanas. Cotton.



**\$7** Save 21%-29%. Our 8.97-9.97 Ea. Choice of colorful smocks. Sizes S-M-L Women's 34-38



**\$7** Save 29%. Our 9.97 Ea. Women's pants of Fortrel® polyester. 32-42. \*Fortrel is a Reg. TM of Celanese Corp.



**\$7** Save 21%. Our 8.97 Ea. Women's tank tops in sizes 38-44.



**\$4** Save 32%-42%. Our 5.96-6.97 Ea. Women's shorts in sizes 32-40.



**\$7** Save 21%-29%. Our 8.97-9.97 Ea. Girls' 2-pc. sets or "shortalls" Styles may vary by store

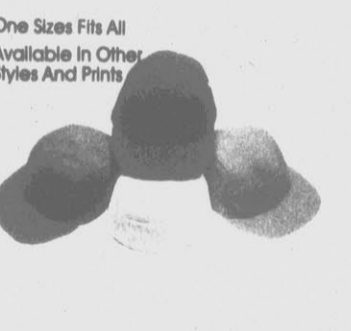

**\$4** Save 32%. Our 5.97 Ea. Women's baseball-style fabric hats.

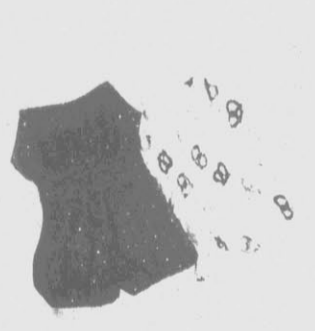

**\$2** Save 30%. Our 2.88 Ea. Infant girls' rompers. Sizes 9-18 mos.

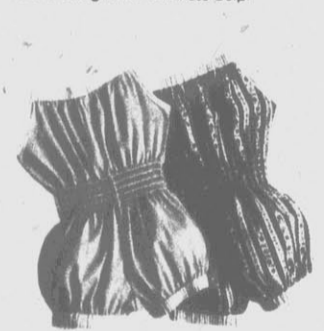

**\$2** Save 30%. Our 2.88 Ea. Toddler girls' rompers. Sizes 2-4.



**\$2** Save 32%. Our 2.97 Ea. Girls' rompers in sizes 4-12.



**\$4** Save 32%. Our 5.96 Ea. Little girls' shorts in sizes 4-6X. Styles may vary by store



**\$4** Save 32%. Our 5.96 Ea. Little girls' tank tops. Sizes 4-6X. Styles may vary by store



**\$4** Save 32%. Our 5.97 Ea. Women's Ivy-league-style fabric hats.



**\$3** Save 39%. Our 4.97 Jr. boys' 2-piece short sets. Sizes 4-7.



**\$4** Save 32%. Our 5.97 Ea. Toddler boys' 2-pc. short sets. Sizes 2-4.



**\$2** Save 32%. Our 2.97 Ea. Toddler girls' sunsuits. Sizes 1-3.



**\$5** Save 37%. Our 7.96 Ea. Girls' summer tops. Sizes 7-14.



**\$6** Save 24%. Our 7.97 Ea. Girls' sun dresses in sizes 4-14.



**\$1** Save 36%. Our 1.57 Nylon Panty Hose. Misses' S-M-L, queen size.



**\$1** Save 27%. Our 1.37 Pr. Misses' girls' sport socks. FH 9-11, 7-8½.



**\$4** Save 42%. Our 6.97 Ea. Toddler girls' 2-pc. short sets. Sizes 2-4.



**\$4** Save 49%. Our 7.97 Ea. Toddler girls' "shortalls" Sizes 2-4.

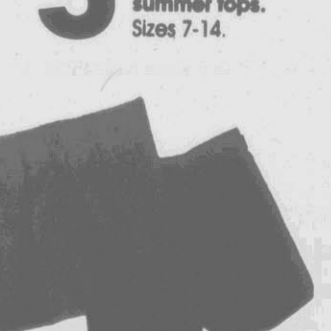

**\$5** Save 28%-37%. Our 6.96-7.96 Ea. Girls' shorts in sizes 7-14.



**\$6** Save 33%. Our 8.96 Ea. Little girls' 2-pc. sassy sets. Sizes 4-6X.



**\$5** Special Purchase\* Pr. Women's casual step-ins of cool comfortable mesh. Cushioned canvas insole for warm-weather comfort; durable Shell® Kraton® sole. Choice of white or beige.  
\*Limited quantities available



**\$4** Save Up To 32%. Our 4.97-5.97 Ea. Boys' coordinated athletic wear includes tank tops, tee-shirts, cut-off tops and shorts. All of polyester/cotton. Sizes 8-18.



**2\$9** For Save 43%. Our Reg. 7.97 Ea. Men's coordinated tops and shorts in a sporty array of colors. Choose tank tops, crew- or V-neck shirts, matching shorts. Cotton blends; sizes S-XL.



**2\$5** Prs. Save 37%. Our 3.97 Pr. Women's thongs.



**\$5** Special Purchase\* Pr. Women's canvas casuals.  
\*Limited quantities available

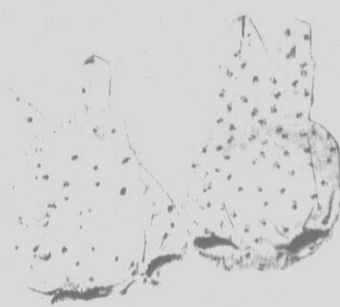

**\$2** Save 32%. Our 2.97 Ea. Infant girls' sunsuits. Sizes 9-24 mos.

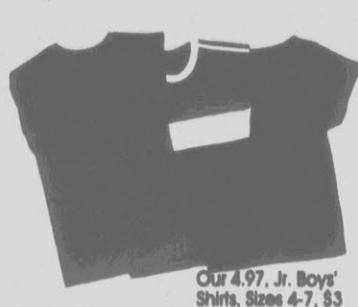

**\$4** Save 32%. Our 5.97 Ea. Boys' muscle shirts in polyester/cotton



**\$8** Save 38%. Our 12.97 Ea. Men's jeans of cotton denim.

**GoldenBlend**  
Underwear  
Our 5.97, Men's Golden Blend® Briefs, Pkg. Of 3, \$4

**\$5** Save 28%. Our 6.97. Pkg. of 3 men's Golden Blend® T-shirts.



**\$5** Save 28%. Our 6.97 Pr. Women's comfortable sandals.

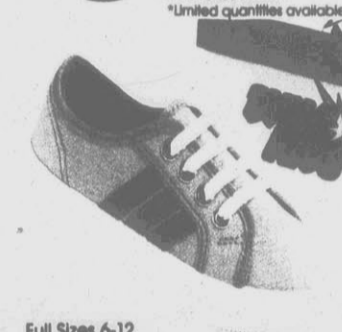

**\$4** Special Purchase\* Pr. Children's canvas court shoes.  
\*Limited quantities available



**\$2** Save 27%. Our 2.77 Ea. Jr. boys' shorts in sizes 4-7. Choice of colors.

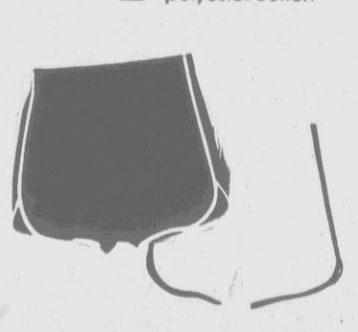

**2\$5** For Save 23%. Our 3.27 Ea. Boys' shorts.



**\$6** Save 33%. Our 8.97 Ea. Men's sport shirts. Colorful plaids. S-XL.



**\$7** Save 21%-29%. Our 8.97-9.97 Ea. Men's short-sleeve dress shirts.



**\$4** Special Purchase\* Pr. Children's canvas T-strap shoes.  
\*Limited Quantities Available



**\$6** Save 33%. Our 8.97 Pr. Men's Canvas Slip-on Boat Shoes.

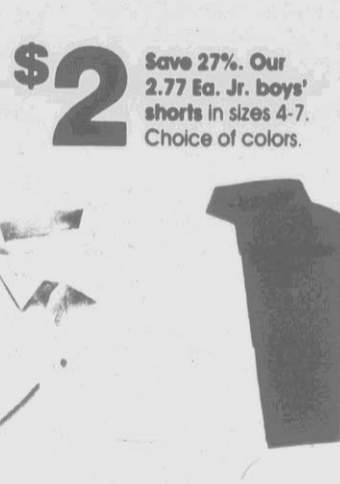

**\$6** Save 39%. Our 9.97 Ea. Men's knit golf shirts. In color choice.



**\$3** Save 32%. Our 4.97 Ea. Men's printed tank tops, solids, stripes.



**\$11** Save 33%-41%. Our 14.96 Ea. Men's dress slacks.  
Our 16.96, Extra-large Sizes, \$12



**\$3** Save 39%. Our 4.97 Ea. Men's neckties; clip-on style.

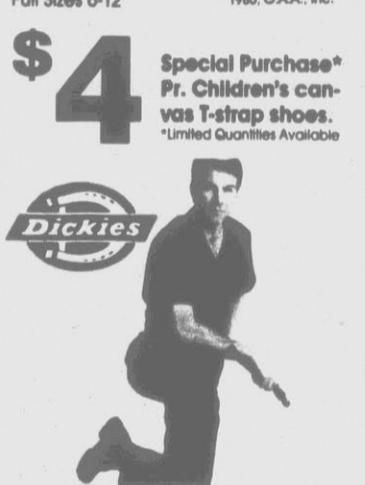

**\$13** Save 26%. Our 17.68. Men's short-sleeved coveralls.  
Breeds may vary by store

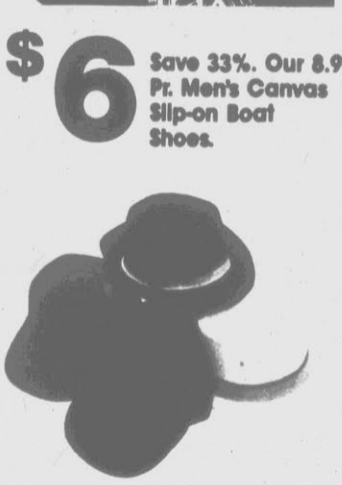

**2\$3** For Save 49%. Our 2.97 Ea. Men's hats.



**\$7** Save 41%. Our 11.97. Men's shorts; Ban-Rol® waist.



**\$4** Save 26%-32%. Our 5.47-5.97 Ea. Men's printed tee shirts.



**\$8** Save 38%. Our 12.97 Ea. Men's short-sleeved shirts.

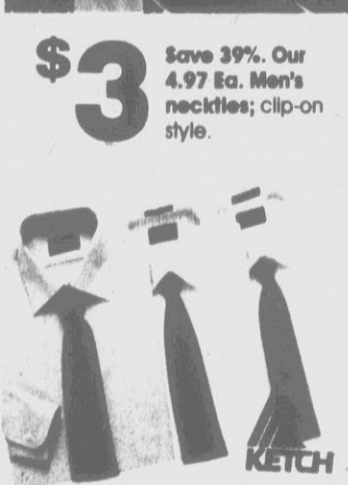

**\$8** Save Up To 27%. Our 9.97-10.97 Ea. Men's long-sleeve dress shirts.

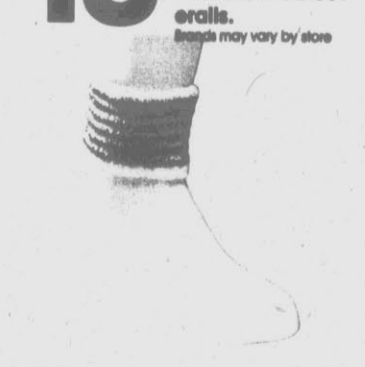

**\$1** Save 27%. Our 1.37 Pr. Girls' sport socks. Fit 7-8½.



**\$1** Save 21%. Our 1.28 Pkg. 2 prs. anklets. Fit misses' 8½-11.



**2\$3** For Sale Price. Large selection of jewelry.



**\$5** Save 28%. Our 6.97 Pkg. of 6 prs. men's tube socks. Fit 10-13.



**\$5** Save 22%. Our 6.47. Pkg. of 6 prs. boys' tube socks. Fit 9-11.



**3\$2** Prs. Save 24%. Our 88¢ Pr. Boys', misses' socks.

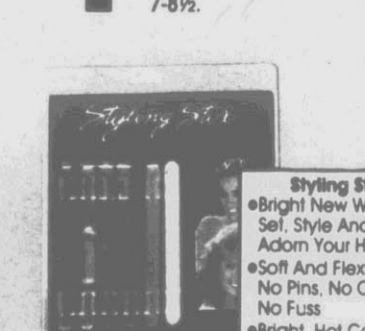

**\$4** Sale Price. Pkg. of 6, 8" Styling Stix™ flexible rollers.

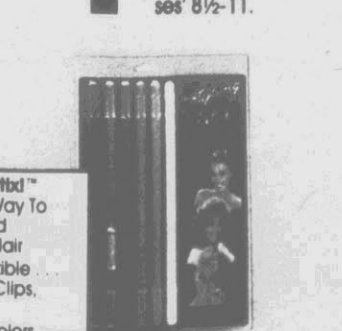

**\$5** Sale Price. Pkg. of 6, 10" Styling Stix™ flexible rollers.



**\$3** Sale Price. Accessory box with tray for rollers, more.



**\$4** Our Reg. 4.97. Handy nylon diaper/tote bag. Extra roomy.

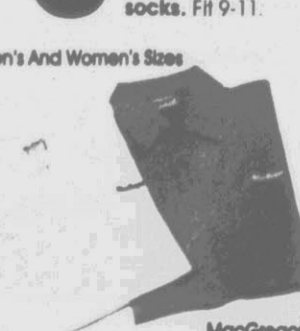

**\$10** Save 28%. Our 13.97 Ea. Coaches' shirts.



**\$10** Save 28%. Our 13.97. Coaches' shorts.



**2<sup>\$</sup>1** For **1** 24" pick-up tool or handy tool magnetizer.



**1** Our 1.57 Set. 8-pc. hex allen wrench set in pouch.

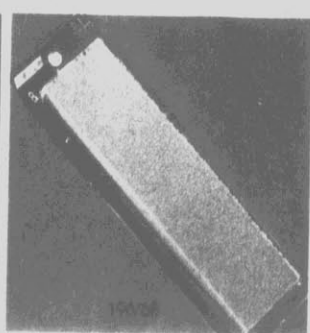

**2** Handy 8" size sharpening stone for knives.



**1** Our 1.27. Pkg. of 2 handy utility hooks. Multiuse.

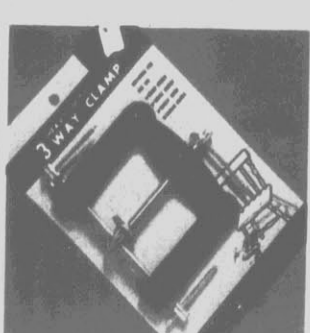

**1** Save 40%. Our 1.68. 3-way clamp for door, table.



**1** Our 1.56-1.68 Ea. 18" wrecking bar or 12-oz. mallet.



**1** Save 43%. Our 1.77. 6" combination slip-joint pliers.



**1** Our 1.47. 6-pc. screwdriver set. Short handles, assorted tips.

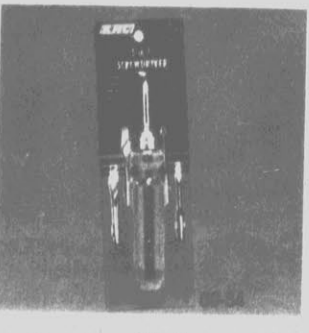

**1** 5-in-1 screwdriver. Bits store in handle.



**1** Our 1.37 4-pack Soft-Light™ bulbs in choice of sizes.



**1** Our 1.28. 9' polarized cord. U.L. listed, rotary safety caps.



**2** Combination square. 12x1" Locking handle.

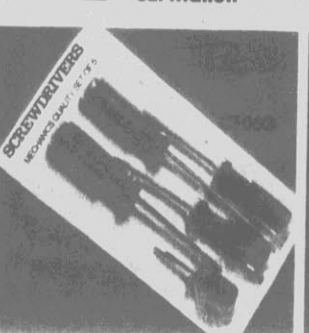

**2** Save 32%. Our 2.97. 5-pc. screwdriver set.



**2** Our 2.97. 6 1/4" flat-nose pliers. Many uses.

# Kmart The Saving Place®

## dollar days

Take A Shopping Break

**3** Hot turkey sandwich with whipped potatoes, gravy and fresh strawberry pie. Available Only In Store With Cafeteria.

**2** 6-pc. jigsaw blade set for metal, wood cutting.

**2** 2-pc. spring clamp or 3-pc. "C" clamp

2 Pkg. **4** K mart® Sale Price - **1** Less Factory Rebate  
2 Pkg. **3** Your Net Cost After Rebate  
Rebate limited to mtr.'s stipulation  
**2-pack. GE® bug lights. 60-watt.**



**3** Save 20%. Our 3.77. automatic night light.



**3** Our 3.28. 6-V lantern battery with springs.

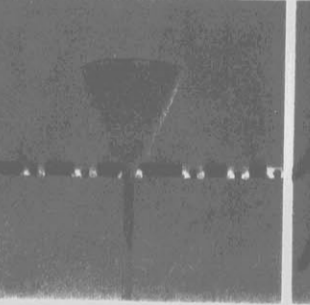

**3** Save 24%. Our 3.97. 4' tool holder, 6 hangers.

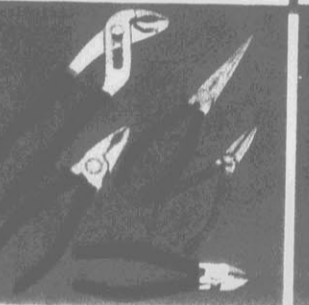

**4** Sale Price Ea. Choose from variety of quality pliers.

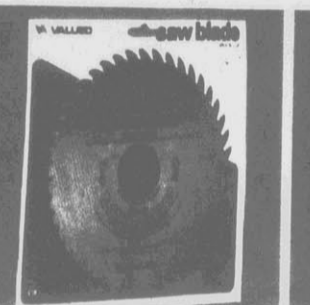

**5** Save 28%. Our 6.97. Circular saw blade.



**5** Our 5.97. Gun hose nozzle for yard, garden.



**5** Save 28%. Our 6.97. 2-arm high-rise lawn sprinkler.

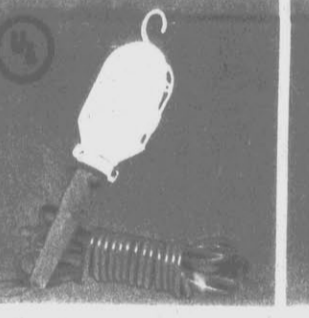

**6** Save 29%. Our 8.48. Utility light with 25' cord.

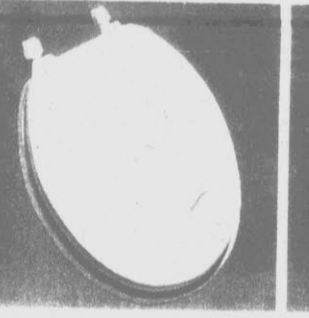

**6** Our 6.97. Enameled wood toilet seat. White. Mtr. may vary.

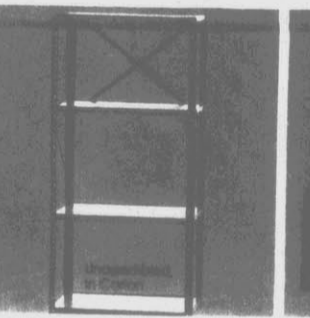

**10** Save 22%. Our 12.86. Metal shelf unit. 30x12x60"

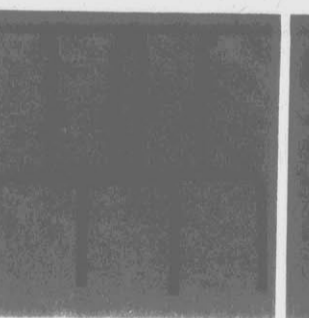

**11** Save 21%. Our 13.96 Pr. Folding table legs. 29x24" size.

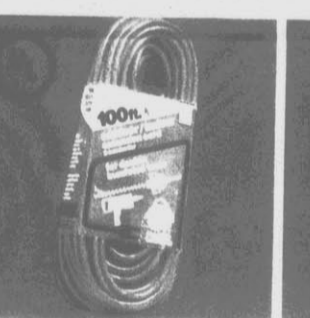

**11** Our 12.96. 100' extension cord for indoors or out.

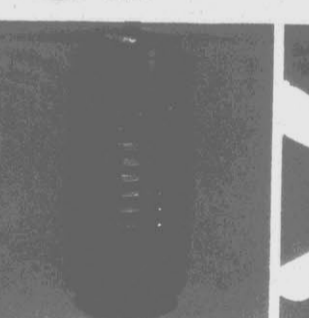

**12** Save 36%. Our 18.88. Outdoor bug light.

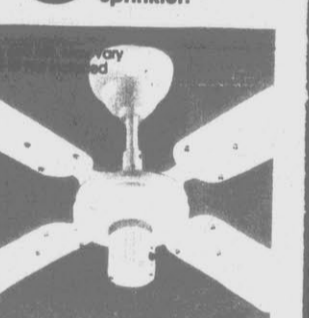

**25** Sale Price. 36" ceiling fan. Brown or white.



SIZE	SALE
P165/80R13	37.00
P185/80R13	42.00
P185/75R14	43.00
P195/75R14	46.00
P205/75R14	48.00
P215/75R15	55.00
P225/75R15	58.00

SERVICES INCLUDE:  
1 Install front disc brake pads or brake linings on rear wheels  
2 Resurface drums or true rotors  
3 Inspect front calipers  
4 Rebuild rear wheel cylinders, if possible, replace, if necessary, at additional parts cost per wheel cylinder drum brakes  
5 Repack inner and outer bearings (Non-drive wheels)  
6 Inspect master cylinder  
7 Replace front grease seals (Non-drive wheels)  
8 Refill hydraulic system

**30** Sale Price. P155/80R13 Econo-plus steel belted radials with highway tread design for dependable traction and mileage. Popular P metric sizes. \*Limited tread wear-out warranty. Tires And Service In Stores With Service

**55** 2-wheel brake special offers service for many U.S. cars, foreign cars. Light trucks are higher. Additional parts and services which may be needed are at extra cost. Semimetallc Pads. \*13 More

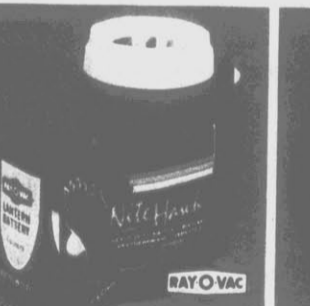

**3** K mart® Sale Price - **1** Less Factory Rebate  
**2** Your Net Cost After Rebate  
Rebate limited to mtr.'s stipulation  
**Sturdy lantern with 6-V battery.**



**8** Our 9.97 Ea. Men's or women's sport watch.

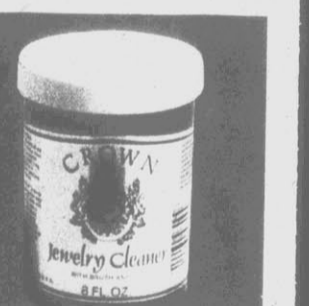

**1** Save 46%. Our 1.87. 8-oz. jewelry cleaner \*Fl oz.



**1** Sale Price Ea. Paint, cleaner or treatment.



**2** Our 2.47-2.97 Ea. Tire shine or white wall cleaner.

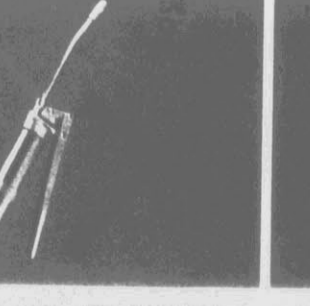

**3** Our 3.97-5.97 Ea. Lug wrench or mini grease gun.



**7** Our 10.97. 5-gal. plastic gas can with spout. Mtr. may vary

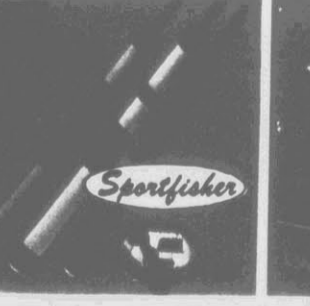

**10** Sale Price. Rod or spincast reel.

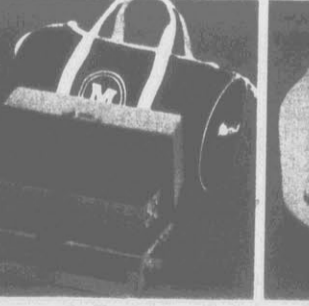

**10** Roll bag or 3-tray tackle box.



**10** K mart® Sale Price - **2** Less Factory Rebate  
**8** Your Net Cost After Rebate  
Rebate limited to mtr.'s stipulation  
**1000® 6-quart cooler.**



**10** K mart® Sale Price - **2** Less K mart's Rebate  
**8** Your Net Cost After Rebate  
Rebate limited to K mart's stipulation  
**1-gal. body filler kit.**



**13** Major brand oil, lube, filter special.

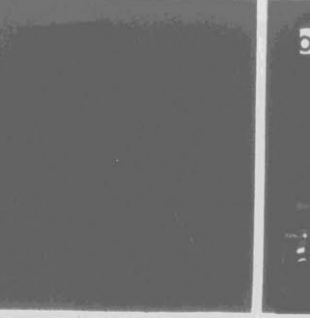

**13** Our 22.88 Pr. Car ramps of solid steel.



**39** Sale Price. AM/FM cassette stereo.



**39** Sale Price. 475 cca Battery.



**13** Sale Price. Maxfli® golf balls. Dozen.



**27** K mart® Sale Price - **4** Less Factory Rebate  
**23** Your Net Cost After Rebate  
Rebate limited to mtr.'s stipulation  
**48-qt. cooler with snap-lock.**

# WINN-DIXIE now has 10,000 Unbeatable Low Prices.

Plus, you still get our famous  
W-D Brand, western, grain-fed,  
U.S. Choice beef!



At Winn-Dixie, you don't sacrifice quality for low prices. We've been selling only the finest U.S. Choice beef for over 60 years, and we don't intend to offer you any less now. W-D Brand beef and over 10,000 everyday low prices...

*That's an unbeatable combination  
other food stores can't match!*

**TODAY'S**

**WINN  DIXIE**

*The New Place For Low Prices!*

# TODAY'S

# WINN DIXIE



2-LTR. BTL.  
**PEPSI-COLA**

•DIET PEPSI •MTN DEW  
•PEPSI FREE •SUGAR FREE  
PEPSI FREE

**98¢**

WITH 10.00 OR MORE  
ORDER (LIMIT 2)



4-ROLL PAK  
**CHARMIN**  
BATHROOM TISSUE

**98¢**

WITH 10.00 OR MORE  
ORDER (LIMIT 1)

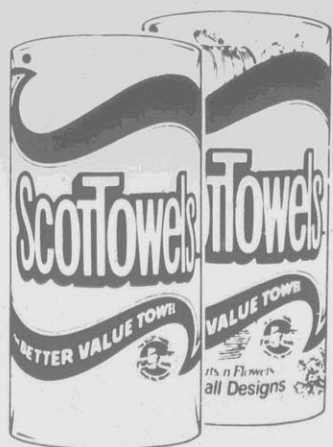

JUMBO ROLL  
**SCOTT**  
TOWELS

**57¢**

WITH 10.00 OR MORE  
ORDER (LIMIT 2)

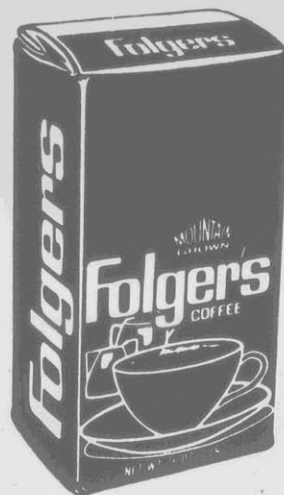

1-LB. BAG  
**FOLGERS**  
COFFEE

**198**

WITH 10.00 OR MORE  
ORDER (LIMIT 1)



42-OZ. BOX  
**LILAC**  
DETERGENT

**75¢**

WITH 10.00 OR MORE  
ORDER (LIMIT 1)



48-OZ. BTL.  
**PURE VEGETABLE**  
CRISCO OIL

**248**

WITH 10.00 OR MORE  
ORDER (LIMIT 1)



3-LITER  
**GALLO**  
WINES

•CHABLIS BLANC  
•RHINE •RED ROSE

**499**



6-PAK 12-OZ. CANS  
**COORS OR**  
COORS LIGHT  
BEER

**249**



1-LB. PKG.  
PEELED &  
DEVEINED  
**SHRIMP**

**249**



COUNTRY PRIDE GRADE 'A'  
COMBO PACK .99  
HILLSHIRE SMOKED  
SAUSAGE . . . . 1.99  
1-LB. PKG. HICKORY SWEET  
SLICED BACON 1.49

**PLUS  
OVER**

**10,000**

LISTED BELOW ARE JUST A FEW...

	WHY PAY	OUR PRICE	YOU SAVE
SMITHFIELD COUNTRY HAM	1.79	1.69	10c
RAEFORD TURKEY BOLOGNA	.99	.79	20c
14-OZ. JESSE JONES BOLOGNA	1.79	1.69	10c
1-LB. PKG. OSCAR MAYER WIENERS	2.09	1.99	10c
1-LB. JIMMY DEAN PORK SAUSAGE	1.88	1.79	9c
32-CT. SOMINEX FORMULA II	3.99	3.77	22c
16-CT. NYTOL SLEEPING TABLETS	2.55	2.35	20c
12-CT. ROLAIDS	.99	.89	10c
3-PAK ROLAIDS	1.39	1.10	29c
14-OZ. METAMUCIL	6.90	6.80	10c
12-OZ. MARIE'S SALAD DRESSING	1.69	1.53	16c
12-PAK JELL-O PUDDING POPS	2.49	2.38	11c
6-OZ. MINUTE MAID ORANGE JUICE	.79	.76	3c
11-OZ. EGGO WAFFLES	.99	.89	10c
10-OZ. LENDER'S RAISIN BAGELS	.79	.71	8c
39-OZ. CHEF SPAGHETTI & MEAT BALLS	1.95	1.82	13c
40-OZ. CHEF BEEF A RONI	1.95	1.82	13c
40-OZ. CHEF BEEF RAVIOLI	1.95	1.82	13c
16-OZ. CREMORA COFFEE CREAMER	1.73	1.59	14c
16-OZ. FRENCH'S SQUEEZE MUSTARD	.89	.83	6c

LISTED BELOW ARE JUST A FEW...

	WHY PAY	OUR PRICE	YOU SAVE
12-OZ. STOUFFER'S ESCALLOPED APPLES	1.28	1.21	7c
30-OZ. ORE IDA CRISPY CROWNS	1.65	1.56	9c
6-OZ. SWANSON PANCAKE & SAUSAGE	.99	.96	3c
10-OZ. JENO'S CRISP 'N TASTY PIZZA	1.09	.98	11c
14-OZ. STEAKUMM SANDWICH STEAKS	2.99	2.49	50c
12-OZ. OSCAR MAYER BOLOGNA	1.79	1.69	10c
12-OZ. ARMOUR STAR FRANKS	1.29	1.19	10c
1-LB. KAHN'S LI'L FRANKS	2.79	2.59	20c
9 1/2-OZ. RUDY'S FARM SAUSAGE BISCUITS	1.99	1.89	10c
GRADE 'A' REGULAR TURKEYS	1.99	1.89	10c
16-OZ. HEAVY MINERAL OIL	1.45	1.25	20c
20-CT. CO-TYLENOL CAPSULES	3.55	3.35	20c
24-CT. DRISTAN TABLETS	3.68	3.07	61c
5-CT. HALL'S SUGAR FREE COUGH DROPS	.59	.37	22c
40-CT. ANACIN ARTHRITIS PAIN FORMULA	2.80	2.60	20c
3-OZ. DEVEILED SPAM	.51	.47	4c
24-OZ. DINTY MOORE BEEF STEW	1.75	1.56	19c
3-OZ. HORMEL BACON BITS	1.55	1.39	16c
7 1/4-OZ. GOLDEN GRAIN MAC & CHEDDAR	.37	3/.99	4c
7 1/2-OZ. RENUZIT SPRING BLOSSOM	.89	.79	10c

# The New Place For Low Prices

With

## DEEP CUT RED HOT SPECIALS!

PRICES GOOD 7 FULL DAYS THRU WED., MAY 22ND!

\*NONE TO DEALERS \*WE RESERVE THE RIGHT TO LIMIT QUANTITIES \*COPYRIGHT 1985, WINN-DIXIE STORES, INC.



U.S.D.A. INSPECTED  
FRESH FRYER  
LEG QUARTERS

**35**¢  
LB.

LIMIT 10 LBS., PLEASE

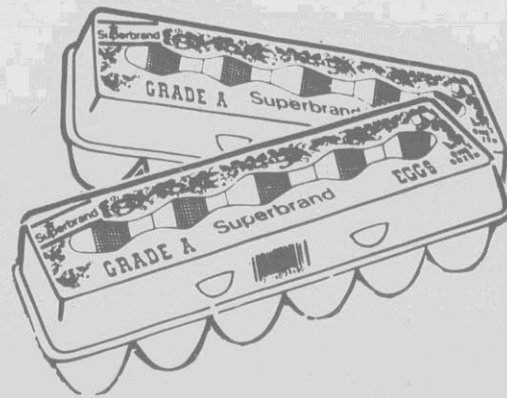

1-DOZ. SUPERBRAND  
GRADE 'A' WHITE  
LARGE EGGS

**48**¢

WITH 10.00 OR MORE  
ORDER (LIMIT 2)



U.S. CHOICE WESTERN GRAIN FED  
WHOLE UNTRIMMED  
BONELESS  
BEEF RIB EYES

**317**¢  
LB.

SLICED FREE INTO  
STEAKS, ROASTS &  
TRIMMINGS.

W-D BRAND U.S. CHOICE  
BONELESS  
RIB EYE STEAKS LB. 3.89

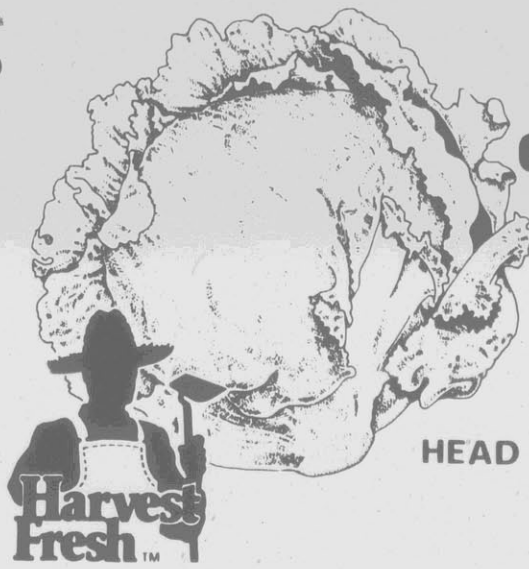

HARVEST FRESH  
CRISPY ICEBERG  
LETTUCE

**48**¢  
HEAD



12-PAK SUPERBRAND FROZEN  
FUDGE BARS OR  
TWIN POPS

**99**¢



1-GAL. JUG SUPERBRAND  
BLUE TOP 1/2% STA-FIT  
SKIM MILK

**159**¢



LEAN AND TENDER  
BOILED HAM

**298**¢  
LB.

SLICED TO  
ORDER

16-OZ. LOAF FRESH BAKED  
FRENCH BREAD .89  
CREAMY MACARONI  
SALAD ..... LB. .98  
HICKORY SMOKED CHOPPED  
PORK B.B.Q. . . . LB. 3.49

AVAILABLE IN DELI BAKERY  
STORE ONLY!



75-CT. TUMS  
PEPPERMINT OR  
ASSORTED FLAVORS  
ANTACID  
TABLETS

**199**¢



12-OZ. BTL. MYLANTA II  
LIQUID ..... 3.97  
36-CT. FOIL PACK  
ALKA SELTZER 2.59  
4.6-OZ. TUBE MINT, GEL OR  
REGULAR CREST  
TOOTHPASTE ..... .99  
60-CT. EFFERDENT DENTURE  
TABLETS ..... 2.87



# EVERYDAY LOW PRICES!

LISTED BELOW ARE JUST A FEW... WHY PAY OUR PRICE YOU SAVE

2-LB. SEAFOOD KITCHEN FISH STICKS	2.29	1.99	30¢
4-LB. SWIFT HOSTESS CANNED HAM	9.98	8.89	1.09
1-LB. JAMESTOWN PORK SAUSAGE	1.09	.99	10¢
1-LB. BROOKWOOD FARM B.B.Q.	2.69	2.59	10¢
3-LB. BEEF PATTIES	3.99	3.49	50¢
LE MENU CHICKEN a la KING	2.55	2.41	14¢
LE MENU BEEF SIRLOIN TIPS	3.25	3.19	6¢
1-LB. LAND-O-LAKES BUTTER	2.19	2.05	14¢
8-OZ. KRAFT CHEESE WHIZ	1.29	1.27	2¢
8-OZ. SARGENTO SHREDDED CHEDDAR CHEESE	1.69	1.59	10¢
1/2-OZ. ADOLPH MEAT MARINADE	.69	.63	6¢
22-OZ. WINDEX W/LEMON	1.69	1.50	19¢
10-OZ. ENDUST	2.99	2.69	30¢
16-OZ. FUTURE FLOOR FINISH	2.85	2.59	26¢
16-OZ. STEP SAVER	1.95	1.79	16¢
16-OZ. BTL. WHITE ALCOHOL	.79	.59	20¢
.5-OZ. MURINE PLUS	1.99	1.87	12¢
10-OZ. JOHNSON BABY OIL	3.40	2.85	55¢
.5-OZ. BABY ORAJEL	2.59	2.27	32¢
40-CT. BABY FRESH WIPES	1.59	1.32	27¢

LISTED BELOW ARE JUST A FEW... WHY PAY OUR PRICE YOU SAVE

16-OZ. CLOROX PRE WASH	1.65	1.50	15¢
24-OZ. CLOROX II	1.29	1.17	12¢
5-OZ. LIBBY'S VIENNA SAUSAGE	.50	.39	11¢
15-OZ. LIBBY'S CORNED BEEF HASH	1.09	.99	10¢
8-OZ. THANK YOU ONION DIP	1.24	1.12	12¢
16-OZ. WHITE HOUSE APPLE SAUCE	.48	2/.79	9¢
2 1/2-OZ. CUP O'NOODLES	.65	.56	9¢
15-OZ. VAN CAMP'S KIDNEY BEANS	.49	.46	3¢
15 1/2-OZ. VAN CAMP'S MEXICAN CHILI BEANS	.49	.46	3¢
64-OZ. SENECA APPLE JUICE	1.29	.99	30¢
1 1/2-OZ. ARRID XX ROLL ON DEODORANT	2.15	1.94	21¢
2.5-OZ. BAN ROLL ON REG. DEODORANT	2.99	2.80	19¢
1.5-OZ. SOFT & DRI ROLL ON	2.05	1.95	10¢
1.25-OZ. SURE ROLL ON REG. DEODORANT	2.19	1.83	36¢
1.25-OZ. SECRET ROLL ON DEODORANT	2.19	1.83	36¢
1.5-OZ. BAN ROLL ON	2.30	1.94	36¢
2.5-OZ. DRY IDEA UNSCENTED	3.90	3.25	65¢
2.5-OZ. DIAL A/P REG. SCENT	1.90	1.59	49¢
11-OZ. NOXZEMA MENTHOL SHAVE	2.33	1.94	39¢
6-OZ. MENNEN SKIN BRACER	3.20	2.68	52¢

TODAY'S

WINN  DIXIE

and



INVITE YOU TO  
ENTER THE  
WINNER'S CIRCLE  
SWEEPSTAKES



Registration forms and complete details available at the Coca-Cola display at area Winn-Dixie stores. No purchase necessary. You do not have to be present to win. Must be 18 or older to register. Winners will be notified.

GRAND PRIZE!

VIP WINNER'S CIRCLE WEEKEND INCLUDES:

- Two passes good for seats in the Winn-Dixie Suite at Charlotte Motor Speedway on Saturday, May 25th and Sunday, May 26th.
- Accomodations for two at the Charlotte Marriott City Center on Friday, May 24th and Saturday, May 25th.
- Transportation allowance of \$200.00 for travel to and from Charlotte, NC.
- Transportation to and from Charlotte Motor Speedway on race days.

One Grand Prize Winner will be drawn from all entries received from the 108 Winn-Dixie Stores in Virginia and Eastern North Carolina.

PLUS A WINNER IN EVERY STORE OF:

- Two tickets to The Coca-Cola World 600 on Sunday, May 26th at the Charlotte Motor Speedway.
- Two tickets to "The Winston" and the Winn-Dixie 300 on Saturday, May 25th at the Charlotte Motor Speedway.

One winner will be drawn in each store at 6 p.m., Sat., May 18, 1985.



46-OZ. CAN  
HI-C  
FRUIT  
DRINKS

79¢

Win tickets to stock car racing's biggest weekend:

The Coca-Cola World 600, "The Winston" and the Winn-Dixie 300, May 25-26 at the Charlotte Motor Speedway!

WHO KNOWS  
WHAT LURKS IN  
THE DEPTHS OF  
YOUR CARPET?

carpet magic KNOWS

For the most dramatic carpet cleaning results you've ever seen! • Professional Results at a Low Do-it-Yourself Price! • Loosens and lifts the deepest dirt! Restores color and brightness to any type carpet! Cleans, Rinses, and Vacuums all in one! Dries your carpet as it cleans!

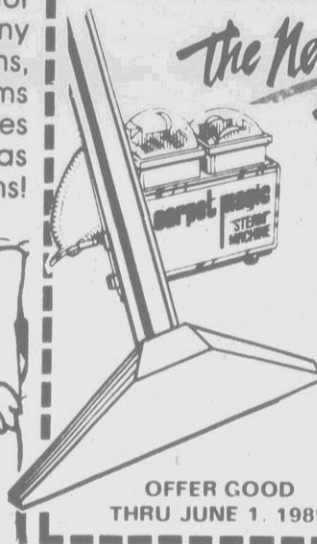

TODAY'S  
WINN  DIXIE

The New Place  
For Low Prices!

\$3.00 OFF  
COUPON

This coupon entitles the bearer to \$3.00 off the regular \$13.99 rental of a CARPET MAGIC "STEAM" MACHINE

RENTER'S NAME \_\_\_\_\_  
ADDRESS \_\_\_\_\_  
SIGNATURE \_\_\_\_\_  
DATE RENTED \_\_\_\_\_ RENTAL RECEIPT NO. \_\_\_\_\_

OFFER GOOD THRU JUNE 1, 1985



42-OZ. BOX  
RINSO  
DETERGENT

99¢



22-OZ. BTL. DOVE DISHWASHING LIQUID DETERGENT .99  
22-OZ. BTL. LUX DISHWASHING LIQUID DETERGENT .99  
64-OZ. BTL. ALL HEAVY DUTY LIQUID DETERGENT 2.49  
BATH SIZE  
LIFEBUOY SOAP 3 FOR \$1  
3-BAR PAK BATH SIZE  
LUX SOAP .89



35-OZ. BOX  
ALL  
DISHWASHER  
DETERGENT

149



64-OZ. BTL.  
WISK  
LIQUID  
DETERGENT

256

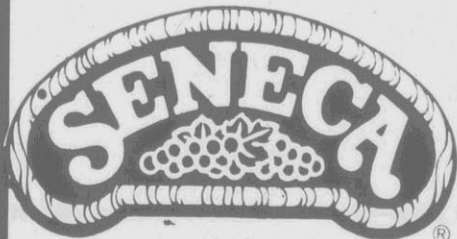

48-OZ. JAR  
SENECA  
GRAPE  
JUICE

129

Folgers PRESENTS FREE  
AN EVENING WITH  
TG SHEPPARD Saturday, May 25  
Charlotte Coliseum

Present 1 inner seal from any size Folgers Crystals and one UPC code from any Folgers ground roast at the box office for FREE admission.  
Special Guest Reba MacIntyre CHILDREN UNDER 12 ADMITTED FREE  
1 LB BAG FOLGERS COFFEE 1.98  
8 OZ FOLGERS INSTANT COFFEE 3.39  
WITH 10.00 OR MORE ORDER (LIMIT 1)



4-PAK  
GENERAL ELECTRIC  
MISER 55-70-95 WATT  
LIGHT BULBS

259

3 WAY GENERAL ELECTRIC 15 125 150 WATT LIGHT BULBS 2.59



7-OZ. BOX ORTEGA TACO DINNER . . . . 1.49  
10-CT. BOX ORTEGA TACO SHELLS . . . . .89  
8-OZ. JAR ORTEGA TACO SAUCE . . . . .89



18-OZ. JAR  
PETER  
PAN  
PEANUT  
BUTTER

•SMOOTH •CRUNCHY  
•NO SALT

168

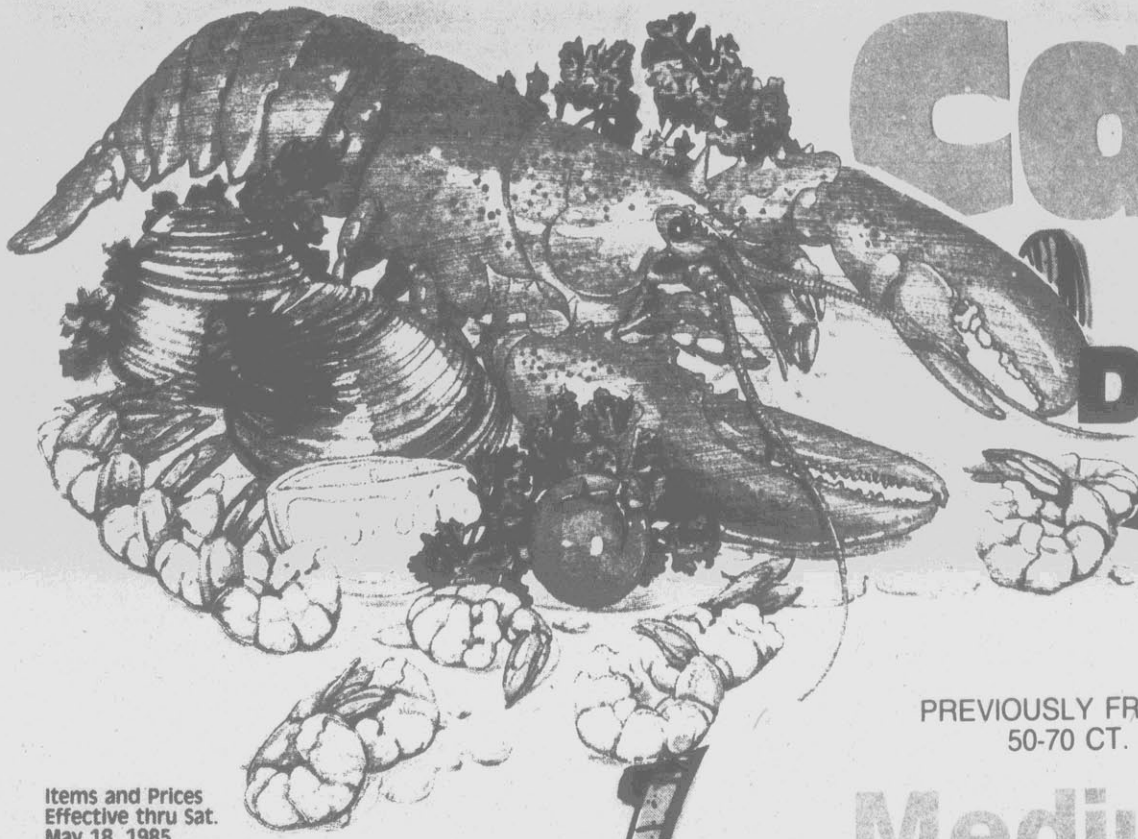

# Catch the Difference

PREVIOUSLY FROZEN  
50-70 CT.

## Medium Headless Shrimp

# \$ 2.99

Lb.

**MARKET  
BREAK!**

Items and Prices  
Effective thru Sat.  
May 18, 1985.

**Go Krogering for an  
Oceanful of Savings in the  
Kroger Seafood Shoppe....**

Only Kroger gives you a fabulous selection of fresh and frozen seafood. You'll find over 50 varieties, like fresh perch, sea bass, trout, crab legs, shrimp....even live Maine Lobster. So catch the Difference....Go fishing at Kroger!

**We Redeem  
ALL FOOD &  
DRUG STORE  
Coupons!**

Please see  
details at store.

SPRINGDALE HOMOGENIZED

**Whole Milk**  
**\$ 1.88**

Gal.  
Jug

ASSORTED CENTER & END CUT

**Pork Chops**  
**98¢**

10  
Lbs.  
Or  
More

Lb.

ADVERTISED ITEM POLICY  
Each of these advertised items is required to be readily available for sale in each Kroger Sav-on, except as specifically noted in this ad. If we do run out of an item we will offer you your choice of a comparable item when available, reflecting the same savings or a raincheck which will entitle you to purchase the advertised item at the advertised price within 30 days. Only one vendor coupon will be accepted per item.

Copyright 1985  
Kroger Sav-on  
Quantity Rights Reserved  
None Sold To Dealers

# Kroger Sav-on

*Feel the Difference...*  
**Go Krogering**

**PLUS DOUBLE  
MANUFACTURERS'  
COUPONS**

SEE  
DETAILS  
ON PG.  
4

**OPEN 24 HOURS EVERYDAY  
600 Greenville Blvd. - Greenville**

Kroger  
Sav-on

double  
up  
BINGO

HERE ARE JUST A FEW OF

Karen Reeves

Joe Eubanks

Ivy M. Thomas



Trip Winner



\$2000



\$2000 Winner



ASSORTED VARIETY  
(SAVE UP TO \$1.90) KROGER

**Chef-Size  
Spices . . . . .** Asst  
Sizes **99¢**

KROGER (WITH 25¢ INSTANT REDEEMABLE COUPON) FRENCH, ITALIAN, OR  
**1000  
Island  
Dressing . . . . .** 16  
Oz  
Btl **99¢**

KROGER REGULAR OR  
**Lite  
Mayonnaise . . . . .** 33  
Oz  
Jar **99¢**

DIET PEPSI, PEPSI  
FREE, PEPSI LIGHT OR  
**Pepsi  
Cola . . . . .** 2 Ltr  
NRB **99¢** LIMIT 3 PLEASE

KRAFT HICKORY SMOKED,  
PLAIN OR  
**Hot Barbecue  
Sauce . . . . .** 18  
Oz  
Btl **89¢**

CRYSTALS  
**Tetley  
Iced Tea . . . . .** 6 Oz  
Jar **\$2.69**

ASSORTED VARIETY SPAGHETTI  
**Prego  
Sauce . . . . .** 32  
Oz  
Jar **\$1.49**

ASSORTED GRINDS  
**Maxwell  
House Coffee . . . . .** 1 Lb  
Bag **\$2.29**

GREEN GIANT WHOLE KERNEL OR  
NO SALT  
**Niblets  
Corn . . . . .** 2 12 Oz  
Cans **89¢**

KROGER  
HOMESTYLE CUCUMBER SLICES  
KOSHER OR POLISH DILLS  
**Fresh-Pack  
Pickles . . . . .** 32  
Oz  
Jar **99¢**

COORS LIGHT  
OR BANQUET  
**Coors  
Beer . . . . .** 6 \$ 2.59  
12 Oz  
Cans

LIBBY'S  
**Vienna  
Sausage . . . . .** 2  
5 Oz  
Cans **79¢**

KRAFT DELUXE  
**Macaroni  
& Cheese . . . . .** 14  
Oz  
Box **\$1.17**

BURGUNDY RHINE VIN  
ROSE CHABLIS BLANC  
**E & J Gallo  
Premium Wine . . . . .** 3 Ltr  
Btl **\$4.99**

CHOCOLATE OR CHOCOLATE PEANUT  
BUTTER  
**Pillsbury  
Milk Bars . . . . .** 8 Oz  
Box **\$1.59**

25¢ OFF LABEL  
**Mazola  
Corn Oil . . . . .** 32  
Oz  
Btl **\$1.74**

ENRICHED  
**Mahatma  
Rice . . . . .** 3  
Lb  
Bag **98¢**

FAMILY  
**Pillsbury  
Brownie Mix . . . . .** 22  
Oz  
Pkg **\$1.49**

# OUR MANY LUCKY WINNERS — CONGRATULATIONS!

Marcus Stewart

Elizabeth C. Crawford

Charlotte Boyd

Gerald Davis

Bill Barker

## ODDS CHART

ODDS CHART EFFECTIVE APRIL 27, 1988

PRIZE VALUE	NUMBER OF TICKETS	ODDS FOR ONE GAME TICKET	ODDS FOR 4 GAME TICKETS	ODDS FOR 8 GAME TICKETS
\$1,000	11	1 In 189,265	1 In 47,317	1 In 23,658
\$500	63	1 In 51,072	1 In 12,768	1 In 6,384
\$200	143	1 In 22,500	1 In 5,625	1 In 2,813
\$100	204	1 In 15,773	1 In 3,944	1 In 1,972
\$50	480	1 In 6,500	1 In 1,625	1 In 823
\$25	1,110	1 In 2,669	1 In 672	1 In 363
\$10	2,968	1 In 641	1 In 160	1 In 80
\$5	8,040	1 In 177	1 In 44	1 In 22
TOTAL	30,440	1 In 34	1 In 8.6	1 In 4.7



\$2000 Winner

\$1000 Winner

\$1000

\$1000

\$1000



CORONET  
**Paper Towels** Jumbo Roll  
**59¢**

3 BTL. FOR \$2.78 - TEXIZE  
**Pine Scent Cleaner**... BUY TWO GET ONE **FREE**  
FACIAL  
**Scotties Tissue**... 200 Ct. Pkg. **79¢**



ASSORTED COLORS BATHROOM  
**Coronet Tissue**... 4 Roll Pkg. **88¢**

TOILET BOWL CLEANER  
**Automatic Vanish**... 12 Oz. Box **99¢**  
BATHROOM  
**Fantastik Cleaner**... 16 Oz. Btl. **\$1.29**  
REFILL  
**Spray N' Wash**... 32 Oz. Btl. **\$2.39**  
AUTOMATIC  
**Sunlight Dish Detergent**... 35 Oz. Pkg. **\$1.49**

DOG FOOD  
**Pet Pride**... 25 Lb. Bag **\$5.99**  
ASSORTED VARIETY  
**Unique Cat Food**... 4 6.5 Oz. Cans **\$1**  
LAUNDRY  
**Gain Detergent**... 49 Oz. Box **\$1.99**



REGULAR OR DIP COUNTRY OVEN  
**Potato Chips**... 1/2 Lb. Bag **59¢**

CHUNKY WHITE AND DARK  
**Swanson Chicken**... 5 Oz. Can **85¢**



KROGER  
**Multi-Grain Bread**... 2 16 Oz. Lvs. **88¢**

LAWN AND LEAF  
**Hefty Bags**... 10 Ct. Box **\$1.99**  
LIQUID  
**Joy Dish Detergent**... 32 Oz. Btl. **\$1.99**



COST CUTTER HAMBURGER OR  
**Hot Dog Buns**... 3 8 Ct. Pkgs. **\$1**

NATURAL CHIPS  
**Wise Cottage Fries**... 12 Oz. Bag **\$1.89**  
CHIPMATES, CHOCOLATE CHIP, SOUTHERN PECAN OR OATMEAL  
**Country Oven Cookies**... 12-13 Oz. Bag **\$1.09**



SHRIMP, BEEF PEPPER OR CHICKEN CHOW MEIN  
**LaChoy Bi-Packs**... 42 Oz. Can **\$2.19**  
ASSORTED VARIETY  
**LaChoy Ramen Noodles**... 4 3 Oz. Pkgs. **\$1**  
LACHOY SOY SAUCE (10 OZ. BTL.) OR WHOLE OR SLICED  
**LaChoy Water Chestnuts**... 8 Oz. Can **79¢**

*Feel the Difference...*  
Go Krogering

# DOUBLE MFG.'S COUPONS!

MANUFACTURER'S COUPON	MFG'S CENTS OFF	YOU SAVE AT KROGER
<b>COUPON A</b>	<b>20¢</b>	<b>40¢</b>
<b>COUPON B</b>	<b>39¢</b>	<b>78¢</b>
<b>COUPON C</b>	<b>50¢</b>	<b>\$1.00</b>
<b>COUPON D</b>	<b>75¢</b>	<b>\$1.00</b>

We will double 5 mfg.'s coupons  
(up to 50¢ face value) for every \$10 purchase!

### EXAMPLE

\$10 Purchase . . . . . 5 Coupons  
\$20 Purchase . . . . . 10 Coupons  
\$100 Purchase . . . . . 50 Coupons

Between now and May 18, we will redeem national manufacturer's cents off coupons up to 50¢ for double their value. Offer good on national manufacturer's coupons only. If food retailer coupons not accepted. Customer must purchase coupon product in specified size. Expired coupons will not be honored. Coupons for free merchandise excluded from this offer. Offer does not apply to Kroger or other store coupons whether manufacturer is mentioned or not. When the value of a coupon exceeds 50¢, this offer is limited to \$1.00. If double the value of a coupon exceeds the value of the item, this offer is limited to the retail price. Limit one cigarette or coffee coupon per customer. Limit one coupon for any one particular item. If you, for example, have two coupons for 15¢ off on Miracle Whip and intend to purchase two jars of Miracle Whip, only one of these coupons will be doubled. You may use the second coupon, but its face value remains at face value.



ASSORTED VARIETY  
**Totinos Pizza . . . 10 Oz. Pkg. 89¢**

PEPPERONI OR COMBINATION TOTINOS'

**My Classic Pizza . . . . . 21-24 Oz. Pkg. \$2.49**

BIRD'S EYE FROZEN  
**Awake Juice . . . . . 12 Oz. Can 69¢**

BANQUET CHICKEN NUGGETS OR  
**Chicken Patties . . . . . 6.5-7 Oz. Pkg. \$1.09**

ORE-IDA  
**Chopped Onions . . . . . 12 Oz. Pkg. 59¢**

ORE-IDA  
**Golden Patties . . . . . 15 Oz. Pkg. \$1.19**



ASSORTED SELECTED VARIETIES-WITH CHEESE SAUCE  
**Birds Eye Vegetables 10 Oz. Box \$1.09**



KROGER  
**Cream Cheese 8 Oz. Pkg. 79¢**

FAMILY SIZE  
**Mrs. Filberts Spread . . . . . 3 Lb. Bowl \$1.49**

KROGER SHARP, PIZZA, OR MOZZARELLA  
**Shredded Cheese . . . . . 8 Oz. Pkg. \$1.29**



KROGER SKIM, 2% OR HOMOGENIZED  
**Whole Milk . . . 1/2 Gal. Ctn. 99¢**



WHIPPED TOPPING  
**Cool Whip 12 Oz. Cup \$1.19**

PET RITZ MULTI-PACK  
**Pie Shells . . . . . 25 Oz. Pkg. \$1.75**

ASSORTED VARIETY  
**Keebler Krunch Twists . . . 8 Oz. Bag \$1.09**

STONE CREEK WHEAT, RYE OR DOUGH  
**Keebler Crackers . . . . . 9-11 Oz. Pkg. \$1.09**

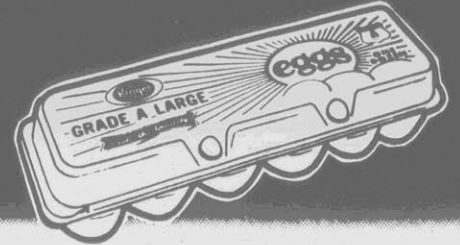

KROGER GRADE A  
**Large Eggs . . . . . Doz. 55¢**  
LARGE BROWN EGGS...Doz 65¢

ASSORTED VARIETY  
**Light N Lively Yogurt 6 Oz. Cup 39¢**

BREAKSTONE  
**Sour Cream . . . . . 16 Oz. Cup 99¢**

SEALTEST  
**Cottage Cheese . . . . . 2 12 Oz. Cups \$1.50**

LIGHT N LIVELY  
**Cottage Cheese . . . . . 24 Oz. Cup \$1.49**

ASSORTED VARIETY  
**Breakstone Gourmet Dip . . . 8 Oz. Cup 79¢**



CHILLED 100% PURE OLD SOUTH  
**Orange Juice . . . 1/2 Gal. Ctn. \$1.19**



Visit the Kroger Deli Bakery and Celebrate

# MAYFEST

## Cheese Shoppe-

RINDLESS, MILD

**Swiss Cheese** . . . . . Lb. **\$3.49**

BUTTER KASE OR

**Cream Havarti** . . . . . Lb. **\$3.99**

GERMAN

**Mozzarella Cheese** . . Lb. **\$2.99**

WHITE OR YELLOW

**Processed Cheese** . . Lb. **\$2.99**

CHEWY

**Gummi Bears** . . . . . Lb. **\$2.99**

ALPENJOY TYPE-PLAIN OR

**Salami Cheese** . . . . . Lb. **\$3.99**

CHEESE-CREAMY & RICH

**Blue Bavarian** . . . . . Lb. **\$5.99**



PLAIN

**German Brie** . . . . . Lb. **\$3.99**

4 OUNCE

**Liederkrantz Cheese** . . . . . Ea. **\$2.99**

## -Bakery-

CAKE OF THE WEEK! 4 LAYER, 8 INCH GOURMET INTERNATIONAL

**German Chocolate Cake** . . . . . Ea. **\$5.99**

FRESHLY MADE WITH WHIPPED TOPPING

**Strawberry Pie** . . . . . Ea. **\$3.49**



SANDY MAC

**Boiled Ham** . . . . . Lb. **\$2.99**

AMERICAN OR MUSTARD POTATO SALAD CREAMY OR SWEET COLE SLAW, OR MACARONI SALAD

**3-Lb. Picnic Pak Salads** . . . . . Ea. **\$2.49**

MOTHER'S DAY CHICKEN SPECIAL INCLUDES 6 ROLLS

**12-Pc. Bkt. Wishbone Chicken**

**\$5.99**

SAVE \$2.00



SAVE \$1.29



FRESHLY BAKED 6 CT PKG

**Kaiser Rolls**

BUY ONE PKG. GET ONE PKG.

**FREE**

MIX OR MATCH-BESTS CORNED BEEF PASTRAMI, OR

**Peppered Beef** . . . . . Lb. **\$3.99**

TAHITIAN SALAD (LB. \$1.75) PINEAPPLE WALNUT DELIGHT (Lb. \$1.99) OR PINA COLADA DESSERT (LB. \$2.39)

**Dessert Salad Sale** . . **20% OFF**

GERMAN

**Potato Salad** . . . . . Lb. **99¢**

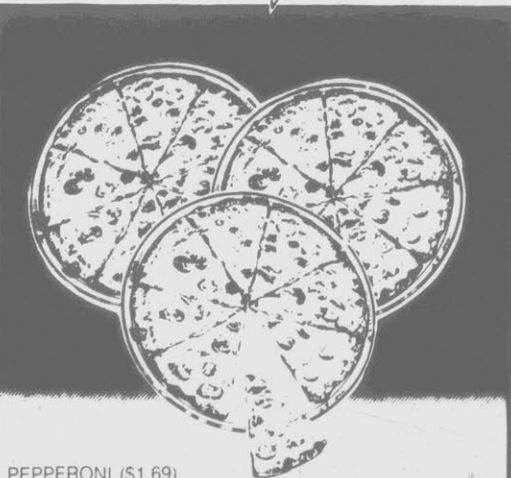

PEPPERONI (\$1.69) COMBO (\$1.89) OR DELUXE (\$1.99) NEW DELI-FRESH

**8" Individual Pan Pizza**

BUY TWO GET ONE **FREE**

FRESH YEAST RING

**Glazed Donuts** . . . . . Doz **\$1.89**

SHELLS, CINNAMON SWIRLS OR

**Long John Donuts** . . . **6** For **\$1.89**

8 INCH FRESH BAKED

**Apple Or Peach Pie** . . . . . Ea. **\$1.99**

# KROGER MEANS BETTER

Choose from over 200 Kinds & Cuts in the Kroger Meat D

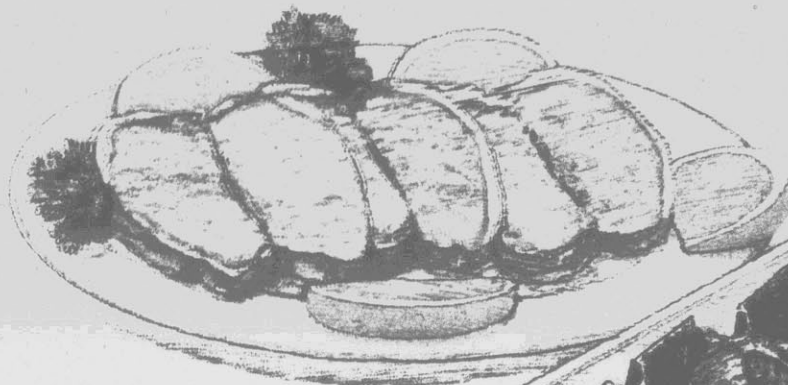

ASSORTED CENTER AND END CUTS  
QUARTER PORK LOIN  
CUT UP INTO

**Pork Chops**  
**\$1.48**  
Lb.



CENTER CUT  
**Boneless Pork Chops**  
**\$2.98**  
Lb.



ASSORTED CENTER AND END CUTS

**Pork Chops**  
**98¢**  
Lb.

CENTER CUT

**Rib Pork Chops**  
**\$1.78**  
Lb.

10 Lbs. Or More

FRESH DOMESTIC UNTRIMMED

**Whole Leg Of Lamb .** Lb. **\$2.28**

BULK PACKAGED COUNTRY STYLE

**Sliced Bacon . . . . .** 3 Lbs. Or More Lb. **\$1.38**

ARROW

**Beef Patties . . . . .** 5 lb. Box **\$3.99**

USDA GOV'T INSPECTED

**Genuine Ground Chuck .** 3 Lbs. Or More Lb. **\$1.58**

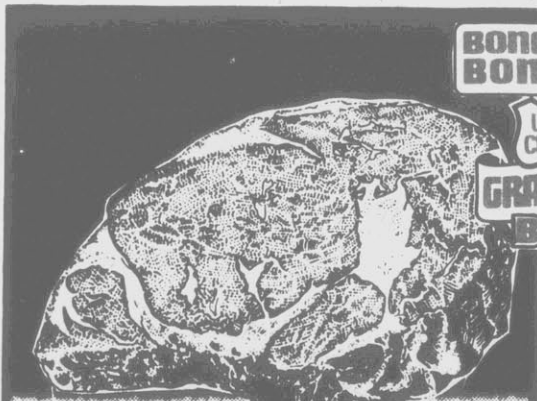

USDA CHOICE HEAVY WESTERN GRAIN FED BEEF, BONELESS

**Rib Eye Steak . . .** Lb. **\$3.98**



USDA CHOICE HEAVY WESTERN GRAIN FED BEEF, BONELESS

**Top Sirloin Steak . . .** Lb. **\$2.98**



JIMMY DEAN HOT OR MILD

**Pork Sausage .** Lb. **\$1.48**

# MEAT Department.



HOLLY FARMS CUT UP MIXED FRYER PARTS OR GRADE "A"

LIMIT 3 PKGS.

**Whole Fryers . . .** Lb. **38¢**

BARONS **Chicken Nuggets**

1 1/2 Lb. Bkt. **\$3.99**

OLDE VIRGINIE WHOLE (6-9 LB. AVG.)

**Boneless Ham . . . . .** Lb. **\$1.88**

WHOLE BOSTON BUTT CUT UP INTO

**Pork Steaks . . . . .** Lb. **\$1.28**

KROGER ALL MEAT OR

**All Beef Wieners . . . . .** 12 Oz. Pkg. **98¢**

OLD VILLAGE REGULAR OR POLISH

**Smoked Sausage . . . . .** Lb. **\$1.98**

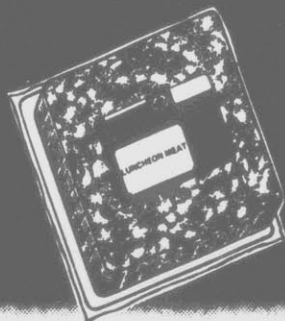

SERVE N SAVE ALL VARIETIES SLICED

**Luncheon Meat . . . . .** 1 Lb. Pkg. **98¢**

Kroger **Sav-on**

IS

# THE BIG WHEEL

When it comes to **Seafood!**

PREVIOUSLY FROZEN 40-50 CT.

**Headless Rock Shrimp** Lb. **\$2.99**

PREVIOUSLY FROZEN 20-30 CT.

**Jumbo Headless Shrimp** Lb. **\$5.99**

PREVIOUSLY FROZEN 36-42 CT.

**Large Headless Shrimp** Lb. **\$4.99**

PREVIOUSLY FROZEN 10-15 CT. HEADLESS

**King Size Shrimp . . .** Lb. **\$6.99**

FROZEN **Headless**

**Rock Shrimp**

**\$1.99**

Lb. **SOLD IN 2 1/2 LB. BOXES ONLY! EA. BOX...\$4.97**

SEA MAID 9 OZ. **Shrimp Cocktail**

**BUY ONE GET ONE**

**FREE!**

SAVE \$2.69

PREVIOUSLY FROZEN 50-70 CT.

# Medium Headless Shrimp

**\$2.99**

Lb.

BASSIT **Crab & Shrimp Boil**

3.25 Oz. **\$1.39**

BENNETTS SHRIMP **Cocktail Sauce**

12 Oz. Jar **\$1.39**

FROZEN ALASKAN

**Snow Crab Clusters**

**\$2.49**

Lb.

FROZEN ALASKAN **King Crab Legs**

**\$6.99**

Lb.

FROZEN CHEFS DELITE **Stuffed Crab**

**89¢**

5 Oz. Pkg.

DELICASEAS WHOLE LEG **Sea Stix**

**\$3.99**

Lb.

FRESHLY PREPARED!

ABBOTTS CLAM DIP OR **Clam Picante**

**\$2.39**

8 Oz. Cup

# Hot Dog

the Kroger Meat Department brings you these specials from

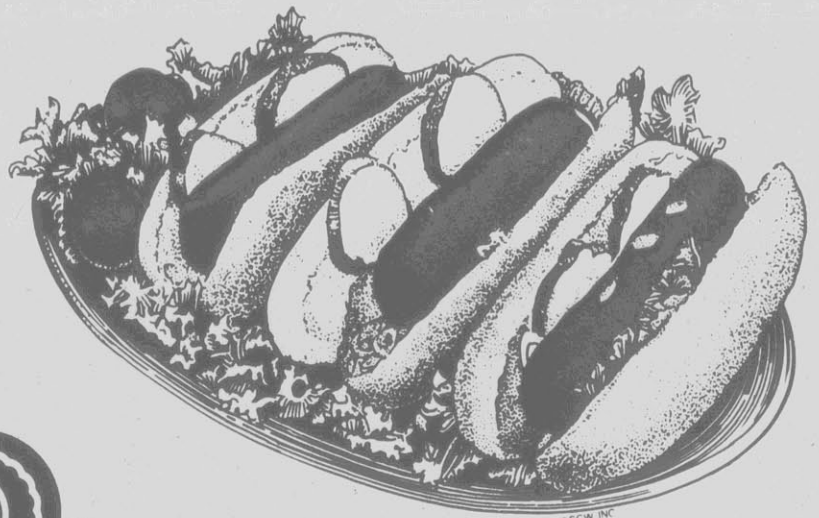

**Louis Rich**

&



OSCAR MAYER ALL MEAT

**Sliced Bologna** 8 Oz. Pkg. **99¢**

OSCAR MAYER SLICED

**All-Beef Bologna** 8 Oz. Pkg. **\$1.09**

OSCAR MAYER ALL MEAT

**Sliced Bologna** 12 Oz. Pkg. **\$1.39**

OSCAR MAYER SLICED

**All-Beef Bologna** 12 Oz. Pkg. **\$1.49**

OSCAR MAYER

**All-Meat Wieners** 1 Lb. Pkg. **\$1.69**

OSCAR MAYER

**All Beef Franks** 1 Lb. Pkg. **\$1.79**

OSCAR MAYER NACHO OR

**Cheese Hot Dogs** 1 Lb. Pkg. **\$1.99**

OSCAR MAYER SLICED

**Cooked Ham** 6 Oz. Pkg. **\$1.59**



OSCAR MAYER

**Sliced Bacon** 1 Lb. Pkg. **\$2.49**

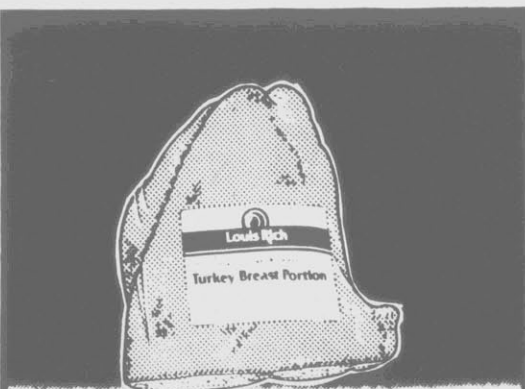

LOUIS RICH OVEN ROASTED OR HICKORY SMOKED

**Turkey Breast** Lb. **\$3.69**

LOUIS RICH SLICED

**Turkey Bologna** 8 Oz. Pkg. **99¢**

LOUIS RICH SLICED

**Turkey Ham** 8 Oz. Pkg. **\$1.79**

LOUIS RICH SLICED

**Turkey Salami** 8 Oz. Pkg. **\$1.39**

LOUIS RICH SLICED

**Turkey Breast** 6 Oz. Pkg. **\$1.79**

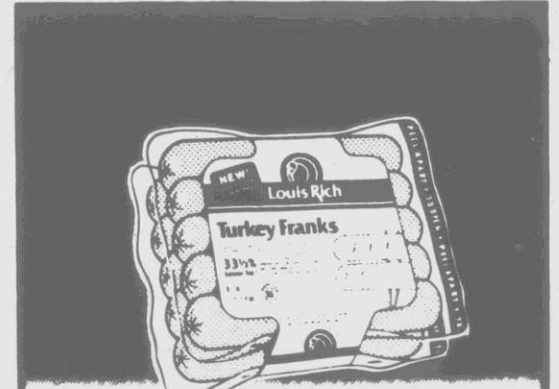

LOUIS RICH

**Turkey Franks** 1 Lb. Pkg. **99¢**

# Spring Values



CONDITIONER OR  
**Flex Shampoo** . . . 15 Oz. Btl.

**\$1.59**

STYLING  
**Flex Mousse** 5 Oz. Btl.

**\$1.59**

BABY  
**Chubs Wipes** . 80-Ct. Pkg.

**\$2.29**



EFFECTIVE ANTACID  
ANTI-GAS

**Liquid Mylanta II** 12 Oz. Btl.

**\$3.39**

ANTIHISTAMINE  
**Actifed Decongestant** 24 Ct.

**\$2.59**

PROTECTION AND COMFORT  
**Tampax Tampons** 40 Ct.

**\$2.99**



WOMEN'S GENTLE  
LAXATIVE  
**Correctol  
Tablets**

60 Ct. Box  
**\$3.49**



EXTRA STRENGTH  
**Tylenol Tablets** 60 Ct.

**\$3.39**

PAIN RELIEVER  
**Goody Powder** 50 Ct.

**\$1.69**

FOR DENTURES  
**Efferdent Cleanser** 60 Ct.

**\$2.09**



40% OFF LABEL  
**Close-Up Toothpaste** 8.7 Oz. Tube

**\$1.29**

## FLEX REFUND OFFER

Flex Shampoo, Flex Conditioner, Flex Mousse  
Try any Body Building Formula

**FREE**

Flex Shampoo **\$1.59**  
Flex Conditioner **\$1.59**  
New Flex Styling Mousse **\$1.59**  
TOTAL COST **\$4.77**  
Less Flex Mail-in Refund **-\$4.77**  
Your Final Cost **FREE**



Offer good on any one (1) Flex Shampoo, Conditioner and any one (1) Flex Mousse.  
OFFER EXPIRES OCTOBER 15, 1985.  
REFUND COUPON AVAILABLE IN-STORE.

## "Trust" The Kroger Pharmacy

We Recognize National  
High Blood Pressure Month

High Blood Pressure is called the "silent killer" because it usually has no symptoms. Early detection by regular testing is the only way to know.

BLOOD PRESSURE IS THE FORCE PLACED ON BLOOD VESSEL WALLS AS THE HEART PUMPS BLOOD THROUGH THEM. HIGH BLOOD PRESSURE SHOULD BE KEPT IN CHECK BECAUSE IT CAN CONTRIBUTE TO HEART DISEASE, STROKES AND KIDNEY DISEASE.

PHARMACY  
COUPON



**10%**  
**OFF COUPON**

10% Off of any New or Refill  
of any High Blood Pressure  
Medication.



Check our low  
prices on  
High Blood  
Pressure Kits

COUPON GOOD  
THRU MAY 22, 1985. LIMIT  
ONE COUPON PER CUSTOMER.



# complete one



**EASY LIGHT CHARCOAL LIGHTER**

LIGHT YOUR GRILL FAST WITH ECONOMICAL EASY LIGHT

32 Oz. Btl.

**99¢**

**AUTO PRIDE ANTIFREEZE COOLANT**

GET READY FOR THE HOT WEATHER COMING. PROTECT YOUR CAR WITH AUTOPRIDE COOLANT.

**\$3.47**  
Gal.

**WINDSHIELD SOLVENT**

ONE GALLON SIZE PERFORMS AS A SOLVENT AND ANTI-FREEZE AS WELL AS A CLEANSER.

**88¢**  
Gal.



**SIZZLER SMOKER GRILL**

EXTERNAL STAY-COOL ADJUSTING KNOBS ADJUSTING THE COOKING GRID TO FOUR HEIGHTS.

**\$27.88**



**GIANT Ice Cube Tray** ..... Ea. **88¢**

PLASTIC **Mustard & Ketchup Dispenser** ..... Only **\$1.69**

MAKES 8 **Frozen Pop Molds** ..... Ea. **\$1.39**

PLASTIC **Round Ashtrays** ..... Ea. **\$1.29**



**YOUR CHOICE HERSHEY'S CANDY**

HERSHEY MILK CHOCOLATE, MILK CHOC. W/ALMONDS, MR. GOOD BAR, KIT KAT, SKOR, REESE'S CUP, OR REESE'S PIECES.

**4 \$1**  
For



**SQUARE Laundry Basket** ..... Only **\$3.88**

PLASTIC **2 Qt. Refrigerator Bottle** ..... Ea. **99¢**

MICROAIDES **Two Section Vegetable Server** ... Only **\$1.97**

DELUXE FLOCKED LINE **Handy Latex Gloves** Pr. **69¢**



**32 OZ. LARGE GLASS TUMBLERS**

TO QUENCH YOUR FAMILIES THIRST THIS SUMMER. STOCK UP NOW.

Only **88¢**



**MEN'S OR WOMEN'S 10 SPEED BIKE**

THE BEST PRICE IN TOWN. HIGH QUALITY RAND TSR-137 MEN'S OR TSR-36 LADIES BIKE.

Only **\$77.88**



**SUPER GLUE TWIN PACK**

SELF-OPENING TUBE-NO PIN NEEDED. BONDS INSTANTLY METAL, RUBBER, PLASTIC & CERAMICS.

OUR LOW PRICE **\$1.00**

MFG MAIL IN REBATE **\$1.00**

YOUR FINAL COST **\$0.00**

# stop shopping



**SUNBEAM  
BUG SNAPPER**

PROVIDES UP TO  
1/2 ACRE COVERAGE  
HEAVY DUTY STEEL  
CONSTRUCTION.

Only **\$29<sup>88</sup>**

**LEISURE-MATE  
CHAISE LOUNGE**

5 POSITION BACK  
ADJUSTMENT  
MOLDED PLASTIC  
YELLOW WEBBING

**\$17<sup>88</sup>**



**LEISURE-MATE  
LOUNGE CHAIR**

MOLDED PLASTIC  
ARMS. COMPACT  
FOLDING YELLOW  
WEBBING

**\$8<sup>88</sup>**



**PLAYMATE 15 QT.  
ICE CHEST**

SWING DOWN LID  
WITH PUSH BUTTON  
RELEASE. TOUGH,  
DURABLE PLASTIC  
EXTERIOR THAT  
WON'T DENT, CHIP  
OR RUST

Only **\$9<sup>88</sup>**



EMBASSY  
**Bamboo Paper  
Plate Holders** 4 Pack **99¢**

PICNIC SIZE  
**Reusable  
Ice** ..... Ea **99¢**

ASSORTED PRINTS  
**6 Pack  
Vinyl Chest** .. Ea **\$2<sup>99</sup>**

FOR CANS & BOTTLES  
**Gott Gripper  
Insulator** ..... Ea **99¢**



**GOTT 60 QUART  
COOLER CHEST**

OUR LOW PRICE **\$34<sup>88</sup>**

MFG. MAIL IN REBATE **\$6<sup>00</sup>**

YOUR FINAL COST **\$28<sup>88</sup>**

BUILT-IN ICE.. FILL  
W/WATER. FREEZE &  
LOCK INTO LID TO  
KEEP CONTENTS  
COLDER LONGER







CUTTER  
**Spray-Insect  
Repellent** ... 6 Oz Can **\$2<sup>67</sup>**

EMBASSY  
**Deluxe  
Hedge Shears** Only **\$6<sup>99</sup>**

RUGGED BUILT ON SPOUT  
**5 Gallon  
J-Can** ..... Only **\$8<sup>88</sup>**

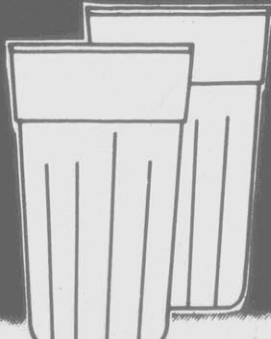
THICK WALL  
**28 Qt. Foam  
Ice Chest** ... Only **\$4<sup>88</sup>**



**22 OZ. STADIUM  
CUPS**

STACKABLE.  
DECORATOR COL-  
ORS. DISHWASHER  
SAFE & DAMAGE  
RESISTANT

**5 For \$1**

**YOUR CHOICE  
24 OZ. ORTHO**

- Rose & Flower Insect Killer
- Kleenup Grass & Weed Killer
- Weed-B-Gon Weed Killer
- Tomato & Vegetable Insect Killer

OUR LOW PRICE **\$3<sup>49</sup>**

MFG. MAIL IN REBATE **\$1<sup>00</sup>**

YOUR FINAL COST **\$2<sup>49</sup>**

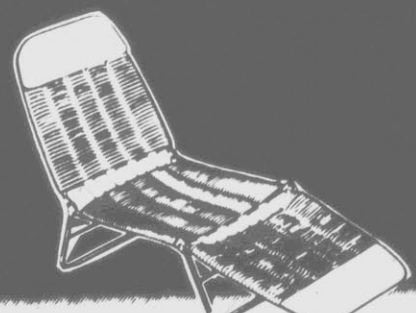
**MULTI-POSITION  
CHAISE LOUNGE**

STURDY FRAME  
WITH DECORATIVE  
COLOR WEBBING

Only **\$7<sup>88</sup>**

# "Golden"

RIPE

## Dole Bananas

29¢

Lb.

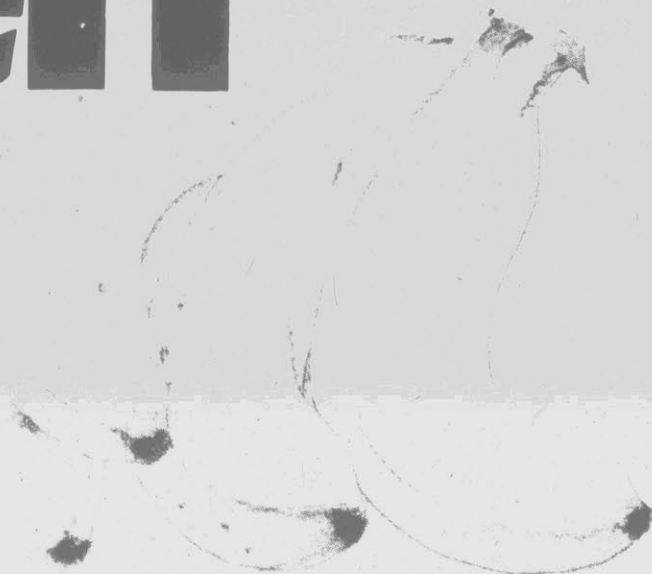

SWEET WHOLE

**Red Ripe Watermelon**

**20**  
Lb Avg Ea **\$3.99**

STUFFING SIZE

**Green Peppers**

**4 \$1**  
For

FRESH

**California Asparagus**

**\$1.29**  
Lb.

ICY FRESH

**California Broccoli**  
**69¢**  
Bch

ORVILLE REDENBACHER'S  
NO SALT (REGULAR OR BUTTERY)

**Microwave Popcorn**

**10.5**  
Oz Pkg **\$2.19**

FRESH

**California Lemons**

**3**  
Lb Bag **\$1.99**

U.S. NO. 1  
GENUINE

**Idaho Potatoes**  
**\$1.98**  
10 Lb Bag

**5** Lb Bag **\$1.58**  
SELECT BAKERS Lb **48¢**



### Salad Fixins

PENCIL THIN  
**Green Onions**

**4 \$1**  
Bchs.

TENDER

**Green Leaf Lettuce**

**2 \$1**  
Bchs.

GREEN TOP

**Bunch Radishes**

**3 99¢**  
Bchs.

FRESH

**California Avocados**

**2 \$1**  
For

### -Floral Shoppe-

FRESH CUT

**Daisy Bouquets**

**\$1.99**  
Ea

DECORATIVE

**Ficus Benjamina**

**\$5.99**  
6" Pot

**Kroger Sav-on**

*Feel the Difference...*  
Go Krogering

WE'LL DOUBLE YOUR MONEY BACK IF YOU'RE NOT SATISFIED WITH THE FRUITS AND VEGETABLES YOU BUY AT KROGER.



# The



# Cost Cutter Difference

## Low, Low Prices EVERYDAY!

### ✓ Last Year

### ✓ Last Week

### ✓ NOW

EVERYDAY



COST CUTTER

Saltine Crackers

39¢

1 Lb. Box

COMPARE ANYWHERE!



THICK RICH

Hunt's Ketchup

77¢

Qt. Btl.

EVERYDAY



GRIND IT FRESH YOURSELF!  
SPOTLIGHT

Bean Coffee

\$1.79

1 Lb. Bag

COMPARE ANYWHERE!



COST CUTTER

Sugar

\$1.38

5 Lb. Bag

EVERYDAY



IN OIL OR WATER

Chicken Of The Sea Tuna

59¢

6 1/2 Oz. Can

COMPARE ANYWHERE!

COMPARE ANYWHERE!



ASSORTED FLAVORS POLAR PAK

Ice Cream

99¢

2 Gal. Ctn.

EVERYDAY

EVERYDAY



COST CUTTER HAMBURGER OR

Hot Dog Buns

3 \$1

8 Ct. Pkgs.

COMPARE ANYWHERE!

COMPARE ANYWHERE!



JIFFY

Corn Muffin Mix

19¢

8 Oz. Box

EVERYDAY



ASSORTED STRAINED HEINZ

Baby Food

6 \$1

4.50z Jars



LUNCHEON MEAT

Spam

\$1.18

12 Oz. Can



DISPOSABLE

Scot Towels

66¢

Jumbo Roll



KRAFT CHEESE

Velveeta

\$3.39

2 Lb. Box

## Quality, Variety, Service, plus COST CUTTER PRICES!



# Kroger Cost Cutters



## LOW PRICES ON ITEMS YOU NEED AND USE Shop...Compare...You Be The Judge!

COMPARE ANYWHERE!



DAIRY SWEET

Condensed Milk

14 Oz. Can

**99¢**

EVERYDAY

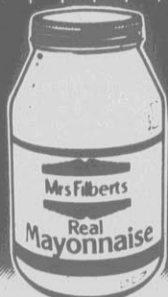

MRS. FILBERTS

Mayonnaise

Qt. Jar

**88¢**

COMPARE ANYWHERE!



ALL FLAVORS

Sugar Free Jello

6-Oz. Box

**66¢**

EVERYDAY



HORMEL

Vienna Sausage

5 Oz. Cans

**2 89¢**

EVERYDAY



BETTY CROCKER

Hamburger Helper

7-8 Oz. Box

**98¢**

COMPARE ANYWHERE!



BRIGHT

1 1/2 Gallon Bleach

Jug

**77¢**

EVERYDAY



COST CUTTER 18% PROTEIN

Dog Food

25 Lb. Bag

**\$279**

COMPARE ANYWHERE!



MORTON HOUSE

Beef Stew

24 Oz. Can

**88¢**

EVERYDAY



Shedd's Spread

1-Lb. Pkg.

**29¢**

COMPARE ANYWHERE!



KROGER WHOLE

White Potatoes

16 Oz. Can

**29¢**

EVERYDAY



COUNTRY CLUB

Butter

1-Lb. Pkg.

**\$166**

COMPARE ANYWHERE!



SMUCKERS

Grape Jam

32 Oz. Btl.

**99¢**

COMPARE ANYWHERE!



COST CUTTER

Peanut Butter

18 Oz. Jar

**89¢**

EVERYDAY



GENERAL MILLS

Cheerios Cereal

10 Oz. Box

**99¢**

COMPARE ANYWHERE!



ASSORTED VARIETY

Fox Pizza

10-Oz. Pkg.

**49¢**

EVERYDAY



VAN CAMPS

Beanee Weenee

7 3/4 Oz. Can

**39¢**

EVERYDAY



OCEAN SPRAY

Cranberry Cocktail

48-Oz. Jar

**\$166**

COMPARE ANYWHERE!



COST CUTTER

Cheese Food Singles

12 Oz. Pkg.

**79¢**

EVERYDAY



ROYAL PINK

Pink Salmon

15 Oz. Can

**\$159**

COMPARE ANYWHERE!



FOR CRISPY CHICKEN

Wesson Oil

48 Oz. Btl.

**\$229**

# Kroger Sav-on

*Feel the Difference...*  
Go Krogering

Prices Effective Thru Tuesday, May 21

# LOWE'S HOME FIX-UP WEEK

**INSIDE**

**SAVE \$40**



**\$39.99**  
**42" Contemporary Style Ceiling Fan With Reversible Motor**  
 With brown motor housing and 4 teakwood blades or white housing and white wood blades. #31716,7

**\$9.99**  
**8" Round, Fan Light Kit** . . . .  
 (Not Shown) #31802,12



**\$199.99** *Hotpoint*  
**5,000 BTU, 115 Volt Room Air Conditioner**  
 Handsome style simulated walnut grill, 2 fan speeds; lightweight and easy to install. Regular \$239.99. #50151

**OUTSIDE**

**SAVE \$5**

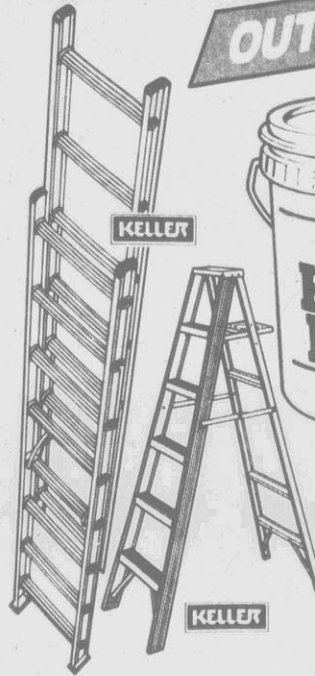

**\$8.99**  
**Exterior Or Interior Flat Latex Paint**  
 Exterior in white; interior in off-white. Covers most colors in one coat. Easy soap and water clean-up. Regular \$13.99. #49922,27

**\$29.99**  
**6' Aluminum Step Ladder** #92524 . . . .  
**\$39.99**  
**16' Aluminum Extension Ladder** #92530 . . .



**\$14.99**

**3/4" x 4' x 8' BC Pine Plywood Panel**

This fine interior/exterior grade is easy to paint or stain and adds structural strength. #12229



Excellent add-on insulation. Has an R-Value of 19. Sold in 48.96 sq. ft. bundles. #13585

Higher R-Value means greater insulating power. Ask Lowe's for an R-Value fact sheet.

**6" x 15" Unfaced R-19 Insulation**

**21¢** *PRE-SEASON SPECIAL PRICE*  
 Sq. Ft.



**6' x 8' Stockade Fence Panel For Privacy And Security**  
**\$19.99** *Per Panel*

Can be painted, stained or weathered. Reg. \$25.99. #99031,51

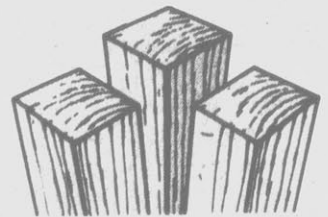

**Pressure Treated 4 x 4 x 8' Post**

**\$3.69** *Each* #05290

**Treated 8' Landscape Timbers**  
**\$3.19** *Each*  
 Reg. \$3.49. #04574



**UP TO \$1,000 Instant Credit**

Or Use Lowe's Low Monthly Payments

**LOWE'S**  
**Home Fix-Up Week**

**10% Low Price Guarantee**

Lowe's has outstanding prices... everyday... and we guarantee it!  
 (See Page 2 For Full Details)

**PRICES  
EFFECTIVE THRU  
MAY 21**



**SPECIAL  
OFFER**

Perfect for your garden wedding! Just present your wedding invitation at our store for an additional \$50 off!

**9' x 9' Solid Redwood Gazebo Kit & Benches**  
**\$899<sup>99</sup>**

Solid California redwood; with benches. Parts are pre-drilled, and hardware is included. Great price. Reg. \$999.99. #04620



**Solid Redwood!**

**Redwood Octagonal 12" Urn With Liner**

**\$10<sup>99</sup>** Reg. \$11.99 #04601

**7" x 24" Redwood Plant Box With Liner**

**\$12<sup>99</sup>** Reg. \$14.99 #04606

Both planters are redwood. And they add beauty to your patio, porch or garden. Buy now!



**Pressure Treated Landscaping Edge Panel**

**\$2<sup>99</sup>** Each

Resists decay, insects, and weather! Save now! Regular \$3.69. #04615



**4 x 4 x 6' Long Pressure Treated Post** #05298  
**Pressure Treated Round-Edge Decking**

<b>1 1/4" x 4 x 10'</b> <b>\$1<sup>99</sup></b> #05422	<b>1 1/4" x 4 x 12'</b> <b>\$2<sup>39</sup></b> #05423	<b>1 1/4" x 4 x 14'</b> <b>\$2<sup>79</sup></b> #05424	<b>1 1/4" x 4 x 16'</b> <b>\$3<sup>19</sup></b> #05425
--	--	--	--

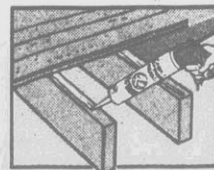

**Treated Wood & Deck Adhesive** #12239 **\$2<sup>99</sup>**  
**Quart Capacity Adhesive Gun** #12238 **\$5<sup>99</sup>**  
**5-Lb. 16D Pressure Treated Nails** #69346 **\$5<sup>99</sup>**



**7/16" x 4' x 8' Waferboard**  
**\$6<sup>49</sup>**

Multi-layered wood wafers bonded with exterior resin for durability! #12212



**SAVE \$3**

**3/4-Inch Plywood Basketball Backboard**

**\$16<sup>99</sup>** 3/4" x 36" x 48" Ext. Plywood

Predrilled and unfinished. Regular \$19.99. #04625



**12-Ga. 48" x 50' Chain Link Fencing Fabric**

**59¢** Linear Foot

Do it yourself with Lowe's accessories and installation kit. Increases property value and security! Sold in 50' rolls. #92149



**48" x 20' Roll Tomato Guard**  
**\$7<sup>99</sup>**

Protects; supports growth. Makes 4 cages. #92249

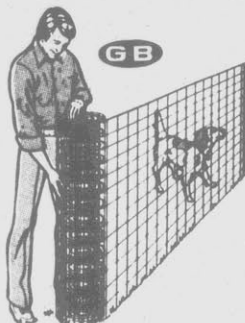

**36" x 50' Welded Fence**  
**\$15<sup>99</sup>**

Great for backyards. 16-gauge. #92251

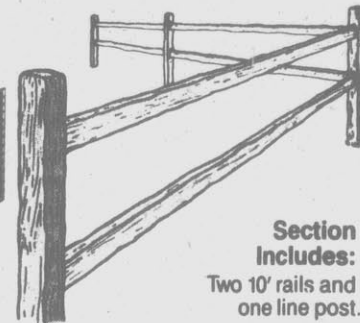

**10' Section Cedar Split-Rail Fencing**  
**\$14<sup>99</sup>** 10' Section

Cedar weathers beautifully! And it naturally resists decay and insects. Regular \$17.99. #98921,2

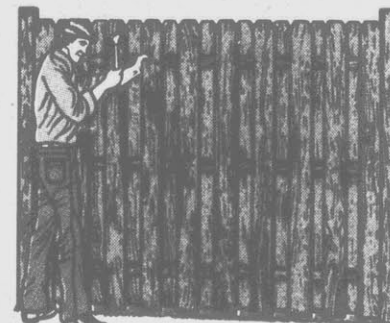

**6' x 8' Treated Shadowbox Fence Panel**  
**\$34<sup>99</sup>** **\$5 OFF**

Resists decay & insects. Reg. \$39.99. #99003

**LOWE'S GOES THE EXTRA YARD...JUST FOR YOU!**

**GREAT PRODUCTS & PRICES**

**10% Low Price Guarantee Policy:**

Lowe's guarantees our everyday low prices. If you find an identical advertised item at any retail competitor currently priced lower than ours, simply bring us written proof of that price. We'll match that price PLUS give you an additional 10% of the difference between the two prices when you buy from us. It must be an identical stock item. Close-out, discontinued and other clearance type sale items are excluded from this offer.

**Satisfaction Guaranteed Policy:**

Lowe's guarantees that you will be satisfied with your purchase. If you are not completely happy with your purchase, simply return it along with your original sales receipt to any Lowe's store. We'll repair it, replace it, or refund your money.

**Lowe's Raincheck Policy:**

If an advertised item is temporarily out-of-stock, we will gladly issue a raincheck (except for items marked limited quantities, discontinued or closeout). When we restock you will be notified so you can buy at the previously advertised price. Our smaller stores may not stock all advertised items; however, every item shown can be ordered for you.



**UP TO \$1,000 INSTANT CREDIT**

**Apply For Your Convenient Lowe's Credit Card!**

Just present your Visa, American Express, MasterCard and you may qualify for up to \$1,000 instant credit on a new Lowe's card. (Even without these cards, your application will be processed with minimum delay.) Stop by Lowe's today for complete details and an application. You'll be able to choose from thousands of products to charge.



**Finance Major Purchases Of Up To \$5,000 On Our Low Payment Credit Plan:**

Our Low Payment Plan offers you an easier way to make those major home improvements and larger purchases, by letting you finance purchases of \$250 to \$5,000 for up to five years. So apply today. You may qualify for up to \$1,000 instant credit when you present your Visa, American Express, MasterCard, Sears or Lowe's Card. Complete details are at Lowe's.



**Lowe's Low Payment Credit Terms:**

Your credit must be satisfactory. Our cash price does not include sales tax. The monthly payment price may be slightly lower, depending upon state law. The monthly payment price includes sales tax of 5%. If sales tax differs in your area, the monthly payment will vary slightly. Credit Life and Disability Insurance is available upon request. Delivery extra.

Ask About Our Quick Delivery!

LOWE'S  
Low Payment  
Credit Plan

For Purchases  
Over \$250.00  
See Page 2 For Details



Free  
Carry Case

**\$149.99**  
16" Chain Saw With  
Free Carrying Case

This lightweight saw is perfect for most any cutting job. It has a powerful 2.0-cubic-inch engine (32cc) and a 16-inch laminated sprocket tip bar. The hard, chrome-plated cylinder helps the engine run cooler and last longer. Ideal for the homeowner. #91614



15" Gas-Powered  
String Trimmer  
**\$89.99**

Has electronic ignition, 44" flex shaft, & debris shield with built-in line cutter. #91578

**BIG VALUE**

Heavy-Duty  
Brush Cutter  
**\$219.99**

- Electronic ignition
  - 8" brush blade with steel blade guard
  - Gasoline powered
  - 60" heavy-duty straight-drive shaft
- For the toughest cutting jobs. #91602

McCULLOCH

McCULLOCH

- 1/3HP electric motor
- Weighs only 4.3 pounds
- Extension tube included

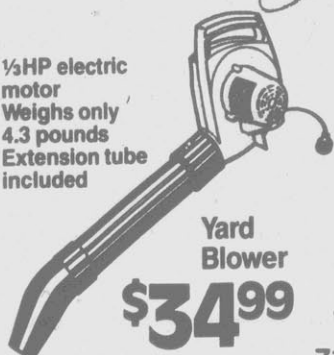

Yard  
Blower  
**\$34.99**

Sweep up leaves, clippings and grass cuttings faster and more easily. Perfect for any clean-up job around the yard. #91551

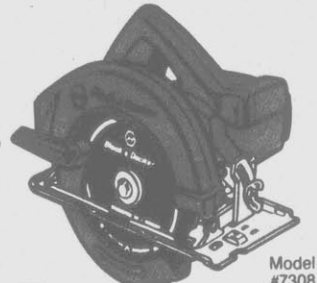

**B-D Black & Decker.**

7 1/4" Circular Saw

**\$34.99**

Low's Price  
Has 6-ft. cord, 1 1/2-HP motor. Rebate expires 6/30/85. Limit 1. #91844

**-\$5.00**

Factory Rebate  
Your Final Cost

**NEW AT LOWE'S**

Heavy-Duty Staple Gun **\$8.99**

Easy one-hand operation is perfect for do-it-yourselfers. #91432

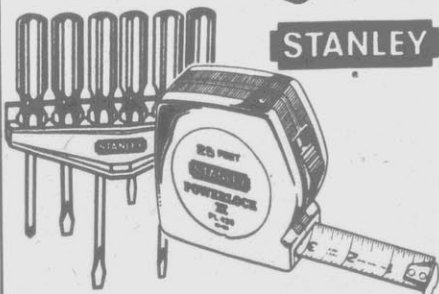
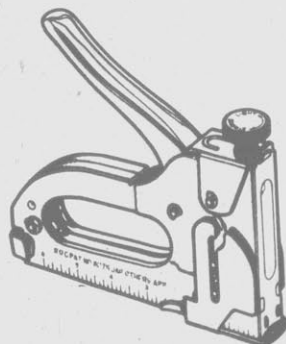

**STANLEY** 6-Piece Set Of  
Screwdrivers  
**\$3.99**

The set comes with a wall hanger. #91526

1" x 25' Tape Rule **\$8.99**

Has large, easy-to-read numbers. #99930



**SAVE \$100**

8-Horsepower  
30-Inch Cut  
Riding Mower

**\$799.99**

Off-Highway  
Use Only.

This fine mower has 5 forward speeds and 1 reverse speed, a height-adjustable steering column and a short turning radius for increased maneuverability. Features electric start and Briggs & Stratton engine. Reg. \$899.99. #95175



10 Cubic Foot  
Dump Trailer **\$99.99**

Made of heavy-gauge steel with welded construction, this unit has a removable tailgate, driver controlled dump action and big 16" tires. Reg. \$139.99. #92858

Monthly Payment **\$33.08\*** For 36 Months

No Down Payment.  
Annual Percentage  
Rate 23.99%.

**SPECIAL**  
3 1/2-Horsepower  
22-Inch Cut  
Push Mower  
**\$139.99**

Has a 4-cycle Briggs & Stratton engine & easy height adjusters. Reg. \$159.99. #95118

Grass Catcher  
For Above Mower  
**\$24.99**

#95156

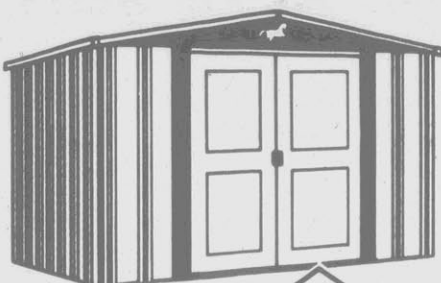

**SAVE \$20**  
10 x 9 Galvanized Steel  
Storage Building  
**\$159.99**

Reg. \$179.99

Has leaf green trim, a hot-dipped galvanized frame and a 3-year limited warranty. Base dimensions: 9'7 1/4" x 8'7 3/4". #92735

Storage Building  
Foundation Kit **\$32.99**

This steel base frame makes a floor or foundation easy. Reg. \$36.99. #92726



3 1/2-Horsepower  
22" Cut Mower With  
Grass Catcher  
**\$199.99**

Human-engineered padded handle; long-life wheels with 2-yr. limited warranty. Reg. \$229.99. #95128

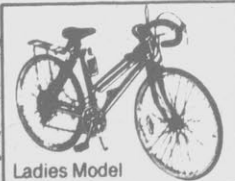

Ladies Model

**YOUR CHOICE**  
Men's Or Ladies' 26"  
Deluxe 10-Speed Bicycle **\$89.99**

Men's bike is black with a 21" frame, and the ladies' bike is blue with a 19" frame. Both bikes come with air pump, water bottle and rear spring carrier. Reg. \$129.99. #99624,6



**SAVE \$10**  
Park Bench Kit  
**\$29.99**

Easy to assemble. Ends are cast iron. Reg. \$39.99. #96818

**PRICES  
EFFECTIVE THRU  
MAY 21**

**\$99<sup>99</sup>**

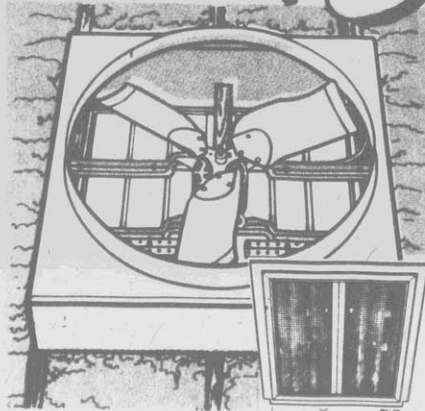

**30" 2-Speed  
Whole House  
Attic Fan**

Keep cool this summer with this easy-to-install, pre-wired attic fan. You get maximum cooling with a minimum of noise and energy use. Shutter (#31273) is extra. #31270

**24" Attic Fan \$89<sup>99</sup>**  
#31266

**Deluxe Interior  
Ceiling Shutter (Extra)**  
#31273

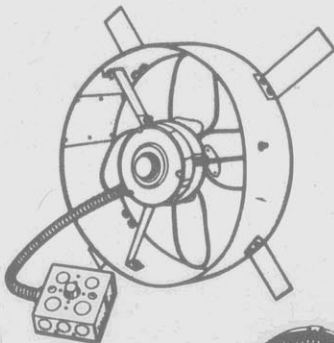

**Galvanized Steel  
Gable-Mount  
Attic Ventilator**

**\$39<sup>99</sup>**

Save up to 1/3 on air conditioning costs. Has an adjustable thermostat and 2-year limited warranty. #30987

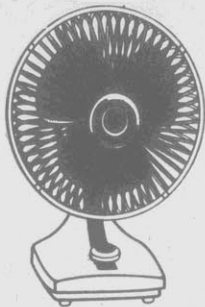

**6" 2-Speed  
Brown & Beige  
Personal Fan**  
**\$7<sup>99</sup>**

Has metal child-guard grille, front and back. UL listed. #39586

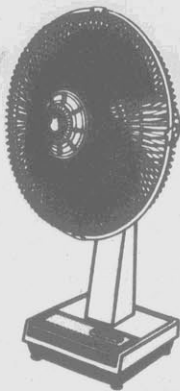

**12" 3-Speed  
Oscillating  
Tabletop Fan**  
**\$19<sup>99</sup>**

Has an adjustable tilt, wide oscillating sweep. Beat the heat! #39587

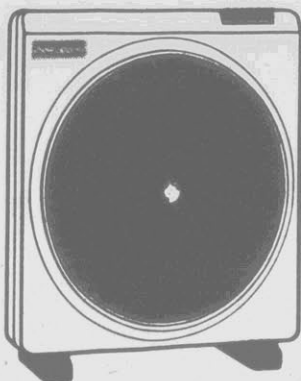

**12" 3-Speed  
Rotating Grille  
Box Fan**  
**\$29<sup>99</sup>**

This portable fan has pushbutton control. Brown & beige. #39585



**36-Inch  
White Ceiling Fan**

Has three white metal blades and a three-speed motor. UL listed. #31703

**\$24<sup>99</sup>**

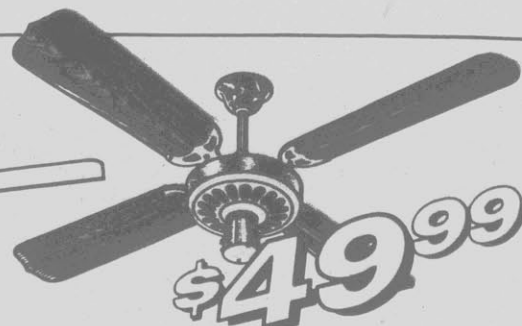

**52" 3-Speed Ceiling Fan**

This good-looking fan has an antique brass finish, four teakwood blades and is light kit adaptable. Reversible motor. UL listed. #31726

**\$49<sup>99</sup>**



**52" Flushmount  
3-Speed  
Ceiling Fan**

Features include an antique brass or polished brass finish, four teak and cane blades, and a reversible motor. It's also light kit adaptable and UL listed. Keep cool with style! #31755,57

**\$64<sup>99</sup>**



**52" 3-Speed  
Ceiling Fan**

**\$79<sup>99</sup>**

Has an antique brass finish, five oak and cane blades and a reversible motor. Adaptable for light kit. UL listed. #31752

All Lowe's  
Fans Are  
U.L. Listed

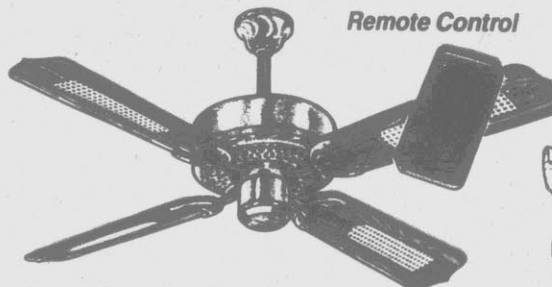

**52" 3-Speed  
Reversible  
Ceiling Fan**

Features a hand-held remote control, an antique brass finish, four oak & cane blades and is light kit adaptable. UL listed. #31789

**\$129<sup>99</sup>**

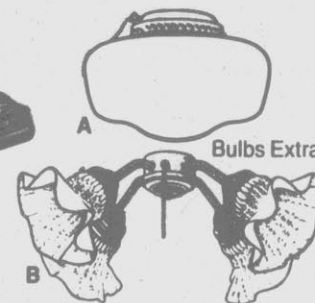

**A. Schoolhouse  
Ceiling Fan  
Light Kit**  
**\$9<sup>99</sup>**

#31804,14

**B. 4-Light  
Victorian  
Light Kit**  
**\$19<sup>99</sup>**

#31806,16

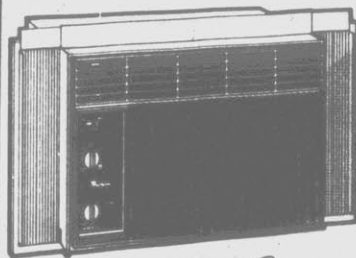

**Whirlpool**

**\$30 SAVINGS**

**7,500 BTU, 115-Volt  
Room Air Conditioner**

**\$369<sup>99</sup>**

Has a 3-speed fan and exhaust control to remove stale air and odors. Regular \$399.99. #50021

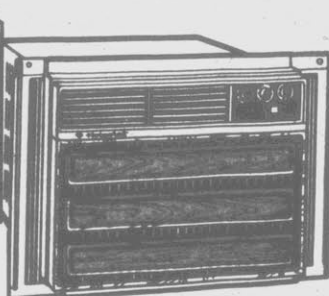

**Hotpoint**

**\$50 OFF**

**9,800 BTU, 115-Volt  
Quick-Mount™  
Room Air Conditioner**

**\$439<sup>99</sup>**

Has quiet Ultra-Lo fan speed for nighttime use; automatic thermostat. Reg. \$489.99. #50167

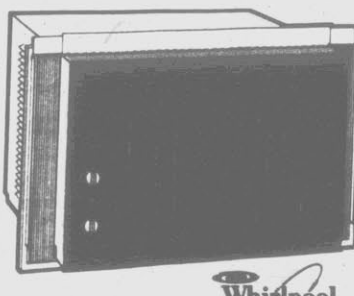

**Whirlpool**

**SAVE \$50**

**12,500 BTU, 115-Volt  
High Efficiency  
Room Air Conditioner**

**\$499<sup>99</sup>**

Features a 3-speed fan, a Fan Only setting for milder days, and simple Insta-Mount™ installation. Regular \$549.99. #50023

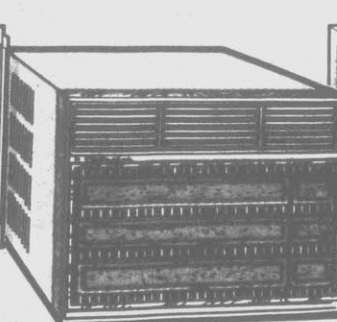

**Hotpoint**

**18,500 BTU, 230-Volt  
High Efficiency  
Room Air Conditioner**

**\$559<sup>99</sup>**

Features adjustable 4-way air direction, an 8-position thermostat and three cooling and "fan only" speeds. #50174

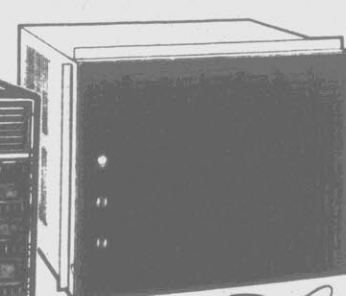

**Whirlpool**

**24,400 BTU, 230-Volt  
High Efficiency  
Room Air Conditioner**

**\$739<sup>99</sup>**

This model features a 3-speed fan, 4-way air direction, an exhaust control to remove stale air and a fresh air control to draw in outside air. #50025



**\$229<sup>99</sup>**  
Space Maker II  
Microwave Oven

Set it on the counter or mount it under your cabinet (bracket included). Features variable power, defrost setting and cooking timer. Regular \$269.99. #51725

Hotpoint

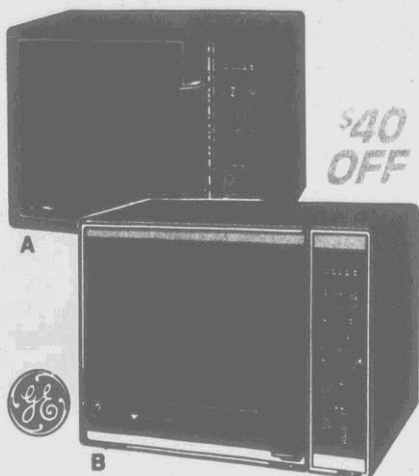

\$40  
OFF

A. Convenient  
Touch Control  
Microwave  
**\$279<sup>99</sup>**

This oven features variable power and temperature probe. Reg. \$319.99. #51753

B. Deluxe  
Microwave  
With Memory  
**\$359<sup>99</sup>**

5 memory functions, variable power and solid state controls. Reg. \$399.99. #51724

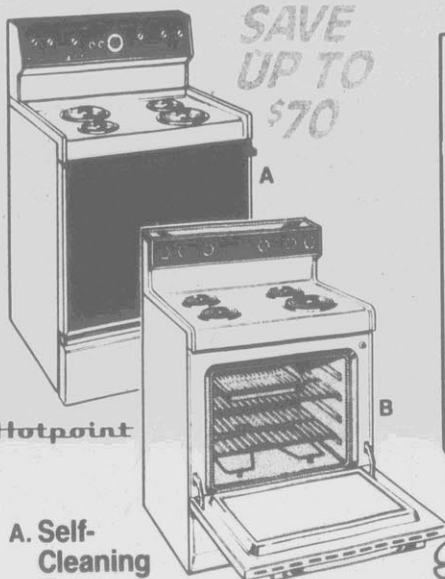

SAVE  
UP TO  
\$70

A. Self-Cleaning  
Range  
**\$459<sup>99</sup>**

4 plug-in surface units. Regular \$529.99. #52837

Monthly Payment  
**\$190<sup>7</sup>\***  
For 36 Months

No Down Payment. Annual Percentage Rate 23.99%.

Hotpoint

B. 30-Inch  
Electric  
Range  
**\$279<sup>99</sup>**

Features 4 surface units, and porcelain oven with lift-off door & broiler pan. Regular \$339.99. #52803

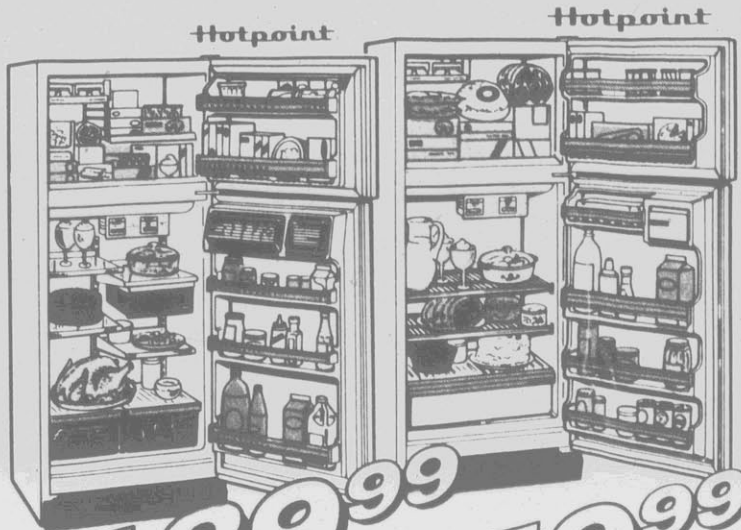

**\$489<sup>99</sup>** **\$459<sup>99</sup>**

Deluxe  
15.5 Cubic Foot  
Refrigerator

This frost-free refrigerator has an energy-saver switch, 2 produce crispers and 4 adjustable glass shelves. Regular \$589.99. #53608

Monthly Payment **\$203<sup>2</sup>\*** For 36 Months

No Down Payment. Annual Percentage Rate 23.97%.

Frost-Free  
14.2 Cubic Foot  
Refrigerator

No messy defrosting! This model does it for you. It has an energy saver switch, plus door shelves, storage drawer and an egg rack. Regular \$519.99. #53600

Monthly Payment **\$190<sup>7</sup>\*** For 36 Months

No Down Payment. Annual Percentage Rate 23.99%.

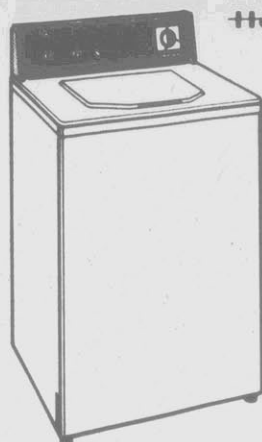

Hotpoint

SAVE  
\$50  
Heavy Duty  
Washer  
**\$369<sup>99</sup>**

Offers 4 automatic cycles, including permanent press. Also 3 temp selections. Reg. \$419.99. #51240

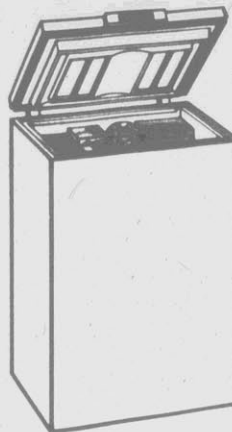

HOLIDAY!

\$50  
OFF

6.1 Cubic Foot  
Chest Freezer  
**\$219<sup>99</sup>**

Compact storage for small areas. Has textured steel finish. Lid is counter-balanced. Regular \$269.99. #50810

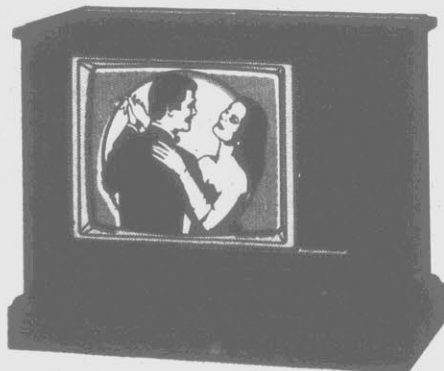

RCA PRICE CUT \$110

25" Diagonal Color Console  
TV With Remote Control  
**\$649<sup>99</sup>**

Regular \$759.99

Has ChanneLock digital remote control, ColorTrak color control, Unitized chassis & Super AccuFilter picture tube in Traditional-style cabinet. #54664

Monthly Payment  
**\$269<sup>2</sup>\***  
For 36 Months

No Down Payment. Annual Percentage Rate 23.99%.



19" Diagonal Color  
Remote Control TV  
**\$329<sup>99</sup>**

Has Color Monitor System, 112-channel capability & programmable remote control. #54527.8

Hi-Boy  
TV Cart ..... **\$39<sup>99</sup>**  
Walnut look; some assembly. #54632

\$50 SAVINGS

19" Diagonal **\$249<sup>99</sup>**  
Color TV

This 100% solid state portable model has a quick-start picture tube and automatic color control. Regular \$299.99. #54480

13" Diagonal  
Color Portable TV  
**\$189<sup>99</sup>**

Features automatic fine tuning and 100% solid state chassis. Also black matrix picture tube. At Lowe's low price! #54483

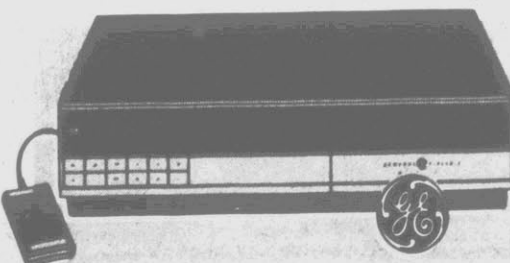

8-Hour VHS  
Video Recorder  
**\$379<sup>99</sup>**

Features freeze frame, frame advance, forward and reverse scan and 7-function wired remote control. #54878.80

**PRICES  
EFFECTIVE THRU  
MAY 21**



**Chrome-Finish Kitchen Faucet With Spray**  
Easy installation makes this washerless faucet just the one you need. Non-metallic  
Regular \$34.99. #24808

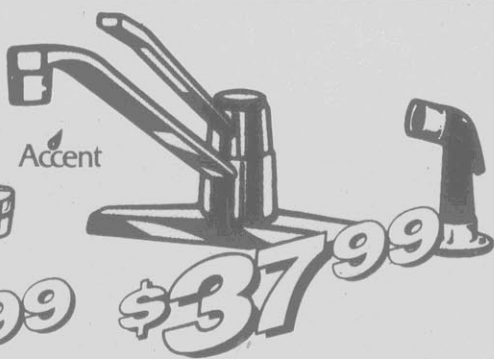

**Chrome-Finish Deluxe Kitchen Faucet & Spray**  
This washerless, drip-free faucet is easy to install. Chrome finish on brass construction.  
Regular \$49.99. #24813



**Chrome-Finish Bathroom Faucet**  
4" centerset with aerator. Includes pop-up drain assembly. Regular \$24.99. #24901



**Decorator Bathroom Faucet**  
This easy-to-install, drip-free faucet has a chrome-plated finish. Includes pop-up drain. Regular \$39.99. #24902

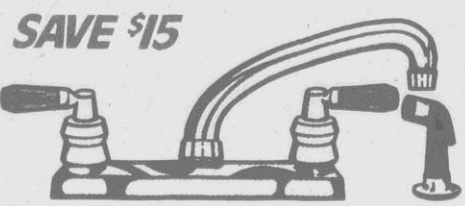

**Deluxe Kitchen Faucet With Spray & Oak Handles**  
**\$49<sup>99</sup>**  
Has chrome-plated finish. Regular \$64.99. #24825

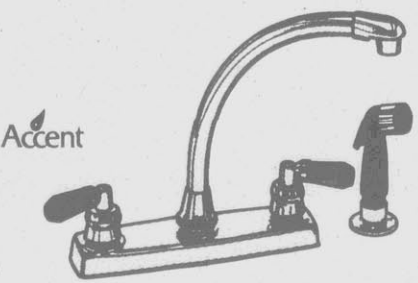

**Hi-Rise Oak-Handle Kitchen Faucet With Spray**  
**\$64<sup>99</sup>**  
Convenient & attractive! Regular \$79.99. #24826



**Bathroom Faucet In Antique Or Polished Brass Finished**  
**\$54<sup>99</sup>**  
It's washerless! Has acrylic handles that give bathroom an elegant touch! Regular \$64.99 & \$59.99. #24909,11



**Polished Brass Bathroom Faucet**  
**\$109<sup>99</sup>**  
Easy to install! Regular \$129.99. #24938

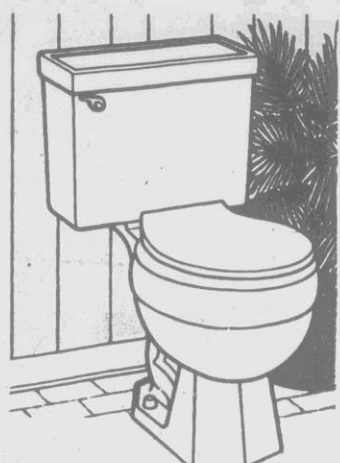

**Water Saver Commode**  
**\$39<sup>99</sup>**  
Features siphon-jet action for a thorough flush. Has easy-to-clean surface! Seat is extra. #20701,2

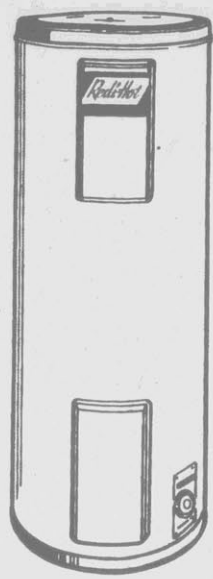

**30-Gallon Single-Element Electric Water Heater**  
**\$89<sup>99</sup>**  
Features pressure valve, thermostat and glass-lined tank. #26325

**40-Gallon Standard Electric Water Heater**  
**\$99<sup>99</sup>**  
Has thermostat and pressure relief valve. At Lowe's low price! #26322

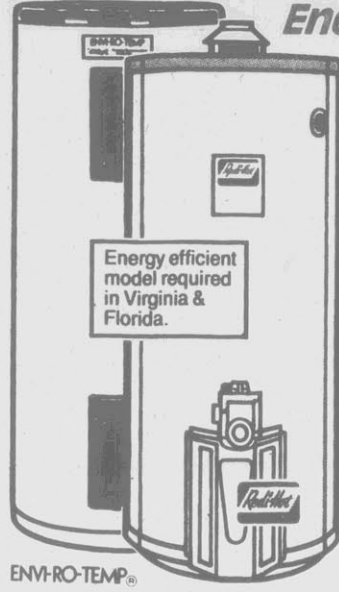

**Energy Saver**

**40-Gallon Energy Saver Water Heater**  
**\$139<sup>99</sup>**  
High-density foam insulation keeps in heat! Double-element heater has pressure valve and thermostat. #26302

**40-Gallon Natural Gas Water Heater**  
**\$129<sup>99</sup>**  
Double-element heater has a rustproof tank. #26334



**LOWE'S LOW PRICE**  
**Stainless Steel 6" Deep Kitchen Sink**  
**\$21<sup>99</sup>**  
Self-rimmed for installation. 33" x 22" durable and easy to clean! Double-bowl convenience. #26025

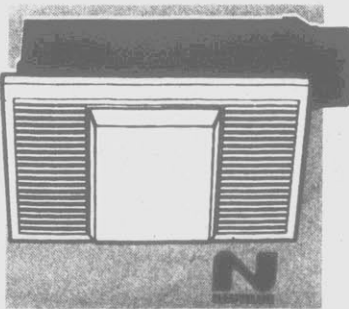

**Bath Exhaust Fan With Light & Heater**  
**\$64<sup>99</sup>**  
Features an extra-quiet, 2-motor system for fan and 1430-watt heater. Housing has adjustable mounting brackets. #25506

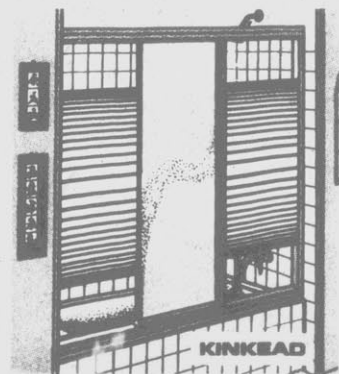

**Deluxe Tri-Door Tub Enclosure**  
**\$199<sup>99</sup>**  
Tempered glass doors in sturdy anodized aluminum frame with handsome bronze finish. #26801



**5-Piece White Tub Surround Wall Kit**  
**\$59<sup>99</sup>**  
Has built-in soap dish and toiletry shelf. It's scratch-resistant, mildew-resistant and easy to clean! And it's warm to the touch. #20781

**5' PVC White Bath Tub**  
**\$79<sup>99</sup>**  
This easy-to-clean tub is scratch-resistant & avoids chipping & peeling. Lowe's low price. #20430,1

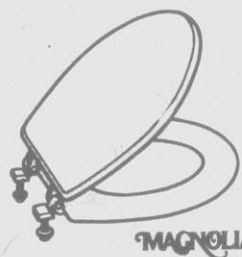

**MAGNOLIA Wood Commode Seat**  
**\$4<sup>99</sup>**  
Easy-to-clean surface! #20590



Ask About Having It Installed!

LOWE'S  
Low Payment  
Credit Plan

For Purchases  
Over \$250.00  
See Page 2 For Details



**22-Watt Circular Fluorescent Fixture**

Just right for anywhere in your home! Has acrylic, easy-to-clean shade. With circular fluorescent lamp. #75431

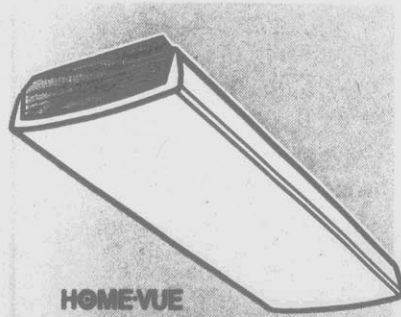

**24" Oak-Trimmed Wraparound 20-Watt Fluorescent Fixture**

Brightens any room! Acrylic diffuser has oak-finish end panels. Uses two 20-watt lamps, which are included. #75411

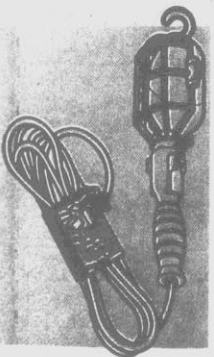

**Trouble Light With 15' Cord**

Bulb extra. #70378



**100' Indoor/Outdoor Extension Cord**

In safety orange. #70372

**SAVE \$130**  
**110-Volt AC/12-Volt DC 750-Watt Generator**

**\$349<sup>99</sup>**  
Ideal for small outdoor jobs. Reg. \$479.99. #72005



Each

**YOUR CHOICE**  
**Post Or Wall-Mount Outdoor Light Fixture**  
Durable, shatterproof lanterns with acrylic panels. Installation is easy! UL listed. Bulb and post sold separately. #73103,9



**Weathered Brass Finish Outdoor Light Fixture**

Wall-mount model. UL listed. #74550



**Ceiling Mount Outdoor Light Fixture**

For your carport or porch. #74520

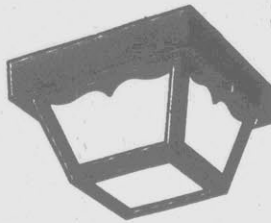

**15-Watt Electronic Bug Killer**

Has a luring area of up to 1/2 acre! Kills flying insects without odor or mess. And it's safe around people and pets. Lamp included. UL listed. #73009

**40-Watt Electronic Bug Killer**

Lures and kills flying insects in up to a 1-acre area. This lantern-style unit includes lamp. Safe and clean! UL listed. #73013



**Swag Light Fixtures**

**"Crystal Rose" Light Fixture**

Has polished brass finish frame and chain. Plus solid oak center column. Regular \$39.99. #75805

**"Floral Arch" Light Fixture**

This fixture has a polished brass finish and solid oak center column. Regular \$44.99. #75804

**PRICES CUT \$10**

Bulbs Extra



**150-Watt Outdoor Flood Lamp**

Extend outdoor work/play time! #75002

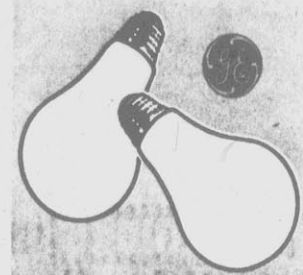

**YOUR CHOICE 40/60/75/100-Watt Light Bulbs**

**49¢ Each**  
Different wattages for every room in your home! Stock up now at Lowe's low price! #75005,6,7,8

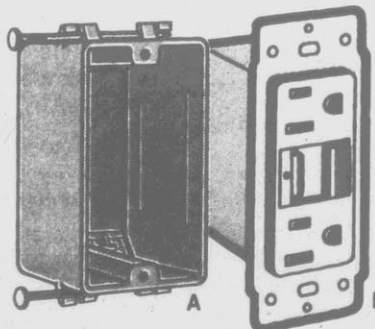

**A. Non-Metallic Wall Box . . . 25¢ Each**

Single-pole, 18-cubic-inch. #70992,72

**B. Ground Fault Outlet \$15<sup>99</sup>**

With pilot light and cover plate. #71915

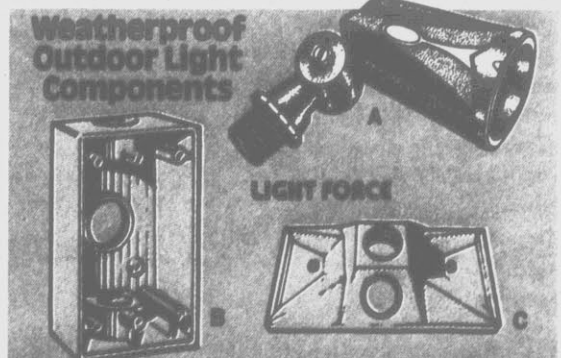

**A. Weatherproof Lampholder \$2<sup>99</sup>**

Black. Gasket is included. At Lowe's low price! #71230

**B. Weatherproof Box \$3<sup>99</sup>**

For outdoor use. Includes plugs. #71235

**C. Weatherproof Cover \$1<sup>99</sup>**

Square, 3-hole. Includes gasket. #71233

Com.

\*Credit Terms On Page 2 7

**PRICES EFFECTIVE THRU MAY 21**



**\$8.99** SAVE \$7



**\$9.99** SAVE \$8

**One Gallon Exterior Flat Latex House Paint**  
Resists fading, peeling and yellowing. Lasts 10 years. Reg. \$17.99. #48514-29  
Custom Colors Mixed At Stock Color Price! #47894-900

**One-Gallon Can Of 5-Way Interior Flat Wall Paint**  
Our finest one-coat interior flat latex. Has a 10-year limited warranty; is fade and stain resistant. Regular \$15.99. #47609-40  
Custom Colors Mixed At Stock Color Price! #47870-6

**SAVE UP TO \$6**

**\$9.99** your choice

**One-Gallon Can Of Stain And Wood Preservative Or Latex Porch And Deck Paint**

A. Helps combat mildew and rot. Available in solid and semi-transparent. A long-lasting stain. Reg. \$13.99. #48869-91

B. 4-year limited warranty. Stands up under heavy traffic and exposure to severe weather. Regular \$15.99. #49881-86



**SAVE UP TO 28% ON ASSORTED 2' x 4' FIBERGLAS-BACKED CEILING PANELS**

- |   |  |  |
|---|--|--|
| <b>Terra Panel</b><br><b>28¢</b> Sq. Ft.<br>Reg. 36¢ sq. ft. #18440 | <b>Nova Panel</b><br><b>32¢</b> Sq. Ft.<br>Special order in most stores. Reg. 38¢ sq. ft. #18443 | <b>Sculptured</b><br><b>36¢</b> Sq. Ft.<br>Special order in most stores. Reg. 49¢ sq. ft. #18441 |
|---|--|--|

**One Gallon Of Paint Thinner**  
**\$2.49**  
Regular \$3.99. #45635



**2' x 4' Lay-In Light Panel . . . \$2.99**  
For use in suspended ceiling. Choice of two patterns. Regular \$3.99. #18425,7

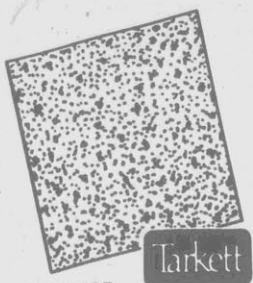

**12" x 12" Sure-Stik™ Adhesive Back Tile 39¢ Ea.**  
Regular 59¢. #16486,7

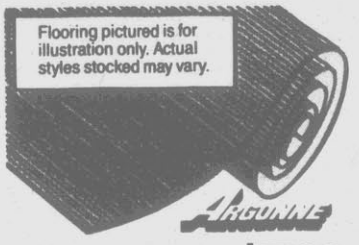

**Level Loop 100% Nylon Carpet . . . \$3.99 Sq. Yd.**  
Has an attached cushioned backing. Easy to install - do it yourself and save! Regular \$4.99. #15230-32



- Triangle Pacific**
- |   |  |   |
|---|--|---|
| <b>Marina I Bath Vanity With Top &amp; Faucet \$99.99</b><br>Classic white finish and gold trim. Top is 19" x 17". #20804 | <b>Salem Oak 24" x 21" Vanity And Marble Top \$139.99</b><br>Top is cultured marble. Faucet not included. #20827,275 | <b>Bedford Oak 24" x 21" Vanity &amp; Marble Top \$199.99</b><br>Cultured marble top. Solid oak doors. Faucet extra. #20947,275 |
|---|--|---|

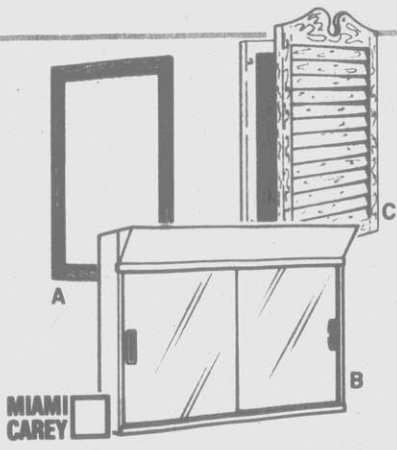

- Medicine Your Choice . . . \$34.99 Ea.**
- A. **Rectangular Oak Frame**  
Recessed steel cabinet body, piano hinge door and 2 adjustable shelves inside. #23711
- B. **Sliding Mirrors With Light**  
Light uses four 60-watt lamps (not included.) One removable shelf. Surface mount. #23716
- C. **Unfinished Wood Door**  
Door is selected white pine, reversible for right- or left-hand swing. Recessed mount. #23718



- Your Choice \$18.99 Each**
- A. **Unfinished Ladderback Chair**  
Ready to paint, stain. Removable seat. #96003
- B. **Chrome Frame Breuer Style Chair**  
Has a natural-finish cane back and seat. Some assembly is required. #96140
- C. **66" Brass-Look Hat And Coat Rack**  
Useful and attractive. Brass plated. Some assembly required. Great price! #96116

Choose From Two Credit Plans!

**LOWE'S**  
Low Payment  
Credit Plan

For Purchases  
Over \$250.00  
See Page 2 For Details

**SPECIAL PRICES ON  
DOORS AT LOWE'S**

Limited Quantities

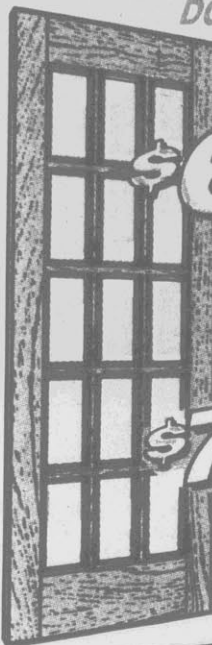

**\$69<sup>99</sup>**

**2'8" Lauan  
Exterior Door**  
1 3/4" thick, 15-lite door.  
Regular \$79.99. #10556

**\$79<sup>99</sup>**

**3' Lauan  
Exterior Door**  
1 3/4" thick 15-lite door.  
Regular \$89.99. #10557



**YOUR CHOICE \$11<sup>99</sup>**  
Pair

**39-Inch Black Or White  
Polystyrene Shutters**

Maintenance-free! Won't warp, split, separate or mildew. Regular \$17.99. #12852,60



**YOUR CHOICE YOUR CHOICE**

**\$39<sup>99</sup>**  
2'8" Or 3'

**Ventilating  
Storm Door**

1" thick. Aluminum  
frame. Reg. \$59.99 &  
\$64.99. #11131-4

**\$74<sup>99</sup>**  
2'8" Or 3'

**Full-View  
Storm Door**

Full-length safety glass!  
Aluminum. Reg. \$84.99  
and \$89.99. #15678-81

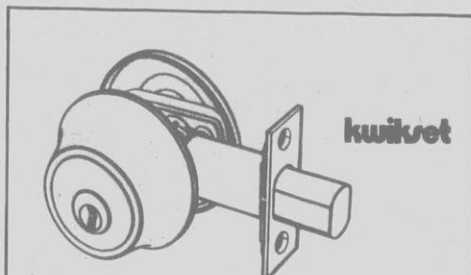

**kwikset**

**Brass Finish  
Deadbolt  
Lock** **\$9<sup>99</sup>**

This polished brass-finished deadbolt has 1" steel pin. Attractive security for your home. Rust resistant. At Lowe's low price. #61318

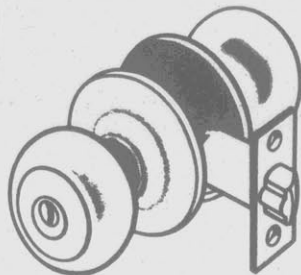

**kwikset**

**Brass Finish  
Entrance Lock** **\$14<sup>99</sup>**

Has smooth, polished brass finish that won't rust or corrode. Sturdy construction protects your family and belongings. Buy now! #61306

**INGERSOLL-RAND  
AIR COMPRESSORS**

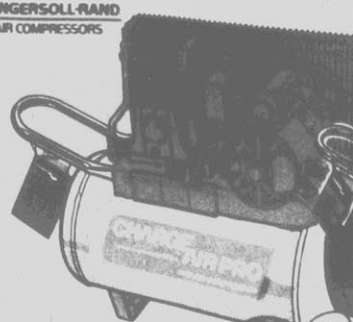

**\$259<sup>99</sup>**

**1-Horsepower  
Air Compressor**

Features dependable valves and heavy-duty motor for safety and long life! Reg. \$299.99. #90927

**INGERSOLL-RAND  
AIR COMPRESSORS**

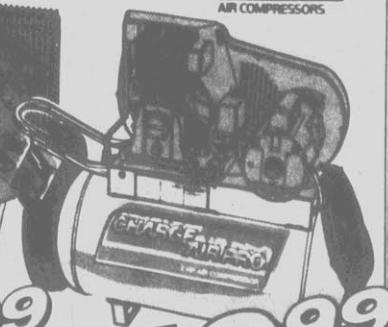

**\$349<sup>99</sup>**

**2-Horsepower  
Air Compressor**

Has enclosed, reusable intake filter and 15' air hose with air chuck. Regular \$399.99. #90929



**INGERSOLL-RAND  
AIR COMPRESSORS**

**YOUR CHOICE \$39<sup>99</sup>**

**Paint Sprayer**

3-way spray gun is great for heavy-duty jobs. #90944

**3/8" Air Drill**

Integral muffler directs exhaust from work area. #90950

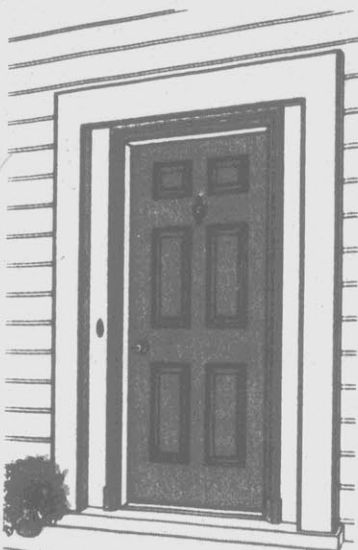

*Benchmark*

**3', 6-Panel Insulating  
Replacement Steel Door**  
**\$134<sup>99</sup>**

Sculptured steel details and an enamel finish provide beauty that lasts and lasts! With extra-tight seal. Insulating foam core. Regular \$164.99. #155078



*PRICES CUT*

**Single Track  
Aluminum  
Storm Window**

**\$11<sup>99</sup>**

23 3/8" x 38 7/8"

Features removable lower panel for easy cleaning. Also fiberglass screen. Aluminum frame. Regular \$15.99. #13132

**\$15<sup>99</sup>** 31 1/8" x 38 7/8"  
Or 35 7/8" x 38 7/8"  
**Storm Window**

Regular \$19.99. #13127,8

**\$17<sup>99</sup>** 31 1/8" x 54 1/8"  
Or 35 7/8" x 54 1/8"  
**Storm Window**

Regular \$21.99. #13130,1



**6-Foot Aluminum  
Sliding Patio Door**

**\$199<sup>99</sup>**

Available in bronze or white finish. Includes screen, so you can enjoy the fresh air with protection from insects. Has 5/8" tempered insulating glass. And it's completely weatherstripped. Save now! Regular \$239.99. #12987,8

Come in and see our line of exterior doors! We have a variety of patio doors, storm doors, screen doors and sturdy entrance doors! All at Lowe's low price! So whether you're building or remodeling, come see us!

**SAVE \$40**

**PRICES  
EFFECTIVE THRU  
MAY 21**



**\$229<sup>99</sup>**

**3' x 3'  
Bronze  
Garden Window**

- Glazed with 1/2" insulating glass
- Side vents with fiberglass screens
- Insulated aluminum humidity pan
- Heavy-duty hardware
- Cam latches on vents

Beautiful solar garden window projects 12" out from your home. Fits over existing window frame. Regular \$259.99. #19440



**PRICE CUT  
\$120**

**\$449<sup>99</sup>**

**6-Foot Swinging  
Wood Patio Door**

Get the beauty of French doors with energy efficient features, including adjustable aluminum sill with thermal break, double-contact weatherstripping and 5/8" tempered insulated glass. Regular \$569.99. #13341.42

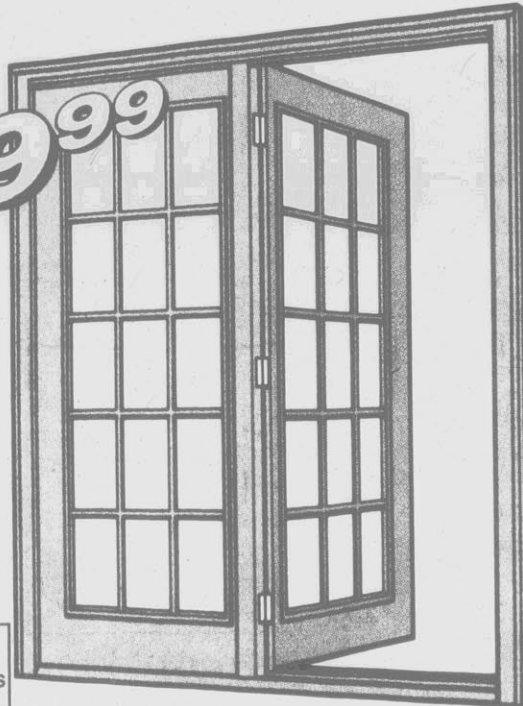

Wood Window Grilles Extra

Monthly Payment **\$18<sup>68</sup>** For 36 Months

No Down Payment.  
Annual Percentage Rate 24.00%.

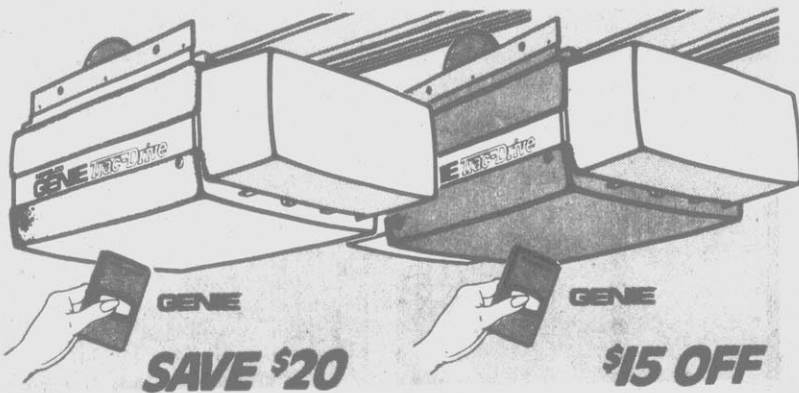

**SAVE \$20**

**\$15 OFF**

**1/3-Horsepower  
Garage Door Opener**

**\$164<sup>99</sup>**

Genie's premium 1/3HP Trac-Drive model with automatic light delay, automatic safety reverse and digital transmitter with personal security code. Quiet operation. Regular \$184.99. #11008

**1/2-Horsepower  
Garage Door Opener**

**\$184<sup>99</sup>**

Genie's top-of-the-line Trac-Drive System, lighted wall button, vacation security switch, automatic light delay and automatic safety reverse. Comes with transmitter. Regular \$199.99. #11009

**Save On Summer Cooling  
With Insulation From Lowe's**



You can easily insulate your home yourself. Insulating in your floors and attic is most common, but there are other areas of your home where you can benefit from using insulation. Exterior walls, interior walls (during new construction), basement walls and even foundation walls with crawl spaces can be insulated. And don't forget to cover between your foundation and sill. The more complete the insulation barrier is around your home, the more energy efficient and comfortable it will be. Ask a salesman for more tips.



The benefits of proper insulation are apparent in your utility bills. The better insulated your home is, the more energy efficient it will be, year-round. Insulation comes in a variety of thicknesses and with a variety of R-values. The R-value measures the insulation's resistance to heat flowing out in winter and flowing in during summer. So, the higher the R-value, the greater the insulating power. Ask Lowe's for a factsheet on R-values. Lowe's will help you select the right type of insulation for your home.

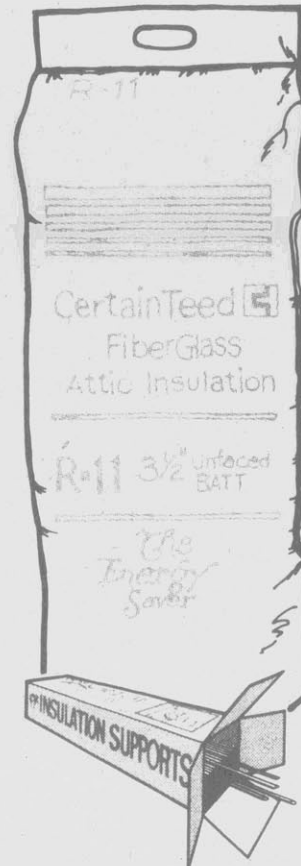

**CertainTeed**

**\$13<sup>99</sup>** Bundle

**3 1/2" x 15" R-11  
Kraft-Faced Insulation**

The kraft facing forms a built-in vapor barrier. 88.12 sq. ft. Regular \$16.99. #13576

**16" Insulation Holders \$2<sup>99</sup>** Pack of 100

The quick and effective way to install insulation under flooring. Regular \$3.99. #12336

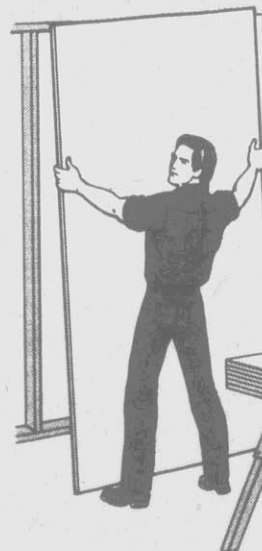

**1/2" x 4' x 8' Gypsum Board**

**\$5<sup>99</sup>**

For a smooth finished wall. Can be applied horizontally or vertically. Makes an easy, do-it-yourself wall project. Low price! #11730



**Gypsum Wall  
Compound**

**\$3<sup>49</sup>** 1-Gallon

Ready-mixed wall-board compound for finishing, patching drywall. #11750

UNITED STATES GYPSUM

We'll Be Glad To Load It For You!

LOWE'S  
Low Payment  
Credit Plan

For Purchases  
Over \$250.00  
See Page 2 For Details



**Celotex**

**SPECIAL PRICE \$13<sup>99</sup>**

**Celotex Dimension III Shingles**

- Available in five dramatic earthtone colors
- Have earned the UL Class "A" Fire & Wind Resistant label
- Backed by a thirty-year limited warranty

These tough, long-lasting laminated shingles complement any home style. They will add security and value to your home. Regular \$16.99. #14940-44



- Has a fifty-year limited warranty.
- Eliminates wood painting costs.

**\$4<sup>59</sup>**

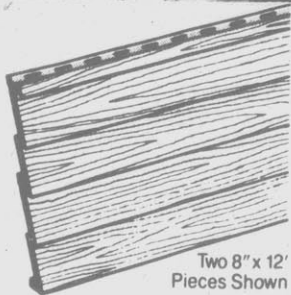

**White Solid Vinyl Siding**

This beautiful siding is more durable than wood and is maintenance free. It doesn't crack or peel, is easy to clean, and it gives your home the warm, traditional look of natural wood siding. Catalog order most stores. Colors available at \$5.99. Regular \$5.59. #17423

**napco**

- Available in solid or vented style.
- Makes an overhang maintenance-free.
- Installation is very simple.

**12" x 4' White Aluminum Soffit \$2<sup>69</sup>**

Can help ventilate attic. Can be installed over existing soffit. End painting chores! Regular \$3.69. #17390,1

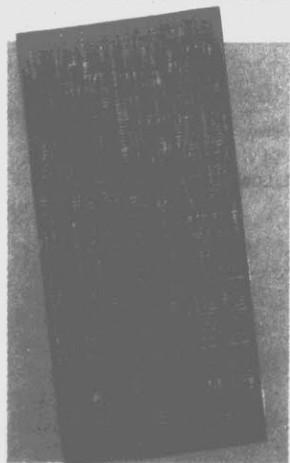

**5/8" x 4' x 8' Pine Siding \$12<sup>99</sup>**

Paint or stain. Grooves 8" on center. Regular \$15.99. #12957

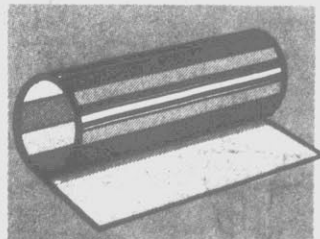

**10" x 10' Roll Aluminum Flashing \$3<sup>99</sup>**

This aluminum is great chimney flashing for roof repairs, as a termite barrier, etc. Reg. \$4.99. #12538

**10" x 10' Painted Flashing \$5<sup>99</sup>**

White or brown. Reg. \$8.99. #12542

**Black 1" Iron Railing 99¢ Linear Foot**

4' or 6' sections. #14215,17

**2 Or 3 Scroll Flat Columns \$12<sup>99</sup> Each**

As available. #14257,61

**2 Or 3 Scroll Corner Columns \$22<sup>99</sup> Each**

As available. #14259,14263

**\$3<sup>99</sup>**



**Vinyl Concrete Patch \$3<sup>99</sup>**

Sold in seven-pound pail. #10390

**Blacktop Patch \$4<sup>99</sup>**

No heating or mixing. 60-lb. bag. #10394

**Vinyl Concrete Patch \$8<sup>99</sup>**

40-lb. bag. #10397

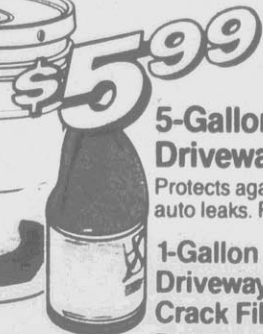

**5-Gallon Driveway Sealer \$5<sup>99</sup>**

Protects against weather and auto leaks. Reg. \$8.99. #10272

**1-Gallon Driveway Crack Filler \$3<sup>99</sup>**

Regular \$4.99. #10273

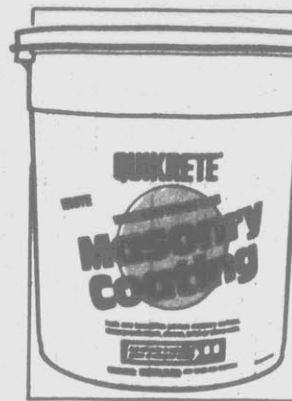

**20-Pound Pail Masonry Coating \$9<sup>99</sup>**

Waterproofs inside or out; gives a decorative finish to masonry surfaces. #10425



**35-Pound Pail Super Thoro Seal \$19<sup>99</sup>**

For your biggest water-proofing jobs, inside or outside. Great for pools. #11383

**END-OF-SPRING CLEARANCE ON FARM FENCING**



**A. Barbed Wire \$24<sup>99</sup>**

1/4 mi. roll  
15 1/2 gauge. #92050



**B. Welded Fencing \$27<sup>99</sup>**

48" x 50'. 12 1/2 ga. #92288

**Welded Fence \$52<sup>99</sup>**

48" x 100' roll. 12 1/2 ga. #92280

**C. Field Fencing \$79<sup>99</sup>**

47" x 330'. 12 1/2 ga. #92268

SAVE \$6

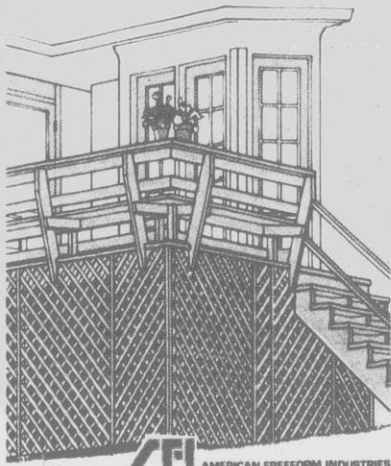

AFI AMERICAN FREEFORM INDUSTRIES

**\$8<sup>99</sup>**

**2' x 8' Pressure Treated Lattice Panel**

Beautiful lattice panel made of pressure treated wood to resist decay and insects. Regular \$14.99. #11129

PRICES GOOD THRU MAY 21



**\$199<sup>99</sup>**

Sunbeam

**Deluxe Dual Burner Gas Grill With Tank**

Has a stainless steel dual burner, 612 sq. in. cooking area, 40,000 BTU. Regular \$249.99. #97276

PRICE CUT



**18HP Lawn & Garden Tractor**

Has a big 42" cut, 2-cylinder Briggs & Stratton engine, four forward speeds & one reverse speed, and a 2-gallon fuel tank. Reg. \$1,899.99. #95193

**Optional Accessories For Tractor**

**Sleeve Hitch \$119<sup>99</sup>**

Needed for other attachments. #95371

**Tractor Plow - 10" \$169<sup>99</sup>**

Plowing depth to 6". Reg. \$189.99. #95374

**Tractor Cultivator \$119<sup>99</sup>**

Adjusts 6" to 42". Reg. \$139.99. #95376

**Disc Harrow \$129<sup>99</sup>**

Discs 29" to 39". Reg. \$149.99. #95378

42% OFF

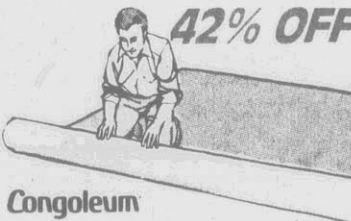

**Congoleum 12' No-Wax Vinyl Flooring \$2<sup>29</sup> Sq. Yd.**

This flooring is highly resistant to scuffs and scratches, and there are 2 attractive patterns to choose from. Regular \$3.99. #16242,3

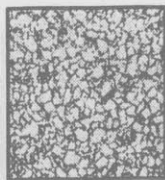

12 Ft. Wide #16242



12 Ft. Wide #16243

SAVE \$60

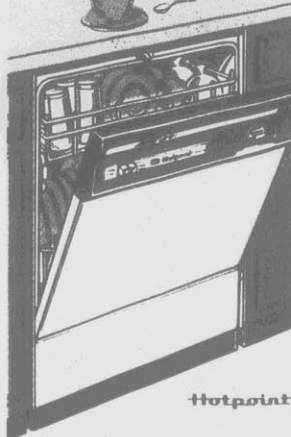

**5-Cycle-Option Undercounter Dishwasher \$259<sup>99</sup>**

Has normal, normal energy saver dry, light wash, light wash energy saver dry, and rinse & hold cycles. Also has a soft food disposer. Sound insulated. Regular \$319.99. #51013

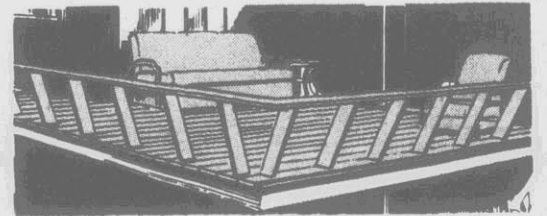

**1 1/4 x 4 x 8' Pressure Treated Decking \$1<sup>39</sup> Each**

"Pressure treated" means it's resistant to weather and insects. #05421

40% OFF



**Tomato Or Garden Stake 29¢ Each**

Regular 49¢. #04597



**12" x 20' White Diamond Border Fence \$3<sup>99</sup>**

Regular \$5.99. #92246



**Plastic Roof Cement \$2<sup>99</sup> Gallon**

Regular \$4.99. #10320



**2 x 4 Economical Handyman Studs 89¢ Each**

Regular \$1.19. #07002

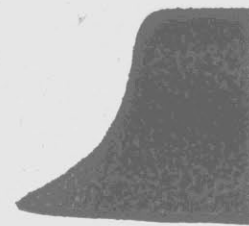

**27" Wide, Green Turf Runner 99¢ L. Ft.**

Regular \$1.49. #16091

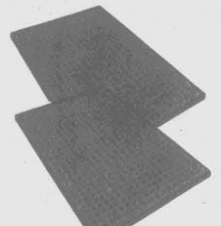

**1/8" x 2' x 4' Perforated Hardboard 99¢ Each**

Regular \$1.79. #15498

**There's A Lowe's Store Near You**

ASHEBORO, NC — Phone 625-6171  
1312 N. Fayetteville St.  
BOONE, NC — Phone 264-8834  
State Farm Rd. at Hunting Lane  
BURLINGTON, NC — Phone 226-6334  
802 Graham Hopedale Rd.  
CARY, NC — Phone 467-3600  
Highway 54  
CHAPEL HILL, NC — Phone 967-2291  
1710 East Franklin St.  
DURHAM, NC — Phone 383-2581  
3417 Hillsborough Rd.  
FAYETTEVILLE, NC — Phone 485-8731  
4103 Raeford Rd.

GOLDSBORO, NC — Phone 778-4100  
N. Berkley Blvd.  
GREENSBORO, NC — Phone 292-4813  
2717 Patterson St.  
GREENSBORO (North), NC —  
Phone 375-4810  
3223 Yanceyville Road  
GREENVILLE, NC — Phone 756-6560  
2728 South Memorial Drive  
HIGH POINT, NC — Phone 885-8031  
Business I-85 @ Prospect  
JACKSONVILLE, NC — Phone 353-6265  
Ellis Rd. at Lejeune Blvd.  
KINSTON, NC — Phone 522-1811  
2200 W. Vernon Ave.

MOUNT AIRY, NC — Phone 789-5021  
Hwy. 52 Bypass, Blumont Rd.  
NEW BERN, NC — Phone 633-2030  
1407 Racetrack Rd.  
NORTH WILKESBORO, NC —  
Phone 667-1221  
Cherry St.  
RALEIGH, NC — Phone 828-3251  
2512 Yonkers Rd.  
REIDSVILLE, NC — Phone 342-4241  
1635 Freeway Drive  
ROCKY MOUNT, NC — Phone 446-2331  
U.S. Highway 301 Bypass, North  
SANFORD, NC — Phone 776-8431  
3122 S. Industrial Dr. @ Wilson Rd.

SPARTA, NC — Phone 372-5531  
101 Alleghany St.  
WASHINGTON, NC — Phone 946-7751  
1849 Carolina Ave.  
WILSON, NC — Phone 237-5211  
Hwy. 301, South  
WINSTON-SALEM, NC —  
Phone 767-4950  
3740 N. Liberty St.  
(across from the airport)  
WINSTON-SALEM, NC —  
Phone 722-9112  
115 S. Stratford Rd.  
ZEBULON, NC — Phone 269-6456  
Highway 97, East

**LOWE'S**

**Home Fix-Up Week**

©1985 Lowe's Companies, Inc. May (132) 33C

USE YOUR CREDIT



**CHARGE IT**

# Products To Make Your Life A Little Easier From Lowe's Catalog Service

## Special Limited Time Mail-Order Offers

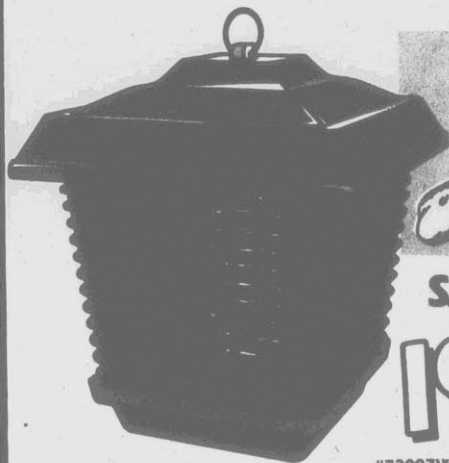

SAVE \$10

19<sup>97</sup>

#73007W Regular \$29.97  
Shipping Weight 7 Lbs.

### This Summer Take The Bite Out Of Annoying Flying Insects And Enjoy The Great Outdoors With This 10-Watt Electronic Bug Killer

Flying insects can really put a damper on any outside activity during the warm days of summer. Now there's a safe effective way to fight back without using messy pest strips or dangerous sprays. Introducing the worst friend any bug with wings ever had... the Evergo 10-watt Electronic Bug Killer.

Just plug it into any standard 120-volt outlet and it's ready to go. Two electrically charged inner grids surround a special insect luring black light. Once bugs touch these grids they're zapped and fall to the ground.

And because it's smokeless and odorless it can also be used indoors too. U.L. listed for operating safety. Completely harmless to people and pets.

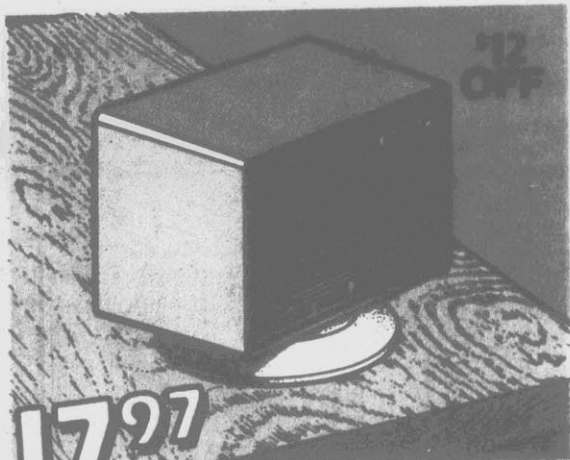

17<sup>97</sup>

#97920W Regular \$29.97. Shipping Weight 1 Lb.

### Rid Your House Of Insects And Mice Safely And Effectively With The High-Tech Ultrasonic Pest Control Device

The secret is ultrasonic sound waves that repel mice and insects from your home. These sound waves irritate the super-sensitive auditory and nervous systems of insects and rodents forcing them from their sound protected areas. And there are no clean-ups of dead insects or rodents to worry about. Pests are repelled by sound waves, not killed by messy chemicals or sprays.

Ultrasonic Pest Control Device emits sounds for above the hearing range of humans and most pets, making it completely safe to use. Push-to-test button. Also mounts on wall.



Dear Customer:

Welcome to our Mail Order Catalog section. With each edition we're giving you some of our best product values ever delivered to your front door. Your personal satisfaction is important to us, so we back all our products with a no risk Guarantee.

"If for any reason you are not happy with your purchase, just return it for an exchange or full refund."

Sincerely, *Bill Grady*

Corporate Sales Manager

*Call Us Now!*

**1-800-334-1148**

In North Carolina Call:

**1-800-672-1148**

Enjoy the Ease and Convenience Of Mail-Order Shopping!



Tools Not  
Included

SAVE  
\$2

7<sup>97</sup>

#92002W  
Regular \$9.97  
Shipping Wt. 7 Lbs.

### Here's A Handy Tool-Carrying Work Seat With Go-Anywhere Portability That Let's You Sit Down On The Job

You'll find thousands of uses for this little helper. The comfortably-sized seat is made of durable particle-board. Frame is steel and features a hard enamel finish. Carry it to the kitchen, workshop or garage. And with the lower storage shelf all of your favorite tools are always within easy reach.

Rounded corners and fittings won't snap or scratch. Easy assembly with hex wrench which we include free, and your screwdriver.

**Black & Decker**



9751

\$5  
OFF

2<sup>97</sup>

#91785W, Regular \$29.97  
Shipping Weight 3 Lbs.

### Strip Paint Quickly And Effectively With The Black & Decker Heat 'N Strip Electric Paint Remover And Heat Gun

Who said paint removal had to be hard? Heat 'n Strip provides an effective alternative to caustic chemicals and wire brushes in all of your paint removal jobs.

The secret is concentrated super hot air (480°F-570°F) that heats and softens paint allowing it to be removed using only an ordinary scraper or putty knife quickly, effectively, and economically.

Heat 'n Strip not only removes paint from such things as furniture, molding and shutters but does so without singeing wood or raising surface grain.

Perfect for hobby projects. Also dries, shrinks and thaws. Lock-on button for continuous use.

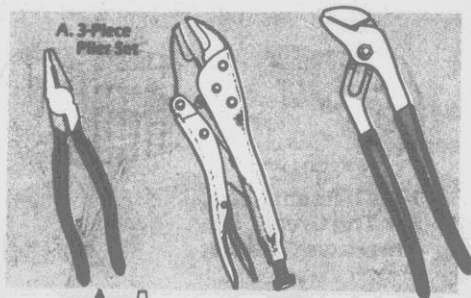

A. 3-Piece  
Plier Set

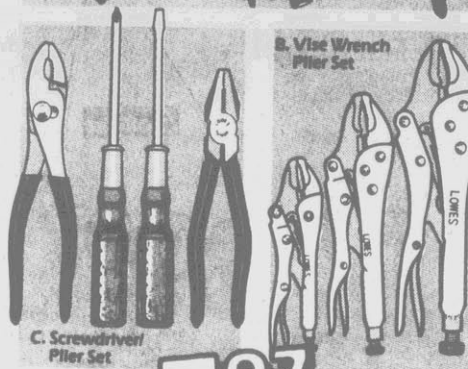

B. Vise Wrench  
Plier Set

C. Screwdriver/  
Plier Set

Your  
Choice 7<sup>97</sup>

Or All  
Three Sets  
for \$22.50

A. #91473W Regular \$11.99. Shipping Wt. 3 Lbs.

B. #91481W Regular \$11.99. Shipping Wt. 3 Lbs.

C. #91474W Regular \$9.99. Shipping Wt. 3 Lbs.

### Presenting A Tool Offer That's Sure To Make Those Household Repair Jobs Easier To Handle

An ideal addition to any tool box. Screwdrivers (1 Phillips, 1 flat head) feature durable wood handles. Pliers and vise wrenches are drop-forged steel.

**SPECIAL MAIL**

Satisfaction  
On Your



9<sup>97</sup>

#95855W  
Regular \$11.99  
Shipping Weight 5 Lbs.

### 8-Quart Cooler With Personalized Handle

Holds up to 10 (12-ounce) cans of your favorite beverage. Hinged for easy opening and closing. Comes with adhesive letters to personalize handle with your initials.

Gott 16-Qt. Cooler \$14.97  
#95856W Regular \$19.99  
Shipping Weight 8 Lbs.

# MAIL ORDER OFFERS

*Guaranteed!  
Money Back*



**24<sup>97</sup>**  
 #95858W  
 Regular \$29.99. Shipping Wt. 14 Lbs.  
**48-Quart Sportsman Cooler With  
 Convenient Lift-Out Food Tray**

If you're an active outdoorsman who's looking for a cooler tough enough to take it, your search is over. Introducing the Gott 48-quart chest cooler. Its heavy-duty construction is designed for years of rugged use. Sturdy hinged top lid is strong enough to sit on. Bottom drain plug for quick draining.

**6<sup>97</sup>**

#97283W  
 Regular \$9.99  
 Shipping Wt. 5 Lbs.

## 18" Charcoal Grill For The Great American Cookout

Enjoy great charcoal cookouts all summer long with this 29-inch high brazier grill. Features include: adjustable cooking level, detachable tubular steel legs (for portability), and a baked enamel finish.

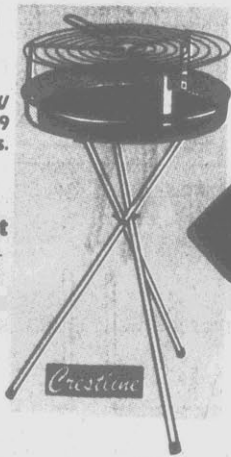

**39<sup>97</sup>**

#97292W  
 Regular \$49.99  
 Shipping Wt. 27 Lbs.

## Charcoal Grill With Wheels

Get ready to receive compliments galore when you serve up food cooked on this charcoal grill from Sunbeam. The hinged lid cover locks in that great charcoal flavor and also helps speed up cooking on the 390-square-inch surface. Also features adjustable draft controls and a 4-position fire pan for added convenience.



**15<sup>97</sup>**

#91710W  
 Regular \$19.99  
 Shipping Wt. 3 Lbs.

## Black & Decker Car Vac™ Plugs Into Most 12-Volt Cigarette Lighters And Includes Reuseable Filter Bag

Cleaning a car's interior at the local car wash's coin-operated vacuum machine can be an expensive and cumbersome ordeal. Now there's an economical and efficient alternative with the Black & Decker Car Vac.

Especially designed for cars, trucks, boats and recreational vehicles, the Car Vac's 12-volt motor provides a powerful suction that deep cleans rugs, mats and upholstery. You'll also receive a crevice tool and upholstery brush for those hard-to-reach spots next to the windshield and under seats.

Best of all is Car Vac's completely portable design. It's small enough to store compactly in your trunk or other storage area. Just unwrap the long 16-foot cord from the special storage area on the handle and you'll be able to clean even the most distant reaches of any vehicle's interior.



**9<sup>97</sup>**

#91251W Regular \$14.99  
 Shipping Wt. 1 Lb.

## Now You Can Take Care Of All Your Soldering Projects With The Weller 25-Watt Soldering Kit

It's the perfect soldering kit for all of your light duty soldering jobs. Comfortable and easy to use, the Weller Soldering Kit is ideal for intricate work on radios, various electronic kits, automobile cassette players and many more projects.

Includes: Weller SP23 iron, three different pre-tinned 1/16" / 1.3mm diameter tips of plated copper, 40/60 resin-core solder and soldering grid tool. Complete with helpful hints and operating instructions.

Use Order Form Or Call Toll Free 1-800-34-1148

**LOWE'S**  
*Catalog Store*



#40831W  
Regular \$9.99  
Shipping Wt. 1 Lb.

**Paper Taper Cuts  
Paint Preparation Time**

Dispenses both paper and masking tape. Adjusts from 3/4" to 2 1/2" tape. Ideal for use around doors, ceilings and more.

3/4" x 60-Yd. Roll Masking Tape ..... **47¢**

#41008W Regular 79¢. Shipping Wt. 1 Lb.

6" x 180' Roll Masking Machine Paper ..... **\$1.67**

#40833W Regular \$1.89. Shipping Wt. 1 Lb.



**Your  
Choice  
Or All Three  
Goops For \$7.95**

Regular \$3.49  
Shipping Wt. 1 Lb.

- A. Plumber's Goop #41117W
- B. Household Goop #41118W
- C. Automotive Goop #41119W

**Presenting Goop; A Multi-Purpose Super  
Adhesive/Sealant That's Stronger Than Glue**

Goop replaces rubber cements, contact cements, adhesives, silicones and super glues. Each tube is 4 1/2 ounces.

*Satisfaction Guaranteed Or Your Money Back*

Name \_\_\_\_\_  
Address \_\_\_\_\_  
City \_\_\_\_\_  
State \_\_\_\_\_ Zip \_\_\_\_\_

**Order Toll Free:  
1-800-334-1148**

In North Carolina: **1-800-672-1148**

ITEM NO.	DESCRIPTION	SHIPPING WEIGHT	PRICE	QUANTITY	TOTAL

Your Daytime Home Telephone # ( ) \_\_\_\_\_

Shipping Weight Total

MDSE. TOTAL

SALES TAX\*

Add Shipping and Handling (see chart)

TOTAL ORDER

Clip And Mail Your Order To:

**LOWE'S CATALOG STORE**  
Attn: Bill Grady - Dept. 1083  
P.O. Box 1111  
N. Wilkesboro, N.C. 28659

**SHIPPING AND HANDLING (UPS)**

Minimum per order	\$ 3.00
5-10 lbs add	4.00
10-15 lbs add	5.00
15-24 lbs add	6.00
25-34 lbs add	7.00
35-49 lbs add	8.00
50-69 lbs add	11.00
70 lbs and over add	20¢ per pound

Prices in Effect Thru 6/9/85

I've enclosed a check or money order payable to LOWE'S

PLEASE CHARGE TO MY CREDIT CARD:



Card Number

EXP. DATE

Your signature \_\_\_\_\_  
(Required For Charge Purchases)

**Yes, I would like to receive my free  
Lowe's Shop-At-Home Catalog.**

# JC

## Percales, Sale 4.99

twin sheet

■ **Reg. 8.99.** Our own solid color percales of Dacron® polyester/cotton in 10 glorious colors. Flat or fitted.

	Reg.	Sale
Full .....	10.99	7.99
Queen .....	16.99	13.99
King .....	19.99	16.99
Standard cases, pr. ....	9.99	7.99
Queen cases, pr. ....	10.99	8.99

Matching bedspreads and comforters filled with Astrofill® polyester.

Twin bedspread .....	45.00	31.99
Full bedspread .....	55.00	39.99
Queen bedspread .....	65.00	47.99
Twin comforter .....	50.00	34.99
Full comforter .....	60.00	39.99
Queen comforter .....	70.00	49.99
Pillow sham .....	20.00	14.99
Twin bedskirt .....	30.00	21.99
Full bedskirt .....	35.00	24.99

King size pillowcases, bedspread and comforter also on sale.

smarter than

'Violets'  
print sheets.

**Sale**  
**8.99** twin

A. Reg. 11.99. 'Violets' polyester/cotton sheets. Flat or fitted:

	Reg.	Sale
Full .....	15.99	13.99
Queen .....	24.99	19.99
King .....	30.99	25.99
Standard cases, pr. ....	12.99	10.99
Pillow sham .....	25.00	19.99

Matching comforters, bedskirts also on sale.



Halston III™  
rose prints.

**Sale**  
**7.99** twin

B. Reg. 10.99. Halston III™ rose-printed polyester/cotton sheets. Flat or fitted:

	Reg.	Sale
Full .....	15.99	12.99
Queen .....	23.99	18.99
King .....	29.99	24.99
Standard cases, pr. ....	11.99	9.99

'Laurie'  
print sheets.

**Sale**  
**4.99** twin

C. Reg. 8.99. 'Laurie' Dacron® polyester/cotton sheets. Flat or fitted:

	Reg.	Sale
Full .....	10.99	7.99
Queen .....	16.99	13.99
King .....	19.99	15.99
Standard cases, pr. ....	9.99	6.99
Twin comforter .....	45.00	29.99
Full comforter .....	55.00	39.99
Pillow sham .....	20.00	14.99

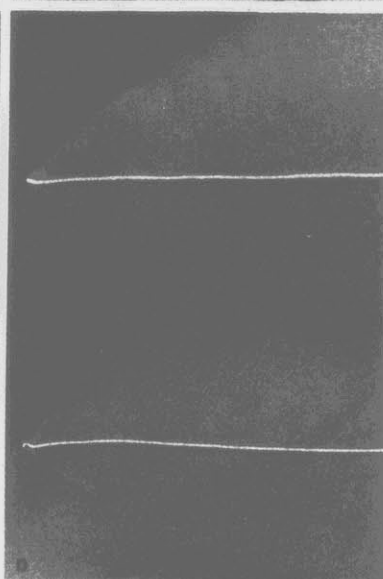
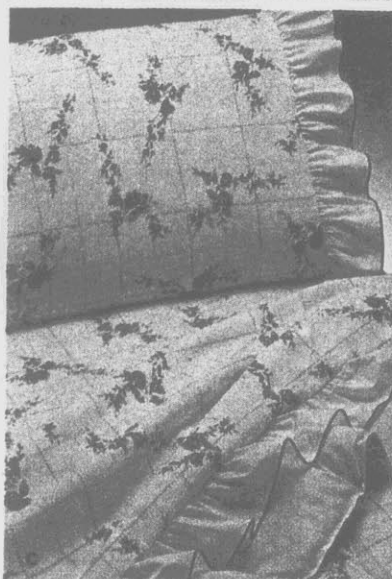

Solid color  
bedpillows

**Sale**  
**6.99** twin

D. Reg. \$11. Solid color bedpillow is polyester-filled, with polyester/cotton cover. In every color below except dark wine, foam green.

	Reg.	Sale
Queen .....	\$14	9.79
King .....	\$16	10.99

Woven acrylic  
blankets.

**Sale**  
**16.99** twin

E. Reg. \$25. Woven acrylic blanket with nylon satin binding. In the 8 colors shown below.

	Reg.	Sale
Full .....	\$30	21.99
Queen .....	\$35	25.99
King .....	\$45	32.99



Supra-Vellux®  
blankets.

**Sale**  
**21.99** twin

F. Reg. \$35. Supra-Vellux® blanket of nylon bonded to polyurethane. In the 8 colors shown below.

	Reg.	Sale
Full .....	\$42	28.99
Queen .....	\$49	34.99
King .....	\$59	43.99

Sale prices on merchandise on pages 1 and 2 effective through Monday, May 27th.

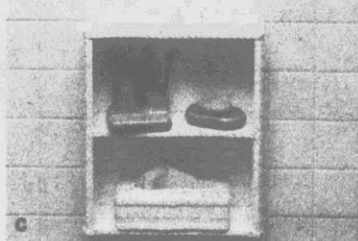
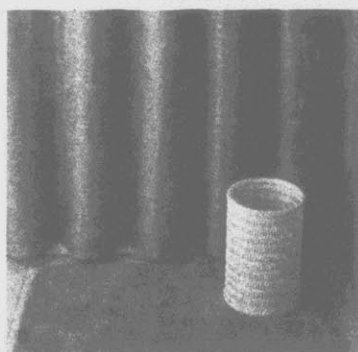
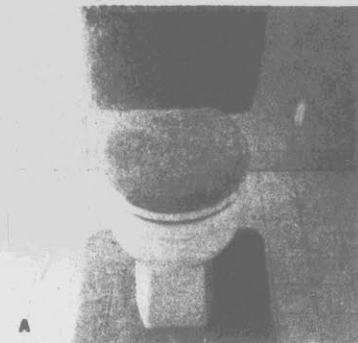

# 20% to 25% off

## Dynasty™ bath sale

Beautiful bath ensembling to coordinate with the Dynasty™ towel.

■ D. Sale 23.99 Reg. \$30 72"

Shower curtain is dobby-weave polyester. Vinyl liner

■ E. Bath accessories of DuPont® Antron® nylon pile.

	Reg.	Sale
Contour or oblong mat	\$16	11.99
Lid cover	\$9	6.75
Tank set	\$19	14.25
4x6' carpet	\$55	41.25

■ F. Sale 6.99 to 34.99 Reg. \$9 to \$45. Natural rattan accessories.

G. Sale 3.99 to 10.99 Reg. \$6 to \$14 (pieces shown). Save on these ceramic bath accents.

■ H. Digital scale. Reg. \$40 Sale 29.99

Sale prices effective through Monday, May 27th.

### 3.99 to 7.99

■ A. Plush DuPont® nylon pile coordinates with latex backing.

	Reg.	Sale
Contour or oblong mat	9.00	6.99
Lid cover	5.50	3.99
Tank set	11.00	7.99

### 19.99 to 23.99

B. JCPenney shower and window curtains with valance. Of slub-textured Kodel® polyester.

	Reg.	Sale
Shower curtain with vinyl liner	\$25	19.99

Not shown:

Double swag shower curtain	\$30	23.99
45" window curtain	\$25	19.99
54" window curtain	\$26	20.80

### \$1 to \$6 off

C. JCPenney solid color plastic accents.

	Reg.	Sale
Tumbler	\$3	1.99
Soap dish	\$5	2.99
Toothbrush caddy	\$6	3.99
White wicker accessories.		
Wastebasket	\$14	9.99
Tissue box	\$12	8.99
2 shelf unit	\$26	19.99
Not shown:		
Soft seat	\$15	9.99



# Towel Sale,

## Sale 8.99

bath

■ Reg. \$12. The Dynasty™ Supima® towel. Made of lush, plush Pima cotton terry. Wrap yourself in one of 16 fabulous colors: navy, ocean blue, dark jade, espresso, vanilla, dark red, light wine, light salmon, fawn, dark lilac, white, sapphire, forest green, bright fuchsia, pale grey, black.

	Reg.	Sale
Hand towel .....	\$ 5	\$ 3.99
Washcloth .....	\$ 3	\$ 2.29
Body sheet (not in all colors) .....	\$22	\$18.99



# 5.99 and 8.99 bath

## Sale 5.99 bath

Reg. \$8. The JCPenney velour towel. Sheared cotton/polyester on one side, terry loops on the other. In 10 dramatic colors: dark true blue, dark red, espresso, bright coral, dark cinnamon, grey, dark lilac, midnight, bright fuchsia, jade.

	Reg.	Sale
Hand towel.....	5.50	4.49
Washcloth.....	2.75	1.99

## Sale 5.99 bath

Reg. \$8. The JCPenney print towel. A luxurious wrap of cotton/polyester in four colors: pale pink, pale blue, vanilla, medium coffee.

	Reg.	Sale
Hand towel.....	5.50	4.49
Wash cloth.....	2.75	1.99

## Sale 5.99 bath

Reg. \$8. The JCPenney Towel. Incredibly thick and thirsty cotton/polyester in 20 fashion colors: ocean blue, vanilla, wine, medium coffee, medium cinnamon, pale blue, dark cinnamon, light ginger, pale pink, espresso, foam green, red, bright raspberry, bright blue, dark true blue, clay, shamrock, lilac, pale lemon, white.

	Reg.	Sale
Hand towel.....	5.50	4.49
Washcloth.....	2.75	1.99
Fingertip towel.....	2.75	1.99
Tub mat.....	10.00	7.99
Body sheet.....	18.00	15.99

Most colors available at most large JCPenney Stores. All colors available through catalog.

Sale prices on merchandise on pages 4 and 5 effective through Monday, May 27th.

Intermediate markdowns may have been taken on originally priced merchandise shown throughout this circular.

Reductions from originally priced merchandise effective until stock is depleted.

Sale prices on regularly priced merchandise effective through Saturday, May 16th unless otherwise noted.



# JCPenney



# All our o... e... e... e...

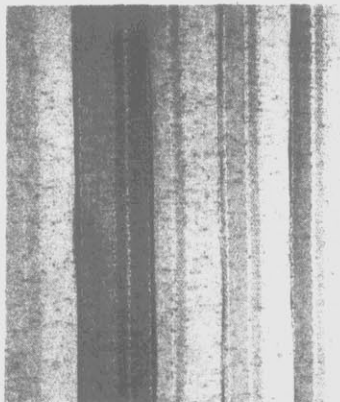
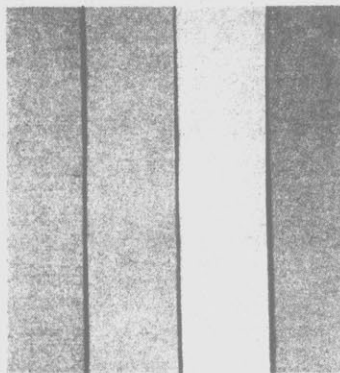
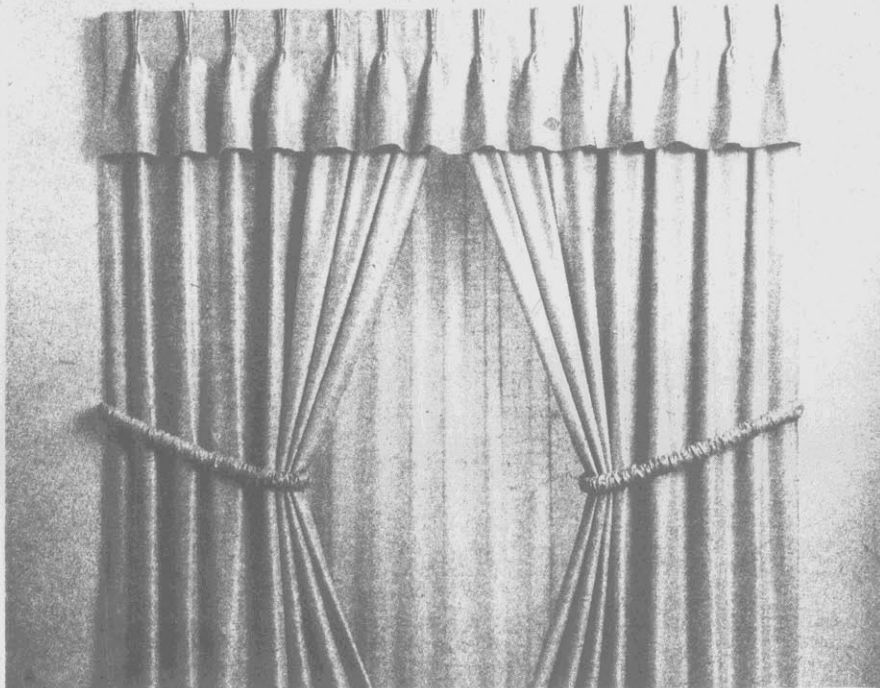

## Sale 47.20 pr. 48x84"

■ A. Reg. \$59. Nob Hill™ draperies of rayon/acetate with the look of antique satin. Lined with Roc-Ion® rain-no-stain cotton. In long-fold hanging bag with Hang Well® hooks already in place.

	Reg.	Sale
72x84" .....	\$ 95 pr.	76.00
96x84" .....	\$125 pr.	100.00
120x84" .....	\$155 pr.	124.00
96x84" patio panel .....	\$135 ea.	108.00
92x24" valance .....	\$ 25 ea.	20.00
33" tiebacks .....	\$ 10 pr.	8.00

Tailored panels of Terital® polyester. 60x84".  
Reg. \$15 Sale \$12 ea.

## Sale \$36 pr. 50x84"

■ B. Reg. \$45. Westwood™ leno-weave draperies are polyester/rayon/acrylic with polyester/cotton lining.

	Reg.	Sale
50x63" .....	\$ 41 pr.	32.80
75x63" .....	\$ 71 pr.	56.80
75x84" .....	\$ 79 pr.	63.20
100x84" .....	\$105 pr.	84.00
125x84" .....	\$130 pr.	104.00
100x84" patio panel .....	\$120 ea.	96.00
1" in-stock wood blinds. 23x64"	Reg. \$50	Sale \$40



# 20% off

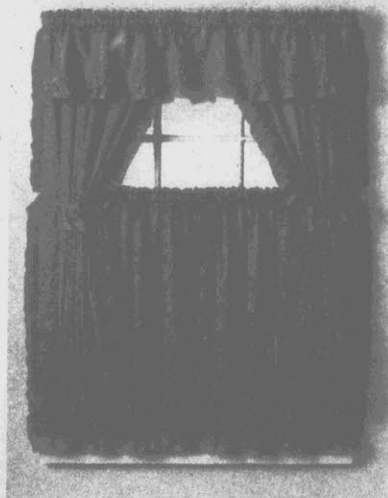

### Entire line of novelties on sale.

20% off the regular prices of a wonderful selection of Cape Cods, cafes, tiers, and more. Choose solid colors, prints, embroideries, and eyelets to suit your kitchen, bedroom, bath, or children's rooms. All in easy-care blends of Kodel® polyester/cotton, polyester/rayon, or all-cotton.

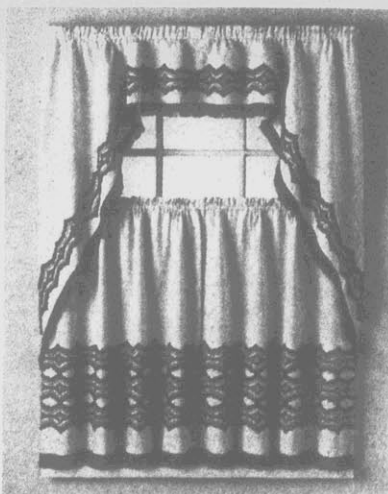

### Entire line of in-stock mini blinds on sale.

20% off the regular prices of in-stock mini blinds you can install the very same day you buy them. Choose metal minis in almond, white, and other colors. Wood minis in walnut, cherry, and oak finishes. 64" long.

35% to 40% off the regular prices of made-to-measure 1" mini blinds, Bali® micro blinds. 1" or 2" wood blinds. Dramatic vertical blinds.

Sale prices on all merchandise on pages 6 and 7 effective through Monday, May 27th.

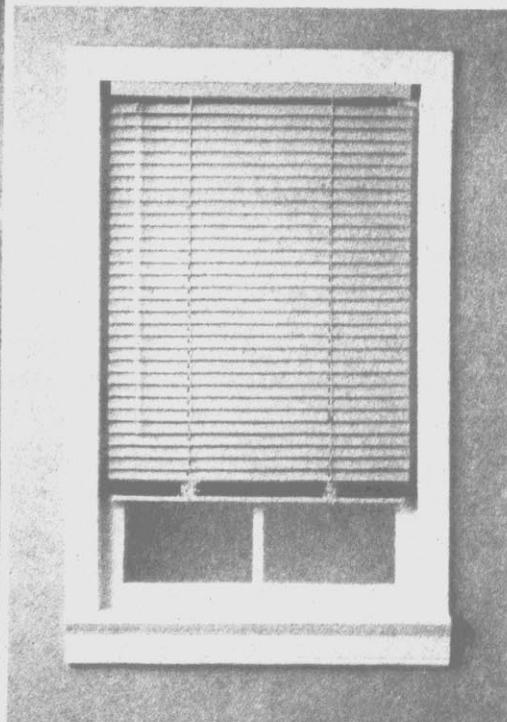
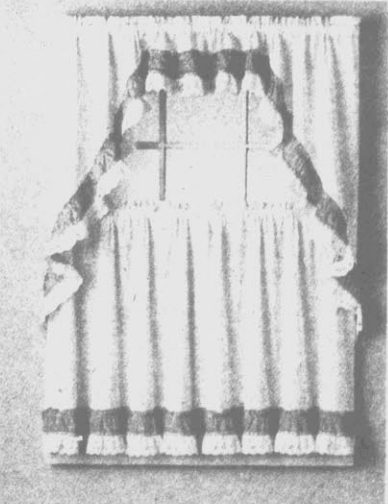

# 40%-50% off



## Sale \$55 to \$82

Orig. \$100 to \$155. Samsonite® Sentry® II molded hardside luggage.

	Orig.	Sale
26" pullman.....	\$155	\$82
Carry-on.....	\$100	\$55
Garment bag.....	\$135	\$69

Other pieces also on sale.

Orig. \$60 to \$180 Sale \$30 to \$99

## Sale \$35 to \$59

Orig. \$58 to \$110. Samsonite® SLX is tough and durable.

	Orig.	Sale
26" pullman.....	\$108	\$55
Carry-on.....	\$ 58	\$35
Garment bag.....	\$110	\$59

Other pieces also on sale.

Orig. \$38 to \$120 Sale \$24 to \$69

## Sale \$30 to \$75

Orig. \$60 to \$145. Samsonite® Sidekicks® of softside nylon.

	Orig.	Sale
28" pullman.....	\$145	\$75
Carry-on.....	\$ 76	\$47
Garment bag.....	\$110	\$62
26" pullman.....	\$125	\$65
Tote.....	\$ 60	\$30

## Sale \$30 to \$67

Orig. \$60 to \$125. American Tourister® 3900 Series of nylon.

	Orig.	Sale
29" pullman.....	\$125	\$67
Carry-on.....	\$ 90	\$45
Garment bag.....	\$110	\$55
26" pullman.....	\$110	\$55
Tote.....	\$ 60	\$30

Refer to page 5 for pricing details.

EVENT STARTS WEDNESDAY, MAY 15 and  
ENDS SATURDAY, MAY 18, 1985

GREENVILLE, NORTH CAROLINA

Shop 10:00am to 9:00pm Daily  
Store Phone 756-1190  
Catalog Phone 756-2145

Advertising Supplement to THE DAILY REFLECTOR



# ECKERD

AMERICA'S FAMILY DRUG STORE

# SUMMER FUNNER Sale Days!

Sale Prices Good Thru Saturday, May 25th.

SAVE 5.00

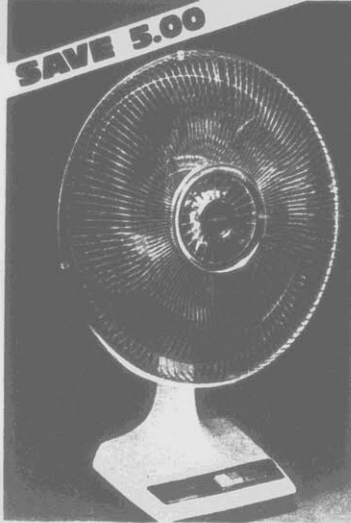

**29.99** GALAXY 16" OSCILLATING FAN #2151-B Reg. 34.99

SAVE 3.00

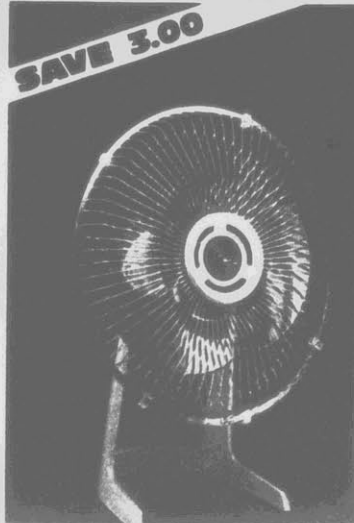

**9.99** GALAXY 9" PERSONAL FAN #2156 Reg. 12.99 4" FAN #3140 6.99

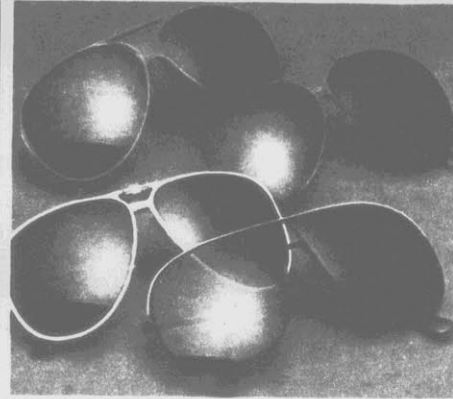

**7.98** FOSTER GRANT PROTECTORS SUNGLASSES Reg. 12.00 to 16.00



**5.00** L'OREAL SAMPLE MAKE-UP KIT with ANY VISUELLE MAKE-UP PURCHASE 12.00 VALUE

SAVE 5.00

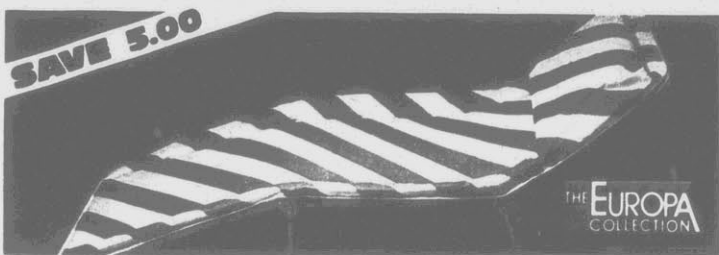

**24.88** EUROPA LOUNGE MASTER Reg. 29.99 Attractive European styling. Can be used as a lounge, guest bed or sun cot.



**1.69** PEPSI, DIET PEPSI, PEPSI FREE or MOUNTAIN DEW 6-PACK, 12-OZ. CANS

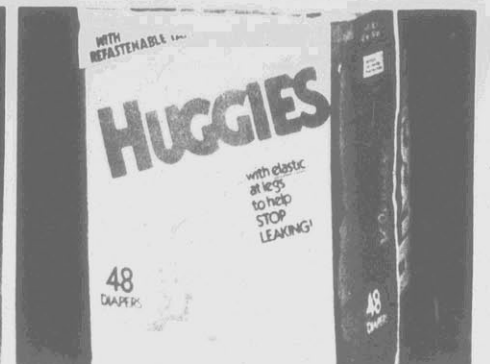

**8.66** HUGGIES CONVENIENCE PACK DISPOSABLE DIAPERS CHOICE OF TYPES Limit 2

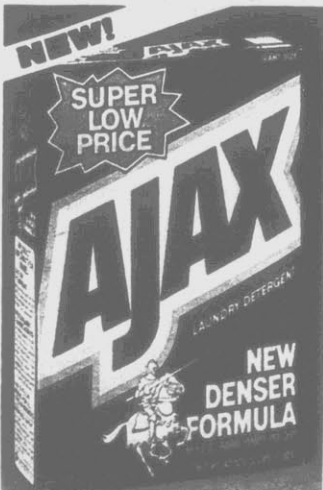

**99¢** AJAX LAUNDRY DETERGENT 42-OZ. Limit 2

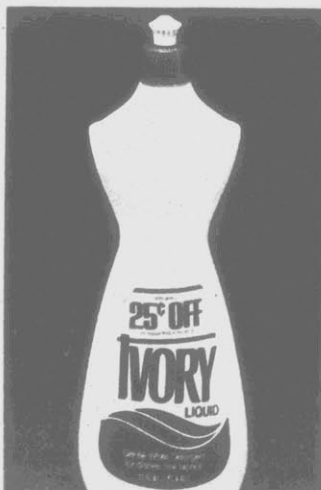

**1.09** IVORY LIQUID 22-OZ. Price reflects cents off label.



**1.49** IVORY SHAMPOO or CONDITIONER 15-OZ. 4 TYPES



**1.09** SNUGGLE FABRIC SOFTENER 64-OZ. Limit 2

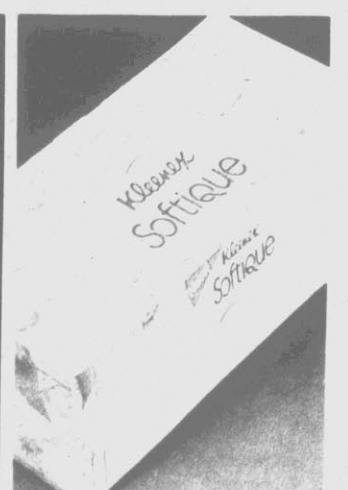

**69¢** KLEENEX SOFTIQUE FACIAL TISSUES BOX OF 150

# ECKERD

## Summer Funner Savings on Eckerd Brand Products! Tested. Retested. And Guaranteed!



**1.09** ECKERD DISPOSABLES  
PACK OF 5  
Compare to Good News.



**2.49** ECKERD NATURAL  
FIBER LAXATIVE  
14-OZ. 2 TYPES  
Compare to Metamucil.

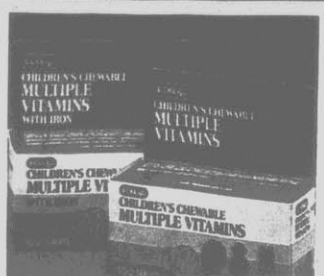

**2.49** ECKERD CHILDREN'S  
MULTIPLE VITAMINS 100's  
Compare to Flinstone's.



**1.19** ECKERD  
BABY POWDER  
14-OZ.  
Compare to Johnson's.



**1.49** ECKERD  
BABY OIL  
16-OZ.  
Compare to Johnson's.

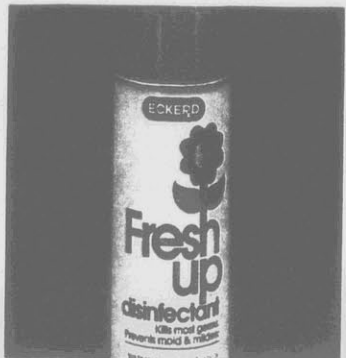

**1.39** ECKERD FRESH-UP  
DISINFECTANT  
SPRAY 13-OZ.  
Compare to Lysol.



**1.27** ECKERD  
ANTISEPTIC SKIN  
CLEANER 10-OZ.  
Compare to Sea Breeze.



**49¢** ECKERD  
ASPIRIN  
100's

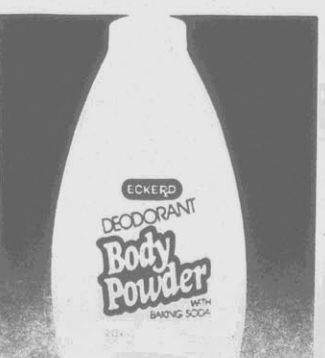

**1.29** ECKERD  
DEODORANT BODY  
POWDER 13-OZ.  
Compare to Shower to Shower.



**99¢** ECKERD  
STICK DEODORANT  
2.5-OZ.  
Compare to Mennen.

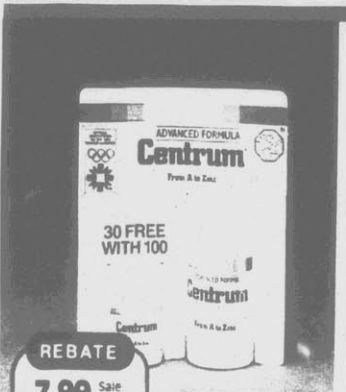

**REBATE**  
7.99 Sale Price  
-1.00 Mail-in Rebate  
**6.99** Final Cost  
CENTRUM  
100 + 30 FREE  
Limit 2



**3.69** NATURE MADE  
STRESS FORMULA  
60's or B-6 100 MG  
100's



**1.99** RIOPAN PLUS  
OR RIOPAN  
12-OZ. Limit 2



**2.44** PRE-FLEX 1.5-OZ.  
OR BOIL n SOAK  
12-OZ.



**1.58** MAXITHINS  
PANTY SHIELDS  
26's Limit 2



**REBATE**  
4.99 Sale Price  
-1.00 Mail-in Rebate  
**3.99** Final Cost  
SLIM-FAST  
16-OZ. CHOICE OF  
TYPES Limit 2



**2.29** DATRIL  
60 TABLETS or 50  
CAPSULES Limit 2

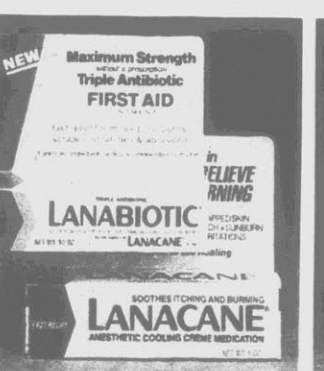

**1.79** LANABIOTIC 5-OZ.  
OR LANACANE  
1-OZ. Limit 2



**1.44** CURAD SHEER  
BANDAGES  
80's Limit 2



**2.66** O.B. TAMPONS  
30's 2 TYPES  
Limit 2



**88¢** CONAIR HAIR SPRAY 7-OZ., SHAMPOO or CONDITIONER 16-OZ. CONAIR PERM ..... 2.99



**20% OFF** REGULAR PRICE REVLON MOON DROPS TREATMENT Reg. 4.75 to 9.00



**1.00 OFF** REGULAR PRICE ENTIRE STOCK OF CLAIROL HAIR COLOR KITS Reg. 1.99 to 4.89



**2.49** COVER GIRL MOISTURE WEAR POWDER, CREAM or LIQUID MAKE-UP



**1.29** CONSORT HAIR SPRAY FOR MEN 13-OZ.



**3.29** LOVE'S CANVAS BAG WITH LOVE'S BABY SOFT PURCHASE A \$12.00 VALUE



**1.99** JHERI REDDING MOUSSE 6-OZ., GEL 5-OZ., SHAMPOO or CONDITIONER 16-OZ.

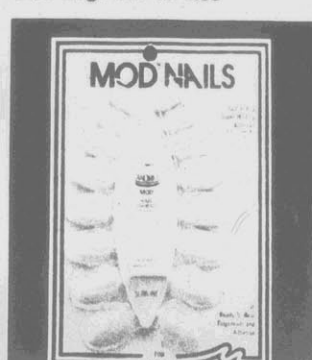

**1.29** MOD NAILS KIT Reg. 1.89 16 nails & adhesive.



**1.99** COVER GIRL MARATHON or PROFESSIONAL MASCARA



**1.77** CUTEX PERFECT COLOR LIPSTICK Reg. 2.29 each



**1.99** ERACE COVER-UP STICK Reg. 2.75 Price reflects 50¢ off label.



**1.77** NOXZEMA SKIN CREAM 10-OZ.



**2.88** NAIR MOUSSE HAIR REMOVER 5-OZ.



**69¢** WONDRA SKIN LOTION 6-OZ. Limit 2



**3.97** BAIN DE SOLEIL TROPICAL DELUXE OIL 8-OZ.



**3.99** HAWAIIAN TROPIC DARK TANNING OIL 8-OZ.



**4.99** FASHION TAN SUN BLOCK LOTION 8-OZ. SPF15



**3.99** PRESUN 4-OZ. SPF15 2 TYPES Reg. 5.89 each



**2.99** TROPICAL BLEND 8-OZ. ALOE VERA GEL 3.75-OZ. or SOLARCAINE 3-OZ.

**ECKERD**

Enjoy The Great Outdoors During Our Summer Funner Sale Days!

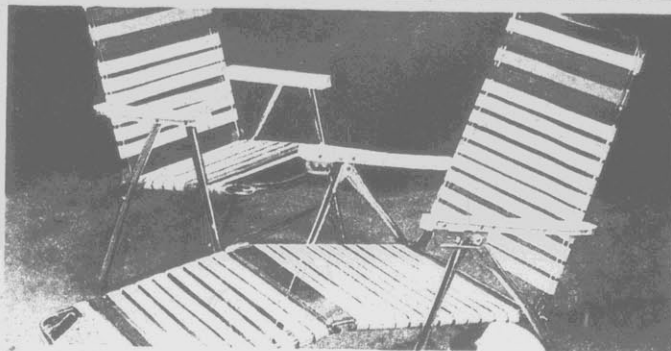

**15.99** MALIBU LAWN CHAIR  
Reg. 24.99

**29.99** MALIBU LAWN CHAISE  
Reg. 39.99

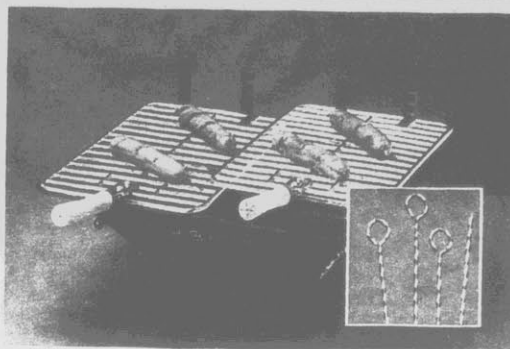

**7.88** 10" x 17" TABLE TOP HIBACHI #H1017CPB Reg. 9.99  
4-PIECE 17" SKEWER SET ..... 66¢

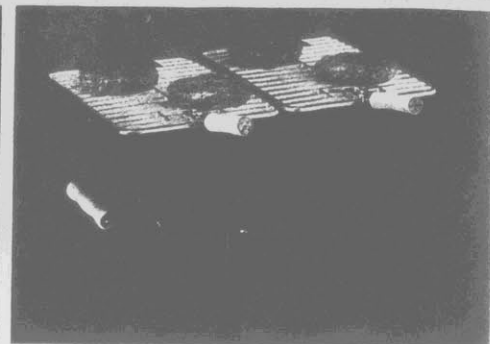

**12.88** 12" x 16" PEDESTAL HIBACHI with BBQ TOOLS #H1216CWTPB Reg. 17.99

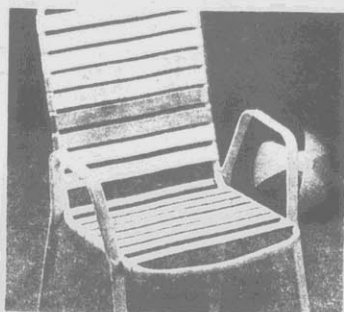

**12.99** VINYL STRAP STACK CHAIR  
Reg. 14.99

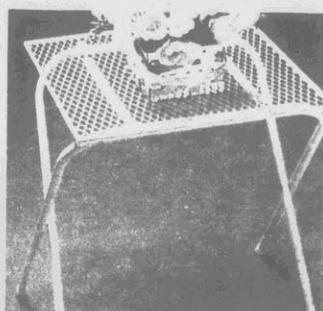

**3.99** 16" x 16" MESH PATIO TABLE  
Reg. 4.99



**29.99** SUNBEAM 21" COVERED GRILL #8008H Reg. 39.99  
8" BBQ GRILL BRUSH .... 1.27



**19.99** TABLE TOP KETTLE GRILL #33070  
Reg. 26.99



**69¢** HOT or COLD STYRO FOAM CUPS 51's, 6.4-OZ.

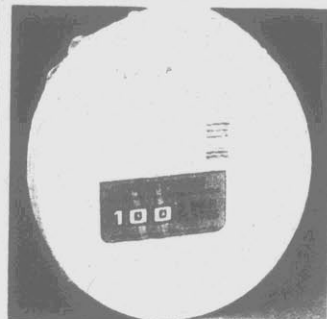

**89¢** 9-INCH PAPER PLATES PACK OF 100



**11.99** GULLO 8-OT. TAG-ALONG COOLER  
Reg. 14.99

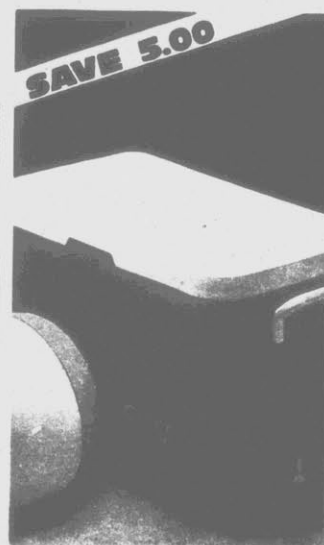

**24.99** COTT 48-QUART ICE CHEST  
Reg. 29.99



**10.99** SANDPIPER 2 1/2-GALLON PICNIC JUG  
Reg. 14.99



**1.39** GULL LIFE CHARCOAL STARTER 1-OT. Reg. 1.89



**2.44** KINGSFORD CHARCOAL 10-LBS. MESQUITE CHUNKS 2-LBS. 99¢

# ECKERD

AMERICA'S FAMILY DRUG STORE

# National Photo Week

ECKERD SALUTES NATIONAL PHOTO

WEEK WITH A FOCUS ON SAVINGS!

# SAVE UP TO 50% THIS WEEK

50mm 1:1.4

LENS MADE IN JAPAN

SAVE 5.00



With FREE processing on your first disc. A \$6.75 value

**29.99** KODAK DISC 3100 CAMERA Reg. 34.99 FREE COOLER BAG OFFER

**44.99** KODAK DISC 4100 CAMERA Reg. 49.99 FREE COOLER BAG OFFER

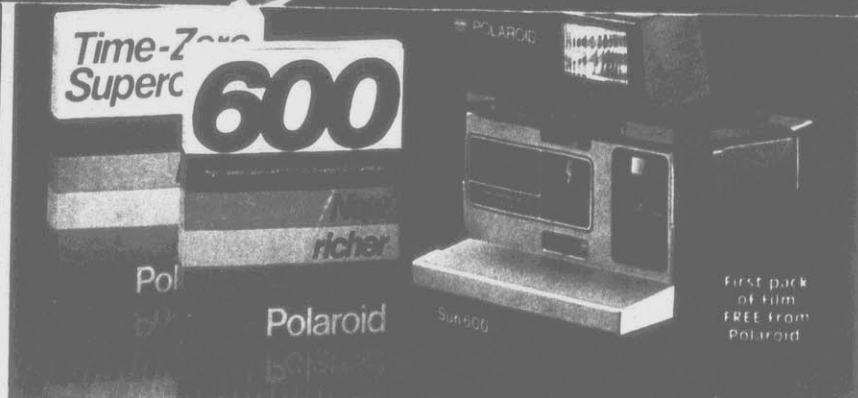

First pack of film FREE from Polaroid

**7.89** POLAROID TIME-ZERO SX-70 or 600 HIGH SPEED FILM

**34.95** POLAROID SUN 600 LMS CAMERA Reg. 39.95 Never needs batteries.



**40% OFF** ENTIRE STOCK OF PICTURE FRAMES Reg. 1.19 to 14.25 Choose from wood, metal or lucite.

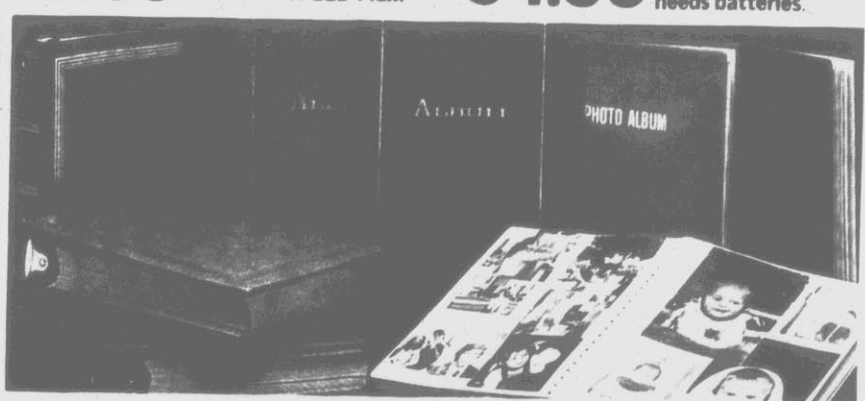

**6.99** 100-PAGE PHOTO ALBUM Reg. 9.99

**1.29** 20-PAGE PHOTO ALBUM Reg. 1.99

4" x 6" 60-POCKET PHOTO ALBUM..... 2/5.00 RA/A-5

# STOCK UP & SAVE 15% to 35% ON KODAK FILM



**KODAK COLOR PRINT FILM**  
CL110-12 VR 200  
**KODAK COLOR PRINT FILM**  
CL110-24 VR 200  
**KODAK COLOR PRINT FILM**  
CL126-12 VR 200

**1.99**  
**2.49**  
**1.99**

**KODAK COLOR PRINT FILM**  
CL135-12 VR 200  
**KODAK COLOR PRINT FILM**  
CP135-12 VR 100  
**KODAK COLOR PRINT FILM**  
CP135-24 VR 100

**2.39**  
**1.99**  
**2.49**

**KODAK COLOR PRINT FILM**  
CF135-24 VR 1000  
**KODAK COLOR PRINT FILM**  
CF135-12 VR 1000  
**KODAK KODACHROME 64 SLIDE FILM**  
20 EXPOSURE

**3.99**  
**3.19**  
**3.39**

**SAVE 15.00**

With FREE processing on your first roll A \$ 5.66 value

Auto load, auto rewind, built-in flash, auto advance and Canon U.S.A. 1-year limited warranty

**74.99** Canon SNAPPY 20  
35mm CAMERA  
Reg. 89.99.

**SAVE 10.00**

With FREE processing on your first roll A \$ 5.66 value

Auto load, auto rewind, built-in flash, auto focus and Canon U.S.A. 1-year limited warranty

**99.99** Canon SNAPPY 50  
35mm CAMERA  
Reg. 109.99.

**SAVE 25.00**

With FREE processing on your first roll A \$ 5.66 value

Auto focus, auto exposure, auto advance, auto rewind and Canon U.S.A. 1-year limited warranty.

**134.99** Canon SURE SHOT  
35mm CAMERA  
Reg. 159.99

**Remember  
with  
Pictures**

## WE'RE CONVENIENT:

All your picture taking needs are at Eckerd, for any occasion. Whenever it's time to take pictures think Eckerd first for your photo supplies. From film to batteries, we have just what you need.

**ECKERD**

AMERICA'S FAMILY DRUG STORE

## YOUR BEST SHOT IS WITH

**SYSTEM 2**

**When sharing  
is important.**

- **TWICE THE PRINTS** with every roll or disc of color print film developed and printed.
- **TWICE THE FILM** two rolls or discs of color print film for the price of one when you have your print film developed.
- **TWICE THE GUARANTEE** buy only the prints you want, even if the error was in the picture taking. Pictures back when promised or get them FREE.



**KODAK EKTACHROME SLIDE FILM**  
 EN135-20 100 ASA  
**KODAK EKTACHROME SLIDE FILM**  
 ED135-20 200 ASA  
**KODAK EKTACHROME SLIDE FILM**  
 EL135-20 400 ASA

**3.99**  
**4.69**  
**5.69**

**KODAK COLOR PRINT FILM**  
 CP135-36 VR 100  
**KODAK COLOR PRINT FILM**  
 CM135-12 VR 400  
**KODAK COLOR PRINT FILM**  
 CM135-24 VR 400

**3.19**  
**2.79**  
**3.49**

**KODAK VR DISC FILM**  
 SINGLE 15'S  
**KODAK VR FILM**  
 TWIN-PACK 30'S

**2.49**  
**4.49**



**29.99**  
**KEYSTONE 3570 35mm**  
**EVERFLASH CAMERA**  
 Reg. 39.99 1-year warranty.



**59.99**  
**KEYSTONE EVERFLASH**  
**AF-2 35mm CAMERA**  
 Reg. 69.95 Positive film advance



**109.99**  
**MINOLTA FREEDOM II**  
**35mm CAMERA**  
 Reg. 129.99 35mm f3.5 lens

**WITH ECKERD FOR FILM & PHOTOPROCESSING**



© When you're serious about 35mm.

- 30% larger prints
- High-Gloss Kodak paper
- Sleeved negatives
- Handsome display folio

Ultralab 35mm Photo Processing, exclusively at Eckerd.

**STOCK UP ON FILM:**

Now buy all the film you think you'll need for that special occasion. Return any extra film or flash and we'll refund your money. Just have your sales receipt.

**ECKERD'S EXCLUSIVE FILM OFFER:**

When you get your film processed at Eckerd, you get 2 rolls of color print film for the price of one, even when it's on sale! Whenever you buy a camera at Eckerd we'll process your first roll of film (A minimum 5.66 value) FREE!

**SATISFACTION GUARANTEED:**

All processing is done by our Kodak trained technicians in our own lab. So trust your memories to Eckerd Photo Processing. Remember, buy only the prints you want, even if the error was in the picture taking. Pictures back when promised or get them FREE!



AMERICA'S FAMILY DRUG STORE

RA/A-7

# ULTRALAB 35<sup>®</sup> SAVES YOU

# 50%

GOING FROM  
HERE...

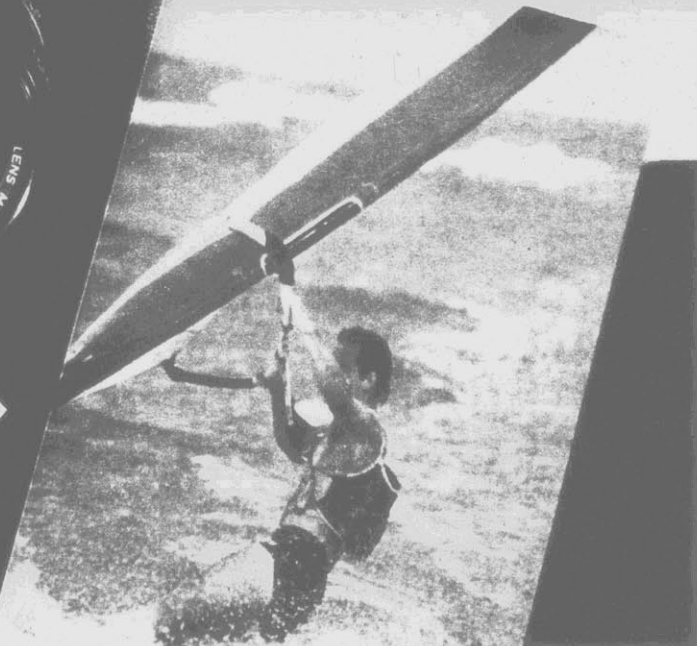

Available Only At

## ECKERD

AMERICA'S FAMILY DRUG STORE

# TO HERE ▶

### Week ONE Savings

ULTRALAB 35

## 50% OFF

REGULAR PRICE OF  
ULTRALAB 35<sup>®</sup>  
PROCESSING

Try Ultralab 35<sup>®</sup>  
processing, when you're  
serious about 35mm!  
One coupon per roll.  
Coupon good May 19 thru  
May 25, 1985 (727)

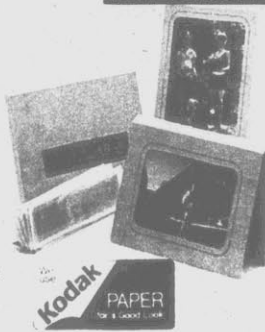

COUPON MUST ACCOMPANY ORDER

### Week TWO Savings

ECKERD COUPON

## FREE

20-PAGE PHOTO ALBUM  
WHEN WE PROCESS  
YOUR NEXT ROLL OF  
DISC FILM

Limit 1 album. Coupon  
good May 26 thru  
June 1, 1985.



(619)

PRESENT COUPON AT ORDER PICKUP

SYSTEM 2

## 13¢

SYSTEM 2 COLOR  
REPRINTS

Get regular-size reprints  
from your negatives.  
Coupon good June 2 thru  
June 8, 1985.



(731)

COUPON MUST ACCOMPANY ORDER

ECKERD COUPON

## 5.99

11" x 14" ENLARGEMENTS  
From color negatives or  
slides. One coupon per  
order. Coupon good  
May 19 thru May 25, 1985



(729)

COUPON MUST ACCOMPANY ORDER

ECKERD COUPON

## 1.99

8" x 10" ENLARGEMENTS  
From color negatives or  
slides. One coupon per  
order. Coupon good  
May 26 thru June 1, 1985



(730)

COUPON MUST ACCOMPANY ORDER

ECKERD COUPON

## 79¢

5" x 7" ENLARGEMENTS  
From color negatives or  
slides. One coupon per  
order. Coupon good  
June 2 thru June 8, 1985



(742)

COUPON MUST ACCOMPANY ORDER

# Savings For Your Garden During Summer Funner Sale Days!

**ECKERD**



**5.99** •MELNOR PULSATING SPRINKLER with METAL SPIKE #9550 •4-WAY TURRET SPRINKLER #267 •OSCILLATING SPRINKLER #61 Reg. 7.99 each



**6.99** RAID OUTDOOR FLEA KILLER with HOSE END SPRAYER 23-OZ. Reg. 7.99



**3.99** RAID FLEA KILLER 16-OZ. Reg. 4.99



**2.49** OFF! INSECT REPELLENT AEROSOL 6.1-OZ.



**9.99** 3/4" x 50' REINFORCED HOSE #1603 Reg. 12.99



**2.97** 3/4" x 50' 2-PLY VINYL GARDEN HOSE #501



**1.49** ORTHO SEVIN 5 DUST 4-LB. BAG Reg. 1.99



**3.49** RAID INDOOR FOGGER 7.5-OZ. Reg. 4.49



**4.99** RAID FIRE ANT KILLER 22-OZ. Reg. 5.99



**2.29** SERGEANT'S FLEA & TICK COLLAR FOR DOGS or CATS Reg. 3.59 each



**1.99** ARMOR ALL PROTECTANT 8-OZ. Reg. 2.99

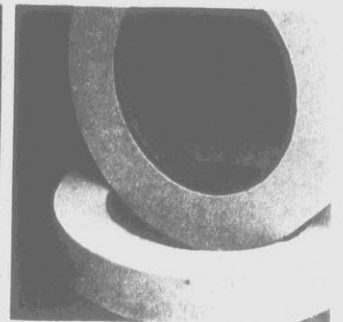

**2/99¢** MASKING TAPE 3/4" x 60-YDS. Reg. 69¢ ea.

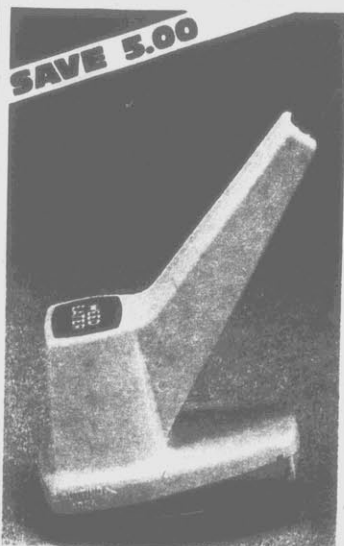

**24.99** WEEDEATER® 10' WEEDER TRIMMER #409 Reg. 29.99



**6.88 to 11.88** GARDEN TOOLS Orig. 8.99 to 12.95 Item availability may vary.



**10.99** RELAX-A-BACK CAR SEAT CUSHION Reg. 12.99



**6.99** TURTLE WAX CLEAR COAT CAR WAX 2 TYPES Reg. 7.99



**3.99** Sale Price  
**-2.00** Mail-in Rebate  
**1.99** Final Cost  
**1.99** CLEAR GUARD PROTECTANT By TURTLE WAX 10-OZ. Reg. 4.99

R1,3,5,7/B-9

**ECKERD**

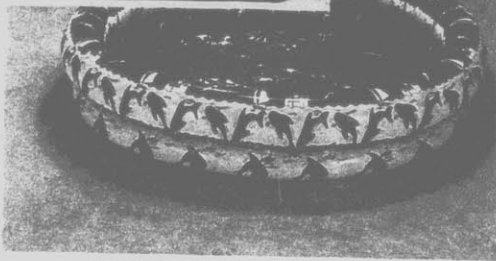

**4.99** 12' x 48" 2-RING POOL  
Reg. 5.99 Safety valve &  
repair patch.  
NOSE CLIP or EAR PLUGS .. 79¢

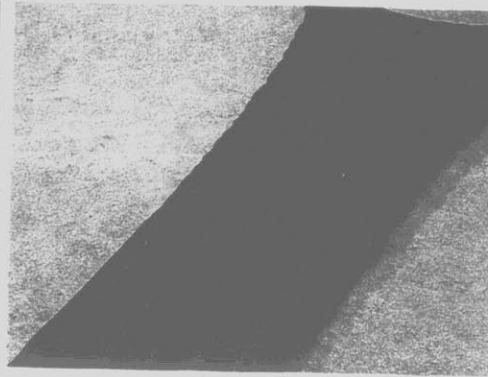

**1.49** 27' x 72" VINYL  
AIR MATTRESS  
24" BEACH BALL ..... 79¢



**1.98** MEN'S or  
LADIES'  
BEACHCOMBERS  
Reg. 2.99 each

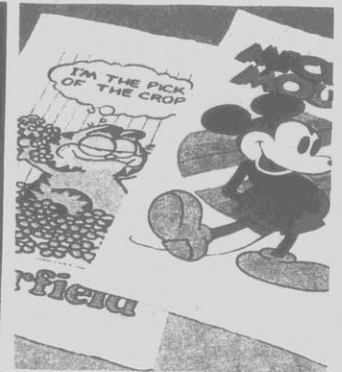

**5.98** 32" x 60" BEACH  
TOWEL-LICENSED  
PRINTS  
Reg. 7.99 ea.



**9.99** 28' x 75" FRENCH  
AIR MATTRESS Reg. 12.99  
TODDLER SWIM RING ..... 99¢



**7.99** 29' x 48" DELUXE  
FABRIC SURFRIDER Reg. 9.99  
ANIMAL FUN FLOAT ..... 2.99



**5.98** REVERSIBLE  
SHORTS or  
PULL-OVER  
SHIRT Reg. 7.99

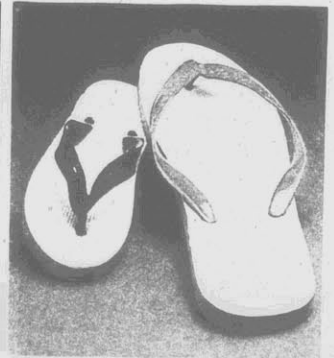

**2 FOR 1.00** MEN'S, LADIES'  
or CHILDREN'S  
ZORRIES  
Assorted colors.



**2 FOR ZEST BATH  
SIZE SOAP  
99¢**  
5.5-OZ.  
Limit 2



**1.27** G.E. 3-WAY  
SOFT-WHITE  
LIGHT BULB  
50/100/150

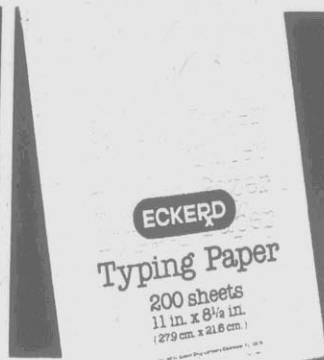

**1.19** ECKERD  
TYPING PAPER  
200 SHEETS



**99¢** ECKERD  
COLD WATER WASH  
16-OZ.  
Compare to Woolite.

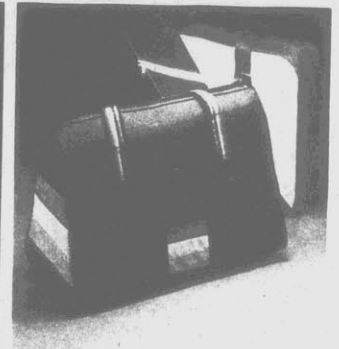

**5.98** CAREFREE  
RAINBOW TOTE  
ROLL BAG  
Reg. 8.99 each



**2 FOR 3.00** SCENTED  
BOUTIQUE  
LINER PAPER  
Reg. 2.49 each



**7.88** 10" SAUTÉ or  
FRY PAN with  
SILVERSTONE®  
Reg. 10.49 each



**99¢** ECKERD  
HOUSEHOLD  
GLOVES 3 SIZES  
Compare to Playtex.



**78¢** SQUARE SHOOTER  
LOLLIPOPS/SUCKERS  
11.75-OZ.

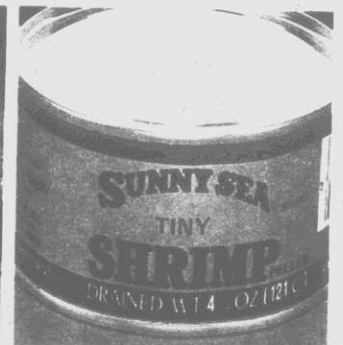

**94¢** SUNNY SEA  
TINY SHRIMP  
4 1/4-OZ.



SAVE 7.00

**REBATE**  
**6.99** Sale Price  
**-2.00** Mail in Rebate  
**-2.00** Bonus Rebate  
**2.99** Final Cost

**VIDAL SASSOON CURLING BRUSH OR IRON #VS111 or #VS101 Reg. 9.99**



SAVE 15.00

**REBATE**  
**24.97** Sale Price  
**-5.00** Mail in Rebate  
**-5.00** Bonus Rebate  
**14.97** Final Cost

**VIDAL SASSOON HAIRSETTER #VS350 Reg. 29.99**



SAVE 25.00

**124.99 SANYO #C30 MINI COMPONENT STEREO #VS350 Reg. 149.99**  
 5 band equalizer.

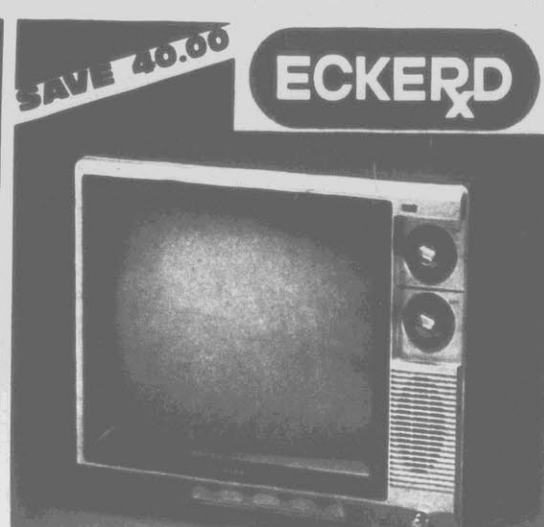

**ECKERD**

SAVE 40.00

**179.99 LLOYD'S 13" COLOR TELEVISION #LS13 Reg. 219.99** Quick start picture tube. 13" diagonal measure. UHF & VHF detent tuners.



SAVE 12.00

**REBATE**  
**29.88** Sale Price  
**-5.00** Mail in Rebate  
**-2.00** Bonus Rebate  
**22.88** Final Cost

**MR. COFFEE ULTRONIC COFFEEMAKER #US-001 Reg. 34.99**



SAVE UP TO 10.00

**29.99 LLOYD'S #V205 MICRO or SANYO #M1010 MINI CASSETTE RECORDER Regs. to 39.99**

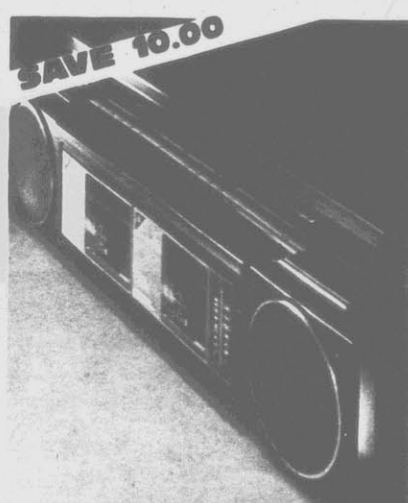

SAVE 10.00

**59.99 GPX AC/DC AM/FM STEREO DUAL CASSETTE PLAYER #C9198 Reg. 69.99**



SAVE 3.00

**11.99 GPX AM-FM STEREO RADIO with HEADPHONES #2830 Reg. 14.99** Featherlight stereo headphones. Receives FM stereo & AM broadcasts.

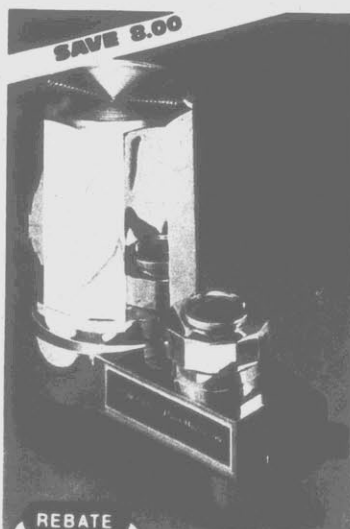

SAVE 8.00

**REBATE**  
**16.88** Sale Price  
**-5.00** Mail in Rebate  
**11.88** Final Cost

**POLLENEX PURE WATER "99" WATER FILTER #WP100R Reg. 19.99**

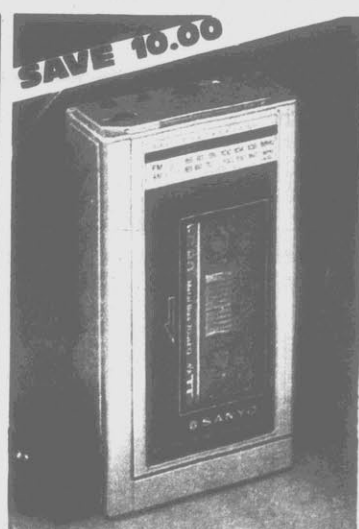

SAVE 10.00

**44.99 SANYO AM/FM STEREO CASSETTE PLAYER #MC-31/41 with HEADPHONES Reg. 54.99**



**50% OFF ENTIRE STOCK OF DIGITECH WATCHES Reg. 2.99 to 9.99** Selection may vary.



SAVE 5.00

**14.99 EMERSON AM/FM ALARM CLOCK RADIO #RED5511 Reg. 19.99** Sleep timer & snooze controls. Battery back-up system.

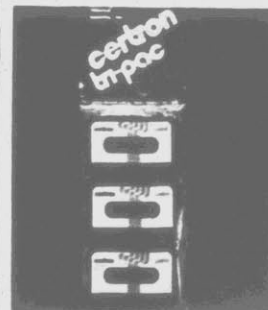

**99¢ CERTRON 90-MIN. CASSETTE TAPES 3 PK. Reg. 1.99**

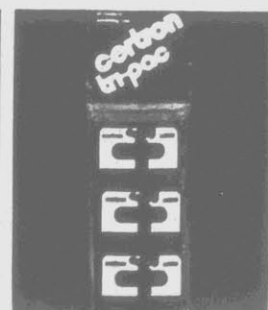

**1.99 CERTRON 90-MIN. CASSETTE TAPES 3 PK. Reg. 2.99**

# ECKERD

AMERICA'S FAVORITE

VISA

MasterCard

## SUMMER FUNNER Sale Days!

AN ADVERTISING SUPPLEMENT  
NC/Atlanta Edition: #T1205195

# RX THE BEST GENERIC RX



SAVE 20.00

**39.99** LORD or LADY TARLETON QUARTZ  
ANALOG WATCHES Reg. 59.99 each  
With day/date and sweep second  
features.



**79¢** LUDEN'S CIRCUS  
PEANUTS 14-OZ. or  
BROCK JELLIES &  
DROPS 16-OZ.

We reserve the right  
to limit quantities.

21A



**2 FOR** SCRIPTO ULTRA  
LIGHT DISPOSABLE  
**79¢** LIGHTER SINGLE



**99¢** AIM TOOTHPASTE  
6.4-OZ. REGULAR or  
MINT Limit 2



**2.29** COPPERTONE  
LOTION or OIL  
4-OZ.

**1.00** REGULAR PRICE  
OFF ENTIRE STOCK OF  
KORDITE TRASH BAGS  
Reg. 2.49 to 4.79 Selection may vary.



REBATE

**14.88** Sale Price  
**-4.00** Mail-in Rebate  
**10.88** Final Cost

IGLOO 15-QUART PLAYMATE COOLER  
Holds 18, 12-oz. cans.  
FREEZE PACK 8-OZ. or 14-OZ. .... 79¢



**99¢** EVEREADY SUPER  
HEAVY DUTY "C"  
or "D" 2-PK BATTERIES  
4-PK. "AA" ..... 1.39



**3.99** OGLIVIE  
PRECISELY RIGHT  
PERMS  
3 TYPES



**1.00** 4 FOR LEAF RAINBLO  
BUBBLE GUM  
ASSORTED  
FLAVORS



**88¢** PLANTERS  
SNACKS  
ASSORTED  
TYPES



**2.39** CRYSTAL LIGHT  
SUGAR FREE  
DRINK MIX  
MAKES 8-QTS.

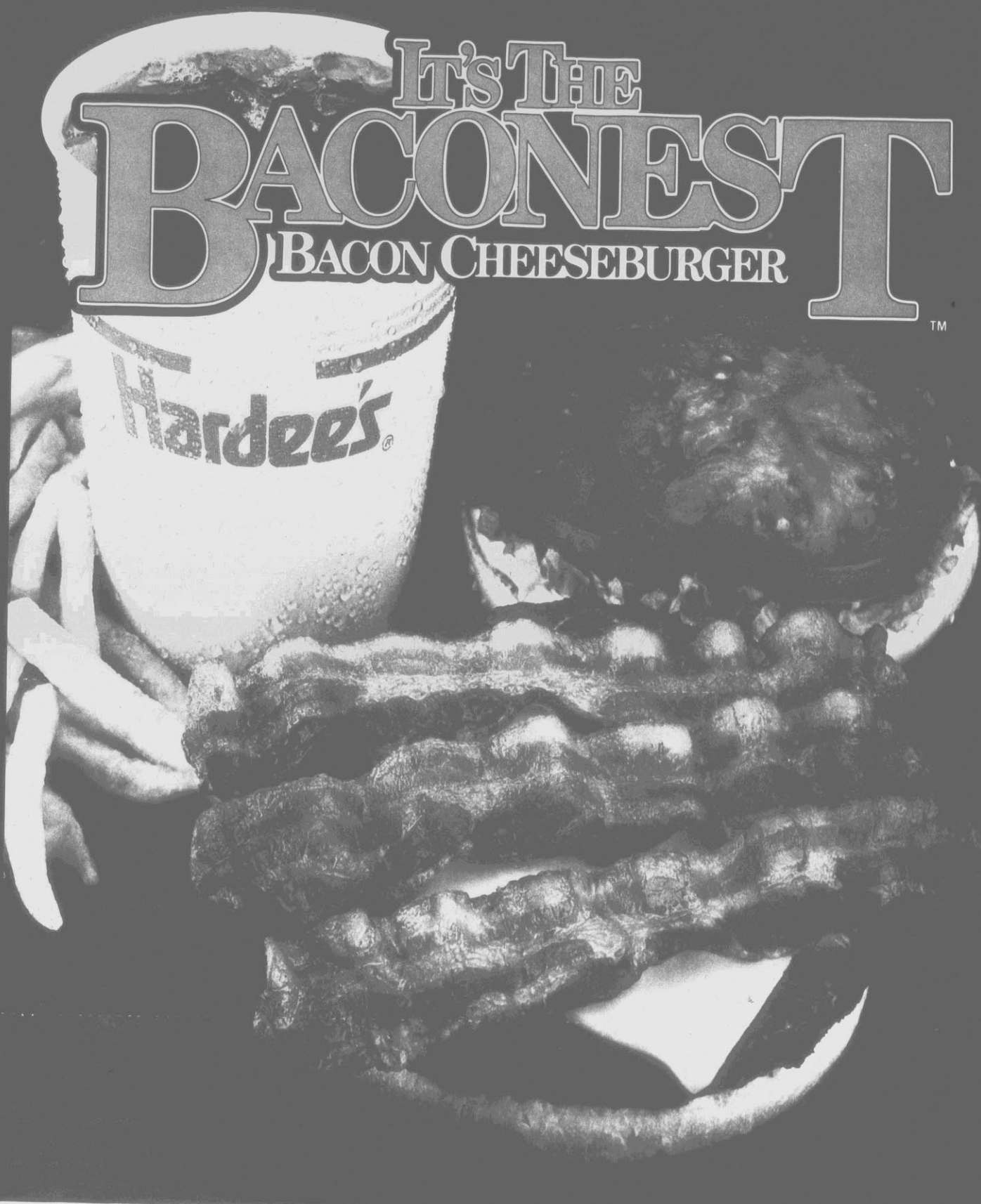

Hardee's Bacon Cheeseburger gives you more of what you buy a bacon cheeseburger for. Bacon. Hardee's uses three whole strips of crisp, sizzling bacon. It's a perfect complement to the quarter pound beef patty, American cheese, real mayonnaise, crispy shredded lettuce, and two tomato slices on a toasted sesame seed bun. Try Hardee's Bacon Cheeseburger and you'll know why Hardee's says, "It's the baconest!"

**Hardee's**

## **THREE CINNAMON 'N' RAISIN™ BISCUITS 99¢**

Offer good at participating Hardee's restaurants. Please present coupon before ordering.  
One coupon per customer, per order, please. Customer must pay any sales tax due.  
Coupon not good in combination with any other offers. Cash value 1/100 of 1¢.

**Offer good during regular breakfast  
hours through May 29, 1985.**

© 1985, Hardee's Food Systems, Inc.

## **A HAM & EGG BISCUIT 99¢**

Offer good at participating Hardee's restaurants. Please present coupon before ordering.  
One coupon per customer, per order, please. Customer must pay any sales tax due.  
Coupon not good in combination with any other offers. Cash value 1/100 of 1¢.

**Offer good during regular breakfast  
hours May 30 through June 12, 1985.**

© 1985, Hardee's Food Systems, Inc.

## **A CHICKEN FILLET SANDWICH \$1.09** **WITH THE PURCHASE OF ANY SIZE FRIES AND ANY BEVERAGE AT REGULAR PRICE**

Offer good at participating Hardee's restaurants. Please present coupon before ordering.  
One coupon per customer, per order, please. Customer must pay any sales tax due.  
Coupon not good in combination with any other offers. Cash value 1/100 of 1¢.

**Offer good after regular breakfast  
hours through May 29, 1985.**

© 1985, Hardee's Food Systems, Inc.

## **A CHICKEN FILLET SANDWICH \$1.09** **WITH THE PURCHASE OF ANY SIZE FRIES AND ANY BEVERAGE AT REGULAR PRICE**

Offer good at participating Hardee's restaurants. Please present coupon before ordering.  
One coupon per customer, per order, please. Customer must pay any sales tax due.  
Coupon not good in combination with any other offers. Cash value 1/100 of 1¢.

**Offer good after regular breakfast  
hours May 30 through June 12, 1985.**

© 1985, Hardee's Food Systems, Inc.

## **A ROAST BEEF SANDWICH \$1.09** **WITH THE PURCHASE OF ANY SIZE FRIES AND ANY BEVERAGE AT REGULAR PRICE**

Offer good at participating Hardee's restaurants. Please present coupon before ordering.  
One coupon per customer, per order, please. Customer must pay any sales tax due.  
Coupon not good in combination with any other offers. Cash value 1/100 of 1¢.

**Offer good after regular breakfast  
hours through May 29, 1985.**

© 1985, Hardee's Food Systems, Inc.

## **A ROAST BEEF SANDWICH \$1.09** **WITH THE PURCHASE OF ANY SIZE FRIES AND ANY BEVERAGE AT REGULAR PRICE**

Offer good at participating Hardee's restaurants. Please present coupon before ordering.  
One coupon per customer, per order, please. Customer must pay any sales tax due.  
Coupon not good in combination with any other offers. Cash value 1/100 of 1¢.

**Offer good after regular breakfast  
hours May 30 through June 12, 1985.**

© 1985, Hardee's Food Systems, Inc.

## **A BIG DELUXE™ BURGER \$1.09** **WITH THE PURCHASE OF ANY SIZE FRIES AND ANY BEVERAGE AT REGULAR PRICE**

Offer good at participating Hardee's restaurants. Please present coupon before ordering.  
One coupon per customer, per order, please. Customer must pay any sales tax due.  
Coupon not good in combination with any other offers. Cash value 1/100 of 1¢.

**Offer good after regular breakfast  
hours through May 29, 1985.**

© 1985, Hardee's Food Systems, Inc.

## **A BIG DELUXE™ BURGER \$1.09** **WITH THE PURCHASE OF ANY SIZE FRIES AND ANY BEVERAGE AT REGULAR PRICE**

Offer good at participating Hardee's restaurants. Please present coupon before ordering.  
One coupon per customer, per order, please. Customer must pay any sales tax due.  
Coupon not good in combination with any other offers. Cash value 1/100 of 1¢.

**Offer good after regular breakfast  
May 30 through June 12, 1985.**

© 1985, Hardee's Food Systems, Inc.