

SWEEP

In their biggest victory in 126 years, conservatives have won the most Parliament seats ever taken by one party in Canada. See page 8.

EXPENSES

Campaign records show Gov. Jim Hunt and Sen. Jesse Helms, in an extremely costly race, also have routine expenses. See page 21.

COACH UNHAPPY

East Carolina Coach Ed Emory was unhappy with the performance of his Pirates against Florida State last Saturday. See Page 15.

THE DAILY REFLECTOR

TRUTH IN PREFERENCE TO FICTION

103rd YEAR

NO. 214

GREENVILLE, N.C.

WEDNESDAY AFTERNOON, SEPTEMBER 5, 1984

38 PAGES

PRICE 25 CENTS



STRIKE VIOLENCE — Violence fared on the picket lines in Dover, England, today as fighting broke out among coal miners returning to work and those who have been on strike for six months. Dockworkers joined the strike two weeks ago, blocking many of England's ports. Hundreds of passengers were airlifted to England today after the luxury liner Queen Elizabeth 2 berthed in France because of the strike. (AP Laserphoto)

Shuttle Returns Home With Perfect Landing

EDWARDS AIR FORCE BASE, Calif. (AP) — Space shuttle Discovery glided to a picture-perfect dawn landing on a desert lakebed today, returning from a 2.5 million-mile maiden voyage that restored confidence in America's space transportation system.

Commander Hank Hartsfield and pilot Michael Coats guided the 102-ton space plane through sparkling clear skies to a touchdown at 10 minutes after sunrise, 6:38 a.m. PDT.

"Welcome home," Mission Control told the crew as the shuttle rolled to a stop on the hard-packed sand.

The sun glistened brilliantly off the craft as it completed final maneuvers and zeroed in on the landing strip.

Discovery and its crew of five men and one woman were back home after a six-day mission marked by extraordinary success despite bouts with a stubborn chunk of ice and a final-hours oxygen leak. Theirs was the 12th flight of a space shuttle, the 10th to land here.

The astronauts emerged from the cabin after 40 minutes and were smiling and buoyant as they did a walk-around inspection of their ship. After a medical examination, they were to meet with their families, who viewed the landing, then fly back to their training base in Houston.

Discovery landed at Edwards because NASA has dictated that any shuttle on its first mission must land on the wide-open lakebed because it provides a large margin of safety in case of error. Starting with the next flight in October, most shuttles will return to a runway near the launch pad at Cape Canaveral in Florida, to avoid the cross-country trip back there for the next takeoff.

The third and newest shuttle was over the Indian Ocean on its 97th orbit when Hartsfield and Coats triggered its big jets for 2½ minutes to drop the spaceship out of orbit and into an hourlong dive through the atmosphere into this Mojave Desert air base.

Mission Control wakened the astronauts 90 minutes early today when it detected a leak in a set of tanks that supply oxygen for the cabin pressure and power-producing

fuel cells.

Hartsfield switched to a backup system and initiated a trouble-shooting procedure that isolated the leak to a pressure control system. The system was shut off and the leak stopped. NASA officials emphasized the problem posed "no hazard" to the crew or the shuttle and that there was enough oxygen on board for Discovery to stay in orbit an extra two days if necessary.

Discovery's six-person crew comes home with an empty cargo bay, graphic evidence of its success in launching a record three communications satellites on a single flight.

NASA reported all three satellites had reached the high orbits necessary for operation and they would soon begin earning money for their owners: American Telephone & Telegraph, Satellite Business Systems and Hughes Communications Services Inc. The companies paid the space agency a total of \$37 million for the delivery service.

Discovery's satellite deployments were the first for commercial customers since last February when two communications payloads went into useless orbits because their booster rocket nozzles failed after successful launches from the shuttle Challenger.

Farmville Turns Out To Examine Plant Proposal

By CAROL BLACKLEY TYER
Reflector Staff Writer

FARMVILLE — Farmville citizens turned out Tuesday night to hear a presentation of the Cogentrix, a firm which wishes to build a coal-burning steam-generating plant in Farmville to supply steam for the Collins and Aikman textile plant and electrical energy for Carolina Power and Light Co.

William Campbell, a representative of Cogentrix, presented information on how the firm proposes to keep down its emissions, bring in 50 carloads of low-sulphur coal a week quietly and with a minimum of coal dust, and provide a \$1 million payroll per year for 25 to 28 employees.

The No. 1 concern of all the citizens who asked questions was what will it do to the ground water level as the firm expects to use 1.2 million gallons of water daily.

Campbell maintained that proper spacing of wells could create a situation in which the aquifer under Farmville wouldn't be seriously

lowered, but local engineer Van Lewis said he does have concern that ground water levels could be seriously affected. He said a U.S. Geological Survey study of the situation is under way and that preliminary findings seem to suggest that the cost of measures to make the removal of this much water from the ground not have a detrimental impact on ground water levels would keep the project from being cost-effective.

The town's agreement with the Pitt County Mutual Aid Group for fire protection was renewed.

Citizen Douglas Vines asked that a stop sign be placed on Cameron Street and that the growth there that makes it a blind corner be cleaned up. Town Administrator Frank Bradham was asked to meet with the police chief and look into improving the safety of that corner immediately.

A public hearing was set to consider whether to allow pet grooming in the home of Cathy Baker as a special exception in R-5 residential.

Rudy Cobb was appointed to a three-year term on the Recreation Advisory Board.

A bid by HESCO for the provision of 400 load management switches for the town utilities system was approved. The amount is \$23,200.

A committee was appointed to consider the Town of Fountain's request that Farmville provide water service to Fountain.

A new policy to prioritize the tiling and covering of ditches in town and include them in a yearly budget-planning process was approved. Work costing \$50,000 will be done this year including: ditches on South Main Street between Cotten and (Please turn to page 6)

County Board Approves Sale Of Tucker Parcel To Planters

By STUART SAVAGE
Reflector Staff Writer

The Pitt County Board of Commissioners approved the sale of the Tucker property Tuesday, authorized the placing of a Vietnam memorial on the courthouse lawn, and heard from a group of senior citizens complaining about the county's property tax structure.

Planters Bank and Trust Co. was the high bidder for the Tucker property, located at the intersection of Third and Washington streets, at an Aug. 24 auction, with a bid of \$105,000.

Tuesday, commissioners approved the sale of the property to the bank, which owns the adjacent property. The sale includes the 6,654-square-foot building and a 14,000-square-foot lot.

The two-story Tucker Building, built in 1927, was purchased by the county in 1935. It has been vacant since the new county office building

on West Fifth Street was opened several years ago.

Commissioners also authorized the placement of a memorial to county residents killed in Vietnam. The action came after Mike Messick, representing the Greenville Jaycees, said the memorial would be similar to memorials already in place at the courthouse for those killed in World Wars I and II and in Korea.

T.R. Jones, representing a group of senior citizens, told commissioners "we are here regarding our present way of taxation. We feel senior citizens and others on fixed incomes are being discriminated against on this property tax."

Jones suggested that people with lower fixed incomes are being taxed "four to eight times greater," based on a comparison with income, "than higher income persons" who get the same county services. "We feel this is discrimination," he emphasized. Jones then suggested that com-

missioners attempt to "implement other revenue sources" by having the General Assembly approve additional sales taxes or income taxes for county use.

"We'd like to suggest that you take a look at that," Jones said. But he added "going to the legislators ... following up ... takes a little more work" than simply raising property taxes.

Board Chairman Bob Martin told Jones and the others, "This is what we've been preaching to the Legislature for 25 years," that property taxes "penalize those on fixed incomes."

Martin pointed out that "this is the fifth year the county has operated without a tax increase" to fund regular county operations, although commissioners "added 10 cents" to the tax rate "this year to correct the school capital outlay situation ... in order to start work and eliminate this situation."

"I agree with you 100 percent," Martin said, property taxes are "oppressive for those on fixed incomes." But he said changes in tax laws have to be done by the General Assembly. "We don't have the authority."

In other business Tuesday, commissioners approved the purchase of 50 voting booths from Governmental Data Systems of Charlotte, which submitted a bid of \$7,200; approved amendments to the county's mobile home, multifamily and subdivision ordinances which will require designers to approve the installation of streets, drainage and septic tanks; and approved a mental health program — Tornado FOCUS (Follow-up and Community Support) — under which mental health workers will go door-to-door in areas hit by the (Please turn to page 6)

REFLECTOR HOTLINE

Hotline gets things done. Write and tell us about the problem or issue into which you'd like for Hotline to look. Enclose photostatic copies of any pertinent information. Our address is The Daily Reflector, Box 1967, Greenville, N.C., 27835. Because of the large numbers received, Hotline cannot answer or publish every item we receive, but we deal with all of those for which we have staff time. Names must be given, but only initials will be published.

PAPERBACKS ASKED

Sheppard Memorial Library is appealing for donations of short paperback books to use in its outreach projects. These books can be light novels, westerns, sports stories, teenage novels, biographies, adventures, humor, inspirational material and popular works on history, science, health, art and music. Those wishing to donate may take the books to Sheppard's main library, 530 Evans St. Call 752-4177 for more information.

CASSETTE RECORDER ASKED

The Therapeutic Recreation Department of Pitt County Memorial Hospital is appealing for a cassette recorder for one of its patients who has extremely limited movement and vision. Anyone who has a cassette recorder to donate may call Debbie Bell at 757-4445.

Forecast

Partly cloudy tonight with lows in the mid 50s. Light northeast winds. Thursday, mostly sunny with highs in the mid 70s.

Looking Ahead

Fair Friday through Sunday with a slow warming trend. High Friday in the 70s warming into the 80s by Sunday. Low Friday and Saturday in the 50s. Low Sunday in mid 60s elsewhere.

Inside Today

Page 4 — Editorials
Page 5 — Area Items
Page 12 — Leisure
Page 14 — Obituaries
Page 15 — Sports
Page 20 — State news

Chernenko Back

MOSCOW (AP) — Soviet leader Konstantin U. Chernenko today appeared at a Kremlin ceremony honoring three cosmonauts, the official government media said. The 72-year-old president had been absent from public view since July, prompting speculation about his health.

Radio Moscow and the news agency Tass said Chernenko gave medals to cosmonauts Svetlana Savitskaya, Vladimir Dzhanibekov and Igor Volk in honor of their Soyuz T-12 mission in July.

Tass did not immediately make photographs of Chernenko available today, but the agency said it expected to have photographs later. The ceremony was not broadcast live on Soviet television.

The Communist Party general secretary was last seen in public July 13, when he met with U.N. Secretary General Javier Perez de Cuellar. Two days later, Tass said Chernenko had gone on vacation. It did not report his return.

United Way Starting Drive

The Pitt County United Way will kick off its 1984 campaign Thursday, marking the beginning of a nine-week drive to raise the \$681,325 needed to meet the 1984 goal.

The goal, a 16 percent increase from last year's goal of \$585,080, will provide support to United Way's nearly 30 health and human services agencies in Pitt County.

Since 1958, the Pitt County United Way has held an annual campaign. This year's campaign chairman, Andy Warren, predicts that goal will be met by Nov. 7.

"For many years, United Way has supported agencies in Pitt County which help other people," Warren said. "By making a contribution, Pitt County residents are saying that they want to help their neighbors in the community."

"Our county's tremendous commitment to the United Way was evident last March when its agencies were on hand to assist tornado victims with rebuilding their lives."

But Warren points out that Pitt County United Way agencies also are available to help with life's

everyday problems, not just big disasters as experienced last spring.

Jane Parker agrees. She is the executive director of the Farmville Child Development Center, a United Way agency since 1969.

"United Way provides us at the child development center with security, knowing that children with moderate to severe retardation and developmental delay have a place to grow and learn year after year," said Parker. Because of continued United Way support, the center has increased enrollment from 13 to 25 children in three years.

The Boys Club of Pitt County, another agency supported with United Way contributions, serves more than 850 boys in the city and county from ages six to 18. According to Boys Club executive director Chet Emerson, making a contribution to the United Way is making an "investment in the future."

"I swear by the United Way and its commitment to the Boys Club," said Emerson. "There is no investment, small or large, with bigger dividends than the investment

you make when you contribute to the United Way."

Under-privileged girls in Pitt County have Operation Sunshine. This after-school and summer program is designed for girls between 7 and 13 years old who are usually neglected by existing or traditional programs. The program began receiving support from Pitt County's United Way in 1968 and has expanded its program to include more than 250 girls during 1984.

Gloria Pearsall, Operation Sunshine activities director since 1978, thinks United Way understands the importance of Operation Sunshine for its girls. "It's a super program that gives girls something to do with their time. I'm just sold on the United Way," she said.

This year, Camp Rainbow, a day camp for children with cancer sponsored by the ECU School of Medicine, will begin receiving United Way support. All agencies and their services, plus new requests, are reviewed each year by a community-based allocations committee to determine budgets and

additional services.

Last year, Hospice of East Carolina and Home Delivered Meals for the Elderly were added to the list of Pitt County's United Way services.

Following is a list of agencies and a description of services receiving support from the Pitt County United Way.

•Advocacy Center for Children's Education and Parent Training provides training, technical assistance, public information and service to parents of handicapped children.

•American Red Cross trained a total of 1,876 in First Aid, CPR and water safety; collected 4,791 units of blood and served 267 military families; assisted more than 200 families following the 1984 tornadoes.

•American Social Health Association has a toll free VD hotline for information and referral; is involved in research for control, prevention and treatment of VD and other sexually transmitted diseases.

(Please turn to page 6)

Dear Abby



By Abigail Van Buren

© 1983 by Universal Press Syndicate

Teachers And Parents Form Partnership Based On Love

DEAR ABBY: Now that school will soon resume, as a teacher in an elementary school, I am submitting some dos and don'ts for parents. I hope you think they're important enough to publish.

MISS B., TRENTON, N.J.

DEAR MISS B.: They are:

- Do sign and promptly return all notes from your child's teacher.
- Do make every effort to attend all conferences and back-to-school nights.
- Do not forget to ask your child if he/she has any homework; then check to see if it is done.
- Do not throw out any of your child's papers without his/her permission.
- Do let the teacher know about any home situation that might affect your child's behavior or classwork.
- Do send your child to school with clean clothes, face, hands, fingernails and hair.
- Do give your child chores at home to develop a sense of responsibility.
- And most of all, do support, praise and love your child.

YOUR CHILD'S TEACHER

DEAR ABBY: My girlfriend says she will break up with me if I don't quit cracking my knuckles.

She said it will give me arthritis. I think she's wrong. If she is, please tell us what causes arthritis.

ALL CRACKED UP

DEAR CRACKED UP: Briefly, arthritis is an inflammation of the joints. The theory that arthritis is caused by cracking one's knuckles is an old wives' tale—a myth.

DEAR ABBY: I am invited to a wedding. I've already bought a nice gift to take to the reception. I've been invited to a miscellaneous bridal shower (same girl), meaning I can bring anything.

Would it be OK if I took my wedding gift to the shower? After I give it to her, I can tell her privately that this is also my wedding gift.

I would like to give her two gifts, but I can't afford it.

CUTTING CORNERS IN MICHIGAN

DEAR CUTTING: Take a separate gift to the shower. It need not be expensive—a kitchen gadget, a pretty Christmas tree ornament or a fancy oven mitt, but save the wedding gift for the wedding.

DEAR ABBY: I have a friend who stops in to visit me regularly. She always brings her dog on a leash, making the comment that she hopes I don't mind.

I do not wish to discourage her visits because she's a good friend, but I do wish she would leave her dog at home.

You would be doing many of us a favor, Abby, if you would suggest to dog owners that other people might own dogs themselves if they wanted dogs around.

TRAPPED IN NEW YORK

DEAR ABBY: After 40 years of what started out to be a wonderful marriage, my husband and I are drifting apart. Why? Because after four heart attacks—and against doctor's orders—he continues to smoke "behind the barn."

I'm disgusted with him for being so weak, and angry with myself for nagging him. Meanwhile my heart aches to help him.

He keeps making excuses to get out of the house (he always needs "something" at the drugstore). He av. ds kissing me because he's afraid I might smell smoke on his breath. He drives his own car and meets me places. I know why, and it infuriates me to see what he's doing to himself. Abby, if I were a grown man and wanted to smoke, I wouldn't hide—I'd smoke right in my own home. The one plus in his having to hide in order to smoke is that he probably smokes less. What a sad way for a man to live!

I am not a nut. Please help me to help him. I love this man and I hate to watch him destroy himself because of a foolish habit.

MRS. X

DEAR MRS. X: Your husband has more than a "foolish habit," he has an addiction that only another addict can understand. No amount of nagging, pleading, shaming or damning will help. If and when he is ready to quit, he will seek out a quit-smok'ng clinic, try hypnosis (it has worked for many), or find out what programs are available through his local American Cancer Society or American Heart and Lung associations.

Prayers are helpful. But the ball is in your husband's court.

DEAR ABBY: I am confused about the words "or so." I am told, "Just wrap the roast in foil and bake it in a 400-degree oven for an hour or so." How long is "or so"? Is it five minutes, 15 minutes or what?

People give me directions. They say, "Go down this street about a mile or so." Again I wonder how far is "or so"? Is it two blocks less than a mile, or three blocks more?

Abby, I take the Tuscaloosa News. If you decide to print this, how long will I have to wait to see it?

FERRELL REYNOLDS IN ALABAMA

DEAR FERRELL: About two weeks or so.

DEAR ABBY: "Guilty Conscience" wrote of her embarrassment at not having written her thank-you notes for wedding gifts she received five years ago. It's been 39 years for me, and I still suffer.

Five days after my big lovely wedding, I cut my honeymoon short and went home to be with my grieving parents. My brother was missing in action for three months before it was confirmed that he had been killed.

During the long weeks of painful waiting for "news," I tried to write my thank-you notes, but I felt as though I was writing for some other bride on some other planet. Meanwhile, my husband (also in the military) was shipped from one base to another, and our "gift book" was packed and unpacked I don't know how many times before I could get my act together. Then the book was lost and I was absolutely horrified!

But I did penance. For years, with every wedding gift I sent, I enclosed an overstated, exaggerated "thank-you note" to myself describing the fabulous gift I had sent, saying it was exactly what the bride and groom had wanted, etc. Then I put the note in a self-addressed, stamped envelope and all the bride had to do was sign it and mail it to me. I received some wonderful P.S.s on my notes. Sign me ...

PENANCE PAL IN TENNESSEE

DEAR PENANCE PAL: It takes a person with a super sense of humor to sit right down and write herself a (thank-you) letter. And it takes a bride with an equally good sense of humor to appreciate it.

All About Yuppies New Subculture Created

By HARPER'S BAZAAR A Hearst Magazine

Yuppies deplore vinyl, drink designer water and are only happy when paying too much for something.

These are some of the conclusions Cynthia Heimel reaches about the Yuppie phenomenon in an article in the September Harper's Bazaar.

"There was no such thing as a Yuppie until Sen. Gary Hart decided that all those people in running shoes and pin-striped suits (an appalling combination) who were voting for him needed to be called something," she writes.

"Yuppie. Young Urban Professional. A fun term. The media liked it. Within minutes someone wrote the 'Yuppie Handbook,' and a new subculture was created. Various people who happen to like raspberry vinegar but otherwise didn't know who they were now have been defined."

She believes Yuppies are what happened when the "me" generation of the '70s met economic recession—they turned into a self-oriented and economically conservative group.

Yuppies don't start trends, she says, because they are under too much peer pressure to conform.

"A Yuppie would never act crazy and decide, 'I'll move to Peru.' A Yuppie would never go off into the night with a mysterious stranger. A Yuppie would never hang a pair of furry dice on his rear-view car mirror."

"A Yuppie, at all times, acts sane and smart. Yuppies are good boys

and girls ... always playing it safe."

Yuppies, Ms. Heimel says, want things: "Things make Yuppies feel better, more secure. Who cares about nuclear proliferation if we've just bought a new Cuisinart? Shopping is a lot safer than Valium. Possessions bring peace of mind."

The author calls Yuppies street smart and professional.

"Forget ethics, there's no time for that now," she writes. "Ethics are for bleeding-heart types—leftovers from the '60s who care about the poor, who feel a brotherhood with the disenfranchised. But face it, how can Yuppies care about the poor? They wear polyester. They wear tacky designer jeans! They don't have interesting jobs!"

She contends a Yuppie is only happy when he is paying too much for something—from designer water to Holland tulips at \$3 a stem.

"When Yuppies get hold of a trend, it's curtains," Ms. Heimel writes. "Not long ago, Yuppies in New York noticed that Cajun food was very hip. Dozens of Cajun restaurants sprang up overnight, all selling dirty rice and jambalaya for hilarious prices."

How can you spot a Yuppie across a crowded room?

Yuppies wear only natural fibers—never synthetics. In luggage and handbags, they insist on leather, never vinyl. They can be found in "horribly spacious restaurants riddled with ferns and pale flowers," eating argula omelets. Especially at brunch.

Ms. Heimel concludes her article in Bazaar by admitting she fears she is becoming a Yuppie herself and her obsessive quest for a vinyl-free garment bag proves it.

"I've just gone to the nearest discount shop to buy the cheapest, most vinyl-laden garment bag I could find." And I found one—a maroon putrescence. But I couldn't bring myself to buy it. I'm afraid I'm one of them now."

Cooking Is Fun

By CECILY BROWNSTONE Associated Press Food Editor

Salads, whose base is cooked white rice, are comparative newcomers to the American culinary scene. Although there are a good many cookbooks devoted to salad-making on my shelves, only a few recently published ones include recipes for rice salads.

My first introduction to rice salad came about 20 years ago when a fine restaurant chef was inspired to concoct a white rice and celery salad dressed with curry mayonnaise and surrounded with slices of fresh fruit. It was a delightful accompaniment for sliced cold chicken and turkey as well as lamb and veal.

Since then we've made all sorts of salads at my house using cooked white rice, but not until recently did I try brown rice in some of them. My young "health food" friends fully approve and here's a Southwestern version they particularly like.

The select brown rice called for holds its shape in cooking. It doesn't get too soft or mushy.

SOUTHWEST BROWN RICE SALAD

- 2-3rds cup chopped (medium-fine) onion
- 1 clove garlic, minced
- 2 tablespoons butter
- 2 and 2-3rds cups water
- 1 cup select brown rice
- 1 1/2 teaspoons salt
- 4-ounce can chopped green chilies, undrained

- 15 1/2-ounce can red kidney beans, drained and rinsed
- 1-3rd cup chili sauce
- 2 tablespoons vegetable oil
- 3 tablespoons lime juice
- Cayenne pepper to taste
- 1 small avocado
- 1 medium tomato, diced (medium-fine)

In a medium saucepan over low heat cook onion and garlic in butter until onion is wilted. Add water and bring to a boil. Stir in rice and 1 teaspoon of the salt. Cover tightly and cook over low heat until all the water is absorbed—50 minutes. Transfer rice to a large bowl. Stir in the chilies and kidney beans.

In a small bowl whisk together the chili sauce, oil, lime juice, remaining salt and cayenne. Pour over rice mixture; toss lightly to combine. Cool to room temperature or chill. Peel avocado and remove the seed. Cut into 3/4-inch cubes. Just before serving add the avocado and tomato to the rice mixture and toss gently.

Makes 6 servings.

Eastern Electrolysis
205 COMMERCE ST.
PHONE 756-4034, GREENVILLE, NC
PERMANENT HAIR REMOVAL
CERTIFIED ELECTROLOGIST

Happy Birthday Don Wilson
Have a great one!
Lois, Donna, Mother, Marie, Ed, Tony, Keith and Kim

Brody's Downtown The Plaza

Oh, what a beautiful price!

"ELLIE"
Classic tailored mid-heel pump with stacked heel. See it now in the autumn toned colors! Navy, wine, sand & black. Sizes N 7-9, M 5-9 to 10
Reg. \$38.00
\$29.00

"CHRISIE"
Whether relaxing, running, jumping or whatever, you'll enjoy Candie's tennis shoes. In white or grey.
Reg. \$23.00
\$17.90

"SWEST"
BOAT SHOE
Classic boat shoe with soft leather upper on a non skid sole. Wine or navy.
Reg. \$52.00
\$39.00

SEPTEMBER IS SHOE MONTH

CLARK GALLERY
formerly
Frame It Yourself Shoppe
Custom & Do It Yourself Picture Framing
• Prints Of All Types
• Original Lithographs
• Skis, Tees
—GALLERY HOURS—
Mon. Sat. 9:30-5:30
Mon. & Wed. Nights 10-12 P.M.

For All Your Back-To-School Dance Supplies

At Barre, Ltd.
422 Arlington Blvd. 756-6670

Grandparents' Day is for kids, too.

When your kids give their grandparents a big bouquet of flowers or a lovely green plant this September 9, they're going to get back something very precious. Lots of love and hugs and kisses. And that's why Grandparents' Day is a special day for kids, too!

Grandparents' Day, September 9

Greenville Flower Shop
1027 Evans Street
Phone 758-2774

Homemaker's Haven

By Evelyn Spangler
Pitt Home Agent

The look for the well-dressed male this fall is somewhat dressier than in previous seasons, both in business and leisure wear.

Business suits generally will be darker in hue, according to the Men's Fashion Association of America (MFA), an industry group representing 450 menswear firms. However, many fall suits have bright colored stripes woven into the fabric, giving them a feeling of depth.

Classic dressing will make a strong showing for all and the double-breasted suit is making a come-back, both looks slightly dressier than in past seasons. Single-breasted suits may show peaked lapels or might be worn with the season's fashion innovation: the vest with lapels.

For a slightly more casual look, sport coats continue their popularity this fall. They'll be available in large, soft plaids and tweeds, some with suede elbow-patches and leather trim.

In slacks for the office, the season's big fabric is flannel in many shades and weights. Also popular will be an array of garbardines, corduroys and mixed tweeds with straight legs still the most popular shape. Pleated slacks are gaining popularity for both office and casual wear. Casual slacks will show a great deal of detail work in addition to the pleats including darts, watch pockets, elastic waists and/or button tabs.

Collar styling is the big news in fall shirts for men with choices including the classic button-down, cutaways, rounded collars and a shorter designer collar. The contrast look remains strong with a white (or light) collar highlighting a shaded or patterned shirt.

There's a strong emphasis for all on outerwear and the MFA says that the look in coats and jackets has never before been so diversified or so handsomely styled. The season will see everything from dressy topcoats to bomber jackets. Outerwear models range from waist-length jackets to ankle-length coats.

Transitional models, with zip-in liners for colder weather, will be popular.

Outerwear includes headgear. The MFA says that many young men are beginning to wear hats in styles ranging from dressy felts to sporty caps.

In sportswear one of the more prevalent trends for fall will be fabric mixing: an ensemble might include a corduroy vest, plaid skirt, cable-knit sweater and poplin slacks. Sweaters will be very popular and will be seen in a variety of weaves, often with geometric patterns.

The rugged outer look is taking over from the running look in leisure wear and oversized shapes are becoming the rule with roomy tops and pleated pants as well as the new big shirt look.

Although the overall look for fall is a slightly dressier one there has been no sacrifice in comfort. Men increasingly are demanding clothing that not only delivers good looks but comfort as well.

Call the Extension Office at 752-2934, extension 370, for a copy of "Basic Primer on Men's Suits." This extension brochure discusses good fit, check points on buying, care and maintenance, fabric characteristics and styles.

REQUIRES CARE

STILLWATER, Okla. (AP) — When a child's favorite stuffed animal or toy becomes worn and dirty, it can be restored and cleaned with proper care, says the Extension clothing specialist at Oklahoma State University.

Angela Criswell says the first step is to brush or vacuum the toy to remove surface dirt and dust; clothes, if any, should be removed and laundered separately.

If there is no label to advise if the item is machine-washable or hand-washable, she suggests opening part of a seam to check if the stuffing is brownish or multicolored. Such material could stain the covering if it gets wet.

These toys, she advises, should be scrubbed with a sudsy brush and rinsed by wiping with a damp cloth. This method can also be used for mechanical toys.

Letter From The Adriatic: Fish, Fashion, Miss Topless

By RUTH E. GRUBER

SIBENIK, Yugoslavia (UPI) — In spotless white uniforms, four young cadets from the local Yugoslav naval academy face the wall in a busy pizzeria, examining their reflections in the long mirror over the counter as they eat.

A Michael Jackson song booms out from the well-stocked jukebox, spilling into the narrow alley near Sibenik's picturesque Old Town. The four young sailors, serious-faced over their pizzas, tap their feet and gently wiggle their hips to the music.

"Michael Jackson," says Klara, 11, a Belgrade girl vacationing in Sibenik and also enjoying a pizza. "He sings good. His songs have good rhythm. But I really like Paul Young."

This is summer on Yugoslavia's Adriatic coast, whose crystal water, hundreds of miles of rocky shoreline and hundreds of Adriatic islands are increasingly a magnet for tourists.

The winding coastal highway, in many places squeezed between plunging mountains and the turquoise sea, is crowded with cars from West Germany, Austria, Czechoslovakia, France and elsewhere.

Private families advertise in German, and sometimes other languages, that they have rooms in their homes to rent out, homemade wine and fiery fruit brandy to sell.

Private restaurants advertise their charcoal-grilled specialties with handmade signs replete with directional arrows and drawings of fish or lamb being roasted on a spit.

Tourism officials say that in late July there were about 1 million tourists on the Yugoslav coast, about two-thirds of them foreigners.

Yugoslavia's severe economic crisis has been a mixed blessing for the tourist industry. Although official figures show the inflation rate at a whopping 60 percent, the Yugoslav dinar at the same time has lost value against Western currencies and prices are still cheap.

At a terrace restaurant overlooking the sea about half an hour's drive up the coast from Sibenik, three customers ate mixed fried shrimps and calamari, salad and 3.3 pounds of grilled, fresh-caught fish, with a liter of homemade wine and mineral water for a total of \$30.

Private accommodation can be had for well under \$8 for a single room.

In some localities, the number of foreign visitors has risen 60 percent over last year — with an average 20 percent increase in foreigners overall. In the first seven months of the year Yugoslavia earned \$425 million from foreign tourists, or 7 percent over the same period last year.

The number of Yugoslav tourists vacationing on the coast, however, has dropped by 25 percent.

Sibenik is about halfway down the coast, between Zadar and Split. It is not one of the famous resorts such as Dubrovnik, Kotor or Opatija and compared to these bigger centers almost seems undeveloped.

Its Old Town is similar to Dubrovnik and other typical coastal towns, with polished stone streets and piazzas like ballroom floors, an ornate cathedral and winding alleys

— some of them steep stairways — lined with tall stone houses.

At sunset, on a long promenade along the waterfront, young people go through a ritual nightly "corso," strolling back and forth in the latest fashions, seeing and being seen.

Cafes are full of tanned young Yugoslavs, beautiful girls and handsome men, in immaculate summer gear, sipping coffee, brandy, beer and wine.

Sibenik's main beach area is a 15-minute trip by ferry boat through spectacular archipelago scenery, and it's possible to take other boats further out to better, more deserted beaches, including nudist areas.

Development of the Yugoslav coast over the past decade or so as a major international tourist resort area is easily seen.

Near Sibenik, for example, the tiny fishing village of Vodice has been turned into a private entrepreneur's paradise.

There are scores of privately run bars, cafes, restaurants, ice cream parlors and pizzerias in the town, most of them opened by Yugoslav "guest workers" who worked in the west and returned home after saving up money. Hundreds of thousands of Yugoslavs work in the west.

"It's all grown up over the past five years," said a Belgrade journalist who regularly vacations in Sibenik.

Two types of posters in the village illustrate the Adriatic attitude.

Many of the Vodice establishments are decorated with pictures of the late President Josip Broz Tito. Tito, architect of Yugoslavia's independent type of communism, died four years ago.

Belk Tyler
carolina east mall greenville

Sale
25.50 For Our

Helene Curtis Uniperm®
Regular 37.50

Soft, radiant, come-alive curls can be yours in just six minutes with the amazing Helene Curtis Uniperm...the computerized perming system. Hair feels and looks natural and healthy.

Regular SALE
Style and Hair cut. . . 16.00 **12.00**

Our Best
Relaxer Perm. 31.00 **24.50**

Call the Beauty Salon at 756-2355 today for your personal appointment.

The
Hair Salon
Phone 756-2355



Open Tuesday thru Friday
10-8, Monday and Saturday 10-6.

DIENERS
BAKERY
"Greenville's finest bakery for 63 years."
815 Dickinson Ave.
Cakes
Fresh Baked Daily
Chocolate Lovers Delight
Chocolate • Pineapple
• Carrot • Gorman Chocolate
• Coconut • Rum • Butternut
• Cupcakes
Decorated Cakes For ALL Occasions.
752-5251

Belk Tyler
carolina east mall greenville

Hanes Alive® Support Sale
September 6-15



Save 1.20 on Alive®
Support Pantyhose!

Regular 6.95 **5.75**
Styles #809, 810 and 811.

Enjoy the beautiful sheerness and discover the ultimate in leg elegance while keeping the support your secret.

Save .85 on Alive®
Support Stockings!

Regular 4.75. **3.90**
Style #805

Shop Monday Through Saturday 10 a.m. Until 9 p.m. — Phone 756-B-E-L-K (756-2355)

John's Flowers

and

Jerry's Sweet Shoppe

Come Visit Our New Stores
Now Located At The Arlington
Blvd. Entrance Of The Plaza

John's Flowers and Jerry's Sweet Shoppe

756-1160

355-2832

Editorials

Record

Are people reading more? They must be if we can judge by the annual report of Sheppard Memorial Library.

The fiscal year 1983-84 set a record for book loans. The library system reported that 286,380 book loans were made during the fiscal year. Interestingly, it has been over 20 years since the previous record was set. The library system lent 275,756 books in 1961-62. There are, of course, far more people in the area now than there were 20 years ago and why it took so long to reach the 1961-62 total is a puzzlement.

Nevertheless it is apparent that the library system use is on the increase and that is positive. Carver Branch had a 24 percent growth rate in 1983-84 while the East branch had a 16 percent increase. The Pitt County Bookmobile circulated 10 percent more items over the previous year. The libraries had 154,066 visits during the fiscal year and the staff answered 35,999 requests for information during the year.

We can hope the increased use of the libraries shows that the public is returning to reading, which is still the best way to obtain information. In addition, books of fiction offer a completely portable entertainment device which can be turned on and off at will. There is plenty of competition for reading in our complex society, but books are clearly holding their own.

Laudable

We would be remiss if the turnaround in nursing scores at North Carolina A&T University were overlooked. Just three years ago only 13 percent of the nursing school grads at A&T passed the national nurses licensing exam. Last month, the school saw an 88 percent passing rate ... a laudable and welcome improvement.

Three years ago the National League of Nursing had put the school on probation and the State Board of Nursing issued a warning. There was a distinct danger it would close. Drastic measures were called for, and a new dean was assigned to solve the problems.

True, only eight graduates took the exam in July, a small percentage of the number of North Carolina grads who took the test, but the promise is there. As part of the upgrading process Dean Marrietta Raines instituted a more careful screening of students. Hopefully the sought-for new standards of attitudes and aptitudes will continue high with accompanying results. We would expect to see growth in the size of classes. The opportunity to encounter quality is a natural magnet.

The school's future at A&T carries an optimistic note.

—Maxwell Glen and Cody Shearer—

Boss Can Obligate Employee

WASHINGTON — Should an employee be held responsible for criminal actions by his employer?

Where the crime is illegal dumping of hazardous wastes, a federal appeals court says yes.

Reversing a U.S. district court's opinion, the appeals panel ruled that the criminal sanctions of federal hazardous waste disposal law applied to knowledgeable employees of a company as well as its owners and operators. The lower court had said that employees could not be held liable for dumping wastes if top management had failed to obtain a permit.

Justice Department officials said that decision had freed from political prosecution the very people who did the actual dumping. Officials argued that, with the prospect of being named co-conspirators, lower- and middle-management personnel would be more likely to turn state's evidence against bosses who have broken the law.

But according to Judson Starr, the Justice Department official in charge of federal environmental law enforcement, the government need

not prove that an employee actually knew the dumping was illegal. Merely his position would be enough to infer that knowledge, Starr said recently.

Ordinarily, employers have been responsible for the actions of their hired help — not the other way around. Justice Department officials, who've had trouble putting toxic dumpers behind bars, would rather round up all the suspects. Admittedly such sweeping action might get better results.

Yet the waste disposal business is, well, dirty in more ways than one. Managers intent on saving their own skins won't always make employees aware that their actions are criminal. Meanwhile, there are employees who, for fear of jeopardizing their jobs or personal safety, will simply decide to keep quiet.

These possible scenarios suggest that the appeals court ruling deserves careful interpretation.

This fall Sweden will become the first nation to place "Sweets may damage your health" notices on

RALEIGH — Truth may be the first casualty of all political campaigns, but not far behind on the casualty list comes laughter. That's certainly the case in Politeca North Carolina this year where things are getting pretty dour. For the candidates, political careers are on the line. For their workers, future employment is at stake. It doesn't make for an atmosphere very conducive to hearty chuckling.

But alas, even in such earnest surroundings, there are people who still find time to laugh. Let this column stand as a tribute to those who, although they're involved in the great debates of our time, still take the opportunity to cackle a bit.

On the Republican side, Dave Flaherty is probably the most famous great laughter. The Boston Irishman, who is GOP state chairman, loves to kid and joke and

then laugh at his own wit. (Sometimes he gets quoted for this stuff and it gets him in trouble.) "Oh, it's just a fat laugh," the cherubic Flaherty says of himself.

Jack Hawke, Jim Martin's gubernatorial campaign chairman, isn't as well known as Flaherty in political circles, but he would make anyone's All Laugh America squad.

"His laugh explodes like a machine gun," one Martin aide says of Hawke. "It's infectious." Hawke is almost always laughing, his friends say.

Over at the reelection campaign of Sen. Jesse Helms, Mark Stephens, campaign director, is considered the best laugher. "One of his legs will start shaking and then the other one will start, then he'll start laughing," one campaign aide reported. "Mark reminds you of a mischievous little

kid who has something up his sleeve when he laughs."

The best laughter in the Democratic camp is, without a doubt, Brenda Summers, press secretary to Bob Jordan, the candidate for lieutenant governor. Ms. Summers, who used to report political news for WBT-TV in Charlotte, laughs at everything. No matter how dumb your joke, she laughs at it. And she keeps on laughing, gradually letting the laugh fade out in the fashion of a rock-and-roll record.

Ms. Summers gets tough laughing competition from two members of Gov. Jim Hunt's Senate campaign staff, Gary Pearce and Stephanie Bass. The Gary and Stephanie Show has been running for eight years, since they staffed Hunt's gubernatorial press office in 1977. Pearce is just plain loud when he laughs. When he gets really worked up, "he'll hold

his sides and slide down in his chair," Ms. Bass reports. Her laugh starts as a high pitched shriek and develops into a loud cackle. Betty McCain, Hunt's longtime political ally from Wilson, also deserved mention but her laugh is more notable because it usually follows one of her own jokes — most of which are very funny.

Of all the candidates on the scene today, Rufus Edmisten, Democratic nominee for governor, and John Carrington, GOP candidate for lieutenant governor, have the most obvious laughs. Edmisten could play Santa Claus. He laughs like "Ho, Ho, Ho." Carrington has a dry, almost cynical, sense of humor and his laugh fits it almost perfectly.

Unfortunately for laughaholics, the state's most outrageous political laugher didn't make it into the campaign. Sen. Cass Ballenger, R-Catawba, laughs like that dog on the old Yogi Bear show. Ballenger bowed out of the governor's race when Martin got in, and Flaherty says Ballenger's laugh may be an impediment to future political success. "I've had more people say he has to do away with his laugh before he runs again."

Public Forum

To the editor:

In his letter to the editor of Aug. 26, John G. Clark Jr. sought to chastise Eddie Knox for the judgments of members of his family. Mr. Clark is laboring under several misconceptions and the load of "personal rancor and spite" which he carries but which he perceives as lodging with the Jesse Helms camp.

The fluent sarcasms and distortions continued in every sentence of his letter point to where the rancor and spite is located. By my count his reference to curtailing Social Security and school lunches is one of 13 sarcastic distortions.

In addition to his load of personal rancor and spite, Mr. Clark is also laboring under another load which makes his life troublesome and misdirected. He believes politics is a game, a game where the winning is the purpose and the end. Undoubtedly this is the belief and practice for many politicians. It is the distinction between politicians and statesmen.

Surely there were fundamental differences between the philosophies and intended gubernatorial programs of Mr. Knox and Mr. Edmisten. Were those differences simply plays in a quest for winning election? Of course not. They were, and are, basic beliefs and as such are inviolable.

Mr. Clark has correctly associated the Knox (candidate for governor) with Jesse Helms who is seeking re-election to the Senate. In this contest there are also differences of philosophies and intentions, closely related to those of Eddie Knox. Playing the game of politics ought not to be the purpose of this election, but instead our aim should be that of statesmanship.

Marshall Helms
Greenville

—Elisha Douglass—

Strength For Today

The Book of Revelation is a much abused and misused section of the Bible.

People either over-emphasize its teachings or neglect them. Those who over-emphasize them keep looking up to heaven expecting a new world to descend upon them shortly. Those who neglect the teachings of Revelation fail to appreciate the glory and triumph which God has promised to the faithful.

This ancient book came out of a great ordeal. It was addressed, like other writings of its type, to people who had passed through inconceivable tribulations. The underlying message of the book is that in the end God and his kingdom of love will triumph.

The destiny which the human race confronts is a destiny of hope. God made us for triumph, not defeat. "Eye has not seen, nor ear heard, neither have entered into the heart of man, the things which God had prepared for them that love him."

Chuckling Still Holds Forth

—Paul O'Connor—

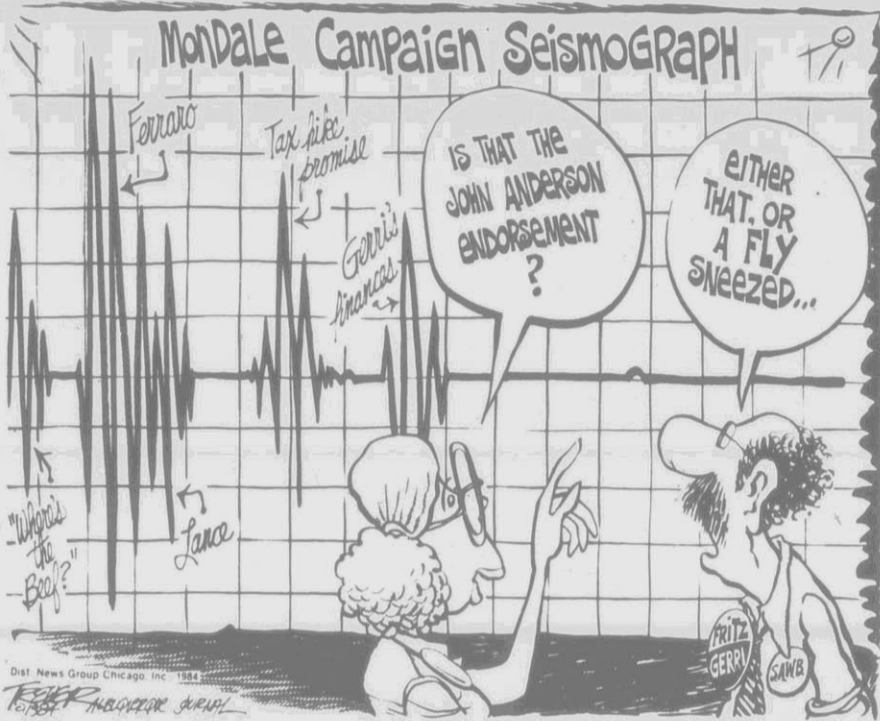

—Evans Witt—

The Issue Of The Commander

WASHINGTON (AP) — George Bush pulled on his flying jacket and climbed into the cockpit of a torpedo bomber last weekend to launch an attack on his newest opponent.

Bush's weapons this time were videotape and photographs — not torpedoes — as he took aim at Geraldine Ferraro without saying a word about the Democratic vice presidential candidate.

Facing the first female opponent of his political career, Bush raised the "commander-in-chief" issue just as carefully as other male politi-

cians have done against women they have confronted across the ballot box.

Sometimes the politician's prop has been a tank, not a plane, but the message has been the same — this man, this candidate has dealt with the military, with the life-or-death decisions of combat, just like the tough decisions of a president or governor.

In Norfolk, Va., ceremonies over the weekend, Bush climbed into the cockpit of a Grumman Avenger torpedo bomber on the anniversary of his being shot down over the Pacific in such a plane in 1944. Pentagon officials declared the ceremony non-political.

But the unspoken political challenge was clear: "Match that, Geraldine Ferraro."

Ms. Ferraro, like most American women, has no military experience and even though the armed forces are including more and more women, they are barred by law from combat jobs.

Bush's weekend exploits recall the best-known example of using a military image against a female candidate.

In Mississippi in 1980, William Winter came in second to Evelyn Gandy in the Democratic gubernatorial primary and faced her in a runoff.

In an ad fashioned by Winter's media consultant, Bob Squier, Winter was shown wearing army fatigues and climbing onto a tank, part of Mississippi's National Guard. The announcer talked about the governor's role as "commander-in-chief" of the state's military.

Such attacks are both successful and controversial.

The ad, part of Winter's successful

effort to deny Miss Gandy the nomination, was roundly booed when it was shown at a National Women's Political Caucus seminar a year ago.

Likewise, Bush's emphasis on his military experience is unpopular with feminists and Democrats.

"Epaulet-flexing" was what Ann Lewis, political director of the Democratic National Committee, called it.

But the military emphasis aims at what the public perceives as a weak spot in female politicians.

A study for the women's caucus found that men were perceived by voters as better in times of crisis than women and better at decision-making under pressure. And these perceptions — or stereotypes — are among the most significant found in the study by the polling firm of Yankelovich, Skelly and White.

The Bush-Ferraro situation is somewhat different from the one in the Mississippi governor's contest.

To begin with, the Republican vice president was decorated with the Distinguished Flying Cross for his World War II exploits over the island of Chichi Jima.

And with the vice president next in the line of succession as commander-in-chief of the nation's armed forces, more is at stake than supervision of the Mississippi National Guard.

Patriotism is a major theme this fall as both parties are trying to outdo each other in wrapping themselves in the American flag.

President Reagan proclaimed the "New Patriotism" on Tuesday to the American Legion, calling it "a change from only a few years ago when patriotism seemed so out of style."

IT'S KIND OF HARD TO BELIEVE!



packages of candy. Barbro Westerhold, chairman of the National Social Welfare Board, also wants to require similar notices for ice cream. "People need to be reminded that there is no nourishment in these products," she said recently.

White House officials are trying to set up a meeting between President Reagan and Soviet Foreign Minister Andrei Gromyko in late September, when the United Nations General Assembly convenes in New York. If the meeting occurs, it will be in New York. It will also be the president's first encounter with a senior Soviet leader since becoming commander-in-chief.

Students made up 1.6 percent of the delegates and alternates at the GOP convention. About 2.5 percent of the delegates were 18 to 24 years of age.

Top American and British military officials are thinking of deploying large stockpiles of deadly chemical weapons in Western Europe. The top brass wants to combat the Russian force of 300,000 tons of chemical weapons that may be used in a conventional war.

On the closing day of the Republican convention in Dallas, executives of all three major TV networks agreed privately that they had spent too much money and manpower in covering what many considered a "non-event." And they agreed in separate conversations that things would be different in 1988.

"The resources we are expending are not justified by the news that is available," one executive said. Nonetheless, the major networks helped their affiliates cover the non-event. All three provided facilities for their affiliates. Forty-three locals used CBS, 12 used NBC and 10 used ABC.

The film used to introduce Vice President Bush in Dallas cost a mere \$3,200 to splice together, according to GOP sources. The Reagan introductory film is said to have cost at least \$500,000.

The Daily Reflector

INCORPORATED
209 Cotanche Street,
Greenville, N.C. 27834

Established 1882

Published Monday Through Friday Afternoon and Sunday Morning

DAVID JULIAN WHICHARD, Chairman of the Board

JOHN S. WHICHARD — DAVID J. WHICHARD, Publishers

Second Class Postage Paid At Greenville, N.C.
(USPS 145-400)

SUBSCRIPTION RATES

Payable in Advance

Home Delivery By Carrier or Motor Route Monthly \$4.00

MAIL RATES

(Prices include tax where applicable)

Pitt and Adjoining Counties \$4.00 Per Month

Elsewhere in North Carolina \$4.35 Per Month

Outside North Carolina \$5.50 Per Month

MEMBER OF
ASSOCIATED PRESS

The Associated Press is exclusively entitled to use for publication all news dispatches credited to it or not otherwise credited to this paper and also the local news published herein. All rights of publications of special dispatches here are also reserved.

UNITED PRESS INTERNATIONAL

Advertising rates and deadlines available upon request.

Member Audit Bureau of Circulation

In The Area

Soccer Program

Registration for the fall girls soccer program for first through sixth grades, sponsored by the Greenville Recreation and Parks Department, will continue through Friday from 3-6 p.m. at Elm Street Center.

Practices will be held on Tuesdays and Thursdays from 3:45-4:45 p.m. at Elm Street Park. The program will begin on Sept. 10 and the cost is \$5.

For more information call Margaret McGlohon at 752-4137, ext. 259.

Safety Council

The board of directors of the Pitt County Safety Council, serving as the executive committee, met recently to plan programs for the upcoming year.

Present were Charles Mayo, president; Joe Schrader, vice president; Polly Dail, secretary, and Margaret Register, publicity chairman. Boyd Lee, the city's director of recreation and parks, will present the September program.

The council, which resumes meetings this month after a summer break, meets on the first Thursday of each month at noon at the Greenville Golf and Country Club. The organization is composed of

interested businesses, industries and individuals.

New GUC Staffer

Dave Frazier has joined Greenville Utilities as director of the newly established customer services department. GUC has announced. Frazier will administer activities of the 15-person department which includes customer and energy services and public information.

Frazier was formerly assistant administrator of customer services in Columbus, Ohio. He has a bachelor's degree in business administration from Franklin University in Columbus. He and his wife, Yvonne, reside in Greenville.

Reading Group

The Greenville-Pitt International Reading Association will meet Monday at Western Sizzlin Steak House on 10th Street to accept new members and dues for the 1984-85 school year.

Writing consultant Cathy Harvey will discuss the young authors' project. Dinner begins at 5:45 p.m., followed by the meeting at 6:30 p.m.

For more information contact Teresa McLawhorn at W.H.

Masonry Contest

The 31st annual apprenticeship masonry contest will be held in Raleigh Oct. 15 at the State Fair, with 24 brick and blocklayer apprentices competing.

Participants must be registered apprentices with the N.C. Department of Labor's apprenticeship division and must be training with an employer who sponsors a registered apprenticeship program. For information contact Barry L. Judge, field representative serving Pitt County, c/o N.C. Dept. of Labor Apprenticeship Division, 4 W. Edenton St., Raleigh, 27601 or phone 733-7533.

Possession Charge

William Thomas Miller II, 26, of 1502 Cedar Lane, was arrested by Greenville police early today on a charge of possession of marijuana.

Officer E.M. Haddock said Miller was found in a car, parked in a lot off Reade Street, about 12:40 a.m. with a small amount of marijuana in his possession.

Arrest Made

Greenville police arrested Francis Wayne Mouser, 21, of Camp Lejeune on damage to real property and assault charges following a 12:15 a.m. incident today at the Elbo Room at 417 Cotanche St.

Cpl. M.C. Jernigan said Mouser was charged with damage to real property after about 10 wall mirrors were broken at the business.

Cpl. J.M. Simonowich said the assault charges resulted from a scuffle between Mouser and two other people.

Man Indicted

Robert F. Perry, 53, of Rustic Ridge Trailer Park, was indicted by a Pitt County grand jury Tuesday on two charges of taking indecent liberties with a minor and one count of dissemination of obscene materials.

The indictments against Perry, news director of WITN-TV in Washington, stemmed from alleged incidents several months ago involving two girls under 16 years of age.

Perry was arrested on warrants issued July 12. Sheriff Ralph Tyson said, as a result of an investigation started by the Craven County Department of Social Services. The Pitt County DSS also assisted in the investigation, said Tyson.

One indictment charged that Perry disseminated "material which he knew or reasonably should have known to be obscene" to a minor on May 12. The other two indictments charge that Perry took indecent liberties with two minors on March 24.

Robinson Elementary School in Winterville, or Leslie Washburn at Elmhurst Elementary School.

Meeting Scheduled

A meeting of the Greenville-Pitt County Black Coalition will be held Thursday night at Nazerene Church of Christ on Skinner Street. Officers and representatives of fraternal and civic organizations are invited.

Johnny Wooten, chairman, said the inaugural convention of black coalition movements in the area is scheduled for Sept. 23-29. Convention sites will be various local churches.

Preaching Service

A preaching service will be held at Holy Mission Holy Church at 7:30 p.m. Thursday with Ralph Love of Holy Trinity United Holy Church as the speaker.

Festival Calendar

A concert by the band "Silver Wings" will be held from 8 p.m. until midnight today in the Harris Shopping Center parking lot, Ayden, and youth night activities will begin at 7:30 p.m. near the Ayden town hall as the 10th annual Collard Festival continues its countdown to the weekend.

Youth night features a Michael Jackson look-alike contest at 8 p.m. and music by youth bands.

Play continued today in the men's softball tournament and carnival rides will begin at 6 p.m. on East Avenue.

Thursday's activities include:

•Men's softball tournament.
•Collard Festival beauty pageant, 8 p.m., Ayden Middle School auditorium, featuring 11 contestants.

PCC Registration

Pitt Community College will crank up Thursday for the fall 1984-85 quarter as classes begin for students previously registered at the college, school officials said.

Registration began Tuesday, PCC President Charles Russell said, and will continue through Friday. Registration for night classes will continue through Monday night.

"It (registration) looks pretty good so far," Russell said. "At this point I would say we have about the same number of students as last fall, maybe more. We have a lot of people registering tonight and tomorrow night, so its hard to say."

Wine 'Blessing'

A "Blessing of the Grape" ceremony will be held at 2 p.m. Saturday at the Duplin Wine Cellars, located half a mile north of Rose Hill.

The ceremony, to be conducted by the company's head winemaker, will be followed by a wine tasting. The wine cellars will be open to the public from 9 a.m. to 5 p.m.



WOOD, METAL, WOOD — Three stages of wood and a discarded metal farm machine add up to a typical Pitt County roadside rural composition. The weed-filled open space has, in the foreground, dead limbs fallen from a large oak tree, a rusting piece of farm equipment, and a sturdy small barn surrounded by trees. (Reflector Photo by Jerry Raynor)

Pilot Dies, Wife Lands

MIAMI (AP) — A woman whose "only thoughts" were to help her fatally stricken husband get to a hospital used radio instructions to safely land a light plane from a mile in the sky despite never having piloted before.

The Piper Cherokee with Elaine Yadwin, 61, at the controls thumped to the ground with the only damage a broken front landing gear more than an hour after her 66-year-old husband, Richard, slumped at the controls from an apparent heart attack.

The Coast Guard flew the couple to Palmetto Hospital, where Yadwin was pronounced dead on arrival, said hospital spokesman Ernie Domenech.

Another passenger, whose name was not released by authorities, at times had to hold back Yadwin's body while Mrs. Yadwin manipulated the controls.

"The only thoughts that went through my mind were, 'I've got to help him, I've got to help him.' We had to come down. He needed help," said a teary-eyed Mrs. Yadwin after her ordeal Tuesday.

Minutes before noon, Mrs. Yadwin took over the Piper Cherokee when Yadwin lost consciousness during a flight over the Everglades, said Jack Barker, a spokesman for the Federal Aviation Administration in Atlanta.

Sixty-three minutes later, the ordeal was over.

New Housing Units Nearing Completion

Housing Authority officials are predicting that units in Greenville's new project, West Meadowbrook, will be ready for occupancy by early October, despite earlier plans to have the units ready by mid to late August.

The delay, director Joe Laney told board members at the authority's regular meeting Tuesday, is in part due to bad weather in July. He added that there have been some contracting problems as well.

Laney said the units are now approximately 70 percent complete; however, he added that he had hoped the project would be 75 percent complete or better by this time.

In other business, housing director Sallye Streeter reported that all authority units were occupied at the end of August. The average rent for units was \$106.14 with \$102 at Meadowbrook, \$107.33 at Kearney Park, \$103.31 at Moyewood I, \$115.92 at Moyewood II, \$99.57 at Hopkins Park, and \$118.30, Newtown.

Laney reported that 118 of the authority's 120 Section 8 units, 107 of

109 Section 8 moderate rehabilitation program units and all 68 University Tower units are occupied.

Discover new worlds! Meet new people! Visit Sheppard-Memorial Library!

#1
Cleaning Service

Well Experienced Bonded

Kelly **Girls**

Now Expanding In Greenville Area. Aiming To Please.

- Homes
- Business
- Routine Help
- Spring Cleaning

946-0609

Definitely Worth Calling For Good Service

Interested In Swimming?
Greenville Swim Club
Fall Swim Program
Ages 6-18 Improve Your Competitive Swimming Skills

For More Information About The Swim Club, The Fees, And Times Of Practice, Contact:

Mary Ann Barnhill	756-4720
Beverly Bartik	757-0181
Mary Jane Mister	756-6577

Name _____ Phone _____
Address _____
Birthdate _____

Detach & Bring With You

Correction

Bob Yow, Ayden resident and captain of the sailboat "Deep Water," was incorrectly identified as a physician in the Reflector's Monday report of his second place finish in a Neuse River regatta. Yow is a nurse practitioner.

MASONIC NOTICE

A stated communication of William Pitt Lodge No. 734 AF&AM will be held at 7:30 tonight. Supper will be served at 6:30. There will be work in the Master Masons Degree.

Student Graduated

Kim M. Defelici of Greenville was one of 11 students who graduated Saturday from the nurse anesthesia program at the Bowman Gray School of Medicine at Wake Forest University.

The daughter of Mrs. Christene Defelici and Alfonso Defelici, she also holds a bachelor's degree in nursing from East Carolina University.

Completion of the two-year program allows a student to take a qualifying examination in December to become to certified registered nurse anesthetist.

Professors Spoke

Several East Carolina University School of Medicine professors spoke recently at a meeting of the state chapter of the American College of Surgeons in Boone.

Speaking were: Dr. Larry Lewis — industrial injuries; Dr. Hans Karlsson — methods of re-routing blood flow from the vessels of the spleen to reduce risks in liver transport, and Dr. L. Dale Williams — research directed at reducing the rejection of transplanted organs.

Wallace Communications

Residential-Commercial
Telephone Installation & Repair
Prewiring Available
Telephone, Data & Sound Services
Willia Wallace, Jr. (919) 758-4388
Rt. 6, Box 311-B, Greenville

Arlington Hall

Sale

Large Group Gift & Craft Items including:
Andrea West, Homestead,
Wind in the Willows &
Children's Clothing

1/2 price

New Artworks, Clothing, Craft & Gift Items Arriving Daily

327 Arlington Blvd. 355-2426
Open Mon - Fri. 10 to 5 & By Appointment

FALL FESTIVAL OF VALUES

20% OFF

Your favorite Styles, Colors and Sizes of...

- SKIRTS
- PANTS
- JEANS
- BLOUSES
- SHIRTS

PLUS:
20% OFF ALREADY
REDUCED ITEMS

Apply for
Cato Credit
or use our
Layaway Plan!

423 Evans Mall Downtown Greenville



RECIPIENTS — These two children are among 25 who attend the Farmville Child Developmental Center, a developmental day care and educational placement facility. The center has received United Way support for 15 years. The United Way launches its 1984 fund-raising drive on Thursday.

United Way ...

(Continued from page 1)

•Association for Retarded Citizens in Pitt County works to assure services for the 3,000 mentally retarded individuals in Pitt County; provides information and referral and public education. Approximately 100 retarded adults attend the ARC bi-monthly social events.

•Boys Club of Pitt County serves 870 boys ages 6-18 providing guidance through health, social, educational, recreational, vocational and character development programs.

•Camp Rainbow is a summer camp for children with cancer and their siblings; served 60 children ages 7-18; sponsored jointly with Pitt County Memorial Hospital and ECU Pediatrics.

•Children's Home Society handled 103 cases from Pitt County through its counseling and adoptive programs; has a toll-free line for ready access in problem pregnancy counseling classes.

•Day Camp for Handicapped Children is attended by 72 mentally and/or physically handicapped children ages 5-17 during the summer.

•Epilepsy Association of North Carolina has programs consisting of community health education, individual and family education, information program of consumer education for persons with epilepsy and chapter/social development; provides self-help skills and service in an advocacy role.

•Farmville Child Development Center serves 25 children in developmental care and educational placement ranging in age from 6 weeks to 16 years. These children generally function in the moderate to severe range of mental retardation or developmental delay.

•Florence Crittenton Services of North Carolina provides a residential facility for the unwed expectant mother. Twenty persons were served through its counseling and expectant mother programs.

•Flynn Christian Fellowship Home served 94 men in 1983 through its program of recovery for alcoholic and shelter for the homeless. Additional services include public education, counseling with families, information and referral.

•Girl Scouts served 433 girls through educational, leadership and character development programs. In addition, 140 adult leaders were trained to serve in the scouting program.

•Home Delivered Meals for the Elderly provided the funds for 18,000 more meals for the homebound elderly delivered by the Pitt County Council on Aging.

•Hospice of East Carolina provides direct volunteer services for advanced cancer patients and their families; services include food preparation, respite care, emotional support and counseling; provides coordination and referral to existing resources and is available to the family for a one-year bereavement period; served 90 patients and 98 families.

•Hospice of North Carolina serves as a service and support organization to local Hospice programs.

•International Social Services works with all agencies to solve individual and family problems which cross national boundaries.

•Medical Research Fund of North Carolina United Way provides a block grant for medical research to East Carolina, as well as the other three medical schools in North Carolina.

•Mental Health Association in Pitt County works through its citizen volunteers toward the prevention of mental illness and the improvement of attitudes, legislation and services for the mentally ill; provides public education promoting mental health and provides services to improve the quality of life for the mentally ill who are hospitalized; programs reach out to serve all persons in Pitt County.

•National Council on Aging provides a grant to the Pitt County Council on Aging to fund 11 service positions for older unemployed or underemployed; concerned with policies, research and programs of the elderly, as well as training and materials for local agencies.

•National Cystic Fibrosis Foundation is concerned with prevention, control and treatment of cystic fibrosis and other lung damaging

diseases; provides funding for treatment center at ECU.

•North Carolina Society for Autistic Adults and Children conducts a summer camp for autistic persons, has a Summer Teacher's Program, works with Division TEACHH for special workshops and conducts programs for parents groups.

•North Carolina United Way provides services, workshops and training for staff and volunteers of local United Way organizations in campaigning, budgeting and planning; convenes budget sessions for statewide agencies and conducts periodic evaluations of statewide agencies.

•Operation Sunshine served 220 girls through its after-school and summer program. Particular emphasis is on attracting girls who are usually neglected by existing or traditional programs.

•Pitt County Boy Scouts served 1,360 boys through its programs of educational leadership development. 454 adults were involved in the program. Explorer program served 261 teen boys and girls.

•Pitt County 4-H Council involved 1,454 youth ages 6-19 in the education learning-by-doing programs throughout the county, assisted by 207 volunteer leaders and 19 teen leaders.

•Real Crisis Intervention Center provided to 4,509 contacts free, confidential, supportive counseling and information and referral services for all problem areas; offers 24-hour telephone counseling, work-in center and off-site crisis teams.

•The Salvation Army assisted 4,711 persons through its programs which include providing food, clothing, fuel, shelter, counseling, disaster and emergency services.

•United Health Services is committed to reducing the incidence of alcoholism and drug abuse through planning, information, education and technical assistance to local groups and agencies.

County ... Farmville ...

(Continued from page 1)

March 28 tornado to gather information on the status of people affected by the storm and to offer assistance.

Jack Richardson, president of Pitt County Memorial Hospital, reported that "over 20 cardiac open heart procedures" have been done at PCMH since the open heart surgery program began in July. He also reported that the new emergency department facilities at PCMH should be ready for use in January.

Social Services Director Ed Garrison reported that applications for aid under the Low Income Energy Assistance Program will be taken beginning in early October, which checks being mailed to qualified applicants in February.

Garrison said county residents participating in the program last year received some \$525,000, and noted that the program in Pitt is "one of the largest ones in the state."

Commissioners also agreed to make space available in the county office building to begin consolidating city and county schools' food service operations.

Commissioners had lunch at the Eastern Carolina Vocational Center, then toured the facility with ECVV Director Daneel le Roux.

(Continued from page 1)

Pine streets (with Community Development Block Grant funds — \$8,500); a ditch from Pitt Street to Prince Road in Clairmont — \$14,000; a ditch behind Contentnea Street — \$24,000; a ditch on the property of Lawrence Speight on Contentnea Street to North Main Street — \$8,000; a ditch in Westwood — \$2,500.

The lease-purchase of a new garbage truck for \$45,000 this year was approved. The new truck has larger capacity and was able to collect residential refuse in less than two loads, completing the work in shorter time and with less fuel consumption. Approval was also given for a new police vehicle at \$9,500 and a utility administration vehicle at \$10,000.

The public works committee was asked to look at the need for paving of Baldree and Blalock streets and

how it can be done, considering the narrow width of the streets.

The Earl Umphlett CPA firm was approved to conduct the closeout audit of the 1980 CDBG program. The cost will be \$1,960.

The McDavid Associates firm was retained to administer the 1984 Community Development Block Grant. Budget amendments were enacted to provide for the purchase of property for a public works center at \$65,000 and to provide money for a load management system for the electrical system at \$43,750.

The need for gymnasium space was discussed. The tearing of the present gym on Belcher Street and the building of a new one adjacent to the J.Y. Monk Building was talked about. Commissioner Oliver Murphrey said he is in favor of pursuing cooperative arrangements with the Pitt County school system, which has three gyms in town.

The Bethel Clinic
Bethel, N.C.
Will Close Sept. 1, 1984

Anyone Desiring Medical Records May Pick Them Up Thursday And Friday, Sept. 6 & 7 Between The Hours Of 9 A.M. And 12 Noon And 2 P.M. To 5 P.M.

sears
Portraits to remember
today's magic moments

\$10⁹⁵ includes 95¢ deposit

2-8x10
2-5x7
10 wallet size

No appointment necessary. 95¢ for each additional subject in a portrait package. Poses our selection. Satisfaction guaranteed or your money back.

Also Available in Addition To This Offer:
Black Background & Double Feature
Portraits • Passport Photos
Copy & Restoration

OFFER GOOD FOR PORTRAITS TAKEN THRU SEPTEMBER 8

Studios located in most larger Sears retail stores. Studio Hours: Sunday: Store hours (where store is open). Monday & Tuesday: Store opening until 5 P.M. Wednesday-Saturday: Store opening until one hour prior to store closing.

Sears Portrait Studio
There's more for your life at Sears

Serum Sought
COLLEGE STATION, Texas (AP) — Scientists who have developed an effective vaccine against herpes in cattle have the long-range goal of creating a similar serum for humans, researchers said. Preliminary tests have shown that a vaccine developed by Baylor College of Medicine in Houston and administered to cattle at Texas A&M University is safe and effective, veterinary virologist Dr. Stewart McConnell said. Cattle herpes is similar to human herpes in makeup and ability to cause recurring infections

Bus Crashes
LEMGO, West Germany (AP) — A double-decker tour bus carrying senior citizens crashed head-on into a gravel truck, hit a tree and flipped over, killing eight passengers and injuring 21, police said. The crash occurred in light rain as the bus was rounding a curve. Police said the cause of the accident was under investigation. The bus was carrying people from the mineral baths at Bad Lippspringe to West Berlin, according to spokesman Volker Brechwald of the HARU-Reisen travel agency, which booked the tour.

—Get the most for your money—
Quality Products & Service
Call 756-3823 Or Visit Our Showroom
At 220 Airport Rd., Greenville
Exsel Industries, Inc.
Your local stocking distributor of chemicals and janitorial supplies.

FAMILY DOLLAR

Register \$100,000 To Win! Sweepstakes
\$25,000 Cash Grand Prize

7-1st Prizes - 1985 Chevrolet Cavalier Sedans
7-2nd Prizes - Hitachi 45 inch Wide Screen TV's
7-3rd Prizes - Fisher Cameras With Magnavox Video Cassette Recorders/Tuners

7-4th Prizes - STP Richard Petty Go-Carts
7-5th Prizes - Panasonic Video Cassette Recorders

89¢ QUART QUAKER STATE Regularly 1.15, Deluxe 10W40 motor oil.

4 FOR \$1 IRISH SPRING Regularly 3 For \$1, 3.5 oz. bar soap. Limit 4.

\$1 BOX 42 OZ. PUNCH Regularly 1.49. All temperature detergent. Limit 2.

1³⁹ BEAUTY AIDS Brand name health and beauty aids including Dial, Jergens, L'Oréal & more.

\$1 KNEE HI HOSE Regularly 1.19. Pack of 2 queen size or pack of 3 regular size pantyhose.

\$4 3 PACK BRIEFS Men's Fruit-Of-The-Loom. 3 Pk. Men's Tees. . . . 5.50 3 Pk. Boys' Briefs. . . . 3.50

99¢ NYLON SOCKS Values To 1.29. Men's and boys' crew & over-the-calf or ladies' & girls' knee hi's.

888 PAIR SAVE ON OUR BEST ATHLETICS Ladies' and men's sport or casual shoes in many colors and styles.

3⁹⁹ EACH MIX 'N MATCH PEASANT TOPS AND PANTS Easy care short sleeve peasant tops in solids or prints. S.M.L. Coordinating solid elastic waist pants. Sizes 8 to 18. Extra Sizes. . . . 4.99

Prices Good At All Family Dollar Stores Through This Weekend. Quantities Limited On Some Items. No Sales To Dealers.

Harris Shopping Center, Memorial Drive Open Mon.-Sat. 9-9
1401 Ayden Plaza, Ayden Open Mon.-Sat. 9-9, Sun. 1-6

Pic 'n Pay Shoes®
The new fall looks you'll love at a very special sale price.

your choice
\$13

Clutches in assorted colors. **\$5**
Sheer-to-waist pantyhose, 3 pairs for **\$2.50**

Greenville Blvd. on 264 Bypass
Greenville, N.C.

Sale prices good thru Sat. MasterCard, Visa or choice. Open evenings

FALL SALE

From corporate to casual.
All around good looks for guys.



Stafford™ and Gentry®

Save on all suits, slacks and more.
Sale \$129.99 Reg. \$165. Suits sportcoats and slacks from our Stafford™ and Gentry® collections. Here, Stafford™ displays its style in a suit of polyester/wool. In stripes and plaids.



Sale 13.99 to 16.99

Lee Wright, Stafford™ and Gentry®
Try the handsome look of Lee Wright, Gentry® or Stafford™ dress shirts. Of comfortable easy-care cotton/polyester and polyester/cotton. Your choice of assorted colors.



20% off

This Sergio Valenti® 3-pc. suit.
Sale \$104 Reg. \$130. Sergio Valenti® 3-pc. tapered suit for the young man on the go. With convenient open patch pockets and side vents. In stripes or solids.

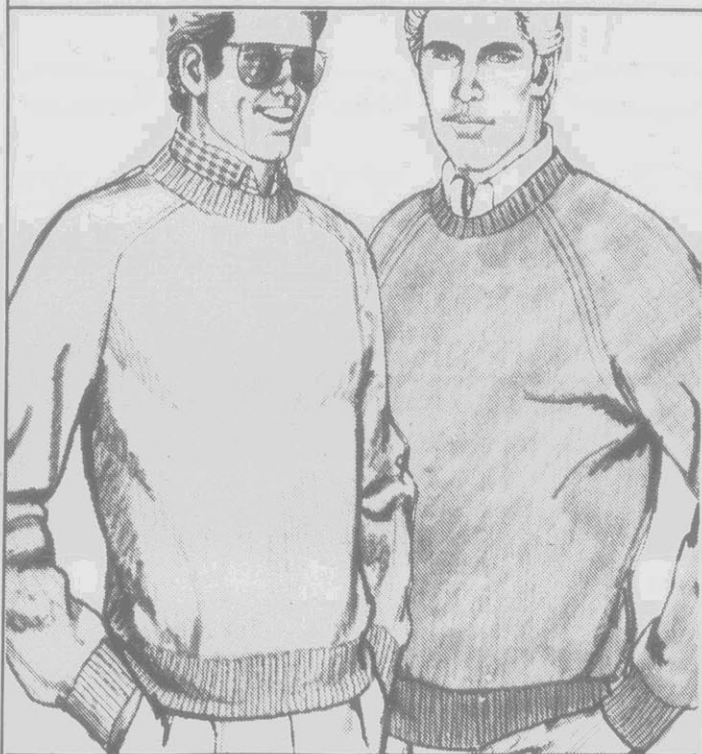

Sale 19.99

Crewneck sweaters for him.
Reg. \$24 and \$26. The choice is yours, a shetland sweater of wool/polyester blend. Or an all-cotton sweater. Both available in fashion colors. Men's sizes.



\$10 off

Dress leathers on sale for men.

Sale \$39.99 Reg. \$50 Oxford classics that never go out of style. Like our best-selling wing-tip and comfortable cushioned oxford. Both have full grain leather uppers. Men's sizes.

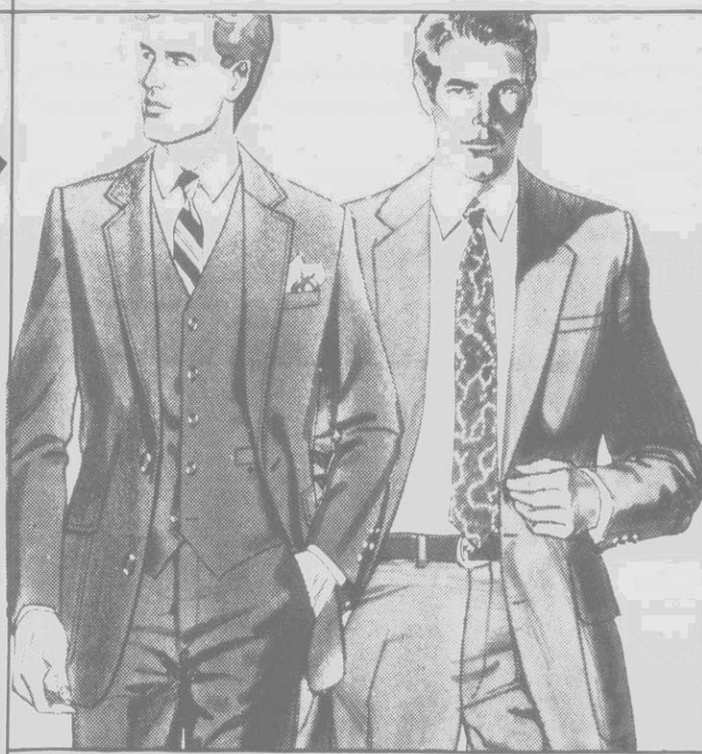

Sale 74.99 and 89.99

Suited separates for men.
Reg. \$96 and \$117. Levi's® and JCPenney Comfort Suited Separates® let you put it all together for a great look. Made of polyester/nylon and Dacron® polyester.



\$27 to \$75

Introducing Wyndham for her.
An exciting new look, exclusively ours. With superb detailing and a pure sense of color. As versatile as they are good looking. In fabrics like acrylic/wool and polyester/wool. For misses' and petites.



\$28 to \$75

Our new Wyndham for petites.
Wyndham designs the fresh, crisp look petites want, and tailors it to a size that fits. Fashion colors in polyester/wool and polyester.



Save \$4 to \$10

Motion™ separates for misses.
Sale \$13.99 to \$39.99 Reg. \$18 to \$50. Pick your favorite looks and put them together! With Motion™ separates. All of polyester. For misses' sizes.



JCPenney



Canadian Conservatives Sweep Election

TORONTO (AP) — Brian Mulroney's Progressive Conservative Party swept to a historic landslide victory over Liberal Prime Minister John Turner, winning the most Parliament seats ever captured by one party in Canada.

The national election Tuesday was the Tories' first majority victory in 26 years. Mulroney's troops trounced the Liberals in all 10 Canadian provinces, ousting a party that had governed for all but nine months of the past 21 years, including 15 years under Pierre Elliott Trudeau.

The Conservatives captured 211 seats in the 282-seat Parliament. The Liberals won 40 and the socialist New Democrats 30. One independent was elected.

The Liberals were crushed even in French-speaking Quebec, where the Tories got just one seat in 1980. This time the Conservatives took 58 of the 75 seats.

Mulroney, who as head of the winning party is almost certain to become the new prime minister, promised today that his Progressive Conservative government will improve conditions for business and "get the economy of Canada moving again."

During his campaign, Mulroney promised to improve relations with the United States and to spark the

economy, which is suffering from 11 percent unemployment.

Speaking early this morning to a cheering crowd in a hockey rink in his hometown of Baie Comeau, Quebec, Mulroney proclaimed "a new day for Quebec and a brand new day for this wonderful Canada."

Quebec has voted solidly Liberal most of this century, and always supported native son Trudeau. Mulroney, a 45-year-old electrician's son who became president of a mining company, won the Tory leadership last year largely on his promise to make inroads in Quebec.

Just a month ago, 12 seats in Quebec would have been considered a victory for Mulroney.

With 99 percent of the vote counted nationally, the Conservatives had 50 percent of the popular vote to 28 percent for the Liberals and 19 percent for the New Democrats.

The victory was the worst thumping the Liberals have received since John Diefenbaker and the Tories won 208 out of 264 seats in 1958.

"The people of Canada from coast to coast have spoken and the people are always right," Turner said in a concession speech. The prime

minister won the district where he was a candidate in Vancouver, and will now be leader of a tiny opposition in the House of Commons.

Mulroney promised to create a "new climate of confidence" for business, fight for women's rights, and work for world peace.

"Our objective and our mandate is to create jobs and to get the economy of Canada moving again," he said. "We owe it to our youth and the elderly as well."

Canadian law leaves it up to

Turner and Mulroney to arrive at appropriate date for the new government to take power. It is expected that Mulroney will need about two weeks to choose a Cabinet and discuss the changeover with civil servants before being sworn in. Conservatives have mentioned Sept. 17 as a possible date.

Turner will go into the history books as the shortest-serving Canadian prime minister of the century. He took office when Trudeau resigned on June 30.

Singed Squirrel Starts Blaze

MINOT, N.D. (AP) — A cemetery gardens manager used a tree-watering tractor to put out a grass fire begun by a squirrel which caught fire when it came into contact with an electrical transformer.

"It was a lucky thing I was here, and I had a tank of water behind the tractor," said Gene Olson, who was watering trees about 400 feet from the spot where the fire started Monday at Sunset Memorial Gardens.

Olson said he heard a snap and soon "saw the smoke" and the "squirrel singed," starting a grass fire in the southwest corner of the cemetery.

With no time to call anyone for help, Olson raced to the fire on his tractor and doused the area with a bucket and water from the 400-gallon tank he was using to water trees. In addition, he threw a couple of buckets of water on two large evergreen trees, which were in line with the fire, he said.

No Sudden Changes Expected By New Canadian Leadership

TORONTO (AP) — Brian Mulroney led the Progressive Conservatives to a crushing victory by promising "profound change," but his government is not expected to produce any sudden shift to the right.

Since replacing former Prime Minister Joe Clark as Tory chief last year, Mulroney has moved the party to the left on many key issues.

"Mulroney is no hard-faced Tory ideologue," his three biographers wrote in their book on Mulroney's life. "He is no clone of Margaret Thatcher or Ronald Reagan."

Mulroney pledged during the campaign to impose a minimum tax on upper-income Canadians, while protecting and even expanding all social programs, which he described as a "sacred trust."

The Tory leader also promised to find about \$3 billion (\$4.3 billion Canadian) in the next 2½ years for new government programs, mostly to combat the current 11 percent unemployment rate.

Many Conservatives in Parliament, however, disagree sharply with Mulroney on these issues. They have kept silent until now, trying not to harm the party's chances in the election.

Political observers are looking forward to seeing how well Mulroney will be able to maintain discipline among the large number of supporters he will have in the House of Commons.

Anyone who thinks Mulroney will move the country sharply to the right is "out to lunch" said Stephen

Clarkson, a political scientist at the University of Toronto.

Whatever his domestic policies, Mulroney will likely get along quite well with the Reagan administration.

He has promised to welcome foreign investment: the Trudeau government set up a government agency with the power to forbid investments not considered "beneficial to Canada."

Mulroney also said he would rewrite Trudeau's energy policy, scrapping a provision giving Canada a 25 percent share of any oil or gas discovery on federal lands. That rule, known as the "back-in" clause, was often cited by U.S. officials as the greatest irritant in relations between the country.

The new prime minister is also promising to treat the United States as a best friend, giving the U.S. government the "benefit of the doubt" on foreign policy issues.

"Mulroney is the most pro-American prime minister in living memory — perhaps forever," Clarkson said.

Mulroney has promised, though, to keep pressing the U.S. administration for action to fight acid rain, which is produced when clouds of pollution from American factories follow the winds to Canada and turn to rain.

A key indication of Mulroney's intentions will be his choice for foreign minister. The leading candidates are thought to be Joe Clark, who is on the party's left wing, and Sinclair Stevens, a right-winger whose policies would be closer to the Reagan administration's.

Vandals Open Valves, Corn Syrup Oozes

PHOENIXVILLE, Pa. (AP) — Emergency crews stuck with cleaning up a 400,000-gallon "lake of corn syrup" created when vandals emptied 28 train cars hoped to suck up the goo before bees swarmed to the sweet scene, officials said.

The cleanup at the railroad siding on the property of the Phoenix Steel Co. was to begin this morning with the syrup pumped into tank trucks, authorities said.

On Tuesday, authorities waded through ankle-deep syrup, turning off opened valves on the tank cars, but it amounted to closing the barn door after the horse was gone.

"I shut 14 tank cars off," said Joseph Moore, foreman of the Phoenixville Friendship Fire Company. "I believe most of them were completely empty."

Officials were worried that the sticky sweetener might attract swarms of bees, as did a similar suspicious spill from a single tank car at the same siding eight days earlier. But cool weather and a light rain apparently kept the insects away.

"It was a massive spill, just like a lake of corn syrup," Moore said.

Police and Conrail investigators, meanwhile, continued their search for the vandals responsible for the spill about 25 miles west of Philadelphia.

Prison Inmates Brawl, 7 Injured

DANVILLE, Ky. (AP) — State prison officials were investigating the cause of a "club-wielding street fight" between black and white inmates that involved up to 100 prisoners and left three guards and four inmates injured.

Warden Dewey Sowders said staff members at the Northpoint Training Center had received tips that there might be trouble before the fighting started Tuesday afternoon. But the exact cause of the 20-minute outbreak of violence was not yet known.

"I have no idea why. Evidently, it was a black and white thing," Sowders said. About 33 percent of the 683 inmates in the 700-inmate medium-security prison are black, he said.

A special emergency team was called in when the disturbance broke out, but no guns, tear gas or riot sticks were used to quell the outburst, Sowders said.

Sowders said guards Joe Chance and Rocky Rouston were admitted to hospitals with apparent concussions. A third guard, identified as Joe Bourne, suffered a wrist injury and was expected to be released from the hospital.

Sowders said he did not know the names or conditions of the four injured inmates, but said "it's nothing life threatening." The four were taken to the hospital, and two of them were expected to be admitted, he said.



THIS IS YOUR LUCKY DAY

... to save a lot of "green".

2 IN 1 WASHER/DRYER

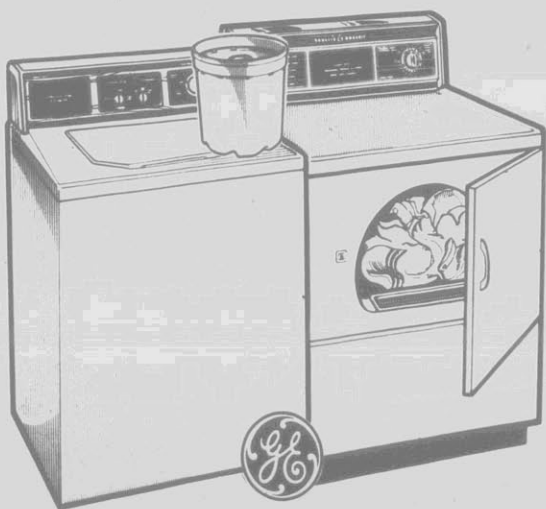

FAMILY-SIZE WASHER
Mini-Basket™ tub. 2 Cycle selections, regular and permanent press. 4 Water level options. 3 Wash/Rinse temperature combinations.

389⁹⁵
MODEL WWA5800B

MODEL DDE5944V
MATCHING GENERAL ELECTRIC AUTOMATIC DRYER
3 Cycles including permanent press. 4 Heat selections. Automatic Temperature Control. Automatic end-of-cycle signal.

319⁹⁵

Big SALE on MAYTAG Washers·Dryers·Dishwashers



\$199⁹⁵

BIG SAVINGS! HURRY!

Savings on Maytag Dryers and Dishwashers too!

Terrific Maytag Features
Number 1 • in long life • in lowest repairs • in lowest service costs • in nationwide preference (Based on a national survey asking consumers which brand of washer they'd like to own)

Hotpoint

■ Compact countertop microwave oven ■ 2 Power levels including Defrost setting ■ 2 Speeds — 35 minute timer ■ Handsome simulated wood grain cabinet.

Model RE53C

...just **\$199⁹⁵**

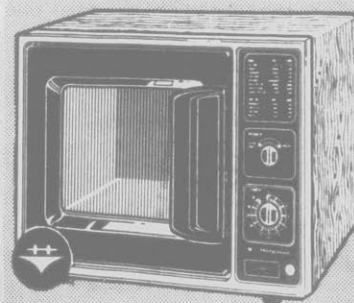

STARTS AS A VALUE ...STAYS A VALUE!

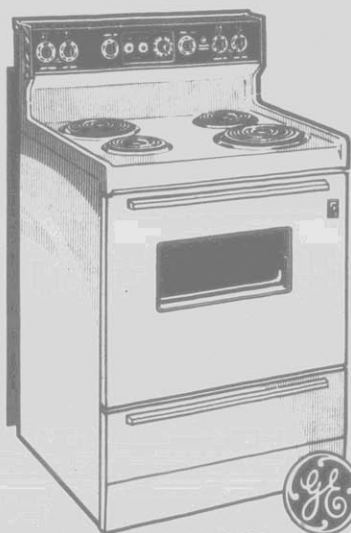

Model JBS26

30" RANGE WITH HANDSOME STYLING
Removable oven door with window. Two 8" Calrod® surface units. Plug-in surface units. Infinite heat surface unit controls. Clock, timer, automatic oven timer.

419⁹⁵

Quality performing built-in dishwasher!

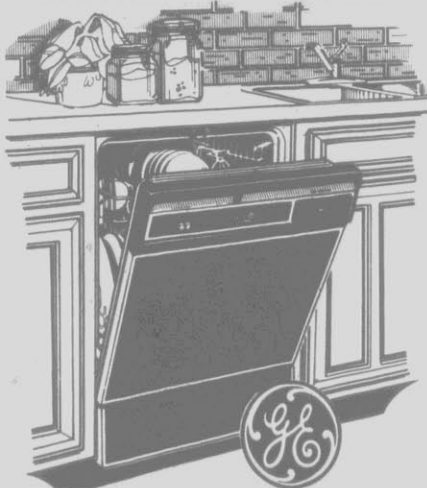

Glamorous glass shelves and energy efficiency



Model TBF17K

- 17.2 cu. ft. no-frost refrigerator.
- 1 full-width and 2 adjustable split-level glass shelves.
- Energy saver switch in normal position helps cut operating cost.
- 4.73 cu. ft. freezer.
- Equipped for optional automatic icemaker.

589⁹⁵

MODEL GSD400YBS

- 5-cycle wash selection normal wash & light wash.
- Energy saver dry option.
- 2-level washing action.
- Sound insulated.
- Dual detergent dispenser.
- Built-in soft food disposer.
- Porcelain enamel tub.
- Contemporary high-gloss jet-black door panel.

299⁹⁵

V.A. Merritt & Sons

207 Evans Street, Downtown Greenville

"Serving Pitt County For Over 50 Years"

752-3736

• The Best Place For The Best Price • The Best Place For The Best Price • The Best Place For The Best Price • The Best Place For The Best Price •



\$17 Each, reg. 21.97
Unfinished ladder-back chair. Paint, stain or use unfinished. An ideal chair for any room in the home. Durable and sturdy.

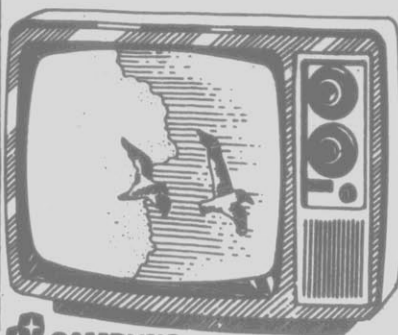

SAMSUNG
59.88 Each, reg. 69.88
Samsung® 12" black and white television. Features solid state chassis and high impact plastic molded construction. Model #BT303NK. Save \$10.

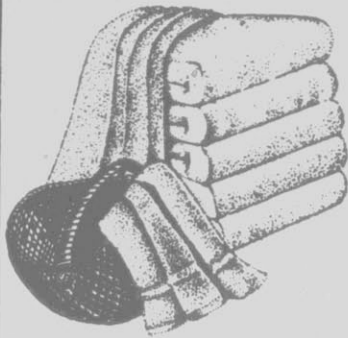

1.00
BATH TOWELS
 Reg. 1.88
2/1.00
WASH CLOTH
 Reg. .88

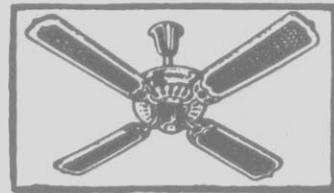

49.00
WORLD FAMOUS 52" CEILING FAN

3 speed, reversible. Antique brass light adaptable. Reg. 59.99



49.99
BENTWOOD OAK FINISH ROCKER

With cane seat and back. A beautiful piece for your home. Reg. 68.88 each.



Household Savings

**Savings worth shouting about!!
 Shop Now and Save Big!!**



3.00
ANCHOR HOCKING COLA GLASSES
 1 dozen 12 oz. clear glasses. Reg. 4.95

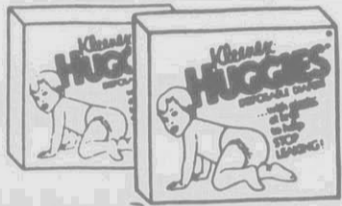

2/5.00
HUGGIE'S DISPOSABLE DIAPERS

Choose newborn, 24 ct., or Daytime, 18 ct., Reg. 3.17



\$1 Each, reg. 1.17
Colorweave utility rug. Multi-color. Machine washable. Reversible. This colorful longwearing rug is useful in any room.



13.88 Each, reg. 16.97
Relax and enjoy bedtime reading with a corduroy bedrest by Linde® Products. Many colors available.



2/3.00
PAMPERS TODDLER 12'S
 Reg. 2.27
2/5.00
PAMPERS NEWBORN 30'S
 Reg. 3.08

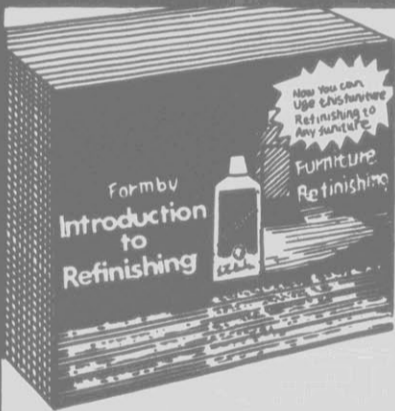

8.88 Kit, reg. 12.99
Formby's® refinishing kit. Everything needed to refinish furniture.



\$2 Each
Krylon® spray paint. Many colors. 12 oz. nt. wt. Reg. 2.97



2/1.00
SCOT TOWELS
 Reg. .79

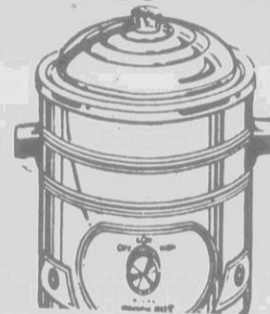

11.00
RIVAL® 3½ QUART SLOW COOKER
 In almond or harvest. Makes cooking easier and saves energy. Reg. 14.97



1.50
KORDITE TRASH BAGS
 Reg. 2.17



2.88 BOX
STAYFREE MAXI PADS
 Available in regular, deodorant or super. 30 ct. box.

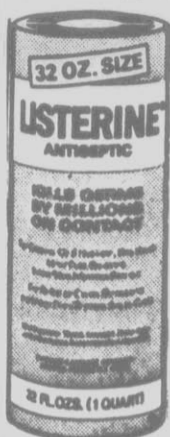

1.97 SAVE 50¢
LISTERINE Antiseptic Mouthwash in 32 fl. oz. bottle. Reg. 2.47

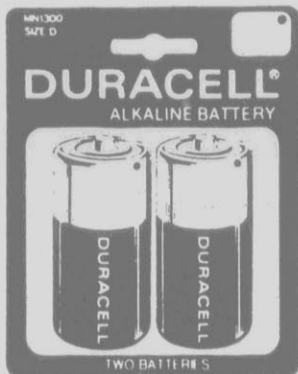

2/3.00
DURACELL BATTERIES
 Reg. to 2.17



11.50
IRONING BOARD
 Adjustable board means less bending. Durable steel. Reg. 14.97

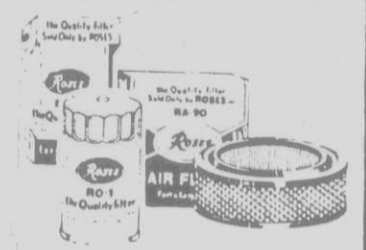

1.96
ROSES AIR & OIL FILTER
 Reg. to 2.96

1.99
SHOWER CURTAIN LINERS
 Reg. 2.87
 Asst. Colors

3/1.00
ODD LOT SKEINS
 By famous knitting worsted 3 oz. weight.

6.00
3 1/2 BENCH VISE
 Reg. 9.97

2/1.00
 Reg. 66¢
 1/2 Gallon
CLOROX

75¢
MARK CHARCOAL LIGHTER
 Reg. 1.18

THE PLAZA

• The Best Place For The Best Price • The Best Place For The Best Price • The Best Place For The Best Price • The Best Place For The Best Price •

• The Best Place For The Best Price • The Best Place For The Best Price • The Best Place For The Best Price • The Best Place For The Best Price •

• The Best Place For The Best Price • The Best Place For The Best Price • The Best Place For The Best Price • The Best Place For The Best Price •

Chile Clamps Down On Anti-Military Protest

SANTIAGO, Chile (AP) — The government enforced a curfew today in the capital and closed four universities after a French priest, one of his slum parishioners and a 14-year-old boy were killed in violent demonstrations against military rule.

More than 50 people were injured and 270 were arrested by riot police Tuesday in the first of two days of planned demonstrations, the most widespread anti-government protests in Chile in six months.

The demonstrations, centered in this Andean capital, forced most shops to close several hours early and sharply curtailed public transport and school attendance.

French Embassy spokesman Jean Mazoyer said the Rev. Andre Jarlan, 43, died in his second-floor office in the Santiago district of La Victoria on Tuesday when he was hit in the neck by two bullets apparently fired through the wall from outside. Witnesses said riot squads had fired automatic weapons at demonstrators on the same block a

half hour before. Earlier Tuesday, a 35-year-old rehabilitated drug addict was shot dead in the back while manning a street barricade in the same slum neighborhood in southwestern Santiago, said the Rev. Pierre DuBois, a Roman Catholic priest. Police said the slain man was a "common criminal" and the shooting was not related to the protests.

In an incident at another street barricade in a suburban neighborhood in southern Santiago, a 14-year-old was fatally shot late Tuesday, police confirmed early today.

The government imposed a curfew of midnight to 5 a.m. in Santiago so police could clear flaming barricades set up by youthful protesters at intersections in a score of outlying districts. It also closed four volatile university campuses, decreed censorship of two independent radio stations and seized editions of two opposition magazines from newsstands.

The protests are intended to pre-

ssure President Augusto Pinochet to restore democratic rule came as the 68-year-old army commander approaches the 11th anniversary of the 1973 military coup that toppled an elected Marxist-led regime and brought him to power.

Gen. Roberto Guillard, governor of metropolitan Santiago, said, "a very small percentage of the people, who have some mental problems," took part in the protests, which he

said were "destined to fail." Mario Sharpe, president of the six-party Democratic Alliance that called the demonstrations, said they "showed the desire of an immense majority of Chileans for democracy." He said the regime imposed censorship "to hide the magnitude of the protest and the violent repression."

The opposition alliance urged Chileans to stay home today, and

leftist groups said they planned to block access roads to keep commuters out of the center of this city of 4 million people. Associations of small businessmen and truckers announced support for the one-day work stoppage.

Most downtown shops closed

Tuesday afternoon after riot police with clubs, dogs and water cannon attacked hundreds of demonstrators singing the national anthem in Santiago's main square, then skirmished with them for hours in the surrounding streets.

Soviet Deputy Premier Dies

BERLIN (AP) — Leonid A. Kostandov, a deputy Soviet premier, died of a heart attack today while visiting East Germany, the official East German news agency ADN said.

Kostandov, 68, one of 10 Soviet deputy prime ministers and a member of the Soviet Communist Party Central Committee, had been on a tour of East Germany after leading the Soviet delegation to the annual Leipzig trade fair during the weekend, the agency said in a dispatch from Berlin.

ADN did not say when Kostandov arrived in East Germany or how long he had planned to stay.

The agency said he died suddenly of "a second heart attack" at 5:30 a.m., but did not say where or give other details.

ADN carried a medical bulletin signed by a Dr. Wittbrodt, identified as the medical director of the government hospital, saying Kostandov "suffered from chronic ... heart disease and arteriosclerosis following a first heart attack."

Details about Kostandov's initial heart attack were not provided.

In a separate report, ADN said East German leader Erich Honecker and other Politburo members "extended their deepest condolences" to the Soviet ambassador in East Berlin.

Kostandov was appointed a deputy premier Nov. 4, 1980, after serving as minister of the chemical industry

for 15 years.

Born Nov. 27, 1915 in what now is the southern Soviet Republic of Turkmenia, he was graduated from the Moscow Institute of Chemical Engineering and worked in Central Asia before being named to a succession of government posts.

Some Ford Prices Will Rise For '85

DETROIT (AP) — Ford Motor Co. has given its dealers a list of tentative prices for 1985 cars showing no increases in the base prices of its two smallest cars and increases on other models no greater than 6.5 percent, a Ford spokesman said.

Ford plans to announce its final prices for the 1985 fleet sometime before the official introduction of the new models Oct. 4, spokesman Gene Koch said Tuesday.

The company's two smallest cars, the subcompact Escort and its twin, the Lynx, tentatively list at \$5,620 and \$5,750, respectively, Koch said.

The lowest-priced Mustang from 1984, the L model, will be dropped from the line, making the LX the least expensive version of that sporty car, Koch said.

Comparably equipped Mustang LX models tentatively carry a base price of \$6,885, down from \$7,281 in 1984, he said.

Tentative prices for other cars range from a \$52 increase for the lowest-price, two-seat Ford EXP to a \$1,181 increase for the Lincoln Town Car, increases of 0.78 and 6.5 percent, respectively.

Other tentative base price increases include 2.3 percent for the Ford Tempo, 3.6 percent for the LTD, 4.9 percent for the Thunderbird, 5.5 percent for the Mercury Grand Marquis and 5.7 percent for the LTD Crown Victoria.

The most expensive car in the 1985 line would be the Lincoln Continental Mark VII, with a tentative base price of \$22,631, up 4.4 percent.

General Motors Corp. has announced tentative price increases for its 1985 base models averaging 2.3 percent; Chrysler Corp., 1.7 percent; and American Motors Corp., 4.1 percent.

GM Price Hike Is Only \$292

DETROIT (AP) — The Associated Press erroneously reported Monday that General Motors Corp.'s initial price increase for 1985 averages \$1,325 per car including options.

The average introductory price increase for 1985 models is \$292, excluding options, according to GM.

However, GM said the average buyer is expected to add options to its car that would boost the average spent on a 1985 model to \$12,931, an increase of \$1,325 over the 1984 average.

**OUR NEW OFFICE
CUMMINGS PLASTIC
SURGERY CLINIC**

Richard E. Cummings, M.D.
Plastic And Reconstructive Surgery
Hand Surgery
Cosmetic Surgery

2508 North Queen Street
Kinston, N.C. 28501
523-7082
1-800-682-2662

BETTER CARPET SALE THAT WILL LAST AND LAST AND LAST AND ...



Bostic-Sugg
Furniture, Inc.
Our 44th Year
Furniture of Excellence

401 West 10th St., Greenville - 758-2513

SPECIAL CLOSE-OUT PURCHASE



**100% NYLON
SCULPTURED
CARPET ALDEN'S...
VALUE UP TO
\$10.00 SQUARE YARD**

SALE PRICE

\$5⁹⁵
SQUARE
YARD

SELECT FROM 5 COLORS
MYSTIC ROSE...
CRYSTAL BLUE
LOTUS...BALSAM GREEN
ON HIGHLAND GREEN.



COMPARE AT \$17.00 SQUARE YARD!!

THICK PLUSH PILE VELVET CARPETS BY ALDEN.

SELECT FROM 4 COLORS...
MARINE BLUE...BEECHNUT TAN...
WEDGEWOOD BLUE...ANTIQUER ROSE.
LUXURIOUS THICK PILE. ONE INCH THICK.

\$11⁵⁰
SALE PRICE SQUARE YARD

COMPARE BOSTIC-SUGG'S CUSHION PRICES.

1/2 INCH THICK PRIME URETHANE CARPET CUSHION.

GOOD QUALITY	BETTER QUALITY	BEST QUALITY
99¢ SQ. YD.	\$2²⁵ SQ. YD.	\$3⁰⁰ SQ. YD.

Copyright 1984 Kroger Sav-on Quantity Rights Reserved None Sold To Dealers

Items and Prices Effective Thru Sat. Sept. 8, 1984

VICKS® LIFESTAGE™ MULTIVITAMINS

ADVERTISED ITEM POLICY: Each of these advertised items is required to be readily available for sale in each Kroger Sav-on except as specifically noted in this ad. If we do run out of an item we will offer you your choice of a comparable item when available. Reflecting the same savings or a raincheck when we will advise you to purchase the advertised item at the advertised price within 10 days. Only one vendor coupon will be accepted per item.

Pure..Lifestage contains no sugar, artificial colors, or preservatives. Personalized...Six individual formulas specially designed to be the best for each member of your family.

Childrens. 60 Ct.	\$2⁸⁷ Ea.
Teen, 30 Ct.	
Womens, 60 Ct.	
Mens, 30 Ct.	
Womens stress, 30 Ct.	
Mens stress, 30 Ct.	

your choice



CHILDREN

NO SUGAR
NO ARTIFICIAL COLOR
OR PRESERVATIVES



TEEN

NO SUGAR
NO ARTIFICIAL COLOR
OR PRESERVATIVES



WOMEN

NO SUGAR
NO ARTIFICIAL COLOR
OR PRESERVATIVES



MEN'S

NO SUGAR
NO ARTIFICIAL COLOR
OR PRESERVATIVES



WOMEN'S
STRESS

NO SUGAR
NO ARTIFICIAL COLOR
OR PRESERVATIVES



MEN'S
STRESS

NO SUGAR
NO ARTIFICIAL COLOR
OR PRESERVATIVES

OPEN 24 HOURS EVERYDAY
600 Greenville Blvd., Greenville

Mondale Tries For 'Fighting Fritz' Label

By WILLIAM M. WELCH
Associated Press Writer

President Reagan, seeking to lose the issue he ignited in Dallas, says critics have "greatly distorted" his views on religion and politics, while Democrat Walter Mondale is attacking the president's tax policies as unfairly favoring the rich.

Mondale, in an effort to regain the "Fighting Fritz" label he earned in winning the Democratic nomination, rolled up his sleeves and loosened his tie to earnestly denounce Reagan's tax cuts.

"I'm mad, I'm angry, I'm damn mad, because I don't think it's right," he said while campaigning Tuesday in California.

Mondale's running mate Geraldine Ferraro joined in the condemnation of the Reagan administration's economic program. But she also acknowledged her family had more money than its pockets because of the tax cuts Reagan sought and won.

Nonetheless, she said the cuts were unfair.

"And actually, could we have done without it? We could have. We would have lived as well," she said. "... There are a lot of people who are suffering in this country as a result of my getting the tax cut and Ronald Reagan getting the tax cut and George Bush and a lot of other people in this country who are upper income, and that's unfair."

Reagan was in Chicago today, ending his four-day campaign kickoff trip with a speech to the Chicago Economic Club before returning to Washington.

Mondale was in Salt Lake City addressing the American Legion, the same group Reagan spoke to Tuesday. And, like Reagan, he planned a morning courtesy call on Mormon Church officials.

Before the Legionnaires and again in Chicago, Reagan addressed the religion-in-politics issue on which he has drawn heat from his Democratic opponent.

Reagan told reporters in Chicago that he had raised the religion issue only once, referring to the large ecumenical prayer breakfast in Dallas on Aug. 23.

"What I said was greatly distorted," Reagan said. "My concern was not with government invading religion but with all those people that are trying to make government turn around and interfere with people's right to prayer."

Speaking on the day he accepted his party's nomination at the Republican National Convention, Reagan told the prayer gathering: "The truth is, politics and morality are inseparable. And as morality's foundation is religion, religion and politics are necessarily related."

Three days ago Mondale responded in a radio address, saying the Republicans in Dallas "raised doubts about whether they respect the wall our founders placed between government and religion."

Wearing a Legionnaire's cap from his own California post, Reagan sought to answer Mondale's criticism in his Salt Lake City speech.

"I can't think of anyone who favors the government establishing a religion in this country. I know I don't," he said.

"But what some would do is twist the concept of freedom of religion to mean 'freedom against religion,'" he added.

Campaign officials labeled Reagan's comments a clarification, but the issue may be raised again this week when both Reagan and Mondale speak to the B'nai B'rith in Washington.

Fellows Named

DURHAM (AP) — A Pulitzer Prize-winning science writer from the New York Times will be among journalists from the Washington Post and Time Magazine who will take part in a Duke University program of visiting journalists.

John Noble Wilford has been named the first Times-Duke Fellow. He and five other members of the New York Times staff to be named will spend a month each on the Duke campus during the current academic year.

All visiting journalists design their own academic programs while on campus, and also give lectures and assist in teaching.

Reagan restated his call for a constitutional amendment permitting organized prayer in public schools — while allowing children to opt out if they wish. He called voluntary prayer in the schools "in the spirit of the Constitution as our forefathers wrote it..."

Vice President George Bush, too, has been on the attack, angrily criticizing Mondale on defense spending and Central America policy in a speech at College Station, Texas. Hours later in Houston, though, he was forced to correct and hedge his charges.

Criticizing the Sandinista government in Nicaragua, Bush shouted: "If you walk like a duck

and you quack like a duck and you say you're a duck, you're a duck. They are Marxist-Leninists. They are not liberals as Mondale says."

At a news conference later, Bush said, "Maybe I used the wrong word" in quoting Mondale. He said the Democrat had called them "leftists ... It's something less than they are."

On the military, Bush contended Mondale wanted to "drastically cut spending" for the Pentagon. Questioned later, he hedged and said he wasn't sure what Mondale's program called for.

Mondale has not advocated cuts in defense spending but said he would increase military spending by

smaller amounts than those sought by the REagan administration.

"I believe he's said he would cut from what we've recommended," Bush said. "But I will now stop so I don't get in any hot water and just wait and see if that point is correct or not."

Mondale was in Compton, Calif., Tuesday before flying to San Jose and then to Utah. Criticizing the Reagan tax cuts in California, Mondale charged that Reagan's re-election would mean "the rich will get richer and the average American will get poorer."

He also dismissed the decline in unemployment rates since the end of the recession, saying that just meant

that Reagan has "put a lot of people he put out of work back to work."

In Washington, meanwhile, Treasury Secretary Donald Regan said Mondale's economic proposals would cost the average American household \$660 more in taxes over the next five years. He said Mondale is trying to "mousetrap the American people into another decade of high taxes, rising spending and still-bigger budget deficits."

Mondale replied: "They cooked up their own budget. Now they are trying to cook up my budget. ... All of it allows them to avoid saying what they will do to reduce the deficit. The deficit is not bad, it is obscene."

SHOP-EZE
West End Shopping Center
Phone 756-0960

WOODLAND

Thursday Luncheon Special
CHICKEN & PASTRY \$2.49

Special Served With 2 Fresh Vegetables & Rolls.

COMPARE OUR 90 DAY INTEREST RATE

00%

PAY 1/4 ON PURCHASE...
1/4 30 DAYS...
1/4 60 DAYS &
1/4 90 DAYS...
JUST LIKE PAYING CASH...
NO FINANCE OR CARRYING CHARGE.

SAVE UP TO 45% ON 100% WOOL IMPORTED ORIENTAL RUGS.

2 FT. X 4 FT. RETAIL SIZE \$45.00	SALE PRICE	\$25
3 FT. X 5 FT. RETAIL SIZE \$65.00	SALE PRICE	\$45
6 FT. X 9 FT. RETAIL SIZE \$175.00	SALE PRICE	\$120
9 FT. X 12 FT. RETAIL SIZE \$350.00	SALE PRICE	\$210



Bostic-Sugg Furniture, Inc.
Our 44th Year
Furniture of Excellence

401 West 10th St., Greenville - 758-2513

1/2 PRICE SALE

RETAIL PRICE \$899.00

RIDGEWAY COUNTRY OAK GRANDFATHER FLOOR CLOCK WITH WESTMINSTER CHIMES AND LYRE PENDULUM.

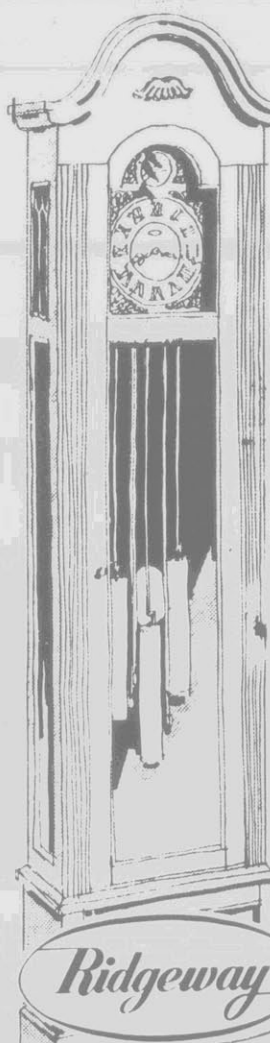

SALE PRICE \$449

- LYRE PENDULUM
- GLASS SIDE PANELS
- 8-DAY WIND
- LOCK ON DOOR
- 71 INCHES TALL
- SILENCER SWITCH
- PRICED SET UP IN YOUR HOME-50 MILE RADIUS OF GREENVILLE.

1/2 PRICE SALE

Ridgeway RIDGEWAY MANTEL CLOCKS

SALE PRICE **\$149**
RETAIL PRICE \$299

- WESTMINSTER CHIMES PLAY EACH QUARTER HOUR
- SOUNDS THE BIG BEN HOUR COUNT
- KEYWIND WEST GERMAN MOVEMENT
- ORNATE DECORATIVE BRASS FINISHED HANDLE
- TRADITIONAL ROMAN NUMERAL DIAL WITH ANTIQUED CORNER OVERLAYS



BOSTIC-SUGG SHOWROOM HOURS
8 A.M. TO 5:30 P.M. MONDAY-SATURDAY
OPEN TIL 9:00 P.M. FRIDAY NITES

QUEEN ANNE 36 INCH TALL PLANT STAND

...WITH GRACEFUL TURNED QUEEN ANNE LEG IN OLD WORLD FINISH!

PRICE IN BOX **\$12⁸⁸**

SALE PRICE **\$12⁸⁸**

36 INCHES TALL 12 INCH TOP



IMPORTED RATTAN CLOSE OUT SALE

 <p>RETAIL \$70.00 ROUND RATTAN PLANT STAND SALE PRICE \$33³³</p>	 <p>RETAIL \$70.00 SQUARE RATTAN PLANT STAND SALE PRICE \$33³³</p>
 <p>RETAIL \$60.00 RATTAN FOOT STOOL SALE PRICE \$27⁵⁰</p>	 <p>RETAIL \$50.00 RATTAN MAGAZINE RACK SALE PRICE \$22⁵⁰</p>

1/2 PRICE SERTA SLEEP SALE

SERTA ORTHO CUSHION AVON

TWIN SIZE **\$79** EACH SET

FULL SIZE... **\$110** EACH PC.

QUEEN SIZE... **\$239** 2 PC. SET

KING SIZE... **\$309** 3 PC. SET

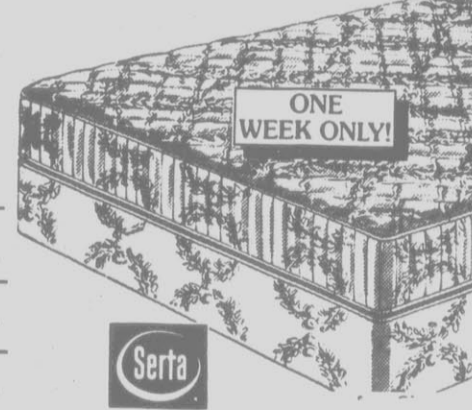

ONE WEEK ONLY!

SERTAPEDIC CLASSIC SLEEP SETS

TWIN SIZE **\$99** EACH PIECE

FULL SIZE... **\$124⁹⁵** EACH PC.

QUEEN SIZE... **\$309⁹⁵** 2 PC. SET

KING SIZE... **\$399⁹⁵** 3 PC. SET



Meet CHIP

Helps With Insurance Claims

Only at **KERR Drug Stores**

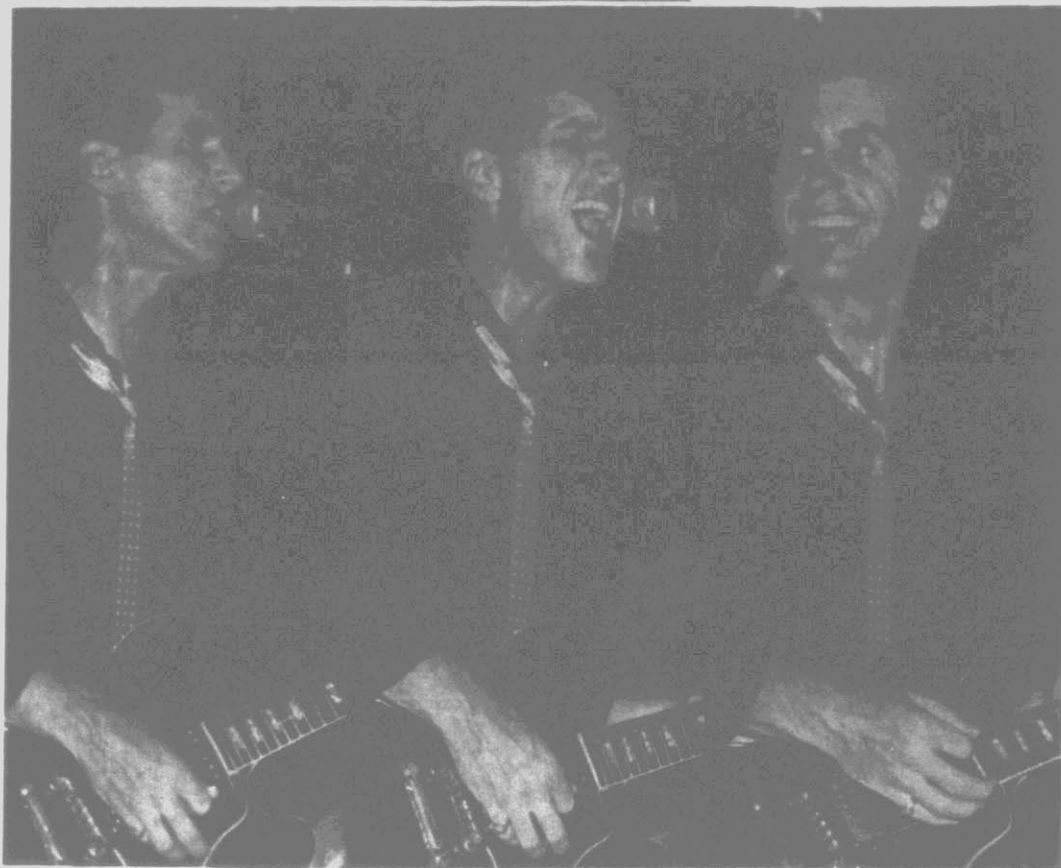

ROCK AND ROLL GUITARIST — Johnny Rivers played Friday at the Carolina Opry House. His short show included his hits "The Poor Side of Town," "Mountain of Love" and "Secret Agent Man." (Reflector photo by Jane Welborn)

'Tired' Singer Disappoints Audience In Local Show

By JANE WELBORN
Reflector Staff Writer

Johnny Rivers, the rock and roll whose hits include "Mountain of Love" and "The Poor Side of Town," played before a crowded, and ultimately disappointed, audience at The Carolina Opry House Friday night.

Rivers, a guitar player and singer, and his band played approximately 30 minutes and returned for two encore songs. His crowd-pleasing songs, as few as they were, included "Maybelline," "Seventh Son," "Secret Agent Man" and "Baby, I Need Your Loving."

During and after the brief show, the 42-year-old Rivers acted tired and unresponsive; he answered questions with short answers and didn't appear interested in talking about his new MCA album, "Heart-break Love," or his video which will be shown on Music Television next week.

Rivers, born Johnny Ramistella, said he was playing the guitar when he was 13 years old and formed his first band when he was in junior high school in his hometown of Baton Rouge, La. He moved to Hollywood in 1960, where he still lives with his family.

Of his early goals, Rivers said, "I

Certificates

SIMS, N.C. (AP) — After hours of grimy, exhausting work cropping tobacco near Sims, eight Haitian migrant workers will climb aboard what they hope is their ticket out of farm work forever.

Thursday, they will climb into a mobile classroom obtained by the Migrant and Seasonal Farmworkers Association this summer to bring English language skills to Hispanics and Haitians working in migrant camps in eastern North Carolina.

The adults in Thursday's class — whose native language is Creole — will receive graduation certificates signifying their attendance in the twice-weekly, 11-week English language curriculum.

MIGRATING PESTS

GREENSBORO, N.C. (AP) — In warm weather, many insect pests migrate from lawns to the inside of homes through cracks in the foundation of a house.

To help prevent insects such as ants and millipedes from entering the house, the makers of Spectracide insect control products suggest patching up cracks and other potential areas of entry. Then, they say, apply a five-foot band of insecticide.

wanted to play rock and roll music. I didn't know exactly what was going to happen."

What happened was a string of gold records beginning with "Memphis" in 1964; Rivers' own record company, Soul City, and publishing firm, Rivers Music, and the Monterey Pop Festival, which he helped found with John Phillips and Paul Simon.

In addition, Rivers discovered a young, black lounge act called The Versatiles, changed their name to The Fifth Dimension, and produced

their first hit, "Up, Up and Away." That single won the grammy award for "record of the year," and Rivers received a grammy as its producer.

Rivers mentioned that one of the highlights of his career was his one-year contract playing at the Sunset Strip nightclub "The Whiskey A Go-Go," starting the Go-Go dance craze in the mid-1960s.

The entertainer said he now is on the road performing three or four months a year. "The crowds are still receptive and I do a lot of big concerts," he said.

On The Town

Here's some of the after-dark entertainment activities scheduled during the coming week in Greenville:

Carolina Opry House

Wednesday, Sept. 5: Super Grit Cowboy Band will entertain. Ladies will be admitted for \$2, while men will be admitted for \$3.
Thursday, Sept. 6: Downtown, a motown band, will play.
Friday, Sept. 7: Downtown will perform, accompanied by the Alkaphonics.
Saturday, Sept. 8: Wendel Atkins will be the guest.

The Veranda at the Ramada Inn

Wednesday, Sept. 5-Saturday, Sept. 8: Blaze will play.

New Deli

Friday, Sept. 7: The Unknown Blues Band will perform.
Saturday, Sept. 8: The Mojo Collins Band will entertain.

Tree House

Tuesday, Sept. 11: Bruce Frye will perform.

King and Queen North

Wednesday, Sept. 5: The Showmen will play. Three Easy Pieces will entertain in the main dining room.

Friday, Sept. 7-Saturday, Sept. 8: Three Easy Pieces will entertain in the main dining room.

The Loft at the Beef Barn

Thursday, Sept. 6: Pianist Tom Jones will perform.
Friday, Sept. 7: Pianist Terry Taylor will entertain.

The Attic

Thursday, Sept. 6: Skip Castro will play. Ladies will be admitted free.
Friday, Sept. 7-Saturday, Sept. 8: Stormz will perform. East Carolina University students will be admitted for \$1.

Sunday, Sept. 9: Turbo Hydromatic will play. Admission for East Carolina University students is \$1.

LAURENCE S. GRAHAM

is pleased to announce the association of
PAMELA WEAVER BEST

in the General Practice of Law

Suite 2
Oakmont Professional Offices
114 Oakmont Drive
Greenville, NC 27834

YOU ARE INVITED
TO A SEMINAR

"HOW DISCOUNT BROKERAGE SERVICES
CAN SAVE YOU MONEY"

Sheraton Inn
Thursday, September 6
5:00-6:00 PM

SPONSORED BY:

FIRST FEDERAL SAVINGS AND LOAN OF PITT COUNTY

RSVP: 758-2145 — Sue Creech

Bookmobile Schedule Announced

The Pitt County Bookmobile schedule for 1984-85 has been announced by Sheppard Memorial Library. The schedule will become effective Monday, Sept. 10 and will continue through June 6, 1985.

The schedule includes 101 stops. There is no charge to borrow books from the bookmobile. Patrons may get a borrower's card from the bookmobile or from any of the libraries in the Sheppard Memorial Library system.

The bookmobile visits each area of the county on a three-week schedule. Listed below is a summary of the areas and dates the bookmobile will cover during the upcoming nine months. For more specific locations of the stop nearest you, call Sheppard Memorial Library 752-4177.

• Winterville Area — Mondays, Sept. 10; Oct. 1, 22, Dec. 3; Jan. 14; Feb. 4, 25; March 18; April 29; May 20.

• Ayden/Grifton — Tuesdays, Sept. 11, Oct. 2, 23; Nov. 13; Dec. 4; Jan. 15; Feb. 5, 26; March 19; April 9, 30; May 21.

• Falkland/Fountain/Farmville — Wednesdays, Sept. 12; Oct. 3, 24; Nov. 14; Dec. 5; Jan. 16; Feb. 6, 27; March 20; April 10; May 1, 22.

• Belvoir Township — Thursdays, Sept. 13; Oct. 4, 25; Nov. 15; Dec. 6; Jan. 17; Feb. 7, 28; March 21; April 11; May 2, 23.

• Pactolus Township — Mondays, Sept. 17; Oct. 8, 29; Nov. 19; Dec. 10; Jan. 21; Feb. 11; March 4, 25; April 15; May 6.

• Stokes/Bethel — Tuesdays, Sept. 18; Oct. 9, 30; Nov. 20; Dec. 11; Jan. 22; Feb. 12; March 5, 26; April 16; May 7, 28.



• North Greenville — Wednesdays, Sept. 19; Oct. 10, 31; Nov. 21; Dec. 12; Jan. 23; Feb. 13; March 6, 27; April 17; May 8, 29.

• Swift Creek/Chicod/Bells Fork — Thursdays; Sept. 20; Oct. 11; Nov. 1; Dec. 13; Jan. 24; Feb. 14; March 7, 28; April 18; May 9, 30.

• West Greenville — Mondays, Sept. 24; Oct. 15; Nov. 5, 26; Dec. 17; Jan. 7, 28; Feb. 18; March 11; April 1, 22; May 13; June 3.

• Bell Arthur/Stantonsburg Road — Tuesdays, Sept. 25; Oct. 16; Nov. 6, 27; Dec. 18; Jan. 8, 29; Feb. 19; March 12; April 2, 23; May 14, June 4.

• Greenville — Wednesdays, Sept. 26; Oct. 17; Nov. 7, 28; Dec. 19; Jan. 9, 30; Feb. 20; March 13; April 3, 24; May 15; June 5.

• Grimesland Area — Thursdays, Sept. 27; Oct. 18; Nov. 8, 29; Dec. 20; Jan. 10, 31; Feb. 21; March 14; April 4, 25; May 16; June 6.

Poisoning

WAKEFIELD, England (AP) — Eleven patients have died of food poisoning at a psychiatric hospital in northern England, health authorities say. About 50 other patients at Stanley Royd Hospital, an 850-bed facility, are being treated for food poisoning.

THE FINEST PECANS!

- For FUND RAISING
- For BUSINESS GIFTS
- For PERSONAL USE



Meaty flavorful new crop pecans all picked with care from our Georgia groves, processed and shipped fresh from our special plant!

ACE PECAN is your direct source for a complete variety of nutmeats—walnuts, pistachios, almonds, cashews, hazelnuts and mixed nuts. There is nothing in your local grocery store that compares in size, quality and just-picked freshness!

WRITE FOR FREE INFORMATION! Brochure, Wholesale Prices, How to Sell Brochure, and SAMPLE OFFER. Learn how organizations profit with our fund-raising program!

ACE PECAN COMPANY, INC.
Ninth and Harris Street
Dept. 764
P.O. Box 65
Cordale, Georgia 31015
Call TOLL FREE 1-800-323-0775
Dept. 764



MasterCard
VISA

Patio Specials Garden Shop

Prices Effective Wed.-Sat.

Prices Good While Supply Lasts

 <p>1.47 our reg. 2.37 20 lb. Potting Soil Ready to use, odorless, non burning, safe and effective to use.</p>	 <p>1.97 Cow Manure 40 lb. bag cow manure</p>	 <p>15.88 our reg. 21.97 Kentucky 31 Fescue</p>
 <p>5.97 our reg. 7.97 Super K Gro 20 lb. bag 27-3-3. Lawn Fertilizer develops thick, green lawns, contains slow release nitrogen.</p>	 <p>11.97 our reg. 15.27 Scotts Plus 2 Scotts Turf Builder plus 2 weed control fertilizer 17 7/8 lb. Scotts Plus 2 35 lbs. 19.97 our reg. 25.88</p>	 <p>9.97 our reg. 11.97 Scotts Turf Builder Lawn Fertilizer for St. Augustine lawns 17 13/16 lb. 21-33 and our Scotts Turf Builder 30 lb. 22-33 13.97 our reg. 16.88</p>
 <p>3.97 our reg. 4.57 50 lb. 8-8-8 Lawn and Garden Fertilizer</p>	<p>Choose From A Selection:</p> <p>AMES Hedge Trimmers Our Reg. 11.97 7.97</p> <p>AMES Hole Diggers Our Reg. 19.97 13.97</p>	 <p>11.97 our reg. 13.97 24" Brazer Grill Sturdy 4 legged grill, adjustable grid.</p>
 <p>49.88 our reg. 59.88 Ceiling Fan 36" 3 speed ceiling fan 10 year warranty, light kit adaptable, with pull chain. Choose from either brown or white</p>	 <p>69.00 Reg. 129.97 20" Electric Lawn Mower Single-blade, rotary mower 120 V 12 amp. 7" wheels, 1 1/2-3" cutting height. Model 7019-B. No rainchecks</p>	 <p>6.97 Fruit and Shade Trees All fruit and shade trees in stock. No rainchecks.</p>

Prices good through Sept. 9, 1984

What Matters Most Is You. KERR FALL OPENING SALE

Drug Stores

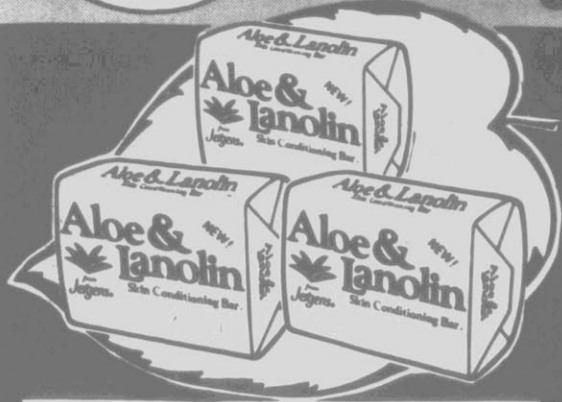

Aloe & Lanolin NEW!
Skin Conditioning Bar
Reg. 59¢ Each 4.75-ounces
2 Bars For \$1
Only
make conditioning your skin a "natural"

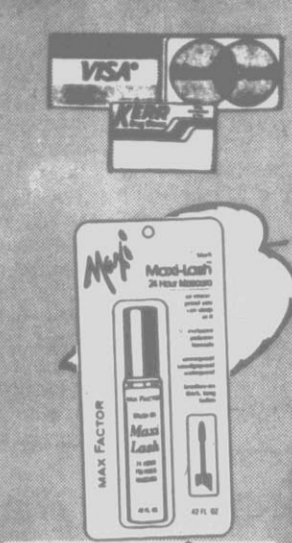

Maxi MAX FACTOR
Maxi-Lash Mascara
Reg. \$3.25 **2.29** each

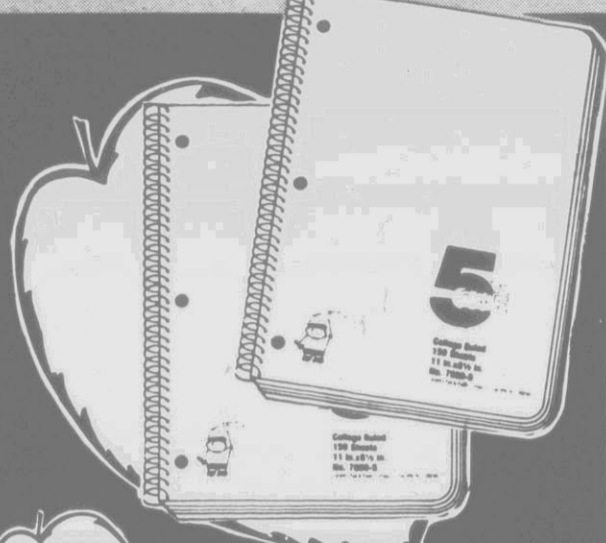

YOU SAVE \$1!
Carolina Pad Theme Book
5-Subject, 150 ct.
Regular \$1.99
99¢ each



Silkience
Shampoo or Conditioner
15-oz., 3 Formulas
Reg. \$3.29 **2.29** each



SAVE 60¢!
DRY IDEA
1.5 oz. Roll-on
Scented or Unscented
Your Choice
Reg. \$2.19 **1.59** each



Bare Elegance
8-oz. Body Shampoo
Reg. \$2.99 4-scents **1.99** each

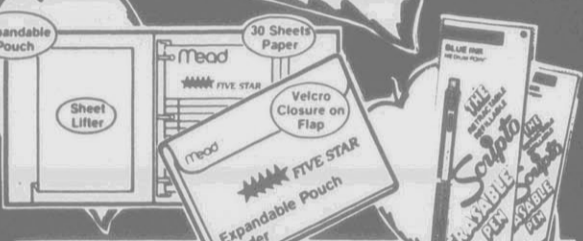

Mead
3-Ring Vinyl Binder
SAVE \$1.50!
Reg. \$5.49 **3.99** each



Scripto
ERASABLE PEN
\$1 Rebate
Reg. Price 1.98
Sale Price 1.00
Mail-in Rebate..... 1.00
Your Cost..... **FREE**

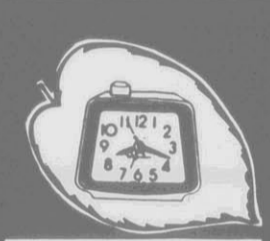

Ingraham
Alarm Clock
with Lighted Dial & Snooze Alarm
Reg. \$6.99 **4.99** each

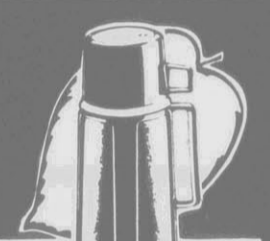

THERMOS.
Vacuum Bottle
Holds 36-oz.
Reg. \$6.99 **4.99** each



L'OREAL
Styling Mousse
Reg. or Extra Hold
Reg. \$3.65 **2.59** each



B.C. Powder
Arthritis Strength
SAVE \$1!
Reg. \$2.99 50's **1.99** Box



Visine
Eye Drops
SAVE 60¢!
Reg. \$2.09 1/2-oz. **1.49** each



Nestle.
Crunch Bar, Chocolate Bar with Almonds, or Milk Chocolate Bar
Your Choice Regular 35¢ each
4 Bars For \$1



YOU SAVE 50¢!
Woolite
Cold Water Wash
Regular \$1.59 Each
12-ounces **99¢** each



Pampers
Convenient Pack
SAVE 60¢!
Reg. \$8.99 **8.39** pack



Chubs
Thick Baby Wipes
Reg. \$1.49 **99¢** pk.



Brillo Steel Wool Pads
Box of 10
Reg. 79¢ **59¢** Box



MUSKOL
THE ORIGINAL
Insect Repellent Aerosol, 6-oz. or Lotion, 1 1/4-oz.
Reg. \$2.99 **2.49** each



2 Rebate
Windmere
Curling Iron
Reg. Price 5.99
Sale Price 3.99
Mail-in Rebate 2.00
Your Cost..... **1.99** each



SAVE \$1.40!
Downy
Fabric Softener
Reg. 2.39 **99¢** ea.
21.5-ounces



EVEREADY. Heavy Duty Batteries
• Size "AA" 4-pk. **1.49** pk.
• Size "C" or "D" 9-Volt, 2-pk. **99¢** Pack of 2

KERR DRUGS COUPON
KERR Film Developing
Print 1
Print 2
It's up to you
SAVE on single and Double Prints of 12, 24 or 36 exposure film for C-110, 126 and 135 type film. Offer applies to film brought in during this sale.
\$1 OFF Regular Price
Offer Expires 9/9/84

★ VALUABLE COUPON ★
Quality Jewelry by Island Magic
Offered to "Thank You" for shopping with
A \$10.00 VALUE
Your Choice Only **\$3.49** EACH
By Using Our Plan
Offer Expires 9/30/84
After purchasing \$10.00 of our other merchandise

How Our Program Works
Every time you purchase merchandise at this store, we will punch out the amount of your purchase. After purchasing \$10.00 worth of merchandise, you then may purchase one of the Exclusive Designs of Quality Jewelry from our Island Magic Display. Values to \$10.00.

Kerr's Policy: Kerr Drugs reserves the right to limit quantities of all items. Kerr's policy is to provide you with the items advertised at the price advertised. If due to some unforeseeable circumstance the item is not available, a rain check will be issued to enable you to buy the item later when available.

Stock And Market Reports

NEW YORK (AP) — Stocks opened broadly lower today, extending the market's post-holiday retreat.

Financial issues were numerous among the early losers, along with retail, auto and telephone stocks.

The Dow Jones average of 30 industrials, which opened at a two-week low, fell another 6.30 to 1,206.05 in the first 30 minutes of trading.

Declines jumped out to a 2-1 lead over advances on the New York Stock Exchange.

Investors remained preoccupied with the fear that U.S. interest rates will move higher in the weeks ahead despite an apparent slowdown in the economy's expansion, brokers said.

Government and private credit demands are expected to remain strong in the fourth quarter, and there is little evidence that the Federal Reserve is prepared to significantly ease its restraint of credit, they added.

Carnation edged up 1/8 to 79 1/2; Nestle S.A. said today it began its tender offer of \$83 for each of Carnation's shares.

Chase Manhattan fell 1/4 to 41 1/2. Merrill Lynch lost 3/8 to 30 3/4 and Manufacturers Hanover was off.

On Tuesday, the Dow Jones industrial average skidded 12.03 to 1,212.35 — its lowest level since Aug. 17, when it stood at 1,211.90.

Losers led gainers 5 to 2 on the NYSE, whose composite index fell 0.90 to 94.96.

Big Board volume totaled 62.11 million shares, compared with 57.46 million Friday. Markets were closed Monday for Labor Day.

At the American Stock Exchange, the market value index lost 1.08 to 214.33.

NEW YORK (AP) — Midday stocks	High	Low	Last
AMR Corp	28 1/2	28	28 1/2
AbtLabs	46 1/2	46	46 1/2
Aleo	35 1/2	35	35 1/2
Am Baker	16 1/2	16	16 1/2
Am Van	51 1/2	51	51 1/2
AmFamily	22 1/2	22	22 1/2
Ameritech	73	72 1/2	72 1/2
Am Motors	4 1/4	4	4 1/4
AmStanol	30 1/2	30	30 1/2
Amer T&T	18 1/2	18	18 1/2
BeatCo	28 1/2	28 1/2	28 1/2
BellSouth	73 1/2	74	74 1/2
Boise Cascd	31 1/2	31 1/2	31 1/2
Borden	59 1/2	59 1/2	59 1/2
Burlingt Ind	24 1/2	24 1/2	24 1/2
CSX Corp	23 1/2	23 1/2	23 1/2
Carroll-Lt	22 1/2	22 1/2	22 1/2
Celanese	72 1/2	72 1/2	72 1/2
Cent Sovia	15 1/2	15 1/2	15 1/2
Champ Int	28	28	28
Chryslr	33 1/2	33 1/2	33 1/2
Chrysler	28 1/2	28 1/2	28 1/2
Coca Cola	61 1/2	61	61 1/2
Colg Palm	23 1/2	23 1/2	23 1/2
Com Edis	33 1/2	33 1/2	33 1/2
ConAgra	38 1/2	37 1/2	37 1/2
Crown Corp	57 1/2	57	57 1/2
Crown Zell	33 1/2	32 1/2	32 1/2
DeltaArl	32 1/2	32 1/2	32 1/2
Dow Chem	31 1/2	31	31
duPont	49 1/2	49 1/2	49 1/2
Duke Pow	25 1/2	25 1/2	25 1/2
EastArl	4 1/2	4	4 1/2
East Kodak	74 1/2	74 1/2	74 1/2
Eaton/Cp	49 1/2	49	49
Exxon	43 1/2	42 1/2	43 1/2
Firestone	17 1/2	17 1/2	17 1/2
FlaPowLt	38 1/2	38 1/2	38 1/2
FlaProgress	21 1/2	20 1/2	21 1/2
FordMot	42 1/2	42 1/2	42 1/2
Fuqua	41 1/2	41 1/2	41 1/2
GTE Corp	40 1/2	40	40
GenCorp	37 1/2	37 1/2	37 1/2
GmDynam	62 1/2	62 1/2	62 1/2
GenElec	53 1/2	53 1/2	53 1/2
Gen Food	58 1/2	58	58 1/2
Gen Mills	54 1/2	54 1/2	54 1/2
Gen Motors	72 1/2	72 1/2	72 1/2
GenPart	29 1/2	29 1/2	29 1/2
GoPac	21 1/2	20 1/2	21 1/2
Goodrich	27 1/2	27 1/2	27 1/2
Goodyear	26 1/2	26 1/2	26 1/2
GraceCo	41 1/2	41	41 1/2
GiNorNek	37 1/2	37 1/2	37 1/2
Greyhound	22 1/2	22 1/2	22 1/2
HerculesInc	34 1/2	34	34 1/2
Homeswell	62 1/2	62	62 1/2
Hosp/Cp	44 1/2	43 1/2	44 1/2
ITT Corp	26 1/2	26 1/2	26 1/2
Ing Rand	44 1/2	44 1/2	44 1/2
IBM	122 1/2	121 1/2	122 1/2
Int'l Harv	8 1/2	8 1/2	8 1/2
Int Paper	54 1/2	54	54 1/2
IntRectil	24 1/2	23 1/2	24 1/2
K mart	22 1/2	22 1/2	22 1/2
KaisrAlum	14 1/2	14 1/2	14 1/2
KanebSyc	12 1/2	12 1/2	12 1/2
KrogerCo	35 1/2	35 1/2	35 1/2
Lockheed	44 1/2	44 1/2	44 1/2

LewisCp	88 1/2	88 1/2	88 1/2
McDermint	28 1/2	28 1/2	28 1/2
McKesson	37 1/2	37 1/2	37 1/2
Mead Corp	39 1/2	39 1/2	39 1/2
MinnMM	81 1/2	81 1/2	81 1/2
Mobil	29 1/2	29 1/2	29 1/2
Monsanto	47 1/2	47	47 1/2
NCNB Cp	28 1/2	28 1/2	28 1/2
NabiscoBrd	47 1/2	47 1/2	47 1/2
Nai Distill	25 1/2	25	25 1/2
NorfolkSou	55 1/2	55 1/2	55 1/2
NYNEX n	67 1/2	67 1/2	67 1/2
OlinCp	30 1/2	30 1/2	30 1/2
OwensIll	43 1/2	42	43 1/2
PacifiTel	61 1/2	61 1/2	61 1/2
Penney JC	49 1/2	49 1/2	49 1/2
PepsiCo	42 1/2	42 1/2	42 1/2
Phelps Dod	18 1/2	18 1/2	18 1/2
PhilipMorr	75 1/2	74 1/2	74 1/2
PhillipPet	38 1/2	38 1/2	38 1/2
Polaroid	30 1/2	30	30 1/2
ProctGamb	55 1/2	55	55 1/2
Quaker Int	66 1/2	66	66 1/2
RCA	24 1/2	24 1/2	24 1/2
RalstonPur	29 1/2	29 1/2	29 1/2
RepubAir	4 1/2	4 1/2	4 1/2
Revlon	39 1/2	38 1/2	39 1/2
ReynoldInd	62 1/2	62 1/2	62 1/2
Rockwel	29 1/2	29 1/2	29 1/2
StRegisCp	55 1/2	55	55 1/2
Scott Paper	31 1/2	31 1/2	31 1/2
SearyRobb	14 1/2	14 1/2	14 1/2
Shaklee	17 1/2	17 1/2	17 1/2
Skyline Cp	14 1/2	14 1/2	14 1/2
Sony Corp	14 1/2	14 1/2	14 1/2
Southwestern Co	16 1/2	16 1/2	16 1/2
SwstBell	63 1/2	62 1/2	62 1/2
Sperry Cp	39 1/2	39	39 1/2
StdOilInd	56 1/2	56 1/2	56 1/2
StGHOR	46 1/2	46	46 1/2
Stevens JP	17 1/2	17 1/2	17 1/2
TRW Inc	71 1/2	71 1/2	71 1/2
Texaco Inc	35 1/2	35 1/2	35 1/2
TenEastns	30 1/2	30 1/2	30 1/2
UniDynam	15 1/2	15 1/2	15 1/2
UnCamp	35 1/2	35 1/2	35 1/2
Un Carbone	33 1/2	33 1/2	33 1/2
Unroyal	13 1/2	13 1/2	13 1/2
US Steel	23 1/2	23 1/2	23 1/2
USWest	60 1/2	60 1/2	60 1/2
Unocal	38 1/2	38 1/2	38 1/2
Wachovia	27 1/2	27	27 1/2
WalMart	43 1/2	43 1/2	43 1/2
WestPep	38 1/2	38 1/2	38 1/2
Westphel	25 1/2	25 1/2	25 1/2
Weyerhae	28 1/2	28 1/2	28 1/2
WinnDix	30 1/2	30 1/2	30 1/2
Woolworth	36 1/2	36 1/2	36 1/2
Wrigley	56 1/2	56 1/2	56 1/2
Xerox Cp	37 1/2	37 1/2	37 1/2

Following are selected 11 a.m. stock market quotations:

Ashland prc	34 1/2
Burroughs	54 1/2
Carolina Power & Light	21 1/2
Conner	15 1/2
Duke	25 1/2
Eastman	46 1/2
Eckerd's	24 1/2
Exxon	43 1/2
Fidres	28 1/2
Flowers Corporation	28 1/2
Hatteras	14 1/2
Hilton	51 1/2
Jefferson	31 1/2
Kelco	71 1/2
Lowe's	19 1/2
McDonald's	76 1/2
McGraw	34 1/2
Omni Aikman	33 1/2
Piedmont	33 1/2
Pizza Inn	11 1/2
P&G	58 1/2
TRW Inc	71 1/2
United Tel	15 1/2
Dominion Resources	24 1/2
Wachovia	27 1/2

Theme Park

ASHEVILLE (AP) — Preliminary plans for a \$10 million year-round aquatic amusement park proposed for Buncombe County were unveiled Tuesday at a county Board of Commissioners meeting.

Mountain Magic Park would be a major theme park on the order of Carowinds, Six Flags and Kings Dominion, offering special discounts to area residents, according to Keith Bartlett of Arden. Bartlett is president of Land of Sky Entertainment Park, the development company.

Attorneys Waived

WILSON, N.C. (AP) — Two Lucama men charged in connection with an alleged child pornography ring have waived the right to court-appointed attorneys in their first court appearance.

James W. Ward, 59, and Doral Ray Mason, 49, waived the attorneys Tuesday in Wilson County District Court. A probable-cause hearing is scheduled for Sept. 10 for Ward and Sept. 17 for Mason.

The men were arrested last week and charged with two counts of crime against nature and taking indecent liberties with a minor.

No Appeal

SPRINGFIELD, Ill. (AP) — A school district that kicked a high school senior out of the National Honor Society after she became pregnant probably will not appeal a court order that she be reinstated, a lawyer for the district said.

U.S. District Judge J. Waldo Ackerman ruled that Linda Wort, 20, was a victim of sex discrimination and was denied equal protection under the law.

"I'm just so excited," said Mrs. Wort, who was dismissed from the honor group in February 1982. She filed the suit "to make sure it wouldn't happen again," she said.

The average person loses 50 to 100 hairs a day.

Man Shoots Officer, Takes One Hostage

CHARLOTTE, N.C. (AP) — A gunman shot and wounded a policeman early today and took a former girlfriend hostage at the home of her new boyfriend in what apparently started as a domestic disturbance, police said.

The gunman had barricaded himself inside the house in a residential neighborhood, police said. Several nearby homes were evacuated and traffic was diverted around the area, said police spokesman Bob Moss.

"We've been in contact with him (the suspect) all morning," Moss said. "We're just playing a waiting game. We don't plan to go on the offense unless it's necessary."

Officers were called to the house around midnight by the owner, said Capt. Roy Phillips.

"The man who lived in the house called the police and told them about the man being out there and being dangerous," said Phillips. Phillips, who was among the officers answering the call, said he was talking to the owner in front of the house when the suspect "opened up with a .22 rifle and there was a bunch of shots" behind the house. He said the gunman was believed to have a 12-gauge shotgun as well.

During the shooting, Officer James G. Brown, a 22-year police veteran, was hit in the shoulder, Phillips said. Brown was listed in stable condition at Charlotte Memorial Hospital this morning.

Police did not identify the suspect, the hostage or the owner of the house.

Tobacco Market

By The Associated Press
Following are final flue-cured tobacco figures for Tuesday on the Eastern Belt as reported by the Federal-State Market News Service:

Market Site	Daily Pounds	Daily Value	Daily Avg.
Ahoksie			no sale
Clinton	346,986	670,650	193.28
Dunn			no sale
Farmvl	404,350	795,780	196.80
Gidsboro	784,784	1,501,718	191.35
Greenvl	805,660	1,579,043	195.99
Kinston	829,094	1,623,773	195.85
Robrsvl			no sale
Rocky Mt.	697,905	1,322,024	189.43
Smithfld	664,074	1,273,131	191.72
Tarboro			no sale
Wallace	324,279	614,723	189.57
Washington	363,334	672,197	185.01
Wendell			no sale
Willmstn	426,170	791,465	185.72
Wilson	1,795,796	3,472,353	193.36
Windsor	420,670	787,136	187.11
Total	7,863,102	15,103,993	192.09
Season Totals	140,134,328	247,166,049	176.38

Average for the day of \$192.09 was up \$8.34 from previous sale. Subject to revision.

Army Activates Green Beret Unit

FORT LEWIS, Wash. (AP) — The Army has reactivated its first Green Beret unit since the Vietnam War, saying that "Soviet expansionism" is making special forces training more important than ever.

"Once again this nation finds itself in need of you," Maj. Gen. Leroy N. Suddath, commander of I Special Operations Command at Fort Bragg, N.C., said at a ceremony Tuesday at Fort Lewis, where the unit will train.

"Soviet expansionism" through support of insurgents continues to create a climate in which it may become necessary to use unconventional forces such as the Green Berets to stop "wars of liberation," Suddath said.

The 776-member unit will be under the command of Fort Bragg, but will train in Washington state, where they can make use of desert conditions at the Yakima Firing Range, forest and Europe-like conditions at Fort Lewis and mountain and snow conditions at Mount Rainier, said Bob Rosenburgh, a civilian spokesman for the base.

Suddath said the Green Berets' wartime mission of infiltrating behind enemy lines and their peacetime mission of training America's allies are essential for the nation's military strategy.

Border Proof

SAN YSIDRO, Calif. (AP) — A 35 percent increase in Border Patrol agents in the Southwest is proof the Reagan administration "means business when it comes to illegal aliens," an immigration official said.

Harold Exell, western regional commissioner of the U.S. Immigration and Naturalization Service, said the 436 new agents are part of an effort to "regain control of our borders." The government hopes the new agents will boost from 50 percent to 85 to 90 percent the number of illegal aliens captured crossing the border.

"If you train to your wartime mission," the general told the troops, "your peacetime mission will be in good hands."

The unit is a descendant of the Devi's Brigade, formed July 5, 1942, and deactivated in France in 1945. It was reactivated as the 1st Special Forces group in 1957 on Okinawa, Japan, and served through the Vietnam War. It was deactivated on June 28, 1974.

The reactivation demonstrates a higher level of deterrent strength and possible need for military advisers, Rosenburgh said.

"If a country is vulnerable and its military too small, the Special Forces can be invited in by the government and set up training camp and train sufficient number of indigenous troops to be able to start training their own people," Rosenburgh said.

Green Berets are primarily advisers, he said. They are fully capable of taking on commando operations on their own, as they did in Vietnam, he said.

Members of the Green Berets must meet special physical and mental qualifications and are specially trained. The Army looks for a "higher caliber" soldier to wear the Green Beret, Rosenburgh said.

The unit has been coming back to strength since last winter, with soldiers from other units and those with prior Special Forces experience being called.

Americans spent \$46.5 billion to improve or keep up their homes in 1981.

Obituaries

Bleau
NEW BERN — Mrs. Margaret Alice Bleau, 64, died Tuesday at Craven County Hospital.

Her funeral service will be conducted at 11 a.m. Friday at Cotten Funeral Home Chapel, New Bern, by the Rev. T.O. Terry. Burial will be in Greenleaf Memorial Cemetery, New Bern.

Mrs. Bleau is survived by her husband, Samuel A. Bleau of the home; two daughters, Mrs. Shirley Johnson of Greenville and Miss Sharon Bleau of Mt. Kisco, N.Y.; three brothers, Harry Ward of Talcott, W.Va., Herschel Ward of Brooks, W.Va., and Kenneth Ward of Alderson, W.Va.; four sisters, Mrs. Elizabeth McGraw of Sandstone, W.Va., and Mrs. Gloria Hodge, Mrs. Gail Cantley and Mrs. Geneva Jones, all of Alderson, W.Va., and two grandsons.

Family visitation will be from 7 to 8 p.m. Thursday at the Cotten Funeral Home Chapel.

Cox
Mr. John Cox, 87, of 403 W. Third St., died Tuesday night at Pitt County Memorial Hospital. He was the father of William E. Cox of the home and Mrs. Minnie Godley of Winterville. Funeral arrangements are incomplete at Mitchell's Funeral Home in Winterville.

Fussell
Mrs. Montie Pearl Stocks Fussell, 56, died Tuesday night at Pitt County Memorial Hospital. She was a resident of Maury.

Her funeral service will be conducted at 2 p.m. Thursday in the Wilkerson Funeral Chapel by the Rev. Charles R. Moseley. Burial will be in Pinewood Memorial Park.

Mrs. Fussell, a native of Greene County, attended the Greene County schools. In 1951 she moved to Conneaut, Ohio, where she lived until she returned to Maury in 1981. She attended the Brooks Frizzelle United Methodist Church.

She is survived by her husband, Joseph C. Fussell; one son, James Earl Fussell of Rock Creek, Ohio; one daughter, Mrs. Thomas Meaney of Kenmore, N.Y.; one brother, Clifton Ray Stocks of Route 1, Ayden; five sisters, Mrs. Magnolia Anderson of Maury, Mrs. Rose Letchworth of Lizzie, Mrs. Virginia Dare Clontz of Gaithersburg, Md., and Mrs. Thelma Dunn and Mrs. Harriett Graves, both of Ayden, and four grandchildren.

The family will receive friends at the funeral home today from 7-9 p.m.

Price
Mr. William Price of 422 Cadillac St. died today in Greenville Villa. He was the son of Mrs. Mary P. Smith. Funeral arrangements will be announced by Flanagan Funeral Home.

Tripp
Miss Velma Kay Tripp, 16, died Tuesday in Pitt County Memorial Hospital.

CASH REGISTERS
\$224 and up!
756-2215 Greenville
2801 S. Evans St.
Century Data Systems
We cannot afford a single dissatisfied customer.

Kenneth G. Hite and E. Cordell Avery

are pleased to announce the formation of a partnership for the practice of law.

JAMES, HITE & AVERY
400 West First Street
Greenville, North Carolina
(919) 758-4100
Dink James (of counsel)

ATTENTION GREENVILLE RESIDENT

Busted Play Turned Into Score

By WOODY PEELE
Reflector Sports Editor

Ed Emory would like to claim that he's a genius for coming up with the "fake field goal" touchdown pass Saturday night against Florida State.

He'd like to, but he can't. It wasn't, Emory explained at his press conference Tuesday, a fake at all — it was a busted play. "Our regular snapper, Stuart Ward, was in the (FSU mobile hospital) getting his chin sewed up after getting hurt, and we had to use Tony Smith (a flanker) to snap. He was high and to the side with his snap, and there was just no way for (Jeff) Bolch to get the ball down."

Emory said that the procedure here is for Bolch to roll out, yelling "Fire!" the codeword to release the backs and receivers into the end zone. However, Bolch, in the excitement forgot and only one re-

ceiver, Jeff Patton, broke to the end zone. "And he got knocked down, but got back up," Emory said. "If no one is open, Bolch is just supposed to throw the ball toward the goal posts, and if the receivers don't see the passer, they're supposed to head for the goal posts. It all worked out and Patton was there to catch his first touchdown pass."

So maybe it wasn't pretty, but it did turn out to be one of the bright spots for the Pirates in their 48-17 loss at the hands of Florida State.

Emory joked that there is talk of getting the legislature to pass a bill forcing certain in-state schools to play East Carolina. "But they're putting in a provision that prohibits us from playing in the state of Florida again."

"Personally, I'd just as soon be back there in December in a bowl game."

Turning to the more serious side,

Emory said the Pirates are exactly where they were a year ago, 0-1. "You can play with numbers and stats, but we're where we were last year now, 0-1."

"We will be a good football team. I just don't know when."

Emory said that Florida State was a better football team than he had given them credit for before the game. "And (Eric) Thomas is a better quarterback than I thought he was too. We tried to recruit him once. We should have kept it up."

But, Emory added, the Pirates helped Florida State as much as possible with two pass interceptions, a fumble and a blocked punt. "We didn't play with much intensity, enthusiasm, spirit or unity," the coach said, "and I'm disappointed in that."

Emory said he thought the Pirates were ready to play at the start of the game. "We stopped them for a field

goal and came right back and scored one of our own. Then, we held them again before starting to give up the ball. And when we were down 17-3 and needed something good to happen, they kicked the ball to Henry (Williams) for the first time and Patton ran into him, knocking the ball loose." FSU recovered around the 20 and scored again, eventually taking a 31-3 halftime lead.

"The defense didn't handle adversity. The tackling was pitiful, poor, poor.... When we tried to find some bright spots on defense, we couldn't find many."

Emory did find some on offense, such as the play of wide receivers Ricky Nichols and Williams, and running backs Jimmy Walton and Reggie Branch.

"We didn't play as well up front, but we haven't had our five starters together much at all," Emory said.

Center Tim Mitchell was the only lineman to draw Emory's praises.

"Still, we averaged 5 1/2 yards a play, had 19 first downs and 350 yards in total offense," Emory pointed out.

The coach thought both quarterbacks used, junior college transfer Robbie Bartlett and red-shirted freshman Ron Jones did well, but that Jones "executed the offense better." For that reason, Jones will draw the starting assignment this week against Temple University.

The big thing for the Pirates this week will be how they come back from the lopsided loss to the Seminoles. "A lot is written about how teams handle winning. And that would be the greatest thing in the world if we could do it this week. But we've got to learn about bouncing back, taking criticism and having a gut check."

"I saw some good things on offense and in the kicking game and some individual things on defense. I said before the season that we'd have to be patient. But the loss comes when we needed a win for the momentum to play Temple, to help our program and to fill Ficklen Stadium."

"Still, Florida State got embarrassed (53-14 by Florida) on December 3 and came back to win the Peach Bowl and then to beat us. Now we've been embarrassed and must come back."

Emory said, too, he was concerned about the senior leadership. "We don't have the Terry Longs and Earnest Byrnes and the like leading us this year; the guys who work their butts off on every play. This team will meet their standard, but I don't know when. Saturday, we got beat from the ears up, our minds got left behind by Florida State."

Chargers Young And Talented

By JIMMY DuPREE
Reflector Sports Writer

LITTLEFIELD — Youth and talent are abundant in the Ayden-Grifton football camp according to new Coach Dwight Tart, but leadership is still a missing factor as the Chargers prepare for their 1984 season opener Friday against Roanoke.

"We have some experience at some positions," Tart said. "But we've got some young guys who will play because of sheer talent. Our experienced players haven't taken over like we had hoped they would."

"We need to find some leadership. We've been inconsistent, as well. One day we'll have a good practice, really laying the sticks; the next day we're real calm — like they're saying to themselves 'we practiced well yesterday, let's take it easy today.'"

"That's something new to me as a coach; I've had to make adjustments."

Tart admits the change to a new coach after Dixon Sauls departed to take over at Farmville Central has presented problems, but he points to other factors that have affected the Chargers.

"(The transition) has been reasonably smooth," Tart said. "There's been a few kids who have not decided to accept a new coaching staff, but they seem to be falling a little more into place now."

"We've had a lot of kids out of practice as far as working on farms. We've been lenient about their work schedule, but when a kid's missed six or seven practices something has to be done."

Tailback Kelvin Harris will miss the opener for disciplinary reasons along with a knee injury, while guards Wheeler Davis, James Lane and Duane Dixon are doubtful after missing practice.

Junior Danny West and senior Shannon Peede have battled for the quarterback slot, but Tart conceded West is the likely starter against Roanoke. Peede will move to wing back in the Chargers' wing-I offense.

"Shannon Peede has shown a little more coolness at quarterback, but Danny probably has a little more ability as far as athletic talent is concerned," Tart said. "No matter which one starts, the other will be at wing back. We used both quarterbacks when we scrimmaged (Lejeune), and both did some good things. They both threw the ball well; I'll pass as much as my offensive line will let me."

"The line opened some nice holes, but as small as we are they don't stay open long. Our running backs fought for extra yardage, and I was impressed by that."

But the Chargers are small up front, averaging 185 pounds according to Tart. Center Mike Connor will be joined by guards Maurice Edwards and Tyrone Sutton, and tackles Jackie Braxton and either Tony McLawhorn or Burnice Bullock.

David Wiggins and Gene Johnson are the tight ends. Senior Mike Dixon and sophomore Alex Chapman are battling at fullback, while Jesse Hooker and Roger West are the leading tailbacks.

"Sometimes (our running backs) have played reasonably well and sometimes they've loafed around," Tart said. "We probably have more talent there than anywhere else, but



Ayden-Grifton Chargers

Ayden-Grifton High School will open the 1984 football season Friday, hosting Roanoke High School. Members of the Chargers are, first row, left to right: Shannon Peede, Mike Burnham, Maurice Berry, Fred Coley, Danny West, Timmy Best, Roger West, Wesley Hardee, Alex Champan, Mike Dixon, Jesse Hooker; second row, Kelvin Harris, Jackie Braxton, Grant Hargrove, John Carmon, Mike Connor, James Lane, Duane Dixon, Wheeler Davis, Reggie Barrow.

Tyrone Sutton, Burnice Bullock, assistant coach Mike Proctor; third row, trainer Denise Neveux, manager Jeff Peacock, assistant coach Alvin Frazier, Tony McLawhorn, Maurice Ellison, David Wiggins, Gene Johnson, Edwin Barfield, Cedric Hines, Charles Harris, Perry Ward, assistant coach Charley Rose, assistant coach Chris Ross, and head coach Dwight Tart. (Reflector Photo)

they've got to perform in the game.

"Both our scoring drives in the scrimmage were impressive because of the length — we took the ball 70 yards twice."

"I don't think we came into practice in good shape as far as wind is concerned. Defensively, I felt like we got tired, and that hurt us. I thought the defense looked good and hit well every series except the when Lejeune scored."

Johnson will be at nose guard, while Ellison and Sutton are the defensive tackles. Connor and Wesley Hardee are the ends, while Peede and Cedric Hines or James Lane are the outside linebackers.

Braxton, an All-Conference selection a year ago, returns at middle linebacker, while Dixon is at cornerback. Maurice Berry and Mike Burnham will alternate at the other cornerback and safety.

The Chargers should have an advantage most of the time with overall team speed, but Tart said their "big weakness is depth."

"If we get hurt in some position, we could be in trouble," Tart said. "We've had some sprains and bruises, but nothing major so far."

"I think we'll stack up in the middle of the (Eastern Carolina Conference). If we get the kids funneled in the right direction, we have chance to be a good football team."

North Pitt suffered a 28-0 setback against Roanoke last week, but the young Panthers hope to bounce back when they open the home schedule with East Carteret Friday.

Freshman quarterback Calvin Hunter connected on five out of 11 passes, but the Panthers managed just 27 yards rushing against the Redskins. North Pitt also gave up three fumbles in the opener.

"Offensively, it's just a matter of timing," North Pitt Coach Larry Bolger said. "I was not really

surprised by our passing; Calvin Hunter put the ball right there for the receivers, and Ashley Shepard, another freshman, caught most of those."

"On defense, a couple of over-active kids out of position on a counter play put them in the end zone. That's something we can correct, so I'm not that upset with the way the played most of the time."

"We're going to learn from our mistakes."

"It ought to be a plus on our side that we've played one already, even if we lost. We had the best practice (Monday) that we've had all year. They know we believe in them, and they know they have a lot to learn."

"We asked them if they were willing put forth the effort we require, and they were."

IF YOU HAVE A FINANCIAL QUESTION, YOU'RE LOOKING AT THE ANSWER.

She's a service-oriented professional who has the answers to your financial questions. She knows the value of life insurance as a financial planning instrument. More than that, she stays abreast of economic trends and changes in the tax laws that could affect your financial future. She analyzes your needs and resources and makes specific recommendations to meet them. Beyond your personal security, she can help you with your business needs, such as group insurance, pension plans, buy-sell agreements, executive compensation and tax positioning. If you have a financial question, you may be looking at the answer. Why not call her today?

Sandy Rugh

Eastern Carolina - Pittman Agency
200 Eastbrook Dr.
Greenville, N.C.
752-6747

LIFE OF VIRGINIA

Eastern Carolina

	W	L	Conf.	Overall	
			W	L	T
SW Edgecombe	0	0	0	1	0
Ayden-Grifton	0	0	0	0	0
Farmville C	0	0	0	0	0
Southern Nash	0	0	0	0	0
C.B. Aycock	0	0	0	1	0
Greene C	0	0	0	1	0
North Pitt	0	0	0	1	0

Last Week's Results

SouthWest Edgecombe 9, Tarboro 3
Conley 14, Greene Central 0
Roanoke 28, North Pitt 0
North Lenoir 21, C.B. Aycock 3
Ayden-Grifton, open
Farmville Central, open
Southern Nash, open

This Week's Schedule

Roanoke at Ayden-Grifton
Farmville Central at Williamston
Beddingfield at Greene Central
East Carteret at North Pitt
North Duplin at C.B. Aycock
Southern Nash at Seabulon
Southeast Halifax at SouthWest Edgecombe

Coastal

	W	L	Conf.	All	
			W	L	T
Conley	0	0	1	0	0
North Lenoir	0	0	1	0	0
West Carteret	0	0	1	0	0
West Craven	0	0	1	0	0
Havelock	0	0	0	1	0
White Oak	0	0	0	1	0

Last Week's Results

Conley 14, Greene Central 0
North Lenoir 21, C.B. Aycock 3
West Carteret 3, Jones 6
West Craven 26, Southwest Onslow 20
New Bern 6, Havelock 2
Jacksonville 14, White Oak 8

This Week's Schedule

Conley at Jones Senior
Havelock at Pamlico
South Lenoir at North Lenoir
West Carteret at Southwest Onslow
Washington at West Craven
Lejeune at White Oak

Sports Calendar

Editor's Note: Schedules are supplied by schools or sponsoring agencies and are subject to change without notice.

Thursday's Sports

Tennis

New Bern at Rose (3:30 p.m.)
East Duplin at Greene Central (3:30 p.m.)
Roanoke at Washington

Football

Rose at Jacksonville JV (7 p.m.)
Greene Central at Beddingfield JV (7 p.m.)

Volleyball

SouthWest Edgecombe at Conley (5 p.m.)

Lady Rams Win Opening Match

STANTONSBURG — Greene Central High School opened its 1984 tennis season with a 5-4 victory over hosting Wilson Beddingfield yesterday.

Beddingfield won the first three singles matches, two of them going three sets, before the Lady Rams came back to take the final three. The Lady Bruins then won the number one doubles but lost the next two as Greene Central took the match.

Now 1-0, Greene Central opens its home season on Thursday hosting East Duplin.

Summary:

- Marchelle Evans (B) d. Kathy Herring, 6-2, 6-3.
- Cindy Lamb (B) d. Carol Jenkins, 3-6, 6-3, 6-4.
- Cathy Cockrell (B) d. Carla Edwards, 2-6, 6-4, 7-5.
- Tangela Craft (GC) d. Anissa Pike, 6-1, 6-1.
- Kim Langston (GC) d. Bonnie Allen, 6-1, 6-1.
- Terry High (GC) d. Christi Fields, 7-5, 6-0.
- Evans-Lamb (B) d. Herring-Craft, 8-4.
- Jenkins-Edwards (GC) d. Cockrell-Pike, 8-0.
- Langston-High (GC) d. Allen-Fields, 8-0.
- Exhibition: Roxanne Beamon (GC) d. Lisa Whitley, 6-2, 6-2.

JV Game Off

HOLLYWOOD — The D.H. Conley-Jones Senior High School junior varsity football game scheduled for Thursday has been cancelled.

No makeup date for the contest is expected.

Buy Your Tickets Now! Attend The

Ronald McDonald House

1st ANNUAL EASTERN CAROLINA CELEBRITY GOLF CLASSIC

Monday, Sept. 10—Brook Valley Country Club

Enjoy the day watching the celebrity golfers in action. All proceeds benefit the Ronald McDonald House in Greenville.

Tickets \$5.00 Available at:
• McDonald's Restaurants • Bonds Sporting Goods
• Coffman's Men's Wear • At the gate

PRE - SEASON SALE ON

STIHL
THE WORLD'S LARGEST SELLING CHAIN SAW

Stihl 011 AU with 16" Bar
199.95 plus tax

Stihl 028 WB with 18" Bar
299.95 plus tax

Stihl 041 AU with 20" Bar
425.00 plus tax

Limited quantity - No Trade In

AYDEN SPORT SHOP

746-6790 312 EAST AVE

Pick 'n Pay Shoes

Sale. Men's GENUINE SUEDE styles

Big boys' sizes...\$10

\$14 your choice

Men's orlon socks...\$1

Greenville Blvd. on 264 Bypass Greenville, N.C.

Sale prices good thru Sat. MasterCard, Visa or choice. Open evenings

Connors Not Looking Ahead

By BRUCE LOWITT
AP Sports Writer

His next opponent is John Lloyd, against whom he has never lost so much as one set. But there is no way Jimmy Connors is looking past him toward McEnroe.

"I don't worry about anybody except the guy I'm playing next. One at a time, that's the way I take 'em," the third-seeded Connors said after he advanced into the quarterfinals of the \$2.55 million U.S. Open Tennis Championships.

"I've seen John play for about 10 years now," Connors said, "but I haven't seen him or anybody else play here. I have enough trouble watching the guys I'm playing while I'm playing 'em."

In today's women's quarters it was No. 1 seed Martina Navratilova vs. Helena Sukova of Czechoslovakia; Lloyd's wife, No. 2 Chris Evert Lloyd vs. Sylvia Hanika of West Germany; No. 3 Hana Mandlikova of Czechoslovakia vs. No. 14 Carling Bassett of Canada and No. 4 Pam Shriver vs. No. 13 Wendy Turnbull of Britain.

5 Andres Gomez of Ecuador and No. 4 Mats Wilander of Sweden vs. No. 15 Pat Cash of Australia.

Both Connors and the unseeded Lloyd advanced with Tuesday night victories over seeded Swedes, Connors defeating No. 16 Joakim Nystrom 7-6, 6-0, 6-3, 16-12 beating No. 9 Henrik Sundstrom 4-6, 6-4, 6-4, 6-2 after the day's schedule was disrupted by rain.

In Tuesday's only afternoon match completed between showers, McEnroe disposed of unseeded Robert Green 6-3, 6-2, 6-2 to advance to a quarterfinal meeting with Mayer, a surprisingly easy 6-3, 6-2, 6-3 winner over No. 13 Tomas Smid of Czechoslovakia.

Also Tuesday night, Wilander beat Tim Mayotte 6-4, 6-4, 7-6 in a four-round match begun Monday night. And Hanika defeated Patra Huber of Austria 6-4, 7-5 to fill out the women's quarterfinal field.

Connors said he wasn't surprised to find Lloyd waiting for him in the quarters. "He's been playing good tennis. He's beaten a lot of good guys to get there."

As usual, Connors played an animated game, reacting to the crowd — which in turn was reacting to him. "I was having a good time

out there," he said. "I sat around all day. Didn't get to hit any balls because of the rain. I just wanted to get out there and try to get going. I was just happy to get out of the hotel room."

Lloyd said he's "very superstitious — I think a lot of players are — and I think I've only lost once in the first round here in the 10 times I've played it. And that was to Jimmy (in 1981).

"But I think I'm a much, much better player now than I've ever been. Jimmy's ranked third in the world, obviously one of the great players, but I'm not going to be overawed by playing him."

Neither, for that matter is Mayer. "I've played well against him, beaten him," Mayer said. "I had a rough match against him the last time we met in the Open (McEnroe winning 4-6, 7-6, 6-3, 4-6, 6-1 in the 1982 quarters). Win or lose, hopefully this one'll be shorter."

McEnroe had no trouble defeating Green, who wasn't supposed to get anywhere near this far in the tournament. "He had nothing to lose and could go out there and hit his shots, which is what he did — except I played better," McEnroe said. "He didn't play badly. He had a great

tournament and I think he should be proud of what he's done."

The Open was only the second Grand Prix tournament in which Green made it past the first round. "You just look for a decent draw and hope for the best," he said. "I thought if I got a good draw, one or two rounds. The fourth round is more than I expected."

He said he'd had a lot of interest shown in him in the 48 hours between his third-round victory over Australian John Fitzgerald and the loss to McEnroe.

"A few agents have been making contact, expressing an interest in getting together," Green said. "Right now I don't have any contracts — clothing, shoes, rackets. I do have a string contract..."

The Atlanta Braves, second in the Western Division to the Los Angeles Dodgers in 1983, had the worst record in the circuit in one-run games, winning 19 and losing 29.

Qawi's Withdrawal Spoils Fight Card

RENO, Nev. (AP) — Challenger Dwight Muhammad Qawi's withdrawal from Friday night's light heavyweight title fight with titleholder Michael Spinks has wiped out the card which was to have included a World Boxing Council cruiserweight championship fight.

Qawi was scheduled to face Spinks Friday, the undisputed 175-pound champion, in a 15-round rematch of their brawl last year in Atlantic City, N.J., which Spinks won by a unanimous decision.

But Qawi left Reno last Friday with what his manager said was an aggravated chronic shoulder injury.

"Since Friday afternoon's pullout, we have been feverishly working to set something up," promoter Butch Lewis said Tuesday.

But the Katz Sports Network, which was to have televised the bout, could not work out a new deal with the sponsors and some 200 television stations set to carry the fight, he said.

Lewis said there also was not time to restructure ticket prices, which ranged up to \$200, for just the second championship bout and the un-

dercard. Carlos "Sugar" DeLeon and Alfonso Ratliff were scheduled to go 12 rounds for DeLeon's WBC cruiserweight title. Lewis said earlier that fight alone would not have been a strong enough draw for prime-time television.

Nevada Athletic Association Commissioner Sam Macias said Tuesday he would recommend that the commission suspend Qawi from fighting in Nevada because he failed to fulfill his contract to face Spinks.

In addition, he said he already had recommended that the WBC remove Qawi, the No. 1 contender, from its ratings and said he would make the same suggestion to the World Boxing Association, which also has him the top contender.

"I feel he should have stayed for an examination" in Nevada, instead of returning to New Jersey on Friday, Macias said.

Qawi's manager, Rocky Newman, said Friday his fighter missed a jab during training the day before and was in such intense pain he could not run the following morning.

AFTER

Labor Day

SAVE NOW ON

Firestone TIRES... SALE



TRIUMPH
Steel belted radial

\$36⁹⁹

Quantities limited!

Size	Whitewall
P165/80R13	39.95
P185/75R13	41.95
P195/75R14	49.99
P205/75R14	51.99
P205/75R15	51.99
P215/75R15	54.99
P225/75R15	57.99
P235/75R15	59.99

90 DAYS SAME AS CASH



on Firestone revolving charge at Firestone stores and many Firestone dealers. For a minimum monthly payment you can have the convenience of cash... and all finance charges are refunded when paid as agreed.

Firestone wants to make it as easy as possible for you to have Firestone tires, batteries, and car service! Ask for details when you come in!

Firestone 721 Steel-Belted Radial

44⁹⁵ P165/80R13 Whitewall, 4-rib tread

All Tires Whitewall

P175/70R13	\$49.95	P215/75R14	\$64.95
P185/80R13	51.95	P225/75R14	67.95
P175/75R14	49.95	P205/75R15	62.95
P185/75R14	54.95	P215/75R15	64.95
P195/75R14	59.95	P225/75R15	67.95
P205/75R14	62.95	P235/75R15	69.95

BUY NOW!

- Over 40 million 721 radials already produced for America's car owners.
- Double belted with steel cord in Firestone's famous "7 over 2 plus 1" construction.
- Long-wearing, road-gripping tread; easy-rolling fuel efficiency.

SAVE ON MAG WHEELS & RIMS

- Greenville's Best Selection
- Reduced Prices
- Free Mounting

We Now Carry LOUVRES and FRONT END COVERS (Bras)



Make your next automotive sound selection from us!

AM/FM Cassette Players
Speakers•Boosters
We have what you need for good sound!

BIAS-PLY BARGAIN!

Deluxe **CHAMPION** polyester cord

\$23⁹⁵

Size	Black	White	Size	Black	White
A78-13	\$26.95	\$29.95	G78-14	\$37.95	\$40.95
B78-13	29.95	32.95	G75-15	38.95	41.95
F78-14	33.95	36.95	H78-15	40.95	43.95
			L78-15	42.95	45.95

IMPORT RADIAL!

S-211 Steel-Belted Radial

\$36⁹⁵

165SR12 Blackwall	PRICE
165SR13	\$40.95
165SR12	43.95
175SR14	48.95
175/70SR13	48.95
185/70SR13	48.95
185/70SR14	49.95
195/70SR14	53.95
195SR15	47.95

Firestone Air Conditioning Service \$17⁵⁰

TUNE-UP

In most domestic and imported cars with electronic ignition, we'll install new resistor spark plugs, adjust idle speed, set timing, test battery and charging system, inspect rotor, distributor cap, PCV valve, ignition cables, air filter, crankcase vent filter and vapor canister filter.

4-cyl. \$24⁹⁵ 6-cyl. \$27⁹⁵ 8-cyl. \$29⁹⁵

DISC BRAKE SERVICE \$49⁸⁸

Front disc brake service for American cars (single piston system)

- 4-WHEEL BRAKE SERVICE
- Re-seat front pads • Resurface rotors
- Inspect the system
- IMPORTANT: Rebuilding of casters often required on disc brake overhauls to extra
- *Add \$12 where semi-metallic disc pads are required

FRONT-END ALIGNMENT \$12⁹⁵

All American cars. Chevettes set toe only. Compacts with front wheel drive and/or MacPherson suspension, set all adjustable angles. We'll set caster/camber and toe-in to manufacturer's original specifications. No extra charge for cars with factory air or torsion bars. Parts extra, if needed. Call for your appointment.

PUGGH'S TIRE & SERVICE CENTER GREENE ST. • 752-6125

90 DAYS SAME AS CASH

AMERICAN EXPRESS, MasterCard, VISA, Shell

NATIONAL ACCOUNTS WELCOME We Now Honor JC PENNEY CREDIT CARDS

PUGGH'S TIRE & SERVICE CENTER PITT PLAZA • 355-6162

AL's West Race Continues Hot

By DICK BRINSTER
AP Sports Writer

First it was the Minnesota Twins breathing a sigh of relief and then the Kansas City Royals took their turn as the hot American League West race continued to be the only real scramble left this season in major league baseball.

Twenty-four hours earlier, Minnesota Manager Billy Gardner was talking about the need for his Twins, who entered the important three-

game series with five straight losses, to win one from the Royals. Round one went to the Twins, 4-1, and their lead grew to two games.

Now, it was Tuesday night, and Kansas City second baseman Frank White, whose sixth-inning single drove in the go-ahead run in a 4-1 victory by the Royals, was holding court.

"You just don't want to get swept," White was explaining, almost as if his script had been

written by Gardner. "Now, if we win tomorrow, we're in a tie for first place, and that makes it that much more interesting."

"This is what baseball's all about," said White, who added that California, only a game behind the second-place Royals, also was not to be overlooked. "There's going to be a lot of excitement and that's what the people pay their money to see."

Gardner did not believe the loss would saddle his players with any serious doubts.

"They're in a good frame of mind," he said. "They'll bounce back."

three-run homer off California reliever Don Aase, 3-1, in the bottom of the ninth.

Mike Witt entered the ninth with a five-hit shutout, but left the game after allowing a leadoff single to Andre Thornton and a two-out walk to Pat Tabler. Bando greeted Aase with his ninth homer of the year.

Fred Lynn, who has driven in 34 runs in his last 35 games, singled, doubled and hit a two-run homer, his 19th, extending his hitting streak to seven games.

Orioles 4, Tigers 1
Cal Ripken and Eddie Murray drove in first-inning runs and Mike Boddicker, 17-9, pitched a six-hitter through seven innings as Baltimore handed Detroit its sixth loss in seven games. Rick Dempsey added a two-run homer for the Orioles in the fifth.

Al Bumbry and Mike Young started the Baltimore first with singles and moved up on a passed ball by Tiger catcher Lance Parrish. Ripken hit a sacrifice fly and Murray singled to chase Dave Rozema, 7-6, after only a third of an inning.

Seaver hurled a five-hitter as Chicago drilled Oakland in a rain-delayed game. Seaver, 13-9, picked up his 286th career victory by pitching eight innings.

Steve McCatty, 7-13, who had a 7-0 lifetime record against Chicago going into the game, gave up five runs in 2-2/3 innings.

Leading 1-0, the White Sox started their rout in the second inning when Walker smashed his first homer of the night, scoring Scott Fletcher, who had doubled, and Jerry Hairston, who had walked.

Pirates Helped Start String

By HERSCHEL NISSENSON
AP Sports Writer

What can the Miami Hurricanes do for an encore?

If you're thinking about an encore to their 1983 national championship, that remains to be seen, although they're off and running — make that passing — with victories over Auburn, the preseason No. 1 team, and Florida.

in the Kickoff Classic, scoring the winning field goal with 6:09 left — a relative laugh.

But last Saturday night they really cut it fine, falling behind Florida 20-19 with 41 seconds left and then marching 72 yards in five plays, using all of 29 seconds, and taking a 26-20 lead on Kosar's 12-yard pass to Brown with seven seconds remaining. Tolbert Bain's 59-yard interception on the final play was just icing on the cake.

But if cliff-hangers whet your appetite, the Hurricanes are on a stretch of five consecutive games that weren't over until, as Yogi Berra would say, they were over.

Nov. 5, 1983 — Miami 12, East Carolina 7: With time running out and their quest for a major bowl bid in jeopardy, Bernie Kosar drove the Hurricanes 80 yards for the winning touchdown. The big play was a 52-yard pass from Kosar to Eddie Brown, which helped set up Kosar's 1-yard run with 1:04 left to play.

Nov. 12, 1983 — Miami 17, Florida State 16: Trailing 16-7, the Hurricanes began their comeback when Kosar teamed up with Brown on a 37-yard scoring pass late in the third period. But they didn't score the winning points until Jeff Davis, who missed two earlier attempts, kicked a 19-yard field goal on the game's very last play.

Jan. 2, 1984 — Miami 31, Nebraska 30: In one of the most exciting games in college football history, Miami completed its story-book climb to the national championship in the Orange Bowl. The Hurricanes led 17-0 only to have Nebraska tie the score early in the third period. They led again 31-17 but once more Nebraska battled back with two touchdowns, the second on Jeff Smith's 24-yard run with just 48 seconds remaining.

The Cornhuskers, ranked No. 1 and needing only a tie to win the national championship since they would have been the only unbeaten team in the country, then kicked away the title by not kicking the extra point. Coach Tom Osborne ordered a 2-point conversion pass from Turner Gill to Smith, but strong safety Kenny Calhoun batted it away.

This year, with Jimmy Johnson at the coaching helm replacing Howard Schnellenberger, Miami has not lost its flair for the dramatic. The Hurricanes opened the season by upsetting No. 1-ranked Auburn 20-18

Penn State meets Texas on Sept. 29 at the Meadowlands — Giants Stadium in East Rutherford, N.J. — which isn't necessarily news except that Texas will be the home team.

That was decided Tuesday by a coin flip at the weekly luncheon of the Football Writers Association of New York at Giants Stadium. Jim Tarman, Penn State's athletic director, called tails and it came up heads.

According to Penn State, when first arranged some years ago, the game was scheduled for a neutral site in the East because Darrell Royal, then the Texas athletic director, wanted to bring the Longhorns to that area.

Mississippi State Coach Emory Ballard reportedly needs a good season to save his job and the Bulldogs took a major step in that direction by thumping Tulane 30-3 despite fumbling away two seemingly certain touchdowns and having another called back by a penalty.

Ballard abandoned the Wishbone, which he helped to invent, in favor of the I-formation. "We put the dot under the I and made it an exclamation point," he said.

With 203 rushing yards, tailback Johnnie Jones was the star of Tennessee's 24-17 victory over Washington State, but the key player probably was quarterback Tony Robinson, who inherited the job when Alan Cockrell bypassed his senior year to sign a pro baseball contract. Robinson, who threw only 12 passes all last season, completed 13 of 16 against the Cougars for 125 yards and scored on a 1-yard keeper.

"I wanted to go out and show everybody I could throw a football," Robinson said. "I didn't have any doubts about the way we would play or I would play. I had a lot of confidence and I think I can do better on down the line."

Minnesota starter Ken Schrom, 4-8, had yielded only one hit through the first five innings until Motley singled to left with one out in the sixth.

Angels 5, Indians 3
Left fielder Joe Carter misplayed Rod Carew's double in the 12th inning, allowing Juan Beniquez to score the tie-breaking run from first base after Cleveland's Chris Bando had tied the game with a two-out,

Minnesota starter Ken Schrom, 4-8, had yielded only one hit through the first five innings until Motley singled to left with one out in the sixth.

Angels 5, Indians 3
Left fielder Joe Carter misplayed Rod Carew's double in the 12th inning, allowing Juan Beniquez to score the tie-breaking run from first base after Cleveland's Chris Bando had tied the game with a two-out,

Minnesota starter Ken Schrom, 4-8, had yielded only one hit through the first five innings until Motley singled to left with one out in the sixth.

Minnesota starter Ken Schrom, 4-8, had yielded only one hit through the first five innings until Motley singled to left with one out in the sixth.

Angels 5, Indians 3
Left fielder Joe Carter misplayed Rod Carew's double in the 12th inning, allowing Juan Beniquez to score the tie-breaking run from first base after Cleveland's Chris Bando had tied the game with a two-out,

Minnesota starter Ken Schrom, 4-8, had yielded only one hit through the first five innings until Motley singled to left with one out in the sixth.

Angels 5, Indians 3
Left fielder Joe Carter misplayed Rod Carew's double in the 12th inning, allowing Juan Beniquez to score the tie-breaking run from first base after Cleveland's Chris Bando had tied the game with a two-out,

Minnesota starter Ken Schrom, 4-8, had yielded only one hit through the first five innings until Motley singled to left with one out in the sixth.

Minnesota starter Ken Schrom, 4-8, had yielded only one hit through the first five innings until Motley singled to left with one out in the sixth.

Angels 5, Indians 3
Left fielder Joe Carter misplayed Rod Carew's double in the 12th inning, allowing Juan Beniquez to score the tie-breaking run from first base after Cleveland's Chris Bando had tied the game with a two-out,

Minnesota starter Ken Schrom, 4-8, had yielded only one hit through the first five innings until Motley singled to left with one out in the sixth.

Angels 5, Indians 3
Left fielder Joe Carter misplayed Rod Carew's double in the 12th inning, allowing Juan Beniquez to score the tie-breaking run from first base after Cleveland's Chris Bando had tied the game with a two-out,

Minnesota starter Ken Schrom, 4-8, had yielded only one hit through the first five innings until Motley singled to left with one out in the sixth.

Announcing:
the arrival of
JACKSON CONSTRUCTION
in Greenville.

Remodeling, Additions, Sundecks
And Small Jobs.

Call 752-0166 for free estimates.

Southern Pawn Shop Inc.
409-B Evans St.
NEED CASH?
752-2464
GREENVILLE

DOUBLE STEEL RADIAL WHITEWALLS
By The World's Largest Manufacturers

155/80R13	34.95
165/80R13	36.95
185/80R13	39.95
185/75R14	41.95
195/75R14	43.95
205/75R14	46.95
205/75R15	47.95
215/75R15	49.95
225/75R15	51.95
235/75R15	53.95

Radials from Germany

29⁹⁵
Any 13" Size

WHITEWALL RETREADS

A78-13	19.95
B78-13	19.95
D78-14	21.95
E78-14	21.95
F78-14	23.95
G78-14	23.95
H78-14	23.95
G78-15	23.95
H78-15	23.95
L78-15	23.95

Exchange

MONEY BACK GUARANTEE
FREE Front End Check IF UNDERSOLD FREE Front End Check

Bias-ply tires at budget prices!
Smooth and Easy!
Dayton Deluxe 78
29.95
Whitewall

Size	White
B78-13	31.95
E78-14	37.95
F78-14	39.95
G78-14	40.95
G78-15	41.95
H78-15	42.95

- Smooth on the road, easy on your budget.
- Long wearing tread, strong polyester cord body.
- Available in most popular sizes.

Long-wearing, fuel efficient radial whitewalls!
Durable!
Dayton Thorobred Steel Belted Radial
as low as
39.95
155/80R13 Whitewall

165/80R13	42.95
175/80R13	43.95
185/75R14	48.95
195/75R14	51.95
205/75R14	54.95
215/75R15	59.95
225/75R15	61.95
235/75R15	64.95

- Two strong steel belts
- Road hugging traction

White letter radial with a wide tread!
Sporty 70 Series!
Daytona Radial 70
as low as...
53.95
195/70R13

Size	Price
215/70R14	59.95
225/70R14	65.95
225/70R15	69.95
235/70R15	74.95
255/70R15	79.95

- Bold outline white letters
- Low profile with wide, road-gripping tread
- Two fiberglass stabilizing belts on a radial polyester cord body

— CHARGE 'EM —

Metric sized radial for imports, small U.S. cars!
Daytona FD8 Steel Belted Radial
\$33.95
155R12

- European-style tread.
- Road-hugging design.

Steel belted radials for imports and compacts!
Daytona Radial GT
Two steel belts for strength, long wear
Classy combination white letter
while slope styling
as low as
54.95
175/70R13

Deep traction tread for pickups, vans, RVs!
Daytona Super Stag
Deep, high angle tread bars
All-position tread pattern
Bold raised white letters
69.95
N78-15
Other sizes available

Balancing
3.75

Professional Alignment
14.95

Brake Specialists
Front End **49.95**
Front & Rear ... **79.95**

Lube & Oil Change
7.95

Maintenance Free 50 Month Battery
Groups 74, 24, 24F
Most Cars
37.95 Exchange

MONEY BACK GUARANTEE IF UNDERSOLD WE DO NOT SELL SECONDS OR BLEMES

SOUTHERN TIRE BROKERS
OPEN MONDAY - FRIDAY 8:00 TIL 5:30; SATURDAY 8:00 TIL 1:00
Greenville Blvd. & Charles Next To The Plaza
756-5823

90 DAYS SAME AS CASH
when you buy Dayton tires or car service on Dayton revolving charge
Minimum monthly payments required All finance charges included when paid as agreed
Credit established in minutes

SPORT LINE

To the editor:
Many area and local citizens have expressed concern about the media coverage of Greenville native, William Frizzell, as compared to the coverage of other local youth who leave the area and excell.

The William "Boo Boo" Frizzell saga began at Rose High School where he started at defensive back. Upon graduation, he attended North Carolina Central University, started at defensive back and made All-League honors four consecutive years. He was a sought-after player by many pro teams and his father made him stay in school. He graduated from "Central" and was drafted by the Detroit Lions this spring.

Last week he played the entire game against the Bengals, survived the cut list and made the team. A jubilant phone call to his mother disrupted our weekly choir meeting last Monday. Being excited along with everybody else and having remember not seeing any coverage at all about "Boo Boo," I immediately ran to the phone to inform the local media. One source did not know who he was and the second source knew little or nothing, but commented on waiting on "info" from the training camps.

When coverage was released, all former ECU standouts were named as doing previously, and followed by a small patch of data concerning William. Had he been a former ECU student, robbed a bank, or been charged with rape, coverage would have been no problem.

In spite of this, we should all be proud of William and this letter to express to the community our pride in a local son.

Sunday before last The Daily Reflector gave excellent coverage to another Greenville native, Martin Daniels, and the community was highly elated.

Congratulations to the families of both Marvin and William on their excellent achievements.

Johnny Wooten
Greenville-Pitt Co. Black Coalition

An oasis of comfort in this desert boot.
STYLE Q3537 \$35.00 **WOLVERINE**
J.P. Davenport & Son
Hwy. 264 E. 752-6930

Cubs Pass First Test, Top Phillies

By The Associated Press
The Chicago Cubs have passed their first test of the final month. Ron Cey homered for the second straight day and Scott Sanderson managed to scatter 13 hits as the Cubs beat the Philadelphia Phillies 7-2 Tuesday night, extending their lead in the National League East to seven games over New York.

The Cubs did it by knocking out Philadelphia ace Steve Carlton, and the impressive victory may have knocked the Phillies out of the pennant chase.

"This is not the time to get cocky," warned Sanderson after Chicago had finished sweeping the two-game series at Veterans Stadium. "But if we had come in here and they won two in a row, it would have given them confidence to get the ball rolling for them."

Instead, Chicago ran its record in September to 4-0 and, coupled with the Mets' 12-2 defeat in St. Louis, helped the Cubs take their biggest lead of the season. Third-place

Philadelphia is 10 1/2 games behind.

The victory came on the same day Chicago received permission from the baseball commissioner's office to start printing playoff tickets, and although it may be early to start counting such things, the Cubs magic number to eliminate the Mets is now 18.

In other NL games, Los Angeles edged San Diego 2-1. Pittsburgh rallied past Montreal 5-3, Atlanta clubbed Houston 8-7 and Cincinnati rolled by San Francisco 8-3.

"It wasn't that I fooled them. But none of their hits were in the gaps, down the lines or over the fence," said Sanderson, who took a shutout into the ninth but lost it when his own error led to two unearned runs.

Cey's 25th homer of the season, a two-run blast, helped the Cubs charge to a 3-0 lead in the first inning.

Gary Matthews and Keith Moreland drew walks from Carlton to start the sixth and Cey followed with an RBI single. Gary Woods

delivered a run-scoring double that brought on reliever Kevin Gross, pinch hitter Leon Durham had a single that made it 6-0 and Sanderson capped the outburst with a sacrifice fly.

The lone highlight for the Phillies came as Carlton, 11-7, struck out four to regain the all-time major league strikeout lead with 3,857, one more than Houston's Nolan Ryan.

Cardinals 12, Mets 2

In St. Louis, George Hendrick went 4-for-5 and drove in four runs. Tom Nieto belted a two-run homer and had a pair of singles. Tommy Herr doubled twice and singled, and Lonnie Smith had three singles.

It added to a 17-hit assault that powered St. Louis over New York. The Mets enjoyed a brief 2-0 lead in the first inning on Darby Strawberry's 20th homer before the Cardinals went to work against Sid Fernandez.

Doubles by Herr and Hendrick made it 2-1 in the bottom of the first, Nieto homered in the second and

Hendrick had an RBI single in the third before St. Louis broke it open with five runs in the fourth.

Fernandez, 4-4, along with Wes Gardner and Brent Gaff, were victimized in the Cardinals' big inning.

Winner Danny Cox, 7-10, gave up four hits over eight innings and Bob Forsch, activated from the disabled list earlier in the day, worked the ninth.

Dodgers 2, Padres 1

Pinch hitter Sid Bream's sacrifice fly with the bases loaded and one out in the bottom of the ninth inning was the game-winner for host Los Angeles.

Ken Landreaux, whose home run in the first inning put the Dodgers ahead, drew a walk from Andy Hawkins, 7-9, with one out in the ninth. Landreaux stole second and continued to third on catcher Bruce Bochy's throwing error.

Hawkins walked Pedro Guerrero and then intentionally walked Greg Brock, leaving it up to Bream.

Braves 8, Astros 7

Dale Murphy is known as a home-run hitter; Alex Trevino is not. They both hit late homers in Atlanta to lift the Braves.

Murphy's NL-leading 30th homer, a two-run shot in the seventh inning, made the score 7-7. In the eighth, Trevino led off with a home run, his third of the season and just the fifth of his six-year career.

"Trevino may not have hit many home runs in his career, but he can sure hit the fastball," said Houston coach Denis Menke, a former Braves player. "And Murphy always wears us out."

Pirates 5, Expos 3

Jason Thompson stroked a two-run single and Tony Pena hit a sacrifice fly as Pittsburgh rallied for three runs in the top of the ninth inning.

With a runner on first and one out in the ninth, Montreal reliever Bob James gave up a double to Lee Lacy. Johnny Ray was intentionally walked to load the bases and then Thompson singled before Pena

drove in an insurance run.

Pittsburgh starter Jose DeLeon, who has lost eight straight decisions, took a one-hitter and a 2-1 lead into the sixth. But Montreal loaded the bases with two out, and Wallace Johnson greeted reliever Rod Scurry with a two-run pinch-single to put the host Expos ahead.

Reds 8, Giants 3

Eric Davis hit a leadoff home run in the fifth inning to lift Cincinnati into a 2-2 tie, and then belted a three-run shot in the eighth inning during a six-run rally.

The visiting Reds went into the eighth trailing 3-2 but Dave Concepcion's RBI double tied it. Pinch-hitter Tony Perez then delivered a run-scoring single and Davis followed with his sixth homer of the year.

Pete Rose doubled for his third hit of the game and later scored on a wild pitch to cap the uprising.

Mario Soto raised his record to 14-7 despite allowing Scot Thompson's first home run since 1980.

TANK McNAMARA

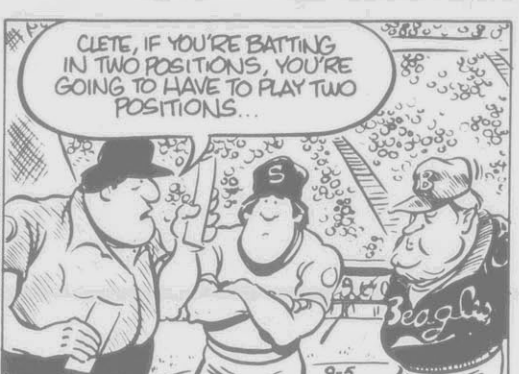

SCOREBOARD

Baseball Standings

By The Associated Press				
AMERICAN LEAGUE				
EAST DIVISION				
W	L	Pct.	GB	
Detroit	38	51	633	
Toronto	30	58	590	7 1/2
Baltimore	23	64	347	12
Boston	21	64	336	13 1/2
New York	13	64	533	14
Cleveland	62	78	443	20 1/2
Milwaukee	52	82	406	31 1/2

By The Associated Press				
NATIONAL LEAGUE				
WEST DIVISION				
W	L	Pct.	GB	
Minnesota	50	68	507	
Kansas City	48	68	500	7
Chicago	64	73	467	13 1/2
St. Louis	64	73	467	13 1/2

By The Associated Press				
NATIONAL LEAGUE				
EAST DIVISION				
W	L	Pct.	GB	
Philadelphia	50	68	507	
Kansas City	48	68	500	7
Atlanta	68	69	496	11 1/2
Oakland	64	75	460	18 1/2
Seattle	62	77	446	20 1/2
Texas	61	77	443	21

by Jeff Millar & Bill Hinds

forced to waive third-string quarterback Bryan Clark in order to add veteran defensive lineman Greg Boyd to the roster.

San Francisco also said it would be without cornerback Eric Wright from three to five weeks because of a strained left knee. The other starting cornerback, Ronnie Lott, will try to play with a sprained ankle.

The Dallas Cowboys reported that Tony Hill, their top wide receiver, suffered a shoulder separation in their 20-13 victory over the Los Angeles Rams and will be lost for from four to six weeks.

That leaves Dallas with only three wide receivers for Sunday's clash with the New York Giants — Doug Donley, Kirk Phillips and Mike Renfro.

Two backup quarterbacks will likely see action this week.

Pittsburgh quarterback David Woodley, who suffered a concussion in the Steelers' 37-20 loss to the Kansas City Chiefs, will miss Thursday night's game with the New York Jets. He will be replaced by Mark Malone.

Denver's starter, John Elway, is listed as questionable for Sunday's

Warner Out For Season, Seahawks Look For Help

By The Associated Press
The Seattle Seahawks, who with a 3-1 preseason and a 33-0 victory to open the regular season were on a run, will run henceforth without Curt Warner.

Exploratory arthroscopic surgery was performed Tuesday on the right knee of Warner, who led American Football Conference rushers with 1,449 yards in his rookie season last year.

The Seahawks didn't like what the surgeons saw — ligament damage requiring immediate surgery that will likely end Warner's season.

"The doctors expect a good recovery," said Seahawks spokesman Gary Wright. "However, we are taking a conservative approach. We expect him to be out for the season."

Warner injured the knee when he cut on the Kingdome's artificial turf in Monday's triumph over the Cleveland Browns.

The San Francisco 49ers head into Monday's game with the Washington Redskins with several defensive injuries.

Torn knee ligaments have ended the year for defensive end Jeff Stover, who was starting in place of holdout Fred Dean. The 49ers were

game at Chicago with a bruised left shoulder he suffered against Cincinnati last weekend. Gary Kubiak, who replaced him and led the Broncos to a 20-17 victory, would replace him.

Clayton Weishuhn, one of New England's starting inside linebackers, injured his knee and will miss Sunday's game against the Miami Dolphins. Patriots Coach Ron Meyer said he was undecided whether to move Larry McGrew from an outside linebacking position or go with Ed Reynolds, Weishuhn's backup.

The Kansas City Chiefs, meanwhile, announced that second-year offensive tackle David Lutz, who sprained his knee in Sunday's victory at Pittsburgh, will be out for about half the season.

Lutz was found not to have sustained the feared ligament damage that would have sidelined him for the year.

game at Chicago with a bruised left shoulder he suffered against Cincinnati last weekend. Gary Kubiak, who replaced him and led the Broncos to a 20-17 victory, would replace him.

Clayton Weishuhn, one of New England's starting inside linebackers, injured his knee and will miss Sunday's game against the Miami Dolphins. Patriots Coach Ron Meyer said he was undecided whether to move Larry McGrew from an outside linebacking position or go with Ed Reynolds, Weishuhn's backup.

The Kansas City Chiefs, meanwhile, announced that second-year offensive tackle David Lutz, who sprained his knee in Sunday's victory at Pittsburgh, will be out for about half the season.

Lutz was found not to have sustained the feared ligament damage that would have sidelined him for the year.

Transactions

By The Associated Press	
BASEBALL	
CHICAGO WHITE SOX	Re-called Steve Christmas, catcher, from Denver of the American Association.
KANSAS CITY ROYALS	Re-called OMAHA Concepcion, shortstop. Recalled Jim Scranton, shortstop. Dave Leeper, outfielder, and Danny Jackson, pitcher, from Tacoma of the Pacific Coast League.
NEW YORK YANKEES	Signed Arthur Lee Calvert, outfielder, and assigned him to Sarasota of the Gulf Coast League.
OAKLAND A'S	Re-called Mike Warren and Dave Leeper, pitchers, and Danny Meyer, infielder, from Tacoma of the Pacific Coast League.
TORONTO BLUE JAYS	Called up Fred Manrique and Kelly Gruber, infielders. Mitch Webster and Ron Shepherd, outfielders, and Toby Hernandez, catcher, from Syracuse of the International League.
National League	ML - Suspended Ozzie Smith, St. Louis Cardinal, shortstop, for seven days, pending appeal.
NEW YORK METS	Re-called Wes Gardner, pitcher, and Kevin Mitchell, third baseman, from Tidewater of the International League. Purchased the contract of John Christensen, outfielder, from Tidewater.
ST. LOUIS CARDINALS	Activated Bob Forsch, pitcher, from the 60-day disabled list.
DETROIT PISTONS	Signed Kelly Tripuka, forward, to a seven-year contract and Vinme Johnson, guard.
Women's American Basketball Association	ATLANTA COMETS - Named Robert Reece head coach and Karen L. Brown general manager.
FOOTBALL	National Football League
ATLANTA FAULTS	Signed Joe Pelligrini, offensive lineman. Placed Richard Williams, running back, on the injured reserve list.
BUFFALO BILLS	Signed John Minter, wide receiver. Placed Joey Smith, wide receiver, on waivers.
DETROIT LIONS	Signed Don Laster, tackle. Placed Rich Strenger, tackle, on the injured reserve list.
LOS ANGELES RAMS	Acquired Booker Reese, defensive lineman, from the Tampa Bay Buccaneers for an undisclosed future draft choice. Placed Gordon Jones, wide receiver, on waivers.
PITTSBURGH STEELERS	Re-signed Terry Echols, linebacker. Placed Calvin Sweeney, wide receiver, on the injured reserve list.
SAN FRANCISCO 49ERS	Signed Greg Boyd, defensive lineman. Waived Bryan Clark, quarterback. Placed Jeff Stover, defensive end, on injured reserve. Re-signed John Macaulay, offensive lineman.
TAMPA BAY BUCCANERS	Placed Mike Washington, cornerback, on injured reserve. Signed Maurice Harvey, defensive back.
WASHINGTON REDSKINS	Placed Jimmy Smith, running back on waivers. Placed Michael Williams, tight end, on injured reserve. Signed Rick Kane, running back.

NFL Leaders

By The Associated Press	
AMERICAN FOOTBALL CONFERENCE	
Quarterbacks	
ATT	YDS TD INT
Mahone, Mia	29 211 3 0
Fouts, S.D.	26 212 2 0
Wooldley, Pitt	17 11 23 2 1
Ferguson, Buff	40 27 26 2 0
Grogan, N.E.	22 12 27 2 1

By The Associated Press	
NATIONAL FOOTBALL CONFERENCE	
Quarterbacks	
ATT	YDS TD INT
Simms, Giants	30 23 46 4 0
Danielson, Det	24 17 27 2 0
Lomas, St. L.	35 25 27 2 0
Montana, S.F.	25 16 18 1 0
Dickey, G.B.	22 16 18 1 1

By The Associated Press	
NATIONAL FOOTBALL CONFERENCE	
Rushers	
ATT	YDS AVG LG TD
McVey, Jets	29 112 3 19 0
Winder, Den	17 94 5 5 0
Campbell, Hou	25 92 3 7 2 0
Collins, N.E.	21 83 4 0 1 1
Allen, Raiders	21 81 3 9 1 1

By The Associated Press	
NATIONAL FOOTBALL CONFERENCE	
Receivers	
NO	YDS AVG LG TD
Collinsworth, Cin	10 111 11 2 0
Franklin, Buff	10 96 9 6 1 0
Stallworth, Pitt	8 167 20 9 1 1
Lippe, Pitt	6 183 30 8 2
Duper, Mia	6 178 29 7 2 2

Jim Martin GOVERNOR

HAVE BREAKFAST WITH NORTH CAROLINA'S NEXT GOVERNOR - CONGRESSMAN JIM MARTIN

SATURDAY SEPT. 8, 1984 8:00 A.M.

RAMADA INN - GREENVILLE

RESERVATIONS - 757-0179 \$25.00

Paid for by Pitt County Martin for Governor Committee



No other kind of ice cream tastes quite the way this kind of ice cream does.

Maola still takes the time to make ice cream the way ice cream ought to be made. Fresh. Rich. Creamy. One spoonful of Maola ice cream and you'll see what we mean.

From our incredible Rocky Road to delicious Tin Roof Sundae, there's no skimping on ingredients. And Maola comes in a rainbow of flavors to satisfy even the most particular ice cream lover. Truly, this is the way ice cream ought to be made.

SAVE 20¢ (20¢)

ON ANY FLAVOR OF MAOLA'S 1/2 GALLON ICE CREAM.

Mr. Retailer: We will redeem this coupon for 20¢ plus 7¢ handling when redeemed for the product specified. Invoices proving sufficient purchase of Maola 1/2 gallon ice cream must be furnished on request. For payment mail coupons to: Maola Milk & Ice Cream Co., 305 Avenue "C," P.O. Drawer S, New Bern, NC 28560. Void if use is prohibited, taxed, or otherwise restricted by law. Good only in U.S.A. Offer limited to one coupon per purchase. Cash value 1/20¢.

OFFER EXPIRES DECEMBER 31, 1984

Available in your favorite supermarket.

**GOREN
BRIDGE**

By CHARLES GOREN
AND OMAR SHARIF
1983 Tribune Company Syndicate, Inc.

Both vulnerable. South deals.

NORTH			
♦ AK72			
♥ QJ83			
♦ AQ			
♦ 1042			
WEST		EAST	
♦ J85	♦ 9643		
♥ K1094	♥ 75		
♦ J1097	♦ 6532		
♦ 53	♦ QJ6		
SOUTH			
♦ Q10			
♥ A62			
♦ K84			
♦ AK987			

The bidding:

South	West	North	East
1 NT	Pass	2 ♠	Pass
2 ♦	Pass	4 NT	Pass
6 NT	Pass	Pass	Pass

Opening lead: Jack of ♠

At times, you may have to tackle more than one suit to develop the tricks you need for your contract. The order in which you play the suits might be crucial.

When North's Stayman inquiry failed to locate a major-suit fit, he made a quantitative raise in no trump. We might have passed with the South hand, but at the table South judged to go on to slam on the strength of his fair five-card suit.

West led the top of his diamond sequence, and declarer could count nine fast tricks. With a normal 3-2 break, two more tricks can be developed in clubs, and the heart suit will always produce a second trick, to bring the total to 12.

However, declarer cannot afford to go after clubs first. Why? Because if he does and the heart finesse fails, the defenders have two tricks before declarer can reel in his dozen. Therefore, declarer should win the opening lead in dummy and immediately take the heart finesse.

If the heart finesse succeeds, declarer would simply surrender a club in the proper fashion (cash one top honor, then lead low from hand) and claim his contract. But when it fails, declarer can no longer afford to lose a trick in clubs. Now his only realistic hope is to find East with both missing club honors.

Assume West continues with a diamond. Win on the table and lead the 10 of clubs. If East does not cover, run it. If he does cover, cross to the board with the jack of hearts and repeat the club finesse. As the cards lie, this line allows you to bring in the whole club suit and, with it, the slam.

Rubber bridge clubs throughout the country use the four-deal bridge format. Do they know something you don't? Charles Goren's "Four-Deal Bridge," will teach you the strategies and tactics of this fast-paced action game that provides the cure for unending rubbers. For a copy send \$1.75 to "Goren Four-Deal," P.O. Box 611, Palmyra, N.J. 08065. Make check payable to Newspaperbooks.

Tass Charge

MOSCOW (AP) — The Soviet news agency Tass has carried a report from Afghanistan alleging that the United States and its allies have supplied chemical weapons to rebels fighting the Soviet-backed regime.

A U.S. State Department spokesman in Washington, Joe Reap, called the report "nonsense." He added: "We have never supplied chemical weapons of any sort" to the Afghan rebels.

Tass, saying it was quoting from the Afghan news agency Bakhtar, wrote: "Washington does not stop at using the dirtiest methods, including supplies for counter-revolutionary scum of barbarous chemical weapons that are used by bandits against Afghan civilians."

An estimated 105,000 Soviet troopers are in Afghanistan supporting the Marxist regime of President Babrak Karmal. They entered the country in December 1979 as the rebels were gaining victories over government troops.

Survivors

FARNBOROUGH, England (AP) — The two-man crew and a passenger on a military transport walked away unhurt after their plane crashed at an air show and caught fire before thousands of spectators.

The twin turbo-prop, Canadian-designed De Havilland Buffalo had put on a two-minute flying display and was demonstrating its short-landing ability when it hit the ground after what appeared to be a too-steep descent.

Its wheels came off and bounced away. First came sparks, followed by a sheet of flame and a cloud of black smoke. Debris flew through the air.

Capt. Bill Loverseed, co-pilot Brad Fowles and passenger Eric Lane left the wreck uninjured.

WINN DIXIE

Now more than ever, we're right for you!

REMODELING SALE

COME SEE OUR BRIGHT NEW LOOK IN OUR RIVERGATE STORE. PRICES GOOD IN BOTH OF OUR GREENVILLE STORES.

REGISTER TO WIN FREE PRIZES



GRAND PRIZE

\$500 SHOPPING SPREE
A FOOD SHOPPER'S DREAM!
NO TIME LIMIT, SHOP AT YOUR LEISURE! FILL YOUR PANTRY AND YOUR FREEZER WITH ONE \$500 SHOPPING SPREE!

2ND PRIZE



GENERAL ELECTRIC 13" COLOR TV

3RD PRIZE



TAPPAN MICROWAVE OVEN

REGISTER EACH TIME YOU VISIT OUR STORE. NO PURCHASE NECESSARY. YOU DO NOT HAVE TO BE PRESENT TO WIN. MUST BE 18 OR OLDER.

WINNERS FOR ALL 3 PRIZES WILL BE DRAWN 7:00 P.M. WED., SEPT. 12!
PRIZES WILL BE AWARDED IN BOTH GREENVILLE STORES.

<p>48-OZ. BTL. WESSON OIL 1.99 WITH 10.00 OR MORE ORDER (LIMIT 1)</p>	<p>8-PAK/16-OZ. BTL. PEPSI-COLA 1.69 PLUS DEPOSIT LIMIT 3 CARTONS, PLEASE</p>	<p>W-D BRAND U.S. CHOICE SIRLOIN STEAKS 2.49 LB.</p>	<p>HARVEST FRESH GOLDEN RIPE BANANAS 61¢ LBS. FOR</p>
---	---	--	---

<p>10-3/4-OZ. CAN CAMPBELL'S TOMATO SOUP 10¢ WITH 10.00 OR MORE ORDER (LIMIT 3)</p>	<p>Lipton TEA BAGS 100-CT. BOX LIPTON TEA BAGS 1.69 WITH 10.00 OR MORE ORDER (LIMIT 1)</p>	<p>W-D BRAND U.S. CHOICE T-BONE STEAKS 2.69 LB.</p>	<p>12-PAK/12-OZ. CANS OLD MILWAUKEE 3.99</p>
---	---	---	--

<p>4-LTR. BTL. CARLO ROSSI WINES *CHABLIS *RHINE *VIN ROSE *BURGUNDY *PINK CHABLIS 5.49</p>	<p>BE SURE TO SEE OUR 8-PAGE FULL COLOR INSERT ELSEWHERE IN TODAY'S PAPER!</p>	<p>U.S. CHOICE ROAST BEEF 3.99 SLICED TO ORDER</p>
---	---	--

<p>1-DOZ. HONEY GLAZED JUMBO DONUTS 1.69</p>		<p>At Winn-Dixie We Really Appreciate People</p>	<p>"SMOKED WITH REAL HICKORY WOOD" BAR-B-QUE PORK SPARERIBS 3.49 LB.</p>
--	--	---	--

*PRICES GOOD THRU WED., SEPT. 12TH *NONE TO DEALERS *WE RESERVE THE RIGHT TO LIMIT QUANTITIES ©COPYRIGHT 1984, WINN-DIXIE STORES, INC.

PRICES GOOD IN OUR GREENVILLE STORES ONLY!

THE BEEF PEOPLE

BUY ONE, GET ONE FREE!

<p>26-OZ. BOX ASTOR SALT BUY ONE & GET ONE</p>	<p>10-OZ. BTL. WISHBONE ITALIAN DRESSING BUY ONE & GET ONE</p>	<p>10-OZ. CAN CASTLEBERRY W/NO BEANS CHILI BUY ONE & GET ONE</p>	<p>FRESH FROM THE DELI ICED CUP CAKES BUY ONE & GET ONE</p>
<p>1-OZ. CAN FISCHER BLACK PEPPER BUY ONE & GET ONE</p>	<p>FRESH FROM THE DELI WINKYS GELATIN DESSERTS BUY ONE & GET ONE</p>		

LIMIT ONE OF EACH FREE ITEM PER CUSTOMER, PLEASE
CAROLINA EAST CENTRE AND RIVERGATE SHOPPING CENTER

Work Release Plan Helps Offenders Find Assurance

ROCKY MOUNT, N.C. (AP) — Trying to reconnect with the world they left behind is perhaps one of the most frightening aspects for people leaving any kind of reform institution.

But a work release program instituted by the Fountain Correctional Center for Women offers its residents a chance to get back into the world, earn a little money, and achieve for themselves a measure of self-assurance and pride.

Beverly Henderson, 27, who has been in the program for about four months, began working at a local sewing factory and is now a waitress. She said her first job gave her the opportunity to prove herself and to prove what she can do.

"I got a feeling of responsibility," she said. "My manager and my supervisor gave me a chance to show myself as being trustworthy and I enjoyed the work. I changed jobs because I was interested in getting something a bit more permanent."

Alex Brown, who owns the restaurant Henderson works in, also employs two other Fountain residents as waitresses.

"They help cooking the food, serving in line, and they get along real nice with the other workers," he said. "It gives them a little freedom to be out and it seems like they enjoy it."

"I can't think of nothing but good coming of the program. I've had nothing but responsible people and good work."

Program Director Madison Fisher said that as of the end of August, there were 32 residents in Fountain's work release program. His goal is to find jobs for 50 residents and increase the number of employers participating in the program.

"It gives the women a feeling that someone cares for them," Fisher said. "Of course, they're nervous when they go out — I guess I would be too — but they take a lot of pride in their jobs and try to do their best. All of the employers say they do an outstanding job."

Ms. Henderson, who expects to be released in December, said "work release is a privilege and gives you something to strive toward."

"Work release is a privilege and gives you something to strive toward," she said.

This program, among many

others, was started when the Richard T. Fountain Youth Center for juvenile male offenders was charged to the Fountain Correctional Center for Women on March 1. It is the first minimum custody center for women operated by the state of North Carolina. Only women 16 and older, convicted of non-assaulted crimes, such as larceny or writing bad checks, are assigned to Fountain.

Fountain is now an advancement center for the women residents, the last stop before they are released. As a result, the facility offers an array of community-based programs to enhance the growth and potential rehabilitation of the center's population.

Soon after Fountain made the transition, Fisher sent a letter to 50 businesses in Rocky Mount informing them of the program. He said the general response was one of curiosity and requesting more information.

The residents are paid minimum wage, out of which they must pay Fountain \$5 a day for room and board, and \$1 a day for transportation. All taxes are taken out.



OPPORTUNITY — Work release participant Anita Sutherland fills glasses of iced tea at a Rocky Mount restaurant on her job away from the Fountain Correctional Center for Women. Participants in the work release program say their coworkers accept them and are supportive. (AP Laserphoto)

IN THE STATE

Teacher Plan

RALEIGH (AP) — The state Board of Education was to consider a five-step career development plan today for teachers that the board says is intended to "attract the best candidates into teaching."

The plan would raise teachers' pay to \$45,696 for instructors with 31 years of experience. The highest salary for a North Carolina teacher now is \$24,840 a year.

It's a revised version of a career ladder proposal submitted to the board in June. The revised plan would allow teachers to move up the ladder more quickly than the previous plan.

DWI Ruling

WINSTON-SALEM (AP) — A District Court judge has ruled that part of the Safe Roads Act applying to teen-age provisional licenses is unconstitutional.

Robert M. Brown, an assistant district attorney, appealed Tuesday's decision by Judge J.W.H. Roberts to Forsyth Superior Court. Roberts is one of several District Court judges in the state who have ruled the same way.

Roberts dismissed a charge of driving after consuming alcohol that had been brought against R.G. Pendergrass, 17, of Pfafftown, who has a provisional license.

Supervisors Cut

ASHEVILLE (AP) — The Reagan Administration is working to cut down on the number of supervisors in the federal government hierarchy, the director of the U.S. Office of Personnel says.

Donald Devine's prepared speech, which was sponsored by the Asheville Chamber of Commerce, was delivered Tuesday by his regional representative after Devine was grounded by storms in Baltimore.

A.M. "Bud" Wandling quoted Devine as saying, "We found the number of employees in supervisory or management positions was 36 percent of the work force — compared with less than 10 percent in private industry. We have been working to reduce this."

Wandling said the government work force had been reduced by 100,000 in the Reagan administration years to 2.1 million — not counting defense personnel.

Ammonia Leak

GREENSBORO (AP) — About 150 employees from the Industries of the Blind were evacuated Tuesday when ammonia began leaking from a neighboring ice plant, authorities say.

Ammonia began leaking from the Ice Delivery Co. plant when workers who were tearing down the facility hit a line to a 20-gallon ammonia tank with a bulldozer.

The employees were evacuated about noon and were allowed to return to work about an hour later.

Reward Paid

RALEIGH (AP) — The Council of State has approved a \$5,000 reward for a Sanford woman whose description of a man who raped and beat her two years ago led to the arrest of the same man for murdering a Harnett County woman.

The council's approval came after it had twice delayed action on a recommendation by Gov. Jim Hunt while other claims to the reward were investigated.

The council approved the reward payment to Carol T. Albright, 33, after Hunt recommended that she and another unidentified claimant receive \$5,000 each.

Mrs. Albright had filed suit against Hunt in June, charging breach of contract after the state refused to pay the reward offered in a 1981 murder. She said she was entitled to the money because information she gave authorities about her 1982 rape and beating led to the arrest of Steven Eugene Martin, who was convicted both in her assault and the 1981 murder of Mavis Jewel Thorne of Harnett County.

Trial Begins

RALEIGH (AP) — A Wake County Superior Court jury has begun hearing a \$6 million lawsuit brought against Carolina Power & Light Co. by a young man crippled by a massive electrical shock.

Lawyers described Tuesday the events of Nov. 11, 1980, that culminated in a sudden rainstorm and a 13,200-volt shock from a power line. The suit contends the accident left Daniel Miller so burned that he lost both forearms and his right leg.

Miller was a temporary employee of William C. Pace II, owner of a kennel in northeastern Wake County, when he was electrocuted when his ladder hit a power line.

Department Head

RALEIGH (AP) — Dr. John A. Bailey, professor of mechanical and aerospace engineering at North Carolina State University, has been named head of the N.C. State Department of Mechanical and Aerospace Engineering.

Bailey, a member of the engineering faculty since 1967, fills a vacancy left by Dr. Ralph A. Burton, who returned to teaching and research in the department.

The Mechanical and Aerospace Engineering Department had an enrollment this fall of more than 1,600 undergraduate and graduate students.

Youths Drown

CHARLOTTE (AP) — Two Charlotte teen-agers drowned Monday in Lake Norman while two friends, who tried unsuccessfully to help, looked on.

Jeff Deese and Phil Cheek, both 17, had been playing football with friends before deciding to take a swim at a Lake Norman boat landing about three miles west of Mooresville.

Mooresville Rescue Squad Chief Jimmy Deaton said signs at the area prohibit swimming, but it is still a popular recreation spot.

Sand Saved

MANTEO (AP) — Along with the lights, the equipment and the costumes, working crews from "The Lost Colony," the nation's oldest outdoor drama, are packing away over a ton of sand, which will be used next year on the outdoor stage.

The drama closed its season Saturday. Spokeswoman Lynn Summerall said the sand, which can be blown away by winter winds, has been costly to replace. It was decided to pack the sand and reuse it.

Summerall said the 1984 drama was seen by more than 91,000 people in 68 performances this year, a record high.

Still Closed

CAPE HATTERAS, N.C. (AP) — Cape Hatteras Lighthouse, closed to visitors since May, will be closed indefinitely while engineering experts try to determine how serious cracks in its wall and deterioration to cast iron parts is.

"The problems were worse than we thought," said National Park Supt. Tom Hartman. "There are two vertical cracks in the inside walls, moisture is seeping through the interior and the metal brackets anchoring the staircase are severely eroded."

Judge Named

RALEIGH (AP) — Gov. Jim Hunt has appointed Lamar Gudger as a special Superior Court judge.

Gudger was named Tuesday to replace Charles C. Lamm Jr., who is now a resident Superior Court judge in the 24th Judicial District.

Gudger, 64, is a native of Asheville. He is a former state representative and state senator. He served as a congressman for four years. His term will expire June 30, 1987.

Scientists Cited

RALEIGH (AP) — Two scientists at North Carolina State University have been selected for William Neal Reynolds Distinguished Professorships.

Dr. R. Wayne Skaggs, professor of biological and agriculture engineering and soil science; and Dr. Harold E. Swaisgood, professor of food science and biochemistry were named at a luncheon for Reynolds professors and university officials.

The professorships were established in 1950 when the William Neal Reynolds Foundation gave NCSU 10,000 shares of Reynolds Industries stock to the school.

Expansion

RALEIGH (AP) — The North Carolina Museum of Art has been in its new home less than two years, but museum trustees are already discussing plans to build a new wing at a cost of \$7.5 million to \$10 million.

At a board meeting Tuesday, the 15 trustees present voted to establish capital construction priorities through the end of the decade. The biggest item on the list could be a two-story west wing to expand the museum's exhibition space.

LIMITED TIME OFFER



Luxurious BUSTER CRABBE POOL with walk-in stairs at NO EXTRA CHARGE.

Don't wait any longer...get the best buy of the year — a genuine Buster Crabbe Pool with convenient walk-in stairs, for the price of the pool alone!

Buster Crabbe Pools are in a class by themselves, with built-in benefits offered by no other pools... benefits that provide much more pleasure and lower energy costs. These pools are built to stay beautiful longer with less maintenance. Regardless of their initial cost, Buster Crabbe Pools are the most economical pools to own.



Select your pool NOW! We'll install it with walk-in stairs at no additional cost.

Paradise Pools & Spas

113 West Fourth Street (behind Globe Hardware) 757-1338



TV • STEREO • FURNITURE • APPLIANCES

America's Best Rent-To-Own System



- ★ RENT-TO-OWN
- ★ NO CREDITORS CHECKED
- ★ NO LONG TERM OBLIGATION
- ★ DELIVERY AND SERVICE INCLUDED
- ★ WE RENT FURNITURE

Phone 355-RENT (355-7368)

Greenville Square Shopping Center Greenville Boulevard

Hours: Monday thru Saturday 9 a.m.-6 p.m. Fridays 'til 7 p.m.

STORES INDEPENDENTLY OWNED AND OPERATED

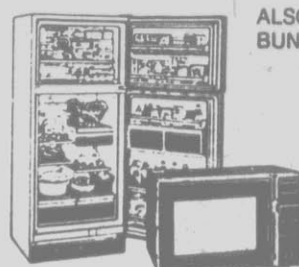
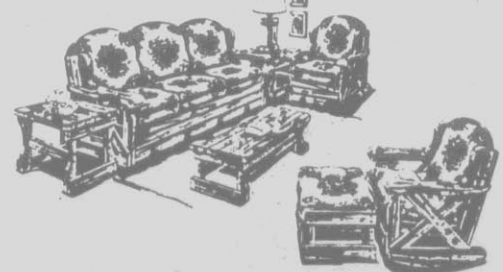
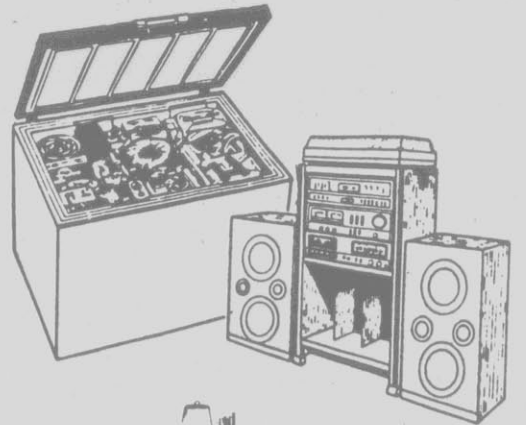

ALSO AVAILABLE: BUNK BEDS • DINNETTES • RECLINERS



Campaign Expenses Include Little Things

By The Associated Press
Gov. Jim Hunt pays a higher salary to his employees in his U.S. Senate campaign, but his Republican opponent, Sen. Jesse Helms, hires more people.

The figures come from federal campaign reports that show the most expensive U.S. Senate race in the country has its share of mundane expenses.

The Helms campaign payroll totaled \$81,300 for 107 workers in June for an average net salary of \$760 each that month. Additional payments for group insurance, Social Security and state and federal taxes added \$30,000.

Reports show the Hunt campaign employed 52 people in June with salaries totaling more than \$52,000, an average of \$1,000 a month. Payroll taxes and insurance added another \$23,000.

Chunks of money also go toward keeping the lights burning, the candidate moving and the office running. Federal campaign records show that the Helms' campaign, which had spent a total of \$9.3 million as of June 30, spent about \$580,000 on administrative operations, travel and supplies.

Hunt, who had spent a total of \$3.9 million in the same period, spent about \$460,000 on operating expenses.

The office equipment also runs up the tab. The Hunt campaign took out a \$76,500 loan last fall to purchase an IBM computer system. About \$10,600 went for two computer terminals, \$7,571 for a word processor and another \$4,280 for personal computers.

Rental of copiers, computer printers, typewriters and maintenance cost the Hunt camp \$13,254 in May and June. Furniture rental for the Raleigh office costs \$550 a month. Rent adds \$1,325 a month and the

Tobacco Allotment Sales Up

RALEIGH (AP) — At a time when many are predicting the demise of tobacco, the state director of the U.S. Agricultural and Stabilization Service says he is surprised to see so many farmers investing in the chance to grow more.

The comment by John Cooper followed his announcement Tuesday that North Carolina flue-cured tobacco farmers have bought about 18,000 acres of allotment from non-growers in the two years since Congress decided that only growers should hold allotments.

"We're showing there's a group of farmers that have confidence in the program, and these days so many people don't have confidence in anything," said Cooper.

The allotment sales from about 18,500 farms, representing about 32.7 million pounds of marketing quota, were first authorized by the No Net Cost Tobacco Program Act of 1982.

The sales by non-growers in the 12 months ended June 15 were double the pace of the previous year, Cooper said.

"The sales of allotments and quota have proven to be a positive step in making the tobacco program stronger because we're putting tobacco back into the hands of the growers," he said.

Cooper said farmers buying allotments were paying from \$1.25 a pound in the Piedmont to \$3.50 a pound in parts of the Eastern Belt. The ASCS is not involved in the financial details of such transactions, he said.

Before 1982, farmers could only lease and transfer allotments — the right to grow the state's biggest cash crop and receive federal price supports.

The 1982 legislation set 1987 as the last year for lease and transfer of allotments and December 1984 as the deadline for corporations to sell off allotments they once rented out.

Wake County led the state in sales, Cooper said, with 1,580 acres and 2.8 million pounds trading hands. Guilford County was second with 785 acres and 1.3 million pounds.

Hospitalized

BARCELONA, Spain (AP) — Surrealist painter Salvador Dali, hospitalized for burns covering 18 percent of his body, remains in serious condition, his doctors say.

The 80-year-old Dali was taken to El Pilar clinic Friday, one day after a fire broke out in his bedroom at his home, Pubol Castle, in northeastern Spain. Friends attributed the fire to an electrical short-circuit.

The painter had at first refused to leave the castle, where his Russian-born wife Gala is buried.

Dali's doctors said the artist also is being treated for malnutrition. He has a respiratory condition and has been in frail health in recent years.

Helms has access to the National Congressional Club's staff and computer services. Jefferson Marketing Inc. functions as the campaign's advertising agency. But some aspects of the Helms campaign's payment for those services have been challenged by Democrats.

Then there are the not-so-usual expenses — like the Hunt campaign's \$3,764 bill for Holiday Inn rooms at the Democratic National Convention in San Francisco. The Helms campaign spent \$8,100 for rooms at the Plaza of America for its entourage at the Republican National Convention in Dallas.

Debate Set Sunday

By The Associated Press
A spokesman for Gov. Jim Hunt says Hunt will emphasize several new issues in his second debate with Sen. Jesse Helms, and a Helms spokesman says the senator may take a different approach in this debate.

Hunt has promised to emphasize issues such as education, the environment and tax fairness. But campaign spokesman Will Marshall said the governor is not preparing

differently for the second meeting.

Helms for Senate campaign spokesman Claude Allen said Helms may take a different approach in this debate.

"This time Gov. Hunt will not get away with making misstatements as he did the last time," Allen said.

Meanwhile, the moderator of the second debate predicts there will be "a little more direct confrontation" in it than the first because the number of questions asked have

been cut by two.

The one-hour debate will be broadcast Sunday from WWAY-TV in Wilmington, beginning at 7 p.m. The moderator again will be George Diab, president-elect of the N.C. Association of Broadcasters and president of WWAY-TV.

Diab said the candidates will stand for the debate. The first confrontation came at the University of North Carolina Center for Public Television in Raleigh, where candidates sat behind a large desk.

The meeting was scheduled to be one of three regional and two statewide debates.



WIN \$1,000.00
IN GROCERIES!
Details at all Food Lion Store locations.



Mixed Fryer Parts **39¢** Lb.
Grade A
Holly Farms

These prices good thru Sunday, September 9, 1984
STORE HOURS:
Mon.-Sat.: 8 a.m. til 10 p.m.
Sunday: 9 a.m. til 9 p.m.

We reserve the right to limit quantities.

\$1.18 Lb.
USDA Choice Beef Chuck - Bone-In
Chuck Roast

\$1.68 Lb.
USDA Choice Beef Chuck
Boneless Roast

\$1.78 Lb.
USDA Choice Extra Lean
Stew Beef

\$1.59 10 Lb. Bag
US #1
White Potatoes

Food Lion Milk **\$1.39** Gallon
1/2% Lowfat

Fine porcelain china... FROM CHINA

69¢ Each

Each basic place setting piece with every \$5.00 purchase.

THIS WEEK'S FEATURE ITEM **Dinner Plate ONLY 69¢** With \$5.00 purchase

CHINA GARDEN

PRESTIGE PATTERN FEATURES:
 ■ Brilliant White Body
 ■ Oversize Dinner Plate
 ■ Delicate Floral Pattern
 ■ Platinum Trim
 ■ Dishwasher Safe

Complete your set with lovely Companion Pieces at fantastic low prices. Each piece will be an elegant addition to your dinner table. See these magnificent pieces at our store display.

A different piece each week. This week's feature Dinner Plates

\$1.09
2 Liter - Diet Cola/Caffeine Free Cola/
Caffeine Free Diet Cola/
Coca Cola

\$1.89
12 Oz. - Wise
Cottage Fries

\$4.39
Pkg. of 12 - 12 Oz. Cans
Old Milwaukee

6800 EVERYDAY LOW PRICES

Talent Hunt Planned To Find Actors For New Stooges

By BOB THOMAS
Associated Press Writer
LOS ANGELES (AP) — The Stooges are coming! The Stooges are coming!

Not in reruns. Not in 30-year-old movies. Larry, Moe and Curly are scheduled to return in a brand new comedy for theaters. "003" — a cut-rate, slapstick version of the James Bond spy capers.

How is that possible? The three original Stooges have died: Curly Howard in 1952, and Moe Howard

and Larry Fine in 1975.

"We will launch a nationwide talent search for actors to replace Moe, Curly and Larry," said Norman Maurer, who is masterminding the Stooze revival.

He is ideally suited for the job. He wrote the stories and produced four Stooze features and directed two of them. He is also Moe Howard's son-in-law.

Columbia Pictures, which made millions from the Three Stooges since they started making shorts for

the studio just 50 years ago, has given the go-ahead for "003." If the new movie is a hit, more will follow. George Gallo is writing a screenplay, which Maurer expects in a week.

"Then we'll launch the talent search and work up a budget," said the producer in an interview. "I expect the cost will be in the medium range — \$8 to \$10 million. That astounds me. I made the last Stooges features for under \$400,000."

Filming is expected to take place

next year in England and Mexico, where the spy adventure takes place.

If "003" comes off, it will mark another chapter in the unending saga of the three knockabout comics who have had an irresistible appeal for two or three generations of Americans.

It all started with a vaudeville comic named Ted Healy, a wild Irishman with an original comic style. In 1922, he hired a two brothers, Moe and Shemp Howard, as victims of his violent comedy. In 1925, a violinist named Larry Fine

joined the act. Later Shemp left to be a single performer and his place was taken by the melon-headed brother Curly.

Ted Healy and His Three Stooges moved on to Hollywood, then in 1934 Healy went off on his own (he died in 1937). Moe, Curly and Larry began their long association with Columbia. After Curly's death, Shemp rejoined the Stooges. He died after three years, and his place was taken in turn by Joe Besser and Joe DeRita.

"The big popularity of the Stooges came after World War II, when the

shorts were released on television," Maurer said. "The kids of the Baby Boom went crazy over the Stooges. They're adults now and their children are now fans. There's a big audience out there for our movie."



STOOGE HEAVEN — The Three Stooges, from left, Curly Howard, Moe Howard and Larry Fine, ham it up in a scene from one of their "Three Stooges" episodes. Although all three have since died, a nationwide talent

search will be launched for actors to replace them in a new film, "003," a slapstick version of the James Bond spy capers. (AP Laserphoto)

Brynnner Schedules New Medical Tests

MINNEAPOLIS (AP) — A national tour of "The King and I" starring Yul Brynner will have to bypass Minneapolis next month because the veteran stage and screen actor will be undergoing medical tests, the Orpheum Theater announced.

The theater said Tuesday that it had canceled performances of "The King and I" from Oct. 1 to Oct. 21 because Brynner must undergo medical examinations in California and Europe.

"We were told that Mr. Brynner will be undergoing examinations with specialists," said Mark Zelenovich, marketing, advertising and public relations agent for the Twin City Theater League. The appearances were part of a national tour of the show.

If the 64-year-old Brynner is able to continue the tour, Zelenovich said

an attempt will be made to arrange other dates at the Orpheum.

Brynner was diagnosed as having lung cancer last year, but underwent treatment and said in an interview in December that the disease had been arrested.

CONSOLIDATED THEATRES
758 337 9 Greenville Square Shopping Center

BUCCANEER MOVIES

1:00-3:05-5:10-7:15-9:20
"PURPLE RAIN" R

1:10-3:10-5:10-7:10-9:10
"THE WOMAN IN RED" PG-13

1-3-5-7-9
"GHOSTBUSTERS" PG
13th BIG WEEK!

STEWART & EVERETT THEATRE

NOW SHOWING!
BO DEREK

Bolero

A CANNON FILM
NO ONE UNDER 17 WILL BE ADMITTED

WEEKDAYS AT
3:00-7:05-9:00

Plaza 756-0088
cinema 1-2-3
PITZ PLAZA SHOPPING CENTER
KRIS KRISTOFFERSON
"FLASH POINT" (R)
WEEKDAYS 3:00-7:10-9:00

ENDS THUR!
"OXFORD BLUES"
3:00-7:05-9:00 (PG-13)

ALL SEATS \$2.00 PLAZA CINEMA
3 PM SHOW ONLY

PARK
UPTOWN GREENVILLE
332-7408

\$1.00 ANYTIME
ENDS THUR.
"SHEENA"
7:00 & 9:00 PG

Bell Invented The Telephone In 1875...

Pizza Inn Perfected The Phone-In Pizza!

Alexander Graham Bell started something when he invented the telephone! Little did he know that almost half of the pizzas made in America would be ordered by phone. Or, that the best pizza you can get is baked by Pizza Inn. Give us a ring and get set for the fastest, freshest pizza you ever put in your mouth. And when you pick up your pizza, be sure to bring your coupon...it's our nickel!

'Tightrope' Holds First In Earnings

LOS ANGELES (AP) — Suspense, supernatural high jinks and sex dominated the final weekend of what is shaping up as the biggest summer in film industry history.

Clint Eastwood's "Tightrope" held first place for a third straight weekend even though its gross of \$7.1 million for the four-day Labor Day holiday was slightly down from the previous three-day weekend.

But feisty "Ghostbusters" almost regained the top spot by scaring up \$6.8 million, nearly \$2 million more than a weekend earlier.

"Bolero," a sexually explicit adventure starring Bo Derek, scored \$4.6 million in its maiden outing to replace "Red Dawn" at third place. But critics predicted a short theatrical life for the film, which was released without a rating because its raciness supposedly would have earned it an X.

The review in the trade publica-

tion Daily Variety began: "There's a real good cartoon at the Hollywood Pacific this week in which a horse does funny things with Woody Woodpecker, followed by 'Bolero' in which Bo Derek does funny things with a horse, her hair and a couple of men. Judging from the audience's reaction, the cartoon will be around longer."

The weekend's other newcomer, Tri-Star's "Flashpoint" starring Treat Williams and Kris Kristofferson, was unable to crack the top 10 with a take of \$1.9 million.

- Final figures for the summer aren't yet in, but most observers expect that total ticket sales for the 50-odd summer releases will surpass the \$3.77 billion reported last year in Daily Variety.
- "The movie business always expands when you give the public
1. "Tightrope," Warner Bros., \$7.1 million, \$30.8 million, three weeks.
 2. "Ghostbusters," Columbia, \$6.8 million, \$188.6 million, 13 weeks.
 3. "Bolero," Cannon, \$4.6 million, 3 days.
 4. "The Karate Kid," Columbia, \$4.2 million, \$70.0 million, 11 weeks.
 5. "Purple Rain," Warner Bros., \$4.1 million, \$45.7 million, six weeks.
 6. "The Woman in Red," Orion, \$3.6 million, \$13.7 million, three weeks.
 7. "Red Dawn," MGM-UA, \$3.3 million, \$29.7 million, four weeks.
 8. "Gremlins," Warner Bros., \$3 million, \$136.7 million, 13 weeks.
 9. "Revenge of the Nerds," Fox, \$2.9 million, \$28.8 million, seven weeks.
 10. "Indiana Jones and the Temple of Doom," Paramount, \$2.2 million, \$167.3 million, 15 weeks.

what they want," Ashley Boone, Columbia Pictures vice president for marketing and distribution, said Tuesday. "This year, they gave them what they wanted."

The review in the trade publica-

tion Daily Variety began: "There's a real good cartoon at the Hollywood Pacific this week in which a horse does funny things with Woody Woodpecker, followed by 'Bolero' in which Bo Derek does funny things with a horse, her hair and a couple of men. Judging from the audience's reaction, the cartoon will be around longer."

The weekend's other newcomer, Tri-Star's "Flashpoint" starring Treat Williams and Kris Kristofferson, was unable to crack the top 10 with a take of \$1.9 million.

Final figures for the summer aren't yet in, but most observers expect that total ticket sales for the 50-odd summer releases will surpass the \$3.77 billion reported last year in Daily Variety.

"The movie business always expands when you give the public

TV Log

For complete TV programming information, consult your weekly TV SHOWTIME from Sunday's Daily Reflector.

WNCT-TV Ch. 9	
WEDNESDAY	12:00 News
7:00 Jokers Wild	12:30 Young & Rubicam
7:30 MASH	1:30 As The World Turns
8:00 Crossroads	2:30 Capitol
9:00 Movie	3:00 Guiding Light
11:00 Update	4:00 Waltons
11:30 Tennis	5:00 Happy Days
12:00 Movie	5:30 A. Griffith
THURSDAY	6:00 News
7:00 Jokers Wild	6:30 News
7:30 MASH	7:00 Jokers Wild
8:00 News	7:30 MASH
8:25 Newsbreak	8:00 Magnum P.I.
9:25 Newsbreak	9:00 Simon & Schuster
10:30 Pyramid	10:00 M. Hammer
10:30 Press Your Luck	11:00 Update
11:00 Price Is Right	11:30 Tennis
11:57 Newsbreak	12:00 Movie

WITN-TV Ch. 7	
WEDNESDAY	10:30 Sale of the Century
7:00 Jeffersons	11:00 Wheel of Fortune
7:30 F. Feud	11:30 Scrabble
8:00 No Payment	12:00 News
9:00 Facts of Life	12:30 Sears For Me
10:00 St. Elsewhere	2:00 Another World
11:00 News	3:00 Santa Barbara
11:30 Tonight Show	4:00 Whitney
12:30 Letterman	4:30 Brady Bunch
1:30 News	5:00 Little House
THURSDAY	6:00 News
5:30 POP Goes	6:30 NBC News
6:00 Almanac	7:00 Jeffersons
7:00 Today	7:30 Family Feud
7:25 News	8:00 Gimme A
7:30 Today	8:30 Family Ties
8:25 News	9:00 Cheers
8:30 Today	9:30 Court
9:00 Muppets	10:00 Hill Street
9:30 All in the Family	11:00 News
10:00 Facts of Life	11:30 Tonight Show
	12:30 Letterman
	1:30 News

WCTI-TV Ch. 12	
WEDNESDAY	10:30 Connection
7:00 Wheel Fortune	11:00 Family Feud
7:30 3's Company	11:30 Making The Grade
8:00 Billy Graham	12:00 Family Feud
9:00 Dynasty	12:30 Ryan's Hope
10:00 Hotel	1:00 All My Family
11:00 Action News	2:00 One Life at a Time
11:30 Nightline	3:00 G. Hospital
12:00 Harry O	4:00 T.B.A.
THURSDAY	4:30 B.J./LOBO
5:00 H. Field	5:30 Sanford & Son
5:30 J. Swaggart	6:00 Action News
6:00 Stretch	6:30 ABC News
6:30 News	7:00 Wheel Fortune
6:55 Action News	7:30 3's Company
7:25 Action News	8:00 Billy Graham
8:25 Action News	8:00 Football
9:00 Good Morning	12:00 Action News
9:00 Phil Donahue	12:30 Nightline
10:00 People Court	1:00 Harry O

WUNK-TV Ch. 25	
WEDNESDAY	12:00 Deal With It
7:00 Report	12:30 Writing
7:30 Women	1:30 Making The Grade
8:00 Special	1:30 Poldark
9:00 Judgement	2:30 Diamonds
10:00 20th Century	3:30 Yan Can Cook
11:00 Dr. Who	5:00 Mr. Court
11:30 Monty Python	5:30 Rainbow
12:00 Sign Off	6:00 Newshour
THURSDAY	7:00 Report
7:45 Weather	7:30 War Game
8:00 Mr. Rogers	8:00 V. Garden
8:30 Special	8:30 Neighbors
9:00 Sesame Street	9:00 Nature of the Beast
10:00 Electric Co.	10:00 Soundstage
10:30 Rainbow	11:00 Dr. Who
11:00 Y.E.S.	11:30 Monty Python
11:30 Footsteps	12:00 Sign Off

264 PLAYHOUSE
INDOOR THEATRE
6 Miles West Of Greenville
On U.S. 264 (Farmville Hwy.)

ENDS TONIGHT
AT YOUR ADULT ENTERTAINMENT CENTER

NEVER ENOUGH

756-0848 RATED X Doors Open
Showtime 6:00 5:45

Come To Western Sizzlin For Bigger, Juicy Beef Tips JUST ASK FOR THE NO. 3!

Lunch Special
Monday-Saturday 11 AM to 3 PM
\$2.99

WE PUT IT ON THE PLATE.

Sizzlin STEAK HOUSE

2903 E. 10th St. 758-2712
500 W. Greenville Blvd. 756-0040

Pappi's Pizzaden
421 Greenville Blvd.
Phone 756-0825

COUPON

2 For 1 Pizza Special
Buy One Pizza At Regular Price And Get Another Of Same Value Or Less Free.

COUPON GOOD AUG. 29-SEPT. 9
(Not Good With Any Other Special)

COUPON

"THE MIRACLE OF THE CENTURY"

SAYS A LEADING BRITISH CHURCHMAN



BILLY GRAHAM
3 TV SPECIALS

MISSION ENGLAND

When future generations study 20th Century history, "Mission England" will possibly be viewed as one of the great Christian events of our day as Billy Graham held forty-one meetings in six major English cities. In rain, wind and summer heat, attendance records were shattered everywhere. 1.2 million people came; 100,000 responded to Dr. Graham's invitation! Tonight see "the miracle of the century!"

PROGRAM NO. 1 TONIGHT 8:00 CHANNEL 12

Deeds

James H. Bailey Jr. to United States of Amer. NS
 Johnny S. Bobbitt al to United States of Amer. NS
 Silas M. Cherry al to Linda Dianne Ross al 10.00
 Winterville Free Will Baptist Church to Gateway Christian Center 10.00
 Woody J. Deyton al to Donna Lynn Zekonis 16.50
 Jasper Ray Hannah al to Harvey Eugene Hardee al NS
 Heritage Develop. Co. to Gary Maurice Dull 41.00
 Heritage Develop. Co. to Irvin W. Kemp al 39.50
 Rozelle Williamson Jones al to Mildred Gwendolyn Lee 40.00
 Kenneth W. Rakestraw al to David Hill 20.00
 Thomas F. Taft al to Claude Barbour Strickland 74.00
 Lovie G. White al to E.T. Vinson al 33.50
 Lenore M. Morton to Carl Johan Bentzel al 121.00
 Francis Blount Allen to Tean Woolard Allen NS
 Lynn Gordon Borchert al to Kenneth G. MacDonald al 68.00
 Bill Clark Const. Co. to William C. Boyce Jr. al 148.00
 Donald Lewis Durland al to Dalas W. Leggett al 22.50
 John D. Ezzelle Jr. al to Thomas L. Potter al 12.50
 Heritage Develop. to Eddie Earl Smith al 40.50
 Elizabeth M. Kelly to Marcus W. Montgomery al 48.00
 Thurston S. Lloyd al to R.H. Lloyd al NS
 R. Guy Mayo Jr. al to William Dennis Vergot al 44.00
 R. Guy Mayo Jr. al to Gordon S. Strout al 5.00
 D.W. McPherson al to Carl Edward Harris al 15.00
 Cora Stocks McCoy to Elbert L. McCoy al NS
 Cora Stocks McCoy to Hazel Squires Rhodes NS
 Tipton Builders Inc. to James E. Welson al 5.00
 Tipton Builders Inc. to Pattie W. Michael 6.00
 Douglas A. Tripp al to Jimmy Ray Tripp al NS
 U.S.-Farmers Home Adminis. to Francis J. Rodenbeck al NS
 Valley Forge Corp. to Freddie Howard Williams NS
 Freddie H. Williams al to Shirlee Rose Williams 15.00
 Eugene Adams to Katie B. Clark 16.50
 William E. Barnes al to Isaac Taft NS
 Randolph Corbett al to Rudolph Robinson al 23.00
 Moses Teel al to Jesse R. Corey al 4.50
 Vanrack Inc. to Henry B. Harris II al 63.00
 Vanrack Inc. to Charles Michael Baucom al 72.00
 Carl L. Miller al to U.S. of America NS
 Myrtle H. Wilson al to Cecil Troy Wilson al NS
 U.S.-Farmers Home Adminis. to Horace P. Parker al NS
 Mitchell Lane Andrews al to Kirby Lee Branch 5.00
 Bill Clark Const. to Louis John Hallow 50.00
 Walter Ray Davenport al to David Lee Spell al 20.00
 B.E. Dixon al to Benjamin B. Tetterton 1.00
 Ralph Thomas Manning al to Si Joon Park al 75.00
 Ronnie J. Sprivey al to Merrill Lynch Relocation Mgmt. Inc. NS
 Merrill Lynch Relocation Mgmt. Inc. to Terrence M. Boardman al 116.50
 Roosevelt Moye to Roosevelt Moye al NS
 Shamrock Realty Co. to Emmett Bruce Koonce 50.00
 Elva Irene Smithson to Joseph Harrison al NS
 Edna B. Williams to Luther Albert Williams NS
 Ringgold Develop. Co. to Eugene H. Phillips al 28.50
 Ringgold Develop. Co. to James R. Reardon al 43.00
 Ringgold Develop. Co. to Charles J. Shaughnessy III 43.00
 Ringgold Develop. Co. to H. Donald Wood al 54.00
 Ringgold Develop. Co. to Cecil J. Waylan al 50.00
 Ringgold Develop. Co. to Charles B. Amick al 43.00
 Ringgold Develop. Co. to Joseph Bonsignore Jr. 27.50
 Ringgold Develop. Co. to Edwin G. Brandle 30.00
 Ringgold Develop. Co. to Robert G. Brown al 27.50
 Ringgold Develop. Co. to Robert G. Brown al 27.50
 Ringgold Develop. Co. to William S. Brown al 27.50
 Ringgold Develop. Co. to Clark S. Lambert al 28.50
 Ringgold Develop. Co. to Willie L. Glenn al 27.50
 Ringgold Develop. Co. to Donald E. Obernesser al 29.00
 Ringgold Develop. Co. to Robert E. Wimbrough al 28.50
 Ringgold Develop. Co. to William B. Pierce al 29.00
 Ringgold Develop. Co. to Sylvia Carter Herbert 30.00
 Ringgold Develop. Co. to Cooper Smith Jr. al 42.00
 Ringgold Develop. Co. to John W. LaCava al 35.50
 Ringgold Develop. Co. to R.J. Lanham al 43.00
 Ringgold Develop. Co. to Bert M. Montague al 30.00
 Ringgold Develop. Co. to Charles James Prizzia 28.50
 Ringgold Develop. Co. to Richard

Celidonio 29.00
 Ringgold Develop. Co. to James E. Aliyetti al 28.50
 Ringgold Develop. Co. to John W. Barts Jr. 50.00
 Ringgold Develop. Co. to Donald Francis Beach 28.50
 Ringgold Develop. Co. to N. Wayne Campbell al 50.00
 Ringgold Develop. Co. to R. Lynn Dewar al 28.50
 Ringgold Develop. Co. to Frederick Fine al 43.00
 Ringgold Develop. Co. to Robert E. Gregory al 28.50
 Ringgold Develop. Co. to James P. Harrington al 42.00
 Ringgold Develop. Co. to Charles Cawley Harris al 30.00
 Ringgold Develop. Co. to Jack R. Johnson al 29.00
 Ringgold Develop. Co. to Jonmar Enter. 42.00
 Ringgold Develop. Co. to Larry Jones al 27.50
 Ringgold Develop. Co. to Lynda Joslyn 28.50
 Ringgold Develop. Co. to Lester Vincent Lowe Jr. al 44.00
 Ringgold Develop. Co. to Mil-Ventures Inc. 53.00
 Ringgold Develop. Co. to Floyd Rudy Mills 27.50
 Ringgold Develop. Co. to Alex McIver Jr. al 42.00
 Ringgold Develop. Co. to Larry Jay Waggoner 44.00
 Ringgold Develop. Co. to Walter M. Walker Jr. 44.00
 Ringgold Develop. Co. to Jack E. Gove al 44.00
 Ringgold Develop. Co. to Nina Belle Redditt 44.00
 Ringgold Develop. Co. to Harold P. Streep al 44.00
 Ringgold Develop. Co. to Thurman Williams Jr. al 44.00
 Ringgold Develop. Co. to Phillip M. Levy al 50.00
 Ringgold Develop. Co. to Keith B. Thompson al 27.50
 Ringgold Develop. Co. to Alvin A. Turner al 42.00
 Ringgold Develop. Co. to Frederick T. Nordman al 42.00
 Ringgold Develop. Co. to Ira M. Hardy II al 70.00
 Ringgold Develop. Co. to Charlie M. Martin 30.00
 Ringgold Develop. Co. to James Palmer Harrington al 52.00
 Ringgold Develop. Co. to George W. Rodormer al 28.50
 Ringgold Develop. Co. to G.R. Lada al 42.00
 Ringgold Develop. Co. to Donald J. Reale al 52.00
 Ringgold Develop. Co. to Samuel S. Sagotsky al 28.50
 Ringgold Develop. Co. to Nathaniel B. Coven al 28.50
 Ringgold Develop. Co. to Peter Alan Beckert 54.00
 Ringgold Develop. Co. to Nina Bell Redditt 29.00
 Ringgold Develop. Co. to Antonio Scenna al 30.00
 Ringgold Develop. Co. to Alva H. Simms al 28.50
 Ringgold Develop. Co. to Harold P. Streep al 36.00
 Ringgold Develop. Co. to Jerome Morton Sovelove al 50.00
 Ringgold Develop. Co. to Harold P. Streep al 29.00
 Ringgold Develop. Co. to Harold P. Streep al 36.00
 Ringgold Develop. Co. to Barbara Ann Rash 27.50
 Ringgold Develop. Co. to Ralph P. Hamilton al 29.00
 Ringgold Develop. Co. to John R. Hummcutt al 50.00
 Ringgold Develop. Co. to Ringgold Trusts 54.00
 Ringgold Develop. Co. to Dawn

Lewis Macy 28.00
 Ringgold Develop. Co. to Dawn Lewis Macy 28.00
 Ringgold Develop. Co. to Aaron McCrickard al 42.00
 Ringgold Develop. Co. to William S. Brown al 42.00
 Ringgold Develop. Co. to Douglas L. Wiggins al 42.00
 Ringgold Develop. Co. to Osilda Garcia Bull 27.50
 Ringgold Develop. Co. to Daniel E. Clark NS
 Ringgold Develop. Co. to Thomas William Coats al 43.00
 Ringgold Develop. Co. to William R. Davies al 52.00
 Ringgold Develop. Co. to John C. Falconer al 43.00
 Ringgold Develop. Co. to Julian Barker al 28.50
 Ringgold Develop. Co. to R. Tilden Burrus al 49.00
 Ringgold Develop. Co. to Harold Dean Garrett al 28.50
 Ringgold Develop. Co. to Gerald J. McQuaid al 27.50
 Ringgold Develop. Co. to Franklin G. Muller al 42.00
 Ringgold Develop. Co. to Salvatore D. Rullo 43.00
 Ringgold Develop. Co. to Fred W. Payne Jr. al 29.00
 Ringgold Develop. Co. to Charles A. Matzen Jr. al 35.50
 Mayfield H. Burton to Marion Mayfield Burton 10.00
 Capital Develop. Co. to Ed N. Warren al 45.00
 Capital Develop. Co. to George L. Pugh al 45.00
 Bill Clark Const. to Susan E. Hice 66.00
 Home Builders & Co. to Norman G. Gooch al 46.50
 Lizzie F. Hudson to Donald Allen Hudson al NS
 Donald Allen Hudson al to Lizzie Lee Hudson NS
 Alice Lane Ross Foreman to Essie Lee Ross Horne al NS
 Dalas W. Leggett to Janice H. Leggett NS
 U.S.-FmHA to Norman G. Macleod al NS
 Lee O. Mooring al to Adell Smith O'Neal al 34.00
 Shamrock Realty Co. to A. Scott Buck al 53.50
 John H. Wellons al to Heritage Develop. Co. 26.00
 Atlas W. Wooten al to Martin Gayle Voncannon al 46.50
 Vanrack Inc. to David Keith White al 6.00
 Bowser Const. Co. Inc. to Richard Alan Whitener 140.00
 Chapin & Assoc. Inc. to L. Grady Lardner 60.00
 Chapin & Assoc. Inc. to Michele M. Arrowood al 68.50
 Ceco Cont. Inc. to John R. Furey al 60.00
 Badger G. Clark Jr. al to Suzanne Moore Shepherd 122.50
 Morris Junior Green al to Myrtle Wilson NS
 Paula B. Harbin to Sybill Lori Lucas 45.00
 Roger Lazzarino to Bennett La Prade Jr. 9.50
 R. Guy Mayo Jr. al to Grace W. Weatherington 6.00
 James A. Nickelsen al to Stanley Peaden Builders
 Ringgold Develop. Co. to Feno S. Volpe al 27.50
 Ringgold Develop. Co. to Feno S. Volpe al 27.50
 Ringgold Develop. Co. to Patrick L. Pascarella to 27.50
 Ed N. Warren al to Billy Whitehurst 19.50
 Myrtle Wilson to Morris Junior Green al NS

FUNKY WINKERBEAN



SHOE



PEANUTS

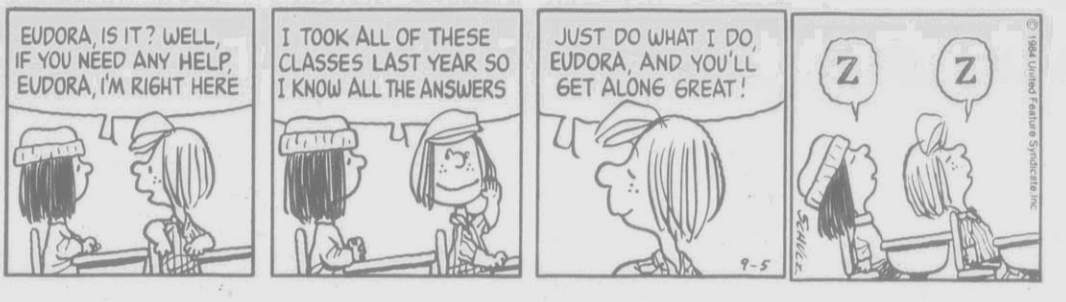

B.C.



NUBBIN

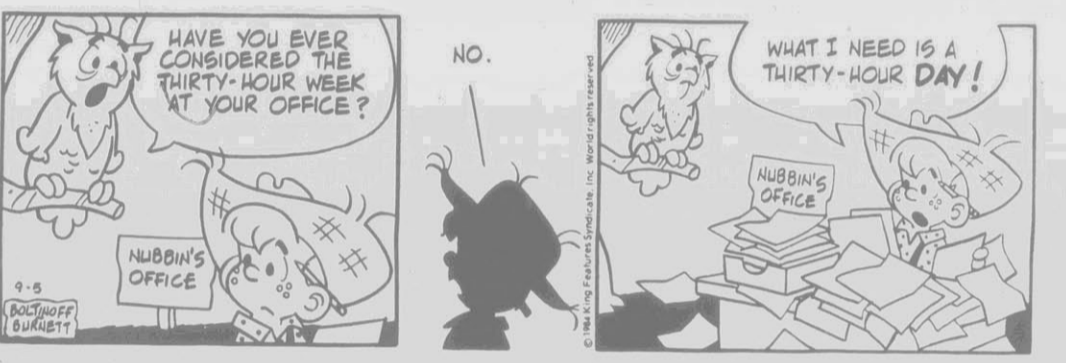

BLONDIE



BETLE BAILEY

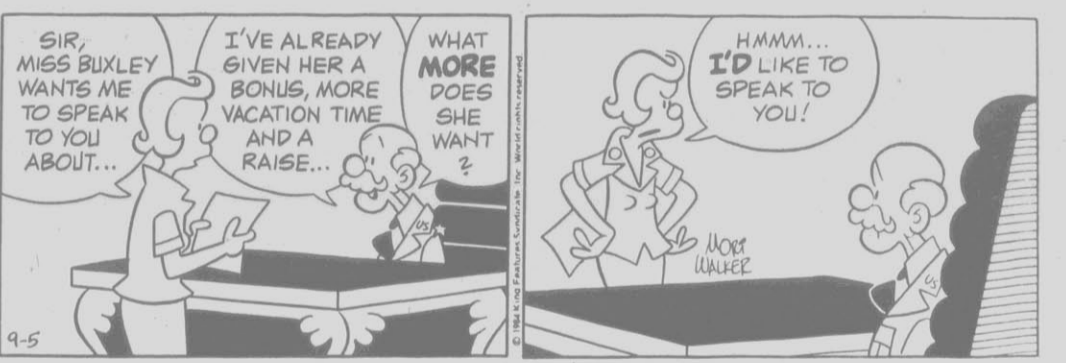

PHANTOM



FRANK & ERNEST

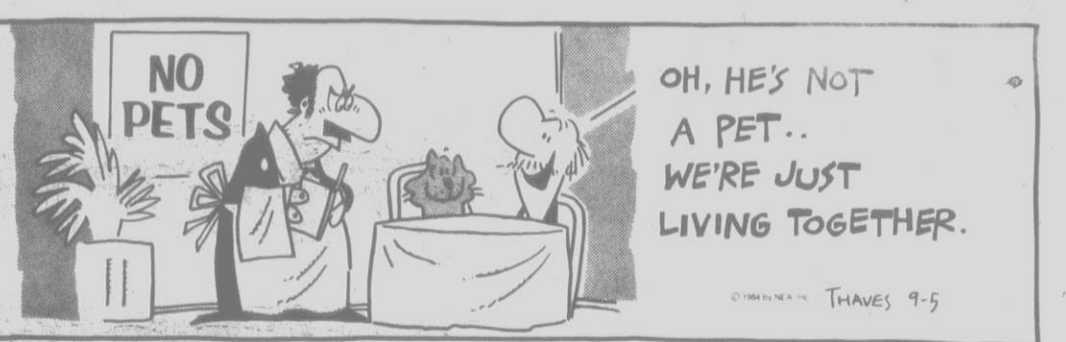

Sammy's
COUNTRY COOKING

512 E. 14th Street (Near Football Stadium)

— Tailgate Party —
 Fried Chicken Box Lunch
 With Potato Salad & Baked Beans
 Or Choice Of Other Vegetables Available
 Call Ahead For Boxes Of Chicken
 We Can Deliver

Sunday Special
 Turkey & Dressing..... **\$3.95** Plus Tax
 Hours: 11-8 Seven Days A Week **752-0476**

Luncheon Buffet

\$2.99 Per Person
 All You Can Eat Best Deal In Town

(CALL FOR GROUP RATES)

MONDAY THRU FRIDAY
 11:30 TIL 2:00 P.M.

Pizza, Spaghetti, Garlic Bread, Salad & Hot Cinnamon Apples

COUPON

That's Amore
PIZZA PIE

\$2.00 off
 Any Large Pizza
 (One Item Or More)

Not Valid With Any Discount Coupon or Daily Special
 PHONE 756-9550

077 Musical Instruments

CLARINET FOR SALE. Phone 756-2352. FREE CHICKERING PIANO. Register for a chance to win now through September 30...

077 Musical Instruments

PIANO FOR SALE. \$450. Located in Washington. Call local 752-3816 after 6:30.

091 Business Services

PROFESSIONAL CLEANING Service is available for your residential and commercial needs. Now fully bonded and insured.

093 OPPORTUNITY

LIST OR BUY your business with C.J. Harris & Co., Inc. Financial & Marketing Consultants. Serving the Southeastern United States.

102 Commercial Property

GREAT OPPORTUNITY for your own place of business. Over 2400 square feet, busy location and adequate parking.

109 Houses For Sale

ATTENTION HORSE LOVERS!! This lovely brick home with 18 1/2 acres can be your paradise.

109 Houses For Sale

CONTEMPORARY Charm: 4 bedroom, 4 baths, Florida room, jacuzzi, central vacuum, call for all the other features.

109 Houses For Sale

FOR SALE BY OWNER. Townhouse, 2 bedrooms, 1 1/2 baths, large patio, many extras.

109 Houses For Sale

FOUR BEDROOMS, two full baths. 12% loan assumption. 410 Sedgewick. \$59,500.

CLASSIFIED DISPLAY

S-1 SENTRY SAFE

\$119 CAROLINA OFFICE EQUIPMENT CO. Corner of Pitt & Green St.

082 LOST AND FOUND

LOST my friend Sam, a Samoyan (all white dog medium sized) with a blue collar.

OWN YOUR OWN

Sportswear, ladies apparel, combination, accessories, large size store. National brands.

100 REAL ESTATE

RED CARPET Steve Evans & Associates, Inc. Full line of Real Estate and Insurance Services.

104 Condominiums For Sale

BY OWNER. New townhouse, 2 baths, large kitchen, laundry room, carpet, near Athletic Club.

106 Farms For Sale

FARMLAND located North of Greenville, 214 acres in Carolina Township. 160 acres cleared.

109 Houses For Sale

ALL THE WORK'S DONE. Everything is like new in this 3 bedroom, 1 1/2 bath home.

109 Houses For Sale

EXECUTIVE HOME on Highway 13. Beautiful past Simpson. REDUCED to \$69,900.

109 Houses For Sale

NEW LISTING in Edwards Acres. Beautiful 3 bedroom contemporary on lovely lot.

ALLIS-CHALMERS PARTS & SERVICE. We have a good stock of ALLIS-CHALMERS Tractor and Gleaner. Combine parts. 5% DISCOUNT for Cash. Boyette Tractor Company, Inc.

CLASSIFIED DISPLAY

PORTER'S AUTO PARTS

24 Hour Wrecker Service Paint & Body Work. We Buy Junk Trucks & Cars. CALL ANYTIME DAY OR NIGHT 752-1510

102 Commercial Property

AYDEN. Commercial vacant lot for sale, rent or lease. 165' frontage, Highway 102 beside new ABC Store.

109 Houses For Sale

CONVENIENT TO Everything. Immaculate 3 bedroom, 2 bath brick ranch with heat pump, garage, deck, payments based on income.

109 Houses For Sale

EXCITING NEW CONCEPT for comfortable, affordable living in Greenville.

109 Houses For Sale

NEW LISTING in Edwards Acres. Beautiful 3 bedroom contemporary on lovely lot.

109 Houses For Sale

PLENTY OF SHADE on an extra large lot make this 3 bedroom home in the country ideal for raising children.

CLASSIFIED DISPLAY

1981 HONDA ACCORD

Tan, AM-FM stereo, 5 speed. Less than 30,000 miles. Exceptionally nice. 90 day warranty. \$6450 Firm. Contact: Don Wilkerson 752-2101 Day 758-9101 Night

109 Houses For Sale

ALL THE WORK'S DONE. Everything is like new in this 3 bedroom, 1 1/2 bath home. \$54,500. Call Nancy Dudley for details at Aldridge & Southerland.

109 Houses For Sale

EXECUTIVE HOME on Highway 13. Beautiful past Simpson. REDUCED to \$69,900. Over 2200 sq. ft. of space for living and entertaining.

109 Houses For Sale

NEW LISTING in Edwards Acres. Beautiful 3 bedroom contemporary on lovely lot.

109 Houses For Sale

PLENTY OF SHADE on an extra large lot make this 3 bedroom home in the country ideal for raising children.

109 Houses For Sale

OWNER ANXIOUS to sell: Nice country home, modern, 6 years old, a real value \$48,000. Listing Agent Pat Terry.

THE MANAGEMENT OF TAR RIVER ESTATES invites you to come by and see one of Greenville's most prestigious Apartment Communities. One, two and three bedroom spacious apartments with all the extras. Office Hours: Mon.-Fri.-9-6 Sat.-1-5 Sun.-1-5 Tar River ESTATES 1400 Willow Street 752-4225 Managed By: U.S. Shelter Corporation

Help Wanted

Full & Part Time Must be neat, honest and dependable. Prefer nondrinker. Apply in person only to Don or Dave. Sam & Dave's Snack Bar 1200 N. Greene Street

CLASSIFIED DISPLAY

FOR SALE BY OWNER

NEW TOWNHOUSE Below market price. Low monthly payments, 2 bedroom, 2 1/2 bath with basement.

CLASSIFIED DISPLAY

CLASSIFIED DISPLAY

Director of Nursing Needed For Our Special People GUARDIAN CARE Cunningham Rd. Kinston, N.C. We are looking for that special R.N. to manage our nursing department. Excellent Benefits Package. Contact: Ethel McLean A Hillhaven Facility 527-5146 E.O.E.

DENTAL RECEPTIONIST For Group Practice Prefer someone with experience. Good salary, good working conditions. Send resume to: Dental Receptionist P. O. Box 1967 Greenville, NC 27835

CLASSIFIED DISPLAY ROOFING STORM WINDOWS DOORS & AWNINGS C.L. Lupton Co. 752-6116

The Best Selection of Re-Conditioned Trade-Ins! There's no better time to buy a previously owned car. We've just returned from two very successful Toyota Tent Sales with an abundant selection of previously owned trades. They've all been re-conditioned to drive like new, and they're all on sale now! Look over this selection, then come see us for the savings!

P-7201 - 1984 Toyota Truck	5660-A - 1983 Chevrolet Camaro Z-28	5683-A - 1981 Chevrolet C-10 Truck
P-7199 - 1984 Toyota Truck	5664-A - 1983 Buick Regal	5689-A - 1981 Mercury Lynx
P-8624 - 1984 Ford Tempo	P-8680 - 1983 Toyota Celica GT	P-7208 - 1981 Toyota Tercel
P-8626 - 1984 Ford Tempo	P-8647 - 1982 Toyota Corolla	P-8609 - 1981 Toyota Celica
P-8628 - 1984 Ford Tempo	P-8622 - 1982 Toyota Celica	P-7216 - 1981 Toyota 4 X 4 Truck
P-8629 - 1984 Ford Tempo	P-7203 - 1982 Toyota Truck	5801-A - 1981 Toyota Tercel
P-8631 - 1984 Ford Tempo	5513-A - 1982 Datsun Diesel Pickup	P-7210 - 1981 Toyota Tercel
P-8632 - 1984 Ford Tempo	R-7077 - 1982 Toyota Cressida	P-8653 - 1981 Pontiac Bonneville
P-8633 - 1984 Ford Tempo	P-8594 - 1982 Volvo GLE	P-8656 - 1981 Toyota Corona
P-7212 - 1984 Toyota Corolla	P-8579 - 1982 Chevrolet Celebrity	P-8657 - 1981 Toyota Corolla
P-7213 - 1983 Toyota Truck	P-8578 - 1982 Buick Century	P-8660 - 1981 Olds Delta
P-7211 - 1983 Mercedes 300-D	P-8572 - 1982 Mercedes-Benz 300-TD	P-8654 - 1980 Toyota Tercel
P-8613 - 1983 BMW	P-8490 - 1982 Toyota Truck	P-8666 - 1980 Pontiac LeMans
R-7193 - 1983 Toyota Truck	4593-B - 1982 Porsche	5723-A - 1980 Chevrolet Truck
R-7196 - 1983 Toyota Tercel	5407-A - 1982 Toyota Truck	5768-A - 1980 Toyota Truck
R-7187 - 1983 Toyota Tercel	5691-A - 1982 Buick Skylark	P-8470 - 1980 Toyota Corona
P-8576 - 1983 Plymouth Horizon	5760-A - 1982 Toyota Corolla	5785-A - 1980 Toyota Corolla
P-8472 - 1983 Toyota Tercel SR-5	P-7206 - 1982 Datsun	P-8580 - 1980 Mercury Marquis
P-8480 - 1983 Toyota Tercel	P-7207 - 1982 Toyota Truck	5813-A - 1979 Datsun B-210
P-8519 - 1983 Toyota Corolla Wagon	5777-B - 1982 Chevrolet Chevette	P-8641 - 1979 Buick LeSabre
P-8548 - 1983 Toyota Tercel	5794-A - 1982 Cadillac Fleetwood	P-7198 - 1979 Dodge Omni
P-8549 - 1983 Chevrolet Citation	P-8662 - 1981 Toyota Celica	P-8487 - 1979 Toyota Corolla
5635-A - 1983 Ford Ranger Pickup	P-8650 - 1981 Toyota Supra	P-8541 - 1979 Mercedes-Benz 300-D
5714-A - 1983 Toyota Blazer	P-8486 - 1981 Mazda GLC	5739-A - 1979 Toyota Corolla
5726-A - 1983 Toyota Corolla	P-8608 - 1981 Pontiac T-1000	5612-A - 1977 Ford LTD II
P-8648 - 1983 Toyota Starlet	P-8591 - 1981 Toyota Tercel	P-8443 - 1969 Austin Healy
R-7171 - 1983 Toyota Truck	R-7163 - 1981 Yamaha Motorcycle	5783-A - 1968 Mercedes 280-SL
5704-A - 1983 Pontiac 2000	R-7183 - 1981 Toyota Motor	P-8479 - 1967 Mercedes-Benz 250-SL

Your Friendly Neighbors At



Know What It Is To Feed A Family

BEALE SLICED
1/4 PORK LOIN
\$1.29
LB.
YOU SAVE 50%



BEALE
SMOKED PICNIC .69^c LB. 79^c LB. SLICED
YOU SAVE 30% WHOLE, LIMIT 2

BEALE
PORK CHOPS \$1.69 LB. \$1.79 LB. 99^c LB.
CENTER LOIN YOU SAVE 60% END CUT YOU SAVE 50%

FRESH
WHITE POTATOES
\$1.29
10 LB. BAG
YOU SAVE 40%

FRESH ONIONS
69^c
3 LB. BAG
YOU SAVE 30%

BEALE'S WHOLE
COUNTRY HAM..... \$1.29 LB.
YOU SAVE 30%

"HOUSE OF RAEFORD" MIXED
FRYER PARTS..... 49^c LB.
YOU SAVE 20%

RED GLO
TOMATOES 303 CANS **\$1.39**
YOU SAVE 10%

DEL MONTE
CATSUP .32 OZ. BOTTLE **89^c**
YOU SAVE 68%

SAUER'S
BLACK PEPPER 25% MORE 5 OZ. CAN **99^c**
YOU SAVE 26%

KRAFT PARKAY
MARGARINE 1 LB. BOX **69^c**
YOU SAVE 16%

OODLAND
COUPON
YOU SAVE 58%

WHITE, BEIGE/PEACH/GREEN OR YELLOW/BLUE
COTTONELLE BATHROOM TISSUE
4 ROLL PKG. **79^c**
Limit 1 With \$10.00 Additional Food Order Or More & This Coupon. Expires Sept. 8, 1984.

FRESH
BROCCOLI 79^c BUNCH
YOU SAVE 30%

NC RED DELICIOUS
APPLES 89^c 3 LB. BAG
YOU SAVE 30%

FRESH SCUPPERNONG
GRAPES 99^c PINT
YOU SAVE 20% FRESH

COLLARDS 37^c LB.
YOU SAVE 12%

DUNCAN HINES
CAKE MIX 19 OZ. BOX **79^c**
YOU SAVE 30%

STOKELY LEMON LIME, ORANGE OR FRUIT PUNCH
GATORADE 32 OZ. BOTTLE **69^c**
YOU SAVE 16% BOTTLE

COCA COLA \$1.09 2 LITRE BOTTLE

BREYER'S
ICE CREAM..... 1/2 GAL. **\$2.59**

OODLAND
COUPON
YOU SAVE 86%

COLD POWER DETERGENT 20% OFF
49 OZ. BOX **\$1.29**
Limit 1 With \$10.00 Additional Food Order Or More & This Coupon. Expires Sept. 8, 1984.

LOG CABIN
SYRUP \$1.99 24 OZ. BOTTLE
YOU SAVE 28%

HUNGRY JACK COMPLETE
PANCAKE MIX REGULAR OR BUTTERMILK 2 LB. BOX **99^c**
YOU SAVE 48%

MINUTE MAID
APPLE JUICE 12 OZ. CAN **99^c**
YOU SAVE 10%

DEL MONTE GOLDEN WHOLE KERNEL OR CREAM
CORN 303 CANS **89^c**
YOU SAVE 18%

DULANY
BROCCOLI SPEARS 10 OZ. BOX **69^c**
YOU SAVE 10%

KELLOGG'S
RAISIN BRAN 20 OZ. BOX **\$1.79**
YOU SAVE 36%

MAXWELL HOUSE
INSTANT COFFEE 6 OZ. JAR **\$3.39**

KEEBLER
ZESTA SALTINES 16 OZ. BOX **99^c**

KEEBLER
VANILLA WAFERS 12 OZ. BOX **\$1.19**

ANACIN 100s **\$3.79**
EVERYDAY LOW PRICE

KEEBLER NEW STONE CREEK
CRACKED WHEAT CRACKERS 11 OZ. PKG. **89^c**

OODLAND
COUPON
YOU SAVE 86%

WESSON OIL 24 OZ. BOTTLE **89^c**
Limit 1 With \$10.00 Additional Food Order Or More & This Coupon. Expires Sept. 8, 1984.

MORTON CHICKEN, TURKEY MEATLOAF, OR SALISBURY
DINNERS..... 11 OZ. BOX **89^c**
YOU SAVE 26%

MARS SNACK BARS SNICKERS, MILKY WAY OR 3 MUSKETEERS 16 OZ. BAG **\$2.19**



DELTA PAPER TOWELS
21.00
ROLLS
YOU SAVE 9%

TOTINO
SAUSAGE, HAMBURGER, PEPPERONI, CANADIAN BACON OR SAUSAGE/PEPPERONI
PIZZA 99^c
10 OZ. BOX
YOU SAVE 50%

GIBBS
PORK N' BEANS
31.00
16 OZ. CANS
YOU SAVE 6%

SHOP EZE NO. 4
WEST END SHOPPING CENTER
OWNED & OPERATED BY SHOP EZE FOOD STORES INC.
MANAGER: JOE EDWARDS
MONDAY-SATURDAY 8 A.M.-9 P.M., SUNDAY 9 A.M.-6 P.M.
VISIT OUR DELI FOR DAILY LUNCHEON SPECIALS



MISS BRECK HAIR SPRAY..... 9 OZ. CAN **\$1.59**
EVERYDAY LOW PRICE

WE WILL GLADLY ACCEPT USDA FOOD STAMPS & WIC VOUCHERS. QUANTITY RIGHTS RESERVED. NONE SOLD TO DEALERS. PRICES EFFECTIVE SEPTEMBER 6, 7, 8, 1984.

SHOP EZE NO. 8
UNDER NEW MANAGEMENT
1411 CHARLES BLVD.
OWNED & OPERATED BY SHOP EZE FOOD STORES, INC.
MANAGER: MELVIN WHITLEY
MONDAY-SATURDAY 7:30 A.M.-9 P.M., SUNDAY 8 A.M.-7 P.M.

Crossword By Eugene Sbeffer

- ACROSS**
 1 Firmament
 4 Blemish
 8 Yucatan Indian
 12 Hasten
 13 African river
 14 Caesar's fatal date
 15 Nocturnal creature
 16 Pride of the U.S.
 18 Rice dish
 20 Deface
 21 Wax
 24 — and Martin
 28 It doesn't cost a cent
 32 Western city
 33 Fate
 34 Whirls
 36 Siamese coin
 37 — Alonzo Stagg
 39 Without tax
 41 Heredity factors
 43 Russian despot
 44 Resinous substance
- 46** Kind of poem
50 Non-staff writer
55 Artificial language
56 Weather word
57 Hawaiian garlands
58 The heart
59 Handle
60 Veal or pork
61 Lodge member
- DOWN**
 1 Store
- 2** Flightless bird
3 Call loudly
4 Fenders or bumpers
5 Irish sea god
6 Barcelona bravo
7 Abound
8 Reflect
9 American humorist
10 Affirmative
11 Ninny
17 Common value
- 19** Top combat pilot
22 Tears
23 Decree
25 Become impaired by use
26 Poker stake
27 Observe
28 Ensign
29 Eternal City
30 English school
31 Grandson of Adam
35 Most trite
38 Girl's name
40 Cook bacon
42 — Mineo
45 Unruffled
47 Food staple
48 Pagan deity
49 Irish county
50 Monk's title
51 Fled
52 Ice, in Bonn
53 Born
54 It followed the OSS
- Avg. solution time: 25 min.



Answer to yesterday's puzzle.

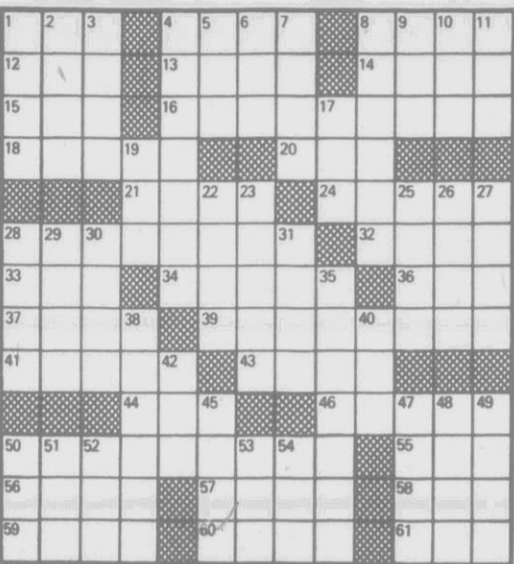

CRYPTOQUIP 9-5

QTXR MJNXOQZL INRNATJ YEIX

WEAR NO YNR WXZMJL?

Yesterday's Cryptiquip — NON-HUMOROUS TIRE SALESMAN IS FULL OF HOT AIR.

Today's Cryptiquip clue: N equals I

The Cryptiquip is a simple substitution cipher in which each letter used stands for another. If you think that X equals O, it will equal O throughout the puzzle. Single letters, short words, and words using an apostrophe can give you clues to locating vowels. Solution is accomplished by trial and error.

© 1984 King Features Syndicate, Inc.

FOCUS



Watching the Watchers

At the start of a new television season, viewers in the 83.8 million U.S. households with television sets may be wondering how their favorite shows will fare in the Nielsen ratings. "The Niensens" estimate the percentage of these households watching particular broadcasts. According to Nielsen, women over 55 watched the most television in 1981. But female teens watched the least. During the 1983-84 season, the TV series with the highest average rating was "Dallas."

DO YOU KNOW — Which network had the highest overall prime-time ratings during the 1983-84 season?

TUESDAY'S ANSWER — Chicago's Sears Tower is the tallest building in the world.

9-5-84

Knowledge Unlimited, Inc. 1984

FARM fresh
SUPER SAVING CENTER
 609 E. GREENVILLE BLVD.
 SERVING ALL OF GREENVILLE
 OPEN 24 HOURS A DAY 7 DAYS A WEEK

WITH OVER 30,000 LOW PRICES... YOU'LL SAVE MONEY!
FARM FRESH INVITES YOU TO ENJOY SUMMER AT
 PICK UP FREE DISCOUNT COUPONS WORTH **\$3.00 OFF**
 THE REGULAR ADMISSION PRICE TO THE OLD COUNTRY
BUSCH GARDENS AND THE OLD COUNTRY RIDE
 WILLIAMSBURG, VA
THE BIG BAD WOLF

PRICES EFFECTIVE THRU 9/8/84. QUANTITY RIGHTS RESERVED.

USDA HEAVY WESTERN
SIRLOIN STEAK. 1⁹⁹ LB.
T-BONE STEAK. 2¹⁹ LB.

USDA HEAVY WESTERN FULL CUT (BONE-IN)
ROUND STEAK. 1³⁹ LB.
BONELESS 1⁶⁹ LB.

FRESH PORK PICNIC SHOULDERS . 79^c LB.

SEAFOOD SPECIALS

CRAB CLAWS 2⁵⁹	FRESH LARGE SPOT 79^c LB.	KING MACKEREL STEAKS 2⁹⁹ LB.
--	--	--

USDA HEAVY WESTERN BEEF "CUT AND WRAPPED-FREE"

WHOLE "BONELESS" BOTTOM ROUNDS 1⁴⁹ LB.	WHOLE "BONELESS" RIB EYES 2⁹⁹ LB.	WHOLE "BONELESS" BEEF TENDERLOINS 3⁴⁹ LB.
--	---	---

FRESH GROUND BEEF
99^c LB.

USDA HEAVY WESTERN
RIB EYES
3⁵⁹ LB.
 USDA HEAVY WESTERN
STEW BEEF
1⁵⁹ LB.

FRESH NEVER FROZEN WHOLE FRYERS
39^c LB.
 LIMIT 3 PLEASE

FIRST OF THE SEASON EASTERN RED DELICIOUS APPLES
39^c LB.

GOLDEN RIPE BANANAS
19^c LB.

POTATOES. . . 10 LB. BAG
88^c

THOMPSON WHITE SEEDLESS GRAPES. 59^c LB.

LIMIT ONE PER CUSTOMER

Announcing:
The Smocking Shop
 Complete Line Of Smocking Supplies
 Classes Offered Beginning Sept. 10:
 Beginning Smocking:
 Monday—9:30-11:30 A.M.
 Tuesday—7-9 P.M.
Open House
 Sunday, Sept. 9 • 2 - 4 P.M.
 805 S. Evans St.
 "In The Calico Square"
 Greenville, N.C.

COKE, DIET COKE, TAB, SPRITE—REGULAR AND CAFFEINE FREE
99^c 2 LITER BOTTLE

BUDWEISER BEER
2³⁹ 6-12 OZ. CANS
 NON-REFRIGERATED

COORS BEER "REGULAR AND LIGHT"
4⁶⁹ 12 OZ. CANS
 NON-REFRIGERATED

CARLO ROSSI WINES 7 ASSORTED FLAVORS
4⁹⁹ 3 LITER BOTTLE

MILLER Lite BEER 6-12 OZ. CANS
2.39

Two Years Of Pain, Struggle In Search For Missing Paperboy

By MARGARET STAFFORD
Associated Press Writer
WEST DES MOINES, Iowa (AP) — They sold candy on street corners to raise money. They sent posters around the country. They hired private eyes. They testified before Congress. And still their boy is missing.

Wednesday will mark two years since Noreen and John Gosch's 12-year-old son Johnny set out to deliver his Sunday newspaper route and never returned.

"Wednesday's going to be a terrible day ... a long, awful day," Mrs. Gosch said in an interview. "You always remember, but on Sept. 5, it hurts a little more."

The Gosches have been leaders in a growing nationwide effort to educate Americans about missing children but, Mrs. Gosch said, "The bottom line is that my son is still missing. That's what it all boils down to for me."

Gosch has said he and his wife would not cease their search "until our bones are dust and we can't move."

Their search took on extra incentive in August when another Des Moines newsboy disappeared, under eerily similar circumstances.

Eugene Wade Martin, 14, had gone to a street corner early Aug. 12 to pick up his copies of the Des Moines Sunday Register for delivery. Witnesses saw him talking to a man.

It was almost a carbon copy of Johnny's disappearance. He had also gone to a street corner to pick up his papers. Witnesses reported seeing him talking to a man who seemed drunk or high on drugs.

Despite searches, reward offers of more than \$100,000 and quick police action, there are no solid leads in the Martin case.

The major difference in the cases, said Mrs. Gosch, was how police and townspeople immediately responded to Eugene's disappearance. The Gosches have been bitterly critical of law officers for refusing to treat Johnny's disappearance as an abduction until the trail was cold. They said police didn't start looking for their son for 72 hours.

"It was an atrocity that they didn't look for Johnny Gosch like they did for Gene Martin," Mrs. Gosch said. "At least the Martins didn't have to go through what we did, at least they didn't have the added burden of fighting the system."

One reason for the quick attention in the Martin case was "Johnny Gosch bill," an Iowa law passed this year making it mandatory that police search for missing persons as soon as they are reported.

Law enforcement officials say they are continuing their search for Johnny.

"We absolutely are still involved in that case," said FBI agent John Evans. "Whenever we receive any information, it's covered. We are doing everything humanly possible to get that child returned to his parents."

Both Evans and Sgt. Lyle McKinney of the West Des Moines Police Department said they were working on the assumption that Johnny is alive.

"I can't afford the luxury of theories about whether he's alive or dead," McKinney said. "We're still working on it. Obviously, the tips have slowed down, but we still get information from all over and we check on it."

Reported sightings of Johnny Gosch still come in. The boy was reportedly seen in Florida and Corpus Christi, Texas, last year. In

February, his mother said a boy who sounded like Johnny called three times in one night, sounding drugged or injured. The calls were too brief to trace.

Mrs. Gosch said the descriptions of the boy believed to be Johnny say he now has long hair, walks with a limp, has slurred speech and is almost 6 feet tall. Each time a sighting is reported, the Gosches' private detective responds. So far, the closest he's come is within four days of the boy — and a man who is with him all the time.

"It's good on the one hand because we know he's alive," Mrs. Gosch said. "But it's frustrating because we can't be there at the same time. Someday, we will be."

The Gosches believe their son was captured for a national child pornography ring. Law officers have told her "stringers" are sent to get young children for pedophiles.

"We've been told these creeps get \$12,000 to \$20,000 a head, depending on how satisfactory the children are," Mrs. Gosch said. "Hey, the risks are pretty high if they get caught, so the pay has to be good."

The authorities have not officially

linked the cases of the two missing paperboys, but the public has. Hundreds of volunteers helped search for both boys after Eugene disappeared.

Mrs. Gosch said she was torn between gratitude for the help and anger that it didn't come sooner. Mostly, she's angry.

"You bet I'm angry," Mrs. Gosch said. "Some people helped us, but a large percentage of the people in Des Moines condemned us. We faced a lot of narrow-mindedness and apathy in this town. It left a bad taste in my mouth."

Dallas Davis, a neighbor, shares the family's anger. "Noreen Gosch has been force-feeding this state for two years about missing children," Ms. Davis said. "But people still sit on their fannies, they still won't believe their children are in trouble."

There are two other Gosch children — Joe and Kristy, both grown — who have also felt the ordeal keenly.

"They are angry too, and frightened that this kind of thing can happen and people can react so cruelly," Mrs. Gosch said.

When Kristy Gosch was selling candy to help raise money for the detectives, a woman spat on her, saying "Your mother is disgusting and I wouldn't do anything to help her."

Mrs. Gosch told of having people watch her while she shopped for groceries, and say things like, "What's she doing buying avocados when her boy is missing?"

At the end of one of Mrs. Gosch's speeches, a man stood up and said he thought she didn't have a son named Johnny and had made the whole thing up to get attention.

"I told him I hoped the next child taken was his," she said. It was the only time she has lost her composure in public.

But Mrs. Gosch is also quick to note the good things that have come along with the bad.

"We have met some wonderful, kind people with whom we never would have known without this," she said. "We have made some positive changes to help the missing children and we're going to push for more."

But the stress takes its toll. The Gosches sometimes "are so tired we feel we can't move another inch."

FORECAST FOR THURSDAY, SEPT., 6, 1984

YOUR DAILY Horoscope from the Carroll Righter Institute

GENERAL TENDENCIES: There should be a flash of electricity in the air today by which you become inspired to perform whatever you have to do in a progressive and original fashion.

ARIES (Mar. 21 to Apr. 19) Contact your finest friends and get their advice concerning how best you can gain your fondest wishes.

TAURUS (Apr. 20 to May 20) Consider your status and plan how to improve your position in life considerably. Get into more modern activities.

GEMINI (May 21 to June 21) Getting into new projects could very well bring you much progress and success at this time.

MOON CHILDREN (June 22 to Jul. 21) New and modern systems can be of great assistance to you now, so be on the alert for them.

LEO (Jul. 22 to Aug. 21) Bringing your finest talents to the attention of bigwigs is wise now, so stop being so timid. Drive carefully.

VIRGO (Aug. 22 to Sept. 22) By the use of modern mechanisms you can get your work or job done efficiently and with less effort.

LIBRA (Sept. 23 to Oct. 22) A fine day to get into new kinds of amusements with your friends and have a wonderful time together.

SCORPIO (Oct. 23 to Nov. 21) Get your home looking more modern, and buy mechanisms that will make it function much better also.

SAGITTARIUS (Nov. 22 to Dec. 21) Be enthused about routine work at hand which can produce fine results, and also gain cooperation of associates.

CAPRICORN (Dec. 22 to Jan. 20) Study your books of record and know how best to make investments and add to present assets.

AQUARIUS (Jan. 21 to Feb. 19) Get your talents working admirably and you can accomplish just about anything you set your mind to now.

PISCES (Feb. 20 to Mar. 20) You get fascinating ideas for gaining a greater abundance, so forget all that conservatism and branch out to bigger things.

IF YOUR CHILD IS BORN TODAY ... he or she will definitely be a New Era product and should be given the opportunity to attend modern schools where such abilities can be best brought out and later put to use. Teach good manners early in life.

"The Stars impel; they do not compel." What you make of your life is largely up to you!
© 1984, The McNaught Syndicate, Inc.

VALUE FAIR

1212 N. Greenville, N.C. Closed Sunday. No Limit On Quantities. None Sold To Other Merchants. We Accept Food Stamps, WIC Vouchers & Manufacturers Coupons.

WAREHOUSE GROCERIES is Committed To Not Being Undersold. Value Fair Buys in Truckload Quantities. Uses Less Advertising, Bulk Stacks, Family Packs & Lets You Carry Your Own Groceries To The Car So We Can Sell You FOOD FOR LESS!! ALL MEATS ARE USDA GRADED "HOUSE OF RAEFORD" MIXED FRYER PARTS 48¢ LB.		BEALE WHOLE SMOKED PICNIC 68¢ LB. LIMIT 2 PLEASE	
BEALE SLICED 1/4 PORK LOIN \$1.28 LB.	BEALE RED SMOKED SAUSAGE \$7.50 10 LB. BOX 78¢ LB.	ONIONS 68¢ 3 LB. BAG	
SWIFT PREMIUM BONE-IN RIB STEAK \$1.98 LB.	BEALE PORK CHOPS END CUT 98¢ LB.	FRESH CRISP LETTUCE 48¢ HEAD WHITE POTATOES 1.18 10 LB. BAG	
RINSO DETERGENT 44 OZ. BOX 88¢	NATURAL LITE BEER 6 PACK 12 OZ. CANS \$2.08	ROLLER CHAMPION SELF-RISING FLOUR 25 LB. BAG \$3.88	RED DELICIOUS APPLES 88¢ 3 LB. BAG
RED GLO TOMATOES 303 CANS	GIBBS PORK N' BEANS 16 OZ. CANS	OLD VIRGINIA APPLE SAUCE 303 CANS	KRAFT GRAPE JELLY 98¢ 32 OZ. JAR
3/ \$1.00			
SHASTA DRINKS 2 LITRE BOTTLE 68¢	PET RICH CREAM PIES ALL FLAVORS 14 OZ. BOX 68¢	BANNER BATHROOM TISSUE 4 ROLL PKG. 78¢	
TROPICANA ORANGE JUICE 64 OZ. JAR \$1.58	PILLSBURY BUTTERMILK BISCUITS 7 1/2 OZ. 4 PACK 78¢	CHATHAM DOG FOOD 50 LB. BAG \$6.88	BEALE'S PURE LARD 4 LB. PAIL \$1.98
STORE HOURS: MONDAY-WEDNESDAY 8:00 AM-7:00 PM THURS.-FRI.-SAT. 8:00 AM-8:00 PM CLOSED SUNDAY			



Different Flavors, Bigger Smiles from MelloButtercup.

NOW COSTS LESS. Try one of our original flavors of delicious premium ice cream for 30¢ off at your favorite grocer's. MelloButtercup. Kids love it!

Save 30¢ on MelloButtercup 1/2 Gallon Ice Cream

Mr. Grocer: MelloButtercup Ice Cream, Inc. will reimburse you in cash or in credit on your next order when you present this coupon to your MelloButtercup route salesman, provided that you redeemed it on retail sales of the named product. We ask that you furnish proof of purchase of sufficient product to cover the redemption amount. Coupon is valid where taxed, prohibited or restricted by law and may not be assigned or transferred. Customer must pay any applicable tax. Cash value 1/30¢. Expires 1-85.

Art Lover Has View Of Museum

By LAURA A. SALSINI
Associated Press Writer
MILWAUKEE (AP) — From his small, cluttered apartment on Marquette University's campus, Leonard Scheller gazes at the school's new glass and brick art museum.

It's appropriate that the 78-year-old retired copy editor for the Milwaukee Journal should have this view, for he is one of Marquette's most generous art donors. He has given the school a set of 58 prints by the French artist Georges Rouault.

His small apartment was cluttered with newspaper clippings, religious statues and books one recent day. A handful of yellow daisies in a tin can adorned his kitchen table, still littered with crumbs from the morning's breakfast.

Scheller has lived on the campus since he first came to the school as a journalism student almost 60 years ago, and he has lived in his present apartment for the past 16 years.

His love of art was born long after he had graduated and started work. One day, he stumbled across a TV program about Rouault and his somber, charcoal prints and was instantly entranced. When a traveling exhibition of the 58-print "Miserere" series came to Marquette, Scheller went to see it.

"I visited it every day — and it was at Marquette for a few weeks," said Scheller as he sat in his favorite rocking chair with Marquette's insignia inscribed in gold on its back.

Scheller looked like a misplaced owl, with ruffled feathers of white hair and benevolent myopic eyes behind thick gold-rimmed glasses, as he talked about why he loved the simple lines of Rouault's work. "Look at the noses — that's his trademark," he said. "The more an artist can tell you with one line, the more of an artist he is."

Scheller was especially taken by print No. 8, which shows a melancholy clown. The clown reveals a universal aspect of the human character, he said.

"The clown paints himself a face whenever he works," Scheller said, like people who hide behind a mask in their dealings with the world.

After seeing the Marquette exhibit years ago, Scheller decided he wanted a print for himself. He tracked down several art dealers in Paris who dealt in Rouault prints, and eventually collected the "Miserere" series.

His brother asked him to lend the series to St. Louis University's new library for its dedication. But Scheller decided to buy another series and simply give it to the university.

He has donated complete sets of original prints to St. Louis, Marquette and the University of Notre Dame. He also has given prints to 25 Jesuit Universities in the United States and to 12 of the state university campuses in Wisconsin.

Scheller explains his philanthropic mission by saying that he wants others to experience Rouault's work as he has. His Christmas cards are usually miniature versions of the painter's art.

Scheller's devotion to Marquette began years ago, when he entered its College of Journalism. He began his school days in 1925, and never really stopped them.

The former newsman is a fixture at Marquette — especially at its basketball games. He has missed a home game of the Warriors for 20 years. And he frequently has students over for lunch, giving them his famous burgers and strawberry shortcake.

"One time Marquette sent around a questionnaire asking the tenants how long we intended to live here. I put down 'until I die,'" he said with a chuckle.

His father was a farmer in Green Bay, but Scheller was always more interested in writing than reaping. His career aspirations were resolved for good in high school when he won an essay contest in history.

"Then and there, I decided I was going to be a writer," he said. "And, best of all, I've never been sorry."

In college, he worked on the school newspaper, The Marquette Tribune. My beat was the modern language club. You can imagine what kind of exciting stories came out of that meeting."

After his graduation 1929, Scheller worked at several Milwaukee newspapers before joining The Milwaukee Journal's copy desk in 1943. He remained there until 1975.

But his graduation didn't mean the end of his education. Scheller continued taking courses in theology, history and economics at Marquette for about 20 years because, he said, it's "so much fun to learn."

The series he gave to Marquette is now tucked away in the bowels of the school's library, where much of the university's nearly 5,000-piece art collection is being housed until its permanent home is dedicated on Nov. 11.

piggly wiggly

QUALITY & SERVICE ARE BETTER THAN THEY HAVE TO BE! PRICES EFFECTIVE SEPT. 5-8 WE RESERVE THE RIGHT TO LIMIT QUANTITIES NONE SOLD TO DEALERS OR RESTAURANTS. WE GLADLY ACCEPT U.S.D.A. FOOD STAMPS

HOUSE OF RAEFORD FRESH FRYER LEG QTRS. OR FRYER PARTS **39¢** LB.

FULL CUT BONELESS ROUND STEAK **148** LB. U.S.D.A. WESTERN BEEF

QUARTER SLICED PORK LOIN **178** LB.

PIGGLY WIGGLY CANNED HAM **549** 3 LB.

FULL CUT BONELESS ROUND STEAK LB. **1.58**
BONELESS TOP ROUND STEAK LB. **1.98**
SIRLOIN TIP OR RUMP ROAST LB. **1.88**
SIRLOIN TIP WHOLE LB. **1.49**
CUBED STEAK LB. **1.98**
FRESH GROUND BEEF 3-LBS. OR MORE **98¢** LB.

LUNDY FAMILY PACK PIG FEET LB. **49¢**
PIGGLY WIGGLY SLICED BACON 12 OZ. **1.28**
PIGGLY WIGGLY REGULAR FRANKS 12 OZ. **98¢**
PIGGLY WIGGLY BOLOGNA 12 OZ. **1.08**
PIGGLY WIGGLY SLICED COOKED HAM 10 OZ. **1.98**
RATH HOT OR MILD PORK SAUSAGE LB. **79¢**
LUNDY FAMILY PACK NECK BONES LB. **49¢**

CENTER CUT PORK CHOPS LB. **208**
LUNDY FAMILY PACK FRESH PIG TAILS LB. **49¢**
LUNDY FAMILY PACK FRESH PIG EARS LB. **49¢**
CENTER CUT SLICED BEEF LIVER LB. **79¢**
PRE-COOKED BREADED FISH PORTIONS LB. **99¢**
PRE-COOKED BREADED FISH STICKS LB. **99¢**

Now "You Can Look It Up" IN YOUR FUNK & WAGNALLS DICTIONARY
• 880 pages
• Over 100,000 entries
• Weights and measures
• Abbreviations
• Gazetteer
• Biographies
• Secretarial Handbook
• Easy to read type

PIGGLY WIGGLY SALAD DRESSING **99¢**

GOLDEN BEST 100 CT. TEA BAGS **99¢**
DUNCAN HINES CAKE MIX **89¢**

PIILLSBURY READY-TO-SPREAD FROSTINGS **109**
MILK CHOCOLATE CHOCOLATE FUDGE AND VANILLA 16-OZ.

ONLY **\$5.98**

PIGGLY WIGGLY WORLD OF PRODUCE "Freshest Buys In Town"
THOMPSON SEEDLESS WHITE GRAPES LB. **59¢**
SNAP BEANS LB. **49¢**
EASTERN RED DELICIOUS APPLES 3 LB. BAG **99¢**
YELLOW CORN 6 EARS **99¢**
LITTLE FRUIT DRINKS 8-OZ. **7/100**

MT. DEW PEPSI, DIET PEPSI **109** 2 LITER
REYNOLDS WRAP 200 FT. **3.99**
QUAKER QUICK GRITS 1 LB. **49¢**
DOVE LIQUID 48 OZ. **1.89**

SUPER SAVER DUKE'S CORN OIL **169** 48 OZ.

MAOLA PIXIE OR SHERBERT 1/2 GAL. **1.59**
MAOLA BUTTERMILK 1/2 GAL. **1.19**
3 MUSKETEERS SNACK BARS **1.99**
SNICKERS MILKY WAY, 3 MUSKETEERS, MARS SNACK BARS

PIGGLY WIGGLY HOMOGENIZED MILK HALF GALLON **99¢**

COUPON **99¢**
HEINZ CATSUP **99¢** 32 OZ.
LIMIT ONE WITH THIS COUPON AND A \$7.50 FOOD ORDER. COUPON EXPIRES SEPT. 8, 1984
PLU-10

JENO'S PIZZA **88¢** 12 OZ. SUPER SAVER
SAVE ON CRISP 'N TASTY PIZZA!
GET \$2.50 IN COUPONS AND FREE COUPON CADDY (WITH PROOF OF PURCHASE) PLUS CRISP 'N TASTY WILL MAKE A SPECIAL DONATION OF \$2.50 TO HELP MUSCULAR DYSTROPHY ASSOCIATION. (SEE SPECIALLY MARKED PACKAGES FOR DETAILS.)

FALL TIME IS CLEAN-UP-TIME
22 OZ. EASY ON SPRAY STARCH **99¢**
EASY OFF, REG. OR LEMON OVEN CLEANER 16 OZ. **1.99**
LIQUID WOOLITE 16 OZ. **1.99**
22 OZ. WOOLITE RUG CLEANER **2.49**
4.5 OZ. TANK II BOWL CLEANER **1.29**
EASY OFF OVER PAD CLEANERS **99¢**
EASY OFF MILDEW REMOVER 16 OZ. **1.79**
6 OZ. PAM SPRAY **1.89**

JIFFY CORN MUFFIN MIX 8 1/2-OZ. **4/100**
PIGGLY WIGGLY SALT 26-OZ. **4/100**
KRAFT PARKAY LITE SPREAD **149** 2-LB. TUB

COUPON **FREE**
GOLDEN BEST MACARONI & CHEESE DINNERS **FREE!** 7-OZ.
LIMIT ONE WITH THIS COUPON AND A \$7.50 FOOD ORDER. COUPON EXPIRES SEPT. 8, 1984
PLU-12

SUPER SAVER FAB **149** 49 OZ. FABRIC SOFTENER

BOUNTY TOWELS **69¢** JUMBO
OSAGE PEACH HALVES **79¢** 29 OZ.

FIELD TRIAL HI PROTEIN DOG FOOD **389** 25-LB. BAG

COUPON **99¢**
PIGGLY WIGGLY SUGAR 5-LB. BAG **99¢**
LIMIT ONE WITH THIS COUPON AND A \$7.50 FOOD ORDER. COUPON EXPIRES SEPT. 8, 1984
PLU-14

WISK **159** 32 OZ.

MUELLER ELBOW MACARONI REG. OR THIN SPAGHETTI **2 for 100** 1 LB.

PIGGLY WIGGLY GARDEN PEAS CUT GREEN BEANS **2/79¢** EACH 17 OZ. - YOUR CHOICE

COUPON **99¢**
PIGGLY WIGGLY ICE CREAM HALF GALLON **99¢**
LIMIT ONE WITH THIS COUPON AND A \$7.50 FOOD ORDER. COUPON EXPIRES SEPT. 8, 1984
PLU-15

DUNCAN HINES COOKIES ALL FLAVORS 12 OZ. **129**

SCOTTISSUE **89¢** 2 ROLLS

PIGGLY WIGGLY CREAM STYLE OR WHOLE KERNEL CORN **2/79¢**

2105 DICKINSON AVE. OPEN 7 AM TO MIDNIGHT SEVEN DAYS A WEEK
Shop PIGGLY WIGGLY

The City of Greenville has a leash law which requires dogs to be confined to the property of the owner and to be on a leash when off the property. For more information, call City Animal Control at 752-3342.

Adventurers Sail Viking Ship Across The Atlantic

BOSTON (AP) — Six adventurers sailed a replica of a 1,000-year-old Viking ship across the North Atlantic and while battling high winds and threatening waves discovered what one of them called "a key to history."

The 57-foot, single-sail ship left Norway June 17 and arrived in Boston Monday. Following a 10th Century Viking trading route, the sailors said they found Viking artifacts along the way and have learned quite a bit about type of ship used by Viking explorer Leif Ericsson.

"Most importantly, we have learned that this is a very seaworthy ship," said Ragnar Thorseth, 36, a writer who is leading the expedition.

"We conclusively proved that Viking ships can sail up to 45 degrees into the wind using a square sail," he said. "That disproves the theory that they had to use oars to turn their ships when there was no tail wind."

"We also found that the rudder on Viking ships was not nearly as important in steering as was the sail. That may sound small to you, but when you put all these small things together, you have a whole, a key to history," he told The Boston Herald.

The ship, Saga Siglar, which means sailer of the sagas, is an exact replica of a knarr, or deep sea trading ships, used in the 10th and 11th centuries. Archeologists recovered one in 1959 from a fjord in Denmark.

The replica weighs 27 tons and is made of Danish oak and Norwegian pine. "We worked with our hands, using the old tools — tools that the Vikings would have used," Jacob Bjorkedal, 29, a member of the crew told The Boston Globe.

His father is a master shipbuilder in Norway.

The ship does have some modern devices — compass, radio, radar and a 22-horsepower diesel engine.

A Boston Globe reporter, who joined the ship in Halifax, Nova Scotia, said that while the crew fished for food along the way, there also were chocolate bars, soda and Canadian beer on board.

"No man escapes his own time," the Globe quoted Thorseth as saying.

"No matter if we have radio or radar, we are still a small, open boat on a big ocean," he said. "The sea, the wind are just as dangerous as they were in Viking times."

The ship ran into a storm with 70-knot winds and 45-foot waves between Greenland and Labrador.

"I knew theoretically that the Saga Siglar could survive high winds and heavy seas," Thorseth said. "But when we began taking on water, I felt doubt, yes, and fear as well..."

The Globe reported that he lashed his 11-year-old son, Erik, to his side and ordered the crew into survival suits. "I was thinking, 'My God, what have I led us into? What are we doing out here?'" he is quoted as saying.

When he was 20, Thorseth rowed alone 100 miles across the North Sea to the Shetland Islands of Scotland, the first person to do so. Two years ago, he led the first Norwegian expedition to the North Pole, and he has traveled to remote parts of the Arctic.

"There is not enough adventure left in the world," he said. "If I do nothing else in my life, even if I die broke and broken, I will at least have had an exciting life."

Officials Replaced

VIENNA, Austria (AP) — Chancellor Fred Sinowatz has replaced his controversial finance minister and three other fellow Socialists in the Cabinet.

Sinowatz, who formed his coalition government with the small Freedom Party 15 months ago, said this week that the realignment was necessary "to ensure the efficiency of the federal government."

He denied reports that ousted Finance Minister Herbert Salcher, criticized sharply by newspapers for his tax reform plans, was doomed in the government after he supplied the state prosecutor with evidence against his predecessor, Hannes Androsch, three weeks ago.

A judge has launched a preliminary investigation into alleged tax evasion by Androsch in financing a private villa. Two prior revenue audits found no wrongdoing by the former minister.

Salcher was replaced by Franz Vranitzky, the director general of Laenderbank, Austria's second-largest commercial bank.

Foreign Minister Erwin Lanc was succeeded by Vienna Mayor Leopold Gratz. Transport Minister Karl Lausacker was replaced by State Secretary Ferdinand Lacina, a 42-year-old expert on nationalized industries. And Family Minister Elfriede Karl was replaced by Gertrude Froehlich Sandner, a deputy mayor of Vienna.

PUT EXTRA CASH in your pocket today. Sell your "don't needs" with an inexpensive Classified Ad.

HARRIS

SUPER MARKETS, INC.

"Where Shopping Is A Pleasure"

DISCOUNT
ON EVERYTHING BUT QUALITY

We Reserve The Right To Limit Quantities
None Sold To Dealers Or Restaurants
We Accept Food Stamps And WIC Vouchers
PRICES GOOD THRU SATURDAY

U.S.D.A. WESTERN

SIRLOIN STEAKS

\$ 2¹⁹

LB.



U.S.D.A. WESTERN

T-BONE STEAKS

\$ 2²⁹

LB.



12 OZ.

HARRIS BACON

\$ 1⁰⁹

PARADE ELASTIC DIAPERS

48 CT. TODDLER

5⁶⁹

PARADE ELASTIC DIAPERS

48 CT. OVERNIGHT

5⁶⁹

PARADE ELASTIC DIAPERS

40 CT. X-ABSORB.

5⁶⁹

U.S.D.A. WESTERN BONELESS

CUBE STEAKS

\$ 2²⁹

LB.

GRADE A

WHOLE FRYERS

55

LB.

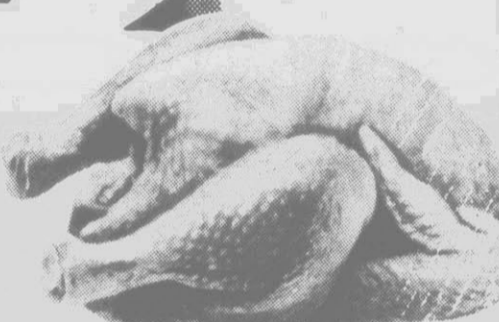

FRESH WHOLE

PORK LOINS

\$ 1¹⁹

LB.

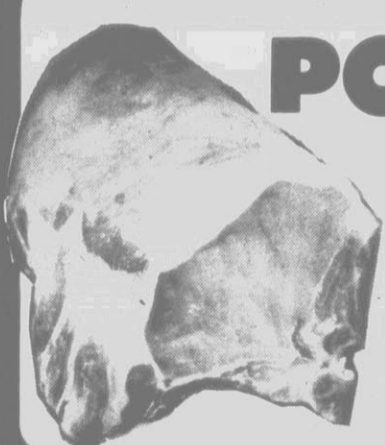

FRESH 1/4 SLICED

1¹⁹

LB.

FRESH CENTER CUT

1⁸⁹

LB.

FRESH THIN CUT

1⁹⁹

LB.

FROSTY MORN

FRANKS

12 OZ.

99^c

SLAB

BACON

LB.

99^c

LOVETTE

LUNCHEON MEAT

1 LB.

1⁴⁹

U.S.D.A. WESTERN

SIRLOIN TIP ROAST

\$ 1⁹⁹

LB.



U.S.D.A. WESTERN

SIRLOIN TIP STEAKS

\$ 2¹⁹

LB.

JAMESTOWN

SAUSAGE

1 LB.

99^c

HAMILTON E-Z CARVE

HAMS

1¹⁹

HAMILTON E-Z CARVE

HAM PORTIONS

1³⁹

FROSTY MORN

BOLOGNA

12 OZ.

1²⁹

PRODUCE

CALIFORNIA ICEBERG
LETTUCE
HEAD

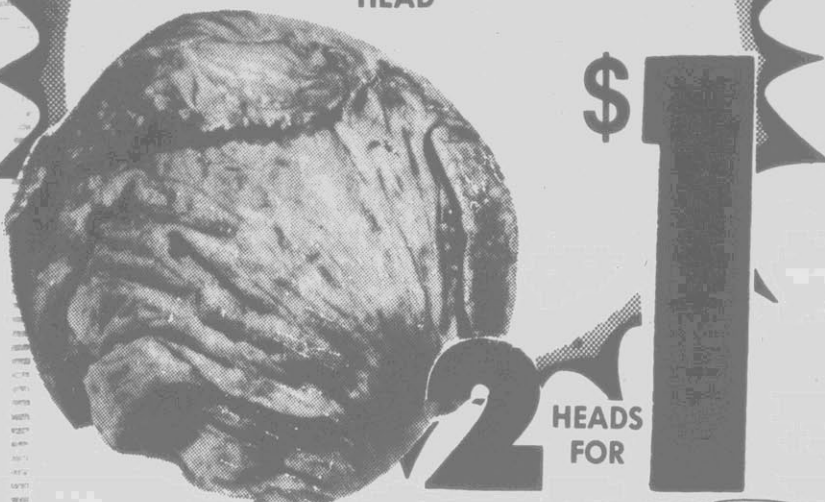

\$**1.29**
HEADS FOR

GALLO
TABLE WINES
ALL 3 LITER VARIETIES

4.99



NATURAL LIGHT 6 PACK 12 OZ. CANS **2.09**

LITE BEER 6 PACK 12 OZ. CANS **2.39**



RED OR GOLDEN DELICIOUS
APPLES 3 LB. BAG **89¢**
MEDIUM YELLOW
ONIONS 3 LB. BAG **69¢**
GOLDEN RIPE
BANANAS 4 LBS. FOR **\$1**
FIRST OF THE SEASON
SCUPPERNONG GRAPES **99¢** PINT

GREEN
CABBAGE

10¢
LB.



New Movie Slated For Lowcountry

By BRUCE M. SMITH
Associated Press Writer
NORTH CHARLESTON, S.C. (AP) — The \$2.4 million television movie "Rearview Mirror" starring Lee Remick will be filmed in the South Carolina Lowcountry over the next six weeks, state officials announced Monday.

Production will begin Sept. 10 and some 175 local residents will be employed as extras, said Lt. Gov. Mike Daniel. In addition, an undetermined number of local residents will be hired as crew members. About half of the production's budget will be spent in South Carolina, he added.

The film, which concerns a nurse who is abducted by a pair of escaped convicts, is expected to air on NBC by the end of the year, according to Paul Freeman, the producer of the Sunn Classics Pictures production.

Scenes will be shot in Charleston, North Charleston, Berkeley County, Johns Island, Sullivan's Island and Mount Pleasant, he said.

Daniel said the film is important because Sunn Classics is a leading film producer and it's important that the state and its citizens offer the firm a warm welcome.

The production could also mean more business for the state's growing film industry down the road, he added.

"Many of those associated with 'Rearview Mirror' will be a part of the production of 'North-South,' a \$30 million mini-series for ABC television to be filmed in January of 1985," he said.

"Because South Carolinians are competitors and want to bring this exciting and positive industry to our state, we want that project filmed in South Carolina as well," Daniel said.

Freeman is also associated with "North-South," a Civil War epic. He said crews have scouted locations in the Lowcountry but no decision has been made on where the film will be produced.

Bud Ferillo, of the lieutenant governor's office, said the announcement of the "Rearview Mirror" means that the state has attracted \$43 million worth of film productions during the past four years.

Veteran Composer Dies After Illness

NEW YORK (AP) — Arthur Schwartz, composer of "Dancing in the Dark," "That's Entertainment" and other songs for Broadway and films, died Monday after a long illness, according to the American Society of Composers, Authors and Publishers. He was 83.

Schwartz, a long-time board member at ASCAP, died at his home in Kintnersville, Pa., according to ASCAP spokesman Ken Sunshine.

Born in Brooklyn, N.Y., Schwartz started playing the harmonica at an early age, wrote little songs and taught himself piano. He wrote and produced shows while at summer camp, wrote college songs while attending New York University and then wrote popular songs while attending Columbia Law School.

His first published song was "Baltimore, Md., You're the Only Doctor for Me." It was published in 1923 and paid him \$8 in royalties.

He continued to write songs while practicing law, and finally gave up the legal profession for music in 1928 at the behest of lyricist Lorenz Hart.

That same year, he met Howard Dietz, his long-time collaborator who died last year. Their first show, produced in 1929, was "The Little Show," starring Fred Allen and Clifton Webb. Among the show's songs were "Little Old New York" and "I Guess I'll Have to Change My Plan."

In 1931, Schwartz and Dietz did the music and lyrics for "The Band Wagon," a major success that was twice adapted to the screen. Among the songs were "Dancing in the Dark" and "I Love Louisa."

Through the 1930s, they continued to write for Broadway, including such songs as "Louisiana Hayride" and "You and the Night and the Music." But box office successes became more rare.

Schwartz turned to Hollywood, writing songs for the screen and producing several film musicals, including "Cover Girl" and "Night and Day."

In 1951, Schwartz returned to the stage with a musical adaptation of "A Tree Grows in Brooklyn," starring Shirley Booth. The show was a hit, with songs like "Love is the Reason" and "I'll Buy You a Star."

Schwartz continued to write. In 1982, he published a song with choreographer George Balanchine — Schwartz wrote the words to "The World is Turning Fast" and Balanchine wrote the music.

Schwartz is survived by his son, Jonathan, a New York radio personality.

PEPSI, DIET PEPSI & MT. DEW
2 LITRE



1.09

DEL MONTE
CATSUP
32 OZ.



89¢

JIF
PEANUT BUTTER
CREAMY
18 OZ.



1.39

SOFT PLY
BATHROOM TISSUE
4 ROLL



69¢

DUNCAN HINES
CAKE MIX
ALL 18 OZ. FLAVORS

79¢

MUELLERS
ELBOW MACARONI, SPAGHETTI OR THIN SPAGHETTI

1 LB.

2/1.00

LIPTON FAMILY
TEA BAGS

24 CT.



1.29

NABISCO SALE
OREO
CREME SANDWICHES
20 OZ.



1.99

RITZ CRACKERS
8 OZ.

1.09

SCOTT TOWELS
JUMBO ROLL

59¢



PARADE
MACARONI & CHEESE DINNER

4/\$1
7 OZ.

PALMOLIVE
DISH LIQUID
22 OZ.

99¢
20¢ OFF LABEL

CHATHAM CHUNK
DOG FOOD 20 LB. BAG **2.99**

EASTWIND PACIFIC
MACKERAL 15 OZ. **2/\$1**

JIFFY
CORN MUFFIN MIX 8.5 OZ. **5/1.00**

OLD VIRGINIA
APPLESAUCE #303 **3/1.00**

PUREX BLEACH . GALLON **79¢**

PUREX HEAVY DUTY
LAUNDRY DETERGENT **99¢**

SUPER TORO
CORNED BEEF 12 OZ. **99¢**

VETS
DOG FOOD FLAVORS **5/1.00**

VISTA
SALTINE CRACKERS . 1 LB. **2/1.00**

FROZEN FOODS

CAROLINA DAIRIES
ICE CREAM
ALL 1/2 GALLON FLAVORS **1.59** SAVE 1.00

OZARK VALLEY
POT PIES . ALL 8 OZ. **4/1.00**

PARADE
PIE SHELLS **2/1.00**
LIMIT 4

PET RITZ
CREAM PIES . ALL 14 OZ. FLAVORS **59¢**

JENOS MR. P'S
PIZZAS ALL 10 OZ. FLAVORS **59¢**



DAIRY FOODS

BLUE BONNET
MARGARINE
1 LB. 1/4'S **2/1.00**

BORDEN
SLICED CHEESE . . 12 OZ. **1.39**

PARADE
ORANGE JUICE GALLON **1.19**

PILLSBURY
BUTTERMILK BISUITS . 4 PACK **79¢**

COUNTRY FRESH HOMOGENIZED
MILK HALF GAL. CARTON **99¢**



Moving away? Make the trip lighter by selling those unneeded items with a fast action Classified ad. Call 752-6166.

Gains Reported On Construction Spending In July

WASHINGTON (AP) — Spending on new construction edged up 0.7 percent in July, reversing a decline of the previous month, the government reported today.

The Commerce Department said that total construction spending rose to a seasonally adjusted annual rate of \$311.4 billion in July following a decline of 0.5 percent in June.

The meager increase, however, was far below the robust hikes of more than 6 percent turned in during the first two months of the year. Analysts have said the construction industry has been hurt by rising interest rates with the weakness in recent months symptomatic of a slowing of the overall economy.

Construction of single-family homes was down for the second straight month, falling 1.9 percent from the June rate.

Spending on apartment buildings rose, however, climbing 7.8 percent after dropping 3.3 percent in June.

Non-residential private construction was up a slight 0.8 percent in July to \$77.4 million, calculated annually, after falling 2 percent the month before. The increase included gains in industrial, office and other commercial building.

Public construction was down 1 percent to an annualized total of \$57 million following an increase of 3.6 percent in June. State and local construction remained essentially unchanged but federal construction declined 9 percent.

The total construction figure was up 14.4 percent from a year ago. During the first seven months of the year, \$168.9 billion of new construction was put in place, a 20 percent increase over construction spending for the first seven months of 1983.

James Nance Dead At 91

PURCELL, Okla. (AP) — James Clark Nance, who built a newspaper empire in Oklahoma and served 34 years in the state Legislature, including a tenure as Speaker of the House, died Monday. He was 91.

Nance purchased the Weatherford Democrat for \$500. He and his late partner, Joe McBride, at one point owned newspapers in Walters, Anadarko, Purcell, Clinton, Hobart, Mangum, Alva, Sulpur, Henryetta, Hominy and Norman.

Nance was first elected to the Oklahoma House in 1920. During his second term, he was named to the investigating committee that brought charges against Gov. J.C. Walton, who later was impeached.

Nance later resigned from the Legislature and went to Lubbock, Texas, where he was involved into another newspaper venture.

He returned to Oklahoma and was elected to the Legislature in 1927. He was chosen Speaker of the House in 1929 and presided over the impeachment of Gov. Henry Simpson Johnston.

Nance served in the House until 1932 when he was elected to the state Senate. After one four-year term, Nance returned to the House.

Nance was re-election to the Senate in 1938 and served for 12 years. He was elected president pro tempore in 1947. He left the Senate in 1949, but returned to politics in 1952 with his election to the House and his election again as Speaker.

It was during the 1953 session when Nance made famous his "pocket veto" of a bill. The Legislature passed a bill Nance did not like, and when the governor's office went to look for it for his signature, the bill could not be found.

After the 15-day deadline passed for gubernatorial action, Nance discovered he'd "accidentally" stuck the bill in his pocket and took it home with him.

Nance is survived by two daughters. Services will be held Thursday.

Long State

SKOKIE, Ill. (AP) — The distance across the breadth of the state of Texas is about 800 miles, according to the Rand McNally "Road Atlas."

It says the straightest route across the state is virtually due west from the eastern border near Shreveport, La., past Dallas and through the center of the state, to El Paso on the western border.

If a motorist wanted to drive it, the trip would take just under approximately 18 hours of continuous driving, the atlas says.

HAPPEN YEARLY

GOLDEN, Col. (AP) — Roughly 60 times a year for the past nine years, a significant earthquake measuring 6.5 or above on the Richter scale has shaken the earth, often causing considerable damage.

Major quakes registering 7.0 to 7.9 occur on an average of 18 times a year and great quakes, 8.0 and above, happen yearly, according to the National Earthquake Information Center.

JANE PARKER

Hamburger Buns

OR Hot Dog Buns

3 100

8 ct. pkgs.

P A&P COUPON

SAVE ON

A&P GRADE A

Large Eggs



dozen only

59¢

A&P LIMIT ONE WITH COUPON AND 7.50 ORDER. GOOD THRU SAT. SEPT. 8 AT A&P #647

P A&P COUPON

SAVE ON

TROPICANA

Orange Juice



1/2 gal. ctn.

99¢

A&P LIMIT ONE WITH COUPON AND 7.50 ORDER. GOOD THRU SAT. SEPT. 8 AT A&P #648



Each of these advertised items is required to be readily available for sale at or below the advertised price in each A&P Store except as specifically noted in this ad.

PRICES EFFECTIVE THRU SAT. SEPT. 8 AT A&P IN GREENVILLE, N.C. ITEMS OFFERED FOR SALE NOT AVAILABLE TO OTHER RETAIL DEALERS OR WHOLESALERS.

BEST PRODUCE IN TOWN!

QUALITY ... VARIETY ... PRICE



GOING ON VACATION? A&P HAS MORE STORES CONVENIENTLY LOCATED TO ANY AREA OF THE GRAND STRAND!

The wisest investment you'll ever make for your family starts with

only 9¢

for Volume 1 (WITH \$5 PURCHASE)

Volumes 2-29 only \$3.99 each (with \$5 purchase)

FREE 2-Volume Dictionary with volumes 2&3

Funk & Wagnalls New Encyclopedia

THE FARM Fresh With Quality

MINI PACK 14 1/2 oz. pkgs. **88¢**

A&P Raisins

Seedless Grapes

CALIFORNIA WHITE

49¢

lb.

CRISP Romaine Lettuce each bunch **58¢**

SOLID Crisp Carrots 1 lb. bag **39¢**

JUMBO SIZE Crisp Celery each stalk **69¢**

NEW CROP RED OR GOLDEN Delicious Apples 3 lb. bag **99¢**

WASHINGTON STATE Bartlett Pears lb. **59¢**

P Frozen Specials

FLAV-O-RICH

Dairy Charm Ice Cream

1/2 gal. ctn. **119**

FLAV-O-RICH Scooter Crunch 6 ct. pkg. **129**

P Dairy Specials

COUNTRY CROCK

Shedd's Spread

3 lb. bowl **179**

ANN PAGE Margarine 2 1 lb. pkgs. **99¢**

P Grocery Specials

GOLDEN CORN - TOMATOES GREEN BEANS

A&P Vegetables

15 1/2 oz. cans **279¢**

P Grocery Specials

DIET PEPSI - MTN. DEW

Pepsi Cola

2 Liter Bottle **1 09**

GOOD ONLY IN GREENVILLE, N.C.

FROZEN Banquet Pot Pies 3 8 oz. pkgs. **89¢**

CHEESE CANNELONI (9.3 OZ.) CHICKEN CHOW MEIN (11 1/4 OZ.) - SPAGHETTI W/BEEF **169**

FRUIT ON BOTTOM Flav-O-Rich Yogurt 8 oz. ctn. **45¢**

SEALTEST Sour Cream 8 oz. ctn. **49¢**

KRAFT DELUXE DINNER Macaroni & Cheese 14 oz. pkg. **1 09**

ALL VARIETIES A&P Dressing 8 oz. btl. **59¢**

SUNSHINE Krispy Crackers 1 lb. pkg. **89¢**

MOTTS Apple Juice 1/2 gal. jug **1 69**

BANQUET Fried Chicken 2 lb. pkg. **2 59**

BIG COUNTRY - SOUTHERN STYLE Pillsbury Biscuits 6 oz. cans **2 69¢**

A&P ALL VARIETIES Spaghetti Sauce 2 lb. jar **99¢**

ALL FLAVORS Gallo Premiums 3 ltr. btl. **4 99**

GOOD ONLY IN GREENVILLE, N.C.

CRISP N TASTY Jenos Pizza **99¢**

10 oz. pkg.

SHARP - EXTRA SHARP Ann Page Cheddar Chunks **1 19**

8 oz. pkg.

ELBOW MACARONI - THIN Skinner Spaghetti **99¢**

2 lb. pkg.

REGULAR Budweiser Beer **2 39**

ctn. of 6 12 oz. cans

GOOD ONLY IN GREENVILLE, N.C.

703 GREENVILLE BOULEVARD-GREENVILLE SQUARE SHOPPING CENTER GREENVILLE, N.C.

P A&P COUPON
SAVE ON
 CHICKEN OF THE SEA
 IN OIL · IN WATER
Chunk Tuna

49¢
 6 1/2 oz. can
 A&P LIMIT ONE WITH COUPON AND 7.50 ORDER. GOOD THRU SAT. SEPT. 8 AT A&P #649

P A&P COUPON
SAVE ON
 ANN PAGE
Mayonnaise

78¢
 32 oz. jar
 A&P LIMIT ONE WITH COUPON AND 7.50 ORDER. GOOD THRU SAT. SEPT. 8 AT A&P #650

P A&P COUPON
SAVE ON
 A&P
Charcoal Briquets

99¢
 10 lb. bag
 A&P LIMIT ONE WITH COUPON AND 7.50 ORDER. GOOD THRU SAT. SEPT. 8 AT A&P #651

Sculpting Lets Worker Relax

By PHYLLIS GUTH
 Allentown Morning Call
 ALLENTOWN, Pa. (AP) — Jack Korbobo sees sculpting as "a way to relax and get away from this crazy world we're in."
 The Chicago native should know. He's employed full time as a mechanic at the Allentown plant of Mack Trucks Inc., and he spends an equal number of hours at his sculpting hobby.

His creativity becomes evident the moment one enters his south Allentown home. Framed ceramic faces on stretched canvas adorn one living room wall; two heads sculpted by Korbobo stand on the opposite side of the room.
 Facing the entrance is a star with a lotus flower in its center — the symbol of a California religious group called the Voice of Astarte. Next to the star is a colorful butterfly that looks very modern, but was actually created using a century-old technique once employed at a Bucks County tile works.

Korbobo studied sculpture for more than 10 years under Richard Lieberman at the Baum Art School.

Lieberman notes that his former student is "very creative" and has a good sense of humor which he says, is very important in art. If he works hard, he'll arrive, Lieberman predicts.

Korbobo didn't set out to be a sculptor, though. What he wanted to do, he says, was create several lanterns for his Japanese garden after he learned that the cost of ready-made ones would run close to \$100.

He began studying pottery with Raymond Gallucci and completed not only the lanterns, at a cost of \$3.50, but also an unusual interior lamp and numerous other pieces. Two years later, he made the switch to sculpture.

C Leslie Cmth, a long-time friend of Korbobo who sells the artist's work in his store, describes his creations as "refreshing, new and exciting."

"It's been very rewarding to me," Korbobo says of his avocation, looking around the living room and the adjoining dining area, alive with color and texture of his work. Examples of his pottery hang from the exposed beams in the kitchen and line the cabinet tops.

Decorating the wall in another room are the heads of a man and a woman, literally bursting out of stretched canvas. Over the couch in his den is a montage he made casting the faces of several people in potters' plaster.

A sculpture he takes particular pride in is the head of Christ, which he has worked on intermittently for several years. He plans to donate the piece to his church when he's finished.

A related sideline for Korbobo is the sculpting of company logos, a venture he says began when William Devaney, president of Stanley Vidmar Inc., ordered more than two dozen of the corporation's honeycomb-and-bee logos from him. Korbobo also has done the logos of the Bank of Pennsylvania and other firms.

Korbobo's attached garage serves as his studio. He works first with a molding compound to create his pieces. From the original sculpture, he makes a mold by coating it with more applications of latex. The finished product is cast in Hydrostone.

At the end of his driveway, Korbobo has an unusual concrete sculpture weighing 3 1/2 tons — the largest he has ever made. A year in the making, the piece — 92 inches at its highest point — was placed there in 1977 and is supported by concrete rods that extend 40 inches into the ground.

Korbobo says he has no favorites among his creations, but admits he hates to part with his pieces. "You become attached to them," he says.

The artist says his hobby will become a full-time occupation after his eventual retirement from Mack. "I'm too ambitious to retire," he says of the prospect of just taking it easy.

DOUBLE Coupon Savings

SEE YOUR LOCAL A&P STORE IN GREENVILLE, N.C. FOR DETAILS



Each of these advertised items is required to be readily available for sale at or below the advertised price in each A&P Store except as specifically noted in this ad.

WESTERN GRAIN FED BEEF WHOLE
Sirloin Tip
 9-12 lb. avg. lb.
158

The Butcher Shop
 with supermarket prices
P Poultry Specials
 COUNTRY PRIDE FRESH
Whole Fryers
 or Mixed Fryer Parts
 lb.
49¢ (Limit 4)

FRESH LEAN COUNTRY FARM SIRLOIN END
Pork Chops
 Economy Family Pack
 lb.
118

WESTERN GRAIN FED BEEF BONELESS
Sirloin Tip Roast
 lb.
198

BALL PARK (BEEF 1-LB. 1.69)
Meat Franks
 1 lb. pkg.
159

A&P QUALITY FRESH EXTRA LEAN
Ground Round
 Ground Fresh Daily
 lb.
198

HONEYMOON (WHOLE OR HALF) BONELESS
Buffet Ham
 lb.
198

SCHOONER BREADED
Fish Portions
 lb.
98¢

U.S.D.A. INSPECTED FRESH
Fryer Leg Quarters
 lb.
58¢

ARMOUR GOLDEN STAR (3 1/2 TO 4 1/2 LB. AVG.)
Boneless Turkey
 lb.
168

OLD HICKORY
Pork Barbecue
 1 lb. pkg.
198

P Variety Shop Specials
 CAROLINA PRIDE
Sliced Bacon
 12 oz. pkg.
139

P Beef Specials
 WESTERN GRAIN FED BEEF
Cubed Steak
 Family Pack
 lb.
198

P Beef Specials
 WESTERN GRAIN FED BEEF
Rib Eye Steak
 Boneless
 lb.
398
 SURF & TURF Cooked Lobster 10.6 oz. pkg. **398**

P Delicatessen
 YOUR CHOICE
 • Comed Beef
 • Turkey Breast
 • Pastrami lb.
 COLBY
Longhorn Cheese lb. **299**
 2 PIECE SNACK PACK
Fried Chicken each **98¢**
 AVAILABLE AT: 703 GREENVILLE BLVD.

VAN CAMP'S
Pork N' Beans
 3 16 oz. cans
100

NORTHERN ASSORTED · WHITE
Bath Tissue
 4 roll pkg.
109

Buy one, Get one FREE
BAN Deodorant
 Roll-on 1.5 oz. pkg.
199

FLEX
Shampoo Or Conditioner
 15 oz. btl.
169

ALL VARIETIES
Ramen Pride Noodles
 4 3 oz. pkgs.
89¢

ALL FLAVORS PURINA 100
Cat Food
 4 6 oz. cans
100

BUY ONE-GET ONE FREE!
Mr. Coffee Filters
 100 ct. box
109

MINT · REGULAR
Crest Toothpaste
 6.4 oz. tube
129

HEAVY DUTY
Yes Detergent
 64 oz. jug
299

DOG FOOD CHUNKS
Field Trial
 25 lb. bag
399

BIC Lighter
 2 ct. pkg.
129

50¢ OFF LABEL
Listerine Mouthwash
 32 oz. btl.
249

DESIGNER
Brawny Towels
 big roll
59¢

ALL FLAVORS
Cadillac Dog Food
 14 oz. cans
3100

SUPER BLEND 10W30 MOTOR OIL
Quaker State
 quart btl.
89¢

Rubbermaid
1/2 Price Sale!
 Save 50% on Quality Rubbermaid Products

Kittens Touched Thief's Heart

ROANOKE, Va. (AP) — A box full of kittens can do the job of a watchdog, says a local business director who learned that a warm heart can deter crime as well as a fierce bark.

A thief broke into Media Works over the weekend, but had a change of heart when he saw a box of kittens that the company's creative director, Kyle Edgell, had brought in after finding them in an alley, Ms. Edgell said Monday.

"I don't know who you are," the thief wrote in a note to Media Works employees, "but you seem to be very nice people, all of you."

"I can feel the love and energy in these rooms. I thought to take as much as possible, but when I saw those kittens ... I could not."

"My family is in need of money. That is why I am doing this."

"Please forgive me what I did take. I understand if you don't."

The burglar took a pistol used as a prop, but he refrained from taking valuable recording equipment.

HOURS: OPEN SUNDAY 8:00 A.M. TO 10:00 P.M. OPEN MONDAY THRU SATURDAY 7:00 A.M. UNTIL 12 MIDNIGHT

OVERTON'S FINEST FULL CUT
ROUND STEAK



OVERTON'S FINEST HEAVY WESTERN
SIRLOIN STEAKS

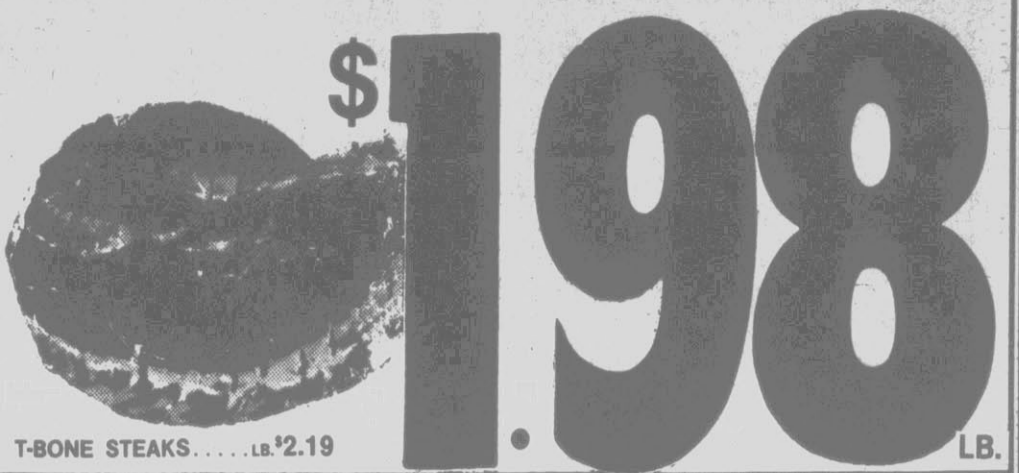

FROSTY MORN
FRANKS 12 OZ. PKG. **99¢**

PRICES EFFECTIVE THURSDAY-SATURDAY

SLICED 7-8 CHOPS
1/4 PORK LOIN LB. **\$1.49**

FAMILY PAK SPECIALS
PORK SPARE RIBS 3-5 LB. PKG. LB. \$1.39
PORK NECK BONES 5-7 LB. PKG. LB. 29¢
EDGEMONT PORK LINK SAUSAGE 10 LB. PKG. \$14.90



IT'S NEW! OVERTON'S DELI
THIS WEEK'S SPECIAL
COOKED HAM . LB. **1.99**

FROSTY MORN
BACON 12 OZ. PKG. **\$1.29**

RATH BLACK HAWK
SAUSAGE LB. ROLL **99¢**

FRESH WHOLE
MAOLA MILK
1/2 GALLON PAPER CARTON
99¢

PILLSBURY
BUTTERMILK BISCUITS 4 PACK 89¢
7.5 OZ. CANS

FRESH PICNICS
69¢

DELTA
PAPER TOWELS . GIANT ROLL **2/\$1**

BUY ONE GET ONE FREE!

MAXWELL HOUSE
INSTANT COFFEE . 10 OZ. JAR **\$3.99**

PETER PAN SMOOTH
PEANUT BUTTER
18 OZ. JAR
99¢

PEPPERIDGE FARM
APPLE JUICE 64 OZ. JUG REGULAR **\$2.09** VALUE
WELCH'S CONCORD 'N APPLE OR
CONCORD JUICE COCKTAIL . . 32 OZ. JUG REGULAR **\$1.39** VALUE
NEW WELCH'S ORCHARD FROZEN
JUICE BLEND 12 OZ. CAN REGULAR **\$1.09** VALUE

STAR-KIST
CHUNK LIGHT TUNA
OIL OR WATER PACKED
6 1/2 OZ. CAN
59¢

WELCH'S
GRAPE JELLY 2 LB. JAR **99¢**

COUPON
CLIP THIS COUPON
RICHFOOD
SUGAR
5 LB. BAG **99¢**
With this coupon and \$10.00 food order excluding advertised items. Without coupon \$1.79. Limit one per customer. Expires 9-8-84.

PURINA
DOG CHOW 30 LB. BAG **\$6.57**

CLOROX BLEACH
GALLON JUG
79¢

COUPON
CLIP THIS COUPON
FABRIC SOFTENER
FAB DETERGENT
GIANT BOX 99¢
49 OZ.
With this coupon and \$10.00 food order excluding advertised items. Without coupon \$1.79. Limit one per customer. Expires 9-8-84.

COCA-COLA
Limit 4 with \$10.00 or more food order. Additional Cokes \$1.09.
2 LITER BOTTLE
99¢

HUBBARD, BUTTERNUT, OR
ACORN SQUASH 5 LBS. **\$1**

TROPICAL FRUIT SPECIALS
LARGE HAWAIIAN PAPAYAS EACH 59¢
EXTRA LARGE MANGOES EACH 69¢
CALIFORNIA JUMBO AVOCADOES 2/\$1.00
EXOTIC KIWI FRUIT 5/\$1.00

NEW CROP
SWEET POTATOES 3 LBS. **\$1**

YELLOW
ONIONS
3 LB. BAG
69¢

JUICY FLORIDA
LEMONS **12/99¢**
IN OUR PRODUCE DEPT.

LOOSE-U BAG 'EM
WHITE POTATOES
10 LBS. LIMIT 10 LBS.
99¢

GREEN MOUNTAIN
CABBAGE
LB. **88¢**

Copyright 1984
Kroger Sav-on
Quantity Rights Reserved
None Sold To Dealers

Kroger
Sav-on

Items and Prices
Effective Thru Sat
Sept 8, 1984

Kroger reminds you...

SCHOOL'S IN!
PLEASE DRIVE CAREFULLY

HOLLY FARMS CUT UP MIXED
FRYER PARTS OR GRADE A

Whole
Fryers

Lb. **39**¢

LIMIT
3 PKGS.
PLEASE



TAB, DIET COKE OR
Coca
Cola

2 Ltr.
N.R.
Btl.

99¢



U.S. NO. 1
ALL PURPOSE

White
Potatoes

10
Lb.
Bag **88**¢

SAVE
\$781

LIMIT 1
BAG PLEASE

FLAVOR SOFT
KROGER

Pork n
Beans

5 **\$1**

16 Oz.
Cans

LIMIT 5 CANS
PLEASE

KROGER 2% LOWFAT MILK,
SKIM MILK OR HOMOGENIZED

Whole
Milk

99¢

1/2 Gal.
Ctn.



U.S.D.A. CHOICE HEAVY WESTERN
GRAIN FED BEEF.

Sirloin
Steak Lb.

\$278

QUALITY,
+ VARIETY,
+ SERVICE
+ LOW PRICES

= **TOTAL VALUE!**



ADVERTISED ITEM POLICY
Each of these advertised items is required
to be readily available for sale in each
Kroger Sav-on, except as specifically noted
in this ad. If we do run out of an item we
will offer you your choice of a comparable
item when available, reflecting the same
savings or a raincheck which will entitle you
to purchase the advertised item at the
advertised price within 30 days. Only one
vendor coupon will be accepted per item.

NONE SOLD
TO
DEALERS

OPEN 24 HOURS EVERYDAY

600 Greenville Blvd. - Greenville 756-7031

TOTAL VALUE BEGINS WITH... **LOW PRICES!**

BEVERAGES

ASSORTED FLAVORS
Big K Soft Drinks



6 \$1
12 Oz. Cans
LIMIT 24 PLEASE

SENECA
Apple Juice 64 Oz. Jar **\$1.19**

PREMIUM
Budweiser Beer



\$2.39
6 12 Oz. Cans

BRUT, COLD DUCK OR
Andre Champagne 3/4 Ltr. Btl. **\$2.79**

DIET COKE, TAB OR
Coca-Cola



99¢
2 Ltr. Btl.

FROZEN & DAIRY

KROGER 2% LOWFAT, SKIM OR HOMOGENIZED
Whole Milk



99¢
1/2 Gal. Ctn.

LIGHT N LIVELY
Cottage Cheese 24 Oz. Cup **\$1.19**

CRISP & TASTY
Jeno's Pizza



79¢
10 Oz. Pkg.

CITRUS HILL OR TROPICANA
Orange Juice 1/2 Gal. Ctn. **\$1.19**

FREEZER PLEEZER
Assorted Pops
BUY ONE 16 CT. PKG.
GET ONE **FREE!**



GROCERY

KROGER HOT DOG OR
Hamburger Buns



99¢
2 12 Ct. Pkgs.

KROGER SMOOTH OR CRUNCHY
Peanut Butter 18 Oz. Jar **\$1.09**

KROGER
Pork & Beans



5 \$1
16 Oz. Cans
LIMIT 5 CANS

KEEBLER PECAN SANDIES OR
Chips Deluxe Cookies 12-13 Oz. Bag **99¢**

FLEECE
Bathroom Tissue



5 \$3
4-Roll Pkg.

COST CUTTER

Tea Bags

99¢

100 Ct. BOX



10W30 MOTOR OIL

Quaker State Super Blend

89¢

Qt. Can



KROGER FROZEN CUT CORN, GREEN PEAS OR

Mixed Vegetables

69¢

20 Oz. Bag



RUFFLES
Potato Chips

99¢

7 Oz. Bag



FOAM

Hefty Plates

\$1.09

50 Ct. Pkg.



COST CUTTER
Instant Coffee

\$1.99

10 Oz. Jar



FOR YOUR LAUNDRY
Punch Detergent

89¢

42 Oz. BOX



KROGER INDIVIDUALLY WRAPPED
Cheese Food Singles

\$1.09

12 Oz. Pkg.



LUNCHEON MEAT
Armour Treet

89¢

12 Oz. Can



PURE VEGETABLE
Wesson Oil

\$1.99

48 Oz. Btl.



CATES

Sweet Salad Cubes

99¢

16 Oz. Jar

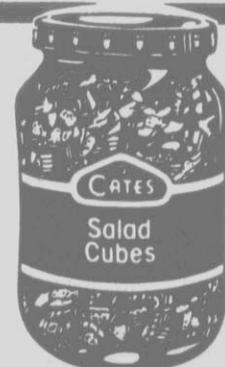

BUTTER, YELLOW OR DEVILS FOOD

Pillsbury Plus Cake Mix

69¢

16.5 Oz. BOX



MARTHA WHITE PLAIN OR
Self Rising Flour

69¢

5 Lb. Bag



AVONDALE
French Fries

\$1.19

5 Lb. Bag



IN WATER OR OIL
Kroger Tuna

49¢

6.5 Oz. Can



One Stop Shopping



7 PIECE COPPER BOTTOM STAINLESS COOKWARE

1 QT. SAUCEPAN WITH COVER, 2 QT. SAUCEPAN WITH COVER 3 QT. DUTCH OVEN WITH COVER AND A 9 INCH FRY PAN.

\$12⁸⁸

All For Only

60¢ OFF LABEL

Pepsodent

PEPSODENT TOOTHPASTE

SUPER SIZE 8.3 OZ. **\$1⁰⁰**
SALE PRICE
LESS MFG'S. **\$1⁰⁰**
MAIL IN REBATE

\$0⁰⁰

FOR EACH TUBE.

Load up on Pennzoil during the...
"CLEAN DEAL SALE"



PENNZOIL 10W 30 MOTOR OIL

MULTI-VIS 10W 30. THE MOTOR OIL WITH 2-7.

89¢

OZ. LIMIT 1 CASE



FINESSE SHAMPOO OR CONDITIONER

RESPONDS TO THE SPECIAL CLEANSING AND CONDITIONING NEEDS OF YOUR HAIR.

\$1⁵⁹

7 Oz. Btl.

PETER PAUL CANDY

YOUR CHOICE OF MOUNDS, ALMOND JOY OR YORK PEPPERMINT PATTIES.

4 For \$1

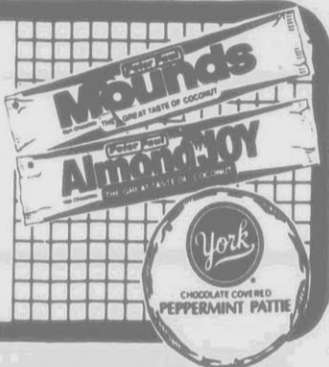

SHARP 8 DIGIT POCKET CALCULATOR

AUTO POWER-OFF FOR EXTENDED BATTERY LIFE. INDEPENDENTLY ACCESSIBLE 4-KEY MEMORY.

\$4⁹⁹

Only MODEL EL 230



11 INCH PLASTIC PLANTERS

ATTRACTIVE PLANTERS IN HEAVY DUTY PLASTIC. ASSORTED COLORS.

\$3⁹⁹

Ea.



G.E. FM/AM RADIO ALARM

WAKE-TO-MUSIC OR MUSIC WITH DELAYED ALARM. SLEEP SWITCH SNOOZE ALARM

\$1⁹⁸⁸

Only



FIVE SUBJECT THEME BOOK

TOP FLIGHT 5 SUBJECT DIVIDER NOTEBOOK.

99¢

Ea.



24 INCH RAPID RAKE

MODEL R-2400. SHADY GREEN FINISH LEAF RAKE.

\$3⁹⁹

Only

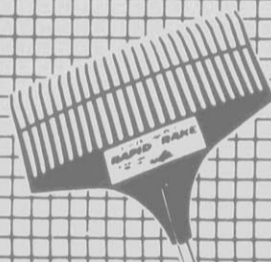

ROUND WICK OIL LAMPS

ATTRACTIVE OIL LAMPS IN TWO STYLES WHILE SUPPLIES LAST. MODEL FW3002.

\$9⁹⁷

Ea.

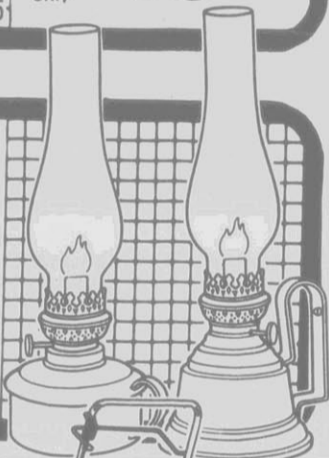

ALBA QUARTZ WATCHES

ASSORTED LADIES AND MENS WATCHES AT AN AFFORDABLE PRICE.

\$4⁸⁸

Ea.



2 1/2 QT. WHISTLING TEAKETTLE

CONVENIENT PUSH-BUTTON FLIP CAP FOR EASY POURING AND FILLING. WHISTLES WHEN WATER BOILS.

\$4⁹⁹

Only



While Supplies Last!

SUMMER CLEARANCE

GRILLS, CHAISE LOUNGES, CHAIRS, WEBBING, MOWERS, WEDEATERS AND MANY MORE.

25% OFF

PHARMACY

Are you paying \$7⁰⁰ for a \$3⁵⁰ prescription?

How Can You Be Assured the Quality of a Generic Drug? By the dependability and integrity of the professional pharmacist and the store where you shop. We at Kroger are dedicated to serving you with dependable products at the lowest possible prices consistent with the highest quality drugs.

How Much Will You Save With a Generic Prescription? Your savings can be as much as 50% and even more, depending upon the drug involved! In most cases, when the brand-name drug is replaced by a generic, the savings are substantial!

Can All Prescriptions Be Filled With Generics? Many, but not all, prescriptions could be filled with generic drugs. Your Kroger Pharmacist will be glad to tell you if a generic equivalent is available for your particular medication.

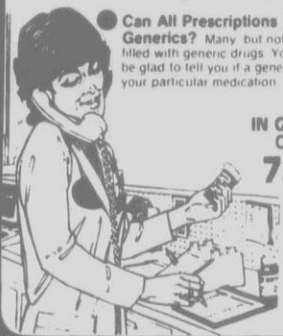

IN GREENVILLE CALL Charles Carter 756-7393

HEALTH & BEAUTY AIDS

SECRET BUY ONE GET ONE FREE!

MAIL IN OFFER ON SOLID 2 OZ. OR ROLL-ON 1.25 OZ. MAIL IN REBATE.

\$1⁷⁹

Ea.



PAMPERS DIAPERS

90 CT. NEWBORN 60 CT. ABSORBENT, 48 CT. TODDLER, 40 CT. MAXI, 54 CT. SUPER ABSORBENT OR 72 CT. REGULAR

\$8⁷⁵

Ea.



LISTERINE ANTISEPTIC

KILLS GERMS BY MILLIONS ON CONTACT.

\$2⁴⁹

24 Oz. Btl.



NOXZEMA SKIN PRODUCTS

GREASELESS, MEDICATED CREAM 6 OZ. OR CLEANSER 4 OZ.

\$1³⁷

Ea.

VHS NO DEPOSIT

Amchair Theatre

BETA NO CLUB MEMBERSHIP

VIDEO CASSETTE RENTAL

AVAILABLE at all Kroger Sav-ons!

Here's all you do:
1) Rent movie of your choice.
2) Rent video player that attaches to your TV - simple hook-up.
3) Enjoy the latest Hollywood movies in your home.

Rent 2 movies get your 3rd rental **FREE!**

SCHICK BLADES

SUPER II 9 CT. OR ULTREX 10 CT.

\$2⁹⁷

Ea.



REVLON BIG LASH MASCARA

NATURAL WONDER, EXTRA LONG OR NORMAL.

\$2¹⁹

Only



LOW Prices, Quality, Variety and Service... That's TOTAL VALUE!

Kroger
Sav-on

Copyright 1984
Kroger Sav-on
Quality Goods Reserved
Name Sold To Dealers

Items and Prices
Effective Thru Sat
Sept. 8, 1984



GRAIN FED BEEF

GUARANTEED FLAVOR
GUARANTEED TENDER
GUARANTEED FRESH
TOTAL SATISFACTION GUARANTEE

Every cut of Kroger U.S.D.A. Choice Grain Fed Beef you buy at Kroger is guaranteed (TENDER, FLAVORFUL AND FRESH) for your total satisfaction. If you are not satisfied, Kroger will replace your item or refund your purchase price.

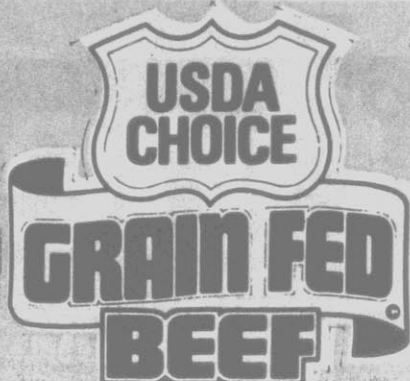

U.S.D.A. CHOICE HEAVY WESTERN
GRAIN FED BEEF

**Rib Eye
Steak**

\$3.98

Lb.



U.S.D.A. CHOICE HEAVY WESTERN
GRAIN FED BEEF

**Sirloin
Steak**

\$2.78

T-Bone Steaks Lb. \$3.78



FREE
6 CT. PKG. KAISER ROLLS
with the purchase of 1 Lb. or more

**Deli-Boiled
Ham**

\$3.99

Lb.



US NO. 1
ALL PURPOSE
**White
Potatoes**

88¢

10
Lb.
Bag

SAVE
\$1.81



LIMIT 1
BAG PLEASE

HOLLY FARMS CUT UP MIXED
FRYER PARTS OR GRADE A

**Whole
Fryers**

39¢

Lb.

LIMIT
3 PKCS.
PLEASE

DELI-BAKERY

DELI-FRESH
TWO TOPPING
**Combo Pan
Pizza**

2 \$8

For

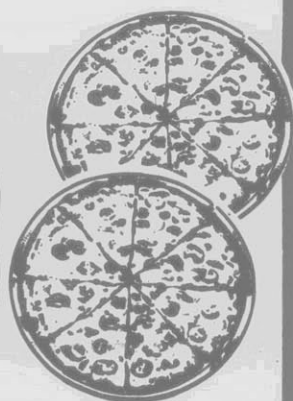

NEW!
**Ham
Salad** Lb. **\$2.99**

NEW!
**Chicken
Salad** Lb. **\$3.99**

AMERICAN OR MUSTARD
**Potato
Salad** 3 Lb. Pack **\$2.69**

FRESH BAKED
**Cinnamon
Rolls** 6 Ct. Pkg. **99¢**

INCLUDES 4 ROLLS AND 1 LB. POTATO SALAD
**Wishbone
Fried Chicken** 8 Pk. **\$5.69**

OA:MEAL RAISIN,
PEANUT BUTTER,
SUGAR OR RANGER
**Fresh Baked
Cookies**

99¢

Doz.

WHITE, WHEAT OR
ONION
Pita Bread
BUY ONE
GET ONE
FREE!

SAVE
99¢

ASSORTED COLORS
**Long Stem
Roses**

\$8.88

Doz.

FREE
GIFT
BOX



PRODUCE

NORTH CAROLINA
NEW CROP GOLD OR RED

**Delicious
Apples**

99¢

3
Lb.
Bag



COUNTRY STAND
**Fresh
Mushrooms** 1 Lb. Pkg. **\$1.59**

JUMBO "STUFFIN" SIZE
**Green
Peppers** 4 For **\$1**

JUMBO 5 SIZE
**Ripe
Honeydews** Ea. **\$1.69**

CALIFORNIA
**Bartlett
Pears** Lb. **59¢**

TENDER FRESH
**Green Leaf
Lettuce** 2 For **\$1**

MEAT SPECIALS

OLDE VIRGINIE 6-8 LB.
AVG. WGT. WHOLE

**Boneless
Ham**

\$1.48

Lb.

SLICED
FREE



U.S.D.A. GOV'T INSPECTED GENUINE

**Ground
Round** Lb. **\$1.78**

U.S.D.A. CHOICE HEAVY WESTERN
GRAIN FED BEEF
**Boneless
Chuck Roast** Lb. **\$1.78**

BULK PACKAGED COUNTRY STYLE
**Sliced
Bacon** 3 Lbs. Or More **\$1.38**

KROGER ALL MEAT OR
**All Beef
Wieners** 12 Oz. Pkg. **98¢**

ALL VARIETIES
SERVE'N SAVE SLICED
**Luncheon
Meats**

\$1.28

1 Lb.
Pkg.



CHEESE SHOPPE

FREE!
14 OZ. BAG DELI
Nacho Chips
when you buy 1 Lb. or more

**Nacho Cheese
Sauce**

\$2.99

Lb.

DANISH
**Swiss
Cheese**

\$2.99

Lb.

NUTRITION SHOPPE

100% PURE
FRESH SQUEEZED
**Orange
Juice**

\$1.68

Qt.

KROGER
**Sweet
Raisins**

\$1.18

15 Oz.
Box

SEAFOOD SHOPPE

MEDIUM
HEADLESS
**Fresh
Shrimp**

\$3.98

Lb.

FRESH
**Bay
Scallops**

\$2.99

Lb.

AMERICA'S FAMILY DRUG STORE

ECKERD

There's never been a sale like this before at Eckerd!

Sale Prices Good Thru Saturday, September 15th

A. PKG. OF 2, 7 WATT NIGHT LIGHT BULBS **2/\$1**

B. PKG. OF 4 SAFE-T™ BULBS 40, 60, 75 OR 100 WATTS. **\$1**

C. PKG. OF 2 OVEN/REFRIGERATOR BULBS 40 WATTS. **\$1**

D. PKG. OF 3, 3-WAY INSIDE FROST LIGHT BULBS **\$2**

E. 150 WATT FLOOD LAMP **\$3**

double days

A. PKG. OF 2 ICE CUBE TRAYS

B. HANDY PLASTIC BASKET

C. 5 COMPARTMENT CUTLERY TRAY

D. STACKING/STORAGE BIN

E. BOWL BRUSH & HOLDER SET

F. 7 QT. VANITY WASTEBASKET

G. 2½ QT. INDOOR WATERING CAN

H. 5 QT. COLANDER

YOUR CHOICE \$1 EA.

\$1

AQUA-FRESH TOOTHPASTE
6.4-OZ. Price reflects cents off label. Limit 2 please.

2/\$1

BRAWNY PAPER TOWELS
Limit 2 rolls please.

4/\$1

PALMOLIVE GOLD BATH SOAP
4.75-OZ. Limit 4 please.

NEW!

YOUR CHOICE 2/\$3

IVORY SHAMPOO OR CONDITIONER
18-OZ. Everything you'd expect from a product named IVORY. Limit 2 please.

YOUR CHOICE \$2

DATRIL EXTRA STRENGTH
50 CAPSULES or 60 TABLETS. Limit 2 please.

\$1

ARM & HAMMER HEAVY DUTY LAUNDRY DETERGENT
65-OZ. Limit 2 please.

HAZEL BISHOP LIPSTICK, NAIL ENAMEL or MASCARA

YOUR CHOICE 2/\$1

MESSENIGILL DISPOSABLE DOUCHE SINGLES
CHOICE OF TYPES Medicated not included. Limit 2 please.

3/\$2

HERSHEY'S BIG BLOCK CANDY BARS
Reg. 55¢ each. Limit 3 please.

YOUR CHOICE 3/\$1

DURKEE OLIVES 5-OZ.
Reg. 89¢ each. Limit 2 please.

2/\$1

EVEREADY GENERAL PURPOSE BATTERIES
4-PACK "C" or "D"; 2-PACK 9-VOLT or 4-PACK "AA"

YOUR CHOICE \$1

ANOTHER PROMOTION FROM ACTION INDUSTRIES, INC.

ECKERD

dollar days

 4 PIECE RUBBER SCRAPER SET \$1	 4 PIECE NYLON UTENSIL SET \$1	 ASSORTED APPLIANCE COVERS \$1 EA.	 7 1/2 IN. DECORATED CERAMIC BOWL \$1 EA.	 PKG. OF 4 CLEANING PADS \$1
--	--	---	---	--

 WOOD-HANDLED KITCHEN TOOLS \$1 EA.	 5 PC. GOURMET WOOD UTENSIL SET \$1	<h1>\$1</h1> <h1>each</h1>	 SET OF 2 CAKE COOLER OR BROILER RACKS (10 In. Sq. or 9 1/2 In. Rd.) \$1 SET	 WOOD-HANDLED KITCHEN BRUSH \$1
 SET OF 5 BOWL COVERS \$1	 ASSORTED CERAMIC SPOONRESTS \$1 EA.		 •MAGNETIC MEMO HOLDER SET •6 COOKIE MAGNETS \$1 PKG.	 STAINLESS STEEL SINK STRAINER \$1 EA.

 SET OF 4 WOODEN NAPKIN RINGS \$1	 BASTING BRUSH & SPATULA SET \$1	 PKG. OF 20 ASSORTED SPONGES \$1	 •WHISK BROOM AND DUSTPAN SET •IRON-SHAPED BRUSH \$1 EA.	 PKG. OF 3 SCOURING SQUARES \$1
--	--	---	---	---

 A. ASSORTED SPONGES AND DISHMOPS	 B. WICKER-LOOK PAPER PLATE HOLDERS	 C. 3 x 9 INCH NOTEPADS	 D. 28 OUNCE BOWL	 E. ASSORTED DECORATIVE MINI FANS
<h1>3/\$1</h1>				
 A. HANDI DRAWER ORGANIZERS	 B. MINI STACKING BIN	 C. 7 INCH HANDLED STRAINER	 D. 1 PINT MEASURING CUP	 E. MINI HANDY BASKET
<h1>2/\$1</h1>				

<h1>2/\$1</h1>	 FLEXIBLE STRAWS PAILLES FLEXIBLES 55 STRAWS, 15 PACKETS 2/\$1 PKG. OF 55 FLEXIBLE STRAWS	<h1>2/\$3</h1>	 11 1/2 IN. SPLATTER SCREEN WITH HANDLE 2/\$3
----------------	---	----------------	---

 SOLID BRASS PLATE HOLDER (Plate not included) 2/\$1	 •QUICK PEEL METAL PEELER •PARING KNIFE 2/\$1	 9 QT. ROUND WICKER-LOOK WASTEBASKET 2/\$3	 1 GALLON REFRIGERATOR JUG 2/\$3
---	--	---	--

 •CHROME-PLATED WIRE WHISK •8 INCH SERVING TONGS 2/\$1	 QUILTED VINYL PLACEMATS 2/\$1	 STAINLESS STEEL MEASURING SPOON SET 2/\$3	 SET OF 3 BOWLS WITH SPOUTS 2/\$3
--	--	---	---

 WOVEN PALM BREAD BASKET 2/\$1	 ASSORTED MINI BASKETS 2/\$1	 5 PC. KITCHEN UTENSIL SET 2/\$3	 LONG-HANDLED MESH SQUEEGEE (18" Handle) 2/\$3
---	--	---	--

 ASSORTED WOVEN PLANTERS 2/\$1	 MEMO PADS action 2/\$1 ASSORTED MEMO PADS	 CLAW HAMMER 2/\$3	 ASSORTED NIGHT LIGHTS WITH BULBS 2/\$3
---	---	---	---

ECKERD

dollar days



\$1
20 PIECE
DELUXE
ARTIST
BRUSH
SET

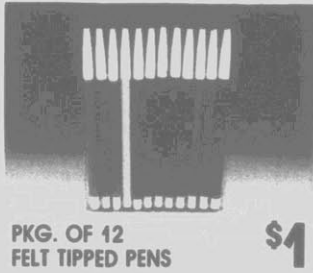

PKG. OF 12
FELT TIPPED PENS

\$1



\$1
SET OF 2
EXPAND-
A-PENS



HAND-CRAFTED
MIYAKO VASES

\$1 EA.

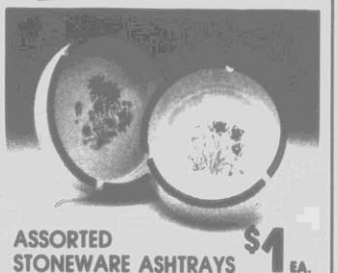

ASSORTED
STONEWARE ASHTRAYS

\$1 EA.



PKG. OF 24
SPRING-TYPE CLOTHESPINS

\$1



FEATHER DUSTER
WITH 19 IN. HANDLE

\$1 EA.

\$1
each



•STAPLER GUN
WITH STAPLES
•PKG. OF 100 PUSH PINS

\$1 PKG.



BLACK PLASTIC EASEL
(6 x 5 in.)
Plate not included

\$1 EA.

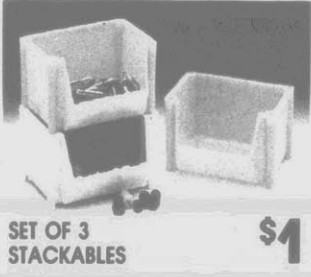

SET OF 3
STACKABLES

\$1



21 SPOOL
BOBBIN BOX

\$1



NOVELTY PENCIL
SHARPENER

\$1 EA.

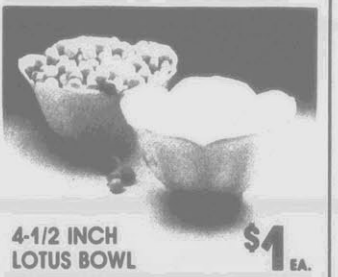

4-1/2 INCH
LOTUS BOWL

\$1 EA.

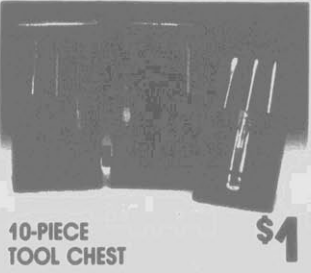

10-PIECE
TOOL CHEST

\$1



PLUMBER'S
FORCE CUP

\$1



•ELECTRICAL TAPE
ON DISPENSER
•PLASTIC DUCT TAPE

\$1 EA.



3 PIECE
PAINT BRUSH SET

\$1



ASSORTED
RAWHIDE PET CHEWS

\$1 PKG.

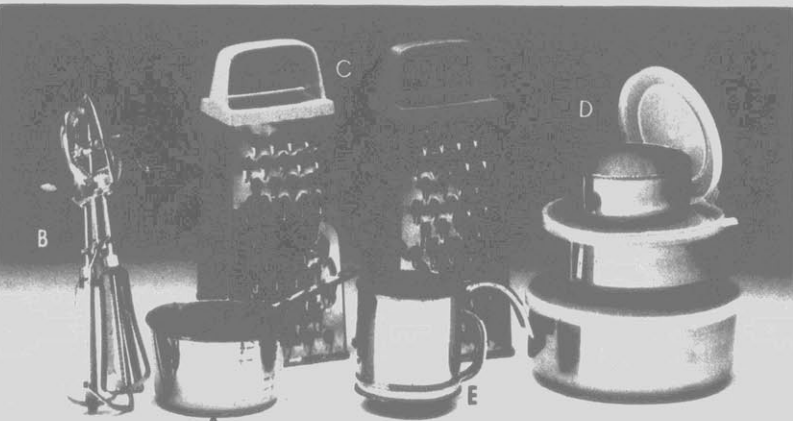

A. 2 CUP
STAINLESS STEEL
MEASURING PAN \$2
B. BEATER/MIXER \$3
C. STAINLESS STEEL GRATER EA. \$3
D. COVERED STAINLESS STEEL BOWLS
•11 OUNCE \$4
•24 OUNCE \$1.50
•41 OUNCE \$2
E. STAINLESS STEEL 1 CUP SIFTER \$2

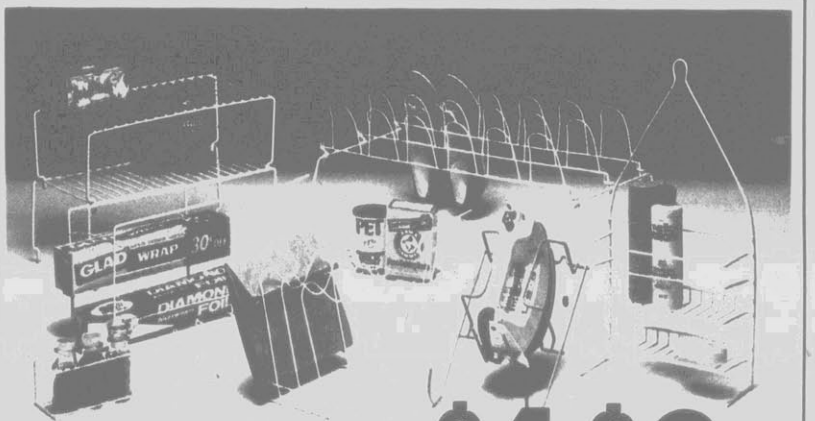

Assorted
Vinyl-Coated Wire
Racks & Caddies

\$1 to **\$3** Ea.

\$2
each



1 BUSHEL ROUND
LAUNDRY BASKET

\$2 EA.

\$3
each

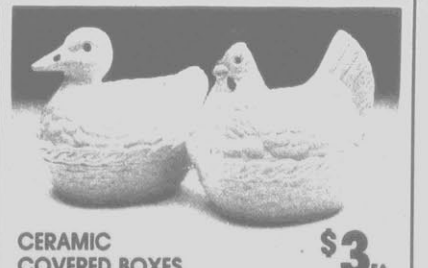

CERAMIC
COVERED BOXES

\$3 EA.

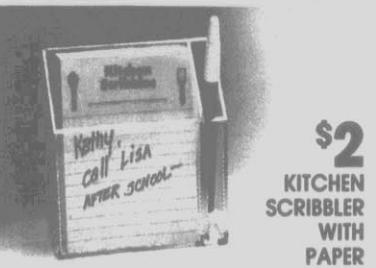

\$2
KITCHEN
SCRIBBLER
WITH
PAPER



CHEESE AND
CRACKERS TRAY

\$2



6 PIECE
FOOD KEEPER SET

\$3



6 PIECE
COVERED BOWL SET

\$3



STAINLESS STEEL/
GLASS SERVERS

\$2 EA.



\$2
2 CUP
SEPARATOR/
STRAINER

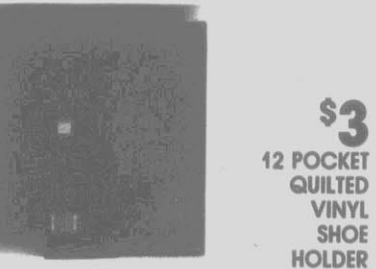

\$3
12 POCKET
QUILTED
VINYL
SHOE
HOLDER



\$3 EA.
DIAL-STYLE
TELEPHONE
INDEX



•LETTER HOLDER
•7 COMPARTMENT
DESK ORGANIZER

\$2 EA.

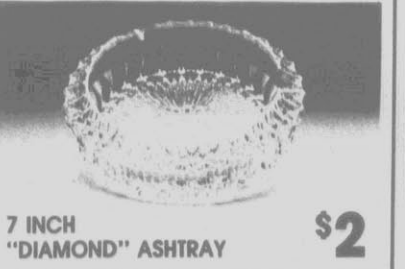

7 INCH
"DIAMOND" ASHTRAY

\$2

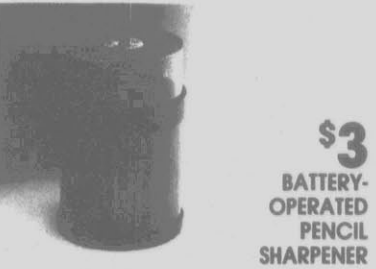

\$3
BATTERY-
OPERATED
PENCIL
SHARPENER



"HELLO"
ORGANIZER

\$3



\$2
WIRELESS
CLOSET
LIGHT
(Batteries not included)

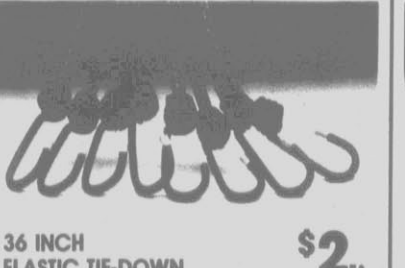

36 INCH
ELASTIC TIE-DOWN

\$2 EA.



SET OF 3 NESTED
HEXAGONAL TRINKET BOXES

\$3



\$3
6 PIECE
JEWELER'S
SCREWDRIVER
SET

ECKERD

dollar days

\$3 MAIL-IN REBATE

REVLON
COLORSILK
HAIRCOLOR
CHOICE OF SHADES.

\$3 Sale Price
- 3 Mail-In Rebate
FREE Your Final Cost
Limit 2 please.



NEW!

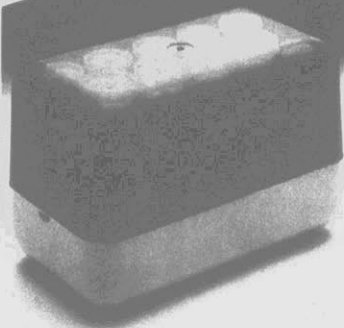

CLAIROL BASIC®
INSTANT
HAIRSETTER
#C14 Reg. 15.99

\$13

\$2 MAIL-IN REBATE

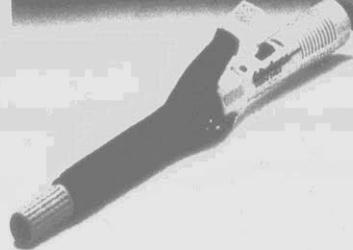

WINDMERE
FLOCKED
CURLING
IRON
#FCI

\$7 Sale Price
- 2 Mail-In Rebate
\$5 Your Final Cost

SAVE \$14

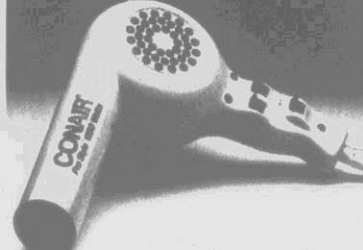

CONAIR PRO
1250-WATT
HAIR DRYER
#085 Reg. 19.99
2 speed &
4 heat levels.

\$15 Sale Price
- 5 Mail-In Rebate
- 5 Bonus Rebate
\$5 Your Final Cost

\$3 MAIL-IN REBATE

REVLON
FROST & GLOW
2 TYPES

\$7 Sale Price
- 3 Mail-In Rebate
\$4 Your Final Cost
Limit 2 please.

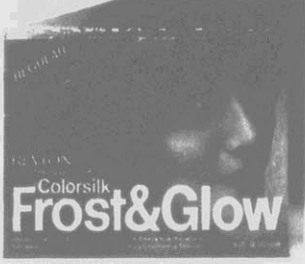

COTY SWEET EARTH FACE
CARE SPECIALS
2-oz. Mud Mask, 1.5-oz.
Peel Away Mask, or
1.75-oz. Suds.
Reg. 1.79 each.
2/\$3



\$2
BRUT 33
SPLASH-ON
LOTION
7-OZ. Limit
2 please.

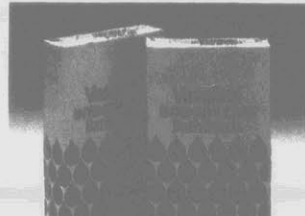

VASELINE INTENSIVE CARE
BATH BEADS
15-OZ.
Limit 2 please.
2/\$3



LOVE'S BABY SOFT
COLOGNE
SPRAY 1-OZ.
6.00 VALUE Reg. 5.50
\$4



NEW!
SMALL
HAND
MIRROR
Choice of colors.
2/\$1



NEW!
FOAM ROLLERS PACK OF 40
+ 8 FREE
Reg. 3.79
pack
2/\$3



NEW!
\$5
YOUR CHOICE
AVIANCE
NIGHT
MUSK
SPRAY
COLOGNE
.65-OZ. or
OIL
PERFUME
.35-OZ.



\$2 OFF
WINDSONG
•.65-OZ. NATURAL SPRAY COLOGNE... REG. 3.95
•1.6-OZ. NATURAL SPRAY COLOGNE... REG. 6.50
•2.9-OZ. NATURAL SPRAY COLOGNE... REG. 8.95
VALUES 7.00-13.00



RAVE PERM REFILL REGULAR
OR BODY ONLY
Limit 2 please.
NEW RAVE SPOT PERM
NORMAL Limit 2 please.
\$3 EACH



\$2
BODY
FLOWERS
BODY SPRAY
DEODORANT
2.5-OZ. Limit
2 please.



NEW!
YOUR CHOICE
2/\$5
ALBERTO
MOUSSE
STYLING
FOAM
6.3-OZ.
2 TYPES.
Limit 2
please.



YOUR CHOICE
\$1



ECKERD BALSAM & PROTEIN
SHAMPOO OR CONDITIONER
16-OZ. Compare to Revlon Flex
•TUSSY CREAM DEODORANT, 2-OZ.
•TUSSY ROLL-ON DEODORANT, 2 1/4-OZ.
•TUSSY STICK DEODORANT, 2 1/2-OZ.
Limit 2 each please.



BUF-PUF FACIAL
SPONGE
REGULAR or GENTLE.
Limit 2 please.
\$2 EACH



VO5 HOT OIL
TREATMENT
2 TREATMENTS + 1 BONUS
Limit 2 please.
\$2



ECKERD BUFFERED ASPIRIN
100 TABLETS Compare to Bufferin.
•PEARS TRANSPARENT SOAP
2.4-OZ. Limit 2 please.
•STYLE HAIR SPRAY
8-OZ. Limit 2 please.
•ECKERD BABY POWDER
14-OZ. Compare to Johnson's



ECKERD FABRIC
SOFTENER
20 SHEETS Compare
to Bounce.
3/\$2



\$2
LISTERINE
ANTISEPTIC
18-OZ. With
40° coupon on
Dixie Bathroom
Cup Dispenser.
Limit 2 please.



ECKERD THICK &
SOFT BABY WIPES
80 WIPES Compare
to Scott's.
\$2



\$2
ECKERD
BELTLESS
MAXIPADS
BOX OF 30,
2 TYPES
Compare to
Stayfree.



\$3
ECKERD
NATURAL
FIBER
LAXATIVE
14 OZ. CHOICE
OF TYPES
Compare to
Metamucil.

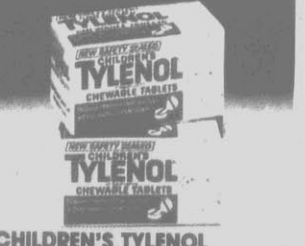

CHILDREN'S TYLENOL
CHEWABLE TABLETS
PACK OF 30
Limit 2 please.
\$2



\$2
CORRECTOL
LAXATIVE
30 TABLETS
Limit 2 please.



\$2
DURATION
NASAL SPRAY
1/2-OZ. Limit 2 please.



EFFERDENT DENTURE
CLEANSER with
FREE "TIPS FROM HELOISE"
BOOK 60 TABLETS
Limit 2 please.
\$2



ECOTRIN ASPIRIN FOR
ARTHRITIS PAIN
70 CAPSULES
or 100 + 25 FREE TABLETS
Limit 2 please.
YOUR CHOICE
\$3

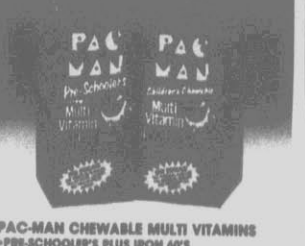

PLIAJEL CLEANING SOLUTION
or UNISOL 4 SALINE
SOLUTION. 8.5-OZ. PLIAJEL
or 8-OZ. UNISOL 4
Limit 2 please.
\$2 EACH



PAC-MAN CHEWABLE MULTI VITAMINS
•PRE-SCHOOLER'S PLUS IRON 60'S
•CHILDREN'S
PLUS IRON 60'S
•WITH EXTRA C 30's
Limit 2 please.
YOUR CHOICE
2/\$7



CALTRATE 600
CALCIUM
SUPPLEMENT
60 TABLETS Limit 2 please.
\$5

\$1 MAIL-IN REBATE
THERAGRAN-M
VITAMIN
SUPPLEMENT
100 + 30 FREE
2 SEE STORE FOR DETAILS ON ECKERD REBATE
\$7 Sale Price
- 1 Mail-In Rebate
- 1 Your Final Cost
Limit 2 please

ECKERD

dollar days

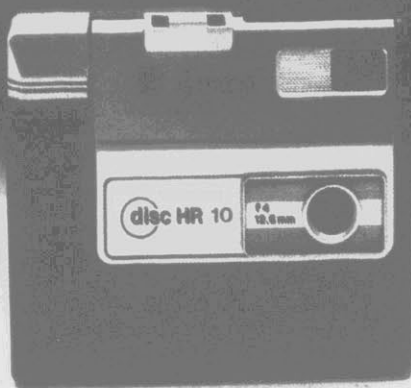

ANSCO® HR-10 DISC CAMERA
Ultra compact! Anso full 3-Year warranty.
\$10

BUY THIS CAMERA AT ECKERD. WE'LL INCLUDE A 6.75 PROCESSING VALUE.



SYLVANIA SUPER 10 FLIP FLASH
10 FLASHES.
Reg. 1.89
\$1

SYSTEM 2
PHOTO PROCESSING

COLOR REPRINTS FROM YOUR COLOR NEGATIVES We'll make 6 regular-size reprints on quality Kodak paper from your negatives. Coupon Good Thru Saturday, Sept. 15. (Code #721)

6/\$4

COUPON MUST ACCOMPANY ORDER



WITH ECKERD PROCESSING, YOU CAN BUY 2 ROLLS OF FILM FOR THE PRICE OF 1, EVEN WHEN IT'S ON SALE!

KODAK VR100 COLOR PRINT FILM
CP-135 36 EXPOSURES.
\$3

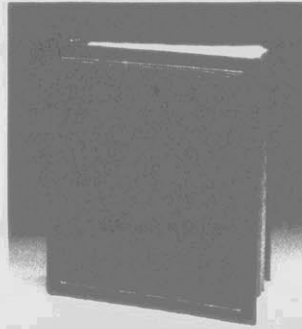

100-PAGE PHOTO ALBUM
Reg. 9.99
\$7

SYSTEM 2 OR **ULTRALAB 35**
PHOTO PROCESSING

COLOR FILM DEVELOPED AND PRINTED

\$1.00 OFF REGULAR PRICE 12-EXP. ROLL or 15-EXP. DISC	\$2.00 OFF REGULAR PRICE 24-EXP. ROLL	\$3.00 OFF REGULAR PRICE 36-EXP. ROLL
---	---	---

Present this coupon with your next original roll or disc film order. Get twice the prints with System 2 or try Ultralab 35® if you're serious about 35mm. Limit 1 order. Coupon Good Thru SATURDAY, SEPT. 15 ON ALL 110, 126, 135 or DISC COLOR PRINT FILM (CODE #720)

COUPON MUST ACCOMPANY ORDER

WHENEVER YOU BUY A CAMERA AT ECKERD, WE'LL PROCESS YOUR FIRST ROLL OR DISC FILM FREE!



SAVE \$10
GTE ULTRALINE II SWITCHABLE DESK TELEPHONE
Reg. 59.00 Ten-number memory dialing.
\$49
NEW!



SAVE \$10
GTE LINEA PULSE TELEPHONE
Reg. 69.99 Last number redial & hold keys.
\$59
NEW!



DIGITECH SOLAR DESK TOP CALCULATOR
#SL881 Reg. 12.99
Three-key memory. 8-digit display.
\$10



SPARTUS DAYSTAR NEPTUNE QUARTZ ALARM CLOCKS
#1807-C1 or #1104-61
Reg. 12.99 each.
\$10



BASF CHROME VIDEO TAPE
VHS T-120 or BETA L-750
Pure Chrome Formulation.
\$7

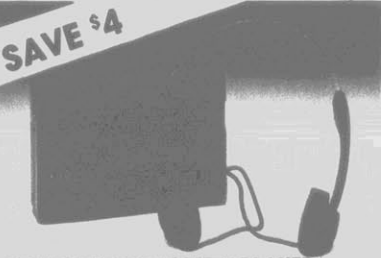

SAVE \$4
GPX STEREO CASSETTE PLAYER with HEADPHONES
#3035/3030 Reg. 19.99
Deluxe feather-light headphones.
\$15

MR. COFFEE DRIP COFFEEMAKER #CM-12
Special Buy \$20
- 5 Mail-In Rebate
= 15 Your Final Cost



NEW!
TOSHIBA AM/FM MINI-COMPONENT STEREO SYSTEM
AC/DC Detachable speakers.
#RTSX1 Reg. 99.99
\$79



SAVE \$10
GPX AM/FM PORTABLE STEREO CASSETTE PLAYER with HEADPHONES
#3050/3060 Reg. 39.99 Fast forward pushbutton control. Auto stop at end of tape.
\$29

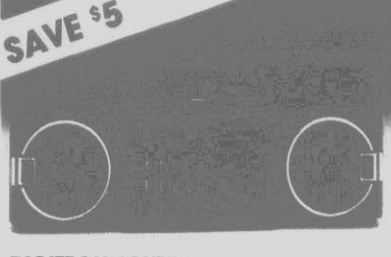

SAVE \$5
DIGITECH AM/FM PORTABLE STEREO RADIO
#275 Reg. 29.99
\$24

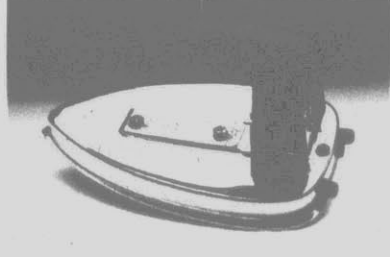

ADVANTAGE TRAVEL IRON
#2319E
Reg. 7.99 Detachable 8-foot cord set.
\$5



SAVE \$7
NORELCO CLEAN AIR MACHINE
#HB1900 Reg. 14.00
\$11 Sale Price
- 4 Mail-In Rebate
= 7 Your Final Cost



L'EGGS SHEER ELEGANCE PANTYHOSE COLOR COLLECTION
Reg. 2.99-3.19 each.
3/\$7

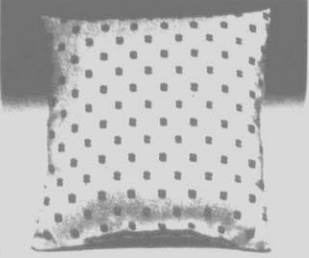

16" DECORATOR PILLOW ASSORTED DESIGNS.
Reg. 2.99.
\$2



CONTOUR BACKREST
Reg. 10.99.
\$8



RAINBOW AIR FRESHENERS
3/\$1



SERGEANT'S SENTRY FLEA & TICK COLLAR FOR DOG OR CAT
Reg. 3.59 each.
\$2 EACH



\$4
HOLIDAY INDOOR FOGGER
14-OZ.
Reg. 6.79



\$3
SPONGE MOP with SCOUR STRIP Reg. 4.49
\$4
CORN BROOM
Reg. 5.99 100% natural fiber.



SAVE \$5
\$12
5-SHELF STEEL SHELVE
12" x 30" x 66"
Reg. 17.99



SAVE \$8
WOODEN DIRECTOR'S CHAIR Reg. 24.99
Canvas covering in choice of colors.
\$16



MEN'S or LADIES' HUSH PUPPIES® BRUSHED PIGSKIN GLOVES
Reg. 6.99 pair.
\$5 EACH

ECKERD Dollar days*

Rx 50 Million
Prescriptions a year
is a lot of trust
See for yourself why more people
trust Eckerd to fill their prescriptions.

We reserve the right to limit quantities.
Item availability may vary at select locations.



CONTACT CAPSULES PACK OF 10 Limit 2 packs please. **\$2**
TUMS ANTACID Bottle of 75 2 TYPES Limit 2 please. **YOUR CHOICE 2/\$3**
ECKERD SWEET TREAT CANDY Compare to Brach's. **YOUR CHOICE 3/\$1**
LAY'S POTATO CHIPS 7.5-OZ. ASSORTED FLAVORS to 8-OZ. REGULAR Reg. 1.39 each. Limit 2 please. **YOUR CHOICE \$1**
CROWN-PRINCE PEELLED SHRIMP FOR SALADS 4.25-OZ. Reg. 1.49 Limit 2 please. **\$1**



SCHICK SUPER II CARTRIDGES PACK OF 9 + 1 FREE CARTRIDGE Limit 2 pks. please. **\$3**
TEK TOOTHBRUSHES ASSORTED TYPES Limit 4 please. **4/\$1**
QUEEN HELENE COCOA BUTTER HAND & BODY LOTION 16-OZ. Limit 2 please. **\$1**
QUEEN HELENE ELASTIN/COLLAGEN CREME OF LOTION 4-OZ. CREME or 16-OZ. LOTION Limit 2 please. **\$4**
JOHNSON'S SWABS PACK OF 100 Limit 2 please. **\$1**
JOHNSON & JOHNSON BAND-AID BANDAGES PLASTIC STRIPS or SHEER BOX OF 50 Limit 2 please. **YOUR CHOICE 2/\$3**



HR VACUUM CLEANER BAGS ASSORTED SIZES Reg. 1.59 each. **\$1 EACH**
EASY WIPE CLOTHS PACK OF 8 •MAGLA LOVING HANDS GLOVES **YOUR CHOICE 2/\$1**
"COUNTRY COLORS" MUGS 13-OZ. Reg. 1.69 each. **2/\$1**
WASH CLOTHS or DISH CLOTHS PACK OF 2. **\$1**
HYPONEX POTTING SOIL 4-QUART BAG. **3/\$1**



25% OFF
TIMEX WATCHES Reg. 16.95-59.95 **MEN'S & LADIES'** Selection may vary by store.
6" x 9" TABLETS OR BOXED ENVELOPES Plain or ruled tablets. 50 business or 100 household envelopes. **YOUR CHOICE 2/\$1**
ECKERD THRIFT TAPE 1/2" x 800'. **3/\$1**
KORDITE KITCHEN or TRASH BAGS **YOUR CHOICE 2/\$3**
 •28, 13-GALLON ODOR SENTRY BAGS
 •20, 26-GALLON TRASH BAGS
 •15, 33-GALLON LARGE TRASH BAGS
 •10, 39-GALLON LAWN & LEAF BAGS



A. ASSORTED DELUXE METAL PHOTO FRAMES.....EA. **\$1**
B. SHOWCASE PICTURE FRAME (6 1/4 in. x 8 1/2 in.) **\$1**
C. ANTIQUE-LOOK PHOTO FRAMES
 •SMALL\$1
 •MEDIUM\$1.50
 •LARGE\$2
D. ORNATE METAL PHOTO FRAMES (3 in. x 5 in.).....EA. **\$2**

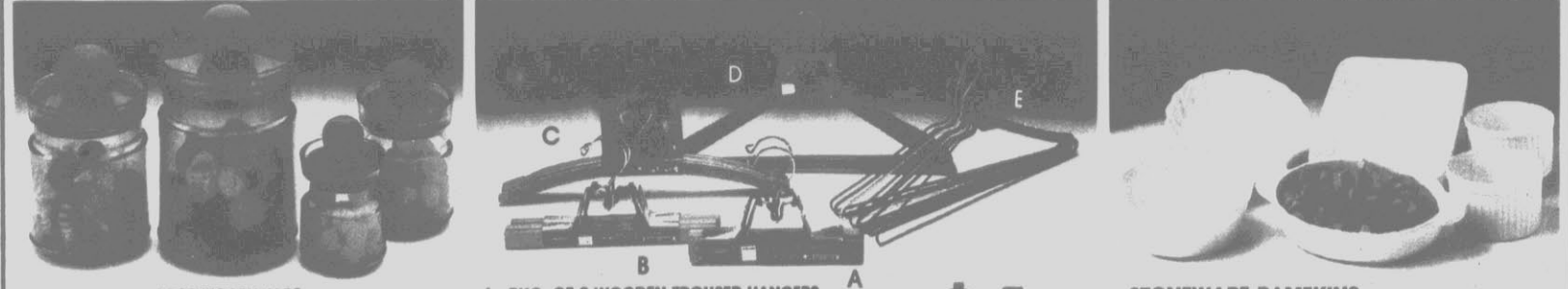

APOTHECARY JARS
 •4 OUNCE **2/\$1** •13 OUNCE **\$1**
 •6 OUNCE **75¢** •22 OUNCE **\$1.50**
A. PKG. OF 2 WOODEN TROUSER HANGERS
B. PKG. OF 2 WOODEN SKIRT HANGERS
C. PKG. OF 4 WOODEN DRESS HANGERS
D. PKG. OF 2 WOODEN CURVED SUIT HANGERS
E. PKG. OF 10 VINYL-COATED HANGERS **\$1 PKG.**
•STONEWARE RAMEKINS Microwave Safe. (4 in. Diam.).....EA. **\$1**
•ASSORTED MICROWAVE DISHES (Square, Shell, Oval or Round) EA. **\$2**

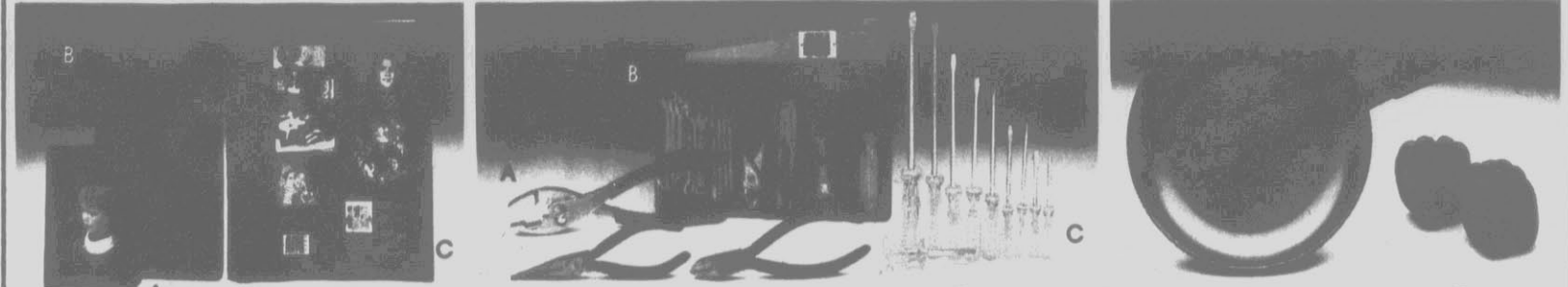

A. BRAG BOOK PHOTO ALBUM **\$1**
B. 96-POCKET PHOTO ALBUM **\$2**
C. 24 PG. GALLERY PHOTO ALBUM .. **\$3**
A. ASSORTED PLIERS
B. 17 PIECE TOOL SET
C. 10 PIECE SCREWDRIVER SET **\$2 EA.**
9 3/4 IN. NON-STICK FRY PAN **\$3**

YA HOO!

2ND BIG WEEK! ROUND UP SALE



OPEN 'TIL MIDNIGHT THURS., FRI., & SAT.!
See Back Page For Special "Moonlight Sale" Bargains!

WINN DIXIE

Now more than ever, we're right for you!

★★ PRICES GOOD 7-FULL DAYS THRU WED., SEPT. 12. ★★

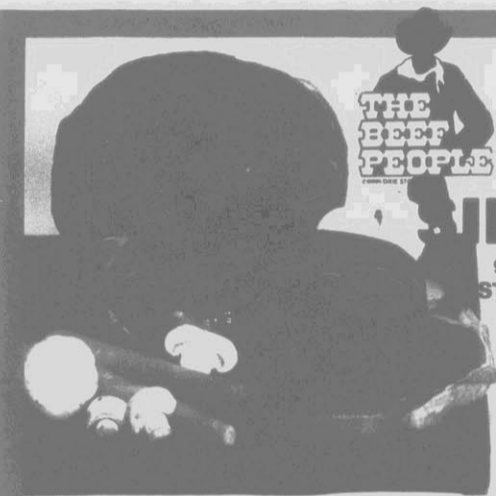

**U.S. CHOICE
GRAIN-FED
WESTERN WHOLE
UNTRIMMED
TIRLOIN TIPS**

9/11-LB. AVG. CUT FREE INTO
STEAKS, ROASTS & TRIMMINGS.

1.39

LB. LIMIT 2, PLEASE

**WHOLE
TALMADGE OR
SMITHFIELD
COUNTRY
HAM**



1.39

LB. 11/13-LB. AVG.
SLICED FREE

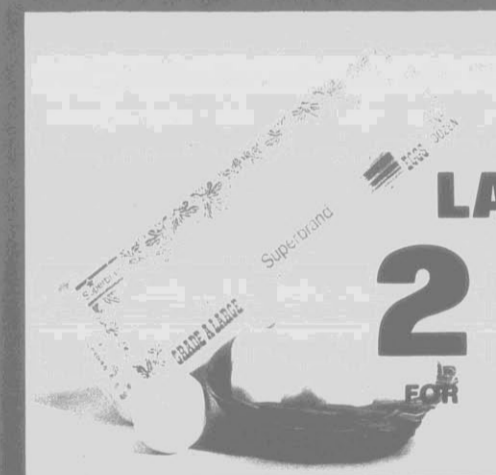

**1-DOZ.
SUPERBRAND
GRADE 'A' WHITE
LARGE EGGS**

2.99[¢]

WITH 10.00 OR MORE
ORDER (LIMIT 2)

**2-LTR. BTLS.
PEPSI-COLA**

•DIET PEPSI •SUGAR FREE
PEPSI FREE •PEPSI FREE
•MTN DEW

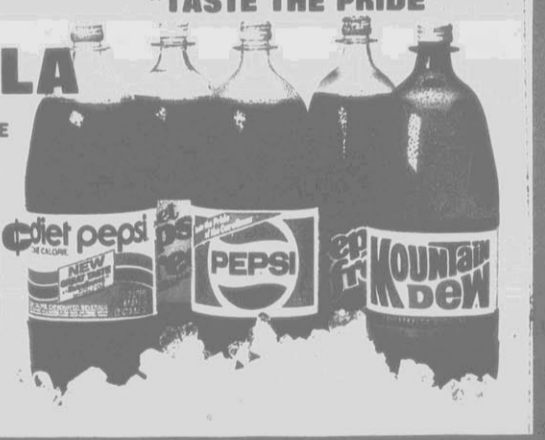

89

WITH 10.00 OR MORE
ORDER (LIMIT 2)



**32-OZ. JAR
DEEP SOUTH
MAYONNAISE**

69[¢]

WITH 10.00 OR MORE ORDER
(LIMIT 1)

**5-LB. BAG
DIXIE CRYSTALS
SUGAR**



1.19

WITH 10.00 OR MORE ORDER
(LIMIT 1)

**PRICES GOOD IN ALL VIRGINIA STORES AND THE FOLLOWING
EASTERN NORTH CAROLINA CITIES ONLY:**

- RALEIGH •DURHAM •FAYETTEVILLE •WILMINGTON •KINSTON •CARY •HENDERSON •WAKE FOREST •LOUISBURG •NEW BERN
- MOREHEAD CITY •ROANOKE RAPIDS •LUMBERTON •HOPE MILLS •JACKSONVILLE •GREENVILLE •GOLDSBORO •ELIZABETHTOWN •ZEBULON
- OXFORD •GARNER •SANFORD •SOUTHPORT •WILSON •ROCKY MOUNT •WASHINGTON •DUNN •EDENTON •CHAPEL HILL •WILLIAMSTON
- SELMA •ELIZABETH CITY

•NONE TO DEALERS •WE RESERVE THE RIGHT TO LIMIT QUANTITIES
©COPYRIGHT 1984, WINN-DIXIE STORES, INC.

WINN DIXIE

Now more than ever, ★ ★
★ ★ ★ we're right for you!

SAVE 25¢ on COUNTRY PRIDE Country Fresh Chicken.

LIMITED WARRANTY TO CONSUMER
★ Good Housekeeping PROMISES
REPLACEMENT OR REFUND IF DEFECTIVE

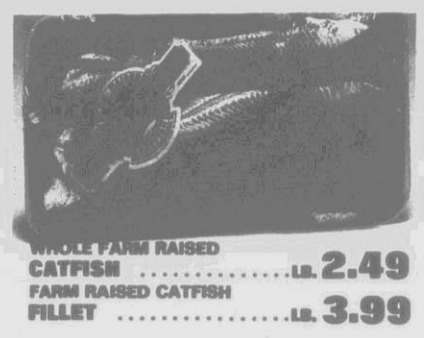

WHOLE FARM RAISED CATFISH **2.49**
FARM RAISED CATFISH FILLET **3.99**

SAVE 25¢ on Country Pride® Country Fresh Chicken Parts; 25¢
Breasts, Thighs, Drums, Legs, or Assorted Parts.
MR. GROCER, Country Pride® will redeem this coupon for 25¢ plus 7¢ handling fee if you receive it on the sale of any package of Country Pride® Country Fresh Chicken Parts. For payment mail to:
COUNTRY PRIDE FOODS
P.O. BOX 1594
CLINTON, IOWA 52734
Coupons are not to be assigned or transferred by you. Any other application constitutes fraud. Invoice proving purchase of stock within last 3 months to cover coupons accepted must be shown on request. Void when presented by outside agency or where prohibited, taxed or otherwise restricted. Consumer must pay applicable sales tax. Good only in USA. **Limit one per purchase.**



25¢ COUPON EXPIRES SEPT. 30, 1984 NO. 194

10½-OZ. CANS
THRIFTY MAID CHICKEN
NOODLE, VEGETABLE OR
**MUSHROOM
SOUP**

3 89¢
FOR



LOUIS RICH
OVEN ROASTED,
HICKORY SMOKED OR
BAR-B-QUE
BREAST OF TURKEY **3 79**



32-OZ. BTL. HEINZ
KETCHUP
89¢

WITH 10.00 OR MORE ORDER (LIMIT 1)
5-OZ. BTL. HEINZ 57
STEAK SAUCE **.89**



11-OZ. CAN
**TNT ROACH &
ANT KILLER**

BUY ONE &
GET ONE **FREE**



12-OZ. BOX CRACKIN GOOD
**GEORGIA
CRACKERS**
79¢

18-OZ. JAR DEEP SOUTH
PEANUT BUTTER .. **.99**



46-OZ. CAN TROPICAL
FRUIT DRINKS
59¢

9-OZ. BOX
CRACKIN GOOD
CHEEZE BITS **69¢**



2-LB. JAR
SMUCKER'S
CONCORD
GRAPE
JELLY
1 19



3-LTR. BTL.
**GALLO
WINES**
•CHABLIS BLANC
•RED ROSE
•RHINE
4 99



32-OZ. BTL.
LILAC
DETERGENT
79¢

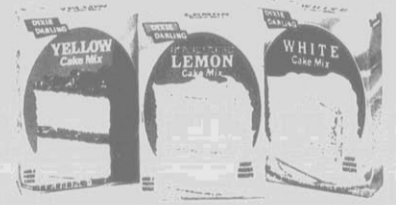

18-OZ. BOX
DIXIE DARLING
CAKE MIXES **59¢**

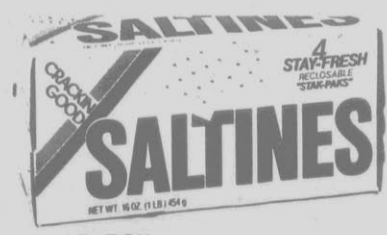

1-LB. BOX
CRACKIN
GOOD
SALTINES **59¢**



18-OZ. BTL.
DEEP SOUTH
BARBECUE
SAUCE
69¢

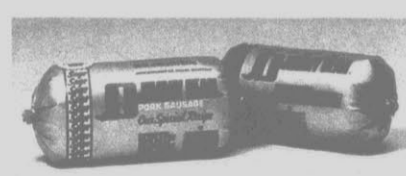

1-LB. ROLL
JIMMY DEAN
MILD OR SPECIAL
RECIPE
SAUSAGE **1 79**

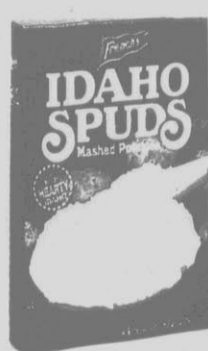

16-OZ. BOX
FRENCH'S
IDAHO
SPUDS
99¢



5½-OZ. JAR
THRIFTY MAID
SPANISH
OLIVES
69¢



32-OZ. BTL.
ARROW
WINDOW
CLEANER
99¢



28-OZ. BTL.
PINE-GLO
CLEANSER
79¢

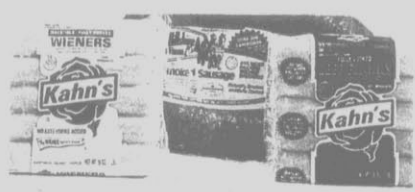

HILLSHIRE SMOKED BEEF OR POLSKA
SAUSAGE **2.49**
1-LB. PKG. KAHN'S ALL MEAT
WIENERS **1.89**
1-LB. PKG. KAHN'S BEEF
FRANKS **1.99**

RIGHT WITH COURTEOUS SERVICE

PRICES IN THIS SECTION GOOD
7-FULL DAYS
THRU WED., SEPT. 12TH!



4-ROLL PAK
NORTHERN
BATHROOM
TISSUE

99¢



250-CT. PKG. NORTHERN
NAPKINS **119**



32-OZ. BTL.
WISK LIQUID
DETERGENT

129



8-OZ. JAR
TASTER'S CHOICE
REGULAR
INSTANT COFFEE

529



8-OZ. JAR TASTER'S CHOICE DECAFFEINATED
INSTANT COFFEE **5.49**
22-OZ. BTL. NESTLE QUIK CHOCOLATE
SYRUP **1.39**
2-LB. CAN NESTLE QUIK
CHOCOLATE MIX **2.59**



14-OZ. CAN EAGLE BRAND
CONDENSED MILK

115

32-OZ. JAR REALEMON
JUICE **1.09**
32-OZ. JAR CRACKER JACK
POPCORN **1.99**



46-OZ. CAN
HAWAIIAN
PUNCH

79¢



12-OZ. CAN ARMOUR
TREET

109

5-OZ. CAN ARMOUR VIENNA
SAUSAGE **2 for .89**
3-OZ. CAN ARMOUR
POTTED MEAT . **4 for \$1**



16-OZ. CAN STOKELY
VEGETABLES

•CORN •PEAS •FRENCH STYLE GREEN
BEANS •CUT GREEN BEANS •SLICED
BEETS •APPLE SAUCE

2 CANS FOR 89¢



5-LB. BAG MARTHA WHITE
FLOUR
PLAIN OR SELF-RISING

79¢

WITH 10.00 OR MORE ORDER (LIMIT 1)



14-OZ. CANS
KAL KAN
DOG FOOD

3 \$1
CANS FOR



14-OZ. BOX
KRAFT DELUXE
MACARONI &
CHEESE
DINNERS

109



16-OZ. BTL. KRAFT
CUCUMBER, 1000
ISLAND, 1000
ISLAND W/BACON
OR REDUCED
CALORIE 1000
ISLAND

DRESSINGS
149



16-OZ. BTL. KRAFT
BACON/TOMATO,
FRENCH,
CATALINA OR
ITALIAN

DRESSINGS
149



20-OZ. BOX
KELLOGG'S
RAISIN
BRAN

175

**RIGHT WITH PRICE
BREAKER COUPONS...
CLIP & SAVE!**

WINN  DIXIE

PRICE BREAKER COUPON



**49-OZ. BOX
FAB
DETERGENT**

139

Full Strength Detergent
Static Free Lemon Fresh

LIMIT 1 PER CUSTOMER WITH 10.00
OR MORE ORDER & COUPON. GOOD
THRU WED., SEPT. 12TH.

PRICE BREAKER COUPON



**1-LB. PKG.
IN QUARTERS
SUPERBRAND
MARGARINE**

10[¢]

LIMIT 1 PER CUSTOMER WITH 10.00
OR MORE ORDER & COUPON. GOOD
THRU WED., SEPT. 12TH.



**15-CT. BOX GLAD
TALL KITCHEN BAGS
OR 30-CT. BOX
GARBAGE BAGS**

99[¢]

**20-CT. BOX GLAD MEDIUM
GARBAGE BAGS .. 1.19**

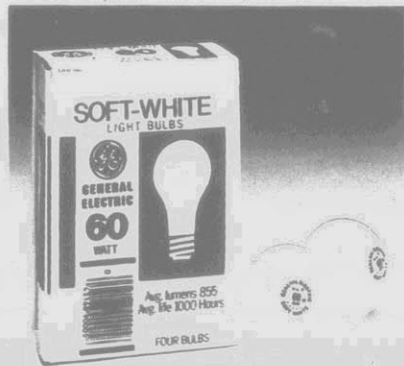

**4-PAK GENERAL ELECTRIC
SOFT-WHITE
LIGHT BULBS**

•40 •60 •75 •100

249



**32-OZ. JAR RAGU
TRADITIONAL OR
CHUNKY
SPAGHETTI
SAUCE**

169



**250-FT. ROLL
BONUS PAK
HANDI-
WRAP**

149

**17-OZ. BTL. TOUGH ACT
BATHROOM
CLEANER 1.69**



**20-LB. BAG
MAINSTAY
DOG
FOOD**

4.99



**3-OZ. BOX ROYAL
PUDDINGS 3 FOR \$1**
**3-OZ. BOX ROYAL
GELATINS 4 FOR \$1**

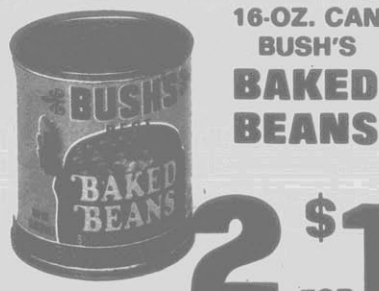

**16-OZ. CAN
BUSH'S
BAKED
BEANS**

**2 \$1
FOR**



**6-OZ. CAN
DURKEE
FRENCH FRIED
ONION
RINGS**

149



**24-OZ. BTL.
NORTHWOODS
SYRUP**

•WAFFLE •MAPLE
•PANCAKE

89[¢]



**128-OZ. JUG
EASY MONDAY
FABRIC
SOFTENER**

99[¢]



**S.O.S.
OVEN CLEANING
PADS**

97[¢]



**6 3/4-OZ. BAG
VERNELL'S
STARLITE
MINTS**

79[¢]



**3-OZ. BAG
OODLES OF
NOODLES**

**5 \$1
FOR**



**6-OZ. PKG.
KEEBLER
GRAHAM
CRACKER
PIE
SHELLS**

79[¢]



Reynolds Wrap

25

Quality Aluminum Foil

**25-FT. ROLL
REYNOLDS
ALUMINUM
FOIL**

59[¢]



**6-OZ. JAR OLD EL PASO HOT OR MILD
TACO SAUCE89**
**18-CT. BOX OLD EL PASO TACO
SHELLS 1.29**

Now more than ever, ★ ★
★ ★ ★ we're right for you!

RIGHT WITH PRICE
BREAKER COUPONS...
CLIP & SAVE!

PRICE BREAKER COUPON

SPECIAL PRICE **63¢**

HI-DRI TOWELS

19[¢]

LIMIT 1 PER CUSTOMER WITH 10.00 OR MORE ORDER & COUPON. GOOD THRU WED., SEPT. 12TH.

PRICE BREAKER COUPON

1-GAL. JUG ARROW BLEACH

29[¢]

LIMIT 1 PER CUSTOMER WITH 10.00 OR MORE ORDER & COUPON. GOOD THRU WED., SEPT. 12TH.

French's
America's Favorite Mustard

NET WT 16 OZ (1 LB.)

16-OZ. SQUEEZE BTL. FRENCH'S MUSTARD

79[¢]

No Caffeine
Never had it. Never will.

2-LTR. BTL. REG. OR DIET 7-UP

99[¢]

4-PAK PERSONAL SIZE IVORY SOAP

79[¢]

6-PAK/12-OZ. CANS PEPSI-COLA

•DIET PEPSI •MTN DEW
•PEPSI FREE •SUGAR FREE PEPSI FREE

179

7-OZ. BAG WISE POTATO CHIPS

NATURAL FLAVOR

potato chips

99[¢]

6-PAK/12-OZ. CANS MILLER LITE OR BUDWEISER

LIMIT 2, PLEASE

239

REAL SEMI-SWEET CHOCOLATE

SEMI-SWEET MORSELS

Nestlé

12-OZ. BAG NESTLE SEMI-SWEET MORSELS

189

Nestlé CRUNCH

Milk Chocolate with Almonds

NESTLE CANDY BARS

•MILK CHOCOLATE •MILK CHOCOLATE W/ALMONDS •NESTLE CRUNCH

4 FOR **\$1**

Mueller's elbows

ENRICHED MACARONI

Mueller's spaghetti

ENRICHED

16-OZ. BOX MUELLER'S ELBOW MACARONI OR SPAGHETTI**59**

ALL METHODS GRIND FOR ALL COFFEE MAKERS

Chock full o' Nuts

The Heavenly Coffee

1-LB. BAG CHOCK FULL O'NUTS COFFEE

WITH 10.00 OR MORE ORDER (LIMIT 1)

189

32-OZ. JAR SUNSWEET PRUNE JUICE

119

16-OZ. BTL. FAYGO SUGAR FREE DRINKS ALL FLAVORS

4 \$1 FOR

LUCK'S Beans

Pinto Beans, Great Northern Beans, Field Peas with Snap, Navy Beans

15-OZ. CANS LUCK'S BEANS

PINTO, NAVY, NORTHERN, BLACKEYE OR FIELD PEAS

39[¢]

64-OZ. BTL. SENECA APPLE JUICE

1.19

FREEZER QUEEN

GRAY & 6 SALISBURY STEAKS

2-LB. BOX FREEZER QUEEN SUPPERS ALL VARIETIES

179

ARMOUR DINNER CLASSICS

10½-OZ. BOX VEAL PARMIGIAN OR SALISBURY STEAK **2.59**

10-OZ. SEAFOOD NEWBERG **3.19**

11-OZ. SIRLOIN TIP **3.39**

5½-OZ. BOX FRENCH'S SPECIALTY POTATOES

2 FOR 109

14-OZ. CAN COMET CLEANSER

39[¢]



12½-OZ. BOX
JENO'S
FRENCH BREAD
PIZZAS
249
ALL VARIETIES

9¾-OZ. BOX MR. P'S
PIZZAS
69¢
6-OZ. BOX JENO'S ALL VARIETIES
PIZZA ROLLS 1.29



7¼-OZ. PKG. FRITO LAY
VARIETY PACK
OR 7½-OZ. PKG.
CHEESE
CHOOSEER'S

169



HAMILTON
E.Z. CARVE
HAM LB. **159**

1-LB. PKG. SMITHFIELD ALL MEAT
FRANKS 1.49
12-OZ. PKG. SMITHFIELD OLD
FASHIONED
BEEF FRANKS 1.19
1-LB. ROLL JAMESTOWN MILD
OR HOT
PORK SAUSAGE .. 1.09
12-OZ. ROLL SMITHFIELD HAM
SAUSAGE 1.49



64-OZ. CTN.
MINUTE MAID
100% PURE
ORANGE
JUICE **199**

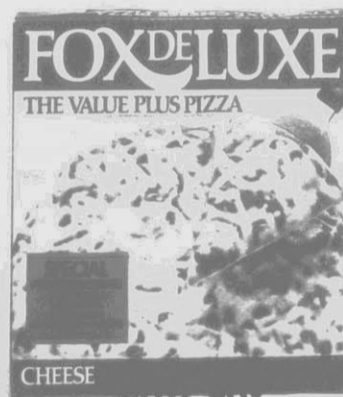

16-OZ. BOX
FOX DELUXE
PIZZAS
ALL VARIETIES
79¢



64-OZ. CTN.
TROPICANA
GOLD 'N PURE
ORANGE
JUICE **169**
32-OZ. CTN. TROPICANA 100%
PURE PREMIUM PACK
ORANGE JUICE ...1.29



16-OZ. CAN
ASTOR 100% PURE
FROZEN
ORANGE
JUICE
149



12-OZ. PKG. PET RITZ DEEP DISH
PIE SHELLS 1.19
26-OZ. PKG. PET RITZ APPLE,
PEACH OR BLACKBERRY
COBBLERS 1.99



3-LB. TUB
SHEDD'S
COUNTRY
CROCK **199**



DINING LITE ENTREES
9½-OZ. BOX STEAK CREOLE OR
PEPPER STEAK 1.99
9½-OZ. BOX CHICKEN ALA KING OR
CHICKEN CHOW MEIN 1.59
8-OZ. BOX BEEF
TERIYAKI 2.29



12-OZ. PKG.
LENDER'S PLAIN
OR RAISIN 'N
HONEY
BAGELS **79¢**



11-OZ. BOX
MORTON T.V.
DINNERS **89¢**
ALL VARIETIES
EXCEPT HAM
& BEEF



12-OZ. PKG.
KRAFT
AMERICAN
CHEESE
FOOD
SLICES **169**



10-OZ. BOX MCKENZIE'S BROCCOLI
OR
LIMAS99
10-OZ. BOX MCKENZIE'S
PEAS89



2-LB. BOX SWIFT WHITE TURKEY
ROAST 3.99
2-LB. BOX SWIFT WHITE/DARK TURKEY
ROAST 3.59
SWIFT BUTTERBALL TURKEY
BREAST LB. 2.19 ... 12-OZ. PKG.
BACON 1.49



9½-OZ. CANS
BUTTER-ME-NOT
BISCUITS **2\$1**
FOR



3-LB. CAN ARMOUR CANNED
HAM 6.99
12-OZ. PKG. ARMOUR
HOT DOGS 1.39



**WINN-DIXIE ... 100% American Owned
And Operated ... And PROUD OF IT!**



DELI-BAKERY



"FRESH BAKED"

24-OZ. SIZE **APPLE PIES** EACH **1.99**

2-DOZ. HONEY GLAZED CAKE DONUT HOLES \$1
FILLED BAVARIAN CREAM, JELLY OR APPLE DONUTS **3 FOR .99**



ORIENTAL SHRIMP, LOBSTER OR PIZZA EGG ROLLS **2 \$1 FOR**



DELI QUALITY PEPPERONI, SAUSAGE OR COMBINATION PIZZA

2.75



CONTINENTAL BRAND CO. BOILED HAM **LB. 2.99**
ALL BEEF BOLOGNA **LB. 2.99**
VIRGINIA STYLE HONEY CURED HAM **LB. 3.89**



TYSONS JUMBO CORN DOGS ... **2 FOR \$1**
SOUTHERN STYLE POTATO SALAD **LB. .89**



BAKERY FRESH CINNAMON SWIRLS **4 \$1 FOR**

16-OZ. LOAF FRESH BAKED FRENCH OR ITALIAN BREAD **.89**
DANISH PASTRY BOW TIES OR BEAR CLAWS . **2 FOR .98**
6-PACK FRESH BAKED JUMBO KAISER ROLLS **.99**



12-OZ. PKG. VALLEYDALE SLICED BACON **1.59**
2-LB. PKG. VALLEYDALE RACERS FRANKS **1.99**
1-LB. PKG. VALLEYDALE TEEN FRANKS **1.99**



12-OZ. PKG. GWALTNEY SLICED BACON **1.59**
12-OZ. PKG. GWALTNEY FRANKS **1.19**
1-LB. PKG. GWALTNEY GREAT DOGS **.99**



PERDUE

PERDUE OVEN ROASTERS **99¢ LB.**

PERDUE BREAST QUARTERS **LB. 1.19**
PERDUE CORNISH HENS **LB. 1.59**



1-LB. ROLL W-D BRAND WHOLE HOG MILD, MED. OR HOT SAUSAGE **1.79**
1-LB. PKG. W-D BRAND ALL MEAT FRANKS **1.59**
12-OZ. PKG. W-D BRAND ALL MEAT BOLOGNA (BEEF 1.29) **1.09**
12-OZ. PKG. MADISON CHICKEN FRANKS **.69**
1-LB. PKG. MADISON OR TURKEY TIME BOLOGNA **.99**
2 1/2-OZ. PKG. W-D BRAND THIN SLICED LUNCH MEATS **2 FOR .89**
12-OZ. PKG. W-D BRAND SLICED HAM **2.59**



RECIPE READY WHOLE PORK TENDERLOINS **LB. 3.99**
12-OZ. PKG. WILSON RIBBON SEAL FRANKS **1.09** BACON **1.59**
CORNING BUFFET HAM **LB. 2.29**



FLOURDER **LB. 1.19**
1-LB. PKG. PEELED & DEVEINED SHRIMP **2.99**
18-OZ. PKG. SEA BEST DEVILED CRAB **2.99**



60-CT. BTL. TYLENOL MAX/STR. TABLETS **3.99**

18-OZ. BTL. CEPACOL MOUTHWASH

1.99



FREE BIC Lighter with adjustable flame
2-PAK BIC LIGHTERS WITH FREE ROLLER PEN **99¢**



4-OZ. BTL. FINAL NET HAIR SPRAY
• UNSCENTED
• SCENTED **1.59**



100-CT. BTL. REG. OR 60-CT. BAYER MAX/STR. ASPIRIN **2.39**



50-CT. BOX BAND-AID BRAND PLASTIC STRIPS OR 30-CT. ALL WIDE SHEER BANDAGES **1.99**



3.75-OZ. TUBE CLINOMINT REG. OR GEL TOOTH PASTE **1.99**



HARD TO HOLD ALBERTO VO5 OR 8-OZ. CAN UNSCENTED PUMP HAIR SPRAY **1.49**
15-OZ. BTL. ALBERTO VO5 NORMAL OR HENNA SHAMPOO **1.49**



2 1/2-OZ. PKG. SLICED ALL VARIETIES LUNCH MEATS **.49**
8-OZ. PKG. SLICED LUNCH MEATS ... **1.29**



2.25-OZ. MENDI SPICE SCENT SPEED STICK **1.99**
1.5-OZ. LADY UNSCENTED OR POWDER FRESH SPEED STICK **1.89**



36-CT. BOX ALKA-SELTZER ... **1.99**

WINN DIXIE

★ Genuine
Cubic Zirconia
 Fashion Jewelry
 The World's Finest
 Diamond Reproduction

Each Cubic Zirconia piece comes in its own **Velour Jewel Box**. The Serpentine and Rope chains come in a jeweler's pouch.



\$9.99
 on our **SAV-A-TAPE** PLAN

each with \$100 worth of register tapes

14kt GOLD FILLED CHAINS
 16" only \$5.99 & 18" \$6.99 with \$100 in tapes

Price without tapes:
 Cubic Zirconia \$19.99
 16" Chains \$12.99-18" Chains \$14.99

Cubic Zirconia is the finest diamond reproduction that man has made. It is renowned throughout the jewelry world as the best diamond substitute ever. Only experts with special equipment can tell the difference. It has almost the clarity and hardness of a real diamond.

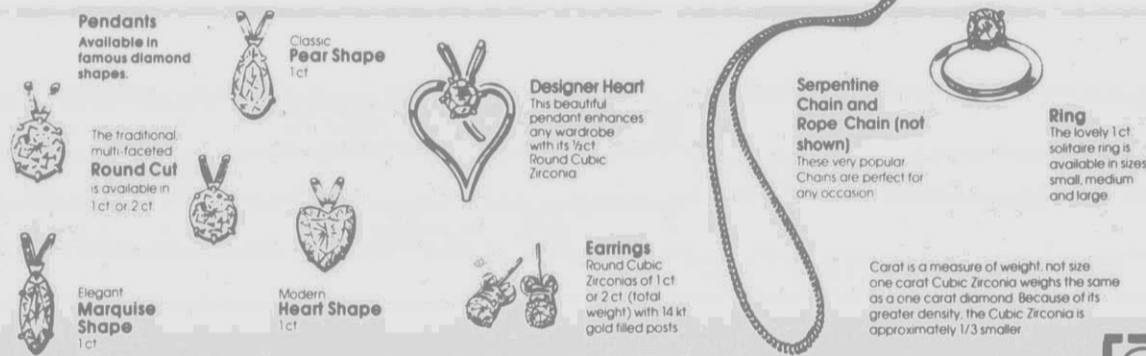

Pendants
 Available in famous diamond shapes.

Classic Pear Shape
 1ct

Designer Heart
 This beautiful pendant enhances any wardrobe with its 1/2ct Round Cubic Zirconia

Serpentine Chain and Rope Chain (not shown)
 These very popular Chains are perfect for any occasion

Ring
 The lovely 1ct solitaire ring is available in sizes small, medium and large

Earrings
 Round Cubic Zirconias of 1ct or 2ct (total weight) with 14kt gold filled posts

Carat is a measure of weight, not size one carat Cubic Zirconia weighs the same as a one carat diamond. Because of its greater density, the Cubic Zirconia is approximately 1/3 smaller

CLIP N' SAVE!

Coupon Below Good For \$100 In Register Tapes! Good Thru Wed., Sept. 12, Only!

Our Cubic Zirconia has been precisely cut in the most popular diamond shapes.

From the elegant Marquise, the classic Pear shape, the modern Heart shape, to the traditional, multi-faceted Round cut. You can choose from a complete selection of these fabulous diamond substitutes.

The lovely and very popular Serpentine and Rope chains are 14kt. gold filled. They're the perfect chains for any pendant you choose. The earring posts are 14 kt. gold filled. And each stone is skillfully set in the 14 kt. gold electroplated setting to best display each diamond shape.

Good for \$100 in cash register tapes toward your first Genuine **-Cubic Zirconia-** piece
 COUPON GOOD THRU SEPT. 12TH. LIMIT 1 PER CUSTOMER

NOBODY SAVES YOU MORE!



★ ★ ★ ★ ★ **During Our 2nd Big** ★ ★ ★ ★ ★
MOONLIGHT SALE
 10 P.M. 'TIL MIDNIGHT, THURS., FRI., & SAT., SEPT. 6, 7 & 8.

Miss A Little Sleep, But Don't Miss These Savings!
MOONLIGHT SPECIALS BELOW GOOD FROM 10 P.M. TIL MIDNIGHT THURS., FRI., SAT., SEPT. 6, 7 & 8 ONLY!

24-OZ. LOAF DIXIE DARLING SANDWICH BREAD

3 \$1

WITH 10.00 OR MORE ORDER (LIMIT 3)

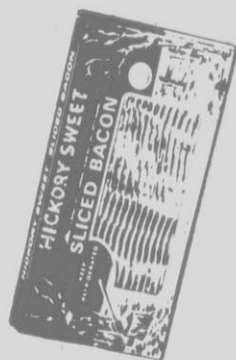

1-LB PKG. HICKORY SWEET BACON

79¢

WITH 10.00 OR MORE ORDER (LIMIT 2)



18½-OZ. BOX DUNCAN HINES LAYER CAKE MIX

2 \$1

WITH 10.00 OR MORE ORDER (LIMIT 2)

Moonlight Sale

Belk

HOME ACCENTS HOUSEWARES SALE

Newcor table setting, see page 2.



Belk

Sale

Your choice 39.99

Reed & Barton/Rebcraft: bonus hostess set with purchase of 50 pc. set at 1/2 off

L'Amour and Carriage patterned stainless steel flatware service for 8 includes 8 each: knife, fork, soup spoon; 16 teaspoons, 2 serving spoons. Reg. 80.00
Bonus hostess set includes pierced spoon, gravy ladle, serving fork, butter knife and shell sugar spoon. Retail value: 20.00

Brigadoon

Sale

29.99 Your choice

Reed & Barton/Rebcraft: bonus hostess set with purchase of 50 pc. set at 1/2 off.

Stainless steel service for 8 includes 8 each: knife, fork, soup spoon; 16 teaspoons, 2 serving spoons. Andrea or Brigadoon patterns. Reg. 60.00
Bonus hostess set features pierced spoon, gravy ladle, serving fork, butter knife and shell sugar spoon. Retail value: 17.50

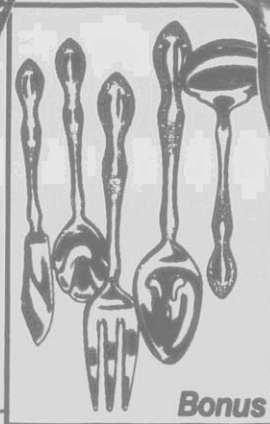

Bonus

Andrea

L'Amour

Carriage

From our cover:

Sale

59.99

Save 36% on table settings with a complete 60 pc. set from Newcor

Extraordinary savings on service for 4, from placemats to glassware! Ceramic dinnerware includes 4 each: dinner, salad plate, soup/cereal bowl, cup and saucer. Matching flatware with 4 each: knife, fork, salad fork, teaspoon and soup spoon. Glassware: 4 10 oz. juice glasses and 4 16 oz. coolers. Plus, an accessory set of 4 each: cotton/polyester placemats and napkins, and coordinating napkin rings. Blue. Reg. 95.00



HOME ACCENTS HOUSEWARES SALE



Horizon

Mirage

Sale
6.99 *Your choice*

Sparkling savings on Crown Corning glasses
Stock up on quality crafted glassware while the savings are on! 11 oz. or 15 oz. sizes in sets of four. Horizon heavy sham bottom with bubble or Mirage knobby sham bottom.

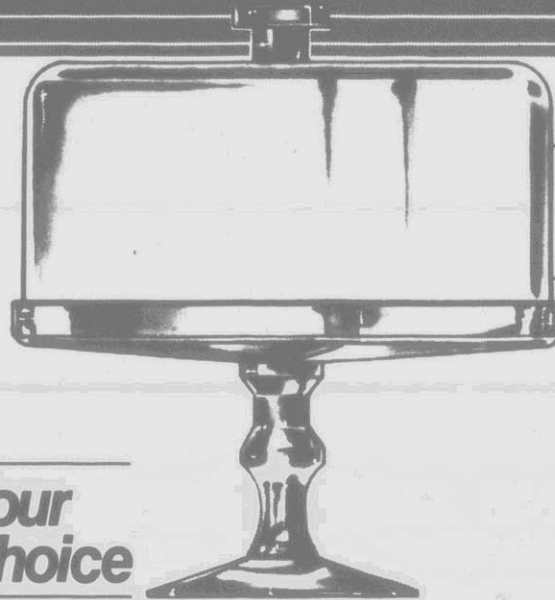

Sale
19.99

Save 50% on covered glass cake server and clearly display your creations
A tremendous value from Import Associates—A clear glass hostess cake server with cover. 10" tall. Reg. 40.00

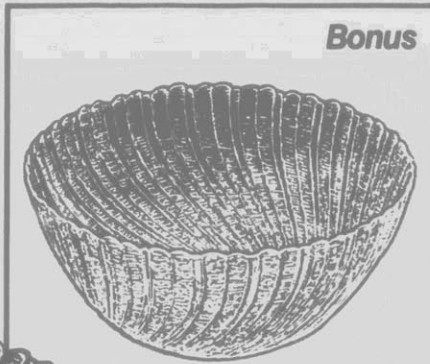

Bonus



Sale
7.99

Bright savings on a Riekes Crisa oil lamp
Save now on this decorative and functional accessory for your home. Glass base, dome; wick included. 18" tall.

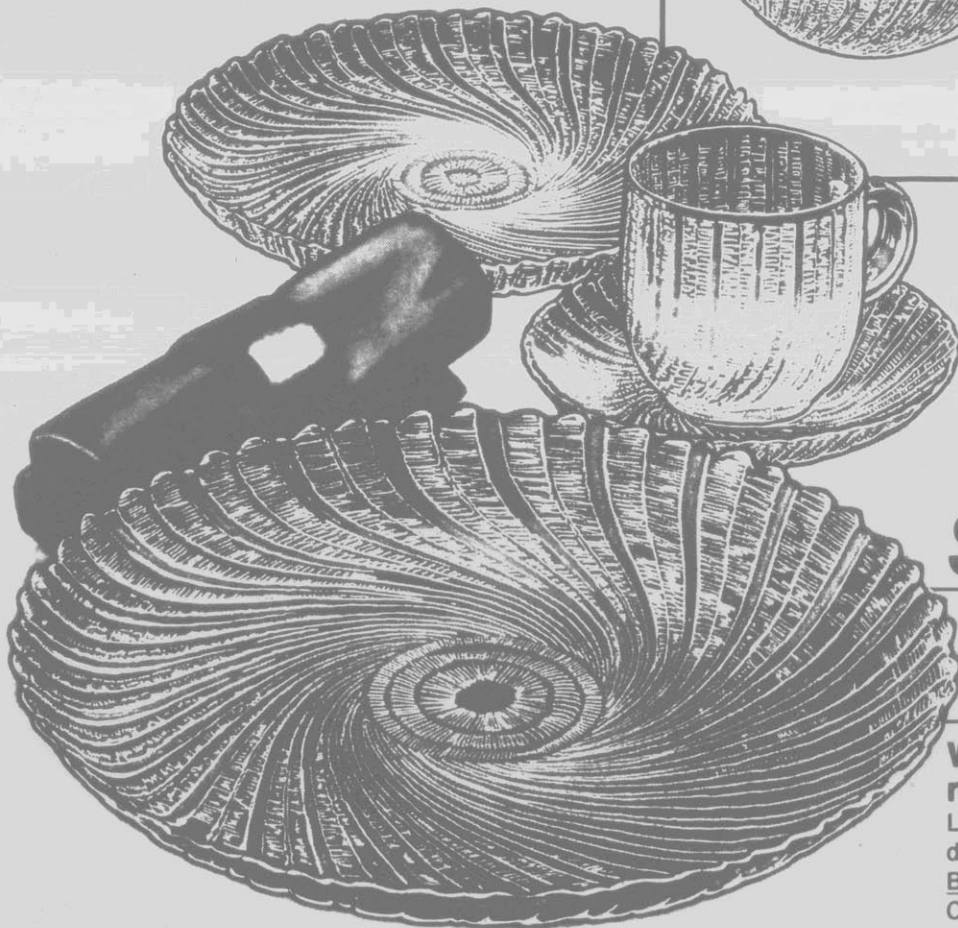

Sale
19.99

With purchase of Durand service for 4, receive this matching bonus salad bowl
Lovely "Seabreeze" 16 pc. dinnerware set features 4 each: dinner, dessert plate, cup and saucer.
Bonus coordinating salad bowl. Retail value 6.00
Complete your table setting from our open stock collection, with a 13" round platter or a 4 pc. salad set. Each **5.99**

Belk

Sale

69.99

Save now on Regal® Duncan Hines® and get a bonus 2 qt. double boiler

Easy to clean, 3 layer stainless steel cookware with carbon core center in a 9 pc. set featuring: 1, 2 & 3 qt. covered sauce pans, 6 qt. covered dutch oven and a 10½" open fry pan.

Bonus double boiler insert. Retail value 9.95

Also: 12" covered fryer. Reg. 46.95 **32.99**



Bonus

Sale

89.99

Invest in kitchen traditions from Revere Ware® and get a bonus steamer

The copper bottom classics in a 12 pc. cookware set, Featuring 1, 2 & 3 qt. covered sauce pans, 1½ qt. double boiler, 4½ qt. covered dutch oven, 9" open fry pan, 3 pc. covered mixing bowl set and 1 cup measurer.

Bonus 2 qt. steamer insert. Retail value 21.00

Save on additional Revere Ware pieces from our open stock collection. Whistling teakettle. Reg. 23.00 **12.99**

10 qt. covered stock pot. Reg. 69.00 **44.99**

12 qt. covered stock pot. Reg. 76.00 **49.99**



Bonus

HOME ACCENTS HOUSEWARES SALE

Sale

59.99

With purchase of a Regal® non-stick cook set, receive an 8½" saute pan as a bonus

Reflections 9 pc. heavy weight aluminum cookware set with SilverStone® interiors and non-stick exteriors for easy cleaning and care, with 1, 2 & 3 qt. covered sauce pans, 5 qt. covered dutch oven and 10" open fry pan.

Bonus saute pan. Retail value 12.50

Save on additional open stock pieces:

Whistling teakettle. Reg. 11.75 **8.99**

12" gourmet saute pan. Reg. 19.95 **12.99**

Bonus

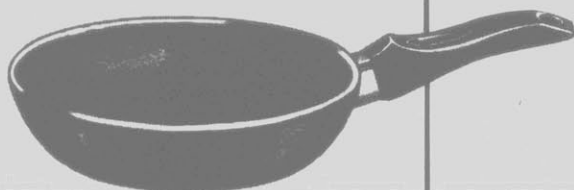

Sale

40%–50% Off

A "Just White" touch from Corning Ware®

The classic casserole dishes in basic white with clear glass covers to mix and match with any of the Corning Ware Designs. Durable dishwasher and microwave safe pieces that go from freezer to oven to table.

	Reg.	Sale
1 qt. covered casserole	13.50	7.99
2 qt. covered casserole	17.00	9.99
3 qt. covered casserole	19.50	11.40
5 qt. covered casserole	24.00	11.99
2 qt. shallow covered casserole	20.00	9.99



Belk

Sale

79.99

Sliced prices on Chicago Cutlery® hardwood kitchen knife sets

Meticulously handcrafted culinary knives featuring rich walnut handles brass riveted to tempered carbon stainless blades that resist rust, staining and pitting while maintaining a sharper edge. The 6 pc. set includes a 3" parer, 5" boner, 6" utility, 8" slicer, 8" chef and a 10" steel in a hardwood block. Reg. 125.00



Sale

32.99

Extra sharp savings on Chicago Cutlery

Conveniently packaged 3 pc. kitchen cutlery set featuring a 3" parer, 6" utility and an 8" slicer. Hardwood handles, tempered stainless steel blades. Reg. 42.00



Sale

27.99

Chicago Cutlery for the table!

Save 24% on this 4 pc. steak set. Sharp, rugged steak knives with 4" blades for entertaining or any time. Reg. 37.00

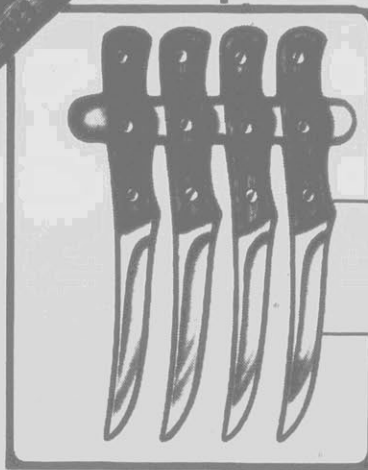

Sale

22.99

All-in-one G.E. Spacemaker™ electric can opener

Free up your counterspace with this compact opener that opens bottles, cans and bags with "hands free" operation. "Power Pierce" system for easy piercing of lids. Reg. 28.99

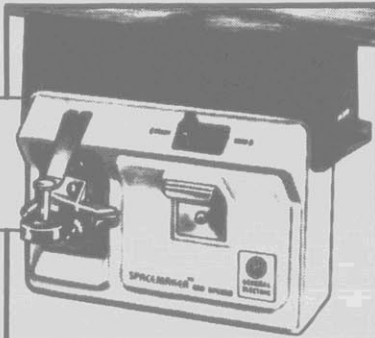

Sale

24.99

Prices carved on the Spacemaker electric knife

Powerful, yet lightweight carving set stores neatly and stays handy for slicing, carving, paring and trimming. Stainless steel blades with safety lock. Reg. 29.99

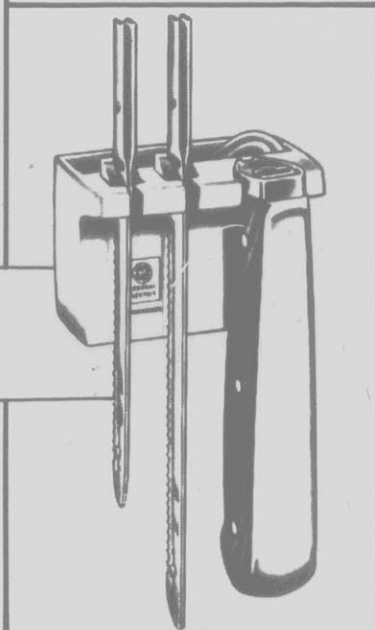

Sale

59.99

Save on time and space with the Spacemaker drip coffeemaker

Wake up to freshly brewed coffee with this streamlined unit that fits and mounts easily underneath your cabinets. Prepare ahead of time, and coffee will start to brew automatically at the set clock time. Full 10 cup capacity with removable water reservoir. Reg. 64.99

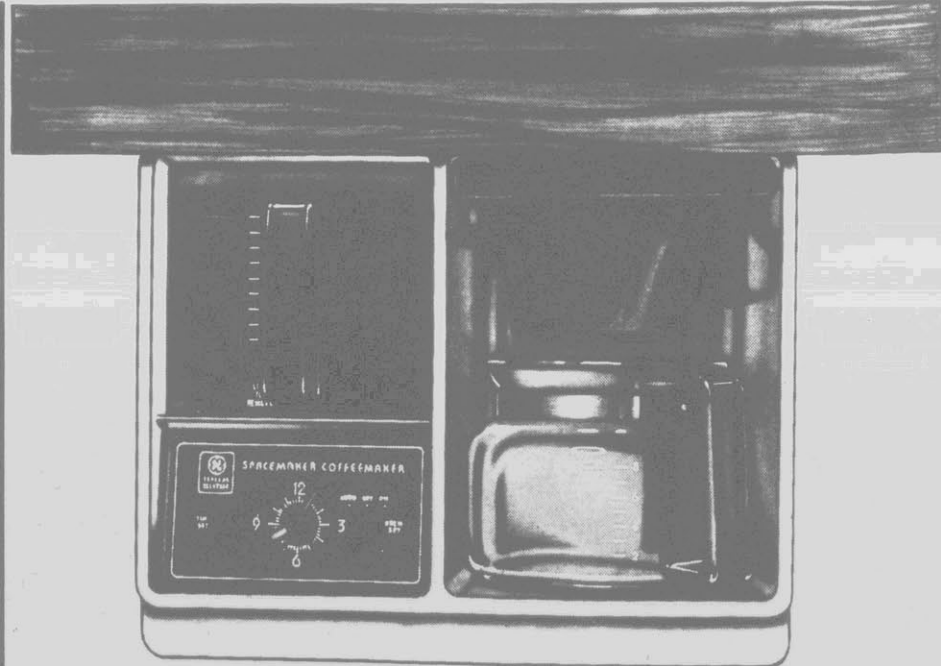

HOME ACCENTS HOUSEWARES SALE

Sale

10.99
Your choice

Enjoy elegant entertaining with "Blanc" from Stylesetter

Exquisitely detailed ceramic serving dishes in soft white to complement your table settings. Open stock pieces available include a large salad bowl, partitioned 4 pocket server, shell chip and dip appetizer dish (also great for shrimp cocktail) and a set of four small shell servers.

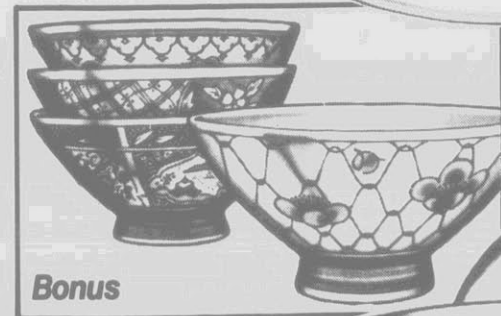
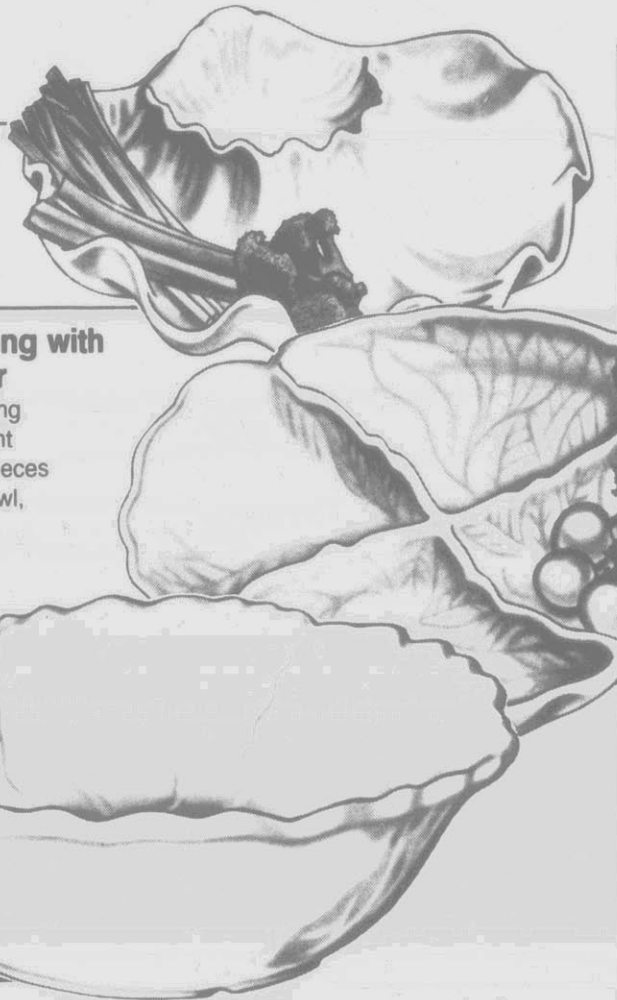

Bonus

Sale

7.99-11.99

Marble kitchen accents by Himark Enterprises

Cool, non-porous marble is the ideal surface for serving cheese and other perishables, and its gray-veined white beauty will last for years to come. Shown here: gourmet rolling pin with wooden handles, cheese slicer and cheese board with glass dome. Also available: round "Lazy Susan."

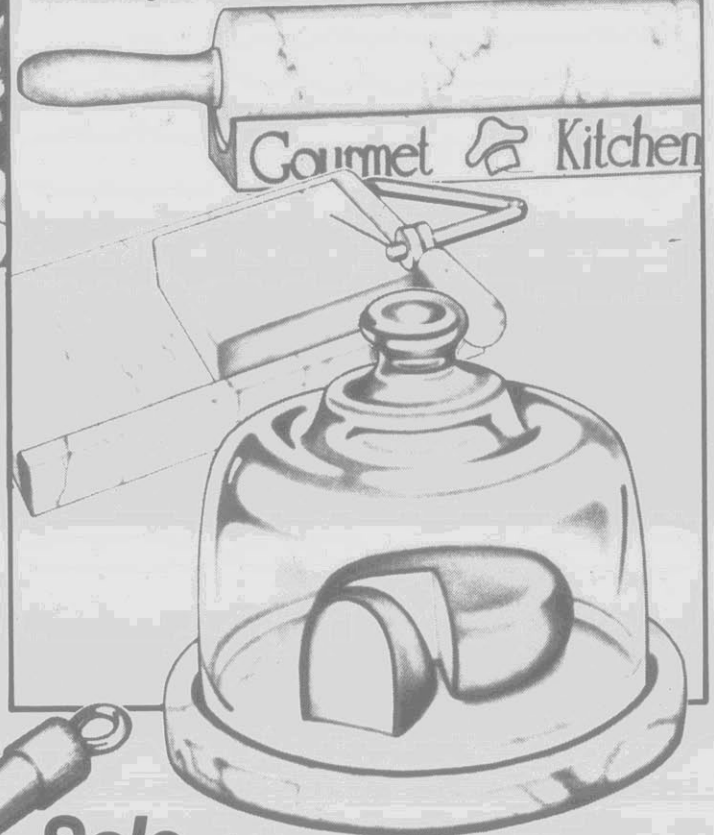

Sale

19.99

With purchase of the Metro 7 pc. wok set, receive 4 porcelain rice bowls as a bonus

Oriental delicacies are easy with this heavy weight aluminum wok complete with steel support ring, stainless ladle and turner, chop sticks and 40 pg. cookbook. Heavy weight single wooden handle for easy handling. **Bonus** set of four porcelain rice bowls. Retail value 8.00 Not shown: 3 pc. bamboo steamer helps food retain its natural flavor, vitamins and color. Use both tiers to prepare two dishes at the same time. Reg. 15.00 **9.99**



Belk

Sale
1.99

Your choice: Claudia wine, goblet, flute
Save 50%-60% on sparkling crystal stemware

Collect a complete set of crystal-clear or delicately etched 24% lead crystal. Claudia wine, goblet or flute Reg. 5.00 Iced tea Reg. 6.00 **2.49**
Cascade wine, goblet or flute Reg. 6.00 Each **2.99** Iced tea Reg. 7.00 **3.49**



Sale
89.99

Save 43% on the country charm of Margaux in this 20 pc. set from Mikasa

Set a lovely table with casual dinnerware patterned in soft florals and ferns on ivory with 4 each: dinner, salad plate, rim soup bowl, cup, saucer. Reg. 159.80



Sale
89.99

Save 52% on the Midwinter® Stonehenge®
40 pc. dinnerware set from Wedgwood

Enjoy the versatility of classic white dinnerware. Place settings for 8 include: dinner, bread/butter plate, soup/cereal bowl, cup and saucer. Reg. 190.00 The matching completer set features: 12" platter, vegetable server, covered sugar and creamer. Reg. 81.00 **29.99**



HOME ACCENTS HOUSEWARES SALE

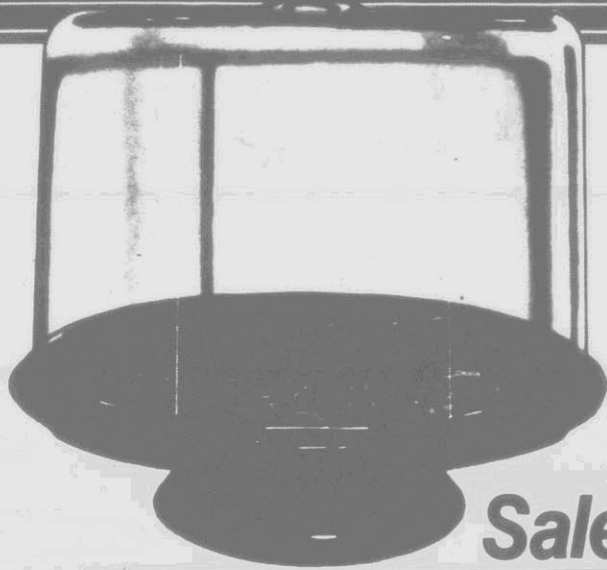

Sale
40% Off

Natural accents from Cornwall Industries

Go with the grain and start a collection of beautiful darkwood accessories for your kitchen and table.

	Reg.	Sale
Covered pedestal cake stand	26.00	15.60
Serving tray	25.00	14.99
Recipe box	14.00	8.40
Paper towel holder	12.00	7.20
Not shown: table organizer, Lazy Susan	20.00	11.99

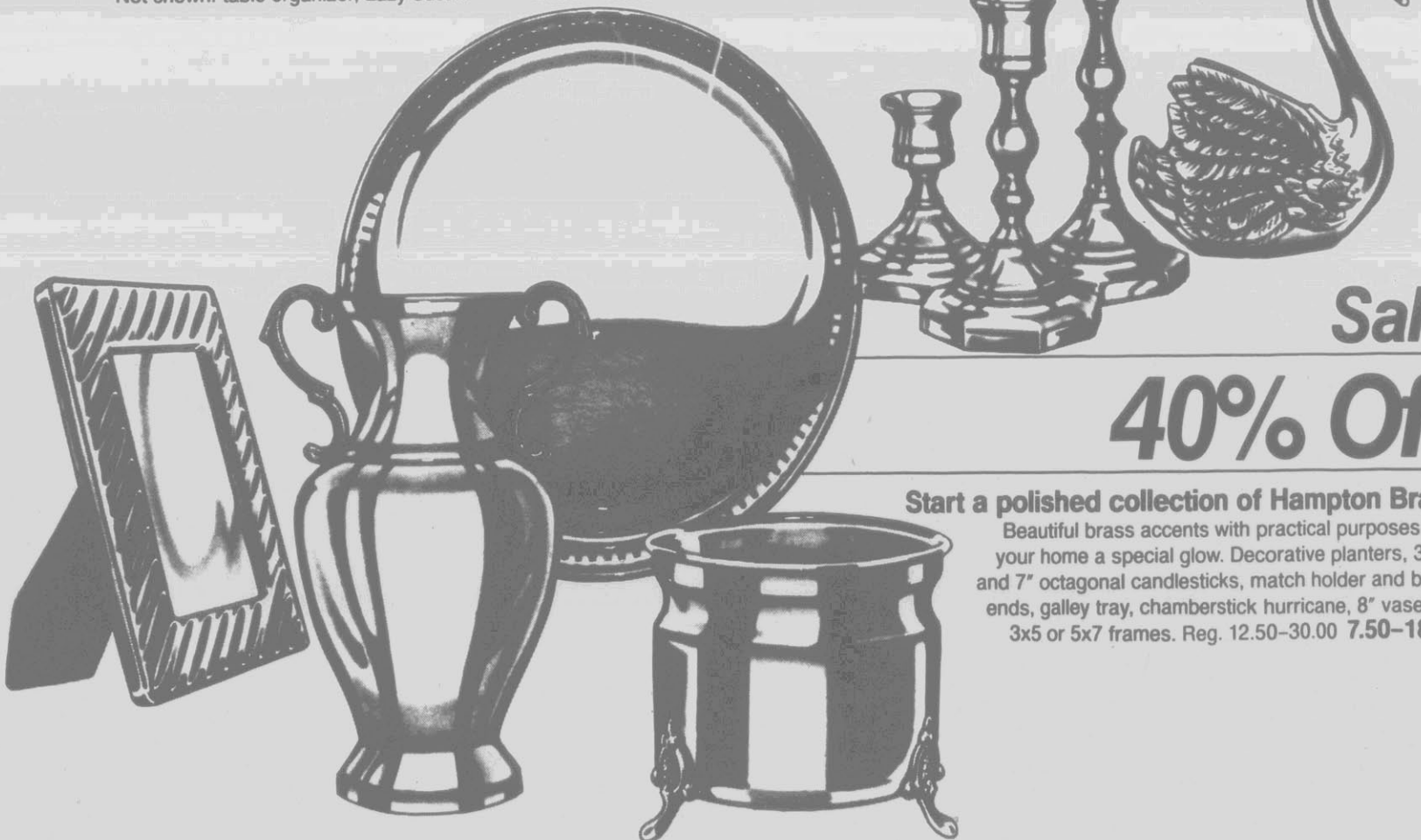
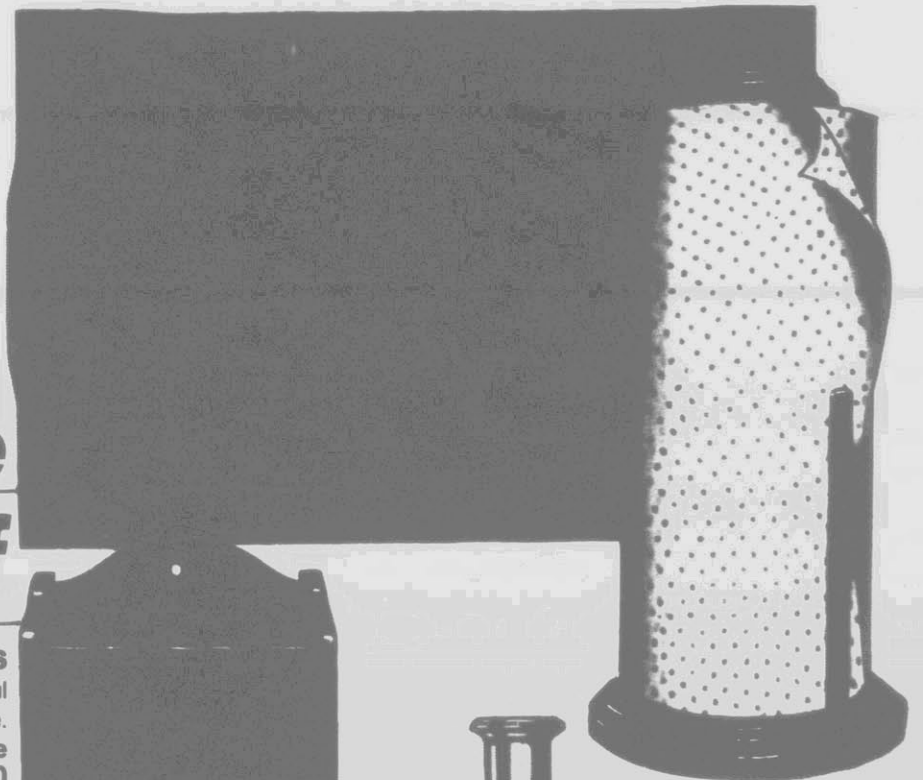

Sale
40% Off

Start a polished collection of Hampton Brass

Beautiful brass accents with practical purposes give your home a special glow. Decorative planters, 3", 5" and 7" octagonal candlesticks, match holder and book-ends, galley tray, chamberstick hurricane, 8" vase and 3x5 or 5x7 frames. Reg. 12.50-30.00 7.50-18.00

Belk

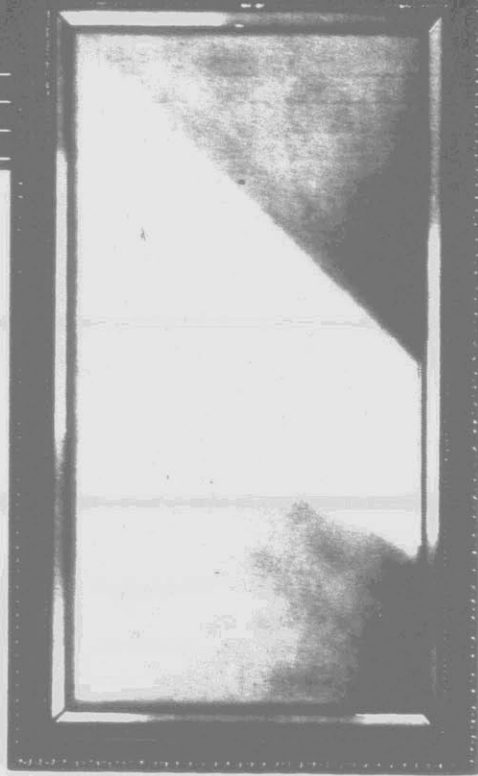
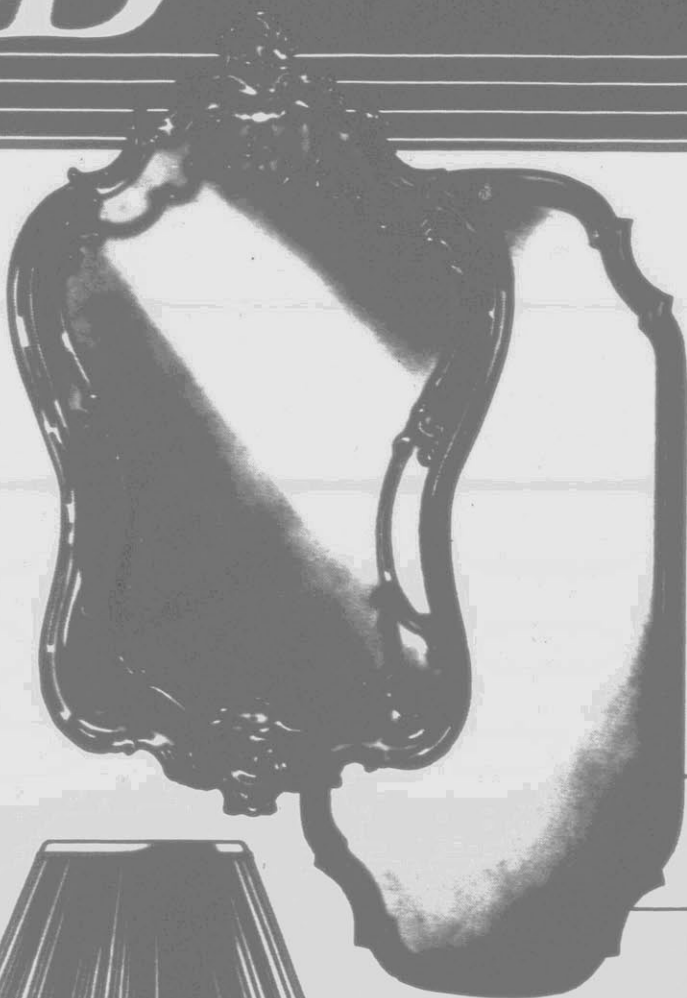

Sale
39.99 *Your choice*

Picture your decorating possibilities
 Complement your decor with the refined elegance of wall mirrors from Carolina Mirror with rich gold-tone finishes in 3 styles. Traditional 21" x 33" beveled rectangle. Reg. 64.00. Sculptured 14" x 36" double rim or classic cut 19" x 37" frame. Reg. 74.00

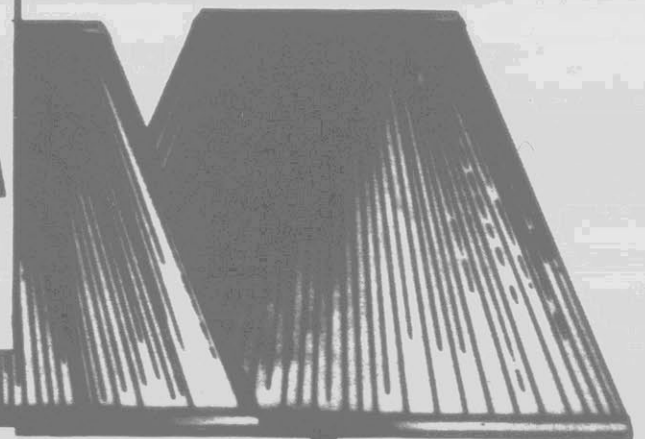
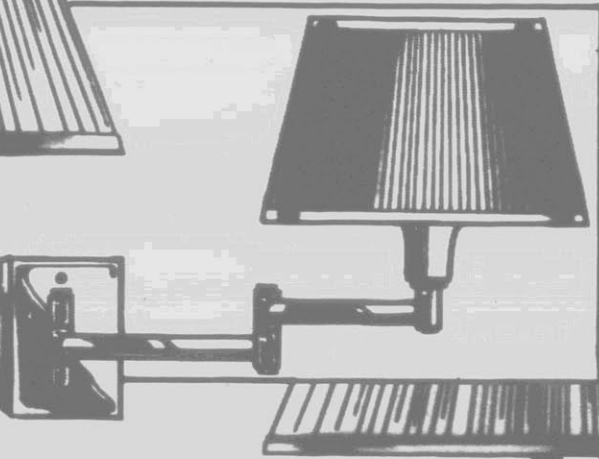
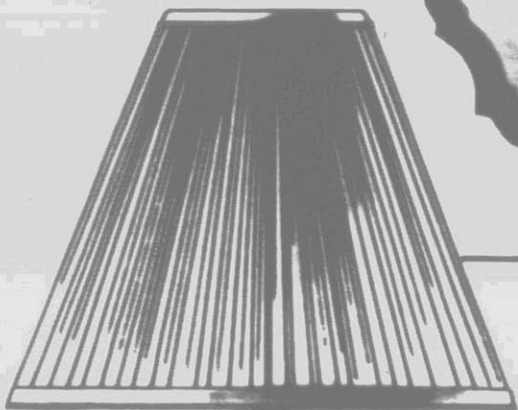

Sale
Your Choice 39.99

Enlightening ideas for brightening up your home

Cycle II creates lovely table lamps for your home with shirred fabric shades and 3-way switches. Frosted poppies on glass beanpot. Reg. 45.00. Glass beanpot with floral design in coral or sand. Reg. 47.00. Glass hexagon in sand or sienna. Reg. 45.00 Also solid brass wall lamp with 17" span. Reg. 47.50 All four lamps are U.L. listed

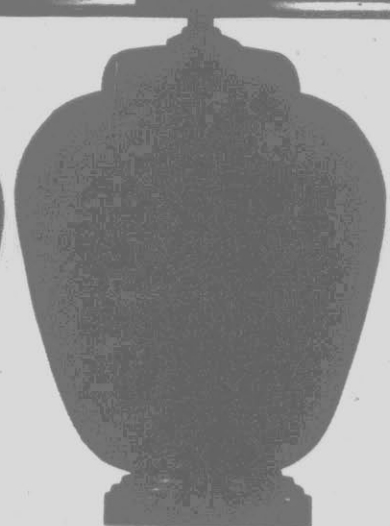

HOME ACCENTS HOUSEWARES SALE

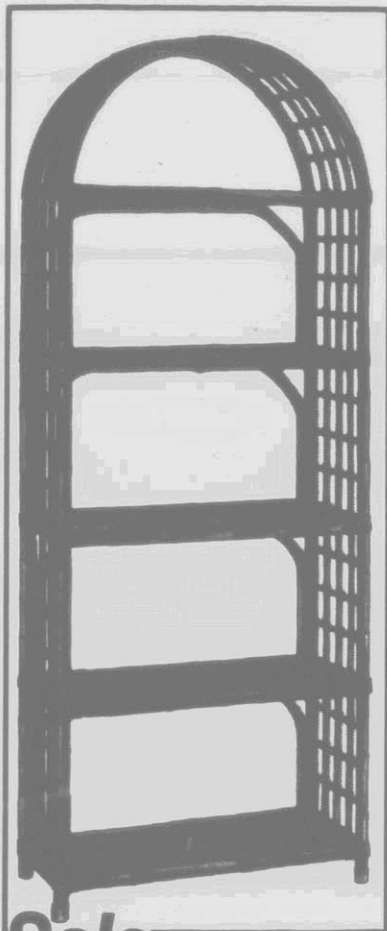

Sale

119.99

Organize naturally with a Clipper Industries etagere

Gracefully arched malacca rattan etagere with 5 shelves naturally flatters the decor of any room.

Sale

59.99

32" x 16" x 17"

Clipper Industries fern trunks add a touch of country charm

Beautiful fern trunks with brass fittings function in a variety of decorative and practical ways and bring a fresh breath of country air to your home. Large 36" x 20" x 21" 79.99



Sale

15.99-24.99

Genuine marble adapted for contemporary lifestyles

Perfect pedestals for favored plants and decorations with thick marble tops and rich mahogany finishes.

Stately 36" tall round stand with pedestal base. Reg. 18.00 **15.99**

14" square or round top stands with decorative detailing double up beautifully as end tables. Reg. 30.00 **24.99**



Sale

**45% -
50% Off**

Baskets of natural beauty from Clipper Industries

Country wicker baskets from the Willow Shopper collection. Stained in deep, rich tones to decorate with or take along. Reg. 18.99-33.99 **9.99-16.99**

Belk

HOME ACCENTS HOUSEWARES SALE

Sale

11.99-15.99

Prepare, serve and store with Kamenstein Store 'N' Serve Series at 30%-33% savings

Durable porcelain on steel bowls with stainless rims and snap-on lids allow you to prepare, heat, serve and store all in one. Attractive country florals in blue/red or yellow/brown. Flat bottoms for easy serving.

	Reg.	Sale
A. Small 3 pc. bowl set	18.00	11.99
B. Large 3 pc. bowl set	24.00	15.99
C. 2 qt. batter bowl	18.00	11.99
D. 12" x 17" roaster/lasagna pan	20.00	13.99



WE ACCEPT BELK CHARGE, MASTERCARD AND VISA

Belk Tyler

ROCKY MOUNT	Uptown
GOLDSBORO	Berkeley Mall
ELIZABETH CITY	Southgate Mall
WILSON	Parkwood Mall
GREENVILLE	Carolina East Mall
KINSTON	Vernon Park Mall
AHOSKIE	East Main Street
TARBORO	Park Hill Mall
WASHINGTON	Washington Square Mall

SEARS

Sale starts Wednesday,
September 5; ends Saturday,
Sept. 8, unless otherwise indicated.

FALL FIX-UP SALE

Most items at reduced prices

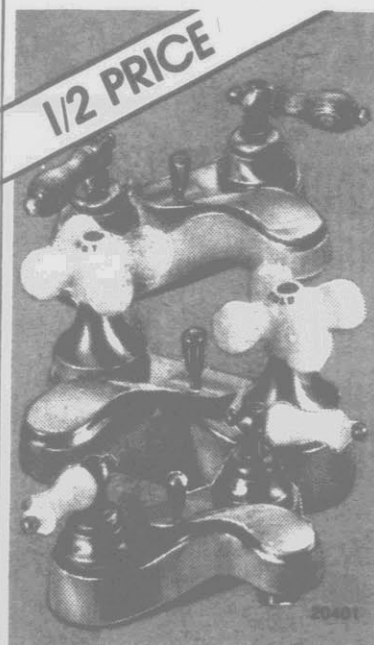

1/2 PRICE

Washerless decorator faucets

Choice of handle styles. Washerless design helps prevent dripping. Water-saving aerator. **49⁹⁹** Reg. \$99.99



SAVE \$50-\$60 on Craftsman portable power tools

Your choice
Reg. \$89.99 ea.

39⁹⁹

- 3/8-HP 3/8-in. reversible drill. No-load speeds 0-1200 rpm. Side assist handle.
- 1/2-HP auto scroller sabre saw. No-load speeds 0-3000 spm. 3/4-in. deep blade stroke.
- 2-HP 7 1/4-in. circular saw. Generates no-load speed of 5400 rpm. With edge guide.

\$26.99
15-pc. drill bit set
6809 18.99

\$25.97*
three 7 1/4-in. saw blades.
14.99 pk.
32383

\$13.49
14 sabre saw blades.
8.99 pk.
26576

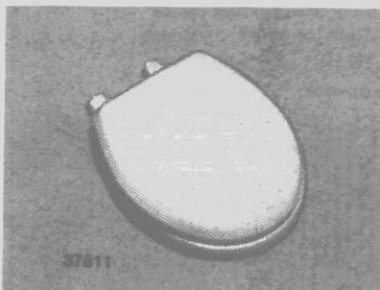

1/2 PRICE Padded toilet seat

White or fashion colors. Non-rust nuts, bolts. **9⁹⁹** Reg. \$19.99

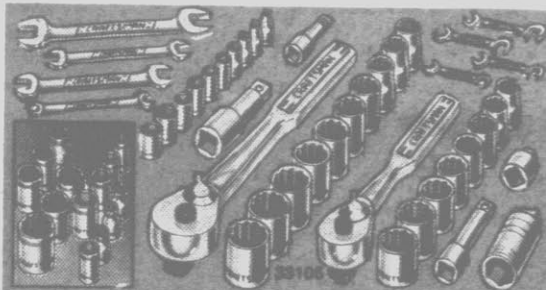

SAVE OVER 50% on Craftsman 57-pc. tool set

1/4, 3/8, 1/2-in. drive sockets and drive tools; wrenches, accessories and fourteen 1/4, 3/8-in. drive metric sockets. Savings based on reg. separate prices in 1984-'85 Tool Specialog **49⁹⁹**

Ask about Sears Credit Plans



SAVE \$15-\$55 on Craftsman tool sets

Choose \$34.99 5-pc. ratcheting box end wrench set, \$46.92* 8-pc. screwdriver set, \$75.88* 12-pc. combination wrench set.

Your choice **19⁹⁹**

*Reg. separate prices total

Satisfaction guaranteed or your money back

©Sears, Roebuck and Co., 1984

Sears pricing policy: If an item is not described as reduced or a special purchase, it is at its regular price. A special purchase, though not reduced, is an exceptional value.

Large items such as furniture and appliances are inventoried in our distribution center and will be scheduled for pick-up or delivery. Delivery is not included in selling prices.

There's more for your life at
SEARS

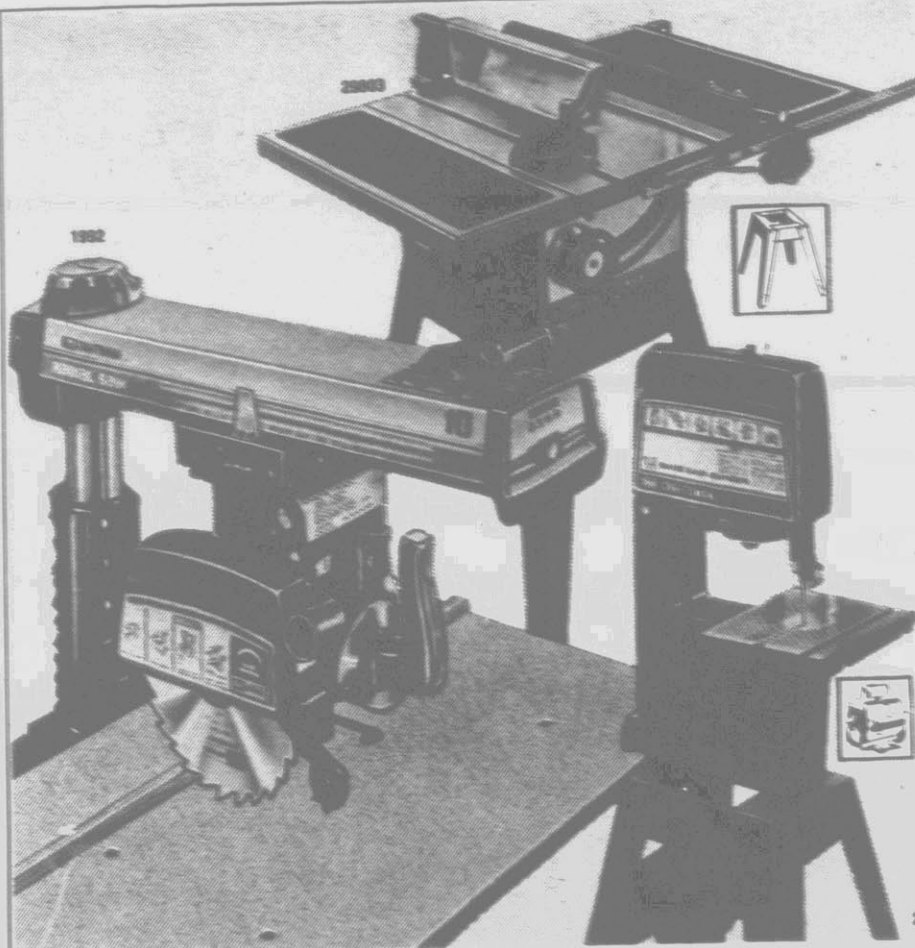

\$89.99 table saw
accessory
kit..... 74.99



\$89.99 radial saw
accessory
kit..... 74.99



\$13.99 10-in.
carbide-tipped
saw blade 9.99



\$39.97* three
10-in. saw
blades, 22.99 pit.

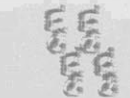

\$59.99 set of four
casters..... 39.99



SAVE \$35-\$70
on Craftsman power tools

Your choice

59⁹⁹

- \$107.35* ½-HP sabre saw with 8 blades
- \$119.99 ½-HP bench grinder, 6x¼-in. wheels
- \$115.96* 1-HP belt sander with case
- \$95.96* ¾-HP 6-in. sander/polisher
- \$99.99 2/5-HP 3¼-in. power planer
- \$129.99 bench top scroll saw-sander
- \$116.96* 1¼-HP router with case

*Reg. separate prices total

SAVE \$170-\$220 on Craftsman bench power tools for the shop enthusiast

- \$499.99 10-in. radial saw. 1½-HP motor develops 2½-HP. With up-front controls. Easy-to-read scales. Legs extra.
- \$499.99 12-in. band saw-sander. ½-HP motor. With leg set. Cuts wood up to 6-in. thick, 12-in. wide. With built-in worklight.
- \$549.99 10-in. table saw. 1-HP motor develops 1-HP. With 2 extensions, leg set. Cast-iron table. Exclusive Exact-Cut indicator.

Bench power tools require some assembly

Your choice

329⁹⁹

\$80 OFF Craftsman 100-pc. tool set

Reg.
\$179.99

99⁹⁹

Includes ¼, ⅜, ½-in.
drive tools; wrenches, acc-
essories. Standard and
metric sizes.

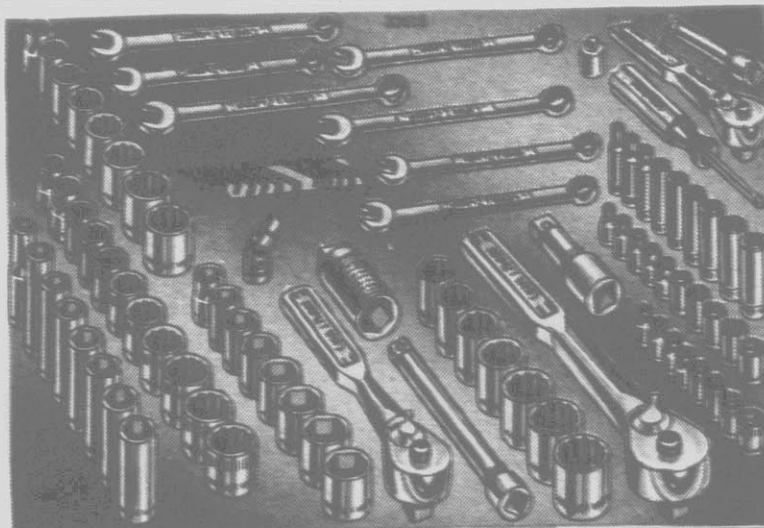

SAVE \$13
Tool box with
socket rack
Craftsman.
18-in. tool
box. Save!
Reg. \$33.98 **19⁹⁹**

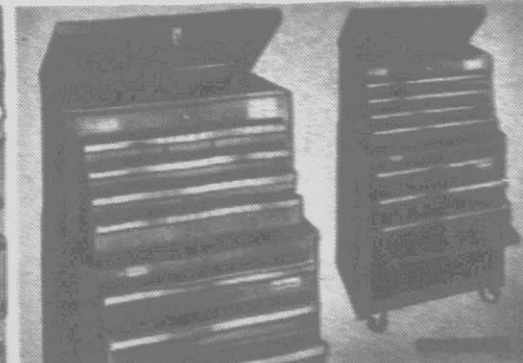

\$80-\$90 OFF Craftsman chest or roll-a-way for homeowners

\$159.99 6-drawer chest or \$169.99 roll-a-way.
Drawers have full-length slides and
full-width pulls. Steel construction.

79⁹⁹
each

National Installation
month



\$60 OFF Sears Premium storm doors

Durable double kick panel. Foam-filled construction and doubleweather stripping helps cut down drafts and save on energy!

169⁹⁹

Reg. \$229.99

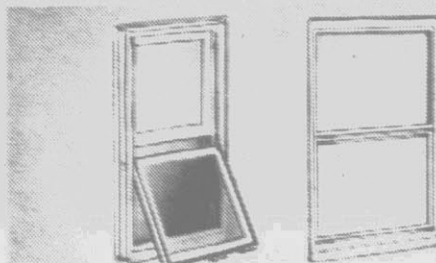

20% OFF replacement and storm windows

Storm windows help reduce drafts. Replacement windows are durable, efficient, and attractive. Many sizes and styles available! FREE ESTIMATES.

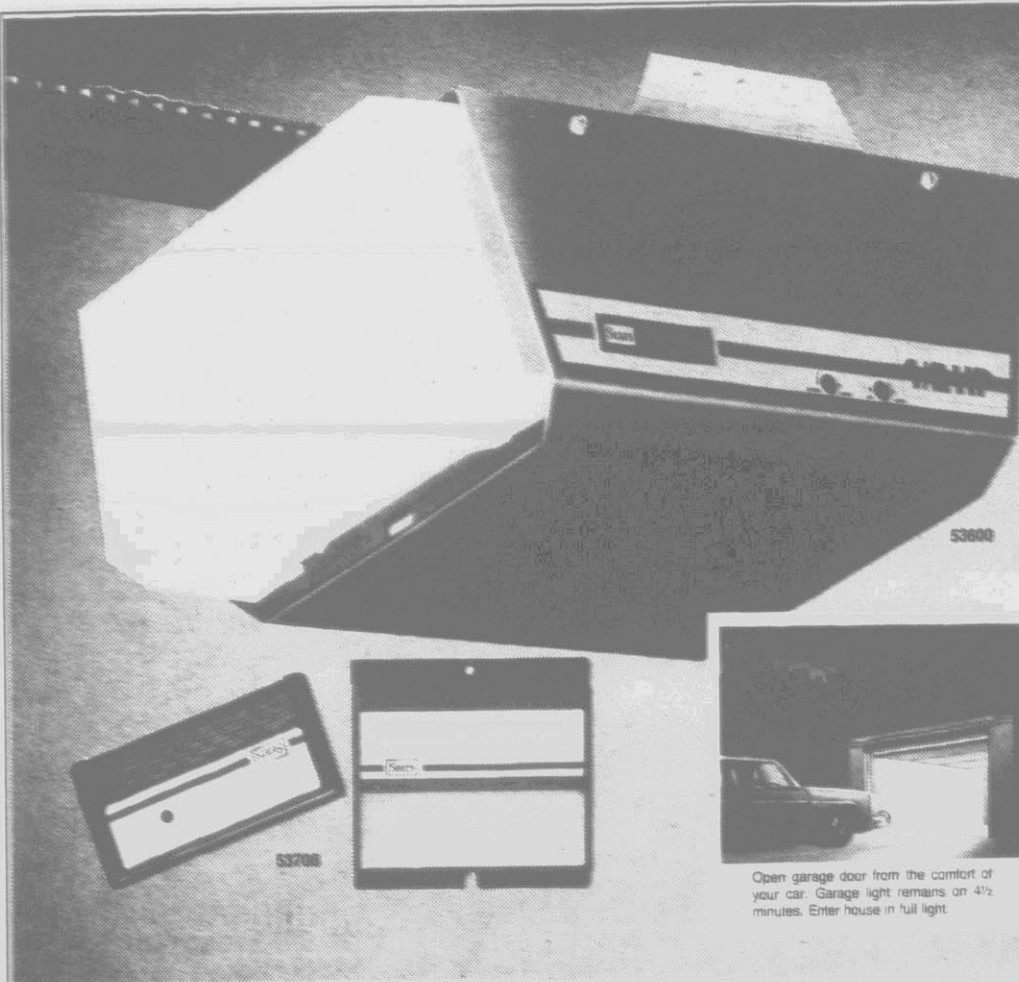

53600

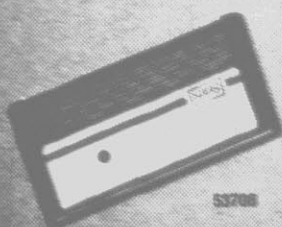

53708



Open garage door from the comfort of your car. Garage light remains on 4½ minutes. Enter house in full light.

SAVE \$100! Powerful Craftsman 1/2-HP garage door opener

Has over 19,000 digital security codes. With lighted wall control. Steel drive system. 5-year limited warranty on motor parts. Labor extra. Reg. \$259.88

Reg. \$29.99 extra transmitter for second car. **24.99**

Ask about Sears Authorized Installation. FREE ESTIMATES.

159⁸⁸

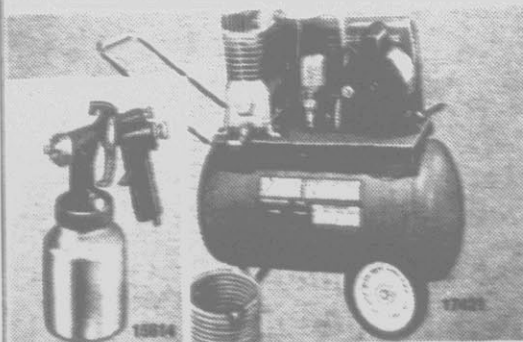

\$220 OFF 1-HP portable electric air compressor

Delivers 6.6 SCFM at 40 PSI. 12-gal. tank.

\$649.99 2-HP model. **429.99**
\$79.99 Craftsman spray gun, **49.99**

329⁹⁹

Reg. \$549.99



Full 2-year warranty against cracking or breaking.

\$6 OFF durable Permanex® 32-gal. trash container

Solid construction holds up to 150 lbs. Friction lid lock. Green. Reg. \$15.99

\$4.99 pkg. of 30, 33-gal. trash bags. **3.49**

9⁹⁹

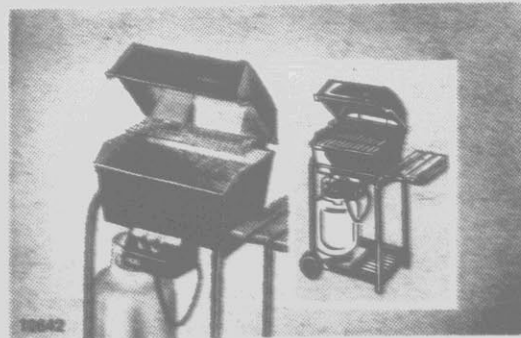

\$120 OFF Kenmore LP gas grill with dual controls and carriage cart

401 sq. in. total cooking area includes 130-sq. in. warming rack. Match-free ignition. **179⁹⁹**
Unassembled.

Reg. \$299.99



SAVE 1/2 on vanity and cabinets.

\$99.99 ea. in our '84 Fall General Catalog, quantities limited

24-in. wood vanity 49⁹⁹

Solid oak framed door. Brass plated door knob and self-closing hinges. Sink top and faucet extra.

Storage cabinet 49⁹⁹

Solid oak framed door matches vanity. Puts extra storage at your fingertips. Adjustable shelf.

Medicine cabinet 49⁹⁹

Solid oak frame with plate-glass mirror. Swing door. Electrical outlet. \$49.99 toilet bowl and tank. . . 44.99

\$20 OFF Economizer 5 water heaters

Need hot water fast? Call for emergency installation (within 24 hours except Sundays and holidays). Installation extra.

30-gallon gas or 40-gallon electric
Reg. \$169.99

149⁹⁹

Other sizes also on sale at \$20 savings. A great buy!

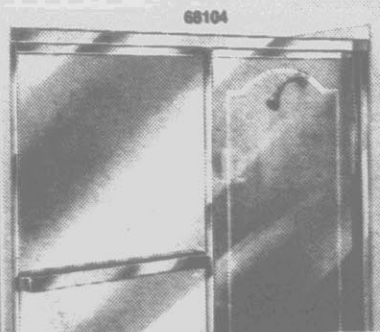

66104

\$70 OFF mirrored bathtub doors

One panel mirrored inside and out so you can shave in the shower! Save now!

Reg. \$199.99
129⁹⁹

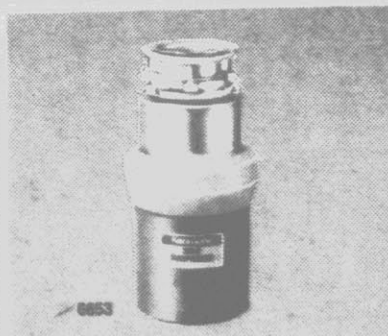

6653

\$30 OFF Kenmore 1/2-hp disposer

Corrosion-resistant stainless steel grinding chamber, jam-resistant impellers.

Reg. \$99.99
69⁹⁹

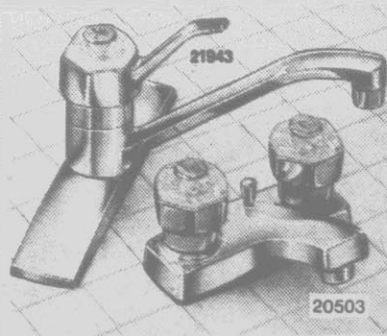

21943

20503

1/2 PRICE our best washerless faucets

Washerless to help prevent drips. 6 color inserts for handle to match your decor.

Reg. \$59.99
34⁹⁹

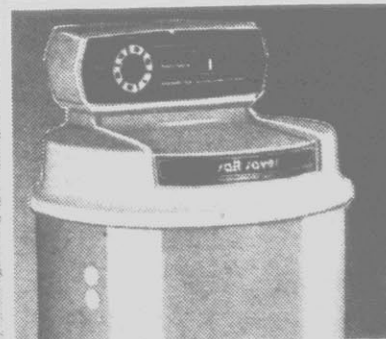

\$150 OFF high-capacity water softener

Soft water for cleaner wash, dishes and bathing. With salt saver.

Reg. \$549.99
399⁹⁹



RP means reserve power

SAVE \$40-\$300 on Craftsman mowers, riding equipment and tillers

- A. 3.5-RP side-discharge mower with dependable solid-state ignition and quick height set. 20-in. Mechanical compression release. Automotive-type air filter. Reg. \$229.99
- B. 11-HP lawn tractor. 36-in. twin blade mower. 3 forward speeds, 1 reverse. Automotive-type differential built into transaxle. Reg. \$1499.99 **1199.99**
- C. 8-HP riding mower. Catcher extra. Reg. \$1199.99 **899.99**
\$219.99 rear-mount grass catcher **179.99**

169⁹⁹

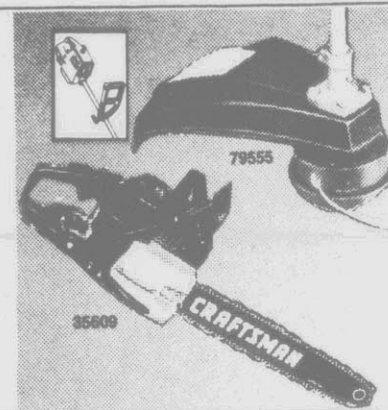

\$60-\$150 OFF Weedwacker® and chain saw

\$449.99 Craftsman gas chain saw with 20-in. bar. 3.7 C.I.D. **299.99**
 \$199.99 gas Weedwacker trimmer. 17-in. swath. Solid-state ignition, **139.99**

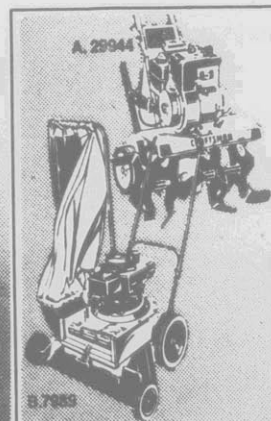

\$100 OFF 5-HP front-tine tiller
 Dual chain drive.
 Some assembly required.

Reg. \$449.99 **349⁹⁹** A

\$100 OFF Vacuum shredder-bagger

Craftsman. 3.5-HP.
 Clears 25-in. path.

Reg. \$399.99 **299⁹⁹** B

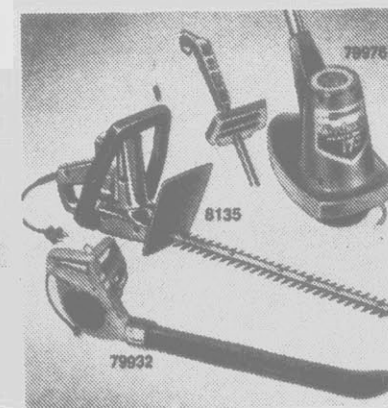

SAVE \$30 power lawn tools

Reg. \$89.99 Craftsman electric Weedwacker trimmer. 17-in. **59.99**
 Reg. \$79.99 Craftsman electric hedge trimmer. 22-in. **49.99**
 Reg. \$79.99 Craftsman 1-HP electric power blower. **49.99**

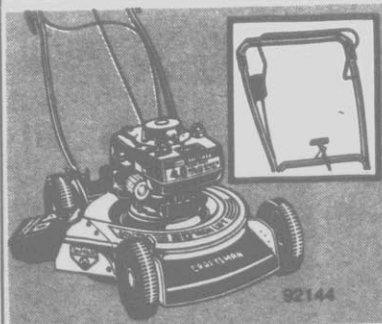

\$100 OFF Craftsman 4.0-RP 2-speed deluxe Eager-1 mower
 Has extended rope start for safe starts. Solid-state ignition. Side discharge.
 Reg. \$329.99. **229⁹⁹**

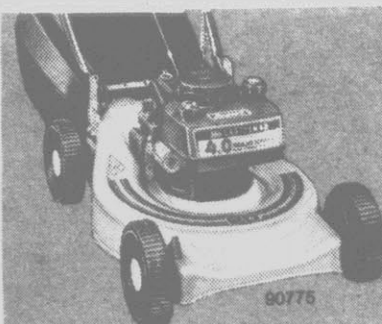

\$120 OFF Craftsman 4.0-RP Deluxe Eager-1 mower
 Rear bagger mower has dependable solid-state ignition. 20-in. Permanex® catcher. Reg. \$369.99. **249⁹⁹**

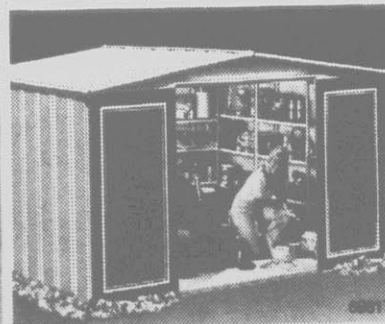

\$90 OFF 10 ft. x 9 Ft.* steel lawn building
 9 ft. 6 in. x 8 ft. 6 in. int. dim. Unassembled. Reg. \$249.99 **159⁹⁹**

*Exterior base dimensions rounded to the nearest foot.

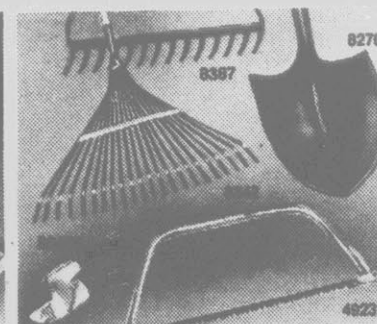

YOUR CHOICE! Craftsman lawn and garden tools

\$10.99 bow saw. \$9.99 pruner. \$9.99 lawn rake. \$11.99 shovel. **6⁹⁹** each
 \$11.99 bow rake.

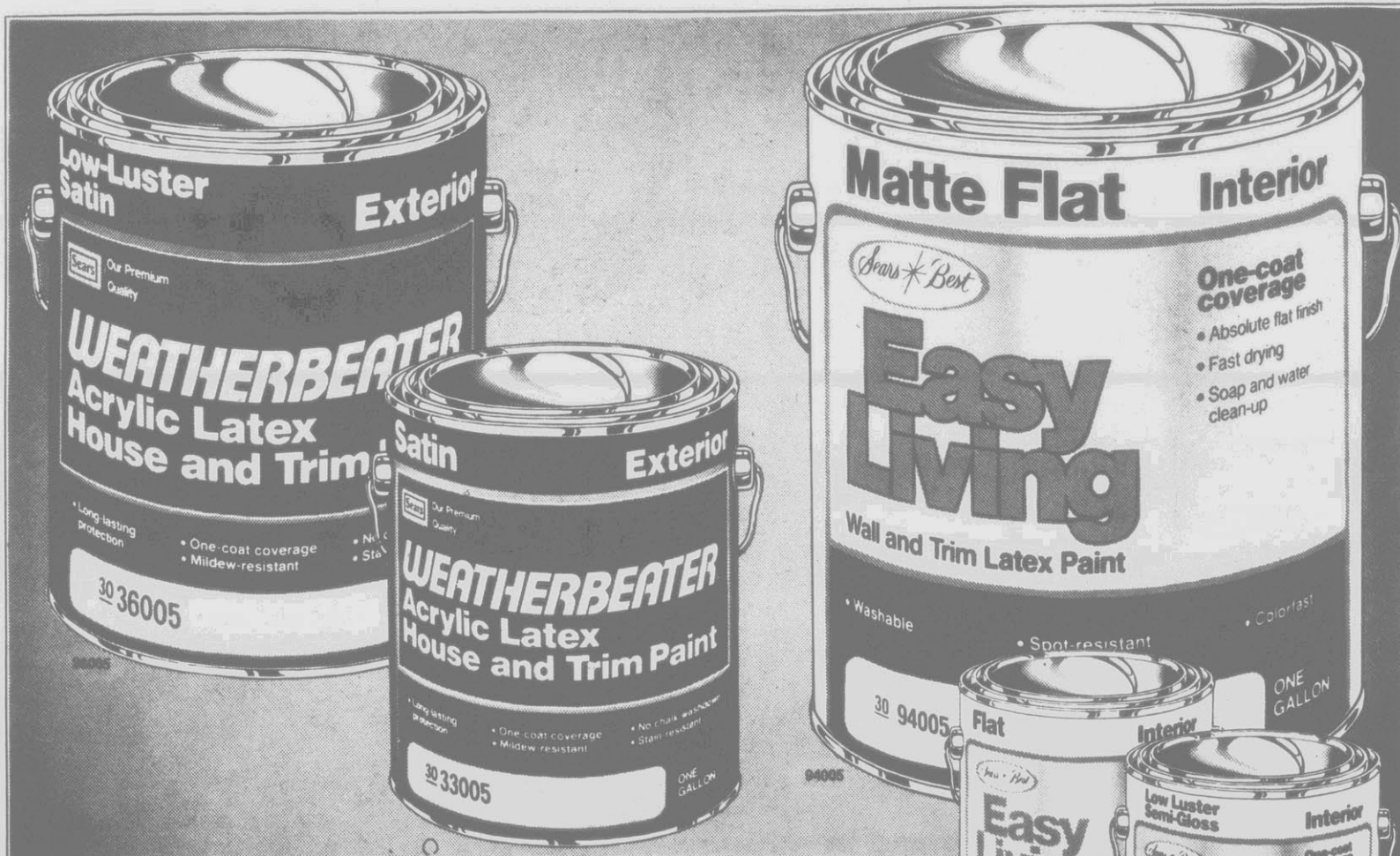

LAST 4 DAYS—SAVE \$6-\$8 Easy Living® and Weatherbeater® 1-coat latex

Sears Best Easy Living interior. Washable. Resists spots, stains and fading.

Weatherbeater exterior. Our premium quality latex provides durable, long-lasting protection.

\$17.99 Easy Living semi-glossgal. 11.99

\$19.99 Weatherbeater satingal. 11.77

YOUR CHOICE

9⁹⁹
gal.

Easy Living matte flat or ceiling, reg. \$15.99

Weatherbeater low-luster, reg. \$17.99

For one-coat results, all Sears one-coat paints must be applied as directed.



**\$8 OFF 40-lb. box
Sears detergent**

Heavy-duty formula. 173 average washes per box.

Reg. \$24.99

16⁹⁹

\$8.99 liquid..... gal. 5.99

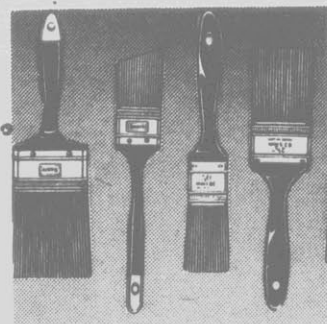

**\$2-\$4 OFF Interior/
exterior brushes**

A full range of sizes for most every need!

Reg. \$4.99 to \$11.99 **2⁹⁹ to 7⁹⁹**

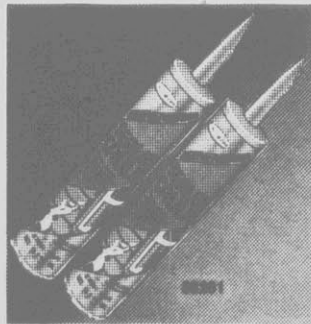

**1/2 PRICE Sears Best
Weatherbeater caulk**

Our most durable sealer. Stays flexible in heat, cold.

10½ ounces
Reg. \$6.49

3²⁴
each

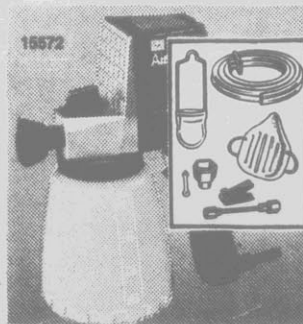

**Save \$20
10-pc. sprayer kit**

Craftsman airless paint sprayer, accessories.

Heavy duty
Reg. \$99.99

79⁹⁹

Ask about Sears Credit Plans

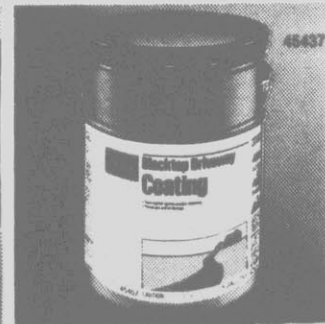

**\$5 OFF Sears Best
driveway coating**

Fills cracks to ½-in. wide. Helps seal and protect.

Heavy duty
Reg. \$19.99

14⁹⁹
5-gal.



Save 30%-50% on beautiful kitchen cabinets

- Piece together your own dream kitchen with the styling of wood cabinets
- We offer FREE professional planning to help you choose the right combination for you
- Twelve cabinet styles are on sale with savings 30% to 50%

Trust Sears to get it installed right
Sears Authorized Installation available for installed items on this page. FREE ESTIMATES!

SAVE \$30 Decorative 42-in. ceiling fan

Beautiful and functional . . . circulates warm air in winter, cool air in summer. Three speeds plus reversing switch. Four walnut-finished, stenciled wood blades. Antique-brass finished steel housing. Light fixture extra.

Reg. \$129.99

99⁹⁹

\$24.99 fan light fixture. White glass with gold-color band. Bulb extra . . . 14.99

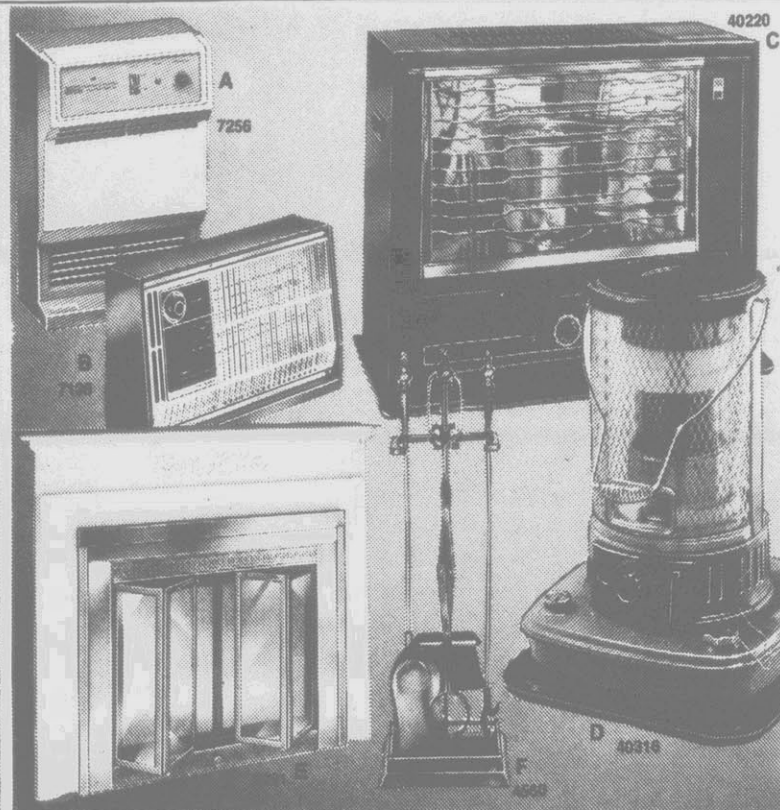
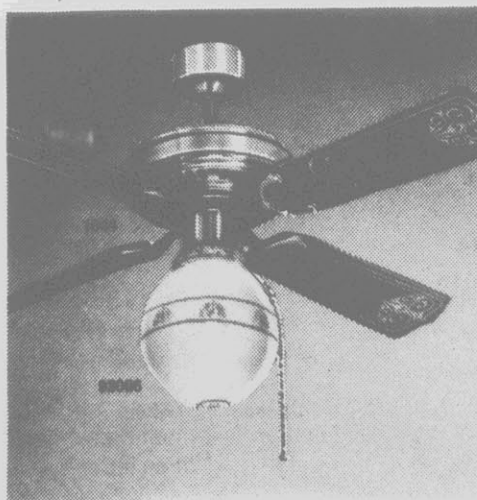

PRE-SEASON BUYS HEATING EQUIPMENT

- | | |
|---|---|
| A. \$10 OFF 750-1500 watt electric heater. Reg. \$59.99 now 49.99 | D. \$50 OFF kerosene heater, 20,000 BTU. UL listed Tip switch. Reg. \$169.99 119.99
<small>Check local codes for permitted use.</small> |
| B. \$10 OFF 1250-1500 watt electric heater. Reg. \$39.99 now 29.99 | E. \$70 OFF HEAT SCREEN™ 75 fireplace doors. Reg. \$169.99. 99.99 |
| C. \$30 OFF kerosene heater. 9,500 BTU. Tip switch. UL listed. Reg. \$99.99. 69.99 | F. \$15 OFF 5-piece fireplace tool set. Reg. \$49.99. 34.99 |

Check local codes for permitted use of kerosene heaters.

SAVE \$100 on Power Miser® gas furnace

Present system old and costly to operate? Replace it now with an energy-efficient gas furnace. Sears Authorized Installation available. FREE ESTIMATES!

Reg. \$649.99

549⁹⁹

\$10 OFF triple set-back thermostat. Helps save energy heating and cooling.

Reg. \$54.99

44⁹⁹



We service Sears and most other brands of central air and heating.

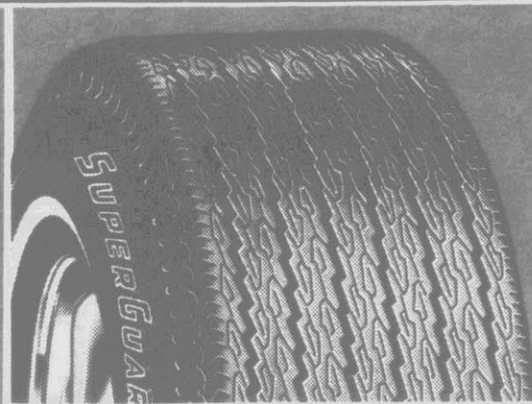

35,000-mile wearout warranty

WeatherHandler radial whitewall	Regular price each	Sale price each	WeatherHandler radial whitewall	Regular price each	Sale price each
P155/80R12	41.99	24.75	P205/75R14	81.99	57.50
P155/80R13	49.99	37.50	P215/75R14	86.99	65.25
P165/80R13	56.99	42.75	P225/75R14	91.99	69.00
P175/80R13	64.99	48.75	P205/75R15	91.99	64.50
P185/80R13	67.99	47.75	P215/75R15	96.99	67.75
P185/75R14	71.99	50.50	P225/75R15	101.99	71.50
P195/75R14	76.99	54.00	P235/75R15	106.99	74.75

35,000-mile wearout warranty

SuperGuard 35 whitewall	May be substituted for	Regular price ea.	Sale price each	SuperGuard 35 whitewall	May be substituted for	Regular price ea.	Sale price each
P155/80B12	6.00-12	45.99	21.99	P205/75B14	F78-14	69.99	44.99
P155/80B13	—	49.99	25.99	P215/75B14	G78-14	72.99	46.99
P165/80B13	A78-13	51.99	28.99	P225/75B14	H78-14	74.99	47.99
P175/80B13	B78-13	54.99	31.99	P215/75B15	G78-15	74.99	47.99
P185/80B13	C78-13	57.99	35.99	P225/75B15	H/J78-15	76.99	48.99
P195/75B14	D/E78-14	66.99	42.99	P235/75B15	L78-15	79.99	49.99

WE INSTALL CONFIDENCE

We perform most automotive services during prevailing store hours

Our 90-minute installation promise... Your tires installed in 90-minutes after written authorization or you get coupon book free.

Limited warranty against tire wearout. For the specified miles, Sears will replace the tire or give a refund charging only for the miles used.

20% to 40% OFF
All-Season radials
4 for \$99 P155/80R12

WeatherHandler. Two steel belts. Aggressive tread for all-weather traction. Our lowest priced all-season radial.

30% to 50% OFF
Our best belted tire
21⁹⁹ P155/80B12

SuperGuard 35. Two fiber glass belts. Polyester ply construction.

A* about Sears credit plans

SAVE \$2 Heavy Duty shocks **5⁹⁹** ea.
SAVE \$3 Heavy Duty Plus shocks... each 8.99
SAVE \$10 SteadyRider® RT or LT shocks... ea. 12.99
SAVE \$15 Booster shocks... pair 34.99
SAVE \$10 Air Adjustable shocks... pair 59.99
Shock installation extra

Closeout. SAVE \$20. Installed MacPherson strut cartridges. For most imports... pr. 79.99
Closeout. SAVE \$30. Installed MacPherson struts. For many American-made cars... pr. 119.99
While quantities last. Wheel alignment extra when needed



SAVE \$20
Sears Best charger
Reg. \$89.99 **69⁹⁹**
4-in-1 charger/tester; for 6 and 12-volt batteries.

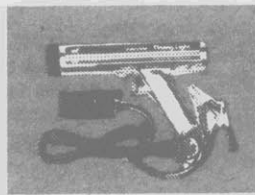

SAVE \$15 Craftsman timing light
Reg. \$49.99 **34⁹⁹**
Inductive pickup... needs no adapters.



Brake service
2-wheel, front or rear. Re-build cylinders, calipers.
Regular \$79.99 **69⁹⁹**
With car care coupon
Coupon book... 19.99



Muzzler® muffler
Aluminized for long life. Acoustically tuned. For most American-made cars. **19⁹⁹**

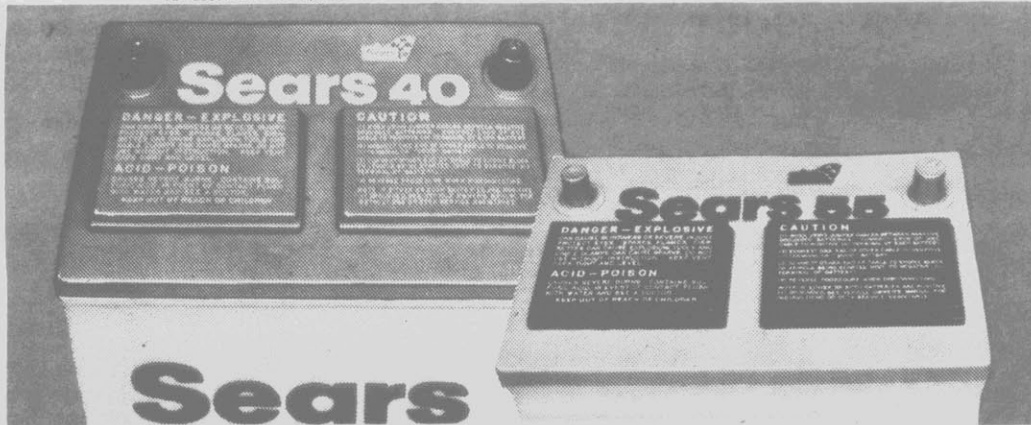

SAVE \$17 on
Sears 40-month auto battery

37⁹⁹ Reg. \$54.99, with trade-in

Our lowest price of the year! 380 amps cold cranking power in Group 24. Installation is included. Hurry in today!

SAVE \$17 on
Sears 55-month auto battery

44⁹⁹ With trade-in

Was \$61.99 in Fall 1984 General Catalog. For most cars. Installation included. While quantities last.

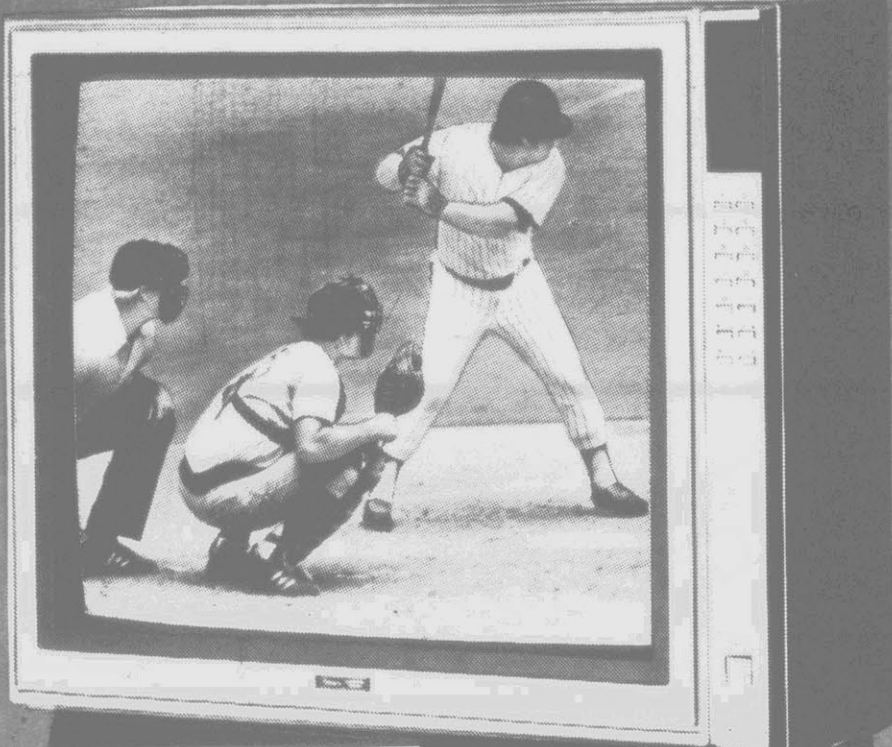

40265

SAVE \$70

13-in. diag. meas. picture color TV. An ideal second set!

Reg. \$299.99 **229⁹⁹**

4152

Simulated TV reception on both sets shown



SAVE \$90 on 3.0 peak HP Power-Mate[®] vac

Powerful (.75 HP VCMA) suction, and beater-bar brush. Active edge cleaner. Quick-release cord storage. Sale ends Sept. 29.

24300

Reg. \$249.99
159⁹⁹

SAVE \$120 Square-view color TV is cable-ready has quartz tuner

20-in. diagonal measure picture square view picture means reduced distortion and reflections. With comb filter and one-button color for a sharp picture. 117 channels; cable-ready.

379⁹⁹

Reg. \$499.99

Ask about Sears credit plans



SAVE \$70 Portable Scholar typewriter

5377

Built-in keyboard correction, power return, repeat, backspace. Thru Sept. 22.

199⁹⁹
Reg. \$269.99

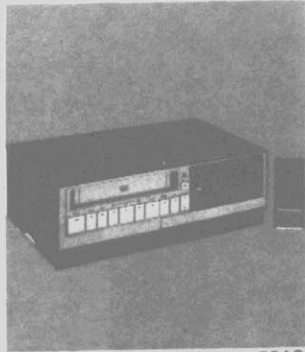

SAVE \$120 on VHS video recorder

53161

14-day/4-program/8-hour capacity. TV/VCR select, record, play, more. Thru Sept. 29.

529⁹⁹
Reg. \$649.99



3610

SAVE \$50 Upright vac with tools

34221

Floor light, 4 pile heights. Full bumper guard. Thru Sept. 29.

Reg. sep. prices total \$129.99
79⁹⁹

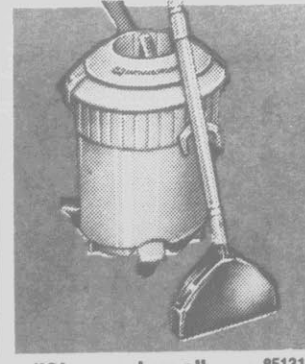

85131

"Steam-type" carpet cleaner

Sprays hot solution. Pulls out dirt, liquid. Dries quickly! Why rent? **99⁹⁹**

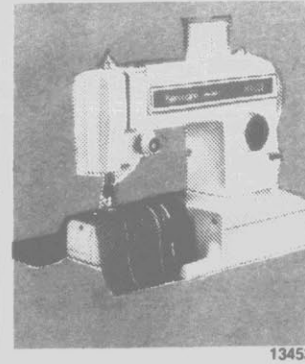

13453

\$100 OFF 8-stitch free-arm sew head

4 utility, 4 stretch stitches. Buttonholer. Use as flatbed. Thru Sept. 22.

159⁹⁹
Reg. \$259.99

Typewriters are not available in Ashland, Shelby and Williamson.

Each of these advertised items is readily available for sale as advertised



SAVE \$170-\$200 on 16.3 cu. ft. refrigerator-freezer

64631/8440

All-frostless. No defrosting ever. 12.33 cu. ft. fresh food section has 2 adjustable full-width shelves and twin crispers. 3.93 cu. ft. freezer. Power Miser switch. Textured steel doors. White.

Without ice maker
reg. \$649.99

479⁹⁹
Ice maker hook-up extra

With ice maker
reg. sep. prices
total \$749.99

549⁹⁹



13201

Washer
299⁹⁹
Reg. \$329.99.
Large capacity.
Heavy-duty.
White only.

Dryers
249⁹⁹
Electric
Reg. \$269.99
Large-capacity.
Similar savings
on gas model.
White only.

65351

SAVE \$180 when you buy this large-capacity laundry pair

2-speed, 5-cycle washer with 3 wash/rinse temperatures. Self-cleaning lint filter. 3 water levels. White. Select colors, extra. Sale ends Sept. 30.

Automatic termination electric dryer has 2 drying temperatures. Touch-up setting. White. Selected colors, extra. Sale ends Sept. 30.

Reg. \$469.99

359⁹⁹

Reg. \$349.99

279⁹⁹

Similar savings on gas dryer
Dryers require connector not included in prices shown.

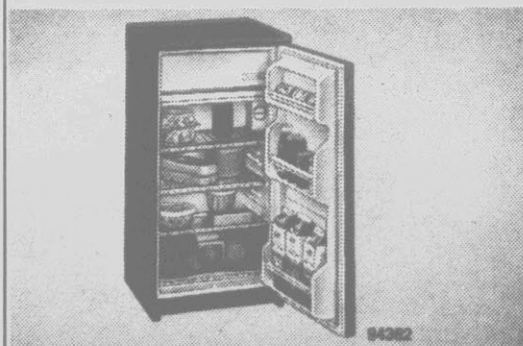

SAVE \$40 Kenmore free-standing compact refrigerator

3.6 cu. ft. capacity. Foam insulation. 2 adjustable shelves, crisper. Brown.

179⁹⁹
Reg. \$219.99



SAVE \$150 Kenmore 19.1 cu. ft. side-by-side with automatic ice maker

All-frostless, never needs defrosting. 12.72 cu. ft. refrigerator with DynaWhite epoxy-coated Spacemaster® shelves that adjust to needs. Fresh meat and deli items store in meat pan, fruit and vegetables in crisper. 6.34 cu. ft. freezer with ice maker. No trays to fill or spill. Porcelain-on-steel liner resists rust. Power Miser switch saves energy.

Regular \$999.99

849⁹⁹
White

Ice maker hook-up extra

Buy now on Sears Deferred Credit Plan. Your monthly payments begin in February. (There will be a finance charge for the deferral period.)

Ask about Sears Credit Plans

Each of these advertised items is readily available for sale as advertised.

A built-in stirrer fan distributes the microwaves so foods cook from all sides.

1	2	3
4	5	6
7	8	9
0	0	0

Convenient electronic touch controls—no buttons to push, no dials to turn.

Also available, space-saving microwave #87051

Reg. \$199.99 **\$179**

87451

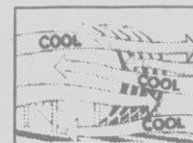
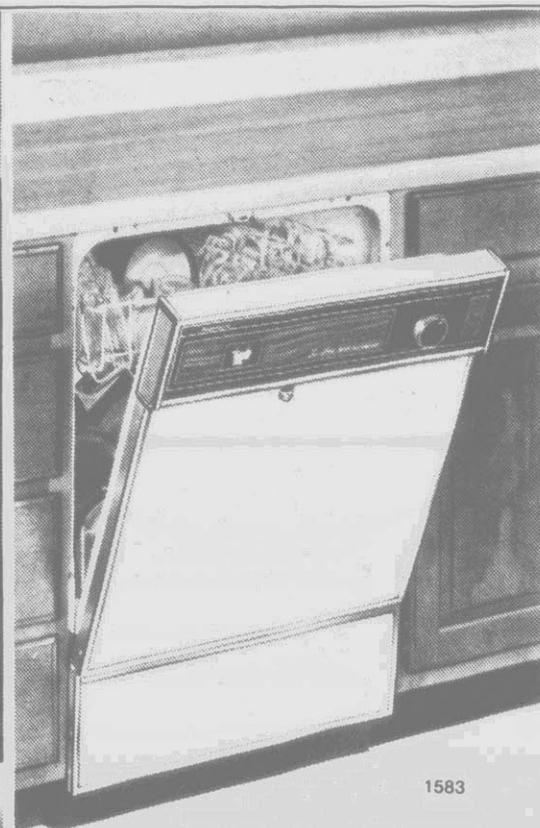

Power-Miser control helps save energy.



Pots/pans cycle for heavily soiled loads.

\$120 OFF Kenmore microwave oven with temperature probe and touch controls

Cook by time or temperature with the probe—it senses when food reaches a preset temperature. Automatic hold/warm helps keep food warm up to 1 hour after desired temperature is reached. Variable power for a wide range of cooking needs. Sale ends Sept. 30.

229⁹⁹
Reg. \$349.99

SAVE \$70 on 24-in. built-in dishwasher

Reversible color panels for your color choice of white, golden wheat or almond.

279⁹⁹
Reg. \$349.99

Sale ends Sept. 22.

Ask about Sears Authorized Installation. FREE ESTIMATES!

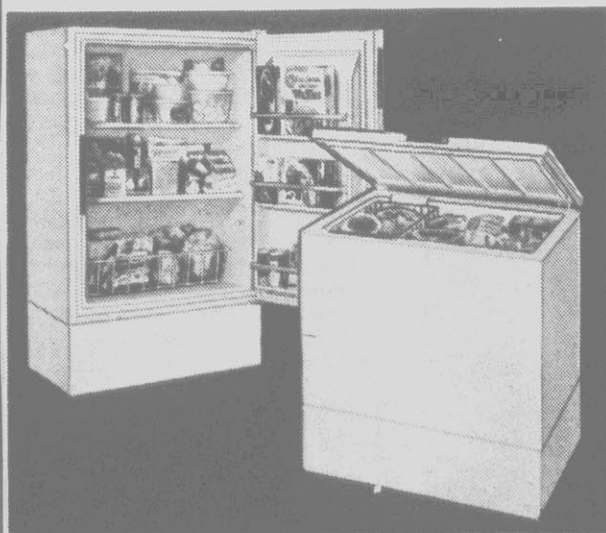

SAVE \$100 on 9.0 cu. ft. Kenmore freezers . . . choice of 2 styles

Store food at true 0° temperature in chest or upright model with adjustable cold control. Foam insulation helps save space and energy. Key-eject lock helps prevent accidentally leaving door open. Almond.

279⁹⁹

Regular \$379.99

Sale ends Saturday.

Ask about Sears Credit Plans®

25098/15098

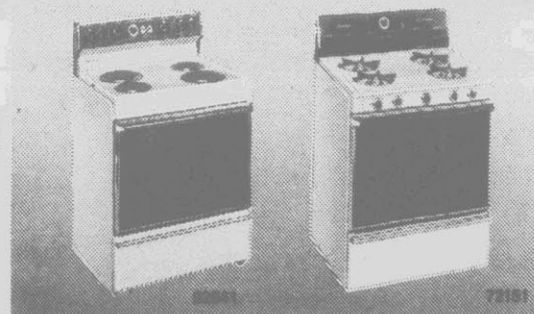

\$100-\$150 OFF Kenmore 30-in. gas or electric range

Each has a continuous cleaning oven to help clean spatters at baking temperatures.

399⁹⁹

White, color available, extra.

Sale ends Sept. 30.

Ranges require connector, extra.

electric, reg. \$499.99
gas, reg. \$549.99

Each of these advertised items is readily available for sale as advertised.

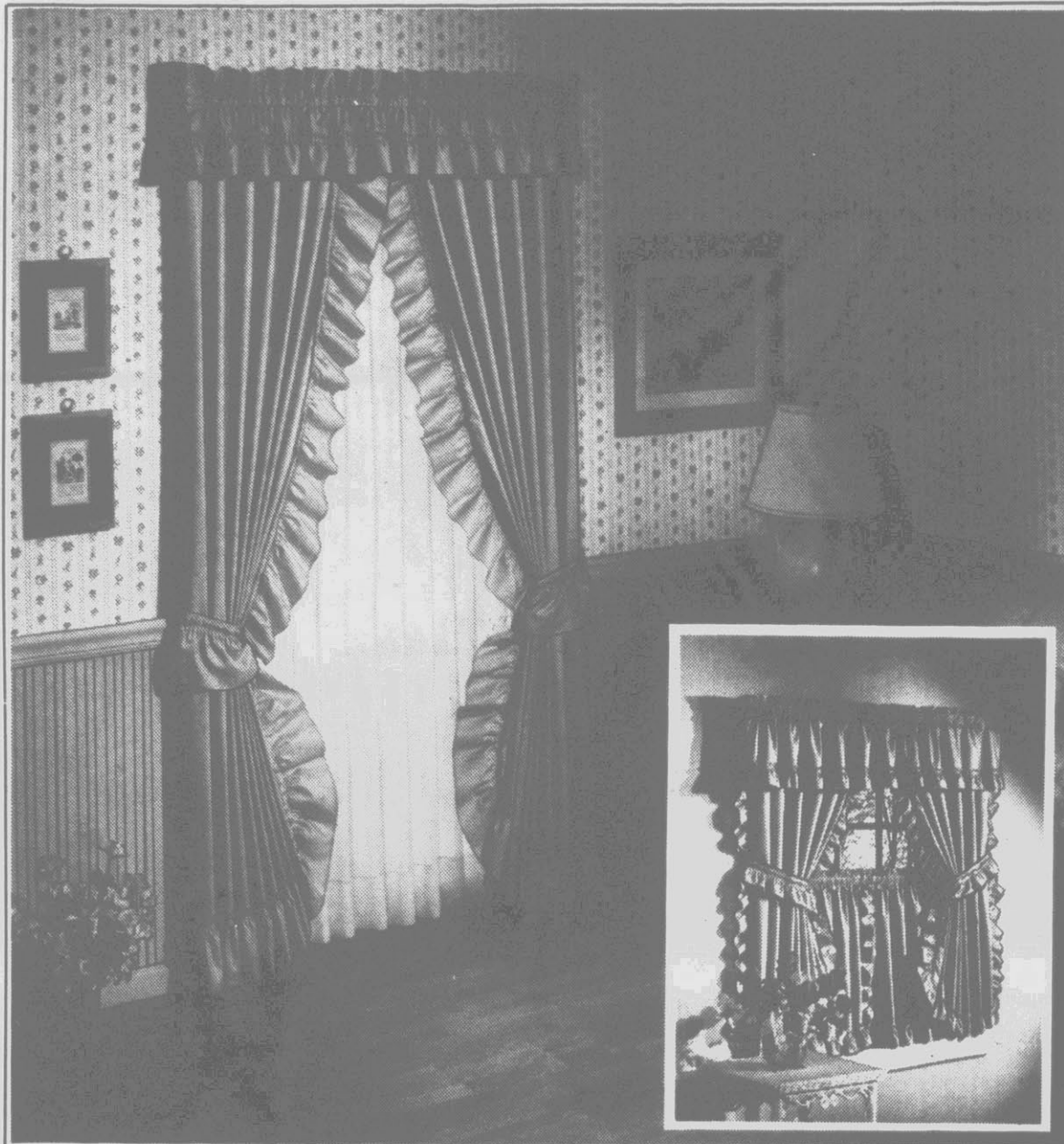

SAVE 20%-25%

Our best selling
priscillas and
ruffle rounds

Inheritance priscillas

17⁹⁹
97x63-in.
Reg. \$22.99

\$34.99 139x63-in. pair	27.99
\$26.99 97x81-in. pair	21.49
\$36.99 139x81-in. pair	29.49
\$49.99 184x81-in. pair	39.99

Inheritance ruffle rounds

\$7.99 24-in. pair	5.99
\$10.99 36-in. pair	8.79
\$12.99 45-in. pair	10.39
\$6.99 Valance	5.59

Open Home priscillas

22⁴⁹
98x63-in./pair
Reg. \$29.99

\$43.99 140x63-in. pair	34.99
\$34.99 98x81-in. pair	27.99
\$49.99 140x81-in. pair	39.99

Open Home ruffle rounds

\$10.99 24-in. pair	8.79
\$14.99 36-in. pair	11.99
\$16.99 45-in. pair	13.59
\$9.99 Valance	7.99

Sale ends Sept. 22

Ask about Sears Credit Plans



ANY SIZE . . . bedspreads and comforters, all at one great low price!

Dress every bed in your home, from twin to king, with a new bedspread or comforter. Choose from a wide assortment of patterns and solids. And they're all at the same low price. Stock up now!

19⁹⁹
each

Special purchase. While quantities last.

20-50% OFF ALL FURNITURE AND BEDDING

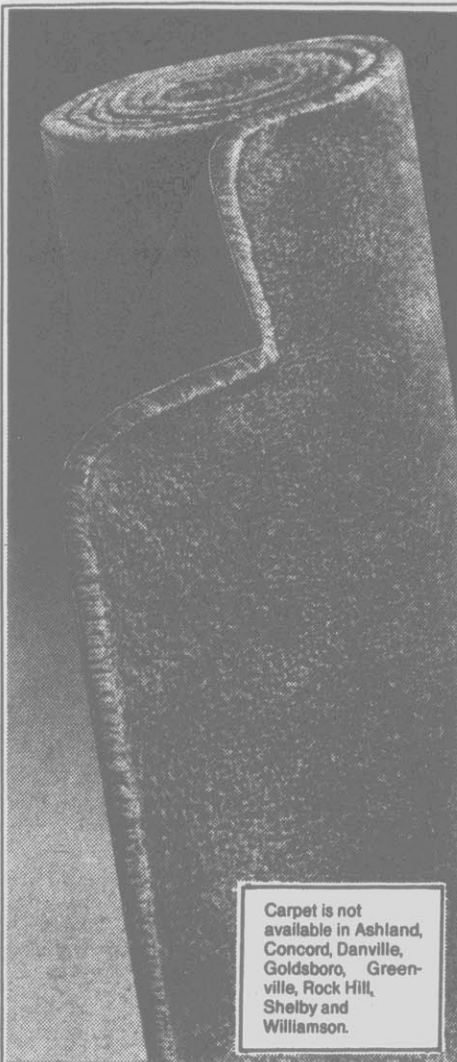

Carpet is not available in Ashland, Concord, Danville, Goldsboro, Greenville, Rock Hill, Shelby and Williamson.

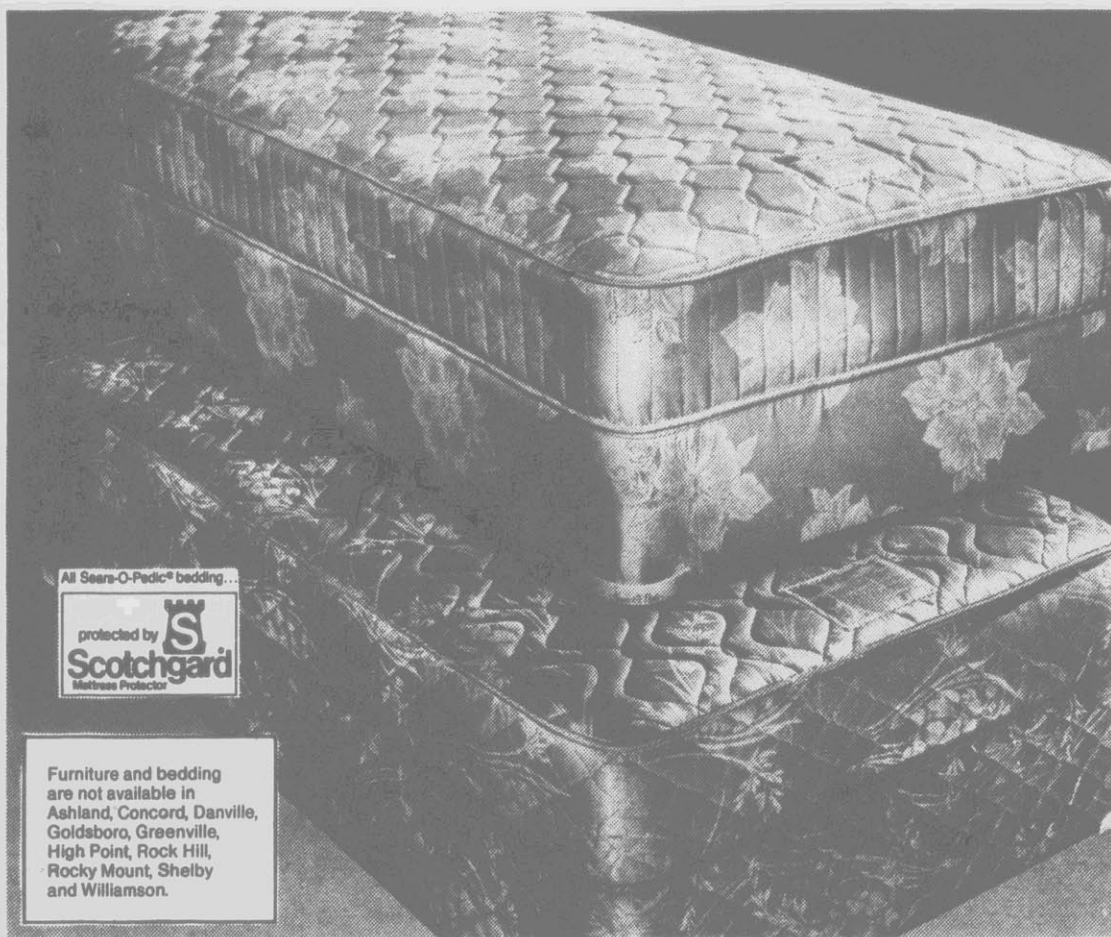

All Sears-O-Pedic® bedding...



Furniture and bedding are not available in Ashland, Concord, Danville, Goldsboro, Greenville, High Point, Rock Hill, Rocky Mount, Shelby and Williamson.

SAVE 40% on Colormate carpet INSTALLED

Reg. \$28.99 **16⁹⁹** sq.yd. installed

Colormate Premium Soil-Resistant Nylon plush pile carpet gives your home new beauty. Other Plush carpets ON SALE! INSTALLED! Thru Aug. 30.

\$13.99 Secret Place, thru Aug. 29 9.99 sq.yd.
\$16.99 Simply Plush, thru Aug. 30 11.99 sq.yd.

NO MONEY DOWN

Pay as little as \$10 monthly (see chart)

If you have an existing SearsCharge Modernizing Credit Plan balance, the addition of this purchase may or may not change your current monthly payment, depending on the highest balance on your account. Sales tax and delivery charges (if any) may cause quoted minimum monthly payment to be higher.

Approximate monthly payments

Sq. Yds.	SECRET DREAM		ANDREA SUPREME	
	SALE PRICE	Monthly Payment	SALE PRICE	Monthly Payment
30	\$299.70	\$10	\$359.70	\$12
40	399.60	12	479.60	14
50	499.50	14	599.50	16

Ask about Sears Credit Plans

SAVE 50% on bedding when bought in sets

Choose Innerspring or polyurethane foam

FIRM Luxury bedding

\$239.99 Full-size mattress or foundation **119.99**

Twin mattress or foundation Reg. \$199.99 **99⁹⁹** ea. pc. in sets

*Savings based on 1984 Fall General catalog prices. Quantities limited. Sale ends Sept. 24

EXTRA-FIRM Sears-O-Pedic®

Supreme II \$259.99* Full mattress, foundation **129.99**

Twin mattress or foundation Reg. \$199.99* **99⁹⁹** ea. pc. in sets

SUPER-FIRM Sears-O-Pedic®

Perfect Dreams \$319.99 Full mattress, foundation **159.99**

Twin mattress or foundation Reg. \$259.99 **129⁹⁹** ea. pc. in sets

Queen and king sizes also on sale

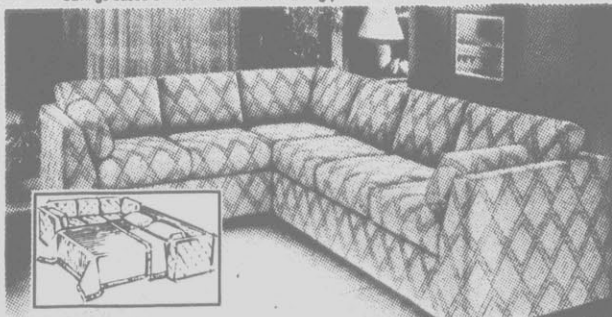

\$500 OFF High Road queen-size sectional sleeper

Sleek, contemporary-style sectional sleeper seats the whole family and sleeps overnight guests! Includes wedge sofa and 1-arm sleeper.

Reg. \$1199.99

699⁹⁹



\$200 OFF He-Man

3-way recliner with Ant-ron® nylon tweed cover.

Reg. \$479.99 **279⁹⁹**



\$200 OFF Foursome

Swivel rocker recliner. Herculon® olefin tweed.

Reg. \$499.99 **299⁹⁹**



**2-Piece fleeced
activewear sets
for misses, just**

15⁹⁹
set

A special purchase brings you this 2-piece set of Creslan® acrylic for this low price! Hooded or zip-front styles in great colors, with pants to match. Quantities are limited.

In our Sportswear Department
Creslan is a registered
trademark of American Cyanamid Corp.



**Intimate apparel savings
30% OFF Timeless Comfort bra**

For a flattering silhouette, try this Timeless Comfort bra! Made of comfortable Spanette® stretch fabric with lace cups, it moves easily with you . . . provides non-binding separation.

Reg. \$11.50 **7⁹⁹**

1/3 OFF nylon panties. Smooth fitting, tailored nylon briefs are a real value! Pkg. of 3 in white. Cotton-lined crotch. Basic styling at a basic, stock-up price.

Reg. \$4.50 pkg. **2⁹⁹**

X-sizes priced higher.

Ask about Sears credit plans



SAVE \$7 on dressy suede or leather-look shoes for her

Spotlight your feet in our collection of women's dress or Pillow Soft® shoes. In contemporary styles and fall fashion colors, they're composed of suede leather or leather-look urethane uppers and man-made soles.

Reg. \$21.99

14⁹⁹

Ask about Sears credit plans

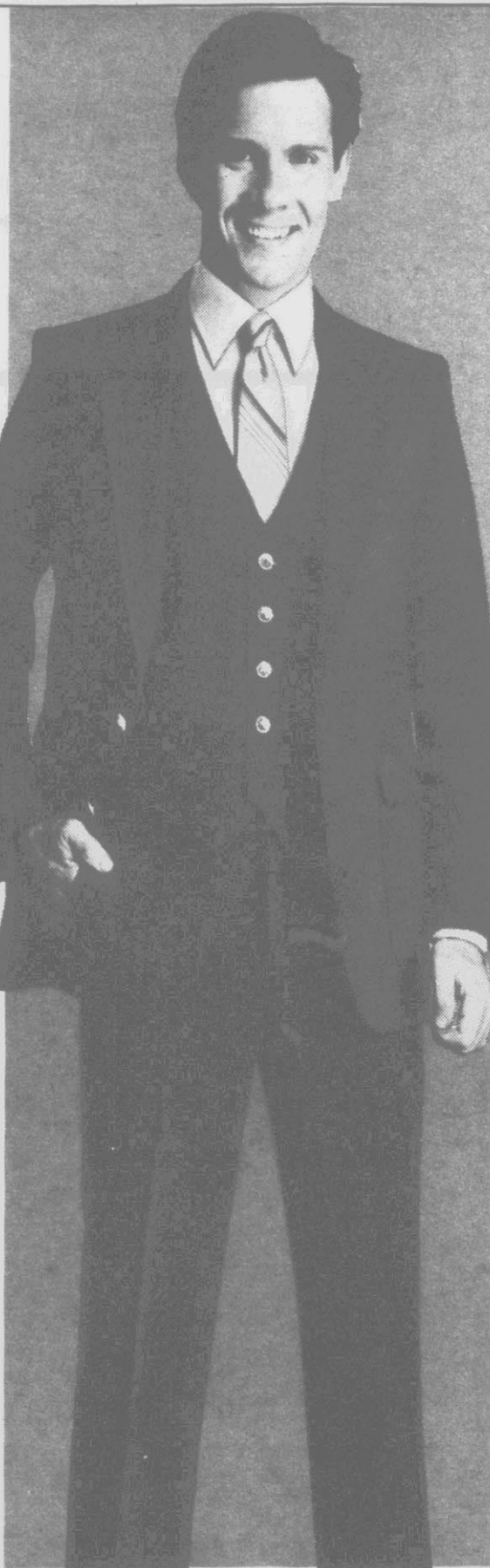

**SAVE \$5-\$25
Look stylish
in our Classic
Collection
separates**

Our Classic Collection separates let you feel great and look great without sacrificing comfort. These two-way stretch woven polyester separates are Perma-Prest® and give for comfort while retaining their shape. The dress slacks have a special stretch Ban-Rol® waistband for a better fit.

Solid jacket
Regular \$75

49⁹⁹

\$27 Solid vest	21.99
\$30 Solid dress slack	24.99
Not shown:	
\$80 Pinstripe jacket	59.99
\$27 Pinstripe vest	21.99
\$30 Pinstripe slack	24.99



**SAVE \$5 on men's
long-sleeve dress shirt**

12⁹⁹

Reg. \$18 each

Polyester and cotton dress shirts have fused collar, cuff and center placket. In assorted solid colors and men's sizes.

\$12 Via Re' neckwear 8.99 each

SEARS

30% OFF Good-looking Toughskins® cord jeans for kids

Reg. \$12.99 **8⁸⁸**

Girls' sizes 7-14 and boys' sizes 8-16. Regular and slim. Good-looking, rough and tough corduroy jeans of Celanese Fortrel® polyester, cotton and DuPont 420 nylon are Sears Best.

Reg. \$10.99 Toughskins cords for little boys, sizes 4-7 and little girls, sizes 4-6x **6.88**
Toughskins jeans available in big girls' Pretty-Plus sizes at similar savings.

30% OFF Levi's® cord jeans

Kids' Western jeans gear up for good looks and lots of action. All cotton or cotton and polyester. Regular and slim sizes.

11⁸⁸

Reg. \$16.99, boys' 8-14

Girls' sizes 7-14, reg. \$18.99 **12.88**

Ask about Sears credit plans

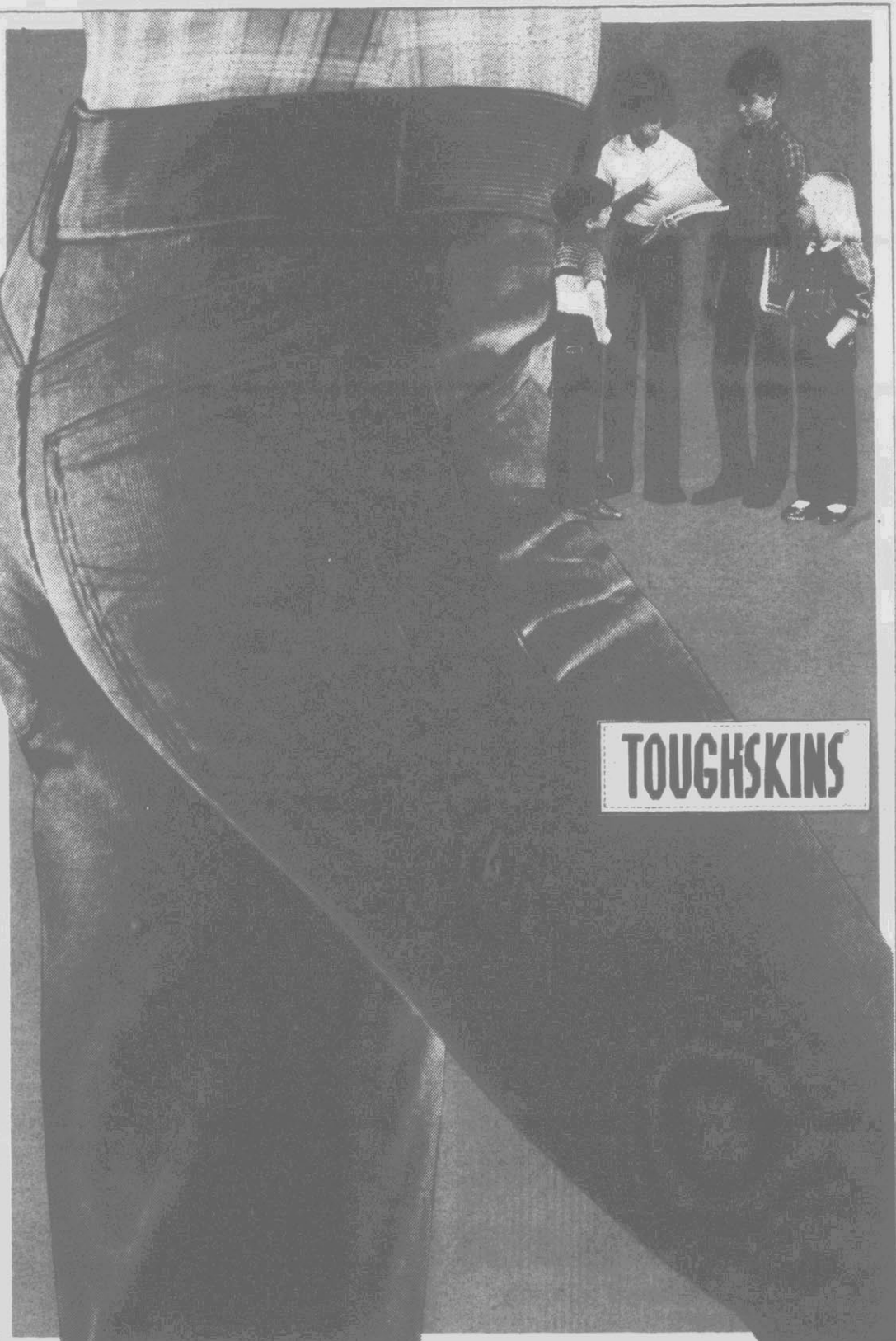
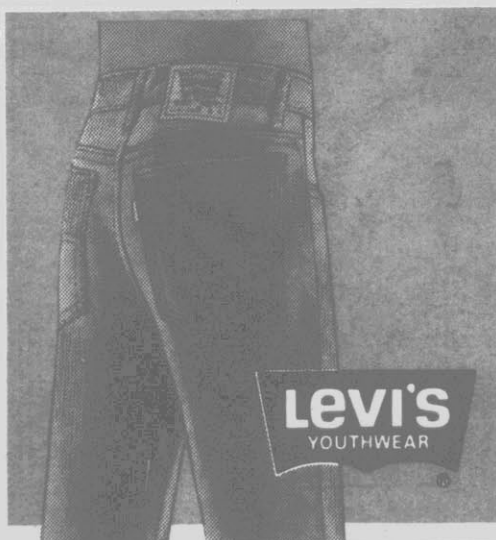

TOUGHSKINS

Levi's
YOUTHWEAR

SHOP YOUR NEAREST SEARS RETAIL STORE

NC: Burlington, Charlotte, (Eastland, Southpark), Concord, Durham, Fayetteville, Gastonia, Goldsboro, Greensboro, Greenville, Hickory, High Point, Jacksonville, Raleigh, Rocky Mount, Wilmington, Winston-Salem
SC: Charleston (Citadel, Northwoods), Columbia, Florence, Myrtle Beach, Rock Hill
VA: Danville, Lynchburg, Roanoke KY: Ashland
WV: Barboursville, Beckley, Bluefield, Charleston

Satisfaction guaranteed
or your money back

©Sears, Roebuck and Co., 1984

There's more for your life at
SEARS