

**Weather**

Partly cloudy tonight and Friday with a low near 40 and highs in upper 40s.

# THE DAILY REFLECTOR

**INSIDE READING**

Page 18 — Gene transfer  
Page 24 — Teamster boss  
Page 35 — Diary of death

TRUTH IN PREFERENCE TO FICTION

101ST YEAR NO. 300

GREENVILLE, N.C. THURSDAY AFTERNOON, DECEMBER 16, 1982

36 PAGES—3 SECTIONS PRICE 25 CENTS

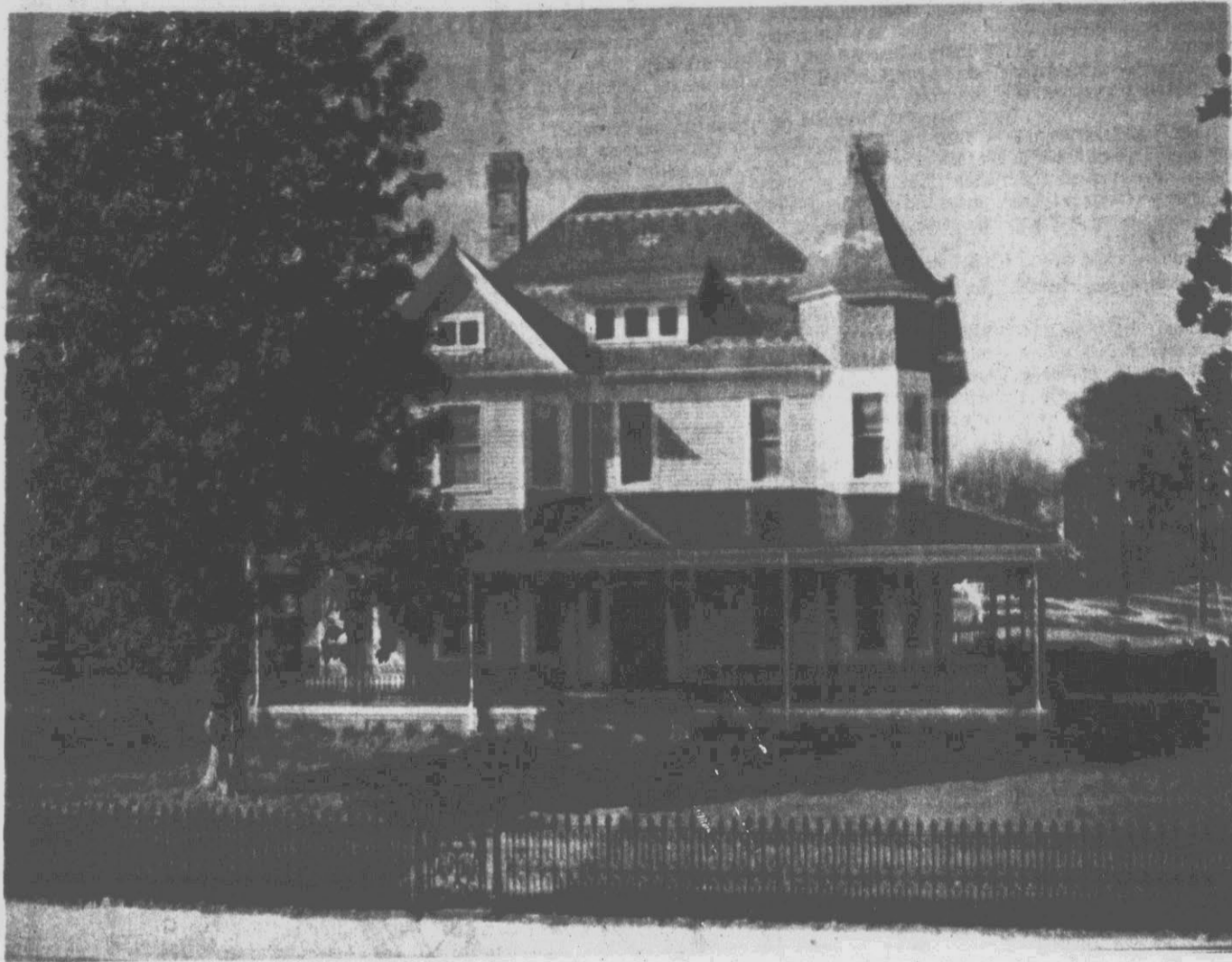

## Nearing A Vote On Filibuster

By CLIFF HAAS  
Associated Press Writer

WASHINGTON (AP) — The Senate is nearing a vote on a filibuster that has stalled action on two important measures — the gas tax bill and the emergency spending resolution needed to keep money flowing to the federal government after midnight Friday.

After two successive post-midnight sessions, Senate Republican leaders scheduled a vote today on shutting off a filibuster. The chamber also plans to take up amendments to the nickel-a-gallon gasoline tax hike, which is aimed at raising \$5.5 billion to finance highway and bridge and mass transit repair jobs.

Majority Leader Howard H. Baker Jr., R-Tenn., predicted today that even after the vote to choke off the filibuster, there will be "several hours of proceedings" before a final vote, involving action on what a Senate aide said were at least 100 amendments.

Final action on the measure would break a logjam in the Senate and allow consideration of the stopgap spending bill.

But even if Congress meets the Friday midnight deadline, President Reagan may veto the so-called continuing resolution. Reagan opposes jobs plans contained in the House-passed version of the measure, and in the Senate Appropriations Committee version.

The proposed boost in the gasoline tax, which has tied up Senate activity all week, also creates public works jobs, but Reagan has endorsed it.

In drafting the stopgap measure Wednesday, the Senate Appropriations Committee approved a \$1.2 billion jobs plan, compared to a \$5.4 billion Democratic package in the

House-passed measure. In addition, the panel rejected a \$9.100 Christmas pay raise for members of Congress that the House endorsed.

The committee's action also knocked out a 27 percent pay increase that would have gone into effect Friday if Congress had taken no action. The panel did this by reinstating the cap on congressional salaries at the existing \$60,662.50 a year.

By doing nothing, Congress could have let the existing cap on salaries expire Friday and thus triggered automatic increases of as much as 27 percent for members of Congress and senior executive-branch officials.

The pay raise provision — already approved by the House — would boost salaries for members of the House and Senate from an annual \$60,662.50 to \$69,800. There would be raises for other top-level government officials, including the vice president, Cabinet officers and top-level civil servants, as well.

But Sen. Ted Stevens, R-Alaska, said an informal head count showed the pay proposal was doomed in the full Senate. He proposed instead a compromise under which House members would receive the \$9,100 pay raise but senators would receive none — meaning different salaries for House and Senate members.

Stevens and he and other legislators said it was likely that House-Senate negotiators would go along with his proposal in their final version of the bill.

Although the Senate bill scaled down the House-passed jobs package, Sen. Mark O. Hatfield, R-Ore., the Appropriations Committee chairman, conceded, "The president does not support this."

## C-of-C Bldg. Dedicated

## Today Amid Ceremonies

## No Announcement, But Lech Walesa Detained

BY JANE WELBORN  
Reflector Staff Writer  
Garlanded with pine boughs and twinkling with Christmas lights, the newly restored Fleming House was unveiled to Pitt-Greenville Chamber of Commerce members this morning in a

dedication ceremony. Despite the rain, approximately 200 members attended the ceremonial opening of the chamber's new home at 302 S. Greene St. Special guests for the dedication service included James and Ellen Fleming,

Louise Fleming and Jean Winstead, all descendants of Sen. James Fleming, builder of the Victorian-style home. The house was built in 1901 and restoration took place from February until November this year. Speakers for the dedication ceremony included Bob Griffin, immediate past chairman of the Board of the chamber; Tommy Edwards,

past chairman of the board and chairman of the Restoration Committee; Charles Gaskins, chairman of the Pitt County Commissioners, and Ed Walker, president of the Pitt-Greenville Chamber of Commerce.

Greenville Mayor Percy Cox, speaking from the porch of the Fleming Home, said, "This building does not only benefit Greenville but also Pitt County and all of eastern North Carolina."

State Rep. Ed Warren commended all those involved in the restoration, saying, "This is an example of volunteerism at its best. It is true example of what we can do in the community."

Rep. Sam Bundy said the three elements needed for this restoration project were foresight, courage and money. He said that the new site of the chamber is an

honor to Sen. Fleming, who worked for the establishment of East Carolina Teacher's College and a chamber of commerce in Greenville.

In a dedication speech, Larkin Little, the chamber's current board chairman, thanked the corporations who contributed funds for the restoration of the rooms of the house. A watercolor depicting the Fleming Home by Greenville artist Bob Pittman was presented to each donor.

A ribbon stretching across the front porch was cut by Little, Cox, Gaskins, Bundy and Warren, officially opening the Fleming House as the new home of the Pitt-Greenville Chamber of Commerce.

The house will be open until 7 p.m. tonight for viewing by the general public.

By BRYAN BRUMLEY  
Associated Press Writer

GDANSK, Poland (AP) — Men in street clothes detained Lech Walesa today, driving him from his home in a black sedan hours before the labor leader was to deliver his first public address in more than a year of martial law.

Reporters at the scene assumed the four men in the car with Walesa were security agents, but it was not known where he was taken. Several hours later, the government had made no official announcement that the former head of the outlawed Solidarity labor union was detained.

Walesa was led from his apartment and driven away in a black Mercedes escorted

by another Mercedes. Both cars, which bore Warsaw license plates, appeared to be government vehicles.

An Associated Press reporter and photographer tried to follow the cars in their own vehicle, but were overtaken by a police car, stopped and questioned for 2½ hours. At least six other Western correspondents and more than a dozen of their Polish assistants and photographers were detained and questioned after they approached Walesa's apartment about a half-hour later.

Walesa, who was released in mid-November from 11 months' martial law imprisonment, had said he would speak today during a memorial service for Poles slain in

anti-government demonstrations in 1970 and 1981.

Walesa refused to appear before a Gdansk prosecutor Wednesday. At the time, sources had predicted he might be detained for 24 hours.

Gdansk, a traditional hotbed of labor unrest, appeared calm and there were no reports of demonstrations immediately after Walesa was detained.

The government had reinforced its Gdansk security forces on Wednesday in a show of force reminiscent of the first days of martial law — imposed Dec. 13, 1981, after 16 months of Solidarity-inspired strikes.

Thousands of uniformed police patrolled the city today.

**REFLECTOR**

### HOTLINE

752-1336



Hotline gets things done for you. Call 752-1336 and tell your problem or your sound-off or mail it to Hotline, The Daily Reflector, Box 1967, Greenville, N.C. 27834.

Because of the large numbers received, Hotline can answer and publish only those items considered most pertinent to our readers. Names must be given, but only initials will be used.

#### SUBSCRIPTION SCAM

Anyone who remembers being approached within the last six months by telephone about extending a subscription to Sports Illustrated Magazine is encouraged to check his or her credit card records and see whether there's billing for it.

The supposed extension is part of a fraudulent credit card bill scam, N.C. Attorney General Rufus Edmisten says. Time Inc., publisher of the nationally distributed magazine, denies any affiliation with the firms that were soliciting subscription extensions by telephone in "a complex, well-organized scheme of double, even triple, billings" on Visa and MasterCard accounts.

Telephone solicitors used a subscription list for Sports Illustrated, targeted those subscriptions with six or more months remaining, and offered three-year extensions plus a free subscription to another magazine.

The false charging scheme surfaced recently when cardholders reported double or triple billings on one or more monthly credit card statements. While duplicated billings were corrected by the card issuers, neither the banks nor their customers had any way of knowing that all subscription offers by these companies were bogus.

"When people began complaining to us, it soon became evident there was a pattern of fraudulent billing," Edmisten said about an investigation which disclosed that the multiple charges for subscriptions were made by various parties in several states who falsely implied that they represented Sports Illustrated.

On Nov. 10 a Tennessee court issued a permanent injunction and settlement judgment against J&B Associates, S&W Associates and 21st Century Advertising — all of Memphis. Included

(Please turn to Page 10)

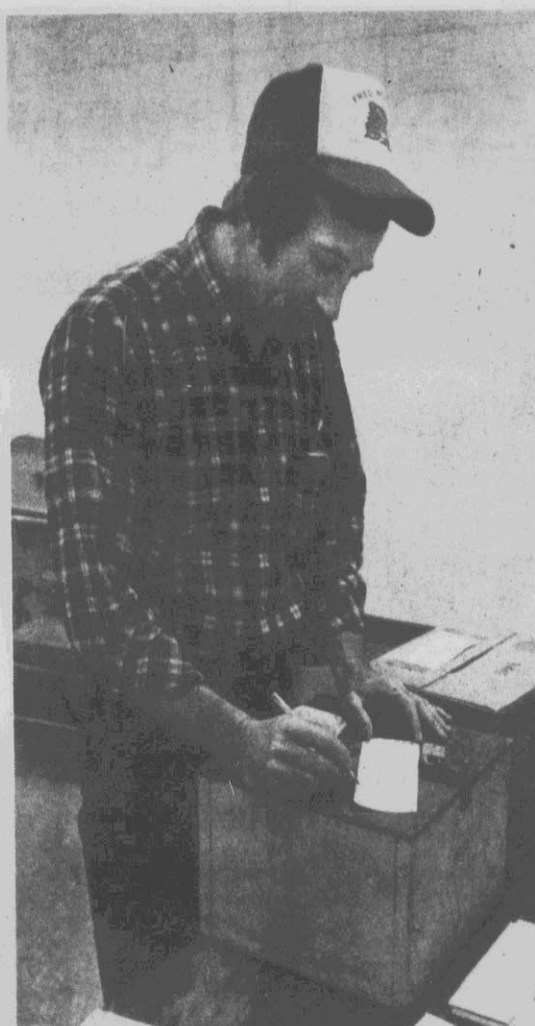

### Referendum Day

MARKS BALLOT ... Don Moya, a Route 6, Greenville, farmer, marks his ballot in voting today to determine whether acreage and poundage controls will be retained for flue-cured tobacco. Tobacco's price support program would be eliminated if the controls were voted down. Moya voted at the Staton House Fire Station on N.C. 11. Only four ballots had been cast at the station by 8:45 a.m. (Reflector photo by Tommy Forrest)

## Gunman Robs Bank in Grifton



GRIFTON — A gunman walked into the First Citizens Bank and Trust Co. office here late Wednesday afternoon, ordered a bag filled with cash, and walked out with between \$5,000 and \$10,000, investigators said.

The 4:30 p.m. holdup was conducted by a man armed with a "long barreled weapon," either a rifle or shotgun, Pitt County Sheriff Ralph Tyson said.

The sheriff said the robber ordered several employees to lie on the floor after announcing he was holding up the bank. He

then had cash from three teller stations placed in a bag, and walked out.

The robber was last seen headed north, away from the West Queen Street bank.

Tyson described the robber as a black man between 25 and 35 years old, and weighing between 160 and 180 pounds.

Cooperating in the investigation of the holdup are the Grifton Police Department, the Federal Bureau of Investigation, the State Bureau of Investigation and the Sheriff's Department.



IN CELEBRATION...of the publication of her new book, Martha Stewart, right, and a friend, Ruth Leserman of San Francisco chop mushrooms while preparing dishes for the celebration luncheon. (AP Laserphoto)

## Author Wants To Inspire

By DOLORES BARCLAY  
Associated Press Writer  
WESTPORT, Conn. (AP) — The air was peppered with calorie laden aromas. The woodiness of grilled eggplant collided with the husky fragrance of roasted oysters and drifted away in a smoky swirl filled with the essences of charcoaled leeks, scallions and mushrooms.

Martha Stewart was entertaining. This particular spread was to celebrate publication of her new book, "Entertaining," which details recipes and hints for cocktail parties, wedding feasts and holiday feasts.

Mrs. Stewart entertains a lot. And as head of her own catering firm, she cooks a lot. With passion.

"I do everything with passion," she said in the sitting room of her renovated 19th century house. "I am an artist, and whatever way I can do art, I do. My book is a record. Food is so ephemeral. You make it, it's gorgeous and you eat it."

"What I really want to do is really inspire people," she said. "I don't care if they follow my recipes to a tee—I just want to give them ideas."

She swept from the room to busy herself in another kitchen on the same floor, her cowboy boots clunking over creaking plank floors.

Copper pots dangled over a work counter where Mrs. Stewart's mother, Martha Kostyra, steamed cabbage pigoris. Baskets of every size wove a wicker ceiling over a low kitchen table where a glass bowl of fresh spinach glistened with salad dressing.

An iron wood-burning stove stood cold with assorted tin molds clustered on its flat top, but flames flickered in the brick fireplace nearby and Mrs. Stewart stoked a smaller blaze in the beehive oven in the brick wall, where she was to cook tiny pizzas.

"Martha's biggest claim to fame as a cook when she was young was when she brought the entire football team home for breakfast," her mother said. "There was burned bacon and the pans were really a mess."

The 41-year-old Mrs. Stewart worked her way through high school in Nutley, N.J., and later Barnard College as a model. She majored in art and art history, then became a stockbroker when she graduated.

"And that I did with a passion too," she said, beaming. "Seven years ago, I retired here to restore the house and I fell into the food business...."

"Julia Child was the greatest influence on my cooking," Mrs. Stewart said. "That was my cooking school and my inspiration."

Out back, in her new studio, about 40 guests were milling around counters laden with desserts in the new two-story building, un-mindful of Ruth Leserman, a friend and restaurant consultant from San Francisco who was cooking risotto with saffron and six kinds of wild mushrooms.

The guests, who came from as far away as Paris and California to help Mrs. Stewart launch her book, fairly attacked the pear tarts and the dark chocolate two-tiered old-fashioned devil's food cake.

Upstairs in a tiny kitchen with a 1930s decor, pies of hot

## At Wit's End

By Erma Bombeck



I overheard an interesting conversation between two airline stewardesses the other day.

"So, how did you find out he was married?" asked the first one.

"Look," she said, "when a guy uses a phone booth to change clothes instead of going home, you've got to figure he's either Superman or he's married."

"And?"

"He was no Superman," she said dryly. With the entire world planning a divorce, getting over one, living with someone or having a trial separation, I figured it must take a real pro

to figure out who's a matched set and who is open stock.

I couldn't help butting in. "Don't tell me you can't tell when a guy is married. There are a lot of ways."

"Name one," they said.

"Okay, when you go out to a romantic dinner by candlelight and he clears the plates and starts to take out the garbage, he's married."

"Not necessarily," said one. "Sometimes old habits are hard to break."

"All right, if he drives a car with 120,000 miles on it and a coloring book replacing a broken window and a car seat in the back, no doubt about it, he's married."

"Sometimes," said the other stewardess, "that's all he got from the divorce."

"What if he brings his lunch

to work and carries his coffee in a Donny Osmond thermos? If that isn't married, I don't know what is."

"Have you seen what you get with a one-room furnished apartment lately?"

"I wasn't ready to give up. How about a ring finger, that's tan except for a white band around it?"

"Some stop wearing their rings after the divorce."

"Wouldn't you get just a little suspicious if you saw him on the society page with a woman clinging to his arm with the same last name?"

The stewardess shrugged as she poured a cup of coffee. "Could be his sister-in-law."

"Look," I said. "Suppose you met this terrific guy on

the plane and you made arrangements to meet him for a drink that evening and you asked him to bring a friend for your roommate... and he brought his wife."

They both looked at me. "Now THAT'S Married!"

**Christmas Trees**  
Fresh N.C. Grown  
Available At  
**Little's Nursery**  
Highway 204 West of Greenville  
3 miles 756-3826

Aloe Vera Juice, Aloe Vera Skin Products And Non Surgical Face Lift  
**Eucalyptus Arthritis Relief**  
Call  
**A & B HAIR CARE & ELECTROLYSIS**  
222 Greenville Blvd.  
Bus. 756-0588 Greenville, N.C. Res. 756-1168

onion, roasted pepper and pumpkin simmered. Warm, newly baked breads with cranberries, cherries and raisins waited to be buttered.

She said she hoped that her 150 guests would get a feeling not only for her book, but for her food as well, by having her eating party spread out over the property she owns with her husband, Andrew.

Queen Marie Antoinette of France was beheaded in 1793.

For Christmas:

Handwoven Shawls etc.	Pottery Leather etc.
Cable Yarns 12:30-5:00 Daily	812 Dickinson Ave 752-0715

**NOW YOU CAN WRITE ON TIME**

A timely idea! Here's a stainless steel ballpoint pen with digital watch readout which features the hour, minute and second, and also gives the month and the date. The watch operates on a 1.5-volt silver oxide battery, which is included. Turn the barrel to open or close the pen, and push it in for the correct time and the date.

**Brody's**

reg. \$20.00  
Brody's Special Price  
**\$5.99**

Downtown Pitt Plaza

6 18 :27

Perfectly Beautiful,  
Beautifully Perfect.  
\$2,000

**LAUTARES JEWELERS**  
DIAMOND SPECIALISTS  
Registered Jewelers  
Certified Gemologists  
414 Evans Street  
We do not sell discount or promotional jewelry.

**Eastern Electrolysis**  
133 OAKMONT DRIVE, SUITE 6  
PHONE 756-4034, GREENVILLE, N.C.  
PERMANENT HAIR REMOVAL  
\*CERTIFIED ELECTROLOGIST

Wishing you all things rare and beautiful

**Brody's**  
Downtown Pitt Plaza

**Trunk Showing of 14 K. Gold**  
Thurs., Fri., & Sat.  
**45% - 65% off**  
On a huge selection of fine diamond cut 14 K. Gold Jewelry.

**We've Got Something For Everyone On Your List...**

Shop Downtown 10:00 a.m.-9:00 p.m.  
Pitt Plaza 10:00 a.m.-9:30 p.m.

✓ Mom-Princess Gardner Leather Checkbook Calculator	\$25 <sup>00</sup>
✓ Dad-Seiko or Pulsar Watch (20% off)	from \$63 <sup>60</sup>
✓ Susie-14K Gold Serpentine Bracelet	(Reg. \$15 <sup>99</sup> ) \$5 <sup>99</sup>
✓ Babysitter-Gold or Silver Fashion Earrings	(Reg. \$4 <sup>99</sup> -\$8 <sup>99</sup> ) \$2 <sup>49</sup> & \$3 <sup>99</sup>
✓ Secretary-Napier Gold Bangle Bracelet	(in gift box) \$18 <sup>00</sup>
✓ Grandma-Menorea Pearls (any length)	\$7 <sup>50</sup> -\$15 <sup>00</sup>
✓ Jennifer-Polo Gift Set	(Belt, Barrettes, Earrings) \$10 <sup>00</sup>
✓ Allison-Colored Fashion Earrings	\$5 <sup>00</sup> -\$6 <sup>00</sup>
✓ Girlfriend-Cubic Zirconia Earrings with free pendant	\$25 <sup>00</sup> -\$35 <sup>00</sup>
✓ Michael-Polo Leather Key Chain	\$7 <sup>50</sup>
✓ Debbie-Etienne Aigner Wallet	(all styles 20% off) Reg. 49 <sup>99</sup> \$39 <sup>60</sup>
✓ Lisa-16" 14K Gold Serpentine Chain	(Reg. \$32) \$16 <sup>99</sup>
✓ Mary-Genuine onyx, opal, tiger eye or jade ring	(Values to \$35) \$7 <sup>99</sup>
✓ Mrs. Jones-I know Brody's has something perfect for her, too. I think I'll stop by Brody's today.	

Come to Brody's for many other gift-giving ideas.



These are just a few selections in our large assortment of Italian chains, bracelets, charms, and earrings.

	Reg.	Sale
Floating Heart Charm	\$4.99	\$1 <sup>99</sup>
7" Serpentine Bracelet	\$15.00	\$5 <sup>99</sup>
Sanddollar Charm	\$16.00	\$5 <sup>95</sup>
Seashell Charm	\$12.00	\$5 <sup>95</sup>
Starfish Charm	\$12.00	\$5 <sup>95</sup>
16" Serpentine Chain	\$32.00	\$16 <sup>99</sup>
18" Serpentine Chain	\$45.00	\$18 <sup>99</sup>
Starfish Earrings	\$30.00	\$15 <sup>99</sup>
Shell Earrings	\$30.00	\$15 <sup>99</sup>

**14 K. Gold Add-A-Beads**

	Reg.	Sale
20" Serpentine Chain	\$47.00	\$24 <sup>99</sup>
24" Serpentine Chain	\$53.00	\$31 <sup>99</sup>
7" Cobra Bracelet	\$24.00	\$10 <sup>99</sup>
16" Cobra Chain	\$39.00	\$21 <sup>99</sup>
18" Cobra	\$45.00	\$23 <sup>99</sup>
24" Cobra	\$53.00	\$29 <sup>99</sup>
7" Herringbone Bracelet	\$38.00	\$19 <sup>99</sup>
16" Herringbone Chain	\$50.00	\$29 <sup>99</sup>
18" Herringbone Chain	\$60.00	\$35 <sup>99</sup>
20" Herringbone Chain	\$67.00	\$39 <sup>99</sup>

\*Heavier Pieces Shown At Pitt Plaza Only.

**Glamour Rings**  
Choose from hundreds of attractive rings with Genuine Opal, Jade, Tigers Eye, and other precious stones.  
Reg. 15.00 to 60.00  
Your Choice  
**\$7.99**  
Now Only

3mm ..... 49 37<sup>c</sup>  
4mm ..... 87 67<sup>c</sup>  
5mm ..... \$1.49 97<sup>c</sup>  
6mm ..... \$2.27 \$1.37  
7mm ..... \$2.49 \$1.47

Don't miss this opportunity to get those special Christmas gifts at great savings!

# Births

**Pope**  
Born to Mr. and Mrs. Perry Leon Pope, Parmele, a daughter, Tomika Larae, December 7 in Pitt County Memorial Hospital.

**Strickland**  
Born to Mr. and Phillip O'Ann Strickland, Bell Arthur, a daughter, Sarah Meagan, December 8 in Pitt County Memorial Hospital.

**Sauls**  
Born to Mr. and Mrs. Roland Dixon Sauls Jr., Farmville, a daughter, Lindsay Chapman, December 8 in Pitt County Memorial Hospital.

**Honeycutt**  
Born to Mr. and Mrs. Dennis Guy Honeycutt, Rt. 7, Greenville, a daughter, Crystal Nicole, December 9 in Pitt County Memorial Hospital.

**Gray**  
Born to Mr. and Mrs. James Lenton Gray, Grifton, a daughter, Jodie Kay, December 9 in Pitt County Memorial Hospital.

**Roberson**  
Born to Mr. and Mrs. William Wallace Roberson, Rt. 1, Robersonville, a daughter, Martha Lynn, December 9 in Pitt County Memorial Hospital.

**Smith**  
Born to Mr. and Mrs. Burnice Richard Smith, Winterville, a son, Andrew Richard, December 9 in Pitt County Memorial Hospital.

**Edwards**  
Born to Dr. and Mrs. Zeno Edwards III, Washington, N.C., a daughter, Robin Casey, on Dec. 11, 1982, in Beaufort County Hospital. Mrs. Edwards is the former Robin Braxton of Ayden.

Dear Abby



## If Santa Doesn't Exist, World's In Trouble

By Abigail Van Buren

DEAR ABBY: Many years ago when your column appeared in the now defunct New York Mirror, a 6-year-old girl named Virginia wrote to you, saying that her friends told her there was no Santa Claus.

Your oft-quoted response was beautiful. Will you please run it again?

E.G.J., DOVER, DEL.

DEAR E.G.J.: To set the record straight, the child was 8, not 6, and the column did not appear in the now defunct New York Mirror — it appeared in the now defunct New York Sun. The letter was not addressed to me, it was addressed to the editor. And the beautiful response was written by Francis P. Church in 1897!

It is a famous, well-loved classic, but has never appeared in my column. And here it is:

"Dear Editor:  
"I am 8 years old.  
"Some of my little friends say there is no Santa Claus.  
"Papa says, 'If you see it in *The Sun*, it's so.'  
"Please tell me the truth. Is there a Santa Claus?  
— Virginia O'Hanlon, 115 West 95th Street"

"Dear Virginia: Your little friends are wrong. They have been affected by the skepticism of a skeptical age. They do not believe except what they see. They think that nothing can be which is not comprehensible by their little minds. All minds, Virginia, whether they be men's or children's, are little.

"In this great universe of our man is a mere insect, an ant, in his intellect, as compared with the boundless world about him, as measured by the intelligence capable of grasping the whole of truth and knowledge.

"Yes, Virginia, there is a Santa Claus. He exists as certainly as love and generosity and devotion exist, and you know that they abound and give to your life its highest beauty and joy. Alas! How dreary would be the world if there were no Santa Claus! It would be as dreary as if there were no Virginias.

"There would be no childlike faith then, no poetry, no romance to make tolerable this existence. We should have no enjoyment, except in sense and sight. The eternal light with which childhood fills the world would be extinguished.

"Not believe in fairies! You might as well not believe in fairies! You might get your papa to hire men to watch in all the chimneys on Christmas Eve to catch Santa Claus, but even if they did not see Santa Claus coming down, what would that prove? Nobody sees Santa Claus, but that is no sign that there is no Santa Claus.

"The most real things in the world are those that neither children nor men can see. Did you ever see fairies dancing on the lawn? Of course not, but that's no proof that they are not there. Nobody can conceive or imagine all the wonders there are unseen and unseeable in the world.

"You tear apart the baby's rattle and see what makes the noise inside, but there is a veil covering the unseen world which not the strongest man, nor even the united strength of all the strongest men that ever lived, could tear apart.

"Only faith, fancy, poetry, love, romance, can push aside that curtain and view and picture the supernal beauty and glory beyond. Is it all real? Ah, Virginia, in all this world there is nothing else real and abiding.

"No Santa Claus! Thank God he lives, and he lives

forever. A thousand years from now, Virginia, nay, 10 times 10,000 years from now, he will continue to make glad the heart of childhood."

DEAR ABBY: I'm nearly 30 and want to get married. I met Junior in 1972, got engaged in 1973 and set a wedding date, but five weeks before the wedding Junior canceled out. He said he wasn't ready.

We went together for six more years and it was one excuse after another. We work for the same company but at different locations. Junior travels for the company. One day he came to see me and a front tooth was missing! (He said he walked into a door.)

Later, company records passed through my hands and I discovered his tooth had been knocked out by a girl named Gloria who works in his office. (They were playing ball.) I went to see her to find out what my competition looked like. She was a pretty, young widow.

I told her I was engaged to Junior, and she said so was she. She had a ring, but it wasn't as big as mine. They had been engaged for three years!

Gloria broke her engagement to Junior, and so did I. Now he's been camping on my doorstep saying that he loves me and wants to marry me. He's begging me to set another date. He even cried. He's the only man I've ever loved. What should I do?

A FOOL IN LOVE

DEAR FOOL: If you want a husband who can't be trusted out of your sight, marry Junior.

### CORRECTION

On Page 8 Of The Sears Wrap Up A Beautiful Christmas Sale Section In Wednesdays Newspaper The No. 99601 Microwave And No. 99221 Microwave Is Not Available. Rain-checks Will Be Issued.

Sears, Roebuck & Co. Greenville, N.C.

### Home Decorating Winners Named

The fourth annual home decorating contest was held by the Cherry Oaks Home and Garden Club Monday evening.

Winners are Mr. and Mrs. Logan Whitehurst, best overall decoration; Mr. and Mrs. J. Larkin Little, best traditional decoration; Mr. and Mrs. Warren Charlton, best novelty decoration.

## Gold & Silver UP!



We Are Paying Higher Prices NOW!

Special Bonus On Silver Dollars And Silver Coins.

Also Buying Name Brand China & Crystal

### GIFT SUGGESTIONS

We have hundreds of beautiful estate pieces in crystal, porcelain, etc. and beautiful estate diamonds.

## THE CHINA CONNECTION

Another Service Of

**COIN & RING MAN**  
OF KEY SALES CO., INC.

401 South Evans ST. 752-3866

OPEN 9:30 A.M. TO 5:30 P.M. MONDAY THRU SATURDAY

"YOUR PROFESSIONAL BUYING SERVICE"

**Belk Tyler**  
carolina east mall greenville

CAROLINA EAST MALL, GREENVILLE

# budget store

**Ladies' Knit Gloves**  
**2.88**  
Special Purchase  
Slightly irregular gloves with vinyl palms. Lots of colors now!

**Ladies' Irregular Bras**  
**3.88**  
If Perfect Values Up to \$10  
Famous maker bras at a low price! White, nude and other fashion colors.

**Junior Sweaters at a Big \$3 Savings!**  
**12.97**  
Everyday Low Price .....  
100% cotton, crew neck, plain. Navy, red, green. Sizes S,M,L.

**Misses' Wool Blend Sweaters at \$2 Off!**  
**10.88**  
Regular 12.97 .....  
Crew and V-neck sweaters of 70% acrylic/30% wool. Grey, navy, kelly, red, tan and pink. Sizes S, M, L. Save!

**Ladies' Argyle Knee Socks**  
**97¢**  
Limited Amount and Sizes  
Popular argyle styles. Slightly irregular. One size fits 9 to 11.

**Misses' Wool Blend Skirts**  
**12.88**  
Special Value  
Polyester/wool in dirndl, back-wrap and more. Sizes 8 to 18.

**Ladies' Sweater Leg Tights**  
**3.88**  
If Perfect \$7  
Irregular but a great value! Perfect for cold weather!

**Excellent Buys on Ladies' Coordinates by Ricki**  
Everyday Low Price  
**12.97** and **14.97**  
Jackets, sweat shirts and pants in navy and purple.

**Men's & Ladies' Jeans at Super Savings!**  
Regular 11.97 to 19.97 ..... **Up to 20% OFF**  
Entire stock of ladies' jeans. Jr. and misses' sizes. Men's corduroy jeans in boot-cut style. Sizes 30 to 42. Save!

**Men's Oxford Dress Shirts**  
Everyday Low Price  
**11.97**  
65% polyester/35% cotton shirts in white, pastels. Sizes 14 1/2 to 17.

**Brody's**  
DOWNTOWN  
Open tonight until 9:00 p.m. for your shopping convenience

**Holiday Savings!**  
Save 20% - 50%

Large Group Of Transitional Sportswear .....	50%
J.G. Hook Shirts (Values to \$44-Now \$22) .....	50%
Group Of Sweaters .....	30%
Group Of Blouses .....	30%
Group Of Dresses .....	20 - 30%

**Fall & Winter Sportswear**  
J.G. Hook Stanley Blacker Jones New York Prophecy Samuel Robert Ultra-Suede..... **20%**  
(Offer Good on Cash or Check Purchases Only!)

**Susan's**  
331 Arlington Blvd.  
10-6 Mon.-Sat. 756-5844

Shop Monday through Saturday 10 a.m. Until 10 p.m.— Phone 756-B-E-L-K (756-2355)

# Preserving The Past

The historic Fleming House, at Third and Greene streets, was formally opened today with an open house which showed off the unique project to the community.

It is something of which to be proud.

The restoration work took 10 months and cost \$233,000. Needless to say this is not just a matter of repainting an old house and moving offices into it. The 80-year-old former dwelling of Sen. and Mrs. James Fleming was completely restored with siding removed to install insulation and replacement of the expensive slate roof. Inside the various rooms of the house have been extensively redecorated and adapted to office use, while maintaining as much of the original trimming as possible.

Use of the house is particularly significant since the chamber was

begun when Fleming called together area business leaders to discuss obtaining the funds for the establishment of what has become East Carolina University. Chamber President Ed Walker, a leader of the project, says this is the first mention found of a chamber here. The house is also expected to be designated a National Historic Site.

The renovation is within \$30,000 of being paid for thanks to contributions by local businesses and individuals. Tommy Edwards was chairman of the restoration committee.

Greenville, Pitt County, ECU and the Pitt-Greenville Chamber of Commerce have all undergone extensive changes since 1902. Our past is important, however, and the chamber with solid community support, has done something significant in preserving an important part of our past.

# SO QUIET-- YOU WONDER IF ANYONE'S HOME!



MORRIS

## SOCIAL SECURITY

# No Progress By Panel

By MARGARET SCHERF  
Associated Press Writer  
WASHINGTON (AP) — Unless President Reagan and House Speaker Thomas P. O'Neill come up with a suggestion on how to save the Social Security system, the commission studying the problem may cancel its last scheduled meeting Friday.

"If I conclude no progress is possible, it would be best we not meet further," the commission chairman, Alan Greenspan, told the National Press Club Wednesday. "What's required is to go to the next step of decision-making."

That step, he said, will have to be taken by top aides to the president and speaker. So far, Reagan and the Massachusetts Democrat have shown no inclination to budge in one another's direction.

However, White House of-

ficials said Reagan's aides had been meeting privately with commission members and among themselves to try to decide what the administration should tell the deadlocked National Commission on Social Security Reform.

Rep. Claude Pepper, D-Fla., a member of the commission, told a reporter he believed little could be accomplished by a meeting Friday.

And Robert Ball, another member generally regarded as a point man for O'Neill on the commission, said he thought there was a 50-50 chance the meeting would be canceled.

Although the commission had scheduled its last meeting Friday, it has until Dec. 31 to come up with a report on how to save the retirement system from bankruptcy. That report is eagerly awaited by Congress because unless financing legislation is enacted, it is estimated benefit funds could run out by next July.

Greenspan said the commission has "gone as far as we can, we have yet to decide precisely what we will publish" as a report. But there definitely will be a report, he said.

Reagan has asserted he is "not scared to touch the issue" but that he wants to make no proposals until the commission issues its report. And O'Neill has said he has no desire to join Reagan in any agreement at this time, although he would be "glad to go over" to the White

House if asked.

Greenspan said that even if the commission cancels its Friday meeting, "we really have made progress. ... A number of ideas on both sides have dropped by the wayside to seek a more central, unified point of view."

He added: "Nobody is talking about cutting short-term benefits. Nobody is talking about solutions outside payroll tax acceleration and COLA (cost-of-living adjustment) changes."

The disagreement is over which should be emphasized. Republicans generally want to lower cost-of-living raises and Democrats want to move up already-scheduled tax increases. Each side is waiting for word from its leader — Reagan or O'Neill — on what to insist on and where to give ground.

Dropped ideas include making the system more voluntary or directly infusing general revenues into it, Greenspan said.

He also pointed to agreement on the size of the problem — up to \$200 billion by 1990 and a long-term deficit of 1.8 percent of taxable payroll — and to a general consensus on bringing new federal workers into the system.

"I don't think progress will be wiped out if we don't go the final step" in spelling out exactly how to make up the shortfall, he said. That has to be done by Congress, Greenspan pointed out, adding that "my view is they will eventually get together."

# Rules For A Non-Shopper

By HUGH A. MULLIGAN  
AP Special Correspondent  
RIDGEFIELD, Conn. (AP) — In these cost-conscious times is it possible to keep Christmas spending under control and build up an immunity to low sales resistance?

We get lots of questions like that here at Hardscrabble House, where in the holiday season the bonhomie flows like bourbon and sometimes is.

The answer is what we specialists in consumer caution call a qualified yes. The qualification being just how determined the shopper really is to keep the old wallet in as tightly zipped a configuration as the traditional generosity of the season will allow.

Firstly, unaccompanied, having life's helpmate along only doubles and sometimes cubes the chances of falling victim to a gifted sales pitch or an attractive counter display. If he or she insists on coming along, there are certain precautions which if reasonably observed can result in reduced holiday deficit spending.

Begin by sallying forth when the stores are closed. Window shopping may make the heart grow fonder for material goods flecked with tinsel and artificial snow but it also inflames the metatarsals and quickly wears down the keeper of the family gift list. When the time comes to do the inevitable purchasing, always pick the busiest store hours, particular just before closing. The combination of lines at the cash register and short-tempered shop assistants can kill many a sale right in the end zone. Overheated department stores, crowded with aggressive overwrought purchasers, may often result in your partner's coming to the delightfully solvent conclusion that "maybe we'd get by just sending them a card ... or one of my fruitcakes ... or just calling them long distance during the holidays."

To assist you when the crunch comes, and your

helpmate seems to be at the lowest ebb of sales resistance, here are a few market-tested buzz words designed to make the salespeople buzz off:

- Stripes (or checks, tweeds, solid colors, etc.) tend to make you look old (fat, thin, washed out), dear.
- Too bad it doesn't go with our decor.
- The Simpsons have one just like it, and I always thought it a trifle bourgeois.
- That's your size, all right, but somehow it's not the real you.
- Great, but let's wait until the after-Christmas sales when the price is bound to be almost half.
- I've seen them advertised on television \$20 cheaper. There's an 800 number you call.
- Isn't our house noisy enough and how often will the children play with it?
- There was a guy with a pushcart in front of our building selling the same brand name for a third as much.
- You're just not a hat (fur, bracelet, cufflink, earring) person.
- It will dominate our room.
- I'd liked the other one better; too bad they didn't have your size.
- Quite a lot of money to pay for a book (album, magazine) that's probably available on loan right now at the library.
- They may call it Valley Girls; I call it the pits.
- The catch is you have to assemble it yourself.
- Aren't our electric bills high enough now?
- O.K., if you can't live without it, but there goes our summer vacation (new dish washer, tennis lessons, braces for Amy, winter cruise, etc.).
- Buy them that and we'll never see any homework done around the place.
- You know Josh isn't old enough yet for a dog (violin, surf board, 10-speed bike, home bar tender's kit, karate lessons, home computer).
- Take off a dozen more

(Please Turn To Page 5)

# U.S. 264 Project Progressing

While nothing is absolutely certain in the world of highway construction, N.C. Secretary of Transportation W.R. "Bill" Roberson feels the U.S. 264 improvements from Wilson to Washington will be done.

That is, of course, dependent upon the Legislature next year finding additional funds to keep the state's entire highway construction program moving. The federal 5 cents

per gallon tax will help, although that will not speed up the U.S. 264 construction schedule.

Right of way acquisition is now moving along and the first phase of the projects should be put out for bids in this fiscal year.

It is good news that the project is progressing. We cannot emphasize enough how important the project is economically to Pitt and other counties along its way.

## THIS AFTERNOON

# Medication Vital

By PAUL T. O'CONNOR  
RALEIGH — Last August, Raleigh police were called to the home of a mental patient who was creating a disturbance. One officer entered the man's home, was attacked by the patient and killed him with his service revolver. The next day it was revealed that the patient had not been taking the psychotropic drugs prescribed to him for the symptoms of his mental illness.

Across the country and in North Carolina, mental hospitals are housing fewer and fewer patients. Instead, patients are being treated with psychotropic drugs and released into the community. Doctors prescribe medicine for these patients to take on an outpatient basis and most take the drugs. It allows them to live near-normal lives with their families.

But there are cases like that in Raleigh in which the patient doesn't take his medicine. Many of them end up in the headlines. Patients who are fine when taking their drugs become raging lunatics without them. Many times they commit dreadful crimes.

The drugs have allowed the state to reduce its population of mental hospital patients by 75 percent in the last 25 years. The proposed closing of Dorothea Dix Hospital in Raleigh is directly tied to decreased demand due to these drugs and the "deinstitutionalized" care which they allow. But the public is concerned that

mental patients who are on the streets can become dangerous when they stop taking their medication.

Why do patients stop taking the drugs? Dr. Gene Douglas, director of the state Division of Mental Health, says there are several reasons. Some tire of the



PAUL T. O'CONNOR

drugs' unpleasant side effects — dry mouth, blurred vision, muscle stiffness and tremors. Some patients incorrectly assume that they're all better and don't need the medicine anymore. Some don't care if they get better and some are so paranoid they think the doctors are trying to hurt them with the drugs.

The N.C. Mental Health Study Commission thinks the legislature should tighten up the laws concerning mental patients who've been released for deinstitutionalized care. As the law reads now, a patient can't be admitted to a

hospital unless he's considered dangerous. Once in the hospital, he can be treated with the drugs but then must be released once they do their job. Since the drugs don't cure mental illness, but only help alleviate the symptoms, his problems will return if he stops taking his medication.

The courts can't force him to take his drugs — even if relatively certain he'll become dangerous without them. All they can do is send him back to the hospital after he's dangerous again. If he's

(Please Turn To Page 5)

However, White House of-

# Public Forum

Letters submitted for Public Forum should be limited to 300 words. The editor reserves the right to edit longer letters

To the editor:

Speaking on behalf of the 450 members of the audience in Wright Auditorium last Sunday afternoon, I would like to voice my sincere congratulations to the Greenville Choral Society and the Greenville Chamber Players for a truly enjoyable musical afternoon. My only regret is that more hearty souls did not brave the cold to witness this memorable Christmas concert.

Sunday's choral treat ranged from the magnificently rendered "Hodie Christus Natus est" by Gabrieli to such traditional carols as "He Is Born" and "The Holly and the Ivy." Under Dr. Fleming's direction, this amateur singing group achieved a musical excellence that only a few professional choruses ever attain. Each member of the Greenville Choral Society should be rightly proud to belong to such an organization.

An additional musical treat was afforded by the Greenville Chamber Players. Both of their numbers were impressively rendered. This group of young musicians featured Amy Moore, Andrea Bath and Jennifer Lucht in their Corelli concerto number; and these three young soloists were both charming and professional. It is hoped that this young group of musicians will continue to favor us with more such appearances.

Another Christmas surprise was the performance by the Women's Ensemble — a "note-worthy" spinoff of chorus members. Their selections were also seasonal and artfully performed.

A Christmas Concert will always be remembered as a choral masterpiece — a fitting Christmas dessert to the masterful Beethoven Ninth just a few weeks ago. Sunday's concert was superbly staged and directed by Dr. Rhonda Fleming — ably assisted by Ms. Candice Dixon, conductor of the Chamber players, and Ms. Carolyn Ippock, director of the skillful Ensemble Singers.

Again, our congratulations — and thanks — for a truly enjoyable musical memory. We are all looking forward to other such concerts in the future.

Arch Manning  
1040 E. Rock Springs Rd.  
Greenville

# Quotes

"Fields are won by those who believe in the winning."  
— Thomas Wentworth

"Advertisements are the most interesting and difficult of modern literary forms."  
— Aldous Huxley

"They who are of the opinion that money will do everything may very well be expected to do everything for money."  
— Lord Halifax

"Fools and wise men are equally harmless. It is the half-fools and half-wise men that are dangerous."  
— Goethe

# Strength For Today

## TRUE UNITY

We hear a great deal today about the necessity for church unity. This is all to the good if it means a greater spirit of unity among Christians. But it is something by no means as commendable if it means merely bigger and more complicated ecclesiastical machinery.

Jesus prayed that those who believed in him would be one, even as he and the Father are one. The unity we must aim for throughout the Christian world is the unity of men for whom there is indeed one Lord, one faith,

one baptism. The ecclesiastical differences between us fade into insignificance when we confront the fact that we and other varieties of Christians follow the same Lord.

Let us have church unity. Let every movement be supported which will heal divisions in the body of Christ and bring his followers closer together. But let us remember that real unity is spiritual unity.

It must all start there, no matter what it may result in later. — Elisha Douglass

# A Simple Answer For Problems

By JACK A. SEAMONDS  
Associated Press Writer  
BOWLING GREEN, Ohio (AP) — A.R. Chowdhury has a simple answer for solving the problems of American business — fire most managers.

Chowdhury, a professor of manufacturing technology at Bowling Green State University, says most industries are guided by people ignorant of science and technology, abrasive or apathetic toward blue-collar workers, obsessed with short-term profits and slow to invest in modernization.

"It's insane to believe you can create jobs, increase productivity and compete in the world markets under such conditions," says Chowdhury, chairman of Bowling Green's business technology program.

His harshest criticism is directed at the holders of master's degrees in business administration who have flooded into corporate leadership over the last decade.

"MBAs are ruining business in this country," he says. "They think only in terms of grabbing a profit today and not what business is going to be like tomorrow."

"Most managers and corporate leaders, the decision makers, are technologically illiterate. They don't understand science and engineering and don't try to. As long as they have that 2 percent profit or 3 percent profit coming in, they're happy."

"Meanwhile, problems continue to build up. And they are problems that are going to cripple this country from competing with others in the future."

Chowdhury, who formed his opinions after taking students on field trips to about 50 factories across Ohio, says he is convinced American business can regain its strength, but it will require changes in management attitudes.

"There is a feeling among white-collar workers that blue-collar workers are beneath them, that they are ignorant, uninformed, not motivated," he says. "But here are people with 20 years of experience and more who could help management solve problems — but they are generally ignored. How can you promote quality and productivity when people are not motivated?"

ment, he says, blue-collar workers go to work and collect a paycheck but have little interest in their jobs.

Most corporate chief executives are lawyers, accountants, managers or economists, Chowdhury says. "They are good at what they do, but these disciplines have been overemphasized. One reason that business is overregulated today is that there are so many lawyers in this country."

Though America remains a world power and an international competitor in most markets, the nation's position in world trade will continue to slip, he says.

"We're drowning in resources, natural resources, human resources, economic resources that are not being used effectively," Chowdhury says. "When you look at what other countries are doing with what little they have — Japan, Korea, Taiwan, Brazil, Argentina — we are lagging behind."

Chowdhury also scorns campaigns to encourage consumers to "Buy American," calling them farces.

"Buy American? Why should they if America can't produce a quality product?"

he asks. "People say to me that I'm not patriotic. That's ignoring the issue, unless you merely want to manipulate the consumer."

Ways to revitalize industry are fairly simple, Chowdhury says.

"Involve people. Get the blue-collar worker interested in his job, involved in the decision making, and productivity will be improved," Chowdhury says. "When people are led intelligently and with sincere consideration, you don't need layers of bureaucracy to solve problems that shouldn't come up in the first place."

Second, industry must modernize, retrain workers to employ new skills to boost productivity. "We must do more, with less," Chowdhury says.

Third, there must be regulation of business at the federal and state levels to encourage the new investment necessary to stimulate growth.

"Many regulatory activities seem designed more to perpetuate the agencies more than protect the worker or the environment," Chowdhury says. "The small businessman can't compete."

# The Daily Reflector

## INCORPORATED

209 Cotanche Street, Greenville, N.C. 27834

Established 1882

Published Monday Through Friday Afternoon and Sunday Morning

DAVID JULIAN WHICHARD, Chairman of the Board

JOHN S. WHICHARD — DAVID J. WHICHARD

Publishers

Second Class Postage Paid at Greenville, N.C. (USPS 145-400)



## SUBSCRIPTION RATES

Payable in Advance  
Home Delivery By Carrier or Motor Route Monthly \$4.00

## MAIL RATES

(Prices include tax where applicable)  
Pitt And Adjoining Counties \$4.00 Per Month

Elsewhere in North Carolina \$4.35 Per Month

Outside North Carolina \$5.50 Per Month

## MEMBER OF ASSOCIATED PRESS

The Associated Press is exclusively entitled to use for publication all news dispatches credited to it or not otherwise credited to this paper and also the local news published herein. All rights of publications of special dispatches here are also reserved.

## UNITED PRESS INTERNATIONAL

Advertising rates and deadlines available upon request.

Member Audit Bureau of Circulation.

**O'Connor Col. . . .**  
(Continued From Page 4)

not yet dangerous, he's a ticking time bomb so long as he refuses to take his medicine. The commission wants to give the courts the authority to order an outpatient to take his medication. Under the proposal, the patient could be brought before a district court judge after his family or his physician became concerned that he wasn't taking the drugs. The judge could then order him to take those drugs. It is hoped that the aura of the courtroom will impress on these people their need to take the medicine. If it doesn't work, the judge would have the ultimate power to cite the patient for contempt of court. Lynn Gunn, staff assistant for the commission, says about 500 outpatients will be affected annually. The idea isn't to throw them into jail, she hopes that happens with few people; but to scare them into taking the medicine. These people are not criminals, she says. Like most of us, they respect the courts and will be very impressed with the power of the judge.

**Mulligan...**

(Continued from Page 4)

pounds and that will look super on you.

—I'm sold, but for the same price we could make a down payment on a new car (toaster, bedroom set, college education, color TV, rumpus room addition, case of Bordeaux).

—The style is a bit old-fashioned for someone who has remained as youthful as you.

—It's a lot of money to pay for a gift that soon will be eaten (smoked, swallowed, sprinkled, sprayed).

—When the wine salesman asked if this bottle was for laying down, I almost fell over.

—Well it's time your brother began wearing ties.

—Whatever you say, dear, but they didn't give us anything near that expensive last year.

—Too bad they don't take personal checks here.

—I know a guy who can get it for us wholesale.

—That bell means five minutes to closing time, let's beat the crowd out of here.

**Study Cause Of 3 Drownings**

SAN ANTONIO, Texas (AP) — The U.S. Attorney's office is studying the drownings of three black teen-agers while they were in police custody to determine if the youths' civil rights had been violated. Anthony Freeman, 18, and Steven Booker and Carl Baker, both 19, were arrested June 19 for possession of a small amount of marijuana and were being taken from an island in Lake Mexia when the boat they were in capsized. Three officers made it safely to shore. The officers were acquitted of state charges of negligent homicide, and U.S. Attorney Edward Prado said Wednesday he was studying records in the case to determine if there were civil rights violations.

**CHURCH BENEFIT**  
New Hope House of Prayer Holiness Church, 304 Brown St., will observe its regular services Sunday at noon. The choral groups Glory Light One and Glory Light Two will present a program at 2 p.m. to benefit the church fund.

**RENTAL TOOL CO.**

RENT IT HERE

We Rent

- Floor Sanders
- Floor Polishers
- Carpet Tools

**RENTAL TOOL CO.**  
Across From Healing Ford  
3014-A. E. 10th St.  
Dial 756-0311

**Belk Tyler**  
carolina east mall greenville

**NOW THRU SATURDAY**



**pre christmas Sale**



**Super Savings On Hanes® Winteralls® While They Last**  
**3.88**  
Regular 4.50

Large selection of cotton/nylon Winteralls® available in brown, wine, navy, grey, ivory, black colors. A-B, C-D, queen sizes. Pantyhose and panties all in one.



**Big \$6 Savings On LEVI'S® Bend Over® Pants For Her!**  
**21.88**  
Originally 28.00

Group of 100% polyester gabardine stretch pants in a variety of colors. Ladies' sizes 6 to 20.

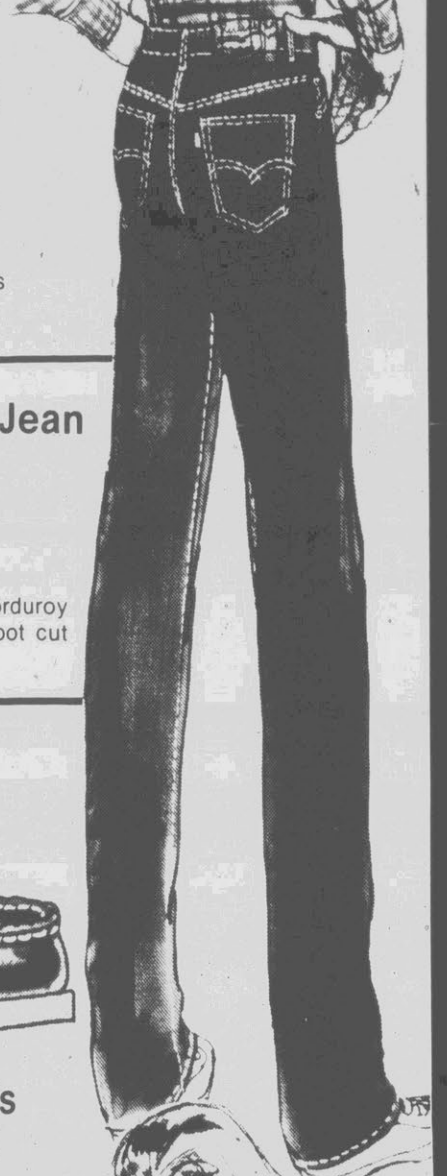

**Sale! Men's & Boys' Jean**  
**12.88**  
Reg. 15.88

Large selection of LEVI'S® cotton corduroy and denim jeans. Straight leg, and boot cut styles. Sizes 8 to 14, 25 to 30, 27 to 42.

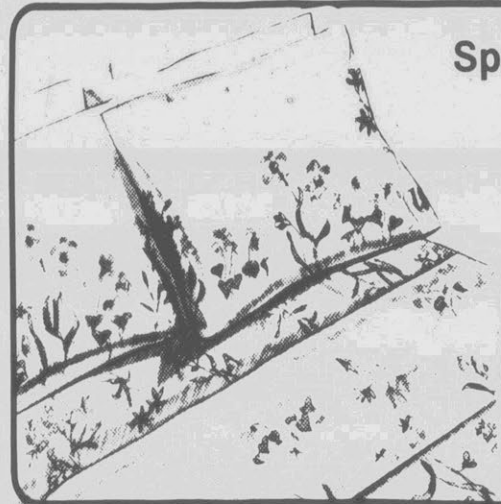

**Springmaid® Sheets Up To 10.00 Off!**  
**4.88 to 16.88**  
Reg. \$8 to \$27

'Summer Breeze', 'Bonaire' and 'Palace Garden' sheets in all sizes. Nice gift!

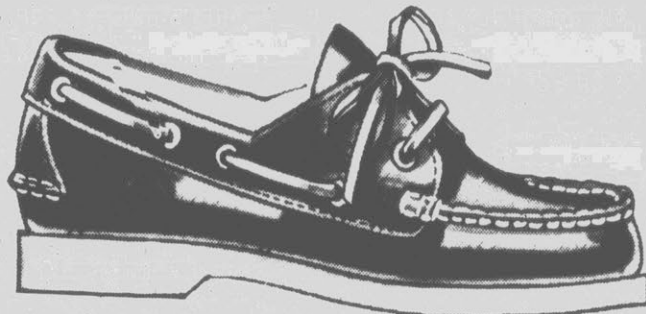

**Over 7.00 Off On Men's Leather Deck Shoes!**  
**24.88**  
Regular 32.00

Brown leather deck shoes with a white non-skid boating sole. Sizes 7 1/2 to 11. Hurry while prices are right and save!



**Ladies' Leather Blazers & Jackets Reduced \$40!**  
**99.88**  
Regular 140.00

Large selection of Nova Cosa® genuine leather blazers and jackets. Fully lined. Short and long styles. Sizes 8 to 16. Burgundy, black and more.



**Sweaters For Men At A Big 6.00 Savings!**  
**17.88**  
Reg. 24.00

Shetland wool sweaters with crew neck styling, gathered waistband and set-in raglan sleeves. Sizes S, M, L, XL.

**Up To 8.00 Off Sweater Vests And Sweaters!**  
YOUR CHOICE  
**15.88**  
Reg. \$22 and \$24

Large assortment of 100% acrylic cardigan sweater vests and sweaters. Your choice of cable stitch or popcorn stitch. Sizes S, M, L, XL. Nice gift!

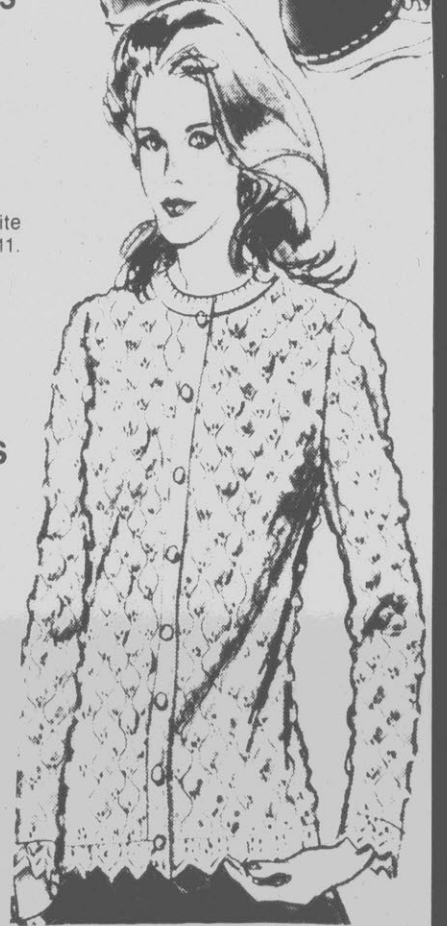

**Ladies' House Boots 21% Off!**  
Acrylic lined boots with vinyl bottom in sizes 5 to 10. Four colors. Regular 10.00. **7.88**

**Danskin® Dancewear for Ladies**  
Tights and leotards in sizes S, M, L. Hurry! Reg. 6.50 to 22.00. **25% Off**

**Heiress® Knee Socks For Her!**  
Acrylic/nylon cable knit socks in five colors. Regular 1.85. **2 for 2.88**

**Heiress® Argyle Knee-Hi Socks**  
Acrylic/nylon argyle socks available in 7 color combinations. Stock up! Regular 3.25. **2.88**

**Save 7.00 On Ladies' Gloves!**  
Fownes® genuine leather gloves with an Antron® lining. Sizes 6 1/2 to 8. Reg. \$26. **18.88**

**Andhurst® Shirts Just For Men**  
Polyester/cotton oxford shirts. Button-down collar. Sizes 14 1/2 to 17 1/2. Reg. \$15. **11.88**

**Ladies' Heiress® Brief Sale!**  
Nylon satin tricot briefs in sizes 5 to 10. Reg. to 2.50. **1.44 to 1.66**

**Save \$6 On Junior Knit Tops!**  
Polyester/cotton knit tops in sizes S, M, L. Short Sleeve. Save! Regular \$18. **11.88**

**Junior Rain Slickers 6.00 Off!**  
Vinyl snap front slickers complete with hood. Sizes S, M, L. Nice gift! Reg. \$22. **15.88**

**Junior Work Pants Reduced 17%**  
Polyester/cotton twill work pants made by Cheeno's®. Sizes 24 to 31. Reg. \$18. **14.88**

**18% Off On Junior Work Pants!**  
Cotton/polyester corduroy pants. Sizes 24 to 31. Solid colors. Regular 22.00. **17.88**

**Jr. & Misses' Designer Jeans**  
Cotton denim Calvin Klein® jeans. Sizes 3 to 15 and 6 to 16. Save! Reg. 44.00. **29.88**

**Save \$28 On Misses' Blazers!**  
Polyester/cotton Etienne Aigner® blazer in sizes 8 to 18. Two colors. Reg. \$111. **82.88**

**Misses' Jackets Reduced 15.00!**  
'Members Only' jackets of polyester and cotton. Zip front. Fully lined. Reg. \$55. **39.88**

**Boys' Oxford Shirts 23% Off!**  
Polyester/cotton oxford cloth shirts in sizes 8 to 20. Three colors. Reg. 15.50. **11.88**

**Andhurst® Crew Socks For Men**  
Acrylic mid-length crew socks in 5 colors. Reinforced toe. Easy care. Regular 1.75. **1.22**

**Men's LEVI'S® Shirts 6.00 Off!**  
Polyester/cotton tapered fit shirts in assorted plaids. S, M, L, XL. Reg. \$19. **12.88**

**Save Over \$10 On Men's Slacks!**  
Haggar® dress slacks made of polyester. Solid colors. Sizes 30 to 42. Reg. \$28. **17.88**

**Sale! Men's Andhurst® Underwear**  
Polyester/cotton boxers, briefs and t-shirts. Reg. 7.59 to 9.29. **20% off**

**Photo Albums Up To 17.00 Off!**  
Grain leather look cover with Magic Cling® pages. Special. **7.88 to 10.88**

**Sale! Martex® Bedroom Ensemble**  
'Houselights' comforter, dust ruffle and more. Reg. to \$115. **11.88 to 86.88**

**Martex® 'Houselights' Sheets**  
Twin, full, queen, king sizes. Stock up! Reg. 11.00 to 22.00. **8.88 to 19.88**

**'Chesterfield' Sheet Special**  
Burlington® sheets with plaid design. Reg. 9.00 to 21.00. **4.88 to 17.88**

**Springmaid® Sheets Reduced!**  
'Spring blossom' sheets in all sizes. Regular 8.00 to 22.00. **4.88 to 17.88**

Shop Friday and Saturday 10 a.m. Until 10 p.m. — Phone 756-B-E-L-K (756-2355)

# House OKs Auto Content Bill

By ROBERT L. SHAFFER  
Associated Press Writer  
WASHINGTON (AP) — Legislation to restrict auto imports swept through the House on a tide of protectionist sentiment, but faces a tougher reception in the Senate.

The so-called domestic content bill, which would require that imported cars contain a substantial amount of U.S. parts and be assembled by U.S. workers, was approved by the House 215-188 Wednesday night. The United Auto Workers promoted the measure as a job-creating mechanism.

A companion bill will be taken up by the Senate Commerce Committee today.

But chances are slim the Senate will approve it this year because of opposition from Republicans and because of an overload of legislation.

Rep. Richard Ottinger, D-N.Y., author of the House bill, said even if the measure does not become law, it will have a propaganda impact. "I think this will send a real message to those who are restricting trade, both in Japan and the European market," he said.

The bill was passed by the House over the objections of the Reagan administration, grain farmers and export industries. Those groups claimed the measure would touch off an international trade war that could eventually cost the United States more jobs than it would produce.

"If we start a trade war, we will all live to regret it," said Rep. Dan Glickman, D-Kan.

Before the final vote, the

House adopted, 195-194, an amendment saying that nothing in the bill could violate existing treaties. UAW spokesman Don Stillman said afterwards, "Thirty-one countries have local-content requirements. It's our position that nothing in this bill violates any treaties."

In a related issue, the Senate Wednesday defeated a "Buy America" provision that would have required the use of U.S.-produced steel and cement in bridge and highway repairs financed by a proposed nickel-a-gallon increase in the federal gasoline tax. Earlier, the amendment passed the House.

Sen. John Chafee, R-R.I., strongly opposed the steel measure. "This is a little bon bon for the wealthiest workers in the United States," he said. "In their greed to get this through for a special group of workers, they are going to trample on the jobs of other workers," he said.

In the House, the auto content bill got strong support from congressmen representing areas of high unemployment. Those lawmakers complained that the Japanese have used non-tariff barriers ef-

fectively to block U.S. imports while enjoying America's open markets.

The UAW says the legislation would create more than 800,000 jobs by forcing foreign automakers to establish plants in this country. Union president Douglas Fraser called the House vote a "major step toward forcing the Japanese to create jobs here in America where they enjoy huge markets."

House opponents tried unsuccessfully to put through an amendment renaming it "The Smoot-Hawley Trade Barrier Bill of 1982."

The Smoot-Hawley Tariff of 1930 was blamed for setting off trade wars between the United States and Europe and has even been cited by historians as a contributing cause of World War II.

The Ottinger bill would require foreign car makers to use increasing ratios of American labor and parts over a three-year span, depending on the volume of their U.S. sales.

In the third year, Toyota, the largest Japanese importer with annual U.S. sales of 700,000 cars and light trucks, would be allowed to produce only about 30 percent of those vehicles outside the United States.



BONUS SHOOTING — New York City police lead Barbara Austin, 38, from a Manhattan office building after the woman was arrested and charged with murder when she allegedly fired two shots into the back of a partner in a law firm. The woman was apparently dissatisfied with the size of her Christmas bonus. Miss Austin operated a word processor at the firm and did not work directly for the victim. (AP Laserphoto)

## Private War On Imports

GREENSBORO, N.C. (AP) — Businessman Clyde Andrew is waging a one-man war on foreign merchandise by urging people in this country to only buy products that are "Made in U.S.A."

Andrew, chairman of Carolina Fabric Label Corp., refuses to buy any product made overseas unless he can't find a domestic item of comparable quality. He's even returned goods to stores after discovering they're not American-made and ordered his son to get rid of a foreign car.

And he has taken out a newspaper advertisement that reads, "Please Santa Claus, Don't bring me anything this Christmas unless it was Made in U.S.A."

The ad in the form of a "letter" is signed: "the unemployed millions."

The ad, occupying about one-eighth of a page, was scheduled to appear in today's editions of The Greensboro Daily News and The Greensboro Record.

Andrew acknowledges an ulterior motive in his buy-American activism. But the fabric label executive insists his biggest incentive is old-fashioned patriotism.

The American textile industry he chairs has been hurt by imports, and that has meant problems for Andrew's company. Carolina Fabric makes the labels found on the back of T-shirts and other apparel manufactured by over 700 companies, nearly all of which are in the United States and Puerto Rico.

RAMPANT INFLATION  
TEL AVIV, Israel (AP) — Israeli prices rose 6.5 percent in November, bringing the inflation rate for the past 11 months to 119 percent, within reach of its record 133 percent inflation of 1980.

2803 Evans St. **U-REN-CO** Evans Plaza  
Rent It... **It's A Better Way** ...And Save!  
It's A Better Way

### Furniture Rental

Living, Dining & Bedroom Complete!

## \$79<sup>00</sup>

Per Month

756-3862

## The Youth Shop

CAROLINA EAST CENTRE, GREENVILLE, N.C.  
NEW STORE HOURS: MON. THROUGH SAT. 10 A.M.-8:30 P.M. PH. 756-6180

IN TIME FOR CHRISTMAS  
**Storewide Sale**  
**20% to 50% off**  
ENTIRE STOCK

FRIDAY AND SATURDAY ONLY  
7-14 GIRLS DRESSES  
**30% Off**

FRIDAY AND SATURDAY ONLY  
7-14 JOG & JUMP  
SUITS  
**1/2 Price**

FRIDAY AND SATURDAY ONLY  
All  
Boys & Girls Coats  
**30% Off**  
London Fog, Rothchild, Weather Tamer, Etc.

FRIDAY & SATURDAY ONLY  
4-6x  
JEANS  
**\$7<sup>00</sup>**  
NOW  
REGULAR \$14.00

## Pick the Gift at Holiday Savings

---

### Men's Dept.

- Izod Sweaters ..... 25% Off
- Group of Men's Flannel Shirts ..... 20% Off
- Group of Men's Sportcoats & Suits ..... 20% Off

---

### Children's Dept.

- All Outerwear ..... 25% Off  
Weather Tamer, London Fog, Tiny Tots
- Children's Robes & Gowns ..... 25% Off  
Toddlers 2-4 Sizes 7-14
- Children's Corduroy Levis ..... \$11<sup>88</sup> to \$16<sup>88</sup>

---

### Ladies Dept.

- Select Group of Ladies Dresses ..... 25% to 50% Off
- All Ladies Gloves ..... 20% Off
- Select Groups of Sportswear ..... 25% to 40% Off  
Jackets, Skirts, Slacks
- Select Group of Ladies Skirts & Blouses ..... 25% to 1/3 Off
- Group of Ladies London Fog Coats ..... 20% Off

---

### Shoe Dept.

- Select Group of Ladies Shoes ..... Up to 1/3 Off

---

### Gift Dept.

- Original Christmas Tree China ..... 25% Off  
by Cuthbertson (Downtown Only)
- Fieldcrest Electric Blankets ..... 1/3 Off  
Sale Prices thru Dec. 18

---

# Blount-Harvey

Shop Downtown Daily 10 to 5:30      Shop Carolina East Mall Daily 10 to 10

## Pulsar Quartz

At Saslow's  
Pitt Plaza

Just in time for Christmas

TU014  
**\$140**

KP178  
**\$145**

Pulsar Quartz.  
Always a beat beyond. In technology. In value.

PITT PLAZA-756-7112

# SASLOW'S

Visa, Amex, MasterCard or Saslows Own Charge Plan  
Open Every Night 'Til 9 For Your Shopping Convenience

# Scientists Lose Radio Contact With Planet

PASADENA, Calif. (AP) — Viking 1, phone home. That's the radio message scientists at Jet Propulsion Laboratory are trying to send to Earth's last robot outpost on another planet. It hasn't been heard from since last month. Frank Bristow, spokesman for the National Aeronautics and Space Administration facility, said the problem seems to be a misaligned

antenna on the Viking 1 lander, which has been operating on Mars since 1976. "We know the spacecraft is all right," Bristow said, adding that NASA scientists are "fairly confident" the problem can be fixed. Bristow said engineers hope to realign the antenna by sending a boosted radio signal that will be strong enough to bounce off the ship's surface and onto the

skewed antenna. The signal would contain enough new instructions for Viking's on-board computer to put the antenna on track. One such attempt has failed, but another will be made Monday and "we're fairly confident because we'll be looking at it from a better angle," Bristow said. Even if that doesn't work, he said, the relative movements of Mars and Earth

should get the antenna aimed earthward long enough to straighten out the problem. Bristow said the antenna apparently was misaligned because of an "inadvertent command" sent up when laboratory technicians were ordering Viking to recharge its batteries a few weeks ago. The problem was discovered when the lander stopped its weekly transmission of Martian weather reports and

terrain photographs. "Then we went to work to find out what was wrong and we figured out that the antenna wasn't looking at us," Bristow said. The Viking 1 lander is the only part still operating from two combination orbiter-lander spacecraft that arrived at Mars more than six years ago. Viking 1 reached the planet in June 1976 and dropped its lander to the

surface a month later. Viking 2 showed up soon after and also dropped off a lander.

The robot laboratories searched in vain for life on the dusty planet and returned vast amounts of information that is still being analyzed. Viking 1 has long outlived its minimum lifetime design of 90 days, and scientists hope it will continue taking weather reports and occasional pictures at least until 1990.

**All Roads Lead To  
Farmville  
Farmville Furniture Company**

122-126 S. MAIN ST. 753-3101  
FARMVILLE

**OPEN MON.-FRI. 'TIL 9**

# SHOP THURSDAY

Save 20% - 60% On Exciting Holiday Values For Everyone

Save 60%	Junior Wool Blazers in navy, berry, grey and camel.	Orig. \$75	Sale \$29.99
Save 20%	Gloria Vanderbilt black denim jeans (Sizes 6-14)	Reg. \$38.00	Sale \$30.40
Save 25%	Entire stock of Modern Juniors Fall Coordinates	Orig. \$20-\$90	Sale \$15.00-\$67.50
Save 25%	Ultra Suede Belts in all colors.	Reg. \$12	Sale \$9.00
Save 20%	Skyr 100% cotton Turtlenecks.	Reg. \$18.00	Sale \$14.40
Save 25%-50%	Groups of Missy Fall Coordinates further reduced.	Orig. \$18-\$110	Sale \$9.00 to \$82.50
Save 30%	Group of Missy Blouses by Judy Bond and Gailord	Reg. \$25.00	Sale \$18.99
Special	Missy British Vogue Cardigan Sweater, assorted colors.	Reg. \$24	Sale \$19.99
Save 25%-50%	Entire Stock of Fall Dresses. Junior, Missy, Half size.	Reg. \$20-\$75	Sale \$15.00-\$37.50
Save 45%	Missy Wool Blazers in navy, grey, camel & berry.	Orig. \$75	Sale \$39.99
Save 25%	Etienne Aigner Leather Blazers (Sizes 6-18)	Orig. \$265	Sale \$199.00
Save 25%	Etienne Aigner All Weather Coat-reversible or trench.	Orig. \$150	Sale \$109.99
Save 25%-33 1/3%	Liz Claiborne separates (Sizes 6-14)	Orig. \$37-\$120	Sale \$27.75-\$80.00
Save 15%-20%	Komar and Evelyn Pearson Long Warm Robes.	Reg. \$33-\$44	Sale \$27.99-\$34.99
Save 20%	Entire stock of Daniel Green Bedroom Shoes.	Reg. \$15-\$20	Sale \$12.00-\$16.00
Save 33 1/3%-40%	Entire stock of Ladies' Fall Shoes.	Orig. \$20-\$78	Sale \$15.00-\$31.20
Save up to 33 1/3%	Shoes by Dexter, Bass and Famalore.	Reg. \$28-\$46	Sale \$20.99-\$34.50
Save 33 1/3%-50%	Children's Shoes, dress and casual.	Reg. \$15-\$29	Sale \$11.25-\$21.75
Save 20%	Entire stock of Etienne Aigner Handbags and Small Leather Goods.	Orig. \$12-\$110	Sale \$9.60 to \$88.00
Save 25%	Groups of Men's Suits and Sportcoats.	Reg. \$132-\$265	Sale \$99.00-\$198.75
Save 20%	Men's All-Weather Hats by Totes.	Orig. \$21	Sale \$16.80
Save 33%	Entire stock of Men's Bass Weejuns, black or brown.	Reg. \$65	Sale \$42.99
Save 25%	Groups of Men's neckwear-Foulards, Stripes and Clubs.	Orig. \$12.50-\$30.00	Sale \$9.37-\$22.50
Special	Polo After Shave; Limit 2-no rainchecks.	Orig. \$9.50	Sale \$7.60
Save 25%	Entire stock of Children's Fall Coats.	Reg. \$34-\$130	Sale \$25.50-\$97.50
Save 20%	Entire stock of Jordache Children's Denim Jeans.	Reg. \$27	Sale \$21.60
Save 25%	Entire stock of Children's Izod Sweaters.	Reg. \$18-\$30	Sale \$13.50-\$22.50
Save 25%	Entire stock of Children's Fall Health Tex.	Reg. \$6.25-\$18.50	Sale \$4.68-\$13.87
Save 60%	14 K Gold Serpentine Bracelet.	Orig. \$15	Sale \$5.99
Save 15%	E.T. Doll.	Orig. \$15	Sale \$12.75
Save 20%	Aris Isotoner Gloves.	Reg. \$21	Sale \$16.80
Save 50%	Picture Frames by Burnes of Boston.	Orig. \$7.00-\$28.00	Sale \$3.49-\$14.00

Shop Downtown 10:00 a.m. - 9:00 p.m.  
Pitt Plaza 10:00 a.m. - 9:30 p.m.

THE JOY OF GIVING

**Brody's**  
Downtown  
Pitt Plaza



**PROUD PARENTS** — Tony and Andria DeCarlo, of Waukegan, Ill., spend some time with their four newborn children, two boys and two girls, who arrived by Caesarian section delivery at Evanston Hospital Tuesday. A hospital

spokesman said Mrs. DeCarlo was not taking fertility drugs which is often the case in quadruple births. The mother was in her 32nd week of pregnancy when the babies were delivered. (AP Laserphoto)

## Flood Of Study Reports Pouring In To Legislative Research Body

RALEIGH, N.C. (AP) — Proposals requiring all insured motorists to pay for losses suffered by the N.C. Reinsurance Facility and forcing stores to keep sexually explicit material out of the sight of children went to a legislative panel Wednesday.

Nineteen legislative study committees turned over mounds of paperwork and reports to the Legislative Research Commission as it prepares for the start of the 1983 General Assembly in January.

Other recommendations sent to the commission included raising the beer and wine tax for money to rehabilitate alcoholics and measures that would ensure that divorced women receive child support payments from their ex-husbands.

The study committees were set up by the 1981-82 General Assembly to study areas where bills may be introduced next session. Some of them completed their work months ago.

The commission voted Wednesday to receive the reports and pass summaries of them along to legislators, who will have the option of introducing the recommended bills.

The proposal on spreading

the costs of poor risk drivers to all insured motorists came from the Insurance Study Committee, which recommended that losses of the North Carolina Reinsurance Facility not be limited to just those who have had traffic tickets or accidents.

If approved by the 1983 General Assembly, the proposal would result in the repeal a bill passed last session that was aimed at making drivers with bad records pay for the facility, which insures drivers who are considered to be a bad risk.

But the study committee said drivers with tickets or accident records were being punished too much.

The Committee on Women's Needs made several recommendations aimed at making sure divorced mothers receive child support payments and would permit garnishment of up to 40 percent of a father's wages for willfully failing to provide child support.

The Committee on Taxation of Alcoholic Beverages recommended increasing the excise tax on unfortified wine from 21 cents to 26 cents per liter and the tax on fortified wine, such as sherry or vermouth, from 24 cents to 34

cents per liter.

The higher tax would generate \$1.3 million for 1983-84 and \$2.1 million the next year. All the additional receipts would be distributed to counties on a per capita basis for alcoholism rehabilitation.

The Committee on Obscenity Laws' proposal would force convenience stores to keep sexually explicit material out of sight of children and would make sure it is considered a felony to engage in child pornography.

The Committee on Revenue Laws proposed an \$11.5 million package of tax reforms in a number of areas. Almost all of the money would pay for conforming state tax laws with federal laws on corporate deductions for depreciation.

House Speaker Liston Ramsey said the state Revenue Department changed its administrative procedures to conform to the law but state attorneys believe that change is unconstitutional and a law must be passed if the practice is to be continued.

Recommendations by the Committee on State Office Building Construction Policy, Public Facilities Design, Construction and Inspection

## Step into Christmas...

### Hush Puppies

Dress them up, dress them down... anything goes with Hush Puppies. Give him fashion and comfort all in one gift... give him Hush Puppies from Roscoe Griffin. From \$29.

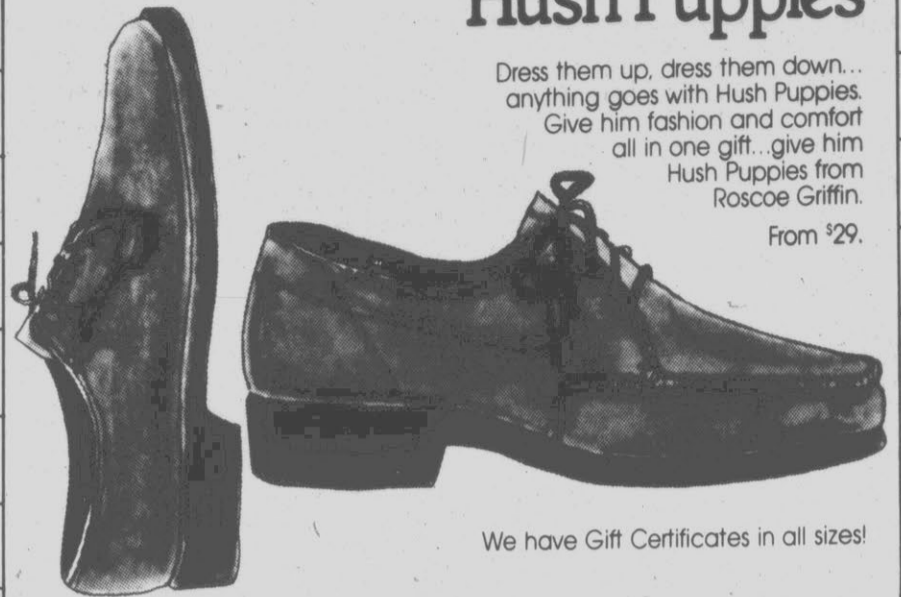

We have Gift Certificates in all sizes!

## ...and fly south in the New Year!

Come register for your chance to win a trip for two to Walt Disney's Magic Kingdom and Epcot Center! There's no purchase necessary...see our display for details.

ROSCOE  
**GRIFFIN**  
*Christmas*  
The World of **Shoe Values**

Carolina East Mall in Greenville, and all other locations.

May All Your Dreams  
Come True  
**THIS CHRISTMAS**

Ladies Diamond Clusters  
Priced From \$79 To \$6600



**30%**  
And More Off  
Entire Stock

**Diamond Pendants From \$49 To \$4000**  
30% & More Off Entire Stock

	Reg.	Sale
.03 ct. ....	\$99	\$49
.10 ct. ....	\$195	\$119
.20 ct. ....	\$360	\$240
1/4 ct. ....	\$490	\$299
1/3 ct. ....	\$640	\$399
1/2 ct. ....	\$1495	\$799



**Diamond Earrings From \$24 To \$2000**  
30% & More Off Entire Stock

	Reg.	Sale
.06 ct. ....	\$99	\$49
.10 ct. ....	\$150	\$99
.20 ct. ....	\$290	\$199
1/4 ct. ....	\$390	\$249
1/3 ct. ....	\$490	\$299
1/2 ct. ....	\$1040	\$599

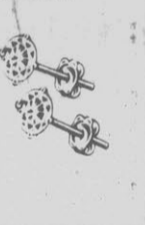

At last! Diamonds that are as reasonably priced as they are beautiful! Each design is as distinctive as the next and perfectly suited to young budgets!

**Diamond Solitaires From \$69 To \$19,000**  
30% & More Off Entire Stock

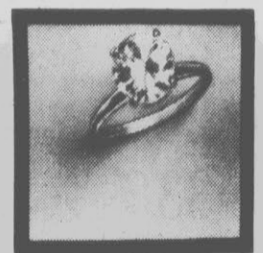

	Reg.	Sale
.10 ct. ....	\$290	\$199
.20 ct. ....	\$490	\$319
1/4 ct. ....	\$690	\$490
1/3 ct. ....	\$900	\$599
1/2 ct. ....	\$1650	\$995
.64 ct. ....	\$2450	\$1495
3/4 ct. ....	\$5800	\$3900
1.00 ct. ....	\$9400	\$5900

Illustrations enlarged to show beauty of detail

**Charms & Earrings**  
14K Gold  
**50% Off**  
Entire Stock

**Watches**  
Bulova, Citizen, Seiko, Caravelle, Accutron Swiss  
**20% Off**  
Entire Stock

**Special Christmas Solitaires**

	Sale Price
1/2 ct. ....	\$699
1.00 ct. ....	\$1995
1.50 ct. ....	\$7900

**14K Gold Chains and Bracelets**

**50% OFF**

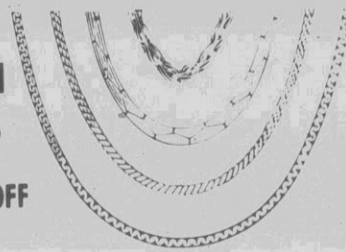

**14K Add-A-Beads**

3mm .....	38¢
4mm .....	67¢
5mm .....	96¢
6mm .....	\$1.34
7mm .....	\$1.44

**Fine Ladies Rings**  
Precious & Semi-Precious Stones  
Diamonds, Rubies, Sapphires & Emeralds

**30% & More Off**  
Entire Stock



This holiday can be the brightest and most exciting ever with a dazzling gift of gold with diamonds, emeralds, pearls and precious more. For Christmas, for love and for all the right reasons, we have the jewelry you always dreamed of, but never thought you could afford. We can make your dreams a reality this Christmas. Come in today for the best selection of jewelry gifts around.



Carolina East Mall  
Greenville, N.C.

**REED'S**  
Fine Jewelers and Diamond Importers

**Charge it Now At REED'S**  
Carolina East Mall - Greenville

5 Convenient Ways To Buy  
Reed's Charge, American Express, Master Card, Visa, or Interest Free Layaway

**Nobody But Nobody Undersells REED'S**

Other Locations: Cary, Chapel Hill, Wilson, Rocky Mt., Jacksonville, Wilmington, Whiteville & Myrtle Beach

HAVE A  
JUST PANTASTIC HOLIDAY

**Levi's**  
JEANSWEAR

Guy's Pre-Washed Denim

Reg. \$23.50  
**\$18.99**

Junior Super-Straights

Reg. \$29  
**\$22.99**

**just pants**

Carolina East Mall 756-9910

# Corona Again Convicted In Migrants' Slayings

By JOHN RICE  
Associated Press Writer  
HAYWARD, Calif. (AP) — Attorneys for Juan Corona, sentenced to prison for his second conviction in the slayings of 25 migrant farm workers, say they will keep seeking a third trial or try to bargain for his release to Mexico.

With Corona's mother and other relatives watching, Judge Richard Patton on Wednesday sentenced him to 25 years to life in prison for killing the drifters whose mutilated bodies were uncovered in peach orchards north of Yuba City in 1971.

Patton said it was the maximum penalty he could legally impose following a seven-month retrial that included more than 1,300 exhibits and 175 witnesses.

The sentencing capped a decade-long, \$4.7 million legal struggle. Corona has been in prison so long that he already is eligible for parole, but Sutter County District Attorney Carl Adams said the chance of his release are "very, very poor."

"It's my view that anyone convicted of 25 murders ... should not be released at any time and you should be kept in custody for the rest of your natural life," Patton told the 48-year-old former contractor, who afterward

thanked the judge for his courtesy.

Corona, a Mexican national, has suffered several heart attacks in prison and an inmate knife attack left him blind in his left eye.

Defense attorneys Terence Hallinan and Michael Mendelson said they will continue to fight for a third trial, claiming misconduct by a "lawless jury," unless Corona can be released on parole and deported to Mexico.

"Leave him to remain in Mexico, where he wishes to stay, and the taxpayers of California can wash their hands of this case," Hallinan told reporters after Patton rejected the motion for another trial.

But Adams said the likelihood of such a deal is "absolutely zero."

"That's a stupid suggestion," he added. "There's no way we're going to let him go."

Corona's 1973 conviction was overturned in 1978 when the state Court of Appeal ruled that he was inadequately defended. His trial attorney had called no witnesses.

Before the second trial, Sutter County officials rejected Hallinan's offer to have Corona plead no contest to two counts of murder if he

could be deported.

Defense attorneys charged that the retrial jury consistently violated the law by ignoring Patton's instructions and failing to report possible bias among its members.

## Report Soviet Has Jets On Siezed Isle

TOKYO (AP) — The Soviet Union has deployed 10 MiG-21 fighter-bombers on a northern Pacific island claimed by Japan but occupied by Soviet forces since the end of World War II, a Japanese newspaper reported today.

The Yomiuri Shimbun said the move last week was apparently aimed at counteracting U.S. plans to station F-16 fighter-bombers in northern Japan.

The newspaper, quoting Defense Agency sources, said the MiG-21s replaced 20 older MiG-17s, deployed on the contested island of Etorofu until late 1981.

The paper said facilities at the Burevestnik airfield on Etorofu have been expanded since the departure of the

One juror and two alternates accused their colleagues of reading news accounts of the trial, eavesdropping on forbidden testimony, dozing during the trial and discussing evidence before deliberations began.

But 10 other jurors filed affidavits denying most of the claims.

Patton said there had been some violations of his instructions, but they had not prejudiced the jury. He recommended that one of the accusers, alternate juror Alison Warriner, be prosecuted on misdemeanor contempt charges.

The judge, who presided over both trials, said, "The evidence of definite guilt on retrial was even more conclusive."

He also questioned defense tactics in the second trial, wondering aloud if it was worse to present no witnesses, as in the first trial, "or is it more damaging to make an opening statement,

as was done in this trial, and then fail to present substantial proof in any significant areas?"

He said the defense hurt its

case by calling witnesses Arie Jones — who lied about his military career — and Cal Cooper — who lied that he had been a top boxer.

"If ever I heard perjury committed in a courtroom, Jones committed it," Patton said.

Christmas Cookies  
18 Different Kinds  
DIENER'S BAKERY  
815 Dickinson Ave.

### MEMBERS ONLY

Racing Jackets By: Europe Craft

Compare At \$55.00

\$36<sup>99</sup>

Ralph Lauren POLO Sweaters

Compare At \$39.20  
\$15<sup>99</sup>  
Ladies V-neck

2 Days Only - Fri. & Sat.

Chic Jeans \$19<sup>98</sup>

Compare At \$36.00

Less Rebate 5<sup>00</sup>

\$14<sup>98</sup>

Your Cost

## SHIRLEY'S 264 OUTLET

264 By Pass Farmville, N.C.

753-3170

Open 9:30 - 6:00  
Friday Nights Till 9:00 P.M.



JUST TESTING — The National Christmas Tree stands on the Ellipse, lights burning brightly during a testing of the lights. The White House is in the background. President Reagan will light the tree tonight from the White House. (AP Laserphoto)

## Bring a video arcade home for Christmas!

### Save on Intellivision<sup>®</sup> components. Plus, get a \$25 holiday rebate.

Mattel Electronics\* now offers a \$25 rebate on an Intellivision<sup>®</sup> Master Component just in time for Christmas. Purchase one at JCPenney anytime between November 29th and December 19th and get ready to enjoy the most vivid, realistic video action available! Just drop in one of the great selection of cartridges (on sale below), then you're set to play. It's like having a video arcade right in your own home. Intellivision<sup>®</sup> Master Component comes ready to play with two 16-position 4 button control units.

See attached instructions for details.  
Rebate offer valid 11/29/82 through 12/19/82 only.  
JCPenney sale prices effective through (local fill).

Our reg. price	<b>269.95</b>
Our sale price	<b>219.95</b>
Less Mfr's rebate	<b>25.00</b>
Your final cost	<b>174.95</b>

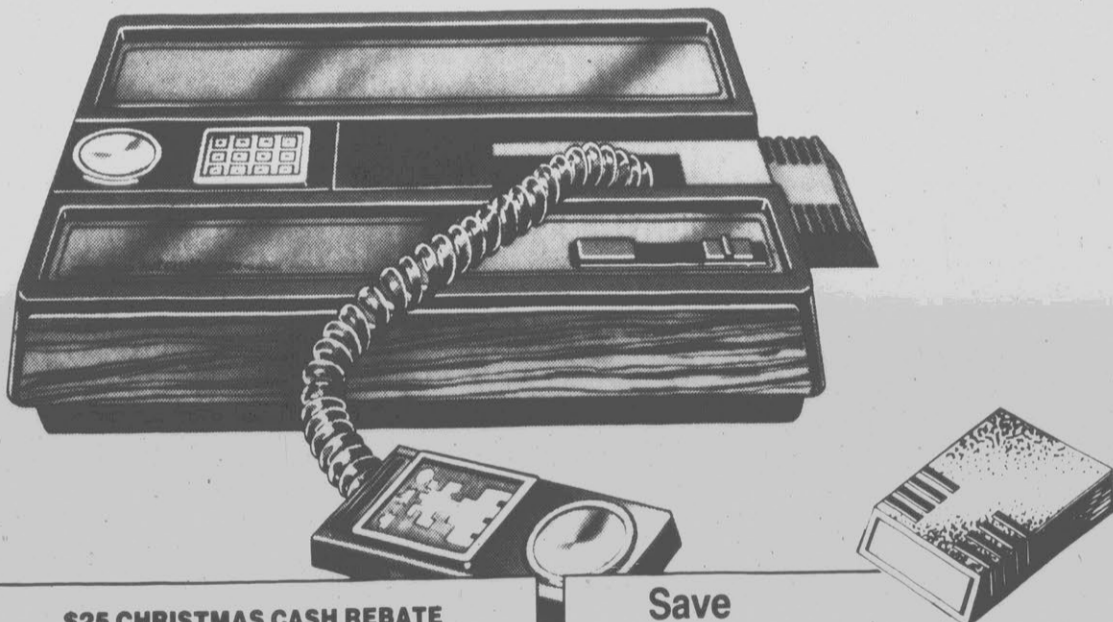

#### \$25 CHRISTMAS CASH REBATE BY MAIL ON MATTEL ELECTRONICS<sup>®</sup> INTELLIVISION<sup>®</sup> MASTER COMPONENT.

1. Purchase an Intellivision<sup>®</sup> Master Component (stock #2069) between November 29, 1982 and December 19, 1982.
2. Completely fill in both mail-in certificate distributed at JCPenney and the Intellivision<sup>®</sup> purchase registration card packed in the Intellivision<sup>®</sup> box. Mail both items with your original cash register receipt to:  
Intellivision<sup>®</sup> \$25.00 Cash Rebate  
P.O. Box #PM 090, El Paso, TX 79977
3. To qualify for the \$25.00 rebate by mail, all three items must be sent in their original form. No reproductions will be accepted.
4. Offer good only in the U.S.A. Any sales tax must be paid by customer. Offer void where prohibited, taxed, or otherwise restricted.  
© Mattel, Inc. 1982  
All Rights Reserved
5. Offer limited to one rebate per master component purchase and limited to one rebate per household address or organization.
6. The Intellivision<sup>®</sup> Master Component must be purchased between November 29, 1982 and December 19, 1982. Purchases before November 29, 1982 and after December 19, 1982 will not be eligible for this rebate offer. Mattel is not responsible for lost, late or misdirected mail.
7. Allow eight to ten weeks for receipt of rebate.
8. Offer subject to availability of Intellivision<sup>®</sup> Master Component and good only while supply lasts. No rainchecks or other price product guarantees made by retailers will be honored.

#### Save on Intellivision cartridges.



## Have Your Picture Taken With Santa Claus In Santa Land

(Located in Roses, Pitt Plaza)

Monday through

Friday 4 p.m. to 8 p.m.

Saturday 12 p.m. to 8 p.m.

Now through Dec. 23

## Pitt Plaza

Business Council-Greenville

MATTEL ELECTRONICS  
**Intellivision<sup>®</sup>**  
Intelligent Television

# JCPenney

THE CHRISTMAS PLACE

Shop 10 am-10 pm—Phone 756-1190—Pitt Plaza

# Thirteen Rescuers Complete Life Support Course

Thirteen members of the Greenville Fire-Rescue Department graduated from an Intermediate Emergency

Medical Technician Advanced Life Support course here today. Successful completion of

this course by 19 members of the department will enable the use of advanced life support skills, including

starting of intravenous fluids, insertion of airways and application of anti-shock trousers by department members. Beginning Jan. 3 at least one person on every rescue call by the Greenville Fire-Rescue Department will be certified by the state of North Carolina to perform these life support duties when any or all are deemed necessary to the well-being of any patient.

The 13 graduates honored today are Kenneth Adams, Hyman Denby, Shepard Hill, Linwood Hines, Herman Mills, Ronald Moore, King Nelson, Charles Owens, Walter Salisbury, Charles Walker, Leonard Waters, Jonathan West and Earl Wilson.

Dr. E. Jackson Allison Jr., chairman of the department of emergency medicine of the East Carolina University, medical director of the Pitt County Memorial Hospital Emergency Department, and medical adviser of the Greenville Fire-Rescue Department, presented the graduate certificates and spoke about the significance of the occasion.

Also being honored are

Tony Smart, Mike Branch, Adam Corbett, John Fisher, Skip Eure and Gary Roberson, all of whom have previously successfully completed the course.

The course consists of 140 hours of classroom instruction, learning laboratory participation, and hospital clinical experience, including a basis EMT recertification course. The graduates began the course in August and completed it Oct. 27.

The Medical School EMS program takes responsibility for developing a proposal to the state EMS office for a rescue group to obtain this educational experience. This is done largely through re-

search of the need — study of how many times during a given period patients brought into the hospital by that squad conceivably could have benefited from the skills taught in the course. They then teach the course and administer the state testing of the skills.

The course is taught by medical school faculty, emergency physicians, psychologists, nurses and physicians assistants.

A second Greenville Fire-Rescue class will begin in February, Dennis Blessing, assistant coordinator of the medical school EMS

program, said. The medical school EMS program previously has trained 17 other similar groups from Pitt, Beaufort, Onslow, Wayne, Wilson, Nash and Chowan counties. Members of the Winterville and Grifton rescue squads are among those trained.



EMPHASIZES IMPORTANCE ... Dr. E. Jackson Allison Jr. emphasizes the importance of the graduates of the intermediate emergency medical technician life support program Thursday. Dr. Allison later presented certificates to the graduates. (Reflector photo by Angela Lingerfelt)

## Hotline...

(Continued from page 1)

were provisions for resolving claims against the firms for false billings and other misrepresentations.

Edmisten said, "The attorney general of Tennessee has agreed to consider North Carolina claims and we need to start forwarding these right away. That's why we're urging people to look at their credit card statements for the last six months (back to June) and report to us any discrepancies involving magazine sales."

Billings in this scam usually were in the amount of \$113.88 or were two or more charges that add up to this amount. Additionally, multiple charges may have appeared from different firms in different states at 10-day intervals.

The deadline for submitting claims to Edmisten's office to be filed with those of Tennesseans is Feb 15, 1983 — the earlier, the better chance for reimbursement through an already-established \$35,000 settlement fund, he said.

File claims with as much documentation as possible with Consumer Protection, Attorney General's Office, Box 629, Raleigh, N.C. 27602. To inquire, call 733-7741.

Edmisten said his office also would like to know about any other suspicious charges on credit card billings as "there may be connected or other similar scams that need investigating."

## Double Transplant Patient Succumbs

HOUSTON (AP) — A man who received a heart and lung transplant, then survived 21 days while being treated with an anti-rejection drug, has died of "intractable lung infections," hospital officials said.

The 41-year-old, who was not identified, died at 8:35 p.m. Wednesday, said Elaine Moore, a spokeswoman at St. Luke's Episcopal Hospital.

The man, who never left the hospital after the surgery, had been suffering from a severe lung ailment and secondary heart disease when the transplant of a heart and two lungs was performed Nov. 23.

The donor organs came from a 19-year-old Pasadena, Texas, man who died in a traffic accident, officials said.

It was the second such operation performed by heart surgeon Dr. Denton Cooley. In 1968, he performed the operation on a 2-month-old girl who died within

hours of surgery.

The latest recipient had been treated with cyclosporine, which researchers say helps promote healing and fight rejection of transplanted tissue without weakening the body's immune system.

Cyclosporine is also being used to treat 45-year-old Mary Gohke of Mesa, Ariz., who on March 9 became the first recipient of a heart-lung transplant in more than 10 years.

Doctors at Stanford University School of Medicine in California credit her survival to cyclosporine.

Stanford has performed 10 heart-lung transplants since March, and seven of those patients are described as doing well. The other three died within a month of their operations.

## Cites Welcome For Dictators

WASHINGTON (AP) — Former President Jimmy Carter's chief human rights official says President Reagan should crack down on abuses by Asian dictators.

Patricia M. Derian, former assistant secretary of state for human rights, told a congressional committee Wednesday said a U.S. failure to enforce its human rights policy abroad is making the administration look hypocritical.

Ms. Derian noted that the leaders of South Korea, the Philippines, Pakistan and Indonesia had all received red-carpet welcomes in this country.

## Circulate Grain Elevator Ideas

WASHINGTON (AP) — The Reagan administration is circulating to management and labor representatives the draft of a proposed regulation designed to improve grain elevator safety.

Doug Clark, a spokesman for the Occupational Safety and Health Administration, said Wednesday that the agency will likely propose for the first time a grain elevator safety standard sometime early next year.



Located In The Greenville  
—Square Plaza—

Come By And See Our Selection  
One Of The Largest Varieties Of  
Wine, Cheese, Specialty Foods, Candies  
And A Fine Array Of Gifts  
For Your Party Or Any Special  
Occasion During The Holidays. Don't  
Miss Our Fine Selection Of Cheese  
And Meat Trays, Hors d'oeuvres And  
Specially Made Spreads

### This Week's Specials

	Reg.	Sale
Port Salute Cheese	\$5.29/lb.	\$4.49/lb.
French Brie	\$6.25/lb.	\$5.25/lb.
Liebfraumilch	\$3.46/btl.	\$2.79/btl.
Charles Krug		
Cabernet Sauvignon	\$7.99/btl.	\$6.99/btl.
Martinelli Sparkling		
Cider-Non Alcoholic	\$3.29/btl.	\$2.79/btl.

Discounts on Case Lot Purchases

For Your Convenience We Will Be Open  
On Sun. Dec. 19th From 1:00 P.M. To 6:00 P.M.

Personalized  
Service

Call  
Us  
756-1889

If We Don't Have It  
We Will Get It

## Perfect Gift For Christmas!

FOR THAT  
VERY SPECIAL  
CHRISTMAS  
GIFT...

20%  
OFF

All Diamond  
Pendants  
And Earrings

Open Monday Thru Saturday  
10 A.M. TIL 9 P.M.  
For Your Shopping Convenience

LAYAWAY OR  
EASY TERM PLAN

Illustrations Enlarged To Show Detail

Visa, Amex, Master Charge, or use Saslow's Own Charge Plan

SASLOW'S

JEWELERS  
PITT PLAZA SHOPPING CENTER  
756-7112

PACKED WITH  
BEST WISHES...

From  
**Blount-Harvey**

Your Christmas Store  
Downtown Greenville &  
Carolina East Mall

Now Open 10 a.m. to 10 p.m. at Carolina East Mall

## Gift Shopping At Blount-Harvey's Is A Christmas Tradition

Ever stop to wonder why people from all of Eastern Carolina visit Blount-Harvey's for their important Christmas shopping? Blount-Harvey's features the finest in apparel year round, not just during the Christmas Holiday Season. But somehow, at Christmas time it seems the fashions, furnishings, accessories and novelty items at Blount-Harvey's are just a bit more glamorous than usual. So if you want a gift that complements your own good taste (and the receivers as well) join the hundreds of discriminating men and women who shop Blount-Harvey's. Make this a Christmas they will long remember with distinguished gifts from Blount-Harvey's fine stores in Greenville.

**Puzzled Over What To Give?**  
We Suggest A Blount-Harvey Gift Certificate  
In The Amount Of Your Choice!

Our Downtown Shoppers will find the parking  
lot behind Blount-Harvey and  
ample on and off-street parking.

# Many Oppose A Split Session

By MARY ANNE RHYNE  
Associated Press Writer  
RALEIGH, N.C. (AP) — Many state lawmakers say they don't want a split legislative session in 1983, and they disagree about the best solution to highway funding problems, indicates an Associated Press survey.

The majority of respondents to a questionnaire mailed to 1983 General Assembly members last month said they also favor continuing the Coastal Area Management Act.

The uncertain economy has prompted discussion of splitting the legislative session so lawmakers could arrive and get oriented in January, go home and return in the spring to vote on the budget when the future financial picture is clearer.

In the past, the Legislature has met from January until June or July.

Of the 170 legislators surveyed by The Associated Press, 103 or 60 percent responded to the questionnaire. Thirty-three of 50 senators and 70 of 120 representatives responded. There was no significant difference in answers between House and Senate members.

Because some of the questionnaires were unsigned, it could not be determined how many Democrats or Republicans responded.

When asked whether they favored a split legislative session, 55 said no, 30 said yes and 18 others were undecided or gave no answer. Several suggested placing a limit on the length of legislative sessions.

The Legislative Committee on Agency Review has suggested limiting the session to 60 legislative days or 90 calendar days.

Legislators also were asked whether they would favor another gasoline tax increase or an alcohol tax increase to pay for highways.

If the state doesn't find about \$60 million, it will lose federal funding for highways in July.

Gov. Jim Hunt proposed a \$180 million highway tax package to the 1981 Legislature, which approved

about \$120 million worth of the proposal. The plan increased the gasoline tax by 3 cents per gallon.

The portion of the plan that was not approved would have raised the tax on beer and liquor.

Hunt has said that the alcohol tax remains on the table for consideration and he will have no new recommendations.

When asked whether they favored a gasoline tax increase or higher alcohol tax to pay for highways, 37 said yes, 35 said no and 31 were undecided or gave no answer.

On another topic, a clear majority of the respondents, 72, said they favor continuing the Coastal Area Management Act. Twelve said they do not favor continuing the act and 19 were undecided or gave no answer.

A legislative study committee has rejected proposals to weaken the act, a land-use plan that covers 20 eastern counties. The panel also has suggested considering a land-use plan for the rest of the state.

On other matters,

legislators said they do not favor restoring the insurance commissioner's powers to block implementation of rate hikes. Currently, companies may implement rate hikes over the commissioner's objections if they set aside money to cover refunds for possible overcharges.

Forty-three said they did not favor such legislation, 30 said they did and 30 others were undecided or did not respond.

The majority were undecided whether a commission should be established to regulate insurance rates as the state Utilities Commission regulates those rates.

Forty-one respondents were undecided or gave no answer, 32 favored such legislation and 30 opposed such a move.

The majority also were undecided whether a state housing commission should be established — a move being considered by a legislative study committee.

Forty-four were undecided or did not respond, 31 said they opposed such a commission and 28 favored establishing the panel.

When asked what other issues may spark heated debate in 1983, legislators mentioned alternatives to prisons, annexation and child support laws.

## Kiss A Pig For Charity

MIAMI (AP) — Her black-and-gold gown and cool composure kept drawing admirers, even though the men in her life knew she'd be more at home in a muddy sty.

But in the name of charity, Sunset High School teachers puckered up to kiss Petunia, a 10-week-old pig, as part of a popularity contest, with students paying money to see their favorite teachers kiss a porker.

"She kinda looks like this girl I dated in high school," woodworking teacher Pete Moroney said Wednesday. He closed his eyes for his piggy smooch.

English teacher John Kendall also took the plunge with Petunia, who remained unmoved by his ardor.

The week-long fund-raiser will pay for meals for the poor at Camillus House, a free-food line operated by Brothers of the Good Shepherd.

Students put money in any of 36 jars for the teacher or school administrator they would like to see kiss a pig. Some \$90 accumulated in Kendall's jar. In all, \$800 was collected.

The third lucky winner, physics teacher Priscilla King, said, "After 19 years of teaching, this has been a dream come true."

## Trapped In A Burning House

PONTIAC, Mich. (AP) — A man accused of trapping his ex-girlfriend's three children in a house and setting it afire was being held in \$175,000 cash bond on arson, assault and attempted murder charges.

Police said that before setting the blaze Dec. 8, Linwood Flack, 32, left a note on the wall of the home of Cheryl Harris, saying, "There will be no fire escape in hell."

Detective Tom Crossno said Flack "intentionally set the fire knowing the children were in there and that the back door was boarded up." The children managed to escape through a broken window.

Flack pleaded innocent to the charges at a hearing Tuesday.

## Five Killed In Collision

FREDERICKSBURG, Va. (AP) — A tractor-trailer driver faces five counts of manslaughter as the result of a collision on Interstate 95 near here that killed five people, including a Rhode Island woman and her three children.

The truck driven by Gerald A. Jones, 22, smashed into the rear of a pickup truck early Wednesday, pushed it 300 feet and crushed it against a roadside tree, killing all five occupants, said Virginia State Trooper R. D. Figgers.

Figgers identified the dead as Katherine G. Dias, 31, her children, Carolyn, 12, and twins Warren and Donna, 10, and the owner of the pickup truck, Norman C. Robeau, 35, all of Woonsocket, R.I.

Figgers said Ms. Dias and her children were moving to Orlando, Fla., where she and her family had planned to live with a sister, and that the pickup truck was loaded with Dias family possessions.

Figgers said Ms. Dias was driving when the tractor-trailer, loaded with general merchandise, hit the pickup at 5:35 a.m. about 10 miles south of here.

Jones, from the Bronx, New York City, escaped unhurt and was charged with five counts of manslaughter and one of reckless driving, Figgers said. Jones was being held in lieu of \$50,000 bond in the Rappahannock Security Center.

A preliminary hearing for Jones was set for Dec. 17 in Spotsylvania County General District Court.

A Christmas Police Tip: If you are planning to be away from home for Christmas, ask your neighbors to watch your home and bring in your mail.

You haven't seen Christmas 'til  
You Visit  
**The Christmas Shop**  
at  
**Farmville Furniture Co.**  
122-126 Main St., Farmville, 753-3101  
Open Mon.-Fri. 'Til 9

**NIKE sale**  
HI or LOW TOP  
**\$24** reg. to 36.95  
MENS 7 1/4-15  
White Leather and Mesh With Natural Or Royal Blue Swoosh.  
**Shoe Show**  
GREENVILLE SQUARE SHOPPING CENTER  
OPEN 10-7 MON.-THURS. 10-4 FRI. & SAT.

# Lord's Jewelers

With Gifts You Will Enjoy Giving Carolina East Centre

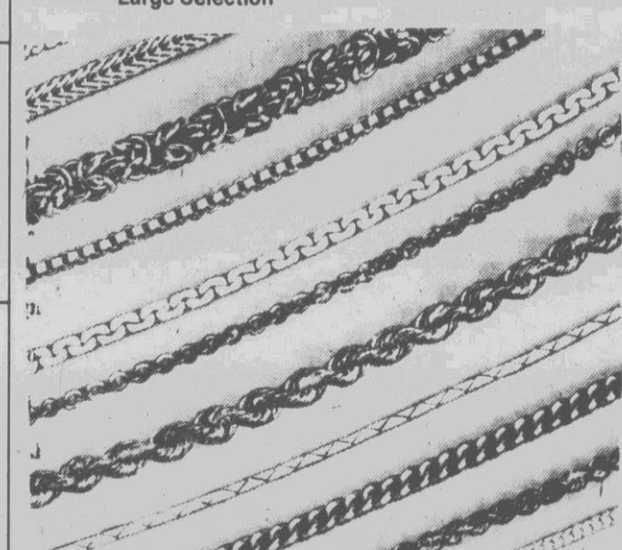
<h3>Diamond Solitaires Sale</h3> <p><b>30% Off</b></p>  <table style="width: 100%;"> <thead> <tr> <th>Reg.</th> <th>Sale</th> </tr> </thead> <tbody> <tr> <td>.03 CT. ... \$99.50</td> <td>\$69.95</td> </tr> <tr> <td>.10 CT. ... \$162.00</td> <td>\$113.40</td> </tr> <tr> <td>.15 CT. ... \$270.00</td> <td>\$189.00</td> </tr> <tr> <td>.20 CT. ... \$328.00</td> <td>\$229.60</td> </tr> <tr> <td>.38 CT. ... \$875.00</td> <td>\$612.00</td> </tr> <tr> <td>.50 CT. ... \$995.00</td> <td>\$696.00</td> </tr> </tbody> </table>	Reg.	Sale	.03 CT. ... \$99.50	\$69.95	.10 CT. ... \$162.00	\$113.40	.15 CT. ... \$270.00	\$189.00	.20 CT. ... \$328.00	\$229.60	.38 CT. ... \$875.00	\$612.00	.50 CT. ... \$995.00	\$696.00	<h3>Diamond Pendants</h3>  <table style="width: 100%;"> <thead> <tr> <th>Reg.</th> <th>Sale</th> </tr> </thead> <tbody> <tr> <td>.03 CT. ... \$49.95</td> <td>\$34.95</td> </tr> <tr> <td>.07 CT. ... \$90.00</td> <td>\$63.00</td> </tr> <tr> <td>.10 CT. ... \$135.00</td> <td>\$94.50</td> </tr> <tr> <td>.15 CT. ... \$190.00</td> <td>\$133.00</td> </tr> <tr> <td>.20 CT. ... \$265.00</td> <td>\$185.00</td> </tr> <tr> <td>.25 CT. ... \$392.00</td> <td>\$274.00</td> </tr> <tr> <td>.50 CT. ... \$895.00</td> <td>\$626.00</td> </tr> </tbody> </table>	Reg.	Sale	.03 CT. ... \$49.95	\$34.95	.07 CT. ... \$90.00	\$63.00	.10 CT. ... \$135.00	\$94.50	.15 CT. ... \$190.00	\$133.00	.20 CT. ... \$265.00	\$185.00	.25 CT. ... \$392.00	\$274.00	.50 CT. ... \$895.00	\$626.00	<h3>Keep Sake Fancy 14 Kt. Wedding Band</h3> <p>Valued To \$380.00 <b>\$95.00</b> Sale</p> <h3>Ladies Eternity Rings</h3> <table style="width: 100%;"> <thead> <tr> <th>Reg.</th> <th>Sale</th> </tr> </thead> <tbody> <tr> <td>\$299.00</td> <td>\$209.75</td> </tr> <tr> <td>\$450.00</td> <td>\$315.00</td> </tr> <tr> <td>\$995.00</td> <td>\$696.00</td> </tr> </tbody> </table>	Reg.	Sale	\$299.00	\$209.75	\$450.00	\$315.00	\$995.00	\$696.00	<h3>Ladies Diamond Princess Ring</h3> <table style="width: 100%;"> <thead> <tr> <th>Reg.</th> <th>Sale</th> </tr> </thead> <tbody> <tr> <td>\$96.00</td> <td>\$67.00</td> </tr> <tr> <td>\$140.00</td> <td>\$98.00</td> </tr> <tr> <td>\$150.00</td> <td>\$105.00</td> </tr> <tr> <td>\$275.00</td> <td>\$192.00</td> </tr> </tbody> </table> <h3>Ladies Friendship Ring - 2 Hearts</h3> <p>Reg. Sale \$89.95 <b>\$62.95</b></p>	Reg.	Sale	\$96.00	\$67.00	\$140.00	\$98.00	\$150.00	\$105.00	\$275.00	\$192.00	<h3>Opals</h3>  <p>Large Selection Styles Vary <b>30% Off</b></p> <table style="width: 100%;"> <thead> <tr> <th>Reg.</th> <th>Sale</th> </tr> </thead> <tbody> <tr> <td>\$59.95</td> <td>\$41.95</td> </tr> <tr> <td>\$79.95</td> <td>\$55.95</td> </tr> <tr> <td>\$89.95</td> <td>\$62.95</td> </tr> <tr> <td>\$125.00</td> <td>\$87.50</td> </tr> <tr> <td>\$295.00</td> <td>\$206.00</td> </tr> </tbody> </table>	Reg.	Sale	\$59.95	\$41.95	\$79.95	\$55.95	\$89.95	\$62.95	\$125.00	\$87.50	\$295.00	\$206.00
Reg.	Sale																																																															
.03 CT. ... \$99.50	\$69.95																																																															
.10 CT. ... \$162.00	\$113.40																																																															
.15 CT. ... \$270.00	\$189.00																																																															
.20 CT. ... \$328.00	\$229.60																																																															
.38 CT. ... \$875.00	\$612.00																																																															
.50 CT. ... \$995.00	\$696.00																																																															
Reg.	Sale																																																															
.03 CT. ... \$49.95	\$34.95																																																															
.07 CT. ... \$90.00	\$63.00																																																															
.10 CT. ... \$135.00	\$94.50																																																															
.15 CT. ... \$190.00	\$133.00																																																															
.20 CT. ... \$265.00	\$185.00																																																															
.25 CT. ... \$392.00	\$274.00																																																															
.50 CT. ... \$895.00	\$626.00																																																															
Reg.	Sale																																																															
\$299.00	\$209.75																																																															
\$450.00	\$315.00																																																															
\$995.00	\$696.00																																																															
Reg.	Sale																																																															
\$96.00	\$67.00																																																															
\$140.00	\$98.00																																																															
\$150.00	\$105.00																																																															
\$275.00	\$192.00																																																															
Reg.	Sale																																																															
\$59.95	\$41.95																																																															
\$79.95	\$55.95																																																															
\$89.95	\$62.95																																																															
\$125.00	\$87.50																																																															
\$295.00	\$206.00																																																															
<h3>Diamond Earrings</h3>  <table style="width: 100%;"> <thead> <tr> <th>Reg.</th> <th>Sale</th> </tr> </thead> <tbody> <tr> <td>.04 CT. ... \$75.00</td> <td>\$52.50</td> </tr> <tr> <td>.08 CT. ... \$110.00</td> <td>\$77.00</td> </tr> <tr> <td>.15 CT. ... \$180.00</td> <td>\$126.00</td> </tr> <tr> <td>.20 CT. ... \$259.00</td> <td>\$181.00</td> </tr> <tr> <td>.25 CT. ... \$315.00</td> <td>\$220.00</td> </tr> <tr> <td>.32 CT. ... \$425.00</td> <td>\$297.50</td> </tr> <tr> <td>.50 CT. ... \$900.00</td> <td>\$630.00</td> </tr> </tbody> </table>	Reg.	Sale	.04 CT. ... \$75.00	\$52.50	.08 CT. ... \$110.00	\$77.00	.15 CT. ... \$180.00	\$126.00	.20 CT. ... \$259.00	\$181.00	.25 CT. ... \$315.00	\$220.00	.32 CT. ... \$425.00	\$297.50	.50 CT. ... \$900.00	\$630.00	<h3>Men's Diamond Ring</h3>  <table style="width: 100%;"> <thead> <tr> <th>Reg.</th> <th>Sale</th> </tr> </thead> <tbody> <tr> <td>.10 CT. ... \$199.95</td> <td>\$139.95</td> </tr> <tr> <td>.25 CT. ... \$650.00</td> <td>\$455.00</td> </tr> <tr> <td>.40 CT. ... \$995.00</td> <td>\$695.00</td> </tr> <tr> <td>.50 CT. ... \$1295.00</td> <td>\$905.00</td> </tr> </tbody> </table>	Reg.	Sale	.10 CT. ... \$199.95	\$139.95	.25 CT. ... \$650.00	\$455.00	.40 CT. ... \$995.00	\$695.00	.50 CT. ... \$1295.00	\$905.00	<h3>Ladies Diamond And Sapphire Ring</h3> <table style="width: 100%;"> <thead> <tr> <th>Reg.</th> <th>Sale</th> </tr> </thead> <tbody> <tr> <td>\$120.00</td> <td>\$84.00</td> </tr> <tr> <td>\$150.00</td> <td>\$105.00</td> </tr> <tr> <td>\$375.00</td> <td>\$262.00</td> </tr> </tbody> </table>	Reg.	Sale	\$120.00	\$84.00	\$150.00	\$105.00	\$375.00	\$262.00	<h3>Fancy Diamond Bridal Sets Sale</h3> <p><b>30% Off</b></p> <table style="width: 100%;"> <thead> <tr> <th>Reg.</th> <th>Sale</th> </tr> </thead> <tbody> <tr> <td>\$119.95</td> <td>\$83.95</td> </tr> <tr> <td>\$145.00</td> <td>\$101.00</td> </tr> <tr> <td>\$196.00</td> <td>\$137.00</td> </tr> <tr> <td>\$245.00</td> <td>\$171.00</td> </tr> </tbody> </table>	Reg.	Sale	\$119.95	\$83.95	\$145.00	\$101.00	\$196.00	\$137.00	\$245.00	\$171.00	<h3>Ladies Diamond Cluster</h3> <p><b>30% Off</b></p> <table style="width: 100%;"> <thead> <tr> <th>Reg.</th> <th>Sale</th> </tr> </thead> <tbody> <tr> <td>\$142.50</td> <td>\$99.75</td> </tr> <tr> <td>1/4 CT. ... \$375.00</td> <td>\$262.50</td> </tr> <tr> <td>1/2 CT. ... \$695.00</td> <td>\$486.00</td> </tr> <tr> <td>3/4 CT. ... \$1050.00</td> <td>\$735.00</td> </tr> <tr> <td>1 CT. ... \$1195.00</td> <td>\$836.00</td> </tr> </tbody> </table>	Reg.	Sale	\$142.50	\$99.75	1/4 CT. ... \$375.00	\$262.50	1/2 CT. ... \$695.00	\$486.00	3/4 CT. ... \$1050.00	\$735.00	1 CT. ... \$1195.00	\$836.00				
Reg.	Sale																																																															
.04 CT. ... \$75.00	\$52.50																																																															
.08 CT. ... \$110.00	\$77.00																																																															
.15 CT. ... \$180.00	\$126.00																																																															
.20 CT. ... \$259.00	\$181.00																																																															
.25 CT. ... \$315.00	\$220.00																																																															
.32 CT. ... \$425.00	\$297.50																																																															
.50 CT. ... \$900.00	\$630.00																																																															
Reg.	Sale																																																															
.10 CT. ... \$199.95	\$139.95																																																															
.25 CT. ... \$650.00	\$455.00																																																															
.40 CT. ... \$995.00	\$695.00																																																															
.50 CT. ... \$1295.00	\$905.00																																																															
Reg.	Sale																																																															
\$120.00	\$84.00																																																															
\$150.00	\$105.00																																																															
\$375.00	\$262.00																																																															
Reg.	Sale																																																															
\$119.95	\$83.95																																																															
\$145.00	\$101.00																																																															
\$196.00	\$137.00																																																															
\$245.00	\$171.00																																																															
Reg.	Sale																																																															
\$142.50	\$99.75																																																															
1/4 CT. ... \$375.00	\$262.50																																																															
1/2 CT. ... \$695.00	\$486.00																																																															
3/4 CT. ... \$1050.00	\$735.00																																																															
1 CT. ... \$1195.00	\$836.00																																																															
<h3>Men's Signet Rings</h3> <p><b>30% Off</b></p> <table style="width: 100%;"> <thead> <tr> <th>Reg.</th> <th>Sale</th> </tr> </thead> <tbody> <tr> <td>\$150.00</td> <td>\$105.00</td> </tr> <tr> <td>\$285.00</td> <td>\$199.50</td> </tr> <tr> <td>\$299.50</td> <td>\$209.00</td> </tr> </tbody> </table>	Reg.	Sale	\$150.00	\$105.00	\$285.00	\$199.50	\$299.50	\$209.00	<h3>14 Kt. Gold Chains</h3> <p>Large Selection <b>50% Off</b></p> 	<h3>Ladies Genuine Stone 14 Kt. Gold Ruby - Emerald - Sapphire</h3> <p>Reg. \$49.95 <b>\$29.95</b> Now</p>	<h3>14 Kt. Serpentine Bracelet</h3> <p><b>\$9.95</b></p>	<h3>Ladies Black Onyx Ring</h3> <p><b>30% Off</b></p> <table style="width: 100%;"> <thead> <tr> <th>Reg.</th> <th>Sale</th> </tr> </thead> <tbody> <tr> <td>\$90.00</td> <td>\$63.00</td> </tr> <tr> <td>\$106.00</td> <td>\$74.00</td> </tr> <tr> <td>\$115.00</td> <td>\$80.00</td> </tr> <tr> <td>\$130.00</td> <td>\$91.00</td> </tr> </tbody> </table>	Reg.	Sale	\$90.00	\$63.00	\$106.00	\$74.00	\$115.00	\$80.00	\$130.00	\$91.00																																										
Reg.	Sale																																																															
\$150.00	\$105.00																																																															
\$285.00	\$199.50																																																															
\$299.50	\$209.00																																																															
Reg.	Sale																																																															
\$90.00	\$63.00																																																															
\$106.00	\$74.00																																																															
\$115.00	\$80.00																																																															
\$130.00	\$91.00																																																															
<h3>Speidel I.D. Bracelets</h3> <p><b>30% Off</b></p>	<h3>Selection Of 14 K Gold Earrings</h3> <p><b>50% Off</b></p>	<h3>Men's Jewelry Boxes</h3> <p><b>30% Off</b></p>	<h3>Selection Of Gift Items</h3> <p><b>3% Off</b></p>	<h3>Ladies Smoky Topaz Rings</h3> <p><b>30% Off</b></p> <table style="width: 100%;"> <thead> <tr> <th>Reg.</th> <th>Sale</th> </tr> </thead> <tbody> <tr> <td>\$95.00</td> <td>\$66.50</td> </tr> <tr> <td>\$105.00</td> <td>\$73.50</td> </tr> <tr> <td>\$165.00</td> <td>\$115.00</td> </tr> </tbody> </table>	Reg.	Sale	\$95.00	\$66.50	\$105.00	\$73.50	\$165.00	\$115.00																																																				
Reg.	Sale																																																															
\$95.00	\$66.50																																																															
\$105.00	\$73.50																																																															
\$165.00	\$115.00																																																															
<h3>Ladies Diamond -Ruby Pendant</h3> <p>Reg. \$130.00 <b>\$90.00</b> Sale</p>	<h3>Lord's Jewelers</h3> <p>Carolina East Centre 756-8963 Hours: 9-9; Mon.-Sat.</p>	<h3>Gold Filled And Sterling Pendants And Crosses</h3> <p><b>20% Off</b></p> <p>From <b>\$16.95</b></p>	<h3>Jewelry Boxes</h3> <p><b>30% Off</b></p> <table style="width: 100%;"> <thead> <tr> <th>Reg.</th> <th>Sale</th> </tr> </thead> <tbody> <tr> <td>\$10.00</td> <td>\$7.00</td> </tr> <tr> <td>\$12.50</td> <td>\$8.75</td> </tr> <tr> <td>\$22.00</td> <td>\$15.40</td> </tr> <tr> <td>\$35.00</td> <td>\$24.50</td> </tr> </tbody> </table>	Reg.	Sale	\$10.00	\$7.00	\$12.50	\$8.75	\$22.00	\$15.40	\$35.00	\$24.50																																																			
Reg.	Sale																																																															
\$10.00	\$7.00																																																															
\$12.50	\$8.75																																																															
\$22.00	\$15.40																																																															
\$35.00	\$24.50																																																															

## MATERNITY WEARHOUSE

PRE-HOLIDAY CLEARANCE  
SANTA'S ARRIVED...

with all the great maternity fashions you've been expecting. Designs by Sasson, Puccini, Evelyn de Jong and many others all at SAVINGS OF 15% TO 50%.

**TOPS** \$14.99  
Special group reduced up to 30%  
**SLACKS** \$10.00 below our already low discounted prices

Special group  
**JUMPERS & DRESSES** as low as \$20

Open late for your convenience before Christmas

Carolina East Convenience Center  
N.C. Highway 11  
Greenville, North Carolina 756-5969  
Mon-Wed, Sat: 10-6, Thu-Fri: 10-9

# Stock And Market Reports

### Hogs

RALEIGH, N.C. (AP) (NCDA) — The trend on the North Carolina hog market today was mostly 25 cents to 50 cents higher. Kinston 54.75, Clinton, Elizabethtown, Fayetteville, Dunn, Pink Hill, Chadbourne, Ayden, Pine Level, Laurinburg and Benson 54.50, Wilson 54.50, Salisbury 54.00, Rowland 54.00. Sows: all weights 500 pounds up; Wilson 46.00, Fayetteville 45.00, Whiteville 46.00, Wallace 46.00, Spivey's Corner 45.50, Rowland 46.00, Durham 45.00.

### Poultry

RALEIGH, N.C. (AP) (NCDA) — The North Carolina f.o.b. dock quoted price on broilers for this week's trading was 41.25 cents, based on full truck load lots of ice pack USDA Grade A sized 2 1/2 to 3 pound birds. Too few sales to report prices. The market is steady and the live supply is moderate for a seasonally moderate demand. Average weights desirable. Estimated slaughter of broilers and fryers in North Carolina Thursday was 1,029,000, compared to 1,645,000 last Thursday.

NEW YORK (AP) — The stock market showed no clear trend today, struggling to halt the slide of the past two sessions.

The Dow Jones average of 30 industrials, down 31.64 points Tuesday and Wednesday, recovered 3.04 to 995.68 by noontime today.

But losers held a 9-5 advantage over gainers among New York Stock Exchange-listed issues. AT&T shares, down 1 1/2 Wednesday, slipped another 1/8 to 60 1/2 in active trading today.

The NYSE's composite index lost .03 to 78.06. At the American Stock Exchange, the market value index was down .45 at 324.80.

Volume on the Big Board totaled 32.89 million shares at noontime, against 36.43 million at the same point Wednesday.

NEW YORK (AP) — Midday stocks:

	High	Low	Last
AMR Corp	22 1/2	22	22 1/2
AbbLabs	38 1/2	38 1/2	38 1/2
Alcoa	28 1/2	28	28 1/2
Amer Brands	45 1/2	45 1/2	45 1/2
Amer Can	30 1/2	30 1/2	30 1/2
Amer Cyan	33 1/2	33 1/2	33 1/2
Amer Family	15 1/2	15 1/2	15 1/2
Am Moxors	6 1/2	6 1/2	6 1/2
AmsStand	27 1/2	27	27 1/2
Amer T&T	60 1/2	60 1/2	60 1/2
Beat Food	23 1/2	23 1/2	23 1/2
Beth Steel	16 1/2	16 1/2	16 1/2
Boeing	32 1/2	31 1/2	31 1/2
Boise Casced	35 1/2	34 1/2	34 1/2
Borden	47 1/2	46 1/2	47 1/2
Burling Ind	24 1/2	24 1/2	24 1/2
CSX Corp	50 1/2	49 1/2	49 1/2
CaroPwLd	21 1/2	21 1/2	21 1/2
Celanese	42 1/2	42	42 1/2
Cent Sova	15 1/2	15 1/2	15 1/2
Chrysler	21 1/2	20 1/2	20 1/2
CocaCola	14 1/2	14 1/2	14 1/2
Colg Palm	50 1/2	49 1/2	49 1/2
Comw Edis	19 1/2	19 1/2	19 1/2
ConAgra	27 1/2	27	27 1/2
Contl Group	33 1/2	33 1/2	33 1/2
DeltaAiri	39 1/2	39	39 1/2
DowChem	39 1/2	39 1/2	39 1/2
DuPont	36 1/2	35 1/2	35 1/2
Duke Pow	21 1/2	21 1/2	21 1/2
EastAiriL	7 1/2	7 1/2	7 1/2
East Kodak	86 1/2	85 1/2	85 1/2
EatonCp	29 1/2	29 1/2	29 1/2
Esmark s	57 1/2	57 1/2	57 1/2
Exxon	28 1/2	28 1/2	28 1/2
Firestone	18 1/2	18 1/2	18 1/2
FiaPowLd	34 1/2	34 1/2	34 1/2

## The Meeting Place

**THURSDAY**  
10:00 a.m. — La Leche League meeting will be held. Call 756-4197  
10:15 a.m. — Town and Country Senior Citizens meet at St. Paul's Episcopal Church  
7:00 p.m. — Greenville Elks Lodge No. 1645 meets  
7:30 p.m. — La Leche League meeting will be held. Call 756-4197  
7:30 p.m. — Overeaters Anonymous meets at First Presbyterian Church  
8:00 p.m. — VFW meets at Post Home  
8:00 p.m. — Coochee Council No. 60, Degree of Pochantons meets at Redmen's Hall

**FRIDAY**  
7:30 p.m. — Red Men meet

### FACTORY CLOSEOUT!

Solid Maple  
**DINETTE CHAIRS**  
\$29.95 EACH

**FURNITURE WORLD**  
10th STREET EXT. • PHONE 752-7613 • TERMS

# Obituaries

### Gilbert

**ROBERSONVILLE** — Funeral services for Mr. Eddie Richard Gilbert, who died Sunday at his home on Route 2, Robersonville, will be conducted Saturday at 1:30 p.m. at St. John Baptist Church, Stokes, by the Rev. L.D. Bizzell. Burial will be in the Council Cemetery.

Mr. Gilbert was an Ayden native who had made his home in the Robersonville area for several years. He was a member of St. John Church.

Surviving are his wife, Mrs. Pauline Sparger Gilbert of the home; 10 daughters, Mrs. Thelma Williams, Mrs. Mary Jenkins, Mrs. Augusta Williams and Mrs. Annie Mae Edwards, all of Greenville, Mrs. Ella Broadie of Charlotte, Mrs. Doris Stanley of Robersonville, Mrs. Annie Little of Stokes, Mrs. Josephine Jones of Woodbridge, Va., Mrs. Minnie B. Clark of Baltimore and Mrs. Letha Dixon of Paterson, N.J.; four sons, David Gilbert of Atlantic City, N.J., Clinton Gilbert of Palm Beach, Fla., Henry Buster Langley of Robersonville and Raymond Langley of Washington, D.C.; two sisters, Mrs. Annie Carmon of Greenville and Mrs. Mattie Wilson of Ayden; two brothers, Leon Gilbert and Roy Gilbert, both of Greenville; 67 grandchildren; 23 great-grandchildren and eight great-great-grandchildren.

The family will receive friends Friday from 7 to 8 p.m. at Flanagan Chapel, Robersonville.

### Hill

**ROCKY MOUNT** — Mrs. Carrie Jane Hill, 92, died Monday in Nash General Hospital. Her funeral service will be conducted Sunday at 3 p.m. at Hillsdale Baptist Church by the Rev. Butler McKinnon. Burial will be in the Unity Cemetery.

Surviving her are two sons, Willie Hill of Greenville and James Hill of Pinetops; five daughters, Mrs. Blanche Powell of the home, Mrs. Leather Jenkins and Mrs. Annie Williams, both of Macclesfield, Mrs. Mary Maynor of St. Paul, and Mrs. Carrie Edge of Rocky Mount; a sister, Ms. Dora Bell of St. Paul; 53 grandchildren and 179 great-grandchildren.

Family visitation will be held at the Hemby-Willoughby Mortuary Chapel in Tarboro Saturday from 7 to 8 p.m.

### Lewis

Mrs. Naomi Gray Lewis, 59, died Wednesday in Pitt County Memorial Hospital.

## Problems Seen By Panamanian

By PETER EISNER  
Associated Press Writer  
**PANAMA CITY, Panama (AP)** — President Ricardo de la Esparilla warns that serious problems threaten the Panama Canal treaties with the United States, providing a possible focus for anti-American sentiment in his economically troubled country.

The 47-year-old president still believes the 1978 canal treaties were "a great step forward for Panama," but says U.S. congressional action already has violated "the spirit of the accords."

"This could turn into a serious problem if it's not resolved... a problem for the future," de la Esparilla said in an interview with The Associated Press.

De la Esparilla, who had been vice president, took office July 30 when the powerful national guard forced President Aristides Royo to resign. Since then, few people have questioned that Gen. Ruben Dario Paredes, the national guard commander, holds the real power in Panama.

The president, who refers to the guard as a "partner in power," said the canal problem remains a major point of contention with the United States.

But he said Panamanian disagreement with Reagan administration policy also extends to the problems of Central America, where Panama, along with Costa Rica, has remained relatively free of civil strife.

Panama faces heavy debt



CUTTING THE RIBBON ... At the dedication of the newly restored Fleming Home are (l-r) Rep. Sam Bundy, Rep. Ed Warren, Larkin Little, Charles Gaskins and Mayor Percy Cox. The house will serve as the new offices of the Pitt-Greenville Chamber of Commerce.

## Probe N.C. Friends Set Up Fund For Lewis's Legal Aid

ASHEVILLE, N.C. (AP) — Federal officials are preparing a grand jury investigation of an international drug smuggling ring with North Carolina connections.

The North Carolina probe comes in the wake of grand jury investigations in West Virginia that led to 45 indictments, including indictments against two Wilkes County men. Bobby M. Parks agreed to testify before the grand jury as part of a plea bargain, and Cletus "Dobe" Powell of North Wilkesboro, identified by the West Virginia grand juries as the leader of the ring, has been a fugitive since May.

West Virginia authorities will turn over information, including secret testimony, to federal authorities in North Carolina.

"It is a major investigation," said Charles Brewer, U.S. Attorney for the Western District of North Carolina. "We are in the preliminaries now, but I have talked to people in West Virginia and the Justice Department in Washington and there will be an investigation of those charges here."

William Kolibash, U.S. Attorney for the Northern District of West Virginia, said the grand jury investigation there is winding down.

"Any further we could go with this really takes us outside of our jurisdiction," Kolibash said. "I don't know if Wilkes County is the hub of a wheel or just part of the line to West Virginia. That investigation will be undertaken in North Carolina."

The grand jury indictments include charges that in 1976 Powell began importing marijuana from South America to North Carolina, and passed the drugs to a network in West Virginia.

SHRINE NOTICE  
Greenville area Nobles of Rofelt Pasha Shrine Temple No. 175 are to report to the home of Noble John B. Smith Saturday at 4 p.m. with six canned goods and a monetary donation for the needy at Christmas.

James Ebron Jr., area coordinator.  
Annias Smith, area secretary.

BUNDY SCHEDULE  
Sam D. Bundy will attend meetings of the Advisory Budget Commission and the State Board of Awards in Raleigh Friday.

Friday night he will speak during a Christmas party of the Security Storage Co. in Goldsboro.

MASONIC NOTICE  
Mount Calvary Lodge No. 669 will meet tonight at 7:30. All Master Masons are asked to be present.

Julius Phillips, Worshipful Master  
Abram Lang, Secretary

KANSAS CITY, Mo. (AP) — A defense fund has been established for Tyleneol extortion suspect James Lewis and his wife by friends who say they "are nothing like the Bonnie and Clyde characters pictured in so many reports."

"We feel there are very powerful institutions involved in this story that have their own objectives ... If the contest gets too unequal, we think the defense will get very costly," Ted Otteson said today of his reasons for helping set up the fund.

"Another reason is that it is an opportunity to remind everybody of the presumption of innocence ... that someone is presumed innocent until proven guilty," he said.

He remembered James and Leann Lewis as the people who prepared his taxes in Kansas City for 10 years and who worked with his

neighborhood association — the Brush Creek Trolley Barn Neighborhood Association. They moved to Chicago last December.

"They kept the books for us, filed reports for us. They were involved in neighborhood cleanups. They were politically active," Otteson said.

Otteson, a part-time lecturer in English at the University of Missouri-Kansas City and Longview Community College, said he hoped to see Lewis to tell him of the defense fund.

Lewis, who was arrested Monday in New York City, is being held in lieu of \$5 million bail pending extradition to Chicago. He faces charges of writing a \$1 million extortion demand to Johnson & Johnson threatening more poisonings after seven Tyleneol poisonings deaths in the Chicago area in September.

Johnson & Johnson is the parent company of the firm that manufactures Tyleneol.

Mrs. Lewis, who surrendered in Chicago after her husband's arrest, is being held in lieu of \$5 million bail on a charge of fraudulent use of a Social Security number.

Otteson said it had been agreed that the names of fund supporters would be confidential. He said it had been agreed not to reveal the size of the fund, describing it as "more than a small amount."

"I think to get them a defense to hold its own, it will take a lot of money, \$50,000 or \$100,000. We have no idea," Otteson said.

Lewis was indicted last month by a federal grand jury here on six counts charging mail fraud and on a charge of making a false application to the Internal Revenue Service.

## EARLY BIRD SALE!

1/3 OFF 1/3 OFF

•ARTIFICIAL CHRISTMAS TREES  
•ORNAMENTS  
•WREATHS  
•LIGHT SETS

•GARLAND  
•TREE SKIRTS  
•STOCKINGS  
•AND STUFFERS  
•AND MUCH, MUCH MORE!

### ENTIRE CHRISTMAS INVENTORY REDUCED!

(RIBBON NOT INCLUDED)

**HURRY— STARTS TODAY!**

# sunshine

EVANS ST. EXT. GREENVILLE  
OPEN 7 DAYS TIL 6 P.M.

## ECU Faces Bayou Classic Host Team

East Carolina's Pirates hit the road again this weekend, seeking to do what they've never done before — win an inseason basketball tournament.

As long as East Carolina has been an NCAA member, the Pirates have not captured an invitational tournament championship. Since the 1964-65 season, when ECU was a probationary member of the Southern Conference, the Pirates have appeared in 15 tournaments. Their record is 10-21 (actually 11-20 after one loss was reversed by a forfeit for an ineligible player use).

They've reached the finals of only four of those tournaments, losing each of them. Not since the 1978-79 season, when the Pirates lost to Connecticut in the finals of the U-Conn Classic have the Pirates reached the finals. In fact, the Pirates have just two wins in their last 14 tournament games.

But on the eve of the Bayou Classic at Southwestern Louisiana, East Carolina coach Charlie Harrison isn't the least bit disturbed.

"I don't give a — about the past," Harrison said. "All I'm concerned about is today, tomorrow and the next day."

The Pirates will get a tough test in the first round, facing the hosting Ragin' Cajuns in the 9:30 p.m. (EST) game. New Mexico State and Grambling State collide in the first game, set for 7:30 p.m.

The winners meet for the title on Saturday night while the losers play in the earlier consolation game.

Harrison has compared Southwest, which brings a 4-0 record into the tournament — one that they've never lost in — to ECU's last foe, 15th ranked N.C. State.

"Being an independent they don't get

as much attention as some clubs, but they were ranked in the top twenty at the end of last season and played in the NCAA tournament," the coach said. "Four of their starters are back from that team."

While Southwestern hasn't the front line height of N.C. State, Harrison said that size doesn't really concern him. "It's how big or how strong they play."

Southwestern is expected to start 6-9 Dan Gay at center, with 6-8 Graylin Warner and 6-7 Dion Brown at the two forwards. Johnny Collins (5-10) and Roy McGrew (6-3) will be the starting guards.

"They have an experienced team," Harrison said. "They are geared to the inside play on offense, and they run a lot of changing defenses. We expect to see three different defenses from them at least."

The front line has been the big

producer so far for the Cajuns, who had beaten Florida International, 105-54, New Orleans, 70-68, Louisiana Tech, 46-45, and Cal State-Santa Barbara, 97-84. That last win came only last night as a warmup for the tournament.

"I don't feel that that's a handicap," Harrison said. "In fact, I wish we were playing." The Pirates haven't taken to the court since last Wednesday when they lost to State, 57-49.

Brown is the leading scorer for the Cajuns, hitting 26.3 points a game prior to last night. Warner is scoring at a 14.7 rate, while Gay has a 9.3 average. McGrew has a 7.3 mark, while Collins is at 8.3.

The Cajuns are also strong on the boards, led by Gay's 8.3 average. Brown has a 7.3 average while Warner is snatching off 5.3 rebounds.

"They are awfully quick and talented,"

Harrison said.

The Pirates, led by freshman Johnny Edwards, bring in a 2-2 record to the game. Edwards is scoring 19.8 points a game and pulling 8.3 rebounds. Three other Pirates are in double figures, Barry Wright at 14.5, Bruce Peartree at 13.8 and Charles Green at 11.3. The fifth starter, Tony Robinson is scoring 6.5 points a game.

The Pirates are hopeful of having two injured players back for the tournament. Thom Brown, who played only one minute against State because of a practice-sustained knee injury, is now back at full strength.

Curt Vanderhorst, the third guard, averaging 5.3 points, missed the State game with an ankle injury, and it was uncertain whether he would be able to go. "If he's not at full speed, we probably won't take him with us," Harrison said.

As far as the tournament is concerned, Harrison is making nothing special of it. "We're taking it just like another game. Being in a tournament doesn't necessarily intrigue me. But it does give the kids a chance for a nice trip."

As far as the other two teams in the field are concerned, Harrison is leary of New Mexico State. That team has won four of six games, most recently downing New Mexico, 101-86, and New Mexico Highlands, 133-85.

No information has been made available to ECU personnel about Grambling. "We'll see them on Friday night," the coach said.

Following the tournament, the Pirates are off until December 28 when they host New Hampshire in Minges in a 7:30 p.m. game. They then open ECAC-South play at George Mason on December 30.

## Eppley Sparkles As Clemson Rolls

By The Associated Press  
It didn't take Clemson's Mike Eppley long to convert from the starting quarterback for the Tiger football team to point guard on the basketball team.

Eppley hit on all five of his field goal attempts and dished out eight assists as Clemson

downed Campbell 76-59 in a non-conference college basketball game Wednesday night.

In the only other game involving an Atlantic Coast Conference team, Georgia Tech blew a 21-point second half lead but rallied to defeat Alabama A&M 90-85.

Yellow Jacket coach Bobby Cremins' team was cruising along with a 62-41 lead with 15:11 to play when the Bulldogs rallied, behind four consecutive 3-point goals from Terry Howard, to take a 77-76 lead with 6:27 to go.

But Georgia Tech regained its composure and won the game, lifting its record to 4-1.

In the only game featuring an ACC team today, top-ranked Virginia takes on Houston in the Sun Belt Classic in Tokyo.

The Tigers, 5-3, took control

early in their game with Campbell and were never really threatened as center Raymond Jones contributed 14 points and 10 rebounds and forward Fred Gilliam added 12 points and nine rebounds against the outmanned Camels.

Center Mike Vandy led Campbell, 2-3, with 15 points, while Ken Griffin had 12, and Harvey Smith and Larry Kennedy added 11 each.

Clemson jumped out to an early lead, but Campbell came back to tie it at 10-10 before the

Tigers rattled in eight unanswered points for an 18-10 lead with 11:47 remaining in the first half.

The Tiger advantage reached 13 points twice and stood at 39-27 at intermission.

With Eppley engineering the fast-paced offensive attack and Gilliam providing outside fire power, the Tigers gradually pulled away during the rest of the game despite excellent defensive play by Campbell.

Clemson coach Bill Foster said Wednesday's game turned out to be a little tougher than expected.

"Campbell played much better tonight than they did when we scouted them, but that's to be expected," he said.

"They were shooting 39 percent coming in, but their center (Vandy) was hitting them from long range, and if we'd been playing with a 3-point basket we would have been in trouble."

Meanwhile, Campbell coach Danny Roberts found much to criticize about his team's effort.

"We had to stop their break, which we didn't do," he said. "We got beat under the boards. Clemson got a lot of easy shots, and we didn't have anyone to match up with them inside."

At Atlanta, Georgia Tech's Cremins praised his team for fighting back after blowing the 21-point lead.

"We could have gone down the tubes tonight," Cremins said.

A&M fought back using Howard's 3-pointers, but Tech freshman Mark Price sank five 3-point baskets of his own. Price scored 24 points to lead Tech and John Salley, another freshman, contributed 20 points and Danny Pearson had 18.

Pearson put Tech ahead to stay 83-81 on a layup with 3:08 to go, and the Jackets hit seven of eight free throw attempts in the final two minutes to lift their record to 4-1.

CAMPBELL	MP	FG	FT	R	A	P	Pt
Griffin	30	5-12	2-3	3	3	1	12
Cannady	37	4-9	3-6	8	0	1	11
Vandy	32	6-13	3-4	7	1	3	15
Smith	40	5-11	1-2	3	4	3	11
Williams	18	2-3	0-0	1	4	0	4
Austin	15	0-2	0-0	2	2	1	1
Spain	7	0-2	0-0	0	0	0	0
Parker	10	2-4	0-0	1	0	0	4
Whitted	1	0-0	0-0	1	0	0	0
Elbaum	2	0-0	0-0	0	0	0	0
Nash	8	0-0	0-0	0	0	1	1
Totals	200	24-57	11-19	27	17	14	59
CLEMSON	MP	FG	FT	R	A	P	Pt
Shaffer	24	2-5	0-0	3	3	1	4
Gilliam	29	6-12	0-0	9	2	4	12
Jones	29	6-9	2-3	10	4	4	14
Wallace	29	4-8	0-0	3	2	1	8
Eppley	27	5-5	1-2	1	8	1	11
Bynum	11	2-4	0-1	2	2	2	4
Michael	5	0-2	0-0	0	0	0	0
Belich	2	1-1	0-0	0	1	0	2
Campbell	17	3-5	0-0	3	4	1	6
McCants	5	0-1	2-2	3	1	1	2
Jenkins	5	2-3	1-1	0	0	1	5
Jarman	17	4-6	0-0	4	1	2	8
Totals	200	35-61	6-9	40	28	18	76

Campbell 27 32-59  
Clemson 39 37-76

Turnovers: Campbell 16, Clemson 13.  
Technical fouls: None.  
Officials: Hausman, Flynn, Little A-4,000.

**SAAD'S SHOE REPAIR**  
QUALITY SHOE REPAIRING  
113 Grand Ave. Phone 758-1228  
Opposite Sherman Williams Parking in Front  
Mon.-Fri. 8-6 Closed Saturday

## Goodbye Hard To Say To Bear

TUSCALOOSA, Ala. (AP) — Like readers lingering over the final pages of a frayed but beloved book, fans, players and gridiron enemies were reluctant to say goodbye to the Paul "Bear" Bryant era.

As the rest of college football grappled with the news that its most successful coach was quitting, University of Alabama students tried to console themselves.

"It's like losing a best friend," said Robert Bruce, a sophomore from Memphis, Tenn., where Bryant will coach his final game. "I'm worried about whether it will hurt recruiting, because everybody has wanted to play for Bear."

And like a novel with a sad ending, Bryant's departure left some of his fans with mixed feelings.

It "leaves a bad taste in my mouth" that Bryant chose to quit after a mediocre year, said Bill Oakley, a May graduate who is working at the school. "I hope he's not basing it on this season, because he's had a great career."

Whatever Bryant's reasons, his decision to quit leaves a vacuum on the Alabama campus, and a bigger one in the hearts of the players he led so well.

"Right now, I'm dumb-

founded," said Jesse Bendross, a junior wide receiver. "I'm just waiting, but I don't know what I'm waiting on. I thought I'd be here four years before he retired."

"It's stunning," added quarterback Paul Fields. "Everybody is pretty much wordless."

Auburn coach Pat Dye, a former Bryant assistant who leads the Crimson Tide's bitter cross-state rival, had a few words for Bryant.

"It's kind of sad that he's getting out," said Dye, who is in Orlando, Fla., for a Tangerine Bowl battle with Boston College this weekend.

"He certainly doesn't have anything to prove," Dye added. "He's proven everything there is to prove in coaching."

The Auburn coach grew visibly upset over questions about what effect Bryant's retirement would have on the Tigers.

"When I came to Auburn, I didn't come on the basis of Coach Bryant would be at Alabama or retire," Dye said. "I'm not going to let that coaching change affect the way we do things at Auburn."

As the tribute to Bryant rolled in — "there will never be a replica of him," said university President Joab Thomas — so too did questions about the future for a Crimson Tide minus Bryant.

New York Giants Coach Ray Perkins, Bryant's successor, "cleaned house when he went with the Giants, and I think that's going to have to be done here," Oakley said. "Not so much in coaches and players but in the style of play."

Despite the general dismay at Bryant's resignation, there were glints of a characteristic optimism in the hearts of Alabama players and fans.

"I feel his decision was made on our part," Bendross said, noting the Tide's 7-4 record this year — shoddy by Bryant's standards. "He felt he had to do something to make us winners again."

Oakley added: "You watch Alabama come back and go undefeated next year."

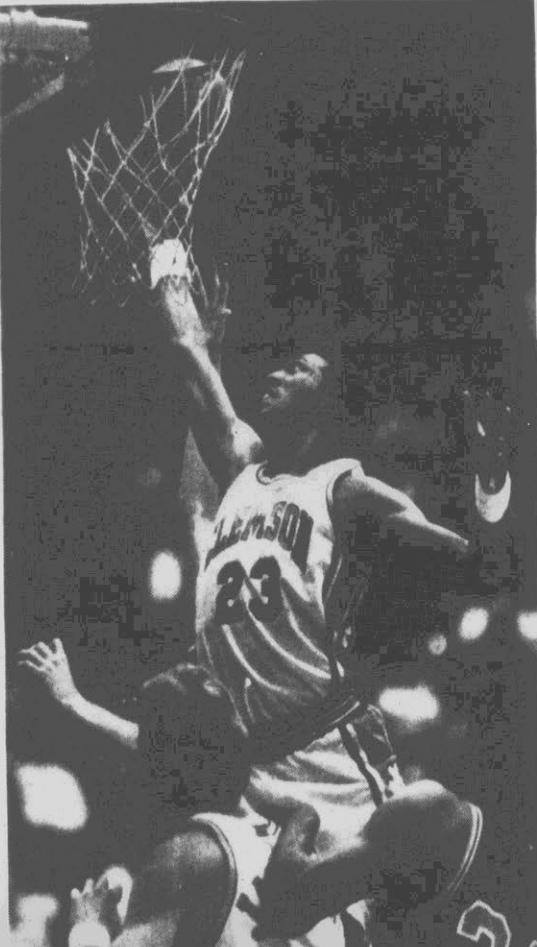

**Tiger Basket**  
Clemson's Raymond Jones (23) tips a basket in as the Tigers went on to defeat Campbell University, 76-59 on Wednesday night. (AP Laserphoto)

## Conley Rallies By White Oak

JACKSONVILLE — D.H. Conley's wrestlers spotted White Oak High School a 21-14 lead after seven weight classes, then stormed back in the remaining six to take a 46-23 victory last night.

Conley won four of the remaining six by pins, and got another six points through a forfeit. Only in the final match did White Oak score again, managing a draw.

Conley is now 5-1 on the year and plays host to New Bern on Friday at 7 p.m. New Bern was 13-1 last season, losing only to Conley, and Coach Milt Sherman feels that the Bears will be out for revenge in the match.

- Summary:
- 98 — M. Parker (WO) won by forfeit.
  - 105 — Todd Cochran (C) won by forfeit.
  - 112 — S. Arnold (WO) d. Chad Clark, 12-1.
  - 119 — Reginald Moore (C) won by forfeit.
  - 126 — S. Willis (WO) d. Joel Maye, 9-7.
  - 132 — Shawn Hardy (C) drew with J. Powers, 4-4.

STIHL 015 CHAIN SAW **\$190**  
and bonus pack  
**HENDRIX-BARNHILL**  
Memorial Dr. 752-4122

**Sports Calendar**

Editor's Note: Schedules are supplied by schools or sponsoring agencies and are subject to change without notice.

Today's Sports  
Wrestling  
Cary at Farmville Central (7 p.m.)  
Basketball  
Bear Grass at Mattamuskeet  
Friday's Sports  
Basketball  
Bethel at Greenville Christian (5:30 p.m.)  
East Carolina vs. Southwestern Louisiana at Bayou Classic (9:30 p.m.)  
Farmville Central at Greene Central (6:30 p.m.)  
Ayden-Grifton at Havelock  
Tarboro at Williamston (6:30 p.m.)  
Belhaven at Jamesville  
Roanoke at Ahoskie  
Conley at North Pitt (6:30 p.m.)  
Wrestling  
Fike at Rose (7 p.m.)  
New Bern at Conley (7 p.m.)

**Opening In April**

**The Greenville Racquet Club**

Composition Courts On Arlington Blvd.

Be A Charter Member And Take Advantage of Membership Discounts Available Until February 1st

For More Details Call Cindy From 9-5 Mon.-Fri. At 756-7711

*On the sixth day of Christmas*  
*Bond's and H.L. Hodges offers you*

# BASEBALL

**GLOVES**  
25% Off All Baseball Gloves  
•Rawlings•Wilson•Mizuno•Louisville Slugger•

**BALLS**  
Rawlings RPB-3 ..... Reg. \$2.95 Sale \$1.95  
Rag Ball ..... Reg. \$5.95 Sale \$3.95

**JACKETS**  
Major League Jackets ..... \$59.95

**HATS**  
Major League Hats ..... Reg. \$12.95 Sale \$9.95

This Offer Good 12/16/82 Thru 12/24/82

**BOND'S** 218 Arlington 756-6001  
**H.L. HODGES** 210 E. Fifth St. 752-4156

SPORTING GOODS  
Bonds Will Be Open Until 9:00 P.M.  
For Your Shopping Convenience  
Starting Friday Dec. 17 Thru Christmas

**Todd's stereo**

Now, Advanced Canon technology comes to portable video with the

# CANON PORTABLE VIDEO SYSTEM

Super-sophisticated, yet simple to use, this is portable video at its finest.

- Lightweight 5 1/2-pound Canon color video camera
- 11 to 70mm Canon zoom lens with Auto Focus and macro
- Salticon® tube for low-light shooting
- character generator
- VCR remote control
- Compact 8 1/2, 6 oz. portable video recorder records up to 8 hours
- SLP and SP selection
- single-frame advance, 10X search, still frame slow motion, Insert Editing
- Cable-ready tuner/timer with 4-program/2-week timer preset
- 105 channels

**FREE Carrying Case Included!**

**Canon**

105 Trade St.  
Phone 756-2293  
Open Daily til 8 P.M.  
Friday Nights til 9 P.M.  
All Day Saturday

VISA  
MasterCard

# American Upsets Georgetown

By The Associated Press  
Georgetown Coach John Thompson says the Hoyas' upset loss to American University can't be blamed on a letdown.

"I think that all the credit should go to American University," Thompson said after fifth-ranked Georgetown's 62-61 defeat Wednesday night. "All the problems we had as a team were caused by American."

The Hoyas, playing their first game since an emotion-charged 68-63 loss last Saturday to top-ranked Virginia, rallied from a 17-point deficit to nearly pull out the victory against their intransigent rival.

But American senior Gordon Austin, despite a high injury that forced him to sleep Tuesday night with his leg tied

down, scored seven of his eight points down the stretch to keep the Eagles in front.

"We have had a reputation as a loser, losing in the first round of the NIT two years in a row," Austin said. "Maybe now we won't have to play second-fiddle to Georgetown and George Washington in the city."

In other college games involving ranked teams, No. 9 St. John's tripped Fordham 74-66, 12th-ranked Louisville bombed South Alabama 94-77 and No. 13 Arkansas blasted Alabama State 108-65.

"We were like a punch-drunk fighter on the ropes waiting for the bell," American Coach Ed Tapscott said of the final, frantic moments of the American-Georgetown game. "I just kept trying to do

something to get Georgetown off my back."

"We got passive in the second half and went to a stall with about eight minutes to go. That's a pretty tough way to try and beat a team like Georgetown," Austin said.

Georgetown, 6-2, trailed 49-32 with 9:44 to play, but an 18-2 burst by the Hoyas cut the deficit to 51-50 with 5:02 left. Then Austin went to work.

He drove past 7-foot center Patrick Ewing to put American ahead 53-50. After a Ewing foul shot, Austin made two foul shots for a 55-51 Eagle advantage.

Driving to the basket again, Austin drew a foul on Ewing, who fouled out of the game with the 3:10 to go. Austin made both free throws to make it 57-51.

The Hoyas rallied once again, but it fell short as first Andre Adams and then Juan Jones each made the front end of a 1-and-1 free throw opportunity to seal the victory for American, now 4-1.

Mark Nickens scored 17 points to lead the Eagles, scoring attack. David Wingate had 24 for Georgetown.

David Russell scored 21 points as St. John's, now unbeaten after eight games, was never threatened after taking a 36-23 lead at halftime. The victory was the 16th in a row over Fordham for St. John's Coach Lou Carnesecca.

Charles Jones and Scooter McCray controlled the boards as Louisville manhandled South Alabama. Jones had 15 points and 15 rebounds and McCray 15 points and 10 re-

bounds for the Cardinals, who outscored South Alabama 18-2 over a 4:16 span in the first half to turn a 15-15 tie into a 33-17 advantage.

Lancaster Gordon added 18 points for Louisville.

Darrell Walker scored a career-high 35 points as Arkansas shook off a nine-day layoff to rip Alabama State. Walker hit 15 of 26 field goals and five of 11 free throws in registering the second-highest total for the Razorbacks since Sidney Moncrief scored 39 against Southern Mississippi in 1979.

Joe Kleine added 16 points for Arkansas on 7-for-7 shooting.

"Darrell Walker had a sensational night," Coach Eddie Sutton said. "He could have broken the 39 points had he not been careless underneath a couple of times and had he hit free throws. He not only scored, but had some great passes and rebounded well. It was the best performance he's had at Arkansas."

In other games, it was Niagara 71, Ohio U 69 in overtime; Georgia Tech 90, Alabama A&M 85; Mississippi 48, Mercer 40; Cincinnati 88, Indiana 83; DePaul 69, Northern Illinois 45; Georgia 75, Texas 54; Washington 76, West Washington 59; and Drake 102, Mankato State 62.

# Foster, After Surgery, May Return In Month

COLUMBIA, S.C. (AP) — South Carolina basketball coach could see limited coaching duty after a month if his recovery from quadruple coronary bypass surgery goes smoothly, says a university spokesman.

Foster, 52, suffered a heart attack Saturday during his team's 59-53 upset victory over Purdue. He underwent quadruple bypass surgery Wednesday morning, and a hospital spokesperson said early this morning he was in stable condition and "resting comfortably."

A member of the firm of surgeons who performed the bypass says Foster had multiple blood vessel disease. "He is a young and vigorous

person, this is for his long-term well-being," said Dr. John Sutton.

The surgery at Providence Hospital took about four hours, according to USC Sports Information Director Tom Price, who said Foster was doing "as well as could be expected."

Doctors said Foster's moderate heart attack was caused by a clot they dissolved about midnight Saturday with the injection of enzymes into the blood. The clot reportedly caused 95 percent blockage of the artery. The need for further procedures was not discussed publicly at the time.

On Saturday, Foster complained of not feeling well before and during the game. Assistant coach Steve

Steinwedel said Foster told him early in the second half that he wasn't feeling well. With about two minutes to go in the game, Foster said he would need to see a doctor as soon as the game was over.

**Don McGlohon**  
**INSURANCE**  
Hines Agency, Inc.  
**758-1177**

# Despite Having Only One Back From Last Year, 'Skins Rolling

By WOODY PEELE  
Reflector Sports Editor  
ROBERSONVILLE — Despite the fact that only one legitimate starter and letterman returns to the Roanoke High School lineup, the Redskins are off to a 5-0 start and are 3-0 against Northeastern Conference foes.

Coach Claude Atkinson returns only 6-4 senior forward Ricky Highsmith off last year's 20-4 team that won the

Northeastern Conference regular season and tournament championships before losing to Northampton in the first round of the district tournament. And that took an overtime to accomplish.

Joining him in this year's starting lineup are Donnie Wallace, a 6-3½ senior center; Greg Everett, a 6-2 senior forward; Spencer Bryant, a 5-7 senior guard, and Buck Duggins, a 6-0 sophomore guard.

Strictly speaking, Wallace could be called a returning starter, since he did open last year's season in a starting role. But an injury kept him sidelined most of the season — so much so that he didn't even earn a letter.

Making up the rest of the team are: Ricky Hines, 5-7 junior guard; Garrett Baker, 6-1 junior forward; Vinnie Boyd, 6-2 junior forward; Willie Congleton, 6-1 senior forward; Herman Bryant, 5-10

senior guard; Lyndale Daniels, 5-9 senior guard; and Marshall Highsmith, 6-1 junior forward.

Atkinson calls Hines his number one backcourt replacement and Baker his first choice in the forecourt.

"We don't have a lot of experience, and we're not big," the coach said. "But we've gotten the breaks so far. A lot of things are going in our direction. And we're playing fairly well defensive-wise."

Atkinson said that the Roanoke shooting has been sporadic. "In a couple of our games, we've shot in the 50 percent range, and in two others, we've only hit in the high 30's. We haven't been consistent. We've made some shots that we shouldn't have made, and we've missed on some that we shouldn't have missed."

"But I think our shooting will definitely come around with more experience."

Rebounding so far has been "a plus for us," Atkinson said. "We've outrebounded everyone we've played." Everett and Highsmith are averaging about eight rebounds a game each.

Atkinson feels that the Redskin defense has been good, both in zone and man-to-man coverage. "We'll be using more man as the season goes along. I feel we'll be a fairly good man-to-man team."

In the Northeastern Conference, Atkinson looks for Bertie to be a tough team, while Plymouth has gotten off to a big start. Plymouth, however, fell to the Redskins on Tuesday night, 59-55. "Washington is always going to be in there too," Atkinson said.

Still, he looks for his team to be up there with the leaders. "I just hope we can finish somewhere in the top four and go back to the districts," Atkinson said.

With the start the Redskins have gotten off to, their chances of getting back would have to appear pretty good at this point.

# Experience Gives Lady Redskins Hope For Title

By WOODY PEELE  
Reflector Sports Editor  
ROBERSONVILLE — With an experienced starting five, first year girls' basketball coach Robbie Calfee of Roanoke High School is looking for some good things. And except for the first two games of the season, he's liked what he's seen.

Roanoke's girls have gotten away to a 3-2 start, winning three in a row after losing the first two to non-conference foes. All three victories have come over Northeastern Conference opponents — the last over previously unbeaten Plymouth High School.

Three starters return from last year's 19-5 team that finished second in the regular season then won the conference tournament before losing in the first round of the district playoffs.

Back are Sheila Howell, a 5-4 senior guard; Mary Bland, a 5-7 senior forward and Dezella Jones, a 5-8 senior forward. Joining them are two letter winners, Cheryl Randolph, a 5-11 sophomore center, and Ginya Smith, a 5-3 junior guard. Together these five make up the current starting unit for the Lady Redskins.

There are six other players on the team. They include Gloria Duggins, 5-3 freshman

guard; Ursella Bell, 5-1 sophomore guard; Theresa Brown, 5-7 junior forward; Patricia Alexander, 5-4 sophomore forward/guard; Marty Knox, a 5-3 sophomore guard; and Anissia Stanley, a 5-9 freshman forward.

"We've got good experience with our five starters," Calfee said. "They've all got good floor savvy. Brown has fairly good experience off the bench, and she's probably our number one reserve."

"Duggins is our top reserve in the backcourt. Although she's just a freshman, she's talented with the ball but has a lot of learning to do," Calfee said. "She averaged 25 points a game in junior high, and she's coming along well. She just has to adjust to learning to play with teammates who can do it too. She's been used to carrying the load herself."

The coach said that these seven players have been playing about equal time and carrying most of the playing time.

Shooting has been up and down for the Lady 'Skins. There have been good and bad nights — the worst in the opener against Ayden-Grifton when Roanoke fell behind by 14-0 as nothing would drop. "We were getting good shots, they just wouldn't fall for us."

"Everybody we've played

has had big inside people and that's caused us some problem too," he said. "We've been a little intimidated. But we've got to learn not to worry about getting a shot blocked since generally we'll get fouled on the play."

Calfee rates the team's speed and quickness as one of its best assets. "We press from the word 'go,'" he said. "That won the game for us against Edenton the other night. Our fullcourt zone press has been effective for us."

Except for the Ayden-Grifton game, Calfee feels that the team's defense has been good. Rebounding has shown an improvement since the season got underway. "We're still learning how to block out and position ourselves."

As far as the Northeastern is concerned, Calfee notes that Tarboro was the pre-season pick in the conference. "They have a big girl who is pretty good. Plymouth is going to be strong too, so I'd have to say that it would be between Tarboro, Plymouth and us. Edenton has a pretty good team too and could come in there."

But with wins already over Edenton and Plymouth, Roanoke is off to a good start. But it won't be until after Christmas that they get a chance to test Tarboro.

## Big East

	Boys Standings		Overall	
	W	L	W	L
Kinston	0	0	5	0
Northeastern	0	0	5	0
Northern Nash	0	0	4	1
Fike	0	0	3	1
Hunt	0	0	2	1
Rocky Mount	0	0	2	1
Beddingfield	0	0	2	3
Rose	0	0	1	3

## Girls Standings

	Conf.		Overall	
	W	L	W	L
Northeastern	0	0	5	0
Kinston	0	0	4	1
Fike	0	0	3	1
Beddingfield	0	0	2	3
Rose	0	0	1	3
Hunt	0	0	1	2
Rocky Mount	0	0	1	2
Northern Nash	0	0	0	5

## Tobacco Belt Conference

	Boys Standings		Overall	
	W	L	W	L
Chocowinity	3	0	3	0
Aurora	2	0	4	0
Columbia	2	1	3	2
Belhaven	2	1	2	2
Mattmauskeet	1	1	3	1
Creswell	1	2	1	2
Bear Grass	0	2	0	2
Bath	0	2	0	2
Jamesville	0	3	0	5

## Girls Standings

	Conf.		Overall	
	W	L	W	L
Bear Grass	3	0	5	0
Belhaven	3	0	4	0
Bath	2	0	2	0
Chocowinity	2	1	2	1
Aurora	1	1	3	2
Columbia	1	2	3	2
Mattmauskeet	0	2	0	4
Creswell	0	3	0	3
Jamesville	0	3	0	5

# Budget Minded

**2 For \$36<sup>00</sup>** A78X13 Whitewall

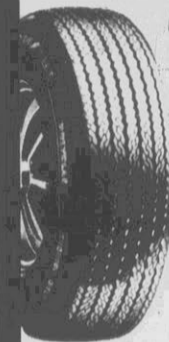

Quality: Guaranteed Recaps

G78X15 2 for \$42<sup>00</sup> Reg. Tread White  
H78X15 2 for \$43<sup>00</sup> Reg. Tread White  
L78X15 2 for \$44<sup>00</sup> Reg. Tread White

Mud & Snow Grips

G78X14, G78X15, H78X15  
L78X15: 2 for \$50<sup>00</sup> All Sizes

Radial Recaps 4 for

AR78X13 Whitewall \$88<sup>00</sup>  
FR78X14 Whitewall \$90<sup>00</sup>  
GR78X15 Whitewall \$95<sup>00</sup>

(Good Casing Required)

All Other Sizes On Sale, At Tremendous Savings

**GOODYEAR**  
TIRE CENTER

West End Shopping Center Phone 756-9371  
Open 8:00-6:00 Mon-Fri Sat. 8:00 to 1:00

729 Dickinson Avenue Phone 752-4417  
Open 8:00-6:00 Mon-Fri Sat. 8:00 to 1:00



# WHY GO SHOPPING WHEN YOU CAN GET SOMETHING FOR NOTHING DURING THE HONDA HOLIDAY GIVEAWAY?

Without a doubt the easiest way to go Christmas shopping this holiday season will be at our dealership.

We'll be holding some drawings you can't afford to miss. Because you could win a blue ATC 70 or Honda Kick 'N Go 2" to put under the Christmas tree.

It's all part of our Honda Holiday Giveaway starting November 25th through December 19th.

And it's going to be a most festive occasion for that most festive time of year. Just for coming in, you'll get a 1983

Honda Holiday calendar free. And a lot of those '83 models featured in the calendar will be in stock for you to check out.

Something else you'll want to check out will be all the great prices we're offering on our '82 models. When you see how they've been cut, we're sure you'll want to wrap up a good deal.

So look for the Christmas tree display when you come in to enter the drawings.

The Honda Holiday Giveaway. Christmas shopping has never been easier.

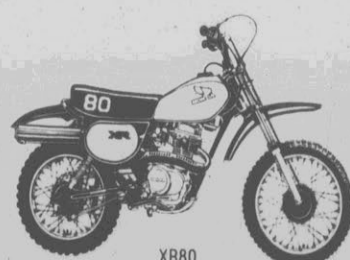

XR80

Sale Price  
**\$595<sup>00</sup>**

Tax Included



ATC 185S

Sale Price  
**\$1250<sup>00</sup>**

Tax Included

# Honda-Suzuki Of Greenville

918 N. Memorial Drive (Hwy. 11 North)

Greenville

Phone 758-3084

**CARRERA**

**brody's**  
for men

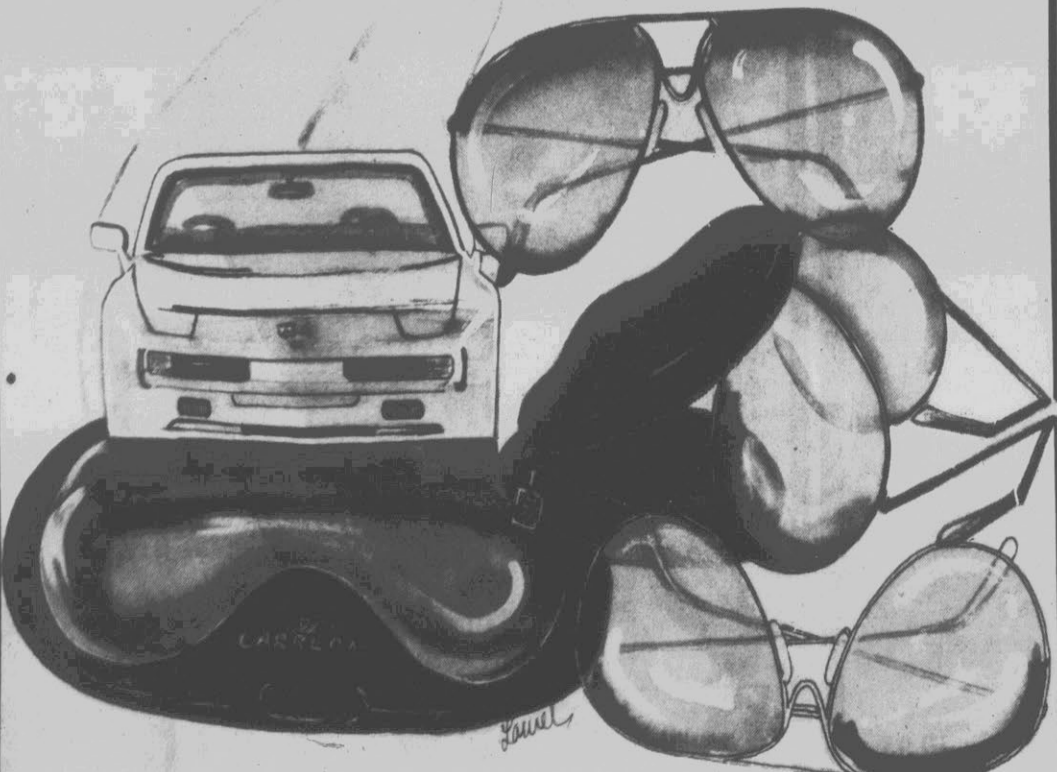

Porsche Carrera sunglasses for the man headed toward the top. Created by Porsche Design. For the individual who likes items with good taste.

Solid black frames \$100.00  
14 Kt. gold plated \$160.00  
Fold up frames \$160.00

"like no other men's store..."

**brody's**  
Pitt Plaza  
for men

# COACHES' CORNER

By CHARLIE HARRISON  
East Carolina Men's Basketball Coach

As the month of December approaches its end, the basketball season at ECU has just begun; yet, it continues as it began — on the road. It seems that we're always (as Willie Nelson's band troop) on the road again, but I'm not that excited to be on the road again. It's difficult to play away from home, but playing teams of the caliber of Duke, N.C. State, Samford and soon Southwestern Louisiana, George Mason and Virginia Tech makes the difficult life on the road even more difficult for our young Pirate basketball team.

Seven of our first nine games are played in front of unfriendly faces in unfriendly arenas. A quick indoctrination for a young team to say the least, but everyone must grow older — and our players have started to become of age basketball-wise. They had to!

Inexperience and youth usually take its toll on a basketball team — especially on the road. It's hard to gain confidence when playing in front of hostile crowds. Our team has played in front of three sell-out and very vocal crowds and "on the road again" we face two more post-season tournament participants from 1982 NCAA who have most of their team returning. Again, the Pirates expect and accept that their arenas will be filled with crowds pulling for the home-town team.

We begin our conference play with George Mason — "on the road again." They, too, are a very good team as they beat UNC-Charlotte very easily at UNC-C. Our league play continues with a home game against James Madison — a three year participant of the NCAA tournament play. The road is long! Still, I can see light at the end of the tunnel. At times, I have been completely overwhelmed by the competitive performance, execution and entertaining play of the ECU Pirate basketball team. We have no Ralph Sampson but to date we have shown pride and improvement. We have entertained the thousands who have watched us — even in defeat. I hope you'll show your support for these young men's efforts and improvements. Try it — you will like it. Even "Mike-y" would like it.

I wish you a joyous Holiday Season and if Santa is reading may he bring us a trick or two from his big bag to help us with a few W's and also — if I'm not being greedy — bring some of you fans into Minges on December 28th and January 8th to cheer for the Pirates (along with "Mike-y.")



## Sheridan Says He Won't Leave

GREENVILLE, S.C. (AP) — Football coach Dick Sheridan says he's decided against leaving Furman, where he's coached the last decade.

Sheridan, who has a 39-16-1 record at the Southern Conference School and four conference crowns in the last five years, has been mentioned as a candidate for head coaching jobs at several colleges in recent weeks.

"After talking in the past few days with my family, staff, supporters, athletic director and president, my

## Ralph Out, Cavs Win

TOKYO (AP) — Top-ranked Virginia, playing without All-American center Ralph Sampson, came away with a 72-63 victory today over 14th-ranked Houston in the Suntry Ball College Basketball Classic.

Othell Wilson scored 14 of his 18 points in the first half to spark the Cavaliers to a 41-31 lead at the intermission.

The 7-foot 4-inch Sampson was sidelined with a stomach ailment.

Virginia upped its record to 7-0, while the Cougars fell to 3-2.

commitment to remain at Furman has been reinforced," he said in a Wednesday afternoon news release. "We will continue to do our best to give Furman a football program it can be proud of."

Sheridan was mentioned as a candidate for the head coaching jobs at South Carolina, North Carolina State, Army, Duke and Tulane, according to Monty Dutton, assistant sports information director at the school.

"There has been a lot of speculation in the last several weeks concerning various head coaching positions and myself," said Sheridan. "I want to re-emphasize that I have not applied for, nor sought, any of these positions."

"I have responded to the invitation of several schools to visit their campuses and discuss with their representatives the vacant football coaching positions. As I have stated many times, I am happy at Furman and have no desire to leave here."

Sheridan has been head coach at Furman for five years after serving as a Furman assistant coach for five years before that. He has won the conference title outright or shared the title every year since he took over the program, except 1979.

# Bear's Boys Are All Over

By The Associated Press  
In 1968, Jackie Sherrill and hundreds of other aspiring coaches were circulating at a meeting of the American Football Coaches Association looking for a difficult-to-land job as an assistant at a major college.

"I wasn't doing too well and I was just standing there," Sherrill recalled Wednesday. "Then somebody came up to me and said 'Coach Bryant is looking for you. He wants to help you get a job.' Can you imagine how it made me feel to know that someone like him wanted to help me?"

Paul "Bear" Bryant announced his retirement Wednesday, but his legacy will live on for decades in Bear's Boys, the long list of college and professional coaches who have either played for him or coached with him at Maryland, Kentucky, Texas A&M and, of course, at Alabama.

One of those, of course, is Ray Perkins, who is leaving the New York Giants of the National Football League to succeed Bryant at Alabama.

Another is Sherrill, who left a potential national champion at the University of Pittsburgh

last season to take the job at Texas A&M for the biggest salary in college coaching history — a six-year deal at an estimated \$287,000 a year in salary and fringe benefits.

There is Bum Phillips of the New Orleans Saints, Dan Ford of defending national champion Clemson, Charlie Pell of Florida. And on and on, all grown men who still call Bryant "Coach," with a capital C, who still feel apprehensive about talking to him.

"I'm 41 and I still feel the same awe for Coach as I did when I was 18," says Pell.

Howard Schnellenberger of the University of Miami probably spoke for all of them Wednesday when he said:

"Paul Bryant had more effect on the game of football than any man ever to coach or play the game... the American football scene will not be the same without him."

What many of Bear's boys talk about are his many faces.

On the one hand, there the Bryant whom his disciples persist in calling "a man's man;" he of the tough, physical, craggy exterior that led Bum Phillips of the New Orleans Saints to call him "the John Wayne of coaches."

"He kicked me in the pants

when I needed it," recalls Ken Stabler, once Bryant's quarterback, now Phillips'. It was good for me. It was a lesson learned."

On the other hand, there was the Bryant whom Sherrill calls "lovable and compassionate." Like Sherrill, who played for Bryant from 1963-1965, the coaches say that were it not for Bryant they would certainly be in another line of work.

There is Larry Laceywell of Arkansas State, who comes from Bryant's hometown of Fordyce, Ark., and who has known Bryant for most of his 45 years. Laceywell remembers how Bryant quietly paid his room and board during the two years he served as a graduate assistant coach at Alabama. And yet Laceywell still says:

"I've always been a little scared of him."

There is Al Kincaid of Wyoming who grew up in Tuscaloosa, literally in the anteroom of Bryant's kingdom. When he couldn't fit him into the Alabama program, Bryant helped Kincaid win a scholarship to Virginia Tech, then brought him back as a graduate assistant, the position from which many of the disciples sprang.

"We were playing Penn State in the Sugar Bowl,"

Kincaid recalls. "I was low man on the totem pole and I needed a job the next year. He gave me the scouting report on Penn State to talk about. I'm convinced he gave it to me so I'd get some publicity, get some exposure and have a better shot at a job."

And there is, finally, the Bryant who was one of the first southern coaches to recruit blacks.

"I think people felt that as long as he was doing it, it was fine," says the nation's foremost black coach, Eddie Robinson of Grambling, who by 1985 could surpass Bryant's 322 victories.

But that was just another facet of his personality. "I think what I remember most about Coach Bryant was his flexibility," says Steve Sloan, the new head coach at Duke

and the middle man between Joe Namath and Stabler in Bryant's triumvirate of great '60s quarterbacks.

To which Sherrill adds: "He could just adjust to the mood of his players. Any kind of players."

**Players**  
**\$100 Entry Fee**  
**9-Ball**  
**Tournament**

Saturday Dec. 18, 1982  
8:00 P.M.

**3 Winners: 70% First Place**  
**20% Second Place**  
**10% Third Place**

All Of Us At Players  
**Wish You A Merry Christmas And Happy New Year.**

Located Beside Kash & Karry  
On Pactolus Hwy. Halfway Between  
Greene St. And 264 By Pass.

## Seaver Set To Return To The New York Mets

NEW YORK (AP) — He epitomized the youth and sense of destiny that characterized those Amazing New York Mets of 1969 and the "You Gotta Believe" team of 1973.

And, in 1977, he epitomized the frustration and sense of betrayal felt by Mets fans as the team plunged from splendor to squalor.

Today, with his return to New York after 5½ years in Cincinnati, Tom Seaver may again herald a transition period for the New York Mets. At least, that's what his faithful following of fans hopes.

The Mets scheduled a news conference for today to make the announcement. The trade, made subject to approval at last week's Winter Meetings, sends young right-hander Charlie Puleo and two minor leaguers to Cincinnati for Seaver.

Seaver, a three-time Cy

Young winner, began his career with the Mets in 1967, when he won 16 games and lost 13 with a team that lost 101 games. Two years later, Seaver was at the forefront of one of team sport's most "Amazing" stories. He won 25, lost 7; the Mets won 100, lost 62. Seaver won his first Cy Young Award, and the Mets won their only World Series.

In 1973, as the Mets won the National League pennant and reliever Phog McGraw coined the phrase "You Gotta Believe," Seaver again was named Cy Young winner with a record of 19-10. Seaver won his third Cy Young in 1975 with a 22-9 mark.

But, after compiling a 14-11 mark in 1976 as the Mets continued their slide into oblivion, New York made The Trade. It has been characterized as the worst deal the Mets ever have made. They sent Seaver to the Cincinnati Reds on June 15,

1977 for pitcher Pat Zachry, infielder Doug Flynn and outfielders Steve Henderson and Dan Norman. Only Zachry, who was 6-9 with a 4.05 ERA last year, remains with the club.

Seaver compiled a 21-6 record in the season during which he was traded, and he went on to post records of 16-14, 16-6, 10-8 and 14-2 with the Reds until his horrendous 5-13 campaign of 1982, during which he complained of arm trouble for the first time in his career.

New York General Manager Frank Cashen and Reds President Dick Wagner announced that they had agreed in principle to the trade during baseball's winter meetings last week in Honolulu. It remained only for the Mets to OK Seaver's medical report and to make a contract with the 38-year-old pitcher before the deal was consummated.

**Barton Reserve... Put this reserve in your starting lineup!**

You'll notice the difference in taste.

**DUNKEL INDEX**  
NATIONAL FOOTBALL LEAGUE

Current ranking

1. Dallas	125.4	15. Seattle	114.8
2. N.Y. Jets	122.8	16. Philadelphia	113.9
3. Cincinnati	122.0	17. Tampa Bay	113.4
4. San Diego	120.5	18. St. Louis	112.6
5. Atlanta	118.8	19. Minnesota	111.7
6. Pittsburgh	118.7	20. Denver	111.3
7. Buffalo	118.6	21. Kansas City	110.9
8. Washington	118.3	22. L.A. Rams	110.1
9. L.A. Raiders	117.7	23. Chicago	110.0
10. N.Y. Giants	117.1	24. Cleveland	109.6
11. San Francisco	116.9	25. New England	109.6
12. Green Bay	116.8	26. New Orleans	107.8
13. Detroit	116.0	27. Houston	107.7
14. Miami	115.9	28. Baltimore	103.0

This week's games with three points added to home team:

HIGHER RATER	DIFF.	LOWER RATER
Sat., Dec. 18		
L.A. Raiders 120.7	(1)	L.A. Rams 110.1
N.Y. Jets 122.8	(4)	Miami 118.9
Sun., Dec. 19		
Dallas 128.4	(2)	New Orleans 107.8
Green Bay 116.8	(1)	Baltimore 106.0
Philadelphia 116.9	(9)	Houston 107.7
Seattle 117.8	(8)	New England 109.6
Detroit 119.0	(7)	Minnesota 111.7
Pittsburgh 118.7	(6)	Cleveland 112.6
Washington 121.3	(4)	N.Y. Giants 117.1
Denver 114.3	(3)	Kansas City 110.9
Buffalo 118.6	(2)	Tampa Bay 116.4
San Francisco 119.9	(1)	Atlanta 118.8
Chicago 113.0	(0)	St. Louis 112.6
Mon., Dec. 20		
San Diego 123.5	(2)	Cincinnati 122.0

\* home team

© 1982 Barton Reserve—A Blend, 80 proof  
Barton Distilling Co., Bardstown, KY Los Angeles, CA

**uniden**  
extend-a-phone

**Cordless Telephone**

- Inside your home, Extend-A-Phone takes the place of all your extension telephones. Use it in any room, upstairs or down...it goes with the conversation.
- Outside, Extend-A-Phone keeps you close to the conversation. Use it on the patio or during work or leisure activities.

Someone on the go that you know would like to have an Extend-A-Phone this Christmas!

**Pair Electronics**

107 Trade St. (Next to Todd's Stereo)  
Open Mon.-Fri. 8:30 A.M. to 5:30 P.M.  
Open Saturday 8:30 A.M. to 5 P.M.

**HOLIDAY SPECIAL!**

**25" Color TV (VIR II)**

Model 3811

**GOOD YEAR**  
TIRE CENTER

Owned & Operated by Wayne L. Trull, Inc.  
729 Dickinson Ave. • West End Shopping Center  
Open Mon.-Fri. 8 a.m. to 6 p.m.  
Open Sat. 8 a.m. to 1 p.m.

**Our Best, Long Wearing Steel Belted Radial**

**Lifesaver XLM Whitewall**

40,000 Mile Warranty  
**SAVE 40%**  
Size P165/80R13 **\$52.56**

\*Lower rolling resistance than non-radials for fuel economy  
\*Two steel belts and polyester cord body for extra strength \*Wide tread for outstanding handling and traction

BF Goodrich Lifesaver XLM				
Size	Trade-In Price	48% Off	Your Cost	F.E.T.
P16570R13	95.00	38.00	57.00	1.98
P17580R13	98.00	36.32	54.68	1.78
P18590R13	93.29	37.29	55.92	1.92
P16575R14	97.00	38.12	58.88	2.04
P18575R14	111.00	44.84	66.16	2.47
P22580R15	113.00	45.29	67.71	2.48
P20575R15	115.40	46.16	69.24	2.47
P22575R15	119.00	47.92	71.08	2.58
P22575R15	124.29	49.69	74.60	2.78

-Coupon-

**Lubrication, Oil Change, Oil Filter**  
**SPECIAL MOST CARS YOU GET:**  
\*Professional chassis lubrication NOW ONLY  
\*Up to 5 qts. oil  
\*New BF3 oil filter  
\*Check of all fluid levels  
**FOR FAST SERVICE... CALL AHEAD.**  
Also at your service: Brakes, Shocks, Muffler, Alignment and Balancing. Come in.  
**FOR FAST SERVICE... CALL AHEAD**

**13.88**

-Coupon-

**4-Wheel Drum Brake or Disc Recline**  
Regular 78.00  
Save 20.00  
**\$59.88**

Will inspect complete brake system, install shoes or 4 wheels, or HD pads on front, add fluid, bleed, adjust, and road check. Additional parts, machining, drums or rotor, extra.  
Call for an appointment  
All American Cars  
Certified Automotive Service Excellence

-Coupon-

-Coupon-

**Wheel Alignment Special**  
**\$13.88**

for most American Cars  
Four wheel alignment extra  
Other Services Available: Brakes, shocks, mufflers, oil, lubrication...to make your ride smooth and safe.

-Coupon-

**BF Goodrich COGGINS CAR CARE**

Tires and Service  
320 West Greenville Blvd.  
Open Monday Thru Friday  
8:00 A.M. - 8:30 P.M.  
Saturday 8:00 A.M. - 1:00 P.M.

Automotive Excellence 756-5244 Certified

WE OFFER BF Goodrich NATIONAL FLEET SERVICE

# SCOREBOARD

### Bowling

Thursday Night Mixed

W	L
High Hopes	36
Jack's Steakhouse	36
Western Sizzlin'	34
Pizza Inn	33
Unouchables	33
Dew Crew	33
Team #1	32
Honey Bee's	32
Home Cleaners	31
Deadly Hits	30
Pin Hunters	30
Team #13	30
High Timers	30
Mixed Family's	28
Conv. Food Mart	28
Outsiders	27
Hang Ten	25
Slo Starters	24 1/2
Bud Lights	23
M&M's	22 1/2
Alley Cats	22
Pair Electronics	21
Spotlight Records	20
Hanging Gang	17

Men's high game Kevin Williams, 237; men's high series, George Moore, 583; women's high game, Sandy Hardison, Dolores Berg, 211; women's high series, Sandy Hardison, 605.

### Hillcrest Ladies

Thorpe Music Co.	38
Haddock's Tires	35
Team #1	34
Team #2	34
H.A. White	33
Peppi's Pizza Den	31 1/2
Cliff's Seafood House	31
T-Shirts Plus	28
Arby's	28
Merry Five	28
Daily Reflector	23
IPCC	23
Brick's Clothing	22
A Taste of Honey	22
Rolling Pins	20
Team #16	17 1/2

High game and series, Sandy Hardison, 228, 571.

### NHL Standings

By The Associated Press

W	L	T	GF	GA	Pts	
NY Isles	17	3	5	127	108	39
Philadelphia	16	11	4	120	101	36
NY Rangers	16	13	2	130	116	34
Washington	13	9	8	114	109	34
Pittsburgh	9	16	6	105	140	24
New Jersey	6	21	7	94	148	19

### NBA Standings

By The Associated Press

W	L	Pct.	GB	
Boston	19	4	82%	—
Philadelphia	19	4	82%	—
New Jersey	12	11	52%	7
Washington	11	11	50%	7 1/2
New York	7	16	30%	12

### Transactions

By The Associated Press

**BASEBALL**

**AMERICAN LEAGUE**

**CLEVELAND INDIANS**—Traded Ray Seagrave, pitcher, to the San Diego Padres for a player to be named later. Signed Rick Manning, outfielder, to a five-year contract.

**NEW YORK YANKEES**—Signed Bob Shirley, Dave Righetti and Shane Rawley, pitchers.

### College Basketball

By The Associated Press

W	L	Pct.	GB	
Los Angeles	17	5	77%	—
Seattle	16	6	72%	1
Phoenix	13	10	56%	4 1/2
Portland	13	11	54%	5
Golden State	10	14	41%	8
San Diego	4	19	17%	13 1/2

### College Football

By The Associated Press

**ALABAMA**—Announced the retirement of Paul "Bear" Bryant, head football coach, and named Ray Perkins to replace him.

**GEORGIA TECH**—Announced that Barry Wilson, assistant coach has resigned to join the Tampa Bay Bandits of the United States Football League.

**MESA COMMUNITY COLLEGE**—Named Roger Schumack interim head baseball coach.

### College Football

By The Associated Press

W	L	T	GF	GA	Pts	
Chicago	20	5	6	140	97	46
Minnesota	19	8	5	143	115	43
St. Louis	11	20	3	115	131	25
Detroit	7	17	7	92	128	21
Toronto	5	18	6	98	134	16

### College Football

By The Associated Press

W	L	T	GF	GA	Pts	
Edmonton	14	11	7	149	135	36
Winnipeg	14	13	3	131	132	31
Los Angeles	13	13	5	110	119	31
Vancouver	12	14	6	122	115	30
Calgary	11	17	6	135	146	28

### College Football

By The Associated Press

W	L	T	GF	GA	Pts	
Arizona	15	9	6	125	110	36
Arizona State	15	11	5	142	110	36
Utah	11	11	5	130	110	36
Utah State	9	14	3	101	134	21
Idaho	8	15	3	98	146	19

### College Football

By The Associated Press

W	L	T	GF	GA	Pts	
San Antonio	16	9	6	140	110	36
Kansas City	13	7	6	150	110	36
Dallas	11	10	3	134	110	36
Denver	10	13	3	135	110	36
Utah	9	14	3	101	134	21

### Thomas Mobile Homes Sales, Inc.

Across From Airport On N. Memorial Dr.

2 Bedroom, 14 Wide - \$8,495.00  
 3 Bedroom, 14 Wide - \$11,995.00  
 Doublewide, 1,130 sq. ft. - \$16,995.00

All Houses 10% Over Cost

## Garvey Is Near Choice

SAN DIEGO (AP) — The race to sign coveted free-agent slugger Steve Garvey has reportedly boiled down to two teams — the San Diego Padres and the Chicago Cubs.

Garvey and his agent, Jerry Kapstein, met separately Wednesday with representatives of the Cubs, Padres and San Francisco Giants. But the Giants have dropped out of the bidding, according to the San Diego Union.

Garvey, who has been non-committal for two weeks while studying contract offers, has presented a counterproposal to the Cubs and Padres, and both teams are studying the plan.

According to newspaper reports, the 33-year-old former Los Angeles Dodgers first baseman is asking for a five-year package worth \$8 million.

Gary Carter of the Montreal Expos and Dave Winfield of the New York Yankees are reportedly the highest-paid players in baseball with contracts that pay them some \$2 million a year.

The Cubs are thought to have offered Garvey a five-year contract worth \$6.75 million, while the Padres are believed to have tendered a \$6-million contract, which also includes some "creative" incentives.

Garvey, Kapstein and his attorney, Bob Teaff, met with Dallas Green, the Cubs general manager, and Cubs President Andrew McKenna Wednesday morning in La Jolla.

McKenna flew back to Chicago after the session, while Green remained in the San Diego area.

## TANK McNAMARA

"We want our lawyers to check it (Garvey's counterproposal) over," Green told the Chicago Tribune. "That's why Mr. McKenna went home, to check out their proposal. I told Kapstein I'd get back to them tomorrow (today)."

Ballard Smith, president of the Padres, met with Garvey, Kapstein and Teaff for about three hours Wednesday night.

"It was of a nature that we'll need time to study it," Smith said after receiving Garvey's counterproposal. "I'm disappointed that we couldn't make a deal; we'll talk to them again tomorrow (today)."

Garvey went through the

free agent re-entry draft last month and was selected by nine teams. The 12-year National League veteran became a free agent after failing to come to terms with the Dodgers. He reportedly rejected a Los Angeles offer of \$5 million over four years.

Over the last nine seasons, the right-hander has averaged 21 home runs a year and has a lifetime batting average of .301.

He was named the National League's Most Valuable Player in 1974 and has played in 1,107 consecutive games, 10 short of Billy Williams' NL record.

### Bowl Games

By The Associated Press

**INDEPENDENCE BOWL**  
 At Shreveport, La.  
 Wisconsin 14, Kansas State 3.  
 Friday, Dec. 17, 8 p.m.

**HOLIDAY BOWL**  
 At San Diego, Calif.  
 Ohio State (8-3) vs. Brigham Young (8-3), 9 p.m.

**SATURDAY, DEC. 18**  
 California Bowl  
 At Fresno, Calif.  
 Bowling Green (7-4) vs. Fresno St. (10-1), 4 p.m.

### Bowl Games

By The Associated Press

**INDEPENDENCE BOWL**  
 At Shreveport, La.  
 Wisconsin 14, Kansas State 3.  
 Friday, Dec. 17, 8 p.m.

**HOLIDAY BOWL**  
 At San Diego, Calif.  
 Ohio State (8-3) vs. Brigham Young (8-3), 9 p.m.

**SATURDAY, DEC. 18**  
 California Bowl  
 At Fresno, Calif.  
 Bowling Green (7-4) vs. Fresno St. (10-1), 4 p.m.



## KENTUCKY GENTLEMAN 8-YEAR-OLD.

WORTH ITS WAIT.

\$4.10 .50L  
 \$6.35 .75L  
 \$13.30 1.75L

Sour mash. Sweet price.

86 PROOF

You can see all the fascinating lore of whiskey-making at the Barton Distillery and Museum of Whiskey History in Bardonia, N.Y. Make it a point to drop in if you're out our way.

© 1981 Kentucky Straight Bourbon Whiskey, 80 and 86 proof. Barton Distilling Co., Bardonia, N.Y.

## THE GEMINI-10 DOT MATRIX PRINTER

More Quality, Flexibility, Convenience And Reliability For Less...And At A Price Less Than The Best Selling Competitor.

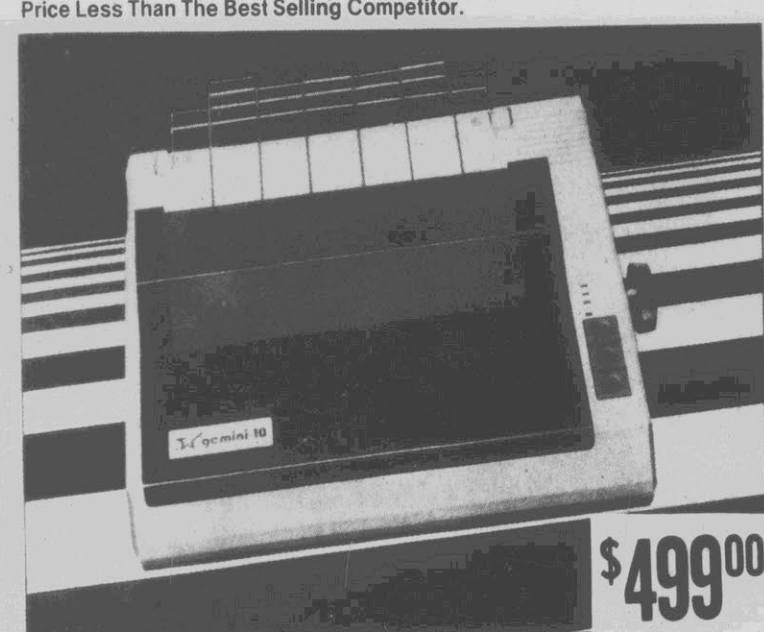

\$499.00

**CHARACTER FONTS**

- Normal (10 cpi)
- Elite (12 cpi)
- Condensed (17 cpi)
- Enlarged (5, 6, 8, 5 cpi)
- Emphasized
- Double Strike
- Italics
- Super and Sub Scripts

**CHARACTER SETS**

- 96 Standard ASCII Characters
- 96 Elite Characters
- 64 Special Characters
- 32 Block Graphic Characters
- 96 Proportional ASCII Characters (Optional)
- 2K User Programmable ROM for Special Characters

**PRINT SPEED**

100 cps, Bidirectional Logic Seeking

**PRINT BUFFER**

2.3K Standard (Additional 4K Optional)

**OFFICE EQUIPMENT CO., INC.**

Your Office & School Supply Store  
 569 S. Evans Street, Greenville, N.C.  
 752-2175

"Our 39th Year"

## FRANC WHITE'S Southern Sportsman RESTAURANT

264 BY PASS (West Marlboro Road) FARMVILLE, N.C. 27828 PHONE (919) 753-2030

This is why people drive from Richmond, Savannah, Charleston and Greenville to dine with us!

### Appetizers

<b>Shrimp Cocktail</b> Our medium size shrimp served chilled with horseradish sauce.	<b>Clam Stuffed Mushrooms</b> Garden fresh mushrooms stuffed with specially seasoned & sautéed clams then broiled to perfection.	<b>Down East Fish Chowder</b> A delicious recipe the Southern Sportsman found in a small fishing village in North Carolina. cup 75¢ bowl \$1.70	<b>Quail Consomme</b> Light refreshing any game lover would delight in this very special soup.
---	---	--	---

**Game ... Southern Sportsman Style**

<b>Quail with Mushroom Sauce</b> ..... \$7.95 Two plump, young quail simmered in our special mushroom sauce and served on a bed of hot rice.
<b>Quail with Grits and Gravy</b> ..... \$7.95 Two delicious quail fried southern style, then simmered in homemade gravy and served on hot grits.
<b>Sherried Quail on Rice</b> ..... \$8.75 Two quails & tender quail simmered in Franc's own recipe flavored with a hint of sherry. IT IS NOT ONLY ACCEPTABLE, BUT PROPER, TO EAT QUAIL WITH YOUR FINGERS!
<b>Sweet and Sour Duck</b> ..... Small \$6.95 Large \$10.95 Franc White's favorite duck recipe. You'll love it too!
<b>Franc's Baked Rabbit Supreme</b> ..... \$6.25 Tender young rabbit baked in a specially seasoned mushroom sauce served on hot rice.
<b>Southern Fried Rabbit</b> ..... \$5.95 Hunters have enjoyed rabbit prepared this way for many years.
<b>Fried Frog Legs</b> ..... \$5.95 The finest eating the world does has to offer.

### Steaks and Chicken

<b>Sirloin Beef Tips</b> ..... \$5.50 Five oz. tender sirloin cubes, cooked over the grill, you like.
<b>6 Oz. Rib Eye Steak</b> ..... \$6.75 This is a most popular steak - tender and juicy, it ages steaks out on request.
<b>Ground Beef Steak</b> ..... \$3.50 Half pound fresh ground beef - onions & garlic, 25¢ extra.
<b>One Quarter Fried Chicken</b> ..... \$3.25
<b>One Half Fried Chicken</b> ..... \$4.50 Plump juicy one chicken is prepared in a special sauce, lightly breaded and fried golden brown.

All dinners served with two vegetables of your choice and your choice of bread, cottage biscuits, hash, potatoes or parmesan toast.

### Seafood Specialties

<b>Franc's Fried Shrimp</b> ..... \$6.25 Marinated and battered in Franc's own special recipe. The best fried shrimp you will ever eat.
<b>Shrimp Sautéed in Butter</b> ..... \$6.50 Prepared and served in a seasoned butter sauce. Most delicate way to prepare this fine seafood.
<b>Shrimp Thermidor</b> ..... \$7.75 Sweet and crisp, these shrimp are baked in a creamy white sauce, seasoned with mushrooms and a hint of dry sherry, and topped with parmesan cheese. - De la France!
<b>Cold Boiled Shrimp</b> ..... \$6.25 Cool - refreshing served with our special horseradish sauce.
<b>Fish Imperial</b> ..... \$6.75 A specially seasoned casserole baked to perfection. One of the best fish dinners you will ever enjoy!
<b>Spicy Broiled Trout</b> ..... \$5.95 Fresh fillet of trout broiled with our spicy and delicious white wine and mustard sauce.
<b>Fillet of Flounder</b> ..... \$6.25 Deep fried or broiled, there is no match for this mild flounder white meat fish.
<b>Merry Ole Sole</b> ..... \$8.25 Two pieces fillet flounder stuffed with shrimp, scallops, crab meat and mozzarella cheese topped with hot-dip sauce and baked until hot and bubbly.
<b>Baked Rainbow Trout</b> ..... \$6.25 Baked fresh water trout filled with our own special fish stuffing.
<b>Fish Croquettes</b> ..... \$2.95 A light but very tasty meal!
<b>Oysters</b> ..... \$5.75 Fresh select never frozen oysters can be prepared several ways - broiled, sautéed or broiled, just let us know.
<b>Sydney Rock Oyster Pastry</b> ..... \$6.95 Homemade pastry filled with fresh oysters, tomato, bacon and seasonings then baked to golden brown.
<b>Scallops</b> ..... \$6.95 Tender deep sea scallops - may be deep fried or broiled.
<b>Trout Delmonico</b> ..... \$7.95 Baked in our special lemon pepper sauce and topped with tender shrimp and fresh oysters. This fillet of sea trout will really bring your taste buds alive!
<b>Deviled Crabs</b> ..... \$3.50 Two 3 oz. deviled crabs in natural shells, may be broiled or deep fried.
<b>Fried Seafood Platter</b> ..... \$6.95 A combination of our four most popular seafoods - flounder, shrimp, oysters and deviled crab.
<b>Broiled Seafood Platter</b> ..... \$7.95 The best way to enjoy fresh seafood - lightly seasoned and delicious.

### Hangtown Fry

Said to be the last request of a condemned man during the gold rush, fresh eggs, fresh bacon, fresh oysters - combined to make the most outstanding meal you will ever enjoy!

\$5.50

**Fish of the Day**  
 ALL YOU CAN EAT  
 Fresh fish head-on and served with natural fat french fries, eggplant, a sauce, and mushrooms.  
 \$4.95

### Beverages

Iced Tea, Hot Tea  
 Coffee, Sanka 35¢  
 Coke, Pepsi, Peps Light, Sprite  
 Mt. Dew, Lemonade 40¢  
 Draft Beer 85¢ Pitcher \$3.00

Vegetables  
 Vegetable of the Day  
 Fried Okra  
 Garden Peas  
 Baked Potato  
 Natural Cut French Fries

Fisherman's Stew  
 Green Beans  
 Fried Onion Rings  
 Salad Bar

Don't let a 15 minute drive keep you from the best meal you may have ever tasted... in any restaurant!

# Fletcher Sentenced To Prison In Jamscam Trial

By ELISSA McCRARY  
Associated Press Writer  
CONCORD, N.C. (AP) —  
Former state Jaycees president Johnny Lee Fletcher was sentenced to three to five years in prison Wednesday after a Superior Court jury found him guilty of helping divert charity funds from jelly sales to pay

for fake Jaycees chapters. Presiding Judge Donald L. Smith also fined Fletcher \$5,000 and court costs. "I could not believe you took the stand and characterized your year (as president) as successful," Smith told Fletcher before sentencing him. "Your year was an absolute fraud.

"I still don't know why the organization itself hasn't been indicted," Smith said. Fletcher could have been sentenced to a maximum of 10 years in prison. Testimony in the eight-day trial showed that 61 of 156 new Jaycees chapters created during Fletcher's presidency in 1977 and 1978

were bogus. Fletcher testified Tuesday that he didn't know money donated for charitable causes was being used to pay membership dues in the fake chapters. Immediately following sentencing, defense attorney Wesley Grant said he would appeal the case.

The seven-woman, five-man jury deliberated four hours before returning the verdict at 3:05 p.m. Wednesday. The panel found Fletcher guilty of one charge of being an accessory to misapplication of \$10,000 in charity funds in January 1978.

As Smith read the verdict, Fletcher and his wife and two teen-age sons, who were sitting behind him in court, stared straight ahead. But as Smith pronounced the sentence, Fletcher's wife, Judy, and his sons, Chris and Rich, began sobbing. "I wish you would look at your wife and family and see what you've done to them," Smith told Fletcher.

Fletcher will remain free on \$20,000 bond pending the appeal. Fletcher, 41, was charged with misapplying \$21,400 in charitable funds. He could

have been sentenced to up to 50 years in prison.

He originally was charged in four two-count indictments with conspiracy to misapply and misapplication of funds totaling \$26,480.50. However, Smith dismissed three of the charges earlier in the trial.

The trial was scheduled to be heard last week in a specially called session of Cabarrus County Superior Court. But the case was continued into this week when all the testimony couldn't be heard in one week.

Two other former Jaycees officials, Robert Rushton of Gray, Ga., and Thomas Alsop of Concord, were to be tried along with Fletcher. Smith said their trials would be scheduled later.

Two former Jaycees presidents, Maurice H. Wilson and J. Harold Herring, who have already pleaded guilty in the case and testified for the state in Fletcher's trial, will be sentenced after Rushton's and Alsop's trials, Smith said.

During Fletcher's trial, prosecutor Lester Chalmers alleged that Fletcher created fictitious chapters to win national awards. Fletcher won a free trip to the

Jaycees' world conference in 1978 for setting a national record for new chapters.

Defense attorneys contended that Fletcher didn't know anything was done wrong during his year as president until a meeting of former Jaycees presidents in 1980.

In the trial, Wilson testified that he and Fletcher conspired to take \$10,000 in proceeds from Jaycees jelly sales and use the money to pay membership fees in fake chapters. He said he discussed taking the money with Fletcher in July 1977 and that they used the funds to pay for fake chapters in January 1978.

The scandal surfaced in the spring of 1980. A probe by the State Bureau of Investigation showed that nearly \$250,000 in Jaycees charity funds had been misapplied.

Most of the money was raised through the sale of grape jelly to benefit the N.C. Burn Center in Chapel Hill, and the case was dubbed "Jamscam."

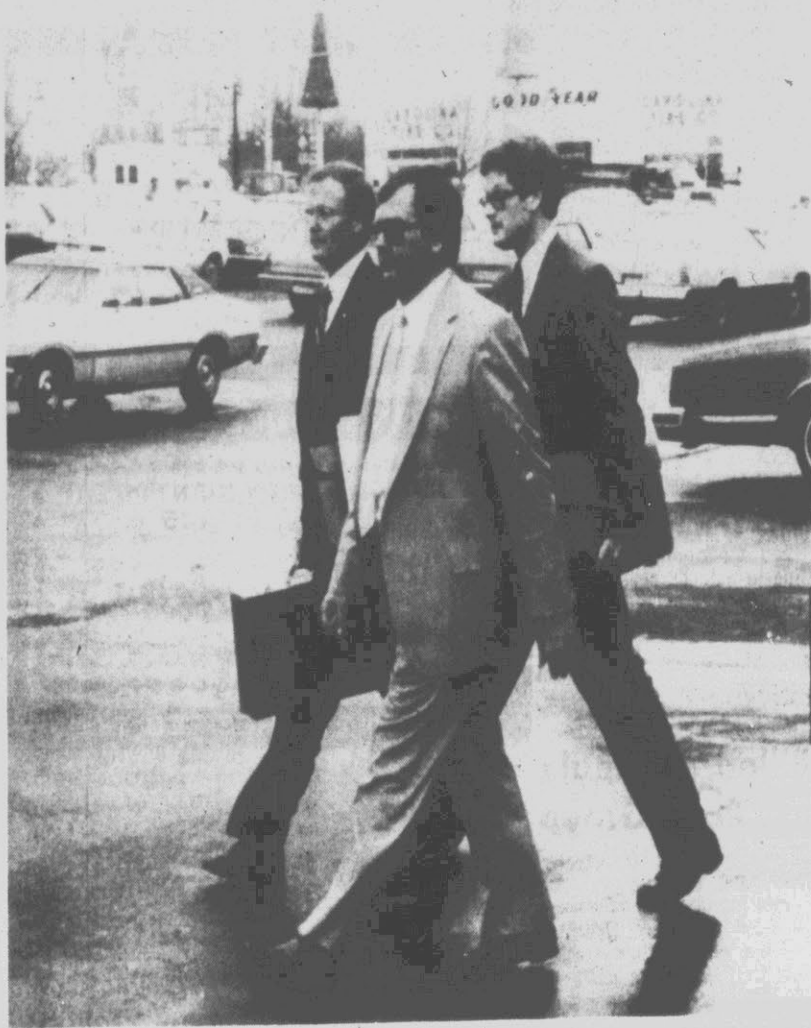

CONVICTED — Johnny Lee Fletcher, center, former president of the N.C. Jaycees, was convicted late Wednesday afternoon for his role in the "Jamscam" controversy. Fletcher — flanked by lawyers — was sentenced to 3 to 5 years. (AP Laserphoto)

## 'Trapped' Into OK For A Pay Raise

WASHINGTON (AP) — Two North Carolina congressmen say they were trapped by procedural maneuvers into voting for a 15 percent pay raise for themselves.

Both U.S. Reps. Charles G. Rose III, D-N.C., and Charles O. Whitley, D-N.C., said their votes do not mean they support the pay raise, which passed 303-109.

The crucial vote on the raise, they said, was a 208-208 tie in which both of them tried to stop the \$9,138 raise. That tie was broken by Speaker Thomas P. "Tip" O'Neill, D-Mass., who voted to preserve the \$9,138 hike.

The pay increase was part of an appropriations bill to permit federal agencies to continue operating after their funding expires at midnight Friday. The original bill included a 27 percent raise and the only alternative to that was an amendment by Rep. Vic Fazio, D-Calif., for a 15 percent increase.

Rose and Whitley said they voted for the 15 percent increase because to do otherwise would have amounted to supporting the 27 percent hike. House and Senate members, who have given themselves one 5.5 percent pay hike since 1977, now receive annual salaries of \$60,662.

Fazio's amendment was followed by a second vote on a proposal from Rep. Bob Traxler, D-Mich., which would have retained the present salary.

Rose and Whitley joined 95 other House members who voted for the 15 percent hike and then voted unsuccessfully to reimpose the

previous pay cap.

"There was no other alternative," Whitley said of his first vote. "I voted for the lower cap instead of leaving the higher one in place."

Whitley, who has been elected to his fourth term, has repeatedly stated during his campaigns that he would not vote for a pay raise to take effect during a term for which he has already been elected.

"There's no way with 10.8 percent unemployment that we can justify giving congress a salary increase," said Michael Mills, an aide to Rose.

**FACTORY CLOSEOUT!**

BASSETT 7 PIECE  
**DINETTE SUITE**  
PECAN FINISH TABLE AND 6 CHAIRS  
**\$499<sup>95</sup>**

**FURNITURE WORLD**

10th STREET EXT. • PHONE 752-7613 • TERMS

**OUR BIG PARTY SIZE MAKES VERY GOOD TONICS, MARTINIS AND SENSE.**

GIVE your parties plenty of good taste with Canada Dry Stitzel-Weller Gin in the convenient, economical 1.75-liter party size.

CANADA DRY STITZEL-WELLER GIN

© 1982 Stitzel-Weller Distillers, Louisville, Kentucky. 100% Neutral Grain Spirit.

**BOB'S TV... Santa's Gift Headquarters**

**ZENITH**  
**19" COLOR TELEVISION**

- Video Guard Tuner
- Slim Line Cabinet
- 19" Diagonal Screen

Now **\$368<sup>00</sup>** Only

All ZENITH TV, Stereos, Video Recorder & Color Camera NOW ON SALE!

90 Days • Instant Credit • Cash Talks • Monthly Terms  
Greenville Store Open Mon.-Fri. Til 8 P.M.

108 East Second St., Ayden, N.C. Telephone 745-4021

3205 South Memorial Dr., Greenville, N.C. Telephone 756-8830

**TV & APPLIANCE BOB'S TV SALES & SERVICE INC.**

**Time may be running out, but our Hickory Farms™ gifts haven't.**

Last minute shoppers, we've still got plenty of gifts, in a variety of shapes, prices and sizes, all filled with mouth-watering delights.

**Hickory Farms OF OHIO™**

We'll give you a taste of old-time country goodness.™

Inside Sears - Carolina East Mall

© 1982 General Host Corporation

**REVOLUTION!**

Home Federal Offers You Financial Freedom With Two New Revolutionary Accounts...

- **INVESTMENT CHECKING** \*Offers unlimited check writing privileges with money market interest rates.
- Home Federal's New **INSURED ACCESS ACCOUNT**. Beginning December 14, 1982 this account will feature money market interest rates with immediate access to your funds. No Penalties...and FSLIC insurance for your protection.

So, join in the revolution at Home Federal where financial freedom is now a reality!

\*Investment Checking combines interest bearing checking with a higher yield of Home Federal's Retail Repurchase Agreements. A Repurchase Agreement is not a savings account or a deposit and is not insured by the Federal Savings and Loan Insurance Corporation. However, the Repurchase Agreements are fully collateralized and directly secured by U.S. Government Agency obligations for our customer's protection.

**HOME FEDERAL SAVINGS AND LOAN ASSOCIATION OF EASTERN NORTH CAROLINA**

HOME OFFICE  
543 Evans Street, Greenville, N.C. - 758-3421

BRANCH OFFICES  
216 Arlington Boulevard, Greenville, N.C. - 756-2772  
206 E. Water Street, Plymouth, N.C. - 793-9031  
205 W. Railroad Street, Bethel, N.C. - 825-8781

MEMBER **FSLIC**  
Federal Savings & Loan Insurance Corp.  
Your Savings Invested to \$100,000

## In The Area

### Greenville Motel Is Sold

The Olde London Inn on Memorial Drive has been sold by the John Yancey Corp. to Elbert Pittman and his wife Hilda. Records at the Register of Deeds' office indicate the motel, built in 1970, was sold for \$1.3 million.

Pittman, a Goldsboro native, worked for the John Yancey Corp. for about 13 years before he purchased the local motel in November.

He began his motel career here in 1970 as assistant manager of the Olde London Inn. Three months later he moved to Newport News as manager of a Yancey motel there, and for about 10 years has been a regional manager for the John Yancey Corp.

"We want to be part of Greenville," Pittman said.

He said 70 of the motel's 132 rooms are now closed for renovation — new carpet, new wallpaper, new furniture. The facility, which has had a number of permanent residents in the past, will be operated "strictly as a motel" when the \$300,000 renovation program is completed, Pittman said.

### Council Hires Director

The North Carolina Council on Alcoholism has employed James Earl Ayers as executive director.

Ayers has been employed by the Walter B. Jones Alcohol Rehabilitation Center, Greenville, for the past four years. A graduate of East Carolina University with a degree in social work and concentration in alcohol and drug abuse, he and his wife, Claudia Kepler Ayers, live in Conetoe with their children.

The Council on Alcoholism is the only state volunteer organization focusing its efforts on prevention, education, treatment and rehabilitation in the alcoholism field.

### Christmas Expressions

The YPHA of Holy Trinity United Holy Church on Douglas Avenue will present a program of Christmas expressions entitled "Glad Tidings" Saturday at 7 p.m.

The program will feature Christmas poems, readings, prayers and musical selections as the Christmas story is told. YPHA President Wanda Kay Jones will narrate the program.

### Annual Tour Scheduled Sunday

The third annual East Main Street Old House Christmas Tour is scheduled for Sunday from 1-5 p.m. in Washington, according to Stuart Everett, chairman of the tour.

The tour will begin at the Diamond House, 245 E. Second St., and end with the Woolard House, 705 E. Main St., where refreshments will be served. All the houses included in the tour were built at the turn of the century.

An addition to this year's tour is an interpretive liturgical ballet, under the direction of Christina Williams, to be performed at St. Peter's Episcopal Church at 3 p.m.

Tickets cost \$2 and are on sale at Washington stores and will also be available Sunday at the first house of the tour.

### Cleaning Firm Entered

A break-in at Stadium Cleaners at 205 E. 10th St. was reported at 7:01 a.m. today, Police Chief Glenn Cannon said.

Cannon said thieves entered the building through a window and took an undetermined amount of clothes. An investigation of the incident was under way.

### Christmas Blues Is Concepts Topic

The Christmas blues, a state of mind that takes most of the joy out of the holiday season, is the topic for "ECU Concepts" Sunday at 8 a.m. on WOOW Radio.

Dr. James Mathis, chairman of psychiatry at the ECU School of Medicine, will discuss why some people feel depressed over Christmas. He will also suggest ways to cope with the problem.

"ECU Concepts" is a 15-minute weekly program produced by ECU. James Rees of the department of drama and speech is host.

### Girl Scout Director Named

Judy Hunter was appointed executive director of the Coastal Carolina Girl Scout Council effective Wednesday.

A native of Kentucky, she joined the Coastal Carolina staff at the Goldsboro Service Center in August 1978 as director of field services. She previously worked with the Kentuckiana Girl Scout Council for seven years in several capacities.

### Tough Law For Drunk Drivers

COLUMBUS, Ohio (AP) — Ohio's new drunken driving law provides a mandatory three-day jail sentence for first offenders and suspension of a driver's license for up to three years.

The law, effective March 16, also says a 0.1 percent blood-alcohol level is "conclusive proof" of drunkenness, while the current law says that level only provides a presumption of intoxication.

The new measure also authorizes a police officer to confiscate the license of any drunken driver.

# See Larger Cattle In Gene Transfer

By WARREN E. LEARY  
AP Science Writer  
WASHINGTON (AP) — A group of hefty mice may be forerunners to giant cattle that produce greater food supplies, say scientists who have used genetic manipulation to produce the big rodents.



**BIG MICE** — Researchers say they transferred gene from rats into mice that resulted in animals up to twice their normal size, according to a report published today in Nature, a British science journal. (AP Laserphoto)

## \$2 Million In Bag Discovered 'Gone'

MIAMI (AP) — A locked canvas bag containing \$2 million in cash and checked as luggage was discovered missing from an Eastern Airlines flight bound from New York to Peru, officials said.

The money was being shipped by Republic National Bank of New York to Lima and was accompanied by a bank courier, said FBI special agent Joseph Corless.

A second bag containing \$2.5 million arrived safely in Santiago, Chile, aboard the same flight, investigators said Wednesday.

Federal agents are investigating whether the money was stolen or whether the bag was lost at Miami International Airport and mistakenly loaded onto another flight.

"If it was lost, we haven't found it yet," said Eastern spokesman James Ashlock.

The courier, whom investigators would not identify, rode in a passenger seat but checked the canvas bags as luggage. In Miami, he got off the plane to check the money in the baggage compartment.

The courier told investigators that although cargo workers wouldn't allow him into the actual loading area, they displayed the pouch for him from a distance during the Miami stopover.

Ashlock said the flight was an L-1011 that arrived in Miami shortly after midnight Monday and took off again for Lima and Santiago.

"We carry these money shipments all the time," said Ashlock.

A Republican National Bank spokesman told WTVJ-TV here that shipping large amounts of money by plane is routine and the money was insured.

The plane returned to Miami on Wednesday afternoon and FBI agents photographed the cargo hold. They would not comment on what, if anything, they found.

**SURVIVED ORDEAL**  
MOSCOW (AP) — A Soviet airliner made a forced landing on a mountain in Far Eastern Siberia on Dec. 5, but those aboard survived the landing and five days marooned in a blizzard, Pravda reported Wednesday.

Researchers said in a report published today that the transfer of genes from rats into mice resulted in animals up to twice their normal size. The genetic engineering development could be applied to farm animals, they said.

The research done by scientists from four institutions shows that cross-species genetic manipulation can have a major effect on subsequent generations, they say.

In a report published in Nature, a British science journal, researchers say the resulting big mice are visual examples of the impact of planning genetic change.

Similar genetic alterations have been accomplished in past research with bacteria, flies and mammals, but the results have been subtle. This work mostly involved passing on the ability to make enzymes or other chemicals that are noticeable only through laboratory measurements.

"We wanted to make changes that you could see, changes that were obvious," said Dr. Ralph L. Brinster of the University of Pennsylvania School of Veterinary Medicine, where the work was done.

Dr. Richard D. Palmiter of the University of Washington in Seattle, another collaborator, said the researchers "essentially created a genetic disease comparable to gigantism in humans."

Palmiter said the new mice model may be useful in studying gigantism, the rare human disease that results in abnormal growth. "Another important goal is to see if you can make it work in species other than mice," he continued.

Although it would be more difficult, said the researchers, it may be possible to apply this technique to increase the size of food animals as a supplement to traditional breeding methods.

"The implicit possibility is to use this technology to stimulate rapid growth of commercially valuable animals," said the report. "Benefit would presumably accrue from a shorter pro-

duction time and possibly from increased efficiency of food utilization as well as immediate milk production."

The researchers took the gene that produces growth hormone in the pituitary gland of rats and combined it with part of a mouse gene. Growth hormone is a major factor controlling the growth and size of mammals.

This gene combination made of deoxyribonucleic acid (DNA), the basic substance of heredity, then was injected into fertilized mouse eggs and the eggs were put into female mice to continue their development.

From the 170 eggs inserted into foster mothers, 21 mice developed and seven of these produced abnormal amounts of growth hormone in their livers. These mice showed different levels of the hormone, indicating varying amounts of the transferred genes had been incorporated into the animals' normal DNA.

"Growth hormone levels in some of the transgenic mice were up to 800-fold higher than in normal mice, resulting in animals nearly twice the weight of their unaffected littermates," said the study. And one of the mice

transmitted the combined gene to 10 of 19 of its offspring, suggesting that the new gene was stably integrated into the animals' hereditary material, said the report.

Other researchers on the project are Dr. Robert Hammer and Myrna Trumbauer of the University of Pennsylvania, Dr. Michael G. Rosenfeld of the University of California at San Diego and Drs. Neal C. Birnberg and Ronald M. Evans of the Salk Institute for Biological Studies in San Diego.

The work was sponsored by the National Institutes of Health, the National Science Foundation and the Howard Hughes Medical Institute in Seattle.

**\$1.00 Off**  
Any Plate - With Coupon  
Friday Or Saturday Only  
4:30 P.M. - 9:30 P.M.

**Cliff's Seafood House and Oyster Bar**  
Washington Highway (N.C. 33 Ext.) Greenville  
Phone 752-3172  
One Coupon Per Person

COUPON—COUPON—COUPON

\$3.00 off reg. price ANY GIANT PIZZA  
\$2.00 off reg. price ANY LARGE PIZZA  
AT **Pappi's Pizzeria**  
421 Greenville Blvd. Phone 750-0825  
(Not valid with any other specials)

COUPON EXPIRES FEB. 28, 1983

### Billed As Finale For Rock Group

RICHFIELD, Ohio (AP) — For what could be the last time, an American audience listened to Roger Daltrey open a concert with the rock anthem "My Generation."

Some 18,500 fans crowded into the Coliseum on Wednesday night to see what was billed as the final U.S. concert in the British rock group's 17-year history.

Peter Dinklage, guitarist and chief songwriter, said this week that the group might record another album or two before disbanding.

"I expected it to be a lot tougher," Dinklage said in a radio interview. "I expected more flak (about the decision to stop touring) from the fans and the media. ... In actual fact, we've been treated very sympathetically."

**"The Loft"**  
Greenville's Best Live Entertainment  
During Early Happy Hour!

Thursday, Dec. 16th 5:30-7:30  
**Michael O. Keys** at the keyboard  
Friday Dec. 17th 5:30-7:30  
**Michael O. Keys** at the keyboard  
7:30 - Until  
**Chris Kemp** at the keyboard

Mon.-Fri., Early Happy Hour 5-7 pm  
Mon.-Thurs., Late Nite Happy Hour 10-12

400 St. Andrews Drive Greenville

**BEEF BARN**

above just a step

### Mother Dies, Still In A Coma

ROSEBURG, Ore. (AP) — Julie Ann Evans, who gave birth to a child while in a coma, died of natural causes while still on the respirator her family had gotten permission to remove.

Mrs. Evans, 23, who suffered from an inherited deformity in her brain stem and fell into a coma Oct. 26, 1981, gave birth to a girl Feb. 25.

The comatose mother died Wednesday, two days after her family received permission to remove the respirator but before she could be taken off the life-support system.

CONSOLIDATED THEATRES  
ALL SEATS \$2.00 EVERYDAY 'TIL 5:30 P.M.

**BUCCANEER MOVIES**  
756 3307 • Greenville Square Shopping Center

NOW SHOWING!  
RICHARD PRYOR 1:20  
JACKIE GLEASON 3:20  
**THE TOY** 5:20  
7:20  
9:20  
A COLUMBIA PICTURES RELEASE PG

LAST DAY!  
**THE LAST AMERICAN VIRGIN** (R)

LAST DAY!  
**THE SLAYER** (R)

**STARTS TOMORROW!**  
CHECK TOMORROW'S PAPER FOR SHOWTIMES

Can you keep a secret?

In the next 72 hours, this desperate, unemployed actor will secretly audition for the female lead of a soap opera. And become America's hottest new actress.

**DUSTIN HOFFMAN**  
**Tootsie**  
PG

**STARTS TOMORROW!**  
CHECK TOMORROW'S PAPER FOR SHOWTIMES

In Six Weeks, you can find memories to last a lifetime.

**Six Weeks**

introducing KATHERINE HEALY  
Music Composed and Performed by DUDLEY MOORE

DUDLEY MOORE • MARY TYLER MOORE

PG PARENTAL GUIDANCE SUGGESTED

**Seafood Lovers - You Win!**

**J.B.'s Island Seafood**  
Open: Sunday Thru Thursday 5-9:30  
Friday & Saturday 5-10 - Closed Monday

Serving the finest selections from the sea prepared "island" style. Raw, steamed and broiled to your delight.

**THURSDAY - ISLAND NIGHT**

Steamed Shrimp ..... \$5.00  
Steamed Oysters ..... \$3/Doz.  
Steamed Clams ..... \$5.00  
Steamed Crab Legs ..... \$8.25

Located in  
Rivergate Shopping Center  
E. 10th St. Greenville  
752-1275  
"Our Specialty is Quality"

**Celebrate The Holidays at The Alamo**

Thursday, Dec. 16th-D.J. 9 to 1  
Late Nite Happy Hour 10 to 1  
Admission Free All Nite

Friday, Dec. 17th-The Breeze Band 9 to 1  
Admission Free 'Til 8

Saturday, Dec. 18th-The Mighty Majors 9 to 1  
Admission Free 'Til 8

Sunday, Dec. 19th-First Time In The Area  
BILL DEAL & THE RHONDELS 8 to 12  
Happy Hour From 4:30 to 8  
Admission Free 'Til 7

\$4.95 Includes Buffet-Mexican-American-Served Nightly  
Tax & Beverage

For More Information Call 757-0005  
1104 N. Memorial Drive  
(Across From Airport)

## GOREN BRIDGE

BY CHARLES GOREN  
AND OMAR SHARIF  
© 1982 Tribune Company Syndicate, Inc.

TRADE 1 WINNER FOR 2 WINNERS, AND WIN

Both vulnerable. South deals.  
**NORTH**  
♠ 62  
♥ 864  
♦ K Q 109  
♣ 9763

**WEST** EAST  
♠ 8 ♠ 9754  
♥ J 10973 ♥ Q  
♦ 84 ♦ J76532  
♣ AK 1084 ♣ J2

**SOUTH**  
♠ AK Q J 103  
♥ AK 52  
♦ A  
♣ Q5

The bidding has proceeded:  
South West North East  
2 ♠ Pass 2 NT Pass  
3 ♠ Pass 4 ♠ Pass  
Pass Pass  
Opening lead: King of ♣.

Watch the cards your opponents play. The story they tell can often salvage a seemingly doomed contract.

North-South bid normally to four spades. Of passing interest was North's decision to raise to four spades rather than rebid no trump. South had shown an unbalanced hand with his spade rebid, so there was no reason for North to prefer no trump with all his values in one suit only.

West led the king of clubs, on which East started an echo with the jack. After cashing the ace of clubs as well, West shifted to the jack of hearts. Declarer noted with interest that East followed to this trick with

the queen. It might seem that declarer's chances for game were not overly sanguine — the only hope for a 3-3 heart distribution had all but vanished because of the way the play had developed. It seemed that declarer would have to lose two heart tricks in addition to the two club tricks already banked by the defenders.

Declarer won the king of hearts and started to draw trumps. His prospects brightened when West showed out on the second trump. If the defenders had carded honestly, and there was no reason to suppose otherwise, the contract was now a sure bet. South cashed the ace of diamonds and one more high trump, then led the ace of hearts in case East had been unblocking with a doubleton queen.

Had East ruffed the ace of hearts, he would have been forced to return a diamond, thereby allowing South to discard his two heart losers on dummy's high diamonds. So East sluffed a diamond, but he was merely postponing the inevitable. Declarer exited with his low trump, and now there was no way for East to escape his fate. Declarer sacrificed a trump trick he did not have to lose, and gained in exchange two diamond tricks that he apparently had no way to cash.



MERV — Metromedia Inc., which syndicates The Merv Griffin Show nationwide, is taking it off prime time on the station it owns in Los Angeles, KTTV. (AP Laserphoto)

# No Ad-Libbing By Marty Ingels As Voice Of 'Pac-Man' Tonight

By FRED ROTHENBERG  
AP Television Writer  
NEW YORK (AP) — The next time some critic starts harping that network television executives live in never-never land, remember this story from Marty Ingels, the voice of "Pac-Man," ABC's Saturday morning cartoon show.

"We were taping one day, and I ad-libbed the phrase 'pacapacawooow,'" Ingels said. "It was really an innocuous thing, but the director stopped everything and asked me to repeat it. I said, 'Pacapacawooow,' and before I knew it, the director and some other people were huddling in the corner."

"Then they were calling New York to check out 'pacapacawooow.'" The executives there did some more heavy thinking before they threw it out. They told me: 'No more ad-libbing, Ingels.'"

Tonight, when Pac-Man comes to prime time in ABC's "Christmas Comes to Pacland," the popular video game character won't say anything unscripted. Nor will

he sound like he does in the arcades. The Federal Communications Commission forbids commercial sounds on TV programs.

When the talent-hunters at Hanna-Barbera were casting the voices behind Pacland's dots and dashes, they couldn't find Pac-Man. Ingels, a comedian who now heads an international celebrity brokerage agency, was looking for work for his client, actor Robert Culp.

"I was calling Universal Pictures, and I misdialed by two numbers and got Hanna-Barbera," Ingels said. "I asked for casting and got Gordon Hunt. He said there was an opening for Pac-Man. I thought he was talking about a luggage company. But I said Culp would be perfect for it anyway. Hunt said no, that I was the one with the crazy voice."

Ingels, who was in the sit-com, "I'm Dickens-He's Fenster," in the early 1960s, comes by his gravelly voice naturally.

"It's always been peculiar," he said. "When I was a kid, doctors were

always looking for growths on my throat." They didn't find anything, and Ingels found that his distinctiveness had some fringe benefits.

"It turned women on, fascinated babies, and infuriated animals," he said. "When I get a cold, though, I sound like Orson Welles."

Ingels, who suffered a nervous breakdown after the cancellation of "I'm Dickens-He's Fenster," enjoyed returning to the limelight.

"I love to be well known," he said. "I have all the money I want. It's love that I need."

The comic's alter-ego is a combination of Popeye (power pellets make him chomping strong), Captain Marvel, William Bendix, Fred Flintstone and himself.

"ABC wanted light, uncomplicated, total escape," he said. The network also wanted animated competition against "The Smurfs" on NBC. "Pac-Man" has overtaken "The Smurfs" in the 30 minutes the shows are head to head, but NBC remains the top-rated network on Saturday morning.

Ingels said ABC won't identify him as Pac-Man in the credits, for fear that he'll get too big and become indispensable to the program. If he had more power over the character and the show, Ingels would make changes.

"My fight is with the writers," he said. "I want to build the family relationships, rather than have

Pac-Man always fighting ghosts. The Christmas special has more emotional moments than the Saturday show."

The mentality of Saturday morning programming mitigates against anything real, creative or serious. "Pac-Man can't even kiss his wife," Ingels said.

But, if he wanted to, he could hit her with a 2-by-4, and nobody would get hurt. It seems the unreal hard knocks on Saturday mornings never have any physical consequence or emotional impact.

"It's Tom and Jerry violence," said Ingels. "There's no death, and the ghosts always come back. What do you expect, 'Sesame Street'?"

## TV Log

For complete TV programming information, consult your weekly TV SHOWTIME from Sunday's Daily Reflector.

### WNCT-TV — Ch. 9

THURSDAY 11:57 Newsbreak  
7:00 Jokers Wild 12:00 News  
7:30 Tic Tac 12:30 Young and  
8:00 Magnum P.I. 1:30 As the World  
9:00 Simon & 2:30 Capitol  
10:00 Knots L. 3:00 Guiding L.  
11:00 News 4:00 Wallston  
11:30 Movie 5:00 Hillbillies

FRIDAY 6:00 News 9  
5:00 Jim Bakker 6:00 CBS News  
6:00 Carolina 7:00 Jokers Wild  
6:00 Morning 7:30 Tic Tac  
6:25 News 8:00 Dukes  
9:25 News 9:00 Dallas  
10:00 Pyramid 10:00 F. Crest  
10:30 Childs Play 11:00 News 9  
11:00 Price Is 11:30 Movie

### WITN-TV — Ch. 7

THURSDAY 10:30 Wheel Of  
7:00 Jeffersons 11:00 Texas  
7:30 Family Feud 12:00 News  
8:00 Fame 12:30 Search For  
9:00 Cheers 1:00 Days of Our  
9:30 Taxi 2:00 Another Wor.  
10:00 Hill Street 3:00 Fantasy  
11:00 News 4:00 Doctors  
12:30 Letterman 4:30 Dark Shadows  
1:30 Overnigh 5:00 Little House  
2:30 News 6:00 News  
FRIDAY 6:30 News  
5:00 Jimmy S. 7:00 Jefferson  
6:00 Almanac 7:30 Family Feud  
7:00 Today 8:00 Powers of  
7:25 News 9:00 Knight R.  
7:30 Today 10:00 Steele  
8:25 News 11:00 News  
8:30 Today 11:30 Tonight  
9:00 Muppets 12:00 Letterman  
9:30 All In The 2:00 Overnigh  
10:00 Facts Of Life 3:00 News

### WCTI-TV — Ch. 12

THURSDAY 10:00 Romance  
7:00 3's Company 10:30 Laverne  
7:30 Alice 11:00 Love Boat  
8:00 Joanie Loves 12:00 Family F.  
8:30 Christmas C. 3:00 Ryan's Hope  
9:00 Too Close For 1:00 All My  
9:30 11 Takes 2 1:00 One Life  
10:00 20/20 3:00 G. Hospital  
11:00 Action News 4:00 Carnival  
11:30 Nightline 4:30 BJ/LOBO  
12:00 Movie 5:30 People's  
7:00 Early Edition 6:00 Action News  
6:30 ABC News  
FRIDAY 7:00 3's Company  
5:00 AG Day 7:30 Alice  
5:30 J. Swagart 8:00 Benson  
6:00 News 8:30 New OddC  
7:00 Good Morning 9:00 Movie  
6:25 Action News 11:00 Action News  
6:55 Action News 11:30 News  
7:25 Action News 12:00 Classics  
8:25 Action News 1:30 An Evening  
9:00 Phil Donahue 2:30 Early Edition

### WUNK-TV — Ch. 25

THURSDAY 11:50 Readalong 2  
7:00 Report 12:00 Ways of Law  
7:30 T.B. Journal 12:30 Tip Top Ten  
8:00 Previews 12:30 Word Shop  
8:30 W. America 12:45 Electric Co.  
9:00 Nature of 1:15 Music  
10:00 Austin City 1:45 Give and Take  
11:00 Hitchcock 2:30 Fast Forward  
11:30 Dave Allen 3:00 Over Easy  
FRIDAY 3:30 Jacques Pepin  
7:45 AM Weather 4:00 Sesame St.  
8:00 In The 5:00 Mr. Rogers  
8:35 Write On 5:30 Powerhouse  
8:40 Partez Moi 6:00 Dr. Who  
8:50 Readalong I 6:30 Dr. In House  
9:00 Sesame Street 7:00 Report  
10:00 Terra 7:30 Stateline  
10:20 Word Shop 8:00 Washington  
10:35 Fiction 8:30 Wall St.  
10:55 Write On 9:00 Six Great  
11:00 StoryBound 10:00 Nature  
11:15 Soup To 11:00 A. Hitchcock  
11:30 Carousel 11:30 Dave Allen

## Feels No Need, Yet, To Remarry

NEW YORK (AP) — Mary Tyler Moore, divorced from Grant Tinker after 19 years, says she feels no need to remarry "but I never say 'never.'"

Miss Moore said the marriage broke up because "relationships evolve and go through changes. Nothing is forever."

The comedian and dramatic actress, in an interview published Wednesday in the January issue of McCall's magazine, said she doesn't want "the foreverness of marriage."

"And all that paperwork when it turns out not to be forever ... why go through it?" she added.

Miss Moore, whose name has been linked with multimillionaire Sir Gordon White and New York public relations executive Ed Menken, conceded that she would like a man in her life.

"I have wants and desires, certainly ... but not somebody who was my tall, strong leader. I would like him to be strong, but strong enough to let go."

Miss Moore said she has made major changes in her life since the divorce.

One was the move from a Hollywood mansion to a small apartment on New York's Upper West Side, where she said she has kept a few old things — "Something's left of my former life" — but has done a complete redecorating job.

## Bob Hope Plans Lebanon Trip

LOS ANGELES (AP) — Comedian Bob Hope won't be home for Christmas if he gets his way. Instead, he'll be entertaining U.S. troops in Lebanon if doctors can treat his recurrent eye problems, his publicist says.

Hope, who has an eye inflammation, checked into New York Hospital late Wednesday for two days of examinations.



TO WED — Actress Stockard Channing will marry Charleston, S.C. businessman David L. Rawle at the Episcopal Church of the Heavenly Rest in New York on Saturday. (AP Laserphoto)

## Cary Grant To Narrate Show

HOLLYWOOD (AP) — Cary Grant will narrate a half-hour religious television program featuring his late friend Princess Grace of Monaco, who acted as hostess.

"The Nativity," completed about three months before the princess's death, will be broadcast during the Christmas season on 160 stations, producer Frank O'Connor said.

In his voice-over tribute, Grant says: "The film you're about to see was completed just before the late Princess Grace of Monaco died. Indeed, it was the last film she was to make, and as such becomes a fitting memorial."

Princess Grace died Sept. 14 in a car crash on the French Riviera.

## 264 PLAYHOUSE INDOOR THEATRE

6 Miles West of Greenville On U.S. 264 (Farmville Hwy)

STARTS TODAY

AT YOUR ADULT ENTERTAINMENT CENTER

EXCLUSIVE 1st RUN!

THE MISTRESS  
STARRING KELLY WICKS  
RATED XXX  
756-0848 Doors Open  
Showtime 6:00 5:45

PLITT THEATRES \$2.00 Daily 'Til 6 P.M.  
Give Plitt Reduced Admission Tickets  
For The Ride of Your Life "Airplane II" 2:30-4:10-5:30-7:30-9:10-PG  
27th Week "E.T." 2:30-4:45-7:00-9:15-PG  
CAROLINA EAST CENTER 756-1449 SOON KISS ME GOODYBY  
EDDIE MURPHY "48 HOURS" 2:00-3:45-5:30-7:15-9:00-R DOUBLE FEATURE I, THE JURY 3:05-7:05-R MONSIGNOR 3:05-9:05-R

PARK UPTOWN GREENVILLE 752-7649  
Another World, Another Time... In the Age of Wonder.  
THE DARK CRYSTAL  
NOTICE! 3 PM SHOW MON.-FRI. OVER AT 4:40 PM  
LORD GRADE Presents for ITC ENTERTAINMENT A JIM HENSON film "THE DARK CRYSTAL"  
Directed by JIM HENSON and FRANK OZ  
Produced by JIM HENSON and GARY KURTZ Screenplay by DAVID ODELL  
Story by JIM HENSON Music by TREVOR JONES  
MON.-FRI. 3:00-7:10-9:00 SAT.-SUN. AT 3:30-5:20-7:10-9:00

Plaza cinema 1-2-3 756-0088  
PITT-PLAZA SHOPPING CENTER  
Starts TOMORROW!  
Frank Galvin has one last chance to do something right.  
THE VERDICT  
TWENTIETH CENTURY-FOX presents A ZANUCK/BROWN PRODUCTION  
PAUL NEWMAN / CHARLOTTE RAMPLING  
JACK WARDEN / JAMES MASON  
THE VERDICT / MILO O'SHEA  
MUSIC BY JOHNNY MANDEL / EXECUTIVE PRODUCER BURT HARRIS  
SCREENPLAY BY DAVID MAMET / BASED ON THE NOVEL BY BARRY REED  
PRODUCED BY RICHARD D. ZANUCK AND DAVID BROWN  
DIRECTED BY SIDNEY LUMET  
SHOWS MON. THRU FRI. 3:00-7:05 AND 9:30  
SHOWS SAT.-SUN. 2:15-4:40-7:05-9:30 P.M.  
BURT REYNOLDS GOLDIE HAWN  
Best Friends STARTS TOMORROW!  
SHOWS MON.-FRI. 3:00-7:00-9:05 SAT.-SUN. 2:50-4:55-7:00-9:05  
MARVELOUS-RICHARD SCHICILLE, TIME  
CELEBRATE CHRISTMAS WITH US!  
STARTS TOMORROW!  
Clint Eastwood and Kyle Eastwood  
Honkytonk Man  
SHOWS MON.-FRI. 3:00-7:00-9:15 SAT.-SUN. 2:30-4:45-7:00-9:15

PARK UPTOWN GREENVILLE 752-7649  
ALL SEATS \$1.50  
FIRST SHOW EVERYDAY "HANDS OF LIGHTNING" SHOWS 7:10-9:00 (R)  
The Little Whorehouse in Texas SHOWS 3:00-7:05-9:15  
Plaza cinema 1-2-3 756-0088  
PITT-PLAZA SHOPPING CENTER ALBERT FINNEY CAROL BURNETT BERNADETTE PETERS  
Annie SHOWS 3:00-7:05-9:30  
WE ARE THE FUTURE! Stop Us If You Can! CLASS OF 1984 SHOWS 3:00-7:10-9:00

CONSOLIDATED THEATRES ALL SEATS \$2.00 EVERYDAY 'TIL 6:30 P.M.  
BUCCANEER MOVIES  
1:20-3:20-5:20 7:20-9:20  
THE SLAYER THE TOY  
JACKIE GLEASON TOLD HIS SON TO GET ANYTHING HE WANTED FOR CHRISTMAS... SO HIS SON BOUGHT...  
RICHARD PRYOR  
PG

OUTLET  
LAST MINUTE GIFTS  
Ladies Button Collar Blouses by Manor House Reg. \$22 \$12.99 Our Price  
Ladies Panties by Carole \$1.45  
Belts \$2.99 & Up  
Handkerchiefs ... 3 For \$2.00  
Mens Dress Socks .... \$10.99 Doz.  
Mens Long & Clip On Ties ..... \$3.50 & \$4.50  
Mens Button Collar Solid & Plaid Shirts by Oxford ... \$11.99 & \$13.99  
We Carry Ladies Apparel In Sizes From 3/4 to 44  
Ask About Our Layaway Plan  
MILL OUTLET CLOTHING  
Hwy. 264 By-Pass Across From Nichols Open Mon.-Sat. 9:30 'Til 6:00

**Crossword** By Eugene Sbeffer

**ACROSS**  
 1 Pack up  
 5 Type  
 9 Toward the stern  
 12 Veritable  
 13 Eager  
 14 - de France  
 15 Atmospheric flow  
 17 Regret  
 18 Foremen  
 19 Ski resort  
 21 Print measure  
 22 Waterway  
 24 Linen source  
 27 Spar  
 28 Damages  
 31 French king  
 32 Pub order  
 33 Catch  
 34 Monster  
 36 Mayday call  
 37 Sensuous  
 38 Candle  
 40 Article  
 41 Steeple  
 43 Midwest area  
 47 Boar

**DOWN**  
 4 Ancient kingdom of England  
 5 Averages  
 6 "Got a Secret"  
 7 Govt. agency  
 8 Madison Ave. worker  
 9 The Spruce  
 10 Chimney  
 11 Adolescent  
 16 Number for Moses  
 20 Houston, for one  
 22 Tint  
 23 Cutting tools  
 24 To's counterpart  
 25 Ship record  
 26 Hermetically sealed  
 27 Headquarters  
 29 Actor Harrison  
 30 Piggery  
 35 Corn spike  
 37 Entraps  
 39 Claps  
 40 TV's Link-letter  
 41 Carpet type  
 42 Sit for  
 43 Enquires  
 44 Beak  
 45 - fact  
 46 Initials for a rush job

**Answer to yesterday's puzzle:** 50 Pole

Avg. solution time: 27 min.

TUBA RAP OGLE  
 ARANAWA RAIL  
 BARGAINS DINA  
 SLEEPS TRENDS  
 LET ATRS  
 FAR SNEY DEALE  
 IDES SAC DYER  
 ROGHS MEL SON  
 ANOIA LLD  
 SPIDERHOOSEN  
 HONER GAIN TIME  
 ONERS OPS ELITS  
 WEIDS SOT SORT

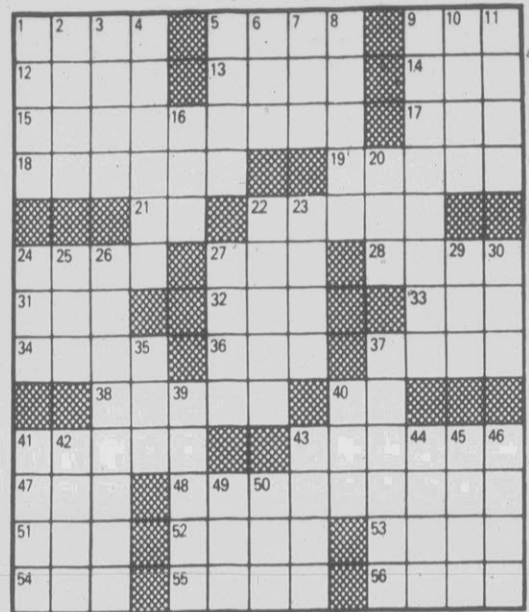

CRYPTOQUIP 12-16

MNZC EWTKA AYX MECTKR K-WTEA  
 YER RKWANAZXR

Yesterday's Cryptoquip - DEER HUNTER HADN'T ANY BUCKS TO BUY SOCKS.

Today's Cryptoquip clue: W equals B.

The Cryptoquip is a simple substitution cipher in which each letter used stands for another. If you think that X equals O, it will equal O throughout the puzzle. Single letters, short words, and words using an apostrophe can give you clues to locating vowels. Solution is accomplished by trial and error.

© 1982 King Features Syndicate, Inc.

**Wrecks Cause Heavy Damage**

An estimated \$5,650 damage resulted from three traffic collisions investigated Wednesday by Greenville police.

Officers said heaviest damage resulted from a 5:32 p.m. collision on Greenville Boulevard, 1500 feet east of the Hooker Road, involving cars driven by Dorothy Evans Hudson of Route 2, Winterville, and Clarence Ray Holland of Route 2, Winterville.

Police, who charged Holland with failing to reduce his speed enough to avoid an accident, set damage at \$1,800 to the Hudson car and \$450 to the Holland vehicle.

An estimated \$2,000 damage resulted to a truck driven by Michael Wynn Bissett of Route 8, Greenville, when the vehicle struck the curb on Fifth Street, 45 feet east of the Latham Street intersection about 7:55 a.m. and overturned.

No charges were made in connection with the incident. Cars driven by Nina Ellen

Bland of 418 W. Fifth St. and William Samuel Colt of 1801 Fairview Way collided about 3:25 p.m. at the intersection of IThird and Pitt streets, resulting in an estimated \$500 damage to the Bland car and \$900 damage to the Colt vehicle.

**REQUESTS APPROVED**  
 Police Chief Glenn Cannon has announced the approval of two requests for solicitation permits in Greenville.

He said the requests were submitted by: the Pitt County chapter of the Shaw University Alumni Association to conduct a merchant solicitation Dec. 15 through Feb. 15 to raise funds for the university and the Shaw Players and Company; and by York Memorial A.M.E. Zion Church to conduct a merchant solicitation Dec. 13 through Feb. 13 to sell advertisements for a souvenir book to be sold to raise money for the building fund.

**YOUR DAILY Horoscope**  
 from the Carroll Righter Institute

**GENERAL TENDENCIES:** This is a good day and evening to adopt a new attitude with associates and gain a better relationship. A friend in a position of authority can give you a helping hand now.

**ARIES (Mar. 21 to Apr. 19)** Associates will come to a better agreement now and mutual success is possible. Strive to gain added prestige.

**TAURUS (Apr. 20 to May 20)** Fine day for improving conditions around your home and making it more comfortable. Look for quiet pleasure.

**GEMINI (May 21 to June 21)** Show appreciation to associates and you gain their added cooperation. A special talent can bring added income.

**MOON CHILDREN (June 22 to July 21)** You are able to make your home more functional with little effort. Pay more attention to financial affairs.

**LEO (July 22 to Aug. 21)** Be more cooperative with associates and get better results. Be extra careful in the expenditure of money today.

**VIRGO (Aug. 22 to Sept. 22)** Take time to study every angle of a property matter that could add to your abundance. Strive to be more successful.

**LIBRA (Sept. 23 to Oct. 22)** Use your charm to make a good impression on others. Showing more consideration for loved one brings more harmony.

**SCORPIO (Oct. 23 to Nov. 21)** You are able to handle civic matters in a most intelligent way and add to your prestige. Obtain the data you need.

**SAGITTARIUS (Nov. 22 to Dec. 21)** You have fine ideas that should be put in operation without delay. Enjoy social affair in the evening.

**CAPRICORN (Dec. 22 to Jan. 20)** You can accomplish much in the business world today by applying yourself more. Avoid tendency to be extravagant.

**AQUARIUS (Jan. 21 to Feb. 19)** Meet the expectations of associates and you gain increased benefits. Express happiness with the one you love.

**PISCES (Feb. 20 to Mar. 20)** Follow your hunches which are accurate now. Being more thoughtful of loved one brings fine results at this time.

**IF YOUR CHILD IS BORN TODAY...** he or she will be one who can easily communicate with others, so be sure to give the type of education that will steer your progeny to success. Be sure to give good religious training. One who will be good at sports.

"The Stars impel, they do not compel." What you make of your life is largely up to you!

© 1982 McNaught Syndicate, Inc.

**Could Impound Town Property**

**CLARKTON, N.C. (AP)** - The town of Clarkton may have its police cruisers, garbage trucks, back hoe or pickup truck impounded by the federal government if it does not come up with \$16,528 in legal fees it owes.

The legal fees were ordered following two trials in U.S. District Court earlier this year in which Clarkton was found guilty of violating the U.S. Fair Housing Act by refusing to accept 50 units of low-income housing.

Following the trial, Judge Albert Bryan Jr. ordered Clarkton to accept the public housing and pay legal fees to attorney Jim Walls of Lower Cape Fear Legal Services.

In a writ of judgment delivered Nov. 18, the town was ordered to pay the money. Two writs of execution demanding payment of legal fees were filed against the town Monday with the U.S. Clerk of Court's office in Wilmington.

The writs of execution demand payment or forfeiture of property.

Clarkton owns two police cruisers, two garbage trucks, a back hoe, two fire trucks, a road grader, a flat bed and a pick up truck, according to Town Clerk Myrtle Tate. Aside from rolling stock, the town owns the town hall and a water and sewage treatment plant along with assorted tracts of land.

If the vehicles, which the

town clerk says are "pretty old and beatup," don't satisfy the bill, the town could find the U.S. government auctioning off the town hall to cover the difference.

And Clarkton Mayor Dwight Fort said the town doesn't have the money in its \$219,000 budget to pay the fees.

"I don't know what I'll do when they come demanding money, this is the first I've heard about it," Fort said Wednesday. "I suppose they could take our cruisers and trucks because we just don't have it."

"We'll have to cross that bridge when we come to it," he said.

Eddy Sigmon, chief deputy of the U.S. Marshal's office in Raleigh, says he's a little uncertain of how to proceed with serving the papers.

"I have never had to impound from a town before," Sigmon said. "If someone doesn't pay, we can pretty much grab anything that belongs to them."

Sigmon said it is unlikely any papers will be served until after Christmas.

**NEAR THE VATICAN ROME (AP)** - Police burst into an apartment near the Vatican and arrested a suspected Red Brigades member sought for three years, authorities said.

**PEANUTS**



**B.C.**



**NUBBIN**



**BLONDIE**



**BETTY BAILEY**



**PHANTOM**



**FRANK & ERNEST**



**PRIME TIME**



**FUNKY WINKERBEAN**



E. 10th Street  
 Greenville Blvd.

**WE CUT IT FRESH, EVERYDAY...**

**Western Sizzlin'**  
 STEAK HOUSE  
 WE PUT IT ON THE PLATE

Friday and Saturday Special

No. 4 New York Strip  
 \$4.99 ONLY

includes baked potato or French Fries and Texas Toast.

**AND WE DO IT JUST FOR YOU!**

THE DAILY REFLECTOR Classified Advertising Rates

3 Line Minimum 1-3 Days .45¢ per line per day 4-6 Days .42¢ per line per day 7 Or More Days .40¢ per line per day

Classified Display \$2.75 Per Col. Inch Contract Rates Available

DEADLINES Classified Lineage Deadlines

Monday . . . . . Friday 4 p.m. Tuesday . . . . . Monday 3 p.m. Wednesday . . . . . Tuesday 3 p.m. Thursday . . . . . Wednesday 3 p.m. Friday . . . . . Thursday 3 p.m. Sunday . . . . . Friday noon

Classified Display Deadlines Monday . . . . . Friday noon Tuesday . . . . . Friday 4 p.m. Wednesday . . . . . Monday 4 p.m. Thursday . . . . . Tuesday 4 p.m. Friday . . . . . Wednesday 5 p.m. Sunday . . . . . Wednesday 5 p.m.

ERRORS Errors must be reported immediately. The Daily Reflector cannot make allowance for errors after 1st day of publication.

THE DAILY REFLECTOR reserves the right to edit or reject any advertisement submitted.



people read classified

CLASSIFIED INDEX MISCELLANEOUS

Personals . . . . . 002 In Memoriam . . . . . 003 Card Of Thanks . . . . . 005 Special Notices . . . . . 007 Travel & Tours . . . . . 009 Automotive . . . . . 010 Child Care . . . . . 040 Day Nursery . . . . . 041 Health Care . . . . . 043 Employment . . . . . 050 For Sale . . . . . 060 Instruction . . . . . 080 Lost And Found . . . . . 082 Loans And Mortgages . . . . . 085 Business Services . . . . . 091 Opportunity . . . . . 093 Professional . . . . . 095 Real Estate . . . . . 100 Appraisals . . . . . 101 Rentals . . . . . 120

WANTED

Help Wanted . . . . . 051 Work Wanted . . . . . 059 Wanted . . . . . 140 Roommate Wanted . . . . . 142 Wanted To Buy . . . . . 144 Wanted To Lease . . . . . 146 Wanted To Rent . . . . . 148

RENT/LEASE

Apartments For Rent . . . . . 121 Business Rentals . . . . . 122 Campers For Rent . . . . . 124 Condominiums For Rent . . . . . 125 Farms For Lease . . . . . 107 Houses For Rent . . . . . 127 Lots For Rent . . . . . 129 Merchandise Rentals . . . . . 131 Mobile Homes For Rent . . . . . 133 Office Space For Rent . . . . . 135 Resort Property For Rent . . . . . 137 Rooms For Rent . . . . . 138

SALE

Autos for Sale . . . . . 011-029 Bicycles for Sale . . . . . 030 Boats for Sale . . . . . 032 Campers for Sale . . . . . 034 Cycles for Sale . . . . . 036 Trucks for Sale . . . . . 039 Pets . . . . . 046 Antiques . . . . . 061 Auctions . . . . . 062 Building Supplies . . . . . 063 Fuel, Wood, Coal . . . . . 064 Farm Equipment . . . . . 065 Garage-Yard Sales . . . . . 067 Heavy Equipment . . . . . 068 Household Goods . . . . . 069 Insurance . . . . . 071 Livestock . . . . . 072 Miscellaneous . . . . . 074 Mobile Homes for Sale . . . . . 075 Mobile Home Insurance . . . . . 076 Musical Instruments . . . . . 077 Sporting Goods . . . . . 078 Commercial Property . . . . . 102 Condominiums for Sale . . . . . 104 Farms for Sale . . . . . 106 Houses for Sale . . . . . 109 Investment Property . . . . . 111 Land For Sale . . . . . 113 Lots For Sale . . . . . 115 Resort Property for Sale . . . . . 117

PUBLIC NOTICES

NOTICE OF SALE

Pursuant to findings made and entered in that certain Special Proceeding entitled "IN THE MATTER OF THE FORECLOSURE OF A DEED OF TRUST EXECUTED BY CHERRY OAKS, INC DATED MAY 20, 1980, RECORDED IN BOOK 849, PAGE 275, PITT COUNTY REGISTRY, BY KENNETH G. HITE, TRUSTEE" being File No. 82 SP 399, and further in accordance with the provisions of sale upon default as contained in said Deed of Trust, the undersigned Trustee, at the request of the holder of the Note secured by said Deed of Trust, will offer for sale and sell to the highest bidder for cash before the Court-house door in Greenville, North Carolina, on December 17, 1982 at 12:30 p.m. all the following lot or parcel of real estate located in or near the City of Greenville, Pitt County, North Carolina, and described as follows:

Being all of Lot Nos. 12 and 13, Block B; Lot Nos. 1, 2, 3, 4, 5, 6 and 8, Block C; Lot Nos. 9 and 10, Block D and Lot No. 9, Block F, Cambridge Subdivision, Section VI, as shown on map recorded in Map Book 28, at Page 218 of the Pitt County Registry. This property will be sold subject to all prior outstanding taxes, assessments, and encumbrances if any.

The highest bidder will be required to deposit ten (10%) per cent of the first One Thousand Dollars (\$1,000.00) purchase price and five percent (5%) of the excess. This sale remains open ten (10) full days for confirmation. This is the 16th day of November, 1982.

KENNETH G. HITE, Trustee November 26; December 2, 9, 16, 1982

NOTICE OF SALE

Pursuant to findings made and entered in that certain Special Proceeding entitled "IN THE MATTER OF THE FORECLOSURE OF A DEED OF TRUST EXECUTED BY CHERRY OAKS, INC DATED OCTOBER 1976 RECORDED IN BOOK F45, PAGE 500, PITT COUNTY REGISTRY, BY KENNETH G. HITE, TRUSTEE" being File No. 82 SP 397, and further in accordance with the provisions of sale upon default as contained in said Deed of Trust, the undersigned Trustee, at the request of the holder of the Note secured by said Deed of Trust, will offer for sale and sell to the highest bidder for cash before the Court-house door in Greenville, North Carolina, on December 17, 1982 at 12:00 noon all the following lot or parcel of real estate located in or near the City of Greenville, Pitt County, North Carolina, and described as follows:

Being all of Lot Nos. 24, 25, 26 and 31, Block C, Camelot Subdivision Section III, as shown on map recorded in Map Book 25 at Page 91 of the Pitt County Registry. This property will be sold subject to all prior outstanding taxes, assessments, and encumbrances if any.

The highest bidder will be required to deposit ten (10%) per cent of the first One Thousand Dollars (\$1,000.00) purchase price and five percent (5%) of the excess. This sale remains open ten (10) full days for confirmation. This is the 16th day of November, 1982.

KENNETH G. HITE, Trustee November 26; December 2, 9, 16, 1982

NOTICE

Having qualified as Executrix of the estate of Sally Worthington Little late of Pitt County, North Carolina, this is to notify all persons having claims against the estate of said deceased to present them to the undersigned Executrix on or before June 9, 1983 or this notice or same will be pleaded in bar of their recovery. All persons indebted to said estate please make immediate payment. This 7th day of December, 1982. Hilda Little Smith 102A Stancill Drive Greenville, N.C. 27834

Autos For Sale

011 1971 VOLKSWAGEN, \$1500. Also 1978 Malibu, \$3600. Call 756-0732.

013 Buick REGAL 1977. Fully equipped, extra clean. Call Rex Smith Chevrolet, Ayden, 746-3141.

014 Cadillac 1968 CADILLAC, good condition, low mileage, leather interior. \$595. 355-2220 after 6.

015 Chevrolet CASH FOR your car. Barwick Auto Sales, 756-7765.

CHEVETTE 1982 2 door hatchback coupe. Tinted glass, floor mats, deluxe exterior, door edge guards, air conditioning, mirrors, automatic, WSW radial tires, heavy duty battery, AM-FM radio, GM metallic with camel vinyl interior. List price \$7343.44, discount \$884.81. Sale price \$6458.63. Down payment \$500.00 with monthly payments of \$167.76 with approved credit 10.9 Annual Percentage Rate. Call Rex Smith Chevrolet, Ayden, 746-3141.

1976 MONTE CARLO Power steering and brakes, air, 78,000 actual miles. 746-3490.

1977 CAMARO, 1 owner Excellent condition, new tires and new brakes, air, AM/FM \$3,900. 825-5381 after 6.

1977 MALIBU CLASSIC 4 door, loaded, \$2800. Call 758-1198.

1980 CHEVETTE, 4 door, straight shift, air conditioning, excellent condition. \$2995. Call 756-7806 until 9 p.m.

1980 MONZA, 4 speed, 39,000 miles. \$3200. Call 757-1760.

018 Ford THUNDERBIRD 1981, Navy, vinyl top, automatic, AM/FM tape, Call 758-4974.

1965 MUSTANG, good condition, \$1200. 355-2220 after 6.

1965 MUSTANG, rebuilt engine, new transmission, new interior, needs minor repairs, \$1400 or best offer. Call 756-6382 after 6pm.

1967 MUSTANG FASTBACK Minor repairs needed. \$1000. Call after 5, 758-2029.

1979 FORD MUSTANG Call 758-0655 or 752-7073.

020 Mercury COUGAR XR7 CONVERTIBLE 1972. New power steering and brakes. AM/FM stereo. \$1500. Call 752-8920. Can be seen anytime at 1504 Dickinson Avenue.

021 Oldsmobile 98 OLDS REGENCY 1975. Very clean, in very good condition. \$1950. Call 756-6382.

023 Pontiac 1973 STATIONWAGON, full power, original owner, asking \$450. 758-5529 after 5.

024 Foreign MGB, 1977, excellent condition, 1 owner, new top, \$4,000. Call 756-9038 after 6 p.m.

Trucks For Sale

039 1976 JEEP Cherokee Chief. Air, power steering and power brakes. Excellent condition. 756-9908 or \$3500. 756-8987 after 5 p.m.

1977 CHEVROLET El Camino. Excellent condition. 756-9908 or \$3500. 756-8987 after 5 p.m.

1980 JEEP C7J LAREDO Power steering, air, 6 cylinder, 4 speed. 825-5381 after 6.

1981 CHEVY PICKUP low mileage, AM/FM, power brakes and steering. V-8, \$6,000 firm. Call 752-7173.

1981 FORD ECONLINE 150 Long Bed Super Van 3 speed with overdrive, 10,450 miles. \$6995. 758-1023.

1981 JEEP C7J, red, 14,000 miles. \$7695. 746-3490.

040 Child Care RESPONSIBLE mature woman to babysit my 14 month old child, our home, 3 days week, starting January 5. Call 756-7126.

046 PETS AKC BLACK LABRADOR Retriever puppies, \$150. Full blooded, 7-10 p.m. for more information.

AKC COLLIE FEMALE, 2 years superior pedigree and normal eye check. A best in match show winner. Training, grooming, fenced yard or kennel area preferred. 756-2188 days; 946-4314 nights and weekends.

AKC GERMAN Shepherd puppies, pedigree, championship blood line. Black with tan. Father ROM; Mother, a champion daughter of Grand Victor, champion, Ready for Christmas. Call 919-946-2568.

AKC GOLDEN RETRIEVERS, 9 weeks old 2 males left. Shots and wormed 792-2723.

AKC GOLDEN RETRIEVER, only 1 puppy left, female, \$125. Fully trained and potty trained. Will hold till Christmas. 758-5018.

AKC WHITE GERMAN Shepherd puppies, available the week before Christmas. Marion M Mills, 756-355-7272.

CHRISTMAS Labrador Retriever puppies, AKC registered Weaned December 15, 1982. Background information call 756-5391.

CHRISTMAS SPECIAL: AKC white German Shepherd pups. Wormed and all shots. \$155. Females \$100. 106-A Jarvis Street.

EXTREMELY HEALTHY English Springer Spaniel puppy. Only one left. Priced for Christmas giving. 752-3811.

FOR SALE: AKC Yorkshire Terries, Toy Poodles, Fox Terriers, Chihuahuas, Papillon, Spaniels, Schnauzers, Dachshunds, 1 female Boston Terri, 1 Pekinese. Professional groomer. Call 758-2681.

SIAMSE KITTENS, 8 weeks, Seal Point, 1 male and 1 female, wormed and litter trained. \$40. 758-0897.

SIBERIAN HUSKY puppies, 3 males, \$125 each. 2 females, \$100 each. 756-6400.

Work Wanted

PAINT per hour, you supply the paint and equipment. Call Jim, 752-1247 anytime.

PAINTING, WALLPAPERING and Home Repairs. Professional work and reasonable prices. Free Estimates. Serving Kingston and Greenville. Call Collect (919) 523-2845.

PLUMBING AND CARPENTRY All type repairs and remodeling, specializing in bathroom repair. Late License 7037-P 746-2657, if no answer 752-4064.

SALES PERSON, 3 1/2 years experience. Full time but will accept part time. Reliable, dependable. Available now. Call 752-9386.

SANDING and finishing floors. Small carpenter jobs, counter tops. Jack Baker Floor Service, 756-2868 anytime, if no answer call back.

WILL WASH AND POLISH automobiles, \$30. Pickup and delivery service. Call 355-6299.

060 FOR SALE 3 PIECE WICKER SET Call 355-6642.

061 Antiques 064 Fuel, Wood, Coal ALL SEASONED OAK Firewood, split and stacked \$50 for half cord. Call 752-0983, if no answer call 752-4714.

ALL TYPES OF firewood for sale. J. P. Stancill, 752-6331.

CHIMNEY FIRES are dangerous! For thorough, professional sweeping, call Carolina Chimney Cleaners, 758-0174 anytime.

FIREWOOD FOR SALE \$40 for pickup. Call 757-3568 or 758-5063.

MIXED WOOD, \$40. Oak, \$45. 758-6889 or 758-6449.

MIXED WOOD, \$50 a cord; oak wood \$70 a cord. You haul it. 746-3694.

OAK FIREWOOD Dried, stacked, delivered. \$50 1/2 cord and \$90 cord. Guarantee full measure. 746-2267.

065 Farm Equipment CHRISTMAS GIFT IDEAS 5' shop bench vise, \$29.95; 6' vise \$38.95; 8' vise \$49.95; 12 piece 1 1/2" socket set, \$16.49; 21 piece 1/2" drive socket set, \$52.49; 16 ounce claw hammer, \$3.99; 6 1/2" horse power grinder, \$38.49. Agri Supply, Greenville, NC 752-3999.

067 Garage-Yard Sale MOVING SALE! Furniture, records, books, clothing, dishes and other assorted items. Saturday from 11 until 2, 27 D Langston Park Apartments, Stancill Drive.

OPEN AGAIN Raynor Forbes & Clark Flea Market across from Moske Lodge. All spaces inside, Saturday, 7 to 10.

YARD SALE FRIDAY New garbage disposal, lots of miscellaneours, lots of dolls, 3 miles west of hospital on Stantonsburg Road, on left, watch for signs.

072 Livestock BEAUTIFUL 3 1/2 YEAR OLD Quarter Horse 15 1/2 hands. Liver chestnut with white blaze face and 4 white socks. 1975 1/2 Honda motorcycle 752-7270 or 752-6500.

Miscellaneous

AIRLESS CINDER electric paint sprayer on wheels. \$250. Call 752-8559.

BRUNSWICK SLATE POOL Tables. Cash discounts. Delivery and installation. 919-762-9224.

CALL CHARLES TICE, 758-3013, for small loads of sand, topsoil and stone. Also driveway work.

CLASSIFIED DISPLAY

Miscellaneous

BEAUTIFUL fur coat By Sportswear, like new, size 12, \$150. 752-9979, 5 p.m. to 10 p.m.

BEDDING AND WATERBEDS Save up to 1/2 and more. Factory Mattress And Waterbeds, 730 Greenville Blvd, next to Pitt Plaza, 355-2626.

CLASSIFIED DISPLAY

Miscellaneous

CITY DIRECTORY for sale. The official edition of the 1982 City Directory, one copy available at only \$100. Call 756-4619 after 6 p.m.

CONSOLE STEREO, includes a track that records, \$100. Large desk. 758-9982.

COPY MACHINE 1 year old, \$1400. Call 758-2141.

CLASSIFIED DISPLAY

Hastings Ford For Immediate Sale

Ford Motor Executive Cars Save Hundreds Of Dollars

Come In Today And Check Our Tremendous Savings

All Units Equipped With Air Conditioning, Power Steering And Many Other Ford Goodies Too Numerous To Mention

- Stock No. All 1982 Models 2692 Mercury Lynx GL - 4 speed, 1110 miles 2693 Escort GLX Wagon - Automatic, 5475 miles 2694 Escort 4 Door Sedan - Automatic, 8850 miles 2695 Escort GL Wagon - Automatic, 8200 miles 2696 Club Wagon XL - 12 passenger, automatic, 14,210 miles 2697 Escort L 4 Door - 4 speed, 18,250 miles 2698 Mercury Lynx GS 2 Door - Automatic, 9905 miles 2699 Escort L 4 Door - 4 speed, 25,110 miles 2700 Fairmont 4 Door - Automatic, 12,350 miles 2701 Ranger XLT Pickup - Automatic, 6560 miles 2702 Mercury Lynx GS 4 Door - Automatic, 9620 miles 2703 Ford EXP Sport Coupe - Automatic, 16,656 miles

HASTINGS FORD

Dealer No. 5720 758-0114 Greenville, N.C. 27834

SAVE A BUNCH

On These Fine Late Model Used Cars Including Our Recent Purchase Of Factory Executive Cars

- 1982 Dodge D-150 Pickup - White 1981 Chrysler LeBaron - 4 door, white 1982 Chrysler LeBaron - 4 door, silver 1980 Olds Cutlass Supreme - 2 door, beige 1982 Dodge Sportsman Wagon - 8 passenger, tan and beige 1980 Chevrolet Malibu Classic - 4 door, blue 1982 Plymouth Sportsman Wagon - 8 passenger, silver 1980 Chrysler Cordoba - 2 door, burgundy 1982 Dodge Aries - 2 door, silver 1980 Subaru Truck - 4 X 4, gray 1982 Plymouth Gran Fury - 4 door, burgundy 1980 AMC Spirit - 2 door, red 1982 Chrysler Cordoba - 2 door, brown 1980 Dodge Omni 024 - 2 door, gray 1982 Plymouth Gran Fury - 4 door, brown 1980 Ford Courier Pickup - white 1982 Chrysler New Yorker - 4 door, gray 1980 Dodge Aspen - 4 door, blue and beige 1982 Dodge Rampage - Black 1980 Pontiac Sunbird - 2 door, black 1982 Dodge Aries Wagon - 4 door, beige 1979 Dodge Omni 024 - 2 door, green 1982 Chrysler Cordoba - 2 door, red and white 1979 Chrysler Cordoba - 2 door, white 1982 Dodge Aries - 4 door, blue and white 1978 Toyota Corolla - 4 door, white 1981 Plymouth TC-3 - 2 door, white 1978 Dodge Magnum - 2 door, blue and white 1981 Datsun Wagon - 4 door, tan 1978 Plymouth Volare - 4 door, green and white 1981 Ford Thunderbird - 2 door, beige 1978 Dodge Diplomat - 2 door, blue and white 1981 Dodge Omni - 2 door, red 1977 Buick - 2 door, blue and white

Joe Cullipher Chrysler-Plymouth-Dodge Peugeot

3401 S. Memorial Dr. Greenville, N.C.

TAP ALL YOUR KNOWLEDGE LEARNED IN NURSING NEEDED RN'S

\*Full time 3-11:7 \*Part time 7-3 \*Competitive Salaries \*Opportunity to work around school schedules.

Contact Lydia Morgan RN, Director of Nursing, University Nursing Center, 758-2700.

WANTED HOUSEWOMAN, mature female, must have own transportation and able to live in furnished apartment. Must have management, bookkeeping and social skills. Salary negotiable. 758-5632 for interview appointment.

WANTED: live-in companion for senior, elderly woman. Requires cooking, driver's license. Kindly and patient disposition. Room and board provided in pleasant townhome plus salary. References needed. Call 756-5058 after 5 p.m. and weekends.

Work wanted

ALL TYPES free service. Trimming, cutting, storm damage, cleanup, and removal. Free estimates. J.P. Stancill, 752-6331.

ALL TYPES OF MASONRY repair or build. 30 years experience. 756-2581. Free estimates.

BABYSITTING in my home. 758-9827.

CREATIVE HOME Improvements. Quality Construction. Additions, re-modeling, repairs. 757-0799.

EXPERIENCED as cook, governess, cashier, nurse and secretary. Desire to return to work since my father died. Middle aged. Have car and copy license. Call 752-1045.

NO JOB TOO SMALL: remodeling, carpenter and repair work, cabinets and countertops, painting and roofing. 752-1623.

**WOLFGANG VAGNER**

**GUARANTEED USED CARS**

**1981 Audi 4000 5+5 \$10,950**

**1980 Volkswagen Truck \$4495**

**1980 Plymouth Horizon TC-3 \$4395**

**1979 Chevrolet Malibu Classic \$4995**

**1979 Volkswagen Beetle Convertible \$7995**

**1979 Ford Fairmont \$2695**

**1979 Volkswagen Rabbit \$4495**

**1979 Pontiac Sunbird \$4195**

**1979 Volkswagen Dasher Diesel Wagon \$3995**

**1978 Olds Cutlass Wagon \$4995**

**1978 Mazda GLC \$2895**

**1978 Honda Civic \$2795**

**1978 Volkswagen Scirocco \$3995**

**1977 Volkswagen Rabbit REDUCED**

**1977 Chevrolet Caprice Classic \$2995**

**1977 Toyota Corolla \$1995**

**1975 MGB Midget Convertible REDUCED**

**1981 Yamaha 750 Motorcycle SPECIAL**

**JOE PECHELES VOLKSWAGEN**

264 By-pass 756-1135  
Serving Greenville To The Coast For 18 Years

**074 Miscellaneous**

**CURT'S CAR CARE** Specialize in washing and waxing. \$35. Call 524-4064.

**CUSTOM BUILT** handrails, grills, gates, spiral stairways, interior, exterior, residential, commercial. Metal Specialties, 758-4574, 1210 Mumford Road.

**DESK and many furniture items** on sale at Mar Jay and Westbrook Furniture Company, 121 South Evans Street, Monday-Saturday, 12-6.

**DIAMOND WEDDING BAND**, Pearl with sapphire dinner ring, 756-2922 after 7 am.

**DISC JOCKEY**  
Top equipment, top records. Still a few days open for Christmas parties. Bobby Gardner, 756-7707.

**074 Miscellaneous**

**DOLLS:** Madame Alexander, McGuffey Ana and Cinderella, 746-9455.

**EARLY AMERICAN** Hercules sofa. Gold and rust plaid. Excellent condition. 752-4356 or 752-0958 after 7-8-890.

**EARN CASH EXTRA** Now buying aluminum and steel (beer and beverage) cans. Bring to Aluminum Recycling Company, 104 Myrtle Avenue, Greenville. Paying top prices for aluminum/steel cans, copper, brass, old batteries. 752-6453.

**FIREPLACE** heat exchanger, \$50. Assorted V belts, worth \$1500 will take \$600. 756-1632.

**FOR SALE** 1976 Fender D76 12-string Acoustic Guitar with case. \$350. Call 355-6354 after 7pm.

**074 Miscellaneous**

**FREE STANDING** woodstove, black with orange panels, cone shape. \$60. 757-0865.

**GARAGE DOOR** 16 foot wood, glass windows. \$200 firm. Garage door opener. 1/2 horsepower, 2 remote controls for car. \$150. 752-8855 or 756-8690.

**GAS HEATER** Commercial type, overhead with blower. \$200. 756-7417.

**GAS SPACE HEATER**, 30,000 BTU, 4 bricks, open front, economical. 757-3252.

**GIRL'S BEDROOM** furniture, Trundle bed, 3 drawer chest of drawers, 4 drawer vanity or desk. \$250. 756-4746.

**HARRINGTON DARE IV** wood stove. \$500. 756-4746.

**HATTERAS HAMMOCKS** has a limited number of factory seconds available now. Great Christmas gifts for people who like the finer things in life. Over 40% savings. 110 Clark Street, Call 758-0641.

**HORSE SADDLE** Good condition. \$175. 758-4745.

**HOT WATER HEATER**, 40 gallons, electric. Call after 5 p.m., 746-2638.

**LARGE BICYCLE** saddle baskets. Pinball machine. Price negotiable. 752-6702 or 752-3839.

**LARGE REFRIGERATOR** for sale. Deluxe Frigidaire, looks good, runs like new. Priced for quick sale at just \$125. 756-4619 after 6 p.m.

**MAPLE TABLE**, 4 chairs and hutch, like new. \$250. 756-4437 or 756-7178.

**MINK STOLE** Beautiful dark fur, \$250. Child's stereo. 756-7321.

**NET SUPPLIES:** Webbing, rope, floats, lead, everything you need to make your own net or complete net ready to fish. Commercial fishing licenses. Whitchard's Marina, 746-4275.

**NICE BUCK STOVE** for sale, very good price. Call anytime. 756-8392.

**074 Miscellaneous**

**ONE BEAUTIFUL** 3/4 length mink and leather coat. Perfect condition. 752-3178.

**ONE BLUE**, 10 Speed Racer. Excellent condition. ridden only 3 times. \$80. 752-3178.

**ONE USED HOSPITAL BED** with mattress, night stand and overbed table. \$125. Intake and carburetor for 300 Ford. \$50. 756-8469 anytime.

**ONE MONTH OLD** Siberian Husky male, one 2 year old Siberian Husky female. One 16 inch bicycle and one 27 inch 10 speed mens bicycle. 746-3372 or 746-4835.

**OPEN NITELY** Monday thru Thursday until 9:00 P.M. until Christmas. Come by and visit us for low prices on your Christmas furniture needs. Open daily Monday thru Saturday, 10:00 A.M. to 6:00 P.M. Phone 756-6027. Jamie's Furniture and Appliances, 3 miles West 244 to Frog Level, Turn left and 1/4 mile on left.

**PINBALL MACHINE** 2 player, good condition. \$120. 756-7587.

**QUILTS** FOR SALE. Double \$12. King size \$15. 758-8832.

**REFRIGERATOR**, electric range, and portable manual typewriter. \$150. 756-4619.

**REMINGTON ADDING** machine for sale - 10 key model in excellent condition. 756-4619 after 6 p.m.

**SET OF TITILIST GOLF CLUBS** for sale. Excellent condition. Call 756-4799 after 5pm.

**SHAMPOO FOR FALLI** Rent shampoos and vacuums at Rental Tool Company.

**SILVER KING** trampoline and 5 HP oil car, both in excellent condition. Call 753-4108 days, 753-3194 after 5pm.

**SMALL REFRIGERATOR** for sale (18x21x21 1/2). Perfect for office or dormitory room. Reduced to half cost. Only \$65. 756-4619 after 6 p.m.

**SPEED QUEEN** copertone gas dryer, used 2 years sparingly. \$152. 4837.

**STEREO**, Pioneer turntable, Technics receiver, and 2 three-way speakers. \$180. Call 757-1943.

**STUDIO PIANO** Professionally reconditioned and tuned. Call Don Wigen, 355-2830 or days 757-0669.

**TABLE AND 4 CHAIRS**, 3 bar stools to match. 1 mirror. Cash only. 746-2279 between 4 and 8 pm.

**ONE ATARI** with 3 cartridges (less than 1 year old). \$100. 752-4035 or 746-6472.

**074 Miscellaneous**

**WATERBED-QUEEN** size. Bookcase headboard, mattress, 6 drawer pedestal, padded rails, vibrator with controls, heater, 15 year warranty. Only 6 months old. Paid \$650, must sell, \$350. 758-7114 or 355-2626.

**ZENITH** Solid State stereo. \$25. Smith Corona typewriter. \$20. Violin, bow and case, \$125. Green velvet living room chair. \$25. Chest of drawers. \$30. Azuka 10 speed bicycle. \$25. Call anytime 757-1293.

**10 SPEED**, blue and red, free-spirit. Very good condition. \$65. Call after 5 P.M., 752-3186.

**150 GALLON OIL DRUM** with stand; 25 channel Lafayette CB radio, tube type with power mike. \$75. Call 756-0493.

**2 SLIDING GLASS DOORS** \$75. Call 756-0493.

**25" COLOR ZENITH TV** with new rotary antenna. \$275. Zenith speakers in Colonial cabinet, \$75. Book trailer, converts to utility trailer. \$275. 1970 Chevrolet Shortbed work truck, \$475. 1967 Datsun 1000 4 door. \$199. New metal fireplace liner. \$75. Original cost \$475. 3 wire spoke rims, fits Datsun, Toyota, and four lug Mustang. \$65. 2 aluminum mags with new tires. \$80. Low profile chest with drawers, \$10. 25 channel Set 1979 Yamaha motor cycle for flat track. \$35. 758-7404 or 756-7846.

**075 Mobile Homes For Sale**

**BRAND NEW DOUBLEWIDE** for 1982. PIPER Cherokee. Good paint. Good interior. 2 NAV COMS-Transponder. 1500 SMOH 756-2990.

**1982 PIPER Cherokee**. Good paint. Good interior. 2 NAV COMS-Transponder. 1500 SMOH 756-2990.

**25" COLOR ZENITH TV** with new rotary antenna. \$275. Zenith speakers in Colonial cabinet, \$75. Book trailer, converts to utility trailer. \$275. 1970 Chevrolet Shortbed work truck, \$475. 1967 Datsun 1000 4 door. \$199. New metal fireplace liner. \$75. Original cost \$475. 3 wire spoke rims, fits Datsun, Toyota, and four lug Mustang. \$65. 2 aluminum mags with new tires. \$80. Low profile chest with drawers, \$10. 25 channel Set 1979 Yamaha motor cycle for flat track. \$35. 758-7404 or 756-7846.

**DELIVERY and set up included.** VA, FHA and conventional financing. Mobile Home Brokers, 630 West Greenville Boulevard. 758-1919, mobile, 758-1913.

**EXTRA CLEAN** 12x65, 3 bedroom, 1 1/2 bath, low payments. Tri County Homes, 756-0131.

**FOR SALE:** 12x30 Mascot mobile home, 3 bedroom, 1 1/2 bath, air conditioner, 10x14 metal shed. Call 758-3951 after 6.

**MOBILE HOME** with extras at \$1200 per month, equity \$800 can be paid in part. 752-6702 or 752-3839.

**12X46 VIRGINIA**, 2 bedrooms, bath, kitchen, living room. Good condition. \$3000 or best offer. 756-3658.

**12X60 RITZCRAFT** 2 bedrooms, 1 1/2 bath, central heat, and air. Electric appliances. Located in nice trailer park. Partially furnished or unfurnished. \$6500. 756-2564 after 4:30.

**12X65 STYLE-MAR 1971**, 3 bedrooms, 2 full baths, new carpet, central air and heat, deck and shed. Excellent condition. Set in Farmville. \$6200 sacrifice. Call 758-7820 after 5.

**093 OPPORTUNITY**

**FOR SALE:** Seafood Market, good location. Call after 6 p.m. 756-3692.

**LIST OR BUY** your business with C.J. Harris & Co., Inc. Financial & Marketing Consultants, Serving the Southeastern United States. Greenville, N.C. 757-0001, nights, 753-4915.

**SERVICEMASTER** professional home and office cleaning franchise, available in the PHH County area. Includes equipment and training. Financing available. For information call or write to Servicemaster, 204 West Peace Street, Raleigh 27603, 833-2802.

**SMALL BUSINESS FOR SALE** \$14,000 annual gross with greater potential. person can operate. \$14,500. Call 756-9840 after 6pm.

**095 PROFESSIONAL**

**CHIANEY SWEEP** Grid Holloman, North Carolina's original chimney sweep, 25 years experience working on chimneys and fireplaces. Call day or night, 753-3503, Farmville.

**102 Commercial Property**

**LET US HELP YOU!** We manage houses and apartments of all sizes. Mid-Eastern Realty, 757-2540.

**TWO COMMERCIAL** buildings for sale. Call 758-1131 before 5 or 756-1463 after 6.

**WILL LEASE** or sale - 21,000 square foot building located at the corner of Colanah and 14th Street. Lot is 110' x 365' zoned commercial. Multi uses possible. 752-1020.

**106 Farms For Sale**

**FARM** 5 miles east of Ayden. Tobacco allotment. 21/2 acres cleared, 34.9 cut over woodland. Tiled, good road frontage, excellent location. Call Mosley-Jacobs Realty at 746-2146 for full details.

**NEW FARM OFFERING** about 3 miles from Greenville, 21 acres Shreve tobacco and pear orchard. Call Carl Darden at Darden Realty, 758-1983 for details; nights and weekends, 758-2229.

**13 ACRES** all cleared with 21/2 acres tobacco allotment, 8 miles North of Greenville, Aldridge & Southernland Realty. Call 758-2229.

**37 ACRES** with 21 cleared and 2 acres of tobacco. Located near Stokes. For more information contact Aldridge & Southernland, 758-2500; nights-Don Southernland, 758-2540.

**109 Houses For Sale**

**ARE YOU TIRED** OF THE Subdivision lark? How about a "one of a kind" custom built home? Features 3 bedrooms, 2 baths, 1959 square feet on a wooded lot. Call Aldridge and Southernland, 758-2500, nights, Myra Day, 524-5004, D1.

**ATTENTION INVESTORS** - or first time homeowners, small starter home with tremendous potential, living room with fireplace, dining room, kitchen, 2 bedrooms with walk in attic could be converted into 2 more rooms - one room basement and a 2 car garage with small 2 bedroom apartment over it. Fenced in backyard. Reduced as it needs work. For more information call Call Davis Realty, 752-3000, 756-2904, 756-1997, 756-7087.

**BY OWNER** 1500 square feet living room, dining room, 3 bedrooms, large den, deck carport and workshop. Brick veneer. Elmwood. 12% FHA financing with only \$4000 down. Possible rent with option to buy. \$51,500. 756-1062 after 6. No realtors.

**BY OWNER** This cute ranch style home is perfect for the young couple. Features include 3 bedrooms, 2 1/2 baths, fireplace and more all situated on a large lot in the newer section of Sherwood Greens. Seller will pay points and closing costs. Priced to sell at \$41,900. Call 758-7526 after 6 p.m.

**CALL MOORE & SAUTER** and see what Santa's got! No closing cost, only 5% down and monthly payments under \$300. Shared Equity Financing makes your dream of home ownership now possible! 2 or 3 bedroom townhouses - with 3 locations to choose from. Call Moore & Sauter, 758-6050.

**CHARMING OLDER HOME** Features family room with gas logs to keep you warm on these cold nights. Pine paneled sunroom and detached garage and workshop. Ready for you to move in. \$22,000. CENTURY 21 Bass Realty, 756-6666.

**CLUB PINES** Under construction. This two story home features over 2100 square feet of living area, with all formal areas, family room with fireplace, deck out back and much more. Buy now and you can choose your own decor. \$90's. \$350. CENTURY 21 Bass Realty, 756-5869.

**SERVICE MANAGER SPECIALS**

**David Harris** Service Manager West End Store

**Buddy Guthrie** Service Manager Dickinson Ave. Store

**With Coupon \$16.88**

**With Coupon \$13.88**

**FRONT END ALIGNMENT**

**OIL, LUBE & FILTER**

**GOOD YEAR TIRE CENTER**

West End Shopping Center Phone 756-9371  
Open 8:00-6:00 Mon-Fri Sat. 8:00 to 1:00

729 Dickinson Avenue Phone 752-4417  
Open 8:00-6:00 Mon-Fri Sat. 8:00 to 1:00

**RUG DOCTOR**

See Yellow Page 50 for locations and coupon.

**ONE ATARI** with 3 cartridges (less than 1 year old). \$100. 752-4035 or 746-6472.

**CLASSIFIED DISPLAY**

**SPECIAL Executive Desks**

60" x 30" beautiful walnut finish. Ideal for home or office.

Reg. Price \$259.00 Special Price \$179.00

**TAFF OFFICE EQUIPMENT**

589 S. Evans St. 752-2175

**CLASSIFIED DISPLAY**

**WE REPAIR SCREENS & DOORS**

Remodeling—Room Additions

**C.L. Lupton Co.**

752-6116

**075 Mobile Homes For Sale**

**BRAND NEW DOUBLEWIDE** for 1982. PIPER Cherokee. Good paint. Good interior. 2 NAV COMS-Transponder. 1500 SMOH 756-2990.

**1982 PIPER Cherokee**. Good paint. Good interior. 2 NAV COMS-Transponder. 1500 SMOH 756-2990.

**25" COLOR ZENITH TV** with new rotary antenna. \$275. Zenith speakers in Colonial cabinet, \$75. Book trailer, converts to utility trailer. \$275. 1970 Chevrolet Shortbed work truck, \$475. 1967 Datsun 1000 4 door. \$199. New metal fireplace liner. \$75. Original cost \$475. 3 wire spoke rims, fits Datsun, Toyota, and four lug Mustang. \$65. 2 aluminum mags with new tires. \$80. Low profile chest with drawers, \$10. 25 channel Set 1979 Yamaha motor cycle for flat track. \$35. 758-7404 or 756-7846.

**DELIVERY and set up included.** VA, FHA and conventional financing. Mobile Home Brokers, 630 West Greenville Boulevard. 758-1919, mobile, 758-1913.

**EXTRA CLEAN** 12x65, 3 bedroom, 1 1/2 bath, low payments. Tri County Homes, 756-0131.

**FOR SALE:** 12x30 Mascot mobile home, 3 bedroom, 1 1/2 bath, air conditioner, 10x14 metal shed. Call 758-3951 after 6.

**MOBILE HOME** with extras at \$1200 per month, equity \$800 can be paid in part. 752-6702 or 752-3839.

**12X46 VIRGINIA**, 2 bedrooms, bath, kitchen, living room. Good condition. \$3000 or best offer. 756-3658.

**12X60 RITZCRAFT** 2 bedrooms, 1 1/2 bath, central heat, and air. Electric appliances. Located in nice trailer park. Partially furnished or unfurnished. \$6500. 756-2564 after 4:30.

**12X65 STYLE-MAR 1971**, 3 bedrooms, 2 full baths, new carpet, central air and heat, deck and shed. Excellent condition. Set in Farmville. \$6200 sacrifice. Call 758-7820 after 5.

**078 Sporting Goods**

**HATTERAS CANVAS PRODUCTS** All types canvas and cushion repairs. Specializing in marine products. Call Mosley-Jacobs Realty at 746-2146 for full details.

**WEATHERBY VANGUARD 7mm** Magnum .412 scope with range finder. \$425. 756-5682.

**082 LOST AND FOUND**

**FOUND DOG**, downtown area, call for identification. 758-6255.

**FOUND** small long-haired female Terrier on 5th Street. Call 752-1332.

**LOST:** Golden Retriever about 1 year old, light tan, 1 block from campus. Reward. 757-1175 anytime.

**085 Loans And Mortgages**

**NEED CASH**, get a second mortgage fast by phone, we also buy mortgages, make commercial loans, call free 1-800-845-3929.

**091 Business Services**

**BOOKKEEPING & TAX SERVICE.** Payrolls, etc. Mid-Eastern Business Services, 757-3540.

**093 OPPORTUNITY**

**START THE YEAR OUT IN YOUR OWN BUSINESS**

- Roofing and aluminum siding business
- Printing business
- 24 hour ham & egg restaurant
- Bridal shop
- Full service neighborhood supermarket
- Full service glass company
- High end gift shop
- Small town full service restaurant
- Coastal seafood restaurant
- Several convenience stores

These are some of our eastern North Carolina listings. Call for more details. 757-0001

**C.J. HARRIS AND COMPANY, INC.** Financial and Marketing Consultants Serving The Southeastern United States

**CLASSIFIED DISPLAY**

**PLUMBING REPAIR**

Of All Types

756-1898 757-3143  
Days Nights  
State Lic No 5159

**AVAILABLE POSITIONS**

**EDGECOMBE COUNTY SCHOOL SYSTEM**

**COMMUNITY SCHOOLS COORDINATOR**

Position involves responsibility for overall development, organization, operation, coordination, and evaluation of the Community School Program by encouraging maximum involvement of all citizens, organizations, agencies, and groups within the community at large. College Education required (degree in education, public relations and/or communications preferred).

**VOCATIONAL EDUCATION SHOP TEACHER**

For Jr. High disadvantaged students. Previous teaching experience with disadvantaged students preferred. Certification in Industrial Arts or other vocational education area required.

**CONTACT PERSONNEL DEPARTMENT**

412 PEARL ST., TARBORO, NC FOR APPLICATIONS  
PHONE NO. (919) 823-6153

**WE INSTALL ALUMINUM AND VINYL SIDING**

Remodeling—Room Additions

**C.L. Lupton, Co.**

752-6116

# The Gift Spotter

**Gifts for Dad**

**THE PROFESSIONAL WOODCUTTER BUYS STIHL MORE THAN ANY OTHER CHAIN SAW IN THE WORLD.**

**WHICH MEANS ALL THREE OF US ARE DOING THINGS RIGHT.**

**Clark & Co. Of Greenville, Inc.**  
Memorial Dr. Across From Parker Barbeque  
756-2557

**Gifts for Everyone**

**The Year One THE Christmas Plant**

**POINSETTIAS**

**CHRISTMAS TREES & WREATHS**

**Kittrell's Greenhouses**  
2531 Dickinson Ave. Ext. 756-1733

**We've got Garfield, Smurf and Snoopy!**

**Great for Xmas Gifts**

**LEATHER GOODS BOOTS**

**Gifts Under \$20**

**MOCCASINS GLOVES BUCKLES SHIRTS MUCH MORE!**

**Gotcha Covered**  
Highway 11 N. Ayden  
M.C.-Visa  
**OPEN SUNDAY 1-5 PM**

**Gifts for the Home**

**KEROSUN HEATERS**

Save On High Heating Bills

Prices From \*136.88 to \*237.88

Terms Available

**Goodyear Tire Center**

West End 729 Dickinson Ave. 756-8371 752-4417

**Gifts for Mom**

**STIHL**

**Just in Time For Xmas**

**Model 6105 SINGER**

4 basic stitches plus built in button holer, free arm and stretch stitch.

Now Only \$289.99  
10 Year Warranty plus all other Singer benefits.

**GREENVILLE SEWING CENTER**  
756-4747

**GIVE... the warmth and beauty of PINE**

Excellence in design, build and finish choose from a variety of beautiful pieces for him or for her.

**Colonial Furniture Company**

Better Pine Furniture  
220 Airport Rd., Greenville, N.C.  
Mon.-Fri. 10-5. Sat. 9-5 752-7478

**Gifts for the Home**

**Carolina Wood Stove Shop**  
Hwy. 11 North 758-5397

**Maclean TEMP-RITE 10**

11,200 BTU per hour—Heats a 600 sq. ft. area—Operates 15-18 hours—126 cubic ft. storage—Beautiful wood grain cabinet—Automatic electronic ignition—99.9% fuel efficiency for a maximum of energy operation—Automatic instant shut-off if jammed or blocked—No installation or venting required—Light oil fuel tank for easy filling—Listed and Certified by N.E.H.A.

**Gifts for Everyone**

**IZOD SWEATERS**

\$17.95

Select Group Men's IZOD SHIRTS \$12.95 Cotton

DOZEN GOLF BALLS \$14.95

AYDEN GOLF & COUNTRY CLUB 746-3389

**WOODEN DECOYS**

Country Folk Art and Ornaments

15" & 18" Candles Red, White and Ivory Open 11 Pm This Week Only

**Tapscoff**

E. 5th St. Greenville 757-3589

**Gifts for Kids**

**SCHWINN**

**The 10-speed for kids who act like kids.**

To put it mildly, kids don't always take good care of their bikes. That's why our Varsity® is built with rugged steel components. To help it stand up to the bumps and bangs a kid can dish out.

ASSEMBLED AND ADJUSTED AT NO EXTRA CHARGE

**Gifts for Kids**

**Hollowell's DRUG STORES, Inc.**

**Colognes**

Ladies Jontue Charlie Cashet Chantilly Wind Song Many Others

Mens Halston British Sterling Matchabelli Brut Chad Polo

FREE GIFT WRAPPING

SHOP LATE EVERY DAY

FREE CITY WIDE DELIVERY

Three Locations To Serve You  
911 Dickinson Ave. 8th and Memorial Drive Park View Commons

**Gifts for Everyone**

**Stuffed Animals COLLECTIBLE & HANDMADE TOYS**

Ornamental Brass CLARKS NECK SALVAGE  
Clark's Neck Rd. 18 miles east of Greenville

**Gift Suggestions**

Samsonite Attache Cases Sheaffer Pen & Pencil Sets Photo Albums Desk Accessories SCM Portable Typewriters Sentry Safes Globes Appointment Books And Many Other Professional Gifts

**TAFF**

Office Equipment Co., Inc.  
589 S. Evans Street 752-2175

**Gifts for Everyone**

**WARREN'S DOG & HUNTING SUPPLIES**

3026-E East 10th Greenville, N.C. 752-1881

CHRISTMAS DECORATIONS should be stored from year to year. Other items in storage which you don't use should be exchanged for cash... with a Classified ad. Call 752-6166.

**Gifts for Kids**

**SUTTON SERVICE CENTER**

1105 Dickinson Ave. 752-6121

**HAPPY HOLIDAYS**

**1982 Buick Regal Limited**  
Diesel. Extra sharp, loaded with equipment including sun roof, ETR stereo and cassette tape.

**1979 Buick Electra Limited**  
4 door, automatic, air condition, power steering and brakes, power windows, power seats, cruise and much more. Black with black top, red interior.

**1979 Buick Electra Limited**  
4 door. Blue, chamois top, saddle interior. Loaded with all the goodies.

**1979 Buick Skylark**  
4 door. Green, automatic, power steering and brakes, air condition, AM-FM radio.

**1978 Toyota Celica ST**  
Automatic, power steering, air condition, AM-FM radio.

**1977 Plymouth Volare** 4 door. Automatic, power steering, air condition.

**1977 Mercury Cougar XR-7**  
Black with red interior, automatic, power steering and brakes, air condition, AM-FM stereo with tape, tilt wheel, cruise control.

**1976 Olds Delta 88 Royale**  
4 door, automatic, power steering and brakes, power seat, tilt wheel, cruise control, air condition, less than 50,000 miles.

**1978 Ford Custom Pickup**  
6 cylinder, automatic, power steering, less than 37,000 miles, deluxe red and white paint.

**GRANT BUICK INC.**

603 Greenville Blvd., Greenville, N.C.

**"The Dealership Where You Would Send A Friend"**

Weekdays: 8:30 to 6:30  
Saturday: 9:00 to 2:00

Phone 756-1877  
756-1878

**109 Houses For Sale**

**CLASSIC** best describes this three bedroom brick ranch on a private street in the neighborhood. Over 3,000 square feet with all formal areas, den with fireplace, and very spacious. \$71,900. Call CENTURY 21 Bass Realty, 756-5868.

**COLONIAL HEIGHTS** Cute as a button, 3 bedrooms, bath, eat-in kitchen, living room with fireplace, all remodeled. 12x16 den. Assume VA 10% loan. Low monthly payments. P.A. Pines, Call CENTURY 21 Bass Realty, 756-5868.

**CONTEMPORARY** 3 bedrooms, 2 1/2 baths, garage, 2 decks, wooded lot, gourmet kitchen, custom features throughout. Close to pool and tennis courts. \$89,500. By owner. Call 756-6145.

**COUNTRY** living can be yours in this three bedroom home sitting on 1 1/2 acres; formal areas, eat-in kitchen, two car garage, and large detached storage building. Estate Realty Co., 752-5058, nights 758-4476 or 756-2647.

**DOUBLEWIDE \$995 DOWN** 3 bedrooms, excellent condition, 32x53 month. Relocated where you want it at no charge. Immediate occupancy. Corner Mobile Homes, call 756-5033.

**FARMERS HOME ASSUMPTION** 3 bedrooms, 1 bath, country with lots of privacy. \$37,500. Steve Evans & Associates, 355-2727 or 758-3338.

**FARMERS HOME LOAN ASSUMPTION** Situated on a private road on an acre lot. Features central heat and air, three bedrooms, patio, workshop for dad, all this only minutes from Greenville. Call details, \$40,000. 1388 CENTURY 21 Bass Realty, 756-5868.

**IMMACULATE BRICK RANCH** features 3 bedrooms, 2 1/2 baths, fireplace, fenced backyard. Upper \$50's. For more information, call Aldridge and Southerland, 756-3500, nights, Myra Day, 524-5004, D4.

**JUST REDUCED** University area. Excellent investment property. 3 bedrooms, formal areas, 2 baths. For more details call our office, \$47,900. P.A. Pines, Call CENTURY 21 Bass Realty, 756-5868.

**JUST WHAT YOU NEED!** Brook Hill townhomes—the best three bedroom floor plan in town. Own yours for less than rent. Fireplace optional for stocking hangers! No closing cost. \$25 down. Call Moore & Sauter, 758-8050.

**MAINTENANCE FREE RANCH** features large eat in kitchen, 3 bedrooms, 2 1/2 baths, fireplace, 3 room with fireplace. Mid \$30's. Call Aldridge and Southerland, 756-3500, nights, Myra Day, 524-5004, D5.

**NEW LISTING** University area. Affordable home with 3 bedrooms, 1 bath, living room, dining room, eat-in kitchen, and lots of storage space. \$40's. For more information call Alita Carroll at Aldridge & Southerland Realty, 756-3500 or 756-8275.

**NEXT BEST THING TO SANTA** Homeownership for the price of rent! Why rent when you can own? 2 or 3 bedroom townhouse? Investigate our Shared Equity Financing Program. Call Moore and Sauter, 758-8050.

**OLDER HOME IN GRIFTON** features 2 bedrooms, carpeted, hardwood floors, remodeled kitchen and new heating system. \$30's. Call Aldridge and Southerland, 756-3500, nights, Myra Day, 524-5004, D3.

**PINERIDGE**—Owner moving! Must sell contemporary energy efficient home, 3 bedrooms, 2 1/2 baths, fireplace, ceiling fan in great room, heat pump, and garage. Close to hospital. Low equity financing. \$50's. By owner. 752-0046.

**RANCH IN GRIFTON** features living room with fireplace, 2 bedrooms, 2 1/2 baths, and large pantry. Will rent with option. Call Aldridge and Southerland, 756-3500, nights, Myra Day, 524-5004, D2.

**REDUCED** Make us an offer. University area 3 bedrooms, 2 baths, family room with fireplace, block from campus. Steve Evans & Associates, 355-2727 or 758-3338.

**RIVER HILLS** Spacious ranch home with three bedrooms and two baths. Foyer, living room, formal dining room, kitchen with breakfast nook, family room with fireplace, recently painted. This is a possible loan assumption. \$66,900. Duffus Realty Inc., 756-5295.

**SMART HOME BUYER** with tax and apartment. Fenced in yard. Home and apartment. Only \$54,900. Steve Evans & Associates, 355-2727 or 758-3338.

**SPECIAL PRICE, \$37,500** 3 bedrooms, 1 1/2 baths, carpeted, large backyard. Will negotiate. In Farmville. 753-4267 or 756-2750.

**UNIVERSITY AREA** Professionals save your gas and walk from this lovely remodeled older home. Four fireplaces, three bedrooms, two baths, country kitchen and hardwood floors. This is a home to boast about! Don't miss it! \$61,500. #73 CENTURY 21 Bass Realty, 756-5868.

**6 ROOM** house and lot for sale by owner. Approximately 4 miles from Burchoughs Welcome, one mile from Greenville-Bethel Highway. Call 758-6267. Good Buy!

**\$67,900** Centrally located. This 3 bedroom, 2 bath brick ranch features a family room with fireplace, plus formal area. Attractive neighborhood, convenient to schools and shopping. Call June Wyrick at Aldridge & Southerland Realty, 756-3500 or 758-7744.

**121 Apartments For Rent**

**AZALEA GARDENS**

Greenville's newest and most uniquely furnished one bedroom apartments.

- All energy efficient designed.
- Queen size beds and studio couches.
- Washers and dryers optional.
- Free water and sewer and yard maintenance.
- All apartments on ground floor with porches.
- Frost free refrigerators.

Located in Azalea Gardens near Brook Valley Country Club. Shown by appointment only. Couples or singles. No pets.

Contact J T or Tommy Williams 756-7815

**EASTBROOK AND VILLAGE GREEN APARTMENTS**

327 one, two and three bedroom garden and townhouse apartments, featuring Cable TV, modern appliances, central heat and air conditioning, clean laundry facilities, three swimming pools.

Office: 204 Eastbrook Drive 752-5100

**ENERGY EFFICIENCY** 2 bedroom bwnhouse in wooded area. Available December 20. \$285. 756-6295.

**GreeneWay**

Large 2 bedroom garden apartments. Carpeted, dishwasher, cable TV, laundry rooms, balconies, spacious grounds with abundant parking, economical utilities and pool. Adjacent to Greenville Country Club. 756-6869

**IN WINTERVILLE** 3 bedroom apartment, appliances furnished, no children, no pets. Deposit and lease. \$195 a month. Call 756-5007. Available end of December.

**KINGS ROW APARTMENTS**

One and two bedroom garden apartments. Carpeted, range, refrigerator, dishwasher, disposal and cable TV. Conveniently located near shopping center and schools. Located just off 10th Street. Call 752-3519

**LEWIS STREET** One bedroom furnished apartment. Heat, air and water. No pets. Call 758-3781 or 756-0889.

**LOVE TREES?**

Experience the unique in apartment living with nature outside your door.

**COURTNEY SQUARE APARTMENTS**

Quality construction, fireplaces, hard wood floors, heating costs 50% less than comparable units), dishwasher, washer/dryer hookups, cable TV, wall to wall carpet, thermopane windows, extra insulation.

Office Open 9-5 Weekdays 9-5 Saturday 1-5 Sunday  
Merry Lane Off Arlington Blvd. 756-5067

**NEAR UNIVERSITY**, 2 bedrooms, newly renovated. No pets. 1726 7615

**NEW 1/2 BEDROOM APARTMENT** 2 blocks from campus. 752-3277

**OAKMONT SQUARE APARTMENTS**

Two bedroom townhouse apartments, 1212 Redbanks Road. Dishwasher, refrigerator, range, disposal included. We also have Cable TV. Very convenient to Pitt Plaza and University. Also some furnished apartments available.

756-4151

**121 Apartments For Rent**

**ONE BEDROOM**, furnished apartments or mobile homes for rent. Contact J T or Tommy Williams, 756-7815.

**ONE BEDROOM** Energy Efficient apartment. 756-9025 or 756-5389.

**ONE BEDROOM** furnished apartment. Adj. to ECU. Completely modern with central heat and air. Stadium apartments, 904 East 14th Street, \$190 month. 752-5700 or 756-4671.

**SMALL, EFFICIENCY** apartment. Student or professional person. 756-8785.

**STRATFORD ARMS APARTMENTS**  
The Happy Place To Live  
CABLE TV

Office hours 10 a.m. to 5 p.m. Monday through Friday

Call us 24 hours a day at 756-4800

**TAR RIVER ESTATES**

1, 2, and 3 bedrooms, washer/dryer hook ups, cable TV, pool, club house, playground, Near ECU

Our Reputation Says It All!  
"A Community Complex."

1401 Willow Street  
Office: Corner Elm & Willow 752-4225

**CLASSIFIED ADS** are as close as your telephone. Just dial 752-6146 and ask for a friendly Ad-Visor.

**TWO BEDROOM** apartments for rent. Dickinson Avenue, \$235. Bryton Hills, \$235. Verdant St., \$290. Village East, \$320. All require lease and security deposit. Duffus Realty, Inc., 756-0811.

**TWO BEDROOM** apartment, located at Willow Street Apartments. Rent \$250 month. 758-3311.

**TWO BEDROOMS**, 1 1/2 baths, \$280. Ridge Place. Phone 756-7310.

**UNIVERSITY AREA** 2 bedroom duplex, appliances furnished, ideal for students, \$195. Available now. Call 756-0765.

**WEDGEWOOD ARMS**  
NOW AVAILABLE

2 bedroom, 1 1/2 bath townhouses, excellent location. Carpeted, pumps, whirlpool kitchen, washer/dryer hookups, pool, tennis court. 756-0987

**WHY PAY RENT?** 3 bedroom repro. Payments under \$140. Tri County Homes, 756-0131.

**1 AND 2 BEDROOM** apartments. Available immediately. 752-3211.

**1 BEDROOM** unfurnished apartment for sublease. 2 blocks from ECU. Carpeted, new appliances. 757-1175.

**1402B CHESTNUT STREET** Downstairs apartment, living room, 2 bedrooms, kitchen, bath, utility and laundry room. Partially furnished. 756-1063.

**2 BEDROOM DUPLEX** Jarvis Street, \$240 per month. Central air and heat. Call 757-0468.

**2 BEDROOM DUPLEX** for rent, 1 1/2 baths, dishwasher, garbage disposal, washer/dryer hookups. 752-2106.

**2 BEDROOM TOWNHOUSE** 4 mile West of hospital. Washer/dryer hook up, central air. Call 752-0182 nights, and 756-3780 days.

**2 BEDROOM TOWNHOUSE** 11 1/2 baths, carpet, energy efficient heat pump, range, refrigerator, dishwasher hook ups. \$295. 756-7480.

**121 Apartments For Rent**

**2 BEDROOM** immediate occupancy. \$200 month with \$495 down buys you a home. Corner Mobile Homes, call collect, 756-9333.

**3 BEDROOM** duplex near university. \$290. Call 756-7779.

**122 Business Rentals**

**OFFICE SPACE AND YARD** for sublease. 309 Hooker Road. Office area 400 square feet, excellent parking facility, fenced-in area. 77,000 square feet, with storage garage connecting office. You need to see it to believe it! For more information call 1-800-272-3555, 8-5 Monday-Friday, ask for Don Emy.

**1703 WEST 14TH STREET** Available January 1. Call 758-3743.

**YOU CAN SAVE MONEY** by shopping for bargains in the Classified Ads.

**127 Houses For Rent**

**CHARMING LARGE** 2 bedroom, 2 bath, 4 fireplace. \$350. Ayden. 756-8160.

**EFFICIENCY APARTMENT** Near hospital, \$175. Speight Realty, 756-3220. Nights, 758-7741.

**EXECUTIVE HOME** 3 bedrooms, 2 baths, heat pump. Must see to appreciate. Near Industrial Park, \$375. Speight Realty, 756-3220. Nights, 758-7741.

**FOR RENT TO COUPLE** 5 room frame house, lot size 100x150. 1 1/4 miles from Grimesland on Black Jack Road. 753-2730.

**HOUSE FOR RENT** in Stanton Heights, 3 bedroom home with 1 1/2 bath, living room, dining room, kitchen with eat-in area, large woodstove, 2 car garage, large wooded lot. \$375 month. 746-4227.

**THREE BEDROOM** houses for rent. Grimesland, \$300. Sylvan Drive, \$225. Charles St., \$375. Herdree Acres, \$350. Country Square, \$325. Lynndale, \$600. All require lease and security deposit. Duffus Realty Inc., 756-0811.

**THREE BEDROOM** house with 2 baths, central location. \$425. Call 752-3948 between 1 and 5, ask for Pam.

**5 BEDROOM HOUSE**, 405 West 4th Street, \$300 per month. Call 757-0688.

**OWN, DON'T RENT** 1979 2 bedroom home in excellent condition with brand new furniture. Tri County Homes, 756-0131.

**PINES**, Ayden, 2000 square foot brick home, 3 bedroom, 2 bath, woodstove, 2 car garage, large wooded lot. \$375 month. 746-4227.

**THREE BEDROOM** houses for rent. Grimesland, \$300. Sylvan Drive, \$225. Charles St., \$375. Herdree Acres, \$350. Country Square, \$325. Lynndale, \$600. All require lease and security deposit. Duffus Realty Inc., 756-0811.

**THREE BEDROOM** house with 2 baths, central location. \$425. Call 752-3948 between 1 and 5, ask for Pam.

**5 BEDROOM HOUSE**, 405 West 4th Street, \$300 per month. Call 757-0688.

**OWN, DON'T RENT** 1979 2 bedroom home in excellent condition with brand new furniture. Tri County Homes, 756-0131.

**PINES**, Ayden, 2000 square foot brick home, 3 bedroom, 2 bath, woodstove, 2 car garage, large wooded lot. \$375 month. 746-4227.

**THREE BEDROOM** houses for rent. Grimesland, \$300. Sylvan Drive, \$225. Charles St., \$375. Herdree Acres, \$350. Country Square, \$325. Lynndale, \$600. All require lease and security deposit. Duffus Realty Inc., 756-0811.

**THREE BEDROOM** house with 2 baths, central location. \$425. Call 752-3948 between 1 and 5, ask for Pam.

**5 BEDROOM HOUSE**, 405 West 4th Street, \$300 per month. Call 757-0688.

**127 Houses For Rent**

**UNUSUAL RENTAL** property, 3 bedroom, 2 bath solar contemporary on 4 1/2 acre lot in MacGregor Downs. One year lease, \$550 per month plus deposit. Call Alita Carroll at Aldridge & Southerland Realty, 756-3500/756-8275.

**2 BEDROOM** country apartment, 11 miles south of Greenville on Highway 43. Call 524-5507.

**2 BEDROOM**, 1 bath house on Warren Street. Married couple. Lease and deposit required. \$295 per month. 756-9070 after 5 p.m.

**2 BEDROOM** house for rent. Conveniently located to businesses and school. Reasonably priced. 825-6831 or 825-5661.

**3 BEDROOM** ranch style home. Carpet, storage, quiet subdivision. Call 757-0001 or nights 753-4015, 756-9086.

**3 BEDROOM** house within walking distance of the university. \$325 month. CENTURY 21 B Forbes Agency, 756-2121.

**3 BEDROOM** country home. \$225 a month. 746-4668 after 7 p.m.

**3 BEDROOMS**, 2 bath brick home with fireplace. Country Club Hill in Griffon. \$375 a month. Echo Realty, 524-4148 or 524-5042.

**3 BEDROOM HOUSE** for rent, close to campus. Call after 4 pm. 756-0528.

**3 BEDROOM HOUSE**, garage, 2 1/2 blocks from campus on Jarvis Street. Gas heat. \$250 deposit. \$250 month. Call Tommy at 756-6148.

**3 BEDROOM HOUSE**, 15 miles from hospital. \$200 month. 753-2776.

**3 BLOCKS** from ECU. Lease and security deposit required. Couple preferred. Additional deposit with pets. \$325 monthly. Available February 1. Days 355-2212; evenings 756-0987.

**3 OR 4 BEDROOM** house. Located near campus. Central heat and air. 2 baths, fireplace, fenced in backyard, no inside pets. 756-8848 anytime.

**129 Lots For Rent**

**A LOT AVAILABLE** for rent for a mobile home, up to 12 by 60 feet. Overlooked by Memorial Park. Call Charles Dudley at 756-3852 or 756-3832.

**133 Mobile Homes For Rent**

**AVAILABLE** furnished two bedroom outside Ayden. Private lot. Deposit 746-2445 from 6 to 9.

**BE YOUR OWN LANDLORD** 1979, 14x60, 2 bedroom, 1 1/2 bath with washer, dryer, and central air. Low downpayment and assume pay. \$185 less than rent. Tri County Homes, 756-0131.

**FOR SALE OR RENT**, 2 trailers in Highland Trailer Park and 1 in Oakwood Trailer Park. 758-4476.

**PRIVATE LOT** in Greenville. Couple preferred. No inside pets. Community water. 756-8848 anytime.

**2 BEDROOM** mobile home, furnished, washer and dryer, no pets. References and deposit required. 752-9262 or 752-4088.

**3 BEDROOMS**, 2 full baths, washer, dryer, located at Taylor Estates. 756-1444 after 4.

**133 Mobile Homes For Rent**

**SPECIAL RATES** for students. 2 bedroom with carpet, \$145. No pets, no children. 756-4544.

**TWO BEDROOM** trailer located in Colonial Park. \$160 month, available now. Call 758-6675.

**1 BEDROOM** MOBILE HOME unfurnished, washer/dryer hook-up, central air, storage building, frost free refrigerator. Good location. 1-238-3336 from 5-7 pm.

**1 BEDROOM** for rent. Low rent, small deposit, good location. Call 756-0874 anytime.

**12X45**, 2 bedroom, 2 baths. Furnished. \$130 month. 746-6575.

**2 AND 3 BEDROOM** mobile homes for rent or sale. Located in Meadbrook area. 756-8948 after 5 p.m.

**2 BEDROOM** Mobile Home for rent. Call 756-4687.

**2 BEDROOM** Trailer, furnished. 3 miles North of city. Call 758-2347.

**12X45**, 2 bedroom, 1 bath. Underpinned, 6 miles from Pitt Plaza. No pets. 756-0975.

**2 BEDROOMS** Furnished, washer, air, carpet, good location. No pets. No children. 758-4857.

**2 BEDROOM** trailer, deposit required. 752-1623.

**2 BEDROOMS**, washer, air, carpet, utilities furnished. No pets. 756-0792.

**2 AND 3 BEDROOM** mobile homes for rent or sale. Located in Meadbrook area. 756-8948 after 5 p.m.

**2 BEDROOM** Mobile Home for rent. Call 756-4687.

**135 Office Space For Rent**

**MODERN**, attractive office space for lease. Approximately 1500 square feet. Located 2007 Evans Street beside Moseley Brothers. Call 756-3374.

**NEW DOWNTOWN**, single office to large suite, conference room available. Many extras. 752-5048. Street beside Moseley Brothers. Call 756-3374.

**OFFICES FOR LEASE** Contact J T or Tommy Williams, 756-7815.

**SINGLE OFFICES** or suites, with utilities and janitorial. Chapin Little building, 3106 S Memorial Drive. Call 756-7799.

**STORE/RESTAURANT/SINGLE** office space available now downtown. Offices convenient to courthouse. 756-0041. 756-3466.

**TWO ROOMS** of four room office suite, Highway 284 Business. Eco normal. Private parking. Some storage available. Call Connelly Branch at Clark Branch Realtors, 756-6336.

**135 Office Space For Rent**

**MODERN**, attractive office space for lease. Approximately 1500 square feet. Located 2007 Evans Street beside Moseley Brothers. Call 756-3374.

**NEW DOWNTOWN**, single office to large suite, conference room available. Many extras. 752-5048. Street beside Moseley Brothers. Call 756-3374.

**OFFICES FOR LEASE** Contact J T or Tommy Williams, 756-7815.

**SINGLE OFFICES** or suites, with utilities and janitorial. Chapin Little building, 3106 S Memorial Drive. Call 756-7799.

**STORE/RESTAURANT/SINGLE** office space available now downtown. Offices convenient to courthouse. 756-0041. 756-3466.

**TWO ROOMS** of four room office suite, Highway 284 Business. Eco normal. Private parking. Some storage available. Call Connelly Branch at Clark Branch Realtors, 756-6336.

**137 Resort Property For Rent**

**12X45**, 2 bedroom, 2 baths. Furnished. \$130 month. 746-6575.

**2 AND 3 BEDROOM** mobile homes for rent or sale. Located in Meadbrook area. 756-8948 after 5 p.m.

**2 BEDROOM** Mobile Home for rent. Call 756-4687.

**2 BEDROOM** Trailer, furnished. 3 miles North of city. Call 758-2347.

**12X45**, 2 bedroom, 1 bath. Underpinned, 6 miles from Pitt Plaza. No pets. 756-0975.

**2 BEDROOMS** Furnished, washer, air, carpet, good location. No pets. No children. 758-4857.

**2 BEDROOM** trailer, deposit required. 752-1623.

**2 BEDROOMS**, washer, air, carpet, utilities furnished. No pets. 756-0792.

**2 AND 3 BEDROOM** mobile homes for rent or sale. Located in Meadbrook area. 756-8948 after 5 p.m.

**2 BEDROOM** Mobile Home for rent. Call 756-4687.

**138 Rooms For Rent**

**PRIVATE ROOM** for one, across from college. Call 758-2585.

**PRIVATE ROOM**, student or professional person preferred. Private entrance. 756-8785.

**142 Roommate Wanted**

**FEMALE STUDENT** needed for spring semester. 4 miles from ECU. Call 752-4275 and speak to Ruth only.

**MALE ROOMMATE** furnished 2 bedroom apartment. \$170 month plus 1/2 utilities. 756-9781.

**SHARE 3 BEDROOM** apartment, 5 blocks from campus. 1/2 rent, 1/2 utilities. 757-1292.

**2 FEMALE** roommates wanted, \$91 per month; 1/2 utilities. Pets. Call 756-5114.

**144 Wanted To Buy**

**OLD DOLLS** of any description. Call 746-3284.

**CLASSIFIED DISPLAY**

**CLASSIFIED DISPLAY**

**AUCTION**

**FRIDAY, DECEMBER 17, 1982-10:00 AM**

**FALKLAND, N.C. - PITT COUNTY**

LOCATION: THE CHURCH OF GOD parking lot on NC 43 south in Falkland (formerly the Falkland Elementary School).

**FARM EQUIPMENT OF RUEL TYER AND OTHERS**  
—PARTIAL LIST—

**TRACTORS & TRUCKS**

International Hydro 100 with canopy. No. 2350 front end loader with bucket & fork. 2200 hrs. M F 1105 Diesel with canopy. 2034 hrs. M F 238 Diesel. 153 hrs. 1976 Ford one ton truck. Flat bed electric dump. Auto. trans. \$5,415 miles. F-400 two ton Ford with good 232 six cyl. engine. F-400 two ton Ford for parts.

**BULK BARN & PRIMER**

126 rack LONG barn oil fired with 200 amp service pole and panel box. POWELL one row tobacco primer with both heads.

**COMBINE & TRAILERS**

1975 Ford 622 diesel combine with air cond. cab, three row corn head, 13' grain head. 8'X14' metal tandem tilt trailer. 8'X16' metal three axle trailer.

**EQUIPMENT**

International Cyclo air four row planter with four gandy's. International 338 disc, 10 1/2 ft. 1 H four row rolling cultivator for tobacco. 1 H four row rolling cultivator for soybeans. Lilliston two row rolling culti. Two row sweet potato plow. Viccon spreader, three point hitch. Oliver 66 HP diesel irrigation pump. 6X6, engine model 188. Holland four row transplanter. Powell two row transplanter. Two row stalk cutter. Two row tobacco topper. Lely two row tobacco topper. Three yard plant bed gasser. Two Rapadation pumps-5 HP air comp. Four tobacco trailers. One row Cole planter - 14' Auger. Two 250 gal. aluminum tanks. New Holland two row transplanter with barrels and racks. 1 H 66 four row planter with four gandy's and peanut planting equip. Reddick hole drain digger. 1 H 5 plow semi-mount. Case 4 bottom plow. 3/4 drive socket set.

—NUMEROUS OTHER ITEMS—  
INSPECTION: TUES. DEC. 14 — SALE DAY, FRI. DEC. 17  
TERMS: Cash, Approved Check, or Letter of Credit from Bank  
CONSIGNMENTS ACCEPTED  
—FOR MORE INFORMATION CONTACT THE AUCTION COMPANY—  
Everyone Welcome - Lunch Available  
SALE CONDUCTED BY

**STONE AUCTION CO.**

Phone (919) 235-4636 Box 266, Bailey, N.C. 27807  
Tony R. Stone, Auctioneer NCAL No. 561

**111 Investment Property**

**NEW DUPLEX** Yearly rental of \$600 with assumable loan. Excellent tax shelter. \$61,900. Aldridge & Southerland, 756-3500.

**113 Land For Sale**

**FOR SALE:** 20 acres of cleared and 5000 pounds of tobacco located in Chocowinity, NC. \$40,000. Pm. 946-5198.

**115 Lots For Sale**

**LAYWOOD, TWO ACRE** lot. Financing available. Call 756-7711.

**BEAUTIFUL WOODED LOT** 80X200. The Pines, Ayden. 776-5732 after 6 pm.

**MOBILE HOME** lots. Excellent area. Speight Realty, 756-3220. Nights, 758-7741.

**MOBILE HOME** and lots. Completely furnished, work shop. Speight Realty, 756-3220. Nights, 758-7741.

**TOKES** 3 Acres. Owner financing. Speight Realty, 756-3220. Nights, 758-7741.

**RENTALS**

**LOTS FOR RENT** Also 2 and 3 bedroom mobile homes. Security lots required, no pets. Call 756-4413 between 8 and 5.

**NEED STORAGE?** We have any size to meet your storage need. Call Arlington Self Storage. Open Monday-Friday 9-5. Call 756-9933.

**121 Apartments For Rent**

**CARRIAGE HOUSE** Apartments. Highway 43 south, just past Pitt Plaza. 2 bedroom townhouses. All electric. Dishwasher, refrigerator, fully carpeted, cable TV, pool and laundry room. 756-3456 after 5 p.m.

**Cherry Court**

Spacious 2 bedroom townhouses with 1 1/2 baths. Apartments. Carpet, dishwashers, compactors, patio, free cable TV, washer/dryer hook ups. Pool, sauna, tennis court, club house and pool. 752-1557

**DUPLEX**, almost new, quiet location. \$300 per month. Century 21 B Forbes Agency, 756-2121.

**CLASSIFIED DISPLAY**

**ROOFING**

STORM WINDOWS  
DOORS & AWNINGS  
Remodeling—Room Additions

**C. J. Lupton Co**  
752-6116

**CRAFTED SERVICES**

Quality furniture Refinishing and repairs. Superior carpet for all type chairs, large selection of custom picture framing, survey stakes—any length, all types of pallets, hand-crafted rope hammocks, selected framed reproductions.

**Eastern Carolina Vocational Center**  
Industrial Park, Hwy. 13  
758-4188—8 A.M.-4:30 P.M.  
Greenville, N.C.

**FACTORY INVOICE SALE**

**18 — 1983 Chevrolet Chevettes**

**In Stock & Ready For Immediate Delivery**

**For Only**

**\$100 OVER INVOICE**

**Plus N.C. Sales Tax**

**Sale Ends December 23, 1982**

**CHEVROLET PHELOS GREENVILLE**

West End Circle Phone 756-2150

Keep That Great GM Feeling With Genuine GM Parts

**GENERAL MOTORS PARTS DIVISION**

**PCMH**  
People Care More Here

**EMPLOYMENT OFFICE**

**PITT COUNTY MEMORIAL HOSPITAL**  
P.O. BOX 6028  
GREENVILLE, N.C. 27834  
757-4556  
AN EQUAL OPPORTUNITY EMPLOYER

**MEDICAL TECHNOLOGISTS**

Pitt County Memorial Hospital and Medical Center has immediate openings for Medical Technologists that are ASCP certified or equivalent. Full time and part time positions are available, including day shift work.

Salary is commensurate with experience and benefits are excellent. For immediate consideration call or send resume to:

**The Real Estate Corner**

**Aaction Moves Hospital**

Greenville — After nearly 4,000 man hours and over 100 truck loads, the East Carolina University School of Medicine has found its home in the brand new eight story Brody Building.

With the help of Aaction Moving & Storage, an agent of United Van Lines, the entire medical school faculty and staff was relocated in its new modern facility with relative ease.

A total price tag of 10 million dollars worth of equipment was reshuffled in the move with claims amounting to only \$250.

"We were very pleased with the way things went", said Bill Fodrie, President of Aaction Moving & Storage. "The people at the hospital made everything go a little easier and smoother."

Aaction Moving & Storage, located in Greenville and Washington, holds the distinction of having one of the lowest claim ratios in the entire moving industry. This fact is easily justified upon examination of Aaction's facilities. With the most modern in warehouse equipment and knowledge, Aaction Moving & Storage is able to handle your every moving need, from big machines and office equipment on down to your finest china.

Call Aaction Moving & Storage in Greenville and Washington.

**DAVIS REALTY**

"Helpmate in the State"

752-3000

**NEW LISTING.** Large lot in the country. Assume loan. Neat and well kept starter home. 3 bedrooms, central heat and wood stove, deck in back. Only \$37,500. Call Davis Realty, 752-3000, 756-2904, 756-1997, 756-7087.

**NEW LISTING**

Save time and money and assume this FHA loan of 8 1/2 % with payments of \$292.87 on this 1500 square foot home conveniently located to the university. Spacious great room with fireplace, dining room, fenced-in back yard with a garage. Offered in the upper \$40's.

Mary Stevenson Chapin  
Listing Broker  
756-8431

**CLARK-BRANCH REALTORS**  
756-6336

**REALTY WORLD**

**CLARK-BRANCH REALTORS**  
756-6336

# Teamsters' Boss Convicted, Urged To Step Down

By SHARON COHEN  
Associated Press Writer

CHICAGO (AP) — Teamsters President Roy L. Williams, convicted with four others of trying to bribe Sen. Howard Cannon, should "step down immediately," says a dissident leader of the nation's largest union.

Williams, 67, and his co-defendants, whose conversations were taped by the FBI, were found guilty Wednesday of conspiring to bribe the Nevada Democrat with a lucrative Las Vegas land deal in return for his help to defeat a trucking deregulation bill in Congress.

Cannon was not charged and testified for the defense, while the bill eventually passed with his support. But the prosecutor in the case said the verdict came because of a "lack of credibility" by Williams and the senator.

Williams, who becomes the third Teamsters president convicted of a federal crime in the past 25 years, and who called the charges a "damn lie," said he will appeal. Under federal law, he can keep his job until appeals are exhausted.

Attorneys for the other defendants, including a reputed organized crime figure, also vowed to appeal the convictions, which carry maximum sentences of up to 55 years in prison and \$29,000 in fines.

U.S. District Judge Prentice H. Marshall set sentencing for Feb. 10.

The defendants were each convicted of one count of conspiracy and interstate travel to further bribery, and nine counts of wire fraud.

Gary Shapiro, prosecutor for a Justice Department strike force set up in the Chicago area, said he believed the government had convinced jurors of a conspiracy, "but if we didn't, their (Cannon's and Williams') lack of credibility was decisive."

"I think the jury concluded if they were lying, the only reason they could be lying was because of their guilt," Shapiro said.

Under federal law, a union official convicted of a crime may hold office until appeals are exhausted.

However, Ken Paff, national organizer in Detroit of an 8,000-member dissident faction, Teamsters for a Democratic Union, said the verdict shows "Williams is not worthy of the position of president of our union. We believe Williams should step down immediately..."

Officials at Teamsters international headquarters in Washington all declined to comment on the convictions. Cannon, who last month said publicly about the case

contributed to his failure to win re-election, also declined to comment.

Jackie Presser, a Teamsters vice president based in Cleveland, said he was "dismayed" with the verdict. "I'm hopeful that the appeals process will vindicate them," he said.

Cannon and Williams were the only defense witnesses in the eight-week trial. Both said they couldn't remember many events surrounding Cannon's bidding for the Las Vegas land.

Chief prosecutor Douglas Roller had said Williams displayed an "incredible lack of recollection."

Prosecutors charged the five conspired to bribe Cannon with exclusive rights to buy the land at a reduced price in return for his help in scuttling trucking deregulation. Cannon and his neighbors were allegedly interested in buying the land to prevent adjacent high-rise development, although another group eventually purchased the property.

Defense attorneys argued the defendants only assured Cannon he would get a fair chance to bid for the land.

Both Cannon and Williams denied any bribe had been offered or accepted when they and Allen Dorfman, 59, a millionaire insurance executive and former consultant to the Teamsters Central States Pension Fund, met in 1979.

Roller said Wednesday that about 50 conversations wiretapped by the FBI, the heart of the government's case, were very damaging.

The other defendants were Thomas O'Malley, 46, a pension fund trustee; Andrew Massa, 65, a former trustee; and Joseph "Joey the Clown" Lombardo, 53, a reputed Chicago crime syndicate figure.

After the verdicts, Marshall raised Dorfman's bond to \$5 million and Lombardo's to \$2.5 million and gave them until 4 p.m. Friday to come up with the money. The other defendants remain free on recognizance bonds.

The verdict came moments after the jury began its fifth day of deliberations. The panel, sequestered two weeks ago after some members received crank calls, deliberated for 26 hours over four days.

**"RIGHTLY DIVIDING THE WORD OF TRUTH"**  
**Grace Free Will Baptist**  
400 Watauga Avenue  
757-3888  
9:45 a.m. Sunday School  
11:00 a.m. Worship Service  
7:00 p.m. Evening Service  
7:30 p.m. Wednesday Service  
Fred Lockwood, Pastor  
Jon Forlines, Associate



**Bostic-Sugg**  
Furniture, Inc.  
Our 44th Year  
Furniture of Excellence  
401 West 10th St., Greenville - 758-2513



ROY WILLIAMS, president of the Teamsters Union, was found guilty on all 55 counts in a bribery trial, climaxing a two-month trial and 26 hours of jury deliberation. (AP Laserphoto—

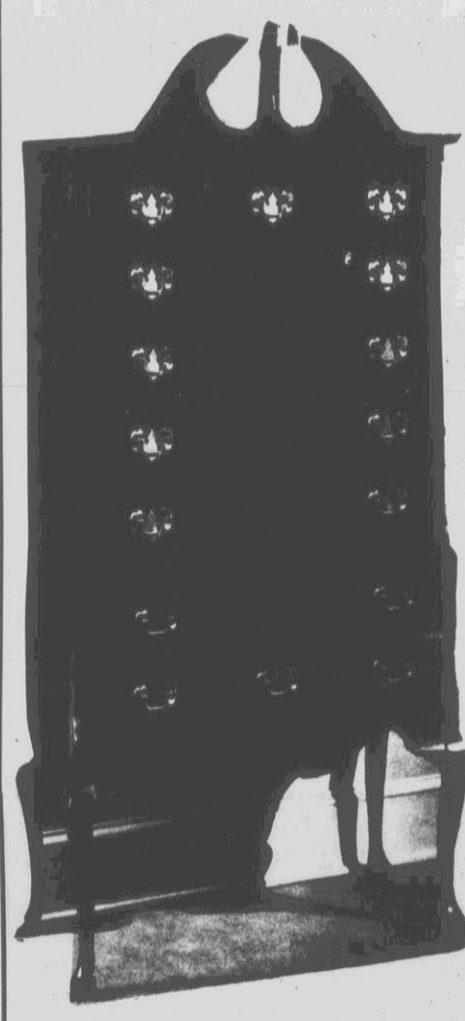

**\$300<sup>00</sup> Off**  
**List Price \$895<sup>00</sup>**  
**18th Century Solid Honduras Mahogany Queen Anne Highboy From The Tompkins Plantation**  
**SALE PRICE \$595**

Seventy-five inches tall. Six small drawers, five large drawers, hand rubbed finish, brass hardware...our best value ever in a solid mahogany Queen Anne highboy.

**SHOWROOM HOURS 8 A.M. TO 5:30 P.M. AND TIL 9 ON FRIDAY NITES.**

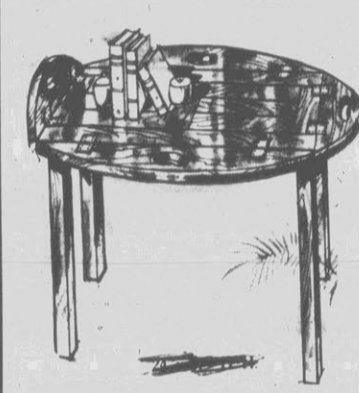

**Full Size Mahogany Finish Butlers Tray Coffee Table**  
**SALE PRICE \$64<sup>50</sup>**  
Brass Hinges...Antique Mahogany Finish.

**Compare at 40% Off**  
**Miniature Butlers Tray Side Table**

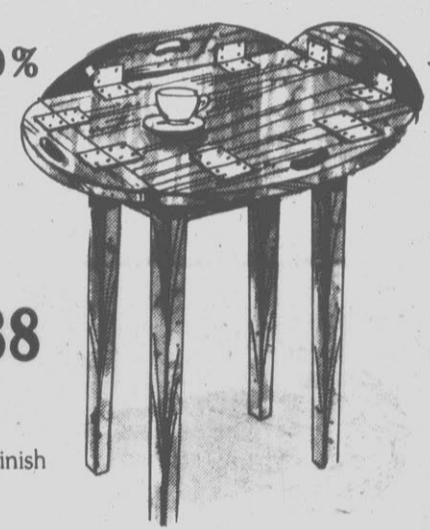

**SALE PRICE \$24<sup>88</sup>**  
Mahogany finish. Brass finish hinges.

**THE CHOICE IS YOURS, THE LOW PRICE IS OURS.**

**Just \$2.29**  
Your Choice Of Entree Plus Two Vegetables

**GREAT AMERICAN FAVORITES**

Select one of three Great American Favorite entrees available each day such as smothered chicken, baked spaghetti, or chopped steak... plus two delicious vegetables... all at the unbelievable low price of just \$2.29.

The Great American Favorites... great eating for less at S&S.

**S&S cafeterias**  
Where America Comes Home To Eat.  
Carolina East Mall  
Mon-Fri LUNCH 11 A.M. - 2:15 P.M.  
SUPPER 4:30 P.M. - 8 P.M. (8:30 Fri)  
Sat & Sun 11 A.M. - 8 P.M. (continuously) (8:30 Sat)

**Victorian Plant Stand**  
With Marbletop  
**SALE PRICE \$35<sup>00</sup>**  
Compare at 70.00. Rich Mahogany finish.

**Compare at 30.00**  
**Butlers Tray Table**  
**SALE PRICE \$17<sup>77</sup>**  
Rich mahogany finish tray. Lifts off.

**SHOP BOSTIC SUGG'S CLOCK GALLERY**

**List Price \$460.00. Save \$110.00**  
**Oak Calendar Clock**  
**SALE PRICE \$350<sup>00</sup>**  
A mantel version of the famous regulator wall clock. This Ridgeway adaptation lives up to its name in styling and timekeeping. Many features—  
• Double dial calendar movement gives month and date.  
• Imported keywind movement strikes on hour and half-hour.  
• Oak finish on oak solids and veneers with burl accents.

**Tambour Clock** — Traditional-styled mantel clock with keywind Westminster chime movement. Brass dial hands and bezel. Light oak finish case has burl accents. Also available in mahogany.  
**SAVE \$65.00**  
**List Price 145.00**  
**SALE PRICE \$80<sup>00</sup>**

**Solid Cherry Bracket Clock By Ridgeway**  
**SALE PRICE \$195**  
**List Price \$330.00**  
**Save \$135.00**

- Roman numerals on brass finished dial
- Keywind movement with Westminster or triple chimes
- Hardwood construction case — Cherry finish on maple veneers and solids

**Oak Calendar Clock by Ridgeway**  
A glimpse backward to the turn of the century is evidenced in this "fashion" clock. Once you get it home, you'll find lots of places for it. All the beauty isn't on the outside; there's many quality features—  
• Imported keywind movement with double dial calendar movement  
• Strikes on the hour and half-hour  
• Cherry finish on cherry solids and veneers  
**List Price 460.00 Save 130.00**  
**SALE PRICE \$330<sup>00</sup>**

**Compare At \$16.00. Solid Oak Construction. Just like the rocker made 50 years ago.**  
**Natural or Red Finish Child's Rocker**  
**SALE PRICE \$11<sup>88</sup>** Take With Price.  
Flat seat...sturdy construction. Will last for years and years.

**Compare At \$300.00**  
**Solid Pennsylvania Cherry Silver Chest by Crescent**  
Queen Anne Desk  
**SALE PRICE \$175<sup>00</sup>**  
Silver cloth lined drawers. 4 drawers hand rubbed-finish.

Call now to order whole Hams, Turkeys, Pies, Cakes and other S&S specialties for the holidays.  
**(919) 756-8950**

# Today's Hard Times Chronicled By The Pop Music

By YARDENA ARAR  
Associated Press Writer  
LOS ANGELES (AP) — They still sing of love and sex, but some pop lyricists are now setting the grimmer facts of contemporary life — unemployment, poverty and loss of hope in the American dream — to music. Rock has caught up with the recession.

"Well, we're living here in Allentown, and they're closing all the factories down" go the opening lines to a song from Billy Joel's new album, "The Nylon Curtain," and he isn't the only one singing the hard times blues these days.

Recession rock runs the gamut from New Wave to

rhythm and blues. Most of the songs differ from protest songs of the 1960s. They don't blame government or demand action to cure the problems, but rather are statements of disillusionment, of something gone awry.

Joel's song, "Allentown," is one of the more striking, with a factory-whistle prelude and a jaunty, uptempo arrangement that contrast with lyrics which talk of unemployment lines and frustrated expectations.

Joel said he'd been toying with the melody and the idea of a song about Allentown for 10 years.

"I didn't know what the subject matter was going to be about until the last year or so, reading about the problems of the steel industry," he said. "The great American blue-collar promise that the postwar kids were raised on isn't there...I really don't know anyone who is untouched by what's happening economically."

Joel said that despite the troubled tone of most of the song, he doesn't take an entirely pessimistic view of the country's future. The last line of the song repeats "We're living here in Allentown" — in other words, Joel says, "we're going to stick it out. This is our heritage, this is our tradition, we're going to make it."

Richard "Dimples" Fields, who last year caused a ruckus in rhythm and blues circles with "She's Got Papers on Me," a song about an errant husband and his scolding wife, is back with "People Treat You Funky When You Ain't Got No Money," a litany of complaints about being poor.

In contrast to some other songwriters, Fields doesn't hesitate to blame government for his problems: "Reaganomics, Reaganomics, mean ghetto-nomics," he sings, "...What happened to the chicken in every pot?"

There's also no optimism in "Bread and Butter" by the Waitresses, a popular New Wave band.

The voice speaking in "Bread and Butter" is clearly that of a young, hip suburbanite: "How do you like your new house? How do you like your new job? You say you never got them? No kidding, me neither."

Waitresses guitarist-songwriter Chris Butler says he was inspired by the band's frequent trips to Detroit, where on each successive visit more and more auto plants were closed. The song took on its middle-class tone because he was writing for lead singer Patty Donahue, whose character in the group's other songs is highly articulate — and usually able to cope with her problems.

"There's no resolution on this one," Butler said. "The character is upset. The character feels cheated. The character feels that things that have been promised have not been delivered. And

lots of people feel that way."

The latest Bruce Springsteen LP, "Nebraska," delivers a disturbing portrait of America through sparsely arranged vignettes about people from the heartland. Economic woes are touched on, but the hard times in "Nebraska" are spiritual as well as material.

"Johnny 99," for example, begins like "Allentown" — "Well they closed down the auto plant in Mahwah late that month" — but then focuses on an unemployed man who gets drunk and commits an armed robbery.

Johnny 99 tells a judge of "debts no honest man could pay," but refuses to pin his actions to money alone: "If you can take a man's life for the thoughts that's in his head... let 'em shave off my hair and put me on that execution line."

Blue-collar malaise is also the theme of "Factory," a song about a worker who has a job, "a barbecue, pink Mustang, fenders chrome," but senses something is missing: "At nine o'clock I sit there in my chair and I don't know why I lose my hair."

Stan Ridgway, songwriter for Wall of Voodoo, the Los Angeles-based band which recorded "Factory," denies his songs are pessimistic. For Ridgway, disillusionment is the flip side of the American tradition of hope, which he strongly believes in.

"The real enemy is giving up," Ridgway said.

Is there a market for recession rock?

Joel, whose "Nylon Cur-

tain" album was in the Top 10 and whose "Allentown" was about halfway up Billboard magazine's Hot 100, says there's a tradition for songs about hard times.

"The biggest song out of the Depression was, 'Buddy Can You Spare a Dime,'" he points out. "I guess people will always be singing the blues."



SINGING THE BLUES — Rock singer Bruce Springsteen's latest album is among those that have begun to reflect the grimmer facts

of contemporary life: unemployment, poverty and what some view as the demise of the American Dream. (AP Laserphoto)

## Moved Less During 1980

By RANDOLPHE SCHMID  
Associated Press Writer  
WASHINGTON (AP) — The number of Americans changing residences in 1980 declined 19 percent from the previous year, a trend that most probably stemmed from the high cost of moving and mortgage money, officials say.

A joint study by the Census Bureau and the Department of Housing and Urban Development showed that 18 percent of all households changed residence during 1980. That accounted for 14,263,000 moves.

The number of moves dropped 19 percent from 1979, when there were 14,993,000 household moves. The 1980 figure was down 20 percent compared to 1978, the study said.

"I suspect the biggest reason is that it's so expensive to move," said Connie Casey of HUD, who cited the high costs both of houses and of mortgage money.

She noted that the most common reason for moving is to obtain a better residence, and home prices have been rising steadily.

For example, the study found the median value of properties purchased by homeowners who moved in 1980 was \$60,400, compared to a median value of \$54,400 for homes bought by 1979 movers. By comparison, the median value for all owned homes was \$51,300 in 1980 and \$47,200 in 1979. Median indicates half were worth more and half less.

Residents of the Western states were most likely to move with 23 percent of all households in that area relocating in 1980. By comparison 19 percent moved in the South, 16 percent in the North Central states and 13 percent in the Northeast.

A Christmas Police Tip: When Christmas shopping, park in a well-lit area, as close to the entrance as possible!

Saslow's  
at  
Pitt  
Plaza



14K  
MEN'S  
NECK  
CHAINS . SAVE

40% OFF REGULAR  
RETAIL PRICE

SALE ENDS DECEMBER 24th

Visa, Amex, Master Charge or  
use Saslow's Own Charge Plan

Open Every Night 'Til 9 For Your Shopping Convenience

**SASLOW'S**  
Jewelers

PITT PLAZA  
756-7112

## WARM GIFT IDEAS



**A KERO-SUN PORTABLE HEATER IS THE ECONOMICAL GIFT THAT SPREADS WARM FEELINGS ALL YEAR LONG.**



Give the warm, money-saving gift that your family and friends can use wherever they go — a Kero-Sun portable heater. There are 10 models and sizes to choose from. All 99.9% fuel-efficient. All cost just pennies per hour to operate. They're smokeless and odorless in operation. Easy to operate. Safely tested and listed by Underwriters Laboratories.

A Kero-Sun portable kerosene heater can be used in the living room, kitchen, basement, vacation home, work place, add-on room... and many more applications.

**PEOPLE REMEMBER YOU ALL YEAR LONG WHEN YOU GIVE A WARM, MONEY-SAVING GIFT.**

See the full line of Kero-Sun portable heaters today.



WE BRING COMFORT TO INNER SPACE

## Hollowell's

**DRUG STORES, Inc.**

911 Dickinson Ave. .... 752-7105  
6th Street & Memorial Dr. .... 758-4104  
Parkview Commons ..... 757-1076

Here comes

# BRIGHT

A fresh new taste experience that outshines menthol.

It not only tastes fresher while you smoke. It even leaves you with a clean, fresh taste.



You never had it this fresh!

7 mg. "tar", 0.5 mg. nicotine av. per cigarette by FTC method.

Warning: The Surgeon General Has Determined That Cigarette Smoking Is Dangerous to Your Health.

# Brandt Struggles To Reverse Decline

By ALISON SMALE  
Associated Press Writer  
BONN, West Germany (AP) — At age 69, when many of his countrymen are settled comfortably into retirement a rejuvenated former Chancellor Willy Brandt is courting youthful West German radicals in hopes of rebuilding the declining influence of his Social Democratic Party.

Perpetually tanned and his weight trimmed down, Brandt is championing peace and environmental causes favored by youthful voters otherwise shunned by his fellow party members, including former Chancellor Helmut Schmidt.

Working from his headquarters in Bonn, where he lives with 35-year-old Brigitte Seebacher since separating from his wife Rut in 1979, Brandt has made overtures to the Greens Party, a small but vocal

group that opposes the use of nuclear energy and would like to turn Europe into a nuclear-free zone.

Brandt's efforts are partly spurred by a drastic decline in support for the Social Democrats, whose standing dropped to 30 percent in one poll last summer compared with 42.9 percent in the last national elections in 1980.

By contrast, the Greens won election in three state parliaments this year and have consistently attracted the young leftist vote that used to go to Brandt's party.

"I want to get the people and the themes I can. I do not prejudice in any way," Brandt said in a recent magazine interview when asked about his efforts to attract young radicals to his socialist party.

"There is absolutely no reason why Social Democrats shouldn't listen to what

is happening in the peace and environmental movements," he said.

So far, Brandt's overtures toward the Greens have yielded little. The Greens' firebrand spokeswoman, Petra Kelly, reacted to a letter from Brandt with demands that West Germany leave NATO and work for a nuclear-free Europe untied to power blocs.

In Hamburg, where the Greens' strong showing in June elections denied any major party a majority to form a local government, Brandt's Social Democrats tried and failed to negotiate a loose alliance that would keep them in power with Greens support.

But the radicals stuck to a campaign platform that included the demand that the city give up nuclear power as an energy source. Nuclear power supplies about 20 percent of Hamburg's needs.

Undeterred by the failure of the talks with the Greens, Brandt said the negotiations were "a constructive enterprise that finds great recognition" among young people.

Brandt's tactics have put him at odds with some of his Social Democratic colleagues, including Schmidt, who fell from national power in October when he lost a parliamentary vote of confidence.

Schmidt had been chancellor since 1974, when Brandt resigned after a leading aide was unmasked as an East German spy.

While Schmidt ran the country, Brandt, as party chairman, played guru and visionary, shaping ideas for the future as he had shaped and then realized the Ostpolitik — his policy of reconciliation with the Soviet bloc.

The differing roles between Brandt and Schmidt reflects their differing backgrounds. Schmidt, who turns 64 Dec. 23, spent World War II like most other Germans his age, fighting in Adolf Hitler's Wehrmacht.

Brandt fled Germany soon after the Nazis came to

power in 1933 and spent the next 12 years in the underground resistance.

It was perhaps the overthrow of Nazism that encouraged Brandt to believe in realizing the impossible. His zest for that led him to dare Ostpolitik, and that same desire now fuels his drive to create a new power structure he said will be "a new majority of the left."

Those who know him say he believes that what's needed is a loose alliance of his Social Democrats with the Greens Party and a host of other autonomous peace and environmental groups that reject West German capitalism, middle-of-the-road consensus and pro-Americanism — factors on which postwar West Germany was built.

Many party colleagues are reluctant. Holger Boerner, Social Democrat premier of

the West German state of Hesse, caused an uproar when he denounced the Greens last summer as new Nazis buoyed by the same other-worldly romanticism that swayed Hitler.

Schmidt, too, is quoted in a diary recently published by his spokesman, Klaus Boelling, as fearing the "dangerous" romanticism of the Greens.

In the final months of his chancellorship, Schmidt struck a much more conciliatory public tone toward peace campaigners and youthful rebels.

But perhaps his instinctive opinion emerged last April at a national party congress when he almost lost a key vote on party support for the new U.S. missiles by losing his temper and denouncing peace movement campaigners as a threat to peace.

It is a measure of young people's influence that Schmidt then made a rare public apology. But he remains isolated from the party left wing on defense issues, and cited differences with party leftists as well as health reasons for not leading the party into new national elections next March.

His replacement is Hans-Jochen Vogel, a Schmidt and Brandt protege who as former mayor of West Berlin has dealt with that city's rebel squatters.

Unlike Schmidt, Vogel talks of Social Democrats having "certain things in common" with the peace movement. As one party worker commented, "If Schmidt had said that, everybody would have cheered and he might have had fewer problems" in his last months as Chancellor.

## HARRIS

SUPER MARKETS, INC.

"Where Shopping Is A Pleasure"

ORDER YOUR

### Fresh Turkeys

Now For

# 79¢

LB.

We can only guarantee orders placed by Dec. 22.

## Successor To The Rubik's Cube Exists

By KAY BARTLETT  
AP Newsfeatures Writer  
NEW YORK (AP) — Adam Alexander would like the world to come to his tub, not his door. There, like the Greek philosopher Diogenes did centuries earlier, he would deliver criticism of his fellow man.

Instead, Adam Alexander is hop-skipping across the country on the talk show circuit huckstering his invention — Alexander's Star — in places like Indianapolis, Detroit and Grand Rapids.

The Star is a 12-starred solid puzzle — a dodecahedron, if you will — that is being brought to you this year by those same people who brought you Rubik's Cube. It is, says Alexander, an extension of the Cube and like the best-selling Cube, a book will be along shortly explaining how

to solve it.

Alexander is a 36-year-old mathematician whose first gray hair appeared at age 9 and whose shoulder-length hair is now completely white. A few dark hairs speckle his beard and he accentuates the whole effect by dressing only in gray. Always.

A native New Yorker, Alexander grew up in the world of private schools, skipping the sixth grade, hanging out at the Stage Deli where "I learned not to get excited by famous people," and since 1952 watching every famous skyscraper go up.

Like Diogenes, he would like to set up his tub — say at a busy Manhattan intersection — and have people stop by for criticism.

"I would have people come by to be criticized by me," he says.

# Merry Christmas!

## HARRIS

SUPER MARKETS, INC.

"Where Shopping Is A Pleasure"

DISCOUNT

We Reserve The Right To Limit Quantities

None Sold To Dealers Or Restaurants

We Accept Food Stamps And WIC Vouchers

We, at Harris Supermarkets would like to thank you for your patronage and wish you a happy and safe holiday season.

**Register At Any Of Our Stores For...**

**THE WORLDS LARGEST CHRISTMAS STOCKING**

(1 AT EACH STORE)

**AND THE WORLDS SECOND LARGEST CHRISTMAS STOCKING**

(1 AT EACH STORE)

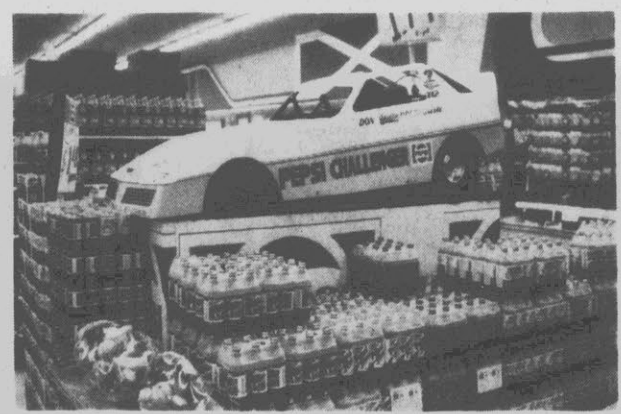

ALSO REGISTER AT ANY STORE FOR

**2 PEPSI MINI CARS AND NEW SEWING MACHINES**

(1 AT EACH STORE)

NO PURCHASE NECESSARY AND YOU DO NOT HAVE TO BE PRESENT TO WIN DRAWING ON DEC. 23rd FOR ALL PRIZES (MUST BE 18 OR OLDER TO REGISTER FOR PRIZES)



**CHECK OUR HOLIDAY NUT SELECTIONS**

LARGE & MEDIUM DIAMOND WALNUTS...	1 LB. \$1.29 BAG
BRAZIL NUTS.....	1 LB. \$1.37 BAG
MIXED NUTS.....	1 LB. \$1.49 BAG
FILBERTS.....	1 LB. \$1.45 BAG
ALMONDS.....	1 LB. \$1.37 BAG

**KRAFT CARAMELS**

BUY 1 GET 1

FREE

(24-OZ. BAG)



**BREAKSTONE GOURMET DIPS**

Toasted Onion, Mushroom & Herb  
Chesapeake Clam Jalapino & Cheddar  
or Bacon & Onion.

**BUY 1 GET 1 FREE**

The Albritton Company

# HOLIDAY BEDDING SALE

Quality bedding by KINGSDOWN

15 YEAR WARRANTY!

TWIN KINGSDOWN SET.....	179 <sup>95</sup>
DOUBLE KINGSDOWN SET.....	219 <sup>95</sup>
QUEEN KINGSDOWN SET.....	259 <sup>95</sup>
KING KINGSDOWN SET.....	379 <sup>95</sup>

COMPARE OUR PRICES... THEN YOU'LL SEE WHY THE ALBRITTON COMPANY SAVES YOU MORE!

**Our Business is Carpet!**

The Albritton Company

264 BY-PASS 3 MILES WEST OF GREENVILLE

also in HOOKERTON      Greenville 756-3546  
Hookerton 747-2821

# Whites

DOWNTOWN SHOPPING CENTER  
601 607 DICKINSON AVENUE  
FREE PARKING



# BARGAINS RING OUT AT OUR CHRISTMAS SALE



Open Every Night  
Til 9 O'clock

One Group, Ladies  
Plaid Long Sleeve  
**Blouse**  
Xmas Sale  
Reg. \$12.99 **\$4.88**

stacyadams  
The Name Says It All  
**Dress Boots**  
For men  
At Tremendous Savings

Dec. Sale  
\$50 Value **\$29.88**  
Black Or Brown  
Gift Wrapped Free

- Unmistakable Craftmanship
- Rich Smooth Leather
- D-Width 7-13
- EEE Width 8 1/2 To 11

stacyadams  
PORTOPED Shoes For Men  
Especially Priced  
During Our Dec. Sale

Compare at \$50.00  
**\$29.88**

- Leather uppers
- Built-in cushion between in-sole and out-sole
- D and EEE widths
- Sale lasts 2 days only
- Sizes 7-13

Men's **Thermal Underwear**  
\$2.97 Ea. Pc.  
Usually \$3.99  
Sizes S-M-L-XL

- 1st Quality
- Full Cut

BEES BEACON  
Leather-Like Kid Grain Vinyl  
Black, Navy, Brown And Wine

Our Reg. \$19.95  
Xmas Sale  
**\$14.88**  
N-M-W Widths

Citations  
Ladies Dress Shoes  
\$19.88  
Dec. Sale  
Reg. \$29.95

- N, M, W Widths
- Sling Back
- 18/8 Heel
- Navy-Black-Brown

Ladies Dacron-Cotton  
**House Coats**  
Sale  
**\$6.00**  
During Christmas Sale Only  
Our Reg. 7.99

Men's Dress **Gloves**  
Lining Looks Like Fur  
Xmas Sale  
**\$3.97**  
Reg. \$4.99

- Leather Look Vinyl
- Acrylic Pile Lining
- Gift Wrapped Free

**Bathroom Set**  
5-Pcs.  
Dec. Sale  
**\$6.88**  
Reg. \$8.99

Ass't Colors

**Dan River**  
Shoos And Pillow Case Sets  
Twin Bed Size  
**\$12.88**  
2-Sheets 1-Case  
Full Bed Size  
**\$15.88**  
2-Sheets 2-Cases

1st Quality  
Gift Wrapped Free

**Heavy Cotton Draperies**  
1st Quality Unlined  
**\$5.88**  
63" Long  
Reg. \$9.95

Men's **Flannel Shirts**  
Matching Plaids-Lined Yoke  
Long Tails  
Dec. Sale  
**\$5.88**  
Reg. \$8.99

- 80% cotton
- 20% poly
- Heavyweight flannel
- Permanent Press
- Two pocket
- Western style button down flap pockets

**Scatter Rugs**  
Reg. \$4.00  
**\$2.88**

**Furniture Throws**  
Quilted Lined  
60x70  
Reg. 7.99  
Sale  
**\$4.00** Each

Luxurious Brushed  
**Long Gown**  
Sizes S-M-L  
Reg. \$4.99  
Sale  
**\$3.88**  
Ex. Lg. Sizes X-XX-XXX  
Reg. \$5.99  
Sale  
**\$4.88**

Cobblers **Aprons**  
Reg. \$4.99  
Sale  
**\$3.40**  
Sizes S-M-L-XL  
Gift Wrapped-Free

Boys' Warm **Ski-Jackets**  
Zip Off Sleeves  
Dec. Sale  
**\$19.88**  
\$30.00 Values  
Sizes 8-18

100% Acrylic Fashionable  
"Nova Knit"  
Ladies And Misses  
**Gloves**  
Dec. Sale  
**\$1.87**  
Reg. \$2.99  
A Nice Christmas Gift  
Buy Now-And Save

Dec. Sale  
Mens **Ski-Jackets**  
With Zip-Off Sleeves  
Reg. \$0.00 And \$5.00  
By "Campus"  
Now Only  
**\$37.88**  
Reg. \$38.99  
Now Reduced To  
**\$24.88**  
Gift Boxed Free

**Campus**

Cut Heat Bill  
up to **50%**  
**Storm Windows**  
2 Complete  
**89¢**

3 Pcs.  
Tier And Valance  
**Curtains**  
Our Reg. \$4.99  
2 For **\$5.00**

Heavy Terry  
**Wash Cloths**  
Reg. 79¢ Ea.  
2 For **\$1.00**  
• Pretty Patterns  
• Solids • No Limit

Vinyl  
**Shoe Bags**  
Reg. \$2.99  
Dec. Sale **\$2.00**

72" x 90"  
Good Quality  
Reg. \$6.99  
Dec. Sale  
**\$4.96**

Ass't. Colors  
**Blankets**

Beautiful Heirloom (Seamed) **BEDSPREADS**  
Reg. \$59.95 Without Seam  
**HEIRLOOM BEDSPREADS**  
\$16.88  
First quality of these spreads sell for \$59.95 each. They are seamed across (Hardly noticeable) which is the reason for this low-low price.

SALE

Men's **Pajamas**  
Sale Price  
**\$6.88**  
• 50% Kodel, 50% cotton, permanent press • Matching piping trim • Elastic waist with adjustable snaps • sizes S-M-L-XL

Hurry Sell-Out Expected  
Twin Full King Queen

Men's Warm Hooded **Sweat Shirts**  
Good Selection Of Colors  
Men's Sizes S-M-L-XL  
• Zipper Front  
• Warm Fleece Lining  
• Two Hand Warmer Pockets  
**\$7.88**

Men's Crew Neck **Sweat Shirts**  
• Heavyweight  
• Double fleeced  
• Raglan sleeves  
• Men's sizes S-M-L-XL  
**\$4.88**

**Hanes UNDERWEAR**  
Underwear For Men At Discount Prices  
**Briefs**  
Pkg. Of 3  
**\$5.97**  
Reg. \$7.99

**T-Shirts**  
Pkg. Of 3  
**\$7.97**  
Reg. \$9.99  
Buy 2-Pkgs. And Get \$3.00 Refund From Hanes Underwear Co.

We're **OPEN LATE** til Christmas

# The Pros And Cons Of Parole System Are Argued

By LIDIA WASOWICZ  
The American parole system is on probation, its continued existence at stake.

Legislation pending before Congress would abolish the system, which originated in this country more than a

century ago.

A UPI survey shows growing momentum among those who claim the system — plagued with contradictions, inefficiencies and inconsistencies — has caused more trouble than it has solved and should be terminated.

On the other side, supporters point to low revocation rates and parolee success stories in what a correctional official called "a valid and necessary release valve for our bulging institutions."

Recent figures from the federal Bureau of Justice Statistics showed there were nearly half as many convicts on parole — 223,800 — as in federal and state prisons and jails — 509,308.

A bill that has passed the U.S. Senate and awaits House action would put an end to parole on the federal level. Parole boards would no longer decide whether to conditionally release inmates prior to completion of their terms. The sentencing judge would set the minimum release date and guidelines.

The Minnesota legislature has abolished its parole board. The prisoner knows his release date — provided he behaves himself — at the time of sentencing.

Since 1976, California, Indiana, Maine, Illinois and Arizona have passed determinate sentencing laws, which specify the term for each crime rather than prescribing an "indeterminate" range of punishments and leaving the actual release at the discretion of the parole board.

Most other states have switched to determinate sentencing for at least some offenses.

"The trend has set in, although we will oppose it to our dying day," says Anthony Trivisono, director of the American Correctional Association in College Park, Md. "Strong forces are trying to remove discretion from the system because some claim the correctional folks can't use that discretion properly."

"The theory of rehabilitation is gone," says attorney Ed Koren of the Prison Law Project in Washington. "There's no money for it. Prisons are now simply places for punishment. People want to know somebody's getting 10 years rather than a vague 5-15. That attitude is behind the move to get rid of parole."

Dan O'Brien, assistant to the commissioner of corrections in Minnesota, which abolished its parole board two years ago, praised the new system, under which the commissioner of corrections establishes sentencing guidelines, taking into account the severity of the crime and the defendant's criminal history.

"There was some concern that knowing when he'd get out anyway would prevent an

inmate from participating in prison programs, but that hasn't happened," O'Brien said. "The intent was to send serious criminals to jail and to get away from the disparity in sentencing across the state. That we have done."

Paul Young, of New York's parole division — the largest in the nation with 600 officers handling 22,000 parolees and with the lowest recidivism rate, 3.4 percent — said "equal time for equal crime" was "bad justice."

"A wino on the bowery picks up a broomstick, hits his friend and takes his bottle. That's robbery first degree. A kid goes into a park, threatens another kid and takes his bicycle. That's robbery first degree. A hardened criminal takes a gun and robs a bank. That's robbery first degree."

"Do you think they should all go to prison together?"

"In determinant sentencing," Young said, "everybody gets the same sentence. You have over-incarceration for minor offenses and a legalized jail break for the more hardened criminals. They have nothing to lose."

Earl Coleman, assistant to the parole board in Indiana, which changed to determinant sentencing in 1977, said, "The problem with such an arbitrary formula is an inmate whom the parole board deems to be a bad risk can be released so long as he behaves himself in prison, without regard to what the board might think

his behavior in society would be."

Officials in California, which made the switch the same year and now holds parole hearings only for convicts serving life terms, said the system was working well.

Newly elected Gov. George Deukmejian, former Attorney General who who campaigned on a tough

law-and-order platform, said his only real concern was "to get harsher penalties for parole violators."

**Negative GAO report**  
Parole opponents, critical of the system's disparate treatment of criminals, received impetus from a 277-page General Accounting Office study completed in July for the Senate Subcommittee on Government

Affairs.

The congressional investigative agency found the federal parole system "riddled with inconsistency, contradiction and inefficiency," said Sen. Sam Nunn, D-Ga., who asked for the study.

"The report lends more support to legislation (passed by the Senate and now before the House) which would abol-

ish the parole system and establish new procedures giving the sentencing judge principal responsibility for setting guidelines governing the convict's early release."

The GAO cited cases of prisoners not eligible for parole being paroled anyway and guidelines being so vague for hearing examiners that they disagreed in 53 percent of the cases.

## NORTH CAROLINA Farm Tips

From Wachovia Bank & Trust Co., N.A.



By Dr. J. W. Pou

Last summer scientists started a fight in the middle of Bobby Stephenson's soybean field in Johnston County.

The fight is between a disease-causing fungus called *alternaria cassiae* and a pesky weed for soybean growers called sicklepod, according to Tom Byrd, agricultural communication specialist at N.C. State University.

So far, the fungus is winning and the scientists are delighted. If the fungus continues to score big, it may become the first biological weed control weapon for soybean growers.

Weeds are a relatively new target in biological pest control. Most research in the past has focused on parasites and predators that attack insects.

However, farmers use many herbicides as well as insecticides, which is now prompting scientists to look for natural means for controlling weeds too.

Research on biological weed control in North Carolina is being led by three scientists (with the Agricultural Research Service of North Carolina State University: Drs. Gerald Van Dyke and Blanche Haning, plant pathologists, and Dr. Douglas Worsham, weed scientist. They are cooperating with scientists from six other southern states and California in their search for diseases that will kill weeds.

"We are looking for plant pathogens (disease-causing organisms) that attack specific weeds but do not infect economic crops," explained Dr. Van Dyke.

Such is the case with the fungus, *alternaria cassiae*, tested last summer in Johnston County. It was discovered at the U.S. Department of Agriculture's research station near Stoneville, Mississippi. After several years of laboratory tests, Abbott Laboratories agreed to produce enough of the fungal spores to provide each cooperating state with 200 grams for field testing.

North Carolina scientists selected a sicklepod "hot spot" on the Stephenson farm west of Smithfield for these tests. The spores were mixed with water and a surfactant and were then sprayed over the top of young soybeans infested with sicklepod. Within two days most sicklepod plants were dead or dying. The soybeans showed no sign of the disease.

One goal of the research is to work out the timing and dosage that will be the most effective. Another goal is to see how long the disease lasts. The hope is that the disease will stay around to infect new sicklepod seedlings as they emerge.

Both pre-emergence sprays and post-emergence applications are being tried. Adjoining plots are treated with a herbicide named Attac for comparison.

Dr. Haning says she hopes larger quantities of the fungal spores can be made available in future years. "This would give us an opportunity to test the disease on large commercial plots applied with commercial equipment," she said.

Haning and Van Dyke say it's too early to compare the cost of biological weed control agents with the cost of chemical weed control. At present, they see weed diseases as more of a supplement to chemicals than as a replacement for them.

"The big advantage of using a disease organism is that it may allow us to reduce the use of chemicals while obtaining longer term weed control," Van Dyke said. "One disadvantage is that we probably would have to use a different disease organism to control each weed."

"Another disadvantage is that some people are afraid that the diseases may get out of control. There is no reason to feel that they would," he added, "since most weed pathogens are very host specific."

### ONLY 9 DAYS 'TIL CHRISTMAS

**Your Litton Christmas Shop Has A Full Line Of Microwave Ovens & Cookware.**  
Nobody Knows More About Microwave Cooking Than Litton  
**Give A Gift They'll Cherish For Years**  
It Fits Over Your Range  
The Litton-Aire Model No. 7190

- Time Saver Controls
- Large 1.1 Cubic Foot Oven

- Meal In One Cooking Performance
- Easy To Install-Do It Yourself

**Litton 426**  
1.2 cubic foot oven capacity\*Variable Power oven control lets you change cooking speeds as you change foods\*Easy to clean acrylic oven interior with sealed-in glass shelf.

**589<sup>95</sup>**

**Litton 1041**  
Model 1041

- Litton's Exclusive Meal-In-One cooking performance
- 700 watts cooking power
- Large 1.3 cubic foot oven cavity
- Variable Power Control
- Automatic Temperature Control
- Electronic Touch Control

**369<sup>95</sup>**

**Henry Tyson Electric Service**  
Appliance Sales And Service 202 N. Railroad St. Winterville (Beside Ray's Barber Shop)  
Open Mon.-Fri. 8:30 'Til 5:30 Saturday 'Til Noon  
Lay Away Now For Christmas      Days 756-2929      Financing Available 10% Down  
For Night Appt. Call 756-8771

## Precious Moments.

**SAPPHIRE AND DIAMOND RING**  
\$395.

**BLUE TOPAZ AND DIAMOND RING**  
\$325.

**PEARL RING**  
\$265.

Present her with a token of your love. Make the moment even more precious with a sparkling genuine stone ring or pendant from Carlyle & Co. Attractively designed, attractively priced.

**BLUE TOPAZ AND DIAMOND PENDANT**  
\$300.

**PEARL PENDANT**  
\$150.

**SMOKY QUARTZ AND DIAMOND RING**  
\$195.

**RUBY AND DIAMOND RING**  
\$135. Photograph enlarged to show detail.

Carlyle & Co.'s sixty day return policy insures your complete satisfaction.  
*Where elegance is always affordable.*  
**CARLYLE & Co.**  
Fine Jewelers since 1922  
Carolina East Mall • 756-8734  
We welcome the American Express Card, VISA, MasterCard, Diners Club and our own Carlyle & Co. Charge.

# THE CHRISTMAS PLACE TO BE

Mall Christmas Hours Monday - Saturday 10 am - 10 pm  
Santa Photo Hours Monday - Friday 12 - 8 pm  
Saturday 10:30 am - 8 pm

**CAROLINA EAST CENTRE**

264 By-Pass on Hwy. 11, Greenville

# The Gift Of Sight Not For Everyone

By BOB DVORCHAK  
Associated Press Writer  
PITTSBURGH (AP) — Sam Atwood was born blind, with congenitally clouded corneas and glaucoma. But he can see today because of a relatively new and extremely delicate surgery for transplanting corneas in infants.

Sam, who was 6 years old on Halloween, had the cornea in his left eye replaced at

Pittsburgh's Eye & Ear Hospital when he was 8 weeks old and his right eye corrected at 5 months.

He's had a number of followup operations to correct complications and his

20-200 vision with glasses still makes him legally blind. But he sees well enough to read enlarged type and go to school.

"In retrospect, it is a miracle. If you have a child who can't see and then he can see, I would call it a miracle," says his mother, Joy Atwood, a kindergarten teacher from East Waterboro, Maine.

Sam was operated on by Dr. Stuart Brown, a pioneer in transplanting infant corneas and chairman of the department of

ophthalmology at Eye & Ear Hospital and the University of Pittsburgh School of Medicine.

The first successful transplant of defective corneas in infants occurred 12 years ago, and only a handful of doctors perform them. Brown has operated on 25 infants in 12 years.

"None of these children will be able to see as well as people born with normal eyes. None will be able to pass a driver's test, but they'll see. They won't be in blind school," Brown says.

Corneas in adults have been transplanted since 1905, and the operation has become fairly routine. The success rate in adults is between 90 and 95 percent, Brown says.

But infants pose special problems, and about two-thirds of the transplants are successful.

"It's very different from cornea transplants in adults," says Brown.

For one thing, infant tissue is flaccid and when the defective cornea is removed, the internal structure of a

baby's eye bulges forward. Doctors use corneas from adult donors to give the baby's eye some rigidity.

A cornea acts like a window to the eye. It is a transparent coating of the eyeball that allows light to penetrate into the interior of the eye, which translates light into sight.

Doctors use a device that resembles a cookie cutter to remove a defective cornea, and then transplant donor tissue in its place during an operation that takes between 30 minutes and an hour.

The procedure does not correct all blindness and can give sight only to babies born with clouded or opaque corneas, which Brown says is a rare condition.

"It isn't an instant miracle. It hasn't been easy. Sam's vision has tempered everything we do," Mrs. Atwood says.

"But it wasn't a difficult decision to make at all. There were no alternatives, other than to have his vision be nil. It's the difference between having no sight and having sight."

**SHOP-EZE**  
West End Shopping Center  
Phone 756-0960

**GOODLAND**

Friday  
Luncheon Special  
Chicken & Pastry  
**\$2.49**

Fried Chicken  
**\$1.59**

Special Served with 2 Fresh Vegetables & Rolls.

## Study Categorizes The Degrees Field Choices

WASHINGTON (AP) — Business and management are the most popular fields with white, Hispanic and Asian college students, but blacks and American Indians more often major in education, a new study says.

The report issued by the National Center for Education Statistics also showed that foreign students who study in the United States are most likely to pick engineering as a major.

The study analyzed degrees granted in 1978-79 according to field of study and the race or ethnic status of the recipient.

Business and management were the top choice of white students with 18.8 percent of

their degrees being issued in that area. Education was No.

2, at 13.6 percent and social sciences followed at 11.5 percent.

Among Hispanics, business accounted for 15.9 percent of the degrees granted; second was education, 14.8 percent; and third was social sciences, 14.6 percent.

While Asians also picked business first, 20.4 percent, their second choice was engineering, 12.1 percent, and their third was social sciences, 10.4 percent. Education wasn't among their top five selections.

Blacks, on the other hand, gave education a narrow margin over business studies, 19.1 percent to 19.0 percent, followed by social sciences at 15 percent.

American Indians gave education a bigger lead,

picking it over business 18.9 percent to 14.8 percent. Social sciences accounted for 14.6 percent of their degrees.

Engineering was the choice among 26.7 percent of foreign students, business 19.6 percent, and social sciences 9.7 percent.

Overall, the study showed that whites collected 87.3 percent of the 919,540 bachelor's degrees issued. At the same time, whites made up 79.6 percent of the population.

Whites also won 83 percent of the master's degrees issued and 80 percent of the doctorates.

Blacks, who constitute 11.5 percent of Americans, received 6.6 percent of the bachelor's degrees issued, 6.5 percent of the masters and 3.9 percent of the doctoral degrees.

## Timber Town Hangs On Despite Closing Of Mill

By C.W. MIRANKER  
Associated Press Writer

MCCLOUD, Calif. (AP) — Before the turn of the century, when Douglas firs and sugar pines grew a dozen feet around, the area's first lumber company settled at the foot of Mt. Shasta with a band of fallers, sawyers and railroaders.

They called the company Mother McCloud.

It gave them jobs. It built them homes, stocked the stores, looked after their health, saw to their children's schooling, and provided jobs for them and their children's children, too.

Then in the mid-'60s, the maternal, company-town system ended. The lumber company, after a change of ownership and a merger, severed itself from the community, first selling residents their houses, then the businesses and finally the railroad.

Then, at Thanksgiving three years ago, the mill closed, a victim of small, uneconomical trees and antiquated equipment. More than 300 people — nearly the whole work force — lost their jobs.

By Christmas, the timber industry began reeling from deteriorating sales and high interest rates. It still is. Up and down the Cascade range, mills have cut back or closed down.

Scores turned to unemployment benefits, food stamps, welfare, relying more than ever on fish, game, home-preserved foods and any part-time job that turned up. Dozens moved.

But most in the town of 1,800 held on, stubbornly attached to the community and captivated by the beauty of the snow-capped mountain.

"McCloud is going to grow," says Bob Wieder, owner of McCloud Building Supply. "Where else on this planet are you going to find clean air, a wild river and a 14,000-foot mountain out your back window?"

A recession on the heels of the mill's demise made job hunting especially bleak for McCloud workers. Nearly a quarter of the county's work force of 18,000 was unemployed last summer.

Determined to stay in McCloud, Joni and Dennis Dalton relied on a succession of part-time jobs to meet

house payments and expenses.

Mrs. Dalton, 31, was an assembly line worker and her 33-year-old husband was a faller when the mill closed. He still works in the woods part time, but she has bounced from job to job.

"This is my home. I don't want to leave. It's a good place to raise our kids," she said.

The McCloud River Railroad also is "here to stay," says president William J. Herndon.

The railroad has become an enterprising agency of change in town, aggressively soliciting new business.

A Colorado company attracted by the railroad has begun stripmining for diatomite outside McCloud. Now mining 160 of 5,000 acres to which it holds mineral rights, American Resources Equity Corp. of Englewood, Colo., hopes to complete a processing plant by 1984 that could employ 50 to 100 people initially.

"We have a long way to go and we are by no means past the crisis stage. But we are going to make it," Herndon says.

**Yours for A Merrier Christmas...**



**EVEREADY**  
Batteries For  
Watches, Calculators,  
Security Purposes  
Lanterns & Flashlights  
Smoke Alarms  
Transistor Radios  
Clocks, Cameras  
Camera Equipment  
Test Equipment

Don't forget EVEREADY BATTERIES for those great Electronic games you'll be giving this Christmas!

**Pair Electronics**  
107 Trade St. Phone 756-2291  
Open Mon.-Fri. 8:30-5:30 Sat. 8:30-5:00

**Sears**

**RED-HOT BUY**  
**PORTABLE KEROSENE**  
**HEATERS, NOW ON SALE!**

**\$70-\$100 OFF**

**LOOK... \$70 OFF**



**NOW ONLY \$129<sup>99</sup>** MODEL 40208  
Regular \$199.99

**SAVE ON THIS 9300 BTU REFLECTION KEROSENE HEATER**

Features electric push-button ignition for easy, fast starts; automatic extinguishing system. Heats up to 15 hours on 1.1 gal. of kerosene. UL listed. On sale when you need it!

**A FANTASTIC \$100 OFF**



**NOW ONLY \$199<sup>99</sup>** MODEL 40309  
Regular \$299.99

**SAVE BIG, 20,000 BTU CONVECTION KEROSENE HEATER**

Heats up to 13 hours on 1.95 gallons of pure kerosene. Features electric push-button ignition for easy starting and porous-ceramic wick. UL listed. As the temperature drops, so has our prices!

**NOW... \$70 OFF**



**NOW ONLY \$179<sup>99</sup>** MODEL 40308  
Regular \$249.99

**SAVE ON THIS 13,000 BTU CONVECTION KEROSENE HEATER**

Heats up to 17 hours on 1.6 gallons of pure kerosene. Features electronic push-button ignition; porous-ceramic wick; pre-starting device. Stay warm and save big at Sears, hurry.

**You can count on Sears**

**Greenville**  
Carolina East Mall  
Monday thru Saturday  
10 A.M. 'til 9 P.M.  
Phone 756-9700

**Durham**  
Northgate Mall  
Phone 286-2951

**Goldsboro**  
703 Berkeley Road  
Phone 778-0200

**Jacksonville**  
344 Jacksonville Mall  
Phone 353-2223

**Raleigh**  
Crabtree Valley Mall  
Phone 782-6800

**Rocky Mt.**  
128 North Church St.  
Phone 442-3131

Ask about Sears Credit Plans

**J.D. DAWSON COMPANY**  
Catalog Showroom

# Christmas CLEARANCE SALE



No. 351-LAX  
**SILVERPLATE & CRYSTAL SAUCE SET**  
Reg. Price \$3.67

Special  
**\$2.70**

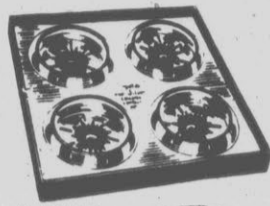

No. 840-LAX  
**ROSEMARK CRYSTAL & SILVERPLATE COASTER SET**  
Reg. Price \$3.87

Special **\$2.80**

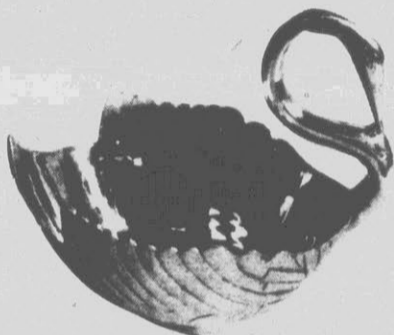

No. 444100-LAX  
**ROSEMARK BRASS SWAN MINT DISH**  
Reg. Price \$18.67

Special  
**\$12.95**



**Big on fashion!  
Little on price!**

What fun! Bold, bright Kaleidoscope refillable ballpoint pens in a riot of colors and perky designs to fit your taste. And at a low price to fit your budget.

Reg. \$2.57

Refillable Ballpoint Pens  
By Sheaffer®

No. 70860  
Queen Of Hearts

Special  
**\$1.98**

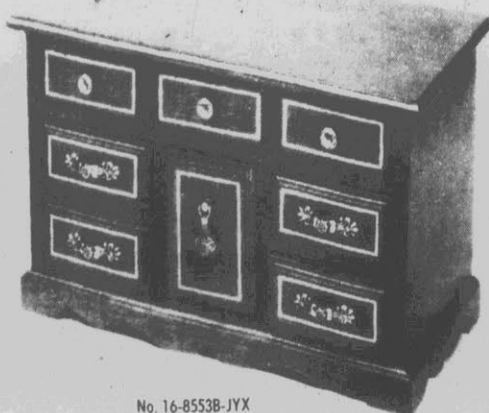

No. 16-85538-JYX  
**MUSICAL JEWELRY**  
6" X 11 1/2" X 7 1/2"  
Reg. Price \$21.97

Special **\$17.84**



No. 5646-ARX  
**MUSICAL DOVES**  
6 1/2" tall  
Reg. Price \$10.97

Special **\$7.94**

**New adventure  
in writing**

*Calligraphy*

**NoNonsense® Pen by  
Sheaffer®**

Here's everything you need to put a new slant on your writing. New NoNonsense refillable pen with italic nibs in a choice of 3 widths. 14 cartridges of ink in 7 colors. Easy-to-follow instruction book. Ruled practice pad. What a great new fun way to write. See it soon.

Makes an ideal gift!

Sheaffer®

No. 72260  
Reg. \$6.88  
Special

**\$5.88**

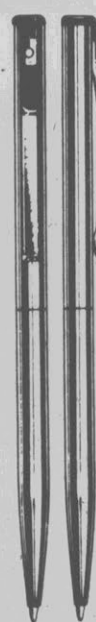

**TRZ pens**  
A new twist.  
TRZ ballpoints and pencils represent tomorrow's standards of design and engineering excellence. But they're ready right now for any gift-giving occasion.

No. 120149  
TRZ30  
Reg. \$8.57  
Special

**\$6.60**



No. 702-SLX  
**SPRINGFIELD "COMMODORE" WEATHER STATION**

Reg. Price \$20.97  
Special

**\$15.98**



**Replogle®**  
**WORLD GLOBES**

No. 30509-RPX  
12"

Special

**\$11.77**

**TEXAS INSTRUMENTS**



No. 1001  
Reg. \$6.77  
Special

**\$5.98**

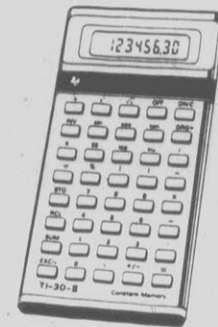

No. 30-II  
Reg. \$12.57  
Special

**\$10.97**

**THE LITTLE PROFESSOR™**  
Electronic Learning Aid

Reg. \$14.97  
Special

**\$9.95**

The Little Professor™ from Texas Instruments—famous math tutor for kids 5 and up.

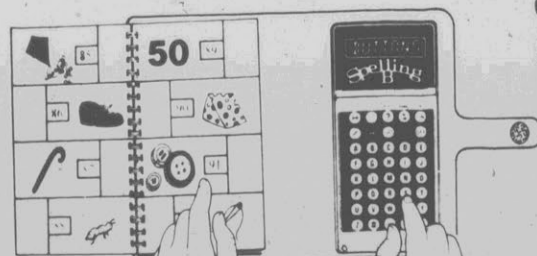

Reg. \$32.77  
Special

**\$10.95**



No. 30961-28-AMX  
**AMITY FRENCH PURSE**  
Vintage Rust Color  
Reg. Price \$9.97

Special

**\$6.95**

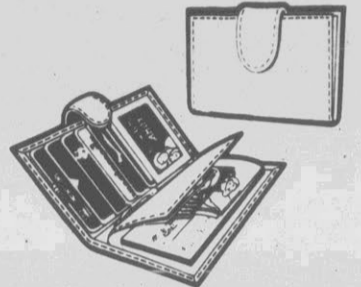

**AMITY SECRETARIAT**

No. 30339-61-AMX  
Palermo Burgundy Color  
Reg. Price \$15.94

Special

**\$10.97**

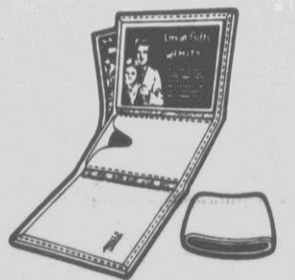

**AMITY TRI-FOLD**

No. 04619-20-AMX  
Sierra Brown Full Grain Leather.  
Reg. Price \$8.94

Special

**\$5.95**

**BENTWOOD ROCKER**

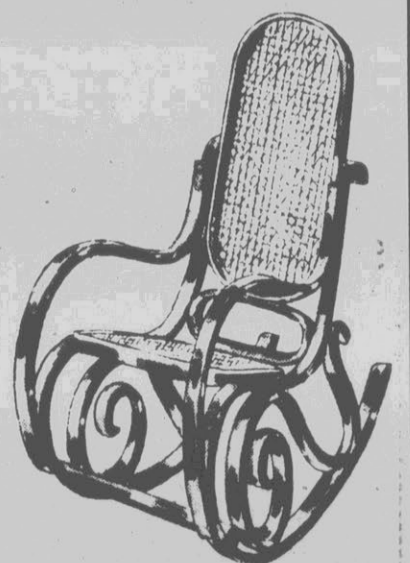

This extra heavy, extra elaborate Bentwood rocker is finished in wainut and has a natural cane seat and back. It's the perfect accent piece.

No. F-458-CIX  
Reg. Price \$58.97

Special

**\$39.95**



AR506

- MAGNAVOX AR506 Stereo Radio Recorder**
- Stereo balance control
  - Auto stop
  - Tone control
  - Two built-in condenser microphones
  - Two 4" speakers
  - Detachable AC line cord

Reg. \$124.94  
Special

**\$106.88**



D3100

- MAGNAVOX D3100 AM/FM LED Clock Radio**
- Unique cube design
  - Slumber
  - Repeat alarm
  - 24-hour memory alarm
  - Power interruption indicator
  - Red LED display

Reg. \$35.54  
Special

**\$29.98**



No. BB3910SL

- MAGNAVOX 5" Diagonal Portable Black & White TV**
- 100% solid-state chassis
  - AM/FM radio
  - Efficient 5" speaker
  - Tone control
  - Tuning/battery meter
  - Earphone jack
  - AC/DC

Reg. \$129.96  
Special

**\$119.96**



D1010

- MAGNAVOX D1010 Portable AM/FM Radio**
- Slide volume control
  - Earphone jack
  - FM telescopic antenna
  - Efficient 2 1/4" speaker
  - Wrist strap
  - Operates on 3 "AA" batteries (not included)

Reg. \$13.97  
Special

**\$11.97**

Special

**\$24.95**

Reg. \$29.94  
No. AS128

This all new LED clock radio from Magnavox will be an ideal bedside companion for years to come. It features a repeat alarm that will re-awaken you every 9 minutes up to six times per morning. And the slumber feature will lull you to sleep the following evening. Operates on AC power.

**ODYSSEY<sup>2</sup>**  
THE KEYBOARD IS THE KEY



Model 7600

Reg. \$149.94  
Special

**\$128.94**

**brother.**



CORRECTION AUTOMATIC 12 MODEL 3800

Reg. \$199.97  
Special

**\$168.88**



02-2130

Reg. \$12.57  
Special

**\$10.57**



Diversified Products

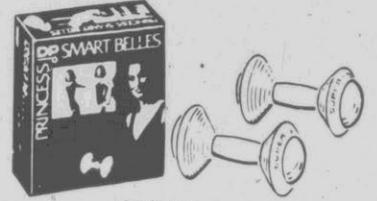

02-2100

Reg. \$10.97  
Special

**\$7.97**



No. 100903  
Reg. \$7.97  
Special

**\$5.88**

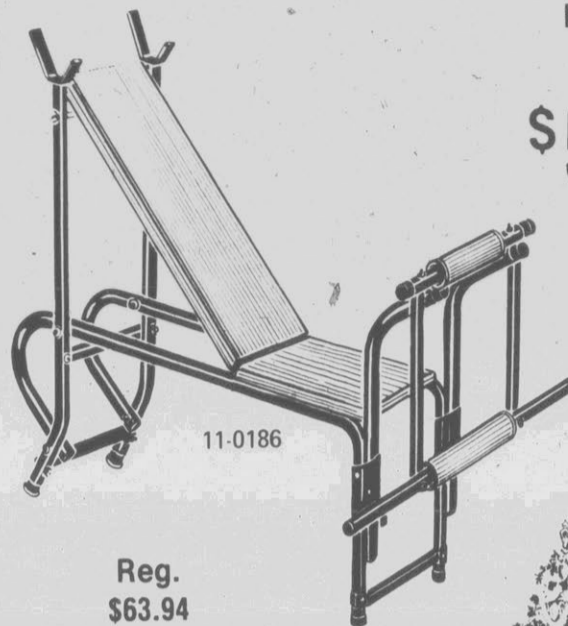

11-0186

Reg. \$63.94  
Special

**\$49.95**



11-0169

Reg. \$24.94  
Special

**\$19.88**

Texas Instruments



Mr. Challenger\* Grades three and up  
Mr. Challenger\* takes you on with four electrifying word games that you can

Reg. \$29.88  
Special

**\$10.95**



03-4170

Reg. \$31.88  
Special

**\$28.88**

01-1150

Reg. \$42.88  
Special

**\$36.88**

Panasonic TR-1010P  
Special

**\$169.97**  
Reg. \$188.97

Ultra-compact B&W TV with 1 1/2" diagonal screen, 3-way operation and electronic tuner, 3-way operation for AC current, car/vehicle battery and either rechargeable or regular batteries (not included).

Panasonic SlimLine RQ-2735  
Special

**\$20.97**  
Reg. \$27.95

SlimLine AC/battery portable cassette recorder features one-touch recording and Auto-Stop.



**PRESTO CARAMEL CORN'R**  
popcorn/caramel corn maker

From popped corn to caramel corn in 7 minutes

No. NPX05000  
Reg. \$26.97  
Special

**\$19.88**



**SALE \$6.94**

SilverStone interior, polished aluminum exterior. 46030-VZX. Reg. \$12.99. Reg. \$8.47

Showroom Hours

Greenville

Mon. - Friday 9:30 A.M. - 9 P.M.

Saturday 9:30 A.M. - 7 P.M.

Belhaven

Mon. - Sat. 9 A.M. - 5:30 P.M.†

Sunday

1 P.M. - 5:30 P.M.

Quantities Are Limited, Shop Early For Best Selections! For Mail Orders Call 1-800-682-2121 Toll Free!

**J.D. DAWSON COMPANY**

2818 E. 10th Street  
Greenville, N.C.

Catalog Showroom

102 E. Main Street  
Belhaven, N.C.

Your Catalog Gift Store And A Whole Lot More!!

# Britons Prepared To Stay On Thatcher Medicine

By MAUREEN JOHNSON  
Associated Press Writer  
LONDON (AP) — On the election trail in 1979, Margaret Thatcher waved two shopping baskets, one full and one half-empty, to demonstrate to voters how much less their money bought after five years of the Labor Party's socialist government.

Since then, the Conservative Party leader who became Britain's first woman prime minister has

pursued her good housekeeping style of economics with a doggedness that has cut inflation to 6.8 percent, its lowest in 10 years.

Her critics charge that the price of Thatcherism, Britain's Reaganomics, has been lengthening welfare lines and causing a slump in industrial output in an economy hit by world recession and squeezed further by her tight money policies.

Opinion polls, however,

show that voters would put Mrs. Thatcher back for another five-year term if general elections were held now — despite record post-1980 unemployment of 3.3 million or 13.8 percent. It was 1.3 million when she took office.

Her electoral support confounds the traditional unpopularity of British administrations past mid-term, and reflects both hope and hopelessness.

Many voters apparently

believe that Thatcherism, however painful, is gradually turning the economy around after generations of profligacy, and want her to have a second term to finish the job.

But many others appear to accept her oft-repeated line: "There is no alternative."

"So it hurts. But I think you've got to swallow the medicine. I'll vote Tory (Conservative) again," says Ineke Nesbitt, 42-year-old secretary in Birmingham, whose husband has been laid off two years in an area where unemployment has tripled to 18 percent since the last election.

Mrs. Thatcher claims to see a "healthy new realism across the country," but her opponents claim to perceive a growing sense of despair.

Whatever the arguments, the Conservatives, with an average 44 percent of the vote in polls in the last three months, are 13 points ahead of their nearest rivals, the Labor Party which lost power in 1979.

More significantly, an analysis by Market Opinion and Research International shows 39 percent Tory support among skilled workers, up 1 percent, and 33 percent among unskilled, up 3 percent — key groups with floating voters who decide elections.

"You have sought to persuade the country there is no alternative to the desperate, dismal policies which you pursue," Labor leader Michael Foot has told Mrs. Thatcher.

She retorts: "There is no future in returning to when the government's reputation at home, and Britain's repu-

tation abroad was that of a spendthrift and supplicant."

This sort of dialogue between Thatcherites clinging to the basic prescription and opposition parties promising higher state spending, is getting shriller with an election perhaps a year away.

The "monetarist" experiment itself shows mixed results.

It is 3½ years since she caught the public imagination by offering lower taxes, freer rein for private enterprise, labor union curbs, lower inflation and state spending.

On the credit side: — Inflation is sharply down, halved within the past year and slashed from a 21.9-percent peak a year after Mrs. Thatcher took office. It is expected to hit 5 percent early next year.

The British rate is still above the United States' 4.8 percent, West Germany's 5 percent and Japan's 3 percent, but below the 7.4 percent average for major industrial nations.

Says Michael Hughes, economist with London stockbrokers de Zoete and Bevan: "The big thing is she has made progress in relation to other countries. Britain is now way down the inflation league instead of near the top and that must make our goods more competitive — some day."

— On the labor front, Mrs. Thatcher heads into what is probably her last pre-election winter without a major strike in sight.

Eight months of sporadic strikes by 750,000 workers in the state National Health Service appear near to collapse.

A pay strike was rejected in October by the nation's 180,000 coalminers, and steel, rail and waterworkers have settled contracts or shown little stomach for a confrontation.

Strikes, often called the British disease, are down but not out. Nearly 7 million working days were lost through strikes in the first nine months of this year, mainly because of the health workers. Last year it was down to 3.26 million days, compared with an average 9.8 million over the past decade.

— Interest rates, which along with North Sea oil kept the pound sterling up to the chagrin of exporters until early this year, are down to 9 percent from a 16-percent peak last year.

That's good news for industrialists and housebuyers, but bad for investors. With suspicions Mrs. Thatcher plans a pre-election ease on spending curbs, low interest rates sent the pound tumbling to a six-year low of 1.60.

— Money supply growth, emerging from a forest of differing measurements, is now said to be within the latest 8 to 12 percent target. Mrs. Thatcher failed to meet targets in 1979-81.

On the debit side: — Unemployment is getting worse and the Conservatives no longer promise an upturn in the near future.

— 5,500 companies went bust in the first six months of this year, 22 percent more than in 1981.

— Manufacturing output has dropped 17.5 percent to a 15-year low since 1979, reflecting a lack of British competitiveness.

— Imports absorb much of the spending power generated by lower mortgage rates and inflation. A recent Treasury statement said in the last five years world trade rose 18 percent, but British exports of manufactured goods were unchanged and imports were up 40 percent.

The Treasury predicts a slight fall in manufacturing output until next spring, and only a modest rise in gross domestic product next year of 1 to 1½ percent.

— Wage increases, averaging about 9 percent this year, are rising faster than prices. Mrs. Thatcher's 3 to 4 percent guideline has not been followed.

Publicly, she remains committed to cutting the

budget deficit but she's trimming the pre-election edges by urging local city halls to spend more.

The deficit is down from 15.87 billion pounds (\$25.4 billion) in 1980-81 to "well within" the 9.5 billion pounds (\$15.2 billion) predicted for the year ending next March.

But state spending continues to rise as a percentage of national income — 40.7 percent compared with 38.2 percent in 1979.

Mrs. Thatcher brushes aside critics who "say I preach merely the homilies of housekeeping or the parables of the parlor."

"I do not repent," she said. "Those parables would have saved many a financier from failure and many a country from crisis."

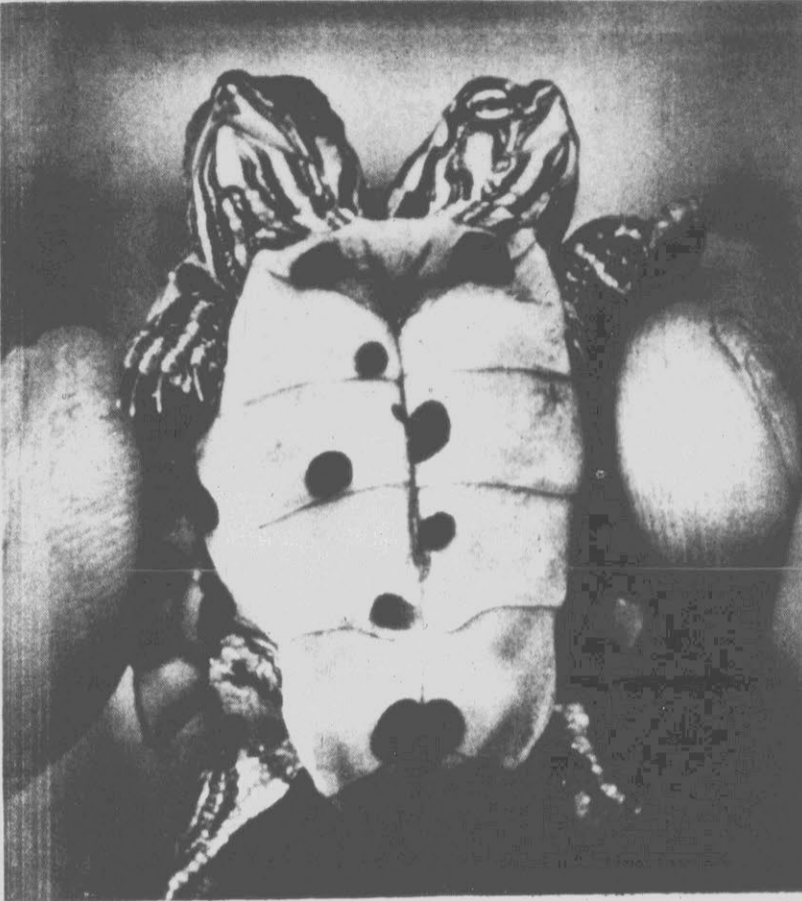

IT'S ALIVE — This small two-headed turtle, discovered by Augusta (Ga.) city employee Mark McGhee while working on a road project in downtown Augusta, is in apparent good health and even eats with both heads. The, as yet, unnamed pet has been in the McGhee house for two months. (AP Laserphoto)

## Try To Develop Basque Tongue

BAYONNE, France (AP) — Once a month, the 24 sages of the Euskalzaindia gather to tackle the problems of an outdated language and a largely neglected culture that straddles two countries with two different attitudes toward it.

The Euskalzaindia — or Basque Academy — functions much like the famed Academie Francaise, as arbiter of the language and creator of new terms necessary to keep up with modern times.

But in addition to efforts to develop the Basque tongue, called Euskadi, the academy also is the major force behind efforts to preserve and develop other aspects of the Basque culture.

"We have a lot of work," says Jean Haritschelhar, professor of Basque language and literature at Bordeaux University, and one of the seven French members of the academy.

"Basque has never been the language of a state, or an official language for public documents, or in the mass media, or in teaching," the professor says, referring to the situation on the French side of the border.

In Spain, Basque is an official language with the same status as Spanish.

The Basques are the oldest surviving ethnic group in Europe. It is estimated that about 800,000 people actually speak Basque, but knowledge of the language in general is on the decline.

In 1969, a few families in Bayonne and one teacher who wanted their children to have a Basque education unavailable in public schools founded an organization called Seaska and opened a kindergarten with three children.

Today, about 600 French children study in kindergarten, primary and secondary Basque schools, called Ikastolak, and the number grows each year.

Seaska, with 57 full-time teachers, now operates 22 kindergartens, seven primary schools and one high school, all privately funded through tuition, donations and special activities.

Seaska and 22 other organizations have presented the French government with a proposition calling for a special law to give the Basque language and culture official status.

## Have You Missed Your Daily Reflector?

First Call Your Independent Carrier.  
If You Are Unable To Reach Him  
Call The Daily Reflector

**752-3952**

Between 6:00 And 6:30 P.M. Weekdays  
And 8 'Til 9 A.M. On Sundays.

## Its Christmas Gift-Giving Time At Garriss Evans



### Amerock Cabinet Aides Problem Solvers

#### Undersink Roll-Out Storage Rack

**20% off**

Gain extra storage convenience under the kitchen sink or vanity. Vinyl-coated wire tray features smooth ball-bearing operation. Top section reverses to allow fitting around either side of plumbing or disposal.

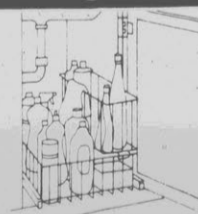

#### Cookbook Rack

**20% off**

Helps keep countertop free for food preparation. Attractive wood rack pulls down to easy reading angle. Folds up under wall cabinet when not in use.

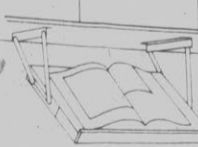

#### Revolving Spice Rack

**20% off**

"Lazy Susan" keeps spices and other packaged items always "up front" in wall cabinets. Durable steel shelves with camel tone enamel finish. Nylon pivot bearing installs with just 4 screws in new or old cabinets.



#### Wire Roll-Out Lid Rack

**20% off**

(for 14½" cabinet opening) ALSO AVAILABLE FOR 20½" OPENING

Vinyl-coated wire rack keeps pan lids organized for easy access. Available in several lid capacities and rack widths to fit most new or old cabinets. Easy to install.

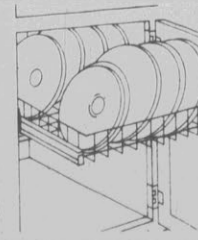

#### KNIFE RACK

**20% Off**

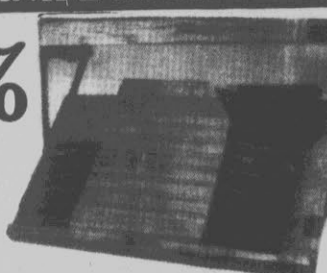

### Black & Decker 7 1/4" Value Plus® Saw

Versatile Saw is double insulated, w/7 1/4" combination blade included. No. 7393.

Reg. 89.99 Sale **\$79.99**

### Black & Decker Sander

Model No. 7456. Heavy Duty. A real value for this price.

Reg. 64.99 Sale **\$55.99**

### Black & Decker 3/8" Drill

General purpose. Recessed center lock button guards against "lock-on". No. 7104.

Reg. 22.99 Sale **\$18.99**

### Black & Decker 1/4" Drill

Good choice for light duty work. Drives all popular accessories for sanding, polishing, etc. No. 7004.

Reg. 19.99 Sale **\$15.99**



### All Fuller Hand Tools

**10% Off**

Pliers, wrenches, vises, etc. Fix Mom a tool box at these great prices!



### Sawhorse Supports

Steel supports for making sawhorses or attach plywood to top of 2 sets for bench.

Reg. \$17.95 Sale **\$16.50**

### Stanley Plier & Wrench Gift Set

Contains 6" Slip Joint Plier & 8" Adjustable Wrench.

Reg. 8.59 Sale **\$7.59**



### ONE ONLY TO SELL Atlanta Wood Stove 27" Firebox

Our Cost Reg. \$99.00

Only **\$79.00**

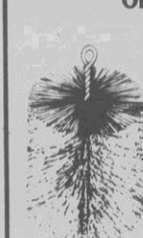

### Chimney Brushes

Be your own Chimney Sweep!

From **\$15.37** Up

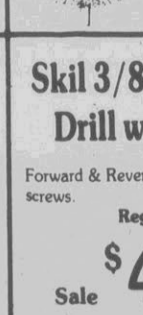

### Skil 3/8" Cordless Drill w/charger

Forward & Reverse to drive & remove screws.

Reg. 49.99 Sale **\$45.99**

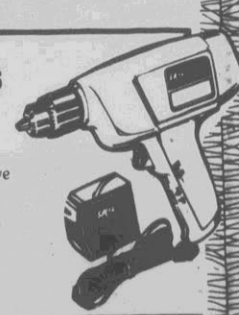

THE LAW FIRM OF  
**McLAWHORN & MITCHELL, P. A.**  
IS PLEASED TO ANNOUNCE THAT  
**ELIZABETH R. WARREN**  
HAS BECOME A MEMBER OF THE FIRM.  
THE NAME OF THE FIRM  
HAS BEEN CHANGED TO  
**McLAWHORN & WARREN, P. A.**

CHARLES L. McLAWHORN, JR.  
ELIZABETH R. WARREN  
Suite 300, 301 Evans Street  
Post Office Box 8188  
Greenville, North Carolina 27834  
(919) 752-2435  
December 1, 1982

**GARRIS EVANS**  
Lumber Co., Inc.

701 W. 14th St.  
Greenville  
Open Weekdays 8-5  
Saturdays 8-Noon  
Telephone: 752-2106  
Sale Prices Good Thru Dec. 23

**FOCUS**



**A Deadly Season**

On this day in 1835, America's first major urban fire destroyed 600 buildings in New York City, resulting in a loss of more than \$20 million. Fire can be a deadly force, and more home and business fires occur during the winter months than at any other time of the year. Space heaters, candles, and fireplaces are the major culprits during this season. In the United States, fire strikes more than 1,500 homes each day and takes more than 12,000 lives every year. About one-fourth of the victims are children. Each year, more than 2.5 million fires strike America's homes, businesses, and wildlife. This holiday season don't let your home become another fire statistic.

**DO YOU KNOW** — What U.S. fire killed more people than any other?

**WEDNESDAY'S ANSWER** — The sun's outermost atmosphere is called the corona.

12-16-82 © VEC, Inc. 1982



**Speaking of Your Health...**

Lester L. Coleman, M.D.

**Fluff Swabs for Ear Safety**

I was warned against cleaning my ears with a cotton swab. How else can I do it? — Miss S.L.K., La. Dear Miss K.:

The cotton tip applicator is the gentlest of all instruments popularly used to clean the ears and remove wax. Obviously, it is a lot better than the silly use of paper clips, bobby pins, safety pins and long fingernails.

Yet even cotton-tipped applicators which seem to be so gentle can sometimes be injurious if they are carelessly handled. The cotton is so tightly bound that often it can injure the wall of the ear canal. For this reason it is advisable that the cotton on these applicators be carefully fluffed at the tip and thus be made softer before use.

Fortunately the ear canal has its own anatomical defense against injury. Its curved structure prevents the eardrum itself from being injured. The canal, lined by a very thin layer of skin, can easily be hurt.

Wax serves a very important function. It lubricates the outer ear and protects the canal from invasion by dust, insects and other particles.

Many people go through life without having any wax removed from the ear. Others, with narrow canals, seem to accumulate wax that then becomes hardened and puts pressure on both the canal and the eardrum. Those with this tendency should have the wax removed by doctors periodically.

There are now a number of drugs which can be purchased over the counter and without a doctor's prescription. Their function is to dissolve the wax. They accomplish their pur-

pose but care must be taken. Some of these substances can be very irritating to the lining of the ear canal and the eardrum itself.

Gentle irrigation with a soft-tipped ear bulb can often remove the wax without injury. A simple salt solution or well-diluted peroxide can be used. Be sure, however, that the water is tepid for cold water used for irrigation may bring on an attack of short-lived dizziness.

\*\*\*  
Twice I have had the painful complication of a dry socket after a tooth was removed. Is this coincidence or am I prone to this painful condition? — Miss R.G., Maine. Dear Miss G.:

It is probably just a coincidence that you have had two such unpleasant complications after the extraction of a tooth. Normally a blood clot covers the site of the extraction and protects the underlying bone as the healing process begins.

A dry socket is considered to be an infection of the bone from which the tooth was removed. Antibiotics and pain killers are used to control the dry socket. The chances are that this will never happen again. There are no familial tendencies that make you a greater candidate for this unpleasant occurrence.

It should also be noted that it is not the technique of surgical removal that is responsible for this distressing complication.

**SERIES OF STAMPS**  
VATICAN CITY (AP) — The Vatican will issue a series of postage stamps next year to mark the exhibition of its art treasures in the United States.

**Farmville Furniture Company**

**Holiday GIFT GUIDE**

Open Monday-Friday; 8:30 a.m. til 9:00 p.m. — Saturday 8:30 til 5:30 p.m.

MasterCard and VISA Welcomed! or use your Farmville Furniture Company Charge Account

**Free—New Plymouth Champ—Free**

We're giving away this car as part of our 77th Anniversary Celebration

You do not have to be present to win  
We've been serving the area since 1905



All Wool Oriental Design Rugs 9'x12' AS LOW AS \$299<sup>95</sup>

**Silver Service Sale**

5-Pc. Service Sale Price **\$319<sup>95</sup>**

5-Pc. Service Chantilly Sale Price **\$899<sup>95</sup>**

**CHRISTMAS CHINA**

- ★ Christmas Tree by Spode
- ★ Holly by Noritake
- ★ Holiday by Lenox
- ★ Christmas by Pfaltzgraff

A Fine Gift Idea

**Wilton Armatale**

Plates • Candle Sticks • Mugs • Goblets  
Casseroles • Bowls • Sugar and Creamers  
Salt and Peppers • Bread Tray

**Hoffritz Steak Knife Sets**

Pearl Handle Set of Six **\$25<sup>00</sup>**

Wood Handle Set of 6 **\$25<sup>00</sup>**

Pistol Handle. Stainless. Set of 6 **\$30<sup>00</sup>**

Bone Handle Set of 6 **\$37<sup>00</sup>**

**Crystal Wine Sets**

DECANTER and SIX GLASSES WITH ETCHING **\$19<sup>95</sup>**

**PUNCH SETS**

14-PC. CRYSTAL PUNCH SETS REGULAR \$89.95 SPECIAL **\$49<sup>95</sup>**

**Silver Punch Set**

13 Pieces Regular \$239.95 Special **199<sup>95</sup>**

Pewter Jefferson Cups **\$14<sup>95</sup>**

Silver Chamber Sticks **\$6<sup>95</sup>**

Ceramic Egg Plates **\$7<sup>95</sup>**

**Brass Plated Candle Sticks**

SPECIAL Set of Three **9<sup>95</sup>** SPECIAL Set of Five **14<sup>95</sup>**

**FINAL CLEARANCE**

Lane Cedar Chests



Oak, Pine, Mahogany, Maple

Prices As Low As **\$199<sup>95</sup>**

Antique English Silver Wine Coolers Circa 1850 Reg. \$2500 pr. **\$1500<sup>00</sup>**

Crystal Wine Glasses EACH **\$3<sup>95</sup>**

Silver and Crystal Cordial Sets **\$15<sup>95</sup>**

**Stainless Steakknives**

Set of 6 **\$16<sup>95</sup>**

Silver Plated Sherbet-Champagnes Reg. \$12.95 Now **\$7<sup>95</sup>**

**24-Pc. Glassware Sets**

8 Ice Tea 8 Water 8 on the Rocks **\$16<sup>95</sup>**

**Silver Cake Stands**

3 Tier Special Reg. \$29.95 **\$19<sup>95</sup>**

Crystal & Silver Relish Dish **\$5<sup>95</sup>**

Crystal Serving Sets **\$6<sup>95</sup>**

**Decorator Super Sofa Sale**

Sofas AS LOW AS

**449<sup>95</sup>**

Wing Chairs AS LOW AS

**149<sup>95</sup>**

Martha Washington Chairs

SPECIAL **\$179<sup>95</sup>**



Sofas, Chairs and Loveseats in Stock For Immediate Delivery. Lamps, Pictures, Mirrors, Andirons, Luggage Valet Stands Card Tables Much, Much More

**Farmville Furniture Company**

122-126 South Main Street

Farmville, N. C.

Tel.: 753-3101

**SHONEY'S FEATURED VALUE EVERY DAY!**



ONLY... **\$2<sup>99</sup>**

**SLIM JIM SANDWICH**

Deli-Thin Ham Slices, Swiss Cheese, Lettuce, Tomato and Our Special Dressing on a Grecian Bun.  
PLUS... ALL-YOU-CAN-EAT Homestyle Soup and Salad Bar.



**SHONEY'S**

264 By Pass Greenville

ALL-YOU-CARE-TO-EAT BREAKFAST BAR OPEN 6:00 A.M.



# Diary Of A Death Describes Fate Of Carl McCunn

FAIRBANKS, Alaska (AP) — Tales of death and despair in the frozen north are not new in Alaskan folklore, but no poet wrote of Carl McCunn's fatal adventure. He wrote it himself.

When the state trooper cut open the tent and found Carl McCunn's wasted body on Feb. 2, he also found a diary the starved man had kept until he ended his torment with a rifle bullet.

"They say it doesn't hurt," McCunn wrote, and pulled the trigger.

He died at age 35 in a wilderness camp near a nameless lake in a nameless valley 225 miles northeast of Fairbanks. He had gone there to photograph the natural beauty and mysteries of the tundra. But he had not been specific about plans to be flown out, and so he was stranded. He died because of a mixup.

His diary, 100 pages of looseleaf paper, began in tidy, block letters recording the wonders of an emerging summer. It ended, eight and a half months later, in the scrawl of an abandoned soul crippled by frostbite, fighting with ravens and wolves for scraps of food.

The diary wound up in the coroner's office in Fairbanks, where, at an inquest, the saga of Carl McCunn unfolded.

On the last page, he wrote: "Am burning the last of

my emergency Coleman light and just fed the fire the last of my split wood. When the ashes cool, I'll be cooling along with them."

McCunn had been flown into the valley about 75 miles northeast of Fort Yukon in March, 1981, as winter was ending. He knew the area. In 1976, he had spent five months alone in the desolate Brooks Range.

This time, with about 500 rolls of film, photo equipment, firearms and 1,400 pounds of provisions, he planned to stay through mid-August. Beans and rice were his staples.

Eventually, he ate tree bark to stay alive.

His father, Donovan McCunn of San Antonio, Texas, described his son. He was 6-foot-2, 240 pounds, with curly, reddish blond hair and an outgoing personality. He was born in Germany to an Army family.

After high school, he tarried in college for a semester before a four-year hitch in the Navy. Then he worked on a ferry between Washington State and Alaska and did odd jobs after making his home in Alaska in about 1970.

At the coroner's inquest, testimony from friends — and McCunn's own diary — suggested he had failed to make specific arrangements to be picked up. The coroner's jury ruled his death a suicide.

Early diary entries detail fascination with the "wail" of loons, and contain descriptions of swans and other waterfowl. He wrote of the return of the creatures to their summer grounds.

By early August, with his supplies dwindling, his concern grew with the change of the season. The temperature dropped and autumn painted the valley in yellows, browns, reds. It rained constantly.

"I think I should have used more foresight about arranging my departure. I'll soon find out. Am down to beans now ... just over a gallon. That may not last two weeks. Finished off the rice yesterday."

By mid-August — his diary entries were not dated — he spent much of his time searching for food. He tells of using a net weighted with links of chain to catch fish in a creek by the lake.

Still no plane. His anxiety grew.

"Come on, please ... don't leave me hangin' and frettin' like this. I didn't come out here for that."

Meanwhile, concerned friends asked the Alaska State Troopers to check on McCunn.

Trooper David Hamilton flew over McCunn's camp. Later, he testified he saw McCunn waving a red bag. He said he circled and McCunn "waved in a casual

manner and watched us fly by."

"On the third pass he turned and walked back toward the tent, slowly, casually," Hamilton said. "No wave, no nothing."

"We surmised there was no immediate danger or need for emergency aid."

In his diary, McCunn tells of first being elated about sighting the plane. Later he realized he had given the wrong signal to the pilot.

He first waved his orange sleeping bag cover, then saw the plane had wheels and quit waving.

"I recall raising my right

hand, shoulder high and shaking my fist on the plane's second pass. It was a little cheer — like when your team scored a touchdown or something."

## CHAPTER MEETING

The Pitt County Food Service Association held its chapter meeting recently at Wellcome Middle School with Don Reeves of the Mental Health Center as the guest speaker. Reeves spoke to the group about handling stress on the job and at home.

"Turns out that's the signal (or very similar) for 'ALL OK ... DO NOT WAIT!' They probably blew me off as a weirdo ... Man, I can't believe it!"

By October, he was competing with wolves and foxes for the rabbits he snared. The foxes and the wolves occasionally beat him to his catches.

His father said that McCunn, on a previous wilderness excursion, had been late, and he had notified police who started checking with McCunn's friends. "He told me not to do that again," the senior McCunn said.

In November, Carl McCunn ran out of food. All he had left were a few specks.

"I feel very down, but not quite out. Damned close, however."

Around Thanksgiving, McCunn was beginning to have dizzy spells.

"I feel miserable. Have had the chills upon awakening for the past three days ... I can't take much more of this ... Can't stop thinking about using the bullet either."

He used the last of his fuel, and fed the fire a final time.

"I (chickened) out once already, but I don't wanna go

through the chills again. They say it doesn't hurt."

"Dear God in Heaven, please forgive me my weakness and my sins. Please look over my family."

He added a separate note asking that his personal items be returned to his father. And he instructed the one who found the note to keep his rifle and shotgun. That was his will.

He signed his name and attached his Alaska driver's license.

"The I.D. is me, match."

With those words, the diary, and the life of Carl McCunn, ended.



LAST PHOTO — A self-portrait taken by amateur photographer Carl McCunn at his camp in March, 1981, captures the 35-year-old man

at the start of an ordeal which ultimately lead to his death. (AP Laserphoto)



## Radio Shack

**Most Stores  
Open Late  
Nights 'Til  
Christmas**

# HOLIDAY ELECTRONICS SALE

### 2-Way Hi-Fi Speaker in Walnut Veneer

Nova-5 by Realistic



Half  
Price

Save  
\$40

## 3995 Each

Reg. 79.95 Each

#40-4030

Give a pair and save \$80. Long-throw 8" woofer and tuned port deliver deep, well-defined bass. 2" tweeter is ferrofluid-cooled for increased power handling capacity. Decorator lattice-work molded grille. 19 x 10 3/4 x 7 1/2".

### AM/FM Stereo Cassette/Phono

Clarinette-90 by Realistic



Half  
Price

Save  
\$40

## 17995

Reg. 219.95

#13-1199

- Edge-Lit Tuning Dial
- Two 18"-High Speakers
- Removable Dust Cover

Records directly from radio, 3-speed changer or "live" with optional mikes. Auto-Stop, Auto-Level, pause and tape counter. Tuner has AFC on FM, FM-stereo indicator. Tone control and headphone jack. Walnut vinyl veneer finish.

### Popular AM/FM Portable

By Realistic



Save  
\$5

Save  
\$3

## 2495

Reg. 29.95

Batteries extra

Great Sound They Can Carry Around!

Priced to please budget-minded Santas. "High 'n wide" tuning dial, tone switch, built-in AFC on FM, AM and telescopic FM antennas. AC/battery operation. #12-711

### Car FM Converter

By Realistic



Save  
\$3

Save  
\$77

## 2195

Reg. 24.95

Adds FM to any AM car radio. Small enough to fit under any dash, uses existing antenna. Easy hook-up with no rewiring. #12-1350

### CB With Channel 9 & 19 Priority

TRC-422A by Realistic



Save  
\$4295

Save  
\$77

## \$4295

Reg. 119.95

Give the fun and safety of mobile 2-way radio. Switch for instant access to Emergency Ch. 9 and Highway Information Ch. 19. #21-1503

### 6-Band Portable Radio

Patrolman CB-60 by Realistic



Save \$40

5995

Reg. 99.95

- VHF Hi and Lo
- UHF • FM • AM
- All-Band Fine-Tuning
- CB Squelch Control

Receives all 40 CB channels, all three police bands, aircraft, VHF weather stations, more. Dual antennas, dial light button, headphone jack. AC/battery operation. #12-766

### 20% Off Our Finest Video Game!

Tandyvision™ One by Radio Shack



Save  
\$50

19995

Reg. 249.95

Powerful microprocessor produces the finest sound effects and color. Attaches to any color TV. Poker/Blackjack cartridge included. #58-1000

### "Radio Shack" Battery Checker

By Micronta



Cut 30%

279

Reg. 3.99

Looks just like our ENERCELL® batteries! Tests 9V, "C", "D" and "AA" sizes. #22-098

### Bike Radio With Horn

By Radio Shack



25% Off

1495

Reg. 19.95

Fits on Handlebars of Most Bikes

AM radio with built-in pushbutton electronic horn, safety reflector. #12-197

### Calculator With 4-Key Memory

EC-273 by Radio Shack



40% Off

1195

Reg. 19.95

Save \$8. Easy-to-read 8-digit LCD, auto power-off. With batteries, case. #65-683

## FREE!

## ENERGY CLINIC



Get the facts on efficient, infra-red quartz heat from a Presto Factory Representative!

Wilson Only  
2101 S. Tarboro St.

## PRESTO QUARTZ Heater

Quartz heat provides direct, radiant heat; just like the sun's rays. Warms people quickly on contact with no need to first heat the air around them. Quartz tube produces heat as much as 500° F. hotter at the source than other types of heaters.

3808-080-0

ENERGY CLINIC SPECIAL!

Presto has the quality Quartz heater with the features you can depend on: Dual quartz tube; "Energy Control" regulates electrical consumption and heat output; top mounted controls; parabolic reflector for wide heat pattern; swing up carry handle and more.

NOW \$3490

