

Weather
Occasional rain tonight and Thursday. Low in mid-40s, Thursday high in low 50s.

THE DAILY REFLECTOR

INSIDE READING
Page 7 — Christmas in Norway
Page 19 — Nancy Roberts, ghost writer visits.

101ST YEAR NO. 299 GREENVILLE, N.C. WEDNESDAY AFTERNOON, DECEMBER 15, 1982 92 PAGES—8 SECTIONS PRICE 25 CENTS



Sewage Treatment Plant May Be Started In 1983

By STUART SAVAGE
Reflector Staff Writer

Construction of a new sewage treatment plant for Greenville could get under way next year — 12 to 24 months sooner than expected — with 87½ percent of the estimated \$10.4 million price tag being paid for from federal and state money, Greenville Utilities commissioners were told Tuesday night.

The Greenville project could be moved to "fifth place in the fiscal year 1983 (Oct. 1, 1982, to Sept. 30, 1983) funding priorities," GUC Director Charles Horne told commission members. But he said the final position of Greenville on the municipal construction grant priority list will depend on a state Department of Environmental Management public hearing next week in Raleigh, and final approval of the funding schedule by DEM in mid-January.

Although planning for the new waste-water treatment plant began in 1973, changes in regulations and federal red tape delayed the completion and final approval of preliminary plans until mid-1981.

At that time, Greenville's priority rating was so low, and the threat of a drastic reduction or complete elimination of federal aid so great, that Utilities Commission members voted to use local money and move ahead with the detailed design of the proposed facility. The commission also created a capital reserve fund to save money to help offset construction costs.

Detailed plans for the new plant were completed earlier this year, at a cost of \$505,000 in local money, but local officials still believed that it would be 1984 or 1985 before any federal funds would be available for construction.

Horne said Tuesday night he is optimistic that Greenville's fifth place position on the priority list will be maintained. If it is, Horne said, final DEM approval of the design could come so the project would be "ready to go to contract by the summer."

close watch on the progress of funding of North Carolina facilities.

The committee has jurisdiction over federal expenditures on military bases.

"There's certainly no guarantee, but it does mean people in North Carolina affected by the bases will have a direct line to the armed services committee rather than having to go through a member of Congress not on the committee," Woodruff said. "It should improve the prospects of their requests' being heeded."

In a news release, East said his appointment "is especially significant for North Carolina because of the many military installations in the state, and because no other member of Congress from North Carolina currently serves on the armed services committee of either house."

East also said he would support President Reagan's effort to counter Soviet military prowess.

"I am very concerned about America's defense posture, given the massive Soviet military buildup of the last decade, and I'm looking forward to working to improve our position," he said.

Woodruff said in a telephone interview that East favors MX missile production.

"Of course, he's very hopeful about talks with the Soviets bringing about arms reduction. But he thinks we need the MX independent of the arms reduction talks," Woodruff said. "He doesn't favor it solely as a bargaining chip."

East was named to the armed services panel by the Republican Conference Committee on Committees. He has not yet received subcommittee assignments.

In exchange for the new assignment, East relinquished his seats on the Senate Labor and Human Resources Committee and the Energy and Natural Resources Committee. He will retain his position on the Judiciary Committee and his chairmanship of the Separation of Powers Subcommittee.

Horne also told commission members that the "federal allocation has been made ... approved," and will pay 75 percent of the cost of construction. An additional 12½ percent of the cost will come from state funds.

Horne emphasized that if construction does begin in 1983, none of the \$4 million in bonds approved by local voters in 1979 for the sewer plant project will have to be

sold. He said the \$2 million now in the reserve fund should be more than adequate to pay the local share of the costs.

The new plant, capable of handling 10.5 million gallons a day, will be located on a tract of land north of the Tar River and east of the Eastern Bypass bridge.

Horne said this morning that "I have to believe" the key to the city's improved

position on the priority list is the fact that the regulations on discharge limits were raised in November, "which makes us in violation (with the old plant) without a special exemption. That moved us up sharply in priority points."

That point, coupled with the fact that "plans are finished and funds are available and we're ready to move ahead, moved us ahead

of some cities. I have to believe they are the basic reasons for it," Horne said.

"An exciting thing about the whole thing," Horne said, "is not that there will be a new 10.5-million gallon plant, but that land is available to expand to 20 million gallons a day ... for long term growth ... 20 or 40 years in the future. We won't be locked in like we are at the present plant."

Losses, But Not In Lives

BROOK VALLEY HOME DAMAGED BY FIRE — Members of the Eastern Pines Fire Department prepare to enter the home of Dolores Ridditt, 103 Dundee Lane, shortly after noon Tuesday. According to Fire Chief Lyman Hardee, the fire started in the den of the brick home. Hardee said no one was home

when the blaze began. Damage to the den was extensive. Heavy smoke and heat damage was reported in the rest of the home. The origin of the fire was not immediately known. Damage was estimated to be about \$30,000. (Reflector Photo by Tommy Forrest)

East Is Named To Choice Committee

By JOHN FLESHER
Associated Press Writer

North Carolina military bases should benefit from U.S. Sen. John East's appointment to the Senate Armed Services Committee, a post East has sought since

his election in 1980, an aide says.

East announced the appointment in a news release Tuesday. He was unavailable for further comment, but aide Jerry Woodruff said East will be able to keep a

close watch on the progress of funding of North Carolina facilities.

The committee has jurisdiction over federal expenditures on military bases.

"There's certainly no guarantee, but it does mean people in North Carolina affected by the bases will have a direct line to the armed services committee rather than having to go through a member of Congress not on the committee," Woodruff said. "It should improve the prospects of their requests' being heeded."

In a news release, East said his appointment "is especially significant for North Carolina because of the many military installations in the state, and because no other member of Congress from North Carolina currently serves on the armed services committee of either house."

East also said he would support President Reagan's effort to counter Soviet military prowess.

"I am very concerned about America's defense posture, given the massive Soviet military buildup of the last decade, and I'm looking forward to working to improve our position," he said.

Woodruff said in a telephone interview that East favors MX missile production.

"Of course, he's very hopeful about talks with the Soviets bringing about arms reduction. But he thinks we need the MX independent of the arms reduction talks," Woodruff said. "He doesn't favor it solely as a bargaining chip."

East was named to the armed services panel by the Republican Conference Committee on Committees. He has not yet received subcommittee assignments.

In exchange for the new assignment, East relinquished his seats on the Senate Labor and Human Resources Committee and the Energy and Natural Resources Committee. He will retain his position on the Judiciary Committee and his chairmanship of the Separation of Powers Subcommittee.

Dedicating New C-Of-C Home Here On Thursday

By MARY SCHULKEN
Reflector Staff Writer

After 10 months and \$233,000 of restoration, the historic Fleming House in Greenville will be dedicated Thursday as the new home of the Pitt-Greenville Chamber of Commerce.

The dedication marks the end of a six-year search for a suitable headquarters for the organization, said chamber President Ed Walker.

"Originally the chamber purchased a lot on Red Banks Road with the idea of building there but the building would have cost \$500,000," said Walker. "We said 'hey, we can't do that.'"

"Then the city bought the entire block that the house was on and we found there was more money available for the preservation of historic buildings. We looked at the Fleming House, studied it and decided it was feasible and the city was willing to give us a 25-year lease in 1981," he said.

"There was also quite a bit of concern that the chamber be located in the downtown business district," said Walker, "and the Fleming House is here."

After that, two committees of chamber members, the building fund committee and the restoration committee, got the project going.

The building fund committee solicited pledges for renovation work and sought sponsors for special rooms and staff offices. The renovation committee oversaw the actual work itself, making certain the authenticity of the modified Victorian style structure was preserved.

Restoration began in February 1982 and was completed in November.

Sponsors for all but three rooms of the house have been found, said Walker, which leaves the chamber around \$30,000 short of paying for the \$233,000 project.

"When we find these sponsors the chamber will be debt-free for the restoration," he said. "We actually lack about \$22,000 paying for it," he said, "but the interest on the balance will bring it to about \$30,000."

A committee is working to raise these monies now, he said. The major restoration projects, said Walker, was replacing the 80-year-old slate roof, a chore which cost in excess of \$38,000, and replacing the weatherboarding on the house, which cost \$19,000.

"During the whole project we never moved more than one wall," said Walker. "We had to move one downstairs to bring the house up to the city code for bathrooms, but all the others are as they were originally."

The house is in the process of being designated a National Historic Site, he said, and that's why close attention was paid to authenticity.

The house, built in 1902, was the home of Sen. and Mrs. James Fleming for many years. Fleming had an architect from Tennessee design the house in 1900 and construction took from 1901 until the summer of 1902.

According to Walker, the house has added significance to the chamber because the first mention of a chamber of commerce in the area is connected with Fleming.

"He (Fleming) called all business leaders together to try to get the money to get ECU here," said Walker, "and that's the first time a chamber in the area was mentioned."



Larkin Little Elected Home Federal President

Larkin Little, executive vice president of Home Federal Savings & Loan Association, was elected president and chief executive officer at the association's 77th annual shareholders meeting here Tuesday.

Little, who is also a member of Home Federal's board of directors, succeeds David J. Whichard II as president.

In his report to shareholders, Little said that savers of Home Federal earned a record \$7,245,000 in interest during the year. He said the deregulation of the financial industry by the government continued at a rapid pace during 1982. Little said that as interest rates began to decline in late summer and prospects for economic recovery began to look brighter, the Depository Institution Deregulation Committee "worked overtime to create new accounts that would be competitive with other

nonregulated investments."

He said Home Federal "welcomes 1983 with renewed optimism as the economic conditions, which continued to test the savings and loan institutions over the past year, begin to stabilize and improve."

Little reported that, "High mortgage rates, the direct result of high savings costs, severely dampened the local housing market last year. Even so, our mortgage portfolio now totals \$53,700,000." He said the firm's assets as of Sept. 30 totaled \$66,719,036.

"Lower interest rates and new powers granted savings and loans will put Home Federal in a stronger position to serve our depositors and borrowers as we move into 1983," said Little.

In addition to Little, officers of the association are: Kenneth K. Dews, chairman of the board; Howard L. Hodges Jr., vice president; Faye G. Adams, vice president and secretary, and Carolyn B. Rollins, vice president and treasurer. Also elected were Jerry A. Carson, Carlyle Hall and C. Hal Knox, assistant vice presidents, and Donna C.



LARKIN LITTLE

(Please turn to page 20)

REFLECTOR

HOTLINE



752-1336



Hotline gets things done for you. Call 752-1336 and tell you problem or your sound-off or mail it to Hotline, The Daily Reflector, Box 1967, Greenville, N.C. 27834.

Because of the large numbers received, Hotline can answer and publish only those items considered most pertinent to our readers. Names must be given, but only initials will be used.

ART SUPPLIES ASKED

Gary Jones, who teaches art to inmates at two correctional centers, in Creswell and Williamston, and also to senior citizens at the Villa Nursing Home in Williamston, has an urgent need for supplies — particularly oils, canvasses, and brushes. Any other art supplies are also badly needed. Jones teaches in these three places under the auspices of Beaufort and Martin community colleges. One of his students at Creswell, Rick Woolard, recently won Best in Show prize at the show of inmate art held at Carolina East Mall in Greenville. Anyone who can donate supplies or other assistance is to call Jones at 792-7007 in Williamston, or Jerry Raynor, 752-6166 in Greenville, to arrange for pickup of donations.

TOOTS SIGHTED?

Some time ago Hotline ran an appeal for the safe return of a beagle-basset hound named Toots. Toots was lost in downtown Greenville and her owners, the Whit Brown family, advertised extensively for her; then Hotline became a last resort. Around Thanksgiving Toots was sighted near the fire tower on State Road 1708 between Bell's Fork and the Old Tar Road (Evans Street Extension), not far from her home, and was all but positively identified by someone who knew her well. However, when her owners arrived, she wasn't there. Anyone having seen Toots, who looks more like a basset hound than a beagle, is asked to call the Browns, 756-8655 or 756-4003.



MARLENE SOROSKY, author of "Marlene Sorosky's Year-Round Holiday Cookbook." (Photograph by Robert R. Steir.)

Marlene Sorosky Enjoys Helping Holiday Cooks

By CECILY BROWNSTONE
Associated Press Food Editor
Cooks who like to entertain at special times, but need help with menus and recipes, may find "Marlene Sorosky's Year-Round Holiday Cookbook" a lifesaver. Marlene's offerings cater to cross-country tastes — some are epicurean, some typically American.

Including Christmas and Hanukkah and New Year's, of course, Marlene's book covers the holidays and special occasions. There's a Valentine's Day Dinner and a St. Patrick's Day party, an Easter gala buffet and a Passover Seder. Mother's Day and Father's Day are treated; so are wedding anniversaries — with a dinner menu for 16 that may be halved or doubled.

She also gives menus and recipes for a graduation party, baby shower brunch, sweet sixteen luncheon and wedding reception. And, of course, patriotic parties get their due: there's a Fourth of July barbecue, a Labor Day picnic and an Election Returns lap party. Thanksgiving isn't neglected, neither are treats for Halloween.

Marlene has studied with some of the best culinary teachers in the United States and abroad and has wide experience in conducting cooking classes herself. I particularly like the way she melds the old and the new. For example, she transforms such a classic dessert as Linzer Torte into Linzer Cookies. As to the new — I vote for her Currant-Studded Pate. I found her chicken liver mixture, with its imaginative addition of currants soaked in white wine, both delicious and interesting — and so did my tasters.

A tree decorating ceremony using Buddy Poppies was held. Funds from the project will be used for veteran relief. Estelle Steiner reported that \$311 was raised for the Cancer Aid and Research Fund. Dorothy Armistead reported on the Lite-A-Bike program.

Participants in the Voice Democracy Contest will be honored at a dinner meeting of the American Legion Post this month.

Margaret Brown, Mattie Askew, Lil Joyner, Mrs. Armistead and Madeline Vincent were meeting hostesses.

Marinate currants in white wine for 4 hours or overnight. Drain, reserving the juices. Melt 4 tablespoons butter in a large skillet. Sauté mushrooms, green onions, salt and garlic until soft, about 3 minutes. Add livers and sauté over moderately high heat, turning until livers are browned

outside but pink within. Stir in the reserved wine and Tabasco sauce. Cover and simmer slowly for 5 minutes. Cool.

Transfer mixture to a food processor fitted with the metal blade or to a blender. Process until smooth. Add remaining stick of butter and blend until smooth. Remove to a bowl and stir in currants. Spoon into a 3-cup crock or pate mold. Cover and refrigerate for at least 4 hours. May be refrigerated for 2 days or frozen for 1 month. Before serving, bring to room temperature. Serve with bread rounds or crackers.
Makes 3 cups; serves about 12.

Recognition Program Held Recently

"Christmas on a Budget" was the theme of the semi-annual recognition of homemakers successfully completing work in the Expanded Food Nutrition Education Program.

Betty Bryant, Peggy Daniels, Addie Daniels, Betty Artis, Patricia Conner, Johnnie Raspberry and Sandra Chapman were recognized.

During the program discussion and demonstrations were given on inexpensive Christmas meals, desserts, gifts (six in one cookies), food safety and storage along with decorating ideas using

natural items, nuts, fruits, popcorn, berries, vines and greenery.

Demonstrations were given by Theresa Aman, Zelma Carmon, program aides, and Addie R. Gore, home economics extension agent. Other aides working in the program are Mary Barrett and Lillie Claxton.

The EFNEP is designed to help homemakers improve their knowledge and skills in preparing nutritious and economic meals for their families.

Duplicate Winners

Mrs. W.R. Harris and Mrs. J.M. Horton were first place, North-South winners Saturday in the duplicate bridge game played at Planters Bank. Their game percentage was .574.

Others placing were Mrs. Lacy Harrell and Mrs. J.W.H. Roberts, second; Mrs. David Stevens and Mrs. Effie Williams, third.

East-West winners were: Mr. and Mrs. Wesley Webb, first with .562 percent; Mrs. Harold Forbes and Mrs. George Martin, second; Mr. and Mrs. Jeff McAllister, third.

Wednesday afternoon winners included: North-South, Mrs. J.W.H. Roberts and Mrs. Lacy Harrell, first with .577 percent; tied for second were Mrs. J.M. Horton and Mrs. Beulah Eagles with Mrs. Dot McKemie and Mrs. Ray Gunderson.

East-West: Mr. and Mrs. Andrew deSherbinin, first with .693 percent; Ms.

Estelle Eastwood and Mrs. C.D. Elks, second; Chris Langley and Ed Yauck, third.

Mrs. Sibyl Basart and Frank Goins were first place winners in the Wednesday morning game played at Planters Bank. Mrs. Eloise Gabbert and Mrs. Beverly Maxon placed second, Mr. and Mrs. Wendell Smiley, third and Mrs. Everett Pittman and Mrs. John McConney, fourth.

Little University Preschool

- Certified Kindergarten
- Pre-Kindergarten
- Class Taught Age 2 and Up
- School Transport-AM/PM

Greenville 752-7148 Farmville 752-5681

In 1894, French Capt. Alfred Dreyfus was condemned and publicly degraded on a charge of selling military secrets to Germany. He subsequently was exonerated on all charges.

Since 1923

Luzier

Personalized
Cosmetics
Especially
Formulated
For Each
Skin Type

Call In
Greenville
District Manager 752-1201

Please Clip For Future Reference

Reports Given At Meet Of Auxiliary

Pam Sinding Larsen of Oslo, Norway was a special guest at the meeting of the Ladies Auxiliary to the Veterans of Foreign Wars. She is visiting friends in this area.

erans of Foreign Wars. She is visiting friends in this area.

Rosa Lee Boyd reported that 23 Gold Star Mothers in the county had been remembered with Christmas gifts. Lillian Bradshaw has delivered gifts to two patients at O'Berry Center. Other patients were given gifts, magazines, books and fruit. Mrs. Boyd, Sally Vainright, Marie Stocks and Mrs. Bradshaw attended the Christmas program at the center Dec. 3.

A tree decorating ceremony using Buddy Poppies was held. Funds from the project will be used for veteran relief. Estelle Steiner reported that \$311 was raised for the Cancer Aid and Research Fund. Dorothy Armistead reported on the Lite-A-Bike program.

Participants in the Voice Democracy Contest will be honored at a dinner meeting of the American Legion Post this month.

Margaret Brown, Mattie Askew, Lil Joyner, Mrs. Armistead and Madeline Vincent were meeting hostesses.

Musical Program Held By Chapter

FARMVILLE — A program of Christmas music highlighted the meeting of the Major Benjamin May Chapter DAR held Saturday at the chapter house here.

Dr. Will Wallace and daughters, Cindy, Laura and Connie presented the program. Dr. Wallace is pastor of the First Christian Church in Greenville. They were introduced by Mrs. Fred Sauls.

Mrs. C.H. Carr presented a book to the DAR Good Citizen Award winner, Jennifer Walston. Rosaland Britt gave the national defense report.

The meeting was conducted by Mrs. Elmer Flake, regent.

Mrs. Alex Allen III, Mrs. Moses Moye, Mrs. R.E. Deans and Mrs. Sauls were meeting hostesses.

Births

Harris
Born to Mr. and Mrs. Lennie Hal Harris, Ayden, a daughter, Nicole Lynn, December 4 in Pitt County Memorial Hospital.

Ivey
Born to Mr. and Mrs. Charles Allen Ivey, Stan-tonsburg, a daughter, Amy Lynn, December 4 in Pitt County Memorial Hospital.

Cannon
Born to Mr. and Mrs. Nathan Lee Cannon, Rt. 3, Ayden, a son, Nathan Cornell, December 6 in Pitt County Memorial Hospital.

Moore
Born to Mr. and Mrs. Donald Eugene Moore, 405 Contentnea Street, a son, Troy Broshon, December 6 in Pitt County Memorial Hospital.

Share the magic of the season.
The FTD Holiday Glow® Lantern Bouquet.

Greenville Flower Shop

1027 Evans Street
Phone 758-2774
Mastercharge & Visa Welcome

Send your greetings with special care.

® Registered trademark of Florists Transworld Delivery Association

Pk 'n Pay Shoes®

dress shoe sale
25% off and more...

...on a great collection
of our newest,
best selling
styles.

\$12

Reg.
\$16.97
and \$18.97

■ Matching clutches.
25% off and more

■ All panty hose... 1/3 off

Greenville Blvd. on 264 By Pass
Greenville, N.C.

Sale prices good thru Sun. MasterCard or Visa. Open evenings

We've Got Christmas All Wrapped Up Ladies Dept.

Select Group Of	25%-50% off
Ladies Dresses	
All	
Ladies' Gloves	20% off
Select Group Of	
Sportswear Jackets, Skirts, & Slacks	25% to 40% off
Select Group Of	
Ladies Skirts & Blouses	25% to 1/3 off
Group Of Ladies	
London Fog Coats	20% off

Children's Dept.

All Outerwear Weather Tamer, London Fog, Tiny Tots	25% off
Children's	
Robes & Gowns Toddlers 2-4 Sizes 7-14	25% off
Children's	
Corduroy Levis	\$11⁸⁸ to \$16⁸⁸

Men's Dept.

Izod Sweaters	25% off
Group Of	
Men's Flannel Shirts	20% off
Group Of	
Men's Sportcoats & Suits	20% off

Gift Dept.

Original	
Christmas Tree China by Cuthbertson (Downtown Only)	25% off
Fieldcrest	
Electric Blankets	1/3 off

Shoe Dept.

Select Group Of	
Ladies Shoes	Up to 1/3 off

Blount-Harvey

December
15 thru 18

Downtown Greenville
Shop Daily 10 to 5:30

Carolina East Mall
Shop Daily 10 to 10



Dear Abby



Invitation May Miss This Ms.

By Abigail Van Buren
© 1982 by Universal Press Syndicate

DEAR ABBY: To educate the uninformed, please print this:
Many women retain their maiden name after they marry. In addressing invitations and cards to a married couple when this is the case, the envelope should read: Mr. Peter Smith and Ms. Joan Jones
Street address and apartment number
City, state and zip code

Notice that the husband's and the wife's name are on the same line. Of course, if Joan uses her maiden name only for her professional life, social invitations to the couple should be addressed to Mr. and Mrs. Peter Smith.

When a couple is not married but lives together, write each name on a separate line in alphabetical order.

My husband and I are part of a growing group of liberated couples who do not choose to use the same last name. We run across many people who just do not know, and a few who refuse to accept the fact, that separate names are correct, proper and socially acceptable.

Abby, your column is responsible for the education of many — how about a lesson in the "new" and "proper" way to address invitations, cards, letters, etc. Just sign me...

I AM A PERSON AND MY FIRST NAME ISN'T MRS.

DEAR ABBY: Recently I had my club of girls over for lunch. There are five of us — all in our 50s. Two girls are heavy smokers. After they left, I noticed a tiny cigarette burn in my best tablecloth!

How can I tactfully suggest to these smokers that they should be more careful?

NO TOWN, PLEASE

DEAR NO TOWN: Actions speak louder than words. Next time you have the girls over, put heavy-duty placemats where you want the smokers to sit. Explain that "someone's" cigarette burned a small hole in your favorite tablecloth, so you are trying to prevent a similar accident from happening again.

DEAR ABBY: My recently retired husband has me worried. John (not his real name) is a good provider, kind, loving and doesn't hit the sauce. His passion is golf.

I don't mind his golfing every day, but I know that it doesn't take all day to play 18 holes of golf.

In the back of my mind I am wondering if maybe there isn't another woman. Please tell me if you think it would

A Christmas Police Tip: If you are planning to be out of town during the holidays, call the Police Department so your home can be checked during your absence - 752-3342.

The Flattering Look Of A Dress

PARTY PERFECT — Special evenings are right around the corner. And just the thing for those gala times is the party dress in silky georgette or rustling taffeta. Whether flirty and feminine,

left, in an off-the-shoulder style, or linear and sophisticated, right, you'll make a sensational entrance at any after-5 event. (Left, by Sweet Talk; right, by Act I; both in Silky Touch polyester by American Enka.)

CORRECTION
In "Wrap Up A Beautiful Christmas At Sears" safe section in today's paper on page 5, the chain saw No. 35714 selling for \$199.99 is no longer available. We are sorry for any inconvenience this might cause you.
Sears, Roebuck And Co.
Greenville, N.C.

Births
Parrish
Born to Mr. and Mrs. Thomas Crane Parrish, 103 Woodhaven Road, a son, Justin Thomas, December 7 in Pitt County Memorial Hospital.
Shields
Born to Mr. and Mrs.

Benjamin Shields III, D-8 Oakmont Square, a son, Benjamin Shields IV, December 7 in Pitt County Memorial Hospital.
Adams
Born to Mr. and Mrs. Richard Luther Adams, Vanceboro, a son, Bradley Keith, December 7 in Pitt County Memorial Hospital.

Mitchell's
Hairstyling Academy
Pitt Plaza Shopping Center
756-3050

Coupon Good Dec. 16, 17, 18, 21, & 22 Only

Lustre Curl. Reg. 39.50 Now **32⁵⁰**
With Coupon Haircut Included

Our Everyday Inflation Fighters
Shampoo & Set... **\$4⁰⁰**
Haircut... **\$4⁰⁰**

Grand Award Perm Reg. \$19 Now **16⁹⁵**
With Coupon Haircut Included

be OK for me to call the club to find out what time John has signed in to play — and what time he finished playing.
HIS WIFE
DEAR WIFE: Don't call the club to check up on John. If you suspect there's another woman in his life, ask him. Maybe he's playing 27 holes. Or 36.
DEAR ABBY: When things get rough, I always recall the wise words of Walt Disney: "You may not realize it when it happens, but a kick in the teeth may be the best thing in the world for you."
OFTEN KICKED IN KICKAPOO, TEXAS

DEAR KICK ED: True. And it's not bad for your dentist, either.

Microwave Class Set

A basic class for new microwave owners will begin Jan. 4 and is being offered by the Pitt County Agricultural Extension Service.

Basic mic rowaving terminology and techniques in preparing meals and dishes including appetizers, casseroles, beverages, soup, meats, eggs, seafood, fruits, vegetables, milk and cheese will be included.

Addie Gore, home economics extension agent, will teach the classes at 10 a.m. and again at 7 p.m. in the extension office.

Registration is \$5.00 in advance and the deadline is Dec. 20. For information call 752-2934, extension 369.

Christmas Trees
Available At
Little's Nursery
Highway 284 West of Greenville
3 miles 756-3825

For Christmas:

- gifts in-
- Handwoven Shawls etc.
- Pottery Leather etc.
- Cable Yarns 12:30-5:00 Daily

812 Dickinson Ave
752-0715

THE WISHING WELL

GREETING CARD AND GIFT SHOP

GREENVILLE SQUARE SHOPPING CENTER

BOXED AND INDIVIDUAL CHRISTMAS CARDS
CHRISTMAS CANDLES • CHRISTMAS PARTY NEEDS •
BRASS • PEWTER • LEAD CRYSTAL GIFT ITEMS • MUSIC BOXES • STATIONERY • CALENDARS • HOLLY HOBBIE CERAMICS • RIBBON • KEPSAKE GIFT CERAMICS • GIFT WRAP • ZIGGY DOLLS AND ZIGGY GIFT ITEMS

Hours 10 AM to 9 PM
American Greetings®
"...when only the finest will do."
Phone 756-0063

Belk Tyler
carolina east mall greenville

Don't Pay Rent on Your Phone Any More! Why Not Buy One Now and Save Later!

YOUR CHOICE 39.88

Take advantage of this special offer. All telephones are completely refurbished by Carolina Telephone and carry a six-month warranty. And with this low, low price you can have one for every room in the house. Choose from the following:

A. Doodle... Rotary and U-Touch phone with pad for taking notes or just doodling while talking on the phone. In cocoa brown and harvest gold.

B. Dawn... Rotary dial phone that would look nice in almost any decor in the house. Cocoa brown.

C. Contempra... Rotary and U-Touch phone with an ultra modern look in cocoa brown and harvest gold.

DON'T RENT... BUY NOW AND SAVE!

Shop Monday Through Saturday 10 a.m. Until 10 p.m. — Phone 756-B-E-L-K (756-2355)

Belk Tyler
carolina east mall greenville

IT'S CHRISTMAS

TRUNK SHOWING!

Misty Harbor® All-Weather Coats Reduced Up to \$34

20% OFF
Reg. \$145 to \$170

NOW \$116 to \$136

All-weather coats complete with a zip-out wool/acrylic lining. It's like having two coats in one! Mr. L.H. Garnett, our representative from Misty Harbor®, will be here in our store on December 16th, 1982 from 10 a.m. Until 9 p.m. He will share with us his complete line of all-weather coats. Select from our stock or special order your choice today! See you there!

Added Bonus:
Bring This Coupon In For An Additional \$10 Off the Sale Price on December 16th Only! Just In Time For Christmas!

COUPON
\$10.00 OFF
Ladies' Misty Harbor All-Weather Coats
Valid December 16th, 1982 ONLY

Shop Monday thru Saturday 10 a.m. Until 10 p.m. — Phone 756-B-E-L-K (756-2355)

Defeat Means Chaos

Tomorrow will be an important day for area tobacco farmers. They will be voting on the continuing of marketing quotas for the next three years.

Stacy J. Evans, county executive director for the Pitt ASCS, said that if the marketing quotas are approved growers will be eligible for price support loans on 1983, 1984 and 1985 crops.

If the referendum should fail there will be no quotas, no price supports and there would be unlimited tobacco production. It is clear that the stakes are high for allotment holders and tobacco producers. The tobacco program faced serious changes in Congress this year, one of the most important

being an assessment on tobacco sold to finance the price support program. Thus the program on which farmers will be voting is far different from the ones of past years.

Nevertheless it is essential that the acreage-poundage marketing quotas be approved. If the issue should lose we can be certain that the most immediate result will be chaos for area farm economy and the tobacco industry in general. Almost certainly there would be considerable overplanting of tobacco next year and with the surplus of tobacco already on hand the result is predictable.

We urge all who are eligible to visit their polling place tomorrow and vote in the tobacco referendum.

Bill Of Rights Is Precious

Perhaps nothing is taken for granted in our nation more than the Bill of Rights, the first 10 amendments to the Constitution.

Yet nothing has affected the lives of Americans more than these amendments.

They guarantee us the freedom to worship as we choose, freedom of speech and freedom of the press.

They guarantee the sanctity of our homes by prohibiting the takeover of homes by the military and banning unreasonable search and seizure. The right to speedy and public trial by impartial jury is guaranteed. Excessive bail, excessive fine and cruel and unusual punishment are banned.

The wording of the Bill of Rights is simple and clear and it was added to the original constitution to protect our individual rights. It has resulted in the building of a free society where we all enjoy freedoms which are envied by much of the world.

Tonight there will be a public program at 7:30 in ECU's Willis Building at which speakers will pay their tributes to these unique privileges that our founding fathers laid out for us. On this Bill of Rights day we should all be thankful for the foresight of those who provided for us this most precious thing — freedom.

THIS AFTERNOON

A Success Story

By PAUL T. O'CONNOR
RALEIGH — Behind the controversy created by the proposed closing of Dorothea Dix Hospital is a success story — a story of how modern medicine has reduced the need to lock away mental patients in large state institutions.

breakthrough — the development of thiorazine, a psychotropic drug. Thorazine and other psychotropic drugs developed since 1956 allow doctors to treat the



PAUL T. O'CONNOR

Dr. Sara Morrow, secretary of the Department of Human Resources and Community Development, has proposed closing the under-used Dix Hospital and transferring its patients to open beds in the state's three other mental hospitals at Goldsboro, Butner and Morganton. A hospital system that once held 10,000 patients now has less than 3,000.

Why is the hospital population down so much? Have we cured mental illness? No, there still is no cure for mental illness but there are drugs which treat the symptoms of mental illness, says Dr. Gene Douglas, director of the state Division of Mental Health. You can't cure the common cold, he says, but medicines exist to treat a runny nose and a bad cough. The same is true for mental illness. You can't cure it, but you can treat the depression, paranoia, hyperactivity and other symptoms mental illnesses create.

Douglas ascribes the success in treating mental illness to a 1956 medical

symptoms of mental illnesses. As long as the patient continues to take his medicine, he'll most likely be able to control his problem. Douglas estimates that 100,000 North Carolinians are taking psychotropic drugs and are thereby controlling symptoms of mental illness.

Since that medical breakthrough, the state's mental hospital population has dropped steadily from an all-time high of 10,267 to about 7,500 in 1970 and to 2,826 in July of this year.

The development of psychotropic drugs has been paralleled by the devel-

opment of 41 local and regional mental health centers that serve outpatients in all 100 counties. "Deinstitutionalization" means that people who are in hospitals today can be released to the care of a local facility, or, people in the community with mental problems can be spared the necessity of ever entering a mental hospital.

As local centers expand services, there'll be less need for large hospitals. Within 10 years the state will need only two hospitals. By the end of the century, only one — for rare disorders, research and training. It will probably serve only 500 patients, Douglas predicts.

Dix has been chosen for closing primarily because it serves the region of the state which has progressed the furthest in the development of local community mental health centers. Several of these centers, Douglas says, offer a complete range of services to local patients and rarely send anyone to Dix.

Dix has an annual budget of \$32 million — \$26 million of which comes from the state. Douglas says that if the hospital is closed, \$12 million would have to be moved to other hospital budgets. DHR is asking that \$6 million go into the improvement of community programs. That means the state would save (Please Turn To Page 5)



By ART BUCHWALD

Bonzo In White House

It has been one of the best-kept secrets of the administration. When the Reagans first moved into the White House they brought "Bonzo," the President's favorite chimpanzee with them. Bonzo keeps to himself playing in the attic or down in the basement, and swinging on trees on the south side of the white House lawn at night when no one is around.

When the Reagans are alone in their upstairs living quarters, Bonzo might sit in the President's lap while they reminisce about their days on the old Warner Brothers lot.

Bonzo has never caused the President any embarrassment until recently.

What happened was that the Reagans had decided not to take Bonzo to California for their Thanksgiving holidays because he had a cold.

Bonzo was very angry about this and as soon as everyone in the White House was gone, he managed to get out of the attic where he was locked up, and started exploring the west Wing, a place he had never been before. The West Wing is where the Oval Office is and where all the President's top administration officials work.

The Chimp walked into an empty office and saw a computer standing in the corner. Bonzo hit a couple of keys and the words MORE BUDGET CUTS came up on the screen. This delighted him and he started to hit some more keys. The words UNEMPLOYED came up on the screen and Bonzo clapped his hands and hit the keys again. The words TAX UNEMPLOYMENT BENEFITS appeared and then Bonzo hit a communications key and the message was dumped into a computer that prints out white House Press releases. The printer immediately

went to work: THE WHITE HOUSE ANNOUNCED TODAY THAT IT WAS CONSIDERING TAXING UNEMPLOYMENT BENEFITS AS A WAY OF GETTING PEOPLE TO LOOK FOR JOBS.

being given serious consideration. Ed Meese, one of the President's top aides, had a tough decision to make. He could either defend the tax that afternoon or wake up the President. He opted for defending the tax rather than interrupt the President's nap.

In the meantime Bonzo was back at the White House having a great time. He got the hang of working the computer and pretty soon he was feeding it stuff like BUDGET CUT IDEAS FOR CHRISTMAS, TAX ALL MEDICAL BENEFITS AS INCOME, RECOMMEND USER TAX ON WHEELCHAIRS, PUT SURCHARGE ON SALVATION ARMY, DO AWAY WITH TAX SHELTERS FOR UNMARRIED MOTHERS, and ADD 10 PERCENT EXCESS PROFITS TAX FOR BLOOD BANKS.



ART BUCHWALD

An AP man picked up the press release and sent it out on the wires and that night on all the news shows it was announced as the lead story of the day.

When the news got to the West Coast White House headquarters in Santa Barbara, everyone was confused as to what had happened. There had been some talk about taxing unemployment benefits, yet it was just one of many options the OMB was going to show the President. But since the word had been officially released, the staff assumed that someone had given the green light to send it out.

Larry Speakes, the White House press secretary, didn't want to look ignorant, as he confirmed to reporters that the unemployment tax was

being given serious consideration.

Ed Meese, one of the President's top aides, had a tough decision to make. He could either defend the tax that afternoon or wake up the President. He opted for defending the tax rather than interrupt the President's nap.

In the meantime Bonzo was back at the White House having a great time. He got the hang of working the computer and pretty soon he was feeding it stuff like BUDGET CUT IDEAS FOR CHRISTMAS, TAX ALL MEDICAL BENEFITS AS INCOME, RECOMMEND USER TAX ON WHEELCHAIRS, PUT SURCHARGE ON SALVATION ARMY, DO AWAY WITH TAX SHELTERS FOR UNMARRIED MOTHERS, and ADD 10 PERCENT EXCESS PROFITS TAX FOR BLOOD BANKS.

After a while Bonzo got bored, and started jumping around. He saw a Telex machine which said HOTLINE TO THE KREMLIN and started hitting the keys. The screen lit up with HAPPY THANKSGIVING TO AMERICAN CAPITALISTS. THIS IS A TEST. Bonzo responded, ANDROPOV IS THE BIGGEST TURKEY IN THE SOVIET UNION. THIS IS NOT A TEST.

Fortunately, at that moment a Secret Service man walked into the west Wing office and grabbed Bonzo away from the hot line and gave him a banana. The agent then called the western White House and told them that he caught Bonzo working the hot line.

(Please Turn To Page 5)

Nancy Likes James Baker

By ROWLAND EVANS and ROBERT NOVAK

WASHINGTON — Evidence that James Baker may well survive as White House chief of staff is word privately passed by Nancy Reagan praising him as a total Reagan loyalist — a status previously reserved in her pantheon for counselor Edwin Meese and deputy chief of staff Michael Deaver.

Until recently, Baker was regarded by the first lady and other Reagan insiders as an outsider, not quite to be trusted and more interested in his own welfare than the president's. Just as pressure on Baker intensifies, Nancy has changed her mind — and is making no secret of it.

A footnote: Definitely not in Nancy's pantheon is Lyn Nofziger, whose unauthorized call for a meeting of Reagan political operatives to plan the 1984 re-election campaign was denounced by Baker. When the Nofziger group met at lunch Dec. 7 without White House blessing, it agreed the most dangerous political problem Reagan faces is neither the nuclear issue nor the economy but the hostility of women.

Secretary of Transportation Drew Lewis enhanced his reputation as the Cabinet's most effective operator but won few friends in the House Republican leadership when he ramrodded the five-cent-a-gallon gasoline tax through the House.

House Republican Whip Trent Lott protested to Lewis about the bill's taxation on the trucking industry, added by the Democrats to the nickel gas tax. Lott urged him to demand of Speaker Thomas P. O'Neill that the taxes be trimmed down.

Lewis would not budge from his deal with O'Neill, lest the gas tax he had pushed relentlessly for two years be endangered. As party whip, Lott grinded his teeth and supported it. But on final passage, about half the Republicans — and half the GOP leadership — voted against the bill.

Weekend In NY

A secret meeting of some 20 conservative House Republicans convened in a Manhattan hotel this

weekend at the call of Rep. Jack Kemp to devise Republican strategy with particular emphasis on monetary policy to bring down interest rates.

Kemp originally envisioned the brainstorming session as an attempt to educate fellow congressmen on his monetary bill, co-sponsored by Kemp and House Republican Whip Trent Lott. But Rep. Newt Gingrich of Georgia, a Kemp ally, argued he had had enough "education" and wanted to make strategy. As a result, the meeting will do both.

As proof that the meeting is not a Kemp-for-President rally, the congressman's operatives note that Lewis Lehrman was on the meeting's agenda briefing the congressmen about monetary policy. Lehrman, 1982 Republican nominee for governor of New York, is widely considered to have presidential ambitions of his own.

Moscow VS. MX
A senior State Department official, furious at Soviet defense minister Dmitri Ustinov's attack on the MX missile two days before the House vote, privately admitted the bitter tirade from Moscow had one advantage: It would assure House approval of the new weapon.

Instead, the Ustinov threat of new Soviet missiles to counteract the big MX (a weapon whose size is more than matched by hundreds of existing Soviet missiles) had no discernible effect on the House. The MX went down under a deluge of votes.

A footnote: The State Department official was not alone in his hope that Ustinov's blackmail would influence congressmen to vote for the MX. Standing at the door to the House chamber during the voting, pro-defense representative Charles Wilson of Texas whispered to his colleagues as they entered the chamber: "A vote against the MX is a vote for Moscow."

Teddy's Non-Advisers

Contrary to published reports that a phalanx of oldtime advisers joined Sen. Edward M. Kennedy's family (Please Turn To Page 5)

Strength For Today

GRATITUDE IS A CULTIVATED VIRTUE

Do you ever worry over the fact that people do not appreciate you? Do you ever recall the ingratitude of those around you — perhaps your own children — and wonder why it is that having received so much they could care so little?

Let us bear in mind that gratitude is a cultivated virtue. People in their natural state are not grateful. It takes the careful tutelage of home life, the good offices of religion, and the loving encouragement of friends to

teach people the virtue and art of gratitude. Don't forget that you yourself are probably lacking in gratitude, and that this shortcoming is noticed by others.

People who are engaged in big and significant activities usually waste little time worrying about their not being appreciated. And don't forget that great people are not so much people who do great things as ordinary people who do ordinary things in a great way. — Elisha Douglass

Limits On Health Care Costs

By JOHN CUNIFF

AP Business Analyst
NEW YORK (AP) — Don't just catch up with the Joneses, the automobile ad said, "pass them." The ad seemed to be from another decade, because many Americans now seem happy to just keep pace with the other guy.

Consumers in the 1980s have learned to understand limitations, and anyone with a pencil in his or her hand can immediately draw up a list of them.

Big, heavier, more luxurious cars became unaffordable, especially after OPEC raised oil prices, so cars shrank. New houses, which had been growing in square footage and rooms in the 1970s, have followed the exact same course.

The eating of lean red meat, attendance at Ivy League colleges, the power of the bureaucracy, the spending ability of the federal government, wage and profit increases, fringe benefits, Social Security — all reached limits.

With all this happening, there is little question that the American dream might

also have reached its limits, temporarily however, because U.S. history shows that while imagination can be depressed for a while it cannot be killed.

But quickly advancing on Americans is a limitation they may not be prepared to accept, individually or collectively. It is the limitation on health care that seems to be ordained by the inability to keep health care costs down.

If there is any area in which people are inclined to say damn the costs, spend whatever is needed, this may be it. Life itself is involved. How do you tell a family that mother can be saved but that it isn't worth the cost?

"We're at a crossroads in this country," says Dr. William R. Fifer, University of Minnesota professor of medicine and public health. "What we're able to do medically exceeds what we're able to afford."

Others in medicine, including a former head of the American Hospital Association, have said essentially the same thing before. In fact, discussion of the subject is frequent in medical and hospital circles.

The answer to high costs was relatively easy when it involved outer space and the knowledge that technology and curiosity could carry the nation much further into that realm. With great disappointment, the nation said no.

It has never been able to give a sustained "no" to health care spending.

In 1960, U.S. health expenditures — personal health care, medical research, new medical facilities, insurance, and government-sponsored public health activities — totaled \$26.9 billion, or 5.3 percent of gross national product.

By 1970 the health care percentage of gross national product had risen to 7.5 percent. By 1980 it was up to 9.5 percent, based on expenditures of \$249 billion. And last year, spending amounted to \$286.6 billion, or 9.8 percent of GNP.

The Health Insurance Association of America, which provided these figures, points out that last year about \$1,200 was spent on health care for each man, woman and child, compared with roughly \$150 in 1960.

Some of the dollar increase

was, of course, a consequence of inflation. But by no means all, as the percentages of GNP indicate. This year, for example, an insurance company survey found that hospital daily service charges leaped 13.48 percent over 1981, at least double the overall inflation rate.

That study, which summarized data provided to Equitable Life Assurance by more than 2,500 hospitals during the third quarter of the year, found the average daily charge in a private room was \$167.50, and in intensive care, \$408.50.

The latter, in which the latest technology is utilized, provides an example of how high costs can go. To \$664.50 a day on average in the District of Columbia, for example. And to \$982.50 a day at a Stanford, Calif. hospital.

"We have discovered there is a finite amount of money available for health care, which places us in the dilemma of deciding how best to use this money," says Fifer.

"How," he asks, "does a nation ration something like health care?"

The Daily Reflector

INCORPORATED
209 Cotanche Street, Greenville, N.C. 27834
Established 1882
Published Monday Through Friday Afternoon and Sunday Morning
DAVID JULIAN WHICHARD, Chairman of the Board
JOHN S. WHICHARD — DAVID J. WHICHARD
Publishers
Second Class Postage Paid at Greenville, N.C. (USPS 145-400)



SUBSCRIPTION RATES
Payable in Advance
Home Delivery By Carrier or Motor Route Monthly \$4.00
MAIL RATES (Prices include tax where applicable)
Pitt And Adjoining Counties \$4.00 Per Month
Elsewhere in North Carolina \$4.35 Per Month
Outside North Carolina \$5.50 Per Month
MEMBER OF ASSOCIATED PRESS
The Associated Press is exclusively entitled to use for publication all news dispatches credited to it or not otherwise credited to this paper and also the local news published herein. All rights of publications of special dispatches here are also reserved.

UNITED PRESS INTERNATIONAL
Advertising rates and deadlines available upon request.
Member Audit Bureau of Circulation.

Public Forum

Letters submitted for Public Forum should be limited to 300 words. The editor reserves the right to edit longer letters.

To the editor:

Recently I read of a study on productivity made for the Wall Street Journal on automobile companies. It was noted that Toyota Motor Car Company produces better than 70 vehicles per year per employee compared with slightly more than 10 per year per employee for General Motors.

Presently there is a bill, HR 5133, on the floor of the U.S. House of Representatives which, if enacted into law, would protect inefficiency by limiting competition. In other words, if it is sold here it must be made here. This has absolutely no regard for the consumer who must pay the higher price for inefficiency.

On December 8 a group of dealers from North Carolina called on the N.C. members of the House and our two senators. The fact that almost all our elected men in Washington took the position that our industry can and will get stronger through competition made me proud to be from North Carolina.

Charles Rose is undecided. Walter Jones is clearly out of step. With one third of our country's agricultural products exported and subject to similar protective retaliation, one would think that these two gentlemen would have more regard for our farmers, if not our consumers.

How about it, consumers? Do you want to protect inefficiency and pay the higher price? If you want to get value and quality for your hard-earned dollar, call or write your Congressman today!

Don L. Cox, president
Cox Toyota Inc.
Burlington



Belk Tyler carolina east mall greenville

THURSDAY, FRIDAY AND SATURDAY

pre christmas Sale

Two-Week-Old Used In Scene

PORTLAND, Ore. (AP) — A state panel has overturned a decision that would have barred movie producers from using a 2-week-old infant in a swimming pool scene.

The Oregon Wage and Hour Commission voted 2-1 Tuesday to allow Pacific International Enterprises Inc., to dip the baby up to its abdomen in the movie stunt. The decision came after Volney F. Morin Jr., a lawyer for the filmmaker, threatened to take future movie business to other states if the request was rejected.

Paul R. Tiffany, State Wage and Hour Division administrator, said he vetoed using the baby in the scene because the request had been made by telephone and pressure was exerted for a quick approval.

O'Connor Col. . . .

(Continued From Page 4)

the other \$8 million — although Douglas says DHR hopes that money will be added to the mental health budget in future years to help further expand local programs.

Politically, the closing of Dix will not be an easy decision to make. There are 1300 state employees involved and the Wake County legislative delegation appears ready to flex its considerable muscle in their defense. But for once, the state has a political controversy rooted not in a calamity — not in deteriorating roads or polluted roadsides — but in a success story.

Buchwald Col. . . .

(Continued From Page 4)

Someone asked the agent to check the budget computer when he reported what was on it, the pieces all started to fall into place concerning the unemployment tax announcement on Thanksgiving Day. The next morning the President had to assure everyone there would be no such tax and also had to send an apology to Andropov.

But when someone on his staff suggested they move Bonzo out of the White House and send him to the Old Actor's Home Hollywood, President Reagan wouldn't hear of it. "He's the best friend I ever had," the President said. "And just because he was in show business doesn't mean he can't come up with some good ideas."

(c) 1982, Los Angeles Times Syndicate

Evans-Novak...

(Continued from page 4)

against his staff in urging him not to run for president in 1984, most of them were not even consulted before he made his decision.

Such old Teddyites as David Burke (who as an American divorcee, was not actively involved.

But many of Kennedy's old backers around the country — typified by John F. English in New York — urged him to run. His present staff was committed to a Kennedy race but was outvoted by the senator's three children.



Sportcoat Sale

124⁸⁸

Reg. 135.00 to 185.00

Selected group of famous name sportcoats names like, Palm Beach, Izod, Cricketteer, 100% wool Camel hair. Herringbones, Tics and solids. Men's sizes 38 to 46 Reg. & Longs. Hurry in, sizes are limited!

Big Savings Up To \$7 On Buxton®

Leather Goods For Ladies

25% Off

Reg. \$12 to \$30

Wallets, cigarette cases, key chains, coupon organizers and more. Several colors. Hurry!



Ladies' Shoes Reduced \$9

Reg. 29.00

19.88

Large group of Sweetbriar® two-eye tie moccasins made of brown leather. Sizes 5 1/2 to 10. Hurry while prices are right!

Men's Long Sleeve Pajamas Reduced 8.00!

16.88

Regular 25.00

Polyester/cotton pajamas in tan, blue and wine stripes. Sizes S, M, L, XL. Machine wash and dry. For yourself or as a nice gift! Stock up!

Boys' Sport Coats And Suits Reduced Up To \$48 For You!

1/3 Off

Reg. \$40 to \$146

Choose from our entire stock of 100% wool coats and sport coats in sizes 8 to 20. Tics, hopsacks, herringbone. A nice gift!

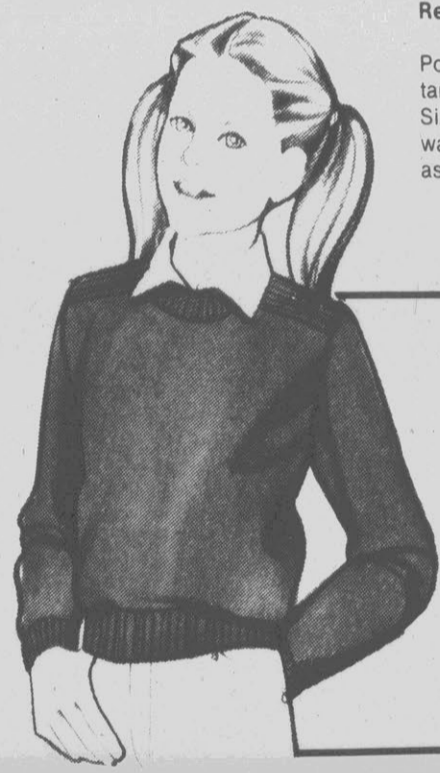

Terrific 27% Savings On Crew Neck Sweaters Just For Girls!

9.44

Regular 13.00

Large assortment of BugOff!® Acrylic sweaters with a strawberry motif on front, ribbed sleeves and bottom. Available in red, navy and white colors. Sizes 7 to 14. Comfort and style all in one. Shop now and save!



Super Savings Over 5.00 On Boys' Knit Shirts By Andhurst®!

6.88

Regular 12.00

Polyester/cotton rugby stripe shirt with 3 button placket, long sleeves. Sizes 8 to 20.

Desk Clock/Calendar At A Great Price!

14.88

Special Purchase

Perpetual calendar on one side, time and date on reverse. Hurry!

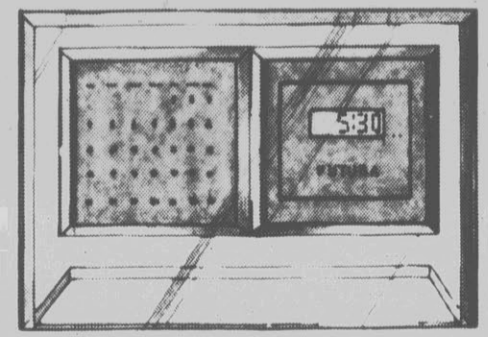

THREE DAYS ONLY!

Totes® Umbrellas Up To \$7 Off!

Push-button umbrellas in solids, patterns. Reg. 10.00 to 22.00. **1/4 Off**

Up To \$21 Off Ladies' Bags!

John Romain® leather handbags. Many styles. Reg. \$35 to \$65. **1/4 Off**

Save 31% On Ladies' Rain Coats!

Vinyl stadium jacket in sizes S, M, L, XL. Reversible. Nice gift! Reg. 10.00. **6.88**

Heiress® Sweater Leg Tights

Orion® nylon sweater tights in petite, average and tall sizes. Regular 7.50. **5.88**

Ladies' Handbags At A Savings!

Canvas and corduroy handbags in several styles. Reg. \$13 to \$17. **1/3 Off**

Girls' Blazers Reduced 10.00!

Cotton corduroy blazers in 4 colors. Sizes 7 to 14. Regular 28.00 to 30.00. **19.88**

Girls' Dresses Up To \$14 Off!

Polyester/cotton in sizes 7 to 14. Regular 16.00 to 37.00. **40% Off**

Sale! Little Girls' Sportswear

Polyester/cotton in sizes 4 to 6x. Regular 13.00 to 32.00. **20% Off**

Save \$7 On Girls' Warm Jackets!

Nylon two-tone jackets with zip-off sleeves. Sizes 7 to 14. Reg. 30.00. **22.88**

Men's Oshkosh® Jeans 20% Off!

Cotton denim jeans with straight leg styling. Sizes 30 to 38. Reg. 20.00. **15.88**

Sweat Clothes At Great Prices!

Drawstring pants, rugby style shirts. Save! Values to \$35. **25% Off**

Save Over 19% On Men's Shirts!

Arrow® cotton flannel shirts. Plaids. S, M, L, XL. Easy care. Regular \$16. **12.88**

Mini Calculator/Pen Watch Set

Black Or burgundy gift set for that person with everything. **Special Buy 19.88**

Up To \$40 Off Crystal Gift!

10" hurricane, 6 1/4 bud vase, 9" vase and more. Reg. \$30 to \$80. **1/2 Off**

Mikasa® Crystal Reduced 8.00!

Fluted style champagne glasses in rose, azure and smoke colors. Regular 16.95. **8.88**

Half Price Savings On Cutlery!

Stainless flatware in 5-piece place settings. A nice gift! Regular 30.00. **15.00**

Mikasa® 'English Chintz' China

5-pc. place settings and more. Reg. 17.85 to 85.30. **8.83 to 42.65**

Wooden Giftware At A Savings!

Candleholders, coaster sets and more. Reg. 14.00 to 18.00. **9.88 to 12.88**

25% off
Gift certificates in any amount can be used anytime. Special price through December 24th. Boxed and wrapped, of course!
Call 752-3980
Dean's Photography
Open Tuesday through Friday 9:30-5:30
Saturday 9-12
Other hours by appointment
Closed Monday
Other discounts may not apply with this offer

Shop Thursday, Friday and Saturday 10 a.m. Until 10 p.m. — Phone 756-B-E-L-K (756-2355)

Contempt Threat Facing EPA Chief

By WILLIAM KRONHOLM
Associated Press Writer
WASHINGTON (AP) — The House, poised to cite Environmental Protection Agency chief Anne M. Gorsuch for contempt of Congress, is embarking on a historic legal confrontation with the Reagan administration.

The House Public Works Committee was filing its formal report on its 28-11 vote last week to cite Mrs. Gorsuch because of her refusal, on President Reagan's orders, to surrender subpoenaed documents on EPA's enforcement of the \$1.6 billion "superfund" toxic waste law.

Once the report is filed, the issue can take precedence over any other floor action. House Speaker Thomas P. O'Neill said Tuesday he expected Rep. James Howard, D-N.J., the committee's chairman, to press for a floor vote sometime today.

"He does intend to proceed with it, and probably tomorrow," Nancy Blades, a Howard aide, said Tuesday night.

While Mrs. Gorsuch is the focus of the contempt citation, the dispute between institutions — the executive and legislative branches, equal under the Constitution, each jealous of its prerogatives and unwilling to surrender authority to the other.

Mrs. Gorsuch has claimed executive privilege to withhold documents that she said are too sensitive to risk premature disclosure. She said they include such explosive documents as analyses of weaknesses in government prosecution cases that would jeopardize lawsuits yet to be filed.

The congressional committees say the claim is a questionable expansion of executive privilege because the documents do not involve foreign relations, national security or Oval Office discussions, the basis of past privilege claims.

"We cannot sit idly by

when the administration asserts sweeping and unjustified claims of executive privilege," said Rep. John Dingell, D-Mich., whose House Energy and Commerce subcommittee voted 9-4 on Tuesday to cite Mrs. Gorsuch in a second contempt resolution over the same documents.

Disputes over Congress' right to police the executive branch happen are common. The last was a contempt citation approved by the House Energy and Commerce Committee against Interior Secretary James G. Watt earlier this year.

But in Watt's case, as with disputes in the Carter and Ford administrations, a

last-minute compromise resolved the issue.

A solution appeared remote in the current dispute. Mrs. Gorsuch told reporters Tuesday that: "I really don't see a compromise."

She has said previously that she expected the House to hold her in contempt in a partisan vote. And she took a slap at Howard's quick action on the citation — three and a half weeks from subpoena to contempt vote — as a "macho rush to judgment."

A contempt vote sends the issue to a federal grand jury, where Mrs. Gorsuch could be indicted for contempt of Congress, a misdemeanor. If convicted, she would be subject to a fine of up to

\$1,000 and a jail term of up to a year.

But in debate on the motion last week, Rep. Gene Snyder, R-Ky., said Mrs. Gorsuch realistically faced jail for no more than "a couple of hours." The conviction would then serve as the basis for appeals, probably going ultimately to the Supreme Court, which would define the constitutional rights of the two branches of government.

The House has not used its contempt power in more than four years. The last time the House approved a contempt citation was Sept. 15, 1978, when it voted 319-2 to cite Korean businessman Hancho C. Kim for refusing to answer questions in the so-called Koreagate scandal.

Instances of House con-

tempt citations against executive branch officials are even rarer. Depending on how broadly the definition of such officials is drawn, the most recent example would be the House's 334-11 vote in 1973 to cite G. Gordon Liddy, a member of the White House "plumbers" group in the Watergate scandal.

Visitor Saved Two Children

WILSON, N.C. (AP) — Four people died in a house fire here Tuesday, but two small children survived through the efforts of a Nash County man who spotted the fire, kicked in the door and helped rescue them, fire officials say.

Junius Pope was warming up his car during a visit in the neighborhood when he spotted the fire.

"He went out to crank the car to warm it up and just happened to turn around and see the fire through the window across the street," Wilson Fire Capt. E.V. Stone said. "Seeing it as soon as he did, he probably saved the two children's lives."

Pope ran to a relative's house, which was three doors down from the fire, Stone said.

"They (Pope and the relatives) ran back up there, and when they got there ... they opened the screen door and pushed the front door in and there were two small children, ages 1 and 2, sitting right near the door. So they grabbed them and got out," Stone said.

Killed were JoAnn Johnson, 21; her son, Antonio, 3; her nephew, Tyron Johnson, 2; and Donnell Sauls, 4, the child of Mrs. Johnson's cousin, the Wilson

Fire Department said.

The two children who were saved were not seriously injured. They were Kiki Sauls, 2, and Tyra Sauls, 1, the children of JoAnn Johnson's sister, Ernestine Sauls, who lived in the destroyed house, a family member said.

Pope ran to a relative's house, which was three doors down from the fire, Stone said.

One of the people who helped break in the door was JoAnn Johnson's mother, Doris Sauls, said Alice Locus, a cousin.

Mrs. Sauls told the family that someone came to wake her up, Ms. Locus said.

"She went over there, and she could hear them (the children) at the front door crying, so they kicked the door in and he got them," Mrs. Locus said.

Brody's
DOWNTOWN
Open tonight until 9:00 p.m. for your shopping convenience

Helen's Grooming World & Pet Motel
Now Accepting Reservations for your Pets For The Upcoming Holidays. Complete Grooming Service For All Breeds.
Remember Your Pet At Christmas. See Our Complete Line of Sweaters, Christmas Toys & Accessories.
10th St. Ext. - Greenville
Call 758-6333 For Reservations



Polo
by RALPH LAUREN

Wishing you all things rare and beautiful

Brody's
DOWNTOWN PITT PLAZA

Ralph Lauren Tailored Classics. Meticulously Detailed Shirts In The Finest All-Cotton Fabrics, Sweaters Made Of 100% Shetland Wool, Each With The Distinctive Polo Signature - The Brody's Collection Of Polo Includes Oxford Cloth, Broadcloth, And Knit Shirts In Solids And Stripes. Twill And Corduroy Trousers and Skirts Are Available In An Array Of Beautiful Lauren Colors. Knit And Madras Dresses Are Also Available. Prices Start At \$21.50.



Shop Pitt Plaza
10:00 a.m. - 9:30 p.m.
Downtown 10:00 a.m. - 9:00 p.m.

Christmas Special

Hampster & Gerbil Starter Kit

Includes: 10 gallon tank, screen top, wood shavings, food & water dish AND 1 free hamster or gerbil with set up.

All \$ **18⁹⁹** For

AKC White German Shepherd Puppies \$ **175⁰⁰**

Large Selection of Birds, Fish, Small Animals & All Accessories.

PET VILLAGE
511 South Evans St. 756-9222 Across From Taft Furniture
Hours: Mon - Fri. 10 to 7, Sat. 10 to 6

Wishing you all things rare and beautiful

Brody's
Downtown Pitt Plaza

Missy Holiday Sale

SHOP PITT PLAZA 10:00 a.m. - 9:30 p.m. DOWNTOWN
10:00 a.m. - 9:00 p.m. DOWNTOWN PITT PLAZA

FURTHER REDUCTIONS!

MISSY WOOL BLAZER REG. \$75 NOW **\$39⁹⁹**

ENTIRE STOCK OF MISSY FALL SKIRTS Wool & wool blend skirts in the latest colors & styling... solids & plaids **25% OFF**

ENTIRE STOCK OF MISSY FALL SLACKS Beautiful slacks in solids and tweeds - Excellent addition to your fall wardrobe **25% OFF**

FROM PERSONAL MISSY LARGE SIZE BLAZER REG. \$90 NOW **\$71⁹⁹**

ENTIRE STOCK OF MISSY FALL COORDINATES Groups from Pant-hr. Personal, Koret, Country, Suburban, Alfred Dunner and more! **25%-50% OFF**

BEAUTIFUL BRITISH VOGUE CARDIGAN REG. \$24 NOW **\$19⁹⁹**

A TRUE CLASSIC! Missy Crewneck Shetland Sweater REG. \$24 NOW **\$19⁹⁹**

GROUP OF Gailord And Judy Bond Blouses REG. \$24 AND \$25 NOW **\$18⁹⁹**

ENTIRE STOCK OF Missy Large Size Coordinates. **25% OFF**

GROUP OF Missy Large Size Blouses **25% OFF**

Wishing you all things rare and beautiful

Brody's
Downtown Pitt Plaza

Trunk Showing of 14 K. Gold
Starts Thurs. Dec. 16
45% - 65% Off
On a huge selection of fine diamond cut 14 K. Gold Jewelry.

These are just a few selections in our large assortment of Italian chains, bracelets, charms, and earrings.

	Reg.	Sale
Floating Heart Charm	\$4.99	\$1.99
7" Serpentine Bracelet	\$15.00	\$5.99
Sanddollar Charm	\$16.00	\$5.95
Seashell Charm	\$12.00	\$5.95
Starfish Charm	\$12.00	\$5.95
16" Serpentine Chain	\$32.00	\$16⁹⁹
18" Serpentine Chain	\$45.00	\$18⁹⁹
Starfish Earrings	\$30.00	\$15⁹⁹
Shell Earrings	\$30.00	\$15⁹⁹

14 K. Gold Add-A-Beads

	Reg.	Sale
20" Serpentine Chain	\$47.00	\$24⁹⁹
24" Serpentine Chain	\$53.00	\$31⁹⁹
7" Cobra Bracelet	\$24.00	\$10⁹⁹
16" Cobra Chain	\$39.00	\$21⁹⁹
18" Cobra	\$45.00	\$23⁹⁹
24" Cobra	\$53.00	\$29⁹⁹
7" Herringbone Bracelet	\$38.00	\$19⁹⁹
16" Herringbone Chain	\$50.00	\$29⁹⁹
18" Herringbone Chain	\$60.00	\$35⁹⁹
20" Herringbone Chain	\$67.00	\$39⁹⁹

3mm 49¢
4mm 87¢
5mm 1.49
6mm \$2.27
7mm \$2.49

Glamour Rings
Choose from hundreds of attractive rings with Genuine Opal, Jade, Tigers Eye, and other precious stones.
Reg. 15.00 to 60.00
Your Choice
\$7.99
Now Only

*Heavier Pieces Shown At Pitt Plaza Only.

Don't miss this opportunity to get those special Christmas gifts at great savings!

Childhood Christmas In Norway Recalled By Guest

By LARONA MURRAY
Pam Sending-Larsen likes to reminisce about childhood Christmases in her native Norway. Ms. Sending-Larsen, of Oslo, is a guest this week of Madeline Vincent of Greenville.

Born in 1905, one of five children, she remembers when holiday festivities extended to 14 days.

"At five o'clock on Yuletide eve," she recalls, "the doors leading to the room that housed the tree would be opened and presents would be given."

According to Ms. Sending-Larsen, before Christianity was introduced in Norway, as far back as about 1,000 B.C. the main god Thor and the lesser god Odim were the principal gods worshipped.

In the early era of Christianity, when the people of Norway chose a day for the

celebration of Christ's birth, they, in harmony with the Romans, adopted as Christ's birthday the festival of Saturnalia — Dec. 24, the birthday of the conquered sun.

"And with the choice came our own legends of huge trolls and the nisse, the bearer of gifts, thus helping lead the way to the Saint Nicholas or Santa Claus figure as we know them today," she said.

One period in Ms. Sending-Larsen's lifetime has left her with memories of Christmases not so pleasant as early or recent ones.

"Five years of occupation by German troops during the late 1930s and early 1940s left us with very few pleasant memories of Christmases at that time," she remembers.

"We were neutral, yet we were under oppression by the Germans. There were days

that we were fearful of venturing out into the street."

The Germans, stalling Norwegian communication with the outside world, wouldn't allow them to own a radio. Ms. Sending-Larsen, a widely known furniture designer, explained that she "designed a chair with broad arm pieces. It was made to conceal a radio at a moment's notice."

Food was scarce in those days. Pam remembers storing up butter made of whale fat, whole wheat flour and artificial sweetener to make cakes from the old Norwegian Christmas recipes. "Due to food rationing, we were allowed one egg a day per person," she said, "so we sacrificed some of our eggs to make the cakes."

Clothing also was hard to come by. There was no importation of cotton or other goods. "We had to

wear wool. It was rough and scratchy."

Adverse conditions in Norway reached a climax in 1940, when many Norwegians, along with King Haakon VII, fled to England, taking what valuables they could with them.

Madeline Vincent met Pam Sending-Larsen when she and another Greenville resident, Carrie Oakley, went on a tour in Europe in 1972. "Carrie and Madeline couldn't evaluate our money," Ms. Sending-Larsen laughed, "so I became their benefactor and we've been good friends ever since."

Mrs. Vincent, a former teacher, is an avid world traveler who likes to collect dolls. From four trips abroad she has acquired dolls from Russia, Thailand, Greece, Spain, North Africa, Hong Kong, New Zealand "and of course, from Norway."

Ms. Sending-Larsen loves the warm sunshine of the Southwestern United States and is in the process of settling down in Sun City, Ariz. She is going there later this week. "Norway is beautiful," Pam notes, "but

it's so cold. The winters and nights are so long."

According to Mrs. Vincent, her guest has such an aversion to the cold, she refuses to drink tea or colas with ice, preferring them at room temperature.

At the age of 77, Pam Sending-Larsen still likes to swim. "It's a good body toner. In Norway, I swam many times in water at about 10 degrees Fahrenheit."

When she was younger she skied and skated a lot. "In fact, what else can you do in so much snow?" she asked.



NORWEGIAN VISITOR ... Pam Sending-Larsen, left, of Oslo, Norway, is currently visiting Madeline Vincent, right, in Greenville. The two pose before shelves containing dolls and other souvenirs of visits by Mrs. Vincent to foreign lands. Ms. Sending-Larsen talked about Christmases past and present in Norway.

Lotterhos To Autograph Book

Woodsmoke Publications of Greenville and Belk-Tyler Co. at Carolina East Mall are jointly sponsoring an autograph session of Jerry F. Lotterhos' book of poems, "People Tunes," on Saturday.

Lotterhos, a professor at East Carolina University, will be on hand at Belk's all day Saturday to autograph copies of his new book of poetry, which has been illustrated by Jody Lynne Praskac of Rumson, N.J., a student in interior design in the ECU School of Art.



Shop Our Christmas Sale!
...Now Going On

Open Nightly 9 PM
'Til Mon. Thru Sat.



HERE'S A HALF PRICE SALE THAT'S SUITABLE FOR FRAMING.

Right now, the Eye Care Center is offering an eye full of frames for half price! So for the classy, conservative or colorful frames to suit your life-style, visit the Eye Care Center today! This sale is being offered for a limited time, so hurry. But remember, in order to take advantage of this offer, be sure to bring this coupon.



See What You've Been Missing GRV

Offer not good in combination with any other offers. Sale ends December 31, 1982.

Dr. Peter W. Hollis

Tipton-Annex, 228 Greenville Blvd. — Greenville, NC, 919/756-9404



Assorted
DRESS CLUTCHES

\$6 reg. 7.99 to 9.95

BLACK PATENT

New Spring & Holiday Shoes



\$12

reg. 18.95 Ladies 5-11 Blk. Patent

reg. 16.95 Ladies 5 1/2 - 11 Black Patent or Red Soft Cushion Insole

SPECIAL SALE

Shoe Show

Greenville Square Shopping Center

Holiday Savings

75¢ On Any Complete Groom

Or 35¢ On Baths

Pretty Up Your Pet Professionally For Christmas.

Call now and make your appointment for grooming or boarding as bookings are being filled rapidly.

Baker's Dozen

Pet Heaven

758-0973

Coupon Expires Dec. 25, 1982

Belk Tyler

carolina east mall greenville

Green Convertible Hoover Upright Vac at a Big \$25 Savings!

69.88

Regular 94.95

This fabulous vacuum cleaner features an all-steel agitator, 4.3 amp motor, 9.5 quart bag and edge-cleaning. Take advantage of big savings! Model #U-4127



MODEL #U-4127

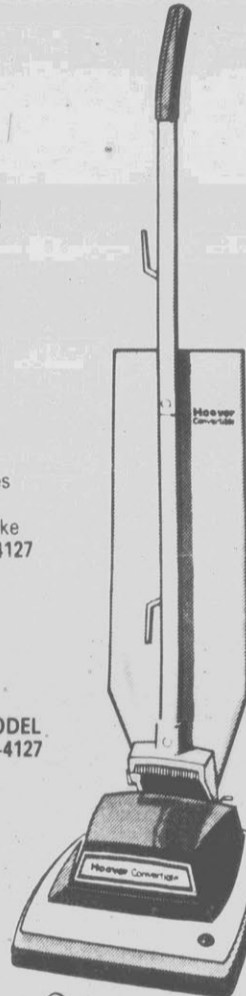

Fantastic Buy on Hoover Upright Vac for You!

79.88

This fabulous vac features: an all-steel agitator, headlight, full-time edge cleaner and 9 1/2-qt. bag. It makes vacuuming a snap! Come and try out this model today! Hurry while supply lasts! Model #U-4315



MODEL #U-4315

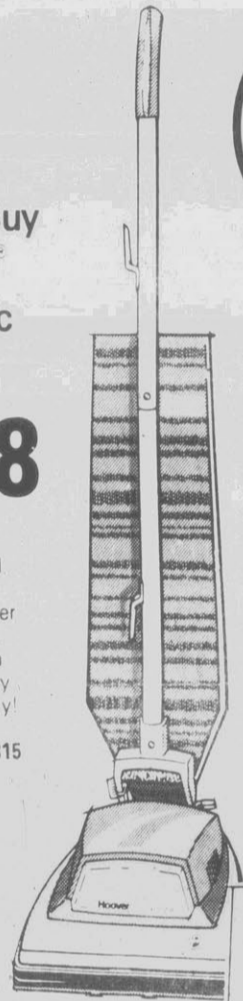

Terrific \$35 Savings on Convertible Hoover Upright Vac!

99.88

Regular 134.95

Convertible upright has dirt finder headlight, wire tread wheels, carpet selector, full-time edge-cleaning. Model #U-4317



MODEL #S-3203

MODEL #S-2039

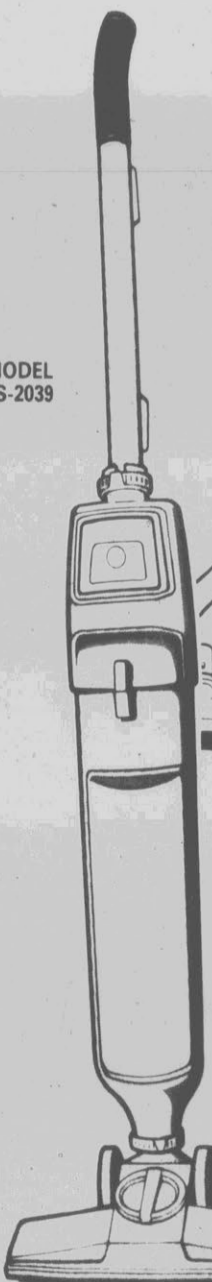

Spirit Portable Canister Vac at a Terrific \$10 Off!

69.88

Regular 79.88

This great vac features dual edge-cleaning to clean those hard-to-get places. Model #S-3203

Terrific \$20 Savings on Spirit Portable Canister Vac Now!

59.88

Regular 79.88

Terrific model with selective edge-cleaning, wheeled nozzle. Get yours today! Model #S-2039

Lightweight Hoover Vacuum Cleaner at a Great Low Price!

34.88

Lightweight vac with disposable bag without cassette. For quick and efficient vacuuming! Hurry now while supply lasts! Model #S-2015

MODEL #S-2015



Shop Monday through Saturday 10 a.m. until 10 p.m. — Phone 756-B-E-L-K (756-2355)

U.S. Attorney Says Letter By Lewis Is A Virtual Confession

By JAMES LITKE
Associated Press Writer
CHICAGO (AP) — James W. Lewis wrote an extortion letter that amounted to a confession to the seven Tylenol poisoning deaths, and while he was a fugitive he threatened to kill President Reagan, a federal prosecutor has charged.

U.S. Attorney Dan K. Webb made the allegations during a bond hearing for Lewis' wife, who surrendered here Tuesday.

Webb cited a "death threat" mailed to the White House among other factors as he asked U.S. Magistrate James T. Balog to set bond at \$5 million for Leann Lewis.

Mrs. Lewis, 33, is charged with fraudulent use of a Social Security number while trying to find work in Chicago. She was taken into custody after arriving at O'Hare International Airport.

Lewis, arrested Monday at a mid-Manhattan library after eluding a nationwide manhunt for nearly two months, has been charged with authoring a \$1 million extortion demand to Johnson & Johnson, makers of Tylenol, in which he threatened a second wave of poisonings.

Webb told the magistrate that in the extortion letter Lewis "confesses" to poisoning seven people in the Chicago area who died between Sept. 29 and Oct. 1 after taking cyanide-tainted capsules of Extra-Strength Tylenol.

But whether the letter "contains false information we simply do not know at this time," he told reporters afterward. The precise contents of the letter have never been revealed.

Webb said the letter that

threatened Reagan, written while the Lewises were fugitives, "alluded to Tylenol and went on to threaten the life of the president and others."

Lewis' threat apparently was motivated by a disagreement with unspecified Reagan administration policies, Webb said.

Balog set bond for Mrs. Lewis at \$5 million and scheduled a hearing for Dec. 22.

Lewis, 36, remained in custody in New York City today, awaiting a hearing set for Dec. 23.

Two FBI agents and two Illinois state investigators flew to New York from Chicago, but Lewis' lawyer, Frank Lopez, said he would not allow authorities to question Lewis about the seven cyanide deaths.

Lewis, while a fugitive, wrote letters to the Chicago Tribune denying he was involved in the deaths.

Lewis was arrested after a library supervisor connected a man he'd seen at the library for several days with a wanted poster in his office.

Authorities had been watching a number of places in

midtown Manhattan, including newsstands at Times Square and Grand Central Station, because of Lewis' penchant for writing to newspapers. He was checking a list of newspapers when arrested.

Webb charged that Mrs. Lewis was "intensely involved" in both the extortion demand and the death threat sent to the president because both envelopes were marked with a postage meter belonging to her former employer, "to which only she would have had access."

Webb also indicated that Kansas City authorities had developed new information about a 1978 homicide in which Lewis was charged, but never tried, in part because some evidence was improperly seized. He said authorities there also wanted to question Mrs. Lewis in connection with the death.

Michael Monico, Mrs.

Lewis' attorney, objected to the inclusion in the court record of those allegations, saying, "the fact that her husband may be implicated in those events does not mean this woman should bear the penalty because she is married to that man."

Monico also said Mrs. Lewis, who remained impassive throughout the hearing, would cooperate with investigators from the task force investigating the cyanide deaths.

Authorities said Lewis will be taken to Chicago to determine whether he was involved in the Tylenol killings, and Webb said both Lewis and his wife would be prosecuted in Chicago.

U.S. Magistrate Ruth V. Washington granted the government request to set bail for Lewis at \$5 million after Lewis refused to give his name at an arraignment Monday.

FRAME-IT-YOURSELF SHOPPE
DO-IT-YOURSELF & 48 HOUR CUSTOM PICTURE FRAMING
606 Arlington Blvd. Telephone 756-7454
OPEN TONITE UNTIL 9 P.M.

The Uptown Clothing Company Ltd
Owner/Manager: Bill Evans

Men's & Women's Designer Fashions
Christmas will be here in a twinkle, so why not greet it in style.
Visit Uptown Clothing, in the corner at Greenville Square for the finest designer fashions in Greenville.

Entire Stock Always Marked
20% Off

Bill Blass
Calvin Klein
Sergio Valenta

Chic
Sasson
Zena

Condor
Organically Grown
Palmetto

Members Only
Lord Isaac
Jordache
Jonathan Martin

Greenville Square Shopping Center
756-9509
Hours: 10-7, Mon. - Sat.

Puzzled By Big Quebec Blackout

MONTREAL (AP) — Utility officials said they do not know why built-in safeguards failed to prevent a massive power outage that left millions of people in Quebec province without electricity in freezing temperatures.

The power failure, which began Tuesday afternoon following an explosion at a transformer near Quebec City, also stopped hydroelectric power to eastern Canada and the United States. It was Canada's most widespread power outage since 1975.

But New York power officials had a 12-minute warning of the cut by the Hydro-Quebec utility and had no trouble making up the shortfall from other stations, officials said.

Though 95 percent of the 2.4 million Hydro-Quebec customers had power restored within eight hours, some isolated areas were without electricity early today, a utility spokesman said.

With an investigation into the explosion under way, Hydro-Quebec technicians tried to determine why its backup and fail-safe systems failed to prevent the network from shutting down.

"We don't know," said Jacques Guevrement, Hydro-Quebec's director of systems operations. "If we had only one fault on the system it should have been stable but it seems that the first fault caused a second fault and the system could not cope with all the variations."

The transformer blast was believed set off by a short circuit, sending flames shooting several feet into the air and starting a fire that took 90 minutes to control.

When the power and heat went off, temperatures ranged from 32 F in the Montreal area to 22 F below zero and snow in the northern parts of the province.

Most Quebec residents were lurching or returning to work when the failure occurred. In major Quebec cities, offices closed and employees were sent home. Montreal firefighters helped people stranded in elevators. Horrendous traffic snarls developed because the Montreal subway shut down, and people returned home as best they could.

REED'S IS A GOLD MINE OF CHRISTMAS GIFTS

Fine Jewelers And Diamond Importers
Carolina East Mall
Greenville

Bridal Sets
14K White and Yellow Gold

	Reg.	SALE
.03 Ct.	\$149.95	\$99 ⁹⁵
.10 Ct.	\$250.00	\$199 ⁰⁰
.20 Ct.	\$750.00	\$595 ⁰⁰

30% Off
14K White Or Yellow Gold
Diamond Wedding Bands

14K Gold Chains And Bracelets
50% Off

14K Charms
50% Off

Ladies Diamond Clusters

From \$79 to \$6600
Entire Stock 30% & More Off

	Reg.	SALE
.07 Ct.	\$150	\$99
.12 Ct.	\$280	\$199
¼ Ct.	\$460	\$290
½ Ct.	\$690	\$490
1.00 Ct.	\$1295	\$890

Diamond Earrings
From \$24 To \$4000
30% & More Off Entire Stock

	Reg.	Sale
.06 ct.	\$99	\$49
.10 ct.	\$150	\$99
.15 ct.	\$240	\$149
.20 ct.	\$290	\$190
¼ ct.	\$390	\$249
1/3 ct.	\$490	\$299
.40 ct.	\$795	\$499
1/2 ct.	\$1040	\$599

Diamond Pendants
From \$49 To \$4000
30% & More Off Entire Stock

	Reg.	Sale
.03 ct.	\$99	\$49
.10 ct.	\$195	\$119
.18 ct.	\$290	\$190
.20 ct.	\$360	\$225
¼ ct.	\$490	\$299
1/3 ct.	\$640	\$399
.40 ct.	\$1295	\$699
1/2 ct.	\$1495	\$799

Men's Diamond Rings

From \$195 to \$5000
40% & More Off Entire Stock

	Reg.	SALE
.20 Ct.	\$630	\$375
.33 Ct.	\$1195	\$695
.75 Ct.	\$1695	\$995
1.00 Ct.	\$2450	\$1450
Onyx & Diamond	\$295	\$195

Genuine Stone Rings
Mens & Ladies
Onyx, Tigereye, Opal, Masonic
20% to 50% off

14K Bangle Bracelets
50% Off

14K Earrings
30% Off

14K Ball Earrings

	Reg.	SALE
3mm	\$22.70	\$14
4mm	\$25.30	\$16
5mm	\$30.80	\$19
6mm	\$41.50	\$24
7mm	\$50.10	\$29

14K Add-A-Beads

3mm	38¢
4mm	57¢
5mm	96¢
6mm	1.34
7mm	1.64

Diamond Solitaires
From \$69 To \$19000
30% & More Off Entire Stock

	Reg.	Sale
.03 ct.	\$99	\$69
.15 ct.	\$390	\$290
.20 ct.	\$490	\$390
.50 ct.	\$2990	\$1990
.64 ct.	\$2450	\$1495
.75 ct.	\$5800	\$3900
1.50 ct.	\$11775	\$7900

Seiko, Citizen, Accutron Swiss Caravelle & Bulova
20% Off

Diamond Solitaires
From \$69 to \$19000
30% & More Off Entire Stock

	Reg.	SALE
.11 Ct.	\$165	\$115
.12 Ct.	\$290	\$190
.20 Ct.	\$599	\$399
¼ Ct.	\$690	\$499
½ Ct.	\$900	\$625
¾ Ct.	\$1240	\$899
1.00 Ct.	\$4150	\$1995

5 Convenient Ways To Buy
Reed's Charge, American Express, Master Card, Visa, or Interest Free Layaway

SHOP NOW FOR CHRISTMAS
All Items Subject To Prior Sale

Nobody But Nobody Undersells Reed's

CAROLINA EAST MALL GREENVILLE
Open 10 A.M. till 10 P.M. Daily

Other Locations: Cary, Chapel Hill, Wilson, Rocky Mt., Jacksonville, Wilmington, Whiteville & Myrtle Beach

FBI Claims 'Solid Leads' In Huge Cash Robbery

By LAWRENCE KILMAN
Associated Press Writer
NEW YORK (AP) — The FBI says it has "solid leads" in the robbery of at least \$9.8 million from an armored car firm by two masked men who left behind millions more along with "unanswered questions" about

the company's security. The heist was the largest robbery in U.S. history. Police initially had estimated the take at \$1 million, based on estimates from officials of Sentry-Armored Car-Courier, then raised it to \$5.3 million, \$8 million and then \$9.8 million

by late Tuesday. The final count was expected to be complete today, said police spokesman Ed Leschack. Sentry officials tallying the loss have refused to talk to reporters. The robbers apparently had an easy time stealing the money from the two-story brick warehouse in the Bronx, and investigators said Tuesday they were focusing on whether the men had inside information.

A joint FBI-New York police bank robbery task force has questioned employees of the company and plans to review the roster of past employees, said a police source who did not wish to be named. "Our indication is that someone really had to know what was in there in order to get past the cameras, the alarm systems and guard," said Richard Seaberg, vice president of Poe Associates, a Tampa, Fla., insurance agency that underwrote a multimillion-dollar policy for Sentry.

"Someone had to have some knowledge of the premises," Seaberg said. "I don't see how they couldn't. There was more than just an alarm system to beat." Seaberg said his firm has conducted two inspections of Sentry since underwriting a \$10 million insurance policy in January. Since everything checked out, Seaberg said, "There are a lot of unanswered questions that have to be asked."

The robbers, who entered the building Sunday night through a hole punched in the tarpaper and sheet metal roof, used an electronic burglary tool to defuse the alarm and a crowbar to pry open the door of the money room, police said. They overpowered the lone guard, handcuffed him to a railing, broke into the money room and used bolt cutters to reach the cash by cutting through a floor-to-ceiling chain-link fence.

For unexplained reasons, they left behind money bags estimated to contain as much as \$20 million after scrawling "robbers was here" on a dusty mirror. "If it's true the money wasn't inside a vault, someone is going to have to answer why," Seaberg said. Sentry has offered a \$25,000 reward for information in the case.

The largest U.S. theft previously on record came on Dec. 11, 1978, when robbers took \$5 million in cash and \$800,000 in jewels from the Lufthansa cargo area at Kennedy Airport in New York.

Dorsey Named Coordinator

RALEIGH, N.C. (AP) — Miriam J. Dorsey, director of the Council on the Status of Women, has been appointed coordinator of

women's policy issues in the Office of Policy and Planning in the Department of Administration.

Handmade
Marzipan
Almond Paste Candy
DIENER'S BAKERY
815 Dickinson Ave.

Dial-A-Prayer
752-1362



Our
After Christmas Sale
starts now.
Save 25% to 50%.
Entire stock of heavyweight coats
and jackets for the family.

**Men's
Outerwear
Sale 20.99
to 59.99**

Orig. \$28 to \$110. Don't get left out in the cold, hurry in for savings on these men's jackets. No-nonsense styling, with knit trims, warm linings, lots of pockets, and more. Rugged-as-all-out doors in a choice of practical blends or leathers. For men's sizes.

	Orig.	Sale
Ski vest	\$28.00	20.99
Zip off sleeve ski jacket	29.99	21.99
Zip off sleeve ski jacket	60.00	29.99
Three-in-one jacket	70.00	39.99
Zip off sleeve jacket	65.00	47.99
Rope coat	85.00	51.99
Suede leather bomber	110.00	55.00
Four-in-one jacket	95.00	59.99
Reversible bomber	85.00	59.99
Short leather	89.99	66.99

**Women's
Outerwear
Sale 24.99
to 143.99**

Orig. \$32 to \$289. Fine styles for every taste. Ski jackets! Stadium coats! Toppers! Wrap coats! Tailored coats! With all the chilly, drizzly weather ahead, it's nice to find a coat that's on your side. Choose from naturally warm wools, fleecy wool/nylon blends, leathers and more. In a rich selection of colors for misses' juniors and half sizes.

	Orig.	Sale
Zip-off sleeve ski jacket	32.00	24.99
Reversible ski jacket	59.00	37.99
Quilted stadium jacket	65.00	47.99
Corduroy stadium jacket	65.00	47.99
Long-quilted coat	85.00	58.99
Wool-blend short coat	110.00	93.99
Wool long coat	179.00	112.99
Long leather coat	289.00	143.99

**Children's
Outerwear
Sale 10.99
to 29.99**

Orig. \$17 to \$52. Get ready for wintry weather now, while our children's winter coats and jackets are on sale. You'll find all the newest warm-ups here including cozy pile coats, warm poplin jackets, ski jackets, down look jackets with zip off sleeves. Or our Storm Plus™ jackets. Lots, Lots more for infants, toddlers, and big and little boys and girls.

	Orig.	Sale
Toddler down look	17.00	10.99
Big girls zip-out ski jacket	32.00	12.99
Little girls cowboy jacket	24.00	14.99
Big girls zip-out ski jacket	36.00	17.99
Little boy's Storm Plus™ jacket	30.00	18.99
Little boy's chitz jacket	25.00	18.99
Big boy's chitz jacket	36.00	23.99
Big boy's plaid lined parka	35.00	23.99
Big boy's 4 in 1 parka	52.00	29.99
Big boy's Storm Plus™	32.00	29.99

JCPenney THE CHRISTMAS PLACE.™

Free Monogramming

Express your individuality. We'll give you a start by putting your own three letter monogramming when you purchase a mens or womens oxford shirt, completely free! Any other merchandise is only \$1.00 per initial, as many as you want.

Gift Savings Guide

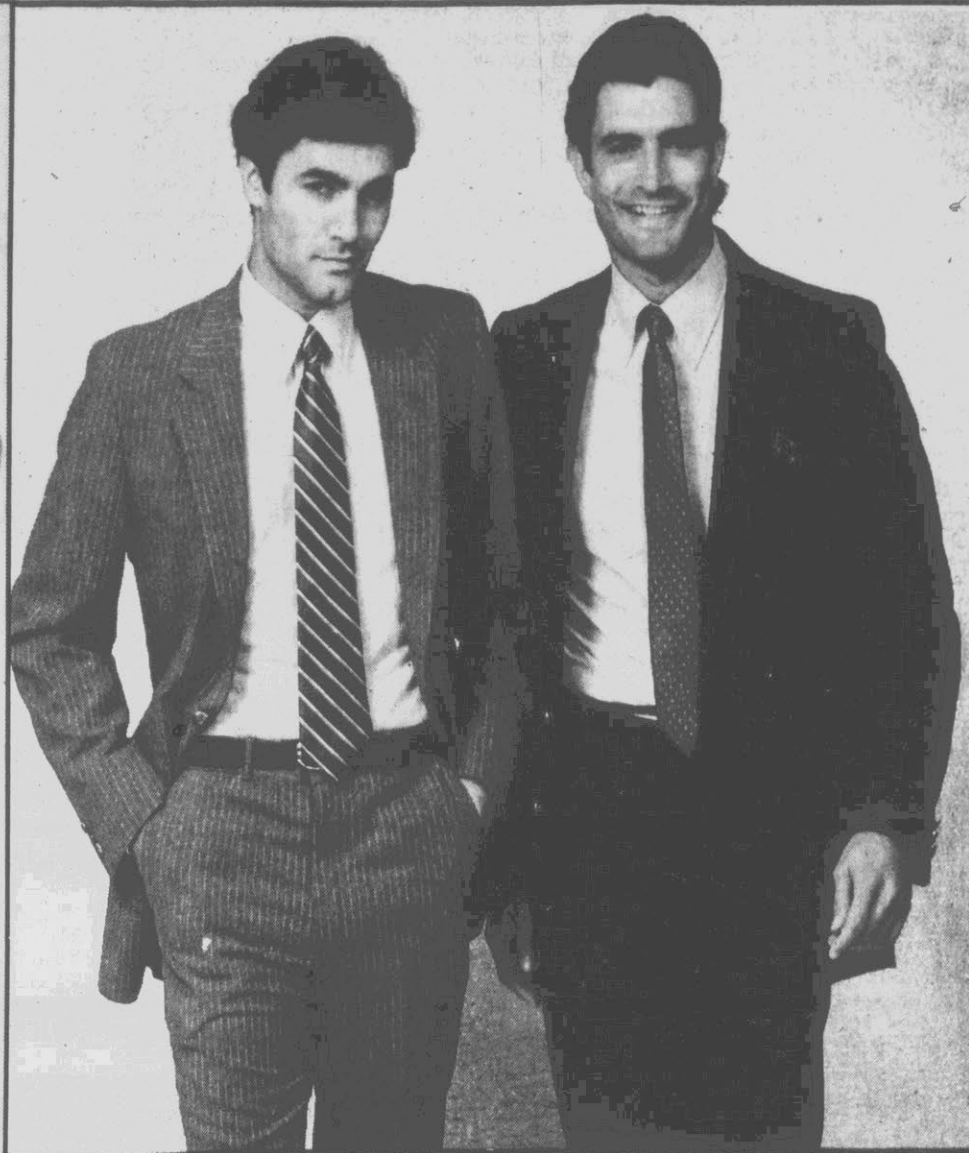

Save 20% Our Comfort blazer. Stafford™, too.

Handsome separates help dress up the holidays. Our Comfort Blazer and slacks. With plenty of give and take. Tailored in today's Dacron® polyester from Kopman Textured Wovens. For another great tradition, choose our pinstripe sportcoat or slacks of texturized polyester. Men's sizes.

	Reg.	Sale
The Comfort blazer	60.00	48.00
The Comfort slack	21.00	15.99
Pinstripe sportcoat	70.00	49.00
Pinstripe slack	25.00	17.50

Save 25% on Western Boots.

Sale 44.25 to \$54. Reg. \$59 to \$72. Save 25% on all men's western boots. Men's sizes.

Save \$15 on Comfort Plus® leather shoes for men.

Sale 49.99 Reg. \$65. Our finest leather shoes. In contemporary and classic styles.

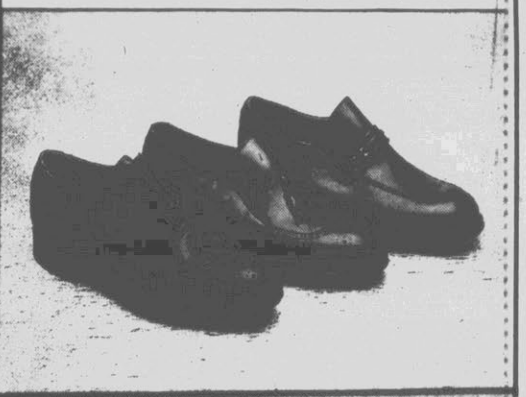

Sale 96.99 and 139.99

Stafford™ Collection suits.

Reg. \$165 and \$175. Dress or country suits with the expert tailoring he deserves. Classic dress suit in solids and stripes. Country Classic in herringbone, plaids and heathers. 55% polyester/45% wool.

Sale 127.99. Reg. \$160. Stafford™ Tropical poly/wool suit.

Sale 10.99 to 13.99 Classic Shirts.

Button down oxfords included. Dressy and casual looks for guys. In easy care fabrics. At prices that take it easy on your budget. All in men's sizes.

	Reg.	Sale
Broadcloth dress shirt	\$12	9.60
Acrylic plaid shirt	\$14	10.99
Cotton flannel shirt	\$14	10.99
Oxford short sleeve dress shirt	\$16	12.80
Plaid & solid oxford button downs	\$18	13.99

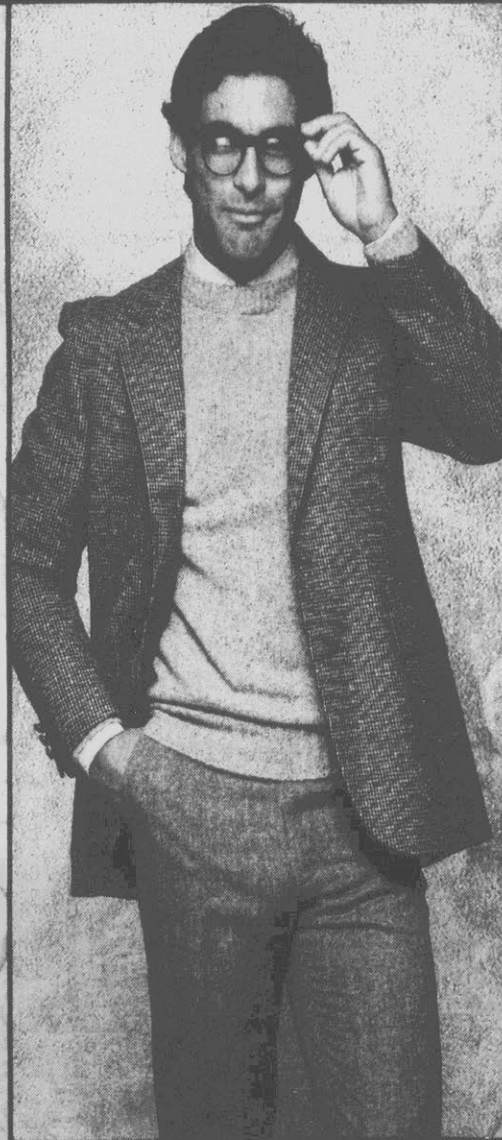

Sale 59.99 Wool Sportcoat.

Reg. \$90. The sportcoat for town or country. The luxury of pure wool. With genuine leather buttons, some with suede elbow patches. In heather solids, plaids and herringbone.

Sale 10.99

Our best selling PJ's.

Reg. \$14. Long-sleeve coat front pajama. Of no-iron cotton/polyester. Solids and prints. Men's S,M,L,XL.

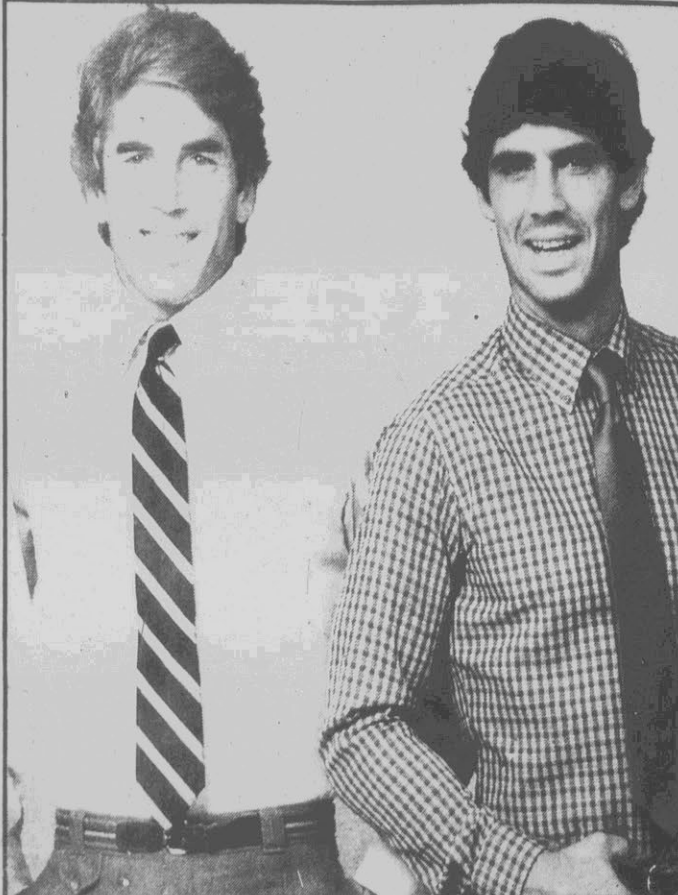

Sale 20.00 Pullover and slack.

Reg. \$26. He's making his list. And you can be sure that this V-neck pullover is on it! A plush orlon® acrylic knit that feels like cashmere. And the price is soft, too. **Sale 21.99. Reg. \$28.** Young men's contour slacks.

Sale 59.99 Stafford™ sportcoat

Reg. \$85. Stafford™ A sportcoat with the quality difference that comes from a traditional blend of 55% polyester and 45% wool.

Sale 13.99

Reg. \$18. Fashion pajamas of no-iron polyester/cotton. In solids and prints. Men's S,M,L,XL.

JCPenney THE CHRISTMAS PLACE.™

Free Monogramming

Express your individuality. We'll give you a start by putting your own three letter monogramming when you purchase a men or women's oxford shirt, completely free! Any other merchandise is only \$1.00 per initial, as many as you want.

Gift Savings Guide

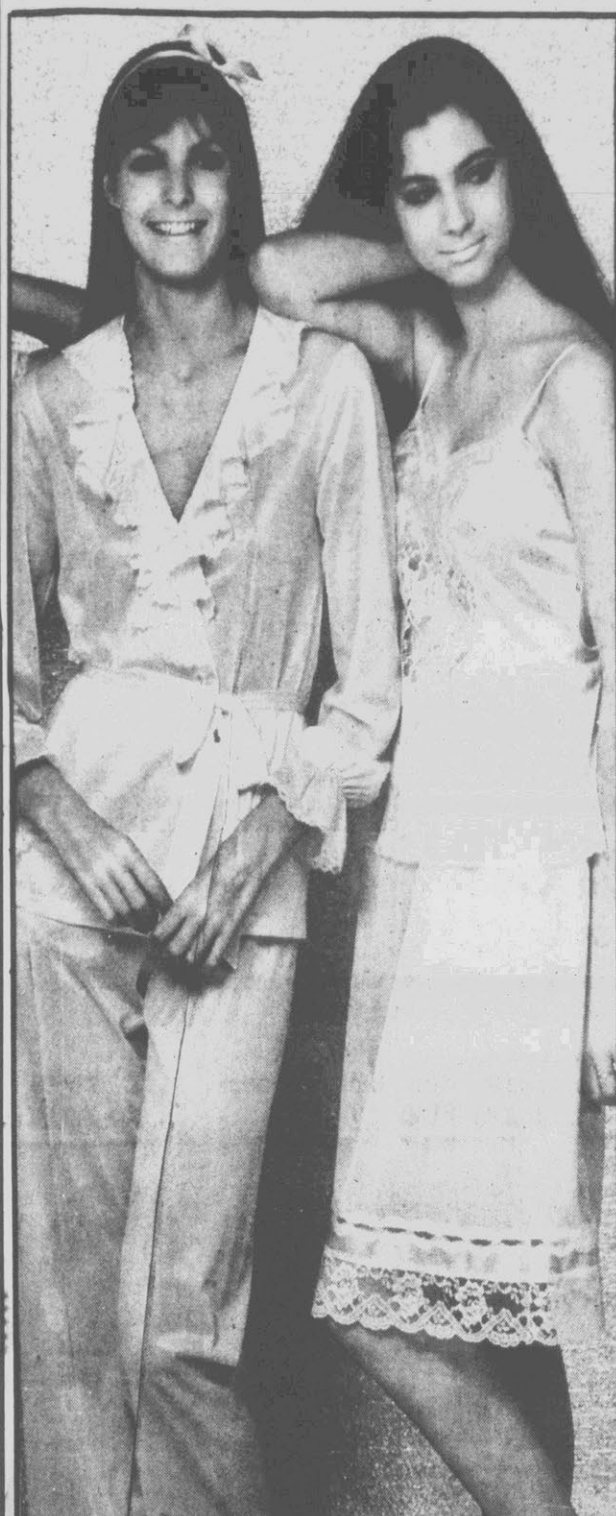

Save 20% Beautiful basics for her nights.

Color her dreams of a white Christmas with our beautifully basic pajamas. One set with a quilted pullover top, the other a wrap style. Both of lullabye soft nylon. Sizes S,M,L,XL.

	Reg.	Sale
Wrap pajama set	20.00	16.00
Yoke pajama set	19.00	15.20

Pretty basics for her day.

Fresh and feminine daytime coordinates. Of the silkiest Antron III® nylon tricot.

	Reg.	Sale
Camisole	9.50	7.13
Half slip	9.00	6.75
Full slip (not shown)	14.00	10.50
Bra	11.00	8.25
Bikini panties	4.50	3.38
3 pr. nylon panties, gift boxed, Special		\$5

Save 20% On all women's robes.

Share the warmth in the spirit of giving. Give her one of our heavyweight robes. All at 20% off. All full length. In easy going fabrics, like Arnel® triacetate/Fortrel® poly. Or Dacron® poly/cotton. Here's a sample, for misses' and juniors' XS,S,M,L.

	Reg.	Sale
Trimmed fleece wrap	\$35	28.00
Braid trimmed zip-front robe	\$42	33.60
Trimmed wrap	\$42	33.60
Quilted zip-up robe	\$28	22.40



Sale 14.40^{ea.} Motion Pant™ or Motion Skirt.™

Get her holiday spirit in motion. With separates tailor-made for today. Motion Pant™ and its easy-care partners. Like Motion Blazer™ and Motion Skirt.™ All of stretch-woven polyester. And to top it off right, a print or ruffled blouse of Ultressa® polyester. Misses' sizes.

	Reg.	Sale
Motion Pant™	\$18	14.40
Motion Skirt™	\$18	14.40
Motion Blazer™	\$50	40.00
Print blouse	\$18	14.40

20% off

Beautiful by day. Beguiling by night. The perfect gift for her. For Christmas. 20% off coordinates of Dacron® polyester and poly/rayon blends. Misses' sizes.

	Reg.	Sale
Striped boatneck	\$22	17.60
Striped skirt	\$20	16.00
Jacket	\$50	40.00
Bow blouse	\$24	19.20
Solid skirt	\$28	22.40
Solid pants (not shown)	\$28	22.40

Sale prices effective through Saturday.

JCPenney THE CHRISTMAS PLACE.™

Shop 10 am-10 pm—Phone 756-1190—Pitt Plaza

Free Monogramming

Express your individuality. We'll give you a start by putting your own three letter monogramming when you purchase a men or womens oxford shirt, completely free! Any other merchandise is only \$1.00 per initial as many as you want.

Gift Savings Guide

Save 34%

On girls' blazers.

Sale 18.99

Orig. \$29. Choose from big girls' blazers of polyester/wool or corduroy. Sizes 8-14.



Save \$30 on exercise bike.

Sale 109.99 Reg. 139.99. Full-size exercise bike with speedometer/odometer/timer. Easy caliper tension device. Comes unassembled.



UNC Basketball Board.

Sale 43.99. Reg. 54.99. NBA Basketball board. Fiberglass Backboard sale 59.99. Reg. 74.99.



20% to 40% Off Velour tops his list

Our casual velour tops. Easy, comfortable looks that top slacks and jeans perfectly. Great fashion colors in cotton/poly blends. For men's sizes S,M,L,XL.

	Reg.	Sale		Reg.	Sale
Open collar pullover	\$30	\$18.99	Striped placket neck	\$28	\$18.99
Color spliced pullover	\$28	\$18.99	Striped V-neck	\$30	\$18.99

Save 30% to 46%

on girls' skirts.

Sale 6.99

Orig. \$10 to \$13. An assortment of big girls skirts in corduroy, wool blends and acrylics in solids or plaids. Sizes 4-14.

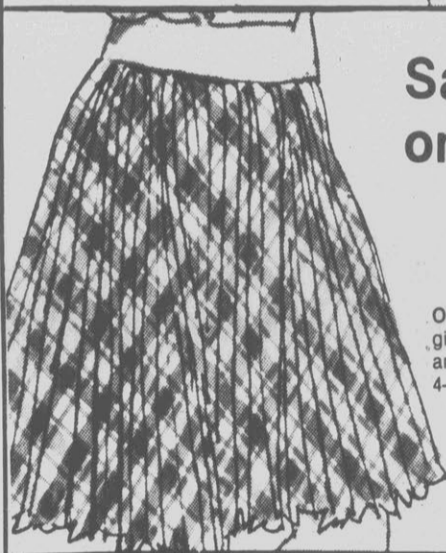

20% off all dart boards

Sale 4.79 to 5.99

Orig. 5.99 to 13.99. An assortment of dartboards from the simple to the deluxe.

Wrap up in a 40% to 50% savings on velour robes

Sale 11.99 & 14.99

Orig. \$20 & \$30. Two styles of plush velour robes. Kimono robe with contrast face and piping, or solid shawl collar robe S,M,L,XL.

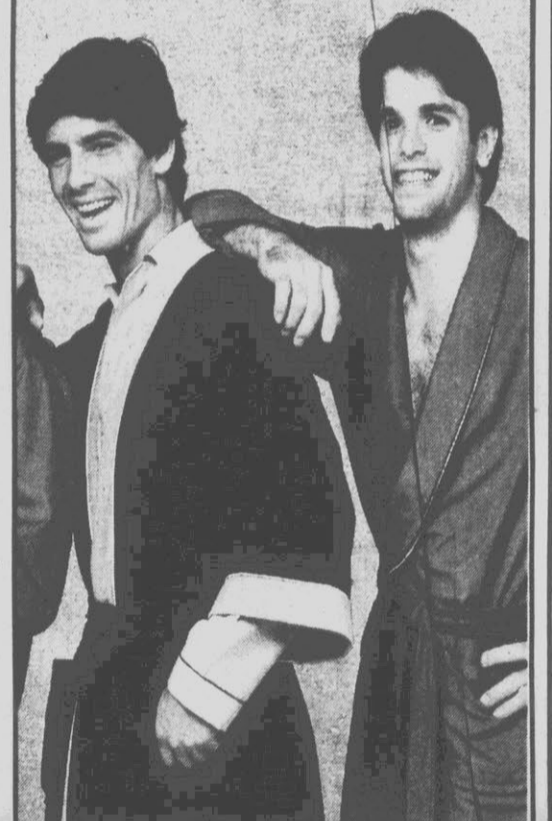

Save 20% to 47% on girls' tops.

Sale 7.99

Orig. \$10 to \$15. An assortment of big girls tops. Choose from velours, ruffled blouses, sweaters or knits.



Save 20% on warm-ups for kids.

Your future champions will be running in style. All in the easy care fabrics.

	Reg.	Sale
Big girls crewneck top	\$11	8.80
Matching sweat pants	\$11	8.80
Big boy's zip front sweatshirt	\$11	8.80
Little boys' zip front sweatshirt	\$9	7.20

Save 37% to 54%

on boy's tops

Sale 5.99

Orig. 9.50 to \$13. An assortment of big boys tops. Choose from knits, flannels or jerseys. Sizes 8-16.



Save 33% to 55% on button-down shirt and belted slacks.

Dressy looks for guys. So comfortable and good looking. In easy-care fabrics. At prices that take it easy on your budget.

	Reg.	Sale
Plaid button-down shirt	\$18	7.99
Contour tri-blend flannel slack	\$27	17.99

Special slack 6.99

Men's polyester/cotton belted slack. Bright holiday colors.



JCPenney THE CHRISTMAS PLACE.™

Gift Savings Guide

Save 20% On All Small Appliances

Sale 21.99

6. Reg. 26.99. JCPenney 2 to 10 cup drip coffeemaker lets you set the brew strength you want, then keeps the coffee warm and ready. 'Brew for two' feature ensures the freshest cups for a 'tete à tete'.

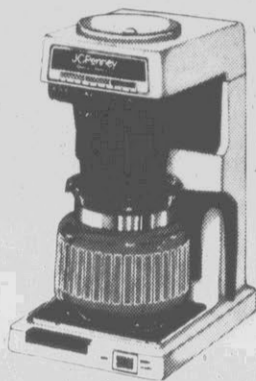

Sale 13.99

Reg. 16.99. Get things popping. Give a JCPenney popcorn popper. It pops a big 4 quarts of nutritious popcorn. Self-buttering, with easy-clean popping surface. Lexan dome doubles as serving bowl.

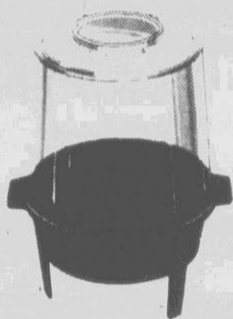

44.99 JCPenney sale price
-5.00 Manufacturer's rebate
39.99 Your final cost

Broiler/oven.

Reg. 54.99. Continuous-clean broiler/oven toasts 4 slices of bread, top browns, bakes and broils. Handy "keep warm" setting. Large window, removable rack and more.

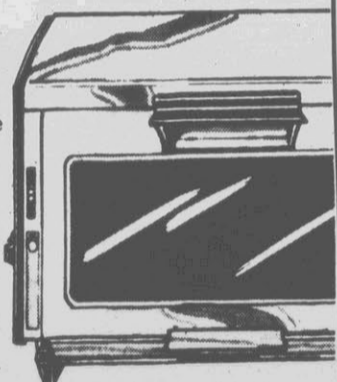

Now 47.99 Hand-held Donkey Kong™ By Coleco.

Reg. 59.99 Authentic version of the hottest video game goes everywhere you go. Batteries not included. Hand-held Frogger™ by Coleco.

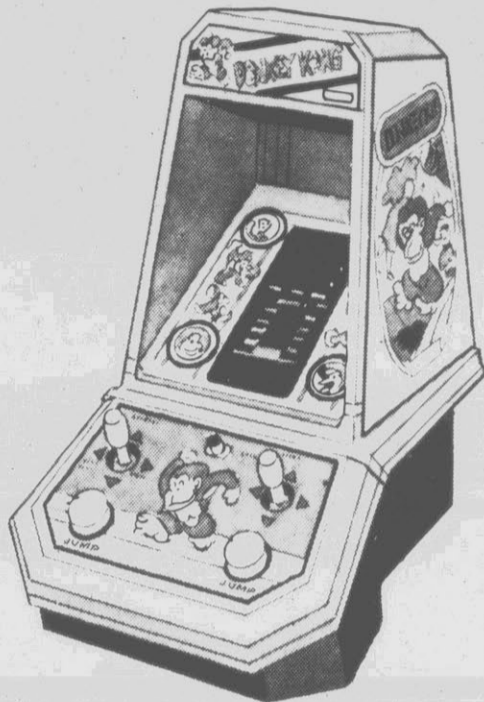

Save 20% On All E.T. Toys

Cuddle up and dream of places far away with E.T. toys.

	Reg.	Sale
E.T. doll	15	12.00
E.T. card game	6.49	5.19
Stunt spaceship	3.99	3.19
E.T. game	12.99	10.39



Bradley collector dolls.

Gifts to treasure. Dolls with hand-painted faces, and fully dressed in period gowns. Certificate of authenticity with each doll.

	Reg.	Sale
10" high doll	\$12	9.00
13" high doll	\$22	18.80
16" high doll	\$30	24.00

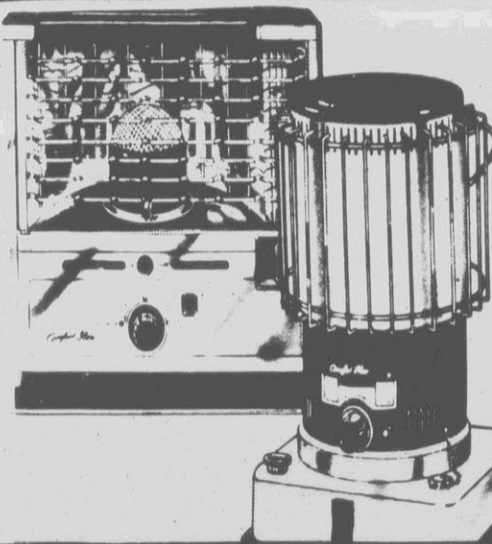

Save \$60 to \$80 Kerosene heaters.

Comfort Glow® kerosene heaters supplies radiant heat from the front and top of the unit. Features self-cleaning wick, pushbutton electric ignition.

	Orig.	Sale
9,000 BTU	199.99	139.99
12,500 BTU	229.99	169.99
20,000 BTU	299.99	219.99



25% Off All Pictures Sale 4.49 to 11.99

Reg. 5.99 to 15.99 A group of appealing pictures at a great price. Prints to hang separately, or arrange as a group. Choose from our collection of assorted subjects.

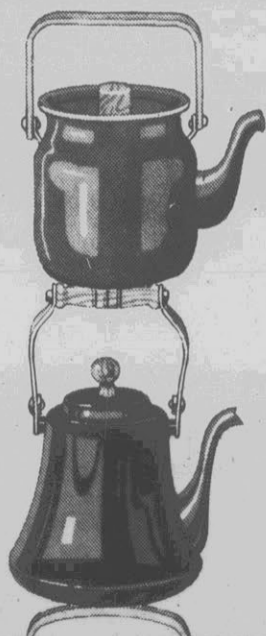

Save 25%

On Tea Kettles Sale 10.39 to 27.99

Reg. 12.99 to 34.99. A select group of our most popular tea kettle. Assorted shapes, sizes and colors.

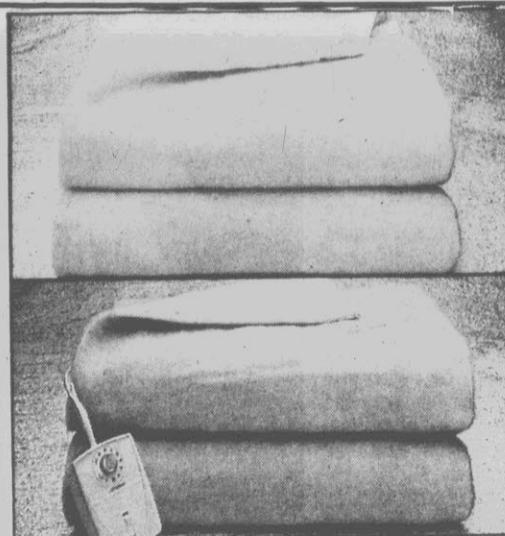

20% off blankets.

Woven acrylic blankets for warm wintering. In a great choice of colors.

	Reg.	Sale
Twin, 66x90"	\$20	15.99
Full, 80x90"	\$25	19.99
Queen, 90x90"	\$30	23.99

Hot buys on electric blankets.

Electric blankets. In acrylic/poly. With handy bedside control.

	Reg.	Sale
Twin with single control	\$30	23.99
Full with single control	\$40	33.99
Full with dual control	\$50	43.99
Queen with dual control	\$60	49.99

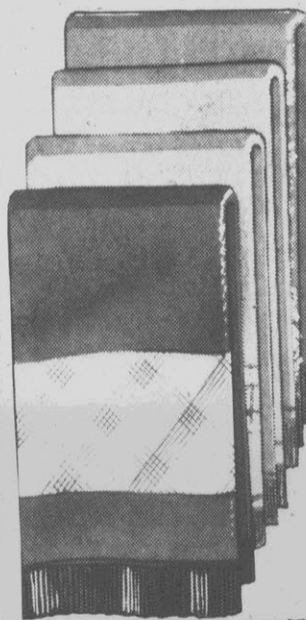

Save 25% On Finger Tip Towels

Sale 1.65 to 2.62

Reg. 2.20 to 3.49 An assortment of finger tip towels. Solids or holiday designs.



Save 25% On All Scales Sale 7.50 to 14.25

Reg. \$10 to \$19 An assortment of bath scales. Choice of styles and colors.

JCPenney THE CHRISTMAS PLACE.™

Shop 10 am - 10 pm Phone 756-1190 Pitt Plaza

In The Area

ECU Nears Holiday Break

Examinations for East Carolina University students will end Friday, after which students will be on holiday-semester break through Jan. 10. The university's staff personnel will begin vacations Christmas Eve and continue through Jan. 3.

Conley Wins Two Awards

"People stood under umbrellas, under awnings, and sat in cars to watch the Greenville Jaycee Christmas parade this past Saturday. Parade turnout was good, despite the cold rain," Jaycee parade chairman Jim Allgood said.

He said the parade lasted about one hour and that more than 80 units and 600 persons took part. First place in the novice float division went to the D.H. Conley High School Literary Club. First place in the band competition went to Conley High School with North Pitt High School taking second place.

Senior Citizen Award Planned

The Winterville Jaycettes is looking for a recipient for their second annual Outstanding Senior Citizen of the Year award. Anyone who wishes to nominate a Winterville senior citizen may contact Jeannie Peed at 756-2027 or Linda Garrett at 355-2095.

Ruritans Install Officers

WINTERVILLE — New officers were installed Tuesday night at the Winterville Ruritans monthly meeting.

The officers for 1983 are: Donald Boyle, president; Bruce Gray, vice president; Ervin Spain, secretary; Elwood Nobles, assistant secretary; Paul Hunsucker, secretary-treasurer, and Keith Knox, sergeant-at-arms. Woodrow Worthington was also sworn in as a director.

Gene Anderson and John Moore from Pioneer Seed Co. were guests at the meeting.

It was reported at the meeting that Tony Moore of Winterville has been elected lieutenant governor of the Greenville-Goldsboro district.

An Artificial Heart Reported

MOSCOW (AP) — Radio Moscow reported what it called the first artificial heart implant in the Soviet Union, on a 3-month-old calf.

The broadcast Tuesday did not say whether the device worked nor did it provide other details, other than to

say it was implanted by Prof. Vladimir Gigauri at the Scientific Research Center of Surgery in Moscow.

The Soviet-run news media has reported the Dec. 2 implantation of an artificial heart in Dr. Barney Clark at Salt Lake City.

Gibraltar's Doors Open

GIBRALTAR (AP) — Spain's iron gate sealing off British-ruled Gibraltar for 13 years stood open today in what the new Spanish Socialist government called a "humanitarian" gesture in its efforts to reclaim the famed rock.

Spanish customs chief Carlos Pozas formally opened the big green gate at midnight (6 p.m. EST) Tuesday. It was first ordered closed by the late dictator Francisco Franco in 1969 to pressure Britain into negotiating the return of the colony to Spain. For 269 years Britain has ruled Gibraltar, a 2 1/4-mile-long limestone rock jutting into the Mediterranean Sea.

The government of Socialist Premier Felipe Gonzalez, which like previous administrations wants Spanish sovereignty over Gibraltar, said the gate would remain open 24 hours a day. The government described the move as a "humanitarian" gesture.

A jubilant Spanish crowd estimated by Spanish National Police to number at least 5,000 turned out to watch, accompanied by a Spanish student band and scores of cameramen and reporters.

The first person to cross into Spain was Carmen Ward, 42, a Spanish-speaking Gibraltar holding a British passport. She told reporters she was thrilled and was going to visit her family in Spain.

Spain is restricting border crossing to passport-carrying Spanish residents entering and leaving Gibraltar, and Gibraltar residents entering and leaving Spain with United Kingdom passports over-stamped to show they are Gibraltarians. With the exception this morning of journalists, no other nationalities are allowed to cross the border.



BOOKS CLOSED — Chairman of the House Ethics Committee Louis Stokes of Ohio, right, and special investigator the panel Joe Califano report at a Capitol Hill news conference that the committee is pressing an investigation into drug use by House employees, but it has closed the books on charges made by two former pages on homosexual activities in Congress. (AP Laserphoto)

Leftists Hold His Daughter

By ALFONSO ANZUETO Associated Press Writer
GUATEMALA CITY (AP) — Security squads stopped cars and searched houses early today for clues to the whereabouts of the daughter of Honduran President Roberto Suazo Cordova after she was kidnapped by leftist guerrillas.

The government announced Tuesday night that an unidentified guerrilla group seized Xiomara Suazo Estrada, a 33-year-old pharmacist who lives in Guatemala City, and demanded publication of a "political manifesto" in return for her life.

Interior Minister Ricardo Mendez Ruiz said the guerrillas had warned in a communique that her life "will be in danger" if the manifesto is not published in Central American and Mexican newspapers by Friday.

Guatemalan officials said security agents began searching the capital after the announcement looking for signs of Miss Suazo Estrada, who was believed abducted by armed men as she was leaving a clinic here.

In a separate statement sent to the news media, the guerrillas set a deadline of 8:30 p.m. (9:30 p.m. EST) Friday.

Speaking over national radio and television, Mendez Ruiz described the kidnapers as "communists" and "extremists without a country" and said the Honduran president's daughter was "a Guatemalan citizen" not connected in any way with Honduran politics.

"Once again innocent persons are victims," he said. "It is not the government that is carrying out these kidnappings. It is one more case of lack of respect for human rights."

He was apparently referring to charges by human rights groups that conservative Central American governments terrorize people with kidnappings and killings to prevent them from associating with leftist insurgent movements.

Miss Suazo Estrada has lived in Guatemala for 20 years with her mother, also a Guatemalan citizen formerly married to the Honduran president, Mendez Ruiz said. He did not further identify the mother.

In Tegucigalpa, capital of Honduras, a government spokesman said Miss Suazo Estrada had received kidnap threats during a three-day visit there two months ago.

The spokesman, who asked not to be identified, said she is Suazo Cordova's daughter by his first marriage. He said she rarely visits her father.

Since Saturday, Suazo Cordova has been in Houston, undergoing treatment for laryngitis. Friends said he has been informed of the kidnapping and planned to return to Tegucigalpa before Thursday.

CORRECTION
A story in Tuesday's edition on the new money-market savings accounts should have identified Beth Smith as being associated with Peoples Bank & Trust Co. in Greenville, rather than Planters National Bank as stated.

Dazzle Her with Diamonds...
16 Diamonds
BENRUS WATCH COMPANY INC.
Benrus Yellow Goldtone Quartz Watch. 16 glistening diamonds enhance this one piece baguette styled dress watch. Champagne dial. Italian mesh bracelet.
9514-524-9 Your Cost \$249.95 \$199.90 \$100.00
Star Special Price in effect thru Friday, Dec. 21th.
Brendle's
2101 S. Tarboro St., Wilson, N.C.
Open 10:00 A.M. - 9:00 P.M. Mon. Through Sat.

kimball YAMAHA HAMMOND ORGAN
ALL AT EXTRAORDINARY DISCOUNT PRICES!
you can save \$400 to \$1000
Piano & Organ DISTRIBUTORS
329 Arlington Blvd. 355-6002 or call toll free 1-800-682-6911

Chimney Sweep
25 years experience working with Chimneys & Fireplaces. Our reputation for professional and prompt service was made from satisfied customers.
— Call — Gid Holloman Farmville, N. C.
Day or Night (919) 753-3503

We are Relocating and must lighten our load
All gift items **20%-40% off**

Item	Reg.	Sale
Cloisonne earrings	\$7.50 pr.	\$5.99 pr.
Cloisonne pendants	\$14.00	\$9.50 ea.
Cloisonne combs	\$5.99	\$3.49 ea.
Cloisonne beads	\$5.99	\$3.99 ea.
Kimonos	\$49.50	\$29.50
Winter jackets	\$38.00	\$29.95
Tea set	\$24.95	\$19.50
Stainless steel 14" Wok set	\$35.00	\$31.49
Bamboo steamer set	\$39.00	\$34.50
Aluminum steamer	\$31.00	\$27.00
Romertope clay pot	\$23.00	\$19.00

You will find gifts to suit everyone on your Christmas list
Shop Early for Best Selection
We would like to take this time to thank our customers for making our first year in business a success
Merry Christmas & A Happy New Year

INTERNATIONAL FOODS & GIFTS
510 Cotanche St. 752-3411
Monday Thru Friday 11:00-5:30 Saturday 10:00-6:00

Everything Must Go!

- Children's Dresses... Reg. To \$15.98 Now \$5.99
- Girl's Knit Shirts... Reg. To \$12.98 Now \$6.99
- Collection Of Children's Shirts... Reg. To \$7.98 Now 99¢
- Boy's Shirts... Reg. To \$9.98 Now \$2.99

60% Off
Boy's Le Tigre Shirts
Oxford Cloth Button Down Collars
Now \$5.99 Reg. \$14.98

60% Off
Ladies Jordache Jeans
Now \$11.99 Reg. \$29.98

60% Off
Ladies Jordache Knickers
Now \$11.99 Reg. \$29.98

50% Off
Boy's Suits
Now \$17.49 Reg. \$34.98

50% Off
Ladies Doggonit Shorts & Tops
Now \$3.99 Reg. To \$20

50% Off
Ladies Long Line Bras
Now \$3.99 Reg. \$12.98

BRICKS FAMILY CLOTHING
Carolina East Centre
Open 10 A.M. To 9 P.M.
Cash, Mastercard, Visa Card Only



REVCO FOR LOW PRICES ON PRESCRIPTIONS

We urge you to compare our prices with the rest. Give us a call and we'll quote you our low, discount prescription prices.

STOCKING UP AT... REVCO DISCOUNT DRUG CENTERS

REVCO BRANDS SAVE UP TO 50%

Save even more with Revco Brand products. Revco Brand products contain virtually the same fine ingredients as nationally advertised brands, yet cost up to 50% less!

Get Up To A \$5.00
Cash Refund

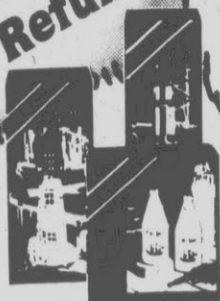

Old Spice Gift Sets & Decanters

Revco's low, everyday discount price from

\$3⁹⁹ to \$7⁹⁹

\$4.00
Mfr. Rebate



Mr. Coffee CM-10 10 cup

Revco's low, everyday discount price... \$19.99
Less \$4.00 Mfr. Rebate... -\$4.00

YOU PAY AFTER REBATE... \$15.99
Pick up mail-in rebate forms at any Revco Discount Drug Center.

\$2.00
Mfr. Rebate

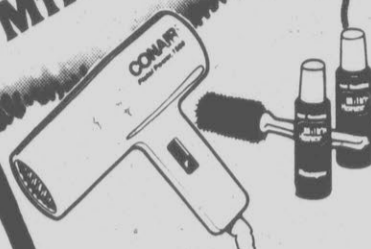

Conair Pistol Power With Free Shampoo

Model #098R, 1500 watt

Revco's low, everyday discount price... \$11.99
Less \$2.00 Mfr. Rebate... -\$2.00

YOU PAY AFTER REBATE... \$9.99
Pick up mail-in rebate forms at any Revco Discount Drug Center.

\$5.00
Mfr. Rebate



CA/90 Ecologizer Air Treatment

Model #7305

Revco's low, everyday discount price... \$19.99
Less \$5.00 Mfr. Rebate... -\$5.00

YOU PAY AFTER REBATE... \$14.99
Use mail-in rebate on package.

MAIL-IN CERTIFICATE

Send us Proofs of Purchase plus a cash register receipt(s) from any OLD SPICE® Gift Sets or Decanters and we will send you up to \$5.00 in cash. The chart to the right shows you how much you can save.

MAIL-IN CERTIFICATE	AMOUNT OF CASH REFUND
1	\$3.00
2	\$4.00
3	\$5.00

NAME _____

ADDRESS _____

CITY _____ STATE _____ ZIP _____

SEND TO: OLD SPICE CASH REFUND
P.O. Box 425, Little Falls, New Jersey 07424

Send me 1. I have enclosed (number) Proofs of Purchase from OLD SPICE® Gift Sets or Decanters plus a cash register receipt for each purchase. OFFER EXPIRES - MARCH 31, 1983. This offer is available to consumers only. Limit one refund per family or address. Good only in U.S.A. Void where prohibited, taxed, or regulated. Confirms no cash or merchandise for cash. This certificate may not be reproduced or copied. Allow 4-6 weeks for processing.

THIS CERTIFICATE MUST ACCOMPANY YOUR REQUEST

**Designer
Fragrances**
10% Off
Manufacturer's
List Price
(at selected Revco stores only)

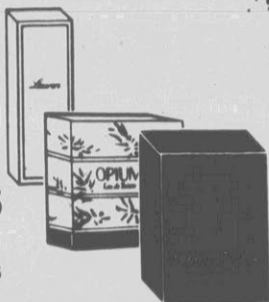

**Courant Or
Herbal Essence**
Spray Cologne
2 fl. oz.
Revco's low,
everyday
discount price **\$1⁹⁹ ea.**



**Jovan
Musk Set
For Women**
Musk Oil Cologne 1/2 fl. oz.
Shaker Talc 2 oz.
Revco's low,
everyday
discount price **\$6⁹⁹**

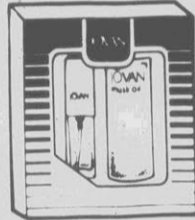

**Brut 33
Splash-On Lotion**
3-1/2 fl. oz.
Stick Deodorant
2.5 oz.
Revco's low,
everyday
discount price **\$3⁶⁹**



**Max Factor
Epris**
Concentrated
Spray Cologne
.6 fl. oz.
Revco's low,
everyday
discount price **\$5⁹⁵**



**Revlon Jontue
Spray Cologne**
.6 fl. oz.
Revco's low,
everyday
discount price **\$5⁰⁹**



**Jovan Musk
Oil Set
For Men**
"Travel Trio"
After Shave, Moisture
Balm, Deodorant Stick
Revco's low,
everyday
discount price **\$7⁶⁹**



**Gloria Vanderbilt
Spray Cologne**
.5 fl. oz.
Revco's low,
everyday
discount price **\$6³⁹**



**Knickerbocker
Stuffed
Animals**
Asst.
Revco's low,
everyday
discount price **99¢ to \$8⁹⁹**



**Coty Wild
Musk Oil**
.5 fl. oz.
Revco's low,
everyday
discount price **\$4⁶⁹**



**Christmas
Gift Wrap**
1 roll, 50 sq. ft., 30"
Revco's low,
everyday
discount price **\$1⁹⁹**



**WYBA AM/FM
Stereo With
Headphones**
Revco's low,
everyday
discount price **\$22⁹⁹**



**English
Leather
Collection**
Revco's low,
everyday
discount price **\$7⁹⁹**



**Schrafft's
Yellow Rose
Chocolates**
1-1/2 lb. box
Revco's low,
everyday
discount price **\$2⁹⁹**



**Cella's
Cherries**
8 oz. box
Revco's low,
everyday
discount price **\$1⁴⁹**



**Holiday Tub
Of Cookies**
1 lb.
Revco's low,
everyday
discount price **\$1²⁹**



COPYRIGHT © 1982 BY REVCO D.S., INC.

Items available while quantities last.

Revco reserves the right to limit quantities.

For your convenience, all Revco Discount Drug Centers will be open Christmas Eve.

**100% NEVER
LATE REBATE
COLOR PRINT
DEVELOPING**

Check your local Revco Discount Drug Center for details.

GREENVILLE
South Park Shopping Center
115 E. Red Banks Rd.

FARMVILLE
U.S. Hwy. 264 & Fields St.
753-2061



Art Museum's Curator Treasures Comics Of Past

By WILLIAM C. MANN
Associated Press Writer
COPENHAGEN, Denmark
(AP) — "Shazam," said crippled newsboy Billy Batson, and suddenly he was Captain Marvel.

A diversion for generations of children of all ages? Of course, says art museum curator Tove Lund Larsen. But she insists the bright colors and strong lines of the C.C. Beck comic book superhero also was art.

Mrs. Larsen became something of an expert on the comics and the cartoonist's art during hundreds of hours of reading and research for an exhibit she calls "Heroes, Heroes! Give Me Heroes!"

"The idea behind it is to show that comics can be art, too," says Mrs. Larsen, curator at the art museum in Hans Christian Andersen's home town, Odense, Denmark.

What her study shows is the development of a form from the comparatively simple lines of cartoonist Joe Shuster's 1938 Superman and Bob Kane's 1939 Batman, to the intricacies of Frank Frazetta's Vampirella in 1969 and Stan Lee's Spiderman of the 1970s.

Along the way, themes and pictures became more explicit, graphic and violent — even pornographic. Nevertheless, says R.

Dahlmann Olsen, curator of Nikolaj, the Copenhagen museum now displaying the exhibit, cartoonists have become better and better. The Belgians call it the seventh art.

"It's a special sort of art, with very great appeal to many people," he said. "I have seen many very good artists involved in this work, and it's really hard work."

"We want to get people from different levels interested in art. We have to get younger people, with differing interests, and this exhibit is doing it."

Its first weekend at Nikolaj attracted almost 2,000 people, Olsen said, and he

expects 15,000 or so to view it during its one-month run. That would make it among Nikolaj's most successful exhibits.

Mrs. Larsen said she chose the comic-book superhero as the focal point of her exhibit.

"All the real superheroes have a mythology," she said. "The creation of the heroes, their fantastic deeds, their moral habits and behavior ... have an absolutely mythological character."

She said she did not set out to analyze the comics, but "in a very simple way to

show as many heroes and hero types as possible. The exhibition is set up as a visual entity."

It traces the history of the comic strip from "Hogan's Alley," which appeared in American newspapers in the 1890s, to Marvel Comics' Fantastic Four of the 1970s; from the 1930s innocence of Felix the Cat to the 1970s raunchiness of Fritz the Cat.

A section dedicated to cartoons on record covers features Porky Pig stuttering "That's all, folks." There's also Richard Corben's album cover drawing for the rock group, Meatloaf, and the famous street scene by Robert Crumb for Big Brother and the Holding Co.

Larger-than-life paintings of Flash Gordon, Wonder Woman, Superman, Captain Marvel, Popeye and 17 other classic characters look down over the exhibition.

History buffs can start by browsing through Egyptian hieroglyphics. They're not exactly cartoons, but they're pictures in a series, and they

tell stories.

Still, it's the modern cartoonist who's the star of the show.

The section on the history of comics includes originals of early strips from the United States, where the art began, and the genesis of the form in Denmark, where comics first appeared around 1938.

Danes are among the most avid readers of comics in the world. Henning Kure, an official of Denmark's largest comics publishing house, said Donald Duck — Anders And in Denmark — has a weekly press run of 125,000 and that the weekly total of all comic books approaches one-half million.

Mrs. Larsen's historical tour goes through the Nazi-fighting superhero era of World War II; the Korean War period with American soldiers depicted as supermen, the North Koreans as dolls; and the superheroes of the 1960s and 1970s, with generous helpings of the underground sex comics of the same period.

Wife And 6 Children Dead

BOISE, Idaho (AP) — A man was hospitalized for shock after he discovered the bodies of his wife and six small children who had suffocated in a mobile home fire, authorities say.

Fire Marshal Neil Coburn said Yick Yim Ng, known as Frank, found the family about 2:40 a.m. Tuesday when he returned home from work. He took five of the children outside the trailer thinking he could save them "before he lost his composure," Coburn said.

An extension cord connected to an electric heater apparently started the fire, filling the mobile home with smoke, authorities said. The deaths were caused by smoke inhalation or carbon monoxide poisoning, officials said.



KATZENJAMMER KIDS — The cartoon strip Katzenjammer Kids, drawn by Angelo DeCesare and distributed by King Features Syn-

dicate, Inc. is 85 years old. DeCesare is the seventh man to draw Hans and Fritz. (AP Laserphoto)

All Roads Lead To Farmville Furniture Company

122-126 S. MAIN ST. 753-3101
FARMVILLE

OPEN MON.-FRI. 'TIL 9

Hutton/Energy Assets Insured Oil And Gas Completion Program

How to reap the rewards of drilling without dry hole risks.*

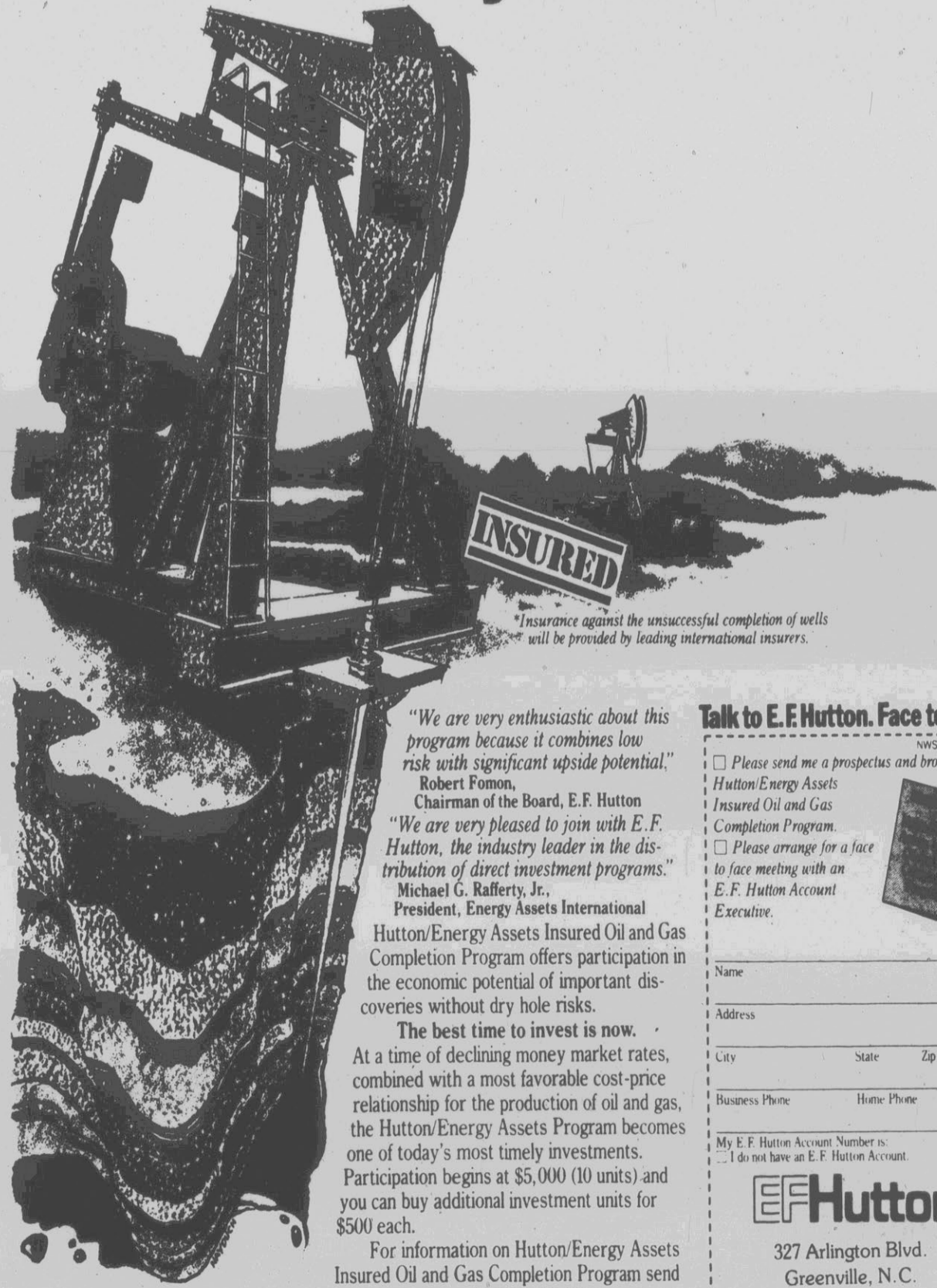

*Insurance against the unsuccessful completion of wells will be provided by leading international insurers.

"We are very enthusiastic about this program because it combines low risk with significant upside potential."
Robert Pomon,
Chairman of the Board, E.F. Hutton

"We are very pleased to join with E.F. Hutton, the industry leader in the distribution of direct investment programs."
Michael G. Rafferty, Jr.,
President, Energy Assets International

Hutton/Energy Assets Insured Oil and Gas Completion Program offers participation in the economic potential of important discoveries without dry hole risks.

The best time to invest is now. At a time of declining money market rates, combined with a most favorable cost-price relationship for the production of oil and gas, the Hutton/Energy Assets Program becomes one of today's most timely investments. Participation begins at \$5,000 (10 units) and you can buy additional investment units for \$500 each.

For information on Hutton/Energy Assets Insured Oil and Gas Completion Program send in the coupon or call 919-756-2000

Talk to E.F. Hutton. Face to face.

- Please send me a prospectus and brochure on Hutton/Energy Assets Insured Oil and Gas Completion Program.
- Please arrange for a face to face meeting with an E.F. Hutton Account Executive.

Name _____
Address _____
City _____ State _____ Zip _____
Business Phone _____ Home Phone _____

My E.F. Hutton Account Number is: I do not have an E.F. Hutton Account.



327 Arlington Blvd.
Greenville, N.C.

When E.F. Hutton talks, people listen.

Tom Togs INC.
SPORTSWEAR & PLAY WEAR

Clearance Sale In Progress

If You're Tired Of Shopping Expensive Department Stores, Set Your Course For

Tom Togs Mill Outlet

We Don't Have To Quote Prices, We Want You To Come And Compare Prices. Come Do Your Christmas Shopping Early And Let Us Help You Stretch Your Dollars.

Large Selection Of Sweaters For The Fall With New Arrivals Every Day. Such Names As Sasson, Osh Kosh, Miss Lizz, Castle Square And Cos Cob.

Specials This Week

Ladies & Juniors Jogsuits	\$9⁹⁹	Good Irregulars
Sasson Twill Pants	Reg. \$36 \$8⁹⁹	Irregulars Sizes 7-16
Ladies & Juniors Velour Tops	Regular \$30 \$5⁹⁹	Irregulars

Hours: Mon-Sat. 9-5
Hwy. 64 East & 42 Between Bethel & Tarboro
We accept Visa & MasterCard

Trying Chief For Perjury

RALEIGH, N.C. (AP) — Perjury charges against former Carolina Beach police chief Rusty Lewis were to go to a Raleigh federal court jury Wednesday, prosecutors said.

Fourteen witnesses testified Tuesday in U.S. District Court that Lewis had often associated with Howard Jenks, had sexual relations with prostitutes who worked for Jenks, and often discussed his association with Jenks and the prostitutes.

Lewis is charged with lying to a federal grand jury investigating corruption in the Carolina Beach Police Department. He allegedly told the grand jury he "did not recall" when asked, "You never stated to anybody that you ever had sexual relations (with prostitutes)?"

He also allegedly lied when asked if he had ever been told not to associate with Jenks.

If convicted, he could be sentenced to 10 years in prison and fined \$20,000.

Lewis testified Tuesday that he had not lied to the grand jury and that the prosecution's witnesses are lying.

Pick 'n Pay Shoes

Cuga sale

Men's, women's, big boys' and children's low cut canvas style. Reg. \$14.97 to \$16.97

\$12

Men's, big boys' & children's hi-top canvas style. Reg. \$14.97 to \$16.97

\$13

■ Cuga® sport socks 30% off

Greenville Blvd. on 264 Bypass
Greenville, N.C.

Sale prices good thru Sun. MasterCard or Visa. Open evenings

This announcement is neither an offer to sell nor a solicitation of an offer to buy limited partnership interests in connection with such oil and gas investment opportunities. Such offers are made by prospectus only in such jurisdictions where lawful.

Moving To Kill Breeder Reactor

By MATT YANCEY
Associated Press Writer
WASHINGTON (AP) — A deficit-conscious Congress is moving to halt the Clinch River Breeder Reactor, a multibillion-dollar project that supporters say opens the door to unlimited energy but critics call a pork-barrel boondoggle.

The House voted 217-196 Tuesday to cut off construction money for the controversial reactor after appropriating \$1.3 billion for it over the past decade.

The \$3.6 billion project at Oak Ridge, Tenn., was intended to show the commercial potential of a plutonium-powered nuclear reactor that would produce — or "breed" — more new fuel than it uses in generating electricity and thus create an inexhaustible source of energy for the future.

But opponents succeeded in convincing a majority of the House for the first time in 10 years that the project is not needed. Bills providing money for the project passed 15 previous times.

Senate Republican Leader Howard Baker, a staunch supporter of the project in his home state, has promised Senate opponents a chance to vote against it before Congress adjourns this weekend. An effort to strip Clinch River of funds failed on a 49-48 vote in that chamber in September.

Though Clinch River has enjoyed congressional support until now, the government did not begin clearing a 90-acre site for it until three months ago.

Construction was thwarted for four years by former President Carter, who ordered licensing suspended because the project's plutonium fuel can be converted into atomic weapons.

President Reagan last year ordered a resumption of licensing activities. A Nuclear Regulatory Commission board now reviewing

the project is expected to rule early next year on whether actual construction could begin.

The House vote Tuesday came on an amendment to a stopgap resolution needed by Friday to keep the government operating until March 15. Its sponsor, Rep. Lawrence Coughlin, R-Pa., said the amendment deletes all money for the Clinch River except for \$44 million needed to start shutting the project down.

But both houses would still have to vote next year to remove the authority for the project before it is ended.

"The truth is we've cut everything out of this budget but the pork," Coughlin said. "And here it is. Can we not get rid of at least a little bit of it?"

"We're looking at a whopping \$180 billion deficit" in the federal budget, said Rep. Claudine Schneider, R-R.I. She helped forge an alliance of fiscal conservatives and environmentalists to oppose the project.

"Frankly, the economics were on our side," Ms. Schneider said. "We're in a pinch and the assumptions on which this project was initially based are no longer valid."

Supporters, however, said Clinch River is a long way from being dead.

"The government has hamstrung itself from accomplishing anything, positive or negative, except to delay," said Gordon Chipman, deputy assistant energy secretary for breeder reactor programs.

When first proposed by former President Nixon,

Clinch River was intended to be the first step in developing a new generation of nuclear plants to replace current reactors when uranium reserves are depleted.

"The issue is whether the United States is going to have a viable nuclear option for generating electricity in the future," Democrat Rep. Marilyn Bouquard, whose Tennessee district is the site for the project, said Tuesday. "We are sacrificing the only technology now able to meet the electrical demands of the nation."

But a virtual halt in new nuclear plant construction, a slowdown in energy growth brought about by a worldwide recession and the discovery of new uranium reserves have curbed demand for the fuel.

The Congressional Office of Technology Assessment now estimates that breeders will not be economically attractive until midway in the 21st Century. France and West Germany both have cut back their breeder programs, though, along with the Soviet Union, they still remain far ahead of the United States.

Meanwhile, the cost of Clinch River soared from \$700 million in 1972 to \$3.6 billion, according to the Department of Energy's latest projections.

The General Accounting Office, an agency of Congress, said earlier this year that the project's cost to taxpayers would actually be \$8.5 billion if included in the calculations was the interest that could be earned by investing the money in U.S. Treasury notes.

Too Tuff Togs Sportswear

Grimesland, N.C. Hwy. 33

Clearance Sale In Progress

Open Three Days A Week
For The Month of December
Thursday & Friday 9:30 a.m.-5:00 p.m.
Saturday 9:30 a.m.-4:00 p.m.

We Now Have More Space To Accommodate You.
Located In The Old Grimesland School Gym.
(Formerly Sears Maintenance Dept.)
Large Selection Of Clothing At Low Discount Prices For Every Member Of The Family.

Some Of The Items We Will Have Are:

Sasson Sleeper for Infants, Sleepwear For Girls

Juniors and Ladies Irregular
Jogsuits..... \$9⁹⁹

Juniors and Ladies Irregular
Sweatshirts.. \$4⁵⁰

Juniors and Ladies Irregular
Velour Tops.. \$5⁹⁹

We Will Also Have First Quality At A Terrific Savings To You Direct From Our Factory. Many More Items You Can't Afford To Miss In Children's, Ladies & Men's Wear. Do Your Christmas Shopping With Us. It Makes Sense To Shop Where You Get More. Entrance To Factory Store Will Be In The Rear Of Gym.

Mark 100 Years

CAGLIARI, Sardinia (AP) — An appellate court has upheld the manslaughter conviction of two Jehovah's Witnesses who refused to allow blood transfusions for their 2½-year-old daughter because their sect does not permit such treatment.

However, the court reduced the sentences of Giuseppe Oneda, 27, and his wife, Consiglia, from 14 years to 10 because they acted out of "moral and social motives." Representatives of the Jehovah's Witnesses said they would appeal to a higher court.

THE ENTERTAINERS
TOKYO (AP) — Despite the protracted slump, Japanese companies spent a record \$13.2 billion to wine, dine and otherwise entertain their clients last year, a survey by the National Tax Administration Agency shows.

SEASONS GREETINGS FROM GREENVILLE JEWELERS



SPECIAL GIFTS FOR THAT SPECIAL PERSON

Spectacular Diamond Solitaire Specials

Stone Shape	Carat Wt.	Compare At	Special
Round	.79	\$4300	\$2499
Round	.75	\$2600	\$1399
Round	.46	\$1650	\$948
Round	.50	\$1299	\$799
Pear	.42	\$1650	\$1128
Pear	.38	\$1850	\$1098
Oval	.34	\$899	\$688
Round	.33	\$699	\$458
Pear	.31	\$899	\$598
Marquis	.26	\$888	\$548
Round	.15	\$368	\$238

FREE: We Will Mount Any Of The Above Diamonds In The 14 Kt. Gold Ring Or Pendant Of Your Choice

Artful Diamond Ensembles

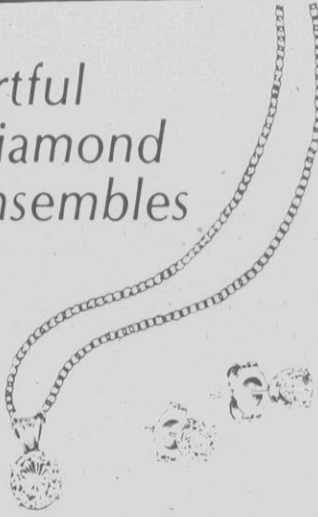

Adorn yourself with the tasteful elegance of a diamond solitaire and matching earrings. Available in a variety of sizes, each diamond is delicately set in 14K yellow gold. (14K gold chain included)

Diamond Earrings

.04 TW	48.00
.08 TW	78.00
.10 TW	108.00
.16 TW	128.00
.20 TW	228.00
.25 TW	318.00
.33 TW	368.00
.40 TW	498.00
.50 TW	748.00

Diamond Pendants

.06 Round	78.00
.12 Round	158.00
.20 Round	288.00
.25 Round	448.00
.16 Marquis	258.00
.20 Pear	358.00
.20 Heart	438.00
.20 Oval	498.00

All Colored Stone, Birthstone And Signet Rings
10% To 50% Off

Special Sale Diamond Pierced Earrings **\$9⁹⁹**



01 Total Weight, Mounted in Surgical Stainless Steel

Sparkling Diamond Cluster Specials

Size	Reg.	Special
77 TW	\$1250	\$999
50 TW	\$650	\$518
45 TW	\$495	\$348
25 TW	\$322	\$258
.18 TW	\$475	\$378
.17 TW	\$325	\$258
.14 TW	\$250	\$200
.07 TW	\$234	\$188

Genuine Pearl Necklaces

16" & 18" Lengths
3 1/2-7mm Graduated
6mm Uniform
6 1/2mm Uniform

\$348⁰⁰
YOUR CHOICE

Santa's Stocking Stuffers

Concept Earrings	14 Kt. Gold Floating Heart	14 Kt. Gold Serpentine Bracelets
25% Off Priced From \$550	Small - \$1 ⁴⁹ Large - \$2 ⁹⁹	\$4⁹⁷

No better gift. No better time. Seiko Quartz.

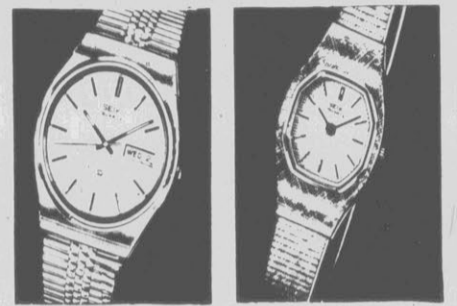

Entire Stock **25% Off**

SEIKO

CITIZEN

Watches
Entire Stock

10% Off

14 Kt. Solid Gold Chains, Charms, And Bracelets

1/2 Price

Finest Quality - Lowest Prices

14 Kt. Gold Add-A-Beads

3mm - 39¢
4mm - 59¢
5mm - \$1⁰⁹
6mm - \$1²⁹
7mm - \$1⁵⁹
Buy All You Want - Subject To Early Sellout

BOB'S TV... Santa's Gift Headquarters



WHIRLPOOL Model SHU-4004
Undercounter Dishwasher with Exclusive In-The-Door Silverware Basket

SALE PRICED **\$298**

Provides more interior loading space... easy to remove for loading/unloading!

- 3 Automatic Cycles • Energy-Saving Air Dry Option
- Exclusive EASY ROLLERS™ Installation Wheels
- ThermalSonic™ Sound Insulation • Plus More!

WHIRLPOOL Washers, Dryers, Refrigerators Ranges, and Microwaves ALL ON SALE!

90 Days • Instant Credit • Cash Talks • Monthly Terms
GREENVILLE STORE OPEN MON - FRI, TIL 8 PM

TV & APPLIANCE



108 East Second St., Ayden, N.C.
Telephone 746-4021

SALES & SERVICE

Layaway Now For Christmas

GREENVILLE JEWELERS

PITT PLAZA PHONE 756-2990
OPEN NIGHTS UNTIL 9

HURRY!
Quantities Limited

3205 South Memorial Dr., Greenville, N.C.
Telephone 756-8830

Israeli Weapons Sales Spark Fresh Controversy

By DANIEL GREBLER
Associated Press Writer
TEL AVIV, Israel (AP) — Critics of Prime Minister Menachem Begin's government are demanding that Israel stop selling arms to regimes with poor human rights records.

But defenders of the policy say the sales, estimated at more than \$1 billion annually, are essential to the survival of Israel's arms industry, and a key element in establishing diplomatic ties with developing countries.

They also contend that Israel need have no qualms about doing what most Western countries have been doing for decades — arming tyrannical regimes.

Defense Minister Ariel Sharon returned this week from Honduras, where a senior Honduran official said Sharon agreed to sell Honduras military leaders "numerous armaments." The Honduran government on Tuesday denied Sharon

made any agreement to sell it arms.

"What do we have with Honduras?" wrote former Prime Minister Yitzhak Rabin in the daily Yedioth Ahronoth. "Israel's military interference in Central America only complicates and damages her position, image, and her interests with the few friends she still has. That's all we need."

As Rabin's article appeared, Foreign Minister Yitzhak Shamir was off to Buenos Aires for talks with leaders of Argentina's ruling military junta.

Although Shamir denied he would discuss arms sales, Israel is known to have sold Argentina millions of dollars worth of aircraft, patrol boats and air-to-air and ship-to-ship missiles.

A week earlier, Shamir was in Zaire, cementing the diplomatic ties that were renewed last May, and reports from the African country spoke of an \$8 million arms deal. Again,

critics protested that Israel was getting too friendly with a regime regarded as dictatorial.

Supporters of the policy retorted that the opposition Labor Party, which has bitterly castigated the Honduras connection, was in office when Israel was selling arms to Nicaraguan dictator Anastasio Somoza.

The director-general of the Foreign Ministry, David Kimche, denied that recent Israeli diplomatic gains in Third World countries resulted from arms sales.

"It would be wrong to claim that Israel is now re-entering Africa and Latin America through military activity alone," he was quoted as telling Parliament's Foreign Affairs and Security Committee. "However, it is the military subject which attracts all the media attention."

Kimche was quoted as observing that many countries are interested in military assistance and was quoted as saying "Israel has its own interests and needs."

Opponents argue that Israel should stick to helping developing countries with advice on agriculture and

their training from Israeli advisers.

Indeed, many of the arms-supplying relationships were forged under Labor governments. Rabin, who so bitterly castigated the Honduras connection, was in office when Israel was selling arms to Nicaraguan dictator Anastasio Somoza.

The director-general of the Foreign Ministry, David Kimche, denied that recent Israeli diplomatic gains in Third World countries resulted from arms sales.

"It would be wrong to claim that Israel is now re-entering Africa and Latin America through military activity alone," he was quoted as telling Parliament's Foreign Affairs and Security Committee. "However, it is the military subject which attracts all the media attention."

Kimche was quoted as observing that many countries are interested in military assistance and was quoted as saying "Israel has its own interests and needs."

Opponents argue that Israel should stick to helping developing countries with advice on agriculture and

health. Labor's Yossi Sarid, an outspoken liberal, claims Israel has "forsaken the green route of agriculture for the red and bloody route of arms."

The steady shift of the Third World toward the Arab cause has pushed Israel into closer ties with countries like South Africa, the Philippines and the Latin American dictators.

The volume of trade is secret and the weapons often move clandestinely through middlemen. Israel's arms industry, founded in the hope of one day making the Jewish state militarily independent, depends heavily on exports.

Israel receives much of its front-line weaponry from the United States. But Israel's Merkava tank, regarded by some experts as one of the world's best, was developed with know-how gained during earlier cooperation with British engineers on the Centurion tank.

The Israelis built the Kfir fighter after their secret agents obtained plans of an advanced French Mirage warplane.

Israel also exports swift patrol boats, armor-piercing shells, and sophisticated anti-guerrilla electronics systems.

While no details on weapons exports are released locally, foreign re-

ports say Israel is the world's seventh largest arms dealer, with annual sales of more than \$1 billion. Both South Africa and Argentina are said to rank among its top customers.

The arms trade "is not a nice business to be in," says Yigal Hurwitz, a former fi-

nance minister under Begin. But Israel is so desperate for hard currency that it should sell "to whichever country wants to buy, on condition that the weapons are not turned against us."

Shulamit Aloni, another Labor liberal, says the Nazi Holocaust should have taught Jews not to abet dictatorships. But Ronnie Milo, a senior member of Begin's Likud faction, says that while he would not help arm a regime engaged in genocide, he believes that

passing judgment "is very complicated and very dangerous."

Aloni says Israel is losing the friendship of liberal Western groups with its arms policies. But Milo dismisses these friends as "bleeding hearts" and "hypocrites."

\$22,000 Is Lost, Found

RANCHO CORDOVA, Calif. (AP) — A diner at a doughnut shop got his dough back thanks to a waitress too honest to pocket his mislaid \$22,000.

The woman, who asked to be identified only as Bonnie, said she found a bag full of \$100 bills shortly after coming to work Sunday at Allen's Do-nut House, which doubles as a Greyhound bus stop for this community near Mather Air Force Base.

"I hollered," she said Monday. "I didn't know there was that much money in this town."

Bonnie said she wouldn't have been able to live with herself if she had kept the cash.

An hour after the find, a man called from the downtown Sacramento bus depot asking about the bag. He described the contents to her satisfaction and hopped a bus back to the doughnut shop.

Bonnie said the traveler was "ordinary," maybe 30 years old.

He said he had won the money gambling in Reno, Nev., and was returning to San Francisco when he stopped for a snack, she said.

"He told me he didn't remember bringing the bag in with him. He thought he left it on the bus," she said.

The man gave her a \$600 reward, which Bonnie split with the bakers on duty that morning.

Cab Robberies Was Organized

NEW YORK (AP) — A pair of gunmen escaped with \$1,500 in cash after entering a Brooklyn cab company, robbing the dispatcher and ordering cabs in from the field so they could rob the drivers, police said.

After robbing the cabbies and locking them in the trunks of their cabs, the gunmen handcuffed the dispatcher and another employee to a bathroom pipe, said Detective Robert Kohler.

The men robbed four of the 15 cars on duty early Tuesday before apparently deciding they had stayed long enough, Kohler said. There were no injuries.

Carol Singing In A County Jail

TALLAHASSEE, Fla. (AP) — The Christmas spirit hasn't been barred from the Leon County Jail, where inmates have started a holiday caroling program.

"Some people believe that no good could ever come from a place like this," says the Rev. Bob Key, jail chaplain. But Monday night, a group of 12 men gathered in a special cellblock dubbed the "Christian Bullpen" and gave a lively rendition of their best carol, "O, Come All Ye Faithful."

Response was reported mixed at the jail. Some inmates listened quietly while others fixed their attention on a television game show.

The public is invited to the jail to hear the inmates sing each weeknight until Dec. 22, officials said.

Shot In Finger By His Cat

GREENWOOD, Ind. (AP) — A 22-year-old man was treated and released at St. Francis Hospital in this Indianapolis suburb after being shot in the finger by his cat, police said.

The incident occurred about 9 a.m. Saturday while Dale Davis was sitting in his living room, officers said. A .38-caliber pistol and the cat were on a coffee table while Davis sat nearby. Suddenly the cat jumped, the gun went off and Davis was hit, police said.

No charge was filed, according to police who ruled the shooting accidental.

Police Report Two Wrecks

An estimated \$2,450 damage resulted from two traffic collisions investigated by Greenville police Tuesday.

Officers said heaviest damage resulted from a 12:23 p.m. wreck at the intersection of Fifth and Jarvis streets involving cars driven by Lisa Cheryl Carlisle of Raleigh and Ricky Allen Smith of Route 1, Oak City.

Police, who charged Ms. Carlisle with failing to yield the right of way, set damage at \$1,000 to the Carlisle car and \$350 to the Smith auto.

Cars driven by Kattie Buck Clark of Route 8, Greenville, and Geraldine Godley Harris of 8E Tripp St. collided about 8:51 p.m. on Memorial Drive, 20 feet north of the Dickinson Avenue intersection, causing an estimated \$600 damage to the Clark car and \$500 damage to the Harris auto.

COMPUTER PROFESSIONALS INCORPORATED

COMPUTER SYSTEMS • HARDWARE • SOFTWARE • INSTRUCTION
SALES • SERVICE • SUPPLIES

Ask about our free office analysis for your new computer system.

Available software includes General Ledger package interactive with Accounts Receivable, Payroll, and Accounts Payable, Word Processing, Electronic Spread Sheets, Modem programs and more.

SANYO
Colonial Data
OSBORNE COMPUTER CORPORATION

VISA MasterCard
WILCAR EXECUTIVE CENTER
223 West Tenth Street
Greenville, North Carolina 27834
(919) 757-3535

GIANT Discount, Inc.
429 Evans Street
Downtown Greenville
Across From Brody's - Downtown

Sale Dates:
December 16 - 18th Only
Quantity Rights Reserved

Christmas Gift TOYS & Games

By Fisher Price - Tonka Kenner And AMF

KODAK DISC 4000 Camera. . . . \$49⁹⁵ Sale

INDIANA GLASS WARE Gift Sets. . . . \$379 To \$779

G.E. HOMESENTRY Reg. \$37.49 Smoke Alarm. . . . \$12.95 Sale 1/2 Price

Posner Bergamot.
7 OZ. Special Sale \$1⁹⁹

Classy Curl Kit Sale \$6⁸⁸

LARGE HAIR SPRAY 9 OZ. 11 Oz. 12 Oz. 177
Adorn Or V05 Sale

FULL LINE OF Christmas Decorations
Lights - Garlands - Paper, Etc.

P.R. 10 Film. . . . Sale \$7⁴⁸

Cigarettes . . . Pack 60¢
Reg. . . . \$5³⁹
100's \$5⁴⁹

—Bring This Coupon—

20% Off
All Non Sale Items With This Coupon.
Does not apply to Cigarettes or sale items.
— Bring This Coupon —

Quantity Rights Reserved

Huge Pre-Christmas DISCOUNTS

SANYO

SLIM 1
Slim Line AC/DC Cassette Recorder
Ultra-Slim Design
6888-943-5

SLIM 4
Slim Line AC/DC Cassette Recorder
Ultra Slim Design
Built-In AC
Deluxe Styling
6888-942-7

1997

26⁹⁰

MG9
Miniature Personal Stereo Cassette Player With Lightweight Headphones
Stereo Music On The Go
Lightweight Stereo Headphones Included
Cue & Review
6888-970-8

34⁹⁷

M6060
Deluxe Portable Stereo Player With Auto Reverse
The Perfect Package for Continuous Stereo Music While On The Go
Auto Reverse Play Mechanism
Metal Tape Play Capability
Counter Rotating Flywheels for Smooth Even Playback Control
Features Pulse Drive Governor Circuitry for Extended Battery Life
6888-971-6

49⁹⁷

DCR150
Solid State AM/FM Stereo Receiver
22 Watts per Channel RMS Power
Bandwidth 20-20kHz with 0.09% THD
8 Ohm Load
Usable FM Sensitivity 2.0 µV (11.2 dBf)
LED Signal Strength Meter
6888-951-8

99⁹⁶

DCR250
Solid State AM/FM Stereo Receiver
22 Watts per Channel RMS Power
Bandwidth 20-20kHz with 0.09% THD
8 Ohm Load
Usable FM Sensitivity 2.0 µV (11.2 dBf)
10-Station Memory Tuning
PLL Frequency Synthesized Scan Tuning
6888-952-8

129⁹⁶

DCR350
Solid State AM/FM Stereo Receiver
33 Watts per Channel RMS Power
Bandwidth 20-20kHz with 0.03% THD
8 Ohm Load
Usable FM Sensitivity 1.9 µV (10.8 dBf)
12-Station Memory Tuning
Digital Frequency Display
PLL Frequency Synthesized Scan Tuning
6888-953-4

179⁹⁶

RD10
Stereo Cassette Deck
Metal Tape Capability
Dolby Noise Reduction System
LED VU Meters
6888-954-2

69⁹⁶

RDS35
Stereo Cassette Deck With Switchable Dolby B & C
Selector Switch for Dolby B or C
Automatic Music Select System
Soft Touch Transport Controls
S/N Dolby C On 77dB (Metal Tape)
Frequency Response 30-18kHz with Metal Tape
0.05% WRM S Wow & Flutter
6888-955-9

99⁹⁶

JXT55
AM/FM Stereo Receiver with Cassette Recorder/Automatic Changer/Two SX850 Speaker Systems
Left & Right Channel LED VU Meters
5-Segment Signal Strength Indicator
Deluxe 2-Speed Changer with Magnetic Cartridge
6888-936-8

199⁸⁷

M6400
Deluxe Mini-Size AM/FM Cassette Recorder With Variable Monitor
Automatic Music Select System (AMSS)
Left & Right LED VU/Sound Level Indicators
Dual 2-Way Stereo Speaker Systems
Powerful 600mW Amplifier
Cue & Review Modes
Full Auto Stop
6888-937-7

129⁹⁴

M8300
AM/FM Cassette Recorder
Deluxe Side Rule Dial
Variable Monitor
Auto Stop
6888-934-4

29⁹⁴

RP6260A
Deluxe AM/FM AC/DC Portable
Striking Contemporary Styling
Rotary Tone Control
Extra Sensitive AM/FM Tuner
Tuning/Battery Meter
6888-960-0

49⁹⁷

Sale Prices in Effect thru Friday, Dec. 24th.

Brendle's

2101 S. Tarboro St., Wilson, N.C.
Open 10:00 A.M. - 9:00 P.M. Mon. Through Sat.

Poet's Ghost Story Incomplete; They'll Have To Read Her Book

By MARY SCHULKEN
Reflector Staff Writer

Nancy Roberts wouldn't tell the students at North Pitt about the two times she's seen a ghost.

The first time, she said, she and her husband Bruce were looking for a place to eat lunch and came upon what they thought was an inn. It was an old house with a fountain in the yard made from a casket, she said, and a spout in the shape of a woman's hand. A closer look revealed it actually was a hand, encased in plaster of Paris.

That's all she told the group. She didn't say what happened inside the house.

"You'll have to read the book to find out what I saw," she said. "But in addition to feeling there was a spirit inside that fountain, I saw something inside that house."

Ms. Roberts, author of numerous ghost books including "Ghosts of the Carolinas" and "America's Most Haunted Places," visited Pitt County schools today and Tuesday, talking about her 20 years of chasing specter stories with her husband, photographer Bruce Roberts.

At North Pitt, she told how it all got started.

"I was doing newspaper work and working out of Charlotte when I was told by a man I considered very educated and reliable that he'd seen a ghost in a house in Fayetteville," said the folklorist.

"While at a party he'd seen a lady in a black dress coming down the stairs and she'd disappeared right before his eyes. I was intrigued. It sounded like a story I wanted to write about so my husband got his camera equipment together

and off we went to Fayetteville."

The Roberts didn't see the ghost, but by talking to many people who had, they unraveled the tale of how the apparition came to haunt the stairway. That was her first ghost story.

"After that I collected stories from all over North Carolina for about a year," said Ms. Roberts. "Carl Sandburg, who was living in Flat Rock, North Carolina, saw them and suggested the stories should be collected and published as a book."

After convincing a

publisher of the same thing, the Roberts published "The Blue Ghost," followed by "Ghosts of the Carolinas" and six other collections.

"All the stories are based on truth," said Ms. Roberts. "We talk to people who have seen ghosts but not the ghosts themselves. We don't just wait for them (ghosts) to parade in front of the camera."

"I've been writing ghost stories for 20 years and I've only seen a ghost twice," she said.

The most important thing in getting a good ghost story, she told students, is being determined.

"You don't stop when you hit a dead end," she said. "You're persistent. You keep asking and asking and hunting and sooner or later the story will appear."



N.C. AUTHOR AT NORTH PITT ... Nancy Roberts, left, talks with North Pitt student Barbara Tyer, right, about the Pictolus Light, a mysterious apparition that allegedly appears to motorists on the Greenville-Washington highway. Ms. Roberts is the author of several collections of ghost stories including "Ghosts of the Carolinas" and "America's Most Haunted Places." She visited Pitt County schools today and Tuesday. (Reflector Photo By Mary Schulken)

Lost A Dispute Over Boundary

WILMINGTON, N.C. (AP) — Pender County lost a boundary dispute with New Hanover County Tuesday when a three-member commission accepted New Hanover's version of where U.S. 421 crosses the county line.

The commission, appointed by a Superior Court judge to solve the problem, deliberated more than three hours Tuesday. The dispute involved how much of an industrial site lies in each county.

Takeda Chemical Industries Ltd. of Japan plans to build a manufacturing facility on a site straddling both the highway and the county line.

Set Big Outlay On Renovating

MOUNT AIRY, N.C. (AP) — Renfro Hosiery Mills plans to spend \$3 million on renovations and new equipment in anticipation of an economic recovery next year, company officials say.

The project, expected to be completed by early 1984, will save about 50 jobs and create 25 new ones, said Robert Merritt, president of the sock manufacturing company.

Renfro employs about 1,100 workers in Surry County.

FOCUS

A Natural Marvel

Depending on the weather, a partial eclipse of the sun should be visible today in Europe, northern Africa, and western Asia. During a solar eclipse, the moon passes between the earth and the sun, blotting out all or part of the sun's light. Long ago, an eclipse was viewed as a sign that the gods were displeased. But even in Biblical times, the Chaldeans understood the cycles of the heavens, and the Greek philosopher Thales used geometry to predict eclipses in about 600 B.C. A partial or total solar eclipse is a marvelous sight. But if you haven't seen one yet, don't worry. Scientists say that our sun should last for another 5,000,000,000 years, so you'll probably have another chance.

DO YOU KNOW — What is the special name for the sun's outermost atmosphere?

TUESDAY'S ANSWER — Clement C. Moore, a U.S. minister, wrote "The Night Before Christmas."

12-15-82 © VEC, Inc. 1982

Wrap Up Christmas Early

ALL HEALTH & BEAUTY AIDS

plus SCHOOL SUPPLIES and STATIONERY

NOW REDUCED 1/2 PRICE

NOW UNTIL CHRISTMAS

BIGGS

300 Evans Mall

FAMILY WANT AD PLAN



I can't afford to advertise. It's too expensive!

fact:

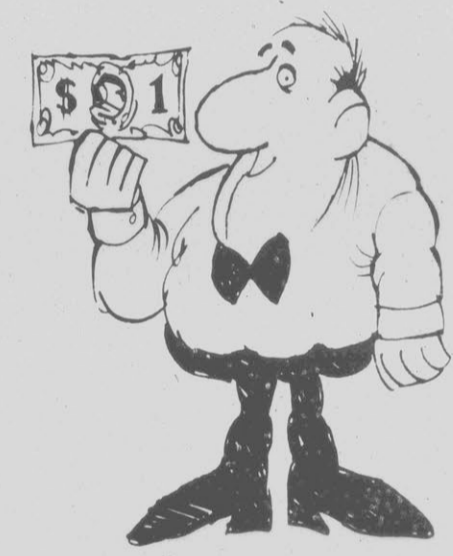

You can advertise in our Classified columns for only \$1.00 per day.

and:

It's as simple as calling us with your ad. We'll do the rest. Indeed, you CAN advertise—inexpensively—with Classified, and be sure of quick response from eager buyers!



3 Lines 4 Days For Only \$4.00

That's Right, Now You Can Advertise For Only \$1.00 Per Day When You Take Advantage Of Our New Family Want Ad Plan. Family Want Ads Must Be Placed By An Individual To Run Under The Miscellaneous For Sale Classification. Limit One Item Per Ad With Sale Value Of \$200 Or Less. Commercial Ads Excluded. All Ads Cash With Order. No Refund For Early Cancellation.

Use Your VISA Or MASTER CARD

THE DAILY REFLECTOR

Classified Ads
752-6166

CIRCUS WORLD

VIDEO HEADQUARTERS

NOW THRU SAT.

Video Invasion Sale Sale Sale

ATARI	INTELLIVISION	COLECO VISION
<p>COMBAT CARTRIDGE INCLUDED</p> <p>129⁹⁷</p>	<p>BLACK JACK/POKER CARTRIDGE INCLUDED</p> <p>SALE PRICE 199⁸⁸</p> <p>-25 MFG. REBATE</p> <p>SALE 174⁸⁸ YOUR FINAL COST</p>	<p>DONKEY KONG CARTRIDGE INCLUDED</p> <p>NOW ONLY 199⁹⁹</p>
<p>PLAYS ON ATARI 2600</p> <p>SUPER BREAKOUT..... 24⁹⁷</p> <p>PLAYS ON ATARI 2600</p> <p>DEFENDER..... 29⁹⁷</p> <p>PLAYS ON ATARI 2600</p> <p>WARLORDS..... 24⁹⁷</p> <p>PLAYS ON ATARI 2600</p> <p>ADVENTURE..... 24⁹⁷</p> <p>PLAYS ON ATARI 2600</p> <p>DEMONS TO DIAMONDS... 19⁹⁷</p> <p>PLAYS ON ATARI 2600</p> <p>BREAKOUT..... 17⁹⁷</p> <p>PLAYS ON ATARI 2600</p> <p>NIGHT DRIVER..... 19⁹⁷</p> <p>PLAYS ON ATARI 2600</p> <p>MAZE CRAZE..... 19⁹⁷</p> <p>PLAYS ON ATARI 2600</p> <p>BERZERK..... 24⁹⁷</p> <p>PLAYS ON ATARI 2600</p> <p>YAR'S REVENGE..... 24⁹⁷</p> <p>PLAYS ON ATARI 2600</p> <p>MATH GRAND PRIZ..... 17⁹⁷</p> <p>PLAYS ON ATARI 2600</p> <p>RAIDERS OF THE LOST ARK 29⁹⁷</p> <p>PLAYS ON ATARI 2600</p> <p>STAR RAIDERS..... 32⁹⁷</p>	<p>PLAYS ON INTELLIVISION</p> <p>BOXING..... 26⁹⁷</p> <p>PLAYS ON INTELLIVISION</p> <p>SPACE BATTLE..... 26⁹⁷</p> <p>PLAYS ON INTELLIVISION</p> <p>SUBHUNT..... 26⁹⁷</p> <p>PLAYS ON INTELLIVISION</p> <p>DUNGEONS & DRAGONS... 31⁹⁷</p> <p>PLAYS ON INTELLIVISION</p> <p>ASTROSMASH..... 26⁹⁷</p> <p>PLAYS ON INTELLIVISION</p> <p>SNAFU..... 26⁹⁷</p> <p>PLAYS ON INTELLIVISION</p> <p>SPACE ARMADA..... 26⁹⁷</p> <p>PLAYS ON INTELLIVOICE</p> <p>B-17 BOMBER..... 34⁹⁷</p> <p>PLAYS ON INTELLIVOICE</p> <p>SPACE HAWK..... 31⁹⁷</p> <p>PLAYS ON INTELLIVISION</p> <p>STAR STRIKE..... 31⁹⁷</p> <p>PLAYS ON INTELLIVISION</p> <p>LOCK N CHASE..... 31⁹⁷</p> <p>PLAYS ON ATARI 2600</p> <p>LOCK N CHASE..... 32⁹⁷</p> <p>PLAYS ON ATARI 2600</p> <p>ASTROBLAST..... 26⁹⁷</p>	<p>PLAYS ON COLECOVISION</p> <p>VENTURE..... 29⁹⁷</p> <p>PLAYS ON COLECOVISION</p> <p>LADYBUG..... 29⁹⁷</p> <p>PLAYS ON COLECOVISION</p> <p>COSMIC AVENGER..... 29⁹⁷</p> <p>PLAYS ON COLECOVISION</p> <p>SMURF ACTION..... 29⁹⁷</p> <p>PLAYS ON ATARI 2600</p> <p>VENTURE..... 29⁹⁷</p> <p>PLAYS ON ATARI 2600</p> <p>MOUSETRAP..... 29⁹⁷</p> <p>PLAYS ON ATARI 2600</p> <p>CARNIVAL..... 29⁹⁷</p>
<p>IMAGIC</p> <p>PLAYS ON ATARI 2600</p> <p>DEMON ATTACK..... 24⁹⁷</p> <p>PLAYS ON ATARI 2600</p> <p>STAR VOYAGER..... 24⁹⁷</p> <p>PLAYS ON ATARI 2600</p> <p>ATLANTIS..... 24⁹⁷</p> <p>PLAYS ON ATARI 2600</p> <p>COSMIC ARK..... 24⁹⁷</p> <p>PLAYS ON ATARI 2600</p> <p>RIDDLE OF THE SPHINX..... 24⁹⁷</p>		

'Bama's 'Bear' To Retire At End Of Year

TUSCALOOSA, Ala. (AP) — Paul W. "Bear" Bryant, the winningest coach in college football history, announced his retirement today and Ray Perkins, coach of the National Football League's New York Giants, was named as his successor.

Bryant, 69, said he would remain as athletic director of the Crimson Tide. Perkins, an All-American receiver at Alabama in the mid-1960s, will stay as coach of the Giants through the end of the season and take over at Alabama for the 1983 season.

The announcements came in simultaneous news conferences here and in East Rutherford, N.J.

Bryant, with a 322-85-17 record as a college coach, said his retirement would take effect after Alabama's Liberty Bowl game against Illinois Dec. 29. This year's Crimson Tide team is 7-4, the team's poorest mark since 1970.

"I'm following — repeat, following — the greatest coach in college football," Perkins said. "It's a great honor to go there."

Bryant has been coach at Alabama for 25 years, compiling a record of 231-46-9. In the final regular-season game of the 1981 season, he registered his 315 career victory, breaking the old mark held by Amos Alonzo Stagg.

Perkins, 41, was a star wide receiver at Alabama under Bryant in 1964-66, gaining All-America honors as a senior. The

Mount Olive, Miss., native went into coaching after playing five years with the Baltimore Colts of the NFL.

He is in his fourth year as coach of the Giants, with a 23-33 record including 3-3 this season. Last year, the Giants made the NFL playoffs for the first time since 1963.

In Tuscaloosa, Bryant told a packed room of reporters that there comes a time when every coach has to "hang 'em up."

In East Rutherford, Perkins said: "I will finish the season as head coach. I look forward to finishing the season. On the other hand, I leave with mixed emotions. It gives me great pleasure to return to my alma mater. It's certainly something I want to do very, very much."

"It's simply something that's a once-in-a-lifetime opportunity for me. If it was anyplace else, any other college team could not lure me from the New York Giants. Nothing could have, I don't believe, kept me from making this decision."

Perkins said he was called by Alabama officials last Thursday and interviewed for the job last Sunday. He was offered the job Monday and made up his mind to take it that day, he added.

Alabama's mandatory retirement age for state employees is 70, so Bryant could not promise potential recruits that he would be their coach for their entire college careers.

Southeastern Conference rivals of the Crimson Tide have

stressed this to recruits in recent years, and it has made recruiting increasingly difficult for the Bear.

Bryant has been a head coach in college for 38 seasons — one at Maryland (1945), eight at Kentucky, four at Texas A&M and the last 25 at Alabama, where he played in the mid-1930s and later was an assistant coach under Frank Thomas from 1936-39.

Bryant, whose record at Alabama is 231-46-9, has often said he would never do anything to hurt the program and wanted to leave it in such good shape that his successor would have even more success than he did. Apparently, he feels the time is ripe before decay sets in.

The promise of October — a 5-0 start, a No. 2 ranking in The AP poll and the dream of a sixth national championship — has turned into the doldrums of December. Alabama finished the regular season with three consecutive losses for the first time in Bryant's reign and the Crimson Tide's 7-4 record was its poorest since a 6-5-1 mark in 1970. Alabama has not been in the Top Twenty for the last four weeks; in the previous 11 years, the Crimson Tide only missed the ratings for one week early in the 1976 campaign.

All indications pointed to the stern-visaged Perkins, a noted disciplinarian just like the "old man," as Bryant's successor.

Perkins, in his fourth year as coach of the Giants, reportedly

was asked to consider it last week when Bryant was in New York for the National Football Foundation's annual banquet. The AP learned that Alabama had formed a small search committee to pursue an eventual successor, but did not really consider Perkins because it felt he was making more money with the Giants than the school could offer.

However, Perkins got word to Bryant that he wanted the job.

Perkins, a native of Mount Olive, Miss., went into coaching after playing at Alabama from 1964-66 as a star receiver. He played five years with the Baltimore Colts in the NFL and then went into coaching, serving as an assistant at Mississippi State University and later with the NFL's New England Patriots and San Diego Chargers before the Giants gave him his first head coaching job in 1979. Last year, the Giants made the playoffs for the first time in 18 years.

While the Giants' star was on the rise, Alabama's seemed to be fading. The Crimson Tide was held without a first down in the first half and thoroughly embarrassed by LSU in a 20-10 pasting Nov. 6. Afterward, Bryant said it was "very obvious now, for three or four weeks, that our team has been very poorly prepared. In any event, I'm going to alert the (university) president, and anybody that wants to know, in a heck of a hurry that we need to make some changes, and we need to start at the top."

Conley Holds Off Farmville

By RICK SCOPPE

Reflector Sports Editor
HOLLYWOOD — D.H. Conley teased Farmville Central nearly the entire second half and it nearly cost the Vikings their unblemished record.

D.H. Conley went to its 1-4 delay — or tease — midway through the third period and saw the Jaguars cut an 11-point lead to two, but DHC hit six free throws in the last 2½ minutes to eek out a 47-44 victory.

In the girls' game, D.H. Conley whipped Farmville, 58-30.

The Vikings led, 29-18, at the half only to have the Jaguars score five points in a row which not only cut the lead to six with four minutes to go but changed DHC's strategy.

D.H. Conley coach Shelley Marsh called for his 1-4. Two turnovers followed and the DHC lead shriveled to 33-29 before guard Keith Gatlin swished a jumper and two free throws to give DHC a 37-29 lead after three periods.

The Vikings stayed with their 1-4 the final period, despite six turnovers that allowed Farmville to cut DHC's lead to two (twice) and one with 1:30 left to go on a jumper by Terrance Pettaway from the left corner.

Two free throws by Mitchell Cox upped DHC's lead to 45-42, but the Jaguars cut the gap again to one on a follow by Tony Hargrove with 10 seconds to go. Donald Wilson sealed the win for DHC with two free throws with one second left.

"We just never could get the ball with a chance to win it. I thought we would win if we did," said Farmville Central coach Mike Terrell, whose team falls to 2-3.

"I'm very proud of the way we played in the second half," Terrell said. "We played good aggressive defense."

Marsh agreed. "Farmville did a good job against our 1-4," Marsh said. "But, our

Gatlin Scores

D.H. Conley guard Keith Gatlin (24) goes up for two of his 18 points last night against Farmville Central. The Jaguars' Terrance Pettway (44) tries to block Gatlin's shot while teammates' Andrew Edwards (32) and Tony Hargrove (20). (Reflector photo by Katie Zernhelt)

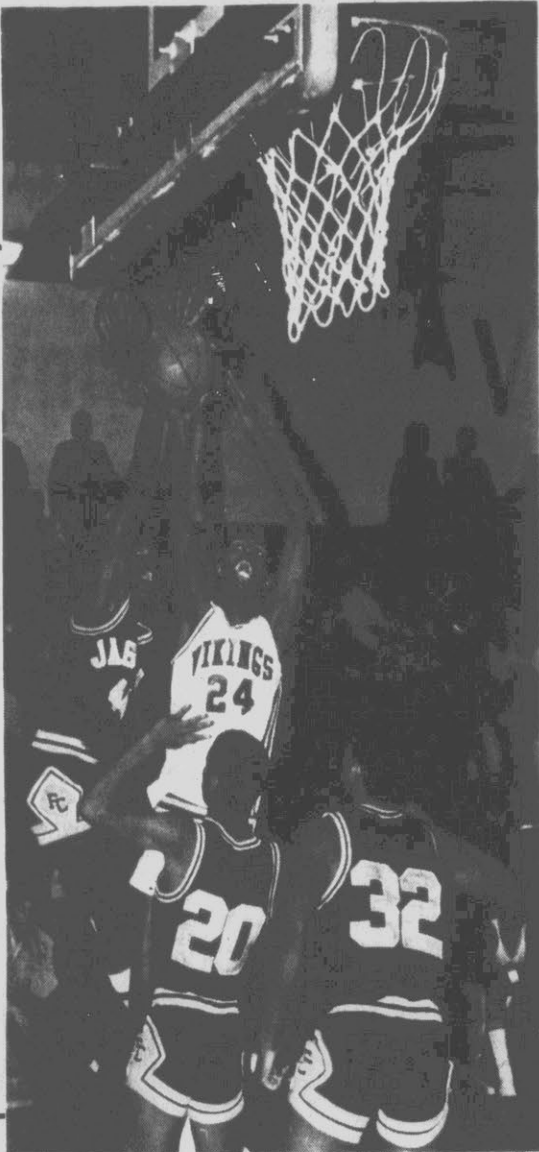

ballhandling was atrocious. They weren't double-teaming us. They just took the ball from us man-to-man and went down and got a layup."

Asked why he went to the 1-4, Marsh said: "We wanted to get Farmville out of (its) offense. They were playing so well on offense we were hoping to get them standing around a little bit."

"It didn't work very good, as you could see."

What it did, however, was slow the pace and force Farmville to gamble: try to steal the ball and risk a foul or sit back and wait for DHC to make a mistake. Terrell chose

(Please turn to page 24)

Rose Rallies By North Pitt

By WOODY PEELE
Reflector Sports Editor

BETHEL — North Pitt, up by nine points with just over a minute left in the first half, lost its poise in the early minutes of the third period and Rose High School's young Rampants won their first game of the season last night, 44-41.

Rose built up as much as a seven point lead late in the game before North Pitt came back to trim it to the final three point margin.

Earlier in the evening, North Pitt's girls avenged an earlier loss to the Rampettes, 47-33, taking advantage of the foul line to do most of the damage.

"We had some people decide to take the game themselves," North Pitt coach Cobby Deans said after emerging from the dressing room following the game. He obviously was disappointed in the play of his

team from the trailing minutes of the second quarter on.

North Pitt built up an early eight-point lead, 10-2, before Rose pulled back within three at 10-7. Still the Panthers managed to hold on and take a 14-10 lead into the second quarter.

Ever so slowly, North Pitt inched further out over the Rampants, finally reaching a nine point lead at 25-16 with 1:55 left in the half. Greg Hines scored on a drive for the

margin, and was fouled on the play — giving him the chance to stretch it to ten.

He missed, however, and Rose came back with three free throws, two of them by Jeff Hopkins, to cut the lead to 25-19 at intermission.

In the second half, the Rampants tried a different tact. "We changed our defense. We came out of the zone and went to man-to-man,"

Coach Jim Brewington said. "We shot a little better and we moved the ball better."

Actually, that was exactly what Deans wanted — to get the Rampants out of their 3-2 zone. "That gave us some trouble and we wanted to get them in a man and into some foul trouble, but we had too many people trying to go one-on-one instead of playing the offense. That took us out of our offense. We just had some people who wanted to control the whole offense."

Tony Clemons and Hopkins hit their first two shots the Rampants took in the half, cutting the lead to two. Then, after Dennis Bradley made the

second of two free throw tries, Rose pulled within one as Allen Dickens hit from the baseline.

Mac Walston pushed Rose into the lead for the first time from underneath, 27-26, but Hines hit two straight baskets to push the Panthers back into a 30-27 lead. It was their last.

Carlton Wilson tapped in a shot with 2:20 left then scored

(Please turn to page 24)

SAAD'S SHOE REPAIR

Quality Shoe Repairing
113 Grande Ave.
758-1228
Opposite Sherwin Williams

Hours
8-6 Mon.-Fri.
Closed Saturday
"Parking In Front"

RB SAILOR

Hwy. 264 East
758-4641
Quality Sailboats

SAFE HOLIDAY DRIVING ON GOODYEAR TIRES

TWO LOCATIONS TO SERVE YOU! SALE ENDS DEC. 24th

A78X13 Power Streak Blackwalls Plus F.E.T.	Size	Sidewall	4 for	Description
	A78x13	White	122 ⁰⁰	4 Ply Polyester
	E78x14	Black	149 ⁰⁰	4 Ply Polyester
	F78x14	White	158 ⁰⁰	4 Ply Polyester
	G78x15	Black	175 ⁰⁰	4 Ply Polyester
	H78x15	White	202 ⁰⁰	4 Ply Polyester

4 for \$109⁰⁰

RADIAL PAIR SALE

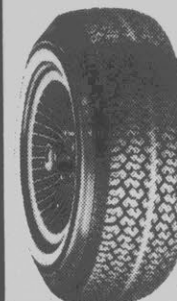
P15580R13 Viva Blackwall Plus F.E.T.	Size	Sidewall	2 for	Description
	P17580R13	Black	88 ⁰⁰	Viva Radial
	P17570R13	White	98 ⁰⁰	Custom Polysteel
	P18575R14	Black	98 ⁰⁰	Viva Radial
	P19575R14	White	140 ⁰⁰	Tiempo
	P20575R15	White	150 ⁰⁰	ARRIVA
	P22575R15	White	160 ⁰⁰	Custom Polysteel

2 for \$80⁰⁰

OIL-LUBE FILTER

\$13⁸⁸
Multigrade Oil
COUPON EXPIRES 12-24-82

FRONT END ALIGNMENT

\$16⁸⁸
Set Caster, Camber & Toe-In
COUPON EXPIRES 12-24-82

\$30.00 Rebate On Selective Models Of



PORTABLE HEATERS LIMITED TIME

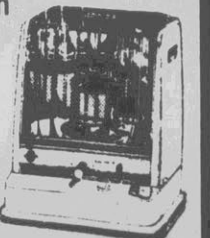

Johnny Joyner
Store Manager
West End Store

GOODYEAR TIRE CENTER

Owned & Operated by Wayne L. Trull, Inc.

West End Shopping Center
756-9371

729 Dickinson Ave.
752-4417

Both Stores Open Mon.-Fri. 8 to 6-Sat. 8 to 1



Phil Trull
Store Manager
Downtown Store

ECU's Edwards Receives Honor

East Carolina's Johnny Edwards has been named the Rookie of the Week by the ECAC-South for his play last week.

Edwards, a 6-6 freshman from Charlotte, scored 28 points and pulled down seven rebounds in ECU's 87-81 basketball victory over Samford then followed that with 19 points and ten rebounds as ECU bowed to 15th ranked N.C. State, 57-49, a few days later.

Edwards is averaging 19.8 points and 8.3 rebounds for the season so far, pacing the Pirates in both departments.

Sports Calendar

Editor's Note: Schedules are supplied by schools or sponsoring agencies and are subject to change without notice.

Today's Sports
Wrestling
Tarboro, Roanoke Rapids at Roanoke (5:30 p.m.)
Conley at White Oak (7 p.m.)
Thursday's Sports
Wrestling
Carey at Farmville Central (7 p.m.)



P.G.H.™ Casual Pants
Selection of several styles and colors elastic waist with drawstring, beltloop button front and elastic waist with button front in navy, grey, royal blue, olive, and tan.

Reg. to 27.00 Now 15⁹⁹
Corduroy Pants 19⁹⁹
Reg. 28.00 Now
brody's Pitt Plaza for men

Bellamy Keys West Craven By G. Central

VANCEBORO — Ronnie Bellamy pumped in 23 points to lead West Craven to a 67-35 victory over Greene Central Tuesday night in a nonconference basketball game.

In the girls' game, Greene Central defeated West Craven, 51-40.

The Rams, now 0-4, led after the first period, 11-10, but the Eagles slipped ahead, 24-22, at the half and outscored Greene Central, 15 to 2, in the third period to up their lead to 39-24.

West Craven, now 5-1, coasted to the win in the final period, outscoring the Rams, 28 to 12.

Tim Cox had 11 points for West Craven. The Rams were led by Clifton Joyner with 12.

In the girls' game, Greene Central outscored the Lady Eagles, 16 to 14, in the first period only to see West Craven go up, 29-24, at the half.

The Lady Rams rallied to take the lead in the third period, outscoring West Craven, 17 to 5, for a 41-33 lead and were never challenged again.

Greene Central, now 3-1, was led by Cindi Hicks with 17 points. West Craven, now 1-5, was topped by Charlotte Smith with 14 and Beverly Peele and Angie Oakes with 14 each.

Greene Central plays host to Farmville Central Friday.

JV Game — West Craven 63, Greene Central 33

Girls' Game
Greene Central (51) — Hicks 8 1-2 17; Bowen 10-22; Cox 3-6 1-6; A. Wilkes 2-3-7; Jones 1-0-2; S. Wilkes 1-1-3; Battle 3-2-8; Myatt 3-0-0 6; Herring 0-0-0 0; Radford 0-0-0; Totals 27-19-51.

West Craven (40) — Oakes 3-5 11; Allen 1-2-4; Sutton 0-0-0; Smith 5-4 14; Peele 5-1-4 11; Heathcock 0-0-0; Peterson 0-0-0; Totals 14 12-23-40.

G. Central 16 8 17 10-51
West Craven 14 15 5 6-40

Boys' Game
Greene Central (35) — Johnson 0 1-2 1; Thompson 3 1-7; Dixon 0 1-2; Warren 0-0-0; T. Edwards 2-0-4; McLawhorn 2-2-4; C. Joyner 6-0-12; S. Edwards 1-0-2; L. Joyner 0 1-2 1; Fulton 0-0-0; Totals 14-17-35.

West Craven (67) — Harris 4-1-9; Cox 5-1-2 11; Bellamy 11-2-23; King 3-0-4; Blount 0-0-0; Mitchell 2-2-6; Crowl 1-2-4; Jenkins 1-0-2; Goodman 0-4-4; Myers 0-0-0; Becton 2-0-1; Totals 28 11-16-67.

G. Central 11 10 2 12-35
West Craven 10 14 15 28-67

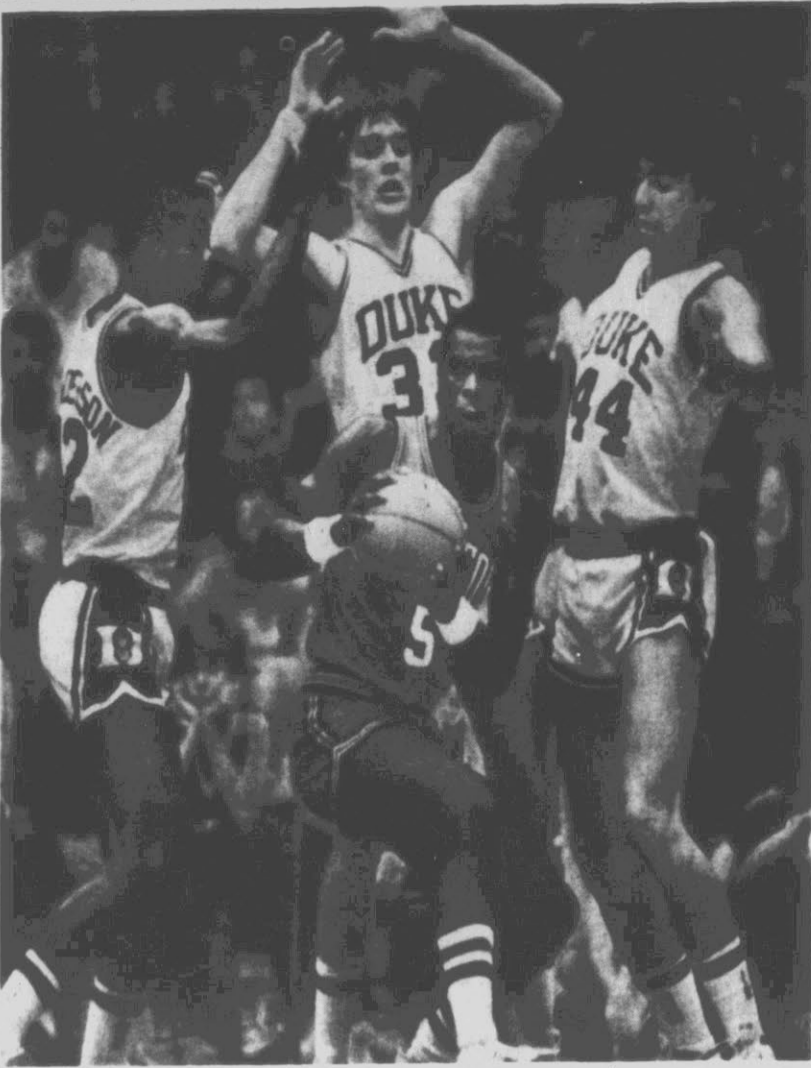

Surrounded
Davidson's Kenny Wilson (5) is surrounded by Duke's David Henderson (left), Mark Alarie (middle) and Todd Anderson (right) during Tuesday night's game played in Durham. The Blue Devils defeated the Wildcats, 63-60. (AP Laserphoto)

Bertie Romps By Tigers

WINDSOR — Bertie Senior High School romped to a 61-35 victory over Williamston last night, evening its Northeastern Conference record at 1-1.

Williamston's girls gained a 47-41 win in their game, moving out to a 2-1 league record. The Lady Tigers are 2-4 overall.

Bertie, now 3-1 overall, rushed out to a 12-5 lead after one period and were never headed by the Tigers. Williamston, now 2-4 overall and 1-2 in the league, fell further behind in the second period, as Bertie built up a 30-11 halftime bulge.

The pullaway slowed in the second half, but Bertie continued to build on it. By the end of the third period, the Falcons were out to a 45-24 lead, and they outscored Williamston, 16-11, in the final quarter.

David Tyler led Bertie with

18 points, while Brian Bunch had 11 and Steve Capehart and Dale Sanderlin each had 10. No one scored in double figures for Williamston.

Williamston's girls eased into a 9-8 lead after the first period of play, but Bertie stormed ahead in the second period with a 13-6 advantage. That made it 21-15 for the Lady Falcons at the half.

In the third quarter, Williamston began to rally, outthumping Bertie, 12-9, to trail by only 30-27 as the final period opened. In that, Williamston scored 20 points while holding Bertie to 11 to pull ahead and claim the win.

Lynn Mills led Williamston with 17 points while Timberly Rodgers had 13 and Lynn Sanders had 10. Mills and Rodgers had 11 and 10 rebounds, respectively, for the Lady Tigers.

Bertie was led by Marie

Pugh with 16 points. Williamston plays host to Tarboro on Friday.

Girls Game
Williamston (47) — L. Mills 5 7-13 17; Bowen 2-0-4 4; T. Rodgers 4 5-12 13; Sanders 3-4-4 10; J. Mills 1-1-2 3; Speller 0-0-0 0; R. Rodgers 0-0-0 0; Totals 15 17-31 47.

Bertie (41) — Holley 1 0-0 2; Gilliam 3 1-3 7; Howard 1 1-7 3; Pugh 8 0-3 16; White 1 0-0 2; Williams 0-0-0 0; Capehart 0-0-0 0; Cary 3-2-4 8; Heckstall 1 1-1 3. Totals 18-5-18-41.

Boys' Game
Williamston (35) — Griffin 2 0-0-4; Speller 0 1-3 1; Little 2 0-0 4; L. Brown 3 0-0-6; Carter 2-2-4 6; Ward 0-1-0 0; Everett 2 1-4 5; Peele 2-2-2 6; Perry 0 2-2 2; C. Brown 0 1-2 1; J. Williams 0-0-0 0; Totals 13-9-18-35.

Bertie (61) — Bunch 5 1-1 11; Ryan 0 2-4 2; Tyler 9 0-0 18; Caliphar 0 0-0 0; Hayes 1 0-0 2; Garman 1 0-0 2; Sessoms 0 0-0 0; Capehart 5 0-0 10; Speller 0 0-0 0; Cook 2 0-1 4; Holley 1 0-0 2; Sanderlin 3-4-4 10; Totals 27-7-10-61.

Williamston 5 6 13 11-35
Bertie 12 18 15 16-61

D'SON	MP	FG	FT	R	A	F	Pt
K. Wilson	31	6-12	2-2	5	2	5	12
Rowan	36	4-8	0-1	9	2	4	8
Tribus	34	8-17	0-0	3	2	16	
R. Wilson	39	4-9	1-2	5	2	9	
Franz	10	0-0	0-0	1	1	0	
Carroll	28	3-8	1-2	0	6	7	
Born	10	2-3	0-0	1	1	4	
Bego	3	0-0	0-0	1	2	0	
McConkey	7	2-2	0-0	0	2	4	
Hernandez	2	0-1	0-0	1	0	0	
Johnson	1	0-0	0-0	0	0	0	
Totals	200	29-60	2-7	26	18	25	60

DUKE MP FG FT R A F Pt
Henderson 11 0-1 0-0 2 0 0 0
Bilas 25 3-6 4-4 9 1 3 10
Alarie 32 4-4 9-11 9 0 4 17
Emma 33 2-5 0-0 2 6 2 4
Dawkins 38 5-10 1-4 2 6 2 11
Meagher 15 1-1 1-3 1 1 4 3
McNeely 3 0-1 0-0 0 0 0 0
Engelland 9 0-4 2-2 1 0 0 2
Jackman 26 5-11 2-2 2 1 1 12
Anderson 8 1-1 2-2 1 0 0 4
Totals 200 21-44 21-28 30 15 16 63
Davidson 27 33-60
Duke 39 33-63

Turnovers: Davidson 17, Duke 22.
Technical fouls: None.
Officials: Clougherty, Brown, Herring.
Att.: 701.

TOW. ST.	MP	FG	FT	R	A	F	Pt
Cooley	35	6-9	0-0	3	2	5	12
Jones	31	6-8	5-7	10	1	4	17
Hendricks	37	2-5	2-3	5	2	4	6
Bruce	34	3-11	4-4	3	2	3	10
Leslie	22	1-8	0-0	4	5	4	2
Page	6	0-2	0-0	0	0	0	0
Gorham	7	0-1	0-0	0	0	0	0
Speicher	9	1-2	2-3	2	0	1	4
Dieter	3	0-0	0-0	2	0	0	0
Kay	11	1-1	2-2	2	0	1	4
Bunsavage	5	0-0	1-2	0	0	1	1
Totals	200	20-47	16-21	33	12	23	56

MARY. MP FG FT R A F Pt
Branch 39 11-15 3-5 3 6 2 25
Veal 29 3-5 1-1 8 1 5 7
Totals 200 20-47 16-21 33 12 23 56

TURNERS. MP FG FT R A F Pt
Knight 18 5-11 2-2 10 2 1 20
Nichols 26 7-14 2-4 10 2 1 18
South 11 2-4 0-0 4 1 2 4
Rivers 26 3-7 0-1 1 0 6 6
Bias 3 0-1 0-0 0 2 0 0
Baxter 14 0-3 0-0 1 2 1 0
Fothergill 18 2-5 0-0 3 2 1 4
Driesell 1 0-0 2-3 1 0 1 2
Palmer 1 0-0 0-0 0 0 0 0
Farmer 1 0-0 0-0 1 0 0 0
Totals 20 27-56 12-20 31 14 19 66

Townson State 28 28-56
Maryland 38 28-66

Turnovers: Townson 18, Maryland 11.
Technical fouls: None.
Officials: Knight, Nichols, South.
Att.: 5,550.

Terps, Blue Devils Win

By The Associated Press

Two of the Atlantic Coast Conference's rising stars — Bill Jackman of Duke and Adrian Branch of Maryland — led their teams to victories over small college opponents Tuesday night.

In games involving ACC teams tonight, Clemson hosts Campbell while Georgia Tech entertains Alabama A&M.

Branch scored 25 points to lead the Maryland to a 66-56 victory over Towson State.

The sophomore forward scored 14 points in the first half, when Maryland built up a 38-28 advantage. Branch made seven of nine field goal attempts and scored eight straight points at one stretch. He also had three assists before intermission.

Maryland guard Jeff Adkins added 12 points.

The Terrapins raised their record to 4-2, with their fourth victory outside of the ACC. East Coast Conference member Towson State, which got a team-high 17 points from Donald Jones, fell to 2-5.

Maryland coach Lefty Driesell says the Terrapins are still struggling, with the exception of Branch.

"We have problems everywhere except Adrian Branch," Driesell said. "Adrian played

well tonight. The rest of them, so-so."

Duke had to rely on a baseline jumper by Jackman with 20 seconds left to defeat Southern Conference foe Davidson 63-60.

Jackman, a 6-foot-8 forward who is another of the Blue Devils highly touted freshman tandem, scored six straight points in the final 4 1/2 minutes, twice pulling his team into the lead after it fell one point down.

Duke was paced by center Mark Alarie's 17 points, followed by Jackman's 12 points. Johnny Dawkins had 11 points and Jay Bilas added 10 as the Blue Devils upped their record to 3-4.

Davidson, 3-3, was led by Cliff Tribus with 16.

Blue Devil coach Mike Krzyzewski said afterward

that the contest was a struggle. "I thought we played pretty good defense and I thought we played hard, but I didn't think we passed the ball well and I didn't think we caught the ball well and I don't know why."

Players \$100 Entry Fee 9-Ball Tournament

Saturday Dec. 18, 1982 8:00 P.M.

3 Winners: 70% First Place 20% Second Place 10% Third Place

All Of Us At Players
Wish You A Merry Christmas And Happy New Year.

Located Beside Kesh & Kerry
On Pachtous Hwy. Halfway Between
Greene St. And 264 By Pass.

The Ideal Christmas Present \$250.00 VALUE FREE!

Buy 4 Cooper Passenger Tires

Get a vacation in sunny FLORIDA FREE

COMPLEMENTS OF WHITE'S TIRE SERVICE

"Buy 4 Cooper Lifeliner steel-belted radials or premium 78's, PRO 60 or 70 radials, PRO 60 or 70 belts, plus our related tire services and we'll give you a FREE VACATION in sunny DAYTONA BEACH, FLORIDA! This is over a \$250 value, yours absolutely FREE! Keep the vacation yourself, or give it as a CHRISTMAS PRESENT.

Your accommodations are only a short distance from fun-filled DISNEY WORLD—Florida's number 1 tourist attraction. Your FREE vacation is good anytime before October 15, 1983.

FREE Mounting

Bonus... On Your Cooper Tire Purchase

THIS OFFER ENTITLES YOU TO A VITALIZER OR A VACATION, BUT NOT BOTH

P-Numbers	Am. Equip.	Reg. Each Pr.	Special Sale
P185/80R13	AR78-13	\$99.65	\$52.32
P185/75R13	BR78-13	103.41	54.29
P185/75R14	DR78-14	110.26	57.89
P195/75R14	ER78-14	112.74	59.19
P205/75R14	FR78-14	117.10	61.48
P215/75R14	GR78-14	123.96	65.08
P225/75R14	HR78-14	131.44	69.01
P205/75R15	FR78-15	117.73	61.82
P215/75R15	GR78-15	124.61	65.42
P225/75R15	HR78-15	132.70	69.67
P225/75R15	JR78-15	132.70	69.67
P235/75R15	LR78-15	143.88	75.54

Plus P.E.T. \$1.69 to \$3.01. Ask about the free of charge replacement limited warranty.

Outline White Letters - High Performance Radial	PRO 60 Belted	PRO 70 Belted
P215/60R13 CR60-13 \$110.52 58.08	A60-13 \$67.07 \$44.02	A70-13 \$82.50 \$41.01
P235/60R14 FR60-14 125.25 65.76	F60-14 78.82 51.72	F70-14 70.72 46.41
P245/60R14 GR60-14 132.59 69.61	G60-14 83.44 54.76	G70-14 73.44 48.20
P245/60R15 HR60-15 133.27 69.97	H60-14 96.02 63.01	H70-14 77.74 51.02
P255/60R15 LR60-15 141.92 74.51	L60-15 83.86 55.03	L70-15 78.13 51.27
P275/60R15 PR60-15 153.92 80.81	PR60-15 96.85 63.56	PR70-15 83.22 54.61

Plus P.E.T. \$2.29 to \$3.40. Plus P.E.T. \$2.07 to \$3.43. Plus P.E.T. \$1.79 to \$3.07.

PRO 70 Radials
OUTLINE WHITE LETTERS HIGH PERFORMANCE RADIAL

P-Numbers	Am. Equip.	Reg. Each Pr.	Special Sale
P185/70R13	AR70-13	\$100.47	\$52.75
P195/70R13	BR70-13	104.23	54.72
P205/70R13	CR70-13	106.97	56.16
P205/70R14	DR70-14	111.14	58.35
P215/70R14	ER70-14	113.67	59.68
P225/70R14	FR70-14	118.03	61.97
P235/70R14	GR70-14	124.97	65.61
P225/70R15	HR70-15	125.60	65.94
P235/70R15	LR70-15	133.75	70.22

Plus P.E.T. \$1.91 to \$3.13.

Cooper TIRES

The Tire with 2 Names - Cooper on the outside and the name of the person that builds the tire on the inside. That's Cooper Quality!

Lifeliner Premium 78**

Size	Reg. Each Pr.	Special Sale
A78-13	\$56.34	\$36.97
B78-13	58.45	38.38
E78-14	63.71	41.81
F78-14	66.19	43.44
H78-14	70.06	45.99
H78-15	74.29	48.75
J78-15	74.99	49.21
L78-15	79.85	51.74
L78-15	81.31	53.38

Plus P.E.T. \$1.67 to \$3.00. **Premium is a Cooper Designation, not an industry standard.

We'll even warehouse and install your tires anytime within the next 12 months during this limited time offer. Ask for full details!

WHITE'S TIRE SERVICE

since 1951 GREENVILLE NEAR PARKER'S BAR-BE-QUE

3012 Memorial Drive Phone 355-2400

OPEN MON.-FRI. 7:30-5:30
OPEN SAT. 7:30-2:00

Aurora Whips Bullets

AURORA — Jeffrey Blango scored 24 points and John Griffin added 13 to key Aurora past Jamesville, 63-47, Tuesday night in a Tobacco Belt Conference game.

In the girls' game, Aurora whipped Jamesville, 42-24. Aurora, now 4-0 overall and 2-0 in the league, inched out to a 9-7 lead after the first period and then exploded for 25 points — to 17 for the Bullets — to take a 34-24 lead at the half.

Aurora upped its lead to 50-35 after three periods and coasted home with the win. Jamesville, now 0-5 and 0-3, was led by Kenneth Moore with 16 points and Rex Bell with 14.

In the girls' game, Jamesville led, 9-2, after the first period, but the Lady Trojans countered with a 12-2 spurt in the second period to lead at the half, 14-11.

Aurora outscored

Jamesville, 17 to 4, in the third period to up its lead to 31-15, and never looked back in the league.

Jamesville, now 0-5 and 0-3, was led by Lori Hardison with

10 points. Aurora was paced by Letti Jo Smith with 12 points.

Jamesville plays host to Belhaven.

JV Game — Aurora 63, Jamesville 38

Girls' Game
Jamesville (24) — Gardner 2-2-3 6; Getchell 1 0-1 2; Floyd 0 2-2 2; Hardison 2 6-9 10; Perry 0 2-8 2; Treadwell 1 0-0 2; Brown 0 0-1 0; Coltrain 0 0-10; Totals 6 12-25-24.

Aurora (42) — Len. Smith 2 1-2-5; L.J. Smith 5 2-5 12; Lewis 3 1-1 7; Simpson 2 3-8 7; Guion 3 0-1 6; Moore 1 0-1 2; Tatum 1 0-1 2; Gettis 0 1-3 1; Aldridge 0 0-0 0; Franklin 0 0-0 0; Sawyer 0 0-0 0; Totals 17 8-22 42.

Jamesville 9 2 4 9-24
Aurora 2 12 17 11-42

Boys' Game
Jamesville (47) — Ange 2 0-0 4; Bell 6 2-4 14; Moore 5 6-8 16; Biggs 3 0-0 6; Peele 3 1-2 7; Perry 0 0-0 0; Roberts 0 0-0 0; Anthony 0 0-0 0; Pierce 0 0-0 0; Totals 18-9-14-47.

Aurora (63) — Blango 11 2-2-24; Ephraim 2 0-0 4; Moore 4 1-5 9; Coffey 2 1-2-5; Tyre 1 0-0 2; Griffin 6 1-2 13; Carter 2 0-0 4; Aldridge 0 2-2 2; Holmes 0 0-1 0; Jackson 0 0-0 0; Williams 0 0-0 0; Hamilton 0 0-0 0; Totals

'Skins Capture Fifth Straight

ROBERSONVILLE — Greg Everett scored 20 points to lead undefeated Roanoke to a 59-55 victory over Plymouth Tuesday evening in a Northeastern Conference basketball game.

In the girls' game, Roanoke downed Plymouth, 57-51.

Roanoke, now 5-0 overall and 3-0 in the conference, jumped out to a 10-point (19-9) lead in the first eight minutes and never allowed Plymouth to take the lead after that.

The Redskins led at the half, 34-27. Plymouth, now 3-2 overall and 2-1 in the league, cut the deficit to 46-43 after three periods but the Red-

skins held on for the win. Spencer Bryant had 12 points for Roanoke and Garrett Baker added 11. Plymouth was led by Lonnie Ford with 19 points. Tony Brown added 13 and Myron Bell had 10 for Plymouth.

In the girls' game, Roanoke jumped out to a nine-point lead (23-14) after the first period only to have the Lady Vikings, now 4-1 and 2-1, cut the lead to 29-27 at the half.

Plymouth took the lead, 43-37, after the third period but the Lady Redskins rallied, outscoring Plymouth, 18-8, in the final period, to win.

Roanoke, now 3-2 and 3-0, was led by Shelia Howell

Phils Get Morgan

GIANTS GET KRUKOW IN 5-PLAYER SWAP

PHILADELPHIA (AP) — Philadelphia Phillies President Bill Giles says he and his top aides decided after last season's runner-up finish in the National League East that the team needed to add left-handed hitting and strengthen its bullpen.

The Phillies did just that Tuesday by acquiring left-handed-hitting second baseman Joe Morgan and southpaw reliever Al Holland in a five-player deal that sent right-handed starter Mike Krukow and two minor leaguers to the San Francisco Giants.

The trade came after Philadelphia was left with a hole at second base last week when it swapped gold glove Manny Trillo to Cleveland for left-handed-hitting outfielder Von Hayes.

The addition to Krukow, the Phillies gave up pitcher Mark Davis and outfielder Charles Penigar. Davis played last year for Oklahoma City in the AAA American Association, and Penigar with the Class A Spartanburg club in the Carolina League.

"Our head major league talent evaluator, Hugh Alexander, says Holland is one of the top four relievers in the National League," Giles said at a news conference Tuesday.

He said that with Morgan and Hayes the Phillies have added 20 to 30 home runs and 40 to 50 stolen bases. And he said that without a top-flight reliever such as Holland, the team couldn't win in the National League East.

But how will Morgan, 39, playing alongside, first baseman, Pete Rose, 42, affect the Phillies' usually tight defense?

"Trillo is the best defensive second baseman in the game," Giles admitted. "But Morgan has a better career fielding average, is a more intelligent player. Also, Morgan is a great leader, a gamer, a great competitor."

Morgan really is a stopgap until Juan Samuel, whom the Phillies believe will be a superstar, is ready to step up from the minors.

Giles said Morgan, who had reached a salary impasse with the Giants, was given a two-year contract, the first year guaranteed. It was believed Morgan got close to the \$600,000 per season he was seeking from San Francisco.

Giles said the deal was made at baseball's winter meetings in Hawaii last week, but could not be announced until contract problems were settled with Morgan.

In San Francisco, Giants General Manager Tom Haller said it was difficult to part

with a player such as Morgan, "but it was increasingly evident that the Giants weren't going to be able to sign him."

Morgan, an 18-year veteran, explained over a telephone hookup that his contract problems with the Giants was based on too many "ifs" and he wanted his money guaranteed.

Morgan hit .289 for the Giants' last year, smacked 14 home runs and drove in 61 runs in 120 games. He also stole 24 bases.

Holland, 30, compiled a 7-3 record with a 3.33 earned run average and five saves. He has a four-year career lifetime record of 19-11, a 2.60 ERA and 19 saves.

Krukow, 30, who came to the Phillies last year, posted a 13-11 record with a 3.12 ERA. Davis, 22, has been plagued with shoulder problems, and was 5-12 with a 6.12 ERA last season.

Krukow, 30, who came to the Phillies last year, posted a 13-11 record with a 3.12 ERA. Davis, 22, has been plagued with shoulder problems, and was 5-12 with a 6.12 ERA last season.

Krukow, 30, who came to the Phillies last year, posted a 13-11 record with a 3.12 ERA. Davis, 22, has been plagued with shoulder problems, and was 5-12 with a 6.12 ERA last season.

Krukow, 30, who came to the Phillies last year, posted a 13-11 record with a 3.12 ERA. Davis, 22, has been plagued with shoulder problems, and was 5-12 with a 6.12 ERA last season.

Krukow, 30, who came to the Phillies last year, posted a 13-11 record with a 3.12 ERA. Davis, 22, has been plagued with shoulder problems, and was 5-12 with a 6.12 ERA last season.

Krukow, 30, who came to the Phillies last year, posted a 13-11 record with a 3.12 ERA. Davis, 22, has been plagued with shoulder problems, and was 5-12 with a 6.12 ERA last season.

Krukow, 30, who came to the Phillies last year, posted a 13-11 record with a 3.12 ERA. Davis, 22, has been plagued with shoulder problems, and was 5-12 with a 6.12 ERA last season.

Krukow, 30, who came to the Phillies last year, posted a 13-11 record with a 3.12 ERA. Davis, 22, has been plagued with shoulder problems, and was 5-12 with a 6.12 ERA last season.

Krukow, 30, who came to the Phillies last year, posted a 13-11 record with a 3.12 ERA. Davis, 22, has been plagued with shoulder problems, and was 5-12 with a 6.12 ERA last season.

Krukow, 30, who came to the Phillies last year, posted a 13-11 record with a 3.12 ERA. Davis, 22, has been plagued with shoulder problems, and was 5-12 with a 6.12 ERA last season.

Krukow, 30, who came to the Phillies last year, posted a 13-11 record with a 3.12 ERA. Davis, 22, has been plagued with shoulder problems, and was 5-12 with a 6.12 ERA last season.

Krukow, 30, who came to the Phillies last year, posted a 13-11 record with a 3.12 ERA. Davis, 22, has been plagued with shoulder problems, and was 5-12 with a 6.12 ERA last season.

Krukow, 30, who came to the Phillies last year, posted a 13-11 record with a 3.12 ERA. Davis, 22, has been plagued with shoulder problems, and was 5-12 with a 6.12 ERA last season.

Krukow, 30, who came to the Phillies last year, posted a 13-11 record with a 3.12 ERA. Davis, 22, has been plagued with shoulder problems, and was 5-12 with a 6.12 ERA last season.

Krukow, 30, who came to the Phillies last year, posted a 13-11 record with a 3.12 ERA. Davis, 22, has been plagued with shoulder problems, and was 5-12 with a 6.12 ERA last season.

Krukow, 30, who came to the Phillies last year, posted a 13-11 record with a 3.12 ERA. Davis, 22, has been plagued with shoulder problems, and was 5-12 with a 6.12 ERA last season.

Krukow, 30, who came to the Phillies last year, posted a 13-11 record with a 3.12 ERA. Davis, 22, has been plagued with shoulder problems, and was 5-12 with a 6.12 ERA last season.

Krukow, 30, who came to the Phillies last year, posted a 13-11 record with a 3.12 ERA. Davis, 22, has been plagued with shoulder problems, and was 5-12 with a 6.12 ERA last season.

Krukow, 30, who came to the Phillies last year, posted a 13-11 record with a 3.12 ERA. Davis, 22, has been plagued with shoulder problems, and was 5-12 with a 6.12 ERA last season.

Krukow, 30, who came to the Phillies last year, posted a 13-11 record with a 3.12 ERA. Davis, 22, has been plagued with shoulder problems, and was 5-12 with a 6.12 ERA last season.

Krukow, 30, who came to the Phillies last year, posted a 13-11 record with a 3.12 ERA. Davis, 22, has been plagued with shoulder problems, and was 5-12 with a 6.12 ERA last season.

Krukow, 30, who came to the Phillies last year, posted a 13-11 record with a 3.12 ERA. Davis, 22, has been plagued with shoulder problems, and was 5-12 with a 6.12 ERA last season.

Krukow, 30, who came to the Phillies last year, posted a 13-11 record with a 3.12 ERA. Davis, 22, has been plagued with shoulder problems, and was 5-12 with a 6.12 ERA last season.

Krukow, 30, who came to the Phillies last year, posted a 13-11 record with a 3.12 ERA. Davis, 22, has been plagued with shoulder problems, and was 5-12 with a 6.12 ERA last season.

Krukow, 30, who came to the Phillies last year, posted a 13-11 record with a 3.12 ERA. Davis, 22, has been plagued with shoulder problems, and was 5-12 with a 6.12 ERA last season.

Krukow, 30, who came to the Phillies last year, posted a 13-11 record with a 3.12 ERA. Davis, 22, has been plagued with shoulder problems, and was 5-12 with a 6.12 ERA last season.

Krukow, 30, who came to the Phillies last year, posted a 13-11 record with a 3.12 ERA. Davis, 22, has been plagued with shoulder problems, and was 5-12 with a 6.12 ERA last season.

Krukow, 30, who came to the Phillies last year, posted a 13-11 record with a 3.12 ERA. Davis, 22, has been plagued with shoulder problems, and was 5-12 with a 6.12 ERA last season.

Krukow, 30, who came to the Phillies last year, posted a 13-11 record with a 3.12 ERA. Davis, 22, has been plagued with shoulder problems, and was 5-12 with a 6.12 ERA last season.

Krukow, 30, who came to the Phillies last year, posted a 13-11 record with a 3.12 ERA. Davis, 22, has been plagued with shoulder problems, and was 5-12 with a 6.12 ERA last season.

Chargers Win, 64-60, In Two OTs

A-G Outlasts North Lenoir

WHEAT SWAMP — Ayden-Grifton struggled through two overtimes before finally pulling out a 64-60 victory over North Lenoir last night in a non-conference basketball game.

North Lenoir's girls used a steady offense to gain a 56-48 win in their game.

The Hawks pushed out into an 18-13 lead in the first period of the boys' game, but Ayden-Grifton came back with an 18-12 margin in the second quarter, taking a 31-30 lead at intermission. North Lenoir inched back in front, 46-45, at

the conclusion of the third period.

Ayden-Grifton edged back into the lead late in regulation, but Larry Johnson scored with nine seconds left to knot it at 56-all, and force the first overtime.

Tyrone Gay then pulled Ayden-Grifton back into a 60-60 tie after North Lenoir had twice taken the lead in the overtime. Both teams then missed out on opportunities to win in the time remaining.

In the second overtime, Jeff Dixon made two free throws to put the Chargers ahead for

good, 62-60. After a North Lenoir miss, Thomas Anderson hit a layup to run the lead to 64-60, and that sewed it up for the Chargers.

Anderson led Ayden-Grifton with 19 points, while Gay had 16 and Calvin Peterson hit 13.

North Lenoir, now 2-4, was led by Maurice Thorbes with 19, while James Fisher had 13 and Johnson had 12.

North Lenoir's girls, now 5-1, fell behind in the first quarter of the girls' game, 12-10, but stormed back with a 14-7 advantage in the second

period for a 24-19 lead at the half.

The Lady Hawks inched that out to 40-31 during the third period and allowed Ayden-Grifton a 17-16 margin in the final frame.

Helen Wooten led North Lenoir with 26 points, while Veronica Chapman had 12 and Stephanie Hemby had 10. Cora Faison led Ayden-Grifton with 19.

Ayden-Grifton's boys are now 2-3, while the girls are 1-4. The Chargers return to action on Friday, traveling to Havelock.

JV Game: North Lenoir 74, Ayden-Grifton 30.

Girls Game

Ayden-Grifton (48) — Faison 9 1-2 19, Griffin 2 2-2 6, McCotter 2 4-4 8, Brown 4 1-3 9, Roundtree 3 0-0 6, Moore 0 0-0 0, Braxton 0 0-0 0, Chamberlain 0 0-0 0, Totals 20-8-11-48.

North Lenoir (56) — Philippe 2 0-0 4, Wooten 12 2-2 26, Chapman 6 0-2 12, Hemby 5 0-0 10, Cratch 2 0-0 4, J. Wooten 0 0-0 0, Totals 27-24-56.

Ayden-Grifton (64) — T. Anderson 8 3-4 19, Gay 8 0-0 16, C. Peterson 5 3-3 13, Dixon 1 4-4 6, Woods 3 0-0 6, Smith 1 0-0 2, Newton 1 0-0 2, Wiggins 0 0-0 0, M. Peterson 0 0-0 0, Totals 27-10-11-64.

North Lenoir (90) — Thorbes 8 3-5 19, Fisher 6 1-3 13, Johnson 6 0-0 12, Lee 3 0-2 6, Britt 3 2-8, McPhail 1 0-0 2, Hobbs 0 0-0 0, Heath 0 0-0 0, Totals 27-6-12-60.

A-Grifton (13) 18 14 11 4 4-6-4

N. Lenoir (18) 12 16 10 4 0-6-0

TANK McNAMARA

by Jeff Millar & Bill Hinds



SCOREBOARD

Bowling		NHL	
Burrhoughs Wellcome		Wales Conference	Patrick Division
W	L	W	L
The Fritos	30	NY Isles	17 13 5 127 108 39
Unicorn Four	29	Philadelphia	16 11 4 120 101 36
Ebony and Ivory	29	Washington	13 9 8 114 109 34
High Hopes	29	NY Rangers	15 13 2 123 115 32
Carolina Cowboys	28 1/2	Pittsburgh	9 16 5 101 136 23
E.T.	27 1/2	New Jersey	6 21 7 94 148 19
Ann's Angels	27	Adams Division	
Pin Wreckers	22	Montreal	18 7 6 149 108 42
Strike Force	22	Boston	17 9 6 136 103 40
Lolly Pops	16	Quebec	15 12 4 147 141 34
Men's high game, Joal Lamonica, 219; men's high series, James Manning, 603; women's high game, Grace Ward, 172; women's high series, Mary Baker, 477.		Buffalo	13 12 6 124 104 32
		Hartford	9 17 4 184 143 22
		Campbell Conference	
		Norris Division	
		Chicago	19 5 6 130 94 44
		Minnesota	19 8 5 143 115 43
		St. Louis	10 20 3 111 129 23
		Detroit	7 17 6 88 124 20
		Toronto	5 17 6 96 130 16
		Smythe Division	
		Edmonton	14 11 7 149 135 36
		Winnipeg	14 12 3 128 122 31
		Los Angeles	13 12 5 109 112 31
		Calgary	12 13 6 120 112 30
		Vancouver	11 17 6 135 146 28
		Tuesday's Games	
		Toronto 4, Quebec 4, tie	
		Washington 7, Los Angeles 2	
		Buffalo 3, NY Islanders 3	
		Hartford 3, Minnesota 3, tie	
		Winnipeg 4, St. Louis 3	
		Wednesday's Games	
		Los Angeles at NY Rangers	
		Detroit at Pittsburgh	
		St. Louis at Toronto	
		Winnipeg at Chicago	
		Montreal at Vancouver	
		Thursday's Games	
		Buffalo at Boston	
		Western Conference	
		Midwest Division	
		San Antonio	16 9 6 40 1
		Kansas City	12 7 6 52 3
		Dallas	11 10 5 34 3
		Denver	9 13 4 09 5 1/2
		Utah	8 14 3 36 6 1/2
		Houston	3 19 13 6 11 1/2
		Pacific Division	
		Los Angeles	17 5 7 73 1
		Seattle	16 6 7 27 1
		Phoenix	13 10 5 55 4 1/2
		Pojland	13 11 5 42 5
		Golden State	10 14 4 17 8
		San Diego	3 19 18 18 13
		Tuesday's Games	
		Detroit 104, New York 99	
		Washington 108, Chicago 102	
		San Antonio 102, Houston 93	
		Portland 107, Los Angeles 103	
		Phoenix 114, Seattle 109, OT	
		Ogden State 122, Dallas 113	
		Wednesday's Games	
		Cleveland at Philadelphia	
		Atlanta at Indiana	
		Boston at Detroit	
		Denver at Milwaukee	
		New Jersey at Kansas City	
		San Diego at Utah	
		Thursday's Games	
		Cleveland at Atlanta	
		Boston at New York	
		San Antonio at Denver	
		Ogden State at Phoenix	
		Portland at San Diego	
		Dallas at Seattle	

Rampants 'Pin' Northern Nash

RED OAK — Rose High School won the final five matches to squeeze out a 34-33 wrestling victory over Northern Nash Monday night.

Rose winners included Mark Brewington at 126 (by forfeit); Amos Edwards at 138 (decision); John Maye at 155 (forfeit); Frank Corey at 165 (forfeit); Greg Davis at 187 (decision); Marvin Fleming at 196 (major decision); and Barry Lyons at unlimited (superior decision).

Rose is now 3-1 and plays host to Wilson Pike on Friday.

College Basketball

EAST

Brown 78, Rhode Island 75

Manhattan 99, St. Francis, N.Y. 57

Maryland 86, Towson St. 56

Massachusetts 76, Bentley 72

Penn St. 78, St. Joseph's 69

Syracuse 91, Ohio St. 85

West Virginia 98, Ohio Wesleyan 50

SOUTH

Ala.-Birmingham 56, Columbus Coll. 42

Duke 63, Davidson 60

Furman 78, Winthrop 60

Ga. Southern 44, Cent. Florida 41

Jacksonville St. 61, Bethel 56

MIDWEST

Bowling Green 86, St. Bonaventure 72

SOUTHWEST

Santa Clara 88, Oklahoma City 68

Texas Wesleyan 72, N. Texas St. 69, OT

FAR WEST

Cal-Irvine 104, Chapman 88

E. Washington 86, S. Oregon 74

New Mexico St. 133, N. Mex. Highlands

Detroit at Philadelphia
Washington at Minnesota
Vancouver at Calgary

Rachel Wahlen

200 Eastbrook Drive Suite B
Greenville, N.C. 27834

Home: 752-1457
Business: 752-6747

LIFE OF VIRGINIA

IRA-Estate Planning
Life-Hospital-Group
Universal Life-Disability

On the fifth day of Christmas
Bond's and H.L. Hodges offers you

FOOTBALL EQUIPMENT

footballs, shoulder pads and jerseys, too.

FOOTBALLS

Rawlings Earl Campbell . Reg. \$19.95 Sale \$16.95

Rawlings BJB-S PeeWee . Reg. \$15.95 Sale \$11.95

Mikasa Rubber Footballs . Reg. \$19.95 Sale \$15.95

NFL Helmets Reg. \$24.95 Sale \$18.95

NFL Jerseys Sale \$8.95

Shoulder Pads Reg. \$24.95 Sale \$18.95

Padded Pants Sale \$18.95

OFFER GOOD 12/15/82 THRU 12/24/82

BONDS / H.L. HODGES

218 ARLINGTON 210 E. FIFTH ST.
756-6001 752-4156

LAST 4 DAYS! INVENTORY CLOSE OUT

ALL STOCK MUST GO TO MAKE ROOM FOR 2,000 DAYTON TIRES

2863	3581	3863	33'36
Retail Sale Price	Retail Sale Price	Retail Sale Price	Retail Sale Price
175/80R13.....58.50 33.42	165/80R13.....75.00 38.62	165/80R13.....79.00 41.81	155' SR13 68.50 36.83
185/75B14.....61.00 34.87	175/80R13.....77.50 40.41	185/80R13.....84.00 46.38	165SR13 71.85 39.63
195/75B14.....63.55 36.10	195/80R14.....82.75 44.50	185/75R14.....88.50 50.64	175SR13 73.75 42.60
205/75B14.....66.50 38.38	205/80R14.....87.75 49.88	195/75R14.....91.85 53.43	175SR15 74.95 43.87
215/75B14.....68.95 39.51	205/80R15.....93.75 55.60	205/75R14.....94.95 56.33	185SR15 74.95 43.87
225/75B14.....75.50 40.65	215/80R15.....94.95 56.74	215/75R14.....96.50 57.84	175/70SR13 73.75 42.60
600x15.....59.00 34.25	225/80R15.....97.50 58.30	225/75R15.....97.50 58.40	185/70SR13 75.75 44.80
205/75B15.....68.50 39.20	235/80R15.....99.00 59.91	215/75R15.....98.30 59.10	185/70SR14 80.95 49.61
215/75B15.....70.95 40.41		225/75R15.....101.95 62.22	195/70HR14 85.75 54.52
225/75B15.....75.00 41.68		235/80R15.....104.50 64.93	205/70HR14 86.95 55.92
235/75B15.....83.50 42.83			

Electronic Tune Up
4 cyl. 21.95
6 cyl. 24.95
8 cyl. 29.95

Brakes Relined All Four Wheel Drum Type
49⁹⁵

Heavy Duty Shock Absorber By Monroe
10⁹⁵

48 Month 12 Volt Battery
39⁹⁵
Free Installation

If it rolls on a wheel, we sell it
-FOR LESS-

Southern Tire Brokers

Corner of Charles Boulevard and Greenville Boulevard

OPEN MON., THURS. & FRI. TIL 9 P.M.

Greenville Blvd. & Charles
Next to Pitt Plaza
756-5823

5th & Market
Washington, N.C.
946-9400

VISA

Columbia Defeats Bear Grass, 66-60

BEAR GRASS — Columbia High School broke away from Bear Grass after a tight first half and gained a 66-60 basketball victory last night in their Tobacco Belt Conference meeting.

Bear Grass' girls remained unbeaten in their matchup, winning 36-20.

Columbia moved out into a 14-10 lead in the first period of the boys' game, but Bear Grass turned in a reverse score in the second frame to leave it knotted at 24-24 at intermission.

In the third period, however, Columbia caught fire and outscored the Bears, 17-11, to move out into a 41-35 lead. Both teams scored 25 points in the final dash to the wire, giving Columbia the win.

Brian Rowson led Columbia with 35 points, while Thomas Bailey had 16 and Harold Hill hit 11. The Bears were led by Lawrence Watson with 23, while Timmy Williams had 17.

The Lady Bears held Columbia scoreless in the first period while rolling in 14 of their own points and were never in trouble. Both teams scored six points in the second frame, giving the Bears a 20-6 lead at the half.

Columbia inched back to 24-11 in the third period, but was outlited, 12-9, in the final quarter.

Angie Michelle led the Bears with 21 points, while Pam Basnight had 13 for Columbia. The Lady Bears are now 5-0, 3-0 in the league. The boys are 2-3, 1-3 in league play.

Bear Grass travels to Matamuskeet on Thursday.

JV Game: Bear Grass 75, Columbia 45.

Girls Game
Columbia (20) — Basnight 6 1-3 13, Leigh 1 2-5 4, Simpson 1 1-3 3, Brickhouse 0 0-0 0, Clegg 0 0-0 0, A. Simpson 0 0-0 0, T. Clegg 0 0-1 0, Marner 0 0-0 0, White 0 0-0 0, Hassell 0 0-0 0, Clough 0 0-0 0. Totals 84-12-20.

Bear Grass (36) — Rogerson 0 3-4 3, Williams 2 0-2 4, Rawls 3 0-3 6, Mizelle 9 3-5 21, Mann 1 0-1 2, Harrison 0 0-2 0, Knox 0 0-0 0, Daniels 0 0-0 0, Cowen 0 0-0 0. Totals 15-6-17-36.

Columbia 0 6 5 9—30
Bear Grass 14 6 4 12—36

Boys Game
Columbia (66) — Rowson 15 5-7 35, T. Bailey 4 8-9 16, Hill 5 1-2 11, Walker 1 0-0 2, Respass 0 2-2 2, James 0 0-1 0, McNair 0 0-1 0, A. Bailey 0 0-1 0, Brickhouse 0 0-0 0. Totals 25-16-23-66.

Bear Grass (60) — Peele 2 0-2 4, Watson 11 1-1 23, T. Williams 4 0-4 8, Price 1 0-0 2, Leggett 0 0-0 0, Sehlike 0 0-0 0, Hardison 0 0-1 0, Taylor 0 0-0 0. Totals 28 4-14-60.

Columbia 14 10 17 25—66
Bear Grass 10 14 11 25—60

on a jumper with 1:54 remaining to put Rose ahead for good, 31-30. Walston made one of two free throws, and Clemons and Walston each hit basket's, the last with five seconds left to run Rose out to a 36-30 lead as the period ended.

There, in the final quarter, Rose missed on an early field goal attempt — then didn't try again from the field.

North Pitt got two baskets from Bradley early to trim to back to 36-34, but could come no closer as Rose put the ball on ice and forced the Panthers to foul.

Walston hit two from the line then Hopkins added another. Clemons made two more for a 41-34 lead with 3:13 left.

Baskets by Hines and Bradley and two free throws by Greg Briley cut it back to one, 41-40 with 31 seconds left, but Clemons then made three of four free throws in the final 25 seconds to sew it up for the Rampants. Bradley made one of two tries after time expired as he was fouled at the horn to cut it to the final margin.

"We needed this one," Brewington said of his team, now 1-3 on the year. "We're young, and we needed a win to help us along."

"We settled down and played like we can. Then, we ate up some time when we had to, and made them come out and foul us."

Neither team shot well. Rose made good on 15 of 40 shots (37.5 percent), while the Panthers hit 18 of 44 (40.9%). Rose canned 14 of 27 free throws, while North Pitt made just five of ten.

Rose also enjoyed a rebounding edge, 39-30, and had three fewer turnovers, 19-16.

Walston led the Rose scoring with ten points, while Bradley had 14 and Hines had 12 for North Pitt, which falls to 3-2.

North Pitt, trailing by one point, 27-26, at the start of the final quarter, exploded for 21 points in that frame — 11 of them at the foul line — to roll up its 47-33 win in the girls' game.

After Rose scored the initial basket in a very cold first period, North Pitt came back to score five points and gain a 5-3 lead by the time the horn sounded.

Rose tied it up early in the second quarter, but Delores Pittman put North Pitt back ahead, and they held until Rose tied it twice at 11-11 and 13-13. Linda Harrell, however, scored on a drive with three seconds left for a 15-13 Pant-HER halftime lead.

During the early minutes of the third period, North Pitt worked up a six-point lead, 21-15 before Rose rallied behind the scoring of Alma Atkinson and Frances Barnhill to finally take the lead, 27-26 with 34 seconds left to play.

Harrell, however, put North Pitt back ahead with a three point play just under a minute into the final period, 29-27. And while Rose was missing its first seven shots for a 33-27 lead, the Pant-HERS added four more points for a 33-27 lead. After Barnhill broke the ice, three free throws, two of them by Sherri Bradley, upped the lead to 36-29.

Both teams shot miserably from the floor, North Pitt hitting on just 27.5 percent and Rose making just 22.4 percent. The Pant-HERS enjoyed a horribly lopsided rebounding edge, 74-38, while committing twice as many turnovers, 28 to 14.

"Our first half wasn't pretty at all," North Pitt coach Randy Avery said. "But we made some foul shots at the end and that was a big part in our game. We had a streak of luck there when things seemed to go right for us."

Rose coach Dennis Gibson was very disappointed in his team's play, and blamed the absence of starting center Doris Richardson, out sick, for much of it.

"We got murdered on the boards, and I knew that we would without Richardson. Sheila Carmon and Frances Barnhill also didn't have their usual nights."

Rose Rallies Past Panthers...

(Continued from page 21)

Officials also called four technicals in the game, two on each team.

Harrell led the North Pitt scoring with 18 points, while Pittman added 14. Atkinson and Barnhill each had nine for Rose.

For All Your Fencing Needs CALL 752-2736 FOR FREE ESTIMATES. Financing Available. Whitehurst & Sons Fence Co.

PEST CONTROL
We specialize in roaches, rats, mice, ants, fleas, silverfish, termites, powder post beetles and other pests. Also smoke odor control. We install moisture barriers, and foundation ventilators to help keep cold out. For more information call Doc Moore & Son Pest Control 752-2065

FCX PRICE BUSTERS
THURSDAY THRU SATURDAY ONLY!
Clear Poly Plastic 3"x100' 4 mil roll 2.99
Co-op Motor Oil 30W qt. 79c
Wells Lamont Gloves No. 701 99c
Big Red Nuggets 50-Lb. Bag 8.65
Prices Good Dec. 16-18 Only

Blitz Sign Ex-Pirates
CHICAGO — Two former athletes from East Carolina University have been signed by the Chicago Blitz of the new United States Football League.

Larry Austin and Noah Clark have both signed contracts with the Chicago entry into the new league.

Austin was a track athlete at East Carolina, while Clark, a native of Robertsonville, played defensive tackle on the ECU football team.

Our older citizens are many times the unfortunate victims of fraudulent schemes. Con artists are slick. A free brochure on Defensive Living for Older Adults is available at the Police Department.

Pitt FCX
Corner of Line Ave. & Chestnut St. • 758-3173 or 758-3174

DHC Holds Off Jaguars....

(Continued from page 21)

the former course.

It worked initially — eight turnovers in the last 10 minutes proved that, but it also cost the Jaguars as DHC hit eight of eight foul shots in the last 8:03 to win.

DHC canned 11 of 11 free throws for the night. Farmville was eight of 14 from the line. Both teams hit nearly 50% from the floor. Farmville was 18 of 37 for 48.6% and DHC was 18 of 38 for 47.4%.

Farmville was led in scoring by Pettway with a game-high 19. Edwards added 10 for the Jaguars.

Gatlin led DHC with 18 points and eight rebounds. DHC outscored Farmville, 23-14. Farmville was led on the boards by Edwards with five.

The game began with both teams pushing the ball up court looking for the fast break. Gatlin scored DHC's first six points, but the Vikings were only able to manage a 6-4 lead.

Center Reggie Smith hit two foul shots and a pair of buckets inside as Conley opened up a 14-11 lead at the end of the first period. Smith scored six of his eight points in the first period.

A pair of free throws by Andrew Edwards tied it at 16-16 and Terrance Pettway hit a jumper from the left to give the Jaguars an 18-16 lead — their first and only lead of the game — with 3:59 left.

Farmville did not score again in the half. DHC, meanwhile, scored 11 straight points — four by Otis Payton underneath and a three-point play by Mitchell Cox — to give the Vikings a 25-18 lead.

Guard Donald Wilson hit two jumpers — one at the buzzer — to complete the run and give the Vikings a 29-18 lead.

Farmville cut the DHC lead to 31-25 midway through the third period and cut it to 33-29 on a bucket by Edwards. Gatlin, however, swished a jumper in the lane and hit two foul shots to give DHC a 37-29 lead after three periods.

The Jaguars cut the lead to two (twice) and one (twice) but could never go on top as the Vikings held on for the win.

"I thought those two bad spots — at the end of the second quarter when they went up, (29-18), at the half and that bad spell late in the third quarter — that hurt us," Terrell said.

The Lady Jaguars were led by Stephanie Newton with 10 points.

D.H. Conley travels to North Pitt Friday while Farmville Central is at Greene Central.

JV Game — D.H. Conley 50, Farmville Central 40.

Girls Game
Farmville Central (30) — D. Joyner 0 0-0 0; Harris 3 2-3 8; Newton 5 2-2 10; J. Peaden 0 0-0 0; Hart 3 0-2 6; Smith 1 0-0 2; Dixon 1 0-0 2; Smith 0 0-0 0; Staton 0 0-0 0; Jennings 0 0-0 0; Williams 0 0-0 0. Totals 13-4-7-30.

D.H. Conley (58) — Cannon 1 2-2 4; Barnhill 7 4-5 18; Kandrotas 2 0-0 4; Mills 0 2-5 2; Kornegay 11 0-0 22; Patrick 0 0-0 0; Chipman 0 0-0 0; Credie 0 0-0 0. Totals 25 8-12-58.

F. Central 8 8 4 10—30
D.H. Conley 13 16 13 16—58

Boys Game
Farmville Central (44) — Caraway 0 0-1 0; Hargrove 1 1-2 3; Willoughby 0 0-0 0; Hobgood 3 0-0 6; Edwards 4 2-3 10; Gorham 1 4-6 6; Pettway 9 1-2 19. Totals 18 8-14-44.

D.H. Conley (47) — Gatlin 7 4-4 18; Wilson 3 2-2 8; Payton 2 0-0 4; L. Cox 1 0-0 2; Anderson 0 0-0 0; Smith 3 2-2 8; M. Cox 1 3-3 5; R. Dawson 0 0-0 0; Reddick 0 0-0 0; Ruffin 1 0-0 2; Coward 0 0-0 0. Totals 18 11-11-47.

F. Central 11 7 11 15—44
D.H. Conley 14 15 8 10—47

The Valkyries, now 5-0, jumped out to a 6-0 lead early and lead, 13-8, at the end of the first period. Kornegay canned a pair of buckets early in the second period as DHC outscored Farmville, 10-2, to take a 23-10 lead. DHC led, 29-16, at the half.

Conley, without all-conference center Karen Barrett, who is out with an ankle injury, upped his lead to 22 (40-22) after three periods and coasted home with the win.

Despite the win, DHC coach Joy James was not particularly happy with the play of her Valkyries.

"I think we had one of those nights when you can't do anything right. We all had fumble fingers," she said.

James praised Kornegay, who scored 22 points, and Barnhill, who added 18. "I thought Mechio did a good job," James said, "and I thought Irish did a good job on the break."

The Lady Jaguars were led by Stephanie Newton with 10 points.

D.H. Conley travels to North Pitt Friday while Farmville Central is at Greene Central.

JV Game — D.H. Conley 50, Farmville Central 40.

Girls Game
Farmville Central (30) — D. Joyner 0 0-0 0; Harris 3 2-3 8; Newton 5 2-2 10; J. Peaden 0 0-0 0; Hart 3 0-2 6; Smith 1 0-0 2; Dixon 1 0-0 2; Smith 0 0-0 0; Staton 0 0-0 0; Jennings 0 0-0 0; Williams 0 0-0 0. Totals 13-4-7-30.

D.H. Conley (58) — Cannon 1 2-2 4; Barnhill 7 4-5 18; Kandrotas 2 0-0 4; Mills 0 2-5 2; Kornegay 11 0-0 22; Patrick 0 0-0 0; Chipman 0 0-0 0; Credie 0 0-0 0. Totals 25 8-12-58.

F. Central 8 8 4 10—30
D.H. Conley 13 16 13 16—58

Boys Game
Farmville Central (44) — Caraway 0 0-1 0; Hargrove 1 1-2 3; Willoughby 0 0-0 0; Hobgood 3 0-0 6; Edwards 4 2-3 10; Gorham 1 4-6 6; Pettway 9 1-2 19. Totals 18 8-14-44.

D.H. Conley (47) — Gatlin 7 4-4 18; Wilson 3 2-2 8; Payton 2 0-0 4; L. Cox 1 0-0 2; Anderson 0 0-0 0; Smith 3 2-2 8; M. Cox 1 3-3 5; R. Dawson 0 0-0 0; Reddick 0 0-0 0; Ruffin 1 0-0 2; Coward 0 0-0 0. Totals 18 11-11-47.

F. Central 11 7 11 15—44
D.H. Conley 14 15 8 10—47

During the early minutes of the third period, North Pitt worked up a six-point lead, 21-15 before Rose rallied behind the scoring of Alma Atkinson and Frances Barnhill to finally take the lead, 27-26 with 34 seconds left to play.

Harrell, however, put North Pitt back ahead with a three point play just under a minute into the final period, 29-27. And while Rose was missing its first seven shots for a 33-27 lead, the Pant-HERS added four more points for a 33-27 lead. After Barnhill broke the ice, three free throws, two of them by Sherri Bradley, upped the lead to 36-29.

Both teams shot miserably from the floor, North Pitt hitting on just 27.5 percent and Rose making just 22.4 percent. The Pant-HERS enjoyed a horribly lopsided rebounding edge, 74-38, while committing twice as many turnovers, 28 to 14.

"Our first half wasn't pretty at all," North Pitt coach Randy Avery said. "But we made some foul shots at the end and that was a big part in our game. We had a streak of luck there when things seemed to go right for us."

Rose coach Dennis Gibson was very disappointed in his team's play, and blamed the absence of starting center Doris Richardson, out sick, for much of it.

"We got murdered on the boards, and I knew that we would without Richardson. Sheila Carmon and Frances Barnhill also didn't have their usual nights."

Officials also called four technicals in the game, two on each team.

Harrell led the North Pitt scoring with 18 points, while Pittman added 14. Atkinson and Barnhill each had nine for Rose.

For All Your Fencing Needs CALL 752-2736 FOR FREE ESTIMATES. Financing Available. Whitehurst & Sons Fence Co.

PEST CONTROL
We specialize in roaches, rats, mice, ants, fleas, silverfish, termites, powder post beetles and other pests. Also smoke odor control. We install moisture barriers, and foundation ventilators to help keep cold out. For more information call Doc Moore & Son Pest Control 752-2065

FCX PRICE BUSTERS
THURSDAY THRU SATURDAY ONLY!
Clear Poly Plastic 3"x100' 4 mil roll 2.99
Co-op Motor Oil 30W qt. 79c
Wells Lamont Gloves No. 701 99c
Big Red Nuggets 50-Lb. Bag 8.65
Prices Good Dec. 16-18 Only

Blitz Sign Ex-Pirates
CHICAGO — Two former athletes from East Carolina University have been signed by the Chicago Blitz of the new United States Football League.

Larry Austin and Noah Clark have both signed contracts with the Chicago entry into the new league.

Austin was a track athlete at East Carolina, while Clark, a native of Robertsonville, played defensive tackle on the ECU football team.

Our older citizens are many times the unfortunate victims of fraudulent schemes. Con artists are slick. A free brochure on Defensive Living for Older Adults is available at the Police Department.

Pitt FCX
Corner of Line Ave. & Chestnut St. • 758-3173 or 758-3174

Cooper Verdict On State Job Said Near

RALEIGH (AP) — University of Tulsa football coach and athletic director John Cooper is expected to announce today whether he will accept the head coaching job at North Carolina State, say reports by two Raleigh newspapers.

The News and Observer and The Raleigh Times both quoted sources at N.C. State as saying Cooper had been offered the job and that an announcement on his decision was expected today.

The Tulsa Tribune also has reported the offer was made to Cooper during the weekend. The six-year Tulsa coach had motel reservations in Raleigh for Tuesday night, the Tribune said.

Cooper guided Tulsa to a 10-1 mark this season and has a 42-24 record at Tulsa.

North Carolina State Athletic Director Willis Casey has previously indicated the university wanted to name a new coach by today.

The Tulsa Hurricane of the Missouri Valley Conference was snubbed by bowl committees at the end of the season, causing speculation that Cooper might be encouraged to take a coaching job at another school.

Jags Down Goldsboro
GOLDSBORO — Farmville Central's wrestlers won four of the eight matches they actually wrestled, but forfeits in five weights allowed Goldsboro to take a 49-18 win over the Jaguars last night.

Injuries and lack of interest by the heavier weight athletes at the school have cut the program to the bone — and it may have trouble surviving.

The Jaguars are now 1-4 and play host to Cary on Thursday at 7 p.m.

HOME ECONOMICS

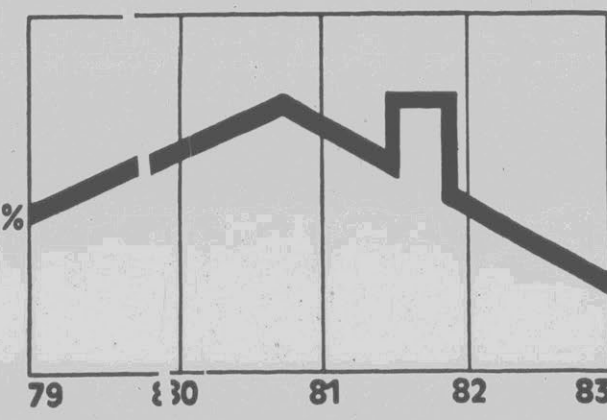

The economics of buying a home now can be described in three words: Supply and demand. Right now interest rates are the lowest they've been in two years. The housing market is up. The demand for new homes is up. And prices will go up soon. So now is the time to buy a new home. While prices and interest rates are down. We have a fine selection of homes in all price ranges. Call us, while you have home economics to suit your taste.

Aldridge & Southerland

756-3500

Searching for the right townhouse? Watch Classified every day.

Shoplifting is a crime!

shoplifters are prosecuted!

Let's call a thief a thief! You may not think it's anything more than a lark... but the fact is, shoplifting is stealing... and that could mean a day in court, a stiff fine, a jail term... even a blot on your record. If you think shoplifting is fun, then you're just not thinking at all!

Campanelli Hopes Identity Not To Hard To Handle

By WOODY PEELE
Reflector Sports Editor

Lou Campanelli, head coach of the James Madison Dukes, is a man who has come to find an identity — and he's hoping that it won't prove too difficult a problem to handle.

Campanelli, who twice guided unsung James Madison into the NCAA tournament — pulling off two major upsets — spoke yesterday at the Greenville Sports Club.

"A couple of years ago, I needed an ID to get a check cashed in Harrisonburg (Va., home of JMU). Now, one of the restaurants has a sandwich named after me. Last year, after we nearly beat North Carolina in the regionals, we had 5,000 people waiting at the airport to cheer us home. But two years from now, if we do the same thing, it might be a lynch mob."

Campanelli is the only basketball coach in the 11-year cage history of James Madison, which went co-ed at that time and decided to put in a fine athletic program with it.

During the course of those ten previous seasons, Campanelli

has brought the program along from the Division III ranks to become one of the better known "little names" in college basketball's Division I ranks. Two years ago, the Dukes upset Georgetown in the NCAA's first round, and last year they beat Ohio State before bowing to eventual champion UNC in a close, hard-fought game in Charlotte.

"I consider myself fortunate," Campanelli said. "Ten years ago, I had the chance to start a program from scratch. I believed in the school's president and athletic director (both still at JMU) when they said it could be done. I asked them if they wanted a program that would be successful immediately, or if they wanted one that would stand the test of time."

Obviously, Campanelli said, they chose the latter.

"I've had a lot of fun the last ten years, and it's probably a better job that most people think. I have a great president who cares about me. When we're down, he doesn't give me a kick, but a pat.

"I'm afraid if I take another job, it won't be as much fun, and

I would be pressured to take shortcuts and to compromise my principles to keep with the Joneses of that conference. And if I can't do it the right way, I ain't goin'."

Campanelli said he felt he has paid his dues, starting his career as coach of parochial school that didn't even have a gym. "But I had to learn from the ground floor up and I think it's made me a better coach," he said.

"It prepared me for James Madison, and the last two years, we've been the Rocky of college basketball. We haven't had the pressure on us, but we might start to get some of that this year. But to get to the NCAA in nine years from scratch is something."

Campanelli said that while he hasn't been able to recruit the "super-stars" he has been able to get overachievers. "They know that we care for them. We work 'em hard, but when they know that you care for them, they'll go that extra mile."

"Last summer, I sent them a clipping about five blind people who climbed Mt. McKinley, the highest mountain in the United

States. I told them that if blind people could do that, just think what we could do with two eyes, two legs, two arms and a heart."

Campanelli said it would be great if coaches were hired and fired, not because of how many wins and losses they had, but by how many of their players graduated. "In my ten years, every player has graduated with his class. This is what college athletics is all about. If you're going to be a dog in class, you'll be a dog on the court, and you're going to lose us a ball game somewhere."

The coach added that he likes to see discipline on the court and that he's sorry to see the shot clock being pushed in the game. "I think the fans will eventually tire of it. It's getting closer to the NBA game, and I don't think that's the kind of ball the fans really want to see. But the nation panicked after seeing the Virginia-North Carolina game last year (on national TV)."

The Sports Club's next meeting, on January 11, will feature ECU women's basketball coach Cathy Andruzzi.

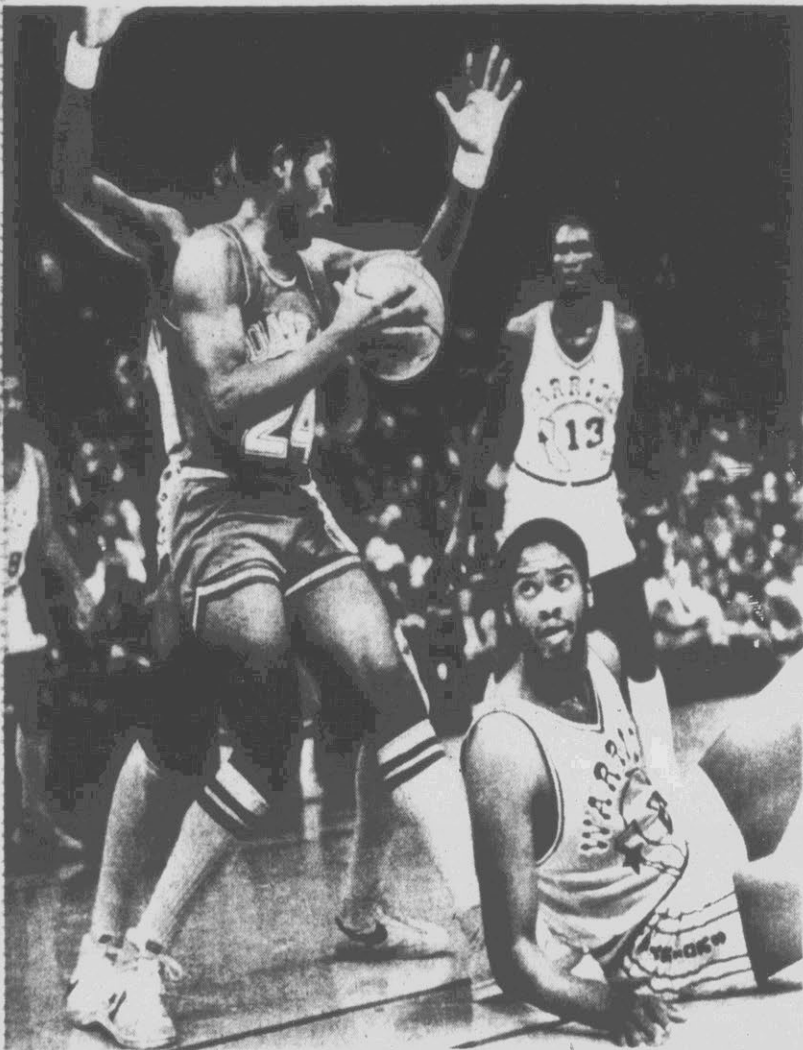

A View From The Bottom
Dallas's Mark Aquirre is covered closely by a Golden State player while Warrior Joe Berry Carroll

looks on while on the court. Watching the action is Golden State's Lorenzo Romar (18) and Larry Smith (13). (AP Laserphoto)

Portland Center Checks Jabbar

By The Associated Press

Even though Wayne Cooper can't block Kareem Abdul-Jabbar's shots, that doesn't mean that the Portland center is powerless to stop the Los Angeles Lakers star.

Cooper held Abdul-Jabbar to two points in the final quarter as Portland defeated Los Angeles 107-103 in a National Basketball Association game Tuesday night.

The 6-foot-10 Cooper, who had 17 points and six rebounds compared to 14 points and four rebounds for Abdul-Jabbar, said the key to containing the 7-2 Lakers center is keeping him away from his favorite shooting spots.

"I don't think he ever got into the flow of the game early, and that hurt him later on," Cooper said of Abdul-Jabbar. "I tried to push him as far away from his spot as I could. He could stand still and I still couldn't block his shot."

Cooper had three blocked shots in the game, one of them with six seconds to go against Bob McAdoo to salvage the victory, Portland's fourth in a row since Cooper became a starter.

"We have not been out-rebounded since we made that change," Portland Coach Jack Ramsay said. "He can shoot, he can rebound and he can block shots."

Cooper was traded by Dallas to Portland for guard Kelvin

Ransey in the off-season.

The Los Angeles-Portland game, was tied 12 times and there were 11 lead changes, but the Lakers seemed to have a comfortable edge, 95-88, with 6½ minutes to play.

But the Trail Blazers fought back to tie the score at 101-101 before Jim Paxson, who scored 24 points, sank two free throws for a 105-103 edge with 18 seconds to go.

Then Cooper blocked McAdoo's shot after a baseline drive, setting up Darnell Valentine's layup with one second left.

Suns 114, Sonics 109

Alvan Adams scored 26 points and Dennis Johnson 25 as Phoenix beat Seattle in overtime for only its second victory in the last eight games.

The Suns led by as many as 15 points in the first half and still had an 85-76 advantage with 8½ minutes to go, but the Sonics came back to take a 93-89 lead behind Fred Brown's 10 points.

After Maurice Lucas scored Phoenix's last six points to tie the game 97-97 at the end of regulation, Larry Nance tipped in a missed shot with 2:50 to go in overtime to give the Suns the lead for good.

Spurs 102, Rockets 93

George Gervin scored 29 points as San Antonio handed Houston its fifth straight loss and held the Rockets to 95

points or less for the eighth consecutive game.

Pistons 104, Knicks 99

Terry Tyler scored 12 of his 26 points in the fourth quarter and Isiah Thomas contributed four points and a key steal in the final seconds to lead Detroit over New York.

The 6-foot-1 Thomas, who scored 19 points, tied the score for the sixth time in the fourth quarter, 97-97, on a tip-in of a missed shot while surrounded by three Knicks. Then after Bill Laimbeer's two free throws gave the Pistons a 99-97 edge, Thomas stole an in-bounds pass, was fouled and hit two more free throws for a four-point lead.

Bullets 108, Bulls 102
Greg Ballard scored 22 points and reserve guard Kevin Grevey added 21 to pace Washington over Chicago.

Warriors 122, Mavericks 113
Purvis Short scored 15 of his 33 points in the fourth period to lead Golden State over Dallas.

You haven't seen Christmas 'til
You Visit
The Christmas Shop
at
Farmville Furniture Co.
122-126 Main St., Farmville, 753-3101
Open Mon.-Fri. 'Til 9

CLIFF'S
Seafood House and Oyster Bar
Washington Highway (N.C. 33 Ext.) Greenville, North Carolina
Phone 752-3172
Wed. & Thurs. Nights

Popcorn
Shrimp **\$2.95**

Takeouts Welcome

Don't be confused by the many savings plans being offered today. Home Federal offers a simple alternative with our new

INSURED ACCESS ACCOUNT

Here's how it works...

1. Requires an opening balance of only \$2,500.
2. Your entire balance earns high money market rates and there are no service charges as long as you maintain an average balance of \$2,500.
3. No penalties - you can withdraw funds at any time.
4. Safety - your account is insured up to \$100,000 by FSLIC, an agency of the U.S. government.

Home Federal's Insured Access Account...a sound investment with a great return!

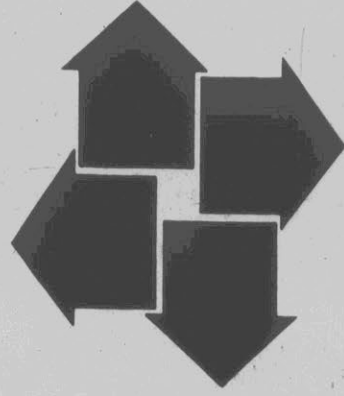

HOME FEDERAL SAVINGS AND LOAN ASSOCIATION
OF EASTERN NORTH CAROLINA
HOME OFFICE
543 Evans Street, Greenville, N.C. - 758-3421
BRANCH OFFICES
216 Arlington Boulevard, Greenville, N.C. - 756-2772
206 E. Water Street, Plymouth, N.C. - 793-9031
205 W. Railroad Street, Bethel, N.C. - 825-8781



Broken Artificial Heart Valve Just One Of Risks

By DONNA ANDERSON
Associated Press Writer
SALT LAKE CITY (AP) — A broken valve in the artificial heart implanted in Barney Clark could have been worse and shows the risks of pioneering medical technology, his doctors say.

The left ventricle of Clark's heart was replaced Tuesday after the 61-year-old retired dentist experienced a sudden drop in blood pressure. He was reported in critical condition early today, but resting comfortably.

"This kind of failure — this is a serious valve failure — could have been more serious. And, in theory, sometime in the future, it could result in his (Clark's) demise," said Dr. Chase Peterson, University of Utah vice president for health sciences.

"As I have said in the past,

if Dr. Clark didn't come down with a major complication apart from the heart, he would die of a failure of the heart — sooner or later," Peterson said Tuesday.

Dr. Robert Jarvik, inventor of the Jarvik-7 artificial heart, said it was fortunate the defective valve allowed time to examine the problem and correct it.

"It is a goal of engineering to create systems that have this kind of failure ... to give you time to correct the failure," Jarvik said.

The problem was caused by a break in the housing of the Jarvik-7 heart's mitral valve, which attaches to Clark's own left atrium. A malfunction of the mitral valve is the most serious that could occur in any of the heart's four valves, Jarvik said.

"This is somewhat of a random failure. We still feel the risk is justified with this kind of valve," he said.

Asked if he had any doubts about the device being ready for use in a human, Jarvik replied: "No. We're going to have to live with things like this."

The possibility that repairs would be needed after the implant was anticipated in the consent form Clark signed Nov. 29 before the heart was implanted Dec. 2.

"I further understand that due to the positioning and nature of the artificial heart ... that in addition to the surgery necessary for the original installation, additional chest surgeries may be required in the event the device needs to be replaced or repaired," the form said.

It also said that in each

such case, it would be up to the patient to consent to the new surgery.

Peterson said any decision to perform more surgery would be up to Clark, his wife, Una Loy Clark, and Dr. William DeVries, the implant surgeon. They consulted Tuesday before deciding to go ahead with the repair operation.

Jarvik said that when Clark's blood pressure plunged, he immediately suspected a problem with a valve.

Blood normally pumping from the left atrium into the left ventricle was backing up into the atrium, and the heart was pumping only three liters per minute instead of the normal quantity of nearly seven liters, Jarvik said.

Clark's own diseased heart was pumping only one liter per minute before the new heart was installed.

Jarvik said he did not know specifically why the valve broke.

"There were certain things related to the way the drive system drives the compressed air to the heart



EXPLAINING THE PROBLEM — Dr. Robert Jarvik, inventor of the artificial heart in Barney B. Clark, and Dr. Chase Peterson, vice president

for health sciences at the Univ. of Utah, explain the problems that caused Clark to be operated on for four hours Tuesday. (AP Laserphoto)

Revised Evaluation Of Teachers Gets Approval

RALEIGH, N.C. (AP) — Proposals calling for major revisions in the way public school teachers are evaluated and giving county commissioners the power to

levy additional sales taxes have received final approval from a legislative study committee.

The Select Committee on Education also recom-

mended on Tuesday that no more than 75 percent of North Carolina's general tax revenues should be spent annually on education.

The sales tax proposal sparked a long discussion and sharply divided committee members, who agreed that county governments need more money but disagreed on the funding method.

Reporters Refused To Keep Briefing Secrets

WASHINGTON (AP) — After 13 reporters refused to sign an unprecedented secrecy agreement, Pentagon officials relented and provided them with an off-the-record briefing on Soviet military developments.

Pentagon spokesman Henry Catto said the briefing was offered Tuesday to inform senior defense correspondents on the growing Soviet threat, as far as national security would permit.

Catto said the strict secrecy sought by the Defense Department was necessary to protect intelligence sources. The briefing dealt

with Soviet advances in strategic nuclear weapons and conventional forces.

The session was arranged following complaints by reporters that Defense Secretary Caspar Weinberger and the defense establishment were not providing military affairs reporters with information enabling them to judge the validity of Reagan administration claims of Soviet military advances.

When the reporters arrived at a meeting room before the briefing, they were asked to sign a one-page statement titled "Department of De-

fense Secrecy Agreement."

Catto and other officials said that intelligence authorities were insistent on obtaining such a formal agreement from reporters before divulging highly sensitive information to them.

But after reporters unanimously refused to sign any such paper, defense officials reconsidered and agreed to go ahead with the briefing on the understanding that the material would be off the record and usable only as background matter when reporters write future stories.



HUNTS LIGHT CHRISTMAS TREE — Governor Jim Hunt and his wife Carolyn stand in front of North Carolina's Christmas tree after they turned on the lights during a ceremony at the State Capitol in Raleigh Tuesday night. (AP Laserphoto)

The committee also voted to recommend that the state assume total responsibility for school construction while local governments shoulder more of the cost of salaries and program operations.

State law now requires that the state pay for operation of the public schools while counties pay for construction, but the committee noted a "gradual blurring" of the responsibilities.

The committee approved the revision in the way public school teachers are evaluated and paid, saying that the current teacher salary schedule "fails to assist in retaining capable teachers, encourages mediocrity, is structured to retain marginal teachers, contains few incentives and generally does not support personal goal-setting and evaluation."

The committee recommended five levels of competence and responsibility for educators spanning a 30-year career. Each level would involve four to eight years of employment.

Differentiation of the teachers' level of responsibility and pay would be based on performance measured by standardized evaluations.

In approving the cap on education spending, the committee said it would give the Legislature "a benchmark for measurement" and "a rational way" to hold down education costs, the committee report said.

The state spent 79.3 percent, or \$2.25 billion, of its total General Fund tax revenues of \$2.8 billion on education from kindergarten to the university level in 1980-81.

But 1980-81 was "an abnormal year in terms of not just education spending, but spending in general," said legislative fiscal analyst David Crotts.

For Your Christmas Shopping...

Philco Portable TVs & Stereos
Hamilton Beach Appliances
Speed Queen Laundry & Kelvinator Appliances
Fleming's Furniture & Appliance

1012 Dickinson Ave.
752-3609

A sweet deal on a real sour cream dip.

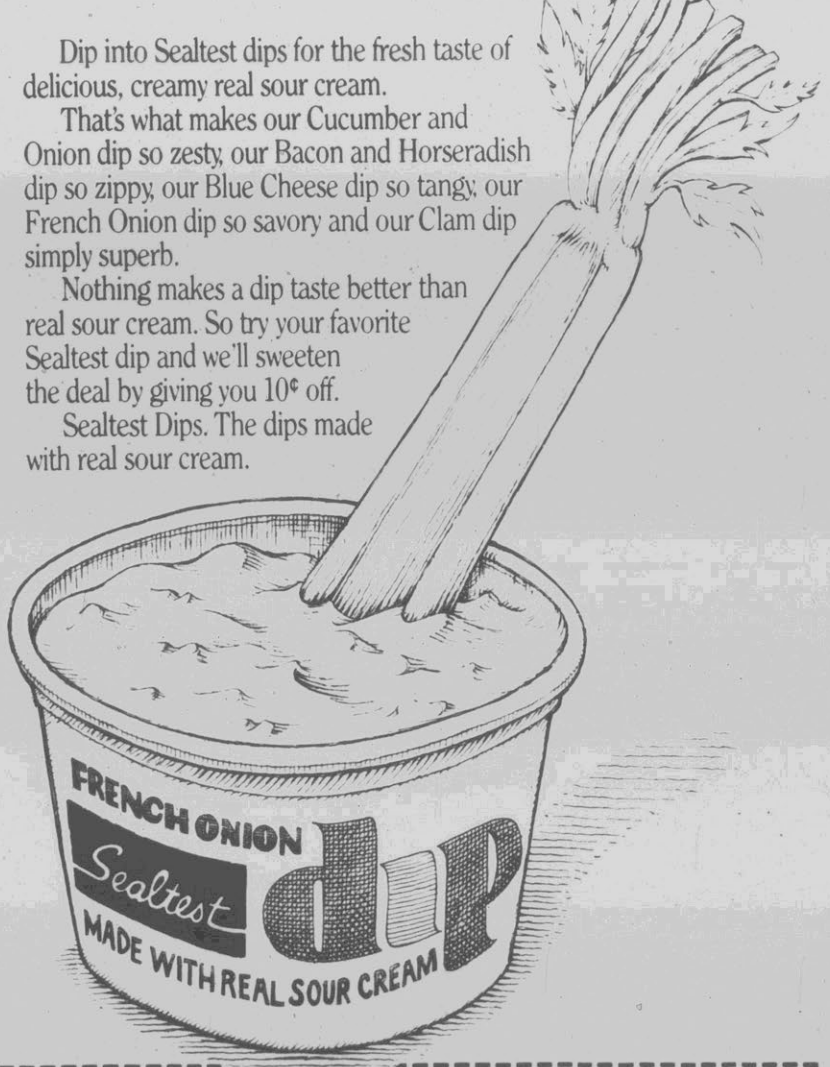

Dip into Sealtest dips for the fresh taste of delicious, creamy real sour cream.

That's what makes our Cucumber and Onion dip so zesty, our Bacon and Horseradish dip so zippy, our Blue Cheese dip so tangy, our French Onion dip so savory and our Clam dip simply superb.

Nothing makes a dip taste better than real sour cream. So try your favorite Sealtest dip and we'll sweeten the deal by giving you 10¢ off.

Sealtest Dips. The dips made with real sour cream.

Now Minute Rice has a new everyday Low price!*

*No Price Reduction on 7 oz. Size

STORE COUPON

SAVE 20¢ 20¢

on Two 7 oz. OR one larger size box

Minute Rice

To the retailer: General Foods Corp. will reimburse you for the face value of this coupon plus 7¢ for handling if you receive it on the sale of the specified product and if upon request you submit evidence of purchase thereof satisfactory to General Foods Corp. Coupon may not be assigned, transferred or reproduced. Customer must pay any sales tax. Void where prohibited. Limited or restricted by law. Good only in U.S.A. Puerto Rico and U.S. Can. 1¢ value. Cash value: 1/20¢. Coupon will not be honored if presented through outside agencies, brokers or others who are not retail distributors of our merchandise or specifically authorized by us to present coupons for redemption. For redemption of property received and handled coupon, mail to General Foods Corp., P.O. Box 483, Hawthorne, N.J. 07042. The coupon good only on purchase of product indicated. Any other use constitutes fraud.

Limit — one request per purchase. Offer expires June 30, 1984. GENERAL FOODS CORPORATION NB06121300

For perfect rice every time use Minute Rice.

In addition to our new low price — here is a coupon for an even better value.

10¢

14300 171551

Save 10¢ on any delicious Sealtest real sour cream dip.

Mr. Grocer Kraft, Inc. will reimburse you for the face value of this coupon plus 7¢ handling allowance if provided you redeemed it on your retail sales of the named products and that upon request you agree to furnish proof of purchase of sufficient product to cover all redemptions. Coupon is void where taxed, prohibited or restricted by law and may not be assigned or transferred by you. Cash value: 1/20¢. Customer must pay applicable tax. For redemption, mail to Kraft, Inc., Dairy Group, P.O. Box 1799, Clinton, Iowa 52734. Offer expires June 30, 1983.

10¢

155517 00E17

Legislators Said Split On New Drinking Age Law

By MARY ANNE RHYNE
Associated Press Writer
RALEIGH, N.C. (AP) — Many state legislators favor raising the legal drinking age from 18 but they are split over whether to increase it to 19 or 21, shows an Associated Press survey.

Most of the respondents to a questionnaire mailed to 1983 General Assembly members last month said they favor a higher drinking age and other proposals by the Governor's Task Force on Drunken Driving.

The proposals give bar owners civil liability for illegally selling alcohol to under-age or intoxicated people, create a single impaired driving offense to replace the existing driving under the influence law and immediately revoke a driver's license for 10 days for driving with a blood alcohol content of .10 percent or more.

Gov. Jim Hunt has proposed raising the age for buying beer and wine but has not suggested a new age limit. Currently, the age for buying beer and wine is 18 and the age for buying liquor is 21.

Hunt also has endorsed the driving while impaired law and 10-day revocation but has made no commitments on the proposal involving bar owners.

The Governor's Crime Commission agrees with the task force's proposals except it wants to raise the drinking age to 21 over a three-year period.

This week the Presidential Commission on Drunk Driving urged states to make 21 the age limit for buying any alcoholic beverage and said legislatures should consider the matter on a near-emergency basis.

Of the 170 legislators surveyed by The Associated Press, 103 or 60 percent responded to the questionnaire. Thirty-three of the 50 Senate members and 70 of 120 House members responded. Answers did not vary greatly between House and Senate.

Because some surveys were unsigned, differences between Democrats and Republicans could not be determined accurately.

When asked: "Do you favor raising the minimum age for buying beer and wine," 73 respondents said yes, 12 said no and 18 were undecided or gave no response.

Of those who favored raising the drinking age, 26 liked a 19-year-old limit, 13 favored a 20-year-old limit, 28 wanted a 21-year-old limit and 24 were undecided.

There was a less support for the task force's other proposals.

The so-called dram shop statute would make bar tenders liable if they serve an under-age or drunken customer and that customer later has an accident because he was drunk. Existing laws make it illegal

to serve alcohol to those under age 18 or those already intoxicated. Some judges have interpreted that to mean bar owners already are liable if such customers have accidents.

When asked whether they favored a dram shop statute, 59 of the survey respondents said yes, 21 said no and 23 were undecided or gave no answer.

Some said they were concerned whether bar keepers could determine who was too intoxicated to keep drinking. Another task force pro-

posal would create a single impaired driving offense to replace existing laws against driving under the influence, driving with a blood alcohol content of .10 percent or more and careless and reckless driving after drinking.

The new law would require judges to weigh certain aggravating and mitigating factors before sentencing drivers. Punishments would range from a fine up to \$100 and 24 hours in jail or 24 hours community service or a 30-day loss of driving privileges or a combination.

The maximum punishment would be 14 days to two years in jail and a fine of up to \$2,000.

The law is aimed at making the punishment more closely fit the crime.

When asked whether they favored a single impaired driving offense, 52 of the respondents said yes, 12 said no and 39 were undecided or declined to answer.

Revocation of a driver's license is the most effective deterrent to drunken driving, the task force concluded. Under one of its proposals, a

magistrate could confiscate a license after finding probable cause that the arrest was proper, the Breathalyzer test was performed correctly and the driver had .10 percent or more alcohol in his blood.

When asked whether they favored 10-day revocation of a driver's license, 61 of the legislators said yes, 16 said no and 26 others were undecided or did not answer.

Some of those who opposed the proposal said they might change their minds if the law called for revocation of a driver's license when the

driver had a higher level of alcohol, for example .15 percent, in his blood.

Others said the Breathalyzer was too easily manipulated and a magis-

trate should never be given authority to revoke a driver's license.

Riverside Oyster Bar

710 North Greene Street

752-0090

Large, Salty Chesapeake Bay Oysters

\$7.75 Peck

Steamed Shrimp - Steamed in Spice

\$3.99 and \$7.50

Steamed Clams Dozen \$4.95

Coldest Beer in Town



SIXTEEN NEW RECIPES...

TWELVE MONTHS OF COUPONS...



Look for the recipes on cartons of Dixie Crystals® 4-X and 10-X Confectioners'; and Dark Brown and Light Brown sugars. These great recipes, most created especially for Dixie Crystals, are on your grocer's shelves now! Try the fantastically rich, "Richest Cheesecake" recipe on our Dixie Crystals 10-X Confectioners sugar box and, fifteen other recipes, only on 1 lb. boxes of Dixie Crystals.

JANUARY THROUGH DECEMBER
GREAT RECIPES AND
MONEY SAVING COUPONS
IN OUR 1983 DIXIE
CRYSTALS DESSERT
CALENDAR.

Twelve cents-off coupons, twelve great recipes, and a 1983 wall calendar featuring twelve beautiful, full-color photographs of each recipe. You'll want the coupons to save money when you shop for those great Dixie Crystals products. We've included a cents-off coupon for every month; \$2.00 worth total. To get your calendar mail us just \$1.00 plus 1 UPC code from any Dixie Crystals product and your 1983 Dessert Calendar will be mailed to your home.

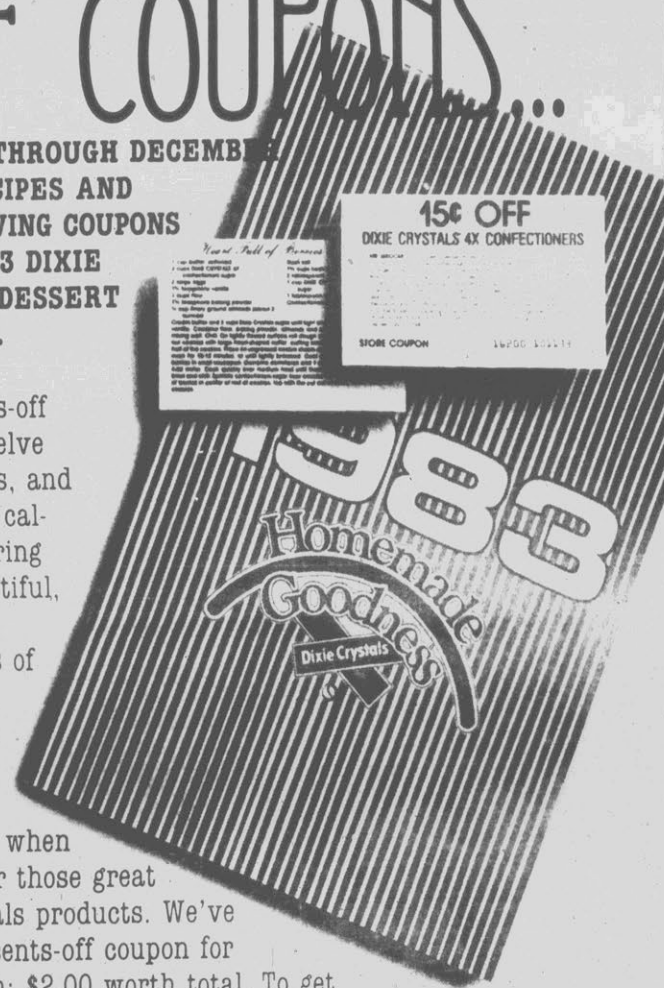

AND A SUBSCRIPTION TO DIXIE CRYSTALS® HOMEMADE GOOD NEWS.

LAST YEAR'S ISSUES OF DIXIE CRYSTALS HOMEMADE GOOD NEWS WERE GREAT. REMEMBER ALL THOSE FANTASTIC "MENUS OF THE MONTH" AND ALL THOSE SUPER HELPFUL HINTS FROM OUR READERS?

We really had a lot of fun hearing from all of you. Thanks for sending in your recipes and helpful hints, they made every issue of Homemade Good News something special. Next year we'll be continuing Homemade Good News, keeping all the best features from 1982 and adding new ones. We'll be including more money-saving cents-off coupons, of course, and adding more color photographs of all those terrific recipes. Please don't miss out, subscribe today. The cost for 12 issues is only \$3.00 plus you'll receive a set of 10 recipe cards as a bonus (about mid-year).



ORDER YOUR DIXIE CRYSTALS DESSERT CALENDAR

YES. Please send my 1983 Dixie Crystals Dessert Calendar. Twelve money-saving coupons, twelve great recipes and a beautiful wall calendar. I have enclosed \$1.00 plus 1 UPC code from any Dixie Crystals product. (Offer good only while supplies last.)

SIGN UP FOR HOMEMADE GOOD NEWS

YES. Add my name to your list of subscribers. I'll be looking forward to each monthly issue of Dixie Crystals Homemade Good News and the bonus gift of 10 full-color recipe cards. I have enclosed a check or money order for \$3.00.

Check YES on one or both offers and mail, along with your check or money order to: Dixie Crystals Christmas Offers, P.O. Box 66, Savannah, Georgia 31402.

Name _____
Address _____
City _____
State _____ Zip _____



Dixie Crystals is a registered trademark of Savannah Foods & Industries, Inc., Savannah, Georgia 31408.

Hospitalized In Ammonia Leak

ROCKY MOUNT, N.C. (AP) — An ammonia leak at the Fast Food Merchandizers Plant sent about 22 people to the hospital Wednesday, company officials said.

The leak was discovered at about 10:30 a.m. when a pressure relief valve on an ammonia supply pump malfunctioned, said plant manager Ron Boorman. He said the cause of the problem was not known.

All but one or two workers were taken to Nash General Hospital in Rocky Mount, while the others were sent to a Wilson hospital, Boorman said. Some employees suffered shortness of breath and nausea, he said.

One woman was admitted for observation, said Nash General spokesman Bill Stancil. He said 19 others were treated and released.

Birthday Party

The membership of Timothy Christian Church was honored at a birthday party Sunday night. "This is Your Life Wilma Smith" was given.

Coy Buck of Ayden and Barry Gaskins of Greenville were program participants.

Representing each month of the year, the 12 decorated tables were judged by Clyde Barber, Ed Davis and Linda Dixon.

Titan Missiles Are Being Retired By Air Force

By ARTHUR H. ROTSTEIN
Associated Press Writer
TUBAC, Ariz. (AP) — For 20 years, a towering nuclear sentry lived here, buried in a hill under a 740-ton door. Now the hole is empty, an

underground nest without a bird, as the Air Force dismantles its obsolete Titan 2 missiles.
Titan Site 1-6, about a mile west of Interstate 19, is the second of 18 sites in

southeast Arizona to be deactivated as the Air Force retires the last of the nation's early generation, liquid-fueled nuclear missiles. Seventeen Titans in Arkansas and another 17 in

Kansas will be taken out of service later.
The Titans were once the centerpiece of the nation's strategic missile force, but they have been superseded by more modern, solid-fuel

multiple warhead Minuteman, of which the Air Force has 1,000 deployed in underground silos.
The Pentagon says it is retiring the 52 aging, leaky, liquid-fuel missiles because they pose safety threats and because they are becoming too costly to maintain.

The Titan system has been plagued by accidents involving spills of its volatile propellant, including fatal accidents near Damascus, Ark., and Rock, Kan.

The latest Titan site to be mothballed, about 45 miles south of Tucson, was opened to the news media Tuesday by Air Force officials for a rare glimpse at its innards.
The missile — 103 feet tall, 10 feet wide and weighing 330,000 pounds — was plucked from the ground about a month ago, after its toxic liquid propellants and nuclear warhead were removed.

The site itself will remain operational and fully manned for about two more weeks.
From above ground, the only indication that a missile once nestled 160 feet below the fenced compound are communications antennas, a wind recorder, sensors, and an 80-foot-square door of concrete and steel covering the silo. Weighing 740 tons — 1.4 million pounds — it is designed to withstand all but a direct nuclear hit.

The door can roll open on its railroad-car wheels in 17 to 21 seconds to reveal the gaping 55-foot-wide hole.
The operation is manned by a four-member missile combat crew working 24-hour shifts. Crew members occupy a control center complex about 30 feet underground, 120 feet from the

silo housing the missile.
The crew uses identification codes to get into the compound. Crewmen walk down a stairwell with a "Watch for Rattlesnakes" sign. With another code, they enter an entrapment area between two doors where TV cameras allow them to be scrutinized by those below.

Next is a set of two 3½-ton blast doors, which allow access to two more identical doors. One opens to a short passage packed with wiring and other equipment that leads to the control center. The other leads to a 100-foot passageway to the silo.

The entire system is built on springs to cushion the facility against earthquakes and allow it to withstand a nuclear blast.
Inside the launch duct, temperatures were kept at about 60 degrees for the missile. Everything remains operational. Metallic shielding lines the walls to absorb sound; sprinkler systems are intact.

Capt. Harvey Longshore and his crew manned the launch control facilities inside the control center Tuesday.
If a missile was still present, and "upon a lawful

command from the president" that passed verification, Longshore would have fed a safe-locked code into a computer, telling it which of three pre-programmed targets the missile would attack.

Without the proper code, it would be impossible to release a butterfly valve in the missile to let fuel and oxidizer reach the engine.
"That's the fail-safe mechanism," said Longshore.

Even then, only when two officers place two keys in two separate control panels and turn them simultaneously could a launch occur.
"One minute from the time the keys are turned, the sortie's gone," Longshore said. The target always is a mystery.

"One is selected and that's it," said Longshore. "I don't know what they are... I don't have the need to know."

SEEK AMNESTY
BOGOTA, Colombia (AP) — Twenty-one leftist guerrillas, 15 men and six women, surrendered to Bishop Jose Luis Serna of Florencia and applied for amnesty, the bishop has announced.

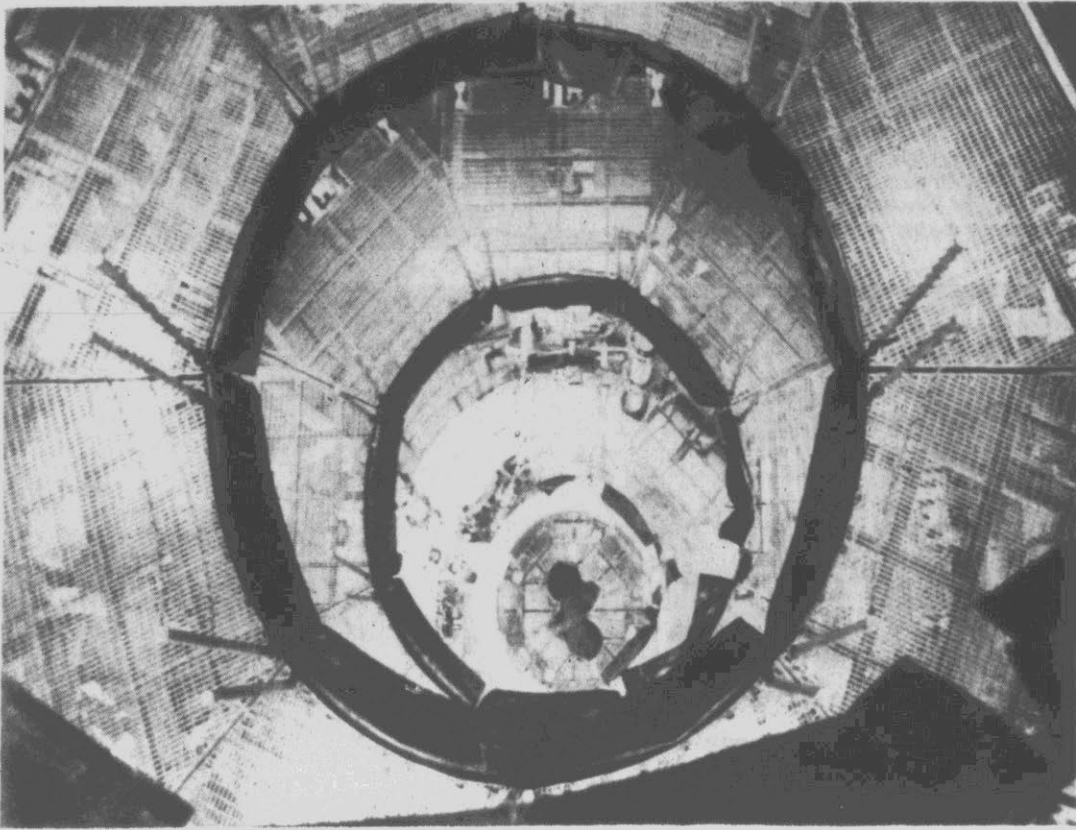

AN EMPTY SILO — The launching duct of a Titan II missile near Tubac, Ariz., sits empty after removal recently of the 103-foot weapon. However, the system remains operational and manned as it moves toward a caretaker status. (AP Laserphoto)

Charged In Bid-Rigging

BOONE, N.C. (AP) — An Asheville electrical contractor and one of its executives have been indicted on charges of rigging bids for a renovation project at Appalachian State University in 1978.

The Watauga County grand jury Monday indicted M.B. Haynes Electric Corp. and officer N.E. Cannady on two counts each: false pretense for allegedly claiming that the bids were competitive and made without collusion, and conspiracy in restraint of trade.

The indictment charge that Haynes corporately and Cannady individually conspired with and paid Watson Electrical Construction Co. of Wilson \$30,000 to inflate the bids for the electrical contract for renovations at the Carol Grontes Belk Library at ASU. Haynes won the bid for the contract, which was let on May 2, 1978.

H.A. Cole, director of the state Justice Department's anti-trust branch, said the indictment grew out of last year's indictment of Watson Electric in connection with bid rigging on a project at East Carolina University's medical school in December 1978.

As part of a negotiated plea in that case, Watson officials agreed to tell investigators about other bid-rigging cases. That is why Watson is named but not indicted, Cole said.

Commission's Plan Requires Trained N. C. Law Enforcers

By The Associated Press
The first in a series of public hearings on a plan requiring mandatory pre-service training for all law enforcement officers is scheduled to begin in Greensboro today.

Wade Barber Jr. district attorney for Orange and Chatham counties, says such training is needed because about two-thirds of North Carolina's new law enforcement officers are sworn in without any training.

"There's a strong sense that there is a need for pre-service training," said Barber, chairman of the Criminal Justice Education and Training Standards Commission, which certifies all the state's 17,292 sworn officers.

Barber says a CJETSC committee has proposed a mandatory pre-service training plan for all officers.

Of the 1,371 new officers hired in 1981, about two-thirds were "sworn in, given a badge and issued a weapon without any training at all," said Barber in a telephone interview from his Pittsboro home.

Currently, law enforcement applicants must meet only minimal requirements. A person must be at least 20 years old, a high school graduate and a U.S. citizen. He also must not have committed a felony or more than three misdemeanors.

Larger cities, such as Charlotte, Winston-Salem, Raleigh and Durham, have their own accredited academies and require more

hours of training than the minimum 240-hour course the commission requires for new officers.

The Raleigh Police Department has a 704-hour training standard, while Charlotte and Fayetteville police require more than 500 hours.

But many medium-sized and small communities are lucky to meet the commission's minimum standards, which have been in effect since 1973, Barber

said. Officers are supposed to complete 240 hours of classes in a 12-month probationary period after they're sworn in.

But some officers who don't finish may ask for a six-month extension, Barber said, and many don't even begin their training until they have been on the job for six to 12 months.

Under the commission proposal, all state law enforcement officers would be required to take a 40-hour,

one-week course before they are sworn in. The 40 hours would be subtracted from the 240-hour requirement, with the remaining hours to be completed in one year.

The courses are conducted at the city police academies, community and technical colleges and at other state training centers.

Other public hearings on the proposal will be in January, February and March in Charlotte, Raleigh, Asheville and Greenville.

NOW OPEN!

In our New Offices And Showroom
Mercer Glass Co.

1306 Evans St. • Telephone 752-5101



Specializing In

- Complete Auto Glass Works
- Commercial Glass Works
- Residential Glass Works
- Store Fronts
- Insulated Glass



Now In Our Showroom

Large Selection Of

Framed Mirrors

- Rattan • Wicker • Gold Leaf
 - Early American
- Perfect For Christmas Giving!

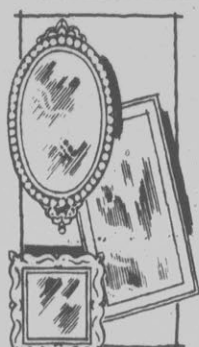

Anniversary Services

Sweet Hope Free Will Baptist Church will observe its pastor's anniversary with services Dec. 15-19.

Scheduled programs will be conducted by: Wednesday at 7:30 p.m., the Rev. Jasper Tyson, with ushers and congregation of Popular Hill Church; Thursday at 7:30 p.m., the Rev. Elmer Jackson, with ushers and congregation of Elm Grove Church; Friday at 7:30, the Rev. James Purvis, with ushers and congregation of Philippi Church; Sunday at 11 a.m., the Rev. Billie R. Anderson, with the senior choir of Sweet Hope, and at 3 p.m., the Rev. W.J. Best and the congregation of Sweet Hope will render services at Sycamore Chapel Church.

At 7:30 p.m. Sunday, the anniversary will close with a sermon by the Rev. W.H. Mitchell, accompanied by the choir, ushers and congregation of Good Hope Church.

Buy a Polaroid 600.



Limited Time Offer

FLY DELTA FREE



Buy a Polaroid 600 Series camera and on a round trip flight with Delta you can get two trips for the price of one.

Purchase a Polaroid Sun Camera or any other Polaroid 600 Series Camera from November 19, 1982 through January 31, 1983, and with a proof of purchase you qualify for free round-trip transportation from Delta Air Lines when you've purchased one unrestricted round-trip coach class adult fare, or 50% off the unrestricted coach adult fare for a single ticket on Delta. You must redeem the proof of purchase at the redemption center by February 28, 1983 and purchase your ticket by April 30, 1983 which you can use through the end of 1983. Come in today for a coupon containing complete details. And, you can also qualify for a \$10 Smile-back Rebate from Polaroid.

*Limited time offer. DELTA AIR LINES

Sun Camera Autofocus 660
 Regular Price \$74.97
 Sale Price \$69.97
 Smile-back Rebate -10.00
\$59.97
 Your actual cost after Rebate

- Piece of the sun fires every time, at no extra cost.
- Autofocus by sound waves.
- Unique Light Mixer blends our light with natural light. Turns any light into good pictures.
- Economical; never needs flashbars or batteries.
- Uses 600 High Speed Land film.
- Shoots indoors 2'-14" (with no special lens); outdoors 2' to infinity.

Sun Camera 640
 Regular Price \$49.97
 Sale Price \$47.90
 Smile-back Rebate -10.00
\$37.90
 Your actual cost after Rebate

- Most economical Polaroid Sun Camera.
- Piece of the sun fires every time at no extra cost.
- Unique Light Mixer blends our light with natural light; turns any light into good pictures.
- Never needs focusing.
- Pictures from 4'-10" indoors, 4' to infinity outdoors.
- Never needs batteries.

600 High Speed film.
 Regular Price \$7.49
 Special Sale Price \$7.19
 600 High Speed film single pack \$14.64
 Special Sale Price \$13.99
 600 High Speed film Two Pack \$14.64
 Special Sale Price \$13.99
 Buy 4, Get 5⁰⁰!

No Rainchecks! Sale Prices in Effect thru Friday, Dec. 24th.
Brendle's
 2101 S. Tarboro St., Wilson, N.C.
 Open 10:00 A.M. - 9:00 P.M. Mon. Through Sat.



CONVICTED — Hitman Charles V. Harrelson gets into a U.S. marshal's car in San Antonio. He was found guilty of conspiracy and obstruction of justice in the murder of a judge in May of 1979. (AP Laserphoto)

The Jury Wept In Returning Guilty Verdicts

By MACK SISK
Associated Press Writer
SAN ANTONIO, Texas (AP) — The government won convictions against three people in the only assassination of a federal judge this century, but the man accused of paying a hit man \$250,000 for the killing still must be tried.

After deliberating 18 hours over four days, an emotional jury panel Tuesday found that convicted contract killer Charles V. Harrelson shot U.S. District Judge John H. Wood Jr. in the back on May 29, 1979.

Prosecutors contended Harrelson killed the judge for a \$250,000 fee from imprisoned narcotics trafficker Jamiel "Jimmy" Chagra. Now the government must try Chagra, 39, accused of having Wood killed because he feared the judge — known as "Maximum John" for his stiff narcotics sentences — would sentence him to life imprisonment in a 1979 narcotics case. He subsequently was convicted.

All nine of the women jurors and one of the men wept as the verdicts were read, although the defendants showed little emotion. Defense lawyers said they would appeal.

Harrelson, 44, who served a 15-year sentence for another hired killing and allegedly boasted, "I've never killed a person who was undeserving of it," was convicted of conspiracy to murder, murder, and conspiracy to obstruct justice.

Chagra's wife, Elizabeth, 28, was convicted of conspiracy to murder and to obstruct justice, and Harrelson's wife, Jo Ann Starr, 41, was found guilty of conspiracy to obstruct justice.

Chief U.S. District Judge William S. Sessions on Tuesday set sentencing for the three defendants for March 8, also after Jimmy Chagra's trial. All three defendants remained in custody.

The next step in what the FBI termed the most exhaustive investigation since the 1963 assassination of President John F. Kennedy will be the Dec. 21 formal sentencing of Chagra's 36-year-old brother, Joseph, an El Paso attorney.

Joseph Chagra appeared as the star witness in the lengthy trial and testified he advised his brother to have Wood shot.

Joseph Chagra pleaded guilty to murder conspiracy in September in exchange for a 10-year prison term and

immunity from state and federal prosecution.

Jimmy Chagra will be tried Jan. 10 and could have two life sentences added to the 30 years without parole he already is serving on narcotics charges.

The key witness in that trial is expected to be Jerry Ray James, Jimmy Chagra's former cellmate at the Leavenworth Federal Penitentiary in Kansas.

Bexar County District Attorney-elect Sam Millsap, who has threatened to retry Wood's killers in state court so he could seek the death penalty, said Tuesday he would make that decision after Jimmy Chagra's trial. Millsap takes office Jan. 1.

Harrelson, already serving 40 years in state narcotics and weapons charges, will receive a mandatory life sentence on the murder conviction. He could receive another life sentence, plus five years on the other two federal convictions.

Mrs. Harrelson, already sentenced to three years in federal prison for using a fictitious name to buy the alleged murder weapon, could receive a maximum five-year sentence on Tuesday's conviction. She also faces five perjury charges in connection with her grand jury testimony, punishable by up to five years on each count.

Mrs. Chagra could be sentenced to up to life imprisonment for murder conspiracy, plus five years for conspiracy to obstruct justice. She also faces an income tax evasion charge.

The trial began with jury selection on Sept. 28 and featured 40 days of testimony from 104 government and 26 defense witnesses, more than 500 pages of documents, and hours of tape recordings.

After the verdict, The El Paso Times Inc. and The Associated Press challenged a federal court rule that bars interviews with jurors in the Wood trial. The rule prohibits interviews with jurors during the trial or with respect to how jurors reached their verdict.

Kenansville Open House

KENANSVILLE — The Liberty Hall Restoration Commission and the Kenansville Beautification Committee will jointly host an open house Sunday from 2 p.m. until 6 p.m. Theme of the open house is "Christmas Memories 1850."

The ancestral home of the Kenan family will be decorated to reflect how Christmas was celebrated in the mid-19th century. There is no admission charged for this event, which is open to the public.

Refreshments will be served guests as they tour the house and the newly retored overseer's house and other support buildings.

EXPELLED
PKING (AP) — The Communist Party has expelled Chen Fuchuan, an electrician, for penning up his 89-year-old mother unattended in a low, dark smelly room while he lived in a fine new house nearby, the Peking Daily reports.

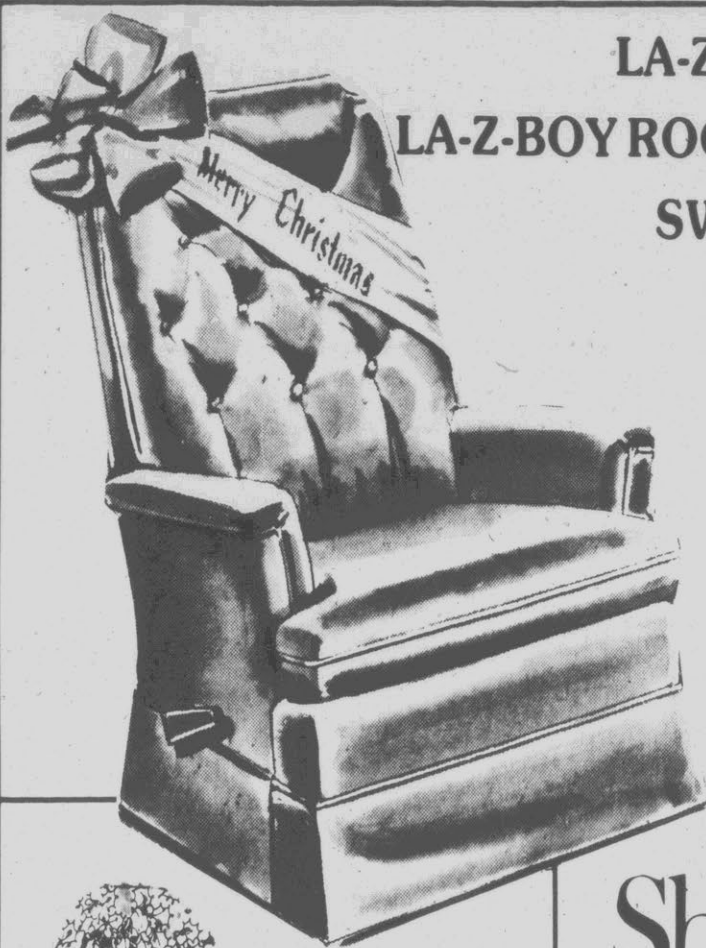

LA-Z-BOY CHAIR SALE
LA-Z-BOY ROCKER-RECLINERS-
SWIVEL ROCKERS &
WALL RECLINERS
AS LOW AS \$179⁰⁰



35% TO 50% OFF RETAIL PRICES

SELECT FROM OVER 200 LA-Z-BOY CHAIRS NOW IN STOCK. SAVINGS MAY NEVER BE THIS GREAT AGAIN.

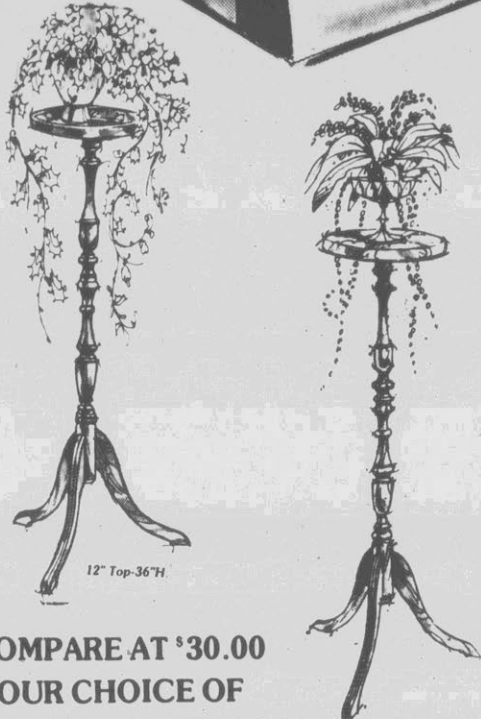

COMPARE AT \$30.00
YOUR CHOICE OF
QUEEN ANNE PLANT
STANDS WITH MARBLE TOPS

SALE PRICE **\$18⁸⁸**

Now, here's a great value for you. This handsome plant/candle stand can be used in any room to display many things. Has beautiful Queen Anne legs and looks great in any setting. Available in old world finish.

SAVE 1/2 NOW
SOLID PINE FLOOR
LAMP WITH TRAY
BY GEORGE BENT

SALE PRICE **\$39⁰⁰**

60 inches tall. Decorator shade. Limit two to a customer.



Victorian Plant Stand

... a distinguished conversation piece, and a bit of classical splendor.

Mahogany Finish With Imported Italian Marble Top.

SALE PRICE **\$35⁰⁰**

Compare At \$69.00



6ft. bentwood hall tree

Sale Price **\$15⁸⁸**

in fruitwood finish

Keep your home looking great with the addition of this beautiful six foot bentwood hall tree from Casard. All wood parts have fruitwood finish and is easily assembled. Adds personality and flair to any room.

\$18.88 If Assembled

She's dreaming of a Lane Christmas

LANE LOVE CHESTS
30% TO 45% OFF

LANE LOVE CHESTS AS LOW AS \$129.00



\$121⁰⁰ TO \$151⁰⁰ OFF

GEORGE BENT COLONIAL ROCKERS



LIST PRICE \$340.00
TRADITIONAL STYLE PLATFORM ROCKER
SALE PRICE **\$189⁰⁰**

LIST PRICE \$320.00
TALL BACK PLATFORM ROCKER
SALE PRICE **\$169⁰⁰**

LIST PRICE \$280.00
LOW BACK PLATFORM ROCKER
SALE PRICE **\$159⁰⁰**

LIST PRICE \$340.00
DARK PINE TALL BACK ROCKER
SALE PRICE **\$188⁰⁰**

50 Plate Glass Mirrors In Beautiful Wooden Gold Metal Finish Frames



RETAIL \$70.00. GOLD FRAME MIRROR 20"X32" **\$49⁰⁰**

RETAIL \$90.00 BAMBOO GOLD FRAMED MIRROR 20"X38" **\$65⁰⁰**

RETAIL \$80.00 ANTIQUE GOLD FRAME MIRROR **\$60⁰⁰**

RETAIL \$88.00 GOLD FRAME MIRROR 36"X20" **\$55⁰⁰**

RETAIL \$140.00 ANTIQUE GOLD FRAME MIRROR 36"X42" **\$105⁰⁰**

RETAIL \$110.00 BEVELED PLATE GLASS GOLD FRAME MIRROR **\$82⁵⁰**

RETAIL \$109.00 GOLD FRAME MIRROR 22"X36" **\$65⁰⁰**

RETAIL \$90.00 LARGE GOLD FRAME MIRROR 36"X42" **\$70⁰⁰**

RETAIL \$155.00 DECORATOR GOLD FRAME MIRROR 36"X54" **\$110⁰⁰**

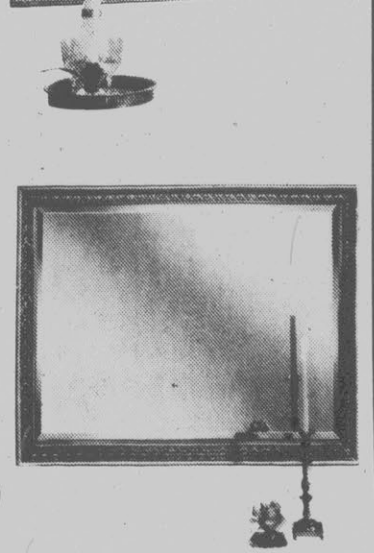
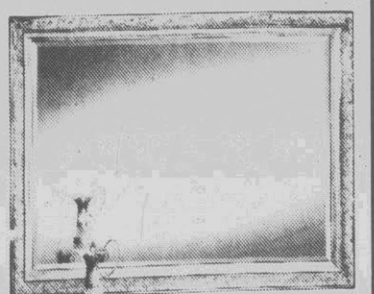

European Peace Activists March Near U.S. Bases

By EDITH M. LEDERER
Associated Press Writer
LONDON (AP) — West European peace activists who turned out in hundreds of thousands in 1981 are marching again, this time in smaller groups outside U.S. bases where 572 nuclear missiles are to be deployed starting next year.

In the new grassroots approach, anti-nuclear campaigners have engaged in mass acts of civil disobedience reminiscent of the U.S. civil rights protests of the 1960s — lying down outside gates of military bases in human blockades and forcing police to drag them away.

"You can't go on having large demonstrations forever," said Lukas Beckmann, a leading member of the pro-environment and anti-nuclear Greens Party in West Germany. "One must get out and do something at the basis (grass roots)."

In Italy, 5,000 pacifists are walking a 950-mile "peace march," and expect to arrive before Christmas outside the Sicilian town of Comiso

where 112 U.S.-built cruise missiles are to be stationed.

In Britain, several dozen women have been maintaining a "peace camp" for the past 15 months outside the U.S. Air Force base at Greenham Common, where the first 96 cruise missiles are scheduled to be deployed. Last weekend, 20,000 women formed what they called a "chain of peace" around the base. Police later hauled away hundreds who formed a human carpet outside the gates.

In West Germany, demonstrators blocked entrances to about 50 military bases Sunday. They protests marked the third anniversary of the North Atlantic Treaty Organization's decision to station the cruise and Pershing 2 missiles in Europe starting next year to counter a perceived Soviet threat.

At the U.S. Forces European Command headquarters in Vaihingen, about 10 miles northwest of Stuttgart, police carried away about 100 demonstrators who held up traffic. Those seized

included two members of Parliament from the opposition Social Democratic Party.

During the past month, peace protesters have demonstrated in Sweden, Norway and Denmark, where the debate over deploying U.S. missiles has been a major foreign policy issue.

NATO decided to deploy medium-range missiles in Europe to counter sophisticated Soviet SS-20s, targeted on all of Western Europe. Last week, U.S. officials said the Soviets have 333 such missiles, each with a triple warhead.

Earlier this month, the Soviet Union indicated it would reduce its medium-range missile force by more than half if the United States halts deployment of the cruise and Pershing 2 missiles in Europe.

U.S. officials say the offer is unacceptable because it would still leave the Soviets with a substantial advantage in medium-range weapons. But European peace campaigners and some opposition political leaders

welcomed the offer.

The West German government's insistence on secrecy about missile sites, the Soviet offer and the new disclosure that the United States plans to shift its command headquarters from West Germany to Britain in wartime will be major issues in West Germany elections expected in March.

The Netherlands and Belgium are to take 48 cruise missiles each, but both have said final deployment will hinge on the success of U.S.-Soviet arms control talks in Geneva which resume Jan. 27.

Here is a brief rundown on anti-nuclear movements in Europe:

BRITAIN — The Campaign for Nuclear Disarmament, which claims a growing membership of 250,000, has supported the Greenham Common peace camp and called for a nationwide crusade to block the stationing of cruise missiles in Britain.

WEST GERMANY — The peace movement, which attracted more than 300,000

demonstrators at the NATO summit in Bonn last June 10, switched to the new tactic of blockading bases. The latest revelation about moving the U.S. command headquarters in war has increased West Germans' fears that they would die in a military confrontation — and provided new fuel for anti-nuclear campaigners.

Chancellor Helmut Kohl said he will campaign in the March elections to get a mandate for stationing 108 Pershings and 96 cruises in West Germany. He also has called for a dialogue with young West Germans, who appear increasingly pacifist.

ITALY — Anti-nuclear militants in Sicily say they have presented the government with a petition against the missiles signed by 1 million people. For the first time, two leading Roman Catholic bishops have condemned the plan to base cruise missiles in Sicily. Bishop Dante Bernini, president of the Italian Bishops Conference and Bishop Luigi Bettazzi of Ivrea, president of Pax Cristi, an international peace

movement, also expressed solidarity with American bishops condemning nuclear warfare.

NETHERLANDS — Mient Jan Faber, head of the Interchurch Peace Movement, the nation's major peace organization, said the movement has begun a lobbying campaign in which members of Parliament are invited to grassroots meetings to see "how strong the mood is not to deploy."

DENMARK — The peace movement experienced an explosive growth in 1981, largely due to the Pan-Nordic Women for Peace group, which organized a massive petition drive and a Copenhagen-to-Paris march. Earlier this month, Parliament suspended payments of Denmark's \$8.8 million share of the bill for installing the cruise and Pershing-2 missiles. Former Prime Minister Anker Joergensen said the move was a signal that Denmark wants "concrete moves" toward disarmament.

SWEDEN — New Social Democratic Prime Minister Olof Palme, whose campaign slogan was "employment and peace," has called for a nuclear-free corridor in central Europe.

NORWAY — The most recent anti-nuclear peace march in Oslo last month drew a record crowd of 11,000 people. But Kaare Willoch's Conservative minority government is firmly behind

NATO, as were nearly 70 percent of Norwegians in the most recent poll.

FRANCE — The Communist-led peace movement in France meant there was no possibility that "under the colors of 'pacifism' a movement could create a policy of disarmament in the face of the fantastic arsenal in Eastern Europe."

spokesman, Michel Vauzelle, said Monday that the absence of a powerful grassroots peace movement in France meant there was no possibility that "under the colors of 'pacifism' a movement could create a policy of disarmament in the face of the fantastic arsenal in Eastern Europe."

Take it easy this holiday season...
TRIM YOUR HOLIDAY TABLE WITH A TURKEY OR HAM FROM S&S!



Choose the S&S Holiday turkey, a meaty 12-lb. bird deliciously prepared in the S&S tradition. Ready to heat and serve with 2 quarts of corn bread dressing and 1 quart of tasty giblet gravy.

\$21.99 plus tax
18 lb* turkeys are also available.

Or serve a juicy S&S ham... 16 to 18 pounds* of tender goodness, prepared with care in the S&S kitchens.

\$31.95 plus tax
*Pre-cooked weight
Call now to place your order...

S&S
cafeterias
Carolina East Mall
(919) 756-8950



PLANS TO STAY WARM — Denny Moore of North Myrtle Beach is making ready for the cold weather that finally reached the Grand Strand. Moore, who heats his house with the wood he cuts, also has been providing Strand residents with

wood for the past three years. Here, Moore slams into a seasoned hickory log, then takes a cigarette break before toting in the wood to throw onto an already warm fire crackling in his wood stove. (AP Laserphoto)

Sentenced For Fraud Of Blind

GREENSBORO, N.C. (AP) — A 23-year-old Greensboro man has been sentenced to one year in prison after being convicted of fraud for handing a blind clerk a \$1 bill and telling her he gave her a \$20 bill.

U.S. District Judge Hiram Ward sentenced Hugh Stanley Quick Tuesday after a jury took almost four hours to reach its decision.

Quick was charged with giving Linda Walston a \$1 bill in the snack bar in the basement of the federal building May 5, telling her he wanted change for a \$20 bill.

Ms. Walston counted out the change for him, then turned to an off-duty federal police officer in the snack bar and asked him if the bill was a \$20, she testified. The officer told her she had a \$1 bill and questioned Quick.

Quick testified on his own behalf that he did not realize Ms. Walston was blind.

POLLARD'S
INDEPENDENT NEIGHBORHOOD STORES
WHERE THERE'S A FRIENDLY DIFFERENCE

**HIGHWAY 43 SOUTH 3 1/2 MILES PAST THE PLAZA CINEMA ON LEFT
OPEN 7 DAYS A WEEK 'TIL 10 P.M.**

We Gladly Accept Food Stamps And WIC.

"YOUR FRESH MEAT HEADQUARTERS"

We Are Proud To Announce That We Will Be Preparing "Real Homemade Pure Pork Sausage" Just For You. No Artificial Protein Fillers, No Water Added - Just Fresh Pure Pork Sausage Like You Used To Get. Only \$1.89 Lb. (Hot or Mild).

GRADE "A" WHOLE FRYERS 40¢ LB. LIMIT 5 Case \$30.79	PEPSI 2 LITRE PRODUCTS EVERYDAY 89¢ NOW THRU CHRISTMAS PEANUT CITY HAM \$1.79 SLICED FRIE
RULL CUT ROUND STEAK \$1.59 LB.	FRESH LEAN GROUND BEEF 99¢ LB. 3 LB. OR MORE GWALTNEY FRANKS 99¢ 12 OZ. PACKAGE FRESH BAKING HENS 59¢ LB.
"OLD TIME WAY" "DRY SALT - NOT PUMPED" CORNED HAM \$1.69 LB.	BANQUET POT PIES 3 for \$1.00 8 OZ.
BUTTER-ME-NOT BISCUITS 1/2 OZ. 2 for \$1.00	TURKEY WINGS 39¢
FLORIDA ORANGES .5 LB. \$1.09 BAG	FRESH GREEN CABBAGE..... 9¢ LB.
WHITE POTATOES 10 LB. BAG 99¢	TANGERINES 7 for \$1.00



**Brim helps you set that special mood
With special savings.**

Nothing sets that special mood like the richness of Brim. And, since Brim is decaffeinated, you can savor its rich, satisfying taste cup after cup.

So clip this coupon and save 40¢ on Brim Ground. Then fill your cup to the rim with the richness of Brim.

Save 40¢ when you buy brim® GROUND DECAFFEINATED COFFEE 40¢

STORE COUPON



To the retailer: General Foods Corp. will reimburse you for the face value of this coupon plus 7¢ for handling if you receive it on the sale of the specified product and if upon request you submit evidence of purchase thereof satisfactory to General Foods Corp. Coupon may not be assigned, transferred or reproduced. Customer must pay any sales tax. Void where prohibited, taxed or restricted by law. Good only in U.S.A., Puerto Rico and U.S. Gov't. install. Cash value: 1/20¢. Coupon will not be honored if presented through outside agencies, brokers or others who are not retail distributors of our merchandise or specifically authorized by us to present coupons for redemption. For redemption of properly received and handed coupon, mail to General Foods Corp., PO Box 103, Kankakee, IL 60902. Offer expires June 30, 1983. This coupon good only on purchase of product indicated. Any other use constitutes fraud.

LIMIT - ONE COUPON PER PURCHASE
GENERAL FOODS CORPORATION
NOT GOOD ON TRIAL SIZE
NB02156300

© General Foods Corporation 1982

We've been offering the "newest thing in banking" for two years now.

The new money market accounts are all two years behind North State.

North State's Funds ManagementSM 12.00%^{*}

Ours is better.

Practically every financial institution in the country is introducing a new account this week. And practically every one of them will have a different name for the one they introduce — designed to try to convince you that theirs is somehow more advantageous.

But if you examine them closely, you'll find that they differ from North State's Funds ManagementSM in four basic respects.

- 1) They require a bigger initial deposit.
- 2) They require a minimum balance.
- 3) They don't pay as much interest.
- 4) They are all brand new.

Compare North State's initial deposit.

North State requires an initial deposit of \$1000 in our Funds ManagementSM Account.

Compare that with other financials that require \$2500 or so to start.

Just like theirs, our Funds ManagementSM is insured to \$100,000. But at North State, you can enjoy the high interest of a money market account for a lot less.

If they have a minimum balance, it's higher than ours.

Funds ManagementSM will pay you money market interest on a nickle. Or a penny. We figure it's to your advantage to keep a high minimum balance. So, except



for a 3-transaction maximum, we don't burden you with restrictions, requirements, fine print or other things like that.

Since we give you the best deal, we feel certain you'll keep a lot of money with us. But we don't require it.

You get the highest rates at North State.

North State will pay you a better rate than the other new accounts, too.

That's our policy.

Nobody's going to give you a better rate now or in the future.

Compare the Funds ManagementSM rate. If nothing else, our rates will convince you that Funds ManagementSM is better.

We've got two year's experience with money market accounts.

Everybody else is two years behind. We have our accounting procedure, all the mechanics for Funds ManagementSM already in place.

We've been competing successfully with money market funds for quite a while. And we believe that makes Funds ManagementSM better.

So examine the new accounts closely. We believe that if you do, you'll come to North State and open a Funds ManagementSM Account.

* This is the net 7-day annualized yield for the preceding reporting week. Reporting weeks are from Tuesday to Monday. The yield will fluctuate each week as money market rates and expenses vary so it is not necessarily representative of future rates. Deposits are insured to \$100,000 by the North Carolina Savings Guaranty Corporation.

Get the highest rates at NORTH STATE North State Savings & Loan Corporation

The Forecast For
Thursday, December 16
• Low Temperatures

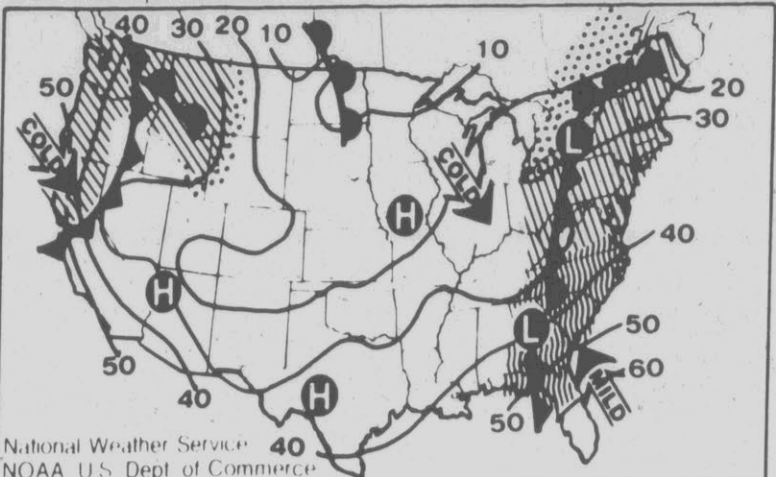

National Weather Service
NOAA U.S. Dept. of Commerce

WEATHER FORECAST — The National and the Pacific Northwest and northern Weather Service forecasts rain and showers Rockies. The Central states will be sunny but for Thursday from Florida to New England. colder. (AP Laserphoto Map)
Snow is expected for the Great Lakes and rain

By The Associated Press
Another rainy period is on tap in North Carolina through Thursday and into Friday.

The recreational weather outlook for North Carolina calls for a good chance of rain for the state the rest of the week.

By tonight rain will have spread over to the coast with minimums mostly in the 40s west and 50s east. Rainfall should be more concentrated over the eastern and central portion of the state Thursday with scattered showers westward and a few snow

flurries over the high elevations of the state.

Rain mixed with freezing rain spread into the mountains this morning. Temperatures today pushed into the 40s over western areas ranging to near 60 along the Outer Banks.

A slow moving cold front moved into the Mississippi Valley area this morning and should work itself over into the Carolinas and Atlantic Seaboard by Thursday.

This weather feature will be the trigger for rain during that time. In fact, some of the mountain areas could have some heavy rains at times tonight. This situation is being monitored closely, for the ground is saturated and any prolong period of heavy rain could cause some concern over the mountains by tonight.

Temperatures continued to warm Tuesday as compared with Monday's cold conditions. By mid and late afternoon low and mid 50s were evident over the coastal plain and eastward while the piedmont peaked into the mid and upper 40s.

Mountain communities were varied in the 40s and

MARKS U.S. TIES

INCHON, South Korea (AP) — A 60-foot high monument of copper-sheathed steel was dedicated Tuesday on a hill in Freedom Park in the final ceremony marking 100 years of relations between Korea and the United States.

Jamscam Jury Expected To Begin Its Deliberating Today

By ELISSA MCCRARY
Associated Press Writer
CONCORD, N.C. (AP) — The jury in the Jamscam trial of Johnny Lee Fletcher was expected to begin deliberations in the case today after hearing more than a week of testimony from 30 prosecution and defense witnesses.

Superior Court Judge Donald L. Smith of Raleigh said he would instruct the jury on the charges in the

case when the trial resumed at 9 a.m. today.

The stage was set for the seven-woman, five-man panel to begin deliberating when defense attorneys rested their case Tuesday morning. Attorneys took up most of Tuesday afternoon with final arguments.

Fletcher, 41, of Concord, a former state Jaycees president, is charged with misapplying \$21,480.50 in Jaycees charity funds in 1977 and 1978. He faces up to 50 years in prison if he is convicted.

Prosecutors contend that Fletcher used money earmarked for Jaycees charitable causes to pay for phony Jaycees chapters in order to win national awards.

Defense attorneys say Fletcher didn't know anything was done wrong during his year as president until a meeting of past Jaycees presidents in 1980.

Fletcher originally was charged in four two-count indictments, including four counts of conspiracy to misapply funds and four counts of misapplication of funds. But Smith dismissed three of the charges at the request of defense lawyer Wesley Grant, saying there was insufficient evidence presented to link Fletcher to the charges.

In closing statements Tuesday, Grant told the jury that the state had failed to prove its case against Fletcher.

"Whatever you believe, you can't believe that John Fletcher masterminded some kind of terrible situation," Grant said. "It just isn't so."

"John's signature wasn't on any of the checks, there was no personal gain except satisfaction for a job well done," Grant said. "Consider the fact that he was just a volunteer."

Prosecutor Lester Chalmers said Fletcher told SBI agent Claude Green about his role in the scandal in 1980, and said Fletcher didn't deny discussing the

transfer of funds from the Jaycees charity account to cover operating expenses.

"Mr. Fletcher has already confessed to Mr. Claude Green about his complicity in the case," Chalmers said.

"The only thing the defendant ain't done in this case...is plead guilty. He's confessed to Mr. Green and he's confessed to you."

In testimony earlier Tuesday, Fletcher said in his own defense that he didn't

know that 61 of 156 new Jaycees chapters created while he was state president were fictitious. He also said he didn't know funds from his \$11,000 travel allowance were used to pay membership dues for the bogus chapters.

"I left the financial problems to state headquarters," he said. "There were three paid staff members there to take care of them."

Williamsburg Illumination On Thursday

WILLIAMSBURG, Va. — Some 15,000 visitors and townsfolk are expected to witness the annual celebration launching Historic Williamsburg's traditional observance of Christmas seasons past in the Grand Illumination on Thursday.

At 5:30 p.m. Thursday, blazing artillery and glowing cressnets will be combined with cannons, mortars and the roar of muskets to usher in the celebration. Also, homes, shops and public building will be lit by some 2,000 candles.

Thursday evening is also opening night for "The Sham Doctor," the newest production of the company of Colonial Performers. The comedy was first performed in Williamsburg by the touring Hallam Company 230 years ago, in 1752. The opening night performance will be at 8:30 p.m. in the Williamsburg Lodge Auditorium.

Tickets for the play, the exhibition buildings, and more information on the Grand Illumination program may be obtained at the information center or by calling 804-229-1000, extensions 2191 and 2196.

EXTENDED WEATHER OUTLOOK FOR N.C.

Chance of rain Friday and Saturday, partly cloudy Sunday. Highs during period mostly in 50s and lows mostly in the 30s.

Companies Join In Well Project

GULF, N.C. (AP) — Eleven brick companies from Sanford, Raleigh and Durham have joined to dig North Carolina's first successful natural gas well near this Lee County town.

"There's a whole lot of it in there from one standpoint," said Sanford geologist Russell Patterson. "From the standpoint of Texas or Oklahoma, it's a dry well."

"There's enough gas there to heat a dozen houses," said Richard Beutel, a Raleigh consultant leading the drilling effort.

But until a transport line is connected to the 1,000-foot well, it will remain in the ground, officials said. For now, the companies can't afford to get the gas out.

Co-Ops Facing Increased Cost

RED SPRINGS, N.C. (AP) — Eighteen rural electric cooperatives will have to pay an average of 9 percent more for wholesale electricity from Carolina Power and Light Co. beginning Jan. 1.

The rate increase amounts to \$11.2 million a year for the 18 co-ops, said Jim Autry, spokesman for the Lumbee River Electric Membership Corp. The Lumbee River co-op will pay about 8.5 percent more, he said.

"This CP&L wholesale rate increase is part of an agreement worked out between CP&L and the 18 cooperatives back in October," Autry said. "The agreement brought a big reduction in a rate hike that CP&L was seeking. It would have raised rates by about 20 percent."

Use Us To Help Save Energy

A newspaper log should burn about as long as a wood log. Roll your newspaper log as tight as possible. The tighter it is rolled the better it will burn.

STEP ONE



STEP TWO



After you have squeezed it tightly, bind it with a coat hanger or metal wire. Soaking the rolled newspaper in water and letting it dry completely will "season" the newspaper and make it burn more efficiently.

STEP THREE



Finally, stack about six dried newspaper logs in a crisscross to provide more ventilation to the fire and light it. Enjoy.

THE DAILY REFLECTOR

SHOP-EZE
West End Shopping Center
Phone 756-0960

OODLAND

Thursday
Luncheon Special

Baked Ham
\$2.49

Fried Chicken
\$1.59

Special Served With 2 Fresh Vegetables & Rolls.

Save 25¢ on Kleenex SUPER DRY® diapers.

Super Dryness for Baby!
...Super Value for Mom!

Save 25¢
on any size Kleenex SUPER DRY® diapers.

For prompt payment, send this coupon to: Kimberly-Clark Corporation, Box #2, Clinton, Iowa 52734. For each coupon you accept as our agent, we will pay you face value plus 7¢ handling charge provided you and your customer have complied with the terms of this coupon. Any other use constitutes fraud. Invoices showing purchases of sufficient stock to cover all coupons submitted must be shown upon request. Void where prohibited or restricted. Your customer must pay any sales tax involved. Offer good only in the U.S. Cash value 1.20¢ off. Registered trademark of Kimberly-Clark Corp., Neenah, Wisconsin 54956. OFFER EXPIRES JUNE 30, 1983.

LIMIT ONE COUPON PER PACKAGE

25¢ STORE COUPON 36000 184295

OODLAND MARKETS

SAVE ON HOLIDAY NEEDS AT FOODLAND

PRICES EFFECTIVE: DECEMBER 16, 17, & 18, 1982

<p>ANGEL FLAKE COCONUT 14 OZ. BAG \$ 1 49</p>	<p>BAKER'S SEMI-SWEET CHOCOLATE FLAVORED CHIPS 12 OZ. BAG \$ 1 19</p>
<p>BAKER'S UNSWEETENED CHOCOLATE 8 OZ. BOX \$ 1 99</p>	<p>BAKER'S SEMI-SWEET CHOCOLATE 8 OZ. BOX \$ 1 79</p>

Here's how to receive **UP TO \$1.50 COUPON** good on any purchase at: **FOODLAND**

To qualify: 1. Clip the universal product code's UPC symbol from among the products listed below and affix to this certificate. 2. Check box indicating the number of product proofs attached. 3. Fill in your name, address, and send to:

GENERAL FOODS CORPORATION
Post Office Box 3021
Kankakee, Illinois 60902

1) Qualifying products for UPC Proofs: 3) Jell-O gelatin dessert

1) 3 Jell-O Gelatin UPC's
2) Please check appropriate box

3 Proofs: \$5.00 coupon
4 Proofs: \$1.00 coupon
5 Proofs: \$1.75 coupon
6 Proofs: \$1.50 coupon

*Note: 3) Jell-O Gelatin UPC's = 1) Purchase Proof! All other brands require only 1) UPC for proof qualification.
This certificate must accompany your request. Substitutions will not be accepted. Offer expires March 31, 1983.
OFFER LIMIT OF ONE REFUND SUBMISSION PER FAMILY.

QUANTITY RIGHTS RESERVED NONE SOLD TO DEALERS
WE WILL GLADLY ACCEPT USDA FOOD STAMPS & WIC VOUCHERS

JELL-O GELATIN DESSERT
3 OZ. BOX **29¢**

SPAIN'S
1414 CHARLES BLVD.
OWNED & OPERATED BY ALTON PAIN
MONDAY-THURSDAY 8 A.M.-8 P.M.
FRIDAY-SATURDAY 8 A.M.-8 P.M.
CLOSED SUNDAY

SHOP-EZE
WEST END SHOPPING CENTER
OWNED & OPERATED BY SHOP-EZE FOOD STORES, INC.
MANAGER-MELVIN WHITLEY
MONDAY-SATURDAY 8 A.M.-9 P.M. SUNDAY 9 A.M.-6 P.M.
VISIT OUR DELI FOR DAILY LUNCHEON SPECIALS

FOODLAND MARKETS

Merry Christmas

WE WOULD LIKE TO WISH ALL OF OUR SHOPPERS THE MERRIEST OF CHRISTMAS. AND TO MAKE IT EVEN MERRIER WE'VE GOT SOME HOLIDAY SPECIALS TO HELP YOU SAVE!

GET YOUR GIFT CERTIFICATES AT FOODLAND STORES!

GRADE "A"
TURKEYS
NORBEST WITH TENDER TIMER
79¢ LB.
YOU SAVE 10¢ LB.
FAMILY PRIDE
LB. **69¢** YOU SAVE 10¢ LB.

SMOKED TENDERIZED
HAMS
BUTT PORTION
\$1.19 LB.
SHANK PORTION OR WHOLE **\$1.09** LB.
YOU SAVE 30¢ LB.

FRESH CRISP
CELERY
LARGE 3'S SIZE
29¢ STALK
YOU SAVE 20¢

FRESH
ORANGES
\$1.19 5 LB. BAG
YOU SAVE 10¢

BEALE OR PEANUT CITY WHOLE
COUNTRY HAMS
\$1.79 LB.
YOU SAVE 20¢

WHOLE OR HALF
CORNEH HAMS
\$1.29 LB.
YOU SAVE 30¢ WE HAVE AMPLE SUPPLY OF DRY SALT CORNEH HAMS

SWIFT HOSTESS
CANNED HAM
\$9.99 4 LB.
YOU SAVE 50¢ THE ROUND ONE

FRESH GREEN
LETTUCE
69¢ HEAD
YOU SAVE 10¢

FRESH
COCONUTS
2 FOR \$1.00
YOU SAVE 38¢

BONELESS
CHUCK ROAST
\$1.49 LB.
YOU SAVE 30¢ LB.

SELECT
OYSTERS
12 OZ. CONTAINER
\$2.99
STANDARD \$2.89

LEAN BONELESS
STEWING BEEF
\$1.69 LB.
YOU SAVE 20¢ LB.

FRESH
GROUND CHUCK
\$1.49 LB.
YOU SAVE 20¢

WE HAVE
BUTTERBALL TURKEYS
ALL SIZES

FRESH
GREEN BEANS
59¢ LB.
YOU SAVE 10¢

FRESH
CRANBERRIES
69¢ BAG
YOU SAVE 10¢

GWALTNEY 1ST GRADE SLICED
BACON
YOU SAVE 20¢ LB.
GWALTNEY
FRANKS
YOU SAVE 10¢ PKG.

BONELESS SHOULDER
ROAST SAUSAGE
\$1.59 LB.
YOU SAVE 20¢ LB.
BEALE'S COURTLAND BRAND ROLL
79¢ 1 LB. PKG.
YOU SAVE 20¢ LB.

KEEBLER SESAME STICKS, SAVORY SESAME, NACHO CHEESE, WHEAT CRISP, CHEDO, PIZZA BITES, SOUR CREAM & ONION TANGY CHEESE, PRETZEL LITES OR FRENCH ONION.
95¢ PKG.

RED OR GOLDEN DELICIOUS
APPLES
79¢ 3 LB. BAG
YOU SAVE 20¢

PILLSBURY SELF RISING OR PLAIN
FLOUR
79¢ 5 LB. BAG
YOU SAVE 10¢

BETTY CROCKER SUPER MOIST WHITE, DEVILS FOOD, CHOCOLATE CHIP, CARROT, LEMON & BUTTER RECIPE OR YELLOW.
CAKE MIX
59¢ 19 OZ. BOX
EVERYDAY LOW PRICE

APRIL SHOWER
PEAS
\$1.00 303 CANS
EVERYDAY LOW PRICE

CRISCO SHORTENING
\$1.97 3 LB. CAN
LIMIT 1 WITH \$10.00 FOOD ORDER OR MORE
EVERYDAY LOW PRICE

PHILADELPHIA
CREAM CHEESE
79¢ 8 OZ. CTR.
YOU SAVE 10¢

LAND O' LAKES
BUTTER
\$1.79 1 LB. BOX
YOU SAVE 20¢

WHITE, PINK, COLD DUCK, AND SPARKLING BURGUNDY ANDRE
CHAMPAGNE
\$2.89 3/4 LITRE BOTTLE

CHABLIS BLANC, RED ROSE, RHINE & HEARTY BURGUNDY GALLO PREMIUM
WINES
\$3.39 1.5 LITRE BOTTLE

CORNBREAD OR CHICKEN
STOVE TOP STUFFING
99¢ 6 SERVINGS
YOU SAVE 20¢

COLD POWER
49 OZ. BOX
\$1.45
YOU SAVE 30¢

WHITE OR ASSORTED WALDORF
BATHROOM TISSUE
4 ROLL PKG.
87¢
YOU SAVE 12¢

FOODLAND
SHORTENING
3 LB. CAN
\$1.29
YOU SAVE 40¢

OCEAN SPRAY WHOLE OR JELLIED
CRANBERRY SAUCE
300 CAN
59¢
YOU SAVE 10¢

DOUBLE LUCK
CUT GREEN BEANS
4 303 CANS
\$1.00
EVERYDAY LOW PRICE

MAXWELL HOUSE MASTER BLEND
COFFEE
13 OZ. BAG
\$1.99

FOODLAND
BREAD
3 1 1/2 LB. LOAVES
\$1.49
EVERYDAY LOW PRICE

WHITE, DECORATOR, ASSORTED, OR DESIGNER
BOUNTY TOWELS
SINGLE ROLL
79¢ EVERYDAY LOW PRICE

KARO RED OR BLUE LABEL
SYRUP
16 OZ. BOTTLE
87¢ EVERYDAY LOW PRICE

REYNOLDS WRAP
12" x 25' ROLL
55¢ EVERYDAY LOW PRICE

FOODLAND
ICE CREAM
HALF GALLON
\$1.19

BAKER'S
ANGEL FLAKE COCONUT
14 OZ. BAG
\$1.49 YOU SAVE 10¢

BAKER'S
CHOCOLATE CHIP SEMI-SWEET
12 OZ. BAG
\$1.19 YOU SAVE 10¢

MAXWELL HOUSE INSTANT
COFFEE
10 OZ. JAR
\$3.95

FOODLAND
COUPON YOU SAVE 50¢
DUKE'S MAYONNAISE
32 OZ. JAR
59¢
LIMIT 1 WITH \$10.00 ADDITIONAL FOOD ORDER OR MORE & THIS COUPON. EXPIRES DECEMBER 16, 1982.

COCA COLA
8 PACK 16 OZ. BOTTLES
99¢
YOU SAVE \$1.00 PLUS DEPOSIT

BRIDGEFORD PARKERHOUSE
ROLLS
25 OZ. BOX
89¢
BIRDS EYE COOL WHIP 8 OZ. CTR. **79¢**
PET RITZ PIE SHELLS PKG. OF 2 **59¢**
WINTER GARDEN COCONUT 12 OZ. BAG **99¢**
MORTON CHICKEN, TURKEY, MEAT LOAF, OR SALISBURY DINNERS 11 OZ. BOX **79¢**
BANQUET PIE SHELLS PKG. OF 2 **39¢**

FOODLAND
CRANBERRY SAUCE
300 CAN
49¢ YOU SAVE 13¢

FOODLAND BROWN N' SERVE
ROLLS
\$1.49 PKGS.
EVERYDAY LOW PRICE

SHOP-EZE
WEST END SHOPPING CENTER OWNED & OPERATED BY SHOP-EZE FOOD STORES, INC. MANAGER-MELVIN WHITLEY MONDAY-SATURDAY 8 A.M. - 9 P.M. SUNDAY 9 A.M. - 6 P.M. VISIT OUR DELI FOR DAILY LUNCHEON SPECIALS

SPAIN'S
1414 CHARLES BLVD. OWNED & OPERATED BY ALTON SPAIN MONDAY-THURSDAY 8 A.M. - 8 P.M. FRIDAY-SATURDAY 8 A.M. - 8 P.M. CLOSED SUNDAY

FOODLAND MARKETS
YOUR NEIGHBORS AT FOODLAND
know what it is to feed a family

SHOP-EZE FOODLAND ACCEPTS ALL FOOD COUPONS THAT APPEAR IN THE DAILY REFLECTOR. QUANTITY RIGHTS RESERVED. NONE SOLD TO DEALERS. WE WILL GLADLY ACCEPT USDA FOOD STAMPS & WIC VOUCHERS. PRICES EFFECTIVE: GROCERY, MEATS & PRODUCE. DECEMBER 16, 17, & 18, 1982.

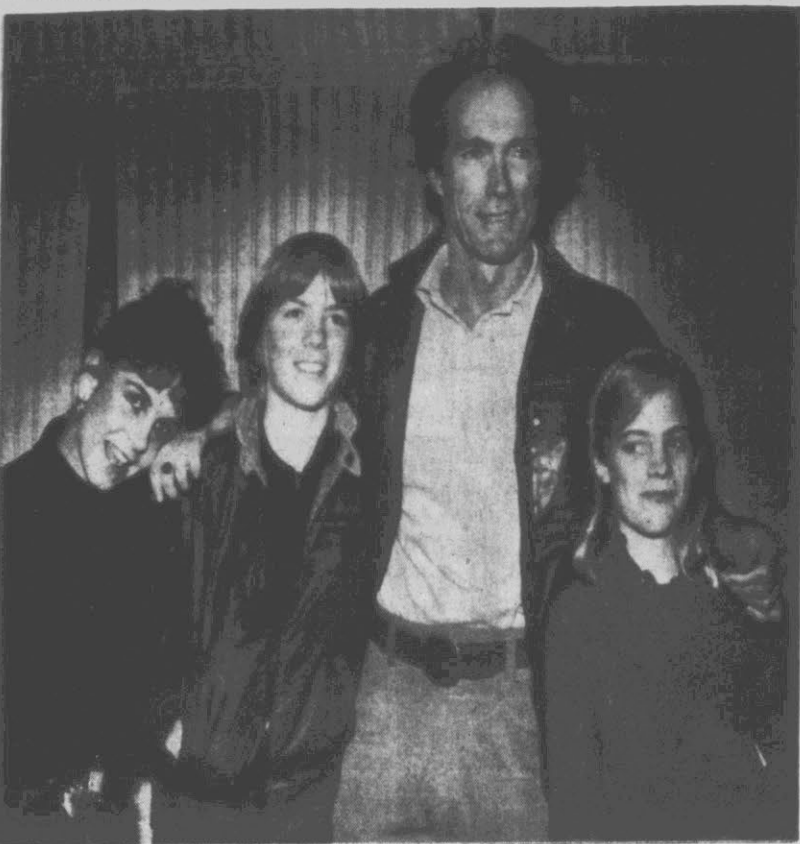

CLINT THE FAMILY MAN — Actor Clint Eastwood, third from left, took time out for photographers in Los Angeles at a screening of his upcoming film "Honkytonk Man". With him from left are Alexa Kenin and son Kyle Eastwood who costar in the movie, and his daughter Alison Eastwood. Clint Eastwood produced and directed the film. (AP Laserphoto)

TV Log Irresistably Real Emotions In CBS Movie Offering Tonight

By FRED ROTHENBERG
AP Television Writer

NEW YORK (AP) — The story vehicle of a mentally depressed mother returning to her family after six years of hospitalization seems artificial, but the emotions are irresistibly real in tonight's CBS movie, "Memories Don't Die."

Lindsay Wagner plays Joanne Tilford, an intruder in her own house who is summoned home to care for her children after her husband, Howdy (Gerald McRaney of "Simon & Simon") suffers a heart attack. Joanne hasn't seen her kids for six years; Shawn is now 9, Kathy a teen-ager. Joanne's return sets up conflicts between mother and daughter, and between mother and surrogate mother. It also opens the characters to guilt and fear, love and caring, while providing viewers an involving TV experience.

It's hard not to be touched by a mother, wrestling with anxieties and her reawakening maternal instincts, attempting to rekindle her children's trust and affection. The audience sympathy is further evoked by a wonderfully warm and sensitive portrait by Miss Wagner, the former "Bionic Woman."

After one suicide attempt, drugs, electric shock treatments and therapy, Joanne's doctor thinks she's capable of being a full-time mother and wife again. Joanne's not so sure. "How can I be ready to go home if I feel this scared?"

She's nervous about her own competency. But, except for flashbacks to her suicide attempt, Joanne remains remarkably composed and together, in fact too much so, giving the movie its most unbelievable element.

As it turns out, her fitness is less a problem than other issues:

Will she be accepted by her children? Does she want to be a mother and wife again? Does she want to accept responsibilities after having the hospital take care of her needs for so long?

When she leaves Chicago for California, she admits: "I feel like I'm leaving home."

Joanne receives a rude welcome. Her husband's sister and brother-in-law, who want custody of the children if Howdy should die, are patronizing and in-

sensitive. But the worst treatment comes at home.

Daughter Kathy (Melissa Michaelsen) is hostile. Her feelings of abandonment are complicated by her extreme protectiveness and possessiveness toward her father, still recuperating in the hospital. Kathy objects when her mother returns to her old bed, and not the guest room.

Another obstacle to family togetherness is the icy housekeeper, Louise, played by Barbara Babcock of "Hill Street Blues." There's immediate competition and an intense disagreement over child-raising. Joanne, as the outsider, doesn't know her place yet, but she gets no sympathy from Louise.

"Trust me to know what's best and please don't interfere," Louise says.

CBS An Easy Winner In Week's Niensens Race

LOS ANGELES (AP) — CBS, taking seven of the Top 10, easily won the weekly Nielsen television ratings for the past week.

CBS finished the week ended Dec. 12 three rating points in front of second-place ABC. The week before CBS was 3.5 points ahead of ABC. NBC was in third place.

The CBS rating was 18.3. Second-place ABC had 15.3 and NBC had 14.7. The networks say this means in an average prime-time minute 18.3 percent of the nation's homes with television were tuned to CBS.

The No. 1 show of the week in the A.C. Nielsen Co. ratings was the CBS magazine show "60 Minutes." The first six shows were all from CBS. "Dallas" was second, "M-A-S-H" was third, "Magnum, P.I." was fourth,

and "The Jeffersons" and "One Day at a Time" tied for fifth.

Seventh place went to the NBC Monday Night Movie, "Remembrance of Love." Kirk Douglas played a Nazi camp survivor who has a brief reunion in Israel with his sweetheart from before the Holocaust.

ABC's "Dynasty," the prime-time soap opera rival to "Dallas," was in eighth place. ABC's "Three's Company" was ninth, and CBS' "Falcon Crest" was tenth.

Some network shows dropped in the ratings this past week because of special non-network programming.

ABC's "T.J. Hooker," went from 41st last week to 70th place. The police show starring William Shatner apparently was affected by the telecast of the

Georgetown-Virginia basketball game by the Turner Broadcasting System. More than 15 percent of the affiliate stations dropped the network show for the ball game.

CBS' "Bring 'Em Back Alive," which also had a more than 15 percent loss of affiliate stations, went from 46th place last week to 69th place in the current listing. The series and several others were affected by such special telecasts as sporting events and the week-long Billy Graham Crusade.

Here are the Top 10: "60 Minutes," a rating of 28.5 or 23.7 million households, CBS; "Dallas," 26.2 or 21.8 million, CBS; "M-A-S-H," 23.8 or 19.8 million, CBS; "Magnum, P.I.," 23.4 or 19.4 million, CBS; "The Jeffersons" and "One Day at a Time," tied, 21.5 or 17.9 million, both CBS; NBC Monday Night Movie, "Remembrance of Love," 21.3 or 17.7 million, NBC; "Dynasty," 21.2 or 17.6 million, ABC; "Three's Company," 21.0 or 17.4 million, ABC; "Falcon Crest," 20.8 or 17.3 million, CBS.

Here are the next 10: "Simon & Simon," CBS; "Archie Bunker's Place," CBS; "Trapper John, M.D.," CBS; "Hart to Hart," ABC; "9-to-5," ABC; "Gloria," CBS, and "Real People, NBC, tied; "Hill Street Blues," NBC; "Little House: A New Beginning," NBC; "Newhart," CBS.

Here are the five lowest-rated shows: ABC Friday Night Movie, "Don't Go to Sleep," ABC; "Bring 'Em Back Alive," CBS; "T.J. Hooker," ABC; "The Devil Connection," NBC; and last, ABC News Closeup, ABC.

WNCT-TV — Ch. 9

WEDNESDAY	11:57 Newsbreak	12:00 News
7:00 Jokers Wild	12:30 Young and	1:30 As the World
8:00 Seven Brides	2:30 Capitol	3:00 Guiding L.
9:00 Special	4:00 Walton	5:00 Hillbillies
10:00 News 9	5:30 A. Griffith	6:00 News
11:30 Movie	6:30 CBS News	7:00 Jokers Wild
THURSDAY	8:00 News	7:30 Tic Tac
5:00 Jim Bakker	8:00 Magnum P.I.	9:00 Simon &
6:00 Carolina	10:00 Knots L.	11:00 News
8:00 News	11:30 Movie	
8:25 News		
9:25 News		
10:00 Pyramid		
10:30 Childs Play		
11:00 Price Is		

WITN-TV — Ch. 7

WEDNESDAY	10:00 Facts Of Life	10:30 Wheel of
7:00 Jefferson	11:00 Texas	12:00 News
7:30 Family Feud	12:00 News	12:30 Search For
8:00 Real People	1:00 Days Of Our	2:00 Another
9:00 Facts Of Life	2:00 Fantasy	3:00 Doctors
9:30 Family Ties	4:30 Dark Shadows	5:00 Little House
10:00 Quincy	6:00 News	6:30 NBC News
11:00 News	7:00 Jeffersons	7:30 Family Feud
11:30 Tonight	8:00 Fame	9:00 Cheers
12:30 Letterman	9:00 News	9:30 Taxi
1:30 Overnight	10:00 Hill Street	11:00 News
2:30 News	11:00 News	12:30 Letterman
THURSDAY	6:30 NBC News	1:30 Overnight
5:30 Addams	7:30 Family Feud	2:30 News
6:00 Almanac	8:00 Fame	
7:00 Today	9:00 Cheers	
7:25 News	9:30 Taxi	
7:30 Today	10:00 Hill Street	
8:25 News	11:00 News	
8:30 Today	12:30 Letterman	
9:00 Muppets		
9:30 All In The		

WCTV-TV — Ch. 12

WEDNESDAY	11:00 Love Boat	12:00 Family Feud
7:00 3's Company	12:30 Ryan's Hope	1:00 My Children
7:30 Alice	2:00 One Life	3:00 Gen. Hospital
8:00 Gold Monkey	4:00 Carnival	4:30 B.J. and the
9:00 Fall Guy	5:30 People's	6:00 Action News
10:00 Dynasty	6:00 Action News	6:30 ABC News
11:30 ABC News	7:00 3's Company	7:30 Alice
12:00 Movie	8:00 Joanie Loves	8:30 Christmas C.
2:00 Early Edition	9:00 Too Close For	9:30 It Takes 2
THURSDAY	6:30 ABC News	10:00 20/20
5:30 AG Day	7:30 3's Company	11:00 Action News
5:30 J. Swaggart	8:00 Joanie Loves	11:30 Nightline
6:00 News	8:30 Christmas C.	12:00 Movie
7:00 Good Morning	9:00 Too Close For	2:00 Early Edition
6:25 Action News	9:30 It Takes 2	
6:55 Action News	10:00 20/20	
7:25 Action News	11:00 Action News	
8:25 Action News	11:30 Nightline	
9:00 Phil Donahue	12:00 Movie	
10:00 Romance	2:00 Early Edition	
10:30 Laverne		

WUNK-TV — Ch. 25

WEDNESDAY	11:50 Readalong 2	12:00 Come Alive
7:00 Report	12:30 Read It	12:45 Electric Co.
7:30 NC Meeting	1:15 Self Inc.	2:00 2-1 Contact
8:00 Creatures	2:30 Give and Take	2:45 Inside/Out
9:00 Previn &	3:00 Over Easy	3:30 Gen. Ed. Dev.
10:00 Mark Russell	4:00 Sesame St.	5:00 Mr. Rogers
10:30 In the Shadow	5:30 Powerhorse	6:00 Dr. Who
11:00 A. Hitchcock	6:30 Dr. In House	7:00 Report
11:30 Dave Allen	7:30 T.S. Journal	8:00 Previews
THURSDAY	3:30 Gen. Ed. Dev.	8:30 W. America
7:45 AM Weather	9:00 Nature of	10:00 Austin City
8:00 Over House	11:00 Music	11:00 Hitchcock
8:35 Two Plus	11:30 Thinkabout	11:45 Write On
8:50 Readalong I		
9:00 Sesame Street		
10:00 Tip Top Ten		
10:10 Jobs		
10:30 Trade-Offs		
10:50 Parlez Moi		
11:00 Music		
11:30 Thinkabout		
11:45 Write On		



FELINE FACES — Four of the members of the cast of "Cats" put on their best cat faces backstage at the Winter Garden Theatre in New York. The players are, from top left: Timothy Scott as Munkustrap, and Harry Groener, as Munkustrap; from bottom left: Anna McNeely as Jennyanydots, and Rene Ceбалlos as Cassandra. (AP Laserphoto)

CONSOLIDATED THEATRES
ALL SEATS \$2.00 EVERYDAY 'TIL 6:30 P.M.

BUCCANEER MOVIES

1	1:20	1:10
3	3:20	3:10
5	5:20	5:10
7	7:20	7:10
9	9:20	9:10

THE SLAYER R. THE TOY PG. The Last American Virgin R.

1:20-3:20-5:20
7:20-9:20

JACKIE GLEASON
TOLD HIS SON TO GET ANYTHING HE WANTED FOR CHRISTMAS... SO HIS SON BOUGHT...

RICHARD PRYOR PG

THE ARBOR

Thursday Night Delight Steak And Brew

Get A One Pound U.S.D.A New York Strip Steak, Choice Of Stuffed Or Baked Potato, Salad Bar And Vegetable. Plus All Of The Draft Beer That You Can Drink During Your Meal For Only \$8.95 Per Person.

Also By Popular Demand
Wed. & Fri. Night Special Feature
"Shrimp And Chablis"

That's All The Fried, Broiled or Boiled Shrimp You Can Eat And Chablis To Drink For \$8.95

756-2792
Dinner Hours 5 P.M. - 10 P.M.

RAMADA INN
Greenville Blvd.

264 PLAYHOUSE
INDOOR THEATRE
6 Miles West Of Greenville
On U.S. 264 (Farmville Hwy)

ENDS TONIGHT

AT YOUR ADULT ENTERTAINMENT CENTER

AUNT PEG GOES HOLLYWOOD
X-RATED

Call Anytime for Showtimes
Valid I.D. Required
756-2644 Doors Open 8:45
Showtime - 9:30

LOCAL NETWORK. CABLE. PAY.

60¢

TV GUIDE

With Expanded CABLE

Local Programs Dec. 18-24, 1982

Nancy Dussault (left) with 'Too Close for Comfort' cast

714356

TV GUIDE HELPS YOU DECIDE.

All those channels. All those shows. All those choices. To help you watch the best that's on, pick up the best...TV Guide. On sale now.

PARK
UPTOWN GREENVILLE
753-7444
ALL SEATS \$1.50
FIRST SHOW EVERYDAY
"HANDS OF LIGHTNING"
SHOWS 7:16-9:00 (R)

The Little Whorehouse
IN TEXAS
SHOWS
3:00-7:05-9:15

Plaza cinema 1-2-3
756-0083
PITZ PLAZA SHOPPING CENTER
ALBERT FINNEY
CAROL BUNNETT
BERNADETTE PETERS
Annie
SHOWS
3:00-7:05-9:30

WE ARE THE FUTURE!
Start Us If You Can!
CLASS
OF 1984
SHOWS 3:00-7:10-9:00

PLITT THEATRES \$2.00 Daily 'Til 6 P.M.

PLITT Give Plitt Reduced Admission Tickets

For The Ride of Your Life "Airplane II"
2:30-4:10-5:50-7:30-9:10-PG

27th Week "E.T."
2:30-4:45-7:00-9:15-PG

CAROLINA EAST CENTER
756-1448

SOON KISS ME GOOBY

EDDIE MURPHY
"48 HOURS"
2:00-3:45-5:30-7:15-9:00-R

DOUBLE FEATURE
I, THE JURY 3:05-7:05-R
MONSIGNOR 5:05-9:05-R

Carolina Grill
Smoked Sausage, 2 Eggs (any style)
Grits, Toast, Jelly & Coffee
\$1.98
Corner of S. 19th & Dickinson 752-1188

Crossword By Eugene Sbeffer

FORECAST FOR THURSDAY, DEC. 16, 1982

YOUR DAILY Horoscope
from the Carroll Righter Institute

ACROSS 36 Jolly — 57 Marries 9 Controversy
Band 38 Sportscaster 58 Drunkard 10 "Swedish
instrument Allen 59 Variety nightingale"
Seance 40 Dad's pride 11 Greek
sound 41 Wild ox 16 Gorillas
Glance 43 Cover 20 — Van
amorously 45 Black 2 Soviet
Isles off widow, 23 Douglas,
Ireland for one 3 Unadorned
4 Milkfish 47 Unfasten 4 Ministering
5 Shore bird 51 Sharpen 5 Dried
6 Shopper's 52 Set back the 27 Sweet potato
goals clock, so to 29 Zodiac lion
7 Actress speak 6 Beard of
8 Merrill 54 Unique 32 Telegraph
9 Slumbers thing 34 Pablo
10 General 55 Goddess of 37 Future fish
tenors harvests and ravioli Casals
11 Hawaiian 56 Yale men 8 Commanded
wreath
12 Makes 37 Future fish
public 39 Jungle cat
13 Distant 42 Ancient
14 Curve of a ship's 44 Lavishes
planking excess
15 American 45 Exhibit
painter 46 Corn bread
16 Caesar's 48 Storage
fatal date building
17 River in 49 Arabian
Missouri ruler
18 English 50 Snug place
clergyman and poet 53 Philippine
volcano

Avg. solution time: 26 min.

12-15
Answer to yesterday's puzzle.

GENERAL TENDENCIES: You can solve a difficult problem when you are fresh and thinking clearly early in the day. Take constructive steps to overcome obstacles in your path of progress.

ARIES (Mar. 21 to Apr. 19) Look to experts for advice you need. Take time to concentrate on making your life more harmonious with close ties.

TAURUS (Apr. 20 to May 20) Concentrate on how you can be more productive in the days ahead. Sidestep one who likes to waste your time.

GEMINI (May 21 to June 21) Ideal day to improve conditions at home. Use your own excellent taste where clothing and furnishings are concerned.

MOON CHILDREN (June 22 to July 21) You can get your points across to others easily in the morning and get ahead in career activities.

LEO (July 22 to Aug. 21) Handle matters of credit intelligently in the morning and later you can join congenials for recreation. Be happy.

VIRGO (Aug. 22 to Sept. 22) Going after your personal aims will see you gaining them quickly. Try to meet the expectations of family members.

LIBRA (Sept. 23 to Oct. 22) Morning should be spent taking care of personal matters, then go after what means the most to you financially.

SCORPIO (Oct. 23 to Nov. 21) Close friends can be helpful in a new project you have in mind. An intuitive prompting could be wrong so forget it.

SAGITTARIUS (Nov. 22 to Dec. 21) Let others know that you are a good citizen. Study a new outlet that looks promising. Relax at home tonight.

CAPRICORN (Dec. 22 to Jan. 20) New ideas you have can be put in operation quickly with good results following. Strive for happiness.

AQUARIUS (Jan. 21 to Feb. 19) Handle your duties wisely, then engage in more pleasurable activities. Avoid the expenditure of too much money.

PISCES (Feb. 20 to Mar. 20) Make better arrangements with those you wish to be associated with in the future. Be practical in making your plans.

IF YOUR CHILD IS BORN TODAY . . . he or she will have the knack for getting others to join in some worthy cause, and should have sufficient education in order to make the most of the ability. One who can easily gain the cooperation of others in almost any endeavor.

"The Stars impel, they do not compel." What you make of your life is largely up to you!

© 1982, McNaught Syndicate, Inc.

Stand-In Santa Is Kept Busy

NORTH POLE, Alaska (AP) — The post office of this tiny town just outside Fairbanks gets thousands of letters in the pre-Christmas season, and the phone of one resident rings almost constantly.

The recipient of all the calls probably comes closer than anyone to being Santa Claus. His name is Con Miller and many people throughout the great Alaska interior are sure he really is old St. Nicholas.

"It all started in 1949," says Miller, 69. "I'd just arrived in Alaska, and bought an inventory of retail goods from someone in Fairbanks. I'd load the goods in my old station wagon, and sell from village to village."

But nobody much was buying, and Miller figured it was because he wasn't making an impression. "About that time I was rummaging through my inventory and came across a complete Santa Claus outfit," he recalls.

"So from then on, whenever I'd pull into one of those villages, I'd be wearing my Santa suit. The kids would get really excited, and as I'd approach, they'd call out, 'Santa Claus is coming!'"

He knew the name had stuck when three years later he was building a trading post in Fairbanks, a carload of kids passed by, and one shouted, "Hey, Santa! Are you building a new house?"

The U.S. Postal Service aided in spreading this case of mis-identity in 1954, when it opened a post office at the North Pole when the settlement was 1 year old.

"I'd guess that postal clerks, seeing kids' letters to Santa at the North Pole, passed 'em onto our post office," Miller says. "And people there naturally turned them over to me, me being Santa Claus — around these parts, anyway."

"It wasn't long before I was getting thousands of letters to Santa Claus. They usually start pouring in around Thanksgiving.

"But what really amazes

me," he adds, "are the phone calls. Last year we got, I'd guess, about 350,000 calls between Thanksgiving and Christmas Eve. Almost all the calls are from young children, and I bet their parents get quite a jolt when the phone bill comes in."

When the telephone rings at his place of business, a huge store stocked almost entirely with Alaska souvenirs and Christmas-related items — where he also lives — he answers "Santa Claus House."

The majority of the callers, and the letter writers too, are concerned with what they would like to see in their yule stockings and under their Christmas trees. But many just want to be able to say they actually spoke to Santa Claus. Many of the letters have no return addresses and quite a few lack stamps, but the post office delivers them to Miller anyway.

Seafood Lovers - You Win!

J.B.'s Island Seafood

Open: Sun Thru Thurs 5:00-9:30
Fri & Sat 5:00-10:00-Closed Mon.

Serving the finest selections from the sea prepared 'island' style. Raw, steamed, and broiled.

Wednesday-Shrimp Night

Steamed Shrimp \$5.00
Fried, Broiled or Steamed Shrimp Platters \$7.95

Special Special!!

Boiled or Pan Fried Shrimp 7.95
Seafood Quiche & Salad 5.95

Located In
Rivergate Shopping Center
E. 10th St. Greenville
752-1275
"Our Specialty is Quality"

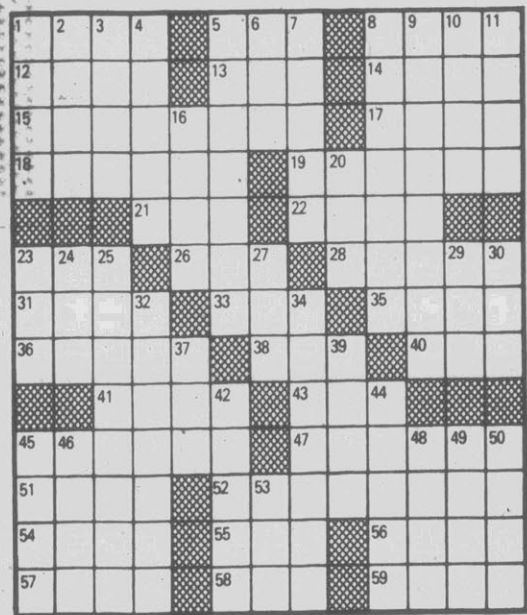

CRYPTOQUIP 12-15
RVVC LNTJVC LGRT'J GTP MNFYW
JK MNP WKFYW

Yesterday's Cryptoquip — THE ORGANIST GOT HIS FINE HURDY-GURDY FOR A SONG.
Today's Cryptoquip clue: N equals U.

The Cryptoquip is a simple substitution cipher in which each letter used stands for another. If you think that X equals O, it will equal O throughout the puzzle. Single letters, short words, and words using an apostrophe can give you clues to locating vowels. Solution is accomplished by trial and error.

© 1982 King Features Syndicate, Inc.

GOREN BRIDGE

BY CHARLES GOREN AND OMAR SHARIF
© 1982 Tribune Company Syndicate, Inc.

TELL PARTNER WHICH TRICKS TO CASH

East-West vulnerable. South deals.

NORTH
♠ 10 7 2
♥ K Q J 10
♦ K 6
♣ Q 7 6 2

WEST EAST
♠ A Q 6 3 ♠ K J 5
♥ 7 ♥ 6 4 3
♦ A Q J 8 3 ♦ 10 9 7 5 2
♣ 10 5 4 ♣ 8 3

SOUTH
♠ 9 8 4
♥ A 9 8 5 2
♦ 4
♣ A K J 9

The bidding has proceeded:
South West North East
1 ♥ Dble Rdbld Pass
Pass 2 ♦ 4 ♥ Pass
Pass Pass
Opening lead: Seven of ♣.

Dear Charlie:

Well, the North Americans almost made a clean sweep of the titles at the World Olympiad. After taking the Mixed, Women's and Open Pairs, a U.S. squad lost by a whisker to my French friends in the final of the Rosenblum team event. In addition, the Canadian team won the Swiss team event.

Despite the magnificent performance by your players, the talk of Biarritz was the strong performance of the four-man Spanish team—to be exact, three men and a woman. They had a considerable lead at the halfway stage of their match against the winning French squad and only faltered in the home stretch.

I was most impressed by the defense of the Spaniards on this deal from an early round match against an American group. It is all very well to have enough tricks to set a contract—you have to cash them if you want to enjoy a happy result.

At both tables the final contract was four hearts. The Spanish West led a trump, and the declarer realized that he would need a spade discard from one hand or the other if he was to make his contract. The fact that the hands were near mirror patterns meant that only the king of diamonds offered any hope.

Declarer overtook the ten of trumps in hand with the ace and led a diamond. West rose with the ace and East contributed the ten. Since East could hardly want a diamond continuation, West interpreted the ten as a suit preference signal, showing values in spades. So he shifted to a low spade and the defenders quickly reeled in the setting tricks.

Looking at all four hands, the defense is simple. But to give you an idea of how difficult it can be in practice, the Americans did not find the spade shift and the Spanish declarer made four hearts.

As ever,
Omar

Searching for the right townhouse? Watch Classified every day.

SHOPLIFTING makes you a criminal!

And criminals do get caught! Now the stores are wise to shoplifters and have the manpower and sophisticated equipment to prove it. Closed circuit cameras, undercover people, specially treated tagging systems...are all used to successfully catch shoplifters. And the stores are taking legal actions. Shoplifters face even stiffer fines...even jail when they're caught...plus the humiliation of getting arrested, and a criminal record that could affect future schooling, jobs, credit rating, and the respect and trust of family and friends. Shoplifting...like any other crime...just doesn't pay!

Let Us Cook Your Christmas Dinner For You!
Your choice of Turkey & Dressing or Ham

2 Vegetables — Rolls Food for 10-12 people \$19.95

Pick up on Christmas Eve-
Call Today & Place Your Order

Extra Special Take-Outs for Christmas
Collards — 5⁰⁰ quart
Yams — 4⁰⁰ quart
Boiled Potatoes — 2⁰⁰ quart
Potato Salad — 4⁰⁰ quart
BBQ — 5⁰⁰ lb.

Abram's Riverside Seafood Barbecue Oyster Bar

Hours:
Sunday-Thursday 11:00 AM-9:00 PM
Friday & Saturday 11:00 AM-10:00 PM

710 N. Greene St. Greenville, N.C. 27834 752-0090

Take Outs Welcome
Catering Specialists We Cater: Anything Anywhere

PEANUTS



B.C.



NUBBIN

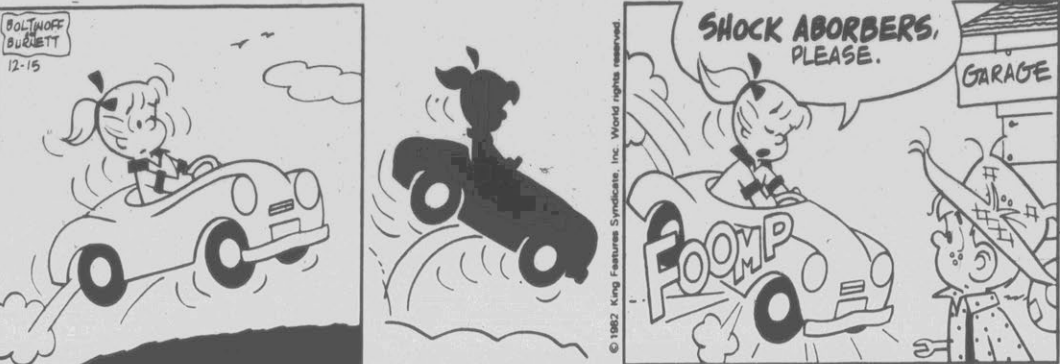

BLONDIE



BETTY BAILEY

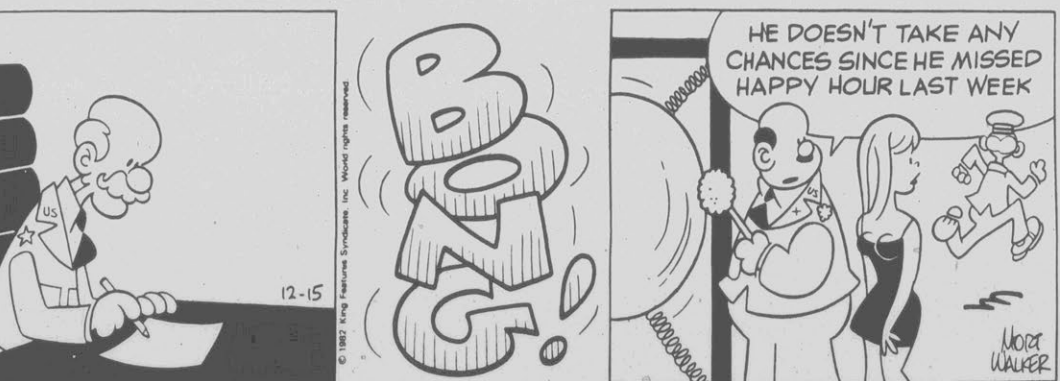

PHANTOM



FRANK & ERNEST



PRIME TIME

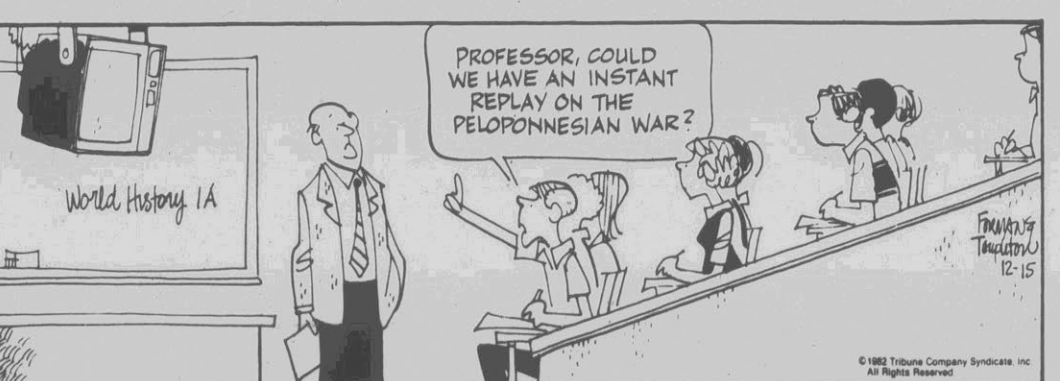

FUNKY WINKERBEAN



Malaysian Capitals A Big Mess

By KENNETH L. WHITING Associated Press Writer KUALA LUMPUR, Malaysia (AP) - Years of haphazard growth have made a municipal mess of one of Asia's smaller capitals.

The litany of Kuala Lumpur's urban woes includes air pollution, traffic congestion, water shortages, electric power cuts, flooding and inadequate sewerage. A quarter of the city's population of 1 million live as squatters in makeshift houses.

Now a master plan promises - on paper anyway - to halt the officially acknowledged decline in the quality of life.

"The problems experienced by Kuala Lumpur are not dissimilar to those faced by other cities in developing countries," said the DSP or Draft Structural Plan that was recently released.

The 94-square-mile federal capital was separated from the state of Selangor in 1971. Kuala Lumpur, which means "muddy river mouth," grew from a tin mining camp in the Klang River basin some 130 years ago.

Frantic construction of high rise office buildings is changing the face of the once sleepy backwater where in colonial times only the turrets and onion domes of mosques and arabesque buildings were taller than the coconut palms.

More than 20 buildings of 20 stories or higher are under construction in the city Malaysians call "K.L."

"Physical development within the city and beyond has apparently been undertaken with scant regard to ecology and environment," according to the DSP.

The 228-page plan for comprehensive development has occupied 15 experts since 1978. It sets a broad policy framework for the next 20 years and projects a population of at least 1.8 million by the year 2000.

Other Third World capitals have blueprints for the future but few are well-heeled enough to carry out their sometimes grandiose plans.

Malaysia is more fortunate. It is the world's largest producer of tin, natural rubber, palm oil, pepper and tropical hardwoods, and has a growing crude oil output.

The economy is being squeezed by recession but there is no widespread unemployment.

Officials say 300 million ringgit (\$129 million) is allocated to build 30,000 housing units for low income residents in Kuala Lumpur.

An estimated 3.83 billion ringgit (\$1.64 billion) will be needed to revamp the city's transportation system.

The DSP calls for the diversion of 40 to 60 percent of passenger movement to public transport to avoid the massive congestion that is likely if private travel goes unchecked.

K.L. has no subways or streetcars, and commuting by train is limited. During rush hours more than 250,000 cars and trucks clog 450 miles of roads.



YOUR AD COULD BE WORKING FOR YOU IN THIS SPACE

ADVERTISE WITH THE CLASSIFIED

NOTICE Having qualified as Executor of the estate of John Waller Smallwood Biggs late of Pitt County, North Carolina, this is to notify all persons having claims against the estate of said deceased to present them to the undersigned Executor on or before June 8, 1983 or this notice or same will be pleaded in bar of their recovery.

NOTICE TO CREDITORS Having qualified as Administrator of the Estate of R. W. MacKENZIE, late of Pitt County, North Carolina, the undersigned hereby authorizes all persons having claims against said Estate to present them to the undersigned, whose mailing address is 300 N. Oak Street, Apt. 2, Greenville, North Carolina 27834, on or before the 9th day of June, 1983, or this notice will be pleaded in bar of their recovery.

MONEY In Your Pocket!

When you need money, cash in on the items that are laying around the house--items that you no longer use.

Our Family Rates 3 Lines 4 Days \$4.00

Family Want Ads Must Be Placed By An Individual To Run Under The Miscellaneous For Sale Classification. Limit One Item Per Ad With Sale Value Of \$200 Or Less. Commercial Ads Excluded. All Ads Cash With Order. No Refund For Early Cancellation.

Use Your VISA or MASTER CARD THE DAILY REFLECTOR Classified Ads 752-6166



PUBLIC NOTICES

Pitt County Registry to which reference is hereby made for a more perfect description. SUBJECT, however, to taxes for the year 1982 and before, special assessments and prior encumbrances of record, if any. Five percent (5%) of the amount of the highest bid must be deposited with the Trustee pending confirmation of the sale.

82 E 496 NORTH CAROLINA COUNTY OF PITT

FILE NO 82 SP 409 IN THE GENERAL COURT OF JUSTICE SUPERIOR COURT DIVISION BEFORE THE CLERK

NOTICE Pursuant to an Order duly entered by Sandra Gaskins, Clerk of Superior Court of Pitt County, North Carolina, on the 1st day of December, 1982, in the above-captioned action, the undersigned Administrator of the Estate of Tony Alan Hardee will, on January 5, 1983, at the front steps of the Pitt County Courthouse, Greenville, North Carolina, at 10:00 A.M. offer for sale to the highest bidder for cash the following described real property:

NOTICE OF SALE Pursuant to an Order duly entered by Sandra Gaskins, Clerk of Superior Court of Pitt County, North Carolina, on the 1st day of December, 1982, in the above-captioned action, the undersigned Administrator of the Estate of Tony Alan Hardee will, on January 5, 1983, at the front steps of the Pitt County Courthouse, Greenville, North Carolina, at 10:00 A.M. offer for sale to the highest bidder for cash the following described real property:

NOTICE OF SERVICE TO: Doris Ann Faulkner, the above named defendant. Take notice that a pleading seeking relief against you has been filed in the above entitled action. The nature of the relief being sought is as follows: Complaint for amounts due on a promissory note.

NOTICE Having qualified as Executors of the estate of Elba H. Ward late of Pitt County, North Carolina, this is to notify all persons having claims against the estate of said deceased to present them to the undersigned Executors on or before June 15, 1983 or this notice or same will be pleaded in bar of their recovery.

NOTICE TO CREDITORS The undersigned, having qualified as Executor of the Estate of PEARL WALDREP TURNER, deceased, late of Pitt County, North Carolina, this is to notify all persons having claims against the said estate to present them to the undersigned or his attorney, James C. Lanier, Jr., at P.O. Box 1505, Greenville, North Carolina, on or before June 15, 1983, or this notice will be pleaded in bar of their recovery.

NOTICE OF SALE Order and by virtue of the power of sale contained in a certain deed of trust executed by CHERYL OAKS, INC. to W DOUGLAS STARR, TRUSTEE, dated the 5th day of September, 1980, and recorded in Book W 49, Page 708, in the Office of the Register of Deeds of Pitt County, North Carolina, default having been made in the payment of the indebtedness thereby secured and the said deed of trust being by the terms thereof subject to foreclosure, and the holder of the indebtedness thereby secured to having demanded a foreclosure thereof for the purpose of satisfying said indebtedness, the undersigned trustee will offer for sale at public auction to the highest bidder for cash at the Courthouse, Greenville, North Carolina, at 12:00 Noon, on the 17th day of December, 1982, the land, as improved, conveyed in said deed of trust, the same lying and being in Pitt County, North Carolina, and being more particularly described as follows:

NOTICE OF SALE Order and by virtue of the power of sale contained in a certain deed of trust executed by CHERYL OAKS, INC. to W DOUGLAS STARR, TRUSTEE, dated the 5th day of September, 1980, and recorded in Book W 49, Page 708, in the Office of the Register of Deeds of Pitt County, North Carolina, default having been made in the payment of the indebtedness thereby secured and the said deed of trust being by the terms thereof subject to foreclosure, and the holder of the indebtedness thereby secured to having demanded a foreclosure thereof for the purpose of satisfying said indebtedness, the undersigned trustee will offer for sale at public auction to the highest bidder for cash at the Courthouse, Greenville, North Carolina, at 12:00 Noon, on the 17th day of December, 1982, the land, as improved, conveyed in said deed of trust, the same lying and being in Pitt County, North Carolina, and being more particularly described as follows:

NOTICE OF SALE Order and by virtue of the power of sale contained in a certain deed of trust executed by CHERYL OAKS, INC. to W DOUGLAS STARR, TRUSTEE, dated the 5th day of September, 1980, and recorded in Book W 49, Page 708, in the Office of the Register of Deeds of Pitt County, North Carolina, default having been made in the payment of the indebtedness thereby secured and the said deed of trust being by the terms thereof subject to foreclosure, and the holder of the indebtedness thereby secured to having demanded a foreclosure thereof for the purpose of satisfying said indebtedness, the undersigned trustee will offer for sale at public auction to the highest bidder for cash at the Courthouse, Greenville, North Carolina, at 12:00 Noon, on the 17th day of December, 1982, the land, as improved, conveyed in said deed of trust, the same lying and being in Pitt County, North Carolina, and being more particularly described as follows:

NOTICE OF SALE Order and by virtue of the power of sale contained in a certain deed of trust executed by CHERYL OAKS, INC. to W DOUGLAS STARR, TRUSTEE, dated the 5th day of September, 1980, and recorded in Book W 49, Page 708, in the Office of the Register of Deeds of Pitt County, North Carolina, default having been made in the payment of the indebtedness thereby secured and the said deed of trust being by the terms thereof subject to foreclosure, and the holder of the indebtedness thereby secured to having demanded a foreclosure thereof for the purpose of satisfying said indebtedness, the undersigned trustee will offer for sale at public auction to the highest bidder for cash at the Courthouse, Greenville, North Carolina, at 12:00 Noon, on the 17th day of December, 1982, the land, as improved, conveyed in said deed of trust, the same lying and being in Pitt County, North Carolina, and being more particularly described as follows:

WANT ADS 752-6166

014 Cadillac
 1968 CADILLAC, good condition, low mileage, leather interior. \$595. 2500. Call 756-2100.
 1975 FLEETWOOD CADILLAC 69,000 miles. \$1995. 752-5334.
 1980 SEVILLE, silver-gray, low mileage, loaded. Call 756-0378 after 5:30.

015 Chevrolet
 CHEVETTE 1982, 2 door hatchback convertible, 2100 miles, metal deluxe exterior, door edge guards, air condition, remote mirrors, automatic, WSW radial tires, heavy duty battery, AM-FM radio, Gold metallic with camel vinyl interior. List price \$7243.45, discount \$684.81. Sale price \$6478.83. Down payment \$500.00, 48 monthly payments of \$160.60 with approved credit. 10.9 Annual Percentage Rate. Call Rex Smith Chevrolet, Ayden, 746-3141.
 CHEVETTE 1982, 2 door hatchback coupe, Tinted glass, floor mats, deluxe exterior, door edge guards, rear window defogger, air condition, sport mirrors, automatic, rally wheels, WSW radial tires, heavy duty battery, AM-FM radio, Charcoal metallic with charcoal vinyl interior. List price \$7576.40, discount \$794.21. Sale price \$6782.43. Down payment \$500.00, 48 monthly payments of \$167.76 with approved credit. 10.9 Annual Percentage Rate. Call Rex Smith Chevrolet, Ayden, 746-3141.
 IMPALA, 1978, only 52,000 miles, 2 door hardtop. Clean \$3000 or \$500 and take up payments. 752-4332.
 1969 CHEVROLET IMPALA Power steering and brakes. Air, 78,000 actual miles. 746-3490.
 1975 CHEVROLET Malibu Classic, automatic, air, AM-FM \$1650. Call 752-5204.
 1976 MONTE CARLO Power steering and brakes, air. \$795. 746-3490.
 1977 CAMARO, 1 owner. Excellent condition, new tires and new brakes, air, AM-FM \$3,900. 823-5381 after 6 p.m.
 1977 MALIBU CLASSIC 4 door, loaded. \$2800. 758-1798.
 1980 CHEVETTE, 4 door, straight shift, air condition, excellent condition. \$3995. Call 756-7806 until 9 p.m.
 1980 CHEVETTE, 5 door, low mileage, excellent condition. Price negotiable. Phone 756-4567.
 1980 MONZA, 4 speed, 39,000 miles. \$3200. Call 757-1760.

018 Ford
 THUNDERBIRD 1981, Navy, vinyl top, automatic, AM-FM tape. Call 756-4914.
 1965 MUSTANG, good condition, \$1200, 355-2220 after 6.
 1965 MUSTANG, rebuilt engine, new transmission, new interior, needs minor repairs. \$1600 or best offer. Call 756-6382 after 6 p.m.
 1979 FORD MUSTANG Call 758-0655 or 752-7073.

020 Mercury
 COUGAR XR7 CONVERTIBLE 1972, new power steering and brakes, AM-FM stereo \$1500. Call 757-8920. Can be seen anytime at 1504 Dickinson Avenue.

021 Oldsmobile
 1973 CUTLAS OLDSMOBILE Runs good, excellent shape \$700. 746-2328.
 98 OLDS REGENCY 1975, Very clean, in very good condition \$1950. Call 756-6382.
 Shopping for a new car? The most complete listings in town are found in the Classified ads every day.

023 Pontiac
 1978 LeMANS, loaded. Call 756-2542 or 756-9318.

024 Foreign
 MGB, 1977, excellent condition, 1 owner, new top, \$4,000. Call 756-9038 after 6 p.m.
 SUPER BEETLE Volkswagen convertible, 1973, Good condition, new paint. \$2200. 756-2774.
 WANTED BIDS 1978 Audi Fox, Good condition, needs rear end body work. Blue book \$4500. Call 756-8815 after 5:30.
 1973 MG MIDGET, new transmission, brakes and front end. \$1700. Call 758-2300 days.
 1974 TOYOTA Corona Mark II 4 door, automatic, air, power steering, New 36 month battery, \$995 firm. Call 752-5650.
 1975 VOLKSWAGEN RABBIT convertible. Low mileage. Call 752-5334.
 1976 FIAT 131-S, 2 door, automatic, radio, \$1,400. Call 746-2463.
 1977 TOYOTA COROLLA Radial tires, very good condition. Excellent gas mileage. For information call 756-8843.
 1978 DATSUN 310GX Fully equipped. Must sell. Call 756-5113 after 5:30.
 1979 TOYOTA COROLLA 48,000 miles, 2 door, 4 speed, good condition. \$2995. 756-7587.
 1980 VOLKSWAGEN RABBIT Diesel, 15,000 miles, new tires. Like new. 752-3104 till 5. 756-4356 miles.
 1981 TOYOTA COROLLA, 4 door, 5 speed, air condition. \$6,100. Call 757-3178.
 1982 HONDA ACCORD, 2 door, perfect condition. Call between 6 and 10 evenings. 756-3009.
 1982 HONDA PRELUDE Blue, automatic. 757-1505.

030 Bicycles For Sale
 FOUR USED boys' bicycles. Prices start at \$35. Call 752-2649.
 2 BIKES, \$25 FOR BOTH One boys and one girls. Good condition. Call 752-9862.

032 Boats For Sale
 DECEMBER SPECIAL 1983 Renken 18 Sailboat with 40 hp outboard, 3.5 HP motor, cutty cabin, color sails, roller furling jib, bow pulpit, outboard bracket, running lights, forward hatch, sleepers. 4. Regularly \$5,650, now \$4,995. The Rag Bag Sailor, Highway 264 East, 756-4641.
 1983's ARE HERE Freedom 21, Renken 18, Sovereign 17 at special introductory prices thru December 31. 20% discount on all accessories. RB Sailor, Highway 264 East. 758-4641. (Leave a message)

034 Campers For Sale
 TRUCK COVERS - All sizes, colors. Leer Fiberglass and Sportsman 250, 250 units in stock. O'Brian's, Raleigh, N.C. 824-2774.
 11 FOOT COACHMAN Slide in Truck Camper. Fully contained. Call after 6. 756-7000.

036 Cycles For Sale
 DELUXE HONDA MINI Dirt Bike with back carriage. Red and Silver. Excellent condition. Call 756-0302 after 5 p.m. \$225.
 YAMAHA 175 dirt bike, runs good, good tires, etc. 756-3821.
 1979 SUZUKI 400, 6,000 miles. Like new. 758-9157 or 757-1272. Barry.
 1980 HONDA DIRT BIKE XR80. Runs good. Call after 4:30 757-1533.
 1981 YAMAHA 650, Special II, \$1300. Also KZ 750, 1981, cylinder Kawasaki. \$2500. Call 758-8153.
 1981 900F HONDA 5,000 miles, kits, cams, special carburetors, air shifting gear system. Will sacrifice for \$2500. Call 355-6299 anytime.

039 Trucks For Sale
 1967 FORD F100, Very good condition. Newly rebuilt 900-427 high performance engine. Newly rebuilt transmission with B and M shift kit. New tires and keystone rims. \$2000 firm. Phone 756-2122 after 6 p.m. or 746-6336 before 6 p.m.
 1973 SCOUT II, 4 X 4 V8, power steering, power brakes, air conditioner, AM-FM, 4 track. Call 756-1486 after 6 weekdays.
 1976 CHEVROLET PICKUP Power steering and brakes. \$2195. 58,000 actual miles. 756-4641.
 1976 CHEVROLET BLAZER, 4x4. \$2200. 756-1660.
 1976 JEEP Cherokee Chief, Air, power steering and brakes. \$2195. 58,000 actual miles. High mileage. 756-4641 after 5 p.m.
 1977 CHEVROLET El Camino. Excellent condition. 756-9908 or 752-7121. Ask for Gilbert Cox.
 1981 CHEVY PICKUP, low mileage, AM-FM, power brakes and steering. V-8, \$6,000 firm. Call 752-3173, ask for Mr. Workack.
 1981 FORD ECONOLINE 150 Long Bed Super Van 3 speed with overdrive, 10,450 miles, \$6995. 758-1042 Gary.
 1981 JEEP CJ7, red, 14,000 miles. \$7995. 746-3490.
 1982 DODGE RAM Charger Royal SE Fully equipped, air, AM-FM stereo, CB, sport wheels, all power. \$11,000. 752-2224 or 758-2291.

040 Child Care
 EXPERIENCED COLLEGE student will baby sit in your home 12-30 p.m. Call 756-4567.
 RESPONSIBLE mature woman to babysit my 9 year old child, our home, 3 days a week, starting January 5. Call 756-7136.
 WILL KEEP CHILDREN in my home in Belvoir area, any age, anytime. Call 758-8944.

046 PETS
 AKC BLACK LABRADOR Retriever puppies, \$125. Also full blooded lab puppies, \$30. 756-7487 between 7-10 p.m. for more information.
 AKC GERMAN Shepherd puppies, pedigree, championship blood line. Black with an Amber. Father's name grand daughter of Grand Victor, champion. Ready for Christmas. Call 919-946-2568.
 AKC GOLDEN RETRIEVERS, 9 weeks old, 2 males, left Shols and wormed. 792-2723.
 AKC GOLDEN RETRIEVER, only 1 puppy left, female, \$125. Fully vetted and paper trained. Will hold till Christmas. 758-5018.
 AKC REGISTERED white German Shepherd pups. Male \$125, Female \$100. 136 N. Jarvis Street.
 AKC WHITE GERMAN Shepherd puppies, available the week before Christmas. 752-7786.
 BORDER COLLIE puppies, 7 weeks old, dewormed, ready for Christmas. Marion M Mills, 756-3279 or 355-2792.
 Chihuahua Labrador Retriever puppies, AKC registered. Weaned December 15th. For background and information call 756-5291.
 EXTREMELY HEALTHY English Springer Spaniel puppy. Only one left. Priced for Christmas giving. 752-3814.
 FOR SALE: AKC-Yorkshire Terriers, Toy Poodles, Fox Terriers, Chihuahuas, Cocker Spaniels, Schnauzers, Dachshunds, 2 female Boston Terri, 1 Pekinese. Professional grooming. Call 758-2681.
 GREAT DANES for Christmas. Black and whites, \$75 to \$150. 756-8833 or 756-8674.
 JUST IN TIME FOR CHRISTMAS AKC registered Siberian Husky puppies. Call 756-1310.
 ONE BEAGLE for sale. Good jump and track dog. 758-0337 after 6.
 SIAMESE KITTENS, 8 weeks, Seal Point, 1 male and 2 female, wormed and litter trained. \$40. 758-0892.
 5 MONTH old male Irish Setter. Already been hunted. Not gun shy. Best offer. \$24,000.

051 Help Wanted
 AUTOMOTIVE MECHANIC, Perdue, Incorporated has immediate openings for 2nd and 3rd shift automotive mechanics. Work experience repairing automobile engines required with formal training or education in automotive maintenance preferred. Experience in diesel engine repair and automotive air conditioning repair will be helpful. Interested applicants should apply at the Personnel Office of Perdue, Incorporated, Green Street, Robersonville, NC. Equal Opportunity Employer.
 COMPUTER HOBBYIST? Turn your fascination with computers into an above average income with unlimited advancement potential. Act Now! This opportunity will be available next week. Call Randy at Thomas & Thomas Vocational Assessment (Personnel Service Division) 757-1098.
 DRIVERS WANTED: Must be 18 or older, have own car and insurance. Need both day and nights driver. Must be willing to work weekends. Apply at Domino's Pizza, 1201 Charles Boulevard. No phone calls please!
 FAMILY NEEDS live in to help with wife convalescing to do light housekeeping and take care of children. Call 756-0120.
 FINANCE EXPERIENCE is all you need to qualify for this management position with a national company. Excellent benefits and salary. Must be willing to relocate. Immediate opening! Call Paula at Thomas & Thomas Vocational Assessment (Personnel Service Division) 757-3398.
 HELP WANTED to buy or sell. Avon. Call 746-3494.
 HOMEWORKERS Wirecraft production. We train house dwellers. For full details write: Wirecraft, P.O. Box 223, Norfolk, Va. 23501.
 HOMEWORKERS Wirecraft production. We train house dwellers. For full details write: Wirecraft, P.O. Box 223, Norfolk, Va. 23501.
 JOB INFORMATION: Overseas, Cruise Ships, Houston, Dallas, Alaska. \$20,000 to \$60,000/year possible. Call 805-687-6000, extension 42752. Call refundable.
 LEGAL SECRETARY Part time, potential full time, fill in for employee on leave. Mag Card in experience preferred. Reply to P.O. Box 7146, Greenville, NC, 752-6161.
 LINEMEN wanted for distribution line construction. Call 946-8164.
 MANAGEMENT Large corporation looking for management potential. Must start in sales, 60 hour week. Some door to door. Salary and benefits. Conner Mobile Homes, 756-0333.
 MECHANIC NEEDED Must have complete tools and experience. Salary plus commission. Good working conditions. Western Auto, 629 Dickinson Ave, Greenville.

REAL ESTATE SECRETARY NEEDED Part-Time
 Must have a pleasant telephone voice, outgoing personality, good typing skills and be able to handle a variety of task. NC Real Estate License a requirement. For your confidential interview, call: Dee Heffren at 756-8724.
 RETAIL MANAGER trainee positions available immediately for person with some college and sales experience. Excellent salary and benefit package. Call now. Paula at Thomas & Thomas Vocational Assessment (Personnel Service Division) 757-3398.
 R E T A I L M A N A G E M E N T opportunity for stable individual with proven track record. Salary commensurate with experience. Call Randy Thomas and Thomas Vocational Assessment (Personnel Service Division) 757-1098.
 RETAIL SALES experience in exclusive women's wear and a mature, responsible personality are qualities needed for this excellent local sales opportunity. Immediate opening! Call Paula at Thomas & Thomas Vocational Assessment (Personnel Service Division) 757-3398.
 SECRETARY/RECEPTIONIST Get a new job for Christmas if you have good clerical skills, pleasant personality and are neat in appearance. Employer most anxious to hire. Call Hilliard at Thomas & Thomas Vocational Assessment (Personnel Service Division) 757-3398.
 SKILLED SECRETARY with paralegal experience or desire to learn field. Resumes only. Post Office Box 3555, Kinston, NC 28501.
 SOUND MAN for rock and roll bands. Must be experienced. Call 946-0302.
 TAP ALL YOUR KNOWLEDGE LEARNED IN NURSING NEEDED RN'S
 •Full time 3-11: 11-7
 •Part time 7-3
 •Competitive Salaries
 •Willing to work around school schedules.
 Contact: Lydia Morgan RN, Director of Nursing, University Nursing Center, 758-7100.
 TEXAS REFINERY Corporation offers plenty of money plus cash bonuses for stable individuals in individual in Greenville area. Regardless of experience, write J. D. Every, Texas Refinery Corporation, Box 711, Fort Worth, Texas 76101.
 WANTED expert salesperson for part time help. Apply in person Thursday 10-12, 410 Evans Street, Mail, New York Fashion.
 WANTED: live-in companion for senile, elderly woman. Require: plain cooking, driver licenses, kindhearted, patient disposition. Room and board provided in pleasant townhouse plus salary. References needed. Call 756-5058 after 5 p.m. and weekends.
 WANTED: HOUSEMOTHER, mature female. Must have own furnished apartment. Must have management, bookkeeping and social skills. Salary negotiable. Call 758-5632 for interview appointment.

052 Help Wanted
 WANTED FEMALE for in store sales with Medical Supply Company. Experience necessary. L.P.N., P.T.A. etc. Must be able to supervise delivery personnel, work with customers, make decisions. Some paperwork. Call 756-3590, 8:30 to 5:00.

059 Work Wanted
 ALL TYPES free service. Trim, mowing, cutting, storm damage cleanup and removal. Free estimates. J.P. Stancil, 752-6331.
 ALL TYPES OF MASONRY repair or build. 30 years experience. 756-2581. Free estimates.
 ALTERATIONS OF all types. Carpentry, masonry and roofing. 30 years experience in building. Call James Harrington after 6 p.m. 752-7765.
 CREATIVE HOME Improvements. Quality Construction. Additions, remodeling, repairs. 757-0799.
 CUSTOM ORDERS Storm windows and doors. Call 5 p.m. B. Wingate, 756-6892 after 5 p.m.
 EXPERIENCED as cook, government, cashier, nurse and secretary. Desire to return to work since my father died. Middle aged. Have car and could live-in. Call 752-1045.
 EXPERIENCED COLLEGE student will baby sit in your home 12-30 p.m. until. Call 756-4567.
 NO JOB TOO SMALL: remodeling, carpenter and repair work, cabinets and counter tops, painting and roofing. 752-1623.
 PAINTING, WALLPAPERING and Home Repairs. Professional work done. Reasonable prices. Free estimates. Serving Kinston and Greenville. Call Collect (919) 523-2845.
 PLUMBING AND CARPENTRY All type repairs and remodeling. Specializing in bathroom repair. State License #7037 P 746-2657; if no answer 752-4064.

059 Work Wanted
 PAINT per hour, you supply the paint and equipment. Call Jim, 752-1247 anytime.
 QUALITY PAINTING Inside and out, year around. We guarantee our work. Call for free estimate. Paint included. Call anytime 756-9721 or 795-4993.
 ROOF COATINGS and repair. Quality, economical. Guaranteed "leak proofing". 758-7165.
 SALES PERSON, 3 1/2 years experience. Full time but will accept part time. Reliable, dependable. Available now. Call 752-9386.
 SANDING and finishing floors. Small carpenter jobs, counter tops. Jack Baker Floor Service. 756-2868 anytime, if no answer call back.
 SHEETROCK WORK, ceilings sprayed, plaster cracks fixed. 752-5048.
 WILL WASH AND POLISH automobiles, 1975 and delivery service. Call 355-4299.

060 FOR SALE
064 Fuel, Wood, Coal
 ALL SEASONED OAK Firewood, split and stacked \$50 for half cord. Call 752-0983, if no answer call 752-4714.
 ALL TYPES OF firewood for sale. J. P. Stancil, 752-6331.
 CHIMNEY FIRES are dangerous! For thorough, professional sweeping, call Carolina Chimney Cleaners, 758-0174 anytime.
 FIREWOOD FOR SALE \$40 for pickup. Call 757-3568 or 758-5063.
 MIXED FIREWOOD for sale. Seasoned, all hard wood, \$80 cord. Free delivery. 756-8358 or 752-9252 anytime.

064 Fuel, Wood, Coal
 MIXED WOOD, \$40. Oak, \$45. 758-6849 or 758-6489.
 MIXED WOOD, \$50 a cord; oak wood \$70 a cord; You haul it. 746-3694.
 OAK FIREWOOD Dried, stacked, delivered. \$50 1/2 cord and \$90 cord. Guarantee full measure. 746-2267.
065 Farm Equipment
 CHRISTMAS GIFT IDEAS 5" shop bench vise, \$29.95; 6" vise \$38.95; 40 piece 1/2" socket set, \$16.49; 21 piece 3/4" drive socket set, \$32.49; 16 ounce claw hammer, \$3.99; 6 1/2" horse power grinder, \$38.49. Agri Supply, Greenville, NC 752-3999.
072 Livestock
 COASTAL BERMUUDA HAY First quality, \$20 per bale cash. Call 752-2552 after 7 p.m.
 HORSEBACK RIDING! Jarman Stables, 752-5237.
 SMALL PINTO mare pony, very gentle, with or without tack. Perfect for Christmas. 756-3821.
 2 NANNY GOATS for sale, \$15 each or \$25 for both. Call 758-0727.
074 Miscellaneous
 AIR conditioners, washers, drivers, ranges and refrigerators. Rebuilt like new \$100 and up. Guaranteed 30 days. Call B J Mills, Authorized Electrical Appliance Service and Repair. 746-2446, Black Jack.
 QUICK ACTION Classified Ads are the answer to passing on your extras to someone who wants to buy.
 BEAUTIFUL fur coat by Sportswine. Like new, size 12. \$150. 752-0979, 5 p.m. to 10 p.m.
 BEDDING AND WATERBEDS Save up to 1/2 and more. Factory Mattress And Waterbeds 730 Greenville Blvd, next to P.H. Plaza. 355-2626.

064 Fuel, Wood, Coal
 ALL SEASONED OAK Firewood, split and stacked \$50 for half cord. Call 752-0983, if no answer call 752-4714.
 ALL TYPES OF firewood for sale. J. P. Stancil, 752-6331.
 CHIMNEY FIRES are dangerous! For thorough, professional sweeping, call Carolina Chimney Cleaners, 758-0174 anytime.
 FIREWOOD FOR SALE \$40 for pickup. Call 757-3568 or 758-5063.
 MIXED FIREWOOD for sale. Seasoned, all hard wood, \$80 cord. Free delivery. 756-8358 or 752-9252 anytime.

074 Miscellaneous
 BELL AND HOWELL Super 8 Movie Camera with lamp. Call 756-2106.
 CONSOLE STEREO, includes 8 track that records, \$100. Large desk. 758-9982.
 BRUNSWICK SLATE POOL Tables. Cash discount. Delivery and installation. 919-763-9734.
CLASSIFIED DISPLAY

074 Miscellaneous
 CALL CHARLES TICE, 758-3013, for small loads of sand, topsoil and stone. Also driveway work.
 CURT'S CAR CARE Specialize in washing and waxing. \$35. Call 524-4064.
 CUSTOM BUILT handrails, grills, gates, spiral stairways, interior, exterior, residential, commercial. Metal Specialties, 758-4574, 1210 Mumford Road.
CLASSIFIED DISPLAY

074 Miscellaneous
 AIR conditioners, washers, drivers, ranges and refrigerators. Rebuilt like new \$100 and up. Guaranteed 30 days. Call B J Mills, Authorized Electrical Appliance Service and Repair. 746-2446, Black Jack.
 QUICK ACTION Classified Ads are the answer to passing on your extras to someone who wants to buy.
 BEAUTIFUL fur coat by Sportswine. Like new, size 12. \$150. 752-0979, 5 p.m. to 10 p.m.
 BEDDING AND WATERBEDS Save up to 1/2 and more. Factory Mattress And Waterbeds 730 Greenville Blvd, next to P.H. Plaza. 355-2626.
CLASSIFIED DISPLAY

074 Miscellaneous
 AIR conditioners, washers, drivers, ranges and refrigerators. Rebuilt like new \$100 and up. Guaranteed 30 days. Call B J Mills, Authorized Electrical Appliance Service and Repair. 746-2446, Black Jack.
 QUICK ACTION Classified Ads are the answer to passing on your extras to someone who wants to buy.
 BEAUTIFUL fur coat by Sportswine. Like new, size 12. \$150. 752-0979, 5 p.m. to 10 p.m.
 BEDDING AND WATERBEDS Save up to 1/2 and more. Factory Mattress And Waterbeds 730 Greenville Blvd, next to P.H. Plaza. 355-2626.
CLASSIFIED DISPLAY

074 Miscellaneous
 AIR conditioners, washers, drivers, ranges and refrigerators. Rebuilt like new \$100 and up. Guaranteed 30 days. Call B J Mills, Authorized Electrical Appliance Service and Repair. 746-2446, Black Jack.
 QUICK ACTION Classified Ads are the answer to passing on your extras to someone who wants to buy.
 BEAUTIFUL fur coat by Sportswine. Like new, size 12. \$150. 752-0979, 5 p.m. to 10 p.m.
 BEDDING AND WATERBEDS Save up to 1/2 and more. Factory Mattress And Waterbeds 730 Greenville Blvd, next to P.H. Plaza. 355-2626.
CLASSIFIED DISPLAY

074 Miscellaneous
 AIR conditioners, washers, drivers, ranges and refrigerators. Rebuilt like new \$100 and up. Guaranteed 30 days. Call B J Mills, Authorized Electrical Appliance Service and Repair. 746-2446, Black Jack.
 QUICK ACTION Classified Ads are the answer to passing on your extras to someone who wants to buy.
 BEAUTIFUL fur coat by Sportswine. Like new, size 12. \$150. 752-0979, 5 p.m. to 10 p.m.
 BEDDING AND WATERBEDS Save up to 1/2 and more. Factory Mattress And Waterbeds 730 Greenville Blvd, next to P.H. Plaza. 355-2626.
CLASSIFIED DISPLAY

074 Miscellaneous
 AIR conditioners, washers, drivers, ranges and refrigerators. Rebuilt like new \$100 and up. Guaranteed 30 days. Call B J Mills, Authorized Electrical Appliance Service and Repair. 746-2446, Black Jack.
 QUICK ACTION Classified Ads are the answer to passing on your extras to someone who wants to buy.
 BEAUTIFUL fur coat by Sportswine. Like new, size 12. \$150. 752-0979, 5 p.m. to 10 p.m.
 BEDDING AND WATERBEDS Save up to 1/2 and more. Factory Mattress And Waterbeds 730 Greenville Blvd, next to P.H. Plaza. 355-2626.
CLASSIFIED DISPLAY

074 Miscellaneous
 AIR conditioners, washers, drivers, ranges and refrigerators. Rebuilt like new \$100 and up. Guaranteed 30 days. Call B J Mills, Authorized Electrical Appliance Service and Repair. 746-2446, Black Jack.
 QUICK ACTION Classified Ads are the answer to passing on your extras to someone who wants to buy.
 BEAUTIFUL fur coat by Sportswine. Like new, size 12. \$150. 752-0979, 5 p.m. to 10 p.m.
 BEDDING AND WATERBEDS Save up to 1/2 and more. Factory Mattress And Waterbeds 730 Greenville Blvd, next to P.H. Plaza. 355-2626.
CLASSIFIED DISPLAY

074 Miscellaneous
 AIR conditioners, washers, drivers, ranges and refrigerators. Rebuilt like new \$100 and up. Guaranteed 30 days. Call B J Mills, Authorized Electrical Appliance Service and Repair. 746-2446, Black Jack.
 QUICK ACTION Classified Ads are the answer to passing on your extras to someone who wants to buy.
 BEAUTIFUL fur coat by Sportswine. Like new, size 12. \$150. 752-0979, 5 p.m. to 10 p.m.
 BEDDING AND WATERBEDS Save up to 1/2 and more. Factory Mattress And Waterbeds 730 Greenville Blvd, next to P.H. Plaza. 355-2626.
CLASSIFIED DISPLAY

074 Miscellaneous
 AIR conditioners, washers, drivers, ranges and refrigerators. Rebuilt like new \$100 and up. Guaranteed 30 days. Call B J Mills, Authorized Electrical Appliance Service and Repair. 746-2446, Black Jack.
 QUICK ACTION Classified Ads are the answer to passing on your extras to someone who wants to buy.
 BEAUTIFUL fur coat by Sportswine. Like new, size 12. \$150. 752-0979, 5 p.m. to 10 p.m.
 BEDDING AND WATERBEDS Save up to 1/2 and more. Factory Mattress And Waterbeds 730 Greenville Blvd, next to P.H. Plaza. 355-2626.
CLASSIFIED DISPLAY

074 Miscellaneous
 AIR conditioners, washers, drivers, ranges and refrigerators. Rebuilt like new \$100 and up. Guaranteed 30 days. Call B J Mills, Authorized Electrical Appliance Service and Repair. 746-2446, Black Jack.
 QUICK ACTION Classified Ads are the answer to passing on your extras to someone who wants to buy.
 BEAUTIFUL fur coat by Sportswine. Like new, size 12. \$150. 752-0979, 5 p.m. to 10 p.m.
 BEDDING AND WATERBEDS Save up to 1/2 and more. Factory Mattress And Waterbeds 730 Greenville Blvd, next to P.H. Plaza. 355-2626.
CLASSIFIED DISPLAY

074 Miscellaneous
 AIR conditioners, washers, drivers, ranges and refrigerators. Rebuilt like new \$100 and up. Guaranteed 30 days. Call B J Mills, Authorized Electrical Appliance Service and Repair. 746-2446, Black Jack.
 QUICK ACTION Classified Ads are the answer to passing on your extras to someone who wants to buy.
 BEAUTIFUL fur coat by Sportswine. Like new, size 12. \$150. 752-0979, 5 p.m. to 10 p.m.
 BEDDING AND WATERBEDS Save up to 1/2 and more. Factory Mattress And Waterbeds 730 Greenville Blvd, next to P.H. Plaza. 355-2626.
CLASSIFIED DISPLAY

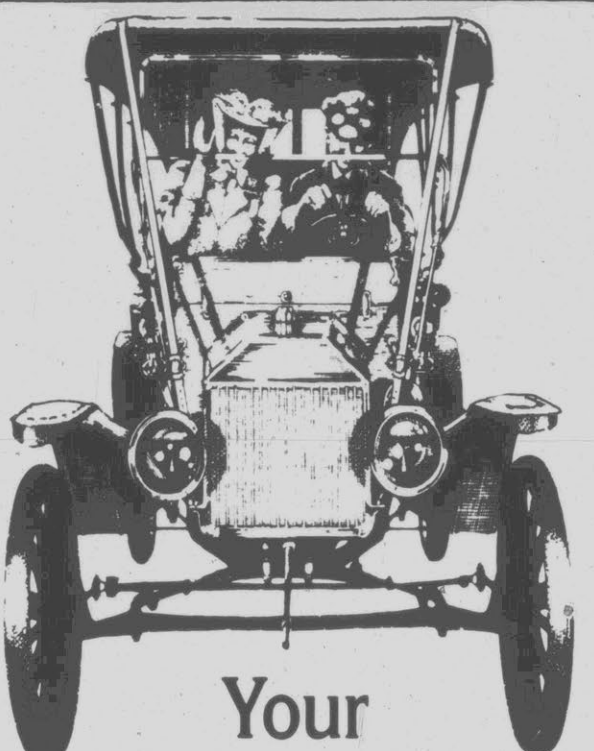

Greenville's Finest Used Cars!

(Located At Honda Store) (Located At Volvo Store)

Your Old Car Is Your Down Payment on a New Toyota!

As long as you can drive your car into Toyota East, you can use it as a down payment on a new Toyota, with approved credit. No matter how old it is...no matter what it looks like...if it drives, it's your down payment at Toyota East.

And don't forget, we have Mercedes, too.

TOYOTA EAST 109 Trade Street Greenville 756-3228

Bob Barbour HONDA 3300 S. Memorial Dr. Greenville 355-2500

Bob Barbour VOLVO/AMC/Jep Renault 117 W. Tenth St. Greenville 758-2000

THESE CARS ARE PREOWNED... BUT! DEPENDABLE! SHOP THE REST... BUY THE BEST!

1981 Lincoln Town Car	1980 AUDI 5000 S
1981 Volkswagen Rabbit	1979 Toyota Corolla
1981 Pontiac Firebird Formula	1979 Pontiac Bonneville
1981 Pontiac Bonneville Diesel	1979 Toyota Celica Supra
1980 MGB	1979 Cadillac Coupe De Ville
1980 Chevrolet Caprice Landau	1979 Pontiac Grand Prix
1980 Cadillac Sedan De Ville	1977 Chevrolet Impala
1980 Fiat Spider Convertible	1977 Pontiac Grand Prix
1974 Buick LeSabre	1973 Volvo 145 Wagon

1981 Toyota Tercel — Silver
 1980 Chevrolet El Camino — White
 1982 Toyota Starlet — Silver
 1981 Toyota 4 X 4 — White
 1980 Mercedes-Benz 240-D — Blue
 1978 Toyota Corolla — Silver
 1982 Mazda 626 GL — Red
 1978 Mercedes 280-E — Ivory
 1982 Toyota Corolla — Blue
 1981 Mercedes-Benz — Blue
 1978 Toyota Celica — Yellow
 1981 Toyota SR-5 — Gold
 1980 Cadillac Seville — Silver
 1979 Pontiac Lemans — Blue
 1980 Pontiac Sunbird — Tan
 1980 Olds Cutlass — Blue
 1977 Pontiac Lemans — Blue
 1981 Toyota Cressida — Blue
 1979 Chevrolet Monte Carlo — Red
 1981 Toyota Cressida — Brown
 1981 Toyota Truck — Red
 1981 Datsun 4 X 4 — Blue
 1979 Buick Regal — Green
 1981 Toyota Truck — Blue
 1980 Toyota Truck — Tan
 1980 Toyota Celica — Blue
 1981 Toyota Starlet — Red
 1978 Dodge Omni — Red
 1981 Toyota 4 X 4 — Blue
 1979 Pontiac Trans AM — White
 1981 Toyota Celica
 1982 Toyota Cressida — White
 1981 Toyota Corolla — Orange
 1982 Toyota Truck — White
 1981 Toyota Starlet — Red
 1981 Chevrolet Chevette — Brown

TOYOTA EAST 109 Trade Street Greenville 756-3228

WOLFGANG logo. GUARANTEED USED CARS. 1981 Audi 4000 5T5 \$10,950. 1980 Volkswagen Truck \$4495. 1980 Plymouth Horizon TC-3 \$4395. 1979 Chevrolet Malibu Classic \$4995. 1979 Volkswagen Beetle Convertible \$7995. 1979 Ford Fairmont \$2695. 1979 Volkswagen Rabbit \$4495. 1979 Pontiac Sunbird \$4195. 1979 Volkswagen Dasher Diesel Wagon \$3995. 1978 Olds Cutlass Wagon \$4995. 1978 Mazda GLC \$2895. 1978 Honda Civic \$2795. 1978 Volkswagon Scirocco \$3995. 1977 Volkswagen Rabbit REDUCED. 1977 Chevrolet Caprice Classic \$2995. 1977 Toyota Corolla \$1995. 1975 MGB Midget Convertible REDUCED. 1981 Yamaha 750 Motorcycle SPECIAL. JOE PECHELES VOLKSWAGEN.

074 Miscellaneous
DIAMOND WEDDING BAND. Pearl with sapphire dinner ring. 756-2992 after 5 pm.
DISC JOCKEY
Top equipment, top records. Still a few days open for Christmas parties. Bobby Gardner, 756-7702.
EARLY AMERICAN Herculon sofa. Gold and rust plaid. Excellent condition. 752-4356 or 752-0958 after 6.
FIREPLACE heat exchanger, \$50. Assorted V belts, worth \$1500-will take \$600. 756-1332.
FOR SALE 1978 Fender D76 12-string Acoustic guitar with case. \$350. Call 355-4354 after 7pm.
FREE STANDING woodstove, black with orange panels, cone shape. \$60. 752-0885.
GARAGE DOOR 16 foot wood, glass windows. \$200 firm. Garage door opener, 1/2 horsepower, 2 remote controls for car. \$150. 752-8855 or 756-8690.
GAS HEATER Commercial type, overhead with blower. \$200. 756-7417.
GAS SPACE HEATER, 30,000 BTU, 4 bricks, open front, economical. \$250. 756-1223.
GIRL'S BEDROOM furniture, Trundle bed, 3 drawer chest of drawers, 4 drawer vanity or desk. \$250. 756-1223.
GIRLS FREESPIRIT 22 inch 10 speed. Like new, \$75 or best offer. 758-7108.
GOLD WING CHAIR, \$40. Gold fabric recliner, \$50. Coffee table \$20. 756-1461.
COPY MACHINE 1 year old, \$1400. Call 758-2141.

CLASSIFIED DISPLAY
WE INSTALL ALUMINUM AND VINYL SIDING. Remodeling - Room Additions. C.L. Lupton, Co. 752-6116.

AVAILABLE POSITIONS
EDGEcombe COUNTY SCHOOL SYSTEM
COMMUNITY SCHOOLS COORDINATOR
Position involves responsibility for overall development, organization, operation, coordination, and evaluation of the Community School Program by encouraging maximum involvement of all citizens, organizations, agencies, and groups within the community at large. College Education required (degree in education, public relations and/or communications preferred).
VOCATIONAL EDUCATION SHOP TEACHER
For Jr. High disadvantaged students. Previous teaching experience with disadvantaged students preferred. Certification in Industrial Arts or other vocational education area required.
CONTACT PERSONNEL DEPARTMENT
412 PEARL ST., TARBORO, NC FOR APPLICATIONS
PHONE NO. (919) 823-6153

074 Miscellaneous
GOLF CART, white, 3 wheeler, good condition. \$500. Call 752-2943.
HARRINGTON DARE IV wood stave. \$550. 756-2466.
HATTERAS HAMMOCKS has a limited number of factory seconds available now. Great Christmas gifts for people who like the finer things in life. Over 40% savings. 1104 Clark Street. Call 758-0641.
HORSE SADDLE Good condition. \$175. 758-2545.
HUNDREDS OF USED kitchen cabinets, doors, windows, ranges, water heaters, commodes, tubs, sinks, electrical boxes and supplies, dressers, chest, tables, chairs, desk, lots more. F. J. Salvage, 2717 West Vernon Avenue, Kinston, NC 22-0806.
LARGE BICYCLE saddle baskets. Pinball machine. Price negotiable. 752-6709.
LYNN AND LAURA Christmas Trees. Choose and cut your own. Virginia pine. \$10-\$25. No checks. Open December 18, 8 a.m. - 5 p.m. Highway 264A, Two miles west of Farmville.
MINK STOLE Beautiful dark fur, \$250. Cash stereo, \$25. 756-7321.
MOVING Zenith 25" console color TV in a solid maple cabinet with automatic fine color, color control, sharp picture, must see to appreciate at this price. \$185. 756-0492.
NET SUPPLIES: Weebings, rope, float, lead, anything you need to make your own net or complete net ready to fish. Commercial fishing licenses. Whitchard's Marina, 94, 4275.
NICE BUCK STOVE for sale, very good price. Call anytime. 758-2792.
NOTHING CLEAN CARPET Like The RUG DOCTOR. See Yellow Page 50 for locations and coupon.
ONE ATARI with 3 cartridges (less than 1 year old), \$100. 752-4035 or 756-1200.
ONE BLUE, 10 Speed Racer. Excellent condition. F ridden only 3 times. \$90. 752-9816.

074 Miscellaneous
OPEN NITELY Monday thru Thursday until 9:00 P.M. until Christmas. Come by and visit us for low prices on your Christmas furniture needs. Open daily Monday thru Saturday, 10:00 A.M. to 6:00 P.M. Phone 754-6027. Jamie's Furniture and Appliances, 3 miles West 264 to Frog Level. Turn left and 1/4 mile on left.
PINBALL MACHINE 2 player, good condition. \$120. 756-7587.
POOL TABLE, 8' Sears Silatone top. \$300. 758-2545.
REALISTIC NAVAHO 40 channel CB, base and mobile. Excellent condition. extras. \$100. 355-2772.
RIDING LAWNMOWER, Murray 5 speed, 8 HP, \$400. Olympia ES 103 Electronic typewriter, \$1000. Table and 4 chairs, \$50. Call 752-2639.
TO PLACE YOUR Classified Ad, just call 752-4144 and let a friendly Ad-Verp help you word your Ad.

SEARS COLDSPOOT frost free freezer. Approximately 22 cubic feet. \$250. 756-5267 or 756-9953.
SET OF TITLITZ GOLF CLUBS and bag. Excellent condition. Call 756-6799 after 5pm.
SHAMPOO FOR FALLI Rent shampooing and vacuum at Rental Shop Company.
SILVER KING trampoline and 5 HP gas car, both in excellent condition. Call 753-4108 days, 753-1394 after 5.
SPEED QUEEN copertone gas dryer, used 2 years sparingly. \$25. 823-8277.
STEREO: Pioneer turntable, technics receiver, and 2 three-way speakers. \$180. Call 757-3943.
STUDIO PIANO Professionally reconditioned and tuned. Call Don Wigen, 355-2830 or days 757-6069.
TABLE AND 4 CHAIRS, 3 bar stools to match. 1 mirror. Cash only. 746-2272 between 4 and 5 pm.
WOOD BURNING furnace-fires fireplace. Insert. Glass doors and blowers. Must sell at sacrifice. Call after 5. 756-1200.
WOULD LIKE to buy used refrigerators and freezers that need repair. Call 758-2446.
ZENITH Solid State stereo, \$20. Vinyl, bow and case, \$125. Green velvet living room chair, \$25. Chest of drawers, \$30. Azule 10 speed bicycle, \$25. Call anytime 757-1293.

1964 CHEVY TRUCK Good condition. \$600. Also 10 speed bike, like new. \$65. chrome slotted disk Volkswagen rims and tires, \$75. CB radio, \$15. charcoal grill, \$30. Call 756-3513, ask for Robert.
1969 PIPER Cherokee. Good paint. Good interior. 2 NAVY COMS Transponder - 1500 SMOH 756-2990.
3 PIECE bedroom suite, Bassett Cherrywood dresser, chest of drawers, headboard. Excellent condition. \$500 or best offer. 752-3229 after 5, ask for Barbara.
3M "VOC" III copier. \$495. Call Bob at 752-7111.

CLASSIFIED DISPLAY
FLEMING FURNITURE & APPLIANCE
New Services
Crosby Appliances
Kelvinator Appliances
Speed Queen Laundry
Fadders Air Conditioners
1812 Dickinson Ave. 752-3689

074 Miscellaneous
2 DUROTHERM oil heaters, Sears humidifier, 100' of wire fencing. Carpet remnant. 757-3681.
3 SLIDING GLASS DOORS \$75. Call 756-0483.
25" COLOR ZENITH TV with new rotary antenna. \$275. Zenith speakers in Colonial cabinet, \$75. Boat trailer, converts to utility trailer, \$275. 1970 Chevrolet shortbed work truck, \$475. 1967 Datsun truck body, \$175. New metal fireplace liner, \$75. original cast 645 3 wire spoke rims, fits Datsun, Toyota, and four Lug Mustang, \$65. 2 aluminum mags with new tires. \$80. Low profile chest with drawers, \$10. Nice work table, \$15. Odds and ends for boats and cars, ask what you need. 350 Yamaha motorcycle for flat track. \$35. 758-7404 or 756-7846.

075 Mobile Homes For Sale
BRAND NEW DOUBLEWIDE for the price of the single. Zenith speakers in Colonial cabinet, \$75. Boat trailer, converts to utility trailer, \$275. 1970 Chevrolet shortbed work truck, \$475. 1967 Datsun truck body, \$175. New metal fireplace liner, \$75. original cast 645 3 wire spoke rims, fits Datsun, Toyota, and four Lug Mustang, \$65. 2 aluminum mags with new tires. \$80. Low profile chest with drawers, \$10. Nice work table, \$15. Odds and ends for boats and cars, ask what you need. 350 Yamaha motorcycle for flat track. \$35. 758-7404 or 756-7846.
DELIVERY and install included. VA, FHA and conventional financing. Mobile Home Brokers, 600 West Greenville Boulevard, 756-0191.
EXTRA CLEAN 12x65, 3 bedroom, 1 1/2 bath, low payments. Tri County Homes, 756-0131.
FOR SALE: 12x50 Mascot mobile home, 3 bedroom, 1 bath, washer, air conditioner, 10x14 metal shed. Call 758-3951 after 6.
MOBILE HOME with extras at Rivers Edge Estates. Assume payments \$147.50 per month, equity \$800-can be paid in part. 752-6702 or 752-3839.
12x46-0 RITZCRAFT 2 bedrooms, 1 1/2 bath, central heat and air, electric appliances. Located in nice setting with heat, deck and shed. Unfurnished. \$6500. 756-2564 after 4:30.
12x65, 2 or 3 bedrooms, 2 baths. Furnished. Excellent condition. 746-6575.
12x65 STYLE-MAR 1971, 3 bedrooms, 2 full baths, new carpet, central air, heat, deck and shed. Excellent condition. Set up in Farmville. \$6200 sacrifice. Call 758-7892.

1982 SKYLINE, 14 X 70, down payment negotiable. Must sell. Owner relocated. Please call 756-2100 after 5. Call 756-8516 evenings only.
1980 12X40 BRIGADIER Parilly furnished, assumable loan of \$150.38. Call after 5. 756-0728.
1981, 14x70, 3 bedroom, 2 bath, washer, dryer, deluxe features. Payments less than rent. Tri County Homes 756-0131.
1983 GUERDON 2 bedroom, 1 bath for only \$9,995. Price includes setup. Ask for John at Country Square Mobile Homes 756-9874.
2 BEDROOM, 1980, 960. Like new, washer, dryer, central air. Tri County Homes, 756-0131.

CLASSIFIED DISPLAY
FLEMING FURNITURE & APPLIANCE
New Services
Crosby Appliances
Kelvinator Appliances
Speed Queen Laundry
Fadders Air Conditioners
1812 Dickinson Ave. 752-3689

077 Musical Instruments
SMALL BALDWIN PIANO, \$600. Call 752-1025 after 4:30 pm.
VIOLIN full size Lewis with case, like new. \$250. Call 757-3122 after 5:30 p.m.
WANT TO BUY used clarinet. Call 758-4074.
YAMAHA SK 20 Polyphonic Synthesizer - Good strings and 93 sounds. 756-2990.
1964 FENDER Jazzmaster electric guitar, Pro-CBS Excellent condition, collector's item, \$225. BIC turntable, BIC speakers, and Realistic receiver, all in excellent condition. \$170. Call 752-0551.

078 Sporting Goods
HATTERAS CANVAS PRODUCTS All types canvas and cushion repairs. Specializing in marine products. 756-0641, 1104 Clark Street.
WATHERBY VANGUARD 7mm Magnum .4123 scope with range finder. \$425. 756-6682.

082 LOST AND FOUND
FOUND DOG, downtown area, call for identification. 758-4255.
FOUND small long-haired female Terrier on 3th Street. Call 752-3332.
LOST - Golden Retriever about 1 year old, light tan, 1 block from campus. Reward. 757-1175 anytime.
085 Loans And Mortgages
NEED CASH, get a second mortgage fast by phone, we also buy mortgages; make commercial loans, call free 1-800-845-3929.
091 Business Services
BOOKKEEPING & TAX SERVICE, Payrolls, etc. Mid-Eastern Business Services, 757-3540.
093 OPPORTUNITY
FOR SALE: Seafood Market, good location. Call after 6 p.m. 756-2692.
LIST OR BUY your business with J. Harris & Co., Inc. Financial & Marketing Consultants. Serving the Southeastern United States. Greenville, N.C. 757-0001, nights 753-4015.
SERVICEMASTER professional home and office cleaning franchises available in the Pitt County area. \$7,800 includes equipment and training. Financing available. For information call or write Servicemaster, 204 West Peace Street, Raleigh 27603, 833-2802.
SMALL BUSINESS FOR SALE potential, 1 person can operate. \$14,500. Call 756-9840 after 6 p.m.

START THE YEAR OUT IN YOUR OWN BUSINESS
Roofing and aluminum siding business.
Printing business.
24 hour ham & egg restaurant.
Full service neighborhood supermarket.
Inflatable glass company.
High end gift shop.
Small town full service restaurant.
VA 10% down, low monthly payments.
Several convenience stores.
These are some of our eastern North Carolina listings. Call for more details.
757-0001
C. J. HARRIS AND COMPANY, INC. Financial and Marketing Consultants Serving The Southeastern United States.

095 PROFESSIONAL
CHIMNEY SWEEP Gid Holloman, North Carolina's original chimney sweep. 25 years experience working on chimneys and fireplaces. Call day or night, 753-3503, Farmville.

102 Commercial Property
TWO COMMERCIAL buildings for sale. Call 758-1131 before 5 or 754-1463 after 6.
106 Farms For Sale
152 ACRES with 31 cleared and 8000 pounds tobacco allotment located 3 miles west of Winterville. Contact Don Southerland at Aldridge & Southerland Realty, 756-3500; nights 756-5260.
28 ACRES with 12 cleared. Near Chico School. 13 miles Southeast of Greenville. Owner financing available. For more information call Aldridge & Southerland Realty, 756-3500; nights Don Southerland, 756-5260.

CLASSIFIED DISPLAY
S-1 SENTRY SAFE \$119
CAROLINA HEAT EQUIPMENT CO.
Corner of Pitt & Green St.

106 Farms For Sale
FARM 5 miles east of Ayden. Tobacco allotment, 55%+ acres cleared, 34.9 cut over woodland. Tiled, good road frontage, excellent location. Call Koseley Marcus Realty at 746-2166 for full details.
108 ACRES with 60 cleared and 9700 pounds of tobacco allotment located 3 miles south of Winterville. Contact Don Southerland at Aldridge & Southerland Realty, 756-3500; nights 756-5260.

109 Houses For Sale
ACT QUICKLY on this one. Older home with lots of potential but needs a handyman. Pay approximately \$3,500 and assume the FHA loan. \$24,500. #367, CENTURY 21 Bass Realty, 756-6666.
ARE YOU TIRED OF THE Subdivision look? How about a "one of a kind" custom built home? Features 3 bedrooms, 2 baths, 1950 square feet on a wooded lot. Call Aldridge and Southerland, 756-3500, nights, Myra Day, 524-5004.
ATTENTION INVESTORS - or first home homeowners - small starter home with tremendous potential, living room with fireplace, dining room, kitchen, two bedrooms plus walk in attic could be converted into 2 more rooms - one room basement and 2 car garage with small 2 bedroom apartment over it. Fenced in backyard. Reduced as it needs love and tender care. Only \$29,900. Call Davis Realty, 752-3000, 756-2904, 756-1997, 756-7087.
BAYWOOD is the location of this live bedroom ranch type home, 3 1/2 baths, roomy kitchen, two-car garage. Call for many fine features. E. H. Hite Realty Co., 752-0058, nights 758-4476 or 752-3647.
BY OWNER 1500 square feet. Living room, dining room, 3 bedrooms, large deck, carport and workshop. Brick Vener. Elmhurst, 17% FHA financing with VA 10% down. Call Myra Day, 524-5004, or 756-6666.

BY OWNER This cute ranch style home perfect for the young couple. Features include 3 bedrooms, 1 1/2 baths, boat shelter, kitchen with breakfast room in the new section of Sherwood Greens. Seller will pay points and closing costs. Call Myra Day, 524-5004, or 756-6666.
CALL MOORE & SAUTER and see what Santa's got! No closing cost, only 5% down and monthly payments under \$300. Shared Equity Financing makes your dream of home ownership realistic. 2 or 3 bedroom townhouses with 3 locations to choose from. Call Moore & Sauter, 758-6690.
CHERRY OAKS Perfect for the family, 4 bedrooms, 3 full baths, entry floor, formal areas, den with fireplace, huge kitchen with granite counter top, designer interior, beautiful landscaping. Aldridge & Southerland, 756-3500; Allie Carroll, 756-9278.
CHERRY OAKS! This light and lovely four bedroom home features large living room and dining room, great for entertaining. Located on private street with wooded lot. Low fixed rate assumable loan available with no qualifying income. \$90's. #292, CENTURY 21 Bass Realty, 756-6666.
COLONIAL HEIGHTS Cute as a button, 3 bedrooms, 2 baths, eat-in kitchen, living room with fireplace, all remodeled. 12x16 den. Assume VA 10% down, low monthly payments. P. Peggy at Aldridge & Southerland 756-3500 or 756-0942.
CONTEMPORARY 3 bedrooms, 2 1/2 baths, gas, wood, tiled, gourmet kitchen, custom features throughout. Court to pool and tennis courts. \$89,500. By owner. 756-6145.

COUNTRY HOME REDUCED!! This beautiful home features fabulous country kitchen with island and built-in Jenn. Air range, five bedrooms, family room with fireplace, all tile floors. \$48,900. #346, CENTURY 21 Bass Realty, 756-5868.
ENTERTAINING A BREEZE in this lovely brick home in Eastwood. Features include tile floor, serve them in the L-shaped living/dining room, and relax in the VA 10% down. Call Myra Day, 524-5004, or Elaine Troiano, 756-6346.
IMMACULATE BRICK RANCH features 3 bedrooms, 2 baths, formal areas, family room with fireplace, fenced backyard. Upper \$30's. For more information call Aldridge and Southerland, 756-3500; nights, Myra Day, 524-5004, D4.
JUST REDUCED University area. Excellent investment property, 6 bedrooms, formal areas, 2 baths. For more details call our office. \$47,900. P. Peggy at Aldridge & Southerland 756-3500 or 756-0942.
JUST WHAT you need! Brook Hill townhomes - the best three bedroom floor plan in town. Own your own or less than rent. Fireplace optional for stocking hangers. No closing costs, 5% down. Call Moore & Sauter, 758-6050.

EXCELLENT STARTER HOME 3 bedrooms, family room, fenced in yard \$39,900. Greve, Call Myra Day, 524-5004, or Associates, 355-2727 or 758-3338.
FARMER'S HOME Brick ranch, garage, 3 bedrooms, 2 baths. Large lot. \$59,200. Greve, Call Myra Day, 524-5004, or Associates, 355-2727 or 758-3338.
HORRIBLE WORD! Advertised that you can take advantage of an excellent assumable FHA loan if qualified and enjoy the comforts this fine brick home only 5 months old offers. Living room, kitchen with separate dining area, inside laundry area, 3 bedrooms, 1 1/2 baths, lovely lot and neighborhood. Don't delay, call today! \$41,500. Call Myra Day, 524-5004, or Elaine Troiano, 756-6346.

RENT WITH OPTION TO BUY! This three bedroom home is vacant and waiting for you. Rent with fresh paint inside and out. Convenient to shopping and schools. Better hurry! \$30,795. #292, CENTURY 21 Bass Realty, 756-5868.
SPECIAL PRICE, \$37,500, 3 bedroom, 1 1/2 baths, carpeted, large backyard. Call for details. In Farmville. 753-4267 or 758-3338.
TODAY'S BUY-Tomorrow's Security! A friendly home in Eastwood offers 10% fixed rate loan assumption with total monthly payments of \$347.34. Here's a home you can just move into and live! Recently painted inside and out, new vinyl and wallpaper. Features living room with ceiling fan, kitchen and dining room with granite counter, 3 large bedrooms, 1 1/2 baths, inside laundry room. If you like antiques you'll love this home. Call Myra Day, 524-5004, or Associates, 355-2727 or 758-3338.

CLASSIFIED DISPLAY
ROOFING STORM WINDOWS DOORS & AWNINGS
Remodeling - Room Additions. C.L. Lupton, Co. 752-6116.
CLASSIFIED DISPLAY
WARM GIFTS IDEAS
A KERO-SUN PORTABLE HEATER IS THE ECONOMICAL GIFT THAT SPREADS WARM FEELINGS ALL YEAR LONG.

Give the warm, money-saving gift that your family and friends can use wherever they go. A Kero-Sun portable heater. There are 10 models and sizes to choose from. All 99.9% fuel-efficient. All cost just pennies per hour to operate. They're smooth and effortless in operation. Easy to operate. Safety-tested and listed by Underwriters Laboratories.
A Kero-Sun portable kerosene heater can be used in the living room, kitchen, basement, vacation home, work place, add-on room - and many more applications.
PEOPLE REMEMBER YOU ALL YEAR LONG WHEN YOU GIVE A WARM, MONEY-SAVING GIFT.
See the full line of Kero-Sun portable heaters today.
KERO-SUN HEATERS. WE BRING COMFORT TO INNER SPACE.
OWNED & OPERATED BY WAYNE L. TRULL, INC. NOW WITH TWO LOCATIONS.
729 Dickinson Avenue Telephone 752-4417 Phil Trull, Store Mgr.
West End Shopping Center Telephone 756-8371 Johnny Joyner, Store Mgr.

LOCK THE DOOR against high rent; live more cheaply in your own home. Qualified VA applicant can purchase with no downpayment. FHA applicant with as little as \$1,400 down; seller will pay closing cost and points. Near 848 home features perfectly manicured yard with barbecue and detached garage with workshop; living/dining room, kitchen with refrigerator and range, 3 bedrooms, 1 bath, ceiling fans, tile floors, central air, carpeted porch. Only \$37,900. Call Myra Day, 524-5004, or Associates, 355-2727 or 758-3338.
LOOKING FOR A NICE three bedroom home that you can fix up? Look no more! Here it is! Ranch style home in nice neighborhood with friendly neighbors. No 90's. #416, CENTURY 21 Bass Realty, 756-5868.
LOVE THOSE TERMS! That's what you'll say when you see this three bedroom home in the Winterville School district that has an assumable low fixed rate loan. Spacious galore inside, with all formal areas and den, with woodstove, \$50's. #292, CENTURY 21 Bass Realty, 756-6666.
LYNNDALE - New construction. You really gotta see this gorgeous home on a large lot in a great area, screened in backporch. Ready for you to select your favorite color palette. Call Myra Day, 524-5004, or Associates, 355-2727 or 758-3338.
MAINTENANCE FREE RANCH features large, 3 baths, large living room with fireplace, mid \$30's. Call Aldridge and Southerland, 756-3500; nights, Myra Day, 524-5004, D5.
MARYLAND DRIVE You can buy this pretty ranch home under FHA or VA financing - Interest rate only 9.5% - 12% AP. Seller pays points! Three bedrooms, 1 1/2 baths, living room with fireplace, family room with fireplace, brick carport, \$52,900. Duffus Realty Inc., 756-5395.
MODERNIZED COUNTRY PLACE just outside city limits with home-spun atmosphere, resting on approximately 1 acre. Features include living room with fireplace, large dining room, central air, screened porch and detached garage. 13% fixed rate loan assumption. Call today, a qualified buyer. \$56,900. Call Myra Day, 524-5004, or Associates, 355-2727 or 758-3338.
NEW LISTING University area, Affordable home with 3 bedrooms, 2 1/2 baths, living room, dining room, eat-in kitchen, and lots of storage space. \$48,900. Call Myra Day, 524-5004, or Associates, 355-2727 or 758-3338.
NEW LISTING 4 bedrooms, 2 1/2 bath condominium with many other extra features. Only \$66,900. Steve Evans & Associates, 355-2727 or 758-3338.
NEXT BEST THING to Santa (Homeownership for the price of rent!) Why rent when you can own? Investigate our 2 or 3 bedroom townhouse? Investigate our Shared Equity Financing Program! Call Moore & Sauter, 758-6050.

NOW IS THE TIME to see this new listing in Ayden with all extras included! Located in a great neighborhood, this 2 or 3 bedroom home with fireplace combine to give you that at home atmosphere. Roomy dining area plus the master bedroom. Very little upkeep and maintenance. Only \$56,900. #443. Listing by Myra Day, 524-5004, or Associates, 355-2727 or 758-3338.
OLDER HOME IN GRIFTON features 2 bedrooms, 2 baths, ceramic tile, hardwood floors, remodeled kitchen and new heating system. \$30's. Call Myra Day, 524-5004, or Associates, 355-2727 or 758-3338.
OWNER MOVING! His loss is your gain! Has solar heat and solar hot water! This three bedroom home is located in nice neighborhood and has eat-in kitchen, double carport, \$40's. #429, CENTURY 21 Bass Realty, 756-6666.
PINERIDGE - Owner moving! Must sell. Contemporary energy efficient home, 3 bedrooms, 2 baths, fireplace, ceiling fan in great room, heat pump, and garage. Close to hospital. Low equity, assumable loan. \$50's. By owner. 752-0046.

PRICE REDUCED In time for the holidays! Located in beautiful Belvedere. Owner needs to sell and you need to see it. Excellent loan assumption available. Priced in the \$60's. #361, CENTURY 21 Bass Realty, 756-5868.
RANCH IN GRIFTON features living room with fireplace, 3 bedrooms, 2 baths, utility room, and large pantry. Will rent with option. Call Aldridge and Southerland, 756-3500; nights, Myra Day, 524-5004, D2.
REDUCED!! DELLWOOD This three bedroom brick ranch has been cut to the bone. Owner says sell at once. Fixed rate loan assumption. \$50's. #216, CENTURY 21 Bass Realty, 756-5868.

REDUCED JUST IN TIME for Christmas! This three bedroom home has an FHA assumable loan. Two baths, large eat-in kitchen, living room with fireplace and central air. Call Myra Day, 524-5004, or Associates, 355-2727 or 758-3338.
RENT WITH OPTION TO BUY! This three bedroom home is vacant and waiting for you. Rent with fresh paint inside and out. Convenient to shopping and schools. Better hurry! \$30,795. #292, CENTURY 21 Bass Realty, 756-5868.

CLASSIFIED DISPLAY
ROOFING STORM WINDOWS DOORS & AWNINGS
Remodeling - Room Additions. C.L. Lupton, Co. 752-6116.
CLASSIFIED DISPLAY
WARM GIFTS IDEAS
A KERO-SUN PORTABLE HEATER IS THE ECONOMICAL GIFT THAT SPREADS WARM FEELINGS ALL YEAR LONG.

Give the warm, money-saving gift that your family and friends can use wherever they go. A Kero-Sun portable heater. There are 10 models and sizes to choose from. All 99.9% fuel-efficient. All cost just pennies per hour to operate. They're smooth and effortless in operation. Easy to operate. Safety-tested and listed by Underwriters Laboratories.
A Kero-Sun portable kerosene heater can be used in the living room, kitchen, basement, vacation home, work place, add-on room - and many more applications.
PEOPLE REMEMBER YOU ALL YEAR LONG WHEN YOU GIVE A WARM, MONEY-SAVING GIFT.
See the full line of Kero-Sun portable heaters today.
KERO-SUN HEATERS. WE BRING COMFORT TO INNER SPACE.
OWNED & OPERATED BY WAYNE L. TRULL, INC. NOW WITH TWO LOCATIONS.
729 Dickinson Avenue Telephone 752-4417 Phil Trull, Store Mgr.
West End Shopping Center Telephone 756-8371 Johnny Joyner, Store Mgr.

Give the warm, money-saving gift that your family and friends can use wherever they go. A Kero-Sun portable heater. There are 10 models and sizes to choose from. All 99.9% fuel-efficient. All cost just pennies per hour to operate. They're smooth and effortless in operation. Easy to operate. Safety-tested and listed by Underwriters Laboratories.
A Kero-Sun portable kerosene heater can be used in the living room, kitchen, basement, vacation home, work place, add-on room - and many more applications.
PEOPLE REMEMBER YOU ALL YEAR LONG WHEN YOU GIVE A WARM, MONEY-SAVING GIFT.
See the full line of Kero-Sun portable heaters today.
KERO-SUN HEATERS. WE BRING COMFORT TO INNER SPACE.
OWNED & OPERATED BY WAYNE L. TRULL, INC. NOW WITH TWO LOCATIONS.
729 Dickinson Avenue Telephone 752-4417 Phil Trull, Store Mgr.
West End Shopping Center Telephone 756-8371 Johnny Joyner, Store Mgr.

109 Houses For Sale

UNIVERSITY AREA This duplex like a home. One side has three bedrooms with fireplace in the master and a fireplace in the living room. Rent out house or side to help with payments. \$60's. 4322 CENTURY 21 Bass Realty, 756-6666.

211 BETH STREET, 3 bedroom ranch with 2 1/2 baths, family room, kitchen with dining area, wood stove and heat pump, below market financing available and priced to sell immediately at \$63,500.00. Call Diversified Financial Services, Inc. (a subsidiary of Home Federal Savings) at 758-3421. EQUAL HOUSING OPPORTUNITY LENDER.

6 ROOM house and lot for sale by owner. Approximately 4 miles from Burroughs Weatherford. 3 miles off Greenville/Bethel Highway. Call 752-6267. Good Buy!

61,500. Centrally located. This 3 bedroom, 2 bath, family room with fireplace, plus formal area. Attractive neighborhood, convenient to schools and shopping. Call June Wyrick at Aldridge & Sutherland Realty, 756-3500 or 758-7744.

FOR SALE: 20 acres of cleared land, 5000 sq. ft. of tobacco. Located in Chocowinity, NC \$40,000 firm. 946-5198.

100 FOOT LOT on Bath Creek just 40 miles from Greenville. Long pier already built and sandy beach \$42,500. For more information contact Aldridge & Sutherland Realty, 756-3500; nights Don Sutherland, 756-5260.

100 FOOT LOT on Bath Creek just 40 miles from Greenville. Long pier already built and sandy beach \$42,500. For more information contact Aldridge & Sutherland Realty, 756-3500; nights Don Sutherland, 756-5260.

100 FOOT LOT on Bath Creek just 40 miles from Greenville. Long pier already built and sandy beach \$42,500. For more information contact Aldridge & Sutherland Realty, 756-3500; nights Don Sutherland, 756-5260.

100 FOOT LOT on Bath Creek just 40 miles from Greenville. Long pier already built and sandy beach \$42,500. For more information contact Aldridge & Sutherland Realty, 756-3500; nights Don Sutherland, 756-5260.

100 FOOT LOT on Bath Creek just 40 miles from Greenville. Long pier already built and sandy beach \$42,500. For more information contact Aldridge & Sutherland Realty, 756-3500; nights Don Sutherland, 756-5260.

100 FOOT LOT on Bath Creek just 40 miles from Greenville. Long pier already built and sandy beach \$42,500. For more information contact Aldridge & Sutherland Realty, 756-3500; nights Don Sutherland, 756-5260.

100 FOOT LOT on Bath Creek just 40 miles from Greenville. Long pier already built and sandy beach \$42,500. For more information contact Aldridge & Sutherland Realty, 756-3500; nights Don Sutherland, 756-5260.

100 FOOT LOT on Bath Creek just 40 miles from Greenville. Long pier already built and sandy beach \$42,500. For more information contact Aldridge & Sutherland Realty, 756-3500; nights Don Sutherland, 756-5260.

100 FOOT LOT on Bath Creek just 40 miles from Greenville. Long pier already built and sandy beach \$42,500. For more information contact Aldridge & Sutherland Realty, 756-3500; nights Don Sutherland, 756-5260.

100 FOOT LOT on Bath Creek just 40 miles from Greenville. Long pier already built and sandy beach \$42,500. For more information contact Aldridge & Sutherland Realty, 756-3500; nights Don Sutherland, 756-5260.

100 FOOT LOT on Bath Creek just 40 miles from Greenville. Long pier already built and sandy beach \$42,500. For more information contact Aldridge & Sutherland Realty, 756-3500; nights Don Sutherland, 756-5260.

100 FOOT LOT on Bath Creek just 40 miles from Greenville. Long pier already built and sandy beach \$42,500. For more information contact Aldridge & Sutherland Realty, 756-3500; nights Don Sutherland, 756-5260.

100 FOOT LOT on Bath Creek just 40 miles from Greenville. Long pier already built and sandy beach \$42,500. For more information contact Aldridge & Sutherland Realty, 756-3500; nights Don Sutherland, 756-5260.

100 FOOT LOT on Bath Creek just 40 miles from Greenville. Long pier already built and sandy beach \$42,500. For more information contact Aldridge & Sutherland Realty, 756-3500; nights Don Sutherland, 756-5260.

100 FOOT LOT on Bath Creek just 40 miles from Greenville. Long pier already built and sandy beach \$42,500. For more information contact Aldridge & Sutherland Realty, 756-3500; nights Don Sutherland, 756-5260.

100 FOOT LOT on Bath Creek just 40 miles from Greenville. Long pier already built and sandy beach \$42,500. For more information contact Aldridge & Sutherland Realty, 756-3500; nights Don Sutherland, 756-5260.

100 FOOT LOT on Bath Creek just 40 miles from Greenville. Long pier already built and sandy beach \$42,500. For more information contact Aldridge & Sutherland Realty, 756-3500; nights Don Sutherland, 756-5260.

100 FOOT LOT on Bath Creek just 40 miles from Greenville. Long pier already built and sandy beach \$42,500. For more information contact Aldridge & Sutherland Realty, 756-3500; nights Don Sutherland, 756-5260.

100 FOOT LOT on Bath Creek just 40 miles from Greenville. Long pier already built and sandy beach \$42,500. For more information contact Aldridge & Sutherland Realty, 756-3500; nights Don Sutherland, 756-5260.

100 FOOT LOT on Bath Creek just 40 miles from Greenville. Long pier already built and sandy beach \$42,500. For more information contact Aldridge & Sutherland Realty, 756-3500; nights Don Sutherland, 756-5260.

100 FOOT LOT on Bath Creek just 40 miles from Greenville. Long pier already built and sandy beach \$42,500. For more information contact Aldridge & Sutherland Realty, 756-3500; nights Don Sutherland, 756-5260.

100 FOOT LOT on Bath Creek just 40 miles from Greenville. Long pier already built and sandy beach \$42,500. For more information contact Aldridge & Sutherland Realty, 756-3500; nights Don Sutherland, 756-5260.

100 FOOT LOT on Bath Creek just 40 miles from Greenville. Long pier already built and sandy beach \$42,500. For more information contact Aldridge & Sutherland Realty, 756-3500; nights Don Sutherland, 756-5260.

100 FOOT LOT on Bath Creek just 40 miles from Greenville. Long pier already built and sandy beach \$42,500. For more information contact Aldridge & Sutherland Realty, 756-3500; nights Don Sutherland, 756-5260.

100 FOOT LOT on Bath Creek just 40 miles from Greenville. Long pier already built and sandy beach \$42,500. For more information contact Aldridge & Sutherland Realty, 756-3500; nights Don Sutherland, 756-5260.

100 FOOT LOT on Bath Creek just 40 miles from Greenville. Long pier already built and sandy beach \$42,500. For more information contact Aldridge & Sutherland Realty, 756-3500; nights Don Sutherland, 756-5260.

100 FOOT LOT on Bath Creek just 40 miles from Greenville. Long pier already built and sandy beach \$42,500. For more information contact Aldridge & Sutherland Realty, 756-3500; nights Don Sutherland, 756-5260.

100 FOOT LOT on Bath Creek just 40 miles from Greenville. Long pier already built and sandy beach \$42,500. For more information contact Aldridge & Sutherland Realty, 756-3500; nights Don Sutherland, 756-5260.

121 Apartments For Rent

ONE 2 BEDROOM and one 4 bedroom. Stove and refrigerator furnished. Located in Winterville, NC Call 758-1280 after 6:30 weekdays, anytime weekends.

STRATFORD ARMS APARTMENTS The Happy Place To Live CABLE TV

Office hours 10 a.m. to 5 p.m. Monday through Friday Call us 24 hours a day at 756-4800

TAR RIVER ESTATES

1, 2, and 3 bedrooms, washer-dryer hook-ups, cable TV, pool, club house, playground, Near ECU

Our Reputation Says It All - "A Community Complex."

1401 Willow Street Office - Corner Elm & Willow 752-4225

THREE ROOM furnished apartment with private bath and entrance. Prefer married couple without children. 413 W. 4th St.

TWO BEDROOM apartment, refrigerator, stove and dishwasher, hook-up for washer and dryer. 5 blocks from the University. No pets. 752-0180 or 756-2766.

TWO BEDROOM DUPLEX, 4 1/2 miles west of new hospital, available December 1. 756-8996 or 756-3780.

TWO BEDROOM apartment, located at Willow Street Apartments. Rent \$250 month. 758-3311.

TWO BEDROOMS, 1 1/2 baths, \$280. Ridge Place. Phone 756-7310.

UNIVERSITY AREA 2 bedroom duplex, appliances furnished, ideal for students. \$195. Available now. Call 756-0765.

WEDGEWOOD ARMS NOW AVAILABLE 2 bedroom, 1 1/2 bath townhouses. Excellent location. Carrier heat pumps. Whirlpool kitchen. Washer/dryer hookups, pool, tennis court. 756-0987

WHY PAY RENT? 3 bedroom repro. Payments under \$140. Tri County Homes. 756-0131.

1 AND 2 BEDROOM apartments. Available immediately. 752-3311.

1 BEDROOM unfurnished apartment for sublease. 2 blocks from ECU. carpeted, new appliances. 757-1175.

1402B CHESTNUT STREET Downstairs apartment, living room, 2 bedrooms, kitchen, bath, utility and laundry room. Partially furnished. 756-1063.

2 BEDROOM DUPLEX Jarvis Street. Call 757-0688.

2 BEDROOM DUPLEX for rent. 1 1/2 baths, dishwasher, garbage disposal, washer/dryer hookups. 752-2106.

CLASSIFIED DISPLAY

121 Apartments For Rent

2 BEDROOM TOWNHOUSE 4 miles West of hospital. Washer/dryer hook up, central air. Call 752-0181 nights, and 756-3780 days.

2 BEDROOM TOWNHOUSE 1 1/2 baths, carpet, energy efficient heat pump, range, refrigerator, dishwasher hook-ups. \$295. 756-7480.

2 BEDROOM duplex near university. \$290. Call 756-7779.

122 Business Rentals OFFICE SPACE AND YARD for sublease. 309 Hooker Road. Office area 400 square feet, excellent parking facility, fenced in area, 27,000 square feet, with storage garage connecting office. You need to see it to believe it! For more information call 1-800-672-7555, 8-5 Monday-Friday, ask for Don Emery.

1203 WEST 14TH STREET Available January 1. Call 756-3743.

Looking for an apartment? You'll find a wide range of available units listed in the Classified columns of today's paper.

127 Houses For Rent 3 BEDROOM country home, 11 miles south of Greenville on Highway 43. Call 524-3507.

2 BEDROOM, 1 bath house on Warren Street. Married couple. Lease and deposit required. \$295 per month. 756-9070 after 5.

2 BEDROOM house for rent. Conveniently located to businesses and school. Reasonably priced. 825-6831 or 825-5661.

3 BEDROOM ranch style home. Warren Street. Call between 10 a.m. and 5 p.m. 753-4015, 756-9006.

3 BEDROOM house within walking distance of the university. \$225 month. CENTURY 21 B Forbes Agency. 756-2121.

3 BEDROOMS, nice house, nice neighborhood. Call between 10 a.m. and 5 p.m., Carolina Property Managers. 756-7995.

3 BEDROOM country home. \$225 a month. 746-4668 after 7 p.m.

3 BEDROOMS, 2 bath brick home with fireplace. Country Club Hills in Grifton. \$375 a month. Echo Realty. 524-4148 or 524-5042.

3 BEDROOM house for rent, close to campus. Call after 4 p.m. 756-0528.

3 BEDROOM house, garage, 2 1/2 blocks from campus on Jarvis Street, gas heat, \$250 deposit; \$250 month. Call Tommy at 756-6148.

3 BLOCKS from ECU Lease and security deposit required. Additional deposit with pets. \$325 monthly. Available February 1. Days 335-212; evenings 752-6984.

3 OR 4 BEDROOM house. Located near campus. Central heat and air, 2 baths, fireplace, fenced in backyard, no inside pets. 756-8848 anytime.

3 BEDROOM HOUSE, 405 West 4th Street, \$300 per month. Call 757-0688.

129 Lots For Rent A LOT AVAILABLE for rent for a nice home, up to 12 by 40 feet. Riverside Trailer Park. Call Charles Dudley at 756-3852 or 756-3832.

NEAR UNIVERSITY 3 or 4 bedrooms, carpeted. Located on Forbes St. 1 bath, refrigerator, range. No pets. Lease and deposit required. \$325 per month. Call 752-3948 between 1 and 5, ask for Pam.

OWN, DON'T RENT 1979-2 bedroom home in excellent condition with brand new furniture. Tri County Homes, 756-0131.

PINES, Ayden, 2000 square foot brick home, 3 bedroom, 2 bath, woodstove, 2 car garage, large wooded lot. \$375 month. 746-4227.

THREE BEDROOM house with 2 baths, central location. \$425. Call 756-5961 or 756-4410.

UNUSUAL RENTAL property, 3 bedroom, 2 bath, solar compliant, 4 1/2 acre lot in MacGregor Downs. One year lease. \$550 per month plus deposit. Call Ailta Carroll at Aldridge & Sutherland Realty, 756-3500/756-8278.

WHEN SOMEONE IS ready to buy, they turn to the Classified Ads. Place your Ad today for quick results.

CLASSIFIED DISPLAY

127 Houses For Rent

2 BEDROOM country apartment, 11 miles south of Greenville on Highway 43. Call 524-3507.

2 BEDROOM, 1 bath house on Warren Street. Married couple. Lease and deposit required. \$295 per month. 756-9070 after 5.

2 BEDROOM house for rent. Conveniently located to businesses and school. Reasonably priced. 825-6831 or 825-5661.

3 BEDROOM ranch style home. Warren Street. Call between 10 a.m. and 5 p.m. 753-4015, 756-9006.

3 BEDROOM house within walking distance of the university. \$225 month. CENTURY 21 B Forbes Agency. 756-2121.

3 BEDROOMS, nice house, nice neighborhood. Call between 10 a.m. and 5 p.m., Carolina Property Managers. 756-7995.

3 BEDROOM country home. \$225 a month. 746-4668 after 7 p.m.

3 BEDROOMS, 2 bath brick home with fireplace. Country Club Hills in Grifton. \$375 a month. Echo Realty. 524-4148 or 524-5042.

3 BEDROOM house for rent, close to campus. Call after 4 p.m. 756-0528.

3 BEDROOM house, garage, 2 1/2 blocks from campus on Jarvis Street, gas heat, \$250 deposit; \$250 month. Call Tommy at 756-6148.

3 BLOCKS from ECU Lease and security deposit required. Additional deposit with pets. \$325 monthly. Available February 1. Days 335-212; evenings 752-6984.

3 OR 4 BEDROOM house. Located near campus. Central heat and air, 2 baths, fireplace, fenced in backyard, no inside pets. 756-8848 anytime.

3 BEDROOM HOUSE, 405 West 4th Street, \$300 per month. Call 757-0688.

129 Lots For Rent A LOT AVAILABLE for rent for a nice home, up to 12 by 40 feet. Riverside Trailer Park. Call Charles Dudley at 756-3852 or 756-3832.

NEAR UNIVERSITY 3 or 4 bedrooms, carpeted. Located on Forbes St. 1 bath, refrigerator, range. No pets. Lease and deposit required. \$325 per month. Call 752-3948 between 1 and 5, ask for Pam.

OWN, DON'T RENT 1979-2 bedroom home in excellent condition with brand new furniture. Tri County Homes, 756-0131.

PINES, Ayden, 2000 square foot brick home, 3 bedroom, 2 bath, woodstove, 2 car garage, large wooded lot. \$375 month. 746-4227.

THREE BEDROOM house with 2 baths, central location. \$425. Call 756-5961 or 756-4410.

UNUSUAL RENTAL property, 3 bedroom, 2 bath, solar compliant, 4 1/2 acre lot in MacGregor Downs. One year lease. \$550 per month plus deposit. Call Ailta Carroll at Aldridge & Sutherland Realty, 756-3500/756-8278.

WHEN SOMEONE IS ready to buy, they turn to the Classified Ads. Place your Ad today for quick results.

CLASSIFIED DISPLAY

ARMY SURPLUS CAMPING SPORTING MILITARY GOODS Over 1000 Different Items New and Used

ARMY-NAVY STORE 1501 S. Evans

133 Mobile Homes For Rent

FOR SALE OR RENT, 2 trailers in Highland Trailer Park and 1 in Oakwood Trailer Park, 758-4476.

PRIVATE LOT in Greenville, Co. No inside pets. No children. 758-4541.

SPECIAL RATES for students, 2 bedrooms, No inside pets. No children. 758-4541.

TWO BEDROOM trailer located in Colonial Park, \$160 month, available now. Call 758-6679.

1 BEDROOM MOBILE HOME Unfurnished, washer/dryer hook-up, central air, storage building, frost free refrigerator. Good location. 1-238-3336 from 5-7 p.m.

1 BEDROOM for rent. Low rent, small deposit, good location. Call 756-9874 anytime.

12X65, 2 bedroom, 2 baths, Furnished \$150 month. 746-6575.

2 AND 3 BEDROOM mobile homes for rent with carpet, \$145. No pets. No children. 758-4541.

2 BEDROOM Mobile Home for rent. Call 756-4687.

2 BEDROOM Trailer, furnished. 3 miles North of city. Call 758-2347.

2 BEDROOMS, all electric, Underpinned, 6 miles from Pitt Plaza. No pets. 756-0975.

2 BEDROOMS furnished, washer, air, carpet, good location. No pets. No Children. 758-4857.

2 BEDROOM trailer, deposit required. 752-1823.

2 BEDROOMS, washer, air, carpet, completely furnished, no pets. 756-0792.

3 BEDROOMS, 2 full baths, washer, dryer, located at Taylor Estates. 756-1444 after 4.

135 Office Space For Rent MODERN, attractive office space for lease. Approximately 1500 square feet. Located 2007 Evans Street beside Moseley Brothers. Call 756-3374.

135 Office Space For Rent

NEW DOWNTOWN, single office to large suit, conference room available. Many extras. 752-5048.

OFFICE AND WORKSHOP space available on 264 Business. 2 offices with new carpet and fresh paint, heat pump, \$170 per month; garage with rear workshop, \$90 per month; workshop and storage area with private bath, \$60 per month. Call Realty World, Clark-Branch, Realtors. 756-6336.

OFFICES FOR LEASE Contact J.T. or Tommy Williams, 756-7815.

SINGLE OFFICES or suites, with utilities and janitorial. Chapin-Little Building, 3106 S. Memorial Drive. Call 756-7799.

SMALL OR LARGE office suites for rent. Reasonable rates including utilities and janitorial. Minges Building, Evans Street. Call Clark-Branch, Realtors 756-6336.

STORE/RESTAURANT/SINGLE or multiple offices available now downtown. Offices convenient to courthouse. 756-9041, 756-3466.

TWO ROOM or four room office suite, Highway 264 Business, Econormical. Private parking. Some storage available. Call Conally Branch at Clark Branch Realtors, 756-6336.

300 SQUARE FEET two room office and 440 square feet three room office. Joyner-Lanier Building, 219 North Woorhe Street. Parking Available. Call Jim Lanier, 752-5505.

CLASSIFIED DISPLAY

WE REPAIR SCREENS & DOORS Remodeling-Room Additions

C.L. Lupton Co. 752 6116

138 Rooms For Rent

PRIVATE ROOM for one, across from college. Call 758-2585.

140 WANTED ATTENTION TRAPPERS and hunters! I want to buy your raw furs. Top prices and honest grade! Danny Joe Humphrey, Kingston. 522-5478.

142 Roommate Wanted FEMALE Three bedroom, nice house \$95 month plus 1/3 utilities. Call 758-0966.

FEMALE STUDENT needed for spring semester. 4 miles from ECU. Call 752-4275 and speak to Ruth only.

MALE ROOMMATE furnished 2 bedroom apartment. \$120 month plus 1/2 utilities. 756-9781.

SHARE 3 BEDROOM apartment, 5 blocks from campus. Rent, 1/3 utilities. 757-1293.

CLASSIFIED DISPLAY

142 Roommate Wanted

2 FEMALE roommates wanted, \$91 per month; 1/3 utilities. Pets. Call 756-5114.

144 Wanted To Buy GOOD USED GO Cart suitable for 11 year old. Ask for Janice or Wayne. 756-4652 after 5.

OLD DOLLS of any description. Call 746-3284.

WANT TO BUY used weight bench and weights. Call 756-0567.

CLASSIFIED DISPLAY

A.B. WINGATE BUILDING CONTRACTOR for all your building needs

Call 756-6892 after 5 p.m.

111 Investment Property NEW DUPLEX Yearly rental of \$6000 with assumable loan. Excellent tax shelter. \$61,000. Aldridge & Sutherland Realty, 756-3500.

113 Land For Sale FOR SALE: 20 acres of cleared land, 5000 sq. ft. of tobacco. Located in Chocowinity, NC \$40,000 firm. 946-5198.

115 Lots For Sale BAYTREE SUBDIVISION Attractive wooded lots within the city. 90% financing available. Call 758-3421.

120 RENTALS LOTS FOR RENT Also 2 and 3 bedroom mobile homes. Security deposits required, no pets. Call 758-4413 between 8 and 5.

121 Apartments For Rent AZALEA GARDENS Greenville's newest and most uniquely furnished one bedroom apartments.

121 Apartments For Rent CHERRY COURT Spacious 2 bedroom townhouses with 1 1/2 baths. Also 1 bedroom apartments.

121 Apartments For Rent EASTBROOK AND VILLAGE GREEN APARTMENTS 327 one, two and three bedroom garden and townhouse apartments, featuring Cable TV, modern appliances, central heat and air conditioning, clean laundry facilities, three swimming pools.

121 Apartments For Rent GREENWAY Large 2 bedroom garden apartment with 1 1/2 baths, dishwasher, cable TV, laundry rooms, balconies, spacious grounds with abundant parking, economical utilities and pool. Adjacent to Greenville Country Club. 756-8869.

121 Apartments For Rent IN WINTERVILLE 3 bedroom apartment, appliances furnished, no children, no pets. Deposit and lease. \$195 a month. Call 756-5007. Available end of December.

121 Apartments For Rent KINGS ROW APARTMENTS One and two bedroom garden apartments. Carpeted, range, refrigerator, dishwasher, disposal and cable TV. Conveniently located to shopping center and schools. Located just off 10th Street. Call 752-3519.

121 Apartments For Rent LARGE ONE BEDROOM within walking distance of University and downtown. Immediate occupancy. Partial utilities furnished. \$200 per month. 756-9318 days, 756-2542 before 6 p.m.

121 Apartments For Rent LEWIS STREET One bedroom furnished apartment. Heat, air and water furnished. 1 block from University. No Pets. Call 758-3781 or 756-0889.

127 Houses For Rent THE REAL Estate Corner COMING SOON! Office Condos Financing arranged, small down payment, payments in line with lease arrangements with all the tax advantages of ownership. Call now for appointment to discuss details.

133 Mobile Homes For Rent AVAILABLE, furnished two bedroom outside Ayden. Private lot. Deposit:

Service & Quality
Better than It Has To Be!

We reserve the right to limit quantities. Some sold to dealers or restaurants. We gladly accept U.S.A. Food Stamps.

PRICES EFFECTIVE DEC. 15-18

Fantastic Digital Timepiece Offer!

\$8.99 Each with \$100 in our register tapes.

An \$18.00 value, only \$8.99 plus tax and \$1.00 in register tapes. Warranted for 1 full year.

(A) Men's 3-function digital wristwatches. Gold-tone or silver-tone.
(B) Women's 3-function digital gold-tone pendant watch with mesh chain.
(C) Women's 3-function digital silver-tone pendant watch with mesh chain.
(D) Women's 3-function digital wristwatches. Gold-tone or silver-tone.

SEE OUR DISPLAY OF BEAUTIFUL JADE JEWELRY

Ideal for Gifts!
Prices Start at... **6.99**

Beer Sold At Cost or Below!
Greenville's Best Beer Prices!

SUPER SPECIAL!

PIGGLY WIGGLY **BLEACH** GALLON **59c**

HOUSE OF RAEFORD TOM TURKEYS 18-22 LB. AVG. **59c** LB.

ALWAYS DEPENDABLE

SWIFT'S BUTTERBALL TURKEYS 10-22 LBS. **99c** LB.

LIMIT ONE PLEASE!

HOUSE OF RAEFORD 10-18 LB. HEN TURKEYS **79c** LB.

PIGGLY WIGGLY 4-7 LB. TURKEY BREASTS **1.29** LB.

PIGGLY WIGGLY BAKING HENS 4 to 7 LBS. **59c** LB.

Gwaltney Spiced Luncheon Meat, P.P. Loaf Liver Loaf... 8 Oz. 89c

Old Town Hot or Mild Sausage . . . Lb. 89c

Lundy's Sliced Bacon . . . Lb. 1.48

Frosty Morn Franks. . . 12 Oz. 99c

Gwaltney Cooked Ham . . . 6 Oz. 1.39

GOLDEN BEST SHORTENING 42 OZ. **1.09**

LIMIT ONE, PLEASE!

KRAFT MIRACLE WHIP Salad Dressing QUART **1.39**

LIMIT ONE, PLEASE!

SUPER SPECIAL!

LIPTON **TEA BAGS** 100 CT. **1.78**

Swift's Premium Beef!

BONELESS CHUCK ROAST LB. **1.48**

BONELESS CHUCK STEAK . . . LB. 1.68

CUBE CHUCK STEAK . . . LB. 2.58

BONELESS STEW BEEF LB. **1.68**

FRESH GROUND BEEF (3 LBS. OR MORE) **99c**

PIGGLY WIGGLY WORLD OF PRODUCE
the Freshest Buys in Town!

FRESH FLORIDA ORANGES 8 LB. BAG **1.49** 5 LB. BAG **1.39**

BOX PRICE 125's 8.79

FRESH Tangelos . . . doz. 99c

125's PINK OR WHITE GRAPEFRUIT 4/1.00

FRESH FLORIDA TANGERINES 150's **99c** DOZ.

FRESH COCONUTS 2/1.00

FRESH CELERY 2/79c

5 LB. BAG BAKING POTATOES . . . 89c

WASHINGTON STATE RED DELICIOUS APPLES 49c LB.

FRESH CRANBERRIES 12 OZ. BAG 79c

PIGGLY WIGGLY PINEAPPLE JUICE 46 OZ. **79c**

WALDORF BATHROOM TISSUE 4 PK. **79c**

SUPER SPECIAL!

PIGGLY WIGGLY **Orange Juice** 1/2 GAL. **98c**

COKE & MELLO YELLO 8 16 OZ. BOTTLES **99c** PLUS DEPOSIT

10% DISCOUNT TO ALL CHURCH AND CIVIC GROUPS ON BOX ORDERS.

MERICO BISCUITS 9 OZ. **3/1.00**

PIGGLY WIGGLY CRANBERRY SAUCE 15 OZ. **3/1.19**

SUPER SPECIAL!

MT. OLIVE **SALAD CUBES** 22 OZ. **79c**

KRAFT CRACKER BARREL SHARP & EXTRA SHARP CHEESE 10 OZ. **1.99**

PIGGLY WIGGLY ICE CREAM 1/2 GAL. **\$1.19**

MAOLA PINE OR SHERBERT 1/2 GAL. 1.39

PIGGLY WOOLY MILK GAL. 1.89

1/2 GAL. MAOLA BUTTERMILK . . . 99c

MAOLA SOUR CREAM AND DIP 8 oz. 2/99c

MEADOW GOLD CREAM CHEESE 8 OZ. **69c**

"LUV MY CARPET" DEODORIZER 2.5 OZ. **4/1.00**

SUPER SPECIAL!

BANQUET **Pie Shells** 2 PK. **3/1.19**

COUPON FREE

PIGGLY WIGGLY **CRANBERRY SAUCE** 15-OZ. SIZE **FREE!**

EXPIRES 12/18/82

PIGGLY WIGGLY CORN MUFFIN MIX 7 OZ. **5/\$1.00**

PIGGLY WIGGLY BREAD 3 LB. LOAVES **1.00**

BLUE RIBBON POUND CAKE 1.09

ASSORTED DUCHESS PIES 8 INCH 99c

ASSORTED VARIETIES KEELER SNACK CRACKERS 8 OZ. 99c

ASSORTED NABISCO SNACK CRACKERS 99c

PIGGLY WIGGLY HEAVY DUTY HEAVY DUTY FOIL . . . 18x25 99c

PIGGLY WIGGLY TRASH BAGS 10 CT. 99c

KRAFT SANDWICH SPREAD . . PT. 99c

PILLSBURY PIE CRUST 15 OZ. 1.29

KRAFT LaCreme Topping . . . 9 oz. 99c

ROYAL PINK PINK SALMON . . TALL CAN 1.49

KRAFT MARSHMALLOW CREME 7 OZ. **59c**

KRAFT GRAPE JELLY BUY ONE GET ONE FREE!

COUPON 49c

ROLLER CHAMPION PLAIN OR SELF-RISING FLOUR 5-LB. BAG **49c**

EXPIRES 12/18/82

COUPON 69c

PIGGLY WIGGLY **BUTTERMILK BISCUITS** 4 PK. **69c**

LIMIT ONE WITH THIS COUPON AND A \$7.50 FOOD ORDER (EXPIRES 12/18/82)

MR. CLEAN 28 OZ. **1.99**

SANKA Instant Coffee 5 OZ. **4.29**

ARMOUR'S VIENNA SAUSAGE 5 OZ. **2/1.00**

Health & Beauty Aids

SX-70 POLAROID FILM 7.29

FOHO Shampoo or Conditioner 7 oz. 1.59

COUPON 279

MAXWELL HOUSE **COFFEE** 1 LB. CAN \$2.79 **30c off**

(EXPIRES 12/18/82) [Coupon No. 4445-3]

TIDE 49 OZ. **1.89**

LIMIT ONE, PLEASE!

FOLGER'S COFFEE 13 OZ. BAG **1.99**

MAXWELL HOUSE Master Blend COFFEE 13 OZ. **2.19**

PIGGLY WIGGLY

Pepsi, Mt. Dew, Sunkist Orange, Pepsi Free, & Diet Pepsi

2 LITER BOTTLE 89c

PIGGLY WIGGLY KEEPS AMERICA SHOPPING WITH EVERYDAY LOW PRICES!

2105 DICKINSON AVE.
Open Mon. - Sat. 7 A.M. to 12 A.M.
Open Sun. 7 A.M. to 9 P.M.

WED., THURS.,
FRI., SAT. SALE

Holiday Hours
Mon.-Sat.
9:30-10

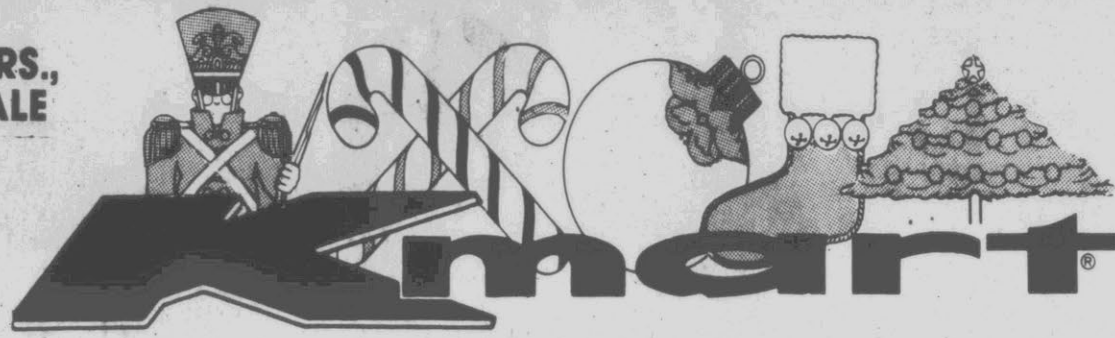

THE CHRISTMAS SAVING PLACE

Gifts for Everyone

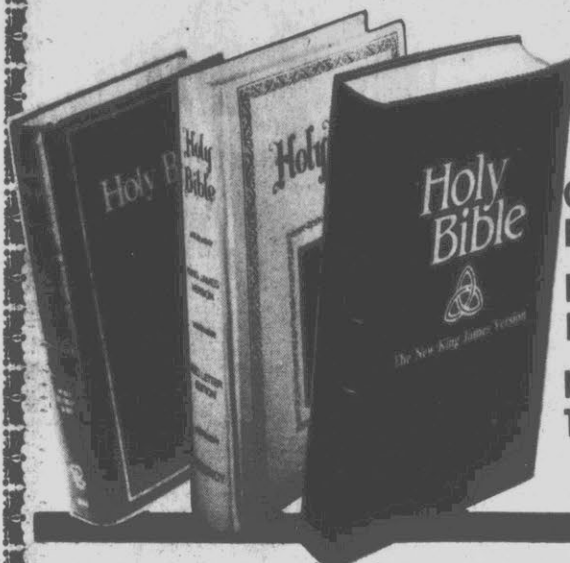

BIBLES
 Family Altar Bible... Our Reg. 10.96 **8.96**
 Giant Print Bible... King James Version **10.96**
 Regency Award Bible... Our Reg. 4.99 **2.97**
 New Testament... Our Reg. 1.57 **1.27**

K mart® ADVERTISED MERCHANDISE POLICY
 Our firm intention is to have every advertised item in stock on our shelves. If an advertised item is not available for purchase due to any unforeseen reason, K mart will issue a Rain Check on request for the merchandise (one item or reasonable family quantity) to be purchased at the sale price whenever available or will sell you a comparable quality item at a comparable reduction in price.

2.97

Pretty Poinsettias For The Holidays
 Surprise someone or indulge yourself with the festive good looks of our 6" potted poinsettia plant. Save now.

This Year Give THE Christmas Plant
POINSETTIAS



*Batteries not included

K mart® Sale Price **39.96**
 Less Factory Rebate **-10.00**
 Your Net Cost After Factory Rebate **29.96**
Dungeons & Dragons™ Game
 A computer labyrinth game of strategy and adventure.



2.99 Our Reg. 4.27
Taylor Lake Country Wine
 Choose red, pink or white.

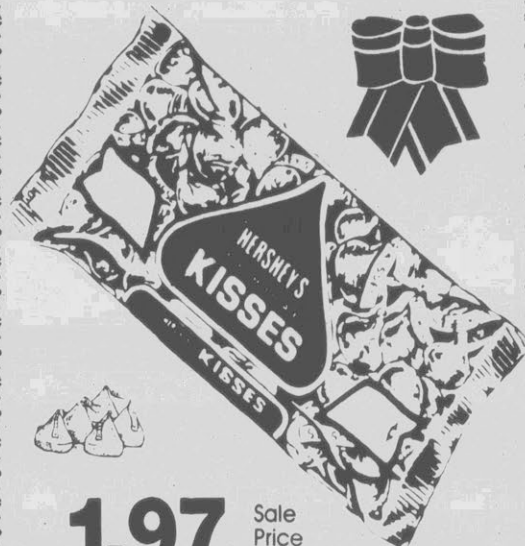

1.97 Sale Price
Foil-wrapped Hershey® Chocolate Kisses®
 Add to the holiday festivities with a 14-oz. bag of delicious Hershey® Kisses® that please kids and grownups. Save.
*Net wt.



99¢ Your Choice Save!
Matchbox® And Hot Wheels® Favorites
 Ever-popular miniature cars and trucks by Matchbox® and Hot Wheels® offer hours of delight to young boys and girls.

1.27 For Ages 3 And Up
4-pack Play-Doh®
 Clean, pliable, non-toxic. Colors. Rebate limited to mfr.'s stipulation.



3.94
Create With Play-Doh® Fun Factory
 Fun factory includes 10 different shapemakers, extender, 2 die-strips, trimmer and two 6-oz.* cans of Play-Doh®.
*Net wt.

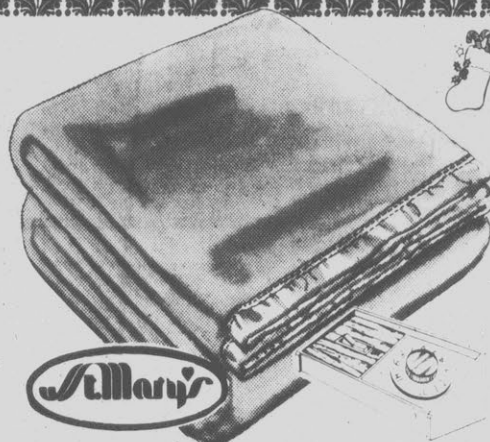

Our 32.96, Double With Single Control... 25.96
 Our 39.96, Double With Dual Control... 32.96
 Our 48.96, Queen With Dual Control... 39.96

Twin With Single Control
19.96 Our Reg. 28.96

Fully Automatic Electric Blanket
 Cuddle in comfort with machine-washable polyester/acrylic electric blanket. 11 comfort settings. 3" nylon trim. Colors.



6.66
Color And Paint With Crayola® Art Kit
 Encourage the young artist with kit that includes crayons, chalk, poster paints, watercolors, sharpener, brush and more.



9, 20x30" Sheets
88¢ Our Reg. 1.17
Christmas Paper
 37-sq.-ft. holiday wrapping paper.



19.99 Our Reg. 24.88
Wooden Rocker
 Children's Gloucester style rocker. Maple finish.



7.97 Our Reg. 10.97
Gift Cheese Sets



44.96
Dark Tower
 Experience the ultimate game of electronic wizardry! Dare you enter the Dark Tower to face what lurks inside?



36.96
Electronic Battleship® Game
 Computer memory game with live action, realistic sounds.

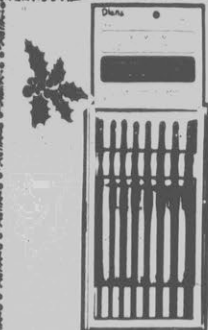

3.97 Our Reg. 5.77
Crochet Hook Gift Set
 Set of 8 hooks: D/E/F/G/H/I/J/K. Plastic box.



15.88
Hot Air Corn Popper™
 Continuous feed action and butter melter.



Fit Men's 10-13
5.97 Our Reg. 6.97
6 Pr. Men's Tube Socks
 Over-the-calf tube socks. Gray with stripes.

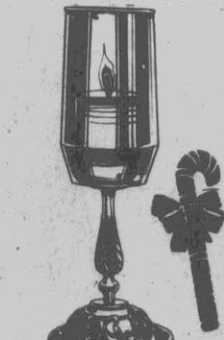

2.97 Our Reg. 3.97
Ruby Candle-lite
 Candle holder on brass-finish base.



4.97 Save!
2 Cassette Tapes
 60-min. blank Memorex® cassette tapes.

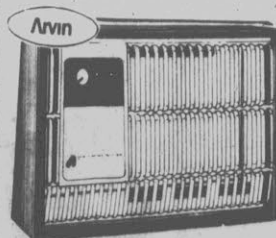

17.97
1500-Watt Heater 11½x18¼"
 With rotary dial automatic thermostat, wide angle radiant reflector. Save!



K mart® Sale Price **13.97**
 Less Factory Rebate **-3.00**
 Your Net Cost After Factory Rebate **10.97**
Air Purifier
 Freshener, deodorizer. Replacement Filters, 1.97.
Rebate limited to mfr.'s instruction.



1.99
Fruit Bowl
 Ruby-tinted bowl with clear pedestal and stem.

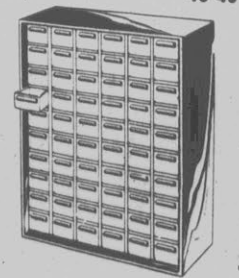

13.97 Sale Price
Handy Parts Chest
 60-drawer cabinet. Heavy-duty frame.

TAKE ADVANTAGE OF OUR APPAREL LAYAWAY PLAN

- ladies and girls' apparel
- men's and boys' apparel
- infants'wear
- shoes
- fashion accessories
- hosiery
- millinery
- sporting goods apparel

warm winter cover-ups

\$10 To \$14

A. Our Reg. 19.97, Men's Velour Bathrobes
Warm calf-length leisure/bath robe in acetate/nylon velour. Double belt loops, smart fashion solid colors. One size fits all. ***14**

B. Our Reg. 14.97, Men's Velour Karate Robe
Lush velour robe in the shorter length men enjoy for after shower. Of warm acetate/nylon, solid colors. One size fits all. ***10**

C. Our Reg. 13.96-18.96, Girls' Plush Robes
Cozy, comfortable robes of warm SEF® modacrylic polyester plush; wrap styles, more. Super colors; sizes 4-14. ***10-14**
* Monsanto Reg. TM

D. Our Reg. 16.96, Fleece Fashion Robes
Gift robes, like this plush wrap with satin trapunto-trimmed front and sleeves; Celanese® Arnel® triacetate/nylon. Misses'. ***14**
* Arnel is a Reg. TM of Celanese Corporation.



\$7

Our Reg. 9.97

Men's Long-sleeve Broadcloth Pajamas
Nicely tailored coat-style pajamas of cotton/polyester; solid colors or prints. A-D.



\$3

Our Reg. 3.97

Men's Tees With Fun Print Designs
Solid color polyester/cotton tee, popular fun sayings, designs, some metallic accents.



Sizes 38-44

\$11 Our Reg. 12.96-13.96

Full Figure Blouses
Many styles. Crisp polyester/cotton

\$10 Our Reg. 12.96

Full Figure Pants
Zip-front, belted; stretch polyester.



Sizes 7-14

\$6 Our Reg. 7.96

Girls' Knit Tops
Stripe polyester/cotton tunic, more.

\$7 Our Reg. 9.96

Girls' Denim Jeans
Cotton blends; 7-14. Our 8.57, Sizes 4-6X, \$6



\$11

Our Reg. 15.96

Pretty Holiday Dresses For Girls
Dots, ruffles, more; polyester and blends. 4-6X. Our Reg. 17.96, Holiday Dresses, Sizes 7-14, \$14



A. \$14

B. \$10

D. \$14

Gift Ideas





132.87

Atari Video System
Atari® Video Computer System™ comes with joystick and paddle controllers. Combat Game Program™ cartridge, TV switch and AC adapter.



6.97 Our Reg. 12.97

Show your lifestyle at a glance with a 'Collection' frame! Assorted size openings and full strength protective glass. Dark oak color wood frame fits any decor.



Our Reg. 103.97

67.00

All Pro 3-Speed Bicycle
While They Last—No Rainchecks

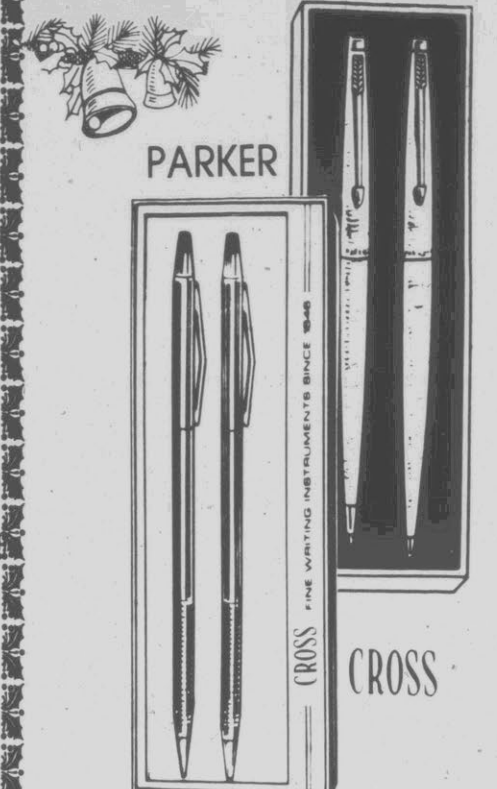

PARKER

CROSS



5.97 Our Reg. 7.97

7"-high Crib Bumper Pad
All-around pad features knife edge. Matches crib mattress.



14.97 Our Reg. 19.97

Circular Walker
Trainer walker with tip-resistant base, folding legs, tray.

Our Reg. 32.97, **Super Coupe Walker** 27.97



Only 2 To Sell

38.97 Our Reg. 48.97

Save! 38" Padded Playpen
Close-weave safety mesh, chrome design, vinyl pad.

12.97 9.97

Pen And Pencil Set
Cross® pen and pencil set in handy case for gift giving. Chrome.

Parker® Pen And Pencil
Classic black matte pen and pencil set in convenient case. Save now!



Sizes 9-18 Mos.

5.97 Save 14%
Our Reg. 6.97

Infant Girls' Fancy Diaper Set
Polyester/cotton top with short puff sleeves, matching elasticized panty.



4.97 Save *2
Our Reg. 6.97

Tot Boys' Long-sleeve Velour Shirt
Easy-care cotton/polyester crew-neck shirt. Solid colors with stripe. 2-4.

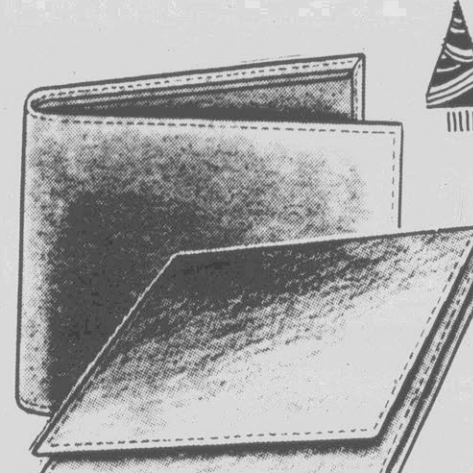

6.88

Leather Trifold Or Billfold
Billfolds and trifolds of top-grain cowhide leather with a variety of designs. Choose from plain, western, dog or mallard design. Available in basic colors. Save now.

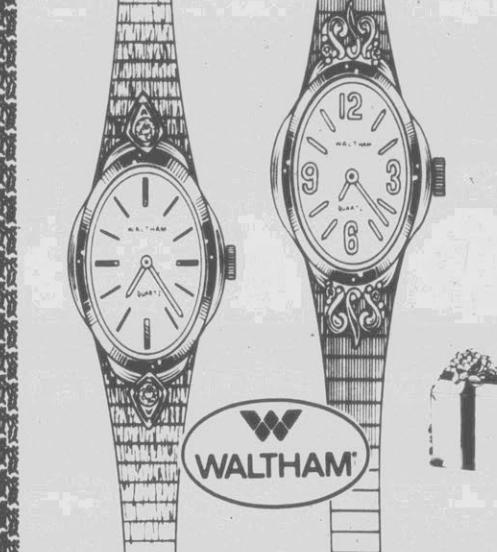

49.97

Women's Diamond Watches
Watch her face light up as she unwraps her own analog diamond watch. This precision timekeeper is available in gold tone or chrome. A gift she's sure to treasure.



ORLON
A DU PONT FIBER

97¢ Save 29%
Our Reg. 1.38 Pr.

Cable Design Knee-highs in Colors
Orlon® acrylic/nylon knee-highs in basic colors. Fit misses' 9-11, girls' 8-9½.
*Du Pont Reg. TM



Celanese Arnel

8.88 Save 2.09
Our Reg. 10.97

Toddler Girls' Top And Pant Set
Panne velvet top of Celanese Arnel® triacetate/nylon/polyester. Polyester pants.
*Arnel is a Reg. TM of Celanese Corp.

Sizes 2-4



Men's 8" Leather Steel Toe Boot
Men's black leather work boot. PVC foam padded collar, Goodyear® welt, steel shank, and oil resistant outsole. Men's sizes.

TEXAS STEER®

Sale Price
27.99
Our Reg. Price \$39.97



Men's Insulated Waterproof Pac Boot
Men's green rubber boots. Steel shank support, comfortable lining. Men's full sizes.

Sale Price
\$13 Special Purchase



3.97 Save 27%-33%
Pr. - Our 5.47-5.97

Warm Leather-palm Driving Gloves
Acrylic driving gloves with leather palm, for men and women. Solid colors.



3.49 Save 3.48
Ea. - Our Reg. 6.97

Brighten The Holidays With A New Bag
Rayon canvas or nylon holiday tote bags in styles with front snap pocket. Save.

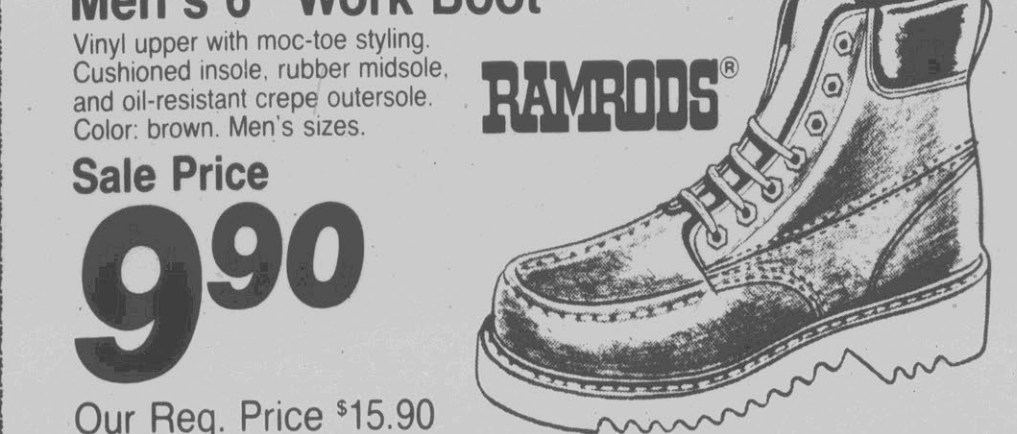

Men's 6" Work Boot
Vinyl upper with moc-toe styling. Cushioned insole, rubber midsole, and oil-resistant crepe outsole. Color: brown. Men's sizes.

RAMRODS®

Sale Price
9.90
Our Reg. Price \$15.90



H
O
L
I
D
A
Y

SALE

\$99

Olympus® XA2 Pocket-size 35mm Camera
Automatic, focus-free setting; self timer.
Olympus® A-11 Electronic Flash For XA2, 22.88

\$269

Canon® AE-1 Program Camera
35mm with f1.8 lens programmed automation, just focus, shoot. L.E.D. read out in viewfinder.

\$127

Canon® 35mm "Sure-Shot" With Handy Case
With auto-focus, built-in electronic flash and automatic film winding. F2.8 lens, pouch case. Batteries not included.

\$149

Pentax® K1000 35mm Camera With F.2 Lens
Built-in hot shoe, match-needle exposure system.

\$179

Minolta® XG-1 35mm SLR Camera With F2 Lens
Electronic self-timer, aperture priority, more.
XG Camera Case 18.47



Focal® Bonus Gift
Yours! 1 roll of 135/20 color-print film with purchase of any advertised 35mm camera.

K mart Photofinishing Coupon Book
With the purchase of any featured 35mm camera, book of 24 coupons good for savings on photofinishing.



44.88

Disc 4000 Camera
Built in flash and lens cover.

14.50

Color Print Film
20-exp. film for Kodamatic™ cameras.

Trade-in And Film Offer
Bring in any used camera, in any condition, and receive the specified trade-in allowance. Plus, get five \$2 cash-back certificates from Kodak® - good for future purchases of Kodamatic™ film. See store for details.



54.97

Kodamatic™ 970L

13.47

Kodamatic™ Champ™



196.88

Kodak® Carousel® 4400 Slide Projector
Features remote focus/forward-reverse changer, hi-lo lamp switch, much more.



Give Focal® Camera Accessories

- MC Auto 28mm F2.8 Wide-angle Lens ... 59.97
- MC Auto 135mm F2.8 Telephoto Lens ... 59.97
- 80-200mm Auto Compact Zoom F4.5 Lens* ... 139.97
- M200 Electronic Flash Unit ... 9.97
- M500T Tristor Zoom Electronic Flash ... 29.97



8.96

Perfection® For Perfect Family Fun
Choose the traditional game or Mr. Pop® beginner's version. Great family gift!

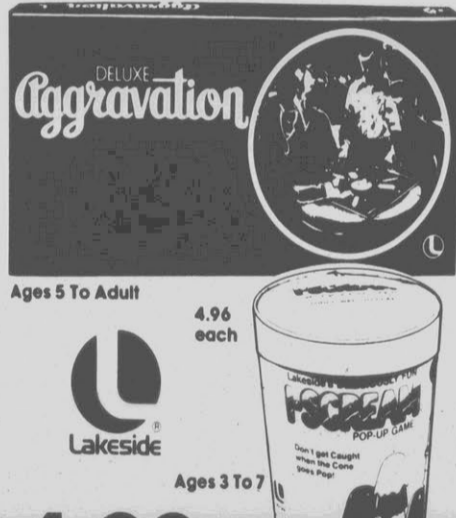

4.96

Deluxe Aggravation® Or I-Scream®
Fast-paced board game or build an ice cream cone against the clock. Save.

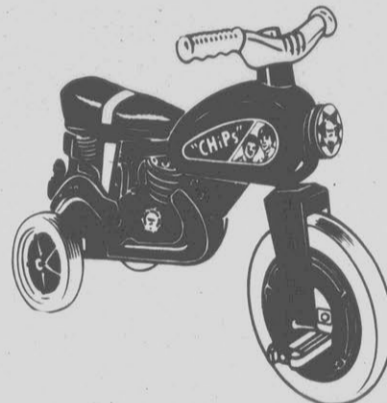

9.88

Chips & Kawasaki Motorcycles
While Supply Lasts
For boys and girls. Motor-like sound, easy pedal action, steerable front wheel. Quick and easy assembly.

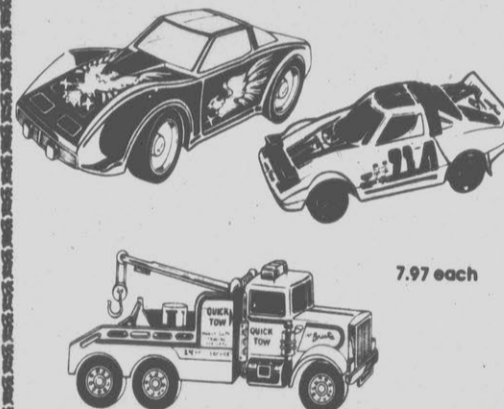

7.97

Remote-control Vehicles For Christmas
Choose Thundervette, Lancia or wrecker. Look and sound real. For kids 3 and up. Batteries not included.



7.96

Guess Who?® Funny Face Guessing Game
For 2 players. Ask the right questions and guess secret face card. 6 to adult.



2.96

Crozzle® Crossword Or Poker/Keno Game
Increase word skills with crossword. Enjoy the excitement of a "real" casino.



1.87

Colorforms - Still A Playtime Friend
Bright, durable plastic forms you arrange on scenic, box-enclosed board. Hours of fun.



3.47

Playskool® Wooden Puzzles For Lil' Kids
Contain from 4 to 15 pieces. Bright and colorful scenes, characters kids will know.



3.86

Shopping Cart
Durable, bright plastic. Wheels.



3.77

Play Food Set
32-piece set in colorful plastic.



3.77

Cleaning Set
Broom, vacuum, mop, more. Ages 3 to 9.



7.96

CONSPIRACY

Grab that top-secret briefcase and bring it to headquarters at all cost! Ages 10 adult, 2-4 players.



3.93

Ball Machine
Shoots 7 Ping-Pong® balls rapidly. Save.



97¢

Slinky® Toy
"Walking" spring toy. Sturdy metal.



\$10

Etch A Sketch®
With Activity Center.



CHRISTMAS TREES

42.88 Our Reg. 54.88

6½' Fast n' Easy Outswept Balsam
150 Tips

22.96 Our Reg. 29.96

6' Fast n' Easy Scotch Pine
(Upswept). 92 Tips

69.88 Our Reg. 89.88

6½' Rhine Pine Soft Needle Tree

Prices Good While Limited Quantities Last



8.44 Our Reg. 9.96

FROGGER™

Look before you leap in this madcap race for survival across a busy highway and a churning river! Ages 7-14, 2 players.

7.96 Our Reg. 8.96

CONNECT FOUR

Try to build a row of four checkers in any direction while blocking opponents from doing the same. Ages 7-adult, 2 players.

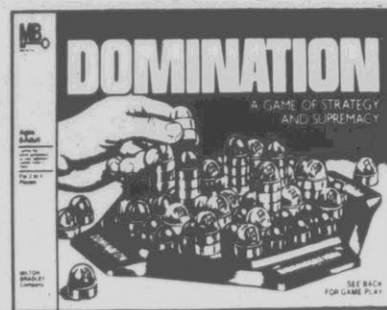

7.44 Our Reg. 9.96

DOMINATION

Stay on top of your opponent in a fierce battle of wits and strategy! Ages 10-adult, 2 or 4 players.

6.27 Our Reg. 7.27

FAMILY FEUD

Find the most popular answers to various questions and win \$5,000 in the "Fast Money" round. Ages 10-adult, 2 or more players.

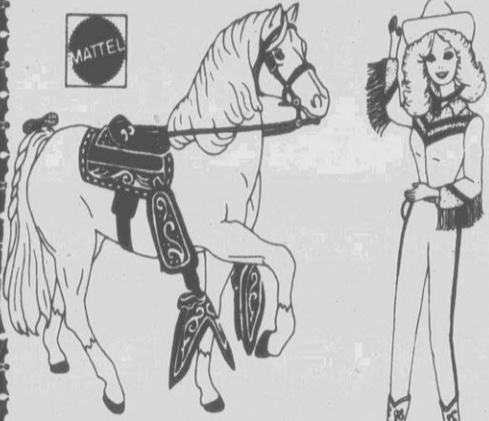

11.44

Dallas™
BARBIE® Doll's Horse

Dallas is specially made for BARBIE® doll so she can sit and hold the reins.



8.96

Western Barbie® Doll.
She's a famous Western star!

COME AND ENJOY THE MAGIC OF TOYLAND



22.88 Our Reg. 39.88

Black Beauty Ride 'em Pony
20 Only To Sell At This Price

Sturdy metal frame with adjustable saddle height. "Grows" with your child.



6.96 Your Reg. 7.76
Choice To 9.86

Holiday Games For Family Funtime

Suspenseful Survive™. Probe™ secret word game or action-packed Nerf™ Ping Pong™.



Our Reg. 10.96

8.96

HANGMAN
Try to figure out the letters in your opponent's mystery word! Each wrong guess brings you closer to the gallows. Ages 8-adult, 2-players.

Our Reg. 9.96

8.44

OPERATION
Try to remove "ailments" with a pair of tweezers and a steady hand so not to set off the buzzer to win. Ages 5-10, 2-4 players.



36x45" Layout

K mart® Sale Price

22.97

Less Factory Rebate

- 3.00

Your Net Cost After Factory Rebate

19.97

King Of the Road™ Train Set

5-unit train with gear-driven locomotive. Operating headlight. Bridge/trestle set. Rebate limited to mfr. stipulation.



16.96 Your Choice

Thrill-packed Electric Road Racing Sets

Thrilling racing action with Police Pursuit™ or Double Danger™. 2 racers in each.



Our Reg. 54.96

47.96

the **TEACH & LEARN** COMPUTER™ system

A talking electronic system that includes a computer and an expanding library of varied Learning Volumes to bring a world of Learning Fun to a child's finger tips. Computer comes with one Learning Volume.



1.86 Your Choice

Adult Supervision Required

Favorite Character Shrinky Dinks™

Kids will enjoy making these Smurf™, Garfield™ and Pac-Man™ stand-up collectibles.

™ Mawoy Mfg Co. © United Features Syndicate, Inc. Reg.™



5.96 Our Reg. 6.96

Monopoly

A classic favorite board game for all ages. Save.



Our Reg. 14.97

7.77

Thumbelina
16" THUMBELINA®
SOFT INFANT DOLL

*16" with a soft huggable body and her arms and legs are of soft vinyl.
*Pink romper outfit with set sleeves and high center yokes.
*Classic sculptured head with rooted hair and ma-ma voice.



SHOP OUR TREASURE CHEST OF **TOYS**

Our Reg. 11.96

3.97

While Supply Lasts!

Microscope Set

Play-Doh modeling set to crank out crazy critters and make them grow.



10.88 Our Reg. 12.96

Lite-Brite

Contains hundreds of glowing pegs in 8 brilliant colors to create beautiful pictures.



\$2

Uno® Card Game
Match colors and numbers to win.



8.87

Down The Tubes™
Chinese checkers with a new twist.



49.86

Arcade Games



Our Reg. 39.96

35.96

Fisher-Price
Tape Recorder
Fun, creative and educational!



Your Choice

2.44

G.I. Joe® Figures
Action figures in life-like garb.



15.44

My Pretty Pony
Lovable pony with brushable mane and tail wiggles her ears and tail and winks.



9.96

Vanity Case
Light-up mirror, hair dryer, more.



Pkg. Of 4 "AA", 2.18

1.43 Our 2.18

Battery Savings
Two "C" or "D" cell or one 9-V.

3.97
Old Spice® Gift Set:
2 1/4-oz.™ After Shave,
2 1/4-oz.™ Cologne



3.97
Old Spice® Gift Set:
2 1/4-oz.™ Stick Deodorant
4 1/4-oz.™ After Shave



6.97
Old Spice® Gift Set:
4 1/4-oz.™ After Shave
4 1/4-oz.™ Cologne



7.97
Old Spice® Deluxe Travel Kit:
6-oz.™ Shave Cream
2 1/2-oz.™ Stick Deodorant
4 1/4-oz.™ After Shave

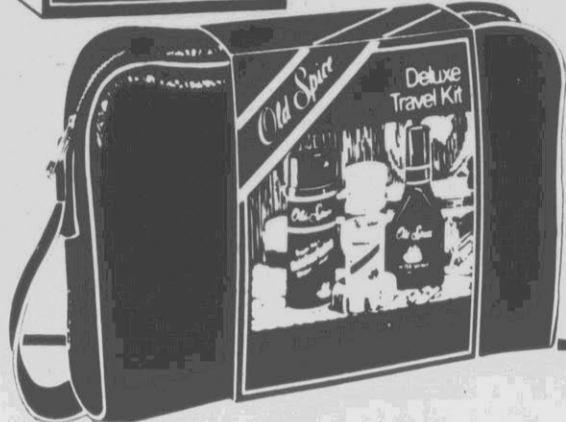

7.97
Blue Stratos®
After Shave And
Cologne, Ea. 1 1/2 Oz.™



4.97
English Leather®
After Shave In
3 Scents, Ea. 2 Oz.™

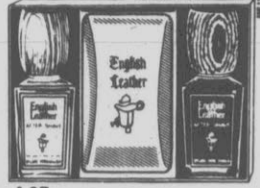

4.97
English Leather®
After Shave And
Cologne, Ea. 2 Oz.™ ;
4-oz.™ Bath Soap



3.97
Aqua Velva® 4-pc.
Collection, Ea. 1/2 Oz.™



6.97
Aqua Velva® Travel
Kit With After Shave
And Lotion, Ea. 1 1/2 Oz.
Atra® Razor, Travel Bag



8.97
British Sterling®
After Shave And
Cologne, Ea. 3.8 Oz.™



6.97
Hawk® After Shave
And Cologne, Ea. 3.2 Oz.™



3.97
Mennen® Skin
Bracer After Shave
In 4 Scents, Ea. 1 1/2 Oz.™



6.97
Aqua Velva® Travel
Kit With After Shave
And Lotion, Ea. 1 1/2 Oz.
Atra® Razor, Travel Bag

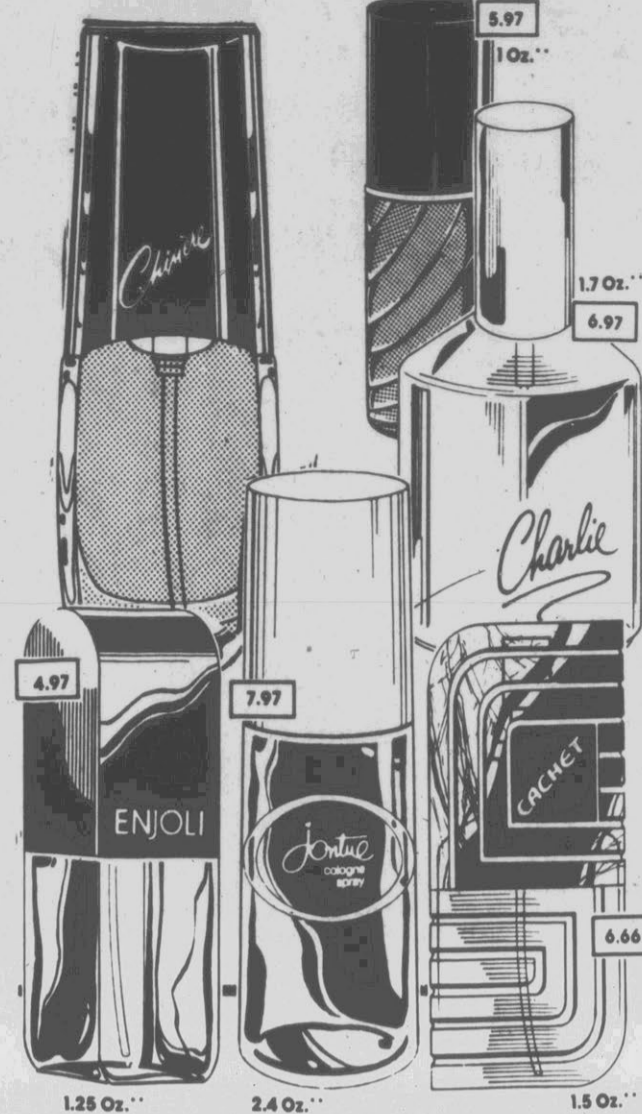

1.25 Oz.™

2.4 Oz.™

1.5 Oz.™

MAIL-IN CERTIFICATE

Send us Proofs of Purchase plus a cash register receipt from any OLD SPICE® Gift Set(s) or Decanters, and we will send you up to \$5.00 in cash. The chart to the right shows you how much you can save.

Send me \$ _____ I have enclosed _____ (number) Proofs of Purchase from OLD SPICE® Gift Sets or Decanters plus a cash register receipt(s) for each purchase.

NAME _____
ADDRESS _____
CITY _____ STATE _____ ZIP _____

THIS CERTIFICATE MUST ACCOMPANY YOUR REQUEST.

# OF GIFT SETS OR DECANTERS	AMOUNT OF REFUND
4	\$5.00
3	\$3.50
2	\$2.25
1	\$1.00

BIG SAVINGS ON MEN'S COMBINATION GIFT SETS BIG SAVINGS ON OUR SPRAY COLOGNE COLLECTION

3.97 To 8.97

Give the gift he'll enjoy this Christmas and all year long. Smart selection of gift sets combining cologne and after shave, soap, skin bracer, lotion or cologne in gifty variety packs.

English Leather® After Shave Set 4.97 Hawk® Gift Set 6.97
English Leather® Gift Set 4.97 Skin Bracer Variety Pack 3.97
British Sterling® Gift Set 8.97 Aqua Velva® After Shave 3.97
Blue Stratos® Gift Set 7.97 Aqua Velva® Travel Kit 6.97

4.97 To 8.88

Delightful selection of your favorite fragrances. Colognes range from the light and natural scent of Cachet® to the enticing aroma of Halston®. Each in convenient spray bottle.

Charlie® Spray Cologne 6.97 Chimere® Spray Cologne 8.88
Jontue® Spray Cologne 7.97 Cachet® Spray Cologne 6.66
Scoundrel® Spray Cologne 5.97 Enjoli® Spray Cologne 4.97



Twin Size
12.97 Our Reg. 17.97

"Petite Point" Thermal Bedsread Of Cozy Cotton
79x106" bedsread delicately decorated with fringe. Warm color selection. Our Reg. 20.97, Full Size, 14.57.



17.97 Our Reg. 24.97

Corning Ware® 3-pc. Menu-ette Set In Decorator Patterns
Durable 3-piece set includes 1- and 1 1/2-pt. covered saucepans, 6 1/2" skillet. Spice O' Life® or Wildflower™ pattern.



74.88 Our Reg. 98.88

5-pc. Bridge Set With 4 Fully Padded Metal Chairs
Folding table and chairs for family activities. 35" table with washable vinyl top, chairs with padded seat and back.



Cotton/Polyester Tick,
Dacron® Polyester Fill

DACRON

Twin Set
13.97 Our Reg. 17.97

Our 27.97, Full-size™ Set, 22.97
Our 34.97, Queen-size™ Set, 28.97

"Sheffield Rose" Percales In Pretty Multicolors
Set includes 1 pillowcase, 1 flat and 1 fitted sheet. No-iron Dacron® polyester/combed cotton, 180 threads per sq. inch. Includes 2 pillowcases. Du Pont Reg.™

Great Holiday VALUES

Our Reg. 4.77

3.77

6" Griddle
Polished aluminum with non-stick SilverStone® surface.

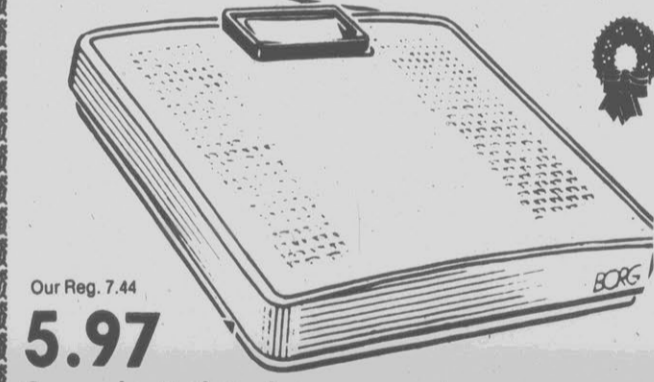

Our Reg. 7.44
5.97

Counselor Bath Scale
Long lasting steel construction in modern styling has up to 300 lb. weight capacity. Easy to clean surface.

E.T.™ Bedroom Accents

16.47
To
21.47

Our 21.97, E.T.™ Twin-size™ Sheet Set, 16.47
Our 17.88, 48x63" Insulating Drapes, Pr., 13.47
Our 28.97, Twin Quilted Bedsread, 21.47
TM Universal Studios, Inc.
*1 flat, 1 fitted sheet, 1 pillowcase



3.99

18-piece Punch Bowl Set
With crystal-look glass 6-qt. bowl, 8 cups, 8 hooks, ladle



60x84" Oblong, 9.97

7.97

"Princess" Tablecloth
Polyester/cotton with soil-release finish.

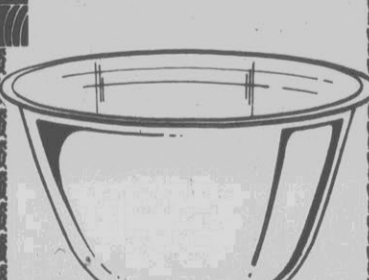

2.66 Our Reg. 3.66

Stainless Steel Mixing Bowl
Lightweight stainless steel mixing bowl in 5-quart size. Save.

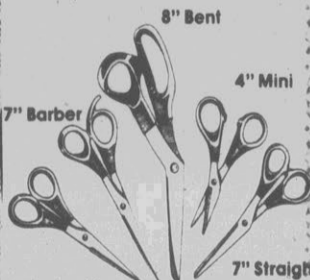

4.47 Each Our 5.97

Choice Of Fiskars® Scissors
With surgical steel blades. Our 6.97, 8" Bent Scissors, 5.47.



21.47 Our 29.88

62x68" Slumber Bag
Soft cotton/polyester with nylon tricot lining and plump polyester fill.

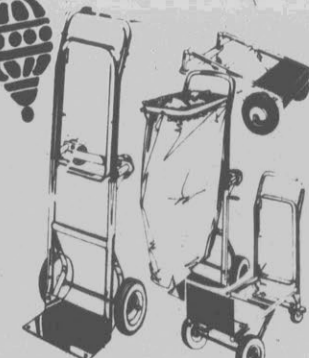

25.00 Our Reg. 31.97

Hand Truck 'n Dolly
4-wheel wonder™ has 36-46" height range. Steel.



43.88 Our Reg. 55.97

Vapor Sealer Cook Set
8-pc. set utilizes minimum moisture cooking.

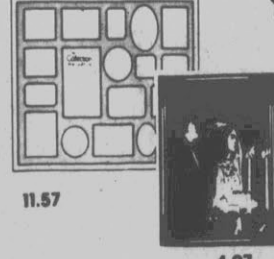

4.97 Our Reg. 6.33

Gold-tone Photo Frame
5x7" or 8x10"; metal. Save. 16x20" Wood Frame, 16.97



3.77 Our Reg. 4.77

3 Pc. Sauce Pan Set
Easy clean enamel, 1 1/2 quart, quart and 1/2 quart sizes.

EAGLE FORCE™ from HG

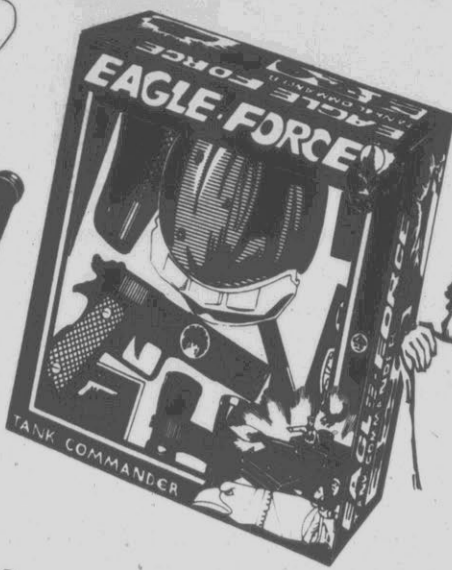

Combat Games And Action Toys

Eagle Force™ Tank Commander Set

The unique Eagle Force™ tank needs a commander dressed in official helmet with detachable transmitter and receiver, goggles, 1:1 scale hammer action .45 automatic pistol, holster, binoculars and strap, insignia, Capt. Eagle eye patch and weapons data cards.

9.97

Chips® Complete Police Set

Deluxe official CHIPS® Motorcycle Helmet Set. Has safe durable plastic helmet, with tinted movable visor with adjustable headband and chin strap. Snub nosed hammer action magnum, holster, CHIPS® badge, handcuffs and keys, walkie-talkie and "hook-up" wire, traffic tickets.

10.97

Eagle Force™ Commando Assault Set

Aussie type cowboy hat plus Capt. Eagle eye patch, 24" long rapid fire automatic weapon with real 2X magnifying scope, detachable shoulder stock for machine pistol look, and detachable ammo clip, hand grenade, web belt and buckle with detachable bullets, insignia and weapons data cards included.

5.97

Eagle Force™ Automatic Weapon Set

Every boy wants to be Capt. Eagle and this is the set just for him. Featuring 1:1 scale hammer action .45 automatic pistol, holster, web belt, grenade, Capt. Eagle eye patch and weapons data cards.

3.97

The Dukes Of Hazzard™ Official Archery Set

The Dukes of Hazzard™ western belt and buckle with attachable plastic quiver to store safe play arrows and durable bow.

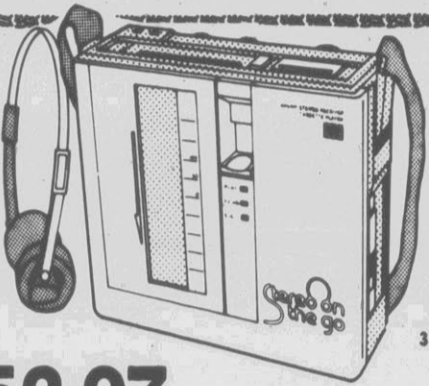
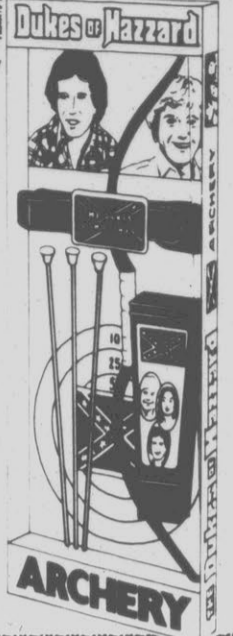

52.97

Portable AM/FM Stereo Radio With Cassette Player
Battery-operated. With tuning dial, muting button and slide switches. Shoulder strap and headphone included.
*Batteries not included

BSR



19.88

Quality-built AM/FM Digital Clock Radio
With large lighted numerals, 24-hour wake-up system, AFC, auto-volume control and slide rule dial. Walnut look.



K mart® Sale Price **6.00**
Less Factory Rebate **- 2.00**

Your Net Cost After Factory Rebate **4.00**

A New Twist™ Hot Curling And Styling Brush
Tangle-free, bristle-design brush for shaping and curling, stay-cool tip, on/off switch and indicator light.



SANTA'S SPECIALS!

Our Reg. 13.97
10.97

3½-qt. Crockery Kettle
Cooks 8-10 hours unwatched; no burning. Metal case.



K mart Sale Price **32.97**
Less Mfg. Rebate **-5.00**
Your Net Cost After Rebate **27.97**

12" Skillet With Non-stick SilverStone®
Thick aluminum construction helps spread heat evenly. SilverStone® interior resists scratching. Save.
*DuPont Reg. TM

20.87

Quality 7-speed Blender
Removable blade assembly, 5-cup shatterproof pitcher, 2-pc. lid, measuring cup. At savings.

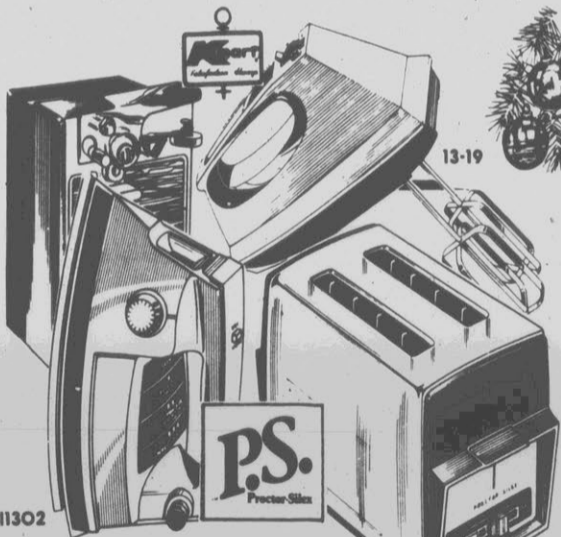
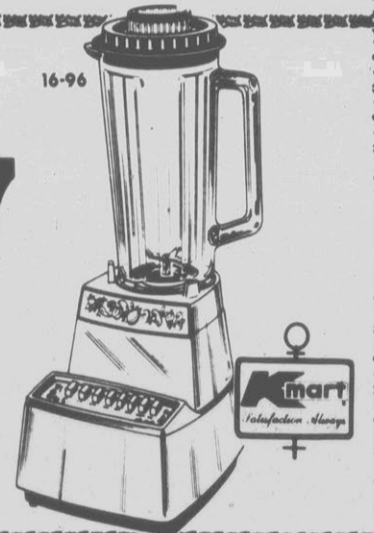

10.87 Your Choice

- Electric can opener •Lightweight 3-speed hand mixer
- Lightweight™ steam/dry iron •Convenient 2-slice toaster



19.97
Multifunction 5-quart Dutch Oven Cooker/Fryer

Wide top opening with glass cover, heat control dial and perforated aluminum basket with handle. "Garden Pattern."



K mart® Sale Price **14.87**
Less Factory Rebate **-5.00**
Your Net Cost After Factory Rebate **9.87**

Smoke Detector/Alarm
Detects visible and invisible fumes. With 9-volt carbon zinc battery.

K mart® Sale Price **19.87**
Less Factory Rebate **-5.00**
Your Net Cost After Factory Rebate **14.87**

Smoke Alarm With Light
Escape Light™ gives extra visibility. 2 9-volt batteries included. Save.

Rebates limited to manufacturer's stipulations



39.97 Our Reg. 49.97

AM/FM-AC/DC Cassette Tape Recorder
Features condenser microphone, automatic stop, slide rule tuning, volume control, antenna, built in line cord, jacks for earphone and more.

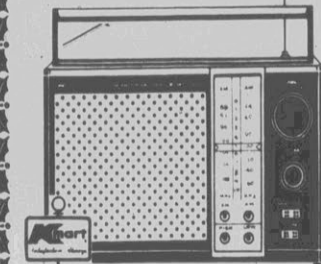

14.88

AM/FM Portable Radio
AC/DC*, full-circuitry, earphone jack.
*Batteries not included



Our Reg. 12.97
9.97
4-PIECE FIRE SET

Useful 28" high set includes brush, shovel, poker and stand.

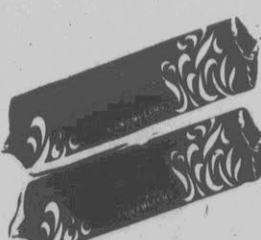

69¢
FIREPLACE LOG
Burns color flames for ½ to 3 hours.

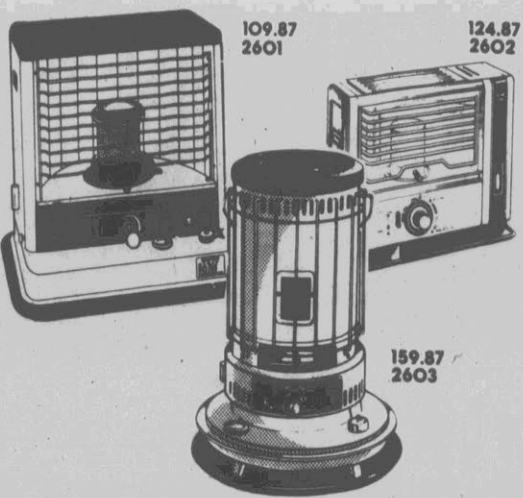

109.87

Portable Kerosene Heater
9600 BTU's heater offers safe, warm radiant and convection energy. With push-button ignition for instant lighting. Save!

10,500 BTU's Portable Kerosene Heater.....**124.87**
20,000 BTU's Portable Kerosene Heater.....**159.87**



Our Reg. 69.88

47.00

36" All-year Energy-saving, 4-speed Ceiling Fan
In winter, gentle circulation of air adds personal comfort and cuts fuel costs.
Our Reg. 79.88, 48" Ceiling Fan.....**49.00**

Kmart

Wed.-Sat.
Sale

ADVERTISED MERCHANDISE POLICY
Our item selection is to have all advertised items in stock on our shelves. If an item is not available for purchase due to any unforeseen reason, we will issue a Rain Check on request for the merchandise. Items are not available in quantities to be purchased at the sale price unless otherwise specified or will sell at comparable quality items at a comparable reduction in price.

Escort
Installation Available



Our Reg. 88.88
64.88
Cruise Control Electronic, Automatic, std. trans.
For Many Cars, Trucks, R.V.'s



Auto And Sporting Goods

gifts for everyone

Store Hours
Mon.-Sat.
9:30 'til 9



1983 AUTO REPAIR MANUAL 1983



9.57



13.97

Our Reg. 11.97 Our Reg. 18.88
9.57 13.97
Repair Manual Sporty Wheel Cover
The 1983 edition is Chrome, 13-, 14- or here! In large 8 1/2 x 11" - 15-in size. Basket design paperback. Save! Taches for cleaning.

7.97



9.97 (by car vac)

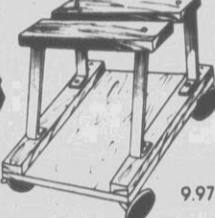

9.97

Our Reg. 12.88 Our 13.88
7.97 9.97
40-pc. Socket Set Mechanic's Seat
1/4- and 3/8-in dr. Rolling seat with Metric, SAE. Save! convenient tray.
Our Reg. 14.96, 12-volt Car Vacuum With 3 Attachments. Plugs into Lighter. 9.97

Save 34%



12.97

Our Reg. 19.88
12.97
Highway Emergency Kit
With booster cables, tire inflater, 12-V spotlight, more. Save!



SPARKOMATIC
Save 29.91
LC100

Our Reg 79.88
49.97 Pr.
The Sparkomatic® Amplified Speaker System Creates A Rainbow Of Sound
6x9-inch coaxial speakers with full-range amplifier to increase output by 40 watts. Installation Available



Our Reg. 35.97
\$27
600x12" Plus 1.43 F.E.T. Ea.

BIAS PLY BLACKWALLS
All Tires Plus F.E.T. Each Mounting Included • No Trade-in Required

SIZE	REG.	SALE	F.E.T.	SIZE	REG.	SALE	F.E.T.
A78x13	38.97	30.97	1.59	F78x14	48.97	41.97	2.12
600x15	45.97	34.97	1.72	G78x14	50.97	43.97	2.26
B78x13	42.97	34.97	1.71	G78x15	52.97	45.97	2.35
C78x14	44.97	37.97	1.88	H78x14	53.97	45.97	2.49
E78x14	47.97	40.97	2.01	H78x15	54.97	46.97	2.54

Sale Price
69.88
Ball Joints Installed
Alignment For Many Cars, Trucks, 15.88

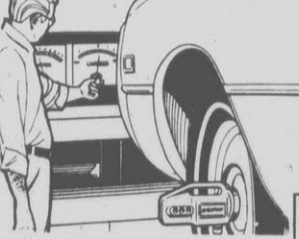

Chrysler® products and cars with one-piece ball joint and control arm assembly higher. Additional parts or services are extra, foreign cars excluded.

With Exchange
On Sale Thru Dec. 31



Kmart® Sale Price 52.88
Less Kmart® Mail-in Rebate -5.00
Your Net Cost After Kmart® Rebate **47.88**

PRICE AFTER REBATE 47.88
Motorvator™ 60 Maintenance-free Battery
In popular sizes to fit many American and foreign cars, light trucks. At savings now! Rebate limited to Kmart's® stipulation

Front Only Many U.S. And Foreign Cars
Light trucks higher. Additional parts and services, which may be needed, are at extra cost. Semi-metallic pads \$10 more.



68.88 Sale Price Your Choice

Disc Brake Special At Kmart® Savings

- Replace front brake pads
- True rotors
- Rebuild calipers (single piston only)
- Repack inner and outer bearings
- Refill hydraulic system
- Replace front grease seals
- Inspect master cylinder
- Inspect rear lining for wear (additional cost if repairs on rear are needed)

ARRESTOR PLUS



Complete exhaust system available, additional parts, services extra. Single-unit (welded systems) excluded.

Installed H.D. Muffler Rust-resistant. For many U.S. cars, lt. trucks.

Our Reg. 13.97 - Carryout
9.97 14.28 Each Installed
Premium Radial-tuned Shocks
"Our Best" shock for many U.S. cars.
Our Reg. 15.97, Truck/Van Shocks, Ea. 13.97 *Installed, Ea. 17.28

Solid Fuel Sticks 77¢



1.27

1.27 Our Reg. 1.97
Pocket Hand Warmer
Uses solid fuel. Save!
Our 1.28, 12 Fuel Sticks, 77¢

HUNTING AND FISHING LICENSES SOLD IN MOST SPORTING GOODS DEPTS.



5.97 Our Reg. 9.97
5-spring Chest-pull Exerciser
Zinc plated. Heavy-gauge spring.

Save 33%



1.97 Our 2.97 Your Choice
Hand Grips Or Deluxe Jump Rope
1-pr. grips or 8 1/2' rope with wood handles.

44.97



16.97

44.97 Sale Price
Reliable O88 Single-shot Shotgun
12-, 20- or 410-ga size. Side-lever action release.
Our 20.97, Case, 16.97; Our 22.97, Scope Model, 17.97

Kmart® Sale Price 3 Pkgs. 2.10
Less Factory Rebate -2.00
Your Net Cost After Factory Rebate 3 Pkgs. 10¢



PRICE AFTER REBATE 3 Pkgs. 10¢
Choice Of Batteries
2 "C" or "D" or 1, 9-V, Pkg. Of 4 "AA" 1.27
Rebate limited to mkt.'s stipulation

Jr. Size 12x6x13 1/4"
Adult's Size 12x8x16"



7.97 Ea. - Our 9.97
Mac Gregor® Backpacks
420-D nylon with acrylic coating. Choice of sporty colors.

Men's, Women's, Sizes



Your Choice
3.97 Our 4.57- Pr. 5.97
Pile-lined Ski Gloves
Vinyl, polyurethane. Many sizes, colors.

7 Targets On Roller



1020 9.97

9.97 Our Reg. 13.97
BB Repeater Air Pistol
20-shot. Fast load, easy action.
6.88, Indoor/Outdoor Target, 4.97
Not sold where prohibited by law

4.97 Your Choice Our 5.97 - 7.97
Rugged Sharp® Pocket Knife
Individually boxed. 2- or 3-blade styles with wooden handle.



Kmart® Sale Price 8.97
Less Factory Rebate -2.00
Your Net Cost After Factory Rebate 6.97



PRICE AFTER REBATE 6.97
Lil' Playmate® 6-qt. Cooler
Polyethylene - cooler with push-button, swing-down lid. Rebate limited to mkt.'s stipulation

West Europe's Youths: A Jobhunting Generation

By JEFF BRADLEY
Associated Press Writer
LONDON (AP) — Whether college graduates or teen-age dropouts, young people leaving school in Europe today share a common fear: will they ever find a job?

World recession has pushed the continent's unemployment to post-World War II peaks, and those under 25 are among the most vulnerable.

Budget cuts have brought the age of the newly qualified but jobless doctor. From Italy's Fiat to Britain's ICI, industries are hiring fewer trainees. And some countries, including France, are looking at possible reductions in handouts to the unemployed.

There are now 4 million young Europeans without jobs. Some fear that only the scrapheap lies ahead as traditional industries, such as steel and textiles, contract.

"The situation is absolute-

ly hopeless," said Gert-Jan Goedkoop, a Dutch doctor who graduated last year but can't find work.

"When I entered university seven years ago, every doctor was certain of a job. Now medical care is being hit by severe budget cuts and there are some 800 jobless doctors walking around," he said.

The Common Market Commission wants the 10 West European nations in the trading partnership to guarantee every youngster who graduates or leaves school either a job or professional training.

The problem is "a ticking bomb" threatening society, said the Institute of Social Research in Denmark, where the 15.3 percent youth jobless rate compares with 2.5 percent 10 years ago.

Born in an era when British Prime Minister Harold Macmillan was telling their parents they'd "never had it so good," Europe's young

jobhunters belong to a TV-entertained, good-life generation — which makes the search for a fulfilling job all the harder to take.

"I thought I could survive for a year without feeling anxious, but it hasn't worked out like that," said 23-year-old Flavia Hawkesley, who graduated with a degree in music from England's Sussex University in 1981 but hasn't found a job.

Italy and Luxembourg have the highest under-25 jobless rate, comprising 49.7 percent of the unemployed. Britain, France, the Netherlands and Belgium also are above 40 percent.

British unemployment is at its worst since the 1930s, and half of those leaving school this year moved straight onto the dole, joining a dispirited colony of 1.3 million young people.

In Britain, the numbers would be even higher if it were not for the state-subsidized Youth Op-

portunities Program and other projects keeping about 440,000 young people off unemployment registers.

Among those on \$40 a week state benefits is Stephen Boyd, 18, who lives with his widowed mother in Northern Ireland, where 22,000 of the unemployed are aged 19 or

To Compensate Losses On Tris

WASHINGTON (AP) — The House has approved legislation that would provide a way to compensate firms who lost money when the government banned use of the anti-inflammatory chemical Tris on children's sleepwear.

The legislation, which passed the Senate earlier this year in similar form, would allow textile and garment manufacturers to turn to the U.S. Court of Claims for assessment of their losses.

younger.

Boyd completed a business studies course at Belfast College of Technology two months ago and would like to enter the civil service. But there are no openings.

"The only vacancies seem to be for hairdressers, or jobs where they offer you two pounds (\$3.50) more than your dole money for a week's work," he said.

Outside the labor office in Frankfurt, West Germany, Jacques Weber, 24, talked about the job he lost as a housepainter five months ago.

"I got kicked out of my parents' house because of it, and right now I'm living in my car," he said.

Even prosperous

Switzerland is feeling the pinch. Unemployment is just 0.5 percent. But there are 2,448 people under 25 out of work, according to the government, compared with 915 last year and just 13 a decade ago.

Roman Mueller, 21, completed a three-year Swiss apprenticeship as an offset printer but was laid off because of a lack of orders. He said he spends his time "sleeping in, helping with chores at home and with my hobby, photography."

Italy's giant car manufacturer, Fiat, halted new hiring in 1980. "If there is any turnover at all, we only take on very highly qualified and specialized people," said spokesman Camillo Frei.

Most countries have recognized youth unemployment as a critical issue.

Spain's new government has promised to create 800,000 new jobs in the next four years.

"I expect the Socialists now ruling Spain will do their best to resolve the situation," said Antonio Perez, 26, an unemployed Madrid attorney among more than 100,000 graduate lawyers, architects, engineers and other professionals out of work.

Spain is one of the few countries offering no state benefits to those seeking their first job, although West German youths in the same predicament and living at home also lose out.

France's deficit-ridden benefits program is on the verge of collapse, and a new government plan would halt payments to those who have worked less than six months in the past two years.

But Socialist President Francois Mitterrand's administration has cut the work week from 40 to 39 hours to create a reported 70,000 new jobs and increased civil service recruitment.

Ahold, the biggest supermarket chain in Holland, recently opened a store in the eastern Dutch

city of Apeldoorn which is run by 28 previously jobless people under 25.

Youth unemployment is rising fast in West Germany, now 0.5 percent above the national average of 8.4 percent, although traditional apprenticeships still take about 60 percent of all those who leave school.

Friedrich Krupp GMBH raised its intake of trainees this year by 5.8 percent "for social reasons," and Hoechst, a chemical firm, budgets about \$8,000 for each of its 1,948 apprentices.

Bolster Power In Mail Fraud

WASHINGTON (AP) — The House has passed a bill designed to strengthen the Postal Service's power to protect the public from mail fraud.

The legislation gives the Postal Service new subpoena and investigative powers, enabling it to move more quickly than it can now against suspected mail racketeers.

Present law permits the postal service to shut down a mail order scheme only after lengthy hearings before an administrative law judge.

Opening Doors To Information

By GRAHAM HEATHCOTE
Associated Press Writer
LONDON (AP) — Running a library these days isn't just being wise about books, but also knowing how to press buttons to tap other kinds of information stored in computers.

Paul Channon, Britain's Minister for the Arts, opened a new Information Technology Center in London recently to show how to do it.

He said businessmen, as well as librarians and students, will benefit.

"We have unbelievable stores of information in Britain," Channon said. "The new technology will give proper access to these stores and should help our exports. Small organizations have got to learn how to use the information available. If they don't, they will fall behind their competitors."

The center, unique in Britain, is close to Oxford Circus and housed in the Central London Polytechnic, a college of higher education. Visitors will be shown how to operate a variety of microcomputers that can be used at home or workplace to

connect with information stores.

Channon came into the picture because the center is jointly funded by the state-run British Library, inheritor of the books in the British Museum and several other state libraries, and the government's Department of Industry.

Graham Cline, an information scientist for a food manufacturing research group, who was demonstrating equipment at the center, said card indexes and filing clerks — "expensive and they make mistakes" — are becoming redundant. Information recorded on discs can be called up on microcomputer screens, edited and updated, then put back in.

"The main beauty of the system is that you can search for what you want very rapidly," he said.

Increasingly, specialized libraries are putting their information into computers so that anyone can use it for a fee. The House of Commons library in London has done it and so has the U.S. National Library of Medicine at Bethesda, Md.



ROUGH GOING — Jackie Turbyfill found the going rough as he rode his bike through the field in front of his house after a winter storm dumped five inches of snow on the northwestern

North Carolina community of Elk Park. Temperatures in the single digits made driving a car hazardous on the icy roads, much less a vehicle such as a bicycle. (AP Laserphoto)

Have You Missed Your Daily Reflector?

First Call Your Independent Carrier.
If You Are Unable To Reach Him
Call The Daily Reflector

752-3952

Between 6:00 And 6:30 P.M. Weekdays
And 8 'Til 9 A.M. On Sundays.

It started with a dream. Henry Breyer's dream to make the best ice cream the country had ever seen. So he searched to find the best vanilla beans on earth. And he added only extra-rich, dark chocolate to Breyers ice cream. To this day, only fresh, natural ingredients go into Breyers ice cream. Like real milk and cream. Pure sugar. And nothing artificial. Ever. Sometimes, if you care enough, a dream can last a long, long time.

The all natural ice cream. Since 1866.



HENRY BREYER HAD A DREAM SO REAL HE COULD TASTE IT.

Here's 30¢ to taste a dream.

30¢ off any half-gallon of Breyers ice cream.



Mr. Grocer: Kraft Inc. will reimburse you for the face value of this coupon plus 7¢ handling allowance provided you redeemed it on your retail sales of the named product(s) and that upon request you agree to furnish proof of purchase of sufficient product to cover all redemptions. Coupon is void where taxed, prohibited, or restricted by law, and may not be assigned or transferred by you. Cash value 1/20¢. Customer must pay applicable tax. For redemption, mail to Kraft Inc.-Dairy Group, P.O. Box 1799, Clinton, Iowa 52734. Expires 6/30/83.

14300 205987

YOU'RE GONNA LOVE 'EM!

LIPTON INTRODUCES QUIETLY CHAMOMILE AND CINNAMON APPLE HERBAL TEA.

Now. Enjoy two deliciously different tastes from Lipton. Quietly Chamomile is a soothing blend of chamomile enlivened with hibiscus and natural lemon flavors. Or treat yourself to Cinnamon Apple—an exotic blend of natural cinnamon, hibiscus and apple pieces. And like all Lipton Herbal Teas, both are caffeine-free and delicious!



Save 15¢
on New
Quietly Chamomile, Cinnamon Apple
or
any of your favorite
Lipton Herbal Teas
LIMIT: ONE COUPON PER PURCHASE

15¢

15¢

15¢

CB Radio Craze Virtually Dead After Five Years

By NORMAN BLACK
Associated Press Writer

WASHINGTON (AP) — It took 16 years for most Americans to discover Citizens Band radio. And just five years to forget it.

The decline in popularity has been so swift that the Federal Communications Commission may stop licensing CB users. Officials believe the craze is over and there's no reason to continue.

The FCC won't act until next year but the fact it is even proposing the step emphasizes how things have changed.

Consider:
— At the height of its popularity, about one of every seven vehicles had a CB radio and the FCC received a million license applications a month. At times, the agency's processing backlog extended more than six months.

— The first lady at the time, Betty Ford, made news by getting a license and adopting "First Mama" as her handle. Elvis Presley became "The Music Man," Burt Reynolds, the "Bandit," Billy Carter, "First Brother."

— In 1974, when the boom started, CB radio was 16 years old and had slightly more than 1 million licensees. By 1978, there were more than 14 million. Many had more than one radio. Now only 5 million CBers have licenses.

But there was another element to the boom besides numbers. CB radio came to represent a lifestyle.
"There was a subculture to the thing, definitely, with songs and movies and a proletarian overtone," says John Sodolski, vice president of the Electronic Industries Association which represents radio manufacturers.

"I remember listening to an interview with psychologists at Vanderbilt University discussing what was happening to society, because people were talking to each other without really identifying themselves," recalls James C. McKinney, chief of the FCC's private radio bureau.

"That was the thing, the anonymity," McKinney says. "It was social and outgoing but it was also closed and private. It was weird. People could get their jollies doing things and saying things they normally wouldn't."

It was January 1976 that the FCC recorded its peak of 1 million license applications in one month. Within two years the boom was over and the decline set in. By October, the latest month for which figures are available, the FCC was processing only 30,000 applications — for both new and renewed licenses.

"That's the all-time low for at least the last 15 years," according to McKinney.

Explanations for the decline are varied.
Richard M. Smith, chief of the FCC's field operations bureau, cites the fad element: "A desire to participate in whatever is 'in.' When the novelty wore off, so did consumer interest."

Jerald H. Reese, executive director of REACT International Inc., an organization of CBers who report highway emergencies and assist in disasters, blames the marketplace.

He says that when the FCC increased the number of CB channels from 23 to 40 in 1976, retailers were caught with millions of the older units. Price reductions for those radios kept prices down for 40-channel sets, "reducing profits and drying up money for the advertising and promotion that is needed to sustain any industry."

Reese and Sodolski also contend that more CBers meant more congestion. Sodolski also blamed a period of peak sun

spot activity, which created additional interference. The noise just turned many operators off, they said.

McKinney and Smith have yet another explanation.
"There were two things that caused the boom," says McKinney. "The 1974 oil crisis and the reduction in the speed limit to 55 miles per hour."

"When the truckers began staging strikes and road blockades to protest the fuel shortage, America was exposed to this thing called CB that the truckers were using to organize and keep an eye out for Smokey (police)," adds Smith. "It was free publicity. But now, we've come full circle."

The decline in CB's popularity, however, does not mean it will disappear, says Sodolski.

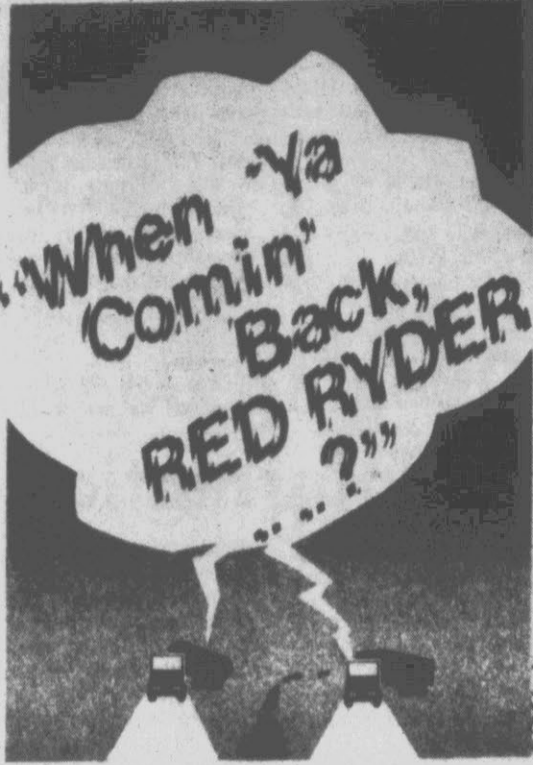

Milk Measured By The Pounds

WASHINGTON (AP) — Everybody knows that milk is sold in stores in gallon, half-gallon or quart containers. You simply don't buy milk by the pound, like meat or potatoes.

So it may be confusing to non-farm people when government and dairy industry experts refer to the number of "pounds" of milk consumed or produced by the nation's cow herd.

The Agriculture Department is trying to end the confusion by explaining the measurements and how much milk goes into dairy products such as cheese, butter and ice cream.

A common denomination in the dairy industry is a hundredweight — 100 pounds — of milk. That is equal to slightly more than 11.6 gallons or 46.4 quarts or 92.8 pints.

Richard Webber of the USDA's Agricultural Marketing Service suggests that "a lot of families frequently have the equivalent of 100 pounds of milk in their refrigerators."

"For example, let's suppose that there's a family gathering and the chief cook has assembled three pounds of butter, a gallon of ice cream, a gallon of milk and three pounds of different cheeses," Webber said. "That alone represents more than 113 pounds of milk."

The report explained Webber's calculations this way:

—It takes 21.2 pounds of whole milk to make one pound of butter.

—A gallon of ice cream, which weighs 4.5 pounds, is made from 12 pounds of milk — 15 pounds if butter and concentrated milk are in the recipe.

—Each pound of cheese requires about 10 pounds of milk.

"The dairy industry, in transactions between farmers and buyers of milk, always deals with milk in terms of pounds rather than liquid measures because it is easier to weigh milk than to meter it," Webber said.

"Also, a large part of the nation's milk goes into manufactured dairy products that cannot be easily

extracts attract coyotes strongly, and these volatile chemicals are being tested on a colony of coyotes at the university's Hopland Field Station. The goal is to isolate an attractant that is both more species-selective than present commercial lures and more effective when used with traps or other control methods.

Will Observe First Flight Anniversary

KILL DEVIL HILLS — Scott Crossfield, the first man to fly the X-15 rocket plane at two and three times the speed of sound, is one of two speakers Friday at the Wright Brothers Memorial for the anniversary of the birth of manned flight 79 years ago.

The other speaker will be Thomas H. Davis of Winston-Salem, chairman of Piedmont Aviation.

Ceremonies will begin at 9:30 a.m., a short distance from the granite boulder marking the spot where Orville Wright, on Dec. 17, 1903, became the first man to experience powered flight. The 12-second flight covered 120 feet across the sands of the Outer Banks. The event was a triumph for brothers Wilbur and Orville Wright, who had experimented in flight for two years at Kill Devil Hills before the Dec. 17 success.

The annual ceremony is sponsored by The First Flight Society of Kitty Hawk in cooperation with the National Park Service and several aviation organizations.

First Flight Society president Marc Basnight of Manteo will extend a welcome following opening remarks by state Sen. Melvin Daniels, D-Pasquotank County, and Capt. Fred Merritt, U.S. Coast Guard (Ret). Others having a part in the opening ceremonies will be Tom Hartman, superintendent of the Cape Hatteras National Seashore, and Kill Devil Hills Mayor Ben Hill.

Davis will speak briefly prior to a commemorative fly-over by military jets. The ceremony will conclude with the traditional laying of wreaths at the monument marking the site of the first flight.

Music will be provided by bands from Northeastern High School, Elizabeth City, and Manteo High School.

A luncheon will follow the ceremony at the Seafare Restaurant in Nags Head.

Persons interested in more information and luncheon reservations may call Claire Bullington at 441-7251.

Seek Allures For Coyotes

KANSAS CITY, Mo. (AP) — Coyotes are a problem for ranchers in many Western states because they prey on livestock, particularly sheep. Coyote control methods have been highly controversial, and lures often are not sufficiently selective or effective for widespread use.

A cooperative project between the University of California, Davis, and the U.S. Department of Agriculture's Western Regional Research Center in Berkeley, Calif., is seeking naturally occurring chemical attractants that could be used to make coyote control methods more effective.

Their research on extracts of sheep liver was reported recently at a national meeting of the American Chemical Society in Kansas City.

A group of USDA chemists led by Roy Teranishi has found that certain sheep liver

Pay Reduced By Stock Prices

NEW YORK (AP) — The base pay of top executives in medium-size companies rose an average of 9.7 percent in 1981, keeping pace with inflation.

However, overall compensation fell, hurt by lower stock prices, according to a survey of 215 companies conducted by a management research firm.

The typical chief executive officer received \$27,000 in capital accumulation last year, compared with \$89,000 the previous year.

Executives in oil companies, where such stock deals are a major part of compensation, fared the worst, while those in manufacturing, where they are not, did better.

Unique Role For Students

ROCHESTER, N.Y. (AP) — Students in the University of Rochester's special London Semester Program have an unusual opportunity: getting academic credit for serving three months as research and administrative

assistants to Members of Parliament.

Their assignments range from handling correspondence with constituents and governmental departments to coordinating constituents' visits to Parliament.

EAST COAST ROOFING

**Congratulates
The Pitt-Greenville
Chamber Of Commerce
On The Opening Of Their
New Building.**

1314 N.
Greene St.752-0400



**The Pitt-Greenville
Chamber of Commerce, Inc.**

Cordially invites you
to attend the official opening of
the new Chamber of Commerce office located in
The Fleming House, 302 South Greene Street
on Thursday, December 16, 1982
Open House 3:00 P.M.-7:00 P.M.

Refreshments Served

Congratulations

**Pitt-Greenville
Chamber of Commerce**

We are pleased to have
been selected to provide
the wallcovering and
painting service for
this renovation.



MILLER & DAVIS
ASSOCIATES
GREENVILLE, N.C. 758-7474



Wingate's Mill Work, Inc.

10th Street Extension • 758-4546

Is pleased to have been selected to do
the mill work for the new home of

**Pitt-Greenville
Chamber Of Commerce**

We are proud to have been a part of
this new, exciting venture. Best
wishes to all!

Congratulations

**Pitt-Greenville
Chamber of Commerce**

We are pleased to have been chosen as
General Contractor for the construction of
your new home and proud to be a part of
this wonderful venture.

Bill Clark Construction Co., Inc.

1902 S. Charles St.
756-6336

Congratulations...

Pitt-Greenville Chamber of Commerce
We Wish You The Best.

John's Hardware

622 Pitt Street
Greenville, N.C.
752-3493
Call Us For All Your Hardware Needs.

Congratulations,

Pitt-Greenville Chamber of Commerce
We're proud to have had a part in remodeling
your new home.



756-2376

— JACK COBB, OWNER —
COMMERCIAL STEEL
FABRICATION
—WELDING—
STEEL, ALUMINUM & STAINLESS
—SHOP DRAWINGS—
COMMERCIAL & INDUSTRIAL
EQUIPMENT DESIGN
FARMVILLE HWY. GREENVILLE, N.C.

Lone Star Layoffs Cutting Deep Into East Texas

By LAURA RICHARDSON
Associated Press Writer
LONE STAR, Texas (AP) — The great smoke stacks of Lone Star Steel's blast furnace and coke ovens stand silent and empty. Where once 4,500 union men worked, 500 are employed. There is no holiday joy.

"I'll tell you how it is. I just feel like a little child," said a man who lost his job when the plant shut down Aug. 21. "I want to crawl into mama's arms, or some loving woman's arms, and just cry, because I'm afraid I'm going to lose it all."

"I can't tell my wife that. I have to say I'm not worried," he said. "If she knew how scared I am, it would just kill her. That would be it."

Mist hangs over the Lake O' The Pines, where people who ought to be working dangle fishing lines over the

sides of little punts, gray shapes on glassy water. A great white heron stands in the shallows with one leg drawn up, and a flock of wild ducks floats motionless.

Tidy stacks of rusting pipe, part of the inventory that is choking the country, cover the Lone Star storage lots. Lone Star catered to the oil industry, and now the party's over. Drilling is down by almost half, and there is no need for pipe. Company spokesman Mayo Lanagan said he didn't know when people might go back to work. Maybe next year.

This part of East Texas was never money-rich. The economy was hard-scrabble farming and bootleg whiskey before the U.S. government built the huge Lone Star plant during World War II. When the plant was turned over to private industry, people got used to high

wages and a country version of the good life.

Strikes and layoffs have hit people before. But never this hard.

"I saw folks lose everything they had in the 1957 strike. That lasted a year, and my next-door neighbors just plain had to start over," said Jimmie Beth Foster, whose husband was laid off in August after 27 years at Lone Star. "But it was different then. You could go somewhere else and find work. Now, I don't know where people are going to go."

"Someone said, all these kids can go home to mama and daddy, but I can't go home because we ARE mama and daddy."

Unemployment in Morris County is 30.1 percent; it's

more than 20 percent in neighboring counties. People are scraping by on \$147 a week from the state, benefits that expire in mid-February.

Everybody who depended on steel or steelworkers hurts. There have been related layoffs at the trucking companies and the Texas & Northern Railroad, pay cuts at the little grocery stores and at the semiweekly newspaper, The Steel Country Bee.

Holiday business is terrible. Only whiskey has shown an increase in sales.

"Our sales generally are off, yes," said Charlie Barker, manager of Anjo Liquor. "Except in whiskey, the smaller sizes. Those are up over what they'd normally be this time of

year. A lot of people are drinking to get drunk, we all know that, and it's cheaper to do it with whiskey than beer."

"It hasn't really soaked in yet," said Johnny Scott, president of Daingerfield's Chamber of Commerce and vice president of the National Bank of Daingerfield. "Morale's pretty high. Now, next month, when Santa Claus is supposed to come, I think you'll see some difference."

"Christmas? What Christmas?" snorted Tim Bazar, a millwright laid off after five years at the plant. "We bought the kids some stuff last January, and that's all they're getting. As for what I'm going to tell them,

you better ask me the day after Christmas, because I don't know right now."

At Lone Star, Bazar made \$12 in less than an hour. Now, he said, he's picking up \$12 to \$20 a day working cattle at livestock auction barns.

"I'm not worried about my family starving," said Tom Van Hoose, 44, a machinist. "I can fish, I can shoot and they eat game real well. We had a pretty good garden last year, and the freezer's full. It's the other stuff — the telephone, the house payments, the truck payment, the utilities. I don't know %0e going to make it."

Van Hoose said he and his wife bought a new house four months before he was laid off. They bought a new \$10,000 pickup truck and a used tractor. They invested \$5,000 in a lakefront lot.

"Based on what I was making then, we could afford it. Now, I just don't know," he said. "Our savings, what little we had, went the first month, and we haven't paid on anything this month."

He said he could not find a buyer for the lake property and expected the developer to foreclose. The bank and credit union carrying his notes on the house and

vehicles have reduced the size of his payments, but he still owes \$701 a month. His wife has taken a baby-sitting job, and he cuts firewood, working out in the woods from sunup to sundown for \$40 a day.

"The banks are working with us every way they can, but of course they're working

on borrowed money, too," Van Hoose said.

"Yes, we're restructuring the loans, and extending some of them," Scott confirmed. "We'd prefer to get partial payments of course. We surely don't want to foreclose. What would we do with 2,000 houses and 4,000 cars?"

Best Wishes

Pitt-Greenville Chamber Of Commerce

We are pleased to have provided the paint for your new offices.

THE PAINT CENTER

Pittsburgh Paint Products
600 Arlington Blvd. • 756-7611

Travelers To Pay More For Hotel Telephone Call

By NORMAN BLACK
Associated Press Writer
WASHINGTON (AP) — Thirty-eight years after it began the practice, the American Telephone & Telegraph Co. is about to stop paying long-distance commissions to hotels. The result, at least in the short run, is likely to be higher phone charges for travelers.

When the commissions stop Jan. 1, the nation's innkeepers will be out roughly \$70 million in annual revenue that they've received on the basis of long-distance phone calls placed from their rooms.

The hotel and motel industry has known the 15-

percent commissions would erid for a year now, because AT&T originally wanted to stop the practice in 1981.

As a result, Stan Rosenzweig, a telephone consultant to the Hotel and Motel Association of America, estimates roughly half of the nation's 52,000 lodging establishments have already tacked surcharges on their guests' phone bills or announced plans to do so.

When the commission money actually stops flowing next month, Rosenzweig says more establishments will follow suit, while others may elect to recover the lost money through higher room charges.

"You must understand that hotel and motel owners have never made money on their telephone service," says Rosenzweig, the president of the Inntech Management Corp. in Mount Vernon, N.Y., who has spent the last 15 months helping the hotel industry prepare for the cutoff.

"They have to spend too much money on administrative costs and checking credit and collecting payments," he said.

Without the commissions, "hotels in the short term will charge more than they have in the past," he continued. "But over the long run, most will likely be charging less."

The reason for that latter prediction, Rosenzweig says, is that hotel operators will install automated call-identification equipment.

With the proper equipment, a long-distance call can be dialed directly from a room and billed by the hotel without any involvement by an AT&T operator. Without the involvement of an operator, the hotel is not charged AT&T's operator-assisted rates for the call.

The problem starting Jan. 1, will be that fewer than 2,000 of the call-identification systems will have been installed, Rosenzweig said.

Congratulations To
The Pitt-Greenville Chamber
Of Commerce
On The Opening Of Your
New Building

General Heating, Inc.

LENNOX
AIR CONDITIONING • HEATING

1100 Evans Street
Greenville, N.C.
Phone 752-4187

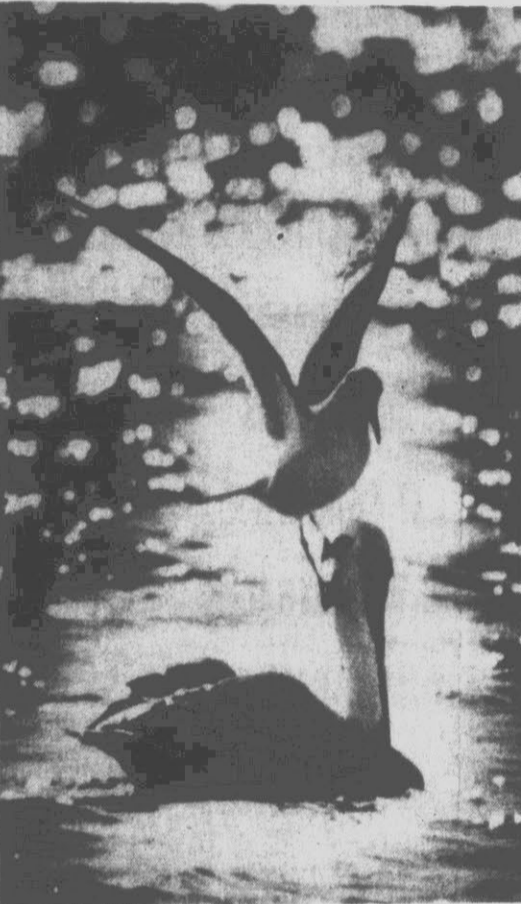

SHORT FLIGHT DECK — This seagull thought he could steal a meal from the pelican whose head he is using as a landing deck, but gave up after he failed in repeated attempts. The original idea was to perch atop the pelican's head and grab a fish as the pelican lifted his head to swallow his catch. (AP Laserphoto)

Speaking of Your Health...

Lester L. Coleman, M.D.

Many Causes for Neck Discomfort

Sometimes when I turn my neck I hear a sharp, clicking sound. Only once in a while, especially when I am fatigued, I get a shooting pain in the neck. I had an automobile accident when I was 20. I am now 46. Could the accident possibly be responsible for this? — Mr. L.G., Ga.

Dear Mr. G.:
There is always the possibility that an injury may be responsible for your complaint. Yet there is a greater possibility that slight osteoarthritic deposits in the cervical spine of the neck may be the cause.

In an effort to track down the cause of your discomfort, X-rays of your neck and the base of the skull are most helpful.

Occasionally the cartilages that comprise the voice box in the front of the neck become calcified. Then the cartilages may override each other and be responsible for the clicking sound you hear.

Some people "cradle" a telephone between the shoulder and the neck while using their hands for other purposes and this is often responsible for episodes of pain.

I recall once quoting an eye

doctor who told me that many of his patients who used bifocal glasses have a tendency to keep their heads in a distorted position. Apparently strain and tensions of the muscles of the neck may be ascribed to this. As you note, there are many strange causes of discomfort of the neck. Muscle spasms and neurological disorders, injury, arthritis, and wear and tear on the ligaments in the neck may all cause discomfort.

It takes a great deal of astute diagnostic study to pinpoint the cause of pain in the neck with or without the clicking sounds you mention.

After exacting clinical studies, X-rays are essential. Doctors probe carefully into a patient's history in an effort to relate the onset of these symptoms to an old injury that might well have been forgotten.

A great many people who have been involved in automobile accidents complain of the "whiplash" syndrome. Far too many of these victims of accidents are subtly accused of feigning a symptom to collect insurance sums.

This is distinctly unfair. For the whiplash injury is a very real and definite result of an automobile accident and one that can cause a great deal of distress long after the accident has occurred.

Before any form of treatment for neck pain can be instituted, it is obvious that an exact diagnosis must be established. Sometimes a protective collar is suggested. Overextension of the muscles of the neck must be avoided. Heavy lifting and too strenuous exercise must also be avoided.

Heat in various forms is excellent to relieve pain and to reduce muscular spasms. A great many excellent analgesics or pain-relieving drugs are now used without fear of addiction or dependency.

Only in special instances is it necessary to use traction to relieve the pain and spasm in the neck.

A great many people delay by many months seeking health. Invariably they give the same story — that they thought it would get better if left alone. Such a delay does one a great injustice. For by neglect anatomical changes occur and other complications make treatment exceedingly difficult.

Congratulations,

Pitt-Greenville Chamber of Commerce

Thank you for letting us do the electrical wiring for your new home.

G.B. Electric, Inc.

Commercial • Residential • Repairs
All Work Guaranteed
Gerald Buck, Owner

758-4688

Congratulations Pitt-Greenville Chamber Of Commerce

We are pleased to have been selected to install the slate roofing and sheet metal work on this fine institution.

E.L. SCOTT ROOFING COMPANY
P.O. BOX 128 KINSTON, N.C.
523-3111

Congratulations

To The
Pitt Greenville Chamber of Commerce.

Thank You For Letting Us Furnish Building Supplies For Your New Home.

HOME BUILDERS SUPPLY CO.

2000 Dickinson Avenue, Greenville, N.C.
758-4151

BIG STAR

Season's Greetings

FROM ALL OF US AT BIG STAR!

OLD FASHIONED DELUXE MOON PIES .. 12 PACK BOX **\$1.59** BIG STAR HOMO GENIZED MILK GAL. **\$1.79**



OUR MEAT DEPT. HAS A COMPLETE VARIETY OF FRESH TURKEYS: COUNTRY HAMS, CORNED HAMS, CANNED HAMS, FRESH HAMS, COOKED 'N FRUITED HAMS, GEESE, DUCKLINGS, CAPONS. SMOKED AND COOKED PICNICS FOR YOUR HOLIDAY ENJOYMENT!

PRICES IN THIS AD ARE GOOD THROUGH SAT., DECEMBER 18, 1982. QUANTITY RIGHTS RESERVED NONE SOLD TO DEALERS OR RESTAURANTS.



USDA A GRADE
YOUNG TURKEYS
18 LBS. & UP **53¢**
10 TO 17 LB. **63¢**

U.S. CHOICE BEEF BONE-IN
BLADE CHUCK ROAST
\$1.28 LB.



PEPSI, DIET
PEPSI, MT. DEW
79¢ 2 LITER

- U.S. CHOICE BEEF LEAN BONELESS **BLADE CHUCK POT ROAST** ... LB. **\$1.98**
- OLDE TOWNE HOT OR MILD **PORK SAUSAGE** 1 LB. PKG. **88¢**
- OLDE VIRGINIE **SLICED BACON** 1 LB. PKG. **\$1.28**
- U.S. GRADE A **BAKING HENS** ... LB. **69¢**
- U.S. CHOICE BEEF—BONE-IN **CENTER CUT CHUCK STEAK** ... LB. **\$1.58**

- TENDER LEAN **WHOLE SMOKED PICNICS** LB. **78¢**
- U.S. CHOICE BEEF—BONE-IN **7-BONE CHUCK ROAST** ... LB. **\$1.38**
- U.S. CHOICE BEEF—ROUND BONE **SHOULDER ARM ROAST** ... LB. **\$1.88**
- 3 TO 5 LB. AVG.—FRESH **PORK SPARE RIBS** ... LB. **\$1.38**

- U.S. CHOICE BEEF—3 LBS. OR MORE LEAN BONELESS **STEWING BEEF** ... LB. **\$1.98**
- 8 LBS. OR MORE—ASST. CENTER & END CUTS **PORK CHOPS** ... LB. **\$1.68**
- OSCAR MAYER REG. OR THICK **SLICED BACON** 1 LB. PKG. **\$2.28**
- OSCAR MAYER **SLICED BOLOGNA** 1 LB. PKG. **\$1.58**
- PULLMAN OR PEAR SHAPE—OSCAR MAYER EXTRA LEAN **CANNED HAMS** 3 LB. CAN. **\$8.98**

- WHOLE **N.C. COUNTRY HAMS** ... LB. **\$1.98**
- MAJESTY BRAND "THE LEAN ONE" **BONELESS COOKED HAMS** 3 LB. SIZE **\$6.98**
- 10 OZ. SUNSHINE **CHEEZ-IT CRACKERS** ... **79¢**
- 15 OZ. CHEF BOY-AR-DEE **ZOORONI W/MEATBALLS** ... **73¢**
- 15 OZ. CHEF BOY-AR-DEE **ABC'S W/MEATBALLS** ... **73¢**
- 32 OZ. WHITE HOUSE **APPLE JUICE** ... **58¢**
- 260 CNT. VIVA ASST. **DECORATED NAPKINS** ... **\$1.39**



SWIFT'S **BUTTERBALL TURKEYS**
18 LBS. & UP **78¢**



HOLLY FARMS U.S. GRADE A **FRYER LEG QUARTERS**
LIMIT 4 PKGS. **38¢** LB.



SWEET ZIPPER SKIN FLORIDA **TANGERINES**
10 FOR **98¢**



COLD POWER LAUNDRY DETERGENT
49 OZ. **\$1.48**

- 1 LB. DIXIE CRYSTALS LIGHT OR DARK **BROWN SUGAR** 2/\$1.09
- 1 LB. DIXIE CRYSTALS 4X OR 10X **CONFECTIONER'S SUGAR** 2/\$1.09
- 18.5 OZ. ASST. BETTY CROCKER **CAKE MIXES** 69¢
- 5 LB. PLAIN OR SELF-RISING **PILLSBURY FLOUR** 79¢
- 12 OZ. BASICS IMITATION **CHEESE SLICES** 99¢
- 9.5 OZ. BIG STAR BISCUITS **BUTTER - ME - NOTS** 3/\$1.00
- 16 OZ. BIG STAR **SOUR CREAM** 95¢
- 8 OZ. MUSHROOM/HERB OR TOASTED ONION **BREAKSTONE DIP** 75¢
- 12 OZ. BIG STAR REGULAR OR LOWFAT **COTTAGE CHEESE** 75¢
- HALF GALLON—**PET ICE CREAM** \$1.99

- HALF GALLON—FARM CHARM **ALL NATURAL ICE CREAM** \$1.99
- QUART—**BREYER'S ICE CREAM** \$1.49
- QUART—**PET EGG NOG** 99¢
- DOVER FARMS **WHIPPED TOPPING** 99¢
- 4 EARS—BIRDS EYE FROZEN **CORN ON THE COB** \$1.29
- 8 OZ. MORTON (CHICKEN, BEEF, TURKEY) **FROZEN POT PIES** 3/\$1.00
- 5 LB. PACKER'S LABEL REG. OR CRINKLE **CUT FROZEN POTATOES** \$1.29
- 1 LB. BAG—**MAXWELL HOUSE COFFEE** \$2.09
- 24 OZ. BIG STAR **BUTTERMILK BREAD** 2/99¢

- SWEET CALIFORNIA RED, WHITE OR BLACK **GRAPES** ... LB. 79¢
- EASTERN WINESAP, McINTOSH, ROME OR RED DELICIOUS **APPLES** 3 LB. BAG 99¢
- SWEET AND JUICY FLORIDA **ORANGES** 5 LB. BAG \$1.19 8 LB. BAG \$1.99
- NORTHWEST **D'ANJOU PEARS** ... LB. 49¢
- NORTH CAROLINA **CURED YAMS** 5 LBS FOR \$1.00
- FRESH **COCONUTS** ... EA. 59¢
- GENUINE HAWAIIAN **PINEAPPLE** ... EA. \$1.69
- LARGE FLORIDA **AVOCADOS** 2 FOR \$1.00
- YOUNG AND TENDER **COLLARD GREENS** ... LB. 39¢
- FRESH **MUSHROOMS** ... LB. \$1.89

OUR PRODUCE DEPT. HAS A LARGE VARIETY OF IN-SHELL NUTS AVAILABLE FOR THE HOLIDAYS!

- MEDIUM **YELLOW ONIONS** 3 LB. BAG 69¢
- POPSRITE **POPCORN** 2 1 LB. BAGS \$1.00
- JUMBO **WALNUTS** 1 LB. PKG. \$1.49
- FANCY **MIXED NUTS** 1 LB. PKG. \$1.59
- LARGE BRAZIL **NUTS** 1 LB. PKG. \$1.59
- EXTRA LARGE STUART **PECANS** 1 LB. PKG. \$1.79

WE ALSO HAVE A LARGE SELECTION OF FANCY FRUIT BASKETS FOR YOUR HOLIDAY NEEDS!



8 OZ. PILLSBURY INSTANT HUNGRY JACK
• MASHED POTATOES
16 OZ. STOKELY
• PEACH HALVES
17 OZ. LESUEUR
• EARLY PEAS
1 LB. QUARTERS
• BLUE BONNET QUARTERS
2 OF YOUR CHOICE \$1.00



16 OZ. POCAHONTAS
• ALL GREEN BUTTER BEANS
16 OZ. VAN CAMP'S
• PORK & BEANS
14.7 OZ. FRANCO AMERICAN
• SPAGHETTIO'S
16 OZ. LUCKY LEAF
• APPLE SAUCE
3 OZ. CHUN KING
• CHOW MEIN NOODLES
3 OF YOUR CHOICE \$1.00



16 OZ. STOKELY
• CUT GREEN BEANS
16 OZ. ROBERT'S
• CANNED TOMATOES
17 OZ. STOKELY
• HONEY POD PEAS
17 OZ. STOKELY
• WHOLE KERNEL CORN
"YOUR CHOICE" 38¢

A Deregulated Banking Industry Sees Big Changes

By LOUISE COOK
Associated Press Writer
The nation's bankers want YOU!

They want your money. They're willing — and now they're able — to pay high interest to get it.

What is happening in the banking business is similar to what has happened in the airline industry. It's called deregulation.

Deregulation of the airline industry was intended to increase competition. It has brought fare wars and new airlines. It has also brought less service and higher fares in areas where it is less profitable for the carriers to operate.

Deregulation of the banking business also is intended to increase competition. It has brought higher interest and new accounts. And it has also brought higher costs for borrowers and for people who don't have a lot of money to deposit.

William L. Kundert, vice president of the personal banking department of Continental Illinois Bank and Trust Co. in Chicago says deregulation "is bringing about a fundamental change in what a consumer can get at a bank."

The change has occurred largely as a result of the Depository Institutions Deregulation Act of 1980, providing a gradual end to limitations on the interest banks and savings and loan institutions can pay and the types of accounts they can offer.

The banking industry fought for deregulation, arguing that other financial institutions like brokerage houses had an unfair advantage because they operated under fewer regulations. Those other institutions were offering services like checking which traditionally had been the province of banks and savings and loan associations; they were paying higher interest and luring depositors from the banks and S&Ls.

Money-market mutual funds, which pool depositors' money and put it in high-interest investments, drew billions of dollars of consumer money — even though the accounts were not insured. By the first week in December, investments in 274 money-market funds measured by the Investment Company Institute hit a re-

cord high of \$231.5 billion. That's equal to about 15 percent of the total assets of the nation's commercial banks and to more than 33 percent of the assets of savings and loan associations.

Now, the banks and S&Ls are getting some new weapons. The Depository Institutions Deregulation Committee, which oversees the deregulation law, has virtually eliminated interest ceilings on accounts of over \$2,500, approving money-market accounts beginning today and SuperNOW high-interest checking accounts starting Jan. 5. And the new accounts will be insured by the government.

Bankers are enthusiastic. The U.S. League of Savings Institutions has estimated that \$100 billion will be deposited in money-market accounts alone at savings and loans in the coming years; the league estimates that up to 30 percent of the total will be "new money," not previously on deposit in S&Ls.

While the new accounts will make it easier for depositors to earn more interest,

however, they also could make it more expensive for borrowers. When banks have to pay more for funds, they charge more.

"It's possible," said Kundert, when asked about higher loan rates. He said that more and more of the money deposited at banks and S&Ls in recent years already has been put in

investments — like certificates of deposit — that earn market-interest rates. At Continental, he said, "about 60 percent of our deposits are in one kind of market-rate instrument or another."

The old regulations also helped banks even while they hurt them; the limits on interest rates meant that

banks often were paying less than they were charging. "We are no longer going to have that kind of protection," said Kundert. "We're going to have to be sharper in our pricing."

For many banks and S&Ls, being sharper in pricing has meant charging fees for services that used to be free. A growing number of in-

stitutions set minimum balances even for passbook savings accounts; no interest is paid if the balance drops below the minimum. Regular checking accounts carry monthly service fees averaging about \$5 if you don't keep a fairly substantial balance and per-check charges range from 10 cents to 25 cents. Charges for

things like overdrafts are up to \$15 at some institutions.

Kundert predicted that money-market and SuperNOW accounts will mean the end of some other new accounts that have been introduced in recent months and years.

"Because of the regulatory restrictions we just had an incredible number of pro-

ducts," said Kundert. "I think we're going to see some of those products being phased out."

"In one sense it's becoming more confusing because of the rapid rate of change, (but) I think on the whole product lines ... really are becoming somewhat more rational and easier for the consumer to understand."

Free School For Jobless

CINCINNATI (AP) — Mount St. Joseph College, trying to open "new vistas" for the unemployed, says it will begin offering free courses to people who have lost their jobs in the past year.

The offer, taking effect in January, is for unemployed people who live within 75 miles of the college.

"As a public service institution, the college of Mount St. Joseph has an obligation to contribute to the quality of life in our community," said college president Sister Jean Patrice Harrington.

Applicants must be at least 18 years old and have a high school diploma, she said. They must have held a full-time job for at least three years and have lost it within the past year.

"At this time of high unemployment in our area, we hope that the free tuition program can open new vistas of learning and career opportunity for the many adults in our area who are unemployed," Sister Harrington said Monday.

Cincinnati has an unemployment rate of 13.8 percent, compared with the 10.4 percent unemployment rate nationwide.

The offer covers tuition, general fees and registration, ranging in value from \$285 to \$369, Sister Harrington said. Participants may take up to three credit hours free and choose from about 400 courses.

The Roman Catholic college has 900 full-time undergraduate students and 1,000 part-time students.

STUDYING ABROAD
PEKING (AP) — China plans to send 15,000 students abroad, most of them to study natural science and technology, as part of its current five-year plan, the Xinhua News Agency reports.

A Christmas Police Tip: Ladies, when Christmas shopping, carry a purse which does not have an open top! Don't invite theft!



UNESCO RATIONS — Palestinian families line up outside the UNRWA offices in Beirut as they wait to pick up their monthly ration of staples. The UNRWA is providing Palestinian refugees with support in the form of foodstuffs, mainly staples like flour, oil and milk. (AP Laserphoto)

OPEN SUNDAY 10 A.M. 'til 7 P.M.

10 Lbs. and Up - Grade A

Food Town 58¢

Turkeys

Lb.

These prices good thru Saturday, December 18, 1982

<p>\$1.18</p> <p>19 - 23 Lbs. Average - Sliced Free - Smithfield Whole</p> <h2 style="font-size: 2em;">Smoked Hams</h2> <p>16-20 Lbs. Avg. - Whole Smoked Hams Lb. \$1.28</p>	<p>68¢</p> <p>10 Lbs. And Up - Food Town Grade A</p> <h2 style="font-size: 2em;">Basted Turkeys</h2> <p>4-8 Lbs. Avg. Smoked Picnics Lb. 98¢</p>	<p>\$8.98</p> <p>4 Lbs.</p> <p>Sliced Free - Swift</p> <h2 style="font-size: 2em;">Hostess Hams</h2> <p>10-14 Lbs. Avg. - Fresh Grade A Turkeys Lb. 78¢</p>
<p>\$3.79</p> <p>1.5 L. - Burg., Chab., Rhine, Rose</p> <h2 style="font-size: 2em;">Taylor Calif. Cellars</h2>	<p>\$3.99</p> <p>Pkg. of 12 - 12 Oz. Cans</p> <h2 style="font-size: 2em;">Old Milwaukee</h2>	<p>\$4.19</p> <p>Pkg. of 12 - 12 Oz. Cans</p> <h2 style="font-size: 2em;">Pabst Beer Schlitz Beer</h2>
<p>85¢</p> <p>2 Liter</p> <h2 style="font-size: 2em;">Coca Cola</h2>		
<p>99¢</p> <p>22 Oz. - 20¢ Off - Dish</p> <h2 style="font-size: 2em;">Sun Light Detergent</h2> <p>Why Pay \$1.37</p>	<p>99¢</p> <p>32 Ounce</p> <h2 style="font-size: 2em;">Del Monte Catsup</h2> <p>Why Pay \$1.19</p>	<p>79¢</p> <p>Quart</p> <h2 style="font-size: 2em;">JFG Mayonnaise</h2> <p>Why Pay \$1.29</p>
<p>\$1.69</p> <p>38 Ounce</p> <h2 style="font-size: 2em;">Wesson Oil</h2> <p>Why Pay \$2.09</p>		
<p>\$1.79</p> <p>49 Oz. - W/Softener</p> <h2 style="font-size: 2em;">Fab Detergent</h2>	<p>49¢</p> <p>119 Sheets - 2 Ply</p> <h2 style="font-size: 2em;">So-Dri Towels</h2>	<p>3/\$1</p> <p>1 Lb. - Food Town</p> <h2 style="font-size: 2em;">Margarine Quarters</h2>
<p>69¢</p> <p>6.5 Oz. - Lt. Chunk, In Oil Tuna</p> <h2 style="font-size: 2em;">Chicken Of The Sea</h2>		
<p>2/89¢</p> <p>17 Oz. - Whole/Cream Style - Golden</p> <h2 style="font-size: 2em;">Del Monte Corn</h2>	<p>99¢</p> <p>46 Oz. - Del Monte</p> <h2 style="font-size: 2em;">Pineapple Juice</h2>	<p>49¢</p> <p>8 Oz. - Whip Topping</p> <h2 style="font-size: 2em;">Quick Maid</h2>
<p>59¢</p> <p>18.5 Oz. - Betty Crocker</p> <h2 style="font-size: 2em;">Cake Mixes</h2>		
<p>10¢ Each</p> <p>Mix or Match - Your Choice</p> <p>Western Red or Golden Delicious Apples Calif. Seedless Navel Oranges Florida Tangeloes Florida Oranges Sunkist Lemons</p>	<p>\$2.99</p> <p>Each - 6"</p> <h2 style="font-size: 2em;">Beautiful Poinsettias</h2>	<p>89¢</p> <p>Quart</p> <h2 style="font-size: 2em;">Sealtest Egg Nog</h2>

Prices good at Greenville Food Town Store only

Campus-Corporate Ties Have Become Partnership

By LEE MITGANG
AP Education Writer
NEW YORK (AP) — You won't find them in the gossip columns, but here are some of America's hottest new couples:

Washington University and Monsanto Corp. Harvard Medical School and DuPont. Carnegie Mellon University and Westinghouse. Cornell University and Exxon.

In the past year, business and higher education have wooed and won each other as never before — as partners in research probing into lucrative, occasionally controversial new fields such as industrial robots and genetic engineering.

Scores of universities have entered into research contracts with big business, in partnerships that both sides believe will help America regain pre-eminence in world markets such as automobiles and electronics.

Industry support of campus research, less than \$100 million in 1975, is over \$200 million this year, and is predicted to climb to \$600 million a year during the 1980s, says Edward E. David, Jr., president of the Exxon Research and Engineering Co.

But the growing ties between campus and corporation have also raised ethical and legal questions — serious enough to have caught the attention of Congress.

Hoping to stave off federal regulation, several hundred industry and campus officials will confer Wednesday and Thursday in Philadelphia under the banner, "Partners in the Research Enterprise."

"We want to establish broad guidelines for campus research before Congress gets in and sets ground rules arbitrarily," says Dr. William H. Danforth, chancellor of Washington University in St. Louis, and one of 16 university and industry leaders hosting the gathering.

Industry-funded research centers are springing up at Princeton University,

Carnegie-Mellon, Stanford University and elsewhere. For business, it means a valuable source of brainpower. For cash-strapped universities, it means millions of dollars, new facilities, and a way to keep top faculty in the thick of developments in their fields.

One typical deal: Washington University signed a \$23.5 million contract with Monsanto in June for medical research. The university would hold any patents and receive royalties from its discoveries, but Monsanto would have exclusive license to market and produce any products.

A panel of Monsanto and university scientists would decide what research projects to fund. Researchers could publish their findings, but only after Monsanto reviewed them.

The economic stakes are high for both business and campus. The more successful campus research complexes have supercharged the economies of whole regions: the microelectronics center at Stanford, for example, was the wellspring for "Silicon Valley," the area south of San Francisco which has become the computer capital of America.

One of Congress's leading skeptics about industry-campus ties, Rep. Albert Gore, D-Tenn., is scheduled to address the Philadelphia conference.

Gore, chairman of the House Science Investigations subcommittee, held hearings last summer on industry-funded campus research. Jim Jensen, a member of the committee staff, said in an interview that one concern was the possibility that some campus research agreements may violate patent law.

Another issue, he said, was raised by a 1981 agreement in which a German drug firm, Hoechst AG, gave \$50 million to Massachusetts General Hospital, which has ties to Harvard University,

to do genetic research. "Biomedical research at Mass General and elsewhere has been largely funded by the federal government. The question is, why should a foreign firm skim the cream of this investment?" Jensen said.

Congressional worries aside, there is lingering uneasiness over the growing ties between campus and corporation that goes to the heart of what each is all about.

University of Chicago President Hanna Gray has expressed deep misgivings about business ties for her school: "One ought to bend

over backward not to allow things to happen, which, however well protected and well intentioned they may appear to be, nonetheless could lead away from some of the essential things universities have to guarantee."

Outside groups, particularly legal aid and environmental organizations, have occasionally protested industry-campus research ties — especially when that research involves fields like genetics or farm pesticides which could affect working conditions or the environment.

Although Cornell Universi-

ty President Frank Rhodes said the Philadelphia meeting was designed to be "very much in the open," no such outside groups were invited to speak.

"That's part of the pro-

blem. Very important elements of society are excluded from these meetings," said Albert Saldamando, executive director of California Rural Legal Assistance, a San

Francisco-based group which has questioned the close ties between the University of California system and agribusiness.

Last March, the public was excluded from a three-day

meeting of about 50 university and business leaders at the luxurious Pajaro Dunes resort in Watsonville, Calif., at which the problem of conflict of interest was discussed.

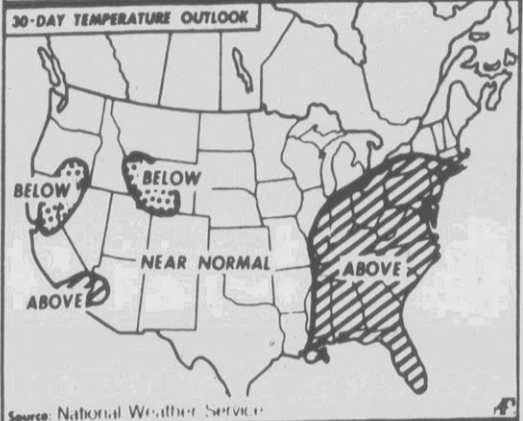
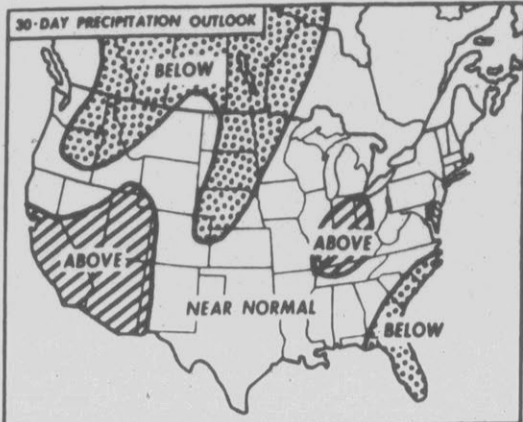

THIRTY-DAY FORECAST — This is the National Weather Service's look at the weather for the next thirty days in terms of precipitation and temperature. (AP Laserphoto)

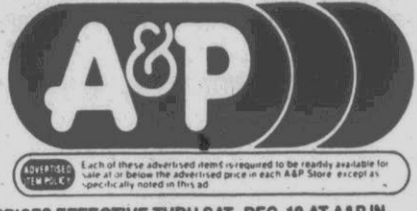

PRICES EFFECTIVE THRU SAT., DEC. 18 AT A&P IN GREENVILLE, N.C.

A&P... Your Complete COLDS & FLU CARE CENTER

703 Greenville Boulevard
Greenville Square Shopping Center

ROBITUSSIN

Expectorant	4-oz.	1.49
CF	4-oz.	2.09
PE	4-oz.	1.99
Night Relief	4-oz.	1.99
DM	4-oz.	1.99

VICKS COLDS RELIEF

Nyquil	10-oz.	4.69
Formula 44	6-oz.	2.99
Formula 44D	3-oz.	2.19
Inhalers	3-oz.	3.89
Vaporub	6-oz.	2.49
	1.5-oz.	3.99
	3-oz.	1.49
	3-oz.	2.79

NEW! HEAD & CHEST

TABS	36's	3.79
CAPS	24's	3.79
LIQUID	4-oz.	2.69

COLD RELIEF & HEADACHE REMEDIES

Contac Severe Cold Formula	10's	2.19
Contac Capsules	10's	2.19
Dristan Decongestant Tablets	24's	2.69
Comtrex Capsules	16's	2.59
Comtrex Tablets	24's	2.59
Coricidin "D" Decongestant	24's	1.99
Triaminic Syrup	4-oz.	2.59
Alka Seltzer Plus	20's	1.89
Afrin Nasal Spray	5-oz.	1.99
Comtrex Liquid	6-oz.	3.39
Comtrex Nighttime Liquid	6-oz.	3.39
4 Way Nasal Spray	5-oz.	1.79
Sucrets Lozenges	24's	1.79
Anacin Tablets	100's	2.99

Zoos Bulging With Animals

By DICK ULMER
Omaha World-Herald
OMAHA, Neb. (AP) — Lions and tigers and bears, oh my! Lions and tigers and bears!

Zoo directors around the world soon might want to adopt the worried chant of Dorothy in "The Wizard of Oz." Zoos have become so successful at breeding and feeding exotic animals that keepers say they're running out of room for all of them.

The Detroit Zoo recently announced plans to reduce its animal population by 20 percent because of overcrowding. A New York zoo director proposed slaughtering some excess animals, then feeding the carcasses to tigers and lions.

Lee Simmons, director of Omaha's Henry Doorly Zoo, says he houses an overabundance of at least three kinds of animals and would like to dispose of four or five of each:

- 21 scimitar-horned oryxes, of the antelope family.
- 21 Lady Gray's waterbucks, also antelope-type creatures.
- 17 ring-tailed lemurs, monkeys.

Simmons says many of the extra animals could be sold or traded to other zoos, ranches or private owners. "The animals that potentially will cause the most grief are the large carnivores — the bears and the cats."

Lions and tigers and bears require big quarters, have voracious appetites and live a long time, Simmons says. They can't be turned out in a farmer's pasture to eat grass like some of the hoofed stock.

"Right now, it's getting difficult to give a tiger away, much less sell one," he says. In a few years, zoo directors must take a cue from Midwest beef ranchers and "cull their herds," eliminating some of the "senile old bulls" that carry bad genes to make room for younger breeding stock, Simmons says.

Exotic animals are prospering in zoos for several reasons, including medical care. "We have made heroic

efforts to save some animals," Simmons says. "In some cases we should quietly have let nature take its course."

Another factor is breeding. Simmons says zookeepers have learned to encourage animals to mate by using tricks to simulate their natural environment. Fake rainstorms put some tropical birds in the mood for love.

Simmons says he probably will list his surplus animals in a newsletter that goes to many of the world's zoos and game preserves.

Sales or swaps can often be worked out. For example, last year the zoo sent six oryxes to an Ohio game preserve, setting a price of \$3,500 a pair.

Simmons says the Omaha zoo got some small animals and a trade credit in return. The credit will be used to acquire birds for the zoo's new aviary, he says.

Fertilizer Trade Continue Low

WASHINGTON (AP) — Tight economic conditions continue to affect the nation's fertilizer trade, with production running nearly a fourth below year-ago levels, according to industry reports.

Edwin M. Wheeler, president of The Fertilizer Institute, said total fertilizer production in October was down 23 percent from a year earlier. For the first four months of the marketing year which began July 1, output was down 22 percent.

Among the three groups of materials — nitrogen, phosphate and potash — only phosphate showed an increase in domestic movement or "disappearance" during the July-October period, Wheeler said.

Phosphate increased 4 percent from a year earlier, while nitrogen products dropped 26 percent and potash, 18 percent, he said.

Isn't it nice to know your favorite flour is in such good company!



And now save 20¢ on your choice!

Particular cooks know that choosing the right flour can mean the difference between a "so-so" pie crust or biscuit and one that's irresistibly light and mouth-watering! That's why great cooks have been choosing from the Martha White family of flours for years. Martha White offers you four choices—you choose the one that you like best. All of these flours have one very important thing in common: each is milled under Martha White's stringent quality standards, so you can choose any Martha White flour with confidence. Now for a limited time, save 20¢ on your next 5 lb. or larger flour purchase with this coupon. Choose from Martha White, Famo, Cream or Roller Champion. That's some of the finest flour you can get at a nice savings! You can trust Martha White for all your baking.

20¢ Save 20¢ 20¢
5 lbs. or larger size.

To the grocer: We will pay you 20 cents plus 7 cents handling for each coupon you accept toward the purchase of a 5 lb. or larger bag of Famo, Cream, Roller Champion or Martha White Flour when terms of this offer have been met by you and customer, who must pay sales tax. Invoices verifying purchases by you must be submitted on demand. Void where prohibited, taxed or restricted by law. Cash value 1/20 of 1¢. Mail coupons to Martha White Foods, Inc., P.O. Box 19362, Houston, TX 77224.

4187

Store Coupon

THE SPECIAL FOODS OF CHRISTMAS

SPECIALY PRICED!

SAVE LIKE NEVER BEFORE AT THE NEW FOODKING

We've Lowered The Prices On Over 6,800 Items and We're Determined To Have The LOWEST Food Prices in Eastern North Carolina LOCATED ON HWY. 33 IN CHOCOWINITY



QUANTITY RIGHTS RESERVED-NONE SOLD TO DEALERS

HOUSE OF RAEFORD
GRADE A
SELF-BASTING

YOUNG TURKEYS

16 LBS. & UP

55¢ LB.

SWIFT'S BUTTERBALL

TURKEYS

12 LBS. & UP

89¢ LB.

GRADE A YOUNG

TURKEY BREAST

\$1.29 LB.

GWALTNEY FRANKS

12 OZ.

99¢

FRESH HAMS

WHOLE **\$1.39** LB.

HALVES **\$1.48** LB.

SMOKED HAMS

WHOLE **\$1.28** LB.

HALVES **\$1.38** LB.

WHOLE

RIB EYE LOINS

\$2.99 LB.

WHOLE

RIB EYE STEAKS

\$3.59 LB.

PRODUCE

FRESH COCONUTS. 2 FOR **\$1.00**

JUICY RED GRAPES..... **69¢** LB.

JUICY WHITE GRAPES..... **69¢** LB.

CELERY..... STALK **39¢**

FLORIDA ORANGES... 5 LB. **\$1.19**

RED OR GOLDEN DELICIOUS APPLES..... 3 LB. **99¢**

COURTLAND ROLL SAUSAGE 1 LB. PKG. **79¢**

PEANUT CITY COUNTRY HAMS

WHOLE **\$1.88** LB.

HALVES **\$1.98** LB.

"REAL" DRY SALT CORNED HAMS

WHOLE **\$1.48** LB.

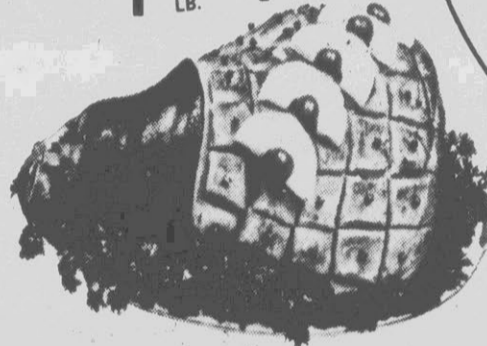

DIAMOND FOIL 12x25' **55¢**

ROYAL GUEST COCONUT 14 OZ. BAG **99¢**

TROPICANA GOLD'N PURE

ORANGE JUICE

64 OZ. CARTON **99¢**

WALDORF BATHROOM TISSUE 4 ROLL WHITE, ASSORTED **79¢**

COLD POWER DETERGENT GIANT SIZE BOX **\$1.39**

KRAFT MARSHMALLOW CREME 7 OZ. JAR **66¢**

STOVE TOP STUFFING MIX

7 OZ. BOX CORN BREAD, CHICKEN OR PORK **88¢**

STOKELY FRUIT COCKTAIL 30.3 CAN 2 FOR **\$1.00**

MAXWELL HOUSE COFFEE 1 LB. BAG ALL GRINDS **\$2.29**

LAND O LAKES BUTTER 1 LB. PKG. **\$1.99**

COCA-COLA 8-16 OZ. CARTON **99¢**

PLUS DEPOSIT

Register For A Free 10 Speed Bike. (No Purchase Necessary. Need Not Be Present To Win.)

DIXIE CRYSTAL SUGAR 4X, 10X, LIGHT BROWN, DARK BROWN 1 LB. BOX **2/\$1.09**

ROYAL GUEST CRANBERRY SAUCE 16 OZ. CAN **39¢**

MARTINDALE SWEET POTATOES 2 1/2 CAN **69¢**

KARO SYRUP BLUE LABEL OR RED LABEL PT. JAR **88¢**

BAKER'S COCONUT 3 1/2 OZ. CAN **67¢**

DOVE LIQUID DETERGENT 22 OZ. BOTTLE **89¢**

OCEAN SPRAY CRANBERRY SAUCE 300 SIZE CAN **58¢**

KRAFT PHILADELPHIA CREAM CHEESE 8 OZ. PKG. **89¢**

YES DETERGENT... 32 OZ. BOTTLE **89¢**

CHATHAM CHUNX DOG FOOD... 25 LB. BAG **\$3.49**

KRAFT MARSHMALLOWS 10 1/2 OZ. PKG. **2/\$1.00**

KRAFT MINIATURE MARSHMALLOWS 12 OZ. PKG. **2/\$1.00**

KRAFT GRAPE JELLY OR JAM... 18 OZ. JAR **79¢**

FROZEN FOODS

FINE FARE PIE SHELLS . PKG. OF 2 **2/88¢**

PET RITZ PIE SHELLS . . . PKG. OF 2 **59¢**

QUIK MAID WHIP TOPPING . 8 OZ. PKG. **49¢**

TOWN TALK ICE CREAM . . 1/2 GALLON **\$1.19**

PILLSBURY FLOUR PLAIN OR SELF-RISING 5 LB. BAG **79¢**

PILLSBURY CAKE MIXES 19 OZ. BOX **59¢**

KRAFT MAYONNAISE 32 OZ. JAR **89¢**

MT. OLIVE SWEET SALAD CUBES 22 OZ. JAR **\$1.19**

Concern On Effects Of Predicting

By ROBERT LOCKE
AP Science Writer

SAN FRANCISCO (AP) — As scientists get better at predicting volcanic eruptions, they're finding themselves drawn into decidedly unscientific public debate over the commotion their warnings can cause.

"The status of predicting eruptions has reached a stage in which it's both very exciting scientifically, but also a source of great responsibility for the scientist in terms of communicating his work to the general public," said seismologist Steve Malone of the University of Washington.

Malone, who helped predict activity at Mount St. Helens in Washington, said technical statements, especially when filtered through the media, often appear either unduly alarmist or dangerously understated.

"Walking that fine line in the middle is becoming something of an art," he said in introducing a volcanic hazards discussion at an American Geophysical Union Conference here Saturday.

Many volcanologists got a rough-and-tumble introduction into media relations when swarms of reporters swept into Vancouver, Wash., after Mount St. Helens' catastrophic eruption in May 1980. Those relations were not always smooth.

"The more difficult things are when science begins to interface with society — that always complicates the problem," said Robert Decker of the U.S. Geological Survey's Hawaiian Volcano Observatory.

But he and other volcanologists urged their colleagues to make the effort, despite occasional distortions.

"Openness is certainly not the easiest solution, but I think we can say from our experience at Mount St. Helens that it does pay off ... because then we are dealing with an educated public," said Chris Newhall of the USGS Cascades Volcano Observatory at Vancouver.

"Even though there are moments when we hate it, I think it's important to have that openness," he said.

The basic quandary seems to be one that for years has faced geologists just learning the art of predicting earthquakes: their work has great potential impact, both good and bad, on the public. But predictions have no value if they are not made promptly and publicly.

The problem emerged last May, when the USGS issued an official "notice of potential volcanic hazard" for the region around the resort town of Mammoth Lakes in California's High Sierra.

Local officials and business leaders bitterly criticized both the volcanologists and the media, saying they exaggerated the risk and scared visitors away from a region that depends heavily on tourism.

Public meetings in August seemed to resolve the problem, and now the frequency of tremors that may indicate volcanic activity seems to be tapering off.

Decker said one possible physical solution could present scientists with "a whole Pandora's box of judicial problems."

Rearranging terrain could divert lava flows into less critical areas, he said, but, "Once you start interfering with acts of God, they are no longer acts of God and you're going to be sued by everybody in sight."

U.S. Indignant Over Killings

WASHINGTON (AP) — The United States has expressed indignation over the killings of at least 15 prominent citizens of the South American nation of Surinam while they were in government custody.

Alan Romberg, the State Department's deputy spokesman, says there are unconfirmed reports that as many as 30 opponents of Surinam's military regime were shot recently.

He noted that Secretary of State George P. Shultz has "expressed his horror" over the slayings.



ADVERTISED ITEM POLICY Each of these advertised items is required to be readily available for sale at or below the advertised price in each A&P Store, except as specifically noted in this ad.

PRICES EFFECTIVE THRU SAT., DEC. 18 AT 703 GREENVILLE BOULEVARD A&P IN GREENVILLE, N.C. ITEMS OFFERED FOR SALE NOT AVAILABLE TO OTHER RETAIL DEALERS OR WHOLESALERS.

Between now and Dec. 18 we will redeem all national manufacturers' cents-off coupons up to 50¢ for double their value. Offer good on national manufacturers' cents-off coupons only. (Food retailer coupons not accepted.) Customer must purchase coupon product in specified size. Expired coupons will not be honored. One coupon per customer per item. No coupons accepted for free merchandise. Offer does not apply to A&P or other store coupons whether manufacturer is mentioned or not. When the value of the coupon exceeds 50¢ or the retail of the item, this offer is limited to the retail price.

Clip the Manufacturers' "Cents-Off" Coupons from your mail, newspapers and magazines . . . then bring them to your A&P Food Store!



Holiday

DOUBLE

Now! At A&P Manufacturers' Cents Off Coupon is Worth TWICE as Much... That's Double Coupon Savings!

GIVE THE GIFT OF GOOD TASTE
A&P Gift Certificates
Get Details At Your Local A&P or Call 704-333-3161



NABISCO
Snack Crackers
Your Choice Regular Size **99¢**

THE FARM
AT A&P
Fresh With Quality

CALIFORNIA CRISP SOLID ICEBERG
Head Lettuce
2 large heads **1.00**

WASHINGTON STATE EXTRA FANCY RED OR GOLDEN
Delicious Apples
Lunch Box Size **48¢** lb.

P Produce Specials

P Produce Specials

P Produce Specials

P Produce Specials

RED RIPE SALAD SIZE
Tomatoes 28 oz. pkg. **99¢**

EASTERN GROWN ALL PURPOSE
White Potatoes 15 lb. bag **1.39**

CALIFORNIA FIRM
Crisp Celery Jumbo 24 size **69¢**

FLORIDA RED OR WHITE
Juicy Grapefruit 3 Jumbo 23 size **1.00**

RED RADISHES (6 OZ. BAG) GREEN PEPPERS
Cucumbers 4 for only **1.00**

CALIFORNIA LUSCIOUS
Red Grapes lb. **69¢**

FRESH FRUIT BASKETS 4.98 AND UP OR
Poinsettias 6 in. pot **3.99**

RICH & BUTTERY
California Avocados 4 60 size **1.00**

P Dairy Specials
FLAV-O-RICH
Egg Nog quart ctn. **89¢**

P Grocery Specials
JANE PARKER
Brown N' Serve Rolls 12 ct. pkgs. **2.88**

P Dairy Specials
A&P CHILLED
Orange Juice 1/2 gal. ctn. **97¢**

P Frozen Specials
ALL NATURAL
Breyer's Ice Cream 1/2 gal. ctn. **2.19**

P Grocery Specials
DEL MONTE CRUSHED • CHUNK • SLICED • TIDBIT
Pineapple Juice 15 1/2 oz. can **59¢**

DEL MONTE LITE PEAR HALVES OR LITE
Fruit Cocktail 16 oz. can **69¢**

DEL MONTE
Golden Corn WHOLE KERNEL • CREAM STYLE
or Sweet Peas 2 17 oz. cans **89¢**

P Grocery Specials
REALEMON
Lemon Juice 32 oz. btl. **1.09**

MARTHA WHITE SELF-RISING
Corn Meal 5 lb. bag **1.19**

P&Q BRAND
Potato Chips Save 70¢ over National Brands 16 oz. bag **1.59**

P Dairy Specials
LAND O' LAKES
Butter 1-lb. pkg. **1.89**

ONION • CUCUMBER ONION • CLAM
Sealtest Dips 8 oz. ctn. **69¢**

KRAFT AMERICAN
Cheese Food Slices 8 oz. pkg. **1.29**

P Frozen Specials
SARA LEE
Pound Cake 10 1/2 oz. pkg. **1.59**

WINTER GARDEN
Coconut 2 6 oz. pkgs. **99¢**

KRAFT PHILADELPHIA
Cream Cheese 8 oz. pkg. **89¢**

P SUPER SAVER COUPON
SAVE 20¢ ON A GRADE
A&P GRADE "A" You Pay Only
Large Eggs dozen only **49¢**

GOOD THRU SAT., DEC. 18 AT A&P. #684
LIMIT ONE WITH COUPON AND 7.50 ORDER.

P SUPER SAVER COUPON
SAVE 20¢ ON You Pay Only
ELECTRIC PERK • REGULAR • AUTO DRIP
Maxwell House Bag Coffee 1-lb. bag **1.79**

GOOD THRU SAT., DEC. 18 AT A&P. #685
LIMIT ONE WITH COUPON AND 7.50 ORDER.

P SUPER SAVER COUPON
SAVE 20¢ ON You Pay Only
10X CONFECTIONERS
A&P Sugar 2 lb. bag **79¢**

GOOD THRU SAT., DEC. 18 AT A&P. #686
LIMIT ONE WITH COUPON AND 7.50 ORDER.

703 Greenville Boulevard Greenville Square Shopping Center Greenville, N.C.

Greetings From A&P



Deeds

COUPON SAVINGS

A&P Doubles the Savings on Manufacturers' Cents-Off Coupons!

You can count on A&P to look for new ways to help you save! Thru Sat., Dec. 18—we're offering you savings you can actually add up before you even come into our stores!

Savings are Great with A&P's DOUBLE SAVINGS COUPONS!			
MFC'S COUPON	MFC "CENTS OFF"	A&P ADDED "CENTS OFF"	TOTAL COUPON AT A&P
COUPON A	25¢	25¢	50¢
COUPON B	18¢	18¢	36¢
COUPON C	50¢	50¢	\$1.00
COUPON D	75¢	25¢	\$1.00

DON'T MISS YOUR CHANCE TO OWN GLITTERING

Genuine Diamond 14 Karat Gold Filled Jewelry

\$5.99 EACH PLUS TAX

CHOOSE FROM 12 DIFFERENT PIECES
All pendants have a 16" 14 Karat Gold Filled Chain
Buy as many as you like every time you show up at A&P. Each comes in an elegant gift box. While supplies last.

SORRY... RAINCHECK POLICY NOT IN EFFECT DURING THIS SPECIAL EVENT ON MANUFACTURERS' COUPON ITEMS.

The Evans Co. of Grvl Inc. to Dennis James Clark al 36.50
Grubb & Ellis Co. to F.F. Fund Corp. 193.00
Grubb & Ellis Co. to F.F. Fund Corp. 134.00
Thomas eli Joyner Jr. al to Dept. of Transportation Ns Neil Realty Co. to Althea Owens 36.50
E. Hoover Taft Jr. al To David A. Evans Jr. al 40.00
Josie Mae Williams al to Levy E. Owens al 4.50
Joseph Earl Worsley al to Jimmy Carroll McRoy 6.00
Joan P. Cassily to Jack P. Morgan Jr. al 53.50
John L. Causey Sr. al to John L. Causey Sr. al to Mildred S. Causey Sr. NS
Richard E. Cherry al to Susan S. Stanfield 25.00
Wanda J. Mills to Curtis N. Mills al NS
Connie L. Mozingo Jr. al to Macn Moore al 10.00
Riverhills Inc. to William H. Daniels 8.00
Lynndale Development Co. to Denis McGillicuddy al 22.50
Secretary of Housing & Urban Development to Daisy B. Best NS
John Yancey Corp. to Elbert Pittman al 1,300.00
Gay R. Atkins-Tr. al to Peoples Bk NS
W.L. Bealsey Jr. al to Roy Mills al 7.00
Paul deVendell Davis al to Peoples Bk NS
Shirley E. Harris Greene to Louis Henry Greene NS
Leonard E. Hignite al to Bobby Ray Mayo al 32.00
Jesse B. Jones to Betty S. Jones NS
Betty Stokes Jones to Jesse Branch Jones NS
Mark A. Wilson al to Tar River Associates 18.00
L.S. Wright al to John C. Lynch al 65.00
William H. Clark al to David A. Evans Sr. NS
W. Eugene Ainsworth Jr. al to Stephen F. Horne II 26.00
Bowser Construction Co. to Williamsburg Manor Inc. NS
J.E. Briley-Exer to William H. Clark 95.00
Phillip E. Carroll to Whittington Inc. 12.50
David A. Evans Sr. al to William H. Clark NS
William A. Forbes al to Clifton David Rouse 3.00
Edward Earl Lewis al to George S. Saad 40.00
William W. Little al to Charles E. Mayo Jr. 32.00
Lynndale Development Co. of Grvl to Waightstill M. Scales al 22.50
Neil Realty Co. to Annie Baker Newton 36.50
William W. Simpson III al to Fred T. Speight Jr. al 12.00
David Ward to Charlie Ray Ward NS
Russell Boyd al to Bernice Boyd Lee 2.00
The Evans Co. of Grvl Inc. to Walter B. Harris al 41.00
Dorothy Smith Hill to Lloyd R. Hill 7.00
David Earl Little to Jearlean Little NS
William J. Little al to Jearlean Little NS
Jane G. Martin al to Willie Dalton Cox al 36.00
Jack W. Richardson al to Richard T. Brittle al 43.00
Southside Realty & Insurance Services Inc. to Robert C. Braswell al NS
Robert H. Neel Jr. al to Heber J. Jolly Jr. al 9.50
Harold D. Wooten al to Billy M. Battles al 60.00

A&P OUR FINEST QUALITY

Butter Basted Turkeys

10 lbs. and up

Self Basting With REAL BUTTER

79¢ lb.

SWIFT Butterball Turkeys 10 lbs. and up lb. 89¢

U.S.D.A. INSPECTED FRESH

Fryer Leg Quarters

6-lbs. or more

48¢ lb.

A&P QUALITY HEAVY WESTERN WHOLE

Smoked Ham

19-22 lb. avg.

118 lb.

Smoked Ham Shank Portion lb. 128 Butt Portion lb. 138

Limit One, Please

A&P QUALITY HEAVY WESTERN GRAIN FED BEEF

WHOLE Sirloin Tip

9-12 lb. avg.

167 lb.

U.S.D.A. INSPECTED

Young Turkeys 10-18 lb. avg. lb. 69¢

U.S.D.A. YOUNG

Turkey Breast 4-7-lbs. avg. lb. 138

EXTRA LEAN SPECIAL TRIM COUNTRY FARM ASSORTED

Pork Chops 8-lbs. or more lb. 168

A&P QUALITY HEAVY WESTERN GRAIN FED BEEF BONE-IN

New York Strip Steak lb. 298

A&P QUALITY HEAVY WESTERN GRAIN FED BEEF BONE IN FULL CUT

Round Steak lb. 229

EXTRA LEAN SPECIAL TRIM COUNTRY FARM REGULAR OR COUNTRY STYLE

Pork Spare Ribs lb. 169

A&P QUALITY HEAVY WESTERN GRAIN FED BEEF BONE-IN (RIB STEAK lb. 2.99)

Rib Roast lb. 279

HONEYMOON BRAND WHOLE BONELESS

Buffet Ham 4-6 lbs. avg. lb. 259

HOUSE OF RAEFORD BONELESS

Turkey Ham lb. 189

MARKET STYLE

Sliced Bacon lb. 149

A&P QUALITY (BEEF LB. 1.69)

Sliced Bologna 1-lb. pkg. 159

COTTAGE BRAND

Smoked Sausage lb. 129

SEA SNACK

Shrimp Cocktail 4 oz. can 189

COOKED

Salad Shrimp 6 oz. pkg. 169

FRESH STANDARD SIZE

Oysters (Pint 3 89, 2 1/2 199)

DUBUQUE

Canned Ham 4-lb. can 988

U.S.D.A. INSPECTED FRESH

Box-O-Chicken

48¢ lb.

EXTRA LEAN SPECIAL TRIM COUNTRY FARM

Fresh Pork Picnic Roast

99¢ lb.

BALL PARK Franks 1-lb. 489 Beef 1-lb. 199 1-lb. pkg. 189

HOLLY FARMS

Chicken Franks or Bologna 89¢ 1-lb. pkg.

CARNATION

Coffee Mate 22 oz. jar 233

GENERAL MILLS

Bugles 7 oz. pkg. 79¢

SILVERBROOK

Homogenized Milk gallon jug 179

A&P QUALITY

2% Lowfat Milk gallon jug 175

A&P Salad Olives 10 oz. jar 109

CATES MIXED

Sweet Pickles 16 oz. jar 99¢

VERY YOUNG TENDER

Le Sueur Peas 17 oz. cans 2 100

GENERIC

Aluminum Foil 2 25 ft. rolls 88¢

A&P QUALITY

Toddler Diapers 40 ct. pkg. 599

MARTINDALE

Cut Yams 29 oz. can 69¢

WATCH THE TOURNAMENT OF ROSES PARADE

GET UP TO \$20 CASH REFUND PLUS \$200,000 TV SWEEPSTAKES

FLEISCHMANN'S REG.

Margarine 1-lb. pkg. 109

ALL FLAVORS

Royal Gelatins 6 oz. pkg. 57¢

PLANTERS

Cocktail Peanuts 16 oz. can 239

PLANTERS

Tavern Nuts 11 1/2 oz. can 199

SUPER SAVER COUPON

SAVE 30¢ ON

ANN PAGE

Vegetable Oil 48 oz. bli 169

You Pay Only

GOOD THRU SAT., DEC. 18 AT A&P. LIMIT ONE WITH COUPON AND 7.50 ORDER. #687

SUPER SAVER COUPON

SAVE 20¢ ON

PLAIN SELF-RISING

Martha White Flour 5 lb. bag 79¢

You Pay Only

GOOD THRU SAT., DEC. 18 AT A&P. LIMIT ONE WITH COUPON AND 7.50 ORDER. #688

SUPER SAVER COUPON

SAVE 30¢ ON

A&P FROZEN FLORIDA

Orange Juice 12 oz. can 69¢

You Pay Only

GOOD THRU SAT., DEC. 18 AT A&P. LIMIT ONE WITH COUPON AND 7.50 ORDER. #689

Has A Passion For Croakers

CHICAGO (AP) — Joel Reznick loves frogs. A gold frog pendant dangles from his neck. His car has "RIBET" license plates. Frogs squat all over his suburban home.

None of the 600 pet amphibians is alive, however.

"I've got friends who send me all kinds of frogs — marble ones, plastic ones, wooden ones, metal ones. I just love them," said Reznick, a collector from Mount Prospect, Ill., who was at the National Collectibles Exposition here Sunday.

The exposition displayed everything from Sleeping Beauty bedroom slippers and a Betty Boop watch to a complete set of official programs for the 1948 Chicago Cubs' baseball season.

Reznick said his passion for croakers started 13 years ago when an aunt gave him a paisley frog bank.

Hours: Open Sunday 7:00 A.M. To 10:00 P.M. Open 24 Hours A Day. Monday 7:00 A.M. to Saturday 12 Midnight.

A Christmas Police Tip: Plan to do your Christmas shopping with someone else, especially at night!

HARRIS

SUPER MARKETS, INC.

"Where Shopping Is A Pleasure"

DISCOUNT
ON EVERYTHING BUT QUALITY

We Reserve The Right To Limit Quantities
None Sold To Dealers Or Restaurants
We Accept Food Stamps And WIC Vouchers

Check Out Our Supply Of Items For Your Holiday Meals: We Have A Good Supply Of Turkeys Of All Kinds. Including Smoked Turkeys - Turkey Breast - Ducks - Geese - Capons - Quail - Cornish Hens. Hams Of All Kinds Including Fresh, Corned - Tenderized - Country - Fruited Hams, Picnic & Fully Cooked Country Hams. We Also Have Nuts, Candies, Dressings, Fruit Cakes & Fruit Cake Mixes.

We Also Have Nuts, Candies, Dressings, Fruit Cakes & Fruit Cake Mixes.

ASK ABOUT OUR HARRIS SUPERMARKETS GIFT CERTIFICATES FOR ANY ITEM OR ANY AMOUNT FOR FRIENDS, RELATIVES, BUSINESS ASSOCIATES OR EMPLOYEES

Register For 2 Pepsi Mini Cars To Be Given Away On Dec. 23rd.
Worlds Largest Christmas Stocking (1 Per Store)
Worlds Second Largest Christmas Stocking (1 Per Store)

Sewing Machine (1 Per Store)
—No Purchase Necessary, Need Not Be Present To Win—
MUST BE 18 OR OLDER TO REGISTER

PRICES GOOD WED. THRU SAT. GREENVILLE-AYDEN-BETHEL-TARBORO



COKE
2
8
MATEUS
WINE.....
TAYLOR CALIFORNIA CELLARS
WINE.....
TAYLOR LAKE COUNTRY
WINE.....
ANDRE
CHAMPAGNES
CANADA DRY



GRADE A WHOLE

TURKEYS

20 LBS. & UP

59 LB.

BAKING OR STEWING GRADE A WHOLE
HENS FRYERS
59 LB. 70 LB. BOX \$30.10
42 LB.

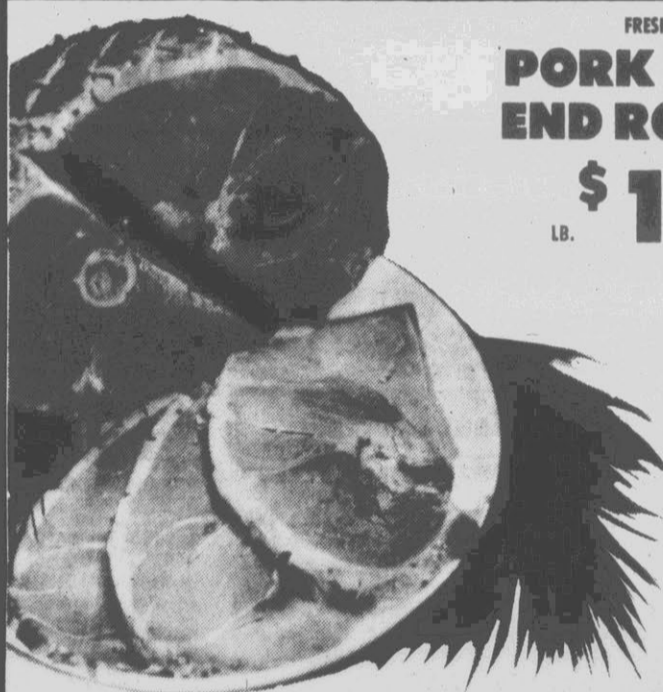

FRESH
PORK LOIN END ROAST
\$1.39 LB.

STANDARD
OYSTERS
PINT SIZE **\$3.49**

AGAR CANNED
HAM
3 LB. CAN **\$6.99** EA.

WHOLE TENDERIZED HAMS

\$1.39 LB.

SWIFT'S
BUTTERBALL TURKEYS
16 LBS. & UP **89** LB.

WHOLE
TURKEY BREAST **\$1.29** LB.

BEEF RIB ROAST
BONE-IN **\$1.99** LB.

FRESH LEAN
GROUND BEEF **99c** LB.

CHICKEN LIVERS 5 LB. BOX **\$1.69**

OLD TARHEEL FRESH
LINK SAUSAGE **\$1.79** LB.
HOT OR MILD

WHOLE
CORNERED HAMS **\$1.29** LB.

WHOLE
COUNTRY HAMS **\$1.89** LB.

GWALTNEY SALE!

GWALTNEY
BACON... 12 OZ. PKG. **\$1.39**
GWALTNEY
FRANKS 12 OZ. PKG. **99c**
SPICE LUNCHEON
MEAT .. 8 OZ. PKG. **\$1.19**

CURTIS MEAT PRODUCTS!

HOT OR MILD ROLL
SAUSAGE..... 1 LB. ROLL **\$1.89**
BOLOGNA REGULAR OR THICK 12 OZ. **\$1.19**
FRANKS.. REGULAR OR BEEF 12 OZ. **\$1.19**
SLICED
BACON 12 OZ. PKG. **\$1.39**

CANNED GOODS SALE

POCAHONTAS GREEN NO. 300
BUTTER BEANS
POCAHONTAS WHOLE KERNEL NO. 303
GOLDEN CORN
POCAHONTAS CREAM STYLE NO. 303
GOLDEN CORN
POCAHONTAS LITTLE PRINCESS NO. 303
GARDEN PEAS
RED GLO
TOMATOES NO. 303

3/1.00

PARADE
CRANBERRY

1 LB. CAN **39**

MAXWELL HOUSE
COFFEE
1 LB. BAG **\$2**
ALL GRINDS

DIXIE CRYSTALS OF
4X, 10X, LI
DARK BROWN
1 LB. **2/\$**

GENERIC
TOWEL
JUMBO ROLL **2/\$**

LUCKY LEAF
CHERRY FILLING
NO. 2 CAN **99**

POWHATAN
SWEET POTAT
NO. 2 1/2 **50**

POCAHONTAS CUT
GREEN BEANS NO. 303
POCAHONTAS FRENCH STYLE
GREEN BEANS NO. 303
POCAHONTAS FIELD
PEAS & SNAPS NO. 300

DEL HAVEN
PEACH HALVES OR SLICES NO. 303
PAK O' GOLD
FRUIT COCKTAIL
THREE RING
PEAR HALVES NO. 303

COKE
2 LITER
39¢
750 ML. ROSE OR WHITE \$2.99
1.5 LITER ALL VARIETIES \$3.79
ALL 1.5 LITER VARIETIES \$2.99
750 ML. WHITE OR PINK \$2.69
LONGER ALE, CLUB SODA OR 7-UP 59¢

DUKES MAYONNAISE .QT. **99¢**
KRAFT MIRACLE WHIP SALAD DRESSING QT. **\$1.29**

MT. OLIVE SALAD CUBES.. 12 OZ. **79¢**
SAUERS BLACK PEPPER... 3 OZ. **69¢**

BETTY CROCKER CAKE MIXES ALL 18 OZ. FLAVORS **58¢**
BETTY CROCKER READY TO SPREAD FROSTINGS 16 OZ. ALL FLAVORS **\$1.19**

ROLLER CHAMPION OR FAMO FLOUR SELF RISING 5 LB. **59¢**
With 20¢ Coupon On Page 54 Of Today's Daily Reflector. 79¢ Without Coupon.

NORTHERN BATHROOM TISSUE 4 ROLL PACK **99¢**

REYNOLDS HEAVY DUTY ALUMINUM FOIL 18" **99¢**
PILLSBURY SELF RISING OR PLAIN FLOUR 5 LB. **79¢**

PARADE PINEAPPLE NO. 2 CAN SLICED OR CRUSHED **59¢**

POCAHONTAS WHOLE SWEET POTATOES 3 SQTs. **59¢**



CELERY **39¢**
SIZE 30
SMALL STALK 29¢ LARGE STALK

Broccoli BUNCH **89¢**
Pineapple EA. **\$1.29**

Mushrooms 1/2 LB. 69¢ LB. **99¢**

Cucumbers 70 COUNT **2.27¢** FOR

Bananas **4/\$1.00**

YELLOW SQUASH 3 LBS. FOR **\$1.00**

ORANGES 20 FOR **\$1.00**

Cranberries 12 OZ. BAG **69¢**

FRESH COCONUTS (40'S) EACH **49¢**

RED GRAPES LB. **59¢**

ONIONS LB. BAG **3.49¢**

SWEET POTATOES 5 LBS. FOR **\$1.00**

RED DELICIOUS APPLES LB. BAG **3.79¢**

NABISCO SALE
NILLA VANILLA WAFERS... 12 OZ. **\$1.09**
RITZ CRACKERS... 12 OZ. **\$1.19**
GOLD LINE COOKIES... ALL VARIETIES **\$1.39**
BAG SNACKS CHIPS, DIGGERS, CHEESE N CRUNCH **79¢**

PARADE RAISINS 15 OZ. **\$1.29**
CAMPFIRE MARSHMALLOWS 10 OZ. **2/\$1.00**

DAIRY FOODS
GRADE A LARGE EGGS DOZ. **59¢**

KRAFT PARKAY MARGARINE 1 LB. 1/4'S **2/\$1.00**

LAKOLINA DAIRIES FRESH EGG NOG QT. **99¢**

MEADOW GOLD SOUR CREAM 8 OZ. **2/\$1.00**

SWIFT'S BUTTER 1 LB. 1/4'S **\$1.69**

COUNTRY FRESH HOMOGENIZED MILK 1/2 GAL. **89¢**

KRAFT CRACKER BARREL SHARP CHEESE 10 OZ. STICK **\$1.69**

KRAFT PHILADELPHIA CREAM CHEESE 8 OZ. **79¢**

MERICO BUTTER-ME-NOT BISCUITS 1/2 OZ. **2/79¢**

4/\$1.00

2/\$1.00

FROZEN FOODS
BANQUET PUMPKIN OR MINCE PIES 20 OZ. **79¢**
COUNTRY FRESH ICE CREAM 1/2 GAL. ALL FLAVORS **\$1.19**

PET RITZ PIE SHELLS 2 PAK **59¢**

BANQUET OR PARADE PIE SHELLS 2 PAK **39¢**

PARADE WHIPPED TOPPING 8 OZ. **2/\$1.00**



Human Cadavers Dissected In High School Class

AGOURA, Calif. (AP) — Human cadavers are "the ultimate in study aids" in an Agoura High School anatomy class where human corpses are dissected along with the remains of cats and frogs.

Tom Carmichael, now a college freshman, said his biology courses at the University of California-Los Angeles are a breeze because he was able to study the cadavers in high school.

"It helped so immensely that I'm just coasting through my biology courses," Carmichael said recently.

Many medical students don't get to work on cadavers until their second year of training.

Tough prerequisites help ensure that only serious students

enroll in his physiology and anatomy class, Jerry Lasnik said. He puts a group of juniors and seniors through about six weeks of lectures, reading and lab work before he introduces the cadaver.

Nobody is forced to work on the cadaver to pass the course, and students who take the class out of morbid curiosity "will flunk out before they get a peek," Lasnik said. But students not taking the class are just as curious.

"They're always asking us about it," said Tom Offerman, one of Lasnik's students. "But as soon as they find out it's studying, they don't want to take it. I always scare them away with the amount of homework I have."

Lasnik covers the faces of the cadavers when he first presents them to the class, making them seem less human.

Removing the cover later in the course also helped students get over their apprehension, said Carmichael.

"Edgar Allen Poe said the eyes are the window to the soul. Once we could see the eyes of this corpse, this cadaver, I could see there was no spark, no life," Carmichael said. "I could equate it with working on the cats, frogs or whatever."

Carmichael said he wasn't uneasy about dissecting the corpses until helping Lasnik remove the brain.

"I realized that what I was holding in my hands was the sum total of emotions, experiences, suffering that this person had gone through," he said. "I was thinking that this four pounds of matter is essentially what this man was."

"It was the ultimate in study aids," said Carmichael. Lasnik has equipped his classroom with items donated by the community. But locating a cadaver was something else.

"Everyone told me, 'For a high school? Forget it!'" Lasnik said. But finally he got a cadaver after contacting John Sykes, a curator at the University of California-San Diego medical school.

"As long as the class is conducted properly — if the purpose is to learn the structure of the human body — then I'm all for

it," Sykes said. Calling Lasnik a "true professional," Sykes said he had no doubt about the Agoura program and agreed to supply cadavers, which cost about \$125 each.

The first time he uses the cadaver, Lasnik generally wheels it out unexpectedly in the middle of a lab session.

"OK, gang, take a few minutes off. We're going to bring out the cadaver," Lasnik told students recently when the time came for a presentation.

There was silence as they gathered about the black plastic body bag wheeled into the classroom on a cot that Lasnik scrounged from a mortuary.

While Lasnik unzipped the body bag and exposed the corpse, he told the students a little about it including age and cause of death.

Expressions on the students' faces ranged from blank stares to distaste. Lasnik fielded a few questions before wheeling the body out of the classroom.

Then the students slowly returned to work on the dead cats they had been dissecting.

"It's created a tremendous enthusiasm among the kids," said Robert Ross, principal at Agoura High School, which is about 30 miles northwest of Los Angeles. "The achievement levels are higher than before."

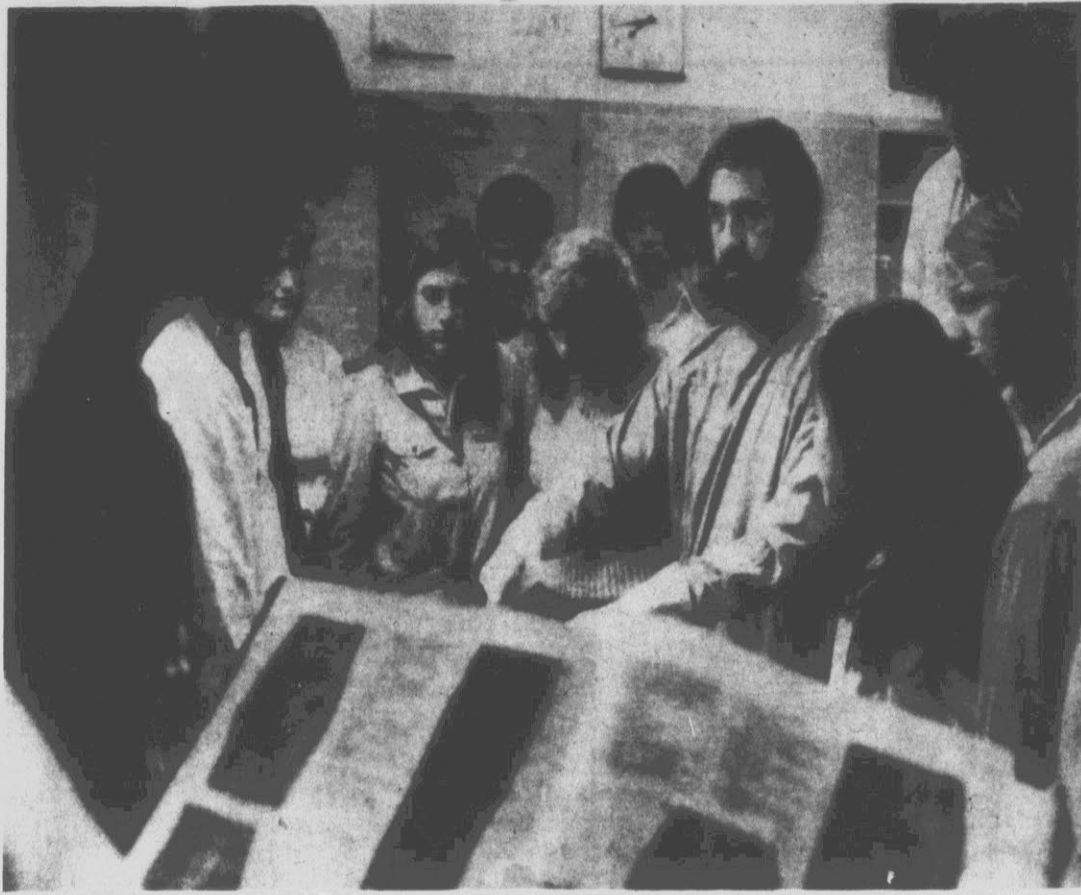

REALISTIC APPROACH — Agoura, Calif. High School instructor Jerry Lasnik speaks to his students during a lab experiment involving a

cadaver. Lasnik believes in using a realistic approach in teaching anatomy and physiology. (AP Laserphoto)

Accelerating Abuse Probes

WASHINGTON (AP) — With rising joblessness placing financial stress on the unemployment insurance compensation trust fund, the Labor Department is accelerating investigations of abuse of the \$20 billion-a-year program.

In a report to Congress, the department says the program has been subjected to minimal auditing in the past; but the report said that in the

last six months of fiscal 1982, monitoring of payments made under the program was stepped up.

Several states have had to borrow money from the federal government to assure continuing payment of benefits to the jobless under the basic 26-week jobless benefit program, which is administered and financed by the states.

Export Of U.S. Table Wine

WASHINGTON (AP) — The value of U.S. exports of table wines is up sharply this year, says the Agriculture Department.

In the first nine months, wine shipments were valued at \$24.5 million, up one-third from the same period in calendar 1981, says the USDA's Foreign Agricultural Service.

Table wines were defined as "still wines containing not

over 14 percent alcohol." Shipments of table wine to the European Community nearly doubled from the previous year to \$9.1 million, the report said. Two-thirds of the shipments went to the United Kingdom.

However, exports of other kinds of wine declined to only \$5.2 million during January-September from \$13.1 million a year earlier, the report said.

<h1>VALUE FAIR</h1>		VALUE FAIR BUYS GROCERIES, MEATS & PRODUCE IN TRUCK-LOAD QUANTITIES SO WE CAN SELL YOU FOOD FOR LESS.
		FAMILY PRIDE GRADE "A" TURKEYS 59¢ LB.
WAREHOUSE GROCERIES 1212 N. GREENE ST. GREENVILLE, N.C. Mon.-Thurs. 8:30 AM-7 PM FRI.-SAT. 8:30 AM-8 PM CLOSED SUNDAY NO LIMIT ON QUANTITIES-NONE SOLD TO OTHER MERCHANTS-WE ACCEPT FOOD STAMPS, WIC VOUCHERS & MANUFACTURERS COUPONS.		SWIFT BUTTERBALL TURKEYS 88¢ LB.
FRESH LEAN GROUND BEEF FAMILY PACK 98¢ LB.	OYSTERS STANDARD 12 OZ. CAN \$2.88 SELECT 12 OZ. CAN \$2.98	SMOKED TENDERIZED HAMS SHANK PORTION OR WHOLE \$1.08 LB. BUTT PORTION \$1.18 LB.
GWALTNEY SLICED BACON \$1.48 1 LB. PKG.	GWALTNEY FRANKS 12 OZ. PKG. 98¢	BEALE OR PEANUT CITY COUNTRY HAMS \$1.78 LB.
WHOLE OR HALF CORNED HAMS \$1.28 LB.	1/2 SLICED PORK LOIN \$1.28 LB.	
FRESH CRISP CELERY STALK 28¢	FRESH FLORIDA ORANGES 5 LB. BAG \$1.08	RED OR GOLDEN DELICIOUS APPLES 3 LB. BAG 78¢
	WHITE POTATOES 20 LB. BAG \$1.58	
MT. DEW OR PEPSI COLA 2 LITRE BOTTLE 88¢	CRISCO SHORTENING 3 LB. CAN \$1.98	POWHATAN SWEET POTATOES 2 1/2 SIZE CAN 68¢
PHILADELPHIA CREAM CHEESE 8 OZ. PKG. 88¢	BETTY CROCKER CAKE MIX DEVILS FOOD, LEMON OR YELLOW 19 OZ. BOX 58¢	REYNOLDS WRAP 12"x25" ROLL 48¢
	KRAFT ORANGE JUICE 1/2 GAL. JAR \$1.38	PUREX LAUNDRY DETERGENT 42 OZ. BOX \$1.18
OCEAN SPRAY CRANBERRY SAUCE 300 SIZE CAN 48¢	TWIN PET DOG FOOD ALL FLAVORS 15 OZ. CAN 18¢	LAND O LAKES BUTTER 1 LB. PKG. \$1.68
SUNSHINE KRISPY CRACKERS 2 1 LB. BOXES FOR 98¢	ROYAL GEM CUT GREEN BEANS 4 303 SIZE CANS FOR \$1.00	
WALDORF BATHROOM TISSUE 4 ROLL PACK 78¢	CHATHAM RATION DOG FOOD 50 LB. BAG \$5.48	ROLLER CHAMPION SELF RISING FLOUR 5 LB. BAG 78¢

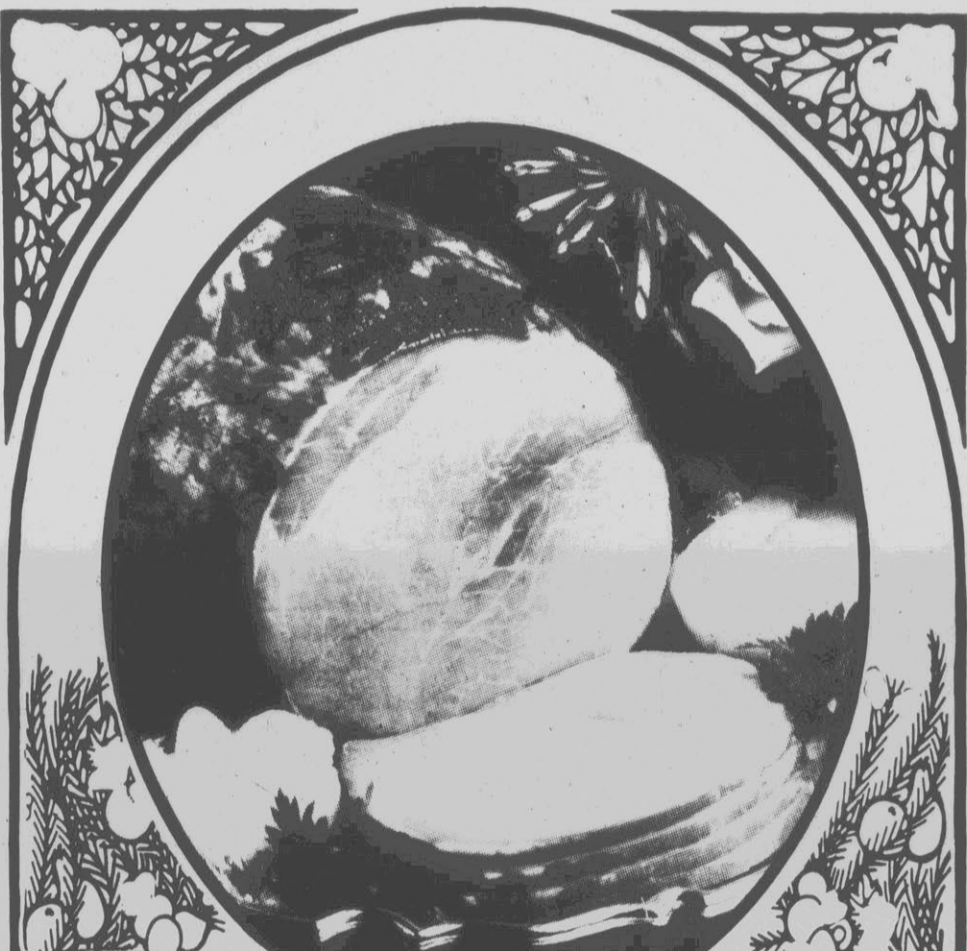

Try delicious slow-baked E-Z-Cut Ham. Smoked twice as long as ordinary ham for a priceless flavor.

E-Z CUT BONELESS HAM

\$2.79 LB.

Look for E-Z-Cut Ham at

HARRIS SUPER MARKETS, INC.

"Where Shopping Is A Pleasure"

GREENVILLE AYDEN-BETHEL TARBORO PRICES GOOD WED. THRU SAT.

Maxwell
FURNITURE

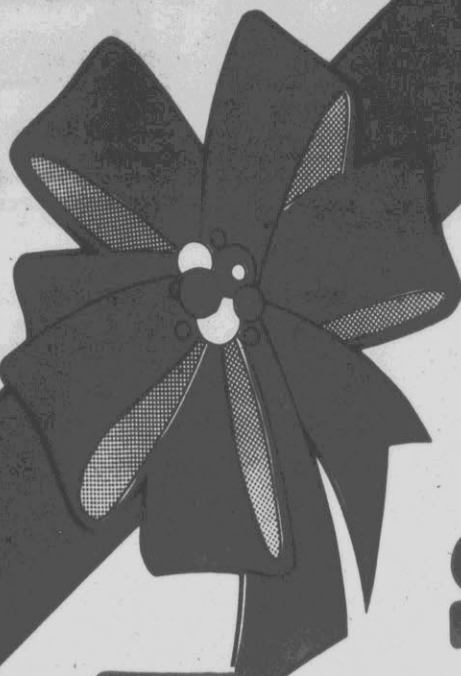

3 Days Only

Buy Now on Our Revolv-Account Credit
No Monthly Payments
and **No Finance Charges**
'til February '83

Special Selection of
Furniture in stock
for **Immediate Delivery**

Now 10% to 50% off!

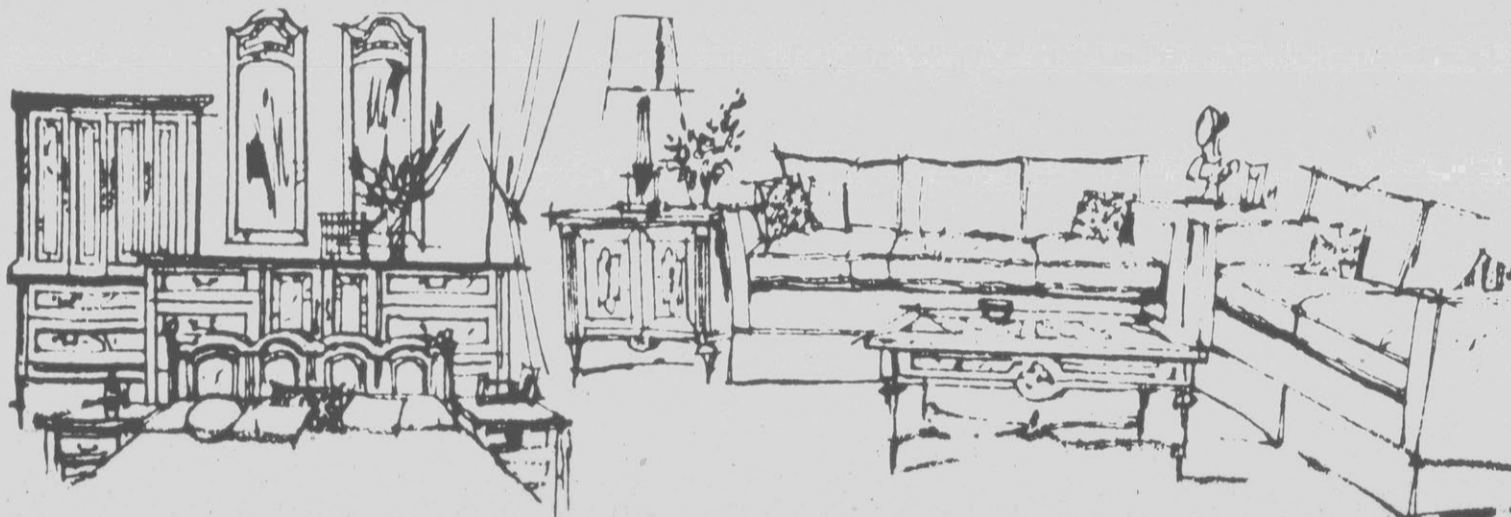

Just in time for Guaranteed Christmas Delivery, we've reduced select pieces of famous brand name furniture throughout our store 10% to 50% below our regular low prices and we're using a special delivery program to bring your purchase to your home for Christmas enjoyment.

All for Guaranteed Christmas Delivery!

Save Over 1/2
Boudoir Chair
\$19⁸⁸

- White wrought iron frame
- Button-tufted 100% polyester seat and back
- Available in Blue, Celadon, Gold and Red

TAKE WITH



Save Over 1/2
All Wood Stool
\$9⁸⁸

- 30" tall
- Padded foam Vinyl seat
- Completely finished

TAKE WITH



Folding Step Stool
\$16⁸⁸
Save \$13.07

- Wide based tubular construction
- Cushioned seat covered in easy-care russett Vinyl

TAKE WITH



- Free & Immediate Delivery On Most Items
- Customer Satisfaction Assured
- 4 Ways To Say "Charge It"

All of This Plus Our Low Prices

4 WAYS TO SAY "CHARGE IT"

Use our own REVOLV-ACCOUNT credit

AMERICAN EXPRESS

MasterCard

VISA

SPECIAL PURCHASE!

GIRLS GROUP
White With Gold Trim

SAVE OVER 60%

RUGS
Assorted Colors
9X12, 12X12, 12X15

1/3 Off

SPECIAL PURCHASE!

BROYHILL PREMIER DINING ROOM

1/2 Off

LARGE SELECTION

SOFAS
All Styles

1/2 Off

ENTIRE SELECTION

MIRRORS

1/2 Off

LARGE SELECTION

DESKS AND WALL UNITS

1/3 Off

TREMENDOUS SELECTION

BEDROOM
All Styles

1/3 Off

ENTIRE STOCK

SLEEPERS

1/3 Off

Maxwell
FURNITURE

604 Greenville Blvd.

SPECIAL HOLIDAY HOURS
OPEN MON.-FRI. 10 AM TIL 8 PM
SAT. 10 AM TO 6 PM

U.S. Hopes Jungle Role An Example

By TRACY WILKINSON
PUERTO OCUPA, Peru
(UPI) — Puerto Ocupa is only 190 miles from Peru's capital, but cannot be reached by road, has no electricity and its 600 Ameusha Indian inhabitants live on oranges and the roots of the yucca plant.

It is also part of a development project that U.S. officials hope will serve as the model for settling Peru's vast, mountainous jungle.

Peruvian President Fernando Belaunde Terry calls it his nation's "hope for the future."

The U.S. government is spending \$22 million in the 195,000-hectare Palcazu Valley in central Peru to develop crops, pasture and even a wildlife sanctuary.

The Peruvian government is providing matching funds for Palcazu and six other projects in the same central jungle zone.

Officials from the U.S. Agency for International Development plan to introduce farming techniques to prevent erosion, a principal cause of jungle flooding that claims dozens of Peruvian lives annually.

"We are putting a lot of hope on this project," Belaunde said during a recent visit to Puerto Ocupa, south of the Palcazu Valley, as 300 barefoot children ran to greet him with flowers.

Thatched-roof huts and a church-school run by a dozen nuns spread out from the shores of the Perene River, scattered among orange, banana and mango trees.

Puerto Ocupa can only be reached by air or by canoe.

The Peruvian government is building a north-south highway through the central jungle designed as the backbone of development in the area.

But critics of past jungle development projects say the government has displaced Indian tribes, misjudged how land should be used and ruined ecological balances.

"We've seen a track record that leaves us very worried," says Carlos Mora of the Amazonic Investigation and Promotion Center, a scientific and social study group.

Mora said the government regularly over-estimated a jungle's economic potential, allowing "spontaneous and uncontrolled" colonization and deforestation.

He says these mistakes were made early in the Palcazu development plan, but he hopes goals will be revised with newer studies.

AID officials say they hope the Palcazu project will show how to avoid past errors.

"Without this project, the area would turn into a disaster," AID Administrator Peter McPherson said during a recent trip to Peru.

AID says the Ameusha Indians in the valley will be given land titles and all development will be carefully mapped out and controlled.

Bill Sugrue, head of AID's regional development office in Peru, said the project is risky but, if it works, it "will be a model for development for the entire high jungle area."

He said AID convinced the Peruvian government that the area should be developed slowly, maintaining the ecological balance.

Half the Palcazu land will be left untouched to protect against erosion, about 15 percent will be turned into pasture for livestock, and only 8 percent will actually support crops.

Advise Higher Drinking Age

WASHINGTON (AP) — State laws should be changed to raise the legal drinking age to 21 to combat drunken driving and highway deaths, a presidential commission has recommended.

President Reagan, presented a copy of the commission's interim report, has promised to give it careful consideration.

A reduction in the drinking age to 18 in several states in the 1970s was accompanied by an increase in the number of alcohol-related traffic deaths. Since 1976, 14 states have raised their drinking age again.

WINN-DIXIE

Now more than ever, we're right for you!

only
1
MORE
WEEK TO
COMPLETE
YOUR SET

Hurry! Haviland China Promotion Ends Friday, Dec. 24th!

The Solution to Your Holiday Gift Giving is as Close as Your Nearest Winn-Dixie.

This Christmas, why not give the gift of fine food, with Winn-Dixie Gift Certificates? Attractive, Convenient, and available in denominations of \$7.50, \$10.00 and \$15.00. And they're redeemable throughout the Southeast and Texas. Ask any cashier for details. She'll be happy to help you.



All Completer Pieces
On Sale While
They Last!

49-OZ. BOX TIDE DETERGENT

\$1.59

WITH \$10.00 OR MORE ORDER (LIMIT 1)

16-OZ. BTL. PEPSI-COLA

\$1.29

PLUS DEPOSIT

3-LB. CAN CRISCO SHORTENING

\$1.59

WITH \$10.00 OR MORE ORDER (LIMIT 1)

*PRICES GOOD THRU SAT., DEC. 18TH *NONE TO DEALERS
*WE RESERVE THE RIGHT TO LIMIT QUANTITIES ©COPYRIGHT
1982, WINN-DIXIE STORES, INC.

2-LITER NO-RETURN BTL. SEVEN UP

•DIET SEVEN UP

99¢

STOKELY

•17-OZ. GREEN PEAS, WHOLE KERNEL OR CREAM STYLE CORN, 16-OZ. BEANS - FRENCH STYLE, REGULAR CUT OR SHELLIE.

3 FOR \$1

16-OZ. CAN **FORD HOOK LIMAS** 69¢

16-OZ. CANS STOKELY HARVARD, TINY WHOLE OR SLICED PICKLED BEETS 59¢

Beer

12 Pk./12 Oz. Budweiser, cans
Budweiser Light, cans

\$3.99

6 Pk./12 Oz.

\$2.89

Lowenbrau Special,
NRB Dark, NRB.

750 ML. Andre Dry

CHAMPAGNE

\$2.73

Pink Cold Duck

1 1/2 Liter Gallo

WINES

Chablis Blanc Rhine Hearty Burgundy

\$3.19

1 1/2 Liter Taylor California Cellars

Rhine Chablis Vin Rose Burgundy

WINES

\$3.79

750 ML. Riunite

Lambrusco Bianco Rosato

WINES

\$2.59

18-OZ. BOX DUNCAN HINES LAYER CAKE MIX

69¢

1-LB. BAG CHOCK-FULL-O-NUTS COFFEE

\$1.89

16-OZ. BOX DIXIE CRYSTALS SUGAR

2 \$1.00 FOR

29-OZ. CAN THRIFTY MAID CUT SWEET POTATOES

69¢

16-OZ. CAN THRIFTY MAID CRANBERRY SAUCE

\$2.10 FOR

16-OZ. CANS STOKELY FRUIT COCKTAIL

3 \$1.00 FOR

Merry Christmas

FROM OUR WINN-DIXIE FAMILY TO YOU AND YOUR FAMILY!

- WE'LL BE OPEN UNTIL 6 P.M. CHRISTMAS EVE.
- CLOSED CHRISTMAS DAY.
- OPEN REGULAR HOURS DEC. 26TH.

Health and Beauty Aids

- 8.2-OZ. GEL, 9-OZ. REGULAR COLGATE TOOTH PASTE \$1.49
- 24-OZ. BTL. LISTERMINT \$2.29
- 300-CT. PKG. Q-TIP COTTON SWABS ... \$2.19
- 10-OZ. BTL. JOHNSON & JOHNSON BABY OIL \$2.99
- 40-CT. SCOTT BABY WIPES \$4.39

GREAT CHRISTMAS GIFTS!

GERALD COUNTER TOP REFRIGERATOR

1.71 CU. FT. U.L. LISTED

\$20.00 OFF

REGULAR PRICE \$119.00

WITH THIS COUPON ONLY **\$99.00**

"WHILE THEY LAST!"

14-IN. MCCULLOUGH EAGER BEAVER

- CHAIN SAW** \$99.95
- G.E. HEATED CURLING BRUSH \$8.99
- G.E. POWER PRO HAIR DRYER \$14.99
- SPACE JOCKEY VIDEO GAME CARTRIDGE \$7.99

Discover The Most Precious Gem Created By Man... The Cubic Zirconia

\$6.99

Your choice of 5 charming pendants with 14 kt. gold filled serpentine chains for only \$6.99 each plus tax with \$100.00 in register tapes.

24-OZ. LOAVES DIXIE DARLING SANDWICH BREAD

2 FOR 99¢

11-OZ. PKG. DIXIE DARLING FLAKY OR TWIN BROWN & SERVE ROLLS

2 FOR 89¢

8-OZ. BAG RUFFLES POTATO CHIPS

89¢

- 10-OZ. JAR MAXWELL HOUSE INSTANT COFFEE \$3.79
- 22-OZ. BTL. LUX LIQUID DETERGENT 89¢
- 30-OZ. CAN LIBBY'S PUMPKIN PIE MIX \$1.09
- 16-OZ. JAR HEINZ SWEET SALAD CUBES... 89¢
- 15-OZ. BOX THRIFTY MAID RAISINS \$1.49

- 13-OZ. CAN CARNATION EVAPORATED MILK 2 for 89¢
- 20-OZ. CAN THRIFTY MAID PINEAPPLE 59¢
- 20-OZ. BAG CRACKIN' GOOD CHRISTMAS COOKIES 99¢
- 48-OZ. BTL. OCEAN SPRAY CRANBERRY JUICE \$1.69
- 12-OZ. BAG NESTLE'S SEMI-SWEET MORSELS \$1.79

Home Loan Delinquents Said Rising

By ROBERT FURLOW
Associated Press Writer
WASHINGTON (AP) — A record number of American homeowners — about 167,000 individuals and families — were facing foreclosure proceedings as the recession continued in the third quarter of this year, a lenders group says.

On the other hand, the group also reported on Sunday that the percentage of people who were late on their mortgage payments declined in the quarter.

Mark J. Riedy, executive vice president of the Mortgage Bankers Association of America, called the drop in payment delinquencies "welcome news in view of the continued worsening employment situation across the country."

He said delinquency rates usually rise when the unemployment rate rises as it did in the third quarter. The jobs rate, estimated at 9.5 percent in June, rose to 9.8 percent in July, held steady in August, then increased to 10.1 percent in September, according to government figures.

"My feeling is that there has been a shake-out of people who are going to be delinquent," Riedy said in the MBA report. "In other words, the most vulnerable borrowers have been recorded in the past as delinquencies and are now somewhere in the foreclosure process."

He noted new foreclosure proceedings were begun on 0.22 percent of home loans in the third quarter, up from 0.2 percent in the second.

"If unemployment continues to rise, or if unemployment benefit programs are exhausted, we may yet see delinquencies rise again early in 1983," he said.

Loans with payments 30 days or more past due declined to 5.48 percent in the third quarter from 5.56 percent in the second, the report said.

It said loans in the foreclosure process rose from 0.58 percent in the second quarter to 0.62 percent in the third. That translates into about 167,400 of the 27 million home loans outstanding nationwide.

The fact that such proceedings have begun does not necessarily mean actual foreclosure will occur, with a lender taking position of a home.

"Lower interest rates have helped and will help homeowners in distress by taking the pressure off those who are forced to sell," Riedy said.

The report said its figures were based on a survey of more than 8 million home loans on residential properties with one to four units. The loans were being serviced by mortgage bankers, commercial banks, savings banks, savings and loan associations and life insurance companies, it said.

Computer Using Valley Girl Talk

MONMOUTH, Ore. (AP) — Gash me with a ginsu, pitch me with a fork — a college computer has learned Valley Girl talk.

Diana Miller, a student at Western Oregon State College, spiced up a math instruction program for her daughter with the latest slang from California's San Fernando Valley.

The mother wrote the program on the college computer and her 5th-grade daughter uses it on a microcomputer at her grade school.

When the girl provides the right answer, the computer responds variously:

"You truly amaze me."
"You are truly Ex."
"Max. You amaze me."
"Jumplin' jelly beans, you did it."

When she muffs a problem, the computer replies:
"Gash me with a ginsu."
"Keep dreamin'."
"Pitch me with a fork."
A ginsu is a type of knife.

THE FINAL TOLL
CAIRO, Egypt (AP) — The final toll is 55 dead and 15 injured in the collapse of a five-story house in a southern suburb of Cairo on Dec. 3, police officials say.

PRICE BREAKER COUPON

5-LB. BAG DIXIE CRYSTALS SUGAR **99¢**

Coupon good thru WED., DEC 22ND.

WITH \$10.00 OR MORE ORDER AND COUPON (LIMIT 1)

PRICE BREAKER COUPON

32-OZ. JAR DUKE'S MAYONNAISE **59¢**

Coupon good thru WED., DEC 22ND.

WITH \$10.00 OR MORE ORDER AND COUPON (LIMIT 1)

ODDS AD OF 12-2-82

Price Value	No. of Prizes	Odds For One Store (1 Visit)	Odds For Store (3 Visits)	Odds For Store (25 Visits)
\$1000.00	110	17891 TO 1	2622 TO 1	4026 TO 1
100.00	600	2500 TO 1	754 TO 1	577 TO 1
100.00	1180	2485 TO 1	828 TO 1	401 TO 1
50.00	1900	9234 TO 1	710 TO 1	565 TO 1
25.00	3700	7059 TO 1	618 TO 1	271 TO 1
10.00	2800	5247 TO 1	402 TO 1	201 TO 1
5.00	4600	2629 TO 1	201 TO 1	100 TO 1
2.00	18000	923 TO 1	71 TO 1	36 TO 1
1.00	35500	78 TO 1	6 TO 1	3 TO 1
Total	100460	68 TO 1	6 TO 1	2 1/2 TO 1

It's new! It's fun! It's Winn Dixie's BEEF PEOPLE BINGO!

U.S. CHOICE WHOLE UNTRIMMED SIRLOIN TIPS
9-12-LBS. AVG. (SLICED FREE)

157¢

W-D BRAND U.S. CHOICE BONELESS CUBED STEAK

W-D BROADBREASTED GRADE "A" TURKEYS
17-LBS. & UP (LIMIT ONE)

55¢

10-14 LBS. LB. 68¢

IDAHO BAKING POTATOES

98¢

10-LB. MESH BAG

16-OZ. CUP SUPERBRAND SOUR CREAM ... 149¢

Dei-Bakery

GOURMET QUALITY TURKEY BREAST

169¢

1/2-LB. SLICED TO ORDER

LEAN AND TENDER COOKED HAM ... 1/4-LB. \$4.69

12-PC. SATCHEL SOUTHERN STYLE FRIED CHICKEN ... 1/2-LB. \$5.99

PLUS 1-DOZEN DINNER ROLLS

16-OZ. LOAF FRESH BAKED FRENCH BREAD 79¢

SOUTHERN STYLE POTATO SALAD ... 1/2-LB. 89¢

AVAILABLE IN DELI-BAKERY STORES ONLY (SEE STORE ADDRESSES AT BOTTOM OF AD.)

Don't trust your Holiday Dinner to chance! Insist on a W-D Brand Broadbreasted Grade 'A' Young Turkey from Winn-Dixie.

We sell only Grade 'A' Turkeys!

- 17-LBS. & UP W-D REDI-BASTED GRADE "A" TURKEYS 1/2-LB. 68¢
- 10-14-LBS. W-D REDI-BASTED GRADE "A" TURKEYS 1/2-LB. 78¢
- 5-9-LB. W-D REDI-BASTED BELT TURKEYS 1/2-LB. 89¢
- 10-LBS. & UP GRADE "A" FRESH TURKEYS 1/2-LB. 79¢

Produce Patch

4-LB. BAG EASTERN RED DELICIOUS APPLES **99¢**

HARVEST FRESH GREEN BEANS .. 2 lbs. 99¢

HARVEST FRESH SWEET POTATOES .5 lbs. \$1

HARVEST FRESH CAULIFLOWER OR BROCCOLI BUNCH 98¢

You've never been able to buy steaks like these ...

Introducing our exclusive W-D Brand Prestige Steaks. Each is hand-selected, specially aged and guaranteed. Prestige Filet Mignon, Strip or Rib Eye Steaks are a dining experience to enjoy yourself and to give as a gift. Ask your Meat Market Manager.

99¢

W-D BRAND U.S. CHOICE ROUND BONE SHOULDER ROAST LB. \$2.98

W-D BRAND U.S. CHOICE EZ CARVE RIB ROAST **2.98**

11-OZ. SIZE FOX DE LUXE PIZZAS **78¢**

ALL VARIETIES

PINKY PIG FRESH PORK SHOULDER PICNICS **99¢**

W-D GRADE "A" BAKING HENS **59¢**

W-D GRADE "A" REDI-BASTED TURKEY BREASTS LB. \$4.49

1-LB. PKG. JAMESTOWN HOT OR MILD PORK SAUSAGE **99¢**

W-D BRAND U.S. CHOICE SIRLOIN TIP ROAST **2.29**

Frozen Foods

16-OZ. CAN ASTOR FROZEN FLORIDA ORANGE JUICE **99¢**

2-LB. PKG. BANQUET FRIED CHICKEN \$2.69

CHRISTOPHER 32-OZ. EDWARDS PECAN PIE . \$3.99

16-OZ. CUP SUPERBRAND WHIPPED TOPPING .99¢

Dairy Products

1-LB. PKG. IN QUARTERS SUPERBRAND MARGARINE **3.99**

FOR

6-PAK SUPERBRAND BUTTERMILK OR SWEETMILK BISCUITS \$4.09

16-OZ. PKG. SUPERBRAND ALL VARIETIES COOKIES \$4.19

8-OZ. CUP KRAFT SOUR CREAM DIP ... 99¢

WINN DIXIE *We're Right for You!*

...RIGHT WITH THE FRIENDLIEST and CLEANEST STORES in TOWN!

Meat Values

- COUNTRY PRIDE GRADE "A" JUMBO PAK DRUMETTES ... 1/2-LB. 99¢
- W-D BONELESS TURKEY ROAST 1/2-LB. 1.49
- 10-LBS. & UP SWIFT BUTTERBALL OR HONEYBUCKLE WHITE TURKEY 1/2-LB. 99¢
- 12-OZ. STANDARD OR SELECT OYSTERS \$2.99
- 5-7-LBS. AVG. U.S. CHOICE WHOLE BEEF TENDERLOINS ... 1/2-LB. \$3.99
- HICKORY SWEET BONELESS HAM 1/2-LB. \$2.79
- HICKORY MOUNTAIN COUNTRY CURED HAM ... 1/2-LB. \$4.19
- 3-LB. CAN WILSON CORN KING CANNED HAM \$7.99
- U.S. CHOICE LAMB LEGS ... 1/2-LB. \$2.99
- 1-LB. CUP TASTY BIRD FRYER GIZZARDS OR LIVERS 49¢
- 8-12-LBS. AVG. U.S. CHOICE WHOLE BEEF RIB EYES (SLICED FREE) LB. \$3.99
- U.S.D.A. INSPECTED TURKEY WINGS 1/2-LB. 39¢
- U.S.D.A. INSPECTED TURKEY DRUMSTICKS . 1/2-LB. 39¢

HOUSE OF RAEFORD YOUNG

16 LBS. & UP

TURKEY



LIMIT ONE WITH \$10.00 FOOD ORDER EXCLUDING ADVERTISED ITEMS. WITHOUT FOOD ORDER LB. 59¢.

49

SWIFT BUTTERBALL TURKEYS..... 12 LBS. & UP LB. 89¢

10-16 LBS..... LB. 65¢

FRESH STANDARD OYSTERS PINT \$2⁹⁹

JOHN MORRELL MORRELL BACON..... 12 OZ. \$1³⁹ PKG.
MORRELL FRANKS..... 12 OZ. 99¢ PKG.

FRESH PICNICS LB. 79¢

PEANUT CITY OR BEALE COUNTRY HAMS \$1⁷⁸ LB.

FRESH FRYER
LEFT QUARTERS..... LB. 59¢
BREAST QUARTERS..... LB. 69¢
FAMILY PAK SPECIALS
PORK CHITTERLINS..... 10 LB. PKG. \$5.99
PORK NECK BONES..... 5-7 LB. PKG. LB. 49¢
PORK SPARE RIBS..... 5-7 LB. PKG. LB. \$1.29

HEAVY WESTERN T-BONE OR SIRLOIN STEAKS \$1⁹⁹ LB.

EDGE MONT CORNED OR SMOKED HAMS LB. \$1⁴⁹ HALF OR WHOLE

PRICES EFFECTIVE THURSDAY THROUGH SATURDAY QUANTITY RIGHTS RESERVED.

HEAVY WESTERN FULL CUT ROUND STEAK FRYERS \$1⁴⁹ LB.

GRADE "A" LARGE EGGS \$5⁹ DOZEN

LIMIT 4 DOZEN AT THIS PRICE

Overton's Supermarket, Inc.

211 JARVIS STREET
2 BLOCKS FROM ECU
"HOME OF GREENVILLE'S BEST MEATS"

MasterCard VISA

BANQUET FROZEN PIE SHELLS . . . PKG. 2 / \$1⁰⁰ OF 2 PKGS.

FRESH WHOLE 42

OCEAN SPRAY JELLIED CRANBERRY SAUCE 303 CAN 59¢

FRESH WHOLE MAOLA MILK 1/2 GALLON PAPER CARTON 89¢

BOUNTY PAPER TOWELS..... GIANT ROLL 78¢

CHARMIN TOILET TISSUE \$9⁸ 4 ROLL PKG.

Squeezeably Soft Charmin

PACKER'S LABEL FROZEN FRENCH FRIES..... 5 LB. BAG 99¢

FRESH FLORIDA (4 SIZE) CELERY STALK 38¢

COCA-COLA 16 OZ. CARTON OF 8 \$9⁸

PLUS DEPOSIT Limit 3 at this price.

DUKE'S MAYONNAISE QUART JAR 98¢

BEAUTIFUL CHRISTMAS POINSETTIAS 6-INCH POTS ONLY \$4⁹⁹

HURRY FOR BEST SELECTION! WE HAVE GIFT CERTIFICATES!

GENERIC EVAPORATED MILK..... 13 OZ. CAN 3/\$1⁰⁰

ALL PEPSI PRODUCTS 2 LITER BOTTLE \$7⁹

LIMIT 6 AT THIS PRICE.

U.S. NO. 1 WHITE POTATOES 10 LB. BAG 98¢

FLORIDA FRESH ORANGES 5 LB. PLASTIC BAG 98¢

DUNCAN HINES CAKE MIX 18 OZ. BOX \$7⁹

YOUR CHOICE YELLOW, LEMON, BUTTER, GOLDEN

LAY'S BRAND RUFFLES POTATO CHIPS 8 OZ. BAG 99¢

APRIL SHOWER EARLY PEAS..... 303 CAN 3/\$1⁰⁰

HAPPY HOST SUGAR 5 LB. BAG

COLD POWER DETERGENT - \$9⁸ GIANT BOX

CLEANS, BRIGHTENS SAVES ENERGY IN COLD WATER

GREEN CABBAGE \$10

sugar granulated \$9⁸ LB.

98 10 98

FAMILY DOLLAR

For More Under Your Christmas Tree

Christmas Sale



Tremendous Savings On Fashion Sweaters And Jeans

5.99

Boys' And Girls' Sizes

7.99

Men's And Ladies' Sizes

- **Sweaters:** select from an assortment of crew, boat, turtle, v-neck, basic cardigan and 5 gauge coat sweaters. Boys' 4 to 18, girls' 4 to 14, men's S,M,L,XL and ladies' S,M,L. Not all styles in all sizes.
- **Jeans:** fashion denim jeans with contrast stitching and back pocket details. Boys' 4 to 18, girls' 4 to 14, men's 28 to 38 and ladies' 5/6-15/16 and 8 to 18. Ladies' corduroy jeans in sizes 5/6-15/16 and 8 to 18.



3.99
Gallon

Dowgard Anti-Freeze
Protects against winter freeze up and helps prevent corrosion.



84¢
Qt.

Quaker State Motor Oil
Reg. Price 1.03! Quaker State HD30 year round motor oil. Limit 5.



3 \$1 4.75 oz.
Bars Lux Soap
Bath size 4.75 ounce Lux beauty soap. Limit 3 bars.



3 \$1 Aluminum Foil
For
12" x 25' Wonderfoil. Stock up now and save. Limit 3.



1.19 49 Oz. Punch
Box Detergent
Reg. Price 1.63! Punch all temperature laundry detergent. Limit 2.



7.99 Polaroid
Pack SX70 Film
Reg. Price 8.49! Time zero film. 10 exposures per pack.

Sale Starts Today! Prices Good Through Dec. 19th Or While Quantities Last.



12⁹⁹ Pair Men's And Ladies' Fashion Dress Boots

Vinyl dress boots with side zippers and soft tricot lining. Men's sizes 8 to 12 and ladies' sizes 6 to 10.



10⁹⁹ Pair Men's Hikers

Heavy gauge nylon uppers with split leather trims. Thick foam padded ankle collar and tongue. Kraton® rubber lug soles.



Slippers For The

- a. Ladies' Fruit-Of-The-Loom Slippers
- b. Men's Vinyl Moc Slippers
- c. Children's Action Hero Slipper Socks
- d. (Not Pictured) Men's And Children's Slippers



Special Purchase!

17⁹⁹

Men's Outerwear Jackets

Compare At *25! Poly filled nylon ski jackets, fashion treatments include styles with zip off sleeves. Corduroy, poplin and bomber jackets. Sizes S,M,L,XL.



5⁹⁹ Men's Dress Shirts

Long sleeve no-iron shirts in white, blue or tan. Sizes 14½ to 17½.

Ties 2.99

10⁹⁹ Pair Dress Slacks

Woven polyester slacks with matching striped belt. Navy, black, brown or tan. Sizes 29 to 42.

Belts 2.99

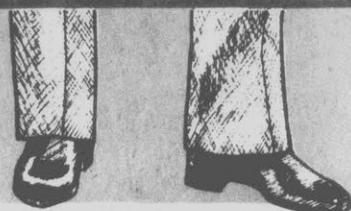

3⁹⁹ Each

Knit Or Western Shirts

- Knit Shirts with long and short sleeves. Crew, v-neck and collar styles with multi-color stripes. Sizes 4 to 18.
- Western Shirts with or without yoke styling. Two front pockets. Assorted plaids. Sizes 4 to 7. Boys' 8 to 18. 4.99

4⁹⁹ Pair

Coordinate Casual Jeans

Twill casual jeans in belted, elastic back and basic styles. Navy, tan, brown or green. Sizes 4 to 18.



2⁶⁹ Men's 2 Pack Famous Make Underwear

100% cotton t-shirts or briefs. Sizes S,M,L,XL. Slightly irregular.

FAMILY DOLLAR Has Holiday Savings On Last Mir



\$1 Each Glass Bakeware

1½ qt. open baker or utility pan, 9" pie plate, deep loaf dish plus others.

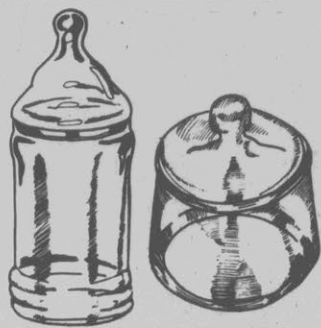

\$1 Each Novelty Jars

24 oz. Boutique, 32 oz. International or 29 oz. Pagoda jars with lids.

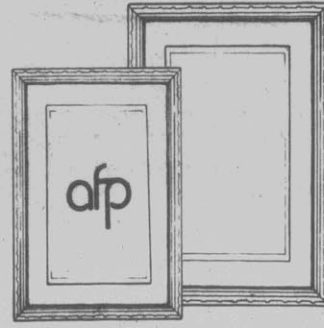

\$2 Each Acme Frames

5" x 7" or 8" x 10" tailored band gold frames with mats. By Acme.

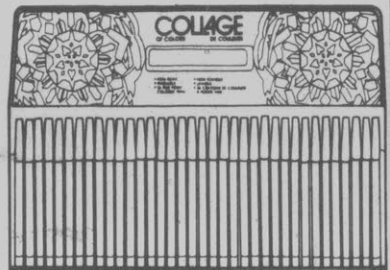

1⁸⁸ 36 Count Markers

Fine point felt tip colored markers. Non-toxic, washable.



For The Family
 The 3.00
 3.99
 1.88
 2.00

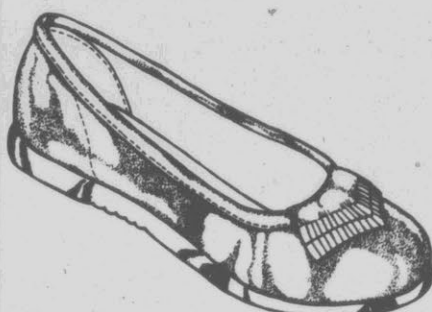

\$6 Pair Ladies' Casuals
 Smooth vinyl or suede low heel shoes. Ballerina styles with kittie flap or drawstring. Sizes 6 to 10.
 Children's Sizes \$5 Pr.



10⁹⁹ Pair
Men's And Ladies' Dress Shoes

• Compare At 19.99! Men's vinyl slip-on dress shoes with tassels and trims. Black or brown.
 • Compare At 16.99! Ladies' patent or smooth vinyl dress shoes with heels and sling back styling. Sizes 6 to 10.



8⁹⁹

Long Robes

Select from quilted and fleece robes with embroidery, lace trim and quilted trims. S,M,L.



4⁹⁹

Ladies' Novelty Tops

Compare To \$10! Solid and striped tops with dolman, ¾ length, mutton and long sleeves. S,M,L. Extra Sizes.....7.99

7⁹⁹

Dressy Holiday Blouses

Blouses with ruffles, tuxedo pleats, stand up and ruffled collars. Plaids or solids. S,M,L.



3 1⁷⁹ Pair
Ladies' Briefs
 Reg. 2.39! 3 pair pack of briefs in white and pastel colors. 5 to 10.



3⁹⁹ Fashion Handbags

Compare At \$8! Leather, suede and leather trim clutches or shoulder strap bags.

3⁹⁹ Sizes 4-6x

4⁹⁹ Sizes 7-14

Tops, Blouses Pants And Skirts

- Novelty Tops with long or ¾ length sleeves in boat and crew neck styles.
- Blouses with ruffles, bows and buttons. Solids, stripes and plaids.
- Pants And Knickers with belts, piping and pockets. Styles include zipper and elastic leg bottoms.
- Skirts in corduroy, prairie, tiered and pleated styles.

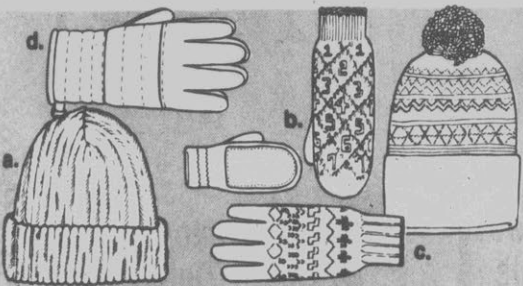
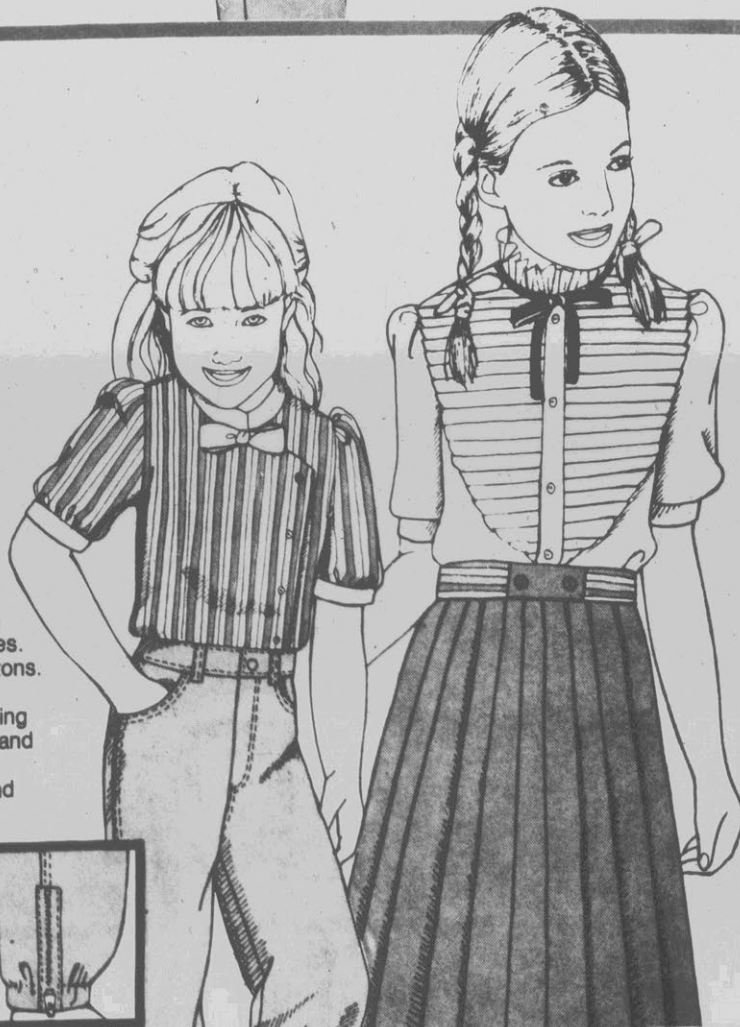

Knitwear For The Family

- a. Men's & Boys' Toboggans.....99¢
- b. Boys' & Girls' Hats Or Gloves.....1.99
- Girls' 2 Pc. Hat & Glove Set...3.99
- c. Ladies' Knit Hats Or Mittens.....2.00
- d. Men's Palm Or Ski Gloves.....2.99
- Ladies' 2 Pc. Hat & Glove Set...4.99

Minute Gifts For Him Or Her....Shop Early And Save!

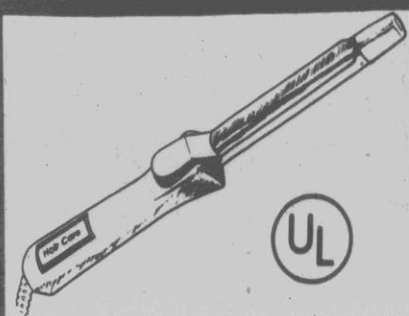

4⁹⁹ Curling Iron

5/8" chrome barrel curling iron with tangle free swivel cord. UL approved.

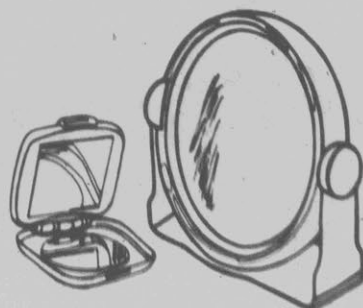

1⁹⁹ Each Make-Up Mirrors

Lighted compact mirror or table/wall two way mirror.

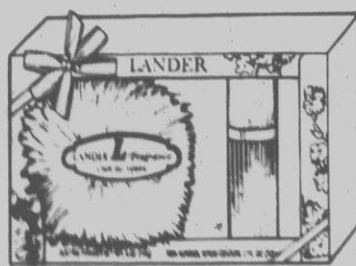

2⁹⁹ Lander Gift Sets

Fragrance set includes 5 oz. dusting powder and 2 oz. cologne.



3⁹⁹ Brut Gift Set

Brut fragrance set includes 1 oz. after shave and 3.5 oz. cologne.

FAMILY DOLLAR

For More Under Your Christmas Tree

Advertising Supplement AB# 16

Christmas Sale

Sale Starts Today!
Prices Good Through
December 19th Or
While Quantities Last!



14.99 Save Up
Twin Size To 50%!

Special Purchase Famous
Make Bedspreads

Decorator print fully quilted bedspreads. Machine wash, tumble dry. Not all patterns in all stores.
Full Size 17.99
King Or Queen Size 19.99

2 For \$5

Cannon
Bath Towels

"Main Street" 24"x 44" print towels or "Santa Cruz" 21"x 45" solid color bath towels. Irregulars. Deluxe Hand Towels 2/3



17.88
Twin Size

Electric Blankets
Save 30%!

Automatically adjusts to changes in room temperature. Machine washable. Reconditioned. Single Control Full 19.88
Dual Control Full 20.88

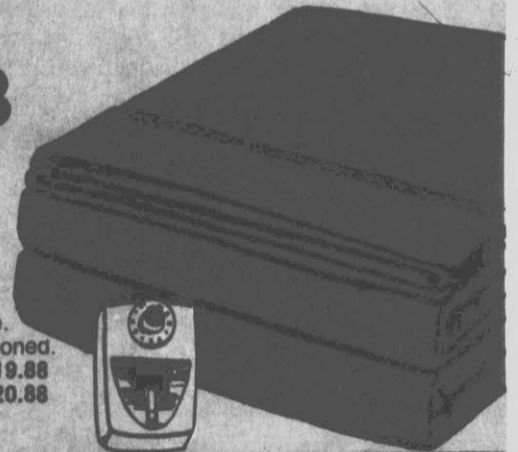

Trim-A-Tree Accessories

Toys • Toys • Toys • Toys

12.99

6 Foot Scotch
Pine Artificial
Christmas Tree

Scotch Pine tree complete with stand, easy to assemble.

2.59
Set

35 Miniature
Light Set

With 2 replacement bulbs and one replaceable safety fuse. UL approved.

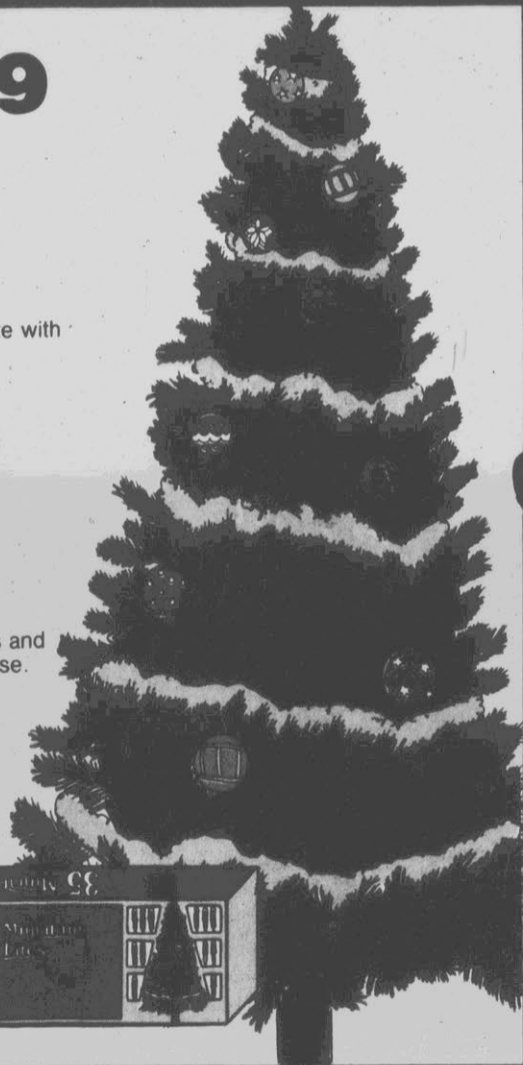

1.79
Each

Kenworth
Interstate Fleet

Assorted die cast metal tractor trailer trucks with names of nationally known trucking companies. HO scale.

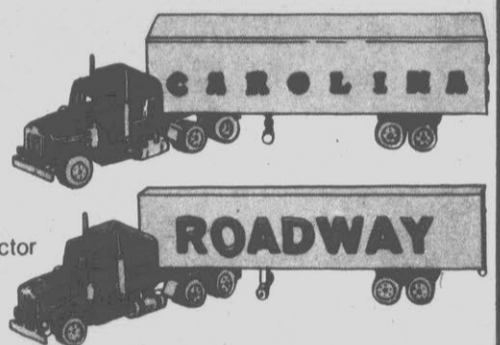

2.99 Lovable
Playmate
Each Animals

Large cuddly, hugable stuffed animals. Choose from T.V. dog, turtle or fire chief dog.



\$1 Assorted
Novelty
Each Dolls

Assorted fashion or baby dolls. Each comes with one complete outfit. Movable arms and legs.



1.19
Pack

Christmas
Gift Boxes

Pack of 2, 3 or 4 assorted size gift boxes.



2.99
Pack

3 Roll
Gift Wrap

100 square feet in a variety of Christmas prints.

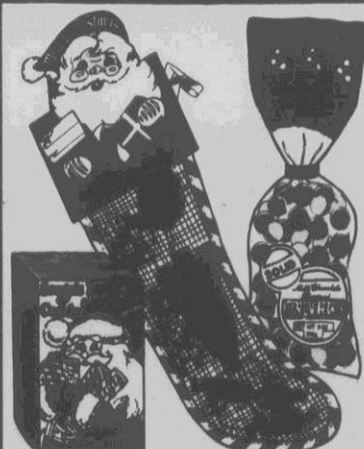

\$1 Stocking
Stuffer
Ea. Candy

9 oz. chocolate balls or bells, 8 oz. Santa book of candy, 12 ct. candy canes plus other varieties.



Eveready Energizer Batteries
Sale Price 2 Packs For \$3
Buy any 2 packs of "C", "D", 9 volt or "AA" batteries and get a \$2.25 cash rebate from Union Carbide.

2.75 Net Cost
Packs After Rebate



69¢

25 Count
Bag Bows

Colorful bows with peel-off adhesive backs.



3 \$1

For
Giant
Mint Sticks

Big 5 ounce size peppermint candy sticks.

Sears

Wrap up a Beautiful Christmas

SALE

Starts Wed., Dec. 15,
Sale Ends Dec. 18
unless otherwise indicated

SEARS
SUPER
VALUES

**25%
OFF**

Our Classic Oxford
Dress Shirts with
Button-Down Collars

SAVE \$4
Regular \$15.99
11⁹⁹

Perma-Prest blends of polyester and cotton in handsome oxford-weave solids and stripes. Man-pleasing details like chest pocket and two-button cuffs. Choice of colors.

\$6 OFF
Stretch-Woven Slacks
9⁹⁹

Regular \$15.99
Super savings on great-looking slacks with comfort woven right in. Perma-Prest polyester with stretch Ban-Rol® waistband.

Underwear SALE
\$2 OFF T-Shirts, Briefs

Pack of 3
Reg. \$10.99
8⁹⁹ pack
Shape-holding blends of polyester and cotton. T-shirts, V-shirts, briefs.

\$1.50 OFF Winterweight

Top or Bottom
Reg. \$6.99 each
5⁴⁹ Each
Woven for warmth, but lightweight for comfort. Rib-knit wrist and ankle bands.

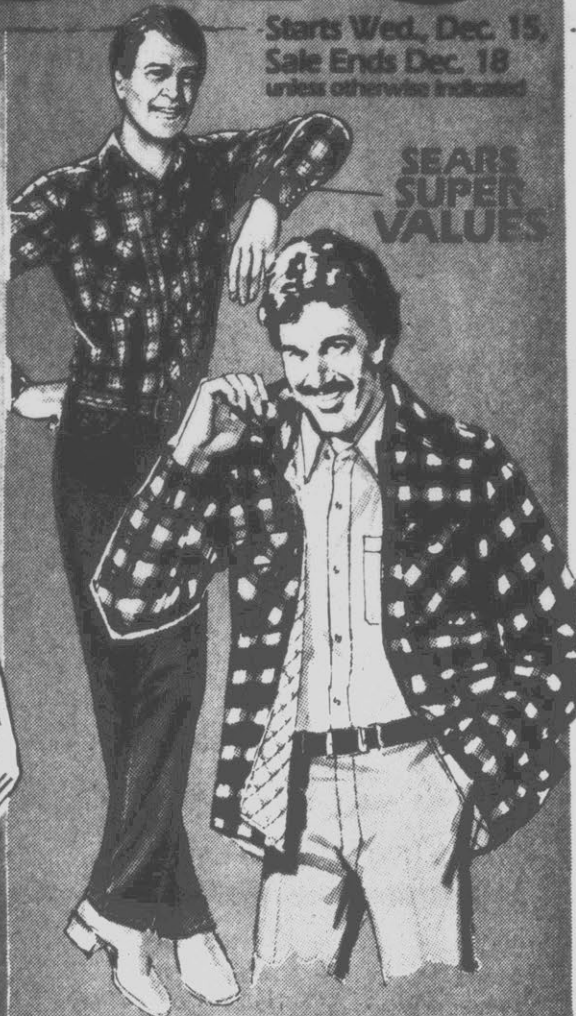
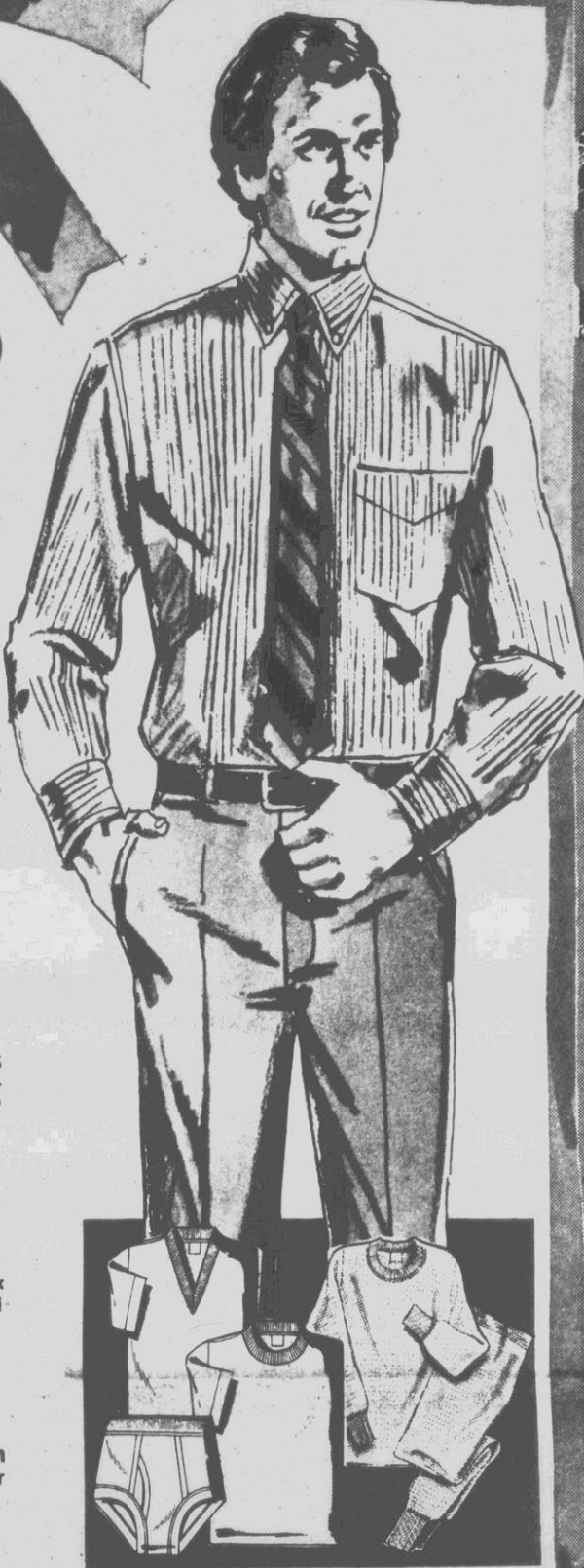

SAVE \$4-\$9
Work and Western Wear

YOUR CHOICE
9⁹⁹

\$18.99 Quilt-Lined Flannel Shirt **9.99**
Doubles as a jacket. Cotton and polyester flannel shell, nylon or polyester lining quilted to polyester fiberfill. Sizes S-XL.
\$20.99 Tall Size Quilt-Lined Shirt **11.99**

\$13.99 Western-Cut Flannel Shirt **9.99**
Details include front and back yokes, snap closures, three-button cuffs. Cotton and polyester in colorful plaids.

Special Purchase. Stretch Jeans **9.99**
Great low price on cotton and nylon stretch jeans built for action and comfort. Hurry, while quantities last.

Work and Leisure Shop

Man-Pleasing Tops
for Less Than \$10

Soft Sweater Shirts

SPECIAL PURCHASE
9⁹⁹

Easy care and comfortable acrylic knits make great gifts. These feature three-button front, rib-knit cuffs and waistband. Several color combinations.

Acrylic Crew-neck Sweaters

SAVE \$3
9⁹⁹

Regular \$12.99
Comfortable, easy-care crew-neck sweaters that look and feel great. Choose from many popular color combinations.
\$11.99 V-neck Acrylic Sweaters **8.99**

Dragon Emblem Pullover

SAVE \$5
9⁹⁹

Regular \$15.00
Cotton and polyester pullovers feature four-button placket front, and flap pocket with our dragon emblem. Solid colors.

Easy-Care Flannel Shirts

SAVE \$4
8⁹⁹

Regular \$12.99
Choose from sporty plaids in Easy-care blends of polyester and cotton. Warm gift ideas.

Ask About Sears Credit Plans

Sears Pricing Policy. If an item is not described as reduced or a special purchase, it is at its regular price. A special purchase, though not reduced, is an exceptional value.



SAVE \$7
Warm, Lightweight
Jackets For Him

YOUR CHOICE
18⁹⁹

A. \$26.00 Warm-Up Jacket has nylon shell with pile lining. Elastic cuffs and snap-front plus drawstring waist. \$28 Tall Sizes **20.99**

B. \$26.00 Anti-Freeze Jacket, nylon taffeta with acrylic fleece lining. Shirt-style collar, zippered front and button cuffs.

Large items such as appliances and furniture are inventoried in our distribution center and will be scheduled for delivery or pickup.

You can count on

Sears

Satisfaction Guaranteed
or Your Money Back

SHOP YOUR NEAREST SEARS RETAIL STORE

N.C.: Burlington, Charlotte, Concord, Durham, Fayetteville, Gastonia, Goldsboro, Greensboro, Greenville, Hickory, High Point, Jacksonville, Raleigh, Rocky Mount, Wilmington, Winston-Salem
S.C.: Columbia, Florence, Myrtle Beach, Rock Hill
VA.: Danville, Lynchburg, Roanoke

sale



25% OFF
Misses' Pull-on
Pants

SAVE \$4
Regular \$14

9⁹⁹

If she loves comfort, give our pull-on pants with set-on waistband. Polyester gabardine pants are easy-care.

1/2 PRICE
The Shirt for
Fashionable Misses

Solids
Regular \$10

4⁹⁹

Choose a flatteringly styled shirt for your special someone.
\$12 Misses Prints 5.99

SAVE \$7
Misses' Cardigans
in 3 Styles

Regular
\$23 to 26

15⁹⁹ to 18⁹⁹

That's right, 3 great styles to choose from in easy-care acrylic. Each makes a perfect Christmas gift.



SAVE \$3
Zip 'n Dash
Dresses from Our
Budget Shop

Regular \$14.99

11⁹⁹

A must for her wardrobe. These easy-care polyester and cotton dresses come in prints, plaids, checks and stripes. Get her one or more of these versatile, practical dresses. Misses sizes.
\$15.99 Half Sizes 12.99

SAVE \$6
Fashionable Handbags
Make Perfect Gifts

Regular \$17

10⁹⁹ each

A new handbag is always a welcome gift. And Sears handbags are the fashionable way to get organized. Fully lined vinyl bags in assorted styles and colors.

In Our Accessory Department



SAVE \$10
Men's Rotomatic
Shaver

Regular \$39.99

29⁹⁹

Sears Best electric shaver. Carrying case.
\$49.99 Men's Rechargeable Shaver 39.99

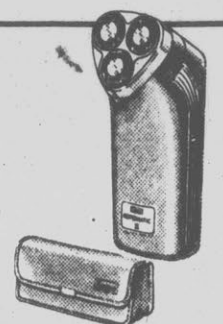

SAVE \$11
4-Way Light
Make-up Mirror

Regular \$35.99

24⁹⁹

4-way lighted make-up mirror. Regular/magnifying center mirror. 2 side mirrors.

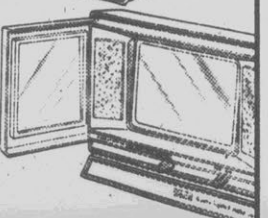

SAVE \$10
Electric
Hairsetter

Regular \$34.99

24⁹⁹

Includes 20 rollers, 6 jumbo, 10 large and 4 small with a clip storage compartment.

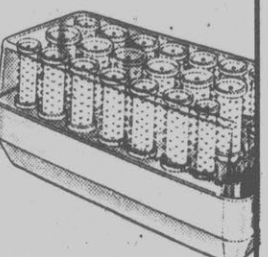

SAVE \$7
1400 Watt*
Hairdryer

Regular \$16.99

9⁹⁹

Concentrator for directing air flow. Separate heat/speed switches. Hurry and save \$7.



SAVE \$5
1000 Watt*
Hairdryer

Regular \$14.99

9⁹⁹

Versatile, fast dryer, 1000 Watt of power. Both high and low settings. Attachments.

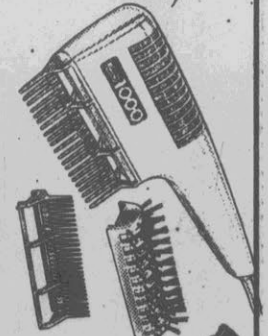

SAVE \$8
Mist Styling
Brush

Regular \$14.99

6⁹⁹

Sears Best. Mist or dry with 2 sets of bristles for long or short hair. Great for spot styling.



30% to 40% OFF

Entire Stock of
Ladies' 1982 Fall
Dress Shoes

Just in time for Christmas. Buy a pair for yourself or as a gift. But hurry. Not all styles and sizes are available in all stores.

While Quantities Last



Sears CREDIT CARD
BEARS PRODUCE AND CO.
0 00000 00000 0
MARY LEWIS 0000
USE THE ONLY CARD THAT BEARS STORE ANYWHERE

APPLY TODAY
You Can Apply for an Account by Phone
Call Toll Free 1-800-323-2780
Ask for Operator 10
Good Nationwide - No Annual Fee

Sears

Wrap up a Beautiful Christmas at Sears

sale

\$4 to \$12 OFF

Cozy Styles for Chilly Nights

SAVE \$6 Warm Blanketcloth Nightwear

Regular \$24 to \$26

17⁹⁹ to 19⁹⁹

A. Robes, 1-piece sleepers or 2-piece pajamas of snugly, warm Acrilan® acrylic blanketcloth. Wear-Dated® by Monsanto. In lovely solid colors. In Junior sizes S,M,L.

\$4 OFF Terry Footed Pajamas

B. You'll be sure of being warm in our stretch terry pajamas of cotton and nylon or cotton and polyester. Assorted colors. Junior's sizes S,M,L.

\$12 OFF Luxurious Fleece Robe

Regular \$45

32⁹⁹

C. Surprise her this Christmas with a robe of washable Arnel® triacetate and nylon in rich hues. Wrap or zip styles. S,M,L.

1/3 OFF All Endurables Hosiery

Regular \$1.49 to \$5.99

99¢ to 3⁹⁹ pair

Our longest wearing hosiery is now on sale. Choose your favorite style.

Ask about Sears Credit Plans

Monsanto full One-Year Warranty Free replacement or refund upon return to any Sears store if an item fails to give normal wear for one year.

25% OFF

TOUGHSKINS- Our Best Jeans for Kids

Regular \$9.99 to \$15.99

74⁹ to 11⁹⁹ pair

A blend of polyester, cotton and nylon denim makes Toughskins Perma-Prest® jeans our longest-wearing. Choose from assorted styles for big and little kids.

25% OFF Sporty Shirts for Kids, too

Regular \$4.49 to \$12.99

3²⁹ to 9⁶⁹

Cozy flannels and woven shirts in many styles and colors. Easy-care cotton or polyester and cotton blends. Sizes for big and little girls and boys. Great for Christmas gift giving.

25% OFF Cardigans, Pullovers, Braggin' Dragon™ Sweaters and More

Regular \$7.99 to \$17.99

5⁹⁹ to 13⁴⁹ each

Our entire stock is now on sale. Choose from fisherman-styles, ski-looks, Braggin' Dragon, jacquard prints and more. Sizes for big and little boys and girls.

Sears Gifts Certificates solve those gift giving problems

Available in any amount you want at the Customer Service Desk at your nearby Sears retail store.



SAVE 20% to 40% Select Group Of Officially Licensed NFL Wear For Big And Little Boys

Sears

Wrap up a Beautiful Christmas at Sears

SAVE 25% on Twin Automatic Blankets

Prelude. Features a control and 11 temperature settings. Made of easy-care polyester, acrylic. Sale ends December 24.

Reg. \$39.99, Twin **29⁹⁹** each

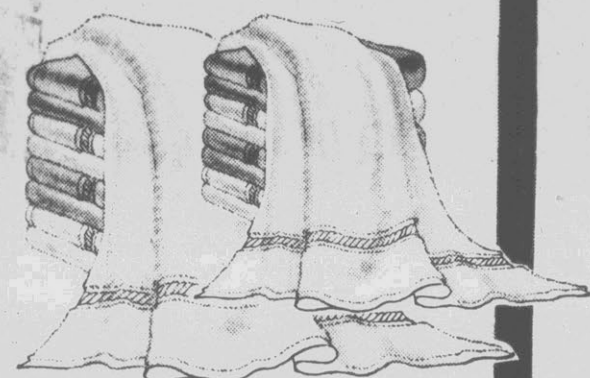

25% OFF Bath Size Colorcore Towels

Velvety soft and smooth with extra absorbency.

Reg. \$6.99

SAVE \$2

\$4.99 Hand Towel **3.99**
\$2.49 Washcloth **1.99**

4⁹⁹

SAVE \$2 on matching Bath Rug, Reg. \$10.99 **8.99**

SAVE \$4 on matching Shower Curtain, Reg. \$16.99 **12.99**

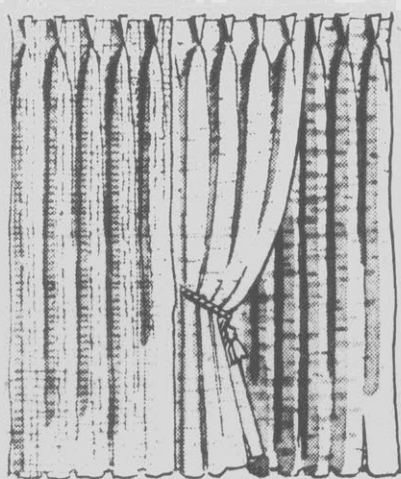

20% to 25% OFF These Best-Selling Draperies

Epic slub-textured drapery of acrylic, polyester rayon blend. Reg. \$29.99. Save today at Sears.

22⁹⁹
48x84-in. pr.

Reg. \$24.99, 48x84-in. pr. Carlisle **19.99 pr.**
Reg. \$24.99, 48x84-in. pr. Chico, unlined **19.99 pr.**

Other sizes are also on sale



ALL RECLINERS ON SALE

SAVE \$200

He-Man Recliner

249⁸⁸

With heater, vibrator, and fingertip controls. Choice of nylon velvet, nylon tweed or vinyl upholstery cover. Save now. Reg. \$449.99.

Sale ends Dec. 24 on all Recliners...shop early for good selection.

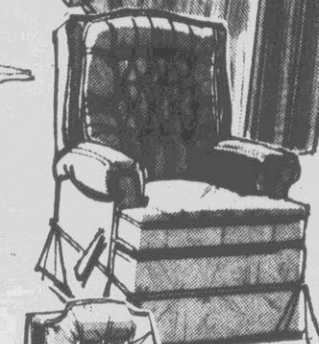

\$150 OFF
Bridgeview II

Reg. \$449.99 **299⁸⁸**

Sears Best. Nylon velvet upholstery cover.

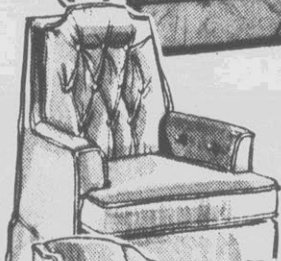

\$50-\$100 OFF
Accent Chairs

Reg. 149.99 to 349.99

99⁸⁸-249⁸⁸

\$249.99 Westway swivel rocker **199.88**

\$349.99 Ashbury wing chair **249.88**

\$299.99 Andrea III accent chair **199.88**

Furniture not in: Concord, Darville, Goldsboro, Greenville, High Point, Rock Hill



\$40 OFF
Reynolds Recliner

Reg. \$219.99 **179⁸⁸**

Vinyl upholstery. Makes a great gift.

SAVE \$50
Rocking Chairs

Reg. \$149.99 to \$199.99

99⁸⁸ to 149⁸⁸

A. \$50 OFF Open Hearth Rocker, Reg. \$199.99 **149.88**

B. \$50 OFF Firecrest Rocker, Reg. \$149.99 **99.88**



SAVE \$2
Colorful Bedrests

Reg. \$10.99 **8⁹⁹**

Makes a great gift. Assorted colors.

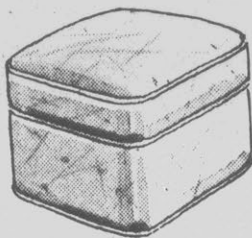

SAVE \$4
Assorted Hassocks

Reg. \$16.99 **12⁹⁹** each

Assortment of sizes, shapes and colors.

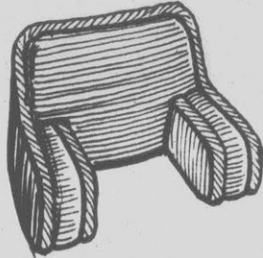

SAVE \$4
Pillow Pals

Reg. \$19.99 **15⁹⁹**

Of wide-wale cotton corduroy. 20x17 in.

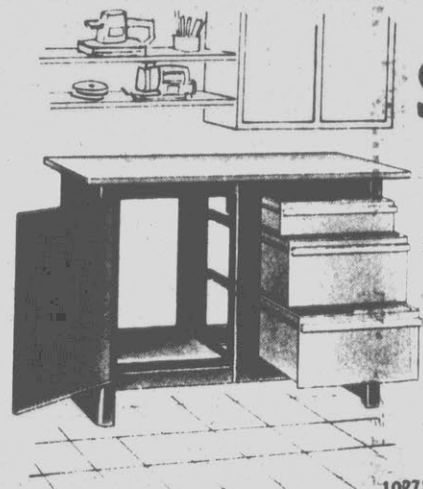

Gift ideas for Mom...

SAVE \$10 to \$30

On Table-top Appliances

SAVE \$10 YOUR CHOICE

Reg. \$34.99 **24⁹⁹** each

A. 14-speed blender. With 2 mix and store jars.
B. Slimline Toaster. Toasts bagels and pastries too.
C. Spray/steam/dry Iron. With self-cleaning valve.
D. 6-qt popcorn popper is self buttering.

\$15 to \$30 OFF
These Gift Ideas

E. Reg. \$59.99 Mixer with 2 bowls. 10-speed **44⁹⁹**

F. Reg. \$59.99 Handy Toaster Oven **44⁹⁹**

G. Reg. \$89.99 Con-venient Food Processor **59⁹⁹**

SAVE 50%

on an 8-pc. cast aluminum cookware set

With SilverStone® Stick-Resistant Surfaces...

Reg. sep. prices total \$140.96 **69⁹⁹** set

Almond color porcelain exteriors with floral design. Solid oak knobs and handles. Thick cast aluminum bottoms.

1/2 PRICE
7-pc. Cookware Set

Reg. sep. prices total \$74.96 **34⁹⁹** set

With SilverStone® interiors for easy, stick resistant cooking. Almond porcelain exteriors.

Not in: Darville, Gastonia, Greenville, Rocky Mount, Shelby



SAVE \$5 to \$20 on These Gift Ideas

\$20 OFF Flatware Set, Reg. sep. priced \$39.99 **19.99**
\$15 OFF Strawberry Canister Set, Reg. \$59.99 **44.99**
\$10 OFF 6-pc. Knife Set with block, Reg. \$29.99 **19.99**
\$10 OFF Merry Mushroom Canister Set, Reg. \$49.99 **39.99**
\$10 OFF Merry Mushroom Cookie Jar, Reg. \$29.99 **19.99**
\$5 OFF Merry Mushroom Clock, Reg. \$29.99 **24.99**

Christmas

sale

SAVE \$30 NOW

on these Craftsman® portable tools

A. 1170

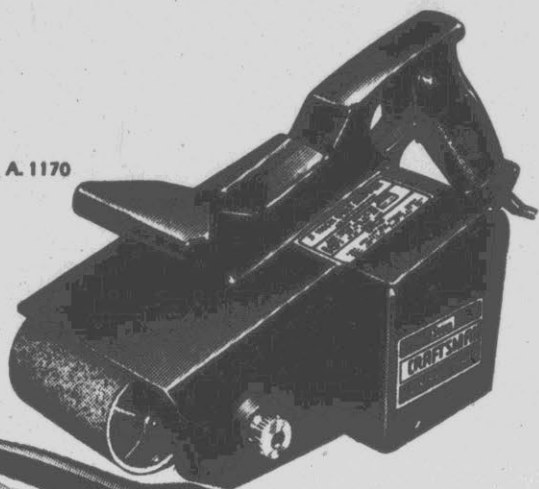

B. 1052



C. 1095



YOUR CHOICE

Reg. \$79.99

ONLY 49⁹⁹

each

A. Craftsman 3-in. Belt Sander

Craftsman quality... develops maximum 3/4 HP. No-load speed of 1300 per min. Has 3x14 in. sanding surface.

B. Craftsman 6-in. Disc Sander-polisher

Two-speed. Includes polishing bonnet and backing pad and more. Save now thru Dec. 18, at Sears.

C. Craftsman 7 1/4-in. Circular Saw

Develops maximum 2 HP. No-load speed of 5400 rpm. Makes a great gift for dad for Christmas.

Tool Sale ends Dec. 18

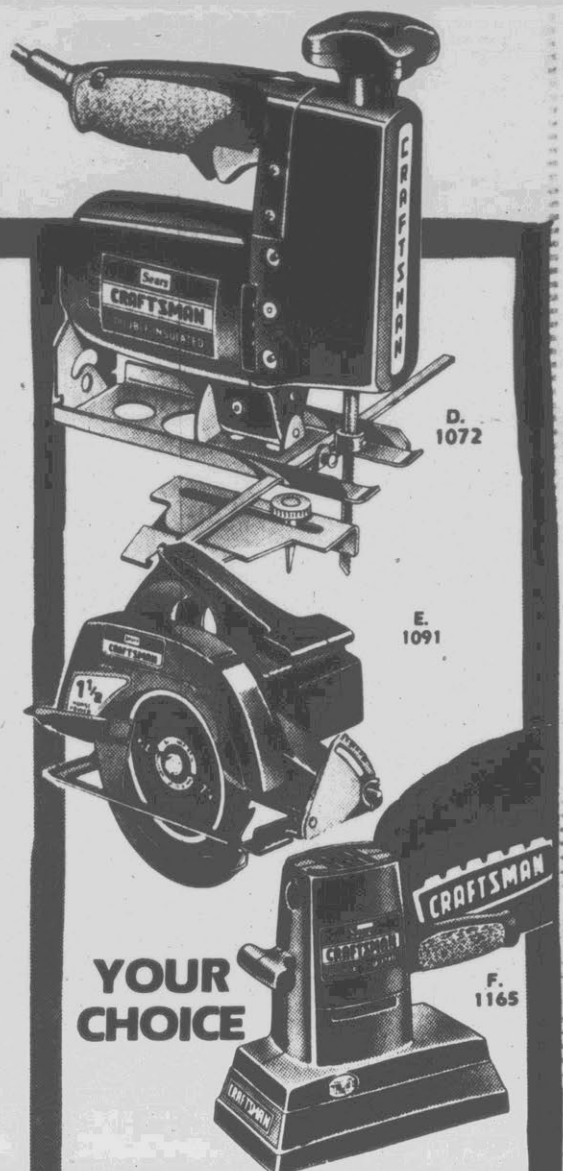

D. 1072

E. 1091

F. 1165

YOUR CHOICE

\$20-\$30 OFF

CRAFTSMAN® Power Tools

Reg. \$59.99 to \$69.99

39⁹⁹

each

D. Reg. \$69.99 Craftsman Scroll Saw
E. Reg. \$59.99 Craftsman 7 1/4-in Circular Saw
F. Reg. \$69.99 Craftsman Pad Sander

Ask about Sears Credit Plans

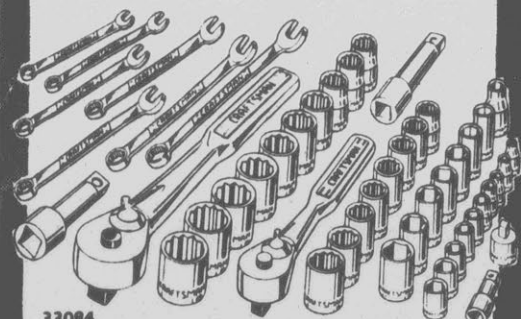

33084

\$85 OFF 49-Pc. Tool Set

Set includes 3/8 and 1/2-in. drive quick-release ratchets, 36 sockets in 1/4, 3/8 and 1/2-in. drive sizes, combination wrenches and more.

Reg. sep. prices total \$145.21
59⁹⁹ set



6500

SAVE \$6 Tool Box

18⁹⁹

Reg. \$24.99
Holds tools up to .17-in. long. With tote tray. Thru Dec. 24.

SAVE \$98

CRAFTSMAN Work Bench

Reg. sep. prices total \$197.94

99⁹⁹

A perfect gift for the man in your life... With two 9-inch deep drawers, one 4-in. deep drawer, shelf, door and hardboard laminated top. Of sturdy steel. Save now thru Dec. 24.

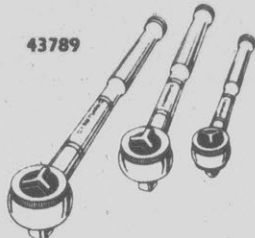

43789

SAVE \$10 3-pc. Ratchet Set

19⁹⁹

Reg. \$29.99
Includes 1/4, 3/8 and 1/2-in. drive ratchets. A great gift for Dad.



1782

SAVE \$60 16-gal. Wet/Dry Vac

99⁹⁹

Reg. \$159.99
It's great for the workshop. Sale ends December 24.

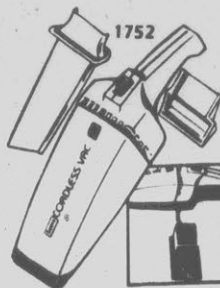

1752

SAVE \$10 Cordless Vac

24⁹⁹

Reg. \$34.99
Convenient and portable. Includes crevice tool, brush and power adapter.



Partially assembled

35714

2.3 cu. in. Gas Chain Saw, Case

16-in. Lo-Kick Friction Fighter guide bar. Power Sharp® chain sharpener. Automatic chain oiler. Solid-state ignition. Reg. \$269.99

199⁹⁹

SAVE \$50 Kerosene Heater

249⁹⁹

Reg. \$299.99
SAVE \$50 on this 20,000 BTU Reflection heater with electric push-button ignition. For up to 13 hours of heat on 1.9 gallons of kerosene. UL listed.

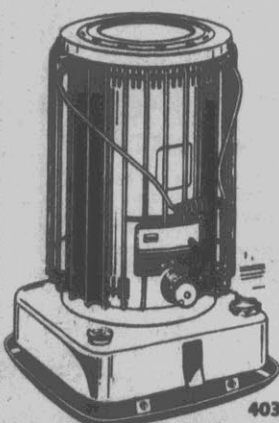

40309

For one-coat results, all Sears one-coat paints must be applied as directed

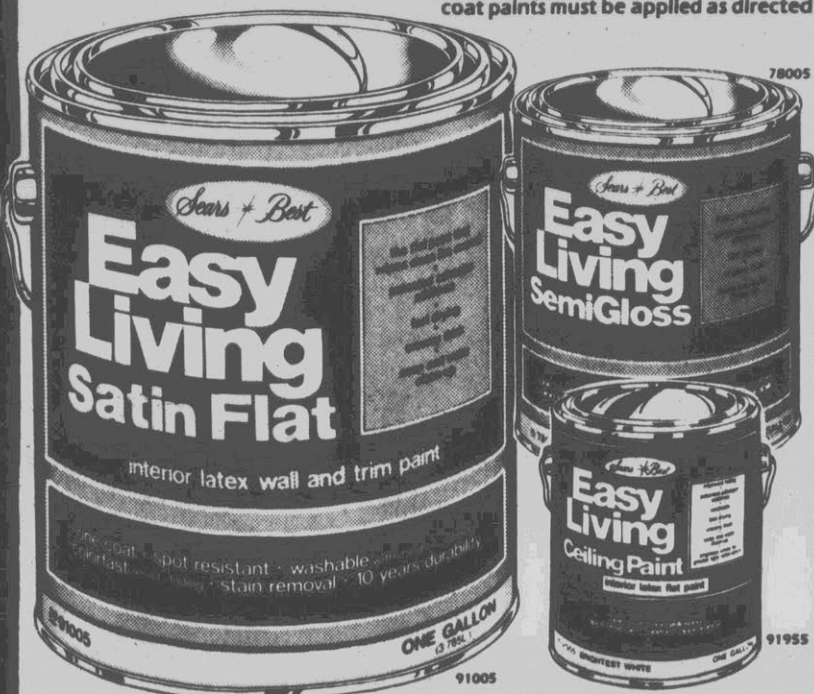

78005

91955

SAVE \$6!

Easy-Living® Satin Flat or Ceiling White Latex

Reg. \$16.99

10⁹⁹

gallon

What a great price... Choose from our best interior latex paint for washable one-coat results. Resists spots and stains. Choose from 23 beautiful, colorfast colors. Easy clean-up. Paint sale ends on December 31.

\$17.99, #78005 Semi-Gloss SAVE \$5 12.99 gallon

Sears

Wrap up a Beautiful Christmas at Sears

sale

SAVE \$60!

NEW 26-inch 12-Speed Racer

99⁹⁹

Reg. \$159.99

each

The perfect Christmas gift. 26-in. racing bike for men or women. Positron derailleur eases pedaling. Stem-mounted shifter, gumwall tires.

Ask about Sears Credit Plans



Sears Bike Shop
• Expert service
• Expert assembly
• Parts in stock
Available at additional cost

SAVE \$40

26-in. Touring Bike

Reg. \$169.99

129⁹⁹

For men or women. Shimano Positron derailleur lets you shift while pedaling, coasting or stopped.



SAVE \$40

FS500 BMX Bike

Reg. \$169.99

129⁹⁹

With full BMX pad set, front and rear caliper handbrakes. Not for stunting.



\$7 OFF Men's Women's Roller Skates
Reg. \$37.99

\$6 OFF Spalding Basketball
Reg. \$18.99

\$5 OFF Wilson Football
Reg. \$17.99

Spincast or spinning rod and reel
reg. sep. prices total \$27.98

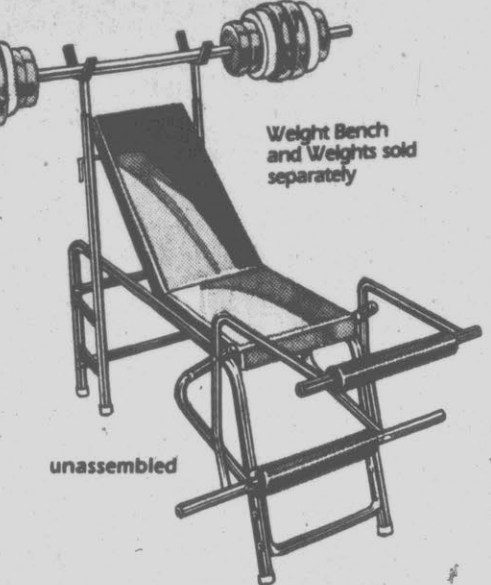

Weight Bench and Weights sold separately

unassembled

SAVE \$90 on Sears Weight Bench and Weights

99⁹⁸

Reg. sep. prices total \$189.98

Heavy duty 800-lb. capacity bench (user plus weight). Versatile 132-lb. weight set includes 14 discs, 72-in. barbell bar.
\$129.99 Weight bench only 69.99
\$59.99 Weight set only 29.99

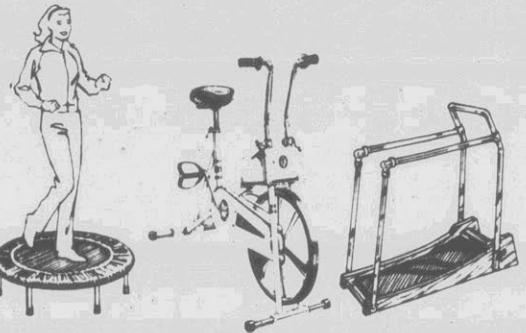

\$20 OFF Jog-n-Tramp, Reg. \$99.99 79.99
\$40 OFF Sears Best Wheel Cycle, Reg. \$179.99 139.99
\$50 OFF Walker/Jogger, Reg. \$249.99 199.99

Exercise equipment requires some assembly

SAVE \$50-\$80

Corrector® Keyboard Correction Typewriter

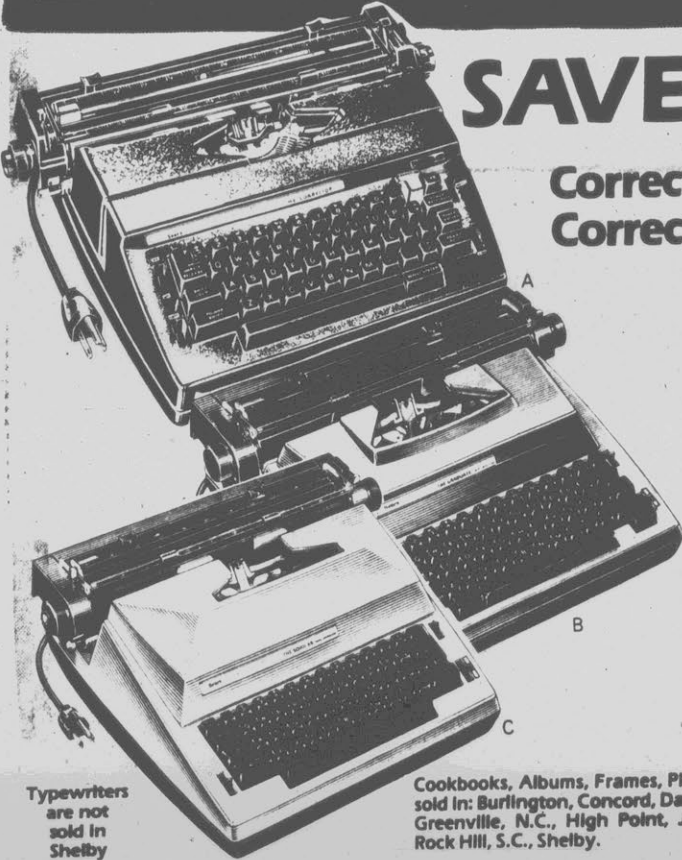

A. \$80 OFF The Corrector
Reg. \$399.99

319⁹⁹

3-step keyboard correction. Easy-load ribbon cassette. Pica or elite type.

B. \$70 OFF The Graduate
Reg. \$319.99

249⁹⁹

4-step keyboard correction. With power paper injector. Pica or elite.

C. \$60 OFF The Scholar
Reg. \$259.99

199⁹⁹

6-step keyboard correction. 12-in. power return carriage. Pica type only.

Cookbooks, Albums, Frames, Photography, Cameras, Binoculars not sold in: Burlington, Concord, Danville, Florence, Gastonia, Goldsboro, Greenville, N.C., High Point, Jacksonville, Lynchburg, Rocky Mt., Rock Hill, S.C., Shelby.

Typewriters are not sold in Shelby

SNAP-HAPPY HOLIDAYS!



SAVE \$36 on Canon AE-1P camera plus Sears accessories

Reg. sep. prices total \$415.95

379⁹⁵

SAVE \$102 on Sears 6-piece KSX 35mm SLR camera outfit

Reg. sep prices total \$351.94

249⁹⁴

SAVE \$80
Our lowest price ever on an 80-200 mm macro zoom lens

Reg. \$179.99

99⁹⁹

f:4.0, 1-touch lens; Canon, Pentax mount.

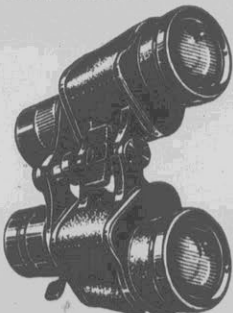

SAVE \$40
Wide Angle Binoculars
Was \$89.99 '82 Spring Catalog

49⁹⁹

35mm wide angle lens. Quick focus.

ZOOM



1/2 PRICE
New cookbook
Betty Crocker revised edition. 1500 recipes.

Reg. \$9.99 in our '82 Christmas Book

4⁹⁹

While Quantities Last

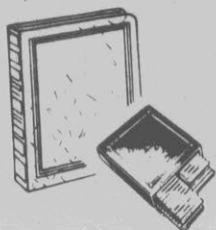

Photo album or storage chest
\$12.99 100-pg. album.
\$10.99 Storage chest.

YOUR CHOICE 7⁹⁹ each

Makes a great gift idea.

Video Arcade SALE

Raiders of the Lost Ark shown, sold separately

WE PLAY FOR KEEPS



\$35 OFF

Video Arcade plays Atari-compatible games the whole family will enjoy

Reg. \$159.99

124⁹⁹



Dungeons & Dragons shown, sold separately.

Super Arcade plays Intellivision-compatible video game cartridges

Reg. \$269.99

199⁹⁹

Poker/Blackjack Incl.



MegaMan game, Atari-compatible
Reg. \$27.99



Dungeons & Dragons, Mattel-compatible
Reg. \$34.99



Pac-Man cartridge, Atari-compatible
Reg. \$32.99



Space Armada game, Mattel-compatible
Reg. \$29.99

THERE'S STILL TIME TO WRAP UP A BEAUTIFUL CHRISTMAS WITH SEARS CATALOGS. . .Get your last minute shopping done the convenient way and avoid empty shelves and bustling crowds. Just call or visit your Sears Catalog Desk today.

Sears AUTO CENTER

OPENS AT 8A.M. MONDAY-SATURDAY

25% OFF

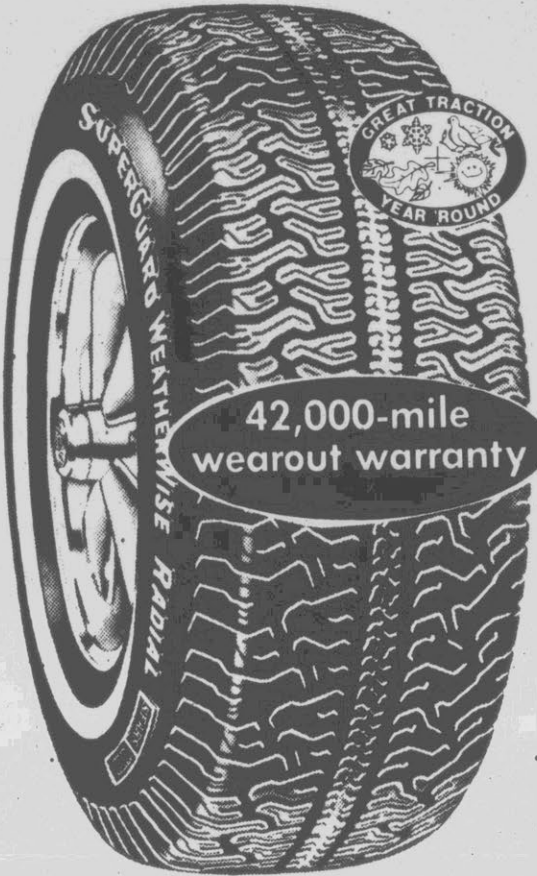

All-Season Radial Tires

Computer-designed tread for great grip on wet, dry, snow and ice. Two steel belts for strength and long wear. Low rolling-resistance helps save gas. Radial design for quick handling. Sale Ends December 31.

P155/80R13
Regular \$72.99
54⁷⁴

Plus \$1.52 FET and old tire

Weatherwise Radial Whitewall	Regular Price Each	Sale Price Each	Plus F.E.T. each and old tire
P155/80R12**	59.99	44.99	1.36
P155/80R13	72.99	54.74	1.52
P165/80R13	82.99	62.24	1.67
P175/80R13*	87.99	65.99	1.74
P185/75R13	87.99	65.99	1.92
P185/80R13*	92.99	69.74	1.91
P185/75R14	98.99	74.24	2.04
P195/75R14	104.99	78.74	2.16
P205/75R14	109.99	82.49	2.30
P215/75R14	114.99	86.24	2.47
P205/75R15	114.99	86.24	2.42
P215/75R15	119.99	89.99	2.57
P225/75R15	124.99	93.74	2.73
P235/75R15	129.99	97.49	2.93



Guardsman Bias-Ply Tires A78-13 Blackwall

29⁹⁹
Plus \$1.42 FET
Two sturdy polyester plies. Other sizes at low prices, too.

Limited warranty against tire wearout

For the specified miles or months, Sears will replace the tire or give a refund charging only for the miles used or months owned.

Wrap up a Beautiful Christmas

sale



SAVE \$12
Sears 45 Car Battery INSTALLED

Regular \$59.99 Exchange
47⁹⁹
With trade

410 amps cold cranking power. Group 24/74. For most American-made cars, many imports. Thru Dec. 18.

Ask About Sears Credit Plans



AM/FM-stereo with Cassette Player and Dolby

Dolby® system reduces high-frequency noise on Dolby tapes and FM. Auto-reverse plays both sides of tape. 14 watts of power. Accepts metal tapes. 4-way balance and loudness control. On sale thru December 24. A perfect gift. idea. Sound installation extra

SAVE \$90

Regular \$249.99
159⁹⁹

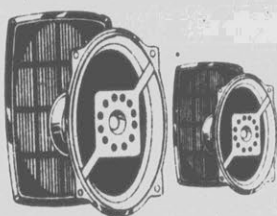

SAVE \$10
Co-Axial Speakers
Regular \$69.99
59⁹⁹

Jensen speakers for car stereo sound. Thru Dec. 24. \$69.99 Tri-Axial Speaker...\$84.99

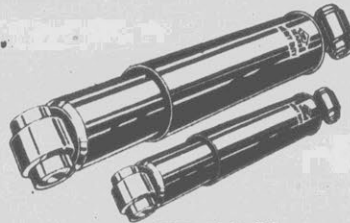

SAVE 16%
Heavy-Duty Shocks
Regular \$5.99
4⁹⁹ Each
More ride control than most 1-in. bore shocks. Installation extra. Thru Dec. 18.

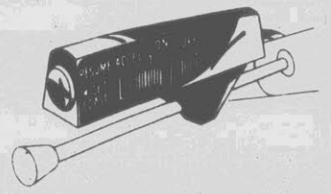

SAVE \$20
Speed Control
Regular \$99.99
79⁹⁹
Automatically resumes speed after stopping or braking. Thru Dec. 24.

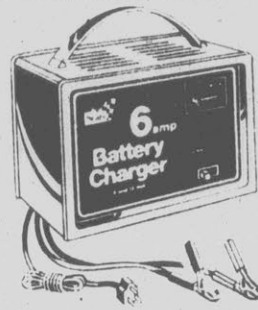

SAVE \$10
Battery Charger
Regular \$34.99
24⁹⁹
6-amp charger for 6 and 12-volt batteries. Thru Dec. 24.



SAVE \$15
Engine Analyzer
Regular \$69.99
54⁹⁹
Inductive analyzer performs 17 tests of engine efficiency. Thru Dec. 24.



SAVE \$15
Timing Light
Regular \$44.99
29⁹⁹
Simple inductive timing light needs no adapters. Thru Dec. 24.

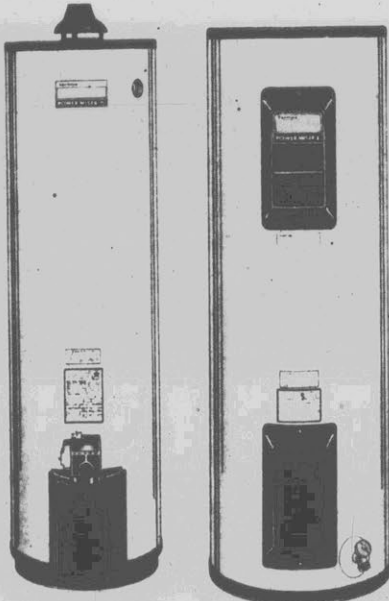

SAVE \$40
Kenmore Power Miser Gas or Electric 8™ Water Heaters

52-Gal. Electric
40-Gal. Gas
Reg. \$279.99
239⁹⁹
Power Miser water heaters have extra insulation that helps keep water hot, helps keep power bills down. All Sears water heaters are equipped with safety Call Sears For Fast Emergency Replacement Water Heater Installation Service.

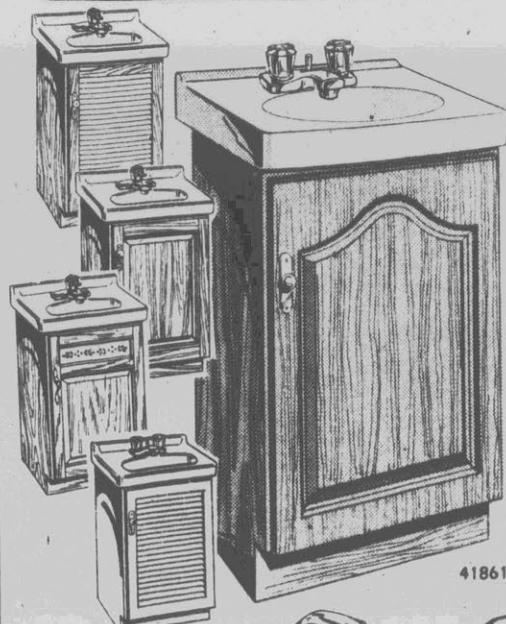

SAVE \$40
Decorative Vanities in 5 Styles with Hardwood Fronts and Panels

20-in. size
Reg. \$120.00
Faucets and Tops Extra

79⁹⁹

Choose Queen Anne, Oaken Splendor, Contemporary Shutter, Raised Panel or White Shutter styles. All have six-step hand-rubbed finish to help protect against heat and moisture. Sale Ends December 18. Similar Savings on 24-in., 30-in., and 36-in. sizes.

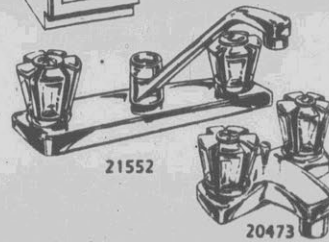

CHOOSE, SAVE \$13
Dual-Control Faucets for Kitchen or Bath

Regular \$37.99
24⁹⁹ Each
Washerless construction to resist drips and leaks. Sale Ends, Dec. 18. \$44.99 Kitchen Faucet with sprayer...\$31.99

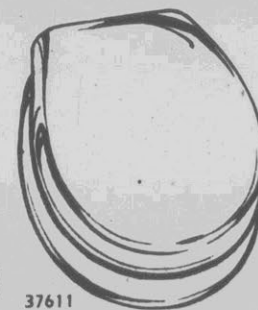

SAVE \$7
Padded Seat
Regular \$17.99
10⁹⁹
Foam-padded toilet seat in white and colors. Thru Dec. 18.

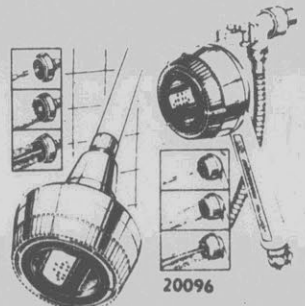

20095
SPECIAL PURCHASE
Massage Showerhead
Wall-mount unit with choice of three sprays. Great gift. **8⁹⁹**
Hand-Held Massager
Direct 3-way spray where you want it. Super Value. While Quantities Last. **14⁹⁹**

See Lots of Great Gift Ideas in our "Western" Specialog
Just one of the special interest catalogs at our catalog desk.

Sears

Wrap up a Beautiful Christmas

Special



42104

SAVE \$110

Touch'n Tune Color TV

Big, 19-in. meas. picture. Reliable electronic tuner with fast Touch'n Tune selection. Super Chromix picture tube, One Button Color. Thru January 1.

Regular \$489.95

379⁹⁵



99601

SAVE \$120

Microwave with Temp Probe

A great gift to help make holiday cooking convenient. This Kenmore Microwave is feature-packed. Come in and buy one today. 1.4 cu. ft. oven. Thru Dec. 24.

Regular \$449.95

329⁹⁵

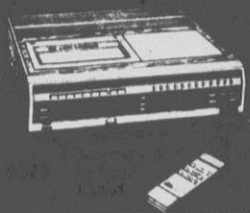

SAVE \$150
VHS Video Recorder

799⁹⁵

Video Cassette recorder has 3-program, 6-hour capacity. Thru Dec. 24.

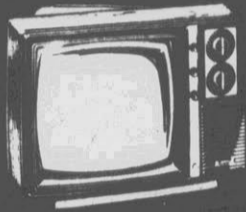

SAVE \$50
Personal-Size TV

79⁹⁵

Was \$129.95 in Mar. '82. Black and White TV has 12-in. diagonal measure picture.

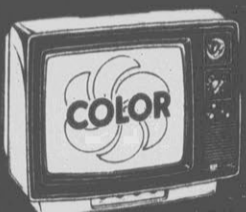

SAVE \$40
Personal Color TV

259⁹⁵

Regular \$299.95. 12-in. diagonal measure picture. Solid-state chassis. Thru Dec. 24.



SAVE \$20
Portable Stereo/Recorder

129⁹⁵

Regular \$149.95. Features include cassette play/recorder, AM/FM stereo radio. Thru 12/18.

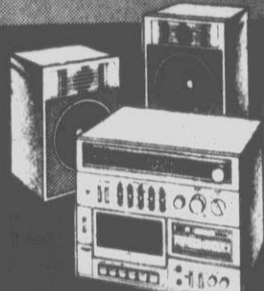

SAVE \$100
Mini Stereo System

199⁹⁵

Regular \$299.95. Space-saver design has AM/FM receiver cassette deck. Thru Dec. 18.



SAVE \$80
2-Speed Washer

349⁹⁵

Regular \$429.95. 9-cycle large capacity, with three water temperatures. Thru Dec. 31.

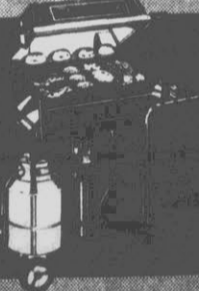

SAVE \$100
Gas Grill with Shelf

199⁹⁵

Regular \$299.95. Match-free ignition. Dual controls. Tank, wheels. Thru Dec. 31.

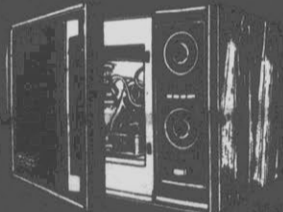

SAVE \$100
Micro-Convection Oven

499⁹⁵

Regular \$599.95. Use as microwave oven, convection oven, or both. Thru Dec. 24.

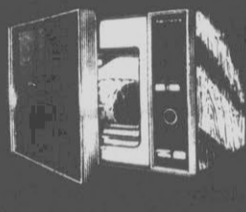

SAVE \$100
Speedy Microwave Oven

249⁹⁵

Regular \$349.98. 0.8 cu. ft. oven with settings for cook, defrost. Thru Dec. 24.

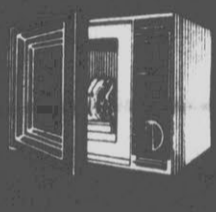

SAVE \$11
Compact Microwave

188⁹⁵

Regular \$199. 0.5 cu. ft. oven perfect for small family. Has menu guide.



SAVE \$100
Kenmore Powermate

199⁹⁵

Regular \$299.95. Strong cleaning power with 3.2 peak HP suction. Thru Jan. 1.

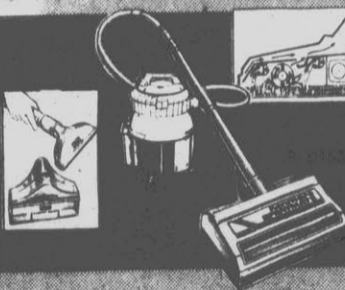

SAVE \$70
Spray Carpet Cleaner

149⁹⁵

Regular \$219.95. A. Sprays to loosen dirt. Vacuums up dirt. Dries quickly. Thru Jan. 1. B. \$80 Spray Mate \$70 (Thru Dec. 8).



SAVE \$80
Self-Propelled Vac

169⁹⁵

Regular \$249.95. Strong suction, double row beater-bar brush. Active edge cleaning. Thru Dec. 24.

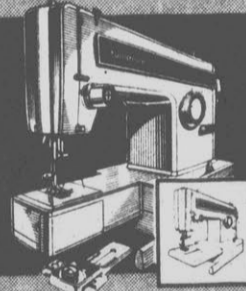

BIG BUY
Convertible Sewing Head

199⁹⁵

Sears Price \$349.98. 12-stitch free-arm sewing head converts to flatbed. Thru Dec. 24. \$120 Wooden cabinet. \$180

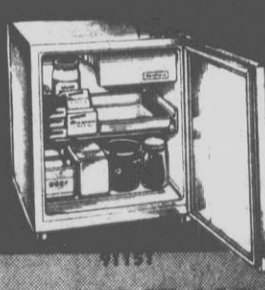

SAVE \$10
Compact Refrigerator

99⁹⁵

Regular \$109. 1.54 cu. ft. refrigerator, 0.16 cu. ft. freezer. Thru Dec. 31.

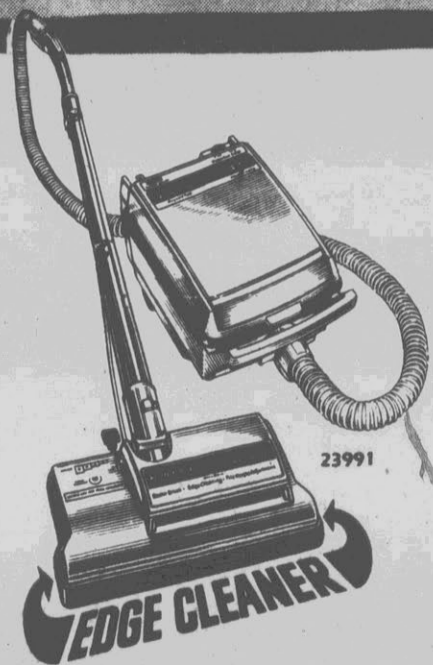

23991

SAVE \$130

Kenmore Powermate® Vac has Two-Speed Motor

Regular \$429.95

299⁹⁵

Our most powerful vac, with double-bristle beater-bar brush, 1 3/8-in. wide. 4.1 HP (peak) motor, floorlight to help you clean in dark corners. Thru Dec. 24.

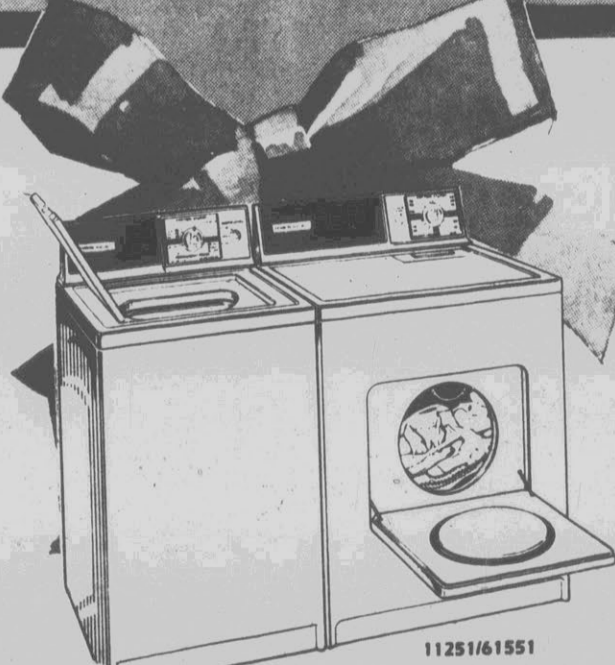

11251/61551

SAVE \$60 ON THE PAIR

Kenmore® Automatic Washer

Two-cycle heavy-duty washer with three water temperatures combinations. Thru Dec. 18. **Regular \$319.95**

289⁹⁵

Kenmore® Electric Dryer

Regular \$269.95

239⁹⁵

3 cycles, including permanent press, air-only.



63611

SAVE \$150
Kenmore 16.0 cu. ft. Refrigerator-Freezer

Regular \$649.95

499⁹⁵

Frost never forms in 12.20 cu. ft. fresh food section, 3.80 cr. ft. freezer. Power Miser switch can help save energy. Twin crispers. Textured steel door. Thru Dec. 31.

Each of these advertised items is readily available for sale as advertised. Ask About Sears Credit Plans.