

## Weather

Cloudy with chance of afternoon and evening thunderstorms through Thursday. Low tonight 70. High Thursday upper 80s.

# THE DAILY REFLECTOR

## INSIDE READING

Court, Page 13  
All-Stars, Page 17  
Obituaries, Page 16

TRUTH IN PREFERENCE TO FICTION

101ST YEAR

NO. 167

GREENVILLE, N.C. WEDNESDAY AFTERNOON, JULY 14, 1982

78 PAGES—7 SECTIONS

PRICE 25 CENTS



Reflector Photo By Tommy Forrest

## Pavement Crumbles On First Street Following Big Rain

## City Street Goes Under During Rain

By MARY SCHULKEN  
and TOM BAINES  
Reflector Staff Writers

The storm that brimmed Greenville's streets with water Tuesday, threatening to float the city away, dumped 3.7 inches of rain and left in its wake a huge crevice in a street, a woman stranded in an elevator and a church organ damaged by lightning.

Public works and Greenville Utilities crews continued work today at the site of a drainage system collapse on First Street that resulted in a section of the street caving in, breaking underground gas, sewer and electric lines.

Mayo Allen, director of public works, termed the situation a "real mess," noting it had necessitated closing of First Street to traffic from Holly to Reade and knocked out electric power to the Willis Building.

Allen explained that a concrete header wall, installed in the 1950s to protect the drainage pipe, collapsed during Tuesday's heavy morning rains, crushing the drainage outlet and backing up water in the upstream areas, including Reade Circle. He indicated that the collapse probably followed years of gradual weakening of the fill around the header wall.

Allen said that a motorist spotted the first cave-in problem and notified him around 11:15 a.m. He said "only about a foot of asphalt and the sidewalk was affected when I first got there." The deluge of water continued to eat away the dirt around the header wall and the problem expanded, Allen said.

Workers this morning were still digging out the street section in an attempt to locate the crushed section and assess the damage, Allen said, adding that "it looks like we might have to replace the whole pipe." He said he would recommend installing a larger pipe to handle the water load that includes the downtown area of the city.

Allen, estimating that the repair project could cost in the neighborhood of \$25,000 to \$30,000 if pipe replacement is necessary, said there are no indications that the asphalt was weak before the shoulder collapsed.

The spokesman said that crews are tearing up the rest of the street to correct the problem and he hopes the corridor will be reopened to traffic early next week. "We are going to fix it right," he said.

(Please turn to page 16)

## Iranians Launch Drive To 'Free' Iraq

By The Associated Press

Iranian forces invaded Iraq and captured hundreds of Iraqi soldiers in an offensive to "liberate Iraq" and topple the regime of President Saddam Hussein, Tehran radio claimed today.

An Iraqi military communique said Iranian troops pushed six miles into Iraq along a six mile front. But it said Iraq counterattacked and inflicted heavy losses on the invaders.

"The enemy began retreating under the courageous blows of our heroic forces, leaving behind large numbers of dead and wounded," the Iraqi communique said.

Iranian couched its announcement in the rhetoric of a holy war, calling the invasion "Operation Ramadan," after the Islamic holy month currently in progress, and promising its soldiers that defeating Iraq would somehow lead to the liberation Jerusalem and its Moslem holy sites from Israel.

Religious differences are among the underlying causes of hostility between the two Moslem countries. Iran is dominated by Shiite Moslems, while Iraq is governed largely by Sunnis, although it has a large Shiite minority. While both sects are Islamic, they have occasionally bitter disputes over doctrine.

There are also ethnic differences. Iraq's population is largely Arab, while Iran's is Persian. Each side has called on the minorities in the other country to rebel.

Iraq opened the war in 1980 by invading Iran's Khuzistan

province, homeland of Iran's ethnic Arab minority and site of most of its oil fields. Iraqi forces seized large portions of the province before the Iranian army rallied early this year and pushed the Iraqi forces out of the country.

Iran's current invasion is pushing into the home territory of Iraq's Shiites.

"Our Islamic army is coming to liberate you," Tehran radio said in an address to the Iraqi people, urging them to "mutiny."

"Our forces will not lay down their arms until this infidel agent regime and all symbols of treason in Baghdad have been toppled."

In an Arabic-language broadcast, Tehran radio claimed that hundreds of Iraqi soldiers had been captured in the offensive it said began Tuesday night.

A later broadcast quoted Iranian leader Ayatollah Ruhollah Khomeini as telling the Iraqis to welcome the Iranian invaders and "cut off the hands" of Hussein's followers.

## Senate Opens Tobacco Debate

By BOB FICK  
Associated Press Writer

WASHINGTON (AP) — Assistant Senate Republican Leader Ted Stevens of Alaska predicted today the Senate will not endorse efforts to change the federal tobacco price support program any more than Southern lawmakers already have suggested.

"The bill, which really is an anti-tobacco bill already, will not be further burdened," Stevens said. "That would be my feeling, and it's the position that I will support."

The Senate was opening debate today on a measure that would significantly reduce tax subsidies for the nation's 2 billion-pound tobacco crop and shift valuable government-issued production rights back to the hands of tobacco farmers.

"I think we are in a period of transition," Stevens said. "But there's no reason for precipitous action."

The bill would give Agriculture Secretary John Block authority to curb future increases in tobacco price supports to avoid overpricing of the American crop. Recent increases are blamed for a 400 million-pound stockpile of flue-cured tobacco as cheaper foreign imports bite into the market.

Sen. Thomas Eagleton, D-Mo., wants more drastic changes in the complex tobacco program, which narrowly survived congressional attacks last fall.

A staunch critic of the program, Eagleton is aiming mainly to force the same kind of congressional review to which all other commodity support programs are subjected every four years. The tobacco industry has vigor-

ously fought similar review proposals in the past.

Eagleton and other critics have complained for years that production restrictions have kept control of the tobacco crop in the hands of those owning about 500,000 federally issued acreage allotments and production quotas. A congressional study says seven of every 10 allotment and quota owners do not grow tobacco but rent or lease their right to grow the crop, often at substantial amounts, to farmers.

Program supporters defend the system, saying it has cost taxpayers little while ensuring substantial incomes for tens of thousands of small family farmers in the South.

Opponents say taxpayers have shelled out more than \$600 million in the last five decades to support tobacco prices.



PRESIDENTIAL SEAL — President Ronald Reagan hugs a stuffed toy seal given him by Baltimore Mayor William Donald Schaefer. The mayor jokingly launched a campaign to make the toy the new presidential seal. (AP Laserphoto)

### REFLECTOR

## HOTLINE

752-1336



Hotline gets things done for you. Call 752-1336 and tell your problem or your sound-off or mail it to Hotline, The Daily Reflector, Box 1967, Greenville, N.C. 27834.

Because of the large numbers received, Hotline can answer and publish only those items considered most pertinent to our readers. Names must be given, but only initials will be used.

### YOUTH EMPLOYMENT FEEDBACK

The local office of the N.C. Employment Security Commission, in response to the Monday item on youth employment, reminds that more than 600 youths have been placed so far this summer in farm jobs. And there are openings.

"Topping and suckering tobacco are going on now," ESC office manager Jim Hannan said, "and boys and girls as young as 13 can legally do this work and the harvesting that is to follow. They should realize, though, that it's hard, hot work that requires stamina and perseverance and that farmers don't want to waste time and wages on young people who're not serious about what they're doing."

Interested persons are asked to contact Barbara Canfield or Frank Gore at the ESC office, 3101 Bismarck Street; phone, 756-2686.

## State Utilities Eye Peak-Demand Tests

# Pilot Bulk Barn Program Approved

By STUART SAVAGE  
Reflector Staff Writer

In an effort to save bulk tobacco barn customers money and at the same time reduce the peak demand for electricity on the entire system — a move which ultimately would save all customers — the Greenville Utilities Commission last night gave approval to an experimental program to be funded in part by a \$40,805 grant from the North Carolina Alternative Energy Corp.

The AEC grant will be coupled with a \$10,500 in-kind match from the GUC and a \$2,000 in-kind grant from N.C. State University to fund the experiment — an adaptation of GUC present "Beat the Peak" program which places radio-controlled switches on residential water heaters and air conditioning units so utilities employees can cut them off to reduce the peak demand on the system.

All electric customers pay an "energy" charge, based on the amount of electricity they actually use. Customers also help pay a "demand" charge, based on the peak demand made on the system, GUC director Charles Horne explained.

The "demand" charge, based on the peak system load which usually occurs during the summer months, is paid all year long, whether that amount of electricity is used again during the year or not.

By reducing the peak demand, the GUC and ultimately the

rate payers save by not having to pay for electricity that is not used, Horne explained.

Since the use of bulk barns occurs during the high peak months of the year, Horne said, electric department superintendent Malcolm Green and members of his staff "have developed a plan for testing methods of peak reduction that would lower our peak summer demand with the idea that as our demand is lowered, the farmers participating would share in the savings," similar to the manner in which GUC's "Beat the Peak" customers receive credit on summer utility bills.

The purpose of the program, Green explained, is "to analyze the potential for electric load reduction," through the voluntary participation of 15 tobacco farmers with 100 bulk barns in the pilot study.

Green said that rather than GUC having control over the barns by radio, the farmers will be requested to shut off the electric air circulation fans of bulk barns during times of peak demand." Each of these fans, he noted, "represents around six kilowatts of demand."

Greene, who said there are some 2,500 bulk barns on the Greenville system, suggested that about half of them would be available for load reduction at any one time. State-wide there are about 41,000 bulk barns, which consume about \$18 million worth of power each year.

Each bulk barn on the Greenville system operating at the period of peak demand "costs us about \$50," Green noted, adding that over 50 percent of the rate paid by bulk barn users is a "demand" charge.

By reducing the "demand" with no harmful effects on the curing process, Green said state-wide, 123,000 kilowatts — or \$6 million, based on the average wholesale cost per kilowatt — could be saved each year, Green suggested.

Part of the grant money, according to Green, will be used to purchase and install magnetic tape meters at the 15 farms to monitor the demand. The participating farmers, he continued, will be notified when peak periods are occurring and the farmers at each test location will determine which barns can be cycled off and for how long, according to curing guidelines developed by N.C. State University (the first two days of the curing cycle are most critical, while barns can be cycled off for up to 8 hours the remaining five days of the cycle with no adverse effects).

Greene noted that Carolina Power & Light Co., Duke Power Co., and other utilities in the state are highly interested in the Greenville experiment.

"Our goal is to determine the feasibility ... to see if it will work," Green emphasized.

If the project is successful, such a program could be implemented state-wide.

# Pat's Pointers

By Pat Trexler

Bold and bright or softly shaded, this handsome afghan is knitted in panels of shaded colors. Depending upon your choice of colors, it can take on a decidedly masculine air or appear soft and feminine. Seven panels make an afghan measuring 42 inches by 64 1/2 inches, with each panel knitted in stockinette and twisted cables. Three colors of knitting worsted weight yarn are used; select your own combination, use one of the choices listed below or, for a look of understated elegance, make it in solid white.

To obtain directions for making the Bold Braid Afghan, send your request for Leaflet No. B-247 with \$1 and a long, stamped, self-addressed envelope to: Pat Trexler ("The Daily Reflector"), P.O. Box 810, North Myrtle Beach, S.C. 29582.

Or you may order Kit No. K-247 by sending a check or money order for \$34.50 to Pat Trexler at the same address. The kit price includes shipping charges, instruction leaflet and 15 skeins of yarn. Off-white yarn is used for the lightest shade with a choice of any of the following for the other two colors: light and dark blue; red and gray; bronze and brown; light and dark green; black and gray; rust and brown; avocado and olive; pale pink and rose. Please specify your choice of the above or order Kit KS-247 if you would prefer a solid off-white afghan.

Cable stitches have fascinated knitters for centuries and are just as popular today with the novice as with the more experienced knitter. Whether used singly, in pairs, in an overall design or in combination with other pattern stitches, cables add depth and interest to any knitted item.

If you have never worked cables, here is a basic pattern stitch for you to try. In addition to your knitting needles



BRAIDED AFGHAN

and some yarn, you will need a cable holder. This can be a cable hook available at most needlework counters, a double-pointed needle or a crochet hook. For the beginner, I would recommend one of the hooks or holders designed for this purpose.

To practice a simple cable, cast on 14 stitches. The odd numbered rows will be the right side of your work. For the first row, purl 4, knit 6, purl 4. For the second row, knit 4, purl 6, knit 4. Repeat these two rows once more.

On the next — or fifth — row, purl 4, slip 3 stitches from the lefthand knitting needle to a cable holder; hold these in front of your work while you knit the next 3 stitches from the lefthand needle. Now, bring the cable holder up, slide the 3 stitches to the left end of the holder and knit them off onto the right needle. Purl the last 4 stitches from the left needle.

Row Six is a repeat of Row Two; Rows Seven and Eight are repeats of Rows One and

Two. When you have completed the eighth row, start over again at Row One and repeat all eight pattern-stitch rows again. Continue to repeat these eight rows over and over several times.

Then, work a few repeats of the pattern, making this change on each repeat of Row Five: Hold the cable hook with the 3 stitches on it in back of your work instead of in front and notice the difference that this makes in your pattern.

To keep track of the rows worked, write the numbers 1 through 8 down one side of a slip of paper or index card. As each row is finished, make a little check mark after the number of the row just completed.

If you are able to work this basic pattern successfully, you should be able to work almost any cable pattern with no difficulty. Many of the Twist and Cross Stitches used in fisherman knits use the same principle, so these, too, are now within your reach.

Dear Abby



## Sour Notes Ruin Harmony

By Abigail Van Buren

© 1982 by Universal Press Syndicate

DEAR ABBY: My daughter and her husband are well, happy and prosperous. They have been married for 20 years and on the surface all seems ideal, but here is the problem:

They have three daughters, 18, 17 and 13. The two older girls, who are 16 months apart, have always been very competitive. It was our hope that as they grew older this rivalry would fade, but it seems to have intensified instead.

The 18-year-old is very jealous of her younger sister, and she's making life miserable for the rest of the family. The 17-year-old just goes along, having a wonderful time, and does nothing to alleviate the situation.

Both girls are very pretty and popular. The 18-year-old has had the same steady boyfriend for three years. He comes over, they watch TV and sometimes they go out for a hamburger or a movie — nothing terribly glamorous.

The 17-year-old has been dating for only six months, but her boyfriend sends her flowers, takes her to expensive places and is giving her the royal treatment! The 18-year-old is understandably very envious, and she takes it out on the entire family, sulking, slamming doors and giving us all the silent treatment.

As a grandmother to these girls, it's very hard to listen to my daughter crying about the unpleasant atmosphere at home. She doesn't know how to handle this and has asked me for my help. I don't know what to tell her, so I am asking you.

OUT OF IDEAS

DEAR OUT: The older girl is hurting and needs to express herself candidly to someone who is sympathetic and non-judgmental. She needs to be assured that while her jealousy is understandable and nothing to be ashamed of, sulking, slamming doors and taking it out on the entire family is childish and unfair.

Family members can't help her. She needs to unload on a professional counselor. Recommend it. Everyone in the family will benefit.

\*\*\*

DEAR ABBY: I'm 18, and my high-school graduation is coming up soon. I want my father to attend, but I don't want Linda. She's his second wife. I'm afraid if I don't invite Linda, Dad won't come.

He left Mom eight years ago to marry this no-good barfly. Mom makes us kids visit Dad on weekends. We hate going there because Linda is so hateful toward us when Dad is not around.

Mom never remarried. She says she's waiting until she has us five kids raised, but we think she's still in love with Dad. She's so much nicer than Linda. We don't know what he saw in her. We'd like to get Mom and Dad back together again. I think he still cares, but he's too bullheaded to admit that he made a mistake.

How can I get Dad to attend my graduation without his wife?

WANTS DAD

DEAR WANTS: If your dad is aware of your dislike for Linda, ask him to attend your graduation alone. (He may surprise you and accept.) If he's not aware, then the invitation should be sent to Mr. and Mrs., and it's up to Linda to accept or decline.

About getting your mom and dad together again: If your father "made a mistake but is too bullheaded to admit it," he will have to live with the consequences.

To prevent colored fabrics from running, soak the garments first in cold water to which some vinegar has been added, then wash in the usual way.

**Eastern Electrolysis**  
133 OAKMONT DRIVE, SUITE 6  
PHONE 756-4034, GREENVILLE, N.C.  
PERMANENT HAIR REMOVAL  
\*CERTIFIED ELECTROLOGIST

## Kiwi Cake Is For Summer

By CECILY BROWNSTONE  
AP Food Editor

To usher in a lovely summertime fruit, you may enjoy making and serving a Kiwi Cake as much as we did.

The cake itself is an old-fashioned hot milk sponge layer — but made speedily nowadays in an electric mixer. Filled and frosted with a Tangy Lemon Cream and kiwis it's both delicious and attractive.

### KIWI CAKE

- 1 cup all-purpose flour
- 1 teaspoon baking powder
- 1/4 teaspoon salt
- 1/2 cup milk
- 1 tablespoon butter
- 2 large eggs
- 1/2 teaspoon vanilla
- 1 cup sugar

Tangy Lemon Cream: recipe follows

6 to 8 kiwis, peeled and sliced

Grease and flour a round layer-cake pan (9 by 1 1/2 inches).

Stir together the flour, baking powder and salt; reserve. (We do this on a sheet of wax paper.)

Into a small saucepan pour the milk and add the butter; reserve.

In an electric mixer, at high speed, beat the eggs and vanilla until thickened and lemon color — about 3 minutes. Gradually beat in the sugar until mixture is very thick and ivory color — about 5 minutes.

At once, over high heat, bring the milk and butter just to a boil; with the mixer at lowest speed, gradually beat the hot milk mixture into the egg mixture only until smooth. Add the reserved flour mixture and beat gently just until the batter is smooth. Turn into the prepared pan.



KIWI CAKE — A sponge cake layer is split and sandwiched together with a tangy lemon cream and slices of a delightful fruit.

Bake in a preheated 350-degree oven until a cake tester inserted in the center comes out clean — 35 to 40 minutes. Place pan on a wire

(Please turn to Page 3)

**PIES Baked Daily**  
**DIENER'S BAKERY**  
815 Dickinson Ave.

There Is A Time For Everything Including Retirement... After 15 Years This Is It!

**The Mushroom Is Retiring!**  
Sale Begins 11 AM, Mon. July 19th

**Everything To Be Sold At Cost**  
(except consigned items)

**All Sales Final**

Mastercharge & Visa Accepted

Notice: "Balloons Over Greenville" Is Not Retiring and will continue in business as usual, delivering Balloon Bouquets, & good cheer!

**THE MUSHROOM**

1967 318 Evans St. Mall 1982  
752-3815

C  
L  
E  
A  
R  
A  
N  
C  
E  
  
S  
U  
M  
M  
E  
R  
  
*Sale*  
Thursday, Friday and Saturday

Dresses

1/3 Off

Or

Buy One At Reg. Price & Get One FREE!

Tops

1/3 Off

Or

Buy One At Reg. Price & Get One FREE!

Shorts

1/3 to 1/2 Off  
(Including O.P.'s)

Skirts

50% Off

Pants

50% Off

Blouses

1/2 Price

Accessories

1/2 Price

Bathing Suits

50% Off & Less



the Snooty Fox

203 E. 5th St. Free Parking

# Things to do tomorrow

1. Get-up bright and early!
2. Dress comfortably, sensibly.
3. Eat a hearty, nourishing breakfast.
4. Wear sneakers.
5. Don't forget your pocketbook.
6. Get to Brody's on time.

The great clearance starts at 10 a.m. Hundreds of spring & summer shoes... from famous name brand manufacturers. These shoes are practically being given away!

Everything is regular Brody Quality!  
Everything is with the Famous Brody's Look!

## SUPER SHOE SALE

Entire Stock

**BETTER SHOES**

Palizzo, Amalfi, DeLiso, Bandolino, Stanley Phillipson, Selby, and Pappagallo ..... reg. \$60 now \$30

1/2 OFF

Group of

**CASUAL SHOES**

Etienne Aigner, Candies, and Pappagallo ..... reg. \$34 now \$17

1/2 OFF

Group of

**CASUAL SHOES**

Bass, Famaloro, Candies, and Pappagallo

1/3 OFF

**BROWSABOUTS**

reg. \$22 ..... now

\$14.90

Wimzee's Washable

**CANVAS BALLETS SHOE**

reg. \$16 ..... now

\$10.90

Pappagallo

**ESPADRILLE** 1/2 Off

reg. \$32 ..... now

\$16

**CHILDREN'S SHOES**

(Pitt Plaza Only)

Boys

**DRESS SHOES**

reg. \$16 ..... now \$9.80

1/2 OFF

Groups of

**CANVAS SHOES**

reg. \$16 ..... now \$9.80

40% OFF

Groups of

**SANDALS**

reg. \$16 ..... now \$9.80

1/3 OFF

Girls

**DRESS SHOES**

Values to \$20... now

\$6 to \$8

**HANDBAGS**

Entire Stock

**WOMEN'S DRESS BAGS**

reg. \$16 ..... now \$9.80

1/2 OFF

Entire Stock

**STRAW AND CANVAS BAGS**

Values to \$16 now \$7 to \$9 Values to \$20 now \$10 to \$11

*Brody's*  
Shop Downtown 10 a.m.-6 p.m.  
Shop Pitt Plaza 10 a.m.-9 p.m.

### Moisturizer

Formulated to protect skin from moisture robbing elements. Softens, soothes and combats dryness and chapping. Promotes increased resilience and elasticity.

Since 1923  
*Luzier*  
Call in Greenville 752-1201

## Debutante Ball Set In Raleigh

Invitations to the 56th annual North Carolina Debutante Ball have been issued, according to James Bell Black III, president of the Terpsichorean Club of Raleigh.

Greenville debutantes are Caroline Pringle Clement, daughter of Dr. and Mrs. James Edwin Clement; Mary Louise Nowell Crisp, daughter of Dr. and Mrs. Sellers Luther Crisp; Anne Robbins Hardy, daughter of Dr. and Mrs. Ira May Hardy II; and LuAnne O'Bannon, daughter of Mrs. Suzanne T. Turcotte and John N. O'Bannon Jr.

Other area debutantes are Mary Tadlock Carson of Bethel, daughter of Mrs. Barbara Davis Carson and Thomas Clayton Carson Jr. and from Williamston, Sydney Eldridge Peel, daughter of Judge and Mrs. Elbert Sidney Peel Jr. and Robin Rhea Rogers, daughter of Mr. and Mrs. John Morris Rogers.

The Debutante Ball will be held in Raleigh Sept. 9-11.

## Kiwi Cake...

(Continued from Page 2)

rack to cool for about 5 minutes. With a small metal spatula, loosen edges; turn out cake onto the wire rack; cool completely. Invert cake onto a serving plate whose edges have been lined with wide strips of wax paper.

Cut the cake in half horizontally to make 2 layers. Spread part of the Tangy Lemon Cream over one of the layers; add a layer of kiwis; top with the other cake layer; frost the top and sides with the remaining Tangy Lemon Cream and garnish with the remaining kiwis. Remove wax paper strips from around the plate. Chill before serving.

### TANGY LEMON CREAM

- 1 tablespoon cornstarch
- 1/2 cup sugar
- 3/4 cup water
- 2 large egg yolks
- Grated rind of 1 medium lemon (about 1 tablespoon)
- 1/4 cup lemon juice
- 1 cup heavy cream

In a 1/2-quart saucepan thoroughly stir together the cornstarch and sugar; gradually stir in the water, keeping smooth. Add the egg yolks and beat gently until blended. Cook over moderate heat, stirring constantly, until mixture is clear, thickened and boiling. Off heat stir in the lemon rind; gradually stir in the lemon juice; let stand at room temperature until cool to the touch. In a small bowl whip the cream until thick; add to the cool lemon mixture and fold in until blended. Makes about 2 1/2 cups.

## Ayden News

Mr. and Mrs. Dallas Edwards and family were visitors here during the weekend.

Claude Dennis is a patient in Pitt Memorial Hospital.

Mr. and Mrs. Leonard Gibson and family were local visitors over the weekend.

Mr. and Mrs. Bob Harris of Lexington, Ky. are visiting Mr. and Mrs. Robert Harris.

Susan Tripp has returned home from Pitt Memorial Hospital.

Mr. and Mrs. Elmer Tripp spent the weekend in Virginia with relatives.

Mr. and Mrs. Reid Coward spent the weekend with Mrs. Blanche Coward.

Mr. and Mrs. Cornelius Woolard of Virginia Beach, Va. spent the weekend with Mrs. Mary T. Mayo.

Snipe Smith is a patient in Pitt Memorial Hospital.

**TIRED OF STRIPPING ALONE**  
Come See The **STRIPPER**

### NEW SUMMER HOURS

- Tues. - Thurs. 10 a.m. to 7 p.m.
- Sat. - Only 10 a.m. to 5 p.m.
- Closed Sun & Mon.
- \* Furniture Stripping
- \* Repairs & Refinishing

757-1982

# Belk Tyler

carolina east mall greenville

NOW THROUGH SATURDAY!

# JULY sales clearance

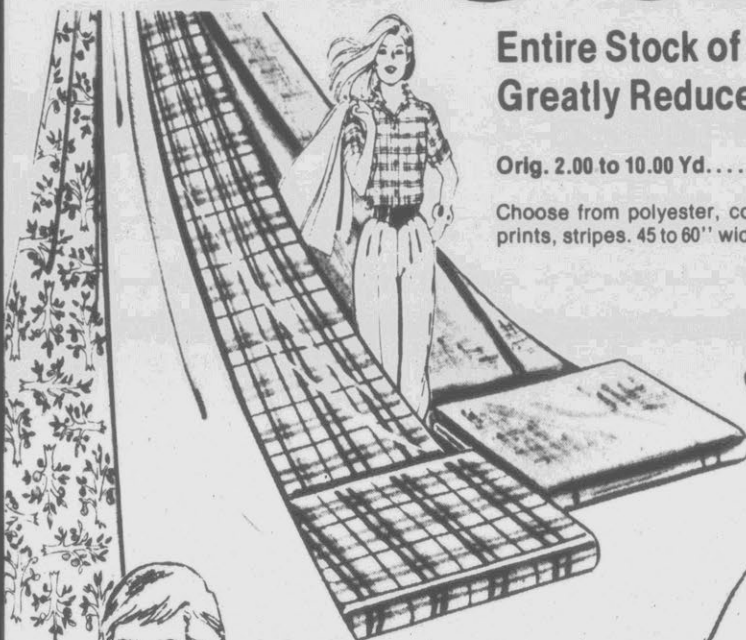

Entire Stock of Summer Fabrics Greatly Reduced!

Orig. 2.00 to 10.00 Yd. .... **50% OFF**

Choose from polyester, cotton, cotton/polyester and other fabric blends. Solids, prints, stripes. 45 to 60" wide.

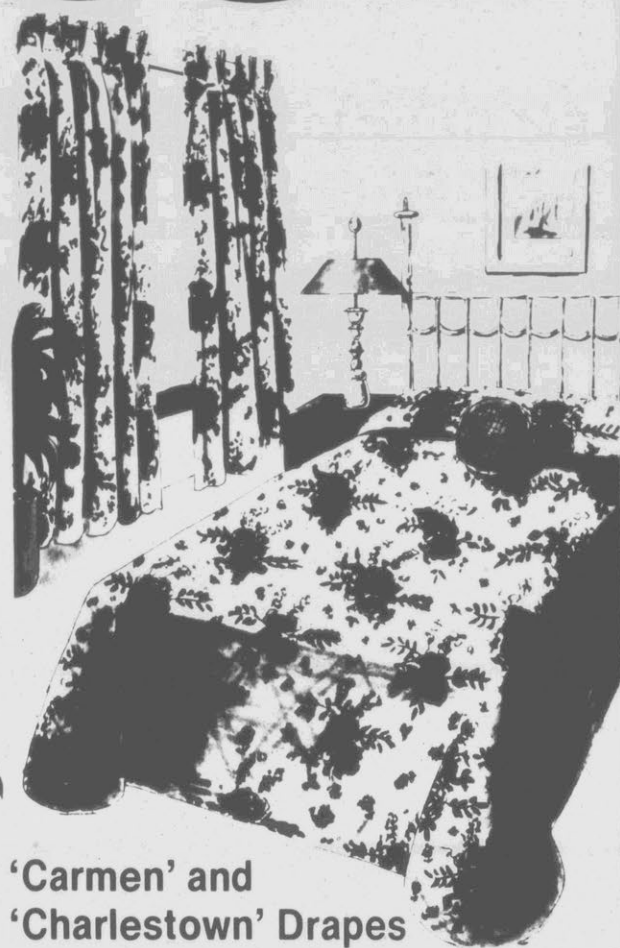

'Carmen' and 'Charlestown' Drapes and Bedspreads By StatePride® Reduced!

Drapes, Reg. \$20 to 45.50  
Bedspreads, Reg. \$28 to \$52 ..... **50% OFF**

Your choice of bouquet design on a moire printed beige background or roses on scroll design printed on beige background. In gold, blue, beige or rose. Drapes are foam lined. Bedspreads are fully quilted. Both are made from machine washable and dryable polyester/cotton.



Entire Stock of Boys' Suits and Sport Coats

**1/2 OFF**

Orig. \$45 to \$140

Choose from assorted styles in polyester/cotton, polyester/wool and 100% polyester. Plaids and solids in assorted colors. Sizes 8 to 20.



Select Group of Ladies' Swimsuits at Fantastic Savings! Buy Now!

Famous name swimsuits in a variety of styles and colors. Junior and misses' sizes available. But hurry in supplies are limited.

Save up to \$9 on Men's Converse® 'All Star' Shoes!

Regular 43.00 to 47.00 ..... **37.88**

Leather uppers on a basketball sole. Your choice of oxford or high top. In white with natural and navy. Sizes 7 to 13.

Group of Men's Spring and Summer Suits and Sport Coats!

Regular 100.00 to 455.00 ..... **25% OFF**

Many famous brand names in tropical weight polyester/wool or polyester/cotton. A variety of styles, patterns and colors. Sizes 38 to 46.

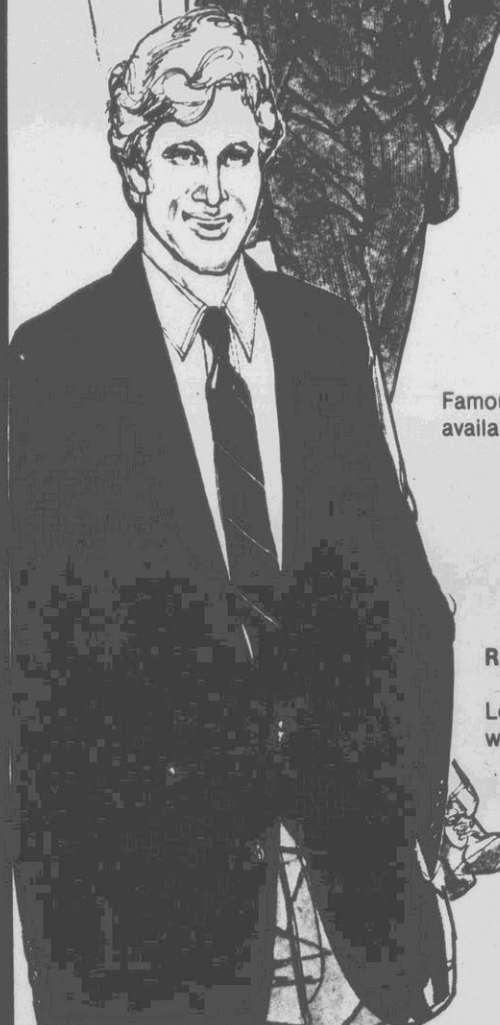

Select Groups of Ladies' Summer Dresses and Sportswear Reduced!

**1/2 OFF**

Dresses in assorted styles; shorts, pants, knit shirts and more. Bright summer colors and assorted pastels. Junior, misses and half sizes. Great buy!

Shop Monday through Saturday 10 a.m. Until 9 p.m. — Phone 756-B-E-L-K (756-2355)

### 'Simplicity' and 'Belfast' Tablecloths

Regular 12.00 to 22.00 ..... **7.88 to 14.88**

### TexTan® Leather Dress Belts for Men on Sale!

Orig. 15.00 & 16.00 ..... **5.88**

### Men's Hathaway® Long Sleeve Plaid Shirts

Regular 28.00 ..... **17.88**

### Girls' 7 to 14 Oscar De La Renta Knit Shirts!

Orig. 20.00 ..... **8.88**

### Infants and Toddlers Shorts Sets Now Reduced!

Regular 6.00 & 7.00 ..... **3.44 & 5.44**

### Boys' 4 to 7 Solid and Stripe Tank Tops

Regular 6.00 ..... **4.44**

### Ladies' Nylon Satin Tricot Briefs by Heiress

Regular 2.00 ..... **1.44**

### Preteen Girls' Solid & Print Swimsuits

Regular 12.00 to 15.00 ..... **1/3 OFF**

### 'Old Salem' Beige & White Ruffled Priscilla Curtains

Regular 18.50 to 42.00 ..... **1/3 OFF**

### Select Group of Ladies' Sleepwear on Sale!

Regular 10.00 to 25.00 ..... **1/3 OFF**

### Ladies' Sperry Top-Sider® 'Seabird' Duck Shoes

Regular 24.00 ..... **19.88**

### Ladies' 14Kt Gold and Sterling Silver Jewelry

Orig. 1.00 to 85.00 ..... **1/2 OFF**

### Men's Straight and Boot Cut LEVI'S® Corduroy Jeans

Regular 19.00 ..... **12.88**

### Men's LEVI'S® Belt Loop Poly-Cotton Slacks

Regular 25.00 to 27.00 ..... **15.88**

### Men's Polyester/Cotton Casual Slacks by Haggar®

Orig. 19.88 ..... **14.88**

### Children's Canvas 'Zips' Shoes by Stride Rite

Regular 17.00 to 28.00 ..... **1/3 OFF**

### Men's Weyenberg® Leather Dress Shoes on Sale!

Regular 28.00 to 54.00 ..... **1/3 OFF**

# One War Behind Us

The Falkland Islands war between Great Britain and Argentina was never declared and it may never be undeclared, but it at least appears to be ended to the satisfaction of British leaders.

The government announced this week it was satisfied that Argentina considered the war over and that it was returning 593 prisoners of war it still holds. The majority of the Argentine prisoners had already been returned to their home land.

The Falkland Islands fight won't be ranked as one of the major conflicts of history. There are many, in fact, who wonder why it ever occurred at all. It was a very real war, however, in the sense that

civilians on the islands were displaced from their homes. It was real in that it cost billions to conduct, and it was real in that young men were killed and maimed in the fighting.

We can hope that there will be no more killing in the South Atlantic. We fervently hope that the fighting is over between England and Argentina. Those two countries and all others which found themselves on one side or the other in the conflict can now begin to look for ways to mend the damage that has been done in relations between nations. The Falklands war should be put behind us and it should spur us on to finding better ways than wars to settle disputes.

# High Placed Vulnerable

In Great Britain an intruder walked right into the queen's bedchamber in Buckingham Palace, sat on the bed and talked for 10 minutes before the queen was able to summon security people.

In this country a couple has been charged with an alleged fraudulent deal involving the sale of President and Mrs. Reagan's California home.

The palace intruder, it seems,

had been arrested previously for breaching security. Here, Mrs. Reagan may be called upon to testify in the case involving the couple.

These two events on opposite sides of the Atlantic seem implausible. It indicates, however, that even as high placed people as the queen and the president are vulnerable to the problems that beset us all.

THIS AFTERNOON

# Radical Solution

By Paul T. O'Connor  
RALEIGH — As director of the state's division of science in the Department of Public Instruction, Dr. Paul Taylor has heard most of the suggestions being offered for improving science and math instruction in North Carolina and across the country. But when he considers that one quarter of all math and science classes in North Carolina are taught by inadequately trained people and that enrollment in math and science courses is dropping rapidly, he wonders if drastic measures aren't needed.

For a while now, Taylor has been thinking about writing up his "radical solution" to the problem. When this reporter happened by his office recently, he laid out his ideas and saved himself the writing. It isn't a formal proposal — just something to think about, he says.

The study of math and science should be declared a matter of national security, he says. Although computers are practically everywhere now and despite being on the verge of a bio-technical revolution in agriculture and medicine, few people are training to become math and science teachers. On the university level, there is a shortage of new engineering professors to train new students.

But a matter of national security? Isn't that a bit severe? Maybe not.

Over Lebanon, Israeli fighter pilots have been terrorizing the Syrian Air Force lately. They've proven that their American weapons are far superior to those of the Soviet Union. Taylor asks how long this country can maintain its lead in high-technology weaponry if such a small portion of the popula-

tion is studying basic math and science.

That might not be as serious a military question as one posed in Western Europe where American soldiers would rely on high-tech weapons to repel an Eastern bloc invasion. Our best science students today may be the best in the world when their time comes to design high-tech weapons in the next generation. But, will our foot soldiers know how to use those weapons? Taylor notes that there's considerable concern about the intellectual fitness to use

and technology but we've about reached the brink in some of these areas," Taylor says.

And then there's the quality of life. Workers in high-tech areas earn very good money and the job opportunities in these fields are growing rapidly. It's a question of providing our young people with the training to get those good jobs. (Some people feel there'll be very few non-technological jobs at all in 20 years.)

So Taylor suggests a national effort to enhance science and math instruction. His idea is to drastically increase teacher salaries — maybe doubling them — as a way of getting more people into math and science education. If that doesn't work, he'd start drafting qualified science teachers. Those currently teaching math and science would have to take night and summer courses to beef up their skills. And then he'd require more science and math as part of the student's basic curriculum. Of course the government would have to pay for it.

But as Taylor looks at the world we'll face in the year 2000, he doesn't see any other choice. To him, it's a matter of our own security.

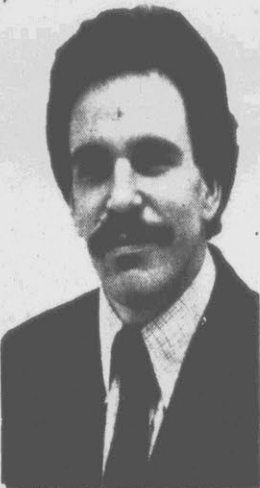

PAUL O'CONNOR

some of the weapons he already has.

There's also a question of protecting America's position in the business world. Our economy depends, to a great extent, on the lead we hold in technological areas. We may not make a widget cheaper than they do in Hong Kong but then they don't stuff a half million gizmos on a silicon chip, either. But they will pretty soon. "American society has relied in the past on its lead in science

THERE SEEMS TO BE A LOT OF COOKS!



BY ART BUCHWALD

# Question Of Geography

Why do American secretaries of State have so much trouble with the White House? It's nothing more than a question of geography. In the good old days the State Department was located in the Executive Office Building, which is right next to the White House and considered part of it now. All the secretary would have to do is cross an alley and walk into the Oval Office.

But then someone in the White House, years ago, got a brainstorm. If they could move the secretary of State down to a swamp called Foggy Bottom, he'd think twice about bugging the President over some silly matter concerning foreign affairs.

The White House used the excuse that it needed the Executive Office Building to house its own staff. To add insult to injury, they built a new State Department which was the ugliest piece of architecture in Washington. But it served its purpose because it kept the secretary of State from easy accessibility to the boss.

Although State is only about 15 blocks away from the White House, the secretary might as well be stationed in Paraguay.

This is what happens to all secretaries of State since they moved out of the EOB:

The President sees his White House staff every day.

"Top of the morning to you sir," they say to him.

Now it goes without saying that a person who says "Top of the morning" to the President every day is going to have more input than a Cabinet officer who has to taxi over to the White House twice a week.

No President spends all his

time just signing bills, and making speeches at prayer breakfasts. He is only human and likes to chew the fat with people. Who does he chew the fat with? His White House staff, of course. He isn't going to call up the secretary of State and say, "Hey, come over and have a beer."

Even if he wanted to, the White House staff members, jealous of their turf, are not going to let an outsider like a secretary of State become part of the inner circle.

Not only is the secretary kept away from the President for bull sessions, but the staff goes to great lengths to see that he doesn't get to see the President too often when it involves affairs of state.

The first rule is that a secretary of State must always call the President before he comes over.

The conversation could go like this:

"This is the secretary of State. I have to see the President of the United States."

"I'm sorry sir. The President is in an important meeting with Charlton

Heston. Can anybody else help you?"

"No, I have to talk to the President about China."

"Haven't you already talked to him about China?"

"I have to talk to him again."

"He has a terribly busy schedule. We could fit you in a week from next Thursday for 10 minutes."

"It's urgent."

"We can't move it up sooner. But if we have a cancellation we'll call you back."

After the White House aide hangs up he turns to another White House aide and says, "Can you imagine the gall of the man? He thinks he can just call up, and see the President on 48 hours' notice. What kind of administration does he think we're running?"

"They're all alike," the other White House aide says.

"They believe just because we let them sit in on Cabinet meetings, they can have access to the President any time they want to. If there is one thing I hate, it's a pushy secretary of State."

# Strength For Today

THE CHURCH ETERNAL

A man who spent a number of years in Communist Russia told an audience recently of a significant event he had observed in Moscow.

It was Easter Sunday. A large crowd had gathered in a great square and was being harangued by enthusiastic atheists who pointed out the absurdity of Easter and all other Christian "superstitions." This indoctrination went on for some time. At last, a very insignificant looking man — not a clergyman — arose and stood for a moment until there was silence. Then he

said very simply "The Lord has risen." And surprisingly, came an audible response from a large number of people in the crowd, "He is risen indeed."

Some dictators have tried, on a number of occasions throughout history, to destroy religion. The result has always been the same — the final, complete failure of their plans. The dictators may set the world afire before they are through, but their fire will never consume religious faith from off the earth. — ELISHA DOUGLASS.

# Lonely Figure

By ROWLAND EVANS and ROBERT NOVAK  
WASHINGTON — when Sen. Charles Percy, chairman of the Senate Foreign Relations Committee, urged President Reagan not to "go ahead" with the sale of 75 F-16 aircraft to Israel, he was a lonely figure of protest amid widespread approval of Israel's invasion of Lebanon by the Reagan administration, Congress and the American public.

Percy has received no response from the White House, and none is expected anytime soon, confirming that the Lebanon occupation has increased Israel's influence in the U.S., not reduced it.

That raises this difficult question: Have the Reagan administration and Congress decided to give Israel full freedom to act on behalf of the U.S. in the Arab-Israeli struggle and in the larger context of Mideast policy. Using as their yardstick the lack of official criticism of Israel's Lebanon adventure, the answer is probably yes.

In the first week of the Israeli invasion when Israeli lobby, sarcastically asked an aide of Sen. Alan Cranston: "Why don't you bring up the Cranston Amendment on the floor now and see what happens?" The Senate Democratic whip's amendment gives Israel unprecedented, open-ended yearly aid high enough to pay past debts to the U.S.

In needing Cranston, Mathias naturally assumed the invasion of Lebanon had weakened Israel in the Senate. On the contrary, Cranston has not been notified of any opposition on the floor to his amendment. He is confident it will pass. One reason is the November election.

Israel's control over U.S. Mideast policy was impressed on the Senate during Prime Minister Menachem Begin's contentious session with the foreign relations committee June 22. Begin, who had come to Capitol Hill from the Oval Office, was quoted to us as saying: "I've spoken to the president. We have his support. We have Jewish support. And we have some Christian support."

Considering its carte blanche over U.S. policy, it is not all that surprising that Israel could create a situation requiring President Reagan to send the U.S. Marines to redeem last Israeli demands in Lebanon. White House aides and a minority of State Department officials are trying hard to dilute this impression.

The line goes that President Reagan actually has concealed the anger he feels for Begin and Defense Minister Ariel Sharon; that Reagan was tough in his final session with Begin last month, warning Israel not to interfere with U.S. arms shipments to "friendly Arab states"; that former secretary of state Alexander Haig was even tougher with Begin in ruling out new Jewish settlements on the West Bank.

But these and other alleged examples of toughness were all behind closed doors. They were therefore no antidote to the image of Israel's unchecked influence in this country. Protest against Israel's military rampage has been largely confined to the press, liberal Jewish intellectuals, church leaders and a few prominent Jewish Americans who long ago deserted Begin because of his expansionist policies. The official U.S. assent to Israeli seizure of Lebanon helps explain the rise of Israel in post-invasion public opinion polls.

Reagan has passed up multiple opportunities since the June 6 invasion to signal distress over what one administration official described to us as "Begin treating Reagan as his chump." Examples: no complaint over the lack of reply to Reagan's formal request asking whether Israel used forbidden U.S. cluster bombs in Lebanon; no protest over Israel's recklessly premature leak of Reagan's offer of the Marines; no marked reaction to new killings of Palestinians on the West Bank and dismissal of another elected Palestinian mayor.

If White House and State Department publicists mean what they say about the president's intention to get "tough" with Israel after Lebanon, he will be fighting a high tide of support for Israel that he himself helped create.

More likely is a further ceding of U.S. policy to Israel's own interests. Begin's American triumph the past five weeks looks like the threshold for more U.S. impotence and greater Israeli victories.

WHAT'S HAPPENING TO PEOPLE?

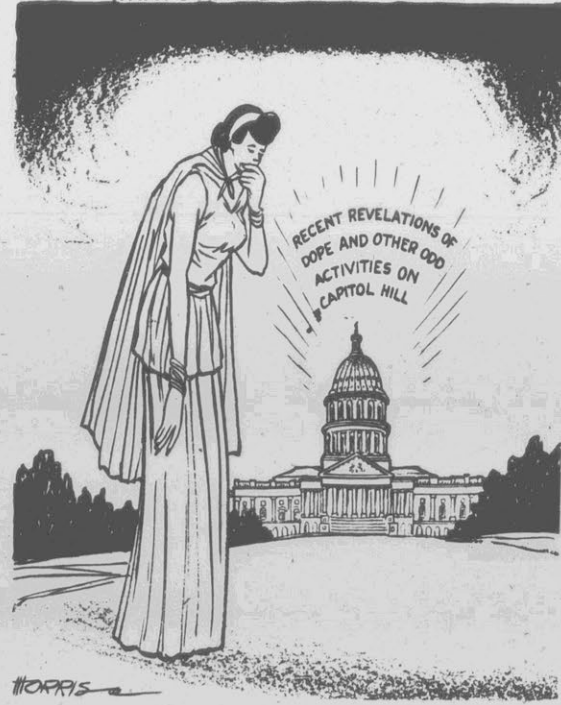

# Public Forum

Letters submitted for Public Forum should be limited to 300 words. The editor reserves the right to edit longer letters.

To the editor:

I was awed to see the Daily Reflector print a front-page feature in the Sunday, July 4, edition describing a segment of the health care industry in your article, "Chiropractic, A Way of Healing Without Drugs."

Since the newspaper, or perhaps specifically Stuart Savage, has such an intense desire to improve its readers' knowledge of health care delivery, you will undoubtedly want to provide equal visibility to the many other existing, well-established professional health providers who can offer "healing without drugs." Your readers should be informed of the fact that tantamount to good treatment is a thorough, scientifically-based diagnosis, without which great harm can result from inappropriate treatment or delays resulting from inappropriate intervention.

When one of your readers suffers with back, neck, muscle or joint pain and/or disability, they have access to "healing without drugs" by seeking physical therapy through their family physician. Physical therapy is the management of pain, disease and disability through the application of physical or non-drug procedures. It offers the patient the benefit of full-spectrum services by the medical community in which the physical therapist provides treatment without drugs in coordination with the physician who may also use drugs or surgery appropriate to the diagnosis.

The newspaper's interest in disseminating information to the public on health care is commendable, but hopefully it will offer similar high-level visibility to other health providers so that misconceptions on availability of services and their characteristics are not presented to its readers.

George F. Hamilton, LPT, chairman  
ECU Department of Physical Therapy

# Reagan Pension Plan Debated

By KEVIN COSTELLOE  
Associated Press Writer  
WASHINGTON (AP) — President Reagan's \$22,444 California pension has been questioned by critics who contend it's an unconstitutional "emolument." But the Justice Department says it's a perfectly legal arrangement.

Either way, the on-again, off-again debate centers on one of those often overlooked sections of the Constitution offering little firm proof of which side is right.

The head of the Sacramento (Calif.) Urban League, for one, notes that the Constitution bars U.S. presidents from getting any state or federal emolument other than their salary.

An emolument, says Webster's New Collegiate Dictionary, is a "profit from office, employment or labor; fees or salary."

But the Justice Department, in a legal opinion,

insists the intent of the men who drafted the clause in the 18th century was to bar payments that could influence presidential decisions.

And that problem is absent, the department says, because Reagan will get the pension money from his days as California governor regardless of what he does in the Oval Office.

A 1973 Library of Congress guide to the Constitution lists no disputes over the presidential "emolument" clause.

Major law school textbooks do not probe the true meaning of the provision, which likely will remain in the ranks of some of the other obscure parts of the Constitution.

Federal officeholders need the consent of Congress to accept any "present, emolument, office or title" from "any king, prince or foreign state."

The Justice Department

says it has received inquiries about Reagan's pension from House Speaker Thomas P. O'Neill, D-Mass., and at least two other congressmen.

And George Dean, president of the Sacramento Urban League, says he informed Attorney General William French Smith by letter that paying the pension as long as Reagan is president is unconstitutional.

Dean, whose group advocates the rights of minorities, says he's asked California officials to stop payments, now set at \$22,444 annually, pending an independent legal review.

The debate over the pension may stay just that — a war of words.

Court challenges may be impossible. If, as is likely, the president keeps on receiving the pension in addition to his \$200,000 salary there's a major question of who could go to court to try

to stop him.

And in the absence of any court challenge, the Justice Department's approval of the pension arrangement last year is almost certain to stand as the last official word.

"The pension is not an emolument within the meaning of the Constitution ... or within the meaning of the laws of California," says Justice Department spokesman Mark Sheehan.

In its original version, the 18th century presidential "emolument" clause reads as follows:

"The President shall, at stated Times, receive for his Services, a Compensation which shall neither be increased nor diminished during the Period for which he shall have been elected, and he shall not receive within that Period any other Emolument from the United States, or any of them."

## The Daily Reflector

INCORPORATED

209 Cotanche Street, Greenville, N.C. 27834

Established 1882

Published Monday Through Friday Afternoon and Sunday Morning

DAVID JULIAN WHICHARD, Chairman of the Board  
JOHN S. WHICHARD — DAVID J. WHICHARD  
Publishers

Second Class Postage Paid  
at Greenville, N.C.

(USPS 145-400)



### SUBSCRIPTION RATES

Payable in Advance  
Home Delivery By Carrier  
or Motor Route Monthly \$4.00

### MAIL RATES

(Prices include tax where applicable)  
Pitt And Adjoining Counties  
\$4.00 Per Month

Elsewhere in North Carolina  
\$4.35 Per Month

Outside North Carolina  
\$5.50 Per Month

### MEMBER OF

ASSOCIATED PRESS

The Associated Press is exclusively entitled to use for publication all news dispatches credited to it or not otherwise credited to this paper and also the local news published herein. All rights of publications of special dispatches here are also reserved.

UNITED PRESS INTERNATIONAL

Advertising rates and deadlines available upon request.

Member Audit Bureau of Circulation.



**CITY OFFICIALS ON THE SCENE** — Greenville officials were on the scene viewing the damage caused by heavy rains Tuesday afternoon. Looking at the large gap in First Street are, left to right, Police Chief Glenn Cannon, Public Works

director Mayor Allen, Fire-Rescue Chief Jenness Allen, Mayor Percy Cox, and City Manager, Gayle Meeks. (Reflector Photo by Tommy Forrest)

**TERMINAL** — Greenville Utility workers Ricky West, front, and Johnny Council wire an electrical terminal on the west side of the large hole Tuesday, in preparation for restoring electrical service. (Reflector Photo by Tommy Forrest)



## Begin Said Willing To Hold Back

By The Associated Press  
Israeli jets staged mock bombing raids over west Beirut today, but a report in Israel said Prime Minister Menachem Begin has decided to give U.S. diplomatic efforts as much time as is needed to end the crisis peacefully.

Israel radio said Begin had told Howard Squadron, chairman of the council of presidents of American Jewish organizations, that invading west Beirut to oust the PLO would cause many Israeli and Lebanese casualties and damage relations with the United States.

There was no immediate comment from Begin's office on the report. It contrasted sharply with the tone of recent Israeli assertions that time is running out and that Israel is prepared to drive the Palestine Liberation Or-

ganization's guerrillas out of Beirut if they do not agree to leave peacefully.

The talks on evacuating the PLO have been snagged for more than two weeks on the question of where the guerrillas would go if they left Beirut and how they would get there. There was no indication of substantial progress today.

The mock bombing raid is a tactic Israel has used

before over Beirut in an effort to frighten the estimated 500,000 civilians living in the Moslem quarter and induce them to leave. No bombs were dropped.

On the ground, both sides reported skirmishes, but the U.S.-mediated cease-fire continued to protect the city from artillery barrages. Palestinian gunners fired anti-aircraft weapons at the low-flying Israeli jets, but

there were no reports that any were downed.

The United States has refused to recognize the PLO until it accepts Israel's right to exist and accepts United Nations resolutions outlining a peace plan for the region.

### Manager Speaks To Retirees

The American Association of Retired Persons held its meeting Monday at the Tar Landing Restaurant. Greenville City Manager Gail Meeks was guest speaker.

She explained the 1982 budget, different departments and the allocation of funds and equipment.

President Eva Cain read a poem in memory of Mrs.

Thela Maxwell and the Rev. Henry Lofquist said a prayer. A report by the Sunshine Committee was given.

Peter Anderson reported that he had received a letter from the Cancer Research Project in Washington, D.C., seeking volunteers to conduct a survey to aid the research program.

### Solar Fraction

The solar fraction for this area Tuesday, as computed by the East Carolina University Department of Physics, was 35. This means that a solar water heater could have provided 35 percent of your hot water needs.

### MASONIC NOTICE

Grimesland Masonic Lodge No. 475, AF&AM, will have an emergent communication Thursday at 11 a.m. for the purpose of paying last respects to Brother W.H. Clark. All Master Masons are invited.

Kenneth Ross, master  
James E. Murray, secretary

**Dial-A-Prayer**  
752-1362

**The Scotch Bonnet**  
NEEDLE ARTS STUDIO, INC.  
Cross Stitch Books  
Selected Group  
**50% Off**  
Open Wednesday Till 9 PM  
602 Arlington Blvd  
756-4877

**Canvas SLIDES**

**\$6**

Reg. 8.95

Ladies' 5-10  
Navy, natural, or red multi

**Shoe Show**

Greenville Square Shopping Center

Mon.-Thurs. 10 to 7  
Fri. & Sat. 10 to 9

**Belk Tyler**  
carolina east mall greenville

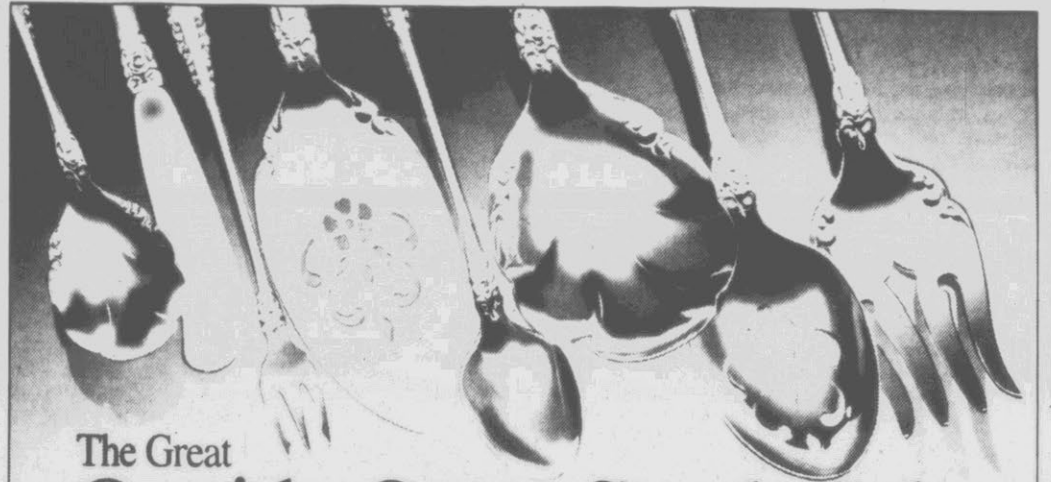

## The Great Oneida Open Stock Sale

Save 33 1/3%!

on Oneida's Finest Stainless

• Twelve Patterns • Full Lifetime Warranty • Most Wanted Pieces

Oneida® Heirloom® LTD™ Stainless

Oneida® Heirloom® Stainless

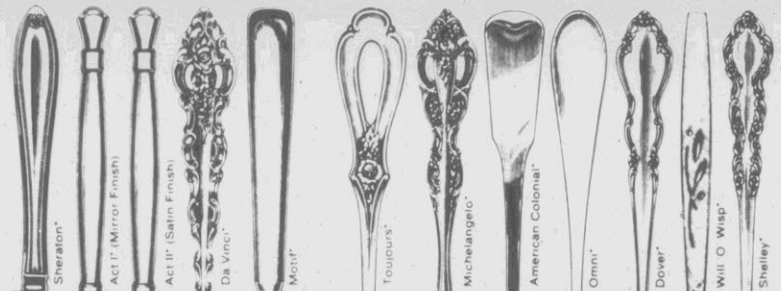

	Oneida® Heirloom® LTD™ Stainless		Oneida® Heirloom® Stainless		Oneida® Heirloom® LTD™ Stainless		Oneida® Heirloom® Stainless		
	Reg.	SALE	Reg.	SALE	Reg.	SALE	Reg.	SALE	
Teaspoon	\$12.00	\$8.00	\$6.25	\$4.17	Stainless	\$12.00	\$8.00	\$11.00	\$7.33
Fruit Spoon	12.00	8.00	6.00	4.00	Stainless	12.00	8.00	11.00	7.33
Place Spoon	12.00	8.00	7.75	5.17	Stainless	12.00	8.00	11.00	7.33
Iced Drink Spoon	12.00	8.00	7.25	4.83	Stainless	13.75	9.17	10.50	7.00
Demitasse Spoon	7.00	4.67	5.25	3.50	Stainless	13.75	9.17	8.50	5.67
Place Fork	12.00	8.00	8.00	5.33	Stainless	18.50	12.33	10.50	7.00
Salad Fork	12.00	8.00	7.75	5.17	Stainless	18.50	12.33	10.50	7.00
Cooking/Seafood Fork	12.00	8.00	7.00	4.67	Stainless	18.50	12.33	13.00	8.67
Butter Spreader	12.00	8.00	10.00	6.67	Stainless	18.50	12.33	13.00	8.67
Place Knife	12.00	8.00	11.00	7.33	Stainless	18.50	12.33	13.50	9.00

1 Available in Dover; Will O'Wisp & Michelangelo only. 2 Not available in Act I, Act II, Motif & Sheraton. 3 Not available in Da Vinci. 4 Available in American Colonial only.

SALE THRU JULY 24, 1982... QUANTITIES LIMITED!

The American Made Tableware  
Your assurance of quality, value and availability

**ONEIDA®**  
The silver cube. Our silversmiths' mark of excellence

\*Trademarks of Oneida Ltd  
\*Warranty details available on request

Shop Monday Through Saturday 10 a.m. Until 9 p.m. — Phone 756-B-E-L-K (756-2355)

**Belk Tyler**  
carolina east mall greenville



### PRE-SEASON BLANKET LAYAWAY SALE!

Now — July 17!

\$2 Down Holds Your Purchase Until Oct. 1st! Snuggle-Up with Savings on StatePride® Blankets!

Save 20% on 'Lucerne' Blankets!

Regular 13.00  
**10.44**

Needle-woven, 100% acrylic blankets! Non-allergenic, moth-proof, mildew-resistant. White, blue and beige. 72x90", full size.

'Hampton' Blankets at 17% Off!

Regular 9.00  
**7.44**

StatePride® Hampton solid color blankets. Luxurious needle woven 100% acrylic. Green, gold, blue, beige. 72x90", full size.

'Heather' Thermals Reduced 19%!

Regular 11.00  
**8.88**

Great buy! Provides warmth without weight! Loom woven thermal of 100% acrylic. White, lemon, blue and beige. Full size.

\$4 Off on Virgin Acrylic Blankets!

Regular 22.00  
**17.88**

Machine washable, moth-proof, mildew-resistant. Conventionally loom-woven 100% acrylic. Champagne, ice blue. 72x90", full size.

25% Off Cotton Thermal Blankets

Regular 17.00  
**12.75**

Warm in winter, with light top cover, cool in summer. Allows air to circulate. 100% cotton thermal woven with diamond motif. Easy-care machine wash. Tan or light blue colors. 74x90", full size.

Electric Blankets at a Big \$7 Off!

Regular 40.00  
**32.88**

StatePride® regular electric blankets of 80% polyester/20% acrylic. Snap fasteners for contour fitting. Attractive control. Champagne, gold and blue colors. Machine washable. 72x84" size.

33% Off on Acrylic Thermals Now

Regular 18.00  
**12.00**

Loom-woven leno construction 100% virgin acrylic thermal blankets. Machine washable. Champagne and lt. blue. Full size.

Shop Monday Through Saturday 10 a.m. Until 9 p.m. — Phone 756-B-E-L-K (756-2355)

# GUC OKs Development Policy

By STUART SAVAGE  
Reflector Staff Writer

Greenville Utilities Commission members Tuesday night voted their approval of a joint statement of policy on development, a tax shelter retirement program for commission employees and an experimental program designed to reduce the demand for electricity created by the operation of bulk tobacco barns.

In approving the statement of policy on development, commissioners joined the Greenville City Council in setting out a five-point policy statement "in order to promote the expansion of the tax base" within the city, "and to encourage the development of land both within the city and within the extraterritorial limits of the city."

The policy statement says water and sewer extensions should be coordinated with the city's comprehensive plan; that land should be developed in accordance with the comprehensive plan; that the development of underdeveloped areas within the city and adjacent to the city limits should be promoted by "adopting innovative policies with incentives" for private development; and that Community Development funds should be used for new street construction and improvements (including all utility system improvements) where applicable.

The statement also said the city and utilities "agree... to require that requests for extension of sewer lines outside the city limits or requests for

service from existing out-of-city sewer lines to serve residential and commercial developments must be accompanied by a petition for voluntary annexation or a petition for annexation to be filed at the earliest time the property to be served meets the statutory requirements for voluntary annexation."

The tax shelter plan given approval will result in an increase in take-home pay of employees by an estimated 2 percent to 4 percent by sheltering the contributions made by employees to the N.C. Local Government Employees' Retirement System.

In approving the program to reduce the demand for electricity from bulk tobacco barn operators, the commission accepted a N.C. Alternative Energy Corp. grant for \$40,805 with which to fund an experimental "Beat the Peak" type program for bulk barns.

In addition to the AEC grant, GUC will provide some \$10,500 in in-kind matching funds for the program, while N.C. State University will contribute some \$2,000 in in-kind services.

The experimental program this summer will explore and test methods of peak reduction, with the goal of saving bulk barn users and ultimately all GUC customers money.

Commission members also approved the search for a consultant to conduct a water and sewer rate study which would establish water and sewer rates on a cost-of-service basis — what it costs to provide specific classes of service — rather than

the present flat rate schedule.

In other business, the commission adopted a resolution to dissolve Power Agency Number 2, which is now inactive because of the establishment of the N.C. Eastern Municipal Power Agency, and approved the write-off of some \$129,561 in delinquent accounts from fiscal year 1980-81. The delinquent accounts amount to .325 percent of the total amount billed during the 1980-81 fiscal year, and include less than \$22,000 in bills for commercial service.

Even though commissioners approved the delinquent bill write-off, the accounts are still carried on the books and efforts will continue to be made to collect them.

Commission members also accepted bids and awarded contracts for supplies and equipment at the session. The low bids and awards included: \$13,719 for 195,000 pounds of chlorine from Suffolk Chemical Co.; \$19,462 for 148,000 pounds of caustic soda from Enece Chemical Sales Inc.; \$27,816 for 450,000 pounds of aluminum sulfate from Gowen Chemicals Inc.; \$8,942 for an air compressor from N.C. Equipment Co.; \$19,654 for a wrecker and body for a currently-owned cab and chassis from Eastern Wrecker Sales Inc.; \$16,030 for two three-quarter-ton pickup trucks from F&D Motors; \$7,626 for one half-ton pickup truck from F&D Motors; \$28,932 for four half-ton compact pickup trucks from Phelps Chevrolet Inc.; and \$23,833 for a tractor-backhoe with front end loader from R. W. Moore Equipment Co.

## New ERA Bill Going To Congress

By PEGGY ANDERSEN  
Associated Press Writer

WASHINGTON (AP) — Vowing the women's equality issue "will not die," supporters of the proposed Equal Rights Amendment are reintroducing the measure in Congress just two weeks after the original amendment failed to win ratification.

"The ERA is about economics and civil rights, not about lifestyles," said Rep. Patricia Schroeder, D-Colo.

The issue of equality of rights for women will not die," Rep. Margaret Heckler, D-Mass., said recently. "Current economic conditions have made the ERA's passage even more vital today than it was when this saga began in 1972."

Her comments were made as Capitol Hill supporters were announcing reintroduction of the measure at a news conference today.

The first ERA died on June 30 because only 35 of the required 38 states had ratified it. Congress approved it in 1972, and extended the seven-year ratification limit by three years in 1979.

The pivotal provision of the 52-word amendment states: "Equality of rights under the law shall not be denied or abridged by the United States or by any state on account of sex."

In the House, Reps. Schroeder and Heckler; Peter Rodino, D-N.J.; and Don Edwards, D-Calif., top a roster of more than 150 co-sponsors.

Among the 46 co-sponsors of the measure in the Senate are Sens. Paul Tsongas and Edward Kennedy, both D-Mass.; Bob Packwood, R-Ore.; Joseph Biden Jr., D-Del.; and Charles Mathias Jr., R-Md.

But Senate Majority Leader Howard Baker of Tennessee has said he advocates "a little cooling off," and opposes efforts to bring up a new ERA this year.

Assistant Senate Republican Leader Ted Stevens of Alaska, a sponsor of the new proposed amendment, told reporters today he does not expect Congress to act on the ERA unless prodded by state legislatures.

Stevens suggested that ERA backers follow the course adopted by supporters of a proposed constitutional

amendment that would require a balanced budget. Those forces persuaded nearly the required two-thirds of state legislatures to adopt resolutions calling for a constitutional convention on the subject.

The Senate is now considering the balanced budget amendment and is expected to approve it.

"We are motivated to a great extent by the number of states that have called for a constitutional convention," Stevens said. "I don't think any of us wants a constitutional convention."

Tsongas has said backers will attempt to line up support from the necessary two-thirds of the Senate before trying to force a vote on the issue.

"There will not be an attempt to press him (Baker) until we know we have the necessary votes," Tsongas said, noting that supporters "hope there will be more pro-ERA supporters after the (November congressional) elections than now."

Several women's rights groups, including the National Organization for Women, indicated after the ERA's defeat that they would rechannel their efforts.

While continuing to support the concept of the amendment, NOW president Eleanor Smeal said several weeks ago, "We will not again seriously pursue the ERA until we've made a

major dent in changing the composition of Congress as well as the state legislatures to include a significantly larger proportion of women and of men who are genuinely feminists."

She cited a recent survey by pollster Louis Harris which indicated that public support for the ERA had reached 63 percent. The poll showed 34 percent of those polled opposed the amendment and 3 percent were not sure.

### CORRECTION

On Page 4 Of The Summer Sale Many Of You Received In Today's Paper, The Men's Slacks Clearance Does Not Include The Entire Stock As Stated. This Is A Clearance Of A Select Group Of Summer Slacks. On Page 5, The Men's Denim Overalls, Jeans And Chambray Shirt Are 100% Cotton, Not Polyester And Cotton. The Bigger Boy's Jeans Are Available In Sizes 8 To 16, Not 8 To 20. We Apologize For Any Inconvenience.

Sears, Roebuck and Co.  
Greenville, N.C.

## Frame - It Yourself Shoppe Inc.



SAVE BY  
DOING YOUR  
OWN FRAMING!

- We cut moulding, glass, mats...you assemble under expert supervision
- 48 hour custom framing service also available
- 450 styles of moulding in stock including a large selection of styles and colors of metal moulding
- Large gallery of framed pictures and posters...for decorating your home and office
- Prints of all types—including limited editions, florals, seascapes, and more
- Large selection of ready made frames in stock including oval and standard sizes.
- Oval mats and glass

OPEN DAILY 9:30-5:30 • MON. & WED. EVENINGS TIL 9 P.M.

606 Arlington Blvd.  
Greenville, N.C.

756-7454

## XTRA SPECIAL "For the Fuller Figure"

50%  
To  
75%  
Off

Pitt Plaza  
756-1600

## REWARD

\$350.00 Reward For Information Leading To The Recovery Of A Substantial Portion Of Jewelry And Other Items Stolen From 604 Queen Anne Road, Greenville, N.C. Some Items Stolen Include: 1 White Gold Engagement Ring; 1 Gold Family Crest Ring (JMH on Inside); 1 Kappa Alpha Fraternity Pin Ring, 1 Wedding Band, Black Onyx Ring, Numerous Other Rings & Jewelry Items, and 15 Pair Of Asahi Tennis Shoes.

Call 756-2188 Mon-Fri 9-5

### SPECIAL SERVICE

A special service will be held at St. Monica Baptist Church at 3 p.m. Sunday. The Rev. J.E. Sugg will be the guest speaker.

### BENEDICT MEETING

The Bachelor Benedict Club will meet at the club at 8 p.m. tonight. Business of importance is to be discussed.

## Pick 'n Pay Shoes

Sale. A great collection of summer sandals...

Women's genuine leather thong. Suede insole. Assorted colors.

**\$6**

Your choice

Women's metallic sandal has ankle strap.

Women's multi-color stretch band sandal with leather trim. Reg. \$9.97  
■ Girls' 9-4, reg. \$7.97...\$5

Women's leather sandals in two styles. Assorted colors. Reg. \$10.97  
■ Girls' 9-4, reg. \$8.97...\$6  
■ Infants' 2-8, reg. \$6.97...\$5  
Two-buckle style only.

Sale. Big savings on a great selection of men's, women's and children's styles.

All men's canvas casuals...  
**30% off and more**

All canvas and nylon handbags...  
**25% off**

Greenville Blvd. on 264 By Pass  
Greenville, N.C.

Sale prices good thru Sunday. MasterCard or Visa. Open evenings

# Things to do tomorrow

1. Get-up bright and early!
2. Dress comfortably, sensibly.
3. Eat a hearty, nourishing breakfast.
4. Wear sneakers.
5. Don't forget your pocketbook.
6. Get to Brody's on time.

The great clearance starts at 10 a.m.  
Hundreds of Spring and Summer Dresses  
are Practically being given away!

Everything is regular Brody quality!  
Everything is with the famous Brody Look!

## Super Dress Sale

Entire Stock  
Junior Fashion Dresses ..... **1/2 OFF**

Entire Stock  
Junior Sundresses ..... **1/2 OFF**  
(Except Lanz)

Entire Stock  
Lanz Sundresses ..... **1/3 OFF**

Entire Stock  
Missy Fashion Dresses ..... **1/2 OFF**  
Choose from famous names such as Henry Lee, Serbin, Leslie Faye, R&K, J.G. Hook, Schrader Sport, and many more.

Missy Sundresses ..... **1/2 OFF**  
Choose from hundreds of styles by names such as Malia, Poppy, and many more!

### BETTER SPORTSWEAR

Better Tops ..... **1/2 OFF**

Better Skirts ..... **1/2 OFF**

Better Co-ordinates ..... **1/2 OFF**

Choose from famous name brands such as Liz Claiborne, J.H. Collectibles, Anne Klein, Harve' Bernard, Marisa Christina, and more!

*Brody's*

Shop Downtown  
10 a.m.-6 p.m.

Shop Pitt Plaza  
10 a.m.-9 p.m.

# Belk Tyler

carolina east mall greenville



**Belk Tyler Proudly Presents Our First Atari's Pac Man Contest**  
Saturday, July 17 From 10:00 A.M. To 5:00 P.M.  
Over \$1500 Worth Of Prizes To Be Given Away

## Grand Prize Atari Game

Action Pak 3 Game Cassettes  
Plus Warlords & Asteroids  
Game Cassettes

**1st Prize For Each Age Category Atari Game With  
Combat Game Cassette Warlords Game Cassette  
& Asteroids Game Cassette**

**2nd Prize For Each Age Category  
Atari Game Plus Combat Game Cartridge**

**3rd Prize For Each Age Category  
Will Be An Action Pak  
3 Game Cassette Set**

Changes For All Ages Up To 18 Years Old

**Three Age Divisions:** Ages Up To 8    Group I  
Ages 9 To 13    Group II  
Ages 14 To 18    Group III

Three Prizes Will Be Awarded To Each Group And The Winner Of Each Division Will Compete For The Grand Prize.

Each Participant Will Compete On A Time Of 3 Minutes.

Preregistration Available In Our Housewares Dept.

Please Register In A Time Slot And Be Present At That Time To Participate.

First Come Basis: When All Slots Are Filled, We Will Have A Standby List To Fill In By.

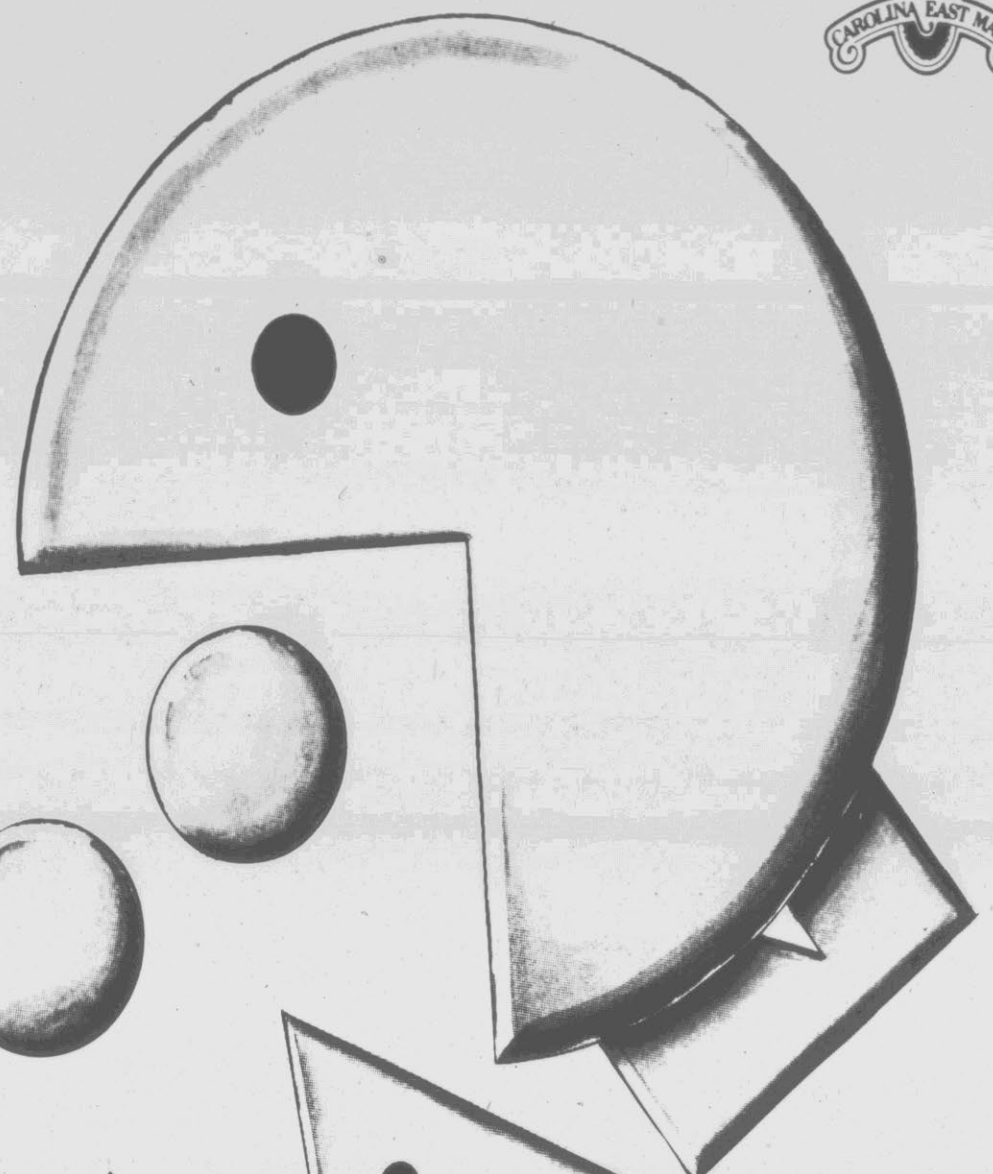

# RAIS HERE



You Can Enjoy Hours of  
Home Excitement with Atari®  
Video Computer Systems™!

## 139.88

Special Purchase



Home entertainment at its best! Easy to connect to your television plus easy to use. Simply plug in the appropriate keyboard, joystick, steering controller or paddle. Then insert the game program cartridge of your choice and have fun! System includes the Combat game cartridge and joysticks.



**Sale**  
**Atari Video Game Cartridges**  
YOUR CHOICE

## 26.88

Regular 29.88

Choose from any of the following great Atari Cartridge games: Brain Game, Haunted House, Missile Command, Asteroids, Kaboom, Sking, Laser Blast, Dragster, Sky Diver, Tic Tac Toe, Freeway, Air Sea Battle, Adventure Of Code Breaker. Great fun for the entire family. Hurry while limited supplies last! When it comes to video games, Atari® knows what you want!

**3.00 Savings on Atari®  
Video Game Cartridges!**

YOUR CHOICE

## 26.88

Regular 29.88 Each

Choose today's most popular Atari® video game cartridges... Haunted House™, Super Breakout™, Space Invaders™, Warlords™, Asteroids™ and Missile Command™.

2 (Trademark of Taito America Corp.)



Shop Monday Through Saturday 10 a.m. Until 9 p.m. —Phone 756-B-E-L-K (756-2355)

## Final Controls For Chemical Dumps Issued

By MARTIN CRUTSINGER  
Associated Press Writer  
WASHINGTON (AP) — The government has issued final standards governing 2,000 hazardous waste landfills across the country, putting in place the last major piece of regulatory machinery to protect the country against leaking chemical dumps.

The Environmental Protection Agency, in unveiling the 600 pages of regulations Tuesday, said they would provide a national "insurance policy" to halt past practices which left a legacy of hundreds of dangerous dumps that must now be cleaned up.

"The regulations ensure that the health of the American people will not be compromised, and that their drinking water will be fully protected," said EPA Administrator Anne Gorsuch. However, environmen-

talists attacked the rules for not going far enough, particularly in regulating existing landfills and storage ponds.

The regulations require new chemical dumps to install leak-proof liners and drainage systems to collect any liquid wastes and monitor for contamination of underground water supplies.

Existing facilities have to monitor for contamination, but they do not have to install liners or drainage systems.

David Lennett of the Environmental Defense Fund, which took the EPA to court to force the agency to finally issue the regulations, said EPA's decision to exempt existing dumps from installing liners and collection systems was a mistake.

"The agency's own data indicates a significant number of existing facilities are unlined and are located directly over a groundwater

source," Lennett said. "The agency should not be sanctioning such management practices."

But EPA officials said it was not feasible to force existing facilities to dig up their wastes and install the liners because of prohibitive costs and dangers that would be presented to workers from disturbing the wastes.

The agency said the ground water monitoring — which must be done at both existing and new facilities — would provide adequate warning of leaks.

The EPA estimated the new rules will cost existing facilities an additional \$7 for each ton of waste handled while new facilities will pay an extra \$15. A typical land disposal dump handles 35,000 tons of wastes annually.

The rules covering 2,000 land disposal facilities are in addition to regulations issued earlier.

# Things to do tomorrow

1. Get-up bright and early!
2. Dress comfortably, sensibly.
3. Eat a hearty, nourishing breakfast.
4. Wear sneakers.
5. Don't forget your pocketbook.
6. Get to Brody's on time.

The great clearance starts at 10 a.m.  
Hundreds of Spring and Summer Children's Sportswear Fashions are practically being given away!

Everything is regular Brody Quality!  
Everything is with the famous Brody Look!

## CHILDREN'S SPORTSWEAR SALE

Entire Stock	<b>SWIMWEAR</b>	<b>1/3 OFF</b>
Boys: infant-size 8		
Girls: infant-Preteen		
Entire Stock	<b>SHORTS</b>	<b>1/3 OFF</b>
Boys & Girls		
Entire Stock	<b>TEE SHIRTS</b>	<b>1/3 OFF</b>
Boys & Girls		

### IZOD

Basic short sleeve polo.  
All colors.

	reg.	now
Toddler	\$13.00	<b>\$11.99</b>
4-7	\$13.50	<b>\$11.48</b>
8-20	\$16.50	<b>\$13.99</b>

Entire Stock  
Girls Spring & Summer  
**DRESSES** **1/2 OFF**

All Remaining  
Spring & Summer  
**SKIRTS** **1/2 OFF**

Girls Calvin Klein  
**DENIM JEANS** **\$24.90** **\$26.90**  
7-14 reg. \$30 Preteen reg. \$32

Entire Stock  
Boys & Girls  
**SUMMER SLEEPWEAR** **1/2 OFF**

*Brody's*  
Shop: Pitt Plaza  
10 a.m.-9 p.m.

## House Democrats Want Higher Taxes, Benefits

By DAVID ESPO  
Associated Press Writer  
WASHINGTON (AP) — House Democrats are working on a plan to increase the income tax on unemployment compensation and use the money to finance additional jobless and welfare benefits as well as cut the federal deficit.

The proposal, likely to spark a fight from Republicans, would provide up to 13 additional weeks of unemployment benefits, providing a maximum of 52 weeks for workers in states where joblessness is highest.

The cost for the program, which would end on Sept. 30, 1983, unless Congress extends it, is pegged at \$562 million.

To finance it — as well make changes in welfare and reduce the deficit at the same time — the proposal would raise taxes on unemployment benefits by nearly \$700 million next year and \$2 billion over the next three years.

The plan already has been approved once by the Democratic-controlled House Ways and Means Committee and is awaiting action in the full House.

But to make sure it gets the fullest consideration possible, Rep. Harold Ford, D-Tenn., arranged to bring it up again today at a subcommittee meeting called to consider 1983 spending cuts required by the budget Congress passed last year.

The session follows one at which a separate Ways and Means subcommittee approved a three-year package of Medicare cuts totalling between \$5 billion and \$6 billion — roughly half of what was envisioned in the budget Congress approved last month.

Together, the two budget-cutting sessions mark the beginning of what is expected to be a long struggle in the Democratic-controlled House to meet tax increase and spending cut requirements in an election-year budget.

Under the Republican-drafted spending plan, the subcommittee Ford heads is required to cut \$593 million in 1983 and about \$2.2 billion over three years from programs such as welfare, Supplemental Security Income and child support enforcement.

Ford produced a package calling for larger than required reductions in the deficit — \$768 million in 1983 and \$2.6 billion over three years — although most of the

money would come in the form of higher taxes on unemployment benefits.

As for the programs themselves, the proposal calls for increasing spending on Aid to Families with Dependent Children by \$71 million in 1983 and \$325 million over three years. Most of the increase would come from expanded eligibility and from permitting recipients to earn more money without suffering a reduction in their benefits.

The panel that met on Tuesday found it impossible to meet its goal of cutting Medicare.

Democrats invited the GOP to take the lead, and Republicans said they opposed any plans to impose higher fees on recipients of the government's health care for the elderly.

While the precise figure was not available, officials said the proposals passed on to the full committee would save between \$5 billion and \$6 billion over three years — in contrast to the \$11.5 billion envisioned in the budget approved last month.

Most of the savings come from a decision to "recognize" a series of regulatory steps the Reagan administration says can cut \$2.3 billion in the next three years.

An additional \$800 million savings through 1985 will result from increased auditing of claims submitted for payment, the subcommittee said.

In addition, the panel

called for consideration of a plan ending the system under which the government reimburses hospitals and nursing homes after services are rendered.

Instead, the government would make a fixed payment in advance, a step that some officials contend would force hospitals to institute cost-saving steps of their own.

### Customer Satisfaction Is Our Number One Goal

Let Us Help You With All Your Decorating Needs

- Custom Draperies
- Top Treatments (Swags, Valances, Cornices)
- Mini-Blinds
- Vertical Blinds
- Woven Woods
- Upholstery Fabric
- Oriental Rugs
- Carpet & Vinyl
- Wallpaper

Country Drapery & Fabric Shop

Rt. 3, Box 376-C, Greenville, N.C.  
Don & Lois Braxton Phone 756-2876  
Monday thru Friday 10 A.M. to 5 P.M.  
Saturday by Appointment

## little people

☆☆ Grand Opening ☆☆

Friday, July 16

Ribbon Cutting By Mayor At 9:30 A.M.  
Open To The Public From 9:30 Until 6:00  
Serving Refreshments

- We Have An Excellent Summer Program That Includes:
- Swimming, Putt Putt Golf, Roller Skating, Movies, And Field Trips.
  - Hot Nourishing Lunches And Nutritional Wholesome Morning And Afternoon Snacks.
  - We Provide Afterschool Care And Free City Pickup Service.

This coupon good towards \$10.00 OFF registration fee!

Come Out To Meet Our Experienced Staff And Find Out About Our Excellent Pre-School Programming.

1310 East Tenth Street  
Call Shelly Joyner or Susan Hall  
758-1610

**BOB'S TV'S**



## Anniversary Sale

The Jenn-Air kitchen. More than a match for any menu.

A Jenn-Air kitchen is so versatile. Consider the amazing Grill-Range. Conventional or glass ceramic cooktops lift out easily to accommodate the famous Char-Flavor grill and a variety of other accessories, including a rotisserie, shish-kebab and griddle. The Grill-Range also offers a dual-use oven with both radiant heat and convection style cooking for faster roasting at lower temperatures. A powerful built-in surface ventilation system keeps your kitchen free of smoke and odors. And, topping everything off is Jenn-Air's Microwave, available separate or built-in with Jenn-Air's full-size, self-cleaning, radiant-heat oven.

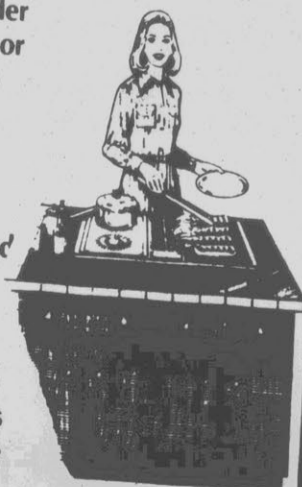

Make your Jenn-Air kitchen happen!

**JENN-AIR**

TV & APPLIANCE  
3205 South Memorial Dr., Greenville, N.C.  
Telephone 756-8830

**BOB'S TV'S**

108 East Second St., Ayden, N.C.  
Telephone 746-4021  
**SALES & SERVICE**

Buy a color TV or appliance and get a 12" B&W TV for only \$4995!

If you LIKE OUR SERVICE... you'll LOVE OUR PRICES!

**SAVICKI**  
Deep-Clean Carpet Care  
STEAMCLEANING AND DEODORIZING  
2529 MEMORIAL DRIVE  
GREENVILLE, N.C.

First room ..... \$24.95  
(up to 12' x 12')

Each Additional Room ..... \$14.95  
(up to 12' x 12')

Free Hall with one or more rooms!  
(up to 12' x 12')

Dupont Teflon Carpet Protector 2" (per sq. ft.)  
Deodorizing ..... Only \$1.50 extra

CALL FOR FREE ESTIMATE  
756-3252

# Balanced Budget Amendment Is Expected To Pass Both Houses

WASHINGTON (AP) — The Senate is moving toward approval of a constitutional amendment to balance the federal budget and the House seems likely to follow close behind.

"It will pass," said House Speaker Thomas P. O'Neill, an opponent of the amendment, on Tuesday.

In two days of Senate debate, only nominal opposition has arisen to the politically popular measure to force the government to match every dollar taken in with every one spent.

A final vote in the Senate was unlikely until later this week or early next week, but the outcome is not in doubt.

One opponent, Sen. Charles McC Mathias Jr., R-Md., said Congress should not enact a balanced budget amendment in the same year

it approved a record federal deficit.

"The American people are bound to wonder how the same Congress that brought back a budget \$100 billion out

of whack can sit here with our hands piously folded in front of us and vote for a balanced budget amendment," Mathias said.

Mathias has introduced a

weaker alternative to the constitutional amendment, but Congress will probably reject the Maryland senator's proposal later this week.

The Mathias alternative includes many of the provisions of the constitutional amendment, but is in the form of legislation requiring a simple majority vote in

stead of two-thirds required by the amendment.

Supporters of the amendment said the Mathias measure, even if enacted, would not work, because

Congress would ignore it once pressure grew to approve federal spending beyond available revenues.

Reagan promised in 1980 to balance the federal budget

by 1982 and O'Neill said the president has backed "a constitutional amendment to deliver on a campaign promise he has not been able to deliver on himself."

# Kmart® PRICEBREAKERS

Prices Effective  
Wed. - Sat.

**Kmart® ADVERTISED MERCHANDISE POLICY**  
Our merchandise is to have every advertised item in stock on our shelves. If an advertised item is not available for purchase due to any unforeseen reason, it may not be substituted. A Rain Check on request for the merchandise, one item or reason, is available. Merchandise to be purchased at the sale price whenever available or will get you a comparable quality item at a comparable reduction in price.

We Honor  
MasterCard VISA

Store Hours  
Mon. - Sat.  
9:30 til 9

## Deeds

Howard M. Allen al TO  
William A. Martin Jr. al 2.00  
Bob Barbour Inc. TO Bobby  
G. Barbour NS

Charles S. Coggins al TO  
Charles K. Chrisman al 56.50  
Donnie M. Hardison Jr. al  
TO Samuel T. Carson al 11.00  
Irma McLawhorn Lang al  
TO Tull H. Worthington al  
16.00

Clifton Earl O'Geary al TO  
John Thomas Aldridge NS  
Dallas J. Sasser al TO Lou  
Ellen Moore 5.00

Raymond B. Barnes al TO  
House of Prayer of Heart to  
Give 10.60

First Fed. S. & L. Assn/Pitt  
Co. TO Carl W. Horton al  
23.50

Larry Rodney Gwaltney al  
TO Sherry M. Nement NS  
John B. Hixson TO Douglas  
Williams

Yan Jeong Lao al TO  
Gregory Lapicki al 48.50  
Floyd F. McLawhorn al TO  
Judy McLawhorn Stox NS

Kenneth R. Wainwright al  
TO J. W. Hunter Co. Inc.  
55.00

Vivian D. Weaver TO John  
David Weaver NS

Douglas B. Williams TO  
Douglas B. Williams al NS

James W. Adams al TO  
Randell Dean Adams NS

J. H. Blount Jr. al TO Tar  
River Realty & Const. Co.  
Inc. 8.00

Joseph B. Clark Jr. al TO  
Judy L. Rollins 20.00

Cornerstone Missionary  
Baptist Church TO City of  
Greenville 148.00

Robert E. Dail al TO John  
C. Falconer al 26.50

Frank H. Edwards al TO  
Tipton Builders Inc. 17.00

Leon R. Hardee al TO  
Franklin F. Gore al NS

Clark C. Harrell TO  
Georgia L. Harrell 4.50

Ollie A. Harrington al TO  
Robert E. Dail al 8.00

Susan A. Lassiter TO  
DeWitt Frank McCarley 18.50

Samuel F. Alexander al TO  
Angela Alexander Tripp NS

Bill Clark Const. Co. Inc.  
TO Jesse R. Laughinghouse  
46.00

Elizabeth Marie Stropnicki  
al TO Susan A. Lassiter 17.50

Twin Oaks Towne Homes-  
Court B Homeowners Assn TO  
Twin Oaks Townhomes-Court  
G, Building 1, Homeowners  
Assn NS

Twin Oaks Towne Homes-  
Court B TO Twin Oaks  
Townhomes Homeowners  
Assn NS

Yvonne M. Allen TO  
Thomas G. O'Neal al 5.00

NCNB TO Larry W. Prewitt  
19.00

William Russell Cayton TO  
Helen Flanagan Cayton NS

Davenport Farms Inc. TO  
Pitt Co. Board of Education  
NS

Michael B. Dixon al TO  
Lloyd G. Carroll Jr. al 25.00

B. B. Drum al TO Moses  
Leary al 5.00

The Evans Co/Grvl Inc. TO  
Donna W. Humphrey 46.00

J. Russell Fleming al TO  
Thomas B. Jones al 42.50

Jeanette A. Hall al TO  
William G. Mister al 19.00

Carl W. Horton al TO  
Rueben Milton Sutton 25.00

Donna W. Humphrey TO  
The Evans Co/Grvl Inc. 7.00



**18 FREEZE POPS**  
Our Reg. 97¢  
**78¢**  
Freezer Sticks  
18 sticks in a variety  
of flavors. Save now.



**Cook-Out**  
EXTRA LARGE  
ALUMINUM DESIGN  
**88¢**  
75 Napkins  
With cookout design.  
2-ply. 15 1/2 x 16 1/2 ea.



**FOIL**  
**88¢**  
Aluminum Foil  
Heavy duty 18" x 25", 37 1/2 sq.  
ft. broiler foil in cutter edge  
box.



**99¢**  
Cookies  
Vanilla, chocolate, duplex  
creme cookies. 19 oz. pkg.



**4.97**  
24-in. Push Broom  
Wood, palm/ra bristles.



1.5-mil Thickness  
**3.22**  
50 Plastic Bags  
For 20 to 30-gal. cans



**6.99**  
Table-top Hibachi  
10x17" steel hibachi  
grill, easy to carry



**1.97**  
1lb. Canned Ham  
Celebrity® boneless,  
fully cooked ham.  
\*Net wt.



**1.37**  
Intensive Care®  
Vaseline Intensive Care®  
10 Oz. size



**1.97**  
Control Top  
Pantyhose  
Nylon/Lycra® spandex, sewn  
on panty with cotton panel.



**5.17**  
Men's Tube Socks  
White cotton/ny-  
lon Fit 10-13. Save!



**97¢** QT.  
Charcoal Starter  
Fast lighting, low odor,  
easy open safety cap.



Our Reg. 29.97  
**24.97**  
Wood Croquet Set  
6-player set with  
handy tote stand.



Save \$5  
**14.97**  
5-in-1 Lantern  
Fluorescent light, red  
emergency, more.

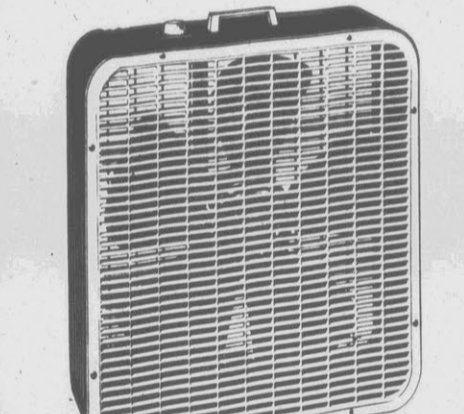

**19.99**  
3-speed Portable Fan  
20". Steel cabinet,  
polypropylene blades,  
handle. Shop now, save.



**89¢**  
Glass Plus® Cleaner  
For appliances, cabi-  
nets, more! 32 oz. \*  
Net wt.



Our Reg. 99¢ Limit 2  
**99¢** Limit 2  
Dow® Bathroom  
Cleaner  
Aerosol disinfects,  
deodorizes. 17 oz. \*  
Net wt.



Our Reg. 1.56  
**99¢** Limit 2  
Crystal Vanish®  
Cleans, disinfects  
toilet bowl. 48 oz. \*  
Net wt.



Our Reg. 1.87  
**1.37**  
Terry Kitchen Towels  
Cheery jacquard designs.  
Ea. Polyester/cotton. 16x28"



Our Reg. 77¢  
**50¢** Each  
Misses' Nylon Bikini Panties  
Choice of styles, pretty pastels. 5-6-7. Save.

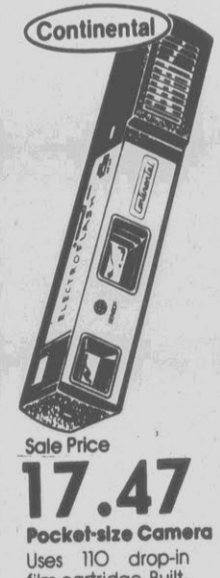

Sale Price  
**17.47**  
Pocket-size Camera  
Uses 110 drop-in  
film cartridge. Built-  
in flash. Model 555.  
Batteries not included.



Our Reg. 2.77  
**1.97**  
No-Pest® Insect Strip  
Indoor insecticide zeroes  
in on flying bugs. Save.  
\*Net wt.

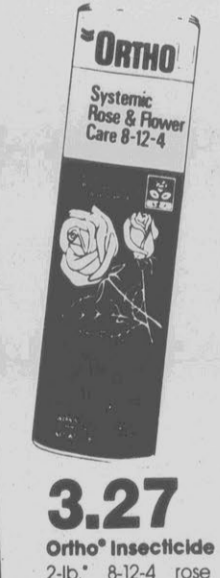

**3.27**  
Ortho® Insecticide  
2-lb.\* 8-12-4 rose  
and flower care.  
\*Net wt.



Our Reg. 5.96  
**3.99**  
Men's Sport Shirts  
Trim polyester/cotton  
shirt with chest pocket.  
solid colors, smart  
prints, or handsome  
Ea. plaids. Shop Kmart.

## 4-DAY TIRE SALE

# STEEL BELTED RADIALS

Our Reg. 62.97-P155/BORT3  
**\$44**  
Plus F.E.T. 1.69 Each  
• Radial mileage and traction

Mfr. Treadwear Rating 140  
Estimated 42,000 Miles

Mounting Included - No Trade-In  
Required  
All Tires Plus F.E.T. Ea.

SIZES	REG.	SALE	F.E.T.
P185/75R13	67.97	32	1.84
P185/75R14	69.97	38	2.04
P195/75R14	73.97	42	2.18
P205/75R14	81.97	48	2.34
P205/75R15	82.97	50	2.47
P215/75R14	82.97	50	2.48
P215/75R15	84.97	52	2.59
P225/75R14	87.97	55	2.68
P225/75R15	88.97	57	2.78
P225/75R15	96.97	63	3.01

Available in Limited Areas  
\*Mfr. treadwear rating based on U.S. Dept. of Transportation's Uniform Tire Quality Grading System



Mon. Thru Sat.  
SERVICES INCLUDE:  
1. Oil change (up to 5 qts.  
K mart® TOW40 motor  
oil)  
2. Install K mart® brand  
oil filter  
3. Chassis lubrication (brill-  
lites extra)  
Labor is included.  
Additional services extra.  
Many U.S. foreign cars

Sale Price  
**\$12**  
Lube, Oil, Filter  
Labor is included.



Mon. Thru Sat.  
HERE'S WHAT WE DO:  
1. Computer balance  
all 4 wheels  
2. Rotate 4 tires  
3. K Care Safety Check  
Additional parts & services extra

Sale Price  
**\$18** For Many Cars  
Balance, Rotation  
Help prolong tire life.



SERVICES INCLUDE:  
1. Replace front brake pads  
2. True rotors  
3. Inspect calipers  
4. Refill hydraulic system  
5. Repack inner and outer bearings  
6. Replace front grease seals  
7. Inspect master cylinder  
8. Inspect rear springs for wear  
(additional cost if repairs on rear  
brakes are needed)

Additional parts, services extra  
Semi-metallic pads \$10 more

Sale Price  
**74.00** Mon. Thru Sat.  
Disc Brake Special  
Many U.S. foreign cars.  
Light trucks higher



Mon. Thru Sat.  
Limited 3 Month Free  
Replacement Limited  
48-36 Month  
Free-of-Charge  
Warranty

Our Reg. 48.88  
**\$39** With  
Exchange  
36-month Battery  
For many cars, lt. trucks.



Sun., Mon., Tues. Only  
**2 For \$3** Our 2.43-2.97  
Sandable Primer Or Chrome Spray Paint  
13-oz.\* metal primer or 11-oz.\* chrome spray enamel.  
\*Net wt.

## Auto Industry Hits Alcohol Lookalikes

By SCOTT KRAFT  
Associated Press Writer

NEW YORK (AP) — Papa has his Michelob. Now junior has "Pickelob."

Papa's got Miller High Life; junior has "Milder Low Life." But that's too much gusto for the American Automobile Association. It wants Pickelob and Milder — as well as Fallstiff, Heinekant, Lowbrow ("The One For Bums") and Von Schultz — out of the hands and mouths of children.

The "Chug-a-Can" candy, sold in 2-inch miniature beer cans made of plastic, are filled with brightly colored candy, not the frothy golden brew.

The AAA has launched a campaign against the beer lookalikes in editorials sent recently to its 178 clubs for distribution through club newsletters nationwide. AAA says Chug-a-Can fosters unhealthy attitudes toward beer-drinking among youngsters, and they want stores to remove the candy.

"Making alcohol consumption a glamorous activity is something that shouldn't be done," says Allan Wilbur, national director of public relations for AAA, which has 22.5 million members. "We've been involved in alcohol education programs for so long, we just felt we had to say something."

Fleercorp, the Philadelphia firm that makes Chug-a-Can, hasn't answered the club's letters.

A secretary to Donald Peck, Fleercorp president, told The Associated Press on Tuesday: "We have no comment on this subject." Peck, she said, was out of town and she refused to bring any other company officers to the phone.

Chug-a-Can, which costs 30 cents to 60 cents per can, contains tiny, sweet balls similar to jawbreakers. It comes in 20 different "brands," looking like the real thing with their flip-top opening and "Don't Litter" imprint on top. Pickelob carries a drawing of a pickle and a resemblance of the real brew's distinctive can design, but adds on the side: "Just a Joke... Pure Fun."

AAA's battle began a few months ago in Maine and New Hampshire.

It persuaded the merchandising manager for 7-11 stores in the eastern division to stop offering the product from its distribution center, which serves seven states and the District of Columbia. But 7-11 stores may sell the product if they buy it elsewhere.

Carol Wisniewski, public relations manager for AAA New Hampshire, says the club also has persuaded Cumberland Farms convenience stores to pull the product in that state.

Other stores haven't come along so quickly.

Harold Frank, president of Bradlees department stores, just doesn't agree with AAA: "We concluded that these tiny cans of candy presented no threat to any future drinking habits of the children who consume it."

But Eric Baxter, public affairs director for AAA Maine, calls it "another example of the 'everybody does it' kind of conditioning."

"To think of a 7 or 8-year-old kid flipping open this little pretend can ... is very, very negative," he adds. "There are enough other ways to market bubble gum and candy without doing it in beer cans."

## Professor Fights Subversive Label

WASHINGTON (AP) — A University of Maryland professor seeking permanent residency is up against U.S. immigration authorities who have labeled him as subversive.

"I don't belong to any party and never have," Angel Rama said Tuesday. "I am not a Communist. I follow the socialist philosophy."

The 56-year-old Venezuelan, a respected member of the university faculty, was given tenure last year as professor of Spanish literature. But his future in that post remains in doubt as a result of the government's failure to drop its 13-year-old description of Rama as a subversive.

The law states that anyone who is or at any time was a communist or anarchist or member of an affiliated group, or anyone who advocates their beliefs, is permanently ineligible for a visa, according to a State Department spokesman John Caulfield.

Rama was classified a subversive in 1969 following an interview with a U.S. consular officer in Montevideo, Uruguay.

During the course of his conversation with the consular officer, Rama admitted making a trip to China in 1962 and a series of visits to Cuba in order to prepare articles on life in those countries.

Despite the subversive label, Rama was granted temporary entry to the United States under a waiver rule in 1969. State Department officials say last year more than 23,000 persons listed as subversives were granted similar entry to the United States.

Last year, after receiving his tenure from the University of Maryland, Rama sought to apply for permanent residency in the United States.

"I wrote to the U.S. ambassador in Venezuela a year ago asking for a review of my status and have yet to receive a reply," Rama said.

# Maxwell Furniture's Gigantic 3 Day

# BONUS SALE!

Increase Your Buying Power With Every Dollar You Spend. The More You Buy, The More The Bonus! 3 Days Only!

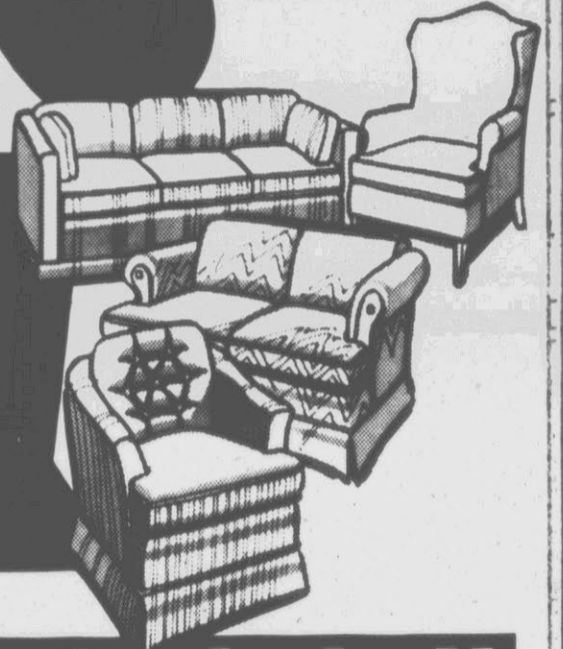

Everything in the store included!

Here's how it works  
For 3 Days Only—  
Thurs. 9-6, Fri. 9-9, Sat. 9-6

Purchase \$250 - \$499<sup>99</sup> in merchandise  
**\$100** Of Additional Merchandise **FREE!**

Purchase \$750 - \$999<sup>99</sup> in merchandise  
**\$200** Of Additional Merchandise **FREE!**

Purchase \$1250 - \$1499<sup>99</sup> in merchandise  
**\$300** Of Additional Merchandise **FREE!**

Purchase \$1750 - \$1999<sup>99</sup> in merchandise  
**\$400** Of Additional Merchandise **FREE!**

Sorry - No Lay-A-Ways Or Hold Orders... All Merchandise Available For Immediate Delivery... Bonus Is Limited To This Special Sale Event and Does Not Apply To Previous Purchases.

## SUMMER SPECIAL

BUY 1 COMPLETE PAIR OF EYEGLASSES AND GET A SECOND FRAME FREE!! (FROM PRE-SELECTED FRAMES)

—Greenville Store Only—

20% SENIOR CITIZENS DISCOUNT  
30% DISCOUNT ON B&L RAYBAN SUNGLASSES (WITH G-15 LENSES)



Ad Must Accompany Order



315 PARK VIEW COMMONS ACROSS FROM DOCTORS PARK GREENVILLE  
CALL US FOR AN EYE EXAMINATION WITH THE DOCTOR OF YOUR CHOICE  
752-1446  
OPEN 9 AM 'TIL 5:30 PM MONDAY THRU FRIDAY

CALL US FOR AN APPOINTMENT WITH THE DOCTOR OF YOUR CHOICE

**Maxwell**  
FURNITURE

604 Greenville Blvd.  
Mon. thru Thur. & Sat. 10 AM to 6 PM  
Fridays Only 10 AM to 8 PM

4 WAYS TO SAY "CHARGE IT!"  
Maxwell CREDIT  
MasterCard  
VISA  
\$1,000 INSTANT CREDIT  
You may qualify for \$1,000 INSTANT CREDIT if you have a valid AMERICAN EXPRESS CARD, MASTER CARD or VISA.

# Rose Opposes Change In Block's Power

By The Associated Press  
U.S. Rep. Charles Rose, D-N.C., says tobacco farmers "would get sold down the river" if Congress approves a proposal to give the secretary of agriculture power to set tobacco price-support levels.

A letter from U.S. Agriculture Secretary John Block released Monday asked Congress to give him authority to set price supports when the Senate resumes debate today on a tobacco reform bill.

Under the current formula, price supports escalate each year under an indexed

formula tied to the cost of production.  
Rose, chairman of the House Tobacco and Peanut Committee, says he was shocked at the timing of Block's recommendation.  
"He has fired the opposition with new ammunition at a very sensitive and critical time in the legislative process," said Rose, who is chief sponsor of the tobacco reform bill.  
Rose says if Congress gave the secretary such authority, then "we could expect substantially lower price supports from a free market oriented type secretary such as John Block."

In North Carolina, reaction to Block's recommendation was mixed, with growers and state officials opposing the move while warehouseman and exporters favored it.  
Tobacco industry leaders were in Washington Tuesday to plot strategy for today's Senate battle.  
James A. Graham, commissioner of the N.C. Department of Agriculture has said he is bitterly opposed to

Block's proposal.  
"A move of this sort would place additional strain on our tobacco farmers. It is not fair to our farmers to give one government official the authority to set support levels at his whim, and at levels that could severely hurt our tobacco farmers."  
The proposal also has been opposed by Gov. Jim Hunt, a spokesman for Hunt said.  
But Hugh S. Kiger, execu-

tive vice president of the Leaf Tobacco Exporters Association of the United States, says a move to lower prices — if that is what Block would do — would be a good thing.  
"If the secretary could take action that could make us more competitive on the foreign and domestic market, it would be something that would be a plus," Kiger said.

# North Carolina Insured Jobless Rate Increases

RALEIGH, N.C. (AP) — State Employment Security Commission officials say they did not expect the state's insured unemployment rate to increase in June, but it did — marking only the second such increase in the last 10 years.

The rate, considered a precursor of change in the overall jobless rate, increased from 4.1 percent in May to 4.5 percent in June.

"This increase was not anticipated," said David Pearce, an analyst for ESC.

Pearce says the only other time the May-June insured jobless rate has increased in the 10 years was in 1980, after credit controls imposed by President Carter's administration threw the economy into a sharp decline.

Pearce says the insured rate usually rises and falls in tandem with the state's jobless rate.

The insured jobless rate measures the number of people receiving unemployment insurance benefits from the ESC. It excludes farmworkers, those who have not had a job recently and others not eligible for benefits.

The ESC will compute the jobless rate later this month.

The ESC report is the state's first economic indicator for June, say private and government economists. Those economists declined to draw conclusions from the report until other information is available about June's business activity.

"We had been optimistic due to two months of falling claims (for unemployment benefits)," said a spokesman for the state Office of the Budget.

The insurance fund decreased from 5.3 percent in March to 4.1 percent in May. But he said the increase back

to 4.5 percent indicates a "deterioration of the labor market" during the past month.

ESC figures showed 103,440 people received unemployment checks during June, or 4.5 percent of the 2.3 million workers covered by unemployment insurance.

The number of laid-off workers increased from 13,772 in May to 15,249 in June, according to ESC figures.

The textile industry had a 7.9 percent jobless rate in June, up from 6.9 percent in May. Unemployment in the apparel industry remained stable at 9 percent, compared with 9.1 percent in May.

The furniture industry's jobless rate jumped from 7.8 percent in May to 9.5 percent in June, according to ESC figures.

Unemployment in the trade sector, which includes retail sales workers, rose from 2.9 percent to 3.2 percent in June. The number of laid-off workers increased from 13,772 in May to 15,249 in June.

**To Feel Great  
Join Dance  
Slimnastics Ltd.  
For Aerobic Fitness.**  
Try Dance Slimnastics Ltd.  
To Tone And Firm Up  
All Over. Trim Inches  
And Energize While  
You Have Fun.  
**Classes Starting July 19th  
Call Now 752-1492**



Member of ACSM, AAFFBI, AAHPER

**COUPON**  
piece goods shop  
**ENTIRE STOCK OF FABRIC**  
**20% OFF**  
STARTS MON.  
SHOP 9 til MON. thru SAT.  
\*GREENVILLE SQ. K-MART CENTER  
Arlington & Greenville Blvd.

THIS COUPON NOT IN ADDITION TO OTHER COUPONS OR DISCOUNTS

**THE Piecegoods SHOP**  
DRESS BETTER FOR LESS

GOOD THRU JULY 17

# Jobless Rate Up

WASHINGTON (AP) — Unemployment in 47 states and the District of Columbia rose in May from year-ago rates, according to the Labor Department.

The rates fell in two states and stayed the same in one, according to a new department report from the Bureau of Labor Statistics giving a state-by-state breakdown of unemployment figures.

The report released Tuesday said the states in which unemployment fell over the year were North Dakota, 4.3 percent from 4.8 percent in May 1981, and West Virginia, 10.9 percent from 13.2 percent. The unemployment rate stayed the same, at 4.5 percent, in South Dakota.

**SHOP-EZE**  
West End Shopping Center  
Phone 756-0960

**FOODLAND**  
Thursday Luncheon  
Special

**BBQ \$2.19**

Special Served With 2 Fresh Vegetables & Rolls.

**PITT COMMUNITY COLLEGE**  
SCHEDULE OF COURSES SECOND SUMMER SESSION  
**JULY 19-AUGUST 25**

REGISTRATION: JULY 19-JULY 22

For application blanks or other information contact:  
COUNSELORS  
PITT COMMUNITY COLLEGE  
P.O. DRAWER 7007  
Highway 11, South  
Greenville, N.C. 27834  
Phone: 756-3130

**RELAX... RIDE GREAT**  
The GREAT Bus  
To and From PCC

Enroll in selected short courses  
Enroll in a combination of regular quarter length course and selected short courses  
Enroll in a program that can result in a reduced course load in the quarters that follow  
Enroll in a course to remove a deficiency that would prevent you from entering a four year school

DAY CLASSES			
Course No.	Title	Cost	Hour and Day
BUS 112	Filing	9.75	8-9, M-F; 2-3 M
BUS 150	Ten-Key Add Mach	3.25	TBA TBA
BUS 151	Full-Key Add Mach	3.25	TBA TBA
BUS 152	Electr Print Cal	3.25	TBA TBA
BUS 154	Cash Register	3.25	TBA TBA
BUS 160	Intro Mag Tap Sel Type	3.25	TBA TBA
BUS 161	Appl Mag Tap Sel Type	3.25	TBA TBA
BUS 162	Appl Mag Tap Sel Type	3.25	TBA TBA
BUS 163	Appl Mag Tap Sel Type	3.25	TBA TBA
BUS 232	Sales Develop	9.75	10-11 M-F; 3-4 M
BUS 235	Bus Mgmt	9.75	11-12 M-F; 3-4 M
BUS 271	Off Mgmt	9.75	1-2 M-F; 2-3 TU
EDP 114	Intro to Comp Concepts	9.75	11-12M-F; 2-3Th
EDU 103	Presch Orientation	9.75	TBA TBA
EDU 104	Presch Observation	9.75	TBA TBA
EDU 225	Seminar-Practicum	19.50	TBA TBA
ENG 100R2-			
ENG 100R4	Read Develop	9.75	12-1 M-F; 3-4 Tu
ENG 101	Grammar	9.75	9-10 M-F; 1-2 W
ENG 101	Grammar	9.75	12-1 M-F; 2-3 Tu
ENG 102	Composition	9.75	11-12M-F; 1-2Tu
ENG 105	Effective Read	9.75	12-1 M-F; 3-4 Tu

Course No.	Title	Cost	Hour and Day
ENV 107	Water Resource Mgmt	16.25	10-12M-F; 2-4W
ENV 112	Air Resource Mgmt	16.25	8-10M-Th; 2-4Tu
MAT 101	Algebra I	16.25	10-12 M-F
SOC 102H	Prin of Soc for Hea Prof	9.75	10-11M-F; 2-3Tu

COLLEGE TRANSFER			
Course No.	Title	Cost	Hour and Day
BUS 167	Bus Law	9.75	8-9 M-F; 2-3 Tu
ECO 151	Economics	9.75	9-10 M-F; 2-3 Th
ENG 152	Composition III	9.75	12-1 M-F; 3-4 M
HEA 150	Personal & Com Hea	9.75	9-10 M-F; 3-4 W
PED 181	Tennis-Adv	3.25	8-9 M-Th
PSY 151	Gen Psychol II	9.75	11-12 M-F; 2-3 M

EVENING CLASSES ONLY			
Course No.	Title	Cost	Hour and Day
AGR 222	Farm Electrification	13.00	5-10 T & Th
ENG 101	Grammar	9.75	7-10 M & W
ENG 102	Composition	9.75	7-10 M & W

It is the policy of Pitt Community College not to discriminate against any person on the basis of race, color, handicap, sex, religion, age, or national origin in the recruitment, employment, training and promotion of faculty and staff, and the operation of any of its programs and activities, as specified by federal laws and regulations.

AN EQUAL OPPORTUNITY/AFFIRMATIVE ACTION INSTITUTION  
\*\*\*PULL OUT FOR FUTURE REFERENCE\*\*\*

# Things to do tomorrow

1. Get-up bright and early!
2. Dress comfortably, sensibly.
3. Eat a hearty, nourishing breakfast.
4. Wear sneakers.
5. Don't forget your pocketbook.
6. Get to Brody's on time.

The great clearance starts at 10 a.m.

Hundreds of spring & summer sportswear fashions. Blouses, skirts, co-ordinates, swimwear, dresses, and jeans, are practically being given away!

Everything is regular Brody Quality!  
Everything is with the famous Brody Look!

## JUNIOR SPORTSWEAR

Junior Swimwear	1/2 Off
Junior Summer Skirts	1/2 Off
Junior Summer Pants	1/2 Off
Junior Fashion Dresses	1/2 Off
Lanz Sundresses	1/3 Off
Junior Summer Tops	1/3 Off
Junior Shorts	1/3 Off
Summer Skirts Lady Thomson	60% Off
Summer Pants Lady Thomson	60% Off
Levi Denim Jeans	\$14.90
Lacoste' For Her	\$14.88

## MISSY SPORTSWEAR

Missy Swimwear	1/2 Off
Missy Summer Skirts	1/2 Off
Missy Summer Coordinates	1/4 to 1/2 Off
Missy Summer Short Sleeve Blouses	1/3 Off
Missy Summer T-Tops	40% Off
Missy Summer Pants	1/4 to 1/3 Off
Koret Koratron	1/3 Off
Large Size Sportswear	1/4 to 1/2 Off

New Reductions! Hurry In!

**Brody's**  
Shop Downtown  
10 a.m.-6 p.m.  
Shop Pitt Plaza  
10 a.m.-9 p.m.

# School Trains Students In Facts Of Business

By ELISSA MCCRARY  
Associated Press Writer

CHARLOTTE, N.C. (AP) — Twenty-six Charlotte area high school students are spending their summer learning how to run a business, and they're getting paid for their effort.

The students were chosen earlier this year to participate in a unique economics program on the free enterprise system. Each student in the six-week institute spends four days a week working with local companies and learning every aspect of the business.

Companies participating in the program donated \$600, \$500 of that going to each student at the end of the course next month.

"We have kids getting up at 5 a.m. to get to their jobs at seven, and it's been tough on them," said program director James Rutherford. "They're doing a different job every day. They're learning what free enterprise is all about."

The students, 12 boys and 14 girls, are rising seniors at Mecklenburg and Union county public and private schools. They were recommended for the course by guidance counselors at their schools on the basis of readership, scholarship and responsibility. Their average grades range from A's to C's.

"What we wanted were bright young people who were interested in finding out about the business world and getting an education to help them make business decisions in the future," Rutherford said.

The economics institute is the only one of its kind offered in the Carolinas. There are only three such programs in operation in the country — one at the Collegiate School in Richmond, and two in Philadelphia.

Rutherford, 42, who has been a teacher for 15 years, believes the program will help bridge the gap between the business community and educators.

"Business does a lousy job of teaching free enterprise," he said. "One of the objectives of this program is to get business people communicating with young people so they will know what's going on out there in the business world when they start making career decisions."

The college-level course has been purposely tough. The students met for one week at the beginning of the course in a classroom setting where they discussed everything from taxes to computer programming. They heard in-depth presentations from 45 area businesses, including E.F. Hutton, IBM, and Family Dollar Inc.

Most days the students brought their own lunches from home to eat between classes or in the car on the way to

dozens of business tours.

But it hasn't been all drudgery. On a recent morning, Rutherford, dressed in an orange shirt and yellow flowered pants "just to get their attention," showed a film on free enterprise called "chickenomics" featuring the San Diego Padres' Chicken. But the movie, with cackling background music by the Hen House Five, dealt with a serious subject — how to make money — using the Chicken as an example of a man who has parlayed a \$2 an hour comedy act into a \$100,000 a year.

"They're laughing, but they're learning, and that's what counts," Rutherford said.

Representatives of the companies who donated their time and money to the program say they are pleased with the

students ability and eagerness.

"It's been a great experience," said Mac Fletcher of Fletcher, Barnhardt and White, a Charlotte advertising agency. "It's been helpful for both sides. Its shown students a slice of life in business, the way things really are."

Rutherford already has planned to expand the program into a year-long course at Charlotte Latin School, where he is head of the Social Studies Department. Eighteen seniors at the school will be taking the course at the beginning of the school year.

"What we're teaching the kids is not economics as such, but real business situations," he said. "We're hoping to take the mystery out of business and free enterprise and replace it with understanding."

**ESTATE SALE**  
Estate of Ruth S. Evans, Deceased  
**Thursday, July 15, 1982**  
**12:00 Noon-Pitt County Courthouse**  
**Public Sale For Cash Subject To Court Confirmation**  
Large landscaped lot and mobile home on north side of S.R. 1711 near D.H. Conley High School.  
W.I. Wooten, Jr., Commissioner  
758-2111

## 00% INTEREST WITH BOSTIC-SUGG'S 30-60-90 DAY SAME AS CASH PLAN...JUST LIKE PAYING CASH!

PAY 1/4 ON PURCHASE-1/4 30 DAYS-1/4 60 DAYS-1/4 90 DAYS

**NO INTEREST OR FINANCE CHARGES IF PAID ACCORDING TO BOSTIC-SUGG'S 30-60-90 DAY CASH PLAN.**

**IF YOUR PURCHASE IS \$800<sup>00</sup> PAY UPON PURCHASE \$200<sup>00</sup> PAY ON AUG. 25TH... \$200<sup>00</sup> PAY ON SEPT. 25TH... \$200<sup>00</sup> PAY ON OCT. 25TH... \$200<sup>00</sup>**

**Bostic-Sugg**  
Furniture, Inc.  
Our 43rd Year  
*Furniture of Excellence*  
401 West 10th St., Greenville - 758-2513

## Tobacco Yield To Be Smaller

RALEIGH, N.C. (AP) — State agriculture officials are predicting that North Carolina's flue-cured tobacco harvest will be down 10 percent this year from 1981, while production of wheat and oats probably will be higher.

The North Carolina Crop and Livestock Reporting Service also said the peach crop was decimated by a spring freeze, which also reduced the apple crop by more than one-third.

North Carolina farmers are expected to produce the third consecutive record harvest of wheat this year, said Carl Cross, service statistician. He predicted a harvest of 17.3 million bushels — 8 percent above last year's. The yield per acre is expected to average 36 bushels, three bushels less than the 1981 average.

The increase in wheat is primarily due to an increase in acreage, he said. An increasing number of farmers, particularly in the coastal plains counties, are double-cropping wheat and soybeans.

"The wheat was seeded in the fall and the harvest is just about completed," Cross said. "The wet weather has delayed some soybean seeding and it's getting a little late now. But they were still planting quite a few soybeans last week."

Carl said the smaller tobacco crop of 683 million pounds is due to a decrease in acres planted and a lower yield per acre.

"The crop was larger than they (farmers) could market last year at good yields," he said. "That comes off in figuring allotments for this year. The quota was lowered by the tobacco program."

About 329,000 acres will be harvested this season, about 7 percent fewer than last year.

The average yield per acre is expected to be about 2,075 pounds — 68 pounds down from last year, Cross said.

"That's still a very good yield — better than average," he said.

Cross said the state's apple crop was "reduced severely by the spring freezes."

He said the crop would be only 135 million pounds, the lowest since 1966 and only 36 percent of last year's production.

Nationally, however, the apple crop is 11 percent better than last year's, he said.

"The peach crop was almost wiped out," he said, adding that the harvest is expected to total only 2 million pounds. The crop will be only 5 percent of last year's crop and the worst harvest since 1955, when freezing weather destroyed the state's entire crop, he said.



**TENNESSEE WALKING HORSES**  
AT STUD  
SUN'S GLORY J.  
AND JULE'S JEWEL  
Standing At:  
TEMPTATION STABLES  
Rocky Mount, N.C.  
(1 1/2 mi. N. of Wilson,  
Rocky Mt. Airport, Hwy. 97.)  
CONTACT:  
SONNY BATTS  
446-7830

Donald H. Tucker, M.D.  
William W. Fore, M.D.  
C. Michael Ramsdell, M.D.  
Douglas F. Newton, M.D.  
Douglas C. Privette, M.D.

Announce  
The Association Of  
Mark Dellasega, M.D.

For The Practice Of Gastroenterology  
and Internal Medicine

With  
Quadrangle Internal Medicine, P.A.

At  
1705 W. Sixth St., Building E.  
Greenville, N.C.

Hours Are By Appointment  
Telephone 752-6101

**Broyhill**  
PREMIER COLLECTION  
PILLOW BACK LOUNGE  
CHAIR AND MATCHING  
PILLOW TOP OTTOMAN

**SALE PRICE \$395<sup>00</sup>**  
SAVE \$239.00. LIST PRICE \$634.00.  
Full Comfort...Luxurious Pillow Back  
...Choice Of Two Colors...Special Purchase.

LARGE  
**Butler's Table**  
Sale Price **\$64.00**  
COMPARE AT \$100.00  
This Beautiful Crafted And Useful Butler's Table Will Be A Perfect Accent In Most Any Decor. The Brass Hinges Add A Very Distinctive And Interesting Touch. Available In Old World Finish.

**Accent Tray Table**  
SALE PRICE **\$18<sup>88</sup>**  
COMPARE AT \$30.00  
This Very Convenient Tray Table Can Be Put To Many Uses In Any Room Of Your Home. Use As A Beautiful Accent Table Or Remove The Handsome Top And Use As A Serving Tray. Available In Old World Finish.

## SAVE 40% TO 48% ON QUALITY KINGSDOWN SLEEPER SOFAS NOW AT BOSTIC-SUGG!! SPECIAL PURCHASE OF DISCONTINUED FABRICS.

**\$520.00 OFF KINGSDOWN COUNTRY-LOOK QUEEN SIZE SLEEPER SOFA.**  
LIST PRICE \$1115.00. Colorful Red Floral Print Fabric. Arm Pillows Included. Innerspring Mattress. **SALE PRICE \$595<sup>00</sup>**

**\$456.00 OFF KINGSDOWN PILLOW BACK QUEEN SIZE SLEEPER SOFA.**  
LIST PRICE \$1051.00. Beige And Blue Floral Print Fabric. One Seat Cushion. Ruffle Loose Pillow Back. **SALE PRICE \$595<sup>00</sup>**

**\$515.00 OFF KINGSDOWN TRADITIONAL QUEEN SIZE SLEEPER SOFA.**  
LIST PRICE \$1065.00. Three Cushion Loose Pillow Back. Green Velvet Fabric. Innerspring Mattress. **SALE PRICE \$550<sup>00</sup>**

**\$409.00 OFF KINGSDOWN TRADITIONAL QUEEN SIZE SLEEPER SOFA.**  
LIST PRICE \$959.00. Blue Floral Print Fabric. Three Cushion Loose Pillow Back... Kick Pleat Skirt. **SALE PRICE \$550<sup>00</sup>**

**\$455.00 OFF KINGSDOWN FULL SIZE COLONIAL SLEEPER SOFA.**  
LIST PRICE \$950.00. Two Cushion Tall Pillow Back. Brown And Beige Small Hercules Plaid Fabric. **SALE PRICE \$495<sup>00</sup>**

**\$445.00 OFF KINGSDOWN CORDUROY LOOK PILLOW BACK SLEEPER SOFA.**  
LIST PRICE \$995.00. Light Green Corduroy Fabric. Three Cushion Loose Pillow Back. Innerspring Mattress. **SALE PRICE \$550<sup>00</sup>**

**\$553.00 OFF KINGSDOWN RUFFLE PILLOW BACK COUNTRY LOOK SLEEPER SOFA**  
LIST PRICE \$1130.00. Queen Size. Beige Plaid. Ruffle Skirt. One Seat Cushion...Innerspring Mattress. **SALE PRICE \$595<sup>00</sup>**

**\$440.00 OFF KINGSDOWN TRADITIONAL LOOK-PILLOW BACK SLEEPER SOFA.**  
LIST PRICE \$1035.00. Grey And Beige Velvet Fabric. Three Cushion Back And Seat. Queen Size. **SALE PRICE \$595<sup>00</sup>**

**\$464.00 OFF KINGSDOWN QUEEN SIZE COLONIAL SLEEPER SOFA.**  
LIST PRICE \$959.00. Linen Like Green And Gold Floral Print Fabric. Three Cushion Tall Pillow Back. **SALE PRICE \$495<sup>00</sup>**

**\$429.00 OFF KINGSDOWN QUEEN SIZE COUNTRY-LOOK SLEEPER SOFA.**  
LIST PRICE \$1024.00. Small Check Fabric In Choice Of Wheat Or Sandalwood. One Seat Cushion. Skirted. **SALE PRICE \$595<sup>00</sup>**

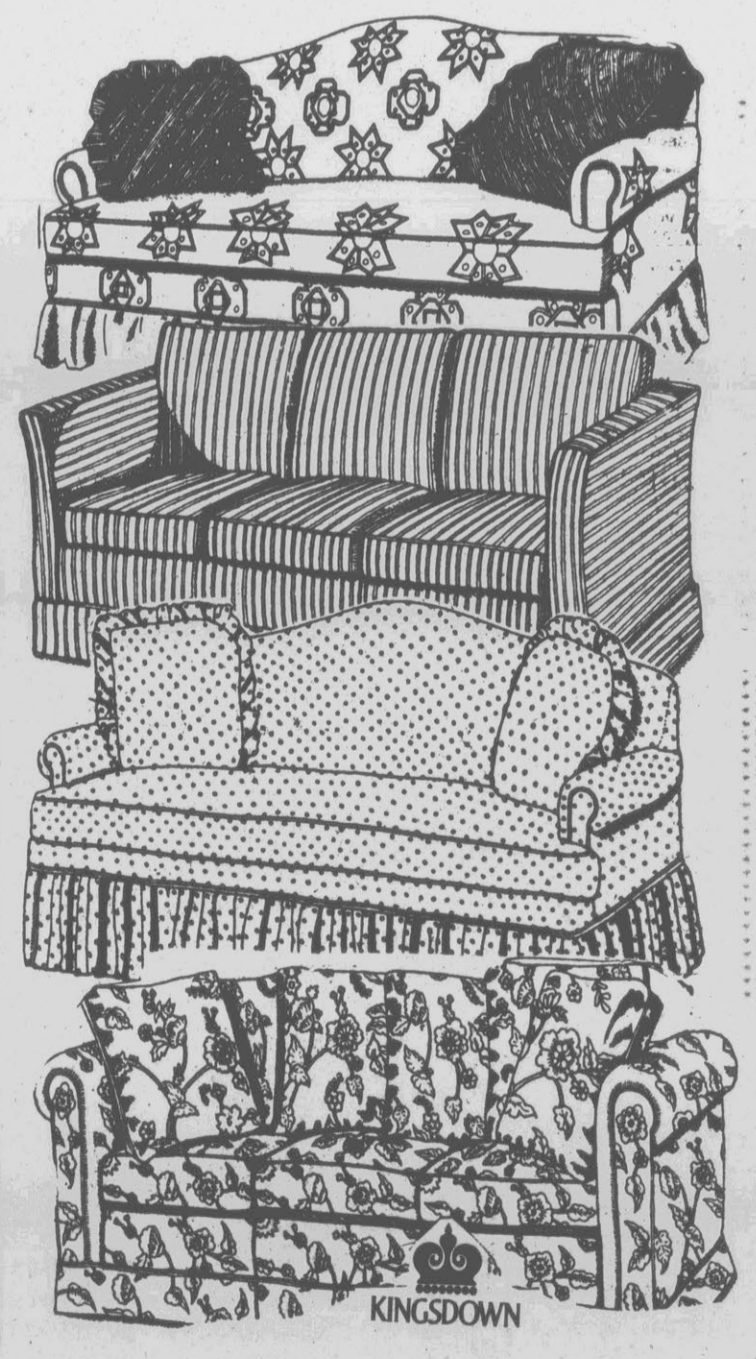

**THIS IS ONLY A PARTIAL LISTING OF TWENTY-FIVE KINGSDOWN SLEEPER SOFAS NOW IN STOCK AT BOSTIC-SUGG FOR IMMEDIATE DELIVERY..MANY ONE OF A KIND.**

# State High Court Supports Brown Lung Victims

By WILLIAM M. WELCH  
Associated Press Writer

RALEIGH, N.C. (AP) — The State Supreme Court, in a ruling that may clear the way for other victims of brown lung disease, has reversed lower court decisions and ruled in favor of a former textile worker who became disabled in 1963.

North Carolina's highest court ruled unanimously Tuesday in the case of Dennie J. Taylor, 69, of Greensboro, that state law in effect before July 1, 1963, did allow workers' compensation awards to victims of byssinosis, or brown lung disease.

In making its decision Tuesday, the state's highest court reversed rulings by the state Industrial Commission and the state Court of Appeals in the case of Dennie J. Taylor, 69, a former mill worker from Greensboro.

Both had ruled that state law in effect from 1935 until mid-1963 excluded benefits for disability due to diseases of the lungs and other internal organs.

State workers' compensation law in effect until July 1 of that year allowed claims for a number of occupational disabilities including those involving "external contact surfaces."

A 1979 law passed by the General Assembly appeared to include pre-1963 cases under the law, but the Court of Appeals ruled on technical grounds that it did not have that effect. With its ruling, the Supreme Court said it did not need to look at the 1979 law.

The Industrial Commission ruled Taylor had permanent injury due to cotton dust exposure, but that because of the timing of his disability no compensation was allowed. A Court of Appeals panel agreed, ruling in a split decision that law in effect at the time of his disability excluded compensation for lung disease.

But the Supreme Court, in a decision written by Justice J. Phil Carlton, ruled that the lungs were "external contact surfaces" because the lungs are "in contact with the outer or external environment."

"We reverse and hold that compensation is allowable for disabling byssinosis contracted prior to 1 July 1963 under the definition of occupational disease contained in the Workers' Compensation Act in effect prior to that date," the court said.

William Stephenson, chairman of the Industrial Commission, said the decision would effect 50 to 75 former textile workers whose claims were being held by the commission pending a ruling in Taylor's case.

It could also spark new claims by other former textile workers who left the mills nearly two decades ago and had not filed claims because of previous legal interpretations, Stephenson and attorneys in the case said.

"I would say it's very significant," said Stephenson. "I can't tell you how many numbers we're dealing with — most of those who were disabled before July 1, 1963, are no longer with us. But it's something that will have an impact."

Taylor was employed by Cone Mills in its White Oak plant

from 1949 to Jan. 4, 1963, and had previously worked in other mills. Court records said that he had been totally disabled by byssinosis, the occupational disease of textile mills attributed to cotton dust, since January of 1963.

Taylor's case has been remanded to the Industrial

Commission for an award of money.

Michael K. Curtis, a Greensboro attorney who represented Taylor, said Taylor was eligible to receive a \$10,000 award plus compensation for his medical expenses.

J. Donald Cowan Jr., attorney for Liberty Mutual

Insurance Co., Cone Mills' insurance carrier, voiced disappointment at the decision.

"There are some people that sopped working in textile factories before July 1, 1963, that have not filed claims and this may bring them forth," he said.

OPEN SUNDAY 10 A.M. 'til 7 P.M.

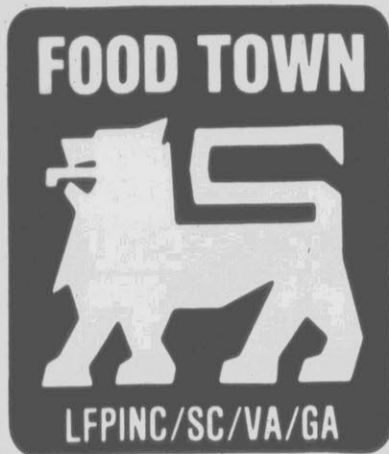

**Chuck Roast** **\$1.18** Lb.  
USDA Choice Beef Chuck Bone-In

**98¢** Lb.  
Holly Farms Grade A

**Chicken Breast**

USDA Choice Beef Chuck Bone-In **Shoulder Roast** Lb. **\$1.98**

**\$1.78** Lb.

USDA Choice Beef Chuck Boneless **Chuck Roast**

USDA Choice Beef Chuck Bone-In **Chuck Steak** Lb. **\$1.28**

**79¢** Lb. - Thompson

**Seedless Grapes**



WINS COURT SUPPORT ... Dennie J. Taylor, 69, of Greensboro won a ruling from the state Supreme Court Tuesday supporting his contention that state law allowed workers' compensation awards to brown lung victims. The ruling may serve as a precedent in other brown lung cases. (AP Laserphoto)

## Shuttle Returns

EDWARDS AIR FORCE BASE, Calif. (AP) — The space shuttle Columbia, which has wound up each of three previous trips into orbit by being ferried piggyback across the country on a jumbo jet, may be making the last such flight.

Weather permitting, the spaceplane was to be flown today, strapped on the back of a 747 jumbo jet, to the Kennedy Space Center at Cape Canaveral, Fla., to be readied for its next flight, tentatively scheduled for Oct. 29.

Because of the experience

gained on July 4 in landing the shuttle on a concrete runway here for the first time, the National Aeronautics and Space Administration may allow the craft to land on the Cape's 15,000-foot strip on its next return from space. That would avoid the piggyback cross-country flights to return the shuttle to its launch pad.

The mated shuttle and jet were to stop for refueling at Dyess Air Force Base near Abilene, Texas, and complete the trip by evening, assuming everything went according to plan.

**Kelvinator NO NONSENSE Sale**

Get A Leg Up On SAVINGS— See our Affordable Appliances Today! Hurry—Limited Time Offer!

**20 PAIR OF PANTY HOSE FREE!!**  
With the purchase of a Kelvinator major appliance

- Automatic Bleach Dispenser
- Full 1-year Warranty; Two Years on Parts
- 4 Water Temperature Selections
- 4 Speed Selections for All Fabrics

**AWL2315 WASHER**

**We service what we sell**  
**Fleming's Furniture & Appliance**  
1012 Dickinson Ave. Financing Available 752-3609

**\$4.39**

Package of 12 - 12 Oz. Cans

**Miller Beer**



**\$6.49**

3 Liter - Chablis, Rhine, Nectar Rose, Burgundy, Sauterne

**Almaden Mountain**

**\$2.19**

Package of 6 - 12 Oz. Cans

**Miller Beer**



**\$1.49**

Package of 6 - 12 Oz. Cans

**Coca Cola**



**79¢** Quart  
**JFG Mayonnaise**  
Why Pay \$1.29



**4/\$1**

6 Oz. - Frozen Concentrate

**Seneca Apple Juice**

Why Pay 51¢ Each



**\$1.59**

5 Lb. - Frozen Crinkle Cut Potatoes

**Tater Boy**

Why Pay \$2.19



**69¢**  
97 Sheets - Large Roll  
**Viva Towels**  
Why Pay \$1.03



**79¢**

6.5 Oz. - Light Chunk In Oil  
**Star Kist Tuna**

**\$1.99**

64 Oz. - 35¢ Off - Downy  
**Fabric Softener**



**89¢**

400 Sheets - 4 Roll Pk. - Coronet  
**Toilet Tissue**

**99¢**

24 Ct. - Family Size  
**Tetley Tea Bags**



**89¢**

22 Ounce  
**Lux Liquid**

**\$1.39**

12 Oz. - Borden's American Sliced Singles  
**Cheese Food**



**\$1.49**

49 Ounce  
**Cold Power**

**4/89¢**

6 or 6.5 Oz. - Tuna Tuna & Chicken Beef & Liver Turkey & Giblets - Cat Food  
**Purina 100**



**\$2.79**  
64 Oz. - 50¢ Off  
**Liquid Wisk**  
Why Pay \$3.33



**99¢**  
12 Oz. - Large  
**Jeno's Pizza**  
Why Pay \$1.29

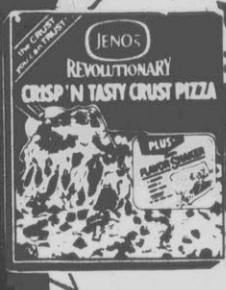

**99¢**  
32 Ounce  
**Del Monte Catsup**  
Why Pay \$1.19



Prices good at Greenville Food Town Store only thru Saturday, July 17, 1982



ECU RESEARCH VESSEL — This 25-foot Privateer built in Chocowinity is the first of an expected fleet of vessels for East Carolina University's program in underwater archaeology and maritime studies. The boat goes into service next week at Cape Lookout during ECU's Underwater Archaeological Research Summer Field School. (ECU News Bureau Photo by Marianne Baines)

## Field Trip Planned

By JERRY RAYNOR  
Reflector Staff Writer

In discussions preceding the adoption of the policy on nepotism at the Monday night's meeting of the school board, some concern was voiced about an interpretation of the nepotism policy in that persons who are immediate family members of someone on the school board will not be permitted employment in the city schools.

Superintendent Delma Blinson said that the interpretation is a significant part of the policy, but that having it this way absolutely absolves anyone from any questions.

In other actions: Permission was granted for a Community Schools summer field trip to Williamsburg, Va. About 100 students from all levels will be making the trip accompanied by five adult chaperons.

Five retiring teachers were honored in a ceremony and awarded certificates of recognition for long and faithful service. One of the five, Effie Baker Thompson, a veteran of 34 years, was present for the ceremony. The four honored in absentia are: Mary Coggins, 30 years; Dr. Rexford Eugene Piner, 26 years; Calla Bonner, 17 years; and Mary E. Whitehurst, 13 years.

In executive session, Rebecca Oats was approved for the position of director of secondary education. She fills the post left vacant by Kay Whitehurst, who has been appointed principal at Aycock Junior High for the coming year. Mrs. Oats, a resident of Greenville, is a math consultant with the State Department of Public Instruction.

**SHRINE NOTICE**  
The July meeting of the Pitt County Shrine Club will be held Thursday at Abram's Restaurant. Dinner will begin at 7 p.m. and the business meeting will be held at 7:30 p.m.  
Edward D. Hartsell, president  
Jim Graham, secretary

## Counties Plan Fight Against Infant Deaths

By LEE CREEK  
Associated Press Writer

DURHAM, N.C. (AP) — Five North Carolina counties will share more than \$270,000 in grants to help fight high infant mortality rates.

The counties selected to share the money from the Robert Wood Johnson Foundation at Duke University were Warren, Granville, Franklin, Person and Vance. They were chosen because their rates were the state's highest, according to Dr. Fred Jelovsek, an associate professor of obstetrics and gynecology and the project director.

The State Center for Health Statistics in Raleigh said the infant mortality rate includes deaths of children under the age of one year per 1,000 live births.

The five counties will receive \$270,360 for 1982-1983 to support a rural maternal health program started two years ago by Duke Medical Center. Each county will receive \$11,644 with the remainder for shared services.

"Although it's too early to tell if we've actually been able to reduce the infant mortality rate, we know the program has greatly improved the level of obstetrical care given in these counties," Jelovsek said.

"It's certainly making some impact," said Joe Lennon, Warren Co. Health Director, adding that it was too early to tell if the impact would be significant.

Among the reasons cited for infant deaths are low income and lack of education among expectant mothers. Jelovsek says the program helps overcome those problems by informing expectant mothers that they need to see doctors earlier.

"One of our major objectives has been to encourage communication between the medical center, where many of these mothers deliver, and the local communities," Jelovsek said. "These areas are predominantly low-income and agricultural."

"We've cut some of the barriers to good perinatal care, but others still exist," he said. "Some of these women are taught birth is such a natural phenomenon that there is no need to go to a physician until the end of pregnancy. And in some of the rural areas, home deliveries still occur."

"We've definitely noticed that more women are coming in for exams during their first trimester than before," he said. "That's one of our goals — to get women in to a clinic during their first trimester of pregnancy. We know for a fact that infant mortality rates decline when the mother seeks care during the first four months of pregnancy."

The perinatal death rate and complications at birth increase by about 50 percent when mothers wait until the fifth month of pregnancy to get care, he said.

The Center for Health Statistics said that statewide, the number of infant deaths decreased last year, from 1,219 in 1980 to 1,102 in 1981. On another comparison basis, the fall was from 14.5 per 1,000 live births to 13.2 per 1,000 live births. Both figures were below the 1977 totals of 1,335 deaths, or 15.8 per 1,000.

North Carolina's rate of 14.5 per 1,000 in 1980 ranked fifth-highest nationally behind Mississippi, 15.9; Louisiana and South Carolina, 15.4; and Alabama at 15.1.

Vance County's 66 is the highest number of deaths in the last five years as it registered a low of 10 in 1979 to a high of 16 in 1981. Last year's figure equaled a rate of 29.6 deaths per 1,000 live births.

The original 1980 Robert Wood Johnson Foundation grant provided funds for organizing perinatal nurse-staffed clinics in each of the counties, using existing health department facilities.

"We planned from the beginning to design a health care system that will exist on its own after 1984, when we anticipate funding will end," Jelovsek said.

## Winterville Board OKs Request For Block Funds

By TOMMY FORREST  
Reflector Staff Writer

WINTERVILLE — Winterville aldermen gave approval Monday night for application of funds through the Community Block Development program.

Town Clerk Elwood Nobles reported the amount the town will apply for would be \$729,254. Nobles said the breakdown of the areas are as follows:

- Water and Sewer — \$38,564
- Street work — \$29,232
- Clearance — \$5,000
- Relocation — \$5,500
- Rehabilitation — \$561,000
- Administration — \$89,558

Nobles said under the street category, curb and gutter would be placed on some streets and paving in addition to curb and gutter on others. Those streets affected will be Myrtle, Hammond, Tyson, Grimes, and parts of North Railroad.

The complete target area will include the following: Chapman, Grimes, parts of Boyd and North Railroad.

Citizens during the public hearing questioned the board as to the specific target areas and the amount of work to be performed.

The grant will be officially filed by the town July 27.

In further business heard by the board, a resolution was passed dissolving Power Agency No. 2, in which Winterville was a member. The town will be getting power through Greenville Utilities in the future.

Approval was given by the board to allow the Pitt County computer center to print the town's 1982 tax bills. The bills are print and ready to mail at an approximate cost of \$400.

The board also authorized the town attorney to secure the deed from the rural fire association for the new maintenance building which the debt paid. The cost of the building which was funded by the association through a loan, cost approximately \$115,000.

In new business approved by the board, a new utility policy will go in effect July 25. The board approved the cutoff date to be the 25th of each month, except when the 25th falls on a Saturday, Sunday, or a town holiday.

Bills not paid by 10 a.m. on the 25th will be subject to a \$10 service charge, whether the power was cut off or not.

The board also gave approval for the town clerk to set up demonstrations and bids for a new street sweeper.

### Upholstery Shoppe

*"We're Furniture Specialists"*

**Jeff Peterson, Owner, Proudly Announces**

**The Addition Of His Brother, George, Former Upholsterer For Y & J Furniture Co. of Durham.**

**Jeff & George Form A Merger Of Upholstery Talent That Enables Them To Offer Unconditionally Guaranteed Workmanship.**

**Now offering 20% discount on fabrics. Large selection of samples from which to choose. (Limited time only).**

**Call Us Today For A Free Estimate**

**746-3567**      515 Park Ave. Ayden, N.C.

## FAMILY DOLLAR

**Special Purchase!**

**\$4** Values To \$17 Each

**Rompers And Short Sets**

- Short sets with wrap or pull-on shorts and matching novelty tops in terry and satin prints, seersucker, gauze and more. Sizes S,M,L.
- Ladies' rompers with bandeau and tie shoulder styles in satin, terry or chintz including jamaican and floral prints. Sizes S,M,L.

---

**84¢** Qt.

**Quaker State Motor Oil**  
HD 30 or regular  
30 W. Limit 5 quarts, please.

**66¢** Gal.

**Purex Liquid Bleach**  
Big, economical gallon jug for a cleaner, whiter wash.

---

**\$1** Box

**65-Oz. Arm And Hammer**  
65-oz. box of concentrated laundry powder for a clean, fresh wash.

**2\$5** For Cannon Bath Towels

Soft velour or terry towels in pretty pastels, stripes or florals. Slight irregulars. 3-Pack Washcloths ... \$1

Prices Good At All Family Dollar Stores Through This Weekend. Quantities Limited On Some Items. No Sales To Dealers.

Harris Shopping Center Memorial Drive Open Monday-Saturday 9 to 9

# The College Shop

194 Carolina East Mall

## Semi-Annual Black Cat Sale

# Sale

Thursday, July 15, 1982

Store Hours 8:00 A.M.-9:00 P.M.

Spring and Summer Merchandise

**Blazers & Suits . . . 50% Off**

**Dresses . . . 50% Off**

**Pants . . . 50% Off**

**Skirts . . . 50% Off**

**T-Shirts . . . 50% Off**

**Shorts . . . 50% Off**

**Bathing Suits . . . 40% Off**

**Sundresses 40% Off**

We Will Be Closed From 6-9 PM on Wednesday, July 14th To Get Ready For Our Sale.

Cash, Mastercharge, Visa Only (No College Shop Charge)

## JEWELRY SALE

**Brody's**

14 KT. GOLD SERPENTINE BRACELETS

NOW ONLY **\$4.99** REG. \$15

DURABLE WEIGHT

ALL HEADWRAPS NOW **1/3 OFF**

GLORIA VANDERBILT SUNGLASSES NOW **1/3 OFF**

ALL CORAL AND TURQUOISE JEWELRY NOW **1/3 OFF**

JEWELRY DIPPED & PRESERVED IN 24 KT. GOLD

REAL SHELLS, LEAVES, SEAHORSES, ETC.

PENDANTS REG. \$5 NOW **\$3.99**

EARRINGS REG. \$7 NOW **\$5.99**

SHOP: DOWNTOWN 10 A.M.-6 P.M. SHOP: PITT PLAZA 10 A.M.-9 P.M.

# BIG STAR

SHOP BIG STAR FOR OUTSTANDING

# SUMMER SAVINGS

OUR BUYERS HAVE PURCHASED TRUCKLOADS OF NATIONAL BRAND PRODUCTS TO ASSURE OUR CUSTOMERS OF MORE OUTSTANDING SAVINGS THROUGHOUT THE SUMMER!

**RED DOT SPECIALS**  
IS OUR SYMBOL FOR DEEP-CUT WEEKLY SPECIALS.

**GREEN ARROW SAVINGS!**  
IS OUR SYMBOL FOR CONSISTENT SAVINGS ON HUNDREDS OF ITEMS PRICED LOW EVERYDAY.

FARM CHARM  
HOMOGENIZED WHOLE  
MILK  
GAL. \$1.95

WESTINGHOUSE  
SOFT WHITE  
LIGHT BULBS  
TWIN PK. 89¢

PRICES IN THIS AD ARE GOOD THROUGH SAT., JULY 17, 1982. QUANTITY RIGHTS RESERVED. NONE SOLD TO DEALERS OR RESTAURANTS.

U.S. CHOICE BEEF  
WHOLE  
**SIRLOIN TIPS**  
9 TO 12 LB. AVG.-CUT FREE



U.S. CHOICE BEEF LB. \$1.59.

U.S. GRADE A  
**BAKING HENS**



USDA GRADE A LB. 48¢.

**PEPSI, DIET PEPSI OR MT. DEW**

2 LITER 99¢

PET ALL NATURAL  
**COOLIE FRUIT DRINKS**

ASSORTED FLAVORS 64-OZ. 59¢.

U.S. CHOICE BEEF-LEAN BONELESS  
**CHUCK POT ROAST** LB. \$1.98.

ASST. CENTER & END CUTS  
**PORK CHOPS** 8 LBS. OR MORE LB. \$1.58.

FRESH FROZEN  
**FRYER DRUMSTICKS** 5 LB. BOX \$2.88.

FRESH PLUMP  
**BLUEBERRIES** PINT \$1.19.

- OLD VIRGINIE SLICED BACON 1 LB. PKG. \$1.18.
- OLD TOWNE (HOT OR MILD) FRESH PORK SAUSAGE 1 LB. PKG. \$1.18.
- U.S. CHOICE BEEF-LEAN BONELESS SIRLOIN TIP ROAST LB. \$2.58.
- U.S. CHOICE BEEF-LEAN BONELESS SIRLOIN TIP STEAK LB. \$2.68.
- U.S. CHOICE BEEF-LEAN BONELESS SHOULDER ROAST LB. \$2.48.
- SWIFT'S SIZZLEAN BREAKFAST STRIPS 12 OZ. PKG. \$1.68.

- 2 LBS. OR MORE-MARKET STYLE SLICED BACON LB. \$1.38.
- OSCAR MAYER CHEESE HOT DOGS 1 LB. PKG. \$1.88.
- OSCAR MAYER REGULAR OR BEEF VARIETY PAK LUNCH MEATS 1 LB. PKG. \$1.98.
- STAR'S COLE SLAW 14 OZ. CUP 68¢.
- STAR'S POTATO OR MACARONI SALAD 13 OZ. CUP 68¢.
- SYCAMORE BRAND SMOKED SAUSAGE 10 LB. BOX \$8.98.

- STEAK-UMM FROZEN SANDWICH STEAK 14 OZ. PKG. \$2.88.
- JIFFY'S ASST. FROZEN MEAT ENTREES 2 LB. PKG. \$1.58.
- JIFFY'S ASST. FROZEN COOK 'N BAGS 5 OZ. PKG. 39¢.
- JESSE JONES (HOT OR MILD) PORK SAUSAGE 12 OZ. PKG. \$1.58.
- JESSE JONES MEAT FRANKS 12 OZ. PKG. \$1.38.
- JESSE JONES SLICED BOLOGNA 14 OZ. PKG. \$1.58.

- CONCORD BLUEBERRY PIE GLAZE 6 OZ. PKG. 69¢.
- "USE LIKE LEMONS"-FRESH FLORIDA SEEDLESS LIMES DOZEN 99¢.
- MEDIUM YELLOW ONIONS 3 LB. BAG 89¢.
- ASST. FLAVORS-MARIE'S SALAD DRESSING 12 OZ. JAR \$1.39.
- LOCAL JUMBO CANTALOUPE EA. 89¢.

HICKORY MOUNTAIN  
1/5 SLICED  
**COUNTRY HAM**

LB. \$1.98.

**LUCK'S**  
•PINTO BEANS W/PORK •NAVY BEANS  
•LIMA BEANS •GREAT NORTHERN BEANS  
"YOUR CHOICE"



17 OZ. CAN 39¢.

**PETER PAN PEANUT BUTTER**  
SMOOTH OR CRUNCHY



18 OZ. \$1.39.

**SEVEN SEAS**  
•FRENCH •ITALIAN •1000 ISLAND  
SALAD DRESSING



8-OZ. BTL. 58¢.

- 20 LB. CHAMP DRY DOG FOOD \$2.39.
- 100 CNT. SUGAR SUBSTITUTE SWEET & LOW 99¢.
- 16 OZ. OUR PRIDE COFFEE CREAMER 99¢.
- 100 CNT. CHASE & SANBORN TEA BAGS \$1.19.
- DOUBLE Q CHUNK LIGHT TUNA IN OIL OR WATER 6.5 OZ. 69¢.
- 5 LB. SOUTHERN BISCUIT FLOUR PLAIN OR SELF-RISING 79¢.

- 3 LB. BAKE-RITE SHORTENING \$1.39.
- 32 OZ. WHITE HOUSE APPLE JUICE 58¢.
- 32 OZ. ASST. STOKELY GATORADE 59¢.
- 49 OZ. LAUNDRY DETERGENT COLD POWER \$1.48.
- 10 LB. EMBER'S CHARCOAL \$1.38.
- 22 OZ. LIQUID DOVE FOR DISHES 88¢.

- GALLON-VALU PLUS LIQUID BLEACH 59¢.
- 10 CNT.-BES-PAK TRASH BAGS 88¢.
- BLUE BONNET QUARTERS MARGARINE 2 1 LB. PKGS. \$1.00.
- 12 OZ. REGULAR OR LOWFAT-FARM CHARM COTTAGE CHEESE 75¢.
- 16 OZ. PET SOUR CREAM 99¢.
- HALF GALLON-FIESTA ICE CREAM \$1.19.

- 12 OZ. COUNTRY TIME FROZEN LEMONADE 59¢.
- 12 OZ. OUR PRIDE FROZEN WHIPPED TOPPING 89¢.
- 32 OZ. ORE-IDA TATER TOTS \$1.19.
- 6 OZ. KITCHEN TREAT POT PIES 29¢.
- 8 OZ. ASST. ORCHARD HILL FRUIT PIES 2/89¢.
- 24 OZ. BIG STAR BUTTERMILK BREAD 2/99¢.

JIFFY  
**CORN MUFFIN MIX**



4 8.5 OZ. BOX \$1.00.

OUR PRIDE  
**MACARONI & CHEESE**



4 7.2 OZ. BOXES \$1.00.

RONZONI  
**ELBOW MACARONI**



4 8 OZ. BOXES \$1.00.

DURKEE O & C  
**POTATO STICKS**



4 1.5 OZ. CANS \$1.00.

POCAHONTAS  
**CUT GREEN BEANS**



4 16 OZ. CANS \$1.00.

VAN CAMP  
**PORK & BEANS**



3 16 OZ. CANS \$1.00.

BIG STAR BRAND  
**SWEET PEAS**



3 16 OZ. CANS \$1.00.

PROGRESSO  
**WHOLE TOMATOES**



3 14 OZ. CANS \$1.00.

FRANCO-AMERICAN  
**SPAGHETTI-O'S**



3 14.7 OZ. CANS \$1.00.

TEXAS PETE  
**HOT DOG CHILI**



3 10.5 OZ. CANS \$1.00.

LUCKY LEAF  
**APPLE SAUCE**



3 16 OZ. CANS \$1.00.

ASST. WHITE ROCK  
**SOFT DRINKS**



5 12 OZ. CANS \$1.00.

ASST. TWIN PET  
**DOG FOOD**



5 15 OZ. CANS \$1.00.

HUNGRY JACK  
**INSTANT POTATOES**



2 8 OZ. BOXES \$1.00.

LESUEUR  
**GREEN PEAS**



2 17 OZ. CANS \$1.00.

ASST. VANITY FAIR  
**PAPER TOWELS**



2 JUMBO ROLLS \$1.00.

PITT PLAZA SHOPPING CENTER • Mon.-Sat. 8 A.M.-10 P.M. - SUN. 9 A.M.-9 P.M.

# Stock And Market Reports

NEW YORK (AP) — The stock market was mixed today as traders awaited the next move in interest rates.

The 10:30 a.m. Dow Jones average of 30 industrials stood at 824.20, unchanged from Tuesday's close.

Losers held a slight lead over gainers in the early tally of New York Stock Exchange-listed issues.

Stock prices rallied late last week and Monday after interest rates in the credit markets took a sharp drop.

But those rates have since turned upward again, and by Tuesday the stock market advance ran out of steam.

Traders' attention today began to focus on the next Federal Reserve report on the money supply, which is expected to show a big increase. The report covers the first week of this month, when a 10 percent federal income tax cut and a 7.4 percent increase in Social Security benefits took effect.

Allied Stores led the active list in early trading, unchanged at 27 3/4. A 550,600-share block changed hands at 27 3/4.

On Tuesday the Dow Jones industrial average slipped .67 to 824.20.

Losers outnumbered gainers by 7 to 6 on the NYSE.

Big Board volume totaled 66.17 million shares, against 74.69 million in the previous session.

The NYSE's composite index dropped .06 to 62.90.

At the American Stock Exchange, the market value index was off .96 at 248.33.

Amer Can	28 1/2	28 1/2	28 1/2
Am Cyan	28 1/2	27 1/2	28 1/2
Am Family	10 1/4	10 1/4	10 1/4
Am Motors	21 1/2	21 1/2	21 1/2
Am Stand	21 1/2	21 1/2	21 1/2
Amer T&T	53 1/2	52 1/2	52 1/2
Beat Food	19 1/4	19 1/4	19 1/4
Beih Steel	16 1/2	16 1/2	16 1/2
Boeing	17 1/2	17 1/2	17 1/2
Boise Casco	22 1/2	22 1/2	22 1/2
Borden	31 1/4	31 1/4	31 1/4
Burling Ind	19 1/4	19 1/4	19 1/4
CSX Corp	39 1/4	38 1/4	38 1/4
Con Ed	19 1/4	19 1/4	19 1/4
Corning	43 1/4	42 1/4	42 1/4
Celanese	10 1/4	10 1/4	10 1/4
Cent Soya	12 1/2	12 1/2	12 1/2
Champion	7 1/4	7 1/4	7 1/4
Chryslr	27 1/2	27 1/2	27 1/2
Coca Cola	36 1/2	36 1/2	36 1/2
Colg Palm	17 1/2	17 1/2	17 1/2
Comw Edis	21 1/2	21 1/2	21 1/2
Con Ed	19 1/4	19 1/4	19 1/4
Delta Air	33 1/2	33 1/2	33 1/2
Dow Chem	21 1/2	21 1/2	21 1/2
DuPont	22 1/2	22 1/2	22 1/2
Duke Pow	22 1/2	22 1/2	22 1/2
East Air	5 1/2	5 1/2	5 1/2
East Kodak	25 1/4	24 1/4	24 1/4
Eaton	43 1/4	43 1/4	43 1/4
Esmark	26 1/2	26 1/2	26 1/2
Exxon	32 1/2	32 1/2	32 1/2
Flint	11 1/4	11 1/4	11 1/4
FlaPowLi	32 1/2	32 1/2	32 1/2
FlaProgess	16 1/4	16 1/4	16 1/4
FordMot	22 1/2	22 1/2	22 1/2
FortKess	31 1/4	30 1/4	31 1/4
Fuqua Ind	16 1/2	16 1/2	16 1/2
GTE Corp	30 1/2	30 1/2	30 1/2
Gen Elec	67 1/2	67 1/2	67 1/2
Gen Flood	38 1/4	38 1/4	38 1/4
Gen Mills	42 1/4	42 1/4	42 1/4
Gen Motors	46 1/4	46 1/4	46 1/4
Gen Tire	24 1/4	24 1/4	24 1/4
Genus	15 1/2	15 1/2	15 1/2
Goodrich	18 1/2	17 1/2	18 1/2
Goodyear	25 1/2	25 1/2	25 1/2
Grace Co	32 1/2	32 1/2	32 1/2
Gibor Nek	13 1/4	13 1/4	13 1/4
Greyhound	13 1/4	13 1/4	13 1/4
Gulf Oil	25 1/2	25 1/2	25 1/2
HerculesInc	18 1/2	18 1/2	18 1/2
Honeywell	68 1/4	67 1/4	67 1/4
Ing Rand	40 1/4	40 1/4	40 1/4
IBM	65 1/4	64 1/4	64 1/4
Int Harv	3 1/4	3 1/4	3 1/4
Int Paper	37 1/2	37 1/2	37 1/2
Int T&T	23 1/2	23 1/2	23 1/2
K mart	18 1/4	18 1/4	18 1/4
KaiserAlum	13 1/2	12 1/2	12 1/2
KaneSvc	12 1/2	12 1/2	12 1/2
KrogerCo	36 1/2	36 1/2	36 1/2
Lecheed	57 1/2	56 1/2	56 1/2
Loews Corp	90 1/2	90 1/2	90 1/2
Masonite	17 1/2	16 1/2	16 1/2
McDermott	16 1/4	16 1/4	16 1/4
Mead Corp	55 1/4	54 1/4	55 1/4
MinnMM	21 1/2	21 1/2	21 1/2
Mohr	63 1/2	63 1/2	63 1/2
Monsanto	12 1/2	12 1/2	12 1/2
NCNB Cp	34 1/4	34 1/4	34 1/4
NabiscoBrd	45 1/4	44 1/4	45 1/4
Nat Distill	18 1/2	18 1/2	18 1/2
NorfolkSou	18 1/2	18 1/2	18 1/2
OlinCp	22 1/2	22 1/2	22 1/2
Owensill	18 1/4	18 1/4	18 1/4
PepsiCo	40 1/4	39 1/4	40 1/4
Phelps Dod	24 1/2	24 1/2	24 1/2
PhillipMor	51 1/4	51 1/4	51 1/4
PhillipsPet	28 1/2	28 1/2	28 1/2
Polaroid	18 1/4	18 1/4	18 1/4
Proct Gamb	41 1/4	41 1/4	41 1/4
Quaker Gat	17 1/2	17 1/2	17 1/2
RCA	13 1/4	13 1/4	13 1/4
RaisinPur	16 1/4	16 1/4	16 1/4
Republic	16 1/2	16 1/2	16 1/2
Republic Sll	27 1/2	27 1/2	27 1/2
Revlon	45 1/4	45 1/4	45 1/4
Reynold	33 1/2	33 1/2	33 1/2
Rockwell	19 1/4	19 1/4	19 1/4
RoyCrown	21 1/2	21 1/2	21 1/2
SIRegis Pap	15 1/2	15 1/2	15 1/2
Scott Paper	32 1/2	32 1/2	32 1/2
SearsRoeb	19 1/2	18 1/2	19 1/2
Shakee	17 1/2	17 1/2	17 1/2
Skyline Cp	18 1/4	18 1/4	18 1/4
Sony Corp	12 1/2	12 1/2	12 1/2
Southern Co	13 1/2	13 1/2	13 1/2
Sperry Cp	27 1/2	27 1/2	27 1/2
StDuCal	38 1/4	37 1/4	38 1/4
StdOilInd	30 1/4	29 1/4	30 1/4
StdOilNc	14 1/4	14 1/4	14 1/4
Stevens JP	51 1/2	50 1/2	51 1/2
TRW Inc	28 1/2	27 1/2	28 1/2
Texaco Inc	44 1/4	44 1/4	44 1/4
TexEastn	8 1/4	8 1/4	8 1/4
UMC Ind	45 1/4	45 1/4	45 1/4
Int Camp	43 1/2	43 1/2	43 1/2
Un Carbide	28 1/2	28 1/2	28 1/2
Unifical	8 1/4	8 1/4	8 1/4
Uniroly	18 1/4	18 1/4	18 1/4
US Steel	24 1/4	24 1/4	24 1/4
Wachov Cp	26 1/2	25 1/2	26 1/2
WalMart	27 1/2	27 1/2	27 1/2
Westing El	27 1/2	26 1/2	27 1/2
Weyerhs	37 1/2	37 1/2	37 1/2
WindDix	18 1/4	18 1/4	18 1/4
Woolworth	33 1/2	33 1/2	33 1/2
Wrigley	32 1/2	31 1/2	32 1/2
Xerox Cp	32 1/2	31 1/2	32 1/2

Traders' attention today began to focus on the next Federal Reserve report on the money supply, which is expected to show a big increase. The report covers the first week of this month, when a 10 percent federal income tax cut and a 7.4 percent increase in Social Security benefits took effect.

Allied Stores led the active list in early trading, unchanged at 27 3/4. A 550,600-share block changed hands at 27 3/4.

On Tuesday the Dow Jones industrial average slipped .67 to 824.20.

Losers outnumbered gainers by 7 to 6 on the NYSE.

Big Board volume totaled 66.17 million shares, against 74.69 million in the previous session.

The NYSE's composite index dropped .06 to 62.90.

At the American Stock Exchange, the market value index was off .96 at 248.33.

Following are selected 11 a.m. stock market quotations:

Burroughs	31
United Telecommunications	17 1/4
Heublein	40
Jeff-Pilot	25
Tri-South	3 1/2
Wix	29 1/2
Wachovia	24 1/2
Eckerd's	19 1/4
Central Soya	10 1/2
McDonald's	75 1/4
Ashland Oil	32
Fieldcrest	20 1/4
Hilton Hotel	30 1/2
Eaton	12 1/2
Virginia Electric & Power	24 1/4
Deere	23 1/4
P&G	85 1/4
Piedmont Aviation	11 1/4
Conner Homes	5 1/4
Pizza Inn	5 1/2
McGraw-Edison	27
NCNB	12 1/2
TRW Inc	28 1/2
Low's Company	14 1/4
Carolina P&L	19 1/4
OVER THE COUNTER	
Planters Bank	22 1/2
Little Mint	2 1/4
Aviation	9 1/2

NEW YORK (AP) — Midday stocks			
High	Low	Last	
AbblLabs	30 1/2	30 1/2	30 1/2
Akzona	15 1/2	15 1/2	15 1/2
Alcoa	24 1/4	24 1/4	24 1/4
Am Airlin	18 1/2	17 1/2	17 1/2
Am Baker	9 1/4	9 1/4	9 1/4
Am Brands	40 1/2	40 1/2	40 1/2

WEDNESDAY  
9:30 a.m. — Duplicate bridge at Planters Bank  
1:30 p.m. — Duplicate bridge at Planters Bank  
6:30 p.m. — Kiwanis Club meets  
6:30 p.m. — REAL Crisis Intervention meets  
6:15 p.m. — Greenville Toastmasters meet at Western Sizzlin' No. 2  
7:00 p.m. — Winterville Jaycees meet at Winterville Grill  
8:00 p.m. — Greenville White Shrine meets at Masonic Temple  
8:00 p.m. — Pitt County Al-Anon Group meets at AA Bldg on Farmville hwy.  
8:00 p.m. — John Ivey Smith Council No. 6600, Knights of Columbus meet at St. Peter's Church Hall  
8:00 p.m. — Pitt County Ala-Teen Group meets at AA Bldg, Farmville hwy. Telephone 524-4779 or 825-8281

THURSDAY  
6:30 p.m. — Exchange Club meets  
7:00 p.m. — Greenville Elks Lodge No. 1645 meets  
7:30 p.m. — Overeaters Anonymous meet at First Presbyterian Church  
8:00 p.m. — VFW meets at Post Home  
8:00 p.m. — Coochee Council No. 60, Degree of Pocahontas meets at Red Men's Hall

AAMA MEETING  
The Pitt County Chapter of the American Association of Medical Assistants will meet Thursday at 8 p.m. at the Greenville Athletic Club. A tour of the facilities will be given and the club's program of physical fitness will be shown.

Writer Plans Study Trip  
CARACAS, Venezuela (AP) — Writer Alvin Toffler will meet with President Luis Herrera Campins and study the economic situation in Venezuela during a visit later this month, the official Venpres news agency reports.

Toffler, author of "Future Shock" and "The Third Wave," will make his first visit to this South American nation to attend the Venezuelan Financial Congress in Maracaibo July 22-23.

The writer also is scheduled to host a question-and-answer conference on the world economy in Caracas July 23, Venpres said Tuesday.

THE MEETING PLACE  
WEDNESDAY  
9:30 a.m. — Duplicate bridge at Planters Bank  
1:30 p.m. — Duplicate bridge at Planters Bank  
6:30 p.m. — Kiwanis Club meets  
6:30 p.m. — REAL Crisis Intervention meets  
6:15 p.m. — Greenville Toastmasters meet at Western Sizzlin' No. 2  
7:00 p.m. — Winterville Jaycees meet at Winterville Grill  
8:00 p.m. — Greenville White Shrine meets at Masonic Temple  
8:00 p.m. — Pitt County Al-Anon Group meets at AA Bldg on Farmville hwy.  
8:00 p.m. — John Ivey Smith Council No. 6600, Knights of Columbus meet at St. Peter's Church Hall  
8:00 p.m. — Pitt County Ala-Teen Group meets at AA Bldg, Farmville hwy. Telephone 524-4779 or 825-8281

THURSDAY  
6:30 p.m. — Exchange Club meets  
7:00 p.m. — Greenville Elks Lodge No. 1645 meets  
7:30 p.m. — Overeaters Anonymous meet at First Presbyterian Church  
8:00 p.m. — VFW meets at Post Home  
8:00 p.m. — Coochee Council No. 60, Degree of Pocahontas meets at Red Men's Hall

AAMA MEETING  
The Pitt County Chapter of the American Association of Medical Assistants will meet Thursday at 8 p.m. at the Greenville Athletic Club. A tour of the facilities will be given and the club's program of physical fitness will be shown.

Writer Plans Study Trip  
CARACAS, Venezuela (AP) — Writer Alvin Toffler will meet with President Luis Herrera Campins and study the economic situation in Venezuela during a visit later this month, the official Venpres news agency reports.

Toffler, author of "Future Shock" and "The Third Wave," will make his first visit to this South American nation to attend the Venezuelan Financial Congress in Maracaibo July 22-23.

The writer also is scheduled to host a question-and-answer conference on the world economy in Caracas July 23, Venpres said Tuesday.

THE MEETING PLACE  
WEDNESDAY  
9:30 a.m. — Duplicate bridge at Planters Bank  
1:30 p.m. — Duplicate bridge at Planters Bank  
6:30 p.m. — Kiwanis Club meets  
6:30 p.m. — REAL Crisis Intervention meets  
6:15 p.m. — Greenville Toastmasters meet at Western Sizzlin' No. 2  
7:00 p.m. — Winterville Jaycees meet at Winterville Grill  
8:00 p.m. — Greenville White Shrine meets at Masonic Temple  
8:00 p.m. — Pitt County Al-Anon Group meets at AA Bldg on Farmville hwy.  
8:00 p.m. — John Ivey Smith Council No. 6600, Knights of Columbus meet at St. Peter's Church Hall  
8:00 p.m. — Pitt County Ala-Teen Group meets at AA Bldg, Farmville hwy. Telephone 524-4779 or 825-8281

THURSDAY  
6:30 p.m. — Exchange Club meets  
7:00 p.m. — Greenville Elks Lodge No. 1645 meets  
7:30 p.m. — Overeaters Anonymous meet at First Presbyterian Church  
8:00 p.m. — VFW meets at Post Home  
8:00 p.m. — Coochee Council No. 60, Degree of Pocahontas meets at Red Men's Hall

AAMA MEETING  
The Pitt County Chapter of the American Association of Medical Assistants will meet Thursday at 8 p.m. at the Greenville Athletic Club. A tour of the facilities will be given and the club's program of physical fitness will be shown.

Writer Plans Study Trip  
CARACAS, Venezuela (AP) — Writer Alvin Toffler will meet with President Luis Herrera Campins and study the economic situation in Venezuela during a visit later this month, the official Venpres news agency reports.

Toffler, author of "Future Shock" and "The Third Wave," will make his first visit to this South American nation to attend the Venezuelan Financial Congress in Maracaibo July 22-23.

The writer also is scheduled to host a question-and-answer conference on the world economy in Caracas July 23, Venpres said Tuesday.

THE MEETING PLACE  
WEDNESDAY  
9:30 a.m. — Duplicate bridge at Planters Bank  
1:30 p.m. — Duplicate bridge at Planters Bank  
6:30 p.m. — Kiwanis Club meets  
6:30 p.m. — REAL Crisis Intervention meets  
6:15 p.m. — Greenville Toastmasters meet at Western Sizzlin' No. 2  
7:00 p.m. — Winterville Jaycees meet at Winterville Grill  
8:00 p.m. — Greenville White Shrine meets at Masonic Temple  
8:00 p.m. — Pitt County Al-Anon Group meets at AA Bldg on Farmville hwy.  
8:00 p.m. — John Ivey Smith Council No. 6600, Knights of Columbus meet at St. Peter's Church Hall  
8:00 p.m. — Pitt County Ala-Teen Group meets at AA Bldg, Farmville hwy. Telephone 524-4779 or 825-8281

THURSDAY  
6:30 p.m. — Exchange Club meets  
7:00 p.m. — Greenville Elks Lodge No. 1645 meets  
7:30 p.m. — Overeaters Anonymous meet at First Presbyterian Church  
8:00 p.m. — VFW meets at Post Home  
8:00 p.m. — Coochee Council No. 60, Degree of Pocahontas meets at Red Men's Hall

# U.S. Pledges Neutrality In Iran-Iraq Fighting

WASHINGTON (AP) — The United States pledged today to remain neutral in the fighting between Iran and Iraq, which Senate Majority Leader Howard H. Baker said poses "a real danger of a major conflict."

Deputy White House press secretary Larry Speakes, in announcing U.S. neutrality in the fighting, urged "an immediate end to hostilities and a negotiated settlement."

He said that the United States was "deeply concerned" about the conflict and that it supported the "independence and territorial integrity" of both Iran and Iraq.

"Our support for the security of friendly states in the region which might feel threatened by the conflict is well known and the United States is prepared to consult with these states on appropriate steps to support their security," Speakes said.

He would not spell out what "appropriate steps" could be taken, but he said the United States was consulting with allies in the region. He said that no additional military aid for friendly nations, beyond on-going programs of assistance, was contemplated.

Baker told reporters that Iran and Iraq "are arrayed in some strength," with Iran maintaining five divisions of troops and Iraq with seven divisions.

"It's a very real danger the war will spread," he said. "The indications are there is a real danger of a major conflict."

However, Baker said, "I don't think there's any real or immediate danger to the United States."

He said he had not been given any information indicating a Soviet role in the conflict.

The White House briefing was conducted by Robert C.

McFarlane, deputy assistant to President Reagan for national security affairs. It was held during a regularly scheduled meeting between Reagan and Republican congressional leaders.

LA LECHE LEAGUE  
La Leche League of Greenville begins a new series of meetings Thursday. The discussion will cover advantages of breast feeding to mother and baby. The 10 a.m. meeting will be held at 714 W. Third St. in Ayden. Call Debbie at 746-4578 for directions.

Thursday's 7:30 p.m. meeting will be held at the home of Julie Keville on E. Cooper Street in Winterville. Call Julie at 756-1007 for directions. For more information about La Leche League contact leader Judy Beckert at 756-4197.

Post Office 90 Years Old  
Ninety years ago today the community of Stokes got a post office.

That's what two of its residents, C.S. Whichard and J.B. Congleton, discovered when they wrote the Postal Service for information about three post offices in eastern Pitt County — Stokes, Whichard's and Pactolus.

"He (C.S. Whichard) was curious about the post offices around here, I guess, so he wrote them (U.S. Postal Service) and asked when they began," said Congleton, longtime resident of the Stokes community and grandson of W.G. Stokes, the town's namesake.

The oldest, they found, was

the now-defunct Whichard's, established in 1891 and discontinued in 1926. Next-oldest was Pactolus, begun in May of 1892.

Stokes, according to the Postal Service, was opened May 14, 1892, and Congleton said his grandmother, Addie Perkins Stokes (also Mrs. W.G. Stokes), was postmistress.

Whichard's information came from Rita L. Moreny, research administrator and historian for the Postal Service.

The Stokes Post Office serves 1,300 persons, according to Postmaster H.C. Edwards, who estimated that in 1892 it served even more. "I imagine there was even

more then (in 1892) because families were larger and then we had two rural routes," he noted.

The post office has no rural routes now but serves as a substitution for one Greenville route.

Edwards said the office planned no celebration of the anniversary. "It's just another normal day," he said.

Backpacking Trip Planned  
The Greenville Recreation and Parks Department, in conjunction with Southeastern Community College, will offer a backpacking program on the Appalachian Trail in the Nantahala National Forest Aug. 4-8.

The cost of the trip, which includes transportation from Greenville, all equipment, except shoes, clothing, toiletries, and all meals on the trail, is \$30. Additional expense of \$10-\$20 can be expected to cover meals while traveling to and from the trail. Minimum age for the program is 18.

Participants will leave Greenville at 5 p.m. Aug. 4. For additional information contact Bill Twine, Greenville Recreation and Parks Department, at 752-4137, extension 201.

ATTENDANCE  
Operation Sunshine Girls Activities Program now has an average daily attendance of 74, with 122 girls having participated so far, according to director Gloria Pearsall.

The girls' projects so far have included making pickles, jelly, macrame towel hangars and key rings, trash cans from egg cartons, silk flowers and candles.

BUNDY TO SPEAK  
Rep. Sam D. Bundy will speak during the annual meeting of the North Carolina Holstein-Friesian Association in Salisbury Saturday at noon.

ALOE VERA JUICE  
100% Pure—Best Prices  
Quart—\$6.70  
Gallon—\$20.00  
Tasty, thousands taking for arthritis, rheumatism, high blood, ulcers, overweight, indigestion, low energy, diabetes, heart disease, sinus.  
Phone 752-0180  
756-2766 Nights

I would like to thank the people of Pitt County who supported me with their time, energy and contributions during my campaign for County Commissioner.

Thank you,  
J. Elliott Dixon  
Paid for by J. Elliott Dixon

EDWARDS & CLARK, P.A.  
CERTIFIED PUBLIC ACCOUNTANTS  
ANNOUNCES THE RELOCATION OF THE FIRM'S OFFICES TO SUITE 200, NCNB BUILDING  
201 W. 1st STREET  
GREENVILLE, NORTH CAROLINA 27834  
RAYMOND W. EDWARDS, CPA  
JAMES W. CLARK, III, CPA  
JOANNE D. BAKER, CPA  
P.O. BOX 7184  
(919) 758-1333  
July 15, 1982

Street ...  
(Continued from page 1)  
He noted that Greenville Utilities expected to have power restored to the Willis Building, located at the corner of First and Reade streets, by midday today.

Allen stressed the teamwork among personnel from public works, GUC and police and fire departments who were on the scene "within 15 minutes" after being called. Officials evacuated about a block and a half of residents as a precautionary measure Tuesday morning in view of the gas line breakage, Allen reported.

In other sections of town, drainage capacities were exceeded during the heavy rains, according to Allen, but runoff took place shortly after the pipes overflowed, causing no major problems. He said "we had more water than any of our drainage systems could handle" but "they were taking water 15 minutes after the rains stopped."

An unidentified resident of University Towers apartments spent 15-20 minutes during the storm trapped in an elevator in the complex but was not injured, reported Fire-Rescue Chief Jenness Allen.

"She was in the elevator yesterday when the current went off," said Allen. "We opened the elevator and removed her and she was very concerned and upset, but not hurt."

The church organ at St. James United Methodist Church was struck by severe lightning that "popped around the church steeple for about 30 minutes" reported Stephen Vaughn, music director. He estimated the damage at several thousand dollars.

"Evidently we had a direct hit on our steeple, which is rather tall, and it knocked the organ out," said Vaughn. Lightning also burned out the church's public address system, he added.

Greenville Utilities' Water Plant measured 3.7 inches of rain from 8 a.m. Tuesday-8 a.m. today.

ALOE VERA JUICE  
100% Pure—Best Prices  
Quart—\$6.70  
Gallon—\$20.00  
Tasty, thousands taking for arthritis, rheumatism, high blood, ulcers, overweight, indigestion

## Frustration Continues For AL As NL Wins Again

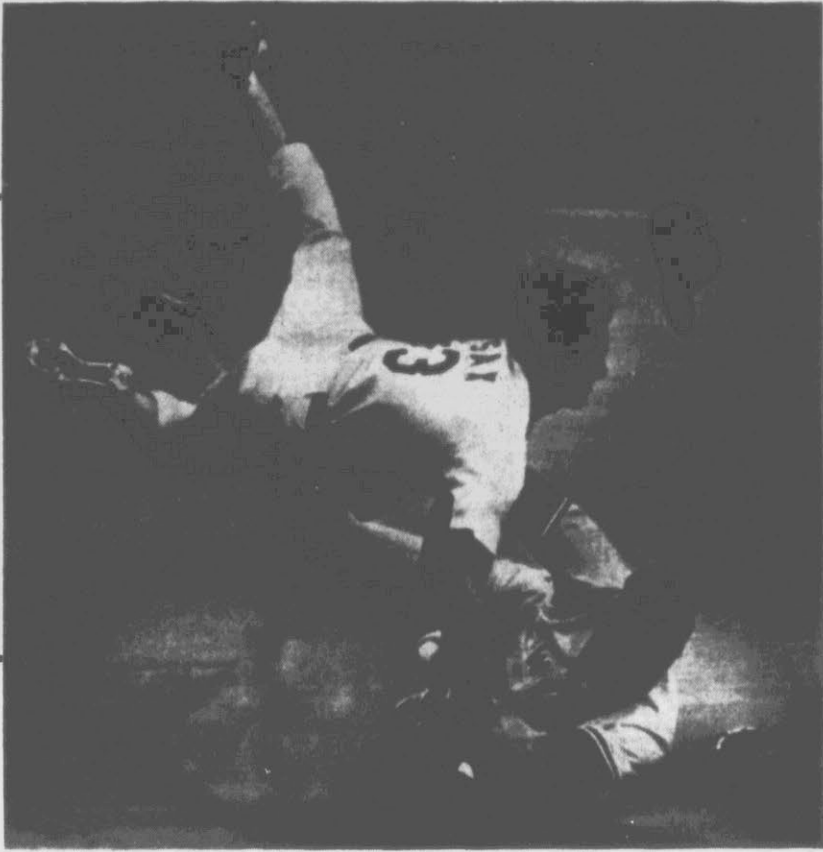

**Sax Overture**  
New York Yankee Dave Winfield sends Los Angeles second baseman Steve Sax up and over him during sixth inning Tuesday in the 53rd All-Star game played in Montreal. Winfield's hard slide prevented Sax from completing a double play on Robin Yount. (AP Laserphoto)

MONTREAL (AP) — For the last 11 years, the National League has found a way to win the All-Star Game. This year, the American League supplied the formula.

The frustrated Americans had pledged to win with speed on the bases, tight defense and tough relief pitching. That combination, spiced by Cincinnati shortstop Dave Concepcion's two-run homer, was just how the Nationals built their 4-1 triumph Tuesday night.

Two vital statistics spelled doom for the AL, which now trails this series 34-18 with one tie and has lost 19 of the last 20 games.

Manager Billy Martin's club struck out 10 times against NL pitchers Steve Rogers of Montreal, Steve Carlton of Philadelphia and Mario Soto of Cincinnati, and left 11 runners on base.

"We had enough opportunities," Martin said. "We just didn't capitalize."

Concepcion did, though, hitting a hanging slider from Boston's Dennis Eckersley into the left-field seats in the second inning to earn the game's Most Valuable Player trophy.

The AL took a 1-0 lead in the first against Rogers, scoring on hits by Oakland's Rickey Henderson, who had three singles, and George Brett of Kansas City, a wild pitch and a long sacrifice fly by California's Reggie Jackson.

"Reggie was a little under that ball or it could have been 3-0," Rogers said.

Boston's Eckersley mowed down the first five NL batters but was having some control problems. He walked Dale Murphy of Atlanta on four pitches, bringing up Concepcion.

"I felt I had lost a little," the Eckersley said. "I gave Concepcion a fastball and he fouled it back. Then I went to a slider and it was good-bye."

"I was looking for an off-speed pitch," Concepcion said. "I guess I got the head of the bat out on it."

In his last batting-practice swing, Concepcion had smashed a line drive into Olympic Stadium's lower left field seats. Eckersley's pitch wound up in almost the same spot.

"He yanked it," Eckersley said. "I was hoping it would

hook foul. You know it's a bad pitch when you throw it. You say to yourself, 'Break!'"

Concepcion, who has only one home run this season, had put the NL in front and Manager Tommy Lasorda of Los Angeles thought the timing was every bit as important as the runs.

"When you have two men out and nobody on base and then you get two runs, well, that's a big lift," said Lasorda, 3-0 as NL manager streak. "It came at a very opportune time."

An inning later, the NL was back for more. Pinch-hitter Ruppert Jones of San Diego led off with a triple that bounced off the base of the wall in right-center.

After Montreal's Tim Lincecum walked and stole second, Jones scored on Pete Rose's sacrifice fly, sliding across just ahead of Jackson's strong throw and tagging the plate with his hand as Chicago catcher Carlton Fisk lunged to make the tag.

That made it 3-1 and Carlton relieved Rogers for the NL. He struck out the side in the fourth, stranding two runners he had walked. In the fifth he surrendered a single to Henderson but then started a double play on Kansas City's Willie Wilson, as the NL erased two of baseball's fastest runners.

Soto relieved in the sixth inning and the AL trend continued — runners left on base and batters striking out. He permitted a leadoff single by

New York's Dave Winfield but mowed down the next three hitters, finishing the inning by striking out Boston's Carl Yastrzemski. But the Cincinnati right-hander saved his best show for the seventh.

The Nationals had increased their lead to 4-1 in the sixth on a double by Al Oliver and an RBI single by Gary Carter as the two Montreal teammates gave the hometown crowd of 59,057 — third largest in All-Star history — something to shout about.

Detroit's Lance Parrish opened the seventh with a double for the AL. Soto then struck out Kansas City's Frank White on a changeup. Henderson stroked his third single and promptly stole second. But Soto fanned Wilson and Texas' Buddy Bell.

"I threw three changeups to White," Soto said. "I started Wilson with a fastball and then went back to the change. Bell, I threw him three or four changeups straight."

"When I'm in trouble, I go back to my change. I'm a fastball, change-up pitcher. My change-up is my second best pitch and I have confidence in it."

The AL wasn't done quite yet. In the eighth, Fernando Valenzuela walked two batters and San Francisco's Greg Minton relieved. Parrish hit a slow chopper over the mound. St. Louis shortstop Ozzie Smith, who had replaced Concepcion, dashed in and made a

dazzling play to end the inning, stranding the ninth and 10th AL runners.

No. 11 came in the final inning when Henderson walked with one out. Lasorda went to his bullpen for the Dodgers' Steve Howe, who retired rookie Kent Hrbek of Minnesota. Then Tom Hume of Cincinnati came on to get Bell, ending the game.

AMERICAN		NATIONAL	
ab	r	ab	r
Rhodes lf	4 1 3 0	Raines lf	1 0 0 0
Lynn cf	2 0 0 0	Carlton p	0 0 0 0
Wilson cf	2 0 0 0	Horner ph	1 0 0 0
Hrbek ph	1 0 0 0	Soto p	0 0 0 0
Brett 3b	2 0 2 0	Thompson ph	1 0 0 0
Bell 3b	3 0 0 0	Valenzia p	0 0 0 0
Jackson rf	1 0 0 1	Minton p	0 0 0 0
Winfield rf	2 0 1 0	Howe p	0 0 0 0
Cooper lb	2 0 1 0	Hume p	0 0 0 0
EMurry lb	1 0 0 0	Rose lb	1 0 0 1
Yount ss	3 0 0 0	Oliver lb	2 1 2 0
Grich 2b	1 0 0 0	Dawson cf	4 0 1 0
Yastzki ph	1 0 0 0	Schmidt 3b	1 0 0 0
Quisberry p	0 0 0 0	Knights 3b	3 0 0 0
Parrish c	2 0 1 0	Murphy rf	2 1 0 0
Eckersley p	1 0 0 0	Casper c	3 0 1 1
Thrntn ph	1 0 0 0	Osmith ss	0 0 0 0
Clancy p	0 0 0 0	Trillo 2b	2 0 1 0
Bannister p	0 0 0 0	Sax 2b	1 0 1 0
White 2b	1 0 0 0	Rogers p	0 0 0 0
Ogilvie ph	1 0 0 0	Jones ph	1 1 1 0
		Baker lf	2 0 0 0
		Smith lf	0 0 0 0
Total	33 18 1	Total	28 48 4

American		National	
IP	H	R	ER
Eckersley L.	3	2	3
Clancy	1	0	0
Bannister	1	0	0
Quisenberry	2	3	1
Fingers	1	2	0
National			
Rogers W.	3	4	1
Carlton	2	1	0
Soto	2	3	0
Valenzuela	2	3	0
Minton	2	3	0
Howe	1	3	0
Hume S.	1	3	0
WP—Rogers T—2.53 A—59.057			

## Pirates Fall To NCSU In Finale

**A Staff Report**  
N.C. State erupted for three runs in the seventh inning to defeat East Carolina 6-2 in North State League play Tuesday evening to move within a half game of league leader Campbell.

The game was the regular-season finale for ECU, which ends up 11-21.

NCSU, now 22-9, finishes its regular season tonight against UNC. The Camels, who are 22-8, have a double-header with UNC-W tonight.

ECU, which clinched a berth in the league's postseason

tournament by beating UNC-W in the second game of a double-header Monday night, saw N.C. State jump out to a 1-0 lead in the second and was unable to come closer the rest of the night.

Jim Toman singled to open the second off Reggie McDonald, who replaced Brian Peterson. McDonald was the second of four pitchers ECU coach Gary Overton used against the Wolfpack.

Toman came around to score on a passed ball and a sacrifice by Tim Barbour to give State a 1-0 lead.

The Wolfpack upped its lead to 2-0 in the fifth when Moe Barbour singled and scored when Kirk Parsons walked three straight hitters.

Both team scored a run in the sixth. Tim Barbour singled and came around to score on Artie Hall's single. ECU countered with a run in the bottom of the inning when Todd Evans walked and scored after singles by Art Barnhardt and Charlie Smith.

Up 3-1, the Wolfpack erupted for three runs in the seventh to seal the much needed win. The Wolfpack reled hits

from Toman, Tim Barbour and Moe Barbour to pace the three-run outburst.

ECU scored its final run in the bottom of the innin. Kelly Robinette singled and scored on Jack Curlings' single.

ECU was led at the plate by Robinette, who was two for three. No one else had more than one hit for ECU.

N.C. State got two hits from Toman, and both Barbour.

NCSU 6 0 0 1 1 3 6 1 3  
ECU 0 0 0 1 1 2 5 3  
Nelson Carlton and Jim Toman; Brian Peterson, Reggie McDonald (2), Bob Davidson (3), Kirk Parsons (4), and Jack Curlings.

## Kiwanis Ties Series With 8-5 Triumph

Robbie McDonald hit a solo homer to start a six-run sixth-inning uprising that helped carry Kiwanis by First Federal, 8-5, to tie the Little League City Championship series at a game apiece.

The third and deciding game is set for today at 6 p.m. After a scoreless first inning, Kiwanis struck for six runs in the second to take a lead that it never relinquished.

McDonald got the inning started with a home run. Two errors, two walks, a wild pitch and a passed ball allowed four more runs to score. The final run of the inning came home on a wild pitch.

First Federal, which defeated Kiwanis, 5-0, Monday in the series opener, cut the gap to 6-3, sparked by an error that allowed two runs to score and a RBI single by Richard Lewis.

First Federal closed to within 6-5 in the fourth on Lee Watson's two-run home run, which came after Frankie Pugh singled to open the inning. But, that was as close as FF could get as Kiwanis scored twice in the sixth.

McDonald singled and came around to score on a passed ball. Curtis Jones then doubled and scored on Charlie Crandell's single to make it 8-5.

McDonald had two hits for Kiwanis. Pugh, Watson and Lewis all had two hits for First Federal.

S. Pitt ..... 13  
Plymouth ..... 3  
WASHINGTON — The Southern Pitt Little League All-Star team captured its second straight lopsided victory in (Please turn to page 19)

### Sports Calendar

Editor's Note: Schedules are supplied by schools or sponsoring agencies and are subject to change without notice.	Leaf
TRW vs. Fieldcrest	East Carolina #2 vs. Public Works
<b>Today's Sports</b>	<b>Thursday's Sports</b>
Baseball	Baseball
Babe Ruth League	Babe Ruth League
District Tournament at SouthWest Edgecombe	District Tournament at SouthWest Edgecombe
Little League	Softball
City Tournament — if necessary	Co-Rec League
Softball	Sunnyside vs. TRW
Industrial League	Nationwide vs. TRW
East Carolina #1 vs. Pitt Memorial	Church League
Grady White vs. Burroughs-Wellcome #2	Victory vs. Jarvis
Union Carbide vs. Burroughs-Wellcome #1	Maranatha vs. Trinity
Fieldcrest vs. Grady White	Memorial vs. First Presbyterian
Empire Brushes vs. Carolina	First Pentecostal vs. Grace
	First Christian vs. Black Jack
	Mt. Pleasant vs. Faith
	Oakmont vs. Arington St.
	Hooker vs. Unity

**STIHL**  
Grass and Brush Cutters  
**HENDRIX BARNHILL**  
752-4122

### Tune Up Your Racket

Century Blue Ace Nylon  
**\$6.00**  
Reg. \$10.00 Special  
A long lasting string for the Economy Player

Century Graphite Play Tennis String  
This String is a high class synthetic string reinforced with Graphite  
**\$10.00**  
Reg. \$18.00 Special

Wintex Blend By Gosen Co. Ltd.  
Recommended by Chris Evert Lloyd  
Wintex Blend. A unique patented blend using space age micro polymers and Gosen technology. Has hollow-veined core made of various blended synthetic materials which allows the racquet to be strung at extra high tension. Carbon powder and resin does much to eliminate string breakage. The string's surface is treated with a super-thin silicone coating which is slightly rough, giving added ball control.  
**\$12.00**  
Reg. \$18.00 Special

Major Black Gold  
Developed specifically for stringing at extremely high tension. It has a tensile strength of 190 lbs. It is the string answer to the challenge of the oversize racquet. Truly a "state of the art" racquet string. Made with a unique specially developed core and a graphite impregnation of the coating. Resulting in higher resiliency, a stronger, and longer lasting string than any of its competitors. Specifications: 190 lbs. tensile strength. Color: Black with gold spiral 16L (1.29mm) 36' coil.  
**\$10.00**  
Reg. \$18.00 Special

Gosen Hy Sheep II  
Extra textured with high tensile strength for the players who want superior top spin. Suggested stringing for large head racquets: 70-80 lbs.; standard size racquets 50-60 lbs. Has higher break strength, high knot break strength, lower elongations and lower gauge than Leona 66. Special Gosen blend of oil is carefully treated to each micro-thread before the wrapping process. Then it is heat-sealed under a double coating. Specifications: 165 lbs. tensile strength, gauge 15L (1.35mm). Color: natural, 36' coil.  
**\$7.00**  
Reg. \$12.00 Special

This will be on a first come first served basis—Offer expires July 24

**Bonds/H.L. Hodges**  
218 ARLINGTON BLVD. SPORTING GOODS 210 E. FIFTH ST.  
OPEN 9:00 TIL 6:00 OPEN 10:5-30  
756-6001 GREENVILLE 752-4156

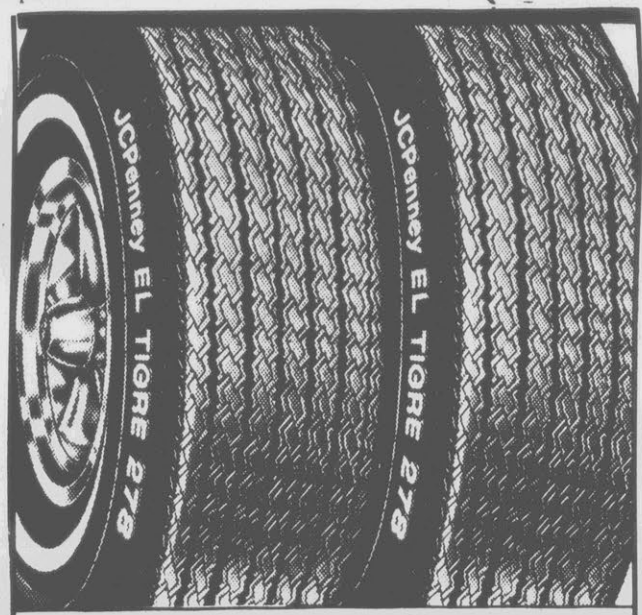

### Closeout

40% off El Tigre 278's

Bias-belted El Tigre 278 is our best belted tire. It features a polyester cord body to allow sidewall to absorb shocks and 2 fiber-glass belts for strength and flexibility. Whitewall. Tread design may vary.

Tire size	Orig	Sale*
A78-13 W/W	\$55	\$33
B78-13 W/W	\$60	\$36
C78-14 W/W	\$65	\$39
E78-14 W/W	\$70	\$42
F78-14 W/W	\$73	\$43
G78-14 W/W	\$76	\$45
G78-15 W/W	\$78	\$46
H78-15 W/W	\$81	\$48
L78-15 W/W	\$85	\$51

\*Plus fed. tax from 1.67 to 3.08 each tire. No trade-in required. Tires mounted at no extra charge.

Save \$6 on heavy-duty shocks.

Sale **9.99** ea.  
Reg. 15.99. Radial Heavy Duty Shock smooths out the ride of radial tires at low speeds, but gives a firm ride with any tire at high speeds.

Shock Installation 1.99 ea. (excluding air & struts.)

JCPenney VISA MasterCard Shop 8:30 am-7 pm—Phone 756-2800

# JCPenney

# 4 days of SALE

- Happens only twice a year for 12 days
- There will be only one markdown
- Markdowns are substantial
- All sale items from regular stock
- All sales cash or credit card
- All alterations are extra
- At all of our fine stores

**Coffman's**  
MENS WEAR

# Oliver Says NL Has More Super Players

## AL Team Had Hopes, But Not The Hits

MONTREAL (AP) — The American League had plenty of hopes. A few more hits might have been more useful.

For the 11th straight time and the 19th in 20 games, the AL fell to the National League in baseball's All-Star Game Tuesday night.

"You think about the streak, but really, tonight, everybody wanted to win and we were intent on winning," California's Reggie Jackson, the American League's starting right fielder, said after the 4-1 setback. "You hope you'll win."

Could it be that the National League relies more on hard work than hope, he was asked.

"When you've lost 18 of 19, you start hoping," Jackson replied.

He kept the American League from being shut out for the first time since 1968 when he lifted a sacrifice fly in the first inning that scored Oakland's Rickey Henderson, who had singled. The AL had eight hits and plenty of other chances but capitalized on none of them.

"Their pitchers pitched well tonight when they had to," said American League Manager Billy Martin of Oakland. "We didn't get the hits at the right time."

Eleven American Leaguers were left on base, and in five innings runners were stranded in scoring position.

"We could have easily scored two or three runs in the first inning or at other times," said Chicago catcher Carlton Fisk. "I don't have any particular theory (about the streak). We had a chance to win this game."

The mood of the American League players was one of disappointment but not extreme sadness. Several players said they weren't embarrassed by the perpetuation of the streak, and Fisk said there was no defeatist attitude on the bench.

He said he didn't think that as the game went on with the American League still trailing, his team, anxious to snap the streak, began pressing.

"I never thought, 'Oh, no. Here it goes again,'" he said.

New York's Dave Winfield, who replaced Jackson in right field, agreed that the American Leaguers didn't feel extra pressure as the loss came closer.

"Maybe teams that lose a lot get down when they're losing, but these guys are all good players and are used to winning," he said. "One swing can change the game. So we were in it down to the wire."

He was at a loss to explain the NL's dominance of the midsummer classic.

"It's like a roll of the dice and it just happens to continually come up the same way," he said.

Kansas City's George Brett, who singled in his two at-bats as the American League's starting third baseman, couldn't shed any new light on the matter.

## SCOREBOARD

Bowling	
Thursday Nite Mixed	
W	L
Team #7	23 5
Western Sizzlin'	19 9
Slayin' Alive	18 10
Low Runners	17 11
High Times	16 12
Team #1	16 12
Bailey's Mart	15 13
Skill #1	13 15
Everett's Shell	13 15
Pair Electronics	13 15
Soul Riders	12 16
Honey Bee's	12 16
Leo Starters	12 16
Stars & Strikes	9 19
All Stars	8 20
Del's Kitchen	6 22
Men's high series & game	
James Manning, 629 & 236	
Women's high series — Ruth Elswick 575; Women's high game — Pat Cannon 265.	

Rec Softball	
Church League	
W	L
Sunshine Girls	26 1/2 5 1/2
Nine Laves	16 16
Hustlers	16 16
Ronnie's Body Shop	13 1/2 18 1/2
Team #6	13 19
Trio	11 21
Women's high game & series — Delores Berg, 200 & 341.	

Major League Leaders	
AMERICAN LEAGUE	
BATTING (175 at bats):	W. Wilson, Kansas City, 344; Hrbek, Minnesota, 332; Harrah, Cleveland, 331; Yount, Milwaukee, 330; Bonnell, Toronto, 325.
RUNS:	R. Henderson, Oakland, 78; Holtor, Milwaukee, 68; Harrah, Cleveland, 67; Evans, Boston, 59; Brett, Kansas City, 57.
HITS:	H. Hrbek, Cleveland, 107; Garcia, Toronto, 106; Yount, Milwaukee, 105; Cooper, Milwaukee, 103; McAra, Kansas City, 101.
DOUBLES:	White, Kansas City, 24; Lynn, California, 23; Evans, Boston, 22; Cooper, Milwaukee, 22; Cowens, Seattle, 22.
TRIPLES:	Herdon, Detroit, 8; Yount, Milwaukee, 8; W. Wilson, Kansas City, 8; Ushaw, Toronto, 6; Brett, Kansas City, 6.
HOME RUNS:	G. Thomas, Milwaukee, 22; Thornton, Cleveland, 20; Re Jackson, California, 20; Cooper, Milwaukee, 19; Ogilvie, Milwaukee, 19.
STOLEN BASES:	R. Henderson, Oakland, 84; Wathan, Kansas City, 26; LeFlore, Chicago, 24; J. Cruz, Seattle, 24; Garcia, Toronto, 20.
PITCHING (11 Decisions):	Vuckovich, Milwaukee, 10-4, 714, 3.09; Zahn,

### F'ville Presbyterian Takes P-P

Farmville Presbyterian led from start to finish to capture the Church League Tournament with a two-round 267 total Tuesday night at the Greenville Putt Putt Golf Course.

Stuart Gordon led Farmville with an 11-under-par 61.

Salem Methodist was second with a 277. Salem was paced by Jeff Taft, who shot a 66.

Arthur Christian finished third with a 292, led by Lanny Morris' 63 while one stroke back was Hopewell Christian in fourth with a 293 total. Danny Pollard paced with a 12-under-par 60, the low round of the tournament.

First Wesleyan finished fifth at 305. Wesleyan was led by Phil Martin with a 69.

Gloria Dei Lutheran rounded out the field, finishing sixth.

**CLIFTON INSURANCE AGENCY**  
 3103 S. Memorial Drive • 756-2220  
 is still in the business of insuring your family and your future

- Auto • Home • Life • Disability
- Commercial • IRA

Ask about our 55% discount on new homes!

Billy Clifton • Open Mon-Fri, 9 to 5:30

**CLIFF'S Seafood House and Oyster Bar**  
 Washington Highway (N.C. 32 Ext.) Greenville, North Carolina  
 Phone 752-3172  
 Wed. & Thurs. Nights

**Popcorn Shrimp . . . . \$2.95**

Takeouts Welcome

MONTREAL (AP) — The National League did it again, and Al Oliver, who has played for both sides, tried to explain why.

Manager Tommy Lasorda's National Leaguers beat the American League in the 53rd All-Star game 4-1 Tuesday night with Dave Concepcion of the Cincinnati Reds, the game's Most Valuable Player, supplying a two-run homer.

Despite their 11th straight victory and 19th in 20 games, the National Leaguers, now leading the series 34-18-1, were again being asked if they are that much better.

Oliver of the Montreal Expos, who played for the AL as a Texas Ranger, sat in front of his locker and tried to shed some light on the subject.

"The difference in both leagues is that while both have super players, the National has more of them," said Oliver, who leads the league in hitting and has knocked in 60 runs.

"I think maybe the personality of the National League players is more outgoing . . . There was no question about it, there was more enthusiasm on our squad."

"Tonight (Tuesday) every time somebody did something, there was nobody sitting down on our bench."

The victory also was a triumph for the once-mighty Cincinnati Reds, who are mired in last place this season in the NL West.

In addition to his homer in the second inning that gave the Nationals a lead they never lost, Concepcion was the middle man in a crucial double play and also reached base on an

error.

Reds' teammate Mario Soto, who pitched four innings Sunday, worked two scoreless innings, striking out four. And Cincinnati reliever Tom Hume retired Texas' Buddy Bell for the final out of the game.

Concepcion said winning the MVP award was one of the great moments of his 13-year career, which includes four World Series and six All-Star games.

He said of the home run, "He (American League starter Dennis Eckersley of Boston) tried to pitch the ball away, but the slider didn't break. It was up and in."

It was only the second home run of the season for Concepcion, one of the "survivors" at Cincinnati.

The Reds have traded or lost through free agency Pete Rose, George Foster, Dave Collins and Ken Griffey.

Soto and Hume shared the relief laurels with the Philadelphia Phillies' Steve Carlton, who worked two innings and struck out four. Carlton started the double play that bailed the Nationals out of the fifth inning.

"We got the American League's fastest runners," Concepcion said of the play on which Oakland's Rickey Henderson and Kansas City's Willie Wilson were retired.

Winning pitcher Steve Rogers of the Expos, who gave up his first runs in seven innings of All-Star pitching, said, "I really didn't have my good rhythm in the first inning. I was fortunate to get out of there, giving up just the one run."

## Legion Title Series To Begin Thursday

Pitt County, the No. 1 seed, and Wilson, the No. 2 seed, will square off Thursday night in the first game of the championship series of the Area I East American Legion tournament.

Game time at Harrington Field is 8 p.m. for the opener of the best-of-five series. Game No. 2 will be played in Wilson Friday night with the third game set for Harrington Saturday night.

A fourth game, if needed, will be played Sunday night in Wilson. A fifth and deciding game, if necessary, will be played Monday night at Guy Smith Stadium because Harrington will be being used for the ECU baseball camp.

Pitt County and Wilson tied for first during the regular season and Pitt Co. won a coin-toss for the tournament's No. 1 seed.

Both teams received first round byes. Pitt County swept Snow Hill (2-0) in its semifinal series while Wilson swept Rocky Mount (2-0) to advance to the title series.

Baseball	
AMERICAN LEAGUE	
Eastern Division	
W	L
Milwaukee	48 37
Boston	49 36
Baltimore	44 38
Detroit	42 41
Cleveland	41 41
New York	39 42
Toronto	37 47
California	49 37
Kansas City	47 37
Chicago	45 37
Seattle	45 41
Texas	35 46
Oakland	38 50
Minnesota	28 58

National League	
Eastern Division	
W	L
Philadelphia	47 38
St. Louis	48 39
Pittsburgh	44 40
Montreal	42 42
New York	40 47
Atlanta	36 53
Chicago	35 53
Los Angeles	46 42
San Francisco	46 47
Houston	37 48
Cincinnati	33 53

Major League Leaders	
AMERICAN LEAGUE	
BATTING (175 at bats):	W. Wilson, Kansas City, 344; Hrbek, Minnesota, 332; Harrah, Cleveland, 331; Yount, Milwaukee, 330; Bonnell, Toronto, 325.
RUNS:	R. Henderson, Oakland, 78; Holtor, Milwaukee, 68; Harrah, Cleveland, 67; Evans, Boston, 59; Brett, Kansas City, 57.
HITS:	H. Hrbek, Cleveland, 107; Garcia, Toronto, 106; Yount, Milwaukee, 105; Cooper, Milwaukee, 103; McAra, Kansas City, 101.
DOUBLES:	White, Kansas City, 24; Lynn, California, 23; Evans, Boston, 22; Cooper, Milwaukee, 22; Cowens, Seattle, 22.
TRIPLES:	Herdon, Detroit, 8; Yount, Milwaukee, 8; W. Wilson, Kansas City, 8; Ushaw, Toronto, 6; Brett, Kansas City, 6.
HOME RUNS:	G. Thomas, Milwaukee, 22; Thornton, Cleveland, 20; Re Jackson, California, 20; Cooper, Milwaukee, 19; Ogilvie, Milwaukee, 19.
STOLEN BASES:	R. Henderson, Oakland, 84; Wathan, Kansas City, 26; LeFlore, Chicago, 24; J. Cruz, Seattle, 24; Garcia, Toronto, 20.
PITCHING (11 Decisions):	Vuckovich, Milwaukee, 10-4, 714, 3.09; Zahn,

National League	
Western Division	
W	L
Milwaukee	48 37
Boston	49 36
Baltimore	44 38
Detroit	42 41
Cleveland	41 41
New York	39 42
Toronto	37 47
California	49 37
Kansas City	47 37
Chicago	45 37
Seattle	45 41
Texas	35 46
Oakland	38 50
Minnesota	28 58

National League	
Western Division	
W	L
Philadelphia	47 38
St. Louis	48 39
Pittsburgh	44 40
Montreal	42 42
New York	40 47
Atlanta	36 53
Chicago	35 53
Los Angeles	46 42
San Francisco	46 47
Houston	37 48
Cincinnati	33 53

Major League Leaders	
AMERICAN LEAGUE	
BATTING (175 at bats):	W. Wilson, Kansas City, 344; Hrbek, Minnesota, 332; Harrah, Cleveland, 331; Yount, Milwaukee, 330; Bonnell, Toronto, 325.
RUNS:	R. Henderson, Oakland, 78; Holtor, Milwaukee, 68; Harrah, Cleveland, 67; Evans, Boston, 59; Brett, Kansas City, 57.
HITS:	H. Hrbek, Cleveland, 107; Garcia, Toronto, 106; Yount, Milwaukee, 105; Cooper, Milwaukee, 103; McAra, Kansas City, 101.
DOUBLES:	White, Kansas City, 24; Lynn, California, 23; Evans, Boston, 22; Cooper, Milwaukee, 22; Cowens, Seattle, 22.
TRIPLES:	Herdon, Detroit, 8; Yount, Milwaukee, 8; W. Wilson, Kansas City, 8; Ushaw, Toronto, 6; Brett, Kansas City, 6.
HOME RUNS:	G. Thomas, Milwaukee, 22; Thornton, Cleveland, 20; Re Jackson, California, 20; Cooper, Milwaukee, 19; Ogilvie, Milwaukee, 19.
STOLEN BASES:	R. Henderson, Oakland, 84; Wathan, Kansas City, 26; LeFlore, Chicago, 24; J. Cruz, Seattle, 24; Garcia, Toronto, 20.
PITCHING (11 Decisions):	Vuckovich, Milwaukee, 10-4, 714, 3.09; Zahn,

# THE GREAT AMERICAN TIRE SALE!

**25% OFF!**  
 AMERICAN EAGLE RADIAL!  
 Discontinued Design  
 Save 25% on all sizes in stock  
 While supplies last. Sorry—no rainchecks

**PERFORMANCE RADIALS!**  
 SAVE ON EAGLE ST—NOW THRU SATURDAY  
 Double-belted gas-saver radial for street machines and vans

**POLYGLAS SALE!**  
 Sale prices on all Cushion Belt Polyglas sizes. If it doesn't say Goodyear, it can't be Polyglas!  
 NOW THRU SATURDAY

**LIGHT TRUCK/RV TIRE SALE!**  
 Save on all sizes. Sizes for pick-ups, panels, vans, campers, RV's, 4WD's  
 NOW THRU SATURDAY

**...Plus These Tires & Services At Everyday Low Prices!**

SIZE	EVERYDAY BLACKWALL PRICE	PLUS-FET & OLD TIRE
A78-13	\$32.00	\$1.42
B78-13	\$35.45	\$1.53
D78-14	\$40.25	\$1.70
E78-14	\$41.25	\$1.80
G78-15	\$46.20	\$2.35
H78-15	\$48.30	\$2.54

Other sizes also low priced. Whitewalls slightly higher.

**Viva Radial**

SIZE	EVERYDAY WHITETALL PRICE	PLUS-FET & OLD TIRE
P155/80R13	\$44.95	\$1.44
P175/80R13	\$48.55	\$1.64
P185/80R13	\$50.75	\$1.78
P195/75R14	\$59.45	\$2.06
P225/75R15	\$72.50	\$2.70

**Arriva Radial**

SIZE	EVERYDAY BLACKWALL PRICE	PLUS-FET & OLD TIRE
P155/80R12	\$48.00	\$1.39
P145/80R13	\$49.45	\$1.36
P155/80R13	\$51.80	\$1.52
P165/80R13	\$55.35	\$1.67
P175/80R13	\$57.80	\$1.74
P185/80R14	\$55.35	\$1.73

Other sizes also low priced.

**Lube & Oil Change \$9**  
 Includes up to 5 qt. major brand motor oil • Most U.S. cars, many imports and light trucks • Oil filter extra, if needed • Please call for an appointment.  
 Diesel oil capacity and filter type may result in extra charges.

**12-Month Tune-Up \$44**  
 Electronic Ignition Systems  
 Includes up to 3 free engine analyses and tune-up adjustment anytime within one year.  
 • Most U.S. cars, many imports and light trucks • Additional parts and services extra, if needed • Check charging, starting and engine systems • Install new rotor, new spark plugs • Set timing to recommended specs  
 Standard ligation. Add \$8.00 for additional points, condenser and labor.

**GUARANTEED 12 FULL MONTHS SEE STORE MANAGER FOR LIMITED WARRANTY DETAILS**

**GOODYEAR Guaranteed Auto Service**  
 COME UP TO GOODYEAR QUALITY & INNOVATION

**Brake Service \$88**  
 Includes: Install new front grease seals, pack front wheel bearings, inspect hydraulic system, add fluid, road test.  
**2-Wheel Front Disc:** Install new front brake pads, resurface front rotors, inspect calipers.  
 OR  
**4-Wheel Drum:** Install new brake lining and resurface all four drums.

Warranted 12 months or 12,000 miles, whichever comes first.

**GOODYEAR AUTO SERVICE CENTERS**  
 Car card for identification and honored only at Goodyear Auto Service Centers.  
 Use any of these ways to buy: Goodyear Revolving Charge Account • MasterCard • VISA • American Express • Carte Blanche • Diners Club • Cash

**WE SERVICE NATIONAL ACCOUNTS**

**729 Dickinson Ave. - Phone 752-4417**  
 Open Mon.-Fri. 7:30 to 6  
 Open Sat. 7:30 to 5  
 Carol Clark, Manager

# NFL Talks

## Owners' Proposal To Extend Contract Being Considered By Players

NEW YORK (AP) — A request by National Football League club owners that the current contract be extended beyond Thursday's deadline was being considered by union leaders as the two sides met for a second day in a row.

Jack Donlan, executive director of the NFL Management Council and the club owners chief negotiator, said if there is no extension, no unsigned player will be allowed into training camp.

Donlan said at last count there were 99 rookies and 71 veterans who had not been signed. The Baltimore Colts

will be the first team to open camp on Friday, with the others to open next week.

Union negotiators made no immediate response to the extension request, and said it would be discussed at today's session.

Ed Garvey, the union's executive director, said as he understood management's position, unsigned veterans could agree to accept a team's latest offer, or 110 percent of last year's salary, even after the July 15 deadline and still attend training camp.

Rookies could also accept a team's last offer after July 15

and report to camp.

"But all the players have to have signed contracts before they start working out," Garvey said.

The team owners at Tuesday's session, the first in more than a month, presented a package of proposals for a new contract.

Management offered to liberalize the game's free agent system, increase both minimum salaries and postseason pay and provide improved insurance benefits.

Players representatives,

however, did not like the offer.

"It's totally insulting," said Gene Upshaw of the Oakland Raiders, president of the players association.

Dick Berthelsen, general counsel for the union, said the offer was "essentially the same as they gave us in Miami in February." He said that according to his side's calculations, the new offer would result "in the owners spending less on the players in 1982 than they did in 1981."

Donlan, meanwhile, saw the offer as a good place to start bargaining.

"We took the existing contract and built upon it," said Donlan, after presenting the package of proposals during the first of three planned days of negotiations. "We feel this proposal is a basis for a settlement, but the response from the union was very distressing."

The owners' pay proposal, a \$50,000 minimum salary for a fifth-year player and \$30,000 for a rookie, is far less than \$140,000 for fifth-year players and \$75,000 for rookies that the players want.

## 1st Federal, Optimist, UC Top LL Teams

League regular season and tournament champ First Federal had four players named to the Tar Heel League All-Star team while Optimist and Union Carbide each had three players picked to the North State All-Star team, it was announced on Tuesday.

Stacy Best, Mark Holloman, John Bolen and William Dyer all were named to the 14-man team. Four other players were picked as alternates, including Frankie Pugh from First Federal.

Carroll & Associates had three players selected: Lloyd May, James Lawler and Billy Carr.

Wellcome, Moose and True Value each had two players picked to the team. Named from Wellcome were Greg Vanscoy and Dallas McPherson while Jay Mattox and L.L. Everett was picked from Moose.

Bobby Bell and Chris Bender were selected from True Value.

Mike Kelly from Pepsi-Cola rounds out the team.

Alternates were Pugh, Wesley Jackson from Moose, Peter Rivera from Pepsi and Chris Brown from Wellcome.

On the North State squad were Jeff Mahoney, Joel Pierce and Terrance Cherry from Optimist and Kevin Fisher, Morris Johnson and Billy Turcotte from Union Carbide.

UC was the regular season champion. Kiwanis, the tournament champ, had two players on the team, as did Coca-Cola, Lions and the Jaycees.

Named from Kiwanis were Robbie McDonald and Jon Chambliss while Tony Evans and Jay Surlis were picked from Coke. Tom Moye and Jarvis Groome were tabbed from the Lions and Bryan Pierce and Brian Willie were named from the Jaycees.

Alternates were David Tinglestad and Nelson Galloway from Optimist, Curtis Jones from Kiwanis and Darrell Joyner from UC.

## Kiwanis Wins...

(Continued from page 17)

the District 7 South Area tournament last night, whipping Plymouth, 13-3.

Southern Pitt, which defeated Aurora, 24-13, in its series opener, will play Washington here tonight with the winner gaining a berth in the finals of the double-elimination.

Willie Little paced Southern Pitt's win with three hits. No one else for S. Pitt had more than one hit.

Paul Jackson was the winning pitcher.

**Babe Ruth**

Kiwanis ..... 11

Winterville ..... 8

FARMVILLE — Kiwanis defeated Winterville, 11-8, Tuesday night to win the Coastal Plains South Babe Ruth tournament here.

Winterville defeated Kiwanis, 12-11, earlier in the day to force a second and deciding game to determine the tournament champ.

Further details were not available.



Cool On The Course

Golfer Jack Nicklaus nibbles an ice cream cone during his practice round Tuesday for the British Open that begins Thursday in Troon. (AP Laserphoto)

## Nicklaus, Watson On Mend For Open

TROON, Scotland (AP) — Jack Nicklaus and Tom Watson, on the list of the walking wounded earlier in the week, are on the mend and ready to hook up in another duel, this time in the 111th British Open golf championship.

The ancient event begins its 72-hole run Thursday on the Royal Troon Links, stretching some 7,067 yards through gorse and heather along the Firth of Clyde. The most international of all the world's major events, it has drawn a field of 150 players from 27 nations.

Aside from the host British, the largest contingent, 32, is from the United States, the nation that has dominated this event in the years since World War II.

Leading that deeply talented contingent are Nicklaus and Watson, who engaged in a final holes confrontation for the U.S. Open only four weeks ago, with Watson winning on a dramatic, chip-in birdie on the 71st hole.

And, it would be no surprise if, when the British Open comes down to its last few holes Sunday afternoon, it is still another Nicklaus-Watson matchup.

Recent history says it's very likely. Either Nicklaus or Watson has been first or second in six of the last seven British Opens and, in 1977, only a few miles down the coast, engaged in that incredible shootout at Turnberry, with Nicklaus playing the last two rounds 65-66 and losing to Watson's closing 65-65.

Britain's legal bookies agree it could happen again. On the eve of the championship, Watson was installed as the 4-1 favorite and Nicklaus listed as the second choice at 5-1.

Each is seeking a fourth British Open title, which would match the most by an American. And each comes into this one with his game in order, with confidence and enthusiasm high and despite a scare early in the week with no physical problems.

Watson skipped practice Sunday with the recurrence of a chronic problem with the little finger on his left hand. He couldn't grip the club.

"Everything's fine now," he said Wednesday, however. "I just took some aspirin and it cleared up. I've been able to play practice rounds the last two days. No trouble."

Nicklaus, too, had some physical problems.

"I had a touch of the flu over the weekend," he said Wednesday. "I'm over it now. Just a little weak, and that's clearing up, too." Watson, now the winner of six major professional titles, has taken three American events this season, is second on the year's money-winning list and is chasing a fifth Player of the Year title.

Nicklaus, 42, has collected a record 17 major professional titles, including four U.S. Opens, five PGA's, five Masters and three British Opens.

Seve Ballesteros of Spain represents the chief non-American threat. But the mercurial young Spaniard said he is having trouble with his swing and lacks confidence.

## Junior Net Tournney To Begin Thursday

The USTA sanctioned Junior Tennis Championships, featuring 83 players from North and South Carolina, gets under way Thursday morning at the River Birch Tennis Center.

Play gets started tomorrow at 9 a.m. for boys and girls in the age groups of 14 and under, 16 and under and 18 and under. Matches will continue throughout the day Thursday and Friday until 7:30.

Eight-three juniors from the two Carolinas are entered in the various age groups.

Among the seeds are two Greenville players: Anne-Lynn Davis in the 16 and under group and Martha Taylor in the 14 and under.

Davis is scheduled to play her first match Thursday at 1:30. Martha Taylor will play her first match Thursday at 3 p.m.

Other seeded players are:

Boys 18 & under — Brian Weil of Goldsboro and Greg Loyd of Raleigh; Girls 18 & under — Kim Scott of Rocky Mount.

Boys 16 & under — Matt Diemar of Wilson and Clay Maynor of Tarboro; Girls 16 & under — Kristy Weathers of Southern Pines, Marry Katherine Moore of New Bern and Tracy Vann of Fayetteville.

Boys 14 & under — John Kang of Wilson; Girls 14 & under — Cindy Dawson of Kinston, Marcia Geiger of Wilmington and Tonja Damon of Salisbury.

For more information contact the River Birch Tennis Center at 756-9343.

For All Your Fencing Needs CALL 752-2736 FOR FREE ESTIMATES Whitehurst & Sons Fence Co.

FARMER'S HOME A SPECIALTY!

We've been helping families qualify for Farmer's Home loans with the same staff for over twelve years! Our experience can work for you too.

EXCELLENT FLOOR PLANS  
40 YEARS OF BUILDING EXPERIENCE  
YOU CHOOSE COLORS, CARPET, WALLPAPER

Call Now for Complete Details  
752-2814

**The Evans Company**  
Of Greenville, Inc. 701 W. Fourteenth St.

# OUR BIG PARTY SIZE MAKES VERY GOOD TONICS, MARTINIS AND SENSE.

Give your parties plenty of good taste with Canada Dry Gin in the convenient, economical 1.75-liter party size.



CANADA DRY GIN

# Choose from hundreds of men's clothing Things to do tomorrow

1. Get-up bright and early!
2. Dress comfortably, sensibly.
3. Eat a hearty, nourishing breakfast.
4. Wear sneakers.
5. Don't forget your pocketbook.
6. Get to Brody's on time.

All summer merchandise is on sale! Choose hundreds of men's items at great prices! Hurry in while the selection is still good.

Groups Of **Men's Summer Suits** ..... 1/4 to 1/3 Off

Groups Of **Men's Summer Sportcoats**..... 1/4 to 1/3 Off

Groups Of **Men's Dress Shirts** ..... 1/4 to 1/3 Off

Groups Of **Men's Neckwear**..... 1/4 to 1/3 Off

Entire Stock **Men's Shorts** ..... 1/4 to 1/3 Off

Entire Stock **Swimwear** ..... 1/4 Off

Group Of **Men's Shoes** ..... 1/4 Off

Groups Of **Men's Summer Knit Shirts** ..... 1/4 Off

"Like no other men's store..."

# brody's

for men

CLASSIFIED ADS will go to work for you to find cash buyers for your unused items. To place your ad, phone 752-6166.

© 1981, Seize-Welby Distillery, Louisville, Kentucky. Gin 80 Proof, 100% Grain Neutral Spirit.

## Quad Cities May Lose Hoch

COAL VALLEY, Ill. (AP) — The Quad Cities Open may lose Scott Hoch, the only one of pro golf's current top 20 money-winners entered in this \$200,000 tournament beginning Thursday.

Hoch, the 1980 Quad Cities champion, has been hampered by a mysterious chest injury. He was considering withdrawing because of it.

"I don't know how it happened. I've had it for the past week or so," said Hoch, rubbing his chest Wednesday. "I may have pulled a muscle."

Hoch was one of five former Quad Cities champions entered in this 10-year-old PGA Tour stop. The others who will compete are Roger Maltbie (1975), Mike Morley (1977), Victor Regalado (1978), D.A. Weibring (1979) and Dave Barr.

Barr, a Canadian, won last year's title in a five-way sudden death playoff involving Woody Blackburn, Frank Conner, Dan Hallderson and Regalado.

Barr parred the eighth extra hole to eliminate Blackburn, his last competition before his first American championship.

Even with only three of the top 40 money-winners — four if Hoch plays — the Quad Cities stop has a uniqueness about it this time.

All four of last week's tournament winners are competing for the first prize of \$36,000 over the par-70, 6,514-yard Oakwood Country Club layout.

Calvin Peete won the Greater Milwaukee Open, Miller Barber the U.S. Senior Open, Bob Byman the Scandinavian Open and Jim Thorpe the Canadian PGA.

Ironically, Thorpe beat Barr in three holes of sudden death for the Canadian crown.

## VMI Tailback Allen Hoping To Prove Doubters Wrong

RALEIGH (AP) — Virginia Military Institute tailback Floyd Allen, once spurned by Atlantic Coast Conference schools, says he's determined to play pro football.

"I am going to play pro football," said the 6-foot, 188-pound Allen, whom scouts consider too small for the National Football League.

"There is no doubt in my mind that I will make it. It

may be in the NFL, the Canadian Football League or the new United States Football League, but I will play professional football."

VMI coach Bob Thalman is also confident that Allen will succeed.

"If he gets a fair opportunity, Floyd's got the ability to get the job done," Thalman said. "He's a real durable player and he has excellent hands which would be an asset to him in the pros."

"But the biggest thing Floyd has going for him is that he is a winner," Thalman added.

Allen said he first plans to complete his degree in economics from VMI.

"Pro football is a goal for me, but it's not on the top of my list," said Allen, keeping himself in shape by working out at a local fitness center. "I feel that an education will be more beneficial to me in the long run than football will be."

Rejection is nothing new to Allen, since he was told by college recruiters that he was too small, too short and too slow. His worth improved, however, after a high school all-star football game in which he scored the game-winning touchdown on offense and intercepted three passes as a defensive back.

Allen said schools in the Atlantic Coast Conference began to show an interest in him following that game, but added that his mind was made up for VMI. He said he does not regret that decision.

"I'm sure I might have gotten more publicity at some other school, but I learned a lot about life at VMI," Allen said.

"Plus, I made a lot of business contacts there — contacts that I don't think I could have made at other schools — that will help me later in life."

Allen's 3,569 yards easily established him as the greatest Keydet rusher in the school's history. He also established school records for career rushing attempts (860), rushing touchdowns (27) and total touchdowns (29).

Perhaps Allen's most notable achievement was his selection as outstanding offensive player in the state of Virginia in 1979 and 1980, beating out Virginia Tech's Cyrus Lawrence and Richmond's Barry Redden.

Redden was a first-round draft pick in the NFL.

## Pirates Sign 6 Swimmers

First-year East Carolina swim coach Rick Kobe has signed six athletes in his initial recruiting class.

Kobe became head coach when Ray Scharf resigned after 15 years at the Pirate helm.

Highlighting Kobe's male signees is Dan Booth of Elkton, Md. Booth is a 6-1, 170-pound breaststroke specialist who also swims the individual medley events. Booth, Kobe said, is ECU's most talented multi-event swimmer in the history of the school.

Also joining the men's team are Chris Pittelli of Cranbury, N.J., and Eric Sebnick of Lake City, S.C.

Pittelli, a 6-0, 155-pounder, will be the top freshman sprinter and has the potential to serve on all three relays.

Sebnick is a transfer from Appalachian State and is the reigning Southern Conference champ in the 100-yard breaststroke.

Michele Joyner, a San Antonio native, heads the three women recruits. Joyner has six personal bests that are better than existing ECU varsity records and, Kobe insists, Joyner is a "sure bet to score at the Nationals."

Sandra Schneider, a transfer from Daytona Beach Community College, and Joanne McCulley of Adphia, Md., round out the list of recruits.

Schneider is a junior college all-America whose team won the national junior college tournament last year. She has six times under existing varsity records in the freestyle and backstroke events.

McCulley, a breastroker, holds two personal bests better than curren ECU marks.



Rogers Admits Cocaine Use  
NFL Rookie of the Year George Rogers (right) sits at a table with New Orleans coach Bum Phillips (center) and lawyer Ed Holler at a news

conference in New Orleans yesterday. All three men read a statement about Rogers' use of cocaine and then left without answering questions. (AP Laserphoto)

## Rogers Admits Using Cocaine

NEW ORLEANS (AP) — George Rogers, the New Orleans Saints' No. 1 draft choice and the National Football League's Rookie of the Year, admits he has used cocaine but won't do it again.

"I made a mistake and it will never happen again," Rogers told a news conference Tuesday in his first public response to reports of his drug use.

"I am sorry for what I did," he said. "I made a mistake, and I have to live up to that."

Rogers, who led the NFL in rushing and set a rookie record with 1,674 yards for the Saints last season, said he underwent testing and treatment for drug abuse last week at a Florida clinic.

His attorney Ed Holler and Saints Coach Bum Phillips also appeared at the news conference, but neither would answer any questions regarding the cocaine scandal surrounding the team and the NFL.

Phillips said it was probably the most important news conference he had ever attended.

"I've been to a whole lot of press conferences in my years in sports — some bad, some good," he said. "I've never been to one as important as I think this one is."

"I think it's important for this football team, this town, the NFL."

"But it's more important for a bunch of individuals who have made a mistake — but not a mistake that can't be rectified."

Holler described Rogers' involvement with the drug as "a brief recreational use of cocaine."

Published reports last month quoted unnamed sources as saying Rogers told a federal grand jury in New Orleans he spent \$10,000 on cocaine last season.

# Summer Sale!

# Firestone SUPERSTEEL!

FIRESTONE'S BEST ... FOR LESS!

## 721° Steel Belted Radial

Tough Prices To Beat!

SALE ENDS JULY 17TH

Four  
721° Radials  
**\$149<sup>00</sup>**  
For  
or \$39.95 Each  
Size 185/80R13 or 175/80R13  
(Plus \$1.69 to \$1.98 f.o.t.)

Four  
721° Radials  
**\$159<sup>00</sup>**  
for  
or \$44.95 each  
Size 185/80R13 or 195/70R13  
(Plus \$1.69 to \$1.98 f.o.t.)

Four  
721° Radials  
**\$179<sup>00</sup>**  
for  
or \$49.95 each  
Size 175/75R14 or 185/75R14  
(Plus \$1.83 to \$2.47 f.o.t.)

Four  
721° Radials  
**\$179<sup>00</sup>**  
for  
or \$49.95 Each  
Size 205/75R15  
(Plus \$1.83 to \$2.47 f.o.t.)

Four  
721° Radials  
**\$229<sup>00</sup>**  
For  
or \$59.95 Each  
Size 195/75R14, 205/75R14  
(Plus \$2.18 to \$3.01 f.o.t.)

Four  
721° Radials  
**\$249<sup>00</sup>**  
For  
or \$64.95  
225/75R15 or 235/75R15  
(Plus \$2.18 to \$3.01 f.o.t.)

## Firestone DELUXE CHAMPION RADIAL BLACKWALL

4 Radials  
For  
**\$199<sup>00</sup>**  
Or \$9.95 Each  
215/75R-15  
225/75R-15  
Plus Tax  
2.49 to 2.70

4 Radials  
For  
**\$139<sup>00</sup>**  
Or \$9.95 Each  
15580R-13  
17580R-13  
18575R-15  
Plus Tax  
1.44 to 2.15

4 Radials  
For  
**\$159<sup>00</sup>**  
Or \$44.95 Each  
18580R-13  
20575R-15  
Plus Tax  
1.78 To 2.38

### MONROE-MATIC® Shocks can make your summer driving more enjoyable!

### Front-end alignment

**\$11<sup>99</sup>**

All American cars except Chevies and compacts with front wheel drive and/or MacPherson suspension.

We'll set caster, camber and toe-in to manufacturer's original specifications. No extra charge for cars with factory air or torsion bars. Parts extra, if needed. Call for your appointment.

### Airconditioning service

**\$12<sup>95</sup>**

We'll check your system including pressure and leak tests; recharge the system. If needed, freon refrigerant oil and DELCO PARTS are extra.

### Muffler Center

Installed By Our Experts

LOW, LOW PRICES ON CUSTOM MUFFLER WORK FOR AMERICAN & FOREIGN CARS, PICK-UPS, VANS, LARGE TRUCKS AND MOTOR HOMES.

Galvanized, double-wrapped mufflers

For many compacts and import cars **\$27<sup>88</sup>** For many standard American cars **\$29<sup>88</sup>**

# PUGH'S

Tire & Service Center, Inc.

SERVING GREENVILLE FOR OVER 30 YRS.  
COMPLETE FARM & ROAD SERVICE  
OFFICIAL N.C. INSPECTION STATION

Corner 5th & Greene Sts.  
752-6125

QUALITY CAR SERVICE BY PROFESSIONAL MECHANICS

## Roberts Produce

- Watermelons
- Cantaloupes
- Vine Ripened Tomatoes
- Corn
- Peaches
- Plums
- Yellow Squash
- Zucchini Squash
- Butternut Squash
- Acorn Squash
- Cucumbers
- Onions
- Red Potatoes
- White Potatoes
- Bananas

- Apples
- Lettuce
- Nectarines
- Butter Beans
- Snap Beans
- Shelled Butter Beans
- Okra
- Honey
- Molasses
- Maple Syrup
- Bell Pepper
- Hot Pepper
- Decorative Baskets
- Canning Vegetables
- Canning And Freezing Produce

Special Wed.-Sunday  
Watermelons 2.00 Each

Evans St. And 264  
Across From Union Carbide

# STRETCH

YOUR FOOD DOLLARS HERE!

AT THE

## NEW FOOD KING

On Highway 33 In Chocowinity  
With Hundreds & Hundreds Of Everyday Low Prices

PRICES  
EFFECTIVE  
JULY 15TH,  
16TH & 17TH,  
1982



DAILY  
SPECIALS  
IN OUR  
HOT DELI  
& BAKERY

Quantity  
Rights Reserved  
- None Sold  
To Dealers

### Meat

FRESH LEAN  
**GROUND CHUCK**

5 LBS. OR MORE **\$1.39** LB.

BONELESS WHOLE  
**RIB EYE LOINS**  
**\$3.29** LB.

BONELESS  
**RIB EYE STEAK**  
**\$3.59** LB.

**1/4 FRYER LEG** **69¢** LB.

**1/4 FRYER BREAST** **79¢** LB.

### SMOKED PICNICS

WHOLE..... **79¢** LB.

SLICED..... **89¢** LB.

BONELESS CHUCK ROAST..... **\$1.49** LB.  
BONELESS SHOULDER ROAST..... **\$1.59** LB.  
BONELESS CHUCK STEAK..... **\$1.89** LB.  
BONELESS SHOULDER STEAK..... **\$1.99** LB.  
BONELESS STEWING BEEF..... **\$1.79** LB.

GWALTNEY BACON..... **\$1.59** 1 LB. PKG.  
GWALTNEY GREAT DOGS..... **79¢** 12 OZ. PKG.  
GWALTNEY COOKED HAM..... **\$1.49** 6 OZ. PKG.

FRESH PORK EARS..... **49¢** FAMILY PACK  
FRESH PORK NECK BONES..... **49¢** FAMILY PACK

### CLIP THESE Money-Saving Coupons

<p><b>*COUPON*</b></p> <p><b>KRAFT MAYONNAISE</b></p> <p>32 OZ. JAR</p> <p><b>89¢</b></p> <p>Limit One (1) Per Customer With Food King Coupon &amp; \$10.00 Or More Food Order. Expires 7/17/82.</p>	<p><b>*COUPON*</b></p> <p><b>BEECH NUT STRAINED BABY FOOD</b></p> <p>3 OZ. JAR</p> <p><b>10¢</b></p> <p>Limit One (1) Per Customer With Food King Coupon &amp; \$10.00 Or More Food Order. Expires 7/17/82.</p>	<p><b>*COUPON*</b></p> <p><b>DELTA PAPER TOWELS</b></p> <p>JUMBO ROLL</p> <p><b>29¢</b></p> <p>Limit One (1) Per Customer With Food King Coupon &amp; \$10.00 Or More Food Order. Expires 7/17/82.</p>
--	---	--

### Produce

WHITE  
**POTATOES**  
**\$1.49** 10 LB. BAG

YELLOW  
**ONIONS** NO. 1 MEDIUM **99¢** 3 LB. BAG

FRESH  
**BROCCOLI** **69¢** BUNCH

**PLUMS**..... **79¢** LB.

**NECTARINES** **59¢** LB.

HONEYDEW  
**MELONS**... **79¢** EACH

STOKELY  
**GATORADE**  
**49¢** 32 OZ. JAR

**TREND DETERGENT**  
**\$3.49** FAMILY SIZE BOX

MAXWELL HOUSE  
**COFFEE**  
**\$2.39** 1 LB. BAG

MAXWELL HOUSE  
**INSTANT COFFEE**  
**\$2.69** 6 OZ. JAR

TROPICANA  
**ORANGE JUICE**  
**\$1.39** 1/2 GALLON

- KELLOGG'S FROSTED FLAKES 20 OZ. BOX **\$1.59**
- EVER READY FLOUR..... 5 LB. BAG **79¢**
- ROYAL JELLO..... 3 OZ. PKG. **5/\$1.00**
- ROYAL PUDDING..... 4 OZ. PKG. **4/\$1.00**
- KRAFT AMERICAN CHEESE SINGLES..... 12 OZ. PKG. **\$1.49**
- SUGAR CREEK BUTTER..... 1 LB. PKG. **\$1.79**
- CORNED BEEF..... 12 OZ. CAN **\$1.29**
- TEXAS PETE HOT DOG CHILI..... 10 OZ. CAN **3/\$1.00**
- PILLSBURY HUNGRY JACK INSTANT POTATOES..... 8 OZ. BOX **2/\$1.00**
- DAWN LIQUID DETERGENT..... 22 OZ. BTL. **\$1.19**

**PEPSI COLA**  
2 LITER DRINKS  
**99¢** EACH

LIPTON  
**TEA BAGS**  
100 COUNT  
**\$1.59**

LIMIT ONE WITH \$10.00 OR MORE FOOD ORDER.

**FROZEN FOOD**

BANQUET  
**CREAM PIES** 14 OZ. PKG. **2 FOR \$1.00**

CHOCOLATE, COCONUT, LEMON, STRAWBERRY OR BANANA

**COUNTRY TIME**  
LEMONADE, LEMON-LIME OR PINK LEMONADE  
10 QT. CAN **\$3.19**

**COCA-COLA, MELLO-YELLO OR TAB**  
12 PACK CAN DRINKS **\$2.99**

BANQUET  
**SUPPERS** 2 LB. PKG. **\$1.39**

TURKEY, SALISBURY STEAK, CHICKEN & DUMPLIN' OR CHICKEN & NOODLE

EATWELL  
**MACKEREL** TALL CAN

SEALTEST LIGHT 'N LIVELY  
**YOGURT** 8 OZ. CUP

**2 FOR \$1.00**

**4 FOR \$1.00**

**LUVS DIAPERS**  
SMALL-24 COUNT  
MEDIUM-18 COUNT  
LARGE-12 COUNT  
**\$2.99**

AWAKE ORANGE  
**DRINK** 12 OZ. CAN **69¢**

FROZEN SHOE STRING  
**POTATOES** 20 OZ. BAG **3/\$1**

TOWN TALK  
**ICE CREAM** 1/2 GAL. **\$1.19**



# Biologists Offer Plan To Halt Condor's Slide To Extinction

By ROBERT LOCKE  
AP Science Writer

LOS ANGELES (AP) — An ambitious plan to stem the California condor's rapid slide toward extinction faces another round of controversy as federal biologists seek permission to take chicks and eggs from the huge birds' lofty nests.

The request to the California Fish and Game Commission comes after four months of trapping failed to produce a single condor for the U.S. Fish and Wildlife Service's proposed captive breeding program.

"It appears California condors may be rather difficult to trap and we are concerned we can't get enough birds through trapping to get a captive flock going fast enough," said biologist Randy Perry of the federal agency's Patuxent Wildlife Research Center in Laurel, Md., head of the service's endangered species field program.

"We are asking to have the option of taking eggs and-or nestlings in order to initiate the captive flock" to produce birds for returning to the wild, Perry said in a telephone interview Monday.

Fewer than 30 of the condors — wide-ranging vultures that soar over the central and southern California mountains on wings that can span nine feet — still survive of the species that once ruled the Western skies from Canada to Mexico. All sides agree extinction is an imminent threat and a mistake could seal the condors' fate. The emotional debate is over strategy.

"There are risks in taking birds from the wild into captivity," Perry said. "But you have to weigh those risks, which we feel are relatively small and can be controlled, against the greater risk of doing nothing and watching the species slowly slip into extinction."

David Phillips, wildlife programs coordinator for Friends of the Earth, points to the death of a condor chick in June 1980, as it was being weighed and measured by a member of the condor recovery team.

He said the latest request "is an absolutely unwarranted risk to condors. The biologists have hurt more than helped ... in a risky effort to try to pull them out of the wild and raise them in zoos."

Phillips also said the environmental group that leads opposition to the plan does "not propose doing nothing (although) some people have misconstrued our position to say we think the condor should die with dignity. We think we should try to protect the habitat and give our best shot at propagating condors in the wild (rather) than go with this high-risk, high-tech gamble on a zoo population."

The decades-long recovery program envisions raising condors at the Los Angeles and San Diego zoos and monitoring radio-tagged birds to study their habits in hopes of discovering why the population loses an estimated two adult birds a year. The National Audubon Society is working with the Fish and Wildlife Service on the project.

Perry said the new proposal, which the state commission is to consider at its August meeting, would permit the capture of up to one adolescent or adult bird, two nestlings and three eggs.

Permission to capture three free-flying but non-breeding birds and to trap and tag two others with radio transmitters came only after a stormy public hearing last year followed by lengthy negotiations and compromise between state and federal wildlife officials.

Captured chicks "would only be handled to the extent that



California Condor

they'd be put into a suitable container for transport to one of the zoos," Perry said. He contends experience with a closely related species, the Andean condor, shows chicks survive well in captivity.

Taking eggs and nestlings would "penalize the wild flock" less than removing young adults, he said.

Condors normally lay only one softball-sized egg every two years. With many birds, when a breeding pair loses an egg it often lays another, a process biologists call double-clutching. This past year two wild condors replaced an egg that had been destroyed.

Double-clutching, the argument goes, would allow at least one egg for hatching in an incubator and another for the parents to handle, doubling the pair's output.

### LOTS OF BOOKS

ROCHESTER, N.Y. (AP) — The University of Rochester owns one of the world's largest collections of dime novels — 11,000 in paperback and about 3,000 on microfilm. The novels are consulted by researchers seeking examples of popular tastes and values of the late 19th and early 20th centuries. Included is every work by Horatio Alger Jr., famous for his "rags to riches" heroes. Many of the books originally cost 5 or 10 cents. Today some bring \$200 to \$300.

*A Sparkling Offer from Canada Dry. Save up to \$6.97*



Save on Canada Dry and other fine products for your home entertaining.

### \$1.00 Refund

On Canada Dry's Sparkling Beverages — Canada Dry Ginger Ale, Canada Dry Club Soda, Canada Dry Tonic Water, Canada Dry Seltzer.

Mail to: Canada Dry Sparkling Offer, P.O. Box 94423, St. Louis, MO 63194.

To get your \$1.00 refund coupon good toward your next purchase of Canada Dry Mixers plus additional coupons good on other quality merchandise, send 4 (four) proofs of purchase (check labels for book labels of case mixers from any family size bottles of Canada Dry Ginger Ale, Club Soda, Tonic Water or Seltzer (28-oz. 3/2-oz. size) and/or 2 (two) proofs of purchase from 2-liter Canada Dry Ginger Ale (Regular or Sugar Free). Refunds require the use of this official form. No taxolimit will be accepted. One refund per family or group.

NAME \_\_\_\_\_  
ADDRESS \_\_\_\_\_  
CITY \_\_\_\_\_ STATE \_\_\_\_\_ ZIP \_\_\_\_\_

Allow 4-8 weeks for delivery. Void where prohibited or restricted by law. Offer good in the U.S.A. only. Offer ends December 31, 1982.

CD-NAT-MX0582 DM

Take advantage of the Canada Dry \$1.00 refund offer and you'll also receive coupons that will save you money on these other quality brands.



12¢ off any purchase of Kraft Jet-Puffed Marshmallows

15¢ off Heinz Barbecue Sauce

15¢ off a package of Nabisco Wheatworth Crackers

25¢ off the 16-oz. jar of Planters' Dry or Regular Roasted Nuts

35¢ off the purchase of any Bico "Cool Tool"

\$3.00 off Barbecuing the Weber Covered Way cookbook by the makers of Weber Grills

\$1.95 off The Entertainer's by Leifira Bairdridge, Canada Dry's new book on home entertaining

Total Savings up to \$6.97.

## VALUE FAIR

### WAREHOUSE GROCERIES

1212 N. Greene St.  
Greenville, N.C.

Mon.-Thurs. 8:30 A.M.-7:00 P.M.  
Fri. Sat. 8:30 A.M.-8:00 P.M.  
Closed Sunday

NO LIMITS ON QUANTITIES-NONE SOLD TO OTHER MERCHANTS. WE GLADLY ACCEPT USDA FOOD STAMPS, WIC VOUCHERS, AND MANUFACTURERS COUPONS

<p style="font-size: small;">FRESH WHOLE</p> <h2 style="margin: 0;">FRYERS 47¢</h2> <p style="font-size: x-small;">LB.</p>		<p>VALUE FAIR will sell you FOOD FOR LESS everyday. We do not have just week-end specials, but FOOD FOR LESS everyday at the lowest possible prices to save you money. We have cut our operating cost so we can sell you 1st quality merchandise at wholesale warehouse cost. VALUE FAIR wants to help you with your budget, we honestly care. Listed below are just a few of over 2,000 items that we sell at cost to you.</p>	
<p style="font-size: small;">LEAN BONELESS</p> <h2 style="margin: 0;">STEWING BEEF</h2> <p style="font-size: x-small;">\$1.78 LB.</p>		<p style="font-size: small;">BONELESS</p> <h2 style="margin: 0;">SHOULDER ROAST</h2> <p style="font-size: x-small;">\$1.48 LB.</p>	
<p style="font-size: small;">LEAN CUBED</p> <h2 style="margin: 0;">CHUCK STEAK</h2> <p style="font-size: x-small;">\$1.68 LB.</p>		<p style="font-size: small;">MARKET STYLE SLICED</p> <h2 style="margin: 0;">BACON</h2> <p style="font-size: x-small;">2 LBS. OR MORE \$1.29 LB.</p>	
<p style="font-size: small;">FRESH LEAN</p> <h2 style="margin: 0;">GROUND BEEF</h2> <p style="font-size: x-small;">FAMILY PACK 99¢ LB.</p>		<p style="font-size: small;">FRESH PORK</p> <h2 style="margin: 0;">PIG FEET &amp; PIG EARS</h2> <p style="font-size: x-small;">39¢ LB.</p>	
<p style="font-size: small;">BONELESS</p> <h2 style="margin: 0;">CHUCK ROAST</h2> <p style="font-size: x-small;">\$1.38 LB.</p>	<p style="font-size: small;">FRESH PORK</p> <h2 style="margin: 0;">PIG TAILS</h2> <p style="font-size: x-small;">49¢ LB.</p>	<p style="font-size: small;">FRESH LEAN</p> <h2 style="margin: 0;">GROUND CHUCK</h2> <p style="font-size: x-small;">\$1.48 LB.</p>	<p style="font-size: small;">FRESH PORK</p> <h2 style="margin: 0;">NECK BONES</h2> <p style="font-size: x-small;">49¢ LB.</p>
<p style="font-size: small;">THOMPSON SEEDLESS</p> <h2 style="margin: 0;">WHITE GRAPES</h2> <p style="font-size: x-small;">99¢ LB.</p>		<p style="font-size: small;">FRESH LOCAL</p> <h2 style="margin: 0;">CANTALOUPE</h2> <p style="font-size: x-small;">68¢ EACH</p>	
<p style="font-size: small;">LOCAL GROWN</p> <h2 style="margin: 0;">SQUASH</h2> <p style="font-size: x-small;">19¢ LB.</p>		<p style="font-size: small;">25 LB. AVERAGE</p> <h2 style="margin: 0;">WATERMELONS</h2> <p style="font-size: x-small;">\$1.49 EACH</p>	
<p style="font-size: small;">LOCAL VINE RIPE</p> <h2 style="margin: 0;">TOMATOES</h2> <p style="font-size: x-small;">49¢ LB.</p>		<p style="font-size: small;">ANHEUSER BUSCH NATURAL LIGHT</p> <h2 style="margin: 0;">BEER</h2> <p style="font-size: x-small;">6 12 OZ. CANS \$1.99</p>	
<p style="font-size: small;">2 LITER BOTTLE</p> <h2 style="margin: 0;">PEPSI COLA</h2> <p style="font-size: x-small;">98¢</p>		<p style="font-size: small;">22 OZ. BOTTLE</p> <h2 style="margin: 0;">DISH LIQUID</h2> <p style="font-size: x-small;">\$1.18</p>	
<p style="font-size: small;">2 LITER BOTTLE</p> <h2 style="margin: 0;">COCA COLA</h2> <p style="font-size: x-small;">98¢</p>		<p style="font-size: small;">2 L.B. JAR</p> <h2 style="margin: 0;">JELLY</h2> <p style="font-size: x-small;">98¢</p>	
<p style="font-size: small;">SUNSHINE HYDROX</p> <h2 style="margin: 0;">COOKIES</h2> <p style="font-size: x-small;">69¢ PER PACKAGE</p>		<p style="font-size: small;">ASSORTED WEIGHTS &amp; FLAVORS</p> <p style="font-size: small;">CHEF BOY AR DEE</p> <h2 style="margin: 0;">PIZZA</h2> <p style="font-size: x-small;">13 OZ. PKG. 98¢ ALL FLAVORS</p>	
<p style="font-size: small;">3 PACKAGES FOR</p> <h2 style="margin: 0;">HOT DOG &amp; HAMBURGER BUNS</h2> <p style="font-size: x-small;">\$1.18</p>		<p style="font-size: small;">16 OZ. CANS FOR</p> <h2 style="margin: 0;">PORK &amp; BEANS</h2> <p style="font-size: x-small;">3 98¢</p>	
<p style="font-size: small;">1 LB. PKG.</p> <h2 style="margin: 0;">MARGARINE</h2> <p style="font-size: x-small;">28¢</p>		<p style="font-size: small;">32 OZ. JAR</p> <h2 style="margin: 0;">MUSTARD</h2> <p style="font-size: x-small;">48¢</p>	
<p style="font-size: small;">SIZE 3/28</p> <h2 style="margin: 0;">APRIL SHOWER PEAS</h2> <p style="font-size: x-small;">\$1.00</p>		<p style="font-size: small;">12 OZ.</p> <h2 style="margin: 0;">ARMOUR TREET</h2> <p style="font-size: x-small;">98¢</p>	
<p style="font-size: small;">5 LB.</p> <h2 style="margin: 0;">FLOUR</h2> <p style="font-size: x-small;">78¢</p>		<p style="font-size: small;">8 1/2 OZ.</p> <h2 style="margin: 0;">STARKIST TUNA</h2> <p style="font-size: x-small;">78¢</p>	
<p style="font-size: small;">ROLL</p> <h2 style="margin: 0;">BRAUNY TOWELS</h2> <p style="font-size: x-small;">2/98¢</p>		<p style="font-size: small;">18 OZ.</p> <h2 style="margin: 0;">DUNCAN HINES CAKE MIX</h2> <p style="font-size: x-small;">78¢</p>	
<p style="font-size: small;">20 LB.</p> <h2 style="margin: 0;">DOG FOOD</h2> <p style="font-size: x-small;">\$5.98</p>		<p style="font-size: small;">ROLL</p> <h2 style="margin: 0;">PAPER TOWELS</h2> <p style="font-size: x-small;">78¢</p>	
<p style="font-size: small;">22 OZ.</p> <h2 style="margin: 0;">GATORADE</h2> <p style="font-size: x-small;">58¢</p>		<p style="font-size: small;">1 LB. BOX</p> <h2 style="margin: 0;">ZESTA SALTINES</h2> <p style="font-size: x-small;">68¢</p>	
<p style="font-size: small;">GALLON</p> <h2 style="margin: 0;">PUREX BLEACH</h2> <p style="font-size: x-small;">78¢</p>		<p style="font-size: small;">32 OZ.</p> <h2 style="margin: 0;">HEINZ CATSUP</h2> <p style="font-size: x-small;">98¢</p>	
<p style="font-size: small;">2 LITER</p> <h2 style="margin: 0;">SHASTA DRINKS</h2> <p style="font-size: x-small;">78¢</p>		<p style="font-size: small;">4 ROLLS</p> <h2 style="margin: 0;">WALDORF TISSUE</h2> <p style="font-size: x-small;">88¢</p>	
<p style="font-size: small;">24 OZ.</p> <h2 style="margin: 0;">FRENCH MUSTARD</h2> <p style="font-size: x-small;">58¢</p>		<p style="font-size: small;">4 ROLLS</p> <h2 style="margin: 0;">WHITE CLOUD TISSUE</h2> <p style="font-size: x-small;">98¢</p>	
<p style="font-size: small;">18 OZ.</p> <h2 style="margin: 0;">PIZZAS</h2> <p style="font-size: x-small;">69¢</p>		<p style="font-size: small;">1 LB.</p> <h2 style="margin: 0;">MRS. FLETCHER'S MARGARINE</h2> <p style="font-size: x-small;">2/98¢</p>	
<p style="font-size: small;">18 1/2 OZ.</p> <h2 style="margin: 0;">TEXAS PINE CHILI</h2> <p style="font-size: x-small;">3/\$1.09</p>		<p style="font-size: small;">14 OZ.</p> <h2 style="margin: 0;">JACK FRASCHETTI COOKIES</h2> <p style="font-size: x-small;">79¢</p>	
<p style="font-size: small;">5 LB. BAG</p> <h2 style="margin: 0;">WHITE STAR SUGAR</h2> <p style="font-size: x-small;">\$1.39</p>		<p style="font-size: small;">3 LB. CAN</p> <h2 style="margin: 0;">CRISCO</h2> <p style="font-size: x-small;">\$1.98</p>	
<p style="font-size: small;">32 OZ. JAR</p> <h2 style="margin: 0;">DUKES MAYONNAISE</h2> <p style="font-size: x-small;">98¢</p>		<p style="font-size: small;">24 OZ. BOTTLE</p> <h2 style="margin: 0;">WESSON OIL</h2> <p style="font-size: x-small;">98¢</p>	
<p style="font-size: small;">2 8 OZ. BOXES FOR</p> <h2 style="margin: 0;">MORTON POT PIES</h2> <p style="font-size: x-small;">79¢</p>		<p style="font-size: small;">48 OZ. BOX</p> <h2 style="margin: 0;">FAB DETERGENT</h2> <p style="font-size: x-small;">\$1.68</p>	
<p style="font-size: small;">32 OZ. BOTTLE</p> <h2 style="margin: 0;">DELMONTE CATSUP</h2> <p style="font-size: x-small;">98¢</p>		<p style="font-size: small;">CARTON YOUR OWN &amp; SAVE DOZEN</p> <h2 style="margin: 0;">EXTRA LARGE LOOSE EGGS</h2> <p style="font-size: x-small;">68¢</p>	
<p style="font-size: small;">100 COUNT BOX</p> <h2 style="margin: 0;">LIPTON TEA BAGS</h2> <p style="font-size: x-small;">\$1.78</p>		<p style="text-align: center;">TELL A FRIEND HOW MUCH MONEY YOU SAVED AT</p> <p style="text-align: center; font-weight: bold;">VALUE FAIR WAREHOUSE GROCERIES!!</p>	

# Bechtel Group Has Extensive Foreign Activity

By EVANS WITT  
Associated Press Writer

Dealing with foreign governments is an everyday enterprise for the Bechtel Group Inc., the secrecy-shrouded corporate complex that may be the world's largest construction firm.

Whether building a new city in Saudi Arabia, a half-billion-dollar resort in Malaysia or a nuclear power plant in Taiwan, Bechtel pursues a "foreign policy" of its own, a policy centered on profits, not on national interests.

Profits and foreign policy create a volatile mixture for all multinational corporations. The nomination of George Shultz, president of Bechtel, as Ronald Reagan's secretary of state raises questions about Bechtel's operations around the world and Bechtel's effect on future U.S. policies.

But Bechtel officials don't see the Shultz nomination as having a major impact on the company's role.

"I don't think Bechtel will have any more influence than in the past," Harvey Brush, the company's executive vice president, said in an interview last week.

Many questions at today's Senate Foreign Relations Committee hearings on the Shultz nomination will focus on Bechtel's long and profitable relationship with Saudi Arabia and other OPEC members. In Saudi Arabia, Bechtel is now building a \$3 billion airport at Riyadh and a whole new city at Jubail that could cost as much as \$20 billion.

Its Middle East links have gotten Bechtel entangled twice with U.S. policy and politics.

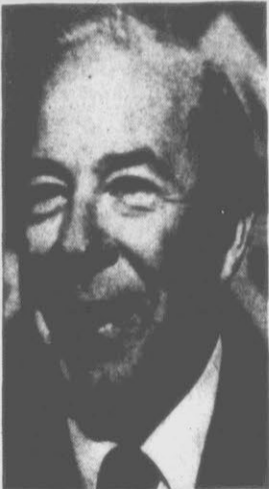

GEORGE SHULTZ

Last year, the then-manager of Bechtel's Washington office sent a letter to members of Congress advocating the sale of AWACS, advanced radar planes, to Saudi Arabia.

Recently, Bechtel's effort to sidestep U.S. law prohibiting compliance with the Arab-backed boycott of companies doing business with Israel was set back by the U.S. Supreme Court. The court refused to free the company from a consent decree barring it from taking part in the boycott.

Partly at Shultz' urging, Bechtel has also attempted to create more favorable attitudes toward its clients among the American public. It has underwritten at least one film, a book and a traveling cultural exhibit, all of which portray Arabs and the Saudis in particular in a favorable light.

With Shultz at State and former Bechtel executive Caspar Weinberger at the Defense Department, critics have asked whether Bechtel's views will sway the course of American foreign policy on Israel and the Arab countries.

The government's Mideast policy is only one area that affects Bechtel. Others include:

—U.S. policy on nuclear proliferation. Bechtel helped build nearly half of the nuclear power plants in the United States. It would like to build more around the world, but U.S. policy has put a damper on such efforts. Bechtel has said it is pushing for changes in that policy.

—The area of trade sanctions as a foreign policy weapon. Shultz has spoken out in the past against the use of trade sanctions, which could limit the company's foreign sales.

Some of Bechtel's public problems arise from its immense size, involvement in dozens of countries around the world and its penchant for secrecy.

Bechtel reported 1981 revenues of \$11.4 billion, which would make it the 26th largest industrial company on the "Fortune 500" list if it were included. One trade magazine ranked it as the largest construction firm in the world in 1981. But Bechtel is privately held, with all the stock owned by 58 people, officers or directors of the company. It does not report its profits, although one published estimate put the 1981 figure at \$150 million.

Now the company has 113 major projects — each worth more than \$50 million — under way in 21 countries. Bechtel, with a current workforce of 119,000, has built major projects in more than 100 countries. It played a major role in building the Hoover Dam, the Alaska pipeline, the San Francisco and Washington subways and the San Francisco Bay Bridge.

Bechtel often works directly for foreign governments, another potential source of problems.

"Outside the United States, a good bit of what we call industry is government-owned. So the governments become our clients," said Brush, now the No. 2 Bechtel executive, directly under Stephen D. Bechtel Jr., whose grandfather founded the company in 1898.

With the slowdown of the nuclear power industry in this country, about half of Bechtel's business now comes from outside the United States, up from only about 6 percent in 1970.

Bechtel executives like to say their company is a service company, providing the people and services needed by their clients, including the foreign governments.

"I don't think you can say we have a foreign policy in the same way as a government does," Brush said. "We look for business in any area of the world. And when you get business, you have to be a good neighbor."

# Named To Panel

Marie E. Ridder, an associate professor in the East Carolina University School of Nursing, has been elected to the national nominating committee of the American Association of Critical Care Nurses.

Ms. Ridder will be her term this month. The AACN is the world's largest specialty nursing organization with local, national and international membership that numbers over 41,000 nurses working in all areas of critical care.

Ms. Ridder is also secretary of the Eastern Carolina Chapter of AACN.



MARIE RIDDER

# Will Introduce New Corkscrew

NEW YORK (UPI) — A new wing-type corkscrew due in stores in September looks like a cross between C3PO, the Star Wars android, and an old-fashioned French waiter with handlebar moustache and patent leather hair and a

tastevin on a chain around his neck. Pierre le Sommelier is made in Italy and imported by Landes International Marketing Corp. of N.Y. The silver-plated corkscrew is expected to sell for about \$15, says showroom manager Claire Worby.

These Locations:  
Ayden  
Greenville  
Bethel

# HARRIS

SUPER MARKETS, INC.

"Where Shopping Is A Pleasure"

Prices Good thru July 28

<p><b>Vitalis</b> Super Hold 5 Oz. <b>175</b></p>	<p><b>4-Way Nasal Spray</b> Reg. 1/2 Oz. <b>205</b></p>	<p><b>Body On Tap Normal</b> 7 Oz. <b>179</b> <b>Body On Tap Oily</b> 7 Oz. <b>179</b></p>	<p><b>Bufferin</b> 60's <b>309</b></p>	<p><b>Ultra Ban II Aerosol Fresh</b> 3 Oz. <b>169</b> <b>Ultra Ban II Aerosol Reg.</b> 3 Oz. <b>169</b></p>	<p><b>Shower To Shower</b> 8 Oz. <b>175</b></p>
<p><b>OB Tampons</b> 16's Regular <b>179</b></p>	<p><b>Tums</b> 75 Ct. <b>169</b></p>	<p><b>Pepto Bismol</b> 8 Oz. <b>209</b></p>	<p><b>Norwich Aspirin</b> 250's <b>165</b></p>	<p><b>Unguentine Aerosol</b> 5 Oz. <b>289</b></p>	<p><b>Chloraseptic</b> 6 Oz. <b>229</b></p>
<p><b>NP-27</b> 2 Oz. <b>209</b></p>	<p><b>Sinarest Tabs</b> 20's <b>159</b></p>	<p><b>Sinarest</b> EXTRA STRENGTH NON-ASPIRIN PAIN RELIEF FORMULA <b>24's 199</b></p>	<p><b>Allerest Tab</b> 24's <b>199</b></p>	<p><b>Rave Perm Extra Curly</b> <b>339</b></p>	<p><b>Rain Tree</b> 6 Oz. <b>139</b></p>
<p><b>Pond's Cocoa Butter</b> 8 Oz. <b>189</b></p>	<p><b>Pond's Cocoa Butter Cream</b> 3 Oz. <b>229</b></p>	<p><b>Pond's Cold Cream</b> 3.5 Oz. <b>225</b></p>	<p><b>Pond's Cold Cream</b> 1.8 Oz. <b>159</b></p>	<p><b>Pond's Dry Skin Cream</b> 3.9 Oz. <b>249</b></p>	<p><b>Arrid Extra Dry Reg.</b> 4 Oz. <b>245</b></p>
<p><b>Q-Tips</b> 300's <b>199</b></p>	<p><b>Vaseline Intensive Care Lotion</b> 6 Oz. <b>159</b></p>	<p><b>Vaseline Intensive Care Lotion Herbal</b> 6 Oz. <b>159</b></p>	<p><b>Vaseline Intensive Care Lotion Extra Strength</b> 6 Oz. <b>159</b></p>	<p><b>Arrid Roll-On Reg.</b> 1.5 Oz. <b>169</b></p>	<p><b>Arrid Powder Roll-On Baby Fresh</b> 6 Oz. <b>169</b></p>
<p><b>Arrid Cream</b> 1 Oz. <b>115</b></p>	<p><b>Sea &amp; Ski Suntan Lotion</b> 4 Oz. <b>279</b></p>	<p><b>Arrid Extra Dry Solid Unscented</b> 2 Oz. <b>229</b></p>	<p><b>Flex Shampoo</b> 16 Oz. <b>219</b></p>	<p><b>Flex Conditioner</b> 16 Oz. <b>219</b></p>	<p><b>Noxzema Cream</b> 2.5 Oz. <b>115</b></p>
<p><b>Noxzema Regular Shave</b> 6 1/4 Oz. <b>145</b></p>	<p><b>Lanacane Cream</b> 1 Oz. <b>165</b></p>	<p><b>Johnson Foot Soap</b> <b>79c</b></p>	<p><b>Odor-Eaters Johnson Super-Tuff Odor Eaters</b> <b>185</b></p>	<p><b>Vagisil</b> <b>165</b></p>	<p><b>Visine eye drops</b> <b>165</b></p>
<p><b>Mink Hair Spray Regular</b> 7 Oz. <b>279</b></p>	<p><b>Aprri Facial Scrub</b> <b>265</b></p>	<p><b>Right Guard AP 6 Oz. Unscented</b> <b>345</b></p>	<p><b>Right Guard AP 6 Oz. Powder Dry</b> <b>345</b></p>	<p><b>SUNDOWN Sunscreen Ultra Protection</b> <b>465</b></p>	<p><b>SUNDOWN Sunscreen Maximal Protection</b> <b>445</b></p>
<p><b>SUNDOWN Sunscreen Extra Protection</b> <b>405</b></p>	<p><b>SUNDOWN Sunscreen Moderate Protection</b> <b>429</b></p>	<p><b>Johnson's Baby Oil</b> <b>165</b></p>			



**CHARGED** ... Ann and James Yarbrough have been charged with trying to bilk President Reagan and his wife Nancy in a deal to buy the Reagans' Pacific Palisades home last summer. They are shown above as they sat in a Los Angeles courtroom earlier this week. (AP Laserphoto)

## Couple Charged In Attempted Reagan Fraud

By LINDA DEUTSCH  
Associated Press Writer

LOS ANGELES (AP) — An elderly, well-dressed couple who authorities say passed themselves off as millionaire prospective buyers of Ronald Reagan's home have been freed under \$1,000 bail each on charges of scheming to defraud the president and first lady.

Ann Yarbrough, 74, and her husband, James, 60, are to be arraigned Friday. They have refused to comment, but their attorney complained the case is "being made into a circus because the president's name is involved."

Authorities, who filed charges against the pair Monday, said the Yarbroughs were such convincing customers that Nancy Reagan had the swimming pool drained at the Reagans' Pacific Palisades home so the prospective buyers could inspect it.

If the case comes to trial, Mrs. Reagan is expected to testify for the prosecution.

Deputy District Attorney Al Botello said the Reagans lost no money to the Yarbroughs. However, he said seven others allegedly were bilked out of \$123,000 in transactions not directly related to the home sale.

"All the victims have one thing in common. They were all lenders of money to the defendants, based on the fact that Ann Yarbrough said she was a wealthy heiress that would be getting money from the estate in the immediate future," Botello said.

Outside court, Botello outlined the alleged real estate scheme in which the Yarbroughs persuaded the Reagans as well as several other people to lend them money Botello said they never intended to repay.

According to Botello, the Yarbroughs were to make a \$400,000 payment for the home, with the Reagans loaning them the balance — "approximately \$1 million." The Yarbroughs opened an escrow account to purchase the house, he said.

The Reagan loan was never made. The Yarbroughs made their \$1.4 million offer last July. They put up a check for \$50,000 on Aug. 14, 1981. A short time later, authorities said, they substituted a check for \$400,000, with the promise that funds to back it would be available by Aug. 19 or Aug. 20. The deal was canceled Sept. 25 when the check had not cleared.

Authorities speculated that the Yarbroughs never expected the deal to go through on the house, but wanted to use papers related to the home sale to help convince others to loan them money based on the claims of an impending inheritance.

The couple was charged Monday with one count of attempted grand theft from the Reagans, one count of conspiracy and seven counts of grand theft from the other victims.

Defense attorney Steven Rheuban told Municipal Judge Samuel Mayerson the couple had lived in the Los Angeles area for 30 years and had children and grandchildren here. He said Yarbrough is on disability and Mrs. Yarbrough is unemployed. They live in a rented home in the San Fernando Valley.

"Ann Yarbrough and her husband, James, were able to deceive the Reagans' agent (attorney Roy Miller) that they were serious buyers," said a confidential memorandum by Botello that was obtained by the Los Angeles Times and the Los Angeles Herald Examiner.

"They accomplished this by displaying to Mr. Miller a false financial statement indicating Ann was worth in excess of \$13 million," Botello said.

The memorandum lists victims including Chatsworth real estate agent Mark Lebens, Northridge dentist John Ellison, former Yarbrough housekeeper Ann Ulrich and a woman who used to drive Mrs. Yarbrough's car, Thomasina Blair.

Lebens said he lost \$47,000, and the other losses ranged from \$4,000 in bad checks to \$25,000, the memo said.

The Reagans raised their children in the custom-built home before Reagan became governor of California and went to Sacramento. They returned after his term in office ended.

After Reagan's election as president, security problems made the Pacific Palisades home inconvenient and he chose his remote Santa Barbara Ranch as the Western White House. The larger family home was placed on the market for \$1.9 million, and was finally bought by Los Angeles attorney Steven Halpern.

## Man Charged In Burning

CHARLOTTE, N.C. (AP) — Authorities arrested a Charlotte man early today and charged him with murder in the death of a woman whose burning body was found Sunday behind a Mecklenburg County service station.

Investigators said James Lee Williams, 27, was arrested in a Charlotte lounge.

Police have identified the dead woman as Evelyn Griggs Rice, 41 of Charlotte. They have declined to give a possible motive for the murder.

# HARRIS

SUPER MARKETS, INC.

"Where Shopping Is A Pleasure"

**DISCOUNT**  
ON EVERYTHING BUT QUALITY

We Reserve The Right To Limit Quantities  
None Sold To Dealers Or Restaurants  
We Accept Food Stamps And WIC Vouchers

PRICES GOOD  
WEDNESDAY THRU  
SATURDAY  
LOCATIONS IN:  
GREENVILLE  
AYDEN-BETHEL  
YARBORO

HARRIS  
**BACON**

12 OZ. PKG.

\$1.39

PKG.

LUTER'S

**HOT DOGS**

\$1.39

GRADE "A" WHOLE  
**FRYERS**

NO LIMIT



\$1.51

LB.

BONELESS BEEF CHUCK

**STEAK**

\$1.59



LB.

FRESH LEAN CRO

**BEEF**

\$1.39

WHOLE OR SHANK HALF

**SMOKED  
HAMS**

\$1.95

LB.



WESTERN

T-BONE OR  
SIRLOIN

**STEAKS**

\$2.79

LB.

SMITHFIELD SALE!

BOLOGNA ALL MEAT

BEEF BOLOGNA

SPICE LUNCHEON MEAT

P & P LOAF

YOUR CHOICE **99¢**

INDIAN SUMMER

**APPLE CIDER  
VINEGAR**

\$1.59

GALLON  
JUG

GRADE A  
MEDIUM

**EGGS**

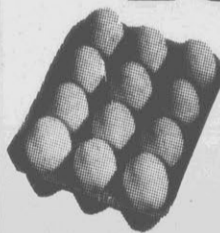

\$1.55

DOZEN

TREND DISHWASHING LIQUID LEMON . . . . 22 OZ. 79¢

LOCKE BEANS CHOOSE FROM PRIMO, GREAT NORTHERN, HEAVY, OR GIANT LIMAS . . NO. 303 2 1/2 \$1.00

CREST TOOTHPASTE . . . . 6.4 OZ. \$1.69

CHEERIOS . . . . . 10 OZ. 99¢

MAALOX PLUS . . . . . 12 OZ. LIQUID \$2.29

SAUCES PURE MUSTARD . . . . . 6 OZ. JAR 49¢

TREND LAUNDRY DETERGENT . . GIANT SIZE . . 42 OZ. 99¢

KINGSFORD CHARCOAL . . . . . 10 LB. \$1.99

**BRAWNY  
TOWELS**

JUMBO ROLL **2/\$1.00**



**COTTONELLE  
BATHROOM TISSUE**

4 ROLL **99¢**

STOKELY  
**APPLE SAUCE**

NO. 303 **3/\$1.00**

PABST BLUE RIBBON

**BEER**

6/12 OZ. CANS **\$1.89**



**HUNTS  
KETCHUP**

32 OZ. JUG

**99¢**



**CRISCO  
SHORTENING**

3 LB.

\$1.99



STARKIST

**TUNA**

IN WATER OR OIL

6 1/2 OZ.

**79¢**



# National Cancer Institute Backs Duke Program

By F. ALAN BOYCE  
Associated Press Writer

DURHAM, N.C. (AP) — A four-drug treatment may double the survival rate in extreme cases of head and neck cancer, which kills an estimated 900 people a year in North Carolina alone, researchers at Duke University Medical Center say.

The National Cancer Institute recently allocated \$750,000 for five more years of tests for the treatment, said Dr. Andrew T. Huang, who directed the original six-year study.

"NCI earlier had funded a study similar to ours at another university," Huang said. "But when they saw our results they extended their open arms to us."

Head and neck cancers — combining tumors of the voice box, mouth, tongue, tonsils and nose — are related in appearance, prognosis and their association with heavy tobacco use, Huang said.

Head and neck cancers account for 8 percent of U.S. cancer deaths, or about 25,000 deaths annually, according to the American Cancer Society. Huang said the cancers are more prevalent in North Carolina than the national average, a fact he attributed to the impact of tobacco.

Scientists used the new drug treatment on patients who had already undergone surgery and radiation therapy and who were classified as "stage three or four" in the severity of their illnesses.

Unlike stages one and two, in which tumors are localized at the original site of the cancer, tumors in later stages extend to the lymphatic system, Huang said.

"Standard treatment for head and neck cancer in stages three and four has a prognosis, using five-year survival, as low as 25 percent," he said. "Most are dead in two years."

Patients in the study were given the four-drug followup every six weeks for 36 weeks, with a subsequent increase in the survival rate.

"If you look at the group of patients with extra treatment after surgery and radiation, there was a doubling of survival to about 92 percent," Huang said.

Huang, who worked with Dr. T. Boyce Cole of the department of otolaryngology and radiation therapist Arnold M. Herskovic, attributed the unusual success rate to the conservative nature of the treatment.

"Our treatment is very modest," he said. "While most other studies would use a fairly impressive dose of drugs, we felt a more modest treatment program is better indicated. We are concerned about wiping out the patient's basic defense mechanisms."

Combining drugs allowed scientists to reduce the dose of each, slowing the development of resistance that often accompanies single drug regimens, Huang said. Lower doses also reduce the toxic effect on healthy tissues.

"The dosages are not excessive. Our patients are really not knocked out by the treatment," he said.

"In addition, the treatment is short. Most (treatments of this kind) take a year or two. Ours is 36 weeks."

Huang said similar treatments have improved the survival rate in extreme cases of breast and bone cancer, but not to the same extent as head and neck cancers.

## Phone Bills Cut

OLYMPIA, Wash. (AP) — Washington State officials expect to save up to \$5 million a year on long-distance telephone calls with the installation of a new computerized channel-communication program, says a management information systems publication.

According to MIS Week — the state will cut its annual \$12 million bill with a

statewide network of trunk and tie-in lines that will interconnect switching centers at Olympia, Spokane, Seattle and Vancouver, with government facilities across the state.

Some 90,000 employees in about 250 government agencies at state, county and local levels will convert to the state-owned management system, which replaces a leased common channel.

## FOCUS

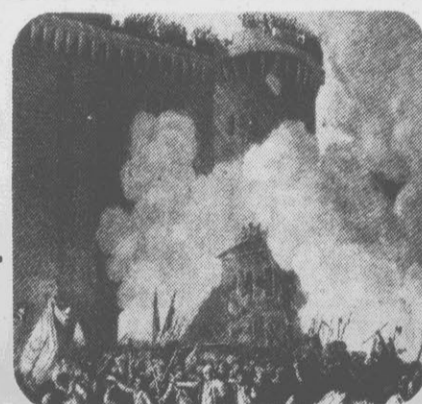

### Revolutionary Holiday

Bastille Day, France's most important holiday, is celebrated today. "Bastille" is actually the French word for any fortified building, but it came to refer to a particular fortress in Paris, which French officials and the nobility used to imprison those who offended them. Prisoners often remained incarcerated for many years without any formal charges or trial. As a result, the Bastille became a symbol of oppression and injustice. In 1789, the French people stormed the prison and freed the captives, thus beginning the French Revolution. But today's celebrations will not be held at the historic prison. After its capture, the Bastille was completely levelled — insuring that it could never again be used in the cause of tyranny.

**DO YOU KNOW** — Who was king of France at the time of the Revolution?

**TUESDAY'S ANSWER** — Ty Cobb was nicknamed "the Georgia Peach."

7-14-82 © VEC, Inc. 1982

## Have You Missed Your Daily Reflector?

First Call Your Independent Carrier. If You Are Unable To Reach Him Call The Daily Reflector

**752-3952**

Between 6:00 And 6:30 P.M. Weekdays And 8 'Til 9 A.M. On Sundays.

# PRODUCE

PRICE & QUALITY. BEST PRICES IN TOWN.  
SHOP HARRIS' PRODUCE DEPARTMENTS AND COMPARE

CALIFORNIA THOMPSON SEEDLESS

**GRAPES**

**88¢** LB.

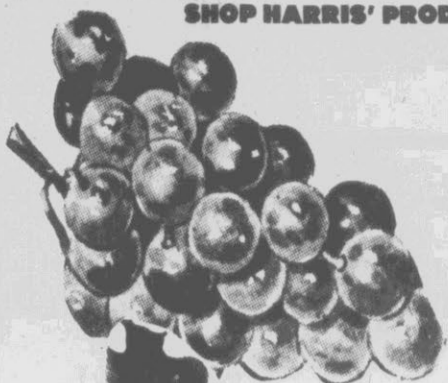

CALIFORNIA RED  
**GRAPES** **88¢** LB.

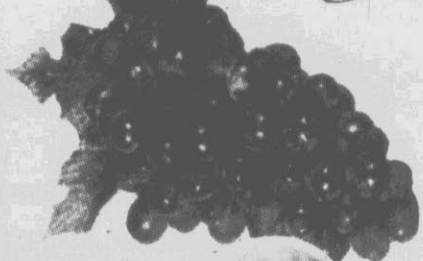

SOUTH CAROLINA SWEET RIPE

**PEACHES**

**3 \$1.00** LBS.



CALIFORNIA LARGE RED  
**PLUMS** **88¢** LB.



CALIFORNIA SWEET

NECTARINES

**58¢** LB.

RED RIPE

**WATERMELONS**

(LARGE 30 LB. AVG.)

**\$2.38**

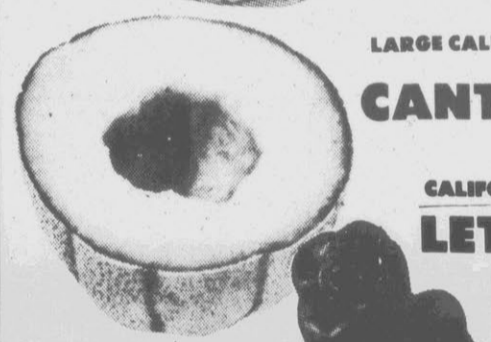

LARGE CALIFORNIA  
**CANTALOUPE** **78¢** EACH

CALIFORNIA ICIBERG

**LETTUCE**

LG. HEAD

FRESH GREEN  
**PEPPERS**

**10¢** EACH



CRISP GREEN

**CUCUMBERS** **10¢** EACH

**CARROTS**

1 LB. CELLO BAG

**3 BAGS \$1.00** FOR



LOCALLY GROWN

SILVER QUEEN

**CORN**

**6 EARS FOR 69¢**

LOCALLY GROWN RED

**POTATOES**

BAG YOUR OWN AND SAVE

**19¢** LB.



TENDER

**GREEN BEANS**

**48¢** LB.

YELLOW

**SQUASH**

**28¢** LB.



GENUINE IDAHO BAKING

**POTATOES**

**4 \$1.00** FOR

LOCAL VINE RIPE

**TOMATOES** **3 \$1.00** LBS.



BONELESS BEEF

**ROAST**

**09**



ROUND

**EF**

**89**

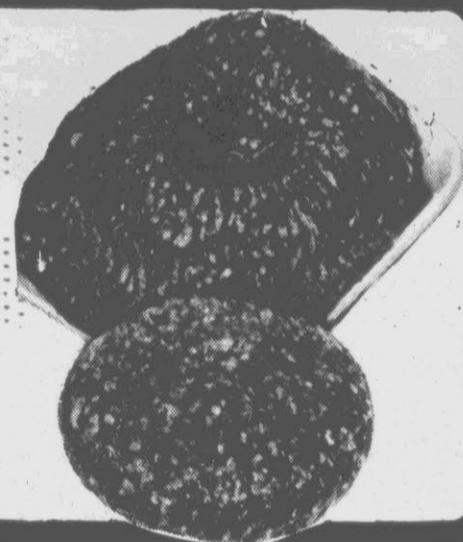

SALTFIELD  
**COOKED HAM** **\$1.49** PKG.

BRIARFIELD SLAB  
**BACON** **\$1.29** LB.

JAMESTOWN ROLL  
**SAUSAGE** **\$1.09** ROLL



LIPTON

**TEA MIX**

**\$1.89**

WITH LEMON  
24 OZ.

## FROZEN FOODS

COUNTRY FRESH

**ICE CREAM**

**\$1.09**

1/2 GAL.

JENOS

**PIZZAS**

ALL 10" VARIETIES  
EVERYDAY LOW PRICE

**99¢**



COMMERCIAL SHOESTRING  
**FRENCH FRIES** **\$1.19** 3 LB. BAG

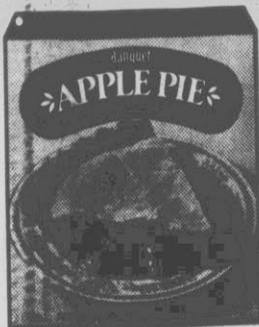

BANQUET

**FRUIT PIES**

BLACKBERRY, PEACH OR APPLE

**69¢** 20 OZ.

**PEPSI &**

**MOUNTAIN DEW**

2 LITER

**99¢**





**REAGONOMICS DOLL** — A humorous, two-sided doll with a caricature of President Reagan on the "Supply Side" and a destitute man appearing on the "Demand Side" throws some sharp by funny jabs at politicians on both sides of the economic dispute. The doll is scheduled to go on sale soon in the Washington area. (AP Laserphoto)

## Ship's Safe Still Closed

NEW YORK (AP) — It's been a year since Peter Gimbel set out to probe the wreck of the Andrea Doria, but his film documentary on the expedition is still in the cutting room and the luxury liner's safe sits unopened in a tank at the New York Aquarium.

Gimbel, a department store heir who has spent most of his adult life going on adventures and making films about them, said Monday his documentary should be finished in mid-August and broadcast this fall.

Whoever buys the rights to the 90-minute documentary also gets to televise at its conclusion the opening of the Bank of Rome safe Gimbel retrieved from the wreck.

Last July, Gimbel observed the 25th anniversary of the Doria's collision with the Swedish liner Stockholm by leading a diving expedition to the wreck on the continental shelf south of Nantucket. The accident occurred on July 25, 1956, killing 51 people.

The networks, however, did not stampede to Gimbel's door, and none currently admits to having any interest in his film.

"Sure, it's a problem," Gimbel said. "It's always a problem getting prime time."

The film will be ready after the sound and music tracks are mixed during the week of Aug. 9, said Elga Andersen, Gimbel's wife and co-leader of the expedition.

Recordings of the divers' voices had to be passed through a "harmonizer," because the helium in their air tanks "made them sound like Donald Duck," explained Ms. Andersen.

"The theme is 30 men and one woman set out on this adventure," she said. "It has the excitement of fiction... it's not the usual narrative documentary."

Gimbel and Ms. Andersen originally hoped to have the film broadcast in early 1982. But none of the networks expressed immediate interest. "They had no original input. We were like an alien coming to them," she said.

But, "we can't feel pressured or uptight," Gimbel said. "We feel it (the film) is pretty strong stuff."

Gimbel said he had not changed his vow not to return to the Doria's wreck. "No," he said with a laugh, "we sure ain't goin' back."

The safe, meanwhile, is in the tank of near-freezing water to which it was moved last fall from a shark tank with warmer water.

The move was made after gas bubbles, which apparently came from bacteria that feed on organic matter, began emerging from the tank.

Although some reports have set the value of the safe's contents at \$1 million, no one knows for sure what's inside.

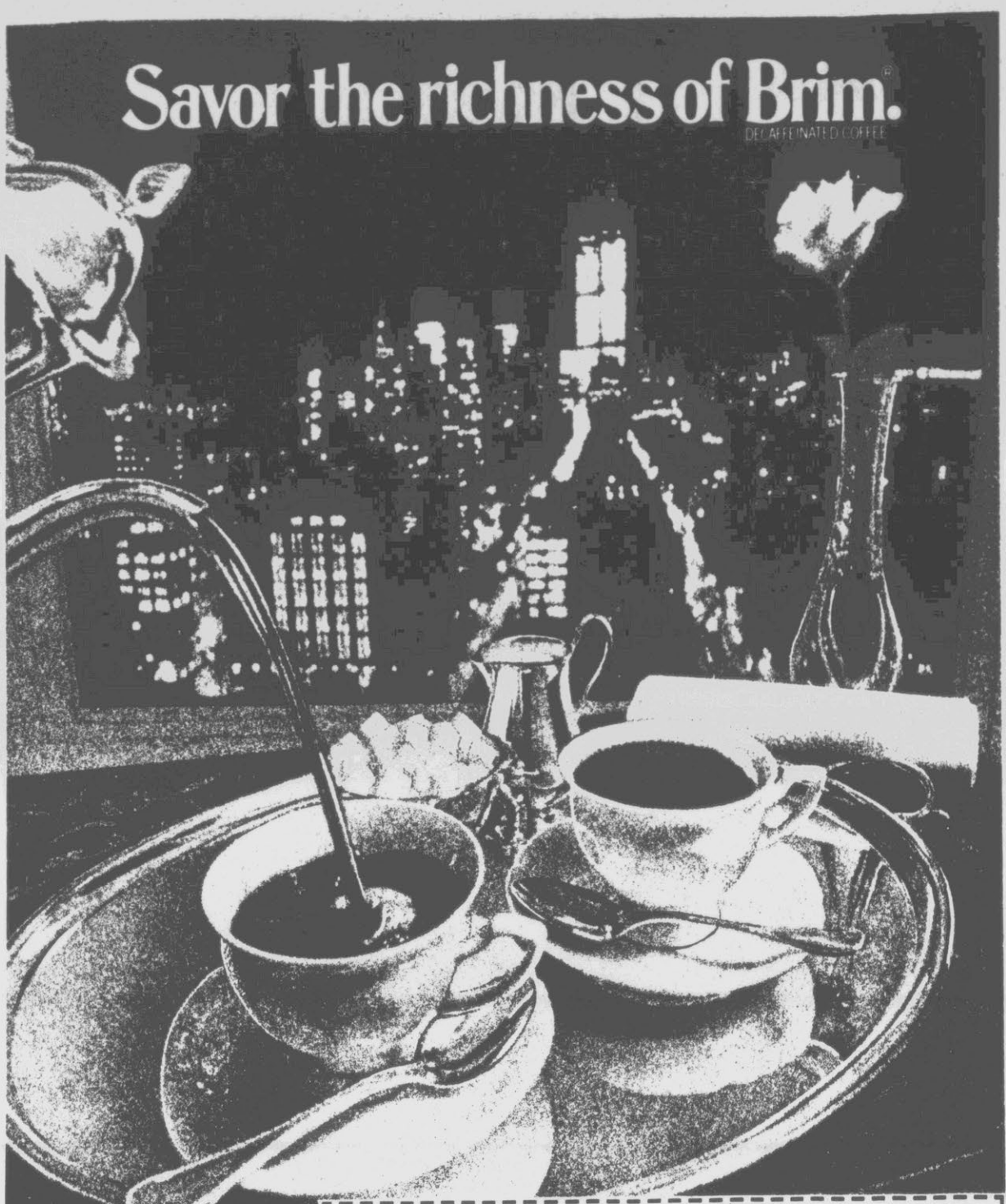

Savor the richness of Brim.  
DECAFFEINATED COFFEE

To fill your days and nights with rich-tasting coffee, use this coupon to save 40¢ on Brim® Ground or Brim Freeze-Dried.

And remember, Brim is decaffeinated... so one rich cup always leads to another.

Fill your cup to the rim with the richness of Brim.

© General Foods Corporation 1982

Save 40¢ when you buy **brim**® DECAFFEINATED COFFEE 40¢



**40¢**

**STORE COUPON**  
COUPON NOT GOOD ON TRIAL SIZES

To the retailer: General Foods Corp. will reimburse you for the face value of this coupon plus 7¢ for handling if you receive it on the sale of the specified product and if upon request you submit evidence of purchase thereof satisfactory to General Foods Corp. Coupon may not be assigned, transferred or reproduced. Customer must pay any sales tax. Void where prohibited, taxed or restricted by law. Good only in U.S.A., Puerto Rico and U.S. Gov't. install. Cash value: 1/20¢. Coupon will not be honored if presented through outside agencies, brokers or others who are not retail distributors of our merchandise or specifically authorized by us to present coupons for redemption. For redemption of property received and hand-died coupon, mail to General Foods Corp., P.O. Box 103, Kankakee, IL 60902. Offer expires January 31, 1983.

This coupon good only on purchase of product indicated. Any other use constitutes fraud.

LIMIT: ONE COUPON PER PURCHASE  
GENERAL FOODS CORPORATION

N802119300

OPEN 7 DAYS A WEEK - 'TIL 10 P.M.  
SALE STARTS THURSDAY THROUGH SUNDAY

# POLLARD'S

HIGHWAY 43 SOUTH - 3 1/2 MILES  
PAST THE PLAZA CINEMA ON LEFT

**CLOROX BLEACH**  
GAL. JUG **59¢**  
WITH \$10.00 FOOD ORDER (LIMIT 1)

**IVORY LIQUID**  
48-OZ. BOTTLE **\$2.29**

**CHATHAM DOG FOOD**  
50 LB. BAG CHUNKS **\$6.39**

**SNYDER'S RIPPLE POTATO CHIPS**  
2 1/2 LB. BAGS **\$1.49**

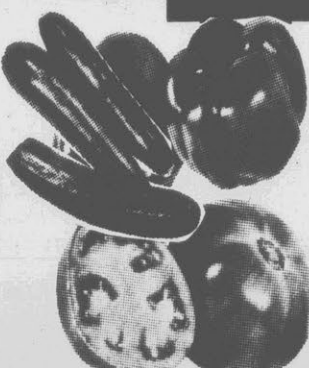

**LIBBY'S CORN** 3 303 CANS **\$1.00**

**TEXAS PETE CHILI SAUCE** 3 10-OZ. CANS **\$1.00**

**BUTTER ME NOT BISCUITS** 2 1/2-OZ. PKGS. **89¢**

**MINUTE MAID ORANGE JUICE** 1/2 GAL. SIZE **\$1.19**

**DEL MONTE CATSUP** 32 OZ. JUG **99¢**

**PFEIFFER 1000 ISLAND OR FRENCH DRESSING** 16-OZ. BOTTLE **59¢**

**ORANGE OR LIME GATORADE** 32-OZ. JAR **65¢**

**Local Produce**

- KY. WONDER BEANS ..... LB. **49¢**
- VINE RIPE TOMATOES ..... 3 LB. **\$1.00**
- FRESH CUCUMBERS ..... LB. **19¢**
- GREEN CABBAGE ..... LB. **19¢**
- YELLOW CABBAGE-COLLARD .... LB. **45¢**
- GREEN BELL PEPPERS ..... EACH **10¢**

**GRADE "A" WHOLE FRYERS** LB. **49¢**

**GROUND BEEF** LB. **\$1.19** (NO LIMIT)

**GREAT DOGS** BUY 1-LB. GET ONE FREE!

**LUTER'S "OLD FASHION" FRANKS** 12-OZ. PKG. **99¢** (HURRY! LIMITED SUPPLY)

**INDIAN SUMMER APPLE CIDER VINEGAR** GAL. JUG **\$1.59**

**BOILED HAM** PER LB. **\$2.99**  
"CUSTOM SLICED" JUST FOR YOU. FRESHER AND MORE ECONOMICAL THAN PACKAGED HAM.

**Lundy's Pork Sale**

- 1/4 PORK LOIN ..... LB. **\$1.49**
- CENTER CUT LOIN CHOPS ..... LB. **\$1.99**
- CENTER CUT RIB CHOPS ..... LB. **\$1.89**
- FRESH PIG FEET ..... LB. **49¢**
- FRESH PIG TAILS ..... LB. **59¢**

**CARLING'S BLACK LABEL 12-OZ. BEER** 6 PACK 12-OZ. **\$1.69**

# NOW OPEN 24 HOURS!

**FOR YOUR SHOPPING  
CONVENIENCE!**

Prices Effective July 14-17  
We reserve the right to limit quantities. None sold to  
dealers or restaurants. We gladly accept U.S.D.A. Food  
Stamps & W.I.C. Food Vouchers. PRICES ON NIGHT  
COUPONS GOOD JULY 14-20:

**Don't Let Anything Stop You**  
you WIN every time you shop



**BEER SOLD AT  
COST OR BELOW!**  
GREENVILLE'S BEST  
BEER PRICES!

- Cookies and Crackers**
- KEEBLER Honey Grahams 16 oz. **1.19**
  - KEEBLER Cinnamon Crisp 14 oz. **1.19**
  - NABISCO NILLA WAFERS 12 oz. **95c**
  - NABISCO Graham Crackers 12 oz. **1.19**

PIGGLY WIGGLY

## Ice Cream

GAL

# 1.09

PIGGLY WIGGLY **SUPER SPECIAL!**

## Wesson OIL

48 OZ.

# 1.88

CENTER CUT (BONE-IN)

## CHUCK ROAST

# 1.28

LB.

BONE-IN

## CHUCK STEAK

# 1.38

LB.

**SUPER SPECIAL!**

PIGGLY WIGGLY

## TOWELS

2 PLY JUMBO

# 2.10

**SUPER SPECIAL!**

ORANGE & LEMON-LIME

## Gatorade

32 OZ.

# 58c

BONE-IN

## Shoulder Roast

# 1.78

LB.

Cube Steak LB. 2.59

WHOLE

## Fryers

# 48c

LB.

2 PER BAG

REG. CUT UP Fryers 55c LB.

## GROUND BEEF

(3 Lbs. or more)

# 1.19

LB.

- JESSE JONES Sausage . . . . . 12 OZ. ROLL **1.29**
- JESSE JONES Bologna . . . . . 12 OZ. PKG. **1.19**
- JESSE JONES Franks . . . . . 12 OZ. PKG. **1.19**

FROSTY MORN SLICED

## Bacon

# 1.29

12 OZ. PKG.

**SUPER SPECIAL!**

ROLLER CHAMPION SELF-RISING

## FLOUR

.25 LB BAG

# 4.39

BEALES

## LARD

.25 LB STAND

# 9.49

## TISSUE

4 ROLL PACK

# 79c

PIGGLY WIGGLY

## PEPSI, MT. DEW, SUNKIST & DIET PEPSI

TWO LITRE BOTTLE

# 99c

NO LIMIT!

PIGGLY WIGGLY

## Margarine

# 3.10

LB.

LIMIT THREE PLEASE

PIGGLY WIGGLY WORLD OF PRODUCE

*the Freshest Buys in Town!*

SANTA ROSA PLUMS . . . . . LB. **79c**

YELLOW CORN 6 EARS **79c**

YELLOW ONIONS 3 LB. BAG **99c**

CELLO CARROTS LB. BAG **3.10**

WHITE

## Potatoes

# 1.49

10 LB. BAG

LOCAL

## Blueberries

# 99c

PT.

## TREND DETERGENT

# 88c

42 OZ.

LIMIT ONE PLEASE

ALL COCA-COLA & PEPSI PRODUCTS

## 6

12 OZ. CANS

# 1.59

Why pay more at a convenience store or another super market when there's a Piggly Wiggly open 24 hours a day! The six coupons below are good only at night between the hours of 9 P.M. and 7 A.M. (Coupons Expire Midnight July 20th.)

COUPON

## HUNT'S KETCHUP

32 OZ.

# 79c

LIMIT ONE WITH COUPON AND \$7.50 FOOD ORDER. COUPON EXPIRES 7/17/82

COUPON

## KRAFT MACARONI & CHEESE DINNER

# 69c

14 OZ.

LIMIT 1 WITH THIS COUPON  
GOOD JULY 14 thru 20, 9 p.m. to 7 a.m.

COUPON

## JESSE JONES BOLOGNA

# 99c

12 OZ.

LIMIT 1 WITH THIS COUPON  
GOOD JULY 14 thru 20, 9 p.m. to 7 a.m.

COUPON

## SUNLIGHT LIQUID DISH DETERGENT

# 19c

12 OZ.

LIMIT 1 WITH THIS COUPON  
GOOD JULY 14 thru 20, 9 p.m. to 7 p.m.

COUPON

## DUKE'S Mayonnaise

32 OZ.

# 69c

LIMIT ONE WITH COUPON AND \$7.50 FOOD ORDER. COUPON EXPIRES 7/17/82

COUPON

## PINE STATE FRUIT DRINK

# 69c

GAL.

LIMIT 1 WITH THIS COUPON  
GOOD JULY 14 thru 20, 9 p.m. to 7 a.m.

COUPON

## JESSE JONES FRANKS

# 99c

12 OZ.

LIMIT 1 WITH THIS COUPON  
GOOD JULY 14 thru 20, 9 p.m. to 7 a.m.

COUPON

## JESSE JONES SAUSAGE

# 1.09

12 OZ. ROLL

LIMIT 1 WITH THIS COUPON  
GOOD JULY 14 thru 20, 9 p.m. to 7 a.m.

**PIGGLY WIGGLY KEEPS GREENVILLE SHOPPING 24 HOURS A DAY!**

# 'Shenandoah' Offers Good Reflections On Human Conditions

## A Reflector Review

The question of whether or not a strong man's determined neutrality in a time of stress ultimately costs more in personal and collective suffering than blind conformance to public emotions is a basic theme in "Shenandoah," the dramatic musical currently playing at McGinnis Theater.

"Shenandoah" has in satisfying proportions what good musicals and rewarding dramas must have, excellent music, and a story that truly reflects a segment of the human condition.

The joy of being alive and exulting in life, old-fashioned virtues of hard work and

personal independence, the sound of music, the inescapable hand of fate in our lives, these are all encompassed in the multilayered sweep of "Shenandoah."

Virginia farmer Charlie Anderson is determined that his family shall not become embroiled in the suffering, the wanton waste of life, the folly of war and the aftermath of bitterness as the Civil War encroaches all about him. Anderson's determination not to sacrifice any of his family of nine or his hard earned prosperity is embodied early in the play in "I've Heard It All Before."

Fate, however, has the upper hand, and even a man

of Anderson's granite character cannot endure continued assaults on his high standards of personal integrity. In "Shenandoah" we witness the fall from grace of Charlie Anderson. It is a painful process, one that shocks his surviving sons as it pains us watching it happen.

Veteran actor Casper Roos gives a sterling performance in repeating his Broadway role. In turn he is playful, compassionate, tender, angry and remorseful. (Except for a few brief moments, for Roos and in one or two instances for other cast members, every sung or spoken word comes across

with the clarity of a bell ringing in mountain air).

Roos has consistently strong support from the large cast — his lovely womenfolk, daughter Jenny and daughter-in-law Anne (Babs Winn and Patricia Preston), his five grown sons, James (Mitch Nathan), Jacob (Michael W. Hill), Nathan (Rodger Baldwin), John (Chris Phillips), Henry (John Gibson), the younger son, Robert (the boy) (Aaron Neiman), are all solid people, stamped with the heritage of inner strength received from their father.

Music and dance share an equal place in the sun with dramatic developments in

"Shenandoah." Most mountain people love music and dance. "Shenandoah" is blessed with generous portions of both — beautifully sung and invigoratingly danced. "Next to Lovin' (I Like Fightin')" echoes a kinship with "Jubilant T. Cornpone." Mavis Ray's delectable choreography comes into play in the deft combination of athleticism and lyricism in all the dances.

"Violets and Silverbells," is a romantic melody as beautiful as its poetic title, enchantingly sung by Jenny and her soldier beau becomes husband Sam (Paul Myers). "Papa's Gonna Make It Alright" is

"Shenandoah's" lullaby of promises, and the play's hymn, "Pass The Cross To Me" rings true as a 19th century church song.

Charlie Anderson suffers the agony of self-doubt in his graveside conversations with his beloved wife Martha, baring his soul to her in the song "Meditation."

Rodney Freeze leads the chorus of battered soldiers in singing the poignant "The Only Home I Know," and Gabriel (Eric Jennings), the young Negro neighboring slave and playmate to Boy Anderson, is simply marvelous in his song and dance number "Freedom" with James Anderson's wife

Anne.

All down the line, members of the cast in lesser roles add full measure in their performances.

Edgar Loessin's direction, Gregory Buch's and David Downing's stunning sets and lights, Joe Distefano's musical direction, and the array of military uniforms and period costumes all enrich the outstanding work of the cast.

"Shenandoah" is a rarity in today's entertainment world, a play of utmost integrity that not once falls back on "in" vulgarity. "Shenandoah" is worthy of admiration, plus being a triumph in entertainment.

Four more performances (nightly at 8:15 through Saturday) are scheduled. For ticket information and reservations, call 757-6390.

Jerry Raynor

## Study Derides TV Programs For Children

By NORMAN BLACK  
Associated Press Writer  
WASHINGTON (AP) — Commercial television programming designed for children provides youngsters with a "distorted mirror" because characters are often portrayed in sexual and racial stereotypes, a new study says.

The study was commissioned by the public interest group Action for Children's Television.

The research by Dr. F.

Earle Barcus of Boston University concludes that family life is portrayed on children's programs "in a traditional and stereotyped manner," with the father being "rather stern, dominant and often engaged in work and adventure activities," and the mother "engaged in household and daily living activities."

Spokesmen for the major commercial networks — ABC, CBS and NBC — all declined comment Tuesday after pointing out that no network executive had yet seen the study.

The Barcus research, released by ACT Tuesday, was funded by the Ford Foundation and the Carnegie Corp. of New York. It is based on a review of 38 hours worth of children's shows aired in the Boston area during January 1981.

Of the 1,145 TV characters that appeared during those 38 hours, Barcus reported only 42 were black and 47 belonged to other minority groups. Females were somewhat better represented, but only 16 percent of all dramatic heroes or major dramatic characters were women.

Blacks, when they did appear, were more often cast as heroes than villains. But blacks and other minorities were more frequently unemployed on television than were white characters, the study found.

Female characters, when attempting to achieve specific goals, "relied on personal charm and dependence on others to a much greater extent that did males who used violence, trickery or deceit and persuasion."

The programming "provides a distorted mirror with outdated models for young children," the study said.

To the question of why such characterizations matter, Barcus wrote: "Simply stated, the rationale for this study is based on the knowledge that children learn from their environment. Thus, if as was found in these studies, 75 percent of the 1,145 characters appearing in the sample were male, there is an implicit message for the child viewer that males are more often recognized, are more visible, are more important than females.

"There is also no doubt that recognition by television legitimizes the status of a particular individual or group in society," he continued. "In this sense, minorities have not yet arrived; they are still waiting for recognition by television. Commercial children's television can only be seen as a major barrier in the battle for recognition of and respect for ethnic groups in this country."



SIGNS UP — Comedienne Phyllis Diller flashes a smile inside the Los Angeles offices of the Social Security Administration. Ms. Diller, who will be 65 on Saturday, signed up

## CBS Holds No. 1

NEW YORK (AP) — CBS, with five of the week's 10 top-rated shows, including "M-A-S-H" in first place, won the networks' ratings race for the third straight week, according to figures from the A.C. Nielsen Co.

It was also the third consecutive week for "M-A-S-H" as the No. 1 show in prime-time, although the audience for the CBS comedy was the lowest for any winning program in the last year.

CBS' rating for the week ending July 11 was 12.6 to 11.9 for ABC and 10.8 for NBC. The networks say that means in an average minute of prime time during the week, 12.6 percent of the country's homes with TV were watching CBS.

The rating for "M-A-S-H" was 19.3. Nielsen says that means in an average minute of the program, 19.3 percent

of the nation's television-equipped homes with were tuned to CBS.

Audience levels normally decline during the summer, but "M-A-S-H" was the first of the No. 1 shows in the weekly ratings to register less than 20 percent of the potential viewers.

Most shows broadcast during the week were reruns. A theatrical film in its television debut — "Rich Kids" on ABC — was the highest highest rated of the week's new programs, No. 29.

A new edition of "Walter Cronkite's Universe" on CBS finished 44th, with an original episode of "Police Squad" on ABC tied for 48th place and a new installment of "Cassie and Company" on NBC was 50th.

NBC had three of the week's five lowest-rated shows. A "CBS Reports"

news special, "A Time to Die," finished 66th, followed by "Code Red" on ABC and the three NBC shows, "Chicago Story," "Father Murphy" and "Lewis and Clark."

Here are the week's 10 highest-rated programs:

"M-A-S-H," with a rating of 19.3 representing 15.8 million homes and "60 Minutes," 18.6 or 15.2 million, both CBS; "Fantasy Island," 18.5 or 15.1 million, ABC; "Alice" and "The Jeffersons," both CBS, and "Hart to Hart," ABC, all 18 or 14.7 million; "Too Close for Comfort," 17.5 or 14.3 million, ABC; "Hill Street Blues," 17.4 or 14.2 million, NBC; "Three's Company," 17 or 13.9 million, ABC, and "House Calls," 16.9 or 13.8 million, CBS.

## Singer Indicted On Drug Charge

JACKSON, Miss. (AP) — Singer George Jones, the Country Music Association's male vocalist of the year in 1981, has been indicted on a cocaine possession charge.

The Hinds County grand jury action was made public this week and stems from a March 29 arrest in which the Mississippi Highway Patrol stopped the singer's 1982 Lincoln Continental for speeding.

The driver, Nancy Sepulvado, 33, of Muscle Shoals, Ala., was charged with speeding.

Jones, 50, was arrested the next day near Aberdeen, Miss., after a one-car accident. In that case, Jones pleaded guilty to driving while intoxicated, reckless

driving, possession of alcohol in a dry county and reckless driving. He was fined \$737.50.

Jones also faces a hearing today in Brentwood, Tenn., on drunken driving charges stemming from a May arrest.

Jones, the ex-husband of singer Tammy Wynette, has been treated twice for alcoholism at a Birmingham, Ala., hospital since 1980.

**tice** Drive-In Theatre  
13.00 Carload  
Arden Highway 756-3033 ADM. \$2.00  
Starts Friday!  
"Sharky's Machine" R  
Burt Reynolds

## Public Notice

NOTICE  
Having qualified as Co-Executor of the estate of Mary Tripp Stocks late of Pitt County, North Carolina, this is to notify all persons having claims against the estate of said deceased to present them to the undersigned Co-Executor on or before December 23, 1982 or this notice or same will be placed in bar of their recovery. All persons indebted to said estate please make immediate payment.

This 21st day of June, 1982.  
Sandra K. Smith  
Rt. 8, Box 458-D  
Greenville, N.C. 27834  
Mary L. Stocks  
Rt. 8, Box 458-C  
Greenville, N.C. 27834  
Co-Executors of the estate of Mary Tripp Stocks, deceased.  
June 23, 30; July 7, 14, 1982

**264 PLAYHOUSE**  
INDOOR THEATRE  
8 Miles West Of Greenville  
On US 264 (Farmville Hwy)

**ENDS TONIGHT**

AT YOUR ADULT ENTERTAINMENT CENTER

Their Fantasies Will Drive You Bananas!  
**Skin on Skin**  
A CAL VISTA INTERNATIONAL LTD. Release  
Copyright MCM LXXXIX

Call Anytime For Showtimes  
Valid ID Required 756-0848  
Doors Open 5:45 Showtime 6:00

## TV Log

For complete TV programming information, consult your weekly TV SHOWTIME from Sunday's Daily Reflector.

**WNCT-TV — Ch. 9**

WEDNESDAY	11:00	Pricis	
7:00	Waltons	12:30	Noon News
8:00	Merlin	1:30	The Young
8:30	TBA	2:30	As The World
9:00	Movie	3:00	Capitol
11:00	9/Alive News	4:00	Guiding
11:30	Late Movie	4:30	Tattletales
		5:00	Rascals
THURSDAY	5:30	Jackie	
5:30	Rascals	6:30	Happy Days
6:00	Carolina	7:00	9/Alive
8:00	Morning	8:00	CBS News
8:25	News	9:00	Magnum
9:25	News	9:00	Simon &
10:00	One Day At	10:00	Knots L.
10:30	Alice	11:30	Late Movie

**WITN-TV — Ch. 7**

WEDNESDAY	10:30	Women	
7:00	Carter	12:00	Love Boat
7:30	Barney Miller	12:30	Family Feud
8:00	Hero	1:00	My Children
9:00	Fall Guy	2:00	One Life
10:00	Dynasty	3:00	Gen Hospital
11:00	Action News	4:00	Bewitched
11:30	ABC News	4:30	Bionic Woman
12:00	Movie	5:30	People's
2:00	Early Edition	6:00	Action News
		6:30	World News
THURSDAY	7:00	Carter	
7:00	Swagart	7:30	Barney Miller
6:30	Stretch	8:00	Darkroom
7:00	America	9:00	Barbara W
7:25	Action News	10:00	Closetop
8:25	Action News	11:30	Nightline
9:00	Phil Donahue	12:00	Movie
10:00	R. Simmons	2:00	Early Edition

**WCTI-TV — Ch. 12**

WEDNESDAY	10:00	Diff Stokes	
7:00	Joker's Wild	10:30	Wheel Of
7:30	Tic Tac	11:00	Texas
8:00	Real People	12:00	News
9:00	Facts Of Life	12:30	Search For
9:30	Love Sidney	1:00	Days Of Our
10:00	Quincy	2:00	Another
11:00	News	2:30	Chips
11:30	Tonight	4:00	Muppets
12:30	Letterman	4:30	Little House
1:30	Overnight	5:30	Jefferson
2:30	News	6:00	News
		6:30	NBC News
		7:00	Joker's Wild
		7:30	Tic Tac
THURSDAY	5:30	Hogans	
5:30	Hogans	8:00	Fame
6:00	Almanac	8:00	Diff Stokes
7:00	Today	9:30	Gimme a
7:25	News	10:00	Hill Street
7:30	Today	11:00	News
8:25	News	11:30	Tonight
8:30	Today	12:30	Letterman
9:00	All in the	1:30	Overnight
9:30	Doctors	2:30	News

**WUNK-TV — Ch. 25**

WEDNESDAY	5:00	Mr. Rogers	
7:00	Report	5:30	Electric Co.
7:30	Last Chance	6:00	Dr. Who
8:00	Geographical	6:30	Dr. In House
9:00	Make of the	7:00	Report
10:00	Hitchcock	7:30	T.B. Journal
11:00	A. Hitchcock	8:00	Paper Chase
11:30	Dave Allen	9:00	Previews
		9:30	Hitch Hiker
THURSDAY	10:00	Austin City	
3:00	Sesame St.	11:00	A. Hitchcock
4:00	Sesame St.	11:30	Dave Allen

**Plaza Cinema 1-2-3**  
PITT. PLAZA SHOPPING CENTER

**ENDS THUR!**  
ALL SEATS \$1.00  
THIS ATTRACTION ONLY!  
COURTESY WOOW RADIO.  
A BATTLE IS ABOUT TO BEGIN.  
STAR **THE WRATH OF KHAN**  
SHOWS 3:00-7:05-9:15

**THE SWORD AND THE SORCERER**  
SHOWS MON.-FRI.  
3:00-7:05-9:00

**ENDS THUR!**  
**HARRISON FORD**  
**BLADE RUNNER**  
3:00-7:10-9:20

**PARK** ENDS THUR!  
**"DUEL OF THE 7 TIGERS"**  
7:10-9:00 (R)

SUMMER KID SHOW  
WED.-THUR.-FRI. 10 A.M.  
"ALICE IN WONDERLAND"

**The Arbor**  
Located Within The Ramada Inn  
Is Proud To Present Our Thursday  
Night Special Feature

**"Ribs And Rose"**

All The Delicious Barbeque Beef Ribs You Can Eat. As If That Is Not Enough, All The Rose' You Can Drink, And You Can Treat Yourself To Our 40 Item Salad Bar. Plus... Your Choice Of Potato And A Vegetable. All For \$6.95 Per Person.

Also By Popular Demand Wednesday  
And Friday Night Special Feature

**"Shrimp And Chablis"**

Thats All The Fried, Boiled Or Broiled Shrimp You Can Eat And Chablis To Drink For 7.95.

**RAMADA INN**  
756-2792  
Dinner Hours: 5 p.m. - 10 p.m.

**THE FOUR SEASONS**

Welcomes You To Our  
**ALL YOU CAN EAT BUFFET**  
For Just \$5.95  
5:00-9:00 P.M. Monday-Saturday  
(Beginning Friday, June 18th)

Buffet Includes: Roast Beef, Chicken, Seafood, Lasagna, Ham, Salads, Vegetables, Bread & More!  
(Coffee or Iced Tea Included)

301 Evans Street-752-5476  
(Basement Of Mingo Bldg.)

**"COUPON"**  
**'1.00 Off Four Seasons Buffet**  
Coupon Good 5-7 P.M. Mon.-Sat. - 1 Per Person  
Expires 8-15-82  
May not be used with any other discount

**J.B.'s Island Seafood**  
Presents  
**A Special Dinner For Two Every Sunday & Wednesday**

☆ 2 Glasses Of Our House Selected Wine

☆ Choice Of Appetizer  
1. 2 Shrimp Cocktails  
2. 2 Garden Salads  
3. 2 Cups Of Soup

☆ Large Fried Seafood Platter  
Select Two Items  
Fish-Shrimp-Scallops-Oysters-Clams  
(Includes 2 potatoes, 2 cole slaws, and hushpuppies)

☆ Plus Coffee Or Tea

**Complete Dinner For 2**  
Specially Priced At  
**\$18.95**  
Includes Gratuity

Located In  
**Rivergate Shopping Center**  
E. 10th St. Greenville  
752-1275

"Our Speciality is Quality"

PEANUTS



B.C.

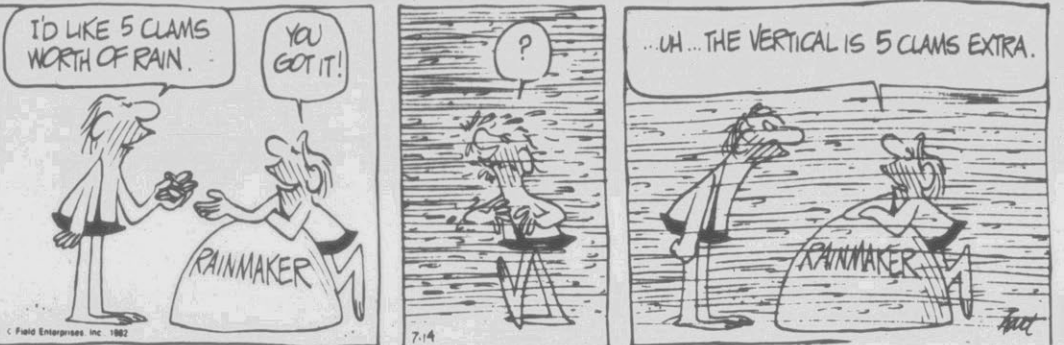

NUBBIN



BLONDIE



BEETLE BAILEY



PHANTOM



FRANK & ERNEST



PRIME TIME

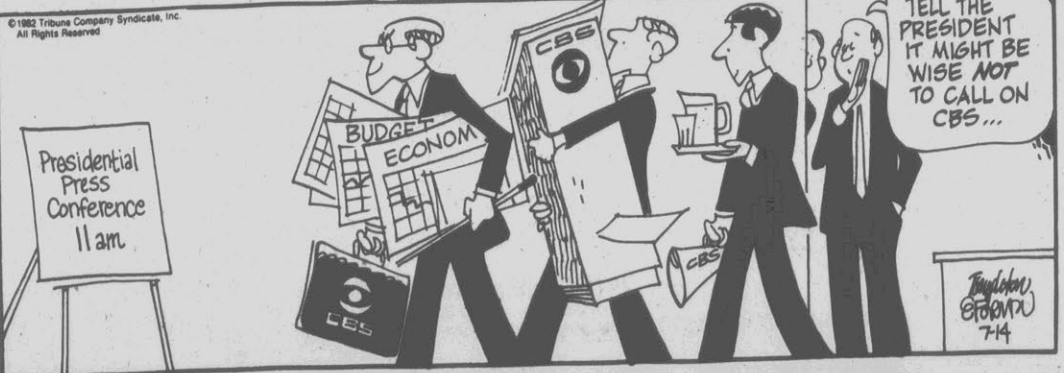

FUNKY WINKERBEAN



**PUBLIC NOTICES**

**ADVERTISEMENT FOR BIDS**  
Sealed proposals, so marked, will be received in the office of the Director of Greenville Utilities Commission, Greenville Utilities Building, 200 West Fifth Street, Greenville, North Carolina, until 3:00 p.m. (EDST), on July 29, 1982, and immediately thereafter publicly opened and read for the furnishing of Cable and Chassis.

Instructions for submitting bids and complete specifications for the equipment or materials to be provided will be available in the office of the Water/Sewer Department Superintendent, Greenville Utilities Building, 200 West Fifth Street, Greenville, North Carolina, during regular office hours.

Greenville Utilities Commission reserves the right to reject any or all bids and to waive informalities.

**GREENVILLE UTILITIES COMMISSION**  
July 14, 1982

**PUBLIC NOTICES**

**NOTICE OF SECOND DEMOCRATIC PRIMARY FOR VARIOUS STATE OFFICES TO BE HELD IN PITT COUNTY, NORTH CAROLINA**  
ON TUESDAY, JULY 27, 1982 Pursuant to G.S. 163-213, notice is hereby given that there will be: (a) a Second Democratic Primary conducted within the County of Pitt, North Carolina for the nomination of various state offices.

(b) Democratic Second Primary for the nomination of two (2) State Judicial Officers for Judges of Court of Appeals, to be voted upon at large.

The second Democratic Primary will be conducted on July 27, 1982 and the voting places will be open for voting between the hours of 6:30 a.m. and 7:30 p.m.

All qualified voters in Pitt County who are affiliated with the Democratic Party will be eligible to vote in the Democratic Primary. There shall be no registration of voters between the dates of the first and second primaries. The second primary is a continuation of the first primary and any voter who has filed proper and timely affidavit of precinct before the first primary may vote in the second primary without having to refile the affidavit to transfer if he is otherwise qualified to vote in the second primary.

Absentee ballots are allowed in the primary and all qualified voters who will be out of the county on Tuesday, July 27, 1982, and who wish to vote, may make application at once.

One-Stop Absentee voting may be done by qualified voter in the office of the Board of Elections upon the receipt of necessary ballots.

Qualified voters who are not certain whether they are registered should contact the Pitt County Board of Elections, 201 E. Second Street, Greenville, North Carolina, Phone 758-4683. The registration books will be open to public inspection by any registered voter of Pitt County between the hours of 9:30 a.m. and 5:00 p.m. on Monday to Friday, inclusive of each week at the office of the County Board of Elections mentioned above and such are Challenge Days.

The Registrars, Judges and other election officers appointed by the County Board of Elections who serve as election officers for said Second Democratic Primary in the twenty-four polling stations in Pitt County, North Carolina.

This 12th day of July, 1982  
CLIFTON W. EVERETT, JR.  
CHAIRMAN  
PITT COUNTY BOARD OF ELECTIONS  
Court House Door  
July 14, 23, 1982

**NOTICE OF DISSOLUTION OF M & S FIRE EQUIPMENT CO**  
NOTICE IS HEREBY GIVEN THAT Articles of Dissolution of M & S Fire Equipment Co. a North Carolina corporation, were filed in the office of the Secretary of State of North Carolina on the 12th day of July, 1982, and that all creditors of and claimants against the corporation are required to present their respective claims and demands immediately in writing to the corporation so that it can proceed to collect its assets, convey and dispose of its properties, pay, satisfy and discharge its liabilities and obligations and do all other acts required to liquidate its business and affairs.

This 12th day of July, 1982.  
M & S Fire Equipment Co.  
P. O. Box 8152  
July 14, 21, 28; August 4, 1982

**NOTICE TO CREDITORS**  
Having qualified as Co-Executors of the Estate of WILLIAM LARRY HUDSON, SR. late of Pitt County, North Carolina, the undersigned hereby authorizes all persons having claims against said Estate to present them to the undersigned, whose mailing address is Route 3, Box 255, Greenville, North Carolina, 27834, on or before the 14th day of January, 1983, or this notice will be pleaded in bar of their recovery. All persons indebted to said Estate will please make immediate payment to the undersigned.

This 14th day of July, 1982.  
Josephine Hardee Hudson  
William Larry Hudson, Jr.  
Route 3, Box 255  
Greenville, N. C. 27834  
Michael A. Colombo  
JAMES, HITE, CAVENDISH & BLOUNT  
Attorneys at Law  
Post Office Drawer 15  
Greenville, North Carolina 27834  
July 14, 21, 28; August 4, 1982

**NOTICE TO CREDITORS OF HUDSON'S WAREHOUSE**  
Notice is hereby given that the partnership formerly existing between W. Larry Hudson, Sr., Larry Hudson, Jr., and Bobby Louis Hudson under the firm name of HUDSON'S WAREHOUSE has been dissolved by the death of W. Larry Hudson, Sr. on June 26, 1982. Notice is given that all persons having claims against the partnership which were in existence at the time of the death of the deceased partner are required to exhibit the same to the undersigned surviving partners on or before the 14th day of January, 1983, or this notice will be pleaded in bar of their recovery. All persons indebted to said partnership will please make immediate payment to the undersigned.

This 14th day of July, 1982.  
W. Larry Hudson, Jr.  
Route 3, Box 220  
Greenville, North Carolina 27834  
Bobby Louis Hudson  
Route 3, Box 224  
Greenville, North Carolina 27834  
Michael A. Colombo  
JAMES, HITE, CAVENDISH & BLOUNT  
Post Office Drawer 15  
Greenville, North Carolina 27834  
Telephone: (919) 752-6000  
July 14, 21, 28; August 4, 1982

**CITY OF GREENVILLE ADVERTISEMENT FOR PROPOSALS**  
Pursuant to General Statutes of North Carolina, Section 143-129, sealed proposals are invited and will be received by the City of Greenville until 10:00 a.m., on Thursday the 22nd day of July, 1982, at which time a meeting of the Purchasing Agent Office, 1300 Beatty Street, Greenville, N. C. the sealed proposals will be publicly opened for the provision of the following:

**ITEMS**  
1. One (1) used 52,000 GVW Dump Truck With minimum fifteen (15) cubic yard body (truck bid not to be older than 1979 model). Formal Bid #825.

The above item must be submitted in an envelope with formal bid number on outside of envelope.

From the date of this advertisement until the date of opening the proposal, the specifications and a complete description of the apparatus, or equipment is on file in the office of the Purchasing Agent, 1300 Beatty Street, Greenville, N. C., during regular business hours, and available to prospective bidders.

No proposal will be considered unless accompanied by a bid security deposit of not less than five percent (5%) of the proposal. Bid deposit are to be in the form of cash deposit, certified check, cashier's check, or his bond. The City Council of the City of Greenville reserves the right to accept or reject any or all proposals, waive informalities, and to make the purchase which is in the best interest of the City.

The bidder to whom contract will be awarded must comply fully with requirements of G. S. Section 143-129, as amended.

This 14th day of July, 1982.  
THE CITY OF GREENVILLE, N.C.  
Leavy Brock  
Purchasing Agent  
July 14, 1982

**PERSONALS**

**RIDER NEEDED** to share expenses to the World's Fair plus Nashville, Tennessee. Leave July 24th, return August 1. 756-6588

**SPECIAL NOTICES**

**CARPOL** from Greenville area to Smithfield, January - June 1983. Call 758-7969 day or evening.

**IDEAS, inventions, new products** wanted now for presentation to industry. Call free 1-800-528-6050.

**NAUTILUS SUMMER Specials**, 1 month, \$25; 3 months, \$60; 6 months, \$110; 1 year, \$190. Call 758-9384.

**PERSONALS**

**DIET MACHINE SERVICE** Cars & Auto Parts. Wholesale parts and machine shop. Diesel block and head repair and engine rebuilding. 1502 North Greene Street, 758-5393

**PERSONALS**

**Autos For Sale**

**JEEPS, CARS, TRUCKS**  
Under \$100, available at local government sales in your area. Call (refundable) 1-714-569-0241, extension 1504 for directory on how to purchase 24 hours.

**SELL YOUR CAR** the National Autofinders Way! Authorized Dealer in Pitt County, Hastings Thundersbird, 1979, AM/FM radio, tape player, drives good, needs some repairs. \$2500. 752-1310

**THUNDERSBIRD**, 1979, AM/FM radio, tape player, drives good, needs some repairs. \$2500. 752-1310

**1971 CHEVY Impala**, \$500. Also 1975 Opel, \$1000. 752-9287

**1979 FIAT Spider Convertible** 2000, excellent condition. \$2450. 1-523-5365

**PERSONALS**

**Buick**

**BUICK Custom Century Wagon**, 1977. Good condition. Air conditioning, 3 seats. Call for details. 746-6274

**CONVERTIBLE Buick Skylark**, 1965. Excellent shape, collectors item. 758-7476.

**Chevrolet**

**CHEVETTE** 1982. 2 door. New Stock no. 548. You can purchase this car for \$4998.74. Call Rex Smith Chevrolet, Ayden, 746-3141.

**CHEVROLET**, 1969, power steering and power brakes, air, 78,000 original miles. 746-3490.

**CITATION** 1982. 4 door. New Stock no. 510. List price \$838.27, discount \$819.94. You can purchase this car for \$7518.13. Call Rex Smith Chevrolet, Ayden, 746-3141.

**WHY BUY GM** leasing at 12.5% on cars and light duty trucks. No down payment to qualified persons. Available at Rex Smith Chevrolet, Ayden, 746-3141.

**CORVETTE** 1978. In good condition. Call 758-8268.

**EL CAMINO**, 1968. Good condition. 350 engine, 4 speed. \$1000. Call 758-5531.

**MALIBU** 1981. 4 door. Low mileage, extra clean. V-6. Call Rex Smith Chevrolet, Ayden, 746-3141.

**NOVA**, 1970 with 427. 400 Turbo, new tires and keystones. \$1200. Call 758-7676.

**1964 CHEVROLET Super Sport**, running 327 engine with Crager rims. Body and paint job in good shape. 758-4232.

**PERSONALS**

**Buick**

**BUICK Custom Century Wagon**, 1977. Good condition. Air conditioning, 3 seats. Call for details. 746-6274

**CONVERTIBLE Buick Skylark**, 1965. Excellent shape, collectors item. 758-7476.

**Chevrolet**

**CHEVETTE** 1982. 2 door. New Stock no. 548. You can purchase this car for \$4998.74. Call Rex Smith Chevrolet, Ayden, 746-3141.

**CHEVROLET**, 1969, power steering and power brakes, air, 78,000 original miles. 746-3490.

**CITATION** 1982. 4 door. New Stock no. 510. List price \$838.27, discount \$819.94. You can purchase this car for \$7518.13. Call Rex Smith Chevrolet, Ayden, 746-3141.

**WHY BUY GM** leasing at 12.5% on cars and light duty trucks. No down payment to qualified persons. Available at Rex Smith Chevrolet, Ayden, 746-3141.

**CORVETTE** 1978. In good condition. Call 758-8268.

**EL CAMINO**, 1968. Good condition. 350 engine, 4 speed. \$1000. Call 758-5531.

**MALIBU** 1981. 4 door. Low mileage, extra clean. V-6. Call Rex Smith Chevrolet, Ayden, 746-3141.

**NOVA**, 1970 with 427. 400 Turbo, new tires and keystones. \$1200. Call 758-7676.

**1964 CHEVROLET Super Sport**, running 327 engine with Crager rims. Body and paint job in good shape. 758-4232.

**PERSONALS**

**Buick**

**BUICK Custom Century Wagon**, 1977. Good condition. Air conditioning, 3 seats. Call for details. 746-6274

**CONVERTIBLE Buick Skylark**, 1965. Excellent shape, collectors item. 758-7476.

**Chevrolet**

**CHEVETTE** 1982. 2 door. New Stock no. 548. You can purchase this car for \$4998.74. Call Rex Smith Chevrolet, Ayden, 746-3141.

**CHEVROLET**, 1969, power steering and power brakes, air, 78,000 original miles. 746-3490.

**CITATION** 1982. 4 door. New Stock no. 510. List price \$838.27, discount \$819.94. You can purchase this car for \$7518.13. Call Rex Smith Chevrolet, Ayden, 746-3141.

**WHY BUY GM** leasing at 12.5% on cars and light duty trucks. No down payment to qualified persons. Available at Rex Smith Chevrolet, Ayden, 746-3141.

**CORVETTE** 1978. In good condition. Call 758-8268.

**EL CAMINO**, 1968. Good condition. 350 engine, 4 speed. \$1000. Call 758-5531.

**MALIBU** 1981. 4 door. Low mileage, extra clean. V-6. Call Rex Smith Chevrolet, Ayden, 746-3141.

**NOVA**, 1970 with 427. 400 Turbo, new tires and keystones. \$1200. Call 758-7676.

**1964 CHEVROLET Super Sport**, running 327 engine with Crager rims. Body and paint job in good shape. 758-4232.

**PERSONALS**

**Buick**

**BUICK Custom Century Wagon**, 1977. Good condition. Air conditioning, 3 seats. Call for details. 746-6274

**CONVERTIBLE Buick Skylark**, 1965. Excellent shape, collectors item. 758-7476.

**Chevrolet**

**CHEVETTE** 1982. 2 door. New Stock no. 548. You can purchase this car for \$4998.74. Call Rex Smith Chevrolet, Ayden, 746-3141.

**CHEVROLET**, 1969, power steering and power brakes, air, 78,000 original miles. 746-3490.

**CITATION** 1982. 4 door. New Stock no. 510. List price \$838.27, discount \$819.94. You can purchase this car for \$7518.13. Call Rex Smith Chevrolet, Ayden, 746-3141.

**WHY BUY GM** leasing at 12.5% on cars and light duty trucks. No down payment to qualified persons. Available at Rex Smith Chevrolet, Ayden, 746-3141.

**CORVETTE** 1978. In good condition. Call 758-8268.

**EL CAMINO**, 1968. Good condition. 350 engine, 4 speed. \$1000. Call 758-5531.

**MALIBU** 1981. 4 door. Low mileage, extra clean. V-6. Call Rex Smith Chevrolet, Ayden, 746-3141.

**NOVA**, 1970 with 427. 400 Turbo, new tires and keystones. \$1200. Call 758-7676.

**1964 CHEVROLET Super Sport**, running 327 engine with Crager rims. Body and paint job in good shape. 758-4232.

**PERSONALS**

**Buick**

**BUICK Custom Century Wagon**, 1977. Good condition. Air conditioning, 3 seats. Call for details. 746-6274

**CONVERTIBLE Buick Skylark**, 1965. Excellent shape, collectors item. 758-7476.

**Chevrolet**

**CHEVETTE** 1982. 2 door. New Stock no. 548. You can purchase this car for \$4998.74. Call Rex Smith Chevrolet, Ayden, 746-3141.

**CHEVROLET**, 1969, power steering and power brakes, air, 78,000 original miles. 746-3490.

**CITATION** 1982. 4 door. New Stock no. 510. List price \$838.27, discount \$819.94. You can purchase this car for \$7518.13. Call Rex Smith Chevrolet, Ayden, 746-3141.

**WHY BUY GM** leasing at 12.5% on cars and light duty trucks. No down payment to qualified persons. Available at Rex Smith Chevrolet, Ayden, 746-3141.

**CORVETTE** 1978. In good condition. Call 758-8268.

**EL CAMINO**, 1968. Good condition. 350 engine, 4 speed. \$1000. Call 758-5531.

**MALIBU** 1981. 4 door. Low mileage, extra clean. V-6. Call Rex Smith Chevrolet, Ayden, 746-3141.

**NOVA**, 1970 with 427. 400 Turbo, new tires and keystones. \$1200. Call 758-7676.

**1964 CHEVROLET Super Sport**, running 327 engine with Crager rims. Body and paint job in good shape. 758-4232.

**PERSONALS**

**Buick**

**BUICK Custom Century Wagon**, 1977. Good condition. Air conditioning, 3 seats. Call for details. 746-6274

**CONVERTIBLE Buick Skylark**, 1965. Excellent shape, collectors item. 758-7476.

**Chevrolet**

**CHEVETTE** 1982. 2 door. New Stock no. 548. You can purchase this car for \$4998.74. Call Rex Smith Chevrolet, Ayden, 746-3141.

**CHEVROLET**, 1969, power steering and power brakes, air, 78,000 original miles. 746-3490.

**CITATION** 1982. 4 door. New Stock no. 510. List price \$838.27, discount \$819.94. You can purchase this car for \$7518.13. Call Rex Smith Chevrolet, Ayden, 746-3141.

**WHY BUY GM** leasing at 12.5% on cars and light duty trucks. No down payment to qualified persons. Available at Rex Smith Chevrolet, Ayden, 746-3141.

**CORVETTE** 1978. In good condition. Call 758-8268.

**EL CAMINO**, 1968. Good condition. 350 engine, 4 speed. \$1000. Call 758-5531.

**MALIBU** 1981. 4 door. Low mileage, extra clean. V-6. Call Rex Smith Chevrolet, Ayden, 746-3141.

**NOVA**, 1970 with 427. 400 Turbo, new tires and keystones. \$1200. Call 758-7676.

**1964 CHEVROLET Super Sport**, running 327 engine with Crager rims. Body and paint job in good shape. 758-4232.

**PERSONALS**

**Buick**

**BUICK Custom Century Wagon**, 1977. Good condition. Air conditioning, 3 seats. Call for details. 746-6274

**CONVERTIBLE Buick Skylark**, 1965. Excellent shape, collectors item. 758-7476.

**Chevrolet**

**CHEVETTE** 1982. 2 door. New Stock no. 548. You can purchase this car for \$4998.74. Call Rex Smith Chevrolet, Ayden, 746-3141.

**CHEVROLET**, 1969, power steering and power brakes, air, 78,000 original miles. 746-3490.

**CITATION** 1982. 4 door. New Stock no. 510. List price \$838.27, discount \$819.94. You can purchase this car for \$7518.13. Call Rex Smith Chevrolet, Ayden, 746-3141.

**WHY BUY GM** leasing at 12.5% on cars and light duty trucks. No down payment to qualified persons. Available at Rex Smith Chevrolet, Ayden, 746-3141.

**CORVETTE** 1978. In good condition. Call 758-8268.

**EL CAMINO**, 1968. Good condition. 350 engine, 4 speed. \$1000. Call 758-5531.

**MALIBU** 1981. 4 door. Low mileage, extra clean. V-6. Call Rex Smith Chevrolet, Ayden, 746-3141.

**NOVA**, 1970 with 427. 400 Turbo, new tires and keystones. \$1200. Call 758-7676.

**1964 CHEVROLET Super Sport**, running 327 engine with Crager rims. Body and paint job in good shape. 758-4232.

**PERSONALS**

**Buick**

**BUICK Custom Century Wagon**, 1977. Good condition. Air conditioning, 3 seats. Call for details. 746-6274

**CONVERTIBLE Buick Skylark**, 1965. Excellent shape, collectors item. 758-7476.

**Chevrolet**

**CHEVETTE** 1982. 2 door. New Stock no. 548. You can purchase this car for \$4998.74. Call Rex Smith Chevrolet, Ayden, 746-3141.

**CHEVROLET**, 1969, power steering and power brakes, air, 78,000 original miles. 746-3490.

**CITATION** 1982. 4 door. New Stock no. 510. List price \$838.27, discount \$819.94. You can purchase this car for \$7518.13. Call Rex Smith Chevrolet, Ayden, 746-3141.

**WHY BUY GM** leasing at 12.5% on cars and light duty trucks. No down payment to qualified persons. Available at Rex Smith Chevrolet, Ayden, 746-3141.

**CORVETTE** 1978. In good condition. Call 758-8268.

**EL CAMINO**, 1968. Good condition. 350 engine, 4 speed. \$1000. Call 758-5531.

**MALIBU** 1981. 4 door. Low mileage, extra clean. V-6. Call Rex Smith Chevrolet, Ayden, 746-3141.

**NOVA**, 1970 with 427. 400 Turbo, new tires and keystones. \$1200. Call 758-7676.

**1964 CHEVROLET Super Sport**, running 327 engine with Crager rims. Body and paint job in good shape. 758-4232.

**PERSONALS**

**Buick**

**BUICK Custom Century Wagon**, 1977. Good condition. Air conditioning, 3 seats. Call for details. 746-6274

**CONVERTIBLE Buick Skylark**, 1965. Excellent shape, collectors item. 758-7476.

**Chevrolet**

**CHEVETTE** 1982. 2 door. New Stock no. 548. You can purchase this car for \$4998.74. Call Rex Smith Chevrolet, Ayden, 746-3141.

**CHEVROLET**, 1969, power steering and power brakes, air, 78,000 original miles. 746-3490.

**CITATION** 1982. 4 door. New Stock no. 510. List price \$838.27, discount \$819.94. You can purchase this car for \$7518.13. Call Rex Smith Chevrolet, Ayden, 746-3141.

**WHY BUY GM** leasing at 12.5% on cars and light duty trucks. No down payment to qualified persons. Available at Rex Smith Chevrolet, Ayden, 746-3141.

**CORVETTE** 1978. In good condition. Call 758-8268.

**EL CAMINO**, 1968. Good condition. 350 engine, 4 speed. \$1000. Call 758-5531.

**MALIBU** 1981. 4 door. Low mileage, extra clean. V-6. Call Rex Smith Chevrolet, Ayden, 746-3141.

**NOVA**, 1970 with 427. 400 Turbo, new tires and keystones. \$1200. Call 758-7676.

**1964 CHEVROLET Super Sport**, running 327 engine with Crager rims. Body and paint job in good shape. 758-4232.

**PERSONALS**

**Buick**

**BUICK Custom Century Wagon**, 1977. Good condition. Air conditioning, 3 seats. Call for details. 746-6274

**CONVERTIBLE Buick Skylark**, 1965. Excellent shape, collectors item. 758-7476.

**Chevrolet**

**CHEVETTE** 1982. 2 door. New Stock no. 548. You can purchase this car for \$4998.74. Call Rex Smith Chevrolet, Ayden, 746-3141.

**CHEVROLET**, 1969, power steering and power brakes, air, 78,000 original miles. 746-3490.

**CITATION** 1982. 4 door. New Stock no. 510. List price \$838.27, discount \$819.94. You can purchase this car for \$7518.13. Call Rex Smith Chevrolet, Ayden, 746-3141.

**WHY BUY GM** leasing at 12.5% on cars and light duty trucks. No down payment to qualified persons. Available at Rex Smith Chevrolet, Ayden, 746-3141.

**CORVETTE** 1978. In good condition. Call 758-8268.

**EL CAMINO**, 1968. Good condition. 350 engine, 4 speed. \$1000. Call 758-5531.

**MALIBU** 1981. 4 door. Low mileage, extra clean. V-6. Call Rex Smith Chevrolet, Ayden, 746-3141.

**NOVA**, 1970 with 427. 400 Turbo, new tires and keystones. \$1200. Call 758-7676.

**1964 CHEVROLET Super Sport**, running 327 engine with Crager rims. Body and paint job in good shape. 758-4232.

**018 Ford**

**NEW FORD CARS, Trucks and Tractors**, good used cars and trucks. R. H. McLaughlin. 756-2845 or 975-2688.

Thinking of selling that motorcycle? Now's the time to do it! Call Classified today. 752-6166.

**021 Oldsmobile**

**CLASSIC 1959 Super 88 Oldsmobile** Good condition. Must sell by weekend. \$625 or best offer. 752-6869

**OLDSMOBILE 1976 Cutlass** Reclining bucket seats, tilt steering, wire wheels, clean. \$2000. Call 757-3474 evenings.

**1973 OLDSMOBILE Cutlass Supreme**, \$750. Good condition. 752-1360.

**022 Plymouth**

**PLYMOUTH DUSTER 1975**, \$1000. Call 756-4799 between 6 and 7 p.m.

**023 Pontiac**

**FIREBIRD** Esprit, 1978, brown. \$4695. 756-8271 after 6 p.m.

**GRAND PRIX**, 1973. Power windows, power brakes, power steering, tilt wheel, AM/FM stereo, 4 new radials. New lunge up. Silver with black vinyl top and black interior. Good condition. \$975. 825-6821 after 6 p.m.

**1979 SILVER FIREBIRD**, light blue, plush interior. AM/FM, 8 track radio, air, extras. Good condition. \$4400. Call 252-2642 after 6 p.m.

**FIAT 850 Hardtop Convertible**, 1970. Radial tires. Good condition. Call 746-4633 or 746-4401.

**MG MIDGET** 1975. New paint job and new transmission. Needs new top. \$2600. Call 756-3495 or 758-4272.

**OPAL GT**, 1973. New rebuilt engine. New electrical starter. \$1200. 758-0880.

**TOYOTA Corolla**, 1978. AM/FM air, automatic. \$2900. Owner must sell. Call 756-4698.

**TR7 Convertible**, 1979. New transmission, broken and battery. Excellent condition. 752-8742 after 6 p.m.

**1975 242DL Volvo**, 4 speed. AM/FM cassette. Leaded. Good condition. \$2950. 756-4822, work 757-4867.

**1981 DATSUN** 210 station wagon. Automatic with air, metallic blue. Good condition. 13,000 miles. Call 756-8286.

**024 Foreign**

**AUDI**, 1974, \$1400. 4 door, blue, air condition. Good condition. 355-2572 after 8:00 p.m.

**CONVERTIBLE Volkswagens**, 1971. Super Beetle. Very good condition. New top. AM/FM stereo cassette. Many extras. \$2950. 756-7846.

**FIAT SPIDER** 2000, 1979. Dark blue, deluxe stripes, baggage racks. Excellent condition. 752-6560.

**FIAT 850 Hardtop Convertible**, 1970. Radial tires. Good condition. Call 746-4633 or 746-4401.

**MG MIDGET** 1975. New paint job and new transmission. Needs new top. \$2600. Call 756-3495 or 758-4272.

**OPAL GT**, 1973. New rebuilt engine. New electrical starter. \$1200. 758-0880.

**TOYOTA Corolla**, 1978. AM/FM air, automatic. \$2900. Owner must sell. Call 756-4698.

**TR7 Convertible**, 1979. New transmission, broken and battery. Excellent condition. 752-8742 after 6 p.m.

**1975 242DL Volvo**, 4 speed. AM/FM cassette. Leaded. Good condition. \$2950. 756-4822, work 757-4867.

**1981 DATSUN** 210 station wagon. Automatic with air, metallic blue. Good condition. 13,000 miles. Call 756-8286.

**032 Boats For Sale**

**CHRISTMAS IN JULY Specials**. Register for free stocking. The Reg Bag Sailor. Hwy 264 East. Call 758-4641.

**16' BOAT**, trailer, and 85 horsepower Evinrude motor. Runs good. \$1500. 757-38

**039 Trucks For Sale**  
 TOYOTA pickup truck, 1982. Loaded. \$7495. 758-8449 after 6 p.m.  
 1969 CHEVY pickup truck. Automatic. Good tires. \$1050 firm. Call 758-5179 after 6 p.m.  
 1969 FORD TRUCK with camper shell. \$1000. Call 758-1577.

**040 Child Care**  
 SOMEONE TO KEEP infant in my home Monday-Friday. References required. Call 756-7189.  
 WANTED: Babysitter in my home between hours of 8:30 p.m. and 8 a.m. Only serious minded individual with references need apply. Send resume to: Baby Sitter, P.O. Box 1967, Greenville, NC 27834.

**046 PETS**  
 FREE KITTENS to good home. 6 weeks old. Litter box trained. Call 757-3359.  
 FREE TABBY KITTENS. Call 756-8413.  
 FULL BLOODED DALMATIAN pups. 6 weeks old. 3 males, 3 females. \$85. 758-6333.  
 GERMAN Short Haired Pointers. AKC registered. 7 males, 3 females. 6 weeks old. Call 756-4582.  
 PIT BULL PUPPIES. Days 752-7177, nights 758-2660.  
 SCHNODDLE PUPPIES. Schaefer/Roodle mix. \$40. Call 752-7521.  
 SIAMESE KITTENS for sale. Female Sealpoint, well bred. 7610.  
 SIAMESE KITTENS, 1 male and 1 female. Sealpoint \$35 each. 756-2658.  
 WHITE GERMAN SHEPHERD pups. AKC registered. Males \$125. Females \$100. Call 752-7780.

**046 PETS**  
 AKC Great Dane puppies. Shots and dewormed. \$75. 746-4034 after 6 p.m.  
 AKC SIBERIAN HUSKIE puppies. Males. Blue eyes. Ready for delivery July 31. Phone 746-6835 and after 8:00-3372.  
 BEAGLE PUPS for sale. 3 to 10 months old. \$30 to \$50. Call 758-0337 after 6 p.m.

**051 Help Wanted**  
 Permanent future with growth potential for responsible individual accustomed to active contact with public. Continuing training program, with local supervision. Position offers stable career with substantial income and managerial opportunity. Send experience and personal data to "Career Opportunity", P.O. Box 1967, c/o The Daily Reflector, Greenville, North Carolina, 27834.

**051 Help Wanted**  
 ACCOUNTANT By CPA firm. Experience preferred. Send resume to: Accountant, P.O. Box 1967, Greenville, NC 27834.  
 APPRAISER/ADJUSTER. Experienced Auto physical damage. Greenville-New Bern area. Part full-time. Age no handicap. Send resume to: Appraiser/Adjuster, P.O. Box 1967, Greenville, NC 27834.  
 ASSISTANT MANAGER needed. College degree and retail experience preferred. Apply in person between 12-5, Monday-Thursday only. Leather 'N Wood, Carolina East Mall.  
 ASSISTANT MANGER wanted. Person with experience in discount or variety store. Apply to the Super Dollar Store in Ayden.  
 AUTOMOTIVE SALES Experience preferred. Must have good references. Call for appointment. 756-4567.  
 BABY SITTERS for varied times, my home. College students or adults. Own transportation. 756-2684.  
 MATURE middle age woman to help 2 elderly people. \$100 a week. Room and board. 756-5480.

**051 Help Wanted**  
**NOW CAREERS**  
 The personnel service division of Thomas & Thomas Vocational Assessment located at 302 Evans Street Mall has immediate openings in sales, management, finance, clerical and technical job areas. All this includes the lowest fee structure in our area. You can't afford not to call 757-1098 or 757-3298.  
 ONE DELIVERY MAN needed. Apply at Daughtridge Oil Company, 2102 Dickinson Avenue between 9 and 4, No phone calls.  
 ONE OF the country's leading insurance companies is looking for an individual in its Greenville office. The candidate must have an aptitude for selling. This is a substantial earning opportunity. Phone 752-3840 between 8 a.m. and 11 a.m., Monday-Friday and ask for Robert Tucci or Ronald Jevicky at the Greenville office, 100 Reade Street, Greenville, NC 27834.  
 OPPORTUNITY for creativity in Nursing of the future. Unique Nursing/Retirement home offers staff position for RN at coastal North Carolina. Hurry while openings are available. Call or write: N.P. Health Care Director, Sailors' Snug Harbor, Sea Level, NC 28577, 718-2255.  
 PART TIME MULTI-LEVEL distributors needed. Some already making over \$5,000 per month in less than a year with a 65% profit and bonus structure. Start your own business with less than \$50. Complete line of pet, home, nutritional, personal, facial, and also various products. Call 756-8712/752-7159 for appointment.

**059 Work Wanted**  
 ACCOUNTANT with N.Y. law firm. Send resume to: T&T, cost budget, finance. Call J. Rosario 752-2879 or 746-1742.  
 ANY TYPE of carpentry work. Remodeling, repairing, decks, and garages. Garland Skinner, 758-0185.  
 CUSTOM TAILORING for women. Blazers, suits, blouses. Call 758-8567.  
 NEEDLECRAFTS done for you. All crafts done by experts. Get your Christmas gifts started. Call Linda at 758-2200 or 756-8228.  
 PAINTING, handy man home repairs, decks, storage buildings, garages. 758-6212.  
 PLUMBING AND CARPENTRY. Free estimates. General repairs and remodeling, specializing in bathroom. No job too small. State License #7037-R. 746-2657. If no answer 752-4064.  
 QUALITY cabinet and carpentry in Greenville area. Employed by leading builder. No job too large or too small. Decks included. Call 746-3788 between 5 and 7 p.m.  
 SANDING AND FINISHING floors. Small carpenter jobs, counter tops. Jack Baker Floor Service, 756-2868. Arriving 11:30 am. Call 752-0717. S.E.Wing. Reasonable. Call 752-0717.  
 WOULD LIKE to babysit in my home. 752-2711.  
 WOULD LIKE to sit with elderly person or sick person five days a week, full time or part time. Call anytime. 758-2910.  
 WOULD LIKE to do babysitting in my home Monday-Friday, D.H. center in Black Jack area. 756-9897 after 6.  
 WOULD LIKE to babysit. Have own transportation. 752-4014.

**074 Miscellaneous**  
 AIR CONDITIONER, like new, 9,000 BTU, 50 pounds. Window unit. Runs on 110 current. \$150. Genuine leather full-length woman's coat, size 7-9, \$125. Tuxedo, 10-speed mens trailer for hauling scaffolding. Call 758-4288.  
 MISCELLANEOUS BABY ITEMS. Sale. Walker, Winnie-the-Pooh rocker, carrier, baby clothes from birth-2 years. Call 756-2845.  
 NEW energy saver Whirlpool, 5,000 BTU, air conditioner. Used 1 month, \$150. Must sell. Call 758-0807.  
 NEW SHIPMENT, beautiful quilted material. Mill Outlet Cloth, 2777 East 10th Street.  
 ONE SET of concrete steps. 4 high. \$21. Call 756-3270.  
 PEACHES, WATERMELONS, lima beans, string beans, tomatoes, potatoes. \$1.00. Call 756-1256. Andy Nease/norn, Reston Garden Market.  
 REDECORATING? A new double roll of 36" wide, 4' long, double wallpaper. Fall colors. Value \$110. Will sell 50% off. 758-0807.  
 SHAMPOO and conditioners. Rent Tool Company.  
 SLATE POOL TABLES. \$249.95. 30 models. New and used. We deliver. 919-763-9734.  
 SOLID LEATHER Western saddle, bridle, and blanket. Call 756-8284.  
 SPANISH style sofa. \$75. Call 752-9275.  
 STEREO COMPONENTS. Realistic AM-FM receiver, realistic cassette deck and turntable, speakers. \$500 value. \$300 firm. May be seen Tuesday and Wednesday at 1400 E. 10th Street. Lot W-20. 756-2684.  
 STEREO SYSTEM. 1 Sony PS-P1 turntable; 1 Marantz EQ-10 equalizer; 1 JBL L-80 loud speakers. \$1100. 752-6560.  
 STOVE FOR SALE. Granda brand. Perfect condition. Good price. Call 752-2593.  
 STROLLER LENGTH Norwegian minnow. Call 756-2684.  
 FACTORY second hammocks, tomatos. 1104 Clark Street.  
 FOOS BALL TABLE, \$85. Phone 756-9036 after five.  
 FOR SALE: Stove, Handicraft, 20" white, electric, in excellent condition. Call 756-4870 after 6.  
 FOR SALE: Diamond cluster with carat center stone. Also diamond wedding band. 756-3283.  
 FOR SALE: Sofa, \$50. Call 752-3552.  
 FRESH Silver Queen corn for sale. \$1.00 dozen. Will deliver. 302 Lindell Drive, 756-2208.  
 FRESH vegetables daily. You pick or we pick. Phone 756-7124.  
 FULL SET OF PGA golf clubs for sale. Best offer. Call 756-7046 after 6 p.m.  
 HUNDREDS OF USED kitchen cabinets and air fresheners for sale. \$1.00. Call 756-7124.  
 IMPORTED grass wall coverings from Schumacher and Seabrook. Only \$12.95 per roll at Larry's Carpetland, 3010 East Tenth Street. See an in-stock wallpaper through July only.  
 KENMORE WASHER and dryer. Two years old. \$400. Call 758-0809.  
 KODAK Moviexide-477, 7 speed. Regular \$5.95. Used twice. Was \$20. Now \$135. Olympus camera-35R. \$90. Guitar and case. \$40. Call 752-5214 between 6 p.m. and 7 p.m.  
 LIMITED TIME 25% off on all GE, Gibson and Linton appliances. Free 10 year Golden Warranty on all Gibson front clear appliances. Sale July 12-16. Financing available. Tyson's Electrical & Appliance, 202 North Railroad Street, Winterville, 756-2929.

**BLUEBERRIES**  
 Carl Crawford Farm  
 756-3682 756-4815  
 Open Daily Starting July 15  
 Pick your own - 45¢ per pound.  
 Starting at Red Oak Church:  
 Travel 2 miles on 264 West  
 Turn left  
 Travel 1/2 mile  
 Look for sign on right.

**EFIRD'S PEST CONTROL**  
**SPECIAL**  
 HAVE ROACHES, FLEAS OR ANTS?  
 Let Us Help You Rid Your Home Of These Pests  
 With Our Special Discount Rate  
 INITIAL Treatment **Only \$40**  
 CALL 752-6440

**060 FOR SALE**  
**064 Fuel, Wood, Coal**  
 ALL TYPES OF firewood for sale. P. Stencil, 759-6331.  
**065 Farm Equipment**  
 CONVEYER CHAIN: 20" \$13.90 per 50' roll, 18" \$10.94 per 50' roll. Foam rollers \$3.59 each for 30' or more. All types of bearings and sprockets available. Agr. Supply Company, Greenville, NC. 752-3999.  
 WANT to buy tobacco sticks. Call 746-3003, 746-4475; nights 746-6211.  
**067 Garage-Yard Sale**  
**POORMAN'S FLEA MARKET**  
 Farmers Market Buy and sell. Open Wednesday-Saturday, 7 a.m.-6 p.m. Sunday, 10 a.m.-5 p.m. Located on Pictious Highway 264 East of Greenville, 752-1400 or 946-2121.  
**YARD SALE: 1500 Ragdale Road.**  
 Air conditioner, kitchen table, electronic equipment, camera gear, television, many more items! July 18-17 & 18 p.m.  
**YARD SALE, Thursday, 9 to 12.**  
 Clothing for men and women. 920 E. 14th Street.

**060 FOR SALE**  
**064 Fuel, Wood, Coal**  
 ALL TYPES OF firewood for sale. P. Stencil, 759-6331.  
**065 Farm Equipment**  
 CONVEYER CHAIN: 20" \$13.90 per 50' roll, 18" \$10.94 per 50' roll. Foam rollers \$3.59 each for 30' or more. All types of bearings and sprockets available. Agr. Supply Company, Greenville, NC. 752-3999.  
 WANT to buy tobacco sticks. Call 746-3003, 746-4475; nights 746-6211.  
**067 Garage-Yard Sale**  
**POORMAN'S FLEA MARKET**  
 Farmers Market Buy and sell. Open Wednesday-Saturday, 7 a.m.-6 p.m. Sunday, 10 a.m.-5 p.m. Located on Pictious Highway 264 East of Greenville, 752-1400 or 946-2121.  
**YARD SALE: 1500 Ragdale Road.**  
 Air conditioner, kitchen table, electronic equipment, camera gear, television, many more items! July 18-17 & 18 p.m.  
**YARD SALE, Thursday, 9 to 12.**  
 Clothing for men and women. 920 E. 14th Street.

**\$2000**

**UP TO**

**DISCOUNT**

**On 1982 Capris**

**And Cougar Sedans In Stock**

**CAPRI**  
 EPA Rated: 22 MPG City  
 33 MPG Hwy  
 4 To Choose From

**COUGAR**  
 EPA Rated: 19 MPG City  
 26 MPG Hwy  
 3 To Choose From

**Examples:**

**1982 Mercury Capri**  
 Stock no. 2121. Power steering, power front disc brakes, V6 radial tires, full instrumentation with tach, 2.3 litre 4 cylinder engine, AM-FM stereo with cassette tape, flip-up open air roof, leather wrapped steering wheel, liftback third door, wide body side moldings, reclining low back bucket seats, automatic transmission, air condition, tinted glass.

**1982 Mercury Cougar**  
 Stock no. 2109. Equipped with automatic transmission, power steering, power disc brakes, radial tires, 3.3 litre 6 cylinder engine, left and right remote control mirrors, split bench seat, tilt wheel, AM-FM stereo, speed control, LS seat trim, deluxe belts, accent paint stripes, wide body side moldings, air condition, luxury wheel covers, tinted glass.

**Special Value Discounts Combined With Large Dealer Discounts Make This Once-In-A-Lifetime Offer Possible**

**Come In Now While The Selection Is Best**

**MERCURY LINCOLN**

**EAST CAROLINA**

**GMC**

West End Circle Greenville, N.C. 756-4267

**LEGAL INSURANCE PARTNER WANTED**

Ambitious, experienced and farsighted business persons required to establish prepaid legal service plan in local area. Must have excellent references and prior extensive sales experience. Security deposit required depending on size of territory. Details call Mr. Stevens 215-627-4426.

**TANKS**

**FUEL STORAGE**  
 550 to 4000 gallon, under or above ground tanks, reconditioned and like new. Tested and guaranteed.  
 BRIDGE CULVERTS From 8" in Diameter to 14' and 24' Lengths DELIVERY AVAILABLE Call Anytime  
**J.D. Allgood**  
 Salvage & Machine Works  
 Hwy. 17, Chocowinity, N.C. 946-6901

**CAR WARS**

**1981 Pontiac Bonneville**  
 2 door coupe. Champagne with champagne metallic landau roof, velour interior, tilt wheel, cruise control, AM-FM radio, wire wheel covers, power windows, power door locks. 24,000 miles.

**1981 Chevrolet Malibu Classic**  
 4 Door. Metallic champagne with vinyl interior, power steering and brakes, air, AM-FM radio, 22,000 miles, nice car.

**1981 Pontiac Bonneville**  
 Medium blue metallic, blue velour interior. Extras include cruise control, AM-FM radio, wire wheel covers, 17,800 miles. One local owner.

**1980 Pontiac Trans AM**  
 White with blue velour interior. Power windows, tilt wheel, cruise control, AM-FM radio, cast aluminum wheels, 25,000 miles, one owner.

**1980 Chevrolet Citation**  
 5 door hatchback. Silver metallic with red interior, automatic, air, radio, aharp car.

**1979 Chevrolet Caprice Estate Wagon**  
 White with woodgrain trim and blue vinyl interior, fully equipped, 3 seats, luggage rack, 38,000 miles, nice family car.

**1979 Mazda 626**  
 Metallic green with beige interior, 4 speed transmission, air, AM-FM radio, 31,000 miles, local car.

**1979 Cadillac Sedan De Ville**  
 4 door. Beige with saddle vinyl top and saddle leather interior. Fully equipped. Wire wheel covers.

**1979 Pontiac Grand Lemans Wagon**  
 Beige with tan vinyl interior, woodgrain trim, power steering and brakes, air, AM-FM radio, rally wheels, 49,000 miles, local car.

**1978 Chevrolet Caprice Classic**  
 4 door. White with white vinyl roof, burgundy interior, Michelin tires, 55,000 miles, new shocks. Car is in excellent shape and extremely clean. Less than half the price of a new one.

**1977 Cadillac Sedan De Ville**  
 Yellow with white vinyl top. Fully loaded, radial tires, extra clean, locally owned.

**1977 Toyota Land Cruiser**  
 Gold with black vinyl interior. 4 wheel drive, AM-FM cassette, low mileage, local owner. Good condition.

**1976 Ford Torino Wagon**  
 Beige with tan interior, power steering and brakes, automatic, air, tilt wheel, 59,000 miles, local car.

**1971 Cadillac Sedan De Ville**  
 4 door. Canary yellow, cloth interior, stereo radio, radial tires, excellent condition, one owner.

**1970 Volkswagen Convertible**  
 2 door. Silver metallic with black interior. Semi-automatic, good condition. Check this great value.

**075 Mobile Homes For Sale**  
 MOBILE HOME for sale. 1974, 12x50. Fairway. Call 752-7877 and leave number.  
 MOBILE HOME and 1/2 acre of land for sale. Air, stove, refrigerator, and washing machine. New carpet throughout trailer. Can be seen at Joyner's Crossroads in Farmville. Asking \$13,000. 752-2701.  
 REPO. Trying to save former customer credit. 70' X 14', 2 bedrooms, 2 full baths with central air, 495 down, assume loan. See J. T. Williams or Tommy Williams at Azalea Mobile Homes, 264 Bypass, 756-7815.  
 TWO BEDROOM trailer, furnished including washer. In good condition. \$5500. 752-3107 or 758-5847.  
 12 X 45. 3 bedrooms, 2 baths, furnished. 12% owner financing. 756-2871 or 758-1543.  
 12x46 with washer and dryer, air conditioner, \$4950. 758-4541.  
 14 X 70. 2 baths. Mastercraft by R-anel. Central air, washer, dryer, set up in town. Pay equity, \$200 monthly. 752-3000 days, 756-1997 nights.  
 14 X 70. 2 baths. Like new, fully furnished, 3 bedrooms. Call 756-7266, 813,500.  
 1974 3 bedroom, Parkwood mobile home. \$1200 and take 24 payments of \$138 month. 758-0809.  
 1975 WESTCHESTER 12 x 60. New central air, 12 x 12 wood deck and underpinning. Priced at \$6500. 758-7115.  
 1979 14x70, 2 bedrooms, garden tub, large den with fireplace, central air, wood underskirt with 10x16 deck on back, and oak deck on front. With storage building. Excellent neighborhood. (Branch Estates). By appointment only. 756-4357 after 6:30 p.m.  
 1981, 70x14, 2 bedroom repo, excellent condition, central air, fireplace, dishwasher, 2 full baths, walk-in closet, and much more. Need to move at once. Assume loan. 752-7891.  
 1981 VOGUE 14 x 70. 3 bedrooms. Partially furnished. Assume payments of \$190 per month. 756-4127.  
 2 bedroom mobile home, completely reconditioned. \$500 equity, \$3800 remaining. 752-3100 after 6 p.m.  
 2 MOBILE HOMES for sale or rent. One 3 bedroom for \$3200 and one 2 bedroom for \$4200. Call 756-0219 or 756-6487.  
**076 Mobile Home Insurance**  
 MOBILE HOMEOWNER Insurance at competitive rates. Smith Insurance and Realty. 752-2764.  
**077 Musical Instruments**  
 BABY GRAND Best offer. Call 752-4733.  
 HOFFMAN STRING INSTRUMENT REPAIRS  
 The shop professional in prefer. Expert refinishing. Complete restoration to custom set-up work. Gibson, Ovalton & Schechter warranty center. Call 872-0447.  
**078 Sporting Goods**  
 AAA Swimming Pool Distributor now has the fantastic, new 31' family-size pools in stock. Ready to go. Call 756-2845.  
 \$978. Complete with deck, fence, filter and warranty. Can finance. Call 872-0447.  
 COMPOUND BOW Left hand with sights and quiver. New. \$100. Call 756-9011.  
**082 LOST AND FOUND**  
 FOUND ON 4th Street, female Kitten about 2 weeks old. 4 white paws, orange tabby stripes. Home 752-7525; work 758-7676.  
**085 Loans And Mortgages**  
 NEED CASH, get a second mortgage fast by phone, we also buy mortgages and make competitive loan calls. 756-445-3929.  
**091 Business Services**  
 WILD ONIONS DESTROYED without destroying your lawn. 758-7704 or 756-8993.  
**093 OPPORTUNITY.**  
 BREAKFAST AND LUNCH in auditorium. Excellent profit. Investment. Confidential Brokers. 756-0644.  
 FAST FOOD RESTAURANT in PINE County. Very profitable. About \$5000 month. Will pay for itself in one year. Asking \$60,000. Some owner financing. Confidential. 756-0644.  
 LIST OR BUY your business with 1200 sq. ft. in Greenville. Excellent Marketing Consultants. Serving the Southeastern United States. Greenville, N.C. 757-0001, nights 756-0515.  
 LOCAL BUSINESS for sale. Inventory and fixtures. \$16,000. Reply to: Business Opportunity, P.O. Box 1967, Greenville, N.C. 27834.

**NOTICE**  
 We Would Like To Buy Your Car. See Us Before You Trade For Any Car!  
 Dickinson Ave. 752-7111

**PONTIAC** **GMC** **Cadillac** **FORD**

**993 OPPORTUNITY**  
**RESTAURANT FOR SALE** part or all. Good terms. Ideal opportunity for experienced person. Serious inquiries only. Write PO Box 2201, Greenville, NC 27834.

**095 PROFESSIONAL**  
**CHIMNEY SWEEP** Gid Holoman. North Carolina's original chimney sweep. 25 years experience working on chimneys and fireplaces. Call day or night, 753-3503, Farmville.

**102 Commercial Property**  
**72 ACRES LOCATED** just off North Green Street on Highway 30. Zoned non-offensive industry with 380 frontage. Call 756-3200. Contact Aldridge & Southernland, 756-3300, nights, Don Southerland, 756-5260.

**109 Houses For Sale**  
**FHA 235 financing** available for a limited period of time on these two bedroom townhomes near the Greenville Athletic Club. If you qualify, your payments could be cheaper than rent. FHA 245 financing available for anyone. Only a few left, so better hurry. Call for additional information. CENTURY 21 Bass Realty, 756-6666 or 756-5868.

**HANDY MAN SPECIAL!** This home features 2025 square feet of living area with four bedrooms, 2 baths. Needs a little work, \$19,900. 110296 CENTURY 21 Bass Realty, 756-6666 or 756-5868.

**IN FARMVILLE** 4 bedrooms with 2 baths, central heat and air conditioning. Convenient to downtown and schools. Reduced in price by owner. Call 753-3101 days, 753-4785 nights.

**INCORPARABLE** executive home solarium plus grand living areas. Reduced to \$148,500. Call Blount & Ball, 756-3000 or Richard Lane, 752-8819.

**LIMITED TIME ONLY!** This loan can be assumed at 9 1/2% with payments of \$434. PITI 1600 square foot house is tastefully decorated and well maintained. Call today before this loan expires. Clark Branch Realtors, 756-6336.

**LOAN ASSUMPTION** 3 bedrooms, 2 full baths, spacious den with sliding glass doors, kitchen/eat-in area, living room, fully carpeted, single car garage. On a wooded lot in excellent subdivision. Steve Evans & Associates, 355-2727 or 756-3338.

**EXCELLENT ROOM** (3500 square feet). Excellent location! Owner financing. (Consider trade cars, mobiles, land, and so forth) 758-9013.

**115 Lots For Sale**  
**MEADOWBROOK** Zoned for mobile homes. Owner financing. Speight Realty, 756-3220, nights, 756-7741.

**ONE ACRE lot** cleared. \$7800. Owner financing at 12% 752-7768 anytime.

**ONE ACRE LOT** on Ram Horn Road, 1 1/2 miles from new fair grounds. Excellent location for a place in the country, yet convenient to town. For more information contact Aldridge & Southernland, 756-3300, nights, Don Southerland, 756-5260.

**STOKES 3 acres.** Owner financing on your terms. Speight Realty, 756-3220, nights, 756-7741.

**2 ACRES LOT** 10 miles east of Greenville. Septic tank and 30 x 30 shedler. \$1,000 negotiable. 758-1115.

**3 ACRES,** near Lake Glenwood on Eastern Pines Road, \$18,500. Call after 5:30 p.m., 758-1185.

**8 LOTS** Windermere Estates. No interest. Finance plan available. Call after 6 p.m., 756-4391.

**121 Apartment For Rent**  
**ATTRACTIVE 2 bedroom** townhouse apartment. Washer/dryer hookups, fully equipped kitchen, outside storage, fireplace. Available immediately. 756-9923.

**DUPLEX 2 bedroom,** 1 1/2 bath, range, refrigerator, dishwasher, washer/dryer hookups. Shenandoah. Preferred Properties, 756-7799.

**121 Apartments For Rent**  
**ONE BEDROOM,** furnished apartments or mobile homes for rent. Contact J.T. or Tommy Williams, 756-7815.

**ONE BEDROOM apartment,** carpeted and appliances, washer and dryer hookups. 211 North Street, \$195. 758-3311.

**ONE BEDROOM apartment,** heat and hot water furnished. 291 North Street, \$275. 756-6666 after 5:00 p.m.

**SHANENDOAH Subdivision,** 2 bedroom duplex, carpet, appliances, washer/dryer hookups. 311 B Tobacco Road, \$280. Call 758-3311.

**SHORT TERM LEASE \$215 and \$220.** One monthly payment covers everything. 3 bedroom, furnished, cable TV, pool, laundry. Weekly rates from \$43-\$125. Ode London Inn, 756-5555.

**121 Apartment For Rent**  
**1 BEDROOM apartment,** 1722 West Fifth Street. Near hospital. Call 752-6197.

**1 BEDROOM, furnished apartment.** Appliances ECU completely modern with central heat and air conditioning. Stadium Apartments, 904 East 14th Street, \$180 per month. Call 752-5700 or 756-4871. Available August 1.

**Sell your used television** the Classified way. Call 752-6166.

**2 BEDROOM townhouse,** carpeted, appliances, washer/dryer hookups. 108 Apartment A Cedar Court, \$280. Call 758-3311.

**704 EAST THIRD STREET** Furnished and unfurnished. 2 bedroom units available. Unfurnished, \$240 month; furnished, \$260 month. 756-1888.

**133 Mobile Homes For Rent**  
**TWO BEDROOM** mobile home for rent. \$170 month. \$85 deposit. Call 756-4687.

**Want to sell livestock?** Run a Classified ad for quick response.

**12 X 6 & 3 THREE bedroom,** 1 1/2 baths, air conditioned. Deposit \$75. Rent \$180. Call 746-2255, 752-2488 nights.

**12X40 3 bedrooms, 2 baths,** furnished. \$155. No pets. No children. 758-4541 or 756-9491.

**137 Resort Property For Rent**  
**ATLANTIC BEACH** oceanfront cottage, sleeps 15. Families preferred. \$300 per week. 756-0041.

**138 Rooms For Rent**  
**ROOMS FOR RENT:** Weekly efficiency, linen furnished, maid service once a week. From \$43.97. Close to bus route. Oldie, London Inn, 756-5355.

**SHARE A fabulous place** with hot tub and sauna. Your own bedroom. \$140 month. 752-5048.

**106 Farms For Sale**  
**28 ACRES** with 12 cleared. Near Chicod School. 15 miles Southeast of Greenville. Owner financing available. For more information call Aldridge & Southernland Realty, 756-3300; nights Don Southerland, 756-5260.

**58 ACRE FARM** Lots of road frontage in S.J. Johns community. Tobacco allotment, pond, and rental house. Moseley-Marcus Realty, 746-2166.

**109 Houses For Sale**  
**BELVOIR 3 bedrooms,** new construction. Owner financing with small down payment. Good deal for price. \$89,500. Speight Realty, 756-3220; nights, 758-7741.

**BEST BUY!** By owner. 3 year old brick ranch, 3 bedrooms, 2 baths, fenced yard, garage, shed and more. Excellent location. Possible 10% loan assumption. \$49,800. Call 746-2641.

**BRICK RANCH** home in Winterville for sale by owner. 1250 square feet, 3 bedrooms, 1 1/2 baths, kitchen, dining room, living room, garage, and sundeck. Assumable loan at \$11,500. Payments, \$418. Low equity. 756-5260. Call 758-6770 days or 756-6050 nights.

**BROOK VALLEY** For sale by owner. Home on 1/2 acre wooded lot. Surrounded by growing orchard. Large kitchen with dining area, family room with fireplace, dining room, living room, 3 bedrooms, 2 baths, glassed-in sun porch, central vacuum, Black Jacker slot inserts, air conditioning. Call 756-5337 for appointment.

**BROOK VALLEY** Drastically reduced! This two story brick ranch home has 4 bedrooms, living room, dining room, den and a play room. Owner is willing to rent with option to buy and has reduced the price to \$89,900. Better hurry! 2183 CENTURY 21 Bass Realty, 756-6666 or 756-5868.

**BROOK VALLEY** You've got to see this 2 story Southern Colonial which features kitchen with separate breakfast nook, lovely hardwood floors and all formal areas. \$90,500. CENTURY 21 Bass Realty, 756-6666 or 756-5868.

**BY OWNER** 1100 square feet, 3 bedrooms, air conditioning, new carpet, new paint. This two story brick patio, 350 square foot storage building, out of city limits. \$39,500. Call 752-1275.

**CHEERFUL SETTING** for a happy family in the university area on corner lot well-shaded by mature trees. Brick ranch home boasts approximately 1152 square feet including large living room, eat-in kitchen complete with dishwasher, range and refrigerator, 3 bedrooms, 1 1/2 baths, central heat and air, hardwood floors and a 1 1/2 car garage. Assumable 13 1/2% fixed rate loan to qualified buyer. \$43,900. Call Movis Realty, 758-6655 or Jane Butts, 756-2851 or Elaine Troiano, 756-6346.

**CLUB PINES** - Quality for the asking. This four bedroom Williamsburg is custom built throughout with over 2000 square feet. All formal areas and a third story storage area. \$104,900. #175K. CENTURY 21 Bass Realty, 756-6666 or 756-5868.

**COUNTRY** with a possible loan assumption. One acre wooded lot, only two years old with 4 bedrooms and two baths. Great room with fireplace, dining room, kitchen, living room and a 1 1/2 car garage. Double garage, separate workshop. Small in-ground swimming pool, deck and patio. \$83,000. Duffy Realty Inc., 756-5395.

**DO YOU OWN** a home in Greenville and work in Rocky Mount? I am willing to trade equity on my home in Rocky Mount a purchase or down payment on a home in Greenville. Jeff Earis, Waters Service Center, 752-4222.

**EXCELLENT** investment area, 3 bedrooms, bath, large family room with fireplace and Casablanca fan. Very attractive. Near university. \$43,900. Call June Wyrick, Aldridge & Southernland, 758-7744 or 756-3500.

**FARMERS HOME** assumption on this 3 bedroom brick ranch in the country. Less than \$1000 to assume this loan. Call today for more details. \$30's #1109. CENTURY 21 Bass Realty, 756-6666 or 756-5868.

**93% ASSUMABLE LOAN** 3 bedrooms, 1 1/2 baths, fireplace with heater system, fenced-in yard, swimming pool. In Ayden. For sale by owner. Call 746-2594 before 6 p.m.

**117 Resort Property For Sale**  
**APPROXIMATELY 1/2 acre** lot, 122 feet on canal, beautiful landscape, approximately 8 miles from Greenville. \$120,000 negotiable. 758-1115.

**LOT ON THE Pungo River** with repairable house, well and septic tank. \$8,300. Estate Realty Company, 752-5058; Billy Wilson, 758-4476.

**PAMLICO RIVER RETREAT** Washington side near marina and country club. Excellent view in sandy beach. 3 bedrooms, living room, bath, air, modernized kitchen. Heavily wooded lot, furnished including 14' boat, recently painted. \$24,900. 237-1069 after 4 p.m., Wilson, NC.

**PUNGO RIVER** nice river cottage with large lot. Owner financing. Speight Realty, 756-3220; nights, 756-7741.

**RIVERFRONT COTTAGE,** 3 bedrooms, screened porch, north side Pamlico River, 100' pier, rustic, a lot of privacy. Call 756-0200, Dan Morgan.

**100 FOOT LOT** on Bath Creek just 1/2 mile from Greenville Long pier, already built and sandy beach. \$42,500. For more information contact Wilmington, Southland Realty, 756-3500; nights Don Southerland, 756-5260.

**EASTBROOK AND VILLAGE GREEN APARTMENTS**  
 327 one, two and three bedroom garden and townhouse apartments, featuring cable TV, modern appliances, central heat and air conditioning, clean laundry facilities, three swimming pools.

Office - 204 Eastbrook Drive 752-3100

**FOR RENT:** 2 bedroom duplex, energy efficient, near ECU Call 756-9006 after 6 p.m.

**GreeneWay**  
 Large 2 bedroom garden apartment, carpeted, dishwasher, cable TV, laundry rooms, abundant parking, economical utilities and POOL. Adjacent to Greenville Country Club, 756-6869

**KINGS ROW APARTMENTS**  
 One and two bedroom garden apartments. Carpeted, range, refrigerator, hot water, central heat and cable TV. Conveniently located to shopping center and schools. Located in Greenville, NC. Call 752-3519

**LANGSTON PARK**  
 Apartment and duplex, 2 bedrooms, carpeted, all appliances, washer/dryer hookups, cable TV, water furnished. 5 blocks from ECU. No pets. Call 752-0180, 756-3210, 756-7766 or 758-1144.

**LOVE TREES?**  
 Experience the unique in apartment living with nature outside your door.

**COURTNEY SQUARE APARTMENTS**  
 Quality construction, fireplaces, heat pumps (heating costs 50% less than comparable units), dishwasher, washer/dryer hook-ups, cable TV, wall-to-wall carpet, thermopane windows, extra insulation.

Office Open 9-5 Weekdays 9-5 Saturday 1-5 Sunday  
 Merry Lane Off Arlington Blvd. 756-5067

**NEAR HOSPITAL**  
 Linbeth Drive, New 2 bedroom duplex, air condition, refrigerator, dishwasher and range, washer/dryer hook-ups. Available immediately, \$295 per month. Call 752-2106.

**NEED SOMEONE** to sublease apartment for 8 months. Call 758-0827 after 5.

**NEW DUPLEX** near hospital. Ready August 1. 2 bedrooms, 1 1/2 baths, fireplace. Bob Whitehurst, 825-8381 days; 825-3611 nights.

**OAKMONT SQUARE APARTMENTS**  
 Two bedroom townhouse apartments. 1212 Redbanks Road. Dishwasher, refrigerator, range, disposal included. We also have cable TV. Very convenient to Pitt Plaza and University. Terms available.

756-4151

**STRATFORD ARMS APARTMENTS**  
 The Happy Place To Live CABLE TV  
 Office hours 10 a.m. to 5 p.m. Monday through Friday.  
 Call us 24 hours a day at 756-4800

**TAR RIVER ESTATES**  
 1, 2, and 3 bedrooms, washer dryer hook-ups, cable TV, pool, club house, playground. Near ECU.  
 Our Reputation Says It All... A Community Complex.  
 1401 Willow Street  
 Office - Corner Elm & Willow 752-4225

**TRIPLEX, 2 BEDROOMS,** 1 1/2 baths, air conditioned, washer/dryer hookups. \$275 per month. Available August 1, 355-6041 after 5:30 p.m.

**TWO BEDROOM** unfurnished duplex located on 2nd Street, Ayden. Refrigerator, stove and dishwasher furnished. Water and utilities separate. Central air and heat pump. Available in June. Call Judy at 756-6336 before 5.

**TWO BEDROOM** apartment near ECU, heat and water furnished, \$265 month rent, \$265 deposit. Call 758-0491 or 756-7809 before 9 p.m.

**TWO BEDROOM** duplex near ECU, freshly painted. Carpet, appliances, energy efficient heat pump, large yard. \$265. 756-7480.

**UNIVERSITY** Condominium Available August 1. 2 bedrooms, 1 1/2 baths, fireplace. Dishwasher, pool privileges. \$275 a month. Call 355-6220.

**127 Houses For Rent**  
**AYDEN** For rent. 3 bedroom, 1 1/2 bath brick home with fenced-in backyard. \$275. 746-4660 after 5:00 p.m.

**AYDEN 2 bedrooms,** living room with fireplace, kitchen with dishwasher, 2 car carport. \$475. Lily Richardson Realty, 752-6535 or 756-5088.

**COLONIAL HEIGHTS** 3 bedroom house \$335 a month. Requires lease and deposit. Blount & Ball, 756-3000.

**HOUSES AND APARTMENTS** in town and country. 746-3284 or 324-3180.

**NEAR FARMVILLE** 3 and 4 bedroom houses with central heat, newly decorated, extra nice. Call 753-3101 days, 753-4785 nights.

**NICE 3 BEDROOM** brick home approximately 2 miles from Bethel. Available August 1. \$275. 752-2488 after 5:00 p.m.

**SPACIOUS, 3 bedroom, 2 bath** house. Located 5 miles outside of Greenville. Large den, \$300 deposit. Available August 1. Rent: \$350 per month with deposit 1 year lease required. Call collect, 791-2559. Serious inquiries only.

**THREE BEDROOM** house, appliances furnished, washer/dryer hookups. University area, 112 East 12th Street. Students or family. \$275. 756-0765 Monday/Thursday.

**3 BEDROOM, 1 1/2 baths,** appliances furnished, washer/dryer hookups, Colonial Heights, \$360 month plus deposit 1 year lease. Call after 4 p.m., 756-1952.

**3 BEDROOMS,** brick. Excellent condition, Colonial Heights. Lease and deposit. \$335 a month. 756-3772.

**4 BEDROOM HOME** with approximately 1850 square feet patio, storage and central air. \$400. Call today, CENTURY 21 B Forbes Agency, 756-2121.

**135 Office Space For Rent**  
**ARLINGTON** Boulevard and Downtown offices. Singles or suites available immediately. Blount & Ball, 756-3000.

**COLONIAL HEIGHTS** 165 square foot office space. Utilities furnished. \$75 month. 756-7417.

**OFFICE BUILDING** Available immediately. Formerly used by physician. Call 752-9279 or 758-2001.

**OFFICE OR BUSINESS** location Colonial Heights Shopping Center, 2741 East 10th Street. Approximately 1900 square feet. Available May 1. \$250 month. Call 758-4257 between 9 and 5 weekdays.

**OFFICE** 1200 square feet, 1209 Evans Street. Parking in rear. \$250. \$559 days, 752-2488 nights.

**OFFICES FOR LEASE** Contact J.T. or Tommy Williams, 756-7815.

**PRIME location,** 311 Evans Mall. Downtown. 1650 square feet. Space for 4 professionals and secretaries. \$750 per month. 756-6866.

**2,000 SQUARE FEET** of office space available now. Reasonable rent. Located on Memorial Drive. 756-5921.

**OFFICE BUILDING,** 700 to 1100 square feet available immediately on East 10th St. Call 758-2200 days.

**142 Roommate Wanted**  
**FEMALE** 2 rooms for rent in nice 3 bedroom house \$95 a month and utilities. 758-0966.

**FEMALE NEEDED** to share 3 bedroom apartment. \$83 rent plus utilities. 758-7078.

**FEMALE ROOMMATE** wanted 2 blocks from campus. Rent \$97.50 plus one half utilities. 752-8707 after 5 p.m.

**RESPONSIBLE roommate** wanted. Must be employed or full time student. Rent \$100 a month plus utilities. Deposit and references required. 756-4567.

**RESPONSIBLE female roommate** wanted. Must be employed or full time student. Rent \$100 a month plus utilities. Deposit and references required. 756-2953 after 6.

**144 Wanted To Buy**  
**WANTED TO BUY** good conditioned used piano. Call 756-6091.

**148 Wanted To Rent**  
**APARTMENT** or house, Country in Greenville, Snow Hill, Kingston tri. angle. Under \$300. 758-7969.

**COTTAGE** on river or sound for responsible 30'ish age group and our parents for wedding reception August 7 and 8. Need large yard and some privacy. Please call Greenville, 758-0797.

**NEW HOMES \$288 PER MONTH**  
 Price includes Lot, Taxes, Insurance and Closing Costs. If you earn \$12,800 per year or more, have good credit, and not many debts, you may qualify for a new home to be built for you. For details call Joe Bowen, East Carolina Builders, 752-7194 Anytime.

**NEW LOG HOME,** 3 bedrooms, 2 baths, 1900 square feet, den with sliding glass doors, kitchen/eat-in area, living room, fully carpeted, single car garage. On a wooded lot in excellent subdivision. Steve Evans & Associates, 355-2727 or 756-3338.

**LOTS OF FINANCING** available on this four bedroom home in Cherry Oaks. Over 2300 square feet of private living area, 3 bedrooms, 2 baths, \$80's. CENTURY 21 Bass Realty, 756-6666 or 756-5868.

**OWNER MUST SELL** make an offer. Many offers, you may qualify for a move in fast for \$54,500. Call Blount & Ball, 756-3000 or Richard Lane, 752-8819.

**OWNER** must sell, 3 bedrooms, 2 baths. Excellent location. Asking \$53,500, will negotiate for quick sale. Call 756-7815.

**OWNER RELOCATING** and must sell 4 bedroom home in Cherry Oaks. Appraised in mid 80's. First offer \$69,900. Call 756-5569 after 4pm.

**SPECIAL financing** available. Four bedrooms, country site kitchen, spacious living room and a garage. Mid 30's, #185. CENTURY 21 Bass Realty, 756-6666 or 756-5868.

**TWIN OAKS** Owner is willing to pay points and closing costs for you to buy this contemporary home. A possible 10% loan assumption to meet current rate. 1722 square feet. Excellent area. Call 756-0766.

**1100 Sq. Ft. TOWNHOUSES \$1200 Down \$288 Per Month**  
 If You Qualify CALL JOE BOWEN 752-7194

**3 BEDROOM HOUSE** and lot. 1 1/2 miles from Grimsland on Black Jack Road. Call 753-3730.

**120 RENTALS**  
**LOTS FOR RENT** Also 2 and 3 bedroom mobile homes. Security deposits required, no pets. Call between 8 and 5.

**NEED STORAGE?** We have any size to meet your storage need. Call Wilmington, Southland Realty, Open Monday - Friday 9-5. Call 756-9923.

**121 Apartments For Rent**  
**A 2 bedroom** duplex, 1 1/2 baths, central air, appliances, hookups, convenient to Southernland Realty. \$270. 756-7716 or 757-6574.

**AZALEA GARDENS**  
 Greenville's newest and most uniquely furnished one bedroom apartments.  
 \* All energy efficient designed.  
 \* Queen size beds and studio apartments.  
 \* Washers and dryers optional.  
 \* Free water and sewer and yard.  
 \* All apartments on ground floor with porches.  
 \* Frost-free refrigerators.

Located in Azalea Gardens near Brook Valley Country Club. Show by appointment only. Couples or singles. No pets.

Contact J.T. or Tommy Williams 756-7815

**CANNON COURT**  
 LUCI DRIVE  
 Two bedroom townhouses available with frost-free refrigerators, dishwasher, garbage disposal, washer/dryer hookups, fully carpeted, bath and a half. No pets. Cable TV provided.

Call Rental office 756-6061. Nights and Weekends: 757-3433.

**Cherry Court**  
 Spacious 2 bedroom townhouses with 1 1/2 baths. Also 1 bedroom apartments. Carpet, dishwashers, compactors, patio, free cable TV, washer/dryer hook-ups, laundry room, sauna, tennis court, club house and POOL. 752-1557

**CLASSIFIED DISPLAY**  
**ROOFING**  
**STORM WINDOWS**  
**DOORS & AWNINGS**  
 Remodeling - Room Additions  
**C.L. Lupton, Co.**  
 752-6116

**VILLAGE EAST**  
 2 bedroom, 1 1/2 bath townhouses. Available now, \$285/month. 9 to 5 Monday/Friday. 756-7711

**WALK TO UNIVERSITY** Super nice one bedroom, utilities furnished. \$220 per month. 756-7417.

**WEDGED WOOD ARMS**  
 Few townhouses left. 4 first floor garden apartments at reduced rates. Red Banks Road. 756-0987

**1 AND 2 BEDROOM** apartments available immediately. Call 758-3311.

**1 BEDROOM** apartment. Heat, air conditioning and water furnished. Near university. No pets. 756-3923.

**1 BEDROOM** energy efficient apartment. 756-5389 or 756-0025.

**YOU CAN SAVE** money by shopping for bargains in the Classified Ads.

**CLASSIFIED DISPLAY**

**133 Mobile Homes For Rent**  
**2 BEDROOMS,** furnished, air, central heat, extra nice. Call collect, 791-2559. No children. No pets. 752-9907.

**2 BEDROOMS** Located in Oak Square Trailer Park. Call 355-6977.

**2 BEDROOMS,** furnished. No children. No pets. Call 758-6679.

**2 BEDROOMS,** furnished, air, washer, carpet. Good location. No pets, no children. 758-4857.

**137 Resort Property For Rent**  
**ATLANTIC BEACH CONDOMINIUM**  
 Available this weekend, last week in July and 2 weeks in August. 752-2579 or 756-1666.

**ATLANTIC BEACH,** nice family 2 bedroom apartment, ocean view, air, by week only \$170. 746-3613, nights 746-4444.

**FURNISHED** mountain cottage. Utilities included. Weekly \$150 plus deposit. Sleeps 5. No linens. Call 754-1936.

**CLASSIFIED DISPLAY**  
**ARMY SURPLUS**  
 CAMPING SPORTING MILITARY GOODS. Over 1000 Different Items. New and Used.

**ARMY-NAVY STORE**  
 1501 S. Evans

**CLASSIFIED DISPLAY**  
**FOR SALE BUILDINGS**  
 7000 SQ. FT., Air Conditioned, Busy Street.  
 2600 SQ. FT., Air Conditioned, Busy Street.  
 Call Day - 758-1131  
 Night - 756-1463

**115 Lots For Sale**  
**BAYTREE SUBDIVISION** Attractive wooded lots within the city. 10% ten-year financing available. Call 758-5421.

**BAYWOOD, TWO ACRE lot.** Financing available. Call 758-7711.

**NEW DUPLEX FOR SALE** Fairlane Farms. Income \$600 per month. Call after 6 p.m., 756-4391.

**RENTAL HOUSES.** One on 10th Street, one on Grimsland. 2 and 3 bedrooms. Call 756-0200.

**121 Apartments For Rent**  
**A 2 bedroom** duplex, 1 1/2 baths, central air, appliances, hookups, convenient to Southernland Realty. \$270. 756-7716 or 757-6574.

**AZALEA GARDENS**  
 Greenville's newest and most uniquely furnished one bedroom apartments.  
 \* All energy efficient designed.  
 \* Queen size beds and studio apartments.  
 \* Washers and dryers optional.  
 \* Free water and sewer and yard.  
 \* All apartments on ground floor with porches.  
 \* Frost-free refrigerators.

Located in Azalea Gardens near Brook Valley Country Club. Show by appointment only. Couples or singles. No pets.

Contact J.T. or Tommy Williams 756-7815

**CANNON COURT**  
 LUCI DRIVE  
 Two bedroom townhouses available with frost-free refrigerators, dishwasher, garbage disposal, washer/dryer hookups, fully carpeted, bath and a half. No pets. Cable TV provided.

Call Rental office 756-6061. Nights and Weekends: 757-3433.

**Cherry Court**  
 Spacious 2 bedroom townhouses with 1 1/2 baths. Also 1 bedroom apartments. Carpet, dishwashers, compactors, patio, free cable TV, washer/dryer hook-ups, laundry room, sauna, tennis court, club house and POOL. 752-1557

**CLASSIFIED DISPLAY**  
**ROOFING**  
**STORM WINDOWS**  
**DOORS & AWNINGS**  
 Remodeling - Room Additions  
**C.L. Lupton, Co.**  
 752-6116

**CLASSIFIED DISPLAY**  
**NEAR HOSPITAL**  
 Linbeth Drive, New 2 bedroom duplex, air condition, refrigerator, dishwasher and range, washer/dryer hook-ups. Available immediately, \$295 per month. Call 752-2106.

**NEED SOMEONE** to sublease apartment for 8 months. Call 758-0827 after 5.

**NEW DUPLEX** near hospital. Ready August 1. 2 bedrooms, 1 1/2 baths, fireplace. Bob Whitehurst, 825-8381 days; 825-3611 nights.

**OAKMONT SQUARE APARTMENTS**  
 Two bedroom townhouse apartments. 1212 Redbanks Road. Dishwasher, refrigerator, range, disposal included. We also have cable TV. Very convenient to Pitt Plaza and University. Terms available.

756-4151

**CLASSIFIED DISPLAY**

**CLASSIFIED DISPLAY**

**WALK TO UNIVERSITY** Super nice one bedroom, utilities furnished. \$220 per month. 756-7417.

**WEDGED WOOD ARMS**  
 Few townhouses left. 4 first floor garden apartments at reduced rates. Red Banks Road. 756-0987

**1 AND 2 BEDROOM** apartments available immediately. Call 758-3311.

**1 BEDROOM** apartment. Heat, air conditioning and water furnished. Near university. No pets. 756-3923.

**1 BEDROOM** energy efficient apartment. 756-5389 or 756-0025.

**YOU CAN SAVE** money by shopping for bargains in the Classified Ads.

**CLASSIFIED DISPLAY**

**CLASSIFIED DISPLAY**

**WALK TO UNIVERSITY** Super nice one bedroom, utilities furnished. \$220 per month. 756-7417.

**WEDGED WOOD ARMS**  
 Few townhouses left. 4 first floor garden apartments at reduced rates. Red Banks Road. 756-0987

**1 AND 2 BEDROOM** apartments available immediately. Call 758-3311.

**1 BEDROOM** apartment. Heat, air conditioning and water furnished. Near university. No pets. 756-3923.

**1 BEDROOM** energy efficient apartment. 756-5389 or 756-0025.

**YOU CAN SAVE** money by shopping for bargains in the Classified Ads.

**CLASSIFIED DISPLAY**

**CLASSIFIED DISPLAY**

**WALK TO UNIVERSITY** Super nice one bedroom, utilities furnished. \$220 per month. 756-7417.

**WEDGED WOOD ARMS**  
 Few townhouses left. 4 first floor garden apartments at reduced rates. Red Banks Road. 756-0987

**1 AND 2 BEDROOM** apartments available immediately. Call 758-3311.

**1 BEDROOM** apartment. Heat, air conditioning and water furnished. Near university. No pets. 756-3923.

**1 BEDROOM** energy efficient apartment. 756-5389 or 756-0025.

**YOU CAN SAVE** money by shopping for bargains in the Classified Ads.

**CLASSIFIED DISPLAY**

**CLASSIFIED DISPLAY**

**WALK TO UNIVERSITY** Super nice one bedroom, utilities furnished. \$220 per month. 756-7417.

**WEDGED WOOD ARMS**  
 Few townhouses left. 4 first floor garden apartments at reduced rates. Red Banks Road. 756-0987

**1 AND 2 BEDROOM** apartments available immediately. Call 758-3311.

**1 BEDROOM** apartment. Heat, air conditioning and water furnished. Near university. No pets. 756-3923.

**1 BEDROOM** energy efficient apartment. 756-5389 or 756-0025.

**YOU CAN SAVE** money by shopping for bargains in the Classified Ads.

**CLASSIFIED DISPLAY**

**CLASSIFIED DISPLAY**

**WALK TO UNIVERSITY** Super nice one bedroom, utilities furnished. \$220 per month. 756-7417.

**WEDGED WOOD ARMS**  
 Few townhouses left. 4 first floor garden apartments at reduced rates. Red Banks Road. 756-0987

**1 AND 2 BEDROOM** apartments available immediately. Call 758-3311.

**1 BEDROOM** apartment. Heat, air conditioning and water furnished. Near university. No pets. 756-3923.

**1 BEDROOM** energy efficient apartment. 756-5389 or 756-0025.

**YOU CAN SAVE** money by shopping for bargains in the Classified Ads.

**CLASSIFIED DISPLAY**

**CLASSIFIED DISPLAY**

**WALK TO UNIVERSITY** Super nice one bedroom, utilities furnished. \$220 per month. 756-7417.

**WEDGED WOOD ARMS**  
 Few townhouses left. 4 first floor garden apartments at reduced rates. Red Banks Road. 756-0987

**1 AND 2 BEDROOM** apartments available immediately. Call 758-3311.

**1 BEDROOM** apartment. Heat, air conditioning and water furnished. Near university. No pets. 756-3923.

**1 BEDROOM** energy efficient apartment. 756-5389 or 756-0025.

**YOU CAN SAVE** money by shopping for bargains in the Classified Ads.

**CLASSIFIED DISPLAY**

**CLASSIFIED DISPLAY**

**WALK TO UNIVERSITY** Super nice one bedroom, utilities furnished. \$220 per month. 756-7417.

**WEDGED WOOD ARMS**

# DEPEND ON US

## FOODLAND

for Savings-Quality-Selection

PRICES EFFECTIVE: GROCERY, MEAT, PRODUCE, JULY 15TH, 16TH, & 17TH, 1982.

WE WILL GLADLY ACCEPT FOOD STAMPS AND WIC VOUCHERS.

MARKETS

QUANTITY RIGHTS RESERVED NONE SOLD TO DEALERS

### 1ST QUALITY MEATS

LUTERS ORIGINAL OLD FASHIONED **FRANKS** 99¢ 12 OZ. PKG.  
SMITHFIELD **BOLOGNA** \$1.19 12 OZ. PKG.

### FARM FRESH PRODUCE

25 LB. AVERAGE **WATERMELONS** \$1.59 EACH

FRESH WHOLE  
**FRYERS**  
47¢ LB.  
CUT UP 59¢ LB.

FRESH SLICED  
**1/4 PORK LOIN**  
\$1.39 LB.

CRISP GREEN  
**LETTUCE**  
49¢ HEAD

FRESH LEAN **SIRLOIN TIP STEAKS** \$1.99 LB.

FRESH LEAN MARKET STYLE **BACKBONE** \$1.39 LB.

THOMPSON SEEDLESS WHITE **GRAPES** 99¢ LB.

EXTRA LEAN **T-BONE STEAKS** \$2.89 LB.

HEAVY WESTERN STEER **SIRLOIN STEAKS** \$2.79 LB.

LOCAL VINE RIPE **TOMATOES** 49¢ LB.

CENTER CUT RIB **PORK CHOPS** \$1.89 LB.

FROSTY MORN SLICED **BACON** 1 LB. \$1.49 PKG.

FRESH **BROCCOLI** 89¢ BUNCH

WHOLE LEAN **SIRLOIN TIP** \$1.69 LB.  
CUT INTO STEAKS OR ROAST FREE

EXTRA LEAN **SIRLOIN TIP ROAST** \$1.89 LB.

LOCAL GROWN YELLOW **CORN** 10¢ EAR

FRESH CENTER CUT **LOIN PORK CHOPS** \$1.99 LB.

MORTON **TV DINNERS** CHICKEN, TURKEY MEAT LOAF, 11 OZ. SALISBURY STEAK PKG. 69¢

**PEPSI COLA** 2 LITER BOTTLE 98¢

**FOODLAND** COUPON  
STARKIST CHUNK LITE **TUNA**  
IN OIL OR WATER  
6 1/2 OZ. CAN **49¢**  
LIMIT 1 WITH \$10.00 FOOD ORDER OR MORE AND THIS COUPON.

**FOODLAND** COUPON  
LIPTON **TEA BAGS**  
100 COUNT BOX **\$1.59**  
LIMIT 1 WITH \$10.00 FOOD ORDER OR MORE AND THIS COUPON.

**FOODLAND** ICE MILK 1/2 GALLON \$1.09  
SEA PAK **HUSHPUPIES** 16 OZ. BAG 69¢  
**STEAK-UMM SANDWICH STEAKS** 14 OZ. PKG. \$2.79  
**EGGO WAFFLES** 11 OZ. PKG. 89¢  
MINUTE MAID PINK OR REGULAR **LEMONADE** 12 OZ. CAN 69¢

**FOODLAND** COUPON  
CHEF BOY AR DEE **SPAGHETTI & MEATBALLS**  
15 1/2 OZ. CAN **49¢**  
LIMIT 1 WITH \$10.00 FOOD ORDER OR MORE AND THIS COUPON.

**FOODLAND** COUPON  
ARMOUR **TREET**  
12 OZ. CAN **79¢**  
LIMIT 1 WITH \$10.00 FOOD ORDER OR MORE WITH THIS COUPON.

**FOODLAND MEDIUM EGGS** 2 DOZEN FOR \$1.00

**PEPSI COLA** 6 PACK OF 12 OZ. CANS \$1.59

**COCA COLA** 6 PACK OF 12 OZ. CANS \$1.59

**COLD POWER** .84 OZ. BOX \$2.89  
GLAD DEODORANT **KITCHEN BAGS** 20 COUNT BOX \$1.59

APRIL SHOWER **PEAS** 303 SIZE CANS FOR \$1.00  
TOP CHOICE OR PUPPY CHOICE **DOG FOOD** BEEF OR EGG FLAVOR 30 OZ. PKG. \$1.59

PETER PAN **PEANUT BUTTER** 18 OZ. JAR SMOOTH OR CRUNCHY \$1.49  
KEEBLER DELUXE GRAHAMS, FUDGE STRIPES OR OATMEAL FUDGE **COOKIES** 99¢ PKG.

LIBBY **CORNED BEEF HASH** 15 1/2 OZ. CAN 99¢

**FOODLAND** MACARONI & CHEESE 7 1/4 OZ. BOXES FOR 3 89¢  
KEEBLER CINNAMON CRISP OR HONEY **GRAHAM CRACKERS** \$1.09 PKG.

LUCKY'S **BEANS** LUCKY'S PINTO, LIMA, NAVY OR GREAT NORTHERN 15 OZ. CANS FOR 2 \$1.00  
KEEBLER **VANILLA WAFERS** 99¢ BOX

DELMONTE **CATSUP** 32 OZ. BOTTLE LIMIT 1 WITH \$10.00 FOOD ORDER 89¢

GIBBS **PORK & BEANS** 3 16 OZ. CANS FOR \$1.00  
FRENCH'S **MUSTARD** 24 OZ. JAR 59¢

CRISCO **SHORTENING** 3 LB. CAN \$1.99

HI DRI **PAPER TOWELS** 2 BIG ROLLS FOR 89¢

CHATHAM RATION **DOG FOOD** 25 LB. BAG \$3.39  
KRAFT **MIRACLE WHIP** 32 OZ. JAR \$1.29

NESTEA **ORANGE JUICE** 3 OZ. JAR \$1.99

DUNCAN HINES **CAKE MIX** 19 OZ. BOX 79¢

**COCA COLA** 2 LITRE BOTTLE 98¢

TROPICANA **ORANGE JUICE** 1/2 GALLON \$1.39

**YOUR NEIGHBORS AT FOODLAND**  
know what it is to feed a family

Be Sure To Register And Play The Fabulous Wheel Of Fortune  
WIN CASH WIN GROCERIES  
THE FABULOUS WHEEL OF FORTUNE  
CASH & GROCERIES GIVE-A-WAY FOODLAND

HOT SHOT ANT & ROACH SPRAY 11 OZ. CAN \$1.99  
HOT SHOT FLEA & TICK SPRAY 15 1/2 OZ. CAN \$2.79  
MAXWELL-HOUSE INSTANT COFFEE 8 OZ. JAR \$2.79  
**SHOP-EZE** WEST END SHOPPING CENTER MONDAY-SATURDAY 8 AM-8 PM SUNDAY 9 AM-5 PM  
**SPAIN'S** 1414 CHARLES BLVD. MONDAY-THURSDAY 8 AM-8 PM FRIDAY-SATURDAY 8 AM-8:30 PM CLOSED SUNDAY

# Kroger Sav-on

Items and Prices Effective Wed., July 14 thru Sat., July 17, 1982 in Greenville

Copyright 1982 Kroger Sav-on Quantity Rights Reserved None Sold To Dealers

**AD ITEM POLICY**  
Each of these advertised items is required to be readily available for sale in each Kroger Sav-on except as specifically noted in this ad. If we do run out of an item we will offer you your choice of a comparable item when available reflecting the same savings or a raincheck which will entitle you to purchase the advertised item at the advertised price within 30 days.

# SUMMER SAVERS



600 Greenville Blvd. - Greenville  
Open 8 a.m. to Midnight  
Open Sunday 9 a.m. to 9 p.m.

**Hang It Grill**  
Model No. 718  
**\$10<sup>99</sup>**  
Only

WHEELER WEA 22 22"  
**3 H.P. Push Lawnmower** Only **\$129<sup>95</sup>**

LASKO MODEL No. 3713  
**20" BREEZE BOX Fan**  
**\$22<sup>99</sup>**  
Only

WHEELER WRBSP 21 21"  
3.5 HP Self Propelled  
**Rear Bag Lawnmower** Only **\$219<sup>95</sup>**  
Limited Quantities Available

## KROGER VALUES

**NO NONSENSE KNEE HIGHS OR SHEER TO WAIST**  
**Pantyhose**  
Pair **99¢**

No nonsense "Wide band knee high"  
No nonsense "Sheer to waist" pantyhose

3-M WHITE OR BROWN 2101 V-SEAL WEATHER STRIP, 2018 PIPE INSULATING TAPE OR #2111 ALL PURPOSE  
**Sealing Tape**  
**\$3<sup>37</sup>**  
YOUR CHOICE

**GREAT BUY!**  
CHILDREN'S SIZES  
**Life Vest**  
**\$4<sup>99</sup>**

9MS PENN FRESH AND SALTWATER LEVEL WIND, FREE SPOOL ACTION  
**Penn Peerless Reel**  
Reg. \$29.99 **\$24<sup>88</sup>**  
SAVE \$5<sup>11</sup>

DS27/ZEB OLYMPIC FRESHWATER OPEN FACE, 2 PC. ZEBCO ROD  
**Spin Combo**  
Reg. \$12.99 **\$8<sup>88</sup>**  
SAVE \$4<sup>11</sup>

KODAK  
**Instant Print Film**  
PR-10 **\$5<sup>88</sup>**  
PR-10 2-PACK **\$11<sup>66</sup>**  
SAVE \$5<sup>07</sup>



RICHMOND CEDAR 4-QT. EASY TO USE ALMOND COLOR, ELECTRIC  
**Ice Cream Freezer**  
Reg. \$16.95 **\$11<sup>88</sup>**



ANCHOR HOCKING  
**Ice Tea Glasses**  
4 16-Oz. Size **\$1**

**5" x 7" Color Enlargement**  
Only **79¢** Each  
From your favorite color slide or color negative.  
Offer good thru Saturday, July 17, 1982  
LIMIT ONE ENLARGEMENT WITH COUPON  
**"Guaranteed Great" Photo Services**  
SUBJECT TO APPLICABLE STATE & LOCAL TAXES. Coupon must accompany order.

RICHMOND CEDAR NO. 78 WOOD FINISH ELECTRIC AUTO RESET BUTTON  
**4-Qt. Ice Cream Freezer**  
Reg. \$28.95 **\$22<sup>88</sup>**



ANCHOR HOCKING 23-Oz. Size  
**Coolers** 2 **88¢**  
LIMITED QUANTITIES

ANCHOR HOCKING 87-OZ. CLASSIC STYLE BEVERAGE  
**Pitcher**  
Reg. \$1.87 **\$1<sup>39</sup>**  
SAVE 48¢

SAVE \$6<sup>07</sup>

KIWI PASTE Shoe Polish  
3-Oz. Can **67¢**  
SAVE 57¢



INSECT REPELLENT DEEP WOODS Off!  
7-Oz. Can **\$2<sup>99</sup>**  
SAVE 67¢



ALABASTER PLASTIC TWIN PACK  
**Ice Cube Trays**  
Reg. 99¢ **77¢**  
SAVE 22¢



EZ-POR FLEXIBLE STRAWS OR  
**Plastic Cutlery**  
2 Pkgs **\$1**

## HEALTH & BEAUTY AIDS DISCOUNT PRICED EVERYDAY!

L'OREAL PROTEIN Shampoo  
8-Oz. Btl. **\$1<sup>29</sup>**



PEPPERMINT OR ASSORTED FLAVORS  
**Tums**  
75-Ct. Btl. **\$1<sup>29</sup>**



FAMILY PACK PLASTIC STRIPS  
**Band Aids**  
60-Ct. Box **79¢**



L'OREAL SHAMPOO OR CONDITIONER  
**Ultra-Rich**  
16-Oz. Btl. **\$1<sup>49</sup>**

L'OREAL HAIR COLOR Preference  
Kit **\$2<sup>89</sup>**



BEAUTY LOTION Oil Of Olay  
4-Oz. Btl. **\$3<sup>17</sup>**



DENTURE TOOTHPASTE Dentu-Creme  
5 1/4-Oz. Tube **\$1<sup>47</sup>**



FOR DIETERS EXTRA STRENGTH  
**Dexatrim**  
20-Ct. Box **\$2<sup>79</sup>**



PLAYTEX DEODORANT Tampons  
28-Ct. Box **\$2<sup>37</sup>**



JOHNSON'S Baby Oil  
10-Oz. Btl. **\$1<sup>99</sup>**



**Kroger Pharmacy**  
Any questions on family health matters? Your Kroger pharmacist is available, accessible and informed.

Greenville  
756-7393

# Kroger Sav-on Let's go

Copyright 1982  
Kroger Sav-on  
Quantity Rights Reserved  
None Sold To Dealers

Items and Prices  
Effective Wed. July 14,  
thru Sat. July 17, 1982  
in Greenville

ADVERTISED ITEM POLICY  
Each of these advertised items is required to be readily available for sale in each Kroger Sav-on, except as specifically noted in this ad. If we do run out of an item we will offer you your choice of a comparable item when available, reflecting the same savings or a raincheck which will entitle you to purchase the advertised item at the advertised price within 30 days.

OPEN Mon. thru Sat. 8 AM TO MIDNIGHT- Sun. 9 AM TO 9 PM  
600 Greenville Blvd.- Greenville

<p>U.S.D.A. CHOICE "HEAVY" WESTERN BEEF 9-11 LB. AVG. WGT. CAP-ON</p> <p><b>Whole Boneless Sirloin Tip</b></p> <p><b>\$1.68</b></p> <p>Lb.</p> <p>CUT UP AND WRAPPED FREE!</p>	<p>RICH Del Monte Catsup</p> <p><b>99¢</b></p> <p>32-Oz. Btl.</p>	<p>BATHROOM TISSUE Cottonelle</p> <p><b>99¢</b></p> <p>4-Roll Pkg.</p>	<p>KROGER GRADE A Medium Eggs</p> <p><b>55¢</b></p> <p>Doz.</p>
--	---	--	---

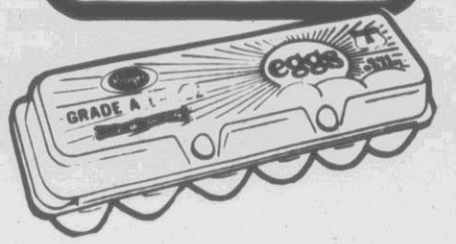

U.S.D.A. CHOICE "HEAVY" WESTERN BEEF 4-LBS. OR MORE (\$2.97 LB.) BONELESS Sirloin Tip Steaks **8 \$1.18**

U.S.D.A. CHOICE "HEAVY" WESTERN BEEF

**Boneless Sirloin Tip Roast**

**\$2.38**

Lb.

USDA CHOICE

VACUUM PACKED COUNTRY STYLE

**Sliced Bacon**

**\$1.38**

Lb.

EMBASSY Tea Bags

**\$1.19**

100-Ct. Box

MARTHA WHITE Flour

**79¢**

5 Lb. Bag

COST CUTTER Long Grain Rice

**\$1.19**

5 Lb. Bag

U.S.A. GOV. 1 INSPECTED QUALITY CONTROLLED

**Genuine Ground Round** **\$1.88**

Lb.

ALL BEEF SANDWICH STEAKS

**Steak-ummm** **\$2.98**

14-Oz. Pkg.

U.S.D.A. CHOICE "HEAVY" WESTERN BEEF BONELESS BEEF

**Cubed Steak** **\$3.18**

Lb.

U.S.D.A. CHOICE "HEAVY" WESTERN BEEF SEMI-BONELESS

**Loin Strip Steak** **\$3.98**

Lb.

WITH FABRIC SOFTENER

**Fab Detergent**

**\$2.99**

84-Oz. Box

PAPER TOWELS Bounty

**79¢**

Jumbo Rolls

FRUIT DRINKS Hawaiian Punch

**69¢**

46-Oz. Can

KROGER ALL MEAT OR All Beef

**Wieners**

**\$1.18**

12-Oz. Pkg.

ALL VARIETIES SERVE N SAVE

**Lunch Meats**

**\$1.38**

1-Lb. Pkg.

DAIRY FOODS

ASSORTED FLAVORS Breyer's Yogurt

**3 \$1**

8-Oz. Cups

KROGER NICE & CHEESY Cheese Spread **2 \$2.99**

Lb. Box

PILLBURY'S Ballard Biscuits **4 89¢**

10-Ct. Pkg.

KROGER ASSORTED Shredded Cheeses **\$1.29**

8-Oz. Pkg.

MARGARINE Land O Lakes

**2 \$1.09**

1-Lb. Qtrs.

DISH DETERGENT Dawn

**\$1.25**

22-Oz. Btl.

CAKE MIX Pillsbury Plus

**75¢**

18 1/2-Oz. Box

FRESH DOMESTIC

**Lamb Shoulder Roast** **\$1.88**

Lb.

HICKORY MOUNTAIN 1/5 SLICED

**Country Ham** **\$2.38**

Lb.

COUNTRY STYLE

**Spare Ribs** **\$1.88**

Lb.

FRESH FROZEN

**Pork Neck Bones** **58¢**

Lb.

CAROLINA PRIDE

**Sliced Bacon** **\$1.98**

Lb.

RUDY FARMS HOT OR MILD

**Pork Sausage** **\$1.98**

1-Lb. Pkg.

KROGER HOMOGENIZED

**Whole Milk**

**\$1.89**

Gal. Jug

COST CUTTER Shortening

**\$1.19**

42-Oz. Can

EMBASSY Mayonnaise **79¢**

32-Oz. Jar

COST CUTTER ORANGE Breakfast Drink **\$1.49**

27-Oz. Can

HOLLY FARMS FRESH CUT UP MIXED

**Fryer Parts**

**48¢**

Lb.

FROZEN SEA FOODS

FRESHORE

**Cod Fillet**

**\$1.99**

1-Lb. Pkg.

FRESHORE

**Sole Fillet** **\$2.39**

1-Lb. Pkg.

FRESHORE BREADED

**Shrimp Shapes** **\$2.99**

1-Lb. Pkg.

FRESHORE CRUNCHY

**Fish Strips** **\$1.69**

14-Oz. Pkg.

FROZEN FOODS

ASSORTED VARIETIES Totino's Pizza's

**\$1.19**

11 1/2-Oz. to 12 1/2-Oz. Pkg.

KROGER Glazed Donuts **99¢**

Doz. Pkg.

ASSORTED VARIETY Pet Ritz Cobblers **\$1.59**

26-Oz. Pkg.

KROGER Potato Wedges With Skins **89¢**

24-Oz. Bag

MINUTE MAID Orange Juice

**99¢**

12-Oz. Can

BAKED FOODS

KROGER

**White Bread**

**2 \$1.19**

24-Oz. Lvs.

BEER & WINE

PABST EXTRA LIGHT OR Pabst Blue Ribbon

**6 \$1.99**

12-Oz. Cans

HOLLY FARMS FRESH

**Fryer Livers** **79¢**

Lb.

WISHBONE BREADED PORK, TURKEY, OR

**Chicken Patties** **\$1.99**

12-Oz. Pkg.

OSCAR MAYER BEEF OR PORK BREAKFAST STRIPS

**Lean 'n Tasty** **\$1.78**

12-Oz. Pkg.

OSCAR MAYER ALL MEAT

**Sliced Bologna** **\$1.58**

12-Oz. Pkg.

CLAUSSEN HALVES OR WHOLE BREAD N BUTTER

**Kosher Pickles** **\$1.58**

24-Oz. Jar

KROGER

**Wheat Breads** **2 \$1.19**

16-Oz. Lvs.

KEEBLER TOWNHOUSE

**Crackers** **99¢**

12-Oz. Box

ROYAL VIKING DANISH

**Cinnamon Twist** **\$1.29**

8-Ct. Pkg.

BIANCO, ROSATO OR Cella Lambrusco **\$2.49**

34-Ltr.

BURGUNDY, CHABLIS, RHINE OR

**Almaden Mountain Rose** **\$6.00**

3-Ltr.

KROGER HAMBURGER OR

**Hotdog Buns**

**2 \$1.19**

8-Ct. Pkgs.

BURGUNDY, RHINE, CHABLIS, OR

**Paul Masson Rose**

**\$3.19**

1.5-Ltr.

# Krogering

**HOT LINE**



DO YOU HAVE A SUGGESTION, COMMENT, OR COMPLAINT?  
**CALL US**  
 AND WE WILL ATTEND TO IT!  
 TOLL FREE NUMBER  
**1-800-532-0300**

for the Best of Everything Including the Price

DIET PEPSI OR  
**Pepsi-Cola**  
**99¢**  
 2-Ltr. N.R. Btl.  
 SAVE 30¢

MINUTE MAID  
**Orange Juice**  
**\$1.09**  
 1/2-Gal. Ctn.

ASSORTED FLAVORS  
**Country Club Ice Milk**  
**99¢**  
 1/2-Gal. Ctn.

LOCAL  
**Cantaloupes**  
**79¢** Ea.

POLAR PAK  
**Ice Cream**  
**\$1.19**  
 1/2-Gal. Ctn.

## Kroger Garden

Where Service Comes First!



COST CUTTER  
**Apple Juice**  
**\$1.28**  
 64-Oz. Btl.

COST CUTTER  
**Paper Plates**  
**99¢**  
 100-Ct. Pkg.

CHICKEN OF THE SEA  
**Chunk Tuna**  
**79¢**  
 6 1/2-Oz. Can

LUNCHEON MEAT  
**Armour Treet**  
**99¢**  
 12-Oz. Can

COST CUTTER  
**Pork 'n Beans**  
**29¢**  
 15 1/2-Oz. Can

BUSH CUT  
**Green Beans**  
**3 \$1**  
 15 1/2-Oz. Cans

CORN  
**Mazola Oil**  
**\$2.39**  
 48-Oz. Btl.

SOFT DRINKS  
**Diet Faygo**  
**6 \$1.59**  
 16-Oz. N.R. Btl.

PICNIC FAVORITES

KROGER BEANS WITH ONIONS OR  
**B.B.Q. Beans**  
**2 16-Oz. Cans 88¢**

KROGER **Sandwich Spread** 16-Oz. Jar **89¢**

COUNTRY OVEN TWIN PACK  
**Potato Chips** 7-Oz. Bag **79¢**

YELLOW  
**Kroger Mustard** 24-Oz. Jar **57¢**

SMOOTH OR CRUNCHY  
**Kroger Peanut Butter** 28-Oz. Jar **\$2.29**

EMASSY  
**Grape Jelly** 32-Oz. Jar **\$1.25**

FRESH **Tropical Mangoes** ..... Ea. **88¢**

THOMPSON SEEDLESS  
**White Grapes** ..... Lb. **\$1.29**

FRESH **Florida Limes** ..... 10 For **\$1**

SWEET RIPE  
**Bing Cherries**  
**99¢** Lb.

MARTHA WHITE  
**Corn Meal**  
**95¢**  
 5 Lb. Bag

COST CUTTER  
**Gallon Bleach**  
**65¢**  
 Gal. Jug

FRESH TENDER  
**Broccoli**  
**69¢** Ea.

GREEN TOP  
**Bunch Carrots** ..... 2 For **\$1**

GREEN TOP  
**Bunch Radishes** ..... 3 For **\$1**

PENCIL THIN  
**Green Onions** ..... 3 For **\$1**

TENDER FRESH  
**Boston Lettuce** ..... Hd. **58¢**

CONVERTED  
**Uncle Ben's Rice** ..... 16-Oz. Box **69¢**

STA-PUF  
**Fabric Softener** ..... Gal. Jug **\$1.44**

KROGER  
  
**nutrition NEWS**  
**NUTRITION NEWS**

Get the facts on vitamins, minerals and calories for a variety of foods. Also extra tips to help balance nutrition in a cost cutting way. Seventeen different pamphlets and thirty-four recipes are at the NUTRITION NEWS stand. Pick up your copies today.

Kroger **Deli Bakery**

Let the Deli Do it!

LOW CALORIE  
**Turkey Bologna** ..... Lb. **99¢**

SWEET OR CREAMY  
**Cole Slaw** ..... Lb. **89¢**

VIRGINIA  
**Baked Ham**  
**\$3.29** Lb. **SAVE 40¢ Lb.**

5-PIECE WISHBONE WITH ROLLS  
**Fried Chicken** ..... **\$2.99**

FREE 12-OZ. COKE WITH A 1/4 LB.  
**Hot Dog** ..... Ea. **99¢**

SLICED TO ORDER  
**Domestic Swiss Cheese**  
**\$2.99** Lb. **SAVE 50¢ Lb.**

FRESH BAKED  
**French Bread**  
**2 \$1.29** Lvs. **SAVE 29¢**

FRUITED  
**Danish Pinwheels** ..... 4 For **\$1**

PLAIN OR GLAZED  
**Cake Donuts** ..... Doz. **\$1.69**

BROCCOLI ITALIENNE

Another all-time FAVORITE RECIPE from

**Better Homes and Gardens**

2 pounds fresh broccoli  
 1/2 teaspoon oregano, crushed  
 1/2 cup mayonnaise or salad dressing  
 1/4 cup shredded sharp process cheese  
 1 tablespoon milk

Cook broccoli until tender in boiling water with oregano; drain. In top of double boiler, mix mayonnaise, cheese and milk; heat over hot, not boiling, water, stirring until cheese melts and mixture is hot. Serve with broccoli. Makes 6 servings.

FOR OTHER RECIPES SEE  
 BETTER HOMES & GARDENS  
 ON SALE AT KROGER.

Copyrighted—used by permission.

SWEET SOUTHERN  
**Peaches**  
**49¢** Lb.

SLICER SIZE  
**Cucumbers** ..... 4 For **\$1**

FRESH  
**Blueberries** ..... Pt. **\$1.29**

FRESH  
**Nectarines** ..... Lb. **89¢**

## Mexican Recession May Step Up Aliens

By PETER EISNER  
Associated Press Writer  
MEXICO CITY (AP) — One of Mexico's worst recessions since World War II will probably increase the flow of Mexicans going illegally to the United States in search of jobs and a better life, American officials here predict.

The economic slump, which started last year with a sharp fall in world oil prices, may get worse. Already, President-elect Miguel de la Madrid says he plans tough austerity measures to restore the nation's economic health when he takes office Dec. 1.

De la Madrid aims to cut government spending, reduce inflation — now running at 60 percent a year — and shrink a foreign debt that is expected to reach \$80 billion by the end of 1982.

Further complicating the country's economic health was the 40 percent devaluation of the peso in February.

All of this adds up to the prospect of about 1 million people out of a job by year's end in a country where unemployment and under-employment combined now total 45 percent of the labor force. Mexico needs to create 850,000 new jobs every year just to keep up with its population growth, one of the world's fastest.

De la Madrid, 47, an economist with a master's degree in public administration from Harvard University, won by a landslide in elections July 4. His Institutional Revolutionary Party has been ruling since it was founded in 1929.

One of his first tasks, aides say, will be to slow down — or even stop for a while — an ambitious industrial development program financed with oil export revenues that outgoing President Jose Lopez Portillo started when he took office six years ago.

De la Madrid took an estimated 73 percent of the vote in the elections, giving him more than enough political strength to try to enforce some unpopular measures.

"If the government party takes its victory as a mandate, there could be a honeymoon period in which he'll have a chance to turn things around," said one American analyst, who asked not to be identified for diplomatic reasons.

"But the economic recovery will be difficult and there will be fewer jobs and less job opportunities. The migration will continue one way or another," the analyst said.

However, so far this year, the recession in the United States has apparently helped reduce the number of illegal aliens arrested at the Mexican border, American authorities say.

Border patrol agents arrested 171,559 aliens since Jan. 1 in Southern California, a drop of 28,212 arrests from the corresponding period last year.

Steve Williams, assistant chief patrol agent of the Chula Vista sector covering most of Southern California, said "When all along the border there seems to be a downturn in arrests, and there had been no real change in the manpower we are using, then it means there is a decrease in the total number of illegal entries."

A bill sponsored by Sen. Alan Simpson, R-Wyo., and Rep. Ron Mazzoli, D-Ky., would increase the United States' control over illegal immigration, apply penalties for employers that hire foreign undocumented worker and establish a system for sponsoring temporary legal aliens to do farm work when Americans cannot be found.

There are no firm estimates on the number of Mexican illegal immigrants in the United States, though various studies have given numbers ranging from 1.5 million to as high as 16 million.

"The most common averages given are from two to four million, and some people say as many as one million Mexican illegal aliens enter the United States illegally every year," said one U.S. official, who spoke on condition he not be further identified.



ADVERTISED ITEM POLICY: Each of these advertised items is required to be readily available for sale at or below the advertised price in each A&P Store, except as specifically noted in this ad.

PRICES EFFECTIVE THRU SAT., JULY 17 AT A&P IN GREENVILLE, N.C.

EXTRA LEAN SPECIAL TRIM COUNTRY FARM HOLLY FARMS  
Whole Smoked Picnics lb. **89¢** Chicken Franks 1 lb. pkg. **79¢**

## LOW SODIUM RECIPES

FOR THE BALANCED MEAL

### • HERB MEATLOAF •

- 1-lb. lean ground beef
- 1 shredded wheat biscuit
- ¼ cup minced onion
- 1 egg
- ¼ teaspoon summer savory
- ½ teaspoon sweet basil
- ¼ teaspoon black pepper
- ¼ cup milk

Pre-heat oven to 350° F. Mix all ingredients together in a bowl thoroughly, spread in lightly oiled loaf pan and bake for sixty minutes. Loaf will be moist.

**P** Beef Specials  
A&P QUALITY HEAVY WESTERN GRAIN FED BEEF  
Boneless Whole  
**Sirloin Tips**  
Cut Free Into Boneless Sirloin Tip Roast and Steaks, Stew Beef, and Chopped Sirloin  
**1.68**  
9 To 12 Lb. Avg. Wt. lb.

**The Butcher Shop**  
with supermarket prices  
**P** Meat Specials  
A&P QUALITY HEAVY WESTERN GRAIN FED BEEF  
**Round Steak**  
Full Cut Bone In  
**1.88**  
lb.

**P** Poultry Specials  
U.S.D.A. INSPECTED FRESH  
**Box-O-Chicken**  
Limit 4 Please  
**45¢**  
lb.

BLUE RIDGE BRAND  
**Sliced Bacon** 1 lb. pkg. **1.29**  
A&P QUALITY HEAVY WESTERN GRAIN FED BEEF—BONE IN  
**Sirloin Steak** T-Bone lb. 3.99 lb. **3.89**

A&P QUALITY HEAVY WESTERN GRAIN FED BEEF or Bottom Round Roast lb. **2.49**  
A&P QUALITY HEAVY WESTERN GRAIN FED BEEF  
**Cubed Steak** lb. **2.89**

BALL PARK  
**Meat Franks** Beef lb. 2.09 1 lb. pkg. **1.99**  
A&P SLICED  
**Meat Bologna** Beef lb. 1.89 1 lb. pkg. **1.59**

WISCONSIN MILD CHEDDAR OLD FASHIONED  
**Hoop Cheese** lb. **1.19**  
INDIVIDUAL QUICK FROZEN  
**Flounder Fillets** lb. **99¢**

**P** Dairy Specials  
A&P CHILLED  
**Orange Juice**  
½ gallon carton  
**99¢**

BONELESS WHOLE Beef Shoulder Cut Free! 8 To 24 Lbs. LB. **1.68**  
**THE FARM**  
A&P  
Fresh With Quality  
RED RIPE SWEET JUICY  
**Watermelon**  
20 Lb. Avg. Weight  
**1.69**  
each only

**P** Frozen Specials  
SAUSAGE COMBINATION, PEPPERONI  
**Mr. P's Pizza**  
10 oz. pkg.  
**79¢**

IN QUARTERS  
**Blue Bonnet Margarine** 2 1 lb. pkgs. **1.00**

EMERALD GREEN SWEET  
**Honeydews** Large 8 Size **99¢**  
FLORIDA—150 SIZE  
**Seedless Limes** 10 for only **79¢**  
NORTH CAROLINA GROWN  
**Tomatoes** Vine Ripened lb. **69¢**

GOLDEN RIPE  
**Bananas** 4 lbs. for **1.00**  
CALIFORNIA SWEET  
**Nectarines** Large Size lb. **69¢**  
CALIFORNIA PLUMP TASTY  
**Red Plums** lb. **89¢**

BEEF, CHICKEN, TURKEY  
**Morton Pot Pies** 3 8 oz. pkgs. **1.00**  
MEAT LOAF, SALISBURY STEAK, CHICKEN, TURKEY  
**Morton Dinners** 11 oz. pkg. **79¢**  
AUTOCRAT—ALL FLAVORS  
**Ice Cream** ½ gal. ctn. **1.19**

**P** Grocery Specials  
GRADE 'A' EXTRA LARGE  
**Loose Eggs**  
Pick Your Own! dozen **69¢**

**P** Grocery Specials  
HUNT'S  
**Tomato Ketchup**  
32 oz. btl. **99¢**

**P** Bakery Specials  
P&Q BRAND  
**White Bread**  
Sandwich Sliced 2 24 oz. loaves **88¢**

**P** Weekly Specials  
**Coca Cola Mello Yello Tab. Sprite**  
two little bottles **99¢**

SILVERBROOK  
**Homogenized Milk**  
Or A&P 2% Lowfat Milk Gallon Jug **1.75**

FAMILY SIZE  
**Lipton Tea Bags** 24 ct. pkg. **1.29**  
ANN PAGE  
**Apple Juice** ½ gal. btl. **1.29**  
P&Q BRAND  
**Bathroom Tissue** 4 roll pkg. **69¢**

25¢ OFF LABEL  
**Quaker Quick Grits** 5 lb. bag **99¢**  
KRAFT  
**Grape Jelly** 2 lb. jar **99¢**  
DOXE WHITE  
**Paper Plates** 100 ct. pkg. **99¢**

15¢ OFF LABEL—YOU PAY ONLY  
**Colgate Tooth Paste** Reg. 5 oz. each Gal. 4.8 oz. only **79¢**  
REGULAR, LIME, MUSK  
**Old Spice** Stick Deodorant 2.5 oz. stick **1.29**  
SOLID—SCENTED, UNSCENTED, FRESH  
**Ladies Choice** Anti-Perseptant 2 oz. stick **1.29**

**P** SUPER SAVER COUPON  
LIGHT  
**A&P Chunk Tuna**  
In Oil In Water 6½ oz. can **29¢**  
LIMIT ONE WITH COUPON AND 7.50 ORDER GOOD THRU SAT., JULY 17 AT A&P.

**P** SUPER SAVER COUPON  
PLAIN OR SELF RISING  
**Pillsbury Flour**  
5 lb. bag **69¢**  
LIMIT ONE WITH COUPON AND 7.50 ORDER GOOD THRU SAT., JULY 17 AT A&P.

**P** SUPER SAVER COUPON  
P&Q BRAND  
**Paper Towels**  
3 big rolls **1.00**  
LIMIT THREE WITH COUPON AND 7.50 ORDER GOOD THRU SAT., JULY 17 AT A&P.

ITEMS OFFERED FOR SALE NOT AVAILABLE TO OTHER RETAIL DEALERS OR WHOLESALERS.

703 Greenville Blvd., Greenville Square Shopping Center, Greenville, N.C.



NOW IN PROGRESS  
THROUGH SATURDAY JULY 17  
DAILY FROM DAWN TO DUSK

703 GREENVILLE BLVD.  
IN GREENVILLE

ADVERTISED ITEM POLICY: Each of these advertised items is required to be readily available for sale at or below the advertised price in each A&P Store, except as specifically noted in this ad.

PRICES GOOD THROUGH SAT. JULY 17 AT A&P IN GREENVILLE  
WE RESERVE THE RIGHT TO LIMIT QUANTITIES

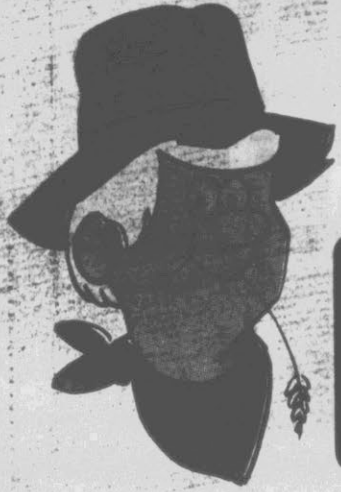

# A&P FARMERS' MARKET

GREAT OUTDOOR SALE!



BOUGHT IN TRUCKLOAD QUANTITIES WITH THE SAVINGS PASSED ON TO YOU! ITEMS LISTED BELOW ARE JUST A SAMPLE OF WHAT YOU'LL FIND!

REGULAR OR DIET

P&Q Cola

2 liter plastic bottle  
**69¢**

WHOLE  
Deer Shoulder . . . 168  
18 To 24 Lb. Avg. Lb.

WHOLE

Sirloin Tip

**168**

9 To 12 Lb. Avg. Lb.

GOLDEN RIPE

Bananas

4 lbs. only **1 00**

Cherries . . . 99¢

LARGE SIZE Honeydews . . . EA. ONLY 99¢

A&P QUALITY

Charcoal Briquets

10 lb. bag **1 49**

WHOLE

Smoked Picnic

**89¢**

LB.

JUICY RED RIPE

Watermelons

Whole

EACH ONLY **1 69**

INDIVIDUAL QUICK-FROZEN Flounder Fillets . . . 99¢

WHOLE BOTTOM & Eye Round . . . 168  
25 To 35 Lb. Avg. Lb.

FLORIDA SEEDLESS Limes . . . 10 Only 79¢

## ARMED FORCES

Cpl. Jimmy S. Stallings, son of Mr. and Mrs. Ed Stallings of Greenville, participated in a two-month "Combined Arms Exercise" at Fort Pickett, Va. Stallings, a member of the 4th Marines at Camp Lejeune, is a 1979 graduate of Rose High School. He joined the Marine Corps in 1979.

Seaman Bettina D. Brinkley, daughter of William B. Brinkley Sr. of Greenville, completed eight weeks of recruit training at the Naval Training Center, Orlando, Fla. She joined the Navy in February.

Airman Curtis V. Joyner, son of Mr. and Mrs. Bennie Joyner of Route 1, Greenville, was assigned to Chanute AFB, Ill., after completing six weeks of basic training at Lackland AFB, Texas. Joyner, who is now receiving training in the aircraft maintenance field, is a 1980 graduate of D. H. Conley High School.

2Lt. Don G. Dempsey II, son of Mr. and Mrs. Don G. Dempsey of Greenville, graduated from pilot training and has received silver wings at Reese AFB, Texas. The pilot is now flying the C-130 aircraft at Dyess AFB, Texas. Dempsey is a 1980 graduate of East Carolina University.

Gary Allen Jenkins, son of Mr. and Mrs. Johnnie Jenkins of Greenville, has enlisted in the Air Force. A 1981 graduate of Rose High School, Jenkins enlisted on June 4th and left for Lackland Air Force Base, San Antonio, Texas, where he is undergoing six weeks of basic training. After completing basic, Jenkins will receive training in the material facilities specialist career field.

Capt. Cornel T. Moses, son of Mr. and Mrs. W.C. Moses of Williamston, was decorated with the second award of the Air Force Commendation Medal at Ramstein Air Force Base, West Germany. Moses is an air intelligence officer.

Spec. 4 George L. Lawrence, son of Mr. and Mrs. Moses Lawrence of Route 4, Williamston, has arrived for duty at Fort Campbell, Ky. Lawrence, an infantryman with the 101st Airborne Division, was previously assigned at Camp Greaves, S.C.

Pfc. Joseph T. Jenkins, son of Mr. and Mrs. Wayland Adams of Route 1, Greenville, recently participated in exercise "Galant Eagle 82." The exercise involved more than 25,000 men in a quick reaction live fire agressed exercise. Jenkins is a member of 2nd Battalion, 9th Marines, Camp Pendleton, California.

Spec. 4 Anthony Daniels, son of Mr. and Mrs. Odell Daniels of Winterville, was named outstanding soldier of the month for the 172nd Support Battalion at Fort Richardson, Alaska. Daniels is a combat engineer with the 172nd Infantry Brigade.

Master Sgt. Ronda Jones, husband of the former Sandra Abbott of Route 2, Grifton, has arrived at Plattsburgh AFB, N.Y. Jones is an avionics technician with the 380th Avionics Squadron and was previously assigned at Kadena Air Force Base, Okinawa Japan.

"The Wild One," a 1954 film starring Marlon Brando as one of a gang of motorcyclists who terrorize a small American town, was banned by the British Board of Film Censors and was not approved for viewing in Britain until 1967.

Old panty hose make good ties for staking tomatoes or other climbing plants. They are flexible and will not cut into tender stalks.

**Crossword By Eugene Sheffer**

ACROSS  
1 Poem  
4 Sacks  
8 German river  
12 A barge  
13 Coin of Iran  
14 Crescent-shaped figure  
15 Wrath  
16 City in California  
18 Unit of gem weight  
20 Defective bomb  
21 Keats, for one  
24 Merit award  
28 City in California  
32 Hindu garment  
33 Meadow  
34 To rage  
36 Nest of pheasants: var.  
37 Poker stake  
39 Legendary city of gold

41 Implements  
43 Broad-topped hill  
44 Play on words  
46 Correct  
50 Mountain in California  
55 Compete  
56 American playwright  
57 Delivery wagon  
58 Being  
59 Clinic in Minnesota  
60 — Kristofferson

61 Korean soldier  
DOWN  
1 Of the ear  
2 Copperfield's first wife  
3 Pitcher  
4 Natives of Brittany  
5 Trouble  
6 A fuel  
7 Winter vehicle  
8 Evades  
9 Press for payment  
10 Conclusion

11 Early car  
17 Chicie  
19 Imitate  
22 Diminutive suffix  
23 Celebrate in song  
25 Andrews or Wynter  
26 Barren  
27 Italian resort  
28 Israeli port  
29 Cotton cloth  
30 Roman statesman  
31 Religious calendar  
35 Instant  
38 Texas city  
40 Aries  
42 To sip  
45 Actor Nolte  
47 Eternally  
48 Spanish boy  
49 Reading table  
50 Stately tree  
51 Worm larva  
52 Coquettish  
53 Sailor  
54 Mr. Onassis

Avg. solution time: 26 minutes

CHIC GUSH PEN  
ATINU ANOVA AXE  
PASSPORTS SIT  
POLO POSTS  
RAPID AIDE  
ORAD PASSESUP  
MIS MARSH ORE  
PASSISON HUGE  
ERGO MOLE  
GENOVA ELON  
NAG PASSEBOOKS  
USE OSSA PARAS  
SER DEER STAY

7-14  
Answer to yesterday's puzzle. 54 Mr. Onassis

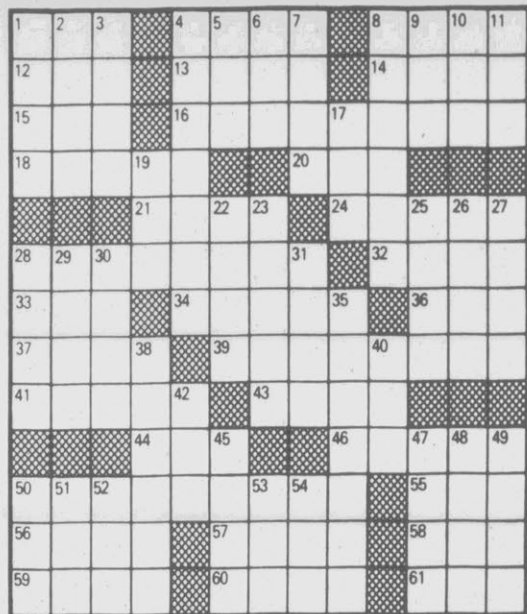

CRYPTOQUIP 7-14

L UTRU IHWFYU DUQGD DRQGGYZ'D  
ITF TWYLD KQZ KHUHZY

Yesterday's Cryptoquip — LITTLE CHILD ECHOED MAMA'S MOTTOES.

Today's Cryptoquip clue: U equals T.

The Cryptoquip is a simple substitution cipher in which each letter used stands for another. If you think that X equals O, it will equal O throughout the puzzle. Single letters, short words, and words using an apostrophe can give you clues to locating vowels. Solution is accomplished by trial and error.

FORECAST FOR THURSDAY, JULY 15, 1982

**YOUR DAILY Horoscope**  
from the Carroll Righter Institute

**GENERAL TENDENCIES:** A day when secondary matters require your attention. Formulate a plan for handling them without delay and get the results you want. A new project needs more study.

**ARIES (Mar. 21 to Apr. 19)** You are able to be meticulous in whatever you do today and get excellent results thereby. Spend your money wisely.

**TAURUS (Apr. 20 to May 20)** Taking the proper health treatments will make you feel better and improve your appearance. Show others you have wisdom.

**GEMINI (May 21 to June 21)** Know what is desired by family members and establish more harmony at home. A new outlet needs further study.

**MOON CHILDREN (June 22 to July 21)** Get busy at the tasks ahead of you and do them in a precise manner. Don't neglect important correspondence.

**LEO (July 22 to Aug. 21)** Cut down on expenses and you can easily add to present abundance. Show increased devotion to loved one.

**VIRGO (Aug. 22 to Sept. 22)** Take the necessary treatments so that you can improve both health and appearance. Engage in more social activities.

**LIBRA (Sept. 23 to Oct. 22)** Forget all that social meandering today and get right down to the work that has to be done. Evening is fine for romance.

**SCORPIO (Oct. 23 to Nov. 21)** Plan time to think over what your true aims are and figure out the best ways to gain them. Attend a group affair tonight.

**SAGITTARIUS (Nov. 22 to Dec. 21)** Take care of unfinished duties early in the day. Don't overlook a pressing bill. Think along logical lines.

**CAPRICORN (Dec. 22 to Jan. 20)** Go to the right sources for the information you need. Making new contacts can bring interesting results now.

**AQUARIUS (Jan. 21 to Feb. 19)** Try a new approach to have more accord with associates. Be sure to keep your promise. Think constructively.

**PISCES (Feb. 20 to Mar. 20)** Discuss mutual aims with associates. Take time to improve your appearance. Use your own excellent taste.

**IF YOUR CHILD IS BORN TODAY...** he or she could easily become a perfectionist but is likely to be intolerant of others who are not similarly endowed, so teach to make allowances for the shortcomings of others. Give ethical and spiritual training early in life.

"The Stars impel, they do not compel." What you make of your life is largely up to you!

© 1982, McNaught Syndicate, Inc.

**Fire Damages Charlotte Grill**

CHARLOTTE, N.C. (AP) — Fire heavily damaged a Charlotte restaurant Monday, just one day before the family who owns it planned to reopen it after a week-long vacation.

Firefighters battled the blaze at the Copal Grill on Wilkinson Boulevard for an hour before bringing the fire under control about 4 p.m. No injuries were reported in the fire.

"It's pretty well gutted," said district Fire Chief W.D. Summers. He said damage to the stone and shingle building was at least \$100,000.



**IF YOU'RE NOT SHOPPING AT WINN-DIXIE, AREN'T YOU TIRED OF PAYING TOO MUCH FOR YOUR GROCERIES?**

**Week After Week After Week, We Beat The Store That Claims To Be "LOWEST" In Head-To-Head Price Comparisons.**

Items Listed Below Were Purchased On The Same Day At Each Store And Are Shown On Each Receipt In The Same Order As Listed.

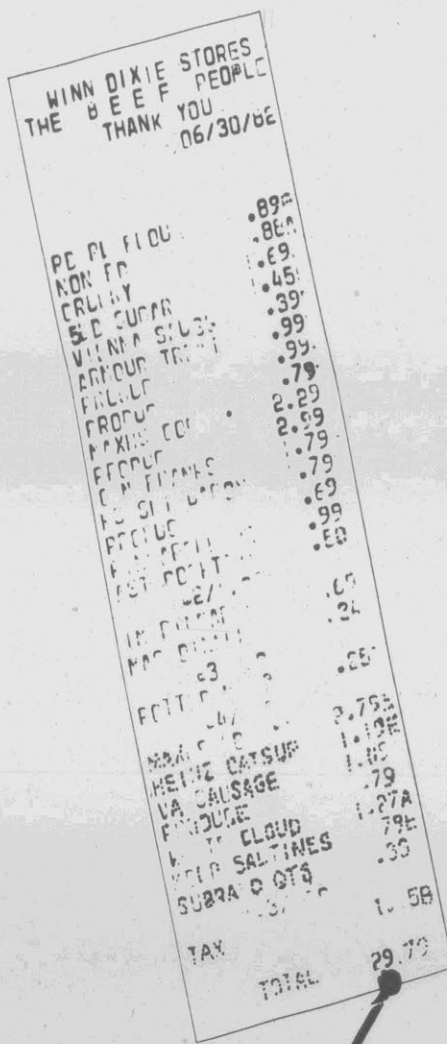

- 5-lb. Pillsbury Flour
- 42-oz. Punch Detergent
- 3-lb. Crisco Shortening
- 5-lb. Store Brand Sugar
- 5-oz. Armour Vienna Sausage
- 12-oz. Armour Treet
- 3-lb. Yellow Onions
- Lettuce
- 1-lb. Maxwell House Bag Coffee
- 10-lb. Idaho Russet Potatoes
- 1-lb. Oscar Mayer Wieners
- 1-lb. Store Brand Bacon
- 2-lb. Carrots
- 46-oz. Store Brand Pineapple Juice
- 16-oz. Store Brand Fruit Cocktail
- 20-oz. Store Brand Crushed Pineapple
- 7 1/4-oz. Kraft Mac & Cheese Dinner
- 3-oz. Armour Potted Meat
- 6-oz. Maxwell House Coffee
- 32-oz. Heinz Ketchup
- 1-lb. Store Brand Pork Sausage
- Celery
- 4-Roll pak White Cloud Bathroom Tissue
- 1-lb. Keebler Zesta Saltines
- 1-lb. Store Brand Margarine

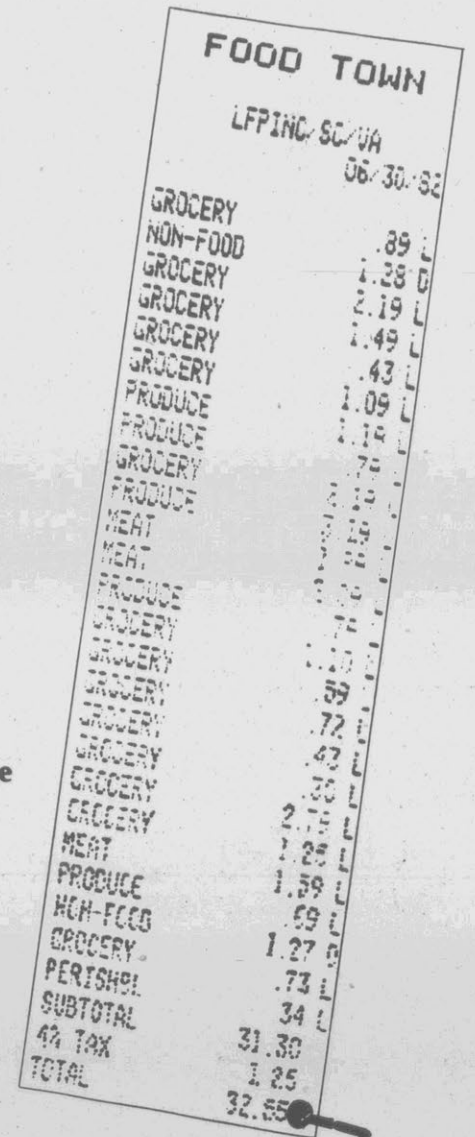

**WINN-DIXIE TOTAL \$29.79**

**FOOD TOWN TOTAL \$32.55**

**Winn-Dixie's Combination Of EVERYDAY LOW PRICEBREAKERS, DEEP-CUT PRICE BREAKER SPECIALS And PRICE BREAKER COUPONS Offer You Unbeatable Savings.**

**Make your own comparison and you'll discover what hundreds of thousands of Winn-Dixie Shoppers already know.....**

**NOBODY SAVES YOU MORE THAN WINN-DIXIE!**

\*PRICE SURVEY DONE ON JUNE 30TH SOME PRICES MAY HAVE CHANGED SINCE THAT TIME.

# WINN DIXIE

Now more than ever, we're right for you!

ODDS CHART AS OF JUNE 2, 1982

PRIZE VALUE	NO OF PRIZES	ODDS FOR ONE STORE VISIT	ODDS FOR 13 STORE VISITS	ODDS FOR 26 STORE VISITS
\$1,000.00 Cash	110	109,091 to 1	8,392 to 1	4,196 to 1
\$100.00 Cash	800	15,000 to 1	1,154 to 1	577 to 1
\$100.00 Gift Certificate	1,150	10,435 to 1	803 to 1	401 to 1
\$50.00 Gift Certificate	1,300	9,231 to 1	710 to 1	355 to 1
\$25.00 Gift Certificate	1,700	7,059 to 1	543 to 1	271 to 1
\$10.00 Cash	2,300	5,217 to 1	401 to 1	201 to 1
\$5.00 Cash	4,800	2,609 to 1	201 to 1	100 to 1
\$2.00 Cash	13,000	923 to 1	71 to 1	36 to 1
\$1.00 Cash	165,500	73 to 1	6 to 1	3 to 1
TOTAL	190,480	6.3 to 1	5 to 1	2 to 1

PRICES GOOD THRU SAT., JULY 17TH • NONE TO DEALERS  
 WE RESERVE THE RIGHT TO LIMIT QUANTITIES  
 COPYRIGHT 1982, WINN-DIXIE STORES, INC.

**\$650,000 IN PRIZES!**

**WIN \$100!**  
**WIN \$1,000!**

**LOTS OF INSTANT WINNERS!**

## PLAY BEEF PEOPLE BINGO

**It's fun!**  
 Pick Up Your **FREE Ticket Today!**

Must be 18 to play. No purchase necessary to participate. This game being played in the one hundred eight (108) participating WINN DIXIE stores located in eastern North Carolina and Virginia. Scheduled termination date: August 31, 1982. Employees of participating stores (and members of their immediate family), the sponsor, its advertising agencies, and game suppliers are not eligible to win any prizes. Beef People is a trademark of WINN DIXIE Stores, Inc.

### GOREN BRIDGE

BY CHARLES GOREN AND OMAR SHARIF  
 ©1982 Tribune Company Syndicate, Inc.

Neither vulnerable. South deals.

- NORTH**  
 ♦ J97  
 ♥ 102  
 ♦ A Q 103  
 ♠ 10975
- WEST**      **EAST**  
 ♦ 652      ♦ 43  
 ♥ 93      ♥ 8765  
 ♦ J74      ♦ K962  
 ♠ QJ863    ♠ K42
- SOUTH**  
 ♦ AKQ108  
 ♥ AKQJ4  
 ♦ 85  
 ♠ A

The bidding:  
 South West North East  
 2 ♦ Pass 3 ♦ Pass  
 4 ♦ Pass 4 ♦ Pass  
 7 ♦ Pass Pass Pass  
 Opening lead: Queen of ♠

The experienced players spot certain tipoffs on how to play a hand. For example, on this deal the clue to the winning line is the fact that declarer and dummy combined hold all the high trumps.

Note North's raise to three spades. After partner opens with a demand bid, the most important duty of responder is to fix the trump suit if a fit exists. Three trumps to an honor is more than adequate support if your hand has the values for a positive response. Blackwood would not have helped South — if North did not have an ace. South would not know how many diamond losers his side had. So South cue-bid his ace of clubs, then leaped to a grand slam when his partner showed first-round control of diamonds.

West led the queen of clubs, and when dummy came down it seemed that declarer would have to rely on a diamond finesse for his grand slam. However, declarer saw that, because his side held all the high trumps, he could land thirteen tricks with a dummy reversal if trumps were 3-2.

Declarer won the first trick with the ace of clubs, then entered dummy by overtaking the eight of trumps with the nine. A club was ruffed with the ace and the ten of spades was overtaken with the jack. Had a defender showed out on this round of trumps, declarer would have had to draw trumps and fall back on the diamond finesse. But when both followed, the hand became a virtual laydown.

Declarer ruffed another club, crossed to the ten of hearts and then ruffed dummy's last club with his own last trump. The ace of diamonds was the entry to the table to draw the last opposing trump with dummy's seven. On this trick declarer discarded his losing diamond. Now declarer's hearts took the last four tricks. The dummy reversal allowed South to score six trump tricks, five hearts and a trick in each minor for a total of thirteen.

Have you been running into double trouble? Let Charles Goren help you find your way through the maze of DOUBLES for penalties and for takeout. For a copy of his DOUBLES booklet, send \$1.85 to "Goren-Doubles," care of this newspaper, P.O. Box 259, Norwood, N.J. 07648. Make checks payable to Newspaperbooks.

#### DON'T SMILE

ROCHESTER, N.Y. (AP) — Researchers at the University of Rochester suggest that if you want to deceive someone try to keep your mouth shut.

Psychology Professor Miron Zuckerman and co-workers asked experimental subjects to conceal their true feelings by controlling their facial expressions as they watched videotapes of unpleasant, pleasant, or neutral scenes. The subjects were then asked to describe what they had seen, disguising their feelings this time by changing their tone of voice.

THE VOICES WERE ELEC-tronically filtered so that words could not be understood, but rhythm, pitch, and volume remained unchanged.

Results showed the subjects deceived others more successfully by controlling their facial expressions than by altering their voices.

3-LB. CAN CRISCO SHORTENING  
**\$1.69**  
 WITH \$7.50 OR MORE ORDER (LIMIT 1)

4-ROLL PAK COTTONELLE BATHROOM TISSUE  
**89¢**  
 WITH \$7.50 OR MORE ORDER (LIMIT 1)

U.S.D.A. INSPECTED FRYER LEG QUARTERS  
**39¢**  
 (LIMIT 10-LBS PLEASE!)

1/2-GAL. CTN. SUPERBRAND SHERBET OR ICE CREAM  
**\$1.19**

16-oz. Btls. COCA COLA  
 Ctn. Of 8 Plus Deposit  
**\$1.39**

12-oz. Cans Pabst Regular Or EXTRA LIGHT BEER  
 (Limit 2 Ctns., Please)  
 Ctn. Of 6  
**\$1.89**

GAL. JUG CLOROX BLEACH  
**69¢**  
 WITH \$7.50 OR MORE ORDER (LIMIT 1)

JUMBO HARVEST FRESH CANTALOUPE  
**78¢**

PRODUCE PATCH HARVEST FRESH LETTUCE  
**2.88**  
 HEADS

HARVEST FRESH NECTARINES ..... lb. 89c  
 3-LB. BAG U.S. #1 MEDIUM YELLOW ONIONS ..... 99c  
 HARVEST FRESH BROCCOLI ..... \$1.09  
 HARVEST FRESH COLLARDS ..... lb. 49c  
 1/2-GAL. JUG SUPERBRAND APPLE JUICE ..... 99c

1 1/2-Liter Btls. CARLO ROSSI WINES  
 —Chablis  
 —Rhine  
 —Vin Rose  
 Ea. **\$3.19**

DELI-BAKERY  
 GOURMET QUALITY TURKEY BREAST  
**\$1.69**  
 SLICED TO ORDER! 1/2-LB.

1-LB. BAG MAXWELL HOUSE COFFEE  
**\$2.19**

MARKET STYLE SLICED BACON  
**\$1.28**  
 SMOKED PORK SHOULDER PICNICS ..... lb. 98c

FROZEN FOODS  
 8-OZ. SIZE MORTON POT PIES ALL VARIETIES  
**3.99**  
 FOR

8-PC. SATCHEL SOUTHERN STYLE FRIED CHICKEN . \$3.49  
 OLD FASHIONED RED RIND HOOP CHEESE lb. \$2.99  
 FRESH BAKED ITALIAN OR FRENCH BREAD loaf 79c  
 CREAMY CHOPPED OR SHREDDED COLE SLAW ... lb. 89c  
 AVAILABLE IN DELI BAKERY STORES ONLY

24-OZ. LOAVES DIXIE DARLING SANDWICH BREAD  
**2.99**  
 FOR

U.S. CHOICE WHOLE UNTRIMMED BOTTOM ROUNDS  
**\$1.79**  
 20-25-LBS. AVG. SLICED FREE!  
 W-D BRAND U.S. CHOICE BONELESS CUBED STEAK lb. \$2.99

6-OZ. CANS ASTOR FROZEN ORANGE JUICE 6 FOR \$2.55 12-OZ. 3 FOR \$2.55  
 6-PAK GREEN GIANT NIBBLERS CORN ON THE COB ... \$1.23  
 14-OZ. SIZE PET ALL VARIETIES CREAM PIES ..... 89c  
 2-LB. BAG CRINKLE CUT FRENCH FRIES ..... 69c  
 14-OZ. PKG. DIXIANA GLAZED DONUTS ..... \$1.29

PEPSODENT SOFT, MEDIUM OR HARD TOOTH BRUSHES .... 59c  
 40-CT. PKG. POLIDENT TABLETS ..... \$1.39  
 6.5-OZ. TUBE PEPSODENT TOOTHPASTE ..... 99c  
 5-OZ. CAN BRUT A/P DEODORANT OR DEODORANT SPRAY ..... \$1.59  
 8-OZ. SHOWER TO SHOWER MORNING FRESH SCENT POWDER ..... \$1.29  
 4.5-OZ. CAN BABE A/P SPRAY DEODORANT ..... \$1.59

16-OZ. CANS VAN CAMP'S PORK N' BEANS  
**3.19**  
 FOR

W-D BRAND U.S. CHOICE BONELESS ROAST OR STEAK  
**\$2.59**  
 LB.

DAIRY DEPT.  
 GAL. JUG SUPERBRAND FRUIT DRINK  
**99¢**

1-LB. PKG. IN QUARTERS SUPERBRAND MARGARINE ... 3 FOR 99c  
 7 1/2-OZ. CANS PILLSBURY BUTTERMILK BISCUITS ..... 4 FOR \$1.17  
 12-OZ. CUP SUPERBRAND STA-FIT OR REGULAR COTTAGE CHEESE ... 89c  
 1-LB. CUP PALMETTO FARM PIMENTO CHEESE ... \$1.69  
 8-OZ. CUP SUPERBRAND SOUR CREAM ..... 65c

Featured this week VOLUME 14  
 Disney's WONDERFUL WORLD OF KNOWLEDGE  
 Volumes 2 - 14 only \$2.99 each!  
 Volume 1 - always available at only 99¢!

#### GROCERY SAVINGS

- 16-OZ. CANS THRIFTY MAID APPLE SAUCE . 3 FOR \$1
- 3-OZ. BOXES ROYAL ALL FLAVORS GELATIN ..... 4 FOR \$1
- 24-OZ. SIZE WYLER'S LEMONADE MIX. \$1.99
- 8-OZ. CANS CONTADINA TOMATO SAUCE 4 FOR \$1
- 7 1/4-OZ. BOXES GOLDEN GRAIN MAC N' CHEDDAR 3 FOR 99c
- 8-OZ. BAG CRACKIN' GOOD POTATO CHIPS . 89c
- 10-LB. BAG ROYAL OAK CHARCOAL ..... \$1.69
- 15-OZ. CANS KOZY KITTEN CAT FOOD . 4 FOR 95c

Superbrand Homogenized

- MILK Gal. Jug \$1.89
- Superbrand 1/2% SKIM MILK Gal. Jug \$1.69

#### MEAT VALUES

- W-D BRAND U.S. CHOICE BONELESS EYE OF ROUND ROAST lb. \$2.99
- W-D BRAND U.S. CHOICE BONELESS SIRLOIN TIP ROAST ..... lb. \$2.99
- 1-LB. PKG. OSCAR MAYER CHEESE DOGS .. \$1.99
- 20-OZ. PKG. SUNNYLAND BREAKFAST LINK SAUSAGE ..... \$2.69
- 1-LB. PKG. W-D WHOLE HOG SAUSAGE \$1.69 2-LB. \$3.37
- FROZEN FRYER LIVERS . lb. 49c
- PINKY PIG FULL SLICED QUARTER PORK LOINS .. lb. \$1.99
- HICKORY SWEET BONELESS HAM ..... lb. \$2.49

# FRESH WHOLE FRYERS



# 47

LB.

CASE PRICE \$35.00

HEAVY WESTERN WHOLE RIB EYES LB. \$2.99

SLICED 7-8 CHOPS 1/4 PORK LOIN LB. \$1.49

HEAVY WESTERN SIRLOIN STEAKS



LB. \$2.79

**Overton's**  
Supermarket, Inc.



FRYER LEG QUARTERS

LB. 59¢

T-BONE STEAKS LB. \$2.89

BREAST QUARTERS LB. 79¢

HEAVY WESTERN FULL CUT ROUND STEAK LB. \$1.69



211 Jarvis Street  
2 Blocks from E. C. U.



FRESH PORK COURTLAND SAUSAGE LB. ROLL \$1.19

GRADE "A" LARGE EGGS  
LIMIT 2  
DOZEN 68¢

GENERIC PEANUT BUTTER 18 OZ. JAR 98¢

SOFT'N PRETTY TOILET TISSUE  
4 ROLL PKG. 98¢



LIPTON FAMILY SIZE TEA BAGS 24 CT. PKG. \$1.28

DUNCAN HINES CARROT OR YELLOW CAKE MIX 18 OZ. BOX 78¢



'Home of Greenville's Best Meats'  
Prices Effective Thursday through Saturday.  
Open Monday-Friday 8 a.m.-8 p.m.  
Saturdays 8 a.m.-7 p.m. Closed Sunday.

FAMILY PAK SPECIALS  
PORK NECK BONES ..... 5-7 LB. PKG. -LB. 39¢  
PORK FEET, PORK EARS..... 5-7 LB. PKG. -LB. 39¢  
PORK CHITTERLINS ..... 10 LB. PKG. \$5.59  
PORK SPARE RIBS ..... LB. \$1.39

BREYERS ASSORTED FLAVORS REGULAR 55¢ EACH  
YOGURT 8 OZ. CUP 3/\$1.00

SEALTEST ASSORTED VARIETIES DIPS 8 OZ. CUP 2/\$1.00

LIGHT 'N LIVELY COTTAGE CHEESE 12 OZ. CUP 2/\$1.00

SEALTEST SOUR CREAM 8 OZ. CUP 2/\$1.00

TATER BOY FROZEN CRINKLE CUT FRENCH FRIES 5 LB. BAG \$1.28

CREST TOOTHPASTE 6.4 OZ. TUBE 98¢ LIMIT 2

SURE DEODORANT 4 OZ. SPRAY \$1.49

BIC LIGHTERS 2/\$1.00

CALIFORNIA FRESH  
BING CHERRIES LB. 88¢  
PLUMS LB. 88¢  
NECTARINES LB. 88¢

LOCAL RED POTATOES 10 LB. BAG 98¢

MORRELL FRANKS 12 OZ. PKG. 98¢  
MORRELL BACON 12 OZ. PKG. \$1.39

GENERIC SWEET RELISH OR SWEET PICKLES PINT JAR 88¢

FRESH WHOLE MAOLA MILK 1/2 GALLON PAPER CARTON 88¢

GENERIC EVAPORATED MILK 13 OZ. CAN 3/\$1.00

2 LITER BOTTLE NO LIMIT 98¢  
COCA-COLA OR PEPSI 16 OZ. CARTON OF 8 \$1.49 PLUS DEPOSIT



CRISCO OIL 32 OZ. BOTTLE 98¢

FRESH LOCAL COLLARDS 4 LBS. \$1.00

COCA-COLA OR PEPSI 16 OZ. CARTON OF 8 \$1.49 PLUS DEPOSIT

CLIP THIS COUPON DIXIE CRYSTALS SUGAR 5 LB. BAG

With this coupon and \$10.00 food order excluding advertised specials. Without coupon \$1.69. Limit one per customer. Expires 7-17-82.



98¢

CLIP THIS COUPON GIANT ROLL DELTA OR HI-DRI PAPER TOWELS

WITH THIS COUPON AND \$10.00 FOOD ORDER EXCLUDING ADVERTISED SPECIALS. WITHOUT COUPON 59¢ EACH. LIMIT 2 PER CUSTOMER. EXPIRES 7-17-82.



38¢

CLIP THIS COUPON KRAFT MAYONNAISE QUART JAR

WITH THIS COUPON AND \$10.00 FOOD ORDER EXCLUDING ADVERTISED SPECIALS. WITHOUT COUPON \$1.58. LIMIT ONE PER CUSTOMER. EXPIRES 7-17-82.



98¢

# SUMMER SALE

Sale prices good thru Sat. July 24th  
We reserve the right to limit quantities.



ECKERD'S SIZZLING

**COMBI LOUNGER**  
Reg. 12.99  
**8<sup>99</sup>**

PADDED HEADREST

**GALAXY 3-SPEED OSCILLATING 12-INCH FAN**  
Model #2150 A/B  
Regular 29.99 .....  
Has mar-resistant feet & carrying handle.

**24<sup>99</sup>**

3 SPEEDS

**REGULAR or DIET PEPSI**  
2-LITER .....  
**1<sup>09</sup>**

**SCOTT TOWELS**  
THE GOOD VALUE TOWEL  
Regular 1.09 .....  
Limit 2 please

**2<sup>100</sup>**

**OIL OF OLAY**  
LOTION  
4-OUNCE .....  
Limit 2 please

**3<sup>29</sup>**

**CREST TOOTH PASTE**  
4.4-OZ. 3 TYPES  
See display. Limit 2 please

SPECIAL BUY 2 GET 2 FREE OFFER

**1<sup>29</sup>**

**MISS BRECK HAIR SPRAY**  
8-OUNCE .....  
Aerosol. Limit 2 please

**1<sup>19</sup>**

**DIAMOND FOIL**  
Reg. 89¢ ea. ....  
12" x 25'

**2/88¢**

**ENERGIZER "C" or "D" BATTERIES**  
PACK OF 2 .....  
Limit 2 please

**1<sup>49</sup>**

**BAN ROLL-ON**  
1.5-OUNCE .....  
Limit 2 please

**1<sup>19</sup>**

**Gillette Good News!**  
Economy 6 Pack  
Limit 2 packs please

**1<sup>19</sup>**

**BARBASOL SHAVE CREAM**  
11-OUNCE .....  
Limit 2 please

**59¢**

**CONSORT HAIR SPRAY**  
For Men 13-OZ.  
Limit 2 please

**1<sup>19</sup>**

**EXTRA-STRENGTH TYLENOL**  
24 Capsules or 30 Tablets ...  
Limit 2 please

**1<sup>59</sup>**

**TEK TOOTHBRUSH**  
3 TYPES .....  
Limit 5 please

**19¢**

**Massengill DOUCHE**  
TWIN PACK ...  
3 types. Limit 2

**88¢**

**YOUR CHOICE 99¢**

<b>MILK'N HONEY SHAMPOO or CONDITIONER</b> By Jheri Redding 8-OUNCE	<b>ARM &amp; HAMMER BAKING SODA</b> 16-OUNCE 3 FOR 99¢	<b>VASELINE INTENSIVE CARE LOTION</b> 6-OUNCE
<b>ECKERD DRY ROASTED PEANUTS</b> 8-OUNCE Reg. 1.39	<b>3M SCOTCH TRANSPARENT TAPE</b> Reg. 88¢ ea. 2 ROLLS/99¢ 1/2" x 450" or 3/4" x 300"	<b>PALMOLIVE DETERGENT</b> 22-OUNCE Regular 1.59



See our early Back-to-School Sale on back page!

# SUMMER SALE

# ECKERD'S SIZZLING

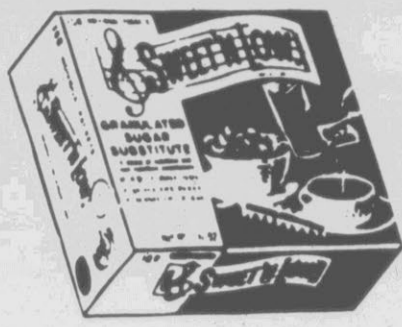

**SWEET & LOW**  
BOX OF 100  
**83¢**

Limit 2 please

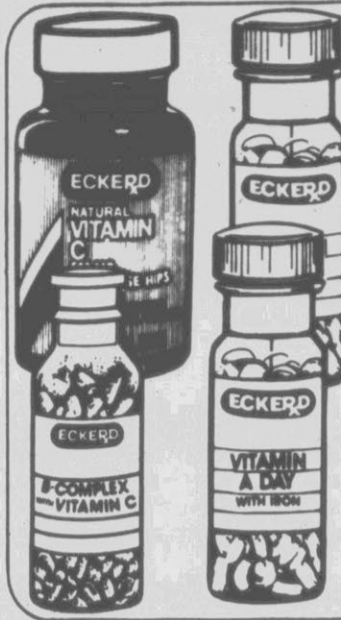

**ECKERD**  
**VITAMIN SALE**

**VITAMIN A DAY**  
REGULAR or WITH IRON  
YOUR CHOICE **1 19**

BOTTLE OF 100 .....  
Compare to One A Day vitamins.

**NATURAL VITAMIN C**  
WITH ROSE HIPs **1 79**  
500 MG.  
BOTTLE OF 100 .....

**B-COMPLEX with C**  
BOTTLE OF 100 .....  
Sale Priced **2 59**

**ECKERD**  
**BUFFERED ASPIRIN**  
BOTTLE OF 100

**1 19**

Compare to Bufferin. Limit 2

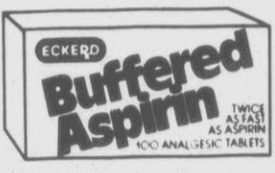

**REVLON NATURAL WONDER MASCARA**  
BIG LASH  
Regular 2.25

**99¢**



**VISINE**  
**EYE DROPS**  
1/2-OUNCE

**1 19**

Limit 2 please



**AAPRI FACIAL SCRUB**  
4-OUNCE

**2 99**



**ECKERD**  
**ROLL-ON DEODORANT**  
2.5-OUNCE

**1 29**

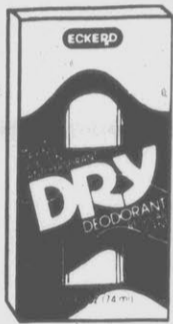

**REVLON SUPER NAILS ENAMEL**  
Regular 1.70

**89¢**



**GRECIAN FORMULA**  
4-OZ. LIQUID or 2-OZ. CREAM

**2 69**



**STRI-DEX MEDICATED PADS**  
BOX OF 42

**1 39**



**BRUT 33 STICK DEODORANT or ANTI-PERSPIRANT**  
2.5-OUNCE

**99¢**



**POND'S CREAM & COCOA BUTTER LOTION**  
8-OUNCE

**99¢**



**ECLIPSE SUNSCREEN**  
4-OUNCE  
2 TYPES

**3 69**



**ECKERD**  
**BABY SHAMPOO**  
16-OUNCE

**1 29**

Compare to Johnson's Baby Shampoo.



**LANACORT CREME**  
1/2-OUNCE

**1 39**

Limit 2 please



**NEET HAIR REMOVER LOTION**  
4-OUNCE

**1 39**



**SEA BREEZE ANTISEPTIC FOR THE SKIN**  
10-OUNCE

**1 99**



**ECKERD**  
**COCOA BUTTER LOTION**  
16-OUNCE

**1 19**



**ISOPROPYL ALCOHOL**  
16-OUNCE

**37¢**

Limit 2 please



**ECKERD**  
**TRIPLE-SIZE PUFFS**  
BAG OF 100

**69¢**

Compare to Curly Puffs.



**OXY 10 or OXY WASH**  
YOUR CHOICE

**2 49**

1-oz. medication or 4-oz. wash.

BUY BOTH & RECEIVE \$2.50 MFR. MAIL-IN REBATE

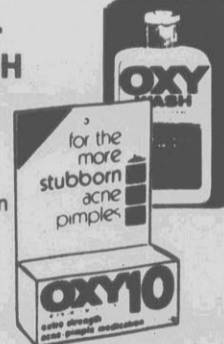

**BARRETTES & PONYTAIL HOLDERS**  
ASSORTED  
Regular 1.09

**77¢**



## SALE SAVE ON YOUR FAVORITE FOODS AND SNACKS

**PLANTERS SNACKS**  
Reg. 99¢  
**77¢**



**PETER PAN PEANUT BUTTER**  
CREAMY STYLE  
18-OZ. Reg. 1.89

**1 39**



**FRITOS CORN CHIPS**  
12-OUNCE  
**1 19**



**DOLE SLICED PINEAPPLE**  
8.25-OZ. Reg. 49¢ ea.  
**3 / 1 00**  
CANS

Limit 3 please



**BAMA GRAPE JELLY**  
32-OZ. Reg. 1.39

**1 09**



**KEEBLER RICH'N CHIPS COOKIES**  
16-OZ. BONUS PACK  
Reg. 1.59

**1 19**



**VIP PRO  
1200 WATT  
GLOBETROTTER  
HAIR DRYER**  
WITH SPECIAL REBATE OFFER\*  
#VP-GT Regular 14.99  
2 speeds & heats. Handle  
folds for compact storage.  
ECKERD'S  
SALE PRICE ..... **9<sup>99</sup>**  
LESS MFR.'S  
MAIL-IN REBATE\* **-3<sup>00</sup>**  
FINAL COST  
AFTER  
REBATE ..... **6<sup>99</sup>**



**CLAIROL  
CARESETTER®**  
Model #KF-20  
Regular 37.99  
**32<sup>99</sup>**  
Flocked rollers for  
easier sets.

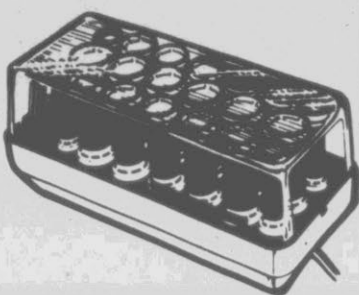

**CONAIR  
CURLING  
BRUSH**  
WITH SPECIAL REBATE OFFER\*  
#BC-10 Regular 10.99  
On/off light, stay-cool  
safety tip.  
ECKERD'S  
SALE PRICE ..... **6<sup>99</sup>**  
LESS MFR.'S  
MAIL-IN REBATE\* **-2<sup>00</sup>**  
FINAL COST  
AFTER  
REBATE ..... **4<sup>99</sup>**



**NORELCO  
DIAL-A-BREW  
COFFEEMAKER**  
WITH SPECIAL REBATE OFFER\*  
#HB-5185 Regular 24.99  
Brews 3-10 cups to taste.  
ECKERD'S  
SALE PRICE ..... **19<sup>99</sup>**  
LESS MFR.'S  
MAIL-IN REBATE\* **-5<sup>00</sup>**  
FINAL COST  
AFTER  
REBATE ..... **14<sup>99</sup>**



**ECKERD  
DIAL  
MESSAGE  
HAND-HELD**  
#DM209E Reg. 24.99  
**19<sup>99</sup>**  
4 distinct spray  
patterns.



**POLLENEX  
"PURE AIR 99"  
AIR FILTER**  
#699R Reg. 29.99  
**23<sup>99</sup>**  
2-speed motor.  
Wall-mount it!  
REPLACEMENT  
FILTER Reg. 4.99 ... **3<sup>99</sup>**

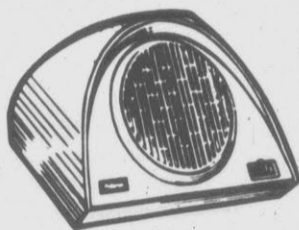

**SOUNDESIGN  
AM/FM  
POCKET  
RADIO**  
Model #2145  
Regular 12.99  
**10<sup>99</sup>**  
Battery not included.



**ENTIRE STOCK  
WALL  
CLOCKS**  
**25%  
OFF**  
REGULAR PRICES  
Indoor & outdoor models  
from Spartus, Ingraham  
& others.

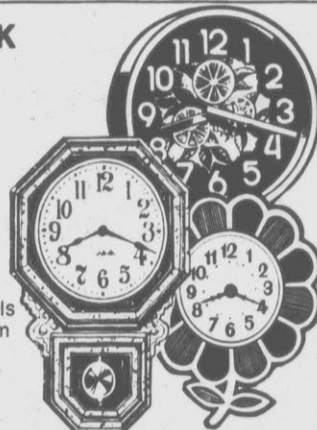

**SAMSUNG  
12-INCH\*  
BLACK & WHITE  
TELEVISION**  
Model BT-311  
Regular 89.99  
**69<sup>99</sup>**  
Quick-start picture.  
\* diagonal measure

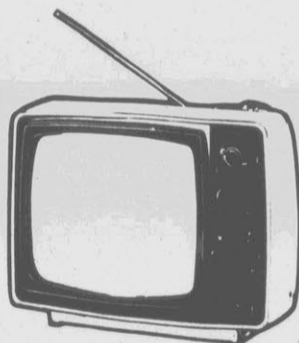

**COPAL  
QUARTZ  
TRAVEL  
ALARM**  
#HQ-255/H-55  
Regular 12.99  
**9<sup>99</sup>**  
Luminous dial &  
hands. With battery.

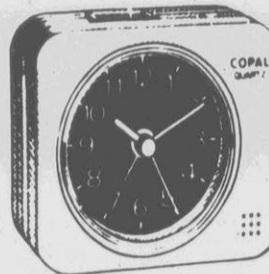

**ALL  
CALCULATORS**  
**20%  
OFF**  
REGULAR PRICES  
Casio, Lloyd's, APF,  
Sharp or Texas In-  
struments models.  
Not all models avail-  
able at all stores.

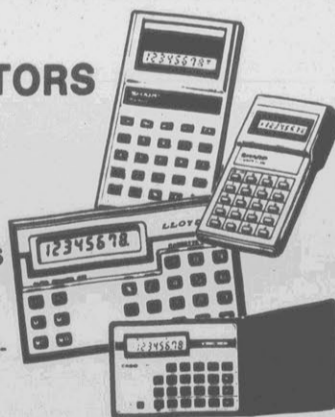

**MEN'S & LADIES'  
TIMEX  
WATCHES**  
**25%  
OFF**  
REGULAR PRICES  
Actual watches may  
vary from illustrations.

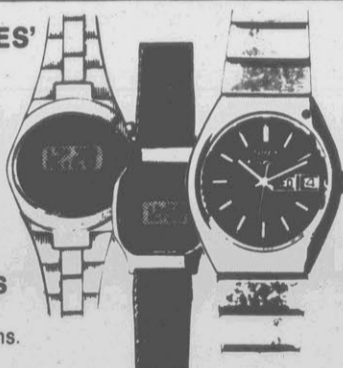

**ENERGY SAVING FAN SALE**

**AIR KING  
52" 3-SPEED  
CEILING  
FAN**  
#5175/5177  
Regular 149.99  
**129<sup>99</sup>**

Reversible speeds.  
Hardwood blades.  
Brass housing.

CEILING FAN  
LIGHT KITS  
**20% OFF**  
REGULAR  
PRICES



**AIR KING  
48" 3-SPEED  
CEILING  
FAN**  
#5184/5185  
Regular 119.99  
**99<sup>99</sup>**

Hardwood blades.  
Fits 8' ceiling.

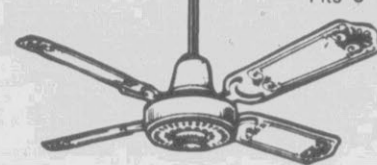

**GALAXY FANS**  
**3-SPEED 16-INCH  
WINDOW FAN**  
27-37" WINDOWS  
#2155 Reg. 54.99 ...  
Reversible speeds. **44<sup>99</sup>**



**3-SPEED  
16-INCH FAN  
OSCILLATING**  
#2151 Reg. 39.99 ...  
Extra-high airflow. **34<sup>99</sup>**

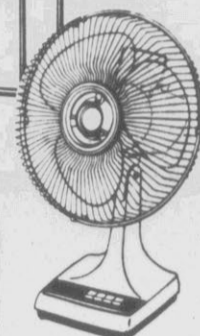
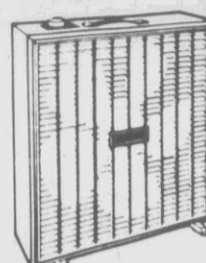

**ROLL-A-BOUT  
STAND**  
Reg. 11.99  
**7<sup>99</sup>**

**20-INCH 3-SPEED  
BREEZE BOX FAN**  
#6713  
Reg. 26.99 ... **21<sup>99</sup>**  
Fine mesh grill, support feet.



**9-INCH  
PERSONAL FAN**  
#2156  
Reg. 15.99 ... **13<sup>99</sup>**  
Step-saving on/off switch.

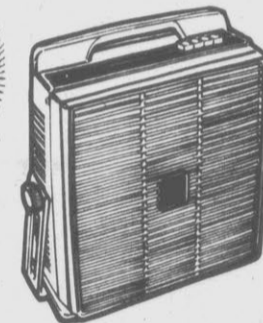

**3-SPEED DELUXE  
12-INCH FLOOR FAN**  
#2153  
Reg. 29.99 ... **24<sup>99</sup>**  
Swivels to direct airflow.

**STEREO SYSTEM SALE**

**GRAN PRIX  
STEREO SYSTEM  
with LED CLOCK**  
#9500X40 Reg. 299.99  
**249<sup>99</sup>**

Play/record cassettes,  
play 8-Tracks. Wake  
to the radio or  
your own tapes!

**GRAN PRIX  
STEREO SYSTEM**  
#8600 Reg. 179.99  
**119<sup>99</sup>**

Make cassettes.  
Play 8-Tracks.

**GRAN PRIX  
AM/FM 8-TRACK  
STEREO SYSTEM**  
#4200 Reg. 119.99  
**79<sup>99</sup>**

Play 8-Tracks.  
Lighted dial.



**ATARI, IMAGIC  
or ACTIVISION  
GAME CARTRIDGES**  
**5<sup>00</sup> OFF**  
REGULAR PRICES  
Pac-Man, Kaboom & other  
favorites!



**GENERAL ELECTRIC  
FLIPFLASH II**  
8 FLASHES  
Sale  
Priced ..... **1<sup>29</sup>**

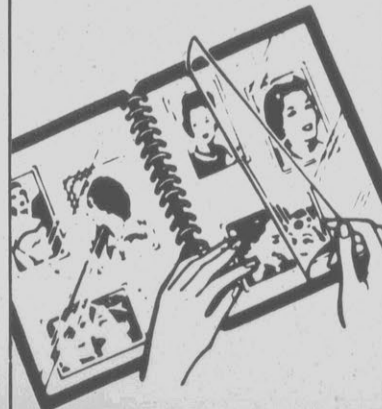

**10-SHEET/20-PAGE  
PHOTO ALBUM**  
Reg. 2.99  
Sale  
Priced ..... **1<sup>88</sup>**



**ANY KODAK or  
POLAROID  
INSTANT CAMERA**  
**5<sup>00</sup> OFF**  
REGULAR PRICES  
Coupon Good Thru Sat. July 24

COUPON



**POLAROID  
TIME-ZERO  
INSTANT FILM**  
10 PRINTS  
Sale  
Priced ..... **7<sup>47</sup>**

# ECKERD'S SIZING SUMMER SALE

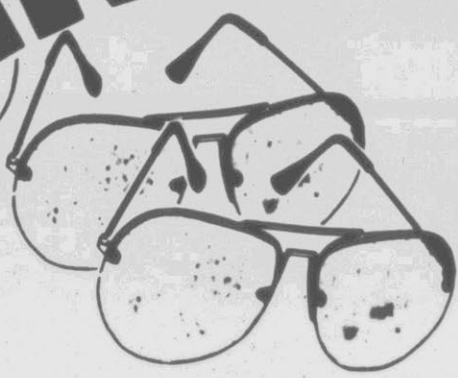

**FOSTER GRANT RIMLESS SUNGLASSES**  
**2/12<sup>00</sup>** BUY 1, GET 1 FREE  
FOR Regular 12.00 ea.

## SUMMER FOOTWEAR SALE

**MEN'S & LADIES' TATAMIS SANDALS**  
**99¢** Regular 1.99

**ASSORTED ZORRIES SANDALS**  
**2/99¢** PAIR Reg. to 89¢ ea.  
CHILDREN'S DISNEY ZORRIES .. 99¢

**MEN'S & LADIES' BEACHCOMBERS**  
**1<sup>99</sup>** Regular 3.99



**BOTANY® MEN'S CREW SOCKS**  
 3 PAIR PACK  
 Reg. 3.99 pk.  
**2<sup>29</sup>**



**FRUIT OF THE LOOM® MEN'S UNDERWEAR BRIEFS**  
**3<sup>79</sup>** PACK OF 3 Reg. 5.49 pk.  
**T-SHIRTS**  
**4<sup>79</sup>** PACK OF 3 Reg. 6.99 pk.



**MAGNAVISION READING GLASSES**  
 By AL-SITE  
 Regular 12.00  
**7<sup>99</sup>**

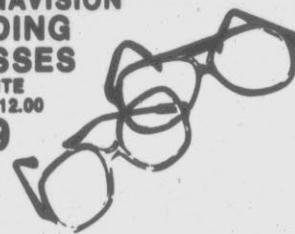

**ARROW MEN'S PULL-OVER SWEATERS**  
 Regular 11.99  
**7<sup>99</sup>**



**KORDITE TRASH BAGS**  
 20, 28-GAL. or 30, 13-GAL.  
 Reg. 2.49 ea.  
**2/3<sup>00</sup>** FOR



**METAL 12-QUART WASTECAN**  
 Regular 2.99  
**1<sup>99</sup>**



**PLASTIC TUBULAR HANGERS**  
 PACK OF 3  
 Reg. 89¢ pk.  
**2/88¢** PACKS

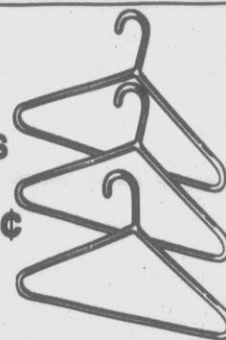

**MR. COFFEE or NORELCO COFFEE FILTERS**  
 100's Reg. 99¢  
**59¢**  
Mr. Coffee fluted or Norelco disc.



**TABLE TOP IRONING BOARD with PAD**  
 Regular 4.99  
**3<sup>99</sup>**

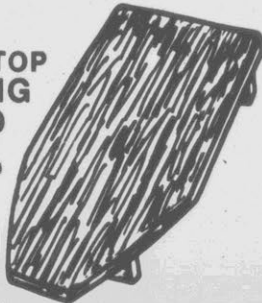

**PLASTIC SHOE STACK**  
 Regular 4.99  
**3<sup>88</sup>**  
 Holds 8 pair.

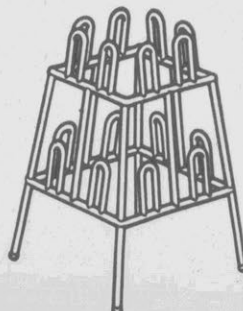

**CON-TACT® SHELF PAPER**  
**25% OFF**  
 REGULAR PRICES  
 Adhesive or non-adhesive types.



**WOODEN CLOTHES DRYER**  
 Regular 9.99  
**6<sup>99</sup>**



**CRAYON or LIFESAVERS® PLASTIC MUG**  
 YOUR CHOICE  
 Regular 1.99  
**1<sup>49</sup>**



**MAGLA LATEX GLOVES**  
 3 SIZES  
 Reg. 99¢ ea.  
**2/1<sup>00</sup>** PAIR



**BATH SCALE**  
 3 COLORS  
 Regular 9.99  
**6<sup>99</sup>**



**BACK JACK LEISURE SEAT**  
 Regular 19.99  
**14<sup>99</sup>**



## STORAGE CHESTS AND BOXES SALE

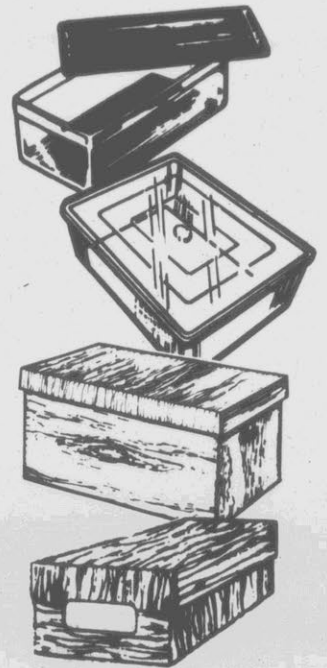

**PLASTIC SHOE BOX**  
 Regular 1.39  
 Sale Priced ..... **99¢**

**PLASTIC SWEATER BOX**  
 Regular 4.99  
 Sale Priced ..... **3<sup>77</sup>**

**UPRIGHT STORAGE CHEST**  
 CARDBOARD  
 Regular 1.69 ..... **99¢**

**UNDER-BED STORAGE CHEST**  
 CARDBOARD  
 Regular 1.69 ..... **99¢**

## FURNITURE AND SHELVING SALE

**PERMABOND ADHESIVE**  
 3-GRAMS  
 Regular 1.59  
**88¢**



**HOYLE PLAYING CARDS**  
 3 TYPES  
**1<sup>19</sup>**



**WD-40 SPRAY LUBRICANT**  
 12-OZ.  
 Reg. 2.49  
**1<sup>69</sup>**



**O'SULLIVAN 3-SHELF BOOKCASE**  
 WOOD-TONE  
 #3028 Reg. 29.99  
**22<sup>99</sup>**

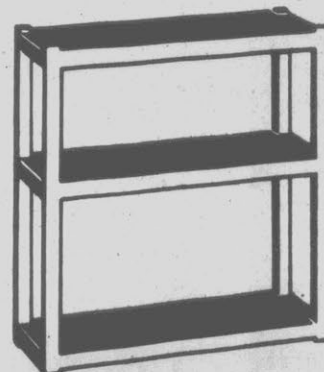

**3-SHELF PLASTIC BOOKCASE**  
 3 COLORS  
 Regular 17.99  
**10<sup>99</sup>**

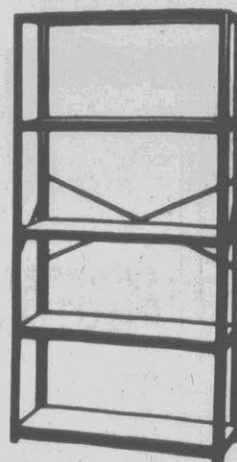

**5-SHELF STEEL SHELVING**  
 Regular 17.99  
**12<sup>99</sup>**



**CANE-LOOK ACCENT TABLES**  
 3 COLORS  
 Reg. 4.99 ea.  
**2/7<sup>00</sup>** FOR

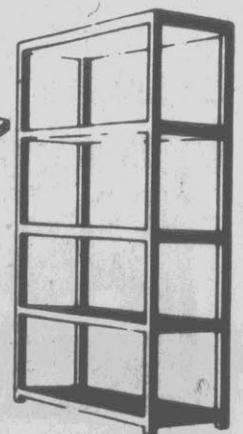

**PLASTIC 5-SHELF ETAGERE**  
 Regular 29.99  
**19<sup>99</sup>**



**TWIN PACK  
FORMULA 409**  
2, 22-OUNCE  
BOTTLES  
**1.99**  
Regular 2.89



**LYSOL  
SPRAY DISINFECTANT**  
18-OUNCE  
2 TYPES  
**2.49**  
Regular 3.29



**QUAKER STATE  
MOTOR OIL**  
SUPER BLEND  
10W30, 1-QUART  
**99¢**  
Regular 1.29  
Limit 6 please



**RAID  
INDOOR FOGGER**  
8-OUNCE  
**2.59**  
Regular 4.49

**OLE DIZ  
CHARCOAL**  
10-POUNDS  
Regular 1.79  
**1.29**



**GULF LITE CHARCOAL  
STARTER**  
1-QT. Reg. 1.59 **1.19**

**OFF  
INSECT  
REPELLENT**  
6-OUNCE  
Regular 2.99  
**1.79**



**BAR-B-Q GRILL SALE**

**SWINGER II  
SMOKER  
GRILL**  
#4400 Reg. 59.99  
**39.99**

4-level grid. Tilt-away hood.

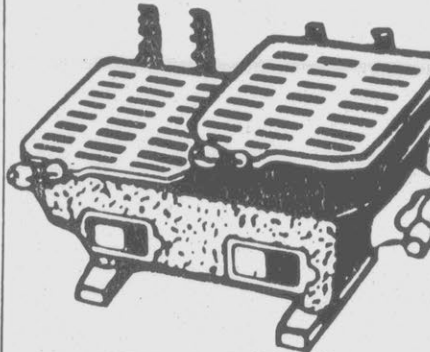

**10-INCH x 17-INCH  
HIBACHI GRILL**  
#2407 Reg. 16.99  
**6.99** Regular 9.99

**24" ROUND  
BRAZIER  
GRILL**  
#2407 Reg. 16.99  
**11.99**

4-position grid with wooden handle.

**FOAM  
CAN  
HOLDERS**  
PACK OF 6  
Reg. 1.59 pk.  
**99¢**



**1/2-GALLON  
PICNIC  
JUG**  
Model #011  
Reg. 2.79  
**1.99**



**PLATE  
HOLDERS**  
PACK OF 4  
Reg. 1.99 pk.  
**1.29**



**WILSON  
TENNIS  
BALLS**  
CAN OF 3  
Regular 2.79  
**2.09**



**MEN'S & LADIES'  
COTTON  
GLOVES**  
Regular 1.09  
**69¢**



**JOBE'S  
PLANT FOOD  
or SPIKES**  
YOUR CHOICE  
Regular 1.99  
**1.39**

60-pack of spikes.  
8-oz. plant food.



**SUPER FLEX  
or BELTED  
GARDEN  
HOSE**  
#8610 or 8640  
Regular 17.99  
**12.99**



4-ply, 3/4" x 50'  
Super Flex. Reinforced 3/4" x 80'.  
FULL WARRANTY & UNCONDITIONAL GUARANTEE

**Douglas®  
PLASTIC  
RAKE**  
22-TINE #19-202  
Regular 3.99  
**2.99**

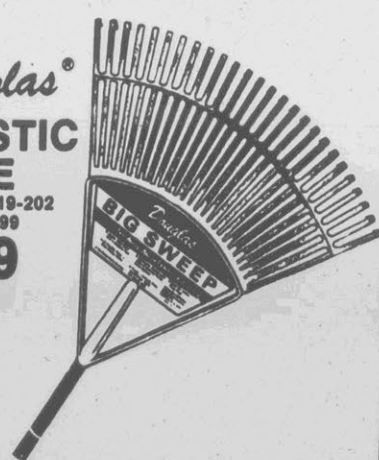

**ECKERD  
FLEA or TICK  
COLLARS**  
Reg. 1.29 ea.  
**2.129**  
FOR  
BUY 1, GET  
1 FREE



**TURTLE WAX  
LIQUID  
CAR WAX**  
18-OUNCE  
Regular 2.39  
**1.88**



**SUMMER CLEARANCE**

**WHILE QUANTITIES  
LAST!**

**35% OFF**

**REGULAR  
PRICES**

- **LAWN FURNITURE**  
Chairs, chaises, rockers, tables. Fabric, web & redwood.
- **WEEDER/TRIMMERS**  
Gas-powered & electric models!
- **REEL & ROD COMBINATIONS**  
READY-TO-FISH COMBOS!
- **INFLATABLES**  
Air mattresses, surfers & more.



# ECKERD'S SIZZLING SUMMER SALE



**ECKERD**

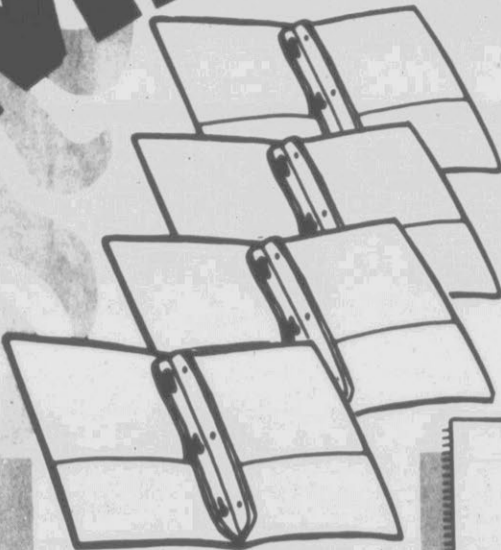

**DUO-TANG REPORT COVERS**  
ASSORTED COLORS Reg. 49 ea.

**4/1.00**  
FOR



**ERASER MATE PEN**  
Regular 1.99 ... **99¢**

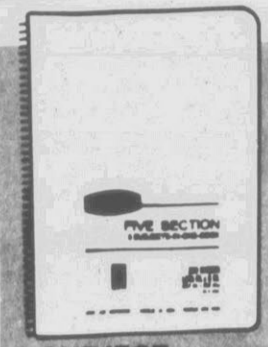

**5-SUBJECT NOTEBOOK**  
200 SHEETS Reg. 2.99 ... **1.39**

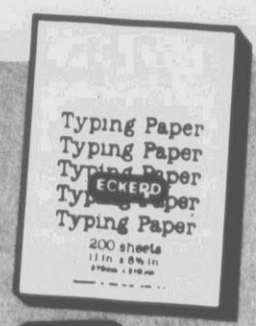

**ECKERD TYPING PAPER**  
200 SHEETS Reg. 1.49 ... **99¢**

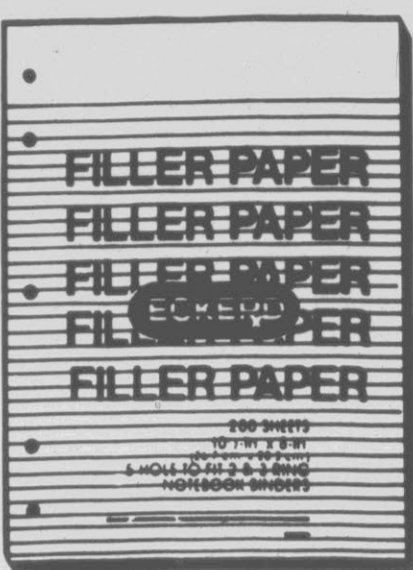

**ECKERD FILLER PAPER**  
PACK OF 200 Reg. 99¢ pk. Limit 2 please

**63¢**

## SHARP BUYS IN SCHOOL SUPPLIES

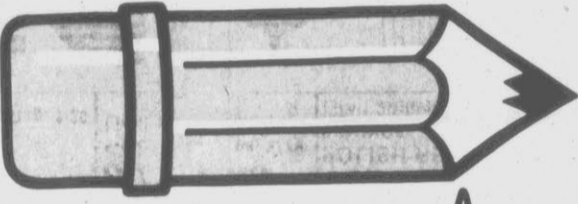

**MEAD SCHOOL ORGANIZERS**  
Regular 4.99 ... **3.49**  
4 types.



**CONSTRUCTION PAPER**  
Reg. 1.00 pk. ... **2/1.00**  
42 sheets.



**ELMER'S GLUE ALL 4-OUNCE**  
Reg. 1.00 **2/88¢**



**ECKERD PENCILS**  
PACK OF 8 Reg. 65¢ pk. **3/1.00**



**CRAYOLA CRAYONS**  
BOX OF 16 Reg. 1.00 ... **59¢**



**BIC SUPER SAVER PENS**  
PACK OF 9 Regular 1.79 ... **88¢**



**SCHOOL LUNCH KITS**  
Reg. 5.99 ... **3.99**



**ASSORTED KNAPSACKS**  
Reg. 8.49 ... **4.99**

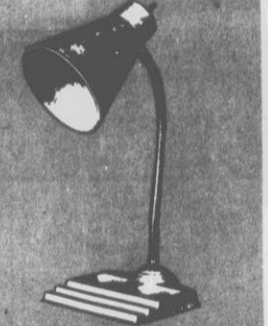

**STUDENT DESK LAMP**  
Regular 5.99 ... **7.88**

<b>TWICE AS FRESH AIR FRESHENER</b> Regular 1.19	<b>GATORADE</b> 32-OUNCE Regular 89¢	<b>WIREBOUND NOTEBOOKS</b> 70-SHEET Reg. 79¢ ea. <b>2/79¢</b>	<b>PAPER PLATES</b> PACK OF 100 Reg. 1.29	<b>DIAL SOAP</b> 5-OZ. Reg. 59¢ ea. <b>2/79¢</b> Limit 2 bars please	<b>CUTEX POLISH REMOVER</b> 8-OUNCE Limit 2 please
---	---	--	--	--	---

**YOUR CHOICE 79¢**

Includes: Gatorade Thirst Quencher, Dial Deodorant Soap, Cutex Polish Remover, and Chef-pak plates.

Sears

NATIONAL  
Home  
Appliance  
SALE

SALE STARTS WED., JULY 14, ends  
SAT., JULY 17 unless otherwise stated

Sears Pricing Policy . . . If an item is not described as  
reduced or a special purchase, it is at its regular price. A  
special purchase, though not reduced, is an excep-  
tional value.

Most items at reduced prices

Ask about Sears Credit Plans

# Summer SALE

Most Items Reduced

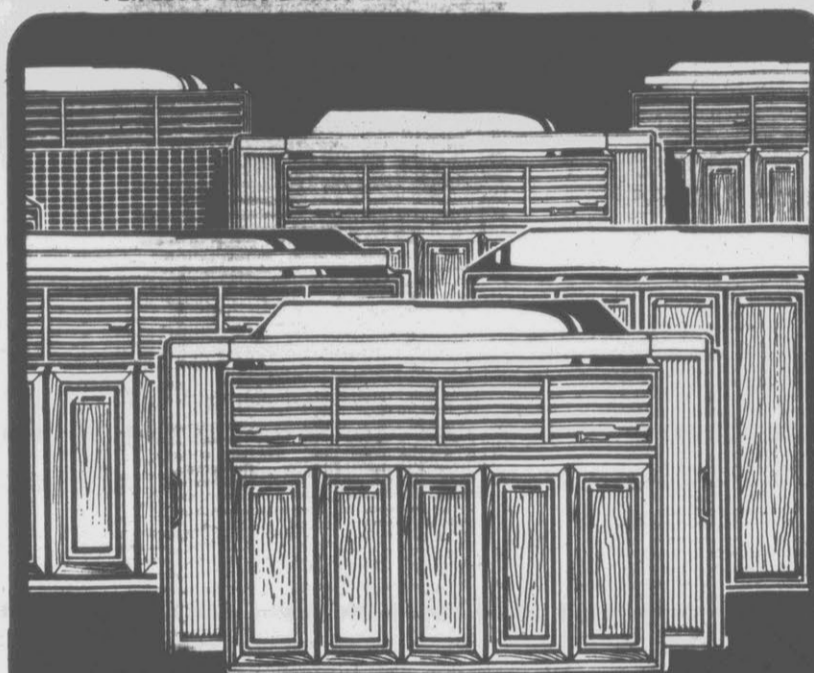

**SAVE**  
**\$20-\$100**

**EVERY KENMORE WINDOW AIR  
CONDITIONER IN STOCK!**

Choose from single or multi-room models some with Super Thrust, many are high-efficiency models with EER ratings as high as 9.6. Choose the unit that fits your needs and save. While quantities last.



**SAVE**  
**\$100 YOUR CHOICE**

**CHOOSE FROM A KENMORE 15.0  
CU.FT. UPRIGHT OR 15.1 CU.FT. CHEST**

Freezers have key-eject lock. Chest freezer has 3 lift-out baskets. Upright freezer has 4 grille type shelves, Power Miser switch. Thru July 31.

YOUR CHOICE  
**399<sup>95</sup>** each



**\$150 OFF**

**Kenmore Icemaker Refrigerator**

BIG 19.0 cu.ft.  
Regular \$699.95

**549<sup>95</sup>**

Ice maker hook-up is optional, extra

No more refilling of messy ice trays. Power Miser switch to help save energy. Twin crispers, adjustable shelves.

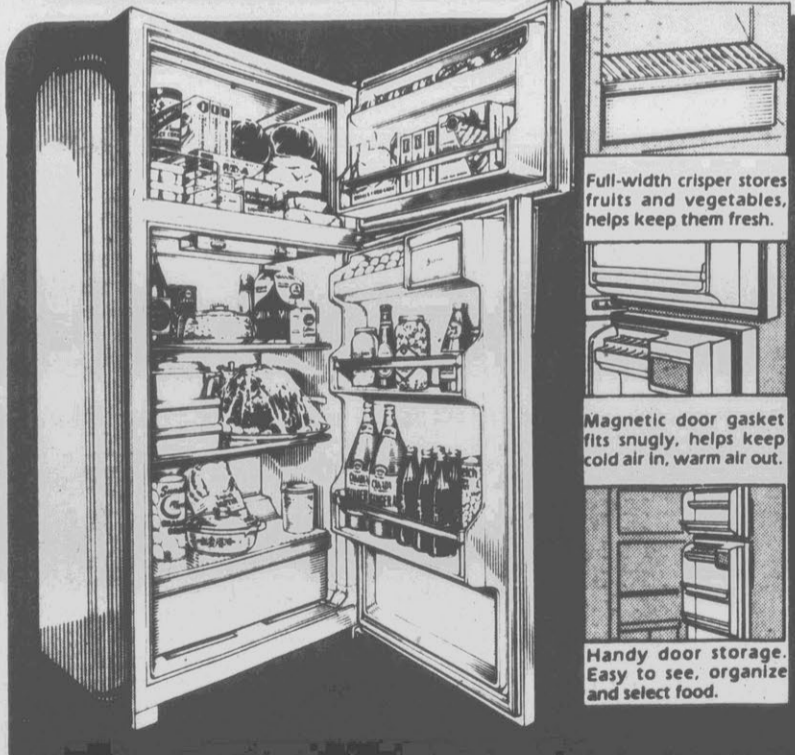

**\$50 OFF**

**Kenmore Refrigerator-Freezer**

14.0 cu.ft.  
Regular \$449.95

**399<sup>95</sup>**

Handy door storage, Full-width fresh food crispers. Magnetic door gasket to help keep cold in. Plenty of storage space.

Delivery not included in selling prices of all items in this circular

Each of these advertised items is readily available for sale as advertised

SHOP YOUR NEAREST SEARS RETAIL STORE

You can  
count on

**Sears**

SEARS, ROEBUCK AND CO.

Satisfaction Guaranteed  
or Your Money Back

N.C.: Burlington, Charlotte, Concord, Durham, Fayetteville, Gastonia, Goldsboro, Greensboro, Greenville, Hickory, High Point, Jacksonville, Raleigh, Rocky Mount, Wilmington, Winston-Salem  
S.C.: Columbia, Florence, Myrtle Beach, Rock Hill  
VA.: Danville, Lynchburg, Roanoke

7/14/82

**SAVE \$160** Kenmore PAIR

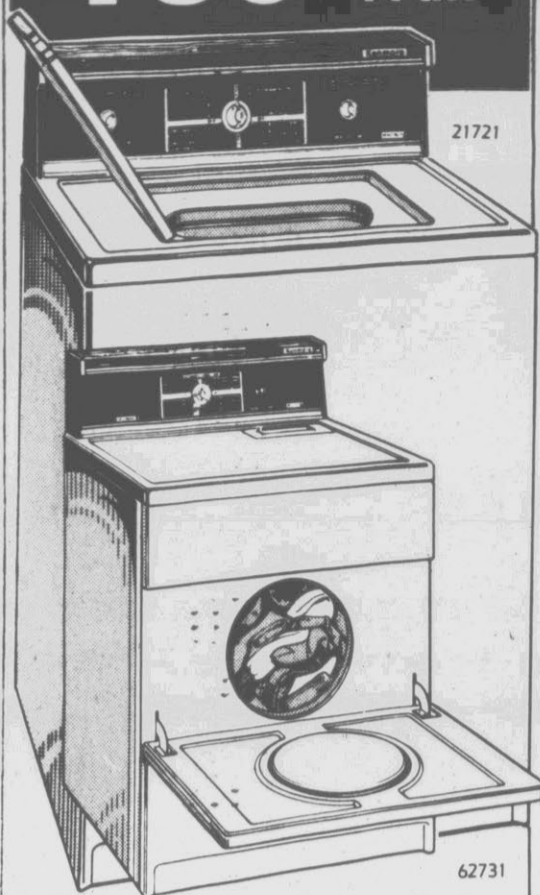

**Kenmore 6-Cycle Washer**  
**SAVE \$110**  
 Includes cotton/sturdy, knit, delicate, permanent press, pre-soak and pre-wash. Dual-action agitator. Self-cleaning lint filter, off balance switch.  
 Regular \$489.95  
**379<sup>95</sup>**

**Fabric Master Dryer**  
**SAVE \$50**  
 Heats shuts off automatically when load is dry. Wrinkle Guard<sup>®</sup> feature and touch-up cycle. Cord is extra.  
 Regular \$349.95  
**299<sup>95</sup>**

Pair Sale Ends July 31

**\$130 OFF**

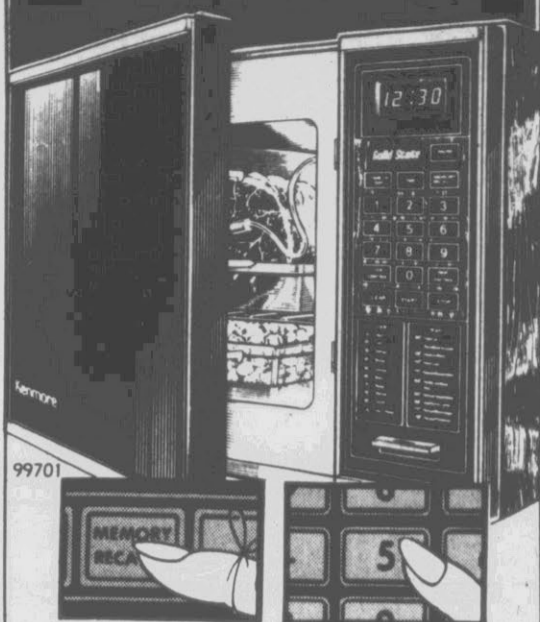

2-stage memory. Set to defrost, then roast, or any 2 other functions.  
 Electronic touch. Finger touch control: no buttons, no dials!

**Kenmore Microwave Oven with 2-stage Memory**

WAS MAY '82 \$529.95  
**399<sup>95</sup>**

2-stage memory lets you defrost and roast or use any 2 functions automatically. Cook a whole meal at one time in spacious 1.4 cu.ft. oven. Probe, delay start. While quantities last.

**SUPER VALUE**  
**Kenmore Compact Microwave Oven**  
**\$199 ONLY**

Features 0.5 cu.ft. oven. 10-min. timer. Oven light. Menu guide.

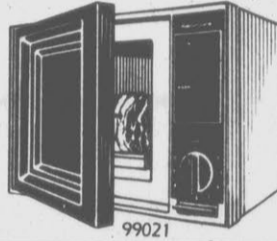

**SAVE \$90**



All electronic tuner is accurate and dependable. All solid-state.  
 Touch n Tune channel selection is fast and easy-to-use.

**BIG-SCREEN Touch n' Tune Color TV**

Regular \$489.95  
**399<sup>95</sup>**

Enjoy a big 19-inch diagonal measure picture. Features a reliable electronic tuner with Touch n' Tune selection. One-Button Color. On sale until July 31.

Ask about Sears Credit Plans

**\$50 OFF**

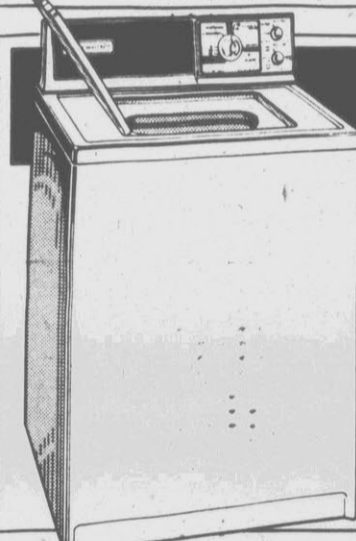

**Kenmore Permanent Press Washer**

Regular \$349.95  
**299<sup>95</sup>**

Large-capacity washer has 3 cycles and 3 water temperature combinations for proper fabric care. 3 water levels to match load size. Thru July 31.

**SAVE \$100**



**Video Cassette Recorder**

Regular \$799.95  
**699<sup>95</sup>**

Preset to record up to 3 days in advance. Up to 5 hrs. per tape. Remote pause control. On sale until July 31.

BetaVision is designed to expand opportunities for your personal in-home TV viewing and not for any usage which might violate the copyright laws.

**\$100 OFF**



**Kenmore LP Gas Grill Package**

Reg. sep. price \$299.95  
**199<sup>95</sup>**

338 sq.in. cooking area includes warming rack for potatoes and rolls. Up-front dual controls. Red-wood shelf. Match-free ignition. Thru July 31.

**SPECIAL PURCHASE**



**REMOTE CONTROL Console Color TV**

ONLY  
**599<sup>95</sup>**

25-in. diag. meas. picture. Electronic Sensor Scan tuning. One-Button Color, sharpness control, beautiful cabinet. While they last at Sears.

**SAVE \$80**



**Self-propelled Kenmore Vacuum**

Regular \$239.95  
**159<sup>95</sup>**

Sears Best. Powerful suction and a double row beater bar brush for thorough, deep down cleaning. Active edge cleaning.

**SAVE \$10**

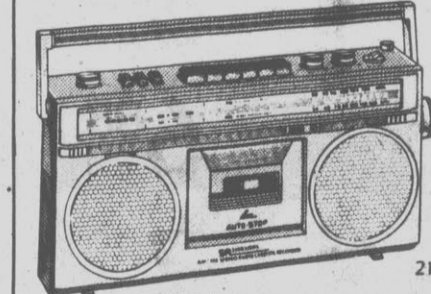

**Portable Stereo Radio/Recorder**

Regular \$99.95  
**89<sup>95</sup>**

Cassette play/record, AM/FM stereo radio. Stereo-wide for enhanced stereo sound. Sleep switch, pause control. On sale until July 31.

**SAVE \$60**



**Kenmore Carpet Cleaner/Spraymate**

Reg. sep. price \$279.95  
**219<sup>95</sup>**

Sprays hot solution into carpet. Spraymate attachment scrubs heavily soiled areas. On sale until July 31 at Sears.

**SAVE \$120**



**Compact Stereo System**

Regular \$299.95  
**179<sup>95</sup>**

Plays and records cassette tapes. Plays 8-track tapes. Has record changer, AM/FM stereo receiver and 2 speaker. On thru July 31.

Delivery is not included in selling prices

Each of these advertised items is readily available for sale as advertised

# SAVE \$20-\$80

## Homestead Teen Bedroom Furniture

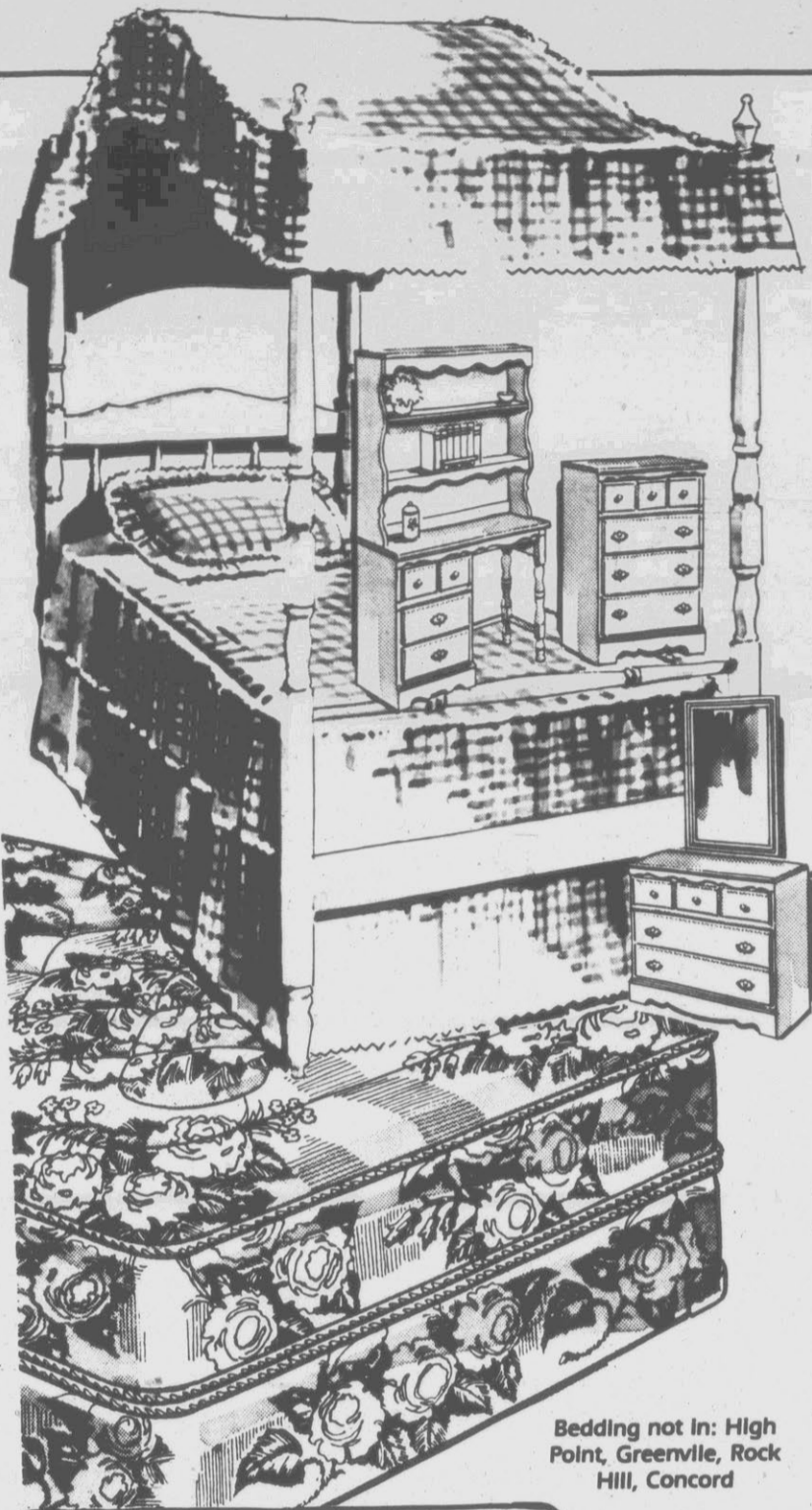

Bedding not in: High Point, Greenville, Rock Hill, Concord

**\$80 OFF** Twin Canopy Bed

**99<sup>88</sup>**

Rails, Frame Included  
Regular \$179.99

Homestead canopy bed is crafted in authentic country style detailing to make you feel right at home. In white, maple or pine colors.

**SAVE \$20 to \$50**  
on Matching Pieces

Your Choice  
Regular \$199.99 each

Choose: Single dresser, 4-dr. chest,  
Student Desk or Lingerie Chest,  
Hutch, Regular \$169.99

**149<sup>88</sup>** each

Furniture not in: Concord, High Point, Greenville, Darville, Goldsboro, Rock Hill

**SAVE \$80-\$100**

per set on Sears Deluxe Bedding Sets

Twin Innerspring, polyurethane  
foam mattress or box spring  
Regular \$119.99

**79<sup>88</sup>** each  
piece

For a comfortable night's sleep... Deluxe twin bedding with 216-coil innerspring or 6-in. Serofoam polyurethane mattress. Hurry to Sears for great savings.

\$159.99 Full mattress or box spring..... 119.88 each  
\$399.99 Queen size set..... 299.88  
\$499.99 King size set..... 399.88

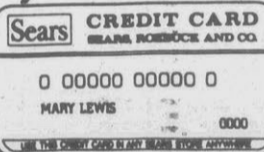

**APPLY TODAY**

You Can Apply for an Account by Phone  
Call Toll Free 1-800-323-2780  
Ask for Operator 10  
Good Nationwide - No Annual Fee

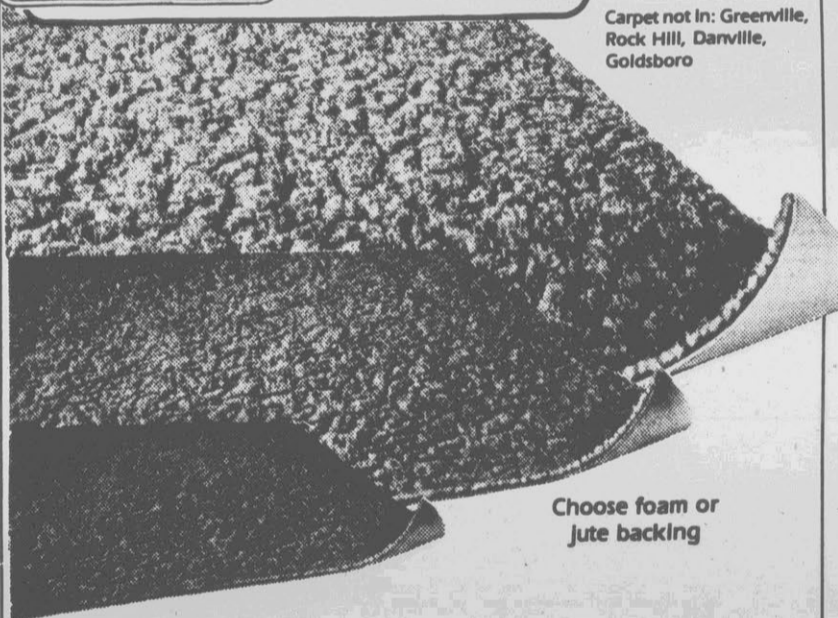

Carpet not in: Greenville, Rock Hill, Darville, Goldsboro

Choose foam or  
jute backing

**23%-28% OFF**

These 3 Durable Nylon Pile Carpets  
**SAVE \$2.11**

**Opening Place.** You'll love this multi-level loop carpet that provides comfort and durability underfoot at a great low price. For family room, bedroom or any room. Reg. \$7.99 sq.yd.

**5<sup>88</sup>**  
sq.yd.

**SAVE \$2.11**

**Special Place.** 12 oz. of nylon pile. Choose from beautiful colors. Choose either foam or jute backing. Reg. \$8.99 sq.yd.

**6<sup>88</sup>**  
sq.yd.

**SAVE \$3.11**

**Pretty Place.** 16 oz. of nylon pile. In fashion colors. Choose either foam or jute backing. Reg. \$10.99 sq.yd.

**7<sup>88</sup>**  
sq.yd.

Cushion and Installation available

Delivery not included

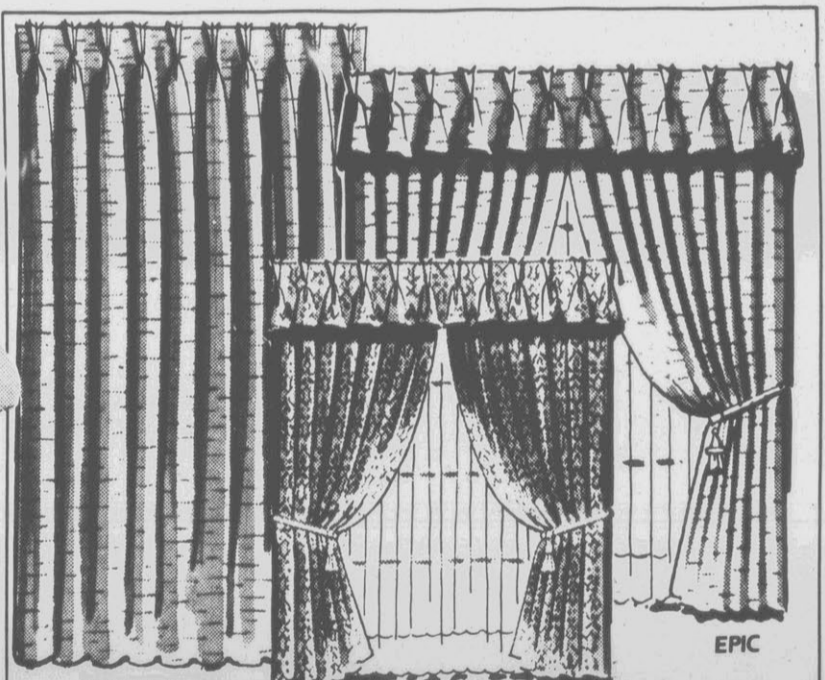

SHERBERT

PETIT PLUME

EPIC

**15%-33% OFF**

These 3 Beautiful Readymade Draperies  
**SAVE \$7.11**

**Sherbert** is a textured drapery with insulating acrylic flocked foam backing. Helps save energy. In an array of colors. Reg. \$26.99.

**19<sup>88</sup>**  
50x84-in. pr.

**SAVE \$10.11**

**Epic.** Rich textured draperies with acrylic flocked foam backing. Save today at Sears. Reg. \$29.99.

**19<sup>88</sup>**  
48x84-in. pr.

**SAVE \$5.11**

**Petit Plume.** Self-lined Perma-Prest® draperies with an intricate pattern. Reg. \$21.99. Save today.

**16<sup>88</sup>**  
50x84-in. pr.

Other drapery sizes now on sale at Sears

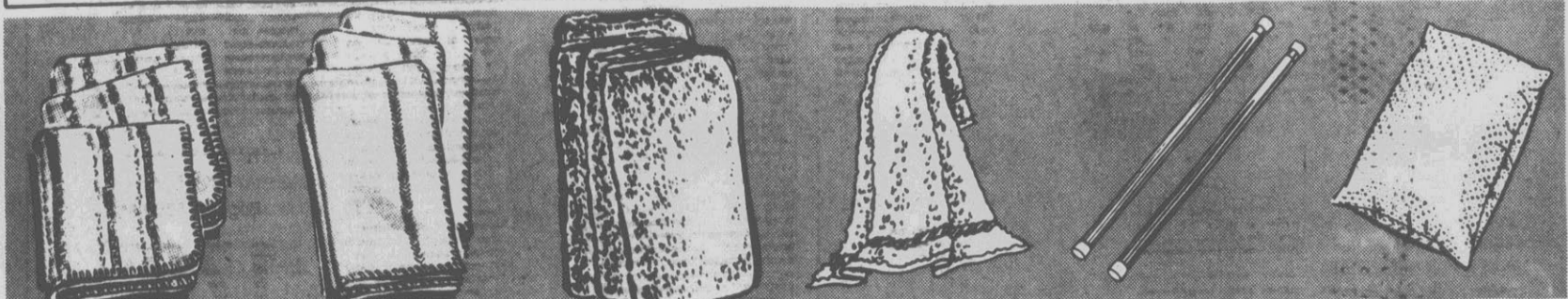

**SAVE 40%**  
Pkg. of 3 Dishcloths

**1<sup>19</sup>**

Reg. \$1.99  
At this great price stock up now. Pkg. of 3. Save 80¢.

**SAVE 40%**  
Kitchen Towels

**1<sup>19</sup>**

Reg. \$1.99  
Comes in a package of 3. Buy several packs. Save 80¢.

**SAVE 43%**  
Pkg. of 4 Washcloth

**79¢**

Reg. \$1.39  
Don't miss this value. Stock up now. Save 60¢.

**SAVE 33%**  
Bath Towels

**1<sup>99</sup>**

Reg. \$2.99  
\$1.99 Hand Towel ..... 1.59  
\$1.29 Washcloth ..... 99¢

**SAVE 25%**  
Tension Rod

**5<sup>99</sup>**

Reg. \$7.99  
Spring tension rod. Fits space 40 to 60-inches wide. Save \$2.

**SAVE 28%**  
Polyester Pillow

**2 for \$5**

Reg. \$3.49  
100% polyester filled pillow. Polyester ticking.

# 30-36% OFF

Sporty Styles on the Move

The Shirt, Misses' Solid

Save \$3.01  
Regular \$9

**5<sup>99</sup>**

Misses' Pull-on Pants,

Save \$3.01  
Regular \$10

**6<sup>99</sup>** pair

Make your fashion move into fall with double-knit Fortrel® polyester pants in dark tones. Team them with a classic style notch-collar polyester shirt in a fall print or solid colors. The Shirt is in Misses' sizes. Pants in Petite and Average lengths.

\$11 Save \$4.01, Misses' Print Shirt . . . 6.99



# SAVE 25%

LAST 4 DAYS TO SAVE

Pre-Season SALE  
Entire Stock of Coats

- Misses, Juniors, Petites, Half Sizes
- Cloth Coats, Some with Fur Trim
- Leather Coats and Jackets
- Rain Coats, Even All-Weather Coats
- Misses' Fake Furs
- Jackets and Much, Much More

Regular prices will be in effect after July 17

See our special order book; some styles are available by special order only.

Not all sizes in all styles. Styles shown are representative of Sears assortment.

Fur products labeled to show country or origin of imported furs.

A 10% deposit will hold your purchase in Lay-Away until October 1.



## Men's Pullover CLEARANCE

ONLY **5<sup>97</sup>** each

There's still a great deal of summertime fun ahead and now we have the casual pullover shirts you love reduced to a tremendously low price. You'll find the style and fabric to suit your every need.

While Quantities Last

## 30% OFF ENTIRE STOCK Men's Slacks CLEARANCE

Dress slacks, casual slacks — reduced now just in time for summer vacations, parties, office or just relaxing at home. Hurry in and see our selection of slacks in a variety of styles, colors and fabrics just right for you.

While Quantities Last

## 20%-33% OFF Men's Dress Shirt CLEARANCE

\$1 to \$2.07 OFF **3<sup>97</sup>** each  
Were \$4.97 to \$5.99

Choose long or short sleeve dress shirt from a selected group of solid colors. Knits and broadcloth fabrics. Sizes 14½-17.

While Quantities Last

Ask about Sears Credit Plans

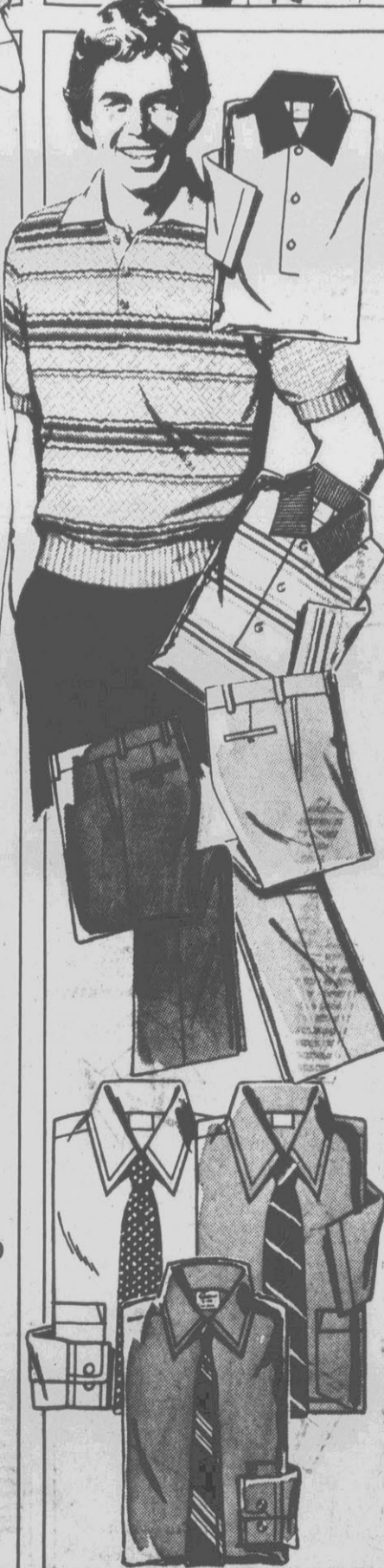

## SAVE 30%

Light 'n' Lacey Bras, High-Thigh Briefs

Save \$3.15  
Lite 'n' Lacey Bra  
Regular \$10.50

**7<sup>35</sup>**

Save \$1.51  
High-Thigh Brief  
Regular \$5

**3<sup>49</sup>**

Seamless cup bras in natural cup and contour cup styles give you a smooth natural look. Polyester scalloped lace and bow trims upper cups.

Light control brief of nylon and Lycra® spandex coordinates with the Lite 'n' Lacey Ah-h Bra. High-thigh cut at leg opening lets you move freely.

D-Cup Bras Prices Higher Sale ends July 24

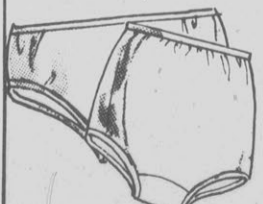

SAVE 30%  
Very Impressive  
Panties

Save \$2.01  
Regular \$6.50 **4<sup>49</sup>**

Briefs, bikinis or hiphuggers in Antron® III nylon. Package of 3 pair.



## SAVE 20%-33%

Cling-alon®  
Hosiery SALE

Regular \$1.29 to \$4.99

**99¢ to 3<sup>99</sup>**

It's the fit to be tried, now at great sale prices. Our sheerest. They're knit of yarn with super stretch and recovery.



Our Summer Catalog is your fair weather friend . . .  
Come and see what Sears has for you

# SAVE \$3

## Children's Wrangler® Jeans



**SAVE on Denim Jeans for Big and Little Boys and Bigger Girls**

Little Boys' Sizes 3 to 6x  
Regular \$11.99 **8<sup>99</sup>** pair

Bigger Girls' 7 to 14  
Regular \$14.99 **11<sup>99</sup>** pair

Bigger Boys' 8 to 20  
Regular \$15.99 **12<sup>99</sup>** pair

Wrangler® denim jeans of cotton or polyester and cotton are not only durable, but they're also very fashionable. Choose jeans in western and fashion styles for big and little boys and bigger girls.

**SAVE 25%**  
Children's  
Outerwear SALE

Regular \$5.44 to \$59.99

**3<sup>99</sup> to 44<sup>99</sup>**

Our entire stock of children's outerwear is now on sale. Choose from coats, jackets, vests, parkas, all-weather coats. Sale ends July 24.

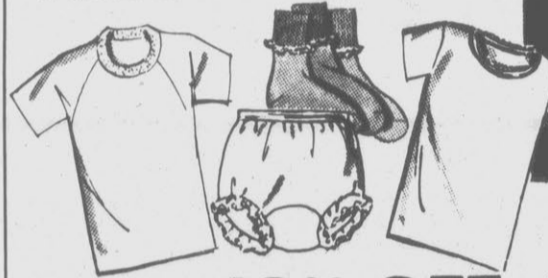

**20% to 33% OFF**  
Children's Underwear SALE

Little Kids' 3 to 6x  
\$4.99 Boys' T-Shirts, Pkg. of 3 ..... 3.99  
\$4.99 Girls' Vests, Pkg. of 3 ..... 3.99  
\$4.99 Girls' Puffed Panties, Pkg. of 3 ..... 3.99  
\$1.49 Knee Socks ..... 99¢ pr.

Bigger Boys 8 to 20  
\$5.99 Sears Best T-Shirt or Brief ..... 4.79  
\$7.99 Sears Best Tube Socks, Pkg. of 6 ..... 6.39  
\$1.49 Crew Socks ..... 99¢ pr.

Bigger Girls 7 to 14  
\$4.99 Briefs, Bikinis or Vests ..... 3.99  
\$1.29 Knee Highs ..... 84¢ pr.

**SAVE \$2**  
Braggin' Dragon  
Tops for Kids'

Little Girls 3 to 6x  
Regular \$7.99 **5<sup>99</sup>**

Little Boys' 3 to 6x  
Regular \$8.99 **6<sup>99</sup>**

Bigger Boys and Girls  
Regular \$9.99 **7<sup>99</sup>**

Braggin' Dragon... proof positive that quality knit shirts need not be expensive. Comfortable polyester and cotton knit is Perma-Prest® so it needs no ironing when tumbled dry. Short sleeves.  
\$10.99 Bigger Girls' Tipped Collar... 8.99

Sears... the store to shop for fashions for your entire family

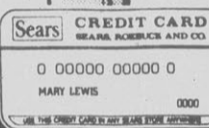

**Apply Today**

You Can Apply for an Account by Phone.  
Call Toll Free 1-800-323-2780  
Ask for Operator 10.  
Good Nationwide - No Annual Fee

**SAVE 16%-25%**

Men's Work Clothing

**SAVE \$4** Perma-Prest® Work Outfits

Shirt Regular \$10.99    Pants Regular \$11.99

**8<sup>77</sup>    9<sup>97</sup>**

Perma-Prest® outfits need no ironing when tumbled dry. Always look crisp and neat in our polyester and cotton twill long-sleeve shirts and pants.

**SAVE \$3 to \$4**  
Denim Overalls Jeans

Denim Bibs Regular \$17.99    Denim Jeans Regular \$12.99

**13<sup>97</sup> pair    9<sup>97</sup> pair**

Durable polyester and cotton denims with reinforced seams and stress points. Plenty of pocket room. Brass plated hardware on bibs.

**SAVE \$2** Long Sleeve Chambray Shirts

Regular \$7.99 **5<sup>97</sup>**

Go to work in style in a soft Perma-Prest® chambray shirt of polyester and cotton. Men's popular sizes.

**SAVE \$3** Cotton Drill Painters' Jeans

Regular \$12.99 **9<sup>97</sup> pair**

Sturdy 100% cotton drill painters' jeans have triple stitched seams for strength and long wear.

In Our Work and Leisure Dept.

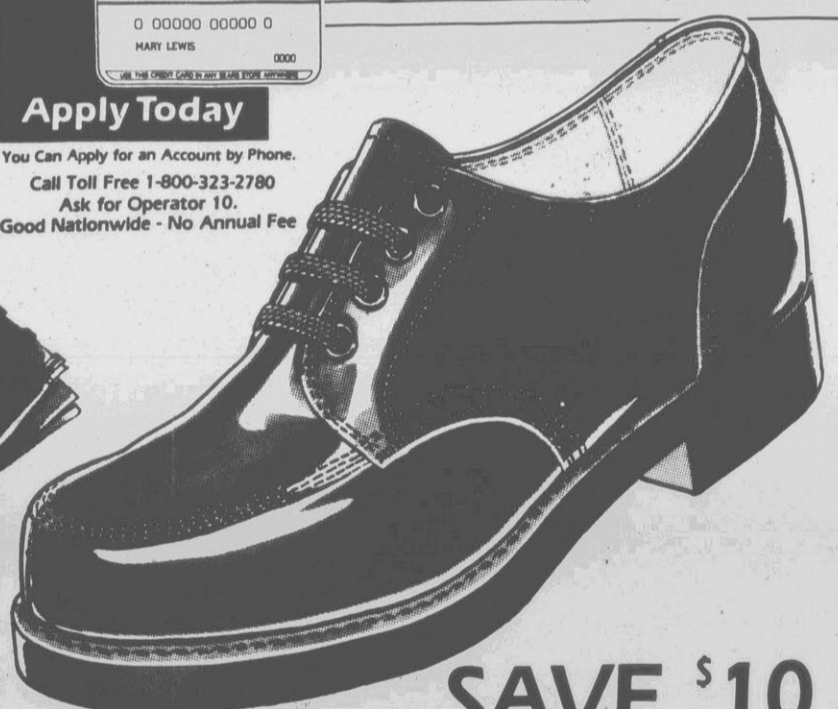

**SAVE \$10**

Men's Garage Oxford Work Shoes

You can rely on Sears garage oxford to do the job. Top grain leather upper, cushioned insole, non-marking rubber sole. Goodyear welt construction.

**34<sup>99</sup>**  
Reg. \$44.99

**GREAT BUYS**  
On Men's Leather Work Shoes

Save \$5.00  
6-In. Shoe  
Reg. \$29.99 **24<sup>99</sup> pair**

Save \$7.00  
8-In. Boot  
Reg. \$34.99 **27<sup>99</sup> pair**

Oxford  
Sears Low Price **21<sup>99</sup> pair**

Each of these hard working shoes has leather upper, rubber soles that resist oil and cushioned insole. Thru July 24.

**If boating and fishing are your games, you should see what Sears has for you!**

**\$10-\$20 OFF**  
on these four  
**Craftsman Power Tools**

**24<sup>99</sup>** Each

**YOUR CHOICE**

A. Reg. \$44.99 Craftsman 3/8-in. Variable Speed Drill  
B. Reg. \$34.99 Craftsman 5 1/2-in. Circular Saw  
C. Reg. \$39.99 Craftsman Sabre Saw with Edge Guide  
D. Reg. \$39.99 Craftsman Pad Sander

On sale until July 24



**\$10-\$30 OFF**  
on these five Craftsman Power Tools

**39<sup>99</sup>** Each

**YOUR CHOICE**

A. Reg. \$69.99 Variable-speed Scroll Saw  
B. Reg. \$69.99 3/8-inch Reversible Drill  
C. Reg. \$59.99 7 1/4-inch Circular Saw  
D. Reg. \$69.99 Pad Sander with Dust Pick-up  
E. Reg. \$49.99 5-inch, 2-wheel Grinder

On sale until July 31



**SAVE \$2**  
7-pc. Wood Drill Bit Set  
Reg. \$9.99 **7<sup>99</sup>**

**SAVE \$3**  
14-pc. Sabre Saw Blade Package  
Reg. \$9.99 **6<sup>99</sup>**

**SAVE \$5**  
13-pc. Craftsman Drill Bit Set  
Reg. \$17.99 **12<sup>99</sup>**

**SAVE 70¢**  
Package of 6 Sanding Sheets  
Reg. \$1.49 **79¢**

Tool Set Sale Ends July 31



**SAVE \$5-\$7** on these 1-Coat Sears Best Paints

**Easy Living Matte Flat**  
interior latex wall and trim paint  
one coat • washable • colorfast • resists fading • spot resistant • 10 years durability  
#93005 ONE GALLON

**WeatherBeater Low-Luster**  
exterior low-luster satin  
HOUSE AND TRIM ACRYLIC LATEX PAINT  
One Coat • Washable • Non-Yellowing • No Chalk V.  
#36005 ONE GALLON

**WeatherBeater Gloss**  
exterior gloss  
HOUSE AND TRIM ACRYLIC LATEX PAINT  
One Coat • Washable • Mildew Resistant  
#31005 ONE GALLON

**SAVE \$5** Regular \$14.99 **9<sup>99</sup>** Gallon  
Sears Best interior latex gives you washable 1-coat coverage and comes in a wide assortment of beautiful colors. Thru Saturday.

**SAVE \$7** Regular \$17.99 **10<sup>99</sup>** Gallon  
Sears Best exterior latex is 1-coat, non-yellowing. On sale until Saturday, so hurry.  
Reg. \$19.99 WeatherBeater Gloss, #31005 ..... **12.99 gal.**

For one-coat results, all Sears one-paints must be applied as directed



**SAVE \$200** on 1-HP Craftsman Sprayer/Compressor  
Regular \$649.99 **449<sup>99</sup>**

Great for around the house or the shop. Delivers 7.5 SCFM at 40 PSI. On sale until July 17 at Sears.

**SAVE \$210** on 2-HP Craftsman Sprayer/Compressor  
Regular \$749.99 **539<sup>99</sup>**

Powerful sprayer great for around the shop. Delivers 10.3 SCFM at 40 PSI. On sale until July 31.



**\$50 OFF** Ceiling Fans

A. 52-in. Ceiling Fan with Wood Blades  
Has three-speeds and is reversible with wood blades. Helps cool in summer to help save energy. Thru July 24.  
Regular \$179.99 **129<sup>99</sup>** Fan alone

B. Reg. \$24.99 Classic globe fixture ..... **21.99**

C. 52-in. Ceiling Fan with 3-speeds  
Deluxe fan is reversible and has wood blades with brass plate housing. On sale until July 24.  
Regular \$299.99 **249<sup>99</sup>** Fan alone

D. Classic School-house look fixture ..... **19.99**

**Light Fixture For Ceiling Fan**  
Sears price **29<sup>99</sup>**  
For Sears ceiling fans. Floral glass diffuser.

Fan Sale Ends July 24



**FULL 2-Year Warranty**  
If, within 2 years from date of purchase, this PermaNex® plastic container or lid cracks or breaks, we will, upon return, replace it free of charge.

**SAVE \$4** on 32-gal. Trash Container  
Reg. \$13.99 **9<sup>88</sup>**  
Sturdy permaNex® trash can resists weather. On sale until July 19.

**SAVE \$20** Sears Covered Cooker  
Reg. \$89.99 **69<sup>99</sup>**  
Cast aluminum grill. Comes unassembled. On sale until July 24.

**1/2 PRICE**  
4-pc. Microwave Cook Set  
Fall '82 Catalog Price \$19.99 **9<sup>99</sup>** While They Last  
Not available in Danville, Greenville, Rocky Mount and Gastonia.



Sears

**SAVE \$150**

**Craftsman 10-HP Tractor**



**Vari-Drive Lawn Tractor**

**1249<sup>99</sup>**

Regular \$1399.99

Vari-Drive combined with a transaxle for variable speeds in each gear — without shifting. Has master-lift for raising or lowering front and mid-mount attachments. With 38-inch floating mower deck to prevent scalping. Don't miss it. Thru July 24.

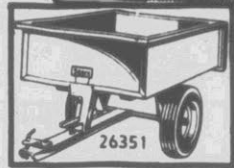

**SAVE \$40**  
**Hauling Cart**  
Reg. \$219.99 **179<sup>99</sup>**

10 cu.ft. capacity. Makes yard work easier.

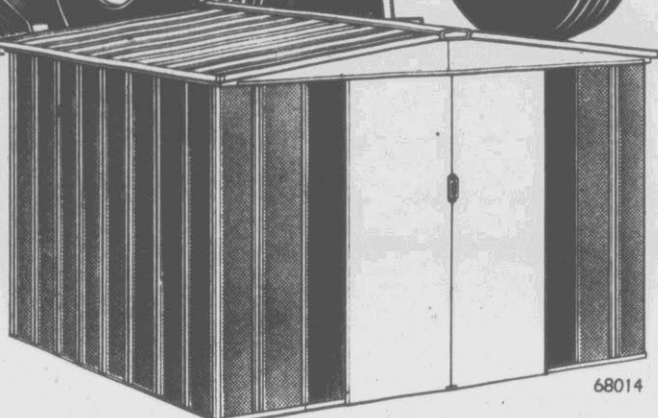

**SAVE \$50** 10x9-ft.  
**Sears Gable Lawn Building**

Reg. \$249.99

**199<sup>99</sup>**

Steel with durable 7-step finish. Measures 8½x9½-ft. inside. Lawn building comes unassembled. Thru July 24.

\*Exterior base dimensions rounded to nearest foot \$199.99 10x6-ft. size **SAVE \$30** ..... **169.99**

**SAVE \$30**

**on Kenmore® Power Miser 5™ Water Heaters**

**YOUR CHOICE 189<sup>99</sup>**  
Gas or Electric  
Reg. \$219.99

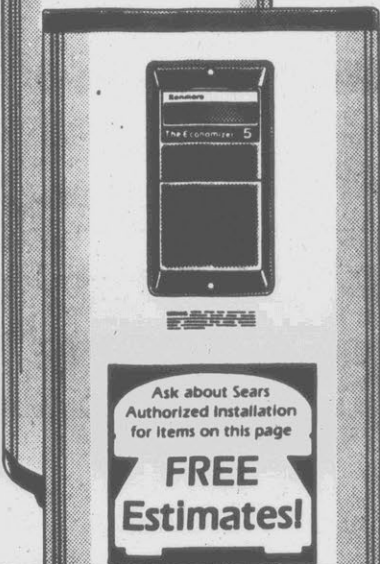
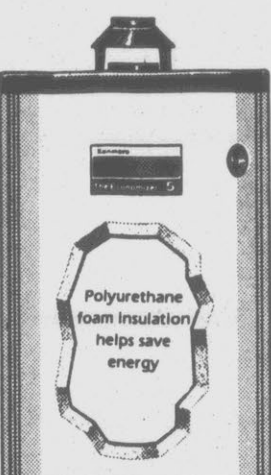

Choose 40-gal. gas or 52-gal. electric. Power Miser 5™ water heaters can save you \$185 in gas bills and \$250 in electric bills over a 5-yr.\* period when compared with our standard models. Thru July 31.

- Fast emergency installation by Sears Authorized Installers
- All Sears water heaters are equipped with safety relief valves

\*In accordance with U.S. Dept. of Energy Test Procedures, the operating cost was calculated on the basis of 64.3 gallons per day of hot water usage by a family of 4 with 90° F. temp. rise, with gas rate of 42.6¢ per therm and electricity rate of 5.64¢ per kilowatt hour (U.S. government 1981 national average cost figures). Savings were calculated by subtracting the operating cost of our Power Miser 5™ 40-gal. gas and 52-gal. electric water heaters. Savings may be more or less depending on your hot water usage and local utility rates.

Ask about Sears Authorized Installation for items on this page  
**FREE Estimates!**



**\$100 OFF Built-in Dishwasher**

Features three-level wash. Water Miser Cycles and Power Miser control to help save energy. Pot/pan cycle for heavily soiled loads. Thru July 31.  
\$439.95 portable model, #70031.... **339.95**

Regular \$399.95

**299<sup>95</sup>**

Each of these advertised items is readily available for sale as advertised  
Normal replacement installation charge for built-in dishwashers .... **only \$75**

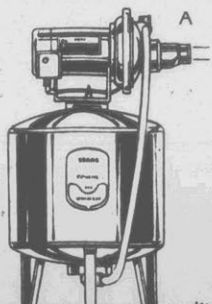

**A. SAVE \$40**  
**Shallow Well Pump**

Reg. 209.99 **169<sup>88</sup>**  
\$120 19-gal. tank ..... \$99

**B. SAVE \$60**  
**1-HP Jet Pump**

Reg. \$299.99 **239<sup>99</sup>**  
Deep well, multi-stage jet pump.

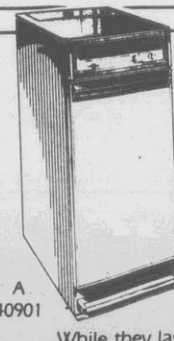
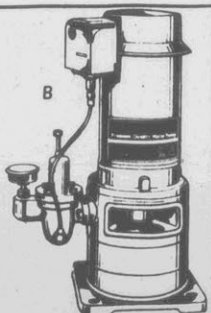

**A. SPECIAL PURCHASE**  
**Kenmore Compact**  
**299<sup>88</sup>**  
ONLY  
Free-standing model. Colors available.

**B. SAVE \$15**  
**1/2-HP Disposer**

Reg. \$89.99 **74<sup>99</sup>**  
Quick mount collar; sale ends July 31.



While they last.

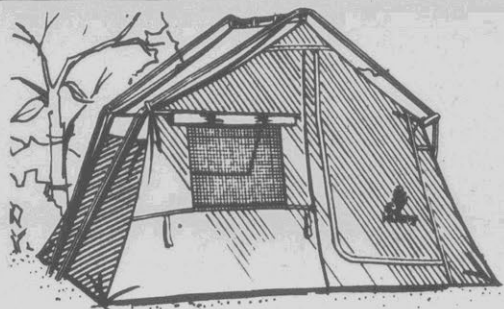

**\$20 OFF 8 x 10-ft. Tent**

Cotton and polyester roof with polyester walls. With sewn-in floor. Save now.  
\$139.99, 9x12-ft. .... **109.99**

Reg. \$119.99 **89<sup>99</sup>**

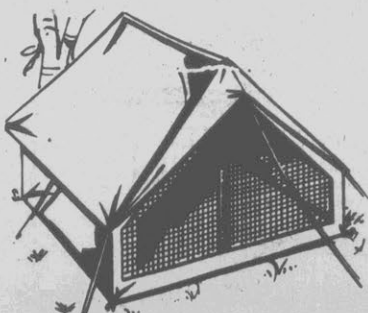

**SAVE \$30**

**Sport Tent with Fly**

Reg. \$99.99 **69<sup>99</sup>**

7x7-ft. nylon tent with screen back window. Guy ropes are included. Save now.

**SAVE \$20 to \$40**

**on Hillary tents**

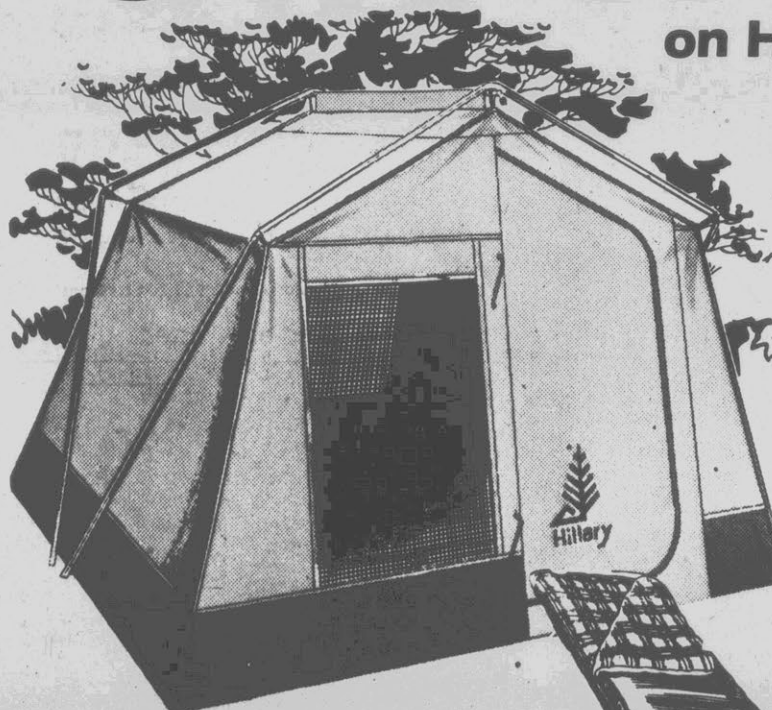

**SAVE \$40**

**8x10-ft. Hillary Tent**

Reg. \$159.99

**119<sup>99</sup>**

Polyester and cotton roof and walls. With sewn-in floor. Has 2 screened windows. Save now.  
\$179.99, 9x11-ft. .... **139.99**  
\$199.99, 10x13-ft. .... **159.99**

**SAVE \$10**  
**Sleeping Bag**

Reg. \$39.99 **29<sup>99</sup>**

With 4-lbs. of insulation. Machine wash.

Shop Sears for all your camping needs



\$21.99 40-qt. ice chest ..... **17.99**

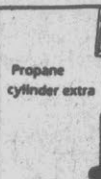

\$16.99 single mantle lantern ..... **13.99**



Sears 5x7-ft. sport tent ..... **19.99**



\$44.99 Pak-A-Potti® **SAVE \$15** ..... **39.99**



\$39.99 two burner propane stove **31.99**

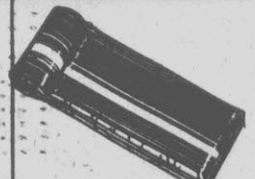

\$16.99 air mattress **SAVE \$4** ..... **12.99**

# Sears

# 25% OFF

## Belted or Radial Tires

### LIMITED WARRANTY - TIRE WEAROUT

For the number of miles or months specified, Sears will upon return, replace the tire or give a refund, charging a pro-rata charge for the miles or months received, if wear-out occurs and is not caused by failure to properly maintain the tire.

### SuperGuard Steel-Belted Radial

P155/80R-12 Regular \$49.99

**37<sup>49</sup>** Plus \$1.43 F.E.T.\*

#### 40,000-MILE WARRANTY

Two steel belts and polyester cord radial ply construction. Low rolling resistance helps save gas. Two steel belts for long wear and to absorb road shocks.

SuperGuard radial	Regular price ea. whitewall	Sale price ea. whitewall	plus F.E.T.* each and old tire
*P155/80R12	49.99	37.49	1.43
P155/80R13	59.99	44.99	1.53
P165/80R13	69.99	52.49	1.69
*P175/80R13	77.99	58.49	1.78
*P185/80R13	79.99	59.99	1.92
*P185/75R14	91.99	68.99	2.04
P195/75R14	94.99	71.49	2.18
P205/75R14	99.99	74.99	2.34
P215/75R14	104.99	78.49	2.48
P205/75R15	104.99	78.49	2.47
P215/75R15	107.99	80.99	2.59
P225/75R15	111.99	83.99	2.78
P235/75R15	113.99	85.49	3.01

\*Available in larger stores only

### SuperGuard 30 Belted Tires

#### Our best non-radial

#### 30,000-MILE WARRANTY

Constructed with two strong fiberglass belts and polyester plies for stability and a smooth ride.

SuperGuard 30	Regular price ea. whitewall	Sale price ea. whitewall	plus F.E.T.* each and old tire
A78-13	51.99	38.99	1.67
*D78-14	67.99	50.99	2.01
E78-14	68.99	51.99	2.08
*F78-14	69.99	52.49	2.44
G78-14	73.99	55.49	2.45
*H78-14	75.99	56.99	2.66
G78-15	75.99	56.99	2.45
H78-15	76.99	57.99	2.66
L78-15	79.99	59.99	2.89

\*\*Federal Excise Tax

Mounting and Rotation Included

Tires sale ends July 31

### 20% OFF RoadHandler All-Season Radials

### Dynaply 20 Bias-ply Tire SALE

#### 20,000-MILE WEAROUT WARRANTY

Dynaply 20	Regular price ea. blackwall	Sale price ea. blackwall	plus F.E.T. each and old tire
6.00-12	31.99	24.75	1.47
A78-13	35.99	27.25	1.59
*C78-13	40.99	31.75	1.80
D78-14	45.99	34.25	1.92
E78-14	50.99	37.75	2.01
F78-14	52.99	39.25	2.12
G78-14	54.99	40.75	2.26
*5.60-15	44.99	33.75	1.66
G78-15	56.99	42.75	2.35
H78-15	59.99	45.25	2.54

#### 50,000-MILE WEAROUT WARRANTY

RoadHandler All-Season radial	May be substituted for	Regular price ea. whitewall	Sale price ea. whitewall	plus F.E.T.* each and old tire
P155/80R13	155R13	84.99	67.99	1.70
P165/80R13	AR78-13	94.99	75.99	1.83
P175/80R13	BR78-13	99.99	79.99	1.99
P185/80R13	CR78-13	104.99	83.99	2.14
P185/75R14	CR78-14	110.99	87.99	2.20
P195/75R14	D/ER78-14	114.99	91.99	2.38
P205/75R14	FR78-14	119.99	95.99	2.51
P205/75R15	FR78-15	124.99	99.99	2.60
P215/75R15	GR78-15	129.99	103.99	2.79
P225/75R15	H/JR78-15	134.99	107.99	2.99
P235/75R15	LR78-15	139.99	111.99	3.23

\*Federal Excise Tax



### Guardsman Light Truck Tires

#### 20,000-MILE WARRANTY

Highway H78-15	<b>72<sup>99</sup></b> Plus \$3.39 F.E.T.
Traction H78-15	<b>76<sup>99</sup></b> Plus \$3.54 F.E.T.
Traction RV 10-15	<b>75<sup>99</sup></b> Plus \$4.30 F.E.T.

### AUTO CENTER OPENS 8 AM

#### \$5 OFF Inductive Timing Light

Regular \$29.99  
Simple to use — needs no adapters. Helps improve performance. Thru July 24.

#### SAVE \$10 Compact 1½-ton Floor Jack

Regular \$54.99  
Compact! Fits in most small car trunks.

#### SAVE \$20 Speed Control

Regular \$99.99  
Resume feature. Lets you resume speed after braking. Installation extra.

#### 28% OFF Spectrum 10W-40 Motor Oil

Regular \$1.25  
Wide range protection during summer and winter driving. Thru July 24.

#### SAVE \$10 17-test Auto Analyzer

Regular \$59.99  
Inductive pickup tests dwell, battery and more. Thru July 24.

#### SAVE \$20 X-Cargo Carrier

Regular \$99.99  
16.8 cu. ft. cargo space. For most cars. Thru July 24.

#### SAVE \$7 Sears 6-amp Battery Charger

Regular \$24.99  
Charges 1/3 faster than

# SAVE \$18

### DieHard® Car Battery

Regular \$72.99

**54<sup>99</sup>** With Trade-In

#### INSTALLATION INCLUDED

Great power for fast starts with 525 amps cold cranking power. Group 24. For most American-made cars and many imports. Sale ends Saturday.

### \$6 OFF

### SteadyRider® Radial Tuned Shock Absorbers

Regular \$19.99 **13<sup>99</sup>** each

Radial-tuned comfort valve helps smooth ride with radial, bias ply and high pressure tires. For most cars and light trucks.

#### Limited Shock Warranty

Limited warranty on SteadyRider® RT shock absorbers for as long as you own the car, including labor, if shocks bought installed.

#### Sears Heavy-duty Shocks

1 3/16 in. pistons help give good ride control. For most American-made cars, many imports. Sears regular low price. **5<sup>99</sup>** each

#### \$10 OFF Booster Shocks

Adds carrying capacity — in front or rear of vehicle. Adds stability, helps reduce sway. Not available in Shelby. Reg. \$44.99. **34<sup>99</sup>** pair



### Brake Job for disc or drum systems

Our trained specialists will inspect brake system, install new disc pads or brake shoes, rebuild calipers or wheel cylinders, turn drums or rotors, install new front grease seals, clean and repack front wheel bearings, flush brake lines and replace with heavy-duty brake fluid. Sears may decline to perform partial brake jobs if it appears, in Sears judgment, that additional work is needed for your brake system to function properly. Replacement of master cylinder, power booster, drum/rotor are extra if needed. Not available in Shelby, Danville, Rock Hill and Rocky Mount.

2-Wheel Sears Price

**69<sup>99</sup>**

Sears Low Price

We'll set caster/camber and toe to manufacturer's specifications and inspect front end. Includes torsion bar adjustment if needed.

### Precision wheel alignment

**19<sup>99</sup>**

### INSTALLED MacPherson Strut replacement cartridges

SAVE \$15 Regular \$114.99

**99<sup>98</sup>**

Restores shock absorbing ability of many imports and some American-made cars.

Services available Monday thru Saturday for most American-made cars and many imports. Not available in Shelby.

# PUT YOUR MONEY WHERE YOUR HOUSE IS

4,000 BTU Porta-Cool Air Conditioner ..... **\$179<sup>97</sup>**



Just Plug It In!  
115 Volt

Hotpoint

Reference Price \$209.95. Features 2 fan speeds for both "cooling" and "fan only" settings. And an adjustable thermostat. Convenient Quick-Mount™ Installation. 115-volt. #50148

30" Variable Speed Deluxe Attic Fan ..... **\$129<sup>97</sup>**

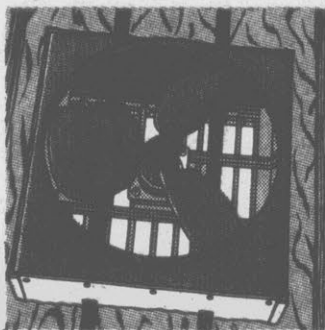

Reference Price \$159.97. Cools your entire home by pulling fresh, cooler air in through doors and windows. Mounts on two attic joists. Shutter extra. #31243



Save \$15.00! 19x17 Vanity Package ..... **\$49<sup>97</sup>**

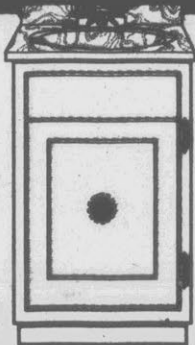

Regularly \$64.97. This classic white 18"x16" vanity is perfect for any bath! Trimmed in gold, it comes with a rich 19"x17" cultured marble top. The faucet is extra. #20805



Lavatory Faucet With Pop-Up  
**\$11<sup>88</sup>**

#24012  
Reference Price \$17.99.



Save \$1.66!  
24" Fan Type Bamboo Rake  
**\$3<sup>33</sup>**  
#00745  
Regularly \$4.99

Save \$4.00!  
21-Piece Socket Set  
**\$4<sup>99</sup>**  
#01451  
Regularly \$8.99



Save \$2.50!  
14"x24" Cocoa Door Mat  
**\$1<sup>99</sup>**  
#10110  
Regularly \$4.49

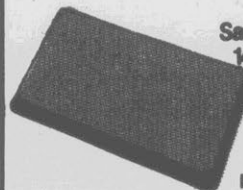

27" Wide Vinyl Carpet Runner  
**49c** #10000  
Linear Ft.\*  
Reference Price 99\*

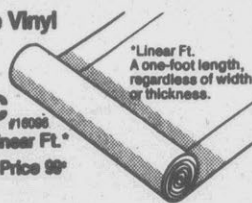

\*Linear Ft. A one-foot length, regardless of width or thickness.

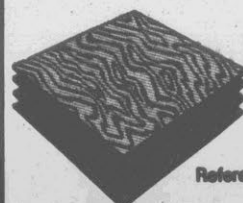

1/4" Exterior 2'x2' Pre-Cut Plywood  
**\$1<sup>69</sup>**  
#11706  
Reference Price \$2.29

Rustic Cedar Split Rail Fence ..... **\$13<sup>99</sup>** 10' Section



Section Includes:  
2 Rails And  
1 Line Post

Ref. Price \$17.99. This 100% genuine red cedar naturally resists rot and insects. Posts: 5 ft. high. Rails: 10 ft. long. #92335,6

Save \$5.00! 6-Year White Latex Flat House Paint ..... **\$8<sup>99</sup>** Gallon



Regularly \$13.99. Warranted to cover any color in one coat. Has 6-year durability. Exterior use. Stock up today! #48539



Save \$1.00! 2 1/2-Inch Paint Scraper  
**\$2<sup>39</sup>** #40528  
Regularly \$3.39

Save 31%! 12"x48" Great Random Shakes ..... **\$1<sup>49</sup>** Piece



Regularly \$2.19. Deeply embossed hardboard. #15633

Great For Indoors or Outdoors



Up To \$750 Instant Credit!

Choose From Two Plans. Lowe's Credit Card Or Our New Low Payment Plan.

Apply today! You could qualify for as much as \$300.00 instant credit on our Lowe's Credit Card, or as much as \$750.00 on our Low Payment Plan when you present your Visa, American Express or MasterCard. Even without these cards all applications will be processed with minimum delay.



We Honor MasterCard & Visa

© Lowe's Companies, Inc.

July '82 (049) N.C.

# LOWE'S

## Your Household Word

2728 South Memorial Drive • Ph: 756-6560  
Greenville, N.C.

SUPPLEMENT TO: The Daily Reflector

We Guarantee The Prices In This Publication Thru July 21st

- Store-Front Free Parking
- Ask About Our Installation Service
- Convenient Locations

Check Our Stores Daily For Unadvertised Specials

# Ceiling And Cooling

White Or Color  
13-Oz. Enamel  
Spray Paint ..... **\$1.69**  
Regularly \$2.99 #48119-73

Save  
**\$1.00!**  
ENTERPRISE

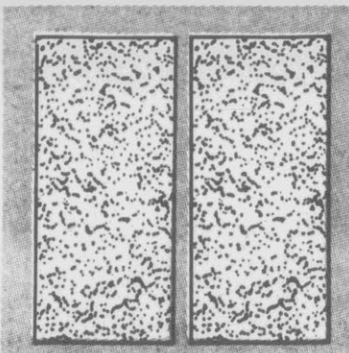

**2'x4' Textured Ceiling Panels**  
**27¢** In 64 Sq. Ft. Cartons  
Square Foot

Reference Price 30¢. They have a handsome textured surface. Designed for suspended ceiling systems. #12325

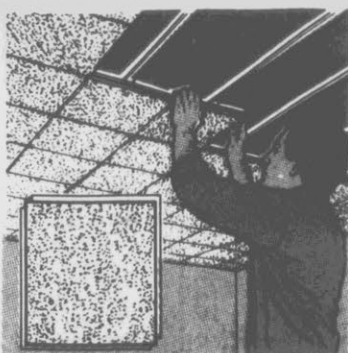

**12'x12' Textured Ceiling Tiles**  
**28¢** Each  
In 64 Sq. Ft. Cartons

Reference Price 32¢. Durable, washable pattern for do-it-yourselfers. Easy to install with Easy Up Kit. #12312

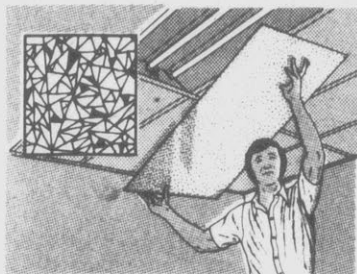

**Clear Fluorescent Light Fixture Panel For Suspended Ceilings**  
**\$2.99**

Reference Price \$3.99  
Reduces glare and diffuses light. Choose the Cracked Ice or Prismatic design. Easy to install. #18425,7

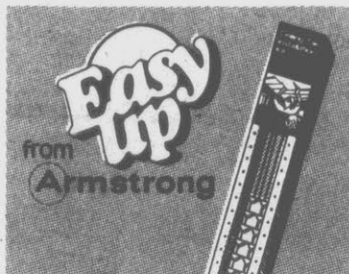

**Armstrong Easy-Up™ Do-It-Yourself Ceiling Tile Installation Kit**  
**\$7.49**

Reference Price \$8.29  
It's easy to install your new ceiling! Just nail up the pre-measured tracks and snap the panels into place. #10411

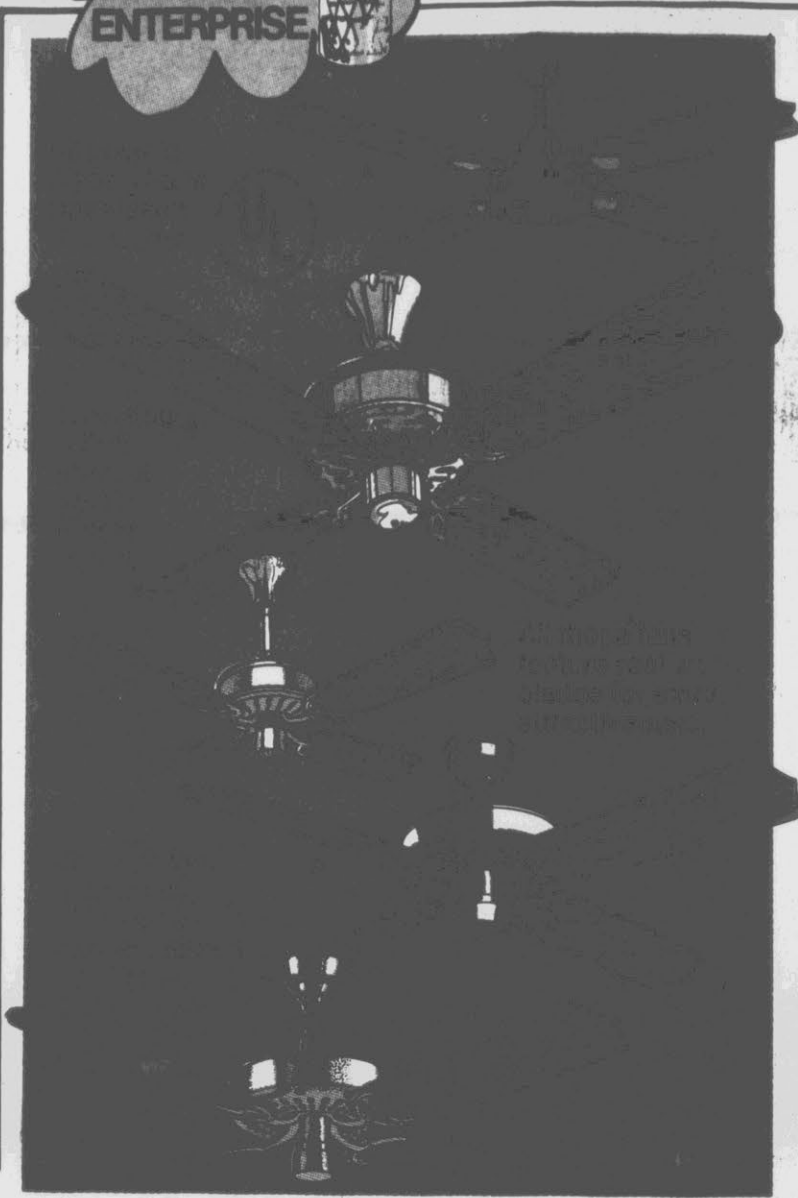

**18,500 BTU High Efficiency 230-Volt Air Conditioner**  
**\$519.94**

Reference Price \$599.95  
Features an 8-position thermostat; energy saving settings; a 3-speed fan; and 4-way louvers. #50174

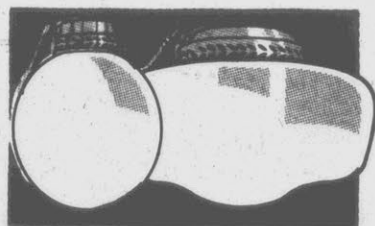

**8" Antique Or Polished Brass Round Globe Or Schoolhouse Light Kit For Ceiling Fans Your Choice**  
**\$12.88**

Reference Price \$14.97. Designed to fit virtually every ceiling fan. Separate on/off switch. #31802,4,12,14

**A. Contemporary Style 48" Ceiling Fan**  
**\$69.97**

Reference Price \$79.97. Brown finish with 4 teakwood blades. #31712

**B. 52" Antique Or Polished Brass Classic Ceiling Fan**  
**\$119.97**

Reference Price \$159.97. The reversible teakwood blades force warm air down in the winter and circulate cool air in the summer. #31745,47

**C. 36" Classic Antique Brass Ceiling Fan**  
**\$99.97**

Reference Price \$119.97. This multi-speed fan is reversible. Blades are teakwood. #31735

**D. 52" Brown Traditional Style Ceiling Fan**  
**\$129.97**

Reference Price \$159.97. Multi-speed fan has four oakwood blades. Plus it's reversible. #31762

**E. 52" Antique Or Polished Brass Ceiling Fan**  
**\$149.97**

Reference Price \$179.97. Traditional style fan with oakwood blades. It's reversible. #31765,7

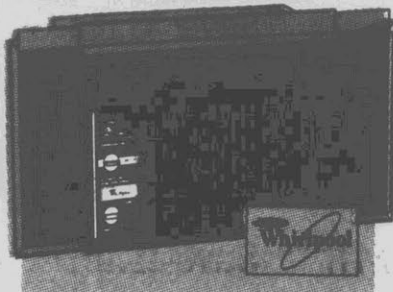

**5,000 BTU 115-Volt Window Air Conditioner**  
**\$219.97**

Reference Price \$259.95  
Features an adjustable thermostat; energy saving options; a 2-speed fan; & 2-way air direction. #50011



**4-Light Victorian Style Antique Brass Or Polished Brass Light For Ceiling Fans**  
**\$39.97**

Reference Price \$49.97  
Add elegance and charm to your ceiling fan with this light. It has separate on/off switch. #31806,16

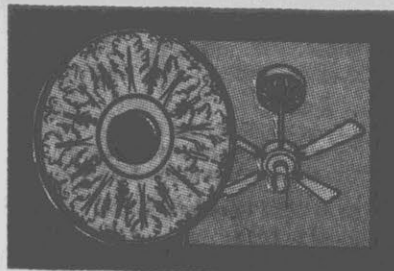

**Save \$3.00!**  
**16-Inch Victorian Style Ceiling Fan Medallion**  
**\$9.99**

Regularly \$12.99  
This decorative ceiling medallion adds beauty to your ceiling fan and can make installation easier. White; can be painted or stained. #15477

1-Gallon Gas Can With Spout ..... **\$1.99**  
Regularly \$2.99

Save 26%!



## For Lawn Care

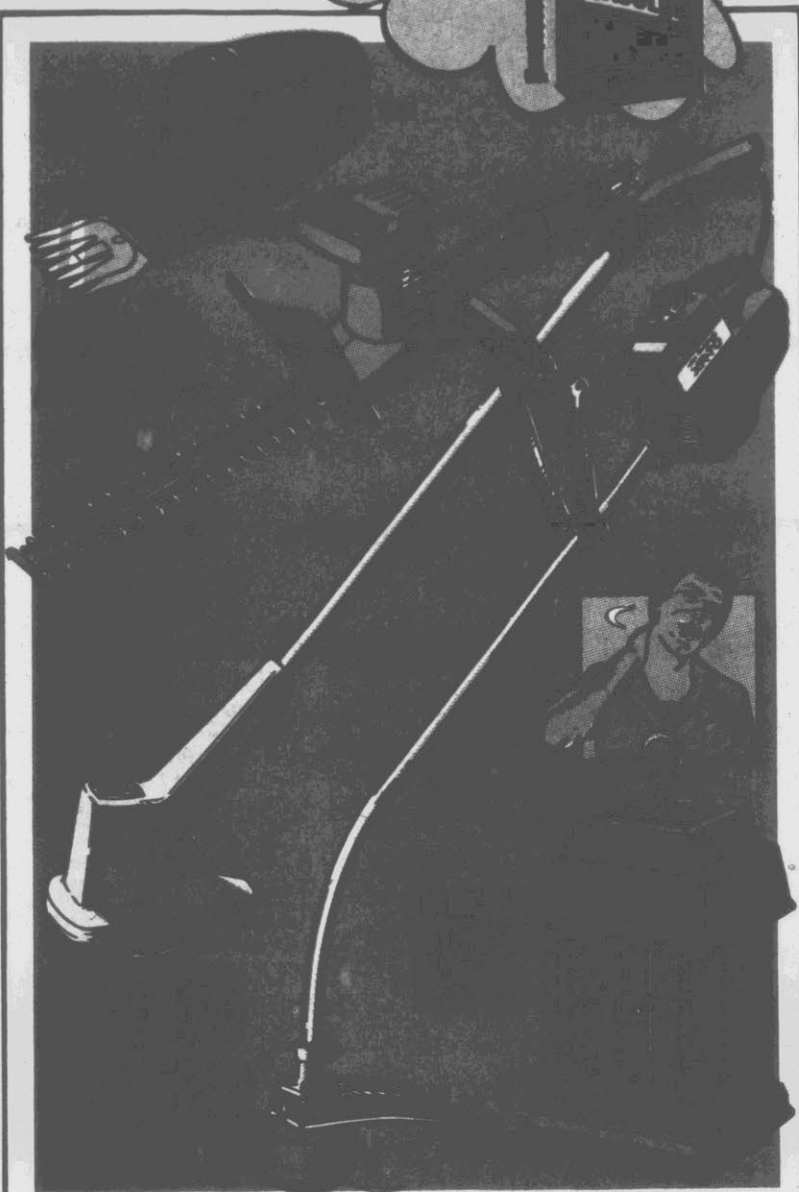

### 5HP 25" Cut Riding Mower

Lowe's Low Monthly Payment **\$2330** For 36 Months  
Lowe's Cash Price **\$569<sup>99</sup>**

No Down Payment\*  
Deferred Payment Price \$638.00  
Annual Percentage Rate 23.99%  
Regularly \$629.99. Has a Briggs & Stratton engine with recoil start & 3 forward speeds plus reverse. #95174  
\*Credit Terms On Back Page.

### 5HP 32" Cut Riding Mower

Lowe's Low Monthly Payment **\$2452** For 36 Months  
Lowe's Cash Price **\$599<sup>99</sup>**

No Down Payment\*  
Deferred Payment Price \$682.72  
Annual Percentage Rate 24%  
Regularly \$689.99. Features a Briggs & Stratton engine with recoil start & 3 forward speeds plus reverse. #95187  
\*Credit Terms On Back Page.

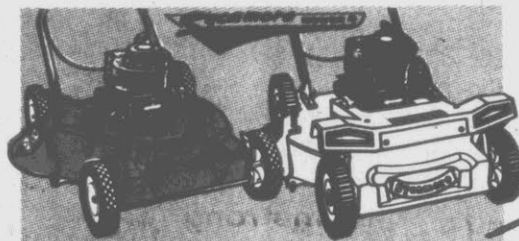

Save **\$15.00!**

Sycamore 3 1/2HP 22" Cut Lawn Mower **\$134<sup>99</sup>**

Regularly \$149.99. Briggs & Stratton engine. #95118  
Attachable Grass Bag #95156 ..... **\$19<sup>99</sup>**

Save **\$30.00!**

Sycamore 3 1/2HP 22" Cut Self-Propelled Mower **\$159<sup>99</sup>**

Regularly \$189.99. Has a Briggs & Stratton engine with a recoil starter. 8-inch wheels. #95152

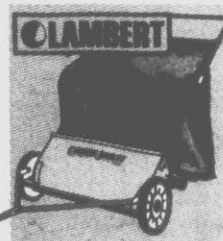

Save **\$11.11!**

Lambert Push Or Pull Lawn Sweeper **\$78<sup>88</sup>**

Regularly \$89.99. Has a 31-inch sweeping width and a lift-off 8 1/2-bushel hamper. #95308

**A. Save \$3.00!**  
**Cordless Grass Shears**  
**\$23<sup>99</sup>**

Regularly \$26.99. Great for trimming in confined areas. With a 3-inch-wide blade plus a locking switch that prevents accidental starts. #91562

**B. Save \$6.00!**  
**Hedge Trimmer**  
**\$26<sup>99</sup>**

Regularly \$32.99. Has double edged blades that allow cutting in any direction; plus a safety switch. #91556

**C. Save \$5.00!**  
**Weed Eater® String Trimmer**  
**\$37<sup>99</sup>**

Regularly \$42.99. This electric model cuts a 14" path. Has Tap-N-Go™ line advance. #91563

**D. Save \$20.00!**  
**Weed Eater® Gas Trimmer**  
**\$139<sup>99</sup>**

Regularly \$159.99. For heavy-duty trimming and edging. Tap-N-Go™ line feed. 17" cut. #91570

**E. 15-Watt Electronic Bug Killer**  
**\$49<sup>99</sup>**

Reference Price \$99.99. The built-in black light attracts flying insects; grid zaps 'em. #73071



Save **\$2.00 To \$3.00!**

Choose From a Garden Bow Rake, Weed Cutter And Hedge Shears

Your Choice **\$6<sup>99</sup>**  
Regularly \$9.99 (Rake and Shears), \$8.99 (Weed Cutter). Each item is quality constructed to provide years of durability. #98774, 87, 61

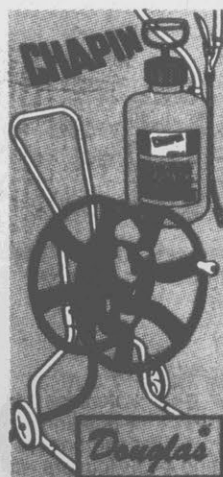

Save **\$3.09!**

2-Gallon Plastic Sprayer Can **\$21<sup>88</sup>**

Regularly \$24.97. Solid brass nozzle. #92485

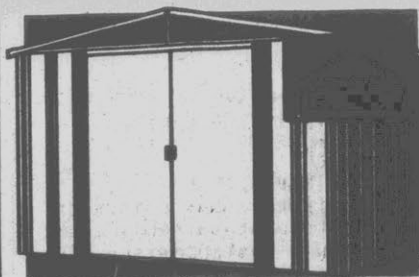

Save **\$30.00!**  
**10x9 Steel Building Kit**  
**\$139<sup>97</sup>**

Regularly \$169.97. Has triple ribbed panels and a galvanized frame. Easy assembly. #82735

Save **\$2.00!** Regularly \$17.99.  
**Steel Building Anchor Kit** ..... **\$14<sup>99</sup>**

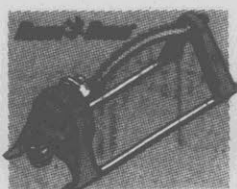

Save **\$2.61!**

Oscillating Lawn Sprinkler **\$8<sup>88</sup>**

Regularly \$11.49. Offers full control of spray and distance. #93021



Save **\$4.11!**

5/8" x 100-Foot Garden Hose **\$12<sup>88</sup>**

Regularly \$16.99. It's 100% vinyl composition. Brass couplings. #92362

Save **\$5.07!**

Convenient Hose Reel Cart **\$24<sup>88</sup>**

Regularly \$29.95. Has a storage capacity of 150 feet. With rollers. #92358

# For Outdoors

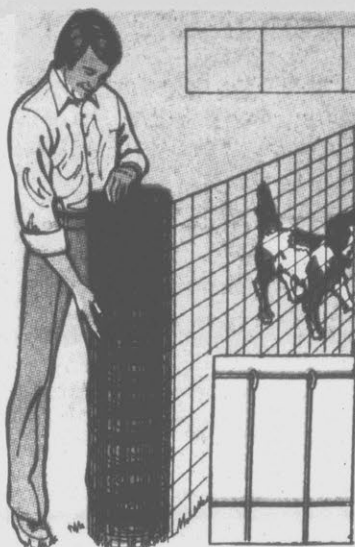

**Save \$2.00!**  
48"x50' Roll  
Green Vinyl  
Lawn Fence

**\$29<sup>97</sup>**

Regularly \$31.97. 2"x4" mesh. Thick vinyl coating won't rust. #2224



All Pound Boxes Of  
Common Or  
Coated Nails  
Regularly 89¢  
**69¢** Ea.



## Pressure-Treated Wood In Varied Lengths & Widths!

2x4x8'	\$1.99
Reference Price \$2.18.	#05261
2x4x10'	\$2.59
Reference Price \$2.88.	#05262
2x4x12'	\$3.29
Reference Price \$3.88.	#05263
2x6x8'	\$3.29
Reference Price \$3.88.	#05266
2x6x10'	\$3.99
Reference Price \$4.18.	#05267
2x6x12'	\$5.39
Reference Price \$5.88.	#05269

4x4x8'  
Posts..\$3.99  
Ref. Price \$4.98. #05290

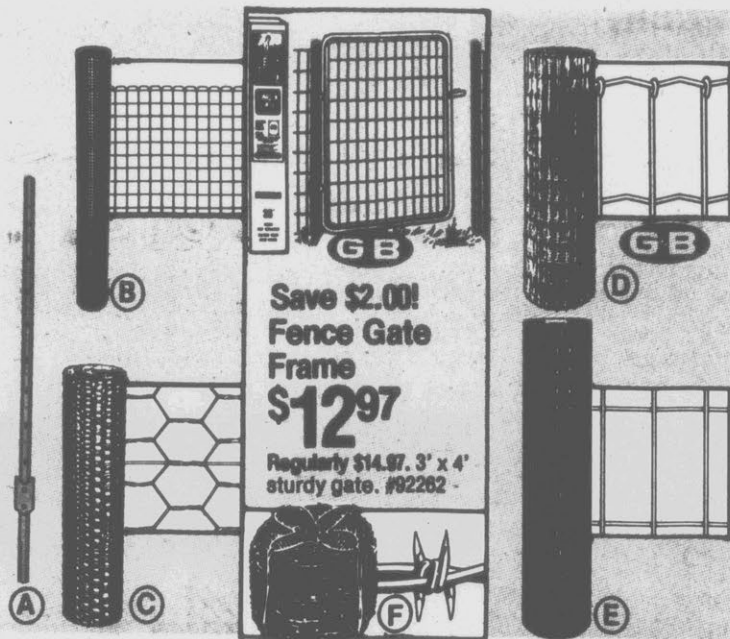

**A. Save 20¢!**  
5-Foot Steel  
Fence Post  
**\$1.69**

Regularly \$1.88. Painted green. Strong. #92064

**B. Save \$2.00!**  
36"x10' Roll  
Hardware Cloth  
**\$10<sup>95</sup>**

Regularly \$12.95. 2x2 mesh. 19-gauge. #92202

**C. Save \$1.00!**  
36"x50' 1-Inch  
Poultry Netting  
**\$13<sup>95</sup>**

Regularly \$14.95. 20-gauge. Tough. #92302

**D. Save \$3.00!**  
36"x50' Fence  
Galvanized  
**\$18<sup>97</sup>**

Regularly \$21.97. 36"x50' roll. 14-gauge. #92256

**E. 48"x50' Roll  
Welded Farm  
Fence - 2"x4"**  
**\$27<sup>95</sup>**

Reference Price \$38.98. 12 1/2-gauge. #92288

**F. 1/4-Mile Roll  
4-Point  
Barbed Wire**  
**\$31<sup>95</sup>**

Reference Price \$38.98. 12 1/2-gauge. #92054

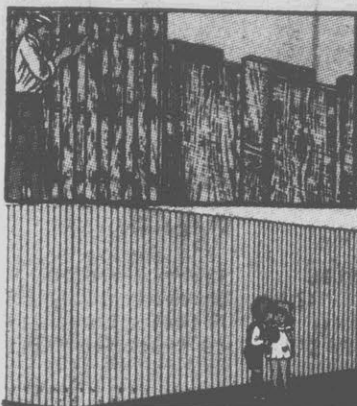

**Rough Dog-Eared Pressure  
Treated Fence  
Pickets** ..... **\$1<sup>29</sup>** Each

Reference Price \$1.69. They're 1/2"x6"x6". #92324

**Rough Square-Edge  
Pressure-Treated  
Fence Pickets** ..... **\$1<sup>19</sup>** Each

Reference Price \$1.49. They're 1/2"x6"x6". #92323

**6'x8' Wood Stockade  
Fence Panel** ..... **\$22<sup>99</sup>**

Reference Price \$29.98. Strong & sturdy. #92313

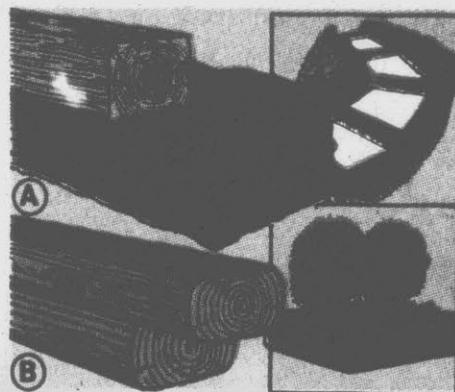

**A. Used Cross-Ties  
Or Landscape Ties**  
**\$7<sup>99</sup>** Each

Ref. Price \$10.99  
Cross-Ties are 7"x9"x8' 6".  
Landscape Ties are about  
6"x6"x8'. #04575,3

**B. 4' Long Pressure-  
Treated  
Timbers** ..... **\$1<sup>99</sup>** Each

Reference Price \$2.48. #04576  
8' Long Timbers..\$3.29 Ea.  
Reference Price \$4.49. #04574



**1-Quart  
Tube Plywood  
Sub-Floor Glue**  
**\$1<sup>99</sup>**

Ref. Price \$2.98  
Strong bond. #12237  
Glue Gun #12238  
Ref. Price \$3.99 \$5.48

**3/4"x4'x8' Sanded  
Pine Plywood Panel**  
**\$16<sup>59</sup>**

Reference Price \$20.98. Can be used indoors  
or out. Ready for paint or stain. #12229



**2x4 Bobby Bunyan  
Economy Studs**  
**89¢** Each

Reference Price \$1.19. Stock up  
for small home projects. #07002

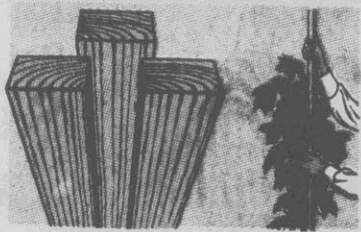

**1x2x8' Furring Strips  
For Gardening, Etc.**

**48¢** Each

Reference Price 89¢. Great for garden  
bracing or framing. Stock up! #04592

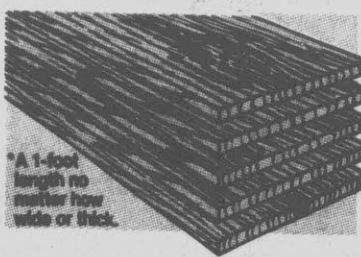

**1x12 Ponderosa Pine  
#3 Shelving Lumber**

**59¢** Linear Foot\*

Reference Price 79¢. Smooth-finished &  
ready to be painted or stained. #01350

Save 20%! 50 Pound  
Bag Of Play Sand  
**\$1.99** Each  
Regularly \$2.49 #10392



# Outside The House

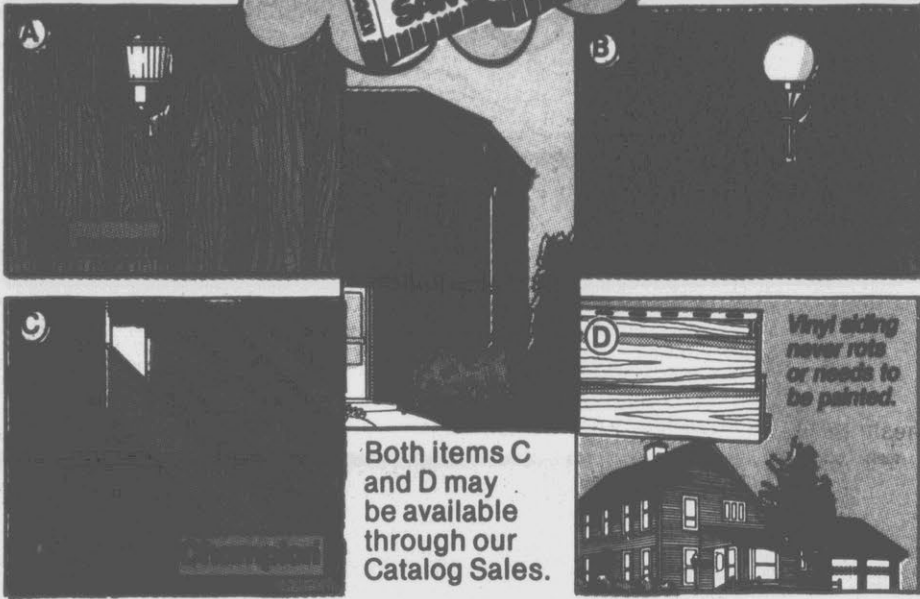
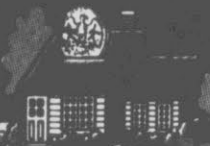

Both items C and D may be available through our Catalog Sales.

Vinyl siding never rots or needs to be painted.

**A. Save \$1.50! 7/16" Thick Woodsman Plank Siding . . . . \$14.49**  
4'x8'  
Regularly \$15.99. Hardboard, with rough cedar texture. Remodel your home's exterior. #15814

**B. Save \$5.30! 5/8" Thick Rough Sawn Pine Siding . . . . \$15.99**  
4'x8'  
Regularly \$21.29. Can be used inside or out. Just add your choice of paint or stain. #12938

**C. Save \$1.50! 7/16" Thick Prefinished Siding . . . . \$22.99**  
4'x8'  
Regularly \$24.49. Durable hardboard Wind Ridge. In Dune Brown and Cape Grey. #15599, 15601

**D. Save 10%! White Solid Vinyl Lap Siding . . . . \$4.99**  
8"x12"  
Regularly \$5.49. Get the look of wood without the maintenance. Colors available (\$5.39). #17423

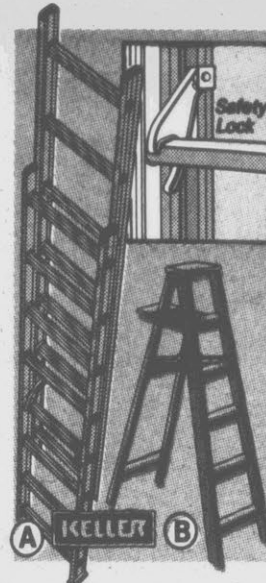

**A. 16' Extension Ladder \$39.99**  
Reference Price \$47.99. 13' working height. #92530

**B. Save \$3.22! 6-Foot Wood Step Ladder \$22.77**  
Regularly \$25.99. With a flip-out shelf. #92508



**A. 10'x20' Aluminum Patio Cover \$249.97**  
Reference Price \$279.97. Includes 1 1/2" posts. 18-gauge panels. #92580

**B. 42" Wide Window Awning \$8.88**  
Reference Price \$9.99. Won't chip or peel. Easy to install. #92578

**Will Your Roof Weather The Next Storm?**  
When it's time for you to re-roof, Lowe's has you covered with the right shingles at the right price! We're the roofing professionals, with a full line of brand-name asphalt and fiberglass shingles. From standard #240 asphalt to the cedar-shake, heavy duty designs.

**Save \$3.00! #90 Asphalt Roll Roofing \$12.79**  
3'x28' Roll  
Regularly \$15.79. Covers 100 sq. ft. per roll. #10280, 5.80

**20% Off! Aluminum Roof Valley \$3.19**  
10"x10" Roll  
Regularly \$3.99. For use on all roofs. #12538

**Save 23%! 26"x6' Brown Fiberglass Panel. . . \$2.29**  
Regularly \$2.99. Durable, shatterproof and safe. Never needs painting. Won't warp. #12587

**1"x4' Economy Iron Railing \$4.29**  
Section  
Reference Price \$6.99. 27 1/2 inches high. #14215  
1 1/4"x4' Iron Railing  
Ref. Price \$8.99 #14205 \$7.99  
2-Scroll Flat Iron Column  
Ref. Price \$13.99 #14261 \$11.99

**10' Section White Aluminum Gutter \$4.29**  
Section  
Reference Price \$5.99. Baked-on finish. #11550  
10' Section Brown Gutter  
Ref. Price \$6.99 #11582 \$4.99  
Plastic Gutter Splashdown  
Ref. Price \$3.99 #11629 \$2.99



# For The Kitchen



**Bring In Your Measurements. We'll Help Design Your Dream Kitchen... For FREE!**

**Act Now And You'll Save 10%.....**  
Cook up a new look with our brand-name quality cabinets, and save 10% in the process. Beautiful styles. Nice prices.



**Stainless Steel Sink Package**

**\$79<sup>99</sup>** *Save \$20.00*

Regularly \$99.99. Price includes a 33" x 22" self-rimming sink; single-lever faucet with spray; chop block and 2 strainers. #26024



**Here's An Economical Way To Have Washable Wall Covering For The Kitchen Or Bath!**

**Save \$2.00! 1/8" Thick "Marble" Tileboard**

**\$10<sup>49</sup>**

4'x8' Panel Regularly \$12.49. Has a smooth melamine finish that not only looks great, but also resists stains and cleans easily. #16614

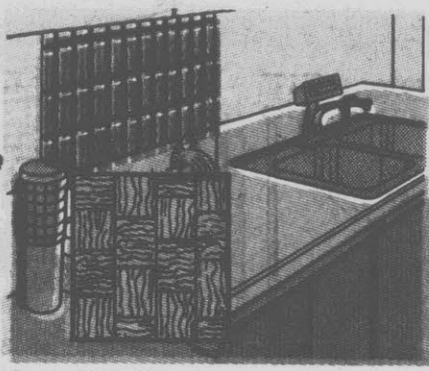

**Save \$4.00! 30" x 96" Butcher Block Laminate . . . \$17<sup>99</sup>**

Regularly \$21.99. Remodel your countertops with beautiful heat-and-stain-resistant laminate in a "butcher block" pattern. #1046 Borden Contact Cement (Gallon)....#10438. . \$9.99



**Save 31%! Frosted 4-Pack Of Light Bulbs 88c** Regularly \$1.29

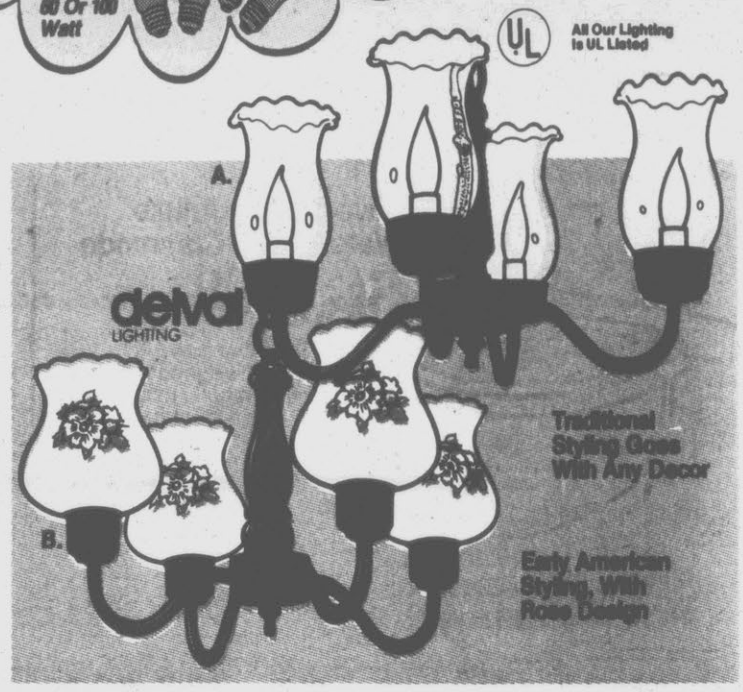

**A. Traditional Fixture** Reference Price \$29.99. Has antique brass finish. (Bulbs extra.) #74921. . . . . **\$19<sup>99</sup>**  
**B. Early American Light** Reference Price \$39.99. Has antique brass finish. (Bulbs extra.) #74923. . . . . **\$24<sup>99</sup>**

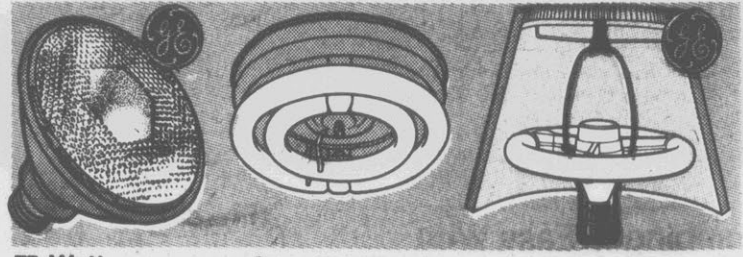

**75-Watt Floodlight** **\$3<sup>99</sup>** *Save \$1.00*  
Reg. Price \$4.99. Has all-weather design for long life. #75173

**Save \$10.00! 2-Light Fluorescent** **\$29<sup>99</sup>**  
Regularly \$39.99. With 2 lamps and chrome-finish base. UL listed. #74220

**10-Inch 44-Watt Circlite™ Bulb** **\$11<sup>88</sup>**  
Ref. Price \$19.99. It's fluorescent! Replaces light bulbs. #75160

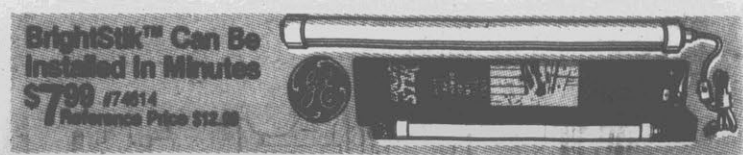

**BrightStik™ Can Be Installed In Minutes**

**\$7<sup>99</sup>** #74614 Reference Price \$12.99

**Single Gang Wall Box** **29c** #7072  
**Brown Or Ivory Duplex Outlet** **59c** #714828  
**Brown Or Ivory Single Wall Switch** **69c** #70071  
**Save \$5.00! Ground Fault Outlet** **\$21<sup>99</sup>**  
Reg. \$26.99, #71615  
**Save \$3.10! 6-Plug Strip** **\$16<sup>99</sup>**  
Reg. \$19.99, #70000

**14/2 Gauge, 250' Copper Cable** **\$19<sup>99</sup>**  
**12/2 Gauge, 250' Copper Cable** **\$17<sup>99</sup>**  
Lowest Price \$21.99  
**Grounded, 300' Cable** **\$12<sup>99</sup>**  
Lowest Price \$14.99  
**20-Amp Box** **\$12<sup>99</sup>**  
Lowest Price \$14.99  
**40 Spaces** **\$16<sup>99</sup>**  
Reg. \$19.99, #70000

Save \$2.00! 2-Foot Wood Stepladder  
**\$5<sup>99</sup>**  
 Regularly \$7.99



# For The Bath



Save \$30.00! Deluxe Water Saver Commode  
**\$69<sup>98</sup>**

Seat Extra  
 Regularly \$99.98. Designed to use less water than regular models. Blue, gold & creme \$10 more. #20711.2

Carefree.

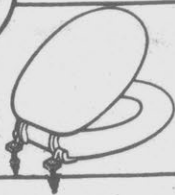

Save \$5.00! Puffy™ Seat  
**\$9<sup>97</sup>**

Regularly \$14.97. Soft vinyl. #20850

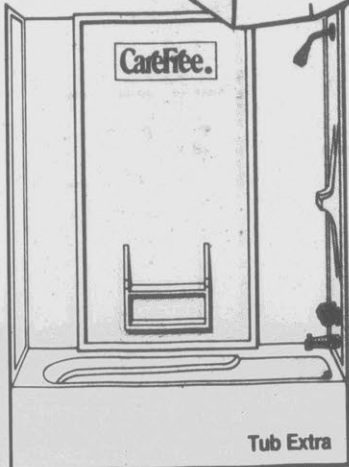

White 5-Piece Wall Surround . . . **\$64<sup>97</sup>**

Reference Price \$79.97. Fits around a 5' tub to protect and beautify walls. And the kit includes caulk, adhesive and easy step-by-step instructions. #20781

Save \$20.00! Combination Fan, Light And Heater  
**\$59<sup>99</sup>**

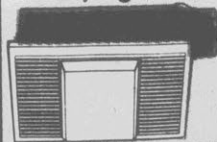

Regularly \$79.99. Also includes 3-way wall-mount control. #25506



## Plumbing Is Easy With Lowe's Quality Supplies

We're the complete plumber's helper. From PVC pipe and fittings to their copper counterparts, Lowe's has everything you'll need. Did you say polybutylene? We've got that, too. Come see for yourself.

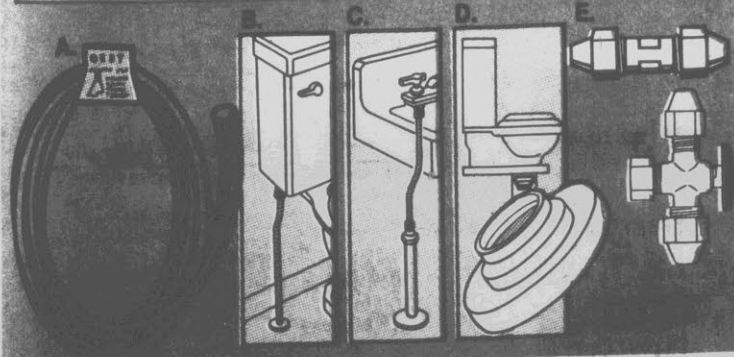
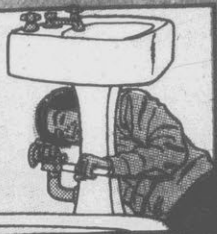

A. Save \$1.00! 1/2" x 50' Water Supply Line  
**\$7<sup>99</sup>**

Regularly \$8.99. Flexible, durable. #22750. Save \$1.00! 3/4" x 25' Roll. Regularly \$7.99. #22751. . . . \$6.99

B. Save 50¢! Tank Water Supply Line  
**79¢**

Regularly \$1.29. Made of polybutylene—it's tough and flexible. #24976

C. Save 50¢! Sink Water Supply Line  
**79¢**

Regularly \$1.29. Made of rustproof polybutylene; easy to work with. #24972

D. Save 29¢! Commode Bowl Ring  
**69¢**

Regularly 99¢. Thick wax ring forms seal between commode and floor. #24391

E. Save 50¢! 1/2" Supply Coupling  
**\$1<sup>39</sup>**

Regularly \$1.88. Made of polybutylene. Use with copper pipe, too. #22789

F. Save \$1.10! 1/2" x 3/4" Stop Valve  
**\$2<sup>99</sup>**

Regularly \$4.08. Made of polybutylene. It resists freeze-bursting. #22793

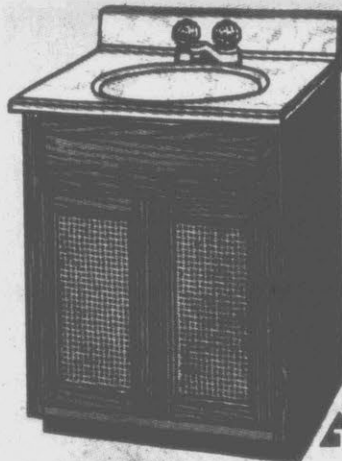

Triangle Pacific

Save \$20.00! 21" x 18" Oak/Cane Vanity Unit  
**\$139<sup>99</sup>**

Faucet Extra  
 Regularly \$159.99. Includes cultured marble top and oak door panels with lightly stained cane inserts. Great addition to any home's bath. #20809

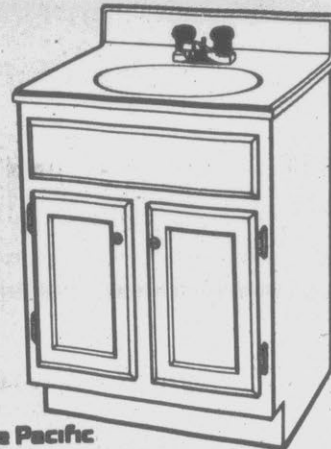

Save \$20.00! 24" x 21" White Vanity Base  
**\$69<sup>99</sup>**

Faucet Extra  
 Regularly \$89.99. With brass-finished hardware. Marble top extra. #20864. Save \$15.00! "Marble" Top. Regularly \$69.97, #20275. . . . \$54.97

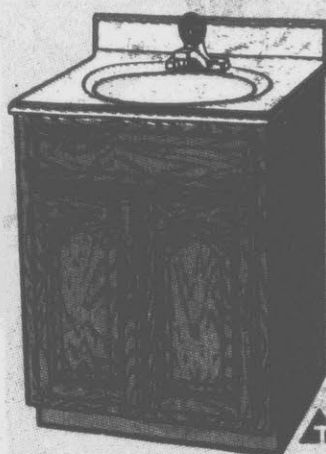

Triangle Pacific

Save \$30.00! 30" x 21" Oak Vanity Base  
**\$119<sup>99</sup>**

Faucet Extra  
 Regularly \$149.99. Solid oak center panels; brass hardware. Top extra. #20848. Save \$15.00! "Marble" Top. Regularly \$74.98, #20276. . . . \$59.99

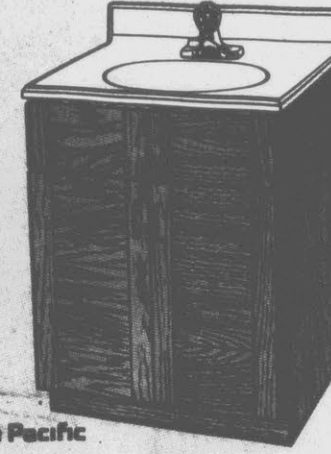

Save \$30.00! 30" x 21" Slatted Oak Base  
**\$139<sup>99</sup>**

Faucet Extra  
 Regularly \$169.99. Flush oak doors & contemporary pulls. Top extra. #20860. Save \$15.00! "Marble" Top. Regularly \$74.97, #20286. . . . \$59.97

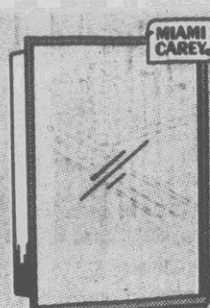

MIAMI CAREY

Save \$10.00! Slim Line Bath Cabinet  
**\$24<sup>99</sup>**

Regularly \$34.99. Steel, with enamel finish. Has 18" x 22" mirror. #23674

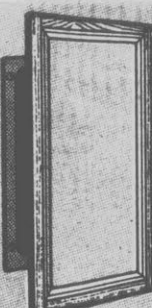

Save \$15.00! White Oak Cabinet  
**\$59<sup>95</sup>**

Regularly \$74.95. White oak-look frame. Cabinet is 14" x 18". #23724

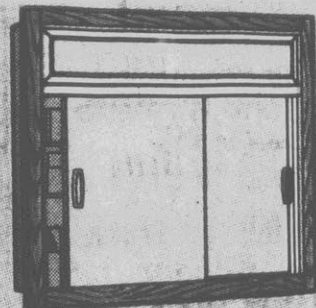

Save \$20.00! Oak Bath Cabinet  
**\$79<sup>95</sup>**

Regularly \$99.95. Solid oak frame and a built-in light. 25 1/4" x 23 1/2". #23720

# On The Wall

Save 50% Bushel of  
1 1/2", 2" Or 3" Brushes  
**79c** Each  
Regularly \$1.29 #40108

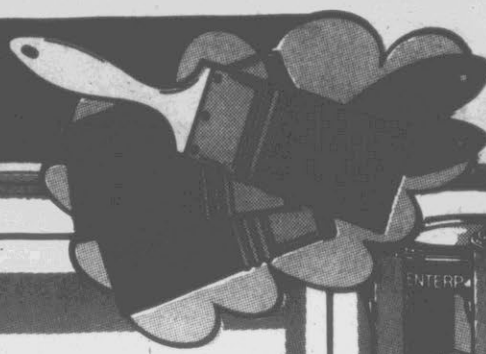

## Paneling Is A Terrific Home Value!

5/32"-Thick Toast Brown Paneling

**\$4.99**  
4'x8'

Reference Price \$6.99. Remodel with this handsome toast brown chestnut design simulated on particleboard base. Fits nicely into any home decor. #13914

Save \$4.00! 3-Way Interior Latex Flat White, Birch White Or Ceiling White Paint

**\$6.99**  
Gallon

Regularly \$10.99. Warranted to cover any color in one coat and to be washable and fade resistant. #47053-47062

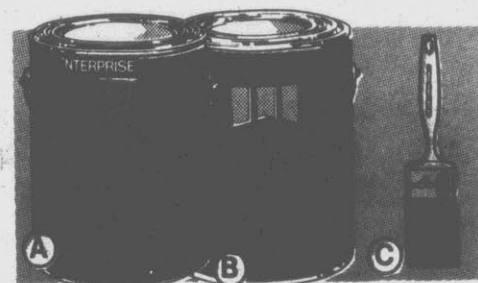

A. Save \$6.00! White Interior Latex  
**\$7.99**  
Gallon

Regularly \$13.99. Semi-gloss is warranted fade & stain resistant. #47784

B. Save \$5.00! Latex Floor Paint  
**\$10.99**  
Gallon

Regularly \$15.99. Has a durable finish. Choose from stock colors. #48280-85

C. Save \$1.70! 4" Golden Dandy Quality Paint Brush.....**\$2.99**

Reg. \$4.69. Great for the paints shown above. It has a chisel trim and a yellow plastic handle. #40298



A. Save 60¢ On 1-Quart Speckling Compound.....**\$2.29**

Regularly \$2.89. It's a patching, repairing and surfacing compound. Can be painted over. #41308

B. Save 70¢ On Rely-On 11-Ounce Latex Caulk.....**79c**

Regularly \$1.49. Seals cracks and openings around window & door frames, masonry and chimneys. #43468

C. Save \$2.30! 10.3-Ounce Clear Silicone Caulk.....**\$3.19**

Regularly \$5.49. It's waterproof, weatherproof and won't crack or crumble. Flexible seal lasts for years. #40084

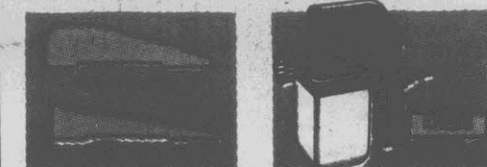

Wood 7-Foot Casing Or 8-Foot Base Moulding  
**\$2.99**

Your Choice! Ref. Price \$3.99. It's real wood and ready to paint or stain. Great for remodeling! #02937

Save \$30.00! 60-Watt, Airless Electric Sprayer  
**\$69.95**

Regularly \$99.95. All-purpose sprayer handles most properly thinned latex paints. #40812

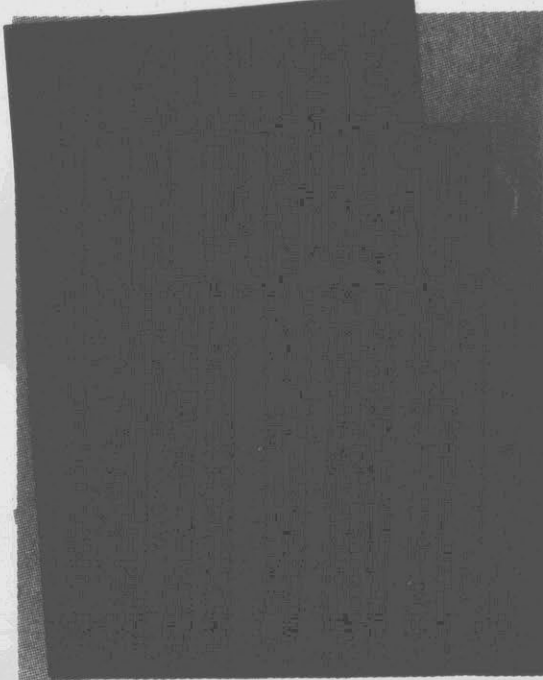
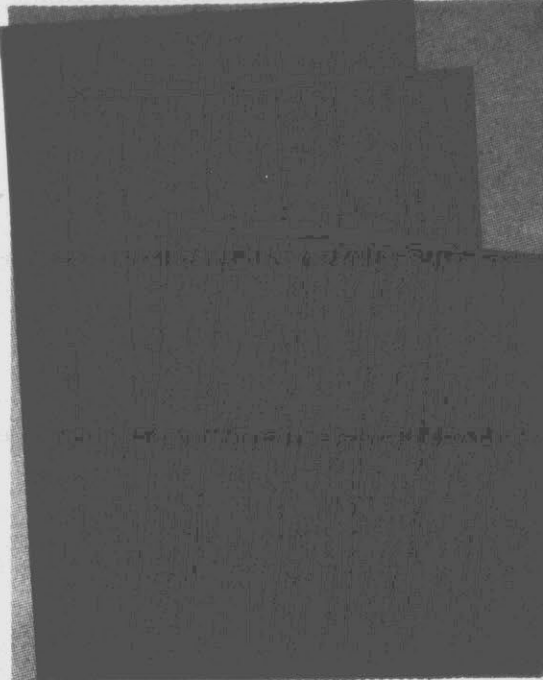

Save \$1.00! 1/4" Thick New-Cut Cedar-Style Paneling For Walls

**\$6.99**  
4'x8'

Regularly \$7.99. Create a handsome new look with this cedar design panel. The paper overlay reproduces every detail of rustic knotty cedar boards. Simulated on 1/4" particleboard base. 4'x8' panel. #13913

Save \$1.50! 5/32" Prestige White Paneling.....**\$9.99**

Regularly \$11.49. An elegant panel for a dining room. Simulated wood grain on lauan plywood. 4'x8'. #13926

Save \$2.00! 5/32" Pegged Pecan Paneling.....**\$10.99**

Regularly \$12.99. Paper overlay on lauan plywood with the look of real pecan boards with pegs. 4'x8'. #13999

Save \$2.00! 1/4" Rustic Brown Paneling.....**\$11.99**

Regularly \$13.99. Made of real aspen wood that's been distressed & stained to look like old wood. 4'x8'. #13987

Save \$1.50! 1/4" Forest Hills Oak Paneling.....**\$13.49**

Regularly \$14.99. Has the warm rustic look of real oak. It's a paper overlay on lauan plywood. 4'x8'. #13957



Save \$3.00! Grey or Brown 3/8" Thick Rustic Pioneer Bamboard Paneling In Random-Width 8-Foot Lengths

**\$11.99**  
21-Square-Foot Package

Regularly \$14.99. Vermont white pine, "aged" through a special process. Catalog order, some stores. #13784.5

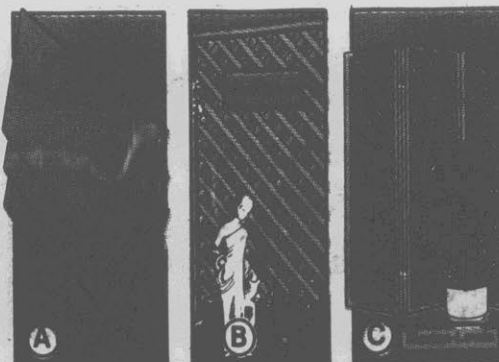

A. Save \$2.50! 1/4" x 4' x 8' Standard Hardboard.....**\$7.29**

Regularly \$9.79. This durable hardboard is smooth on one side for paint. Lots of uses. #15466

B. Save \$7.00! 4'x8'x1/4" Exterior Cedar Lattice Panels  
**\$19.97**

Regularly \$26.97. For a beautiful wall. #10843

C. Save \$15.00! 51"x72" Folding Lattice Screen  
**\$27.88**

Regularly \$42.88. Paint or stain it. #10844

Save 50%! 6-Bushel  
Lawn & Leaf Bags

**\$1.49**  
18 Count  
Reg. \$1.99 #98876

**HANDI-BAG 2PLY**

**LAWN  
& LEAF BAGS**

10

6

**All Around**

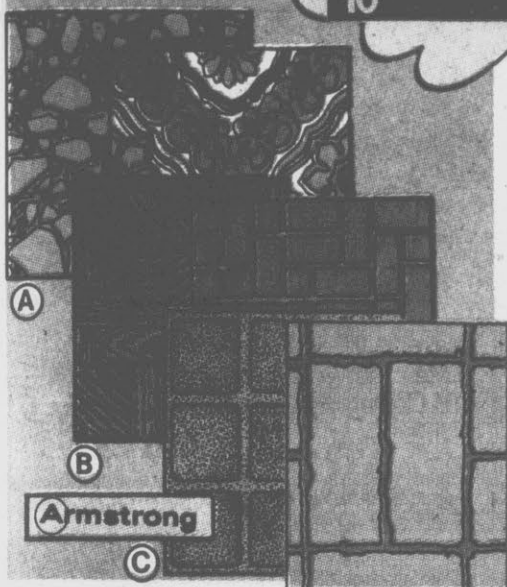

**A. 12' Armstrong Royelle® Vinyl  
No-Wax Flooring**

**\$3.29**  
Square Yard

Reference Price \$4.99. Durable vinyl surface needs no waxing to protect the pattern and color. #16182-16188

**B. 12' Accotone®  
Vinyl No-Wax  
Flooring**

**\$4.29**  
Square Yard

Reference Price \$6.29. Tough vinyl surface resists scuffs and scratches. #16182-16190

**C. 12' Sundial  
Solarian® No-  
Wax Flooring**

**\$7.99**  
Square Yard

Reference Price \$10.49. Keeps "like-new" look without waxing. #16139, 42

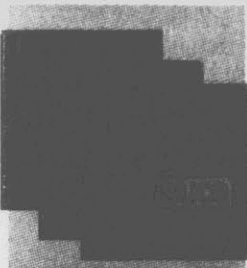

**6" x 6" Solid Oak  
Tile With Tongue  
& Groove Design**

**49c**  
Each

Reference Price 69c. Rustic rich-looking oak parquet pre-finished tiles. #00480



**12" x 12" Real Oak  
Tile, Cushioned  
And Self-Adhesive**

**\$2.29**  
Each

Reference Price \$2.79. Parquet tiles in 3 rustic wood tones. #00489, 70, 71

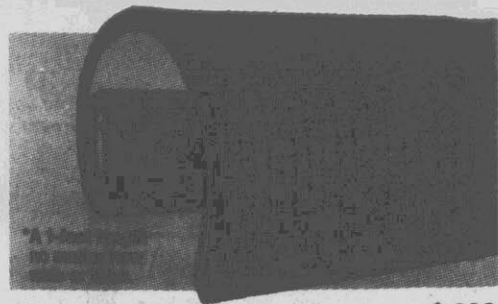

**6-Foot-Wide Green  
Carpet Grass** ..... Linear Foot\*  
Reference Price \$2.99. Resists stains, mold and mildew. Holds up during hard weather. Easy to install. #15282

**\$1.99**

**6-Foot-Wide Coco  
Carpet Grass**

Reference Price \$3.99. Resists stains, & mildew. Beige and brown tweed color. #15258

**6'-Wide Ultimate  
Green Carpet Grass**

Reference Price \$5.99. Stands up under heavy traffic. Resists stains. #15259

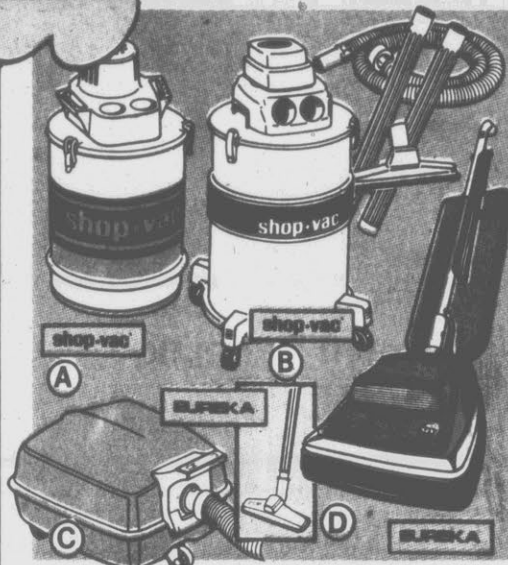

**A. Save \$15.00!  
5-Gallon  
Shop Vac**.....

**\$39.97**

Regularly \$54.97. It will vacuum up wet or dry messes, indoors or out. And it comes complete with attachments. Come in today! #98800

**B. Save \$20.00!  
10-Gallon Shop Vac**.....

**\$69.97**

Regularly \$89.97. Deluxe vacuum for wet and dry cleaning, indoors or out. Rugged! #98802

**C. Save \$10.00!  
Cannister Model  
Vacuum Cleaner**.....

**\$64.95**

Regularly \$74.95. Sturdy all-steel construction. And it comes complete with a 7-piece attachment set. #98650

**D. Save \$30.00! Upright  
Vacuum Cleaner**.....

**\$134.95**

Regularly \$164.95. Features extra suction power and six carpet level positions for versatility. #98675

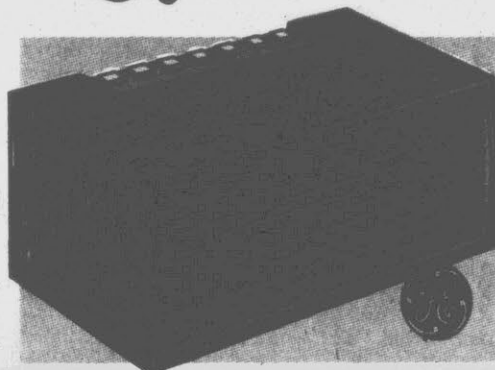

**Save \$7.00 On This  
Zonar™ Burglar Alarm**

**\$12.88**

Regularly \$19.88. Helps protect your home and family while you are there or away. It sounds a very loud, pulsating alarm when the invisible beam is broken. Can guard multiple entries at the same time. You can set a personal code so only you know how to turn off the alarm. Runs on batteries (extra). Comes with warning decals for windows and doors. #73089

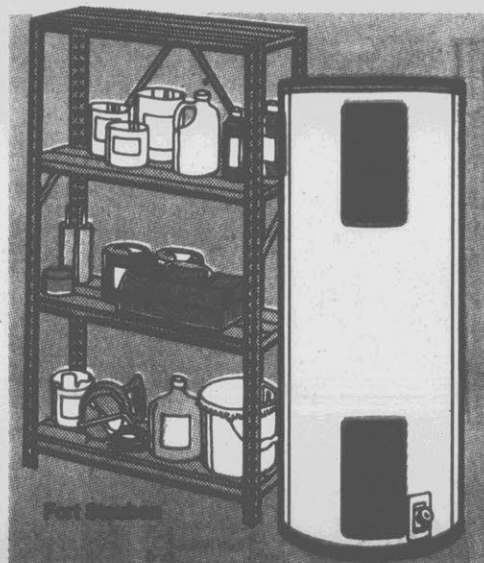

**Save \$2.72 On This Durable  
30" x 60" Steel Shelf Unit**

**\$10.77**

Regularly \$13.49. Rugged steel shelves hold a large quantity of items. Shelves and posts are ribbed for strength, and ribbed sway-braces at back and sides add extra rigidity. All shelves have safety edges and are adjustable. Easy to assemble. #62451

**Save \$40.00 On This 40-Gallon  
Electric Water Heater**

**\$129.97**

**Energy Efficient!**

Regularly \$169.97. Delivers more water compared with an equal amount of energy used by conventional water heaters. The double density insulation surrounds the tank to retain heat longer. Has a set-and-forget thermostat and built-in pressure relief valve. #25302



**A. 8-Ounce High Or Low  
Gloss Tung Oil** .....  
Regularly \$3.19. Gives a handrubbed finish; seals unfinished wood. #40854, 73

**\$2.49**

**B. 32-Ounce Size  
Refinisher**.....

Regularly \$9.99. Removes varnish, lacquer, shellac without stripping the color. #40852

**\$6.99**

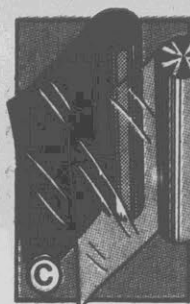

**C. 10' x 25' Clear Or  
Black Polyethylene** .....  
Reference Price \$6.99. Use as a dropcloth, vapor barrier, shrub cover and more. #10825, 6

**\$4.49**

**D. 1'6" To 3'1"  
Jack Post**.....

Regularly \$12.99. Use anywhere a permanent or temporary support is needed. #17228

**\$9.99**

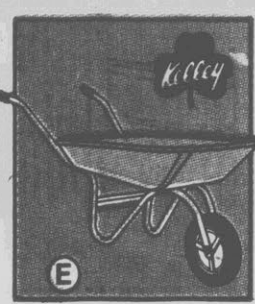

**E. Save \$2.00  
On This Handy  
Wheelbarrow**

Regularly \$19.97. Has 3-cubic-foot capacity. Well-balanced for easy maneuvering. #22855

**\$17.97**

# Grand Openings

12"x12" Dark Cork Squares Pack of 4 ..... **99¢**  
Regularly \$2.19. #10940

## Storm Door Hardware

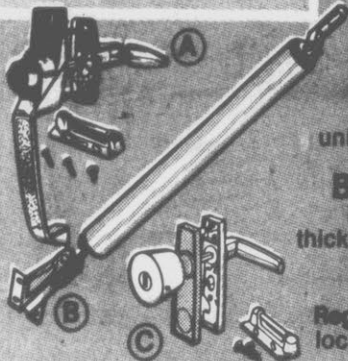

Your Choice!  
**\$6<sup>99</sup>**

**A. Push-Button Latch**  
Regularly \$8.49. Can be locked & unlocked from the inside only. #61254

**B. Hydraulic Door Closer**  
Regularly \$8.29. For doors up to 1 1/2" thick. Polished aluminum finish. #61252

**C. Tulip Knob Latch**  
Regularly \$8.49. Can be locked and unlocked inside without the key. #61252

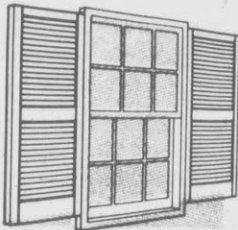

Save \$4.00!  
Exterior Vinyl Shutter Set  
**\$11<sup>99</sup>**  
White Or Black  
Regularly \$15.99. Will not split or rot. 15" wide. 39" high. #12852,60



Save \$10! 9'x7' Garage Door  
**\$159<sup>99</sup>**  
Regularly \$169.99. Door comes unfinished. Easy-to-install. #11030

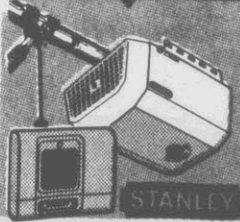

Save \$10! 1/3 HP Door Opener  
**\$179<sup>99</sup>**  
Regularly \$189.99. Has an "instant" safety reverse feature. #11002

## LOWE'S LOOK BOOK Catalog Sales Center



Lowe's Special Order Service is our way of helping you find the items you need in the stores. If you don't carry it, we can order it. Our exciting Look Book on display in each store has a terrific selection of specialty items that can be specially ordered just for you. So if you don't see it, just tell us!

**Roof Window**  
Control the sun and bring fresh air into your living space. The wood frame and built-in weatherstripping are available in a variety of colors or finishes. The built-in rain cap keeps your window safe from rain and snow.

Available with factory installed weatherstripping as well as a double action lock. A ventilation flap provides fresh air even when the window is fully closed.

Choose From 5 Sizes! Come In For More Details

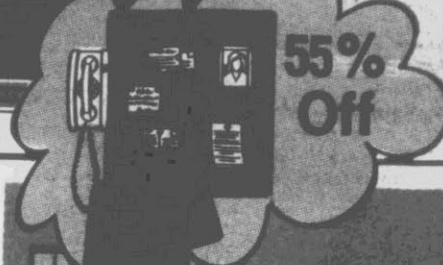

**55% Off**

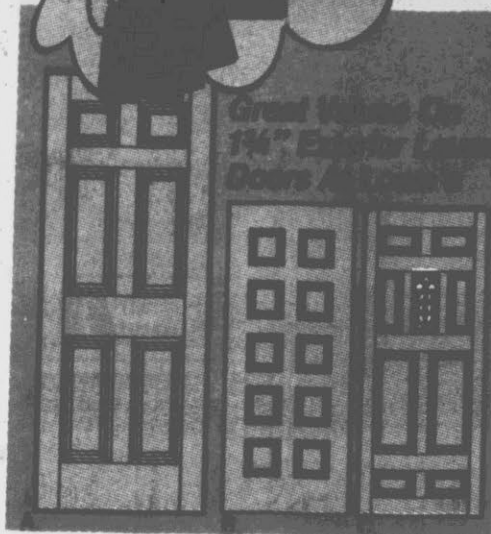

A. Save \$25.00!  
6-Panel Door  
**\$54<sup>99</sup>**

Regularly \$79.99. Comes unfinished. 3' wide. #1052

B. 3' Napoli Door  
**\$69<sup>99</sup>**

Reg. \$98.99. Save \$29.00! Durable! Unfinished. #1052

C. 3' Jailhouse Door  
**\$79<sup>99</sup>**

Regularly \$98.99. Save \$20.00! Comes unfinished. #1052

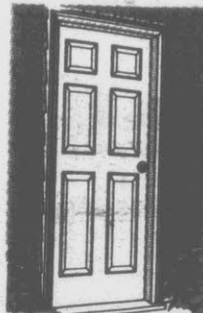

Save \$10.00!  
3'x1 1/4" Solid Fir Door  
**\$79<sup>99</sup>**

Regularly \$89.99. It's American-made. Easy to finish. #10507

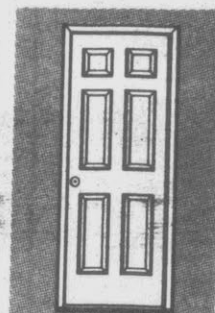

Save \$10.00!  
3' Molded Door With Frame  
**\$89<sup>99</sup>**

Regularly \$99.99. Fully weatherstripped. Sill is included. #13663,4

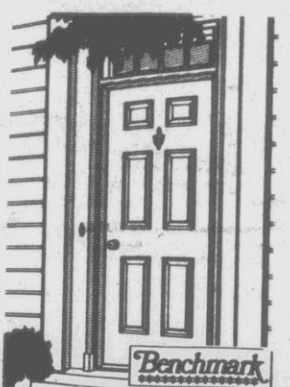

Save \$9.00! Steel Exterior Door Unit  
**\$129<sup>99</sup>**  
3-Foot

Regularly \$138.99. Security & energy-savings in one unit. Fully insulated. #14046,7



Save \$4.00!  
Flush Bifold Luan Door  
**\$17<sup>99</sup>**

Regularly \$21.99. Great for the pantry. Easy to finish. 2'x6'8". #10712



Save \$5.00!  
Louvered Luan Bifold Door  
**\$26<sup>99</sup>**

Regularly \$31.99. This 2'x6'8" door can be painted, stained. #10535

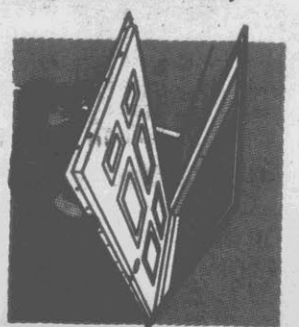

Save \$6.00! Steel Replacement Unit  
**\$139<sup>99</sup>**

Regularly \$145.99. Adds extra security & energy savings to a 3' entrance. #15507,8

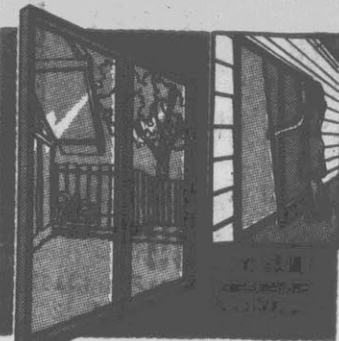

Save \$25.00! 6-Foot Insulated Patio Door  
**\$149<sup>99</sup>**

Regularly \$174.99. Has reversible door and built-in security lock. #13017  
Patio Screen (#13000) Regularly \$18.99. \$23.99

AM/FM  
Radio With  
Headphone ..... **\$1687**  
Ref. Price \$29.95. #55008

Lowe's  
Low Price... \$18.97  
Factory  
Rebate \$2.00

# Entertainment



**A. 25" Diagonal  
40"-Wide-Cabinet  
Color Console TV**

Reference Price \$579.95. The Energy Conscious™ 100% solid state chassis delivers high performance with low power usage. With automatic frequency and color controls. Has a deep pecan finish. #54532

**B. 25" Diagonal  
XL-100 Color TV  
With Electronic Tuning**

Reference Price \$579.95. Features both automatic color and fleshtone correction controls. The 100% solid state chassis yields high level performance with low power usage. Automatic fine tuning. #54660

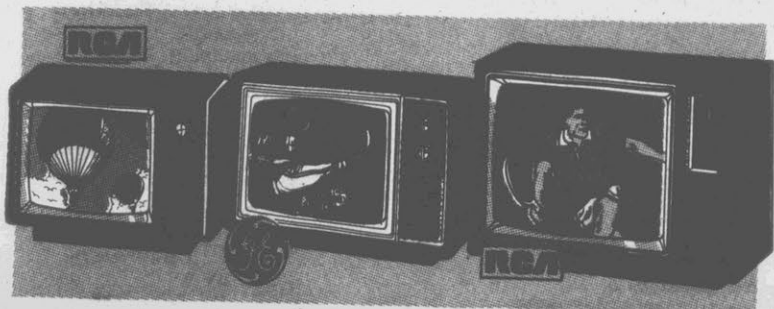

**13" Diagonal  
XL-100 Color TV  
\$289.96**

Reference Price \$339.95. Has a 100% solid state chassis plus auto color & fleshtone controls. #54600

**17" Diagonal  
Color Portable TV  
\$299.98**

Reference Price \$359.95. 100% solid state. Has automatic frequency & color controls. #54518

**19" Diagonal  
XL-100 Color TV  
\$369.97**

Reference Price \$439.95. Automatic fleshtone and color controls. Has 100% solid state chassis. #54610



**12" Diagonal  
Black And White TV  
\$79.97**

Reference Price \$99.95. Features set-and-forget fine tuning. #54553



**5" Diagonal  
Black And White TV  
\$99.96**

Reference Price \$119.95. Runs off AC current or batteries (extra). #54862



**19" Diagonal  
Black And White TV  
\$149.97**

Reference Price \$179.95. 100% solid state. 1-set fine tuning. #54562

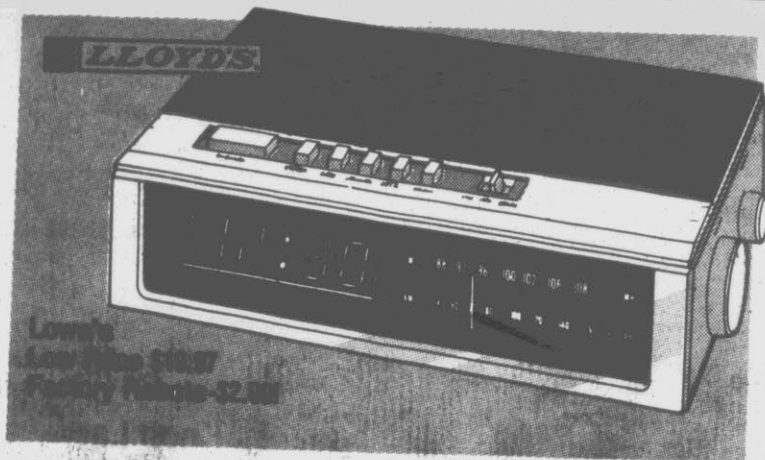

**AM/FM Digital Clock  
Radio With Battery  
Back-Up For Clock ..... \$1797**  
With Rebate  
Reference Price \$29.95. Wake to music or alarm, or hit the snooze bar alarm delay. Has a 3-inch speaker. UL listed. Batteries extra. #55065



**Indash/Underdash AM/FM  
Car Radio With Cassette  
\$59.97**

Reference Price \$99.95. Has a fast forward and eject switch plus balance control. Hardware included. #55223

**6"x9" 2-Way Coaxial  
Stereo Speakers  
\$44.98**  
Pair

Reference Price \$74.95. These 45-watt speakers offer terrific 2-way stereo reproduction. With hardware. #55382

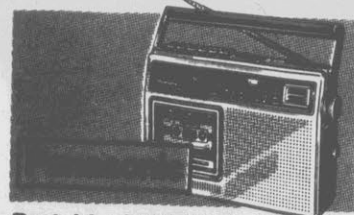

**Portable AM/FM Radio  
With Cassette Recorder  
\$49.97**

Reference Price \$59.95. Runs off AC or batteries (extra). Built-in microphone. Has a "pause" control. #55150



**AM/FM Stereo Radio  
With Cassette Recorder  
\$119.98**

Reference Price \$159.95. Has two built-in microphones. Two 3 1/2" speakers. Plus bass and treble controls. #55145

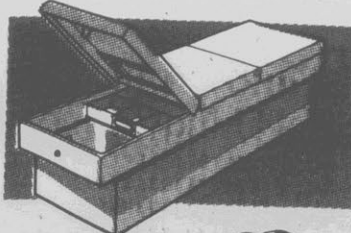

**Save \$25.09! Pick-Up Truck  
Storage Tool Box  
\$84.88**

Regularly \$109.97. In two sizes that fit most wide-bed and smaller bed trucks. Has removable tray. #92402,4

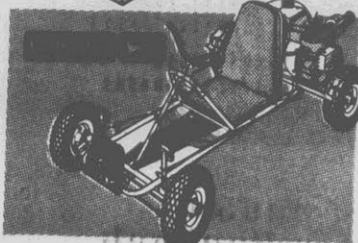

**Save \$30.00! 3HP  
Single-Seat Go-Kart  
\$299.99**

Regularly \$329.99. With a rugged 4-stroke, 1-cylinder engine and floating cam-action brakes. #94828

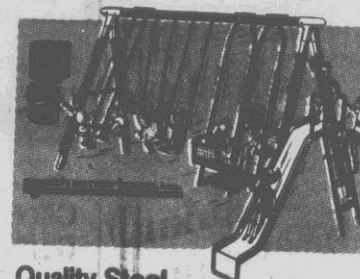

**Quality Steel  
Children's Gym Set  
\$99.97**

Reference Price \$109.97. Overall length is 10'6" including slide. Some assembly is required. #99720

PUT YOUR MONEY  
WHERE YOUR HOUSE IS

Twist 'N Out  
Ice Trays  
**99¢** Pair #53782

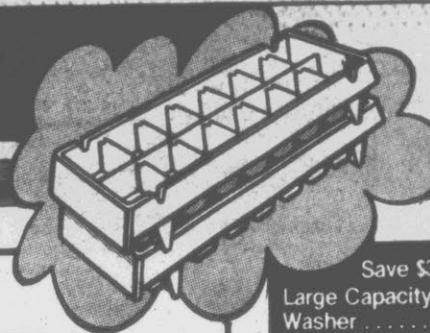

Save \$70.00!  
12.1-Cubic-Foot  
Upright Freezer ..... **\$289<sup>97</sup>**



Regularly \$359.97. Has five door shelves and three compartment shelves for organized easy-to-find storage. Plus adjustable temperature control. #50858

SAVE  
**\$60.00!**



14.8-Cubic-Foot  
Chest Freezer

Lowe's Cash Price **\$299<sup>97</sup>**

Lowe's Low Mo. Payment **\$16<sup>54</sup>** For 24 Months

No Down Payment\*  
Annual Percentage Rate 23.94%  
Deferred Payment Price \$396.96  
Regularly \$359.97. Features and all-textured steel lid and cabinet; and a sliding basket for organized, easy-to-find storage. Come see! #50803

20.0-Cubic-Foot  
Chest Freezer

Lowe's Cash Price **\$399<sup>97</sup>**

Lowe's Low Mo. Payment **\$16<sup>36</sup>** For 36 Months

No Down Payment\*  
Annual Percentage Rate 24.00%  
Deferred Payment Price \$569.96  
Regularly \$459.97. This large freezer has an all-textured steel lid and cabinet with two sliding baskets for organized, easy-to-find storage. #50804

Save \$30.00!  
Large Capacity  
Washer ..... **\$349<sup>97</sup>**



Hotpoint

Lowe's Low Mo. Payment **\$15<sup>85</sup>** For 36 Months

No Down Payment\*  
Annual Percentage Rate 24.00%  
Deferred Payment Price \$475.90

Regularly \$379.97. Features 2 wash/spin speeds, 3 wash/rinse temperatures and 4 water level selections. It has a 2-18 pound capacity for all type fabrics. #51238

Save \$40.00!  
5-Cubic-Foot  
Chest Freezer ..... **\$219<sup>87</sup>**

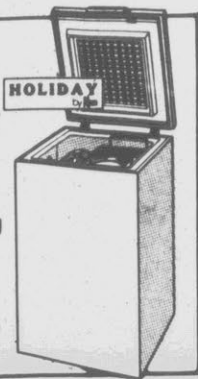

Regularly \$259.87. Features a sliding basket for easy, organized storage; and adjustable temperature control. #50801

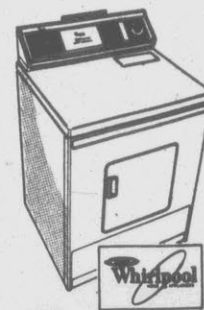

Save \$50.00!  
Electric  
Dryer ..... **\$219<sup>96</sup>**

Reg. \$269.96. Features Cool-Down Care to help reduce wrinkles in perm press fabrics. #51520

Save \$100.00!  
Side By Side  
Refrigerator ..... **\$679<sup>88</sup>**



Regularly \$779.88. Features special food compartments for foods that need high humidity or low humidity to stay fresh. Adjustable temperature control. #53565  
Installation Kit For Ice Maker  
Regularly \$6.99-Save \$1.00 #53755 ..... \$5.99



Save \$40.00! Standard  
30-Inch Electric Range  
**\$259<sup>88</sup>** Whirlpool

Regularly \$299.88. With 6" & 8" plug-in surface units & 2 oven racks. #52851

Save \$100.00!  
Cuisine-Master  
Deluxe Microwave ..... **\$399<sup>95</sup>**

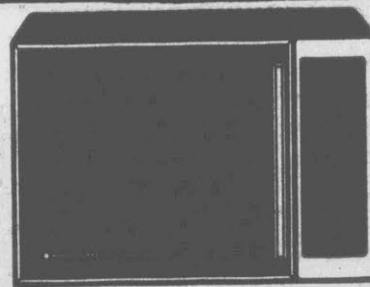

Regularly \$499.95. Cooking is simple and fast with 25 pre-programmed recipes and 55 variable recipes you can program! It has a large 1.5 cubic foot oven. #51738

Save \$100.00!  
21.7-Cubic-Foot  
Refrigerator ..... **\$999<sup>87</sup>**



Regularly \$1099.87. With a convertible meat conditioner; high & low humidity food compartments; 4 adjustable glass shelves; & 3 door shelves. #53577

\*Lowe's Low Payment Credit Terms

Your credit must be satisfactory. Lowe's cash price does not include sales tax. The monthly payment and deferred payment price include sales tax at 4%. If sales tax is different in your area, the monthly payment and deferred payment price will vary slightly. Insurance is available, but not included in our figures. Delivery charges, if any, are not included. Applies to N.C. stores only.

Lowe's Pricing Policy:

Many items in this tabloid carry a reference retail price. The reference is intended to provide a guide to the range of retail selling prices in our area and may be useful in identifying different units of the same manufacturer. An item's reference retail price is either the manufacturer's suggested retail price or our determination of its full retail price based on prices at which it or similar merchandise is offered by principal retailers (department stores, specialty shops and other non-discount sellers) in our selling area. While we believe our reference retail price does not appreciably exceed the highest retail prices at which sales are made in our selling area, we cannot assure you that our reference retail prices, as described above, represent the prices in every community on any given day. Some items in this advertisement are listed at "regular" selling prices. The merchandise is offered at this price except during a special sale. The purpose of showing a reference retail price (or a regular price) is to assist you, our customer, in making a knowledgeable and better informed buying decision. We suggest that you also do comparative shopping and compare our prices. (Prices in this tabloid do not include delivery charges. Ask us about delivery rates.)

Lowe's Raincheck Policy: If we sell out of an advertised item, we'll issue you a raincheck. When we restock, you'll be notified so you can buy at the previously advertised price (except for products marked "Limited Quantities"). Our smaller stores may not stock all advertised items. But every item shown here can be ordered for you.

Save \$70.00!  
14.1-Cubic-Foot  
Refrigerator ..... **\$499<sup>89</sup>**



Regularly \$569.89. Features adjustable slide-out shelves, twin slide-out crispers, a covered butter bin & utility compartment, and egg bin. #53662

**LOWE'S**

**Your Household Word**

# mid-summer sale



1/2 price  
Tee shirts.  
Sale  
6.50

**Orig. \$13.** Summer wardrobe needs a lift? Try our cool-as-a-breeze-fashion tee. Styled in easy-care polyester/cotton with a three-button shoulder. Perfect with skirts or slacks. In colors of natural burgundy, olive, purple, or teal. Misses' sizes.

25% off

**Sale \$18.75.** Reg. \$25. 100% polyester, leather belt, stitch down double pleats in basic and fashion colors. Misses sizes.

**Sale \$15.75.** Reg. \$21. Belted man tailored pant of polyester/cotton twill in solid colors. Misses sizes.

Of course you can charge it



## JCPenney

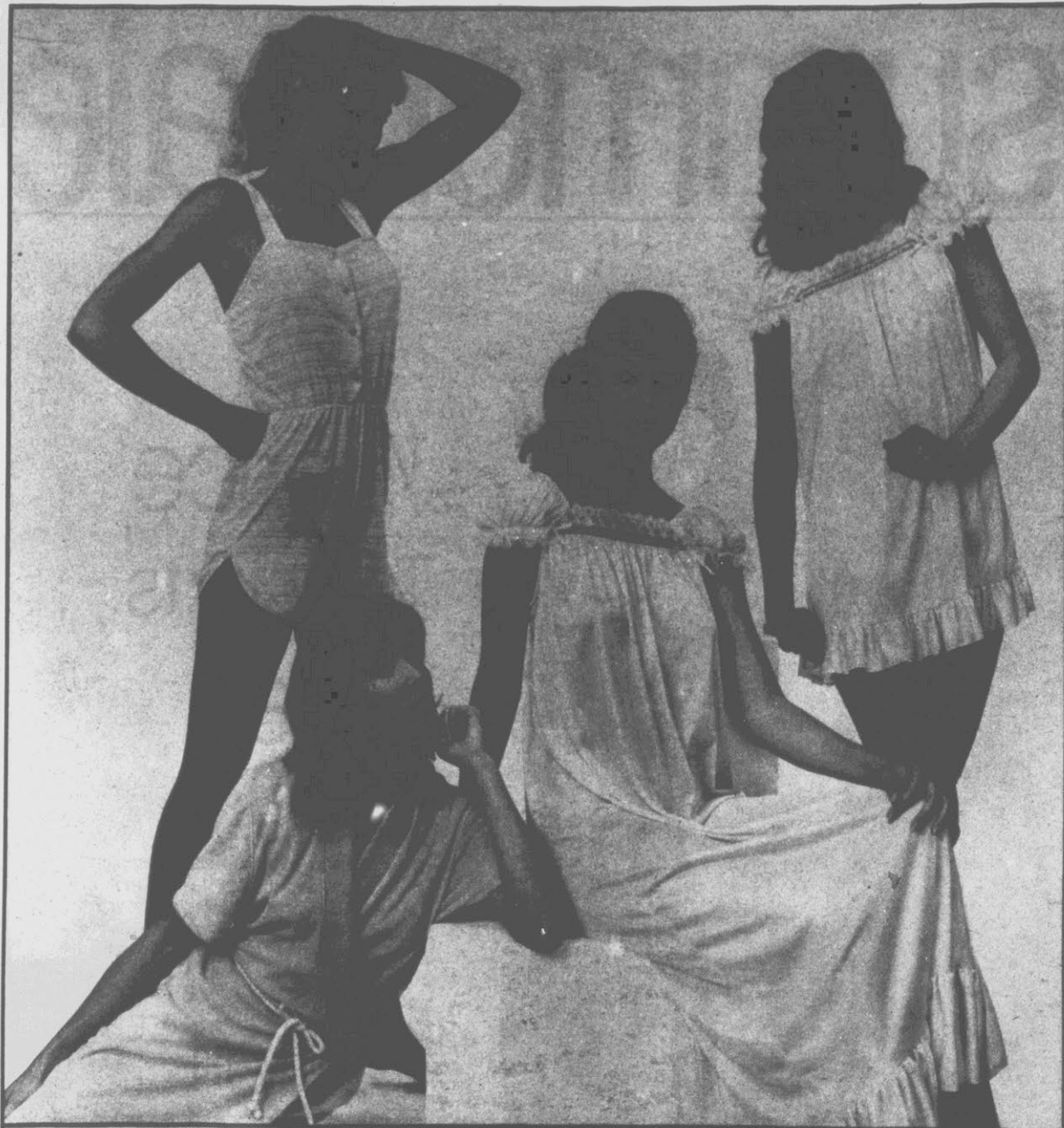

# Save 25%

Soft, romantic  
junior sleepwear.

When the stars come out, you'll shine the brightest in this pretty sleepwear. Beautifully styled in silky nylon tricot. A pleasure to wear, and so easy to care for. Delicately trimmed with lace and ruffles to add a touch of Victorian romance. Your choice of four styles. All in lavender.

	Reg.	Sale
Romper .....	\$12	9.00
Gown .....	\$12	9.00
Robe .....	\$16	12.00
Baby doll .....	\$11	8.25



## Pac Man® bikini. Sale 1.34

Reg. 1.79. Soft cotton print with elasticized edging. Assorted styles to choose from.

## Save 25% Prairie look sleepwear. Sale 16.50

Reg. \$22. Long gowns of soft easy care poly/cotton. Choose from classic look patterns of floral stripes, bands, and ruffles, styled with a touch of Victorian romance.



Save  
25% to  
39%

Smart sale.  
money

Sale 7.99  
to 14.99

Put together a cool summertime look with savings from top to bottom. Go casual with sporty tops and slacks. Or add a bit more polish with our stylish split skirt. In all your favorite warm weather colors.

**Sale 7.99** Reg. \$13. Misses' V-neck poly/cotton tee. Choose solids or stripes in lots of sunny colors. Sizes S,M,L.

**Sale 12.99** Reg. \$18. Misses' poly/cotton shirt. Choice of styles in sporty plaids or stripes. Sizes 8 to 18.

**Sale 9.99** Reg. \$16. Choose from an assortment of knit tops. Polyester/cotton with fashion details like ¾ sleeves, square necklines, ruffle sleeves and more. Solids or stripes. Juniors' S,M,L.

**Sale 11.99** Reg. \$16. A split skirt of easy care fabric that keeps perfect company with summer tops. Misses sizes.

**Sale 14.99** Reg. \$23. Pleat front fashion slacks in cool cotton. In a pretty array of colors for junior sizes 5 to 13.

Great savings  
are in the bag.

Save 25%

**Reg. \$12 to \$16.** Sporty and casual. Or classic and elegant. We have the bags you're looking for in rich leather-like vinyl. To finish off your new outfits beautifully. Choose clutches, hobos, shoulder bags and more. To carry all your essentials.

	Reg.	Sale
Organizer .....	\$15	11.25
Shoulder bag .....	\$12	9.00
Swagger .....	\$13	9.75
Contemporary .....	\$16	12.00





20%  
off

Girls tops  
and bottoms.  
Sale 6.40  
to \$13.60

Reg. \$8 to \$17. For kids active life, cool and comfortable polyester and cotton. Choose from assorted shirts in fancy yarn dyed plaids to pair up with belted twill pants and coordinating belts. Dressy blouses with tucks and ruffles accent skirts in pleated or solid styles. A colorful group at 20% savings.

	Size	Reg.	Sale
Yarn dyed plaid	4-6x	8.00	6.40
Twill pant	4-6x	12.00	9.60
Dressy blouse	7-14	11.00	8.80
Pleated skirt	7-14	13.00	10.40
Twill Pant	7-14	15.00	12.00
Solid dressy blouse	Jr.Hi	14.00	11.20
Plaid skirt	Jr.Hi	16.00	12.80
Dressy blouse	Jr.Hi	14.00	11.20
Belted twill slack	Jr.Hi	17.00	13.60

Of course you can charge it



JCPenney



# 20% off

Cool looks  
for the boys.  
And sizzling  
savings  
for you.

## Sale 5.99 to 12.80

Terrific looks to dress the boys in style, at great savings!

**Sale 7.60** Reg. 9.50. Plaid shirt has front chest pocket, back yoke. Poly/cotton in assorted plaids. Prep sizes XS,S,M.

**Sale 12.80** Reg. \$16. Belted poly/cotton twill pant with front slash and back set-in pockets. Solid colors. Prep sizes 25 to 30.

**Sale 10.80** Reg. 13.50. Poly/cotton knit shirt with collar and placket. Assorted color combos. Prep sizes XS,S,M.

**Sale 7.20** Reg. \$9. Oxford casual or dress shirt, button down collar. Locker loop. Assorted colors. Sizes 8-16.

**Sale 11.20** Reg. \$14. Belted poly/cotton twill slacks. Front slash, back set-in pocket. Big boys' sizes 8 to 16.

**Sale 9.60** Reg. \$12. Little boys' sizes 4 to 7.

**Sale 5.99** Reg. 7.50. Plaid shirt has two chest pockets with treatments. Poly/cotton. Sizes 8-16.

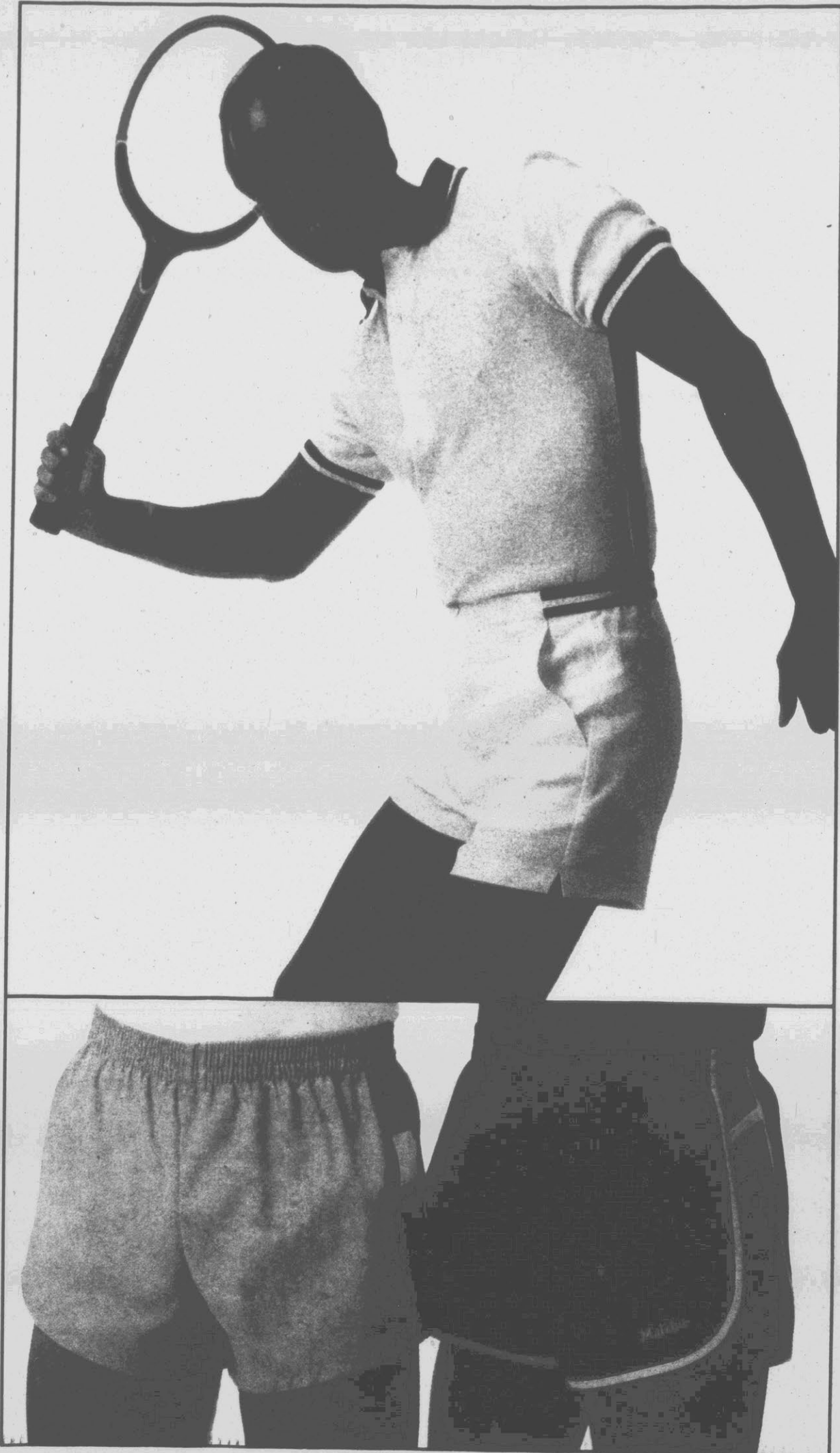

Sale  
9.99

Courtside®  
tennis shirt.

Reg. \$15. Great styling in polyester/cotton interlock. Comfort and good looks. In men's sizes.

Courtside®  
tennis shorts.

Reg. \$15. Coordinates with the shirt. In comfortable 100% texturized woven polyester. Men's sizes.

Special  
9.99

Men's canvas court shoe, vinyl padded collar. Cushioned insole with arch support men's sizes.



Sale  
6.99

Malibu® athletic shorts Reg. \$11. Polyester/cotton. Elastic waist. Contrasting color panels. Men's sizes.

Of course you can charge it



JCPenney

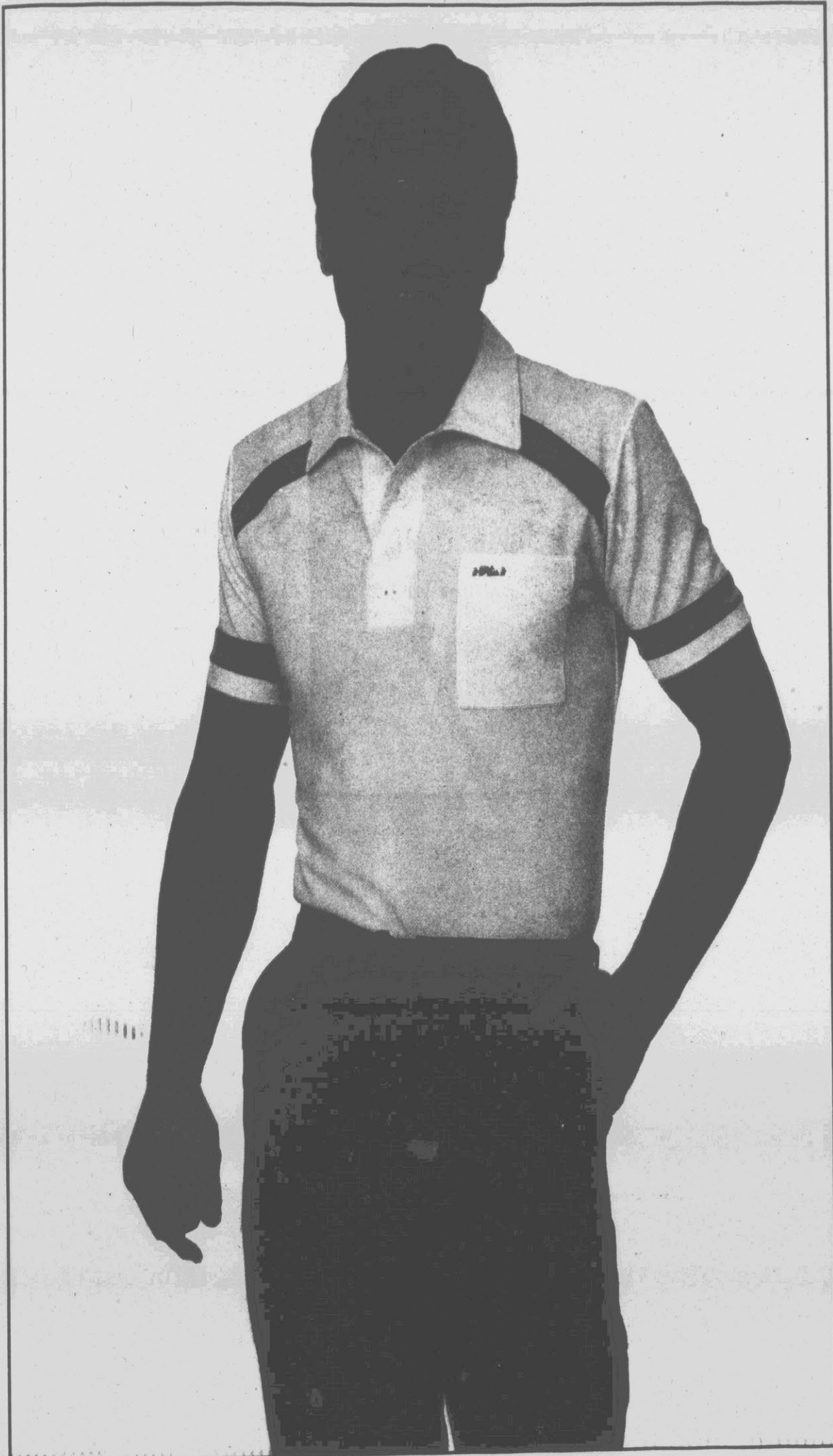

Sale  
10.99

2 Plus 2<sup>®</sup> sport shirts at super savings!

**Reg. \$18.** Great style. Great comfort. That's our 2 Plus 2<sup>®</sup> in comfortable polyester/cotton for men.

Sale  
15.99

The pants.

**Reg. \$23.** Traditional styling in polyester/cotton twill. Color coordinated belt. In transitional colors. Men's sizes.

Sale  
8.99

Traditional boat shoes.

**Reg. \$13.99.** Polyurethane uppers. Rawhide lace. Gripper soles. Men's sizes.





30% to  
35% off

Swing into  
action with  
Par Four<sup>®</sup>  
and more.

Sale 6.99  
to 11.99

**Sale 6.99** Reg. \$10. 3-pocket athletic shorts of poly/cotton with elasticized back-waist. Sporty colors. Men's sizes.

**Sale 11.99** Reg. \$18. Belted Par Four<sup>®</sup> shorts of poly/cotton oxford weave. Basic and fashion colors. Men's sizes.

**Sale 11.99** Reg. \$18. Belted Par Four<sup>®</sup> shorts with back pocket. Poly/cotton kettle cloth in solid colors. Men's sizes.



Sale 6.99  
to 7.99

**Sale 6.99** Reg. \$11. Boxer-style swim trunks of poly/cotton. Elasticized waist with full support. Sporty colors. Men's sizes.

**Sale 7.99** Reg. \$13. Poly/cotton poplin swim trunks with side vents, elasticized waist and full support. Men's sizes.

**Sale 7.99** Reg. \$13. Zip-front swim trunks of poly/cotton. Elasticized backwaist and full support. Men's sizes.

Of course you can charge it



JCPenney



Mid summer savings for women!

Sale 6.99 to 12.99

**Reg. \$19.99.** A sporty little Italian sandal. Interwoven leather strap. Tan. Women's sizes. Sale 12.99.

**Reg. \$16.** Pinwheel® casuals., updated corduroy colors. Dyed to match laces. Rubber protective toe cover. Tan, burgundy, loden, and navy. Women's sizes. Sale 11.99

**Reg. \$19.99.** Leather cross strap sandal. Unit bottom construction. Burgundy. women's sizes. Sale 12.99.

**Reg. \$11.** Shu-Buds® sandal. Leather band. In colors of navy, red, tan and white. Women's sizes. Sale 6.99

Mid summer savings for men!

Sale 34.99

**Reg. \$50.** Men's all leather shoes. Leather uppers and leather soles at a fantastic price. Three styles to choose from. Ornament slip-on, tassel slip-on and wing tip oxford. Men's sizes.

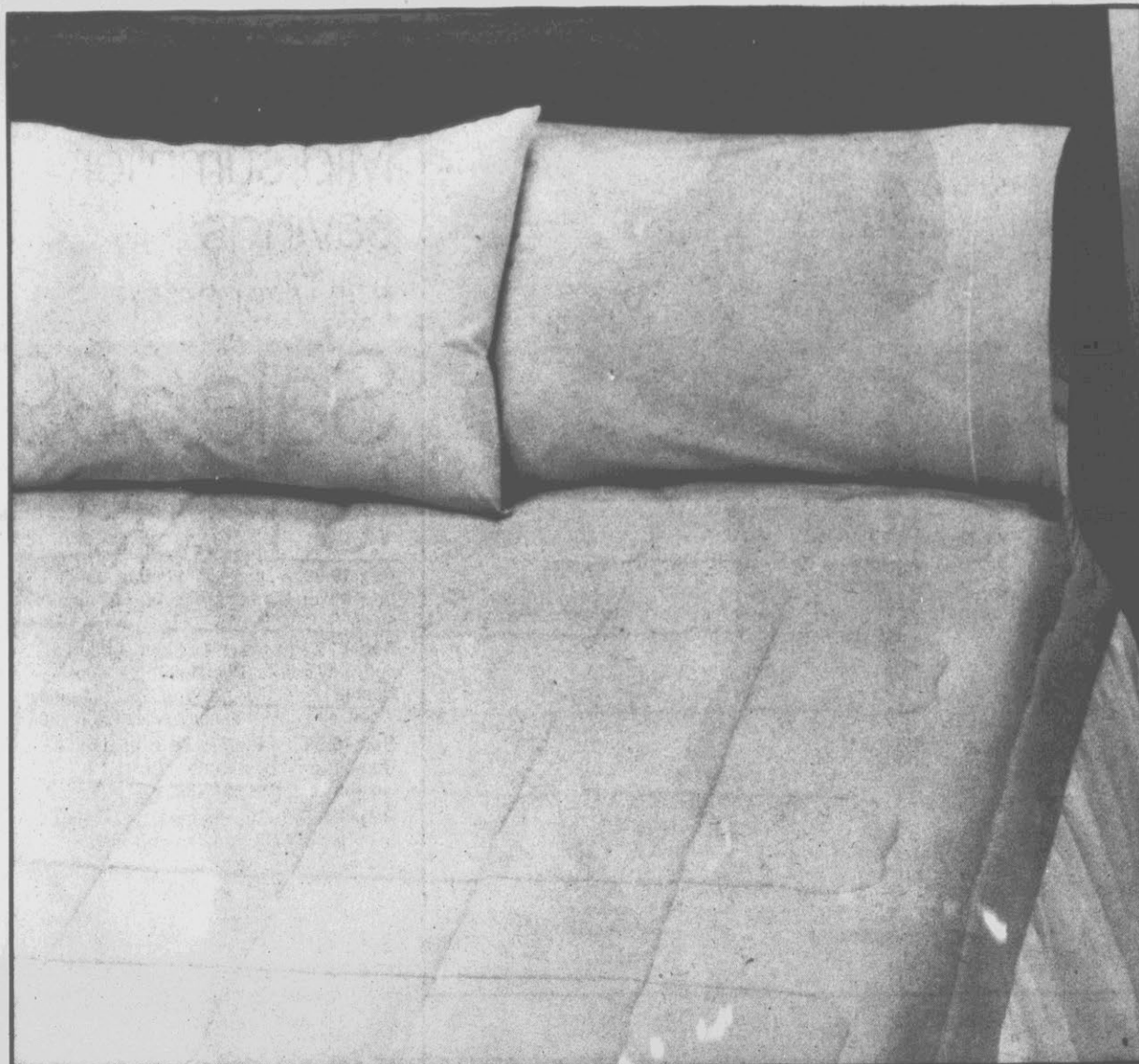

## White Sale.

Save on all  
our sheets  
bedcoverings  
and pillows.

**Sale 4.99** twin sheet

**Reg. 7.99.** Solid poly/cotton percales, in beautiful shades to mix or match. Bed-pillow plumped with Dacron II® polyester. Comforter quilted with Astrofill® polyester. Flat and fitted sheets are same price.

	Reg.	Sale
Full sheet .....	9.99	6.99
Queen sheet .....	15.99	12.99
Pillowcases, by the pair:		
Standard .....	7.99	5.99
Queen .....	8.99	7.99
Twin comforter .....	35.00	28.00
Full comforter .....	45.00	36.00
Queen comforter .....	55.00	44.00
Pillow sham .....	15.00	12.00
Standard bedpillow .....	10.00	7.00
Queen bedpillow .....	13.00	11.70

Matching bedskirts are also on sale.

## Blanket coordinates.

**Sale 15.99** twin

**Reg. \$22.** Vellux® blanket of nylon bonded to polyurethane.

Full, Reg. \$27 **Sale 22.99**  
Queen, Reg. \$35 **Sale 28.99**

## JCPenney towel.

**Sale 4.99** bath

**Reg. \$7.** The JCPenney towel in a thirsty blend of cotton/polyester terry. 25 x 50" of absorbent softness. Choose from a rich array of colors.

	Reg.	Sale
Handtowel .....	5.00	4.50
Washcloth .....	2.20	1.98

**Sale 6.80** Reg. 8.50. Plush nylon pile mats in 21 x 24" contour or 24 x 36" oblong style. Matching tank set, Reg. \$10 **Sale \$8**

You'll find shower curtains and other accessories on sale, too. To give your bathroom a coordinated look.

## Princess towel.

**Sale 3.99** bath

**Reg. \$5.** Cotton terry towel with jacquard design borders. Solid colors.

	Reg.	Sale
Handtowel .....	3.50	2.80
Washcloth .....	2.00	1.60

Coordinating shower curtains, bath mats and tank sets are also on sale.

# JCPenney

## 20% off. Wicker-look accessories

Wicker-look accessories of  
Textilene Cane® fiber:

Upright wicker hamper .....	29.00	23.20
2-shelf unit .....	21.00	16.80
Wastebasket .....	11.00	8.80
Scale .....	28.00	14.40

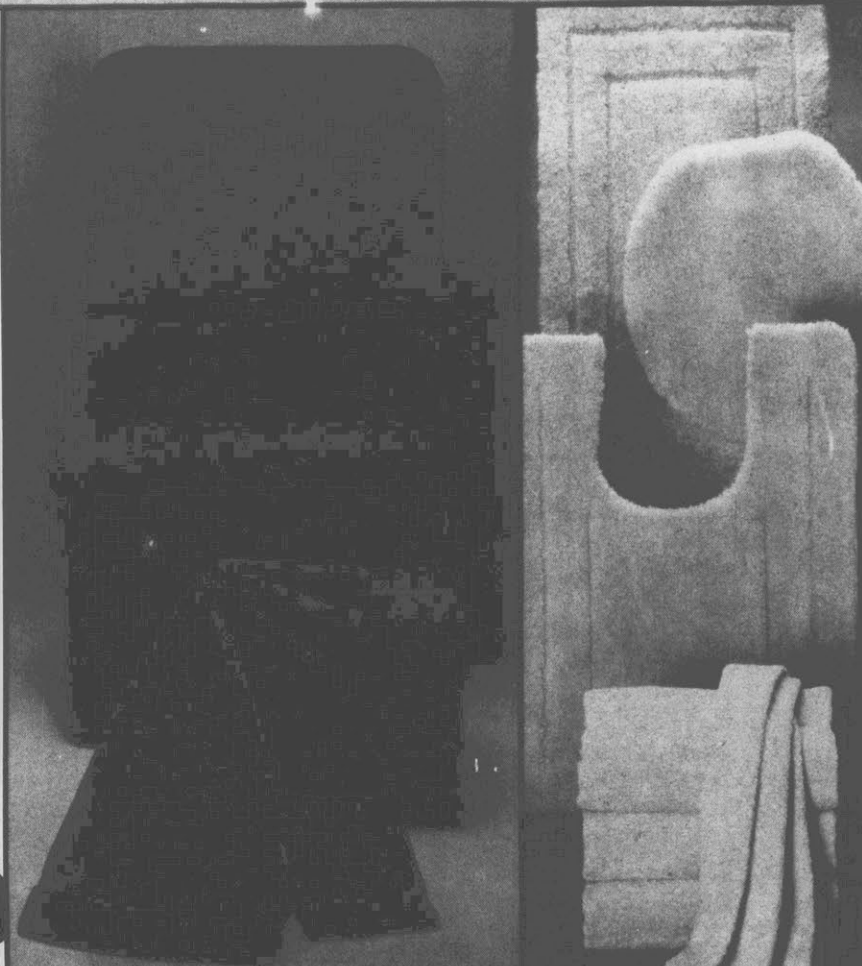
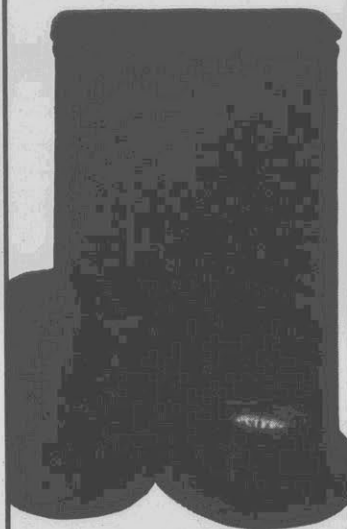



White Sale.  
Save on all our  
bed coverings  
and pillow shams.

**Sale \$32** twin

**Reg. \$40.** Enjoy the rich luxury of this striped comforter. Polyester/cotton quilted to Kodel® polyester fill.

Full comforter, **Reg. \$50 Sale \$40**  
Queen comforter, **Reg. \$60 Sale \$48**  
Pillow sham, **Reg. \$20 Sale \$16**

Coordinating sheets, pillowcases also on sale.

**Sale \$24 to \$72.**

More comforters and bedspreads at dreamy savings!

Ruffled comforter of poly/cotton with lace trim. Fluffed with polyester fill.

	Reg.	Sale
Twin .....	\$60	<b>\$48</b>
Full .....	\$75	<b>\$60</b>
Queen .....	\$90	<b>\$72</b>

Bedskirts and sham also on sale.

Solid color bedspread of poly/cotton is lavishly quilted to polyester fill.

	Reg.	Sale
Twin .....	\$30	<b>\$24</b>
Full .....	\$40	<b>\$32</b>
Queen .....	\$50	<b>\$40</b>

Not shown: Geometric print bedspread of poly/cotton quilted to Astrofill® poly.

	Reg.	Sale
Twin .....	\$40	<b>\$32</b>
Full .....	\$50	<b>\$40</b>

**Sale 15.99.** Reg. \$22. (not shown) Twin Vellux® blanket of nylon pile bonded to polyurethane for cloud-light coziness.

	Reg.	Sale
Full .....	\$27	<b>22.99</b>
Queen .....	\$35	<b>28.99</b>

Dobby textured  
draperies.

**Sale \$22 pr.** 50x84"

**Reg. \$26.** In cotton/poly or rayon/poly/acrylic. With energywise acrylic foam back.

	Reg.	Sale
75x84" .....	\$54	<b>\$44 pr.</b>
100x84" .....	\$69	<b>\$58 pr.</b>
100x84" patio panel .....	\$74	<b>\$52 ea.</b>

Open-weave  
draperies.

**Sale \$34 pr.** 50x94"

**Reg. \$40.** Airy, elegant draperies with a subtle stripe effect.

Rayon/poly/acrylic/with cotton/poly lining.

	Reg.	Sale
75x84" .....	\$ 69	<b>\$58 pr.</b>
100x84" .....	\$ 99	<b>\$84 pr.</b>
125x84" .....	\$120	<b>\$96 pr.</b>



# Sport Sale

You name the game, we'll supply the savings!

## Sale 3.49 to 10.99

Keep him way ahead of the competition with sporty savings on athletic apparel. Tops and shorts that are long on wear and easy to care for. Mostly in poly/cotton blends. Great color combos. Men's sizes.

	Reg.	Sale
Shimmel cut-off t-shirt	4.49	3.49
Stripe-trim gym shorts	5.99	4.99
Adidas® athletic shirt	13.00	9.99
Adidas® athletic shorts	13.00	9.99
Track and Court™ shirt	13.00	9.99
Tennis shorts	13.00	9.99
Stripe trim athletic shirt	6.99	4.99
Quarter sleeve jersey	6.99	4.99
Stripe trim shorts	4.99	3.99
Softball/Coaches shorts	14.00	10.99

### \$3 off adidas® and Nike® for everyone. Sale 15.99 to 20.99

Save on court and running shoes for the family. Nylon or canvas uppers with lots of comfort features.

adidas®:	Reg.	Sale
Men's Low Court	22.99	19.99
Men's High Court	24.99	21.99
Men's/women's Jupiter	23.99	20.99
Youth's Jr. Low Court	19.99	16.99

Nike®:	Reg.	Sale
Men's Courtmaster	19.99	16.99
Men's Court Press	20.99	17.99
Men's/women's Monterey II	21.99	18.99
Youth's Jr. Court Master	18.99	15.99

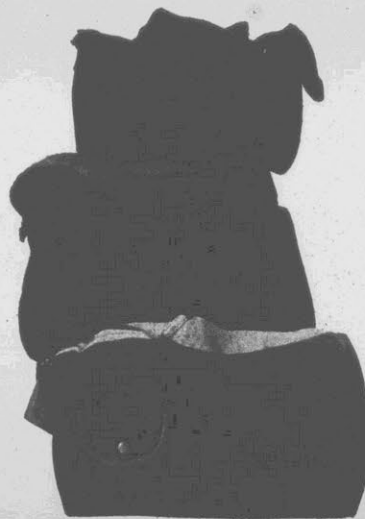

### Soft-touch travelers 15.99 each

Carefree travel is in the bag, with these Sasson nylon shoulder totes in 2 styles. The Cordura® snap pocket travel tote and snap pocket shoulder tote. Assorted colors.

Of course you can charge it



# JCPenney

EVENT STARTS WEDNESDAY, JULY 14 and ENDS SATURDAY, JULY 17

GREENVILLE, NORTH CAROLINA  
PITT PLAZA

Shop 10:00am to 9:00pm Daily  
Store Phone 756-1190  
Catalog Phone 756-2145

Advertising Supplement to THE DAILY REFLECTOR