

Weather

Partly cloudy tonight and Thursday; low in 60s with shower prospects lessening tomorrow.

THE DAILY REFLECTOR

INSIDE READING
Page 11 — Defective babies
Page 14 — Hinckley trial
Page 47 — Guessing game

101ST YEAR

NO. 119

GREENVILLE, N.C.

WEDNESDAY AFTERNOON, MAY 19, 1982

72 PAGES—5 SECTIONS PRICE 25 CENTS



Recognized

SAFETY AWARDS DINNER — An annual safety awards dinner sponsored by the N.C. Department of Labor was held in Greenville Tuesday night to honor 48 area firms. The firms were cited for maintaining a perfect safety record during calendar year 1981 or recording an occupational injury incidence rate at least 50 percent below the statewide rate for that particular industry. Receiving special awards were Clarence Edwards (left),

director of manufacturing for Singer Furniture of Chocowinity, which has compiled 2,278,000 safe employee-hours, and Sheila Needham (right) of Union Carbide, who received the plant's 17th consecutive annual safety award. Presenting the awards is Charles Jefferies (center), assistant state labor commissioner. (Reflector Photo by Tommy Forrest)

British Newspapers Say Falklands Decision Made

By The Associated Press
Prime Minister Margaret Thatcher said today Argentina's response to the latest Falkland Islands peace proposal "doesn't look very encouraging," and British newspapers reported she has already decided to invade the islands.

Mrs. Thatcher said in a British Broadcasting Corp. interview her government

had not yet seen the full text of Argentina's response, but that "the gap looks big" between London and Buenos Aires positions.

Argentina's chief negotiator at the United Nations, Deputy Foreign Minister Enrique Ros, said after he presented the response Tuesday night it was intended to bridge differences and resolve the conflict peacefully.

Earlier, British landing forces were reported closing on the South Atlantic islands, and Mrs. Thatcher was quoted by the London Daily Express tabloid as telling Queen Elizabeth II that she has ordered troops to invade.

"Only the time of a British landing on the Falkland Islands seemed in doubt," the London Times reported today.

Mrs. Thatcher told Parliament on Tuesday that Argentina was stalling for time and the outcome of U.N. talks should be known by Thursday. She said if talks failed, "no military action can be held up in any way."

"I believe that any military action or option cannot and must not be delayed by people who are extending negotiations," she declared.

Britain's Independent Television News said about 50 ships with 3,900 marines and paratroopers aboard were believed massed off the South Atlantic archipelago, ready to challenge the estimated 9,000 Argentine troops sent to the islands since they were seized from Britain April 2.

Press Association, the domestic British news

agency, said reports were circulating in London that the assault force, including the liner Canberra with 2,000 marines aboard, was within 100 miles of the Falklands.

Correspondents with the British task force reported the arrival Tuesday of a container shipload of Harrier jets to reinforce the estimated 37 vertical-takeoff jump jets in the fleet's air arm.

After Ros conveyed Argentina's new proposals to Secretary-General Javier Perez de Cuellar, the U.N. chief delivered them to Britain's U.N. Ambassador Anthony Parsons, who sent them to London for consideration.

The secretary-general's proposed framework for peace reportedly calls for a truce, a phased, supervised withdrawal of British and

Argentine forces from the Falklands area, and a U.N. interim administration of the islands during negotiations on their future.

British and Argentine sources say the main stumbling blocks are:

— Britain's insistence that the Falkland islanders' local government bodies be restored during the interim U.N. administration. Argentina contends these are vestiges of British colonialism.

— A dispute over how far the British fleet would withdraw. Britain is willing to move its fleet 200 miles from the Falklands, nearly the distance of the Argentine mainland from the islands, but Argentina wants the task force much farther away.

— Argentina's insistence on next Jan. 1 as the deadline for settling the sovereignty question, which Britain and Argentina had been negotiating for 17 years before the Argentine invasion. Britain proposes that the U.N. interim administration and negotiations continue if an agreement cannot be reached by a target date.

Britain reported no military attacks in the Falklands area Tuesday. A communique from the Argentine joint chiefs of staff said military action was limited to British "attempts at naval bombardment, which were repulsed by Argentine forces, and reconnaissance flights by British planes, which were foiled by anti-aircraft fire."

Assign School Posts

Greenville school Superintendent Delma Blinson announced today the assignment of Paul Rasberry as principal of Wahl-Coates School and the assignment of Kay Whitehurst as principal of E.B. Aycock Junior High School.

Both assignments are effective July 1.

Rasberry succeeds Rexford (Gene) Piner, who is retiring after 16 years as principal at Wahl-Coates. Rasberry has been principal at Aycock since 1971. Kay Whitehurst currently is director of secondary instruction and has been in that position for 10 years. Prior to that time, she was a teacher at Rose High School.

The director of secondary instruction position is now vacant and Blinson announced that applications for that position would be received through June 4.

Commenting on the reassignments, Blinson said: "We regret the loss of the very capable services of Dr. Piner. Wahl-Coates School has distinguished itself through Dr. Piner's leadership."

"Aycock is an excellent school with one of the most outstanding faculties of any school in the state. Rasberry was principal during some rather difficult times and deserves much credit for what he has done for Aycock."

Blinson said Rasberry had requested the reassignment, "and we are pleased that we can honor his request. Kay Whitehurst has done an excellent job in the central office and she has requested the move to Aycock."

Blinson added that Mrs. Whitehurst "is as knowledgeable about secondary instruction as anyone I know. She has a deep commitment to students and has expressed enthusiasm about the faculty at Aycock."

"I believe the moves will be good for each of these professionals and for Greenville City Schools."

East 10th Street Rezoning Rejected

By TOM BAINES
Reflector Staff Writer

Stated opposition by some residents of the East 10th Street area to a rezoning request Tuesday night was followed by a unanimous vote of the Planning & Zoning Commission to recommend that the City Council deny the zoning change petition.

Board members voted to pass the request by Eula G. Cannon to rezone about two acres at 956 E. 10th St. from an R-9 residential designation to office and institutional along to the council with a recommendation for denial.

Durward Harris, speaking for Edna C. Harris, who is serving as agent for Mrs. Cannon, said the property has served as single-family residential quarters but the owners feel it is an ideal location for use by the college as a sorority or fraternity site. Harris said it is difficult to find someone who is willing to buy the house and property for fami-

ly living quarters. He said he feels it is a "good piece of property for college-related items."

Staff planner Skip Browder said the area basically has single-family dwellings and, while it adjoins East Carolina University property, it is located generally in a residential zoning district. A sorority is located adjacent to the property on the west.

Browder said the city's comprehensive plan recommends that the site continue in residential usage and he added that the planning staff was uncomfortable with rezoning a single lot in view of its spot zoning nature. As proposed, the staff was not in favor of the rezoning, Browder reported.

Charles Cavanaugh of 605 Maple St. said the area remains residential in nature and he felt the "highest and best use" of the Cannon property would be residential. Cavanaugh said there has always been a demand for good property

near the university.

Charles Vincent, whose parents live just east of the Cannon property, said they opposed the rezoning request and he was also against it as their sole heir. Vincent said if the one lot is rezoned, "You will run into 'one lots' all across the area."

The attorney said there is a need to preserve some of the residential areas of the city and if more fraternities and sororities are allowed it will erode the area.

Opposition was also expressed by George Shoe of 950 Shady Lane, who said he resides behind a fraternity located on East 10th Street and it is "not the most pleasant residential living." Shoe said the fraternity at his back door is a "distressing situation."

Paul Jewett, a resident of 957 E. 10th, also stated that he opposed the rezoning matter, saying that the area will be degraded if a fraternity is located in the Cannon home. Jewett said he had experienced no problems with the sorority on East 10th, but he pointed to "filth and loud music all day long and half the night" at the fraternity.

The council will receive the request at the June meeting and can set a public hearing for July.

Planning board members voted to recommend that a request by Judson H. Blount Jr. to rezone 11.096 acres located north of Airport Road, east of N.C. 11-U.S. 13, south of Gum Road, and adjacent to the airport and National Guard Armory, be approved.

Blount is seeking rezoning from unoffensive industry to highway commercial, and

(Please turn to Page 16)

More Cheese

More U.S. Department of Agriculture surplus cheese will be given away in Pitt County Friday and Saturday.

Pitt County Social Services Director Ed Garrison said the giveaway of five pounds of cheese per eligible household will be carried out at the county office building Friday from 9 a.m. to 4 p.m. and Saturday from 8 a.m. to noon by volunteers. Food stamp recipients and others deemed eligible during a previous giveaway will be eligible once again, he said.

REFLECTOR

HOTLINE

752-1336



Hotline gets things done for you. Call 752-1336 and tell your problem or your sound-off or mail it to Hotline, The Daily Reflector, Box 1967, Greenville, N.C. 27834.

Because of the large numbers received, Hotline can answer and publish only those items considered most pertinent to our readers. Names must be given, but only initials will be used.

TOBACCO TWINE BEDSPREADS?

Is there anyone in this area who makes crocheted tobacco twine bedspreads for sale? I know this is nearly a lost art, but I hope there's someone. I want one for an anniversary gift for my parents. D.F.

The Pitt County Extension Homemakers' Office knows of no one locally. If Hotline readers can help, we'll be glad to publish the names they give us. Call 752-1336.



Billy Graham Honored

ALL SMILES — American Evangelist the Rev. Billy Graham (center) smiles with his wife Ruth after he was presented with the Templeton Prize for Progress in Religion from Prince Philip in the Music Room at Buckingham Palace in London

Tuesday. Graham, from North Carolina, received the prize — which consists of a scroll with citation, a medal made of Irish silver, and a check for 110,000 pounds (\$200,200), and is the world's richest religious prize. (AP Laserphoto)

Board Reviews Medicaid Reimbursement Policy

By CAROL TYER
Reflector Staff Writer

The Pitt County Memorial Hospital Board, meeting Tuesday night, heard Steve Morrisette of the N.C. Hospital Association talk about a Medicaid reimbursement policy statement developed by the Task Force on Government Reimbursement of the Association.

Present for the discussion were local legislators Vernon White, Sam Bundy and Ed Warren. It is to the Legislature that hospitals will be looking for decisions on Medicaid reimbursement on the state level, Morrisette pointed out.

The board voted to retain the services of HDR Company of Omaha, Neb., to prepare master plans for expansions of hospital facilities and service through 1990. The fee payment to the firm will be \$110,000, with reimbursement for expenses not to exceed \$20,000. Half of the cost will be paid by the East Carolina University School of Medicine.

The trustees were reminded of the budget workshop to be held in conjunction with the Pitt County Commissioners June 15, the day of the next hospital board meeting.

Hospital plant manager Ralph Hall reported that work on the expansions of the dining room, special services department, laboratory and medical records department is 7 percent complete.

Associate Director Rick Gilstrap said a U.S. Department of Health and Human Services validation survey team will visit the hospital June 9-11.

Gilstrap also reported on an apparently abrupt growth in hospital patient population. The patient count has averaged 413 for the past seven months, he said. Recently a record 443 was reached. Last week that went to 463. Sunday there were 482 patients; Tuesday, 500.

Associate Director for Nursing Betty Trought said that 46 new nurses start to work at PCMH Monday, 40 of them new graduates.

All but one of the 36 new nurses who are ECU graduates participated in the Nurse Extern Program last summer and many worked part-time through the year, she said. She said use of students is helping the hospital several ways: the quality of their work is good; they are gaining on-the-job experience which lessens the need for orientational training later, and many are knowing when they're hired full-time what the hospital and the work here is really like.

She said nurse recruit Helen Abbott has good hopes of adding at least 54 more new nurses between now and October, many from Pitt Community College which holds its graduation in August. She said that if Ms. Abbott can continue to do as well with recruitment and she with nurse retention (about 20 percent turnover this past year) the hospital may not have a nurse shortage next year this time.

Provisional staff privileges were given to

Dr. Joyce Mitchell in emergency medicine; provisional consulting staff privileges to Dr. Satpal Grewal in radiation therapy; courtesy staff privileges (until he establishes a Pitt County residence) to Dr. James Holland in ophthalmology; and consulting privileges to Dr. Clifford Kiehn and Dr. Paul Cunningham.

Approval was given for the purchase of \$63,992.40 of equipment for purchasing, laboratory medicine, operating room, respiratory therapy, central distribution and administration.

ECU Medical School Dean William Laupus said the move into the Brody Medical Science Building will begin in July and that plans for the radiation therapy center of the medical school are proceeding, with plans to be ready to accept bids by the end of this year. He said there will be 64 members of the entering medical school class, with 90 percent saying they wish to be primary care physicians, 60 percent in the field of family medicine.

Dear Abby



Pollsters Rank Low In Reader's Opinion

By Abigail Van Buren

© 1982 by Universal Press Syndicate

DEAR ABBY: In my opinion the Gallup Poll's list of the top 24 professions in order of their reputation for honesty, integrity and ethical standards reveals a high degree of non-professionalism.

Policemen, congressmen and salesmen would no doubt have ranked differently had the terms "police officers, members of Congress and sales representatives" been used, thus recognizing the important contributions women have made to these professions.

And why were nurses, secretaries, schoolteachers and other predominantly female professions omitted?

You can put "pollsters" down at the bottom of my list for integrity and ethical standards.

APPALLED IN PA.

DEAR APPALLED: Move over. A lot of readers were also appalled. But here's a letter from at least one who had a kind word for the piece:

DEAR ABBY: Seeing pharmacists ranked No. 2 on the Gallup Poll list of professionals in order of their reputation for honesty, integrity and ethical standards offered a small consolation to my husband who is a pharmacist.

He's sometimes treated like a pest when he phones doctors' offices to verify prescriptions as he is required to do by state and federal law.

He's insulted by rude, impatient customers who resent being kept waiting until "all that red tape" is completed before he gives them their prescriptions.

He's even faced a crazed drug addict whose trigger finger was nervous on the gun because my husband wasn't moving fast enough to fill his bag with drugs.

Small wonder none of our children want to follow in Dad's footsteps and become pharmacists.

SMALL-TOWN PHARMACIST'S WIFE

DEAR WIFE: You think your husband has problems? Read on:

DEAR ABBY: Recently when the Gallup Poll listed the 24 most "respected" professions, the most important profession of them all didn't even make the list. I refer to agriculture! Since the beginning of civilization, farmers have performed the most indispensable service to mankind — feeding the people.

Farmers today have to be knowledgeable not only in agriculture, but also in veterinary medicine, politics, mechanics and economics — to name a few. They are also at

the mercy of unpredictable weather, government policies and world politics.

Perhaps that's why, in a recent government survey, farmers are listed as having one of the highest stress levels of all workers.

NO RESPECT IN COLORADO

...

DEAR ABBY: Nuts to your suggestion that the cost of the wedding should be split 50-50 between the bride's family and the groom's.

I think the family that wants a big splashy wedding should foot the bill. If they both want it, they can split it, but if only one wants it, the one who wants it should pay for it. PAID FOR THREE AND WANTED NONE

DEAR PAID: Your suggestion makes a lot of sense to me.

CONFIDENTIAL TO WAITING FOR JUSTICE AND FREEDOM IN KENTUCKY, the 23-year-old male in jail, facing the death penalty for murder: Yes, I do want to hear from you. Please write.

DEAN'S LIST

BOONE — Students who made the dean's list at Appalachian State University for the spring semester included David Kent Holley, Lawrence Warren Jones and Donna Kay McLawhorn, all of Greenville; Gloria Luanne Keel of Bethel, and William Thomas Whitehurst of Grifton.

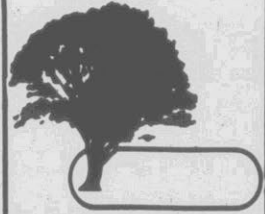

"A NEW WAY OF LIFE"

Your Best Look

314 Plaza Dr.

Announces The Introduction of their

WEIGHT LOSS PROGRAM That Works

Professional Supervision Available At All Times. No Gimmicks Or Fad Diets.

Slim Down - Lose Pounds & Inches Permanently. Individual Counseling Provided.

Call 355-2969

And Get Ready For The Summer Months Ahead!

Make Your Face More Beautiful As You Trim Your Body At Our Skin Care Salon!

The Stretchy... a stretchy slip-on sandal made cushiony with our Red Carpet® insoles. In pastel multi and navy or beige solid.

Only \$26.

The Triad... a strappy, stretchy slip-on also features heavenly comfort. Bright multi and navy or beige solid.

Only \$29.

Sizes 10½ or over, add \$2 per pair. Special orders, no extra charge.

| N | M | W | WW |
|-------|------|------|------|
| 6½-12 | 5-12 | 5-12 | 5-12 |

We have lots of styles in your size. (But not all sizes in all styles.)

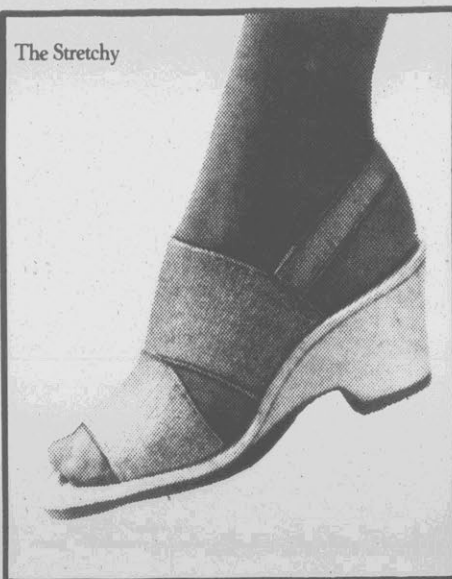

The Stretchy



The Triad

Stretchy Springtime Slip-ons

We've made a fashion out of comfort.



The One-Stop Shop for Sizes, Widths, Selection & Service

Revelations®

Carolina East Mall Greenville, N.C. 756-8944

Mon. to Sat. 10 am to 9 pm



Shop 10:00 A.M. till 9:00 P.M.

Phone 756-9955

LAYAWAYS



Fantastic Weekend SALE



CAROLINA EAST MALL

With Weekend Specials You Don't Want To Miss!!

These 20% Specials This Thursday, Friday and Saturday Only

20% Off

Entire Stock of

Swimsuits

We've Got Just

The Suit For You

Missy Or Junior Sizes

1 Or 2 Piece Styles In

The Finest Name Brands

20% off T-Shirts

Due To Great Response We Are Repeating This Great Savings On T-Shirts.

Don't Miss It!

Hundreds & Hundreds Of Styles

To Choose From.

Herman Geist

Not Included

Sale T-Shirts Get TWO For \$9.90

V-Neck And Round Neck Styles In Summers Brightest Sizes S, M, L.

Skirts

Group Of Sale Skirts Many Styles Like -

Straight Skirt Featuring Zip Front, Knee Pleat, & Pockets In Solid Poly/Cotton.

Was \$35.00 Now **\$23³³**

Print Umbrella Skirt \$19⁹⁰
Button Up Front In Navy And Green Print Was \$26.00 Now

A-Line Skirt \$21⁰⁰
Draw Waist Features Pockets And Hawaiian Print Was \$28.00 Now

Many, Many Other Styles To Choose From

Large Group
Shorts
Super Value Only
\$10⁰⁰

Shorts
Good Selection Of Sale Shorts
Sale **\$11⁹⁰**
And **\$13⁹⁰**

Many Other Sale Items Too Numerous To Mention!!!

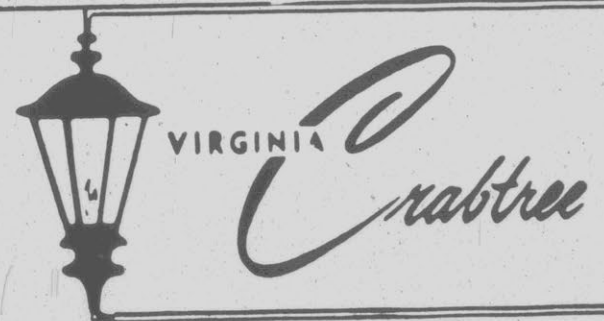

CAROLINA EAST MALL GREENVILLE

New Revolution Ahead

A financial firm recently informed its customers that interest paid on a special fund could be obtained daily by calling an 800 number.

The number, if called, will give the figures in an efficient female voice which is the forerunner of the talking robots that are eventually going to be a part of our lives.

If you think that the information can be recorded by a human for replay, you are correct. There is more, however. Customers with money in the fund can punch in their account numbers. The voice will give the account balance at that time.

It is but another graphic example of how quickly computer technology and delivery of information is changing our lives. If an account

balance can be given us by a computer voice, any individual stock quotation can be given the same way — over the phone and by demand.

Large amounts of information can be obtained by attaching a printer at the home end of the phone line to deliver what is known as a "hard copy."

It is only a matter of time before information on almost anything will be available to us at home and as we ask for it — at a price, of course. It will not only change our personal lives, but it will greatly alter the way business is transacted and even the way our industries operate. It can well be the foundation for the next wave of prosperity such as was brought on by the industrial revolution.

Airlines Can Meet Needs

Braniff International Corp. last week announced the cessation of flights and ordered all its employees not to report to work.

The airline had run out of funds. It hopes to reorganize under court protection and resume operations.

It is distressing when a major corporation such as Braniff runs into financial difficulties. Passengers were inconvenienced and all the airlines' employees found

themselves, with a chilling suddenness, out of work.

It will be argued for sometime as to what was the cause of Braniff's problems. For the most part it can be blamed on the competitive nature of air service at present.

The Braniff situation is a matter of concern to the nation, but it is not a national disaster. There is still an adequate number of airlines with sufficient planes to meet the needs of the traveling public.

THIS AFTERNOON

Scott Cites Need

By PAUL O'CONNOR
RALEIGH — You can tell former Gov. Bob Scott isn't running for political office this year by the speech he's making on the political circuit. In talks across the state and on public TV, Scott is saying the state's politicians should face up to the need for tax increases.

"We cannot keep saying no new taxes," he said while taking part in a panel discussion on UNC-TV. "If you do (keep cutting) and you keep revenues down, the quality of services is going to decline."

Between Scott's administration (1969-73) and last July, there were no general tax increases in North Carolina. Gov. Jim Holshouser did not raise taxes during his term and Gov. Jim Hunt promised the same thing for his first term. Hunt pushed through a three-cent gas tax increase last year and wants higher alcohol taxes to help the Highway Fund. But Hunt says he will not ask for any other kind of tax increase.

During Scott's administration, the General Assembly approved a two-cent tax on cigarettes, a one-cent tax on soft drinks and increased

gasoline taxes by two cents. Since then, economic growth has brought in revenue "that enables state government to continue to improve programs and add a few along the way". But those days of painless revenue growth may be over, he says. "You're either going to have to cut back, or have more revenue."

The state's highway construction program is about to



PAUL O'CONNOR

run out of money and public schools are being forced to cancel programs. Yet, people continue to complain of high taxes and politicians keep promising lower taxes. "North Carolina has probably some of the lower ad valorem taxes in the country. But yet we squawk like the dickens when someone talks about raising taxes... This is all going to get us somewhere down the road. We can't keep putting these things off forever," he said. Several speakers at the Child Watch conference

warned that this is a bad time to seek new programs for children. Scott responded that people said the same thing when he pushed his kindergarten program in 1969. "We didn't have the money back then, either. So I went to the legislature and I'm still disliked by some because I got the first ever tax on tobacco... and soft drinks in this state. If you want it, you have to pay for it, and someone's going to have to pay for and fight for it."

"For a long time, candidates for office have been saying that if you support me, you won't have any new taxes... I wish they'd say that if you support me you won't have any more taxes but I wish they'd go one step further and say this is what's going to happen... your services are going to be cut."

Scott says he won't get involved in the question of

(Please turn to Page 10)

Other Editors Say Undercut Critics

The Fayetteville Observer
The Fayetteville Times

Knee jerk fulminations are not unique to liberal Democrats. Thursday almost 30 New Right and anti-abortion groups rather passionately asked President Reagan to fire the director of the National Institute of Health — Dr. James B. Wyngarden, formerly of Duke University's department of medicine. The poor man had chanced to say that whether to have an abortion was in his opinion a "personal" matter that should be "up to the individual," not regulated by the government.

Dr. Wyngarden's position is a popular one that conflicts directly with the position of Sen. John East, R-N.C., sponsor of a proposed anti-abortion amendment to the Constitution. But that did not impel the professorial Sen. East to abandon reason with an attack on the good doctor's right to express his opinions while he does his federal job. No, Sen. East said, his fellow members of the New Right were wrong. It is not, he opined, necessary for every appointee to meet some kind of ideological "litmus test." East said he saw no evidence Dr. Wyngarden would let "his personal views adversely affect his position..." as a public servant.

Sen. East's refusal to support an anti-abortion witch hunt is refreshing. He has not heretofore drawn attention to himself by being a model of tolerance for dissenting views. By doing so now, he has undercut shrill charges that all members of the so-called New Right are simple-minded dogmatists, and that North Carolina somehow nurtures such people.

Strength For Today

LONELINESS

What was the loneliest moment of your life? Can you remember your first day at school, when your mother left you in a strange room full of strange children? Perhaps you can recall your first night away from home, when the darkness closed over you in an unfamiliar bed, and you would have given anything to be back home in your own room.

How can man be so lonely in a world of men? Yet it happens all the time, and the

LOCKSTEP!

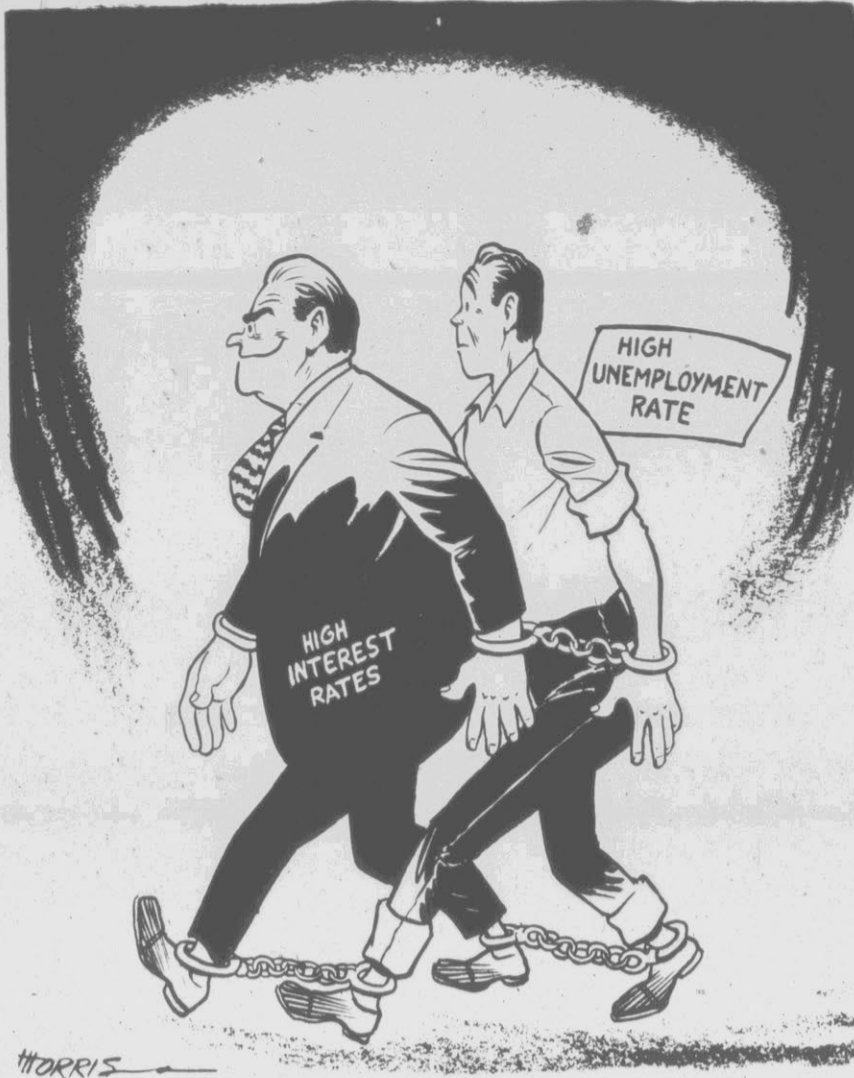

BY ART BUCHWALD

Practice Evacuation

Unlike most people, I take Civil Defense very seriously. While the evacuation plan for Washington hasn't been fully worked out, I know what we're supposed to do. When the sirens go off, we're all to get in our automobiles, grab our credit cards and head for Lickety Split, West Virginia.

The other evening around five o'clock I decided to take a dry run. I came home and told my wife, who was in her housecoat and curlers.

"Get in the car, we're going to have a practice evacuation drill."

"Let me get dressed first." "You don't have time. Do you think when the real thing happens, the Russians are going to wait for you to get all gussied up? Grab the credit cards and let's go."

"What credit cards should I take?" she asked.

"American Express, Visa, Master Charge and Diner's Club." I told her. "If we use up our credit line on one, we can switch to another."

"Do you have gas in the car?" she wanted to know.

"I have half a tank."

"That won't get us to Lickety Split."

"I'm sure if the real thing happens, the Civil Defense people will have emergency gasoline trucks all along the highway. After all, they can't expect us to evacuate Washington during an atomic bomb attack and not supply the petrol. Now stop talking and get in the car. We have to pretend this is not a drill."

As soon as we got near Key Bridge, we found cars bumper to bumper. My mov-



ART BUCHWALD

ed 10 feet every five minutes.

"What's going on?" my wife wanted to know.

"It's normal rush hour traffic," I explained.

"If it's like this now, what's it going to be like when they try to evacuate the entire city?"

"They'll have National Guardsmen on every corner to move the traffic along," I said. "It wouldn't surprise me if they emptied Washington in 20 minutes. The Soviets are in for a shocker when their missiles hit Ground Zero and find nobody there."

We made it over the Key Bridge in 45 minutes and moved smoothly along the George Washington Parkway at 25 miles an hour until we hit the Beltway and were

slowed down to 15."

"I guess you didn't get out of town as fast as you had hoped," my wife said.

"That's because this is just a drill. When people know they're racing against a Soviet ICBM, they'll be doing 80 miles an hour."

"How do we get to Lickety Split?" my wife asked.

"I told you to always keep a map of West Virginia in the car. You never listen to anything I tell you."

She started to cry. "Let's go back."

"We can't go back until the Civil Defense people tell us it's safe. Washington, as far as this drill is concerned, has been completely vaporized."

By asking directions from 40 people, we finally got to Lickety Split six hours later.

It was dark, and no one was on the streets. We knocked on the door of a farmhouse. A man carrying a shotgun answered it.

"Hi," I said, "we're from Washington, D.C., and we were told to come to Lickety Split in case of an atomic attack. We thought we'd arrive early and look the place over just to see where we'd be the most comfortable."

"You got one minute to get off my farm."

"Don't shoot. Haven't you heard from the federal Civil Defense people? You're supposed to open your homes to us until they can rebuild the capital."

"Fifteen seconds."

My wife pulled me away from the door towards the car.

"I'm reporting you to the Federal Emergency Management Administration," I yelled at him. "You're making their atomic war evacuation plan into a farce."

They'd Jump At 'Routine'

By MAXWELL GLEN and CODY SHEARER

WASHINGTON — Each spring, as college seniors prepare for their last all-nighters, they get wind of some poisonous information.

Specifically, they learn that petroleum engineers and computer scientists will garner the top salaries after graduation. This year, such lucky dogs will start work at \$31,000, on the average.

For the vast majority of today's "career-oriented" seniors, however, these annual bulletins offer little solace. The salary report serves as the final "class rank" by which graduates enter the real world. It says nothing about who's career-conscious and who's not; everyone is.

Peer competition, in fact, only heightens the sense of urgency that nagging parents and high unemployment lend to securing a post-commencement job. Only 14 years after Dustin Hoffman (in "The Graduate") looked askance at a career in "plastics," the Class of 1982 seems desperate for just such an opportunity. Better to hitch on to a well-paying routine, they reason, than to languish in the uncertainty of experimentation.

For many, that means taking the plunge into banking. Almost daily, for example, several dozen Brown University seniors rise at dawn to sign up for interviews with bank representatives. As elsewhere, the competition is fierce for "bank trainee" slots at places such as Citicorp, Manufacturers Hanover and First National Bank of Boston.

"Most of the students on line want to live in New York or Boston and make enough money to afford a high lifestyle," admitted David Marcus, Brown senior class president. "They definitely aren't fascinated with IRA's (individual retirement accounts)."

Certainly, there's a rich

tradition of bank apprentices who work their way from teller up to senior vice president. But as the managerial ranks of financial houses have expanded (more than 50 percent) since 1972, banking opportunities have become a salvation for many panicked seniors. Some 10,000 of this year's graduates, according to the American Bankers Association, will have been saved by September.

Said Dave Huddleston, college recruiting manager for Chase Manhattan Bank: "We're reaching out to a lot more students today. We're looking for the well-rounded recruit. All our clients aren't business majors, so why should our employees be?"

Indeed, it seems that undergraduate desperados don't need much background to make a career out of finance. Headhunters notice good presentation, reasonable numbers skills and affability.

Oddly enough, Brown's Marcus told our reporter, John Riccardi, that at least half of all bank-bound graduates "have the notion that they'll be in banking for only five years, just to make a little money and move onto something less stodgy." Nonetheless, the banking world's consistently low turnover rates indicate that many graduates apparently enjoy their new life too much to think there could be any other.

We understand that an almost irrational fear of poverty tends to afflict seniors during their final year. At 22, many seem to feel that time is running out on them.

Yet, there is also something to this "technological age" that seems to breed among our contemporaries a lack of confidence in non-technical areas. With the attention given to math and science wizardry, many graduates forget (or never realize) that

(Please turn to page 10)

Public Forum

Letters submitted for Public Forum should be limited to 300 words. The editor reserves the right to edit longer letters.

To the editor:

Well, the plows have raked the field at Ficklen Stadium. There will be nice green grass next fall for ECU and Rose High football. And in case any of us didn't already know, we've had redefined for us, by university and public school officials, just exactly what it is about education that's most important — football. Even here near the end of the 20th century, we haven't gotten beyond a system of values in which education exists as a front to keep the gridiron going... to keep the savagery a little respectable looking.

Meanwhile, what about the taxpayer whose money goes to refurbish and upkeep that great property over at Ficklen? In an economy in which we all find it hard to make ends meet, how long will we go on paying for such luxurious properties which see so little use? While it is deplorable that no way was found to accommodate the Rose High Graduating Class of 1982 in Ficklen Stadium, it is even worse that our society allows such a gigantic waste of facilities at such great expense while some go hungry and others struggle to keep roofs over their heads. How can we pretend we live in such affluence as to tolerate this mess that even allows room for controversy in the use of a property that lies idle and empty 90 percent of the year? Where is the conscience of the system? Is there one?

Mrs. Kenneth E. Robinson
213 Glenwood Drive
Greenville

Private Sector: Main Engine

By JOHN CUNIFF
AP Business Analyst

NEW YORK (AP) — As the White House views the economy, "the private sector is the central engine of economic growth and progress."

That's the way it was described a few days ago by Murray Weidenbaum, chairman of the president's Council of Economic Advisers. The engine, he suggested, is being stoked and soon will roll down the tracks.

"It is in the private sector that products are created, markets are developed, factories are built, productive jobs are generated, and economic progress truly advanced," he reminded those who, in the midst of recession, might have lost sight of the White House's goals.

As he spoke, however, the engine sputtered and coughed, the sounds of illness rather than health. It hissed with escaping power rather than roared with strength.

Its wheels slipped on the rails.

"Nobody is forecasting an economic Valhalla," said Weidenbaum. "But we really are setting in place the basis for a healthy and sustainable period of growth in the 1980s." And that provokes the question asked more often with each passing day: When in the 1980s will growth begin?

So far, there is very little evidence that much expansion will occur this year, and the worst news of all seems to come from some of the strongest supporters of the president, that is, large businesses.

If business is planning for growth it isn't very obvious. Surveys continue to show little enthusiasm for exploiting the promised economic growth, and many companies have even lowered their spending goals.

The most recent survey by McGraw-Hill shows big cutbacks in capital spending plans, leading to the conclusion that after adjusting

for higher prices there will be a spending decline rather than an advance.

"For the rest of the year," concludes Business Week magazine after examining the survey results, "most businesses will concentrate more on survival than expansion." The comment is typical of other assessments increasingly being made by business and academic economists.

To Weidenbaum, the lag in business investment is nothing exceptional. "Capital spending is traditionally the lagging sector of the economy, and we are seeing that pattern today," he states. But critics point out that tax incentives were supposed to have destroyed that pattern.

They haven't. In his address, to a St. Louis business audience, Weidenbaum confessed that rapid expansion in capital spending "depends heavily on our success in bringing interest rates down much further than we already have." In effect, high rates are offset-

ting tax cuts.

But there is always the consumer, and the consumer will get a 10 percent across-the-board personal tax cut on July 1. This, Weidenbaum claims, "will provide a shot in the arm to the American economy."

The consumer? Long memories will recall the argument that it was an overemphasis on consumption and too little understanding of the need to expand production that got the economy into its current mess.

They will recall the theory of reindustrializing America, of funneling funds and energy into making the engine of production more efficient and productive, and that tax benefits should be given toward that goal.

They will recall also that it became part of the president's program, and they might therefore become a bit confused that it is the consumer again who is being relied on to bring the country out of recession.

The Daily Reflector

INCORPORATED

209 Cotanche Street, Greenville, N.C. 27834

Established 1882

Published Monday Through Friday Afternoon and Sunday Morning

DAVID JULIAN WHICHARD, Chairman of the Board

JOHN S. WHICHARD — DAVID J. WHICHARD

Publishers

Second Class Postage Paid at Greenville, N.C. (USPS 145-400)



SUBSCRIPTION RATES

Payable in Advance Home Delivery By Carrier or Motor Route Monthly \$4.00

MAIL RATES (Prices include tax where applicable)

Pitt And Adjoining Counties \$4.00 Per Month

Elsewhere in North Carolina \$4.35 Per Month

Outside North Carolina \$5.50 Per Month

MEMBER OF ASSOCIATED PRESS

The Associated Press is exclusively entitled to use for publication all news dispatches credited to it or not otherwise credited to this paper and also the local news published herein. All rights of publications of special dispatches here are also reserved.

UNITED PRESS INTERNATIONAL

Advertising rates and deadlines available upon request. Member Audit Bureau of Circulation.

Belk Tyler

carolina east mall greenville

MAY DAZE
THURSDAY,
FRIDAY,
SATURDAY
ONLY!
SALE

Up to \$8 Off on Lovely Jewelry
 and Earring Boxes!
2.88 to 15.88



Regular \$5 to \$24
 Large selection of velvet lined boxes to store your jewels! Your choice of vinyl, floral fabric or simulated leather coverings in a variety of sizes. Some with hinged lids, pop up drawer and more. Stock up and save today!

Save Over 6.00
 on Comfortable
 Knit Tops Now!

7.88

Regular \$14
 Group of 100% cotton tops in rose, lilac, white and bone colors. Select from many styles and patterns all in sizes S, M, L.



Big \$11 Savings
 on Knit Shirts!

Reg. \$20 **8.88**

Oscar de la Renta® shirts of polyester/cotton with 3 button placket. Solids, stripes. In sizes 7 to 14.

Denim and Twill
 Shorts for Girls

Reg. 7.00 **3.88**

Large selection of shorts made of cotton denim and twill. Your choice of many colors. Elastic waist and belt. Sizes 7 to 14.

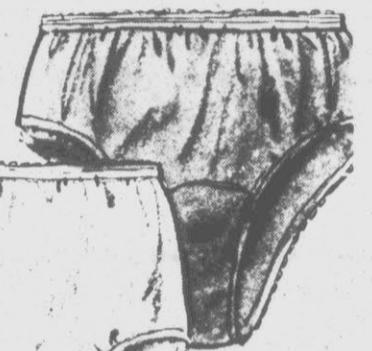

Super Bargain on Bikini and Hipster Panties

97¢

Special Purchase

Group of Dacron® polyester/cotton panties with elastic waist and legs. Choose from prints and solids. Pastel colors. Hurry while they last!

Junior Blouses Reduced
 Over 25% for You!

11.88

Regular \$16

Dacron® polyester/cotton red, navy and blue color blouses in both checks and solids. Sizes S, M, L. Save!

Great Buy
 on Skirts

Great for Summer!

9.88

If Perfect \$18

Large assortment of cool polyester/cotton poplin button front skirts in several colors. Sizes 5 to 13 and 6 to 18.



Cool and Comfortable Patio
 Dresses Reduced Over \$9!

Regular 25.00 **15.88**

Polyester/cotton dresses all with precured durable press finish. Solids and plaids.

Long and Short Sleepwear
 Reduced Over 7.00!

Regular 18.00 **10.88**

Your choice of long and short summer sleepwear made of DuPont Antron® III nylon satin tricot. Several colors and styles. Pink, blue, mauve.

Big 24% Savings
 on Sundresses
 Just for Her!

4.88

Reg. 6.50

Polyester/cotton dresses in 4 styles. Smocked top print, smocked top, flounce hem, solid smocked top, lace bottom smocked top. Sizes 4 to 6X.



Summer
 Sleepwear
 for Juniors
 Over 7.00 Off!

10.88

Regular 18.00

Polyester/cotton sleepwear including short babydolls, long babydolls, knicker sleepers, long robes, short robes, terry rompers and knicker jumpsuits. Easy care in pastels.

Shop Monday through Saturday
 10 a.m. Until 9 p.m.
 Phone 756-B-E-L-K (756-2355)

Belk Tyler

carolina east mall greenville

Converse® Leather and Canvas Shoe Sale!

16.88 to 39.88

Reg. \$20 to \$47
Converse All Star® athletic shoes in both low and hi-top styles. Thick rubber sole, firm arch support and more.

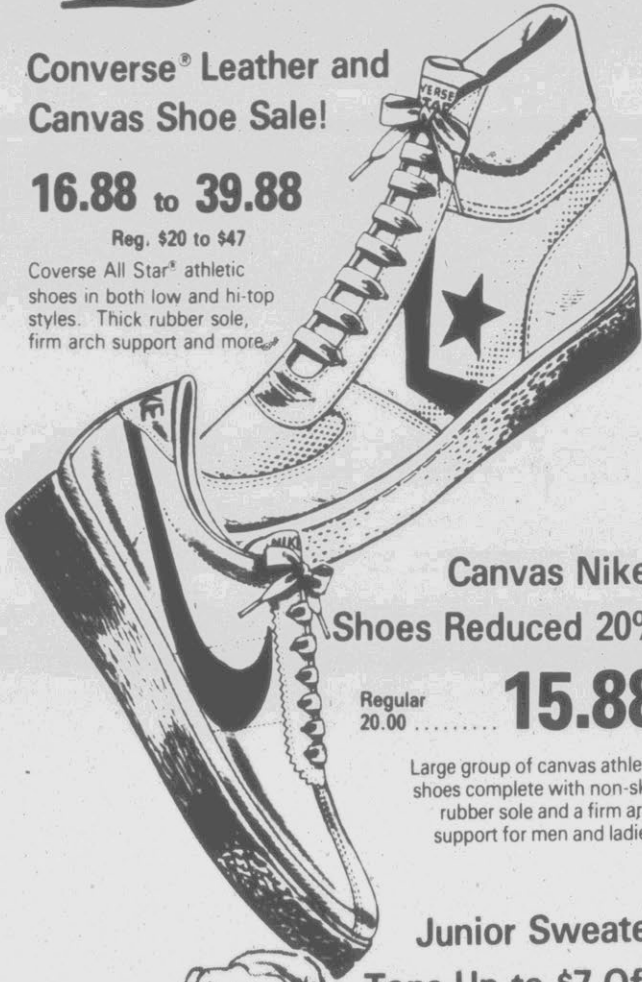

Canvas Nike® Shoes Reduced 20%

Regular 20.00 **15.88**

Large group of canvas athletic shoes complete with non-skid rubber sole and a firm arch support for men and ladies.

Junior Sweater Tops Up to \$7 Off!

Regular \$13 to \$17 ... **9.88** Ea.

100% cotton sweater tops with short sleeves. Double scoop style-neckline with stripes or scoop neck style with a pointelle pattern. Sizes S, M, L. Shop and save!



Save Up to 8.00 on Blouses for Warmer Days!

16.88 Each

Reg. \$20 to \$25

Famous name blouses made of polyester/cotton or 100% polyester. Dots, solids, stripes, florals to choose from. In sizes 8 to 18.



Misses' Knit Tops at a 21% Savings for You!

7.88

Regular 10.00

Large assortment of cotton/polyester tops in light blue, white, navy and red colors in two styles. Pullover with V-neck and roll sleeves or peasant neck and keyhole front. Sizes S, M, L.



Misses' Shorts Reduced Up to \$5 for Warm Days Ahead!

14.88 Each

Reg. \$17 to \$20

Large selection of polyester/cotton twill red, khaki, olive, white and navy shorts available in three different styles. Belted zip front style with jamaica length legs, side elastic style with zip front and bermuda length style with belt loops. Sizes 8 to 18. Stock up!

Shop Monday through Saturday
10 a.m. Until 9 p.m.—
Phone 756-B-E-L-K (756-2355)

- Misses' Coordinate Sportswear
Reg. \$14 to \$24 ... **10.88 and 18.88**
- Junior Short Sleeve Shirt Sale!
Regular 16.00 **9.88**
- Playtex® 18-Hour® Bra Reduced!
Everyday Low Price **10.00 to 10.80**
- Sasson® Knit Tops for Girls
Regular 7.00 **3.88**
- Ladies' LEVI'S® Bend Overs®
Everyday Low Price **19.88**
- Easy Breezy Button Front Skirts
Regular 13.00 **10.88**

- Deck Hugger® Shoes for All
Everyday Low Price **22.88**
- Earrings, Necklaces and More!
Regular \$5 to \$25 **50% OFF**
- Vinyl Handbags at a Savings!
Regular \$48 to \$64 **1/3 OFF**
- Ladies' Dress and Casual Shoes
Regular \$32 to \$64 **25% OFF**
- Hanes® Underalls® Just for Her
Everyday Low Price **2.00**
- Ladies' Sheer Hosiery Reduced!
Everyday Low Price **1.60**

Jordache® Jeans for Juniors at an \$8 Savings!

29.88

Regular 38.00

Group of 5-pocket straight leg jeans made of 100% blue denim. Complete with fancy stitching and Jordache label. Sizes 27 to 33. Great buy!



Cool Knit Tops for Misses' and Juniors

Jr., Reg. 12.00 **8.88**
Misses' Reg. 14.00 **9.88**

Famous name knit tops made of cotton and polyester. Available in red, green, white, navy, royal, purple, yellow, tan and pink colors. Short sleeve pullover style with mandarin V-neck or ribbed collar. Sizes S, M, L. Hurry while our supplies last!



Junior Denim Jeans Reduced Over 10.00 While They Last!

19.88

Regular 30.00

Selection of 100% cotton denim jeans made by LEVI'S®. Your choice of 5-pocket Western straight leg style or a 4-pocket straight leg belted style. Sizes 3 to 15.

Knit Tops on Special for Misses' and Juniors

5.88 and 6.88

Reg. \$7 to \$9

Cotton and polyester knit tops available in several styles. Pullover cap sleeve style with double V, round or V-neck to select from. Sizes S, M, L in a variety of colors to brighten your wardrobe!



Blouses for Girls at a Great Price Now on Sale!

6.88

Regular 8.50

Polyester/cotton short sleeve tops great to wear with shorts, skirts or whatever! Stripes and prints. Sizes 7 to 14. Hurry in and save!

All Weather Coats Drastically Reduced

25.00

80.00 Value

Polyester/cotton long all-purpose coats of poplin. Fly front, belt, contrast color inside collar. Sizes 6 to 16.

Fantastic 24% Savings on Short Shorts for Juniors!

Regular 13.00 **9.88**

Large assortment of polyester/cotton shorts in pink, gold, royal, white, tan, navy, red colors. Choose from elastic waist pull-on, zip fly front with belt and pleated styles. Sizes 5 to 13. Stock up while they last!



Belk Tyler

carolina east mall greenville

MAY DAZE
**THURSDAY,
 FRIDAY,
 SATURDAY
 ONLY!**
SALE

**Big Savings of Over \$10 on
 Summer Dresses Just for Her!**

Regular 30.00 **19.88**

Polyester/cotton and all Dacron® polyester sheer dresses to keep you cool. Misses' and half sizes.

**Up to \$5 Off on Junior
 Swimsuits for Summer!**

Regular \$12 and \$18 **8.88 and 12.88**

One and two-piece styles made of Lycra®. Prints and solids. In sizes 7 to 13.

**Sportswear
 for Girls Up
 to 39% Off Now!**

Regular \$7 and \$8 **4.88**

Shirts, shorts, knit tops, peddle pushers and more in sizes 4 to 6X, 7 to 14. Stock up!

**Fantastic \$10 Savings
 on Dresses for Summer!**

Regular 40.00 **29.88**

Dacron® polyester dresses perfect for all occasions. Solids, prints. Sizes 8 to 20.

**Up to \$12 Off Sandals and
 Dress Shoes for Ladies!**

Regular \$40 to \$48 **25% OFF**

Famous Etienne Aigner® sandals and dress shoes in Aigner wine, taupe colors. Select from our entire stock and save! Sizes 7 to 10. Hurry in today for the best buys.

**Jacket Sundresses
 Reduced Over 10.00!**

Regular 40.00 **29.88**

Large selection of polyester and cotton print sundresses complete with matching solid jackets. In sizes 8 to 16 and 5 to 13. Save!

Half-Size Seersucker Dresses

Regular \$30 **22.88**

Ladies' Floral Print Blouses

Regular \$18 **10.88**

Save \$27 on Dressy Blouses!

Regular \$52 **24.88**

Designer Knit Shirts Reduced!

Special Value **14.88**

Ladies' Shorts for Summer

Regular \$14 **11.88**

Half-Size Sundresses \$4 Off!

Regular \$24 **19.88**

Back-Wrap Skirt Reduced \$4!

Regular \$18 **13.88**

Colorful Slacks Just for Her

Regular \$16 **12.88**

Girls' Elastic Back Jeans

Regular \$12 **7.88**

**Over \$5 Off on Cool
 Jr. Sundresses!**

Regular 25.00 **19.88**

Large group of polyester/cotton sundresses in several styles to choose from. Summer brights and pastels in a variety of prints for you! Junior sizes 5 to 13. Hurry!

**Lovely Dresses
 Reduced Up to
 \$29 for Juniors!**

32.88 to 46.88

Reg. \$52 to \$76

Famous Act I® dresses great for summertime! Well tailored in several classic styles to select from. Polyester/cotton. Easy care.

**Easy, Breezy Dresses
 Reduced Over 9.00!**

Regular 48.00 **38.88**

Large selection of sundresses in summer bright prints. Made of Dacron®/cotton for easy care convenience. Stock up now while our prices are right. In sizes 6 to 14.

**Misses' Dresses Up to
 \$15 Off Just for You!**

Regular \$40 to \$60 **25% OFF**

Select group of ladies' summer dresses by famous makers including some sunback styles. Dacron®/cotton and polyester. Solids, prints. Sizes 6 to 16. Save!

**Girls' Swimsuits at
 a 34% Savings Now!**

Reg. \$12 **7.88**

Large group of one and two-piece style suits. Basic racer, racer with stripes, free back with piping, shoe strings and more.

**Big \$23 Savings
 on Bold Plaid
 Blazers!**

26.88

Regular \$50

Dacron®/cotton plaid blazers in many bold and earth colors to select from. Pay \$5 down and put a blazer on layaway! Available in sizes 4 to 16. Save!

Belk Tyler

carolina east mall greenville

Household Kitchen Gadgets
Special Purchase **88¢**

Place Mat and Napkin Set of 4
Special Value **4.88 Set**

Metal GE Steam and Dry Iron
Special Purchase **13.88**

Cotton Terry Pot Holder Sale!
Special Value **28¢ Ea.**

Large Printed Beach Towels
Bargain Price **12.88**

Strawberry Print Napkin Sale!
Special Buy **28¢ Ea.**

Savings on Straw Table Mats
Special Value **57¢ Ea. or 2 for 1.00**

Decorative Napkin Ring Sale!
Special Value **28¢ Ea.**

Special on Acrylic Table Mats
Originally 2.00 **1.27**

Stainless Steel
5 Pc. Mincing Bowl Sets Limited Quantity **8.88**

MAY DAZE
THURSDAY, FRIDAY, SATURDAY ONLY!
SALE

6-Pc. Steak Knife Set Reduced \$8!

Regular 19.95 **11.88**

All stainless steel knives with pistol handles made to last and stay sharp. Makes a nice gift!

33% Savings on 20-Pc. Stainless Flatware Set

Regular 12.00 **8.88**

A quality stainless steel set of four. Set includes place knife, place fork, salad fork, teaspoon and place spoon. Save!

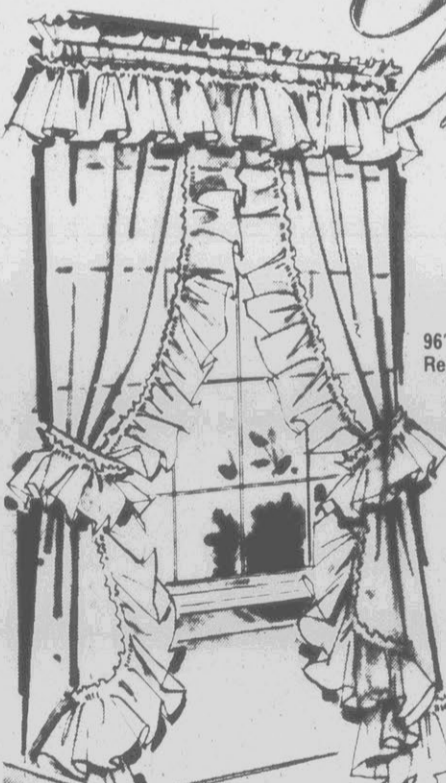

'Old Salem' Curtains at a Savings!

96" x 63" **14.88**
Reg. 19.50

96" x 84" **15.88**
Reg. 21.00

'Old Salem' priscilla curtains with 7" ruffle for the colonial muslin look! White and beige. Polyester/ rayon which is easy care for you!

Save \$71 on Family Size Microwave

\$229

Regular \$300

Saves you space and energy. Includes 15-minute rotary timer, wood grain decor, interior oven light plus a see-through oven window.

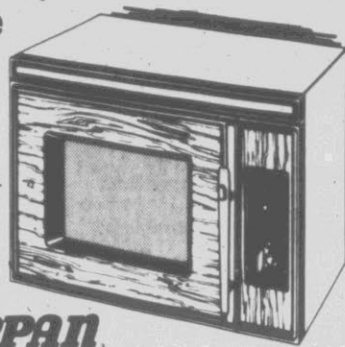

TAPPAN

Microwave with Temperature Probe

\$339

Regular \$480

You can program this oven to automatically defrost and cook your food! Family size oven with black oven door, digital readout, temperature probe and more. Hurry while they last!

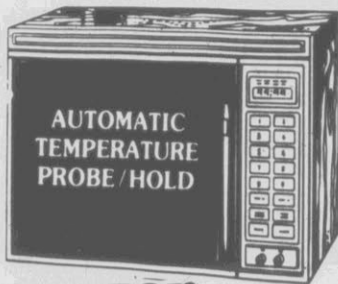

TAPPAN

Tap 'N Touch Oven

Reduced 90.00!

\$439

Regular \$529

Microwave with a removable glass bottom, Tap 'N Touch controls, solid state reliability, ten power levels and much more.

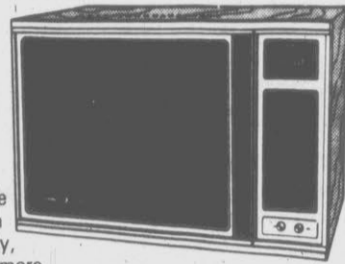

Over \$8 Off on Large

'Breeze Box' Fan

Regular 29.99 **21.88**

Keep the air circulating on warm days ahead with this versatile three-speed box fan. Place in a window, on the floor and more.

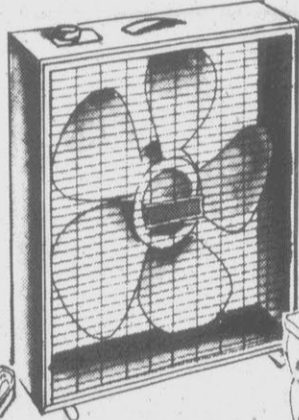

Bed Sets by Burlington®

Just for You!

14.97

19.97

Full Set Queen Set

Polyester/ rayon lustersoft ensembles in pastel prints and solids. Includes two pillow cases, flat sheet, fitted sheet.



Lovely 'Alysia' Tablecloth Sale

Special Value **21.88**

Napkins **1.77 Ea.**

Dacron® polyester lace trim white tablecloths available in 62" x 84" oval, 62" x 104" oblong, 62" x 104" oval, 70" round and 18" x 18" napkins. Treat yourself or give as lovely gifts! Hurry while they last!

Damask Tablecloths at a Special Price!

All Sizes Special Value **25.88**

Napkins **1.88 Ea.**

Imported Damask... sleek elegance for your finest dining occasions! In 63" x 84", 63" x 124", 63" x 104" tablecloths and 19" x 19" napkins to match. Hurry while our prices are right! Save!

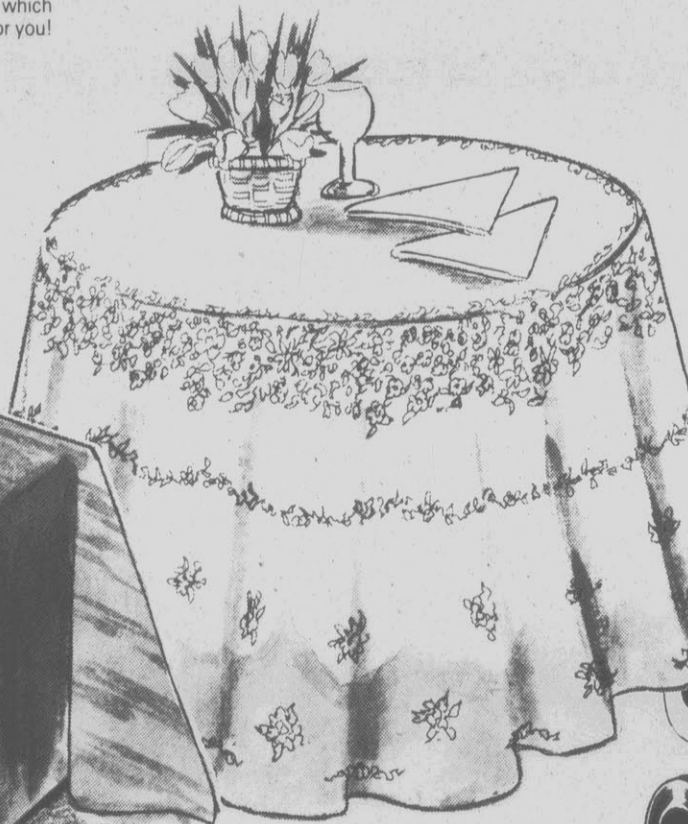

Lovely 'Moire' Tablecloth Sale!

14.88

Special Value

Napkins **1.38 Ea.**

Made of 100% easy care polyester in 52" x 52" square, 52" x 70" oval, 60" x 90" oblong, 60" x 90" oval, 60" x 108" oblong, 60" x 108" oval, 70" round and 90" round sizes. Shop and save today!

Summer Fabrics Reduced for You

2.25 to 4.50

Reg. \$3 to \$6 Yd.

Your choice from our complete stock of summer piece goods. Cotton and cotton blends in a variety of colors. 44/45" and 58/60" widths. Stock up!



Cannon® 'Hillary' No-Iron Muslin Sheets!

3.88 and 5.88

Regular 5.99 and 7.99

Soft muslin sheets available in a variety of colors to brighten your bedroom. Stock up today while our prices are right! Save!



Protective Mattress Pads at a Big Savings!

\$5 and \$6

Reg. 6.99 and 7.99

Large group of protective mattress pads with a new Elasto-band which clings around mattress. Choose from twin and full sizes.

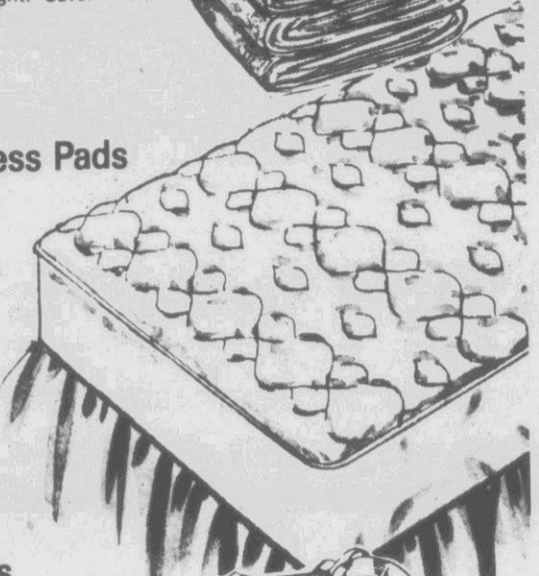

Samsonite® Kicks

Up to \$25 Off!

25.99 to 74.99

Reg. \$40 to \$100

Samsonite Kicks are made of sturdy nylon with washable vinyl lining. Available with handles and an adjustable shoulder strap. Black and khaki.



Save \$20 on Attache Cases!

49.99 and 54.99

Reg. \$70 and \$75

Handsome attache cases show you have good business sense! Your choice of ebony, mahogany and ginger. Get one and save today!



Silhouette® II

Luggage on Sale!

31.99 to 114.99

Reg. \$50 to \$160

Gadget bag, shoulder tote, 24" pullman, 26" cartwheel, deluxe garment bag, 29" cartwheel and much more for ladies and men in cinnamon, brown, blue, wineberry.

Printed Floral Tablecloths!

Special Buy **10.88**

Napkins **97¢ Ea.**

Choose from two prints in four lovely colors. Sizes 52" x 70", 60" x 86", 70" round tablecloths and big 17" x 17" napkins. Save!

Belk Tyler
carolina east mall greenville

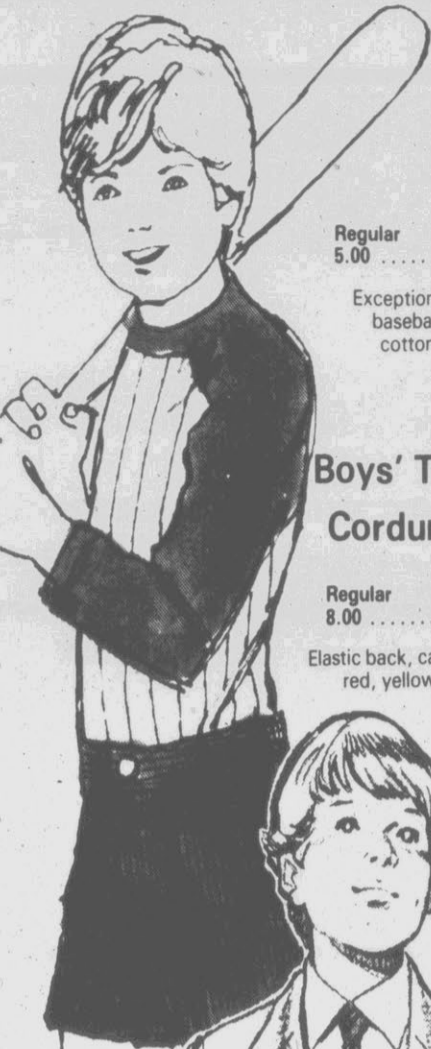

Boys' Baseball Shirts

Regular 5.00 **3.88**

Exceptional savings on boys' baseball shirts. Polyester/cotton. Navy, red, black. Sizes 4 to 7.

Boys' Tuf 'N Ruf® Corduroy Shorts

Regular 8.00 **6.88**

Elastic back, cargo pockets. Kelly, red, yellow, blue. Sizes 4 to 7.



Boys' Summer Suits and Sport Coats!

1/2 OFF

Reg. \$35 to \$140

Famous name brand suits and sport coats of 100% polyester. Solids and stripes. Boys' 3-pc. suits, center vent sport coats. Wide selection to choose from. Sizes 8 to 20.



Men's Short Sleeve Dress Shirts

Regular 11.00 **8.88**

Short sleeve dress shirts of 65% polyester/35% cotton. Solids or stripes in banded collar with chest pocket. Sizes 14 1/2 to 17.

Boys' T-Shirts and Briefs

Regular 3 for 4.29 **3 for 3.44**

Men's Cricketeer® Blazers

Regular 130.00 **99.88**

Boys' Tube Socks on Sale

Regular 6 for 5.17 **6 for 4.88**

Sale! Men's Tube Socks

Regular 6 for 6.49 **6 for 5.22**

Men's Blazers! Great Buy

Special Value **69.88**

Sale! Men's Munsingwear® Knit Shirts

Regular 17.00 to 21.00 **12.88**

Men's and Boys' LEVI'S® Jeans

Special Buy **14.88**

Men's Jordache® Jeans

Regular 38.00 **29.88**

Great Buy on Sport Shirts for Men!

10.88

Special Purchase

Men's Luciean Picard sport shirts. Short sleeve woven shirts in fancy and solid styles. Handsome sport shirts for men who care how they look.

Men's Casual Slacks at a \$5 Savings!

16.88

Regular 22.00

Smart polyester/cotton casual slacks with coordinating belt. Navy, light blue, green, tan, khaki. Sizes 32 to 38.

Member's Only® Jackets at \$15 Off!

39.88

Regular 55.00

Handsome polyester/cotton racing jacket with strip collar. Tan, olive, light blue, red, blue, grape. Sizes 36 to 46.

Boys' Knit Shirts at a 16% Savings!

Reg. 7.00 **5.88**

Special savings on 50% polyester/50% cotton Tuf 'N Ruf® knit shirts. Variety of stripes. Sizes 4 to 7.

Bargain on Boys' Jeans!

Regular \$10 **7.88**

Double knee, durable, easy-care jeans. 75% polyester/25% cotton. Navy denim, green, tan. Exceptional value. By Tuf 'N Ruf®. Sizes 4 to 7. Save!



MAY DAZE
THURSDAY, FRIDAY, SATURDAY ONLY!

SALE



Terrific \$5 Savings on Men's Andhurst® Shirts!

Regular 14.00

8.88

Short sleeve knit shirts. Box collar, rib cuffs and straight hem tails. Comfortable polyester/cotton. Big selection of stripes and solids. Sizes S, M, L, XL.

Men's Haggar® Slacks Up to a Comfortable \$10 Off!

Regular \$28 to \$30

19.88

Men's belted casual slacks in a grand assortment of sizes and colors. Polyester/cotton and 100% polyester. Navy, khaki, red, grey, light blue and green solids. Sizes 32 to 42.



Special on Men's Summer Suits!

89.88

Special Purchase

Fantastic buy on men's Dacron® blend spring and summer suits. Ideal lightweight fabric for hot weather. Sizes 38 to 48R, L.

Men's Haggar® Sport Coats Up to \$50 Off!

49.88

Reg. \$85 to \$100

Great selection of men's handsome solid or print sport coats. Easy-care, lightweight summer fabrics, variety of styles and colors. Center vent, 2 button front coats. Sizes 38 to 46 reg., long.

Men's LEVI'S® 'Action' Slacks Sale!

17.88

Regular \$25 to \$26

Men's 100% polyester dress slacks with belt loops. Available in a wide selection of solids. These great slacks bend with you great for spring and summer! Sizes 30 to 42.

Save \$10 on Men's London Fog® Jackets!

Regular 40.00 **29.88**

Great looking London Fog reversible jackets of 100% nylon. Navy reverses to emerald green. Outdoors unlimited, wash 'n wear jacket with pockets on both sides. Sizes 38 to 44.

Men's Dress Shirts! Save!

Regular 14.50 **10.88**

Andhurst® polyester/cotton long sleeve dress shirts. White, blue and ecru. Button-down collar. Oxford cloth. Sizes 14 1/2 to 17. Shop today!

Men's Haggar® Dress Slacks Up to an \$8 Savings Now!

Regular \$25 to \$26 **17.88**

Men's 100% polyester dress slacks with belt loops. navy, grey, tan, brown, green and black solids. A terrific selection! Sizes 30 to 42.



Earned Degree At N.C. State

RALEIGH — The following Pitt County students received degrees from North Carolina State University during commencement exercises held recently:

GREENVILLE — doctoral degrees: Barbara C. Clark, John H. Cox, Michael A. Davis, Douglas W. Kruger Jr., Therese Lawler and Mary Ann M. Rose; master's degrees: Susan L. Corda, Grace K. Jenkins and Mary K. Kirkpatrick; bachelor's degrees: Elizabeth E. McConnell, Suzanne McGee, Freager R. Sanders III, Sandra B. Savage and Donna J. Worthington.

AYDEN — bachelor's degrees: Kenneth Smith and Thomas K. Wheless.

BETHEL — bachelor's degrees: Chrisa A. Coltrain

and Evelyn L. Griggs. FARMVILLE — master's: Evelyn R. Perkins; bachelors: Kirby R. Bell Jr., Theresa G. Flanagan and Eugene G. Perkins III. Others from Pitt County earning bachelor degrees included: Robert K. Chamberlain, William H. Edwards, Stella B. Mitchell and Alva Worthington.

Area Graduates At Meredith

RALEIGH — The following students were among those receiving degrees from Meredith College during commencement exercises held recently:

WILLIAMSTON — Barbara Laurie Beddard, B.A.; Alisha Gray Robertson, B.A.

FARMVILLE — Margaret Williams McGaughey, B.S.; Donna Lynn Murphrey, B.A.

GREENVILLE — Laura Marie Smith, B.A.; Donna Lynne Tripp, B.S.



BEAUTIFICATION ... is already apparent in an uncompleted planting effort at the Stantonsburg Road County refuse dumpster site. The work is being done by the 18 members of the Candlewick Flames 4-H Club and their advisers. Topsoil was brought by the county and local nurseries and civic

organizations donated the shrubbery and grass seed. Shown here are some of the volunteer laborers, Candlewick Flame members Eric Shine, Paula Yelverton and Erin O'Callaghan, with their parent project chairman, Lynn Shine (far left). (Reflector Photo By Carol Tyler)

Quote
"Money is a stupid measure of achievement, but unfortunately it is the only universal measure we have."
— C.P. Steinmetz

Coming Soon

Winterville Child Care Center

- Fully Licensed
- Experienced Director
- Hot Meals
- Hours: 6:30 a.m.-6:00 p.m.
- Infants To After-School
- S. Church St.; 2 Blocks From A.G. Cox School

Call 756-2256
For More Information

You can now obtain a MASTERCARD and/or VISA. Want Mastercard and/or Visa and been rejected? Credit problems, divorced bankrupt, new or credit? We can help. Savings account & fees required. 95% of applicants accepted under this program. Write or phone for FREE details. Financial Consultant. Route 1, Box 271. Chocoma, NC 27817. 919-975-2535.

FREE Fisher-Price

TUB AND POOL TOY

(Retail Value \$2.49)

When You Make A 95¢ Deposit On Our Portrait Package

Pay your 95¢ portrait deposit and choose one of these Fisher-Price fun activity toys...absolutely FREE!

95¢/\$12.95

Deposit / Total Package Price

Your Portrait Package Contains: 2-8x10's, 3-5x7's and 15 Wallets

VALUABLE COUPON

Clip this coupon and present it, along with the 95¢ deposit to our photographer to receive your Tub and Pool Toy.

These Days Only

| | | | | |
|------|------|-------|------|------|
| May: | Wed. | Thurs | Fri. | Sat. |
| | 19 | 20 | 21 | 22 |

Daily: 10 A.M. to 9 P.M.
Route 7 & Greenville Blvd.
Greenville, N.C.

NICHOLS

One Tub and Pool Toy per subject. 95¢ deposit per subject or group.

VALUABLE COUPON

Graduates From Wake Forest

WINSTON-SALEM — Six students from Pitt County received degrees from Wake Forest University Monday. They were among 1,025 students who graduated from the college.

Receiving degrees from Greenville were: Micah David Ball, son of Dr. and Mrs. Wilbert R. Ball of Route 3; Tommy J. Payne II, son of Mr. and Mrs. Tommy J. Payne of 2606 Evans St.; David Watson Daniel, son of Mrs. Florence McRae Daniel of 227 Orton Drive; Robert Scott Griffin Jr., son of Mr. and Mrs. Robert Scott Griffin of 305 Granville Drive; and Dennis Walter Hearne, son of

Mr. and Mrs. William Walter Hearne of 107 Greenbriar Drive.

Graduating from Grifton was Troy Rhyme Jackson Jr., son of Mr. and Mrs. Troy R. Jackson Sr. of 312 Fairway Drive.

Both Ball and Payne received J.D. degrees from the university's school of law.

Earns Degree

CHAPEL HILL — Robert J. DaVanzo of 885 Briarcliff Road, Northeast Atlanta, Ga., received the doctor of medicine degree from the University of North Carolina at Chapel Hill during commencement exercises held recently.

He is the son of Dr. and Mrs. John P. DaVanzo of 101 Wesley Drive, Greenville. He will begin postgraduate training in ophthalmology at the Medical University of South Carolina at Charleston.

Earns Doctorate

CHAPEL HILL — Danny A. Harrington of Greenville received the juris doctor degree from the school of law at the University of North Carolina at Chapel Hill during commencement exercises held recently.

He is the son of Mr. and Mrs. Allie Harrington of 1603 Brownlea Drive, Greenville.

O'Connor Col...

(Continued from Page 4)

where taxes should be raised. That's up to the current and future office-holders. But now that his political career has ebbed after his resounding loss to Hunt in 1980, he can say some things he really thinks need to be heard. "Maybe I can say it better by virtue of having been there and not seeking to get back there," Scott said.

Peace Graduates

RALEIGH — Two Greenville residents were among 200 women who received their degrees during commencement at Peace College recently.

Sandra Lyn Evans and Dianne Manning received associate of arts degrees.

Miss Evans is the daughter of Dr. and Mrs. A. Ray Evans of 202 Williamsburg Drive. Miss Manning is the daughter of Mr. and Mrs. J.T. Maning of Route 8.

Glen-Shearer...

(Continued from Page 4)

there is a great need all over the country for people who can speak, write and think clearly. Some people say the liberal arts are dead, but such skills will never be obsolete.

Naturally, not everyone who entered college four years ago planned to graduate with a job offer in hand. Many students assiduously avoided the career question in order to concentrate on other matters.

But this faction seems to be dwindling.

Unless seniors expect to show off a spouse, two children and a mortgage at their Fifth-Year Reunion in 1987, they probably don't need to graduate to a \$30,000-a-year contract. On much less, one can get along very well and find out what the big bucks are really worth.

We're Moving!

CLEARANCE SALE

ENTIRE INVENTORY UP TO

50% OFF

NO LAYAWAYS • NO RAINCHECKS

SUNSHINE TOY STATIONS

Pitt Plaza 756-1636 1 & 2 Evans St. Ext. 756-2629

"When my husband the perfectionist had trouble with his eyes, I suggested another perfectionist!"



"I knew Pearle Vision could not only meet my husband's high standards, but exceed them. Right down to the smallest detail. And I was right. He's said he's never seen anyone take so much time and care making sure he got exactly the right prescription. And the perfect pair of frames. He only had one complaint—he couldn't find anything wrong."

PEARLE vision center
A SEARLE COMPANY
Nobody cares for eyes more than Pearle.

Carolina East Mall
756-8834
© 1982 Searle Optical Inc.

Wendy's

ONLY WENDY'S HAS FAMILY-SIZE COUPONS.

Now a family of four can feast for under \$5.00. Use our valuable coupons one at a time, or all at once. So stop by Wendy's today.

| | |
|---|--|
| <p>NOW 99¢ REGULARLY \$1.39</p> <p>Kids' Fun Pak™ — Junior Hamburger, Fries, Frosty Dairy Dessert And Toy Surprise.</p> <p>Cheese, tomato, and sales tax extra. Coupon valid at Wendy's at 10th Street (near E.C.U.) and Greenville Blvd. Please present coupon before ordering. Coupon expires June 30, 1982.</p> | <p>NOW 99¢ REGULARLY \$1.52</p> <p>Regular Size Serving Of Rich And Meaty Chili And 16 Oz. Soft Drink.</p> <p>Sales tax extra. Coupon valid at Wendy's at 10th Street (near E.C.U.) and Greenville Blvd. Please present coupon before ordering. Coupon expires June 30, 1982.</p> |
| <p>NOW \$1.49 REGULARLY \$2.54</p> <p>Hot 'N Juicy Single Hamburger, Fries And 16 Oz. Soft Drink.</p> <p>Cheese, tomato, and sales tax extra. Coupon valid at Wendy's at 10th Street (near E.C.U.) and Greenville Blvd. Please present coupon before ordering. Coupon expires June 30, 1982.</p> | <p>NOW \$1.49 REGULARLY \$2.54</p> <p>All-You-Can-Eat Salad And 16 Oz. Iced Tea.</p> <p>Sales tax extra. Coupon valid at Wendy's at 10th Street (near E.C.U.) and Greenville Blvd. Please present coupon before ordering. Coupon expires June 30, 1982.</p> |

Save \$2.48 when you use all four coupons.

AIN'T NO REASON TO GO ANYPLACE ELSE..

Warned To Care For Defective Babies

By BETTY ANNE WILLIAMS
Associated Press Writer
WASHINGTON (AP) — The Reagan administration, disturbed by a case where a deformed Indiana infant was allowed to die, is investigating charges of a similar case in Illinois and sending warnings to thousands of other hospitals.

The Department of Health and Human Services has sent an investigator to check allegations made against Crawford Memorial hospital in Robinson, Ill., after receiving a complaint contending that a child suffering from the congenital birth defect spina bifida was being denied surgery it needed. The complaint was filed by Laura Canning, assistant director of the Chicago-based Family Life League.

But Gregory Coler, director of the Illinois Department of Children and Family Services, said he met with physicians and others involved in the case and found no evidence that the infant's parents had been negligent. In spina bifida cases, there is an opening in the spinal column which can admit infections and cause death.

Health and Human Services also put 6,800 hospitals receiving federal funds on notice Tuesday that they risk losing the government's financial support if they deny proper care and treatment to any handicapped person.

Betty Lou Dotson, director of the department's office for civil rights, sent letters to hospitals receiving Medicare and Medicaid funds notifying them that denying food or treatment to the handicapped or to infants with birth defects risks violating Section 504 of the 1973 Re-

habilitation Act. That law, which protects the rights of the handicapped in federally-funded programs, forbids discrimination against the handicapped solely because they are handicapped.

"In the aftermath of the recent death of a handicapped newborn child in Bloomington, Ind., there has been a great deal of justified public concern about the protection of newborn infants with birth defects and their right as human beings to receive appropriate treat-

Services Secretary Richard S. Schweiker said in a statement.

In the Indiana case, the deformed infant suffered from Down's syndrome. The Indiana Supreme Court and two lower courts declined to issue orders that would have required that the baby be fed. The baby died April 15.

"President Reagan and I share this concern (for the rights of such infants), and the president has instructed me to make absolutely clear to health care providers in this nation that federal law does not allow medical dis-

crimination against handi-capped infants," he added.

Separately, the department sent a telegram containing the warning to Carlton King, administrator of the Illinois hospital. King would neither confirm nor deny that the infant was a patient in the hospital. But he did acknowledge that the 107-bed hospital was not equipped to handle spina bifida surgery.

He also acknowledged that an investigator from the department had questioned him. But he said he would not disclose information about

patients to even government investigators unless they were armed with a subpoena.

"Because we place confidentiality of our patients as the highest priority, I am not free to release any information on any of our patients," he said.

The Justice Department was monitoring devel-

opments in the Illinois case to determine whether the infant's rights were being protected. A source in the department who had determined the identity of the child's parents, said the infant's father was a physician.

Attempts to contact the parents proved fruitless.

Dial-A-Prayer
752-1362

Graduation Gifts

Lap Boards
Desk Sets
Personalized Stationery

Dictionaries, Bibles,
& Photo Albums
Personalized Free
Through June

Book Barn

117 E. 5th St.
Downtown Greenville

AMERICA'S FAMILY DRUG STORE

YOU'RE GOING TO LIKE OUR...

ECKERD

Coupon Savings

CUT THEM OUT & SAVE

Save up to \$300
and Support your
American Heart Association

COMPLETE DETAILS & ORDER FORM AT
SHELF & ON PRODUCT DISPLAY

NEW FREEDOM MAXI PADS
BOX OF 12
Your choice of regular or super size.
Limit 2.
99¢

Kleenex PAPER TOWELS
Strong & absorbent.
59¢

ECKERD

GLEEM TOOTHPASTE
5-OUNCE
79¢

Sale Priced
Cool burst of freshness. The right toothpaste for today. Limit 2
Coupon Good Thru Sat. May 22

ECKERD

DOVE BATH SOAP
4.75-OUNCE
2/99¢

Sale Priced
Moisturizing bar for skin & body. Price reflects 4 cents off label.
Coupon Good Thru Sat. May 22

ECKERD

PARSONS' AMMONIA
28-OUNCE
2/79¢

Regular 69¢
Phosphate-free. Your choice of Lemon or Regular.
Coupon Good Thru Sat. May 22

ECKERD

DRY IDEA ANTI-PERSPIRANT
1.5-OZ.
2 TYPES
Scented or Unscented Roll-on. Limit 1
Coupon Good Thru Sat. May 22
139

ECKERD

MAX FACTOR TOUJOURS MOI®
Eau de Cologne Spray
1.2-OZ.
9.00 Value
Regular 5.25
Coupon Good Thru Sat. May 22
399

ECKERD

LIP QUENCHER LIPSTICK
Regular 2.35
Sale Priced
Summer Bronze.
Coupon Good Thru Sat. May 22
139

ECKERD

FOAM CUPS
16-OUNCE
Regular 79¢
Pack of 20, disposable cups.
Coupon Good Thru Sat. May 22
59¢

ECKERD

HI-C DRINK
64-OUNCE
YOUR CHOICE
Refreshing fruit-flavored soft drink.
Coupon Good Thru Sat. May 22
119

ECKERD

MASSENGILL DOUCHE
6-OUNCE
Sale Priced
Medicated, ready to use. Disposable. Limit 2
Coupon Good Thru Sat. May 22
79¢

ECKERD

L'OREAL PREMIERE PERM
3 TYPES
Sale Priced
Gives long-lasting results. Gentle to hair.
Coupon Good Thru Sat. May 22
199

ECKERD

QUENCHER NAIL GLAZE
Regular 1.55
Sale Priced
Glossy hard finish for chip-resistant nails.
Coupon Good Thru Sat. May 22
99¢

ECKERD

PEPTO BISMOL ANTACID
4-OUNCE
Sale Priced
"Coating action" for upset stomach.
Coupon Good Thru Sat. May 22
99¢

ECKERD

SUMMER L'EGGS PANTYHOSE
Regular 1.99
Sale Priced
Super sheer from tummy to toes.
Coupon Good Thru Sat. May 22
159

ECKERD

JOHNSON'S BABY SHAMPOO
11-OUNCE
Sale Priced
For a healthy shine you never outgrow.
Coupon Good Thru Sat. May 22
199

ECKERD

12" x 18" PEDESTAL HIBACHI GRILL
11-OUNCE
Sale Priced
Cast iron bowl & adjustable grids.
Coupon Good Thru Sat. May 22
1299

ECKERD

BUTTERFINGER or BABY RUTH CANDIES
PACK OF 6
Regular 1.39
For snacks or anytime. Always delicious.
Coupon Good Thru Sat. May 22
89¢

ECKERD

ISOPROPYL ALCOHOL
16-OUNCE
Sale Priced
A rubbing compound that cools & soothes.
Limit 2
Coupon Good Thru Sat. May 22
44¢

ECKERD

VITAMIN C
250 MG.
BOTTLE OF 100
A vitamin your body needs every day.
Coupon Good Thru Sat. May 22
99¢

ECKERD

SMART TIP by Water Pik
Regular 1.29
Sale Priced
Disposable smoking filter.
Coupon Good Thru Sat. May 22
79¢

ECKERD

EVERYREADY C or D SIZE FLASHLIGHT
#3251/3231
Regular 1.49
Full-sized, long lasting, low priced. Your Choice.
Coupon Good Thru Sat. May 22
99¢

ECKERD

MEGUIAR'S CAR WAX
2 TYPES
Regular 9.95
Paste or liquid wax.
Coupon Good Thru Sat. May 22
599

ECKERD

PIONEER® POCKET PHOTO ALBUM
#RPS-35
Regular 8.99
Full size vinyl album. Pockets for all popular size prints.
Coupon Good Thru Sat. May 22
599

ECKERD

POLY TUB ELECTRIC ICE CREAM FREEZER
#71A
Reg. 19.99
4-qt. Makes ice cream in 30 minutes.
Coupon Good Thru Sat. May 22
1599

ECKERD

PATIO STACK CHAIR
Reg. 19.99
Sale Priced
White metal patio chair.
CHAIR PAD 4.99
Coupon Good Thru Sat. May 22
1699

ECKERD

GALAXY 9-INCH PERSONAL FAN
#2156
Reg. 15.99
Single speed. On/Off switch.
Coupon Good Thru Sat. May 22
1399

ECKERD

MELNOR OSCILLATING SPRINKLER
#65
Regular 9.99
Covers up to 2800-sq. ft. Brass jets.
Coupon Good Thru Sat. May 22
799

ECKERD

24" x 36" INFLATABLE SURF RIDER
Regular 2.19
Sale Priced
For summertime water fun.
Coupon Good Thru Sat. May 22
149

ECKERD

BLACK & DECKER CORD WINDER
#79-790
Reg. 24.99
2 outlets. 25' cord.
Coupon Good Thru Sat. May 22
1888

ECKERD

JANCO POTTERY 8" PLANTER
Regular 3.49
Sale Priced
3 styles to choose from.
Coupon Good Thru Sat. May 22
299

ECKERD

GALAXY 16" WINDOW FAN
#2155
Reg. 54.99
Reversible speeds. Fits most windows.
Coupon Good Thru Sat. May 22
4499

ECKERD

1/2" x 50' GARDEN HOSE
#501
Regular 4.49
100% vinyl. Has full-flow brass couplings.
Coupon Good Thru Sat. May 22
399

ECKERD

ZEBCO 404 REEL & ROD
Reg. 14.98
Sale Priced
Reel filled w/Trilene® line. Pistol grip handle.
Coupon Good Thru Sat. May 22
1098

ECKERD

D-CON FLEA KILL
6-OUNCE
Reg. 4.99
Home room fogger.
Coupon Good Thru Sat. May 22
349

ECKERD

BLACK FLAG ROACH MOTEL
PACK OF 2
Regular 1.69
Waterbug & roach traps.
Coupon Good Thru Sat. May 22
99¢

ECKERD

TORO 1 1/2-H.P. GASOLINE TRIMMER
#1500
Reg. 159.99
Save 40.00
11900

Automatic line feed. Fingertip control. Cuts 17" path.
Coupon Good Thru Sat. May 22

ECKERD

GALAXY 12-INCH FLOOR FAN
#2153
Reg. 29.99
Swivel adjustment stand. Push-button controls.
Coupon Good Thru Sat. May 22
2499

ECKERD

HIGH POINT INSTANT COFFEE
1-OZ. TRIAL SIZE
Regular 59¢
Delicious tasting coffee.
Coupon Good Thru Sat. May 22
2/99¢

ECKERD

PRINGLE'S POTATO CHIPS
9-OUNCE
Regular 1.39
Regular & light.
Coupon Good Thru Sat. May 22
109

ECKERD

Sale Prices good thru Sat. May 22nd

We reserve the right to limit quantities.

MasterCard VISA

ECKERD

Rivergate Shopping Center
Pitt Plaza Shopping Center

Local Pupils

Are Honored

RALEIGH — The U.S. Army Reserve has honored Belinda Haselrig and Roger Williams, both students at Roge High School in Greenville, as Army Reserve "Spirit of Victory" National Scholar/Athlete Award winners.

Haselrig scored 3,692 and Williams 3,636 in academic averages along with athletic ability to win the local honors.

At the spring athletic awards ceremony to be held May 27, the two will be presented with a medallion featuring the American eagle in flight. Their names, the name of the school and the year will be engraved on the back of the medallion.

Now in its second year, the Army Reserve National Scholar/Athlete Awards are being awarded to students in schools all across the nation. The awards are designed to represent the Army Reserve's commitment to the academic and physical well-being of the nation's youth.

Howard Named To N.C. Council

Juanita L. Howard of Greenville has been named by Gov. Jim Hunt to the N.C. Council on Developmental Disabilities.

The council advises the state secretary of human resources on needs it sees for changes in state laws and services for disabled persons and promotes public awareness of developmental disabilities.

Ms. Howard is a counselor in the division of vocational rehabilitation of East Carolina University. She has participated in counseling programs in Winston-Salem and Morganton.

SHOP-EZE
West End Shopping Center

GOODLAND

Thursday Luncheon
Special

Fried Pork Chops \$2.19

Special Served With 2 Fresh Vegetables & Rolls.

Coast Guard Base Idled

CAPE LOOKOUT, N.C. (AP) — The U.S. Coast Guard Station at Cape Lookout was closed Tuesday with a brief, solemn ceremony — nearly 100 years after it first opened.

The search and rescue station has watched over ships passing the treacherous cape for nearly a century. It first opened in 1886 under the U.S. Lifesaving Service, which was a predecessor of the Coast Guard.

"This is a sad occasion to close the Cape Lookout Station after a long and successful history on the Outer Banks," Capt. Joseph Blackett, chief of search and rescue for the guard's 5th district, said to about 50 people attending the ceremony.

Commenting on the station's rustic architecture, Blackett said, "We don't make them like this anymore, and we have lost a great deal with the closing of Cape Lookout."

The station was closed for economic reasons, said Lt. Cmdr. Leo Tyo. He estimated that savings would amount to about \$2.1 million in the next 10 years. Most of the savings will come from automating the nearby Cape Lookout Lighthouse.



OLDEST GRAD — Education officials say that Jessie Byam of Madison Heights, Mich., may be the oldest person in the United States to graduate from high school. "I'm not finished yet," said the strong-willed Mrs. Byam, 98, who spent four years studying English, math and history at the Madison Heights Senior Drop-In Center. Mrs. Byam graduates on Friday. (AP Laserphoto)

AAMA Chapter Meets Thursday

The Pitt County Chapter of the American Association of the Medical Assistants will be meeting Thursday at 7:30 p.m. in the office of Pitt Surgicals, No. 10 Doctors Park.

The guest speaker will be Dr. Richard Taft. His topic will be on the new surgery center.

All members are asked to be present and guests are welcome.

Poll Belief In An Afterlife

NEW YORK (AP) — More college-educated Americans believe in life after death than do people with a high school education or less, and there are more believers in heaven than hell, says a new Gallup poll.

The poll, published Monday in the June issue of McCall's magazine, says two out of three people questioned expressed belief in some sort of afterlife.

Gallup called it the most comprehensive poll ever done on the subject. Of those polled, 71 percent believed in heaven and 53 percent in hell. Asked to choose among descriptions for the afterlife, two-thirds said it would be peaceful. Five percent said it would be boring.

Earned Degrees At Appalachian

BOONE — The following students were among those receiving degrees from Appalachian State University during commencement exercises held recently:

Greenville — Stephanie Gail Hall, Bonnie Lynn Lee

and Donna Kay McLawhorn. Farmville — Stuart Burton James.

Winterville — Michael Terrance Phillips.

Hookerton — William Benjamin McLawhorn.

Snow Hill — Terri Lynn Wade.

Younger Women Being Treated

NEW YORK (AP) — Two out of three women in the United States being treated for alcoholism are under the age of 35, and the problem exists even among junior high school girls, a magazine survey says.

In an article published in its issue dated Tuesday, Redbook Magazine said it surveyed 11,000 women across the country who have

sought help for problem drinking.

The magazine concluded women become intoxicated more easily than men because their bodies contain more fat and less fluid. Men receive a disproportionate amount of money spent to treat alcoholism, in part because the problem in women is often "masked and hidden," it said.

Pentagon Leak Results In Official Reprimand

WASHINGTON (AP) — A Pentagon official won't be fired but will be reprimanded for allegedly violating regulations on classified information, according to his attorney.

The attorney said Tuesday night that Defense Secretary Caspar Weinberger also has dismissed a specific leaking charge against his client. There was no announcement from the Defense Department and a spokesman said he had nothing to say on the matter.

The charges against John C.F. Tillson, a decorated veteran of the Vietnam War, grew out of an alleged leak of information from a high-level Pentagon conference last January.

The attorney, James H. Heller, acknowledged that the penalty decided upon by Weinberger was much less severe than it might have been. But he said his client was innocent. Heller said Tillson has not yet decided whether to file a formal challenge to the letter of reprimand, which is to be placed in his personnel file for two years.

Tillson's lawyer said Weinberger cited Tillson's war record in deciding on the lesser punishment. That record includes two Silver Star medals for bravery while

Tillson, a West Point graduate, was an Army captain in Vietnam.

Tillson is to be returned to his job as director of manpower management in the office of the assistant secretary of defense, from which

he was transferred while his case was under investigation, Heller said.

Weinberger and Deputy Defense Secretary Frank Carlucci were said to have been angered when The Washington Post published a story including the gist of discussions at a meeting of the Defense Resources Board.

Three Named To Committee

Three persons were named to the executive committee of the Pitt County branch of the National Association for the Advancement of Colored People at the branch's executive committee meeting Monday.

New executive committee members include public relations chairman Gloria Grimes, economic development chairman Ashley Fenner and regular membership chairman Dee-dee Morehead.

Erma Carr, a candidate for the Greenville Board of Education, spoke briefly, saying major problems facing the city school system are decreasing enrollment and decreasing funds.



Dixon Strawberries
—Pick Your Own—
First Pound Free!

Phone: 756-7666 or 756-8809

Bring This Coupon

Summer Fanfare

SPECIAL PRICE
Limited Time
\$8 Reg. 9.95

Ladies 5-10

Beige Red/Multi
Blue
Lavender/Multi

Shoe Show Greenville Square Shopping Center

Open 10 A.M. to 9 P.M. Mon. - Sat.

You Can Win

Serta's Perfect Sleeper Contest!

- 3 Grand Prizes. Fabulous Thomson® week-long dream vacations for two. Your choice of the Bahamas, Caribbean or Mexico. Explore island life, beautiful beaches, dine and dance under the stars.
- All prizes will be awarded. This is not a sweepstakes.

Everyone wins with a great night's sleep!

Come in for details.

Bostic-Sugg
Furniture, Inc.
Our 43rd Year
Furniture of Excellence

401 West 10th St., Greenville - 758-2513

Play Therapy . . .

(Continued from Page 2)

grave site or sending a message up on a helium balloon every fourth Sunday.

"The most important thing is very simple. When someone dies, your love will not die. There are many ways to express love for that person. There will be remorse and pain, but also pleasure if you allow yourself to express it," Miss Smith said.

OPEN HOUSE

Sharp Point Volunteer Fire Department will hold open house Sunday from 2-4 p.m. A guest speaker is scheduled and refreshments will be served. The fire department is located one mile east of Cobb Town Grocery and serves both Pitt and Edgecombe counties.

ENROLL NOW!!

Yes, ENROLL YOUR child now for the 1982-83 School Year.

Kindergarten thru Grade 12

MT. CALVARY CHRISTIAN ACADEMY
Established 1968 Hookerton, N.C.

- ✓ Quality Christian Education
- ✓ Christian Character Emphasis
- ✓ Trained Dedicated Staff
- ✓ Transportation Available
- ✓ Low Family Rates
- ✓ Call 747-8111

For information and Appointment With Principal

Last Chance to Buy 1981 Perfect Sleeper® Models

SAVINGS UP TO **43%** OFF RETAIL PRICE

Perfect Sleeper Model Changeover Sale

Now is your last chance to purchase 1981 Serta Perfect Sleeper models at very special savings. For a limited time, Serta offers the finest in sleep comfort, support, and styling along with famous Perfect Sleeper construction and quality. We're making room now for 1982 Perfect Sleeper models. Hurry on in and save now!

SAVE \$190.90 TO \$380.95

Perfect Sleeper® Signature II

HURRY! WHEN THESE ARE GONE, THEY'RE ALL GONE.

Perfect Sleeper SIGNATURE II

An exquisite damask, puff quilted with Sertaform® covers this remarkable sleep set. Fully featured construction, it's a superior way to sleep.

| | Regular | On Sale |
|------------------------------------|-------------------------|-------------------------|
| Twin You Save \$190 ⁹⁰ | \$439 ⁹⁰ Set | \$249 ⁰⁰ Set |
| Full You Save \$200 ⁹⁵ | \$539 ⁹⁵ Set | \$339 ⁰⁰ Set |
| Queen You Save \$270 ⁹⁵ | \$649 ⁹⁵ Set | \$379 ⁰⁰ Set |
| King You Save \$380 ⁹⁵ | \$879 ⁹⁵ Set | \$499 ⁰⁰ Set |

*All savings are based on nationally advertised suggested retail prices. *Nationally Advised Suggested Retail Price

STRAWBERRIES
-PICK YOUR OWN-

DEWS BERRY PATCH

N.C. 903 South
(Past Waller Tractor Co.)
3 Miles From Winterville

756-6165 WINTERVILLE, N.C.
OPEN MON-FRI 7-7, SAT 7-4, SUN 2-4

SOLD IN SETS ONLY - MATTRESS AND BOX SPRINGS

Missing Children's Day To Be Nationally Observed May 25

May 25 has been designated as National Missing Children's Day by Child Find Inc., a national non-profit organization which serves as an international network for locating missing children.

Child Find aims to be a two-way communication system between searching parents and their missing children, its information director, Kristin Cole Brown, said. This, she said, is how Child Find works: Parents register their missing children. The child's photo is placed in Child Find's directory of missing children and in national print and broadcast media. Public service announcements and Child Find's school poster tell children how to contact Child Find.

Most finds are made when the missing children themselves call Child Find's toll-free line, 1-800-431-5005, or when concerned citizens call or write to identify the

locations of stolen children. Child Find chose May 25 to bring national attention to the problem of missing children in recognition of the effort of the family of Etan Patz, a 6-year-old boy who vanished on his way to the school bus stop one and one-half blocks from his home May 25, 1979. There has been no trace of Etan since. The Patz family successfully lobbied for the introduction of a bill into Congress to become known as

"The Missing Children's Act."

Child Find has targeted four primary issues for Missing Children's Day:

- The creation of a national "census" of missing children. No publicly funded body has ever been allocated funds to collect data on missing children. Child Find will work with other missing children-related groups to develop a data-gathering process through which to

assemble the most accurate statistics available.

- Passage of the Missing Children's Act sponsored by Rep. Paul Simon of Illinois and Sen. Senator Paula Hawkins of Florida.

- Introduction of child-safety programs in the schools teaching children how to avoid potential abduction situations.

- Fund-raisers so that Child Find may continue to operate its toll-free line and circulate its directory of missing children, now limited to 10,000 copies. Child Find receives no government monies and is dependent on parent registration fees and tax-deductible private and corporate donations to meet operating costs, Ms. Brown pointed out.

Plan Pediatrics Day On Friday

ECU News Bureau
The department of pediatrics at the East Carolina University School of Medicine will sponsor its fifth annual Pediatrics Day Friday.

Guest speakers for the continuing medical education program include Dr. Wallace F. Berman, associate professor and chief of pediatric gastroenterology, Medical College of Virginia, and Dr. Campbell W. MacMillian, professor of pediatrics and chief of pediatric nephrology, University of Florida College of Medicine.

Also on the program are ECU pediatricians James L. Hughes, Thomas G. Irons, William E. Laupus, Jon B. Tingelstad and John E. Wimmer.

The program will be held from 8:30 a.m. until 5:30 p.m. at Pitt County Memorial Hospital Auditorium.

For more information, call the ECU Office of Continuing Medical Education, 758-5200.

Bundy Schedules Talk Thursday

Rep. Sam D. Bundy will speak at an appreciation dinner for city and county teachers of exceptional children Thursday at 6:30 p.m. The dinner is to be sponsored by the Association for Retarded Citizens-Pitt County.

He will attend the Legislative Commission on Agency Review in Raleigh May 25 at 9 a.m. May 28 he will attend a meeting of the State Board of Awards in Raleigh.

World's Fair Tours
Hill's Motor Coach Tours of Kingston has 10 trips planned to the World's Fair. \$195.00 each for double occupancy. Fully Licensed and Bonded, N.C. No. 159838
For information call 756-4511 or (nights only) 524-4350

Kinlaw Named To Ass'n Post

RALEIGH — Patrick C. Kinlaw, formerly of Greenville, has been named administrative assistant to the executive director of the North Carolina Association of School Administrators.

Kinlaw has been on the faculty of Longwood College in Farmville, Va. In Greenville, he taught in the Pitt County schools, and obtained a master's degree in educational administration at East Carolina University.

The association is an organization composed of principals and other school personnel, personnel of the state Department of Public Instruction, the State Board of Education and university professors. It has a membership of about 2,000.

PRESIDENT'S AWARD
DURHAM — Thomas Howard Callaway III was one of 54 graduating seniors at Duke University to receive the President's Award during commencement exercises held recently. Callaway received his B.A. degree in chemistry.

He is the son of Greenville native Martha Emily Moye Hadley Callaway and Dr. Henry Abbott Callaway Jr. of Maryville, Tenn.

OVER 1,000 ROLLS ALL TOP QUALITY NAME BRANDS
CARPET
VALUES TO \$39.95 per sq. yd.
SALE PRICED \$12.95
When we carpet—Schumacher wallpaper is free. Per Sq. Yd.
WHOLESALE FABRICS DECORATOR WORLD
With this ad. Greenville Direct 757-1441
*Snow Hill *Goldsboro *Rocky Mount *Clinton

The Strawberries Are Ripe And Abundant
STRAWBERRY FIELDS
7 Miles South Of Greenville On Hwy. 11
Open Monday-Saturday 7:30 Until Sunday 1-6
For Phone Orders, Call 746-4000
Come By And Check Out Our New Strawberry Fields T-Shirts And Recipe Books

VISIT THE INTERNATIONAL FOODS & GIFTS

| | | |
|-----------------------------|-----------|----------|
| DRIED BAMBOO SHOOTS | 8 OZ. | \$2.97 |
| BABY SWEET CORN | 15 OZ. | \$1.49 |
| SALTED BLACK BEANS | 8 OZ. | 89¢ |
| HOT BEAN SAUCE-SZECHUAN | 6 OZ. | \$1.14 |
| FUNGUS MUSHROOMS | 1 OZ. | \$2.49 |
| PICKLED VEGETABLES-WEIGHUAN | 6 OZ. | 89¢ |
| FRESH JAPANESE TOFU | 16 OZ. | \$1.19 |
| AVURAGE-FRIED BEAN CURD | 3 PCS. | \$1.49 |
| CHOW MEIN SEASONING | | 69¢ PKG. |
| CUMIN | 1 OZ. | 39¢ |
| CORIANDER | 1 OZ. | 29¢ |
| FROZEN TUNA | 1 LB. | \$9.59 |
| FROZEN GIANT CLAMS | 2 1/2 LB. | \$14.59 |
| FROZEN ABALONE | 1 LB. | \$7.49 |

We Offer Sushi Take-Out Orders (Please Call 1 Day In Advance)
cotanche st. across from the new deli
monday - saturday 10 - 6 p. m.
(919) 752 - 3411

Save on the comforts of home. Starting with America's Garden.

Sale 6.99 twin sheet
Reg. 8.99. Turn your bedroom and bath into a blooming garden. Start with easy-care Kodel* polyester cotton percale sheets. Flat or fitted.

| | | |
|-------|------------|-----------|
| Full | Reg. 10.99 | Sale 8.99 |
| Queen | 16.99 | 14.99 |
| King | 19.99 | 17.99 |

Pillowcases also on sale.

Sale \$28 twin bedspread or comforter
Reg. \$35. Bedspread and comforter are poly/cotton quilted with Kodel* polyester fiberfill.

| | | |
|-------------|-----------|------------|
| Full | Reg. \$45 | Sale 36.00 |
| Queen | \$60 | 48.00 |
| Pillow sham | \$20 | 16.00 |
| King | \$70 | 56.00 |

Men's boat shoe.
Sale 25.99
Reg. \$32. Men's boat shoe is water and salt resistant leather with rawhide lacing. Traction crepe sole.

Men's casual shoe.
Sale 20.80
Reg. \$26. Split leather casual demi-boot with crepe wedge sole. Men's sizes.

Sale 20.88 pr. 100x84
Reg. \$24. Priscilla curtains of crisp Kodel* polyester cotton frame windows with yards and yards of ruffles. In machine washable fashion colors.
Sale prices effective through Saturday.

Women's canvas sneaker.
Sale 11.99
Reg. \$14. Pinwheels* canvas goes flat out for summer fun. They take a little ribbing at the toe and come in a kaleidoscope of lighthearted colors. You'll want them all, the price makes it easy! Sizes 5 to 10.

JCPenney
Shop 10 a.m.-9 p.m.—Phone 756-1190 Pitt Plaza

Avers Hinckley Carried An Inner Rage

By LARRY MARGASAK
Associated Press Writer
WASHINGTON (AP) — John W. Hinckley Jr., "burning with inner rage" and possibly influenced by tranquilizers, thought he had "no choice" but to fire on the president because the Secret Service had spotted his gun, a psychiatrist says.

Dr. David Michael Bear, testifying at Hinckley's trial Tuesday, also said the Colorado psychiatrist who treated the defendant before the March 30, 1981 shootings devised a "disastrous" plan of therapy for his patient.

Bear, who is returning to the witness stand today for cross-examination by government attorneys, concluded that Hinckley was too mentally ill to appreciate the wrongfulness of his conduct.

Hinckley has pleaded innocent by reason of insanity in the wounding of Reagan and three other men outside the Washington Hilton Hotel.

"There was no ability to plan, there was no ability to premeditate," the Harvard Medical School psychiatrist told the jury.

"Do I conclude he was logical and planning? My God, my sense of justice says absolutely not," he said.

That remark prompted U.S. District Judge Barrington D. Parker to inform Bear, "Your sense of justice is not sought here." The jury was out of the room at the time.

Bear said Hinckley told

him during psychiatric interviews that he took four 5-milligram tablets of the tranquilizer Valium before leaving for the shooting scene.

Hinckley should not have been taking the drug at all, Bear said, because it makes psychotic people like Hinckley more aggressive.

One Injured In Accidents

One person was injured and an estimated \$1,350 property damage resulted from three traffic mishaps investigated by Greenville police Tuesday.

Officers reported Jeffrey Lloyd Cooper, 24 of 1504A Fleming St. was injured when he walked into the side of a car driven by Betty Ruth Carmon of 307 Watauga Ave. about 9:45 p.m. on Fleming Street, 75 feet west of the Vanderbilt Street intersection.

Cooper's injuries were listed as minor and no damage resulted to the Carmon car.

Cars driven by Phyllis Spencer Cox of Route 6, Greenville, and Joseph Barnhill of 106 Raleigh Ave. collided about 7:50 a.m. at the intersection of Memorial Drive and Greenfield Boulevard, causing an estimated \$400 damage to each of the two vehicles.

Police charged Barnhill with failing to see his intended movement could be made in safety following investigation of the incident.

Investigators reported a car driven by Florine Clark Everett of Robersonville collided with a railroad crossing gate at the Southern Railroad crossing on Greenville Boulevard near the 14th Street intersection about 4:40 p.m.

Damage was estimated at \$250 to the car and \$300 to the crossing barrier.

"John Hinckley was burning with inner rage," he said. "It's very possible that Valium released this rage."

At the Hilton, Hinckley was amazed he got so close to Reagan without the Secret Service stopping him, Bear said.

"Their eyes were on me. They saw the gun. Now I have no choice. I have to go forward and shoot," Bear said, recalling Hinckley's description of his thoughts.

Once Hinckley had emptied his .22-caliber pistol, he relaxed in a state of "steely calm," Bear said. At the time, the psychiatrist said Hinckley thought, "I'm relieved, it's over."

At the time of the shooting, Hinckley considered himself a failure because he had stalked former President Carter and was unable to kill him, Bear said. And he was also obsessed with actress Jodie Foster and griet-stricken over the murder of his idol, John Lennon.

Bear said the decision to allow Hinckley to remain on Valium was among several crucial mistakes made by Dr. John Hopper, the Evergreen, Colo., psychiatrist who treated the defendant from October 1980 through February 1981.

NEW OFFICER
CHARLESTON — Stephen Jude Lawler of Greenville, N.C., graduated from The Citadel during commencement ceremonies held recently and was commissioned as a second lieutenant in the U.S. Army. He is the son of Dr. and Mrs. D.L. Lawler, 109 Cheshire Drive, Greenville.

Hopper, who had been hired by Hinckley's wealthy parents, testified he believed Hinckley suffered from anxiety and was upset because he couldn't find a career.

Along with Hinckley's parents, Hopper devised a plan that set deadlines for the presidential assailant to get a job and live outside his family home.

"The plan of the therapy was just disastrous," Bear said. "I think the man (Hinckley) should have been in a hospital. It was an inappropriate time to cut him off from his family. This advice was an absolute

calamity."

In addition, Bear said Hopper should have probed more deeply when Hinckley told him of his obsession with Ms. Foster.

The psychiatrist said "to the outside world" Hinckley would have looked normal. Even the law enforcement officers who arrested him could not have determined that Hinckley was suffering from a serious mental illness, he said.

"If Dr. Hopper, who was trained, sat with the man for five months and did not reach a correct diagnosis, would officers on the scene

reach a correct diagnosis?" Bear asked.

The prosecution claims that officers' observations of Hinckley's acute memory and calm demeanor at the time of the shooting indicate he was of sound mind.

Said Bear: "This is not evidence I would use to reach state of mind conclusions."

Hinckley is charged in a 13-count indictment with attempting to assassinate the president and assault with intent to kill Reagan, White House Press Secretary James Brady, a Washington policeman and a Secret Service agent.

'Selective' As To 10 Commandments

WASHINGTON (AP) — Americans believe in the Ten Commandments more than the people of most Western countries, a new survey suggests, but they accept some commandments more than others.

In a Gallup Organization study of changing values in the United States, Japan, South Africa and 12 Western European countries, a higher percentage of Americans than members of other nationalities said the commandments still apply fully to themselves.

But while nine Americans in 10 Americans feel the commandments against killing and stealing are applicable to themselves, fewer than six in 10 feel that way about keeping the Sabbath holy.

Here is how the commandments rate with Amer-

- icans:
- Thou shalt: 93 percent say it applies.
 - Not kill: 93 percent.
 - Honor thy mother and father: 90 percent.
 - Not bear false witness: 89 percent.
 - Not covet thy neighbor's goods: 88 percent.
 - Not covet thy neighbor's wife: 89 percent.
 - Not commit adultery: 87 percent.
 - Have no other gods before me: 79 percent.
 - Not take the Lord's name in vain: 68 percent.
 - Keep the Sabbath holy: 57 percent.

TIRED OF STRIPPING ALONE
Come See The **STRIPPER**
802 Clark St.
NEW SUMMER HOURS
Tues.-Fri. 10 a.m. to 7 p.m.
Sat. Only 9 a.m. to 12 noon
Closed Sun & Mon.
•Furniture Stripping
•Repair/Refinishing
757-1982

Clear Vue Opticians
Greenville's Eyeglass Center
Best Prices And Services In Town

| | |
|--|---|
| Single Vision Eyeglasses Clear Lenses \$24 ⁹⁵ Up To Plus Or Minus 5 Power | Bifocal Eyeglasses Clear Lenses \$36 ⁹⁵ 25mm Flat top Up To Plus Or Minus 5 Power |
|--|---|

Select Choice Of Frames
(Greenville Store Only)
Designer Frames Available by Diane Von Furstenberg, Polo, Anne Klein, Logo Of Paris & Lacoste.

VISA CLEAR VUE OPTICIANS MasterCard

315 PARK VIEW COMMONS
ACROSS FROM DOCTORS PARK
GREENVILLE

752-1446
OPEN 9 AM 'TIL 5:30 PM
MONDAY THRU FRIDAY

CALL US FOR AN APPOINTMENT WITH THE DOCTOR OF YOUR CHOICE

FOCUS



Viva Olivier!

One of the most famous stage actors in history celebrates his 75th birthday on Saturday. In his 50-year career, Laurence Olivier has acted in dozens of plays and more than 50 movies. His roles have ranged from pickpocket to decadent priest, from ex-Nazi to Nazi hunter, from Heathcliff to Hamlet. He has acted with everyone from Noel Coward and Charlton Heston to Marilyn Monroe and Vivien Leigh — his wife for 20 years. His long and brilliant career has won him more than Oscars. In 1947 Olivier became the youngest actor every to be knighted. In 1970 he became "a peer of the realm," the first actor in history awarded a seat for life in Britain's House of Lords.

DO YOU KNOW — For which film did Laurence Olivier win an Oscar for Best Actor in 1948?

TUESDAY'S ANSWER — The annual *Tour de France*, which averages about 3,000 miles and takes about 21 days, is the world's longest bike race.

5-19-82 © VEC, Inc. 1982

Shaklee Meeting
Supervisors & Distributors From All Lines
East Carolina Association Of Shaklee
Distributors Meeting On Saturday,
May 22, 1982, 1:30 to 4:00 P.M.
Willis Building
1st Street
Greenville
Speakers: Durwood & Teresa Johnson

FAMILY DOLLAR

| | | |
|--|--|--|
| 1⁹⁹ Box 76 Ounce Rinso Big economical box of heavy duty laundry powder. | 3\$1 Bars 5-Oz. Dial Soap Big bath size bars of Dial deodorant soap. Limit 3. | 75¢ Pk. 2-Pack Sylvania Light Bulbs Buy 2 packs of 60, 75 or 100 watt bulbs and get *1 mail-in rebate. Your Net: 25¢ Pack! |
| 5⁹⁹ Pair Unit Sole Sandals Leather-look sandal with durable rubber sole. Ladies' and girls' sizes. | \$2 Ea. Tops, Shorts & Rompers •Ladies' tank tops in prints, stripes and solids. S,M,L and 40-46. •Shorts in track, jamaican or cuff bottom styles. S,M,L and 32-40. •Smock waist, tie shoulder rompers. S,M,L. | \$1 Men's Transfer T-Shirts With popular prints and sayings. Slight irregulars. S,M,L,XL. |
| 1⁸⁸ Pair Tatomi Thong Sandals With sponge sole and grass insole. Sizes for the family. | 87¢ Brach's Circus Peanuts 9 1/2-oz. assorted or 10-oz. orange marshmallow candy peanuts. | |

Prices Good At All Family Dollar Stores Through This Weekend. Quantities Limited On Some Items. No Sales To Dealers.

Harris Shopping Center-Memorial Drive
Open Monday - Saturday 9 to 9

BIG HAM TASTE. NEAT LITTLE PACKAGE.



Hamlette
BONELESS HAM-WATER ADDED
SECTIONED AND FORMED
A Smithfield Classic

We took the big smokehouse flavor of Smithfield brand ham and wrapped it up in a convenient little package called Hamlette.

It's our boneless buffet ham. And it's so lean, so versatile, it will last you through more exciting meals than some hams twice its size.

50¢ OFF.

DEALER: Send this coupon to Smithfield Packing Company, P.O. Box 1888, Clinton, Iowa 52732.

Coupon will be redeemed for face value plus \$4 handling if used in accordance with terms hereof. Coupon is not transferable. Invoices covering purchases by you must be submitted upon request. Consumer must pay any sales taxes. Offer void where restricted. Cash value 1¢. Valid only on brands specified. Any other use constitutes fraud. Smithfield Packing Company, Smithfield, Virginia. Offer Expires June 30, 1982.

SMITHFIELD

70800 103361

Pick 'n Pay Shoes

25% off and more on women's casuals.

\$7

your choice

a. Women's stretch band slide.
Leather trim. Reg. \$9.97...\$7
■ Girls' sizes 9-4.
Reg. \$7.97...\$6

b. Women's leather thong.
Reg. \$10.97...\$7
■ Children's sizes 9-4.
Reg. \$8.97...\$7

c. Women's canvas espadrille
has double bow on vamp. Low jute wedge. Assorted colors.
Reg. \$10.97...\$7

Women's panty hose... 1/3 off
Sale. All canvas handbags. 25% off

Greenville Blvd. on 264 By Pass
Greenville, N.C.

Sale prices good thru Sunday. MasterCard or Visa. Open evenings



SERVICE AND QUALITY... BETTER THAN IT HAS TO BE!

PRICES EFFECTIVE MAY 19 THRU 22.
We reserve the right to limit quantities. None sold to dealers or restaurants. We gladly accept U.S.D.A. Food Stamps.

Free Dictionary!

Buy Volumes 2 thru 9 of Funk & Wagnalls New Encyclopedia for just \$3.49 and get a Free Dictionary.

Volume 1 of Funk & Wagnalls New Encyclopedia still only 9c (with a \$5.00 purchase)



WEIGHT WATCHER'S
ICE MILK BARS
6-PK.
99¢

KINGSFORD 10 LBS. CHARCOAL **2.59**
KINGSFORD MATCHLITE INSTANT CHARCOAL 8 LBS. **3.19**

PIGGLY WIGGLY BUTTERMILK
Biscuits
4 PK.
78¢

MAOLA REFRESHO, FUDGE & POPCICLES BUY TWO, GET ONE FREE 6 PK.

VIVA JUMBO
TOWELS
59¢

SUNBEAM DESSERT CUPS 4 PK. **2.99¢**

HEINZ
Ketchup
32 OZ.
1.19

MAOLA TRIM OR GREAT SHAPE MILK 1/2 GAL. **1.09**

PIGGLY WIGGLY SLICED OR HALVES
PEACHES
16 OZ.
2/100

SUNSET GOLD ICE 1/2 GAL. MILK **1.09**

PIGGLY WIGGLY
ORANGE JUICE
1/2 GAL.
98¢

SUPER SPECIAL!
VAN CAMP PORK & BEANS
16 OZ.
3/100

SUPER SPECIAL!
PIGGLY WIGGLY SALAD CUBES
12 OZ.
59¢

SUPER SPECIAL!
PIGGLY WIGGLY Bleach
GAL.
59¢

SUPER SPECIAL!
BREAST O' CHICKEN TUNA OIL & WATER
6 OZ.
78¢

SUPER SPECIAL!
PIGGLY WIGGLY 'VITAMIN D' MILK
GAL. JUG
1.79

Swift's Premium Beef!
FRESH
GROUND BEEF 3 LBS. OR MORE **1.19** LB.
BONELESS CHUCK ROAST **1.68** LB.

BONELESS SHOULDER ROAST **1.98** LB.
BONELESS CHUCK STEAK **1.88** LB.
CUBE CHUCK STEAK **2.78** LB.
BONELESS Shoulder Steak **2.18** LB.
U.S.D.A. GRADE 'A' FRESH WHOLE FRYERS 2 PER BAG **45¢** LB. (Limit 2 Bags Please!)WHOLE SMOKED PICNICS **79¢** LB. SLICED FREE!

BONELESS BEEF STEW **1.78** LB.
WHOLE (LIPON) RIBEYES **3.39** LB.
LUTER FRANKS 12 OZ. PKG. **99¢**
Save An Additional 25¢ With Coupon On Pg. 26

PIGGLY WIGGLY Bologna 12 OZ. **1.09**
LUNDY'S SLICED BACON **1.49** LB. PKG.

1/2 GAL. WISK **3.09**

CHARMIN TISSUE 4 ROLL **1.19**

BRYER'S YOGURT 8 OZ. **3/1.49**

SEALTEST LIGHT & LIVELY YOGURT 8 OZ. **3/1.29**

KRAFT SLICED AMERICAN CHEESE 12 OZ. SINGLES **1.59**

PIGGLY WIGGLY WORLD OF PRODUCE
the Freshest Buys in Town!
SALAD BOWL Lettuce **49¢** HD.
VINE RIPE TOMATOES... LB. **59¢**
WASHINGTON STATE RED DELICIOUS APPLES... LB. **49¢**
BROCCOLI... BUNCH **99¢**
FANCY YELLOW ONIONS... 3 LB. BAG **89¢**
MIXED GREEN SALAD... LB. **49¢**
LOCAL STRAWBERRIES... LB. **89¢**

SAVE WITH SEALTEST!
SEALTEST SOUR CREAM 8 OZ. **69¢**
SEALTEST SOUR CREAM 16 OZ. **1.29**
SEALTEST OR LIGHT & LIVELY COTTAGE CHEESE 12 OZ. **75¢**
SEALTEST OR LIGHT & LIVELY COTTAGE CHEESE 24 OZ. **1.49**

DR. PEPPER, 7-UP, & SUGAR FREES!
2 LITER BOTTLES **99¢**
KRAFT BARBEQUE SAUCE 18 OZ. **58¢**
TEXAS PETE CHILI SAUCE 10 OZ. **3/1.00**

MAOLA 1/2% LOWFAT MILK GAL. JUG **1.58**

COUPON PIGGLY WIGGLY OIL 48 OZ. **1.39**
LIMIT ONE WITH COUPON AND \$7.50 FOOD ORDER COUPON EXPIRES 5/22/82

COUPON PIGGLY WIGGLY Margarine LB. **FREE!**
COUPON EXPIRES 5/22/82 LIMIT TWO WITH COUPON AND \$7.50 FOOD ORDER

COUPON PIGGLY WIGGLY BLEACH GAL. JUG **29¢**
Limit 1 w/ 7.50 food order. Expires 5/22/82

COUPON MAXWELL HOUSE INSTANT COFFEE 10 OZ. **3.69**

TREET **99¢** 12 OZ.

DELUXE MOON PIES 12 CT. **1.69**
HOT SHOT House & Garden Spray 11 OZ. **2.39**
GORTON THRIFT FISH STICKS 40 CT. 2 LB. **3.49**
PILLSBURY HUNGRY JACK FLAKY BISCUITS 5 1/2 OZ. **3/1.00**
NABISCO GAEITY FUDGE 19 OZ. **1.25**
FRANKLIN HONEYBUNS 3 1/2 OZ. **3/99¢**
NABISCO SNACK CRACKERS **95¢**
PET RITZ PIE SHELLS 5" 2 PK. **69¢**
MAXWELL HOUSE INSTANT COFFEE 10 OZ. **3.99**

PIGGLY WIGGLY KEEPS AMERICA SHOPPING WITH EVERYDAY LOW PRICES!

2105 DICKINSON AVE. GREENVILLE
OPEN 8 TO 9 MON. - SAT., OPEN 8 TO 8 SUN.

Stock And Reports

NEW YORK (AP) - Stock prices headed lower today, continuing their week-long decline.

The Dow Jones average of 30 industrials dropped 1.62 to 839.23 in the first half hour.

Losers took a 5-3 lead over gainers among New York Stock Exchange-listed issues.

The market's recent retreat has been blamed on persistent high interest rates and doubts that a hoped-for economic recovery would materialize.

A new problem emerged this week with the disclosure that a small government securities firm, Drysdale Government Securities, couldn't pay \$160 million in debts.

The firms' problems stirred controversy among Wall Street brokerage houses and banks dealing with Drysdale over who would have to cover the debts.

Shares of Chase Manhattan Corp., one company in the middle of the dispute, rose 1/4 to 48 1/2, today after falling 3/2 points Tuesday.

On Tuesday the Dow Jones industrial average dropped 4.47 to 840.85, bringing its loss over the past five sessions to 25.02 points.

Five stocks fell in price for every two that rose on the NYSE.

Big Board volume totaled 48.97 million shares, up from 45.60 million the day before.

The NYSE's composite index fell 52 to 66.84.

At the American Stock Exchange, the market value index was off 1.89 at 273.81.

N.C. eggs: Market steady on large and lower on balance. Supplies moderate. N.C. weighted average price for small sales of consumer grade A white eggs in cartons delivered to retail stores: large 67.47 cents per dozen; medium 57.47; small 47.05.

New York eggs: Prices edged lower on mediums and unchanged on balance. Trade sentiment mostly steady. Cartoned egg demand fairly good where features are in progress but full and disappointing otherwise. Floor stocks of large and heavier weights, fully adequate but clearing reasonably well. Mediums and small ample and difficult to clear in some quarters. Prices to retailers - sales to volume buyers, consumer grade A white eggs in cartons delivered store door: A extra large 64.66; A large 63.65; A medium 52.54.

Graded feeder pig sales: Wallace-Chadborn: 1427 Head sold: 40-50 pound No. 1 and 2s 131.00, No. 3s 123.50; 50-60 pound No. 1 and 2s 112.58, No. 3s 100.25. Turnersburg - 647 head sold: 40-50 pound No. 1 and 2s 130.00, No. 3s 105.00; 50-60 pound No. 1 and 2s 113.55, No. 3s 100.00. Smithfield - 604 head sold: 40-50 pound No. 1 and 2s 131.50, No. 3s 125.75; 50-60 pound No. 1 and 2s 113.50, No. 3s 101.00. Grain: No. 2 yellow shelled corn steady at 2.74-2.98, mostly 2.85-2.98 in the East

and 2.789-3.10, mostly 2.78-3.06 in the Piedmont; No. 1 yellow soybeans higher at 6.65-6.90 12, mostly 6.73-6.90 12 in the East and 6.30-6.68, mostly 6.65-6.68 in the Piedmont; wheat 2.84-3.50, mostly 3.04-3.30; oats 1.50-2.20. (New crop - corn 2.45-2.71; soybeans 6.26-6.54; wheat 2.84-3.25; oats 1.45-1.64). Soybean meal fob N.C. processing plants per ton 44 percent 217.00-222.00. Prices paid as of 4 p.m. today by location for corn and soybeans: Cofield 2.88, 6.86; Conway 2.85, 6.80; Creswell 2.74, 6.66; Dunn 2.93, 6.76; Elizabeth City 2.79, 6.76; Farmville 2.90, 6.65; Fayetteville, 6.85 12; Goldsboro 2.95, 6.66; Greenville 2.85, 6.73; Kinston 2.89, 6.73; Lumberton 2.86, 6.65; Pantego 2.83, 6.73; Raleigh, 6.90 12; Selma 2.97, (6.80-6.90); Whiteville 2.86, 6.65; Williamston 2.85, 6.73; Wilson (2.97-2.98), 6.73; Albemarle 2.82, 6.68; Barber 3.06, 6.65; Mocksville 2.78; Monroe (2.78-3.10); Roaring River 2.78; Mt. Ulla, 6.65; Statesville 3.05, 6.30.

| NEW YORK (AP) - Midday stocks: | High | Low | Last |
|--------------------------------|--------|--------|--------|
| AbtLabs | 30 1/2 | 30 1/2 | 30 1/2 |
| Alcoa | 24 1/4 | 24 1/4 | 24 1/4 |
| Allis Chalm | 14 1/4 | 14 1/4 | 14 1/4 |
| Am BAKER | 24 1/4 | 24 1/4 | 24 1/4 |
| Am Airlin | 17 1/2 | 17 1/2 | 17 1/2 |
| Am Cyan | 29 1/2 | 29 1/2 | 29 1/2 |
| Am Family | 9 1/4 | 9 1/4 | 9 1/4 |
| Am Motors | 3 3/4 | 3 3/4 | 3 3/4 |
| Am Stand | 26 1/2 | 26 1/2 | 26 1/2 |
| Amer T&T | 28 1/2 | 28 1/2 | 28 1/2 |
| Beat Food | 19 1/2 | 19 1/2 | 19 1/2 |
| Beth Steel | 20 1/2 | 20 1/2 | 20 1/2 |
| Boeing | 19 1/2 | 19 1/2 | 19 1/2 |
| Boise Cased | 27 1/2 | 27 1/2 | 27 1/2 |
| Borden | 32 1/4 | 31 1/2 | 31 1/2 |
| Burling Ind | 22 1/2 | 22 1/2 | 22 1/2 |
| Carroll | 42 1/2 | 41 1/2 | 41 1/2 |
| Carroll W | 21 1/2 | 21 1/2 | 21 1/2 |
| Celanese | 52 1/2 | 52 1/2 | 52 1/2 |
| Cent Soya | 11 1/2 | 11 1/2 | 11 1/2 |
| Champ Int | 14 1/2 | 13 1/2 | 14 1/2 |
| Chrysler | 6 1/2 | 6 1/4 | 6 1/4 |
| CocaCola | 33 1/2 | 33 1/4 | 33 1/4 |
| Colg Palm | 17 1/2 | 17 1/2 | 17 1/2 |
| ConEd | 22 1/2 | 22 1/2 | 22 1/2 |
| Contra | 22 1/2 | 22 1/2 | 22 1/2 |
| Conti Group | 28 1/2 | 28 1/2 | 28 1/2 |
| DeltaAiri | 32 1/2 | 31 1/2 | 31 1/2 |
| DeChem | 22 1/2 | 22 1/2 | 22 1/2 |
| duPont | 35 1/2 | 34 1/2 | 34 1/2 |
| Duke Pow | 22 1/2 | 22 1/2 | 22 1/2 |
| EastAiri | 6 1/2 | 6 1/2 | 6 1/2 |
| East Kodak | 73 1/2 | 73 1/2 | 73 1/2 |
| EatonCp | 29 1/2 | 29 1/2 | 29 1/2 |
| Esmark s | 46 1/2 | 46 1/2 | 46 1/2 |
| Exxon s | 28 1/2 | 28 1/2 | 28 1/2 |
| Fireside | 11 1/2 | 11 1/2 | 11 1/2 |
| FlaPowL | 33 1/2 | 33 1/2 | 33 1/2 |
| FlaProgress | 16 1/2 | 16 1/4 | 16 1/4 |
| GenCorp | 23 1/2 | 23 1/2 | 23 1/2 |
| For McKess | 32 1/2 | 32 1/2 | 32 1/2 |
| Fugua Ind | 19 1/2 | 19 1/2 | 19 1/2 |
| Gndynam | 25 1/2 | 25 1/2 | 25 1/2 |
| Gen Elec | 62 1/2 | 62 1/2 | 62 1/2 |
| Gen Food | 36 1/2 | 36 1/2 | 36 1/2 |
| Gen Mills | 41 1/2 | 40 1/2 | 41 1/2 |
| Gen Motors | 43 1/2 | 43 1/2 | 43 1/2 |
| GenTel | 29 1/2 | 29 1/2 | 29 1/2 |
| Gen Tire | 20 1/2 | 20 1/2 | 20 1/2 |
| Gen Parts | 35 1/2 | 35 1/2 | 35 1/2 |
| Gen Pacif | 15 1/2 | 15 1/2 | 15 1/2 |
| Goodrich | 20 1/2 | 20 1/2 | 20 1/2 |
| Goodyear | 23 1/2 | 23 1/2 | 23 1/2 |
| GraceCo | 38 1/2 | 38 1/2 | 38 1/2 |
| Greylong | 17 1/2 | 17 1/2 | 17 1/2 |
| Gulf Oil | 32 1/2 | 32 1/2 | 32 1/2 |
| HerculesInc | 20 1/2 | 20 1/2 | 20 1/2 |
| Honeywell | 73 1/2 | 73 1/2 | 73 1/2 |
| Ing Rand | 48 1/2 | 47 1/2 | 48 1/2 |
| IBM | 63 1/2 | 63 1/2 | 63 1/2 |
| Int'l Harv | 45 1/2 | 44 1/2 | 44 1/2 |
| Int'l Paper | 25 1/2 | 25 1/2 | 25 1/2 |
| Int'l T&E | 18 1/2 | 18 1/2 | 18 1/2 |
| K mart | 18 1/2 | 18 1/2 | 18 1/2 |
| KaiserAlum | 12 1/2 | 12 1/2 | 12 1/2 |
| Kaneb | 17 1/2 | 17 1/2 | 17 1/2 |
| Kroger Co | 31 1/2 | 31 1/2 | 31 1/2 |
| Lockheed | 49 1/2 | 49 1/2 | 49 1/2 |
| Lows Corp | 91 1/2 | 91 1/2 | 91 1/2 |
| Masonite | 23 1/2 | 23 1/2 | 23 1/2 |
| McDermott | 24 1/2 | 24 1/2 | 24 1/2 |
| Mead Corp | 18 1/2 | 17 1/2 | 17 1/2 |
| MinnMM | 33 1/2 | 33 1/2 | 33 1/2 |
| Mobil | 24 1/2 | 24 1/2 | 24 1/2 |
| Monsanto | 67 1/2 | 67 1/2 | 67 1/2 |
| NCNB Cp | 13 1/2 | 13 1/2 | 13 1/2 |
| NaborsInd | 33 1/2 | 33 1/2 | 33 1/2 |
| Nat Distill | 22 1/2 | 22 1/2 | 22 1/2 |
| OwensIll | 26 1/2 | 26 1/2 | 26 1/2 |
| Penney JC | 33 1/2 | 33 1/2 | 33 1/2 |
| PepsiCo | 37 1/2 | 37 1/2 | 37 1/2 |
| Phelps Dod | 25 1/2 | 25 1/2 | 25 1/2 |
| PhillipMorr | 50 1/2 | 49 1/2 | 49 1/2 |
| PhillipsPet | 31 1/2 | 31 1/2 | 31 1/2 |
| Polaroid | 18 1/2 | 18 1/2 | 18 1/2 |
| Proct Gamb | 84 1/2 | 83 1/2 | 83 1/2 |
| Quaker Oat | 40 1/2 | 40 1/2 | 40 1/2 |
| RCA | 21 1/2 | 21 1/2 | 21 1/2 |
| RaisinPar | 14 1/2 | 14 1/2 | 14 1/2 |
| RepubAir | 3 1/4 | 3 1/4 | 3 1/4 |
| Republic SU | 18 1/2 | 18 1/2 | 18 1/2 |
| Revdyn | 20 1/2 | 20 1/2 | 20 1/2 |
| ReynoldInd | 48 1/2 | 48 1/2 | 48 1/2 |
| RockwellInt | 31 1/2 | 30 1/2 | 31 1/2 |
| RoyCrown | 18 1/2 | 18 1/2 | 18 1/2 |
| Silegess Fap | 25 1/2 | 25 1/2 | 25 1/2 |
| Smith Paper | 16 1/2 | 16 1/2 | 16 1/2 |
| SearsRoeb | 19 1/2 | 19 1/2 | 19 1/2 |
| Shaklee | 17 1/2 | 17 1/2 | 17 1/2 |
| Skyline Cp | 14 1/2 | 14 1/2 | 14 1/2 |
| Sony Corp | 15 1/2 | 15 1/2 | 15 1/2 |
| Southern Co | 12 1/2 | 12 1/2 | 12 1/2 |
| South Ry | 25 1/2 | 25 1/2 | 25 1/2 |
| Sperry Cp | 33 1/2 | 33 1/2 | 33 1/2 |
| StdOilCal | 44 1/2 | 44 1/2 | 44 1/2 |
| StdOilInd | 37 1/2 | 37 1/2 | 37 1/2 |
| StdOilOh | 50 1/2 | 50 1/2 | 50 1/2 |
| TRW Inc | 30 1/2 | 29 1/2 | 29 1/2 |
| Texaco Inc | 47 1/2 | 47 1/2 | 47 1/2 |
| TexEastn | 47 1/2 | 47 1/2 | 47 1/2 |
| Un Camp | 47 1/2 | 46 1/2 | 46 1/2 |
| Un Carbide | 45 1/2 | 45 1/2 | 45 1/2 |
| UnOilCal | 35 1/2 | 34 1/2 | 35 1/2 |
| Unroyal | 8 1/2 | 8 1/2 | 8 1/2 |
| US Steel | 23 1/2 | 23 1/2 | 23 1/2 |
| Wachov Cp | 25 1/2 | 25 1/2 | 25 1/2 |
| Wal Mart | 48 1/2 | 48 1/2 | 48 1/2 |
| WestPip s | 23 1/2 | 23 1/2 | 23 1/2 |
| Westing El | 25 1/2 | 25 1/2 | 25 1/2 |
| Weyerhsr | 26 1/2 | 26 1/2 | 26 1/2 |
| WinnDix | 35 1/2 | 35 1/2 | 35 1/2 |
| Woolworth | 19 1/2 | 19 1/2 | 19 1/2 |
| Xerox Cp | 34 1/2 | 34 1/2 | 34 1/2 |

Rescued At North Pole

CALGARY, Alberta (AP) - Seven U.S. tourists scrambled to safety from an aircraft at the North Pole in time to watch the plane sink through the ice, an airline official says.

Steve Penikett, general manager of Kenn Borek Air, said Tuesday the stranded passengers and two crew members were rescued unharmed six hours after the accident last Friday.

The pilot, Rocky Parsons, was landing the Twin Otter on a smooth patch of ice at the pole when all three wheels broke through, Penikett said from his office in Calgary.

"He landed on a lead, which is a crack that has opened and refrozen, giving a smooth landing spot. We've been landing on them for years," Penikett said. "This one happened to be newly refrozen."

The plane began to sink slowly and the passengers evacuated with survival gear while the pilot radioed a base camp at Lake Hazen near the northern tip of Ellesmere Island. Six hours later another Twin Otter landed at the pole for the rescue and other planes were on the way.

Fourteen Americans were on the tour, operated by a travel company called Sobex in Los Angeles. The group flies to Lake Hazen and half go to the pole at a time.

The trip to the pole for the second group was canceled after the accident but the rest of the itinerary, including a visit to an Inuit community and a flight over the North Magnetic Pole, was kept.

The passengers, whose names were not released, were unavailable for immediate comment. The Canadian Department of Transport was investigating.

It is the seventh year that Kenn Borek Air has been flying the tours.

The passengers, whose names were not released, were unavailable for immediate comment. The Canadian Department of Transport was investigating.

Planner Faryce Goode said the undeveloped tract was formerly used as a parking lot for the old fairgrounds. She said residential dwellings are located to the north of the property and there are also businesses in the area.

Ms. Goode said that a buffer might be needed between the R-6 and highway commercial zones.

Commissioners approved what Mac Carley, assistant city attorney, referred to as a technical amendment to Section 9-5-14 of the City Code relative to changing of street names. The amendment removes street name-changing from the subdivision ordinance and places it in the general code under public works.

The planning staff handed out copies of the administrative portion of the proposed zoning ordinance. Planning director Bobby Roberson said other sections of the new ordinance will be distributed in the coming months.

VOTING VIOLENCE MANILA, Philippines (AP) - Fourteen people - including four candidates - were killed and 13 others wounded in political violence connected with Philippine local elections, the military announced Tuesday.

Expects Student Loan Defaults To See Drop

GREENSBORO, N.C. (AP) - A North Carolina A&T State University official says she expects student loan defaults to drop to a level equal to the national average by the 1983-1984 school year after 1980-1981's efforts produced a 9 percent reduction.

Alberta Dalton, the school's director of financial aid, said this past year's reductions were the result of policy enforcement and the hiring of a professional collection agency.

The June 1981 figures - showing a 46 percent default rate - were made public last week during an audit of A&T's financial records, Ms. Dalton said.

Ms. Dalton's goal is to reduce defaults to 20 percent by next year and to 16 percent, about the same as the current national rate, by 1983-1984.

The default rate is a cumulative figure which includes loans made over a period of 20 years.

However, the drop is not indicative of students paying off their loans, but is the result of the school giving up efforts to collect on more than 2,000 old cases.

Those will be turned over to the U.S. Department of Education, causing a rapid

decline in the default rate. A&T must first show proof that it has done everything possible to collect the loans, including court action for students who defaulted after 1978. Ms. Dalton said her office is preparing that proof.

"Once the Department of Education takes the cases, that brings your default rate down," she said.

In June 1981, 3,545 students who attended A&T were in default on \$2.4 million in National Direct Student Loan funds. In 1980, June's default rate was 55 percent, with nearly 4,100 students in default on \$2.1 million in loans.

The NDSL program provides government funds to individual colleges to establish their own revolving loan accounts, based on student needs. Students can borrow at 5 percent and

repayment doesn't begin until after they leave school.

Because of its high default rate, A&T has received no federal contribution for its NDSL account since the 1976-77 school year. Funds are cut off to campuses with default rates of 25 percent or more.

Other Greensboro campuses haven't had as much trouble collecting on loans as A&T, one of 16 campuses in the University of North Carolina system. The University of North Carolina at Greensboro, another local UNC-member school, had a 1981 default rate of 6.65 percent.

Last year's default rate was 9.8 percent at Greensboro College; 7 percent at Guilford College; and 18 percent at Bennett College, all independent schools.

Unmowed Lawn Is Supported By Jury

CAMBRIDGE, Mass (AP) - The grass may not always be greener in Frank Paone's neighbor's yard, but it's taller - much taller, in fact - and a Middlesex Superior Court jury says it can stay that way.

The jury on Tuesday found Abul Sayied innocent of charges he violated the state's sanitary code by not cutting the grass or shrubs in his yard.

Sayied, a mathematician and physicist, called the trial a "gigantic waste of money and time. Sheer harassment."

He said grass was meant to grow naturally, and when cut, all kinds of chemicals are needed to maintain it.

Sayied was brought to court after Paone, his 72-year-old neighbor, complained to the city health board.

"You mean he can keep it that way?" asked Paone when he heard the jury's verdict. "He hasn't swept the outside of the place once or cut the grass in 14 years. His shrubs are growing above the second-story window."

The retired maintenance man, said he won't quit in his efforts to get Sayied to clean up his property.

"I keep my place up all the time and I'm old," he said. "He's a young man and he won't do a thing. All I want is for him to clean it up and make it presentable."

Cite Value In College-Closing

ANN ARBOR, Mich. (AP) - The closing of up to 200 U.S. colleges by 1990 may provide valuable information on why some institutions fail, according to two University of Michigan researchers.

About 235 colleges and branch campuses have closed since 1960, yet there has been no systematic study of the trend, James L. Miller Jr. of the Center for the Study of Higher Education and J. Michael Erwin, project director at the Institute of Labor and Industrial Relations, said Tuesday, in a statement.

They urged a "a thorough, objective study of college closings" to guide decisions by colleges that are still functioning.

DEGREE AWARDED CHAPEL HILL - Jimmie W. Adcock received the doctor of medicine degree recently from the University of North Carolina at Chapel Hill. He is married to Terry Manning Adcock, formerly of 1303 Wright Road, Greenville.

CHURCH EVENTS

Burney's Chapel Free Will Baptist Church will begin its weekend services Friday at 7 p.m. with quarterly conference.

Holy Communion will be observed Saturday at 7:30 p.m. with Vice Bishop J. Taylor and the congregation of Corey's Chapel in charge.

Sunday activities will begin with Sunday School at 9:30 a.m., followed by morning worship at 11 a.m. with the Rev. James H. Wilkes, pastor, and the senior choir. Dinner will be served at 2 p.m. and St. Monica Church of Grimesland and its pastor and congregation will be charge of 3 p.m. services.

MEMORIAL SERVICE SEOLU, Korea (AP) - At least 200,000 people attended memorial services in Kwangju yesterday on the second anniversary of a bloody uprising in the southern city against martial law.

REVIVAL BETHEL - A revival will start tonight at the Bethel Church of God and continue through Sunday. The speaker will be the Rev. Brad Keeter.

Obituaries

Brown Mr. Elijah Brown of Greenville died Tuesday in the University Nursing Center. He was the father of Ms. Barbara Brown of Route 1, Hookerton. Funeral arrangements are incomplete at Norcott and Company Funeral Home.

Eller AYDEN - Mrs. Nora Lou Eller, 95, died today. Funeral services will be conducted at 11 a.m. Friday at Farmer Funeral Chapel by the Rev. Gilbert Myster. A graveside services will be held at 4:30 p.m. Friday at the Mountain View Cemetery in Danville, Va.

Mrs. Eller was a native of Danville and was a member of the First Baptist Church of Ayden.

Surviving are one son, Raymond Eller of Greensboro; two daughters, Mrs. Joe Crouch of Ayden and Mrs. Fred Gregory of Tucson, Ariz.; two brothers, Vernon Miller and Charles Miller, both of Lenoir; four sisters, Mrs. Clyde Mitchell of Statesville, Mrs. Deanie Byrd and Mrs. Lola Jarvis, both of North Wilkesboro, and Mrs. Hazel Brown of Mooresville; four

grandchildren, seven great-grandchildren and six great-great-grandchildren. Family visitation will be at the home from 7-9 p.m. tonight.

Grimsley, Mr. Brian Dudley Grimsley, 22, of Route 4, Greenville, died early Tuesday morning. Graveside services will be conducted Thursday at 2 p.m. from Crestlawn Memorial Gardens by the Rev. Rick Jennings and the Rev. Judy Jennings. Entombment will follow in the Cemetery Mausoleum.

Mrs. Warren Mrs. Queenie McGowan Warren, 58, died Tuesday in Pitt County Memorial Hospital.

Her funeral service will be conducted Thursday at 4 p.m. in the Wilkerson Funeral Chapel by the Rev. Willis Wilson and the Rev. Leon Harris. Burial will be in the Bethel Cemetery.

Mrs. Warren, a native of Pitt County, spent most of her life in the Robersonville community. She attended Greenville schools and was a graduate of East Carolina University. She taught home economics in the Robersonville School for 25 years and, for the past few years, had taught at Roanoke High School. She was a member of Hickory Grove Free Will Baptist Church and the NCAE.

Surviving her are her husband, Garland E. Warren; three sons, Garland Edward Warren Jr. of Route 3, Williamston, George Douglas Warren of Bethel and Jeffrey Lee Warren of Route 1, Washington; three brothers, Kinsey McGowan of Miami and Tom McGowan and Ford McGowan, both of Greenville; two sisters, Mrs. Frank Banzet of Warrenton and Mrs. Jean Wells of Greenville; and two grandchildren.

The family will receive friends at the funeral home tonight from 7 to 9 o'clock.

Early Alert In Sputum Study

LOS ANGELES (AP) - By counting cells in a person's sputum - saliva mixed with mucus - scientists believe they can obtain early warnings on the development of lung cancer, emphysema or chronic bronchitis.

Gay Hurls No-Hitter As A-G Clinches ECC Crown

Table with columns for player names and statistics (ab, r, h, r, b, etc.) for various teams.

By RICK SCOPPE
Reflector Sports Writer
LITTLEFIELD — Ayden-Grifton showed Tuesday evening it knows what to do when opportunity knocks — let left-hander Tyrone Gay open — and then slam — the door.

over North Pitt.
The victory secured, the Chargers finish the regular season at 15-6 overall and 10-2 in the league, one game in front of Aycock. North Pitt ends up 8-12 and 3-9.

some help this year, but we won't ourselves. We had to win tonight and we did."
Thanks mainly to Gay — and five errors by the Panthers that allowed A-G to score seven runs in the first two innings and then coast the rest of the way behind Gay.

ball," he added. "but I threw a little harder tonight."
Said Wilson: "He threw the ball well. I've seen him throw better, but he did a good job tonight. Over at North Pitt they hit the fast ball a lot. He threw his curve more tonight."

It was not only the Panthers' lone run of the night but the only one of two times a North Pitt runner made it past first. The only other time came in the fourth when Gay issued back-to-back walks to Trellis Moore and Greg Briley to lead off the inning.

Chris Strickland reached on an error by second baseman Lee Manning to start the inning and stole second — the first of eight steals for Ayden-Grifton. A sacrifice bunt by Bernard Ricciarelli moved Strickland to third.

Strickland. A bad throw to third by first baseman Ken Whitehurst scored Harris and A-G led, 2-0.
Locust was later cut down trying to steal third on a double-steal attempt with Doug Coley, who had walked. Coley later scored on an error to up the Chargers' lead to 3-0.



Rampants Pound Hunt, 21-3, For 21st Win
Williams, Stalls Lead Rose Romp

By WOODY PEELE
Reflector Sports Editor
WILSON — Roger Williams banged out five hits, including a homer and two doubles, and Rudy Stalls added four hits for six runs batted in as Rose High School celebrated its 21st romp of the season with a 21-3 romp over Wilson Hunt last night.

11 strikeouts.
Oddly enough, however, it wasn't the win, but a loss that might come of it that drew first attention of coach Ronald Vincent afterwards. Catcher Crowell Pope took himself out of the game before going behind the plate in the bottom of the first with a hand injury.

along.
Bueie opened the game with a single to center and stole second. Mont Carter walked and with one away, Williams got a single to left, driving in Bueie.

Rose pumped its lead out to 17-1 in the third inning batting around for the second time. Carter opened with a walk and moved up on an error on a pickoff try. With one down, Williams singled him in, and Douglas walked. Curtis Evans reached on an error, loading the bases, and Warren reached on an infield hit, scoring runner Wilson. Kittrell then banged a long single, driving in all three runners. Kittrell, who advanced on the relay home, took third on a passed ball and scored on Stalls' single.

the 350 sign in left center. Bobby Bueie then walked and Evans singled to left. Johnson walked and Stalls singled to center, scoring two for his six rbi total.
Hunt picked up its first run off Williams in the second. John Logan led off with a double to left and scored on Brent Pope's single.

Two For Baltimore
Baltimore shortstop Bob Bonner forces out Minnesota's Jesus Vega at second base and throws on to first to complete a double play Tuesday night. The Twins won, 8-7. (AP Laserphoto)

first to complete a double play Tuesday night. The Twins won, 8-7. (AP Laserphoto)

Table with columns for player names and statistics (ab, r, h, r, b, etc.) for the Rampants vs Hunt game.

Table with columns for player names and statistics (ab, r, h, r, b, etc.) for Williams vs Stalls game.

Table with columns for player names and statistics (ab, r, h, r, b, etc.) for Rose vs Wilson game.

Table with columns for player names and statistics (ab, r, h, r, b, etc.) for Rose vs Wilson game.

SAAD'S SHOE REPAIR
Quality Shoe Repairing
We sew leather coats.
113 Grande Ave.
758-1228
Opposite Sherwin Williams
Hours
8-6 Mon.-Fri.
Closed Saturday
"Parking In Front"

Jaguars Down
S. Nash, 10-6

STANHOPE — Randy Daniels drove in three runs and Farmville Central held off a late comeback by Southern Nash en route to a 10-6 victory in an Eastern Carolina Conference baseball game.
Farmville ends the season at 6-13 overall and 4-8 in the ECC. The Jaguars won their last two games and three of their last four. Southern Nash ends up 10-11 and 7-5.
Farmville jumped out to a 6-0 lead in the top of the first and suffered only one challenge from the Firebirds — a four-run seventh inning keyed by a grand slam home run by Paul Bisette.

Sports Calendar
Items on the Sports Calendar are supplied by schools or sponsoring agencies and are subject to change.
Today's Sports
Tennis
Regionals
Baseball
Little League
First Federal vs. Wellcome
Kiwanis vs. Optimists
Softball
Life of Virginia vs. New Dell
Pantano Bob's vs. Ervin's
Attie vs. Bio-Meds
Cannon vs. N.C. Autobrokers
Industrial League
Kilowatts vs. Eaton
Grady-White vs. Enforcers
Fieldcrest vs. Carolina Telephone
Fire Fighters vs. Union Carbide
Burroughs-Wellcome #2 vs. Winn Dixie
Pitt Memorial vs. Coca-Cola
ECU #1 vs. TRW
Public Works vs. C.I.S.
Women's League
Cavaliers vs. Burroughs-Wellcome
Pitt Memorial vs. Copper Kettle
Greenville Travel vs. Western Sizzlin'
Thursday's Sports
Baseball
Northeastern at Rose (4 p.m.)
Nash Central at E.B. Aycock (4 p.m.)
Prep League
First State Bank vs. Hendrix & Dail
Little League
True Value Hardware vs. Pepsi-Cola
Sportsworld vs. Coca-Cola
Track
Regionals
Softball
Northeastern at Rose (4 p.m.)
Nash Central at E.B. Aycock (4 p.m.)
City League
Pair vs. Hughes
Metal Craft vs. Regional Auto
Church League
Hooker vs. Grace
Oakmont vs. Trinity
Mt. Pleasant vs. First Presbyterian
Black Jack vs. St. Paul
Arlington vs. Memorial
Unity vs. Maranatha
First Free Will vs. First Pentacostal
Immanuel vs. Peoples
Women's League
Prepshirt vs. Carolina Telephone
Tennis
Regionals

Fantastic Tennis Sale
Prince Racquets No. 1 Over Sized Racquet!
Prince Pro
The New Prince Pro Will Improve Your Game.
You'll Hit More, Faster And More Accurately.
Reg. \$110 Special 99.95
Prince Classic
You'll Play Better Immediately!
The Prince "Classic" is a forgiving racquet which has added dimensions of pleasure and effectiveness to any players game.
Reg. \$72 Special 64.95
Prince J/R 25
Introducing the Prince J/R 25, designed and engineered specifically for the young tennis player.
Reg. 45.95 Special 39.95
Pro Kennex Power Ace
A black aluminum racquet, featuring a graphite-fiberglass throat piece.
Reg. 69.95 Sale 59.95
Pro Kennex Silver Ace
The Silver Ace is flexible where it needs to be flexible, stiff where it needs to be stiff, light where it needs to be light, and strong where it needs to be strong.
Reg. 109.95 Sale 99.95
Pro Kennex Black Ace
New cosmetics. New racquet cover, an improved foam core system as well as a change in the molding process.
Reg. 159.95 Sale 139.95
Pro Kennex Diamond Ace
All new 70% graphite, 30% boron. This is the firmest of all 4 racquets.
Reg. \$275 Sale 249.95
Wilson Tennis Balls Reg. 2.98 Sale 2.50
Asahi Tennis Shoes-A Feet For Your Feet
Mens Leather Reg. 38.95 Sale 34.95
Mens Canvas Reg. 23.95 Sale 21.95
Ladies Leather Reg. 36.95 Sale 33.95
Ladies Canvas Reg. 21.95 Sale 19.95
Shoe Club Cards Excluded
Suppliers Of
SYMBOL OF FINE ACTIVE SPORTSWEAR
BOAST
Court Casual
For Men & Women
Bonds/H.L. Hodges Co.
Sporting Goods
218 Arlington Blvd.
Open 9:00 Til 6:00
756-6001
Greenville
210 E. Fifth St.
Open 10-5:30
752-4156

Attention
All Mobile Home Owners
Announcing
Opening Of
Glenn's Mobile Home
Supplies & Hardware
Come In And Let Glenn Worthington
& Herbert Branch Help You
We Have A Complete Line Of:
• Mobile Home Supplies • General Hardware
• Plumbing & Electrical Supplies
• Anchors • Underskirting • Mobile Home Doors
• Windows • Roof Coating • Hot Water Heaters
• And Many, Many More Items
Opening Day Monday, May 17
Hours: Mon.-Sat. 7 a.m. to 8 p.m.
756-5288 Located On Hwy 43-
Beside Pollard's Grocery - 3 Miles From Pitt Plaza

BFG Wholesale
Prices
BFG 15 Inch
Steel Belted Radial \$37.95 Each
Blem Special
BFG XLM Steel Belted 205/75R15
MOST OTHER SIZES AVAILABLE
COUPON
Car Shake?
We Eliminate!
Rotate, Balance, and Alignment \$32.95
COUPON
Lubrication, Oil Change
Oil Filter
SPECIAL
NOW ONLY \$13.88
COUPON
Ask About Our
EASY CREDIT PLAN.
BFG Goodrich COGGINS CAR CARE
Tires and Service
756-5244
325 West Greenville Blvd.
Open Monday
Thru Friday
9:00 A.M. - 6:30 P.M.
Saturday
9:00 A.M. - 1:30 P.M.

Youth Ball

Prep League

Shop-eze 7

Auto Specialty 5

Andrew Perry banged out four hits and drove in four runs in leading Shop-eze Foodland to a 7-5 Prep League baseball victory over Auto Specialty last night.

Auto Specialty grabbed the lead in the game in the first inning, scoring twice, but Shop-eze came back with one in the second as Perry drove in his first run in the third. Shop-eze added four more runs to take a 5-1 lead, and Perry drove in two of those.

Then, in the fourth, Shop-eze added two more to clinch it. Tim West singled with one way and moved up on the second out. He scored on Terry Warron's double, and after Brian Broady reached on an error, Perry closed out the scoring with a single, driving in Warron.

Auto Specialty added two in the fifth and one in the sixth.

In addition to Perry's four hits, Warron had three and Neal Bullock and West each had two. No one had more than one for Auto Specialty.

Little League

Union Carbide 8

Jaycees 2

Union Carbide got four-hit pitching from Kevin Fisher and rolled to an 8-2 victory over the Jaycees yesterday in the North State Little League.

Union Carbide pushed over two in the first to take the lead.



What Did You Say?

California's Reggie Jackson points to umpire George Maloney after being called out on strikes

When added what proved to be the winner in the second, Paul Powers singled and moved up on a wild pitch. He scored on Morris Johnson's double for the 3-0 lead.

Union Carbide added four in the fourth and one in the sixth for its eight-run total.

Both of the Jaycee runs came in the third on a two-run hit by Bruce Koonce.

Johnson, Billy Turcotte and Powers led the UC hitting with two each, while Koonce had two for the Jaycees.

Carroll & Assoc. 1

Moose 0

Billy Carr scored in the sixth inning to give Carroll & Associates a 1-0 win over the Moose in the Tar Heel Little League yesterday.

C&A pitcher Lloyd May limited the Moose to only two hits, both off the bat of Chris Christopher in getting the shutout victory.

But Carroll had almost as much of a problem with Jay

last night against Milwaukee. Looking on is catcher Ned Yost. Jackson celebrated his 36th birthday as the Angels won, 4-1. (AP Laserphoto)

Mattox of the Moose, who gave up only three hits.

The killer came in the bottom of the sixth. Carr opened the inning with a double to left. After one out, he scored when James Lawler reached on an error, giving C&A the victory.

No one on C&A had more than one hit.

S. Pitt LL

Chicod 25

Grifton 18

GRIFTON — The Chicod

Hornets outslugged the Grifton Bears, 25-18, Tuesday in a Southern Pitt Little League baseball game.

Gray Mills picked up the win on the mound.

Casey Pittman led Chicod with four hits. Dale Sutton and Russ Pittman had three hits for Chicod while Mills, Aaron Swinson and Eric Bradley all had two hits.

Eugene Stancill had three hits for Grifton.

SCOREBOARD

Bowling

| Guys & Dolls | W | L |
|-------------------|---|---|
| Ruth's Station | 4 | 0 |
| Kings & Queens | 4 | 0 |
| Team #12 | 4 | 0 |
| Screw Balls | 3 | 1 |
| Jimmy's Citco | 2 | 2 |
| Team #8 | 2 | 2 |
| Team #1 | 2 | 2 |
| Team #2 | 2 | 2 |
| Team #7 | 2 | 2 |
| Team #14 | 2 | 2 |
| Cornwell Builders | 2 | 2 |
| Pac Attack | 2 | 2 |
| Family Affair | 1 | 3 |
| Strike Brokers | 0 | 4 |
| Four Aces | 0 | 4 |
| Team #11 | 0 | 4 |

Men's high series — Steve Shankle, 592. Men's high game — Cecil Keel III, 237. Women's high series — Dolores Berg, 571. Women's high game — Vivian Brantley, 200.

Rec Softball

| Church League | W | L |
|--|---------|-----------|
| St. Paul | 000 | 000-0 |
| Faith | 213 | 011-18 |
| Leading hitters: F — Paul Bradford 4-5, Mike Williams 3-4. | | |
| Peoples | 502 | 200-6-15 |
| Hooker | 101 | 200-0-4 |
| Leading hitters: P — David Harris 3-4, Don Sheppard 4-5; H — Joe Goddette 3-5, Phil Gibbs 3-4. | | |
| Ist. Pent. | 400 | 435-16 |
| Immanuel | 100 | 000-1 |
| Leading hitters: P — Dickie Rook 2-3, Jim Tauton 2-3. | | |
| Victory | 200 | 101-0-4 |
| Arlington | 000 | 013-7-11 |
| Leading hitters: V — Eddie Taylor 2-3, Barry Berryman 2-3; A — Bill Woodard 2-3, Todd Galloway 2-3. | | |
| Oakmont | 120 | 132-0-9 |
| Grace | 211 | 000-0-4 |
| Leading hitters: O — Butch Jones 4-4, Ashley Ferrell 4-4; G — James Hardee 3-3, Hayward Outland 3-3. | | |
| Mt. Pleasant | 420 | 011-1-8 |
| Trinity | 101 | 400-0-6 |
| Leading hitters: MP — Ray Elks 4-4, Jerry Simpson 3-4; T — Lee Cherry 4-4, Mike Gillin 4-4. | | |
| Ist. Christ. | 503 | 311-13 |
| Ist. Presby. | 400 | 100-15 |
| Leading hitters: C — Mike Waters 4-5, Eddie Bunch 4-5; P — Joe Smith 3-4, Bobby Sasser 3-3. | | |
| Black Jack | 421 | 062-3-18 |
| Ch. Of God | 510 | 010-2-9 |
| Leading hitters: CG — James Ross 4-4 (HR), Danny Boyd 4-4. | | |
| Memorial | 101 | 024-11-10 |
| Unity | 600 | 300-00-9 |
| Leading hitters: M — D. Bogan 3-4; U — S. Harris 2-3, E. Walker 2-4. | | |
| Women's League | | |
| Carolina Tel. | 101 | 000-2 |
| Coca-Cola | 405 | 438-24 |
| Leading hitters: CT — D. Elks 2-3; CC — D. LaVictoire 3-4, J. Roth 2-3. | | |
| Co-Rec League | | |
| Space World | 430 | 010-8 |
| Sunnyside | 221 | 000-5 |
| Leading hitters: SW — J. Moskop 2-3; S — J. Wilson 3-3, H. Vainright 2-3. | | |
| City League | | |
| Regional Auto | 000 | 00-0 |
| Sunnyside | 160 | 82-17 |
| Leading hitters: S — Kemp Bradshaw 3-4 (HR), Talbot Talbot 3-4. | | |
| J.A.'s | (10)187 | 1-26 |
| Ormonds | 000 | 166-7 |
| Leading hitters: JA — Mike Congar 4-4, Bill Kykendall 3-3 (HR); O — Bob Neel 2-2, David Pope 2-2. | | |

Baseball

| AMERICAN LEAGUE Eastern Division | | | | |
|----------------------------------|----|----|------|--------|
| Team | W | L | Pct. | GB |
| Detroit | 22 | 12 | .647 | — |
| Boston | 23 | 13 | .639 | — |
| Milwaukee | 18 | 16 | .529 | 4 |
| New York | 16 | 19 | .457 | 6 1/2 |
| Cleveland | 15 | 19 | .441 | 7 |
| Baltimore | 14 | 20 | .412 | 8 |
| Toronto | 14 | 21 | .400 | 8 1/2 |
| Western Division | | | | |
| California | 23 | 12 | .658 | — |
| Kansas City | 20 | 15 | .571 | 3 1/2 |
| Oakland | 20 | 18 | .526 | 5 |
| Seattle | 17 | 23 | .429 | 8 1/2 |
| San Diego | 15 | 23 | .395 | 12 |
| Minnesota | 12 | 27 | .300 | 15 1/2 |

Tuesday's Games

| Cleveland 6, Toronto 7 | 6-1, 857, 2-40; Ra Jones, New York, 5-2, 714, 3-15; Pales, New York, 4-2, 667, 3-72; Garber, Atlanta, 4-2, 667, 1-67; Berenyi, Cincinnati, 4-2, 667, 3-35; Welch, Los Angeles, 4-2, 667, 3-31; Noles, Chicago, 5-3, 625, 3-71 |
|-------------------------------|---|
| Detroit 11, Oakland 9 | STRIKEOUTS: Soto, Cincinnati, 66 |
| Chicago 10, Texas 2 | Carlton, Philadelphia, 63; Rogers, Montreal, 51; Ryan, Houston, 41; Lollar, San Diego, 41 |
| Wednesday's Games | |
| Toronto 12, Oakland 3 | STRIKEOUTS: Soto, Cincinnati, 66 |
| Minnesota 2, Baltimore 7 | Carlton, Philadelphia, 63; Rogers, Montreal, 51; Ryan, Houston, 41; Lollar, San Diego, 41 |
| Seattle 1, Boston 9 | STRIKEOUTS: Soto, Cincinnati, 66 |
| Philadelphia 6, Kansas City 2 | Carlton, Philadelphia, 63; Rogers, Montreal, 51; Ryan, Houston, 41; Lollar, San Diego, 41 |
| San Diego 2, St. Louis 1 | Carlton, Philadelphia, 63; Rogers, Montreal, 51; Ryan, Houston, 41; Lollar, San Diego, 41 |
| Los Angeles 4, Cincinnati 3 | Carlton, Philadelphia, 63; Rogers, Montreal, 51; Ryan, Houston, 41; Lollar, San Diego, 41 |
| San Francisco 2, Pittsburgh 1 | Carlton, Philadelphia, 63; Rogers, Montreal, 51; Ryan, Houston, 41; Lollar, San Diego, 41 |
| Atlanta 4, Montreal 4 | Carlton, Philadelphia, 63; Rogers, Montreal, 51; Ryan, Houston, 41; Lollar, San Diego, 41 |
| Houston 2, Philadelphia 1 | Carlton, Philadelphia, 63; Rogers, Montreal, 51; Ryan, Houston, 41; Lollar, San Diego, 41 |
| St. Louis 2, San Diego 0 | Carlton, Philadelphia, 63; Rogers, Montreal, 51; Ryan, Houston, 41; Lollar, San Diego, 41 |
| Los Angeles 2, Chicago 0 | Carlton, Philadelphia, 63; Rogers, Montreal, 51; Ryan, Houston, 41; Lollar, San Diego, 41 |
| San Francisco 2, Pittsburgh 1 | Carlton, Philadelphia, 63; Rogers, Montreal, 51; Ryan, Houston, 41; Lollar, San Diego, 41 |
| Atlanta 4, Montreal 4 | Carlton, Philadelphia, 63; Rogers, Montreal, 51; Ryan, Houston, 41; Lollar, San Diego, 41 |
| Houston 2, Philadelphia 1 | Carlton, Philadelphia, 63; Rogers, Montreal, 51; Ryan, Houston, 41; Lollar, San Diego, 41 |
| St. Louis 2, San Diego 0 | Carlton, Philadelphia, 63; Rogers, Montreal, 51; Ryan, Houston, 41; Lollar, San Diego, 41 |
| Los Angeles 2, Chicago 0 | Carlton, Philadelphia, 63; Rogers, Montreal, 51; Ryan, Houston, 41; Lollar, San Diego, 41 |
| San Francisco 2, Pittsburgh 1 | Carlton, Philadelphia, 63; Rogers, Montreal, 51; Ryan, Houston, 41; Lollar, San Diego, 41 |
| Atlanta 4, Montreal 4 | Carlton, Philadelphia, 63; Rogers, Montreal, 51; Ryan, Houston, 41; Lollar, San Diego, 41 |
| Houston 2, Philadelphia 1 | Carlton, Philadelphia, 63; Rogers, Montreal, 51; Ryan, Houston, 41; Lollar, San Diego, 41 |
| St. Louis 2, San Diego 0 | Carlton, Philadelphia, 63; Rogers, Montreal, 51; Ryan, Houston, 41; Lollar, San Diego, 41 |
| Los Angeles 2, Chicago 0 | Carlton, Philadelphia, 63; Rogers, Montreal, 51; Ryan, Houston, 41; Lollar, San Diego, 41 |
| San Francisco 2, Pittsburgh 1 | Carlton, Philadelphia, 63; Rogers, Montreal, 51; Ryan, Houston, 41; Lollar, San Diego, 41 |
| Atlanta 4, Montreal 4 | Carlton, Philadelphia, 63; Rogers, Montreal, 51; Ryan, Houston, 41; Lollar, San Diego, 41 |
| Houston 2, Philadelphia 1 | Carlton, Philadelphia, 63; Rogers, Montreal, 51; Ryan, Houston, 41; Lollar, San Diego, 41 |
| St. Louis 2, San Diego 0 | Carlton, Philadelphia, 63; Rogers, Montreal, 51; Ryan, Houston, 41; Lollar, San Diego, 41 |
| Los Angeles 2, Chicago 0 | Carlton, Philadelphia, 63; Rogers, Montreal, 51; Ryan, Houston, 41; Lollar, San Diego, 41 |
| San Francisco 2, Pittsburgh 1 | Carlton, Philadelphia, 63; Rogers, Montreal, 51; Ryan, Houston, 41; Lollar, San Diego, 41 |
| Atlanta 4, Montreal 4 | Carlton, Philadelphia, 63; Rogers, Montreal, 51; Ryan, Houston, 41; Lollar, San Diego, 41 |
| Houston 2, Philadelphia 1 | Carlton, Philadelphia, 63; Rogers, Montreal, 51; Ryan, Houston, 41; Lollar, San Diego, 41 |
| St. Louis 2, San Diego 0 | Carlton, Philadelphia, 63; Rogers, Montreal, 51; Ryan, Houston, 41; Lollar, San Diego, 41 |
| Los Angeles 2, Chicago 0 | Carlton, Philadelphia, 63; Rogers, Montreal, 51; Ryan, Houston, 41; Lollar, San Diego, 41 |
| San Francisco 2, Pittsburgh 1 | Carlton, Philadelphia, 63; Rogers, Montreal, 51; Ryan, Houston, 41; Lollar, San Diego, 41 |
| Atlanta 4, Montreal 4 | Carlton, Philadelphia, 63; Rogers, Montreal, 51; Ryan, Houston, 41; Lollar, San Diego, 41 |
| Houston 2, Philadelphia 1 | Carlton, Philadelphia, 63; Rogers, Montreal, 51; Ryan, Houston, 41; Lollar, San Diego, 41 |
| St. Louis 2, San Diego 0 | Carlton, Philadelphia, 63; Rogers, Montreal, 51; Ryan, Houston, 41; Lollar, San Diego, 41 |
| Los Angeles 2, Chicago 0 | Carlton, Philadelphia, 63; Rogers, Montreal, 51; Ryan, Houston, 41; Lollar, San Diego, 41 |
| San Francisco 2, Pittsburgh 1 | Carlton, Philadelphia, 63; Rogers, Montreal, 51; Ryan, Houston, 41; Lollar, San Diego, 41 |
| Atlanta 4, Montreal 4 | Carlton, Philadelphia, 63; Rogers, Montreal, 51; Ryan, Houston, 41; Lollar, San Diego, 41 |
| Houston 2, Philadelphia 1 | Carlton, Philadelphia, 63; Rogers, Montreal, 51; Ryan, Houston, 41; Lollar, San Diego, 41 |
| St. Louis 2, San Diego 0 | Carlton, Philadelphia, 63; Rogers, Montreal, 51; Ryan, Houston, 41; Lollar, San Diego, 41 |
| Los Angeles 2, Chicago 0 | Carlton, Philadelphia, 63; Rogers, Montreal, 51; Ryan, Houston, 41; Lollar, San Diego, 41 |
| San Francisco 2, Pittsburgh 1 | Carlton, Philadelphia, 63; Rogers, Montreal, 51; Ryan, Houston, 41; Lollar, San Diego, 41 |
| Atlanta 4, Montreal 4 | Carlton, Philadelphia, 63; Rogers, Montreal, 51; Ryan, Houston, 41; Lollar, San Diego, 41 |
| Houston 2, Philadelphia 1 | Carlton, Philadelphia, 63; Rogers, Montreal, 51; Ryan, Houston, 41; Lollar, San Diego, 41 |
| St. Louis 2, San Diego 0 | Carlton, Philadelphia, 63; Rogers, Montreal, 51; Ryan, Houston, 41; Lollar, San Diego, 41 |
| Los Angeles 2, Chicago 0 | Carlton, Philadelphia, 63; Rogers, Montreal, 51; Ryan, Houston, 41; Lollar, San Diego, 41 |
| San Francisco 2, Pittsburgh 1 | Carlton, Philadelphia, 63; Rogers, Montreal, 51; Ryan, Houston, 41; Lollar, San Diego, 41 |
| Atlanta 4, Montreal 4 | Carlton, Philadelphia, 63; Rogers, Montreal, 51; Ryan, Houston, 41; Lollar, San Diego, 41 |
| Houston 2, Philadelphia 1 | Carlton, Philadelphia, 63; Rogers, Montreal, 51; Ryan, Houston, 41; Lollar, San Diego, 41 |
| St. Louis 2, San Diego 0 | Carlton, Philadelphia, 63; Rogers, Montreal, 51; Ryan, Houston, 41; Lollar, San Diego, 41 |
| Los Angeles 2, Chicago 0 | Carlton, Philadelphia, 63; Rogers, Montreal, 51; Ryan, Houston, 41; Lollar, San Diego, 41 |
| San Francisco 2, Pittsburgh 1 | Carlton, Philadelphia, 63; Rogers, Montreal, 51; Ryan, Houston, 41; Lollar, San Diego, 41 |
| Atlanta 4, Montreal 4 | Carlton, Philadelphia, 63; Rogers, Montreal, 51; Ryan, Houston, 41; Lollar, San Diego, 41 |
| Houston 2, Philadelphia 1 | Carlton, Philadelphia, 63; Rogers, Montreal, 51; Ryan, Houston, 41; Lollar, San Diego, 41 |
| St. Louis 2, San Diego 0 | Carlton, Philadelphia, 63; Rogers, Montreal, 51; Ryan, Houston, 41; Lollar, San Diego, 41 |
| Los Angeles 2, Chicago 0 | Carlton, Philadelphia, 63; Rogers, Montreal, 51; Ryan, Houston, 41; Lollar, San Diego, 41 |
| San Francisco 2, Pittsburgh 1 | Carlton, Philadelphia, 63; Rogers, Montreal, 51; Ryan, Houston, 41; Lollar, San Diego, 41 |
| Atlanta 4, Montreal 4 | Carlton, Philadelphia, 63; Rogers, Montreal, 51; Ryan, Houston, 41; Lollar, San Diego, 41 |
| Houston 2, Philadelphia 1 | Carlton, Philadelphia, 63; Rogers, Montreal, 51; Ryan, Houston, 41; Lollar, San Diego, 41 |
| St. Louis 2, San Diego 0 | Carlton, Philadelphia, 63; Rogers, Montreal, 51; Ryan, Houston, 41; Lollar, San Diego, 41 |
| Los Angeles 2, Chicago 0 | Carlton, Philadelphia, 63; Rogers, Montreal, 51; Ryan, Houston, 41; Lollar, San Diego, 41 |
| San Francisco 2, Pittsburgh 1 | Carlton, Philadelphia, 63; Rogers, Montreal, 51; Ryan, Houston, 41; Lollar, San Diego, 41 |
| Atlanta 4, Montreal 4 | Carlton, Philadelphia, 63; Rogers, Montreal, 51; Ryan, Houston, 41; Lollar, San Diego, 41 |
| Houston 2, Philadelphia 1 | Carlton, Philadelphia, 63; Rogers, Montreal, 51; Ryan, Houston, 41; Lollar, San Diego, 41 |
| St. Louis 2, San Diego 0 | Carlton, Philadelphia, 63; Rogers, Montreal, 51; Ryan, Houston, 41; Lollar, San Diego, 41 |
| Los Angeles 2, Chicago 0 | Carlton, Philadelphia, 63; Rogers, Montreal, 51; Ryan, Houston, 41; Lollar, San Diego, 41 |
| San Francisco 2, Pittsburgh 1 | Carlton, Philadelphia, 63; Rogers, Montreal, 51; Ryan, Houston, 41; Lollar, San Diego, 41 |
| Atlanta 4, Montreal 4 | Carlton, Philadelphia, 63; Rogers, Montreal, 51; Ryan, Houston, 41; Lollar, San Diego, 41 |
| Houston 2, Philadelphia 1 | Carlton, Philadelphia, 63; Rogers, Montreal, 51; Ryan, Houston, 41; Lollar, San Diego, 41 |
| St. Louis 2, San Diego 0 | Carlton, Philadelphia, 63; Rogers, Montreal, 51; Ryan, Houston, 41; Lollar, San Diego, 41 |
| Los Angeles 2, Chicago 0 | Carlton, Philadelphia, 63; Rogers, Montreal, 51; Ryan, Houston, 41; Lollar, San Diego, 41 |
| San Francisco 2, Pittsburgh 1 | Carlton, Philadelphia, 63; Rogers, Montreal, 51; Ryan, Houston, 41; Lollar, San Diego, 41 |
| Atlanta 4, Montreal 4 | Carlton, Philadelphia, 63; Rogers, Montreal, 51; Ryan, Houston, 41; Lollar, San Diego, 41 |
| Houston 2, Philadelphia 1 | Carlton, Philadelphia, 63; Rogers, Montreal, 51; Ryan, Houston, 41; Lollar, San Diego, 41 |
| St. Louis 2, San Diego 0 | Carlton, Philadelphia, 63; Rogers, Montreal, 51; Ryan, Houston, 41; Lollar, San Diego, 41 |
| Los Angeles 2, Chicago 0 | Carlton, Philadelphia, 63; Rogers, Montreal, 51; Ryan, Houston, 41; Lollar, San Diego, 41 |
| San Francisco 2, Pittsburgh 1 | Carlton, Philadelphia, 63; Rogers, Montreal, 51; Ryan, Houston, 41; Lollar, San Diego, 41 |
| Atlanta 4, Montreal 4 | Carlton, Philadelphia, 63; Rogers, Montreal, 51; Ryan, Houston, 41; Lollar, San Diego, 41 |
| Houston 2, Philadelphia 1 | Carlton, Philadelphia, 63; Rogers, Montreal, 51; Ryan, Houston, 41; Lollar, San Diego, 41 |
| St. Louis 2, San Diego 0 | Carlton, Philadelphia, 63; Rogers, Montreal, 51; Ryan, Houston, 41; Lollar, San Diego, 41 |
| Los Angeles 2, Chicago 0 | Carlton, Philadelphia, 63; Rogers, Montreal, 51; Ryan, Houston, 41; Lollar, San Diego, 41 |
| San Francisco 2, Pittsburgh 1 | Carlton, Philadelphia, 63; Rogers, Montreal, 51; Ryan, Houston, 41; Lollar, San Diego, 41 |
| Atlanta 4, Montreal 4 | Carlton, Philadelphia, 63; Rogers, Montreal, 51; Ryan, Houston, 41; Lollar, San Diego, 41 |
| Houston 2, Philadelphia 1 | Carlton, Philadelphia, 63; Rogers, Montreal, 51; Ryan, Houston, 41; Lollar, San Diego, 41 |
| St. Louis 2, San Diego 0 | Carlton, Philadelphia, 63; Rogers, Montreal, 51; Ryan, Houston, 41; Lollar, San Diego, 41 |
| Los Angeles 2, Chicago 0 | Carlton, Philadelphia, 63; Rogers, Montreal, 51; Ryan, Houston, 41; Lollar, San Diego, 41 |
| San Francisco 2, Pittsburgh 1 | Carlton, Philadelphia, 63; Rogers, Montreal, 51; Ryan, Houston, 41; Lollar, San Diego, 41 |
| Atlanta 4, Montreal 4 | Carlton, Philadelphia, 63; Rogers, Montreal, 51; Ryan, Houston, 41; Lollar, San Diego, 41 |
| Houston 2, Philadelphia 1 | Carlton, Philadelphia, 63; Rogers, Montreal, 51; Ryan, Houston, 41; Lollar, San Diego, 41 |
| St. Louis 2, San Diego 0 | Carlton, Philadelphia, 63; Rogers, Montreal, 51; Ryan, Houston, 41; Lollar, San Diego, 41 |
| Los Angeles 2, Chicago 0 | Carlton, Philadelphia, 63; Rogers, Montreal, 51; Ryan, Houston, 41; Lollar, San Diego, 41 |
| San Francisco 2, Pittsburgh 1 | Carlton, Philadelphia, 63; Rogers, Montreal, 51; Ryan, Houston, 41; Lollar, San Diego, 41 |
| Atlanta 4, Montreal 4 | Carlton, Philadelphia, 63; Rogers, Montreal, 51; Ryan, Houston, 41; Lollar, San Diego, 41 |
| Houston 2, Philadelphia 1 | Carlton, Philadelphia, 63; Rogers, Montreal, 51; Ryan, Houston, 41; Lollar, San Diego, 41 |
| St. Louis 2, San Diego 0 | Carlton, Philadelphia, 63; Rogers, Montreal, 51; Ryan, Houston, 41; Lollar, San Diego, 41 |
| Los Angeles 2, Chicago 0 | Carlton, Philadelphia, 63; Rogers, Montreal, 51; Ryan, Houston, 41; Lollar, San Diego, 41 |
| San Francisco 2, Pittsburgh 1 | Carlton, Philadelphia, 63; Rogers, Montreal, 51; Ryan, Houston, 41; Lollar, San Diego, 41 |
| Atlanta 4, Montreal 4 | Carlton, Philadelphia, 63; Rogers, Montreal, 51; Ryan, Houston, 41; Lollar, San Diego, 41 |
| Houston 2, Philadelphia 1 | Carlton, Philadelphia, 63; Rogers, Montreal, 51; Ryan, Houston, 41; Lollar, San Diego, 41 |
| St. Louis 2, San Diego 0 | Carlton, Philadelphia, 63; Rogers, Montreal, 51; Ryan, Houston, 41; Lollar, San Diego, 41 |
| Los Angeles 2, Chicago 0 | Carlton, Philadelphia, 63; Rogers, Montreal, 51; Ryan, Houston, 41; Lollar, San Diego, 41 |
| San Francisco 2, Pittsburgh 1 | Carlton, Philadelphia, 63; Rogers, Montreal, 51; Ryan, Houston, 41; Lollar, San Diego, 41 |
| Atlanta 4, Montreal 4 | Carlton, Philadelphia, 63; Rogers, Montreal, 51; Ryan, Houston, 41; Lollar, San Diego, 41 |
| Houston 2, Philadelphia 1 | Carlton, Philadelphia, 63; Rogers, Montreal, 51; Ryan, Houston, 41; Lollar, San Diego, 41 |
| St. Louis 2, San Diego 0 | Carlton, Philadelphia, 63; Rogers, Montreal, 51; Ryan, Houston, 41; Lollar, San Diego, 41 |
| Los Angeles 2, Chicago 0 | Carlton, Philadelphia, 63; Rogers, Montreal, 51; Ryan, Houston, 41; Lollar, San Diego, 41 |
| San Francisco 2, Pittsburgh 1 | Carlton, Philadelphia, |

ACC To Try Clock, 3-Point Field Goal

MYRTLE BEACH, S.C. (AP) — The Atlantic Coast Conference voted Tuesday to try a 30-second shot clock in next season's basketball games along with a 3-point field goal for shots of 19 feet or longer.

The rules changes will have to be approved by the NCAA rules committee, but ACC Commissioner Bob James said there should be no problem with the one-season shot-clock trial.

James declined to reveal details of the voting, noting only that a two-thirds majority among those present is required for approval.

Conference school representatives also voted to recommend that the date at which basketball high school players can sign letters of intent be moved forward to Nov. 1 from April.

Propose that the January 1983 NCAA convention establish a \$6,000-per-year salary for part-time football and basketball coaches.

Endorse a recent report by representatives from 14 colleges around the country calling for minimum academic standards for athletic recruits and stricter penalties for recruiting violations.

The clock will not be operated for the final four minutes of any game or of any overtime period.

Conference President Charles Taff of the University of Maryland said the change would speed up the game and bring "the return of more finesse to basketball."

Calls for a shot clock intensified after the slow-paced ACC championship game between North Carolina and Virginia last season.

EAST CAROLINA INSURANCE AGENCY, INC.
 Personal — Commercial
 "Where Customers Become Friends"
Fred Alcock, General Mgr.
 752-4323



Johnny Bench

Johnny Bench Former All-Star Doesn't Miss Action Behind Plate

By The Associated Press

Johnny Bench, the third baseman, has no envy of Johnny Stearns, the onetime premier catcher.

"John Stearns asked me that," said the veteran all-star slugger of the Cincinnati Reds, referring to the man who wears the mask for the New York Mets.

"First time I came to bat Monday night, Stearns asked me, 'John, do you ever regret giving up the mask and the pads?' I told him emphatically, 'No.'"

"I'm not sorry I started out as a catcher. I loved it when I was young, strong and full of pepper. But, if I'd had to remain behind the plate, I am convinced I couldn't have lasted another year."

As it is, the bull-shouldered Oklahoman, sporting a 32-inch waist and a new three-year contract (\$900,000 per), is into his 16th season as a Red with a refreshed enthusiasm.

"People keep asking me why I didn't hang on and try for Al Lopez' record (1,818 games behind the plate)," he said. "I don't need that record. If they had tried to make me do it, I would have turned to something else."

"Seventeen hundred games over 13 years. That's enough."

In a career that makes him a cinch for almost automatic induction into baseball's Hall of Fame, Bench caught 1,738 games, 180 short of Lopez' record and fourth in the all-time list. He left a fielding percentage of .991, less than five points off the National League record set by Johnny Edwards and just two back of Bill Freehan's all-time major league mark.

But statistics fail to record the pain and suffering Bench had to undergo as one of the game's most aggressive and hardest hitting catchers.

"I've had my left foot broken six times and my right foot five times," he said. "I had my little finger broken once while batting. After a game, my legs were so stiff that it would take me several minutes to get comfortable on a plane."

"The worst shot I ever took was in a game against the Giants in 1975. Gary Matthews was storming home on a hit to left field. (Pete) Rose threw short and the ball took two bounces. I was a sitting duck for Matthews who smashed into me like an army tank, wrenching my forearm and shoulder."

"The pain was almost unbearable. But I kept on catching. Every day I'd get a shot of cortizone. At night, I'd try to lie down in bed, and I would shoot straight up. It was like getting hit by a hammer."

"A few years later I got hit by a pitched ball and fell flat on my face. I went to the hospital for X-rays. The doctor said the X-rays showed five old breaks in my ankle but nothing new. I still had to walk on crutches."

Bench said he never regretted choosing what have been called the "tools of ignorance."

"In the first place, I don't think that term is relative any more," he said. "Sure, years ago, people thought it was crazy for a guy to want to put on that equipment. He was the fat guy who couldn't run, the last chosen on any team."

"Yogi Berra helped change that. Some looked upon him as a buffoon. But he turned out to be dumb like a fox. With all those World Series checks and rings, he became an institution. They even named a comic strip character after him."

"And I may have helped change the image. 'Actually, it's a fascinating position. You are in the middle of everything. There are so many different ways you can get satisfaction. You can call a good game. That leaves you feeling good. You can throw runners out. You can block runners from scoring. And you can hit.'"

"No other position offers so many possibilities. But I paid my dues."

Used at first base for a period, Bench became the Reds' regular third baseman this year after playing 34 games there experimentally in 1981.

"I'm getting there," he said. "It's a big change for me. You move forward on the ball instead of laterally and you have to stay on your toes. I've never been known for my speed."

"I almost got killed last week in a game in St. Louis. Gene Tenace hit a cannon shot which hit the dirt and grazed my left ear. If it had caught me flush, it would have taken my head off."

Vikings Defeat Havelock, 10-7

HOLLYWOOD — Chris Buck and Doug McRoy each drove in two runs as D.H. Conley closed out the year with a 10-7 victory over Havelock Tuesday in a Coastal Conference baseball game.

Conley used a decoy steal with runners on second and third to take a 1-0 lead in the first only to have Havelock counter with two runs in the top of the second.

But, the Vikings came back with four runs in the bottom of the inning to take a lead they never lost.

Greg Toler singled and Jimmy Kaler and Keith Mills walked to load the bases. Wesley Smith then singled home Toler and Buck followed with a single to score Kaler and Mills.

Smith subsequently scored on a sacrifice fly to leftfield by Dixon Page to make it 5-2.

Havelock came back with two runs in the top of the fourth but Conley answered with three runs in the bottom of the inning. Smith and Buck singled and Page walked to load the bases.

Smith then scored on a sacrifice fly by Jeff Cox and McRoy followed with a double to score Steve Mills, who was running for Buck, and Page to make it 8-4.

The Vikings scored a run in the fifth to up the lead to 9-4 before the Rams scored three runs in the sixth. DHC scored its final run in the bottom of the sixth.

Smith and McRoy were both two for three for DHC. Buck was two for four. Mike Green was two for three for Havelock. Rob Rice had a triple for the Rams.

Havelock 630 203 0-7 9 0
D.H. Conley 140 311 x-10 9 4
Gaskell, Clark (2), Boyer (7) and Young, Cox and Buck, McCarter (7).

ACC Officials Pleased With Vote

MYRTLE BEACH, S.C. (AP) — Atlantic Coast Conference coaches and officials say they are pleased with the decision to adopt a 30-second shot clock and a three-point field goal for the 1982-1983 conference basketball season.

ACC Commissioner Bob James said the proposals were approved by officials as the league's six-day business meeting ended Tuesday.

Although James would not give a vote count, he said conference rules required at least six affirmative votes for passage. He also said the proposals were a package deal.

"If the NCAA Rules Committee does not accept our changes in toto, we will not approve any change at all," James said.

Most surprising was the 19-foot distance set for the three-point field goal. Previously, the least distance used for the shot was 21 feet.

The shot clock is also the shortest in college basketball, with the Sun Belt Conference using a 45-second timer.

"The shot clock will run until the last four minutes of the game," James said. "It will be in effect in overtime until the last four minutes."

James said a 1981 ACC survey showed that 99 percent of the shots taken were sent goalward within 20 seconds.

"It was felt the clock won't affect the game that drastically," he said. "But we felt the two changes together are sensible at this time."

James said the ACC schools would not use the new rules in non-conference games without the consent of opposing teams.

"I'm glad to hear it," said Maryland coach Lefty Driesell of the changes. "It will keep people from jamming back in a zone. The 19-foot shot will help the little guy, the outside jump shooter."

Driesell said he wanted to keep the clock on the entire game, but said "this is fine, too."

Driesell said the 30-second clock was chosen over the 45-second clock because it was felt teams would hold the ball for 30 seconds and then run a play in the final 15 seconds.

"The little guy will play a greater role," said Clemson coach Bill Foster. "The first thing I thought of was (Duke's) Chip Engelland's stock goes up immediately."

"These changes will be good for the players and they're good for the fans," Foster said. "We felt the equalization of talent has changed things. We can all recruit."

"For me personally, it's not good where my program is right now," said Georgia Tech coach Bobby Cremins of the shot clock. "It's definitely terrible from Georgia Tech's standpoint at this time. But what's more important: me this season or the game of basketball over the long haul?"

Williamston ends its regular season Thursday when the Lady Tigers travel to Edenton. Williamston 005 014 0-10 11 12 Bertie 100 100 3-5 11 12 WP — Sharon Hopkins.

Southern Nash 10
Farmville C. 3

STANHOPE — Southern Nash wrapped up the Eastern Carolina Conference softball title with a 10-3 victory over Farmville Central yesterday.

Southern finishes the season with an 11-1 ECC record, 14-2 overall. Farmville Central drops to 2-10, 2-18, respectively.

Southern got all it needed in the second inning, scoring in the second, third and fourth times. The Lady Firebirds then added one in the fourth, three in the fifth and two in the sixth for the ten-run total.

The game closed out the regular season for the two teams, with Southern advancing into the AAA-AAAA playoffs next week.

Farmville C. 000 003 0-3 5 4 So. Nash 040 132 x-10 9 3 WP — C. Dozier.

Plymouth 22
Roanoke 13

PLYMOUTH — Plymouth scored 22 runs in the first two innings and held on to beat Roanoke, 22-13, Tuesday in a Northeastern Conference softball game.

Plymouth jumped out to a 12-0 lead in the first inning and upped its lead to 22-0 in the second.

Roanoke, which ends the season at 3-11 overall and in the league, scored two runs in the third and added a run in the fourth, two in the fifth and three in the sixth as the Lady Redskins battled back.

Roanoke scored five more runs in the seventh, but it was still not enough as Plymouth held on for the win.

Georgia Biggs and Deboraha Savage each had four hits for Roanoke. Biggs had a two-run home run. Vivian Biggs, Gwen Wynn and Lou Wilson all had three hits for Roanoke. Biggs had two two-run home runs.

Roanoke 002 123 5-13 17 6 Plym. (12)(10) 000 0-22 22 1

Valeria Smith and Sharon Hopkins were both three for four for Williamston. Gail Smith was two for four with a double for the Lady Tigers.

Williamston ends its regular season Thursday when the Lady Tigers travel to Edenton. Williamston 005 014 0-10 11 12 Bertie 100 100 3-5 11 12 WP — Sharon Hopkins.

Southern Nash 10
Farmville C. 3

STANHOPE — Southern Nash wrapped up the Eastern Carolina Conference softball title with a 10-3 victory over Farmville Central yesterday.

Southern finishes the season with an 11-1 ECC record, 14-2 overall. Farmville Central drops to 2-10, 2-18, respectively.

Southern got all it needed in the second inning, scoring in the second, third and fourth times. The Lady Firebirds then added one in the fourth, three in the fifth and two in the sixth for the ten-run total.

The game closed out the regular season for the two teams, with Southern advancing into the AAA-AAAA playoffs next week.

Farmville C. 000 003 0-3 5 4 So. Nash 040 132 x-10 9 3 WP — C. Dozier.

Plymouth 22
Roanoke 13

PLYMOUTH — Plymouth scored 22 runs in the first two innings and held on to beat Roanoke, 22-13, Tuesday in a Northeastern Conference softball game.

Plymouth jumped out to a 12-0 lead in the first inning and upped its lead to 22-0 in the second.

Roanoke, which ends the season at 3-11 overall and in the league, scored two runs in the third and added a run in the fourth, two in the fifth and three in the sixth as the Lady Redskins battled back.

Roanoke scored five more runs in the seventh, but it was still not enough as Plymouth held on for the win.

Georgia Biggs and Deboraha Savage each had four hits for Roanoke. Biggs had a two-run home run. Vivian Biggs, Gwen Wynn and Lou Wilson all had three hits for Roanoke. Biggs had two two-run home runs.

Roanoke 002 123 5-13 17 6 Plym. (12)(10) 000 0-22 22 1

ing Elizabeth City Northeastern.

Rose 630 210 0-11 12 3 Hunt 330 012 0-8 9 5 WP — Niansa Outlaw.

G. Central 12
SW Edgecombe 5

SNOW HILL — Greene Central used a three-run home run by Sharon Suggs to power by SouthWest Edgecombe, 12-5, Tuesday afternoon in an Eastern Carolina Conference softball game.

The Lady Rams, who finish the season at 16-5 overall and 8-4 in the ECC, fell behind, 1-0, in the top of the first only to score twice in the bottom of the inning to take the lead.

The Lady Cougars, which end up 9-9 overall and 7-5 in the league, regained the lead with three runs in the third but the Lady Rams rallied to cut the deficit to 4-3 with a run in the home half of the inning.

It stayed that way until the fifth when Greene Central struck for three runs to take a 6-4 lead. Suggs then keyed a six-run sixth inning with her three-run home run that sealed the win.

Suggs was three for four as were Jackie Holmes and Gail Carmen. Carmen had a triple and Holmes a double. Wanda Atkinson was two for three and Lisa Radford two for four.

SouthWest 103 000 1-5 7 2 G. Central 201 036 x-12 15 5 WP — Cindy Meadows.

Williamston 10
Bertie 5

BERTIE — Williamston scored five runs in the third inning and then held off a late rally by Bertie to come away with a 10-5 victory Tuesday afternoon in a Northeastern Conference softball game.

The Lady Tigers, who lead the conference with a 13-2 mark, fell behind, 1-0, in the first but rallied for five runs in the third to take a lead they never lost.

Bertie scored one run in the fourth but the Lady Tigers got it back in the fifth and then added four more runs in the sixth to go up, 10-2. Bertie then scored three runs in the seventh, but Williamston held off Bertie the rest of the way for the win.

Williamston 000 010 3-4 7 1 D.H. Conley 020 000 0-2 7 5

Rose 11
Hunt 8

WILSON — Rose High School's girls scored six runs in the first inning and went on to record an 11-8 softball victory over Wilson Hunt yesterday.

Rose added two more in the second inning on a two-run homer by Linda Winstead, and picked up two more in the fourth and one in the fifth for the 11 run total.

Hunt scored three times in the first, twice in the second, and got one in the fifth and two in the sixth for its total.

Laura Vincent led the Rose hitting with three, while Frances Barnhill added two. Sharon Evans led Hunt with three hits.

The win left Rose with a 6-7 Big East record and an 8-10 overall mark.

The Lady Rampants wind up the season on Thursday, host-

ing Elizabeth City Northeastern.

Rose 630 210 0-11 12 3 Hunt 330 012 0-8 9 5 WP — Niansa Outlaw.

G. Central 12
SW Edgecombe 5

SNOW HILL — Greene Central used a three-run home run by Sharon Suggs to power by SouthWest Edgecombe, 12-5, Tuesday afternoon in an Eastern Carolina Conference softball game.

The Lady Rams, who finish the season at 16-5 overall and 8-4 in the ECC, fell behind, 1-0, in the top of the first only to score twice in the bottom of the inning to take the lead.

The Lady Cougars, which end up 9-9 overall and 7-5 in the league, regained the lead with three runs in the third but the Lady Rams rallied to cut the deficit to 4-3 with a run in the home half of the inning.

It stayed that way until the fifth when Greene Central struck for three runs to take a 6-4 lead. Suggs then keyed a six-run sixth inning with her three-run home run that sealed the win.

Suggs was three for four as were Jackie Holmes and Gail Carmen. Carmen had a triple and Holmes a double. Wanda Atkinson was two for three and Lisa Radford two for four.

SouthWest 103 000 1-5 7 2 G. Central 201 036 x-12 15 5 WP — Cindy Meadows.

Williamston 10
Bertie 5

BERTIE — Williamston scored five runs in the third inning and then held off a late rally by Bertie to come away with a 10-5 victory Tuesday afternoon in a Northeastern Conference softball game.

The Lady Tigers, who lead the conference with a 13-2 mark, fell behind, 1-0, in the first but rallied for five runs in the third to take a lead they never lost.

Bertie scored one run in the fourth but the Lady Tigers got it back in the fifth and then added four more runs in the sixth to go up, 10-2. Bertie then scored three runs in the seventh, but Williamston held off Bertie the rest of the way for the win.

Williamston 000 010 3-4 7 1 D.H. Conley 020 000 0-2 7 5

Rose 11
Hunt 8

WILSON — Rose High School's girls scored six runs in the first inning and went on to record an 11-8 softball victory over Wilson Hunt yesterday.

Rose added two more in the second inning on a two-run homer by Linda Winstead, and picked up two more in the fourth and one in the fifth for the 11 run total.

Hunt scored three times in the first, twice in the second, and got one in the fifth and two in the sixth for its total.

Laura Vincent led the Rose hitting with three, while Frances Barnhill added two. Sharon Evans led Hunt with three hits.

The win left Rose with a 6-7 Big East record and an 8-10 overall mark.

The Lady Rampants wind up the season on Thursday, host-

ing Elizabeth City Northeastern.

Rose 630 210 0-11 12 3 Hunt 330 012 0-8 9 5 WP — Niansa Outlaw.

G. Central 12
SW Edgecombe 5

SNOW HILL — Greene Central used a three-run home run by Sharon Suggs to power by SouthWest Edgecombe, 12-5, Tuesday afternoon in an Eastern Carolina Conference softball game.

The Lady Rams, who finish the season at 16-5 overall and 8-4 in the ECC, fell behind, 1-0, in the top of the first only to score twice in the bottom of the inning to take the lead.

The Lady Cougars, which end up 9-9 overall and 7-5 in the league, regained the lead with three runs in the third but the Lady Rams rallied to cut the deficit to 4-3 with a run in the home half of the inning.

It stayed that way until the fifth when Greene Central struck for three runs to take a 6-4 lead. Suggs then keyed a six-run sixth inning with her three-run home run that sealed the win.

Suggs was three for four as were Jackie Holmes and Gail Carmen. Carmen had a triple and Holmes a double. Wanda Atkinson was two for three and Lisa Radford two for four.

SouthWest 103 000 1-5 7 2 G. Central 201 036 x-12 15 5 WP — Cindy Meadows.

Williamston 10
Bertie 5

BERTIE — Williamston scored five runs in the third inning and then held off a late rally by Bertie to come away with a 10-5 victory Tuesday afternoon in a Northeastern Conference softball game.

The Lady Tigers, who lead the conference with a 13-2 mark, fell behind, 1-0, in the first but rallied for five runs in the third to take a lead they never lost.

Bertie scored one run in the fourth but the Lady Tigers got it back in the fifth and then added four more runs in the sixth to go up, 10-2. Bertie then scored three runs in the seventh, but Williamston held off Bertie the rest of the way for the win.

Williamston 000 010 3-4 7 1 D.H. Conley 020 000 0-2 7 5

Rose 11
Hunt 8

WILSON — Rose High School's girls scored six runs in the first inning and went on to record an 11-8 softball victory over Wilson Hunt yesterday.

Rose added two more in the second inning on a two-run homer by Linda Winstead, and picked up two more in the fourth and one in the fifth for the 11 run total.

Hunt scored three times in the first, twice in the second, and got one in the fifth and two in the sixth for its total.

Laura Vincent led the Rose hitting with three, while Frances Barnhill added two. Sharon Evans led Hunt with three hits.

The win left Rose with a 6-7 Big East record and an 8-10 overall mark.

The Lady Rampants wind up the season on Thursday, host-

ing Elizabeth City Northeastern.

Rose 630 210 0-11 12 3 Hunt 330 012 0-8 9 5 WP — Niansa Outlaw.

G. Central 12
SW Edgecombe 5

SNOW HILL — Greene Central used a three-run home run by Sharon Suggs to power by SouthWest Edgecombe, 12-5, Tuesday afternoon in an Eastern Carolina Conference softball game.

The Lady Rams, who finish the season at 16-5 overall and 8-4 in the ECC, fell behind, 1-0, in the top of the first only to score twice in the bottom of the inning to take the lead.

The Lady Cougars, which end up 9-9 overall and 7-5 in the league, regained the lead with three runs in the third but the Lady Rams rallied to cut the deficit to 4-3 with a run in the home half of the inning.

It stayed that way until the fifth when Greene Central struck for three runs to take a 6-4 lead. Suggs then keyed a six-run sixth inning with her three-run home run that sealed the win.

Suggs was three for four as were Jackie Holmes and Gail Carmen. Carmen had a triple and Holmes a double. Wanda Atkinson was two for three and Lisa Radford two for four.

SouthWest 103 000 1-5 7 2 G. Central 201 036 x-12 15 5 WP — Cindy Meadows.

Williamston 10
Bertie 5

BERTIE — Williamston scored five runs in the third inning and then held off a late rally by Bertie to come away with a 10-5 victory Tuesday afternoon in a Northeastern Conference softball game.

The Lady Tigers, who lead the conference with a 13-2 mark, fell behind, 1-0, in the first but rallied for five runs in the third to take a lead they never lost.

Bertie scored one run in the fourth but the Lady Tigers got it back in the fifth and then added four more runs in the sixth to go up, 10-2. Bertie then scored three runs in the seventh, but Williamston held off Bertie the rest of the way for the win.

Williamston 000 010 3-4 7 1 D.H. Conley 020 000 0-2 7 5

Rose 11
Hunt 8

WILSON — Rose High School's girls scored six runs in the first inning and went on to record an 11-8 softball victory over Wilson Hunt yesterday.

Rose added two more in the second inning on a two-run homer by Linda Winstead, and picked up two more in the fourth and one in the fifth for the 11 run total.

Hunt scored three times in the first, twice in the second, and got one in the fifth and two in the sixth for its total.

Laura Vincent led the Rose hitting with three, while Frances Barnhill added two. Sharon Evans led Hunt with three hits.

76ers Go For Berth In NBA Championship Tonight

BOSTON (AP) — The sizzling Philadelphia 76ers can clinch their third berth in the National Basketball Association title round in six years tonight by continuing their domination of the out-of-sync Boston Celtics.

Only 10 days ago, that prospect seemed extremely unlikely. Boston handed the 76ers their worst playoff loss ever, 121-81, on May 9. But Philadelphia bounced back with three straight victories and is a hot team going into the fifth game of the best-of-seven Eastern Conference final.

Boston, which lost playmaker Nate Archibald for the series with a dislocated shoulder in a 99-97 third-game loss, has been less organized than it was in compiling the league's best record, 63-19.

Still, the 76ers know all too well that a 3-1 lead doesn't guarantee another shot at the Los Angeles Lakers, who beat them

in the 1980 final round and have won this year's Western Conference championship.

"We have a mission, a purpose," said forward Mike Bantom, who joined the 76ers this season. "It's not to win just one game. It's to win four; 3-1 does not win this series."

It didn't last year, when Philadelphia also went out to a 3-1 lead over Boston in the Eastern Conference final, then blew the last three games in the final minutes by a total of five points.

"Last year we probably had a feeling that the series was over and there would be no way they would be able to come back," said Philadelphia guard Lionel Hollins. "We learned from that. We learned that it's a seven-game series."

That comeback also taught the Celtics a lesson that could boost their confidence as they struggle to stay alive in their

battle for the club's 15th championship and second in a row.

Although it's been done only four times, the Celtics feel they can win after trailing 3-1 because they already have accomplished it.

"Being down 3-1 last year is no different than this year other than they know we can do it. We know we can do it," said Boston forward Larry Bird. "It was tough last year. You can't get any harder games than the last three we played."

Last season, Boston trailed Philadelphia by six points with 1:51 left in the fifth game, was tied with 40 seconds left in the sixth, and was behind by nine with 5:23 to go in the seventh.

"I don't think it can be any tougher than last year," said Celtic guard M.L. Carr. "That was unreal to do that."

However, Boston hasn't been playing

as well as it did in the first four games against the 76ers last year. It also will be without Archibald, who had 27 points and 19 assists in the first two games.

"Philadelphia is making everything happen, and we're not doing anything," Bird said. "That can switch around. We know we're capable of winning the championship."

The 76ers last won the NBA title in 1966-67. Ten years later, they lost in the final round to Portland.

Boston's bid to become the first NBA team since the 1967-68 and 1968-69 Celtics to win consecutive championships hinges on its ability to shut down Andrew Toney and to regain its own offensive rhythm.

Toney's average of 25 points per game leads all scorers in the series. He was virtually unstoppable in pouring in 39 points in Sunday's 119-94 win at Philadelphia that put the 76ers up 3-1.

"If we don't find some means to contain Toney, then I don't think that we can win," said Boston forward Cedric Maxwell, the most valuable player of last year's playoffs.

"I don't think there's a legal way in which you can stop him," said Philadelphia's Julius Erving, who has averaged 17 points during the series. "He's able to handle the ball and get into his rhythm. His wrists are so strong that he's capable of getting his shot off against any type of pressure."

With Archibald out, Boston has had trouble adjusting to Gerald Henderson as the starting playmaker.

"We're not cohesive on offense at all," said Henderson, who prefers to stay outside and stick to set plays more than Archibald, who likes to penetrate to the basket and create opportunities.

"If our outside shots were falling,"

Bird said, Philadelphia's double-teaming of Boston big men Maxwell, Robert Parish and Kevin McHale wouldn't be a problem. "Kevin, Max and Robert can start scoring a lot easier in there because somebody's got to start guarding their man. They can't be playing a zone all night long."

Boston didn't lose three consecutive games during the regular season and never has lost four straight in Bill Fitch's three years as coach. The Celtics had the NBA's best home record this season, 35-6, but Philadelphia's 26-15 road mark is worse than only Boston and Los Angeles.

If Boston wins tonight, Game Six will be Friday night in Philadelphia. A seventh game, if necessary, would be here Sunday.

If the 76ers win tonight, their championship series against Los Angeles will begin Sunday in Philadelphia.

Rams Pound SWE, 15-4

PINETOPS — Greene Central scored six times in the second inning and romped to a 15-4 baseball victory over SouthWest Edgecombe in the Eastern Carolina Conference yesterday.

The win closed out the season for the Rams, who finish 13-10 overall and 7-5 in league play.

SouthWest grabbed the initial lead in the game, scoring once in the bottom of the first. With two away, Harold, Hobgood singled and stole second. He moved up on a passed ball then scored on a wild pitch for the 1-0 lead.

But that lead quickly evaporated as Greene Central pushed over six runs in the second. After one out, James Mayo walked and Richard Chase was hit by a pitch. John Mayo followed with a double, driving in two runs. Donald Warren singled and Elmer Dixon also doubled, driving in two more. Tony Goff followed reaching on an error, and — you guessed it — Chris Ginn hit a two-run double.

Greene Central went on to score seven in the third and one each in the fourth and fifth, the last on a solo homer by Goff.

SouthWest added three more in the third.

Mayo led the Ram hitting with four, including two doubles and a triple, while Ginn had three, one a double. Goff and Warren each had two for the Rams.

SouthWest was led by Hobgood with three, one a triple, and Hank Farmer, with two.

SouthWest ends the season with a 2-10 league record and a 3-18 overall mark.

Table with 2 columns: Team, Record. Rows include Greene C. (067 110 0-15 14 1), SouthWest (103 000 0-4 9 3), Chase and Warren, Harrell (4), Justice, Drake (2), Wilson (3), Naylor (3), and Richardson, Summerlin (2), Barnell (5).

Judge's Ruling Expected Soon On Oakland Move

LOS ANGELES (AP) — A federal judge says he expects to rule by the middle of next week on whether to grant an injunction that would allow the Oakland Raiders to move to Los Angeles.

U.S. District Judge Harry Pregerson must grant the injunction before the team can move even though a jury decided the the National Football League had violated the nation's antitrust laws in refusing to allow the team's transfer in 1980. An injunction is necessary to enforce the jury's decision.

The NFL asked for a stay of the injunction on Friday, and Pregerson said Tuesday he needed more time to review briefs on the issue.

"We had assumed they would ask for a stay in the 9th Circuit Court of Appeal. It was a last minute maneuver by the NFL," said Raiders attorney Joseph L. Alioto.

Attorney Maxwell Blecher of the Los Angeles Coliseum argued that the judge must allow the team to move.

"If you grant a stay, you are sending vibrations to the court of appeals that you don't agree with the jury."

Raiders attorneys said the team is ready to move to Los Angeles this season if "they didn't have the threat of a stay hanging over their heads."

But the NFL argued that refusal of a stay would "disrupt the status quo until a final decision on the legality is resolved."



Qver and Under San Francisco Giants' second baseman Duane Kuiper, the ball gloved, leaps over a safe and sliding

Lee Lacy of the Pittsburgh Pirates in the third inning of their game at San Francisco Tuesday night. (AP Laserphoto)

Bears Edge Lakers, 7-5

SWAN QUARTER — Bear Grass High School closed out the 1982 baseball season with a 7-5 Tobacco Belt Conference victory over Mattamuskeet High School last night.

The Bears jumped ahead in the top of the first. Mark Taylor walked, stole up and scored on a sacrifice fly by Jody Peaks.

Mattamuskeet came back with two in the bottom of the inning on a homer by Harris, but the Bears regained the lead

with four in the third, taking a 5-2 lead. Bob Peele provided some of the punch in the inning with a three-run homer.

The Lakers came back with one in the bottom of the third and another in the fifth to close within 5-4.

Then, in the sixth, the Bears scored twice to wrap it up. Greg Harrison singled and Tony Leggett and Darius Cratt both walked, loading the bases. Jay Lilly walked, scoring Harrison, but Leggett was then

thrown out trying to advance. Peele then singled to score Cratt.

The Lakers added one more run in the bottom of the inning, but their rally fell short. Peele and Harrison led the Bear Grass hitting with two each, while Dave Cratt and Lawrence Watson each had doubles. Harris had three hits to lead the Lakers.

Bear Grass 104 002 0-7 7 3
Mattamuskeet 201 011 0-5 6 0
Watson and Peaks; Williams, Cahoon (6) and Tooley.

Guerrero HR Fells Cubs

By The Associated Press
One thing about Pedro Guerrero: He doesn't think small.

"I wasn't thinking single or double," the Los Angeles Dodger outfielder said about his trip to the plate Tuesday night leading off the bottom of the ninth inning against the Chicago Cubs. "I was thinking home run."

Guerrero translated his thoughts into action, belting a 3-1 pitch from Bill Campbell into the center field seats at Dodger Stadium.

The result was a dramatic 2-1 victory for the Dodgers over Chicago that saved some embarrassment for reliever Tom Niedenfuer, who had given up the Cubs' tying run in the top of the ninth.

"I knew I would hit one," said the confident right fielder who has delivered the long ball on eight other occasions this season for the defending world champions. "You've got to feel good after winning a game like that. (Manager Tom) Lasorda told me to get on base. But as I walked to the plate, I wasn't just thinking about getting on base."

He would have preferred to hit with a man in scoring position, of course.

"I love to hit with men on base, I'm a better hitter," said Guerrero, who has driven in 23 runs, second among the Dodgers.

Guerrero's blast off Campbell, 0-2, made a winner of Niedenfuer, 1-1. The Cubs had tied game in the top of the ninth when Keith Moreland and Leon Durham hit one-out singles to chase Dodger starter Bob Welch and pinch-runner Gary Woods scored on Larry Bowa's single off Niedenfuer.

Bill Russell's sacrifice fly in the seventh inning had given Welch a 1-0 lead. Welch struck out nine, his high for the season, before Niedenfuer came on in the ninth.

Cardinals 2, Padres 0
Bob Forsch pitched a five-hitter and singled home a run and Gene Tenace blasted a homer as St. Louis blanked San Diego.

Forsch, 5-0, drove in the Cardinals' second run with a two-out single in the seventh after Tenace had walloped his homer leading off the inning. The right-hander walked one and struck out two.

John Curtis, 2-2, pitched eight innings for San Diego, allowing seven hits, and was locked in a scoreless duel with Forsch until Tenace slammed a 3-2 pitch for his third homer of the season.

Forsch had not won since beating Houston 5-4 on April 29, failing to get a decision in his last three starts. His last shut-out came in 1979.

"Tonight I felt comfortable and when they did hit the ball the infield made some great plays," Forsch added. "One time out doesn't mean I'm back in the groove, but I'm throwing the ball real well."

Mets 2, Reds 4
Gary Rajsich hit a three-run homer, the first of his major league career in a four-run fifth inning, as New York defeated Cincinnati.

Randy Jones, 5-2, was the winner with relief help in the eighth when Neil Allen, who gained his 10th save, Cincinnati starter Bruce Berenyi, 4-2, lasted five innings and gave up all the Mets' runs.

Jones walked to start the New York fifth, Mookie Wilson singled and Wally Backman beat out a bunt to load the bases. Rusty Staub's sacrifice fly scored Jones to give the Mets a 4-1 lead and Rajsich

then hit Berenyi's first pitch over the right field wall at Shea Stadium.

"The first time up Berenyi threw me all fastballs," Rajsich said. "The next time he made me look bad on three curveballs, and I struck out. I saw Berenyi was throwing the slider at me the third time, and I just stayed back and waited for the pitch. It was fastball all the way, and I just connected."

Braves 6, Expos 4
Bob Horner and Chris Chambliss hit successive home runs in the fifth inning to send Atlanta over Montreal. The Braves trailed 2-1 before Horner opened the sixth with a game-tying homer off Expos starter Bill Gullickson, 2-3. Chambliss followed with another homer.

The Braves then sewed it up with three runs in the seventh. Dale Murphy brought home one run with a single. A throwing error by left fielder Terry Francona allowed another to score, and Murphy eventually scored the third run of the inning on Chambliss' sacrifice fly.

Phil Niekro, 2-0, struck out four and walked four before needing Gene Garber's relief help in the eighth.

Astros 2, Phillies 1
Alan Ashby's two-out single in the 12th inning scored pinch-runner Scott Loucks from third base to lead Houston over Philadelphia.

Ray Knight, who earlier extended his batting streak to 15 games, opened the 12th with a double off reliever Ed Farmer, 1-2. After Jose Cruz fled out, Loucks, running for Knight, advanced to third on an infield out by Joe Pittman.

The Phillies elected to walk hot-hitting Phil Garner, who had hit in 14 of his last 16 games, to face Ashby. Ashby, who snapped an 0-for-17 slump with two hits Monday night, then spoiled the strategy by lining a single to center.

Giants 2, Pirates 1
Rookie Bill Laskey pitched a four-hitter and batterymate Bob Brenly belted three hits and scored twice as San Francisco ended a four-game losing streak by beating Pittsburgh.

Laskey, 3-2, allowed singles in the first, third and eighth innings before giving up Jason Thompson's 11th home run with two out in the ninth. He retired 12 straight batters between the fourth and eighth, and finished with seven strikeouts and two walks.

The Giants totaled eight hits off Pittsburgh starter John Candelaria, 0-2, who pitched seven innings.

A QUIET GIVER

HOUSTON (AP) — Calvin Murphy, the crack guard of the Houston rockets, believes actions speak louder than words, doubly so in the case of his big teammate, center Moses Malone.

Murphy recalled the time Malone donated \$3,000 to a baton-twirling group he heads. "He came up to me, stuck a wad of money in my hands and said, 'That's for the kids,'" Murphy said. "I tried to get his OK to make the contribution public, but he wouldn't let me. Doesn't that say something about the kind of a guy Moses is?"

SPORT LINE



To The Editor:

A while back I criticized The Reflector for its failure to have covered a perfect game pitched by a Greenville Rose high school jayvee. I must say that since then the Reflector's coverage has tremendously improved. Woody and Rick have been as good as any reporters in the state that I know of. Congratulations.

The Rose High varsity baseball team is 20-0 as of (this writing). What a fantastic achievement. What a masterful job by Ronald Vincent and his very talented (and deep) players. We had a crowd of 1,700 at Guy Smith the last time were were here in the state playoffs. This year, if we play there, we ought to triple that number present, at least.

Our team is excellent and these boys deserve our presence and support.

Let me say a word about our seniors. We will miss Roger Williams with his great finesse, skill in fundamentals, bat and leadership. We'll miss Gordon Douglas' fastball, fielding and overall talent; Bill Kittrell's fielding and bat will be gone. Mont Carter's great bat, baserunning, and pitch selection will be lost, and the glue that holds the team together, Sammy Hodges, who is solid in every area of the game. Crowell Pope, an extremely hard worker and a hard nose, will be gone. Keith Phillips, a winner all the way, will be gone. Last but not least, a great all around athlete with great intensity and savvy, Tom Buie. What a great bunch of young men and great athletes. We in Greenville are extremely proud of all of them, not just the seniors.

The road to the State 4-A championship can be very rough. (I understand that Richmond County is 20-0.) But, the Rampants can take it. Let's all help them by our support.

Frank Kirkland
3997 Maryland Dr.

Madlock Says Comments True

PITTSBURGH (AP) — scout who discovered Hall of Famer Roberto Clemente, said Pittsburgh fans won't come out if there are too many blacks on the National Baseball League team.

"We're going to have to trade for some whites," Haak said. "I'd say you have to have about four whites starting."

Haak said the Class AAA farm club at Portland, Ore., where the Pirates played an exhibition game Monday night, is overloaded with black and Latin American players, some of whom may have to be traded to make room for more whites on the major league team. Eleven of the 25 players on Pittsburgh's major league roster are white.

Galbreath, a businessman in Columbus, Ohio, said he

couldn't believe Haak would make such statements. Galbreath said Haak's remarks did not reflect his own views or those of his son, Dan Galbreath, the Pirates' president.

"That's not the attitude of myself or my son or the ball club. I assure you of that," Galbreath told WBNS-TV.

"In fact, the question I don't think has ever come up in our minds here between Dan and myself, and I'm just as disappointed as the devil that Howie, being the fine scout he's been over the years, would make a statement like that," Galbreath said.

Galbreath said he was so shocked by the remarks that he wasn't prepared to make any

comment on what might be done about them.

Madlock told The Pittsburgh Post-Gazette that Haak's remarks had some basis in fact.

"Now when the Pirates call up a white player from the minors, there might be a black player who will feel he wasn't called up because he is black," Madlock said.

Baseball Commissioner Bowie Kuhn a strong statement Tuesday rejecting Haak's statements.

"In baseball, color or nationality has nothing to do with a player's ability to succeed," Kuhn told the Post-Gazette. "It is a man's talent which determines whether he should be playing — that and nothing more."

Advertisement for 'All in one place' featuring a large illustration of a clock, a lamp, and a typewriter. The text reads: 'All in one place', 'Classified!', 'Find what you want easily, conveniently in classified.', and 'The Daily Reflector 752-6166'.

BIG STAR

ALL ABOARD!...
BIG STAR'S

RED DOT EXPRESS

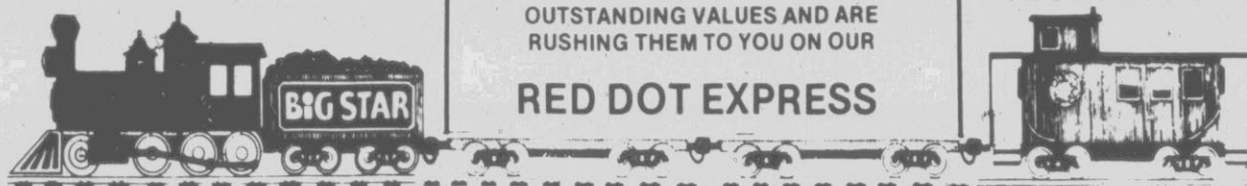

THE RED DOT INDICATES BIG STAR DEEP-CUT WEEKLY SPECIALS. WE HAVE PUT TOGETHER A WHOLE TRAINLOAD OF THESE OUTSTANDING VALUES AND ARE RUSHING THEM TO YOU ON OUR

RED DOT EXPRESS

FOR EXTRA SAVINGS!

2 LITRE
SPRITE
OR SUGAR FREE
SPRITE
89¢

PRICES IN THIS AD GOOD THRU SATURDAY, MAY 22, 1982 - QUANTITY RIGHTS RESERVED - NONE SOLD TO DEALERS OR RESTAURANTS.

U.S. CHOICE BEEF
FULL CUT BONELESS

ROUND STEAK

U.S. CHOICE BEEF

\$1.98
LB.

U.S. GRADE A

BAKING HENS

USDA A GRADE

48¢
LB.

INSTANT
MAXWELL HOUSE

COFFEE

10 OZ. JAR

\$3.79

SWEET LUSCIOUS CALIFORNIA

STRAWBERRIES

QUART

\$1.39

HOLLY FARMS U.S. GRADE A FRYER
BREAST QUARTERS
OR LEG QUARTERS

68¢
LB.

OLDE TOWNE (HOT OR MILD)

FRESH PORK SAUSAGE

\$1.18
1 LB. PKG.

OLD VIRGINIE

SLICED BACON

\$1.18
1 LB. PKG.

TROPICANA GOLD 'N' PURE

ORANGE JUICE

HALF GALLON CARTON

\$1.29

U.S. CHOICE BEEF LEAN BONELESS

CHUCK POT ROAST

\$1.98
LB.

SYCAMORE BRAND

SMOKED SAUSAGE

LB. **98¢**
5 LB. BOX **\$8.98**

GWALTNEY'S

GREAT DOG FRANKS

1 LB. PKG. **98¢**

RED RIPE WATERMELONS

HALF MELON **\$1.49**

U.S. CHOICE BEEF - 3 LBS. OR MORE
LEAN BONELESS

STEWING BEEF

\$1.98
LB.

COUNTRY SKILLET BRAND

FRYER LIVERS

8 OZ. CUP **48¢**

GWALTNEY'S SLICED

MEAT BOLOGNA

1 LB. PKG. **\$1.58**

SWEET AND TENDER
YELLOW CORN

5 EARS **79¢**

8 LBS. OR MORE
ASST. CENTER & END CUTS

PORK CHOPS

\$1.48
LB.

ALL VARIETIES
HILLSHIRE

SMOKED SAUSAGE

\$2.28
LB.

GWALTNEY'S

MEAT FRANKS

1 LB. PKG. **\$1.58**

GENUINE VIDALIA
SWEET ONIONS

LB. **59¢**

Celebrity BRAND

SLICED COOKED HAM

12 OZ. PKG.

\$2.68

TV SPECIAL

DIXIE CRYSTALS
GRANULATED

SUGAR

5-LB. BAG

\$1.29

LIMIT 1 WITH \$7.50 ORDER

TV SPECIAL

VAN CAMP'S

PORK & BEANS

16 OZ. CANS

3 \$1.00

TV SPECIAL

SUPERMAN

SMOOTH OR CRUNCHY PEANUT BUTTER

18 OZ. JAR

\$1.39

LIBBY'S VIENNA

SAUSAGE

5 OZ. CAN **39¢**

BAKE-RITE

SHORTENING

3 LB. CAN **\$1.39**

RED CAP DRY

DOG FOOD

20 LB. BAG **\$2.49**

DOVER FARM'S WHIPPED CREAM

TOPPING

8 OZ. CTN. **99¢**

WHITE HOUSE

APPLE JUICE

32 OZ. BOTTLE **58¢**

BIG 'G'

CHEERIOS

10 OZ. PKG. **79¢**

FARM CHARM

ICE MILK

HALF GALLON **99¢**

11 OZ. ASSORTED

MR. "P's" PIZZA

79¢

ROYAL PINK BRAND

PINK SALMON

15 OZ. CAN **\$1.79**

BRAWNY ASST. DESIGN JUMBO

TOWELS

2 ROLLS **\$1.00**

BREYER'S

ICE CREAM

HALF GALLON **\$2.49**

BIG STAR ASST. BROWN 'N' SERVE

ROLLS

2 12 OZ. PKGS. **99¢**

CHASE & SANBORN

TEA BAGS

100 CNT. PKG. **\$1.19**

LAUNDRY DETERGENT

COLD POWER

49 OZ. PKG. **\$1.48**

FIESTA

ICE CREAM

HALF GALLON **\$1.19**

BIG STAR 12 OZ. PLAIN, 12 OZ. SOURDOUGH OR 14 OZ. HONEY WHEAT

ENGLISH MUFFINS

2 FOR **\$1.09**

BETTY CROCKER ASSORTED

CAKE MIXES

18 1/2 OZ. PKG. **69¢**

JUST DANDY PINK OR LEMON LIQUID DISH

DETERGENT

2 32 OZ. BOTTLES **\$1.00**

12 1/2 OZ. ASSORTED

JENO'S PIZZAS

98¢

BIG STAR BUTTERMILK BREAD

2 24 OZ. LOAVES **99¢**

TWIN PET FISH FLAVOR CAT FOOD OR
ASST. DOG FOOD

5 15 OZ. CANS **\$1.00**

O & C

POTATO STICKS

4 1.5 OZ. CANS **\$1.00**

OUR PRIDE

MACARONI & CHEESE

4 7.2 OZ. BOXES **\$1.00**

DOUBLE "O" CHUNK

LIGHT TUNA

IN OIL OR WATER
6 1/2 OZ. CAN **69¢**

BUSH'S

PINTO BEANS

4 15.5 OZ. CANS **\$1.00**

STOKELY

CUT BEETS

4 16 OZ. CANS **\$1.00**

POCAHONTAS

BLACKEYE PEAS

4 15 OZ. CANS **\$1.00**

LESUEUR

EARLY PEAS

2 17 OZ. CANS **\$1.00**

BIG STAR

SWEET PEAS

3 16 OZ. CANS **\$1.00**

GREEN GIANT

WK GOLD CORN

3 17 OZ. CANS **\$1.00**

PROGRESSO

WHOLE TOMATOES

3 14 OZ. CANS **\$1.00**

BLUE BONNET QUARTERS

MARGARINE

2 1 LB. PKGS. **\$1.00**

WHITE HOUSE

APPLE SAUCE

3 16 1/2 OZ. CANS **\$1.00**

MUELLER

ELBOW MACARONI

3 8 OZ. BOXES **\$1.00**

FRANCO-AMERICAN

SPAGHETTI-O'S

3 14.7 OZ. CANS **\$1.00**

AJAX

CLEANSER

3 14 OZ. CANS **\$1.00**

PITT PLAZA SHOPPING CENTER • Mon.-Sat. 8 A.M.-10 P.M. - SUN. 9 A.M.-9 P.M.

Nigerian Sangodeyi Hoping Next Stop Is NBA

NEW YORK (AP) — He didn't get the publicity that surrounded James Worthy of national champion North Carolina. He's not an All American like DePaul's Terry Cummings or Quintin Dailey of San Francisco. Yommy Sangodeyi of Sam Houston State, though, does have the same career ambition. He wants to play in the National Basketball Association next season.

Sangodeyi, a 24-year-old, 6-foot-9 center from Nigeria, Worthy, Cummings and Dailey were among a dozen players who decided to end their collegiate careers early and seek professional status, the NBA announced Tuesday.

Eleven of the 12 are juniors, while Sangodeyi is a freshman.

Other players who also filed letters of intent to the NBA office postmarked prior to the Saturday, May 15th deadline were: John Bagley of Boston College; Ollie Johnson of Washington State; Clark Kellogg of Ohio State; Cliff Levingston of Wichita State; Michael McDuffen of Murray State; LaSalle Thompson of Texas; Dominique Wilkins of Georgia and Rob Williams of Houston.

"Frankly, we're surprised he (Sangodeyi) declared," said Rick Campbell, Sam Houston's

sports information director. "He's got a lot of raw, natural talent. He's strong and agile, but he plays like a freshman, good one game, bad the next."

Sangodeyi, who played for the Nigerian Olympic team, averaged 11.9 points per game and 4.6 rebounds in helping Sam Houston State to a 22-9 record. He was named the Lone Star Conference Freshman of the Year.

"We thought he would stay in school at least one more year," said Campbell, who added that Sam Houston didn't recruit Sangodeyi, who he said is a cousin of Houston freshman center Akeem Abdul Olajuwon.

"They played together in Nigeria and since we're only 70 miles from Houston he came here."

Sam Houston, an NAIA member, will be playing NCAA Division II basketball next year. Sangodeyi will be trying to make a bigger jump.

The NBA draft will be held June 29 in New York with the team to get the first pick to be determined Thursday at noon EDT. A coin flip between the Los Angeles Lakers, who own Cleveland's No.1 pick, and the San Diego Clippers will determine which gets to choose first from a mediocre crop of seniors and a bumper crop of

underclass eligibles.

Worthy, a 6-9 second team All-American, could be to first underclassmen picked. He scored a career-high 28 points when North Carolina beat Georgetown, D.C. 63-6 for the NCAA title.

Cummings, 6-10, averaged 12 rebounds and over 20 points per game for DePaul, while Dailey was the nation's fifth leading scorer at 25.2.

Bagley, who had a 21.1 point per game average — the same as Williams — helped Boston College to the finals of the

Mideast Regional. Thompson was the nation's leading rebounder with a 13.5 average. Wilkins, 6-7, led Georgia in scoring. Kellogg averaged 10 rebounds a game, while Levingston, 6-8, decided to make a bid for the pro after Wichita State was placed on three years probation by the NCAA for recruiting violations.

Virginia's Ralph Sampson, college basketball's Player of the Year last season, for the third year in a row passed up an opportunity to go for early entry in the pros.

Salem Methodist Captures P-P

Salem Methodist, behind Ray Taft's 66, came in first in Putt-Putt Church League action last night.

Salem's 288 total put the team on top of the standings for the opening week. Salem is 9-0.

There was a close match for the next few positions as Faith Pentecostal (8-1) shot 300 for Farmville Presbyterian's (7-2) 3-1 and Arthur Christian's (6-3) 303. They were led by Lynn Cherry, 70; Scott Lewis 67; and Lanny Morris, 70, respectively.

Last year's champ, Hopewell Pentecostal (5-4) could finish no better than fifth with a 327, six strokes ahead of Gum Swamp Free Will Baptist (4-5) and 13 strokes ahead of First Wesleyan (3-6). This trio was led by Danny Pollard, 68; Greg Buck, 75; and Mike Roberts, 75, respectively.

First Baptist (2-7) of Ayden, Falkland Church of God (1-8) and Gloria Day Lutheran (0-9) played in the league for the first time. They were led by Fain Worthington, 81; Gordon Braxton, 87, and Trena Stallings, 108, respectively.

Spread it Around.

French's has come up with a brand-new taste in mustards.



French's, the makers of America's favorite mustard for over 75 years, has just come up with something new. Bold 'n Spicy Deli Mustard. It's tangy, it's tasty, it's unlike any mustard you've ever tasted. Clip the coupon and spread some New Bold 'n Spicy around.



STORE COUPON

Save 15¢ on French's New Bold 'n Spicy Deli Mustard.

TO GROCER: The R. T. French Company will redeem the value of this coupon not to exceed 15¢ plus 7¢ handling if you receive it for the purchase of any size jar of French's Bold 'n Spicy Deli Mustard. Any other application constitutes fraud. Invoices showing your purchase of sufficient stock to cover all coupons redeemed must be shown upon request. Coupons may not be assigned or transferred. Void where prohibited by law. Cash value: 1/20 of 1¢. Customer pays any sales tax. For redemption of properly received and handled coupons, mail to: The R. T. French Company, P.O. Box 1345, Clinton, Iowa 52734. Offer limited to one coupon per purchase.

002-01-B-13-5-82-15 GRE

15¢
© 1982 The R. T. French Co.
15¢

Valentine Out For Replay At Atlanta

ATLANTA (AP) — Tommy Valentine fought Tom Watson down to the third hole of a sudden-death playoff to lose the 1981 Atlanta Classic golf tournament, but "last year seems like a million years ago," says the Georgia golfer.

Valentine, who hails from nearby Gainesville, Ga., says he'd like nothing more than an instant replay of his 1981 performance, but he's not sure he can deliver when play starts Thursday in the \$300,000 event over 6,945-yard, par-72 Atlanta Country Club course.

"There really isn't any carryover," he said Tuesday. "This is still the toughest tournament for me to play in because it's close to home. It's great to play well in front of these fans but gosh awful to play bad. I've done both, and it just adds to the pressure."

Although he lost last year, the event boosted Valentine into a higher echelon of pro golf. He won \$97,323 and for the first time made the top 60 list.

"For the first time in my life, I was considered a success. I believed it and others did, too. It has made playing the tour easier and a hell of a lot more fun. You don't have to worry about getting sponsor exemptions or just making the cut so you could play the next week," he said.

"Now, there's the luxury of being able to plan a schedule, play where you want to and rest when you want to," he added.

The golfer says he still has not reached the "upper echelon, not up there with Watson, (Jerry) Pate and some of those guys."

After his close call at Atlanta, he led another event in Abilene, Texas, until late in the final round, when he shot back-to-back double bogeys at 10 and 11 to wind up three strokes behind Tom Weiskopf.

In this year's Heritage, he led at the midway point but ballooned with a 79 and 77 on the final two rounds when the weather turned bad, finishing tied at 45th place. He's tied for 15th at New Orleans, tied for fifth at Houston and was 34th last week at the Colonial.

"Winning will come, I believe that," he said, "and I believe it probably will come when I least expect it. I've got to learn to handle my game in stressful situations, which isn't easy when you're trying so hard."

"It seems I never play well until this time of year, but I don't know how I'll do this week. I don't have a lot of confidence in my swing right now — the ball could go anywhere," he said. "I wish I could offer an instant replay of last year, and maybe it will work out that way, but I don't feel it right now."

Rampants Roll...

(Continued from page 17)

Tommy Walston hit a sacrifice fly, scoring Logan, and Jones advanced when the ball got past Evans on the relay. A passed ball moved him to third, and he scored when the throw-down bounced past third.

"We were real aggressive tonight," Vincent said. "I hope some of it is going to carry over into the playoffs."

Those playoffs are scheduled to begin next week. Rose, now 21-0 overall and 13-0 in the conference, winds up the regular season on Thursday, hosting Northeastern at 4 p.m. in Guy Smith Stadium.

The Rampants then open the 4-A State Playoffs by hosting Raleigh Millbrook, the Cap-Eight runner-up, on Tuesday at 7:30 p.m. at Guy Smith.

Hunt falls off to 13-8 on the year and 5-8 in the league.

A-G Clinches ECC Crown...

(Continued from page 17)

ciarelli's single. Gay then singled and Harris, in for Gay, stole second to give A-G runners at second and third.

Locust's sacrifice fly to left scored Ricciarelli and Harris came home on a twisting pop-up to shallow rightfield by Coley that fell in for a double

and A-G led, 7-0. A-G's final run came in the fourth. With one gone, Gay singled and Harris, in once more for Gay, stole second. Locust then singled home Harris to make it 8-1.

Ayden-Grifton travels to Roanoke today for its season finale.

VALUE FAIR

WAREHOUSE GROCERIES

1212 N. Greene St.
Greenville, NC

Mon.-Thurs. 8:30 AM-7:00 PM
Fri.-Sat. 8:30 AM-8:00 PM
Closed Sunday

No Limits On Quantities-None Sold To Other Merchants. We Gladly Accept USDA Food Stamps And Manufacturers Coupons.

| LIPTON | VALUE FAIR PRICE | YOU'VE BEEN PAYING | ALL BRANDS | VALUE FAIR PRICE | YOU'VE BEEN PAYING | FRESH LEAN | VALUE FAIR PRICE | YOU'VE BEEN PAYING |
|---|------------------|--------------------|---|------------------|--------------------|--------------------------------------|------------------|--------------------|
| TEA BAGS 24 COUNT | \$1.35 | | CIGARETTES KING SIZE CARTON | \$4.58 | | GROUND BEEF FAMILY PACK | 99¢ | LB. |
| KELLOGGS CORN FLAKES 18 OZ. BOX | \$1.08 | | TWIN PET DOG FOOD 15 OZ. CAN | 5/\$1.00 | | WHOLE PORK LOINS FAMILY PACK | \$1.19 | LB. |
| KELLOGGS RICE KRISPIES 10 OZ. BOX | \$1.05 | | KOZY KITTEN CAT FOOD 15 OZ. CAN | 3/89¢ | | FRESH NECK BONES FAMILY PACK | 49¢ | LB. |
| KELLOGGS RAISIN BRAN 15 OZ. BOX | \$1.29 | | CHATHAM CHUNX DOG FOOD 50 LB. BAG | \$6.79 | | BEECH NUT STRAINED BABY FOOD PER JAR | 21¢ | |
| DUKES MAYONNAISE 32 OZ. JAR | 98¢ | | WISK GAL. | \$6.37 | | SIMILAC BABY MILK 13 OZ. CAN | 95¢ | |
| KRAFT MAYONNAISE 32 OZ. JAR | \$1.49 | | DAWN LIQUID 32 OZ. BOTTLE | \$1.61 | | LUVS DIAPERS 48 COUNT | \$7.69 | |
| KRAFT MIRACLE WHIP 32 OZ. JAR | \$1.49 | | CLOROX BLEACH GAL. | 93¢ | | PAMPERS DIAPERS 60 COUNT & 90 COUNT | \$7.25 | |
| SAUERS MAYONNAISE 32 OZ. JAR | 89¢ | | PUREX BLEACH 1/2 GAL. | 49¢ | | CRISCO SHORTENING 3 LB. CAN | \$2.12 | |
| PETER PAN PEANUT BUTTER 18 OZ. JAR | \$1.59 | | TIDE 48 OZ. BOX | \$1.84 | | SWIFTNING SHORTENING 42 OZ. CAN | \$1.29 | |
| DELMONTE CATSUP 32 OZ. JAR | 99¢ | | TREND DETERGENT 42 OZ. BOX | 99¢ | | DUNCAN HINES CAKE MIX 19 OZ. BOX | 78¢ | |
| FRENCH'S MUSTARD 24 OZ. JAR | 59¢ | | HI DRI PAPER TOWELS SINGLE ROLL | 2/98¢ | | SOUTHERN BISCUIT FLOUR 5 LB. BAG | 69¢ | |
| LYNNHAVEN MUSTARD 32 OZ. JAR | 58¢ | | CHARMIN 4 ROLL | \$1.09 | | COUNTY FAIR BREAD 1 1/2 LB. LOAF | 3/\$1.18 | |
| KRAFT FRENCH DRESSING 8 OZ. JAR | 77¢ | | BOUNTY SINGLE ROLL PAPER TOWELS | 79¢ | | MAXWELL HOUSE COFFEE 18 OZ. JAR | \$3.78 | |
| RED GLO TOMATOES 303 SIZE CAN | 3/\$1.19 | | G&W PIZZAS 13 OZ. BOX | 69¢ | | CAMPBELLS TOMATO SOUP 10 1/2 OZ. CAN | 4/\$1.00 | |
| APRIL SHOWER PEAS 303 SIZE CAN | 3/\$1.00 | | PACKERS LABEL FRENCH FRIES 5 LB. BAG | \$1.68 | | STARKIST TUNA 8 1/2 OZ. CAN | 85¢ | |
| STOKELY CUT GREEN BEANS 303 SIZE CAN | 3/\$1.00 | | OLD SOUTH ORANGE JUICE 12 OZ. CAN | 88¢ | | SWIFT CORNED BEEF 12 OZ. CAN | \$1.29 | |
| GIBBS PORK & BEANS 2 1/2 SIZE CAN | 63¢ | | MAOLA HOMOGENIZED MILK 1/2 GAL PAPER CARTON | 98¢ | | BUTTER ME NOT BISCUITS 8 OZ. CAN | 3/\$1.00 | |
| CREAMETTES MACARONI & CHEESE DINNER 7 1/4 OZ. BOX | 3/\$1.00 | | WHITE STAR SUGAR 5 LB. BAG | \$1.39 | | LIPTON TEA BAGS 100 COUNT | \$1.78 | |
| TOTAL | \$18.96 | | TOTAL | \$33.97 | | TOTAL | \$34.53 | |

Briley's Strawberries

PICK YOUR OWN

264 East Pactolus Hwy.
3 miles from 264 Bypass Stoplight

758-2996 758-3976

Call after 8:00 P.M.

Kroger Sav-on

Let's go Krogering

Items and Prices Effective Wed., May 19, thru Sat., May 22, 1982 in Greenville

Copyright 1982 Kroger Sav-on Quantity Rights Reserved None Sold to Dealers

HOLLY FARMS CUT UP MIXED

Fryer Parts

48¢ Lb.

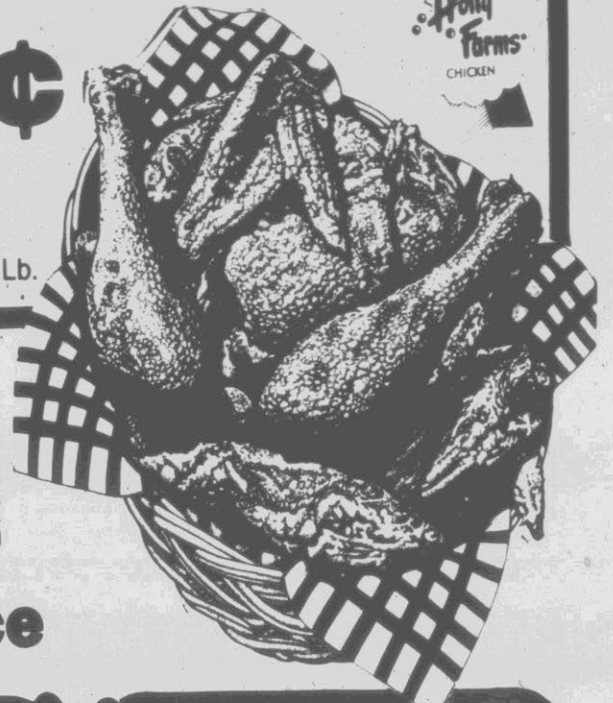

ADVERTISED ITEM POLICY
Each of these advertised items is required to be readily available for sale in each Kroger Sav-on, except as specifically noted in this ad. If we do run out of an item we will offer you your choice of a comparable item when available, reflecting the same savings or a raincheck which will entitle you to purchase the advertised item at the advertised price within 30 days.

for the Best of Everything including the Price

DISCOUNT HEALTH & BEAUTY AIDS

BEAUTY LOTION
Oil Of Olay
4-Oz. Btl. **\$3.17**

L'OREAL ULTRA RICH CONDITIONER OR Shampoo
16-Oz. Btl. **\$1.49**

COATED ASPIRIN TABLETS
Ecotrin
100-Ct. Btl. **\$1.97**

TOOTHPASTE REG. 5-OZ. OR GEL. 4.6-OZ. Btl. **\$1.97**

Colgate 88¢ Each Tube

Colgate Great Regular Flavor
Colgate Winter Fresh Gel

KROGER
2% Lowfat Milk
\$1.79
Gal. Jug

CENTER CUT RIB
Pork Chops
\$1.98
Lb.

U.S.D.A. CHOICE "HEAVY" WESTERN BEEF TOP
Boneless Sirloin Steak
\$2.98
Lb.

DIET PEPSI OR SAVE 30¢
Pepsi-Cola
\$1.09
2-Ltr. N.R. Btl.

RATH HOT OR MILD
Pork Sausage
\$1.08
Lb.

WILSON CORN KING 2-4 LB. AVG. WGT. HALVES
Boneless Ham
\$2.28 SLICED FREE!

ASSORTED VARIETY ALL NATURAL
Breyers Ice Cream
\$2.19
1/2-Gal. Ctn.

KROGER GRADE A
Large Eggs
59¢
Doz.

SERVE 'N SAVE
Wieners
88¢
12-Oz. Pkg.

SPRING VALUES

SPRAY FABRIC PROTECTOR
Scotch Guard
Reg. \$5.99 **\$2.99**

JUBILEE ROLL-TOP
Sport Socks
Pair **\$1.27**

NO-NONSENSE PANTYHOSE
Ultra-Sense
Pair **\$2.46**

WESTINGHOUSE 60 OR 100 WATT LIGHT BULBS
Bug-A-Way
2-Pk. Pkg. **\$1.49**

Sandwich Bread 2 \$1.19
24-Oz. Loaves

KROGER
Pork 'n Beans 3 \$1
16-Oz. Cans

KROGER GRADE A LARGE
Brown Eggs
69¢
Doz.



FLORIDA FRESH PAK
Orange Juice
\$1.09
1/2-Gal. Ctn. IN THE DAIRY

AVONDALE
French Fries 5-Lb. Bag **\$1.49**

BEER
Old Milwaukee 12 \$3.99
12-Oz. Cans

MIX 'N MATCH CORNED BEEF OR
Roast Beef
\$3.99
Lb. SAVE 80¢ Lb.

ASSORTED VARIETY
Kroger Pot Pies 8-Oz. Pkg. **35¢**

BURGUNDY, RHINE, CHABLIS OR
Colony Classic Rose 1.5-Ltr. **\$2.99**

ANY TWO FRESH INGREDIENTS
Combination Pizzas SAVE \$1.96 2 For **\$6**

TEA BAGS
Lipton Tea 100-Ct. Box **\$1.99**

Green Giant SALE

YOUR CHOICE 16-Oz. 17-Oz. Cans **2 \$88¢**

- GREEN GIANT SWEET PEAS
- CREAM STYLE OR WHOLE KERNEL CORN
- NIBLETS CORN (12-OZ.)
- KITCHEN SLICED OR CUT GREEN BEANS

FRESH BAKED
French Bread SAVE 29¢ 2 Lvs **\$1.29**

LAUNDRY
Rinso Detergent 44-Oz. Box **\$1.29**

SWEET MILD GENUINE
Vidalia Onions
59¢
Lb.

2 LAYER 8" **German Chocolate Cake** SAVE \$1 Ea **\$3.99**

Kroger Pharmacy

Any questions on family health matters? Your Kroger pharmacist is available, accessible and informed.

Greenville 756-7393

SNO-WHITE
Mushrooms
\$1.49
1-Lb. Pkg.

TENDER FRESH
Broccoli
69¢
Bch.

Bloodworth Is Announced Dept. Head

ECU News Bureau
William Andrew Bloodworth Jr., a member of the East Carolina University English faculty since 1972, will become chairperson of the department later this year.

Dr. Bloodworth, 39, succeeds Dr. W. Erwin Hester, who is resigning after serving for the past 14 years. His appointment will become official at the beginning of fall semester.



DR. Wm. BLOODWORTH

Announcing the appointment, Dr. Angelo Volpe, dean of the ECU College of Arts and Sciences, commented, "I am delighted that Dr. Bloodworth has accepted this important position. He brings a wealth of experience to the leadership of the English department, and I am eagerly looking forward to working with him."

"I would like to thank Dr. Erwin Hester for bringing 14 years of fine and dedicated leadership to the students and faculty of the department of English," he added. "It has been a pleasure to work with him and I wish him the very best as he resumes teaching and research on a full-time basis."

A specialist in American literature with research interests in post-Civil War American fiction, the literature of the American West and popular culture, Bloodworth has degrees from Texas Lutheran College, Ladar University and the University of Texas. He is a native of San Antonio, Texas.

Before joining the ECU faculty as an assistant professor, Bloodworth taught in Texas public schools and at the University of Texas. He was promoted to associate professor in 1977, having served as assistant to the English chairperson since 1974. With the beginning of fall semester, he assumes the rank of professor.

Among Bloodworth's numerous activities in campus service have been chairing the ECU Planning Commission's Subcommittee on Institutional Support and campus-wide Continuing Education Committee.

His civic activities include presidency of the Sadie Sautler Elementary School Parent-Teacher Association and the Greenville City-Wide P.T.A. Council.

Bloodworth's wife, the former Julia Rankin of Beaumont, Texas, is a staff member in the ECU Student Supply Store. The Bloodworths are the parents of two children.

Prize-Winning Science Project

SALISBURY — Michael Edwin Williams won first place in the senior physical science division of the annual meeting of the North Carolina Student Academy of Science held at Rowan Technical College last weekend.

Williams presented his science project entitled "Use of Spectral Reflectance to Make Remote Sensing Possible." He received a certificate, blue ribbon, plaque and a \$25 check for the most outstanding presentation in the field of aerospace engineering.

He also won the Triangle Communications Award, a plaque presented by the Triangle Communication center for Outstanding Research.

Williams is the son of Mr. and Mrs. John Williams of Farmville.



ADVERTISED ITEM POLICY Each of these advertised items is required to be readily available for sale at or below the advertised price in each A&P Store, except as specifically noted in this ad.

PRICES EFFECTIVE THRU SAT. MAY 22 AT A&P IN GREENVILLE, N.C.
ITEMS OFFERED FOR SALE NOT AVAILABLE TO OTHER RETAIL DEALERS OR WHOLESALERS.

We Gladly Redeem U.S.D.A. Food Stamps

P SUPER SAVER COUPONS

ASSORTED

Hi Dri Towels

2 79¢

big rolls

LIMIT TWO WITH COUPON AND 7.50 ORDER #686

GOOD THRU SAT., MAY 22 AT A&P IN GREENVILLE, N.C.

P SUPER SAVER COUPONS

KRAFT SALAD DRESSING

Miracle Whip

32 oz. jar

99¢

LIMIT ONE WITH COUPON AND 7.50 ORDER #687

GOOD THRU SAT., MAY 22 AT A&P IN GREENVILLE, N.C.

P SUPER SAVER COUPONS

PURE VEGETABLE

Ann Page Shortening

3 99¢

lb. can

LIMIT ONE WITH COUPON AND 7.50 ORDER #688

GOOD THRU SAT., MAY 22 AT A&P IN GREENVILLE, N.C.

AN A&P EXCLUSIVE OFFER

GENUINE IMPORTED STONEWARE

From the Highland Floral Collection.

A GREAT VALUE AT A GREAT PRICE!

THIS WEEK'S FEATURE ITEM

Cup 69¢

With Each 5.00 Purchase PER PLACE SETTING PIECE

A&P COUPON SAVE 50¢ When You Purchase A Covered Butter Dish Reg. 6.99 With This Coupon You Pay Only 6.49 #689

Good Thru Sat., May 22

SEE STORE DISPLAY FOR COMPLETE DETAILS.

P Grocery Specials

SHOWBOAT

Pork & Beans 3 15 oz. cans 88¢

ANN PAGE WHITE OR YELLOW

Facial Tissue 200 ct. box 69¢

TEXIZE 10¢ OFF LABEL

Pine Power 15 oz. btl. 1.09

MAXWELL HOUSE-ALL GRINDS

Coffee 1 lb. bag 2.35

15¢ OFF LABEL-YOU PAY ONLY

Charmin Tissue 4 roll pkg. 1.14

P Health & Beauty Aids Specials

NORMAL, DRY OR OILY

Pert Shampoo 15 oz. btl. 1.69

REGULAR OR UNSCENTED DEODORANT

Secret Roll On 2.5 oz. btl. 1.99

20¢ OFF LABEL

Crest Toothpaste

Regular • Gel • Mint

You Pay Only 1.19

6.4 oz. tube

P Dairy Specials

PILLSBURY

Buttermilk Biscuits

4 99¢

7 1/2 oz. 10 ct. cans

P Grocery Specials

SILVERBROOK

Homogenized Milk

OR A&P 2% LOWFAT MILK

1 75

gal. jug

P Grocery Specials

KRAFT

1000 Island Dressing

• Creamy Italian • Italian • Creamy Cucumber • Catalina

8 oz. btl. 69¢

8 oz. btl. 73¢

P Frozen Specials

SEALTEST

Light n' Lively Ice Milk

1 49

1/2 gal. ctn.

SENECA Apple Juice 12 oz. can 89¢

P Dairy Specials

STRAWBERRY • BANANA/STRAWBERRY BLUEBERRY • PEACH

Light N Lively Yogurt

2 8 oz. ctns. 79¢

IN QUARTERS

Shedd's Spread

3 1 lb. pkgs. 89¢

P Grocery Specials

SENECA

Apple Juice 32 oz. btl. 79¢

LONG GRAIN

Comet Rice 14 oz. pkg. 49¢

P Grocery Specials

KRAFT DELUXE

Macaroni & Cheese 14 oz. pkg. 99¢

GREEN GIANT (MUSHROOMS IN BUTTER 3 1/2 oz. 79)

Sliced Mushrooms 2 1/2 oz. jar 69¢

P Frozen Specials

SALISBURY STEAK TURKEY • MEAT LOAF • CHICKEN

Ann Page Dinners 11 oz. pkg. 79¢

PEPPERONI, SAUSAGE, COMBINATION

Mr. P's Pizza 11 oz. pkg. 79¢

KRAFT MILD

Cheddar Cheese

8 oz. pkg. 1.29

KRAFT

Barbecue Sauce

• Plain • Hot • Smoked

28 oz. Plain 1.09 18 oz. btl. 69¢

DOG FOOD

Field Trial Chunks

25 lb. bag 3.99

GREEN GIANT NIBBLERS

Corn On Cob

CRINKLE CUT Ore Ida Potatoes

2 lb. bag 1.19 6 ears only 99¢

KRAFT

American Singles Cheese Slices

12 oz. pkg. 1.29

KELLOGG'S

Raisin Bran

25 oz. box 1.89

Save up to \$3.00 and Support your American Heart Association

KLEENEX ASSORTED FAMILY SIZE

Facial Tissue 200 ct. pkg. 79¢

Toddler Diapers 12 ct. pkg. 1.89

NEW FREEDOM BELTLESS Maxi Pads 12 ct. 30 ct. 1.39 pkg. 3.39

KLEENEX SUPER DRY-EXTRA ABSORBENT Disposable Diapers 24 ct. pkg. 2.99

COMPLETE DETAILS & ORDER FORM AT SHELF & ON PRODUCT DISPLAY

NEW FREEDOM BELTLESS PADS Mini Pads 30 ct. pkg. 2.39

NEW FREEDOM Any Day Liners 30 ct. pkg. 2.29

NEW FREEDOM (12 CT. 1.39) Super Maxi Pads 30 ct. pkg. 2.99

KLEENEX ASSORTED Family Napkins 140 ct. pkg. 79¢

MORE WITH Coupons!!

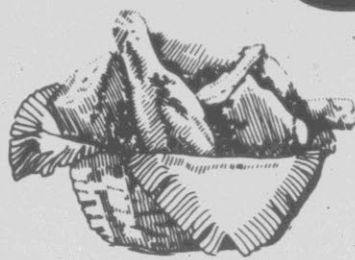

Delicatessen Specials
 SAVE 1.00 AVAILABLE AT 703 GREENVILLE BLVD.
Turkey Breast lb. **2⁹⁹**
 LEAN DELICIOUS
Baked Ham lb. **3²⁹**
 WHITE OR YELLOW SLICED
American Cheese lb. **2⁹⁹**
 PASTRAMI OR
Corn Beef lb. **3⁹⁹**

The Butcher Shop

with supermarket prices

Meat Specials

A&P QUALITY HEAVY WESTERN GRAIN FED BEEF
WHOLE BONELESS
Shoulder Roast
 Cut Free Into
 Boneless Shoulder
 Roast, Steaks,
 Stew Beef and
 Ground Beef
169
 lb. 18 to 24 Lb.
 Avg. Wt.

U.S.D.A. INSPECTED FRESH
Whole Fryers
 2 IN A BAG
 (LIMIT TWO BAGS)
49¢
 lb.

Pork Specials
 EXTRA LEAN SPECIAL TRIM COUNTRY FARM
 COUNTRY STYLE
Spare Ribs
169
 lb.

Poultry Specials
 U.S.D.A. INSPECTED
Fryer Legs
89¢
 lb.

Meat Specials
 A&P QUALITY HEAVY WESTERN
 GRAIN FED BEEF
Cubed Steak
2⁹⁹
 lb.

Beef Specials
 A&P QUALITY SLICED
Beef Liver
89¢
 lb.

EXTRA LEAN SPECIAL TRIM COUNTRY FARM
1/4 Pork Loin Sliced lb. **179**
 A&P QUALITY
Ground Beef 5 lb. roll
 pkg. lb. **138**

A&P QUALITY
 SHANK PORTION
Smoked Ham Butt Portion
 lb. 1.39 lb. **129**
 (BEEF LB. 1.99)
Ball Park Franks 1-lb.
 pkg. **189**

HILLSHIRE FARMS
 (ALL VARIETIES EXCEPT BEEF)
Smoked Sausage lb. **2²⁹**
 TALMADGE FARM
Country Ham 12 oz.
 pkg. **249**

A&P QUALITY HOT OR MILD
Pork Sausage 1-lb.
 pkg. **109**
 CAMECO
Cooked Ham 10 oz.
 pkg. **199**

Poultry Specials
 U.S.D.A. INSPECTED FRESH
**Box-O-
 Chicken**
49¢
 lb.

Meat Specials
 A&P QUALITY HEAVY WESTERN GRAIN
 FED BEEF
**Sirloin Tip
 Roast**
 BONELESS
 (Steak
 lb. 2.59) **249**
 lb.

Pork Specials
 BLUE RIDGE BRAND
**Sliced
 Bacon**
 OLD HICKORY
 Pork
 Bar-B-Cue
 1 lb.
 pkg. **199**
 1-lb.
 pkg. **129**

Cookout Specials
 TALMADGE FARM
**CHICKEN BOLOGNA OR
 Chicken
 Franks**
 TALMADGE
**Red
 Hots**
 20 oz. **139**
 pkg.
 12 oz.
 pkg. **59¢**

P&Q SANDWICH SLICED
White Bread 24 oz.
 loaves **88¢**

JANE PARKER HOT DOG OR
Hamburger Rolls 8 ct.
 pkgs. **99¢**

AUTOCRAT
Ice Cream 1/2 gal.
 ctn. **119**

AUTOCRAT
Ice Milk 1/2 gal.
 ctn. **99¢**



GOLDEN RIPE
**Dole
 Bananas** 3 lbs.
 for **100**

FLORIDA GROWN (54 SIZE)
Fresh Limes 4 for
 only **49¢**

IMPORTED FROM CHILE
 • Red
 • White
 • Blue
Grapes lb. **99¢**

THE FARM

AT A&P
 Fresh With Quality

MILD TENDER MEDIUM SIZE
**Yellow
 Onions** 3 lb. bag **99¢**

GREAT IN SALADS
Fresh Spinach 10 oz.
 bag **99¢**

GREEN ONIONS (BUNCH) OR
Crisp Carrots 3 lb.
 pkgs. **100**

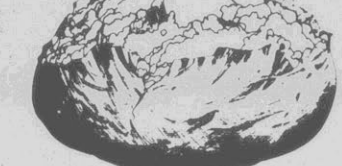

U.S. #1 EASTERN GROWN
**Russet
 Potatoes** 10 lb. bag **169**

RED RIPE
Tomatoes Salad
 Size 26 oz.
 pkg. **99¢**

FOR YOUR PLANTING NEEDS
Potting Soil 20 qt.
 bag **169**

EXTRA LARGE
**Loose
 Eggs**
 Grade
 'A'
 doz.
 only **67¢**

CALIFORNIA LARGE LUSCIOUS
**Red Ripe
 Strawberries**
 JANE PARKER
Shortcakes 6 ct.
 pkg. **69¢**
Pie Glaze 15 oz.
 jar **89¢**
 qt.
 box **99¢**

NEW CROP
**Sweet Juicy
 Cantaloupes**
 POPSRITE BRAND
Popcorn
 2 lb. bag **99¢**
 large
 size **99¢**

Deeds

Margaret D. Allen TO
 Narendra-Dayalji Patel al
 450.00
 Anne Evans Brewer al TO
 William H. Fleming al 25.00
 Thomas Lee Dobson al TO
 Lila Forbes McGowan 30.50
 Johnnie F. Edwards al TO
 Quintet Realty Co. Inc. 55.50
 George M. Thornburg Jr. al
 To Debra Joyce Sabin 5.50
 Lucy Cannon F. Barnhill
 TO William Matthew Barnhill
 NS
 Jasper D. Boyd Sr. al TO
 Ronnie Earl Boyd NS
 B. T. Eastwood TO Thomas
 L. Myers al 56.00
 Eastwood Realty &
 Development Co. Inc. TO B.
 T. Eastwood NS
 Allen Ray Forrest al TO
 William Rutchka al 79.00
 Sylvia B. Haddock TO
 Truman D. Haddock 8.50
 Joseph D. Joyner TO
 Margaret F. Morgan 60.00
 Richard G. Jubert al TO
 Robert T. George al 19.00
 Tommie L. Little Builders
 Inc. TO Charles R. Smith
 110.00
 Johnnie E. May al TO
 Shamrock Realty Co/Pitt Co.
 Inc. 28.50
 S. Reynolds May al TO J. R.
 Yorke Const. Co. Inc. NS
 S. Reynolds May al TO J.
 R. Yorke Const. Co. Inc. NS
 Mildred Lavon Scott
 McDaniel TO Susan J.
 McDaniel NS
 Larry M. McLawhorn al TO
 Walter E. Harvin 3.50
 Mildred M. Dye McDaniel
 TO Susan J. McDaniel NS
 Charles R. Smith al TO
 Tommie L. Little Builders
 Inc. 36.00
 Kenneth R. Vincent al TO
 Charles Anderson Jr. al 1.00
 Paul E. Waldrop Jr. al TO
 Sam M. Purcell al 55.00
 J. R. Yorke Const. Co. Inc.
 TO Wilbur I. Bennett 43.00
 J. R. Yorke Const. Co. Inc.
 TO Ruby W. Jackson 43.00
 Dorothy B. Carraway TO
 Steven I. Cohen 24.00
 Avery S. Jones al TO Isaac
 Jackson Edwards Jr. 10.00
 S. Reynolds May al TO J.
 R. Yorke Const. Co. Inc. NS
 S. Reynolds May al TO J.
 R. Yorke Const. Co. Inc. NS
 Neil Realty Co. Inc. TO
 Robert Douglas Swords al
 43.50
 Vivian S. West al TO C.
 Wayne Mercer al 27.00
 J. R. Yorke Const. Co. Inc.
 TO Karen Jean Mills 43.00
 J. R. Yorke Const. Co. Inc.
 TO P. Branch Goodson al
 43.00
 Charles Barrett al TO The
 Evans Co/Grvl Inc. 4.50
 Blount & Ball Realty Co.
 Inc. TO Michael L. Bowman
 al 23.00
 James W. Brewer al TO
 John R. White 77.50
 Bonnie Carmon TO
 Beatrice J. Harper al 21.50
 The Evans Co/Grvl Inc. TO
 Michael J. Darnell 44.50
 William Edward Fulford
 Jr. al TO Charles Barrett al
 NS
 Johnnie Jenkins al TO Eva
 Lee James al 5.00
 Gorman W. Ledbetter Jr.
 TO Basnight Pilgreen al 1.00
 Michael F. Moyer TO
 Charles J. Costello al 5.00
 George W. Stokes al TO
 Jarvis R. Everett al 4.00
 George W. Stokes al TO
 Melvin B. Stokes al 4.00
 Unity Inc. TO Frances Hill
 Dawson NS
 Edith F. Worthington TO
 Carolyn W. Paramore NS
 Lila C. Bendall TO Frances
 Bendall White NS
 John L. Causey Sr. al TO
 Roselind P. Causey Gibson
 Bill Clark Const. Co. Inc.
 TO Nancy D. Landon 6.50
 Arthur R. Diani al TO
 Richard H. Ray al 33.50
 Harrison Jr. Foreman al
 TO Lillian F. Tyler al NS
 Jamid M. Ghorashi al TO
 John Antal al 97.00
 William C. James Jr. al TO
 Norma G. Lutz 29.00
 S. Reynolds May al TO J.
 R. Yorke Const. Co. Inc. NS
 S. Reynolds May al TO J.
 R. Yorke Const. Co. Inc. NS
 D. W. McPherson al TO
 Willie Ray Gardner al NS
 Neil Realty Co. TO William
 Thomas Cooper 35.50
 Seaboard Coastline
 Railroad Co. TO M. O. Blount
 & Sons Inc. 20.00
 J. R. Yorke Const. Co. Inc.
 TO Betsy C. Drake 43.00
 J. R. Yorke Const. Co. Inc.
 TO Carol Ann Tucker 43.00

Graduates
 WINSTON-SALEM —
 Bachelor degrees were
 awarded to the following
 students by Winston-Salem
 State University during
 commencement exercises
 held recently:
 Dianne Joyner and Horace
 Williams, both of Farmville;
 Mildred D. Harris and
 William E. Peterson, both of
 Greenville, and Lynne Grif-
 fin of Stantonsburg.

Hours: Open Sunday 7 A.M. to 12 Midnight. Open 24 Hours Monday 7 A.M. 'til Saturday 12 Midnight

Crossword By Eugene Sbeffer

- ACROSS
 1 Spool for thread
 4 Swabs
 8 A stopple
 12 Uncle: dial
 13 Incite
 14 Roster
 15 Local tavern
 16 Strong liquor
 18 The black vulture
 20 Negative vote
 21 Formerly: archaic
 24 Asian country
 28 A cooling drink
 32 Capital of Latvia
 33 Toddler
 34 Male and female
 36 Held session
 37 Greek underground
 39 Box elder
 41 Kind of race
 43 Sap: Fr.
- 44 Low haunt
 46 Garden tool
 50 Arizona senator
 55 Harem room
 56 Wicked
 57 Wheel hub
 58 Entreat
 59 Tardy
 60 Matured
 61 Wrath
- 3 Andean country
 4 East African trees
 5 Broad sash
 6 Through officers
 7 British gun
 8 Orison
 9 Fate
 10 Indian
 11 Pike-like fish
 17 Pallid
 19 Beau: dial.
 2 Persian poet
- 22 Fret
 23 U.S. border state
 25 Italian city
 26 Turkish officers
 27 Slat
 28 Roman road
 29 — Porter
 30 And others: abbr.
 31 Network
 35 Cut
 38 English, for one
 40 Buttons or Skelton
 42 Large evergreen
 45 Zola novel
 47 Desert in Asia
 48 German river
 49 Storm
 50 Jellylike material
 51 Eggs
 52 Ignited
 53 Child's game
 54 Actress
 Arden

Avg. solution time: 26 min.

ACES NEST BAT
 BURP AREA REE
 BREAKDOWN ERA
 BREST ERIK
 LAVE BERUFFLE
 LIKE MINIM AUK
 PENDANTS ESTE
 BOLD ANTES
 BERRA BERG
 ULE BREAKAWAY
 OLA AUNT GAPE
 YAK REDS EDEN

Answer to yesterday's puzzle.

| | | | | | | | | | | |
|----|----|----|----|----|----|----|----|----|----|----|
| 1 | 2 | 3 | 4 | 5 | 6 | 7 | 8 | 9 | 10 | 11 |
| 12 | | | 13 | | | | | 14 | | |
| 15 | | | 16 | | | | | | | |
| 18 | | 19 | | | 20 | | | | | |
| 21 | | 22 | 23 | | 24 | | 25 | 26 | 27 | |
| 28 | 29 | 30 | | | 31 | | 32 | | | |
| 33 | | | 34 | | | 35 | | 36 | | |
| 37 | | 38 | | 39 | | | | 40 | | |
| 41 | | | 42 | | 43 | | | | | |
| 44 | | 45 | | 46 | | 47 | 48 | 49 | | |
| 50 | 51 | 52 | | | 53 | 54 | | 55 | | |
| 56 | | | 57 | | | | | 58 | | |
| 59 | | | 60 | | | | | 61 | | |

CRYPTOQUIP 5-19

XFCAGB VGW XFSBXJYB VAY RCEGW
 VQSW ZYVEXSREJ ZJCBBQB

Yesterday's Cryptoquip.— PIONEER COLONISTS LIVED VIVID EPIC OF OUR WONDERFUL WEST.
 Today's Cryptoquip clue: J equals L

The Cryptoquip is a simple substitution cipher in which each letter used stands for another. If you think that X equals O, it will equal O throughout the puzzle. Single letters, short words, and words using an apostrophe can give you clues to locating vowels. Solution is accomplished by trial and error.

YOUR DAILY Horoscope
 from the Carroll Richter Institute

GENERAL TENDENCIES: This is no day to force any activities upon your friends and acquaintances. Refrain from being too demanding in your attitude towards others. Strive for increased happiness.

ARIES (Mar. 21 to Apr. 19) You can now easily get over stumbling blocks in the path of your progress that were difficult in the past. Be logical.

TAURUS (Apr. 20 to May 20) Get busy early in the day and improve your financial position. Do nothing that could ruin your good reputation.

GEMINI (May 21 to June 21) You have good ideas that need more study before going ahead with them. One who opposes you could cause trouble.

MOON CHILDREN (June 22 to July 21) Be sure to use diplomacy in the handling of promises to others, or you could have more trouble than you want.

LEO (July 22 to Aug. 21) An annoying situation could come up early in the day. Replace this with a new interest and get better results. Be cheerful.

VIRGO (Aug. 22 to Sept. 22) Not a good day to put a new system to work. Discuss it further with associates. Make the evening a quiet and relaxing one.

LIBRA (Sept. 23 to Oct. 22) The daytime is not good for recreation since you have important practical affairs to attend to now. Engage in hobby tonight.

SCORPIO (Oct. 23 to Nov. 21) Don't become embroiled in a family squabble. Keep your mind active on important business affairs. Think constructively.

SAGITTARIUS (Nov. 22 to Dec. 21) The planets are not favorable for starting new projects at this time. Show increased devotion to the one you love.

CAPRICORN (Dec. 22 to Jan. 20) Be sure to protect your assets, or you could feel the pinch later on. Be more outgoing in social activities.

AQUARIUS (Jan. 21 to Feb. 19) Don't neglect any business matters early in the day. Be sure to control your temper at all times today.

PISCES (Feb. 20 to Mar. 20) Don't throw away gains you've made on some worthless investment at this time. Avoid one who wastes your valuable time.

IF YOUR CHILD IS BORN TODAY... he or she will want to be of service to others so direct the education along humanitarian lines for best results. Make sure you give good religious training early in life. One who will appreciate music a great deal.

"The Stars impel, they do not compel." What you make of your life is largely up to you!

1982, McNaught Syndicate, Inc.

Receives Grants

ECU News Bureau
 Two grants-in-aid have been awarded to Margaret Kathryn Park of Goldsboro, a special education major in the East Carolina University School of Education.

The grants were provided by the two Greenville chapters of Delta Kappa Gamma international honor society for women educators. The Beta Alpha chapter grant totaled \$300 and the Delta chapter grant \$150.

PICK UP A little extra money by selling used items in the classified section of this newspaper. Call 752-6166.

Recognized By Girl Scouts

ROCKY MOUNT — Fifty-eight Cadette and Senior Girl Scouts of the Girl Scout Council of Coastal Carolina were recognized at the annual awards ceremony for older girls Sunday at Lakeside Baptist Church in Rocky Mount.

Fifty-four Senior and

Cadette Girl Scouts from Carteret, Wayne, Wilson, Columbus, Pitt and Brunswick counties received awards. Girl Scouts from Pitt County who received Gold Leadership Awards were Sherri Beatty and Donna Beatty. Susan Hewett and Sandra Beatty received Silver Leadership Awards.

Renston Garden Market
 Pick Your Own

•Strawberries •Broccoli •Tomatoes
 •Peas •Potatoes •Collards •Beets •Carrots

3.5 Miles SW of Winterville
 on N.C. 903

756-3343
 Andy & Eva McLawhorn

SMART MONEY **save 40¢**
COUPONS

save 20¢
 when you buy one package any size, any flavor

PRINGLES
 Potato Chips

0687-PG

20¢

LIMIT ONE COUPON PER PURCHASE
 PROCTER & GAMBLE—STORE COUPON 343250

Cash redemption value 1/10¢ (1¢ x 20)

save 20¢
 when you buy one any size ROLL-ON, SOLID or AEROSOL

Secret

0498SE

20¢

LIMIT ONE COUPON PER PURCHASE
 PROCTER & GAMBLE—STORE COUPON 343250

Cash redemption value 1/10¢ (1¢ x 20)

TEACH AN OLD DOG NEW TRICKS.

Any good hot dog can cut the mustard in a bun. But when you want to cook up something really special and different, there's just no substitute for good old Luter's Original Old-Fashioned Hot Dogs.



- CREOLE WIENERS**
- 8 slices bacon, diced
 - 3 cups minced onion
 - 1 can (16 oz.) tomatoes
 - 3/4 teaspoon salt
 - 1/8 teaspoon pepper
 - 1 lb. Luter's hot dogs

Here's a main course that serves six with a flavor that says "barbecue." Fry the bacon and onion in a large skillet until the bacon is crisp and the onion is tender. Drain all but two tablespoons bacon drippings from skillet. Stir in tomatoes, salt and pepper, heat to boiling, reduce heat and simmer 15 minutes, stirring occasionally. Add hot dogs, cover and simmer for 15 minutes.

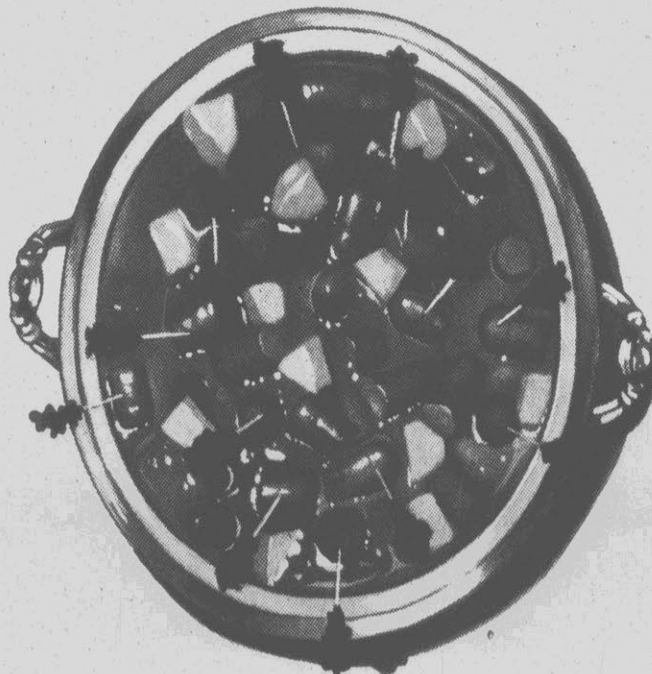

- SWEET AND SOUR HOT DOGS**
- 10 oz. currant jelly
 - 10 oz. ketchup
 - 8 oz. Dijon mustard
 - 2 lbs. Luter's hot dogs

For a tangy hors d'oeuvre that serves 30, start by cutting the hot dogs into bite-size pieces. Separately, heat the jelly, mustard and ketchup until the jelly melts. Add hot dogs, heat for 20 minutes, garnish with pineapple chunks and serve in a chafing dish. One word of caution: If you settle for anything less than Luter's Original Old-Fashioned Hot Dogs, just remember, you'll have those 30 guests to answer to.

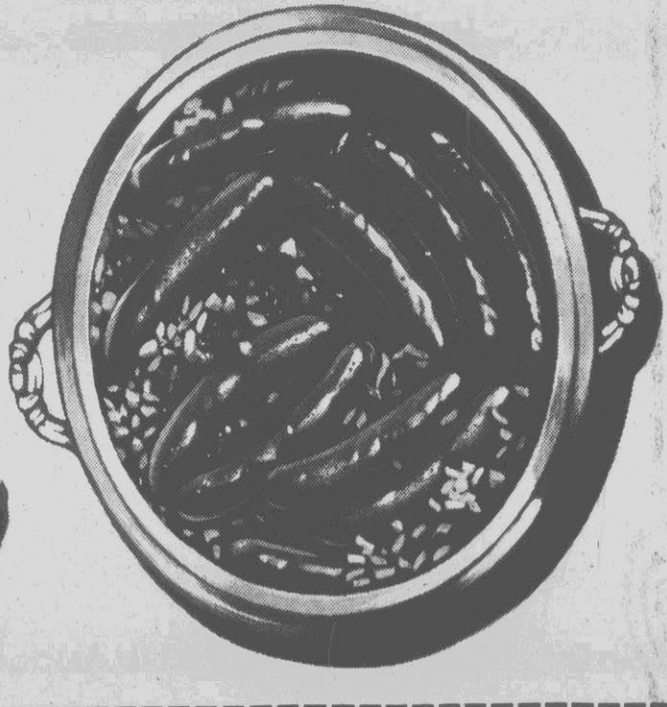

SAVE 25¢

DEALER: Send this coupon to Smithfield Packing Company, P.O. Box 1888, Clinton, Iowa, 52732. Coupon will be redeemed for face value plus 5¢ handling if used in accordance with terms hereof. Coupon is not transferable. Invoices covering purchases by you must be submitted upon request. Consumer must pay any sales taxes. Offer void where restricted. Cash value 1/20 of 1¢. Valid only on brands specified. Any other use constitutes fraud. Smithfield Packing Company, Smithfield, VA. Offer Expires June 30, 1982.

70800 103130

SAVE 10¢ on Comet® Rice Mixes

- No Packet to Mix
- Flavor Steeped In
- Cooks in 15 Minutes
- Makes as Much as Needed

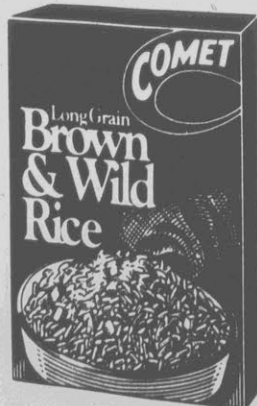

10¢ off on any box of Comet Rice Mix.



TO DEALER: For each coupon you accept from consumer at time of purchase of the specified product we will pay you face value (plus 7¢ handling) provided you and your customer have complied with the terms of this offer. Presentation for redemption without such compliance constitutes fraud. Invoices proving purchase of sufficient stock to cover coupons presented must be shown upon request. Coupon may not be assigned or transferred. Customer must pay any sales tax. Offer good only in U.S.A., void where prohibited, taxed or restricted by law. Coupons will not be honored if presented through unauthorized persons. Cash value 1/20 of 1¢. Unauthorized reproduction of this coupon is prohibited. Coupon is redeemable only if mailed to COMET RICE, INC., P.O. Box R-7028, El Paso, Texas 79975.

Limit one coupon per customer. Offer expires December 31, 1982

PRICES GOOD
MAY 20, 21 & 22



OLD FASHIONED Savings



AT THE NEW FOOD KING
LOCATED ON HWY. 33
IN CHOCOWINITY

QUANTITY RIGHTS RESERVED—NONE SOLD TO DEALERS

—CLIP THESE COUPONS—

| | | |
|---|--|---|
| <p>*COUPON*</p> <p>DEL MONTE CATSUP 32 OZ. BOTTLE</p> <p>59¢</p> <p>Limit 1 Per Customer With Food King Coupon And \$10.00 Or More Food Order, Excluding Advertised Specials. Expires 5-22-62.</p> | <p>*COUPON*</p> <p>COCA COLA 2 LITER DRINK</p> <p>79¢</p> <p>Limit 1 Per Customer With Food King Coupon And \$10.00 Or More Food Order, Excluding Advertised Specials. Expires 5-22-62.</p> | <p>*COUPON*</p> <p>PILLSBURY BUTTERMILK BISCUITS 4 PACK</p> <p>59¢</p> <p>Limit 1 Per Customer With Food King Coupon And \$10.00 Or More Food Order, Excluding Advertised Specials. Expires 5-22-62.</p> |
|---|--|---|

BONELESS CHUCK ROAST



\$1.49 LB.

WHOLE
BOTTOM ROUNDS
18 TO 22 LBS.

\$1.89 LB.

Cut Free into Steaks, Eye Round Roast, Bottom Round Roast, Rump Roast.

WHOLE
NEW YORK STRIPS
BONELESS

\$3.49 LB.

NEW YORK
STRIP STEAKS

\$3.99 LB.

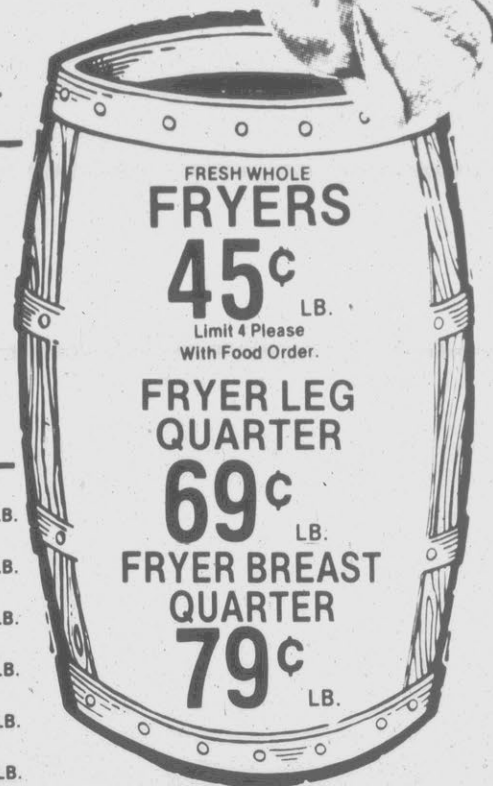

FRESH WHOLE
FRYERS
45¢ LB.

Limit 4 Please With Food Order.

FRYER LEG QUARTER

69¢ LB.

FRYER BREAST QUARTER

79¢ LB.



LIPTON
TEA BAGS
100 COUNT

\$1.59

TREND DETERGENT
GIANT SIZE BOX

99¢

IVORY SOAP
4 BAR **79¢**

KRAFT
ORANGE JUICE
½ GALLON
\$1.49

PLANTER'S
CHEEZ BALLS
5 OZ. CAN **79¢**

PLANTER'S
CHEEZ CURLS
6½ OZ. CAN **79¢**

- BONELESS SHOULDER ROAST \$1.59 LB.
- BONELESS CHUCK STEAK \$1.99 LB.
- BONELESS SHOULDER STEAK \$1.99 LB.
- BONELESS CUBED STEAK \$2.39 LB.
- WHOLE RIB EYE LOINS 10 TO 12 LB. AVG. \$3.49 LB.
- RIB EYE STEAK \$3.99 LB.
- LUNNY FRESH SAUSAGE \$1.49 LB.
- FRESH PORK SPARE RIBS \$1.79 LB.
- SLAB BACON CHUNKS \$1.19 LB.
- GWALTNEY FRANKS 12 OZ. PKG. 99¢
- GWALTNEY BOLOGNA 1 LB. PKG. \$1.39
- SMOKED BONELESS BOSTON BUTTS \$1.99 LB.

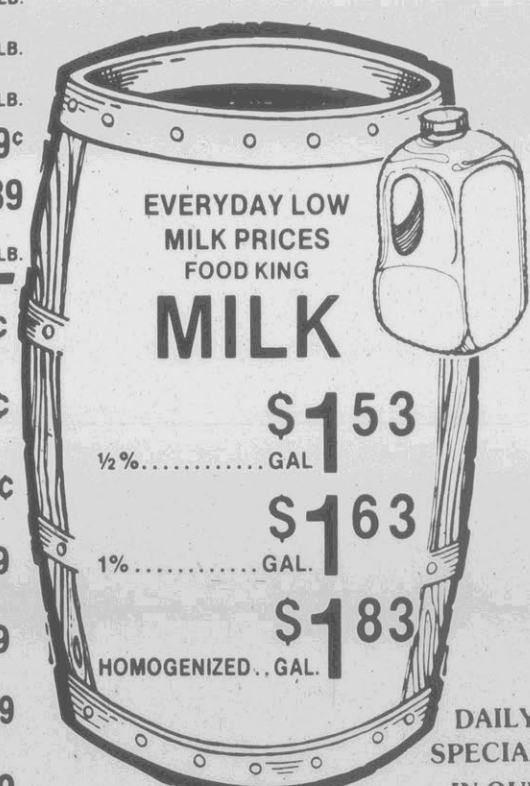

EVERYDAY LOW MILK PRICES
FOOD KING

MILK

\$1.53

½% GAL

\$1.63

1% GAL

\$1.83

HOMOGENIZED .. GAL

DAILY SPECIALS IN OUR HOT DELI AND BAKERY

PRODUCE

WASHINGTON STATE
RED OR GOLDEN DELICIOUS
APPLES
3 LB. BAG **\$1.19**



FRESH BROCCOLI .. LARGE BUNCH **69¢**

RED GRAPES **89¢** LB.

BLACK GRAPES **89¢** LB.

MUSHROOMS .. 8 OZ. PKG. **99¢**

YELLOW CORN ... 5 EARS FOR **\$1.00**

MRS. FILBERT'S
MARGARINE
1 LB. PKG.

2 FOR \$1.00

DEL MONTE CORN CREAM STYLE OR 303 WHOLE KERNEL CAN **2/89¢**

DEL MONTE SWEET PEAS .. 303 CAN **2/89¢**

ARMOUR VIENNA SAUSAGE 5 OZ. CAN **2/89¢**

CHATHAM CHUNX DOG FOOD 50 LB. BAG **\$6.49**

CLOROX II 25% OFF 61 OZ. BOX **\$1.89**

A-1 STEAK SAUCE 10 OZ. BTL. **\$1.49**

JIFFY CORN MUFFIN MIX ... 6 OZ. BOX **4/\$1.00**

SAUER'S GROUND BLACK PEPPER... 4 OZ. CAN **79¢**

O & C POTATO STICKS... 1½ OZ. CAN **4/\$1.00**

ROYAL GUEST CHEESE SINGLES... 1 LB. PKG. **\$1.89**

KRAFT GRAPEFRUIT JUICE .. ½ GAL. **\$1.49**

FROZEN FOODS

SHOE STRING FROZEN POTATOES 20 OZ. BAG **3/\$1.00**

DOWNY FLAKE WAFFLES 13 OZ. PKG. **79¢**

TREESWEET ORANGE JUICE 12 OZ. CAN **99¢**

MRS. SMITH'S APPLE PIE 26 OZ. PKG. **\$1.59**

CAROLINA DAIRY NUTTY BUDDY ICE CREAM 4 PACK **69¢**

SEALTEST LIGHT & LIVELY YOGURT **2/\$1.00**



ROLLER CHAMPION
FLOUR
5 LB. BAG

79¢

ARMOUR
TREET
12 OZ. CAN

99¢

MAXWELL HOUSE
INSTANT COFFEE
10 OZ. JAR **\$3.99**

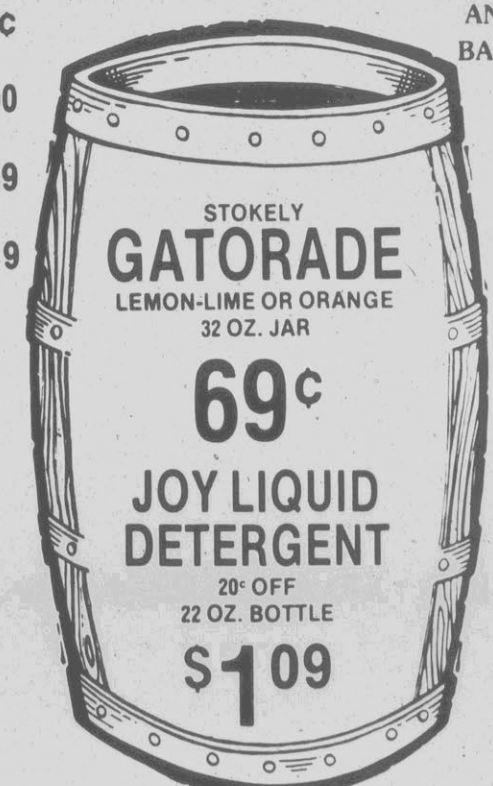

STOKELY
GATORADE
LEMON-LIME OR ORANGE
32 OZ. JAR

69¢

JOY LIQUID DETERGENT
20% OFF
22 OZ. BOTTLE

\$1.09

GOREN BRIDGE

BY CHARLES H. GOREN AND OMAR SHARIF
 © 1982 Tribune Company Syndicate, Inc.
 Both vulnerable. South deals.

NORTH
 ♠ 8543
 ♥ K73
 ♦ Q52
 ♣ K63

WEST
 ♠ K1097
 ♥ J109
 ♦ 97
 ♣ J874

EAST
 ♠ AQJ6
 ♥ Q852
 ♦ 864
 ♣ 109

SOUTH
 ♠ 2
 ♥ A64
 ♦ AKJ103
 ♣ AQ52

The bidding:
 South West North East
 1. ♦ Pass 1 NT Pass
 3 ♣ Pass 4 ♦ Pass
 5 ♠ Pass Pass Pass
 Opening lead: Jack of ♠.

Sometimes, the same suit combination can be tackled in different ways. How would you handle the club suit on this hand?

After he had limited his holding with his one no trump response, North felt that his fine support for both of his partner's suits merited a jump preference. South took heed of the fact that he could not expect more than nine to ten points in his partner's hand and wisely settled for game.

West led the jack of hearts. Since he would surely have to lose a trick in each major suit, the fate of the contract hinged on declarer being able to avoid losing a club trick. Obviously, if the suit were to split 3-3, there would be no problem, but since the odds favored a 4-2 division, the fourth club could present a problem.

One way to manage the suit is to draw two rounds of trumps and then play off three rounds of clubs. However, it is unlikely that the hand that is short in clubs would also have only two trumps. Therefore, that line must be combined with another possibility — that the hand short in clubs might have to waste a trump by ruffing "on air" instead of trumping a high club.

That can be accomplished only if East is the defender who is short in clubs. With the king of hearts in dummy and cash the ace-king of diamonds. Now the clubs must be handled with care. Cash the ace and king of clubs and lead a club toward the queen. If East does not ruff, win the queen and ruff your fourth club with dummy's high trump, and you make your contract.

But it does help East to ruff the club, for now you follow with your low club and East has ruffed your loser.

'Soldier Girls' Is No Laughing Matter

By FRED ROTHENBERG
 AP Television Writer
 NEW YORK (AP) — Boot camp is supposed to make men out of boys. But what happens when the military recruits are girls, who began life playing with dolls and not

tin soldiers? "Soldier Girls," on PBS tonight, is an intimate look at the painful personal moments and the public humiliations of a platoon of women volunteers taking basic training at Fort Gordon, Ga.

In particular, the cameras probe behind the scenes with four recruits, who are seen commiserating about their ordeals, comforting each other and doing whatever it takes to survive the kind of harsh conditions that were laughing matters in the movie "Private Benjamin."

Although this documentary has its comic moments, it generally concludes that basic training is so dehumanizing that one's sex is irrelevant.

After watching sergeants from "Charlie Company" physically and mentally torment recruits, the realization is that these motivational techniques aren't used in a discriminatory fashion. Trainees may go in as boys and girls, but everybody who makes it comes out a drab-green soldier.

Except for more tears and lesser physical prowess, there's very little feminine about the recruits in "Soldier Girls." The strongest scenes counterattack those slick, upbeat television commercials that say the Army offers opportunities to "be all that you can be."

If women are supposed to have a softer nature, the forever barking sergeants aren't interested in finding it. Women are seen marching and chanting "I want to go to Iran, I want to kill an Iranian." One sergeant tells a scared woman on the firing range that the Army has no room for emotion.

During a survival lecture, the need for food is considered. One gun-ho commander demonstrates the fastest way to kill a chicken: biting off its head.

The soldiers are also coached in surviving a nuclear attack. "Turn away from the blast," one sergeant says, "and brush off the radioactive dust." He then flicks away some imaginary specks like they were lint.

These graphic images are captured by cinema verite

filmmakers Nicholas Broomfield and Joan Churchill, who also did "Tattooed Tears," about juvenile prisoners.

Broomfield and Miss Churchill spent 3½ months in early 1980 shooting basic training, and the result is a fascinating, stark picture, but one lacking real explanations why these women wanted military careers.

The cameras and microphones of the documentarians seem as unobtrusive as possible, under the circumstances. And it looks like business as usual at Fort Gordon. One exception seems to be one subject, Joann Johnson. Her persistent smirk, which may reflect some hamming for the cameras, infuriates one sergeant.

"Are you a Russian spy?" he asks her. Miss Johnson happily quits basic training, hugging some recruits and the filmmakers before departing in a yellow cab.

Of the four profiled women, Miss Johnson and Clara Alves don't complete their training. This disproportion may slant the documentary a bit — and the military has criticized it as

not representative — but the resistance of Miss Johnson and Miss Alves does enliven the documentary.

Miss Alves, for example, is punished for being lazy and is forced to dig ditches long into the night. She gets hysterical, and, apparently, assaults her superior with a shovel. At least her commanding officers intimate that she did when three of them castigate her during a brutally harsh interrogation.

In contrast, one dedicated woman recruit asks for combat duty, and her male

sergeant advises against it by recounting his own spiritual sickness from Vietnam. War robbed him of part of his humanity, and he says he's lost the emotional capacity to love.

"I can't give nothing to anybody else anymore," he says.

Carolina Grill
 Corner 9th & Dickinson
 Cheese & Egg Sandwich 59¢
 Ham & Egg, Bacon & Egg, & Sausage & Egg Sandwiches ... 99¢
 Phone 752-1188 For Take-Outs

ABC Wins In Rating Again

NEW YORK (AP) — ABC won the networks' ratings race for the third week in a row, thanks in large measure to "Inside the Third Reich" and a couple of light-hearted specials, figures from the A.C. Nielsen Co. show.

Two programs, CBS' broadcast of the Miss USA Pageant and "Too Close for Comfort" on ABC, finished in a tie for first place in the competition for the week ending May 16, and Part I of NBC's 10-hour "Marco Polo" miniseries was third.

But ABC had nine shows in the Top 20, more than any other network, including "It's Not Easy Being Me: Rodney Dangerfield" in 12th place, and "Hollywood: A Gift of Laughter," 17th.

The conclusion of "Inside the Third Reich," a two-part made-for-TV movie, was No. 5 for the week.

The prime-time schedules of all three networks were loaded with special shows for the May ratings "sweeps," which determine advertising rates for local stations.

A CBS special, "Eleanor, First Lady," finished 15th, and the network was moderately successful with a two-part movie, "Rules of Marriage." The first installment was No. 33 for the week, with the conclusion tied for 25th place.

The rating for Miss USA, as well as "Too Close for Comfort," was 22.5. Nielsen says that means in an average minute of the show, 22.5 percent of the television-equipped homes in the country saw at least part of each program.

The rating for ABC was 15.4 to 15.2 for CBS and 13.2 for NBC. The networks say that means in an average minute of prime time, 15.4 percent of the nation's homes with TV were tuned to ABC.

NBC had four of the week's five lowest-rated shows, with

TV Log

For complete TV programming information, consult your weekly TV SHOWTIME from Sunday's Daily Reflector.

WNCT-TV — Ch. 9

WEDNESDAY
 7:00 Hulk
 8:00 Hulk
 9:00 Movie
 11:00 9/Alive News
 11:30 Late Movie

THURSDAY
 5:30 Rascals
 6:00 Carolina
 8:00 Morning
 10:00 One Day At
 10:30 Alice
 11:00 Price Is
 11:57 Newsbreak
 12:00 Noon News

WITN-TV — Ch. 7

WEDNESDAY
 7:00 Joker's Wild
 8:00 Tic Tac
 9:00 Today
 11:30 Tonight Show
 12:30 Letterman
 1:30 News

THURSDAY
 5:30 Hogans
 6:00 Almanac
 7:00 Today
 7:25 News
 8:30 Today
 8:50 America
 9:00 All in the
 9:30 Doctors
 10:00 Diff. Stokes
 10:30 Wheel Of

WCTI-TV — Ch. 12

WEDNESDAY
 7:00 Sanford
 7:30 Barney Miller
 8:00 Hero
 9:00 Fall Guy
 10:00 W. Newton
 11:00 Action News
 11:30 ABC News
 12:00 Movie
 2:00 Early Edition

THURSDAY
 6:00 J. Swagart
 6:30 Stretch
 7:00 America
 7:25 Action News
 8:25 Action News
 9:00 Phil Donahue
 10:00 R. Simmons
 10:30 Women
 11:00 Love Boat
 12:00 Family Feud

WUNK-TV — Ch. 25

WEDNESDAY
 7:00 Report
 7:30 Town Meeting
 8:00 Survival
 9:00 Performance
 10:30 Austin City
 11:30 Dave Allen

THURSDAY
 7:45 AM Weather
 8:05 Over Easy
 8:35 Poetry
 8:50 Readalong
 9:00 Sesame St.
 10:00 Word Shop
 10:15 Music &
 10:30 Trade-offs
 10:45 Parlez Moi
 11:00 Book Bird
 11:15 Soup To
 11:30 Thinkabout
 11:45 Common
 12:00 Advocates

CONSOLIDATED THEATRES
 ALL SEATS \$1.50 EVERYDAY TIL 5:30 P.M.

BUCCANEER MOVIES
 12:45, 2:50, 4:55
 7:00, 9:05

PORKY'S **PARADISE** **WRONG IS RIGHT**

PARADISE ENDS THURSDAY!

The Arbor and The Veranda Lounge
 bring to you their all new Thursday night double feature...

Ribs and Rose
 that's with all the succulent barbecue beef ribs to eat and rose to drink for \$6.95 per person

Plus Free admission into the Veranda where you can dance the night away to the finest in live entertainment

Also by Popular Demand Wednesday and Friday night double feature

"Shrimp and Chablis"
 that's with all the fried Shrimp to eat and Chablis to drink for \$7.95. Plus Free admission into the Veranda where you can dance the night away to the finest in live entertainment

The Arbor and Veranda are both located within the

RAMADA INN A
 Where we make it happen!
 756-2792
 Dinner hours 5 PM - 10 PM

WATCH OUT—THIS MAN MEANS DANGER!

A week ago they were strangers. An hour ago they were lovers. Now they're together, running for their lives.

NICK NOLTE in **WHOLL STOP THE RAIN**

Also starring Tuesday Weld, Michael Moriarty and Anthony Zerbe.
 A CBS SPECIAL MOVIE PRESENTATION **9 PM**

Stay with the News Leader at 11 pm.

264 PLAYHOUSE INDOOR THEATRE
 6 Miles West Of Greenville On US 264 (Farmville Hwy)

ENDS TONIGHT
 AT YOUR ADULT ENTERTAINMENT CENTER

KISS & TELL
 RATED X

Starring **LONI SANDERS & TIPI ROCKS**
 And A Cast Of Sizzling Centerfolds
 Directed By Suze Randall
 Screenplay By Humphry Knipe
 A Suze Randall Production

Call Anytime For Showtimes
 Valid ID Required 756-0848
 Doors Open 5:45 Showtime 6:00

Footlight Theatre/Lollipop Playhouse, Inc.
 Presents The Hit Musical **Fiddler on the Roof**
 Masonic Theatre New Bern, N.C.
 May 13, 14, 15, 20, 21, 22, 1982
 Curtain 8:15 PM

Adv. Tickets: Athlete's Corner, van Beers Gallery, Branch's, Susanne's Craftory, Favorite Things, Harvey Mansion.
 Information: Call 633-6108, 638-3205

Sammy's Country Cooking
 Open Saturday & Sunday 12-8
 Open For Breakfast Mon.-Fri. at 6:00 A.M.
 Specializing in Tenderloin Biscuits

Mon.-Fri. 6:00 a.m. to 8:00 p.m. Take Outs 752-0476 512 E. 14th St. Greenville, N.C.
 (Near University Seafood)

PLITT THEATRES SUMMER KID SHOW TICKETS ON SALE \$3.00 FOR ALL 10 SHOWS

PLITT SOON "CHARIOTS OF FIRE"
 ENDS THURSDAY "DEATH TRAP" 7:00-9:10 PG
 FULL OF FEELING "PERSONAL BEST" 7:00-9:15 R

CAROLINA EAST CENTER 758-1448
 "IF YOU COULD SEE WHAT I HEAR" 7:00-9:00 PG
 USE PLITT REDUCED ADMISSION TICKETS
 ENDS THURSDAY "CLASH OF THE TITANS" 7:10-9:20 PG

THIEF WARRIOR GLADIATOR KING

ALL SEATS \$2.00
 3:00 P.M. SHOW ONLY

CONAN THE BARBARIAN
 SHOWS MON-FRI. 3:00-7:10-9:30
 Plaza cinema 1-2-3
 PITTSBURGH SHOPPING CENTER
 ENDS THURS. ALAN ALDA "THE FOUR SEASONS"
 SHOWS 3-7-9

PARK UPTOWN GREENVILLE 753-7449
 ENDS THURSDAY "SHOGUN WARLORD"
 SHOWS 7:10-9:00

TONIGHT, THE SPECTACULAR CONCLUSION!

MARCO POLO

The love of loves. The betrayal of betrayals. And the battle of battles for China's destiny!

8:00PM **7** WITN-TV
 Sponsored by The Procter & Gamble Company

PEANUTS



B.C.



NOBBIN

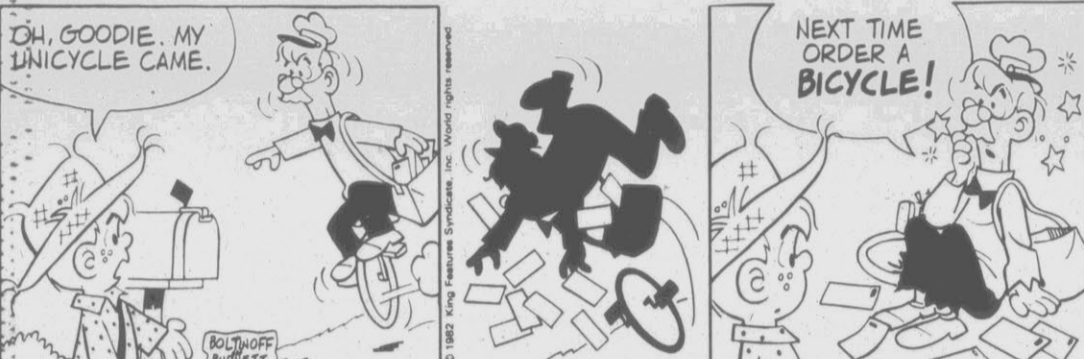

BLONDIE



BEETLE BAILEY



PHANTOM



FRANK & ERNEST



PRIME TIME



FUNKY WINKERBEAN



PUBLIC NOTICES

IN THE GENERAL COURT OF JUSTICE SUPERIOR COURT DIVISION NORTH CAROLINA COUNTY OF PITT...

IN THE GENERAL COURT OF JUSTICE DISTRICT COURT DIVISION PITT COUNTY TOWN OF WINTERVILLE...

NOTICE OF SALE Under and by virtue of an Execution issued by the Clerk of Superior Court of Pitt County...

ADVERTISMENT FOR BIDS Sealed proposals, so marked, will be received in the office of the Director of Greenville Utilities Commission...

ADVERTISMENT FOR BIDS Sealed proposals, so marked, will be received in the office of the Director of Greenville Utilities Commission...

002 PERSONALS WIDOW 50, short gray hair, Hazel eyes, lovin the simple things in life...

007 SPECIAL NOTICES GRAY'S Pineview Family Care Nursing Home has vacancies, male and 1 female...

015 Chevrolet VEGA GT, 1974, 61,000 miles, re-bull engine, air, clean, dependable...

051 Help Wanted

ATTENTION TEACHERS!! You can make money this summer with Avon, the complex, most desired beauty company...

051 Help Wanted ZALES JEWELERS is looking for a person to train for store management...

059 Work Wanted ANY TYPE OF carpentry or remodeling and repair work...

061 Antiques MUSEUM QUALITY ANTIQUES Appraised by Southbey's of New York...

063 Building Supplies BRICK, APPROXIMATELY 8,000 sand finished face brick...

064 Fuel, Wood, Coal ALL TYPES OF firewood for sale J.P. Stancil, 752-6331

065 Farm Equipment TRANSPLANTER parts to fit the Holland transplanter...

072 Livestock HORSEBACK RIDING Jarman Stables, 752-5237

074 Miscellaneous AIR CONDITIONER, 18,000 BTU, excellent condition...

CATCH THESE UNBELIEVABLE PRICES 10% above cost on all GE and Gibson appliances...

MANPOWER Temporary Services 116 Reade Street An Equal Opportunity Employer

127- Houses For Rent

HOUSE FOR SALE or rent to couple with option to buy. 1 1/2 miles from Grimesland on Black Jack Road. Call 752-3730 or 752-5484.

HOUSE FOR RENT in Cherry Oaks, 4 bedroom elegant home, requires 1 year lease. Hardwood floors, 3 bedrooms, wood stove, \$300. CENTURY 21, Bass Realty, 754-6666.

HOUSES AND apartments in town and country. 746-3384 or 324-3180.

IN AYDEN 2 bedroom house, carpet, central heat and air, refrigerator and stove, no pets. \$265 a month. 752-5167 or 746-6394.

NICE 3 bedroom home in Colonial Heights. Family only, no pets. \$300. 754-7716 after 6 p.m.

RENTING VERSUS ownership. Let us show you how you can own your own. 14 X 70, 3 bedroom, 1 1/2 bath home. All appliances and fully furnished for \$199 per month. Call 756-0131.

SIX BEDROOM house for rent 2 blocks from ECU. Call 758-1274 or 752-2077.

SPACIOUS (1922 square feet) architecturally designed 2 bedroom home in excellent neighborhood. Convenient to ECU. This house offers living room/dining room combination, cherry paneled den, full ceramic tile baths, utility room, sun room, glassed-in back porch, carport and generous storage inside and out. Equipped with central air and new economical gas furnace. Situated on beautifully landscaped lot. Will consider renting with option to purchase 1408 North Overlook Drive. Family or mature party only. \$425 per month. 758-5299.

133 Mobile Homes For Rent

BEHIND VENTERS GRILL 3 bedrooms, washer. \$160 per month. Also have 2 bedrooms at \$120 per month. All clean and furnished. Deposit required. Call 756-4962 after 3 p.m. and anytime weekends.

LOCATED ON private lot 3 miles West of Greenville. Call 756-7498.

SPECIAL SPRING rates on 2 bedroom mobile homes, \$120 and up. No pets. No children. 758-4541 or 756-9491.

TRAILER FOR rent or sale, 3 bedrooms, washer/dryer, air. Available now. No pets, no children. 758-2679.

TWO BEDROOM mobile home for rent. \$170 month, \$85 deposit. Call 756-4487.

TWO BEDROOM, furnished, air, washer, good location. No pets. 758-4857.

12 X 60, Washer/dryer, central air, road front lot 3 miles north of Greenville. Call 758-2347.

12 X 60, 2 bedrooms, washer, air. Very clean, couple preferred. No pets. Call 756-0264.

12 X 65, Air condition, furnished. Call 758-2347.

2 AND 3 BEDROOMS, washer, dryer, air, carpet. No pets. Call 756-0792.

135 Office Space For Rent

OFFICE OR BUSINESS location. Colonial Heights Shopping Center, 2741 East 10th Street. Approximately 900 square feet. Available May 1, \$250 month. Call 756-4257 between 9 and 5 weekdays.

OFFICE SPACE FOR RENT, approximately 1,000 square feet on Greenville Boulevard. Call 756-8724.

OFFICES FOR LEASE Contact J.T. or Tommy Williams, 756-7815.

STORES/OFFICES/restaurant on downtown mall. Available immediately. 756-0041, 756-3446.

1000 SQUARE FEET of office space available. Rent negotiable. Pitt Plaza. Call 756-0842.

2,000 SQUARE FEET of office space available now. Reasonable rent. Located on Memorial Drive. 756-9791.

OFFICE BUILDING, 700 to 1100 square feet available immediately on East 10th St. Call 756-2300 days.

903 DICKINSON AVENUE, 2000 square feet, parking, Zoned CDF \$350. Contact Ken Brown, 752-0816.

137 Resort Property For Rent

ATLANTIC BEACH, waterfront private cottage, 6 bedrooms, families only. Call 758-3183 or 756-2404, Greenville, NC.

COTTAGE for rent at North Myrtle Beach, 2 bedrooms. Rented by weekend, week or month. 758-0266.

EMERALD ISLE Beach House: 3 bedrooms, 2 baths, central air, cable TV \$275/week, 919-354-3301.

MYRTLE BEACH, Brandywine South, new, completely furnished townhouse, convenient to all recreational facilities. Available May 30. Call 756-5575, preferably after 6 pm.

PRIVATELY OWNED beach condominium for rent. On ocean, sleeps 7, 2 pools, cable TV, washer/dryer. Call now to reserve the perfect place for your vacation. 752-0847.

138 Rooms For Rent

FOR RENT furnished bedrooms with kitchen privileges, washer and dryer, near campus. Call after 5 p.m., 756-2025.

142 Roommate Wanted

FEMALE ROOMMATE wanted for summer. Move in anytime. 2 or 3 bedrooms. 1/2 of \$325 plus utilities. Call 756-8996.

FEMALE ROOMMATE needed for June 1st occupancy at River Bluff Apartments. 1/2 rent, 1/2 utilities. Call Amy at 1-792-3055.

MALE ROOMMATE needed for 2 bedroom apartment. \$125 rent plus \$50 deposit. Located behind Harris Supermarket. 758-9764 or 752-3761.

MATURE FEMALE wanted to share 2 bedroom apartment. \$83.33 a month. Water and heat included. Close to campus. No pets. Non-smoker preferred. Call 758-5211.

RESPONSIBLE FEMALE roommate to share two bedroom house. \$100 rent and deposit. 752-6004.

142 Roommate Wanted

RESPONSIBLE female roommate needed. Call 757-3709 after 5 p.m.

146 Wanted To Lease

WANTED TO LEASE off or on land peanut pounds in Pitt County or will buy quota pounds. 825-3871 after 6.

CLASSIFIED DISPLAY

ARMY SURPLUS CAMPING SPORTING MILITARY GOODS
Over 1000 Different Items
New and Used

ARMY-NAVY STORE
1501 S. Evans

CLASSIFIED DISPLAY

VANNAN STUDIO

118 NORTH MARKET STREET
WASHINGTON, N. C. 27889

946-3484 Business 946-3228 Home

"STILL THE BEST"

Jim & Shelby Mizelle, OWNERS

129 Lots For Rent

LOT FOR RENT, \$40 per month. Off New Bern Highway. Call 756-7091.

135 Office Space For Rent

APPROXIMATELY 1000 square feet divided into several offices. Greenville Boulevard. Call 756-8724.

COLONIAL HEIGHTS 165 square foot office space. Utilities furnished. \$75 month. 756-7417.

OFFICE BUILDING available immediately. Formerly used by physician. Call 752-0929 or 758-2001.

THESE CARS ARE PREOWNED... BUT

DEPENDABLE!

SHOP THE REST... BUY THE BEST!

- 1981 Chevrolet Malibu Classic**
4 Door. Metallic champagne with vinyl interior, power steering and brakes, air, AM-FM radio, 22,000 miles, nice car.
- 1981 Ford Mustang**
2 Tone silver with vinyl interior, 4 Speed, AM-FM radio, power steering, radial tires, 20,000 miles, local car.
- 1981 Chevrolet Camaro**
White with blue vinyl interior, power steering and brakes, automatic, air, AM-FM stereo tape, 305 engine, tilt wheel, 10,500 miles.
- 1981 Pontiac Bonneville**
2 door coupe. Champagne with champagne metallic landau roof, velour interior, tilt wheel, cruise control, AM-FM radio, wire wheel covers, power windows, power door locks. 24,000 miles.
- 1981 Pontiac Grand Prix**
Black with beige velour interior. Brougham model. Fully equipped, diesel engine, sharp, one local owner.
- 1981 Datsun Maxima**
4 door. Medium metallic blue with blue interior, fully equipped including sunroof. 11,700 miles, local one owner.
- 1980 Chevrolet Citation**
5 door hatchback. Silver metallic with red interior, automatic, air, radio, sharp car.
- 1980 Pontiac Sunbird**
Beige with tan interior, 4 speed, air condition, approximately 38,000 miles, one owner, local car.
- 1980 Toyota Corona Wagon**
Deluxe. Automatic, air, blue with blue interior, AM-FM radio, deluxe wheel covers.
- 1980 Pontiac Grand Lemans**
4 door. Beige with tan cloth interior, automatic, air, AM-FM radio, 36,000 miles.
- 1980 Olds Delta 88**
Bronze metallic with bronze top and cloth interior. Wire wheels, 27,000 miles, clean car.
- 1979 Mazda 626**
Metallic green with beige interior, 4 speed transmission, air, AM-FM radio, 31,000 miles, local car.
- 1979 GMC Pickup**
Tu-tone blue and white, automatic, air, AM-FM cassette tape, V-8 engine.
- 1979 Fiat X 1/9**
Burgundy with tan vinyl interior, 5 speed, air condition, AM-FM radio, 37,500 miles, sharp car.
- 1978 Chevrolet Monza Wagon**
Medium blue metallic with blue interior, power steering, manual transmission, radio.
- 1978 Chevrolet Caprice Classic Landau**
2 Door. White with white landau roof and red velour interior, fully loaded. 52,800 miles.
- 1977 Lincoln Mark V**
Cream exterior with leather interior. Fully equipped, 19,800 miles, local one owner. Extra nice.
- 1977 Ford F-150 Pickup**
Tu-tone red and white with red interior. Power steering, automatic transmission.
- 1977 Chevrolet Impala Wagon**
Brown metallic with tan vinyl interior, tilt wheel, AM-FM radio, power rear window, luggage rack, local car.
- 1977 Olds Cutlass Supreme**
Burgundy with white interior, tilt wheel, cruise control, power windows, AM-FM stereo tape, bucket seats.
- 1971 Cadillac Sedan De Ville**
Cream, cloth interior, 75,000 miles, one owner, fully loaded.

Brown-Wood, Inc.

Dickinson Ave. 752-7111

PONTIAC GM Cadillac FIAT

Greenville's Finest Used Cars!

- 1981 Datsun 200-SX**
Medium blue, blue interior, 5 speed, air condition, AM-FM stereo, sun roof, 11,000 miles.
- 1981 Honda Civic 1500**
Automatic, silver with maroon interior, AM-FM radio, rear window defogger, radial tires, 23,000 miles.
- 1980 Mazda GLC Wagon**
Bronze with tan interior, 4 speed, AM-FM radio, 42,000 miles.
- 1980 Honda Accord**
Silver with maroon interior, 5 speed, air condition, AM-FM radio, digital clock, automatic hatch release, 14,000 miles.
- 1980 Ford Mustang**
White, automatic transmission, AM-FM radio, radial tires, 30,000 miles.
- 1979 Chevrolet Chevette**
Blue with blue interior, 4 speed, AM-FM radio. Cheap to own and operate.
- 1979 Pontiac Sunbird**
Medium blue. 4 cylinder, 4 speed, AM-FM radio.
- 1979 Honda Civic**
White, 4 speed, AM-FM radio, cruise, one owner, 39,000 miles.
- 1979 Chevrolet Corvette**
Light blue with dark blue leather interior, one owner, tilt wheel, cruise control, power windows, power door locks, AM-FM stereo with cassette, glass T-tops. Must see this one.
- 1979 Mercury Bobcat**
Jade green with black interior, fully equipped.
- 1979 Honda Accord**
4 Door. Maroon with maroon velour interior, one owner, air, AM-FM stereo with cassette, automatic deck lid release, rear door locks, digital clock, reclining seats.
- 1979 Honda Civic CVCC**
Hatchback. 5 Speed, air condition, AM-FM stereo, only 24,000 miles.
- 1979 Toyota Corolla Wagon**
White with blue interior, 5 speed, air, AM-FM stereo, radial tires, 22,000 miles.
- 1978 Ford Fiesta**
Tan with buckskin interior, one owner, 4 speed, AM-FM radio, 23,000 miles.
- 1977 Honda Civic Hatchback**
Blue, 4 speed, AM-FM radio, cheap transportation.
- 1977 Toyota Celica**
Liftback. White, tan interior, 5 speed, air condition, AM-FM stereo, 54,000 miles.
- 1977 Chevrolet Monte Carlo**
Maroon with maroon interior, fully equipped, 48,000 miles.
- 1976 Honda Civic**
Tan with tan interior, 4 speed, AM-FM radio, good basic transportation.

Bob Barbour
VOLVO/AMC/Jeep/Renault

117 W. Tenth St. Greenville 758-7200

Bob Barbour
HONDA

3300 S. Memorial Dr. Greenville 355-2500

133 Mobile Homes For Rent

2 BEDROOMS, completely furnished, washer/dryer. Call 752-0196.

CLASSIFIED DISPLAY

CERTIFIED PUBLIC ACCOUNTANT

Desires work at home

INCOME TAXES BOOKKEEPING PAYROLL, ETC.

Has access to computer. Reasonable rates.

CALL 758-5674
Weekdays 8 to 9 PM
Saturdays 9AM to 5 PM

CLASSIFIED DISPLAY

ROOFING
STORM WINDOWS
DOORS & AWNINGS
Remodeling—Room Additions.

C.L. Lupton, Co.
752-6116

The Real Estate Corner

"A NEW WAY OF LIFE"

223 Joseph Street

Deceiving to the eye, this home has a double garage and over 900 sq. ft. of basement. Other features include 3 bedrooms, 2 baths, family rm., dining rm., kitchen-break-fast comb., wood stove and heat pump, large wooded lot (450 ft. depth), and below market financing available...all of \$74,000.00...Call Diversified Financial Services, Inc. (a subsidiary of Home Federal Savings) at 758-3421.

FARMERS HOME HOUSING

LOTS PLANS APPLICATION ASSISTANCE

Contact

TAR RIVER REALTY & CONSTRUCTION COMPANY, INCORPORATED

Box 700, Bethel, N.C. 27812

PHONE 919-825-8381

BOB WHITEHURST Residence 825-3561
FERRELL BLOUNT 825-6411

NEW LISTING

GREAT LOCATION GREAT PRICE GREAT HOUSE

The owners hate to leave this lovely home at 1303 South Wright Road. Almost like new with a great floor plan featuring large great room with fireplace, formal dining room, kitchen with lots of extra's three bedrooms, two full baths, nice lot, carport with storage area, current loan balance of approx. \$39,000 with P&I Payment of \$449.71.

PRICED AT \$64,900.

D.G. Nichols Agency
752-4012

FOUR SUPER VALUES FROM BOB BARBOUR!

Renault Le Car
\$134^{38*} Per Month on Europe's Best Selling Car!

Features: Thermostatically controlled electric engine cooling fan; rear window defogger; column-mounted controls: 2-speed/single-sweep wipers, washers, lights, horn & turn indicators; "tilt-away" bucket seats in body vinyl; flow-through ventilation; side window defoggers; unitized monocoque body/chassis construction; fold-down rear seat; radio console & mini-console; undercoating; rust-resistant coating; black rally stripes with integral "Le Car" name.

Plus: Air conditioning; AM/FM stereo radio; 5 Michelin tires & 4-wheel independent suspension.

*With approved credit and \$800 down, cash or trade; Sale Price: \$5,478; APR: 16.5%; Term: 48 mos; Finance Charge: \$1,772.24; Total of Payments: \$6,450.24; plus tax and tags.

Jeep CJ-7
Up to \$2,000 discounts on Jeeps in stock!

Quality Automobiles from a Quality Dealer!

Bob Barbour
The Name Means Quality

Volvo DL 2-door Sedan
\$217⁸³ Per Month! No Money Down!

5 year lease. First monthly payment and \$300 refundable security deposit required at beginning of lease. Payment shown includes dealer prep charges; tax and tags not included.

Features: Fuel-injected, 4-cylinder overhead camshaft engine, 4-speed manual transmission with overdrive; power-assisted rack & pinion steering; power-assisted 4-wheel disc brakes; front & rear stabilizer bars; steel-belted radial tires; halogen hi-beam headlights; electric rear window defroster; tinted glass; intermittent cycle windshield wipers; front bucket seats with adjustable lumbar support; quartz crystal clock; trip odometer; illuminated, lockable glove compartment with vanity mirror; rear seat center arm rest; 4 3-point self-adjusting safety belts; storage compartments on front doors; remote control rear view mirror.

Plus: Protector paint shield & fabric shield; accent stripe; wheel opening moldings; trim rings; deluxe carpet floor mats.

All New Renault Fuego!

Features: Reclining bucket seats, fabric-covered with split rear seat; deluxe door panels with armrest and color-keyed trim; digital clock; carpeting; inside hood release; interior lights; courtesy, map, & glove box; passenger vanity mirror; adjustable steering column; leather-wrapped steering wheel; AM/FM stereo radio with 4 speakers; trip odometer; tachometer & oil level gauge; anthracite lower body side paint; tinted glass; rectangular head lamps; left remote control mirror; 5-speed manual overdrive transmission; rear window defogger; power steering; extra-quiet insulation; front & rear stabilizer bars; Michelin black (steel) radial tires; intermittent wipers.

Europe's Hot Selling Sporty Coupe!

117 West 10th Street, Greenville, N.C. 758-7200

FOODLAND MARKETS

QUANTITY RIGHTS RESERVED
NONE SOLD TO DEALERS

WE WILL GLADLY
ACCEPT FOOD STAMPS
AND WIC VOUCHERS

ALL-AMERICAN SAVINGS ARE YOURS DURING OUR...

CELEBRATION

SALE



SMITHFIELD 1ST GRADE SLICED
BACON .. \$1.49
SMITHFIELD
FRANKS 12 OZ. PKG. **99¢**

SMITHFIELD DUTCHESS BONELESS
1/2 HAMS
\$2.29 LB.

Prices Effective: Grocery-Meat-Produce: May 20, 21, & 22, 1982

LEAN TENDER
CHUCK ROAST
\$1.49 LB.
Boneless
\$1.19 Blade Cut LB.
Center Cut LB.



FRESH
GROUND CHUCK
\$1.49 LB.



DEL MONTE 1ST GRADE GOLDEN RIPE
BANANAS
29¢ LB.



FRESH PORK
BOSTON BUTT **\$1.49** LB.

LEAN TENDER BONELESS
STEWING BEEF **\$1.69** LB.

RED RIPE
STRAWBERRIES **49¢** LB.



LEAN TENDER SHOULDER
ROAST
(ROUND BONE)
\$1.39 LB. (BONELESS) **\$1.59** LB.



FRESH CRISP
CARROTS..... **25¢** EACH BAG
FRESH
RADISHES **25¢** 6 OZ. BAG
FRESH GREEN
SNAP BEANS **49¢** LB.

FRESH GREEN
LETTUCE **39¢** HEAD



FRESH PORK STEAK **\$1.49** LB.

FOODLAND
COUPON
NORTHERN
BATHROOM TISSUE
4 ROLL PKG. **79¢**
Limit 1 With \$10.00 Additional Food Order Or More & This Coupon.

FOODLAND
COUPON
PUREX
DETERGENT
(You Save \$1.10)
147 OZ. BOX **\$3.39**
Limit 1 With \$10.00 Additional Food Order Or More & This Coupon.

FROZEN FOODS:
BIRDS EYE
COOL WHIP ... 8 OZ. CTR. **79¢**
GREEN GIANT NIBBLER
CORN ON COB ... 6 EARS IN A BOX FOR **99¢**
GREEN GIANT WK NIBLET
CORN ... 10 OZ. BOX **89¢**
GREEN GIANT
BROCCOLI SPEARS
(WITH BUTTER SAUCE) **99¢**
OR CUT
BROCCOLI SPEARS 10 OZ. BOX (WITH CHEESE SAUCE) **99¢**
GREEN GIANT
MIX VEGETABLES 10 OZ. BOX **89¢**

SUNBEAM
BREAD
1 1/2 LB. LOAVES **69¢**
PEPSI COLA, MT. DEW
OR DIET PEPSI
2 LITRE BOTTLE **\$1.09**
LIPTON
TEA BAGS
100 CT. BOX **\$1.99**

FOODLAND
COUPON
FOODLAND MEDIUM
EGGS
DOZEN **29¢**
Limit 1 Dozen With \$10.00 Additional Food Order Or More & This Coupon.

BLUE BONNET
MARGARINE 2 1 LB. PKG. **98¢**



FIELD TRIAL
DOG RATION 50 LB. BAG **\$6.49**
GIBBS
PORK N' BEANS 30 OZ. CAN **69¢**

LIPTON
TEA (CANISTER) 32 OZ. **\$2.79** (Low Calorie) 4 OZ. JAR **\$1.99**



GREEN GIANT
PEAS 2 17 OZ. CANS **89¢**

CARESS
BATH SOAP (7" OFF) 5 OZ. BAR **58¢**
A-1 STEAK SAUCE 10 OZ. BOTTLE **\$1.59**

Keebler Sesame Sticks, Savory Sesame, Nacho Cheese, Wheat Crisps, Wheat Sticks, Chedo, Cheese Shindigs, Pizza Bites, Sour Cream & Onion Or Tangy Cheese **89¢** Pkg.

GAIN
DETERGENT 35% OFF 84 OZ. BOX **\$2.99**
KEEBLER
ZESTA 2 LB. BOX **\$1.49**



JOHNSON LEMON, WOOD SCENT OR REGULAR
PLEDGE ... 7 OZ. CAN **\$1.49**



KEEBLER TOWN HOUSE 16 OZ. BOX **\$1.19**
Maola Homogenized
Milk **\$1.99** 1/2% Low Fat ... **\$1.99** 2% Low Fat ... **\$1.99**

WHITE/DECORATOR, ASSORTED, OR DESIGNER
BOUNTY
PAPER TOWELS
1 ROLL PKG. **75¢**



ARMOUR TREET ... 15% OFF 12 OZ. CAN **\$1.09**
FOODLAND SALT .4 26 OZ. BOXES **\$1.00**

DUNCAN HINES
CAKE MIX
19 OZ. BOX **79¢**



CHEF-BOY-AR-DEE
SPAGHETTI & MEATBALLS
BEEF-A-RONI, OR BEEF-O-GETTI
15 OZ. CAN **59¢**



EXTRA STRENGTH BUFFERIN 50 CT. BOTTLE **\$2.59** (ARTHRITIS STRENGTH) 40 CT. BOTTLE **\$2.09**
HIGH POINT COFFEE 4 OZ. JAR **\$2.39**



KRAFT MAYONNAISE
32 OZ. JAR **\$1.29**



YOUR NEIGHBORS AT
FOODLAND
know what it is to feed a family

SHOP-EZE
West End Shopping Center
Monday-Saturday 8 A.M.-9 P.M.
Sunday 9 A.M.-6 P.M.
SPAIN'S
1414 Charles Blvd.
Monday-Thursday 8 A.M.-8 P.M.
Friday-Saturday 8 A.M.-8:30 P.M.
CLOSED SUNDAY

CHINET DISPOSABLE TABLEWARE
DINNER PLATTERS..... 8 CT. **\$1.29**
DINNER PLATES..... 15 CT. **\$1.49**
BOWLS..... 20 CT. **\$1.29**
DESSERT PLATES 25 CT. **\$1.39**
SECTION PLATES 15 CT. **\$1.49** (10 3/8 INCH) **\$1.99** (9 1/4 INCH) **\$2.59**

Be Sure To Register
And Play The Fabulous
Wheel Of Fortune
WIN CASH WIN GROCERIES
"WHEEL OF FORTUNE"
CASH & GROCERIES GIVE-A-WAY
FOODLAND

We Honor  

K mart® ADVERTISED MERCHANDISE POLICY
 Our firm intention is to have every advertised item in stock on our shelves. If an advertised item is not available for purchase due to any unforeseen reason, K mart will issue a Rain Check on request for the merchandise (one item or reasonable family quantity) to be purchased at the sale price whenever available or will sell you a comparable quality item at a comparable reduction in price.

STORE HOURS
MON. - SAT.
9:30 TIL 9:00

SALE ENDS SATURDAY

 The Saving Place®

Kmart COUPON

Limit 4
 Our Reg. 83¢ Ea.
287¢ WITH COUPON
 For **BIC® Disposable Lighters**
 With adjustable flame; in a variety of colors. Save.

COUPON GOOD THRU MAY 22, 1982

Kmart COUPON

Your Choice
 Limit 2
1.18 WITH COUPON
Colgate® Toothpaste
 7-oz.* regular with MFP* flouride or 6.4-oz.* gel.
*Net wt.



COUPON GOOD THRU MAY 22, 1982

Kmart COUPON

Limit 2
 Sale Price
1.32 WITH COUPON
Pam® Vegetable Spray
 For non-stick baking and frying. Low calorie. 4 oz.*
*Net wt.



COUPON GOOD THRU MAY 22, 1982

Kmart COUPON

Limit 2
 Sale Price
68¢ WITH COUPON
1-lb.* Bag Marshmallows
 Fluffy, white Campfire® marshmallows. Delicious.
*Net wt.



COUPON GOOD THRU MAY 22, 1982

Kmart COUPON

Limit 2
 Sale Price
1.19 WITH COUPON
Liquid Softsoap™
 10.5-oz.*; leaves hands clean, soft. Accent colors.
*Fl. oz.



COUPON GOOD THRU MAY 22, 1982

Kmart COUPON

Limit 2
 WITH COUPON
2.28
24-oz.* J & J® Baby Powder
 Pure, fresh-smelling protection for the whole family.
*Net wt.



COUPON GOOD THRU MAY 22, 1982

Kmart COUPON

Limit 16
 Our Reg. 20¢ Ea.
8\$1 WITH COUPON
 For **Tubular Hangers**
 Sturdy plastic. Choice of colors. Save now.



COUPON GOOD THRU MAY 22, 1982

Kmart COUPON

Limit 2
 Sale Price
38¢ WITH COUPON
Palmolive® Green Bar Soap
 4.75-oz.* bar mild, all-family soap. Fresh scent.
*Net wt.



COUPON GOOD THRU MAY 22, 1982

Kmart COUPON

Limit 2
 Sale Price
99¢ WITH COUPON
22-oz.* Liquid Windex®
 With trigger sprayer, ammonia. Sparkles, brightens.
*Fl. oz.



COUPON GOOD THRU MAY 22, 1982

Kmart COUPON

Limit 2
 Sale Price
1.97 WITH COUPON
64 Oz. Yes Detergent
 Heavy duty detergent plus fabric softener.



COUPON GOOD THRU MAY 22, 1982

Kmart COUPON

Limit 2
 Sale Price - Box
78¢ WITH COUPON
18 Freeze Pops
 Flavored Freezer Sticks
 A cool, refreshing treat in a variety of flavors. Box of 18.
*Net wt.



COUPON GOOD THRU MAY 22, 1982

Kmart COUPON

Limit 2
 Sale Price
1.77 WITH COUPON
Glad® Trash/Lawn Bags
 10, 1.5-mil bags with ties. 20 to 30 gallon capacity.



COUPON GOOD THRU MAY 22, 1982

COUPONS

Kmart®

The Saving Place®

Store Hours
Mon.-Sat.
9:30-9

K mart® ADVERTISED MERCHANDISE POLICY
Our firm intention is to have every advertised item in stock on our shelves. If an advertised item is not available for purchase due to any unforeseen reason, K mart will issue a Rain Check on request for the merchandise (one item or reasonable family quantity) to be purchased at the sale price whenever available or will sell you a comparable quality item at a comparable reduction in price.



Prices Effective
Wed.-Sat.

COUPON SALE

Kmart COUPON

Choice Of Colors

94¢ WITH COUPON

Plastic Webbing Kit
Weatherproof polypropylene webbing for lawn furniture. 2 1/4" x 39".

Limit 4

Coupon Good May 19 thru May 22, 1982

Kmart COUPON

68¢ Pkg. WITH COUPON

Plastic Tumblers
Choose 20, 9-oz. size, 18, 10-oz. size or 12, 14-oz. clear tumblers.

Limit 3 Pkgs.

Coupon Good May 19 thru May 22, 1982

Kmart COUPON

48¢ Pkg. WITH COUPON

Save! Plastic Cutlery
Package of 24 pieces includes 8 forks, 8 knives and 8 spoons.

Limit 3 Pkgs.

Coupon Good May 19 thru May 22, 1982

Kmart COUPON

1.77 WITH COUPON

2 1/2-qt. Covered Pitcher
Large, durable plastic pitcher in choice of decorator colors.

Limit 2

Coupon Good May 19 thru May 22, 1982

Kmart COUPON

86¢ WITH COUPON

Bright Plastic Mugs
Big mugs with designer-look handle. Stackable. 14-oz. capacity. Save.

Limit 6

Coupon Good May 19 thru May 22, 1982

Kmart COUPON

1.87 WITH COUPON

1 gal. Picnic Jug
Plastic outer construction with polyurethane insulation. Wide mouth.

Limit 2

Coupon Good May 19 thru May 22, 1982

All Styles Not In All Sizes
Illustrated Style In 4-6X Only

All Styles Not In Every Store
Sizes 4-14

Our 3.96 - 4.57 Our 5.57 - 5.96

3.33 4.33

Girls' Summer Tops Girls' Pull-on Shorts
Many styles, trims. Polyester/cotton with great fashion trims.

Save 19% To 25%

7.22 Our Reg. 8.96 - 9.57

Misses' Enchanting Fashion Tops
Many styles, including this polyester/cotton peasant look with embroidery.



Save 27%

9.44 Ea. Our Reg. 12.94

Summer Dresses For Every Figure
Newest summer styles. Polyester and polyester blends. Jr. 3-15, misses' petite 6-16, misses' 8-18, full figure 14 1/2-24 1/2.

Save 22%

Our Reg. 8.88

6.88

Misses' Swimsuits
1-pc. styles of nylon/Lycra® spandex. *Du Pont Reg. TM

LYCRA

2.50 Our Reg. 3.57

Clever Tank Tops For Misses
Classic tanks of cotton, polyester and more. Fashion detailing. Save now!

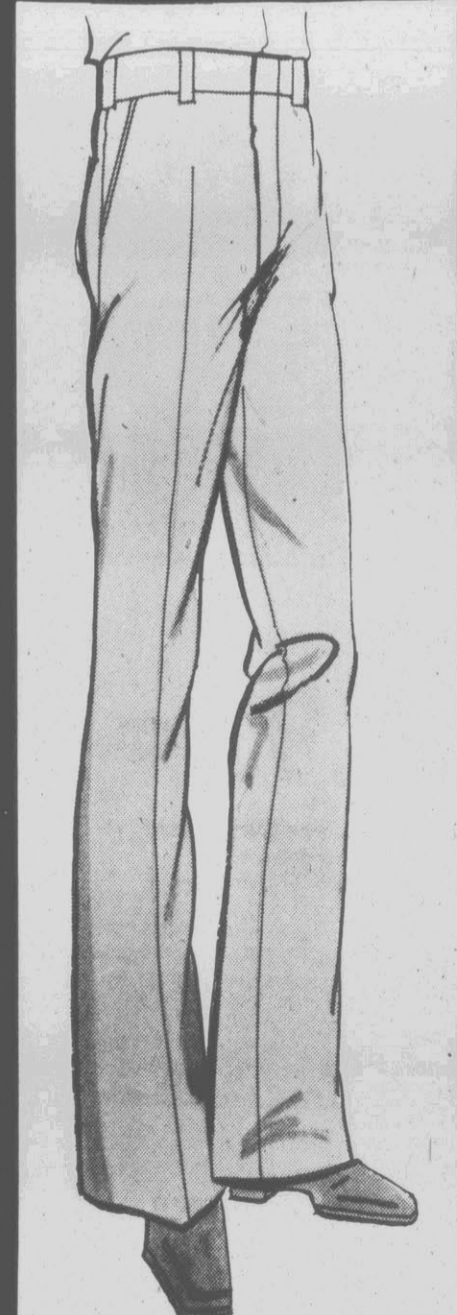

\$8 Each Our Reg. 10.96

Men's Woven Or Double-knit Slacks
Easy-care polyester in solid colors. Tailored, 4-pocket styling. Save now.

4.50 Pair Our 5.90

Women's Canvas Sneakers
With comfortable terry lining, foam innersole and long-wearing outersole. White or navy.

Trax
QUALITY LEISURE FOOTWEAR ONLY AT K mart



2.40 Pair Our 3.40

Summer-wise Slides For Women
Vinyl-band upper, natural rope wedge, matching padded insole. Teak, navy.

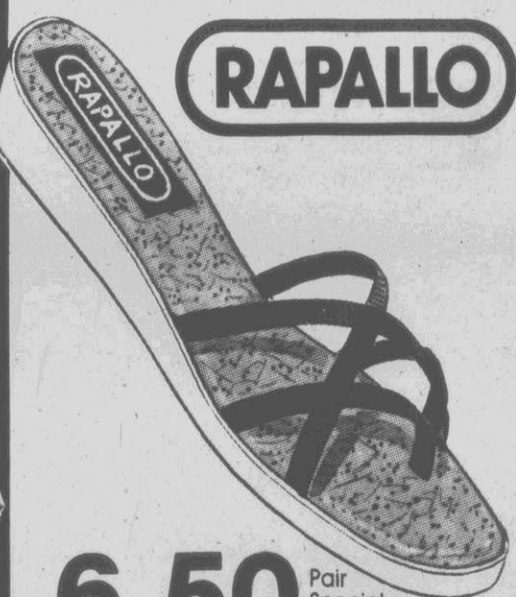

6.50 Pair Special Purchase

Casual Canvas Sandals For women
Strappy thong on durable molded sole. Genuine split-suede insole. Navy. Save.

Kmart

The Saving PlaceSM

STORE HOURS
MON.-SAT.
9:30-9

K mart® ADVERTISED MERCHANDISE POLICY
Our firm intention is to have every advertised item in stock on our shelves. If an advertised item is not available for purchase due to any unforeseen reason, K mart will issue a Rain Check on request for the merchandise (one item or reasonable family quantity) to be purchased at the sale price whenever available or will set you a comparable quality item at a comparable reduction in price.



Prices Effective
Wed.-Sat.

COUPON SALE



Save 12% - 39% On Summerwear

\$3 Save 39%
Our Reg. 4.99

Misses' Carefree Summertime Rompers
Choose solid colors or prints on acetate/nylon loop knit. Spaghetti straps, more. Save!

\$3 Save 12%
Our Reg. 3.44

Halter Dresses For Toddler Girls
Attractive halter-style of cotton/polyester. Dainty prints and pastel colors. 2-4. Save.

\$5 Save 27%
Our Reg. 6.88

Girls' Light And Breezy Sundresses
Choose prints or solid colors of polyester/cotton. Pretty fashion trims. 4-14. Save now!

2.50 Save 37%
Our Reg. 3.97

Toddler Girls' Tie-shoulder Romper
Darling, one-piece romper of easy-care cotton/nylon terry knit. Sized 2-4. Save now!

\$3 Save 25%
Our Reg. 4.67

Girls' Terry Rompers For Summer Fun
Cotton/polyester; other styles in knits. 7-14. **Our 3.96, Little Girls' Romper 4-6X. \$3**

\$5 Save 27%
Our Reg. 6.88

2-pc. Sassy Sets For Little Girls
Many styles in cotton/polyester. This one with ruffles and eyelet trim. 4-6X. Save now!

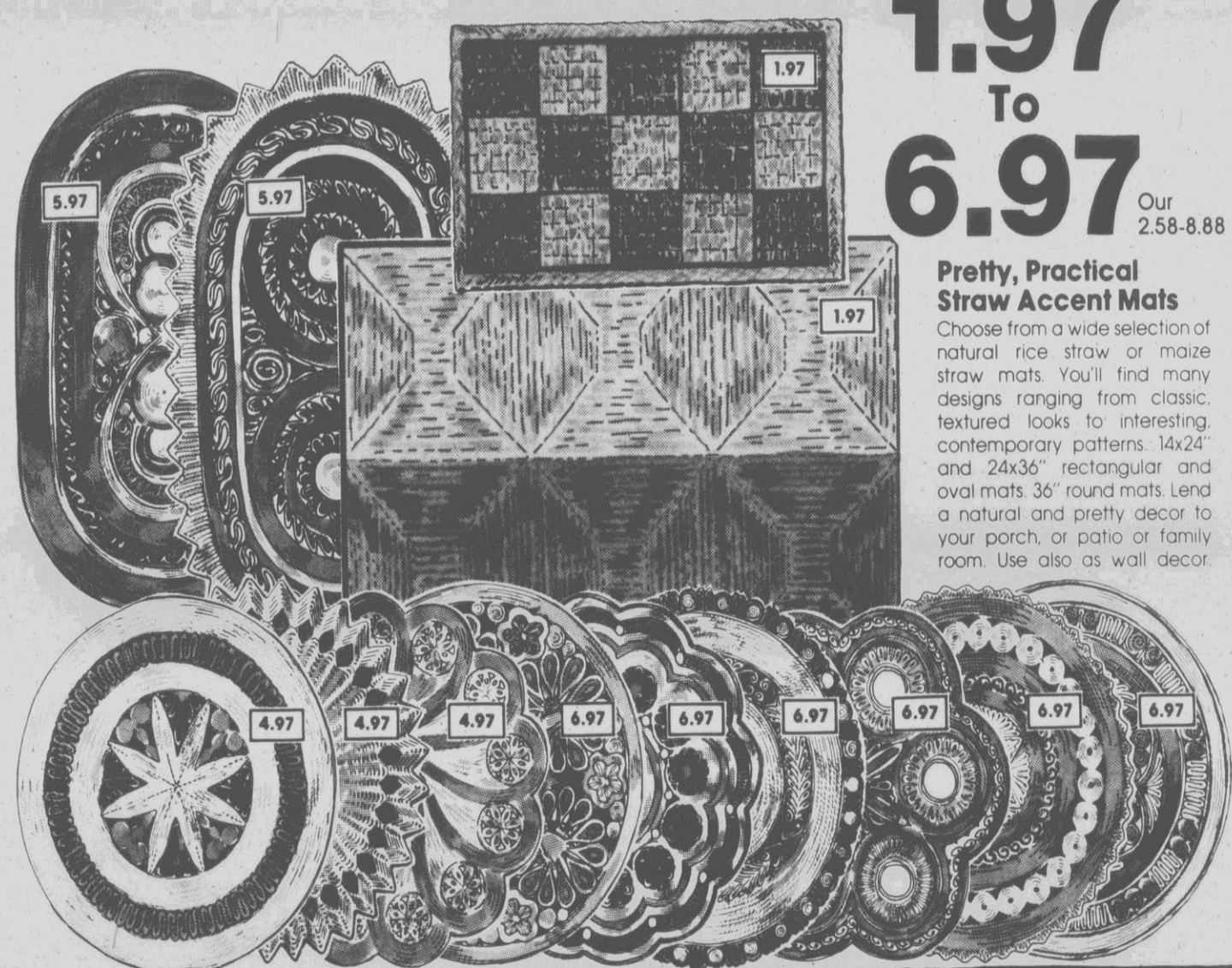

1.97 To 6.97
Our 2.58-8.88

Pretty, Practical Straw Accent Mats
Choose from a wide selection of natural rice straw or maize straw mats. You'll find many designs ranging from classic, textured looks to interesting, contemporary patterns. 14x24" and 24x36" rectangular and oval mats. 36" round mats. Lend a natural and pretty decor to your porch, or patio or family room. Use also as wall decor.

Kmart COUPON

Our Reg. 19.97
16.97 WITH COUPON
Chronograph For Men
LCD, 8-digit watch with quartz accuracy, stopwatch function.
Limit 2
COUPON GOOD THRU MAY 22, 1982

Kmart COUPON

99¢ WITH COUPON
"Gift Mates" Package
Gift-wrap set includes 6" ribbon, bow, 24x30" paper and gift card
Limit 4
COUPON GOOD THRU MAY 22, 1982

Kmart COUPON

WITH COUPON
K mart® Sale Price **12.87**
Less Factory Rebate **-3.00**
Your Net Cost After Factory Rebate **9.87**
"Fresh Air Machine"
Air freshener and deodorizer with RX12™ triple filtering system.
Coupon Good Thru May 22, 1982
Limit 2

Kmart COUPON

1.97 WITH COUPON
Blank Cassette Tapes
3-pak of 90-minute blank cassette tapes. 4 1/2-hours total time.
Coupon Good Thru May 22, 1982
Limit 2

Kmart COUPON

3.97 WITH COUPON
AM Pocket Radio
DC, 9-volt radio with 2 1/4" speaker, direct tuning, handle strap.
Coupon Good Thru May 22, 1982
Limit 2
*Battery not included

Kmart COUPON

15.77 WITH COUPON
Limit 2
AM/FM Portable Radio
AC/DC, full-circuitry, earphone jack.
Coupon Good Thru May 22, 1982
*Batteries not included

Kmart[®]

The Saving PlaceSM

Store Hours
Mon.-Sat
9:30-9

Kmart[®] ADVERTISED MERCHANDISE POLICY
 Our item attention is to have every advertised item in stock on our shelves. If an advertised item is not available for purchase due to any unforeseen reason, Kmart will issue a Rain Check on request for the merchandise (one item or reasonable family quantity) to be purchased at the sale price whenever available or will set you a comparable quality item at a comparable reduction in price.



Prices Effective
Wed.-Sat.

COUPON SALE



Save On Family Funwear

- | | | | |
|---|---|--|---|
| <p>\$7 Our Choice Our Reg. 8.96-9.96 Misses' Short Sets And Playsuits 1- and 2-pc. fashion looks of cotton blends. Solid colors.</p> | <p>\$4 Our Reg. 5.97 Toddler Boys' Playwear Set Striped tank top, solid color shorts. Polyester/cotton. 2-4.</p> | <p>4.88 Our Reg. 5.97 Save On Boys' Athletic Shorts Polyester/cotton with elastic waist and liner. Solid colors.</p> | <p>4.97 Our Reg. 6.97 Save! Men's Jogging Shorts Polyester/cotton in heather shades with contrast trim.</p> |
| <p>5.44 Our Reg. 6.96 Girls' 2-piece Short Sets Many styles. Polyester/cotton. Our 5.96 Similar Styles 4-6x, 4-66</p> | <p>\$3 Our Reg. 3.97 Jr. Boys' 2-pc. Shorts Sets Screen-print top, solid-color shorts. Polyester/cotton. 4-7.</p> | <p>3.94 Our Reg. 4.97 Boys' Sparty-style Shirt Lightweight polyester/cotton, popular styling. Solid colors.</p> | <p>\$4 Our Reg. 4.97 Men's Actionwear Shirt Polyester/cotton crew neck with short-sleeves, contrast trim.</p> |

Kmart COUPON

Misses' S/M, MT/T, Queen Size

Sale Price
117 Ea.
 WITH COUPON

PANTI-ALL[®] Panty Hose
 Choose regular or control top. Nylon with cotton panel. Basic colors.
 Coupon Good Thru May 22, 1982.

Limit 4

Kmart COUPON

BUDGET PACK!

Our Reg. 3.97
327 WITH COUPON

Men's Handkerchiefs
 Package of 10, white, polyester/cotton handkerchiefs. Satin stripe.
 Coupon Good Thru May 22, 1982.

Limit 2 Pkgs.

Kmart COUPON

FRUIT OF THE LOOM

237 WITH COUPON

Men's Pocket T-Shirt
 Comfortable cotton tee with short sleeves, crew neck and handy pocket.
 Coupon Good Thru May 22, 1982.

Limit 2

Kmart COUPON

Adjustable

Our Reg. 2.97
197 WITH COUPON

Emblem Cap For Men
 Nylon mesh back and polyester/cotton visor. Variety of colors and emblems. Shop Kmart!
 Coupon Good Thru May 22, 1982.

Limit 2

Kmart COUPON

Our Reg. 3.22
250 WITH COUPON

Versatile Tube Tops
 Choice of fabrics and styles. Some sparked with metallic threads.
 Coupon Good Thru May 22, 1982.

1 Size Fits All

Kmart COUPON

Our Reg. 1.96
144 Pkg. WITH COUPON

Strapless Tube Top Bra
 Antron[®] nylon/Lycra[®] spandex in white or beige. For summer.
 *DuPont Reg. TM
 Coupon Good Thru May 22, 1982.

A or B Cup Fits 32-36

233

Art Set By Crayola[®]
 Chalk sticks, crayons, brush, 4 mixing trays, watercolor tray, glue.

Our Reg. 77¢
58¢

Plain white or tinted inside for security. Choice of sizes. Save!

Security: 80, 6 1/2" 40, 7 1/2" 50, 10 40, 10

Kmart COUPON

Our Reg. 16.97
1497 WITH COUPON

Canon[®] Calculator
 Multifunction, slimline, 8-digit calculator. With battery. Save!

Limit 2

COUPON GOOD THRU MAY 22, 1982

Kmart COUPON

1.97 Our Reg. 2.78 Ea. WITH COUPON

Sentry[®] V Cat Or Dog Flea Collar
 Helps protect your pet from fleas and ticks for up to 5 months. Save now!

Coupon Good Thru May 22, 1982

Limit 2

Sale Price
266

Frypan with Teflon II[®]
 Polished aluminum with easy-to-clean Teflon II[®] interior. 10-in. size.
 *Du Pont Reg. TM

Kmart®

The Saving Place™

COUPON SALE

STORE HOURS
MON.-SAT.
9:30 - 9

K mart® ADVERTISED MERCHANDISE POLICY
Our firm intention is to have every advertised item in stock on our shelves. If an advertised item is not available for purchase due to any unforeseen reason, K mart will issue a Rain Check on request for the merchandise (one item or reason) in the same quantity to be purchased at the same price whenever available or will set you a comparable quality item at a comparable reduction in price.



Prices Effective
Wed. - Sat.



1.88

Adorn Hair Spray
Regular, extra hold, unscented, ultimate hold, soft hold, 9 oz.



93¢

Liquid Soap
Choose tan or blue decor dispenser. 10.5 fl. oz.



1.54

Right Guard® Solid
Choose regular or unscented. 2.5 oz.-net-wt. stick. Save!



2.96

Clairette® Hair Color
Shampoo-in formula. Flattering Shades. 1 application.

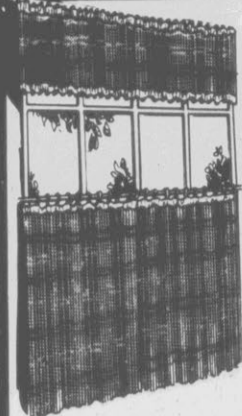

Versatile Vinyl Reed Cafe Curtains

A stylish, contemporary look of easy-care vinyl reed in popular decor colors. Save now at your local Kmart®.

Kmart COUPON

Limit 2

Sale Price
1.99
WITH COUPON

Save! Strawberry Jam
With a name like Smuckers® you know it's got to be good. 32-oz.-net-wt. jar. Save!

Coupon Good Thru May 22, 1982



1.27

Raintree Lotion
Contains natural protein. Absorbs instantly. 10-oz. bottle.



1.97

New Freedom® Mini Pads
Bellless, package of 30. Maxi Pads, 30's 2.68



9.25x8.58" Tissues

66¢

Kleenex® Tissues
Box of 200, 2-ply facial tissues. White and pastels.



3.42

Teldrin
40 Multisystem allergy reliever. Helps give 24-hr. tissues. White and pastels.

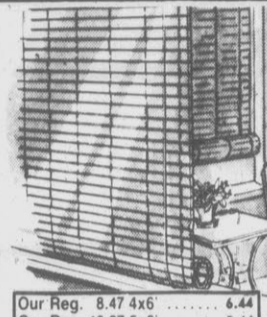

2.97

2 1/2 x 4'

Decorator-inspired Roll-up Blinds
Choose contemporary white or rich fruitwood-look 1/2" slat vinyl blinds. Heavy-duty cordlock and Vinylon® cord. Savings.

Kmart COUPON

Limit 2

77¢
WITH COUPON

Reusable Ice Pak
Colder than water. Keeps food cold in picnic cooler. 7x3 3/4 x 1 1/2". Save.

Coupon Good May 19 Thru May 22, 1982

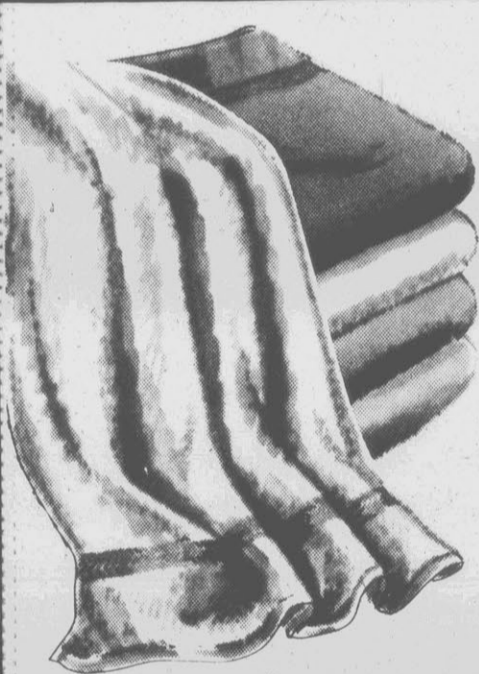

12x12" Matching Washcloth, 87¢
15x25" Matching Hand Towel, 1.37

1.97

Sale Price

22x42" Unsheared Terry Bath Towel
Cotton/polyester towels have 1-inch border and hemmed ends. Choose pretty decorator solid colors for your bath.

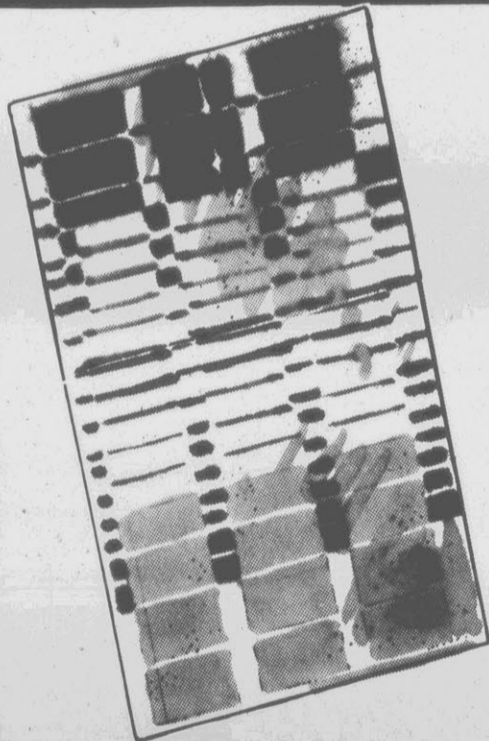

5.47

Our Reg. 6.77

Handsome Jacquard Beach Towels
Absorbent cotton towels in choice of good-looking designs. 30x57-inch size is big enough to stretch out on. Save now.

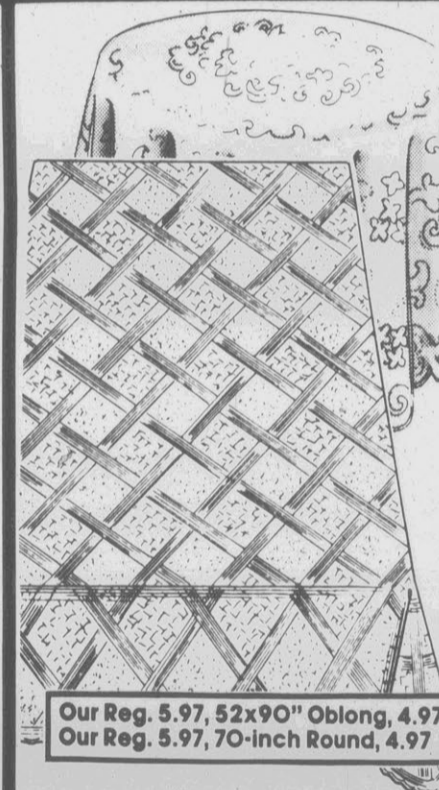

Our Reg. 5.97, 52x90" Oblong, 4.97
Our Reg. 5.97, 70-inch Round, 4.97

2.97

Our 3.97
52x70" Oblong

Embossed Vinyl Tablecover At Savings
Choose geometric "Plaza" or lacy-looking "España" designs in your choice of neutral colors or white. Easy, wipe-clean vinyl.

Kmart COUPON

Limit 2

Our Reg. 9.96
\$7
WITH COUPON

Fluorescent Adapter
Energy-saver adapter with 22-W fluorescent bulb. Ready to install.

Coupon Good Thru May 22, 1982

Kmart COUPON

Limit 2

1.72
WITH COUPON

Johnson's Lotion
Soothing, gentle baby lotion in flip-top bottle. 9-fl.-oz. size. Save now!

Coupon Good Thru May 22, 1982

Kmart COUPON

Limit 2

1.42
WITH COUPON

Q-tips® Cotton Swabs
Pkg. of 300 multipurpose cotton safety swabs. Double tipped.

Coupon Good Thru May 22, 1982

Kmart COUPON

Limit 2

Sale Price
2.66
WITH COUPON

Frypan with Teflon II®
Polished aluminum with easy-to-clean Teflon II® interior. 10-in. size. *Du Pont Reg. TM

Coupon Good Thru May 22, 1982

Kodak WE SELL CAMERAS FILM

Kodak Ektralite 10 CAMERA WITH FILM BUILT-IN ELECTRONIC FLASH 29.97

KODAK TELE-EKTRALITE Camera Outfit 56.47

Sensalite flash

KODAK TELE-EKTRALITE 300 Camera Outfit

Batteries not included with cameras shown here

Your Choice

56.47 25.97

Tele-Ektralite™ Camera Set
Normal and telephoto lenses, built-in electronic Sensalite™ flash, cover/handle, film.

Choice Of Camera Outfits
Aim 'n shoot Tele-Ektra™ 300 has 2 lenses, film, Ektralite™ 10 with built-in flash, film.

Kmart COUPON

17.47
WITH COUPON

110 Pocket Camera
Electro-Flash 555™ features built-in electronic flash, f.8 lens.
Coupon Good Thru May 22, 1982

Limit 2

Kmart COUPON

15.67
WITH COUPON

Kodamatic™ Color Film
Twin pack of Kodak® instant color film. 20 total exposures.
Coupon Good Thru May 22, 1982

Limit 2 Packs



Store Hours
Mon.-Sat. 9:30-9

K mart® ADVERTISED MERCHANDISE POLICY
Our firm intention is to have every advertised item in stock on our shelves. If an advertised item is not available for purchase due to any unforeseen reason, K mart will issue a Rain Check on request for the merchandise (one item or reasonable family quantity) to be purchased at the sale price whenever available or will sell you a comparable quality item at a comparable reduction in price.



Prices Effective
Wed.-Sat.

COUPON SALE



'KM Economiser'
4-ply
Blackwalls
Our Reg. 29.97 - A78x13*
24.97
Plus F.E.T. 1.59 Each

| SIZES | REG. | SALE | F.E.T. |
|--------|-------|--------------|--------|
| B78x13 | 34.97 | 28.97 | 1.71 |
| E78x14 | 39.97 | 33.97 | 2.01 |
| F78x14 | 42.97 | 35.97 | 2.12 |
| G78x14 | 45.97 | 37.97 | 2.28 |
| G78x15 | 47.97 | 39.97 | 2.35 |

All Tires Plus
F.E.T. Each

*Mfr's. Treadwear Rating Est. 18,000 Miles

MOUNTING INCLUDED - NO TRADE-IN REQUIRED

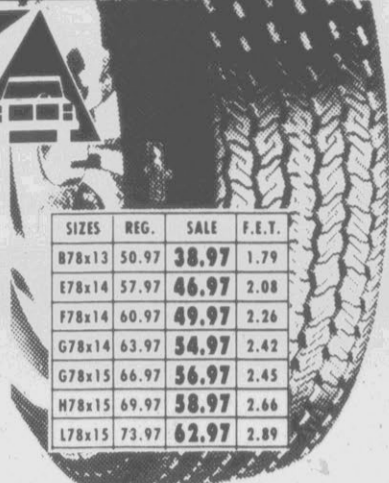

'KM' 200'
FIBERGLASS
BELTED
WHITEWALLS
Our Reg. 44.97 - A78x13
33.97
Plus F.E.T. 1.67 Each

| SIZES | REG. | SALE | F.E.T. |
|--------|-------|--------------|--------|
| B78x13 | 50.97 | 38.97 | 1.79 |
| E78x14 | 57.97 | 46.97 | 2.08 |
| F78x14 | 60.97 | 49.97 | 2.26 |
| G78x14 | 63.97 | 54.97 | 2.42 |
| G78x15 | 66.97 | 56.97 | 2.45 |
| H78x15 | 69.97 | 58.97 | 2.66 |
| L78x15 | 73.97 | 62.97 | 2.89 |

*Mfr's. Treadwear Rating Est. 30,000 Miles

*Manufacturer's Treadwear Rating Based On The U.S. Department Of Transportation's Uniform Tire Quality Grading System

Kmart COUPON

Save \$4
Our Reg. 11.97
7.97
7mm Spark Plug Wire Set
For many American and foreign cars.
WITH COUPON
Coupon Good thru May 22, 1982

Kmart COUPON

Sale Price
2 For \$3
8-oz. Armor All® Spray Protectant
Helps to protect and beautify. Save.
*Net wt.
WITH COUPON
Coupon Good thru May 22, 1982

Kmart COUPON

Sale Price
2.77
Comfortable Seat Cushions
For summer 'n winter comfort. Multi-color.
WITH COUPON
Coupon Good thru May 22, 1982

HERE'S WHAT WE DO:
1. Computer Balance
2. Front Wheels
3. Align Front End
4. K Care Safety Check

Additional parts and services are extra

23.88 Sale Price
Computer Balance And Alignment
For many U.S. cars. Foreign cars excluded.

SERVICES INCLUDE:
1. Replace front brake pads
2. True rotors
3. Inspect calipers
4. Refill hydraulic system
5. Repack inner and outer bearings
6. Replace front grease seals
7. Inspect master cylinder
8. Inspect rear linings for wear (additional cost if repairs on rear brakes are needed)

Additional parts and services, which may be needed, are at extra cost. Semi-metallic pads \$10 more.

78.88 Sale Price
Front Disc Brake Service Special
For many U.S., import cars. Lt. trucks higher.

Top-Or Side-terminal Styles

Limited 3 Month Free Replacement. Limited 4th-48th Month Pro-rate Adjustment Warranty.
*Many states require a state seal.

46.88 Our Reg. 58.88
Maintenance-free 48-month Battery
For many U.S., import cars, lt. trucks.

Save \$20

68.88 AVX400/AVX600
Our Reg. 88.88
68.88
AM/FM/8-tr. Or Cassette
Stereos with original equipment styling. Fits many cars and light trucks.
Our 38.88, 5 1/4" Coaxial Speakers, Pr. 28.97

33.97 SK6920C
28.97 SK620C
Installation Available

Save 16%

83 AVX605
Our Reg. 98.88
\$83 Ea.
AM/FM/Cassette For Small Cars
Designed for import and X-body cars. With fast forward, eject, local/distance switch.
Our 43.88, 6x9" Coaxial Speakers, Pr. 33.97

Model 737
9.97 Combo.

Model 2100
9.97 Combo.

Model 727
Our Reg. 14.44
9.97
Each Combo. Set
Spincasting or Spinning Reel With Two-piece Fiberglass Rod
*404" spincasting reel with "737" rod or "2100" spinning reel with "727" rod

YOUR CHOICE

Kmart COUPON

Our Reg. 2.97
1.77
Folding Poncho For Foul Weather
Handy 52x80-inch hooded poncho folds to fit into pocket. 1 size fits all.
WITH COUPON
Coupon Good thru May 22, 1982

#108-S
DAIWA

9.97 Our Reg. 12.88
Apollocast™ Spin-cast Reel
80-yd. of 8-lb. test. Multidisc drag, anti-reverse feature.

Sporting Goods Dept.

2.99 Our Reg. 3.97
Polyester Sport Shorts
Gym shorts with handy back pocket. Choice of colors, sizes.

MacGregor

Sporting Goods Dept.

Men's
2.97 Our Reg. 3.97 Pr.
Men's Over-the-calf Socks
Of Orlon® acrylic/nylon/cotton/elastic. Colorful stripes.
*Du Pont Reg. TM

Save \$2

SLAZENGER

8.97 Our Reg. 10.97
"Demon" Wood Tennis Racket
Professionally styled, has leather grip. Save at Kmart®

Kmart COUPON

Limit 6 Cans

Sale Price
1.99
Penn® Heavy-duty Tennis Balls
3 yellow balls in a pressurized can.
WITH COUPON
Sporting Goods Dept.
Coupon Good thru May 22, 1982

Save \$6

19.97 Our Reg. 25.97
Motorcycle Safety Helmet
AAMVA approved* in youths' and adults' sizes. Colors.

Coleman

Sporting Goods Dept.

24.97 Sale Price
Convenient 42-qt. Cooler
Steel reinforced for durability. Food tray and drain. Save.

MacGregor

2.97 Our Reg. 3.47
Men's Baseball-style Cap
Fashioned of cool 'n comfortable polyester/nylon mesh.

BRINKMANN

200,000 Candlepower

15.97 Sale Price
Super Spot™ Sport Lite
Operates on 12-V. DC, automotive or marine power.
*Battery not included

Kmart COUPON

GUARANTEED CUT PROOF
PGA GOLF

4.99 Box of 12
Our Reg. 6.97
"Wonderball" Cutproof Golf Balls
Long distance balls. Cutproof cover.
Coupon Good thru May 22, 1982



The Saving Place®

Store Hours
Mon.-Sat. 9:30-9

WED. THRU
SAT. SALE

HOUSE 'N' GARDEN sale



2/1.00
Bedding Plant Pack
Flower and vegetable plants for your garden

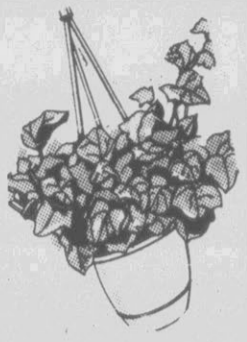

3.99
10" Hanging Baskets
Choice of foliage.



1.97 Our Reg. 2.77
Potting Soil
40 lb. bag is ideal for houseplants, flats, window boxes, etc.

2.27 60 lbs. Our Reg. 2.97
Sakrete® Concrete

3.17 60 lbs. Our Reg. 3.97
Sakrete® Mortar Mix

Economical SAKRETE Concrete and Mortar Mixes let you make great home improvements and long-lasting repairs. Quality controlled; guaranteed for dependability.



1.57
Broadleaf Evergreens
Hardy, ready to plant, in 1-gallon pots.



While Supply Lasts
3.97 Our Reg. 4.97
1-Gal. Rose Bushes
Healthy bushes in radiant colors.

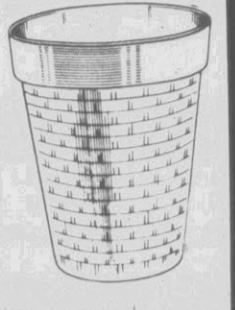

3.97 Our Reg. 4.97
15" Flower Pot
Sturdy plastic with attractive basket-weave design.



1.57
40-lb. Bag Organic Peat
For lawns, gardens, and shrubs. *Not wt.

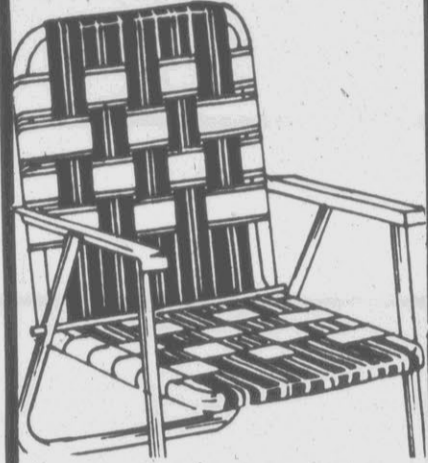

6.97 Our Reg. 8.97
Beach Chair With Aluminum Frame
With extra-sturdy loop legs and flat arm rests. Multicolor polypropylene webbing on weather-resistant aluminum frame.

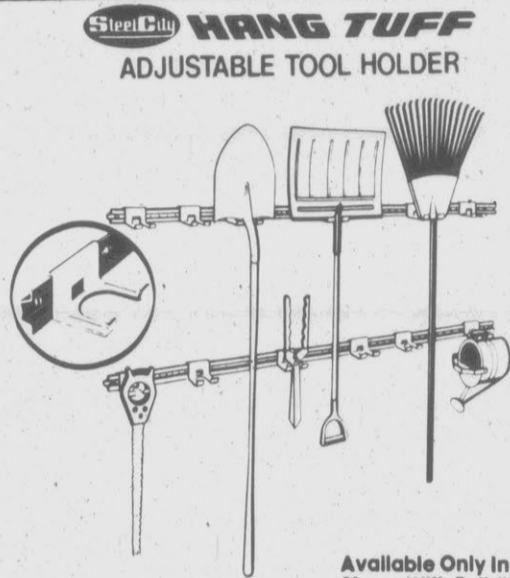

2.97 4-ft. Length
Save Now! Rugged Steel Hang Tuff® Tool Holder

A neat and practical way to keep track of all your tools. 6 adjustable hangers. Can be mounted on a wall.

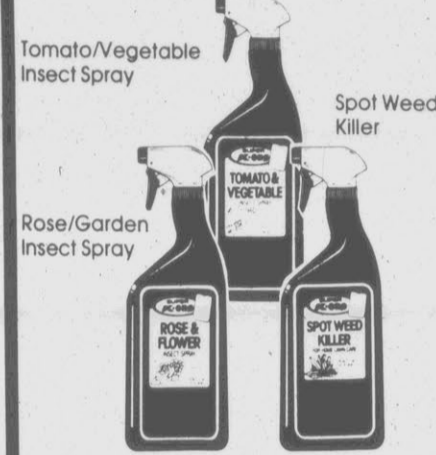

2.88
Save On Weed, Insect Killers
Ready to use. Each 40-oz. * size. *Fl. oz.

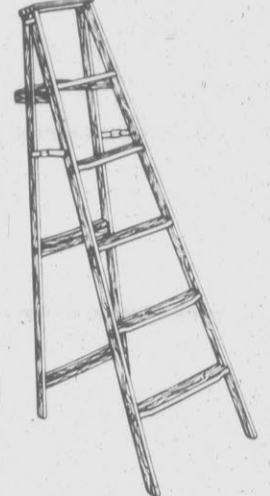

24.47
6-ft. Wood Ladder
Sturdy wooden ladder for spring, summer chores.



Our Reg. 27.88-29.88
21.88
Root-Lowell Sprayers

3 gallon (model no.1993) and 2 gallon (model no. 1992) sprayers have thick, chemically resistant tanks that won't rust or dent; vinyl hose; brass extension rod.



1.37 50 lb. Bag
Aglime®
Pulverized agricultural limestone reduces soil acidity for green lawns, productive gardens.

Lawn/Garden Tool Sale

- Our Reg. 7.47 **Shovel** **6.97**
- Our Reg. 7.77 **Rake** **6.97**
- Our Reg. 15.77 **Hole Diggers** **13.77**
- Our Reg. 9.37 **Hedge Trimmer(model 23-002)** . . . **7.97**



58.88 Our Reg. 79.77
48" Ceiling Fan
Ageless beauty and quality. 3 metal blades.



1.87 Per Panel
2x4" Fiberglass Lay-In Ceiling Panels
Quality Owens Corning White, Cotillion design fiberglass panels provide a sound barrier and attractive ceiling.

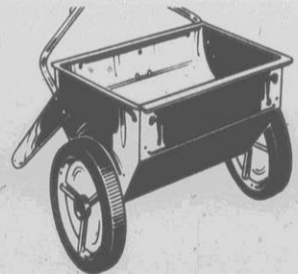

15.88 Sale Price
20" Precision Drop Spreader
Accurate flow control system.



3.77 our Reg. 4.97
Sphagnum Peat Moss
For dressing lawns, mulching and transplanting. 2 cu. ft.



2.47 Our Reg. 2.96
2.47 13-oz. Rust-Oleum®
Easy-on spray. White, colors. *Not wt.
2.97 Gal. Our 5.17
Latex Redwood Stain
For exterior redwood.

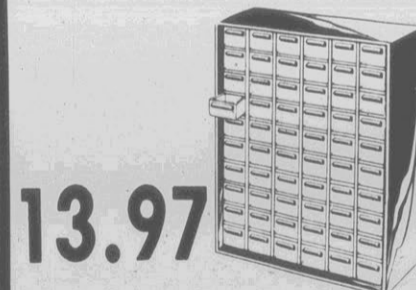

13.97
60-Drawer Parts Cabinet
Helps protect and organize small parts. Heavy-duty frame.

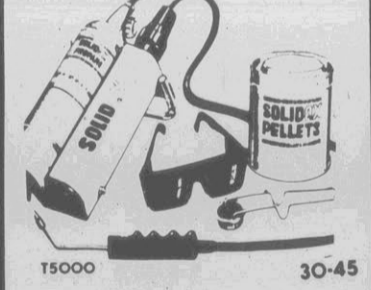

19.77 Our Reg. 29.97
Solidox® Braze/weld Kit
Torch, propane cylinder, more

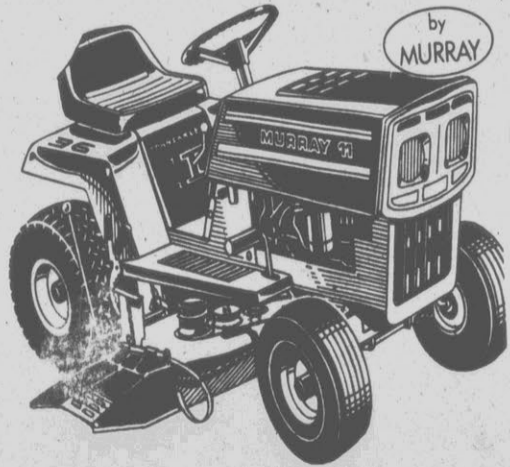

897.00
11 H.P. Riding Lawn Mower
Electric start, 36" cut. 12 volt battery w/alternator, full floating deck, dual braking system and more.

16 H.P. Tractor Mower
Includes cutting deck, disk harrow, 2 rear wheel weights **\$1600**

Save On K-mart Brand Chemicals

- Our Reg. 1.97 **1 Lb. Sevin Garden Dust (08-13)** **1.48**
- Our Reg. 11.77 **1 Gal. Weed & Grass Killer (08-01)** **8.83**
- Our Reg. 6.97 **1 Qt. Southern Broadleaf Killer (08-09)** **5.23**
- Our Reg. 4.77 **1 Qt. Weed & Grass Killer (08-00)** **3.58**
- Our Reg. 3.97 **Tomato & Veg. Insect Spray(08-92)** **2.98**
- Our Reg. 3.97 **Spot Weed Killer (08-96)** **2.98**
- Our Reg. 3.97 **Vegetation Killer(08-94)** **2.98**
- Our Reg. 2.77 **Tomato-Veg. Dust (08-11)** **2.08**
- Our Reg. 3.37 **2 Lbs. Sys. Rose & Flower Care (08-35)** **2.53**
- Our Reg. 2.47 **Wasp & Hornet Killer Spray(08-88)** **1.85**
- Our Reg. 4.97 **1 Pt. Liquid Sevin(08-25)** **3.73**
- Our Reg. 3.97 **8 Fl. Oz. Diazinon(08-20)** **2.98**
- Our Reg. 6.47 **1 Pt. Diazinon(08-21)** **4.85**
- Our Reg. 2.87 **8 Fl. Oz. Malathion 50 (08-15)** **2.15**
- Our Reg. 4.87 **1 Pt. Malathion 50(08-16)** **3.65**
- Our Reg. 7.97 **Liquid Fence & Grass Edger(08-55)** **5.98**
- Our Reg. 2.77 **Rose & Floral Dust(08-10)** **2.08**
- Our Reg. 1.97 **Rotenone Dust (08-13)** **1.48**



94.88
Gas-Powered Trimmer
Lightweight line trimmer features direct drive, 15" cut, automatic line advance.

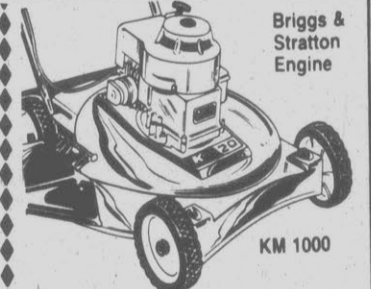

97.88
20" Recoil-Start Mower
Side-discharge power mower. 3-HP. Throttle control on handle.



119.00
22" Recoil-Start Mower
Side-discharge power mower. 3½-HP. Throttle control on handle.

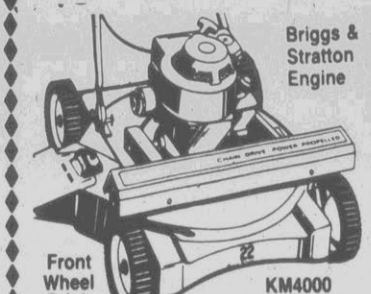

149.00
22" Self-propelled Mower
Recoil-start power mower. 3½-HP. Throttle control on handle.

Mexico Weighs Suspending Nuclear Power Plans

By RICHARD BOUDREAU
Associated Press Writer
MEXICO CITY (AP) — Burdened with an acute financial crisis, Mexico is considering a suspension of its atomic energy program, the most ambitious in the developing world.

The decision will affect the nuclear industries of Canada, France, Sweden, the United States and West Germany, which have dispatched heads of state, cabinet officials and atomic scientists to lobby for the first of a series of contracts worth an estimated \$32 billion in current prices.

President Jose Lopez Portillo, whose administration wrote the energy plan as part of his oil-financed push to industrialize Mexico, planned to sign the first contract before leaving office Dec. 1, 1982. It calls for construction of two of the 20 atomic reactors planned for the year 2000.

But soon after the bids were opened Feb. 1, the Mexican peso collapsed under the strain of declining oil revenue and a \$70 billion foreign debt. The 40 percent devaluation set off a burst of inflation and forced an 8 percent slash in government spending.

The Federal Electricity Commission is assuring

bidder its 180-member evaluation team will meet the original August deadline for awarding a contract. But the president is reportedly under pressure from financial aides to let the next administration decide whether to sign it.

"There are currents in the government that are against the project, given the extremely difficult situation Mexico is in," West German Science Minister Andreas von Buelow said last week after talks with Lopez Portillo. "No decision has been taken, but my assumption now is the entire nuclear program will be delayed."

Seven companies spent millions of dollars promoting their bids for the twin-reactor plant and delivered truckloads of supporting documents. The 2,300-megawatt project would be built at the Mexican Gulf coastal site of Laguna Verde, where the nation's first atomic generator has been under construction since 1973.

The bidders are Westinghouse, General Electric and Combustion Engineering of the United States, Atomic Energy of Canada, Framatome of France, ASEA-ATOM of Sweden and Kraftwerk Union

of West Germany.

Competition is keen because the government is also committed to deciding, by August 1983, which bidder will supply fuel-cycle technology for all 20 plants. Their production target is 20,000 megawatts of electricity — more than Mexico generates from all sources today and about double the goals of such big atomic planners as Argentina, Brazil, India, South Korea and Taiwan.

Until the financial crisis, opposition to the plan was limited here to a small group

of academics. Foreign powers, they contended, want to saddle Mexico with dependence on expensive and hazardous technology, inappropriate for a country with the world's fourth largest oil and gas reserves.

Even with today's oil glut, government planners argue hydrocarbons are more valuable earning export dollars for Mexico than generating its electricity. But they admit budget pressures could stall the switch to atoms.

"If the economic situation continues to be this critical

two or three years from now, then clearly we cannot build nuclear reactors," Juan Eibenshutz, the electricity commission's planning chief, said. "It's like being stuck in an apartment. Buying a house makes better long-run economic sense, but at the moment, we cannot afford one."

Costly construction delays on the first Laguna Verde plant have dealt the government a sobering lesson. A joint venture of Mexican firms and General Electric, it was first billed as a three-year project costing

\$263 million. Nine years later, \$2 billion has been spent or allocated, with a completion date tentatively set for 1984.

An example of what is at stake is Canada's nuclear industry. Forseeing slack times after its reactor orders from Romania run out in 1985, it spent "\$10 to \$25 million" on the Mexican bid, a Canadian diplomat said. Roy McLaren, the Canadian parliament's energy secretary, called it the country's "largest and most comprehensive export proposal ever."

Worth about \$2 billion at face value, the initial Mexican contract could generate "35,000 man years of employment and \$8.8 billion in spinoff benefits" for Canada's economy, the industry journal Nucleonics Week quoted McLaren as saying.

Canadian Prime Minister Pierre Trudeau came here to make a sales pitch for his country's technology as did Swedish King Carl XVI Gustaf, French President Francois Mitterrand and U.S. Vice President George Bush.

France and West Germany gained an edge over U.S. competitors by offering Mexico formulas for enriching its own uranium for atomic fuel. Though Mexico has signed the Nuclear Non-Proliferation Treaty, U.S. law bars the transfer of such "sensitive" technology.

Even so, Reagan administration officials told Mexico they were willing to discuss such a transfer if U.S.-sponsored studies show that enriching uranium in Mexico is cheaper than importing the fuel, U.S. industry sources said.

Winter Death Toll Is Believed Heavy

By RANDOLPHE SCHMID
Associated Press Writer
WASHINGTON (AP) — The suddenness and severity of January's cold snap may have caused an unusually high death toll for the winter just past, according to a government report.

Although the 1981-82 winter was not the worst on record, the death toll of 350 is believed to be higher than normal, the Center for Environmental Assessment Services said in a report Monday. It said the estimate was based on reports from state and local disaster assistance centers and that the actual toll may have been much higher than 350.

The report said the impact of January's bitter cold was heightened because it came after a relatively mild fall. By contrast, said Malcolm Reid of the center, the death toll was far lower in the winter of 1976-77, which was colder overall. The pattern of plunging temperatures that winter was more gradual and there was less snow, he said.

Even though center officials say they are confident the death toll last winter was higher than usual, they say they have no firm figures for comparison because they are just now devising a mechanism for keeping track of such estimates.

In addition to the human toll, the winter of 1981-82 cost the nation an estimated \$8.2 billion, compared to \$36.6 billion during the winter of 1976-77, the most severe on

record, according to government estimates.

The largest estimated economic losses were for property damage and transportation losses in traffic, damage to roads and bridges and increased costs for snow removal. Contributing to the total economic figure were production losses in major industries, increased energy consumption and severe damage to agriculture, including Florida's citrus crop.

Overall, the center ranked the winter of 1981-82 the nation's third most expensive in terms of the per capita cost of energy consumption and snow removal. Only the winters of 1976-77 and 1977-78 were more costly, according to the study.

Helped Plane For Retirement

STAMFORD, Conn. (AP) — Because all too often employees who reach retirement age are set adrift without guidance, a program to help retirees prepare for a second career is being conducted by a manufacturer of postal and office equipment.

Employees of Pitney Bowes Inc. who are at least 50 years old are reimbursed up to \$300 a year to help defray the costs of preparing for a second career. The employees can take retirement courses until an aggregate total of \$3,000 is reached.

Since the program was instituted in 1978, nearly 500 employees and spouses have availed themselves of the financial assistance by taking a wide range of courses in areas such as business management, real-estate appraisal, ceramics, sewing and cooking.

Part-Time Jobs An Indicator

WASHINGTON (AP) — An indication of worsening times for many Americans is a large number of part-time employees.

According to the U.S. Department of Labor, more than 5.7 million people held part-time employment in March because they could not find full-time positions.

"It indicates a serious weakness in the economy," according to Sar A. Levitan, a labor economist and head of George Washington University's Center for Policy Studies.

"What it means is that more than a million more families have had to live on short rations compared to a year ago," he said.

OK Compromise Welfare Role

WASHINGTON (AP) — The National League of Cities has decided to support to a key compromise on the future of welfare payments, enhancing chances President Reagan will see enactment of a "new federalism" program.

The league, largest of the country's local government coalitions, said Monday it would not obstruct the welfare swaps proposed by Reagan if certain safeguards are provided, specifically that all states will be required to maintain minimum benefit standards and those that can't afford it will get federal help.

The league position, accepts Reagan's proposal that the states take over Aid for Families with Dependent Children, better known as AFDC, the country's largest welfare program. Reagan had proposed initially that the federal government take over the costly Medicaid program and later agreed to keep the food stamps program if the states would take over AFDC.

HEALTH BOARD

The Pitt County Board of Health will meet Thursday at 7 p.m. in the conference room of the Health Department.

In ancient Egypt, it was common for women to pluck out all of their hair and to polish their scalp to a brilliant shine.

Maxwell
FURNITURE

79th Anniversary Sale!

Save \$80-\$140
On La-Z-Boy
Recliners

Just in
time for
Father's Day

JUST IN TIME FOR FATHER'S DAY!
We're celebrating our 79th Anniversary with tremendous savings on famous quality La-Z-Boy Recliners. Many styles and fabrics to choose from. All sale priced for this exciting event! Shop early for best selection to insure delivery for Father's Day!

PRICES
STARTING
AT
\$188

- Ladder Back Chairs
Unfinished
Reg. 39.95 Now **\$12⁸⁸**
- Step Stool
Folds, Constructed of Tube
Steel With Two Steps And Seat
Reg. 29.95 Now **\$16⁸⁸**
- Throw Pillows
Large Selection To Choose
From. Solids & Prints
Reg. 6.95 Now **\$2⁹⁹**
- Princess Chairs
Choice of Fabrics
Reg. 44.95 Sale **\$19⁸⁸**
- Straw Mats
36" Round With
Different Designs
Reg. 7.95 Now **\$3⁹⁹**

FREE! 5" Cut Crystal-Like Ash
Tray Just For Coming In



TRADITIONAL STYLED
RECLINA-ROCKER®
\$339⁹⁵ SAVE \$140
• Covered in 100% Nylon Velvet fabric
• High, button-tufted back
• Fitted arm and headrest covers included

TRADITIONAL STYLED
RECLINA ROCKER®
\$299⁹⁵ SAVE \$140
• Covered in toast Nylon Velvet with shirring effect
• Diamond design, button-tufted back



LA-Z-BOY®
RECLINA-ROCKER®
\$269⁹⁵
SAVE \$100

- Covered in durable beige Herculon® textured fabric
- 40" high, button-tufted back

- Free & Immediate Delivery On Most Items
 - Customer Satisfaction Assured
 - 4 Ways To Say "Charge It"
- All of This Plus Our Low Prices

Maxwell
FURNITURE

LA-Z-BOY®
604 GREENVILLE BLVD.
Greenville, N.C. Phone 756-3142
Thursday, Shop 10 a.m. to 6 p.m.
Friday, Shop 10 a.m. to 8 p.m.
Saturday, Shop 10 a.m. to 6 p.m.

4 WAYS TO SAY "CHARGE IT"
CREDIT
\$1,000 INSTANT CREDIT
You may qualify for \$1,000 INSTANT CREDIT if you have a valid AMERICAN EXPRESS CARD, MASTER CARD or VISA.

Long War Final Stages

By JAMES R. PEIPERT
Associated Press Writer
NAIROBI, Kenya (AP) —
In the mountainous terrain of
northern Ethiopia, the army
of the nation's Marxist govern-
ment appears to be in the
last stages of a campaign to
end Africa's longest-running
war.

Diplomats and Ethiopian
sources interviewed last
month in Addis Ababa, the
Ethiopian capital, and by
telephone more recently
from Nairobi, said the key
military objective is the
mountain town of Nakfa, the
last redoubt of Eritrean
guerrillas fighting a
21-year-old war of secession.

"It's the only thing to
capture. I think they're now
in the final stages," one
diplomat said of Nakfa, held
by the rebels since March
1977.

The capture of the town
would be a highlight in the
career of Ethiopia's Marxist
leader, Lt. Col. Mengistu
Haile Mariam, who on Jan.
25 launched what is seen as
an all-out effort against the
guerrillas.

Some diplomats following
the so-called Red Star cam-
paign through the skimpy
official reports said the cap-
ture of Nakfa, about 110 air
miles north of Asmara,
capital of Eritrea Province,
might come soon but others
said it could take longer.

At least two Western jour-
nalists who reached Nakfa
recently by way of neighbor-
ing Sudan reported the guer-
rillas are well dug-in and
have repulsed Ethiopian at-
tacks on the town.

Some diplomats said
Nakfa's capture would not
necessarily end the war,
because the guerrillas —
estimated at more than
10,000 — would simply melt
into the mountains and con-
tinue their campaign with
hit-and-run raids on the
army's supply lines.

The secessionist movement
was born in the former
Italian colony in 1961. The
Italians settled in Eritrea in
the late 19th century and it
remained an Italian colony
until 1941 when Britain took
it over during World War II.

In 1950 the United Nations
recommended a federal ar-
rangement that would ensure
self-government for the pro-
vince. But during the next
decade under the reign of
Emperor Haile Selassie —
who was deposed in 1974 and
died in 1975 — Eritrea's
autonomy started to erode,
giving rise to separatist
movements.

The Eritrean People's Lib-
eration Front and the rival
Eritrean Liberation Front
scored major victories in the
province in 1977 when gov-
ernment forces were spread
thin by Somalia's invasion of
the Ogaden region in the
southeast.

But the government began
to turn the tide in the Ogaden
and Eritrea in 1978 with an
influx of thousands of Cuban
personnel and some \$1.8
billion worth of Soviet arms,
and regained control of all
the major cities in Eritrea.

The EPLF repulsed a gov-
ernment assault on its Nakfa
stronghold in December,
1979, and Mengistu seems
determined to root out the
guerrillas this time.

"You couldn't have a big-
ger commitment, so he's got
to win," said one diplomat,
noting that Mengistu has
deployed half of Ethiopia's
250,000-man army in Eritrea.

Diplomatic sources said an
estimated 80,000 to 90,000
troops already in Eritrea
were reinforced for the Red
Star campaign by some
30,000 soldiers from the re-
latively peaceful former bat-
tlefronts in the Ogaden.

"I would not care to make
a prediction," a senior
Ethiopian official said when
asked about the prospects of
Nakfa's capture. "But we
are more determined than
ever to weed out the band-
its."

The main weapons de-
ployed around Nakfa, diplo-
mats said, are heavy
artillery, Soviet-made MI-24
helicopter gunships and
MiG-21 and MiG-23 fighter
planes.

The Ethiopians also have
at least 650 operable Sovi-
et-made T-54 and T-55 medi-
um tanks, said one senior
envoy. But their effective-
ness is limited in the rugged
terrain, similar to that in
Afghanistan where Soviet
forces are fighting a similar
war against Afghan guer-
rillas.

Throughout the campaign,

the guerrillas have claimed
major successes against the
government forces in com-
munique issued from their
offices in Rome, Paris,
Kuwait and Khartoum,
capital of Sudan.

The claims have included
the shooting down of MiG
jets, the bombing of
Asmara's airport, the killing
or capture of thousands of
Ethiopian soldiers, destruc-
tion of an oil depot and even
the wounding of the
42-year-old Mengistu in a
mortar attack.

The Ethiopians strongly
denied the claim about
Mengistu and ignored the
others.

The Ethiopians have not
reported their own
casualties, and most reports
on Red Star have em-
phasized reconstruction work
in the war-ravaged province.
Foreign diplomats, however,
estimated that about 3,000
government soldiers have
been killed or wounded since
Red Star began.

There were no reliable
estimates available on guer-
rilla casualties.

Despite the casualties,
Mengistu seems to have the
backing of most Ethiopians,
and even many Eritreans
weary of two decades of war
and uncertainty, diplomats
said.

Playing on the Ethiopians'
traditional nationalism and
injecting a strong dose of
Marxist ideology, the official
media have depicted the Red
Star campaign as a struggle
against imperialism.

Citing the numerous con-
struction projects planned or
under way in a pacified
province, the media seems to
be trying to convince the
Eritreans that socialism —
not independence — offers
the best chance for devel-
opment.

Live Wasps Need Filled

ITHACA, N.Y. (AP) — A
call for 300 live wasps by
researchers at Cornell Uni-
versity, who sweetened their
offer with a reward of honey,
has brought results from as
far as California.

"The public response has
been overwhelming," said
Kenneth G. Ross, a graduate
student who is seeking the
live, queen yellowjacket
wasps for research on an
antidote to their venom.

Ross called off the invita-
tion last week after the quota
was nearly filled in just two
weeks. Each wasp carried a
reward of a pound of honey,
but Ross said about one in
four people declined the re-
ward.

"People are genuinely in-
terested in the type of work
we are doing," said Cornell
entomologist Roger A.
Morse, who supervises Ross'
research.

Ross is trying to establish
large colonies of yellow-
jackets under controlled
conditions to collect venom,
needed to develop antidotes
for people who are highly
sensitive to the wasp's some-
times deadly sting.

Queen yellowjackets were
easy to collect because they
are the only kind flying at
this time of year.

The "picnic wasps" have
become a problem
throughout the eastern United
States, Ross said,
especially around picnic
tables, where they are at-
tracted to hamburgers, hot
dogs, soft drinks and beer.

Civil War Will Resume In July

MEMPHIS, Tenn. (AP) —
The Civil War "resumes"
next July when a Union
gunboat in the Mississippi
River engages in a duel with
a Confederate cannon on the
bluffs overlooking Memphis.

Visitors to Mud Island, a
\$63-million, 50-acre education
and entertainment center,
will get the full impact of the
battle.

Visitors will find
themselves aboard a full-size
reproduction of the gunboat
under simulated fire. They
will hear what Union sailors
say between explosions as
they receive and return the
fire. Later, they will find
themselves on the bluffs,
looking down on the siege
and listening as Confederate
soldiers talk about the battle.



DON'T BE FOOLED BY CLAIMS OF "LOWEST FOOD PRICES"!

WINN-DIXIE URGES YOU TO JUDGE FOR YOURSELF!

Week After Week After Week, We Beat The Store That
Claims To Be "LOWEST" In Head-To-Head Price Comparisons.

Items Listed Below Were Purchased On The
Same Day At Each Store And Are Shown On
Each Receipt In The Same Order As Listed.

| WINN-DIXIE STORES THE BEEF PEOPLE THANK YOU 05/05/82 | |
|---|-------|
| GROCRY | .39E |
| T M JUICE | .99C |
| GROCRY | 1.29C |
| NON FD | .99A |
| GROCRY | 1.69E |
| O M FRANKS | 1.09C |
| GROCRY | .34L |
| 186/1.99 | .34C |
| GROCRY | .30L |
| 186/1.99 | .30L |
| CUT LBN BEA' | .59C |
| 183/.89 | .69L |
| GATORADE | .33C |
| GROCRY | |
| GUBRAND BT. | |
| 183/.99 | .45F |
| DEANE WENE | |
| 182/.89 | .49E |
| GROCRY | .34C |
| BAKING SODA | |
| 183/1.00 | 1.69E |
| STARKST TUNA | .99E |
| GROCRY | 1.69E |
| ELB DINNER | 1.69F |
| HS SLI BACON | .98C |
| VA SAUSAGE | .33E |
| PRODUC | |
| 183/.99 | .59A |
| NON FD | .33E |
| POT PIE MURT | |
| 183/.99 | 1.69E |
| 160Z PEPSI | .80D |
| BT DEP | .89H |
| TAX | |
| TOTAL | 23.77 |

WINN-DIXIE
TOTAL
\$23.77

- 1-lb. Store Brand Saltines
- 46-oz. Store Brand Pineapple Juice
- 5-lb. Dixie Crystal Sugar
- 49-oz. Punch Detergent
- 3-lb. Crisco
- 16-oz. Oscar Mayer Wieners
- 17-oz. Store Brand Peas
- 16-oz. Store Brand Corn
- 16-oz. Store Brand Green Beans
- 32-oz. Gatorade
- 32-oz. Store Brand Salad Dressing
- 1-lb. Store Brand Margarine
- 7-oz. Van Camp's Beanee Weenees
- 1-lb. Luzianne Bag Coffee
- 16-oz. Arm & Hammer Baking Soda
- 7-oz. Starkist Tuna in Spring Water
- 12-oz. Peter Pan Peanut Butter
- 2-lb. Morton Supper
- 1-lb. Store Brand Bacon
- 1-lb. Store Brand Sausage
- 1-lb. Carrots
- Bounty Towels
- 8-oz. Morton Pot Pies
- 8-pak 16-oz. Pepsi
- Bottle Deposit

FOOD TOWN
TOTAL
\$27.02

| FOOD TOWN LFPINC/SCAM 05/05/82 | |
|--------------------------------------|--------|
| GROCRY | .49 I |
| GROCRY | 1.10 L |
| GROCRY | 1.49 L |
| NON-FOOD | 1.49 D |
| GROCRY | 1.28 D |
| MEAT | 2.19 L |
| GROCRY | 2.19 L |
| GROCRY | .34 L |
| GROCRY | .41 I |
| GROCRY | .36 I |
| GROCRY | .69 I |
| GROCRY | .99 I |
| PERISHBL | .34 I |
| GROCRY | .45 I |
| GROCRY | 1.88 I |
| GROCRY | .44 I |
| GROCRY | 1.49 I |
| PERISHBL | 1.17 I |
| MEAT | 1.59 I |
| MEAT | 1.44 I |
| PRODUCE | 1.29 L |
| NON-FOOD | .34 L |
| PERISHBL | .87 D |
| PEPSI PRODC | .34 L |
| BOTL DEP | 1.49 L |
| SUBTOTAL | .80 H |
| 4% TAX | 26.01 |
| TOTAL | 27.02 |

Winn-Dixie's Combination Of EVERYDAY LOW PRICEBREAKERS,
DEEP-CUT PRICE BREAKER SPECIALS And PRICE BREAKER
COUPONS Offer You Unbeatable Savings.

Make your own comparison and you'll discover what
hundreds of thousands of Winn-Dixie Shoppers
already know.....

NOBODY SAVES YOU MORE THAN WINN-DIXIE!

*PRICE SURVEY DONE ON MAY 5TH SOME PRICES MAY HAVE CHANGED SINCE THAT TIME.



PRICE BREAKER COUPON

LUX LIQUID DETERGENT

59¢

22-OZ. BTL.

LIMIT 1 PER CUSTOMER WITH COUPON AND \$7.50 OR MORE ORDER.

GOOD THRU SAT., MAY 22ND

PRICE BREAKER COUPON

THRIFTY MAID FLORIDA GRAPEFRUIT JUICE

29¢

46-OZ. CAN

LIMIT 1 PER CUSTOMER WITH COUPON AND \$7.50 OR MORE ORDER.

GOOD THRU SAT., MAY 22ND

*PRICES GOOD THRU SAT., MAY 22ND *NONE TO DEALERS *WE RESERVE THE RIGHT TO LIMIT QUANTITIES *COPYRIGHT 1982, WINN-DIXIE STORES, INC.

MAXWELL HOUSE COFFEE

1.99

1-LB. BAG

WITH \$7.50 OR MORE ORDER (LIMIT 1)

PRICE BREAKER SPECIAL

12-oz. Cans Regular or Light

BUDWEISER BEER

(Limit 2 Ctns. Please)

Ctn. of 12 **\$4.19**

1 1/2-LITER BTL.

CARLO ROSSI WINES \$3.23

-Chablis -Rhine -Ea.

W-D BRAND U.S. CHOICE CENTER CUT CHUCK ROAST

1.48

LB.

PRICE BREAKER SPECIAL

SMOKED PORK SHOULDER PICNICS

73¢

LB.

(LIMIT 2, PLEASE)

PRICE BREAKER SPECIAL

PRICE BREAKERS

MELLO-GOLD OIL

\$3.49

49-OZ. BOX

WITH \$7.50 OR MORE ORDER (LIMIT 1)

CHEER DETERGENT

1.59

49-OZ. BOX

WITH \$7.50 OR MORE ORDER (LIMIT 1)

PINKY PIG ECONOMY CUT PORK CHOPS

1.28

LB.

PRICE BREAKER SPECIAL

Superbrand Homogenized MILK

\$1.99

Gal. Jug

Superbrand 1/2% SKIM MILK

\$1.75

Gal. Jug

ARMOUR POTTED MEAT

4

3-OZ. CANS

ARMOUR TREET

99¢

12-OZ. CAN

ARMOUR VIENNA SAUSAGE

39¢

5-OZ. CAN

W-D BRAND U.S. CHOICE SIRLOIN STEAK

2.98

LB.

PRICE BREAKER SPECIAL

MEAT VALUES

2-LB. PKG. SHENANDOAH WHITE, DARK OR COMB. TURKEY ROAST \$2.99

W-D BRAND U.S. CHOICE ROUND BONE SHOULDER ROAST LB. \$1.99

COUNTRY PRIDE GRADE "A" FRYER BREASTS LB. \$1.18

1-LB. PKG. OSCAR MAYER FRANKS \$1.89

1-LB. PKG. HOLLY FARMS CHICKEN FRANKS 88c

THRIFTY MAID CORN PEAS GREEN LIMAS MIXED VEGETABLES

6

16-OZ. CANS

\$1.99

BREAST O' CHICKEN TUNA

59¢

6 1/2-OZ. CAN

CHEK DRINKS

3.99

12-OZ. CANS

CASE OF 24

WITH \$7.50 OR MORE ORDER (LIMIT 1)

PRICE BREAKER SPECIAL

W-D BRAND U.S. CHOICE E-Z CARVE RIB ROAST OR RIB STEAK

3.28

LB.

COUNTRY PRIDE GRADE "A" FRYER THIGHS OR DRUMSTICKS

89¢

LB.

Featured this week... **VOLUME 6**

Disney's WONDERFUL WORLD OF KNOWLEDGE

Volumes 2 - 6 only \$2.99 each!

Volume 1 - always available at only 99¢!

Superbrand MARGARINE

3.99

1-LB. PKG. IN QUARTERS

PRICE BREAKER SPECIAL

THRIFTY MAID CUT GREEN BEANS APPLE SAUCE BEETS POTATOES

3.13

16-OZ. CANS

HARVEST FRESH CALIFORNIA STRAWBERRIES

3.19

PINTS

PINT.....69c

PRICE BREAKER SPECIAL

Superbrand ICE CREAM OR SHERBET

1.19

1/2-GAL. CTN.

PRICE BREAKER SPECIAL

DAIRY DEPT.

12-OZ. CUP SUPERBRAND STA-FIT OR REGULAR COTTAGE CHEESE 79c

16-OZ. CUP SUPERBRAND SOUR CREAM 99c

12-OZ. PKG. SUPERBRAND COUNTRY SLICES 99c

1-LB. CUP PALMETTO FARM PIMENTO CHEESE \$1.49

DELI-BAKERY

LEAN AND ROUND VIRGINIA BAKED HAM

1.69

1/2-LB. (SLICED TO ORDER)

SMALL AND MEATY BBQ SPARE RIBS LB. \$2.98

12-PC. SATCHEL SOUTHERN STYLE FRIED CHICKEN \$6.99

GET 1-LB. CUP POTATO SALAD - 1-DOZ. ROLLS

FREE

AVAILABLE IN DELI-BAKERY STORES ONLY!

PRODUCE PATCH

10-LB. BAG U.S. #1 MAINE RUSSET BAKING POTATOES \$1.68

2-LB. BAG HARVEST FRESH CARROTS 2 For \$1.00

U.S. #1 WESTERN RED DELICIOUS APPLES 6 For 99c

CALIFORNIA VALENCIA ORANGES 6 For 99c

FROZEN FOODS

11-OZ. SIZE FOX DELUXE ALL VARIETIES FROZEN PIZZA 89c

1-LB. PKG. TASTE-O-SEA PERCH FILLETS \$1.49

5-LB. BAG COUNTRY COUSIN FRENCH FRIES \$1.49

14-OZ. SIZE MORTON ALL VARIETIES CREAM PIES 79c

Excavating 'Treasures' Threatened

By WILLIAM C. MANN
Associated Press Writer
COPENHAGEN, Denmark
(AP) — Archeologists say science stands to lose much of the value of one of northern Europe's richest Iron Age digs because of a gravel pit.

The site is made up of 300 graves, filled with porcelain, iron, precious metals, cloth and other objects of the Germanic peoples inhabiting Denmark 16 centuries ago.

By early summer, 270 of the graves will have been excavated and their contents recovered. Then bulldozers will gouge out gravel at the site near Sejlflod, the prehistoric north Jutland village where the graves were found in the late 1960s.

The remaining 30 worry the archeologists, even though they are out of reach of the bulldozers and not threatened directly by the encroaching pit.

Jens Nielsen, the archeologist heading the excavation team, said the pit will lower the level of groundwater and within two years will ruin almost all their artifacts unless private financing can be found for the excavation of the 30 graves.

The same Danish law that allowed the Environment Ministry to finance excavation of the 270 graves — "rescue excavations," to save digs directly threatened by encroaching civilization — forbids it from financing work on the last 30.

Carl Johan Becker, a professor of archeology at Copenhagen University's Iron Age Institute, said finding the money is important for science.

"We have the possibility of excavating two very rich burial areas," Becker said. "It should be possible to excavate them totally." He said only a study of the contents of all 300 graves would give a full picture of the people who dug them.

Nielsen said the graves under excavation are yielding about 15 items each, which he said makes the Sejlflod find one of the most scientifically lucrative from the period 400-500 A.D.

"There are very few finds at all from this particular period, and these are some of the richest graves in all of the Iron Age," he said. "From a scientific point of view, it is important that we excavate all 300."

Svend Erik Albrethsen, the Environment Ministry official who handles money for preserving antiquities, estimated that the ministry has spent 500,000 kroner (about \$63,300) since excavation of the graves began in 1979.

"Even if we had very much money — which we don't — we couldn't pay for excavating the last 30 graves," he said. "Our money is strictly bound by the law for rescue excavations."

Environment Ministry money entered the picture in 1979 when the gravel pit, being dug by a private company 10 miles southeast of Aalborg, came dangerously close to the site.

At the time, the graves were only black spots on aerial photographs taken in 1968 by a British scholar, J.K. St. Joseph of Cambridge University.

Nielsen said they were thought to be only fire pits associated with the nearby village, which is not especially well preserved.

"It was possible for us to make limited excavations in 1979, when the limits of the gravel pit came very close," he said. "During the excavations, we discovered the graves. And because the owners told us the gravel pit would include the area they were in, we had to excavate them."

"The amount of information we have already is so big that it will influence all Danish and northern European knowledge about this period of the Iron Age."

PUBLIC WORKS WEEK
Mayor Percy R. Cox has proclaimed May 23-29 as National Public Works Week.

According to Cox, "Public works services in our community are an integral part of our citizens' everyday lives... The health, safety, and comfort of this community greatly depend on these facilities and services."

Soviets Not Informed Of Kremlin Role

By BRYAN BRUMLEY
Associated Press Writer

MOSCOW (AP)—Despite a roar of Kremlin rhetoric on the dangers of nuclear war, Soviet leaders give their citizens little information on Moscow's role in the arms race or how a nuclear war would affect them.

Soviet newspapers and radio and television reports are filled with accounts about anti-nuclear demonstrations in the United States, western Europe and Japan, but public debate and demonstrations on arms are tightly controlled here.

The Kremlin has given generous encouragement to the pacifist movement outside the socialist bloc, a role that Western leaders charge is designed not to bring peace to the world, but to advance Soviet strategic interests.

The most recent example of Soviet support for the "peace movement" was the World Conference of "Religious Workers for Saving the Gift of Life from Nuclear Catastrophe," held in Moscow May 10-14.

The Russian Orthodox organizers and delegates from countries friendly to the Soviet Union have steered the conference close to the Soviet line, laying sole blame for the nuclear build-up on the United States.

U.S. clergymen at the gathering expressed concern over its anti-American tone, but their remarks were ignored by Soviet news media. Westerners at the conference also criticized a Soviet decision to bar Dutch delegate Wim Bartels from delivering a speech condemning the nuclear policies of both Moscow and Washington.

Westerners taking part in the conference, unaccustomed to the workings of Soviet society, were apparently surprised by Kremlin tactics at the conference.

Soviet leaders debate their nuclear strategy behind closed doors, with virtually no information leaked to the public.

The names and numbers of Soviet nuclear weapons go unmentioned in the Soviet press. The exception came last fall in an interview given by President Leonid I. Brezhnev. He disclosed estimated levels of Soviet medium range nuclear weapons deployed against western Europe.

The Soviet names of nuclear armaments are not used publicly. Western arms control negotiators have reported that the Kremlin penchant for secrecy is so pervasive that Soviet military leaders will not discuss their own force levels with civilian Soviets present.

Although Brezhnev regularly advocates reducing the nuclear stockpiles of the two superpowers, no one in the country has dared to call publicly for unilateral disarmament.

Despite Soviet support of gestic peace activists, Soviet leaders tolerate no anti-war sentiment at home. Nikolai V. Ogarkov, first deputy defense minister and chief of staff, warned in a recent book of the need to counter growing pacifism among Soviet youth.

Official Soviet media, movies and popular literature play their role in shaping the popular view of war and overcome their silence on the effect of a nuclear war with heroic and tragic tales from World War II. Twenty million Soviet people died in the conflict.

The Kremlin is also careful in manipulating public demonstrations. During a May 1 parade, thousands of Soviet workers marched through Red Square pushing large, wheeled signs bearing approved slogans against the neutron bomb and North Atlantic Treaty Organization plans to deploy Tomahawk cruise and Pershing II missiles in western Europe.

In contrast, uniformed and plainclothes police quickly detained seven western Europeans in Red Square on April 19 after they tried to distribute pamphlets urging the Kremlin to ease world hunger by reallocating money "wasted on conventional and nuclear arms."

Soviet media regularly report western opinion polls showing sentiment against nuclear weapons. But the Kremlin does not release similar information on the Soviet Union.

A book issued this spring, "The Danger of Nuclear War," gave detailed medical data on the U.S. atomic bombings of Hiroshima and Nagasaki at the close of World War II.

The book and its principal author, heart specialist Yevgeny Chazov, have been widely quoted by Soviet media. Neither the book nor the Soviet press, however, speculated on the possible destruction of Moscow, Leningrad or other major cities in a nuclear holocaust.

Chazov, reportedly Brezhnev's personal doctor, is emerging as a key figure in the "Soviet peace movement," due largely to his role as founder of "International Physicians for the Prevention of Nuclear War." The group includes prominent doctors from a number of western countries.

Chazov's book, subtitled "A Physician's Viewpoint," referred repeatedly to "western militarist circles" who, it said, "readily resort to nuclear blackmail to achieve their political ends and gain unilateral advantage."

The closest Chazov's book came to admitting the destructive potential of the Soviet nuclear arsenal was the observation that "experts estimate that the U.S.A. and U.S.S.R. have enough weapons, taken together, to kill all living things on earth many times over."



SENTENCED TO SCRUB — An unidentified youth scrubs the outside of a subway car window in New York. The youth was sentenced to scrub away graffiti as part of a new program which New York officials hope will serve two purposes. Their aim is to punish minor offenders such as farebeaters and graffiti writers in a meaningful way, and to provide the public with cleaner subway cars. (AP Laserphoto)

HARRIS

SUPER MARKETS, INC.

"Where Shopping Is A Pleasure"

DISCOUNT
ON EVERYTHING BUT QUALITY

We Reserve The Right To Limit Quantities
None Sold To Dealers Or Restaurants
We Accept Food Stamps And WIC Vouchers

PRICES GOOD
WEDNESDAY THRU
SATURDAY
LOCATIONS IN:
GREENVILLE
AYDEN-BETHEL
TARBORO

**STONEWARE
PIECE OF
THE WEEK
SALAD PLATE**

89¢

WITH \$3 PURCHASE



DR. PEPPER
WITH DATE & W
EACH STORE ON
NOT HAVE TO BE

GRADE "A" FRYERS

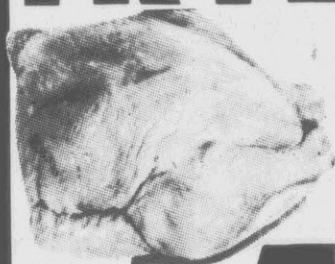

WHOLE

44¢

(LIMIT 4) LB.

WESTERN BONE-IN SIRLOIN STEAK



\$2.69

LB.

WESTERN T-BONE STEAKS



\$2.79

LB.

SMITHFIELD FRANKS

12 OZ. PKG.

94¢

With Coupon From Page 26 in Today's Daily Reflector.

SMITHFIELD BONELESS 1/2 HAMS

\$2.69

50% OFF
With Coupon From Page 14 in Today's Daily Reflector.

OWALTHEY GREAT BOLOGNA

\$1.09

LB. PKG.

- DINNER BELL SALE!
- SMOKED SAUSAGE..... \$2.09 LB.
 - KIELBASA SMOKED SAUSAGE..... \$2.09 LB.
 - BONELESS SLICE PORTION HAM..... \$1.99 LB.
 - CENTER SLICED SMOKED BONELESS HAM..... \$2.99 LB.

OLDE TOWNE BACON

\$1.39

LB. PKG.

WHOLE BONELESS BEEF RIB EYES

\$3.29

LB.

SKINNED ELBOW MACARONI

WINDIX

GLASS

CLEAR

ROYAL

GELATIN

NEW HI-C

FRUIT

DRINK

GENER

TOWER

CAN

BATH

50¢

DAIRY GRADE A LARGE EGGS



DOZEN

59¢

OLD SOUTH CHILLED ORANGE JUICE

1/2 GALLON CTN.

99¢



PARKAY MARGARINE
1 LB. 1/4'S

2/\$1.00

SEALTEST SOUR CREAM

16 OZ.

\$1.09

COUNTRY FRESH HOMOGENIZED MILK

1/2 GALLON

89¢

COUNTRY FRESH 1/2% LOWFAT MILK

GALLON

\$1.59



FRANKLIN ENGLISH

MUFFINS

PLAIN OR SOUR DOUGH
6 CT.

**BUY ONE AT 65¢
GET ONE FREE**

GENERIC BLEACH

\$1.00

LIMIT 2

GALLON

2/

32 OZ. IVORY LIQUID

27% OFF

\$1.49

DUKE'S MAYONNAISE

QT.

99¢



PFEIFFER SALAD DRESSINGS

ALL FLAVORS
16 OZ.

79¢



2 LITER
R.C. DIET
NEW
FLAV
& N
R.C.



70¢

2 LITER DR. PEPPER **99¢**

REGISTER AT ANY STORE FOR MID WOOD ANTIQUE REPRODUCTION PEPPER, FREE PENDULUM WALL CLOCK

A WIND-UP-BRASS MOVEMENT. ONE WILL BE GIVEN AWAY AT 10:00 A.M. ON SATURDAY MAY 29TH—NO PURCHASE NECESSARY. YOU DO NOT NEED TO BE PRESENT TO WIN.

ECONOMY CUT PORK CHOPS **99¢**



BUY ONE AT 79¢ GET ONE FREE

89¢

5/\$1.00

4/\$1.00

2/\$1.00



DIXIE CRYSTALS SUGAR

5 LB. **\$1.39**

CHARMIN BATHROOM TISSUE

4 ROLL PAK **99¢** LIMIT 2 PKGS.

PETER PAN CREAMY PEANUT BUTTER 18 OZ. **\$1.49**

NEW HERSHEY CAKE FROSTINGS ALL FLAVORS 16 1/2 OZ. **\$1.19**

FROZEN FOODS

NEW JELLO PUDDING POPS

CHOCOLATE 12 CT. BANANA 12 CT. VANILLA 12 CT. **\$1.69**

NEW JELLO PUDDING POPS VARIETY PAK 6 CT. **89¢**

CAROLINA DAIRIES NUTTY BUDDY 4 PAK **BUY ONE GET ONE FREE**

COLA, TRITE, MEHI AVORS NEW C. 100 9¢

PRODUCE

VINE RIPENED TOMATOES .48¢ LB.

CALIFORNIA ICEBERG LETTUCE... 48¢ HEAD

CELLO PAK CARROTS 3 \$1.00 1 LB. FOR

LOCALLY GROWN GREEN ONIONS 3 \$1.00 BUNCHES FOR

CELLO PAK RADISHES .25¢ PKG.

PASCAL CELERY .38¢ LARGE 2 1/2 SIZE STALK

MUSHROOMS .98¢ LB.

FRESH GREEN BROCCOLI LARGE BUNCH 78¢

MEDIUM YELLOW ONIONS ... \$1.00 4 LBS. FOR

TENDER YELLOW SQUASH... \$1.00 3 LBS. FOR

NEW FLORIDA WHITE POTATOES .18¢ LB.

TENDER GREEN BEANS 58¢ LB.

FRESH POLE BEANS 58¢ LB.

SWEET RIPE PEACHES... 68¢ LB.

RED GRAPES.... 98¢ LB.

BLACK GRAPES.... 98¢ LB.

WHITE GRAPES.... 98¢ LB.

CALIFORNIA VALENCIA ORANGES (88 COUNT) FOR \$1.00 5

B'ANJOU PEARS 58¢ LB.

WASHINGTON STATE RED DELICIOUS APPLES ... 98¢ 3 LB. BAG

CUT WATERMELONS 17¢ LB.

WHOLE WATERMELONS \$2.69 LB.



Foster Nest For Eaglets

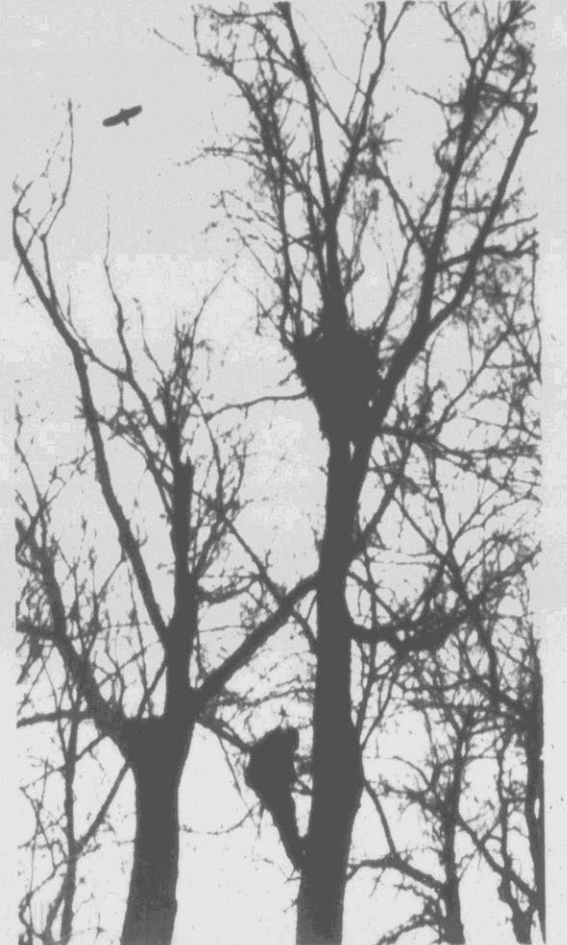

DANGEROUS DUTY — While the mother bird soars overhead, Dennis Case makes his way up a tree toward the eagle's nest. The method is used by Case to introduce a captive wild eagle chick into the nest of a pair of wild birds who are unable to hatch their own. (AP Laserphoto)

By MARIANNE MCGOWAN Associated Press Writer CLEVELAND (AP) — Two large eagles, shrieking disapproval, hover overhead as Dennis Case places a fuzzy eaglet into a nest of sticks high up in a cottonwood tree along Lake Erie.

With an offering of a fish and just the right timing, Case hopes the male and female bald eagles will accept the little bird as their own. The eaglet was born about a month before in a Maryland laboratory and brought to Ohio under the state's bald eagle preservation program, designed to bolster depleted ranks of the majestic bird.

Since the 1970s, America's national bird has been an endangered species.

"We were losing nesting pairs and not getting replacements. So we try to increase production in nests by taking young eaglets and putting them in," said Case, a field biologist for the Ohio division of wildlife and head of the state's eagle program.

The program, started in 1975, helps eagles do what should be a natural process — reproduce and fledge healthy eaglets. Many have not been able to because pesticides, particularly DDT, have become concentrated in eagles through their principal source of food — fish. That has caused females to lay eggs with thin shells.

"The shells would break as the eagles were hatching them or else the levels (of pesticides) would be so high they would cause the embryo to die," Case said.

DDT has been banned since 1972, but it takes a long time for the chemical to work its way out of the food chain and out of the eagle's system, Case said. So the problem remains.

Loss of forest land also has driven the eagle away and many are killed in collisions with high-voltage power lines.

"We've had a steady decline in nesting pairs in Ohio since the late 1950s," said Case. "In 1959, the first year accurate records were kept, 15 pairs of eagles were nesting in the state. That declined to only four pairs in 1979."

Fostering was begun in Ohio in 1979 and so far, four eaglets have been successfully adopted by adult pairs. That accounts for 4 percent of eagle production in the state, said Case, who reports no failures.

Case said his efforts appear to be working. But for now, he's "cautiously optimistic."

The number of Ohio's nesting pairs — a male and female who mate for life and produce eggs each spring — was five in 1980, six in 1981 and seven in 1982.

"The result of the program and the general trend nationally is to see improvement in productivity in bald eagles as a result of the banning of pesticides and the environment getting cleaner," Case said.

Case estimates Ohio's total bald eagle population at 29, most of them along the western shore of Lake Erie or near other bodies of water. There are believed to have been 250,000 eagles in the country at the turn of the century. The National Wildlife Federation, which began counting eagles four years ago, says there now are about 13,400.

Other states are actively trying to protect eagles, including New York, Maine, New Jersey, Delaware, Maryland, Pennsylvania, Arkansas and Mississippi.

Case spent his first several years in the program locating and studying eagles. The large white-headed birds nest only when ready to reproduce. Two eaglets are usually fledged per nest. Eggs incubate for 35 days with the male and female sharing responsibility for keeping it warm.

"When you foster a young eagle into a nest, you're either dealing with a situation in which the eggs are infertile and don't hatch, or only one young is hatched in the nest," Case said.

Because fostering is such a delicate procedure, understanding the eagles' behavior through observation is crucial.

Case scouts the nests from a helicopter and observes the birds from the ground through binoculars or a spotting scope.

"Starting in late February, we watch all breeding territory to see when they're incubating eggs," Case said. "If they're disturbed during late February or during early stages of incubation, they're likely to abandon their nests."

"The parents will either be taking care of existing young or incubating bad eggs," Case explained. "We climb the tree, put the eaglet in, remove the eggs and just get out of the area as quickly as possible."

Often, the parents perch nearby and watch. They become agitated and make a noise Case describes as "rapid, high-pitched clucks." But they will not attack humans, he said.

One recent attempt in Sandusky was called off because Case discovered after climbing the tree that the eaglet already in the nest was too old to have a month-old sibling. When there is an age gap between the young birds, the smaller ones lose the competition for food.

Ohio's eagle preservation program currently is financed through the sale of hunting and fishing licenses. That provides about \$50,000 a year and wildlife officials are trying to establish an income tax check-off procedure aimed at generating \$1.2 million annually.



MARIJUANA DETECTOR — Dr. Stanley Gross of the UCLA School of Medicine and Receptor Research Laboratory, demonstrates a "marijuana breathalyzer" that has been developed recently by UCLA researchers. The "breathalyzer" traps particles of tetrahydrocannabinol (THC) in a relatively simple and accurate test on those suspected of being under the influence of marijuana. (AP Laserphoto)

Liberty City Shares Hope

By MIKE McQUEEN
Associated Press Writer
MIAMI (AP) — Two years after rioting claimed 18 lives, the neighborhood known as Liberty City still has run-down housing, high unemployment and vacant storefronts that serve as hangouts for out-of-work young men.

But financial commitments by private industry, government-backed loans and minority hiring by the police have some given black leaders hope for long-term improvements — if the city can get through the summer without new rioting.

Miami Police Chief Kenneth Harms says the summer could be "critical," with the national recession leaving more than half of the black youths unemployed and with little to do but congregate for "street discos." Police say they have noted increases in the number and size of youth gangs in the city.

Young blacks were blamed for the worst violence and most of the \$100 million in damage in three nights of rioting in 1980. The disturbances were touched off when an all-white jury in Tampa acquitted four white former Dade County police officers of charges stemming from the beating death of black businessman Arthur McDuffie.

Dade County's two major police agencies have responded with intense minority-recruitment drives and special community-relations patrols of troubled areas. Eighty percent of the Miami police department's new hires since the riots have been members of minority groups.

"I'm very optimistic about the rebuilding efforts going on right now," said Charles H. Rogers of the mostly black Miami-Dade Chamber of Commerce. "I think the effort is well-placed. The strength of a community is its businesses."

Howard V. Gary, Miami's first black city manager, said city government deserved no better than a "C" for its efforts to provide government contracts to black-owned businesses. "But I assure you next year, it'll be at least a 'B.'"

Only 2,148, or 1.5 percent, of all businesses in metropolitan Dade County are black-owned, according to the Census Bureau. Of those establishments, Dade's community revitalization board says 82 percent are owner-operated and have no employees.

Nationwide, about 3.8 percent of all businesses are minority-owned, according to a study done this year for the Commerce Department's Minority Business Development Agency.

In Miami, Rogers said he's particularly optimistic about the Greater Miami Chamber of Commerce's \$5.4 million private-industry revitalization plan. It calls for businesses to donate money to train black entrepreneurs, build an industrial park and set up a job-skills training center.

Among the more ambitious

rebuilding projects is the move to establish Dade County's first black-owned bank. Black millionaire Sonny Wright has asked the Federal Reserve for permission to buy a branch of People's National Bank.

Revitalization efforts by municipal government include a commitment by Dade County to buy 17 percent of its supplies from blacks. The city has promised to buy 10 percent of its goods from black suppliers.

The short-term worry that tempers the long-term optimism is the high jobless rate among Miami's black youths, which leaders say breeds crime and hopelessness.

The South Florida Employment and Training Consortium, an association of government job-training programs in southern Florida, places the black youth jobless rate at 50 percent.

"I think this is going to be one of the most critical summers in the history of Miami," said Harms.

"Reductions in certain classes of jobs and federal assistance in those job programs will impact on the community. Now, to the extent that idleness contributes to criminality, then we could and should expect an increased level of criminality," the police chief said.

Rogers, who's optimistic about the prospects of an improved black business community, concedes that joblessness and government cutbacks could mean an explosive summer.

"I'm concerned that we're going to have another civil disturbance," Rogers said. "When you have unhappy folks who are out of work with no money, things happen."

Wood Waste Is Energy Source

USING WOOD WASTE
PORTLAND, Ore. (AP) — Georgia-Pacific used wood waste to supply 90 percent of the energy needed to produce 1.4 billion board feet of lumber in 1981. In the energy-intensive pulp and paper industry, Georgia-Pacific provided 70 percent of its own energy from "wastes."

The whole paper industry reduced its annual use of fuel oils by 40 percent, between 1972 and 1981, the company reported.

ICE CAP
BOSTON (AP) — The world's largest island is Greenland, located about 1,800 miles north of here. An ice cap, two miles thick in places, covers the island.

If the ice cap were removed, you would see a ring of mountains surrounding a lot of water. The center of Greenland, about one-third of the land area, lies more than 1,000 feet below the surface of the sea.

HARRIS

SUPER MARKETS, INC.

"Where Shopping Is A Pleasure"

These Locations
Ayden - Greenville -
Bethel
Prices Good
thru June 2, 1982

Ponds Natural Dry Powder
4 Oz. Sale
95¢

| | | | | | |
|---|--|---|--|--|--|
| <p>Vaseline Intensive Care Baby Oil 10 Oz. Sale \$159</p> | <p>Vaseline Hair Tonic 1.75 Oz. Sale \$149</p> | <p>SUNDOWN Sunscreen Ultra Protection Sale \$449</p> | <p>SUNDOWN Sunscreen Maximal Protection Sale \$439</p> | <p>SUNDOWN Sunscreen Extra Protection Sale \$399</p> | <p>SUNDOWN Sunscreen Moderate Protection Sale \$389</p> |
| <p>Correctol LAXATIVE 30's The Woman's Gentle Laxative For dependable, more natural relief! Sale \$229</p> | <p>ANACIN ANALGESIC CAPSULES Anacin Capsule 20's Sale \$139</p> | <p>ANACIN CAPSULES FAST PAIN RELIEF Anacin Capsule 40's Sale \$199</p> | <p>Maximum Strength Anacin Capsules 36's Sale \$199</p> | <p>Anbesol Stops pain on contact! Anbesol .31 Oz. Sale \$189</p> | |
| <p>Wella Shampoo 8 Oz. Sale \$159</p> | <p>FAST PAIN RELIEF BAYER ASPIRIN Bayer 50's Sale \$129</p> | <p>ORANGE FLAVORED BAYER CHILDREN'S CHEWABLE ASPIRIN WITH CHILD GUARD CAP 36 TABLETS 1/4 GRS. EA. Bayer Childs Aspirin 36's Sale 65¢</p> | <p>Bayer 200's Sale \$395</p> | <p>White Rain Hair Spray Regular 7.5 Oz. Sale \$179</p> | <p>White Rain Hair Spray Extra Hold 7.5 Oz. Sale \$179</p> |
| <p>White Rain Hair Spray Unscented 7.5 Oz. Sale \$179</p> | <p>Tame Cream Rinse Normal 8 Oz. Sale \$159</p> | <p>Tame Cream Rinse Oily 8 Oz. Sale \$159</p> | <p>Tame Cream Rinse Extra Body 8 Oz. Sale \$159</p> | <p>Clearasil 10% benzoyl peroxide plus extra oil absorbing power Clearasil .85 Oz. Reg. Sale \$199 Clearasil Vanishing Formula .85 Oz. Sale \$199 Clearasil Reg. 1 Oz. Sale \$299 Clearasil Vanishing Formula 1 Oz. Sale \$299</p> | |
| <p>Fixodent THE #1 DENTURE ADHESIVE CREAM Fixodent 1.5 Oz. Sale \$149 Fixodent 2.5 Oz. Sale \$249</p> | <p>SINE OFF SINUS MEDICINE 24's Sale \$239</p> | <p>DIETAC Diet Aid Capsules Dietac Capsules 14's Sale \$249</p> | <p>Contac Severe Cold Capsules 10's Sale \$219</p> | <p>Dietac Capsule 20's Maximum Strength Sale \$329</p> | |
| <p>Contac Jr. 4 Oz. Sale \$299</p> | <p>Pamprin pre-period relief tablets Pamprin Tablets 24's Sale \$189</p> | <p>Pamprin Maximum Strength Capsules 16's Sale \$199</p> | <p>Scripto Lighters Sale 2 For \$100</p> | <p>EX-LAX THE CHOCOLATED LAXATIVE TABLETS Ex-Lax Chocolate 18's Sale \$139</p> | <p>GAS-X TABLETS FOR RELIEF OF SYMPTOMS OF INTESTINAL GAS 12 Tablets, 80 mg each Sale \$119</p> |
| <p>Oral-B Toothbrush Sale \$129</p> | <p>TUSSY CREAM DEODORANT 2 OZ. NET WT. Tussy Cream Deodorant 2 Oz. Sale \$109</p> | <p>TUSSY ROLL-ON DEODORANT REGULAR 2 OZ. NET WT. Tussy Roll-On 2 Oz. Sale \$109</p> | <p>TUSSY STICK DEODORANT 1.7 OZ. NET WT. Tussy Stick Deodorant Sale \$109</p> | <p>TUSSY SPRAY DEODORANT 5 OZ. NET WT. Tussy Spray Reg. 5 Oz. Sale \$159</p> | <p>TUSSY SPRAY FRESH 5 OZ. NET WT. Tussy Spray Fresh 5 Oz. Sale \$159</p> |
| <p>Murine for irritated eyes .6 Oz. Sale \$149</p> | <p>Murine 1.5 Oz. Sale \$269</p> | <p>Murine Clear Eyes Sale \$159</p> | <p>Murine Plus for better vision 1/2 Oz. Sale \$159</p> | <p>Selsun Blue Reg. 4 Oz. Sale \$199</p> | <p>Selsun Blue Normal 7 Oz. Sale \$339</p> |
| <p>Primatene MIST BRONCHIAL RELIEF 2.5 OZ. NET WT. Primatene Mist 1/2 Oz. Sale \$539</p> | <p>ARRID EXTRA DRY SPRAY 2.5 OZ. NET WT. Arrid Extra Dry Spray 2.5 Oz. Sale \$175</p> | <p>ARRID XX REG. 2.5 OZ. NET WT. Arrid XX Reg. 2.5 Oz. Sale \$175</p> | <p>ARRID EXTRA DRY CREAM 1 OZ. NET WT. Arrid Cream 1 Oz. Sale \$129</p> | <p>ARRID EXTRA DRY SOLID 2 OZ. NET WT. Arrid Extra Dry Solid 2 Oz. Sale \$199</p> | <p>PEARL DROPS TOOTH POLISH 3 OZ. NET WT. Pearl Drops 3 Oz. Sale \$189</p> |

Hottest Guessing Game: Will Reagan Run Again?

By ANN BLACKMAN
Associated Press Writer

WASHINGTON (AP) — At a recent Washington cocktail party, each of the 70 guests was handed a red jellybean and asked to deposit it in one of two glass jars. One jar was labeled "He Runs," the other, "He Runs Not."

No one needed further explanation. For one of the hottest guessing games in town is whether or not Ronald Reagan will seek another term as president.

Election Day is 2½ years away, and chances are, even the president doesn't know for sure.

The political and economic conditions that will prevail in 1984 are impossible to predict. But Washington without speculation would be like Reno without blackjack, so the guessing is fast and furious.

The party guests included VIPs from the White House and Capitol Hill, Republicans and Democrats, political analysts and reporters. When their jelly bean ballots were cast, the vote was 3-to-1 that Reagan will not seek another term.

"It was apparent from early on in the evening which jar was filling up faster," said party host Marty Plissner, who is political editor at CBS news in Washington.

The "He Runs" camp generally argues that it is unlikely that the president will accomplish his goals of reshaping government in four years, that Reagan is a healthy man who will stay until the job is done. These people are usually happy to be quoted by name.

"I definitely think he'll run, though a lot can change in two years," said Nancy Reynolds, a close friend of the Reagans and a vice president of The Bendix Corp. "The Reagans are settling in, and if the president feels he has a job to finish, he will (run)."

Sen. Paul Laxalt, R-Nev., another close friend of the Reagans, put it this way: "I hope the president sees fit, Lord willing and all that, to run for a second term. It's apparent from the magnitude of the problems we have here that it will take at least that long."

Richard S. Williamson, White House strategist for the "new federalism" program, predicted that Reagan will not make his decision for another 15 months.

"If his economic recovery plan is in place and he has reasserted world leadership and been successful with the new federalism, if all is done in fulfilling his dreams, he won't run again," Williamson said. "He is more likely to run if he feels the job is undone."

"Of course there is sound reason for Reagan supporters to cast the 'He Runs' ballot. In Williamson's words, 'To make him a lame duck wouldn't help.'"

The president will be 73 years old in 1984 and, as one White House insider said, off-the-record, "that plays a factor." They point also to the tightened security measures since the assassination attempt 14 months ago and say Reagan sometimes feels cut off from his friends.

Those in the "He Runs Not" camp argue that public support for Reagan's policies is eroding, that even Americans who voted for Reagan are less enthusiastic about his economic program as high unemployment, federal budget deficits and high interest rates persist.

These people rarely like to be quoted by name, usually because a Republican with political aspirations has nothing to gain by offending a Republican president — or his aides.

"I think the job is harder than he expected," said a high-ranking White House official who claimed he would lose his position if he allowed his name used. "I think he likes the job but will find four years enough."

An Associated Press-NBC poll taken last week found Americans are divided on the subject. Forty-two percent of the respondents said the president should run again; 43 percent said he should not.

Mrs. Reagan's attitude about a second term is another

subject of close attention. It's no secret in Washington that the first lady is extremely protective of her husband and that she was enormously shaken by the attempt on Reagan's life.

Some Republican insiders say the first lady's personal

desire would be for her husband to retire from politics when his term ends, but that she is careful not to express her private views.

Mrs. Reagan's press secretary, Sheila Tate, said the first

lady insists she and the president never talk about whether he will seek another term.

"No decision has been made, and I don't think she's even thinking about it," Mrs. Tate said.

OPEN SUNDAY 10 A.M. 'til 7 P.M.



Chuck Roast **\$1.18** Lb.
USDA Choice Beef Chuck Bone-In

\$1.78 Lb.
USDA Choice Beef Chuck Boneless
Chuck Roast
Fresh Daily - 5 Lb. Pkg. or More
Ground Beef Lb. **\$1.28**

\$1.78 Lb.
USDA Choice Extra Lean
Stew Beef
USDA Choice Beef Chuck Bone-In
Chuck Steak Lb. **\$1.28**

\$1.29
Quart - California
Straw-Berries

\$1.99
Pkg. of 6 - 12 Oz. Cans Reg/Light
Pabst Beer

\$3.59
1.5 Liter - Soft Red, White, Pink
Taylor Lake Country

\$3.99
Package of 12 - 12 Oz. Cans
Old Milwaukee

\$1.05
2 Liter
Coca Cola

69¢
97 Sheets - Large Roll
Viva Towels
Why Pay \$1.03

3/99¢
16 Ounce
Phillips Pork & Beans
Why Pay 2.81¢

89¢
Quart
JFG Mayonnaise
Why Pay \$1.29

49¢
16 Oz. - Sunshine
Krispy Saltines

\$1.49
49 Oz. - Detergent
Cold Power
Half Gallon - White House
Apple Juice

3/89¢
14 Oz. - Dog Food - Beef & Egg Beef
Beef & Cheese Liver, Egg & Bacon
Friskies Dinner
5 Lb. - Frozen Crinkle Cut Potatoes
Tater Boy

89¢
400 Sheets - 4 Roll Pack - Coronet
Toilet Tissue
24 Ct. - Family Size
Lipton Tea Bags

99¢
12 Oz. - Large
Jeno's Pizza
Why Pay \$1.29

4/\$1
6 Oz. - Frozen Concentrate Seneca
Apple Juice
Why Pay 51¢ Each

99¢
32 Ounce
Del Monte Catsup
Why Pay \$1.19

Prices good at Greenville Food Town Store only

Different Pay In Same Jobs

By DOLORES BARCLAY
Associated Press Writer
NEW YORK (AP) — John Laws, a radio announcer in Australia, recently signed a five-year contract for about \$5 million to do his show.

President Junius R. Jayawardene of Sri Lanka earns \$243 a year.

High school teachers in Chicago earn \$22,455 a year. That's about \$14,000 less than high school teachers in Geneva, Switzerland, make.

But it's \$20,000 more than teachers in Bangkok, Thailand, earn.

These are some of the salary oddities compiled by David Harrop in his book, "World Paychecks," published by Facts on File.

Harrop, who two years ago pried loose the financial secrets of the famous and not-so-famous people in the United States for his book, "America's Paychecks," now has detailed those countries where politicians, police officers and bus drivers are paid the most.

"It was an enormous, and an almost comic project," Harrop said. "So many people didn't want to give me information. People in England, Japan, Switzerland and France don't like to talk about incomes. It has a more social connotation in those countries than here."

Also, he said, in many foreign countries there is the problem of income tax evasion, so discussions about income are avoided.

Sir David Steel, chairman of British Petroleum, was paid \$232,000 in 1979. Robert O. Anderson, chairman of Atlantic Richfield Co. in the United States, made \$1,650,000, the book says.

Harrop said Steel earned 17.5 times as much as the average British Petroleum worker, who earned \$13,280. Anderson made 45.9 times as much as the average petroleum worker at his company, who earned \$23,000, Harrop said.

In the legal profession, Harrop said lawyers' salaries in the United States are the envy of the world. The average pay for lawyers in all countries, he said, is less than \$45,000 a year. But graduates from the best law schools in the United States can start at about \$46,000.

Harrop said he was surprised by "the enormously larger number of lawyers we have in America."

"Japan graduates 500 lawyers a year. We graduate 35,000."

Law as a profession in Japan also receives little esteem. But journalists have more prestige than in any other country.

At a major city newspaper in Japan, a top reporter or columnist can earn \$80,000 a year. In France, reporters with 10 years experience earn \$17,234. And in China, editors at the People's Daily make \$1,716.

That's still more than what Prime Minister Zhao Ziyang of China makes in a month — \$319, or \$3,828 a year.

Prime Minister Malcolm Fraser of Australia receives a salary of \$117,913 a year. That's higher than what Canadian Prime Minister Pierre Trudeau makes, \$53,760. Prime Minister Margaret Thatcher of Great Britain earns \$70,879.

BOATING MISHAP
PEKING (AP) — At least 25 people died when a boat sank in a park lake in Tianjin, northeast China, a local daily newspaper reports.

FRYER PARTS

STORE HOURS

8AM-8PM
Monday-Friday
Saturday 8 A.M.-7 P.M.
Closed Sunday

PORK CHOPS

FIRST CUT

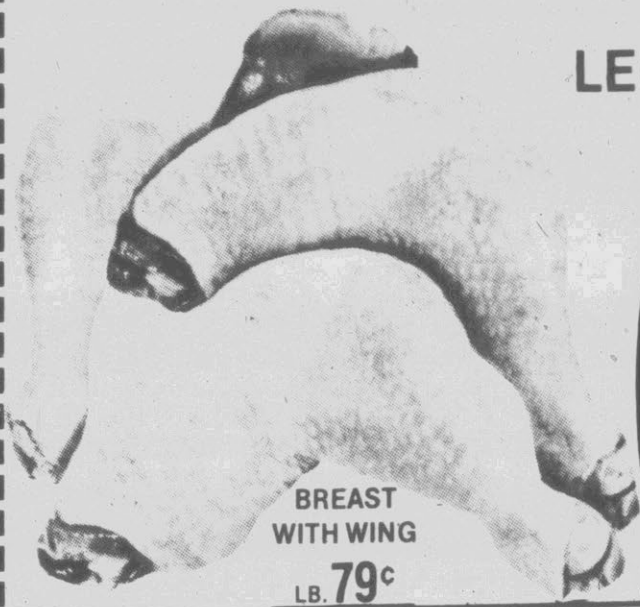

LEG WITH THIGH

69¢

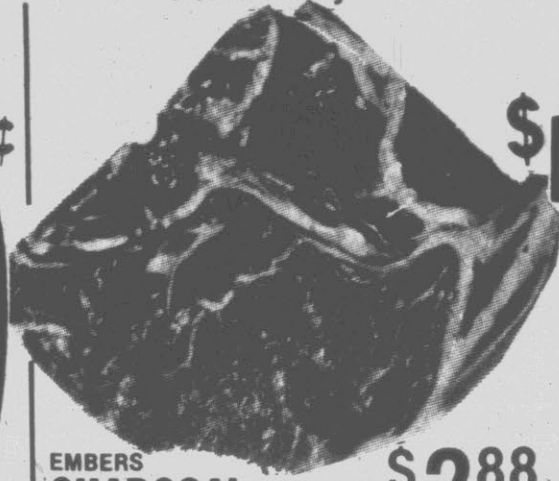

EMBERS CHARCOAL 20 LB. BAG \$2.88

1.109



GWALTNEY FRANKS 12 OZ. PKG. **99¢**

HOUSE OF RAEFORD TURKEY BREAST . LB. **\$1.29**

STAR'S BACON 12 OZ. PKG. **\$1.39**

HEAVY WESTERN SIRLOIN STEAKS **\$2.79**



MORRELL CANNED HAM 3 LB. CAN **\$6.99**

HEAVY WESTERN FULL CUT ROUND STEAK . LB. **\$1.99**

COURTLAND PURE PORK SAUSAGE . . . LB. ROLL **99¢**



GRADE "A" LARGE EGGS

59¢

HEAVY WESTERN T-BONE STEAKS **\$2.89**

FAMILY PAK SPECIALS
PORK NECK BONES . . . 5-7 LB. AVG. LB. **39¢**
PORK PIG FEET . . . 5-7 LB. AVG. LB. **49¢**
PORK PIG TAILS . . . 5-7 LB. AVG. LB. **49¢**
PORK CHITTERLINS . . . 10 LB. PKG. **\$6.50**
WHOLE HOG SPARE RIBS . . . LB. **\$1.19**

Prices Effective Thursday-Saturday.

WHOLE FRESH FRYERS
46¢
CASE PRICE . . . **\$34.30**

KRAFT MIRACLE WHIP . . . QUART **\$1.28**

COTTONELLE TOILET TISSUE

4 ROLL PKG.



Limit 2 Please

98¢



211 Jarvis Street
2 Blocks from E.C.U.
"Home of Greenville's Best Meats"
Quantity Rights Reserved

GENERIC TEA BAGS 100 CT. PKG. **78¢**

GENERIC EVAPORATED MILK 13 OZ. CAN **3/\$1.00**

NEWBORN PAMPERS YOUR CHOICE
EXTRA-ABSORBENT 60 CT. **\$6.98**
TODDLER 48 CT.
NEWBORN 90 CT.

COCA COLA 2 LITER BOTTLE **\$1.08** NO LIMIT

2 LITER BOTTLE (R.C.'s) NO LIMIT



78¢

DUNCAN HINES BLUEBERRY MUFFIN MIX (13 OZ.) OR BROWNIE MIX . . . 23 OZ. PKG. **98¢**

18 OZ. PKG.

CAKE MIX

78¢



PACKER'S LABEL FROZEN STEAK FRIES 2 LB. BAG **3/\$1.00** Limit 3

SUGAR CREEK BRAND BUTTER LB. PKG. **\$1.69**

PURINA DOG CHOW 10 LB. BAG **\$2.99**

FRESH WHITE MUSHROOMS LB. **98¢**

FRESH LOCAL COLLARDS 3 LBS. **\$1.00**

LITTLE DARLING SLICED BEETS OR CUT GREEN BEANS 303 CAN **4/\$1.00**



48¢

TREESWEET REGULAR OR PINK GRAPEFRUIT JUICE . . . 46 OZ. CAN **69¢**

NEW CROP TEXAS ONIONS 3 LB. BAG **78¢**

TENDER VITTLES ALL VARIETIES CAT FOOD 24 OZ. PKG. **98¢**

CLIP THIS COUPON
HAPPY HOST SUGAR

5 LB. BAG

With this coupon and \$10.00 food order excluding advertised specials. Without coupon \$1.58. Limit one per customer. Expires 5-22-82.

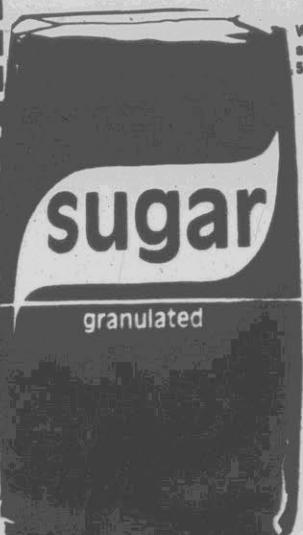

98¢

RED RIPE LOCAL STRAWBERRIES QUART **98¢**

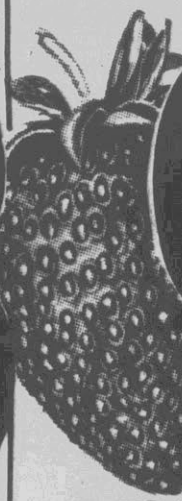

CLIP THIS COUPON
COLD POWER DETERGENT

GT. BOX

With this coupon and \$10.00 food order excluding advertised specials. Without coupon \$1.98. Limit one per customer. Expires 5-22-82.



98¢



\$4-6 OFF
Sears Superfine
lawn food

Reg. \$9.99

5⁹⁹

Superfine gives quick-release and prolonged nitrogen feeding. 20-lb. bag covers up to 5000 square feet. \$16.99, 40-lb. bag, covers up to 10,000 sq. ft. **10.99**
40-LB-BAG Sale ends May 29

Sears

**GIGANTIC
GARDEN AND
HARDWARE
SALE**



SAVE 53%
Craftsman®
stainless steel
garden sprayer

Reg. \$63.99 in
Spring '82
General Catalog **29⁹⁹**

Durable corrosion-resistant stainless steel. For garden and lawn. Brass nozzle sprays fine mist to steady stream.

Sale ends May 29
or while quantities last

Most items at reduced prices



5% OFF
Tomato
cages
Reg. \$1.59
99¢
Sturdy basket-
design wire
cage helps pre-
vent rot and
root damage.

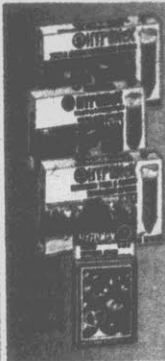

30% OFF
Hyponex®
spikes
Reg. \$3.59
2⁴⁹
Convenient fer-
tilizer in stick-
form. Pkg. of 8.
Tomato spikes
not available



\$2 OFF
Weed-B-Gon®
weed killer
Reg. \$5.49
3⁴⁹
Helps rid your
lawn of broad-
leaf weeds and
dandelions. One
pint size can.



35% OFF
Miracle-Gro®
plant food
Reg. \$2.19
1³⁹
Great for heal-
thy growth of
both indoor and
outdoor plants.
8-oz. size.



\$1 OFF
Hose-end
sprayers
Reg. \$3.99
2⁹⁹
Conveniently
mixes chemicals
with water.
Choose 6 or 15-
gallon size.



\$3 OFF
Lawn
sprinklers
Craftsman
oscillating
sprinker.
Reg. \$12.99
9⁹⁹
Craftsman
pulsating
sprinker.
Reg. \$11.99
8⁹⁹



\$5 OFF
Drop-type
spreader
Reg. \$27.99
22⁹⁹
Disperses seed
with precision.
Unassembled.
Reg. \$29.99, Broadcast
spreader, 24.99
Sale ends May 29



\$2 OFF
Lawn edging
Reg. \$4.99
2⁹⁹
Black plastic. 4-
in. x 20-ft. roll.
\$3 OFF
Border wire
Reg. \$8.99
5⁹⁹
Green or white.
14-in. x 25-ft. roll.



\$1 OFF
Plastic mulch
sheeting
Reg. \$2.59
1⁵⁹
Will help re-
duce weeds to
make way for
plant growth. 3
x 50 ft. rolls.



\$3 OFF
2 1/2-gallon
steel gas can
Reg. \$8.99
5⁹⁹
Heavy-gauge
lead-coated
Craftsman gas
can. Rust resist-
ant steel.

Supplement to:
BURLINGTON Times News • CHARLOTTE Observer • COLUMBIA State & Record • CONCORD Tribune • DANVILLE Register & Bee • DURHAM Herald & Sun • FAYETTEVILLE Times & Observer • FLORENCE Morning News • GASTONIA Gazette • GOLDSBORO News-Army • GREENSBORO Daily News & Record • GREENVILLE Daily Reflector & Shopper's Guide • HICKORY Record • HIGH POINT Enterprise • JACKSONVILLE Daily News & Post-Tribune • KANAWHA Valley Independent • LYNCHBURG News & Daily Advance • MYRTLE BEACH Daily Shopper • RALEIGH News & Observer • ROANOKE Times & World News • ROCK HILL HERALD & Piedmont Shopping News • ROCKY MOUNT Telegraph • WASHINGTON Star News • WINSTON-SALEM Journal & Sentinel • SHELLY Daily Star

ADP

Sears has a credit plan to suit most any need.

Sears pricing policy: If an item is not described as reduced or a special purchase, it is at its regular price. A special purchase, though not reduced, is an exceptional value.

Sale prices indicated are in effect through Saturday, unless otherwise specified.

SAVE \$30-\$50



on these Craftsman Eager-1® 3.5-RP mowers, featuring:

- Solid-state ignition for reliable starts
- Gear-assist starter for easy pulling effort
- Quick cutting height adjusters
- Low-maintenance automotive-type air filter

A. Rear-bag 20-inch mower

Includes catcher. Has 1-quart non-rusting gas tank, two-position folding handle and vacuum-action steel housing. 5 cutting heights.

Regular \$229.99

189⁹⁹

B. Side-discharge 20-inch mower

Has 1-quart non-rusting gas tank, two-position non-sag folding handle for easy storage and vacuum-action steel deck. 5 cutting heights.

Regular \$199.99

169⁹⁹

C. Propelled 22-inch mower

With front-wheel cog drive. Has 1-quart non-rusting gas tank, folding handle and vacuum-action steel deck. 5 cutting heights.

Regular \$259.99

219⁹⁹

Catcher for #9781 and #92132 mower. Sears price, 24.99

D. Propelled 20-inch rear bagger

With catcher, front-wheel cog drive, 1-quart non-rusting gas tank, 2-position folding handle, vacuum-action deck. 5 cutting heights.

Regular \$279.99

229⁹⁹

GIGANTIC VALUE



79416

Sears Best 60-ft. rubber garden hose

Special purchase

15⁹⁹

1/2 in. fittings

While quantities last



6956

\$15 OFF
Hose cart

Reg. 544.99 **29⁹⁹**

Rugged. Front-winding.

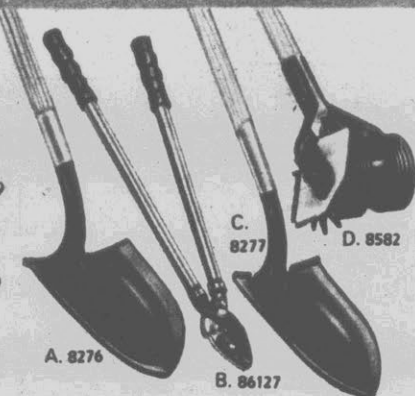

A. 8276

B. 86127

C. 8277

D. 8582

\$2-\$4 OFF Craftsman tools

YOUR CHOICE

8⁹⁹

- A. \$12.99 long-handle shovel
- B. \$12.99 lopping shears
- C. \$11.99 "D"-handle shovel
- D. \$11.99 2-wheel edger
- E. \$11.99 hand pruner
- F. \$12.99 garden rake
- G. \$10.99 grass shears
- H. \$11.99 hand cultivator

Sale ends May 29



E. 86458

F. 8389

G. 8688

H. 8431

Sears

SAVE \$200

on Craftsman® 10-HP lawn tractor that helps reduce mowing time up to 25%

Reg. \$1399.99

1199⁹⁹

In tests, we saved an average of 25% in mowing time on a 1½ acre lawn with this 10-HP Vari-Drive lawn tractor compared to our standard 10-HP lawn tractor. Vari-Drive lets you select proper ground speed to suit the job without shifting or slowing mower blades!

SAVE ON THESE VERSATILE ATTACHMENTS



SAVE \$50, lawn sweeper. 3.5 cu. ft. capacity. Reg. \$189.99
139.99



SAVE \$50, cart hauls up to half a ton. Reg. \$219.99
169.99

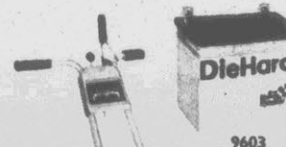

SAVE \$5 on Utility DieHard® battery. For tractors, riding mowers. Reg. \$44.99, \$39.99. With trade-in

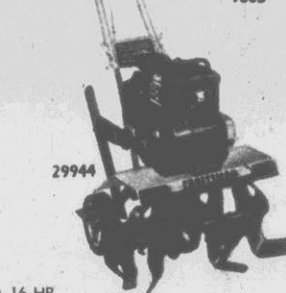

SAVE \$40 Craftsman 5-HP tiller. Reg. \$369.99
329⁹⁹

Powerfully efficient dual-chain drive. Quick start/stop tine control. Digs, 12, 22, or 24-in. wide paths. Partially assembled



High-back, foam-padded seat is adjustable for rider comfort

Convenient electric starting; alternator charges 25-amp battery

2 speed transaxle with Vari-Drive

Accepts a full line of optional lawn care attachments

30-in. floating mower deck helps prevent scalping your lawn

Iso-Vib engine mounts help reduce riding engine vibrations

Tight 33-inch turning radius helps make tractor more maneuverable



Self-bagger optional at extra cost

Single-lever height adjusts to 7 positions

Iso-Vib engine mounts help reduce vibrations

In-line gear transmission with 5 forward speeds

30-in. mower deck floats to help prevent scalping

25611 26932

SAVE \$100 on Craftsman 8-HP, 5-speed riding mower. Reg. \$999.99

899⁹⁹

Mower only
Iso-Vib mounts on engine will help reduce vibration. 30-in. floating mower deck. Single-lever height adjustment. 6-bushel self-bagger, 219.99



Manual master lift, spring assistance

High-back, spring mounted seat for rider comfort

3 speed transaxle with Vari-Drive

Tight 30-in. turning radius

25372

SAVE \$400 on Craftsman 16-HP Vari-Drive garden tractor. Reg. \$2099.99

1699⁹⁹

Twin-cylinder 16-HP engine. 3-speed transaxle with Vari-Drive. Handles a full line of optional lawn care and snow removal attachments.

SAVE \$20-\$40

on these four
lawn and yard
power hand tools

A. Electric Weedwacker® trimmer

Regular \$69.99

49⁹⁹

Uses nylon line to cut a 17-inch diameter swath.
Nylon spool for #7984, 20 ft. Reg. \$5.49 **4.49**

B. Gas Weedwacker trimmer

Regular \$159.99

119⁹⁹

Nylon spool for #79551, 40 ft. Reg. \$6.49 **5.49**
Gas Weedwacker, 15-in. dia. swath., reg. 109.88, **99.99**

C. Gas Brushwacker™ trimmer

Regular \$219.99

179⁹⁹

With 26.2-cc engine. 8-inch reversible steel weed blade. 40-inch curved steel shaft. Shoulder harness.

D. 1-HP electric power blower

Regular \$89.99

59⁹⁹

Variable nozzle air speeds of up to 125 mph.
Sears 1/3-HP electric blower. Sears price. **39.99**



100-ft. extension cord.
Reg. \$17.99 **9.99**

7799

Both gas-powered trimmers have:

- Solid-state ignition
- All-position carburetor to allow the engine to operate at any angle
- Clutch to let the engine idle without the blade turning

- Permanent magnet motor for quiet, efficient operation
- Power filter switch to cut back to 3/8 HP for normal jobs yet deliver a full 3/4 HP for heavy jobs

- Permanent magnet 1-HP motor
- Shoulder harness



79886

\$36.99 vacuum attachment for blowers, **29.99**

79887

\$26.99, 8-pc. gutter kit for blowers, **19.99**

Sears has a credit plan to suit most any need

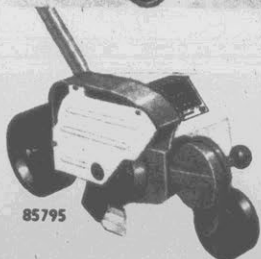

85795

SAVE \$10
Electric lawn edger

Permanent magnet motor.
\$11.97 pack of 3 edger blades **9.99**

Reg. \$69.99
59⁹⁹

Edger sale ends May 29



8159

SAVE \$20
Bushwacker® trimmer

Sears Best 22-inch hedge trimmer with double edge 58-tooth blade.

Reg. \$69.99
49⁹⁹



SAVE \$15
Craftsman wheelbarrow

Recommended 300-lb., 4 cu. ft. capacity. Hardwood handles. Seamless tray.

Reg. \$59.99
44⁹⁹



CUT \$30
14-in. gas chain saw

Reg. \$179.99

149⁹⁹

35267

2.0 cu. in. engine; solid-state ignition. Automatic oiling. Partially assembled.

SAVE 50%

Ask about Sears
Authorized Installation
for items on this page
FREE
Estimates!

on Armadillo® 11½-gauge chain link fence fabric

when you buy posts, fittings and
top rail at our regular low prices

Add long-lasting privacy and security to your home. Ideal for privacy around the pool, or for keeping kids and pets in the yard. Triple-coated framework has 50% more rust-resistant zinc than that of our leading competitor.

Aluminum filler strips extra.

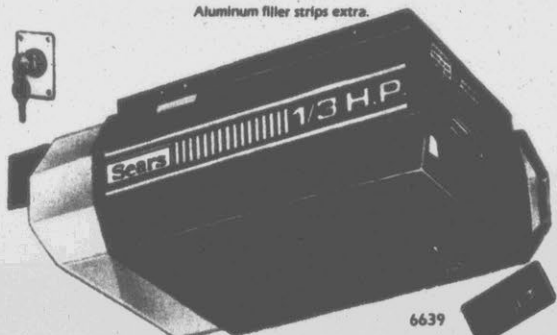

6639

CUT \$60 Sears premium garage door opener

With over 19,000 digital code combinations for security.
4½-min. light delay. 1/3-HP.

Regular \$229.99
169⁹⁹

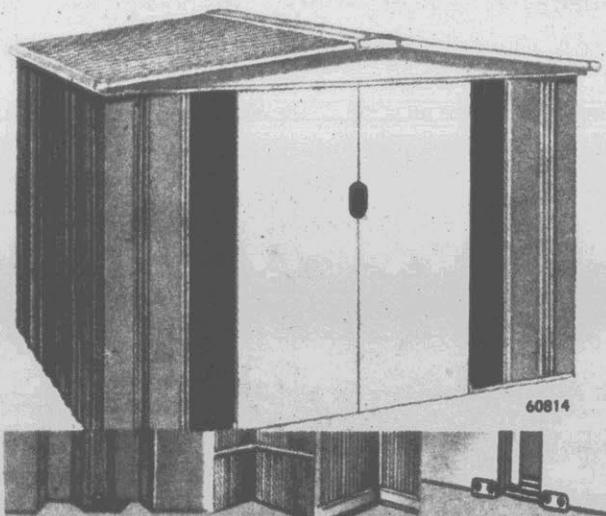
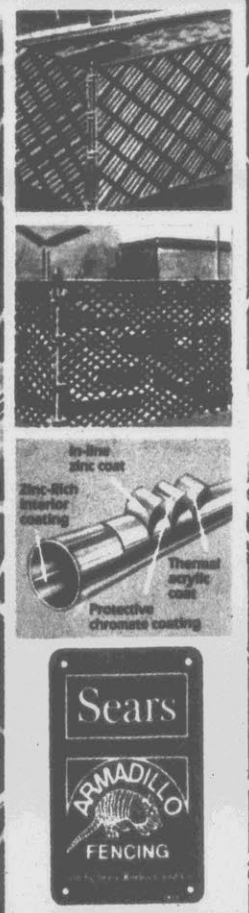
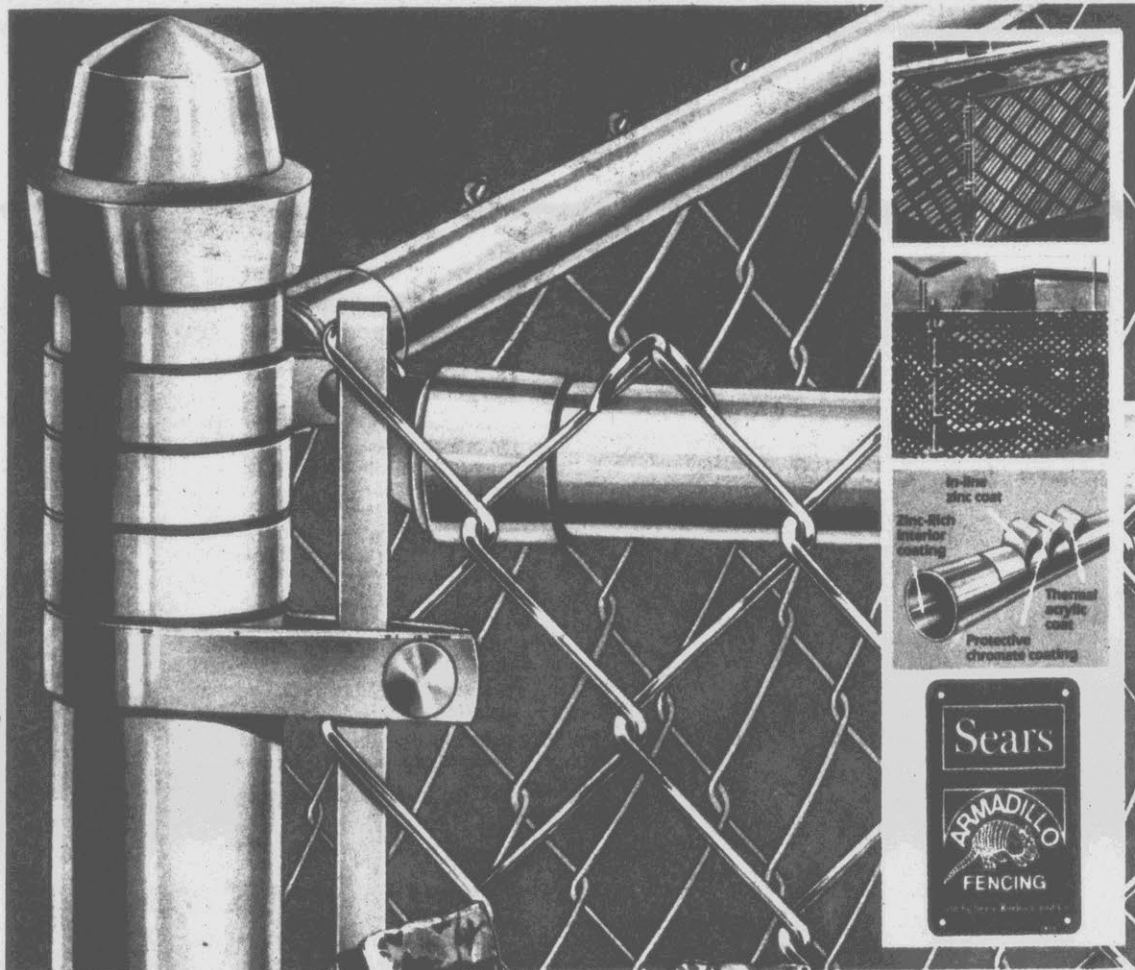

60814

Overlapping double
ribbed wall/roof panels

Midwall bracing, gal-
vanized floor frame

Overlapping door
flanges close securely

SAVE \$70

Steel storage building with 7-step finish

Reg. \$249.99

179⁹⁹

A 10 x 9-ft.* building. 7-step finish to help protect against rust, weather—inside and out! 9½x8½-ft. inside measure.

*Exterior base dimensions rounded to nearest foot
Unassembled.



90306

SAVE \$20

3-pc. redwood outdoor patio furniture set

Reg. \$119.99

99⁹⁹

Cut from 2-in. rustic redwood stock for durability and beauty. Weather-resistant redwood stain finish. Vinyl cushions. Chaise and 2 chairs. Unassembled

Sears

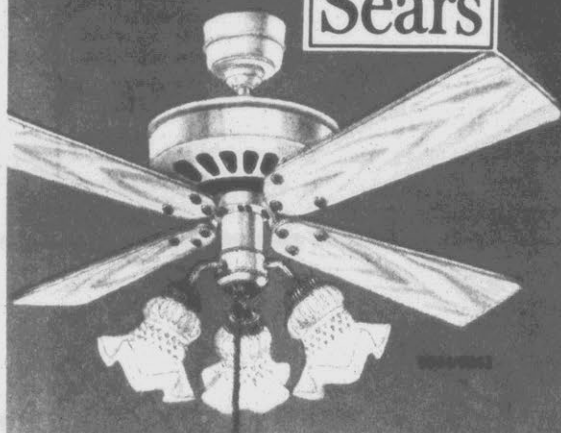

\$40 OFF 52-in. ceiling fan in brown or white finish

Has woodgrain textured polystyrene blades and 3-speed direct-drive motor. Brown or white housing.

Reg. \$169.99

129⁹⁹

Fan only

Victorian-style 3-light fixture.....

44.99

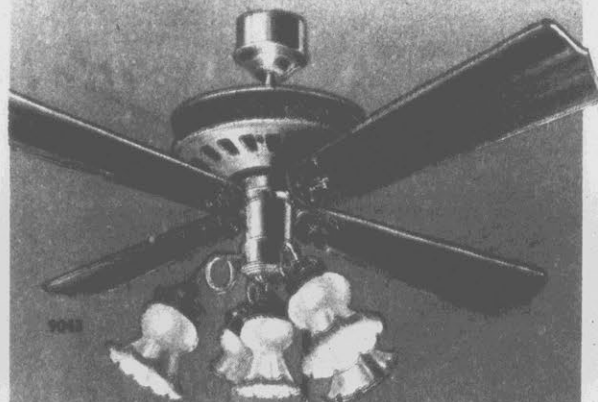

\$50 OFF 52-in. ceiling fan with real wood blades

Handsome fan has walnut-finished blades with reversible variable speed motor. Antique brass-plated steel housing.

Reg. \$299.99

249⁹⁹

Fan only

Trumpet-style 5-light fixture.....

69.99

Other ceiling fans start as low as \$69.99

Light fixtures for ceiling fans

A. Schoolhouse fixture
White opal-color glass diffuser, 2 1/2 x 7 in. high

19⁹⁹

B. Classic globe fixture
White glass 8-in. diameter globe, gold-color band

24⁹⁹

C. Victorian-style fixture
Shaded white tulip glass shades with polished or antique brass-look finish

69⁹⁹

SAVE \$30-\$40 on Sears Better bath vanities

20-in. size vanity
Regular \$85
Faucet, top extra

\$55

Choose white or woodtone louver, or white with gold-color trim. Vanities have tough 5-coat finish to help resist warping, cracking and peeling.

Regular \$95...24-in. size Better vanities in three styles..... \$65
Regular \$105...30-in. size Better vanities in three styles..... \$70
Regular \$155...36-in. size Better vanities in three styles..... \$115
Regular \$99.99...Matching storage cabinets in three styles..... \$79.99
Regular \$119.99...3-way medicine cabinets in white and antique brass, 104.99
Regular \$49.99...Matching light bars for medicine cabinets..... 44.99
Reg. \$17.99. Lift-off toilet seat in white and colors.....12.99

Sears "Better" is part of Sears Good, Sears Better and Sears Best series of bath vanities.

Sears has a credit plan to suit most any need

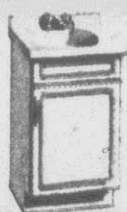

White with gold-color trim 41531



Woodtone louver 41522

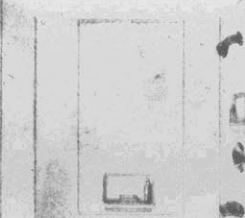
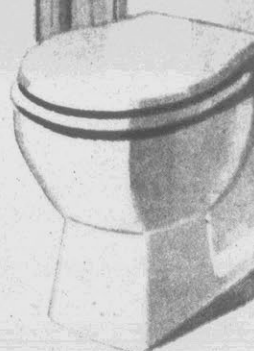

\$20 OFF Tub surround
Regular \$99.99 **79⁹⁹**

In white. 2 shelves. Color surrounds are \$10 extra.

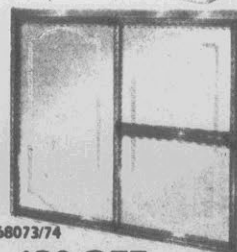

\$20 OFF Arch tub doors
Regular \$119.99 **99⁹⁹**

Sliding glass. Choose silver or gold-color frames.

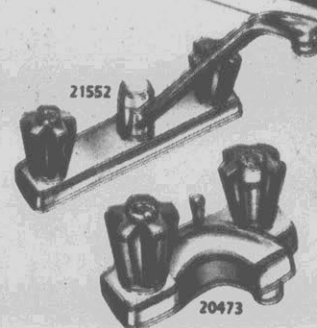

SAVE \$10 Bath or kitchen faucets
Reg. \$34.99 **24⁹⁹**

Washerless to resist drips, leaks. Reg. 41.99, Kitchen faucet with spray**31.99**

SAVE 30-35%

on quality kitchen cabinets



8200 Chapel Oak

Chapel Oak cabinets feature:

- Solid oak doors, fronts and drawers
- Slide-out shelves in base cabinets for ease of storage and access
- Each kitchen custom-built to your specifications

SAVE on other pictured cabinet styles, too!
Sink, faucet, countertop, appliances, hardware extra.

Chapel Oak comes complete with hardware

Ask about Sears Authorized Installation for items on this page

FREE ESTIMATES

Each of these advertised items is readily available for sale as advertised.

KENMORE® CLEAN-UP TRIO

\$100 OFF
Kenmore built-in
dishwasher

Reg. \$399.95

299⁹⁵
5 colors

With 3-level wash. Water Miser cycle and Power Miser control help save energy. Pot/pan cycle. \$439.95 free-standing model in white..... \$39.95
Colors extra on portable

\$50 OFF
Kenmore built-in
trash compactor

Reg. \$379.95

329⁹⁵

Compresses up to three 20-gal. cans of trash into one neat bag. Only 15-in. wide. \$389.95 free-standing compactor model, \$39.95

SAVE \$20
Kenmore 1/2-HP
waste disposer

Regular \$79.99 in
1982 Home Improvement Catalog

59⁸⁸

With quick-mount collar for easy installation. Sound insulated. Efficient!

While quantities last

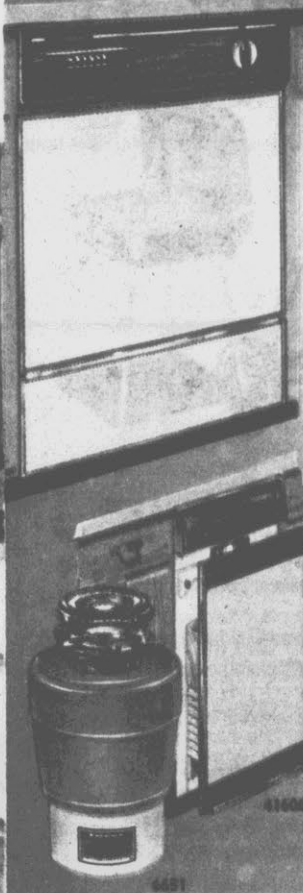

\$70 OFF
Kenmore built-in
dishwasher

Reg. \$329.95

259⁹⁵
5 colors

With Power Miser control for choice of hot or unheated drying. Stainless steel pulverizer blade.

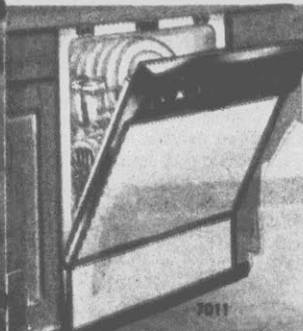

KENMORE BUILT-IN OVENS

\$70 OFF pilot-free
gas wall oven

Reg. \$549.95

479⁹⁵
Colors

Clock with timer. 24-in. \$599.95 gas wall oven, black glass door..... \$29.95

\$80 OFF self-cleaning
electric wall oven

Reg. \$649.95

569⁹⁵
Colors

Fits 27-in. cabinets. \$699.95 electric wall oven, black glass door. . 619.95
All built-in cook units are sold on a special order basis only.

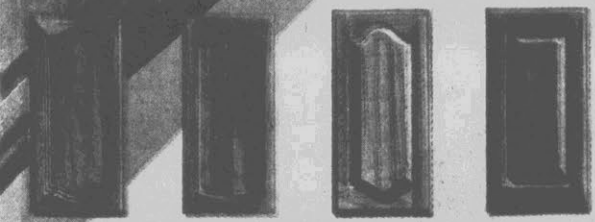
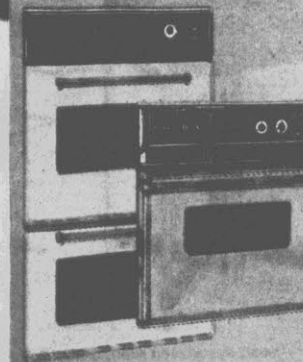

2300 Monticello

3500 Flanders

3400 Winfield

2700 Cherry Wood

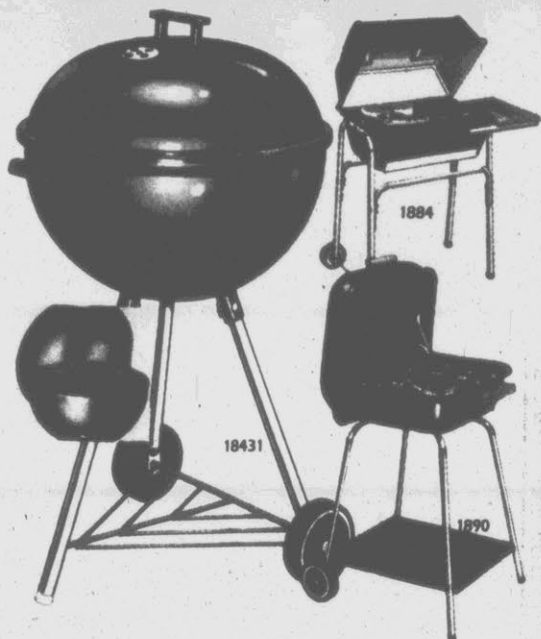

SAVE \$10 on covered barbecue grill

High-low grid tilts to cook rare to well-done at the same time. Fire grate/ash pan lifts out to empty. Wheels make it portable. **39⁹⁹**

SAVE \$10 on hinged-lid kettle grill

Durable smoker grill has porcelain-coated interior; ash pan lifts out for easy disposal. Convenient hinged lid; 3 bottom vents. **44⁹⁹**

SAVE \$15 on cast-aluminum grill

Rust-resistant cast aluminum construction with enamel finish. Large 14 x 23-in. grid. Lift-off wood side shelf; adjustable grate. **74⁹⁹**
Grills are partially assembled

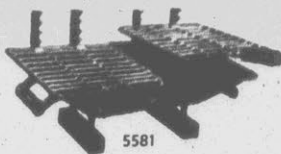

SAVE \$2 on hibachi grill

Reg. \$7.99 **5⁹⁹**
Durable cast iron body with wood handles. Adjustable cooking grid; bottom drafts.

SAVE \$80 on Kenmore gas grill with shelf

Reg. sep. prices total \$279.95

199⁹⁵

460 sq. in. cooking area with warming rack. Match-free ignition, handy dual controls.

Sale ends May 28



SAVE on all Sears wall bracket outdoor lighting fixtures

A. 79472 B. 79822 C. 79024 D. 7945 E. 7949

A. \$3 OFF classic-look fixture
Black plastic body with aluminum top resists corrosion. Acrylic panels. **11⁹⁹** Reg. \$14.99

B. \$8 OFF solid brass fixture
Antique-finish brass 1-light fixture is 14 1/2 in. high. Glass panels. **31⁹⁹** Reg. \$39.99

C. \$21.99 Aluminum fixture, black finish 14.99
D. \$15.99 Glass globe wall fixture 11.99
E. \$8.99 Acrylic panel wall fixture 5.99

Bulbs for fixtures sold at additional cost

\$2 OFF floodlight holders
2-lt. holder **7⁹⁹** Reg. \$9.99
Black enameled cast aluminum shade. \$7.99 holder...5.99

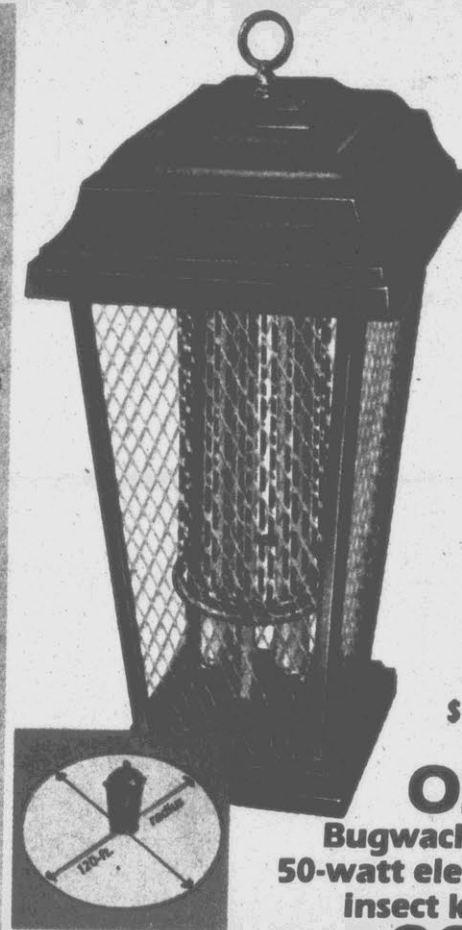

\$70 OFF
Bugwacker™
50-watt electric insect killer
99⁹⁹
Reg. \$169.99

Help rid your property of annoying insects with a lantern style Bugwacker. Two, 25-watt ultraviolet bulbs and reflector lure insects up to 120-ft. away. Protective screen grid. Bait tray for daytime use. 15-watt Bugwacker, reg. price, \$4.99



SAVE \$6 Heavy-duty detergent

24-lb. box, reg. \$12.99 each

2 24-lb. boxes for **19⁹⁸**

Removes more soil than the nation's leading detergent. 104 average loads per box.

SAVE \$1.30 on 1-gal. liquid detergent

Reg. \$7.29 **5⁹⁹**



SAVE \$4 Permanex® 2 trash container

Big 32-gal can resists freeze cracking and heat warping. Friction-fit high dome lid.

Reg. \$12.99 **8⁹⁹**

FULL 2-YEAR WARRANTY: If within 2 years from date of purchase, this Permanex® plastic container or lid cracks or breaks, we will, upon return, replace it free of charge.

Sears Best 32-gal. Permanex® 6 can, Reg. \$19.99, **13.99**

SAVE on trash bags

25% OFF! Reg. \$5.99

444 Box

35 (33-gal.) heavy duty trash bags.

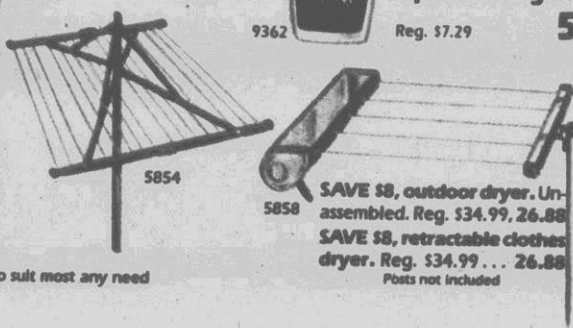

SAVE \$8, outdoor dryer. Un-assembled. Reg. \$34.99, **26.88**

SAVE \$8, retractable clothes dryer. Reg. \$34.99... **26.88**

Posts not included

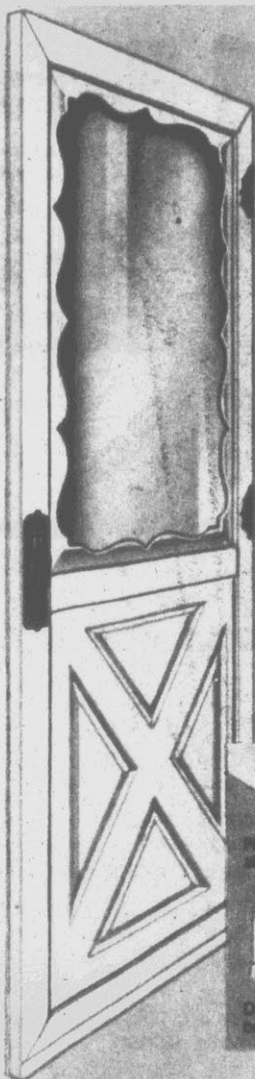

**SAVE
\$40**
on all Sears
premium
insulating
storm doors

Crossback shown,
reg. \$199.99

159⁹⁹
32 and
36x80 in.

Helps save energy! In-
sulated around edges
to help stop drafts.

\$199.99 full view, 159.99

\$199.99 equalite, 159.99

\$199.99 sidelite, 159.99

Custom sizes available at
similar savings.



Storm Doors Qualify for Energy Tax Credit

Energy Tax Credit for qualified products applies to those products when installed in a principal residence built before April 20, 1977. The credit amounts to 15% of the first \$2000 spent on any qualifying product before January 1, 1986 (a maximum credit of \$300). But at least \$67 must be spent on qualifying products.



20% OFF
Sears "20" glass fiber
shingles when we
arrange installation.
Class A fire resistance rating
from UL. 75% more weath-
erproofing asphalt than
ordinary shingles.



10% OFF
Continuous guttering
when we arrange
installation.
We'll go to any length for
you! Fabricated and in-
stalled on the spot. Baked-
on enamel finish.

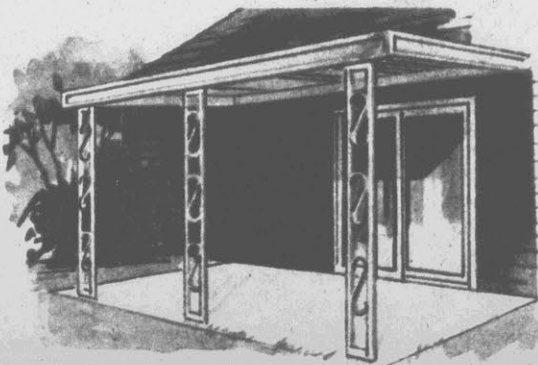

\$50 OFF
10x20-ft. aluminum patio cover
Provides 200 sq. ft. of protected out-
door living space. Decorative scroll
columns. Baked-on enamel finish.
Reg. \$449.99
399⁹⁹
SAVE 15% on custom patio covers

**ONLY
\$649**

for an energy-efficient
22,800 Btuh central air
conditioning system
with 8.5 SEER*

Also available in higher capacities:

28,400 Btuh capacity central air conditioning
system (8.5 SEER) \$749
35,400 Btuh capacity central air conditioning
system (8.5 SEER) \$799

These SPECIAL PURCHASE central air
conditioning systems come in capacity
ratings to cool most homes.

- Copper tube construction in both
indoor and outdoor coils
- Convenience grouping of common
components includes do-it-yourself
instructions and quick-connect re-
frigerant fittings for replacing most
any brand
- Replace your old, inefficient system
now with this sensational value...
but hurry, quantities are limited

Thermostat and installation at an extra charge

*Seasonal energy efficiency ratio

Ask about Sears Authorized
Installation and free estimates



INCLUDES

- Outdoor
condensing unit
- Indoor
evaporator coil
- 25-ft. of copper
refrigerant tubing

82821



3412

**CUT
30%**
Multi-purpose
water filter
housing

Reg. \$18.99

12⁹⁹

Whole house or
single faucet ap-
plication. Purch-
ase cartridge
separately.

SAVE \$160-\$306

on Craftsman® radial or table saw outfit

Sears Best 10-in. radial arm saw

Regular \$459.99

299⁹⁹

Capacitor-start, induction-run
1½-HP motor develops 2½ HP.



**\$10 OFF leg set
for radial saw**
Reg. \$59.99 **49⁹⁹**

Sears Best 10-in. table saw outfit

Regular separate prices
total \$655.94

349⁸⁸

Ball-bearing motor, steel leg set,
2 extensions, hold-down clamp.
Sale ends May 29



**\$7 OFF set
of 4 casters**
Reg. \$36.99 **29⁹⁹**

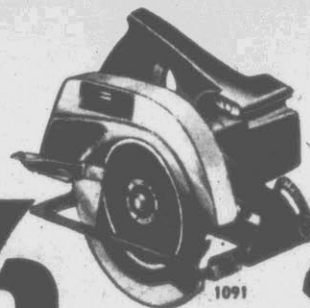
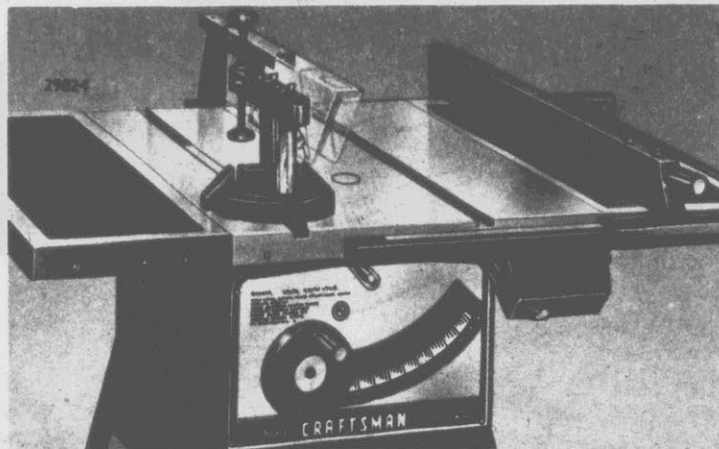
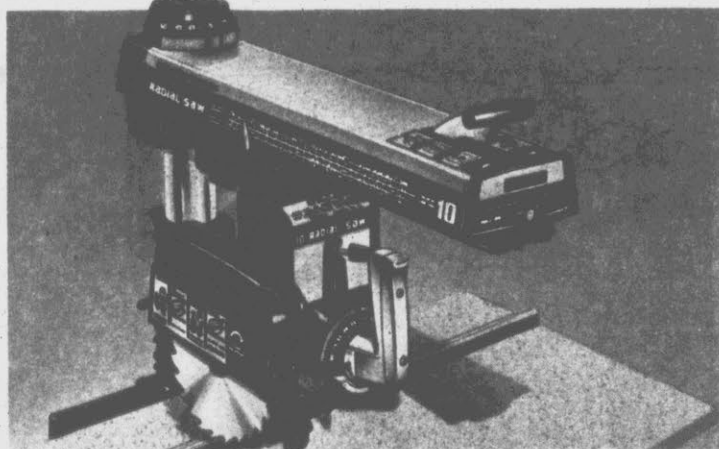

1091

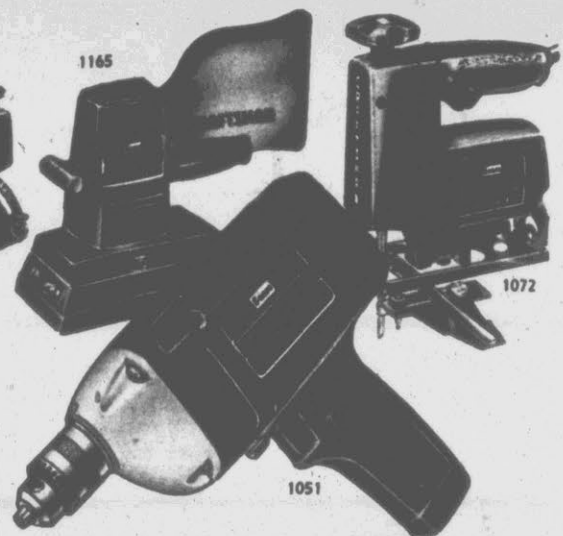

1165

1051

1072

SAVE \$20-\$30 on Craftsman® portable tools

YOUR CHOICE

39⁹⁹

7¼-inch circular saw

Develops maximum 1½ HP. 4800 rpm no-load speed.
Cuts wood up to 2¼-in. thick at 90°. Reg. \$59.99.

Pad sander with built-in dust pickup

Develops maximum ¼ HP, 4000 spm no-load speed.
Straight-line or orbital motion. Uses ½ sheet. Reg. \$69.99.

Variable-speed scroll saw

Develops maximum ¼ HP, 0-3600 spm no-load speeds.
Turning of knob pivots blade. Reg. \$69.99.

Reversible ½-inch drill

Develops maximum ½ HP. Variable 0-1200 rpm no-load
speeds. Locking trigger switch. Reg. \$69.99.



6813



25311-2-3



32337



28576

\$39.99, 21-pc.
high-speed
steel drill bit
set. \$4.99

\$1.19 six 3½
x 9-inch F, M
or C sanding
sheets. 69¢

\$20.97* pack of
three 7¼-inch
circular saw
blades. \$8.99

\$9.99, 14-pc.
assorted sabre
saw blade
pack. \$8.99

*Regular separate prices total
All bench power tools come partially assembled

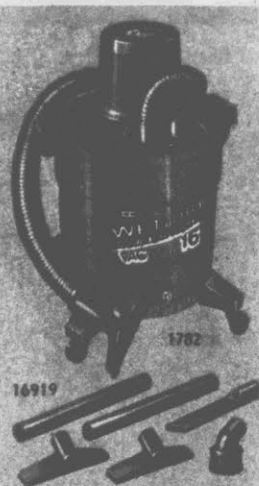

SAVE \$40 on 16-gallon Craftsman wet/dry vac

Reg. \$139.99 **99⁹⁹**

Craftsman vac with 16-gallon size non-rusting tank. Outfit includes 6-ft. hose, utility nozzle and four casters.

\$29.99, 6-pc. vacuum attachment kit . . . 24.99

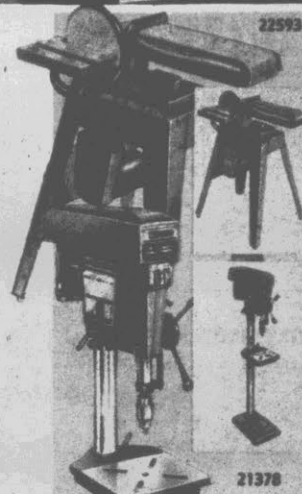

22593

SAVE \$80 Belt-disc sander outfit

Reg. \$379.99 **299⁹⁹**

With 6 x 48-inch belt, 9-inch disc, leg set.
\$3.99, 6 x 48-in. replacement sanding belt. . . . 2.99

SAVE \$90 Drill press combination

Reg. \$439.99 **349⁹⁹**

Craftsman 15½-inch drill press. 8 motor pulley speeds.



\$40 OFF Arc welder

Reg. \$199.99 **159⁹⁹**

With dual 30-140 amp and 40-230 amp ranges.

\$50 OFF Gas welder outfit

Reg. \$239.99 **189⁹⁹**

Oxy-acetylene 2-stage outfit. Regulators, tips, more.



36153-4

A.

B.
44603C. 54285
45381
E.

D. 5188

**SAVE
33%-40%**

on these Craftsman tools

- | | |
|--|---|
| A. \$16.99, 24-in. hand saw..... 9.99 | F. \$13.99, 16-oz. curved-claw hammer, 8.99 |
| B. \$10.99, 8-inch adjustable wrench... 6.66 | G. \$22.96*, 4-pc. wood chisel set \$15 |
| C. \$32.41* propane torch kit.... 19.99 | H. \$28.98*, 2-pc. pipe wrench set... 17.99 |
| D. \$64.99, 4-inch bench vise... 39.99 | J. \$12.76* assortment of 725 fasteners, 8.49 |
| E. \$8.99, 9 1/2-in. Arc Joint® pliers, 5.99 | K. \$44.99 leather work apron, 29.99 |

*Regular separate prices total



F. 3820

G. 36868

H. 55674

K. 45147

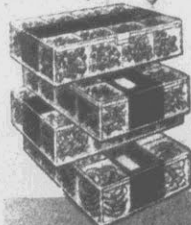
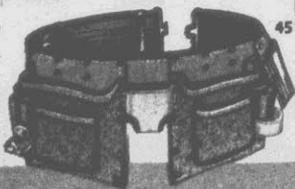
71187
J.

Sears

SAVE \$82

on Craftsman®
42-pc. mechanics'
tool set

Reg. sep
prices total
\$122.38

39⁹⁹

- Two reversible quick-release ratchets
- 1/4, 3/8 and 1/2-inch drive sockets
- Adapter and socket extension bars
- Open-end and ignition wrenches
- Great buy for the do-it-yourselfer

Sale ends May 29

**Craftsman Hand Tool
Full Unlimited Warranty**

If any Craftsman hand tool ever fails to give complete satisfaction, return it for free replacement.

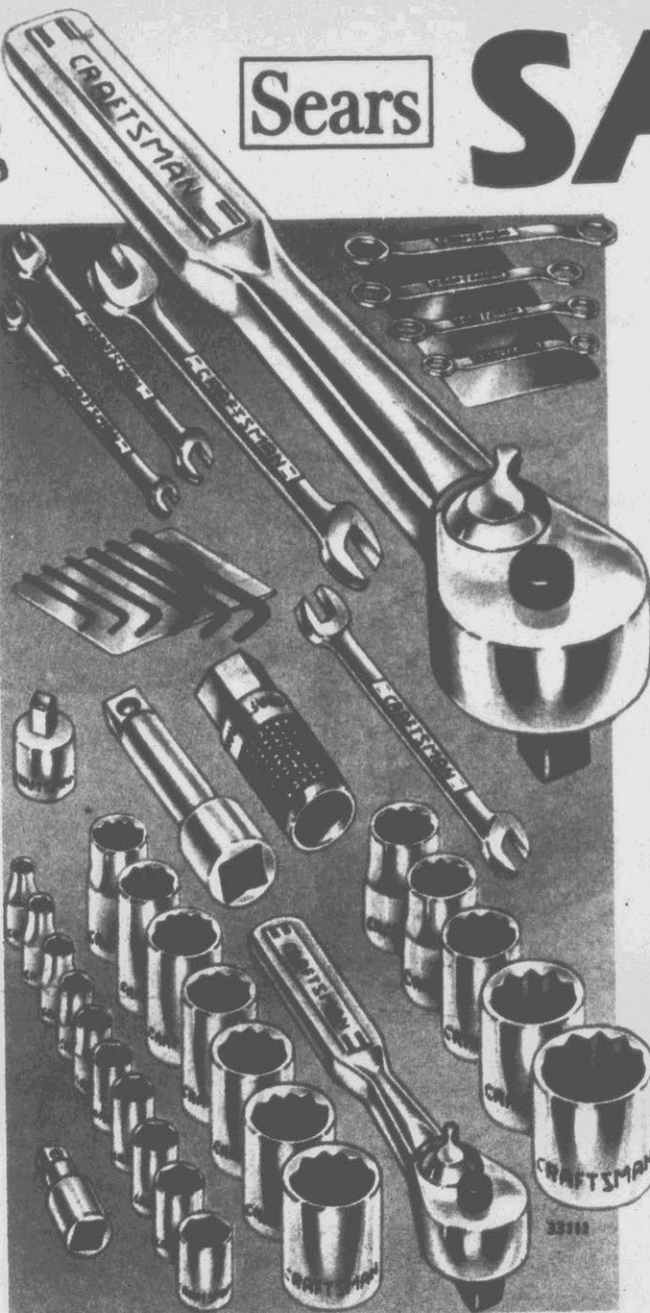

33134

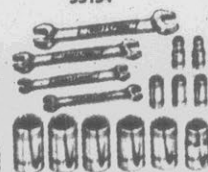

**METRIC
15-pc. accessory
tool set**
Sears
price

14⁹⁹

Craftsman 1/4, 3/8-inch drive sockets, and four open-end wrenches.



6512

**SAVE \$5
Craftsman
tool box**

Reg.
\$24.99

19⁹⁹

Heavy-gauge steel. Holds tools up to 19 inches long.

SAVE \$5 to \$8



44002

4389 4397

44616-7

\$16.99, 1/4-inch drive socket wrench set, 11 pcs., case, 9.99

\$17.99, std. or metric 3-pc. 3/8-in. drive socket set, metal tray, 9.99

\$21.95* std. or \$20.25* metric 5-pc. open-end wrench set, \$13

*Regular separate prices total

Hardboard
laminated
top

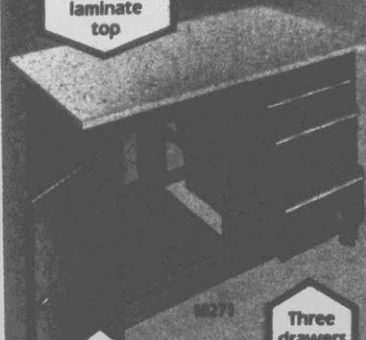

46271

Three
drawers

Locking
steel
door

Sears has a credit plan to suit most any need

SAVE \$93

Staggered steel
frame workbench
Reg. sep.
prices total
\$192.94

99⁹⁹

Sale ends May 29

- Two 9-inch deep drawers
- One 4-inch deep drawer
- 60 x 24-inch top
- Steel shelf
- Steel door

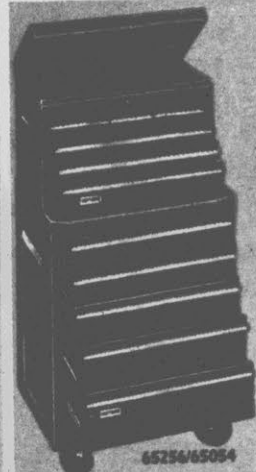

65256/65064

**SAVE \$60
when you buy
both chest
and cabinet**

Chest
Reg.
\$169.99

139⁹⁹

Cabinet
Reg.
\$209.99

179⁹⁹

Craftsman combination 6-drawer chest and 5-drawer cabinet. Top compartment and tote tray. Tumbler locks and bottom casters.

8555 11

Sears
GIGANTIC
GARDEN AND
HARDWARE
SALE

SAVE \$5-\$7

on Sears Best one-coat latex paints



\$200 OFF
Craftsman 1-HP
sprayer/compressor

Delivers 7.5 SCFM at 40 PSI, 100 PSI max. With Craftsman spray gun.
399⁹⁹
 2-HP Craftsman, reg. \$699.99... 499.99
 2-HP compressor sale ends May 29



Easy Living® interior latex

Satin flat or ceiling white, regular \$15.99

9⁹⁹
gallon

Our best interior latex gives you washable one-coat coverage that resists spots and stains. In 23 colorfast colors. \$16.99 Easy Living semi gloss, 11.99 gal.

Weatherbeater® exterior latex

Flat finish, regular \$16.99

9⁹⁹
gallon

Sears Best exterior latex is stain and mildew resistant. One-coat coverage in 50 non-yellowing colors.

\$18.99 Weatherbeater satin... 11.99 gal.

Paint and Stain Sale ends May 29

\$3 OFF
Weatherbeater
exterior stains

Latex, reg. \$14.99

11⁹⁹
gal.

Oil-base, reg. \$15.99

12⁹⁹
gal.



\$40 OFF

Sears Best hand-held airless sprayer
 Reg. \$139.99 **99⁹⁹**

Craftsman compact 1/2-HP compressor kit
 Reg. \$179.99 **139⁹⁹**
 Sprayer, kit sale ends May 29

For one-coat results, all Sears one-coat paints must be applied as directed

Sears has a credit plan to suit most any need



SAVE \$1.49

Aerosol enamel
 13-oz. can reg. \$2.99

1.50

Durable high gloss enamel for interior or exterior use.

65618

FREE FRAME
 when you buy roller cover at its regular price of 2⁹⁹



Sears Best 111364/11464

\$4 OFF
Weatherbeater 4-in. brush
 Reg. \$12.99 **8⁹⁹**

Specially shaped filaments for one-coat coverage.



14008

1/2 PRICE

Latex caulk
 Reg. \$3.99 tube **1⁹⁹** each

Flexible, paintable, fast-drying caulk. In 11-oz. tubes.



38159



1/2 OFF one-coat interior latex paint

Flat or ceiling, regular \$9.99

4⁹⁹
gal.

Semi gloss, regular \$10.99

5⁹⁹
gal.

Easy to roll on, easy to clean up. Choose from 14 exciting colors. Ceiling in white only.

12H 8555

You can count on **Sears**

SEARS, ROEBUCK AND CO.

Satisfaction Guaranteed or Your Money Back

SHOP YOUR NEAREST SEARS RETAIL STORE

N.C.: Burlington, Charlotte, Concord, Durham, Fayetteville, Gastonia, Goldsboro, Greensboro, Greenville, Hickory, High Point, Jacksonville, Raleigh, Rocky Mount, Shelby, Wilmington, Winston-Salem
 S.C.: Columbia, Florence, Myrtle Beach, Rock Hill
 VA: Danville, Lynchburg, Roanoke

8555

PRE-HOLIDAY SALE

Most items at reduced prices
 Sears Pricing Policy... If an item is not described as reduced or a special purchase, it is at its regular price. A special purchase, though not reduced, is an exceptional value.

25% OFF Summer Playwear

The Shirt, solids, Reg. \$8

Doubleknit Shorts, Reg. \$5

5⁹⁹
 SAVE \$2.01

2⁹⁹
 SAVE \$2.01

The Shirt, cool sleeveless style with classic open notch collar. A summertime favorite in solids. 10-20. Doubleknit shorts, Dacron® polyester Perma-Prest® shorts are pull-on style with stitched creases. An array of colors in Misses sizes.
 Reg. \$10 Misses' print shirts.....6.99

\$5 OFF, Body Shaping Swimsuits

Reg. \$25-\$30

19⁹⁹ to 24⁹⁹

Slim-Allure™ fabric suits of Antron® nylon and Lycra® spandex for subtle shaping. In a rainbow of colors and three styles: maillots, boyleg, sheaths in Misses sizes.

In our Sportswear Department

25% OFF Jacketed Sundresses go from noon to night

Regular \$31

22⁹⁹

SAVE \$8 on 2-pc. summer essentials to wear jacketed or not. The dresses come with A-line, full or tiered skirt styles; the looks include prints, stripes, and solid-and combinations. Misses sizes. Don't miss Sears Pre-Holiday Sale.

In our Dress Department
 Ask about Sears Credit Plans



30% OFF Fashionable Lace-trimmed Bras

Reg. \$6 B or C cup

4¹⁹

Deep plunge bra has shiny cups with fashionable ladder-lace trim. Natural cup style, in white or beige.

\$6.50 Contour Cup.....4.49

20%-30% OFF Control Top and Support Pantyhose

- Endurables™ • Hug-alon® II • Cling-alon®
- \$4.99 Endurables® firm control.....3.49
- \$5.99 Endurables support.....4.19
- \$3.49 Cling-alon® moderate control.....2.79
- \$4.99 Step-Lively® support.....3.99
- \$1.99 Hug-alon® II moderate control.....1.59
- \$2.49 Hug-alon II firm control.....1.99
- \$2.89 Hug-alon II light support.....2.29



24-oz. Scope Mouthwash
 Limit 2 per customer **1⁵⁹** each



Secret Spray Unscented or Regular
 Limit 2 per customer **1⁵⁹** each



Shick Super II Blades
 Limit 2 per customer **2¹⁹** pkg.



15-oz. Pert Shampoo Normal/Dry or Oily
 Limit 2 per customer **1⁷⁹** each



SAVE \$5
 1200-watt* Dryer
 Regular \$14.99 **9⁹⁹**

Sears has on hand sufficient quantities to meet reasonable consumer demand. Sears reserves the right to limit quantities sold to commercial purchasers.

Sale prices includes amount off stated manufacturer's label plus our additional savings.

Turbo-flow design. Folding handle. On sale thru Saturday. *Manufacturer's rated wattage

You can count on



SEARS, ROEBUCK AND CO.

Satisfaction Guaranteed or Your Money Back

SHOP YOUR NEAREST SEARS RETAIL STORE
 N.C.: Burlington, Charlotte, Concord, Durham, Fayetteville, Gastonia, Goldsboro, Greensboro, Greenville, Hickory, High Point, Jacksonville, Raleigh, Rocky Mount, Wilmington, Winston-Salem
 S.C.: Columbia, Florence, Myrtle Beach, Rock Hill
 VA.: Danville, Lynchburg, Roanoke

Sears



SAVE \$2 pkg.
Men's Comfortable Combed Cotton Underwear

Regular \$8.99
Package of 3

6⁹⁹

Soft, comfortable and shrinkage controlled. You'll want to stockup now at this great price during our 2-Day Holiday Sale. In packages of 3.
\$8.99 V-Neck Shirts 6.99 pkg.
Men's pajamas—a special purchase
Lightweight pajamas of cotton and polyester. Short sleeve in knee and ankle length styles. Solids, patterns. S-XL.
White quantities last 5.77 each

25% OFF
ACTIVE WEAR

SAVE \$4
Regular \$14.99

10⁹⁹

Tennis Shirt. Classic collar and placket pullover for the court. Polyester and cotton knit. In solids and patterns. Just right for summer fun. Save during our 2-day Holiday Sale.

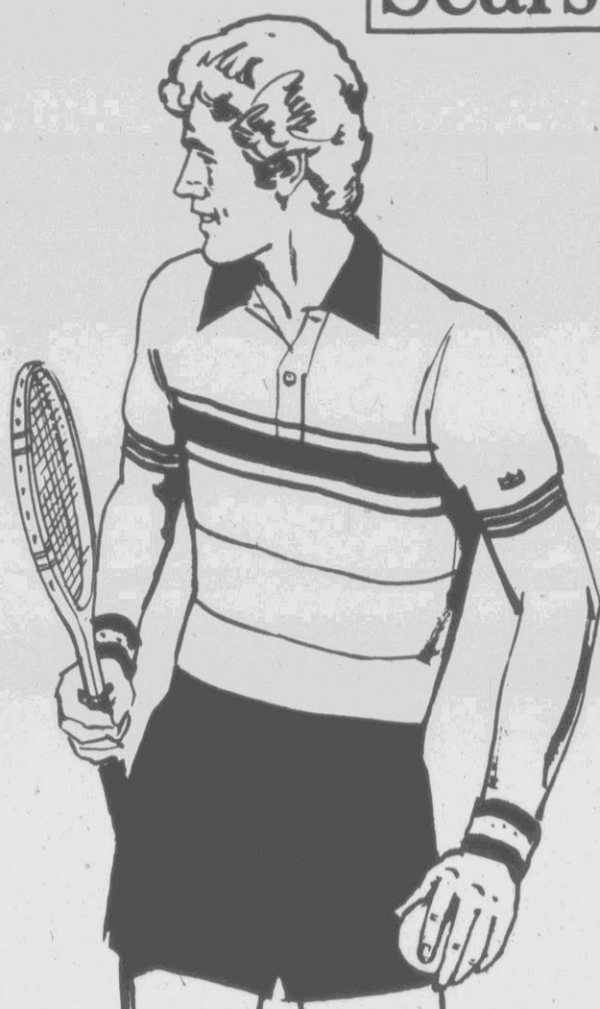

SAVE \$4
Regular \$14.99

10⁹⁹

Woven Tennis Shorts. It's your game in stretch woven polyester shorts with easy-action leg vents. In solid colors. Shop Sears Pre-Holiday Sale, you'll find storewide savings.

\$13.99 Double knit shorts not shown . . . 10.49 pr.

Ask about Sears Credit Plans

VALUE . . . Men's durable work shoes and boots
YOUR CHOICE



ONLY

19⁸⁸
pair

SAVE \$9 on
6-in. Leather Work Boot

A. Save \$9 on this work boot with soft leather uppers and cushioned leather insole. Has non-marking rubber sole. Goodyear welt construction. A savings you won't want to miss, at Sears. Regular \$28.99.

GREAT VALUE

B. You'll love this everyday low priced work shoe with leather uppers and oil resistant rubber soles. In sizes 7 1/2-11, 12 D. Don't miss this value.



SAVE 25%

Denim Jeans and Bib Overalls

Jeans Reg. \$14.99 Overalls Reg. \$19.99

10⁹⁹ 14⁹⁹

Heavy-duty polyester and cotton denim.

\$2 OFF Painter Jeans

Reg. \$12.99 **10⁹⁹**

100% cotton drill. Brush and hammer hoops.

\$1 OFF Chambray shirt.

Reg. \$7.49 **6⁴⁹**

All-cotton, long sleeved.

\$6.49 short sleeve . . . 5.49

Cotton canvas gloves

2 pair per pack **12⁴**

Special purchase
Quantities limited



TRIPLE STRIPE SPORTSWEAR

Sure winners team up with 25% savings . . .

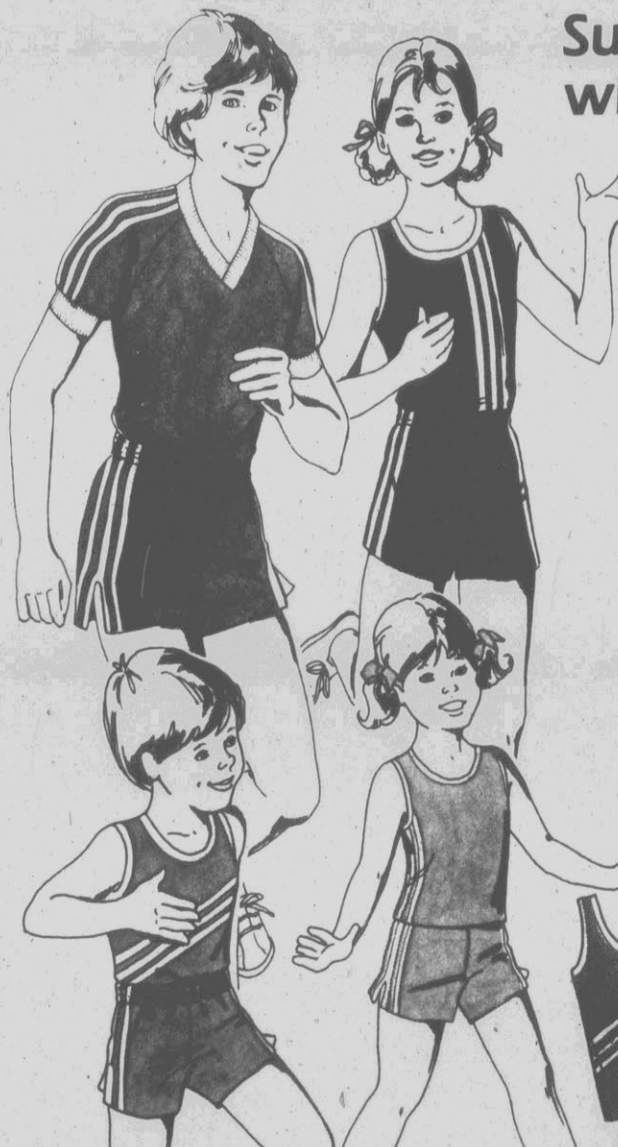

Little Kids 3-6x
Shorts
Reg. \$3.99

2⁹⁹
pr.

Triple stripe sportswear in easy-care fabrics, assorted colors. Save during our 2-Day Holiday Sale going on now at Sears.

FOR KIDS 3-6x

\$3.99 Little Boys' tank top 2.99

\$3.99 Little Girls' tank tops 2.99

\$4.99 Toddler Boys' shirt 3.74

\$3.99 Little Girls' bubble 2.99

\$11.99 Little Boys' pant set 8.99

FOR BIG BOYS 8-16

\$4.99 Big Boys' tank top 3.74

\$5.99 Big Boys' tank top, L-XL 4.49

\$4.99 Big Boys' shorts 3.74

FOR BIG GIRLS 7-14

\$5.99-\$6.99 Knit tops 4.49 to 5.24

\$3.99 Big Girls' shorts 2.99

DON'T MISS THESE GREAT SAVINGS



20%-25% OFF Summer Nightwear for Kids' . . .

Reg. \$6.99
to \$10.99

5²⁴ to 8²⁹

Easy to wear and easy-care. We show just a few styles from our collection. Save today at Sears.

Here are a Few Examples:

\$6.99 Little Girls' character print nightshirt 5.24

\$6.99 Little Boys' screen print pj's 5.24

\$8.99 Big Boys' character print pj's, 8-14** 6.99

\$6.99-\$10 Big Girls' baby doll pj's or short gown 5.24-8.24

PRE-HOLIDAY SALE

SPECIAL PURCHASE

Bedding with Important Quality Features Found in Our More Expensive \$169.99 Supreme Twin Bedding



ONLY 89⁸⁸
Twin Innerspring, Serifoam Polyurethane Mattress or Box Spring

- Both bedding sets have 260-coil Innerspring or 6½-in. Serifoam polyurethane mattress
- Both sets have steel backbone; and Scotchgard® Brand Fabric Protector
- Only the cover design is different

Full Mattress or Box Spring 139.88
Queen Size Bedding Set 319.88
King Size Bedding Set 419.88

While Quantities Last

SPECIAL PURCHASE Sturdy Bunk Beds

While Quantities Last

199⁸⁸

Your son will love the country flavor of our bunk beds constructed of pine with honey pine finish. Built-in ladder/guardrail and mattress boards. Converts into 2 twin size beds. Mattress is extra.

Ask about Sears Credit Plans

SAVE \$100 Somerville Sofa
Regular \$349.99
249⁸⁸

Get a full size sleeper that's perfect for overnight guests with olefin upholstery cover. Sale ends May 22.

Regular \$349.99
249⁸⁸

Furniture, Bedding not sold in Greenville, High Point, Rock Hill

Delivery is not included in selling prices of furniture and bedding

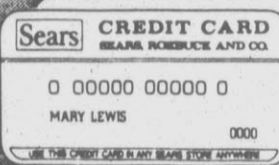

APPLY TODAY

You Can Apply for an Account by Phone
Call Toll Free 1-800-323-2780
Ask for Operator 10
Good Nationwide - No Annual Fee



SPECIAL PURCHASE

Sculptured Carpet with These Important Performance and Quality Features Found in Our More Expensive \$24.99 sq. yd. Andrea Supreme

- Both carpets have a thick 54-oz. per sq yd. of Premium Soil Resistant nylon pile
- Both carpets have the same sculptured nylon pile texture that stands up to wear
- Both carpets are treated with Scotchgard® Brand Carpet Protector to resist stains, soil and reduce annoying shock
- Special Andrea Supreme carpet is available in 8 multicolors

Special Andrea Supreme

12⁸⁸ sq. yd.

Limited Quantities
Cushion and Installation Extra
Not available in Greenville, Rock Hill



SAVE 20% to 30% Quilted Bedspreads from Sears

Choose Contempo with bold stripes, Windwood or Meadowland floral print spreads. All Perma-Prest® spreads are of polyester and cotton or polyester and rayon. Hurry and save at Sears.

\$39.99 Full Sizes 29.99
\$49.99 Queen sizes 39.99
\$59.99 King Sizes 47.99

SAVE 15%-20% on Coordinating Draperies
Your choice of Contempo, Windwood or Meadowland draperies, 48x84-in. pair.

Your Choice Regular \$36.99

25⁸⁹ Twin

21⁹⁹ Reg. \$26.99

Ironsone is available in larger stores only.



SAVE \$3
Spring Bath Scale

Regular \$7.99 **4⁹⁹**
Daybreak scale with steel bottom. Weigh in today.

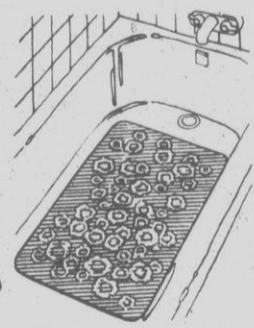

SAVE \$3
Bathtub Mat

Regular \$7.99 **4⁹⁹**
Suction cup mat resists slipping. Makes bath a safer place.

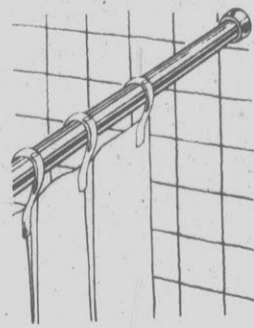

SAVE \$3
Shower Curtain Rod

Regular \$7.99 **4⁹⁹**
Spring-tension rod extends 40 to 60-in.



SAVE 42%
Bath Towels

Regular \$6.99 **3⁹⁹**
\$4.99 Hand Towel 3.49
\$2.49 Washcloth 1.99



SAVE 25%
20-pc. Ironstone

Berryband Regular \$39.99 **29⁹⁹**
Goes from oven-to-table-to-freezer. Microwave safe.



SAVE 33%
20-pc. Ironstone

Strawberries Regular \$59.99 **39⁹⁹**
Goes from oven-to-table-to-freezer. Microwave safe.



SAVE \$20
Hand-Held Print

Regular \$79.99 **59⁹⁹**
Compact 12-digit calculator with display, memory.



SAVE \$35
Desk Print

Regular \$134.99 **99⁹⁹**
12-digit capacity, dual memory, with display.

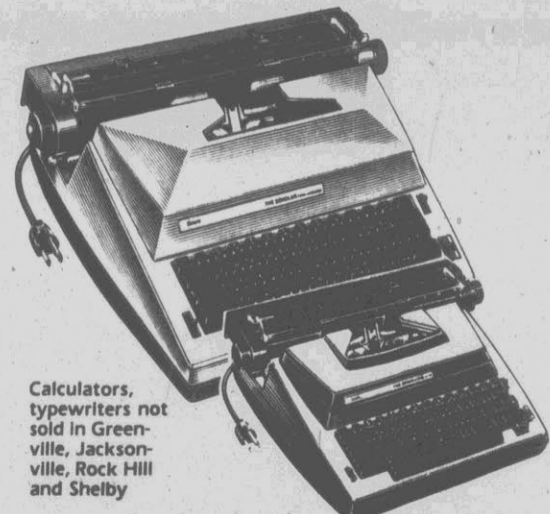

Calculators, typewriters not sold in Greenville, Jacksonville, Rock Hill and Shelby

SAVE \$60 The Scholar Typewriter

Regular \$259.99

199⁹⁹

6-step correction. Power return, full key-tab, power repeat keys. Pica type.

\$179.99 Electric I Typewriter 159.99

SAVE \$60 The Graduate Typewriter

Regular \$299.99

239⁹⁹

4-step correction. Half-space key, paper advance, carriage lock. Pica or elite type.

Sears

PRE-HOLIDAY SALE

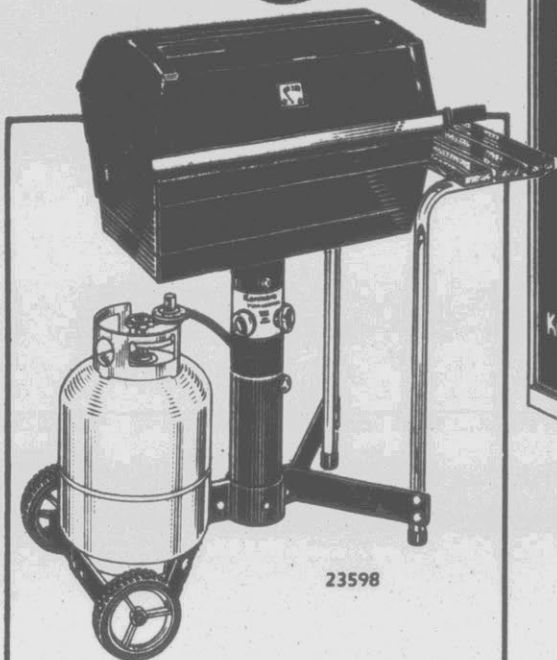

23598

SAVE \$80
Kenmore Gas Grill Package

Regular \$279.95

199⁹⁵

Match-free ignition lights instantly! 373 sq. in. cooking area with warming rack. Twin flame settings, stainless steel burner. Redwood stain side shelf. On sale until May 29.

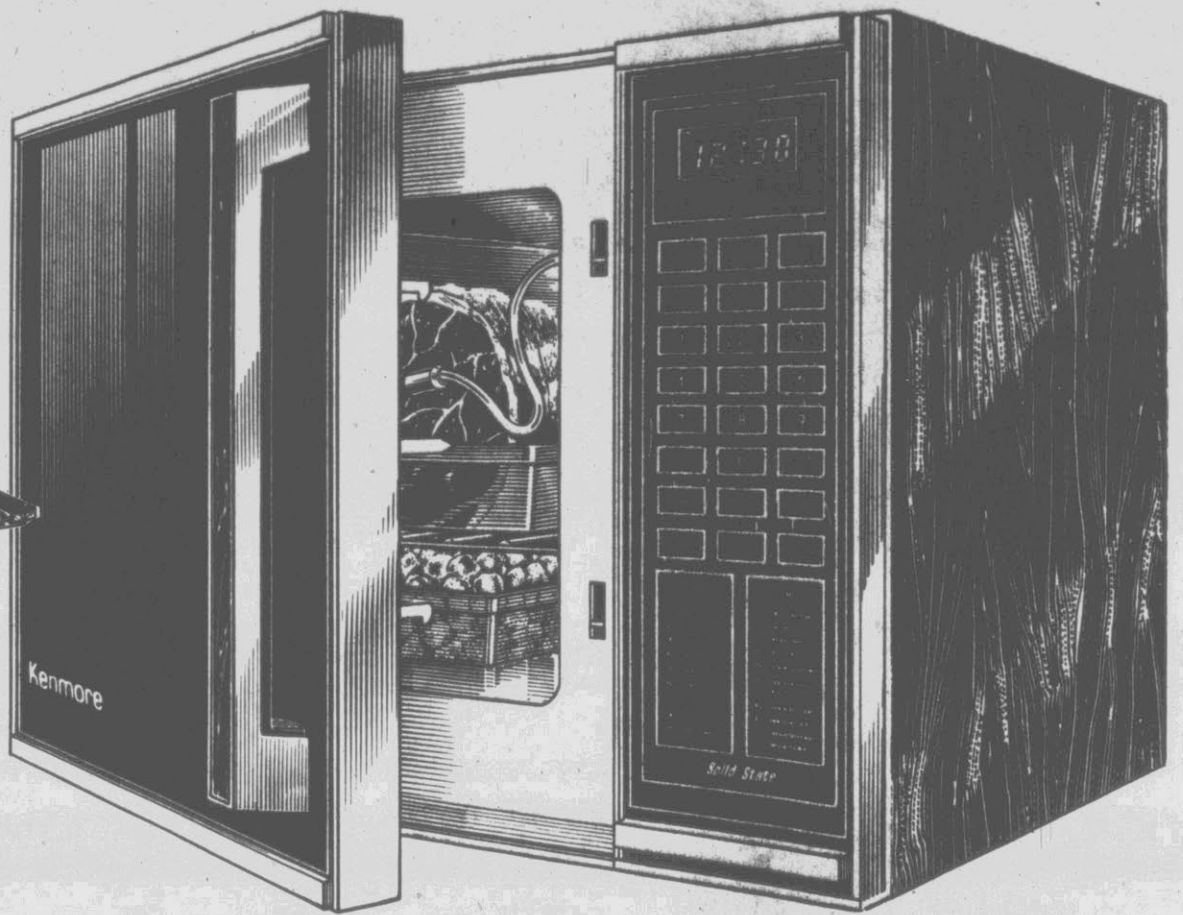

SAVE \$150!

Kenmore 3-Stage Microwave Oven

Regular \$599.95

NOW ONLY...

449⁹⁵

- Delay-start, cook and off
- Electronic touch controls
- Sensing probe cooks by temperature

- 80 recipes—25 preset
- Program up to 55 of your own
- 3-stage memory

On sale at Sears until May 29

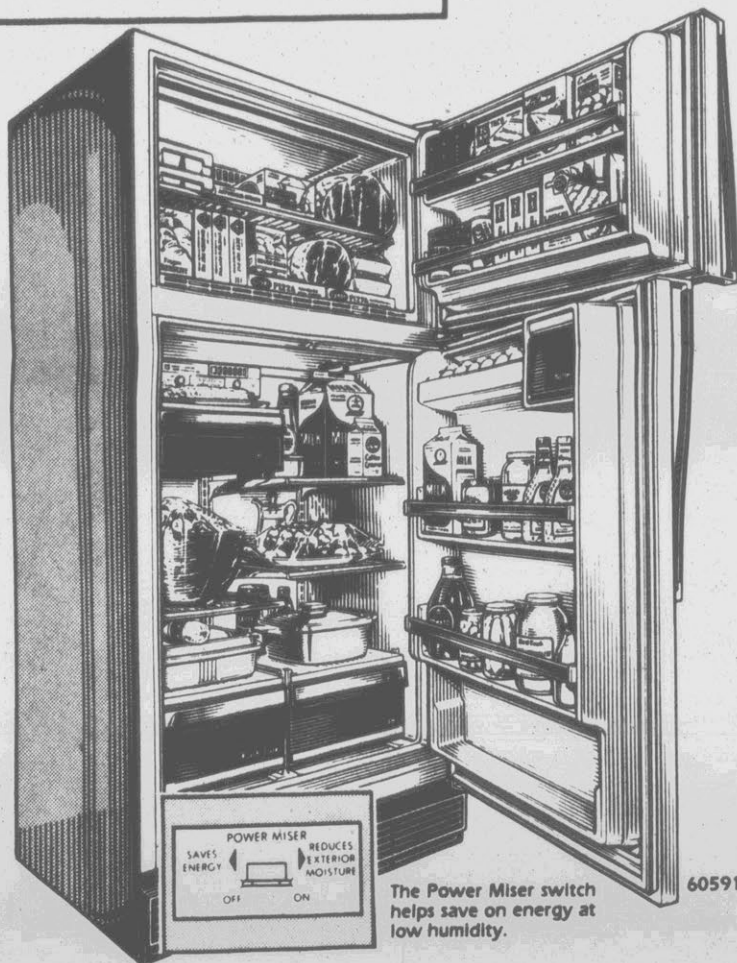

60591

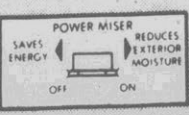

The Power Miser switch helps save on energy at low humidity.

SAVE \$100

Kenmore 15.1 cu. ft. Refrigerator

Regular \$599.95

499⁹⁵

All-frostless...no defrosting chores ever! Has twin crispers and meat pan. Shelves adjust to fit your needs. Textured steel doors. On rollers. Thru May 29.

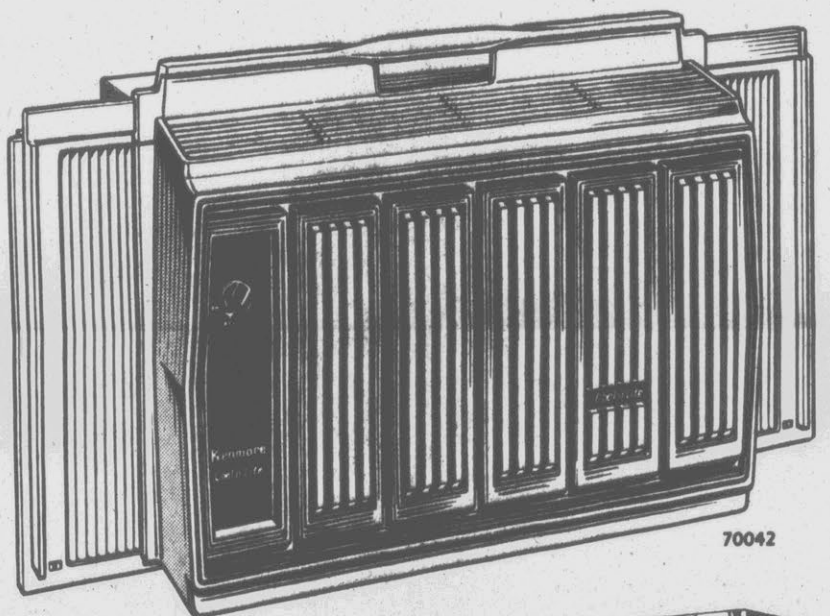

70042

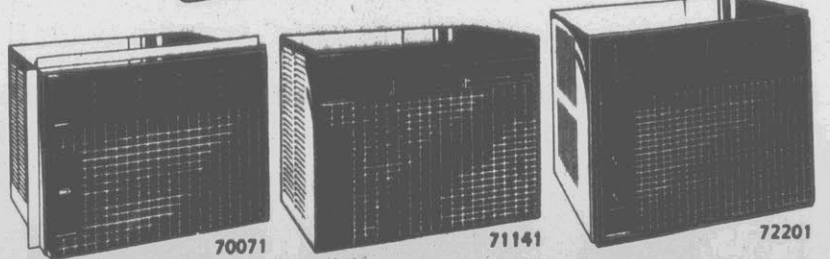

70071

71141

72201

Kenmore Cool n' Lite Air Conditioner

ONLY

\$169

4,000 BTUH window unit is portable, has a built-in carrying handle. Runs on 115-volts. Cool where you need it.

7,500 BTUH Window Air Conditioner

Has a 1-speed fan, cools 1 large room. Beat-the-heat.

\$279

13,600 BTUH Window Air Conditioner

Has a 2-speed fan and an adjustable thermostat.

\$389

20,000 BTUH Window Air Conditioner

Has a 2-way air-flow and a 2-speed fan.

\$499



61911

SAVE \$150

19.0 cu. ft. Ice-maker Kenmore Refrigerator

Regular \$749.95

599⁹⁵

Has a 13.65 cu. ft. fresh food section with twin crispers, meat pan, 5.35 cu. ft. freezer. Convenient ice-maker for plenty of ice. On sale until May 29.

Icemaker hook-up is optional, extra



22154 15.0 cu. ft.

12153 15.1 cu. ft.

SAVE \$50-\$100

Kenmore Upright or Chest Freezer
Your Choice

399⁹⁵

15.0 cu. ft. Upright Freezer has a lighted interior with 4 shelves. Textured steel door and key-eject lock, Reg. \$499.95.

15.1 cu. ft. Chest Freezer has lighted DynaWhite epoxy-finish interior. Adjustable cold control. Regular \$449.95.

On sale until May 29

Each of these advertised items is readily available for sale as advertised

Delivery is not included in selling prices

Ask about Sears Credit Plans

Sears
PRE-HOLIDAY
SALE

SAVE
\$100

Big-Screen
Color TV, 1-Button Color

Regular
\$529.95

429⁹⁵

Big 19-in. diagonal measure picture for family viewing. Electronic tuner, One-Button Color and Light Sensor. Change channel at the touch of a button. On sale until May 29.



4214



SAVE \$100

Console Color TV
with Touch n' Tune

Regular \$699.95
In your choice of two styles **599⁹⁵** each

Reliable solid-state electronic tuner. Touch n' Tune selection lets you jump instantly to the channel you want. Sale ends May 29 at Sears.



SAVE \$30

Portable
Black and White TV

Regular \$129.95 **99⁹⁵**

12-in. diagonal measure picture. Great for bedroom or kitchen. Has a dependable solid-state chassis. Sale ends Saturday.



SAVE \$60

Stereo System
with Cassette

Regular \$219.95 **159⁹⁵**

Make your own tapes by recording from AM/FM stereo receiver and full-size record changer. Two speakers. Sale ends May 29.



A. 2174

AC/DC; batteries extra B. 2124

C. 2330

SAVE
\$10-\$20

YOUR
CHOICE

49⁹⁵ each

A. \$59.95, Mini Cassette Recorder, AC/DC
B. \$69.95, Portable Radio/Recorder
C. \$59.95, AM/FM Stereo Clock Radio
\$69.95, Multi-Band Radio, #2411, (not shown)

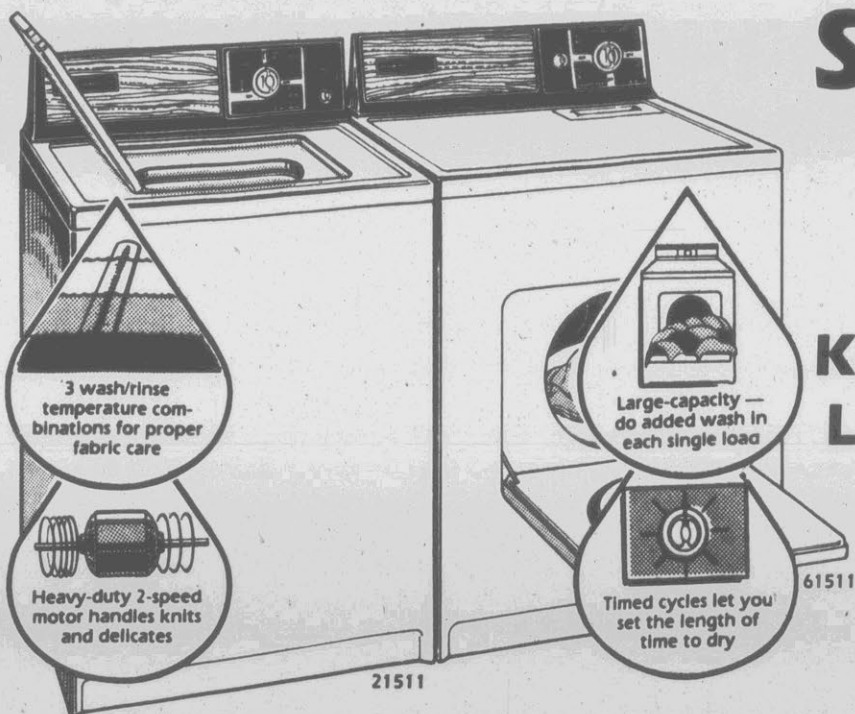

SAVE
\$80

ON THIS
KENMORE
LAUNDRY
PAIR

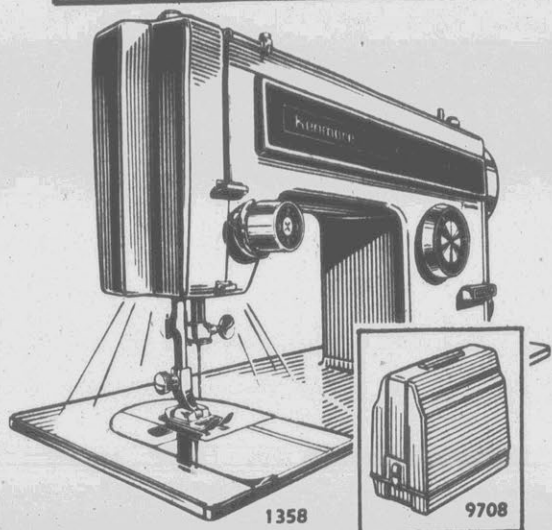

SAVE \$30
10-Stitch Flatbed Machine

Regular \$199.95

169⁹⁵

10 built-in stitches; 5 stretch and 5 utility. Reverse stitch balance and an automatic button-hole attachment to sew 3 styles in 10 sizes. On sale until May 29. Reg. \$35.00, Sewing Case, #9708.....\$30

Large-Capacity
2-speed Washer

Regular \$379.95 **329⁹⁵**

Large-capacity with cotton/sturdy, permanent press timed fabric cycles; plus air-only for fluff-drying special items. On sale until May 29. Dryer cord is extra.

Delivery is not included in selling price

Large-Capacity
3-Cycle Dryer

Regular \$279.95 **249⁹⁵**

Large-capacity with cotton/sturdy, permanent press timed fabric cycles; plus air-only for fluff-drying special items. On sale until May 29. Dryer cord is extra

Ask about Sears Credit Plans

VALUE-PRICED!
Kenmore Heavy-duty
Washer and Dryer

Washer
Sears Price
269⁹⁵

Washer has 3 preset water temperature combinations for proper fabric care...all with cold rinses.

Dryer
Sears Price
219⁹⁵

Dryer has 2-cycles including an air-only setting for fluff drying items. A terrific value. Dryer cord is extra.

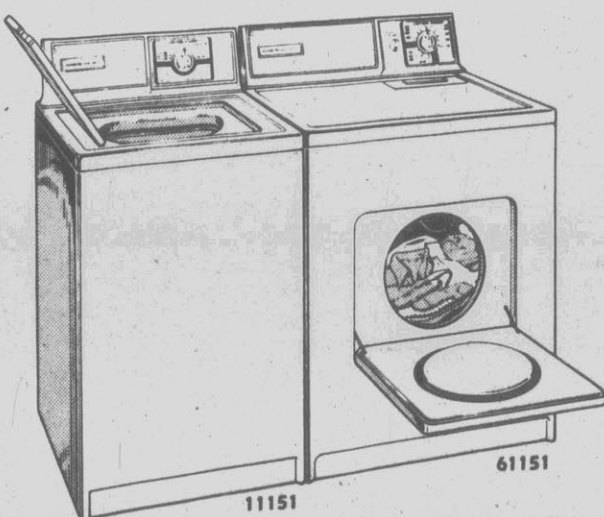

Each of these advertised items is readily available for sale as advertised.



Power-Mate
Kenmore Canister Vac
199⁹⁵

Regular \$269.95

2.5 peak HP suction (1.05 HP VCMA) and a beater bar brush for getting deep dirt. Has edge cleaning feature. 4 heights. Thru May 29.

CHECK-OUT SEARS POWER TOOL SPECIALTY CATALOG
FOR OUR COMPLETE LINE OF QUALITY CRAFTSMAN TOOLS

CAMPERS' SAVINGS

Sears

**AUTO CENTER
OPENS at 8 AM**

50% OFF

\$30 OFF

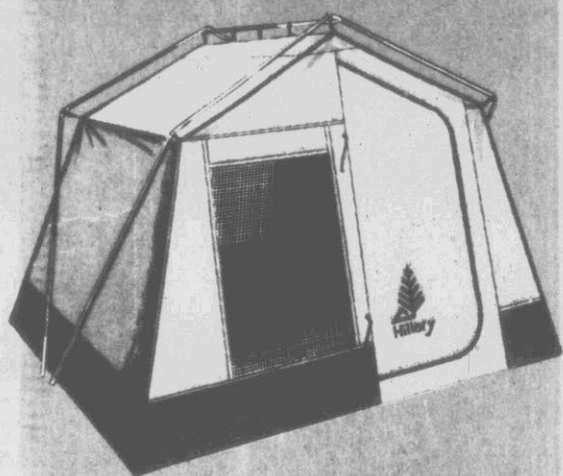

Hillary Family-Size Tents

Regular \$159.99
8x10-ft. tent

129⁹⁹

Polyester and cotton roof and walls, polyethylene sewn-in floor. 2 nylon screened windows. Sleeps up to 4 adults.

\$179.99, 9x11-ft. tent 149.99
\$199.99, 10x13-ft. tent 169.99

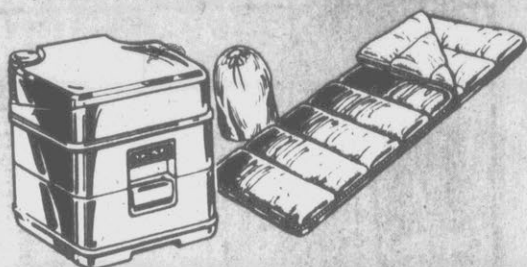

**SAVE \$15
Pak-A-Potti I**

Reg. \$64.99 **49⁹⁹**

2-piece, 100% self-contained portable toilet. Up to 25 fresh water flushes.

**SAVE \$10
Sleeping Bag**

Reg. \$64.99 **49⁹⁹**

3-lbs. of Dacron® Hollofil II® polyester insulation. Nylon outer and liner.

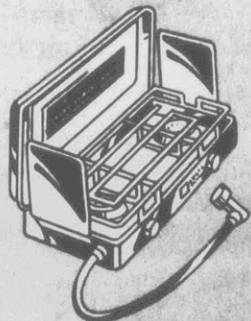

**SAVE \$5
Camp Stove**

Reg. \$39.99 **34⁹⁹**

Double burner propane stove. Nickel plated drip trays. Cylinders extra.



**SAVE \$5
Propane Lantern**

Reg. \$24.99 **19⁹⁹**

Double mantle lantern has output equivalent to 175 watts. Cylinders extra.

SUPER BUYS



**YOUR CHOICE
21⁹⁹**

Gamefisher Spincast Rod and Reel
4.1 to 1 gear ratio includes 85 yds. of 4-lb. test line. 2-pc., 6-ft. rod.

Gamefisher Spinning Rod and Reel
3.7 to 1 gear ratio Line cap: 200 yds., 8-lb. test, not incl. 2-pc., 6½-ft. rod.

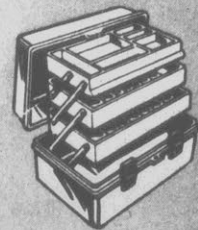

**SAVE \$4
Tackle Box**
Reg. \$14.99 **10⁹⁹**
Polyethylene box with three trays.

INSTALLED SPECIAL

SAVE 10%



SEARS AWNINGS

A beautiful way to keep your home cool during the hot summer. Helps save on air conditioning costs too. Custom made in choice of colors.

Ask about Sears Credit Plans.
By Sears Authorized Installers

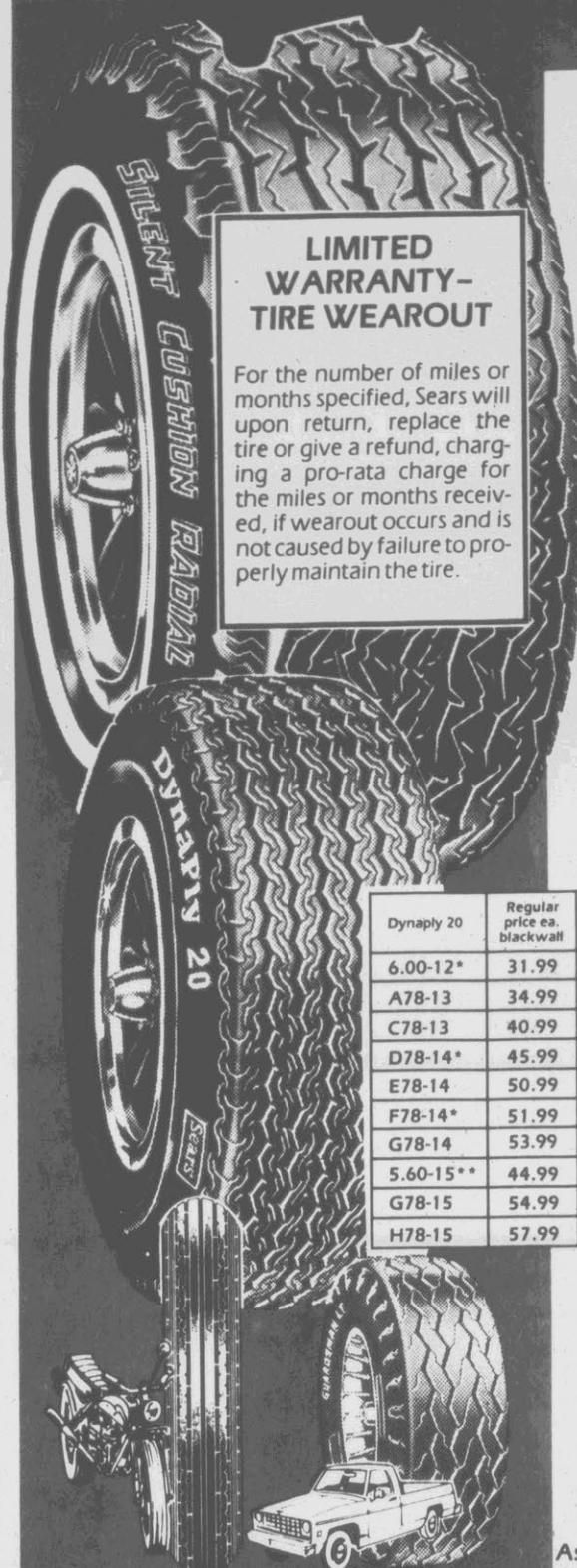

LIMITED WARRANTY-TIRE WEAROUT

For the number of miles or months specified, Sears will upon return, replace the tire or give a refund, charging a pro-rata charge for the miles or months received, if wearout occurs and is not caused by failure to properly maintain the tire.

our 1982 Spring General Catalog prices on Silent Cushion radials

42,000-Mile Tread Wear-Out Warranty

Two aramid belts . . . strong yet so flexible this is one of our smoothest-riding tires. Low rolling-resistance helps save gas. While quantities last.

| Silent Cushion Radial | 1982 Spring Gen. Catalog Price | Sale Price ea. Whitewall | plus F.E.T. each and old tire. |
|-----------------------|--------------------------------|--------------------------|--------------------------------|
| P155-12* | 69.99 | 34.99 | 1.40 |
| P155-13 | 89.99 | 44.99 | 1.44 |
| P165-13 | 94.99 | 47.49 | 1.67 |
| P175-13 | 99.99 | 49.99 | 1.64 |
| P185-13* | 104.99 | 52.49 | 1.78 |
| P185-14 | 114.99 | 57.49 | 1.93 |
| P195-14 | 119.99 | 59.99 | 2.06 |
| P205-14 | 124.99 | 62.49 | 2.31 |
| P215-14* | 126.99 | 63.49 | 2.47 |
| P205-15 | 134.99 | 67.49 | 2.38 |
| P215-15 | 139.99 | 69.99 | 2.49 |
| P225-15 | 145.99 | 72.99 | 2.70 |
| P235-15 | 151.99 | 75.99 | 2.89 |

SAVE on Sears Dynaply 20 Tires

20,000 Tread Wearout Warranty

\$31.99, 600-12 Blackwall

2 for \$57 Plus F.E.T. and old tire

Dynaply 20 and Dynaply 20 Sport. Polyester cord plies add strength and help give a smooth ride.

| Dynaply 20 | Regular price ea. blackwall | Sale price ea. blackwall* | plus F.E.T. each and old tire |
|------------|-----------------------------|---------------------------|-------------------------------|
| 6.00-12* | 31.99 | 28.50 | 1.47 |
| A78-13 | 34.99 | 31.50 | 1.59 |
| C78-13 | 40.99 | 36.50 | 1.80 |
| D78-14* | 45.99 | 41.00 | 1.92 |
| E78-14 | 50.99 | 45.50 | 2.01 |
| F78-14* | 51.99 | 46.50 | 2.12 |
| G78-14 | 53.99 | 48.50 | 2.26 |
| 5.60-15** | 44.99 | 40.00 | 1.66 |
| G78-15 | 54.99 | 49.50 | 2.35 |
| H78-15 | 57.99 | 52.00 | 2.54 |

| Dynaply 20 Sport | Regular price ea. blackwall | Sale price ea. blackwall | plus F.E.T. each and old tire |
|------------------|-----------------------------|--------------------------|-------------------------------|
| P155/80D13 | 32.99 | 29.50 | 1.46 |
| 165-15 | 43.99 | 39.50 | 1.65 |

Sears Value Motorcycle Tires

Rib Tread 325-19 Plus 57* F.E.T. **29⁹⁹**

Street Tread Plus 79* F.E.T. **36⁹⁹**

Not available in Shelby

Tire Sale Ends May 29
Ask About Sears Credit Plans

Guardsman Light Truck Tires

20,000-Mile Tread Wear-out Warranty

Highway H78-15 Plus 3.39 F.E.T. **72⁹⁹**

Traction H78-15 Plus 3.54 F.E.T. **76⁹⁹**

Traction RV 10.15 Plus 4.30 F.E.T. **75⁹⁹**

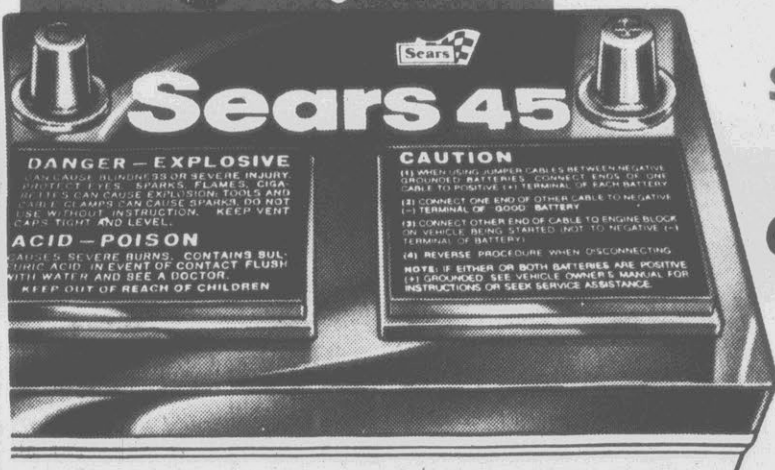

Sears 45

DANGER - EXPLOSIVE
DO NOT SMOKER OR SEVERE INJURY. SPARKS, FLAMES, OR HOT SURFACES CAN CAUSE EXPLOSIONS. DO NOT OPEN BATTERY CAPS WITHOUT PROPER INSTRUCTIONS. KEEP VENT CAPS TIGHT AND LEVEL.
ACID - POISON
CAUSE SEVERE BURNS. CONTAINS BULBULOUS ACID. IN EVENT OF CONTACT FLUSH WITH WATER AND SEE A DOCTOR. KEEP OUT OF REACH OF CHILDREN

CAUTION
1) WHEN USING JUMPER CABLES BETWEEN BATTERIES, CONNECT POSITIVE (+) CABLE TO POSITIVE (+) TERMINAL OF EACH BATTERY.
2) CONNECT ONE END OF OTHER CABLE TO NEGATIVE (-) TERMINAL OF GOOD BATTERY.
3) CONNECT OTHER END OF CABLE TO ENGINE BLOCK OR VEHICLE BODY. BEING SURE NOT TO CONTACT (-) TERMINAL OF BATTERY.
4) REVERSE PROCEDURE WHEN DISCONNECTING.
NOTE: IF EITHER OR BOTH BATTERIES ARE POSITIVE (+) GROUNDED, SEE VEHICLE OWNER'S MANUAL FOR INSTRUCTIONS OR SEEK SERVICE ASSISTANCE.

**\$15 OFF
Sears 45 Car Battery
INSTALLED**

Reg. \$54.99

39⁹⁹ with trade-in

Get a fresh start for summer travel with the savings on Sears 45 battery. 410 amps cold cranking power help give fast starts. Group 24. For most American-made cars and many imports. Sale ends May 22.

Sears

| | | |
|---|--|--|
| DieHard® Motorcycle Battery 39 ⁹⁹ Exchange | DieHard® Utility Battery 39 ⁹⁹ Exchange | DieHard® Marine and Light Truck Battery Reg. \$72.99 62⁹⁹ Exchange |
|---|--|--|



**SAVE \$30
In Dash Stereo Radio with Cassette**

Regular \$129.99 **99⁹⁹** Each

Enjoy great sound at a low price! Features cassette with locking fast forward and automatic stop. Automatic tape reverse plays second side of tape after first side is completed. Installation extra.

SAVE \$4 Heavy-Duty Plus Shocks

Reg. \$11.99

7⁹⁹ Each

Over-size 1-3/16-in. piston for good ride control. Also has piston-rod wiper ring. Sale ends May 29

SAVE \$6

The SteadyRider Radial-Tuned Shocks

Reg. \$19.99 **13⁹⁹** Each

Comfort valves help smooth ride with radial, bias ply, and high pressure tires. Fits most American, many import cars. Sale ends May 22



Limited shock warranty

Limited warranty on Heavy-duty Plus and SteadyRider RT shock absorbers for as long as you own the car, including labor, if shocks bought, installed.

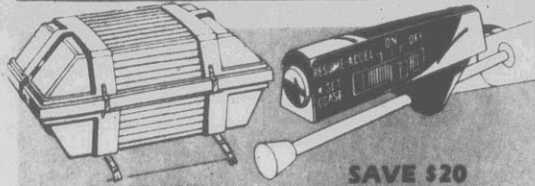

**SAVE \$20
X-Cargo Carrier**
Reg. \$99.99 **79⁹⁹**

16.8 cu. ft. car-top storage.

**SAVE \$20
Speed Control**
Reg. \$99.99 **79⁹⁹**

Adapter kit extra if needed. Thru May 29. Installation extra



**SAVE \$1.25
Spectrum Oil**
Reg. \$6.20 **4⁹⁵**

5-quart jug, 10W-40 motor oil. Easy pour.



**SAVE \$1.50
Dual Filter**
Reg. \$3.49 **1⁹⁹**

Spectrum filter helps keep engine parts clean.

SAVE 40% Oil and Filter Change

We'll install up to 5 quarts of Spectrum 10W40 motor oil and an new Sears Dual Oil Filter, and lubricate the chassis. Extra charge for cars with sealed grease fittings. Sale ends May 22

Reg. \$19.69
For most American cars, many imports. Not available in Shelby

11⁹⁷