

Redistricting: A Frustrating Experience

By STUART SAVAGE
Reflector Staff Writer

"I've never seen anything to beat it in my life ... never seen anything so frustrating," Sen. Vernon White said of the state Senate redistricting plan approved Tuesday which establishes Pitt County, seven townships in Martin County and one Beaufort County township as the 9th Senatorial District.

Under the old plan, which failed to win the approval of the U.S. Justice Department, Pitt and Martin counties were joined as the 9th District with one senator.

The new plan adds Beaufort County's Chocowinity Township to the 9th District, while splitting Martin County's Goose Nest, Hamilton and Robersonville townships — giving

them to the 2nd District.

The only change in the House redistricting plan, which also failed to win Justice Department approval, divides Cumberland County into two districts — one with two representatives and a 57 percent black voter registration and a predominantly white district with three representatives.

"The House was already messed up so bad it didn't bother us anymore," Rep. Ed Warren said, pointing out that under the plan approved Tuesday, Pitt's Bethel and Carolina townships are still split from the rest of the county.

The revised plans were designed to accommodate objections by the Justice Department over the Cumberland County

House district and several Senate districts in the northeast.

The biggest problem with the Senate plan was with Sen. J. J. "Monk" Harrington's 2nd District. The new plan increases black representation in that district.

However, by increasing the number of black voters in the 2nd District, a series of shifts that affected six other districts was needed.

Tyrrell and Perquimans counties were moved from Harrington's district to the 1st District with part of Washington County.

Portions of Halifax and Edgecombe counties and Martin's Robersonville, Hamilton and Goose Nest townships were moved into the 2nd. Beaufort's Chocowinity Township was

moved from the 1st to the 9th and Warren County was put in the 6th District, while Pamlico County was shifted from the 1st to the 3rd and Mannings Township in Nash County was moved from the 10th to the 11th District.

"We're just hoping they (the Justice Department) will approve this," Warren noted.

If the redistricting plans are approved by the Justice Department, the primary will be held June 10. The General Assembly is scheduled to reconvene on June 14.

Justice Department spokesmen gave tentative oral approval to the redistricting proposals Tuesday. A written acceptance, or rejection, is expected later.

'Total War Zone' Is Declared

By The Associated Press
Britain declared today that a "total" war zone 200 miles around the Falkland Islands would go into effect at 7 a.m. EDT Friday, and Argentina put its forces on "maximum alert."

The two sides also said they were studying a U.S. peace plan relayed by Secretary of State Alexander M. Haig Jr. But Argentina said it expects "military operations" in the Falklands area in 24 to 48 hours.

Details of the plan were not known, but a government source in London said: "Clearly Mr. Haig wants to bring some sort of finality to the issue, with some sensible way of resolving it."

As prospects for peace grew dim, the British Defense Ministry announced that any ship or aircraft, including Soviet vessels, that are found within the "total exclusion zone" will be regarded as hostile and liable to attack.

The British move came amid mounting speculation that the task force now off the Falkland Islands was poised to launch an assault on the South Atlantic archipelago seized by Argentina April 2.

It also followed an emergency Cabinet meeting presided over by Prime Minister Margaret Thatcher. Government sources in London said the session produced "no fresh optimism" of a negotiated settlement.

The British Defense Ministry stressed that the war zone extends to the airstrip at Stanley, the Falklands' capital.

"Any aircraft on the ground in the Falkland Islands will be regarded as being in support of the illegal (Argentine) occupation and accordingly is liable to attack," the British Defense Ministry said.

The zone extends a 200-mile maritime blockade

around the islands declared by Britain April 12 to include aircraft. Defense Ministry spokesmen said the new move includes civilian aircraft and ships as well as military and naval craft.

In Moscow, the Soviet Communist Party newspaper Pravda accused Britain of aiming to resolve the Falklands crisis by "military force" and said the dispute's "negative influence already makes itself felt, disrupting normal shipping in the southern Atlantic and world trade in general."

Western diplomats in Moscow speculated that the reference to shipping and trade reflected Soviet anxiety that the crisis could interfere with the Kremlin's grain purchases from Argentina. The Soviets buy \$2.7 billion of grain from Argentina annually and is the Argentine junta's leading trade partner. Argentina also is a major supplier of meat for the Soviet Union.

ABC News reported the vanguard of the British war fleet was within shelling distance of the Falklands, 250 miles east of Argentina's southern coast. The report said the main British force, including the aircraft carriers Hermes and Invincible, 20 fighter-bombers and some 1,500 marines, was only one day away.

Reports from Buenos Aires to the British media said Argentine naval sources were predicting a British attack at dusk tonight. These reports said 16 Argentine warships were at sea to challenge the British armada.

The Argentine news agency DYN said a fierce winter storm was lashing the Falklands but otherwise Argentine naval sources reported "everything is calm." The sources said coastal patrols had been increased to detect British commando landings, the agency said.

The British Broadcasting Corp. and DYN reported Haig discussed the U.S. peace plan with Foreign Minister Nicanor Costa Mendez in Washington.

The BBC said the Argentina junta was "holding Mr. Haig at arm's length," and DYN said they rejected his offer to make another trip to Buenos Aires to discuss the proposals.

Costa Mendez told a meeting of the Organization of American States in Washington Tuesday that Britain would attack the Falklands in 24 to 48 hours. The OAS early today approved a resolution calling on Argentina to withdraw from the Falklands and for Britain to "cease immediately" hostilities. But unlike the earlier U.N. resolution, the OAS statement recognized Argentine sovereignty over the islands that have been a British colony for 149 years.

Military analysts said Britain probably would first establish a beachhead on West Island, where Argentina was said to have only 900 troops, and then confront the

estimated 9,000 troops on East Island, which includes the Falklands capital Port Stanley.

But experts said earlier the landing on East Island was not likely for about two weeks, until a backup fleet with 3,000 troop reinforcements reached the area.

Until then, the main British military activity is expected to be an air blockade to cut off supplies and reinforcements for the Argentine garrison. Press Association, the domestic British news agency, published a smuggled letter from a British school-teacher in Port Stanley who wrote: "Many of the soldiers are teen-agers, and lots have died from exposure — some, too, have blown themselves up. ... Livestock has been stolen or killed; they're eating the cats and, we suspect, the horses, too."

Speculation about an invasion was fueled Tuesday when the British government imposed a near-total blackout on news from the war fleet. Argentina also did some blacking out, ordering all foreign correspondents to

(Please turn to Page 12)

Roster Cuts For Schools

By MARY SCHULKEN
Reflector Staff Writer

The Pitt County Board of Education voted to snip approximately 60 persons from its employment roster for the 1982-83 school year Tuesday night, including several positions in the areas of speech, special education and exceptional children funds.

Those affected include both certified (teachers, administrators) and non-certified (aides, custodians, secretaries) personnel.

Most of the teachers being eliminated, said Associate Superintendent Thomas Craft, had contracts for 1981-82 only and these contracts were not renewed. "The 20 or so teachers were filling for others on leave," he noted. "Those from the special programs such as speech, special education and exceptional children are half-time positions."

The board said uncertainty of state, federal and local funds motivated the special programs cuts. "We are uncertain what money we'll have and it looks as though we will not have the money for these positions," noted Craft.

Board members also approved contracts for teacher-coaches. Under this resolution, the responsibility of coaching is incorporated into a teacher's contract and abandonment of coaching duties violates the contract.

"There has been some concern in regards to persons who are employed to teach PE and coach and for one reason or another, become disillusioned with it, get tired of being away from home on games night, etc., and stop coaching," explained Craft. "This puts a hardship on the schools. The new contract specifies that an individual is employed as a teacher-coach and the two are inseparable."

Craft reminded principals, teachers and parents that Friday, originally scheduled as a teacher workday, will be a snow make-up day instead.

REFLECTOR

HOTLINE

752-1336



Hotline gets things done for you. Call 752-1336 and tell your problem or your sound-off or mail it to Hotline, The Daily Reflector, Box 1967, Greenville, N.C. 27834.

Because of the large numbers received, Hotline can answer and publish only those items considered most pertinent to our readers. Names must be given, but only initials will be used.

POODLE SUSPECTED STOLEN

I have advertised, called around, done everything I know to try to get my 4-year-old silver poodle, Peppy, back. He's wearing a brown leather collar with a Davie County rabies tag. (I fairly recently moved here). Isn't there anything anyone can do about all the dog thefts around here? I don't know, but I have to believe, as thoroughly as I've searched, that Peppy was stolen. B.M.

Pitt County Sheriff Ralph Tyson agrees with you that there are some dog thefts going on in Pitt County. Most of the dog theft reports his department gets are about hunting dogs, he said. About three years ago, he said, it was worse than it is now, but one or two arrests made at the time appeared to weaken the trend.

He asks that all suspected dog thefts be reported, because the solution of one could lead to the solution of another. "We'll put out the word and be on the lookout all over the county," he said. He also asked that anyone having information about anyone who's stealing dogs contact his department. This information will be kept confidential.

Greenville Police Chief Glenn Cannon says his department has had few, if any, dog theft reports in recent months, but has assisted with locating some lost dogs. The department is glad to render this assistance to citizens, he said, and would like to be made aware of any suspected thefts and provided knowledge about any individuals or groups believed to be stealing dogs.

Sheriff Tyson adds that prevention is more effective than searching and suggests that owners have their identity tattooed on the dog by a veterinarian and that purebred dogs not be left unattended.

Anyone finding a lost dog is asked to report it to law enforcement offices and/or to the Pitt County Humane Society, 752-9922 (Barbara Haddock) or 756-4867 (Elizabeth Savage). Those having lost dogs should also check with the Humane Society.

The owner of a dog wearing a Pitt County rabies tag can be traced by calling in the number on the tag to the Animal Control Section of the Pitt County Health Department, 752-4141.



Signals To Resume

TRAFFIC SIGNALS RE-INSTALLED — Lawrence Boone of the traffic services division of the North Carolina Department of Transportation, wires a signal over the intersection of Evans and 14th streets Tuesday. Supervisor Pete Edwards said the signals are the same units that were removed

when the street improvements were made recently. Edwards said the timing of the lights will have a protected left turn when the traffic warrants. The lights are expected to be placed on "blink" in the near future. (Reflector Photo by Tommy Forrest)

Reagan Invites O'Neill For Summit Meeting On Budget Agreement

By MAUREEN SANTINI
Associated Press Writer

WASHINGTON (AP) — With negotiations to find a compromise on his 1983 spending plan apparently at an impasse, President Reagan has stepped into the controversy by inviting House Speaker Thomas P. O'Neill to a budget summit.

Reagan telephoned the Massachusetts Democrat on Tuesday to propose the rare session. The call was placed about an hour after the latest of 13 meetings between White House and congressional negotiators broke up without agreement.

O'Neill — en route to his suburban Maryland home when call was placed — returned it from his house and accepted Reagan's invitation. They agreed to meet at the Capitol in the early afternoon.

Even before the meeting began, Democratic and Republican budget negotiators offered somewhat different interpretations of how apart Reagan and O'Neill are.

Sen. Ernest Hollings, D-S.C., said on the NBC-TV "Today" show he was not optimistic that the meeting would produce a breakthrough.

"I don't think we're going to get one. ... I'm very hopeful, but not optimistic," Rep. Robert Michel, interviewed on the same program, said he thinks "there's a good possibility they can come to agreement on some items."

He acknowledged, however, that on other issues "there would be serious disagreement."

Earlier, O'Neill urged the president to "face up to the fact that the Reagan economic program is not working and needs to be overhauled." The speaker said Reagan should stop searching for

"new alibis" and "stop passing the buck."

At the White House, deputy press secretary Larry Speakes disputed the contention that the budget negotiators had all but failed. He said they had made "substantial progress in the weeks and days we have been talking."

Speakes said negotiators had "narrowed the range of differences on most major issues ... The major difference is taxes — how much and what kind."

But Christopher Matthews, an aide to O'Neill, said, "Social Security is still in dispute." Another Democrat, speaking anonymously, said, "Nothing has been agreed to."

And Senate Finance Committee Chairman Bob Dole of Kansas, a negotiator, issued a statement saying: "Whether we meet again will be up to the president and the speaker and the decisions that only they can make."

Senate Majority Leader Howard H. Baker also will attend the meeting with Reagan and O'Neill, along with White House Chief of Staff James A. Baker III, Treasury Secretary Donald Regan, Budget Director David Stockman, House Majority Leader James Wright, House Rules Committee Chairman Richard Bolling and others.

House Republican Whip Trent Lott of Mississippi, a negotiator, said the group needed some guidance from Reagan and O'Neill.

"We need some direction from our principals, that's the basic point," Lott said. "Maybe a little cooling off time by the negotiators would be worthwhile."

On the tax issue, Lott said negotiators "could not talk about those numbers any further. And it was really up

to the president and the speaker — two great Irishmen — to sit down and see if they could work out some agreements."

He predicted, "It's going to take real effort on their part" to make more concessions than the negotiators were willing to make.

According to Speakes, Reagan is holding firm on his three-year tax cut plan, but is open to other tax hikes in an effort to reduce the deficit. The latest worksheet envisions a 1983 deficit of between \$105 and \$110 billion.

For the Democrats, the Social Security issue remained unresolved. But sources said House Democrats were prepared to back a plan to give a 5 percent cost-of-living increase to Social Security recipients in 1983 and 1984 in exchange for concessions from Reagan on taxes and on other matters.

Commencement

ECU News Bureau
East Carolina University will confer degrees upon 3,044 students at its 73rd annual commencement May 8 in Ficklen Stadium.

The graduation list — subject to outcome of final exams and grades this week — was presented to the board of trustees by Dr. John D. Bridgers, chairman of the academic affairs committee, and approved. Bridgers said the list includes 2,176 candidates for bachelor's degrees and 868 for graduate degrees, including 36 doctorates of medicine.

Allan W. Ostar, president of the American Association of State Colleges and Universities, will be the commencement speaker.



Fall Fashions

BLASS FASHIONS - Models display some of Bill Blass' 1982 collection for fall and winter in New York earlier this week. (AP Laserphoto)

DAR Congress Held In Nation's Capital

The 91st Continental Congress of the National Society, Daughters of the American Revolution was held at Constitution Hall, Washington, D.C., April 20-24.

The President General, Mrs. Richard Denny Shelby, presided at the conference. Dr. Fred C. Ikle, under secretary of defense for policy, was keynote speaker Thursday. His topic was "The Defense Policy of the Ronald Reagan Administration."

In her report, Mrs. Shelby told of the progress of her project "A Legacy Preserved." On Friday members attended the annual pilgrimage to the Tomb of the Unknown Soldier and Mount Vernon. Mrs. Shelby was assisted by Mrs. Thomas Martin Egan, chaplain general, in wreath laying ceremonies. A memorial service for deceased members followed at Constitution Hall.

Many of the North Carolina delegation attended the national defense luncheon and the American Indian breakfast and assisted at the North Carolina-Alabama tea Friday afternoon. They also acted as hostesses at the North Carolina room where

the gamiture set given by Mrs. A.B. Stoney of Morganton was displayed. Mrs. Rhoderick T. Williams and Mrs. Jack Riley were delegates from the Major Benjamin May Chapter of Farmville. Mrs. Donald McLane, Mrs. D.W. Johnson and Mrs. Wetzel Smith represented the Susanna Coutanch Evans Chapter in Greenville. Mrs. Smith was a page at the congress.

Homemaker's Haven

By Evelyn L. Spangler
Pitt Home Agent

Potpouri Of Home Care Ideas Ceramic Tile

Ceramic tile scratches easily, but fortunately, it can be cleaned with water and a sponge. If a build up of soap scum occurs, add one teaspoon washing soda or packaged water softener to the cleaning solution. Nonabrasive cleaning powders may also be used. Be sure to remove all traces of the cleaning agent. To do this, flood a small area at a time and sponge up the water quickly. This action causes the dirt to float off instead of remaining in the grout.

Stained grout is practically impossible to restore. If scouring powder and a stiff brush won't do the job, try rubbing the joints lightly with a folded piece of sandpaper. Or treat the area with a weak solution of water and oxalic acid.

One caution: the acid solution is a severe treatment which causes etching of the grout and removes the top layer. No more than two applications of this solution are recommended unless regrouting of the tile is the only other alternative.

Chromium
Plumbing fixtures, appliances, and even some furniture are chromium plated. These items need gentle care because chromium is easily scratched by abrasive

household cleaners and metal polishes.

Usually the only care that chromium requires is rubbing with a damp cloth, followed by polishing with a dry, soft cloth. Sticky chromium usually responds to a washing with detergent and water. A

liquid household cleaner or baking soda on a cloth should remove gummy buildup. For stubborn spots, make a paste of whiting, or fuller's earth, and household ammonia. Apply the paste with a soft cloth and rub. Never use abrasives; they will scratch chromium finishes.

Eastern Electrolysis
133 OAKMONT DRIVE, SUITE 6
PHONE 756-4034, GREENVILLE, N.C.
PERMANENT HAIR REMOVAL
*CERTIFIED ELECTROLOGIST



If You're Tired Of Paying Too Much, Shop Tom Togs Mill Outlet

Let Us Help You Stretch Your Dollars Sale Now In Progress New Spring Arrivals Daily

Men, Ladies, Children, Infant Department

Our Aim Is To Please Our Customers - That Is Why We Have Merchandise Priced To Beat Our Competitors.

We Have First Quality And Factory Irregulars Such Names As Saxon • Osh Kosh • Carol Richman Castle Square • Pizzazz • Poly May Originals Many More To Choose From

Come See What You've Been Missing

Hours: Mon-Sat 9-5
Hwy 64 East & 42 Between Bethel & Tarboro
We accept Visa & MasterCard

Dear Abby



By Abigail Van Buren
© 1982 by Universal Press Syndicate

Bubble Gum Bothers Workers

DEAR ABBY: Our daughter is engaged to marry a nice young man she met in college about a year ago. I'll call him Doug. He lives in a nearby town (70 miles away), but we've never met his parents. The kids are planning to be married in September but haven't set the date yet. I don't want to seem snobbish, but according to etiquette, Doug's parents are supposed to make the first move and invite us over to get acquainted. So far we have not heard from them. We "met" over the phone just to say hello when the kids were here and told us they were getting married. I imagine Doug's parents aren't aware that it's their place to call us. Should we tell our daughter to tell Doug to tell his parents to call us? We don't want to start off on the wrong foot.

STICKY PROBLEM

DEAR STICKY: Common sense, consideration and kindness are more important than etiquette. Don't wait for Doug's parents to make the first move. Call and invite them to come and meet you.

DEAR ABBY: A co-worker was ordered to quit smoking in the office after several of us complained to the boss. (She was a chain smoker.) Now she chews bubble gum instead, and the constant cracking and popping of her gum is driving us crazy. Can you believe a woman in her 40s chewing bubble gum all day in an office? I think she does it just to bug us.

When we ask her to please keep the noise of her gum-chewing down, she says, "What do you want from me? I can't smoke because you complained, and I have to do something!" Any suggestions?

GOING CRAZY

DEAR GOING: Complain to the boss about bubble gum. A person has no more right to subject co-workers to irritating noises than to air pollution.

DEAR ABBY: I am writing to thank you for the most wonderful Christmas I've ever had. I don't expect you to remember me, but my name is Phil and I'm 43. I stood in line at Macy's in San Francisco last December to buy a copy of your book, "The Best of Dear Abby." I asked you to autograph it to Tim - my lover of many years.

I gave it to Tim for Christmas and we read it together. After reading Chapter 5, "The Homosexual Hassle," I immediately bought another copy of your book and sent it to my parents, asking them to read Chapter 5 very carefully. You see, Abby, my parents disowned me 18 years ago because I told them I was gay and they just couldn't handle it.

To make a long story short, my parents agreed to meet me at my sister's house in San Leandro - the first time in 18 years! And yes, I brought Tim along. My mother loved him, and my dad actually talked to Tim and me as though we were real human beings. I couldn't believe it! It took 18 years, a \$10 book, and you, Dear Abby, to make my parents understand and accept my gay lifestyle.

A simple "thank you" is not sufficient. You will never know what you did for me, Tim and my family. As melodramatic as it may seem, you brought a family together. God bless you. Your rewards will be eternal. The names are real and you may use any part or all of this letter.

PHIL IN SAN FRANCISCO

DEAR PHIL: Thank you. Your letter made my day.

Truckload Sale at Belvoir Manufacturing

Men, Ladies, Children And Infant Wear

Tuesday Only

9:30 A.M. To 4:00 P.M.

Hwy. 33
Belvoir, N.C.

WE'RE CHANGING

With... **New Products
Special Prices
And
New Ownership**

NEED A CHANGE TOO??

In... **Appearance
Weight Loss
Health**



Our professional staff is ready to help you

make these changes happen.

Call Today!

PROFESSIONAL DIET CONTROL

230 Greenville Blvd.
Located in Tipton Annex
756-8882

Reduce heat loss from mobil homes with insulated underskirting around the bottom of the exterior frame.

A hot water bottle that has sprung a leak can be repaired using inner tubepatching materials.

Littons Lowest Price Ever On An Electric Touch Control Microwave Oven Save \$150.00 This Litton microwave oven saves space on the counter and in your budget.



Model 1041

- Litton's Exclusive Meal-In-One cooking performance
- 700 watts cooking power
- Large 1.3 cubic foot oven cavity
- Variable Power Control
- Automatic Temperature Control
- Electronic Touch Control

Nobody Knows More About Microwave Cooking Than Litton. \$399

Financing Available
Henry Tyson Electric Service
Appliance Sales And Service
202 N. Railroad St.
Winterville
(Beside Rays Barber Shop)
756-2929

Belk Tyler
carolina east mall greenville



A Sunny Savings on a 3-Piece Solid Wood Furniture Set!

This deliciously warm combination table and chairs set speaks well for your home. Using this wonderful trio, you can have a cup of coffee or a tasty meal. This furniture will last for years and one day become a real treasure. In solid wood only. Choose from oak, pine or maple finish. The table has a formica type finish to resist burning or staining. Extra chairs, buffet and hutch to match are available through a special order. Don't miss this bargain buy!

Regularly: 225⁰⁰

Sale: **164⁸⁸**

Shop Monday Through Saturday 10 a.m. Until 9 p.m. - Phone 756-B-E-L-K (756-2355)

Walters-Gray Vows Spoken

LILLINGTON — The Lillington Presbyterian Church was the setting for the April 18 marriage of Diane Marie Gray and Edward Thomas Walters. The three o'clock candlelight ceremony was performed by the Rev. Robert Temple.

The bride is the daughter of Mr. and Mrs. Robert Alton Gray of Lillington. Parents of the bridegroom are Mr. and Mrs. Thomas Harold Walters of Fayetteville. The bride is the granddaughter of the late Mr. and Mrs. Henry Abram Gray of Stokes.

A program of nuptial music was provided by Gwen Sherman, organist, and Margaret Hightower of Lillington, vocalist.

Escorted by her father, the bride was given in marriage by her parents. She wore a white satin gown with pearls and embroidered alencon lace which adorned the bodice and accented the sweetheart neckline and waist. The three-quarter length puff sleeves gathered into flat satin ruffles which touched the shoulders. The gathered skirt extended into a chapel train. Her veil of silk illusion featured an alencon lace Juliet cap. She wore her mother's pearl necklace and carried a cascade bouquet of silk white rosebuds, gardenias and lily of the valley with touches of stephanotis and ivy, tied with satin and lace streamers.

Carol Dean Walters of Fayetteville was matron of honor. Bridesmaids were Debbie Gray of Willow Springs, sister-in-law of the bride, Susan and Beth Walters of Fayetteville, sisters of the bridegroom, Kathy Gower of Dunn, Joy Barham of Lillington and Joette Horton of Raleigh.

Honorary bridesmaids were Peggy Brockman of New Albany, Ohio, Carolyn Gore of Fairfax, Va., Karla Horton of Raleigh, Cyndy Muters of Brevard, Lynne Scott of Roanoke Rapids, Carolyn Whitford of New Bern, Kathy Woody of Raleigh and Donna Wyckoff of Angier.

The father of the bridegroom was best man and ushers were the bridegroom's brothers, Rob and Chris Walters of Fayetteville, the bride's brother, Robert Gray of Willow Springs, Clyde Johnson of Statesville, Charlie Sherrad of Raleigh and Eric Vestal of Gastonia.

Sue Horton of Raleigh and Carol Chappell of Sanford presided at the registers. Ann Bethune of Lillington distributed wedding bulletins. Dorothy Hales of Lillington directed the wedding.

A reception was held at the home of the bride and was directed by Jean Farrar of Lillington. Guests were received by the bridal couple and their parents. Mrs. Clyde Brooks directed guests to the reception area. Debbie Gray presided at the bridal register. Dorothy Barham and Meta Adcock served wedding



Mrs. Edward Thomas Walters

cake and poured punch. Charlotte Whitford of New Bern, Jane Lanier of Lillington, Lucille Uzzell of Charlotte and Christian Swiers of Bules Creek assisted.

The bridegroom's parents gave a rehearsal dinner at The Barn, Fayetteville. A bridesmaids brunch was held Saturday morning at the home of Jennie Brooks in Dunn.

The bride received her B.S.B.A. from East Carolina University and is employed by the NCR Corp., Raleigh. The bridegroom received a B.S.B.A. from ECU. He is owner of Walters Home Security, Raleigh, and is associated with his uncle at Handyman Hardware.

The couple will be living in Raleigh following a wedding trip to Bermuda.

Officers Elected

The Prospective Eastern Carolina Chapter of Sweet Adelines, Inc. elected officers Thursday. Mary Koonce will be serving as president.

Other officers are: Janet Rodgers, vice president; Violet Blackwelder, secretary; and Etsil Mason, treasurer. Members of the board of directors are Ms. Blackwelder, Peg Cetera, Laural Hill, Retha Johnson, Ruth Shaw and Helen Walter.

Sweet Adelines is a non-profit organization for women who sing four-part barbershop harmony. The chapter here meets each Monday at 7:30 p.m. at The Memorial Baptist Church.

Pete's Upholstery
758-5488

Engagement Announced

Mr. and Mrs. Ernest Watson of Greenville announce the engagement of their daughter, Delores R., to William A. Jones, son of Mrs. Annie Jones of Plymouth and the late Mr. Ernest Jones. A May 8 wedding is planned.

Surprise Party Held Saturday

John Ward Jr. and Howard Pearce entertained their wives, Marjorie and Yvonne, at a surprise birthday party Saturday evening at Courtney Square club house.

Special guests attending were the Rev. and Mrs. J. Earl Williams, Mr. and Mrs. Cleveland Lewis, Gregory Ward, Ida Speight, Maggie Ward, O.Z. Ward, Minnie W. Hopkins, Charlie Ward, Mr. and Mrs. Alston Lane, Lucinda and Marietta Neverson, Murdis Gay, Brenda Gay and Dr. Lee Trent.

Approximately 110 relatives and friends attended.

When bathing a cat or a dog in the tub, a piece of steel wool placed in the drain opening will catch any stray hairs and prevent clogging of the drain.

Bridal Policy

A black and white glossy five by seven photograph is requested for engagement announcements. For publication in a Sunday edition, the information must be submitted by 12 noon on the

Microwave Class Set

A basic microwave cooking program has been scheduled for May 13 by the Agricultural Extension Service, 1717 W. Fifth St.

The class is for new microwave oven owners and has been designed to help persons understand how to operate and cook with the microwave. Filmstrips, displays and exhibits about microwave, along with sampling foods prepared in class will be included.

The class will be conducted by Addie R. Gore, home economics agent, from 9:30 a.m. until noon and again from 7-9:30 p.m.

Call 752-2934, extension 370, by noon May 10 to register for the class.

Joseph's
For IBM Typewriter Service
Fastest, Cheapest, Local
752-0545
place ad on typewriter

preceding Wednesday. Engagement pictures must be released at least three weeks prior to the wedding date. After three weeks, only an announcement will be printed.

Wedding write-ups will be printed through the first week with a five by seven picture. During the second week with a wallet size picture and write-up giving less description and after the second week, just as an announcement. Wedding forms and pictures should be returned to "The Daily Reflector" one week prior to the date of the wedding. All information should be typed or written neatly.

Ayden News

Mr. and Mrs. J.T. Martin of Haw River were local visitors Saturday.

Mrs. Ed Tucker of Raleigh spent several days last week with her parents, Mr. and Mrs. Harry Stillman. Stillman was a patient in Pitt Memorial Hospital last week.

Mr. and Mrs. Reid Coward spent the weekend with Mrs. Blanche Coward.

Mr. and Mrs. Charlie Tripp Jr. spent the weekend in Apex.

Gertrude Coward spent the weekend with her mother, Blanche Coward.

Mr. and Mrs. Curtis Barfield of Plymouth spent the weekend as guests of Mrs. Mary T. Mayo.

Rubbing new golf clubs with clear shoe polish will preserve the shine and prevent early rust and corrosion.

A few pieces of blue carpenter's chalk in a tool box will absorb moisture which can cause tools to rust.

fun favorites

Ladies 6 1/2-10
Navy or Beige
Fabric.



Reg. 10.95

only...

\$7

Girls 9-4
Ladies 4 1/2-11
Brown
Genuine Leather



Reg. 9.95

Shoe Show

Greenville Square Shopping Center

Belk Tyler

carolina east mall greenville

Give Your Budget A Break! Shop Our Handy Gadget Sale!

Are you always putting off buying useful items to make your life a little easier because they are too expensive? Now is your big chance to stock up and save on bunches of useful little gadgets like a Swedish meatballer, salad scissors, tomato wedger, lid and spoon rest, apple and pear divider, 4-sided grater tin, trivet, salad drier, plastic chopping board and much more. Hurry in today!

 S.S. & NYLON POT SCRUBBER w/tray	 TRIVET Assort. Colors	 MIXING BOWL 3 QT. CAP.	 SALAD DRIER	 PITCHER 1/2 Gal Cap. Plastic	 HOUSEHOLD ORGANIZER W/TRAY
 LAYER CAKE PAN 10"x11" with lid	 SERVING TRAY METAL 13"	 PLASTIC STRAWS	 4 SIDED GRATER TIN	 MIXING BOWL 2 QT. CAP.	 TUMBLERS 5/2 30 OZ. PLASTIC
 SALT & PEPPER SHAKER	 APPLE & PEAR DIVIDER	YOUR CHOICE 88¢		 SUGAR DISPENSER	 PLASTIC CHOPPING BOARD
 STANDING CLIPBOARD	 LID & SPOON REST			 PAINT BRUSH 2"	 BELT HANGER
 GRAPEFRUIT SPOONS SET OF 2	 4 P.C. PLASTIC GADGET SET: Scoop, Funnel, Tea Strainer and Egg Separator	 TOMATO WEDGER	 LAUNDRY HOOKS	 LOAF PAN 6 X 3 1/2 X 2	 SCOOP Set of 3 PLASTIC
 DOUBLE HOOK with Strong Adhesive Back	 VINYL SHOPPING BAG	 LARGE PUSH PINS 5/10 Assort. Colors	 ICE TONGS	 RINGS & THINGS Hldr. Assort. Colors	 KITCH. UTENSIL HOLDER
 CAKE RACK 5/2	 CANAPE TRAYS-SET OF 2	 COOK'S MEASURE	 SALAD SCISSORS, Clear Plastic	 PLASTIC STRAINER SET	 SWEDISH MEATBALLER

Shop Monday Through Saturday 10 a.m. Until 9 p.m. — Phone 756-B-E-L-K (756-2355)

Springtime is..

a beautiful collection of dresses and sportswear from **J.G. Hook**

also accessories & espadrilles from Hook.

and remember... **Matthew Hertzberg** will be in our store on **May 17, 18 & 19** to pick up your furs for storage.

C.H.F. HOOK

C. HEBER FORBES
Evans Mall

Vote Right Needs Using

Somewhere in the land there are people saying they are concerned about minority voting rights and their answer is a "march" on Washington. We hear it said there is a matter of fear a weakened version of the 1965 Voting Rights Act may be passed in the Senate.

Still, if those people are really concerned about voting rights they could use their time more effectively by organizing voter registration drives in their own backyards.

They had an object lesson in a nationally distributed picture of a little Louisiana lady (age 113!) registering as a voter for the first time. She was registering to please a friend. Somehow, "marching on

Washington" over the past decades just didn't impress her.

The roadblock today that prevents any group of voters from exercising its full political power is not oppression, but its own failure to register to vote.

It is not just a minority failure to register that concerns us, a dreadfully high number of all citizens regularly ignore their right, privilege and duty.

Remember El Salvador's recent elections? A turnout that dwarfed anything we know about in this country flocked to the polls. They defied threats, bombs, guns and a leftist-ordered boycott. Voting meant a great deal to them. How about us?

Unemployment With Us

The unemployment rate in North Carolina hit 9.7 percent in March. It was higher than the national unemployment rate and the highest rate since the recession of 1974-75.

The high rate was partially attributed to the large amount of textile and furniture manufacturing in North Carolina.

Furniture manufacturing has been affected by the slowdown in housing sales, and textiles have

been affected by slumping auto sales and other factors.

The drop in those industries has had its effects on down the line.

There is obviously not a lot that can be done short term to improve the situation at the state level. The state industries will recover when the national economy snaps back.

For the long range North Carolina might look at ways to increase employment in sectors that could better ride out future recessions.

THIS AFTERNOON

New Ill-Will High

By PAUL T. O'CONNOR
RALEIGH — When the U.S. Justice Department rejected North Carolina's redistricting plan for the state House last week, the ill-will level between the two sides may have hit an all-time high.

State lawyers and legislators said Justice had gone back on a deal and openly questioned whether Justice had any plans of ever ending the redistricting mess.

At issue was a single-member House district formed in the Fort Bragg area of Cumberland County. In February, state lawyers told the Legislature that Justice was recommending a single-member House district comprised of Fort Bragg and two Fayetteville precincts. Because few base residents vote in North Carolina, it was felt that the two predominantly black precincts would control the district election and send a black to the House.

In rejecting the House plan under the 1965 Voting Rights Act, the Justice Department specifically cited Cumberland County, however, Justice said more single-member districts could be formed there. State attorneys and law makers immediately said Justice was hedging on the deal they had offered only two months before. "Lack of integrity" was the phrase most often used to describe Justice's action.

Gerry Cohen, a lawyer on the Legislature's staff, began work last Tuesday on a plan for further dividing Cumberland to suit Justice. The

best black concentration he could find, he told House leaders, was about 45 percent. To date, Justice has said that when blacks could form 55 to 60 percent of a House district, one should be drawn for them.

Cohen's findings left legislative lawyers horrified. If Justice was going to come back and say black districts had to be drawn everywhere a 45 or 50 percent concentration could be found, the House plan might have to be scrapped. Lawyer Bill Hale pulled out a map and pointed at Edgecombe County, which has a 51 percent black population. He also looked at Warren and Vance counties and wondered if some kind of 45 percent black district couldn't be drawn there.



PAUL O'CONNOR

Justice hasn't mentioned those counties yet but the fear among the lawyers was that Justice was playing games with North Carolina — that if the Legislature bent

to Justice wishes in Cumberland, Justice might find other places to complain about later and reject the plan again. That kind of thing could go on forever. As assistant State Attorney General Jim Wallace said, "I can't help but think that they have additional objections in reserve."

Wallace said he had two theories on the reasons behind Justice's actions. First, that North Carolina Republicans, who want as many single-member black

(Continued on page 5)

Other Editors Say Notable Strides

(Henderson Dispatch)

Protection of mankind's environment is among the most important challenges facing the world today. There are few who would dispute that reality.

Impressing upon all citizens the need for such protection is one of the objectives of Earth Day, marked Thursday of last week.

In conjunction with the 1982 observance, North Carolina Human Resources Secretary Sarah Morrow and Natural Resources and Community Development Secretary Joseph Grimsley called attention to a number of significant strides made in North Carolina since the previous Earth Day.

Those advances are noteworthy and should be gratifying to most Tar Heels:

— Last summer the General Assembly passed the Waste Management Act of 1981, which established a citizens board to develop a long-range plan for managing North Carolina's hazardous and low-level radioactive wastes.

— North Carolina recently became the second state in the country to receive federal authorization to issue permits for hazardous waste treatment, storage and incineration facilities.

— In the last 12 months the state monitored and inspected more than 1,000 industries in North Carolina that generate at least a ton of hazardous waste per month.

— Increased awareness of the importance of managing hazardous wastes has led to a record number of spills being reported in 1981, making possible quick containment and cleanup of most spills.

— The state continues to promote recycling of wastes into useful materials by offering tax incentives.

— North Carolina is one of only nine states authorized by the Federal Environmental Protection Agency to issue "Prevention of Significant Deterioration" permits for major new sources of air pollution of existing sources that are being modified.

In contrast with some other states, North Carolina has been fortunate in having generally excellent rapport among citizens, businesses and industries, and government agencies in the effort to treat the environment with the respect it deserves. As an example, it is said that 99 percent of the more than 4,000 companies with air permits were in compliance with their permit limits last year.

Strength For Today

VITAL IMPORTANCE OF THE GOSPEL
What do most people want in a sermon? Many want comfort. And comfort, indeed they should have, for the Bible is full of assurances of comfort. Many are seeking for light, since the glare of modern science has partially blinded them to the truths of divine revelation. Some few want to be entertained, but these drift quickly away from the church.
The great American preacher of the nineteenth cen-

BLESSED BE THE PEACEMAKER???



BY ART BUCHWALD

Concern Over The Cost

People outside of Washington say that those of us who live here don't care what a piece of defense equipment costs. We care a lot. Just the other night a group of us were sitting around Harry's Bar . . . Situation Room, and Hindenburg, a Pentagon purchasing agent, said, "I walked into an airplane shop today and guess how much they were asking for B-1 bombers?"

Massbaker said, "Ten billion dollars."

"Don't you wish it," Hindenburg replied. "The man who waited on me said he could not build one for less than \$20 billion."

We all whistled.

"Of course," said Hindenburg, "those are 1982 dollars,

but even so, I thought that was a lot of money. So I told the guy if he didn't come down in his price, I might only order 50. You know what he said?"

Nobody in the group did.

"He said if I only ordered 50, I'd have to pay double,

After he checked out the figures, he said, 'These planes are not going to cost \$20 billion. They're going to cost \$27 billion.'"

"You mean," said

Hellman, "he was making a stink over a lousy \$7 billion?"

Hindenburg said, "I couldn't believe it. He actually embarrassed the plane builder in front of me by accusing him of making the estimate too low so he could get the contract."

"What did you do?"

Massbaker asked.

"I told the GAO man to butt out, and it was none of his business what the actual cost of the B-1 would finally be. I said we needed them as a stop gap plane until the Stealth oomooer got off the drawing boards."

"Good for you" Groton said.

"The GAO bureaucrat claimed he worked for Congress and he was responsible for keeping defense costs in line, and while \$7 billion didn't seem to be a lot of money, there was a principle involved."

"What was the guy behind the counter doing?"

"He was in tears. He said it was unfair for anyone to expect him to build 100 bombers for \$20 billion, and if he thought Congress was going to hold him to that estimate, he would have never bid on the planes in the first place."

"I hope you took his side," I said to Hindenburg.

"Of course I did. What do you think I am — a whistle blower?"

(Continued on page 5)

because it cost so much to tool up for a bomber, that he only broke even on 50, and his profit came from every one he built after that."

"A few years ago," said Groton "you could equip the entire Air Force for \$20 billion"

"Well, it's a different world now," said Hindenburg, "and you're lucky to get a hangar for \$20 billion." "So did you order the planes?" I asked Hindenburg.

"I was about to when some wise guy from the General Accounting Office came in and said he wanted to go over the estimates. You know how picky those guys can be.

sector economy.

How do the next few months look? Henry Kaufman, economist for the investment firm of Salomon Brothers Inc., summarizes his views in an article entitled "Continued Economic and Financial Uncertainties."

Written as part of the company's quarterly investment strategy report, it is accompanied by this condensation:

"Strong financial support for this economic recovery continues to be lacking. The present national economic policy mix is likely to induce another economic stalling either late this year or in 1983."

"Nominal interest rates will continue to be highly volatile, which, in combination with large U.S. Treasury cash needs, will force long-term interest rates back up to their postwar peaks of 1981."

If uncertainty is the curse of the investing class, high interest rates are the death of them. Donald Regan, treasury secretary, knows it. "High interest rates," he said, "have brought the economy to its knees." We are, he conceded, "in a very deep recession."

This month two New York Stock Exchange companies

Baker Won't Lift The Lid

By ROWLAND EVANS and ROBERT NOVAK

WASHINGTON — Sen. Howard Baker has ignored a bipartisan appeal from four senators for a secret Senate session on the Soviet military threat, raising suspicions that the majority leader wants to keep the lid on alarming intelligence that would make it harder to reduce budget deficits by cutting defense spending.

Some defense officials say Baker fears the Defense Intelligence Agency (DIA) briefing on rising Soviet power would convert fence-sitters — perhaps even some outright opponents — into supporters of President Reagan's defense budget. Instead of welcoming the bid for a secret session, Baker has not even responded to the March 24 letter. Two Republicans, Sens. Paul Laxalt and Steve Symms, and two Democrats, Sens. John Glenn and David Boren, asked him to arrange the unusual closed-door briefing.

That performance casts doubt on the savvy majority leader's current devotion to the Reagan program. In his intense efforts to shape a bipartisan agreement on the budget, Baker has implied that he knows better than the president how much these spending cuts and tax increases should be.

What is unusual is not the closed-door session (there have been many in past years) but the information to which senators would be exposed. Three examples may explain why Baker has not agreed:

Example No. 1: At their current pace, the Soviets will double the nuclear warheads on their giant SS-18 intercontinental missiles in the next 18 months. This is the counterforce weapon that is the greatest threat to U.S. land-based missiles.

Example No. 2: The Soviets today have eight different types of submarines under construction at the same time; the U.S. has two.

Example No. 3: The Soviets have added slightly over 12 divisions to their army in the past year, only partly connected with vast new undertakings in Afghanistan. The full reason for the growth is unknown.

The DIA briefing would drive home to all senators these and other details of the Soviet military buildup, scrupulously documented. Its impact would be profound, but the letter from the four senators gathers dust on the desk of the majority leader. He would scarcely welcome the intrusion into the Senate debate of new political and military facts that might hurt the defense-cutting game.

When we asked Baker's aides for an explanation, they answered that an attic hideaway just below the Capitol dome could be made available for DIA briefings. This room, they said, is far more secure against eavesdropping than the Senate chamber. Senators could be briefed there in small groups for as long as necessary.

But that is not at all what is wanted by the four letter-writers and a growing number of other senators ready to join the request for the secret briefing. A closet in the attic would deprive the session of its essential element: the group dynamic of the whole Senate exposed at one time to the shock effect of the DIA briefing. As Glenn wrote his colleagues separately on March 4, "It is vital that every member" of the Senate hear the evidence.

The suggestion of Baker's aides that the Senate chamber is difficult to make secure has not bothered the Senate before. On four occasions in the last four years, the Senate has closed its doors to hear top-secret information dealing with the Panama Canal, arms sales to the Middle East and other sensitive matters.

(Continued on page 5)

Public Forum

Letters submitted for Public Forum should be limited to 300 words. The editor reserves the right to edit longer letters.

To the editor:

I would like to call public notice to Mrs. Jane Wilson, director of "South Pacific," to be presented by D.H. Conley High School April 29-30 and May 2.

For the past two and a half months, Mrs. Wilson has spent every minute turning regular everyday Conley students into Broadway stars! From chasing down stolen props to help choreograph dances, she has kept her sanity and smiles. She is not only our director, but our drama, chorus and dance teacher here at Conley.

We would like for everyone to know we appreciate all her hard work, though we don't always show it. All her hard efforts will certainly be rewarded, we assure her of that. We aim to make Conley's "South Pacific" the best musical ever presented in Pitt County. We would also like to thank Mr. Wilson for being gracious enough to share his wonderful wife with us. We love Mrs. Wilson!

Daune Mills, dancer
D.H. Conley High School

Uncertainty As To The Future

Statistics show that new businesses continue to be formed during recessions, but partly in desperation. Workers without jobs establish low-capital enterprises, but in despair rather than hope.

The failure rate, always high for new businesses, is likely to be even higher because of high interest rates. It costs at least 15 percent, usually much more to get a loan. How many new businesses, even without debt, can expect to earn 15 percent profit?

As many investment analysts have observed, why invest money, hard work and hard knocks in a new business when you put your money in the bank, do nothing, and earn more than you would in the new business?

And that, it seem, may be what's happening.

Consumer waits for producer and producer waits for consumer and both wait for government to come up with a budget while the Federal Reserve observes that until things improve it won't let up on the money supply.
End Adv Ppm Tuesday April 27.

The Daily Reflector

INCORPORATED

209 Cotanche Street, Greenville, N.C. 27834

Established 1882

Published Monday Through Friday Afternoon and Sunday Morning

DAVID JULIAN WHICHARD, Chairman of the Board
JOHN S. WHICHARD — DAVID J. WHICHARD

Publishers

Second Class Postage Paid
at Greenville, N.C.
(USPS 145-400)



SUBSCRIPTION RATES
Payable in Advance
Home Delivery By Carrier
or Motor Route Monthly \$4.00
MAIL RATES
(Prices include tax where applicable)
Pitt And Adjoining Counties
\$4.00 Per Month
Elsewhere in North Carolina
\$4.35 Per Month
Outside North Carolina
\$5.50 Per Month

MEMBER OF ASSOCIATED PRESS
The Associated Press is exclusively entitled to use for publication all news dispatches credited to it or not otherwise credited to this paper and also the local news published herein. All rights of publications of special dispatches here are also reserved.

UNITED PRESS INTERNATIONAL

Advertising rates and deadlines available upon request.
Member Audit Bureau of Circulation.

FOCUS

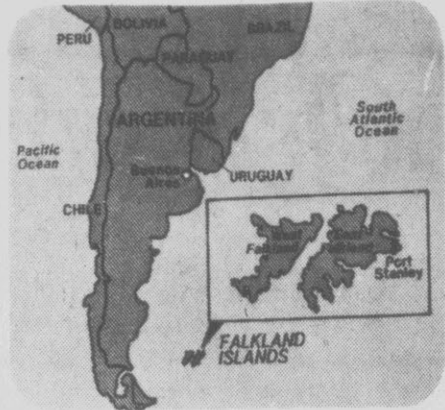

Roaring Lions and Shivering Sheep

Who'd want a place with no trees, few resources, constant winds averaging 15 knots, and where most of the inhabitants are sheep? Britain, France, Spain and Argentina! All four countries have haggled over the tiny Falkland Islands. In 1770 Britain and Spain nearly went to war over the islands, a foreshadowing of today's crisis. Even U.S. involvement has its historical antecedents, although today's shuttle diplomacy was, in 1831, gunboat diplomacy. When Argentine settlers on the Falklands seized three American sealing ships, the U.S. Lexington solved the sovereignty problem drastically. It levelled the settlement and proclaimed the Falklands free of all governance whatsoever.

DO YOU KNOW — What is the Argentinian name for the Falklands?

TUESDAY'S ANSWER — Chester A. Arthur succeeded Garfield as President.

4-28-82 © VEC, Inc. 1982

O'Connor Col... Contributions Pour In To Massacre Villages

(Continued from Page 4)
districts as they can get, are engineering the decisions. Second, Justice lawyers want to keep the situation here in turmoil so long that a federal judge will finally have to redistrict North Carolina's House seats.
If the Republicans are behind it, no one bothered to tell Sen. Cass Ballenger of Hickory. The probable Republican gubernatorial candidate got so angry about the plan's rejection that he said everybody at Justice ought to be fired. Taking more black voters out of Fayetteville's multimember district, however, would serve Republican interests by increasing the chance of electing a Republican there.
Regardless of Justice's intentions in backing away from the deal they apparently made, relations between the two sides have now soured. As Raleigh Rep. Al Adams, said, "When I'm negotiating for a client and I get him to make a concession and then I go to the other side and they ask for something else, that's when you stop negotiating."

SEOUL, South Korea (AP) — Koreans poured more than \$700,000 in donations into Uiryong county as funerals began today for 57 victims of a drunken policeman who rampaged through five villages with rifles and hand grenades before he killed himself.
Thirty-five others wounded by 27-year-old Woo Bum-kon were still hospitalized, and some were listed in critical condition.
Home Minister Suh Chung-hwa, whose ministry is in charge of the police, visited the area in southern Korea Tuesday to console the families of the dead and the wounded survivors, then submitted his resignation to atone for the shooting. President Chun Doo-hwan accepted the resignation today, naming Sports Minister Roh Tae-woo, a retired four-star general and close ally of

Chun, to replace him.
Prime Minister Yoo Chang-soon also offered his resignation, but Chun would not accept it.
As voluntary contributions for the families of the dead and the wounded flooded in, officials said government compensation also would be paid to them. Officials on Tuesday put the death toll at 58 but reduced it today by one.
Woo reportedly got drunk at a fight with his 25-year-old common-law wife, Chun Mal-soon, and took two carbines, 180 rounds of ammunition and seven hand grenades from an unguarded

police armory.
Then he made his way through five villages, firing the carbines and throwing grenades. After eight hours, he entered a farmhouse and killed himself and the three occupants with a grenade.
Mrs. Chun was among the wounded. A Seoul newspaper reported she said she angered Won by slapping flies from his chest while he was asleep.
The government also announced that the mayor of Seoul, Park Young-su, resigned because of a subway construction accident in the capital April 3 that killed 10 people. He was replaced by

Kim Sung-bae, a provincial governor.
It is customary in some Asian countries for high-level officials to resign as an assumption of responsibility for actions of their subordinates.

Cakes For Mother's Day

DIENER'S BAKERY
815 Dickinson Ave.

J.B.'s Island Seafood
Announces
New Summer Schedule
Open Tuesday Thru Sunday
Serving Dinner 5:30 to 10:30

J.B.'s Bar Opens 4:30 P.M.
Early Happy Hour 4:30-7:00
Beer & Wine At Reduced Prices
Late Night Happy Hour 11:00-1:00
All Cocktails At Reduced Prices

Dinner Specials Nightly

Sunday	Shrimp Night
Tuesday	Oyster Night
Wednesday	Fish Night
Thursday	Island Night — Steamed Seafood
Friday & Saturday	Chef Specials

Closed Monday

Located In
Rivergate Shopping Center
E. 10th St. Greenville
752-1275
"Our Specialty is Quality"

Evans-Novak ...

(Continued from page 4)
Now, with one month of Baker's silence behind them, the four senators have decided to move under Senate rules. They want to force a vote on the issue of a secret session before the defense authorization bill comes to the floor late this week.
Without such a move, the Reagan rearmament is imperiled. The bipartisan budget-makers on Capitol Hill working with White House chief of staff James Baker are not fighters for Reagan's attempt to restore the nation's defenses. Of the 18 lawmakers, only Republican representative Trent Lott and Democratic senator Fritz Hollings have any claim to defense expertise.
That leaves the defense budget vulnerable to the give-and-take of deficit-shrinking. Defense-cutter James Baker joins arms with defense-cutter Howard Baker in taking money from the military to induce the Democrats into

accepting a budget compromise.
The missing ingredient might well be the DIA's facts about the Kremlin war machine. The irony of Washington today is that the president has to hurdle his own majority leader to unveil them.
Copyright 1982 Field Enterprises, Inc.

Clean-Up Day By Association

The Tar River Neighborhood Association, the Sierra Club and the Greenville Appearance Commission will jointly sponsor a "Tar River Clean Up Day" Saturday from 10 a.m. to 1 p.m.
Persons interested in helping, and those with a canoe who would like to participate, can contact the project chairman at 752-4390.

Depot Invaded

ARMAGH, Northern Ireland (AP) — A gang of armed, masked men invaded a bus depot here early today and held two security guards captive while they planted bombs on 24 buses.
The buses blew up, and the men when they escaped left a car blocking the depot entrance. While bomb disposal experts checked the car, firemen couldn't get into the depot to fight the fire.

Buchwald Col. ...

(Continued from page 4)
"So did you give the guy the order?"
"I told him to go ahead and start tooling up, because I was certain even if he couldn't bring them in at the price promised, we'd dig up the money somewhere to get the job finished."
"It was the only thing you could do," Groton said. There isn't a man alive who knows what a B-1 bomber is going to cost until he actually makes one."
"What did the GAO guy do?" I asked.
"Be stomped out of the

shop in a rage and said he was going to report me to Congress."
"Big deal," someone said.
"Congress pays as much at-

tention to the General Accounting Office as James Watt does to the National Audubon Society."
(c) 1982, Los Angeles Times Syndicate

The Scotch Bonnet
NEEDLE ARTS STUDIO, INC.

Teneriffe Embroidery
Patterns, Materials, Free Instructions
Old Timey Stitchery For That Country Look

Open Wednesday Til 9 P.M.
602 Arlington Blvd. 756-4877

CALICO SQUARE

Quilt & Gift Shop
Mon. 10-5
Wed.-Sat. 10-5
Tue. 10-9
Across from the
Museum of Art
758-4317

Combine Calicos For
Cool Clothing And Quick
Quilts. Exciting Prints &
Solids. Low Prices.

Belk Tyler
carolina east mall • greenville

ONE DAY ONLY!

Entire Open Stock of 'Blue Canton' China at Elegant Savings for You!

20% OFF
Regular Prices

Beautiful 'Blue Canton' china early became a part of the heritage of many Americans. Exquisitely tasteful pieces are available in 5-pc. place settings. Plus cider jug, coffee pot and leaf tray. Spruce up your dining table with 'Blue Canton' today!

Shop Monday Through Saturday
10 a.m. Until 9 p.m. —
Phone 756-B-E-L-K (756-2355)

Belk Tyler
carolina east mall • greenville

Super Savings on Lovely Hardwood Furniture for You!

25% OFF

Your choice from our entire stock of all mahogany furniture made by Virginia Galleries, Hickory Chair, Carolina Craftsmen, Kittinger, and Madison Square. Select from dining tables and chairs, chests, trays and tea tables, secretary and many more pieces all made of the finest hardwoods. Treat yourself!

Tremendous Buy on All Upholstered Furniture

25% OFF

Select from our entire stock of upholstered loveseats, chairs and sofas made by Hickory Chair, Kittinger, and Laine. Some of the finest furniture in the area!

Shop Monday Through Saturday 10 a.m. Until 9 p.m. — Phone 756-B-E-L-K (756-2355)

Voting By Senators, Representatives

ROLL CALL REPORT

WASHINGTON — Here's how area senators were recorded on major roll call votes April 15-21. There were no record votes in the House.

TELEVISIONING THE SENATE — By a vote of 47 for and 51 against, the Senate refused to end a filibuster against a proposal to televise Senate proceedings to the American public. A three-fifths majority was needed to silence the talkathon against S Res 20. The measure would put the Senate on a par with the House, which makes live, gavel-to-gavel coverage of its activity available to cable TV outlets and film clips available to commercial networks and to congressmen for their own distribution.

Sen. Charles Mathias, R-Md., a supporter of Senate TV, said the American people feel increasingly victimized by government decisions they do not understand, and that the senate can ease this frustration "by making it possible for the average citizen to participate in the proceedings of the U.S. Senate."

Opponent Wendell Ford, D-Ky., said: "Let us not rush into action that would irreversibly convert the Senate chamber

into a television studio. Proceeding a step at a time, first to radio, and then later to television, if the facts support such a move, will not deprive the public of information."

Virtually all senators voting "nay" opposed moving immediately to televising Senate proceedings.

Sens. John East, R, and Jesse Helms, R, voted "nay."

DECORUM — The Senate rejected, 46 for and 51 against, an amendment requiring senators to be present at their assigned desks when they vote on roll calls. Senators vote orally, in contrast to House members who vote electronically via a computer system. Presently senators can state their vote from any point in the chamber, and critics say this creates disorder and diminishes the accountability of senators to their colleagues. The amendment was offered to S Res 20 (see preceding vote). Since it required a change in Senate rules, its adoption would have aided the cause of senators filibustering against Senate TV. When rules change is at issue, a 67 percent rather than 60 percent majority is needed to end a filibuster.

Sponsor Jennings Randolph, D-W.Va., an opponent of Senate TV, said: "If there is to be television in the Senate, the

public certainly has a right to see the members...in a posture of decorum and not milling around like players in a rowdy and unruly hockey match."

Opponent James McClure, R-Idaho, said fundamental changes in Senate rules would be processed through the Rules Committee and not piggybacked onto measures such as the pending one dealing with Senate television.

Senators voting "yea" wanted to require senators to vote from their desks, and many supporters also liked the amendment because it bolstered the filibuster against Senate TV.

East and Helms voted "nay."

Panelist Says Parole Board Not Informed Of Threats By Sirhan

By LINDA DEUTSCH
Associated Press Writer
SOLEDAD, Calif. (AP) — A member of the board that set a parole date for Sirhan Sirhan says the panel would have acted differently had it known that Robert F. Kennedy's convicted assassin made death threats from prison.

"I don't think there would have been a parole date set, to be honest with you," Manuel Quevado Jr., a retired parole board member, testified Tuesday before a parole board considering rescinding Sirhan's 1984 parole date.

But Quevado testified he believed his board was "locked into" the guidelines that led to the 1975 decision to set Sirhan's parole.

Sirhan has admitted he wrote a death threat to Robert Blair Kaiser, the author of a 1971 book, "R.F.K. Must Die," which suggests Sirhan might have been programmed by others to kill.

Official inquiries into that theory produced no evidence, but Kaiser testified Tuesday he still believes Sirhan was part of a conspiracy.

"It's still my belief that Sirhan did not think it up alone, and he was psyched into shooting Bob Kennedy," Kaiser said.

Kennedy was slain June 5, 1968, just after he won the California Democratic presidential primary, in the pantry of the Ambassador Hotel in Los Angeles. Sirhan, a Palestinian immigrant, was quoted by witnesses as saying, "I did it for my country," and it was later said he was angered by Kennedy's pro-Israeli policies.

Sirhan was sentenced to death, but his term was changed to life imprisonment after the U.S. Supreme Court overturned California's death penalty law. The parole board gave Sirhan a 1986 parole date, which was moved up to Sept. 1, 1984, because of his good behavior in prison.

Los Angeles County District Attorney John Van de

Kamp, who is running for state attorney general this year, began a campaign last year to have Sirhan's parole date rescinded, saying new evidence indicated Sirhan had vowed to kill Edward Kennedy if the Massachusetts senator were elected president.

Inside the walls of Soledad Prison, where Sirhan's future is being decided,

Kaiser told the parole board he predicts violence if Sirhan is released in 1984. He shifted nervously in his seat as Sirhan glared at him from across a table in the prison hearing room.

Kaiser said he began to fear Sirhan after seeing a 1971 letter from the prisoner. The letter warned if Kaiser kept "mouthing off" about Sirhan on TV, there would be trouble. "If he gets his brains splattered he will have asked for it like Bobby Kennedy did."

"RBK must shut his trap or die," the letter concluded. Sirhan's attorney, Luke McKissack, said the letter was written 11 years ago when Sirhan was a prisoner on death row. McKissack said Sirhan was merely venting his frustrations.

Asked by McKissack why he delayed reporting the letter, Kaiser bristled and said, "I had just wasted three years of my life writing the book and I was just sick of it, the whole thing."

Quevado, in his testimony, referred to the Kaiser letter and a threat by Sirhan in 1975 to kill prison officials if he was not provided with treatment for problems with his teeth.

"Those letters certainly would have made me uneasy," he said. Quevado insisted he and a fellow board member, James Hoover, were following specific guidelines in 1975 which required setting parole dates for life term prisoners.

"I was only carrying out the board's wishes and what the law was," said Quevado. "I felt we were locked into the guidelines."

Hoover, who chaired the panel that set Sirhan's date, also blamed the guidelines set down by former state prison chief Raymond K. Procunier.

"Unless you could specifically point to a negative factor," he said, "you would grant the parole."

He said he searched through Sirhan's prison records for negative reports but found none.

Guide For The Handicapped Now On File

An "Accessibility Guide for the Handicapped" for people living in Greenville is now on file at Sheppard Memorial Library. As a public service, personnel at the library will provide information contained in the handicapped file to anyone calling the library (phone 752-4177).

The accessibility guide has been prepared by students at East Carolina University who are majoring in rehabilitation counseling subjects. Dr. Sheldon Downes, chairman of the department of rehabilitation counseling, is coordinator of the project.

The guide, which consists of a series of cards, contains individual cards for churches, banks, businesses, restaurants, medical offices, government offices, libraries, food stores and other facilities surveyed.

Information contained on each facility includes notations on factors such as availability of entrance ramps, ramps or elevators to upper stories, widths of aisles and doors to facilitate use of wheelchairs, ease of accessibility to bath rooms and water fountains, and other factors essential to the handicapped when they go out into the public.

Data on the cards are kept up to date, and are revised as changes are made in facilities listed on the card files.

A Circus Is Coming To Farmville

FARMSVILLE — The Great American Circus is coming to Farmville for two performances Monday on the grounds of the Walter B. Jones Commons.

The circus, being presented as a community service project by the Farmville Jaycees, may be seen at 5:30 p.m. and again at 8 p.m. Tickets will be available at the gate prior to performance hours.

The Great American Circus, one of the few remaining circuses that travel to small towns and rural areas for one-day shows, rolls from place to place in 20 trucks and trailers carrying people, animals, equipment, seats, tents, props, musical instruments and costumes.

Among the performers of The Great American Circus are a group called the Pretty Girls; the tall clown Buck Nolan; Oscar Macias, who does a one-finger stand on a globe; Carlos Abraham, whose specialty is head balancing high above the audience; Captain Teak with his herd of Hoxie's trained elephants; Billy Martin and his precision balancing on the rolla bola; Ming Wong, the lady who hangs by her hair from the top of the tent, and Ian Garden Jr. who shows a trained dressage horse as well as other horses, ponies and dogs in center ring.

The Great American Circus also has the youngest ringmaster in the country, Billy Martin, and musician Dave Miller to provide circus music for the hour and 40-minute performance.

One of the major attractions of a circus coming to town is the arrival of the people and animals followed by the exacting coordination of work that goes into erecting the tent. The big elephants are the star workers in this display of planned precision, and the public may watch as these powerful beasts, guided by their handlers, get into place the canvas city that will go up on the commons on Monday morning.

UP IN SMOKE

WASHINGTON (AP) — American cigar makers exported more cigars to foreign customers than they imported in 1981, according to an industry report.

Total cigar exports amounted to 131.8 million, an increase of 5.2 percent over 1980, the Cigar Association of America says, with the United Kingdom (23 million) and the Netherlands (10 million) the biggest buyers.

Pic 'n Pay Shoes

Sale. 33% off women's genuine leather Brazilian tan sandals.



\$6 Eyelet purses. Reg. \$8.97

Greenville Blvd. on 264 By-Pass
Greenville, N.C.

Sale prices good thru Sunday. MasterCard or Visa. Open evenings

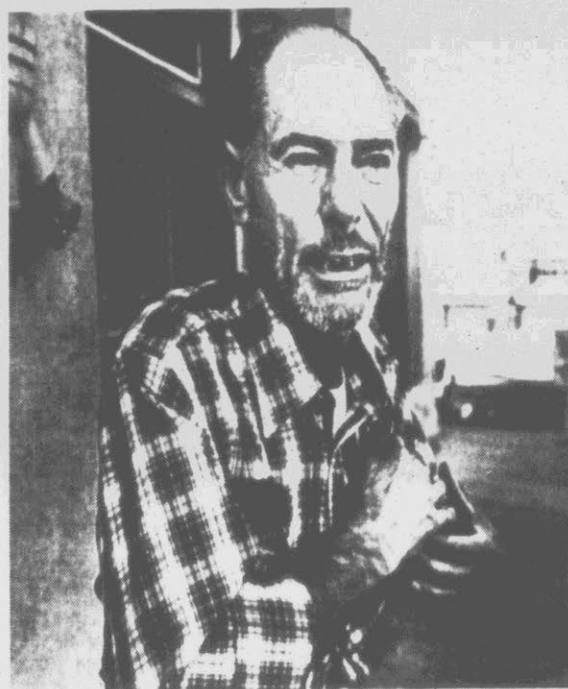

JACKPOT SPENT — Cecil Burns, who won \$400,000 earlier this month on a Las Vegas slot machine, is back on Seattle's Skid Road after spending \$300,000 of his windfall. He hasn't paid taxes on his winnings to the Internal Revenue Service, saying, "I already spent their money too." (AP Laserphoto)

Tryouts

for the

TRYON PALACE LIVING HISTORY

Production

Saturday, May 1, 10 a.m.-5 p.m.

Sunday, May 2, 2 p.m.-5 p.m.

Jones House

231 Eden Street, New Bern
Parts available for 1 female 16-25
2 males

Full summer employment
Please prepare a 3 to 5 minute audition
Further information call: Nancy Blades
919-633-3977

Belk Tyler

carolina east mall greenville

Beautiful Pfaltzgraff® Dinnerware Sale and Brides Free Honeymoon Special! Register Today!

25% OFF

Regular 2.40 To 110.00

Fabulous sale on all Pfaltzgraff® dinnerware sets and open stock. Choose from four classic stoneware patterns: 'Heritage', 'Village', 'Yorktown', and 'Folkart'. Choose from place setting pieces, serving pieces and a large selection of accessory pieces; each piece is oven, microwave and dishwasher safe.



SAVE NOW ON PFALTZGRAFF



Shop Monday Through Saturday 10 A.M. Until 9 P.M. — Phone 756-B-E-L-K (756-2355)

Belk Tyler

carolina east mall greenville

GORHAM SILVERPLATED FLATWARE

NOW ON SALE!

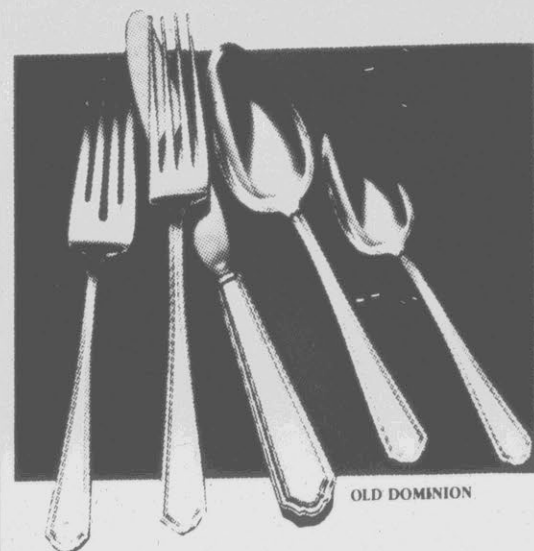

SAVE 25%

on any active Gorham Silverplated Pattern in four, five and six piece place settings. Also, 20% SAVINGS on Open Stock.

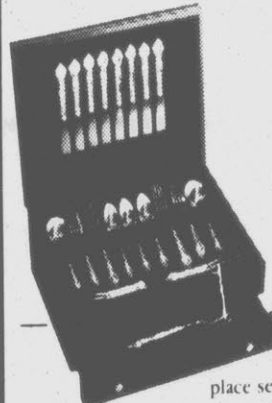

As a special bonus opportunity, receive a

SILVER STORAGE CHEST, FREE!

by special order
Gorham #831/1, a \$95 value with the purchase of a 45* piece set at a 25% SAVINGS.

*45 piece set (eight 5 piece place settings, cold meat fork, gray ladle, sugar spoon, tablespoon and pierced tablespoon.)

Shop Monday Through Saturday 10 a.m. Until 9 p.m. Phone 756-B-E-L-K (756-2355)

FREE HONEYMOONS. REGISTER HERE.



Register your favorite Pfaltzgraff stoneware pattern with our Bridal Registrar. And you and your new husband could win one of three glorious honeymoons in the Bahamas. Eight sunny days, and seven romantic nights.

Pfaltzgraff stoneware has been gracing American tables since 1811. Both beautifully practical and beautifully affordable.

So, come register your favorite pattern before July 20. That's the deadline for registration. Pfaltzgraff will announce the winners by August 1. Oh, there's no purchase necessary.

Collector

Wants To Buy Old Guns, Knives, Swords, War Relics, Medals, Hats, Helmets & Uniforms, Related Items.

Call Steve: 756-9322 Or 752-0800

After 5:30 P.M. Or Weekends

Seekers Of Homes Now Like Looks Of Love Canal

By JOHN C. GIVEN
Associated Press Writer
NIAGARA FALLS, N.Y. (AP) — A growing number of people are eager to move into the houses that hundreds of Love Canal residents fearful of chemical contamination were eager to vacate just a few years ago.

"People have been coming in for months and months," said Richard Morris, director of the Love Canal Revitalization Agency, which has been buying up the properties in the neighborhood since last year.

So far, according to Mayor Michael O'Laughlin, the "informal, unsolicited" list of potential buyers exceeds

130 names.

"The whole world's a chemical dump, so what's the difference?" said Florence Deyo, 34, who is on the list.

Authorities are awaiting the results of a \$5.5 million federal Environmental Protection Agency study of the neighborhood.

Families began leaving the area of the former Hooker

Chemicals & Plastics Corp. toxic waste dump after the state and federal governments declared health emergencies in 1978 and 1980.

Chemicals — including some known cancer-causing agents — were found to have migrated from the canal into the surrounding neighborhood. In 1976, the state purchased 276 homes from owners nearest the dump. These are slated for demolition this summer.

A second federal

emergency decree in 1980 led to the establishment of a \$15 million fund of mostly federal money for buying up to 555 more homes. So far, Morris said, his agency has purchased 401 of these at prices ranging from \$7,500 to \$90,000.

Ranch-style and wood-frame houses with boarded-up windows line the silent streets of this former middle-class neighborhood. Some houses have been vandalized. Others are occupied by owners who are still negotiating — or who refuse to leave.

Like the hard-core holdouts and Morris, who moved his family into a Love Canal house last summer, the prospective buyers apparently don't believe that all Love Canal homes are dangerous.

"I think there's health problems wherever you live, no matter where you go," Ms. Deyo said. "If I was so worried, my husband and I wouldn't take our six kids over there."

Clayton Miller, 63, also signed the list. "I don't remember seeing where anybody was proven to have suffered any effects. They tested a whole bunch of people, but I don't remember reading they proved it," he said. "I know a guy, retired, lived there a long time and he didn't have any effects."

Calling the Love Canal exodus "hysterical," Margaret Stewart, 73, said it was "a follow-the-leader thing. Those people who moved out wanted to get something out of it — money, honey."

Like many others, the three also said they were lured by the chance of finding a bargain property.

But they may be disappointed, Morris said.

"The fact is, we've got a lot of people who never sold their homes, who had their life savings invested in their property and it's all they have," he said. "We do not intend to undercut those who are remaining. We have a commitment to those who stayed throughout all this."

And nothing will be sold until the EPA report is released.

Officials expect to use that document to determine the areas where homes are safe enough to be sold.

"I do not believe the EPA report will offer a guarantee of a healthy life forever ...

But by virtue of the number of tests and samples they took, they'll be able to quantify what they found and where they found it," he said.

"Therefore, the Love Canal area will be the most

stringently tested environment anywhere I'm aware of. I've also maintained that when this is done, that it'll be the safest place in Niagara Falls, because you'll know exactly what's here and in what quantities."

Bid-Rigging Pleas Filed

ELIZABETH CITY, N.C. (AP) — Lawyers for seven companies and 10 executives entered pleas of innocent for their clients on charges of rigging bids on a Pasquotank County water project.

Pasquotank County Superior Court Judge Charles B. Winberry Jr., who accepted the pleas Monday, gave the defendants until May 24 to file motions.

A grand jury returned the indictments in connection with bids totaling \$7.6 million for a county water system.

Each defendant was charged with violating the state's antitrust law, a misdemeanor, and with a felony charge of conspiring to commit false pretense.

Those charged include Dickerson Inc. of Monroe and company officer Frank W. Carpenter, Propst Construction Co. of Concord and vice president Dewitt P. Hodges, RGK Inc. of Burlington and president Ronald G. Kirkpatrick, Byrant Utilities Construction Co. of High Point and president J. Lyndon Wall, T.A. Loving Co. of Goldsboro and company officers James Smith and Samuel P. Hunter, Hickory Sand Co. of Hickory and president Wayne H. Propst, and Kenneth W. Tucker, Jack H. Tucker and Harold R. Tucker, partners in Tucker Brothers Construction Co. of Pell City, Ala.

Each defendant was charged with violating the state's antitrust law, a misdemeanor, and with a felony charge of conspiring to commit false pretense.

Those charged include Dickerson Inc. of Monroe and company officer Frank W. Carpenter, Propst Construction Co. of Concord and vice president Dewitt P. Hodges, RGK Inc. of Burlington and president Ronald G. Kirkpatrick, Byrant Utilities Construction Co. of High Point and president J. Lyndon Wall, T.A. Loving Co. of Goldsboro and company officers James Smith and Samuel P. Hunter, Hickory Sand Co. of Hickory and president Wayne H. Propst, and Kenneth W. Tucker, Jack H. Tucker and Harold R. Tucker, partners in Tucker Brothers Construction Co. of Pell City, Ala.

Each defendant was charged with violating the state's antitrust law, a misdemeanor, and with a felony charge of conspiring to commit false pretense.

Those charged include Dickerson Inc. of Monroe and company officer Frank W. Carpenter, Propst Construction Co. of Concord and vice president Dewitt P. Hodges, RGK Inc. of Burlington and president Ronald G. Kirkpatrick, Byrant Utilities Construction Co. of High Point and president J. Lyndon Wall, T.A. Loving Co. of Goldsboro and company officers James Smith and Samuel P. Hunter, Hickory Sand Co. of Hickory and president Wayne H. Propst, and Kenneth W. Tucker, Jack H. Tucker and Harold R. Tucker, partners in Tucker Brothers Construction Co. of Pell City, Ala.

Three Vehicles In A Collision

An estimated \$3,200 property damage resulted from a three-vehicle collision about 5:20 p.m. Tuesday on Memorial Drive, four-tenths of a mile south of the Greenville Boulevard intersection.

Police Department investigators identified the drivers of the cars involved as Linda Faye Tripp and Rebecca Allen Covington, both of Winterville, and Thomas Darrell Patterson of Route 1, New Bern.

Damage from the collision was set at \$1,500 to the Tripp car, \$1,200 to the Covington vehicle and \$500 to the Patterson car.

Police Department investigators identified the drivers of the cars involved as Linda Faye Tripp and Rebecca Allen Covington, both of Winterville, and Thomas Darrell Patterson of Route 1, New Bern.

Damage from the collision was set at \$1,500 to the Tripp car, \$1,200 to the Covington vehicle and \$500 to the Patterson car.

Police Department investigators identified the drivers of the cars involved as Linda Faye Tripp and Rebecca Allen Covington, both of Winterville, and Thomas Darrell Patterson of Route 1, New Bern.

Damage from the collision was set at \$1,500 to the Tripp car, \$1,200 to the Covington vehicle and \$500 to the Patterson car.

Four Cars In Traffic Mishap

An estimated \$3,400 property damage resulted from a 3:10 p.m. collision Monday on Charles Boulevard, two-tenths of a mile south of the Charles Street intersection.

Drivers of the cars involved, according to police, were Felton Wallace Jr. of Route 1, Hookerton, Milissa Ann Bailey of Route 3, Greenville, Frederic Drew Lorber of Raleigh, and Donna Marie Parrish of 156 Jarvis Hall.

Officers, who charged Ms. Parrish with failing to see her intended movement could be made in safety, estimated damage at \$100 to the Wallace car, \$500 to the Bailey vehicle, \$1,200 to the Lorber car and \$1,600 to the Parrish car.

Drivers of the cars involved, according to police, were Felton Wallace Jr. of Route 1, Hookerton, Milissa Ann Bailey of Route 3, Greenville, Frederic Drew Lorber of Raleigh, and Donna Marie Parrish of 156 Jarvis Hall.

Officers, who charged Ms. Parrish with failing to see her intended movement could be made in safety, estimated damage at \$100 to the Wallace car, \$500 to the Bailey vehicle, \$1,200 to the Lorber car and \$1,600 to the Parrish car.

Officers, who charged Ms. Parrish with failing to see her intended movement could be made in safety, estimated damage at \$100 to the Wallace car, \$500 to the Bailey vehicle, \$1,200 to the Lorber car and \$1,600 to the Parrish car.

Officers, who charged Ms. Parrish with failing to see her intended movement could be made in safety, estimated damage at \$100 to the Wallace car, \$500 to the Bailey vehicle, \$1,200 to the Lorber car and \$1,600 to the Parrish car.

Officers, who charged Ms. Parrish with failing to see her intended movement could be made in safety, estimated damage at \$100 to the Wallace car, \$500 to the Bailey vehicle, \$1,200 to the Lorber car and \$1,600 to the Parrish car.

WILL BE FREED
CAIRO, Egypt (AP) — The Egyptian government says it will release more than half the 650 people still held under the state of emergency declared after President Anwar Sadat was assassinated last October 5.

EXTENDED WEATHER OUTLOOK FOR N.C.
Generally fair Friday through Sunday with highs in 70s in the east, 60s over mountains. Low in 50s with mainly 40s over mountains.

COMPARE OUR 30-60-90 DAY INTEREST RATE

00%

SAVE EVEN MORE WHEN YOU SEE BOSTIC-SUGG'S INTEREST FREE 30-60-90 DAY CASH PLAN - PAY 1/4 ON PURCHASE, 1/4 30 DAYS, 1/4 60 DAYS & 1/4 90 DAYS. NO FINANCE OR INTEREST CHARGES.

Clothing Warehouse **Jeans**

THURSDAY SPECIAL

Gloria Vanderbilt Jeans **\$24⁹⁹**

Watch For Daily Specials

Next to McDonald's On 264 By Pass Greenville, N.C. Phone 756-0857

Bostic-Sugg Furniture, Inc.

Our 43rd Year Furniture of Excellence

401 West 10th St., Greenville - 758-2513

Perfect Sleeper Model Changeover Sale

For a limited time you can get these specially priced Perfect Sleepers at even greater savings! We're making room for next year's models. During this sale, Serta offers the finest in sleep comfort, support and styling along with famous Perfect Sleeper construction and quality. Hurry on in and save now on Perfect Sleeper Signature II sets.

LAST CHANCE to buy this Perfect Sleeper below 1981 prices! SAVE \$190.00 to \$380.95 on sets.

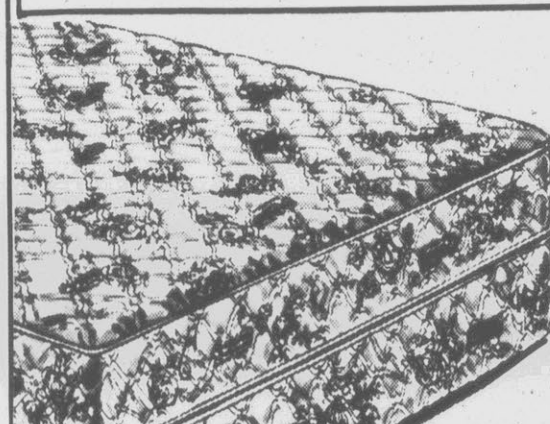

Serta Perfect Sleeper Signature II Extra Firm

TWIN SIZE PERFECT SLEEPER SIGNATURE II	FULL SIZE PERFECT SLEEPER SIGNATURE II
LIST PRICE \$439.99	LIST PRICE \$539.95
SAVE \$190.00 A SET	SAVE \$200.00 A SET
SALE PRICE \$249⁰⁰	SALE PRICE \$339⁰⁰
..... 2 PC. SET 2 PC. SET

Serta

Be certain it's Serta

SLEEP BETTER LIVE BETTER

*All savings are based on nationally advertised suggested retail prices. *Nationally Advised Suggested Retail Price

QUEEN SIZE PERFECT SLEEPER SIGNATURE II	KING SIZE PERFECT SLEEPER SIGNATURE II
LIST PRICE \$649.95	LIST PRICE \$879.95
SAVE \$270.95 A SET	SAVE \$380.00 A SET
SALE PRICE \$379⁰⁰	SALE PRICE \$499⁰⁰
..... 2 PC. SET 3 PC. SET

NUTMEG MAPLE FINISH BEDROOM PIECES AT SAVINGS OF 33% NOW!!

SAVE NOW AS NEVER BEFORE. ALL DRESSERS, CHESTS AND NITESTANDS HAVE MICARTS TOPS. RICH BROWN NUTMEG MAPLE FINISH. BRASS HARDWARE. QUALITY CONSTRUCTED.

Save \$95.00. Six Drawer Double Dresser And Landscape Mirror. List Price \$280. 2 To Sell	SALE PRICE \$185⁰⁰	Save \$27.50. Commode Nite Stand. 1 Drawer. 1 Shelf. List Price \$82.50	SALE PRICE \$55⁰⁰
Save \$47.50. Three Drawer Single Dresser And Landscape Mirror. List Price \$225. 2 To Sell	SALE PRICE \$150⁰⁰	Save \$52.50. Single Pedestal Student Desk. List Price \$155.00. 1 To Sell	SALE PRICE \$102⁵⁰
Save \$78.50. Three Drawer Batchelor's Chest. 30"x18"x31". List Price \$140. 1 To Sell	SALE PRICE \$92⁵⁰	Save \$72.50. Double Pedestal Student Desk. List Price \$220.00. 3 To Sell	SALE PRICE \$147⁵⁰
Save \$52.50. Four Drawer Chest. 31"x17"x37". List Price \$155.00. 3 To Sell	SALE PRICE \$102⁵⁰	Save \$32.50. Panel Beds. Twin Or Full Size. List Price \$100.00. 8 To Sell	SALE PRICE \$67⁵⁰
Save \$60.00. Five Drawer Chest. 31"x17"x44". List Price \$180.00. 1 To Sell	SALE PRICE \$120⁰⁰	Save \$40.00. Spindle Beds. Twin Or Full Size. List Price \$125.00. 8 To Sell	SALE PRICE \$85⁰⁰
Save \$70.00. Six Drawer Chest. 31"x17"x52". List Price \$215.00. 3 To Sell	SALE PRICE \$145⁰⁰	Save \$41.00. Low Poster Beds. Twin Or Full Size. List Price \$140.00. 4 To Sell	SALE PRICE \$99⁰⁰
Save \$72.50. Eight Drawer Double Chest. 38"x17"x37". List Price \$220. 1 To Sell	SALE PRICE \$147⁵⁰	Save \$40.00. Full Size Spindle Headboard. List Price \$90.00. 1 To Sell	SALE PRICE \$50⁰⁰
Save \$25.00. One Drawer Nite Table With One Shelf. List Price \$75.00. 2 To Sell	SALE PRICE \$50⁰⁰	Save \$20.00. Full Size Panel Headboard. List Price \$60.00. 1 To Sell	SALE PRICE \$40⁰⁰

MAGNESIUM FIND.
PEKING (AP) — China's largest magnesium deposit, with verified reserves exceeding 100 million tons, has been discovered in the southern Guangxi region, the Xinhua news agency reports.

J.D. DAWSON COMPANY

Catalog Showroom

ANNIVERSARY SALE

Celebrating Our 66th Anniversary In Belhaven And Our 5th Anniversary In Greenville

LAST THREE DAYS

AM/FM Cassette Recorder



3-5213
GE AM/FM
Radio Cassette Recorder

Convenient pushbutton recorder with variable monitor when recording directly "off the air." Makes exciting "live" recordings, too!

Reg. \$52.97
Special

\$49⁹⁵

TAKE CHARGE

RECHARGEABLE FM/AM RADIO WITH 3-WAY POWER Plays On: ★ Built-in rechargeable batteries ★ AC power cord ★ Regular "AA" batteries (not incl.)

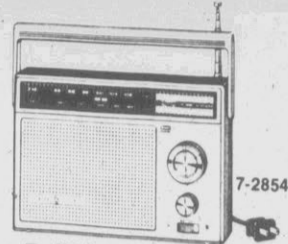

Reg. \$32.97
Special

\$28⁹⁵

GE DIGITAL ALARM CLOCK (8142)

• Snooz-Alarm® lets you sleep, then wakes you up again. Lighted dial for easier night viewing. • Large read-out.



No. 8142-412
Reg. \$11.88

Special **\$10⁸⁸**



GE 3 SPEED MIXER (M24)

• 3 speed fingertip control. Beater clips for storing beaters fastened to mixer. Up front beater ejector, balanced handle.

No. M24
Reg. \$12.47
Special

\$11⁴⁷

NORELCO CURL FRIEND™

YOUR HAIR'S BEST FRIEND

Mist or dry, Curl Friend electric hairsetter curls, waves, sets, and styles your hair in minutes.



No. HB1630
Reg. \$22.67
Special

\$20⁹⁵

REGISTER FOR FREE PRIZES!



- Panasonic Portable Stereo
- Coleman Products
- Century Car Seat
- Northern Electric Blanket
- Presto 17 qt. Cooker Canner
- Igloo Cooler

General Electric
19" Color T.V. And Many Many Prizes

Must be 16 years old to register
No Purchase Necessary To Win
You Do Not Have To Be Present To Win.

YOUR CATALOG GIFT STORE AND A WHOLE LOT MORE!

RADIO CASSETTE VALUE

AM/FM Radio Cassette Recorder

Direct "on air" recording. Listen to favorite AM or FM programs or record and play cassettes.



Reg. \$45.97
Special

\$39⁹⁷

DIGITAL GE CLOCK RADIO

7-4305
FM/AM Digital Clock Radio

Digital Clock readout with large, lighted numerals. • Wake-to-Music or Wake-to-Alarm • Forward and reverse time set control • Adjustable volume tone alarm



Reg. \$20.97
Special

\$19⁹⁴

GE COFFEEMATIC® II DRIP COFFEEMAKER (DCM9)

• For morning fresh coffee that's easy to make. Brews 2-10 cups of your favorite coffee. Counter-efficient, space-saving design.



GE MEAL FIXER (SS1)

• Your everyday kitchen helper. Great for slicing salad vegetables, shredding cheese, chopping nuts and much more. 3 stainless steel cutters. Chute folds down neatly for easy storage.

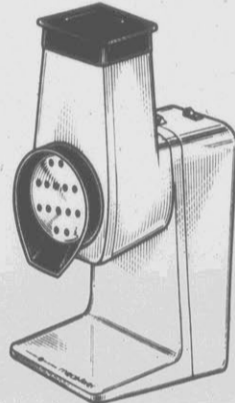

No. 551
Reg. \$34.97
Special

\$29⁹⁹

PRESTO® PRESSURE CANNER AND COOKER



No. 01780
22 Quart
Reg. \$63.97
Special

\$60⁹⁷

PRESTO Family Size Griddle



No. 07012
Reg. \$34.97

Special **\$28⁹⁹**

PRESTO® STAINLESS STEEL PRESSURE COOKER

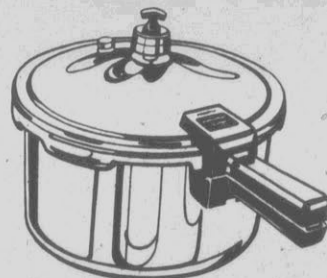

No. 01350
6 Quart
Reg. \$44.87
Special

\$42⁸⁷

GE VERSATRON™ ELECTRONIC COUNTERTOP OVEN (CTO2000)



• Electronically controlled with automatic timer. Bakes, broils, roasts, toasts, reheats, and top-browns. Comes apart for easy cleaning.

Reg. \$87.97
Special

\$79⁹⁵

GE LIGHT 'n EASY® SURGE OF STEAM, STEAM & DRY IRON (F318)



• Lightweight, easy to use, so ironing is less tiring. Cool-touch outer shell won't burn you if accidentally touched. Polished aluminum soleplate.

Reg. \$21.97
Special

\$20⁸⁸

NORELCO ROTATRACT™ ROTARY RAZOR™ with twin action rotary blades.



NO. HP1601
Reg. \$45.97
Special

\$43⁹⁵

Black & Decker. NYLON-LINE GRASS TRIMMER



No. 8201
7 Inch
Reg. \$16.96
Special

\$10⁹⁶

SMITH-CORONA® CORONET® SUPER 12



LOOK!
homework gets the electric
look with The Super 12
at a super value price.

- full sized keyboard with full range tabulator
- switch side-load cartridges in seconds
- use professional looking carbon film or fabric
- make corrections, clean and quick
- get this double walled case, too.

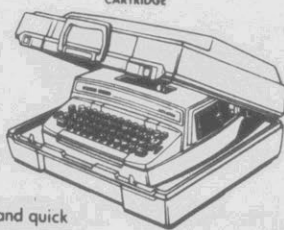

No. 6LEF
Reg. \$239.97

Special **\$229⁹⁵**

PFALTZGRAFF® POTTERS IN AMERICA SINCE 1811

Our Low Price
20% Off Retail

Pfaltzgraff Village



No. 06032
5 Pc. Place Setting
Special
\$5⁹⁵

Polaroid's SX-70 Sonar

- The world's finest instant camera.
- Automatic focusing by sound waves.
 - Never needs batteries; folds flat for easy carrying.
 - Uses new Time-Zero Supercolor SX-70 film.
 - Versatile (extreme close-ups; extended flash range).

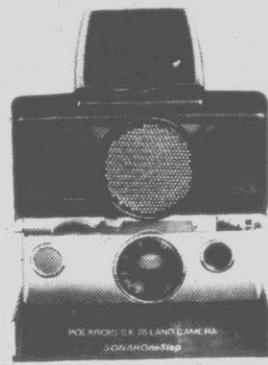

Reg. \$169.96
Special

\$139⁹⁶

Polaroid's OneStep

- The world's simplest camera.
- Never needs batteries.
 - Uses new Time-Zero Supercolor SX-70 film.
 - Lightweight; compact; fits in the palm of your hand.

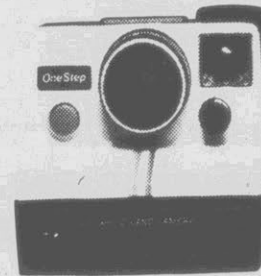

Reg. 27.77
Special

\$15⁹⁶

Clairol KINDNESS®

- The Quartz Dryer for Curly Hair
- Great for naturally curly or permed hair
 - Quartz radiant heat and gentle airflow won't disturb curls
 - Lightweight, compact design
 - Convenient, easy-grip handle
- Model IR-1



Reg. \$24.97

Special
\$18⁹⁷



**\$10
REBATE**

KODAK COLORBURST 250 Instant Camera

- Built-in electronic flash
- Automatic, motorized print ejection
- Simple aim-and-shoot operation

Reg. Price \$ 45.95
Factory Rebate -10.00
YOUR PRICE AFTER REBATE
\$ 35⁹⁵

Remember Someone You Love



KODAK TELE-EKTRALITE 600 Camera Outfit



Versatile KODAK TELE-EKTRALITE 600 camera switches from normal to telephoto lens to bring the fun closer. SENSALITE™ Flash turns itself on when you need it, off when you don't, automatically. Outfit includes film and battery. Select your gift for someone you love today.

No. AJ60
Reg. \$54.94

Special **\$48⁹⁵**

THE SHOWER MASSAGE by Water Pik®

- Refreshes, Revives, Invigorates
- Easy to Install
- Available in Wall-Mount or Hand-Held Models

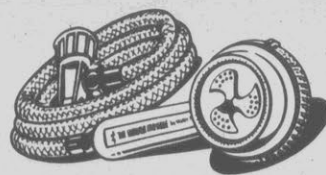

Model SM-3U

Reg. \$27.97
Special
\$26⁹⁷



Model SM-2U

Reg. \$17.97
Special
\$16⁹⁷

Polaroid film

New Time-Zero
Supercolor
SX-70



\$6⁷⁵

Clairol Set-a-Way®

Travel Hairsetter

- Revolutionary 1½-minute heat-up time
- 8 fast heating rollers in 2 sizes for unlimited curls and styles
- Ready dots indicate when rollers are ready to use
- Universal travel voltage (120 thru 240V AC) for use overseas



Reg. \$25.97

Special **\$21⁹⁷**

CRAZY BRUSH®

- Heated Electric Styling Brush
by Clairol
- Round brush and controlled heat lifts, flips, smoothes, and curls
 - Can be used on 120 thru 240 volts AC for worldwide travel

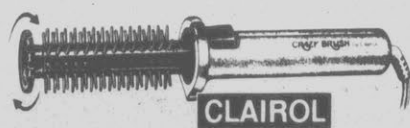

No. CB2
Reg. \$12.47

Special **\$9⁹⁵**

Toastmaster®

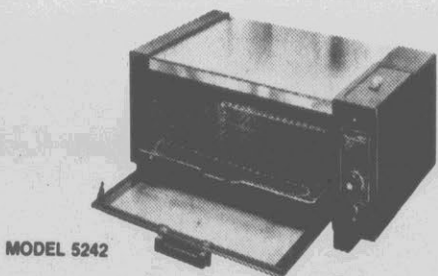

MODEL 5242

Toastmaster Oven-Broiler

Reg. \$52.97

Special **\$46⁹⁵**

EMERSON CASABLANCA DESIGNER CEILING FAN



SALE
\$84⁹⁶

36"
3 Speed
Fan

Quantities Are Limited. No Special Orders. No Layaway.

Hoover. Self-propelled CONCEPT ONE™ Cleaning System

Quadraflex™ agitator

deep cleans with double the brushing & grooming action of previous models.

Edge cleaning plus...

edge brusher deep cleans close to the wall.

Automatic carpet adjustment

adapts cleaner to most carpet. Special plush & shag settings!

16 qt. bag capacity

more cleaning per bag! You'll like the Quick & Clean bag changer.

Twin lamp headlight

Broad, bright beam of light helps seek out litter.

Soft touch cord rewind

Controlled rewind for smooth retraction.

Reg. \$236.97

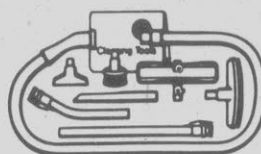

Complete with 9 piece Power-seal Attachments



No. U3101-9

Special **\$199⁹⁵**

J.D. DAWSON COMPANY

2818 E. 10th Street
Greenville, N.C.

Catalog Showroom

102 E. Main Street
Belhaven N.C.

Hollywood Celebs Raise Funds For Liberal Causes

By DEBORAH BELGUM
Associated Press Writer
HOLLYWOOD, (AP) —
Comic actors Chevy Chase and John Ritter teamed up with Hal Linden and Robin Williams to poke fun at the Reagan administration and help found a clearinghouse to match stars with liberal politicians needing support.

"I breathe the air, so I'm concerned about the environment. I'm a resident chicken, so I'm concerned about the (nuclear) arms buildup," said Linden Tuesday night.

"My show just ended," added Linden, whose "Barney Miller" TV series is being dropped by ABC, "so I'm very concerned about unemployment."

A star-studded audience attended the show at the Wilshire Ebell Theatre on behalf of Citizens in Politics, a new group forming a bank of 30 to 40 celebrities willing to make public appearances for any candidate for na-

tional office that meets the group's criteria.

The idea is to match stars, by interest, with candidates who seek the group's help.

Linden is among those celebrities, as is actress Linda Kelsey of TV's "Lou Grant" series.

"I'm strong on environmental issues and women's issues," she said.

The highlight of Tuesday night's show was the showing of outtakes, discarded film segments, from the sets of three Ronald Reagan movies.

In one well-received scene, a young Reagan tried unsuccessfully to buckle and zip up the pants of an Army uniform. In exasperation, he mumbled a profanity.

Chase, best known for his stint on "Saturday Night Live," delighted spectators who paid \$25 to \$250 a ticket for the benefit performance with his well-polished newsman skit from the late-night television comedy

series.

Pamela Lippe, director of Citizens in Politics, said the group wants to counter the "radical right" and its ability to raise money.

"There is such an incredible disparity between the amount of money that is available to the right wing and money that is available to the progressives or liberals," she said.

Ms. Lippe said the 1980 elections saw the defeat of many liberal candidates for the U.S. Senate and the House of Representatives.

"We will match up a member of the entertainment community with the right candidate for them on the basis of the issues they are most concerned about. If they (the celebrities) are concerned about safe energy, we will suggest they help

someone who has been a real champion on that issue in the House or the Senate," she said.

Citizens in Politics is a special project of the National Committee for an Effective Congress, a citizens action group formed in 1948.

"What is possible with an entertainer is to reach out beyond the usual political constituency to develop new resources, new people that wouldn't be accessible to the candidate, and that is what is significant about this program," said Russell

Hemenway, the national director of the committee.

Ed Asner, star of "Lou Grant" and president of the Screen Actors Guild, said he would help candidates who "favor a nuclear freeze, a benevolent attitude in Latin America, and the people's revolution that may take place there, and a government that believes in the reduction of (nuclear) arms."

Asner's outspoken support of liberal political causes has angered a group of guild members led by Charlton Heston.

Heston, star of such movies as "Ben-Hur" and "The Ten Commandments," has said that with Asner as president, the guild has

become more involved in political issues. Heston said many guild members criticized Asner's stance on El Salvador, a stance that was illustrated by Asner's Feb. 15 Washington news conference to send medical supplies to El Salvador through left-wing guerrillas.

Jury To Decide

WASHINGTON, N.C. — A Beaufort County jury was expected to decide today whether Greenville neurosurgeon Ira M. Hardy II is a legal resident of Greenville or Bath, where he serves on the town board and is president of the Historic Bath Association.

Bath real estate salesman David C. Everett Jr. has filed a complaint calling for Dr. Hardy's removal from the town board. Everett has contended that Hardy, who maintains homes in both Greenville and Bath and has a medical practice in Greenville, is actually a resident of Greenville.

The Beaufort County Board of Elections and state elections officials have accepted Hardy's contention that Bath is his legal home.

Hardy testified Tuesday that he has been a property owner in Bath since 1972 and moved his residence to the Beaufort County town in 1976, became a registered voter there in 1977 and switched his church membership.

Attorneys for both sides were to present their final arguments this morning, with Superior Court Judge John D. McConnell to charge the jurors later in the day.

McConnell rejected a defense motion Tuesday calling for dismissal of the complaint, ruling that the jury should decide the case on its merits.

Appointed To Chairmanships

Farmville Central students Rodney Reeves and Angela Liverman have been appointed to chair standing committees of the North Carolina High School Library-Media Association.

Reeves, the son of Carrie Reeves of Route 4, Greenville, will chair the club of the year committee. Miss Liverman, daughter of Mr. and Mrs. Thomas Liverman of Farmville, will chair the publicity committee.

Both students are active in the Farmville Central Library Club.

Solar Fraction

Greenville's solar fraction calculated by the department of physics of East Carolina University was 58 Tuesday, which means that a solar water heater could have provided 58 percent of your hot water.

Service Tonight

A prayer and praise service will be conducted at Holy Mission, 905 Dickinson Ave., tonight at 7:30 p.m.

A tarry service and preaching will be held Friday night. Saturday the Rev. Tyrone Turnage of Little Creek Free Will Baptist Church will render a service.

IT'S REED'S FOR 14 K CHAINS & BEADS! BEADS!! BEADS!!!

ADD-A-BEADS

3mm	49¢
4mm	99¢
5mm	\$1.49
6mm	\$1.79
7mm(Super Special)	\$1.49

SERPENTINE CHAINS

Reg.	Sale
30 Inch	\$69.95 \$34.95
24 Inch	\$59.95 \$29.95
20 Inch	\$54.95 \$27.00
18 Inch	\$49.95 \$24.95
15 Inch	\$39.95 \$19.95
Bracelet	\$19.95 \$9.95

REED'S
Fine Family Jewelers & Diamond Importers Since 1893
Carolina East Mall, Greenville

DEAN'S LIST
SANFORD — Mary G. Deyton of Greenville has been named to the dean's list for the winter quarter at Central Carolina Technical College. To make the dean's list a student must maintain 3.0 average for the quarter.

Now Open
B & S Crafts
Cross Stitch Frames, Books,
Cross Stitch Supplies
Custom Framing

1804 Dickinson Ave.
Next To Buddy's Lock Shop **752-4892**

Pick 'n Pay Shoes

25% off & more on women's spring casuals.



Terry top canvas casuals
for women and girls.
Assorted spring colors.

\$5



Women's canvas classic.
Assorted colors.
Reg. \$10.97

\$8

● All canvas bags, reg. \$6.97...\$5
● Women's pom-pom socks...2 prs. for \$1.30

Greenville Blvd. on 264 Bypass
Greenville, N.C.

Sale prices good thru Sunday. MasterCard or Visa. Open evenings

piece goods shop **CROSS STITCH SALE** GOOD thru SATURDAY

<p>COUPON CROSS STITCH FABRIC PIECES APPROX. 12" x 16" REG. \$1.49 1/2 off</p>	<p>COUPON CROSS STITCH ENTIRE STOCK BOOKS \$1 off Each Book</p>
<p>COUPON CROSS STITCH 60" CAMEL CLOTH 18 COUNT REG. 50¢ INCH 1/2 off</p>	<p>COUPON DMC EMBROIDERY FLOSS 35¢ VALUE 22¢ SKEIN</p>
<p>COUPON DMC FLOSS PROJECT CARDS 70¢ to \$1. ea. PROJECT & MASTER CARD 1/2 off</p>	<p>COUPON MAGNETIC STITCH FINDER USE WITH CHARTED DESIGNS Reg. \$3.99 22¢ Ea.</p>
<p>COUPON FLOSS ORGANIZER RULER PLASTIC 8 INCHES REG. \$1.29 1/2 off</p>	<p>COUPON 2 1/2" FRAMES CLEAR PLASTIC FRONT AND ADHESIVE BACKING Reg. \$1.99 69¢ Ea.</p>
<p>COUPON HARDANGER, AIDA or FIDDLERS FABRIC PACKAGES 3 PIECES 6" x 6" EACH REG. \$1.69 1/2 off</p>	<p>COUPON 60" AIDA & HARDANGER EVEN WEAVE LINES REG. \$1.99 24¢ INCH</p>

REGISTER FOR PRIZES Over \$1,000 in FREE Gifts

DON'T MISS THIS WEEK'S LIVE PERFORMANCE OF TOTAL SHOP.

RE-DO IN '82 CAROLINA EAST MALL
Thursday April 29 thru Saturday May 1
Demonstrations every hour.



10" TABLE SAW 16 1/2" DRILL PRESS HORIZ. BORING MACHINE 34" LATHE DISC SANDER

FIVE BIG POWER TOOLS IN ONE DEMONSTRATED RIGHT BEFORE YOUR EYES.

Total Shop is the ultimate home power tool. In fact, it's five of the most important power tools in one compact package.

It's got everything. A 10" Table Saw, 16 1/2" Drill Press, Horizontal Boring Machine, 34" Lathe and Disc Sander.

Total Shop's one motor and single worktable is a real workhorse. The ruggedly built Total Shop can equal or surpass the quality specifications of most individual professional tools in less room than it takes to store a coffee table.

You'll see just how easy it is to operate Total Shop at our live woodworking demonstrations. Whether you're a beginner or a professional, you'll see how simple it is to get top results with Total Shop.

SAVE \$300 ON TOTAL SHOP. THIS WEEK ONLY \$895.

For a limited time only, you can save \$300.00 on Total Shop at our demonstrations. That's another smart reason to come on in and see the world's most versatile power tool. Total Shop.

ABOUT THOSE FREE PRIZES...

Be sure to register, because we'll be giving away:

TWO 8" 3/4HP Bench Grinders — Retail Value \$289 each
TWO 6" Swivel Bench Vices — Retail Value \$139 each
TWO 14 Piece Combination Wrench Sets — Retail Value \$89 each

No purchase necessary. You need not be present to win.

Total Shop
Total Shop/P. O. Box 16297/Greenville, SC 29606
United Metal Services, Inc. 1981

Sears

SAVE 10% to 50%

Tire Sale . . . Thurs., Fri., Sat. ONLY

AUTO CENTER OPENS AT 8 A.M. . . . HURRY!

All Tires Available While Quantities Last. No Tires Sold to dealers. No C.O.D. or Phone Orders. Installation Now or at Later Convenient Time.

50% OFF

Our Spring 1982 General Catalog prices
Silent Cushion Radials

42,000-MILE TREAD WEAR-OUT WARRANTY
Featuring two strong aramid belts for outstanding impact-resistance, plus smooth-riding flexibility.

40% OFF

Our Spring 1982 General Catalog prices
Dynaglass Belted 32

32,000-MILE TREAD WEAR-OUT WARRANTY
Constructed with two strong fiberglass belts, plus polyester plies for stability and a smooth ride.

15% OFF

Entire stock of Sears
All-Weather Tires

Included in this long-wearing group: RoadHandler All-Season, WeatherHandler, and SuperGuard WeatherWise. Save Now.

25% OFF

Every Size in long-wearing
Dynaglass Belted 25

25,000-MILE WEAR-OUT WARRANTY
Two fiberglass belts add strength for good mileage. Two polyester plies for smooth ride.

15% OFF

Our All-ready Low Price of
Dynaply 20 Tires

20,000-MILE WEAR-OUT WARRANTY
Constructed with 4 plies of durable polyester, our smoothest-riding bias ply material.

25% OFF

Our Best Highway Tread Tire
RoadHandler Radials

44,000-MILE WEAR-OUT WARRANTY
Two steel belts, two radial cord body plies. Extra-wide six-rib tread with five voids.

LIMITED WARRANTY - TIRE WEAR-OUT

For the number of miles or months specified, Sears will upon return, replace the tire or give a refund, charging a pro-rata charge for the miles or months received, if wear-out occurs and is not caused by failure to properly maintain the tire.

10% to 25% OFF

Entire Stock
Sears Highway and Traction Tread Truck Tires

Choose from Guardsman, SuperGuard, RoadHandler Steel or Radial Highway or Traction tread.



SAVE \$5

Sears 40 Battery

44⁹⁹ with trade-in

Installation Included
Regular \$49.99

Excellent replacement battery at this low price. 380 amps cold cranking power, 85 minutes reserve capacity. Group 24. For most American-made cars, many imports.

SAVE \$6

SteadyRider® RT Shocks

13⁹⁹ each

Regular \$19.99

Radial-tuned comfort valve helps smooth ride with most tires. For most American-made cars and many import cars.



SAVE 16% - 50%

YOUR CHOICE 99¢

Moly E.P. Grease Cartridge. Excellent all-weather lubrication. Reg. \$1.69

Tire Gauge. Calibrated from 8 to 40 lbs. Reg. \$1.99.

STP Gas Treatment. Treats 14 gallons of gas. Reg. \$1.19.

SAVE 20%

Spectrum 10W-40 Motor Oil

Reg. \$6.20 **4⁹⁰**

5-quart container. Provides wide-range protection. Thru Saturday.

SAVE \$7

on Quartz Halogen Light

Reg. \$16.99 **9⁹⁹**

Fluted amber fog lights help you see in fog, rain and snow. Not in Shelby.

SAVE 28%

on Sears Regular Air Filter

Reg. \$2.79 **1⁹⁹**

Designed for most American-made cars, many imports. Thru Saturday.

SAVE 40%

Oil Change, Filter and Lube

Reg. \$18.91 **10⁹¹**

We'll install up to 5 quarts of Spectrum 10W-40 oil, regular oil filter and lubricate the chassis. Extra charge for cars with sealed grease fittings.

Auto Services available for most American-made cars and many imports. Not available in Shelby.

Wheel Bearing Repack

DRUM Reg. \$21.98 **12⁹⁹**

DISC. Reg. \$37.98 **22⁷⁸**

We'll clean inner and outer bearings, inspect for wear or damage, repack bearings, install new grease seals and adjust bearings to specs.

Hinckley Juror Selection Continuing



By LARRY MARGASAK
Associated Press Writer
WASHINGTON (AP) — The pool of prospective jurors was narrowed further today in the trial of presidential assailant John W. Hinckley Jr., as the judge ordered those remaining to "turn a deaf ear" to news accounts of the case.

On the second day of jury selection, U.S. District Judge Barrington D. Parker dismissed CBS White House correspondent Bill Plante, who said Tuesday he had covered stories involving Hinckley and knew a number of potential witnesses in the case.

Plante was the third prospective juror to be dismissed, narrowing jury pool from 90 to 87 people. The final panel of 12 jurors and six alternates will be asked to decide the fate of the 26-year-old drifter charged with trying to assassinate President Reagan nearly 13 months ago.

Parker has decided to allow jurors to return home each night during the trial, but he cautioned remaining members of the jury pool to avoid exposure to trial publicity.

"You are instructed to turn a deaf ear, to close your eyes and close your ears" to news accounts, the judge said.

Parker then proceeded to call prospective jurors one by one to the bench to question them out of earshot of the others and of reporters.

Hinckley appeared to be wearing the same tan suit that he wore Tuesday when the trial — which is expected to last at least one month — got under way.

Hinckley spent most of the first day staring silently at the defense table, where he sat under the watchful gaze of three U.S. marshals. Today, he glanced around the 200-seat ceremonial courtroom and studied the mounted portraits of judges.

Government prosecutors, in a memorandum filed Tuesday, offered evidence suggesting that Hinckley stalked former President Carter during the 1980 election campaign before he turned his attention to Reagan one year ago.

The memo detailed Hinckley's proximity to

Carter on two occasions in 1980 but did not draw any conclusions about the incidents.

Hinckley, who is accused of shooting Reagan, presidential press secretary James Brady and two law enforcement officers outside the Washington Hilton Hotel 13 months ago, has pleaded innocent by reason of insanity.

The government memo, which outlines the case it intends to make to the jury, said Hinckley appeared in two cities where Carter was campaigning in October 1980 — and in one instance got within six feet of the former president.

The government said it plans to show videotape of Hinckley in Dayton, Ohio on Oct. 2, 1980. The tape "will show Mr. Hinckley in a crowd approximately six feet from President Carter," the memorandum said.

On Oct. 9, 1980 in Nashville, Tenn., Hinckley

was arrested on weapons possession charges the same day that Carter was there campaigning.

But by March 29, 1981, when he arrived in Washington on a bus, Hinckley focused on Reagan, the prosecutors indicated in the memorandum. The shootings occurred the next day.

"Evidence will be introduced to show that after the shooting Mr. Hinckley's hotel room at the Park Central was searched and the items recovered include: a newspaper showing the president's schedule ... and various writings including a letter to (actress) Jodie Foster setting forth Mr. Hinckley's plan to shoot President Reagan," the memo said.

At one point Tuesday, Parker asked the prospective jurors: "How many have not heard or read anything about the case?"

No one stood in response to

the question. Parker smiled and said, "Well, you don't surprise me."

The judge told them that jurors need not be ignorant about a case, but must be able to "lay aside opinions and render a verdict based solely on all the evidence."

The prospective jurors sat behind the blond defendant who is a month away from his 27th birthday. Hinckley stared all day at the defense table, never turning around to face the pool of potential jurors.

The defendant, in a tan suit, cut a lonely figure at the defense table much of the day while his lawyers were busy helping to question jurors at the bench. His only company was three marshals who didn't talk to him.

Hinckley is charged with attempting to assassinate Reagan and is accused of 12 other felony counts including assault on a federal officer; use of a firearm during commission of a federal offense; assault with a dangerous weapon; assault on a police officer and carrying a pistol without a license.

Five of the charges carry a maximum sentence of life in prison.

World's Fair Tours

Hill's Motor Coach Tours of Kinston has 10 trips planned to the World's Fair. \$195.00 each for double occupancy. Fully Licensed and Bonded, N.C. No. 159838 (AFTER 5 P.M.) For information call 756-4511 or 524-4350.

ONCE THE FUTURE MAN? — A model of a toothless, snake-eyed creature will be displayed at the Canadian National Museum of Natural Sciences as how dinosaurs would have evolved if they had not become extinct. The model, called a dinosaurid by its creator paleontologist Dale A. Russell, is about 4 feet tall. According to an article in the May issue of Omni the creature would have become the dominant life form on earth if a catastrophe had not destroyed the dinosaur. (AP Laserphoto)

Share A Decline In Oil Earnings

Total War Zone...

(Continued from Page 1)
leave Comodoro Rivadavia, the chief staging port for the

Falklands, by Thursday.

The British government's determination to go ahead with military action impelled the opposition Labor Party to withdraw its support of Mrs. Thatcher's policy after three weeks of support.

Labor members shouted "Warmonger!" when she told the House of Commons, "Unless we bring military pressure to bear, the Argentines are unlikely to withdraw from the Falklands." Labor Party leader Michael Foot, whose initial support of Mrs. Thatcher drew resistance within his party, urged her "not to take military action."

Foot told the prime minister she should send Foreign Secretary Francis Pym to New York for talks with U.N. Secretary-General Javier Perez de Cuellar, who appealed to both sides to comply immediately with Security Council resolution 502, calling for an end to hostilities. But Mrs. Thatcher said further recourse to the United Nations would "achieve nothing."

ERUPTS AGAIN

JAKARTA, Indonesia (AP) — The Galunggung volcano has erupted again, officials reported Tuesday, but caused no casualties. Two previous eruptions killed at least 14 people.

Sell your used television the Classified way. Call 752-6166.

NEW YORK (AP) — First-quarter profits of many of the nation's biggest oil companies are down sharply from last year, and the companies are nearly unanimous in blaming the worldwide oil glut and recession.

Among the international companies, Exxon Corp. reported Tuesday a 22.5 percent slide and Standard Oil Co. of California said its profit plunged 65 percent. Earlier, Texaco Inc. said its earnings fell 44 percent.

Those three companies, which along with Mobil Corp. comprise the Arabian American Oil Co. that produces most of Saudi Arabia's crude oil, were hurt more than most other oil companies because of that Saudi relationship. Mobil has not yet reported its results for the quarter.

The Saudis refused to lower their \$34-a-barrel price while the Aramco partners often were earning less than \$29 a barrel on products refined from that oil. The Aramco partners maintained their contracts with Saudi Arabia because it is considered a relatively stable and reliable source.

"They were caught between the proverbial rock and a hard place," said Alvin Silber, an energy analyst at the investment firm Dean Witter Reynolds Inc.

While most companies that operate mainly in the United States did better than the internationals, Amerada Hess Corp. was an exception.

It reported a loss of \$16.2 million compared with year-earlier profit of \$174.5 million. Its revenues slid to \$2.37 billion from \$2.97 billion.

Silber and other analysts believe the first quarter will prove to be the low point this year for oil company earnings. Improvement is tied to an expected recovery of the U.S. economy and an easing of the oil glut.

Exxon, the biggest U.S. oil concern, said its profit fell to \$1.24 billion, or \$1.43 a share, from \$1.60 billion, or \$1.85 a share, in the same period last year. Revenue dipped to \$27.1 billion from \$30.3 billion.

Socal said its profit dropped to \$230 million, or 67 cents a share, on revenue of \$10 billion. A year earlier it earned \$666 million, or \$1.95 a share, on sales of \$12 billion. The \$230 million in profit was the lowest for Socal since the first quarter of 1977 when it earned \$224 million.

Gulf Oil Corp., ranked No. 6 among oil companies, said its profit fell 12 percent, to \$267 million, or \$1.44 a share, from \$303 million, or \$1.55 a share, in the year-earlier quarter. Revenue fell to \$7.54 billion from \$7.88 billion.

City Schools Student Loss Seen A Problem

By MELVIN LANG
Reflector Staff Writer

Funding and the loss of students are the major problems facing Greenville's city school system, candidates for the city Board of Education agreed Tuesday evening.

The candidates — incumbents Erma S. Carr and Donavan Phillips and challengers Wilson Rhodes, George Williams, Pennie Dunn and Mary Williams — appeared together for brief presentations at a Pitt-Greenville Chamber of Commerce "Pepsi Break" at the Willis Building.

Under rules laid down by the chamber's education committee, the candidates were restricted to a five-minute time slot to answer questions submitted to them in advance.

Each candidate, in turn, cited the flight of students from the city system and the reduction in funding as Greenville's major school problem. None offered a concrete solution, although most cited such possibilities as merger or partial merger with Pitt County's school system, a state bond referendum and realigning school districts.

Phillips noted that the system had lost an average of \$1,700 per student for each of the 500 students lost during the last five years.

Joan Shappley, representing the chamber's education committee, served as moderator for the candidates' panel.

OVER 1,000 ROLLS ALL TOP QUALITY NAME BRANDS

CARPET

VALUES TO \$30.95 per sq. yd.

SALE PRICED **\$12.95** Per Sq. Yd.

When we carpet — Schumacher wallpaper is free.

WHOLESALE FABRICS **WORLD**

With this ad.
Greenville Direct 757-1441
•Snow Hill •Goldsboro •Rocky Mount •Clinton

Will Bestow Six Degrees

DURHAM, N.C. (AP) — Duke University officials plan to present six honorary degrees at the school's May 9 graduation exercises, including one to an African scientist who is a member of the Masai tribe of Kenya.

Duke President Terry Sanford will present a doctor of science degree to Dr. G.M.O. Maloy, professor of animal physiology at the University of Nairobi.

Also receiving a doctor of science degree will be Dr. George Hitchings, former director of Burroughs Wellcome Company and now director and president of the Burroughs Wellcome Fund.

Doctor of humane letters degrees will be presented to Dr. Hanna Holburn Gray, president of the University of Chicago who will be the Commencement speaker; Donald F. McHenry, U.S. permanent representative to the United Nations; Dr. James E. Cheek, president of Howard University and a native of Roanoke Rapids; and Floyd M. Riddick, parliamentarian emeritus of the U.S. Senate and a Troyville native.

Art & Camera Frame Shop & Gallery

526 Cotanche St. Greenville, N.C.

752-4620

Your Complete Framing Headquarters

Fast, Expert Service

Friendly Sales Staff

Reasonable Prices

Mother's Day Special

Art & Camera Frame Shop

All Cross-Stitch

Stretched Free With This Coupon With Purchase of Frame

(Void After May 15, 1982)

Mothers Day Special

Art & Camera Frame Shop

10% Off Any Framing Order

With This Coupon

(Void After May 15, 1982)



Miss N.C. at JC Penney's Fashion Carnival.

Lynn Williford, the reigning Miss North Carolina, will be at JC Penney's Women's Fashion Department, Pitt Plaza May 1, from 11 a.m. until 3 p.m.

Miss Williford will serve as hostess for a "working women's brunch" during the second week of Fashion Carnival. The brunch starts at 11 a.m. Saturday.

A Wilmington native, Miss Williford is a graduate of New Hanover High School and East Carolina University, where she was graduated in 1979.

JCPenney

ATTENTION GREENVILLE UTILITIES CUSTOMERS WITH ELECTRIC OR NATURAL GAS HEATED HOMES!

Our Budget Billing enables you to spread your heating cost over a 12-month period.

Budget Billing is available to all residential customers who use electricity or natural gas for home heating. Just ask our Customer Service Supervisor, George Reel, about our Budget Billing agreement.

For more information, simply call George Reel, at 752-7166, extension 219.

GREENVILLE UTILITIES COMMISSION

SASLOW'S MOTHER'S DAY SALE

Gold Chains

14K

GOLD CHAINS SAVE 44%

DIAMOND PENDANT & EARRING

Matching Set 14K Yellow or White Gold

Reg. \$147.95

NOW \$99.95

LADIES 7 DIAMOND CLUSTER

JUST IN TIME FOR MOTHER

\$99.95 ONLY

SASLOW'S

JEWELERS

PITT PLAZA SHOPPING CENTER

756-7112

Apply For Jobs Open By Alien Raids

By GRAHAM VINK
Associated Press Writer

More than 1,000 unemployed workers in Los Angeles applied for jobs made available by a week-long national crackdown on alleged illegal aliens in desirable jobs, but criticism of the raids surfaced in several areas.

The Immigration and Naturalization Service said its nine-city "Project Jobs" had snared more than 2,000 alleged illegal aliens through Tuesday.

Their average wage was about \$4.50 per hour, said spokesman Duke Austin in Washington. The INS said the raids were designed to capture illegal aliens in more desirable jobs than menial labor, making the positions available for American workers.

The Price Pfister Brass Manufacturing Co. plant in the Los Angeles-area community of Pacoima, where 82 suspected illegal aliens were arrested Monday, was deluged with job applicants Tuesday, mostly young blacks and Hispanics, said company President Peter Gold.

He said about 1,000 applications were taken in a few hours before people were turned away.

Two smaller California companies raided Monday, U.S. Sales Co. in Pacoima and Pharmavita, located in Arleta, also reported a surge of job applicants.

The total of suspected illegal aliens arrested through Tuesday topped 2,000, including 282 in the Los Angeles area, 409 in Chicago, 230 in San Francisco and 475 in Dallas, Fort Worth and Houston, the INS said.

The businesses raided ranged from a shoe manufacturer and Mexican food processor in Los Angeles, to a masonry and statutory concern and meat-packing plant in suburban Chicago.

INS officials hope to capture as many as 5,000 people nationwide during the raids.

In Chicago, Ray Romero, an attorney with the Mexican-American Legal Defense and Education Fund, said rights of detainees were being violated.

"They're putting people on planes and forcing them to sign waivers — written in Spanish — giving up the right to remain silent, to speak to a lawyer, the right to post bond pending a deportation hearing," Romero said.

The leftist International Committee Against Racism called for a strike by all workers to protest the raids, which a committee spokesman in Los Angeles compared to the Nazi tactic of blaming minorities for economic problems.

"These raids are an attack on all workers because they divided us at the very time workers need to unite — citizen and immigrant, black, Latin, Asian and white — to build a strong movement against racism and for jobs," committee member Barbara Hertz said at a news conference.

But Ted L. Giorgetti, deputy director of enforcement of the INS in Chicago, called the raids "routine area control operations" meant to open up "some very good jobs for U.S. citizens."

"If this is politically motivated," Giorgetti said, "I don't think it's wrong."

Joe Salgado, the INS national enforcement chief, said Tuesday in Washington that the agency made the planned sweep public Friday after leaks threatened to torpedo the operation.

Arnold Torres of the League of United Latin-American Citizens said at the time that the raids would help perpetuate the "lie" that illegal aliens are responsible for high U.S. unemployment.

Salgado said rumors in some minority communities "had us sweeping through residential areas, rural communities and 50 to 60 cities simultaneously, rounding up huge numbers of illegal aliens indiscriminately and shipping them out of the country."

FRAME-IT-YOURSELF SHOPPE
DO-IT-YOURSELF & 48 HOUR CUSTOM PICTURE FRAMING
606 Arlington Blvd. Telephone 756-7454
OPEN TONITE UNTIL 9 P.M.

Group Picture Frames
1/2 Price
We Suggest
• China Bathroom Sets
• Personalized Stationery
• Music Boxes
• Albums
• Cookbooks
• Hummel Pendulum Clocks

BOOK BARN
Downtown Greenville 117 E. 5th St.

MOTHER'S DAY
MAY 9TH

Maxwell FURNITURE

Wall-to-Wall CLEARANCE

Condemn Pledge Of Opposition

WASHINGTON (AP) — Members of the Senate Foreign Relations Committee have overwhelmingly condemned a proposed resolution pledging U.S. opposition to Cuban aggression in the Western Hemisphere by force if necessary.

Most members present spoke against the resolution Tuesday, with Sen. Jesse Helms, R-N.C., the only one to speak in favor of it. A vote was to be scheduled later.

Sen. Steve Symms, R-Idaho, sponsored the resolution, a restatement of one adopted during the 1962

Cuban missile crisis. He said it would make clear to the Cubans that the United States "will not tolerate the export of revolution" to nations in Central America.

Sen. Paul Tsongas, D-Mass., called it "a good old-fashioned, jingoistic resolution that is all talk and no action."

On April 20, a State Department official told the committee that Secretary of State Alexander M. Haig Jr. had decided the administration would support the resolution, reversing the department's earlier stance.

Save 10% to 50% ON SELECT ITEMS

Top quality merchandise marked down. Wall to wall specials in all styles, all colors and finishes. Hurry, limited time! Shop early for best selection.

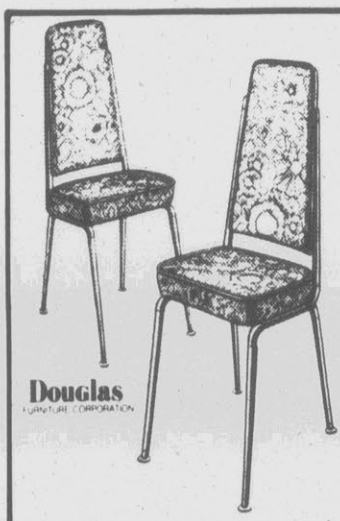

DINETTE CHAIRS 2 FOR \$19.95 SAVE 1/2
• Covered in durable Vinyl
• Floral pattern
• If purchased separately \$14.95 each

- Free & Immediate Delivery On Most Items
 - Customer Satisfaction Assured
 - 4 Ways To Say "Charge It"
- All of This Plus Our Low Prices



BASSETT 4 PIECE BEDROOM GROUP \$599.95 SAVE \$309.85

- Triple dresser
 - Mirror • Chest
 - Full/Queen-size headboard
- Night stand priced separately at \$129.95
Bed frame and bedding priced separately

5 PIECE CONTEMPORARY DINETTE \$399.95 SAVE \$189.70
• 42" round, clear glass top table with brass-plated base
• 4 chairs covered in rust Velvet

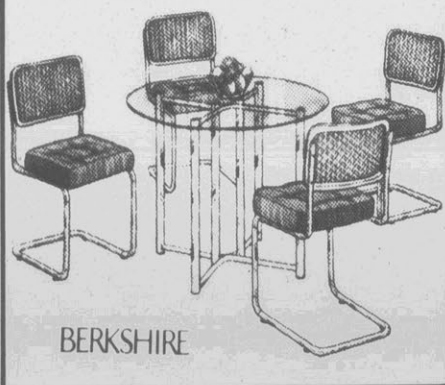

BERKSHIRE

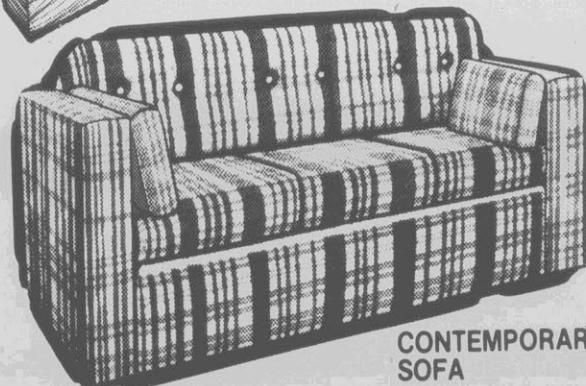

CONTEMPORARY STYLED SOFA \$199.95 SAVE \$80

- Covered in soil & stain resistant 100% Vectra® fabric
 - Plump, reversible seat cushions
- Loveseat... \$169.95 Chair... \$119.95

UNFINISHED LADDER BACK CHAIRS - Limited \$15.88
Quantity To Sell Reg. 39.95 Sale

30" BAR STOOL Oak With Padded Top \$9.88
Reg. 19.95 Sale

4 PIECE REDWOOD GROUP - Includes Settee, \$99.95
2 Chairs & 1 Table Reg. 149.85 Sale

48" LAWN SWING - Easy To Assemble \$59.95
Reg. 99.95 Sale

5 PIECE REDWOOD GROUP - Includes Round \$99.95
Umbrella Table & 4 Benches Reg. 149.95 Sale

THROW PILLOWS - Large Selection To Choose \$2.99
From Reg. 6.95 Sale

CHEST FREEZER - 5.3 Cubic Feet Perfect For A \$299.95
Mobile Home Or That Small Room Reg. 349.95 Sale

3 PC. DINETTE - Includes Drop Leaf Table & 2 \$89.95
Vinyl Chairs Reg. 119.85 Sale

3 PC. LIVING ROOM - Special Close Out Sofa, \$499.95
Chair & Wing Chair Reg. 1,259.85 Sale

8 PC. LIVING ROOM - Includes Sofa, Loveseat, Chair, \$599.95
2 Hex End Tables, Cocktail Table

& 2 Lamps Reg. 869.65 Sale \$599.95

4 PC. EARLY AMERICAN BEDROOM SUITE - Triple Dresser, \$399.95
Mirror, Chest, Headboard Reg. 609.95 Sale

QUEEN SIZE BEDDING - Mattress & Foundation \$188.00
10 Year Warranty Reg. 299.95 Sale

QUEEN, FULL, TWIN SIZE BRASS HEADBOARDS \$38.88
Reg. 59.95 Sale

FOLDING STEP STOOL - Tube Steel With Two \$16.88
Steps And Seat Reg. 29.95 Sale

STRAW MATS - 36" Round With Different Designs \$4.88
Reg. 7.95 Sale

GRAND OPENING

The easy, safe hunger-free weight loss program comes to Goldsboro!

The Nutri System Weight Loss Medical Center Program, the no-decision, no calorie counting way to quickly and safely lose weight has come to Goldsboro.

Now you could lose up to a pound a day or more with Nutri System Weight Loss Medical Center's medically supervised program.

Proven with those who have tried every other method and failed. The Nutri System Weight Loss Medical Center treatment will quickly and safely melt away pound after pound without hunger, drugs, injections, loss of energy or exertion.



NO DRUGS
NO INJECTIONS
Enter the FREE DREAM TRIP for the next 30 days!

GOLDSBORO 751-0650
313 N. Berkeley Blvd.

nutri/system weight loss medical centers

Over 500 Centers Nationwide

\$20 Grand Opening Offer save \$20.00 act now
Here's your opportunity to start losing weight with Nutri/System 2000
Present this coupon to **THANK YOU GOLDSBORO** and **FINAL WEEK** expires May 7, 1982
\$20



604 Greenville Boulevard
Greenville, N.C. Phone 756-3142
MONDAY-10 AM TO 6 PM
TUESDAY-10 AM TO 6 PM
WEDNESDAY-10 AM TO 6 PM

4 WAYS TO SAY "CHARGE IT!"
CREDIT
\$1,000 INSTANT CREDIT
You may qualify for \$1,000 INSTANT CREDIT if you have a valid AMERICAN EXPRESS CARD, MASTER CARD or VISA

Crossword By Eugene Sbeffer

- ACROSS
- 1 Bye-bye
 - 5 Pindar's forte
 - 8 Sleeveless garments
 - 12 - Bator
 - 13 Legal profession
 - 14 Humdinger
 - 15 Crumpling
 - 17 Cicatrix
 - 18 Soap plant
 - 19 Tended the furnace
 - 21 Pitcher
 - 24 Goddess of harvests
 - 25 Chicago team
 - 28 Strange comb. form
 - 30 Large parrot
 - 33 Eskimo knife
 - 34 English navigator
 - 35 Those in office
 - 36 Leather moccasin
- DOWN
- 37 Verily
 - 38 Brittle cookie
 - 39 Dutch hawk's eyes
 - 41 Rachel's sister
 - 43 Writing pad
 - 46 Summarize
 - 50 Butter
 - 51 Cowboy
 - 54 Thin
 - 55 Macaw
 - 56 Western city
 - 57 English sand dune
 - 58 Free Close, as a number
 - 59 Down
 - 1 Saxhorn
 - 2 Astringent
 - 3 Mexican dish
 - 4 Tarsi
 - 5 Kimono sash
 - 6 Hebrew tribe
 - 7 Work units
 - 8 American queen
 - 9 Kind of columnist
 - 9 Kind of leather
 - 10 Wings
 - 11 Irrational number
 - 16 Actor Ayres
 - 20 Blow a horn
 - 22 School test
 - 23 An insurgent
 - 25 Recipe unit
 - 26 The gums
 - 27 Bog plant
 - 29 Not any
 - 31 Spanish queen
 - 32 Viper
 - 34 Instance
 - 38 Clips wool from sheep
 - 40 Solitary
 - 42 Captained by Noah
 - 43 Spilled the beans
 - 44 Not aweather
 - 45 Skier's lift
 - 47 Indian
 - 48 First-class
 - 49 Steno group
 - 52 Swiss canton
 - 53 Bounder

Avg. solution time: 26 min.



Answer to yesterday's puzzle.

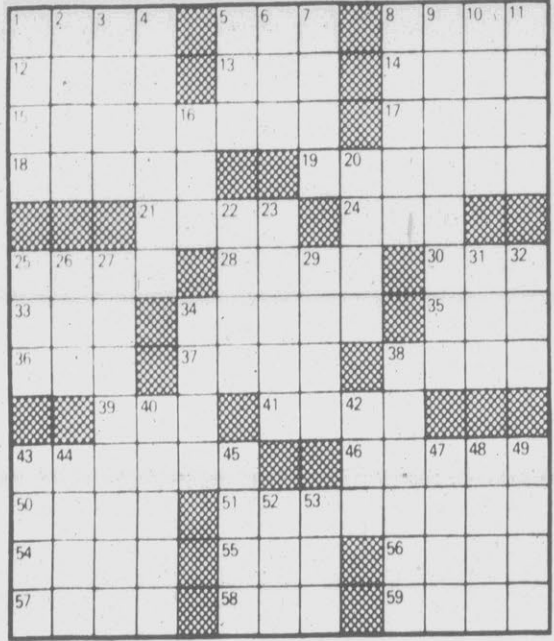

CRYPTOQUIP 4-28

KYECRWMD ZHCZHMERZYHC EFT E LFTELWMD KYFT

Yesterday's Cryptoquip - DAMAGED GOODS ARE PUT UP AT RURAL RUMMAGE SALE.

Today's Cryptoquip clue: K equals B

The Cryptoquip is a simple substitution cipher in which each letter used stands for another. If you think that X equals O, it will equal O throughout the puzzle. Single letters, short words, and words using an apostrophe can give you clues to locating vowels. Solution is accomplished by trial and error.

© 1982 King Features Syndicate, Inc.

GOREN BRIDGE

BY CHARLES H. GOREN AND OMAR SHARIF

1982 The Line Company Syndicate, Inc.

Both vulnerable. South deals.

NORTH ♠ K 10 4 ♣ 6 4 2 ♢ A K 6 ♣ A K 10 6

WEST ♠ 7 3 2 ♣ A Q J ♢ K 8 3 ♣ 8 4 ♣ Q J 9 7 3 ♠ 8 5

EAST ♠ A Q J ♣ A 9 7 5 ♢ 10 7 3 2 ♣ 8 5 ♠ 9 8 6 ♣ Q J 10 ♢ Q J 9 5 ♠ 4 2

The bidding: South West North East Pass Pass 1 ♠ Pass 1 NT Pass 2 NT Pass Pass Pass Opening lead: Seven of ♣.

Dear Charlie:

I don't want you to think, from my last note, that the caliber of play in the NatWest Trophy was undistinguished. Zia Mahmood, who played for Pakistan in the 1981 World Team Championship, starred against us on this hand.

British internationalist Rob Sheehan decided that, because of the plethora of aces and kings, his hand was suit oriented, so he elected to open one club rather than one no trump. Zia responded one no trump and Sheehan made an invitational raise which, not surprisingly,

South declined.

Our defense was picture-perfect. My partner, Paul Chemla, led a spade. I won the jack and shifted to a low heart. Paul took his king and reverted to a spade, my queen winning. I now played ace and another heart.

Declarer could take seven fast tricks. If he tried to set up his eighth trick in spades, I would defeat him by cashing my long heart. But my Pakistani friend is not known as one of the world's great dummy players for nothing. Seemingly without a moment's thought, he led a club from his hand. Naturally, my partner played low, and declarer finessed dummy's ten. That was his eighth trick, and our sparkling defensive effort came to naught.

If my opponents are going to play that well, how am I going to win!

As ever, Omar

Have you been running into double trouble? Let Charles Goren help you find your way through the maze of DOUBLES for penalties and for takeout. For a copy of his DOUBLES booklet, send \$1.85 to "Goren-Doubles," care of this newspaper, P.O. Box 259, Norwood, N.J. 07648. Make checks payable to Newspaperbooks.

Acquit Warden Of Driving Violation

RALEIGH, N.C. (AP) - Central Prison Warden Samuel P. Garrison has been acquitted of a driving violation after a federal judge heard testimony saying health problems and prescription medicine caused Garrison's erratic driving.

"I feel relieved, and I feel that justice was done in my case," Garrison said afterward. He was arrested Dec. 20 and charged with driving under the influence of alcohol.

Trooper E.B. Fleming testified that Garrison had bloodshot eyes, was unsteady on his feet and had alcohol on his breath when he was stopped.

Fleming said he watched Garrison cross the center line three times, and found two unopened bottles of wine in Garrison's car.

He said Garrison refused the Breathalyzer test. Fail-

ure to take the test results in an automatic six-month suspension of a driver's license and Garrison has surrendered his license.

During the 4½ hours Garrison's case was before the court Monday and Tuesday, his attorneys maintained that his prescription medicine and an inner ear problem caused him to drive erratically and appear unstable on his feet.

Garrison's physician, Dr. Dennis I. Becker, testified that the warden was taking tranquilizers and several other medicines for diabetes, an irregular heartbeat, an inner ear problem and a severe condition of chronic nervous exhaustion.

"I am concerned about his (Garrison's) health problems," said Rae McNamara, head of North Carolina's Division of Prisons and Garrison's superior.

FORECAST FOR THURSDAY, APR. 29, 1982

YOUR DAILY Horoscope from the Carroll Righter Institute

GENERAL TENDENCIES: The morning brings a new view on a project you have in mind and you can easily express yourself and gain the support you need. Be sure to plan the future wisely.

ARIES (Mar. 21 to Apr. 19) New opportunities come your way early in the day. Showing more thought for the one you love pays off at this time.

TAURUS (Apr. 20 to May 20) You can communicate well with others in the morning. Later study new ventures that could be profitable in the future.

GEMINI (May 21 to June 21) Good day to study monetary affairs and improve your status in life. Come to a better understanding with associates.

MOON CHILDREN (June 22 to July 21) You can reach some personal aim in the morning that means much to you. Expand where finances are concerned.

LEO (July 22 to Aug. 21) Make personal plans and then talk them over with persons who can be helpful to you. Improve your appearance.

VIRGO (Aug. 22 to Sept. 22) Avoid criticizing others if you want to make greater progress in the future. Be more precise in handling your duties.

LIBRA (Sept. 23 to Oct. 22) Know what is expected of you by higher-ups and you get ahead faster. Sidestep one who has an eye on your assets.

SCORPIO (Oct. 23 to Nov. 21) Engage in a new enterprise in the morning that will have much success connected with it. Express happiness.

SAGITTARIUS (Nov. 22 to Dec. 21) Be sure to keep promises you have made. Carry through with civic duties and gain added prestige.

CAPRICORN (Dec. 22 to Jan. 20) You are able to come to a true understanding with associates in the morning. Show others that you have wisdom.

AQUARIUS (Jan. 21 to Feb. 19) Commence the day properly by attending to important work without delay. Strive to gain your most cherished aims.

PISCES (Feb. 20 to Mar. 20) Use modern methods that will make your job easier and become more efficient. Avoid one who imposes on you.

IF YOUR CHILD IS BORN TODAY... he or she will be one of those fascinating young persons who can easily understand the needs of the public in general and should have as fine an education as you can afford. Upon reaching maturity much success is possible.

"The Stars impel, they do not compel." What you make of your life is largely up to you!

1982, McNaught Syndicate, Inc.

Local Soldier Recruiter Aide

The Army District Recruiting Command in Raleigh announced that Pvt. Christopher Broadrick of Greenville has been selected to participate in the hometown recruiter aide program.

Broadrick is working at the Greenville recruiting station, 326 Evans St.

Son of Mr. and Mrs. Tom Broadrick of Greenville, he is a graduate of Rose High School and reported for active duty last October. He received basic training at Fort McClellan, Ala., and training as a chapel activities specialist at Fort Monmouth, N.J. Upon completion

of recruiter aide duty, Broadrick will be stationed at Ford Ord, Calif.

SHOP-EZE West End Shopping Center



Thursday Luncheon
Deli Special
CHICKEN N' PASTRY
\$2.19
Special Served With 2 Fresh Vegetables & Rolls

When the unexpected happens,

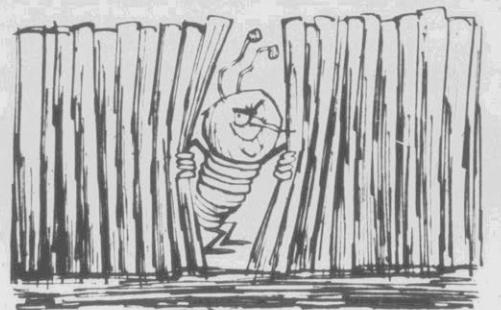

you'd better have good insurance.

Life has a way of delivering unpleasant surprises. Fortunately, with the proper insurance, you can be ready for most of them.

Whether you need protection for your home, auto, RV or business, let us help you find the best policy for you from one of the many companies we represent.

Then relax. The proper insurance protection will keep you snug as a bug in a rug.

EAST CAROLINA INSURANCE AGENCY



"Where Customers Become Friends"
Fred Alcock, Gen. Mgr. 752-4323

Complain Egypt Is Impairing U.S. Aid

By MORRIS W. ROSENBERG

Associated Press Writer

WASHINGTON (AP) - A House Foreign Affairs subcommittee, approving a \$400-million military aid increase for Egypt, complained Tuesday that Egyptian subsidies are distorting its economy.

The panel adopted a report noting that Egypt is subsidizing energy products by \$3 billion a year and that the price of gasoline in Egypt is roughly one-fifth of the market price.

The subcommittee on Europe and the Middle East said, "such huge subsidies do not give hope for future development, and they impair the effectiveness of the United States economic assistance for Egypt."

The panel acted in approving Reagan administration requests that would raise military aid to Egypt for fiscal 1983 to \$1.3 billion.

The panel also endorsed an administration increase of \$300 million in military aid to Israel for a total of \$1.7 billion.

The administration had asked that grant aid of \$550 million in the Israeli military assistance package be reduced to \$500 million, but the panel voted instead to increase the grant aid to \$750 million.

Total U.S. military and economic aid packages pro-

posed for fiscal 1983 are \$2.485 billion for Israel and \$2.052 billion for Egypt.

The subcommittee called on the United States to follow through on its promises to improve the performance of the U.S. economic aid program for Egypt.

"It is equally essential for the Egyptian government to press ahead with its stated intentions to develop new economic policies," the panel said.

"It is the challenge of the Egyptian and American government for the 1980s to combine Egypt's own policy initiatives with American support, flexibility and creativity to insure growth and economic stability," the subcommittee said.

"Without those efforts, frustrations in the Congress over the inability of this program to achieve its stated objectives will multiply and the commitment to maintain high levels of assistance will wane," the panel said.

Custom Built Homes For Sale

Spacious Lots In The Country
95% Financing Available To Qualified Borrowers At 15.5% Fixed Rate For 30 Years.
Minimum Income Limits Of \$22,000
All Closing Costs Paid By Seller

Prices Start At **\$37,500**

Call Jimmy Hughes Inc., At 752-1848 Between 7:30 A.M. And 5:00 P.M., Monday Through Friday

NOTICE OF REVENUE SHARING PROPOSED USE HEARING

Public notice is hereby given that the City of Greenville will conduct a proposed use hearing on the appropriation of Revenue Sharing Funds for the 1982-83 fiscal year. The public hearing will be held before the City Manager and is scheduled for 7:30 pm, Thursday, April 29, 1982, in the City Council Chambers on the third floor of the Municipal Building.

The City of Greenville expects to receive the following revenues in the 1982-83 fiscal year:

Allocation Payments	\$623,332
Interest On Investments	5,000
Fund Balance	35,000
	<u>\$663,332</u>

All interested citizens should be present at the public hearing at which time they will be afforded an opportunity to provide written and oral comments on the possible use of Revenue Sharing funds for 1982-83.

TIRED OF STRIPPING ALONE

Come See The STRIPPER
802 Clark St.
NEW SUMMER HOURS:
Tues.-Fri. 10 a.m. to 7 p.m.
Sat. Only 9 a.m. to 12 noon
Closed Sun & Mon.
•Furniture Stripping
•Repair/Refinishing
757-1982

GOODYEAR PAIR SALE

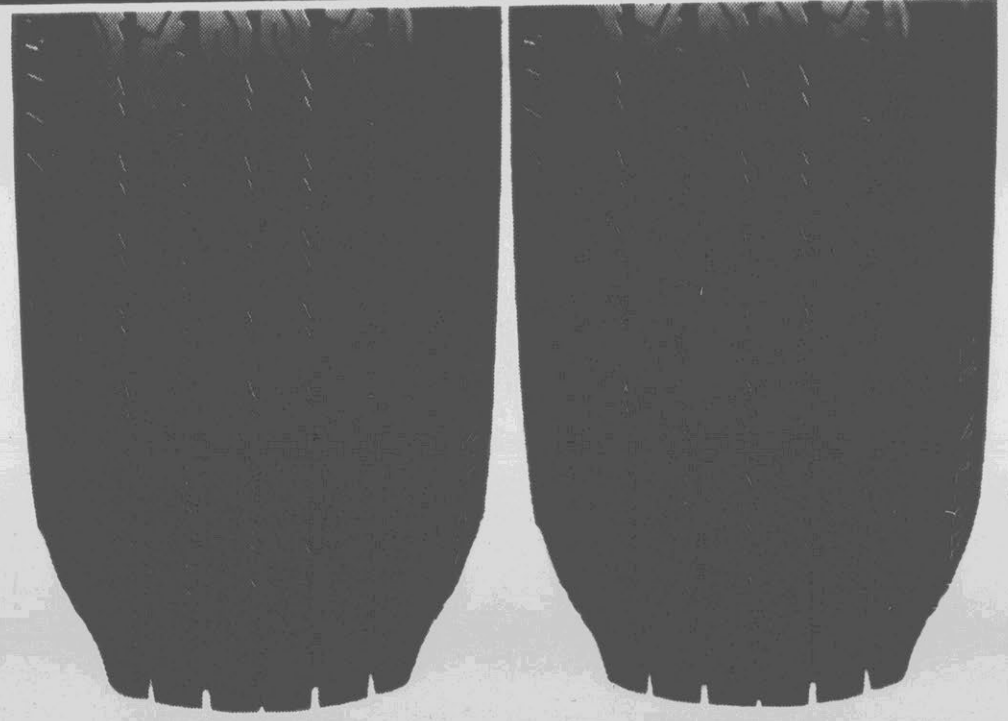

POWER STREAK II 2 FOR \$57

A78-13 Blackwall Plus \$1.42 FET per tire No trade needed

- Our newest diagonal-ply tire.
- Individual crossplies of tough polyester for strength.
- Shoulder-gripping edges for extra bite into curves.

RAIN CHECK - If we sell out of your size we will issue you a rain check, assuring future delivery at the advertised price.

Sale ends Sat. Night.



ARRIVA RADIAL FOR IMPORTS! LOW PRICED!

- Gas saving radial construction.
- All-season tread for all-weather driving conditions.
- Smooth, quiet ride - good news for imports.

\$48 Per Tire

P155/80R12 Blackwall Plus \$1.39 FET, and old tire.

Blackwall Size	Everyday Low Price Per Tire	Plus FET, and old tire.
P155/80R13	\$51.80	\$1.52
P165/80R13	\$55.35	\$1.67
P165/80R15	\$56.55	\$1.79
P165/70R13	\$58.85	\$1.48

Other Sizes Also Low Priced

Brake Service Your Choice



\$88

Import or domestic cars. Additional parts and services extra if needed.
Includes: install new front grease seals, pack front wheel bearings, inspect hydraulic system, add fluid, road test.
2-Wheel Front Disc: install new front brake pads, resurface front rotors, inspect calipers.

OR
4-Wheel Drum: install new brake lining and resurface all four drums.
Warranted 12 months or 12,000 miles whichever comes first.

Wheel Alignment



\$19 Warranted 90 Days or 3,000 miles whichever comes first

Imports with adjustable suspension includes front wheel drive Chevies, light trucks and cars requiring MacPherson Strut connection extra. Parts and additional services extra if needed.

Lifetime Alignment \$44

We will align your car as stated above then recheck and align it every 6 months or 5,000 miles - or whenever needed. Valid only at the store where purchased. Offer does not cover the replacement of tires and/or parts that become worn or damaged. Agreement void if service work affecting the alignment is performed by any other outlet.

GOODYEAR

Use any of these ways to buy: Goodyear Revolving Charge Account • MasterCard • Visa • American Express • Carte Blanche • Diners Club • Cash

WE SERVICE NATIONAL ACCOUNTS

729 Dickinson Ave. Open Mon.-Fri. 7:30 to 6, Sat. 7:30-5
Phone 752-4417. Carol Clark, Manager



QUALITY & INNOVATION



SERVICE AND QUALITY... BETTER THAN IT HAS TO BE!

PRICES EFFECTIVE APRIL 28 thru MAY 1
We reserve the right to limit quantities. None sold to dealers or restaurants. We gladly accept U.S.D.A. Food Stamps.

FREE DICTIONARY!

Buy volumes 2 thru 9 of Funk & Wagnall's New Encyclopedia for just \$3.49 and get a Free Dictionary.

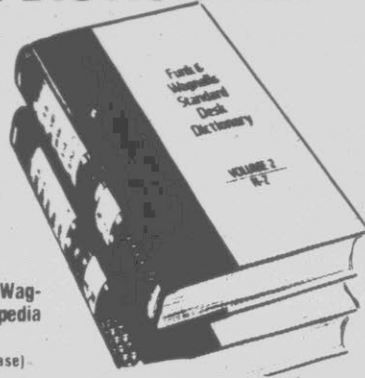

Volume 1 of Funk & Wagnall's New Encyclopedia still only 9c (with a \$5.00 food purchase).

LIMITED TIME OFFER!

Funk & Wagnall's HAMMOND WORLD ATLAS

ONLY **4.98**

Detail maps of the States and Canadian Provinces. Geographical Maps. World History in Maps. The Solar System...and much more.

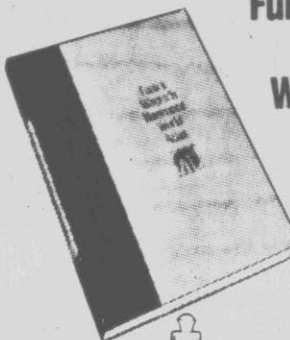

PIGGLY WIGGLY WORLD OF **PRODUCE**
the Freshest Buys in Town!

FARM FRESH

CABBAGE



19c LB.

YELLOW BAGGED ONIONS 3 LB. BAG **79c**
LARGE BELL PEPPERS ea. **10c**
FRESH STRAWBERRIES PT. **79c**
SWEET POTATOES 4 LBS. **\$1**
LOCAL MIXED SALAD LB. **49c**

WELCH GRAPE JELLY OR JAM 2 LBS. **1.49**

SUPER SPECIAL!

LIPTON TEA BAGS 24 CT.

1.18

DELUXE MOON PIES 12 CT. **1.69**

SUPER SPECIAL!

PIGGLY WIGGLY SALAD DRESSING QT.

78c

BEST PAK TRASH BAGS 10 CT. **99c**

SUPER SPECIAL!

GATORADE

58c QT.

PIGGLY WIGGLY SHOESTRING POTATOES 20 CT. **69c**

SUPER SPECIAL!

PIGGLY WIGGLY DRINKS 2 LITER

78c

GOLDEN BEST SHORTENING 42 OZ. **1.33**

U.S.D.A. GRADE 'A' FRESH WHOLE

FRYERS 2 PER BAG **38c** LB.

LIMIT 2 BAGS, PLEASE!

U.S.D.A. GRADE 'A' FRESH CUT UP

FRYERS **48c** LB.

Swift's Premium Beef! WHOLE BONELESS

Bottom Rounds

1.78

20-25 LB. AVERAGE LB.

CUBE STEAK LB.

2.68

BONELESS **Bottom Round** LB. **2.58**

BONELESS BOTTOM ROUND OR **Rump Roast** LB. **2.48**

FRESH **GROUND BEEF** 3 LBS. OR MORE **1.19**

CURT'S BARBECUE 15 OZ. **1.79**

FROSTY MORN FRANKS 12 OZ. **99c**

PORK SALE! QUARTER PORK LOINS LB. **1.49**

FAMILY SIZE SAVINGS! JUBILEE SMOKED SAUSAGE... 5 LB. PKG. **4.99**

LUNDY'S SLICED BACON LB. PKG. **1.39**

BIG TOP BOLOGNA LB. PKG. **79c**

COUNTRY STYLE BACK BONES LB. **1.49**

PORK NECKBONES. 10 LB. PKG. **4.90**
LUNDY'S BULK SAUSAGE. 10 LB. PKG. **9.90**

COUPON **49c**
ROLLER CHAMPION PLAIN OR SELF RISING FLOUR 5 LBS. **49c**
LIMIT ONE WITH THIS COUPON AND A \$7.50 FOOD ORDER (COUPON EXPIRES 5/1/82)

COUPON **69c**
HUNT'S KETCHUP 32 OZ. **69c**
LIMIT ONE WITH THIS COUPON AND A \$7.50 FOOD ORDER (COUPON EXPIRES 5/1/82)

COUPON **49c**
PIGGLY WIGGLY SALT 26 OZ. **FREE!**
LIMIT ONE WITH THIS COUPON AND A \$7.50 FOOD ORDER (COUPON EXPIRES 5/1/82)

COUPON **69c**
COCA COLA & MELLO YELLO 8 16 OZ. BOTTLES **89c** PLUS DEPOSIT
LIMIT ONE WITH THIS COUPON AND A \$7.50 FOOD ORDER (COUPON EXPIRES 5/1/82)

PIGGLY WIGGLY **SALT** 26 OZ. **4/1.00**

PIGGLY WIGGLY **BREAD** 3 1 1/2 LB. LOAVES **\$1.49**

JIFFY CORN MUFFIN MIX 8 1/2 OZ. **4/\$1**

WEIGHT WATCHER ICE MILK BARS 6 PK. **99c**

GRADE 'A' SMALL BROWN EGGS 2 DOZ. **1.00**

MASTER BLEND COFFEE 13 OZ. BAG **2.09**

PIGGLY WIGGLY ORANGE JUICE 1/2 GAL. (PAPER CTN.) **98c**

ROLLER CHAMPION SELF-RISING FLOUR 25 LB. BAG **4.39**

BEALE'S LARD 25 LB. STAND **9.49**

PIGGLY WIGGLY VITAMIN 'D' MILK GAL. JUG **1.89**

PIGGLY WIGGLY MILK 1/2 GAL. **99c**



PIGGLY WIGGLY KEEPS AMERICA SHOPPING WITH EVERYDAY LOW PRICES!

2105 DICKINSON AVE. GREENVILLE
OPEN 8 TO 9 MON. - SAT., OPEN 8 TO 6 SUN.

Stock And Market Reports

RALEIGH (AP) (NCDA) - N.C. eggs: Market unchanged. N.C. weighted average price for small sales of consumer grade A white eggs in cartons delivered to retail stores: Large 71.47 cents per dozen; medium 64.69; small 54.19.

RALEIGH (AP) (NCDA) - Graded feeder pig sales: Turnersburg - 557 head sold: 40-50 pound No. 1 and 2s 128.91, No. 3s 108.00; 50-60 pound No. 1 and 2s 112.75, No. 3s 92.00. Wallace-Chadborn - 1689 head sold: 40-50 pound No. 1 and 2s 129.71, No. 3s 119.25; 50-60 pound No. 1 and 2s 115.28, No. 3s 97.00. Smithfield - 499 head sold: 40-50 pound No. 1 and 2s 130.00, No. 3s 120.75; 50-60 pound No. 1 and 2s 113.50, No. 3s 100.00.

RALEIGH (AP) (NCDA) - Grain: No. 2 yellow shelled corn lower at 2.72-2.91, mostly 2.82-2.91 in the East and 2.77-3.10, mostly 2.77-3.00 in the Piedmont; no. 1 yellow soybeans lower at 6.47-6.76 14, mostly 6.51-6.76 14 in the East and 6.25-6.55, mostly 6.45-6.55 in the Piedmont; wheat 3.00-3.68, mostly 3.44-3.64; oats 1.93-2.20. (New crop - corn 2.56-2.82; soybeans 6.34-6.53; wheat 3.30-3.29; oats 1.54-1.64); soybean meal for N.C. processing plants per ton 44 219.70-220.00. Prices paid as of 4 p.m. Tuesday by location for corn and soybeans: Cofield 2.87, 6.71; Conway 2.80, 6.58; Creswell 2.72, 6.47; Dunn 2.82, 6.60; Elizabeth city 2.82, 6.62; Farmville 2.90, 6.55; Fayetteville, 6.76 14; Goldsboro 2.91, 6.58; Greenville 2.81, 6.51; Kinston 2.85, 6.51; Lumberton 2.82, 6.55; Pantego 2.79, 6.51; Raleigh, 6.76; Selma 2.85, (6.66-6.78); Whiteville 2.82; 6.55; Willimiston 2.81, 6.51; Wilson (2.87-2.91), 6.51; Alvermarle 2.86, 6.53; Barber 3.00, 6.55; Mocksville 2.77; Monroe (2.77-3.10); Mt. Ulla, 6.45; Roaring River 2.77; Statesville 3.00, 6.25.

NEW YORK (AP) - The stock market opened lower today, extending Tuesday's slide, amid concern over budget negotiations in Washington and tensions in the South Atlantic. The Dow Jones average of 30 industrial stocks fell .67

point to 856.83 in the early going, with declines leading advances by a 4-3 ratio on the New York Stock Exchange. The stock market haphazard gains in each of the past six weeks and traders say the pullback that began Tuesday reflected selling by investors taking advantage of the recent runup in prices. President Reagan was scheduled to meet House Speaker Thomas O'Neill today in an attempt to break an apparent impasse in budget negotiations. Investors fear that failure to narrow projected record deficits would push interest rates higher, reducing chances for an economic recovery. Prospects for further military action in the South Atlantic heightened as Britain declared it would establish a "total" war zone 200 miles around the Falkland Islands on Friday, and Argentina placed its forces on "maximum alert." Today's early prices included Sony, down 1/4 at 14; Standard Oil of California, unchanged at 30 3/4; International Business Machines, down 1/2 at 65; Exxon, unchanged at 28 3/4; General Motors, down 1/2 at 43 3/4; and American Telephone & Telegraph, down 1/2 at 55. On Tuesday, the Dow Jones average of 30 industrial stocks fell 8.08 to 857.50 with part of the decline attributed by traders to rumors - denied by the White House - that the president was ill. Five stocks fell in price for every three that rose on the NYSE. Big Board volume totaled 56.48 million shares, down from Monday's 60.50 million. The NYSE's composite index fell .64 to 67.95. At the American Stock Exchange, the market value index was off 2.82 at 273.47.

NEW YORK (AP) - Midday stocks:

AbtLbs s	High	Low	Last
Alkoma	30 1/4	30 1/4	30 1/4
Alcoa	9 3/4	9 3/4	9 3/4
Alumina	25 1/4	25 1/4	25 1/4
Am Airline	14 1/4	14 1/4	14 1/4
Am Baker	13 1/4	13 1/4	13 1/4
Am Brand s	44 3/4	43 3/4	43 3/4
Am Can	27 3/4	27 3/4	27 3/4
Am Cyan	29 1/4	29 1/4	29 1/4
Am Family	9 3/4	9 3/4	9 3/4
Am Motors	3 1/4	3 1/4	3 1/4
AmStand	27 3/4	27 3/4	27 3/4
Amer T&T	55 1/4	54 1/4	54 1/4
Beat Food	19 1/4	19 1/4	19 1/4
Beth Steel	22 1/4	22 1/4	22 1/4
Boeing	20 1/4	20 1/4	20 1/4
Boise Casco	29	29	29
Borden	33 1/4	33 1/4	33 1/4
Burling Ind	22 1/4	22 1/4	22 1/4
CSX Corp	47 1/4	47 1/4	47 1/4
CaroP&L	22 1/4	22 1/4	22 1/4
Celanese	57 1/4	57 1/4	57 1/4
Cent Soy	11 1/4	11 1/4	11 1/4
Chrysler	16 1/4	16 1/4	16 1/4
CocaCola	5 1/4	5 1/4	5 1/4
Colg Palm	34 1/4	34 1/4	34 1/4
Colg Edis	18 1/4	18 1/4	18 1/4
ConAgra	20 1/4	20 1/4	20 1/4
Contl Group	30 1/4	30 1/4	30 1/4
Delta Air s	32 1/4	31 1/4	31 1/4
DowChem	23 1/4	22 1/4	22 1/4
duPont	35 1/4	35 1/4	35 1/4
Duke Pow	23 1/4	23 1/4	23 1/4
EastAirl	6 1/4	6 1/4	6 1/4
East Kodak	73 1/4	72 3/4	72 3/4
EatonCo	39 1/4	39 1/4	39 1/4
Eastman	46 1/4	46 1/4	46 1/4
Exxon s	28 1/4	28 1/4	28 1/4
Firestone	10 1/4	10 1/4	10 1/4
FlaPowLL	32 1/4	32 1/4	32 1/4
FlaProgress	16 1/4	16 1/4	16 1/4
FordMot	22 1/4	22 1/4	22 1/4
For McKess	30 1/4	30 1/4	30 1/4
Fugua Ind	18 1/4	18 1/4	18 1/4
GenDynam	29 1/4	28 1/4	28 1/4
Gen Elec	66	65 1/2	65 1/2
Gen Food	3 1/4	3 1/4	3 1/4
Gen Mills	41 1/4	40 1/4	40 1/4
Gen Motors	43 1/4	43 1/4	43 1/4
GenTel&El	31 1/4	31 1/4	31 1/4
Gen Tire	18 1/4	18 1/4	18 1/4
GenParts	17 1/4	16 1/4	16 1/4
GalPacif	17 1/4	16 1/4	16 1/4
Goodrich	20 1/4	20 1/4	20 1/4
Goodyear	22 1/4	22 1/4	22 1/4
Grace Co	39 1/4	39 1/4	39 1/4
GINor Nek	37	36 1/2	36 1/2
Greyhound	14 1/4	14 1/4	14 1/4
Gulf Oil	21 1/4	21 1/4	21 1/4
HerculesInc	21	20 1/2	20 1/2
Honeywell	70 1/4	70 1/4	70 1/4
IBM	49 1/4	48 1/4	48 1/4
Ing Rand	65 1/4	65 1/4	65 1/4
Int Harv	4 1/4	4 1/4	4 1/4
Int Paper	37 1/4	37 1/4	37 1/4
Int Rectif	12 1/4	12 1/4	12 1/4
Int T&T	28 1/4	28 1/4	28 1/4
K mart	19 1/4	19 1/4	19 1/4
KaiserAlum	12 1/4	12 1/4	12 1/4
Kane Mill	13 1/4	13 1/4	13 1/4
KaneBsv	16 1/4	16 1/4	16 1/4
KrogerCo	30 1/4	30 1/4	30 1/4
Lockheed	53 1/4	52 3/4	52 3/4
Loews Corp	96	95 1/2	95 1/2
Masonite	21 1/4	21 1/4	21 1/4
McDermott	24 1/4	24 1/4	24 1/4
Meacham	21 1/4	21 1/4	21 1/4
MinaMtl	56	55 1/2	55 1/2
Mobil s	22 1/4	22 1/4	22 1/4
Monsanto	67	66 1/2	66 1/2
NCNB	13 1/4	13 1/4	13 1/4
NaborsCorp	34 1/4	34 1/4	34 1/4
Nat Distill	23 1/4	23 1/4	23 1/4
OilCorp	21 1/4	21 1/4	21 1/4
OwensIll	26 1/4	25 1/4	25 1/4
OwensIll JC	36 1/4	35 1/4	35 1/4
PepsiCo	38 1/4	38 1/4	38 1/4
Phelps Dod	27 1/4	26 1/4	26 1/4
PhillipMorr	52 1/4	51 1/4	51 1/4
PhillipPet	31 1/4	31 1/4	31 1/4
Polaroid	18 1/4	18 1/4	18 1/4
Proct Gamb	86 1/4	86 1/4	86 1/4
Quaker Oat	42 1/4	42 1/4	42 1/4
RCA	12 1/4	12 1/4	12 1/4
RalstonPur	3 1/4	3 1/4	3 1/4
RepubAir	20	20	20
Republic SU	20	20	20

WEDNESDAY
1:30 p.m. - Duplicate bridge at Planters Bank
6:30 p.m. - REAL Crisis Intervention meets
6:30 p.m. - Kiwanis Club meets
6:15 p.m. - Greenville Toastmasters meet at Western Sizzlin, Greenville Boulevard
8:00 p.m. - Open meeting of Pitt County Al-Anon Group at AA Bldg., Farmville Hwy.
8:00 p.m. - John Ivey Smith Council No. 6600, Knights of Columbus meets in St. Peter's Church Hall
8:00 p.m. - Pitt County Ala-Teen Group meets at AA Bldg., Farmville Hwy. Call 544-4779 or 829-8281

THURSDAY
6:30 p.m. - Exchange Club meets
7:30 p.m. - Overeaters Anonymous meets at First Presbyterian Church

ALOE VERA JUICE
100% Pure - Best Prices
Quart - \$6.70
Gallon - \$20.00
Tasty, thousands taking for arthritis, rheumatism, high blood, ulcers, overweight, indigestion, low energy, diabetes, heart disease, sinus.
CALL - 752-8926



We're big in size. We're big on service.

Manpower Temporary Services, with 900 offices, is the world's largest temporary help company. We grew big because we're big on service. On providing businesses like yours with qualified temporary workers. Whether it's in Greenville, San Francisco or Paris.

A big part of our service is our Predictable Performance System.

- Advanced interviewing, testing and selection techniques. So we send out the right temporary to step in.
- Customer evaluation of our temporary's on-the-job performance. Feedback that assures greater job satisfaction for everyone.
- Special recognition of those temporaries who are "office superstars".
- A permanent staff that takes care of your temporary help needs quickly and professionally.

Call us today. We'll help, in a very big way.

757-3300

MANPOWER 118 Reade Street
TEMPORARY SERVICES

World's Largest Temporary Help Service

Reylon	26 1/4	26 1/4	26 1/4
RockwellInt	48 1/4	48 1/4	48 1/4
Roy Crown	32 1/4	31 1/4	32 1/4
Siligs Pap	17 1/4	17 1/4	17 1/4
Scott Paper	26 1/4	26 1/4	26 1/4
SealdPow	26 1/4	26 1/4	26 1/4
SearsRoeb	19 1/4	19 1/4	19 1/4
Shaklee	19 1/4	19 1/4	19 1/4
Skyline Cp	15 1/4	14 1/4	15 1/4
Sony Corp	14	13 1/4	14
Southern Co	13	12 1/4	13
South Ry	92 1/4	92 1/4	92 1/4
SidOutInd	28 1/4	28 1/4	28 1/4
SidOutOH	34 1/4	34 1/4	34 1/4
Stevens JP	30 1/4	29 1/4	30 1/4
TRW Inc	51 1/4	51 1/4	51 1/4
Texaco Inc	49 1/4	49 1/4	49 1/4
TexEastn	49 1/4	49 1/4	49 1/4
Un Camp	48 1/4	47 1/4	47 1/4
Un Carbide	48 1/4	47 1/4	47 1/4
UnOilCal	33 1/4	33 1/4	33 1/4
Unroyal	7 1/4	7 1/4	7 1/4
US Steel	23 1/4	23 1/4	23 1/4
Wal Mart	23 1/4	23 1/4	23 1/4
WestPep s	23 1/4	23 1/4	23 1/4
Westing E	26 1/4	26 1/4	26 1/4
Weyerhae	29 1/4	29 1/4	29 1/4
WinnDix	36	36	36
Woodworth	17 1/4	17 1/4	17 1/4
Xerox Cp	37 3/4	36 1/4	36 1/4

Keeping Faith

SINGAPORE (AP) - Vice President George Bush said today the United States intends to remain a Pacific power and is ready to help Asian nations strengthen their defense capabilities. Bush spoke to the American Business Council, an unofficial group of businessmen, on the third stop of an Asia-Pacific tour. He previously visited Japan and South Korea. "Our administration is embarked on a major strengthening of our military forces, including our naval forces in the Pacific," he said. "We are going to remain faithful to our treaty commitments."

Again Dismiss Standards

WASHINGTON (AP) - A three-judge panel of the U.S. Court of Appeals for the District of Columbia has again thrown out key environmental standards for licensing nuclear power plants. The effect of the decision was unclear because the court said in its 2-1 decision it was not throwing out any licenses granted under those standards. The case arose from a challenge by the Natural Resources Defense Council to a nuclear reactor operated by Vermont Yankee Power Co. near Vernon, Vt.

Name Officers Of Fellowship

Lon Felker has been elected president of the Greenville Unitarian-Universalist Fellowship. Other new officers are Carol Cox Threewitts and Beatrice Behr, program co-chairmen; Elaine Schaal and Edith Webber, co-secretary and co-publicity chairmen; and Roy Schaal, treasurer. At the next meeting to be held May 9 Kacem Sebtli will speak on "Harbingers of Hope." For information, call 752-0787.

Clerk Robbed At Knife-Point

FARMVILLE - A clerk in the Expressway Food Mart at Marlboro just south of here was robbed at knife point Tuesday morning. Paul Corsivo called Farmville police at 1:15 a.m. to report that a man wearing a stocking over his head left the store on foot headed east on U.S. 264. He described the suspect as black and not old, about 5-foot-9. A butcher knife was held at his side while the man emptied the cash register of an amount of money not disclosed by the police. Corsivo was not injured. Farmville Police Chief Ron Cooper said the investigation of the robbery, the first for this convenience store, was being coordinated by Capt. W.G. Barber.

Their Ducks Disappearing

JACKSONVILLE, N.C. (AP) - Elizabeth Lake residents say they're upset because their ducks keep disappearing. And the man who owns most of the ducks says if they're found, it may be on a menu. "They just might wind up on somebody's dinner table," said Ira Paul, who says the entertaining creatures may not have been stolen as pets. Cynthia Silence Marcoux, who witnessed the ducknappings from her parents' lake-shore home, described the villain as short, "with a beer belly and having dark hair and a full beard." She said he drove off with several mallards peering out the rear door of his camper. Paul said the lake's waterfowl population has dropped from about 80 or 100 ducks three months ago to 35 or 40, including a number of ducklings orphaned when their mothers were plucked from their midst. "Our main problem here now is that we have only a few females left," Paul said. But other lake residents have taken up the slack. Two male geese, one a white domestic and the other a dark Canadian, have adopted one orphaned duckling brood and another whose mother is still on the lake, he said. The other ducks, including the bewildered mother, can't get near the adopted ducklings without ruffling the feathers of the two jealous geese, who honk and hiss at the approach of strangers.

Noguchi Loses His Position

LOS ANGELES (AP) - Dr. Thomas Noguchi, who was removed by county supervisors from his position as coroner, will challenge his demotion to physician specialist in court, his attorney says. Godfrey Isaac called the decision by the board of supervisors "another sham action" and said he expected to go to court today to try to overturn the demotion. Noguchi was demoted Tuesday after supervisors met in executive session. He was not present at the session, but Isaac, reached at a Torrance court, said supervisors were trying to "embarrass" his client, who he said would fight the demotion in court. Asked if Noguchi would assume the role of a regular medical examiner doing autopsies, Isaac said: "He won't take any chances on being insubordinate. He'll go to work as a medical examiner if we aren't successful in court." On Monday, Isaac was unable to obtain a temporary restraining order to halt the demotion. But Superior Court Judge John L. Cole said that he would reconsider the order if supervisors demoted Noguchi the following day. Following Tuesday's session, Board of Supervisor Chairman Pete Schabarum said Noguchi's responses to a letter citing reasons for possible dismissal were "totally inadequate." Said Schabarum, "The Board of Supervisors has

More Shot By Israeli Troops

Israel does not intend to give up the remaining occupied territories. The military command also reported a stone-throwing incident in Dahariya, about 30 miles south of Jerusalem in the occupied West Bank, but no injuries were reported. On Monday, a military spokesman said, soldiers shot and wounded two Palestinian demonstrators in the legs during a clash with Arab youths protesting the closure of a school in the West Bank town of Nablus. Soldiers shot four Arabs in the legs at Jabalya after firing shots in the air failed to disperse the mob. Five Arabs were hit by gunfire in another demonstration in Nablus, the largest West Bank town, a military spokesman said. The incidents did not disrupt festivities marking Israel's 34th birthday, and plans proceeded for ground-breaking ceremonies for 11 new paramilitary settlements in the West Bank. Israel seized the West Bank and Gaza during the 1967 Middle East war. Militant Palestinians are demanding Israeli withdrawal and their own state. Independence Day is a traditional day of demonstrations against the 15-year Israeli occupation, but the trouble this year was a continuation of Palestinian unrest over a crackdown on what Israel calls extremists. Aggravating Arab tempers were well publicized plans for the new outposts and six new civilian settlements in the West Bank approved last Sunday by Prime Minister Menachem Begin's Cabinet. The renewed focus on West Bank settlement was partly aimed at dispelling the gloom engulfing this nation after relinquishing the Sinai Desert to Egypt on Sunday and uprooting Sinai settlements. The Arabs see the settlements as certain indications

Raps Delay On Aspirin Report

WASHINGTON (AP) - The chairman of the House Energy and Commerce Committee has criticized the government for being slow to disclose a connection between aspirin and potentially fatal Reye's syndrome in children. The rebuke by Rep. John Dingell, D-Mich., was made Tuesday as a consumer group asked Congress to investigate whether the aspirin industry persuaded the government to delay issuing a warning that aspirin may increase risk of the disease. A warning was issued Feb. 11 by the Centers for Disease Control - after the flu season had begun and nearly four months after a panel of experts suggested making such a statement. "What is intolerable is that the (Food and Drug Administration) has not acted six months after the CDC panel made its recommendation," said Dingell, adding that he would ask Health and Human Services Secretary Richard Schweiker for a reply to the charges.

Obituaries

Buck
Mr. George W. Buck Sr., 89, of Route 1, Vanceboro, died Tuesday in Beaufort County Hospital, Washington, N.C. His funeral service will be conducted Thursday at 2:30 p.m. in the Wilkerson Vanceboro Funeral Chapel by the Rev. Ralph Clegg. Burial will be in Palmetto Free Will Baptist Church Cemetery. A Craven County native, Mr. Buck spent all his life in the Vanceboro community. He was a retired farmer and a member of the Vanceboro Missionary Baptist Church. Surviving him are his wife, Mrs. Annie Gaskins Buck; four daughters, Mrs. Mildred Clegg, Mrs. Jane Lowe and Mrs. Vivian Lowe, all of Durham, and Mrs. Marjorie Ilock of Vanceboro; two sons, George W. Buck Jr. of Route 1, Vanceboro, and John Frank Buck of Charleston, S.C.; a sister, Mrs. J.A. Gaskins of Vanceboro; 16 grandchildren and 25 great-grandchildren. The family will receive friends at the funeral home tonight from 7 to 9 p.m.

Warren
SNOW HILL - Mr. Milton Lee (Sack) Warren of Route 2, Snow Hill, died Sunday in Lenoir Memorial Hospital. Funeral services will be held Friday at 2 p.m. at Friendship Free Will Baptist Church in Snow Hill by the pastor, the Rev. E.L. Garner. He was born and raised in Greene County and was a 1968 graduate of South Greene High School. He was a member of Friendship FWB Church. Surviving are his wife, Mrs. Mona Lisa Collins Warren; one daughter, Laticia Mitchell Warren of the home; his parents, Mr. and Mrs. Milton Warren of Snow Hill; one brother, Roger Lee Warren of Snow Hill; and three sisters, Mrs. Mural Warren Lanier of Snow Hill, Mrs. Shelby Warren Reid of Landover, Md., and Miss Connie Sue Warren of Snow Hill. Family visitation will be Thursday night from 8-9 at Friendship FWB Church.

Surviving are one son, William R. Moore of Danville, Va.; one daughter, Mrs. Ben G. Tucker of Grifton; two sisters, Mrs. Daniel Lane of Lake Junalaska and Mrs. Helen Dixon Russell of Ayden; two grandchildren and two great-grandchildren. The family will be at the funeral home from 7-9 p.m. Thursday. In lieu of flowers a memorial contribution may be made to the First Baptist Church in Ayden.

Guest Speaker

CONETOE - Dr. Harold Slighter of Greenville, S.C., will speak at New Hope Baptist Church Thursday through Saturday at 7:30 each evening. He is pastor of the Tabernacle Baptist Church in Greenville.

MASONIC NOTICE
Greenville Lodge No. 284 AF&AM will hold an emergent communication Thursday at 7:30 p.m. for work in the fellow craft degree. All master masons are invited.
E.H. Smith, Master
H.R. Phillips, Secretary

The Pactolus Ruritan Club

SPRING FISH FRY

Two Locations To Serve You
Pactolus Fire House, Pactolus, N.C.
Foodland Shoppe Parking Lot, Washington, N.C.

Saturday, May 1, 1982
11:00 a.m. to 7:30 p.m. or until sold out
\$3.00 per plate

Joyner's Mortuary
Farmville, N.C.
753-4658
If no answer, call
753-4535

IRA VS IRAs

At last, some good news for the American taxpayer. Now, with an NCNB IRA, a working couple can deduct up to \$4,000 a year* from Federal and North Carolina tax returns every year. And that's not the only tax break that you'll be getting. Unlike other savings plans, you pay no tax on the interest building up in your IRA. Later on, when you start withdrawing from your NCNB IRA, you'll have to pay taxes, but chances are, by then you'll be retired and in a lower bracket. The new IRA at NCNB. One of the biggest tax breaks in our history is right in your neighborhood. And our people have been trained to help you make the most of it. Come in and talk it over. Now. The sooner you start, the better.

NCNB

**Working individuals can contribute as much as 100% of their salary or wages, up to a maximum of \$2,000 (\$4,000 total for working couples). Substantial interest penalty for early withdrawal. All depositors insured to \$100,000 by FDIC.*

Carolina Grill
Corner 9th & Dickinson
Cheese & Egg Sandwich 59¢
Ham & Egg, Bacon & Egg, & Sausage & Egg Sandwiches . . . 99¢
Phone 752-1188 For Take-Outs



Jim And Gail Waldron Will Hold A Children's Crusade At Washington Assembly Of God
Washington, N.C.
May 2 - 5 7:00 P.M.
Registration 6:30 P.M. Each Night
Located on the right on Hwy. 264E

The NCNB IRA Tax Cut.

AMOUNT CONTRIBUTED	1982 TAX BENEFITS*
\$1000	\$1000 ded. plus no tax on \$129.35 interest
\$2000	\$2000 ded. plus no tax on \$258.70 interest
\$3000	\$3000 ded. plus no tax on \$388.06 interest
\$4000	\$4000 ded. plus no tax on \$517.41 interest

**Based on 12% Annual Interest, Compounded daily on a 365/360 basis, and deposits made first day of the year.*

Crump, Robbins Selected In 4th Round Of Draft

A Staff Report
East Carolina defensive tackle George Crump and offensive tackle Tootie Robbins were both picked in the fourth round of the National Football League draft Tuesday afternoon.

Crump, a 6-4, 260-pounder from Chesapeake, Va., was picked by the New England Patriots while Robbins, a 6-5, 270-pounder from Mery Hill, N.C., was picked by the St. Louis Cardinals.

Crump was the second player in the fourth round picked and the 86th player overall picked. Robbins, who many thought would be the top ECU draft choice, was the seventh player picked in the fourth round.

Three Atlantic Coast Conference football players were chosen in the first round of the draft and 13 ACC players in all were selected in the first six rounds.

The draft concludes today in New York.

"I'm surprised, definitely," Crump said of his selection. "I'm surprised how high I went and that I was picked before Tootie."

"I'm still in a state of

shock right now. Today's Wednesday, right? But I can't believe it. It's like a dream. All the work paid off, definitely," he said. "All the work paid off."

Said his agent, Ken Hutcherson, "George Crump is a perfect example of a kid who worked hard and, since January, has gone from almost a nothing to the 86th player picked."

Crump joins former ECU running back Anthony Collins in New England. Collins was drafted in the second round last season by the Patriots. His name was inadvertently omitted from a list run yesterday in the Daily Reflector of ECU players in the professional ranks.

"It's nice, very nice to be going up there," Crump said. "I was a little surprised they picked me. I had narrowed the teams (I thought would draft me) down and they hadn't talked to me that much."

Crump watched the draft on television with ECU nose guard Fee Griffin but it was not until it went off the air and Crump had returned to

his apartment that the call came.

"They only televised the first three and a half rounds and after that I came back home and layed around awhile," he said. "I figured the draft was over (a little later). It was about quarter to six then."

"Then, about ten to six I got a call. They asked if this was George Crump and I said, 'Yes, it is.' And they said, 'This is the New England Patriots and we've drafted you in the fourth round.'"

Crump will now report to a mini-camp on May 11.

Robbins, unlike Crump, had mixed feelings about his fourth round choice by the Cardinals.

"I'm pretty pleased. The fourth round is okay, but I felt I should have gone earlier. Still I'm glad to get a chance to play pro ball."

Robbins said he talked with St. Louis last night following his pick. "I talked briefly with the head coach, and they told me to report to mini-camp on May 16." That camp will be held at St. Louis.

"I don't know much about St. Louis," he said. "I didn't keep up with them that much, but I guess I'll have to learn a lot about them. It won't be any problem."

"I'm just glad I got the chance to play. I feel like I have a better chance of playing with St. Louis than I would, say with someone like Pittsburgh," he said. "I feel I have a good chance to make the team and stick around for a while."

Robbins, who was a second-team All-American this past season, said he will be working out with the weights before he leaves for the mini-camp, where he and the other rookies will be going through two-day drills for a week. "Then, I'll be back and working in lifting and running until I report to regular camp."

For Robbins, who left the team several times during his freshman and sophomore years, making the pros completes a turnaround begun two years ago. "I'm very pleased with myself that I came back and had an outstanding junior and senior year."

San Diego Picks Tiger DB Hollis

NEW YORK (AP) — Hollis Hall, a defensive back from Clemson, became the San Diego Chargers' first pick Wednesday — the 188th player, overall — in the seventh round of the 1982 National Football League college draft.

The Chargers in effect sat out the entire first day of the draft Tuesday. They had dealt away their first-, second-, third-, fourth- and sixth-round choices before the draft began. And on Tuesday, they also traded away their fifth-round choice to Chicago for what was called "past considerations."

The Washington Redskins, during the George Allen era, set the record for the most rounds without a pick. In 1972, their first selection came in the eighth round — and they used it to take 28-year-old Moses Denson, a running back from Maryland State.

Earlier, Jeff Roberts, a linebacker from Tulane, was selected by the New England Patriots to start the second day's drafting and the Detroit Lions traded defensive back Luther Bradley to Houston.

Roberts was the first player picked in the seventh round — the draft runs 12 rounds — while Bradley went to the Oilers in exchange for their seventh-round pick. With it, Houston took fullback Phil Bates from Nebraska.

With Bert Jones and Russ Francis having been traded and with Ken Sims officially drafted, the 28 teams went about the more mundane business of looking for "bodies," relatively unknown players with a chance to make their rosters.

The gallery, packed with excited spectators — most of them New York Giants or New York Jets fans — was virtually empty today, only a few hard-core draft followers ob-

serving the proceedings.

The big names were long gone, particularly this year, one which most scouts called one of the thinnest drafts in recent memory. Some called it a one-man draft, Sims being that one. The University of Texas defensive tackle was No. 1, taken Tuesday by the New England Patriots to open the first of the 12 rounds. The 6-foot-6, 265-pounder strode into the spotlight at draft headquarters — and probably into a million-dollar contract, compliments of Patriots owner Billy Sullivan, who knows the value of a buck.

Jones also is close to \$1 million richer. The "franchise" quarterback for nine years in Baltimore was fed up with playing for the Colts — a 2-14 season in 1981 didn't help — and said the only way he'd sign another contract with them was if they then traded him.

On Tuesday, they dealt him to Los Angeles for the Rams' first-round and second-round picks.

And after picking linebacker Johnnie Cooks of Mississippi State with their own choice (No. 2 overall), the Colts used the Rams' No. 5 in the opening round to replace Jones with Ohio State quarterback Art Schlichter.

Rain Brings On Postponements

Rain again forced the postponement of a number of area sports events yesterday. The games delayed, and their scheduled replay:

Baseball: Rose at Northeastern, today; Conley at West Craven, today; C.B. Aycock at North Pitt, today; Roanoke at Bertie, May 12; Ayden-Grifton at SouthWest Edgecombe, Thursday; Jamesville at Chocowinity, Friday; and Farmville Central at Greene Central, Thursday.

Softball: Rose at Northeastern, today; Greenville Christian at Mt. Calvary, May 11; Farmville Central at Greene Central, Thursday; North Pitt at C.B. Aycock, Thursday; Ayden-Grifton at SouthWest Edgecombe, Thursday; Roanoke at Bertie, May 12; Conley at West Craven, today; Jamesville at Chocowinity, Friday.

Tennis: Rose at Northeastern, Monday; C.B. Aycock at Greene Central and Bear Grass at Cape Hatteras, no dates set.

Golf: Hunt at Rose, no date set; Eastern Wayne, Fike, Williamston at Farmville Central, Tuesday.

No report was received on the status of the Williamston-Washington tennis match.



A New Twist
Clay Johnson (34) of the Los Angeles Lakers gives a little twist to the game as he goes up and out-of-bounds while trying to save the ball against the defense of Joel Kramer (50) of the Phoenix Suns. (AP Laserphoto)

Of NFL Draft 3 ACC Players Go In 1st

NEW YORK (AP) — North Carolina State wide receiver Mike Quick was one of three Atlantic Coast Conference football players chosen in the first round of Tuesday's National Football League draft, and he left no doubt about his feelings.

"Great. I couldn't be in a better spot I don't believe," said Quick, the 21st player chosen overall and first for the Philadelphia Eagles.

"I was expecting to go in the first," Quick said. "I knew Philadelphia was interested. I actually thought I might have gone earlier to New Orleans or maybe Oakland, from news I had received previously. But I'm happy Philly picked me."

"They've got three good wide receivers, but they are still looking for another one they can count on," Quick added. "And I believe I can do the job."

The 6-foot-2, 186-pound, Hamlet native did the job for the Wolfpack, catching 32 passes for 508 yards last year. He set school career records for receptions (116), yards (1,934) and touchdown passes (10).

"We think he's an exceptional prospect," said Eagles' wide receiver coach Dick Coury. "We like his toughness, concentration on the football

and jumping ability. And, he's the best blocking wide receiver we've seen coming out of college. The only negative is that he does not have the burning speed some people like."

Two Clemson players, Jeff Bryant and Perry Tuttle, were also chosen on the first round. In all, 13 ACC players were chosen along with a pair from East Carolina in the draft's first six rounds.

Seattle was expected to pick guard Mike Munchak to give quarterback Jim Zorn more protection, but instead went for Bryant, a defensive end. Bryant was the seventh overall selection and first from the ACC.

Tuttle, a wide receiver, was the 20th overall pick and first choice of Buffalo to finish a trade with Denver.

North Carolina linebacker Calvin Daniels was chosen in the second round by the Kansas City Chiefs.

In the third round, Duke wide receiver Cedric Jones was the first player chosen, with the New England Patriots calling his name. Wake Forest wide receiver Kenny Duckett was drafted by New Orleans, on a choice acquired from Washington, and North Carolina State linebacker Robert Abraham was taken by Houston in a pick received in a three-way deal.

The two East Carolina players both went in the fourth

round. Defensive end George Crump was the round's second pick as New England dipped once more into the Carolinas, and offensive tackle Tootie Robbins was picked by St. Louis, a choice acquired from Seattle.

Virginia linebacker Stuart Anderson was picked by Kansas City in the fourth round while Duke linebacker Charles Bowser was selected by the Miami Dolphins.

Linebacker Jeff Davis of Clemson and Duke defensive back Dennis Tabron were fifth-round choices. Davis was tabbed by the Tampa Bay Bucs while Chicago got Tabron on a deal from San Diego.

SAAD'S SHOE REPAIR
Quality Shoe Repairing
We sew leather coats.
113 Grande Ave.
758-1228
Opposite Sherwin Williams

Hours
8-6 Mon.-Fri.
Closed Saturday
"Parking In Front"

Sports Calendar

Items on the Sports Calendar are supplied by schools or sponsoring agencies and are subject to change.

Thursday's Sports
Baseball
Rose at Northern Nash (4 p.m.)
Aurora at Jamesville (8 p.m.)
Bear Grass at Belhaven
Nash Central at E.B. Aycock (4 p.m.)
Roanoke at Tarboro (7:30 p.m.)
Ayden-Grifton at SouthWest Edgecombe
Farmville Central at Greene Central

Softball
Rose at Northern Nash (4 p.m.)
Aurora at Jamesville (6:30 p.m.)
Bear Grass at Belhaven
Nash Central at E.B. Aycock (4 p.m.)
Roanoke at Tarboro (7:30 p.m.)
Farmville Central at Greene Central
North Pitt at Charles B. Aycock
Ayden-Grifton at SouthWest Edgecombe

Track
Coastal Conference girls meet at White Oak
Rose at Northeastern (3:30 p.m.)
Eastern Carolina Conference girls meet at SouthWest Edgecombe
North Carolina Conference girls meet at Tarboro

Tennis
Greene Central at Southern Nash (3 p.m.)
Rose at Northern Nash (3:30 p.m.)
Roanoke Rapids at Williamston (3 p.m.)
Roanoke at Tarboro
C.B. Aycock at Farmville Central
Golf
New Bern at Rose (2 p.m.)

Riggan Shoe Repair Shop
Parking in Front & Rear
113 W. 4th Street
Downtown Greenville
758-0204
Open: Mon.-Fri. 8 a.m. - 6 p.m.
Saturday 9 a.m. - 11:30 p.m.

ECU Softball Club Gains AIAW Regional Berth

East Carolina's Lady Pirate softball team has been selected to play in the AIAW Regionals, set Friday and Saturday at Graham.

The Lady Pirates, who had the best record in the state during regular season, finished second to Western Carolina in the state championship, and will be making their third straight trip to the regionals. Last year's team finished third in the nation.

East Carolina will face Milligan College in the first round of the tournament, starting at 2 p.m. Friday. At the same time, in the same bracket, Northern Kentucky will meet the University of North Carolina.

In the opposite bracket, playing at 3:15, Virginia Commonwealth faces UNC Charlotte, while Appalachian State will play Western Carolina in the other game.

Play will continue until a champion is decided in the double elimination field, with the winner receiving an automatic berth in the nationals. Other teams may also be picked as at-large entries.

Termites Are Swarming!
756-5630
•Termite Control
•Powder Post Beetles
•Moisture Control
•Automatic Ventilation
EVERETTE'S PEST CONTROL CO.
LEROY EVERETTE, JR.

Fencing
"Best Price In Town"
Free Estimates 758-5937
Seegars Fence Co.

WHITE'S TIRE SERVICE

FIRST OFFER OF A U.S. SAVINGS BOND OR A CASH REBATE*

FREE \$100.00 U.S. SAVINGS BOND OR A CASH REBATE!

*Purchase four Michelin passenger car tires at our special BCR exchange, save more and ask how you can get ABSOLUTELY FREE \$100 U.S. Savings Bond or a cash rebate directly from White's Tire Service.

MICHELIN PUT AMERICA ON RADIALS!

MICHELIN XZX
Featuring a European-style tread designed to enhance the car's overall handling characteristics, this long-wearing radial tire is performance proven for imported cars. The XZX provides measurable fuel savings over bias-ply tires and traction on wet and dry roads, even in light snow. The XZX is available in P-series sizes for imported as well as some American cars.

MICHELIN XWW
Specially engineered for American cars and highways, this quiet-running radial tire is designed to provide a smooth ride, long tread mileage, responsive handling, excellent traction and proven fuel economy over bias-ply tires.

White's carries one of the largest MICHELIN inventories in America! Thousands and thousands of affordable MICHELINS for your car!

Since 1951

WHITE'S TIRE SERVICE

ASK ABOUT OUR LOW PRICES ON TRUCK TIRES!

RALEIGH: 758-1111
GARNER: 778-1850
DURHAM: 286-2100
GREENSBORO: 774-6375
ROCKY MOUNT: 443-2887
GREENVILLE: 352-3400
WILSON: 237-5998
WILMINGTON: 343-8604
GOLDSBORO: 734-7132
734-3600

26% Protein - 10% Fat
High Quality Ingredients in Joy Special Meal Are Blended And Fully Cooked To Appeal To Dogs Of All Sizes. High Concentrated Formulation Permits Less Pounds Of Joy To Be Fed While Maintaining Growth, Vigor, And Good Health In That Canine Of Yours.

SPECIAL MEAL 26% Protein - 10% Fat
Available in:
25 Lb. Bags \$7.15
50 Lb. Bags \$11.75
Puppy Food
20 Lb. \$6.43

Dealer Inquiries Welcome
Free Samples

Warren's Dog & Hunting Supplies
3028 E. 16th St.
Greenville
Across From Hastings Ford
Phone 752-1881
Mon.-Fri. 9:30-5:30
Sat. 9:30-4:00

NOW OPEN!

Chuck Autry's Paint & Body Shop

All Types Of Body Work, Foreign & Domestic Also Minor & Major Mechanical Repairs. Former Owner & Operator Of 264 Shell Pantry.

1806 Dickinson Ave.
Across From Pepsi-Cola Bottling Co.
Phone 756-3348

Daytime Wrecker Service 756-3348
Night time Wrecker Service 756-2366

Lakers, Spurs Take Openers In Playoffs

By The Associated Press
The Los Angeles Lakers hadn't played in nine days, so it seemed logical that they would come out cold in the first quarter.
Logic, it turned out, had nothing to do with Tuesday night's National Basketball Association playoffs, as the Lakers hit 15 of their first 20 shots for a 32-20 first-quarter lead against the Phoenix Suns.
The Lakers, who had a bye in the first round of the playoffs, went on to an easy 115-96 victory and a 1-0 lead in their best-of-7 series.

"Los Angeles came out strong in the first quarter and set the tone," said Phoenix Coach John MacLeod. "We couldn't recover. We were never in position to establish momentum."

But Lakers Coach Pat Riley still is worried about tonight's second game, also in Los Angeles, because it will be necessary for his team to be ready to play again so quickly after Tuesday's success.

"It was a good first-night win," Riley said. "In a back-to-back situation like this on our court, we have to make sure Phoenix doesn't steal one. We'll need the same effort in the next game."

In the other Western Conference playoff opener, the San Antonio Spurs beat Seattle 95-93, negating the SuperSonics' home-court advantage.

The second game of that series is tonight in Seattle, and the Eastern Conference playoffs also resume with Washington at Boston and Milwaukee at Philadelphia.

The Celtics and 76ers won Game 1 of those series last Sunday.

Jamaal Wilkes led the Lakers' balanced scoring with 28 points, followed by Earvin "Magic" Johnson with 23, Norm Nixon with 22 and Bob McAdoo with 21. Los Angeles'



Looking For The Out

Los Angeles center Kareem Abdul-Jabbar (33) searches for the out against defensive pressure by

Truck Robinson (21), Rich Kelly (right) and Walter Davis (far left) of Phoenix during NBA playoff game last night. (AP Laserphoto)

top scorer in the regular season, Kareem Abdul-Jabbar, was held to 11.

Dennis Johnson and Alvan Adams led the Suns with 20 points apiece and Len Robinson had 18.

Spurs 95, Sonics 93
Seattle, which neutralized the individual talents of Houston's Moses Malone in the first round of the playoffs, couldn't handle San Antonio's 1-2 punch of NBA scoring champion George Gervin and Mike Mitchell in the opener of

their second-round series. Gervin scored 31 points and hit the game-winning 18-foot jump shot with five seconds left, while Mitchell added 30 for the Spurs.

San Antonio took advantage of the absence of Seattle scoring leader Gus Williams for most of the third quarter to turn a 45-44 halftime deficit into a 19-point lead, 76-57, late in the period.

Williams, who limped off the court early in the second half with a leg cramp, came back

with 12 points in the fourth quarter as the Sonics nearly erased the huge deficit.

Thirteen straight Seattle points cut San Antonio's lead to 83-80 with 5:40 left. But the Sonics never pulled ahead although they managed a 93-93 tie on Lonnie Shelton's basket with 1:35 left.

There was no more scoring until Gervin's game-winner. Jack Sikma led Seattle with 26 points, Shelton added 20 and Williams 17.

Anthony Pads Lead

AKRON, Ohio (AP) — Earl Anthony, of Dublin, Calif., finished fifth in the best-paying tournament on the Professional Bowlers Association tour and collected \$7,000 to pad his tour-leading total of \$108,940.

Art Trask of Fresno, Calif., continues in second place with \$70,640, including \$1,600 from the Firestone event.

Southern Nash Blisters Jags

STANHOPE — Southern Nash did not lose a set en route to an easy 9-0 win over Farmville Central Tuesday afternoon in an Eastern Carolina Conference tennis match.

Farmville is 0-6 overall and in the conference.

The Jaguars travel to Charles B. Aycock Thursday.

Summary:

Steve Williams (SN) d. Mark Rapaport 6-3, 6-1.
Kevin Cook (SN) d. Phillip Wainwright 6-4, 6-0.
Keith Daniels (SN) d. Paul Bassett 6-2, 6-1.
Ted Sanderson (SN) d. Bobby Evans 6-3, 6-4.
Ronnie Taylor (SN) d. Brian East 6-2, 6-4.
Bradley Lee (SN) d. Greg Bullock 6-1, 6-2.
Williams-Ellen Lewis (SN) d. Rapaport-Wainwright 9-7.
Cook-Lee (SN) d. Bassett-Evans 9-7.
Taylor-Sanderson (SN) d. Bullock-Jeff Dixon 8-2.

BETTER HOMES FAIR APRIL 29, 30 & MAY 1



Hundreds of ideas available on home improvements, interior and exterior designs for your home and energy conservation.

Free "How-To" and product demonstrations hourly. Saturday, May 1—Central Court



and Carolina East Centre
264 By-Pass on Hwy. 11, Greenville

Is Lendl Tennis' New No. 1 Player?

DALLAS (AP) — The Association of Tennis Professionals' computer says John McEnroe is the No. 1 one men's tennis player in the world.

Ivan Lendl's record suggests something else.

The 22-year-old Czechoslovakian, currently ranked No. 3 behind McEnroe and Jimmy Connors, strengthened his bid for the top spot as he scored his fourth consecutive victory over McEnroe in the World Championship of Tennis Finals played Monday night.

McEnroe did make one stride forward in his 6-2, 3-6, 6-3, 6-3 loss. His second-set triumph broke Lendl's nine-set

streak, but the numbers are clearly on the Czech's side.

Lendl now has a 4-2 record over the 23-year-old defending Wimbledon and U.S. Open champion and has won 11 of the last 12 sets they played. All but one of those victories have come on surfaces more styled to McEnroe's serve-and-volley style.

A fourth-round win in the French Open was the Czech's first over McEnroe, who has not fared well on the Parisian red clay courts. Two months later, Lendl and his Czechoslovak teammates came to Flushing Meadow, the site of the U.S. Open, for semifinal Davis Cup action.

Though his team lost, Lendl scored a 6-4, 14-12, 7-5 victory over McEnroe on the same court where the New Yorker has claimed three consecutive Open titles.

The next meeting was on the indoor carpet at Madison Square Garden in the finals of the Grand Prix Masters Tournament. Lendl extended his streak with a 6-4, 6-2 win.

"Obviously his record is better than mine. No one is arguing. He's playing better than I am, winning tournaments. Ivan is letting the results speak for themselves right now," McEnroe said.

Those results include a near-total domination of the 1982 men's tour, winning 78 of 80 matches and earning \$900,000. He can reach the \$1 million mark with a victory in the Tournament of Champions at Forest Hills later this month.

"At the beginning of the year, I said I liked the WCT even before I started winning all the tournaments," Lendl said after picking up \$150,000

for his Dallas victory.

But the money pales for the 6-foot-2 man from the steel-mill town of Ostrovia. Beating McEnroe is what counts.

"Everytime I beat him, it is important. This (the WCT finals) was my second biggest (victory) ... the Grand Prix Masters was the first ... the next will be the French Open," Lendl said.

When asked if there was any additional pressure in reaching the top of the tennis world, Lendl said: "I don't feel any pressure about it. I don't read the newspapers. There is no pressure if you don't know what people are saying."

But many are saying there seems to be a new pairing in the battle for tennis supremacy.

**Part-Time
Tree Service**
Professional Work
Tree Removal-Stump Grinding
Phone 752-5042
Royce Everette

Bearing repack · Import car service · Tire air pressure check

GIGANTIC SPRING TIRE SALE



TIRE SALE

Firestone SUPERSTEEL!

FIRESTONE'S BEST ... FOR LESS!

721[®] Steel Belted Radial

Tough Prices To Beat!

4-721 Radials
For **159⁰⁰**
Or 44.95 Each
16580R-13
17580R-13
18580R-13
19570R-13
Plus Tax 1.88 To 1.98

4-721 Radials
For **179⁰⁰**
Or 49.95 Each
17575R-14
18575R-14
20575R-15
Plus Tax 1.83 To 2.47

4-721 Radials
For **239⁰⁰**
Or 64.95 Each
19575R-14
20575R-14
21575R-15
22575R-15
23575R-15
Plus Tax 2.18 To 3.01

Our Big
SPRING SALE
Is For
ONE WEEK ONLY!

Firestone DELUXE CHAMPION RADIAL BLACKWALL

<p>4 Radials For 139⁰⁰ Or 39.95 Each 15580R-13 17580R-13 19575R-15 <small>Plus Tax 1.44 To 2.15</small></p>	<p>4 Radials For 159⁰⁰ Or 44.95 Each 18580R-13 20575R-15 <small>Plus Tax 1.78 To 2.38</small></p>	<p>4 Radials For 199⁰⁰ Or 59.95 Each 21575R-15 22575R-15 <small>Plus Tax 2.48 To 2.78</small></p>
---	---	---

QUALITY CAR SERVICE BY PROFESSIONAL MECHANICS

Pughs Tire & Service Center, Inc.

Corner 5th & Greene Sts.
752-6125

SERVING GREENVILLE FOR OVER 30 YRS.
COMPLETE FARM & ROAD SERVICE
OFFICIAL N.C. INSPECTION STATION

Firestone

90 DAYS SAME AS CASH on revolving charge at Firestone stores and many Firestone dealers. Minimum monthly payment required. All finance charges refunded when paid as agreed.

Alignment · Air filters · Anti-freeze · Transmission service

Batteries · PCV filter · Battery check · Tire service · Tie rod ends · Grease seals · Light truck service · Mufflers · Oil change · Tune-up · Brakes · Shock absorbers · Tune-up · Ball joints · Wheel balancing · Oil filters · Air conditioning service · Radiator service · Struts

Padres In First With 11th Straight Win

By The Associated Press

It was a moment to savor for the San Diego Padres.

"It's like somebody who hasn't eaten in a long time and then somebody gives him a steak," said Eric Show.

Show was the winning pitcher Tuesday night on a momentous occasion for the long-suffering Padres. An 8-5 victory over the New York Mets vaulted them past Atlanta and into first place in the National League West.

It not only was a club-record 11th-straight victory for the

The Pittsburgh Pirates won only seven games and lost 20 against left-handed pitching in 1981.

surprising Padres, but marked the latest into any season of their history that they had been on top.

"I think everybody's starting to realize it's about time to take the Padres seriously," said Show.

Padre Manager Dick Williams relishes San Diego's fast start, of course, but is keeping his euphoria on hold.

"It's nice to be in first place now, but it would be nicer in October," Williams said. "I just hope we keep playing this way."

Luis Salazar tripled in a pair of runs and Sixto Lezcano doubled in two more for the Padres.

Kurt Bevacqua, pinch-hitting for starter John Curtis in the San Diego fourth, singled in the

go-ahead run to snap a 5-5 tie. Salazar reached second to open the inning off reliever Jesse Orosco, 0-3, when second baseman Bob Bailor misplayed his pop fly for an error. Bevacqua delivered his single one out later.

Show, 3-0, took over for Curtis, who had given up eight hits and five runs, and worked the final five innings to gain the victory.

The triumph moved the Padres, now 12-4, into first place by percentage points over the Atlanta Braves, who lost their fifth straight game, 10-4 to Pittsburgh. The Padres' streak broke their 10-game winning string of 1978.

Pirates 10, Braves 4
Tony Pena belted a grand-slam home run, Jason

Thompson hit two homers, and Tom Griffin and Kent Tekulve combined on a five-hitter as Pittsburgh beat Atlanta.

The Braves continued to spin after opening the season with a record-setting 13-game winning streak.

Griffin, 1-1, was relieved by Tekulve in the ninth after giving up a two-run homer to Bob Horner with no outs. Bob Walk, 2-2, was the loser.

"I was just looking for a ball I could hit hard," said Pena after hitting his slam off reliever Jose Alvarez in the fifth inning. "I don't consider myself a home run hitter. I just want to hit line drives. I haven't hit many, but I knew that one was gone when I hit it."

Astros 3, Cardinals 0
Ray Knight, Phil Garner and

Jose Cruz each knocked in a run and Vern Ruhle allowed only four hits in 71-3 innings to lead Houston over St. Louis.

The loss was the Cardinals' third in a row following a winning streak of 12 games.

Ruhle, 1-2, was lifted after giving up Lonnie Smith's double in the eighth inning and was relieved by Joe Sambito, who gained his fourth save. Steve Mura, 2-1, was the loser.

Knight's single brought home the first Houston run in the first inning. Garner had an RBI double in the seventh and Cruz hit a home run in the ninth off reliever Joaquin Andujar.

"They're not slumping," said Ruhle of the Cardinals. "Tonight I'd have to say I had some exceptional pitches. I could have gotten hit if I'd

made some bad ones."

Reds 6, Cubs 3

Johnny Bench hit his first home run of the year and Cesar Cedeño drove in three runs to lead Cincinnati past Chicago. Bench's two-run homer in the fifth inning erased a 2-1 Chicago lead and Cedeño doubled home two of his runs in a three-run seventh that locked up the game for the Reds.

Bruce Berenyi, 4-1, gained the victory with relief help from Jim Kern, who posted his first save for the Reds with four innings of work. Dan Larson, 0-2, absorbed the loss.

"We got something today that we haven't been getting: RBI production," Cincinnati Manager John McNamara said. "We've been getting runs here and there, but there

hasn't been any consistency."

Dodgers 3, Phillies 0

Jerry Reuss hurled a four-hitter and Pedro Guerrero slugged a two-run homer to lead Los Angeles over Philadelphia. Ken Landreaux, the NL's leading hitter, also singled twice, scored a run and stole two bases as the Dodgers won for the fifth time in their last six starts.

Reuss, 2-1, who pitched a one-hitter in his last start against Houston, hurled his 32nd career shutout. The left-hander got 20 of the 27 outs on ground balls. He struck out two and walked one.

Larry Christenson, 1-2, took the loss. "I'm pitching as well as I ever have," Reuss said. "I can't remember pitching two

shutouts in a row."

Expos 3, Giants 2

Chris Speier belted three hits, including a triple and home run and scored twice to lead Montreal over San Francisco.

Winning pitcher Steve Rogers, 3-1, scattered seven hits and broke a 2-2 tie with a run-scoring single in the seventh following Speier's leadoff triple. Rogers struck out seven and walked two.

Al Holland, 1-3, was the loser.

For All Your Fencing Needs
CALL 752-2736
FOR FREE ESTIMATES
Whitehurst & Sons Fence Co.

Tigers Win 3-Team Meet

WILLIAMSTON — Despite double wins by Roanoke's Ronnie Broadie and Donnie Wallace, Williamston High School took first place in a tri-meet Northeastern track meet yesterday at Williamston.

Williamston finished with 68 points, while Washington had 60 and Roanoke had 44.

Wallace won the shot and discus, while Broadie won the 400, 200 and shared first place in the 100.

Williamston's Vincent Washington won both of the hurdle events, while Washington's Boston took the long and triple jumps.

The teams return to action next Thursday, May 6, in the Northeastern Conference championship meet at Tarboro.

Summary:

Shot put: Wallace (R) 55-9/8; Andrews (R) 47-8/8; Wooden (Wa) 47-5/8; White (Wa) 47-2.

Long jump: Boston (Wa) 19-11/8; Purvis (Wm) 18-7; Stanley (Wa) 18-1/8.

High jump: Purvis (Wm) 6-2; Everett (Wm) 5-4; Speller (Wm) 5-4.

Discus: Wallace (R) 142-0; Davenport (Wa) 135-6/8; Samuelson (Wa) 124-4; Perkins (Wm) 120-5/8.

Triple jump: Boston (Wa) 41-4/8; Mathewson (R) 39-3; Everett (Wm) 37-4; Edwards (R) 33-7.

Pole vault: Speller (Wm) 11-6; Brady (Wa) 11-0; Purvis (Wm) 8-4.

110 high hurdles: Washington (Wa) 15-57; Holley (Wa) 16-0.

100: Wooden (Wa) and Broadie (R), tie for first, 10-82; Hudgins (Wm) 11-0; Hagan (Wm) 11-3.

800 relay: Washington 1:34; Williamston 1:37.

Mile: McIvory (Wa) 5:03; Roberson (Wm) 5:14; Glover (R) 5:17; Whitley (R) 5:29.

400 relay: Washington 46.1; Williamston 46.3.

400: Broadie (R) 53.69; May (Wa) 55.0; Brown (Wm) 57.6.

300 low hurdles: Washington (Wm) 40-44; Holley (Wa) 44-0; Everett (Wm) 46-17; Brady (Wa) 46-91.

600: Corey (Wm) 2:15.59; Daniels (R) 2:16; Ore (R) 2:18.11; Stanley (Wa) 2:20.

200: Broadie (R) 22.36; Hudgins (Wm) 22.85; Moore (Wa) 23.6; Jackson (R) 24.5.

Two-mile: Roberson (Wm) 11:38; name unavailable (R) 12:05; name unavailable (Wa) 12:25.7; name unavailable (Wm) 13:17.

Mile relay: Williamston 3:46; Washington 3:54.

Buyout Costs Dodgers Bucks

LOS ANGELES (AP) — Los Angeles Dodger owner Peter O'Malley told his administrative assistants not to let money get in the way of dropping pitcher Dave Goltz, so they didn't.

The world champions ate \$1.65 million of his contract, reportedly the largest payoff in major league baseball. He had four seasons left at \$425,000 a season.

That's the second time the Dodgers have had the distinction of the largest major league baseball buyout. They paid Don Stanhouse \$1.36 million to drop him from the team. He had four seasons left at \$340,000 a season.

Goltz was signed in 1980 as a free agent for an estimated \$3 million on a six-year contract. Stanhouse was signed the same year for \$1.36 million.

Goltz was 7-11 and 2-7 in his past two seasons and made only one start this season—a losing effort.



Not In Yankee Lineup

New York Yankee players line up to shake hands with former Yankee star Reggie Jackson, now with the California Angels, prior to Tuesday night's game at Yankee Stadium. It was Jackson's

first game in New York since signing as a free agent with the Angels. From left the players are: Willie Randolph, Jackson, Bucky Dent, Dave Collins and Dave Winfield. (AP Laserphoto)

Reggie (Who Else?) Lifts California Past Yankees

By The Associated Press

It was a situation tailor made for Reggie Jackson — fraught with tension, adulation, and irony.

There he stood, the man who WAS the New York Yankees for five years until George Steinbrenner let him get away. He hadn't had an extra base hit in his first month as a California Angel. It was as if he had saved it up for one swing.

It came on Ron Guidry's first pitch of the seventh inning.

"I'm very happy and pleased. It's like a load off my shoulders. I'll never forget that one," Jackson said after his monumental home runoff the upper deck facade at Yankee Stadium highlighted a 3-1 Angel victory Tuesday night.

Steinbrenner, the New York owner who had dumped Manager Bob Lemon on Sunday in the latest episode of Yankee upheaval, kept a low profile as he watched Gene Michael's debut in his second turn as manager go down the drain.

But the New York fans were anything but quiet. They chanted Jackson's name as they had done many times in the past when he wore pinstripes. And they added a new, obscene chant directed at Steinbrenner.

Jackson admitted the fans moved him. "They gave me a lift, a great feeling of appreciation," he said. "There were signs saying, 'Thanks for the memories.' When you're down,

you need to be lifted."

Jackson also had a single and scored in the fifth inning of the game, which was called after seven innings when a steady rain turned to a downpour. Rookie Angel Moreno, who held the Yankees to four singles, got the win for the Western Division-leading Angels.

Red Sox 7, Royals 5

Aging Carl Yastrzemski, saying he's "in a good groove and just trying to keep it going," drilled a two-run single in the second inning and set up a tie-breaking run with another hit in the fifth as the Red Sox won their eighth game in a row.

Yaz, closing in on his 43rd birthday, leads Boston with 15 runs-batted-in and five homers while hitting at a .349 clip in the first 18 games.

Reliever Bob Stanley bailed out Boston starter Dennis Eckersley with two men on and none out in the fifth inning, worked out of the jam and stopped K.C. on two hits the rest of the way.

Tigers 5, Twins 2

Jack Morris weathered a bad cold as he shut down the Twins on six hits and ran his record to 4-1 as Detroit won for the ninth time in 10 games.

The Tigers, who boast the same 12-6 record as Boston, jumped to an early lead on Lou Whitaker's two-run single in the second inning and made it 3-0 on Lance Parrish's home

run to lead off the fourth. Randy Johnson homered for the Twins, who lost for the ninth time in the last 11 games.

White Sox 11, Brewers 2

Back in 1974, Ron LeFlore made his major league debut against Jim Slaton and struck out three times. Tuesday night the Chicago center fielder had the last laugh — albeit a little late — when he cracked grand slam homer off Slaton to highlight a seven-run second inning for the White Sox.

"There was super location on the pitch," LeFlore conceded. "It was an inside fastball, and I got out and got it. That pitch has given me difficulty most of my career."

Steve Kemp cracked a two-run homer and Carlton Fisk had a solo blast to complement LeFlore's blow, and the White Sox barrage made a winner of Lamarr Hoyt, who ran his record to 4-0 with eight strong innings.

Mariners 7, Indians 4

Jim Maler lined a drive just past Cleveland third baseman Von Hayes with two men on and nobody out in the 11th inning. That drove in the run that broke a 2-2 tie and opened the way for a five-run Seattle rally capped by back-to-back

Coming To Greenville Soon!

PEANUT QUOTA WANTED

Keel Peanut Co. Wants To Rent Your Peanut Quota

Call Rufus Keel 752-7626

JCPenney Auto Center
We won't steer you wrong.

Scat Trac Super AF/X

Sale \$45^{ea.}

Reg. \$53 plus fed. tax. Size A70-13. Scat Trac Super AF/X in wide 60 and 70 series has a polyester cord body with 2 fiberglass belts. Outlined white letters.

Tire size	Reg.	Sale*
A70-13	\$53.00	45.00
E70-14	61.00	52.00
F70-14	64.00	54.00
G70-15	69.00	59.00
H70-15	73.00	62.00
B60-13	59.00	50.00
G60-14	76.00	65.00
G60-15	79.00	67.00
H60-15	88.00	75.00

*Plus fed. tax from 1.79 to 3.43 each tire.

Sale 49.99

The JCPenney 400XP Battery

Reg. \$4.99 The JCPenney 400XP Battery has greater starting power than most original equipment batteries. Never needs water. Maintenance-free reliability for most American cars.

Save \$35

Electronic speed control.

Sale 74.99 Reg. 109.99. Speedostat electronic speed control lets you maintain constant speed without using the accelerator. Fits most American vehicles. Some imported and domestic cars require installation kits.

COUPON

Save \$4 With Coupon Only

Front Wheel Alignment. Sale 12.88

Reg. 16.88. Helps to improve tire wear and to make for improved road handling. We'll adjust caster, camber and toe to manufacturer's specification for most domestic cars. Air conditioned cars slightly more. Coupon effective 4/26 thru 5/1.

JCPenney

JCPenney

Shop 8:30 a.m. - 7 p.m. Phone 756-2800 Pitt Plaza.

CLIFF'S Seafood House and Oyster Bar

Washington Highway (N.C. 33 Ext.) Greenville, North Carolina Phone 752-3172

Tues., Wed. & Thurs. Nights

Popcorn Shrimp... \$2.95

Takeouts Welcome

Canucks Outlast Chicago In 2 OTs

CHICAGO (AP) — Vancouver goalie Richard Brodeur was hot and as a result the Canucks played their kind of game, albeit a long one.

It took five periods Tuesday night, but the Canucks eventually beat the Chicago Black Hawks 2-1 in the second overtime period.

The end came on Jim Nil's rebound goal at 8:58 of the second sudden-death session. It gave the Canucks a one-game advantage in the best-of-seven semifinal National Hockey League Stanley Cup series.

"We kind of played our game," said Coach Roger Neilson. "It doesn't make any difference who we play. We count on tight checking and great goaltending."

"Brodeur played well all season but he was outstanding in the last part of the season and unbelievable in the playoffs," said Neilson. "He keeps coming up big game after game."

"We've been in four



Digging In
Vancouver's Doug Halward tries to get at the puck as Chicago goalie Tony Esposito inches up to defend during semifinal Stanley Cup playoff action last night in Chicago. Vancouver won in two overtimes, 2-1. (AP Laserphoto)

bounce back. If we don't, we don't deserve to win. "I'm disappointed that we lost but not in the way we lost it," said Pulford. "Tony was great in goal and it took a break to beat us, but we had so many chances that we can't complain that we were unlucky."

The Canucks now have won eight of nine playoff games. They swept Calgary in three games and dropped only one in eliminating Los Angeles in five games.

Neilson felt his team had an advantage because, "We were going with six defensemen and they were using four so we tried to hit a little more to wear them down. Overtime is always tense time but we're getting used to it."

Isles 'Formula' Dooms Quebec

UNIONDALE, N.Y. (AP) — By taking advantage of their opportunities — and not allowing the opposition very many chances — the New York Islanders won two straight Stanley Cups.

They used that formula to perfection again Tuesday night, downing the Quebec Nordiques 4-1 in the opening game of the National Hockey League semifinals. The power-play clicked, the forechecking was relentless and the goaltending was solid when needed.

"It was a perfect game to win to start the series — good checking and tight defense," said Islanders captain Denis Potvin, who had a goal and two assists for the two-time defending champions. "We broke up their flow. We did what we wanted to do. It was our best defensive effort."

The tired Nordiques, who had only one day off after eliminating Boston in a grueling seven-game quarterfinal that ended Sunday, never really challenged. The Islanders were well-rested, having finished off the Rangers last Friday, and it made a difference.

"The rest helped the whole team," added Potvin. "The guys felt a lot of zip tonight. We didn't have to reach for the reserve."

"We played a solid hockey game," said Butch Goring, whose second period power-



SCOREBOARD

Prep Standings

NOTE — Standings Through Monday's Games

Tobacco Belt Conference Baseball				
W	L	W	L	L
Bath	7	1	11	3
Jamesville	9	2	10	3
Creswell	6	2	7	4
Mattamuskeet	4	3	5	3
Chocowinity	4	4	5	5
Bear Grass	3	6	3	7
Aurora	3	6	3	8
Columbia	4	8	9	9
Belhaven	0	5	0	5

*Forfeiting remaining games because of lack of players.

Rec Softball

Pre-Season Tournament

W	L	W	L	L
Bath	8	1	9	2
Jamesville	7	2	9	2
Bear Grass	7	3	8	4
Aurora	6	3	6	3
Columbia	4	6	6	6
Creswell	2	5	4	6
Belhaven	1	5	1	5
Chocowinity	1	6	2	6
Mattamuskeet	1	6	2	6

Eastern Carolina Conference

Baseball

W	L	W	L	L
C.B. Aycock	6	0	11	5
A-Grifton	5	1	10	5
G. Central	4	2	10	7
S. Nash	3	3	6	9
North Pitt	1	5	4	8
Farmville	1	5	10	3
SW Edgecombe	1	5	11	1

Coastal Conference

Baseball

W	L	W	L	L
North Lenoir	3	0	8	6
Havelock	3	0	10	2
W. Carteret	2	1	6	4
White Oak	0	2	7	3
D.H. Conley	0	2	4	8
West Craven	0	3	9	9

Softball

W	L	W	L	L
D.H. Conley	2	0	11	2
North Lenoir	2	1	11	4
West Craven	0	1	0	1
White Oak	0	2	6	4
*W. Carteret	0	0	0	0

*Does not have a team.

Big East

Baseball

W	L	W	L	L
Rose	6	0	14	0
N. Nash	3	3	10	3
Hunt	3	3	11	3
Kinston	3	3	7	7
Beddingfield	3	3	5	9
Northwestern	2	4	5	7
Rocky Mt.	2	4	5	10

Softball

W	L	W	L	L
Kinston	5	1	5	1
Northwestern	4	2	7	3
Rocky Mt.	3	3	6	4
Rose	3	3	5	6
Beddingfield	2	4	6	5
Fike	2	4	6	5
N. Nash	2	4	5	9
Hunt	2	4	0	0

Northeastern Conference

Baseball

W	L	W	L	L
R. Rapids	6	2	11	4
Edenon	5	3	9	4
Williamston	4	3	6	3
Bertie	4	4	9	6
Ahoscie	4	4	4	6

Greenville Netters Triumph

The junior high boys' tennis team, sponsored by the Greenville Recreation and Parks' Department won its third match of the season yesterday, downing Kinston, 16-2.

The Greenville team is now 3-0, and will host Greenfield Academy of Wilson on Thursday at 3 p.m. at the River Birch Tennis Center.

Summary:

Clay Jackson (G) d. Dwayne Canady, 8-0.
Lane Odum (G) d. Andrew Ross, 8-2.
Rock Ziehr (G) d. Rick Davis, 8-3.

Dail Music Co.

Joe Cullipher	65	63
Strike Force	61	67
The Lost One's	54	74
The Misspass	52 1/2	75 1/2
Team #2	49	79
Big John	46	82
Team #1	36	92

Major League Leaders

AMERICAN LEAGUE

BATTING (35 at bats): E. Murray, Baltimore, 508; Cooper, Milwaukee, 431; Harrah, Cleveland, 418; R. Johnson, Minnesota, 382; Cabell, Detroit, 378.

RUNS: Herbek, Minnesota, 17; R. Henderson, Oakland, 15; Harrah, Cleveland, 15; Hoffman, Boston, 14; J. Cruz, Seattle, 14.

RBIs: Herbek, Minnesota, 20; Thornton, Cleveland, 17; Oglvie, Milwaukee, 17; Maler, Seattle, 16; E. Murray, Baltimore, 15; Yaztrzewski, Boston, 15; Otis, Kansas City, 15.

HITS: E. Murray, Baltimore, 28; Cabell, Detroit, 28; Cooper, Milwaukee, 28; Zisk, Seattle, 27; Garcia, Toronto, 24; Herbek, Minnesota, 24.

DOUBLES: Otis, Kansas City, 9; E. Murray, Baltimore, 7; Cabell, Detroit, 7; Lynn, California, 7; DeCinces, California, 6; Armas, Oakland, 6.

TRIPLES: Cabell, Detroit, 2; Jorg, Toronto, 2; Upham, Toronto, 2; Morrison, Chicago, 2; LeFlore, Chicago, 2; McRae, Kansas City, 2.

HOME RUNS: Herbek, Minnesota, 8; Downing, California, 7; Yaztrzewski, Boston, 5; Harrah, Cleveland, 5; Thornton, Cleveland, 5.

STOLEN BASES: R. Henderson, Oakland, 16; LeFlore, Chicago, 8; Lopes, Oakland, 6; J. Cruz, Seattle, 6; Manning, Cleveland, 6; Morgan, New York, 5; Wathan, Kansas City, 5; Mazzilli, Texas, 5.

PITCHING (2 Decisions): Hoyt, Chicago, 44, 1,000, 1.35; Tudor, Boston, 34, 1,000, 2.05; Zahn, California, 34, 1,000, 3.34; F. Bannister, Seattle, 34, 1,000, 3.46; Caudill, Seattle, 34, 1,000, 1.29; Aponte, Baltimore, 34, 1,000, 0.83; Morgan, New York, 24, 1,000, 3.65; Sanchez, California, 24, 1,000, 1.86.

STRIKEOUTS: F. Bannister, Seattle, 33; Perry, Seattle, 32; Eckersley, Boston, 22; Guidry, New York, 22; T. Underwood, Oakland, 22.

Baseball

AMERICAN LEAGUE Eastern Division

W	L	Pct.	GB	
Boston	12	6	.667	—
Detroit	12	6	.667	—
Milwaukee	8	7	.533	2 1/2
Cleveland	6	9	.400	4 1/2
New York	6	9	.400	4 1/2
Toronto	6	11	.353	5 1/2
Baltimore	8	10	.286	6

Western Division

W	L	Pct.	GB	
California	14	5	.737	—
Chicago	10	6	.625	2 1/2
Kansas City	9	7	.563	3 1/2
Seattle	10	10	.500	4 1/2
Oakland	8	10	.444	5 1/2
Texas	6	9	.400	6
Minnesota	7	13	.350	7 1/2

Tuesday's Games

Oakland at Baltimore, ppd., rain
Toronto at Texas 4
Boston at Kansas City 5
Seattle at Cleveland 4, 11 innings
California at New York 1, 7 innings, rain
Chicago at Milwaukee 2
Detroit at Minnesota 2

Wednesday's Games

Oakland (Norris 9-2 and Kousser 2-1) at Baltimore (Finagan 9-2 and Mcgregor 0-2), 2:55 p.m.
Texas (Tanna 1-2) at Toronto (Clancy 0-2), (n).
Kansas City (Leonard 1-1) at Boston (Tudor 3-0), (n).
Seattle (Moore 1-2) at Cleveland (Barker 2-1), (n).
California (Forsch 2-1) at New York (John 0-3), (n).
Chicago (Burns 2-0) at Milwaukee (Caldwell 1-1), (n).
Detroit (Petty 2-1) at Minnesota (Redfern 1-2), (n).

Thursday's Games

Seattle at Cleveland, (n).
Oakland at Baltimore, (n).
California at New York, (n).
Detroit at Chicago, (n).
Toronto at Kansas City, (n).
Only games scheduled.

NATIONAL LEAGUE Eastern Division

W	L	Pct.	GB	
St. Louis	13	6	.684	—
Montreal	9	5	.643	—
New York	9	8	.529	3
Pittsburgh	7	8	.467	4
Chicago	6	12	.333	6 1/2
Philadelphia	4	12	.250	7 1/2

Western Division

W	L	Pct.	GB	
San Diego	12	4	.750	—
Atlanta	13	5	.722	—
Los Angeles	9	5	.500	4
Houston	8	12	.400	6
Cincinnati	7	11	.389	6
San Francisco	6	11	.353	6 1/2

Tuesday's Games

Cincinnati at Chicago 3
Pittsburgh at Atlanta 4
Houston at St. Louis 4
San Diego at New York 5
Los Angeles at Philadelphia 0
Montreal at San Francisco 2

Wednesday's Games

Cincinnati (Seaver 0-2) at Chicago (Nolan 2-2), (n).
Houston (Nieko 2-1) at St. Louis (Forsch 3-0), (n).
Montreal (Gallickson 1-0) at San Francisco (Laskey 0-0), (n).
Pittsburgh (Solomon 1-2) at Atlanta (Walk 2-0), (n).
New York (Jones 2-1) at San Diego (Lollar 1-0), (n).
Philadelphia (Ruthven 0-2) at Los Angeles (Hooton 0-1), (n).
Thursday's Games
New York at San Diego
Houston at Pittsburgh, (n).

Vilas Romps In Grand Prix

MADRID, Spain (AP) — Second-seeded Guillermo Vilas of Argentina defeated Pedro Rebolledo of Chile 6-2, 6-0 in the second round of the \$200,000 Volvo Grand Prix of Madrid tennis tournament.

In other matches, France's Henry Leconte upset fifth-seeded Victor Pecci of Paraguay 4-6, 6-4, 10-8; Jose Higuera of Spain stopped Jan Kodes of Czechoslovakia 7-5, 6-1; Tomas Smid of Czechoslovakia defeated Spain's Fernando Luna 6-1, 7-6; and third-seeded Yannick Noah of France outlasted Gianni Occhipetto of Italy 6-3, 7-6.

At Hilton Head Island, S.C., top-seeded Mark Edmondson of Australia easily beat Jim Delaney 6-1, 6-1 and No. 2-seed Andres Gomez of Ecuador defeated Mark Vines 6-0, 6-4 in the first round of the \$100,000 World Championship of Tennis Shipyard Classic.

BF Goodrich Steel Belted Radials

Our Best Steel Belted Radial \$49.40 For Size P195x13 plus F.E.T. 1.98

LIFESAVER XLM WHITEWALL

- Lower rolling resistance than non-radials for fuel economy
- Two steel belts and polyester cord body for extra strength
- Wide tread for outstanding handling and traction

Size	Price	FET
P185/80R13	59.80	1.92
P195R14	59.95	2.18
P205R14	61.40	2.34
P205R15	74.10	2.47
P215R15	76.90	2.59

GT-200 Steel Belted Radial Made for Small Imports!

- Excellent handling, stopping and traction
- Quiet performance and long tread life
- Aggressive tread minimizes hydroplaning and adds to control in wet weather

Size	Our Price	F.E.T.
165R13	48.40	1.62
175R13	51.90	1.76
175R13	53.40	1.66
165R14	53.60	1.80
175R14	57.30	1.89

Car Shake? We Eliminate! \$32.95

Rotate, Balance, and Alignment Most American Cars

—COUPON—

Lubrication, Oil Change Oil Filter SPECIAL NOW ONLY \$13.88

MOST CARS

- Professional chassis lubrication
- New BFG oil filter
- Check of all fluid levels

Also at your service: Brakes, Shocks, Muffler, Alignment and balancing. Come in.

FOR FAST SERVICE...CALL AHEAD

—COUPON—

BF Goodrich COGGINS CAR CARE

Tires and Service

756-5244
320 West Greenville Blvd.
Open Monday Thru Friday
8:00 A.M.-5:30 P.M.
Saturday
8:00 A.M.-1:00 P.M.

WE OFFER BF Goodrich NATIONAL FLEET SERVICE

AMERICAN EXPRESS

Automotive Excellence Certified

NEED FURNITURE

to repair, refinish and strip. New and antique furniture.

FREE ESTIMATES

Four styles of chair caning
Rush Bottom, Flat Reed, Press Caning and Hand Weave Caning

CUSTOM PICTURE FRAMING
Over 200 selections with quick service.

Visit or Call
Eastern Carolina Vocational Center
Staton Road Open 8 til 4:30 M-F Call 758-4188

BIG STAR

PRICES GOOD THROUGH SAT., MAY 1, 1982. QUANTITY RIGHTS RESERVED. NONE SOLD TO OTHER DEALERS.

PET 12 OZ. CTN. COTTAGE CHEESE

REGULAR or FRESH 'N LIGHT



79¢

SCHLITZ BEER

CTN. OF 6 12-OZ. CANS



\$2.28

GALLO PREMIUM WINE

• ROSE • RHINE
• CHABLIS • BURGUNDY
1.5 LTR. BOTTLE

\$3.59

FULL CUT BONELESS ROUND STEAK

U.S. CHOICE BEEF

LB. \$1.98

U.S. GRADE A BAKING HENS

USDA A GRADE

LB. 44¢

"QUALITY CONTROLLED" FRESHLY GROUND BEEF

5 LBS. OR MORE

LB. \$1.18

SWEET LUSCIOUS CALIFORNIA STRAWBERRIES

QUART

\$1.39

OLDE TOWNE FRESH PORK SAUSAGE

HOT OR MILD 1 LB. PKG.

98¢

OLD VIRGINIE SLICED BACON

1 LB. PKG.

98¢

U.S. CHOICE BEEF WHOLE BOTTOM ROUND

22/28 LB. AVG. CUT FREE

LB. \$1.78

WASHINGTON ST. EXTRA FANCY RED or GOLDEN DELICIOUS APPLES

138 SIZE 12 FOR \$1.29

WASHINGTON ST. EXTRA FANCY RED or GOLDEN DELICIOUS APPLES

113 SIZE -LB. 49¢

U.S. CHOICE BEEF LEAN BONELESS CHUCK POT ROAST

LB. \$1.98

ASST. CENTER & END CUTS PORK CHOPS

8 LBS. OR MORE LB. \$1.38

U.S. CHOICE BEEF TOP ROUND STEAK

LB. \$2.58

SWEET AND TENDER YELLOW CORN

5 EARS FOR 79¢

U.S. CHOICE BEEF LEAN BONELESS STEWING BEEF

3 LB. OR MORE-LB. \$1.98

FRESH PORK SPARE RIBS

3/5 LB. AVG. LB. \$1.28

HOLLY FARMS SLICED BOLOGNA or FRANKS

1 LB. PKG. 88¢

RED RIPE SLICING TOMATOES

LB. 59¢

U.S. CHOICE BEEF LEAN BONELESS SHOULDER ROAST

LB. \$2.38

U.S. CHOICE BEEF BOTTOM ROUND STEAK

LB. \$2.48

ARMOURS GOLDEN STAR CANNED HAM

1/2 LB. CAN \$4.58

SUN MAID 1.5 OZ. NATURE SNACKS

3 FOR \$1.00

MEDIUM YELLOW ONIONS

3 LB. BAG 99¢

DUNCAN HINES ASSORTED CAKE MIXES

18 1/2 OZ. 78¢

BOUNTY PAPER TOWELS

JUMBO ROLL 78¢

ASST. FARM CHARM ICE MILK

HALF GALLON 99¢

ASSORTED OR DESIGN BRAUNY TOWELS

2 JUMBO ROLLS \$1.00

DOUBLE Q CHUNK LIGHT TUNA

IN OIL OR WATER 6.5 OZ. 69¢

OUR PRIDE READY-TO-SPREAD FROSTINGS

16.5 OZ. 99¢

KELLOGG'S CORN FLAKES

18 OZ. 99¢

ASST. FIESTA ICE CREAM

1/2 GAL. \$1.19

LIBBY 5 OZ. CAN VIENNA SAUSAGE

39¢

RED BAND PLAIN OR SELF RISING FLOUR

5 LB. BAG 88¢

WELCH GRAPE JELLY

2 LB. \$1.39

BIG STAR 24 OZ. LOAF BUTTERMILK BREAD

2/99¢

SEVEN SEAS FRENCH ITALIAN 1000 ISL. SALAD DRESSING

8 OZ. 58¢

BAKE RITE SHORTENING

3 LB. \$1.39

CHEF BOY-AR-DEE SPAGHETTI

29 OZ. CAN w/GROUND BEEF \$1.29

BIG STAR 16 OZ. LOAF CRACKED WHEAT BREAD

2/\$1.00

CASTLEBERRY 24 OZ. CAN BRUNSWICK STEW

89¢

BREAKFAST CEREAL CHEERIO'S

10 OZ. 79¢

BLUE BONNET 1/4'S MARGARINE

1 LB. FOR \$1.00

MCKENZIE COLLARD MUSTARD or TURNIP GREENS

16 OZ. 69¢

ROYAL PINK BRAND PINK SALMON

15 OZ. \$1.79

BASICS WHITE BATH TISSUE

4 PK. 65¢

KITCHEN TREAT ASSORTED POT PIES

6 OZ. 29¢

MCKENZIE CROWDER or BLACK EYE PEAS

16 OZ. 99¢

CHASE & SANBORN TEA BAGS

100 CT. \$1.19

LAUNDRY DETERGENT COLD POWER

48 OZ. \$1.48

OUR PRIDE 10 OZ. PIE SHELLS

2 PK. 59¢

MCKENZIE CUT or BABY OKRA

16 OZ. 99¢

BETTY CROCKER ASST. CAKE MIXES

18 1/2 OZ. 69¢

GLAD 15 CT. LGE. GARBAGE BAGS OR TRASH BAGS

10 CT. \$1.19

OUR PRIDE 16 OZ. WHIPPED TOPPING

99¢

GARDEN CHARM 20 OZ. SHOESTRING POTATOES

59¢

STOKELY CUT BEETS

16 OZ. CANS 4 \$1.00

GREEN GIANT W/K GOLD CORN

17 OZ. CANS 3 \$1.00

STOKELY GREEN BEANS

16 OZ. CANS 3 \$1.00

OUR PRIDE MACARONI & CHEESE

7.2 OZ. BOXES 4 \$1.00

JIFFY CORN MUFFIN MIX

8.5 OZ. BOXES 4 \$1.00

BUSH'S BEST PINTO BEANS

15.5 OZ. CANS 4 \$1.00

VAN CAMP'S PORK & BEANS

16 OZ. CANS 3 \$1.00

DURKEE O & C POTATO STIX

1.5 OZ. CANS 4 \$1.00

AJAX CLEANSER

14 OZ. CANS 3 \$1.00

POCAHONTAS BLACK EYE PEAS

15 OZ. CANS 4 \$1.00

WHITE HOUSE APPLE SAUCE

16 1/2 OZ. CANS 3 \$1.00

PROGRESSO WHOLE TOMATOES

14 OZ. CANS 3 \$1.00

FRANCO-AMERICAN SPAGHETTI-O'S

14.7 OZ. CANS 3 \$1.00

BIG STAR SWEET PEAS

16 OZ. CANS 3 \$1.00

WHITE HOUSE APPLE JUICE

32 OZ. BTL. 58¢

MUELLER ELBOW MACARONI

8 OZ. BOXES 3 \$1.00

Archeologists Seeking Site, Fate Of Lost Colony

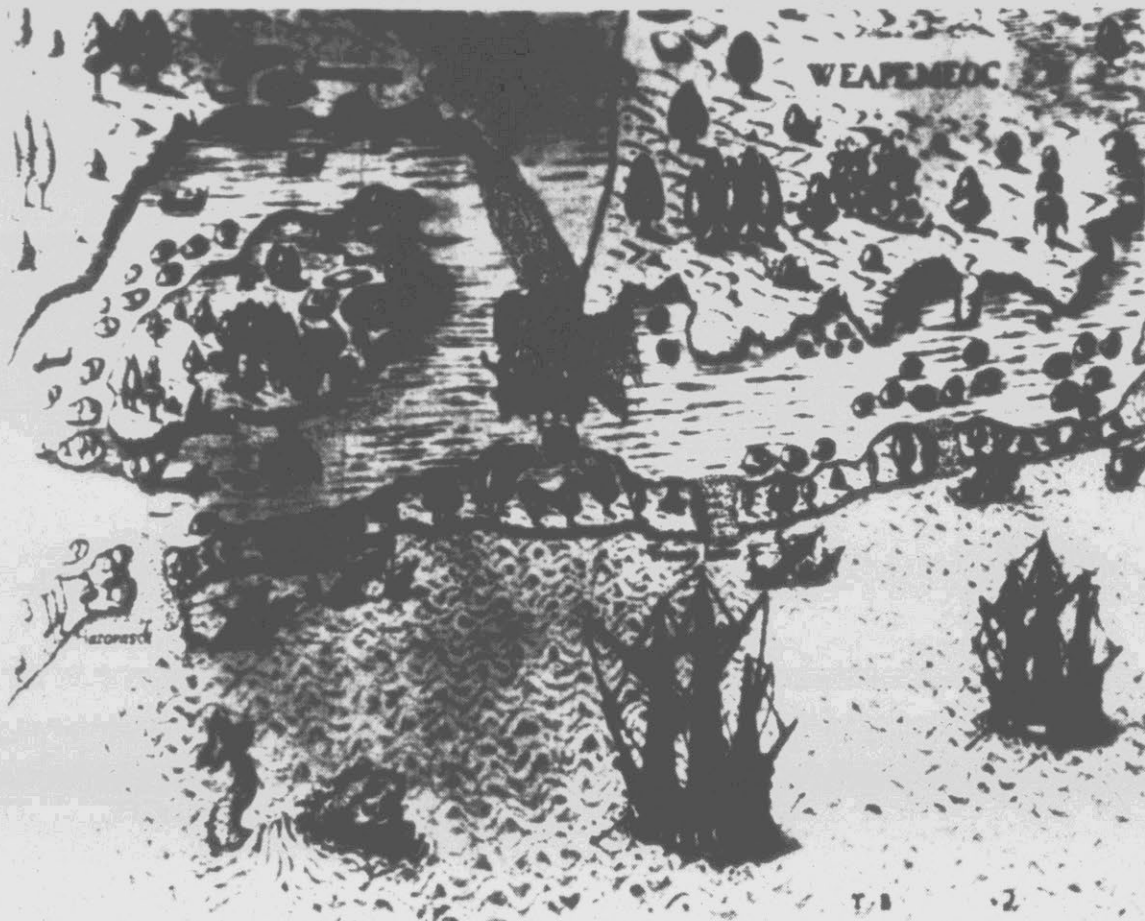

CLOUD OVER LOST COLONY—Discolorations in this engraving of a map drawn by English explorer in 1590 resemble a cloud over Roanoke Island, site of America's first English settlement.

By F. ALAN BOYCE
Associated Press Writer

RALEIGH, N.C. (AP)—In 1590, John White returned from Great Britain to find America's first English settlement overgrown by vegetation, its buildings in disrepair, its colonists inexplicably vanished.

For nearly four centuries, the half-timber houses, thatched with weeds and interwoven with willow branches, melted into

The colony and 100 settlers vanished, but archeologists hope to resurrect the settlement with modern techniques. (AP Laserphoto)

the Roanoke Island wilderness until they, too, disappeared. But this summer, archeologists armed with proton magnetometers and soil resistivity tests hope to find clues to the settlement that eluded the shovels of earlier investigators.

The search will concentrate on the northern end of the 11-mile-long island, radiating from Fort Raleigh, an earthwork outpost built to protect the "Cittie of Raleigh," said Phil Evans, a National Park Service technician.

Archeologists gathered Tuesday at the historic park near the fort to review previous excavations, plan strategies and explore historic records.

Sir Walter Raleigh applied for the colony's charter in 1584. A year later, 108 men led by Ralph Lane hacked the settlement from the island wilderness, but Indian hostilities and near starvation forced them to return to England after 11 months.

New settlers reoccupied the village in 1587, sending White, their governor, back to England for supplies. White's return was delayed by the Spanish armada until 1590, when he found the island deserted.

When J.C. Harrington, a National Park Service archaeologist, confirmed the location of Fort Raleigh in 1965, he unearthed clues that led modern scientists to believe the lost colony might lay literally at the fort's doorstep.

Archeologists in the 1940s and 1960s may have been misled by inaccurate expectations, Evans said.

"In the 1940s you probably would have expected houses with nice little brick foundations," he said. "But most of the houses that have been excavated on the early 17th century sites in Virginia show they were mainly built by burying posts in the ground as the upright members of the frame of the house."

Better technology and a more accurate description of the lost colony should improve the chances of success, Evans said.

"Fortunately, (post) holes remain after 400 years," he said. "Even a resealed hole will leave a stain in the soil. You can pretty well plot these soil stains and get an outline of a structure or a house."

While the park service and scientists from the Southeast Archaeology Center in Tallahassee, Fla., look for post holes, phosphates and artifacts near the fort, another effort may be mounted at sea.

Dr. Gordon Watts, a historian at East Carolina University and a former state underwater archaeologist, believes the settlement lies beneath the waters of Roanoke Sound, perhaps four miles from the fort.

"What's happening from a geological perspective is the north end appears to be sinking while the south end is rising," Watts said. "In addition, there has been a tremendous amount of erosion on the north end of the island and the sea level appears to have risen about one foot per 100 years. When you put the two together, the remains of the settlement might well lie in the sound."

Watts believes Fort Raleigh, made of dirt piled to surround a star-shaped enclosure, is too small to have protected the colonists, suggesting it may have been an outpost for a settlement based further to the south and west.

Remote sensing will be used to explore sites both on land and at sea, said Evans. Tiny changes in the Earth's magnetic field may reveal metal weapons or pieces of iron forged by colonists, while differences in electrical resistance in the soil could signal post holes, brickwork foundations or trenches dug long ago.

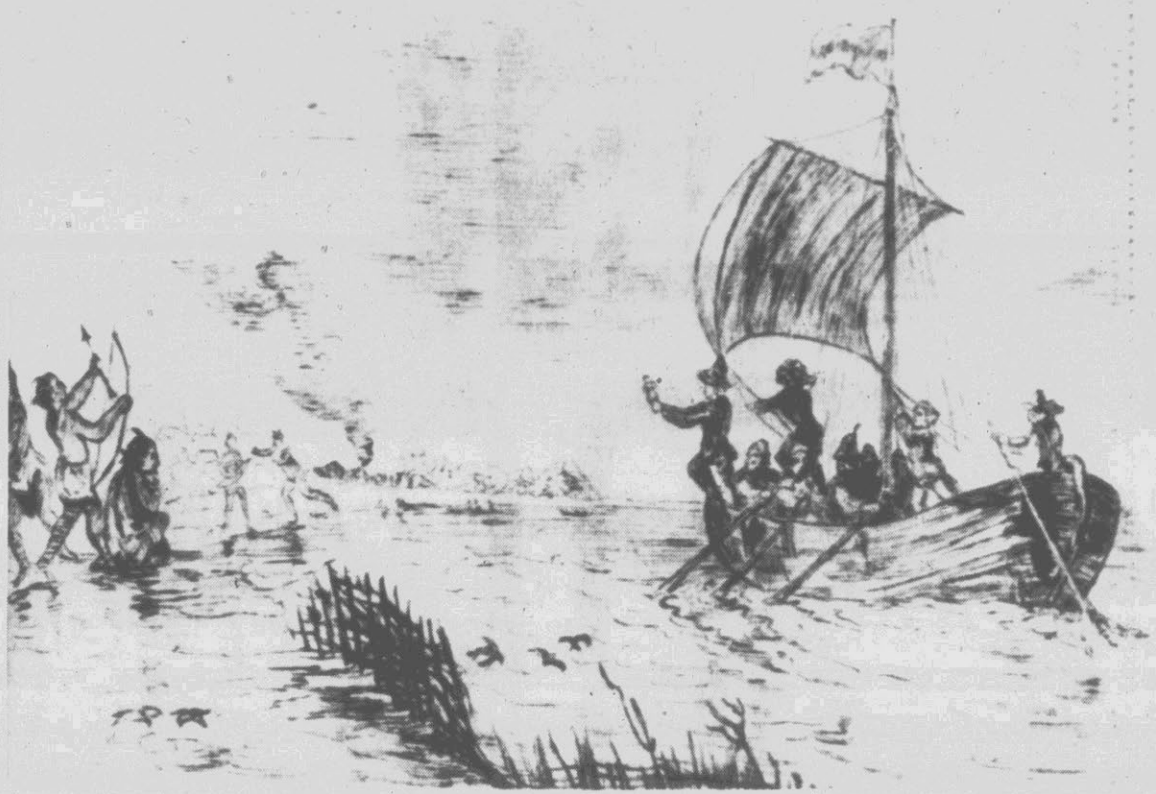

COLONY LOST—English explorer John White is shown here as he may have appeared upon his return to America's first English colony in the 1500s. Indians remained at the site, but more than

100 colonists had abandoned the settlement. Archeologists are trying to find the colony this summer. (AP Laserphoto)

Watts plans to use sonar to get a profile of the features at the bottom of the sound, sending divers to examine promising areas.

Both Evans and Watts hoped gravesites or skeletal remains might reveal what befell the colonists.

"Even if skeletal remains are found outside the settlement, the formation of areas on the skull, along with things like height, could determine whether it came from an Indian or Englishman," Watts said.

Results from remote sensing will be analyzed by computer at the University of Florida, said Richard Faust, director of the Southeast Archaeology Center. That study, directed by John Ehrenhard, a research archaeologist at the center, is being funded by a \$15,000 grant from the Eastern National Park and Monument Association with additional funds from the park service.

If promising sites are uncovered in June or July, workers will return to conventional trenching and photography to more carefully scrutinize the area in August or September, Faust said.

The renewed interest in the colony has been sparked by plans to celebrate its 400th anniversary on July 13, 1994—a celebration that tips off America's 400th anniversary.

America's Four Hundredth Anniversary Committee, based in Raleigh, has earmarked \$275,000 of \$3 million to be raised in the next two years for archaeological expeditions, said Dr. John Neville, a historian and secretary for the group. Watts and Evans both planned to request support from the committee, which has raised \$800,000 since October.

Even if the old Cittie of Raleigh is located, it is unlikely to be restored like the fort, Evans said.

"That is something that we try to shy away from because, if you restore something, chances are 20 years from now somebody is going to find out that you did it wrong by finding

new information and you're going to look like a fool," he said. However, an artist may be commissioned to paint the settlement as it once was, commemorating the founding—and finding—of the lost colony.

Say Foresight Paid Dividends

CULLOWHEE, N.C. (AP)—Foresight by the director of Western Carolina University's environmental health program paid dividends during a recent chemical plant explosion which forced the evacuation of 2,000 Hazlewood residents.

Joe Beck said he purchased a toxic-gas analyzing system for his department last spring. He said he thought of it not only as an educational tool, but as something which might be of use in a potentially life-threatening situation in the community.

Beck found himself in one of those situations April 21 when three explosions rocked Benfield Industries Inc. in Hazlewood, sending smoke laden with toxic gas throughout the area.

A couple hours after the explosion, state and local officials asked Beck to test for hazardous chemicals in the surrounding air, using the university's analyzing equipment.

It was the results of those test which prompted authorities to order the evacuation of the residents around the chemical re-packaging plant.

"I had no doubt when I ordered this equipment that we'd use it for something like this," Beck said. "I've worked in public health long enough to know that there is very little equipment like this available for use by health and disaster-response agencies. When an emergency arises, equipment like this can be very valuable in saving lives."

Beck said because the system costs \$500 and fresh chemical indicators are needed every six months, the

system isn't economical for most county health departments.

Beck tested the air for chlorine, hydrogen sulfide, benzene and vinyl chloride. He first sampled the air while flying through a black cloud of smoke in an airplane at 5,000 feet above the burning plant.

"When you get inside a cloud that's pitch-black, over a potentially explosive area in between mountains that are higher than you are flying, it's a spooky feeling," Beck said. "I'm terrified, by the way, of airplanes, but I think I had greater anxiety about being in that cloud. You never know what's in something like that. It could have been hydrogen cyanide. That's what they use in gas chambers."

Beck said he was surprised to find such a large quantity of chemicals stored in the middle of a highly-populated area, saying he thinks "it demonstrates the need for industrial land planning in this area."

Beck said the type of testing equipment he used is primarily used to determine toxic levels of gas in mines. He said he has used it to test for gas vapors in a store and for the presence of formaldehyde in private homes and public buildings.

PUBLIC NOTICE COUNTY OF PITT

In accordance with the General Statutes of North Carolina (G.S. 105-283, 287, 317, 322), the Pitt County Board of Equalization and Review will meet in the County Commissioners Conference Room, First Floor of the Pitt County Office Building, 1717 West Fifth Street, Greenville, North Carolina 27834, on the following dates and times:

- Monday, April 19, 1982 -2:00 p.m.
- Monday, May 3, 1982 -2:00 p.m.
- Monday, May 17, 1982 -2:00 p.m. (Adjournment Date)

If the need for additional meetings arise, notice of these meetings and a later adjournment date will be published in this paper. The Board of Equalization and Review meets for the purpose of examining the tax scroll and the new appraisals for 1982 in accordance with the laws of North Carolina.

Appraisals are on file in the office of the Tax Supervisor and should be examined prior to the meeting of the Board. For the convenience of any tax-payer wishing to appeal to the board, please call the Tax Supervisor's office, 752-4711, for an appointment with the Board of Equalization and Review. This will enable the Tax Department to have your records available with the least possible delay.

Speaker Talks Mower-Safety

The Candlewick Flames 4-H Club heard Robert Baker of the Winterville Winner 4-H Club talk about safe use of lawn mowers.

Each of the 19 members present was presented a book titled, "Lawn and Garden Equipment Safety."

The members auditioned for a talent show. The winners—Paula Yelverton in jazz dance; Andrea Shine in sign language and Missy Young in violin—qualified to compete in the county 4-H talent show.

The club will gather Saturday to beautify the Pitt County dumpster site on the Stantonsburg Road.

GET MORE! FOR LESS!

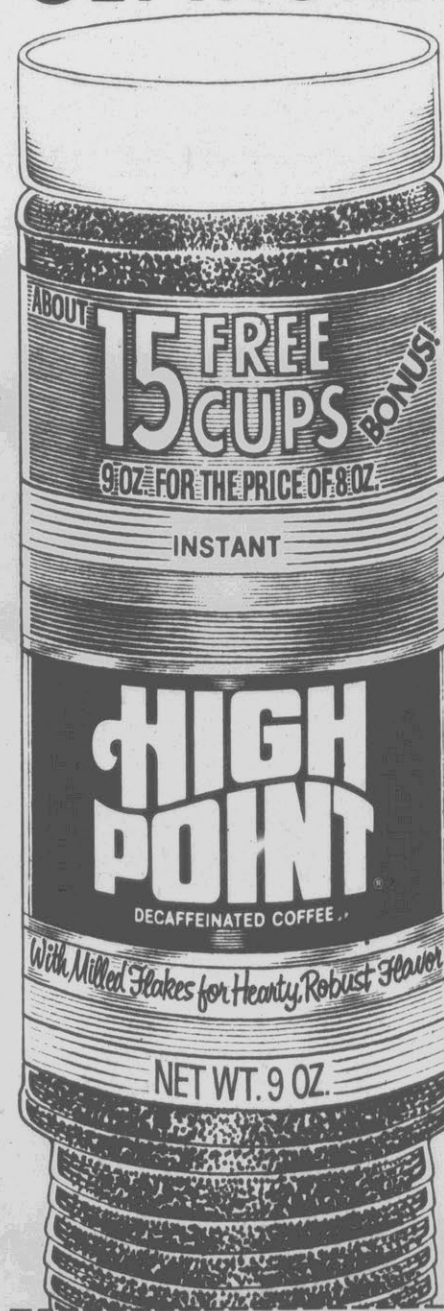

SAVE 50¢

On Instant High Point Decaffeinated Coffee.

High Point Decaffeinated Coffee gives you two savings. First you can redeem this coupon on any size of Instant High Point. Second, if you redeem this coupon on High Point's Instant 9-oz. bonus jar, you'll get about 15 extra cups of



hearty, full-bodied flavor. High Point Decaffeinated Coffee—more coffee and more flavor, for less! (Coupon good on any size of Instant High Point.)

"High Point—it's my favorite coffee!"
Lauren Bacall

*Available in limited quantities.

0761H TAKE THIS COUPON TO YOUR STORE

50¢ when you buy 50¢

ONE 9 oz. or 8 oz. or 4 oz. Jar or TWO 2 oz. Jars, Instant*

THIS COUPON NOT VALID ON THE 1 OZ. TRIAL SIZE (*Also good on Ground Roast High Point where available)

TO THE CONSUMER: CAUTION: Don't endorse your dealer by asking to redeem coupons without making the required purchase of this brand. General Conditions: Apply to redemption. Any other use constitutes fraud. GENERAL CONDITIONS: This coupon is redeemable only by a consumer purchasing the brand size indicated with the face value of the coupon (shown by the dealer's retail selling price). This coupon may not be reproduced and is non-transferable and not to be sold or given to anyone else. The consumer must pay any sales tax imposed. TO THE DEALER: You are authorized to act as our agent for redemption of this coupon upon compliance with the GENERAL CONDITIONS and following terms and with your agreement to present to Procter & Gamble, an exact evidence of purchase of sufficient stock to cover coupons presented. You will be reimbursed for the face value of this coupon or, if coupon stock is low, for your retail selling price plus 1¢ for handling. Coupon reimbursements are not to be deducted from Procter & Gamble invoices. Failure to observe these terms and GENERAL CONDITIONS for proper redemption may void this coupon. Procter & Gamble, and all coupons submitted for reimbursement and they may be retained as property of Procter & Gamble without payment. Your properly validated and identified coupons will be accepted for redemption only if submitted to us by the following date: 11/30/82 through 1/31/83. Submission by unauthenticated intermediaries will not be accepted. PROPERLY REDEEMED COUPONS SHOULD BE SENT TO: PROCTER & GAMBLE, 7150 SUNNYSIDE DRIVE, CINCINNATI, OHIO 45227. Cash value: 1/100 of 1¢. 343250

LIMIT ONE COUPON PER PURCHASE FOLGER COFFEE CO. 343250

SAVE A BUNDLE

AT THE NEW FOOD KING
LOCATED ON HWY. 33 IN CHOCOWINITY

PRICES GOOD APRIL 29TH
THRU MAY 5TH, 1982

QUANTITY RIGHTS RESERVED
NONE SOLD TO DEALERS

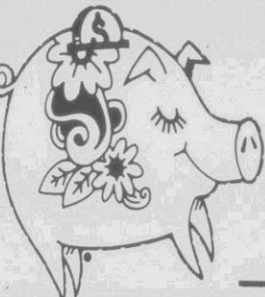
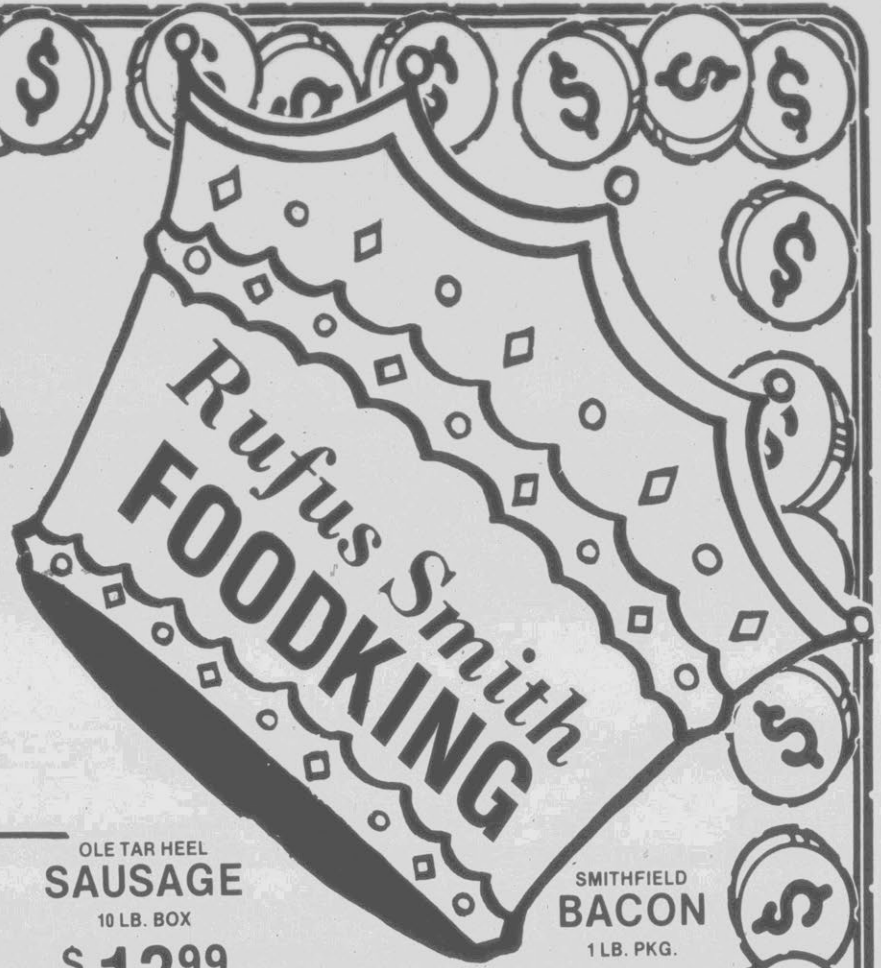

FRESH WHOLE
FRYERS **39¢** LB.
LIMIT 4 PLEASE WITH FOOD ORDER.

HEAVY WESTERN STEER
ROUND STEAK

FULL CUT
\$1.69 LB.

TOP ROUND STEAK, . . . BONELESS **\$2.49** LB.

BONELESS CUBED STEAK **\$2.39** LB.

BONELESS SIRLOIN TIP STEAK **\$2.59** LB.

BONELESS SIRLOIN TIP ROAST **\$1.99** LB.

BONELESS RUMP ROAST **\$2.19** LB.

WHOLE RIB EYE LOINS **\$1.79** LB.
SLICED INTO STEAKS & ROASTS FREE

OLE TAR HEEL SAUSAGE
10 LB. BOX **\$13.99**

SMITHFIELD BACON
1 LB. PKG. **\$1.49**



PRODUCE

FRESH CRISP

LETTUCE

HEAD . . . **39¢**

MUSHROOMS . . . 8 OZ. PKG. **99¢**

RED GRAPES . . . **\$1.29** LB.

WHITE SWEET CORN . 3 EARS **59¢**

YELLOW ONIONS . 3 LB. BAG **99¢**

FRESH STRAWBERRIES . PINT **69¢**

RIB EYE STEAKS **\$3.39** LB.

FRESH WHOLE PORK LOINS SLICED INTO STEAKS & ROASTS FREE . . **\$1.19** LB.

MEATY SHORT RIBS OF BEEF **\$1.59** LB.

PIG EARS **49¢** LB.

PIG FEET **49¢** LB.

GWALTNEY GREAT BOLOGNA **\$1.09** 1 LB. PKG.

GWALTNEY FRANKS **99¢** 12 OZ. PKG.

HUNT'S MANWICH SAUCE 15 OZ. CAN **89¢**

WISK LIQUID DETERGENT 15' OFF 32 OZ. BTL. **\$1.69**

STA-PUF FABRIC SOFTNER SHEETS 50 CT. **\$1.59**

CHATHAM CHUNX DOG FOOD 25 LB. BAG **\$3.39**

STOKELY APPLE SAUCE 303 CAN **3/\$1.00**

SANKA INSTANT COFFEE 8 OZ. JAR **\$3.99**

CRISCO OIL 48 OZ. BTL. **\$2.19**

A-1 STEAK SAUCE 10 OZ. JAR **\$1.29**

FROZEN FOODS

STEAK FRY FROZEN FRENCH FRIES 2 LB. BAG **39¢**

BANQUET SUPPERS 2 LB. PKG. **\$1.49**

SALISBURY STEAK, CHICKEN/DUMPLIN, TURKEY, CHICKEN NOODLE **\$1.09**

FUN ICE MILK 1/2 GALLON **\$1.19**

PILLSBURY MICROWAVE POPCORN . . **\$1.19**

GORTON'S FISH STICKS 15 OZ. PKG. **\$1.89**



KRAFT MIRACLE WHIP

SALAD DRESSING

99¢

32 OZ. JAR
LIMIT ONE WITH \$10.00 OR MORE FOOD ORDER.

KRAFT **BARBECUE SAUCE**

PLAIN, HOT OR SMOKE FLAVOR

59¢



EVERY DAY LOW MILK PRICES!!!

CAROLINA DAIRY

MILK

HOMOGENIZED 1 GAL. **\$1.83**

2% 1 GAL. **\$1.63**

1/2% 1 GAL. **\$1.53**

KRAFT

MUSTARD . . . 25 OZ. JAR **69¢**

AMERICAN CHEESE SINGLES 12 OZ. PKG. **\$1.49**

GRAPEFRUIT JUICE 1/2 GAL. **\$1.49**

ORANGE JUICE 1/2 GAL. **\$1.49**

GRAPE JELLY 3 LB. JAR **\$1.69**

SOUTHERN BISCUIT

FLOUR

PLAIN OR SELF RISING

89¢

5 LB. BAG

STOKELY **FRUIT COCKTAIL**

303 CAN

2 \$1.00

FOR

KRAFT PARKAY

MARGARINE

1 LB. PKG. **2 \$1.00**

TREESWEET ORANGE JUICE 6 PACK **\$1.09**

TREESWEET GRAPEFRUIT JUICE 6 PACK **\$1.09**

PLAIN OR PINK

6 PACK

DAILY SPECIALS

IN OUR

HOT DELI

& BAKERY

CHARMIN
BATHROOM TISSUE

99¢

4 ROLL PKG.
WHITE, PINK, GREEN, YELLOW OR BLUE
LIMIT ONE WITH \$10.00 OR MORE FOOD ORDER

STOKELY CUT GREEN BEANS

303 CAN **3 \$1.00**

CLIP THESE COUPONS!

-COUPON-
PEPSI COLA
2 LITER DRINK **79¢**
LIMIT ONE PER CUSTOMER WITH THIS COUPON AND \$10.00 OR MORE FOOD ORDER, EXCLUDING ADVERTISED SPECIALS. EXPIRES MAY 5, 1982.

-COUPON-
TEXAS PETE HOT DOG
CHILI
10 OZ. CAN **15¢**
LIMIT ONE PER CUSTOMER WITH THIS COUPON AND \$10.00 OR MORE FOOD ORDER, EXCLUDING ADVERTISED SPECIALS. EXPIRES MAY 5, 1982.

-COUPON-
HAPPY HOST
SUGAR
5 LB. BAG **89¢**
LIMIT ONE PER CUSTOMER WITH THIS COUPON AND \$10.00 OR MORE FOOD ORDER, EXCLUDING ADVERTISED SPECIALS. EXPIRES MAY 5, 1982.

HARRIS

SUPER MARKETS, INC.
"Where Shopping Is A Pleasure"

DISCOUNT
ON EVERYTHING BUT QUALITY

We Reserve The Right To Limit Quantities
None Sold To Dealers Or Restaurants
We Accept Food Stamps And WIC Vouchers

PRICES GOOD WEDNESDAY THRU SATURDAY
LOCATIONS IN:
GREENVILLE
AYDEN-BETHEL
TARBORO

STONEWARE PIECE OF THE WEEK
COFFEE CUP

89¢
WITH \$3 PURCHASE

ANHEUSER-BUSCH
NATURAL LIGHT BEER

12 12 OZ. CANS **\$3.99**

CELLA LAMBRUSCO, BIANCO, ROSATO
\$1.99
750 ML.

Little Debbie **LITTLE DEBBIE OATMEAL CAKES** 16 OZ. 12 COUNT **79¢**



OUR PRODUCE DEPARTMENT
JUST ONE BIG BOWL OF SAVINGS

GRADE 'A' WHOLE
FRYERS
LIMIT 4
37¢
LB.

HARRIS BLUE RIDGE FARMS
WHOLE COUNTRY
HAMS
\$1.49
LB.

Blue Ridge Farms
COUNTRY HAM

ECONOMY CUT
PORK CHOPS
89¢
LB.

WHOLE
PORK LOINS
\$1.09
LB.

VINE RIPE TOMATOES
3 LBS.

- CALIFORNIA **LETTUCE**
- LONG GREEN **CUCUMBERS** ...
- GREEN **PEPPERS** 100 CT.
- CARROTS** 3 PKG.
- CRISP **CELERY**..... STALK
- FRESH BUNCH **TURNIPS**.....
- TENDER **POLE BEANS** ...
- YELLOW **SQUASH** 3 LB.
- YELLOW **CORN**..... 3 FOR
- WHITE **MUSHROOMS** . 1/2 LB.
- YELLOW **ONIONS** 3 LB.
- SNOW WHITE **CAULIFLOWER** .
- RED DELICIOUS WASHINGTON STATE **APPLES**..... 3 LB.
- CALIFORNIA **LEMONS** 6 FOR
- RED, WHITE OR BLACK **GRAPES** FROM CHIL.
- BANANAS** 3 LB.
- CANTALOUPE**

BONE-IN
CHUCK STEAK **\$1.49**
LB.

BONE-IN
POT ROAST **\$1.49**
LB.

BONE-IN SHOULDER STEAK \$1.59 LB.	SYCAMORE 2 LB. BAG SMOKED SAUSAGE \$1.99 BAG	FROSTY MORN FRANKS 12 OZ. PKG. \$1.09	FROSTY MORN BACON 12 OZ. PKG. \$1.29	FROSTY MORN BOLOGNA 12 OZ. PKG. \$1.19	DUTCHESS 1/2 PICNICS \$1.79 LB.
--	---	--	---	---	---

SNOWDRIFT SHORTENING
3 LB.
\$1.59
Limit 1 With \$10.00 Order.

WALDORF
BATHROOM TISSUE
4 ROLL PAK
LIMIT 2 PKG. **79¢**

DUNCAN HINES YELLOW
CAKE MIX
18 OZ. **79¢**

PFEIFFER DRESSINGS
ALL IN 1
EVERYDAY LOW PRICE

NABISCO SALE

ALL ASSORTED **SNACK CRACKERS** \$1.09

PREMIUM SALTINE **CRACKERS** 1 LB. **79¢**

NEW GOLDLINE **CHIPS AHoy COOKIES** 10 OZ. **\$1.69**

ASSORTED **COOKIES** .. VARIETIES **\$1.25**

BONUS PAK BAKERY **FUDGE COOKIES** 19 OZ. **\$1.25**

DEL MONTE
CATSUP 32 OZ. **99¢**

KRAFT
BBQ SAUCE ALL FLAVORS
18 OZ. EVERYDAY LOW PRICE **59¢**

JOY
DISHWASHING LIQUID
20' OFF
22 OZ. **99¢**

TIDE
LAUNDRY DETERGENT
GIANT SIZE
49 OZ. **\$1.89**

POCAHONTAS
KETCHUP
14 OZ. **4/\$1.00**
LIMIT 4 WITH \$10.00 ORDER.

DAIRY

MERICO BUTTER-ME-NOT
BISCUITS 4 FOR **\$1.00**
9 OZ.

COUNTRY FRESH HOMOGENIZED
MILK **89¢**
1/2 GAL. CARTON

FROZEN FOODS

7-FARMS
FRENCH FRIES 2 LB. BAG **2 \$1**

PARADE
WHIPPED TOPPING 8 OZ. **2 \$1**

COUNTRY FRESH
ICE MILK 1/2 GAL. **99¢**

JENOS
Everyday Low Price
PARTY PIZZAS... ALL 10" VARIETIES **99¢**

TEXIZE SALE

GLASS PLUS..... 22 **\$1.29**

SPRAY N WASH .. 22 **\$1.49**

FANTASTIK SPRAY CLEANER .. 22 **99¢**

PINE POWER .. 28 **\$1.99**

FLUFFY FABRIC SOFTENER 10' OFF Label 1/2 GAL. **89¢**

SPRITE, SUGAR FREE SPRITE
2 LITER **79¢**

PEPSI & MT. DEW
2 LITER **\$1.09**

BRAWNY TOWELS
JUMBO ROLL **2/\$1.00**

DUKES
MAYONNAISE
1/2 QT. **99¢**
EVERYDAY LOW PRICE

COUNTRY FRESH GALLON PLASTIC JUG
1/2 % LOWFAT MILK **\$1.59**

SHEDD'S SPREAD
MARGARINE 1 LB. 1/4'S EVERYDAY LOW PRICE **3/\$1.00**

OLD SOUTH CHILLED
ORANGE JUICE 1/2 GAL. **99¢**

DEALTEST
SOUR CREAM..... OZ. **59¢**

GRADE A JUMBO
EGGS **59¢**
2 1/2 DOZ. TO CARTON PER DOZEN

WATERMELON
28 LB. AVG.
\$2.99
EACH

Little Town 'Home Base' Of Hoos-Hoos

GURDON, Ark. (AP) — So much has happened lately in this little southwest Arkansas town of 2,707.

Last month, there was that big basketball game — the one where the Class AA Gurdon Go-Devils beat Class AAAAA Little Rock Hall for the state championship.

And, in February, the town became the headquarters of the International Order of Hoo-Hoo.

Who?
"Hoo-Hoo International — The Fraternity of the Forest Products Industry," says the group's executive secretary, Russell McClain, a retired psychology professor and copy editor for the New York Times.

The Hoo-Hoos supposedly originated in 1892 when six lumbermen stranded by a flood spent the night in Gurdon's Hotel Hall and decided to organize something different for men of their trade.

"I think they got to drinking a little," said Joyce Taylor, who's helping publish The Log & Tally, a magazine for the 9,000 Hoo-Hoo members. Some live as far away as Canada and Singapore.

"There're all kinds of stories about where they got the name," McClain, the city's mayor, says.

Hoo-Hoo literature said that the name originated when one of the founders spied a single tuft of hair on the head of a fellow founder and whimsically dubbed it "hoo-hoo."

"They didn't want it to be like any other organization," McClain said. "So, they adopted a black cat as their symbol. Everybody else thought it was bad luck, and they wanted to adopt it as their symbol of good luck."

The organization's 255 clubs get some of their philosophy from Egyptian mythology. The emblem is based on the sacred Egyptian black cat, and the group uses the mythical nine lives of the cat as its basis. Membership is limited to 99,999.

"Everything's in nines," McClain said. "The convention is the ninth day of the ninth month." Meeting times must have a nine in the number. Initiation fees are \$24.99.

The cat, whose tail curls like the number nine, decorates the Hoo-Hoos' log cabin headquarters. It welcomes visitors at the front door; it hisses from a big orange and white flag; it sits on a table — carved from wood, of course.

During an initiation, Hoo-Hoo participants wear black and orange robes with black cats painted on them. They also wear pointed caps with the cat symbol.

The order's chief officer, "the snark of the universe," is Dan Brown of Klamath Falls, Ore. His title comes from a Lewis Carroll poem, "The Hunting of the Snark."

Members must earn half their income from a lumber-related function. But the rule is flexible. McClain got in by owning about 40 acres of wooded land and by being mayor of a lumber town.

The Hoo-Hoos moved the headquarters from Norwood, Mass., to Gurdon because overhead would be cheaper, because Gurdon was the group's birthplace and because of the log building.

To become the headquarters, the Gurdon Hoo-Hoos had to replace the building's plastic toilet seats with wooden ones. "They try to have everything wood," McClain said.



ADVERTISED ITEM POLICY: Each of these advertised items is required to be readily available for sale at or below the advertised price in each A&P Store, except as specifically noted in this ad.

PRICES EFFECTIVE THRU SAT. MAY 1 AT A&P IN GREENVILLE, N.C. ITEMS OFFERED FOR SALE NOT AVAILABLE TO OTHER RETAIL DEALERS OR WHOLESALERS.

We Gladly Redeem U.S.D.A. Food Stamps

P SUPER SAVER COUPONS

PLAIN OR SELF RISING

Red Band Flour

LIMIT ONE WITH COUPON AND 7.50 ORDER



5 **59¢** lb. bag #669

P GOOD THRU SATURDAY, MAY 1 AT A&P IN GREENVILLE, N.C.

P SUPER SAVER COUPONS

FAMILY SIZE

Lipton Tea Bags

LIMIT ONE WITH COUPON AND 7.50 ORDER



24 **99¢** ct. pkg. #670

P GOOD THRU SATURDAY, MAY 1 AT A&P IN GREENVILLE, N.C.

P SUPER SAVER COUPONS

BIRDS EYE

Cool Whip Dessert Topping

LIMIT ONE WITH COUPON AND 7.50 ORDER



16 oz. bowl **99¢** #671

P GOOD THRU SATURDAY, MAY 1 AT A&P IN GREENVILLE, N.C.

AN A&P EXCLUSIVE OFFER

GENUINE IMPORTED STONEWARE

From the Highland Floral Collection.

A GREAT VALUE AT A GREAT PRICE!

THIS WEEK'S FEATURE ITEM

69¢

DESSERT DISH With Each 5.00 Purchase PER PLACE SETTING PIECE

A&P COUPON
SAVE 50¢ When You Purchase A

Reg. 11.99 **Coffee Server** 11.49 #668

With This Coupon You Pay Only

P Good Thru Sat. May 1

SEE STORE DISPLAY FOR COMPLETE DETAILS.

P Weekly Specials

NABISCO—SAVE 30¢

Chips Ahoy 19 oz. pkg. **1.69**

P&Q BRAND—COLA

Soft Drinks 2 liter bottle **69¢**

*TAB *SPRITE *MELLO YELLO

Coca Cola 2 liter bottle **1.09**

P Frozen Specials

PET RITZ REGULAR

Pie Shells 10-oz. 2-ct. **69¢**

PET RITZ Deep Dish

Pie Shells 12 oz. 2 ct. **99¢**

SEALTEST

Polar B'ars 6 ct. pkg. **1.179** Save 50¢

P Weekly Specials

IN QUARTERS

Shedd's Spread

3 1-lb. pkgs. **89¢**



P Grocery Specials

JUMBO

Loose Eggs

doz. only **67¢**

P Grocery Specials

SUNSHINE

Krispy Crackers

16 oz. pkg. **59¢**



P Frozen Specials

ALL VARIETIES

Look-Fit Ice Milk

½ gal. ctn. **1.29** Save 30¢



P Dairy Specials

LIGHT & LIVELY

Cottage Cheese

12 oz. ctn. **79¢**

AMERICAN • PIMIENTO • SHARP

Ched-O-Bit Cheese Food Slices 8 oz. pkg. **1.09**

ANN PAGE MILD

Cheddar Cheese lb. **2.69**

KRAFT (MED. CHUNKS 8 OZ. 1.29)

Sharp Cheddar 8 oz. pkg. **1.49**

P Grocery Specials

BETTY CROCKER SUPER MOIST

Cake Mixes 18½ oz. pkg. **79¢**

STOKELY

Apple Sauce 3 16 oz. cans **1.00**

GREAT VALUE!

Greer Peaches 29 oz. can **59¢**

INSTANT

Tang Drink 27 oz. jar **2.39**

KEEBLER TOWN HOUSE

Crackers 1 lb. pkg. **1.19**

P Grocery Specials

JANE PARKER

Hamburger Rolls or hot dog 2 pkgs. **99¢**

REGULAR OR LIGHT

Black Label Beer ctn. 12 oz. of 12 cans **2.99**

P Frozen Specials

APPLE • BLACKBERRY • STRAWBERRY

Pet Ritz Cobblers 26 oz. pkg. **1.79**

PET RITZ

Graham Pie Shells Deep Dish 6 oz. pkg. **89¢**

ANN PAGE • Chicken • Beef • Turkey

Pot Pies 3 8 oz. pkgs. **1.00**

GREEN GIANT BUTTER SAUCE • CREAM STYLE

Niblet Corn 10 oz. pkg. **99¢**

HOT BUTTERY

Downyflake Waffles 13 oz. pkg. **89¢**

Technology Week Is Proclaimed Here

Mayor Percy Cox has proclaimed May 3-7 Radiologic Technology Week in Greenville. The N.C. Society of Radiologic Technologists has also designated May 3-7 as a week set aside to honor the members of this profession. Pitt County Memorial Hospital will be observing this occasion with special events throughout the week.

MORE LEPROSY
LONDON (AP) — Leprosy is increasing in Western countries as well as in the Third World, says Dr. Richard Dawood, a Briton who studied the disease in the United States.

SAVINGS JACKPOT

(Everybody Wins!)

DEL MONTE WHOLE KERNEL

Hawaiian Punch 46 oz. can **89¢**

Golden Corn 2 17 oz. cans **89¢**

DEL MONTE

Sweet Peas 2 17 oz. cans **89¢**

DEL MONTE CUT • FRENCH STYLE

Green Beans 2 16 oz. cans **89¢**

DEL MONTE

Fruit Cocktail 2 17 oz. cans **1.19**

DEL MONTE YELLOW CLING

Sliced Peaches 2 16 oz. cans **1.19**

DEL MONTE

Pear Halves 2 16 oz. cans **1.19**

DEL MONTE LITE CHUNKY

Mixed Fruit 16 oz. can **79¢**

CHUN KING CHICKEN

Chow Mein 42 oz. can **2.49**

CHUN KING

Chow Mein Noodles 5 oz. can **79¢**

CHUN KING CHOW MEIN

Vegetables 16 oz. can **79¢**

CHUN KING

Soy Sauce 5 oz. bot. **55¢**

P&Q

White Bread

24 oz. loaves **2.88¢**

SILVERBROOK

Homogenized Milk

gal. jug **1.75**

703 Greenville Blvd. Greenville Square Shopping Center Greenville, N.C.

MORE WITH Coupons!!

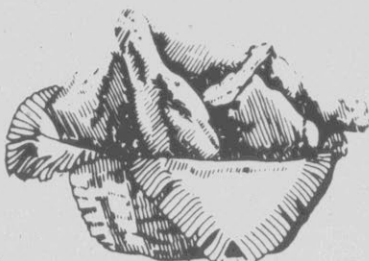
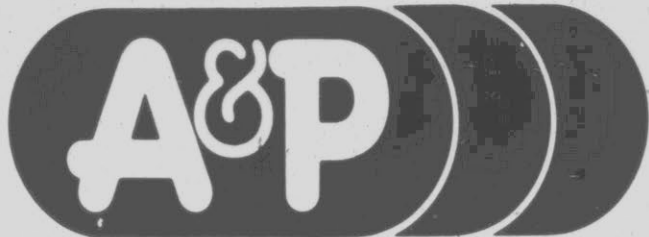

The Butcher Shop
with supermarket prices

A&P Delicatessen

AVAILABLE AT 703 GREENVILLE BLVD.

PLATE LUNCH

Fried Chicken SLICED TO ORDER	each only	1⁹⁹
Baked Ham SLICED TO ORDER	lb.	3¹⁹
Roast Beef	lb.	3⁹⁹
Apple Pie	each only	1⁶⁹

BLUE RIDGE BRAND

Sliced Bacon

1-lb. pkg. **99¢**

U.S.D.A. INSPECTED FRESH

Fryer Leg Qtrs.

8 Lbs. Or More Pkg. (Limit 4 Pkgs.) lb. **39¢**

A&P QUALITY HEAVY WESTERN GRAIN FED BEEF BONELESS BOTTOM

Round Roast

lb. **1⁹⁹**

P **Pork Specials**

MARKET STYLE

Sliced Bacon

1-lb. pkg. **1²⁹**

EXTRA LEAN SPECIAL TRIM COUNTRY FARM **1/4 Pork Loin** Sliced lb. **1⁴⁹**

EXTRA LEAN SPECIAL TRIM COUNTRY FARM LOIN END (SLICED LB. 1.69) **Pork Roast** lb. **1⁵⁹**

P **Beef Specials**

A&P QUALITY HEAVY WESTERN GRAIN FED BONELESS

Shoulder Roast

18-24 lb. Cut Free! avg. lb. **1⁷⁹**

A&P QUALITY HEAVY WESTERN GRAIN FED BEEF BONELESS BOTTOM **Round Steak** lb. **2²⁹**

A&P QUALITY HEAVY WESTERN GRAIN FED BEEF BONELESS **Cubed Steak** lb. **2⁹⁹**

P **Meat Specials**

A&P QUALITY HEAVY WESTERN GRAIN FED BONELESS

N.Y. Strip Steaks

lb. **3⁹⁹**

A&P QUALITY HEAVY WESTERN GRAIN FED BEEF BONELESS **Eye Round Roast** lb. **2⁸⁹**

A&P QUALITY HEAVY WESTERN GRAIN FED BEEF BONELESS **Rib Eye Steak** lb. **4⁹⁹**

P **Poultry Specials**

U.S.D.A. INSPECTED

Fryer Legs

Whole lb. **89¢**

HORMEL **Canned Ham** 3 lb. can **6⁹⁹**

OSCAR MAYER (SMOKIE LINKS 12 OZ. 1.99) **Meat Franks** (Beef 1-lb. 1.89) 1-lb. pkg. **1⁷⁹**

P **Cookout Specials**

HOLLY FARMS

Chicken Franks

Chicken Bologna 1-lb. pkg. **99¢**

1-lb. pkg. **79¢**

P **Poultry Specials**

U.S.D.A. INSPECTED

Box-O-Chicken

lb. **49¢**

P **Beef Specials**

A&P QUALITY HEAVY WESTERN GRAIN FED BEEF

New York Strips

Whole or Half Cut Free! Whole 16-20 lb. avg. lb. **2⁹⁹**

P **Beef Specials**

MARKET STYLE

Ground Beef

3 lbs. or more lb. **1²⁹**

P **Household Specials**

GOLD • WHITE **Dial Soap** 3 3/4 oz. bars **99¢**

JOHNSONS **Lemon Pledge** 7 oz. can **1⁴⁹**

BRITE NO WAX **Floor Polish** 16 oz. btl. **2²⁹**

A&P QUALITY **Liquid Bleach** gal. jug **59¢**

P&Q BRAND **Dry Dog Food** 25 lb. bag **3³⁹**



EASTERN GROWN U.S. #1 **Russet Potatoes** 10 lb. bag **1⁶⁹**

SWEET JUICY RED RIPE **Watermelon** 1/4 melon **1²⁹**

LOCALLY GROWN **Sweet Potatoes** lb. **39¢**



WASH. STATE RED OR GOLDEN **Delicious Apples** lb. **59¢**

IMPORTED FROM CHILE **Red Grapes** lb. **99¢**

TROPICANA GRAPE • PUNCH • OR **Orange Drinks** 4 10 oz. btl. **1⁰⁰**



RED RIPE **Salad Tomatoes** 26 oz. family pack **99¢**

SNOW WHITE **Cauliflower** large head **1⁴⁹**

SUNKISS **Raisins** 15 oz. box **1³⁹**

20¢ OFF LABEL LIQUID

Joy Dish Detergent

You Pay Only **1⁰⁹**

22 oz. btl.

CALIFORNIA CRISP SOLID

Head Lettuce

large head **39¢**

LARGE LUSCIOUS RED

Ripe Strawberries

JANE PARKER (Shortcakes) 6 pk. pkg. **69¢**

qt. basket **99¢**

Plan Heritage Week Activities

WINTERVILLE — In observance of North Carolina Heritage week, April 26-30, special activities have been scheduled at W.H. Robinson School revolving around the theme "Retold Tales: A Look At Tar Heel Memories."

Each morning, a North Carolina folktale will be read over the intercom by the principal to the student body. Traditional folkdances will be taught during physical education classes and traditional quilt patterns will be reproduced during art classes. Songs about the state will be written by third graders and preparation of a time capsule to be sealed for 10 years will culminate the week's activities.

MEETING

The quarterly meeting at the Guiding Light Temple of Faith will be held May 8-9 beginning with a service at 7:30 p.m. Saturday. On Sunday, there will be a service at 11 a.m. Dinner will be served at 2 p.m. and a service will begin at 3 p.m.

Public Notices

PUBLIC NOTICE

Public notice is hereby given that the Greenville City Council will conduct a public hearing on Thursday, May 13, 1982, at 7:30 p.m. in the City Council Chambers of the Municipal Building, 201 West Fifth Street, for the purpose of considering a request by Greenville Cable TV, Inc., for an increase in the maximum bulk rate cable tv fee and the establishment of a motel bulk rate.

The rates proposed by Greenville Cable TV, Inc., are as follows:

Bulk rate
1st room \$4.30 per unit per month
Additional outlets .75 each per month

Motel Bulk Rate
1st room \$7.50 per month
Additional rooms (1st 100) 1.50 each per month
Additional rooms (2nd 100) .75 each per month

Persons desiring more information on the proposed rates may contact the City Manager's Office at 752-4137.

All interested citizens should be present at the public hearing at which time they will be afforded an opportunity to provide comments on the proposed rates.

Lois D. Worthington
City Clerk
April 28, May 5, 1982

NORTH CAROLINA
PITT COUNTY
NOTICE OF DISSOLUTION OF BEACON PIANO COMPANY, INCORPORATED

NOTICE IS HEREBY GIVEN THAT Articles of Dissolution of Beacon Piano Company, Incorporated, a North Carolina corporation, were filed in the office of the Secretary of State of North Carolina on the 29th day of March, 1982, and that all creditors of and claimants against the corporation are required to present their respective claims and demands immediately in writing to the corporation so that it can proceed to collect its assets, convey and dispose of its properties, pay, satisfy and discharge its liabilities and obligations and do all other acts required to liquidate its business affairs.

This the 2nd day of April, 1982, BEACON PIANO COMPANY, INCORPORATED
Mattox & Davis, P.A.
P.O. Box 686
Greenville, North Carolina 27834
April 7, 14, 21, 28, 1982.

82 E 132
NORTH CAROLINA
COUNTY OF PITT

The undersigned, having qualified as Executor of the estate of ARISTEAD TAYLOR MOORE, deceased, late of Pitt County, North Carolina, this is to notify all persons having claims against said estate to present them to the undersigned Executor at 11 Quail Ridge Road, Greenville, North Carolina 27834, on or before October 8, 1982, or this Notice will be placed in bar of their recovery. All persons indebted to said estate will please make payment to the undersigned Executor.

This 2nd day of April, 1982,
IRENE VENTERS JOYNER
Executor
Gaylord, Singleton & McNally, P.A.
Attorneys at Law
P.O. Box 545
Greenville, NC 27834
April 7, 14, 21, 28, 1982

FILE NO: 82 J 25
FILM NO:
IN THE GENERAL COURT OF JUSTICE
JUVENILE COURT DIVISION
NORTH CAROLINA
PITT COUNTY
IN RE: OMAR RAHSHARD DAUGHTRY, A MINOR CHILD
SERVICE OF PROCESS
BY PUBLICATION

TO: Johnny Mack Daughtry, father of the minor child Omar Rahshard Daughtry.

TAKE NOTICE that a Petition seeking to terminate your parental rights for Omar Rahshard Daughtry, a minor child, has been filed in the above entitled action. The nature of the relief being sought is as follows: Termination of Your Parental Rights.

You are required to make defense to such pleading not later than May 13, 1982, and upon your failure to do so the party seeking service against you will apply to the Court for the relief sought.

You are hereby notified that as the parent of the above named minor child, you are entitled to appointed counsel if you are indigent, provided you request counsel at or before the time of the hearing on termination of your parental rights. You are further notified that you are entitled to attend any hearing affecting your parental rights.

This the 9 day of April, 1982,
WILLIAMSON HERRIN STOKES & HEFFELFINGER
By
ANN J HEFFELFINGER
ATTORNEY FOR PETITIONER
210 S WASHINGTON STREET
P O BOX 552
GREENVILLE, NC 27834
TEL: (919) 752-3104
April 28, May 5, 12, 1982

LEGAL NOTICE

Pursuant to G.S. 131C-16, the Easter Seal Society of North Carolina, Inc., Raleigh, North Carolina, discloses for the year ended August 31, 1981, fund-raising expenses as 23% of contributions. Funds were raised for the purpose of providing therapeutic equipment, special health needs, and other services to disabled children and adults.

April 26, 27, 28, 1982

Hours: Open Sunday 7 A.M. to 12 Midnight. Open 24 Hours Monday 7 A.M. 'til Saturday 12 Midnight.



BARNEY MILLER WRAP-UP PARTY — Actors Hal Linden, center, Ron Carey, right, and Dino Natali share a few moments during a wrap-up party at Chasen's in Beverly Hills for the cast and crew of ABC's "Barney Miller", which, after eight years on the network, taped its last show Friday. Linden plays Miller in the show, Carey the uniformed cop Leavitt. Natali appeared in a number of shows but was not a regular character. (AP Laserphoto)

CBS Movie Examines A Well-Traveled Theme

By FRED ROTHENBERG
AP Television Writer

NEW YORK (AP) — "A Question of Honor" explores the well-traveled police corruption theme from a road rarely taken. Tonight's three-hour CBS movie examines the cop not on the take, who can be squashed by overzealous, callous investigators intent on their own political profit.

It's a nice twist on "Serpico" and the latest of the genre, "Prince of the City," which starred Treat Williams as the corrupt cop who reluctantly rats on his fellow narcotics officers to save his own skin.

In "A Question of Honor," Ben Gazzara plays Joe DeFalco, a strong family man and an honest cop on the drug task force, who won't go along with the federal agents and suffers for it.

The point is blunt. Justice is perverted when decent cops are victimized, while stool pigeons and informants get a better shake from investigators, some of whom are operating for their own personal — and political — prestige. Uncovering corruption sometimes can be an afterthought.

"A Question of Honor" is an interesting, inside perspective on the illegal police practices that spawned watchdog groups, like the Knapp Commission in New York during the early 1970s. Its approach comes from former city detective Sonny Grosso, who was Eddie Egan's partner on the famous "French Connection" drug bust, which became a popular movie.

Grosso's book "Point Blank," the story of one of his friends on the force, is the basis for "Question of Honor." Budd Schulberg, who won an Oscar for his "On the Waterfront" script, wrote the teleplay for tonight's dynamic film.

"A Question of Honor" spins a wonderful web of intrigue and double-dealing that is bound to snare viewers and raise questions about where the proprieties lie in this type of internal police investigation.

Paul Sorvino, as usual, is splendid as the gentleman drug dealer, Carlo Danzie, who becomes the bait that federal agents want to use to hook corrupt cops on the city's narcotics detail. Robert Vaughn and Danny Aiello

are the men in charge of the operation.

Danzie is caught by American agents in Italy. Often, a TV movie will use English, even in foreign countries. But the use of subtitles here reflects that "A Question of Honor" is an intelligent, reality-based film.

Danzie is brought to New York, and the trap is set to catch a crooked cop who is fingered by an informer, played by Tony Roberts. The informer role is similar to the role Williams played in "Prince of the City," but Roberts' character is even more spineless in sacrificing others to save himself.

The entrapment plan goes awry when Gazzara's DeFalco inadvertently makes the arrest. DeFalco won't accept Danzie's money; he's not motivated by payoffs but by a driving ambition for bigger busts. He also won't return Danzie to the federal agents, thus jeopardizing the scam operation.

The ruthless Frederick Walker (Vaughn) vows to punish him. Walker has Danzie continually tempt DeFalco in the hopes that the federal agents can get leverage on DeFalco and make him turn police informer. Meanwhile, DeFalco places his faith in Danzie to lead him to a multimillion dollar drug deal.

It's a thrilling cat-and-mouse game, one heightened by Sorvino's suave performance and Gazzara's gritty strength. Even the obligatory domestic scenes with the single-minded DeFalco and his neglected family aren't intrusive. In fact, these situations humanize DeFalco and help us understand the intense sense of honor that motivates him.

It's a deeply disturbing film that provides a different look at the corruption-busters who, according to this movie, grab big headlines on the backs of some good people.

Bixby To Host On New Show

HOLLYWOOD (UPI) — Bill Bixby, star of the defunct "Incredible Hulk" TV series, will play host on the new "Book of Lists" show.

The hour-long variety show will make its debut May 4 on CBS. Each week Bixby will be joined by a different co-host.

PLITT THEATRES BUY PLITT REDUCED ADMISSION TICKETS

HENRY FONDA

On Golden Pond

WEEKDAYS
7:05-9:10

Richard Pryor

Some Kind of Hero

WEEKDAYS
7:05-9:05

QUEST FOR FIRE

WEEKDAYS
7:25-9:20

If you could see what I hear

WEEKDAYS
7:00-9:00

PLITT CAROLINA THEATRE CENTER 756-1444

The Arbor and The Veranda Lounge

bring to you their all new Thursday night double Feature...

Ribs and Rose'

that's with all the succulent barbecue beef ribs to eat and rose' to drink for \$6.95 per person.

Plus... Free admission into the Veranda where you can dance the night away to the finest in live entertainment.

Also by Popular Demand Wednesday and Friday night double feature

"Shrimp and Chablis"

that's with all the fried Shrimp to eat and Chablis to drink for \$7.95. Plus... Free admission into the Veranda where you can dance the night away to the finest in live entertainment.

The Arbor and Veranda are both located within the

RAMADA INN A

Where we make it happen!
756-2792
Dinner hours 5 PM - 10 PM

264 PLAYHOUSE INDOOR THEATRE
4 MILES WEST OF GREENVILLE ON U.S. 264 (FARMVILLE HWY.)

ENDS TONIGHT AT YOUR ADULT ENTERTAINMENT CENTER

EXCLUSIVE FIRST RUN!

A CIRCLE OF PASSION
Georgina Spelvin in
RING OF DESIRE

HNR Associates Presentation
Rated X

Call Anytime for Showtimes
Valid I.D. Required
756-0848 Doors Open 5:45
Showtime - 8:00

Cinema Verite Is Reintroduced

NEW YORK (UPI) — It's been said that a prophet is not without honor, "save in his own country." Ask Robert L. Drew. He didn't even get to name the film technique he invented. He had to wait to introduce it all over again to some of the network moguls who snubbed it the first time around.

Cinema Verite, in loose translation from the French, means "real movie," and until Drew came along, there wasn't very much of that. In his hands, for the first time, the camera became an extension of the viewer, exploring the world without manipulation by actors or the distraction of human voices struggling to explain what the viewer was seeing.

It was bold, innovative and therefore suspect in the circles of American network television.

"When we made our first films," said Drew, "we showed them to our friends at the nets and a friend of mine at CBS said, 'You've got some good footage there.' But he just didn't see it because there wasn't a correspondent.

"So we took it to Europe

and it was a bombshell! For a while, Paris was the place where our stuff was appreciated before it ever got on the air here, and back came the word 'Cinema Verite.'

"I've never claimed Cinema Verite is the absolute truth, but I thought it wasn't a bad term in the sense that anything that gets the viewer closer to reality has probably got the chance of being truer."

With all three networks betting their Nielsen ratings on expansion of news programming — especially in the area of the documentary — Drew said Cinema Verite finally is going to come into its own in the United States.

"The whole idea of Cinema Verite is that you go out and get what's really happening, and by doing it in a sensitive way you can get more drama and more character," he said.

"So Cinema Verite, which looks like an oddity because you don't see much of it and because half or more of it is badly done, has the answer for a lot of the big news questions that are coming up."

power — the original power — and that's not phony. That's the real thing.

"If you have a really strong story going and strong things are happening and you've got a dramatic logic going and you go to a correspondent and start talking, you kill. You kill!

"Good Cinema Verite is like looking at movies. You're there, seeing for yourself, looking through characters, looking into characters. Characters change. Things happen. And that's the way I think good reporting has to go."

Drew, whose Drew Associates created such award-winning Cinema Verite classics in the early 1960s as "Primary," "On the Pole," and "The Children Were Watching," has not been content to watch while others perfect his technique in Europe.

He has just finished a video tape documentary of "work, conscience and murder" among the young in California and his wife, Anne

Drew, has just finished a film on Indira Gandhi.

But it is his 10th anniversary Watergate special, to be syndicated in every major national market in mid-June, that most excites Drew. Watergate, he said, is made for Cinema Verite.

"When we collapse that story into two hours, the drama will be powerful," he said. "We've got all the stock footage and we're shooting interviews with some of the

Carolina Grill

Breakfast \$1.65
Hot Lunch \$2.25

Corner of 9th & Dickinson
752-1188

CONSOLIDATED THEATRES
ALL SEATS \$1.50 EVERYDAY 'TIL 5:30 P.M.

BUCCANEER MOVIES

1-3-5-7-9
DEATH WISH II 12:45, 2:50, 4:55, 7:00, 9:05
6TH WEEK!

1-3-5-7-9
BRONSON'S LOOSE AGAIN
When murder and rape invade your home, and the cops can't stop it... This man will. His way.
DEATH WISH II

TV Log

For complete TV programming information, consult your weekly TV SHOWTIME from Sunday's Daily Reflector.

WNCT-TV — Ch. 9

WEDNESDAY	12:00 Noon News
7:00 Hulk	12:30 The Young
8:00 WKRP	1:30 As The World
8:30 Two of Us	2:30 Capitol
9:00 Movie	3:00 Guiding
11:00 9/Alive News	4:00 Walton
11:30 Late Movie	5:00 Happy Days
	5:30 M*A*S*H
THURSDAY	6:00 9/Alive
7:30 Tic Tac	6:00 Carolina
8:00 Morning	6:30 CBS News
10:00 One Day At	7:00 Hulk
10:30 Alice	8:00 Magnum
11:00 Price Is	9:00 Special
11:57 Newbreak	11:00 9/Alive News
	11:30 Late Movie

WITN-TV — Ch. 7

WEDNESDAY	10:30 Wheel Of
7:00 Joker's Wild	11:00 Texas
8:00 Real People	12:30 Search For
9:00 Facts of Life	1:00 Days Of Our
9:30 Teachers Only	2:00 Another
10:00 Quincy	3:00 Chips
11:00 News	4:00 Muppets
11:30 Tonight Show	4:30 Little House
12:30 Letterman	5:30 Jefferson
1:30 News	6:00 News
THURSDAY	6:30 NBC News
7:00 Jokers Wild	7:00 Beach Music
7:30 Almanac	8:00 Fame
7:00 Today	9:00 Diff. Strokes
7:25 News	9:30 Gimme a
7:30 Today	10:00 Hill Street
8:25 News	11:00 News
8:30 Today	11:30 Tonight Show
9:00 All in the	12:30 Letterman
9:30 Doctors	1:30 News
10:00 Diff. Stokes	

WCTI-TV — Ch. 12

WEDNESDAY	12:30 Ryan's Hope
7:00 Sanford	1:00 My Children
7:30 Barney Miller	2:00 One Life
8:00 Hero	3:00 Gen. Hospital
9:00 Fall Guy	4:00 Bewitched
10:00 Dynasty	4:30 Happening
11:00 Action News	5:00 Laverne
11:30 ABC News	5:30 Good Times
12:00 Movie	6:00 Action News
2:00 Early Edition	6:30 World News
THURSDAY	7:00 Sanford and
6:00 J. Swagart	7:30 Barney Miller
6:30 Street	8:00 No Soap
7:00 America	8:30 Mork and
7:25 Action News	9:00 Barney Miller
8:25 Action News	9:30 Taxi
9:00 Phil Donahue	10:00 20/20
10:00 R. Simmons	11:00 Action News
10:30 Women	11:30 Nightline
11:00 Love Boat	12:00 Movie
12:00 Family Feud	2:00 Early Edition

WUNK-TV — Ch. 25

WEDNESDAY	12:30 Footsteps
7:00 Report	1:00 Reading
7:30 Town Meeting	1:10 19th Century
8:00 Geographic	1:45 Write On
9:00 N.C. 2000	1:50 Reading
10:00 Changing	2:00 Electric Co.
11:00 Twilight Zone	2:30 Living Things
11:30 Dick Cavett	2:40 Metric
	3:00 Sesame St.
THURSDAY	4:00 Sesame St.
7:45 AM Weather	5:00 Mr. Rogers
8:05 Over Easy	5:30 Electric Co.
8:35 Poetry	6:00 Dr. Who
9:00 Sesame St.	6:30 Wildlife
10:00 Word Shop	7:00 Report
10:15 Music &	7:30 Almanac
10:30 Trade-offs	8:00 Cousteau
10:45 Parley Me!	9:00 Previews
11:00 Book Bird	9:30 Fawcett T.
11:15 Soup To	10:00 Dr. In
11:30 Thinkabout	10:30 Dave Allen
11:45 Common	11:00 Twilight Zone
12:00 Advocates	11:30 Dick Cavett

Drew would be the last to say that all those high-priced anchormen and on-the-scene correspondents who grin us through the news every evening must go. In fact, he said Cinema Verite works only where they do not.

"The nightly newscast has to stay just about the way it is," he said. "It's got to be a succession of items and those things have to be presented in word logic, so you need a correspondent. You'd have to invent him if you didn't have him.

"But where everything goes haywire is when you put the correspondent into and on top of a documentary that is a one-hour special... Imagine Dan Rather standing up in the middle of a good movie to tell you what's going on. He would just be lousing things up, right?"

Drew called the network penchant for "sticking a correspondent with a mike in his hand" in front of a bombed-out hotel in Lebanon "a phony element."

"What's real is that hotel behind him," he said. "Now if you go in and take pictures of the corridors of the hotel and those things speak for themselves in some way, then you can generate a real

TONIGHT!

KEEP YOUR EYE ON EYEWITNESS NEWS at 6PM and 11PM

7 WITN-TV

ROCKETS, WRESTLERS & RACERS!

Flying Saucer Builder! 510-lb. Wrestler! Pony Express, 1982 Style! AND MANY MORE! • Sarah Purcell • Skip Stephenson • John Barbour • Bill Rafferty

REAL PEOPLE 8:00PM

ALL-NEW

MARRIAGE-GO-ROUND!

Jo has a "pretend" marriage in class. But will her attraction to her "husband" change her feelings about her real boyfriend?

FACTS OF LIFE 9:00PM

A MATTER OF PRINCIPAL!

The principal is having his mid-life crisis. Can the teachers teach this old dog some new tricks?

Norman Fell
Adam Arkin

LYNN REDGRAVE STARS IN TEACHERS ONLY 9:30PM

NEW HIT SERIES

MURDER AHOY!

One dead admiral and his three grieving widows lead Quincy through a wacky web of spies and espionage!

JACK KLUGMAN IN QUINCY 10:00PM

7 WITN-TV

ALL-NEW

OUR PRIDE IS SHOWING

South Pacific
D.H. Conley High School

April 29, 30 8:00 p.m.
May 2 Matinee
Students \$2.50 Adults \$3.50

Tickets available D.H. Conley office

PUBLIC NOTICES

FILE: 81 CVM 3216
IN THE GENERAL COURT OF JUSTICE
DISTRICT COURT DIVISION
STATE OF NORTH CAROLINA
COUNTY OF PITT
Robert D. Rouse, III and Marcus C. King
vs.
Diane Perkins
NOTICE OF SALE
By virtue of an execution directed to the undersigned...

PUBLIC NOTICES

Misc. assortment of kitchen utensils
1 wooden homed chest
1 box misc. glassware
1 box misc. household what-nots
1 cornwall battery clock
1 box misc. household goods
1 midland 8 track stereo model

PUBLIC NOTICES

penses as 19% of contributions. Funds were raised for the purpose of education, research and client services.
FILE NO: 82 J24
FILM NO.
IN THE GENERAL COURT OF JUSTICE
DISTRICT COURT DIVISION
NORTH CAROLINA
PITTSBOROUGH COUNTY
IN RE: ABDUL RAMAL DAUGHTRY, A MINOR CHILD
DAUGHTRY, A MINOR CHILD
SERVICE OF PROCESS
BY PUBLICATION

PUBLIC NOTICES

IN THE GENERAL COURT OF JUSTICE
SUPERIOR COURT DIVISION
NORTH CAROLINA
COUNTY OF PITT
IN THE MATTER OF THE ESTATE OF LEONA C. NORLANDER
NOTICE TO CREDITORS
Having qualified as Executor of the Estate of Leona C. Norlander...

032 Boats For Sale

21' COBIA with 135 horsepower
Evinrude, 1981 Long trailer
Excellent condition. 1550.00
Call Bob at 758-9132 after 6 or 758-4641.

051 Help Wanted

ATTENTION RNs! Tired of shifts, weekends? Try the challenge of Preventive Health.
Starting salary \$15,120.52 depending upon education.
Call Personnel Office, P.H. County Health Department, Greenville, NC, 919-752-4141.

065 Farm Equipment

CHAIN LINK FENCING. All the parts you need are now in stock to start and complete the job yourself.
2" X 50' roll wire, \$37.95. Line post, \$3.79. Top rail, 106'. \$5.99 each. 3 1/2" X 4 galv. \$38.95. Agri Supply Company, Greenville, NC, 752-3999.

075 Mobile Homes For Sale

ASSUME Low payments \$142 with equity. On this like new stock in bedroom Oakwood home. Set up in park. Call 758-1997 or 758-3525.

PEANUTS



LEGAL NOTICE

Pursuant to G.S. 131C-16, United Central Pals of North Carolina, Inc. of Raleigh, N.C. discloses for the year ended 1981 fund-raising ex...

002 PERSONALS

WHITE HANDSOME MALE, 6'4", weighing 225 pounds would like to meet real good looking woman with a good sense of humor...

003 SPECIAL NOTICES

SAMMY'S COUNTRY Cooking. Open breakfast, lunch and supper 7:00 a.m. Monday-Friday, 12:00-10:00 p.m. Saturday, and Sunday. Daily special, \$1.99. Take outs, 752-0476.

039 Trucks For Sale

ALL TOYOTA trucks priced to sell. 2 wheel drive and 4x4 short and long beds. 2 wheel drive long bed, 4 speed, 5 speeds, automatic overdrives, 13 models to choose from.

074 Miscellaneous

APPROXIMATELY 80' of galvanized chain length 80' & high with 24 x 24 steel pipe...

072 Livestock

HORSEBACK RIDING Jarman Stables, 752-5237. HORSEBACK RIDING Jarman Stables, 752-5237.

076 Mobile Home Insurance

MOBILE HOMEOWNER Insurance of competitive rates. Smith Insurance and Realty, 752-7254.

B.C.

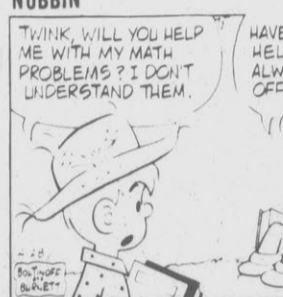

011 Autos For Sale

Most makes and models under \$200. Sold through local government sales. Call 1714-0214, extension 1504 for directory on how to purchase.

013 Buick

BUICK REGAL LIMITED, 1981, Silver, blue vinyl top. Full power. All extras. Diesel. Call 756-2430 after 6 p.m.

015 Chevrolet

CHEVETTE 2 door hatchback, 1977, 67,000 miles. Full power transmission, air, excellent condition. Best offer over \$2350. 752-1237.

040 Child Care

LULLABY DAY CARE CENTER. We take all ages, 24 hour service. Babysitting evenings and weekends. Low rates. 2403 Memorial Drive, Raleigh, NC. 752-2904.

046 PETS

AKC REGISTERED Labrador puppies, 5 weeks old, 3 males, 3 females. \$50 each. Call 1-823-5447 after 4.

051 Help Wanted

ASSISTANT SUPERINTENDENT of Public Works. Report to and administer the principles and practices of Public Works Operations...

059 Work Wanted

ANY TYPE repair work. Carpentry, plumbing, electrical, etc. Call James Harrington, 752-7765 after 6 p.m.

BLOONDIE



018 Ford

FOR SALE 1971 Torino GT. Very good condition. Call 757-1023 anytime.

022 Plymouth

PLYMOUTH Arrow GS, 1978, good condition, air, low mileage. \$3000.00 or best offer. 795-4772 after 6 p.m.

023 Pontiac

GRAND PRIX, 1981, 5,000 miles. Grand windows, cruise control, AM/FM stereo, air, \$8500. 752-1183 after 5 p.m. or 355-2857 anytime.

051 Help Wanted

TRUCK DRIVER Part time. Class A license at least 24 months, 5 years driving experience minimum. Call for appointment, 756-5982.

059 Work Wanted

CARPET AND VINYL installers. Reasonable rates. Call Bob or small! Call Charles Mills at 752-3858 day or night.

059 Work Wanted

ANY TYPE repair work. Carpentry, plumbing, electrical, etc. Call James Harrington, 752-7765 after 6 p.m.

059 Work Wanted

ANY TYPE repair work. Carpentry, plumbing, electrical, etc. Call James Harrington, 752-7765 after 6 p.m.

BEETLE BAILEY



024 Foreign

COROLLA 1980, 5 speed, 2 door, air. Radio white leather, 30,000 miles. 746-2838 after 5.

022 Plymouth

PLYMOUTH Arrow GS, 1978, good condition, air, low mileage. \$3000.00 or best offer. 795-4772 after 6 p.m.

023 Pontiac

GRAND PRIX, 1981, 5,000 miles. Grand windows, cruise control, AM/FM stereo, air, \$8500. 752-1183 after 5 p.m. or 355-2857 anytime.

051 Help Wanted

TRUCK DRIVER Part time. Class A license at least 24 months, 5 years driving experience minimum. Call for appointment, 756-5982.

059 Work Wanted

CARPET AND VINYL installers. Reasonable rates. Call Bob or small! Call Charles Mills at 752-3858 day or night.

059 Work Wanted

ANY TYPE repair work. Carpentry, plumbing, electrical, etc. Call James Harrington, 752-7765 after 6 p.m.

059 Work Wanted

ANY TYPE repair work. Carpentry, plumbing, electrical, etc. Call James Harrington, 752-7765 after 6 p.m.

PHANTOM



024 Foreign

COROLLA 1980, 5 speed, 2 door, air. Radio white leather, 30,000 miles. 746-2838 after 5.

022 Plymouth

PLYMOUTH Arrow GS, 1978, good condition, air, low mileage. \$3000.00 or best offer. 795-4772 after 6 p.m.

023 Pontiac

GRAND PRIX, 1981, 5,000 miles. Grand windows, cruise control, AM/FM stereo, air, \$8500. 752-1183 after 5 p.m. or 355-2857 anytime.

051 Help Wanted

TRUCK DRIVER Part time. Class A license at least 24 months, 5 years driving experience minimum. Call for appointment, 756-5982.

059 Work Wanted

CARPET AND VINYL installers. Reasonable rates. Call Bob or small! Call Charles Mills at 752-3858 day or night.

059 Work Wanted

ANY TYPE repair work. Carpentry, plumbing, electrical, etc. Call James Harrington, 752-7765 after 6 p.m.

059 Work Wanted

ANY TYPE repair work. Carpentry, plumbing, electrical, etc. Call James Harrington, 752-7765 after 6 p.m.

FRANK & ERNEST



024 Foreign

COROLLA 1980, 5 speed, 2 door, air. Radio white leather, 30,000 miles. 746-2838 after 5.

022 Plymouth

PLYMOUTH Arrow GS, 1978, good condition, air, low mileage. \$3000.00 or best offer. 795-4772 after 6 p.m.

023 Pontiac

GRAND PRIX, 1981, 5,000 miles. Grand windows, cruise control, AM/FM stereo, air, \$8500. 752-1183 after 5 p.m. or 355-2857 anytime.

051 Help Wanted

TRUCK DRIVER Part time. Class A license at least 24 months, 5 years driving experience minimum. Call for appointment, 756-5982.

059 Work Wanted

CARPET AND VINYL installers. Reasonable rates. Call Bob or small! Call Charles Mills at 752-3858 day or night.

059 Work Wanted

ANY TYPE repair work. Carpentry, plumbing, electrical, etc. Call James Harrington, 752-7765 after 6 p.m.

059 Work Wanted

ANY TYPE repair work. Carpentry, plumbing, electrical, etc. Call James Harrington, 752-7765 after 6 p.m.

PRISTINE TIME



024 Foreign

COROLLA 1980, 5 speed, 2 door, air. Radio white leather, 30,000 miles. 746-2838 after 5.

022 Plymouth

PLYMOUTH Arrow GS, 1978, good condition, air, low mileage. \$3000.00 or best offer. 795-4772 after 6 p.m.

023 Pontiac

GRAND PRIX, 1981, 5,000 miles. Grand windows, cruise control, AM/FM stereo, air, \$8500. 752-1183 after 5 p.m. or 355-2857 anytime.

051 Help Wanted

TRUCK DRIVER Part time. Class A license at least 24 months, 5 years driving experience minimum. Call for appointment, 756-5982.

059 Work Wanted

CARPET AND VINYL installers. Reasonable rates. Call Bob or small! Call Charles Mills at 752-3858 day or night.

059 Work Wanted

ANY TYPE repair work. Carpentry, plumbing, electrical, etc. Call James Harrington, 752-7765 after 6 p.m.

059 Work Wanted

ANY TYPE repair work. Carpentry, plumbing, electrical, etc. Call James Harrington, 752-7765 after 6 p.m.

FUNKY WINKERBEAN



024 Foreign

COROLLA 1980, 5 speed, 2 door, air. Radio white leather, 30,000 miles. 746-2838 after 5.

022 Plymouth

PLYMOUTH Arrow GS, 1978, good condition, air, low mileage. \$3000.00 or best offer. 795-4772 after 6 p.m.

023 Pontiac

GRAND PRIX, 1981, 5,000 miles. Grand windows, cruise control, AM/FM stereo, air, \$8500. 752-1183 after 5 p.m. or 355-2857 anytime.

051 Help Wanted

TRUCK DRIVER Part time. Class A license at least 24 months, 5 years driving experience minimum. Call for appointment, 756-5982.

059 Work Wanted

CARPET AND VINYL installers. Reasonable rates. Call Bob or small! Call Charles Mills at 752-3858 day or night.

059 Work Wanted

ANY TYPE repair work. Carpentry, plumbing, electrical, etc. Call James Harrington, 752-7765 after 6 p.m.

059 Work Wanted

ANY TYPE repair work. Carpentry, plumbing, electrical, etc. Call James Harrington, 752-7765 after 6 p.m.

109 Houses For Sale
SPACE PLUS! Exceptional executive home features formal living and dining rooms, den with fireplace, 4 bedrooms, 2 baths, rec room over double garage, outside storage, 13% fixed rate loan assumption to qualified buyer \$77,900. Call Mavis Butts Realty, 758-0655 or Elaine Troiano, 756-6346.

SPACIOUS STONE house in beautiful Washington Park. 1 1/2 blocks from Pamlico. 3,400 square feet, 5 bedrooms, 3 baths, large lot well built with many extras. Assumable loan. Call for appointment 946-7084.

CLASSIFIED DISPLAY

109 Houses For Sale
REDUCED AND READY to move into! Adorable 2 bedroom, 2 bath in Bethel. Many extra features. huge fenced lot and reasonable owner. Aldridge & Southernland, Jean Hopper, 756-3500, 757-3979.

SINGLE TREE Fixed rate assumable loan is available on the attractive three bedroom brick ranch. Owner is willing to finance a good portion of the equity. For just a little bit you can have this great room with a fireplace. Reduced to \$49,900. CENTURY 21 Bass Realty, 756-6666 or 756-5868.

IF YOU'RE RESOLVED to live in luxury and privacy this 1 acre lot and custom ranch home is in 3 bedrooms, 2 baths, all formal, fireplace in den, covered patio - too much to list. 11 1/2% Federal Land Bank financing available. \$81,000. Call Mavis Butts Realty, 758-0655 or Elaine Troiano, 756-6346.

IMMEDIATE SALE NEEDED 3 bedroom, 3 year old house. Route 3, Griffon (Lenoir County). Make appointment to see us and make an offer. \$30,000 loan balance, 10.5% VA loan. 1-524-8180.

NEW LISTING University area. Owners are willing to be creative in the financing of the large older home with a fireplace, three bedrooms, and lots of spacious rooms. Low 50's CENTURY 21 Bass Realty, 756-6666 or 756-5868.

CLASSIFIED DISPLAY

109 Houses For Sale
NEW LISTING Like new, located on a wooded lot, this three bedroom home with cedar siding on the exterior is a real charmer. Assumable FHA, 235 loan is available if you qualify. CENTURY 21 Bass Realty, 756-6666 or 756-5868.

OUT-OF-TOWN owner wishes to sell his immaculate 4 bedroom, 2 1/2 bath Tudor style home in Riverhills. Immediate occupancy. Features include all formal, den with fireplace, eat-in kitchen, outside storage, 15 1/2% fixed rate loan assumption or new Federal Land Bank financing available. \$74,900. Call Mavis Butts Realty, 758-0655 or Elaine Troiano, 756-6346.

UNIVERSITY CONDOMINIUM, 28 Golden Road. Priced to sell at \$32,500. Owner buying new home. Get ready for the pool time fun. Fees are already paid for this year. The Evans Company, 756-5258; Winnie Evans, 752-4224.

WINTERVILLE Farmers Home Loan. Fits your pocketbook. Gorgeous corner lot, 3 bedroom, garage, cute and cozy. Aldridge & Southernland, Jean Hopper, 756-3500, 757-3979.

10% LOAN ASSUMPTION or a possible new loan at a less than current rate. 2222 square feet. Excellent area. Call 756-0766.

1914 FAIRVIEW WAY Approximately 2100 square feet of tastefully decorated, well planned living space. Formal living room, dining room, den with fireplace, 3 bedrooms, 2 baths, carpet, covered patio. Centrally located, established neighborhood. 8 1/2% assumable loan. Just reduced from \$86,500. The Evans Co., 752-2814; Faye Bowen, 756-5258; Winnie Evans, 752-4224.

3 AND 4 BEDROOM homes in Griffon. \$27,000-\$49,500. Financing available. Unity, Incorporated, 303 Queen Street, Griffon, North Carolina. Max Waters, Broker, Phone 524-4147, 524-4007 nights.

CLASSIFIED DISPLAY

109 Houses For Sale
DUPEX Call 756-4953. Good buy for young married couple.

ELMHURST AREA, 1006 Hillside Drive, for sale by owner. Two story traditional, living room with fireplace, dining room, den, playroom, 3 bedrooms, hardwood floors and carpet. 9% assumable loan. \$60's. 756-0362. Shown by appointment only.

FABULOUS FIFTIES If you are looking for a starter home, we gottem and with creative financing as well as assumable fixed rates. For more information, give us a call. CENTURY 21 Bass Realty, 756-6666 or 756-5868.

FAIRLANE provides the setting for this attractive 3 bedroom, 1 1/2 bath brick ranch home. Large 125 X 146 lot, backyard deck, fireplace in den, central air are featured. 14% fixed rate loan assumption with no qualifying. \$45,000. Call Mavis Butts Realty, 758-0655 or Elaine Troiano, 756-6346.

FANTASTIC BUY! Must sell. Pay equity and assume 10 1/2% loan, 3 bedroom, 2 bath, great room with woodstove, large lot and great neighbors. Located in Ayden. Call 746-3839 after 7 p.m. weekdays, anytime weekends.

FARMVILLE. Lovely country home on 2 1/2 acre lot. 3 bedrooms, 2 baths, double garage, many extras. Aldridge & Southernland, Jean Hopper, 756-3500, 757-3979.

FHA ASSUMPTION will delight you! Low interest rate means low monthly payment! 3 bedroom home is in excellent condition, featuring foyer, living room, large kitchen and dining area plus den. Aldridge & Southernland, Jean Hopper, 756-3500, 757-3979.

HILLCREST DRIVE, Robinson Heights, Winterville. 4 bedroom with carpet. Farmers Home Loan assumption. House has lots of space. New storage building added in the back yard. \$41,000. The Evans Company, 752-2814; Winnie Evans, 756-5258; Faye Bowen, 756-5258; Winnie Evans, 752-4224.

HILLSDALE Just painted on the inside and outside. New carpet, new stove. Two bedrooms, bath, dining room, living room, family room. Adjacent lot included in price. Seller will pay \$2000 towards closing costs. All this for \$47,500. Duffus Realty Inc., 756-5395.

CLASSIFIED DISPLAY

109 Houses For Sale
ATTRACTIVE owner financing available on this newly remodeled 2 bedroom, brick home with fireplace and central heat and air. Asking price: \$31,500. Located in West Greenville. Call 919-286-0713 after 6 p.m.

BY OWNER, 11 1/2% FHA Assumable loan available on this 2 year old brick home situated on a large corner lot. 4 bedrooms, 2 1/2 baths, fireplace, dining area, garage. Call days, 758-1403; evenings, 758-8549.

CAMELOT. Beautiful area, lovely home. Roomy, comfortable floor plan with 3 bedrooms, 2 baths, super kitchen with breakfast bar, separate laundry room, garage. Owner negotiable. Aldridge & Southernland, Jean Hopper, 756-3500, 757-3979.

CONTEMPORARY COMFORT is yours in this like new 3 bedroom, 2 bath home. Lovely living room with fireplace, dining area, super kitchen, office or sewing room upstairs. Master bedroom has its own sitting room. Huge deck for summer entertaining. Aldridge & Southernland, Jean Hopper, 756-3500, 757-3979.

COUNTRY SUBDIVISION offers immaculate home featuring all formal, den with fireplace, 3 spectacular bedrooms, baths, very attractive home and lot. 13 1/2% fixed rate loan assumption to qualified buyer. \$69,900. Call Mavis Butts Realty, 758-0655 or Elaine Troiano, 756-6346.

CLASSIFIED DISPLAY

115 Lots For Sale
BAYTREE SUBDIVISION. Attractive wooded lots within the city. 90% ten-year financing available. Call 758-3421.

BAYWOOD, TWO ACRE LOT. Financing available. Call 756-7711.

BEAUTIFUL WOODED lot in country, perked water available. Buy now, build later. \$7000. Call days, 752-3000; nights, 756-1997.

CHOICE RESIDENTIAL Lots. Wooded. Westhaven IV. Preferred Properties, 756-7799.

HALF ACRE LOTS. East side of Ayden on Highway 102. \$2000. Call 758-4212 or 746-4574.

NEARLY AN ACRE with septic tank and well already in place. Financing available at a low rate of interest. Price \$6000. Aldridge & Southernland, 756-3500. Nights: Dick Evans, Realtor 758-1139.

ONE ACRE LOT cleared, approximately 8 miles from Greenville on Grimesland Highway, \$6800. Owner financing at 12%. 752-7768 anytime.

RESIDENTIAL LOTS Linnalee, Club Pines, Westhaven III, Call Barry Sumrell 756-7252.

INTEREST The owner will finance these duplex lots in Greenville's prime growing area. All amenities. Darden Realty, 758-1983, nights and weekends, 758-2230.

2 LOTS FOR SALE 1 mile from Sunshine Garden Center. Old Lot A Road. Call 752-3318 or 756-5891.

CLASSIFIED DISPLAY

121 Apartments For Rent
A BEAUTIFULLY decorated, energy efficient, 2 bedroom, 1 bath, townhouse. \$280 a month. Call 752-8949.

APARTMENT for rent. Located close to university. Call 756-0528 after 4.

IF THERE'S something you want to rent, buy, trade or sell, check the classified columns. Call 752-8146 to place your ad.

APARTMENT FOR sublease. In May. 2 bedroom townhouse, 1 1/2 bath. Deposit required. Call 569-7661 or 756-4151.

APARTMENT for rent. furnished, suitable for 2 college students. Call 752-4661 or 756-4013.

AZALEA GARDENS

Greenville's newest and most uniquely furnished one bedroom apartments.
 • All energy efficient designed.
 • Queen size beds and studio couches.
 • Washers and dryers optional.
 • Free water and sewer and yard maintenance.
 • All apartments on ground floor with porches.
 • Frost-free refrigerators.

Located in Azalea Gardens near Brook Valley Country Club. Shown by appointment only. Couples or singles. No pets.

Contact J T or Tommy Williams 756-7815.

CANNON COURT

LUCI DRIVE
 Two bedroom townhouses available with frost-free refrigerators, dishwashers, garbage disposal, washer/dryer hookups, fully carpeted, bath and a half. No pets. Cable TV provided.

Call Rental office 758-6061. Nights and Weekends: 757-3453.

CARRIAGE HOUSE

Charles Street Extension. Close to Plaza. 2 bedroom townhouses. All electric, fully carpeted, cable TV, pool, laundry room. 756-3450.

Cherry Court

Spacious 2 bedroom townhouses with 1 1/2 baths. Also 1 bedroom apartments. Carpet, dishwasher, washer/dryer hookups, laundry room, sauna, tennis court, club house, pool. 752-5557.

CYPRESS GARDENS

2308 E. 10th Street
 Two bedroom apartment, fully equipped, refrigerator, dishwasher, washer/dryer hookups and LOW HEATING BILLS. For an appointment. Days: 758-6061, Nights: 758-5661 or 758-1535.

DOCTORS PARK

Beasley Drive
 Energy efficient two and three bedroom apartments available immediately. Call for appointment. Days: 758-6061, Nights: Weekends: 758-7715.

DUPLEX, LARGE, freshly painted, fireplace, garbage pump heating and cooling. Call 756-4953.

DUPLEX 2 bedroom, 1 1/2 bath, range, refrigerator, dishwasher, washer/dryer hookups. Also some furnished apartments. Call 756-7799.

EASTBROOK AND VILLAGE GREEN APARTMENTS

327 one, two and three bedroom townhouse apartments, featuring Cable TV, modern appliances, central heat and air conditioning, clean laundry facilities, three swimming pools.

Office: 204 Eastbrook Drive 752-5100

OKAMT SQUARE APARTMENTS

Two bedroom townhouse apartments or 1 or 2 bedroom for rent. Contact J T or Tommy Williams, 756-7815.

ONE BEDROOM furnished apartment. Adjoins ECU. Completely modern. Central heat and air conditioning. Stadium Apartments, 404 East 14th Street, \$190 per month. Call 752-5700 or 756-4671. Available May 1.

ONE bedroom apartment, 3 blocks from campus and downtown. Heat and air included in \$215 month. Call between 8 p.m. and 11 p.m. 752-6992.

SHORT TERM LEASE \$215 and \$225. One monthly payment covers everything! 1 bedroom, furnished, cable TV, pool, laundry. Weekly rates from \$63-\$125. Olde Lodges Inn, 756-5555.

SPACIOUS ONE bedroom apartment, appliances and utilities furnished. Suitable for single or couple. Call 752-6197.

SPACIOUS 5 room duplex, also extra nice 2 bedroom apartment, both located 2 blocks from college in residential neighborhood. 758-5991.

STRATFORD ARMS APARTMENTS

The Happy Place To Live
 CABLE TV

Office hours 10 a.m. to 5 p.m. Monday through Friday
 OPEN SATURDAY FROM 9-1
 Call us 24 hours a day at 756-4800

CLASSIFIED DISPLAY

WANT TO SELL YOUR CAR?
 "The Real Estate Concept Of Selling Your Car"

WE NEED LISTINGS
NATIONAL AUTOFINDERS
 Exclusive Brokers For Pitt County

HASTINGS FORD
 10th Street & 264 By-pass 758-0114

WE INSTALL ALUMINUM AND VINYL SIDING
 Remodeling—Room Additions.
C.L. Lupton, Co.
 752-6116

New AutoTerm® Plan makes possible...

• No Money Down!

• \$13281 Per Month!

On New '82 1301 Tercel

9 Colors To Order From

• 3 Year/45,000 Mile TEMA Available!

Explanation: The remarkable new AutoTerm plan—available now at Toyota East in Greenville—brings down the high cost of transportation. AutoTerm is less costly than the conventional way of buying a car... and it's better than any lease you've ever seen.

Imagine, a new Toyota for under \$133 per month... and with no money down! The savings on your monthly payments and down payment add up to hundreds of dollars. That's money in the bank... earning you money!

All vehicles qualify for TEMA (Toyota East Maintenance Agreement)—3 year, 45,000 mile extended service plan.

Term is 48 months. To calculate total of payments, simply multiply 48 by the monthly payment amount. First monthly payment and a refundable security deposit in that same amount required at beginning of lease. You have no responsibility at end of term... you may purchase the car or walk away... your option. Prices shown require approved credit and do not include tax and license.

Examples:

2-door Corolla 5 speed \$159²⁹ per month

Half-ton Truck \$155²⁴ per month

TOYOTA EAST
 109 Trade Street Greenville, NC 756-3228

CLASSIFIED DISPLAY

Home Repairs Siding Roofing
 Eastwood Construction Co.
 758-0246

CLASSIFIED DISPLAY

111 Investment Property
FOR SALE: DUPLEX Lot 0-0% interest. \$4000.00 down, balance forward at \$200.00 a month for 3 years. Call 758-4276 weekdays, 355-2437 weekends.

NEW DUPLEX Yearly rental of \$6600 with assumable loan. Excellent tax shelter. \$61,000. Aldridge & Southernland, 756-3500.

TWO BEDROOM duplex, drive in garage on 3rd Street near the mall. Central air and heat. Partial owner financing available. \$54,900. Call 756-9339, evenings.

113 Land For Sale
WOODED ACRES off the old Washington Highway. Owner will finance with \$4500 down. Darden Realty, 758-1983, nights and weekends, 758-2230.

CLASSIFIED DISPLAY

VOLKSWAGEN QUANTUM

The Roomiest And Most Luxurious Volkswagen Ever!

• Quality •
 • Performance •
 • Engineering •

Compare This Automobile To Volvo, Audi, BMW And Peugeot. We Think You'll Be Impressed With Our New Volkswagen Quantum.

IN STOCK. IMMEDIATE DELIVERY

Joe Pecheles Volkswagen, Inc.
 Greenville Blvd. 756-1135
 Serving Greenville To The Coast For 17 Years

Greenville's Finest Used Cars!

1981 Datsun 200-SX
 Medium blue, blue interior, 5 speed, air condition, AM-FM stereo, sun roof, 11,000 miles.

1981 Honda Civic 1500
 Automatic, silver with maroon interior, AM-FM radio, rear window defogger, radial tires, 23,000 miles.

1980 Mazda GLC Wagon
 Bronze with tan interior, 4 speed, AM-FM radio, 42,000 miles.

1980 Honda Accord
 Silver with maroon interior, 5 speed, air condition, AM-FM radio, digital clock, automatic hatch release, 14,000 miles.

1980 Ford Mustang
 White, automatic transmission, AM-FM radio, radial tires, 30,000 miles.

1979 Chevrolet Chevette
 Blue with blue interior, 4 speed, AM-FM radio. Cheap to own and operate.

1979 Pontiac Sunbird
 Medium blue, 4 cylinder, 4 speed, AM-FM radio.

1979 Honda Civic
 White, 4 speed, AM-FM radio, cruise, one owner, 39,000 miles.

1979 Chevrolet Corvette
 Light blue with dark blue leather interior, one owner, tilt wheel, cruise control, power windows, power door locks, AM-FM stereo with cassette, glass T-tops. Must see this one.

1979 Mercury Bobcat
 Jade green with black interior, fully equipped.

1979 Honda Accord
 4 Door, Maroon with maroon velour interior, one owner, air, AM-FM stereo with cassette, automatic deck lid release, rear door locks, digital clock, reclining seats.

1979 Honda Civic CVCC
 Hatchback, 5 Speed, air condition, AM-FM stereo, only 24,000 miles.

1979 Toyota Corolla Wagon
 White with blue interior, 5 speed, air, AM-FM stereo, radial tires, 22,000 miles.

1978 Ford Fiesta
 Tan with buckskin interior, one owner, 4 speed, AM-FM radio, 23,000 miles.

1977 Honda Civic Hatchback
 Blue, 4 speed, AM-FM radio, cheap transportation.

1977 Toyota Celica
 Liftback, White, tan interior, 5 speed, air condition, AM-FM stereo, 54,000 miles.

1977 Chevrolet Monte Carlo
 Maroon with maroon interior, fully equipped, 48,000 miles.

1976 Honda Civic
 Tan with tan interior, 4 speed, AM-FM radio, good basic transportation.

Bob Barbour VOLVO/AMC keep Renault
 117 W. Tenth St. Greenville 758-7200

Bob Barbour HONDA
 3300 S. Memorial Dr. Greenville 355-2500

THESE CARS ARE PREOWNED...BUT DEPENDABLE!

SHOP THE REST...BUY THE BEST!

1981 Chevrolet Malibu Classic
 4 Door. Metallic champagne with vinyl interior, power steering and brakes, air, AM-FM radio, 22,000 miles, nice car.

1981 Ford Mustang
 2 Tone silver with vinyl interior. 4 Speed, AM-FM radio, power steering, radial tires, 20,000 miles, local car.

1981 Chevrolet Camaro
 White with tan vinyl interior, power steering and brakes, automatic, air, AM-FM stereo tape, 305 engine, tilt wheel, 10,500 miles.

1981 Pontiac Grand Prix
 Fully equipped, diesel engine, sharp, one local owner.

1980 Chevrolet Malibu Classic
 2 door. Dark blue with tan landau roof, AM-FM stereo cassette, wire wheels, 44,000 miles, local owner.

1980 Pontiac Bonneville Coupe
 2 Door. White with blue landau top and blue vinyl interior. Extras include tilt wheel, cruise, AM-FM radio, rally wheels.

1980 Chevrolet El Camino
 2 Tone blue, blue bucket seats, sonsole, power windows, power door locks, cruise control, AM-FM stereo, low mileage, rally wheels.

1980 Pontiac Sunbird
 Dark blue metallic with white landau top and blue vinyl interior. Power steering, 4 speed, air, AM-FM radio, rally wheels, luggage rack, new tires, 25,500 miles. Clean car.

1980 Pontiac Sunbird
 Beige with tan interior, 4 speed, air condition, approximately 38,000 miles, one owner, local car.

1980 Pontiac Grand Prix
 White with burgundy velour interior. Automatic, air, AM-FM, 60-40 seat, wire wheels, 6 cylinder, 17,900 miles.

1980 Toyota Corona Wagon
 Deluxe. Automatic, air, blue with blue interior, AM-FM radio, deluxe wheel covers.

1980 Cadillac Sedan De Ville
 Gleaming black with black vinyl roof, grey velour interior. Fully equipped with wire wheel covers, 30,000 miles, nice car.

1979 GMC Pickup
 Tu-tone blue and white, automatic, air, AM-FM cassette tape, V-8 engine.

1979 Fiat X 1/9
 Finished with tan vinyl interior, 5 speed, air condition, AM-FM radio, 37,500 miles, sharp car.

1978 Chevrolet Monza Wagon
 Medium blue metallic with blue interior, power steering, automatic transmission, radio.

1977 Ford F-150 Pickup
 Tu-tone red and white with red interior. Power steering, automatic transmission.

1978 Fiat 128
 2 door. White, tan vinyl interior, 4 speed, 60,000 miles, one owner, local car, new Michelin tires.

1978 Chevrolet Caprice Classic Landau
 2 Door. White with white-landau roof and red velour interior, fully loaded, 52,800 miles.

1977 Chevrolet Impala Wagon
 Brown metallic with tan vinyl interior, tilt wheel, AM-FM radio, power rear window, luggage rack, local car.

1977 Olds Cutlass Supreme
 Burgundy with white interior, tilt wheel, cruise control, power windows, AM-FM stereo tape, bucket seats.

Having Trouble Selling Your Car?
 Give us a call. We will sell your car for you.

Brown-Wood, Inc.
 Dickinson Ave. 752-7111

PONTIAC GM Cadillac FIAT

HELP WANTED
 Part time and full time help needed. Fastest growing copier company in eastern N.C. needs shipping and receiving clerk. Mechanical aptitude also necessary. Only mature, responsible persons need apply. Career path and opportunity for advancement for the right person. Apply at Crech & Jones Business Machines, Inc., 103 Trade Street, Greenville, N.C. 756-3175.

Unlimited Sales Opportunity

Leader in Cable TV industry seeks professional salesperson to assist in direct marketing efforts. We are a "recession proof" industry with constantly changing incentives. Only the serious and experienced need apply.

Apply in Person
 Equal Opportunity Employer

Greenville Cable TV, Inc.
 Phone 756-5677

517 Arlington Blvd. Greenville, N. C.

AUCTION
 Saturday, May 1st - 11 A.M.

Location: 1/2 mile south of Washington on Hwy 17.

1 - 2640 John Deere with 1300 hours
 1 - Roanoke 153 Rack Bulk Barn (Gas Fired)

Sale Conducted by
 COUNTRY BOYS AUCTION AND REALTY CO.
 P. O. Box 1235 Washington, North Carolina
 Phone 946-6002, Jim Hudson

AUCTIONEER COL. JIM HUDSON
 STATE LICENSE NO. 946
 DOUG GURKINS Greenville, N. C. 758-1875
 RALPH RESSES Washington 946-3477
 NOT RESPONSIBLE FOR ACCIDENTS

121 Apartments For Rent

ENERGY EFFICIENT two bedroom townhouse, wooded area, all appliances, washer-dryer hook ups. \$275. 756-6295.

FOREST MANOR APARTMENTS Large 1 and 2 bedroom apartments. Stove and refrigerator furnished. Close to college. Pool privileges, new carpet. Available May 1. Call 757-6274 from 8-5 and ask for Gail and 756-5577 after 5:30.

FREE MONTHS RENT 2 bedroom apartment at Kings Row available anytime after May 5. Call anytime. 756-8458.

Greenway

Large 2 bedroom garden apartment. Carpeted, dish-washer, cable TV, laundry rooms, spacious grounds with abundant parking, economical utilities and pool. Adjacent to Greenville Country Club. 756-6869.

IF YOU HAVE rental property and wish to house students, faculty or staff beginning summer or fall, please contact the off campus housing office, East Carolina University, 757-6881 now. This is a free referral service. East Carolina University prohibits discrimination on the basis of race, color, creed, handicap or national origin.

IN WINTERVILLE 3 bedroom apartment. Appliances furnished. No children, no pets. Deposit and lease. \$195 per month. Call 756-5007.

KINGS ROW APARTMENTS

One and two bedroom garden apartments. Carpeted, range, refrigerator, dishwasher, disposal and cable TV. Conveniently located to shopping center and schools. Located just off 10th Street. Call 752-3519

LOVE TREES?

Experience the unique in apartment living with nature outside your door.

COURTNEY SQUARE APARTMENTS

Quality construction, fireplaces, heat pumps (heating costs 50% less than comparable units), dishwasher, washer/dryer hook-ups, cable TV, wall-to-wall carpet, thermopane windows, extra insulation.

Office Open 9-5 Weekdays
9-5 Saturday 1-5 Sunday
Merry Lane Off Arlington Blvd.
756-5067

NEW TOWNHOUSES 2 bedrooms, 1 1/2 baths, fireplaces, outside storage. 756-7522.

122 Business Rentals

1500 SQUARE FEET ample parking at 1806 Dickinson Avenue. Available now. Call 355-2969 days and 756-3194 after 6.

125 Condominiums For Rent

NEW FULLY equipped, carpeted, 2 bedroom units. Without walking distance to campus and downtown. \$300 a month. 756-9074.

CLASSIFIED DISPLAY

127 Houses For Rent

AYDEN, NC 2 and 3 bedroom houses for rent. Deposit required. Call 746-9116 or 746-3308 after 5 p.m.

FOR RENT completely restored farm homes. Central heat, wall-to-wall carpet, blinds, water heater, new kitchen, 3 and 4 bedroom homes, \$330 month. 1 mile from city schools on Highway 264 A. Farmville, NC. Call days, 753-3101; nights, 753-4785.

HOUSE FOR RENT 5 miles from Greenville. 2 or 3 bedrooms, nice yard. Rent negotiable. Call 355-2352.

IN BETHEL, 3 bedroom house, 1 1/2 baths, central heat and air. Nice neighborhood. \$225 month, lease required. 895-0446 after 7 p.m.

NICE RENTAL homes in Grifton. \$200-\$300 monthly. Unity, Incorporated, 803 Queen Street, Grifton, North Carolina. Max Waters, Broker. Phone 524-4147, 524-4007 nights.

TWO BEDROOM house near Winterville. Married couple. \$250 per month. Call 756-2322.

WOODED LOT! A nice little square 1/2 acre lot with 4 bedrooms. Nice and established neighborhood. \$350 per month. Couples preferred. Call Greg Darden, 758-1983; nights and weekends, 758-2230.

2 BEDROOMS near university. 118 North 7th Street. \$220. 756-3292.

206 SOUTH WARREN STREET, 4 bedrooms, 2 baths, den, living, and dining room in quiet neighborhood. No pets. 1 year lease and deposit. \$425 per month. 752-2615 or 758-1355.

4 BEDROOM Available immediately. Located West Fifth Street. \$125 deposit. \$175 rent. 752-3311.

4 OR 5 bedroom house. Close to campus. Call 752-0864.

4 OR 5 spacious bedrooms. Ideal for large family or 4 or 5 students. Centrally located, gas heat. \$450, lease and deposit required. No pets. Call 756-5217, 756-0489 or 756-6386 (after 5 p.m.).

133 Mobile Homes For Rent

CLEAN 2 bedroom on shady lot. Married couples only and no pets. 752-9245.

TWO BEDROOMS, furnished, air, washer, carpet, good location, no pets. Call 758-4857.

TWO BEDROOM mobile home. Completely furnished. Call 758-1976 between 5 and 9.

TWO BEDROOM mobile home for rent. \$170 month, \$85 deposit. Call 756-4687.

12 X 40 furnished mobile home located in Oakwood Acres. Available. Call 758-7724.

2 BEDROOMS, completely furnished. No pets. Available the 1st. Call 752-5505.

2 BEDROOMS Washer and dryer, 2 bedrooms or unfurnished. Good park. No pets. 756-0801 after 5 p.m.

60X12 2 bedroom with washer, air conditioner, furnished. \$160 month. \$75 deposit. Call Tommy, 756-7815.

137 Resort Property For Rent

COTTAGE for rent at North Myrtle Beach. 2 bedrooms. Rented by weekend, week or month. 752-3546.

138 Rooms For Rent

AVAILABLE 2 air condition rooms with kitchen privileges for students. 1/2 block from college. 752-3546.

CLASSIFIED DISPLAY

133 Mobile Homes For Rent

FOR RENT OR SALE 3 bedrooms, washer and dryer, no pets or children. Available now. 758-2879.

FOR RENT: 2 bedroom furnished mobile home. References and deposit required. 752-5282 or 752-4008.

SPECIAL SPRING rates on 2 bedroom mobile homes. \$120 and up. No pets. No children. 758-4541 or 756-2971.

THREE BEDROOM, 1 1/2 bath with washer, dryer and air conditioner on private country lot 1 mile beyond Pitt Plaza. Call 756-0264.

135 Office Space For Rent

FOR LEASE 1000 square feet office space. Excellent location. Call 752-1733.

OFFICE OR BUSINESS location. Colonial Heights Shopping Center. 2741 East 10th Street. Approximately 1700 square feet. Available May 1, \$250 month. Call 758-4257 between 9 and 5 weekdays.

OFFICES FOR LEASE Contact J.T. or Tommy Williams, 758-2815.

STORES/offices/restaurants in downtown mall. Available immediately. 756-0041, 756-3466.

2,000 SQUARE FEET of office space available now. Reasonable rent. Located on Memorial Drive. 756-5991.

636 SQUARE FEET carpeted office, utilities and janitor furnished. Parking available. Joyner-Lanier Building, 219 Colaniche Street. Contact Jim Lanier at 752-5505, from 9-5.

OFFICE BUILDING, 700 to 1100 square feet available immediately on East 10th St. Call 758-2300 days.

142 Roommate Wanted

MALE ROOMMATE needed immediately. 1 block from campus Overton's and laundrymat. Energy efficient. Opening May 1. Call 757-1993 or 758-6148.

MATURE, responsible roommate needed to share large, spacious house. Close to campus. 752-8486.

ROOMMATE needed to share new furnished 2 bedroom duplex. Call 756-7045.

WANTED WORKING male or female to share apartment with middleaged businessman. I travel a lot. Need the company. Write PO Box 1293, Washington, NC 27889.

WANTED: Roommate for summer, May 15-August 15. Furnished bedroom, access to kitchen, \$75. Also roommate needed beginning May 15, unfurnished bedroom in large apartment complex, \$65 month and 1/4 utilities (females). Call 752-8925 after 7 p.m.

144 Roommate Wanted

FEMALE needed to share 2 bedroom apartment. Hospital area. Call 752-4623, 9-5, Monday-Friday. Mrs. Stallings.

FEMALE ROOMMATE for 3 bedroom townhouse. Pool, tennis courts, sauna, \$130 plus 1/2 utilities. Call 756-2491.

FEMALE ROOMMATE needed to share 2 bedroom apartment, 2 1/2 blocks from campus. \$140 month includes heat, air, water and cable. Deposit required. 752-4016.

FEMALE ROOMMATE WANTED Call 825-0766 for more information.

FEMALE ROOMMATE wanted. Very nice, 2 bedroom trailer. \$87.50 per month plus 1/2 utilities. 752-1675 before 9 p.m.

I AM LOOKING for an elderly man, woman or retired person to live-in my home. Call 758-4681.

144 Wanted To Buy

PAY IN CASH for a mobile home, wheels, tires and axles. Local number - 752-0214, extension 19, after 7 p.m. or 853-224-8942.

YOU CAN SAVE money by shopping for bargains in the Classified Ads.

CLASSIFIED DISPLAY

WE REPAIR SCREENS & DOORS
Remodeling—Room Additions.
C. L. Lupton Co.
752-6116

138 Rooms For Rent

FURNISHED air conditioned bedroom with refrigerator. Across from college. 758-2883.

PRIVATE ROOMS to rent in family home 3 blocks from campus. 110 South Woodlawn behind Overtons. \$110-\$130 per summer sessions. Also available for fall. One spacious room ideal for art major. Call 752-0495 after 4 p.m.

ROOMS FOR RENT: Weekly efficiency. Linen furnished, maid service once a week. From \$43-70 per week. Close to bus route. Olive London Inn, 756-5555.

1000 SQUARE FEET of office space available. Rent negotiable. Pitt Plaza. Call 756-0842.

142 Roommate Wanted

MALE ROOMMATE needed immediately. 1 block from campus Overton's and laundrymat. Energy efficient. Opening May 1. Call 757-1993 or 758-6148.

MATURE, responsible roommate needed to share large, spacious house. Close to campus. 752-8486.

ROOMMATE needed to share new furnished 2 bedroom duplex. Call 756-7045.

WANTED WORKING male or female to share apartment with middleaged businessman. I travel a lot. Need the company. Write PO Box 1293, Washington, NC 27889.

WANTED: Roommate for summer, May 15-August 15. Furnished bedroom, access to kitchen, \$75. Also roommate needed beginning May 15, unfurnished bedroom in large apartment complex, \$65 month and 1/4 utilities (females). Call 752-8925 after 7 p.m.

144 Wanted To Buy

PAY IN CASH for a mobile home, wheels, tires and axles. Local number - 752-0214, extension 19, after 7 p.m. or 853-224-8942.

YOU CAN SAVE money by shopping for bargains in the Classified Ads.

CLASSIFIED DISPLAY

Energy Systems Service Co.
1214 Mumford Road
Greenville, N.C.
Phone 757-1504

Sunmate Solar Products
Heating • Cooling
Electrical • Plumbing

24 Hour Repair & Service

142 Roommate Wanted

FEMALE needed to share 2 bedroom apartment. Hospital area. Call 752-4623, 9-5, Monday-Friday. Mrs. Stallings.

FEMALE ROOMMATE for 3 bedroom townhouse. Pool, tennis courts, sauna, \$130 plus 1/2 utilities. Call 756-2491.

FEMALE ROOMMATE needed to share 2 bedroom apartment, 2 1/2 blocks from campus. \$140 month includes heat, air, water and cable. Deposit required. 752-4016.

FEMALE ROOMMATE WANTED Call 825-0766 for more information.

FEMALE ROOMMATE wanted. Very nice, 2 bedroom trailer. \$87.50 per month plus 1/2 utilities. 752-1675 before 9 p.m.

I AM LOOKING for an elderly man, woman or retired person to live-in my home. Call 758-4681.

144 Roommate Wanted

MALE ROOMMATE needed immediately. 1 block from campus Overton's and laundrymat. Energy efficient. Opening May 1. Call 757-1993 or 758-6148.

MATURE, responsible roommate needed to share large, spacious house. Close to campus. 752-8486.

ROOMMATE needed to share new furnished 2 bedroom duplex. Call 756-7045.

WANTED WORKING male or female to share apartment with middleaged businessman. I travel a lot. Need the company. Write PO Box 1293, Washington, NC 27889.

WANTED: Roommate for summer, May 15-August 15. Furnished bedroom, access to kitchen, \$75. Also roommate needed beginning May 15, unfurnished bedroom in large apartment complex, \$65 month and 1/4 utilities (females). Call 752-8925 after 7 p.m.

144 Wanted To Buy

PAY IN CASH for a mobile home, wheels, tires and axles. Local number - 752-0214, extension 19, after 7 p.m. or 853-224-8942.

YOU CAN SAVE money by shopping for bargains in the Classified Ads.

CLASSIFIED DISPLAY

Energy Systems Service Co.
1214 Mumford Road
Greenville, N.C.
Phone 757-1504

Sunmate Solar Products
Heating • Cooling
Electrical • Plumbing

24 Hour Repair & Service

144 Wanted To Buy

WOULD LIKE to buy some land, 3 to 20 acres to build a home around the Greenville area from 1 to 5 miles radius. Call collect, Jacksonville, 455-3435, and ask for J. Burrell.

146 Wanted To Lease

WANTED TO LEASE off or on land peanut pounds in Pitt County or will buy quota pounds. 825-3871 after 6.

148 Wanted To Rent

WANT TO RENT garage apartment or upstairs apartment with private bath and kitchen. 752-8786 anytime.

CLASSIFIED DISPLAY

ROOFING STORM WINDOWS DOORS & AWNINGS
Remodeling—Room Additions.
C. L. Lupton, Co.
752-6116

CLASSIFIED DISPLAY CLASSIFIED DISPLAY

David Briley Enterprises

Dealer No. 2825
Rt. 1 Box 232-C
Grimesland, N.C.

Dealer For:
• MFG Quality Boats
• Fisher Marine Aluminum Boats
• Long Trailers

New Area Dealer For Johnson Outboards & Accessories
No. 1 Selling Outboard In The World

• Factory Trained Service

20% Discount On Johnson Motors
9.9 - 235 H.P. Through May

Excellent Inventory Of Used Motors And Boats

WASHINGTON MOTOR CO., INC.

1103 Carolina Avenue
Washington, N.C.

946-7798
946-6424



1981 Dodge Aries K Wagon
4 door, white, 4 cylinder, automatic, front wheel drive, air conditioning, 15,000 mi.

1981 Buick Electra Limited
4 door, black, black vinyl roof, dark red crushed velour, diesel, still has window sticker, save thousands

1981 Buick Electra Limited
2 door, light bronze, tan landau roof, tan velour interior, full power, Buick road wheel, showroom condition

1981 Buick Century
4 door, light copper, beige vinyl roof, V-6, air condition, low mileage

1981 Ford Mustang
3 door hatchback, medium blue, 4 speed overdrive, cassette tape, showroom condition

1980 Ford Thunderbird
2 door, midnight blue, dark blue vinyl roof, tilt, cruise, power windows, stereo, air conditioning, wire wheel covers. We sold it new

1980 Oldsmobile Delta 88
Royale Brougham. 4 door, silver blue, silver blue vinyl roof, diesel, full power, tilt, cruise, wire wheel covers, 27,000 miles

1980 Buick Skylark
4 door, medium blue, medium blue vinyl roof, front wheel drive, 4 cylinder, automatic, air conditioning, price a new one & then price this one.

1980 Chevrolet Monte Carlo
2 door, silver, navy cloth interior, small V-8, automatic, power steering, power brakes, air, am/fm

1980 Chevrolet Caprice Classic
4 door, light grey, 305, automatic, air conditioning. Save money on this one.

1980 Chevrolet Camaro Z28
2 door, silver, "T" top, full power, very sharp

1980 Oldsmobile Cutlass LS
4 door, light grey, black vinyl roof, small V-8, automatic, power steering, power brakes, air

1980 Chevrolet Corvette
2 door, T-top, carmine yellow, black leather, tilt, cruise, power windows, and doorlocks, cassette, aluminum wheels, glass roof

1980 Pontiac Trans Am
2 door, black, saddle cloth interior, tilt, stereo with 8 track, air, rally wheels

1979 Buick Riviera
2 door, dark green, vinyl roof, full power, stereo, wire wheel covers, very clean. A bargain compared to a new one.

1979 Chevrolet Malibu Classic Wagon
medium blue, small V8, automatic, power steering, power brakes, air conditioning, am/fm, luggage rack, wire wheel covers, very clean

1979 Mazda RX-7
2 door, red, GS package, 5 speed, air conditioning, stereo, alloys

1979 Buick Regal Limited
2 door, light blue, blue landau roof, blue crushed velour, tilt, cruise, power windows and door locks, stereo, 32,000 miles, one owner

1979 Buick Century Estate Wagon
white with woodgrain, V8, automatic, air conditioning, luggage rack, wire wheel covers

1979 Volvo 264 GL
4 door, green saddle leather, power windows & outside mirrors, stereo, air conditioning, sunroof, alloy wheels, 1 owner

1978 Ford Thunderbird
2 door, dove grey, cranberry vinyl roof, "T" top, tilt, cruise, power windows, stereo, air, wire wheel covers

1978 Ford Mustang
2 door, silver, red vinyl roof, 4 cylinder, 4 speed, air conditioning, cassettes, sun roof

1978 Audi 5000
4 door, wedgewood blue, 5 cylinder, automatic, air conditioning, stereo, alloy wheels, priced less than half of a new one!

1978 Mercury Grand Marquis
2 door hardtop, clean, cream vinyl roof, leather interior, power windows, power six way seat, tilt wheel, cruise, stereo, 40,000 miles

1978 Pontiac Grand Prix "LJ"
2 door, black, black landau vinyl roof, saddle velour bucket seats, console, power windows, and locks, tilt & cruise, 1 owner

1978 Pontiac Firebird Esprit
2 door, T-top, tilt wheel, cruise, control, power windows, am/fm, honeycomb wheels

1978 Ford Mustang
2 door, silver, red vinyl roof, 4 cylinder, 4 speed, air conditioning, cassette, sun roof

1977 Ford Mustang
2 door, black, 4 cylinder, automatic, air, stereo

1977 Cadillac Seville
4 door, slate blue, blue vinyl roof, blue leather interior, loaded with every Cadillac option including sunroof

1977 Toyota Corolla
2 door, lift back, red, automatic, am/fm, clean

1976 Volvo 264 GL
4 door, champagne, midnight blue velour interior, overdrive, sunroof, power windows, outside rear view mirrors.

1976 Ford LTD Country Squire Wagon
silver, with wood grain, stereo, air, 10 passenger

1974 Fiat 124 Spider Convertible
lime yellow, black convertible top, 4 speed, low mileage

1974 Ford LTD Country Squire Wagon
green with woodgrain, loaded with equipment

1974 Oldsmobile Cutlass Supreme
2 door, light green, light green vinyl roof

1974 Chevrolet Corvette
2 door, T-top, white, automatic, air, stereo

1973 Pontiac Lemans
2 door, silver, burgundy vinyl top, automatic, air, rally wheels, extra clean

TRUCKS

1982 Ford Econoline Custom Van
Bittersweet with custom striping, quad captain chairs, tilt, cruise, air, CB radio, ice box, chrome wheels and more. Brand new!

1982 AMC Jeep CJ7
4x4, Laredo package, chestnut brown, metallic, hard top, 5 speed, stereo, leather interior, all the chrome, 1,800 mi.

1981 AMC Jeep CJ5 Renegade
4x4, midnight blue with light blue stripes, 6 cylinder, 10,000 miles, chrome spoke wheels, goodyear wrangler, showroom condition

1981 Ford Courier
light gold, 4 cylinder, 4 speed, 11,000 miles

1981 Ford F-100 Custom
short wheel base, 2 tone burgundy, 6 cylinder, 4 speed overdrive, showroom shape

1981 GMC Sierra Grande
red, 6 cylinder, automatic, power windows, steering, step side, 13,000 miles

1981 Ford Bronco
custom, 4x4, red and white, 2 tone, 302 V-8, automatic, air, stereo, white spoke wheels, terrain tires, 19,000 actual miles, like new, priced thousands less!

1980 Ford F100 Custom
red, 6 cylinder, 3 speed, step bumper, 1 owner

1980 Ford F100 Custom
light green, 6 cylinder, 3 speed, step bumper, low mileage

1980 Toyota Pickup
4x4, yellow, chrome spoke wheels, terrain tires, tool box, 1 owner

1980 Ford F150 Ranger XLT
4x4, short wheel base, black, tilt, cruise, cassette, air conditioning, box rails, chrome spoke wheels, all terrain tires, 1 owner, very sharp!

1979 AMC Jeep CJ5 Renegade
4x4, bronze with gold stripes, 6 cylinder, 3 speed, white, spoke wheels, 25,000 miles

1979 Chevrolet Custom Conversion Van
White with custom striping, quad captain's chairs, V-8, automatic, air, mag wheels and more! Like new!

1979 Ford F150 Custom
4x4, midnight blue & cream 2 tone, short wheel base, air conditioning, stereo, chrome spoke wheels, terrain tires

1979 Chevrolet Blazer Cheyenne
4x4, gray and silver, 2 tone, tilt, cruise, air condition, power door locks, chrome spoke wheels, 28,000 miles, real sharp

1979 Ford F-350 Custom
one ton, light yellow, 351 V8, 4 speed, new 12 foot flat body with sides, dual rear wheels, 10,000 GVW package, extra clean

1979 Toyota Pickup
medium blue, 5 speed, step bumper

1979 Chevrolet Sport Truck
red & black, 2 tone with stripes, flare side body, V8, automatic, power steering, air conditioning, stereo, white spoke wheels, Goodrich T/A's, 1 owner

1979 Chevrolet Scottsdale
short wheel base, 4x4, black, V8, automatic, power steering, power brakes, air conditioning, am/fm, white spoke wheels, all terrain tires

1979 Ford Ranger XLT
light blue, 351 V8, automatic, tilt, cruise, air conditioning, stereo, box rails, tool box

1979 Ford F-150 Ranger
4x4, red and white 2 tone, short wheel base, air, stereo, sliding rear windows, white spoke wheels, terrain tires, sharp!

1978 Chevrolet El Camino
black, V-8 automatic, power, steering, air conditioning

1977 Chevrolet Blazer
4x4, brown and white, air condition, stereo, low mileage, very clean!

1975 AMC Jeep CJ5
4x4, medium green, 6 cylinder, 3 speed, alloys, new radials, 55,000 actual miles

1975 GMC Jimmy
4x4 gold, V8, automatic, power steering, power brakes, air conditioning, new chrome spoke wheels & all terrain tires

FEDERAL BANKRUPTCY LIQUIDATION & PUBLIC AUCTION SALES
FRIDAY & SATURDAY APRIL 30 & MAY 1, 1982

50% to 75% OFF

421 Evans Street (On the Mall)
Greenville, N.C.

50% to 75% OFF

Liquidation Sale: Begins FRIDAY 9:00 A.M. and continues on SATURDAY until 2:00 P.M. AUCTION TIME.

Public Auction: SATURDAY 2:00 P.M. All unsold merchandise and fixtures WILL BE SOLD TO HIGHEST BIDDER.

ALL SHOES & OTHER MERCHANDISE WILL BE MARKED DOWN 50% TO 75%

EVERYTHING MUST BE SOLD DURING LIQUIDATION & AUCTION

Large inventory (over 2,000) MENS, LADIES & CHILDRENS SHOES to be sold at these FANTASTIC PRICES. HANDBAGS & OTHER ITEMS Most fixtures & equipment will be priced to sell during OVER-THE-COUNTER sale. Includes: NCR cash register, Checkout counters, Leather chairs, Office SAFE, File cabinets, Glass showcases, Show Racks, Desks & Chairs, Typewriter, etc. All items not sold will be SOLD AT PUBLIC AUCTION ON SATURDAY.

SALE NO. 2 FOUR SEASONS FOAM INSULATION, INC.
(Same Location as Sale No. 1)
SATURDAY MAY 1, 1982 2:00 P.M.

The following will be **SOLD AT PUBLIC AUCTION SAT.**

1973 International Truck W/18 ft. Closed Body
10 H.P. Air Compressor
Onon 5KW Generator
Krendel 600 Insulation Blower
Heat Detector

ALL SALES "AS IS, WHERE IS" NO REFUNDS OR EXCHANGES

Bankruptcy Trustee
Richard D. Sparkman
Angler, N.C.
639-6181



WE WILL GLADLY ACCEPT FOOD STAMPS AND WIC VOUCHERS.

QUANTITY RIGHTS RESERVED NONE SOLD TO DEALERS

ABAGFULL OF BARGAINS ARE YOURS AT



FRESH CORN 15¢ EACH EAR

SMITHFIELD BACON 1 LB. PKG. \$1.39
 LUTER'S ORIGINAL OLD FASHION FRANKS 12 OZ. PKG. 99¢
 SMITHFIELD BOLOGNA 12 OZ. PKG. \$1.19

Prices Effective: Grocery-Meat- Produce April 29, 30, & May 1, 1982

HEAVY WESTERN BEEF
SIRLOIN STEAK
 \$2.79 LB.
 HEAVY WESTERN BEEF T-BONE STEAK \$2.89 LB.



FRESH
GROUND BEEF
 \$1.19 LB.



FRESH
BROCCOLI
 79¢ BUNCH



LEAN MEATY BONELESS ROUND ROAST \$1.99 LB.

LEAN TENDER SWISS STEAK \$2.29 LB.

SPRING ONIONS 33¢ BUNCH

HEAVY WESTERN BEEF CUBED
STEAK \$2.39 LB.



USDA INSPECTED WHOLE
FRYERS 39¢ LB.

FRESH GREEN CABBAGE 19¢ LB.
 FRESH PINK GRAPEFRUIT . 5 LB. BAG \$1.09

FRESH LEAN EYE OF ROUND STEAK \$2.69 LB. LEAN TENDER EYE OF ROUND ROAST \$2.39 LB. HEAVY WESTERN BEEF BONELESS RUMP ROAST \$1.99 LB. FRESH CANTALOUPE 99¢ EACH

COUPON
 FOODLAND MEDIUM
EGGS
 39¢ DOZEN
 LIMIT 1 DOZEN WITH \$10.00 ADDITIONAL FOOD ORDER OR MORE & THIS COUPON.

COUPON
 WESTINGHOUSE
LIGHT BULBS
 REGULAR GRAY PACKAGE
 60 WATT 25¢ EACH
 70 WATT
 100 WATT
 LIMIT 4 WITH \$10.00 ADDITIONAL FOOD ORDER OR MORE & THIS COUPON.

FROZEN FOODS:
 BIRDS EYE COOL WHIP . 20' OFF 12 OZ. CTR. 79¢
 PET RITZ DEEP DISH PIE SHELLS PKG. OF 2 89¢
 DULANY CUT YELLOW CORN . . . 16 OZ. BOX 89¢
 GORTON FISH STICKS . . . 2 LB. BOX \$2.89
 OLD SOUTH ORANGE JUICE 16 OZ. CAN 99¢

COUPON
LUVS
 MEDIUM DIAPERS
 \$2.59 18 CT. BOX
 LIMIT 1 WITH \$10.00 ADDITIONAL FOOD ORDER OR MORE & THIS COUPON.



COUPON
TREND
 DETERGENT
 69¢ 42 OZ. BOX
 LIMIT 1 WITH \$10.00 ADDITIONAL FOOD ORDER OR MORE & THIS COUPON.



WHITE HOUSE
APPLESAUCE 2.79 303 CANS

PERFECTION LONG GRAIN RICE 3 LB. BOX 89¢
 KRAFT AMERICAN SINGLES CHEESE 12 OZ. PKG. \$1.49
 CHATHAM CHUNX DOG FOOD 25 LB. BAG \$3.49

CHEF-BOY-AR-DEE, BEEF-A-RONI MINI OR BEEF RAVIOLI, OR SPAGHETTI & MEATBALLS 40 OZ. CAN \$1.59



DEL MONTE PEAS 303 CAN 39¢
 PETER PAN SMOOTH OR CRUNCHY PEANUT BUTTER 18 OZ. JAR \$1.49



LIBBY VIENNA SAUSAGE 5 OZ. CANS 2.89

DOVE WHITE OR PINK BATH SOAP . 4' OFF 5 OZ. BAR 69¢

CAMPBELL'S CHICKEN WITH RICE SOUP . .3 \$1.00 10 3/4 OZ. CANS



LIBBY POTTED MEAT 4 \$1.00 3 OZ. CANS



MAOLA HOMOGENIZED MILK GALLON \$1.99
 MAOLA 1/2% LOW FAT MILK GALLON \$1.69

NABISCO PREMIUM CRACKERS 16 OZ. BOX 79¢

WHITE, PINK/BLUE, OR YELLOW/GREEN
WHITE CLOUD BATHROOM TISSUE
 99¢ 4 ROLL PKG.
 LIMIT 2 WITH \$10.00 FOOD ORDER OR MORE.



“THE MONEY SAVERS”
 SOUTHERN DISCUIT SELF RISING FLOUR . 5 LB. BAG 89¢
 SUPERMAN CREAMY OR CRUNCHY PEANUT BUTTER 18 OZ. JAR \$1.39



FOODLAND
MACARONI & CHEESE
 4 7 1/4 OZ. BOXES \$1.00



DEL MONTE CUT GREEN OR FRENCH CUT GREEN BEANS 3 303 CANS \$1.00



SWIFTNING SHORTENING 42 OZ. CAN \$1.19
 CHEF-BOY-AR-DEE SPAGHETTI & MEATBALLS 15 OZ. CAN 69¢



CRISCO OIL (20' OFF) 38 OZ. BOTTLE \$1.39



NABISCO SNACK CRACKERS ASST. WTS. 99¢

NABISCO CHIPS AHoy 19 OZ. PKG. \$1.59

YOUR NEIGHBORS AT
FOODLAND
 know what it is to feed a family

SPAIN'S 1414 Charles Blvd. Monday-Thursday 8 A.M.-8 P.M. Friday-Saturday 8 A.M.-8:30 P.M. CLOSED SUNDAY
 SHOP-EZE West End Shopping Center Monday-Saturday 8 A.M.-9 P.M. Sunday 9 A.M.-6 P.M.

FOLGERS FLAKED COFFEE 13 OZ. BAG \$2.09
 HIGH POINT COFFEE 8 OZ. JAR \$4.29



Be Sure To Register And Play The Fabulous Wheel Of Fortune
 WIN CASH WIN GROCERIES
 THE FABULOUS WHEEL OF FORTUNE
 CASH & GROCERIES GIVE-A-WAY FOODLAND

Repeat Offenders 'In Trouble'

By JANET PLUME
Associated Press Writer
OKLAHOMA CITY (AP)—
Jackson Monroe Martin slumped in his chair and stared at the floor. He couldn't believe he had been sentenced to 99 years in jail for indecent exposure.

"I don't think it's right for me to get that much time for that kind of crime," said Martin, whose 11 prior convictions for burglary enabled the prosecutor to ask for the long sentence.

"Maybe a fine and 30 days, or even a year in the county jail. But not 99 years!" the 42-year-old man complained at his sentencing hearing.

"People are just tired of crime," said Ron Stubbiefield, the district attorney

in Bryan County, Okla., where Martin received his long sentence. "And they want the repeat offenders off the streets."

Throughout the country, prosecutors are increasingly using habitual criminal codes to seek longer terms.

The stiffer punishment depends on the crime, but can range from the sentence for the next higher class offense—in South Dakota—to life without parole—in Louisiana and Arkansas.

Maine and Pennsylvania are the only states without laws or pending legislation for habitual or repeat offenders, according to a recent Justice Department study done at American University in Washington.

In Ohio, a measure by state Rep. Edward J. Orlett of Dayton calling for mandatory sentencing for some felonies unanimously cleared the state House earlier this month.

The proposed law would require judges to impose an "actual incarceration" period ranging from three to nine years on career criminals.

"Society has a right to protect itself against criminals for a specified period of time," said Orlett, who noted the bill is "the first major change in a decade in the state's criminal sentencing law."

Some law enforcement officials contend early releases by parole boards take the muscle out of prison sentences.

"One reason for the increase in the use of the habitual criminal statute is that there was a realization that a 20-year sentence didn't mean 20 years," said Pete Adams, president of the Louisiana District Attorneys Association.

"It's a better bet to put them away, these people who are constantly costing the taxpayers money. People are realizing rehabilitation is not working. The answer is long sentences."

In 29 states, the habitual criminal charge can be considered on the second felony, according to a study by the Rand Corp. Nineteen states consider the charge upon a third offense, two states consider it on the fourth and three states have increased penalties for the fifth conviction.

Another study by the National Council on Crime and Delinquency indicates that at least 17 states have enacted or have introduced within the past five years legislation directed toward getting career criminals off the streets.

U.S. Sen. Arlen Specter, who was a district attorney in Philadelphia for eight years, has sponsored a bill that would make a third armed robbery or armed burglary conviction a federal offense punishable by at

least 15 years in prison.

A study by the senator's staff revealed that robbers serve an average of three years behind bars, and a robber with prior convictions serves an average of only 3½ years.

Research based on interviews after arrest revealed professional lawbreakers individually commit 50-100 robberies or 200-400 burglaries a year, said Paul Michele, a spokesman for the Pennsylvania Republican.

Furthermore, 6 percent of those arrested for robbery and burglary commit 60 percent of those crimes, Michele added.

"These people are one-man crime waves," he said.

In Oklahoma, the Legislature this month approved a bill requiring a three-time armed robber be sentenced to a mandatory 10 years imprisonment.

Other approaches to putting away the career criminal also are being considered. David Armstrong, president of the National Association of District Attorneys, advocates truth in sentencing, in which 20 years means 20 years.

"The sentencing phase of a criminal trial has become a charade," Armstrong said from his Louisville, Ky., office.

"The habitual criminal law is a fair concept," Adams said from Baton Rouge, La. "Judges and district at-

torneys still maintain a fair amount of discretion in deciding whether or not there is any chance to rehabilitate this man or if the smartest thing to do is to put him away."

However, the prosecutors disagree on whether stiffer sentences actually prevent crime.

"I can't say it's a deterrent because we're trying to take these people off the streets," Adams said. "Instead, we should say with these people off the streets, more people are not encouraged to commit crimes."

Others say it's too early to make conclusions about the effect of the law.

"It's an evolutionary process," said Tony Burns, district attorney in Duncan, Okla., where a jury last year handed down the county's first death sentence in half a century for a triple murder conviction. "It'll be years before they'll think twice about committing a crime."

"But criminals are coming to understand that they have a better chance with appeals courts and parole boards than in state courts," he said.

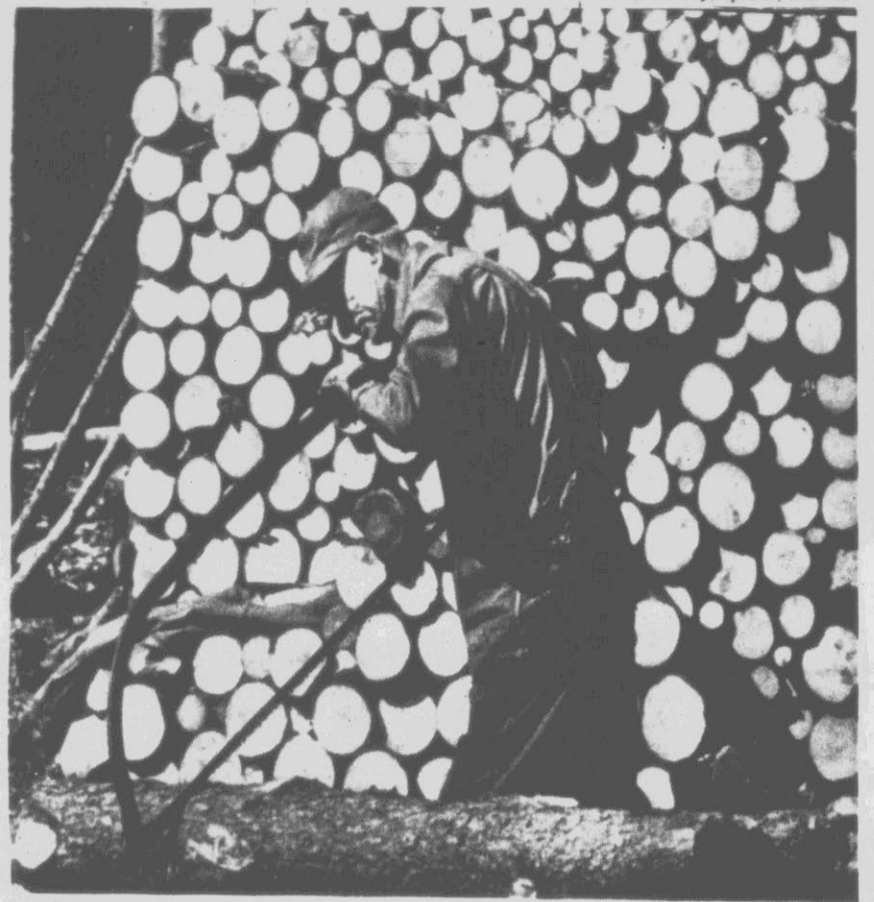

WHAT CHAINSAW? — It doesn't look like 68-year-old Leroy Hudson needs a chainsaw as he pushes and pulls his bowsaw through log after log behind his house in the South Mountain area of Burke County, N.C. The rack of logs behind Hudson are proof that he doesn't have any use for modern conveniences like the noisy chainsaw. The trees fell during an ice storm this past winter and like most people Hudson is just now getting around to cleaning the mess up. But, wood will not be hard to find next year. (AP Laserphoto)



HE'S A DRESSER — A frog named Roller Derby Billy was one of the worst jumpers among 1,500 competing in last weekend's 29th annual Del Mar Jumping Frog Jamboree near San Diego. But he was probably the snazziest dresser. The winner, Spike, leapt 14 feet 10 inches. (AP Laserphoto)

Newsprint Price Boost Delayed

By LORRAINE CICHOWSKI
AP Business Writer

Major newsprint producers in Canada and the United States have delayed a 5 percent price increase to their U.S. customers until June 1, and analysts say the price hike could be deferred even longer if publishers do not start depleting supplies.

In eastern Canada, a spokeswoman for Consolidated-Bathurst Inc. of Montreal confirmed Monday the company's planned \$25 increase for U.S. customers to \$525 (U.S.) a metric ton had been delayed from March 1 to June 1. Prices to Canadian customers were increased as scheduled, however, to \$540 (Canadian) a metric ton.

A metric ton equals 2,204 pounds.

Last month, Consolidated-Bathurst said its price increase to U.S. customers had taken effect, as scheduled, on March 1. But president Oscar Stangland said at the time the company was providing discounts to some customers.

Industry sources said Toronto-based Abitibi-Price Inc. — the world's largest newsprint producer — had deferred a similar increase until June 1, but company officials did not return calls Monday.

Spokesmen for Reed Paper Ltd. of Toronto and Great Lakes Forest Products Ltd. of Thunder Bay, Ontario, said the companies had put off their price increases to U.S. customers until June 1.

"When Abitibi-Price deferred until June 1, that had

such a major effect on the marketplace," said Nick Keene, vice president of marketing at Reed Paper. He said "market conditions" and "the actions of our competitors" led to the price deferral.

In the United States, Kimberly-Clark Corp. of Neenah, Wis., and New York-based St. Regis Paper Co., said they had deferred until June 1 a \$25-a-ton increase that had been set to go into effect April 1. A spokesman for International Paper Co. of New York said the company's prices declined to comment on the company's prices.

When Consolidated-Bathurst announced in November that it intended to raise newsprint prices March 1, some pulp-and-paper analysts said they were

surprised the companies would try to increase prices in light of the weak economy and large newsprint inventories now held by American publishers. The other companies followed Consolidated's lead.

According to the American Newspaper Publishers Association, the publishers had a 58-day supply of newsprint on hand at the end of March.

Ed Dunleavy, an analyst who follows the industry for the investment firm Salomon Brothers Inc., said the supply would have to be reduced to 35 days for the price increase to take effect June 1. And only a lengthy strike by eastern Canada paperworkers whose contract expires Friday could deplete the supply by that much.

INTRODUCING



Monday-Saturday 9 A.M.-7 P.M.
Closed Sunday
All Prices Effective While Quantities Last

VALUE-FAIR Is A Warehouse Grocery Store That Will Sell You FOOD FOR LESS Every Day Of The Week. We Offer Many Groceries, Meats, Produce, Dairy Products And Frozen Foods To You At Wholesale Warehouse Cost Because We Have Cut Our Operating Cost. We Buy Our Products In Bulk Quantities, Because It's Our Business To Sell You FOOD FOR LESS And Save You Money. We Don't Have Expensive Decorations, Gimmicks, Games Or Stamps. We Bulk Stack Groceries And Produce, Offer Family Pack Meats, Open Less Hours, And Let You Bag Your Own Groceries And Carry Them To The Car, Because When We Save Money, You Save Money. At VALUE-FAIR Your Budget Is Important To Us, We Honestly Want To Sell You FOOD FOR LESS. We Have Bought Truckloads Of Items From Manufacturers Who Are Offering Deals And Off Labels So We Can Sell You FOOD FOR LESS. At VALUE-FAIR We Are Committed To Not Being Undersold. At VALUE-FAIR We Offer You 1st Quality Name Brand Groceries And Still Sell

At VALUE-FAIR We Offer You 1st Quality Name Brand Groceries And Still Sell

You FOOD FOR LESS. Come Shop With Us, We Want To Be Your Grocery Store. These Are Just Some Of The 2000 Items That You Can Save Money On At VALUE-FAIR.

FRESH WHOLE FRYERS 39^c LB.	BEALES COURTLAND BRAND ROLL SAUSAGE 69^c 1 LB. ROLL	SMITHFIELD, FROSTY MORN OR GWALTNEY SLICED BACON \$1³⁹ 1 LB. PKG.	GOLDEN RIPE BANANAS 23^c LB.	COUNTY FAIR BREAD 3 1½ LB. LOAVES FOR \$1¹⁹ Save 5¢ Per Loaf	JACKS VANILLA WAFERS 2 9 OZ. PKGS. FOR \$1⁰⁰ 1.38 Value	SOUTHERN BISCUIT FLOUR 69^c 5 LB. BAG Save 30¢	Murrays Duplex Creme Cookies Buy One 16 Oz. Pkg. At 89¢ And Get 1 Free Regular Price 89^c Per Pkg.	PEPSI COLA 79^c 2 Litre Bottle
---	---	--	--	---	--	---	--	--

Do A Friend A Favor, Tell Them How Much Money You Saved At VALUE-FAIR Warehouse Groceries.

Czech Economy Sees Darkening Clouds On Horizon

Paralyzed Podiatrist Will Be Aiding Other People To Walk

CHICAGO (AP) — Even Louis M. Lissuzzo admits it's ironic: He's confined to a wheelchair and can't even wiggle his toes, but he plans to help other people walk.

Almost 11 years after a motorcycle accident left his legs paralyzed, Lissuzzo is becoming a doctor of podiatric medicine — a foot doctor.

"It's just a little crazy," Lissuzzo said. "I'm a wheelchair podiatrist who helps people walk. ... But if you want to know something funny — I was a shoe salesman in high school."

He said he'll be a competent doctor.

"We handicapped people do just as well as anyone else," he said. "All you need is your head and hands, not a foot."

Lissuzzo, 29, is scheduled to graduate cum laude from the Illinois College of Podiatric Medicine on May 21, and he has worked at three hospitals in Chicago while in school.

Podiatry is a medical specialty for the treatment and prevention of foot disorders. A doctor of podiatric medicine completes a four-year course of study and is allowed to prescribe drugs and perform minor surgery,

such as removal of corns.

Lissuzzo credited a special wheelchair and encouragement from a paraplegic podiatrist, Thomas Garrison, with helping him complete his studies.

"A terrific guy and a terrific chair," he said. "He helped me, inspired me, keeps me going. And the chair is motorized, goes up and down. I take it around to the various hospitals and haven't had any problems anywhere."

Lissuzzo's paralysis resulted from a 1971 motorcycle accident. "I really don't like to talk about it," he said. "It's irrelevant. I'm a professional now and that's how I want people to see me."

After seven months in the hospital, he began attending a junior college. "I always wanted to be a doctor and no accident was going to get in my way," he said.

Lissuzzo transferred to Loyola University, where he graduated in 1976 with a biology degree. In 1978, he earned a master's degree in biology from Loyola.

That summer, he was ac-

cepted at the podiatric college. He said his friends, his family and his wife, Claudia, 31, a secretary whom he met and married after his accident, share credit for his graduation.

"The people at school pay me one of the best compliments," he said. "They look up to me, even though I'm in the chair. They say, 'You're doing it, we can do it. You're a real inspiration.'"

"It's been a great struggle for him and he's managed to do it, he and Claudia," said his mother, Pauline Lissuzzo, 55. "In the worst weather and everything."

Lissuzzo said he hasn't had any trouble dealing with patients, and his wheelchair enhances his rapport with the people he treats. "It gives us a great starting point, something to talk about. They want to know all about it."

After a Hawaiian vacation, Lissuzzo plans to set up practice in one of Chicago's western suburbs. "The legwork is over," he said. "Now it's time to be a professional."

By LARRY GERBER
Associated Press Writer
PRAGUE, Czechoslovakia (AP) — Planners in Czechoslovakia's government are wrestling with an economic sluggishness that threatens one of the most prosperous standards of living in the communist world.

Although the Czechs and Slovaks, with an average monthly income equal to about \$270, are still better off than their allies in Poland and Romania, "things are slowly going downhill," said one economist who requested anonymity.

Price increases for gasoline and food in recent months mean fewer people are eating out and taking trips to the country, residents say.

In a popular restaurant a 20-minute drive outside Prague, one waiter said business had dropped by about 70 percent since the government increased the price of gasoline by 15 percent in October.

High-grade gasoline costs the equivalent of about \$3.20 a gallon.

"We had 10 wedding receptions last March. This March we had one," said the waiter.

Judging by the "for sale" ads in some publications, many Prague residents are trying to sell their second homes or looking for something closer to the city.

"Working in my garden in

the country was how I worked off the frustrations" of living in this tightly controlled society, said one Prague resident. "Now it's getting harder to even do that."

Seeds for tulips, hyacinths and climbing beans are said to be among the short-supply items along with staples such as good-quality cheese, pork fat and butter.

Sharp increases in food prices this year included a 41 percent average hike in the price of meat. Beef jumped from the equivalent of \$1.50 a pound to \$2.50.

The price increases for meat were seen as especially significant because Czechoslovakia has one of the world's highest per-capita meat consumption rates.

Much of the belt-tightening stems from the government's determination not to go the way of Poland and Romania, which drove themselves into debt by borrowing for imports.

Western sources put Czechoslovakia's debt to the West at \$3.5 billion, a relatively modest sum, and authorities say no increase in borrowing is planned.

In past years, "we had to import more fodder than was planned," said Zbynek Zima, an adviser in the Government Planning Commission. "We are demanding that agriculture drop its demand for imports."

The nation is trying to

become self-sufficient in grain for food and animal fodder, he added.

Meanwhile, shoppers are lining up and paying more for favored cuts of meat.

A Western businessman who deals in cigarettes and other goods sold in special hard-currency shops said his business was off by about two-thirds in the past year — an indication that the average citizen has less Western money than before.

Even though the shops are ostensibly only for foreigners, Western suppliers say local residents make up the bulk of the market.

The government is also trying to maintain the present level or reduce imports of oil, most of which comes from the Soviet Union.

Although Czechoslovakia pays, by some estimates, only about half the \$34-a-barrel OPEC price for the oil it gets from the Soviets, the price has increased nearly fivefold in the past 10 years and the volume of imports has nearly doubled.

"We had a growth of 85 percent in crude oil consumption over the past 10 years," said Zima. "No economy can sustain a growth of this magnitude."

He cited an ambitious nuclear-energy program that should be producing 20 percent of Czechoslovakia's electrical power by 1985, if all goes according to plan.

That would be about the

same time the current oil pricing agreement with the Soviet Union runs out, leaving the country facing sharply higher prices.

The emphasis is also shifting away from bulk production of chemicals and other goods to more energy-saving production goals, Zima said. This includes granting bigger incentives to energy-saving enterprises.

With investments remaining the same, or even decreasing, the target of 2 percent to 2.6 percent annual growth in the gross national product will have to be achieved mostly by "increased efficiency," said Jan Sakala, another government planner.

"We must economize on imported materials for production, while at the same time satisfying the needs of the population," he said.

But there are signs of uncertainty about exactly how to achieve that. The last five-year plan expired at the end of 1980, and so far no comprehensive new plan has been published. Officials could not say when it was expected.

The lag is "caused by the fact that ... some external conditions have changed" since expiration of the last plan, said Planning Commission spokesman Rudolf Cerny. The planners cited high interest rates in the West, the worldwide slowdown in trade demand and other factors.

Deeds

- Tipton Builders Inc. to Walter Ellis Everett Jr. al 5.00
- Richard L. Tucker al to James H. Tucker Sr. al 12.50
- Joseph Lee Cash al to Betty Jean Feamster al NS
- Neil Realty Co. to Susan M. McDevett 6.00
- Neil Realty Co. to Billy Paramore 6.00
- William R. Parry Jr. al to Charles Schwartz al 21.00
- Richard C. Taft al to Kirit G. Amin al 22.00
- Tucker Farms Inc. to Shenandoah Development Co. Inc. 43.00
- Ariane D. Clark al to Edgar L. Harrington Jr. NS
- Bill Clark Const. Co. Inc. to Billy Ray Smith 6.50
- Edward H. Cobb al to James Frank Corbett Jr. al 16.50
- Lloyd Foreman Sr. al to Lloyd Foreman Jr. al NS
- Willard Ray Hall al to Tipton Builders 4.50
- W. Deaton Hurley to Dewey R. Stocks al 7.00
- Loyd A. McLawhon al to Gentry V. McLawhon al NS
- Clarence Hardy Moye al to Don E. Lee al 40.00
- Clarence Hardy Moye al to Don E. Lee al 60.00
- Angela B. Weaver to Edward Weaver Jr. NS
- Pauline Taylor Whitehurst to Charlie Donald Anderson al 37.00
- Elias Williams to Lottie Bell Pugh al NS
- Roland B. Williams al to David D. Overton al 73.50
- James C. Adams to Evelyn L. Adams Manning NS
- William Manning Adams al to Demetrius Smith 1.50
- Joseph A. Hill al to Classic Enterprises Ltd NS
- Bobby Ray Harper to Bobby Ray Harper NS
- Clarissa Edwards May to Kenneth M. Buck NS
- Stanley Peaden Builders Inc. to Roland Williams al 12.00
- Walter Scott Drake to Louise Jennings Drake NS
- Russell Houston III-Sub Tr to Liberty Financial Planning 27.00
- H. Terry Hutchens Sub Tr to Administrator/Veterans Affairs 29.50
- R. Guy Mayo Jr. al to Willard A. Fraley al NS
- Ronald Dean Payne to Mary Frances Payne NS
- Patricia Smith to Leroy Smith NS

Speaking of Your Health...
Lester L. Coleman, M.D.

Post-Hysterectomy Depression

My mother had a hysterectomy operation done about a year ago. She is 51. She was always a placid woman. Since the operation, however, she is another person. Sometimes she is so depressed that I can barely get her out of her blues. She sometimes snaps at me and my father without the slightest provocation. Can't something be done about this?

—Miss L.R., Va.
Dear Miss R.:

This is not unusual. Many women who seem to be tranquil, well organized, gentle and free from psychological stress react markedly to the removal of the uterus. Those women who have had a history of emotional turbulence are even more prone to overreacting to this type of surgery.

The uterus (womb) has always been a symbol of femininity. When the childbearing function is halted by hysterectomy, it is a threat to the feminine image, especially in a highly sensitive woman.

The fear that the removal of this organ may diminish a woman's attractiveness or sensuality frequently pushes her into a tailspin of anxiety.

Now, in addition to the psychological impact of the operation, there are some very real symptoms that can be annoying and very distressing, especially if the ovaries were also removed at the time of surgery.

The sudden onset of menopause following surgery is frequently associated with increased fatigue, irritability, headaches, hot flushes and episodes of depression. These symptoms are common and are attributed to a hormone imbalance after the ovaries are removed.

When women are carefully prepared for these possible

changes after surgery, the severity of their response is diminished. When, however, these symptoms come as a surprise, the depression that follows can be severe and prolonged. During the immediate postoperative period, the constant support of the family, especially of the husband, is essential.

Since your mother's symptoms have persisted for almost a year, a frank discussion between your father, your mother and her doctor is imperative. Should it be evident that the depressive symptoms are deeply ingrained, a very active approach to the problem must be taken.

There now are a number of excellent and quite remarkable drugs that are specifically aimed at alleviating this kind of depression. The results are often spectacular and when used under proper medical jurisdiction, they can liberate a woman from the depths of misery and help return her to the happiness she deserves.

Far too many people just "wait" for the symptoms of depression to disappear without the help of a psychiatrist or without drugs. The dangers implicit in this approach are great. The advantages of proper treatment are greater.

Dr. Coleman welcomes questions from readers. Please write to him in care of this newspaper.
© 1982 King Features Syndicate, Inc.

NOW A MILLIONAIRE
BRUSSELS, Belgium (AP) — Hungarian inventor Erno Rubic has earned more than \$1 million from his puzzle, "Rubic's Cube", a Belgian newspaper reports.

SNACK and SAVE 40¢

Save 40¢ when you clip all three coupons below. Get big savings on great-tasting Corn Diggers, crispy-light Buenos Tortilla Chips, tasty Cheese 'n' Crunch, or any delicious Nabisco bag snack. Plus get bonus savings on crunchy, delicious Mister Salty Pretzels. Look in the chip section for Nabisco snacks for your first picnic this Spring.

<p>SAVE 15¢ ON ANY NABISCO BAG SNACKS</p> <p>TO THE RETAILER: Coupon will be redeemed for 15¢ plus 7¢ for handling when you comply with offer terms. Any other application constitutes fraud. Invoices proving sufficient purchases of this product to cover coupons presented must be available on request. Consumer to pay applicable sales tax. Coupon may not be assigned or transferred by you. Coupon void when presented by outside agency or broker or where use is prohibited, restricted or taxed. Good only in U.S.A. Cash value 1/20¢. Mail to: NABISCO BRANDS, INC., P.O. Box 1754, Clinton, Iowa 52734. Only one coupon redeemed per purchase. COUPON EXPIRES APRIL 25, 1983.</p> <p>44000 107019</p>	<p>SAVE 10¢ ON MISTER SALTY PRETZELS</p> <p>TO THE RETAILER: Coupon will be redeemed for 10¢ plus 7¢ for handling when you comply with offer terms. Any other application constitutes fraud. Invoices proving sufficient purchases of this product to cover coupons presented must be available on request. Consumer to pay applicable sales tax. Coupon may not be assigned or transferred by you. Coupon void when presented by outside agency or broker or where use is prohibited, restricted or taxed. Good only in U.S.A. Cash value 1/20¢. Mail to: NABISCO BRANDS, INC., P.O. Box 1754, Clinton, Iowa 52734. Only one coupon redeemed per purchase. COUPON EXPIRES APRIL 25, 1983.</p> <p>44000 107035</p>	<p>SAVE 15¢ ON ANY NABISCO BAG SNACKS</p> <p>TO THE RETAILER: Coupon will be redeemed for 15¢ plus 7¢ for handling when you comply with offer terms. Any other application constitutes fraud. Invoices proving sufficient purchases of this product to cover coupons presented must be available on request. Consumer to pay applicable sales tax. Coupon may not be assigned or transferred by you. Coupon void when presented by outside agency or broker or where use is prohibited, restricted or taxed. Good only in U.S.A. Cash value 1/20¢. Mail to: NABISCO BRANDS, INC., P.O. Box 1754, Clinton, Iowa 52734. Only one coupon redeemed per purchase. COUPON EXPIRES APRIL 25, 1983.</p> <p>44000 107027</p>
--	---	--

Novel Helped By Critique

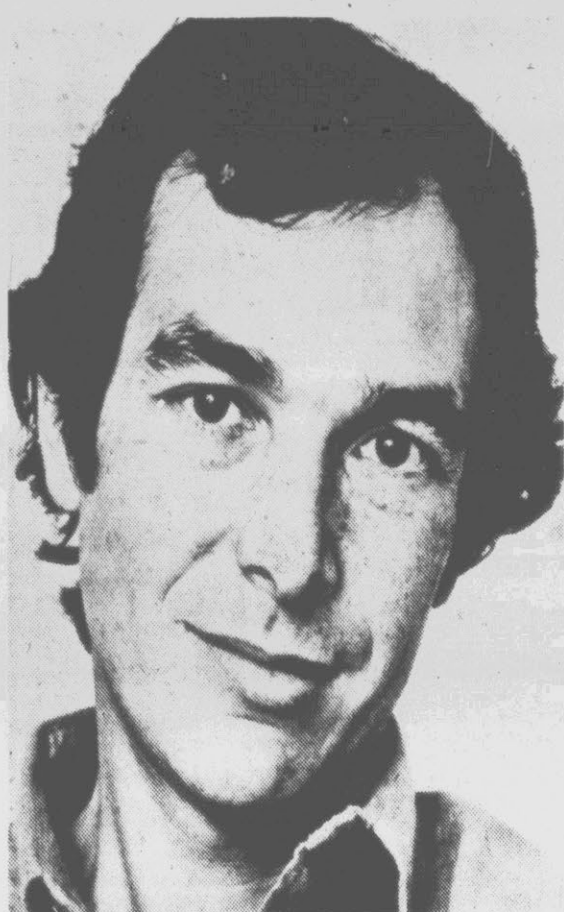

MARTIN CRUZ SMITH

By MARLENE AIG
Associated Press Writer
NEW YORK (AP) — When Martin Cruz Smith first learned that a Soviet critic had condemned his novel "Gorky Park" as "rubbish" and labeled him "scum," he says, "I became quite irritated. It was so low, so nasty. I was not amused."

Smith viewed the attack as "character assassination." His Soviet emigre friends, however, "were pleased. They told me I was being treated as the best Russian writers were treated."

And the 40-year-old author, whose tale of a Soviet detective investigating a bizarre series of murders has topped both hard- and soft-cover best-seller lists, now laughs. "It is a form of literary criticism new to me, but not to them."

The critique was written by Kirill Senin in the journal of the Soviet Union of Writers, Literaturnaya Gazeta. It begins as a parody of Smith's novel, switching the location from Moscow's Central Park to New York's Central Park and then launches the assault. The review calls the novel "anti-Soviet" and says Smith's portrayal of KGB as well as FBI-CIA corruption "discredits all supporters and friends of detente."

The book has not been translated into Russian, but the British edition seems to be fairly available, especially to students, according to Smith, "many of whom know a good deal of English."

The scathing attack "tells us that someplace books are still important, that Russia's respect for words is stronger than ours," Smith now says, having recovered from the shock of the critique.

"Gorky Park" is an atypical best seller, not just because it is set in the Soviet Union, but because it is not a quick and easy reading novel. The characters are painstakingly well-drawn, the mystery intricate and dependent on an understanding of two ways of life, the American and Soviet.

"Soviet life is more complicated than most people think," Smith says. "There's an enormous amount of corruption in the Soviet Union. If I'd written this about America, no one would have noticed. It's a Soviet fabrication that life is perfect."

And that, Smith maintains, is why the book has found such popularity in the Soviet Union. "It connects with reality and it's about ordinary Russian people. It's a shock of recognition."

All things considered, it's somewhat of a surprise that "Gorky Park" has managed to touch such a tender Soviet nerve.

Smith spent only two weeks in Russia, in 1973. He spoke no Russian and, as with all American tourists, his trip was carefully planned so that he wouldn't see the wrong things.

He did stroll through Gorky Park and managed to figure out the places he wanted in his book. But when he applied to return to Moscow, "telling them what I wanted to do," he was denied a visa. "I did try to give them a chance."

Through a reporter friend, Smith contacted Russian emigres who gave him the inside information he needed to write the book.

Finally, eight years later, the book was published and Smith, who wrote minor mysteries and minor novels to support himself while "trying to get recognized," now is.

Smith's early literary career was not brilliant. He graduated from the University of Pennsylvania, then had a few brief stints as a reporter and editor.

He wrote two novels featuring a gypsy hero, then did a series of books with the secret world of the Vatican as their locale.

While doing so, he was working on "Gorky Park," backed only by his wife and agent.

"I always assumed it would be a best seller," Smith now says, smiling. "It's too good a story."

The book is perfect for him, he says, because he sees himself as a "19th-century narrative writer." And the Russians, he says, "are a 19th-century narrative people. They live a narrative life and have a sense of the narrative of life and country. Our lives are broken into daily newscasts."

With "Gorky Park" optioned for the movies, Smith, his wife and children now live in California while he works on his new book, set in New Mexico. Part Indian himself, Smith admits there will be some Indians in the new book, but prefers not to talk about it, saying only it is "more ambitious and more controversial" than "Gorky Park."

Except, of course, it probably won't receive such attention and cause such furor in a place so far away as the Soviet Union. Which, Smith says, is okay by him.

Qualities Eyed In Management

BARTLESVILLE, Okla. (AP) — Interested in getting a job in management?

Here are what four Phillips Petroleum vice presidents believe to be important qualities in a good manager:

—Being what you are and not trying to appear what you are not.

—Communicating clearly and concisely.

—The ability to develop people to levels of self-confidence and performance beyond their own expectations.

—Well-defined goals, with the ability to accomplish them.

BACKING UP CLAIM

MANILA, Philippines (AP) — Prime Minister Cesar Virata has reasserted Philippine sovereignty over a disputed cluster of South China Sea islands claimed by three other countries, and said they were "bristling" with armament to back up the claim.



WE DON'T MAKE THE CLAIM OF "LOWEST FOOD PRICES" BUT WE BEAT THE ONES THAT DO!

Week After Week After Week, We Beat The Store That Claims To Be "LOWEST" In Head-To-Head Price Comparisons.

WINN-DIXIE STORES THE BEEF PEOPLE THANK YOU 04/14/82	
LIPTON TEA	1.79E
CHARMIN TISS	.79A
CG SALTINES	.59E
RICE KRISPIE	.59E
CHICKN DINNR	.00E
SLIC. BOLLGNA	.59E
5LB SUGAR	1.99E
WESSON OIL	1.50L
PRODUC	.26E
VC PORK BEAN	
164/1.00	.35E
POT PIE MORT	
103/.99	.59E
12OZ WD FRK	.79A
LUX LIQUID	.59E
PINEAPPLE JR	.59E
PRODUC	.00E
VA SAUSAGE	.09E
TM PINEAPPLE	.59E
PRODUC	.09E
ELECTRA PERK	1.09E
ARMOUR TREET	.59E
SALAD DRS	1.59L
CUT GRN BEAN	.59E
103/.89	.04L
T M CORN	
100/1.00	1.59E
HS SLI BACON	1.25E
16 OZ COKE	.00E
BT DEP	1.49L
16OZ PEPSI	.00E
BT DEP	1.49L
CHARCOAL	1.12H
TAX	
TOTAL	30.56

- 100-ct. Lipton Tea Bags
- 4-Roll Pak Charmin Bathroom Tissue
- 1-lb. Private Label Saltines
- 13-oz. Kellogg's Rice Krispies
- 11-oz. Morton Frozen Dinner
- 12-oz. Private Label Bologna
- 5-lb. Private Label Sugar
- 48-oz. Wesson Oil
- 10-lb. Idaho Potatoes
- 16-oz. Van Camp's Pork n' Beans
- 8-oz. Morton Pot Pie
- 12-oz. Private Label Franks
- 22-oz. Lux Dishwashing Liquid
- 46-oz. Private Label Pineapple Juice
- Celery
- 16-oz. Private Label Pork Sausage
- 20-oz. Private Label Crushed Pineapple
- Lettuce
- 13-oz. Maxwell House Master Blend Bag Coffee
- 12-oz. Tréet
- 32-oz. Miracle Whip
- 16-oz. Private Label Green Beans
- 17-oz. Private Label Sweet Corn
- 1-lb. Private Label Bacon
- 8-Pak 16-oz. Coca-Cola
- Btl. Deposit
- 8-Pak 16-oz. Pepsi-Cola
- Btl. Deposit
- 10-lb. Embers Charcoal

WINN-DIXIE
TOTAL
\$30.56

FOOD TOWN
TOTAL
\$36.80

FOOD TOWN LFP INC./SC/VA 04/14/82	
GROCERY	1.49 L
NON-FOOD	1.27 D
GROCERY	.49 L
GROCERY	1.22 L
PERISHBL	.79 L
MEAT	1.29 L
GROCERY	1.79 L
GROCERY	2.09 L
PRODUCE	2.79 L
GROCERY	.41 L
PERISHBL	.34 L
MEAT	1.09 L
NON-FOOD	.89 D
GROCERY	1.10 L
PRODUCE	.59 L
MEAT	1.29 L
GROCERY	.72 L
PRODUCE	1.09 L
GROCERY	1.49 L
GROCERY	1.14 L
GROCERY	1.61 L
GROCERY	.36 L
GROCERY	.39 L
MEAT	1.89 L
COKE PRODUCT	1.49 L
BTL DEP	.80 H
PEPSI PRODUCT	1.49 L
BTL DEP	.80 H
NON-FOOD	1.65 D
SUBTOTAL	35.45
4% TAX	1.35
TOTAL	36.80

Winn-Dixie's Combination Of EVERYDAY LOW PRICEBREAKERS, DEEP-CUT PRICE BREAKER SPECIALS And PRICE BREAKER COUPONS Offer You Unbeatable Savings.

Make your own comparison and you'll discover what hundreds of thousands of Winn-Dixie Shoppers already know.....

NOBODY SAVES YOU MORE THAN WINN-DIXIE!

*PRICE SURVEY DONE ON APRIL 14TH. SOME PRICES MAY HAVE CHANGED SINCE THAT TIME.

Author Says Followers Are Wrong

By DENISE MEYER
Associated Press Writer
PORTLAND, Ore. (AP) — Once a guru of the counterculture and leader of a madcap group of LSD adventurers, author Ken Kesey now farms, coaches wrestling, and considers himself a "solid citizen."

The 46-year-old author of "One Flew Over the Cuckoo's Nest" and "Sometimes A Great Notion" says he's been misunderstood by many of the people who thought they were his followers.

"A lot of the long-haired hippie people never understood," he said. "We're as solid citizens as can be. Family types — college educated. I met my wife at junior high."

Although "we still smoke a lot of dope...and wear crazy clothes," he said he feels like "I'm the John Wayne of dope smokers."

Kesey, who led a group of LSD-users on a 1964 trip across the country in a brightly painted school bus — a trip chronicled in Tom Wolfe's "The Electric Kool-Aid Acid Test" — now juggles writing with chores on his 70-acre farm near Springfield, Ore., where he raises cattle, sheep, fowl and trout.

Since his heyday in the 1960s, Kesey has published six issues of a literary magazine, "Spit in the Ocean." A final issue is planned.

But Kesey said it's been difficult to write while farming and raising his children.

"I felt like you can write forever, but you have such a short time to raise a family," he said. "And I think a family is a lot more important than writing."

"It's not that I haven't written. But I haven't gotten a single thread," he said.

"So much of your thoughts and energy needs to go into writing. Writing is like juggling a whole lot of balls — all those ideas, plots and subplots. You can't be distracted by a kid when he comes in and he's got a bloody nose — all the balls fall. And it takes a couple of days to get them all back."

Now that his three oldest children are in college and the youngest is in high school, he believes he can again work on his next novel, he said.

"I've been taking notes for a year. It will be in Alaska — something like 'Great Notion.' I want to do a fishing book and I don't know too much else about it than that."

The former high school and collegiate wrestler who won his class in the 42-50 age group in a recent state tournament coaches wrestling occasionally at Lane Community College. He accepts speaking engagements when he believes the cause warrants it, and he's lobbying for an Oregon law legalizing use of marijuana.

"A lot of the things I did were taken as sarcasm," he said. "But it really wasn't...I gave America my heart."

Kesey said he began using hallucinogens when he was a paid subject for government experiments on LSD, mescaline and other drugs at the Menlo Park, Calif., Veterans Administration hospital.

He organized a smattering of counterculture conferences during the 1970s in Oregon, but isn't anxious to renew his efforts.

"I'd like to see someone else do it," he said.

\$100 Bills Not So Rare Today

WASHINGTON (AP) — Big spenders are having a harder time impressing people with the flash of a \$100 bill.

The Treasury Department says that last year \$100 bills accounted for 41 percent of all the currency in circulation. In 1976 it was 31 percent, while in 1971 it was 25 percent of the value of all bills.

While many people like a thin wad of bills, there are still many who have never seen whose portrait adorns the \$100 bill. It's Benjamin Franklin's.

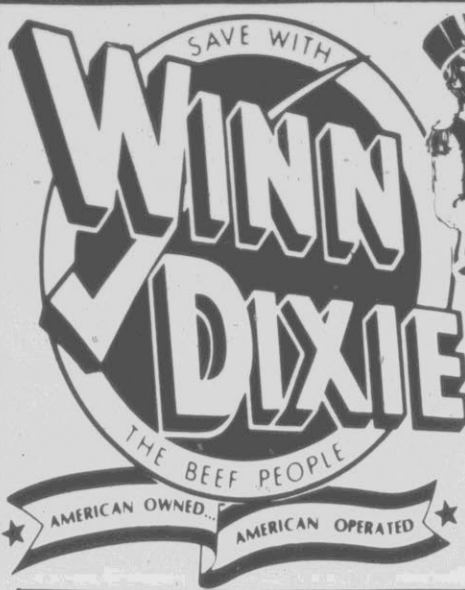

WINN DIXIE'S Anniversary Jubilee

SIDEWALK SALE

Featuring Our Super Savin'

With So Many Bargains They're Spilling Onto Our Sidewalks!

A SUPER BUY!
COMPARE PRICE & QUALITY
AND YOU'LL BUY SEVERAL!
52-IN. BLADE
CEILING FANS

2 FOR \$119.00

ROYAL OAK CHARCOAL

10-LB. BAG \$1.59

WITH \$7.50 OR MORE ORDER (LIMIT 1)

HI-DRI TOWELS

2 JUMBO ROLLS 89¢

16-OZ. BTLs. PEPSI-COLA

\$1.49

CTN. OF 8 PLUS DEPOSIT

WITH \$7.50 OR MORE ORDER (LIMIT 2)

5-SPEEDS...2 BEAUTIFUL STYLES! PLUS CHARCOAL GRILLS, LAWN FURNITURE, PLANTS, FERTILIZER, GARDEN NEEDS, ETC., ETC.!

30-OZ. SIZE POLY TUMBLERS .4 FOR \$1

OAK WHISKEY BARRELS ... WHOLE \$12.89

FLIP FLOP CHAIR BED ... EA. \$56.99

6-FT. REDWOOD STAINED PICNIC TABLES . EA. \$34.99 WITH BENCHES

PRICES GOOD THRU SAT. MAY 1ST • NONE TO DEALERS • WE RESERVE THE RIGHT TO LIMIT QUANTITIES • COPYRIGHT 1982, WINN-DIXIE STORES, INC.

PRICE BREAKER JACKPOT

IMPORTANT NOTICE!
Our "Price Breaker Jackpot" will end April 30th!
All remaining tickets will be distributed to our customers by closing time Wed., April 28th.
All Potential Winning Tickets must be turned in to your local store by closing time Fri., April 30th.
Winners will receive their checks on or about May 15th.
GOOD LUCK!

PRICE BREAKERS

Everyday Rock-Bottom Low Prices On Basic Items:

- 32-OZ. CAN REGULAR OR W/IRON SIMILAC \$1.39
- 23-OZ. BOX DUNCAN HINES BROWNIE MIX \$1.31
- 7-OZ. BOX CHERIOS 72c
- 10-OZ. BTL. A-1 STEAK SAUCE \$1.46
- 15-OZ. BOX THRIFTY MAID SEEDLESS RAISINS \$1.37
- 14-OZ. SIZE COMET CLEANSER 45c
- 12-OZ. CAN SPAM \$1.36
- 5-LB. BAG PURINA DOG CHOW \$1.89
- 26-OZ. SIZE MORTON SALT 32c
- BATH SIZE DIAL SOAP 2 FOR \$1
- 22-OZ. BTL. JOY LIQUID DETERGENT \$1.35
- 10 1/2-OZ. CANS CAMPBELL'S CHICKEN NOODLE SOUP ... 3 FOR 89c

DELI-BAKERY

LEAN & ROUND VIRGINIA STYLE BAKED HAM

\$2.98 SLICED TO ORDER!

- ROTISSERIE COOKED WHOLE BBQ CHICKEN EA. \$2.99
- 8-PC. SATCHEL SOUTHERN STYLE FRIED CHICKEN \$4.99
- FREE 1-LB. CUP POTATO SALAD - 1/2-DOZ. ROLLS FRESH HOMESTYLE POTATO SALAD LB. 79c
- RING ANGEL FOOD CAKE EA. \$1.49
- FRESH BAKED FRENCH BREAD ... LOAF 79c
- FRESH BAKED CHOCOLATE, LEMON OR COCONUT MERINGUE PIES \$1.99

AVAILABLE IN DELI-BAKERY STORES ONLY!

THRIFTY MAID SUGAR
5-LB. BAG
99¢
WITH \$7.50 OR MORE ORDER (LIMIT 1)

PILLSBURY FLOUR
PLAIN • SELF RISING
5-LB. BAG
59¢
WITH \$7.50 OR MORE ORDER (LIMIT 1)

MAXWELL HOUSE COFFEE
1-LB. BAG
\$1.99
WITH \$7.50 OR MORE ORDER (LIMIT 1)

THRIFTY MAID SUGAR
5-LB. BAG
99¢
WITH \$7.50 OR MORE ORDER (LIMIT 1)

PILLSBURY FLOUR
PLAIN • SELF RISING
5-LB. BAG
59¢
WITH \$7.50 OR MORE ORDER (LIMIT 1)

MAXWELL HOUSE COFFEE
1-LB. BAG
\$1.99
WITH \$7.50 OR MORE ORDER (LIMIT 1)

THRIFTY MAID SUGAR
5-LB. BAG
99¢
WITH \$7.50 OR MORE ORDER (LIMIT 1)

PILLSBURY FLOUR
PLAIN • SELF RISING
5-LB. BAG
59¢
WITH \$7.50 OR MORE ORDER (LIMIT 1)

MAXWELL HOUSE COFFEE
1-LB. BAG
\$1.99
WITH \$7.50 OR MORE ORDER (LIMIT 1)

THRIFTY MAID SUGAR
5-LB. BAG
99¢
WITH \$7.50 OR MORE ORDER (LIMIT 1)

PILLSBURY FLOUR
PLAIN • SELF RISING
5-LB. BAG
59¢
WITH \$7.50 OR MORE ORDER (LIMIT 1)

MAXWELL HOUSE COFFEE
1-LB. BAG
\$1.99
WITH \$7.50 OR MORE ORDER (LIMIT 1)

THRIFTY MAID SUGAR
5-LB. BAG
99¢
WITH \$7.50 OR MORE ORDER (LIMIT 1)

PILLSBURY FLOUR
PLAIN • SELF RISING
5-LB. BAG
59¢
WITH \$7.50 OR MORE ORDER (LIMIT 1)

MAXWELL HOUSE COFFEE
1-LB. BAG
\$1.99
WITH \$7.50 OR MORE ORDER (LIMIT 1)

GROCERY VALUES

- 48-OZ. BTL. SENECA APPLE JUICE 99c
- 26-OZ. BOX ASTOR SALT 2 FOR 45c
- 46-OZ. CAN THRIFTY MAID FLORIDA ORANGE JUICE 89c
- 28-OZ. BOX COMET LONG GRAIN RICE 76c
- 18-OZ. JAR DEEP SOUTH PEANUT BUTTER \$1.29
- 32-OZ. JAR TROPICAL GRAPE JELLY 99c
- 22-OZ. JAR ASTOR COFFEE CREAMER \$1.39
- 46-OZ. JAR DEEP SOUTH FRESH PACKED KOSHER DILLS \$1.19
- 32-OZ. JAR ASTOR ICE TEA MIX \$1.99
- 50-LB. BAG FIELD TRIAL RATION DOG FOOD \$7.99
- 16-OZ. BOX THRIFTY MAID ELBOW MACARONI 2 FOR \$1

CHEE-TOS CHEESE SNACKS
NACHO CHEESE FLAVOR
PUFFED CHEESE
CRUNCHY CHEESE
8-OZ. BAG
99¢

Casual Elegance

Imagine... A Complete 20-pc. set service for 4 with purchase of only 40 Lay-A-Way Certificates. WITH EACH \$3.00 PURCHASE

VALUABLE COUPON
On Sale During Dates Shown Below. No limit to number of pieces you may buy with each coupon.
Save \$1.00
Reg. \$6.99
Special \$5.99 with coupon
APRIL 29
MAY 1
2 Soup Bowls

W/D PRICE BREAKERS
CRACKIN' GOOD POTATO CHIPS
8-OZ. BAG 79¢

CRACKIN' GOOD SNACK PIES
2 9 1/2-OZ. BOXES \$1.09

CRACKIN' GOOD BIG SIXTY COOKIES
20-OZ. PKG. 99¢

CRACKIN' GOOD BIG SIXTY COOKIES
20-OZ. PKG. 99¢

Title To The Falklands Long-Talked

By DAVID MASON
Chief European Correspondent

LONDON (AP) — Britain has been trying to give the Falkland Islands to Argentina for years, but the pro-British islanders have always blocked the transfer.

Professor J.C.J. Metford of the University of Bristol, a Falklands expert, wrote before the current crisis reached a warlike state that Argentina's best ally "might well be, paradoxically, British officialdom."

"The Falklands were acquired (in 1833) at a time when a base near the Straits of Magellan was essential for naval control of the Pacific coast of South America and the South Atlantic...."

"Strategically, they are no longer important...To the realistic official mind, therefore, the islands are scarcely worth retaining, especially in view of the damaging effect of the dispute on Anglo-Argentine commercial relations."

London began discussing the Argentine claim in 1947 and has repeatedly entertained arguments from Buenos Aires at the negotiating table.

Just five weeks before Argentina invaded the islands April 2, British and Argentine diplomats met in New York on the islands' future.

In 1947 and 1955 Britain offered to hand the dispute over to the International Court of Justice in The Hague, but Argentina refused to go along. Ten years later the U.N. General Assembly passed a resolution urging the two nations to work for a peaceful solution of the dispute.

All efforts devised by the Foreign Office to alter the islands' status were opposed by the 1,800 Falklanders, who are mostly of British descent. In 1968 the Falklanders became so alarmed at rumours of a sell-out that their strong lobby in London addressed an open letter to Parliament declaring they "did not want to become Argentines."

The British Foreign Secretary at the time, Michael Stewart, retreated. "The wishes of the Falkland Islanders are more important than those of either the government of the United Kingdom or that of Argentina," he said.

Even so, sovereignty talks resumed and by 1971 efforts to link the islanders with Argentina had intensified. Air and sea communications with the mainland were established, and educational and medical facilities in Buenos Aires were provided for the Falklanders.

In 1974, Britain and Argentina signed two further agreements on trade, and the Argentine state oil company was allowed to supply the islands. The underlying British plan was to link the Falklands to Argentina so closely that the sovereignty issue would dissipate.

In 1976, a government-backed survey team headed by Lord Shackleton pointed to final transfer of sovereignty to Argentina. Suggestions of offshore oil and gas were tempered by the lack of enthusiasm to invest in the area while the sovereignty issue raged.

In 1980, Foreign Office Minister of State Nicholas Ridley was told to make another try for a settlement. He suggested a joint British-Argentine administration, with sovereignty transferred to Argentina but Britain leasing the islands for 20 to 25 years.

Even if the huge British task force succeeds in recapturing the Falklands from Argentine occupation forces, the ceding of sovereignty in some form will be necessary in any peace settlement.

A commentator in the Sunday Times wrote last weekend:

"The worst thing that could happen in the Falklands would be the sinking of the British fleet. But just about the next worst thing would be for Britain to get the islands back...This must be the first war in history for territory which one combatant wanted — and still wants — to donate to the other."



BUY ONE...GET ONE...FREE!

- 17-OZ. CAN **LE SUEUR PEAS** BUY ONE & GET ONE **FREE**
- CELESTE PIZZAS-FOR-ONE** SAUSAGE, PEPPERONI, & DELUXE BUY ONE & GET ONE **FREE**
- 1-LB. CUP **TASTY BIRD FRYER LIVERS** BUY ONE & GET ONE **FREE**
- OLD HICKORY PORK BAR-B-QUE** BUY 1-LB. CUP & GET 8-OZ. CUP **FREE**

FREE FREE FREE FREE

WITH \$7.50 OR MORE ORDER (LIMIT 1 FREE CAN)

- BUY 12-OZ. CUP JANET'S **POTATO SALAD** - GET 12-OZ. CUP **COLE SLAW** **FREE**
- 32-OZ. PKG. **QUAKER MAID STEAKS** BUY ONE - GET ONE **FREE**
- 1-LB. BAG **SUPER POP POPCORN** BUY ONE - GET ONE **FREE**
- JUMBO CORN DOGS** BUY ONE & GET ONE **FREE**
- 10-OZ. PKG. **DIXIANA FROZEN WAFFLES** BUY ONE - GET ONE **FREE**
- 12-OZ. BOWL **ALL VARIETIES WINKY CREAM DESSERT** BUY ONE - GET ONE **FREE**
- 12-OZ. PKG. **JENNIE O TURKEY FRANKS** BUY ONE - GET ONE **FREE**
- 8-OZ. PKG. **HIGH LINER FROZEN FISH STICKS** BUY ONE - GET ONE **FREE**
- 8-OZ. **TUMBLER SHEDD'S SPREAD** BUY ONE - GET ONE **FREE**
- 8-OZ. CUP **DEAN'S FRENCH ONION DIP** BUY ONE - GET ONE **FREE**

If You Buy One Of Each Of The Above Items You'll Receive **FREE Merchandise Worth \$18.84!**

*PRICES GOOD THRU SAT., MAY 1ST *NONE TO DEALERS *WE RESERVE THE RIGHT TO LIMIT QUANTITIES *COPYRIGHT 1982, WINN-DIXIE STORES, INC.

W-D BRAND U.S.D.A. INSPECTED 100% PURE GROUND BEEF
\$1.09 LB.
5 & 10-LB. HANDI-PAKS
LIMIT 10-LBS. PLEASE!

USDA U.S. CHOICE WHOLE BEEF RIB EYES
\$3.78 LB.
SLICED FREE!

HARVEST FRESH YELLOW CORN
10 \$1.00 EARS

PRODUCE PATCH

HARVEST FRESH WESTERN RED DELICIOUS APPLES
6 FOR 99¢

HARVEST FRESH **STRAWBERRIES**... 3 PINTS \$1.99
CALIFORNIA VALENCIA **ORANGES**... 6 FOR 99¢
HARVEST FRESH **CUCUMBERS** OR **BELL PEPPERS**... 4 FOR 99¢
HARVEST FRESH **PINK OR WHITE GRAPEFRUIT**... 3 FOR 99¢
1-LB. BAG **HARVEST FRESH CARROTS**... 3 FOR 99¢
10-INCH ASSORTED **HANGING BASKETS**... EA. \$6.99
1/2-GAL. JUG **SUPERBRAND APPLE JUICE**... 99¢

- ### FROM THE BEEF PEOPLE
- W-D BRAND U.S. CHOICE BEEF **CUBED STEAK**... LB. \$2.98
 - W-D BRAND U.S. CHOICE BEEF **STEW OR LEAN GROUND CHUCK**... LB. \$2.28
 - W-D BRAND U.S. CHOICE **BONELESS SHOULDER ROAST**... LB. \$2.58
 - W-D BRAND U.S. CHOICE **BONELESS SIRLOIN TIP ROAST**... LB. \$2.98
 - U.S. CHOICE **WHOLE BONELESS NEW YORK STRIP LOIN** SLICED FREE!... LB. \$3.78
 - U.S. CHOICE **VEAL CUTLETS, LOIN CHOPS OR RIB CHOPS**... LB. \$4.99
 - U.S. CHOICE **VEAL BONELESS CHUCK ROAST**... LB. \$2.49
 - 10-LB. BOX **PORK TENDERLOINS**... \$22.99
 - 1-LB. PKG. **HICKORY SWEET SLICED BACON**... \$1.59 2-LB. PKG. \$3.17
 - 1-LB. PKG. **JESSE JONES SMOKED SAUSAGE**... \$1.38
 - 12-OZ. PKG. **SUNNYLAND SLICED BOLOGNA**... \$1.09
 - 1-LB. PKG. **SMITHFIELD FRANKS**... \$1.39
 - 8-OZ. **RUDY FARM HAM & BISCUIT** OR **SAUSAGE & BISCUIT**... \$1.89
 - 1-LB. PKG. **GWALTNEY GREAT DOGS**... 99¢
 - FROZEN **FLOUNDER I.Q.F. FILLETS**... LB. 99¢
 - 12-OZ. PKG. **OSCAR MAYER VARIETY PAK**... \$1.99 BEEF \$2.09
 - 1-LB. PKG. **GUNNOE HOT OR MILD SAUSAGE**... \$1.79
 - CHEF PANTRY **BREADED FRIED CHICKEN PATTIES**... LB. \$1.28

PINKY PIG SLICED QUARTER PORK LOINS
\$1.48 LB.

SUPERBRAND ICE CREAM OR SHERBET
\$1.19 1/2-GAL. CTN.

OLDE VIRGINIE PORK SAUSAGE
98¢ 1-LB. PKG.

SUPERBRAND MARGARINE
399¢ 1-LB. PKG. IN QUARTERS

FROZEN FOODS

MORTON FAMILY MEALS (ALL VARIETIES EXCEPT SLICED BEEF, VEAL PARMAGIAN & BEEF STEW)
\$1.69 2-LB. SIZE

11-OZ. SIZE **JENO'S ALL VARIETIES PIZZA**... 99¢
16-OZ. CAN **MINUTE MAID ORANGE JUICE**... \$1.64
5-LB. BAG **COUNTRY COUSIN FRENCH FRIES**... \$1.49
8-OZ. CUP **SUPERBRAND WHIPPED TOPPING**... 59¢
14-OZ. SIZE **CHOCOLATE, LEMON OR COCONUT PET CREAM PIES**... 89¢

DAIRY DEPT.

SUPERBRAND COTTAGE CHEESE STA FIT OR REGULAR
79¢ 12-OZ. CUP

16-OZ. CUP **SUPERBRAND SOUR CREAM**... 99¢
12-OZ. PKG. **SUPERBRAND COUNTRY CHEESE SLICES**... 99¢
8-OZ. **SUPERBRAND SWISS STYLE OR ALL NATURAL YOGURT**... 2 FOR 89¢
GAL. JUG **SUPERBRAND LEMON, ORANGE OR FRT. PUNCH FRUIT DRINK**... 99¢

HEALTH & BEAUTY AIDS!

7-OZ. TUBE **COLGATE REGULAR OR GEL TOOTH PASTE**... \$1.39
24-OZ. BTL. **SCOPE MOUTHWASH**... \$2.19
25-CT. PKG. **ALKA SELTZER**... \$1.49
12-OZ. **MAALOX PLUS LIQUID**... \$2.39 REG. \$2.29

Featured this week... **Volume 3**

Disney's WONDERFUL WORLD OF KNOWLEDGE

Volumes 2-3 only \$2.99 each!
Volume 1 — always available at only 99¢!

COUNTRY PRIDE GRADE "A" FRYER BREASTS
\$1.08 LB.

W-D BRAND U.S. CHOICE ROUND BONE SHOULDER ROAST
\$1.99 LB.

LILAC LIQUID DETERGENT
59¢ 32-OZ. BTL.

LILAC DETERGENT
99¢ 42-OZ. BOX

W/D PRICE BREAKERS

12 INCH ARROW FOIL
2 25-Ft. ROLLS \$1.00

Moroccans Erect Cities In The Disputed Sahara

By MORT ROSENBLUM
AP Special Correspondent
EL AAIUN, Morocco (AP) — Safe behind a guerrilla-resistant great wall of Morocco, workmen hurry to build white-washed model

cities in the Sahara, bases for a diplomatic war the wall cannot keep out. "This whole place is a building site," said Mohammed Mounir, one of the legions of Moroccans sent

south to breathe fire into this once somnambulant Spanish colonial capital. El Aaiun is getting schools, hospitals, mosques, a stadium, government buildings and a zoo, along with thousands of little domed houses for slum dwellers. A railroad link to Casablanca is expected by 1984.

Smara, 120 miles west and just inside the new defense perimeter, has its first two-story building: a secondary school. The Beau Geste town of Dakhla, formerly Villa Cisneros, now bustles.

Morocco moved into the Spanish Sahara in 1976 after King Hassan II amassed 350,000 people on the border — the Green March — to press a claim. A second chunk was added in 1979, when Mauritania left.

Saharans who demand independence, the Polisario Front, waged war. With Algeria and Libya supplying Soviet weapons to the guerrillas, and rich phosphate deposits at stake, implications are major.

The 280-mile-long wall — the "berm" — was bulldozed in the rocky sand two years ago to stop hit-and-run Polisario raids. Bristling with dug-in artillery and protected by land mines, it describes a hemisphere around most populated centers in the 120,000-square-mile territory, the size of Colorado.

"If by war you mean control of the useful Western Sahara, Morocco has already won," said a Western military specialist who could not be named. "If you mean until

the last Polisario guy somewhere in Brazil gives up, it could go on forever."

But a subsequent arms race, and the cost of keeping nearly 100,000 men in the disputed territory, drains heavily on an economy already weakened by drought, foreign exchange problems and social unrest.

In six years, perhaps 10,000 men have been killed on both sides.

Last October, guerrillas overran Guelta Zemmur, forcing Moroccan troops to withdraw behind the wall. Five Moroccan aircraft were shot down. Western specialists say the Polisario used SA-6 heat-seeking missiles, among the Soviets' most sophisticated.

Morocco depends on well over a billion dollars a year in Saudi military subsidies. Closer ties with the United States mean moral support but only limited new hardware.

The wall is no final solution. Its fire bases, blends of miniature Crusader castles and Mexican bandit hideouts, have radar that can spot a fox at 20 miles. But the terrain can hide a tank column. In places, the final warning system is a rusty tin can full of pebbles which a forward sentry rattles by pulling a string.

Recently, Polisario leaders have focused on legitimizing their Saharan Arab Democratic Republic which claims the land on both sides of the wall.

"This Polisario business is artificial, concealing a subversive, destabilizing mov-

ement, led by African activists," Moroccan Foreign Minister Mohammed Boucetta charged in an AP interview.

But 26 African nations recognize the Polisario government, and, in January, Organization of African Unity officials accepted it as a member. Morocco and others object, paralyzing the OAU until a solution is found.

Last June, King Hassan offered a referendum, based on a 1974 Spanish census that named 74,500 urban dwellers and nomads in the disputed area.

Polisario leaders count 150,000 Saharans in refugee camps at Tindouf, in southern Algeria, and claim another 750,000 legitimate Saharans live elsewhere.

Morocco says the Polisario is blocking a referendum, in fear of losing. But neutral political analysts suggest Saharans might choose independence, if given a fair choice.

People here don't talk politics. Journalists are kept under a careful, if friendly, eye. But conversations out of official earshot reveal some discontent.

"Things are so-so," allowed a Saharan shopkeeper, speaking in Spanish. "Moroccans now run most stores. Local people have moved out or to the outskirts." He cast a glance around and added: "They've ruined it."

In Smara, a young man also speaking in Spanish, while cutting carrots at the back of a coffee shop: "Most young people have gone."

Asked if many joined the guerrillas, he replied: "Yes. Some."

Asked if he was Moroccan or Saharan — a distinction the government insists does not exist — he said with sudden force: "Saharan." Then, nervous, he went back to his carrots.

"These people just live their lives," explained one veteran observer, who asked anonymity. "They waved the flag for Spain and for Mauritania. They'll wave it for Morocco."

The government takes few chances. Long-distance direct dialing has been put off so operators can listen in, engineers say. Visitors, though told they are in a province like any other, are carefully scrutinized.

Most nomads have moved to towns, along with their goats, and they need military permits to move. The wall keeps out infiltrators but also cuts off traditional flows across the desert.

Morocco spends nearly a billion dollars a year on development and government programs in the Sahara. El Aaiun Gov. Salah Zemrag says there is no special priority.

"This is a simple willingness to do what has not been done before for these victims of colonialism," he told a visitor.

But an influential politician in Rabat put it differently, driving over an unrepaid highway: "These bumps, they're because of the Sahara. That's where our money goes. But it's worth it."



SNIFFER — Charity, a 5-year-old beagle, is escorted up the gangplank of the submarine tender USS Frank Cable by Boatswain's Mate Gary Stevens, the ship's drug enforcement officer. Specially trained to sniff out traces of marijuana and other drugs, the dog has been responsible for at least 55 "hits" involving civilians and sailors at Charleston Naval Base since last fall. (AP Laserphoto)

Years Haven't Changed Old Union Leader

By RICHARD M. HARNETT
SAN FRANCISCO (UPI) — If anyone thinks old Harry Bridges has mellowed, Harry is here to tell you "stuff it."

The craggy ex-waterfront union leader vows he is still a Marxist, insists capitalism can't work and urges the "working stiffs" of the world to unite.

He is planning a trip to Russia.

Approaching his 81st birthday, Bridges agreed to a rare interview at his modest home on the side of a hill overlooking San Francisco Bay.

Despite his dogmatic pronouncements on what is wrong with the world, and despite the fact his health is failing, Bridges said he is an optimist.

"Every day that goes by right now, this world is a better place. There is better education, better health, better housing every single day.

"And that doesn't mean we are living in a paradise. We've got plenty of problems. In Africa people are starving. Nevertheless, the world looks good to me."

When Bridges retired five years ago after 40 years as president of the International Longshoremen's and Warehousemen's Union, shipping executives and public officials celebrated him as a "labor statesman."

One lawyer who often sat opposite him at the bargaining table declared that Bridges was not a Marxist at all but "in reality an American capitalist" who merely enjoyed stirring up public controversy.

"I'm sorry. We are good friends. But he is just wrong," Bridges told UPI.

When he speaks intensely, still with a tinge of the accent of native Australia, the words do not come out fast enough. He skips some.

"I know, old age, retired, respectable. I understand. But the basic thing, what I'm telling you right now, is still there. My thinking, my philosophy is still Marxist philosophy. And, again, I can't see any future for the world, especially for world peace, without following that philosophy."

Asked about the present state of the labor movement in the United States, Bridges said:

"I know what you are saying. It looks like it's not doing its job. It's shot to hell and so forth. My answer to that is the labor movement, with all its weaknesses — and I have some severe disagreements with its leadership and its policies — nevertheless, there's no other way, there's no other group, as far as I am concerned, that could have my faith for the future, for the welfare, for the better future of the workers, plus all of the people of this country."

He said the problems of unemployment and inflation are "incurable under our system... They are the sort of things that go into our social,

economic and political system... They can't be cured under our system."

He said in the Soviet Union "unemployment doesn't exist" and people don't know what inflation means. "I had a helluva time explaining what inflation means. They couldn't grasp it."

But in collective bargaining Bridges never let Marxist ideology stand in the way of a practical settlement with capitalism.

"Certain things can be done," he said, "certain reforms."

Conditions are better, Bridges said, than when he came from Australia in 1920 and the ship he was working on was laid up in Boston.

"They were selling people on the Boston Common," he said. "It wasn't a publicity stunt. It was just before Christmas. The postwar depression was on. They were selling people for one year's room and board."

Already a radical organizer among seamen on his ship, Bridges learned that the industries around Boston, mainly shoe manufacturing, textiles and electric goods, were demanding that the unions grant concessions, or else the industries would move south for cheaper labor.

"That puzzled me. How in hell can you negotiate a wage cut? At that time you didn't have to worry about such things as pensions and welfare. It was strictly wages and hours."

He said the unions "conceded to all these things then. But, two years later the companies said, 'Sorry, we're closing up anyway.'"

The situation of American unions like the auto workers now may be more complex, he conceded.

"It's easy to say. I'm just wondering what I'd do if I were up against this, with hundreds and thousands of layoffs... I'm not going to be too critical because I'm not in there to make the decision."

One matter he is in no way in doubt about is the effort of some unions to seek a role in management. "It's a phony program. I've got no time for that. What is this? Trying to join the boss."

Once Paid For Escalator-Use

FARMINGTON, Conn. (AP) — Escalators might be considered a good travel bargain since they cost nothing to ride on, but Shanghai shoppers once actually paid to do so, according to researchers for a lift maker.

In the early 1900s, when Otis Elevator installed Shanghai's first escalator in the Sun department store, customers were so amazed by the "moving stairs," the police had difficulty in controlling the crowds who wanted to set foot on them.

Many shoppers readily paid 30 cents, redeemable in store merchandise, for a ride on the then-unique people mover.

Minor Burn Can Be Serious

WASHINGTON (AP) — What causes most burns?

The Red Cross says the most common causes of burns include carelessness with matches and lighted cigarettes, scalds from hot liquids, defective equipment, and the use of open fires.

The severity of a burn is determined by its depth and its extent. A minor burn covering a large part of the body can be more serious than a deep burn of only a small area.



WE STILL MAKE HOUSE CALLS

to bring you every edition of

The Daily Reflector

\$4.00

ONLY PER MONTH

FOR HOME DELIVERY

Here's just a few reasons why YOU need home delivery of 'The Daily Reflector':

1) home delivery of 'The Daily Reflector' is a sure bet for up-to-the minute coverage of local, state, national and international news and sports, advertising messages from local and national retailers, insightful commentaries and so much more.

2) home delivery eliminates the need to make a trip to 'The Daily Reflector' newspaper rack each evening, saving you gas, money and time. Buying the paper regularly from a rack costs you almost \$8 per month. For only \$4.00 a month you can have it delivered to your front door.

3) the Sunday morning edition of 'The Daily Reflector' features a weekly television guide with cable listings, color comics, 'Family Weekly' magazine and an expanded sports section. Not to mention a variety of interesting features about people and places both near and far.

4) a subscription to 'The Daily Reflector' can save you money on your ever increasing grocery bill. The weekly coupon savings can add up to dollars in your pocket, not someone else's. The cost of the subscription is more than offset by the savings you'll realize.

Don't Miss Out On A Single Issue!

Call 752-6166 to start using and enjoying 'The Daily Reflector' at once. Or use the handy coupon below. Just fill it out and mail to 'The Daily Reflector', Circulation Sales, P.O. Box 1967, Greenville, N.C. 27834.

YES, I would like to have THE DAILY REFLECTOR delivered to my home.

I understand that my route carrier will contact me and collect \$4.00 per month for home delivery of THE DAILY REFLECTOR.

Name

Address

City

Telephone

FOR OFFICE USE ONLY
Carrier Route Number

THE DAILY REFLECTOR

Since 1882, a mirror of the community

Millions Turn To Sunglasses

NEW YORK (AP) — Americans have seen the light when it comes to protecting their eyes from the sun's rays.

Some 86 million pairs of non-prescription sunglasses were purchased in the United States last year at a cost of \$870 million, says Becky Jones of the Corning Glass Works sunglass-products department.

Photochromic lenses, those that change from light to dark in sunlight, continued to shine in popularity, she says, with sales reaching the 15.4 million mark in 1981, nearly 13 times as great as a decade ago when they were introduced.

Collector Eyes Bricks As Rare Pieces Of History



ROCK OF AGES — Basil Saffer, curator of General Shale's Museum of Ancient Brick, holds a 400-year-old inscribed block from the Great Wall of China. (AP Laserphoto)

By TOM EBLEN
Associated Press Writer
JOHNSON CITY, Tenn. (AP) — Basil Saffer has spent 18 years collecting bricks, and although he admits others might see little glamor in the clay blocks, he is fascinated by the building material of Nero and Nebuchadnezzar.

"Every brick is a piece of history," said the 63-year-old soft-spoken Englishman.

Saffer is curator of General Shale Corp.'s Museum of Ancient Brick, a 200-piece collection housed a stone's throw away from the corporate offices of one of America's largest brick manufacturing companies.

Saffer said he has spent hundreds of thousands of dollars and logged 80,000 miles traveling around the world collecting samples that include two of the oldest bricks known to man — 10,000-year-old rounded blocks of sun-dried clay from Jericho.

"I guess brick really is a mundane thing. How often do you stop to think about a brick?" he said. "Really, it's a romantic subject once you get into it."

The collection, displayed like priceless gems, includes bricks from ancient Egyptian tombs and an unfinished palace of the Roman Emperor Nero; bricks made by Alexander the Great's soldiers and the subjects of Biblical kings Solomon, David and Nebuchadnezzar.

"We will not put anything on display that we cannot verify," Saffer said. "If we're doubtful about the date, I won't include it in the collection."

Last December, China gave the museum a rare,

inscribed block from the Great Wall — the first such brick the government had allowed out of that country since the communist revolution.

The inscription says the block was laid in 1584, during the 12th year of the reign of Ming Emperor Wan Li, Saffer said.

The collection also includes bricks from America's past: used as ballast on the Mayflower and later laid into a foundation at Plymouth Colony; bricks from George Washington's Virginia birthplace, the original White House and Jefferson Davis' Montgomery, Ala., home.

There's a brick from the Springfield, Ill., law office where Abraham Lincoln began his career, and one from the Virginia farmhouse where his fugitive assassin, John Wilkes Booth, died in an Army ambush.

The museum was the brainchild of George C. Sells, who decided in 1964 that someone should study and preserve his industry's history.

He gave the task to Saffer, a former British merchant sailor, world traveler and self-taught archaeologist who was then General Shale's marketing director.

"George told me, 'I don't care where you have to go or what you have to do, but I want that museum,'" Saffer said.

Traveling by boat, car, foot and camel to archaeological digs and ancient ruins, he has built the collection brick-by-brick.

Many countries are represented in the collection. Greece was the only country to refuse Saffer's requests.

"Greece I'm just ignoring," he said. "I want them to be conspicuous by their absence," he said.

With the help of some prominent archaeologists, Saffer said he has thoroughly studied each brick's history

and construction. "Apparently I'm the only brickologist in existence, so my archaeologist friends tell

me. Nobody else studies just brick," he said. General Shale has spent hundreds of thousands of

dollars on the collection, Saffer said, but it would be hard to estimate the value of the museum.

"If you tried to put it in dollars, I don't know," he said. "So many of them are irreplaceable."

OPEN SUNDAY 10 A.M. 'til 7 P.M.



Sirloin \$1.58
10-12 Lb. Avg. Wt. **Lb.**
USDA CHOICE
USDA Choice Beef Round Whole - Sliced Free

\$3.98 Lb.
USDA CHOICE
USDA Choice Beef Rib
Rib Eye Steaks

\$1.48 Lb.
Fresh Daily
Ground Chuck

99¢ Quart - Red Ripe
Strawberries

\$2.19
Package of 6 - 12 Oz. Cans
Miller Beer

\$1.99
750 ML - Bianco, Rosato, Lambrusco
Cella Wine

\$2.09
Package of 6 - 12 Oz. Cans
Schlitz Beer

\$1.05
2 Liter
Pepsi Cola

89¢
22 Ounce
Lux Liquid
Why Pay \$1.39

99¢
32 Ounce
Duke's Mayonnaise
Why Pay \$1.35

79¢
6.5 Oz. - Light Chunk In Oil
Star-Kist Tuna
Why Pay 99¢

99¢
12 Oz. - Large
Jeno's Pizza
Why Pay \$1.29

Synfuels Plant Will Get Funds

WASHINGTON (AP) — The government has decided not to pull the financial plug on a company building a multibillion-dollar synthetic fuels plant in Colorado.

But the federal Synthetic Fuels Corp. is requiring more guarantees from Tosco Corp. that taxpayer won't lose money in constructing a facility to produce synthetic crude oil.

The corporation had debated for the past month whether to cancel Tosco's \$1.1 billion federal loan guarantee, one of the largest ever issued by the government. By comparison, the loan guarantee for Chrysler Corp. was \$1.2 billion.

The corporation was concerned about projected sharp construction cost overruns. When Tosco was awarded the subsidy, it estimated the plant near Parachute, Colo., would cost \$3.2 billion. However, Exxon, Tosco's partner in the venture, now says the plant may cost up to \$5 billion.

Tosco has disputed Exxon's \$5 billion estimate, saying that was a preliminary planning figure and the plant

should cost less than \$4 billion.

The Synthetic Fuels Corp. board of directors held a closed two-hour meeting Monday by telephone conference call at which it hammered out an agreement continuing the loan guarantee.

The resolution says Tosco will be required to pay back any loan guarantee funds it withdraws between now and the end of the year if the corporation decides the loan guarantee should not have been made. So far, Tosco has drawn down about \$78 million of the \$1.1 billion guarantee.

To raise the money to pay back the government advances Tosco could be required to sell off part of its share to Exxon, which already owns 60 percent of the Colony oil shale project. Exxon is not asking for any government aid for its share of the plant.

Under the board resolution, both Tosco and Exxon must meet deadlines to submit better cost estimates to the government and Tosco must supply other guarantees to protect taxpayer money.

\$2.99
96 Oz. - 40¢ Off Downy
Fabric Softener

99¢
32 Ounce
Del Monte Catsup

\$2.99
84 Ounce
Fab Detergent

89¢
400 Sheets - 4 Roll Pack - Coronet
Toilet Tissue

\$1.29
12 Oz. - American Sliced Singles
Borden Cheese

5/\$1.00
6.5 Oz. - Liver & Beef Bits-O-Kidney Beef & Heart Simmered Supper Cat Food
Kal Kan

49¢
1 lb. - Margarine Quarters
Mrs. Filbert's

49¢
16 Ounce - Crackers
Sunshine

5/79¢
Ears - Sweet
Yellow Corn

\$2.99
Half Gallon
Detergent Wisk
Why Pay \$3.83

69¢
97 Sheet - Large Roll
Viva Towels
Why Pay \$1.03

Prices good at Greenville Food Town Store only



DOORBUSTER!
PURINA DOG CHOW
 30 LB. BONUS BAG
\$5.98



DOORBUSTER!
BOLD 3 DETERGENT
 1 GALLON 3-STEP ACTION
 1 CONTAINS 3-STEP ACTION
 1 CONTAINS 3-STEP ACTION
 GT. BOX **\$1.59**

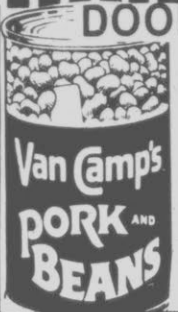

DOORBUSTER!
 VAN CAMP'S
PORK AND BEANS
 300 SIZE **3/\$1.00**



DOORBUSTER!
 DUNCAN HINES DOUBLE FUDGE
BROWNIE MIX
 23 OZ. BOX **98c**

OPEN
8 am-8 pm
 Monday through Friday
 Saturday 8 a.m.-7 p.m.
 Closed Sunday

HEAVY WESTERN
STEAKS

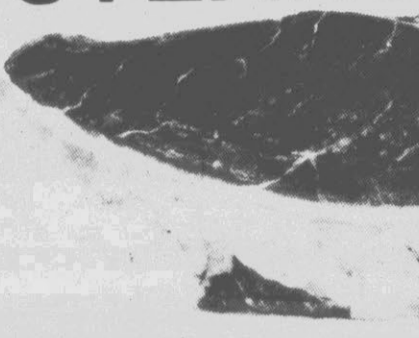

2.59
 LB.

Prices Effective Thurs.-Sat.
 April 29-May 1

FRESH FRYERS

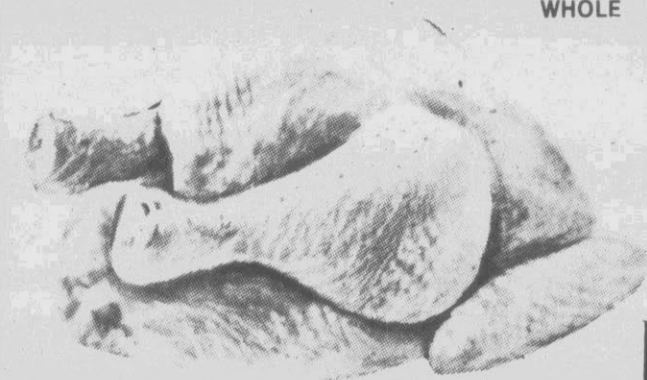

WHOLE
3.39
 LB.

HEAVY WESTERN
T-BONE STEAKS **\$2.69**
 LB.

CASE PRICE FRYERS **\$30.10**

LIMIT 4
 PER CUSTOMER.



GWALTNEY
FRANKS 12 OZ. PKG. **99c**
 COURTLAND PORK
SAUSAGE LB. ROLL **99c**

FRESH LEAN
GROUND BEEF PATTIES
\$1.69
 LB.

PORK SPARE RIBS
 (EXTRA LARGE)
99c
 LB.

HEAVY WESTERN FULL CUT
ROUND STEAK **\$1.89**
 LB.

Gwaltney Bacon 12 OZ. PKG.
 Gwaltney Bologna 12 OZ. PKG.
\$1.39



GRADE "A" FRESH
LARGE EGGS
78
 DOZEN

SLICED 7-8 CHOPS
1/4 PORK LOIN **\$1.49**
 LB.
 FAMILY PAK SPECIALS
 PORK CHITTERLINS 10 LB. PKG. **\$5.99**
 PORK NECK BONES 5-7 LB. AVG. - **LB. 29c**
 QUANTITY RIGHTS RESERVED.

FRYER PARTS
LEG QUARTERS
5.59
 LB.
BREAST QUARTERS
69c
 LB.

LIPTON FAMILY SIZE
TEA BAGS 24 CT. PKG. **98c**

COTTONELLE
98
 TOILET TISSUE
 4 ROLL PKG.
 Limit 2 With \$10.00 Food Order.



211 Jarvis Street
 2 Blocks from E.C.U.
 "Home of Greenville's Best Meats"

SEALTEST ALL FLAVORS
ICE CREAM
\$1.88
 1/2 GALLON CTN.

KITTY WHITE—WHY PAY MORE?
CAT LITTER 10 LB. BAG **68c**

BOUNTY PAPER TOWELS
68
 GT. ROLL
 Limit 2 with \$10.00 or more food order.

KRAFT
MUSTARD 25 OZ. JAR **58c**
 DUNCAN HINES YELLOW, LEMON, BUTTER GOLDEN, DEVIL'S FOOD

WHOLE HOMOGENIZED
MAOLA MILK 1/2 GALLON PAPER CARTON **98c**

OVEN GOLD FRESH
BREAD LONG (24 OZ.) LOAF **2/99c**

KRAFT HOT OR REGULAR
BARBECUE SAUCE 18 OZ. JAR **78c**

CAKE MIX 18 OZ. BOX **78**
 PILLSBURY PLUS YELLOW
CAKE MIX 18 OZ. BOX **59c**

TENDER
BROCCOLI PER BUNCH
78c
 YELLOW
ONIONS 3 LB. BAG **78c**

Coke, Pepsi, Sunkist
 2 Liter Bottle
 Limit 4 Total (Your Choice)
98

PURITAN
OIL 48 OZ. BOTTLE **\$1.88**

RUTABAGAS LB. **13c**

DOUBLE Q KETA
PACIFIC SALMON 15 1/2 OZ. CAN **\$1.38**

CLIP THIS COUPON
 DIXIE CRYSTAL OR HAPPY HOST
SUGAR 5 LB. BAG
 With this coupon and \$10.00 or more food order excluding advertised specials. Without coupon \$1.58. Limit one of your choice. Expires 5-1-82.
98

ONLY A DIME AND 3 PENNIES
 WHITE
POTATOES LB.
 GREEN
CABBAGE LB.
13

CLIP THIS COUPON
 COCA COLA 16 OZ. CARTON OF 8
 Plus deposit with this coupon and \$10.00 or more food order excluding advertised specials. Without coupon \$1.78 plus deposit. Limit one carton at sale price. Expires 5-1-82.
98

Belk Tyler

SUPPLEMENT TO: THE MOUNT OLIVE TRIBUNE, THE ENTERPRISE, TUESDAY, APRIL 27, 1982; THE NEWS HERALD, THE DAILY ADVANCE, THE GOLDSBORO NEWS ARGUS, THE DAILY REFLECTOR, THE KINSTON DAILY FREE PRESS, THE NORTHAMPTON NEWS, THE ROANOKE BEACON, THE EVENING TELEGRAM, THE TARBORO DAILY SOUTHERNER, THE WASHINGTON DAILY NEWS, THE WILSON DAILY TIMES, WEDNESDAY, APRIL 28, 1982 AND THE CHOWAN HERALD, THE FARMVILLE ENTERPRISE, THE BERTIE LEDGER, THURSDAY, APRIL 29, 1982.

WEDNESDAY, THURSDAY, FRIDAY AND SATURDAY

FOUNDER'S DAYS SALE

Up, Up and Away With Big Savings for Spring! Never Before Could You Buy So Much for Your Money In Carolina East Mall, Greenville!



Fantastic Savings Up to \$35 on Spring Sport Coats Made by Haggar®!

64.88

Reg. \$85 to \$100

21.88 If Perfect \$85 to \$100

Large selection of sport coats for men who care how they look! Dress to impress with Haggar! 'Ultra-suede look' 100% polyester coat with patch pockets and single-vent in light blue, beige, rust, camel and navy. Polyester blend coats in a variety of colors, patterns. Irregular Coats Not in Parkwood Wilson... Shop Downtown



HAGGAR

Haggar® Slacks at a Great Savings for You!

Regular \$28 to \$30 **19.88**

First Quality and Irregular \$24 to \$34 Values **14.88**

Regular \$25 to \$26 **17.88**

Large assortment of belted slacks made of polyester/cotton and 100% polyester. Your choice of navy, tan, green, light blue, heather, grey, khaki and red solids for spring. Some slacks available without belts. Also, a slightly irregular group of polyester/cotton golf pants in light blue, yellow, pink, beige, navy, red colors. Hurry in today for the best selections! Irregular Slacks Not in Parkwood Wilson... Shop Downtown

Great Buy on Cool Tops Made Just for Girls!

Regular 8.00 **6.88**

Knit tops with short sleeves in a variety of stripes and solids. Tops with contrast binding and tops with screen prints! Sizes 7 to 14. Buy today and save!

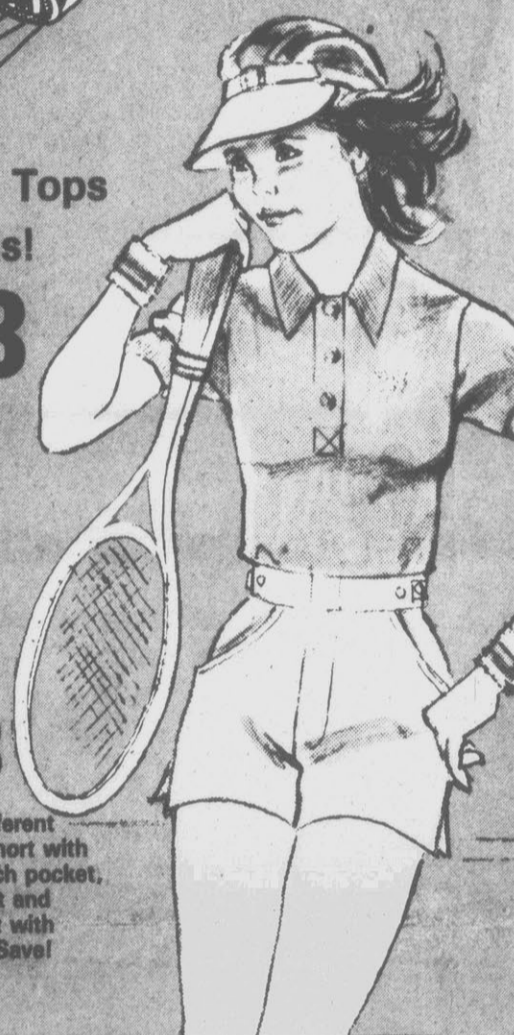

BugOff® Shorts at a Great Price

Regular 8.00 **6.88**

Large group of shorts in three different styles to choose from. Merona short with vented leg and rounded back patch pocket, polyester/cotton twill cuffed short and polyester/cotton twill tennis short with vented leg. Girls' sizes 7 to 14. Save!

Comfortable Knit Tops Now \$3 Off

8.88

Regular 12.00

Polyester and cotton blend shirts all with short sleeves. Your choice of white, navy, red, blue, pink, green, rose, khaki and yellow. Junior and misses' sizes. Great buy!

Ladies' Knit Tops for Spring

5.88 8.88

Misses' Half Sizes

Short sleeve polyester/cotton tops with contrast trim. Sizes S, M, L. (Not Shown)



22% Off Boys' Tennis Shorts

8.88

Regular 11.50

Polyester/cotton twill tennis shorts in white, navy and light blue for you. Sizes 8 to 20 reg., 8 to 16 slim. Stock up and save!

34% Off Men's Tennis Shorts

10.88

Regular 14.00

Polyester/cotton tennis shorts with a non-slip waistband, vented legs. Ten colors. In men's sizes 29 to 42. Hurry!

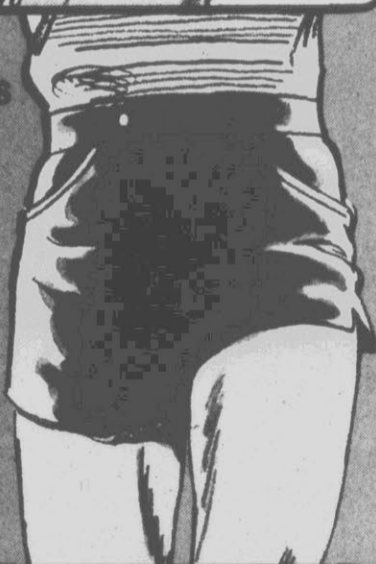
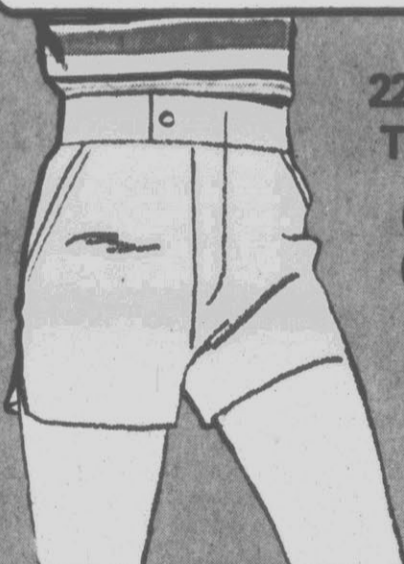

Lovely Serpentine Chains Sale Priced!

7" Chain Reg. 22.50 **15.75**
 16" Chain Reg. 40.00 **28.00**
 18" Chain Reg. 45.00 **31.50**
 20" Chain Reg. 47.50 **33.25**
 24" Chain Reg. 55.00 **38.50**
 30" Chain Reg. 67.50 **47.25**

Large assortment of beautiful chains to add that finishing touch to your spring wardrobe. Stock up today!



Save 30% on 14-Kt. Gold Chains Just for Her!

30% OFF

Regular 20.00 to 190.00

Serpentine, cobra and herringbone chains. Hurry!

Boys' Knit Shirts Reduced

Regular 4.50 **3.44**

Crew neck knit shirts with a heat transfer front. Polyester/cotton. Short sleeves. Assorted colors and transfers to choose from. Sizes S, M, L.

The Cube Puzzle

Special Purchase **1.99**

Cube puzzle for hours of fun. Give it a try today!

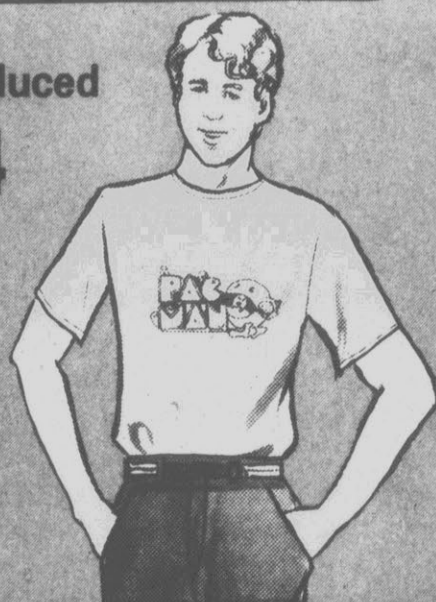

SHOP THROUGH SATURDAY, MAY 1st AT BELK TYLER IN ROCKY MOUNT • GOLDSBORO • WILSON • WILLIAMSTON • EDENTON • MOUNT OLIVE • FARMVILLE • MURFREESBORO • ELIZABETH CITY • GREENVILLE • KINSTON • TARBORO • WASHINGTON • AHOSKIE • PLYMOUTH

Belk Tyler

**It's Not What You Pay . . .
It's What You Get For What
You Pay . . . And You Get It
All At Belk Tyler! Remember
To Come Early For Best Buys!**

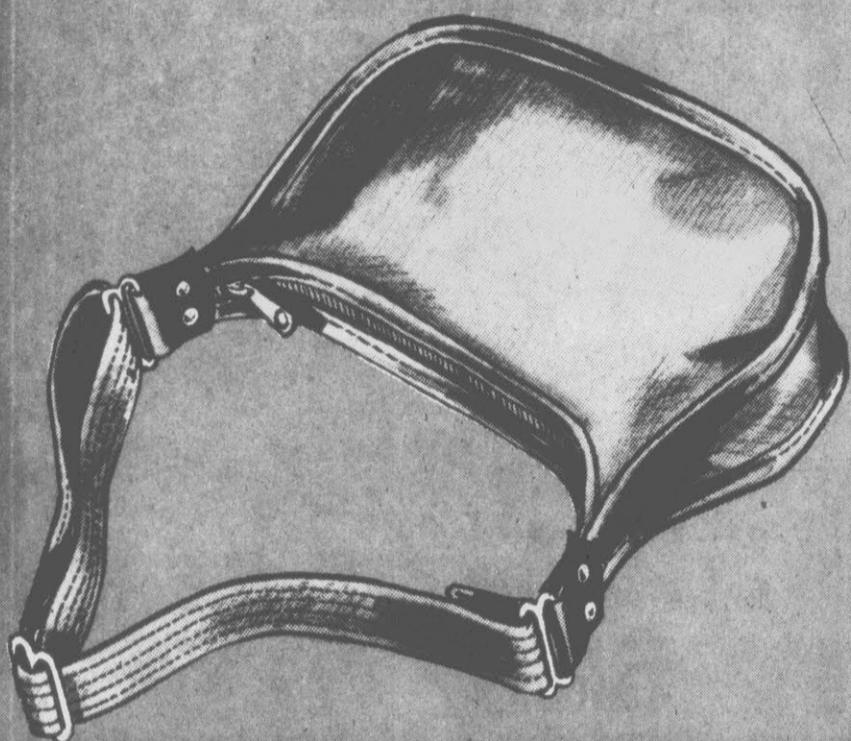

**Tremendous Savings Over 6.00
on Canvas Handbags for Ladies!**

14.88

Regular 21.00

Choose from five different styles of canvas casuals including duffel bag, top zip hobo, double handle bucket, double handle top zip, small double handle top zip. Kelly/navy, navy, tan, natural, red/navy colors to pick from. Complete your spring outfits with a new handbag! Get one today!

Playtex® Bras at a Great Price!

Regular 12.50 and 13.50 . . . **10.00 and 10.80**

Large selection of 18-Hour® bras complete with beautiful lace cups, stretch side and back panels and stretch straps. White color only. Your choice of A, B and C cups. Hurry in today. Style #20.

Heiress® Pantyhose Just for Her

Everyday Low Price . . . **1.60**

Large group of plain sheer pantyhose complete with sandalfoot. The exceptional quality of these pantyhose means greater value through longer wear. Junior petite through extra tall sizes.

Press-On L.C.D. Calendar Clock Sale

Special Value . . . **5.88**

Quartz accuracy that fits anywhere! Measures only 1 1/4" diameter. Displays hours and minutes, then month and date, adjusts for short months. Great for car, home or wherever. Several colors.

Time Pen With Digital Clock Sale!

Special Price . . . **9.88**

Time pen with digital calendar clock with a very clear digital display shows time then date and has seconds timer. Fits in a shirt pocket, handbag or attaché case. Uses Parker refills.



**Up to 26% Off on
Sunsuits and Shifts
for Little People**

**3.88
to 5.88**

Regular 5.25 to 8.00

Polyester/cotton sunsuits and shifts great for warmer days to come! Girls' cross-over lined back shift set. Boys' sunsuit with grippers. Boys' lined shortall. All with applique trim. Toddler and infant sizes.

**Tremendous 22% Savings
on 2-Pc. Short Sets
Just for Little Ones**

Regular 7.00 . . .

5.44

Large assortment of polyester/cotton short sets for boys and girls. Machine wash and dry. Available in four assorted styles for sizes 9 to 24 months and 2 to 4 toddler. Stock up while prices are right!

**Ladies' Fashion Belts
Reduced Up to 6.00!**

5.44

Reg. \$8 to \$12

Your choice of belts made of cotton web, woven straw, elastic hemp and stretch gabardine. Nautical and natural combinations. Stock up!

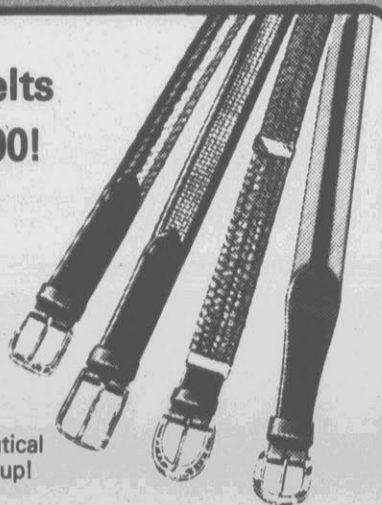

Ladies' Ultra-Suede® Belts at a Special Price

9.88

Regular 12.00 . . .

Large group of Ultra-suede belts in two styles. Single 45" belt which is 2 1/2" wide with double-stitching. Navy, red, off white. Ultra-suede sash with pearl stitches with tapered ends. 50" long. Buckles are available at an extra charge.

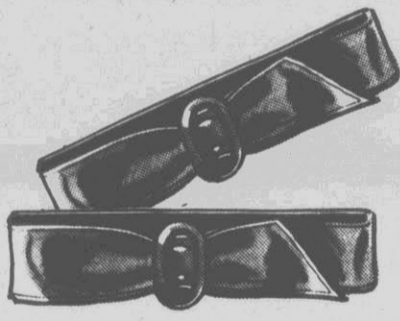

**Lovely Watches
at a Special
Price for Her**

19.88 8.88

Leather Strap Patent Strap

Patent leather strap in white, red, navy, yellow, black, brown. Leather strap in same colors. L.C.D. quartz accuracy with five functions. Fashion accessory, too!



**Save 40% on
Sunglasses
by Landmark®**

Regular \$10 . . . **5.88**

Large assortment of sunglasses with plastic and metal frames. Choose from styles for both men and ladies. Sunglasses should do more than just filter the sun! Wear them to look great too! Hurry while limited supplies last!



**Decorative Lucite Desk
Clock at a Savings!**

9.88

Special Purchase

Attractive digital clock set in crystal clear Lucite stand which tells hour and minute plus changes every two seconds to show month and date. Battery is included. Measures 3-3/4" high and 3" wide. Get one today!

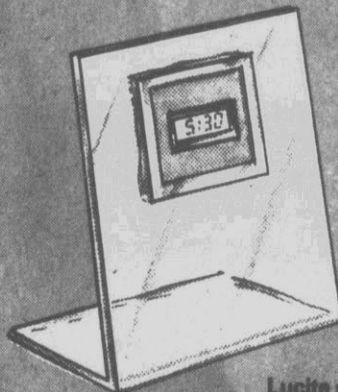

**Hanes® Underalls®
Pantyhose for
Ladies Worth
Noticing!**

2.00

Everyday Low Price

Panties and brief pantyhose all rolled into one. Sandalfoot with cotton crotch. No show pantie lines because panties are knit right in. Suntan, taupe colors. Great buy!

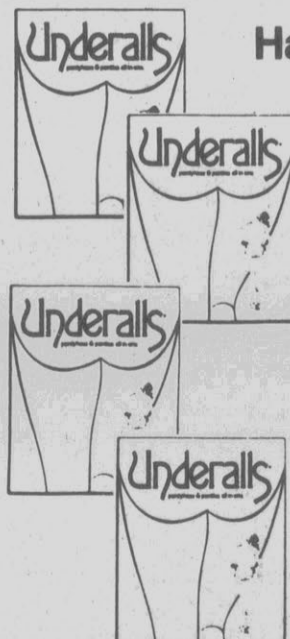

**Tremendous Sale of
New Spring Jewelry**

1/2 PRICE

Regular 4.00 to 25.00

Large assortment of earrings, chains, bracelets, necklaces and more all in gold, silver and white colors. Hundreds of styles included in this collection. Hurry while our limited supplies last! Great buy!



SENSATIONAL PRICES AND TERRIFIC VALUES DURING OUR FOUNDER'S DAY SALE!

Big Savings of Over 22% on Girls' Spring Tops!

Large assortment of BugOff!® tops. Some with screen prints, contrast binding. Sizes 4 to 6X. Reg. \$7 **5.44**

Girls' BugOff!® Anklets at a Fantastic Price!

Cotton/stretch nylon anklets with terry cuffs. White with assorted appliques. Reg. 2.00 **1.58**

Fantastic Savings on Cool Shorts for Girls

Merona short with vented leg, twill cuffed short with elastic back, twill tennis short. Sizes 4 to 6X. Reg. \$7 **5.88**

BugOff!® Twill Shorts Made for Active Girls

Polyester/cotton twill vented leg shorts with side stripes. Girls' sizes 4 to 6X. Reg. 4.00 **3.44**

Save 14% on One-Piece Swimwear for Girls

Your choice of one-piece swimwear with a flower applique and multi-color bandeau. Sizes 4 to 6X. Reg. \$8 **6.88**

Girls' Footies Drastically Reduced for You!

Orlon®/polyester/stretch nylon striped terry pom footie and some with contrast stitching. Reg. 1.15 **88¢**

SALE ENDS SATURDAY, MAY 1st!

FOUNDER'S DAYS SALE



SALE!

Fantastic Buy on BugOff!® Swimsuits Made Just for Girls!

7.88
Regular 9.00

Large assortment of lovely one-piece swimsuits that will make a splash this summer! Choose from floral applique one-piece suit in a variety of colors. Girls' sizes 7 to 14.

Super 20% Savings on Gilead® Sleepwear, Jumpsuits and More!

9.60 to 26.40
Regular \$12 to \$33

Lace trimmed shift gowns and button front coats made of nylon in solids. Cover-ups, rompers and jumpsuits made of cotton/polyester. Short wrap cover-up with lace trim. Terry romper with tie belt and lace trim. Jumpsuits with lace trim, tie belt and elastic leg cuffs. Ladies' sizes.



Super Savings of Over 7.00 on Lovely Printed Sundresses!

26.88

Regular 34.00

Lovely selection of bright, lightweight dresses perfect for all those warmer days to come. Your choice of printed dresses with black background, bright background or white background. Scoop neck and back with a built up shoulder. Polyester/cotton. Machine wash and dry. Misses' sizes 10 to 18. Save!

Great Fitting LEVI'S® Jeans Just for You!

Girls' Sizes 4 to 7 **11.88**
Toddler **9.88**

Blue denim jeans for toddlers and girls. Girls' with boot-cut styling and elastic back. Hurry while our limited supplies last! Stock up!

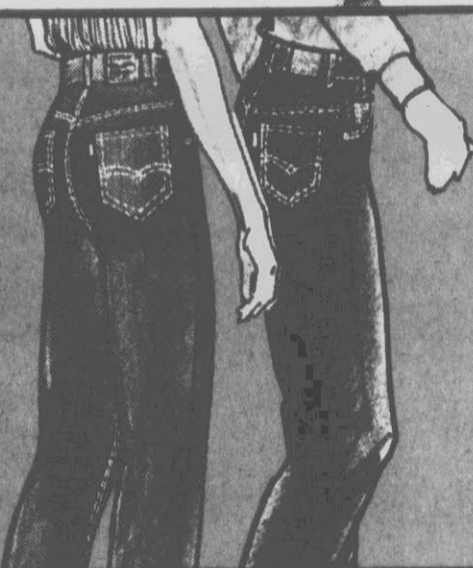

Special Buy on Girls' Denim Jeans by LEVI'S®!

14.88

Special Purchase

Large group of 64% cotton/36% polyester five pocket Western jeans with super straight legs. Navy denim color only. Girls' sizes 7 to 14.

Ladies' LEVI'S® Bend Overs® Pants! Save!

19.88

Everyday Low Price

Selected group of pants made of 100% polyester gabardine that stretch and move with you. One-button closing, fly front and beltless waistband in teal, green and mulberry colors to choose from. Sizes 6 to 20 average and petite. Hurry in today for best buys!



Great Fitting LEVI'S® Denim Jeans for Her

24.88

Everyday Low Price

Be prepared for all the action with blue denim jeans made by LEVI'S®. Straight leg styling and five pockets. Can you ever have enough jeans? Machine wash and dry. Stock up while prices are right! Junior sizes only.

Cheeno's® Work Pants Made for Junior Girls!

13.88

Everyday Low Price

Large group of polyester/cotton twill work pants in khaki and navy colors for spring. Complete with man tailored curtain waistband, 2 side pockets, belt loops and 2 back pockets. Sizes 24 to 31 waist. Stock up!



Save Over \$6 on Rainslickers!

Regular 22.00 **15.88**

Short length button front coat with patch pockets and drawstring hood. Rayon lining. Green/navy or blue/navy. Sizes S, M, L.

Sale! Girls' Rainslickers

Regular 9.50 **7.44**

Button front rainslicker with patch pockets, hood with drawstring. Available in green/yellow with strawberry design lining. Hurry!



CELEBRATE SPRING WITH SAVINGS FROM BELK TYLER FOR WOMEN AND GIRLS!

Belk Tyler

Ladies' Canvas Espadrilles Reduced Over 25%!
White, navy and green canvas espadrilles with a rope covered heel. Stock up today! Reg. \$16 **11.88**

Ladies' Two Eye Tie Canvas Shoes Over \$3 Off!
Your choice of green, white and navy canvas shoes great for casual wear. Ladies' sizes. Reg. \$12 **8.88**

Mexican Multi-Color Sandals Perfect for Spring
Lovely 'Rose' urethane sandals with suede padded sock and 7/8" unit sole. Great buy! Reg. \$14 **10.88**

Ladies' Action/80 Canvas Tennis Shoes Reduced
Be prepared for all the action! White canvas tennis shoes with thick non-skid rubber sole. Reg. \$17 **13.88**



Big Savings on Attractive Leather Sandals for Spring!

Ladies' Regular 14.00 **10.88** Child's Regular 12.00 **9.88**

Large assortment of 'Nu-Perch' and 'Perch' sandals available in cinnamon color only. Wearing these comfortable slip-on sandals is the next best thing to being barefoot! 'Perch' sandal with 7/8" unit bottom, a suede padded sock and carefully made of leather to last! Shop today and save!



Fantastic Savings Over 22% on Ladies' 'Dixie' Sandals!

Regular 14.00 **10.88**

Selected group of chestnut color leather sandals with adjustable toe and leg straps. Complete with 7/8" unit bottom, suede padded sock. Hurry!



SALE!

Action/80[®] Canvas Deck Huggers for Everyone!

Men's Regular 18.00 **14.88**

Ladies' Regular 17.00 **13.88**

Child's Size 3 1/2 to 6 Regular 17.00 **13.88**

Child's Size 12 1/2 to 3 Regular 16.00 **12.88**

Child's Size 8 1/2 to 12 Regular 13.00 **9.88**

Large assortment of natural color canvas Deck Hugger[®] shoes with white boating sole. Be ready for all the action this spring and summer! Ladies' shoes also available in navy canvas. Stock up!

Men's 'Moby' Casual Shoes of Leather

Large group of casual leather tie oxfords complete with wedge crepe bottom in tan color only. Moccasin construction. Hurry while our supplies last! Men's sizes in D and EE widths. **38.88** Everyday Low Price

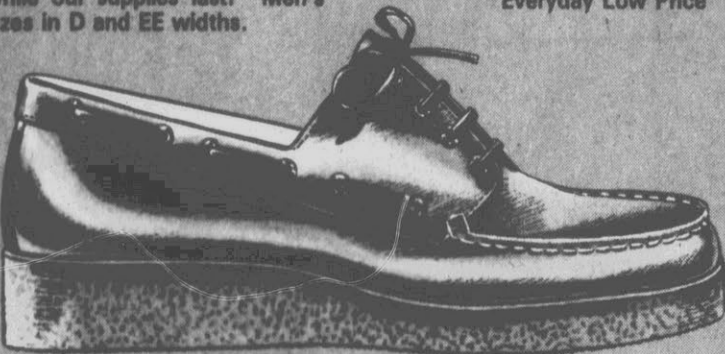

Men's Action/80[®] Jogging Shoes \$4 Off!
Lightweight performance shoe made of nylon/suede. Navy/white. Great buy! Reg. \$17 **12.88**

Boys' Action/80[®] Jogging Shoes \$4 Off!
Nylon/suede performance shoes just like dad's. Navy/white. Hurry! Reg. \$16 **11.88**

Men's Action/80[®] Shoes Low Priced!
White canvas low cut basketball shoes with a cushioned insole. Everyday Low Price **13.88**

Action/80[®] Canvas 'Court' Shoes for Boys
Large group of canvas court shoes in boys' sizes 2 1/2 to 6. Get yours now! Reg. \$16 **12.88**

White Canvas Action/80[®] Children's Shoes
White canvas low cut athletic shoes in sizes 8 1/2 to 12. Firm arch support. Reg. \$14 **11.88**

White Canvas Action/80[®] Low Cut Shoe Sale!
White canvas low cut basketball shoes in sizes 12 1/2 to 2. Hurry in today! Reg. \$15 **12.98**

Super Value! Ladies' Terry Bedroom Scuffs
White, pink, blue, yellow scuffs in sizes S, M, L, XL. Machine wash. Reg. \$5 **2.88**

Ladies' Casual Canvas Shoes Over \$3 Off!
Canvas tie shoes with wedge heel and rope covered heel in four colors. Reg. \$20 **16.88**

Ladies' 'Salato' Urethane Shoes \$5 Off!
Black shiny urethane shoes with self-covered heel and padded sock. Available in white also. Reg. \$19 **13.88**

Ladies' 'Nice' Shoes Reduced Over 5.00!
Urethane shoes complete with a self covered wedge heel. Bone and multi. Reg. \$19 **13.88**

Children's 'Sandy' Sandal Sale!

Reg. \$12 **8.88**

Group of tan, white and wine color leather sandals with adjustable toe and leg straps. Sizes 4 to 12.

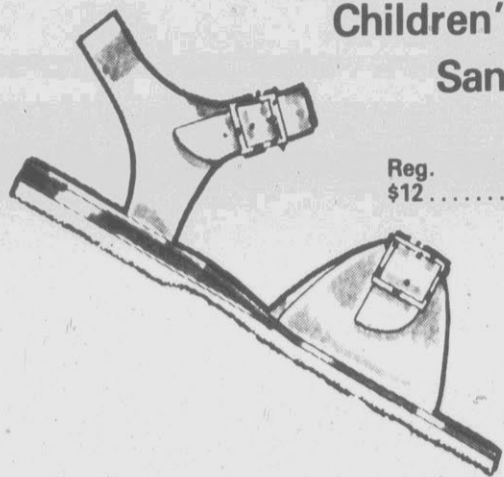

Children's Espadrilles Reduced Over 20%!

Reg. 15.00 **11.88**

Assortment of sailcloth espadrilles with rope wrapped wedge heel. Chino, navy colors. Stock up!

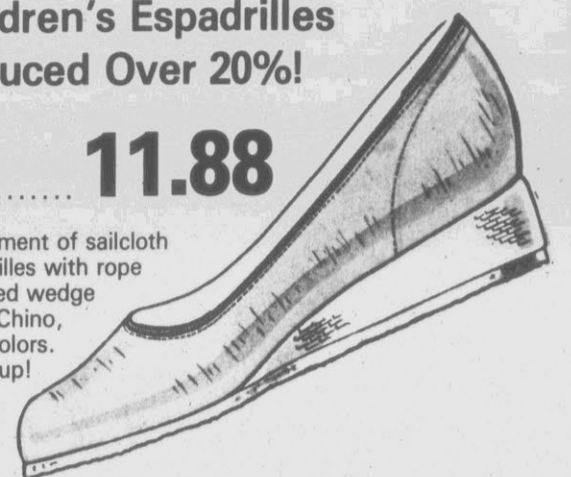

Save Over 6.00 on Espadrilles Made Just for Ladies!

Regular 20.00 **13.88**

Sailcloth 'Newport' espadrille shoes complete with 14/8" rope wrapped heel. Navy, sand and green colors to pick from. Comfort and style all in one!

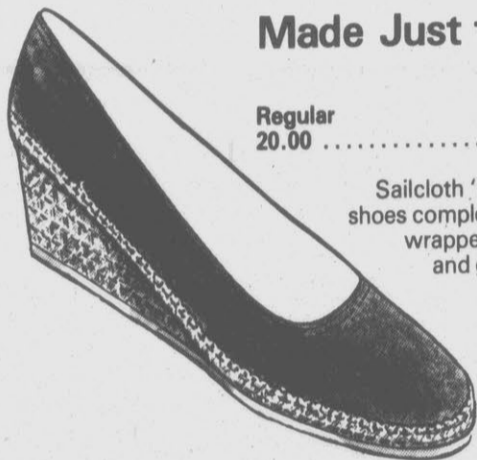

Ladies' Shoes for Dress and Casual Wear at \$4 Off!

Regular 17.00 **12.88**

Open toe sling back wedge of urethane and ballerina canvas pump with a drawstring for you. Stock up!

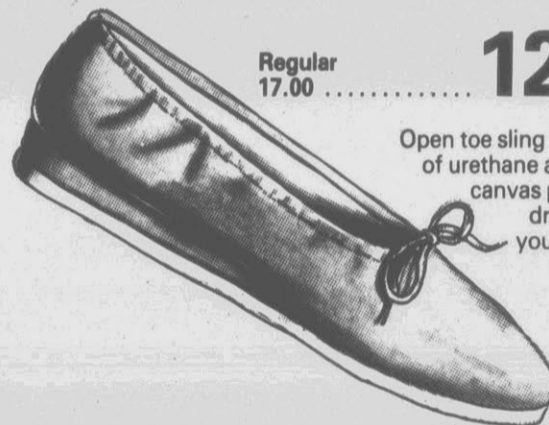

Children's 'Nu-Shelly' Two Buckle Sandal Sale!

Reg. 12.00 **10.88**

Group of 2 buckle sandals made of cordo leather by BugOff![®] It's almost like being barefoot!

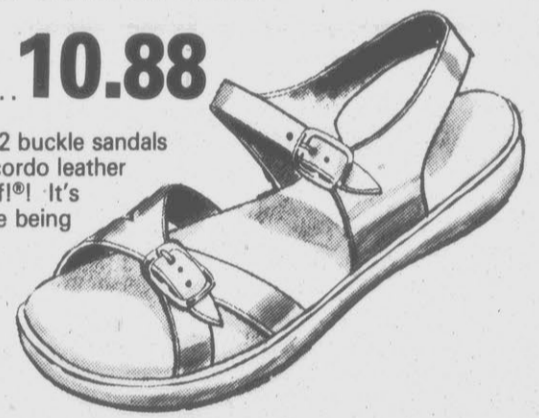

Great Price on Women's Canvas Athletic Shoes!

Everyday Low Price **8.88**

Light blue or navy oxfords with thick, ground hugging sole. Lined and trimmed with terry.

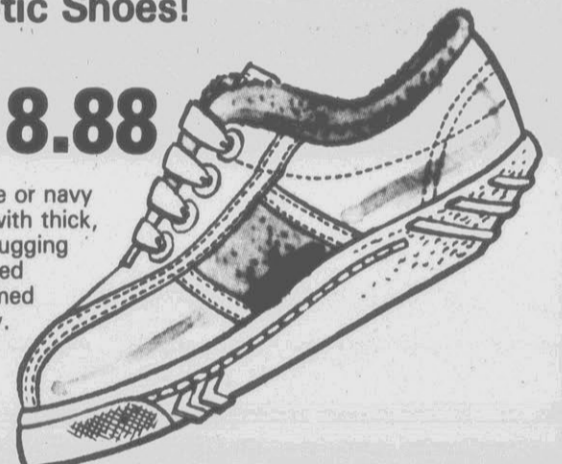

Leather 'Camp Moc' Shoe Values!

24.88 21.88 19.88

Men's Reg. 32.00

Ladies' Reg. 27.00

Child's Everyday Low Price

Four eye tie leather shoe with brown unit wedge bottom, tru-moc construction. Hurry in today!



'Penny' Loafers for Men and Ladies

Men's Everyday Low Price **32.88** Ladies' Everyday Low Price **21.88**

Large group of mecca brown 'Penny' loafers made of leather to last and last. Complete with tru-moc construction and a handsewn leather upper. Shop and save!



Deck Shoe Sale for Everyone!

24.88 22.88 19.88

Men's Reg. 32.00

Ladies' Reg. 28.00

Child's Reg. \$25 to \$27

Do more than just cover your family's socks with brown leather deck shoes complete with a non-skid white boat sole. Tru-moc construction, 2-eye tie, leather lacing around sides and arch support. You'll be prepared for all the action with these casual shoes.



Nike[®] Athletic Shoes for You

Men's and Ladies' Regular 24.00 **18.88**

Child's Regular 19.00 **15.88**

Large assortment of 'All Court', 'Lady All Court' and 'Curt' athletic shoes for everyone in the family. All are white canvas with a blue swoosh. Hurry while supplies last. Save!

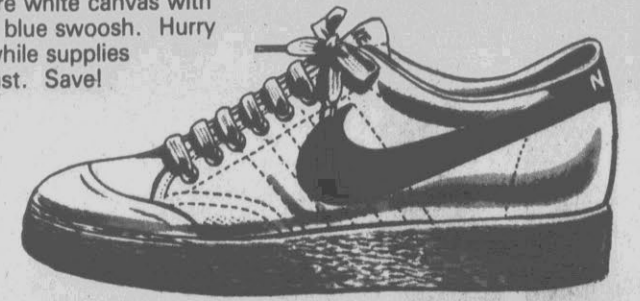

DON'T YOUR FEET DESERVE THE BEST? CHECK OUT OUR SHOES AT BIG SAVINGS!

★ budget store ★

Belk Tyler

THURSDAY, FRIDAY AND SATURDAY ONLY!

FOUNDER'S DAYS SALE

Ladies' Reigning Beauty® Panties at a Low Price!

Your choice of white, blue, pink and maize briefs of rayon acetate tricot. Everyday Low Price **3 Pair for 2.66**

Excellent Value! Ladies' Reigning Beauty pantyhose

Dura sheer mesh pantyhose with reinforced toe and nude heel. Available in five colors. Everyday Low Price **77¢**

Soft, Comfortable Ladies' Bedroom Shoes at 7.00 Off

Corduroy slippers in red or black and scuff style also in two colors. Let your feet relax too! Reg. 10.00 **2.88**

Ladies' Adjustable Chain Necklace Low Priced!

Chain adjusts from 15 to 30". Gold tone in either cobra or serpentine chain styles. Great gift idea! Special **2.88**



Great Buy on Knit
Tops for Ladies!

3.88

Regular 6.97

Large selection of polyester/cotton knit tops in navy, red, white, yellow, kelly and pink colors to choose from. Scoop neck, V-neck and double V-neck styles. Sizes S, M, L.

Comfortable Knit
Tops at a Low
Price for You!

8.88

Everyday Low Price

Your choice of knit tops in three different styles. Short sleeve with contrast trim. Kelly, white, red, navy, rose and yellow in sizes S, M, L. Great buy!

Save \$3 on
Print Skirts

12.88

Reg. 15.97

Polyester/cotton skirts in wrap, dirndl with belt and button front styles. Pick from bright prints in sizes 8 to 16. Hurry!

Tennis Shorts
at Over \$2 Off!

8.88

Regular 10.97

Select group of polyester/cotton tennis shorts with an extended waistband in navy, white, blue, kelly and khaki colors. Sizes 8 to 18. Stock up today!

Save Over \$14
on Ladies'
Denim Jeans

10.88

Regular 13.88 to 14.97

Large group of ladies' denim jeans in a variety of styles. Machine wash and dry. Jeans that look as great as they fit! Sizes 8 to 18. Hurry while limited supplies last!

Save 21%
on Junior
Work Pants

10.88

Reg. 13.88

Polyester/cotton work pants in kelly, navy, khaki and white colors. Straight leg styling. Sizes 3 to 13. Shop and save!

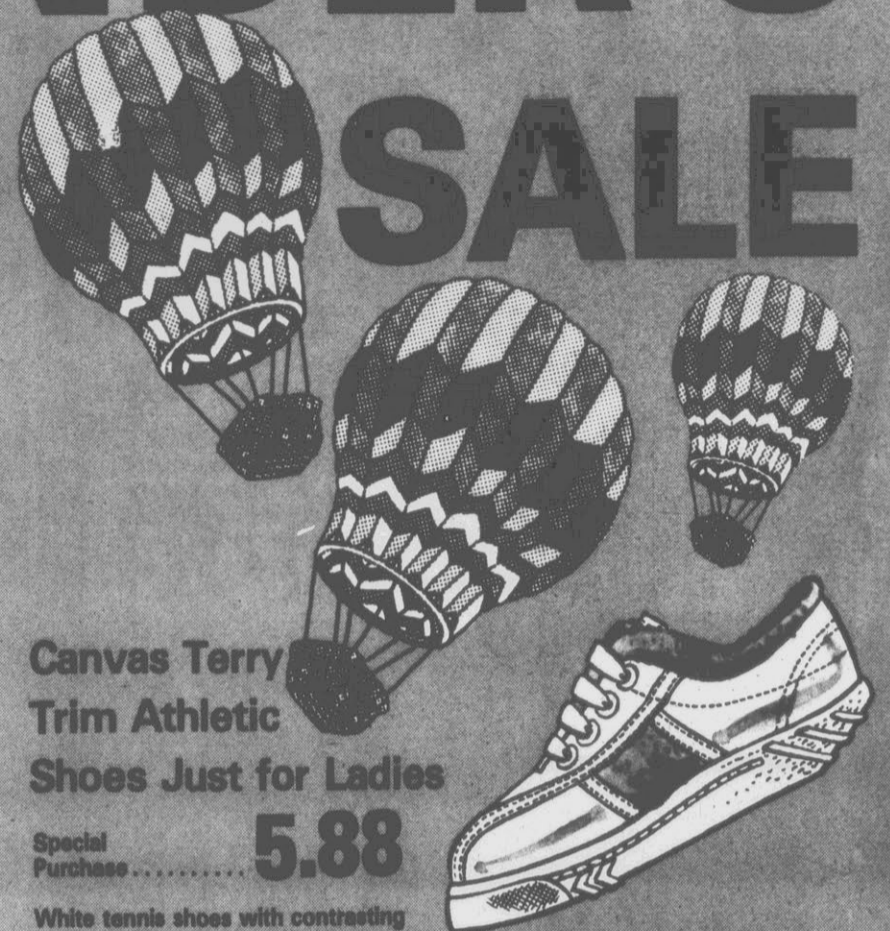

Canvas Terry
Trim Athletic
Shoes Just for Ladies

Special
Purchase **5.88**

White tennis shoes with contrasting terry trim for comfort. Non-skid rubber sole. Sizes 5 to 10. Save!

Fantastic Buy on Ladies'
Colorful Panties for You!



Special
Purchase

77¢

Slightly irregular group of panties in white and pastel colors. Choose from a variety of styles. Elastic waistband and legs. Hurry!

Reversible
Rainslickers
for Ladies at a
Great Low
Price!

5.88

Special Purchase

Large assortment of ladies' reversible rainslickers in navy, red, kelly green, tan and brown colors. Comfort and style all in one. Sizes S, M, L. Get yours today!



Valerie® Jean Skirts
at a Savings of Over 22%!

10.88

Regular 13.97

Five pocket denim jean skirts complete with side pockets and belt loops. You will feel and look great! Be prepared for the warm days to come. Sizes 8 to 18. Hurry while limited supplies last!



Tremendous Savings
Over 16% on Oxford
Cloth Shirts Now!

9.88

Regular 11.88

Selected group of polyester/cotton short sleeve shirts complete with a button-down collar. Choose from white, blue, pink, yellow and lavender colors. Sizes 8 to 18. Stock up now!

Up to \$4 Savings
on Short Sleeve
Plaid Shirts!

7.88

Reg. 9.97 and 11.88

Your choice of polyester/cotton shirts in several styles. Short sleeves. Assorted plaids. Sizes 8 to 18. Stock up now!



ITEMS ON THIS PAGE AVAILABLE ONLY IN OUR BUDGET STORES • AHOSKIE • GOLDSBORO • GREENVILLE • KINSTON • MOUNT OLIVE • TARBORO • WASHINGTON • DOWNTOWN WILSON • ELIZABETH CITY

★ budget store ★

Belk Tyler

Ladies' Popsicle Slide for You!

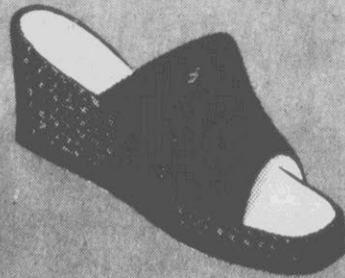

Special Purchase ... **3.88**

Vinyl casual shoes with an attractive rope wedge sole. Comfort and style.

Heavy Duty Work Shoes Now at a Great Price!

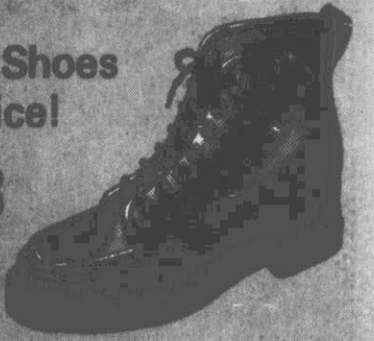

Everyday Low Price **24.88**

Large group of welt construction shoes with soft cushion insoles. Do more than cover your socks!



Men's Short Sleeve Knit Shirts Just in Time for Warm Days Ahead

9.88

If Perf. \$16 to \$18

Fine assortment of short sleeve knit shirts made of polyester and cotton. Some with emblem on chest. Slightly irregular but wear not affected. Sizes S, M, L, XL.

Terrific Buy on Men's Casual Golf Slacks Just for You

14.88

If Perfect 36.00

Slightly irregular group of beltless golf slacks in a variety of fashion colors including khaki, yellow, red, navy, light blue and pink. In men's sizes 28 to 42. Shop and save today!

Fantastic 20.00 Savings on 2-Pc. Archdale® Suits

49.88

Regular 69.97

Large assortment of men's 2-pc. suits made of 100% woven texturized polyester. Your choice of heather stripes, solids, stripes, plaids and tic weaves in a variety of spring colors. Two-button coat and a belt loop pant. Sizes 36 to 48. Not in Mount Olive



Great Buy on Sport Coats!

Special Purchase **21.88**

Slightly irregular group of polyester and polyester/cotton coats. Solids and plaids.

Men's Dress Shirt Sale

Regular 8.97 **7.88**

Polyester/cotton short sleeve shirts in 4 colors. Sizes 14 1/2 to 17. Shop and save!



Wrangler® Shirts Reduced Over 5.00

9.88

Regular 14.97

Polyester/cotton shirts with short sleeves and button-down collar in solids and plaids. Sizes S, M, L, XL.

Men's Poplin Slacks at a 14% Savings!

11.88

Regular 13.97

Polyester/cotton slacks in light blue, navy, tan, red and green colors. Matching belt. Machine wash and dry. Men's sizes 30 to 42. Save!

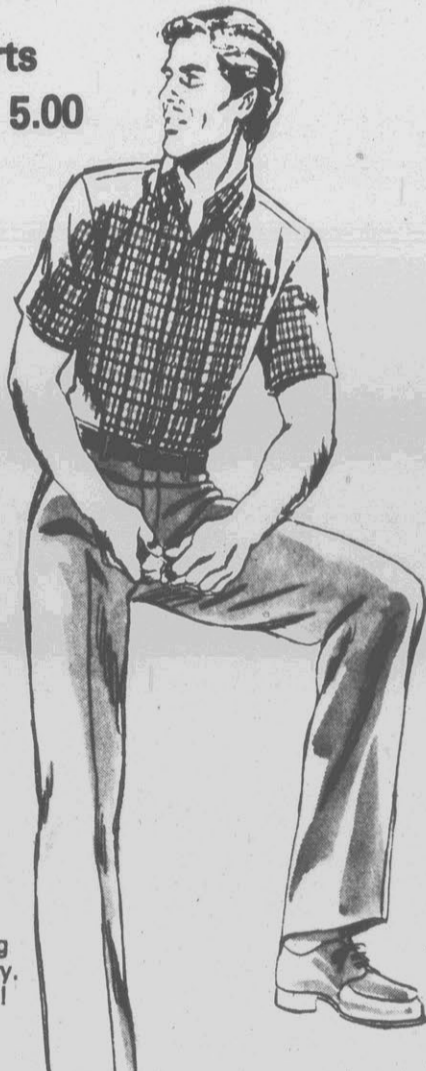

Tennis Shorts at a Great Price

10.88

Special Purchase

Tennis shorts made of polyester/cotton in light blue, navy and green colors in sizes 28 to 40.

Great Buy on Thirsty and Thick Towel Sets!

Bath Towel ... **3.27** Hand Towel ... **1.97** Wash-Cloth ... **97¢**

Large assortment of Cannon® "Biker" Towel Sets made of 88% cotton and 14% polyester. Complete with fringed and jacquard border in a variety of solid colors. Slightly irregular but wear not affected. Great buy!

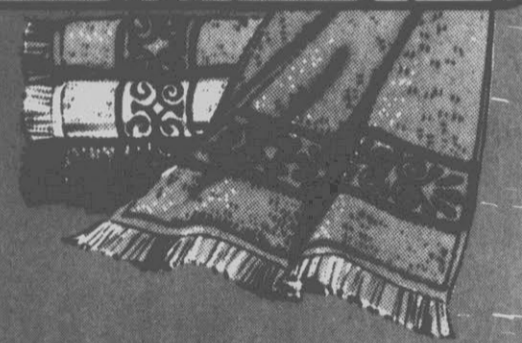

Pantyhose for Ladies at a Great Buy for Springtime!

77¢

Special Purchase

Great fit and great looks just for you. Now you can buy several pair for spring and summer and save a bundle!

Over 6.00 Off Short Sleeve Work Shirts

4.88

Regular 10.97

Large group of 100% cotton short sleeve work shirts with two front chest pockets in spruce green, khaki, grey and light grey colors. Hurry while limited supplies last!

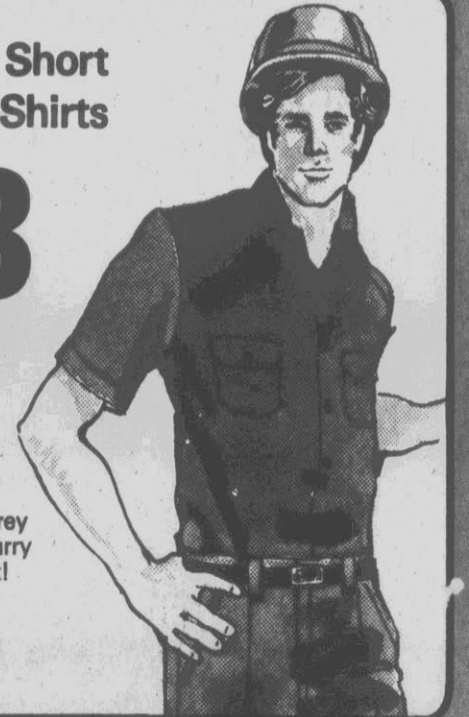

Men's Screen Printed T-Shirts at a Great Price

Slightly irregular screen printed T-shirts in solid colors. Sizes S, M, L, XL. If Perfect \$7 to \$8 **2.22**

Men's First Quality T-Shirts in Time for Spring

Men's solid color T-shirts perfect for the warm days to come. Sizes S, M, L, XL. Great buy **2.88**

Fantastic Savings on Men's Stretch Denim Jeans

Slightly irregular polyester/cotton jeans in sizes 30 to 42. Light and dark colors. If Perfect \$25 **11.88**

Men's Archdale® Tennis Shorts at a Special Price

Polyester/cotton tennis shorts in 5 colors. Men's sizes 30 to 42. Hurry and shop now! Special Value **10.88**

Great Buy on Men's Spring and Summer Shirts!

Polyester/cotton short sleeve shirts in a variety of plaids and solids. Sizes S, M, L, XL. Reg. 8.97 and 9.97 **7.88**

ITEMS ON THIS PAGE AVAILABLE ONLY IN OUR BUDGET STORES • AHOSKIE • GOLDSBORO • GREENVILLE • KINSTON • MOUNT OLIVE • TARBORO • WASHINGTON • DOWNTOWN WILSON • ELIZABETH CITY

SALE ENDS SATURDAY, MAY 1st!

Boys' Tuf 'n Ruf® Casual Pants Reduced!

Polyester/cotton in five colors. Boys' sizes 8 to 12, 26 to 30. Regular \$13 and \$15 **9.88 and 11.88**

Men's Tube Socks at One Low Price for You!

Package includes 6 pairs of over-the-calf socks. Sizes 10 to 14 **6 for 5.88**

Economy Pack of Boys' Tube Socks Sale Priced!

Over-the-calf stripe top socks. Package of six pairs. Stock up! **6 for 4.88**

Boys' Tuf 'n Ruf® Nautical Knit Shirt Sale!

Short raglan sleeve shirt with white, red and navy stripes. In sizes 4 to 7. Regular 7.00 **5.44**

Boys' Striped Baseball Knit Shirts Reduced!

Polyester/cotton. 3/4-length raglan sleeves. Shirt comes in white only with contrasting stripes. The stripes come in 5 colors. Sizes 4 to 7. Reg. \$5 **3.88**

Tuf 'n Ruf® Nautical Shorts Just for Boys

Polyester/cotton shorts with belt loops, pockets. Navy, red, white. Sizes 4 to 7. Regular 8.00 **6.44**

FOUNDER'S DAYS SALE



SALE!

Fantastic Savings of Over 10.00 on Men's Classic Blazers Just for You!

69.88

Regular 80.00

Large selection of 55% polyester/45% wool blazers in your choice of brown, navy, tan, grey, blue, green, pink and yellow colors. For every man who dares to advance from drabness up to distinction! Sizes 39 to 46 regular, 40 to 44 long. Shop today while we still have the blazer you want!



Hanes® Briefs and T-Shirts at a Great Low Price!

5.75

Briefs, Pkg. of 3 Everyday Low Price

7.19

T-Shirts, Pkg. of 3 Everyday Low Price

Large selection of first quality underwear for men. Available in packages of three. All-cotton knit briefs are absorbent, soft and comfortable. White. Sizes 28 to 42. All-cotton crew neck T-shirts are tailored to keep shape and retain fit. White. Sizes S, M, L, XL. Machine wash and dry. Hurry while they last!



30% OFF!

Big Savings of Over \$40 on Men's 3-Pc. Spring Suits!

89.88

130.00 Value

Dress to impress this spring in smart looking 3-pc. polyester suits. You belong in this clothing that's designed for the way you live! A suit that combines the casual, elegant fashion favors with all of the versatility you need. Pinstripes. Men's sizes.



LEVI'S® Jeans for Boys

Sizes 8 to 12, 26 to 30
Everyday Low Price ... **14.88**

Sizes 4 to 7
Everyday Low Price ... **11.88**

Large group of blue denim jeans made of 84% cotton/36% polyester. Straight leg and boot-cut styles to choose from. Machine wash and dry. Great buy!

Poplin Walk Shorts for Him

7.88

Regular 10.00

Large selection of polyester/cotton poplin walking shorts in a variety of solid colors. Prepare for all those warm and beautiful days to come. Easy Men's sizes 32 to 42.

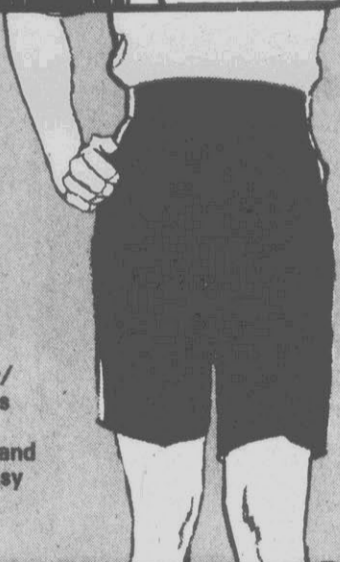

Cool and Comfortable Knit Shirts for Men

Everyday Low Price

11.88

Large assortment of 50% polyester/50% cotton shirts in two styles. Tailored collar or fashion box collar, short sleeves and front placket. Sizes S, M, L, XL. Stock up!



LEVI'S®

Dress Slacks Over 8.00 Off!

Regular 26.00

17.88

Large selection of slacks made of 100% texturized polyester complete with belt loops and pockets. Your choice of many solid colors to brighten up your wardrobe for spring and the pretty warm days ahead! Machine wash and tumble dry.

Boys' Knit Shirts by Andhurst® in Time for Spring!

8.88

Everyday Low Price

Large group of 50% polyester/50% cotton knit shirts with short sleeves, a two-button placket and long tail. Navy, white and light blue colors. Stock up while the prices are right! Boys' sizes 8 to 20.



Men's Short Sleeve Knit Shirts 5.00 Off

8.88

Regular 14.00

Short sleeve knit shirts of easy-care cotton and polyester. Box collar, rib cuffs and straight hemmed tails. Feel as great as you'll look in these comfortable shirts. Stock up today and save!



Big Savings on Hanes® Briefs and T-Shirts for Boys!

4.44

Pkg. of 3

T-Shirts or Briefs, Reg. 5.39

Packages of three T-shirts or briefs made of 100% cotton available in white only. Feel good all under with Hanes. Boys' sizes 8 to 20. Hurry!



PRICES SLASHED ON USEFUL ITEMS FOR MEN AND BOYS! HURRY IN TODAY!

Belk Tyler

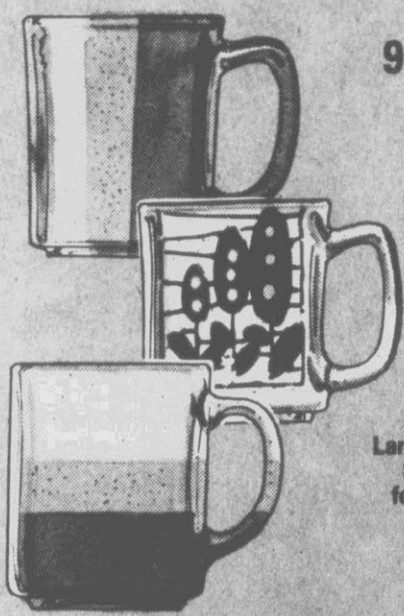

9 or 10-Ounce Ceramic Mugs Drastically Reduced Over 50%!

99¢

Regular 2.00 Ea.

Large assortment of handy ceramic mugs in 9 and 10-oz. sizes to choose from. Great for use at home, office or wherever. Your choice of solids and fancies. Great buy!

Great Buy on 20-Pc. Stainless Steel Flatware Set!

8.88

Regular 12.00

A quality stainless steel set of four. Set includes place knife, place fork, salad fork, teaspoon and place spoon. 'Saxony' and 'Topaz' patterns available.

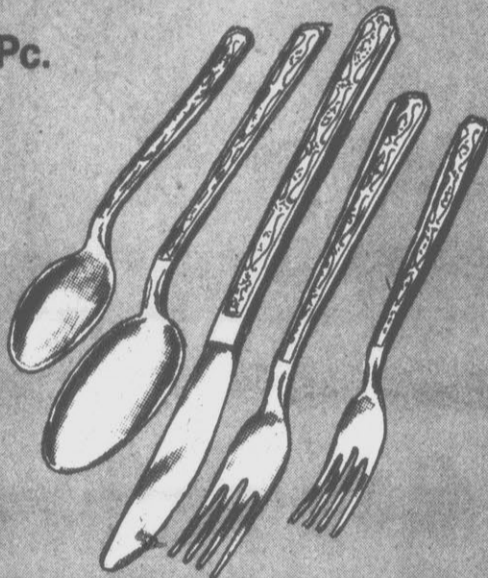

Big \$8 Savings on 6-Pc. Steak Knife Set!

11.88

Regular 19.95

All stainless steel knives with pistol handles made to last and stay sharp. Great for yourself or as a nice gift! Great buy!

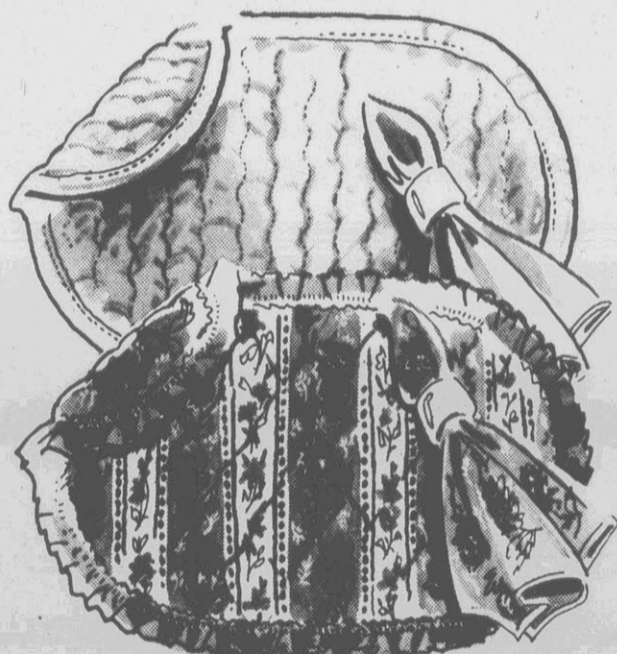
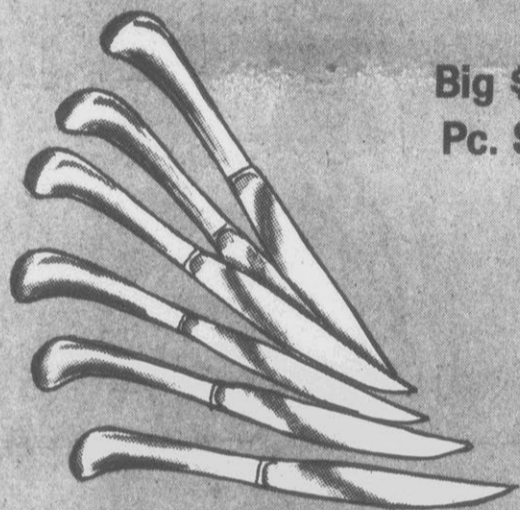

Quilted Place Mats with Napkins

Place Mats, Reg. 3.00 and 3.90

1.99 and 2.22

Napkins, Reg. 1.75 and 1.80

99¢ and 1.10

Large assortment of decorative place mats and napkins to dress up your table. Made of polyester/cotton. Machine wash and dry in solids and patterns. Some mats with lace ruffle edges. Stock up!

Handy Ring and Over-the-Door Hanger on Sale!

Ring, Reg. \$3

2.39

Hanger, Reg. 5.75

4.59

Belt and accessory chrome-plated ring with hook. Also, a swing-down hanger which has 12 hanger holes to keep items in place. Removable insert made to fit all doors. Make the best out of all the closet space. Hurry while supplies last!

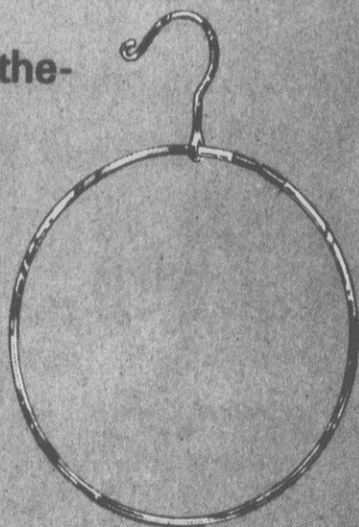

Great Buy on Double Old Fashion Glasses

Heavy sham base glass which holds 14 ounces. Stock up! Regular 8 for 7.88

8 for 3.88

Heavy Duty 10-Qt. Galvanized Pail Reduced!

Galvanized steel pail perfect for washing your car. Made to last! Regular 3.95

2.88

20% Off Set of Four Shirt 'Add-a-Hangers'!

Holds skirts, slacks or shorts fast with plastic tipped clips. Useful! Regular 5.00

3.99

Handy Six-Tier Blouse and Shirt Tree Sale!

Hang six items in the space of one. Arms swing out. Chrome plated metal. Regular 4.50

3.59

Skirt and Blouse 'Add-a-Hanger' Set Sale!

Set of three hangers for clothes to save space. Adjustable vinyl clips. Regular 5.25

4.29

Over-the-Door Shoe Rack Reduced Over \$8!

Chrome-plated tubing and wire rack which holds 18 pairs of shoes. Save! Regular 28.00

19.88

Women's Shoe Keeper at a Great Savings!

Chrome-plated shoe keeper which holds nine pairs of shoes. Easy to assemble. Regular 9.75

7.79

Men's Shoe Keeper Drastically Reduced!

Chrome-plated six pair shoe keeper. Space saver and easy to assemble. Regular 9.75

7.79

Swing Arm Slack Rack Reduced

Five-tier chrome-plated slack rack with vinyl tubing. Hurry in today! Regular 8.25

6.59

Versatile Expanding Rod at a Great Price!

Expands from 39" to 74" for use in doorway, cars or wherever. Hurry! Regular 12.25

9.79

Super Savings of Up to 23.00 on Lightweight Luggage!

East/West Tote, Reg. 45.00

33.75

22" Carry-On, Reg. 62.50

46.88

24" Pullman, Reg. 70.00

52.50

26" Pullman, Reg. 85.00

63.75

44" Garment Bag, Reg. 95.00

71.25

Large assortment of DuPont® Cordura nylon luggage with vinyl trim. Your choice of sangria/burgundy and black/honey colors. Lightweight. Easy care. Hurry while our limited supplies last! Save!



Heavy Duty Denier Nylon Luggage Sale!

22.88 Each

Special Purchase

Your choice of 44" garment bags or 20" duffles of denier nylon. Garment bag with vinyl trim in black, brown, navy, khaki, burgundy and green. Duffie with vinyl trim, outside pockets and shoulder straps in black, brown, navy, khaki, green and burgundy. Hurry for best selections!

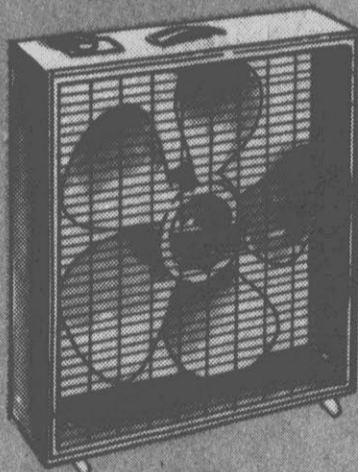

Large Energy Saving 3-Speed 'Breeze Box' Fan

22.88

Special Purchase

Keep the air circulating on those warm days ahead with this versatile three-speed box fan. Great buy!

West Bend® Electric Corn Popper Sale!

Special Purchase **14.88**

Buttermatic® 4-qt. electric corn popper with attractive yellow cover, automatic shut-off and non-stick surface.



Waring® Can Opener and Knife Sharpener All-in-One

9.88

Regular 14.95

Waring® Seven-Speed Blender Drastically Reduced Over 19.00!

16.22

Regular 35.95

Gold color can opener with magnetic lid holder, cord storage, handy knife sharpener, built-in carry handle and more. Make all your time in the kitchen a breeze! Buy today and save!

Seven speed blender complete with plastic container, flexi-grip lid, self aligning drive tabs to reduce vibrations and easy-to-read panels. Blending assembly is removable for easy cleaning. Almond color only.

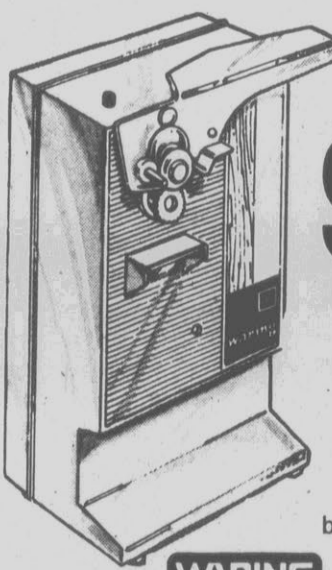

WARING



VERSATILE AND USEFUL ITEMS FOR HOME AND TRAVEL ALL REDUCED FOR SPRING!

SALE ENDS SATURDAY, MAY 1st!

Cannon® Towels at Low Prices!

StatePride® first quality terry towels in assorted colors. Regular 1.79 to 3.99 **1.44 to 3.44**

Thick and Thirsty Cannon® Towel Ensemble
 'Independence' slightly irregular towels. Not in Parkwood Wilson . . . Shop Downtown Bath Hand Washcloth Regular 4.77 3.97 1.97

Soft and Fluffy 'Caress' Bed Pillows at \$3 Off!
 Standard size pillows filled with Dacron® Fiberfill II. Regular 7.99 **4.88**

Great Price on Handy Lap Desks Just for You!
 Blue denim, printed duck and solid color brushed corduroy. Special Value **6.88**

Soft, Medium and Firm Pillows at Big Savings!
 Three different densities of polyester. Standard size. Regular \$7 to \$11 **6.88**

FOUNDER'S DAYS SALE



SALE!
20% OFF!

Add a Dramatic Accent to Your Home with Our Lovely Wicker Peacock Chair Now Reduced Over 10.00!

39.88 Regular 49.95

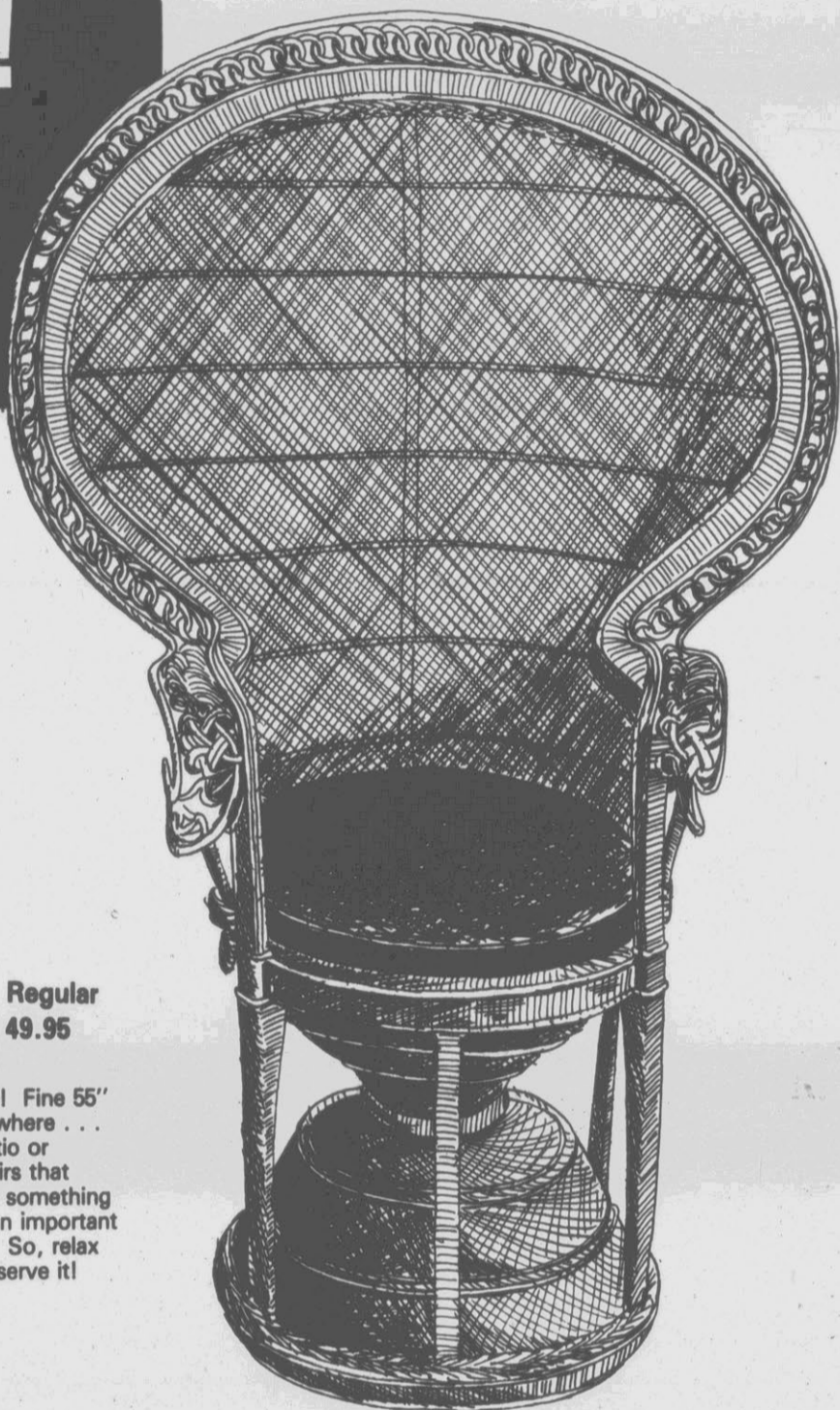

Dramatic accents in decorative furniture! Fine 55" spread wicker chairs that would go anywhere . . . living room, hallway, bedroom, den, patio or wherever you choose to 'perk up'. Chairs that are different by design . . . offering you something unique and exciting. Your furniture is an important investment for you and we realize that. So, relax and have a seat on us. We feel you deserve it!

SALE!

Save Over \$15 on Florentine Brass Lamps to Light Up Your Home!

24.88

Regular 39.95

Your choice of lovely Florentine lamps in two styles for you! Ball and taper 30" brass lamp and faceted taper column 30" brass lamp both with eggshell colored vinyl pleated shades and 3-way switches. Dramatically designed to light up the beauty of your home! For the right kind of light wherever you need it most! - Light up your life!



Lovely 'Pinafore' Percale Sheets

6.88 Standard Cases Reg. 7.99 Pr. **6.88** Twin Sheets Reg. 7.99 Ea. **8.88** Full Sheets Reg. 10.99 Ea.

Large assortment of no-iron percale sheets made of 65% Kodol® polyester/35% cotton. Made to match with most patterns from Spring Mills. Available in a variety of soft pastel colors. Flat or fitted sheets.

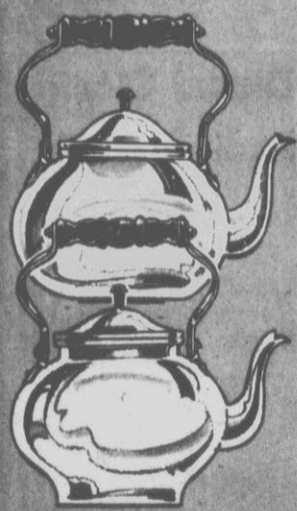
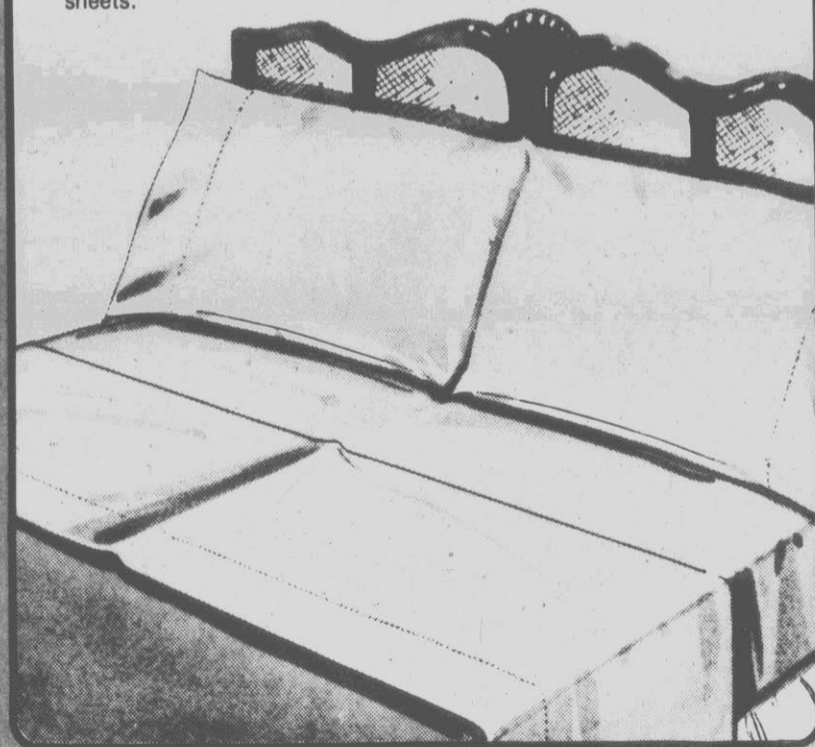

Lovely Copper Teakettles Reduced 5.00!

12.88 Regular 18.00

One and two-quart copper teakettles with self handles to use or just display. Get yours today while they last!

Great Buy on Cannon® 'Santa Cruz' Towel Ensemble!

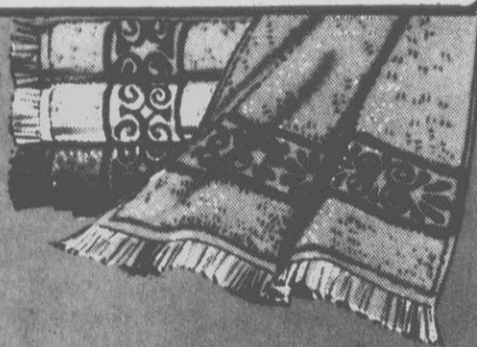

Bath Towel **3.27** Hand Towel **1.97** Wash-Cloth **97¢**

Slightly irregular group of thick and thirsty towels made of cotton/polyester. Fringed plush terry towels complete with jacquard border in a variety of solid colors. Not in Parkwood Wilson . . . Shop Downtown

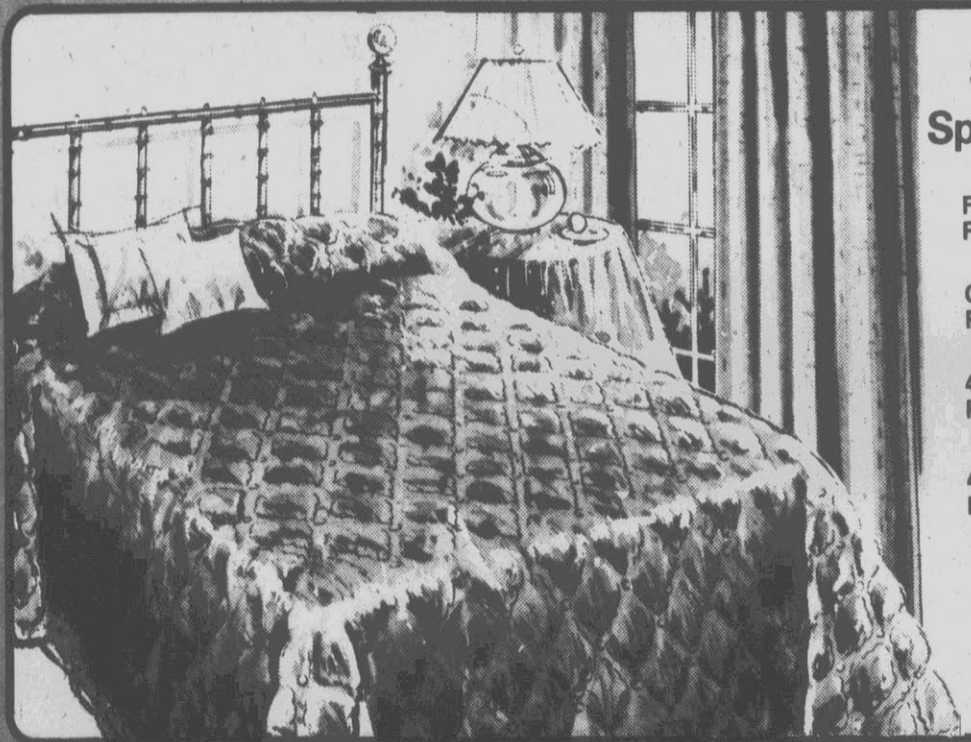

StatePride® 'Aurora' Spread & Drapery Set

Full Bedsread Regular 33.00 **24.88**
 Queen Bedsread Regular 43.00 **32.88**
 48x63" Drapes Regular 19.00 **15.88**
 48x84" Drapes Regular 20.00 **16.88**

Permanent press ensemble of cotton/polyester. Polyester-filled spread with nylon tricot back. Matching pinch pleated drapery with a flock foam lining. Easy care.

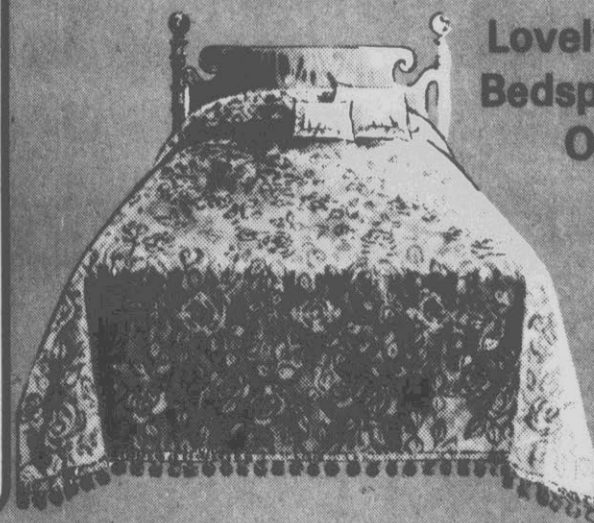

Lovely 'Regal Rose' Bedsread Reduced Over 7.00 Now!

24.88 Regular 32.00

A rich looking woven matelasse type spread with rose design made of 100% cotton. Ball fringe trim. Machine wash. Full size only. 95" x 108"

CELEBRATE SPRING AND STOCK UP ON FANTASTIC ITEMS FOR YOUR HOME!

Belk Tyler

The Longer You Wait, the Less You'll Have to Pick From! Get the Most for Your Money at Belk Tyler!

FOUNDER'S DAYS SALE



Atari® Video Computer System
at a Fantastic Price for You

139.88

Special Purchase

Large group of video computer systems are waiting to bring you hours of home entertainment and fun! Complete with a joystick and paddle controllers, combat game program cartridge, television switch and AC adapter. Hurry and get yours today!

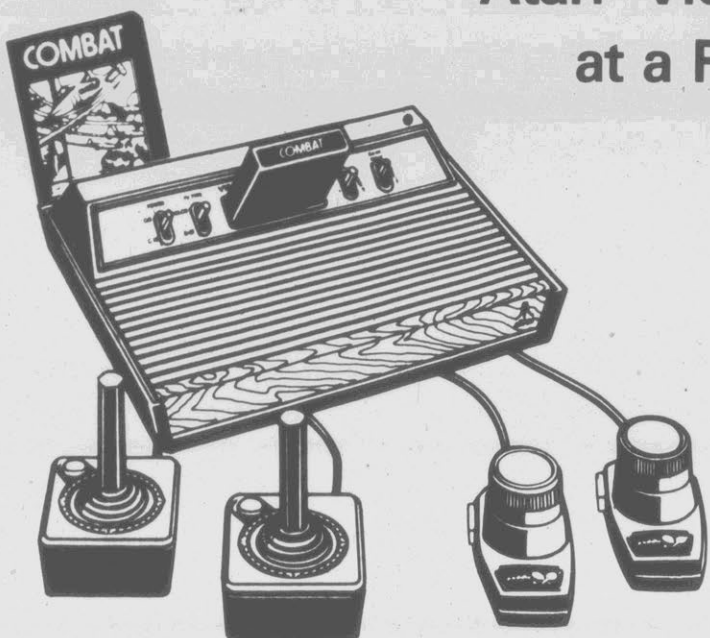

Big 10% Savings
on Video Game
Cartridges!

26.88

Regular 29.88

Choose from our large assortment of today's most popular Atari® game cartridges. Asteroids™, Missile Command™, Super Breakout®, Warlords and more. Get yours today!

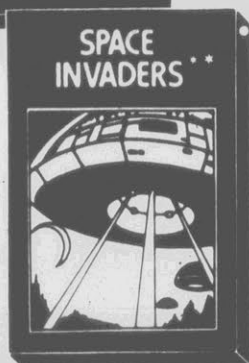

Save \$4 on Atari® Video
Game Cartridge Sets Now

45.88

Regular 49.88

'Action Pack' set including a combination of 3 great Atari® game cartridges for a savings! Othello®, Breakout® and Dodge Em™. Total value of these 3 games is sold separately . . . 89.00!

1 (Othello® is a registered trademark of CBS, Inc. for its strategy disc game and equipment.)

GE AC/DC
Cassette
Recorder for You!

Everyday
Low Price **28.88**

Simulated woodgrained side panels and metal-look grill. Model #3-5151.



GE AM/FM Dial Hand Clock Radio
at a Low, Low Price!

Everyday
Low Price **23.88**

Easy-to-read dial, walnut grain cabinet, wake-to-music control. Model #7-4580.

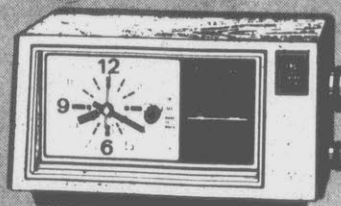

GE AM/FM Portable Radio
with Handy Carry Handle

Everyday
Low Price **19.88**

Head for the beach with this inexpensive, compact size radio, complete with 2-way power. Slide rule dial, integrated circuit. Silver tone and black. Makes a nice gift. Model #7-2650.



GE Programmable
Clock Radio

Everyday
Low Price **54.88**

Keyboard entry AM/FM digital clock radio. Program two wake up times or use 'Grad-U-Wake' direct entry of exact time and wake-up functions. Hurry! Model #7-4800.



AM/FM Digital Clock
Radio by GE!

Everyday
Low Price **28.88**

Large lighted digital clock read-out for easy time-telling in dark or daylight. Model #7-4305.



GE FM/AM Electronic
Clock Radio

Everyday
Low Price **34.88**

Space-saving digital clock radio. Wake-to-music or music with delayed alarm. Model #7-4625.

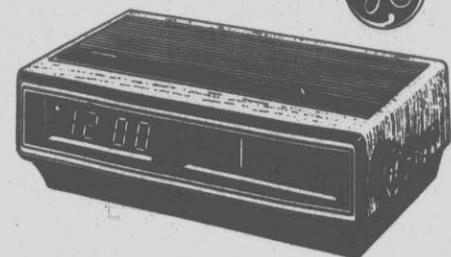

GE AM/FM Miniature Radio at
a Fantastic Price for You

11.88

Everyday Low Price

Take this miniature AM/FM radio anywhere: a rugged radio with a big sound, integrated circuit with 2 1/2" dynamic speaker, slide-rule dial scale, an earphone jack for private listening. Model #7-2592.

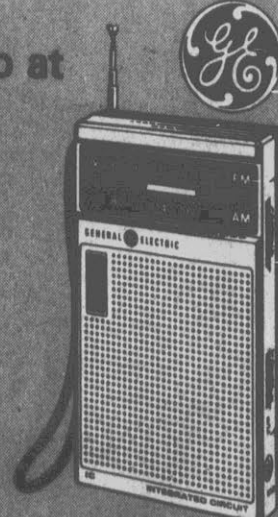

GE AM/FM Radio
Cassette Recorder

44.88

Everyday Low Price

AM/FM radio and cassette recorder all together in one. Live or 'off the air' recording. Runs on 4 'C' batteries or just plug it in. Model #3-5206.

GE Radio with
Weather Band!

38.88

Everyday Low Price

Portable AM/FM/TV/weather radio. Plays on batteries or AC house current. Built-in cord storage, slide rule dial and 4" speaker. Hurry in today. Model #7-2940.



GE 'Silver
Signature
Collection'
Radio and
Recorder

179.88

Everyday
Low Price

'Silver Signature Collection' AM/FM stereo radio cassette recorder all in one. Top-line features include quality dolby noise reduction and standard tape capability. Buy one today while our limited supplies last! Model #3-5286.

GE Stereo
Cassette
Recorder/
AM/FM Radio

88.88

Everyday Low Price

Stereo cassette recorder with AM/FM stereo radio. Has two 4" speakers, two built-in condenser mikes for 'live' stereo recording or recording direct from radio. Automatic end-of-tape shut-off. Model #3-5251.



ELECTRONIC ITEMS REDUCED FOR THE WHOLE FAMILY NOW AT BELK TYLER!

FAMILY DOLLAR

500th

GRAND OPENING



Win A 1983 Ford Ranger Pickup--Valued At \$10,350.00!

•Nothing To Buy•No Obligation•You Do Not Have To Be Present To Win
 •You Must Be 18 Years Old Or Older To Register•The Odds Of Having
 Your Name Selected Are Based On The Number Of Entries•Void
 Where Prohibited By Law•Employees Or Agents Of Family Dollar And
 Their Families Are Not Eligible.

2 For \$5 Summer Activewear For The Whole Family!

For Ladies: Smock waist and tie shoulder rompers in summer colors. Shorts in track, jamaica and cuff styles. Tank, short and ¾ length sleeve tops in prints, solids and stripes. Regular and extra sizes.

For Men: Knit shirt with collar, placket and pocket. Crew and v-neck shirts with shoulder stripes. Slightly irregular screen print t-shirts. S,M,L,XL.

For Boys: Screen print mesh or football shirts in sizes 8-18. Baseball shirts with screen print designs in sizes 4-7.

For Girls: Tees, polos, crew and v-neck tops with embroidery front in solids and prints. 4-14.

5.88 Pair Joggers And Sport Shoes

Nylon joggers with imitation suede trims in sizes to fit the whole family. Canvas, terry trimmed, tennis shoes in ladies' and children's sizes.

\$2 3-Pack Men's And Boys' Tube Socks

Over-the-calf style. White with striped top. Acrylic/polyester blend.

5 \$1 For Tropicana Fruit Drinks

10-oz. grape, orange or fruit punch flavored drinks.

\$1 Pack Of 5 40, 60 And 100 Watt Light bulbs

Pack of 5 long life Tungsten bulbs. Brass bases. 60-Watt Bug Lamp \$1

85¢ Quaker State Motor Oil

Super Blend 10W-30 multi-grade oil for all seasons. Limit 5 quarts.

500th Grand Opening Special

1.55 Pack 8-Roll Bath Tissue

Special family pack. Softly quilted 2-ply prints. Limit 2.

66¢ Gal. Purex Bleach

Big gallon size jug for a cleaner, whiter wash.

99¢ Trend Detergent

Reg. Price 1.39! 42-oz. heavy duty laundry powder.

3 \$1 Bars 3.5-Oz. Caress

Caress body bar with bath oil. Limit 3, please.

12.99 20-Pc. China Set

Includes 4 dinner plates, bowls, saucers, salad plates and cups. 3 patterns. Porcelain.

500th Grand Opening Special

Sale Starts Today! Prices Good Through Tuesday, May 4th, Or While Quantities Last!

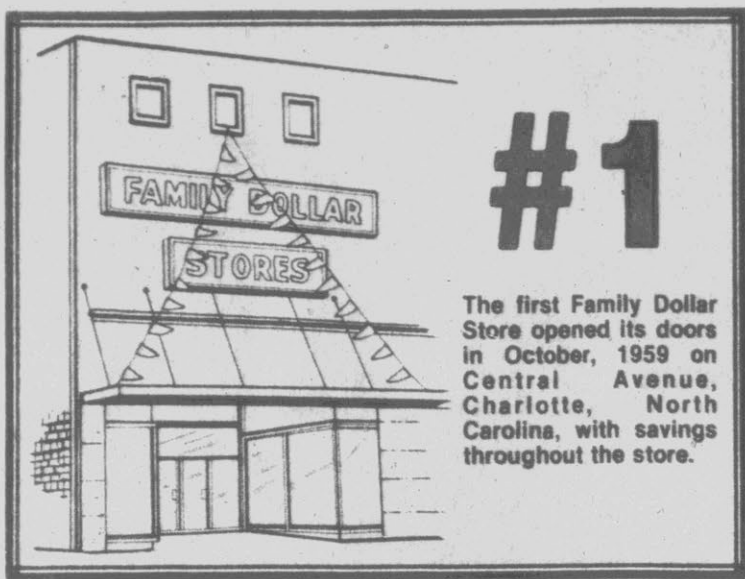

#1
The first Family Dollar Store opened its doors in October, 1959 on Central Avenue, Charlotte, North Carolina, with savings throughout the store.



500th Grand Opening Special

4.99 Each Compare Up To \$7!

Men's Dress And Sport Shirts

Short sleeve, no-iron, solid or print dress shirts and woven plaid sport shirts. Sizes 14½-17. Men's Ties... 2.99



1.99

Men's Print T-Shirts

Short sleeve, poly/cotton screen print t-shirts with popular designs and sayings. Slightly irregular. S,M,L,XL.

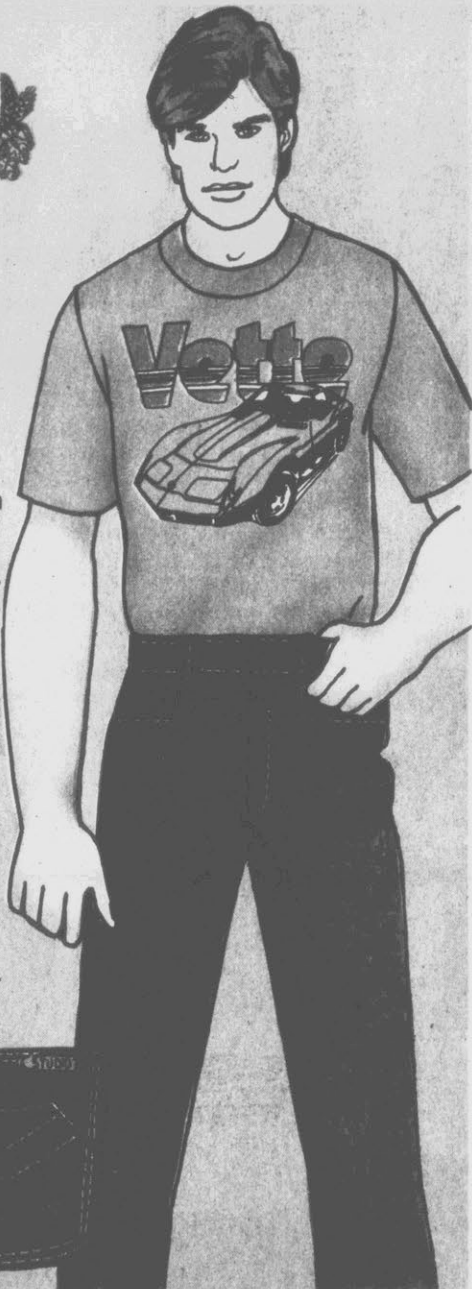

8.99 Pair

Men's Fashion Jeans

100% cotton denim jeans with a variety of back pocket treatments. 28-38.

10.99 Compare At 16.99!

Belted Casual Slacks

Twill casual slacks in navy, tan, black, light blue and white with matching striped belt. 30-40.

9.99 Compare At 12.99!

Dress Pants

No-iron, full cut, polyester dress pants in black, navy, brown and grey. 29-42. Men's Belts..... 2.99

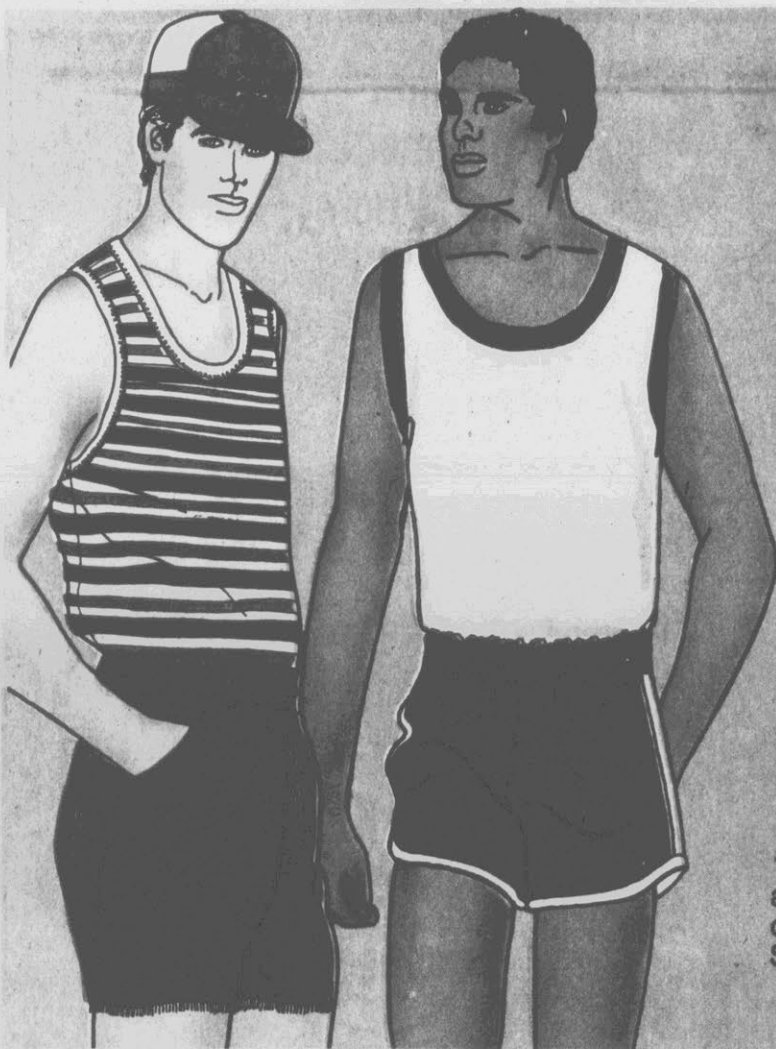

2.69 Each

Men's Tank Tops And Gym Shorts

- Solid and striped tank tops with contrasting trim. S,M,L,XL.
- Elastic waist gym shorts with contrasting trim. S,M,L,XL.

Emblem Sports Cap 1.89

5.99 Pair

Men's Cut-Off Shorts

100% cotton denim cut-off and fray bottom shorts in cargo and 5-pocket styles. Sizes 29-38.



#100

The 100th Family Dollar Store opened on October 26, 1971 in Brevard, North Carolina. The Company was operating stores in five Southeastern states.

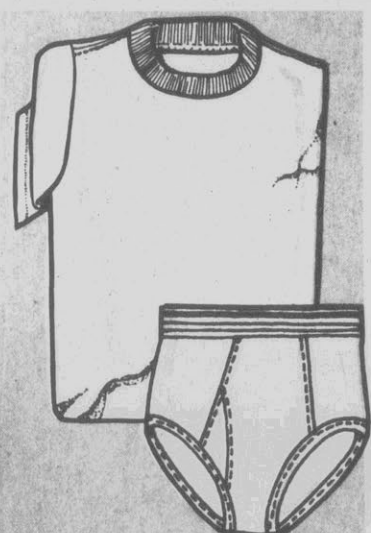

1.50 Boys' 2-Pr. Pack

\$2 Men's 2-Pr. Pack

Famous Maker Briefs & Tees

Pack of 2 100% cotton briefs or t-shirts. Slight irregulars. S M L XL



1.99 Each

Boys' Polos, Tanks And Shorts

- Short sleeve polos in solids and stripes. 8-16.
- Tank tops in stripes or solid colors with contrasting trim. 8-16.
- Twill jogging shorts with contrasting side trims. 4-16.

Boys' 4-7 Tops..... 2/3



2.99 Set

Boys' 4-7 Short Sets

Screen print tank tops or short sleeve knit shirts with matching jogging shorts.



3 \$1 For Die Cast Cars

Choose from metal cars, vans and trucks.

\$1 Each Assorted Toys

Choose from CHIP's Wallet, Barbie Travel Case and more.



500th Grand Opening Special

FAMILY DOLLAR STORES

#200

Family Dollar's 200th store opened in Dallas, North Carolina on October 3, 1974. The Stores were still concentrated in North Carolina, South Carolina, Virginia, Tennessee and Georgia.

\$5 Each

Ladies' Summer Fashions

- Short sleeve knit and woven tops in plaids, solids and prints. S,M,L.
 - Woven shorts in fly front and pull-on styles with pleats, embroideries and more. 7/8-15/16 and S,M,L.
 - Print skirts in a variety of styles including 4-gore and smock waist. 6-16.
 - Sundresses in stripes, solids and prints with smocking, shoulder ties and more. S,M,L and 16½-24½.
 - Terry, satin and knit rompers with print and piping details. S,M,L.
- Pleated And Tiered Skirts 6.99**
Scarf Hats And Sunvisors 1.47



\$4

Ladies' Handbags
 Canvas and straw fashion handbags for spring in assorted colors and naturals.

1.89 Each

Girls' Playwear

Terry, satin and woven shorts, midriff, tube and tank tops in solids and prints. 4-14.

500th Grand Opening Special

3.99 Each

Girls' Summer Fashions

- Woven shorts with embroidery and cuffs in pretty summer colors. 7-14.
- Short sleeve shirts and novelty tops in solids and stripes. 7-14.
- Polyester sundresses in prints or stripes. 4-14.
- Short Sets: Short sleeve, v-neck print tops with matching shorts in prints and solids. 4-14.

\$5 Pair

Girls' Fashion Jeans

100% cotton denim jeans with back pocket treatments. 4-14.
 Size 7-14 Fashion Leg Pants 6.99



4.99 Each

Ladies' Novelty Tops

Tank and short sleeve tops in a variety of styles including pebbles, embroideries and lace trims. S,M,L.

7.99 Pair

Ladies' Fashion Jeans

Pleated trouser and 4-pocket jeans with designer type stitching and color piping on back pockets. 5/6-15/16 and 10-18.
 Extra Size Jeans 9.99



3.99[¢] Prs.
Girls' Panties
 Poly/cotton panties in colorful prints. Slight irregulars. 4-14.

99[¢] Pair
Sport Socks
 Terry socks with roll tops and pom poms in solids and stripes.

99[¢] Pair
Pantyhose
 Sandalfoot, reinforced toe and panty pantyhose in four fashion colors. Queen Size 1.59

\$3 Each
Dorm Shirts Or Bra And Panty Set

- Short sleeve pastel dorm shirts with screen print front. Slight irregulars. S,M,L.
- Bra with front closure. Matching panty with cotton crotch. Solid colors with lace trim. S,M,L.

\$5
Ladies' Terry Shifts

Loop terry shifts with snap front, tie shoulder or shirred waist. Stripes and bright colors. S,M,L,XL and 16½-24½.
 Tube Tops *2

2.47
Lace Trimmed Half Slips

Ladies' nylon half slips in solids and pastels. S,M,L.
 Full Slips 4.47
 X-Size Full Slips 4.99
 Briefs & Bikinis 4.99



300

Family Dollar opened its 300th store in Newnan, Georgia on August 24, 1978. The Company had added Alabama and West Virginia locations, expanding its territory to seven states.



Dan River

Wendy

Bel-Fleur

500th Grand Opening Special

500th Grand Opening Special



\$7 Pair

Decorator Draperies
Special Purchase! Washable pinch pleated draperies in solids and prints. Foam backed or unlined. 48"x63" and 48"x84".

Ninon Panels, 40"x 63" 3.99
Ninon Panels, 40"x 81" 4.49

2.99

Twin Size

Dan River® Decorator Sheets
Danville's Wendy or Bel-Fleur pattern no-iron muslin sheets. Flat or fitted.

Full Size.... 4.99 Pillowcases.... 3.49 Pr. Queen Size.... 6.99



\$4 Set

Tier And Valance Set
36" tier with matching valance in a variety of patterns and colors.



2 For \$5

Fluffy Bed Pillows
Durable, non-allergenic, odorless, foam filled pillow. Standard size.



88¢ Skein

Remember™ Yarn
Strong, soft 4-ply acrylic yarn in 16 beautiful solid colors. 3-oz. skein.



\$2 Each

Cannon® Bath Towels
A beautiful selection of velour towels in solids and prints. Slight irregulars.

Cannon 4-Pk. Wash Cloths \$1

\$1 Infants'
1.69 Toddlers'

Tank Tops And Shorts For Summer Play

- Terry and knit tank tops in stripes and solids with contrasting trim.
- Athletic style, terry shorts in solid colors with contrasting trim.



2 For \$5

Diaper Sets
With matching terry tank and shorts in solid colors with contrasting trim.
Receiving Blanket 2.47

2.99

Infant's Sleep N' Play
Lightweight knit 1-pc. suit for day or night. Zipper closing. Gift boxed.

\$5 Pair

500th Grand Opening Special

Ladies' Dressy Two Band Wedge
Special Purchase! 2-band stretch slide with suede-look wedge heel in navy and beige.

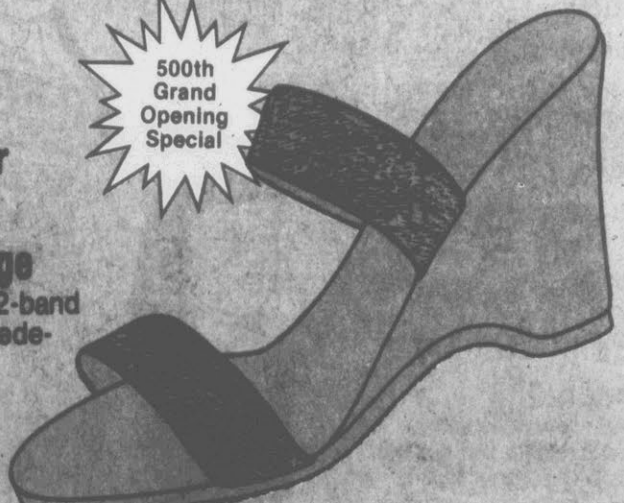

500th Grand Opening Special



1.88 Pair

Ladies' Washable Scuffs
Perfect for Mother's Day! Machine washable terry or velour. Soft and comfortable.



6.88 Pair

Unit Sole Sandals
Popular stretch fabric slide or leather-look strap sandals.
Girls' Sandals 5.99



3.19

Kleenex Disposable Diapers
Box of 24 extra absorbent diapers.
Newborn 30's 2.89
Toddler 12's 1.99



4.99

Pack Of 6 Cloth Diapers
Six 27"x27" Birdseye diapers. Soft, absorbent and fast drying. By Riegel.



3.88

Ladies' Exercise Sandals
Made in Italy. Famous clog style. Perfect for beach or casual wear.
Children's Sizes 2.88



6.88

Leather-Look Cork Wedges
Woven vamp slide sandal in wine or white. Perfect for casual or dress.



FAMILY DOLLAR

#500

Brunswick, Georgia is the location of Family Dollar's 500th Store. The store opened on March 31, 1982. The Company now operates in ten Southeastern states including stores in Kentucky.



1-Gallon Plastic Decanter

Stacking Storage Bins

Bowl Brush And Holder

Set Of 6 Cereal Or Salad Bowls

Ice cube Tray & Storage Bin

Packs Of 2 Assorted Wooden Hangers

Set Of 6 12-Oz. Plastic Tumblers

2-Pk. Ice Cube Trays

Stainless Steel Sink Strainer

48-Oz. Pink Or Lemon Dish Washing Liquid

\$1 Each

Kitchen Scoop Or Can Opener

3-Pc. Nylon Utensil Set \$1
 Pack Of 10 Jumbo Push Pins \$1
 Oil Spout Or Flex Funnel \$1
 Super Magnetic Memo Holders..... \$1

4 Rolls Colored Tape(3/4"x12' Ea.) . \$1
 Electrical Tape(3/4"x60')..... \$1
 Pencil Type Tire Gauge..... \$1
 Pack Of 3 Self Adhesive Hooks \$1

Not All Items Available In All Stores. Quantities May Vary!



\$3 Each

•2-Bushel Laundry Basket With Detergent Slot
 •4-Piece Sink Set With Built-In Silver Tray



\$4 Each

Swing Top Waste Baskets

Choose 40-qt. or 44-qt. sturdy plastic, swing top waste baskets in brown and yellow. By Sterilite.



2 For \$1

Your Choice!

- Safety Scissors
- Mini Address Book
- Two Piece Soap Dish
- Assorted Memo Pads
- Stick-On Ball Point Pens
- 9"x12" Drop Cloth
- Crystal Bon Bon Dish
- Chrome Plated Wire Whisk

Not All Items Available in All Stores. Quantities May Vary!



2 For \$1

Natural Palm Fans

Colorful, woven palm fans to decorate your home.



\$9

3-Pc. Wall Photo Album

Includes one 13"x16" and two 7"x9" pictures frames.



\$5 Each

Spartus Wall Clocks

Special Purchase! Electric wall clocks perfect for the kitchen or den. Not all styles available in all stores.

500th Grand Opening Special



5.99 Set

3-Pc. Cast Iron Set

Quality heavyweight cast iron for even heating, better cooking. Set includes 6 1/2", 8" and 10 1/2" skillets.

500th Grand Opening Special



2.99

Kitchen Tool Set

5-pc. set includes ceramic holder with 4 gourmet cooking utensils. Great gift for Mom!

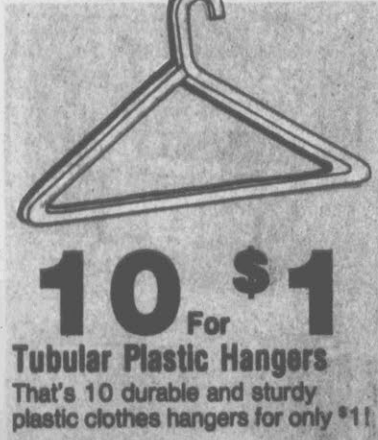

10 For \$1

Tubular Plastic Hangers

That's 10 durable and sturdy plastic clothes hangers for only \$1!



2 For \$1

Plastic Earring Tree

Crystal clear earring tree keeps jewelry within easy reach.



\$1 Each

Note Pad Or Pencil Sharpener

Choose bulletin board note pad or miniature antique pencil sharpener.

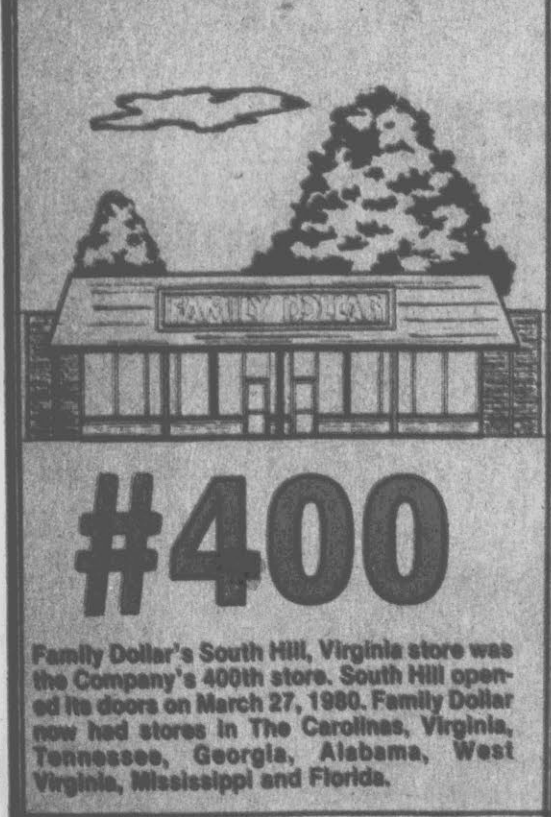

#400

Family Dollar's South Hill, Virginia store was the Company's 400th store. South Hill opened its doors on March 27, 1980. Family Dollar now had stores in The Carolinas, Virginia, Tennessee, Georgia, Alabama, West Virginia, Mississippi and Florida.



3.99 Gal.

Wall Paint Or Redwood Stain

Super-Glo dripless, flat finish wall paint in white and five colors. Latex redwood stain beautifies and protects outdoor woodwork.

9.99

2-Gal. Bucket House Paint

Big economical size. Easy to use, washes up with soap and water. One coat covers.



3.99

Glass Jewelry Box

Glass jewelry box or curio with stained glass design on lid.



\$1

Wall Or Table Decorations

Wooden wall or table decoration to brighten up your home



1.99

Paint Tray & Roller

Big 9-in. roller with 1-qt. capacity tray.



\$1 Each

Colonial Figurines

Fine porcelain miniatures of colonial era men and women.

500th GRAND OPENING

Register To Win A 1983 Ford Ranger!
 Family Dollar is Celebrating The Opening Of Its 500th Store In Brunswick, Georgia. So Come In And Register To Win A 1983 Ford Ranger Pickup, Valued At \$10,350.00.



FAMILY DOLLAR



1.29 Each
STP Gas Or Oil Treatment
 12-oz. gas treatment helps save gas. 15-oz. oil treatment helps reduce oil consumption in many cars.

2.49 Each
STP Oil Filters Or Protector
 •STP full-flow single oil filter.
 •8-oz. Son-Of-A-Gun protector/beautifier with exclusive sunscreen formula.

Save On All Your Vacation Needs At Family Dollar!

1.55 10-Lb. Bag Embers Charcoal
 Easy light, long burning charcoal.
 Lighter Fluid 1.33

1.69 Foam 30-Qt. Ice Chest
 Lightweight foam ice chest perfect for picnics.

8.99 36 Position Lounger
 Made from sturdy vinyl strapping and metal frame.
 PVC Matching Chair.... 8.99

2.99 7/16"x50' Water Hose
 Heavy duty green vinyl garden hose.

5.99 18-In. Charcoal Grill
 3-position, easy to assemble, chrome plated grill. 22-in. tall.

12.99 Hardside Ice Chest
 Tough, durable, 32-qt. ice chest perfect for summer camping trips.

\$2-3.99
4.99
 And **Sunsensor®**
Fashion Sunglasses
 Choose from metal or plastic frames with Sunsensor® and regular tinted lenses.

Health And Beauty Aids
 Our Everyday Low Prices!

- 100-Ct. Bayer Aspirin 1.57
- 60-Ct. Extra Strength Tylenol Tablets 2.99
- 12-Oz. Maalox Liquid 1.93
- 40-Ct. Tampax Regular Or Super Tampons 2.39
- 18-Oz. Listerine Mouthwash 1.99
- 10-Oz. Aqua Net Regular Or Hard-To-Hold Hair Spray 1.07
- 12-Oz. Vaseline Intensive Care Lotion, Reg. Or Extra 1.67

1.29
New Freedom Super Maxi 12's
 You Pay \$1.29
 Mail-In Rebate -1.29
 Your Net **FREE!**

\$1 Twin Pack **Bic Lighters**
 You Pay \$1.00
 Rebate From Bic -.50
 Your Net **50¢!**
 8-Pk. Bic Shavers *1

79¢
Tussy Deodorant
 Save Up To 40%! Choose 2.25-oz. roll-on, 2-oz. cream or 2 1/8-oz. deodorant stick.

2 For \$1
Lander Products
 Choose from economical Lander shampoos, lotions and bubblebaths.

500th Grand Opening Special
\$1 Each
Queen Helene
 Reg. 1.69, 16-oz. cocoa butter hand and body lotion or Reg. 1.49, 5-oz. creme.

77¢ Each
Plates Or Tumblers
 25-ct. Kordite foam compartment plates or 14-ct. 10-oz. Hefty tumblers.

\$1 Box
Holiday Trash Bags
 Choose 12-ct. 20-gal. bags, 15-ct. 44-qt. bags or 9-ct. 30-gal. bags.

500th Grand Opening Special
99¢ Each
Room Deodorizers
 •Twin pack of Airwick powder or heavy duty Stick-Ups.
 •15.5-Oz. Glamorene Rug Fresh carpet and room deodorizer.

500th Grand Opening Special
1.99
Spray N' Vac
 24-oz. Glamorene Spray N' Vac no scrub rug cleaner and deodorizer.

5 For \$1
Delicious Snacks
 Choose from 1 1/4-oz. Potato Chips, 1 1/4-oz. Cheese Snaps, 1 1/4-oz. Popcorn and more.

5 Bars
79¢ Pack
5-Pk. Candy Bars
 Zero, Payday, Butternut and Milkshake candy bars. By Hollywood.

Sale Starts Today! Prices Good Through Tuesday, May 4th, Or While Quantities Last!
 Advertising Supplement

MOTHER'S DAY



ECKERD

AMERICA'S FAMILY DRUG STORE

Sale Prices good through Sat. May 8th
We reserve the right to limit quantities.

CHARLIE or JONTUE SPRAY

VALUE **3.49**
Reg. \$6.00

Choose .4-oz. Charlie or .6-oz. Jontue. Unforgettable fragrances she'll love. Limit 2 please.



LATEST SPRING STYLES

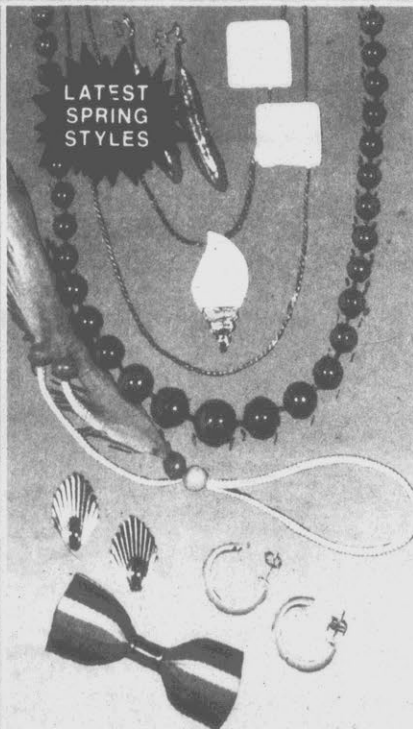

JEWELRY Sale 50% OFF REGULAR PRICES

Entire selection of necklaces, earrings, bracelets & more at a terrific savings.

VIDAL SASSOON PRO 1200 STYLING DRYER

WITH SPECIAL REBATE OFFER* No. VS-210 Reg. 16.99

2 speeds & 3 heats. Lightweight.
ECKERD'S SALE PRICE **11.99**
LESS MFR.'S MAIL-IN REBATE* .. **-2.00**
FINAL COST AFTER REBATE **9.99**



TV SPECIAL!

NORELCO CLEAN AIR MACHINE

WITH SPECIAL REBATE OFFER* No. HB1900 Reg. 24.99

Removes undesirable odors.
ECKERD'S SALE PRICE **19.99**
LESS MFR.'S MAIL-IN REBATE* .. **-3.00**
FINAL COST AFTER REBATE **16.99**

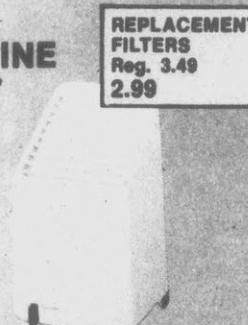

REPLACEMENT FILTERS Reg. 3.49 **2.99**

WHITMAN'S SAMPLER CHOCOLATES

Assorted chocolates, creams, nuts & more.

1-POUND **3.49**
Reg. 4.95

2-POUND **6.79**
Reg. 9.90



FOSTER GRANT SUNGLASSES

Reg. 14.00
ea. PAIR **2/14.00**

Current-fashion group of men's & ladies' eyewear.



BUY ONE GET ONE FREE

ECKERD



COLGATE TOOTHPASTE

5-OZ. PASTE or 4.8-OZ GEL **89¢**

Fluoride toothpaste. Limit 2 please
Coupon Good Thru Sat. May 8

COUPON

ECKERD



HI DRI PAPER TOWELS

Reg. **2/99¢**
79' ea. ROLLS

Absorbent towels for many uses. Choice of colors.
Coupon Good Thru Sat. May 8

COUPON

ECKERD



2-LITER TAB or COCA-COLA

Sale Priced **1.09**

Popular carbonated beverage in plastic bottle.
Coupon Good Thru Sat. May 8

COUPON

ECKERD



JOY LIQUID DETERGENT

22-OUNCE Reg. **99¢**
1.59

Lemon scented. Price reflects ¢ off label.
Coupon Good Thru Sat. May 8

COUPON

ECKERD



QUAKER STATE MOTOR OIL

1-QUART 10W30 Reg. **89¢**
1.29

Premium-quality Super Blend engine lubricant.
Coupon Good Thru Sat. May 8

COUPON

The **ECKERD** brand means satisfaction guaranteed.

**ECKERD
BALSAM & PROTEIN
SHAMPOO or
CONDITIONER**
24-OZ. **1²⁹**

BONUS SIZE ...
Regular or Extra Body
Formula.

**ECKERD
OIL OF BEAUTY**
6-OZ. **1⁶⁹**

BONUS SIZE ...
Richly moisturizing skin lotion
for a softer complexion.

**ECKERD
POLISH
REMOVER**
8-OZ. **69¢**

BONUS SIZE ...
With conditioners. Easily
removes old polish.



**ECKERD
TOOTHPASTE**
6.4-OZ.
3 TYPES **79¢**
Reg. 1.09

Economical fluoride tooth-
paste in Regular, Mint or
New Gel.

**ECKERD
MOUTHWASH**
32-OZ. **1²⁹**

BONUS SIZE ...
Mint or Antiseptic formula for
fresher breath.

**ECKERD
FLOSS AWAY™**
100-YDS. +
25-YDS. FREE **79¢**
Reg. 1.19

Waxed or Unwaxed floss
for healthier gums.



**ECKERD
BABY POWDER**
14-OZ. **99¢**

Reg. 1.39
Softens & helps protect
baby's skin. Soft fragrance.

**ECKERD
BABY OIL**
16-OZ. **1³⁹**

Reg. 1.89
Moisturizes & softens. For
the whole family.

**ECKERD
DISPOSABLE
DIAPERS**

**YOUR
CHOICE
Sale Priced ... 6⁹⁹**

Choose 48, Toddler size or
60, Extra Absorbent diapers.
Limit 1 each



**VITAMIN
SPECIALS**

**ECKERD
VITAMIN C**
500 MG.
BOTTLE **1³⁹**

Reg. 1.99
Essential vitamin the body
cannot store. Take it daily!
Limit 2 please

**ECKERD
VITAMIN E**
400 I.U.
BOTTLE **2²⁹**
Reg. 3.99

Synthetically derived
extra-strength capsules.
Limit 2 please



**ECKERD
BUFFERED
ASPIRIN**

**BOTTLE
OF 100 ... 99¢**
Buffered to reduce stomach
irritation. Limit 2



**ECKERD EXTRA-STRENGTH
PAIN RELIEF
TABLETS**

**BOTTLE
OF 60 ... FOR
BUY ONE-GET ONE FREE 2/1⁹⁹**
High-strength tablets. Contains
no aspirin. Limit 2



**ECKERD
FABRIC
SOFTENER**

20 SHEETS 79¢
Reg. 1.19
Just toss in dryer to add
freshness to laundry.



**ECKERD DOG or CAT
FLEA COLLARS**

**YOUR
CHOICE 2/1²⁹**
Reg. 1.29 ea. FOR
BUY ONE-GET ONE FREE
Help protect pets from fleas &
ticks for months.

**ECKERD
PRIVATE
LABEL
GUARANTEE**

Every Eckerd product is manufactured to highest quality specifications and offers substantial savings to you. Try these products with confidence. If for any reason you are not satisfied, return the unused portion and we will replace it with the national brand equivalent or refund your money in full.

BAN
ROLL-ON
ANTI-PERSPIRANT
 1.5-OZ. **99¢**
 3 TYPES ...

Regular, Unscented, Fresh
 Scent. Price reflects ¢ off
 label. Limit 2 please



BAYER
ASPIRIN
 BOTTLE
 OF 100 **1.49**
 Sale Priced ...
 Analgesic tablets for head-
 ache & fever. Limit 1



BIC
DISPOSABLE
SHAVERS
 PACK OF 5 **69¢**
 Sale Priced
 Single blade disposable
 shavers. Limit 2 pks. please



STRESSTABS
600 FORMULA
VITAMINS
 BOTTLE
 OF 60 **4.49**
 3 TYPES
 Choose Regular, With Iron
 or With Zinc. Limit 2 please



EXTRA STRENGTH
DEXATRIM
DIET CAPSULES
 20-CAPSULES **2.49**
 2 TYPES
 Sale Priced ..
 With or Without Caffeine. 1-
 capsule daily. Limit 1 of ea.



CORTAID
CREAM
 0.5-OZ. **1.79**
 Sale Priced
 Use on rashes & minor
 skin irritations.



CURITY
SUPER SOFT
PUFFS
 BAG OF 100 **69¢**
 Sale Priced
 Triple-size puffs for cosme-
 tic use & more. Limit 2



ALBERTO VO5
HAIR SPRAY
 11-OUNCE **1.39**
 Sale Priced
 Aerosol spray for lasting hold naturally.
 Limit 2 please

JHIRMACK
SHAMPOO or CONDITIONER
 8-OUNCE **2/3.00**
 YOUR CHOICE FOR
 pH balanced for manageability & con-
 trol. Limit 2 please

CONSORT
HAIR SPRAY
 13-OUNCE **1.19**
 Sale Priced
 For men. Aerosol spray for manage-
 able hair. Limit 2 please



SIGNAL
MOUTHWASH
 24-OZ. **1.49**
 Sale Priced
 Price reflects ¢ off labels.
 Limit 2 please

EFFERDENT
TABLETS
 60 TABLETS **1.49**
 Sale Priced
 Denture cleanser. Price re-
 flects ¢ off label. Limit 2

HAWAIIAN TROPIC
FOREVER TAN
 8-OZ. Limit 1 **3.99**



JOHNSON & JOHNSON
SUNDOWN
SUNSCREEN
 4-OZ. **3.49**
 Sale Priced
 Your choice of Moderate
 to Ultra Protection.

HAWAIIAN
TROPIC
LOTION or OIL
 8-OZ. **2.19**
 YOUR CHOICE
 For a deeper, darker tan.
 Limit 1 of each please

VASELINE INTENSIVE
CARE LOTION
 12-OUNCE **1.29**
 Sale Priced
 Rich, penetrating skin care lotion.
 Limit 2 please

SALLY HANSEN
HARD AS NAILS
 .45-OZ. **2/1.29**
 Sale Priced
 Clear polish to help strengthen nails.
 Limit 2 packs please

NEET LOTION
HAIR REMOVER
 4-OUNCE **1.39**
 Sale Priced
 With Baby Oil plus 2 skin conditioners.
 Easily & safely removes hair.

LOOSE or PRESSED
CORN SILK POWDER
YOUR CHOICE **1.89**
 Reg. 3.17
 Translucent no-color powder helps
 absorb oil. Limit 2 please



MOTHER'S DAY



8.50 VALUE
6⁰⁰

BABE & TOUCH OF CLASS SPRAY COLOGNE
2-OZ. Babe & 1.6-OZ. Touch of Class. From Faberge'.



Regular 8.00
4⁹⁹

JOVAN MUSK OIL SPRAY COLOGNE
2-OUNCE. Intriguing scent for the uninhibited female. Limit 2



Regular 1.75
1⁴⁹

SCOUNDREL COLOGNE SPRAY
0.25-OUNCE. Discover Scoundrel cologne. Limit 2

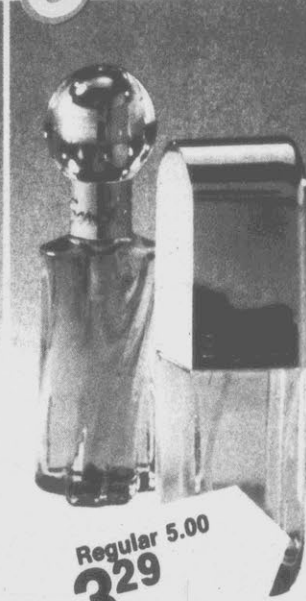

Regular 5.00
3²⁹

ENJOLI or SENCHAL SPRAY COLOGNE
0.5-OZ. Enjoli or 0.6-OZ. Senchal. Limit 2 please

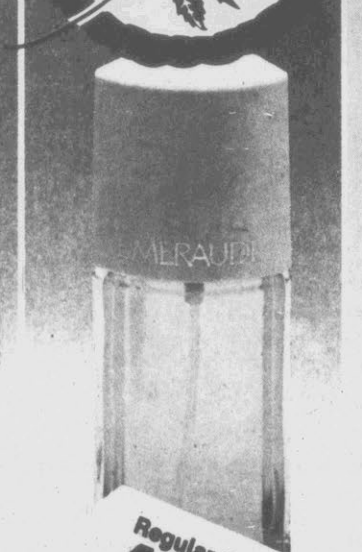

Regular 6.50
4⁴⁹

COTY EMERAUDE SPRAY COLOGNE
1.5-OUNCE. Make her feel special on Mother's Day.



HOUBIGANT FLORAL ASSORTMENT
1⁷⁵ TO 3⁵⁰

Includes lotion, talcum powder & more in choice of scents.



3⁹⁵

CACHET or WIND SONG SPRAY COLOGNE
1-OZ. 7.50 VALUE
3⁹⁵
She'll stay on your mind with these unique scents.



TOUJOURS MOI
1.2-OZ. 8.00 Value
5²⁵

EPRIS SPRAY COLOGNE
0.33-OZ. Gift Priced
5⁵⁰
By Max Factor. The provocative scent for her on Mother's Day.



CHANTILLY HAND & BODY LOTION
FREE

WITH CHANTILLY PURCHASE OF \$6.00 OR MORE
8-oz. moisturizing lotion free.



SENCAL DUO SET
15.00 VALUE
9⁵⁰

ENJOLI DUO SET
14.75 VALUE
Sale Priced
7²⁵
Set includes 0.6-oz. Spray Cologne & 1/4-oz. Perfume.

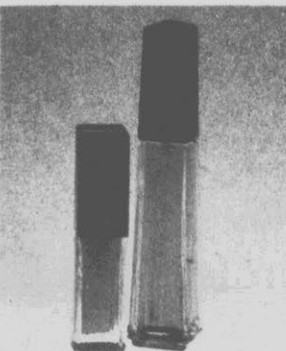

TABU BONUS BY DANA
Gift Priced
6⁵⁰
Free 1/4-oz. Tabu eau de Parfum with purchase of 1.5-oz. pure spray at 6.50.



5⁴⁹

NINJA PERFUME or COLOGNE SPRAY
1-OZ. COLOGNE/ 1/4-OZ. PERFUME
Reg. 6.00
5⁴⁹
If you like Opium or Cinnabar, you'll love Ninja.



1⁰⁰ OFF

REVLON LIPSTICK
1⁰⁰ OFF
REGULAR PRICES
Choice of assorted fashion shades. Limit 2



4⁹⁹

EUROPEAN COLLAGEN COMPLEX BY REVLON
Reg. 6.50
4⁹⁹
Moisturizing 1 1/2-oz. beauty creme or 1 1/4-oz. lotion. Limit 2

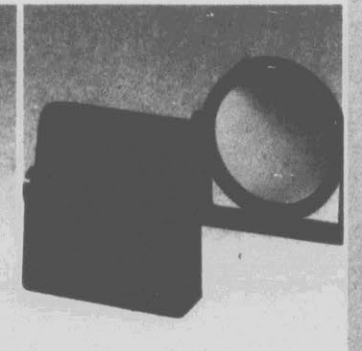

ASSORTED MAKE-UP MIRRORS
No. 359/360
Reg. 3.99
2⁹⁹
Regular & magnifying sides. With tortoise frame.



TV SPECIAL!

PROCTOR-SILEX 10-CUP COFFEEMAKER

WITH SPECIAL REBATE OFFER*

ECKERD'S SALE PRICE	17 ⁹⁹	No. A301N
LESS MFR.'S MAIL-IN REBATE*	-3 ⁰⁰	Reg. 22.99
FINAL COST AFTER REBATE	14 ⁹⁹	Brews just 2 cups with Brew-For-Two basket.

VIP PRO DRY CURLING IRON

No. VP1T	4 ⁹⁹
Reg. 8.99	
Save 4.00	

2 heats, on/off switch. Safety tip & ready dot.



TV SPECIAL!

ENTIRE STOCK OF CALCULATORS 30% OFF

REGULAR PRICES
Lloyd's, Casio, Sharp & more. Assorted features. Not all models at all stores.



SANYO SLIMLINE CASSETTE PLAYER/RECORDER

No. SLIM1	19 ⁹⁹	Battery operated. Ultra slimline design. Auto level control!
Reg. 27.99		
Save 8.00		

GRAN PRIX MULTI-BAND RADIO

No. APW215	18 ⁹⁹
Reg. 24.99	
Save 6.00	

AM, FM, Air, Police & Weather. AC/DC.



LLOYD'S AM/FM LED CLOCK RADIO

WITH SPECIAL REBATE OFFER*		
ECKERD'S SALE PRICE	22 ⁹⁹	No. J-274
LESS MFR.'S MAIL-IN REBATE*	-2 ⁰⁰	Reg. 29.99
FINAL COST AFTER REBATE	20 ⁹⁹	LED display. Wake to alarm or music.



POLAROID TIME-ZERO SX-70 FILM

SUPERCOLOR 10 PRINTS

747

Brilliant-color instant pictures that develop in seconds.



ENTIRE STOCK OF TIMEX® WATCHES 30% OFF

REGULAR PRICES
Men's & ladies' styles. Assorted faces, features & bands.



POLAROID "BUTTON" INSTANT CAMERA

WITH SPECIAL REBATE OFFER*	
No. 2101	Reg. 24.99
No focus, just aim & shoot! Never needs batteries.	
ECKERD'S SALE PRICE	21 ⁹⁹
LESS MFR.'S MAIL-IN REBATE*	-5 ⁰⁰
FINAL COST AFTER REBATE	16 ⁹⁹



PLASTIC FLASHLIGHTS

Reg. 1.89	1 ²⁹
Sale Priced	

Lightweight plastic selection. Assorted sizes.



32-GALLON TRASH CAN

No. 364	8 ⁸⁸
Reg. 12.99	
Save 4.11	

Weather-resistant plastic. Domed lid & handles lock.



GENERAL ELECTRIC SOFT-WHITE LIGHT BULBS

Reg. 3.72	PACK OF 4 / 1 ⁷⁹
pk. ...	

40, 60, 75 or 100 watts for most lighting needs.



VIP PRO 1500 PLUS HAIR DRYER

No. VP-15-P	15 ⁹⁹
Reg. 24.99	
Save 9.00	

2 speeds, 4 heats & 5 styling attachments.



GENERAL ELECTRIC 60-WATT BUG LITE

Reg. 3.08	PACK OF 2 / 1 ⁹⁹
pk. ...	

Yellow bulb bugs can't see. For patios, more.



CRICKET DISPOSABLE LIGHTERS

Reg. 99¢	2 / 89¢
ea.	FOR

By Gillette. Disposable butane lighters.

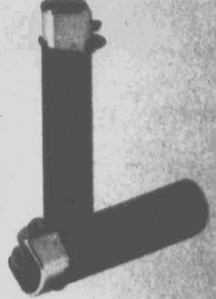

ATARI VIDEO GAME CARTRIDGES

Asteroids, Space Invaders, Missile Command, Break-out & more. Selection may vary at each store.

Reg. 22.95	Save 6.00	16 ⁹⁵
Reg. 31.95	Save 10.00	21 ⁹⁵
Reg. 37.95	Save 11.00	26 ⁹⁵



EVEREADY "C" or "D" SUPER HEAVY DUTY BATTERIES

Reg. 1.30	PACK OF 2 / 88¢
pk. ...	

No. 1235/1250. Extra-strength power cells.



FULL
WARRANTY &
UNCONDITIONAL
GUARANTEE



GARDEN HOSES

5/8" x 50' SUPER FLEX or
5/8" x 80' DURATRED

YOUR
CHOICE
Reg. 17.99

14⁸⁸

Duratred No. 8640
or Super Flex No.
8610. Reinforced
for burst
resistance.

**MELNOR
OSCILLATING
SPRINKLER**

No. 61
Reg. 6.99 **5⁸⁸**
Covers to 2400 sq. ft.



**MELNOR
PULSATING
SPRINKLER**

No. 9570
Reg. 9.99 **7⁹⁹**
Covers 75-ft. circle.



**RAINTIME
RING SPRINKLER,
FAN SPRAY or
PLASTIC NOZZLE**

YOUR
CHOICE **99¢**
Reg. 1.59
Sprinkling attachments.



**ORTHO
SEVIN DUST**

1-POUND
Reg. 3.29 **1⁹⁹**
General insecticide.
No. 02422



**ORTHO
FENCE & GRASS
EDGER**

1-GAL.
Reg. 9.99 **6⁹⁹**
Kills weeds & grass
along sidewalks & more.



**SCOTT'S
FERTILIZER**

2½-LB. **2⁷⁷**
Reg. 3.49 ...
For flowers, trees &
shrubs & vegetables.

QUAKER STATE
2-CYCLE OIL
1-QT. 2 TYPES
1²⁹

**K & S
1½-H.P.
GAS
POWERED
WEEDER/
TRIMMER**

No. GB-762
Reg. 139.99

99⁹⁹

Tap-to-Trim® auto line
feed, 2 cycle, 31 cc en-
gine. Cuts 16" swath.

**5/8-H.P. K & S
ELECTRIC
WEEDER/
TRIMMER**

No. GB-1015
Reg. 49.99
Save 10.00

39⁹⁹

Tap-to-Trim® auto line feed. In-
stant start/stop switch.

50-FT. EXTENSION CORD Reg. 11.29 **7.99**

**22-TINE FAN-STYLE
LAWN RAKE**

No. 19-537
Reg. 7.99 **5⁹⁹**
Has tension spring.

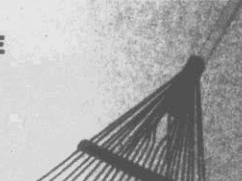

**FLOATING-BLADE
GRASS SHEAR**

No. G513311
Reg. 3.99 **2⁹⁹**
Heat treated 13½" blades.
Safety lock in handle.



GARDEN TOOLS

YOUR
CHOICE **79¢**
Reg. 1.09 ...
Transplanter, cultivator or
trowel. Wooden handles.

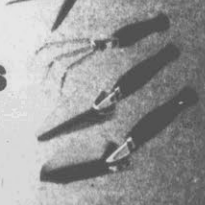

**MEN'S or LADIES'
WORK GLOVES**

8-OZ. **69¢**
Reg. 1.09 ...
Washable cotton fiber.
For garden & yard work.



LADIES' PLASTIC DOT GARDEN GLOVES . 39¢

**LONG-HANDLE
GARDEN TOOLS**

YOUR
CHOICE **5⁹⁹**
Reg. 7.99
Round point shovel, bow
rake or garden hoe.



12-QT. COOLER CHEST

No. 036 Reg. 12.99
Molded polyethylene. Holds 2, 6-
packs. Cover inverts for tray.

9⁹⁹

IGLOO LUNCHMATE

6-QT. No. 2321 Reg. 15.99
Sturdy plastic with food tray.
Fold-down lid & built-in handle.

11⁹⁹

THERMOS® COOLER

35-QT. No. 7719 Reg. 21.99
Hinged lid, rugged end handles,
rust-proof construction.

15⁹⁹

**KORDITE
TRASH BAGS**

Reg. 2.49
ea. **2/3⁰⁰**
FOR
Choose 20, 26-gal. or 30,
13-gal. bags with twist ties.



**KORDITE
FOAM PLATES**

PACK OF 50 **1⁴⁹**
Reg. 1.99
Disposable plates for pic-
nics, barbecues & more.



**OLE DIZ
CHARCOAL
BRIQUETS**

10-POUNDS **1³⁹**
Reg. 1.79
Fast starting, hickory
flavor briquets.



BBQ TOOL SET

3-PIECE **3⁸⁸**
Reg. 4.49
Fork, tongs & turner.

BARBECUE MITT

Reg. 1.29
Sale Priced **88¢**
Teflon/percale.

WOOD CHUNKS

Reg. 1.29
Sale Priced **99¢**
Hickory. 2-pound bag.

CHARCOAL LIGHTER

ELECTRIC **4⁹⁹**
Reg. 5.99
550 watts. UL listed.





GAS GRILL COVER
Reg. 8.99
7⁹⁹

BRADLEY DUAL BURNER GAS GRILLS

DELUXE MODEL
No. 1208 Reg. 189.99

149⁹⁹ Full-feature grill has step-up grid for 469-sq. in. cooking area & up-front controls.

STANDARD MODEL
No. 606 Reg. 149.99

119⁹⁹ Features 270-sq. in. cooking area, cast iron grates.



REDWOOD & ALUMINUM LAWN FURNITURE

Durable redwood furniture. Tubular aluminum frame Chaise adjusts 7 positions.

CHAIR

Reg. 19.99

Save 4.11

15⁸⁸

CHAISE

Reg. 39.99

Save 7.11

32⁸⁸

VINYL AIR MATTRESS

27" x 72" **1⁹⁹**

Reg. 2.49

Inflatable mattress for beach or pool.



12" x 16" TABLE TOP HIBACHI

Reg. 14.99 ... **10⁹⁹**

Adjustable grids & drafts. Cast iron bowl. Portable.



TROPHY CHARCOAL/WATER SMOKER

No. T-18 Reg. 59.99 **44⁹⁹**

Barbecue or water-smoke up to 25-lbs. of foods. Can hold 10-lbs. of charcoal.



SWINGER II SMOKER GRILL

No. 4400 Reg. 59.99 **39⁹⁹**

Features 352-sq. in. plated grid, 4 cooking heights & tilt-away, vented hood.



MEN'S or LADIES' BEACHCOMBERS

Reg. 3.99 Sale Priced **2⁴⁹**

Casual footwear with rubber sole & cloth strap.



ZORRIES SANDALS

Reg. 2.99 to 89¢ pr. **PAIRS 1⁰⁰**

Men's, ladies' or children's. Assorted colors.



PENN TENNIS BALLS

CAN OF 3 Reg. 2.69 **2⁰⁹**

For most surfaces. Wear-resistant, yellow felt.

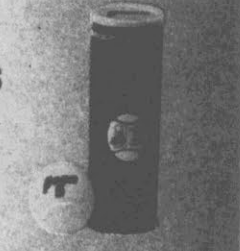

ZEBCO 202 REEL & ROD

Reg. 8.98 Sale Priced **6⁹⁹**

Spincase combo with pistol grip handle.



AUTO SEAT CUSHION
Reg. 4.99
3⁹⁹



SEE MFR.'S MAIL-IN \$1.25 REBATE IN-STORE

AUTO SPECIALS

- LIQUID TURTLE WAX 18-OZ. Reg. 2.39 **1⁹⁹**
- RAIN DANCE CAR WAX 16-OZ. PASTE or LIQUID Reg. 6.99 ... **5⁹⁹**
- HERCULON SEAT CUSHION Reg. 10.99 **6⁹⁹**
- ENGLISH CHAMOIS CLOTH 1 1/4-sq. ft. Reg. 3.19 **2⁴⁹**
- ZIP WAX CAR WASH Reg. 1.79 **1⁴⁹**

WINDEX GLASS CLEANER

22-OZ. ... **1¹⁹**
Reg. 1.59

Cleans more than windows. Trigger sprayer.



COMET CLEANSER

14-OZ. **3/1⁰⁰**
Reg. 49¢ ea. FOR

Scouring powder. Price reflects ¢ off label.

LYSOL SPRAY DISINFECTANT

12-OZ. ... **1⁸⁹**
Reg. 2.49

Regular or Scent II. Deodorizes & disinfects.

SUPER GLUE ADHESIVE

3-GRAM Reg. 1.69 **99¢**

Permanently bonds many surfaces with single drop.



LEPAGE'S THRIFTAPE

Reg. 79¢ ea. ... FOR **2/88¢**

1/2" x 1500". Economical transparent tape. No. 3939

Supplement to: Aiken Standard, Albermarle Stanly News & Press, Anderson Independent & Daily Mail, Asheboro Courier Tribune, Augusta Chronicle & Herald, Asheville Citizen/Times, Boone Watson Democrat, Bristol Herald-Courier & Bristol Virginia-Tennessean, Burlington Daily Times-News, Danville Register, The Village Advocate, The Enterprise, Charleston News & Courier Post, Charlotte Observer, The News Messenger, The Picture, Radford News Journal, Pulaski Southwest Times, Clinch Valley News, Sampson Independent, Sampson County Shopping Guide, The State & Columbia Record, Concord Tribune, The Horry News & Shopper, The Georgetown News & Shopper, The Dunn Daily Record, Durham Morning Herald, Elizabeth Newspapers, Inc., Elizabeth City Daily Advance, Fayetteville Observer-Times, Florence Morning News, Gastonia Gazette, Goldsboro News-Argus, Greensboro Daily News & Record, Greenville Daily Reflector & Reflector Shoppers Guide, Greenville News & Greenville Piedmont, Greenwood Index-Journal, Henderson Daily Dispatch & Tri-County Shopping Guide, Hendersonville Times-News, Hickory Daily Record, High Point Enterprise, Thomasville Times, Jacksonville Daily News, Johnson City Press Chronicle, Kannapolis Daily Independent, Kings Mountain Herald, Kingsport Times-News, Kinston Daily Free Press, Lenoir County Exchange, Lenoir News Topic, Lexington Dispatch, The Robesonian, McDowell News, Mecklenburg Gazette & Dollarsworth, Monroe Enquirer-Journal, Carteret County News-Times, Moore County News Outlook, Morganton News Herald, The Mount Airy News, The New Bern Sun-Journal, Whitesville News Reporter, The North Wilkesboro Journal-Patriot, Norton Coalfield Progress, Oconee Shopping Guide, Orangeburg Times & Democrat, Raleigh News & Observer, Reidsville Review, Richlands News-Press, Roanoke Rapids Sunday Herald, Rock Hill Evening Herald, Richmond County

Daily Journal, The Rocky Mount Evening & Sunday Telegram, Sanford Daily Herald, Salisbury Post, Savannah News-Press, Shelby Daily Star, Smithfield Herald, Spartanburg Herald-Journal, Statesville Record & Landmark, Sumter Daily Item, Union County Times, Waltherboro Press and Standard, Waynesville Mountaineer, Whitesville News Reporter, Wilmington Morning Star, Wilson Daily Times and Winston-Salem Journal & Sentinel & Wytheville Southwest Va. Enterprise, Rutherford County News & The Enterprise-Section C, Friday, April 23, Tuesday, April 27, Wednesday, April 28, Thursday, April 29, or Sunday, May 2, 1982.



MULTI-POSITION COMBI LOUNGER

FULL-SIZE

Regular 12.99

Save 3.11

Weather resistant vinyl covering on plated steel frame. Adjusts 7 ways for comfort.

9⁸⁸

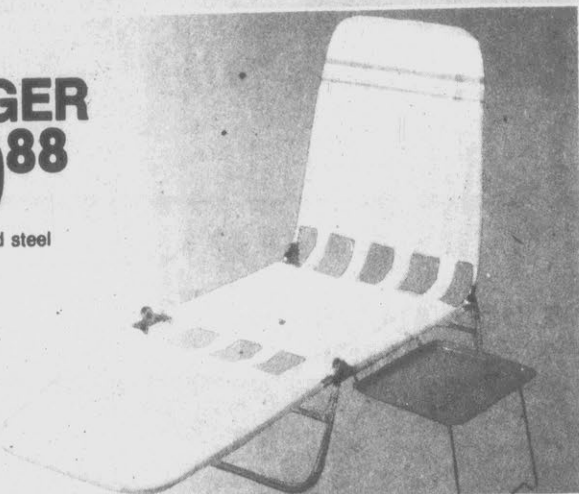

FOLD-A-TRAY
Regular 2.99
2⁴⁹

PLANTERS SNACKS

YOUR CHOICE

Reg. 99¢ **69¢**

Cheez Curls, Cheez Balls & more in resealable cans.



MAGIC CHEF BLACK PEPPER

4-OZ. **2/1⁰⁰**
Reg. 69¢ ea. . . CANS

Finely ground seasoning in shaker canister.



REGULAR or CONTROL TOP



L'EGGS SHEER ELEGANCE PANTYHOSE

Regs. to 2.79

Sale Priced **1⁹⁹**
Sheer Elegance or Sheer Elegance Control Top. Assorted shades & sizes.

LIMITED 5-YR. MOTOR WARRANTY

SCHOOLHOUSE LIGHT KIT No. 6717 **14⁹⁹**



TV SPECIAL!

AIR KING ANTIQUE BRASS 52" CEILING FAN

No. 5175/5177 Regular 149.99 Save 20.00

129⁹⁹

Reversible, 3-speed motor. White or teak-look solid wood blades.

GALAXY 20-INCH FLOOR FAN

No. 6713 Reg. 26.99 Save 5.00 **21⁹⁹**

Steel constructed. Fine mesh grill, support feet.



3 SPEEDS

ROLLABOUT FAN STAND No. 6701 **7⁹⁹**

GALAXY 12" OSCILLATING FAN

2150A/B Reg. 29.99 Save 5.00 **24⁹⁹**

Maximum airflow with minimum energy use.

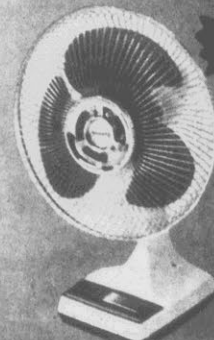

3 SPEEDS

ECKERD

TV SPECIAL!



SWEET 'N LOW

BOX OF 100 **77¢**
Sale Priced

Granulated sugar substitute in packets. Limit 1 please
Coupon Good Thru Sat. May 8

COUPON

ECKERD



FOAMY SHAVE CREAM

11-OZ. **99¢**
Sale Priced

Price reflects ¢ off label. Limit 2 please
Coupon Good Thru Sat. May 8

COUPON

ECKERD



POTTING SOIL

4-QT. **2/88¢**
Reg. 89¢ ea. BAGS

Sterile & ready-to-use. For indoor or outdoor needs.
Coupon Good Thru Sat. May 8

COUPON

ECKERD



PALMOLIVE GOLD BATH SOAP

5-OZ. **3/1⁰⁰**
Reg. 45¢ ea. . . BARS

Fragrant bath bars for lasting deodorant protection.
Coupon Good Thru Sat. May 8

COUPON

ECKERD



DIAMOND ALUMINUM FOIL

Reg. 69¢ ea. . . ROLLS **2/89¢**

12" x 25-ft. For wrapping, storing & baking needs.
Coupon Good Thru Sat. May 8

COUPON

SPRING PEST CONTROL

Kroger Sav-on Bargains

kenco® Rid-a-Bug®

- ECONOMICAL
- KILLS ROACHES AND OVER 200 OTHER INSECTS FOR MONTHS



PEST CONTROL
Rid-a-Bug

Or

FLEAS-TICKS

Rid-a-Bug

\$2.49

26-Oz. Btl.

- USE ON CARPET AND FURNITURE

- USE INDOORS AND OUTDOORS

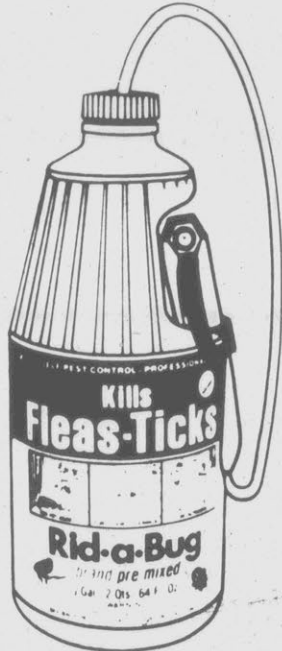
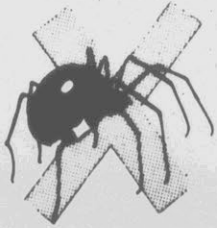

PRE-MIXED PEST CONTROL

Rid-a-Bug

\$3.97

64-Oz. Btl.

Reg. \$4.99



PRE-MIXED FLEAS-TICKS KILLER

Rid-a-Bug

\$4.97

64-Oz. Btl.

Reg. \$5.99

FOR DOGS & CATS
NEW SPRAY

Rid-a-Flea

\$2.49

15-Oz. Btl.



- Insecticide for general garden use and for vegetables, tomatoes, strawberries, etc.
- Kills tomato hornworms, armyworms, cutworms, squash bugs and certain other garden pests.

ORTHO
Sevin 5 Dust

\$1.39

4 Lb. Bag



- A multi-purpose dust to control many insects and diseases on tomatoes, melons and certain other vegetables.
- Can be used on tomatoes up to 7 days before harvest.

ORTHO
TOMATO AND VEGETABLE Dust

\$2.99

10-Oz. Duster

ORTHO

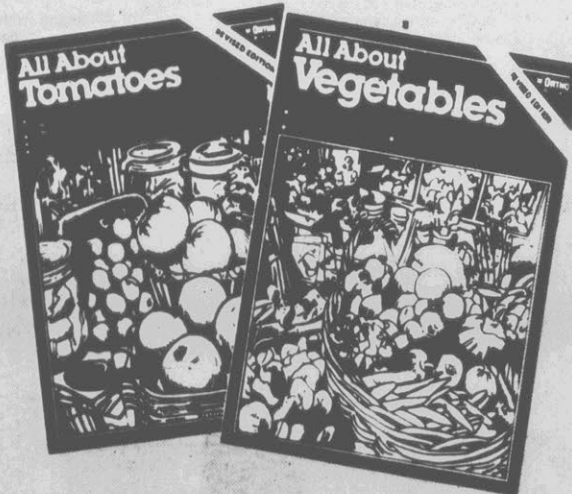

YOUR CHOICE
BIG 96-PAGE BOOK ALL ABOUT VEGETABLES OR

Tomatoes

\$4.95

Lb.



- Multi-use insecticide protects fruits and vegetables.
- Works fast.

ORTHO
INSECT SPRAY Diazinon

\$3.49

8-Oz. Btl.



- Controls wide range of insects on fruit trees, vegetables, ornamentals.

ORTHO
INSECT SPRAY Malathion

\$4.69

16-Oz. Btl.

DO-IT-YOURSELFERS!

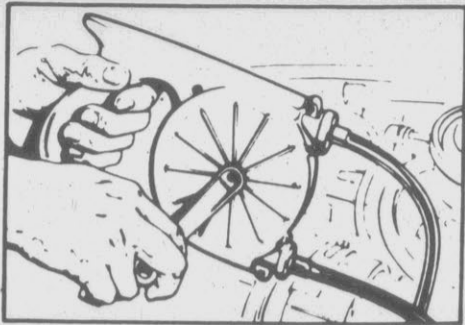
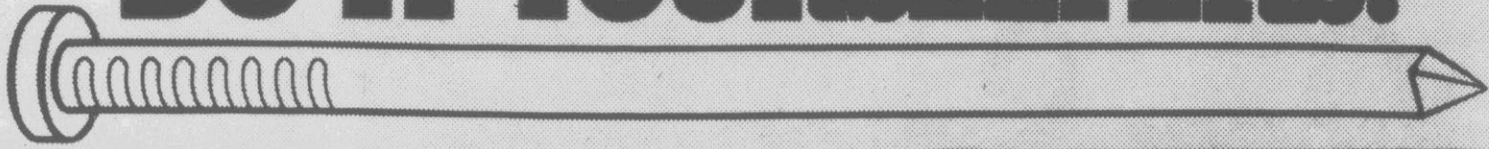
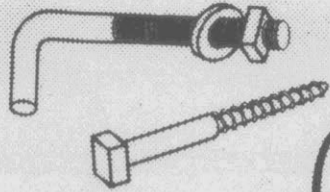

Black & Decker Jack Rabbit™ PUMP and SPRAYER

A multi-purpose hand pump for hundreds of household, auto, marine and farm uses. Take it anywhere-needs no electricity. Self-priming and easy to operate, pumps 1-2 gallons a minute. Comes with 7 ft. clear tubing, 3 ft. dip tube, 5 ft. intake hose, sprayer weight with screen, hose clamp and dip tube marker.

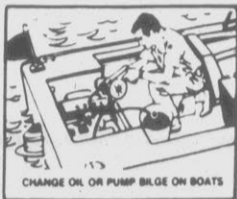

Model JSO-1500

\$9⁹⁹
Reg. \$14.99



Black & Decker POLISHING AND SANDING KIT

\$3⁹⁹ Model U1450

All you need for sanding and polishing with portable electric drills. Includes wheel arbor, backing pad, polishing bonnet, 6 assorted sanding discs.



Black & Decker PAINT MIXER

\$1⁶⁹ Model U1509

A highly efficient and fast way to mix paint. Stirs up to a gallon can. Fits most makes and sizes of power drills.

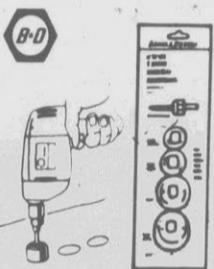

Black & Decker 5-PC. HOLE SAW ASSORTMENT

\$9⁹⁷ Model 71-120

Considerable saving over buying items separately. Includes 4 most used hole saws (1 1/2", 1", 2", 2 1/2" diameter) and mandrel with pilot bit. For wood and composition cutting.



Black & Decker ABRASIVE PAPER ASSORT.

Reg. \$1.19 **99¢** Pkg.

Open coat, aluminum oxide. For all platen-type power sanders using 3 1/2" x 9" abrasive paper. Assortment of 2 #60, 2 #100, 2 #150 grit.

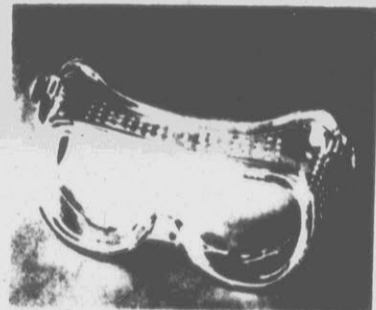

72-000

Black & Decker Safety Goggles

Only **\$2⁹⁹** Pr.

Protects eyes from flying particles. Distortion-free lens. Ventilated. Fits over person glasses. Complies with OSHA and ANSI standard Z87, 1-1979.



ORTHO

ORTHO
KLEENUP
systemic
Weed & Grass Killer

ORTHO WEED & GRASS KILLER

Ready to Use Kleenup

\$2⁹⁹
24-Oz. Btl. Reg. \$4.19

ORTHO WEED & GRASS KILLER Systemic Kleenup

\$4⁹⁹
1-Pt. Btl. Reg. \$6.49



Stops weed growth up to 1 yr.
Great for walks, patios, driveways, fence rows.

Fast knockdown of unwanted weeds and grasses.
Use around roses, shrubs, other plants.



ORTHO Vegetation Killer Triox

\$4¹⁹
1-Qt. Can Reg. \$5.59

ORTHO WEED & GRASS Spot Control

\$2⁸⁸
Reg. \$3.88 Aersol Can

SAVE BIG NOW!

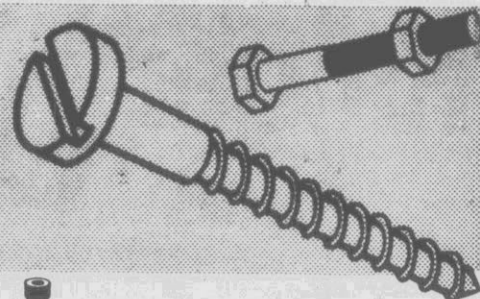

STANLEY
FAMOUS QUALITY TOOLS

YOUR CHOICE

10-99 Only **\$2.99** Each

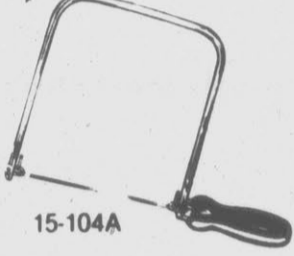

- UTILITY KNIFE
- POCKET KNIFE
- MINI SAW
- TRIM PLANE
- COPING SAW
- 8' TAPE RULE
- 5" TORPEDO LEVEL
- COMBO SQUARE
- CHALK LINE & REEL

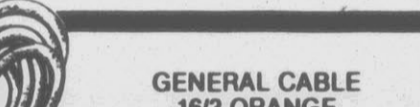
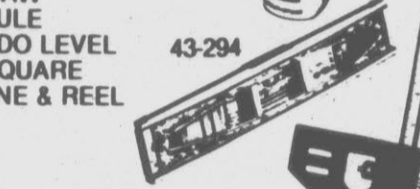

ELMERS CARPENTERS
Wood Glue
\$1.49
8-Oz. Btl.

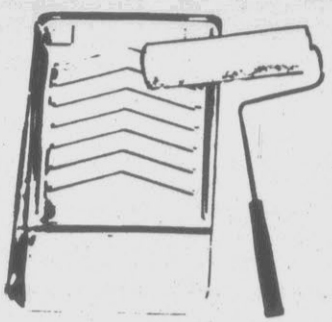

9" METAL PAN & Roller Set
\$1.99
Reg. \$2.69

ELMERS CAULKING GUN OR INDOOR/OUTDOOR WHITE
Latex Caulk
99¢
10.8-Oz. Tube



CLEAN SPRAY LUBRICATION
WD-40
\$1.29
9-Oz. Can

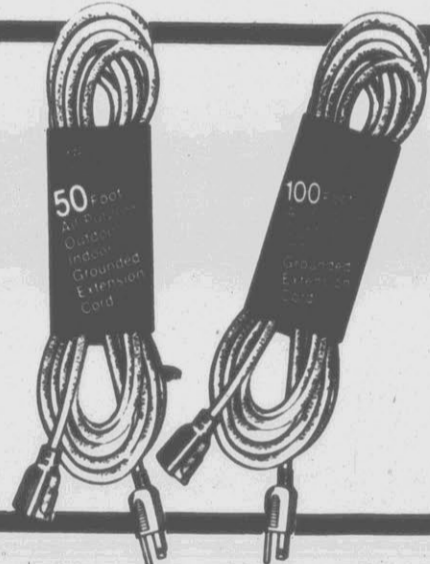

GENERAL CABLE 16/3 ORANGE INDOOR-OUTDOOR
50-Ft. Extension Cord
\$6.88
Reg. \$9.98
100-Ft. INDOOR/OUTDOOR Cord **\$12.99**

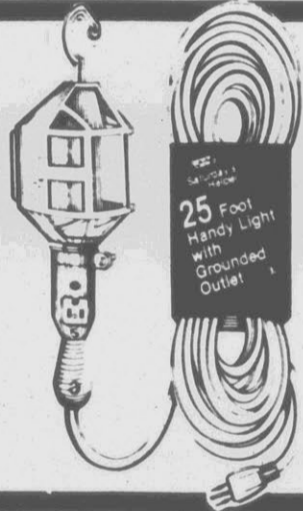

GENERAL CABLE 25 FT. 16/3 GROUNDED OUTLET
Handy Light
\$5.99
Reg. \$8.99



DURO PERFECT MATCH HOUSEHOLD VINYL
Repair Kit
\$4.99
Reg. \$6.99
Perfect repairs on torn vinyl and leather.



DURO
FIRST ADHESIVE OF ITS KIND
Depend Adhesive
\$1.88
Reg. \$2.29



DURO A DROP WILL DO! SUPER STRONG
Super Glue
\$1.19
3-Gr. Tube Reg. \$1.69



DURO SUPER GLUE
Remover
99¢
Reg. \$1.59

DURO DISSOLVES RUST QUICKLY, IMPROVED
Navel Jelly
\$1.79
8-Oz. Btl. Reg. \$2.49



Water resistant bonds on wood, metal, plastic, concrete...almost anything. BONDS ONCE & FOR ALL!

Removes all types of instant glues (cyanoacrylate) from skin, ceramics, glass, rubber, and most plastics.

Kroger Sav-on **PETERS**[®] soluble plant food



Ask 3 out of 4 professional growers about Peters[®] Plant Foods. You'll find that Peters[®] has a strong reputation for results. For strong, healthy growth. For beautiful blooms and foliage. The same results you want with your own house and garden plants. Now available in home-size packages, Peters[®] Plant Foods are easy to use. And the results will open your eyes. You'll never settle for an ordinary plant food again.

PETERS SOLUBLE
PLANT FOOD

20-20-20

Or

15-30-15

\$2.29

YOUR
CHOICE

1-Lb.
Pkg.

HARTZ



DOG OR CAT
FLEA & TICK
2-in 1 Collar
\$1.77

Reg.
\$3.29



HARTZ
LOVE YOUR DOG
Shampoo
\$1.99

12-Oz.
Btl.

Reg.
\$2.98

HARTZ
RID FLEA

Shampoo
\$1.99

12-Oz.
Btl.

Reg.
\$2.89



HARTZ
DOG OR CAT
2 in 1 Powder
\$1.37

4 1/2-Oz.
Can



HARTZ
DOGS OR CATS
**Flea & Tick
Dip**
\$2.99

12-Oz.
Btl.

HARTZ FOR DOGS
FLEA & TICK
Killer Spray
\$1.99

8-Oz.
Btl.

Reg.
\$2.98



HARTZ CREME
Shampoo
\$1.99

12-Oz.
Btl.

Reg.
\$2.98



HARTZ
FOR DOGS
Flea Soap
99¢

Reg.
\$1.59

JCPenney Fashion Carnival Sale



Suit yourself
to a tee. Eleven
summer-perfect
colors. Save 30%.

Sale 6.99 ea.

Reg. \$10. For those sunny days ahead. Look sensational and stay cool, too. In our T-shirt of soft poly/cotton with short sleeves and a flattering scoop neck. Choose from a rainbow of colors: bright blue, green, red, bright pink, light blue, yellow, light pink, lilac, khaki, navy and white. Misses sizes 8-20.

Skirt the issue
and save 41%.

Now 9.99 ea.

Orig. \$17. Here are three favorites, ready and waiting for a carefree summer. Choose our back-wrap style, split skirt or dirndl. All in cool poly/cotton. Summer colors to mix and match with tee shirts. Misses sizes 8-16.

Of course you can charge it



JCPenney



© 1982 JCPenney Co., Inc. S2W13

EVENT STARTS WEDNESDAY, APRIL 28 and ENDS SATURDAY, MAY 1
GREENVILLE, NORTH CAROLINA
PITT PLAZA

Shop 10:00am to 9:00pm Daily
Store Phone 756-1190 • Catalog Phone 756-2145
Advertising Supplement to THE DAILY REFLECTOR

Sun-sational dresses.
White to bright.
27% to 34% off
Sale 24.99

Reg. \$38. Beautiful misses jacketed sundresses, perfect for work or evening wear. Choose from three solid jacket styles and assorted colorful print dresses, all accented by a tie waist. Designed in easy care woven fabrics. Come in and see the selection awaiting you!



Sale 15.99

Reg. \$22. With summer around the corner, set your sights on this fabulous selection of spring sundresses. Choose from classic styling in assorted summer colors. Ruffle trim accents the season. Tie shoulder straps and elasticized tie-waist lends the casual feeling. Easy care fabric of polyester and cotton. Four electrifying looks for the snappiest sundresses this side of summer.



Save \$6
Take it from the top.

43% off
Sale 7.99

Orig. \$14. Just in time for summer. Misses casual tops of easy care lightweight poly/cotton, featuring a front flap pocket, notched collar and button cap sleeves. Available in a summertime array of eight fashion colors.



20% off on all boys and girls shorts and tops.

We've got styles for big and little boys and girls. Lots of terrific colors.

	Reg.	Sale
Big boys' athletic shirt	4.44	3.55
Athletic shorts big boys'	4.50	3.60
Big girls' tank top	4.50	3.60
Athletic shorts big girls'	4.50	3.60
Little girls' tank top	5.50	4.40
Cuffed shorts little girls'	5.00	3.99
Little boys' shirt	3.49	2.79
Camp short little boys'	5.00	3.99

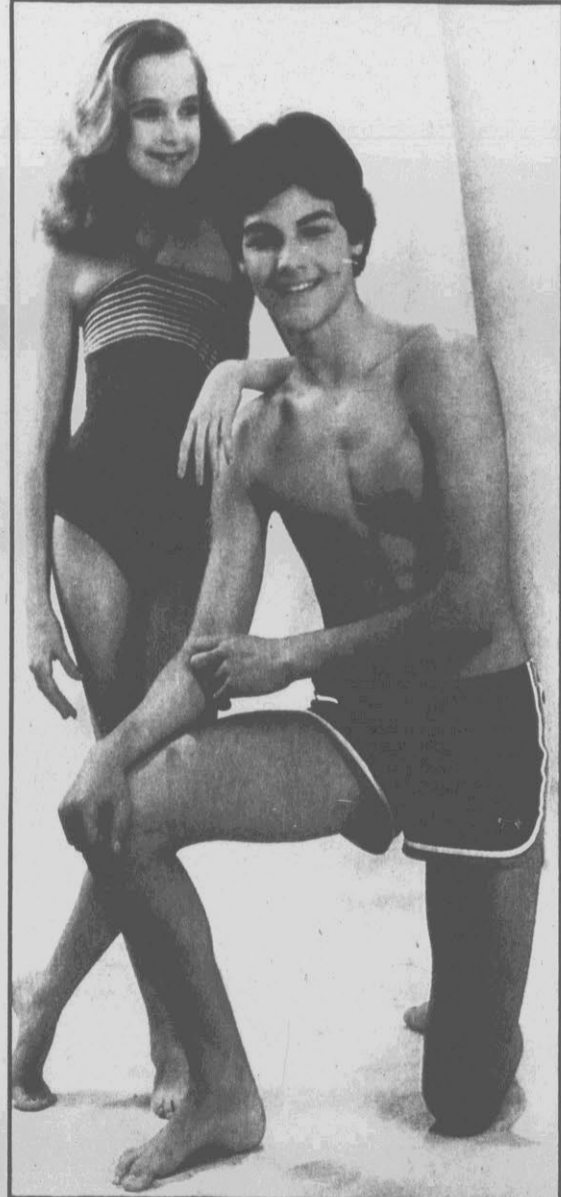

20% off on all boys' and girls' swimsuits.

Sale 8.80 Reg. \$11. Big girls' stripe-trim suit in 3 styles. Nylon/Lycra® spandex. Little girls' Strawberry Shortcake™ suit, (not shown), Reg. \$8 Sale 6.40

Sale 7.20 Reg. \$9. Big boys' Fox™ swim trunks. Double contrast trim. Elastic waist. Nylon supporter. Polyester/cotton. Little boys' Fox™ suit, Reg. \$8 Sale 6.40

Strawberry Shortcake™
© American Greetings Corp.

Fashion Carnival Sale



Novelty pants
and nautical tees.
28% to 40% off
Sale 17.99

Orig. \$25. Summer fashion means novelty pants in cotton and cotton blends. Choose from eight great styles in a rainbow of bright summer colors. Select several to complete your wardrobe. Junior sizes.

Sale 5.99

Orig. \$10. Junior nautical tee shirts go great with novelty pants. Several styles to choose from.



**Save
20%**
on all* junior,
misses' and
women's
skirts.

Fashion's the bottom line. Skirts to color-up your wardrobe. Choose from belted solids with fashion pleats, tropical multi-colored prints, button fronts, or a split fashion look. We've got the colors and textures to suit your style. At prices with a style of their own.

	Reg.	Sale
Twill hideaway	\$22	17.60
Print	\$20	16.00
Sailcloth split skirt	\$24	19.20
Split	\$20	16.00
Poplin button front	\$16	12.80
Dirndle step in	\$18	14.40

*Does not include skirts from coordinate groups or suits.

JCPenney

Fashion Carnival Sale

Mix 'n match
summer coordinates.

30 to 40% off

**Sale 19.99
to 41.99**



Orig. \$34 to \$60. Terrific savings on a simply stunning misses mix 'n match transitional coordinate group. The traditional famous maker group is of beautifully tailored easy care fabrics in colorations of grey and a black and purple floral print. The blazers are fully lined and have slash pockets. In misses sizes. 6 to 16.

	Orig.	Sale
Cardigan style blazer	\$60	41.99
Traditional blazer	\$60	41.99
Grey pant	\$34	19.99
Pleated print skirt	\$41	23.99
Ruffle print blouse	\$43	23.99
Solid dirndle skirt (not shown)	\$37	21.99



Save 20%
on juniors
seersucker
coordinates.
**Sale 13.60
to \$24**

Reg. \$17 to \$30. Be first in line at any summer outing in our group of blue seersucker, designed to look it's best during dress or casual affairs. A seersucker shortwaist jacket of woven polyester-and-cotton displays a contrasting white piping trim, white button front and sleeves, front pockets and pleated shoulders. The skirt has a fly front with a zipper and button closure and back split. The pleated walk shorts are cuffed and has side pockets, fly front with zipper and button, and contrasting red belt. The shortwaist button front white blouse has a round collar with red piping and red tie and has ruffled short sleeves. In junior sizes, 5 to 15.

	Reg.	Sale
Shortwaist jacket	\$30	24.00
Seersucker skirt	\$17	13.60
Seersucker walk short	\$18	14.40
White blouse	\$18	14.40
Seersucker pant (not shown)	\$20	16.00

JCPenney

Copyright 1982
Kroger Sav-on
Quantity Rights Reserved
None Sold to Dealers

Items and Prices
Effective Wed., April 28,
thru Sat., May 1, 1982
in Greenville

ADVERTISED ITEM POLICY
Each of these advertised items is required to be readily available for sale in each Kroger Sav-on, except as specifically noted in this ad. If we do run out of an item we will offer you your choice of a comparable item when available, reflecting the same savings or a raincheck which will entitle you to purchase the advertised item at the advertised price within 30 days.

Kroger Sav-on

Let's go Krogering COOKOUT SPECIALS



ASSORTED-CENTER
AND END CUT

Pork Chops

\$1.08

10-Lbs.
Or More Lb.

EMBERS
Charcoal
\$1.29
10-Lb. Bag



GWALTNEY
Great Dogs
88¢
1-Lb. Pkg.



KROGER ALL MEAT

Jumbo Dinner Franks Lb. **\$1.38**

OLDE VILLAGE REG.
OR POLISH

Smoked Sausage Lb. **\$2.08**

HOLLY FARMS CUT UP MIXED

Fryer Parts Lb. **58¢**

U.S. GOVT. INSPECTED
QUALITY CONTROLLED

Ground Beef Lb. **\$1.38**
A 5-LBS. OR MORE

¼ PORK LOIN CUT UP INTO

Pork Chops Lb. **\$1.68**

U.S.D.A. INSPECTED QUALITY
CONTROLLED GENUINE

Chopped Steak Lb. **\$1.88**

U.S.D.A. CHOICE "HEAVY"
WESTERN BEEF BONELESS
4-LBS. OR MORE (\$2.97 LB.)
SIRLOIN

Tip Steaks Lb. **\$1.18**
8-Oz. Avg. Wgt. Steaks

CENTER CUT BONELESS

Chuck Steak Lb. **\$1.98**

FRESH DOMESTIC
50-55 LB. AVG. WGT.

Whole Lamb
\$1.58
Lb.

CUT UP AND WRAPPED FREE
PLEASE ALLOW 5 DAYS FOR
PROCESSING

U.S. GOVT. INSPECTED
QUALITY CONTROLLED

Genuine
Ground Chuck
\$1.68
Lb.

ANY
SIZE
PKG.

CENTER CUT
Pork Steaks
\$1.28
Lb.

U.S.D.A. CHOICE "HEAVY"
WESTERN BEEF CENTER CUT
Boneless
Chuck Roast
\$1.88
Lb.

USDA
CHOICE



EXTRA LEAN
ROYAL SUPREME BUFFET

Dubuque Ham

\$7.68

4 Lb. Ham

SLICED
FREE!

VAC PAK
COUNTRY STYLE

Sliced Bacon Lb. **\$1.48**

RATH BLACK HAWK
Sliced Bacon Lb. **\$1.98**

SERVE 'N SAVE SLICED

Lunch Meat Lb. **\$1.28**
1-Lb. Pkg.

FRESH FROZEN PORK
Neck Bones Lb. **58¢**

RUDY FARMS
HOT OR MILD

Pork Sausage Lb. **\$1.88**

RATH HOT OR MILD
Pork Sausage Lb. **98¢**

FROZEN SEAFOOD

FRESHORE FROZEN Cod Fillet \$1.69 Lb.	FRESHORE BREADED Shrimp Shapes \$2.69 1-Lb. Pkg.
FRESHORE CRISPY CRUNCHY Fish Fillet \$1.69 1-Lb. Pkg.	Stuffed Clams \$2.69 30-Oz. Pkg.

NONE SOLD
TO
DEALERS

OPEN 8 AM TO MIDNIGHT

MON.
THRU
SAT.

OPEN SUNDAY
9 AM TO 9 PM

600 Greenville Blvd. — Greenville
Phone 756-7031

Kroger Sav-on

Copyright 1982
Kroger Sav-on
Quantity Rights Reserved
None Sold To Dealers

Let's go

TOTAL SATISFACTION GUARANTEE

Everything you buy at Kroger Sav-on is guaranteed for your total satisfaction regardless of manufacturer. If you are not satisfied, Kroger Sav-on will replace your item with the same brand or a comparable brand or refund your purchase price.



KROGER
Sandwich Bread
2 \$1.19
24-Oz. Loaves

TAB OR
Coca-Cola
\$1.09
2-Ltr. N.R. Btl.
SAVE 30¢

SPRINGDALE HOMOGENIZED
Whole Milk
\$1.79
Gal. Jug

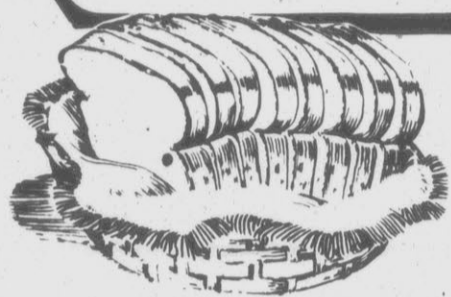

NEW! EXCLUSIVE AT KROGER SAV-ON

CHOCOLATE, VANILLA OR BANANA
Jello Pudding Pops
\$1.19
6-Ct. Pkg.

FREEZER PLEEZER CHOCOLATE, BUTTERSCOTCH OR STRAWBERRY
Pudding Time Bars
89¢
6-Ct. Pkg.



GRANULATED
Kroger Sugar
5 \$1.39
Lb. Bag

KROGER 1/2%
Lowfat Milk
\$1.59
Gal. Jug

TEA BAGS
Lipton Tea
\$1.99
100-Ct. Box

SALAD DRESSING
Miracle Whip
\$1.39
32-Oz. Jar

COST CUTTER
Long Grain Rice
\$1.19
5 Lb. Bag

INSTANT
Folgers Coffee
\$3.69
10-Oz. Jar

IN OIL OR WATER STARKIST LIGHT
Chunk Tuna
79¢
6 1/2-Oz. Can

INSTANT
Nestea Tea Mix
\$2.77
32-Oz. Cannister

CAKE MIX
Duncan Hines
79¢
18 1/2-Oz. Box

STOKELY CUT
Green Beans
39¢
16-Oz. Can

COST CUTTER
Plain or S.R. Flour
79¢
5 Lb. Bag

FRUIT DRINKS
Hawaiian Punch
69¢
46-Oz. Can

COST CUTTER
Vegetable Oil
\$1.29
38-Oz. Btl.

STOKELY WHOLE
Kernel Corn
2.88¢
17-Oz. Cans

AVONDALE
Pork 'n Beans
29¢
15 1/2-Oz. Can

KROGER
Catsup
79¢
32-Oz. Btl.

COST CUTTER
Apple Juice
\$1.19
64-Oz. Btl.

COST CUTTER
Paper Towels
49¢
Jumbo Roll

DUKE'S
Mayonnaise
99¢
32-Oz. Jar

SNACK CRACKERS
Kroger Zips
69¢
16-Oz. Box

DETERGENT
Cold Power
\$1.59
49-Oz. Box

STOKELY
Tomato Sauce
3.88¢
8-Oz. Can

NABISCO CHIPS A-HOY
Chocolate Chip Cookies
\$1.79
19-Oz. Bag

KROGER
Hamburger or Hotdog Buns
2 \$1.19
8-Ct. Pkgs.

CHAMP
Dog Food
\$2.99
25 Lb. Bag

LIQUID
Sunlight Detergent
\$1.29
22-Oz. Btl.

BIG K
Soft Drinks
79¢
2-Ltr. N.R. Btl.

KROGER WHOLE WHEAT OR
Cracked Wheat Bread
2 \$1.19
16-Oz. Loaves

BEER & WINE

REG OR LIGHT
Black Label Beer
12 \$3.08
12-Oz. Cans

BURGUNDY CHABLIS OR
Paul Masson Rose 3 Ltr. **\$7.15**

BURGUNDY CHABLIS RHINE OR
Cribari Mountain Rose 3 Ltr. **\$5.35**

WINE
Yago Sangria 3 Ltr. **\$1.99**

ANHEUSER BUSCH
Natural Light 12 Cans **\$4.39**

BIANCO, ROSATO OR
Cella Lambrusco
\$1.88
3/4 Ltr.

ZESTY SALAD TOPPERS

FRENCH, THOUSAND ISLAND, ITALIAN, LIQUID
Kroger Lite Salad Dressings
69¢
8-Oz. Btl.

TOASTED SEASONED, GARLIC, CHEESE OR
Salad Magic Kroger Croutons 6-Oz. Pkg. **69¢**

BACON, CHEESE, OR ONION
Kroger Garlic Buds 3 1/4 To 4-Oz. Jar **89¢**

KROGER
Salad Dressing 32-Oz. Jar **\$1.43**

KROGER
Salad Olives 9-Oz. Jar **99¢**

KROGER
Salad Seasoning 2 1/2-Oz. Jar **\$1.45**

FROZEN FOODS

KROGER
Natural Flavor Ice Cream
\$1.99
1/2-Gal. Ctn.

ASSORTED VARIETY
Banquet Pot Pies 3 8-Oz. Pkgs. **\$1.09**

KROGER
Apple Juice 16-Oz. Can **89¢**

ASSORTED VARIETY
Pet Ritz Cream Pies 14-Oz. Pkg. **75¢**

TURKEY, CHICKEN & DUMPLINGS OR SALISBURY STEAK
Kroger Easy Dinners 2 Lb. Pkg. **\$1.49**

CHOPPED BROCCOLI CORN OR
Kroger Peas 10-Oz. Boxes **2.89¢**

DAIRY FOODS

KROGER
Cottage Cheese
99¢
24-Oz. Cup

QUARTERS
Land O Lakes Margarine 1-Lb. Qtrs. **2 \$1.09**

EXTRA SHARP CHUNK
Kroger Cheddar Cheese Random Weight Lb. **\$2.49**

PILLBURY COUNTRY STYLE OR
Buttermilk Biscuits 6 4 1/2-Oz. Can **\$1**

KRAFT ASSORTED
Shredded Cheese 8-Oz. Bag **\$1.39**

COST CUTTER IMITATION INDIVIDUALLY WRAPPED SINGLES
Cheese Spread 12-Oz. Pkg. **99¢**

Krogering

CUSTOMER **HOT LINE**

Kroger Save-on

DO YOU HAVE A SUGGESTION— COMMENT, OR COMPLAINT? **CALL US** AND WE WILL ATTEND TO IT!

TOLL FREE NUMBER **1-800-532-0300**

for the Best of Everything including the Price

GIANT ENAMELED SUN YELLOW
Corn Pot
\$5⁸⁸
Reg. \$7.97



PLASTIC, WITH PRONGS
Corn Holders 6-Ct. Pkg. **59¢**

ZEBCO 808
POWERFULL, LINE FILLED
Spincast Reel
\$19⁸⁸
Reg. \$21.99



BASS BUSTER FAMOUS BEETLE
Spin Lures ... Ea **77¢**

4 cubic foot capacity
Long hardwood handles
16" pneumatic tire
Seamless steel tray



KELLY FARM/HOME
Wheelbarrow
\$38⁸⁸
Reg. \$54.99

SAVE \$16.11 OFF REG. PRICE

GIANT SERVING PLASTIC COLORS
Pitcher
\$1⁶⁶
Ea



PLASTIC ICE CUBE
Trays

MICRO-SERV
Food Tray
\$1⁹⁹
Only



2.88¢ Pack

KROGER 24" X 70" DELUXE
Chaise Lounge
\$8⁸⁸
Reg. \$10.99



MOORE #24550 5/8" X 50" VINYL
Garden Hose
\$4⁹⁹
Reg. \$5.69



MELNOR #69 OSCILLATING
Sprinkler
\$8⁷⁷
Reg. \$9.88



GROW GREEN DOMESTIC
Peat Moss
\$1⁴⁹
40-Lb Bag



MICROAIDES COOKWARE
Exclusively Designed For Microwave Ovens

- DURABLE
- LIGHTWEIGHT
- EASY TO CLEAN
- COOKS FASTER THAN GLASS OR CERAMIC



#13160

#13154 MICROAIDE Roaster	\$5⁸⁸	#13168 DIVIDED Vegetable Dish	\$5⁸⁸
#13150 ROUND Cook Tray	\$5⁸⁸	#13176 3-SECTION Tray	\$5⁸⁸
#13160 IN 1 Casserole	\$5⁸⁸	#13152 Bacon Rack	\$2⁹⁹
#13164 MUFFIN Egg Cooker	\$5⁸⁸		

Yard Care SPECIALS

TOMATO PLANT METAL SUPPORTS
Tomato Rings
2 \$3 For



GREEN PLASTIC 42" TALL, DISSASSEMBLES
Tomato Cage
\$3⁴⁴
Reg. \$4.29

TOMATO-PLANT SUPPORTS 8216

GROW GREEN Cow Manure
40 Lb Bag \$1⁷⁷



ASSORTED TROWELS, WEEDERS
Hand Tools
99¢ Ea



JOBE'S FERTILIZER
Tomato Spikes
99¢ Pkg

STERNS FOR TOMATOES
Miracle Grow
\$1²⁹
Reg. \$1.57



NO NEGATIVE! NO PROBLEM!
Prints from
Instant Prints
Regular Prints
Slides
Only 33¢ ea.



Offer good thru Saturday, May 1, 1982
LIMIT ONE WITH COUPON

Guaranteed Great Photo Services

Standard size only
Coupon must accompany order

FABRIC PROTECTOR
Scotch Gard
\$2⁹⁹
16-Oz. Can

TOILET BOWL DEODORANT
3 \$1 For

RAID PROFESSIONAL ANT & ROACH
Killer Spray
\$2⁹⁹
16-Oz. Can

RAID CRACK & CREVICE
Spray 16-Oz. Can **\$2⁹⁹**

RAID FLYING INSECT
Spray 12 1/4-Oz. Can **\$1⁹⁷**

PLAYTEX
Living Gloves
99¢
Reg. \$1.89

LIGHT & EASY
Sponge Mop
\$3⁸⁸
Reg. \$6.69

RAID WASP & HORNET
Spray
\$3⁹⁹
18-Oz. Can

RAID FLEA KILLER
Spray 16-Oz. Can **\$3⁴⁴**

DISCOUNT HEALTH & BEAUTY AIDS

ANTI-PERSPIRANT, 6-OZ. OR SUPER SPRAY, 8-OZ. Secret Spray \$2⁰⁹ Ea	REFRESHING SHAMPOO Pert \$1⁹⁷ 15-Oz. Btl.	LATHERING GEL FOR A CLOSER SHAVE Edge \$1³⁷ 7-Oz. Can	HAND & BODY LOTION Soft Sense \$1⁸⁷ 10-Oz. Btl.	CLAIROL HAIR SPRAY Clairmist \$1²⁹ 8-Oz. Btl.
MAXI-PADS REG. OR DEODORANT Stayfree \$2⁸⁷ 30-Ct. Box	60" OFF SHAMPOO OR CONDITIONER Agree \$1⁸⁷ 16-Oz. Btl.	DAYTIME DIAPERS, 60-CT. OR EXTRA ABSORBANT Comforts \$4⁶⁹ 48-Ct. Box	NATURES GLO COCOA BUTTER Lotion \$1¹⁹ 16-Oz. Btl.	K.F.P. REGULAR OR IRON MULTIPLE Vitamins \$1¹⁹ 100-Ct. Btl.
MINI-PADS Stayfree	30-Ct. Box \$2³⁷			

Kroger Pharmacy

Any questions on family health matters? Your Kroger pharmacist is available, accessible and informed.



Greenville
756-7393

DARK TANNING LOTION OR OIL
Hawaiian Tropic
\$3²⁹
8-Oz. Btl.

PROFESSIONAL TANNING OIL
Hawaiian Tropic 8-Oz. Btl. **\$4⁴⁹**

Discover the Kroger Garden

WHERE SERVING YOU COMES FIRST!



The Kroger Garden is full of delicious fruits and crisp fresh vegetables carefully selected by Kroger experts at their peak of flavor. Select one or a dozen from more than 150 varieties and if you need assistance the friendly Kroger Gardener is always available to help with recipes and offer serving suggestions.

FLORIDA
Yellow or White
Sweet Corn

15¢

IN HUSK EAR

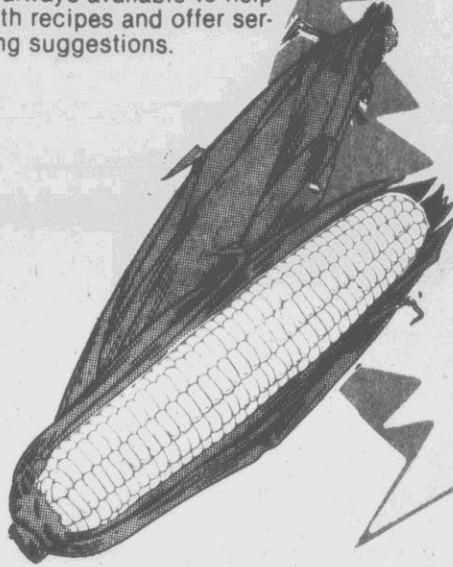

RED RIPE
California

Strawberries

\$1.38

Full Quart



SWEET RIPE
Cantaloupe

\$1.19

Ea.

RED RIPE
Watermelon

19¢

Lb.

US. NO. 1
Idaho Potatoes

10 \$2.39

Lb. Bag

WASHINGTON STATE
Red Delicious Apples

15¢

138-Size Each

PLUMP
Purple Eggplant . . . **2 \$1**

For

FRESH
Collard Greens . . . Bch. **49¢**

FRESH
Salad Size Tomatoes . Lb. **69¢**

CALIFORNIA
Tender Asparagus Lb. **\$1.29**

10 OZ. SIZE
Tropicana Fruit Drinks **3 \$1**

For



SALAD FIXIN'S

TENDER FRESH Boston Lettuce . . . **58¢**

Hd.

GREEN TOP Bunch Radishes

3 \$1

For

GREEN TOP Bunch Carrots **2 \$1**

For

PENCIL THIN Green Onions **3 \$1**

For

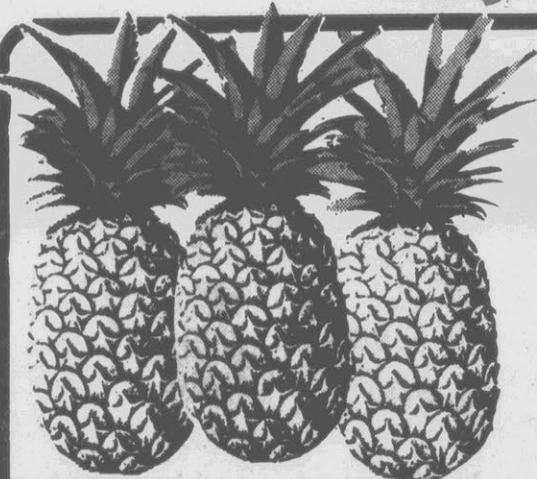

PLANTATION RIPE

Pineapple

\$1.19

Ea.

GRANNY SMITH Apples . Lb. **89¢**

IMPORTED Ribier Grapes . . . Lb. **\$1.49**

FRESH Kiwi Fruit . . . **2 \$1**

For

English Cucumbers **88¢**

Ea.



SWEET AND SOUR OR CREAMY
Cole Slaw

79¢

Lb.

EXTRA LEAN BAKED
Virginia Ham

\$3.29

Lb.

YELLOW OR WHITE
American Cheese

\$2.79

Lb.



8-INCH DOUBLE LAYER
Chocolate Mound Cake

\$3.89

Ea.

SAVE 40¢

RESTAURANT

ONE DOZEN DINNER ROLLS

FREE!

with purchase of 9-piece or more Fried Chicken

SAVE 99¢

INCLUDES MEAT, 2 VEGETABLES, ROLL & BUTTER

Daily Lunch Special . . . **\$1.99**



FRESH CHEESE OR
Pepperoni Pizzas

2 \$5

For

SAVE \$1.78

ALL WHITE MEAT
Gourmet Turkey Breast Lb. **\$3.19**

RUSSER Cooked Salami Lb. **\$2.19**

FRESH FRIED DAILY
Glazed Donuts

\$1.69

Doz.

SAVE 20¢

A DESSERT TREAT
Tahitian Salad Lb. **\$1.59**

Lb.

SLICED TO ORDER
J & J Bologna

\$1.69

Lb.

SAVE 30¢ Lb.

15%-30% OFF

Selected Readymade Draperies



Petit Plume rich jacquard Perma Prest® draperies are made of cotton and polyester. With acrylic foam backing for insulation. Reg. \$21.99.

Epic slub-textured draperies for a distinctive look. With acrylic foam back for insulation. Reg. \$26.99.

Chico lined openweave draperies are made of rayon, acetate, polyester and cotton. In a variety of colors. Reg. \$34.99.

14⁹⁹
50x84-in. pr.

18⁹⁹
48x84-in. pr.

24⁹⁹
48-84-in. pr.

Other sizes are also on sale

Sears Pricing Policy . . .
If an item is not described as reduced or a special purchase it is at its regular price. A special purchase, though not reduced, is an exceptional value.
Most items at reduced prices.

YOU CAN COUNT ON US FOR HOME AND FAMILY FASHIONS, APPLIANCES—FABULOUS VALUES ARE BLOOMING ALL THROUGH THE STORE

Sears

SPRING HOME SALE

SALE starts Wed., April 28, ends Sat., May 1, unless otherwise indicated

SAVE \$80

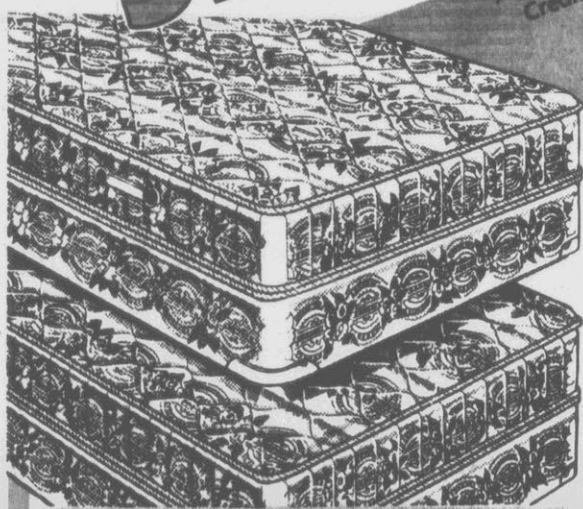

1/2 OFF

Sears Bedding

Regular \$199.99

Twin innerspring, polymeric foam mattress or box spring

99⁸⁸ ea. pc.

Sears-O-Pedic® Elegance bedding has 297-coil twin innerspring mattress or 6 1/2-in. polymeric foam mattress.

\$259.99 Full mattress or box spring 129.88

\$649.99 Queen size set 324.88

\$799.99 King size set 399.88

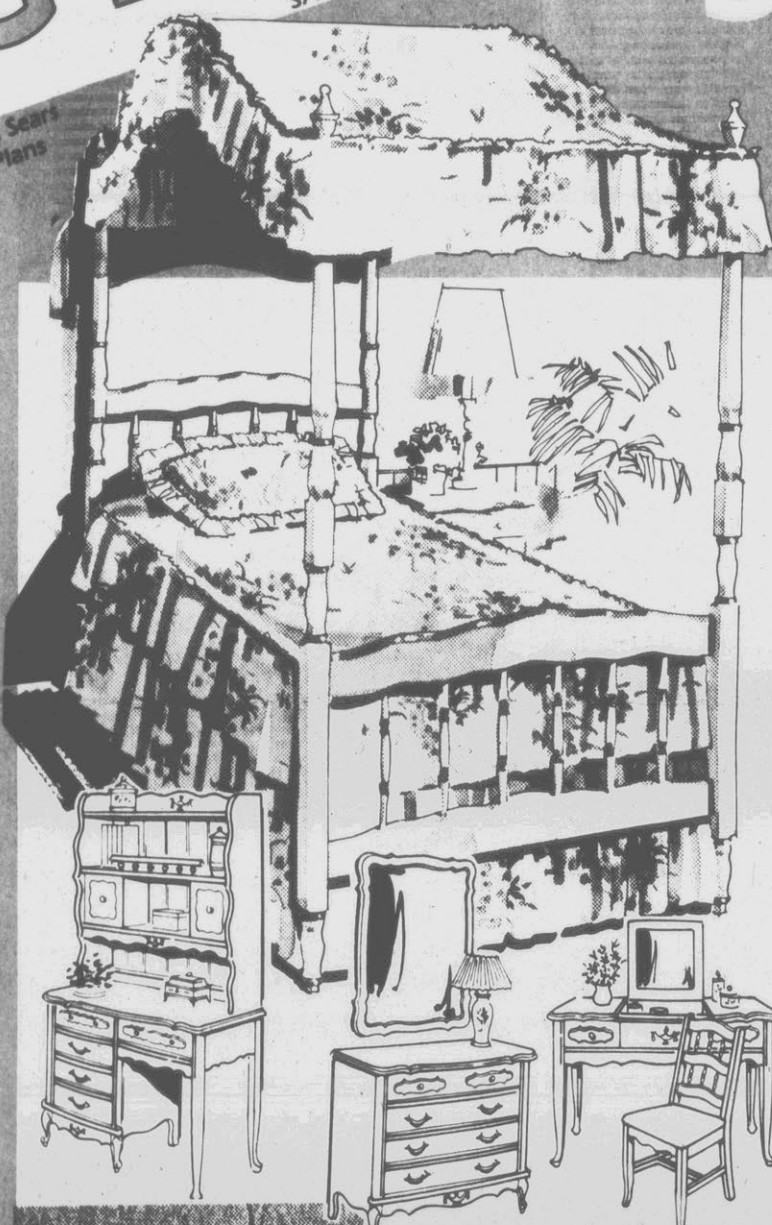

Bonnet twin canopy bed with rails and frame . . .

Reg. \$179.99

99⁸⁸

Bonnet canopy bed has the authentic look of French Provincial styling that everyone loves. Delicate gold-color detailing with plastic laminated tops and an antique white finish. Save during our Spring Home Sale.

SAVE \$20 - \$30 on Matching Pieces

\$169.99 Hutch 149.88
\$179.99 Poudre Table 149.88
\$179.99 Dresser 149.88
\$179.99 Student desk 149.88

Mirror, chair and nightstand extra

Furniture and Bedding not available in High Point, Greenville, Rocky Mount, NC

SPECIAL PURCHASE sculptured carpet with these important performance and quality features found in our more expensive \$24.99 a sq. yd. Andrea Supreme carpet

SPECIAL ANDREA SUPREME

12⁹⁹ sq. yd.

- Both carpets have 54 oz. per sq. yd. of Premium Soil Resistant Nylon pile
- Both carpets have the same delicately sculptured nylon pile texture that stands up to wear
- Both carpets are treated with Scotchgard® Brand Carpet Protector
- Special Andrea Supreme carpet is available in 8 multicolors

While Quantities Last

cushion and installation available

Not available in Rocky Mount and Greenville, NC

Delivery not included in selling prices of all items in this circular

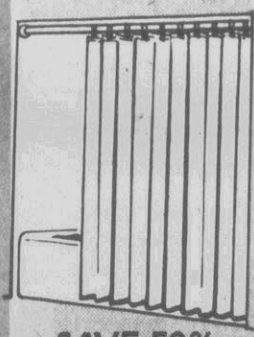

SAVE 50% Shower Curtain

Reg. \$3.99 **1⁹⁹**

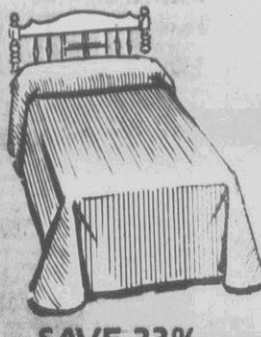

SAVE 23% Toughcord® Bedspreads

Reg. \$16.99 **12⁹⁹** twin

Other sizes on sale

Limit 6 Pkgs.

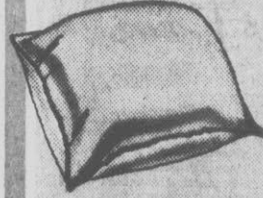

SAVE 50% Polyester-filled pillow

Reg. \$3.49 **1⁶⁹**

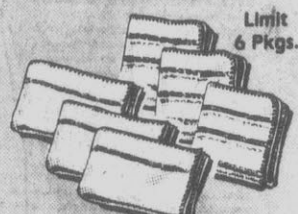

SAVE 50% YOUR CHOICE

Reg. \$1.99 Pkg. of 3 **99[¢]**

Choice of dish towel or dishcloth.

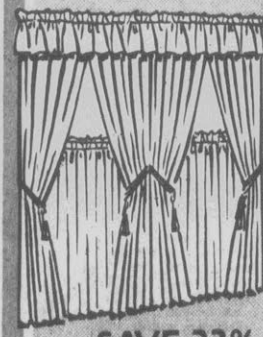

SAVE 33% Spindrift Panels

Reg. \$5.99 40 x 81-in. **3⁹⁹**



30%-33% OFF Ceramic Lamps

Reg. \$49.99 to \$59.99 **34⁹⁹-39⁹⁹**

Available in larger stores

You can count on

Sears

Satisfaction Guaranteed or Your Money Back

SHOP YOUR NEAREST SEARS RETAIL STORE

N.C.: Burlington, Charlotte, Concord, Durham, Fayetteville, Gastonia, Goldsboro, Greensboro, Greenville, Hickory, High Point, Jacksonville, Raleigh, Rocky Mount, Wilmington, Winston-Salem.
S.C.: Columbia, Florence, Myrtle Beach, Rock Hill
VA.: Danville, Lynchburg, Roanoke



**SAVE
25%**

Sporty yet feminine
... Misses' sportswear
that plays it pretty

SAVE \$5
Jeans
Regular \$18

12⁹⁹

You'll love these all-cotton navy denim jeans with fancy back pocket stitchery. They are sporty, yet feminine.

SAVE \$3
Shorts, tops
Regular \$12

8⁹⁹
each

Choose these easy-care all-cotton navy denim shorts with fancy pockets and team with white polyester and cotton knit top trimmed in multi-color embroidery.



**SAVE
25%**

Misses' Long
and Short
Terry Coverups

SAVE \$5
Regular \$18

13⁴⁹

Great for lounging around the house. Choose either short or long styles in polyester and cotton. Shop early for good selection of sizes and colors, during our Spring Home Sale.

4 Mini-terry wrap in assorted colors 10.49
6 Knee-length wrap in solids 11.99

Ask about Sears Credit Plans



**Kids' Play Wear
for Under \$2**

SAVE 32%
Reg. \$2.49
For Little Kids

1⁶⁷
each

SAVE 34%
Reg. \$2.99
For Big Boys

1⁹⁷
each

Sporty athletic looks, fashion styles and more. Tops and shorts in sizes for infants, toddlers and little boys and girls, and big boys. Stock up now at this great price.

SAVE 34%
Kids' Sport Socks

Regular \$2.99

1⁹⁷
pkg.

Package of 4 pair of sport tube socks for big boys. At this great price you'll want to stock up for the summer and save.

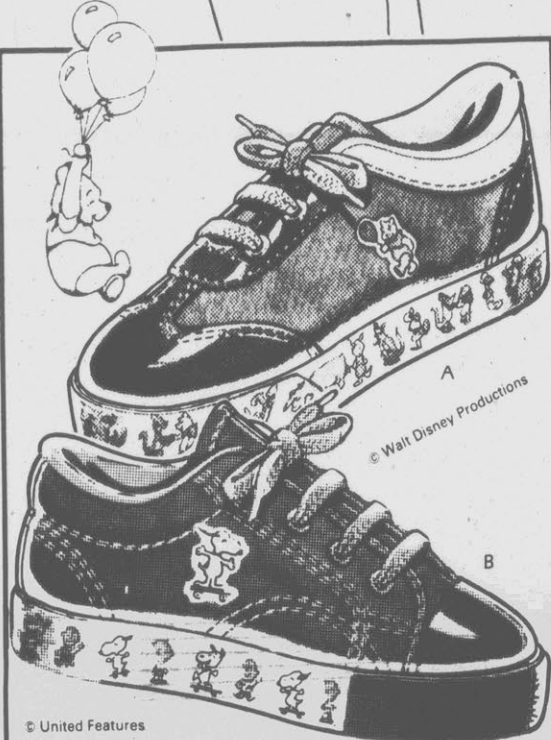

© United Features
Syndicate, Inc.

SAVE \$2

Kids' Casual Play Shoes

Your Choice
Regular \$10.99

8⁹⁹
pr.

A. Winnie-the-Pooh oxford. With molded rubber sole and toe guard. Winnie-the-Pooh character on side and sole. 5-12 M.

B. Snoopy emblem oxford. Sturdy fabric upper with rubber sole and toe guard.



**SPECIAL PURCHASE
Big Girls' Play Wear**

Special Purchase
ONLY

1⁹⁷

Stock up on shorts, tank tops, tube tops and midriiffs for big girls. Assorted styles, colors.

While Quantities Last

\$60 OFF

Gamefisher® Jon Boat



11½-ft. Car-Top Jon Boat
Regular \$359.99
299⁹⁹

Gamefisher aluminum jon boat fits easily on car top. 3 seats with built-in flotation. 355-lbs. maximum weight capacity.
\$399.99 13½-ft. Jon Boat 349.99

SAVE \$30 Gamefisher® 3.0-HP Motor
Regular \$329.99
299⁹⁹

Compact, lightweight Gamefisher motor stores and transports easily. And it's corrosion resistant. Don't miss this savings.

SAVE \$60 Gamefisher® 5.0-HP Motor
Regular \$499.99
439⁹⁹

Gamefisher motor has energy-saving loop design, twist-grip throttle, Troll-Control for "hands off" trolling.

Ask about Sears Credit Plans

BIG BUY Gamefisher® Spincast Rod and Reel

2-piece, 6-foot rod. Spincast reel has 2.5 to 1 gear ratio. Line capacity is 80 yards, 12-lb. test (included).

Sears Price
21⁹⁹

Gamefisher® Spinning Rod and Reel

Spinning reel has 4.8 to 1 gear ratio. Line capacity: 230 yards, 8-lb. test (not included). 2-piece, 6½-ft. rod.

Sears Price
21⁹⁹

SAVE \$20
Gamefisher® Baltcast Reel
Regular \$59.99 **39⁹⁹**
Line cap.: 180 yds., 8-lb. (line extra).

SAVE \$8
Gamefisher® Baltcast Rod
Regular \$32.99 **24⁹⁹**
Graphite/fiber glass 1-pc., 5½-ft. rod.

SAVE \$4
Polypropylene Tackle Box
Regular \$14.99 **10⁹⁹**
3 tiers, 23 compartments.

FISHING TACKLE SPECTACULAR

TACKLE VALUES

- A. Bush Hog Spinner Bait with hammered nickel blade . . . 1.39
- B. Culpit Worm, the original split color shad worm 2.79
- C. Bass Buster Pack for all game fish 5.29
- D. Bomber Smilin' Minno . . . 1.99
- E. Uncle Josh Pork Rind . . . 1.19
- F. Garland Mini Jigs 79¢
- G. Fisherman's Pliers with Sheath 2.99

Round Cricket Box
Sears Price **1⁷⁹**
Plastic top and bottom, 6x6-inch size.

Wire Fish Basket
Sears Price **2⁹⁹**
13½x18-in. anodized wire basket. 5/8-in. wire mesh.

Minnow Bucket
Sears Price **5⁶⁹**
Metal outer bucket, perforated inner liner. 10-qt. capacity.

Bamboo Pole
Sears Price **99¢**
Aluminum rolled edge slip ferrules. Mahogany finish. Rod, Reel, Jig Combo **9.99**

SAVE \$30 Winnie-the-Pooh 6-Leg Gym Set
Includes 2 swings, glide ride and 2-passenger lawn swing. 6-foot galvanized slide.
Regular \$159.99
129⁹⁹

\$50 OFF 4-Leg Gym Galvanized to Resist Rust
2-inch tubular steel frame. 6-foot attached galvanized slide. SAVE \$50.
'81 Toy Cat. \$139.99
89⁹⁹

Sears

SAVE 25% Men's Branded Denims



SAVE \$3.50 to \$4.50 Thumbs-up™
Regular \$12.99 to \$16.99
9.49 to 12.49 pair
Western style in your choice of cotton or cotton and polyester. Jeans and Mature fit.

SAVE \$5 to \$7.51 Flexjeans™
Regular \$18.99 to \$29
13.99 to 21.49 pair
Jeans for all occasions. You'll find our Flexjeans™ of cotton and nylon in several styles. Jeans and Mature fit.



SAVE \$5 to \$5.50 Roebucks®
Unwashed, Reg. \$16.99
11.99 pair
Washed, Reg. \$18.99
13.49 pair
100% cotton denim jeans have authentic five-pocket western styling with riveted stress points.

SAVE \$5.50 Wranglers®
Regular \$18.99
13.49 pair
A name that means quality. Authentic western style, five pocket jeans of 100% cotton.

SAVE 25% Men's Fashion Underwear

YOUR CHOICE
Reg. \$3.49 **2.59** each

Great-looking underwear in an assortment of fabrics, solids and patterns. Choose bikinis, lower rise, briefs and trim cut boxer styles.

In Our Men's Store

NATIONAL PAINT WEEK SALE

SAVE \$3 to \$7

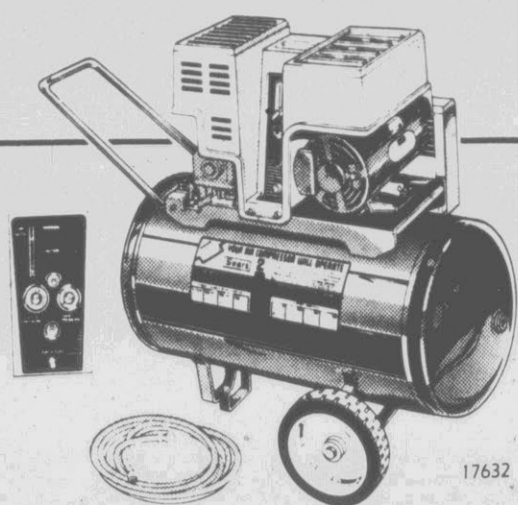

17632

SAVE \$180
2-HP Air Compressor

449⁹⁹

Reg. \$629.99

Delivers 9.0 SCFM at 40 PSI, 125 PSI max. Has 20-gal. ASME air tank and safety valve, 15-ft. air hose, tire chuck, regulator and gauges. Safety-shrouded. Save during our Spring Home Sale.

\$15-\$20 OFF
Sturdy Aluminum
Extension Ladders

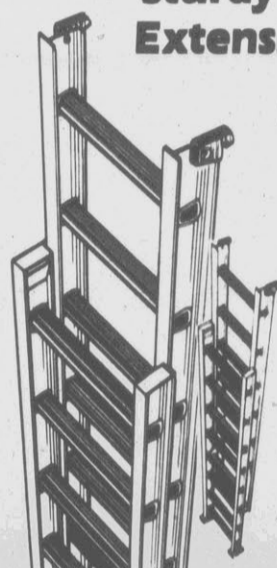

\$64.99, 16-ft. total.
13-ft. max. working length

49⁹⁹

\$84.99, 20-ft. total.
17-ft. max. working length

64⁹⁹

Ideal for most household jobs. Tested for maximum strength. Flat rungs with safety treads.

\$20 OFF
CRAFTSMAN®
1-HP Electric
Edger-Trimmer

Reg. \$89.99

69⁹⁹

Heavy-duty motor. Dynamic brake stops blade within seconds. Double-insulated.

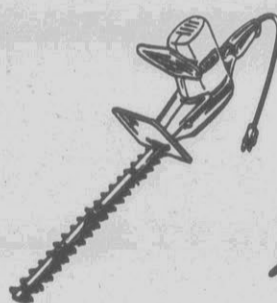
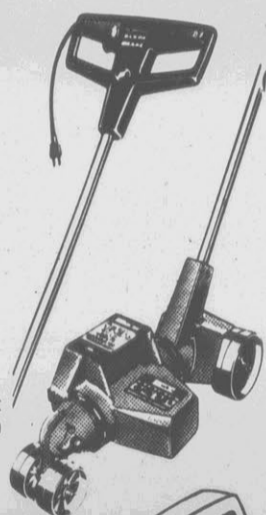

SAVE \$3
Bushwacker®

Reg. \$29.99

26⁹⁹

Double-edge 60-tooth hedge trimmer, 16-in. long. Save.

SAVE \$7
Cordless Shears

Reg. \$26.99

19⁹⁹

Craftsman rechargeable electric grass shears.



SAVE \$5
Garden Hose

Reg. \$19.99

14⁹⁹

Sturdy nylon, 5/8-in. x 50-ft. \$29.99 Garden Hose, 5/8-in. x 75-ft. 19.99

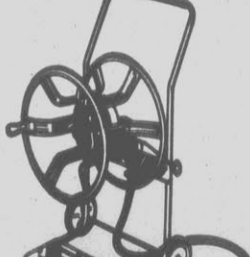

SAVE \$10
Garden Hose Reel

Reg. \$39.99

29⁹⁹

Holds 200-ft., 1/2-in. or 150-ft., 5/8-in. hose.

**Our Summer Catalog
is Your
Fair Weather Friend**

Great selection of sports and recreational equipment. Loads of lawn and garden items. 10 pages of Cheryl Tiegs sportswear . . . and lots more

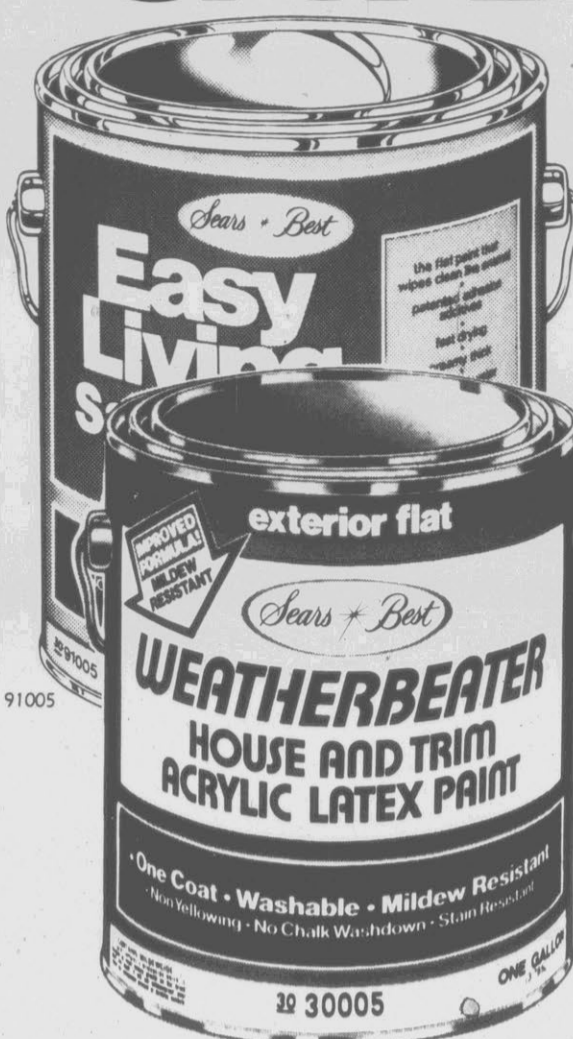

**SAVE \$6 on Easy Living
Satin Flat Interior Latex**

Reg. \$15.99

9⁹⁹
Gallon

Sears Best interior latex gives you washable one-coat coverage in 23 color-fast shades. Soap and water clean-up. \$16.99 Semi-Gloss Easy Living 11.99

**SAVE \$7 on Weatherbeater
Exterior Latex Paint**

Reg. \$16.99

9⁹⁹
Gallon

Our best exterior flat latex is mildew-resistant. Choose from 50 non-yellowing one-coat colors. Save during Sears National Paint Week.

For one-coat coverage, all Sears paints must be applied as directed.

1/2 PRICE

**Sears One-Coat
Latex Paint**

Regular \$9.99

4⁹⁹

Flat or ceiling white, our low-price interior latex covers in one coat. It's washable and cleans up with soap and water. Paint and save.

\$10.99 Semi-Gloss Latex . . . 5.49



54005

**SAVE
\$3**

**Latex Porch
and Floor Paint**

Reg. \$14.99
Washable one-coat coverage in 15 long-wearing colors.

SAVE \$40-\$70
on these Craftsman® Mowers

SAVE \$50

20-in. Eager-1® Mower

Regular \$249.99

199⁹⁹

4-RP Craftsman mower features solid-state electronic ignition, and quick cutting-height adjusters. 20-in. cut.

SAVE \$70
Propelled Eager-1 Mower

Regular \$329.99

259⁹⁹

Front-wheel gear drive for easier rolling. 4.0-RP engine with solid-state ignition and 22-inch cut.

SAVE \$40
Rear-Bag Propelled Mower

Regular \$279.99

239⁹⁹

Solid-state ignition with gear-assist starter. Front wheel cog drive. Quick height adjusters. 3.5-RP, 20-in. cut.

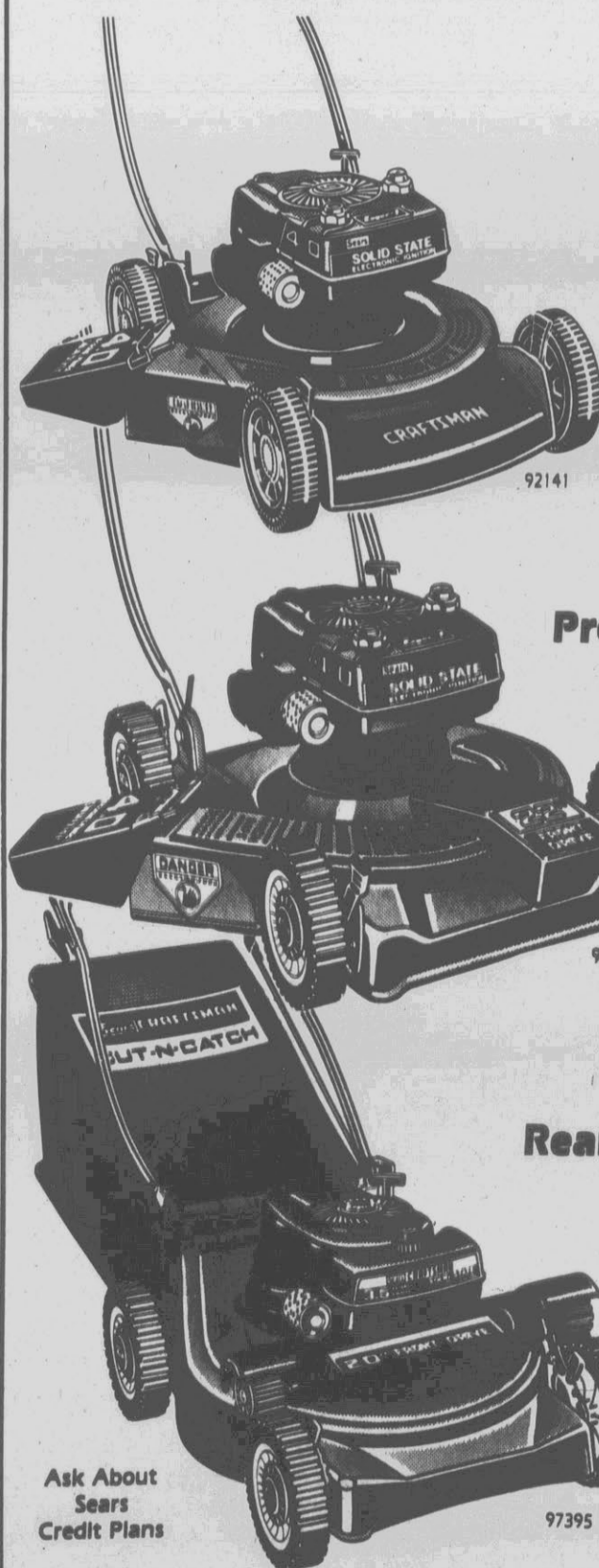

Ask About
Sears
Credit Plans

97395

Delivery is not included in selling prices

Sears

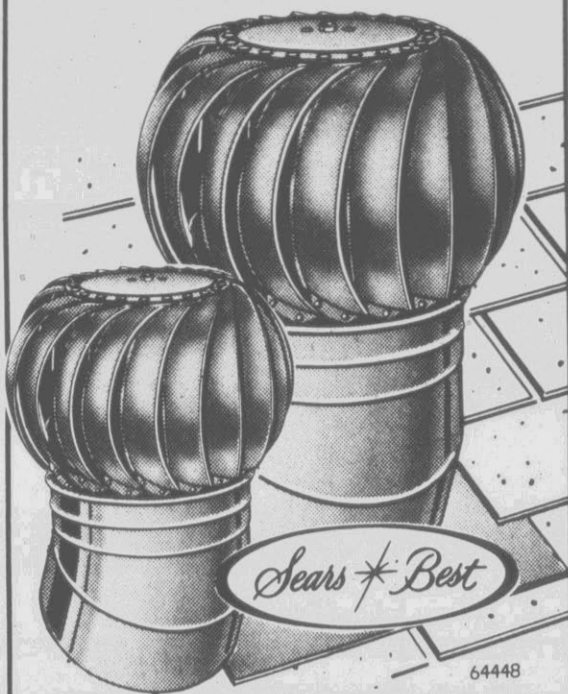

Sears * Best

64448

SAVE ENERGY — SAVE ON HOME COOLING COST
Sears Best Turbine Roof Ventilators

TWO INSTALLED FOR ONLY

86⁸⁸

Lowered attic temperatures help cut through-the-ceiling heat gain so the load on an air conditioning system is reduced. Wind-powered, no operating costs. Rust-resistant aluminum construction. Installed on single story roof of normal construction within 15 mile radius of Sears retail store.



SAVE \$50

64820

2-speed Whole-house Fan
 Regular \$209.99

Moves up to 3460 CFM to circulate air. Includes white ceiling shutter.

159⁹⁹

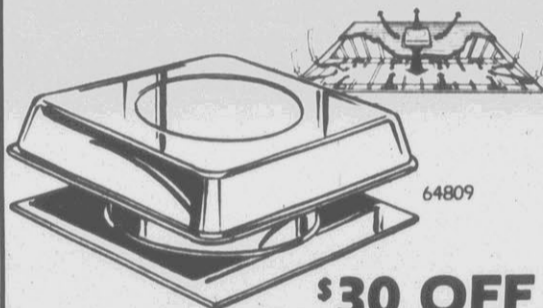

64809

\$30 OFF

1860 CFM Attic Ventilator
 Regular \$129.99

Large 14-in. blades. Aluminum and steel construction. Adjustable thermostat. Vents up to 2310 sq. ft. Save \$30.

99⁹⁹

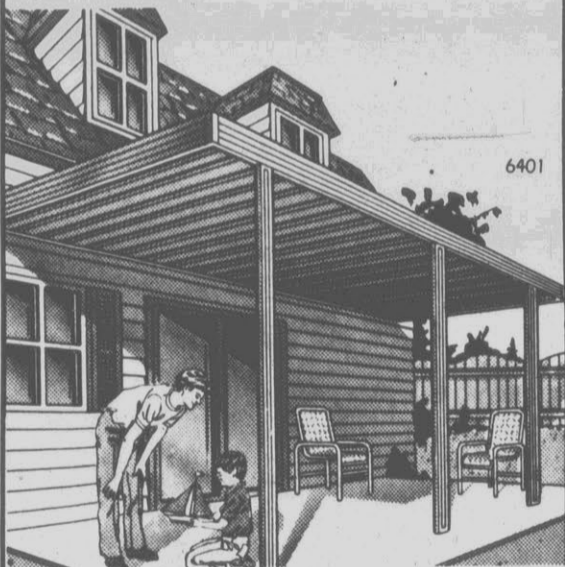

6401

SAVE \$50 8 x 16-ft. "Ready-Made" Patio Cover
 Regular \$239.99

189⁹⁹

SALE ENDS SATURDAY

Provides 128 sq. ft. of space. Structurally shaped natural finished roof panels. Professional installation is available.
 \$339.99, 10x20-ft. cover, #64015 289.99

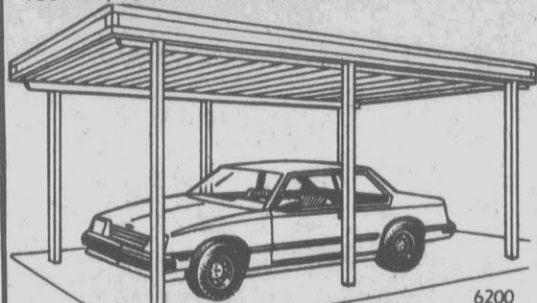

6200

SAVE \$50, 10x20-ft. Free-Standing Carport

Helps keep car looking new by protecting it from harmful rays of the sun. Durable 6-post construction. Unassembled.

349⁹⁹
 Regular \$399.99

SAVE \$200

On Every Size of Kenmore "7" Central Air Conditioner



WE SERVICE WHAT WE SELL — NATIONWIDE

Sears * Best

81781

Do you have a central air conditioner that's old, inefficient and failing? Install this energy-efficient, dependable whole house cooling system to help shut out noise and harmful air pollutants. Professional installation available by Sears authorized installers. Free estimates. Thermostat, refrigerant tubing, installation extra. Save \$200.

22,800 BTUH Unit, Regular \$1249

\$1049

with "A" cooling coil

Ask about Sears Credit Plans

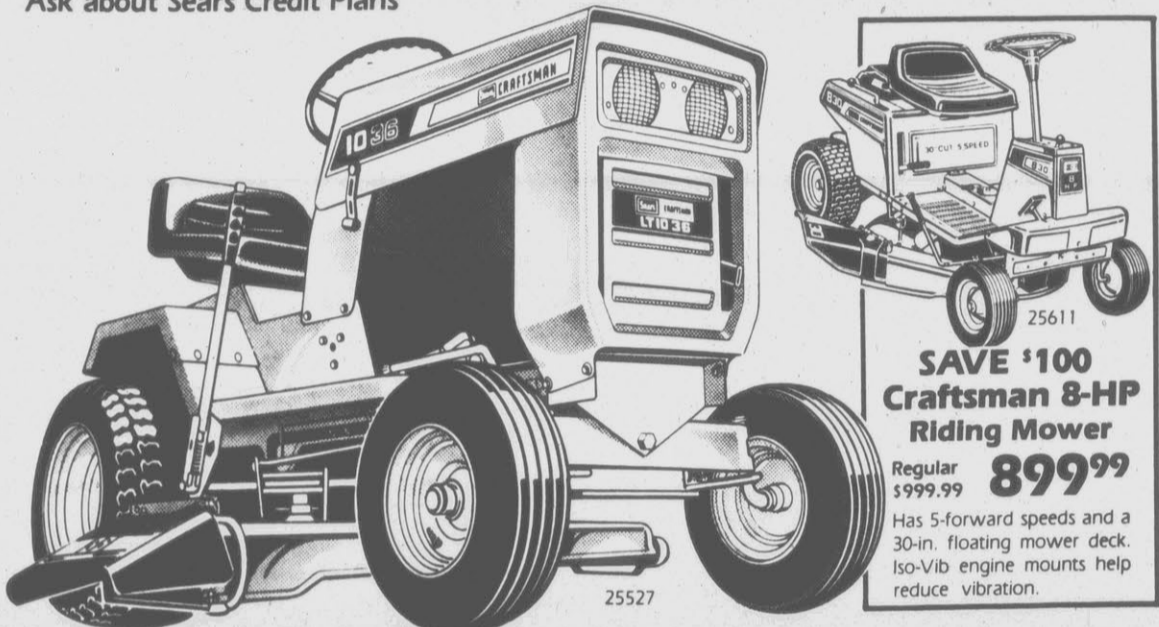

25611

SAVE \$100 Craftsman 8-HP Riding Mower

Regular \$999.99 **899⁹⁹**

Has 5-forward speeds and a 30-in. floating mower deck. Iso-Vib engine mounts help reduce vibration.

SAVE \$100 POWERFUL 10-HP Lawn Tractor

1049⁹⁹
 Regular \$1149.99

Save Big on this 10-HP lawn tractor with 3 forward speeds plus reverse. 36-in. mower deck floats over your lawn to help prevent scalping. With Iso-Vib engine mounts. Save \$100.

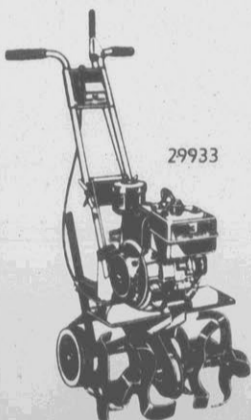

29933

SAVE \$20

3-HP Chain Drive Tiller
 Reg. \$309.99

289⁹⁹

Chain drive front tine tiller. Partially assembled. A great Sears value. Save today.



29936

SAVE \$60

6-HP Chain Drive Tiller
 Reg. \$459.99

399⁹⁹

Has 1 forward speed plus reverse. Digs 12, 22 and 24-in. path. Partially assembled.

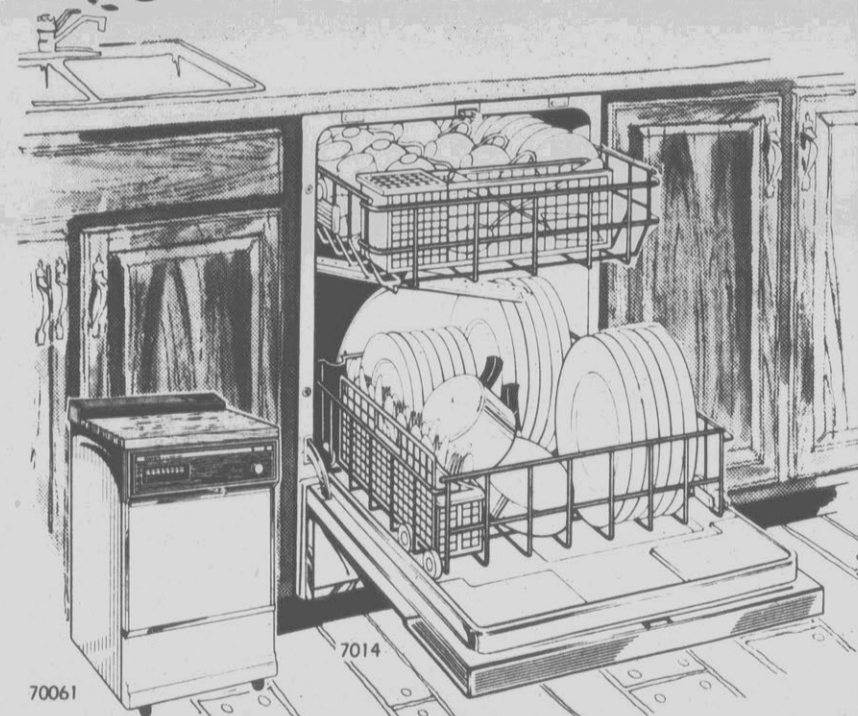

70061

7014

SAVE \$100 on Kenmore Dishwasher with 3-Level Wash Action

Built-in Reg. \$449.95

349⁹⁵

Portable Reg. \$489.95

389⁹⁵

Make kitchen work easy with this efficient dishwasher. The Water Miser cycle uses 20% less hot water than our normal wash cycle. Reversible color panels for choice of 5 colors in undercounter model. Normal replacement charge for built-in . . . \$70. Installation is available.

Each of these advertised items is readily available for sale as advertised

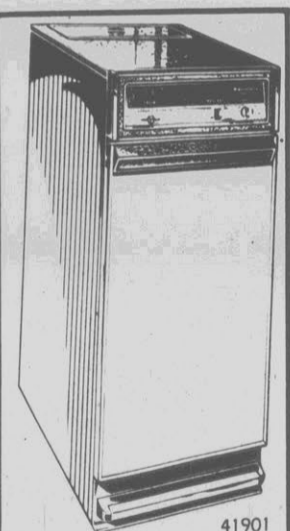

41901

SAVE \$60, Sears Best Kenmore Compactor

Regular \$389.95 **329⁹⁵**



6653

SAVE \$15 1/2-HP Disposer

Regular \$89.99 **74⁹⁹**

Stop-by Our Catalog Desk and Take a Look at Our New Boating & Fishing Speciality Catalog
 • Terrific buys on boating and fishing equipment

SPRING HOME SALE

Sears

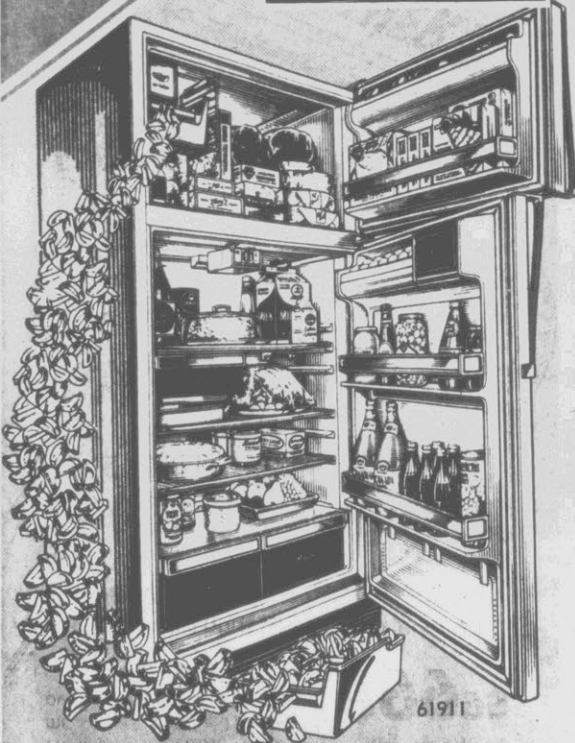

61911

SAVE \$150!

19.0 cu. ft. ICEMAKER Refrigerator

Features a large fresh food section with twin crispers and a large freezer with convenient icemaker. Icemaker hook-up is optional.

Reg. \$749.95

599⁹⁵



60021

SAVE \$100
19.0 cu. ft. Side-by-Side

Regular \$699.95
599⁹⁵
Frost-free. Has a 12.71 cu. ft. fresh food section and a 5.35 cu. ft. freezer.

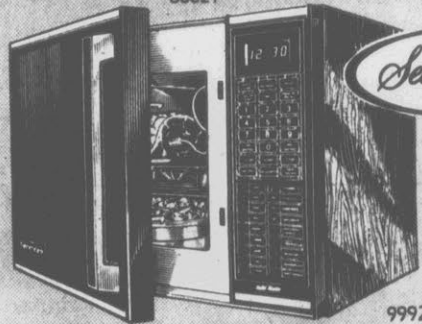

*Sears * Best*

99921

SAVE \$150 Microwave Oven with 3-Stage Memory

18 speed keys, 80 recipes, programmed defrost, wholemeal cooking. 1.4 cu. ft. oven.

Reg. \$649.95

499⁹⁵



99721

SAVE \$150 Microwave Oven with 2-Stage Memory

Programmed defrost, wholemeal cooking, probe. 1.4 cu. ft. oven. Convenient and fast.

Reg. \$549.95

399⁹⁵

Ask about Sears Credit Plans

SEARS SUPER VALUE

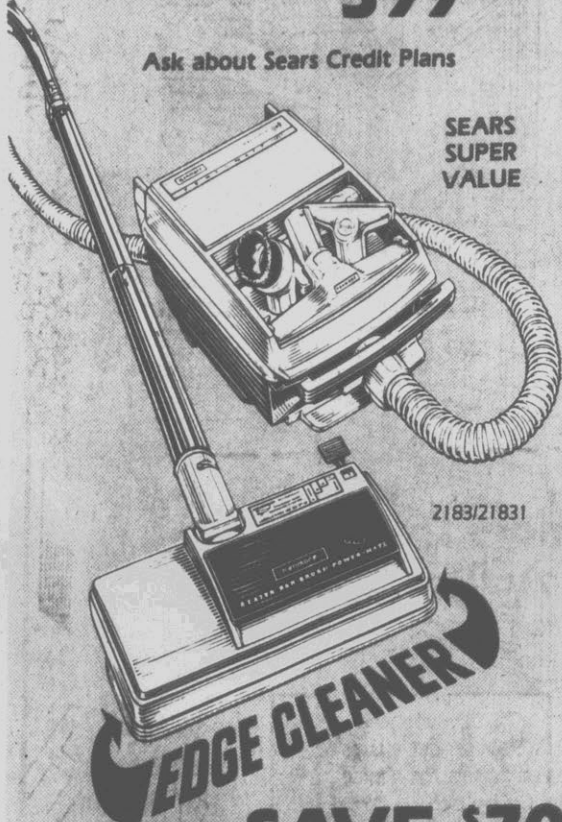

2183/21831

SAVE \$70

Power-Mate® Canister Vac

A powerful vacuum with Power-Mate to help get deep-down dirt and edge-cleaning.

Reg. \$229.95

159⁹⁵

\$50 OFF THIS PAIR

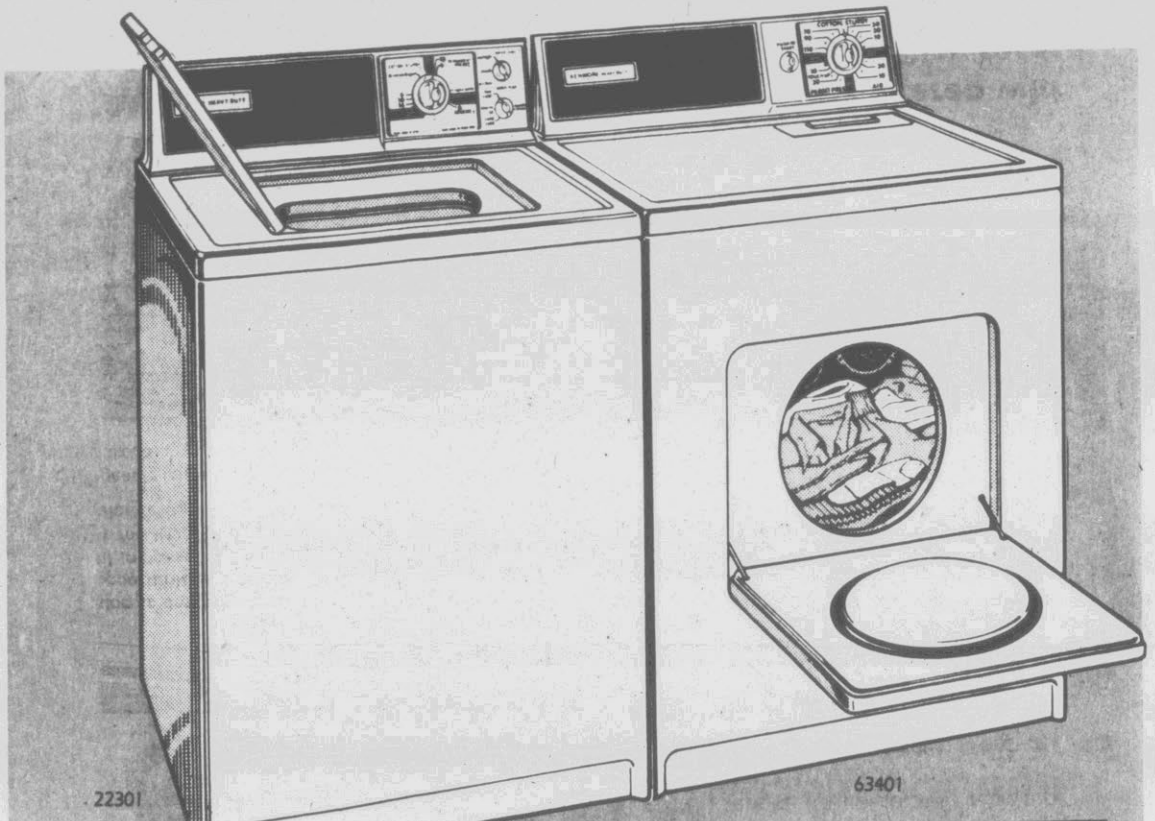

22301

63401



3 wash/rinse temperature combinations for proper fabric care.

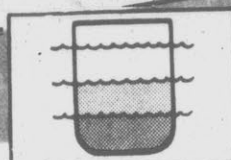

3 water levels — match water to size of load. Helps save energy.



Permanent press cycle for easy fabric care ... neat, fresh look.



"Air-only" option for gentle fluff-drying of special items.

Large-capacity Washer

299⁹⁵

Regular \$329.95

Large capacity to do added wash. 3 preset water temperature combinations for proper fabric care, 3 water levels.

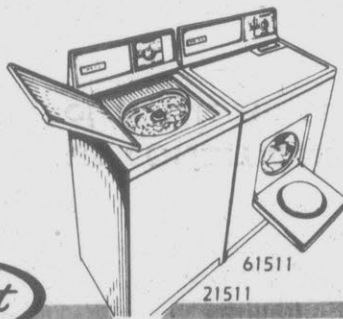

61511

21511

Kenmore Dryer

239⁹⁵

Regular \$259.95

3 cycles including permanent press and air-only setting for fluff-drying. Extra large top-mounted lint screen cleans easily. Dryer cord extra.

SAVE \$90 ON THIS PAIR

Kenmore Dryer

Regular \$279.95
249⁹⁵

Has 2-cycles, including air-only setting for fluff-drying. Large-capacity. Cord extra.

Kenmore Washer

Regular \$379.95
319⁹⁵

3 preset water temperature combinations for proper fabric care ... all with cold rinses. Large-capacity.

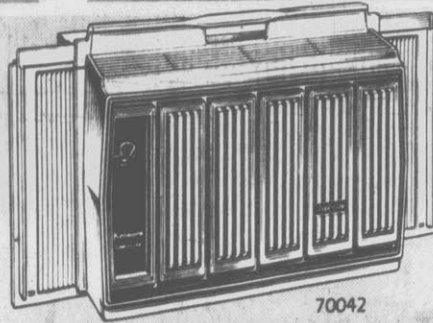

70042

AIR CONDITIONER SALE
Cool 'N' Lite Air Conditioner

4,000 BTUH cooling capacity. It's portable and has a built-in handle. Runs on 115 volts.

149⁹⁵

Reg. \$174.95

MODEL NUMBER	BTUH CAPACITY	REGULAR PRICE	SALE PRICE	YOU SAVE
71075	7,500	\$369.95	299.95	\$70
71118	11,000	\$499.95	449.95	\$50
72201	20,000	\$569.95	499.95	\$70

Air Conditioners on sale until April 30

SAVE \$50

Kenmore 15.1 cu. ft. Chest Freezer

Regular \$369.95
319⁹⁵

15.1 cu. ft. Chest Model. Easy-to-open counterbalanced lid with magnetic gasket. Thinwall foam insulation. Total contact cold freezes foods quickly.

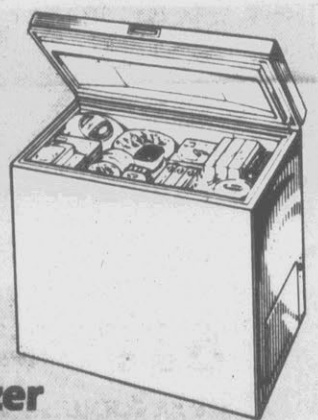

10151

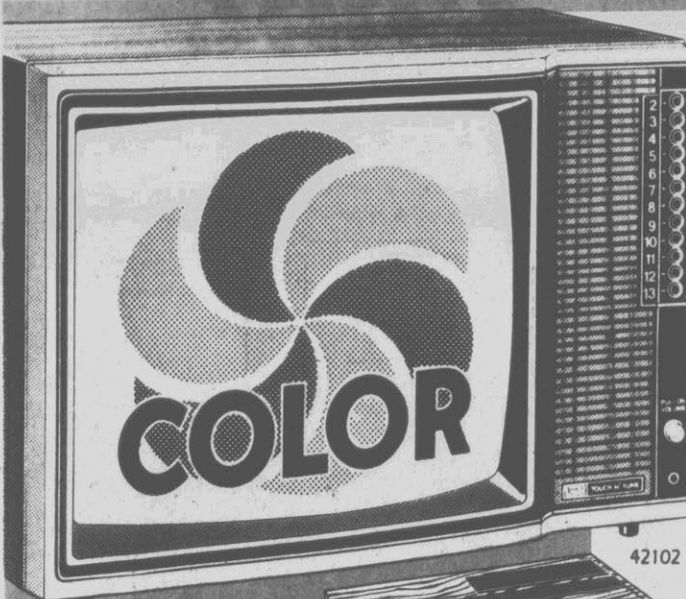

42102

SAVE \$70
Electronic-Tune Color TV

Regular \$469.95

399⁹⁵

SEARS SUPER VALUE

Enjoy a big, 19-in. diag. meas. picture Super Chromix® picture tube for bright, natural color. Reliable tune with fast, accurate Touch 'n' Tune channel selection. Automatic 1-button color. Save \$70.

SAVE \$100!

BetaVision Video Cassette Recorder

Programmable VCR, up to 5 hrs. per tape. BetaScan picture search.

Reg. \$799.95

699⁹⁵

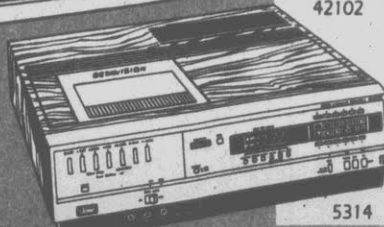

5314



50384

SAVE \$30, Go-Anywhere Black/white TV with AM/FM Radio

5-in. diag. meas. picture. Exclusive light optic screen, AM/FM radio. Earphone.

Regular \$189.95

159⁹⁵

SAVE \$100, Stereo with Cassette/8-track Play/record

Features electronic digital frequency display. AM/FM, record changer. Save \$100 during Spring Home Sale.

Regular \$349.95

249⁹⁵



91969

Store Hours Mon.-Sat. 9:30 Till 9

Kmart

The Saving Place™

FINAL WEEK OF OUR ANNIVERSARY SALE...DON'T MISS THESE GRAND BUYS

Wed. Thru Sat.

20 GRAND YEARS OF SAVING

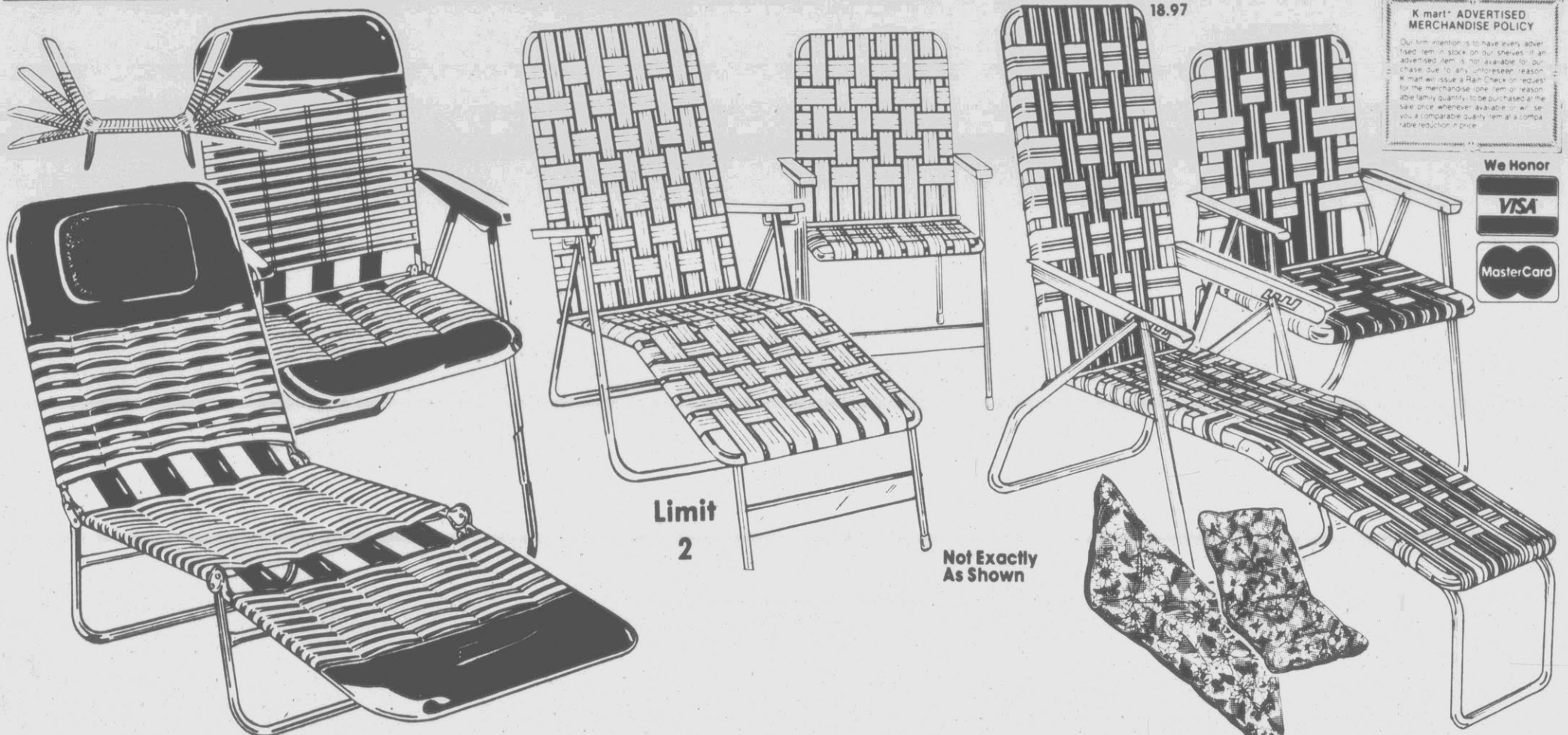

K mart® ADVERTISED MERCHANDISE POLICY
 Our merchandise is sold as advertised. We do not accept returns on advertised merchandise. Due to the large volume of merchandise, we cannot accept returns on advertised merchandise. We reserve the right to change prices without notice. All merchandise is sold as shown. © 1982 Kmart Corporation.

We Honor



Limit 2

Not Exactly As Shown

8.97

Comfy "Banana" Lounger
 Multiposition vinyl/steel. Vinyl Lounger Pad... 4.97

7.97

Vinyl Lounge Chair
 Mate to banana lounger. Weather-resistant vinyl/steel.

14.97

Lawn Chaise
 7 position reclining chaise and matching chair for lawn or patio. Lightweight frame with durable webbing.

6.97

Lawn Chair

18.97

Adjustable Lounger
 Vinyl web, aluminum frame. Tufted Chaise Pad... 9.97

6.97

Beach Chair
 Aluminum arms. 23" x 22 3/4" Tufted Chair Pad... 7.97

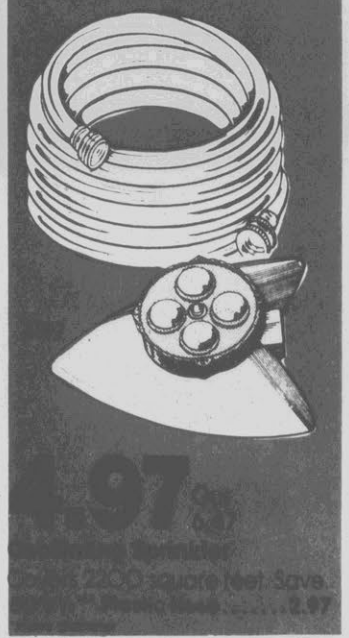
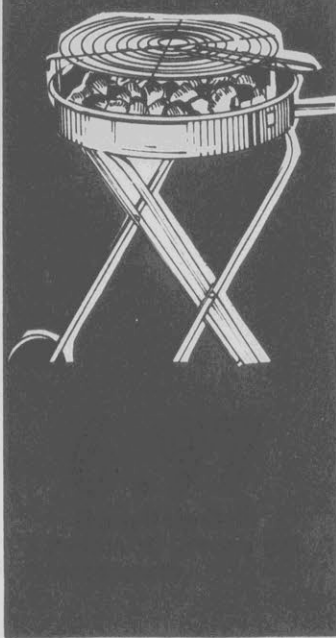
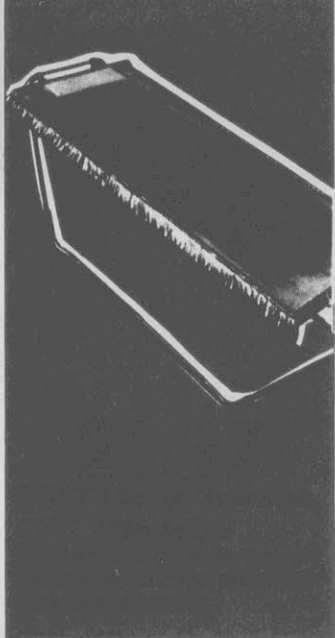
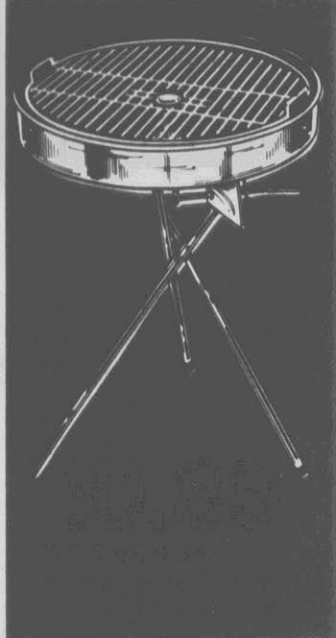
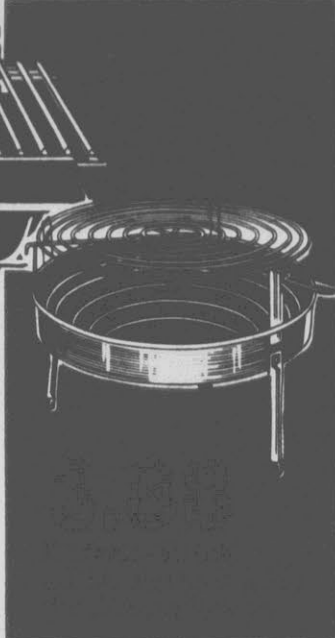
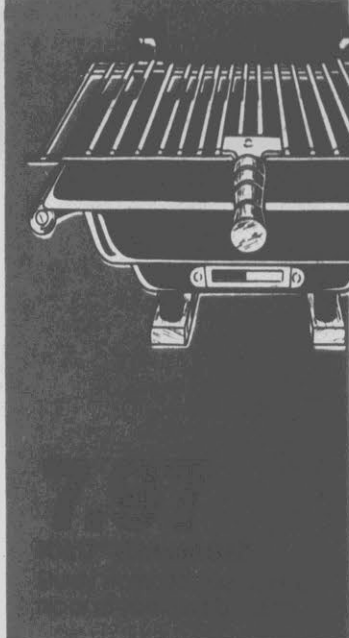
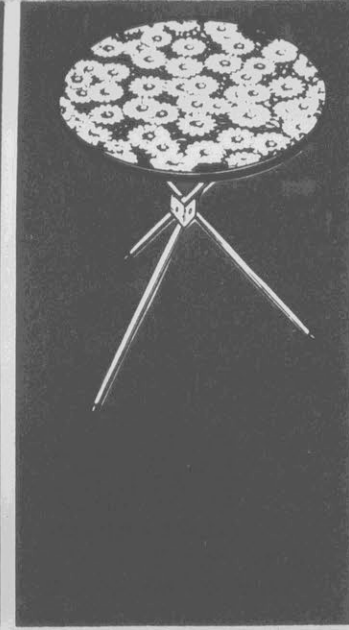
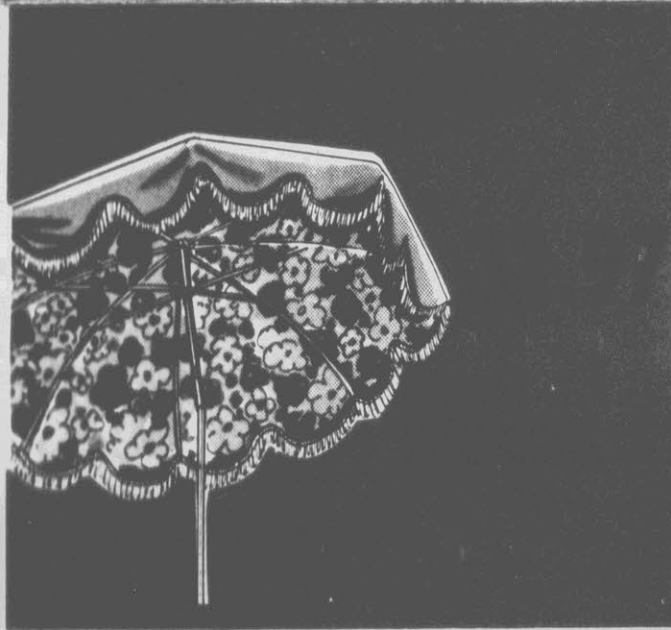
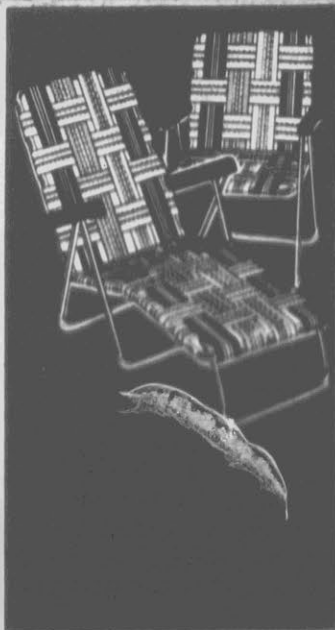
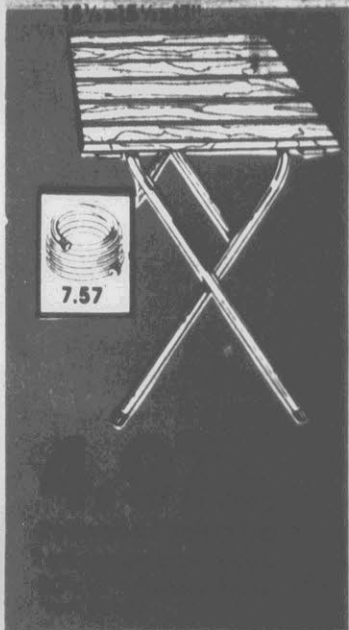

Our Reg. 68¢
39¢
 WITH COUPON

Limit 2

Plastic-foam Cups For Picnics
 50, 6.4-oz. cups are perfect for hot or cold beverages.

Coupon Good Thru May 1, 1982
K mart COUPON

Our Reg. 2.18
1.67
 WITH COUPON

Limit 2

Whoppers® Malted Milk Balls
 10, 1 1/4-oz.* Boxes of Delicious, chocolate-coated treats. Save.*Net wt.

Coupon Good Thru May 1, 1982
K mart COUPON

1.47
 with coupon

Nabisco Chips Ahoy
 Chocolate chip cookies made with real chocolate chips. 19 oz.

Coupon Good Thru May 1, 1982
K mart COUPON

Our Reg. 38¢ Each
4 \$1
 For WITH COUPON

Limit 12

16-oz. Glass Tumblers
 "Honeycomb" pattern in gold or clear. Dishwasher safe.

Coupon Good Thru May 1, 1982
K mart COUPON

2.29
 Per Pound WITH COUPON

Save On Delicous Ham
 Sliced-to-order for hearty sandwiches, great snacks. Available Only in Stores With Delicatessen.

Coupon Good Thru May 1, 1982
K mart COUPON

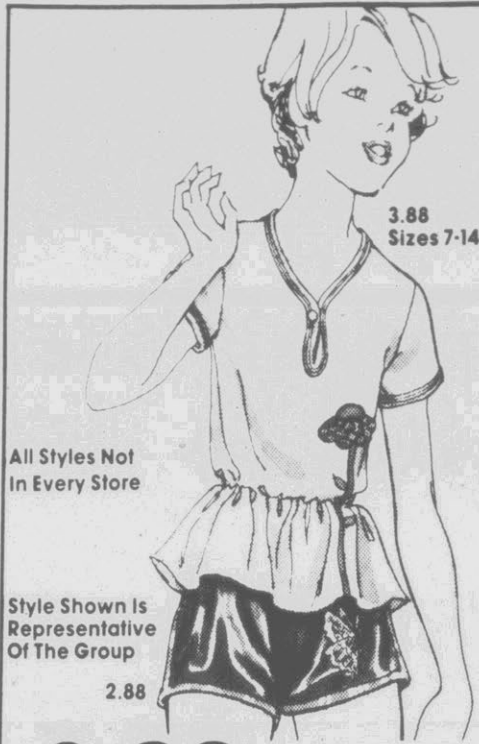

All Styles Not In Every Store

Style Shown Is Representative Of The Group

3.88 Your Choice
Our Reg. 4.96

Girls' Novelty Tops With Upstayed Trims
Band-bottom tops of polyester. New colors.
Our 3.96, Similar Sizes, 4-6X. 2.88

2.88 Your Choice
Our Reg. 3.47-3.77

Good-looking Fashion Shorts for Girls
Screen-print and other styles of polyester/cotton, more summery colors. 4-14.

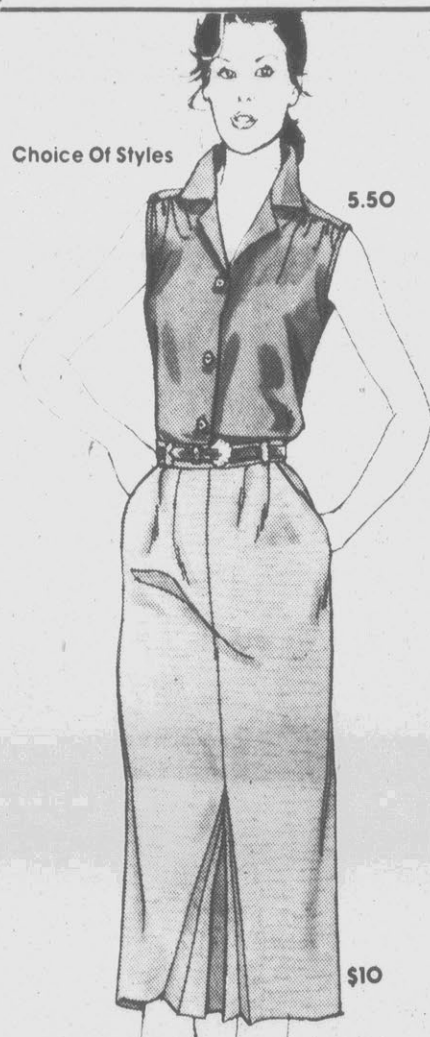

Choice Of Styles

5.50

\$10

5.50 Your Choice
Our Reg. 6.96

Smart Sleeveless Tops In Misses' Sizes
Crisp cotton/polyester in spring colors.
Our 7.96, Full Figure Sizes 40-44. \$6

\$10 Your Choice
Our Reg. 12.96-14.96

Misses' Stunning Skirts For Summer
Trouser-pleated, wraps, dirndls, more! Fashion details. Fabric, color choice. 5/6, 15/16. Save.



Your Choice

Baby-doll PJ's Also In The Group

Badische

3.33 Ea.
Our \$5 To 5.50

Nylon Nightgowns In Waltz Or Long Length For Misses And Full Figures

Whisper-soft gowns of Bright Zefran® nylon in waltz- or long-length styles, lavishly accented with lace and embroidery. Dreamy colors. Misses' sizes, full figure 42-48. Save. *Dow Badische Reg. TM



Your Choice

Some Junior Sizes In The Group

9.94 Ea.
Our 12.94

Beautifully Tailored Casual Dresses In Misses' or Full Figure Sizes

Pretty, yet practical, styles of polyester or cotton/polyester with fashion detailing. Solid colors, prints. Misses' sizes 8-18, full figure 14 1/2-24 1/2. Save now at Kmart®!

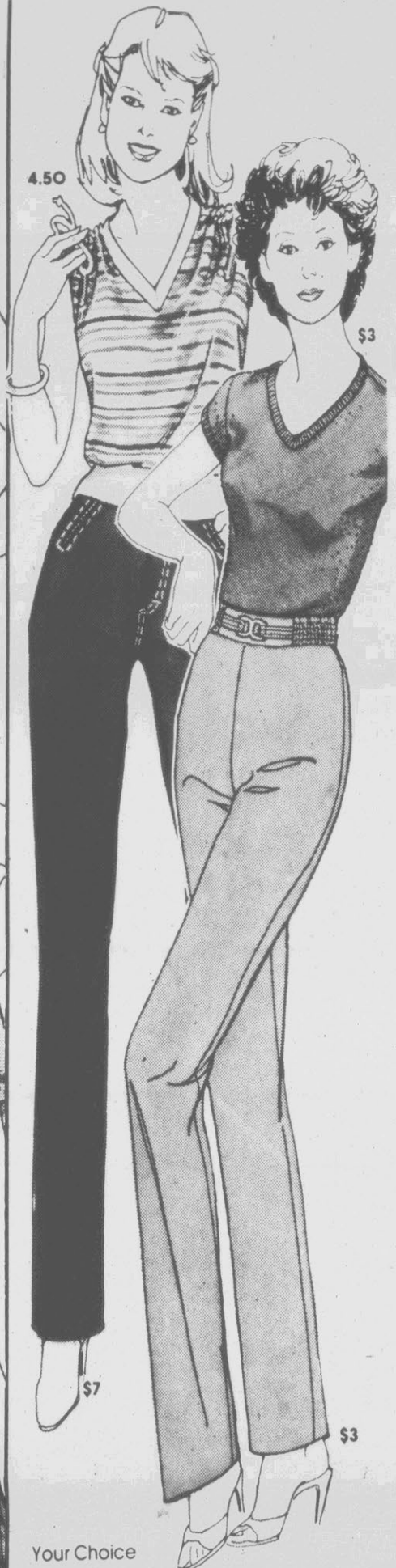

4.50

\$3

\$7

\$3

Your Choice

Save 25% To 40%

\$3 Our Reg. 3.96 **2.98** Our Reg. 5.96

Misses' Terry T-Shirts Or Pull-On Pants
Easy-to-care-for polyester. Color choice.
Our 6.88, Full-figure Pants, 32-40. \$4

4.50 Your Choice
Our Reg. 5.57-5.96

Knit Fashion Tops In Misses' Sizes
Top off pants or skirts with these jazzy tops. Many styles, colors and fabrics. Save now!

\$7 Your Choice
Our Reg. 10.96

Traditional Blue Cotton Denim Jeans
Featuring a variety of fashionable pocket styles and priced to save. Misses' sizes. Save.



Season Colors

3.50 Each
Our 5.97

Shoulder-strap Or Clutch-style Fashion Bags

Bags that beg to be carried everywhere! Latest styles in the newest fabrics...parachute nylon or rayon canvas...or straw-look polypropylene. Some have front pocket for those little odds and ends.



78¢ Per Pkg.
Our Reg. 1.07-1.17

Comfortable Stretch Nylon Panty Hose

With cotton panel. Choice of reinforced toe or sheer-to-waist. Basic fashion shades.



1.17 Per Pkg.
Our Reg. 1.57-1.74

Light Support Or Control Top Panty Hose

For extra control where you want it. Nylon with cotton/nylon panel. Misses' P/M, MT/T.



Natural Shades

'Blossom'

Our Reg. 14.88

11.88

'Blossom' Wig
Soft, natural-look wig of modacrylic.

'Nancy'

Our Reg. 21.88

15.88

Our 'Nancy' Wig
Chic curls, very feminine. Of modacrylic.



2.66 Our Reg. 3.97

Screen-print Rain Ponchos For Children
When the rain won't go away, ponchos of vinyl keep kids dry! In bright crayon colors.



1.77 Per Pkg.
Our Reg. 2.27

Save on Big Mama® Fashion Panty Hose
Luxurious nylon with cotton panel in re-useable panty. Large and extra-large sizes.



47¢ Pair
Our Reg. 68¢

Big Mama® knee-high's With Comfort Top
Sheer nylon knee-high's with reinforced toe and comfort top. Basic shades. Fit 8 1/2-11.

Our Reg. 4.96

3.66

Tailored Dress Shirts For Spring And Summer

Lightweight polyester/cotton shirts in white or solid colors to smartly set off a man's warm-weather wardrobe. Smooth, sleek styling plus short-sleeve comfort makes these shirts a super bargain! Save more when you shop Kmart®.

2.78

Your Choice
Our Reg. 4.47

Save Now On Selection Of Four-in-hand Ties

Ties... ties... and more ties! Easy-care polyester ties in handsome prints and solid colors to appeal to your fashion sense! Save now at Kmart®.

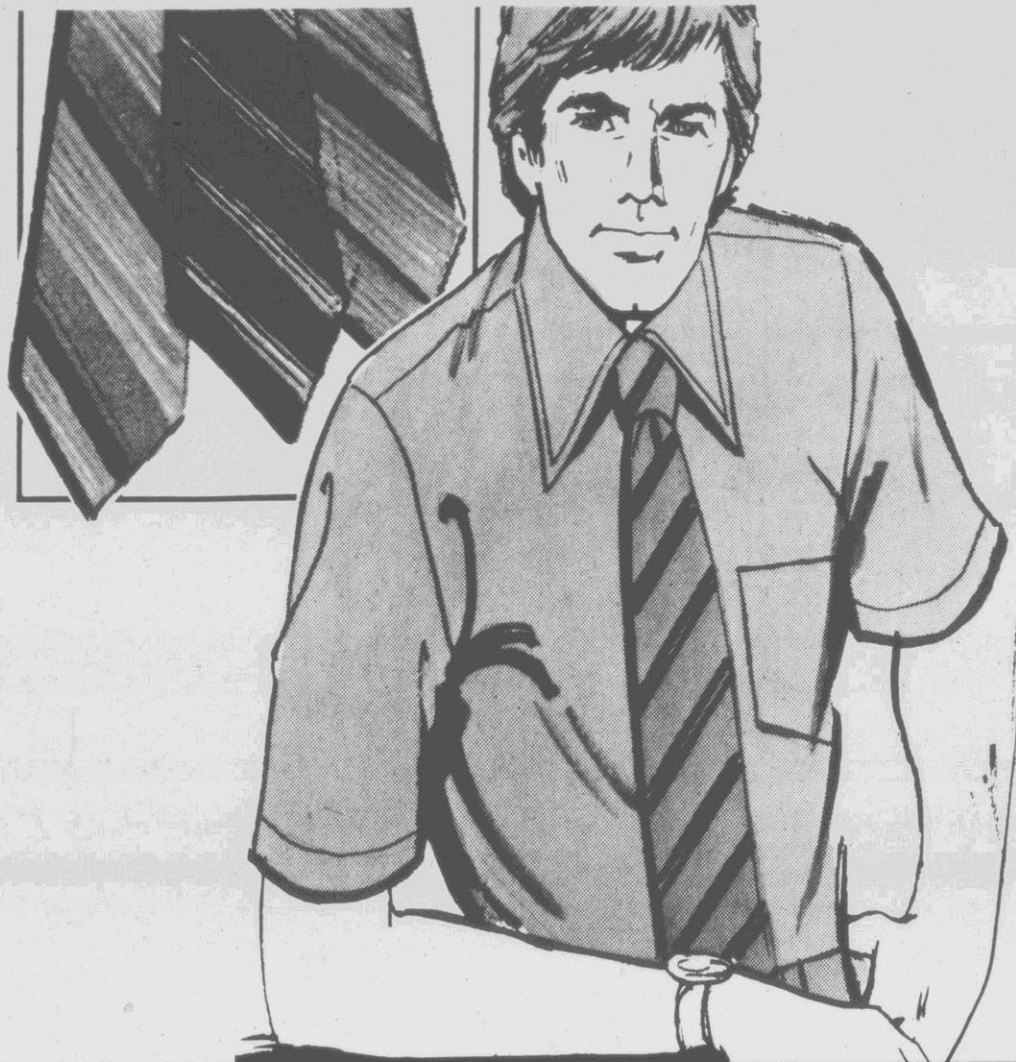

6.66

Our Reg. 9.97

Sporty Pullover Sweater For Men

Swing into spring in an eye-catching V-neck sweater of easy-care Orlon® acrylic. Du Pont Reg. TM

Spectacular Spring Celebration Savings!



3.88

3.33

3.33

Jr. Boys' 4-7
Our Reg. 3.97-4.48

3.88

Boys' Sizes
Our Reg. 4.97

Boys' And Jr. Boys' Smart Sport Shirts

Comfortable short-sleeve shirts to make him feel spring is really here! Wash 'n wear polyester/cotton in new season selection of woven solid colors, prints or plaids. Button front, chest pocket detail. Save now.

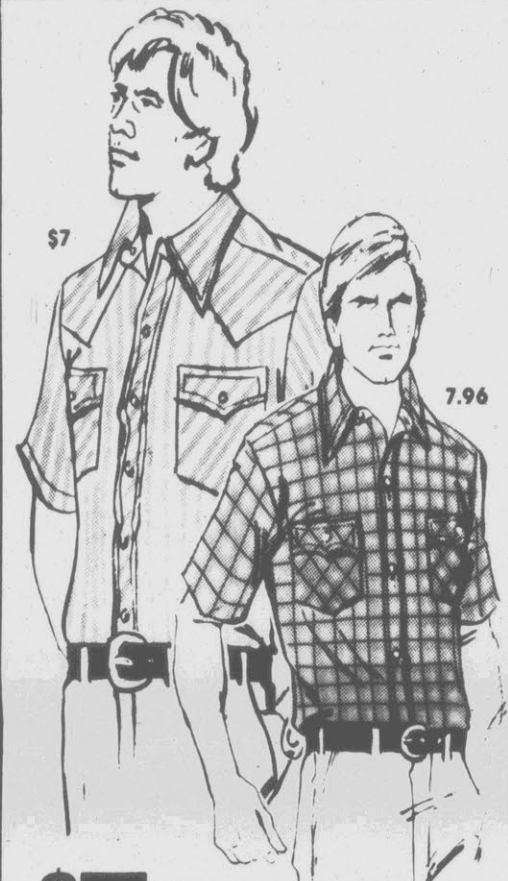

\$7

7.96

\$7

Our Reg. 8.96

Men's Casual Jeans-style Sport Shirt

Short-sleeved polyester/cotton shirt with attractive plaid design and button front.

7.96

Our Reg. 9.96

Men's Western "Air-weave" Sport Shirt

Easy-care polyester/cotton styled with a western touch. Choice of solid colors.

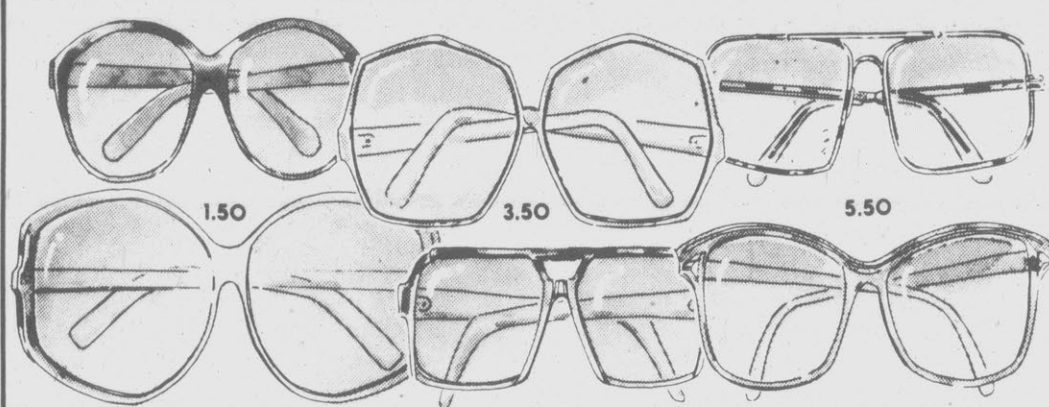

Our Reg. 4.97 - Ea. Pair

Our Reg. 6.97 - Ea. Pair

Our Reg. 8.97 - Ea. Pair

2.97

3.50

5.50

Mens & Womens Fashion Sunglasses

Choose from a large assortment of styles, frames, and lenses.



7.44

Pkg. Of 12

Curity® Softcare® Pre-folded Diapers

Super absorbent and soft, with fiber sponge center panel for extra protection. Save.



2.57

Pkg. Of 2
Our Reg. 2.97

30x30" Heavyweight Receiving Blankets

Long-life, heavyweight cotton blankets available in prints or solid colors. Save.

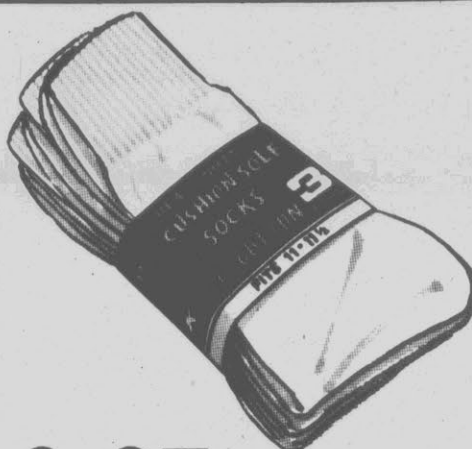

2.27

3-pr. Pkg.
Our Reg. 3.27

Men's Work Socks With Cushioned Sole

Heavy-duty cotton with cushioned foot for extra comfort. White. Fit 10-13. Save.



Solid Colors And 2-tone Shades

Our Reg. 1.97

1.28

Men's Visor Cap

Cotton. Visor has adjustable back.

Our Reg. 2.38

1.88

Men's Roll-up Hat

Cotton/polyester. Solid colors, prints.

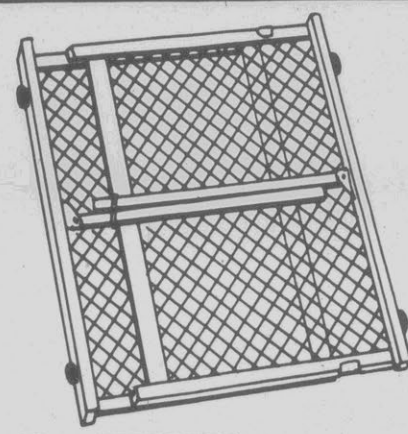

8.77

Our Reg. 11.97

Sturdy Expandable Security Mesh Gate

24"-high gate reaches from 26½"-36". Plastic-covered wire/plastic mesh, wood frame.

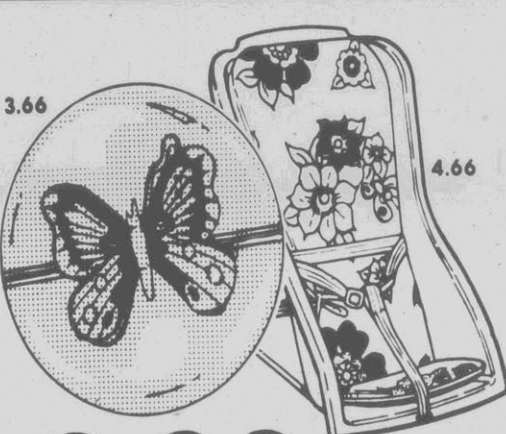

3.66

4.66

3.66

Our Reg. 4.44

Save On 7" Butterfly-action Play Ball

Ball contains "turn-action" butterfly. Save Century® Tot-Toter®.....4.66



2.40

Pair
Special Purchase

Save On Comfortable Slides For Women

Smooth vinyl with tricot lining and cushioned insole for comfort. White or teal.



3.97

Your Choice
Our Reg. 4.97

Pin-up Wall Decorations For The Little Ones

Favorite characters from children's stories, nursery rhymes and cartoons, in sturdy ¼"-thick chipboard. Save.

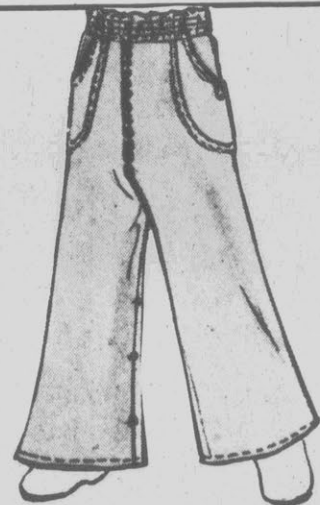

2/5.00

Our Reg. 3.67

Infants Boxer-Style Pants

Assorted solids of 50% cotton/50% polyester, with gripper snaps.

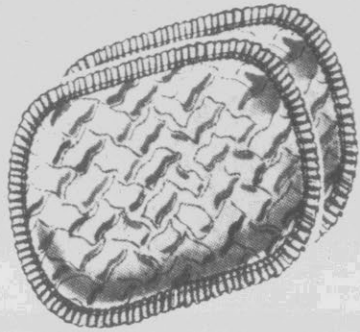

2/3.00
Quilted Placemats

13x19" Quilted placemats available in white, bone, rose, and blue.

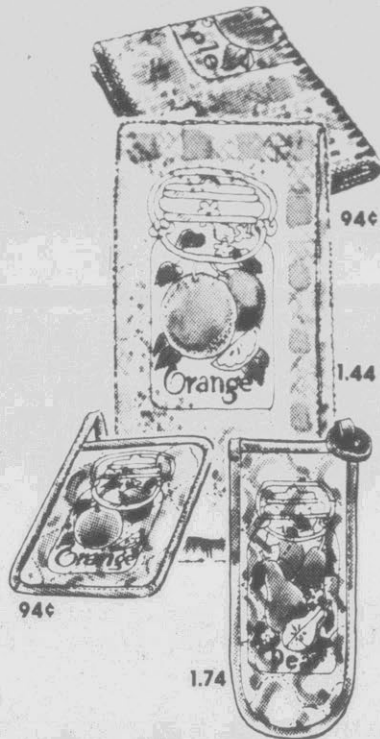

1.44 16x25" Kitchen Towel

"Country Gingham" Towel
Polyester/cotton kitchen towel in perky gingham pattern.

13x13" Dishcloth Or 7x7" Potholder, Ea. 94¢

Oven Mitt 1.74

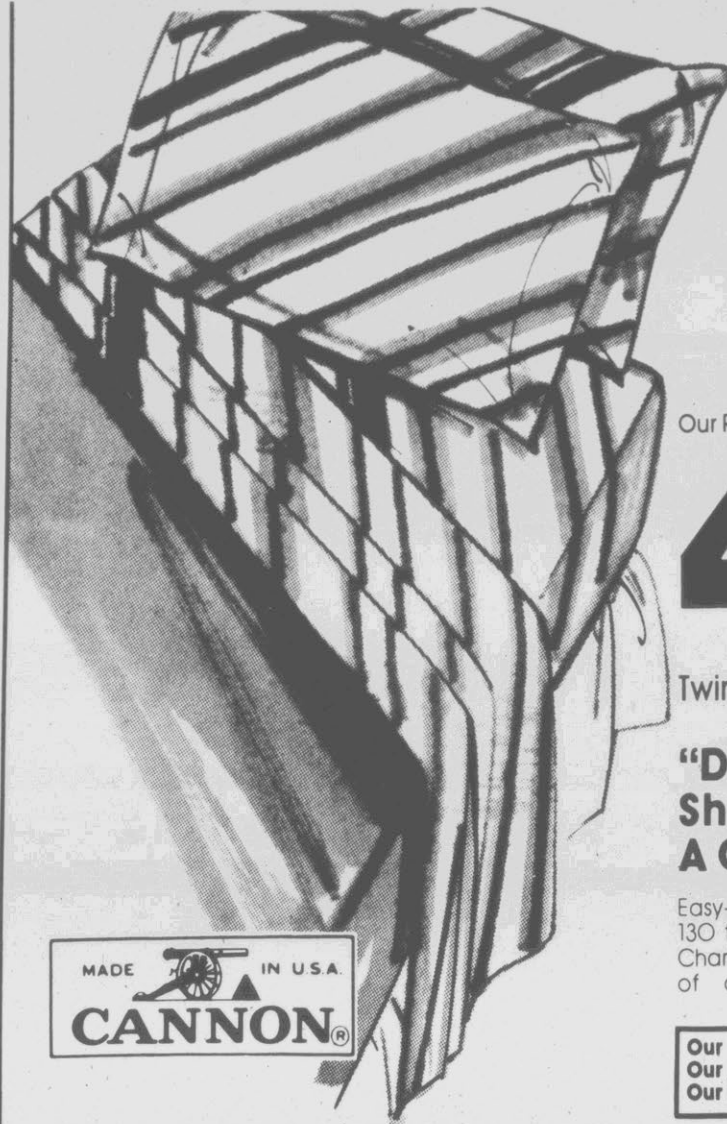

MADE IN U.S.A.
CANNON

Our Reg. 5.54 **Save 23%**

4.24

Twin Size, Flat Or Fitted

"Diagonal Fantasy" Sheets By Cannon For A Contemporary Bedroom

Easy-to-care-for polyester/cotton sheets with 130 threads per square inch for long wear. Charming diagonal stripe pattern in choice of decorator colors. Kmart® priced.

Our Reg. 7.24, Full Sheet, Flat Or Fitted, 5.94
Our Reg. 10.84, Queen Sheet, Flat Or Fitted, 9.24
Our Reg. 5.25, Standard Pillowcases Pr., 3.94



Our Reg. 2.17-2.47
1.77
6 Wash Cloths

11"x11". Available in solids or prints.

Kmart 20 Grand Years Of Saving On

<p>1.38 Limit 2 Crest® Toothpaste Regular, mint, gel *Net wt.</p>	<p>88¢ Our Reg. 1.17 Enhance 8 Oz. shampoo or conditioner.</p>	<p>97¢ Your Choice Curad® Bandages 80 plastic or sheer.</p>	<p>2.08 Johnson's Baby Washcloths 60's. For gentle cleaning.</p>	<p>1.58 Each 11-oz. Pert® Shampoo Normal/dry *Fl. oz.</p>	<p>68¢ Pkg. of 3 Disposable Razors Gillette® Good News® razors give you a close, comfortable shave.</p>	<p>2/1.48 VO5® Shampoo 15 Oz. with Acrin® Normal, Oily, Dry, Henna</p>	<p>2.18 Kmart® Sale Price Less Factory Rebate Your Net Cost After Factory Rebate 1.18 Mitchum® Deodorant *Net wt.</p>
<p>1.96 Cream & Cocoa Butter 12-oz. ** lotion, with pump</p>	<p>4.47 Rave® Soft Perm Kits Regular, extra curly.</p>	<p>2.22 Raintree® Skin Care Moisturizes, softens. *Fl. oz.</p>	<p>1.84 Vaseline® Lotion Dermatology formula™ *Fl. oz.</p>	<p>4.22 Your Choice Stay free® Maxi-pads Economy box of 48.</p>	<p>1.17 Alka-Seltzer® Tablets For stomach upset. 25.</p>	<p>1.77 Chloraseptic® Liquid Menthol. 6-fl. oz.</p>	<p>1.11 Pkg. of 18 Lozenges Cherry flavor. Antiseptic</p>
<p>4.94 40 Dietac® Capsules Maximum strength.</p>	<p>3.17 Control® Capsules Stimulant-free. 28.</p>	<p>1.98 Ayd's AM/PM 28 Time-release caps.</p>	<p>6.19 Geritol® Tablets 100 tablets. Save.</p>	<p>5.28 Vitamin E Capsules 600 I.U. 60 capsules.</p>	<p>2.36 60 mg Zinc Tablets Bottle of 100. Save.</p>	<p>1.57 Time-release C 500 mg. 50 tablets.</p>	<p>3.22 Flintstones® Vitamins 60 chewable tablets.</p>
<p>81¢ Save! Sweet 'N Low® 100 single packets.</p>	<p>1.98 Pure Vite Vitamins & minerals. 90 Tabs.</p>	<p>1.89 100 Vitamin "C" 500mg tablets with rose hips.</p>	<p>7.88 400 I.U. Vitamin E Natural. 250 capsules.</p>	<p>2.18 Save! B-50 Vitamins B-complex. 50 tablets.</p>	<p>1.42 Natural Vitamin A 100 capsules. Save now</p>	<p>1.88 C With Rose Hips 500 mg. 100 tablets.</p>	<p>1.99 Boil 'n Soak® Liquid Saline solution. 12 oz.* *Fl. oz.</p>
<p>7.22 Theragran-M 130 vitamins minerals</p>	<p>2.28 24 Chlor-Trimeton® Decongestant tablets.</p>	<p>1.88 Your Choice 4-oz. Triaminic® Syrup or cough formula. *Fl. oz.</p>	<p>7.82 Myadec Tablets 100-plus 30 free.</p>	<p>1.28 Your Choice Murine® Eye Drops Reg. or plus formula. *Fl. oz.</p>	<p>2.88 Your Choice Douche Products 2-qt. syringe water bottle combination or 2-qt. folding syringe.</p>	<p>2.98 Dietac Capsules 12-Hour, time-release. 28's.</p>	

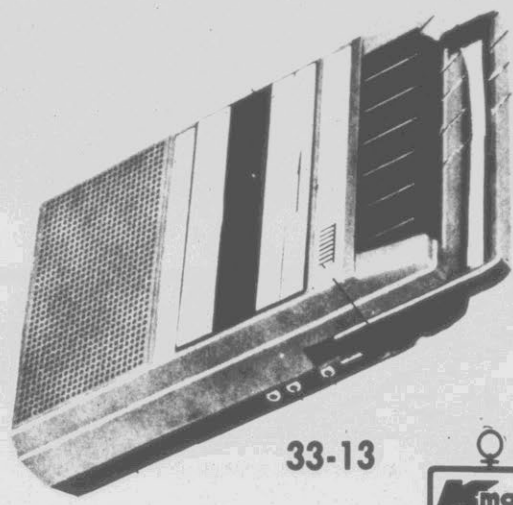

33-13



21.97

Cassette Player/Recorder

Cassette player-recorder features auto/stop function, auto level control, built-in condenser mike and jacks for earphone and mic*

*Earphone & mic not included

- UHF/VHF/FM
- 20 Elements
- Signal Splitter Included

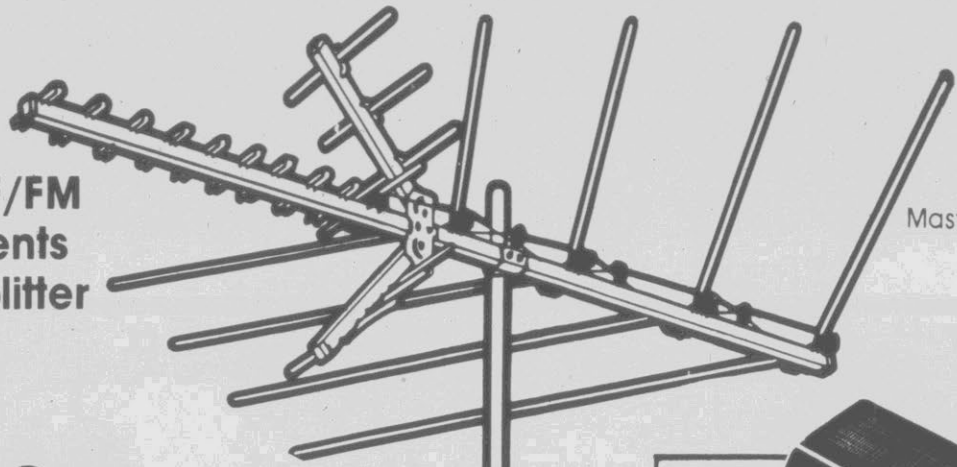

Mast Not Included

18.97

'Bullseye!' TV Antenna With Signal Splitter

For vivid viewing! Quality 'Bullseye!' antenna comes pre-assembled with snap-open elements for do-it-yourself installation. 20 elements capture all available signals including FM stereo. Gold-tone finish fights corrosion. Signal splitter included at no extra cost.

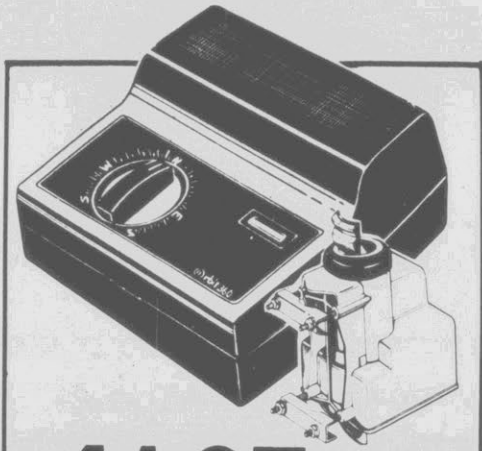
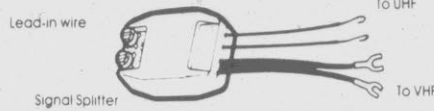

41.97

Save! Automatic Antenna Rotator

More stations and more vivid color at your finger tips. Accurate to within 1° the Orbit® 360 rotator comes fully assembled for your convenience.

Super Specials For You And Your Home

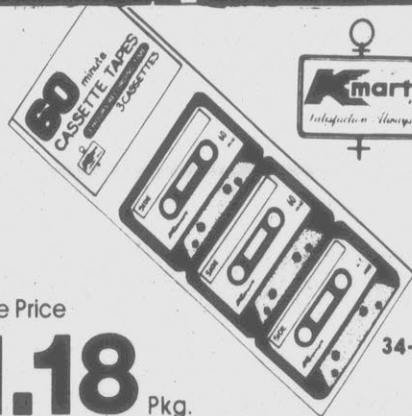

Sale Price

1.18 Pkg.

Blank Cassette Recording Tapes
Package of 3 cassette tapes with 60 minutes of recording time per cassette. Save now!

34-87

MAJOR APPLIANCE CLOSE-OUT SPECIALS

All Refrigerators, Televisions, Freezers, Washing Machines

25% Off

Our Already Reduced Prices!

No Rainchecks!..... All Sales Final!

Many items \$50 to \$100 below our cost. Items good only while quantities last!

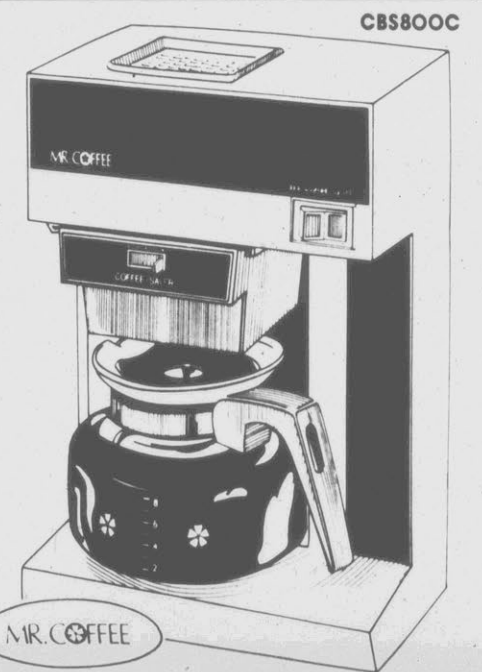

CBS800C

MR. COFFEE

K mart * Sale Price **26.87**
Less Factory Rebate **-7.00**

Your Net Cost After Factory Rebate **19.87**

Mr. Coffee® Coffee 10-cup Maker
Serves 2 to 10 cups. Has ultra-speed brewing system. Coffee Saver™ funnel.



53.97

Stereo Cassette Player
Easy to take stereo with separate left/right volume controls, lightweight stereo headphones. Also includes tone control, tape timer, and demonstration tape. Automatic shut-off.

33-02

MACDONALD

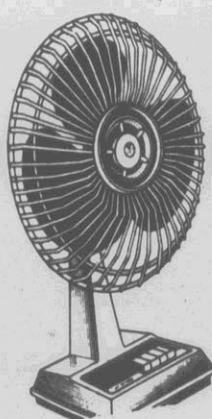

27.87

12" Oscillating Fan

Cools entire room with rotating movements. 3 speeds, blue and white.

Outdoor TV Antenna Sale

- *UHF/VHF/FM, 51 Element 156" Boom, (J51)..... **58.88**
- *VHF/FM, 6 Element, 32" Boom (P6) **8.88**
- *VHF/FM, 13 Element, 84" Boom (P13) **21.88**
- *VHF/FM, 18 Element, 102" Boom (P18) **25.88**
- *VHF/FM, 34 Element, 161" Boom (P34) **50.88**

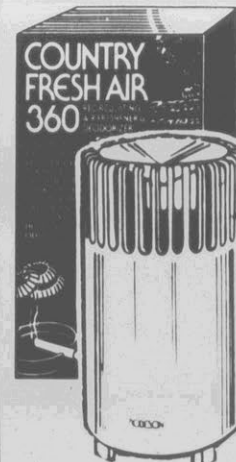

COUNTRY FRESH AIR 360

K mart Sale Price **16.88**

Less Factory Rebate **-3.00**

Your Net Cost After Factory Rebate **13.88**

"Country Fresh" Room Air Purifier
Filters smoke, pollen, dust; deodorizes.

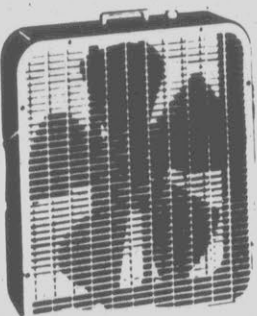

21.97

20"-3 Speed Fan

Whisper quiet, for cool comfort, standard window size.



Smoke Detector With Escape Light
First Alert smoke detector has light that cuts on when electronic horn sounds.

Sale Price **14.87**

Less Mfg. Rebate **-5.00**

Your Net Cost After Rebate **9.87**

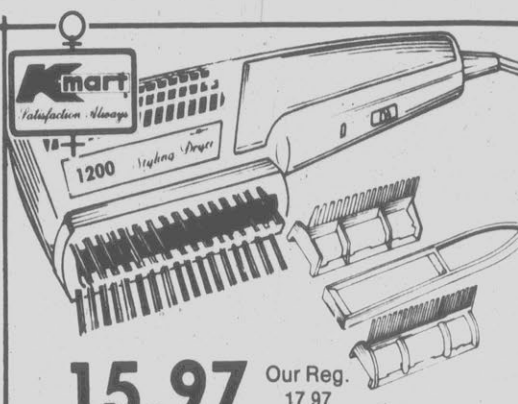

15.97 Our Reg. 17.97

Kmart Styler/Dryer
1200 Watts for styling/drying. 4 styling/combing attachments, handle.

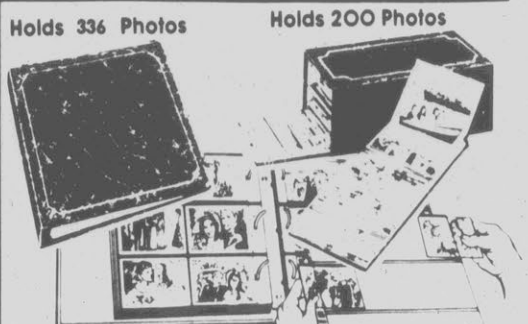

Holds 336 Photos

Holds 200 Photos

8.88

Your Choice

Convenient Photograph Organizers
Each roomy style accommodates photographs that measure up to 3 1/2 x 5 1/2 inches. Save



Dr. Pepper Sugar Free
Dr. Pepper 7-Up
Diet 7-Up
2 Litre Bottle
88¢



57¢ Pack
Limit 12 Packs
Levi Garrett®
One plug of premium chewing tobacco.



3/1.00
Our Reg. 61¢
Scripto Lighters
Disposable butane lighter.
Buy now & save.

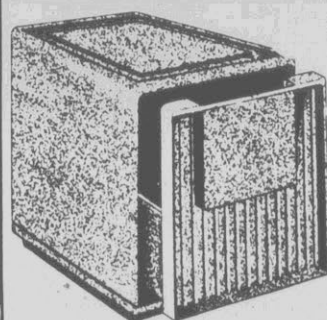

17.97
Our Reg. 22.88
Tuff File
Sturdy metal file will not rust or dent. 18.5/8x15 1/4x14 1/2"



30-60
7.77
Our Reg. 10.77

Durable Instant-lighting Propane Torch Kit
Kit includes precision-made valve assembly, interchangeable propane tank. Burns in any position.

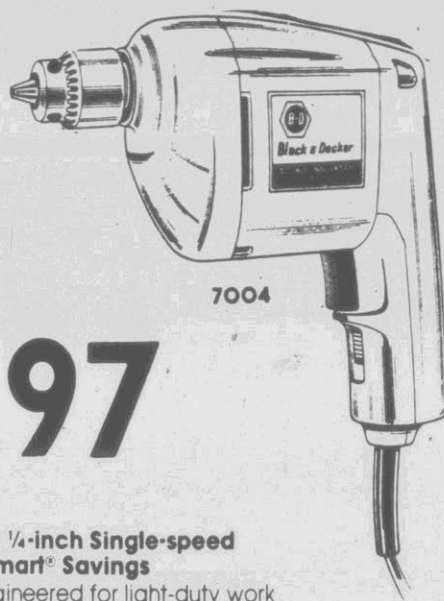

9.97

Black & Decker® 1/4-inch Single-speed Drill At Grand K mart® Savings
Designed and engineered for light-duty work and do-it-yourself projects. Double insulation and metal mounted bearings. Runs cool.



Save \$3
8.96 Gallon
Your Choice
Our Reg. 11.97
Latex 1-coat Wall or Ceiling Paint
White being painted, no paint in white and tint. 5-year durability. Save now.

Save \$3
9.96 Gallon
Our Reg. 12.97
K mart® Satin Lustre Latex Enamel
Premium satin lustre latex enamel. White and tints. 5-year durability. Save.



Save \$3
2.97 Our Reg. 4.17
Redwood Stain
Protects and restores redwood beauty.

ITEMS BELOW AVAILABLE ONLY IN STORES WITH BUILDING SUPPLY DEPTS.

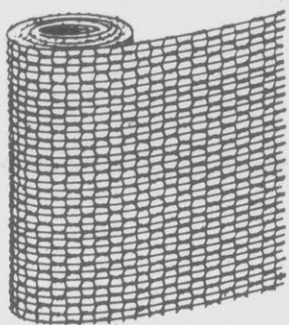

36"x25' Roll Chicken Wire 7.97
48"x25' Roll Chicken Wire 10.97

5.97 Our Reg. 8.37
24"x25' Roll Chicken Wire

1" Mesh, reinforcement wire posts, fittings available.

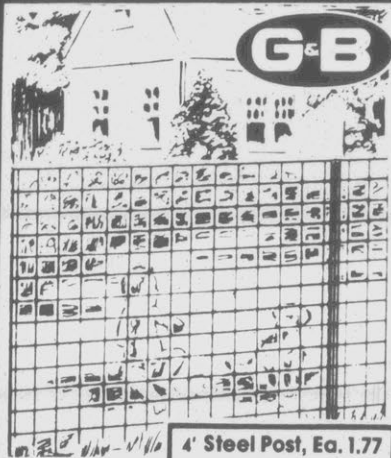

Our Reg. 28.97
19.97 Roll
36"x50' Welded Wire Fencing

2x2 5/8" Mesh, vinyl coated wire.

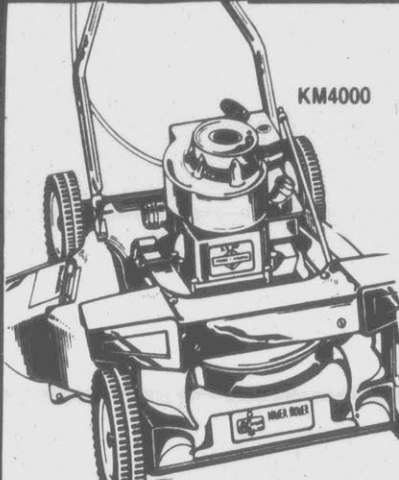

149.88
KM4000 Rotary Mower

3 1/2-HP, 22" Self propelled mower. Throttle control on handle, side discharge. B&S® engine.

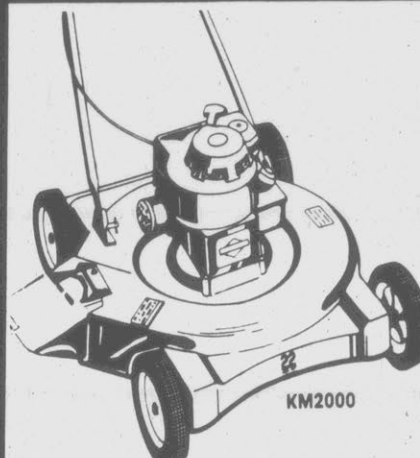

119.00
KM2000 Lawn Mower

3 1/2-HP, 22" side-discharge mower of rugged construction has B&S® engine, 8" wheels.

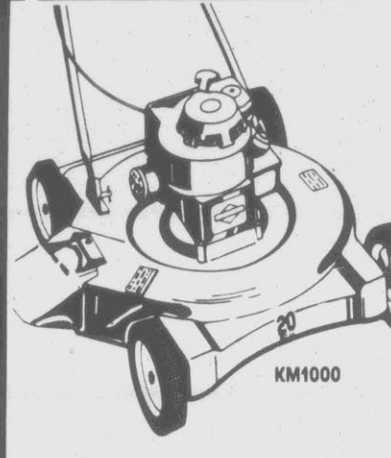

99.00
KM1000 Lawn Mower

3-HP, 20" gas-powered, recoil start mower has side discharge, throttle control on handle.



297.00

5 HP Tiller

Chain drive, 14x26" Bolotines Safety Clutch, 10"x1.75 wheels adjustable tail piece, controls on panel.

No Rainchecks



19.97 Our Reg. 24.97
Kentucky 31 Fescue

For thick, green southern lawns. 50 lb. bag.



2.97
Charcoal Briquets
20 lb. bag Embers charcoal. Stock up early.

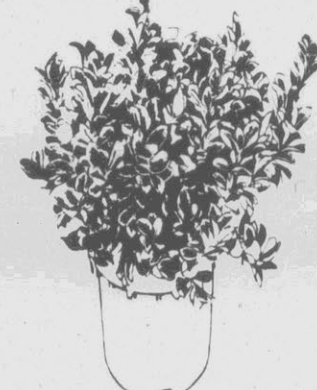

1.67
1-Gallon Shrubby
Choose from a large selection.

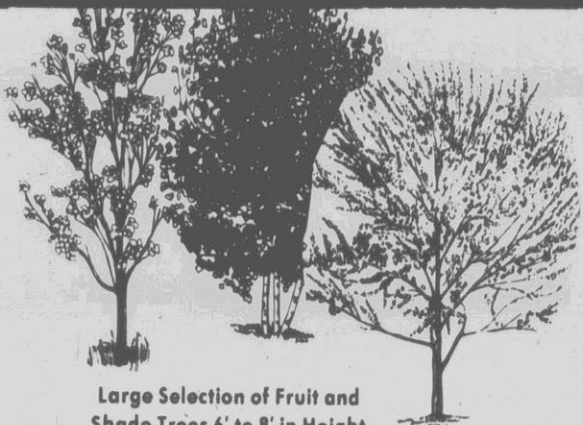

Large Selection of Fruit and Shade Trees 6' to 8' in Height

Peach (Hale Haven, Georgia Belle, others)	Our Reg. 7.97	5.97
Plum (Santa Rosa, Blue Damson)	Our Reg. 7.97	5.97
Dwarf Fruit Trees (Apple, Peach, Cherry, Pear)	Our Reg. 8.97	6.97
Dogwood Trees (4' to 5')	Our Reg. 8.97	5.97
White Birch	Reg. 8.97	5.97
Red Maple	Reg. 8.97	5.97
Sugar Maple	Reg. 8.97	5.97



97¢ Ea.
Geraniums in 4" Pots
Potted geraniums to add color to yard or patio.



3.97 Ea.
Hanging Flower Baskets
Lovely flowering greenery in 10" hanging baskets. Save.



5.97
18-lb. Bag of Super K-Gro®
27-3-3 fertilizer to develop thick green lawns. Save.



1.77
40-lb. Vita Hume® Soil
Ideal top dressing soil for patching, potting planting.



2.97 Our Reg. 4.27
5-lb. Grass Seed
For quick, hardy growth; covers 750-1000 sq. ft.

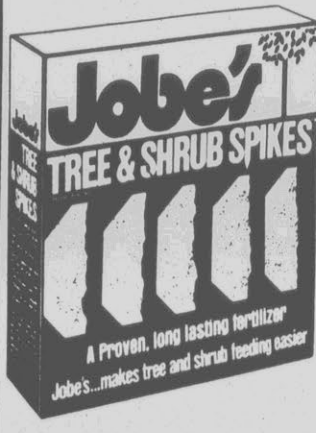

Box Of 5
1.97 Our Reg. 2.97
Tree And Shrub Spikes
Jobe's tree food, shrub or fruit fertilizer spikes. Save.



1.97
Decorative Bark Nuggets
3-cu.-ft. bag nuggets for garden and landscape use.



1.77
40-lb. Organic Peat
This peat mixture retains moisture and enriches soil.



2.17
50-lbs Landscape Stone
White natural ornamental stone for landscape use.



Your Choice
1.47 Our Reg. 1.97
8-oz. Boxes of Plant Food
Miracid® or Miracle-Gro® for plants, roses and tomatoes.

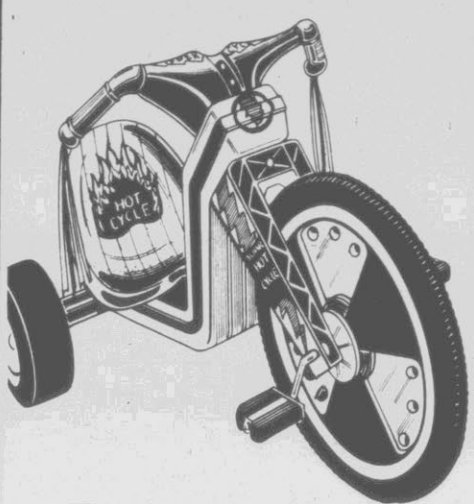

18.97 Our Reg. 22.97

The Super Wide-track Hot Cycle*
16" front wheel pedal drive, safety-styled handlebars and wide-track racing tires.

20% OFF

ALL BIKES IN STOCK

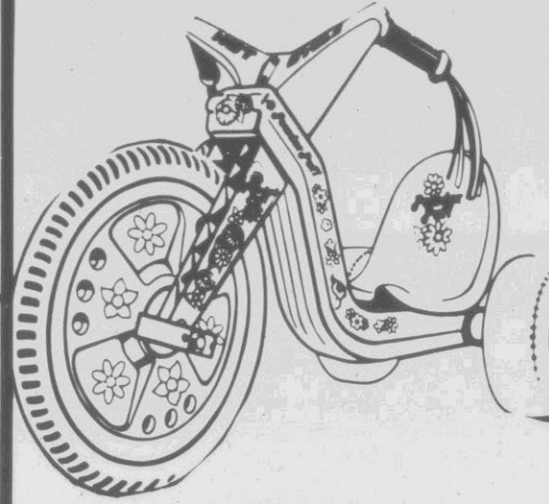

17.97 Our Reg. 22.97

Powder Puff Hot Cycle
Features road hugger suspension, adjustable bucket seat, wide track mag wheels, sure grip handle bar. Easy assembly.

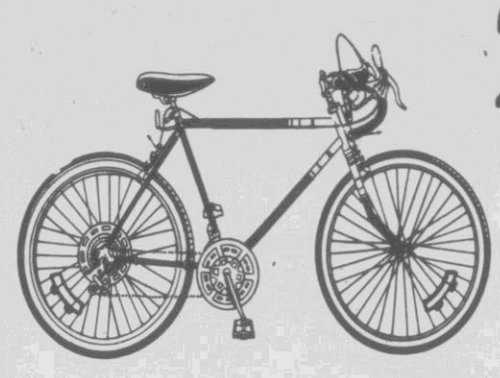



16.97 Our Reg. 19.97

10" Wheel Beginner Trike
Well made "first" trike. Chrome plated fender, handlebars.

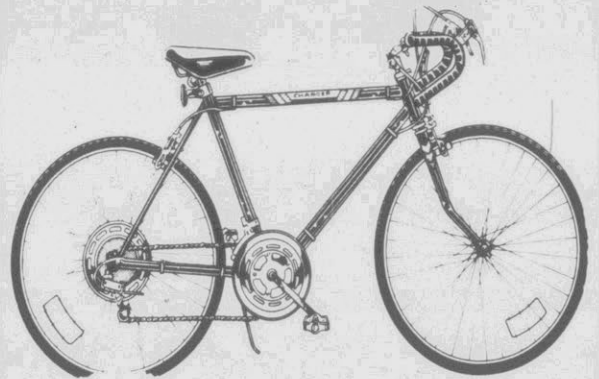

SPORTS CENTER SPECIALS



Save \$5
24.97 Our Reg. 29.97

5x7-ft. Two-person Nylon Tent
Roomy, 5x7' tent with 3 1/2' center height, nylon screen door, 10x18" zipper window and 3-piece poles. Save at K mart®.

HUNTING AND FISHING LICENSES SOLD IN MOST SPORTING GOODS DEPTS.



Choice of Berkley® Cherrywood Rods
Feature ceramic guides and tip. Cushioned grip and anodized reel seat. Available in a selection of lengths and actions. Great savings!

15.97 K mart® Sale Price
-2.00 Less Factory Rebate
13.97 Your Net Cost After Factory Rebate



Daiwa® or Zebco® Sportfisher Rods
Your choice of spinning or spincast model fiberglass rods with ceramic guides in a selection of lengths and rod actions. Save at K mart!



Save \$10
14.97 Our Reg. 24.97

3-lb. Polyester Fill Sleeping Bag
Adult sleeping bag. 33x75" finished/size. Navy cotton cover. Tricot lining. Savings.



Your Choice 4.97 Ea.

Your Choice 4.97 Each Our Reg. 6.97

Save! Portable Lamp Or Floating Lantern
Lamp with push-button switch. Break-resistant. Waterproof lantern has extra large lens. Batteries not included.



RAPALA 2.77 Each Our 2.97-3.47

Rapala® Balsa Wood Floating Lures
Extremely lightweight for bouyancy. Hand-tested and balanced. Save now.



Save \$10
19.97 Our Reg. 29.97 Pr.

Men's "Soft Ones" Golf Shoes
California leather-look vinyl shoes with soft-stepping crepe sole. Lightweight and flexible. Tan or white.



16.97 Our 27.97

Zebco 20/20 Reel
Star drag, auto anti-reverse.



7.97 Our Reg. 9.97

Woodstream® Tackle Box With 23 Compartments
Compact, 3-tray box with adjustable compartments in top tray. Lockable.



1.97 Box Of 44 Cards Sale Price

Special Issue Baseball Cards
Box of limited-edition cards with gum. An exclusive K mart® offer. Sold in Candy Dept.



23.97 Our 27.97

Cardinal™ Spinning Reel
4.9:1 ratio. Black reel. Save.



4.97 Our Reg. 7.47

RAPALA 4.97
6x24-inch Wooden Fish Fillet Board
Heavy steel power jaw clamp. V-rib surface. Our 10.97, Fillet Knife, 6.97

TV SPECIAL On Sale Thru May 2



SIZES	REG.	SALE	F.E.T.
P185/75R13	59.97	51.97	1.84
P185/75R14	63.97	54.97	2.04
P195/75R14	69.97	59.97	2.18
P205/75R14	72.97	62.97	2.34
P205/75R15	73.97	65.97	2.47
P215/75R14	73.97	65.97	2.48
P215/75R15	75.97	67.97	2.59
P225/75R14	78.97	70.97	2.68
P225/75R15	79.97	71.97	2.78
P235/75R15	87.97	73.97	3.01
P225/70R15	89.97	77.97	2.88

STEEL BELTED RADIALS

Our Reg. 56.97
P165/80R13 **42.97** Plus F.E.T. 1.69 Each

Mounting Included - No Trade-in Required - All Tires Plus F.E.T. Ea.

*70 Series Tread Different. Available in Limited Areas.

TV SPECIAL! Installed With Exchange



46.88 Our Reg. 58.88

Save! 48-mo. Battery
Sizes available for many cars and light trucks.

SERVICES INCLUDE:

1. Install front disc brake pads and brake linings on rear wheels
2. Resurface drums and true rotors
3. Inspect front calipers
4. Rebuild rear wheel cylinders, if possible; replace, if necessary, at additional parts cost per wheel cylinder
5. Repack inner and outer bearings
6. Inspect master cylinder
7. Replace front grease seals
8. Refill hydraulic system

98.88 Sale Price

Disc/Drum Brake Special
Services for many U.S. import cars. Lt. trucks higher.

Installation Available



10.88 Ea. Our Reg. 13.97

Radial Tuned Shocks
For many U.S. cars. Radial, bias, belted tires.

SERVICES INCLUDE:

1. Align Front End
2. Repack Wheel Bearings
3. Replace Front Grease Seals
4. Install Front Coil Spring Stabilizers*
5. Computer Balance Front Tires
6. Issue Alignment Service Contract

11.99 Sale Price

Lube, Oil And Filter
Services for many cars and light trucks. Save.

Installation Available



5.97 14-ozs. Net Wt.

Lever Grease Gun
With hydraulic coupler. Grease Tube97*

AM/FM Car Stereo
Choose 8-track or cassette player.

59.97 Our Reg. 78.88

Coaxial Speakers
5 1/4" 20-oz magnets. 6x9" Coax Speakers, Pr.26.88

21.88 Pair-Our 29.88

Hardshell Carrier
15-cu. ft. of cargo space. Heavy-duty.

49.96 Our Reg. 62.88

1-gallon Gas Can
With top vent and leakproof spout.

2.57 Our Reg. 3.88

Blue Poly® Waxes
Choose 16-oz.* liquid or 16-oz.** paste form. *Fl.oz. **Net wt.

6.97 Ea. Our Reg. 9.37

Save 25%



Store Hours Mon.-Sat. 9:30 'Til 9

Kmart®

The Saving Place™

HURRY FINAL WEEK ANNIVERSARY SALE

Wed. thru Sat.

20 GRAND YEARS OF SAVING



3.97

Our Reg. 5.17

6 Pair Pkg. Boys Tube Socks
Orlon/acrylic blend. White with striped top. 9-11.



88¢

Your Choice
Sale Price

Pkg. of Regular Or Queen-size Panti-all® Panty Hose
Sheer nylon. Sandal foot, cotton panel. S/M, MT/T, queen.



2.88

Pair
Special
Purchase

Men's Comfortable Canvas Basketball Sneakers
Cushioned insole, sure-traction sole. White, navy. Save.

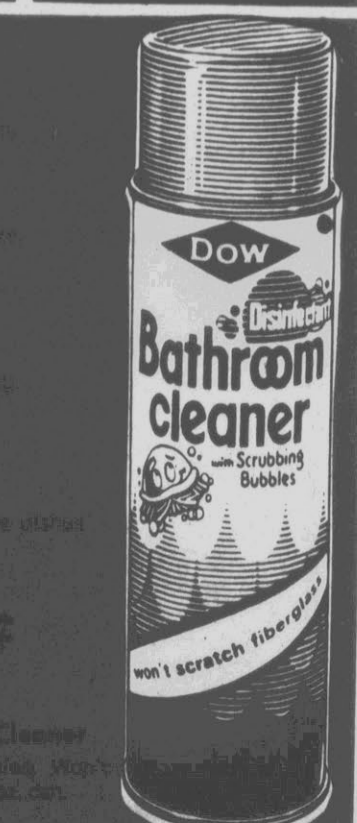
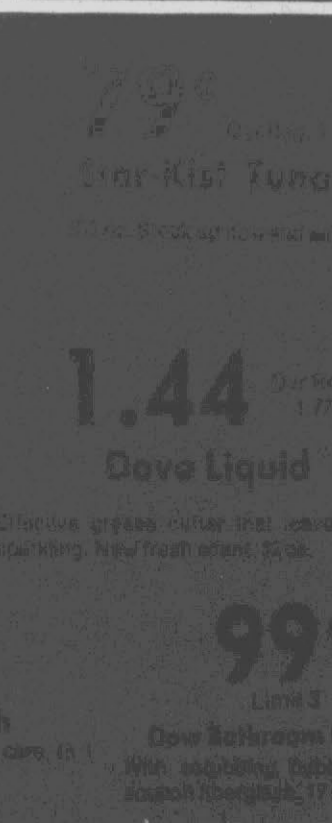
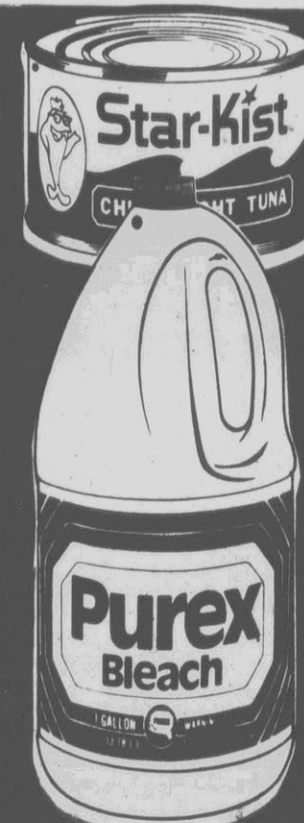
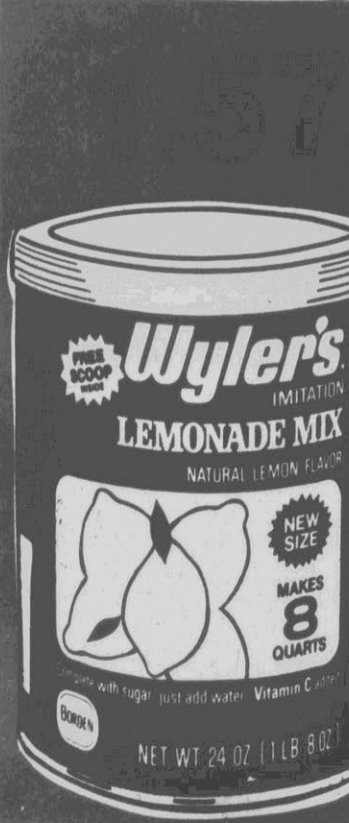
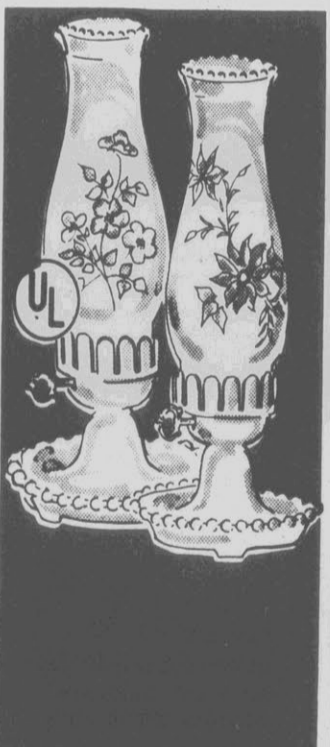
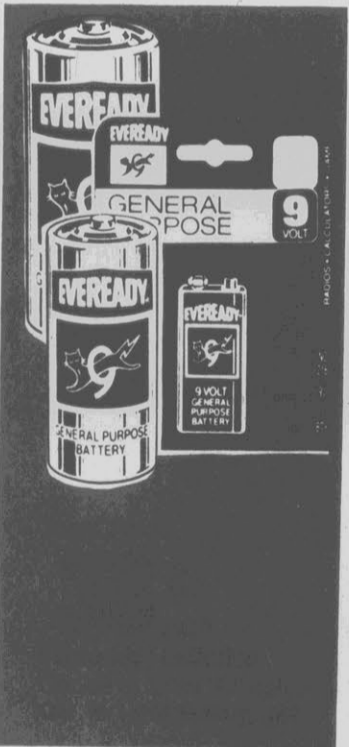
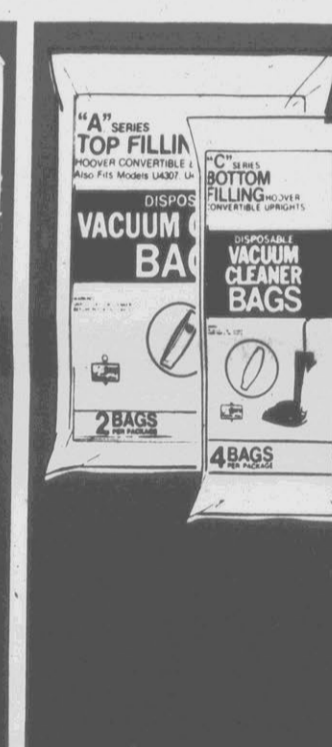
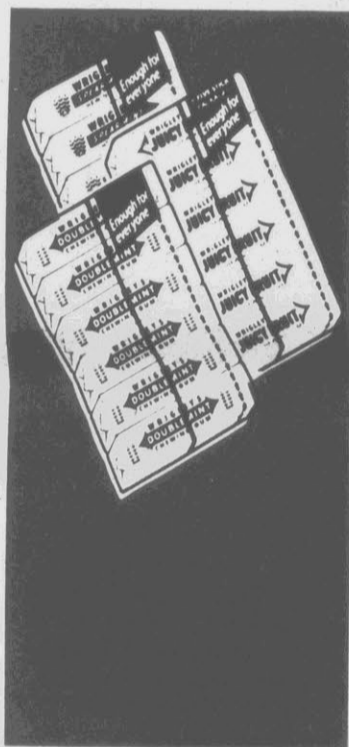

Wyler's
IMITATION
LEMONADE MIX
NATURAL LEMON FLAVOR
NEW SIZE
MAKES 8 QUARTS
NET WT 24 OZ (1 LB 8 OZ)

Wyler's
IMITATION
LEMONADE MIX
NATURAL LEMON FLAVOR
NEW SIZE
MAKES 8 QUARTS
NET WT 24 OZ (1 LB 8 OZ)

Star-Kist
CHUNK LIGHT TUNA

Purex
BLEACH

Dove
LIQUID SOAP

1.44

Dove Liquid

Effective against dirt and grease without
scrubbing. New Freshness Scent.

99¢

Dow Bathroom Cleaner

With scrubbing bubbles. Won't
scratch fiberglass.