

## Indicators Fail Show Down Trend

WASHINGTON (AP) — A government index for predicting future economic trends was down 0.1 percent in June, partly due to a slowdown in employment and factory orders, the Commerce Department reports.

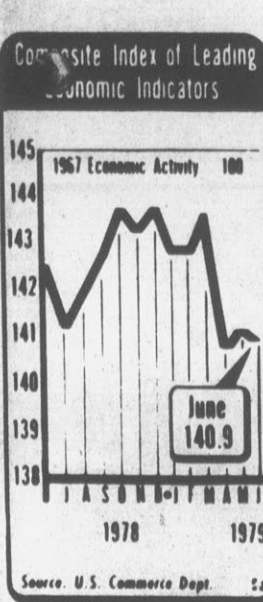

months of downward movement, a traditional measure of impending recession. The June drop came after a 0.3 percent gain in May and a 2.1 percent decline in April.

much of a recession we are in for," said department economist William Cox.

The decline began in the second quarter of this year, according to earlier department reports on the U.S. inflation-adjusted gross national product, and is expected to continue through the third quarter. The leading indicators have shown a decline since December, although the monthly pattern has been erratic.

The Carter administration, acknowledging the economy is in a recession, has predicted it will be mild and short-lived.

The barometer of future trends fell 1.7 percent in the second quarter of the year after a 0.2 percent drop in the first quarter. The index rose in all four quarters of 1978.

The index in June stood at 140.9, or 140.9 percent of the 1967 base period, compared with a revised 141.1 for May. Both are below the 143.7 reported in December.

The Commerce Department report indicates the average work week fell and the layoff rate increased in June, signs that consumers may have less to spend in future months. Factory orders were off, as were vendor performance and sensitive prices.

Five index components showed improvement: contracts and orders for plant and equipment, stock prices, building permits, money supply and liquid assets.

### REFLECTOR

## HOTLINE



752-1336



Hotline gets things done for you. Call 752-1336 and tell your problem or your sound-off or mail it to Hotline, The Daily Reflector, Box 1967, Greenville, N.C. 27834.

Because of the large numbers received, Hotline can answer and publish only those items considered most pertinent to our readers. Names must be given, but only initials will be used. Transcribing is done once a day.

### RETURN FOR EXCHANGE?

My eight-year-old son earns his spending money by collecting and selling soft drink bottles and aluminum cans along the roadside. He sells the cans to the recycling truck at Pitt Plaza each Friday and turns in the "return for deposit" bottles at stores for refunds. This project has been a valuable experience for him. He's using his spare time constructively; he's learning to spend money that was not easy to earn wisely; and, in a small way, he's helping to keep Pitt County beautiful. Recently I took him to the Fast Fare Store on Hooker Road with six bottles. He was told that he could get only merchandise, not cash, in return for his bottles. I wouldn't call this spending money wisely. If outlets for soft drinks are going to refuse to pay cash for bottles, perhaps the bottles should be stamped, "return for exchange." B. P.

Hotline called the Fast Fare Division Office and talked to Mrs. Pat Johnson. She said it is Fast Fare policy to pay cash for returned bottles if this is what the customer requests. She said the Hooker Road store may have encountered some problem that caused the individual store to start this policy, but that the company would insist from now on that cash be paid for bottles when requested at this and all Fast Fare stores.

### HOTLINE APPEAL

#### CAR HIT IN SIDE

My husband and I discovered this morning that my 1976 cream-colored Mustang hatchback has been hit in the side. This could have happened only when I went to Hollowell's Drug Store on Memorial Drive for medicine for my grandson Monday between 2:30 and 3 p. m. I would appreciate it if anyone who may have seen the car, parked about three parking spaces from the door of the store, hit during that time would call me at 752-7816. F.S.

## School Merger Study Group

By REBECCA BUFFALO  
Reflector Staff Writer

The Pitt County Board of Education Tuesday night authorized chairman Mark Owens to appoint members Bill McLawhorn, Beverly Congleton, Jim Black, William Earl House, Dr. J. O. Carson, and Dr. Thomas Patterson to work with Greenville City Board of Education members Ms. Terry Shank, Miles Frost and Donovan Phillips on a committee devoted to studying the possible merger of the two school systems.

The special call meeting Tuesday was held in lieu of the regular August 7 meeting. The board will not be meeting again until September 4, when children in grades K-9 go for orientation day.

Owens' authorization came after board members discussed the idea that county school age children comprise two-thirds of the total county school population. With that in mind, the board felt that the county should be represented by six members to the city board's three to equally represent the population.

"The more I look at the situation from a personal

standpoint, the more I'm concerned that any two groups meeting to evaluate this situation must reflect the makeup of students as represented by the two boards," said Dr. Thomas Patterson.

Transportation Supervisor Rodney Bullock came before the board to discuss triple transportation for children in the Stokes-Belvoir area. Bullock noted that under the present system, Belvoir children in grades K-8 are the first to get to school and usually among the last to be picked up for the afternoon, putting kindergarten children in school around 7:50 a.m. and coming home around 3:40 p.m. The board approved a change whereby buses would be provided for children in K-5, 6-8 and 9-12. With the new system, kindergartners would go into school around 8:15 a.m. and get out about 3 p.m.

Bullock pointed out that there would only be a four to five per cent increase in the number of drivers needed in the new plan, with no need for extra buses.

The board also approved the moving of a mobile unit from Bethel Elementary to

Belvoir Elementary, and two mobile units to be moved to D. H. Conley, one from Bethel and one from Griffon Elementary.

George Laws, energy control officer, reported on the new federal emergency energy conservation measures, whereby grades 7-12 buildings should be cooled no less than 78 degrees and heated no higher than 65 degrees. He pointed out that buildings housing grades K-6 are exempted from the federal guidelines.

Laws noted that the county board of education's policy was based on ranges of 68-72 for heating and 78-82 for cooling. He stated that buildings that house grades K-8 would have to strive toward maintaining federal guidelines in seventh and eighth grade classrooms to comply with the rules.

After a review presented by Superintendent Ott Alford, the board approved a plan for personnel evaluation with the exception of a list of teachers who would be exempted from evaluation. Superintendent Alford pointed out that the exemption was made so that no ill will would be felt toward those teachers who were not evaluated.

Following information presented by Associate Superintendent Tom Craft, the board approved existing

(Continued on page 6)

## Dollar Day

One of Greenville's oldest trade events, "Dollar Day," will be held Thursday, sponsored by the Downtown Greenville Association.

John Shannonhouse, president of the association, said that Greenville merchants will be participating in the final merchandise clearance event of the summer.

"Hundreds of bargains will be offered and local merchants have invited everyone to take part," the DGA spokesman said. Free parking will be available all day in the downtown area for the convenience of shoppers taking advantage of the traditional late summer sale, it was noted. Brown paper bags will again be used to designate free parking areas.

Shannonhouse said that heavy crowds are anticipated for the "Dollar Day" activities, in view of this year's early tobacco market opening.

## Says Consumer Revolt Behind State Action

By STUART SAVAGE  
Reflector Staff Writer

Joseph M. Parker, secretary of Operation Overcharge, said here yesterday that, "it is our belief that the climate created by what can be called a consumer revolt, made it possible," for the North Carolina Utilities Commission to order the Virginia Electric and Power Co. to convert five of its oil fired generating plants to coal use by the end of 1980 and refund some \$31 million to its retail customers in Eastern North Carolina.

Parker, editor of "The News Herald" in Ahoskie, said the utility commission decision only affects about half the residents of Northeastern North Carolina. The others, he said, are served by cities and towns that own their own electric systems and by electric coops, whose rates are set by the Federal Energy Regulatory Commission.

"Operation Overcharge intends to do something about

that," within the next few weeks, Parker indicated.

Parker said some 45,000 residents of the 22 counties in the state served by VEPCO, who signed petitions last year that asked Gov. Jim Hunt to do what he could to seek reductions in VEPCO's rates, resulted in an investigation of the utility by the Utilities Commission's Public Staff. That investigation led to the commission's decision which was made public yesterday.

The commission, based upon the investigation and several hearings, determined that VEPCO's management has operated inadequately in the areas of management and maintenance of its generating facilities. "That's exactly what Operation Overcharge has been saying all along, Parker emphasized.

The petitions were circulated by various chambers of commerce in the East, and some 25,000 of the 45,000 signers of the petitions came from the Greenville-Pitt County area.

## Mailing City Tax Billings

Floyd Little, tax collector for the city of Greenville, reported that 1979 city tax billings will be mailed today. Little said that some 16,000 bills will be mailed out, representing a total levy of \$2.5 million at a total valuation of \$350 million.

The official urged local taxpayers to take advantage of the two percent discount offered by the city for payment of 1979 taxes during the month of August. He said that early payment will alleviate last-minute standing in line.

Little reminded local businesses that the final day for the purchase of 1979 privilege licenses was Tuesday, Aug. 31. A five percent penalty now applies for late purchases.

City taxes and license fees are paid at city hall, located at the corner of Fifth and Washington Streets.

Little said that persons with questions concerning their taxes should call city hall at 752-4137.

## Taking Oath

RALEIGH, N.C. (AP) — Associate Justice Joseph W. Branch was scheduled to take the oath of office today to become the 21st chief justice of the state Supreme Court.

Branch, 63, an associate justice since 1966, was named by Gov. Jim Hunt to succeed Chief Justice Susie M. Sharp, 72.

Ms. Sharp retired from the post Tuesday.



AT OPENING ... of Carolina East Mall, Greenville Mayor Percy Cox and mall manager Barbara DeVoss stand on platform in midst of crowd,

welcoming the shoppers to the city's newest shopping area moments before the mall opened for business.

## Carolina East Mall Formally Opened

By TOM BAINES  
Reflector Staff Writer

A fast paced year of construction and preparation culminated today in the grand opening of the new \$16 million Carolina East Mall here, a 64-store regional shopping complex.

Grand opening ceremonies took place at the facility's main entrance and a sizable gathering rushed into the new complex after Vern Davenport, a kicker with the East Carolina University football squad, launched a football

over simulated goal posts and onto the mall roof.

Mayor Percy Cox welcomed the mall personnel to Greenville and said that the opening represented "probably one of the greatest events Greenville has seen."

Cox recalled that the city was approached a little over three years ago by Ernest W. Hahn Inc. regarding possible rezoning and annexation of the 37-acre mall site. The mayor said that the rezoning and annexation took place but the city "never anticipated

what you (area citizens) will see this morning."

The city official noted that Greenville is "getting to be the regional center for the East" and he pointed out that the new mall will be one of the biggest drawing cards in all of eastern North Carolina.

Greenville, he said, is fortunate to be the hub of eastern North Carolina and he congratulated the Hahn company for having the foresight to locate here.

John Gilchrist, vice presi-

(Continued on page 6)

## Carter Asks GOP To Support His Proposed Windfall Profits Tax

By FRANK CORMIER  
Associated Press Writer

WASHINGTON (AP) — President Carter, back from a trip to the grassroots he said gave him "a much clearer sense of what this nation is, what its problems are," asked Republican congressional leaders today to support his proposed "windfall" oil profits tax.

Senate GOP Leader Howard H. Baker Jr. of Tennessee said he told Carter at a breakfast meeting in the White House that "the chances of getting a windfall profits tax enacted are very good, indeed."

However, Baker said the president and the Republican leadership are not in agreement on the distribution of the revenue from the proposed tax on oil companies.

Baker said he thought a compromise was possible. "You don't have to have a 100 percent plowback," he told reporters.

The senator also praised Carter for making an effort to open regular communication with congressional Republicans.

The president's nine-hour

trip Tuesday to the lush green hills of Kentucky also brought him campaign-like acclaim in the small, whiskey-making city of Bardstown, where he held his first U.S. "town meeting" in four months.

And before heading back to Washington, the president made a surprise trip to a tiny Indiana town struck by severe floods last week. He had declared the area a disaster area before departing Washington.

The stop at English, Ind. — which took him 65 miles out of the way on a helicopter trip from Bardstown back to Air Force One at Louisville — drew favorable reviews from some of the town's 600 residents. "You've restored our faith in government," said one woman. "It shows he's concerned," said Harvey Dearborn.

The questions put to him by citizens at Bardstown, with one exception, dealt with topics and concerns Carter often is asked about in Washington: prospects for gasoline rationing and a resumption of the military draft, the new Strategic Arms Limitation Treaty, the plight

of Vietnamese refugees and environmental concerns.

The exception was one woman's complaint about her local telephone service, which Carter promised to look into within 24 hours.

One topic that surely would have been broached in Washington, however, was not mentioned in Bardstown — the president's purge of his Cabinet.

Carter made energy the No. 1 topic for the trip by stopping first at a coal-fired power plant near Louisville, where he met for an hour with coal industry leaders and talked to 200 hardhat workers about the need to place greater reliance on American-mined coal.

Stepping onto a flower-bordered, red-carpeted platform in the steamy gymnasium at Bardstown High School, the president again talked about coal and the energy problem, saying: "America is the Saudi Arabia of coal, blessed with enormous reserves. ...I would rather burn a ton of Kentucky coal than see our nation become dependent by buying another barrel of OPEC oil."

## ECU Searching For Needed Student Housing

ECU News Bureau

East Carolina University, bracing for the opening of the fall semester Aug. 25, is expecting a severe housing shortage.

ECU's residence halls, which have a normal capacity of 5,500, are filled for the

fall semester and Housing director Dan Wooten said a waiting list of approximately 397 already exists. On a temporary basis, three students will be housed per room in 48 rooms and 21 students will be assigned also temporarily, to living space in the ECU In-

firmary.

It is expected that these students assigned three-in-a room and in the infirmary will be able to move during the first month of the semester into regular semi-private rooms as vacancies are created by "no shows" and

early withdrawals.

Chancellor Thomas B. Brewer noted that all possible steps are being taken to alleviate the housing situation for ECU students.

"The supply of off-campus housing information which is usually maintained by the

Housing Office has been exhausted. This, coupled with the shortage of residence hall space, has created a critical situation for students presently seeking housing," Dr. Brewer said.

"The University is in desperate need of assistance

from residents in the community who may be in a position to rent space in their homes," Brewer said. "Anyone interested in offering assistance is asked to call the Housing Office at East Carolina University, 757-6450 or 757-6639."



By Abigail Van Buren

© 1979 by Chicago Tribune-N.Y. News Synd. Inc.

**DEAR ABBY:** As the father of an intelligent, well-developed 17-year-old daughter, I would like your opinion on a matter that troubles me.

Lisa wear short shorts that are just about as short as shorts can get. To be even more specific, a good portion of her shapely rear end is exposed to public view. It wouldn't be quite so offensive at the beach, but when she walks around the shopping center in high heels with half her behind showing, I must object. My wife agrees with me.

I voiced my disapproval to Lisa, and she informed me that it's the accepted mode of dress these days for her generation, and furthermore, my prudishness amazed her.

What do you say, Abby? Sign me...

OUT OF WORDS

**DEAR OUT:** Inform Lisa that it may be the accepted mode of dress these days for her generation, but her Southern exposure is offensive to yours. And to please show a little more consideration—and a little less cheek.

**DEAR ABBY:** This is in response to a letter from JOHN who complained because his name is synonymous with a toilet, a hooker's customer, and a "Dear John" letter saying, "It's all over, so get lost."

Well, my name is Mary. And my name, too, has been abused. For example, "Lazy Mary, won't you get up," "Mary, Mary, quite contrary," "Bloody Mary," and don't forget that suggestion that "we all make Mary."

Yes, I know there is a song stating that "Mary" is a grand old name, but that doesn't help.

Sign me...

"RATHER BE SUSIE" IN OREGON

**DEAR ABBY:** I'm 33, married to a wonderful man, and we have two fine children. So what's my problem?

I eloped at 16 and never had a wedding, which is the one big regret in my life.

My husband and I are going to Las Vegas for a vacation soon and I understand there are places where couples can get married in a church-like setting. I am told they have beautiful chapels, filled with flowers, and they even have someone to perform the ceremony. Furthermore, you can rent a lovely wedding gown and tux, and have regular wedding pictures taken.

I want to know if you think I'm crazy to want a really beautiful wedding, Abby. My dream is to have a picture of myself as a bride in a real wedding gown.

I am embarrassed and ashamed to ask my husband what he thinks of my secret wish, but if you reply I will show him your letter, unless you think the whole idea is completely nuts. Sign me...

SENTIMENTAL IN TEXAS

**DEAR SENTIMENTAL:** I don't think the idea is nuts. It's lovely. Since you are already married, why not have your marriage vows renewed in that lovely Vegas chapel. Five will get you 10 that your husband will agree to it. I hope so.

**CONFIDENTIAL TO F.S. IN ARLINGTON, VA.:** True, a new broom sweeps clean. But the old broom knows where the dirt is.

## Censured Congressman Back To Normal Duties

By JAY PERKINS  
Associated Press Writer  
WASHINGTON (AP) — Rep. Charles C. Diggs Jr. was returning to his normal duties as a congressman today after a climactic day in which he became only the 19th member in the history of the republic to be censured by his House colleagues.

The House voted 414-0 Tuesday to censure the Michigan Democrat for financial misconduct. Four members voted present.

While embarrassing to Diggs, the action had little, if any, practical effect on his congressional standing. He still retains his right to vote, his committee assignments and the perquisites

that go with being a congressman.

He has no positions of power, having relinquished both his chairmanships after his federal court conviction last year on 29 counts of mail fraud and of making false statements.

Diggs, the first congressman to be censured in 58 years, showed no emotion during the debate or as House Speaker

Thomas P. O'Neill pronounced the censure.

Censure, the strongest punishment short of expulsion, requires the member to stand in front of the House while his actions are formally condemned.

The censure was based on an admission by Diggs that he violated House rules by using his congressional payroll to help pay his personal expenses.

The House action has no effect on Diggs' federal conviction, which he is appealing. Nor does the censure close the door to further disciplinary action by the House should Diggs's appeals.

Diggs, a former chairman of the House Black Caucus, faces a three-year prison sentence if his appeal is rejected.

The veteran congressman presented no defense on the House floor, and his comments afterwards were muted. "I don't have anything to say," he told reporters. "It (the censure) speaks for itself."

Asked if he would resign, as one member suggested, Diggs replied: "I'm still here and I expect to serve out my term." Asked whether he intends to seek re-election next year, he said, "Oh, yes."

### Some 'Lightly' Contaminated

SOUTHPORT, N.C. (AP) — Carolina Power & Light Co. said Tuesday four or five workers were contaminated, none seriously, when a small leak occurred in its Brunswick nuclear plant last month.

Officials said the accident occurred when control rods were being withdrawn from the No. 2 reactor at the plant.

Spokesman Fred Tollison said all of the men went back to work immediately after cleaning their clothes, he said.

### Vote 'Near' On Talmadge

WASHINGTON (AP) — The Senate Ethics Committee is close to a vote on whether to recommend censure or some other disciplinary action against Sen. Hermand Talmadge for financial misconduct.

The committee scheduled a meeting today to consider a recommendation of censure from Carl Eardley, the panel's special counsel who headed a 14-month-long investigation into the Georgia Democrat's finances.

The committee could postpone any decision on the case until after the Senate's 30-day August recess which begins Friday.

But committee sources indicated Tuesday it was more likely some vote would be taken today.

Talmadge has been accused of five specific violations of Senate rules, including turning campaign contributions to his personal use and knowingly claiming Senate expense funds to which he was not entitled.

### EXTENDED WEATHER OUTLOOK FOR N.C.

Partly cloudy with scattered evening showers Friday through Sunday. Highs in the 80s to low 90s and lows in mid-70s except in the mountains during the period.

Censure was recommended for two other members in this century but both motions were defeated. Those motions involved Democrats Adam Clayton Powell of New York in 1967 and Edward R. Roybal of California last year.

## FRAME-IT-YOURSELF SHOPPE

NEW ADDRESS  
606 Arlington Blvd. Phone 756-7154

OPEN TONITE UNTIL 9 P.M.



West End Shopping Center  
756-6611

### Formerly A-1 Values

Large Assortment  
**Dress Fabrics**  
Knit Prints  
Broad Cloths  
Gingham Checks

**Polyfoam**  
By The Yard  
&  
Bag Of Stuffing



Unbleached Muslin...  
Pinsonic Quilts...  
Interfacing...

# Fashion

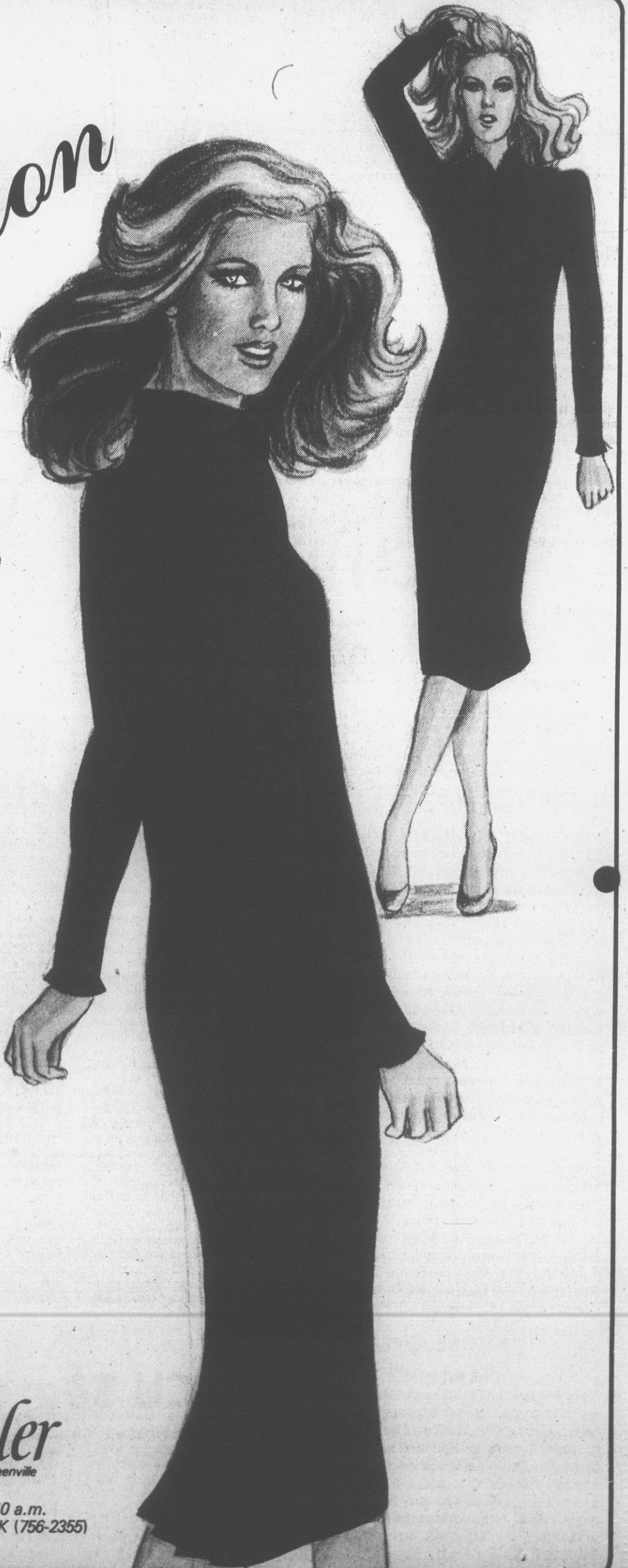

### The Chemise... a New Slant on Tailoring by Kasper for Joan Leslie

Kasper's very chic chemise makes a hit for fall in magenta with tailored emphasis on the back... 6 rows of tucking from the neck down and precisioned knife pleats beginning just above the knee. Ruffled neck with bow tie, button tab front and button tab, ruffled cuff. Acetate/rayon, \$154.

Visit our Regency Room, Now Open at Carolina East Mall

## DOLLAR DAY

### VALUES IN BOYS CLOTHING

A Group of Suits Values to \$105 Reduced to **\$35**

A Group of Sport Coats Values to \$57.50 Reduced to **\$20**

A Group of Pants Values to \$22.00 Reduced to **\$4.50** Each

A Group of Knit Shirts **1/2** Price

A Group of Dress Shirts **75%** Off  
Sizes 10 and 12 Only

A Group of Boys Ties **\$2.00** Each

All Alterations Extra



On The Mall in Downtown Greenville



Shop Monday Through Saturday 10 a.m. Until 10 p.m. — Phone 756-B-E-L-K (756-2355)

## 'Buy Better Quality' Says Fashion Head

Buying better quality garments, and fewer of them, is advice offered to mothers coping with inflation by Jack Simpson of Chicago, Ill.

As fashion director of children's wear for Sears, Roebuck and Co., Simpson was here prior to the opening of Carolina East Mall today.

Continuing he said, "Mothers should also stick to basic colors and relative basic styling — avoid-gimmicky styling. He also recommends buying ahead within reason. Considering Greenville's climate, mothers might try layering instead of investing in an expensive outer garment when considering growth.

"Using a garment for a double purpose — such as a flannel shirt as a lightweight jacket or as a shirt."

In discussing future fashions or trends in children's clothing, Simpson said, "I think clothing will become simpler and more functional with the use of stretch fabrics in very basic tops and bottoms over the next 20 years.

"Changes over the years have been in selections, particularly in the boys' line. There has been a lot more fashion input, more of a selection for dressing, more colors and a wider variety. The performance of fabrics, year by year, improves — we can do

more interesting things with fabrics and make them easy care."

As the design and fashion coordinator for all children's apparel, he provides direction to Sears children's wear departments on merchandising fashion apparel. He travels to Europe and other world fashion centers several times a year viewing styles.

He works mostly now with designers, not actually in designing, "but more or less screening the designs, adding to or subtracting ideas if needed. I have unconsciously done some designing, but primarily I screen or edit. In most cases its taking away an extra tier on the skirt or a button at the neckline.

"One of my peeves is seeing a youngster dressed like an adult. The garment or style has to be altered to fit the child's size."

Of his position, Simpson said, "It's a fun job. Kids are very honest, very perceptive and they know what they like or dislike and we listen to them. I'm lucky enough to see the merchandise created and follow it through to the point where it's presented to the customer."

Simpson has appeared on national television on the Mike Douglas, Virginia Graham, Dinah Shore and Julia Meade shows. He has taken the Winnie-the-Pooh Collection to Russia and served as Pooh's campaign manager in nationwide political "campaigns" during the past three elections.

"When Sears decided to market the Winnie line, I was assigned to help develop and promote the idea throughout the United States," he added.

—Rosalie Trotman

## Homemaker's Haven

By Sue B. May  
Pitt Home Agent

### "Home Ownership?"

Over the past two years we have seen housing prices skyrocket. Comments like "when will it all stop" and "it's getting so that you can't afford a home" are heard. This situation leaves the average consumer with the question, "Should I buy a house today?"

Some experts tell us that the average cost of a new house is close to \$50,000. If you're considering a new home, you might want to ask yourself, "Can I afford a new house and still have money left over for other things?"

It's not just the initial cost of the house that's high. Taxes, interest charges, maintenance, and fuel costs are rising, too. In fact, these last four items could be the final straw that breaks the house-buyer's back.

An old rule of thumb used to say that you could afford to pay two and one-half times your yearly income for a house. Some financial advisors now say this amount is a little steep for most families.

A more realistic figure is a house that costs just one and one-half times your yearly income. It's true that home ownership brings pride, privacy, some tax breaks and freedom. The first question is, "Can you afford a new home?"

A second consideration for owners of either new or older homes is adequate home insurance. If your house is getting older — its value might be getting higher. So you might do well to check over your homeowners insurance and make sure that

it's adequate. Suppose you could get fifty thousand dollars for your present home. The important question would be, "How much would it cost you to build a new house of the same caliber?"

Keep in mind that the cost of construction materials has risen about ten percent a year. So if your house is 10 years old, building another one just like it could cost you almost double the original amount. This cost of replacement is what you need to insure against.

According to some insurance agents, you should be carrying at least eighty percent of the replacement cost. Unless your insurance company has been adjusting your coverage each year — you may discover your home owner's insurance is far from adequate.

The crystal ball does not guarantee that purchasing a new home is necessarily a profitable investment. As always, making a wise decision rests in the hands of each individual family and depends on a variety of factors which must be weighed carefully.

## Pre-Football Dance Planned For Saturday

The Greenville Jaycettes' second annual pre-football season charity dance will be held Saturday at the Greenville Moose Lodge from 9 p.m. to 1 a.m.

Tickets are \$12 per couple and are available from any Greenville Jaycette or by calling Debbie Callow, 752-0189, or Donna Tripp, 758-6226. Tickets will also be available at the door.

Proceeds will be used to assist the handicapped families in Pitt County and other club projects.

**CLOTHING EXPERT URGES INDIVIDUALITY**  
STILLWATER, Okla. (AP) — Develop a personal style to express your own individuality in the clothes you wear, urges Marjorie Baker, Extension clothing specialist at Oklahoma State University.

"By studying your wardrobe, you can see what you like about clothes you enjoy wearing and what you dislike about ones you do not wear," Mrs. Baker says. "Ideas you get from this study will make good guidelines for your next shopping trip."

Lemon Custard Pies  
No Preservatives Added  
**Diener's Bakery**  
815 Dickinson Ave.

To keep children from running in and out of the house to see what time it is, try putting a clock, face out, in a window.

Happy Birthday  
**Ernest Jones**

We Love You.

# DOLLAR DAY Sale

Entire  
Summer Stock  
60% & 70% OFF

Includes  
Swim Suits Skirts  
Blouses Slacks  
Blazers



**Susan's**  
331 Arlington Blvd.



FASHION DIRECTOR. . . of children's wear for Sears, Jack Simpson visited the new store last week.

## Births

### Hines

Born to Mr. and Mrs. Michael Lee Hines, Rt. 6, Greenville, a son, Michael Lee II, on July 24, 1979, in Pitt Memorial Hospital.

July 25, 1979, in Pitt Memorial Hospital.

### Casper

Born to Mr. and Mrs. Thomas Cecil Casper, Walstonburg, a daughter, Melissa Dawn, on July 25, 1979, in Pitt Memorial Hospital.

### West

Born to Mr. and Mrs. Kenneth William West Jr., 413 Abel St., a son, Kenneth William III, on July 24, 1979, in Pitt Memorial Hospital.

### Ogburn

Born to Dr. and Mrs. Nichols Lee Ogburn, 1102 W. Wright Rd., a daughter, Stacey Nichole, on July 25, 1979, in Pitt Memorial Hospital.

### Boykin

Born to Mr. and Mrs. Michael Duane Boykin, Hamilton, a daughter, Teresa Gayle, on July 25, 1979, in Pitt Memorial Hospital.

### Webb

Born to Mr. and Mrs. Norman Wayne Webb, Greenville, a daughter, Billie Anne, on July 25, 1979, in Pitt Memorial Hospital.

### McCotter

Born to Mr. and Mrs. Ronnie Thad McCotter, Rt. 1, Grifton, a daughter, Ronsenia Truelish, on

### Cruz

Born to Mr. and Mrs. Jesus Cruz Jr., Maury, a son, Billy Joe, on July 26, 1979, in Pitt Memorial Hospital.

### Bass

Born to Mr. and Mrs. Ronald Elliot Bass, Farmville, a son, Ronald Elliot II, on July 26, 1979, in Pitt Memorial Hospital.

### Harris

Born to Mr. and Mrs. Bobby Ray Harris, Rt. 1, Farmville, a son, Cory Terrell, on July 27, 1979, in Pitt Memorial Hospital.

### Harris

Born to Mr. and Mrs. James Elais Harris, Rt. 4, Greenville, a daughter, Tameka Nicole, on July 27, 1979, in Pitt Memorial Hospital.

## Personal

Mrs. Althea Wooten, of 700 McDowell St., is a surgical patient in Pitt County Memorial Hospital, room 114-S.

In the early days of potato development in Europe, potatoes came in many colors and some were even two-toned. Skin color seem to have no connection with the cooking quality of the potato.

*Fashion Amalfi*  
by Rangoni  
Florence Italy

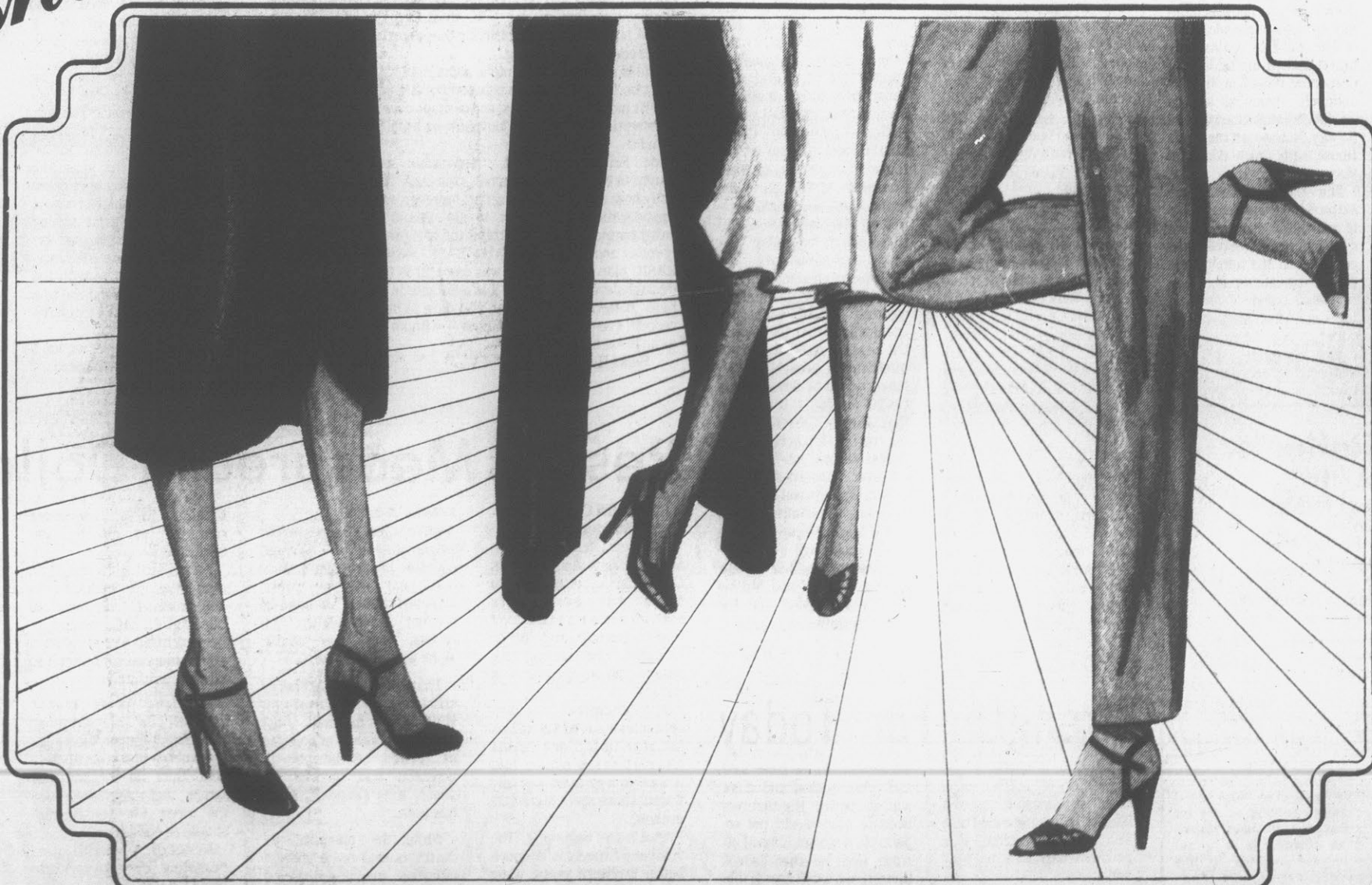

Amalfi by Rangoni Announces Fall's Arrival with Sleek Femininity

Very elegant, very fashionable Italian styled shoes. Shoes to set the tone for your gracious fall season. "Sibra", in black mink and taupe, is made of leather and suede and fashioned with a petaled vamp. Taupey brown kid leather "Sellino" features an open toe in a sandal style with a puckered vamp. Black mohave suede leather composes "Orfo", an open toe sandal with a scalloped vamp. All with the latest fashionable high heels. Sizes 6 1/2 to 7N and 5 1/2 to 9M. \$54 and \$68.

**Belk Tyler**  
carolina east mall greenville

Now Open — Shop Monday Through Saturday  
10 a.m. Until 10 p.m. — Phone 756-B-E-L-K (756-2355)

# Eye On Waste Is First Step

Rep. Sam Bundy, speaking to the Pitt-Beaufort Conservation Union, has said that the General Assembly is becoming more conservative.

"For the first time in recent history legislators discussed not how to raise taxes, but how to reduce them," Bundy said.

This General Assembly will be remembered for what it did not do as much as for what it did do, Bundy commented.

The trend toward more careful spending on the part of the Legislature can be a good one. There

are many needs of our citizens which can and certainly should be met, and it would be a mistake for General Assembly members to go on a wild cost cutting spree.

At the same time every new spending request should be looked at carefully, and even current expenditures should be examined to determine that they are still wise ones.

North Carolina, and all levels of government, can provide the services citizens expect, and also eliminate waste in government.

# Once Again Need For Student Housing

In the years after World War II there was great pressure locally for student housing each fall.

In the 1950s and 1960s many dorms and private housing were built for students and, at times, the shortage of housing for ECU students eased.

This fall, however, there is a shortage once

again and the ECU administration is appealing for housing for entering students.

Making a room available temporarily for a new student could make the difference in whether that student can attend school. It will indeed be a good gesture.

THIS AFTERNOON

# Two-Language Tar Heels

By BILL NOBLITT  
 RALEIGH — A funny thing about North Carolinians: we talk two different languages, switching from one to the other without even realizing it.

That phenomenon, says Professor Wm. S. Powell, is a dead giveaway of a native Tar Heel. It also traps many a Brooklyn native trying to "pass."

In the sophisticated urban centers, the universities, the downtown commercial installations, Standard English is the rule.

But back home in the rural areas for a weekend — or even when enough North Carolinians are gathered together in some hoity-toity place — we all tend to lapse un-self-consciously into the words and pronunciations we grew up with back home.

All of this is complicated by the fact that three distinct dialects make up that second tongue. The trained ear can spot a mountain-reared person; an easterner; or the Outer Banks native. Further, an expert like Powell can often even pinpoint the county where the speaker grew up.

Human History

A history professor at the University of North Carolina at Chapel Hill, Powell escapes the musty image which shrouds so many in his chosen field. A sprightly, human, humorous fellow with a twinkle in his eye, he has published a history of North Carolina which reflects his own personality.

It is, he says, "for those who love North Carolina, and those who would like to be North Carolinians ... if they could only pull up their roots elsewhere." And, he might add, somehow get rid of that slip-of-the-tongue accent, and learn to pronounce the tricky North Carolina place names. Those names, more than any other, will trap the unwary imposter Tar Heel.

Powell's book, he insists, is not for scholars, but for people; and he hopes it will find a place not only in the homes but in libraries and particularly in schools.

"Our children in school today are being slighted. They are not being taught North Carolina history as we were," he feels.

There is no need for history to be stuffy. The North Carolina history did not involve major research to pin

down obscure names and dates. To the contrary, says Powell, he wrote it from lecture notes, memories, and impressions.

"It was almost like writing a novel....I would just sit down and let it flow. The difference being, of course, it is based on fact."



BILL NOBLITT

The central theme running through the slender volume is independence: "North Carolinians don't like to be told what to do....never have."

The other pattern running through the history of the state, Powell finds, is a propensity to set off on the wrong track and every body move off in a giant, sweeping stampede toward certain disaster.

Repeatedly This has happened time and again throughout history.

But then, short of total disaster, the stampede stops. "The good sense of the people prevails at last," Powell

chuckles.

What other traits does he assign us from his many years of scholarly study and life as a native son? The people of the state are very tolerant of others and their divergent viewpoints. That's why newcomers from other sections of the country so often find a home in this state.

You can typically trust a North Carolinian to do the right thing — once he figures out what is the right thing.

And, you can find people typified as rural, backwoods Tar Heels investing huge amounts of time, energy and money in such things as art museums, symphony orchestras, outdoor dramas, schools of the art and such.

Complex people in a complex society? Not really — at least not hard to understand for those of us who automatically speak two languages.

Powell's book is part of a series of histories supported by the federal National Endowment for the Humanities and directed by the American Association for State and Local History in Nashville, Tenn.

WELL, DON'T JUST STAND THERE!

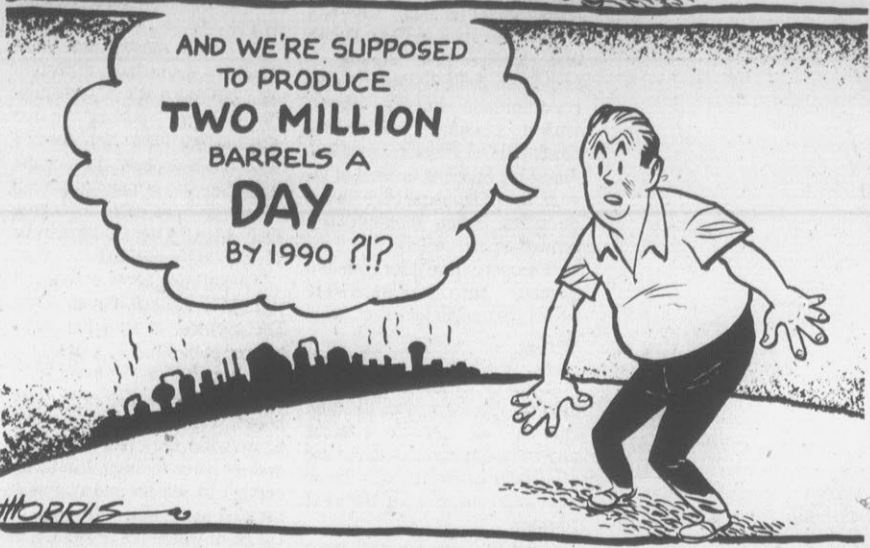

By ART BUCHWALD

# Tool Of Self-Criticism

SHANGHAI, China — The Chinese path to Marxism, Leninism and Socialism is strewn with criticism. In fact the key tenet to their system of government is to criticize themselves and each other, according to the principles of whoever is in power at the time.

Weekly meetings are held by whatever unit you have been assigned to, where you are expected to confess your own failures. No one is safe from self-criticism, and the

object of the meetings is to clear the air, motivate the individual and show that in an egalitarian society nobody is perfect.

While not advocating the Chinese form of government, I believe weekly self-criticism sessions could be very helpful in this country and might make everyone a better person.

Let us assume that all the people involved with the gas crisis in this country met once a week to confess their

sins. The Chinese method would go something like this:

Oil executive: I am a stupid capitalist roader and have failed in my struggle to fulfill the oil quota goals set for us by our beloved Chairman Carter.

Government energy official: No, comrade, it is I who must take the blame for letting down the motherland. My worthless regulations and bureaucratic blundering have done nothing but impede the free flow of gasoline to the workers and peasants. I deserve to wear a dunce cap and be marched through the streets.

# Public Forum

Letters submitted for Public Forum should be limited to 300 words. The editor reserves the right to edit longer letters.

To the editor:

What is the real issue concerning abortion? Is it really the rights of a woman over her own body (as opposed to the rights of the unborn child to be born)? Or is it "being realistic": abortion is here to stay, so let's deal with it as best we can?

I suggest a more basic issue to be dealt with or at least offered for consideration.

We can go in circles arguing different aspects of abortion, depending on where we are and have been experientially. But one thing is for certain: we all need a set of absolute values on which to make our basic value judgments.

I believe that most citizens in this area base their values on the Christian ethic. If this is true, God's Word should clarify Christianity's stand on abortion. The Bible clarifies that life begins at conception (Jer. 1:15, Amos 1:13, Ga., 1:15, Psalms 139:13,14,16); therefore clarifying that abortion is taking a life and is consequently wrong.

Life is not always so simple, some may say. Sometimes we must be forced to choose between the life of an unborn child and its mother. To me, this, and perhaps rape, would be the only exceptions to the value judgment we have just hypothetically made.

Ms. Fridley was right, "responsible sexuality must be taught in HOMES (caps mine), churches, and schools." (Exactly how schools are doing this, however, is another issue for consideration.) Education, to me, should include spiritual enlightenment, for lack of this is the root problem of our society today and its presence is our BASIC answer. Our Creator's BASIC plan for humanity was and still is totally redemptive through Jesus Christ, and it is available in all aspects of our lives. Believing this, we can also dare to believe that He can redeem even the worst situations — without the use of murder as an instrument.

Blake Honeycutt



ART BUCHWALD

Consumer: You may try to take the blame for the gas shortage, comrades, but it is I, through my laziness, slothful tendencies and privilege seeking, who has brought about the shortfall in fuel. I am guilty of naked materialism and lack of fortitude to sacrifice my own comfort for the good of the republic. Consider me a miserable rat nibbling away at our greatest resource.

Politician: All that you have said is true. But my inertia and personal interest, not to mention my failure to show leadership, have resulted in the gasoline drought. In trying to appease the bourgeois oil interests I failed the proletariat, setting class against class, and bringing about a state of anarchy that I will live with the rest of my life. Send me to a rice paddy so that I can learn from my mistakes.

Oil executive: No, no, no. I

(Continued on page 5)

THE INSIDE REPORT

# Carter Tax Cut Hinted

By ROWLAND EVANS and ROBERT NOVAK

WASHINGTON — Although it came out in his old fuzzy use of language, now supposedly replaced by decisive rhetoric, President Carter last week tipped a change that dwarfs all the recent cosmetic transformations: a tax cut effective next Jan. 1.

The eight members of the House and Senate gathered at the White House Thursday morning to discuss anti-inflation policy could scarcely believe their ears. Shortly after entering the meeting, the president made a statement that, according to note-taking lawmakers, was close to this: It might be a very good idea if, in about October, we propose a tax cut of around \$20 billion effective Jan. 1, 1980.

Whether this constituted a flat statement of a 180-degree policy change was cloaked by Carter's old imprecision. But even if he was not proclaiming an instant abandonment of his iron line against any tax reduction in the face of deepening recession, he was obliquely signalling a high probability that change is on its way. Nobody left the White House with much doubt on that score.

The political implications surpass anything done so far to salvage Carter's presidency. Republicans have been counting on the administration to remain in the deep rout canal school of political economy: when people really suffer from economic policy, it must be working. If Carter instead embraces tax reduction, it may blunt the

Republican edge for 1980 while restoring his own political fortunes.

The first sign of this reassessment came after we reported that Carter, just last year, was lagging behind the conservative tax-cut coalition in Congress. One senior administration official, a member of the Economic Policy Group, told us he agreed with that assessment and hinted that change was ahead.

The change was suggested at Carter's July 25 news conference. Responding to a question about Republican tax-cut plans, he declared "there is no free lunch" but did not rule out a tax cut. "When I heard that," one influential liberal Democratic congressman, who has been backing the president's hold-the-line campaign against tax cuts, told us, "I felt a cold chill."

Chill or not, this congressman was in the White House next morning for a regular meeting of the Democratic congressional task force against inflation with anti-inflation czar Alfred Kahn. Sen. Lloyd Bentsen of Texas started the fireworks by declaring that with

unemployment expected to surpass 8.5 percent in the current recession, a tax cut is absolutely imperative.

That set off a barrage from practically everybody else present, especially the Democratic fiscal big guns of Capitol Hill, all ardent root canal advocates: Chairman Edmund Muskie of the Senate Budget Committee; Chairman Robert Gaijmo of the House Budget Committee; Chairman Al Ullman of the House Ways and Means Committee. They insisted on tight fiscal policy, no matter how deep the recession goes.

Bentsen, chairman of the Joint Economic Committee, retorted that his colleagues could think what they would but he was predicting the administration, probably by October, would be advocating a tax cut for Jan. 1. It was then that Jimmy Carter entered the room to lend credence to Bentsen's forecast.

Carter's opaque statement — a cross between a hedged forecast, a melancholy wish and a teasing hint — left the congressional budget-balancers with their mouths gaping. Gaijmo and Muskie quickly responded that the

(Continued on page 5)

# Strength For Today

THE SOURCE

The story of Saul, the son of Kish, who became the first King of Israel and ended up a failure and a suicide, is a pathetic narrative of folly and violence.

The night before he died, Saul sought out the Witch of Endor and asked that she call up a spirit to give him guidance. The spirit that appeared in response to the witch's incantations was that of Samuel. And Saul's pathetic cry was, "What shall I do?"

Saul made the mistake of going to the wrong place for

his answer. To be sure, Saul had cried to God and there was no answer. But that was because Saul would not repent. Having shut himself off from God he then betook himself to a witch hoping that magic would solve his problem.

We Christians have a source to which we can always go, as long as we go in sincerity and repentance. "Come unto me all ye that labor and are heavy laden," said Jesus, "and I will give you rest."

Elisha Douglass

# Results Measured In Dollars

By JOHN CUNIFF  
 AP Business Analyst  
 NEW YORK (AP) —

Several years ago American Cyanamid Co. set up a plan to save energy in its conglomerate of manufacturing and office facilities, and learned the results can be measured in dollars.

The chemical concern estimates it saved \$19 million last year. Its U.S. and Canada fuel bill was \$106 million. Had it used energy in the old way it would have spent about \$125 million.

That's the beginning. The company expects to do much better in future years, when the program is extended to overseas operations. Present savings come from U.S. and Canadian facilities only.

When Cyanamid began the program, it sought by 1980 a 14 percent saving over 1972 usage, in keeping with an industry goal set by the Department of Energy. It reached 16 percent by 1977; it

aims for 30 in 1980.

While these figures seem extraordinary — savings equalled 12 percent of profits last year — they were achieved without damage to product or job quality. The reverse was true; waste alone was eliminated.

That's the beauty of energy efficiency, say its advocates. It often pays for itself, if not immediately then in a period of years. Although its potential was ignored for years, it is simply efficient business.

While the chemical industry is said to be energy-intensive, meaning it uses a lot of energy, most other companies can benefit from keeping an eye on the fuel bill, and save 10 percent to 30 percent, says Cyanamid.

First they should have an audit, perhaps by a consultant such as the E.I. duPont company (which developed expertise in auditing its own plants), said

Eugene Steel, corporate manager of energy conservation.

Steam heat traps should be examined, for example, to determine if the heat is blowing through instead of being utilized. The problem is a common one not difficult to correct, said Steele.

Lighting is a major wastrel. In his opinion, fluorescent lamps, which use less energy and generate less heat than do incandescent lamps, and therefore reduce the need for air cooling, should be considered.

According to Steele, "Lighting levels historically have been higher than needed," based on Illuminating Society of America standards.

Waste heat should be utilized, Steele continued. "We have processes in which the temperature of the final product must be cooled. We'd use water to do it, and then we'd cool the water. Now we

# Sees A Pledge Too Far

By BROOKS JACKSON  
 Associated Press Writer

WASHINGTON (AP) — President Carter seems to have promised more than he can deliver with his pledge to "cut the total size of the federal workforce."

He said that in an address to the nation Oct. 24 in which he outlined several steps he would take to combat inflation.

But at last count the total federal workforce has actually grown since then. As of May it was up about 27,000 people, to 2.9 million civilian workers.

Even discounting normal summer hirings and hiring in the Postal Service, Congress and other areas outside direct presidential control, federal employment is still creeping up.

In fact, the president may soon be forced to throw 1,000 to 2,000 federal workers off the payroll next Oct. 1 to meet a new legal ceiling on federal employment. He had hoped to cut employment through attrition and, in the process, in well under the ceiling.

But so far Carter hasn't delivered what he promised, much as he failed to deliver on his campaign pledge to cut the number of federal agencies from an alleged 1,900 or so to 200.

Carter now has no hope whatsoever of getting the total number of governmental units any.

(Continued on page 5)

# 40 Years Ago Today

August 1, 1939

K.T. Futrell, superintendent of public welfare in Pitt County, today called on private industry to absorb the unemployment load dumped in the county through dismissals in the county of WPA employees who have been on relief rolls for 18 months.

Futrell said the law provides for such employees filing requests for relief benefits with the county welfare office if they are unable to obtain work through a re-employment office. However, he added, "Such action will tend to place an extra financial burden on the county."

While reiterating the fact that over 100 WPA employees have lost their jobs in the county within the past month, the Pitt welfare official appealed to private employers to "give applications from this group careful and sympathetic consideration; for, unless private industry offers them work, they have no alternative but to try again to get on WPA or work relief from the county."

The American Steamer Illinois is aground off Beacon No. 14 in Cape Fear River, according to reports received today from Coast Guard headquarters.

Commander R.S. Lucas stated he had received a message to the effect that the steamer was not badly damaged. Crews from the Oak Island Coast Guard station are standing by to render any assistance.

— Stuart Morgan

## The Daily Reflector

INCORPORATED

209 Cotanche Street, Greenville, N.C. 27834

Established 1882

Published Monday Through Friday Afternoon and Sunday Morning

DAVID JULIAN WHICHARD, Chairman of the Board  
 JOHN S. WHICHARD — DAVID J. WHICHARD  
 Publishers

Second Class Postage Paid at Greenville, N.C. (USPS 145-400)



SUBSCRIPTION RATES  
 Payable in Advance  
 Home Delivery By Carrier or Motor Route Monthly \$3.50  
 MAIL RATES (Prices include tax where applicable)  
 Pitt And Adjoining Counties \$3.50 Per Month  
 Elsewhere in North Carolina \$3.85 Per Month  
 Outside North Carolina \$5.00 Per Month

MEMBER OF ASSOCIATED PRESS  
 The Associated Press is exclusively entitled to use for publication all news dispatches credited to it or not otherwise credited to this paper and also the local news published herein. All rights of publications of special dispatches here are also reserved.

UNITED PRESS INTERNATIONAL

Advertising rates and deadlines available upon request. Member Audit Bureau of Circulation.

# Woman Deputy Would Not Hesitate To Shoot

DURHAM, N.C. (AP) — Durham County may have hired two women as sheriff's deputies to control traffic and crowds at fires, but one of them says she will not hesitate to pull her gun and shoot if necessary.

Lucy Zastrow, who along with Susan Stuart are the first women in the county's history assigned to ride in patrol cars, said Monday the opportunity has not arisen to use her gun, but she believes that possibility goes with the job.

"Every day is different," know what to expect from one minute to the next."

Miss Zastrow said going into law enforcement was her mother's idea.

"I had decided to go back to school, and I sent her to Durham Technical Institute to pick up information on courses," she said. "I thought I would like nursing because I like to help people."

Her mother returned with a

brochure on the police-science curriculum instead, but told her there were no women deputies. Mrs. Zastrow told her daughter she did not know if the Durham County Sheriff's Department hired women deputies.

"Good, I'll be the first one," Miss Zastrow said she told her mother.

Miss Zastrow said after taking only part of the course, she was convinced she had found her career. She went to Sheriff Bill Allen and asked for a job.

Allen said he was concerned that hiring women would create resentment among the men in his department. But he said to date this has not materialized, and is considering hiring more women deputies.

"These women are doing a real good job," he said. "I think they may be trying to show the men up."

In filling future openings for deputies in his department, Allen said he would make no distinction between the sexes.

"If a woman is healthy and otherwise meets the standards of the department, I'll hire her."

"After he hired me, he told me that he had liked my qualifications and had planned to hire me all along," Miss Zastrow said. "He said I hadn't had to get down on my knees for the job."

Mrs. Stuart was a deputy with a sheriff's department in

Louisiana for more than six years before moving to Durham.

"Crime investigation and all that goes with a field deputy's work are just part of the job," Mrs. Stuart said. She said she patrolled Louisiana's Quatchita Parrish for 3½ years.

"I find that if you treat people with dignity and respect, they don't give you much trouble," she said.

Mrs. Stuart, who earned a bachelor's and masters degree in criminal justice at Northeastern Louisiana University, entered law enforcement because she felt "you shouldn't sit back and complain and criticize others who are doing the job."

## Trial Date Set For 3 Killings

RUTHERFORDTON, N.C. (AP) — A tentative trial date of Sept. 17 has been set for a Rutherford County man charged with three counts of first degree murder in connection with the May 31 death of two sheriff's deputies and a Highway Patrol trooper.

A Rutherford County grand jury returned indictments Tuesday charging James W. Hutchins of the Green Hill community with the deaths.

Hutchins, 50, is accused of murder in connection with the deaths of Capt. Roy Huskey, 42; Sgt. Owen Messersmith, 58, and Trooper R.L. "Pete" Peterson, 37.

## AUCTIONS BOOMING

LONDON (AP) — London's three top auction houses announced record sales in Britain and abroad totaling \$724 million in the 1978-79 season. Sotheby Parke Bernet, with sales of more than \$408 million, remained the leader; followed by Christie's and Phillips.



**NAMED DIRECTOR** — R. Robert Russell was nominated in Washington Tuesday as new director of the Council on Wage and Price Stability, the president's anti-inflation agency. Russell, an economics professor from California, will take over from the departing Barry Bosworth. (AP Laser-photo)

## Mixed Drinks In Fayetteville

FAYETTEVILLE, N.C. (AP) — When the first mixed drink is served in Fayetteville today, it will be the first time in 81 years that drinkers have legally been able to purchase a cocktail in a commercial establishment in Cumberland County.

Although the regulations in 1979 on mixed drink licenses are myriad, tavern owners in the 1700s and 1800s also were strictly regulated by the local governments.

Taverns, also known as ordinaries, were licensed by the county court and applicants had to provide bond. A provision passed in 1766 authorized the justices of each county to set rates and prices to be charged at ordinaries for not only liquor, but for food, lodging, corn, oats, fodder, stabling and pasturage.

## Buchwald Col. ...

(Continued from page 4)

refuse to let anyone else take the blame for our woeful condition. In my desire to seek windfall profits, I took the ultra-right political line, holding down productivity, raising prices and exploiting the OPEC dictatorship, to reap short-term gains at the expense of the masses. If nothing else, I deserve to be tarred and nationalized.

Government official: What you say may be true, but that does not let me off the hook. My deplorable lapse of judgment in accepting false and inaccurate reports on your ability to produce fuel was the biggest contribution to the chaos and strife we face. If I wasn't going to get a pension in two years, I would be asking to be sent to a pig farm.

Consumer: I cannot allow the oil companies and the bureaucrats to take this disaster on their shoulders. You are innocent victims of a massive conspiracy by me and my ilk to bring about a counterrevolution to abolish the 55 m.p.h. speed rule. Take away my car and give me a bicycle until I can mend my ways.

Politician: I have listened to all of you and I have come to the conclusion that you are right. In retrospect, I don't see any reason to blame myself for your mistakes, and since I'm the only one running for office in 1980, even if I am partially to blame, I would be a fool to admit it.

## Jackson Col. ...

(Continued from page 4)

close to 200. That Carter promised Oct. 24 was this: "We will slash federal hiring and cut the federal workforce.... I'm ordering tonight a cut in federal hiring (that) will cut the total size of the federal workforce."

Though he promised to cut "total" employment, he ordered only a semi-freeze on hiring, only in the segment he controls directly, and only of full-time, permanent employees. He left a loophole for part-time and temporary help.

But it sounded stronger to promise a "total" cut than to promise a cut in "full-time permanent employment in the executive branch, excluding the Postal Service," which is what he actually attempted.

Carter let agencies fill only half their full-time vacancies as they came open. The order lasted only a few months and was quietly replaced by specific personnel ceilings in January.

These actions have had their effect. As of May, the latest period for which the federal Office of Personnel Management has figures, there were 28,212 fewer full-time federal workers under Carter's direct control than there were when he spoke.

But bureaucrats have endured hiring freezes off and on for decades, and know how to get the government's work done in spite of them. This time they seem to have hired more than 40,000 part-time and temporary workers to take up the slack. While full-time, permanent employment is down in Carter's segment of the government, total employment in that segment — including part-time and temporary workers — has actually increased by about 14,000 since his speech.

All this leaves Carter with nearly 27,000 more federal workers drawing pay than will legally be allowed on the payroll Oct. 1, under a ceiling imposed by Congress even before Carter promised his cut.

## Evans-Novak ...

(Continued from page 4)

president's own balanced budget must not be abandoned.

After Carter left the room, Sen. Daniel Patrick Moynihan of New York (who had remained silent) approached White House domestic policy chief Stuart Eizenstat and asked him whether it was not true that the president had just advocated tax reduction. No, the imperturbable Eizenstat replied calmly, the president was merely promising to take another look in October.

Whether Eizenstat joins the congressional liberals in opposing quick tax reduction, it is considered certain that Vice President Walter Mondale (present but silent during the Thursday morning meeting) will be fighting against them. Despite Carter's surprise, nobody believes the battle is over.

The new element is that the president was obviously impressed with what Bentsen told him on the mountain during the Camp David meetings. Considering the inflationary boosts of income tax brackets and the Social Security payroll taxes, it will take over \$20 million for the American taxpayer to stay even. At least another \$10 billion is needed to promote capital formation. Add to this rising unemployment rolls, and the president may become an ardent tax-cutter.

**BETTY GARRENTON ABEYOUNIS IS BACK!**  
Glenda's Beauty Salon  
224 Greenville Blvd.  
756-4366

# Dollar days,



## 75% off women's summer sportswear.

A summer fashion windfall, summery sportswear including tops, slacks, shorts, skirts and more. Junior and misses sizes at a big 75% savings.

This is JCPenney

•Shop 10 A.M. 'til 9 P.M.  
•Phone 756-1190

**Dollar Day**  
THURSDAY, AUGUST 2  
Downtown Store Only

GROUP OF SUITS & PANTS ..... 70% OFF

GROUP OF T-SHIRTS ..... 50% OFF

GROUP OF SKIRTS ..... 70% OFF

GROUP OF DRESSES ..... 50%-70% OFF

**The College Shop**  
222 East Fifth Street  
Downtown Greenville  
"Not For Coeds Only"

**BISSETTES DISCOUNT CENTER**  
On The Mall Downtown Greenville

**DOLLAR DAY**

PRICES GOOD THRU SAT **VALUES!**

**SUN GLASSES**  
Styles For Everyone  
Values To \$7.50  
**88¢**

**SUPER THIN "CASIO" THINNER THAN 2 QUARTERS!**  
**"Casio" Mini Thin Calculator**  
\*Measures an incredible 3 1/2" x 2-1/8" and only 1/8" thick, about the size of a deck of 10 business cards  
\*Fully functional: 8 digit liquid crystal display, floating decimal, percentage  
\*Leather type wallet case.  
VALUE \$30  
**\$17.98**

**SUMMER HATS**  
For Men or Women. Many styles and colors. Values to \$5.  
**1/2 Price**

**ICE BUCKET**  
Natural Teak Finish-A Beautiful Bar Accessory  
7.50 VALUE  
**\$4.88**

**WALL ALBUM**  
Features a 5/8" walnut finished frame with 9 - Opening Mat.  
**\$1.99**  
Save \$1.00  
**Scholl**

**Jug/Cooler Combo**  
Rustproof, plastic 35 qt. Cooler and 1 gal. Spout Jug. Both urethane insulated to keep foods fresh and beverages cold all day. Rugged molded construction.  
Now Only ...  
**\$10.99**  
REG. 16.44

**EXERCISE SANDALS**  
Look great, feel fantastic in this world famous sandal. Exclusive toe crest sculpted on smooth beechwood base helps tone legs naturally as you walk. In exciting NEW Natural Wheat and Chocolate with dark-toned base.  
**10<sup>95</sup>**

**COOK-OUT CLOSE OUT**  
ALL GRILLS, LAWN CHAIRS, COOLERS, PATIO LIGHTS, PICNIC BAGS, SWIM MASKS FLOATS  
**25% OFF**  
OUR LOW DISCOUNT PRICES

**Take it easy this summer with Polaroid's OneStep Kit.**

**Polaroid OneStep Land Camera Kit**  
Includes: Polaroid SX-70 Land Film  
Sylvania FlashBar

Take it easy this summer with Polaroid's OneStep Kit. **OUR REG. \$44.95**

The least expensive way to get SX-70 pictures. Includes case, film and flash.  
**\$37.88**

- Aim-and-shoot (fixed focus).
- Motorized and fully automatic.
- Beautiful SX-70 color every 1.5 seconds.
- Never needs batteries.

### School Bd...

(Continued from page 1)

lunch prices of 45 cents for children in grades K-8 and 50 cents for those in 9-12. Adult lunch prices were raised from 85 cents to 90 cents. In order to hold down costs to consumers, the board voted to eliminate hot cooked desserts, such as cakes and cookies, from the regular Type "A" lunch, and offer it as a supplemental item.

The board voted to name Irene Hanifer as Building Principal to serve the Extended Day Program at Agnes Fullilove School. A list of school treasurers and school depositories was also approved.

### Board Members

#### At Workshop

Members of the Pitt County Board of Election will attend a training session sponsored by the State Board of Elections Friday, August 3, at the Blockade Runner Hotel, Wrightsville Beach. Members from the county will include Clifton W. Everett Jr., Myra H. Cain, and Nelson B. Crisp.

Margaret Register, supervisor of the county board of elections, will also attend the training session, as well as a meeting of the North Carolina Association of Supervisors of Elections Thursday at Wrightsville Beach. Miss Register noted that the county office, located at 201 E. Second St., Greenville, will be maintained during the supervisor's absence.

### Mall Opens...

(Continued from Page 1)

dent for development for the California-based Hahn company, pointed out that Hahn looked at Greenville at the prompting of Goodman Segar Hogan, agents for the company. Goodman Segar, according to Gilchrist, felt that a market existed here that was untapped and the resulting mall project was a "joint venture" that involved the efforts of "a lot of people."

The Hahn spokesman said that the new facility is "not really the Hahn mall or Sears or Belks mall, but the people's mall."

Gilchrist said that the Hahn company has "never been greeted with the warmth and hospitality that we received here."

Members of the football team, along with ECU cheerleaders, led the rush through the goal posts into the air conditioned comfort of the facility as most visitors received their first look at the interior of the new complex.

A large number of the shops that had been designated for today's opening were ready for their first customers, while several others were busy taking care of final merchandise details and hurrying to meet the opening day deadline.

Of the 64 businesses slated for mall occupancy, approximately 40 were expected to be ready for customers today. The remaining stores are scheduled for openings by the end of October. Belks and Sears are the two major mall tenants.

Taking part in the activities

### A Review

## Magic Of Summer Theater Is Musical

In the same week that sees the opening of Greenville's new shopping center, the old magic of Summer Theater has returned to brighten the entertainment scene.

"Starting Here, Starting Now," which opened Monday night at the A. J. Fletcher Recital Hall, is a pleasant parade of more than two dozen songs that convey a broad range of sentiments.

Two local performers, Del Lewis of the ECU Speech and Drama Department and Carolyn Greene, a graduate student in music, are joined by out-of-town singer Michelle Réilley to form the trio of performers.

today were the Greene Central High School band and an Army Reserve color guard unit from Rocky Mount.

Edgar K. Loessin's crisp direction keeps this talented trio moving at a snappy pace well suited to this show, and Terry Rieser's choreography lends just the right touch to enliven the songs.

The score, with music by David Shire and lyrics by Richard Maltby, Jr. focuses on many facets of today's society in songs that are by turn hopeful, youthful, wistful, happy, and expressive of regrets in a lighthearted vein. The merest thread of a story—boy, girl, and a second girl, serves to tie the material together nicely.

One of the many pleasures in "Starting Here, Starting Now" is the clear delivery of the beautifully crafted lyrics. Time and again, Maltby's lyrics aptly pinpoint a fundamental truth in a new light with a minimum of poetically fashioned words—"The moment you win someone's heart/ That's when the

burden starts. . . " These are lyrics worthy of being read as literature.

Contemporary society's more outlandish foibles are grist for some of the most effective numbers— instant celebrity in "The Girl of the Minute," the mania for relating in "We Can Talk To Each Other"— which turns out to be an unexpected reversal of roles with the male as the dominant talker; and "I Don't Believe It," emphatically caricaturing and puncturing the pretensions of smug individuals.

There are echoes of many musical styles in these songs—a Victor Herbert kind of old fashioned charm in "Beautiful," the brilliant, catchy phrasing in "Crossword Puzzle," and the lilting shuffle of "One Step," which is also the subject of a superb traditional top hat and cane dance routine.

"Starting Here, Starting Now" is ideal summer musical fare,

good music, captivating lyrics, and a winsome trio adding luster to top notch material.

The back up musicians— Brett Watson and Michael Howe on piano, Larry White, percussion, and Rich Vizachero, bass, provide sparkling accompani-

ment that plays a major role in the professional polish of this welcome return to summer theater in Greenville.

The limited size of the Recital Hall is fortunate, as it adds to the intimacy and easy listening of this miniature musical.

"Starting Here, Starting Now" has four performances left—at 8:15 nightly tonight through Saturday night. For ticket information and reservations, call 757-6390.

Jerry Raynor

FARMVILLE CHRISTIAN ACADEMY

GRADES 1-12 REGISTERING NOW

Complete Christian Curriculum  
Individualized Learning  
Professional Staff

Opening Date Sept. 4th  
Ending Date June 6th  
Daily Schedule 8:30-3:15

Modest Dress  
Christian Growth  
Christian Atmosphere

Registration Fee \$50.00  
Tuition Monthly 1 Child - \$50  
2 Children - \$85  
3 Children - \$110  
4 or more - \$130

Tuition Paid On 10 Month Basis

LIMITED SPACE AVAILABLE

Train up a child in the way he should go, and when he is old, he will not depart from it. Proverbs 22:6

MINISTRY OF TRUE GOSPEL BAPTIST CHURCH

Hwy. 264 East, Farmville, N.C. William Dilds, Pastor  
For further information call 753-2009, 749-6611 or 756-0948

### Will Speak On Sunday



REV. JOHN L. LEARY

The Philippi Church of Christ is celebrating Founder's Day this week with services beginning at 8 p.m. each night.

Sunday, August 5, 11 a.m., the Rev. John L. Leary, D. D., pastor of the New Mt. Hebron Baptist Church of Baltimore, Md., will deliver the sermon.

The Rev. Leary is a native of Greenville and attended the area schools. He is a graduate of Jones University, Baltimore, Md. He studied at the Baptist Training Center in Maryland and at the Baptist Theological Seminary in Lynchburg, Va., where he earned his doctorate of divinity degree.

A former Sunday School teacher and deacon of Philippi Church, the Rev. Leary will return Sunday to speak at the morning service. The public is invited to attend.

### Plan Events For Singles

The Greenville Singles Club has planned the following events for August:

Aug. 1—membership meeting at Peppi's Pizza Den at 7:30 p.m.

Aug. 4—pig picking at a member's home. For more information, call 756-0135.

Aug. 8—monthly "bull session" at 8 p.m. at the home of a member.

Aug. 11—Second Saturday dance in the Western Room of the Moose Lodge from 8:30 p.m. to 12:30 a.m.

Aug. 16—bowling at Hillcrest Lanes at 8 p.m. If interested, call 758-2590.

Aug. 17—Card night. Call 746-6808 if you'd like to play.

Aug. 18 Attendance of "Blackbeard." Reservations must be made by Aug. 1 during the membership meeting or by calling 946-2003.

Aug. 22—Newsletter mailing and social at the home of a member.

Aug. 24—miniature golf at 8 p.m. If interested, call 758-7144.

Aug. 25—Interclub dance at VFW in Kinston from 9 p.m. to 1 a.m.

For more information regarding eligibility for participation in the Singles Club, one may call John Grimsley, 756-0135 or 758-5644, or Jeff McAllister, 752-1717 or write Box 872, Greenville. Visitors are welcome.

**TYPHOON APPROACHING TAIPEI, Taiwan (AP)**—The Central Weather Bureau reported that Typhoon Hope was approaching Taiwan from the southeast at 17 miles an hour and was expected to hit the south coast of the island tonight with 140-mile center winds.

Liz Claiborne, James Kenrob, Ellen Tracey, Harve Benard, Jones of New York, John Meyer, Pendleton, Leslie Fay, Amy Adams, Act I, The Kollection, Leslie Pomer, Ruffin wear, Hearsay, Suitime, Jerry Silverman, Alice Stuart, Garland, Calvin Klein Jeans, Sasson Jeans, Gloria Vanderbilt Jeans, Bali, Vanity Fair, Vasserette, Gilead, Warners, Joyce, Red Cross, Stanley Phillipson, Bass, Fomalore, Pappagallo, Clinic, London Fog, Etienne Aigner Handbags, Fomalore, Liz Claiborne, Harve Benard, Jones of New York, Leslie Fay, Amy Adams, Leslie Pomer, Ruffin wear, Jerry Silverman, Alice Stuart, Calvin Klein Jeans, Sasson Jeans, Bali, Vanity Fair, Vasserette, Gilead, Warners, Joyce, Red Cross, Stanley Phillipson, Bass, Fomalore, Pappagallo, Clinic, London Fog, Etienne Aigner Handbags, Bali, Act I, Jones of New York, John Meyer, Adams, Act I, The Kollection, Hearsay, Suitime, Jerry Silverman, Gloria Vanderbilt Jeans, Warners, Joyce, Red Cross, Stanley Phillipson, Bass, Brody's Downtown, Brody's Pitt Plaza

Fashion Is SHOE SHOW Fun

"SHOE SHOW IS YOUR SHOE STORE"

A. Black or Camel. 13.95

B. Wine or Black Slip-On with Brown Wooden Sole & Heel. 12.95

Greenville Square Shopping Center  
Open 10 A.M.-6P.M. Mon.-Sat.



## Extraordinary Fashion Value Days!

Wednesday thru Saturday August 4th  
celebrate with us, enjoy **20%** savings

All fall '79 dresses, sportswear, lingerie, shoes, handbags are reduced. The 20% savings does not apply to items previously marked down, and not to cosmetics. In time for your advance fall shopping. Your chance to make big savings at the beginning of the season. Wednesday thru Saturday only!

# Fire Gutted Apartments



**APARTMENTS RUBBLED** — Firefighters pour water on a large west Houston apartment complex Tuesday afternoon, spending over three hours bringing the fire under control, spending anxious moments worrying over possibility of the fire's spreading. (AP Laserphoto)  
Copyright by The Houston Chronicle by Mike Robinson.

By LIZ NEULIN  
Associated Press Writer  
HOUSTON (AP) — Whipped by strong northerly winds, a fierce fire tore through a huge, wood-shingled apartment complex, gutting hundreds of fashionable apartments and leaving residents stunned and homeless.

Fire Chief V.E. Rogers said it was the worst blaze he'd seen in 24 years on the force.

The flames first appeared about 2:30 p.m. Tuesday and quickly jumped from building to building. At the height of the fire, more than 35 buildings were in flames, but no one was killed, authorities said.

As many as 1,000 of the estimated 1,100 15-year-old apartments were destroyed. Officials estimated that up to 1,500 people were homeless.

On the tennis courts, people arranged plush velour sofas and oak china cabinets, preparing for the night.

Standing beside the swimming pool were two young women in bikinis — their only clothes.

"Everything, everything's gone," mumbled Peggy Gardner, 19, a waitress. "No shoes, no money" She and roommate Bette King, 21, spent the day at a Galveston beach about 30 miles south of Houston. "When we got home, our apartment was burned to the ground," Ms. Gardner said.

Arson is suspected, officials say. "We're questioning a couple of people right now," officer Danny Holmes of the police arson division said late Tuesday night.

No figures were available on the extent of the damage. Rogers blamed the quick spread of the fire on the wood shingles that covered the huge Woodway apartment complex on the city's affluent near west side.

Just a few hours earlier, the Houston City Council had tabled an ordinance to strengthen safety requirements for wood-shingle roofs. Houston Mayor Jim McConn said he thought the measure would be reconsidered quickly.

"We're lucky nobody was killed," McConn said after a helicopter tour of the area.

Since most residents were away when the fire started, only a few were injured. Three persons were admitted to Houston hospitals.

Frank W. Tyler, 20, was in

stable condition in Hermann Hospital with second-degree burns over 50 percent of his body. Another resident was admitted for cuts on the arm, and a firefighter was admitted for smoke inhalation. Ten others, including some firefighters, were treated and released.

The Red Cross and others quickly set up shelters for the homeless, and two bulletin boards in the apartment clubhouse were filled with offers of help: homes for the night, free meals, animal shelters, storage areas.

It was the second disaster in a week in the Houston area.

Tropical storm Claudette chased 5,000 out of their homes last Wednesday and Thursday, dumping up to 30 inches of rain on the Texas coast.

## Pony Express Riding Again

GLENROCK, Wyo. (AP) — Pony Express riders are galloping across Wyoming again this week — but padmuh, things ain't quite like they was.

Today's riders still face heat, tornadoes and rattlers, but the beef jerky has been replaced by grub flown in from New York's famed "21 Club." And the upstarts even have a publicity agent.

Twelve riders are racing 1,905 miles from St. Joseph, Mo., to Sacramento, Calif., this summer to commemorate the 100th anniversary of the death of Sir Rowland Hill, an Englishman credited with inventing the first adhesive postage stamp.

The race is being sponsored by the British Post Office. Riders left Missouri on July 14 and hope to reach California on Aug. 22. They rested a day at Glenrock this week, dining on baby roasted turkey and wild rice stuffing to "let the riders know we appreciate them," said Albert Chioda, publicity agent for the British Post Office.

**GROWING INDIFFERENCE**  
ROME (AP) — The number of church weddings is going down in Italy because of growing indifference to religion, Roman Catholic researchers say. Civil ceremonies now account for 11 percent of Italian weddings.

# Brody's

DOWNTOWN  
PITT PLAZA

## Tomorrow!

Doors Open At 9:00 A.M. Downtown And At 10:00 A.M. Pitt Plaza.

- Set Your Alarm Clock Earlier
- Don't Make Luncheon Appointments
- Go Without A Coffee Break
- Miss Dinner If Necessary

But Get Your Share Of  
Reductions  
At  
Brody's  
During...

# Dollar Day!



### Giveaway Prices! Slacks

Were To \$27	Now \$11
Were To \$24	Now \$10
Were To \$22	Now \$9

### Giveaway Prices! Tee Tops

Were To \$11	Now \$4.50
Were To \$14	Now \$6.00
Were To \$16	Now \$7.00

### Giveaway Prices!

One Group Of  
Robes & Gowns

1/2 Price  
•Short & Long•

### Giveaway Prices! Special Savings On 14 Kt. Gold Jewelry

Bracelets 7"	Reg. 21.00	Now 11.90
Ear Rings	Reg. 21.00	Now 11.90
Chains 15"	32.00	21.90
18"	35.00	23.90
18"	40.00	26.90
20"	46.00	29.90
24"	54.00	34.90

### Giveaway Prices!

One Group  
Costume Jewelry  
•Pins•Earrings•Necklace

1/2 Price

### Giveaway Prices! Slacks

Were To \$24	Now \$10
Were To \$30	Now \$12

### Giveaway Prices!

American  
Tourister Luggage  
2500 Series

Tote Bag Was \$55	Now \$27 <sup>50</sup>
22" Size Was \$65	Now \$46 <sup>80</sup>
24" Size Was \$75	Now \$54 <sup>00</sup>

### Giveaway Prices!

Children's Wear

Were To \$15

\$1 to \$5  
Grab Rack!

### Giveaway Prices! Dresses

\$15	Regular \$36
\$18	Regular \$37 To \$40
\$20	Regular \$45 To \$50
\$24	Regular \$55 To \$60
\$28	Regular \$65 To \$75
\$34	Regular \$80 To \$100

### Giveaway Prices! Shoes

\$9	Regular \$23 To \$27
\$11	Regular \$28 To \$33
\$13	Regular \$34 To \$39
\$15	Regular \$40 To \$60

### Giveaway Prices! Better Sportswear

Blazers	Were To \$50	Now \$17
Skirts	Were To \$34	Now \$15
Blouses	Were To \$38	Now \$14

### Giveaway Prices! Skirts

Were To \$22	Now \$7
Were To \$24	Now \$8
Were To \$27	Now \$9
Were To \$30	Now \$10
Were To \$40	Now \$15

### Giveaway Prices!

Briefs •Bikinis

•Hipster

3 For \$4<sup>50</sup>

### Giveaway Prices!

One Group Of  
•Bras•

Discontinued Styles By Vanity Fair, Warrens, & Bali.

1/2 Price

### Giveaway Prices! Bathing Suits

Were To \$22	Now \$9
Were To \$24	Now \$10
Were To \$30	Now \$13
Were To \$45	Now \$15

**RICHARD K. WORSLEY**

Certified Public Accountant

Is Pleased To Announce The Association Of

**M. MICHAEL COLLINS, CPA**

In A New CPA Firm Located At  
2415 South Charles Street  
(New Bern Highway)  
Greenville, N.C. 27834

August 1, 1979 Tel. (919) 756-6266



**A LOVELY WAY TO SPEND A DAY** — When summer's heat is at a peak, there's nothing finer than to be on a beach in North Carolina, cooled by ocean breezes with lots of warm sand to sit on

between swims. The two young ladies here doing just that on the sands of Atlantic Beach are Joann Pelletier (left) and Gail Daughtry, both of Goldsboro. (Reflector Photo by Jerry Raynor)

## Zimbabwe Rhodesia Big Issue At Commonwealth Meeting

LUSAKA, Zambia (AP) — Zimbabwe Rhodesia is the big issue at the Commonwealth Conference opening today, but British officials predict much debate and no new action.

Commonwealth Secretary-General Shridath Ramphal told reporters Tuesday there was no expectation of "getting it all together" on the problem. He said just to avoid a split in the week-long meeting of Britain and its 38 former colonies would be an achievement.

British Prime Minister Margaret Thatcher met with Zambian President Kenneth Kaunda Tuesday night amid intensified maneuvering to prevent an open row over her leaning toward recognition of Prime Minister Abel Muzorewa's new government in Zimbabwe Rhodesia.

Mrs. Thatcher, who has been

denounced as a racist by the Zambian government's two newspapers, also met with Australian Prime Minister Malcolm Fraser, a fellow Conservative and a key figure in the moves to prevent a blowup.

"Everyone recognizes that there is a new situation in Zimbabwe Rhodesia. This happens to be a fact that cannot be ignored," Fraser told reporters on arriving in Lusaka. But he added: "The position of the Australian government is that there has been a change but it is not such as would warrant recognition."

Australian officials said Fraser, in preliminary discussions with Nigerian leaders, proposed that the conference not slam the door on Muzorewa's government but instead call for it to reduce the vast powers retained by the white minority in

Zimbabwe Rhodesia and end the war with the guerrillas led by Joshua Nkomo and Robert Mugabe.

Representatives of Nkomo and Mugabe, whose guerrillas fought the white regime for seven years and now are fighting to oust the elected black-majority government, were reported anxious to meet with Fraser to hear his views.

The Asian and African majority of the Commonwealth countries contend the constitution Muzorewa and other black leaders inside Zimbabwe Rhodesia agreed to is a facade for the preservation of white domination since it gives the white minority control of the army, police, judiciary and civil service as well as a veto over changes in the constitution.

Across the border in Zimbabwe Rhodesia, Muzorewa's

government tried to improve its image abroad by offering homes to 1,000 Vietnamese refugees. The announcement followed a telephone call to the prime minister from U.S. Sen. Jesse Helms, the North Carolina Republican who is Muzorewa's biggest defender in the U.S. Senate.

## Pk 'n Pay Shoes fall fashions afoot!



Women's moc-toe sport oxford has accent stitching and new bottom design. Rust. **8.00** Reg. \$10.97



Girls' back-to-school t-strap wedge with perforated vamp. 8½-4. Rust. **6.00** Reg. \$7.97



**Cuga**  
Men's nylon Cuga in blue with gold trim. Sizes 6½-12. **12.00** Reg. \$16.97  
Big boys sizes 2½-6. Reg. \$15.97 ... **11.00**

Women's suede and leather body bags. Reg. \$10.97 **8.50**

All knee hi socks and hose. **20% off regular price.**

**264 BY-PASS**

Across From

Nichols Discount City

OPEN MON. THRU FRI. 10 TO 9, SAT. 9 TO 8

Master Charge or Visa. Open evenings



Today's Expressions Are Tomorrow's Memories

**FREE** 8x10 Color Portrait

Take advantage of this opportunity to obtain a beautiful 8x10 color portrait absolutely free. Choose from our selection of 8 backgrounds. You may select additional portraits offered at reasonable prices. See our large Decorator Portrait. Satisfaction always, or your money cheerfully refunded.

WED THURS FRI SAT

THESE DAYS ONLY - AUGUST: 1 2 3 4

DAILY: 10AM - 8PM

ROUTE 7 & GREENVILLE BOULEVARD, GREENVILLE

**NICHOLS**

First sitting free. Additional subjects \$1.00 each. Poses are our selection. All ages welcome. Children must be accompanied by a parent. Backgrounds subject to change.



**CATO**  
Back-to-School  
**\$7-\$11 Sale**

**TOPS...\$7**  
**JEANS...\$11**

Jeans and Tops . . . The Back-to School Look . . . Now at Cato at super low prices. Our special group of \$7 tops includes flannel shirts, brushed acrylic tops in stripes and solids, knit tops, big tops, turtle necks and more!

Pair them up with our very special \$11 jeans . . . with fashionably narrow legs and great details like pleated waists, leather trim, and interesting pocket treatments. In petite, junior and missy sizes.

Hurry for the best selection during Cato's fantastic 7\*11 jean and top sale.



**CATO**

On The Downtown Mall 758-3700

# DOLLAR DAY

COME EARLY AND STAY LATE

## Thursday Aug. 2

On Dollar Day we disregard the cost of merchandise. Most items on this sale are priced at only a fraction of the manufacturer's cost. We almost give it away to make room for fall merchandise.

<p>One Table About 700 Yds <b>POLYESTER INTERLOCK PRINTS</b> Reg. 3.99 And 4.99 <b>\$1.00</b> \$ Day Yd</p>	<p>One Table <b>BLUE DENIM</b> Short Lengths \$ Day <b>\$1.00</b> 2 Yds</p>	<p>One Table <b>COTTON TEE-SHIRT KNITS</b> 60-72 Inches Wide Reg. 2.99 Yd \$ Day <b>\$1.00</b> 2 Yds</p>	<p>One Group-Only 28 <b>FITTED CHAIR COVERS</b> Reg. 9.95 \$ Day <b>\$2.00</b> Each</p>		<h1>1</h1>	
<p><b>PLACE MATS</b> Cloth Foam Back Reg. 69¢ \$ Day <b>\$1.00</b> 4 For</p>	<p>Odd Lot <b>DRAPERIES</b> Values to 12" <b>\$5.00</b> \$ Day Each</p>	<p><b>RUGS</b> Size 18x30 Reg. 2.00 \$ Day <b>\$1.00</b> Each</p>	<p><b>CURTAINS</b> Tier And Valance Sets Tiers 24 And 30 Inches Long (Ideal For Mobile Homes) <b>\$1.00</b> \$ Day Set</p>			
<p>One Group <b>LACE DRAPERIES</b> Reg. 3.99 \$ Day <b>\$2.00</b></p>	<p>One Rack Girl's Summer <b>Dresses</b> Sizes 2/6x-Reg. 7.99 to 11.99 - \$ Day- 7/14 Reg. 11.95 to 13.95-\$ Day <b>\$5 \$6</b></p>	<p>21 Only <b>LADIES PANT SUITS</b> Reg. 22.95 \$ Day <b>\$10.00</b></p>	<p>One Group Ladies <b>SATIN SHORT &amp; TOP SETS</b> Reg. 7.99 \$ Day <b>\$5.00</b> Each</p>			
<p>One Group Ladies <b>POLYESTER &amp; COTTON GOWNS</b> Reg. 3.99 \$ Day <b>\$2.00</b></p>	<p>34 Pair <b>GIRLS BLUE DENIM JEANS</b> Reg. 7.99 Sizes 7/14 \$ Day <b>\$2.00</b></p>	<p>One Rack <b>LADIES POLYESTER KNIT DRESSES</b> Values From 15.95 to 22.95 \$ Day <b>\$5.00</b> Each</p>	<p>Entire Stock <b>LADIES SUN DRESSES</b> Were 9.95 \$ Day <b>\$5.00</b></p>			
<p>One Rack <b>LADIES TOPS</b> Shortsleeves And Sleeveless \$ Day <b>\$2.00</b> Reg. 4.99 Each</p>	<p>One Group <b>GIRLS TOPS</b> Sizes 7/14 \$ Day <b>\$1.00</b> Reg. 3.99 Each</p>	<p>One Group Ladies-Long And Short Sleeve <b>BLOUSES</b> Reg. 7.99 to 13.95 \$ Day <b>\$3.00</b> Each</p>	<p>One Rack <b>LADIES SLACKS</b> Reg. 9.00 \$ Day <b>\$3.00</b> Each</p>	<p>One Rack <b>CHILDRENS DRESSES</b> Reg. 9.95 to 12.95 \$ Day <b>\$2.00</b> Each</p>	<p>One Rack Ladies Polyester And Cotton <b>SLACKS</b> Reg. 12.95 \$ Day <b>\$3.00</b> Each</p>	
<p>One Group <b>LADIES DRESSES</b> Reg. 12.95 to 15.95 \$ Day <b>\$2.00</b></p>	<p>One Group Ladies Sun Top <b>DRESSES</b> Reg. 7.00 \$ Day <b>\$3.00</b> Each</p>	<p>One Group Ladies Large Size <b>BLOUSES</b> Short And Long Sleeves Sizes 44 to 52 Reg. 9.95 and 10.95 \$ Day <b>\$5.00</b> Each</p>	<p>14 Only <b>LADIES BLAZERS</b> Reg. 12.95 \$ Day <b>\$5.00</b> Each</p>	<p>One Group Ladies <b>RAYON PANTIES</b> Seconds at Reg. 1.06 Panties \$ Day <b>19¢</b> Each</p>	<p>Boys 8 to 18 <b>TANK TOPS</b> \$ Day 2 For Values to 2.99 <b>\$3.00</b></p>	
<p>Boys Short Sleeve <b>SPORT SHIRTS</b> \$ Day 2 For Reg. 4.99 - Knits And Broadcloths <b>\$5.00</b></p>	<p>Boys Blue Denim <b>WRANGLER JEANS</b> \$ Day Values to 11.95 <b>\$5.00</b></p>	<p>Size 3 to 7 Boys <b>SHIRT AND SHORT SETS</b> \$ Day Values to 6.99 <b>\$2.00</b></p>	<p>11 Only Size 2 to 6 <b>BOYS SUITS</b> Reg. 27.95 \$ Day No Lay-A-Ways <b>\$10.00</b></p>	<p>28 Only Size 8 to 18 <b>BOYS SUITS</b> Reg. to 55 \$ Day No Lay-A-Ways <b>\$19.00</b></p>	<p>Boys 8 to 18 <b>GYM SHORTS</b> \$ Day 2 For Values to 2.99 <b>\$3.00</b></p>	
<p>Short Sleeve - Zip Front <b>MEN'S COVERALLS</b> \$ Day <b>\$8.00</b> Reg. 16.95 Value - Dacron/Cotton Poplin</p>	<p>Mens Screen Print Front <b>TEE SHIRTS</b> Values to 2.99 \$ Day <b>\$1.00</b></p>	<p>For Men And Women <b>SEA GRASS HATS</b> Reg. 1.99 \$ Day <b>\$1.00</b></p>	<p><b>TENNIS VISORS</b> Reg. 1.99 \$ Day <b>\$1.00</b></p>	<p>Mens Dacron &amp; Cotton <b>KNIT SHIRTS</b> \$ Day Reg. 4.99-Crewneck &amp; Placket Styles <b>\$2.00</b></p>	<p>29 Only Mens Straw <b>DRESS HATS</b> \$ Day <b>\$2.00</b> Reg. to 7.99</p>	<p>One Group Mens <b>KNIT SHIRTS</b> Reg. 10.95 to 14.95 \$ Day <b>\$5.00</b></p>
<p>Mens Summer <b>PAJAMAS</b> \$ Day <b>\$3.00</b> Reg. 7.99 Short Sleeve With Short Or Long Legs</p>	<p>Reg. 2.49 <b>JELLO SANDALS</b> \$ Day Childrens And Ladies Sizes <b>\$1.00</b></p>	<p>One Group Misses <b>DRESS SHOES &amp; SANDALS</b> \$ Day Values to 8.99 <b>\$3.00</b></p>	<p>One Group <b>MENS SLACKS AND JEANS</b> Values to 16.95 \$ Day <b>\$7.00</b></p>	<p>One Group Mens <b>DRESS SHIRTS</b> \$ Day Short Sleeves Reg. 8.95 <b>\$3.00</b></p>	<p><b>\$ Day Sale</b> <b>LADIES SUMMER FOOTWEAR</b> Dress-Casual-Sandals Formerly 8.99 to 17.95 Now All Reduced <b>\$3 • \$4 • \$5 • \$6</b> Hundreds Of Pairs On Sale Med. And Wide Widths</p>	
<p>43 Only Mens <b>SUMMER SUITS</b> 3 Pc. Vested Styles \$ Day <b>\$35</b> No Lay-A-Ways -No Alterations Reg. to 99.95</p>	<p>Terrific Group <b>CHILDREN'S SPORTSWEAR</b> 2 Pc. Sets And Separates One Group Values to 3.99... <b>\$1.00</b> One Group Values to 5.99... <b>\$2.00</b> One Group Value to 7.99... <b>\$3.00</b></p>		<p>Entire Stock Ladies <b>SUMMER HANDBAGS</b> \$ Day Sale Reg. to 8.95... <b>\$3.00</b> Reg. to 12.95... <b>\$5.00</b></p>		<p>Mens Canvas <b>Converse Pro-250 Basketball Shoes</b> Hi-And Low Tops Reg. 17.95 Values \$ Day <b>\$8</b></p>	
			<p>Childrens 2 to 4 <b>GYM SHORTS</b> \$ Day Reg. 1.99 <b>\$1.00</b></p>	<p>One Group-Odd Lot <b>MENS SHOES</b> Dress-Casual-Work \$ Day <b>\$4</b> Values to 24.95</p>		
			<p>One Group Children <b>POLO SHIRTS</b> \$ Day 2 For Reg. - to 1.99 Size 9 to 24 Mo. <b>\$1.00</b></p>			



# Whites

DOWNTOWN SHOPPING CENTER  
451-457 DICKINSON AVENUE  
FREE PARKING



# Stock And Market Reports

**RALEIGH (AP) (NCDA)** — N.C. Eggs: Market 1 cent lower on large, medium fractionally lower, smalls 2 cents lower. Supplies moderate. N.C. weighted average price for small sales of consumer grade A eggs in cartons delivered to retail stores: 65.48 cents per dozen for large white; medium 56.84; small 38.95.

**RALEIGH (AP) (NCDA)** — N.C. Broilers: Market steady. Supply moderate. Demand good. N.C. dock weighted average price is 38.98 cents per pound this week for small purchases of plant grade broilers picked up at processing plants. Estimated slaughter Tuesday totaled 1,620,000 head and average live weight 3.95 pounds per bird on July 27.

**RALEIGH (AP) (NCDA)** — N.C. Hens: Market steady to firm for heavy type hens. Supply fully adequate. Demand moderate. Prices paid per pound for hens over seven pounds at farm 12 12 to 13 cents.

**RALEIGH (AP) (NCDA)** — Hogs: steady at N.C. buying stations. Wilson 38.00 per hundred pounds; Clinton, Fayetteville, Dunn, Elizabethtown, Pink Hill, Pine Level, Chadbourne, Ayden, Laurinburg and Benson 38.50; Kinston 37.00; Spivey's Corner - Sows

(325-600 lbs.) 23.00-25.00; Fayetteville - Sows (450 pounds up) 26.00.

Following are selected 11 a.m. stock market quotations:

Burroughs	68 1/2
United Telecommunications Prd.	25 1/2
Heublein	28 1/2
Jeff Pilot	34 1/2
Tri South	35 1/2
Wicks	15
Wachovia Realty Investments	5 1/2
Eckerd	28
Central Soya	13
Hardies	14
Integon	28 1/2
Fieldcrest	29 1/2
Hatteras Income	13 1/2
Veeco	42
Eaton	37 1/2
John Deere	74 1/2
P & G	13
Piedmont Aviation	13 1/2
Conner Homes	13 1/2
McGraw Edison	29
NCNB Corporation	14 1/2
OVER THE COUNTER	
Combined Insurance	18 1/2
Planters Bank	18 1/2
Low	18 1/2
Little Mint	7 1/2

**NEW YORK (AP)** — The stock market advanced slightly today in a carryover of buying from Tuesday's rally.

The Dow Jones average of 30 industrials edged up .17 to 846.59 in the first half hour. Gainers outnumbered losers by a 5-3 margin in the early tally of New York Stock Exchange-listed issues.

The market's rise Tuesday was attributed partly to a rally by the dollar in foreign exchange, accompanied by a \$5-an-ounce decline in the price of gold.

Analysts noted encouragement over the assertion by Paul Volcker, chairman-designate of the Federal Reserve Board, that he would stick with an inflation-fighting program even if it meant

Today the dollar showed less strength, but the gold price tumbled again, falling by between \$5 and \$7.

Ohio Edison led the active list, off 1/8 at 15 1/2. A 106,400-share block traded at that price.

On Tuesday the Dow Jones industrial average climbed 7.68 to 846.42.

Advances outnumbered declines by more than a 2-1 spread on the NYSE.

**WEDNESDAY**  
6:30 p.m. — Kiwanis Club meets  
6:30 p.m. — REAL Crisis Intervention meets  
7:00 p.m. — Winterville Jaycees meet at Winterville Grill  
8:00 p.m. — Pitt County Al-Anon Group meets at AA Bldg., on Farmville Hwy. Telephone 752-5284 or 756-1274  
8:00 p.m. — Pitt County Ala-Teen Group meets at AA Bldg., Farmville Hwy. Telephone 825-9751 or 753-5355

**THURSDAY**  
12 Noon — Greenville-Martinborough Lions Club meets  
2:00-5:00 p.m. — Game day at Woman's Club  
6:30 p.m. — Exchange Club meets  
7:00 p.m. — Winterville Kiwanis Club meets at community Bldg.  
7:30 p.m. — American Legion Auxiliary meets at Legion Home  
8:00 p.m. — VFW meets at Post Home  
8:00 p.m. — Cochee Council No. 60, Degree of Pochontas meets at Redmen's Hall

**MASONIC NOTICE**  
William Pitt Lodge No. 734, A. F. & A. M., will hold a stated communication Wednesday, August 1, 7:30 p.m. All Master Masons are invited.  
Van Johnson III, Master  
Melvin L. Evans, Sec'y

Big Board volume came to 34.36 million shares against 28.64 million the day before.

The NYSE's composite common-stock index rose .35 to 59.14.

At the American Stock Exchange, the market value index was off .61 at 198.69.

# Leaf Average Edged Higher

The average price per pound for tobacco sold on the Greenville market on Tuesday edged upward to \$128.61 per hundred pounds, up \$2.59 per 100 pounds from Mondays average of \$126.02.

J. N. Bryan, sales supervisor of the Tobacco Board of Trade in Greenville, reported that Tuesday's sale registered in at 912,973 pounds selling for \$1,174,164 for the \$128.61 average.

This brings the season total of sales to 4,437,450 pounds selling for \$5,574,397 for a season average of \$125.62 per 100 pounds.

# City Counts 2 Collisions

More than \$4,000 property damage resulted from two collisions investigated by Greenville Police yesterday.

Officers reported heaviest damage resulted from an 11:26 a.m. mishap at the intersection of Chestnut and Wilson Streets involving cars driven by John Paul Hunt of Shady Knoll and David Pitt of 410 West Village Dr.

Damage was estimated by police at \$1,500 to the Hunt car and \$600 to the Pitt auto.

A car driven by Doris Brown Washington of 1809B Hopkins Dr. and a truck operated by Jesse Bell Childers of 100 West Cambridge Dr. collided about 12:43 p.m. on Memorial Drive, 300 feet north of the Trade Street intersection, resulting in an estimated \$150 damage to the Washington car and \$1,800 damage to the Childers vehicle.

Police charged Mrs. Washington with failing to see her intended movement could be made in safety.

# Commissions In Call-Meeting

The Greenville and Joint City-County Planning and Zoning Commissions will meet today at 4 p.m. in a special call session.

The meeting will be held on the third floor at city hall in the Council chambers.

### CORRECTION

The driver of the 1979 Ford Bronco, Dana Leigh Hartley of Rt. 5, Greenville, involved in a 1:45 a.m. accident Monday, was passed by a tractor trailer and apparently lost control of her vehicle. The 1979 Bronco was pulling a 1978 Ford pickup truck with a tow bar, not a tow chain as reported in the Tuesday edition.

# KING PROJECT

WASHINGTON (AP) — The House of Representatives voted Tuesday to approve a resolution authorizing the expenditure of \$25,000 for a statue or bust of Dr. Martin Luther King Jr. to be displayed in the Capitol.

# Tobacco Markets

	Pounds	Dollars	Average
Ahoskie	no sale		
Clinton	no sale		
Dunn	no sale		
Farmville	741,995	924,077	124.54
Goldsboro	717,226	933,893	130.21
Greenville	912,960	1,174,164	128.61
Kinston	852,370	1,102,140	129.30
Robersonville	no sale		
Rocky Mount	465,819	567,776	121.89
Smithfield	382,811	469,640	122.68
Tarboro	no sale		
Wallace	371,094	463,994	125.03
Washington	no sale		
Wendell	no sale		
Williamston	404,890	512,877	126.67
Wilson	1,559,960	1,965,071	125.97
Windsor	377,044	474,017	125.72
Totals	6,786,169	8,587,649	126.55
Season Total	33,678,602	42,090,869	124.98
Stabilization	1,151,704		17 percent

# Panama Treaty 'Unusually Low' Chapter Meets Thursday

WASHINGTON (AP) — There seems little chance Congress will complete work on a bill to implement the Panama Canal treaties until just before the treaties take effect Oct. 1.

Rep. John Murphy, D-N.Y., said Tuesday a conference committee working out differences between the House and Senate versions probably won't finish its work until September despite his pleas that the matter be wrapped up this week.

The treaties turn most of the canal zone over to Panama on Oct. 1. Panama gets the canal itself Dec. 31, 1999.

FARMVILLE — Quality primings on the Farmville Tobacco Market are selling for unusually low prices, according to Louis Williams, Sales Supervisor of the Farmville Tobacco Board of Trade.

He said a few sheets of cutters have sold for as much as \$1.55 a pound, but that most grades are selling for less than the same grades last year. Some of the better grades of lugs are bringing fair prices, he said. Primings and lugs accounted for most of the volume on yesterday's sale. Stabilization receipts are running ahead of last year.

The Pitt County Chapter of the American Association of Medical Assistants will meet Thursday at 7:30 p.m. The meeting will be held in Conference Room A at Pitt County Memorial Hospital.

Dr. Gene Hamilton will be guest speaker and discuss orthopedic problems with the group. All members and interested persons are invited to attend.

Yesterday the market sold 741,995 pounds of tobacco for an average of \$124.54. So far this season, 2,654,869 pounds have been sold for \$3,333,107, for a season's average of \$125.55.

**BREAKFAST SPECIAL** ..... 95¢  
**HAM-EGG SAND** ..... 75¢  
Breakfast Served All Day  
**Carolina Grill**  
ORDERS TO GO!

# Obituaries

### Fallowfield

Herbert Fallowfield, 69, died Tuesday in Pitt Memorial Hospital. Memorial services will be held Thursday, 2 p.m., in St. Paul's Episcopal Church by the Rev. Pat Houston.

Mr. Fallowfield was a native of Barrow-in-Furness, England, but had lived in Greenville since 1961.

Survivors: Mrs. Mattie Virginia Fallowfield; two daughters, Diane Dunn of Jacksonville, Fla. and Sandra Holt of Abbingdon, Pa.; a brother and sister, both in England; five grandchildren.

In lieu of flowers, contributions should be made to the Greenville Rescue Squad or the Bonner's Lane Daycare Center.

Visiting hours will be from 7-9 p.m. Thursday at Farmer Funeral Home, Ayden.

### Pitt

Mr. John Eddie Pitt died at his home on Rt. 1, Bethel, Tuesday. He was the father of Linbergh Pitt of Plymouth. Funeral arrangements are incomplete at Flanagan Funeral Home.

### Riley

Mrs. Mattie Riley died Tuesday in the N. C. Special Care Center in Wilson. She was the sister of Bender and Charles James Little, both of Grimesland. Funeral arrangements are incomplete at Flanagan Funeral Home.

### Short

Mr. Isaiah Short died at his home on Rt. 4, Greenville Tuesday. He was the brother of Mrs. Eula Johnson of the home. Funeral arrangements are incomplete at Flanagan Funeral Home.

### Mills

AYDEN — Mrs. Elsie Williams Mills, 58, died Tuesday in Greenville Villa Nursing Center. Mrs. Mills was a native of the Black Jack community and had been a resident of Ayden for the past 35 years. She was a member of First Baptist Church Ayden. Graveside services will be held Friday, 11 a.m., at Pinewood Memorial Park, Greenville by the Rev. Gilbert Mister.

Survivors: two sons, Roger Mills of Aken, S. C. and Tony Mills of Ayden; her mother, Mrs. Sadie Williams of Chocowinity; two sisters, Mrs. Vivian Elks of Grimesland and Mrs. Verbele Roberts of Durham; one grandchild.

### SEVENTEEN VICTIMS

LERWICK, Shetland Islands (AP) — Thirty persons, most of them North Sea oil workers, escaped from a British charter plane that nose-dived into the sea as it took off from Mainland Island in the Shetlands north of Scotland; but 17 others drowned, authorities said today. First reports said all 47 were British.

# Card of Thanks

We, the family of the late Harvey J. Hewett Jr. wish to express our gratitude to our many friends and neighbors for their thoughtfulness and kindness during our time of bereavement. May God bless each of you.

Mrs. Harvey Hewett, Jr. & Family

# Card of Thanks

The Ruffin & Black Family would like to thank each and everyone of you for the kindness shown to them during the loss of a dear husband and a good friend who we love, Mr. Archie (Muletrain) Ruffin.

The Ruffin & Black Family

# Card of Thanks

Thank you to all my friends and family for the cards, flowers, and most of all, your prayers and visits while in the hospital and since I've been home. I will always treasure each kind deed. May God bless you all.

Gratefully,  
Catherine Louise Dennis

# Save 20¢ on a fresh supply of Raid Roach-Tape.

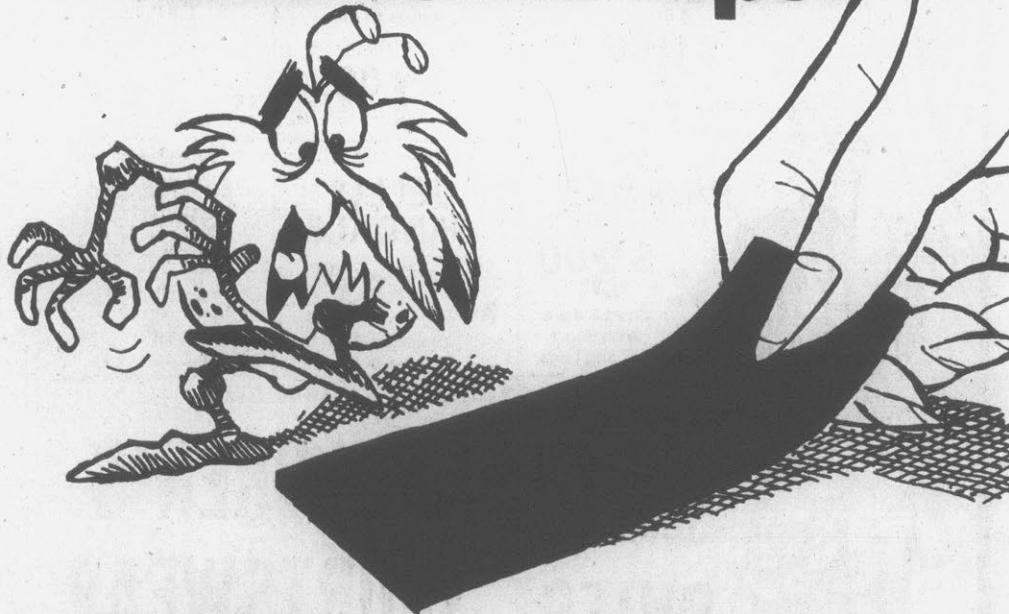

Keep up that long lasting protection against roaches. Without spraying.

Raid Roach-Tape kills roaches dead for a long time. But even Raid can't last forever. So if you've begun to see roaches again, it may be time to put down new Roach-Tape.

If you don't see roaches, your present Roach-Tape is still working. But stock up anyway. You'll save 20¢ and be ready with Raid.

**Save 20¢ on Raid Roach-Tape.**  
The insecticide is in the tape for long lasting protection against roaches—without spraying.

To the Dealer: For each coupon you accept as our authorized agent, we will pay you face value plus 5¢ handling charges, provided you and your customer have complied with the terms of this offer. Any other application constitutes fraud.

Invoice showing your purchase of sufficient stock to cover all coupons redeemed must be shown upon request. Your customer must pay any sales tax. Cash value 1/20 of 1 cent. Void where prohibited by law. Offer good on one purchase only in U.S.A. and expires August 3, 1980. Redeem by mailing to S. C. Johnson & Son Redemption Center, P.O. Box 1711, Elm City, North Carolina 27898.

104273 20¢

**ROACH-TAPE**

KILLS ROACHES CONTINUOUSLY WITH ONE EASY APPLICATION

104273 20¢

S. C. Johnson & Son Inc.

# Dollar Day Sale

Dresses & Sportswear

50 To 60% Off  
Some \$5. - \$10.

Bathing Suits

\$2. To \$12.

All Shorts In Stock

\$2. To \$5.

Pants

\$5. To \$10.

Tops Starting At \$3.50

Scarves Your Choice

2 For \$5.

Canvas Bags All \$3.50

One Rack Blouses 1/2 Price & Less



203 East Fifth Street Downtown Greenville Free Parking

# Glue-Sniffing Messed Up His Life, Says Tucker



**LEAVES HEARING** — James Keith Tucker, 18, of High Point, N.C., is escorted by an FBI agent after his hearing Tuesday in Florence, S.C. before a U.S. magistrate. (AP Laserphoto)

By ELIZABETH P. LATT  
Associated Press Writer  
FLORENCE, S.C. (AP) — James Keith Tucker says sniffing glue, a habit he acquired at the age of 12, "messed up" his brain and is largely to blame for his problems with the law in recent years.

"When I'm on that glue, I don't think too good," Tucker said Tuesday afternoon as he sat in a cell at the Florence Detention Center in South Carolina, where he was being held on \$250,000 bond.

The 18-year-old High Point, N.C., native is charged with kidnapping 5-year-old Caroline Thompson from a parking lot of a Daytona Beach, Fla., motel and bringing her to Myrtle Beach, S.C. He was arrested there Monday night and the child was returned unharmed to her parents, Russell and Rachel Thompson of Dunwoody, Ga.

Throughout the incident, Tucker said, he sniffed glue. He told Caroline it was medicine. "She's just 5 years old. She didn't know."

Tucker is expected to be sent later this week to Florida. He also is charged with interstate transportation of a stolen vehicle.

Tucker, a slight, soft-spoken man who dropped out of school in the ninth grade, said he didn't mean to take the child. She was in the back seat of her parents' car when it was taken

from the Florida parking lot Saturday.

He said his biggest concern was the child's safety. "I wouldn't harm the girl in no way," he said. "I was scared. She was 5 years old. If anything happened to her, if she got hurt in any way, it would be my fault."

Tucker said he thought about leaving her somewhere along the way. But he added as he puffed on a cigarette, "I was afraid she couldn't get back to her mama."

Tucker, recently paroled from a North Carolina prison, said he took good care of the child. "I didn't let her go hungry. I fed her good."

He said he used money and charge cards that had been in Mrs. Thompson's billfold to pay for the food and for the motel accommodations Sunday in Myrtle Beach.

Tucker said the child even swam in the pool at the Caribbean Quality Inn. Other guests at the motel notified police Monday night after they realized that a man and child who registered at the motel the day before resembled pictures shown on a television news program.

Tucker said he calmed the

child by stopping twice during the trip from Florida and telling her he had called her parents. He also told her he was taking her home to Georgia.

"I know what I done was wrong," he said. "Yeah, it was wrong. I'm talking about everything."

Tucker was paroled July 13 from a North Carolina prison where he was committed earlier this year as a youthful offender for two auto thefts, prison department records show.

Since his release, he had been working at a furniture factory in High Point. But one day about two weeks ago, he said, he left work for his lunch break about noon and had some beers. "I stole this man's truck and decided I'd take off."

With \$20 in his pocket, he set out for Daytona Beach because he had "never been to the beach before," he said.

He picked up a friend in Asheville, N.C., and headed

being driven here from South Carolina by a motel employee.

"We had a very bad time every minute she was gone," said Mrs. Thompson. But she and her husband Russell, both 34, spoke gratefully of the kidnaper.

"He took good care of her," Mrs. Thompson said. "We're so grateful to him. He didn't hurt her in any way. He tried to comfort her."

Tucker had told the child he was "taking her home to her mommy and daddy," Mrs. Thompson said.

Caroline said at first she cried "just a little ... and I told him to take me back. He said, 'No.' He said, 'Shut up.'"

Tucker evidently drove straight through to Myrtle Beach, stopping to sleep in the car on Saturday night and arriving early Sunday.

He and the girl checked into a motel and stayed until Monday afternoon, when a guest recognized them from news descriptions. Authorities were notified and a highspeed chase ended in Tucker's arrest.

## Mother Hopes The Law Looks Kindly On Youth

By IKE FLORES  
Associated Press Writer  
DAYTONA BEACH, Fla. (AP) — Rachel Thompson, resuming the family vacation that became a 2½-day nightmare when her 5-year-old daughter was kidnapped, says the law should look kindly on the man charged in the abduction.

"I think it should certainly be taken into account that he did not mean to hurt the child," Mrs. Thompson said Tuesday. "To punish him for something

he didn't mean to do wouldn't be right." Police have said car theft — not kidnapping — was the aim of the man who jumped into the Thompson's station wagon at a motel here Saturday and drove off with the screaming child and the family dogs in the back.

Suspect James K. Tucker, 18, a paroled auto thief, is being held on \$250,000 bond in Florence, S.C., some 60 miles west of Myrtle Beach, S.C., where little Caroline Thompson was recovered late Monday.

FBI officials say Tucker will probably be moved to Florida this week to face charges.

The man was "mean and yelled," Caroline said, but did not mistreat her or her two pets.

"We ate hamburgers and french fries at McDonalds and he let me go swimming by myself in the motel pool," said the blond, blue-eyed youngster, sitting cross-legged on her rumpled bed at the Holiday Inn where the ordeal began.

The family planned to remain here several days. Their car, with all their belongings, was

## Captain's Restaurant Seafood-Steaks Table

1113 Third St. Ayden (AT HARRIS SHOPPING CENTER)

NEW HOURS SUN.-THURS. 11-9 FRI.-SAT. 11-10

SERVING FRESH SEAFOOD AND STEAKS DAILY ALSO ASK ABOUT OUR DAILY LUNCHEON SPECIAL

(11 A.M. TIL 2 P.M.)

29 Item Salad Bar

746-2601

TRY OUR TAKE OUT SERVICE

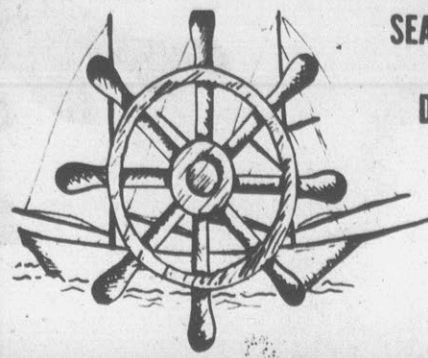

**fashion! Quality! always at ROSES...and you'll love the savings too**

**\$400 EACH VALUES TO 6.96**

Cool, comfortable and appealing sleepwear of poly/cotton blend. Several styles include baby doll pajamas, waltz length and full length gowns. Sizes S-M-L in pink and blue print.



Packaged Briefs for Ladies... SAVE 33¢

166 PKG. REG. 1.99

Package of 3 ladies panties of comfort wearing rayon. Sizes 5-10 in many colors.

Package of 10 Girl's Bikinis \$2.99 PKG.

Ladies Bikini Panties reg. 96¢

76¢ Save 20¢

Choose From Several Styles And Colors. Different Materials. Such As 100% Spandex, 100% Nylon, And Poly/Cotton Blend. Sizes 5-6-7.

Similar To Illustration

Ladies Solid & Printed Colored Bikinis

SAVE 52¢

2 PAIR \$1

REG. 78 PR. Bikini style briefs for ladies of Antron® III. Sizes 5-6-7 in many colors.



Lovely Bras that give You Style and Support

Deep Plunge Fiberfilled 166 REG. 1.99

Padded Criss-Cross 197 REG. 2.88

Choose two styles of bras that are styled for today's fashions. Choose padded criss-cross elastic front bra or deep plunge double fiberfilled bra with stretch straps. Many popular sizes.

# DOLLAR DAYS

SALE LASTS THROUGH SATURDAY, AUGUST 4

WOVEN SMOCKS AND TUNIC TOPS

\$8.98 Values

**\$3.90**

NOW ONLY

COWL-NECK SWEATERS

\$11.98 Values

**\$6.90**

NOW ONLY



# D.A. Kelly's

Evans Mall Downtown Greenville Phone 752-8965



OPEN DAILY FROM 9:30 A.M. TO 9:00 P.M.

PRICES EFFECTIVE THRU SAT. PITT PLAZA SHOPPING CENTER GREENVILLE, N.C.

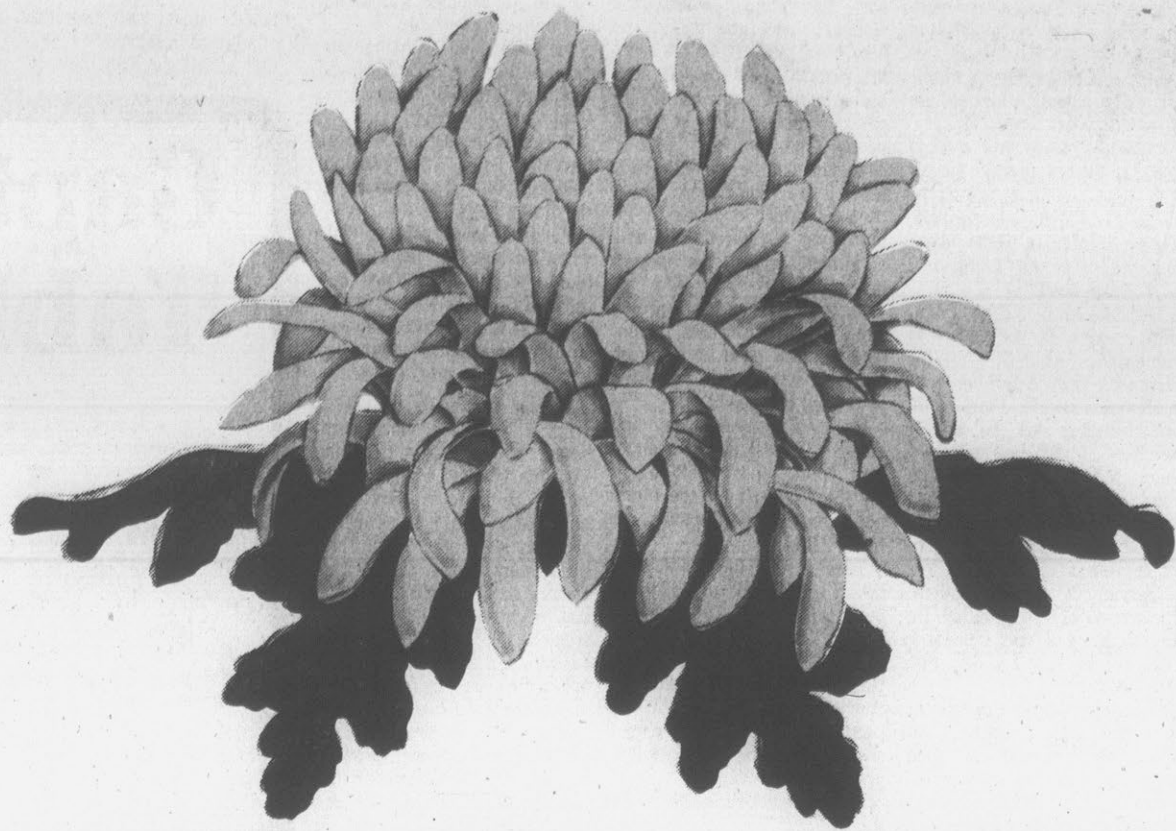

## *Mum Was The Word*

*...and now our secret is out. Eastern Carolina's most fashionable, elegant store has opened.*

*And, it's all because of You. Our special thanks for a successful opening celebration.*

*We look forward to better serving your shopping needs in the years to come.*



**Belk Tyler**  
carolina east mall greenville

## Winfield Paces Padres

By FRANK BROWN  
AP Sports Writer

Dave Winfield buys tickets so kids who can't afford them can see baseball games for free. Dave Winfield also hits very well for the San Diego Padres.

He leads the National League in hitting with a .345 average, is tied with Philadelphia's Mike Schmidt for the lead in runs batted in with 81, and his 25 home runs puts him third behind Schmidt and Chicago's Dave Kingman.

His fielding, throwing and baserunning aren't bad, either, if you like understatements. Despite all this, Winfield insists: "People just don't know who Dave Winfield is."

Atlanta's Phil Niekro knows. The Braves' right-hander gave up three of the five Winfield hits and two of the four Winfield RBI that helped the Padres to a 10-3 rout of the Braves Tuesday night.

"I've had a consistently good season," he says, "but I let my

peers determine how good a player I am. (Pittsburgh's Dave) Parker is a great player and you hear people talk about him a lot. People just don't know who Dave Winfield is."

In the other NL games, Phil Niekro's brother, Joe, became the first 15-game winner when the Houston Astros beat the San Francisco Giants 6-4; the Los Angeles Dodgers held off the Cincinnati Reds 7-6, the Montreal Expos blanked the St. Louis Cardinals 5-0, the Phila-

delphia Phillies bested the Chicago Cubs 4-1 and the New York Mets edged the Pittsburgh Pirates 2-1.

**Astros 6, Giants 4**  
Craig Reynolds' two-run triple in the Houston second helped the Astros beat San Francisco and give Joe Niekro his 15th victory against six losses.

A fielding error by Reynolds led to three San Francisco runs in the seventh. The Giants added a ninth-inning run on Jack Clark's single.

**Dodgers 7, Reds 6**  
Dusty Baker and Bill Russell drove in two runs each and Los Angeles survived a ninth-inning rally by Cincinnati to nip the Reds and give Don Sutton his first victory in six weeks.

**Expos 5, Cardinals 0**  
Rudy May pitched a three-hitter in his first start of the season and recorded his first shutout since Sept. 26, 1978 as Montreal blanked St. Louis. Rodney Scott scored on Andre Dawson's first-inning groundout to give May all the offense he needed.

**Phillies 4, Cubs 1**  
Nino Espinosa's six-hitter helped the Phillies beat the Cubs. Bake McBride's inside-the-park homer got Philadelphia started. His drive to right-center appeared to have been caught by center fielder Jerry Martin after a long run, but he collided with right fielder Scot Thompson and the ball fell loose.

**Mets 2, Pirates 1**  
An RBI single by Lee Mazzilli and a run-scoring groundout by Willie Montanez backed the combined four-hit pitching of Tom Hausman, Wayne Twitchell and Ed Glynn as New York trimmed Pittsburgh.

## Defensive Line Has Experience But Depth Could Be A Problem

By WOODY PEELE  
Reflector Sports Editor

Veteran players return at all three of the interior defensive line positions at East Carolina, but coach Wayne Hall is still not sure that the situation there is all that rosy.

"We have experience, but we don't have a lot of backup strength right now. We are hoping that a couple of freshmen might come through for us, and the return of another veteran could also help us."

At the tackle spots, there is experience as Vance Tingler (6-3, 225, Sr.) returns on the left side, and Noah Clark (6-1, 225, Sr.) is back on the right.

"Vance is a fifth-year player for us, and is probably our most experienced player. He has the best technique and is a solid performer. Noah has more ability than anyone on the line, and this gives us a strong point there," Hall said.

Clark didn't start last year, after being a starter as a sophomore. "D.T. Joyner (now graduated) just beat him out," Hall said. "It wasn't so much of an off-year for Noah as it was a good year for D.T. Noah played a lot. He has quickness and ability, but his technique has lapses at times."

Hall feels that the nose guard situation is a question mark. "We didn't have anyone show himself to be a winner there in the spring," he said.

This was in spite of the fact that John Hallow (5-11, 210, Soph.) returns to the position. He was the top relief man for Oliver Felton last year, and saw plenty of action.

Along with him is Fee Griffin (6-1, 230, Soph.), who also didn't play as well as was hoped for in the spring.

"Hopefully between the two of them, we'll come up with some good play. They were pretty even at the end of the spring."

In the backup roles, Nate Wigfall (6-4, 275, Jr.) will be at tackle, and Hall notes that right now, that is the extent of the reserve depth.

There is the possibility that Wayne Poole (6-0, 230, Sr.) will return from an injury that kept him sidelined all of last year, including the spring. "But we just don't know at this time how he'll do. We hope that he'll come along. That would give us solid men at both tackles both on first and second teams," Hall said.

Doug Smith (6-5, 225), an incoming freshman regarded as the top line prospect ever signed at East Carolina, is looked for some of the backup work at nose

guard. In addition, two other incoming freshmen, Gary Gambrell (6-2, 220) and James Barron (6-2, 230) are looked to for addition help in the line.

"If Poole comes back and we can bring two of the three freshmen along in time to help us, we could be in pretty good shape. That would give us solid two-deep depth everywhere. It would allow us to play a lot of people, just like we did last year, and I think that was a big factor in our only giving up 26 points (in 12 games) in the final quarter all last year. We were able to keep fresh people out there and wear down our opponents."

Hall said, however, that compared to last year, the situation is similar to some extent. "We didn't know what we had last year. We didn't have a lot of experience, but things fell into place for us. This year, we do have some experience, but unless we get some help from places we don't see it from now, we could be hurting."

## Dad Looks To Race

TALLADEGA, Ala. (AP) — Richard Petty said Tuesday he's looking forward to the day he can race "tooth-and-nail" with his 19-year-old son, Kyle.

Young Petty could debut Sunday in NASCAR's Winston 500 at Talladega.

But he has wrecked twice on previous attempts to earn a starting position against his father. The smashups came at Charlotte, N.C., and Daytona Beach, Fla.

Petty said his son's problems hurt father as much as son—probably worse.

"When I get home, his mama (Lynda) jumps all over my head. Kyle's not having any more problems than I did when I started. I tore up a bunch of cars, too. There just weren't that many people watching."

"We're coming to Talladega with a fresh start," said young Petty, who won a 200-mile preliminary event earlier this year at Daytona. "Right now, I just hope the car goes home in one piece."

Being the son of a famous stock car driver creates a lot of pressure, he said. "After what I did at Charlotte and Daytona, they might be looking at it like I need experience, just like any other driver starting out needs. "That's what I hope to get at Talladega Sunday."

"You can learn a lot more on the race track than you can in the pits as a member of the crew."

Meanwhile, Petty will be trying to become the first repeat winner of the Talladega 500. He won the race in 1974. In the ten years of the race, there have been no repeat winners.



Vance Tingler

## Putting Winners

The Top Ten out-putted the Ace Machines and the Aces had an easy win over the King Putters last night.

The Top Ten (10-1) were led by Junior Knox with a 58, Johnny Carrow with a 60, and Barbara Logsdon at 64. Jeff Taft with a 83 was the low man for the Ace Machines (4-6).

The Aces (6-5) were led by Danny Harris and Geoffrey Smith with 60's.

**SAAD'S SHOE SHOP**  
QUALITY SHOE REPAIRING  
WE ORDER SHOES  
Located at College  
View Cleaners  
113 Grande Avenue  
"Parking in Front"

## EXCEPTIONAL VALUES FOR DOLLAR DAY



30 Suits Reduced To \$50  
Values from \$120 to \$220

20 Sport Coats Reduced To \$45  
Values from \$90 to \$165

150 Pr. Pants  $1/2$  Price

100 Knit & Sport Shirts  $1/2$  Price

55 Pr. Shoes  $1/2$  Price

A Group Of Ties  $1/2$  Price

A Group Of Suits Reduced  
 $1/3$  To  $1/2$  Price

A Group Of Sport Coats Reduced  
 $1/3$  To  $1/2$  Price

All Alterations Extra



On The Mall  
In Downtown Greenville

## DOLLAR DAY

FINAL REDUCTION SALE PRICES GOOD THRU SAT.

ON ALL WOMEN'S TENNIS CLOTHES... 40% OFF

MEN'S TENNIS SHIRTS 40% OFF

GREAT FOR BACK-TO-SCHOOL

ALL SPEEDO SWIMSUITS... 1/2 PRICE

SHOES ON SALE

NIKE WAFFLE TRAINER... REG. 28.95 \$21.95

ALL PRO KEDS BASKET BALL SHOES 40% OFF

FISHING DEPARTMENT

ALL FISHING RODS .20% OFF



"The Name Of Our Game Is Service"  
Arlington Blvd.  
Off 264 By-Pass Behind Kings  
In Greenville  
Shop Daily 10:00-6:00 p.m.  
Friday 'Til 9 p.m.  
756-6001



### Sports Calendar

Today's Sports  
Baseball  
State Little League Tournament  
Softball  
Industrial League Tournament  
City League Tournament  
Thursday's Sports  
Softball  
Church League Tournament

### WINE AND CHEESE SHOP

COLD BEER  
6-Pk. of 12-Oz. Cans.....1.88

Budweiser Schlitz Stroh's  
Miller's Pabst Busch

Belk Tyler  
carolina east mall greenville

Now Open — Shop Monday Through Saturday 10 a.m. Until 10 p.m. — Phone 756-B-E-L-K (756-2355)

# Garcia's Luck Keeps Going

By KEN RAPPOPORT  
AP Sports Writer

Things have been perfect for Dave Garcia in the past week or so. For Don Zimmer, they've been perfectly awful. And Tuesday night took the cake.

"I want to cry," said the manager of the Boston Red Sox.

It wasn't only that Zimmer's team lost a double-header to the Cleveland Indians, 11-10 in 11 innings and 3-0. It was how the Sox were dropped.

They held a 10-5 lead going into the ninth inning of the first game, but poor relief pitching

allowed the Indians to tie the game and send it into extra innings. Then Toby Harrah won it for Cleveland with a run-scoring double with two out in the 11th.

Len Barker combined with Sid Monge on a two-hitter as the Indians won the second game.

In other American League action, Baltimore defeated Milwaukee 9-5; Kansas City edged Toronto 6-5; Texas routed Detroit 11-3; New York whipped Chicago 7-3; California turned back Seattle 8-1 and Oakland beat Minnesota 2-1.

**Orioles 9, Brewers 5**  
Ken Singleton's two-run homer capped a

four-run third inning, and Eddie Murray hit a grand slam homer in the ninth, powering Baltimore over Milwaukee. Sammy Stewart, 7-4, earned the victory in relief of Mike Flanagan for the Orioles, who have won 12 of their last 14 games. Stewart allowed only three hits in 5 1-3 innings.

**Royals 6, Blue Jays 5**  
George Scott slammed a two-run, seventh-inning homer to lead the Royals over Toronto. Scott's blast over the left-center field fence off Jesse Jefferson, 1-9, followed a leadoff single by Al Cowens and erased a 5-4 Toronto lead. It was his fifth homer of the season.

Reliever Marty Pattin, 4-2, gained the victory.

**Rangers 11, Tigers 3**  
Al Oliver collected three hits as Texas rocked four Detroit pitchers for 16 hits and rolled to an easy victory over the Tigers. Oliver had one of six Texas doubles, along with two singles, and drove in one of the Ranger runs. Four Texas players knocked in two runs each — Dave

Roberts, John Ellis, Pat Putnam and Nelson Norman.

**Yankees 7, White Sox 3**  
Jim Spencer hit a three-run homer to power New York over Chicago for Ron Guidry's ninth victory. Spencer's 13th homer of the year came in the fourth inning off Randy Scarbery, 1-6. Guidry is 9-7.

**Angels 8, Mariners 1**  
Dave Frost pitched a five-hitter and Bobby Grich singled twice to drive in three runs and lead California past Seattle. Grich singled in the sixth to drive in the first two Angels' runs. In the seventh, his single scored one and capped a five-run Angel rally.

**A's 2, Twins 1**  
Pinch-runner Larry Murray scored from third on a wild pitch by Minnesota's Geoff Zahn in the ninth inning, giving Oakland its victory over the Twins.

Zahn, 9-3, threw the ball in the dirt, it bounded away from catcher Butch Wynegar and Murray scored standing up.

## PGA Tourney Doesn't Get Major Headlines

An AP Sports Analysis  
By WILL GRIMSLEY  
AP Special Correspondent  
BIRMINGHAM, Mich. (AP)

On the calendar, it's the last of golf's Big Four major championships. Traditionally it is the toughest, the least prestigious, the least publicized.

What's the matter with the PGA National Championship, anyhow?

Once the blame was laid to poor courses. This situation has been rectified. In recent years, it has been played on the nation's finest, most challenging layouts, such as Oakland Hills, just outside Detroit, this week.

Once they said the trouble lay in the original format — match play, head-to-head, sudden death. Too often, the star players — the Hogans, Demarets and Sam Sneads — were eliminated in the 18-hole early rounds, stripping the event of its glamor for the windup. This was changed in 1958 when the tournament was given the regular 72-hole medal design.

This didn't help, either. The PGA remained the orphan child of the "biggies," outshone by the Masters, U.S. Open and, since Arnold Palmer first led the Yankee march across the Atlantic, the British Open.

Meanwhile, efforts have been made to upgrade rival events such as the TPC (Tournament Players Championship), Tournament of Champions, World Series of Golf and even Jack Nicklaus' Memorial at Muirfield, a takeoff on Bob Jones' Masters. All are reach-

ing for "major" status, the TPC and World Series particularly with the nudging of Commissioner Deane Beman.

But the PGA plugs along, 63 years old, reflector of the game's legends, once the pride of the pros but no longer the pet of the guys on tour who now have their own event.

While the late Bob Jones in the '20s was undisputed monarch of the amateurs — and of all golf — the feisty, benighted Gene Sarazen and the flamboyant Walter Hagen set up a little kingdom of their own in the PGA, out of Bobby's reach.

Sarazen won three times, the first in 1922 and the last 11 years later. The majestic Hagen, who was known to appear on the first tee in a tuxedo after an all-night party, won five in the space of seven years in the 1920s, including four in a row. Then came the era of Ben Hogan, Byron Nelson and Sam Snead, playing eyeball-to-eyeball thrillers until match play was abandoned to satisfy the insatiable appetite of TV.

After that, the hiatus. The PGA lost much of its flavor. It evolved largely into just another 72-hole tour event. Its saving grace was that it remained the fourth and last jewel in golf's quadruple crown should anybody take the first three — Masters, U.S. and British Opens — as Hogan did in 1953 only to snub the PGA.

In the latter part of his career, Hogan spurned the PGA. Arnold Palmer, on the other hand, remained faithful but

never managed to win one, a bitter irony. Jack Nicklaus, bent on filling his trophy room with major championship trophies, won his first PGA title in 1963 and has added three since, the last in 1975. Gary Player has won two.

The PGA has not lacked for talent. It has been dressed up, well promoted and placed on the traditional championship courses.

### Charlotte Is Champ

Charlotte Broadmoor captured the 13-year-old Babe Ruth League State Championship here last night, downing Pitt County 4-3 in eight innings.

Charlotte went through the double-elimination tournament without a loss, winning in three games. Pitt, which won in the first round, lost in the second round to Charlotte, then fought back through the losers' bracket to gain the finals, but had to sweep Charlotte twice to win the title.

Going into the seventh inning, the game was tied at 2-2, and each team picked up a run in the seventh, leaving it tied at 3-3. Charlotte pushed over the winning run in the eighth, however, to claim the win.

Charlotte will not move into regional competition later this month.

Further details of the game were not available.

## NE Mecklenburg And Brunswick In Finals

North East Mecklenburg and Brunswick County slipped into the finals of the North Carolina State Little League championships here yesterday, each winning close contests.

North East Mecklenburg edged past Roanoke Rapids, 7-6, while Brunswick nipped Southwest Forsyth 8-7.

The championship game is set for 5 p.m. today at Elm Street Park. The winner advances to the Southern Regional, set to begin August 12 in St. Petersburg, Fla.

In the opener, North East pushed over four runs in the bottom of the second to grab the lead. Jeff Prince opened things up with a solo home run. Brian Prince followed with a single and Gary Preslar cracked another homer, scoring two runs. Wes Black walked, moved up on a balk, and scored when Chip Ferguson singled.

After seeing Mecklenburg score twice more in the third, Roanoke Rapids pushed over two in the fifth to get on the scoreboard. Darrell Mitchell singled and Brian Barnes walked. Both advanced on a wild pitch, and a balk brought Mitchell home. Brent Edwards then grounded out, allowing Barnes to score.

Roanoke Rapids then rallied

for four more in the sixth tying the score at 6-6. All four runs came on a home run by Lee Abshire.

But Mecklenburg came back with the winning run in the bottom of the sixth. Alan Lewis doubled and moved up on a fly ball. He then scored when Randy Sussamon's grounder was too late in getting relayed to the plate.

Preslar led the Mecklenburg hitting with three, while Lewis and Chip Ferguson each had two. Abshire and Todd Arthur each had a pair for Roanoke Rapids.

Southwest Forsyth jumped off to a four-run lead in the top of the first frame. David Ernst singled and scored on a two-run blast by Jeff Cox. Rodney Blackwell then singled and Mike Holtsclaw added a second two-run homer.

Brunswick County came up

with three in the bottom of the first to trail 4-3. Rusty Johnson reached on an error and Linwood Walker cracked the game's third home run. Rick Green followed with a fourth round-tripper, a solo shot.

Brunswick tied it up in the second with one run, then took the lead with three in the fourth. Southwest came back to score three in the fifth, two of them on a homer by Holtsclaw, making it 7-7.

Then, in the bottom of the seventh, Brunswick got the winning run. Jeff Johnson doubled and took third when the ball was misplayed. A passed ball then allowed him to score.

Ernst, Cox, Blackwell and Holtsclaw each had two hits to pace Southwest, while Rusty Johnson, Walker and Dexter Robinson each had a pair for Brunswick County.

# DOLLAR DAY

THURSDAY, AUGUST 2ND  
OPEN 8 A.M. TIL 6 P.M.

Good for \$1.00 off on purchases of \$10.00 or more!

#1

H. L. Hodges

Series 1979

ODGES' BUCKS

SPORTS STORE RESERVE NOTE

This note is legal tender for dollar day only.

Tennis Dresses .....	1/2 Price
Ladies Separates .....	1/3 Off
Men's Shirts & Shorts .....	1/3 Off
One Group T-Shirts & Gym-Shorts .....	\$1.95 Ea.
Ladies Swimwear .....	1/3 Off
One Rack & Table Of Assorted Items	1/2 Price Or Less
Men's & Ladies Running Gear .....	1/3 Off

### RACKETS

Davis Classic I, II, & III .....	\$44.95
Davis Duke .....	49.95
Davis Lady Elite .....	\$36.95
Davis Imperial Deluxe .....	\$39.95
Davis Imperial .....	\$29.95
Wilson Advantage .....	\$44.95
Wilson Lady Advantage .....	\$44.95
Wilson World Class .....	\$29.95
Yonex 8700 .....	\$59.95
Spalding Accomplish .....	\$39.95
Spalding Natural .....	\$34.95

### SHOES

Nike Lady Roadrunner .....	19.95
Nike Lady Waffle Trainer .....	21.95
Nike Lady All Court .....	14.95
Nike Lady Oceania .....	14.95
Nike Men's Cortez II .....	22.95
Nike Children's Dan Dakota .....	13.95
Nike Children's Burt Bruin .....	16.95
Nike Men's Roadrunner .....	21.95
Nike Seniorita Cortez .....	19.95
Converse World Class Trainer II .....	24.95
Diadora Rally .....	24.95
Adidas Lady Dragon .....	14.95
New Balance 320 .....	21.95
New Balance 355 .....	23.95

Family Tents .....	25% Off
All Igloo Coolers .....	25% Off
Baker Tree Stands .....	20% Off
Big Buck Tree Stands .....	10% Off
Duxbak Hiking Shoes & Shirts .....	25% Off
All Dog Training Supplies .....	10% Off
All Camping Supplies .....	20% Off
All Surf Rods .....	1/2 Price
All Other Rods .....	1/3 Off
All Herman Survivor Boots .....	Greatly Reduced
All Reels .....	10% & Free Line - Penn Reels 20% Off
Tackle Boxes & Tackle .....	20%
All New & Used Rifles & Shotguns Reduced .....	10%

Free Scope Mounting On All New Rifles

**H. L. HODGES COMPANY**  
210 E. 5th St. Phone 752-4154  
THE SPORTS STORE

## Tri-County Feed Mills, Inc.

### Customer

### Appreciation Day

Thursday, Aug. 2nd

### Specials On

### Omolene &

### Hi-O Pig Startena

10% Off On

### Purina Sanitation Products

### Refreshments

### Door Prizes

Purina...  
planning tomorrow  
with research today.

U.S. 64 East  
Bethel, N.C.

## DOWNTOWN DOLLAR DAYS

Doors Open At 9:00 A.M.

ONE GROUP SUITS 1/2 PRICE

ALL SALES FINAL!

LARGE GROUP SPORT COATS \$25.00  
VALUES TO \$100.00

ONE GROUP KNIT SHIRTS 1/2 PRICE

ALL SALES FINAL!

### GRAB TABLE VALUES

KNIT SHIRT .....	\$5.00
DRESS SHIRT .....	\$5.00
PANTS .....	\$5.00
BELTS .....	\$3.00

DOWNTOWN ONLY

NYLON JACKETS 1/2 PRICE

SHORTS 1/2 PRICE

TENNIS WEAR 1/2 PRICE

### ALTERATIONS EXTRA

(ALLOW ONE WEEK)

ALL SALES FINAL!  
DOWNTOWN STORE ONLY!

**Steinbeck's**  
MEN'S SHOP



# GRAND OPENING



## PREVIEW

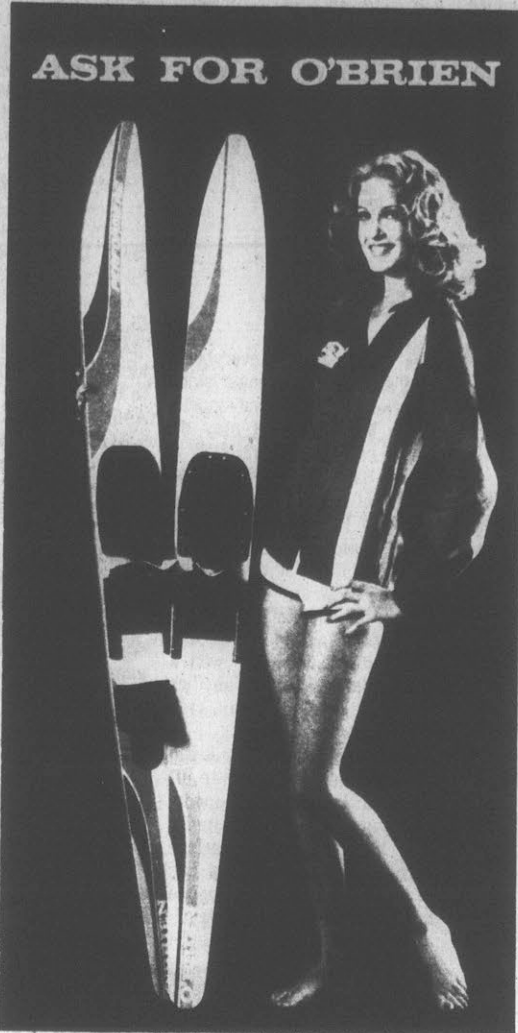

ASK FOR O'BRIEN

### THE PERFORMERS

For the beginning to intermediate skier.

- Red & orange graphics on bright yellow ABS top
- Fiberglass wrapped foam core
- Wide tapering design for easy deep water starts
- Full tunnel on both skis
- Small bevel for stability
- Fully textured bottom
- Soft black bindings lined with yellow sponge
- Easy-to-adjust glass-filled nylon binding hardware
- Extremely lightweight
- One size, 170cm

Regular \$130.00 **\$99<sup>95</sup>** Our Price

Thursday - Friday - Saturday

The Nation's Largest Water Ski Dealer.

Overton's Competition Skis

Free Donuts & Pepsi  
Thursday And Friday

ASK FOR



O'BRIEN

O'BRIEN



### WORLD TEAM COMP®

For the advanced intermediate to excellent skier.

- Green and blue graphics on silver aircraft aluminum top
- Fiberglass wrapped foam core
- Full funnel 45° bevel
- Fully textured bottom
- Bright blue sponge-lined neoprene bindings
- Black glass-filled nylon binding hardware
- Anodized alum. drop thru fin
- Sizes 62-64-66-68-70-72

Regular \$205.00

**\$162<sup>95</sup>** Our Price

O'BRIEN

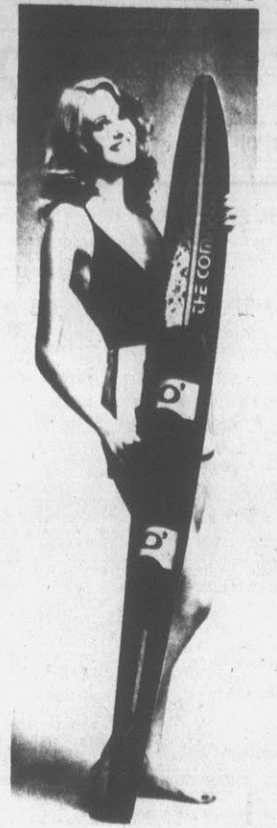

### THE COMPETITOR®

For the great & near great skier.

- Black & green graphics on silver aircraft aluminum top
- Foam core wrapped in fiberglass and Kevlar strands for improved strength and dampening
- Wide variable-depth tunnel
- 3-texture running surface
- 2-stage rounded 45° bevel
- Nylon-lined neoprene bindings
- Glass-filled nylon hardware
- Anodized alum. drop thru fin
- Optional: Plate binding fixed rear heel cup of double adjustable bindings
- Sizes 65.5-67.5

Regular \$235.00 **\$179<sup>95</sup>** Our Price

All Sunglasses **20% Off**



All Ladies

Swimwear **30% Off**

### Jobe Skis

Jobe Shortcut

Overton's Price  
Regular \$185.00 **\$129.95**

Jobe Professional  
Overton's Price  
Regular \$255.00 **\$179.95**

Free Jobe Short Cut  
To Be Given Away Saturday, August 25, 1979.

No Purchase Necessary. Do Not Have To Be Present To Win.

**JOBE**

For The Small Fry  
CAPTAIN KIDD COMBO SKIS

Retail 51.00 Overton's **\$35<sup>95</sup>**

CYPRESS GARDEN JRS.  
Retail 54.95 **\$39<sup>95</sup>**

DICK POPE III

Retail 69.95 **\$49<sup>95</sup>**

Maharajah  
Wood Lapoint

Regular 230.00 Overton's Price **\$139<sup>95</sup>**



HONEYCOMB SKIS  
XR7 Slalom Demo's  
Regular \$109.95  
Overton's Price **\$69<sup>95</sup>**



Complete Line Of Ladies & Men's

## WET SUITS

ATTENTION COACHES!

The Nicest Stop Watch Money Can Buy!

ACCUSPLIT STOPWATCHES

No. 705

Lightweight,  
Waterproof, Electronic.

Overton's Price **\$29<sup>95</sup>**

Regular 39.95

## NAME YOUR SKIS!

Over 1000  
skis in stock!



JOBE VECTOR BASSETT

CONNELLY O'BRIAN EP

MAHARAJAH STINGER

CYPRESS GARDENS TAPERFLEX

LAKE REGION WESTERN

SURFER HOUSE WET SUITS

ROBES by CASAD & PRO LINE

JET SKIS by Kawasaki

**Overton's**

3rd & Jarvis Streets  
Greenville, N.C.

Open 9 A.M. - 6 P.M. Mon. - Sat.

P.O. Box 2  
Greenville, N.C.  
27834

Phone (919)  
**758-7600**



**CORRECT CRAFT BOATS**

We've got 'em in stock

# Son's Tip May Help Nicklaus

## U.S. Team Ices Third

By BOB GREEN  
AP Golf Writer  
BIRMINGHAM, Mich. (AP) — A lesson from a 17-year-old kid, a little tip given in private by a teen-ager to his father, may change the complexion of the 61st PGA National Championship.

It could be the tip that turns the season around for Jack Nicklaus.

"I was going to go see Jack Groat (his life-time teacher), but I called him and said, 'Jack, who needs you?'" Nicklaus said.

A tip from son Jackie may have solved his problems, Nicklaus indicated.

And he has had his problems this year. For the first time in his unmatched career, Nicklaus has failed to win. He ranks a distant 50th on the season's money-winning list. He failed to make the Ryder Cup team. He isn't eligible for the World Series of Golf.

It has been, without question, the most frustrating season of his golfing life.

But things are turning around for the man who owns a record

15 major professional titles, who generally is regarded as the finest player the game has ever seen. The hints are there. The game is coming together. The tip from Jackie could be the nudge that makes him a winner again.

And should he win in this event that starts Thursday on the famed Oakland Hills Country Club course, it would turn around the entire season for Nicklaus, who places such great store in the game's major events.

"It's hard to say you've had

a successful season if you don't win one of the majors. It's hard to say you've had a bad season if you do win one of them," he has said.

He has played his best in the Big Four. He missed a playoff for the Masters title by a single shot. He had a very good — but too late — last round in the U.S. Open. He tied for second in the British Open.

"I'm making some putts now," he said. "That's the difference. I'm probably not playing all that much better than I was. But I'm making some

putts and that can make a world of difference.

"I got the ball close several times last week (at Philadelphia). I still missed some putts, but I made some. And that helps."

And a little session, early this week, with son Jackie could have straightened that out.

"I was hitting balls and he said, 'Dad, where did you tell me to put the weight when you want to hook it?'" Nicklaus said.

"I said, 'Back in the stance.'"

"He said, 'And if you want to fade it?'"

"Up in the stance."

"He said, 'Then why have

you got the ball so far back in your stance?'"

He paused, significantly.

"I've tried to teach him to analyze swings, problems in others. It's nice to have a little feedback."

If that corrects, even partially, the tiny flaws that have frustrated Nicklaus this season, he will move from a place in a list of those likely to win to a role as solid favorite.

If it doesn't, a clear-cut favorite is difficult to determine. Tom Watson — a four-time winner this year, collector of a record \$387,000 already this season — would be a logical

choice. But Watson has had last-round difficulties in his last few starts. His game could be suspect.

Among the other likely contenders on the 7,014-yard, par 70 Oakland Hills Country Club course are U.S. Open champ Hale Irwin, Masters king Fuzzy Zoeller, Lee Trevino, Ray Floyd, Ben Crenshaw, Hubert Green, Lanny Wadkins, Tom Weiskopf, Jerry Pate and Gary Player, the little South African who won the PGA the last time it was played here.

ABC will provide national television coverage of portions of the final two rounds Saturday and Sunday.

MOSCOW (AP) — The U.S. men's basketball team whipped Latvia, 97-86, Wednesday and clinched third place in their group at the Spartacade summer tournament.

The victory was the second in a row for the Americans, who defeated Estonia, 73-65, in action Tuesday at Vilnius, Lithuania.

The U.S. finished Group B play with a record of three victories and two defeats. They beat Yugoslavia last Saturday and lost to both The Ukraine and Leningrad.

U.S. assistant Coach Tom Bennett of Mesa, Ariz., said the Americans shot only 38 percent from the floor in their losses, which eliminated them from a chance to win a medal in the 12-team tournament.

The U.S. women's volleyball team dropped a close 3-2 decision to the Russian Federation team late Tuesday for their first loss in three matches.

Games scores were 15-13, 12-15, 15-5, 6-15 and 13-15.

A controversial call by a Soviet linesman in the crucial fifth game may have cost the Americans a victory.

A U.S. return appeared to have caught the sideline, but the linesman called the ball out and the Soviet referee didn't overrule him. The Russian squad then went on to take the close two-point victory.

The Americans face Poland Thursday and Byelorussia Friday, and if they win both games as expected, they would play for the bronze medal Saturday against another Soviet team, Cuba or Japan.

Shortstop Mark Belanger of the Baltimore Orioles made the last two outs in three triple plays by his team.

# scoreboard

### Recreation Ball

**Industrial League**  
Carolina Leaf 001 000 1-2  
Empire Brushes 060 045 x-15  
Leading hitters: CL—David Manning 2-3; Alfred Gilbert 2-3; EB—Randy Moyer 3-4; Gary Summerall 3-3.

**Gr. Square** 105 000-6  
GUCCO 003 230-8  
Leading hitters: GS—Mike Brincefield 1-2; Bob Peak 2-4; GUCCO—Willie Eakes 3-4; Ted Hardee 2-3.

**City League**  
Taff's 021 005 0-8  
Cheetahs 000 000 0-0  
Leading hitters: TOS—Mike Board 2-3; Robert Carraway 1-1; Ike Arnold HR; C—No one had more than one.

**Church League**  
Trinity 040 003 2-9  
Memorial 000 401 0-5  
Leading hitters: T—Tommy Cooks 3-3; M—Woody Simpson 1-3.

**1st Christian** 000 010 13 2-15  
Arlington St. 020 010 0-3  
Leading hitters: FC—Mike Waters 2-3; J.J. Stencil 2-3; U—Ward Parker 3-3; Tom Harris 2-3.

**Mt. Pleasant** 011 011 0-4  
University 002 400 x-6  
Leading hitters: MP—Buddy Teel 2-3; Ray Elks 2-3; Dwight Vernelson 2-3; J.J. Stencil 2-3; U—Ward Parker 3-3; Tom Harris 2-3.

**First Free Will** 101 010 0-3  
St. Paul's 403 015 x-13  
Leading hitters: FFWB—Gene Pittman 4-4; Carl Belch 3-4; SP—Mark Conway 4-4; Tommy Williams 3-4; Jackson Williams 3-4.

### Junior League

Reds 209 032 3-20  
Phillies 000 103 0-r  
Leading hitters: R—Gyrene Barrett 4; Dwight Smith 4; P—Bobby Gorham 2.

Giants 020 001 0-3  
Dodgers 200 000 0-2  
Leading hitters: G—Jerry Mayo 3; D—Anthony Cobb 2; Cedric Reid 2.

### Baseball

#### NATIONAL LEAGUE

Team	W	L	Pct.	GB
Montreal	57	43	.570	—
Pittsburgh	57	45	.559	1
Chicago	54	46	.540	3
Philadelphia	54	49	.524	4
St. Louis	51	49	.510	6
New York	43	56	.434	13 1/2

Team	W	L	Pct.	GB
Houston	51	47	.565	—
Cincinnati	58	51	.532	3 1/2
San Francisco	52	55	.486	8 1/2
San Diego	49	59	.454	12
Los Angeles	45	61	.425	15
Atlanta	43	63	.406	17

**Tuesday's Games**  
New York 2, Pittsburgh 1  
Philadelphia 4, Chicago 1  
Montreal 5, St. Louis 0  
San Diego 10, Atlanta 3  
Los Angeles 7, Cincinnati 4  
Houston 6, San Francisco 4  
**Wednesday's Games**  
Philadelphia (Notes 2-2) at New York (Ellis 1-3)  
Chicago (McClothen 9-8) at Montreal (Grimsley 8-6), (n)  
St. Louis (B.Forsch 4-9) at Pittsburgh (D. Robinson 4-5), (n)  
San Diego (Jones 8-6) at Atlanta (Solomon 4-8), (n)  
Los Angeles (Hough 2-1) at Cincinnati (Bonham 5-4), (n)  
San Francisco (Blue 8-8) at Houston (K. Forsch 7-6), (n) **Thursday's Games**  
Chicago at Montreal  
Philadelphia at New York, 2, (1 n)  
St. Louis at Pittsburgh, (n)  
San Diego at Atlanta, (n)  
Only games scheduled

#### AMERICAN LEAGUE

Team	W	L	Pct.	GB
Baltimore	71	24	.676	—
Boston	62	40	.608	7 1/2
Milwaukee	63	43	.594	8 1/2
New York	57	48	.543	14
Detroit	53	50	.515	17
Cleveland	53	52	.505	18
Toronto	32	74	.302	39 1/2

Team	W	L	Pct.	GB
California	61	46	.570	—
Minnesota	55	48	.534	4
Texas	55	49	.529	4 1/2
Kansas City	52	50	.500	7 1/2
Chicago	46	59	.438	14
Seattle	45	63	.417	16 1/2
Oakland	30	77	.280	31

**Tuesday's Games**  
Cleveland 11-3, Boston 10-0, 1st game 11 innings

### Major League Leaders

**BATTING** (250 at bats): Winfield, San Diego, .345; Foster, Cincinnati, .333; Hernandez, St. Louis, .328; Templeton, St. Louis, .323; Briff, St. Louis, .323.  
**RUNS**: Schmidt, Philadelphia, 77; Lopes, Los Angeles, 77; North, San Francisco, 77; Matthews, Atlanta, 76; Royster, Atlanta, 75.  
**RBIs**: Schmidt, Philadelphia, 81; Winfield, San Diego, 81; Kingman, Chicago, 77; Matthews, Atlanta, 76; Foster, Cincinnati, 72.  
**HITS**: Winfield, San Diego, 139; Matthews, Atlanta, 127; Garvey, Los Angeles, 126; Templeton, St. Louis, 122; Moreno, Pittsburgh, 128.  
**DOUBLES**: Rose, Philadelphia, 33; Cromar, Montreal, 28; Hernandez, St. Louis, 28; Matthews, Atlanta, 28; Parker, Pittsburgh, 27; Reitz, St. Louis, 27; Griffey, Cincinnati, 27.  
**TRIPLES**: Templeton, St. Louis, 12; McBride, Philadelphia, 9; T. Scott, St. Louis, 9; Winfield, San Diego, 9; Henderson, New York, 8; Moreno, Pittsburgh, 8; Hernandez, St. Louis, 8.  
**HOME RUNS**: Schmidt, Philadelphia, 36; Kingman, Chicago, 35; Winfield, San Diego, 25; Matthews, Atlanta, 23; Lopes, Los Angeles, 22.  
**STOLEN BASES**: Moreno, Pittsburgh, 45; North, San Francisco, 44; T. Scott, St. Louis, 30; Taveras, New York, 29; R. Scott, Montreal, 28; J. Cruz, Houston, 28.

**PITCHING** (10 Decisions): Tidrow, Chicago, 8.2, 800, 1.92; J. Niekro, Houston, 15.6, 714, 3.25; LaGosca, Cincinnati, 10.4, 714, 2.59; Littell, St. Louis, 7.3, 700, 3.11; Blyleven, Pittsburgh, 9.4, 692, 3.52; Marlin, St. Louis, 9.4, 692, 3.04; Seaver, Cincinnati, 10.5, 667, 3.43; Rogers, Montreal, 10.6, 625, 2.45.  
**STRIKEOUTS**: Richard, Houston, 182; P. Niekro, Atlanta, 120; Perry, San Diego, 119; Blyleven, Pittsburgh, 116; Carlton, Philadelphia, 115.

**AMERICAN LEAGUE**  
**BATTING** (250 at bats): Downing, California, .336; Kemp, Detroit, .336; Lez-

### Transactions

**FOOTBALL**  
**National Football League**  
BALTIMORE COLTS—Released Tim Black of SMU and Raymond Peyton of Mississippi State, linebacker; Tim Gibbons of Missouri, kicker; Orin Griffin of Albany State, wide receiver; Paul Rice of East Texas State and Dave Riley of West Virginia, running backs; Lucien Nibbs of North Carolina A&T and Earl Bryant of Jackson State, defensive linemen.  
CLEVELAND BROWNS—Released free agent Cliff Laboy of Hawaii, defensive end.  
NEW YORK JETS—Waived draft choice Keith Brown, safety.  
**HOCKEY**  
**National Hockey League**  
BUFFALO SABRES—Named Jim Roberts an assistant coach.  
**BASKETBALL**  
**National Basketball Association**  
LOS ANGELES LAKERS—Named Paul Westhead an assistant coach.  
**Women's Basketball League**  
Named John Nucatola supervisor of officials. Named Meg Griggs public relations director. Named Janet Gal operations assistant.  
NEW YORK APOLLO—Waived Pascual Invari, forward.

# Bart Conner Newest Star In Gymnastics

By VERN ANDERSON  
AP Sports Writer  
COLORADO SPRINGS, Colo. (AP) — Bart Conner grabbed the hem of the mantle that proclaims Kurt Thomas America's top gymnast and gave it a sharp tug.

Conner, a 21-year-old University of Oklahoma student who began gymnastics at 10, won gold medals in three events, including the high bar that was Thomas' downfall Tuesday night at National Sports Festival II.

Thomas, 22, world champion in the floor exercise and sixth all-around, attempted a triple flyaway dismount — his first in competition — and landed on his knees. He needed a 9.65 from the judges to win the event, but was awarded a 9.55.

"Everybody tries new things, and sometimes you do it and sometimes you don't," Conner said of Thomas' flyaway.

He said he was a little surprised to win the high bar, but added, "After seeing Kurt's routine, I should have won."

Conner estimated Thomas' landing cost him up to .4 on scorecards.

Conner also won gold medals in the vault and parallel bars, while taking second in floor exercise and third in the rings.

Thomas, who passed up a near-cinch gold medal in floor

exercise, won the pommel horse as expected but was second to Conner in the high bar and parallel bars and second again to Larry Gerard in the rings.

The Indiana State graduate was named all-around champion in team competition earlier, and it was Thomas the overflow crowd of 7,300 at the Air Force Academy Fieldhouse came to watch.

"I didn't want to end in a crash," Thomas said later, adding that he had the difficult dismount on his mind all through his routine.

Thomas said he was working on his weaknesses — strength, flexibility and technique in some areas — in getting ready for the World Championships in Dallas in December.

"I'll be ready for it," he said, and predicted the United States gymnastics team could place as high as fourth in the 1980 Olympics in Moscow. The Soviet, Japanese, Chinese and East German teams present the main obstacles, he said.

Conner, a member of the 1976 Olympic squad, expressed surprise at doing so well at the Festival. "The routines I'm doing now are routine," he said. But he is adding new elements for the world title competition and the Olympics.

"The guy who puts in a new

trick that blows everybody away has got it," Conner said. "I have a brand new dismount in the high bar that may be ready by December. It's a double back with two twists. It's about as rare as a triple flyaway."

Gymnastics held sway for the second night in a row at the six-day Festival, which ends tonight. Monday night, Tracee Talavera, a 74-pound sprite who will be 13 next month, won a gold medal and tied for another after taking the all-round title in women's competition.

Elsewhere Tuesday, Justin Whiting scored two goals to lift the East to a 5-1 gold-medal victory over the West in men's field hockey, while Charlene Morett scored a goal and had an assist as the East tripped the West 4-0 in women's play.

Shortstop Mark Belanger of the Baltimore Orioles made the last two outs in three triple plays by his team.

## HADDOCKS CONSTRUCTION

Specializing In  
Septic Tank Installation-Back Hoe Work-  
Driveways Poured-Lot Clearing-

Maehew Haddock      Phone  
Owner      Day - 758-2056  
Night - 756-9885

# Porsche 924

The legend lives on.

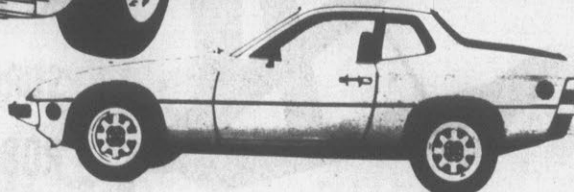
**Porsche 924**  
Born to a proud heritage, the Porsche 924 lives up to its name. It has aerodynamic styling with room for two. And performance to satisfy the most enthusiastic driver. Drive the legend today.

## Carl Johnson's

PORSCHE+AUDI /MERCEDES-BENZ

Highway 17 South      New Bern 919-633-0123

AUTHORIZED PORSCHE+AUDI/MERCEDES-BENZ DEALER



NOTHING EVEN COMES CLOSE

## NOW UNDER NEW OWNERSHIP



Announces Its  
**DAILY SPECIALS**

4 P.M. To Closing Every Day

**MONDAY:** Buy One Dinner - Get Second One Free!

**TUESDAY:** Family Day - 50¢ Off A Ribeye or Chopped Steak

**WEDNESDAY:** Kid's Day - Child's Plate For 1¢  
With Paying Adult (One 1¢ Meal Per Adult)

**THURSDAY:** All You Can Eat - Country Fried Steak

**FRIDAY:** FREE Beverage With All Meals

**SATURDAY:** College Day - All Students Receive  
25% Discount On Everything!

**SUNDAY:** Senior Citizens Day - 25% Discount  
For Everyone Over 55

264 By Pass      Hours:  
Greenville      11:00 A.M. To 10:00 P.M.  
Daily

# House Sets Price On Gasoline-Rationing Measure

By TOM RAUM  
Associated Press Writer  
WASHINGTON (AP) — The House is ready to give President Carter the gas-rationing authority he wants, but only at

a price he may be unwilling to pay — repeal of part of his month-old mandatory thermostat-setting program.  
The House was meeting today to complete action on the ratio-

ning legislation after giving the president the latest in a long string of unwelcome energy surprises late Tuesday.  
The rationing bill's floor manager, Rep. John D. Dingell,

D-Mich., says adoption of the thermostat-law rollback has added new controversy to the legislation and again put its passage in jeopardy.

complain about how uncomfortable Americans have been under the law.

Under the amendment by Rep. Chalmers P. Wylie, R-Ohio, buildings could be exempt from the temperature control law if utility bills — or other documentary evidence — could be produced to show that an equivalent amount of energy had been saved through other means.

Dingell said there's no question about the White House position on the amendment — it's opposed.  
"We tried to stop it but there was nothing we could do," Dingell said. "It's just another example of the House approving something it didn't understand."

Democratic leaders claimed the same thing last Wednesday after the House unexpectedly approved a Republican-sponsored amendment giving Congress two chances to block a

gas-rationing plan proposed by the president.

The House reversed that vote Tuesday after a heavy lobbying campaign by the White House and the Democratic leadership. The vote was 234-189 to give the president a free hand in preparing a standby rationing plan.

The bill stipulates rationing would be used only in a severe fuel shortage, of at least 20 percent.

And the House decided to retain Congress' right to reject a rationing plan by having either house veto it once the president actually moved to implement it. But this was a condition the president said he could live with.

The House rejected the first Carter rationing plan entirely last December.

Thus it seemed things were going well for the president Tuesday night until adoption of the Wylie amendment.

And leaders are no longer as optimistic that the legislation can be placed on the president's desk by the end of the week — the start of the month-long congressional summer recess.

The apparent rationing victory the House gave the president Tuesday night was short-lived. It was followed up by a 267-152 vote to repeal the law championed by Carter requiring commercial buildings to set their thermostats at no less than 78 degrees in the summer and no more than 65 degrees in winter.

That law has been in force only since July 1, but member after member took to the floor of the House — itself held at an energy-saving 78 degrees — to

IT'S NOT TOO LATE to seek information on enrollment at

## RANDOLPH-MACON ACADEMY

in Front Royal, Virginia

a concerned college-preparatory school emphasizing the development of sound academic, moral, and physical values within a wholesome atmosphere

- GRADES 7-12, PG
- AIR FORCE JR. ROTC
- 88th YEAR
- SMALL CLASSES

For Further Information, Contact:  
DR. THOMAS M. PARKER, PRESIDENT  
RANDOLPH-MACON ACADEMY, BOX GR  
FRONT ROYAL, VA. 22630  
703-635-4141 (Collect)

1979-80 SESSION BEGINS SEPTEMBER 4



OVERTON COMPETITION SKIS... Thursday. (Reflector Photo by Stuart Savage).

## GOODYEAR SERVICE STORES

## Overton's Competition Skis Opens Tomorrow

The grand opening on Thursday of Overton's Competition Skis at 211 Jarvis Street was announced by Parker Overton, president.

The business, a division of Overton's Supermarket Inc. here, is located in a new 7,000 square foot facility adjacent to the supermarket development.

Overton said that the business began in 1976 as a hobby when he purchased four skis from a Redmond, Washington firm. He began a mail order business in 1977 in the rear of Overton's Supermarket and operated there until building the new structure.

The owner, who noted that the business will be managed by Herman (Boogie) Norris along with assistant manager Jimmy Wynne, said that the firm offers

a complete line of competition water skis, ladies and men's swimwear, life vests and water sports accessories, including stop watches, sunglasses and wet suits.

Overton's is also a franchised dealer for Correct Craft Ski Boats and Kawasaki Jet Skis, he said.

The spokesman added that Overton's offers "Watts" line services for customers

throughout the United States, excluding North Carolina.

During the winter months, it was mentioned, the business will market snow ski clothes and equipment.

Overton's, which will operate from 8 a.m. until 6 p.m., employs eight shipping clerks to market the firm's selection of over 1,000 water skis, the owner said.

The business currently advertises in four national magazines.

## Prices Drop On Ga.-Fla.

VALDOSTA, Ga. (AP) — Average prices dropped on the Georgia-Florida flue-cured tobacco markets Tuesday, with almost all heavy grade volumes bringing less than on Monday, the U.S. Department of Agriculture reported.

The USDA's Federal-State Market News Service said a few grades showed small gains, mainly on lower quality lugs.

Sales on Georgia markets grossed 2,981,618 pounds at an average of \$136.54 for \$4,071,136 Tuesday, and 27,525,635 pounds at an average of \$131.80 for \$36,278,607 for the season.

Sales on Florida markets grossed 376,879 pounds at an average of \$132.75 for \$500,294 on Tuesday and 5,621,355 pounds at an average of \$124.97 for \$7,025,263 for the season.

Total sales on Georgia-Florida flue-cured tobacco markets grossed 3,358,497 pounds at an average of \$136.12 for \$4,571,430 on Tuesday; and 33,146,390 pounds at an average of \$130.64 for \$43,303,870 for the season.

The volume of sales was heavy, and the practical top price remained at \$155 per hundredweight.

## FRIDAY'S 1890 Seafood Thursday Night Family Special All You Can Eat

Trout Or Perch..... \$2.29  
Flounder..... \$3.25  
Shrimp..... \$4.75  
Oysters..... \$4.75  
Seafood Platter..... \$4.95  
(Shrimp, Oysters, Flounder, Devil Crabs Scallops)  
No Reorders On Deviled Crabs Or Scallops  
—No Take-Out On Specials—

New Hours:  
Open For Lunch 11:30 A.M. - 2:30 P.M.  
Sunday Thru Friday  
Dinner:  
Sunday Thru Thursday 5 P.M. - 10 P.M.  
Friday And Saturday 5 P.M. - 10:30 P.M.

2311 S. Evans St.

## C'mon Americal Get on Goodyear

Power Streak 78

- Goodyear's best selling diagonal ply tire
- Smooth, thump-free ride
- Road-gripping 6-rib tread

Blackwall Size	SET OF 4 PRICE	Plus FET per tire and old tires
B78-13	\$ 93.00	\$1.69
F78-14	\$122.00	\$2.22
G78-14	\$127.00	\$2.38
H78-14	\$138.00	\$2.61
G78-15	\$134.00	\$2.44
H78-15	\$140.00	\$2.66

WHITEWALLS ONLY \$3.00 MORE PER TIRE

# 4 for \$79

A78-13 blackwall, plus \$1.63 FET per tire and old tires

### POLYGLAS BUY!

Cushion Belt Polyglas—Double Belted for Strength!

## \$35.95

B78-13 whitewall, plus \$1.86 FET and old tire  
OTHER SIZES LOW PRICED TOO!

### Goodyear Retreads

## \$15

Choose 6.95-14, C78-14 or D78-14 blackwall plus \$2.25 to \$10 FET depending on size. No trade needed.  
OTHER SIZES LOW PRICED TOO! WHITEWALLS ONLY \$3 MORE.

# SHOP HOLT

Why? Because

We Have The Highest Gas Mileage Car You Can Buy Anywhere.

## Holt Olds-Datsun

101 Hooker Rd. 756-3115

GOODYEAR SERVICE STORES...WHERE QUALITY AND CONFIDENCE COST NO MORE

### MAINTENANCE FREE! POWER GARD 40 BATTERY

Maintenance-free means water is not added under normal operating conditions.

## \$45.95

Group 27F with each.

Flush top-seal battery eliminates periodic checking, protects against improper watering. Stays clean in service, resists heat, vibration and overcharging.

ASK FOR OUR FREE BATTERY CHECK

Never Needs Water

FREE INSTALLATION

### E-T DEEP DISH MAG WHEELS

\$36.95 13x5.5 \$38.95 14x6.75 \$44.95 15x7.5

Deep-dish, slotted one-piece aluminum wheels. High gloss finish shines bright — draws attention to your car!

Expert wheel service also available: Mounting — Balancing — Alignment

### Just Say 'Charge It'

Goodyear Revolving Charge Account

Use any of these 7 other ways to buy: Our Own Customer Credit Plan • Master Charge • Visa • American Express Card • Carte Blanche • Diners Club • Cash

### Lube & Oil Change

## \$5.88

Includes up to five quarts major brand 10/30 oil. Oil filter extra if needed.

HELPS PROTECT MOVING PARTS

- Chassis lubrication and oil change
- Includes light trucks
- Please call for appointment

### Front-End Alignment and FREE tire rotation

## \$15.88

Parts and additional services extra if needed. Front wheel drive and Chevies excluded.

HELPS PROTECT TIRES AND VEHICLE PERFORMANCE

- Inspect and rotate all four tires
- Set caster, camber, and toe-in to proper alignment
- spect suspension and steering systems • Most U.S. cars, some imports

### Engine Tune-Up

## \$46.88

6-cyl. \$41.88 4-cyl. \$49.88 8-cyl.

Includes listed parts and labor — no extra charge for air conditioned cars. \$4 less for electronic ignition.

HELPS INSURE QUICK STARTS

- Electronic engine, charging, and starting systems analysis
- Install new points, plugs, condenser, rotor
- Set dwell and timing
- Adjust carburetor
- Includes Datsun, Toyota, VW, and light trucks

Goodyear Is Open Saturdays Til 5 P.M.

## WE SERVICE NATIONAL ACCOUNTS

# GOODYEAR SERVICE STORES

729 Dickinson Ave., Open Mon.-Fri. 7-8; Sat. 7-5, Phone 752-4417, Johnny Joyner, Mgr.

### Crossword By Eugene Sheffer

- |                           |                       |                           |                         |
|---------------------------|-----------------------|---------------------------|-------------------------|
| ACROSS                    | 38 Conciliatory bribe | 59 Declares DOWN          | 11 Witticisms           |
| 1 Flowing garment         | 40 Decompose          | 1 Chapter of the Koran    | 16 Letter phrase        |
| 5 Aries                   | 41 Lath               | 2 War god                 | 20 Baseball great       |
| 8 Chick-pea               | 43 Cut off            | 3 Frees                   | 23 Prohibit             |
| 12 Popular novelist       | 45 Chemical substance | 4 Pines and Wight         | 24 Grape                |
| 13 Peer Gynt's mother     | 47 Turkish inn        | 5 Type of music           | 25 Fly-catching warbler |
| 14 San —, Italy           | 51 Abba —             | 6 Sturdy tree             | 27 Latin conjunctions   |
| 15 Traffic signal         | 52 Artist's pigment   | 7 Paris subway            | 29 New: comb. form      |
| 17 Mine entrance          | 54 Ord or Dix queen   | 8 Deo —                   | 30 Choose               |
| 18 Agree                  | 56 Far: comb. form    | 9 Willow used in basketry | 32 Early movies         |
| 19 Rotating blades        | 57 Defeats, at bridge | 10 Moslem noble           | 34 Period of recreation |
| 21 Hindu title of respect | 58 Opener             |                           | 37 Operated             |
| 22 American inventor      |                       |                           | 39 California Indian    |
- Avg. solution time: 26 min.

PACA CAP COLA  
AMEN UTA OLAN  
CORDUROY REST  
ERE STP AMATI  
CEE TIO  
ASTOR CORRECT  
ROAR EON ALAL  
CORTEGE SNARL  
ITO ALT  
AMICE TAA IST  
SERA CORVETTE  
OMIT APO VEAL  
ROSE DEN ARBA

Answer to yesterday's puzzle.

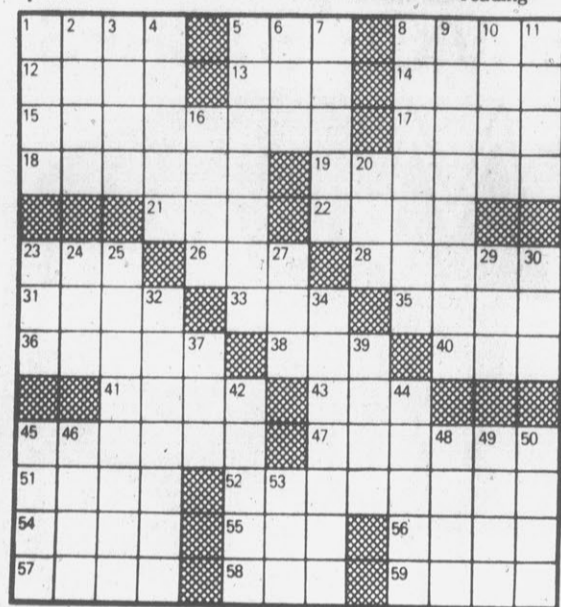

CRYPTOQUIP 8-1

JMGP PMPG KMSX NXCK SCYHKK  
HTX TNXCJ TMYXG

Yesterday's Cryptoquip — ILLICIT VOTING RENDERED GENERAL ELECTION INVALID.

Today's Cryptoquip clue: J equals M

The Cryptoquip is a simple substitution cipher in which each letter used stands for another. If you think that X equals O, it will equal O throughout the puzzle. Single letters, short words, and words using an apostrophe can give you clues to locating vowels. Solution is accomplished by trial and error.

© 1979 King Features Syndicate, Inc.

## Opines Wetzel Lucky To Be Alive

RALEIGH, N.C. (AP) — Frank Wetzel "is lucky he didn't get the gas chamber" for the murders of two highway patrolmen in 1957 and shouldn't

be moved from Central Prison to a medium-security institution, the commander of the Highway Patrol said Tuesday. "People have been given the

gas chamber for murdering one person and he murdered two," said Col. John T. Jenkins. "The general consensus of the patrol is that he not be paroled."

Wetzel was sentenced to consecutive life terms for murdering two patrolmen Nov. 4, 1957. Jenkins, who was on-duty as a patrolman the night Wetzel killed Troopers Wister Lee Reece and James Thomas Brown, said the patrol was a close organization that didn't easily forget the slayings of "family."

Family members of the slain troopers themselves said Tuesday they had not forgotten either.

"It wouldn't be fair for Wetzel to go free while my brother is in the ground," said Fred M. Reece of Randleman. "He not only killed my brother, but another man."

Mrs. Lee Brown Sr. of Statesville, mother of the other slain trooper, agreed. "I wouldn't want him to be removed (from Central Prison), because I wouldn't want him to escape," she said. "I still think he ought to serve his terms for both men."

Wetzel, 58, has spent 22 years in Central Prison, the state's only maximum-security institution.

In 1974 he was promoted to medium-custody classification. Twice, however, his requests to transfer to a medium-security

unit have been denied by state prison officials.

On Thursday U.S. District Court Judge Franklin T. Dupree Jr. ordered the Department of Corrections to transfer Wetzel out of the Central unit the court could rule on his claim that prison officials' refusal to transfer him violated his right to due process of law under the 14th Amendment of the U.S. Constitution.

## Becomes PCA New President

Arnold B. Parris has been elected president of the Pitt-Greene Production Credit Association, effective today, according to an announcement by David Harold Smith, board chairman.



ARNOLD PARRIS

Parris, a Greene County native, joined the Pitt-Greene PCA in March of 1959 and was transferred to the Snow Hill office as manager in October, 1959. He was elected vice president in 1975.

In 1978, Parris transferred back to the Greenville office to head the Credit Department and was promoted to executive vice president in February of this year with major duties in credit and operations.

The new president, a graduate of Atlantic Christian College, is married to the former Rachel Albritton of Greene County and they have one son.

Parris succeeds F. L. Little Jr., who has been elected as consultant to the association.

The Pitt-Greene PCA, which extends short and intermediate credit to farmers in the two counties, has home offices in Greenville and a branch office in Snow Hill. Loans presently outstanding are in excess of \$50 million, with 1,706 members.

### Greenville Opticians

Will Be Closed  
The Week Of  
**Aug. 6-10**  
For Vacation.

### CLEANCO'S

CARPET LABORATORY  
DOES A BETTER JOB

"Truck-Mounted Steam  
Cleaning Unit"



WE BRING THE CARPET CLEANING PLANT TO YOUR

HOME - THE MOST POWERFUL  
CARPET CLEANING PROCESS  
AVAILABLE.

- ☆ CLEANS DEEPER ☆ DRIES FASTER
- ☆ NO NEED FOR YOUR HOT WATER
- ☆ NO HEAVY EQUIPMENT IN YOUR HOME
- ☆ NO NEED TO USE YOUR ELECTRICITY.

**CLEANCO**  
PROFESSIONAL  
Maintenance

**758-5310**

CARPET CLEANING  
SPECIAL

Any Living Room  
Or Dining Area  
And Hall

Living Room,  
Dining Area And  
Hall

UPHOLSTERY  
CLEANING ALSO

© Lorillard, U.S.A., 1979

# Triumph. Only 3 mg. tar. And a taste good enough to stay with.

Read how new Flavor-Intensified™ Triumph gives you surprisingly satisfying taste at only 3 mg. tar... one of the lowest tar levels in cigarettes.

Triumph. The first and only cigarette that delivers good taste with only 3 mg. tar.

If you've ever been disappointed by one of the very low tar cigarettes, you will understand why Triumph is quite an achievement.

Even the draw is a surprise.

The smoke comes through abundantly. The taste reaches you smoothly. Effortlessly. With none of the struggle you may have experienced in other very low tar brands. You don't have to pull—you just puff on Triumph.

No gimmicks, no miracles.

No less remarkable than Triumph itself, is the technology that enabled us to build it.

The crux of it: Instead of searching for some yet unimagined answer, Lorillard scientists took a more sensible tack.

Why not, they said, take everything we've learned about cigarettes, and push that technology further than we've ever pushed it before.

Delivering taste, limiting tar.

We found, for example, that combining two types of filter fiber produces the best combination of taste and draw.

That tiny "vents" in the filter-rim smooth the taste.

That lower-leaf tobaccos (shaded from the heat of the sun) tend to be milder and lower in tar than those at the top of the plant.

In short, everything we could find that might intensify flavor at 3 mg. tar, was built into Triumph.

Taste you won't get tired of.

What it all comes down to is this: Triumph is not one of those ultra low tars that spoil your pleasure by short-changing you on taste.

Triumph, at only 3 mg. tar, is a cigarette with a taste you can stay with. So good, we believe you'll never want to go back to your old cigarette.



# TRIUMPH®

One of the lowest tar cigarettes you can smoke.  
The one with taste enough to stay with.

Warning: The Surgeon General Has Determined That Cigarette Smoking Is Dangerous to Your Health.

3 mg. "tar," 0.4 mg. nicotine av. per cigarette by FTC Method.

## Pleading Guilty To Fraud On Passport

ASHEVILLE, N.C. (AP) — An attorney for Joyce McKinney, who gained nationwide attention when she was charged with forcing a Mormon missionary to have sex with her, says she plans to plead guilty to fraudulently obtaining a passport.

Miss McKinney, whose trial is set for the week beginning Sept. 2, was released Monday from Asheville's Appalachian Hall, a private psychiatric hospital. She entered the hospital July 20 for evaluation ordered by a U.S. magistrate.

Miss McKinney, who is free on \$5,000 bond, waived a preliminary hearing Monday and asked to be tried in Asheville instead of Seattle, said Bruce Elmore Sr., her lawyer.

The trial date will be a formality, however, because Elmore said she will plead guilty. She faces a maximum sentence of five years in prison and a \$2,000 fine.

Miss McKinney, 28, of Avery County, and Keith May, 26, of Los Angeles, were charged in Britain in 1977 with kidnapping the missionary, tying him to a bed and forcing him to have sex with her. May and Miss McKinney skipped bail and slipped out of the country last year.

British officials are not seeking extradition, however.

Miss McKinney and May were arrested July 18 in Buncombe County on the passport charge.

Home Savings  
Money Market Certificates\*

**9.301%** Per Annum

Effective Aug. 2 thru Aug. 8  
26-week Term \$10,000 Minimum Deposit

Treasury Security  
Certificates\*

**7.95%** Per Annum

Effective Aug. 1 thru Aug. 31  
4-year Term \$500 Minimum Deposit

Earn a high rate of interest on these certificates of deposit.

\*A substantial interest penalty is required for early withdrawal.

**HOME SAVINGS**  
Greenville, Bethel, Plymouth.

MEMBER  
**FSLIC**  
LENDER

# Judge Opines Killer 'Total Waste Of Humanity'

By RICK SPATLING  
Associated Press Writer  
MIAMI (AP) — Condemned by a judge as "a total waste of humanity," Theodore Bundy has been ordered to pay with his life for the beating and strangulation murders of two sleeping women. But it may be a long time before the people of Florida collect.

"In a way, this is my opening statement," the articulate former law student said in an emotion-choked monologue Tuesday shortly before he was ordered to die in Florida's electric chair.

"This is just the first ... early round of a long battle," Bundy vowed between sniffs. "I haven't given up by any means." It was the first time in his five-week trial he had shown any emotion.

He refused to plead for mercy. "Absurd," said Bundy, "to ask for mercy for something I did not do."

Judge Edward D. Cowart was unimpressed.

"It's a tragedy for this court to see such a total waste of humanity," said the judge. "You're a bright young man. You'd have made a good lawyer. I'd have loved to have you practice before me. But you went another way, partner." Twice the judge ordered Bundy

put to death "by a current of electricity ... passed through your body until you are dead," for the deaths of Margaret Bowman, 21, and Lisa Levy, 20.

Cowart said the beating of Miss Bowman "was vicious, vile, wicked and atrocious."

Both women were attacked with a crude oak club as they slept in the Chi Omega Sorority house at Florida State University in Tallahassee the morning of Jan. 15, 1978. Bundy also was convicted of three counts of attempted murder in the beatings of three other women who lived in the sorority house and in a

nearby apartment. Cowart sentenced Bundy to 198 years in prison for burglary.

Louise Bundy, 52, of Tacoma, Wash., looked at the courtroom floor as the sentences were imposed on the son she has called "my pride and joy." Then she

left, tight-lipped, saying nothing.

Death sentences have taken on added impact in Florida since the state sent convicted murderer John Spenkink to the electric chair on May 25.

But Bundy's determination to

fight his sentence, combined with other pending trials and an automatic Florida review process, seem certain to push any potential execution date years into the future.

Bundy is due for trial Sept. 17 in Lake City, Fla., on a charge

of strangling 12-year-old Kimberly Diane Leach on Feb. 9, 1978. The prosecutor there says he expects Bundy to be made available.

Bundy also is charged with murdering a Michigan nurse near Aspen, Colo., in January

1976, but Colorado authorities say they're probably the last in line for Bundy. A 15-year Utah prison sentence awaits him for the 1974 kidnapping of Carol DaRonch near Salt Lake City.

Bundy's attorneys have already announced they will seek

a new trial in the Chi Omega case. And they say they have found a half-dozen constitutional grounds for appeals. Meanwhile, Bundy has an automatic right of appeal straight to the Florida Supreme Court.

## Revival Series Is Under Way

Revival services are being held this week at Emmanuel Holiness Church, Pactolus Highway, with the Rev. Russell Kinlaw as evangelist.

Services are being held nightly at 7:30 p.m. The church is located behind Parker Chapel Church. The public is invited to attend.



WALKING IN THE RAIN — Rosalyn James was walking home with her daughter Deandre when the skies opened, pouring rain on her and her year-old passenger. Having only one umbrella, there was only one thing for a good mother to do, and that is to get wet. At least Deandre stayed relatively dry for the remainder of the trip to her Columbus (Ga.) home, although she doesn't seem to be enjoying the ride much. (AP Laserphoto)

### FORECAST FOR THURSDAY, AUG. 2, 1979

## YOUR DAILY Horoscope

from the Carroll Righter Institute

**GENERAL TENDENCIES:** A good day and evening to spend your time finding out whatever you do not understand and to make constructive plans for the future. Keep cheerful at all times.

**ARIES (Mar. 21 to Apr. 19)** Show that you are conscientious in handling both debtors and creditors. Plan a particular favor for the one you love.

**TAURUS (Apr. 20 to May 20)** Study business conditions so you will know what course to take. Make the evening a happy one from a social standpoint.

**GEMINI (May 21 to June 21)** Attend to regular routines and soon they are behind you. Make the most of the talent you have. Be logical.

**MOON CHILDREN (June 22 to July 21)** Making sure that your special talents are working well can bring added income in the future. Take it easy tonight.

**LEO (July 22 to Aug. 21)** The situation at home may be difficult at this time, so use tact. Not a good day or evening to extend invitations to others.

**VIRGO (Aug. 22 to Sept. 22)** Go to the right source for the data you need to become successful. Take no chances with your reputation at this time.

**LIBRA (Sept. 23 to Oct. 22)** Handle small details connected with property and finances and work them out to your advantage. Be careful of one who is tricky.

**SCORPIO (Oct. 23 to Nov. 21)** Know what your personal aims are and be positive in going after them. Contact friends who can be helpful to you.

**SAGITTARIUS (Nov. 22 to Dec. 21)** Good day to concentrate on whatever is puzzling you and come up with the right answers. Be careful of strangers.

**CAPRICORN (Dec. 22 to Jan. 20)** A good time to state your aims to good friends who can be helpful. Make sure that you are not too extravagant now.

**AQUARIUS (Jan. 21 to Feb. 19)** Discuss with a higher-up how to advance in career affairs. Avoid one who has an eye on your assets. Express happiness.

**PISCES (Feb. 20 to Mar. 20)** You have new ideas to work out and study before you can put them in operation. Make this a memorable day.

**IF YOUR CHILD IS BORN TODAY . . .** he or she will one who will want to get at the core of any situation, so be sure to equip with a good education so that the most can be made of this fine ability.

"The Stars impel, they do not compel." What you make of your life is largely up to you!



# Something Special Has Come to Greenville!

At last. The cafeteria Americans have "come home" to eat in 100 million times has come to Greenville. Announcing the Grand Opening of your S & S Cafeteria, in the Carolina East Mall.

## SPECIAL SELECTIONS

You can feast on over 100 delicious items prepared fresh every day... tender roast beef, mouthwatering seafood, sumptuous steaks, and golden fried chicken. Whet your appetite with one of our fresh salads. Complement your meal with our home baked breads or a side dish from our variety of garden vegetables. But leave room for dessert, because S & S offers a sweet shop full of your favorites.

## SPECIAL SERVICE AND VALUE TOO!

Great food is only the beginning at S & S! You're special to us and our smiling service will show you just how special. You'll get the best of both food and service for a price that will make you feel at home.

So come on, Greenville. Join us for

lunch or dinner today. See for yourself why S & S means "Something Special."

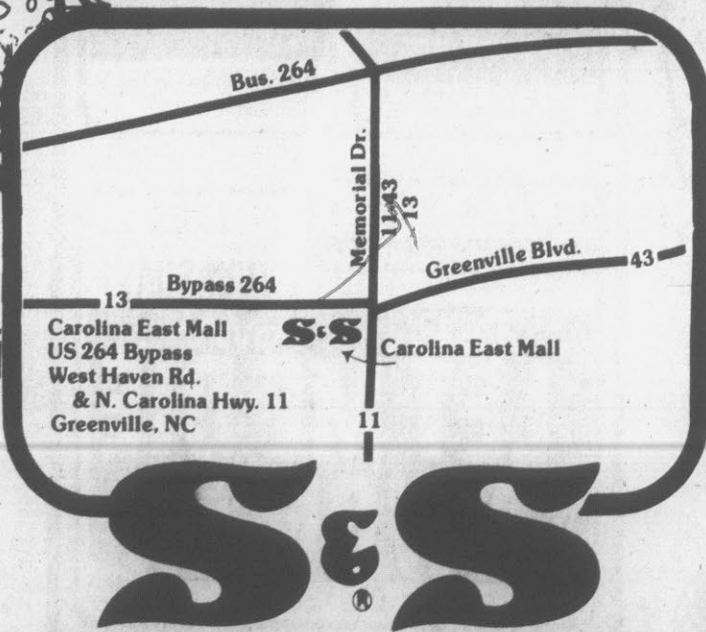

**S & S cafeterias**  
Where America Comes Home to Eat  
Carolina East Mall, US 264 Bypass, West Haven Rd. and N. Carolina Hwy. 11  
Serving Continuously 11 A.M.-8 P.M. (8:30 P.M. Friday and Saturday)

# In October, A Marciano Film ABC Up Front With The Week's Re-Runs

By PETER J. BOYER  
AP Television Writer  
LOS ANGELES (AP) —  
Fwap! A short right connects hard, leather-to-chin and a spray of flying sweat. It is a quick, mean punch, and catches its victim by surprise.

Stunned, he slumps one knee to the canvas and remains frozen there for a moment, as if thinking, "How did this happen?" Then he rolls onto his back with a gentle thump, defeated.

The challenger, not a stylish fighter, is escorted to his corner of the ring as the fallen champion lies silent beneath the count. "... eight ... nine ... ten, out!" shouts the referee, and it is over.

It is Sept. 23, 1952, 43 seconds into the 13th round of a title fight the champ thought he'd already won. But a brutal right that nobody saw proved him wrong, and now Rocky Marciano is the heavyweight champion of the world.

He is, at least, until the leather-lunged fellow in the baseball cap screams "Cut!" and the pleasant, smoky little reverie ends. It is only a TV movie, you're reminded, and it's not Marciano in the ring at all, only an actor making be-

lieve. A make-up lady fusses with the actor's hair.

Marciano was a good champ, a great champ. An enduring champ. After doing away with Jersey Joe Walcott that September night in Philadelphia, Marciano never again entered the ring as challenger. He never lost a fight, retiring in 1956 as the only undefeated heavyweight champion in history.

But he was not a magical, pretty champ. He was a brute in the ring, employing the grace of a Teamster unloading a haul. He didn't float like a butterfly.

"He was very methodical in the ring, with the instincts of a killer," says John Stephens, producer of "Marciano." "But out of the ring he was a quiet man, very softspoken. Not good copy. He didn't make commercials."

ABC's story of Rocky Marciano will be a love story. But

that's okay. As Stephens says, "there have been a rash of boxing movies lately," and besides, Marciano's story makes a nifty yarn without the sports and grunts.

Marciano was born to a mean life, and wanted out. He saw boxing as the way. He fought his way to the top, and with his wife by his side, he stepped out

a winner. He was killed in a plane crash in 1969.

To play Marciano, Stephens hired Tony Lo Bianco, who bears a spooky resemblance to Marciano. This and the meticulous efforts at exact duplication ("If he went down from a left hook, that's what he goes down from in the movie," says Stephens. "Not only the actual

punch, but in the same spot in the ring") will likely make the few fight scenes in "Marciano" vividly realistic.

"Marciano," scheduled for an October Sunday Night Movie run, sounds like a natural. The scramble from down-and-out, triumph, love and tragedy.

This Rocky didn't float, and he wasn't as pretty as Sylvester Stallone. But, to paraphrase that latter Rocky, he wasn't just another bum from the neighborhood.

HOLLYWOOD (AP) — ABC led CBS in their continuing nip-and-tuck network rerun battle and won the national Nielsen ratings for the week ending July 29.

NBC's highest-ranked show, "CHiPs," was in 29th place.

Leading the shows was ABC's "Three's Company," which had a rating of 23.6.

ABC won the week with an overall rating of 14.9 and CBS was a close second with 14.6. NBC was third with a rating of 12.3. CBS had finished or tied for first in four of the preceding five weeks.

The A.C. Nielsen Co., which compiles ratings estimates for the three networks, says each rating point equals about 750,000 homes equipped with one television set or more. The latest figures were released Tuesday.

"WKRP in Cincinnati" continued its good performance in summer ratings, showing up second in the list. CBS pulled the show off the air for a short time last season.

The top 10 for the week:

1. "Three's Company," 23.6 (ABC);
2. "WKRP in Cincinnati," 23.0 (CBS);
3. "M-A-S-H," 22.6 (CBS);
4. "Taxi," 22.3 (ABC);
5. "Lou Grant," 22.2 (CBS);
6. "The Jeffersons," 22.2 (CBS);
7. "Alice," 22.0 (CBS);
8. "Mork & Mindy," 21.6 (ABC);
9. "Laverne & Shirley," 20.7 (ABC);
10. "Vegas," 20.6 (ABC).

This weeks Nielsen's reflect a widespread belief in the industry about the American TV viewers' tastes — give them light situation comedy, even if they've seen it before. All 10 of the top-rated programs were reruns, eight of them sitcom reruns.

The bottom 10:

**TICE**  
DRIVE-IN • AYOUDEN HWY  
NOW SHOWING 10:15  
**STAR CRASH**  
8:45 Death Sport

**THE AMITVILLE HORROR**  
**Pitt**  
DOWNTOWN  
Daily 7:00 & 9:15

**TONIGHT!**  
**"SUPER WEDNESDAY"**  
AT  
**CHAPTER TEN**  
WITH  
**WRQR "ELECTRIC DISCO"**  
STARRING  
**RICKY PROCTOR**  
9:30-1:30  
**75% DISCO 25% BEACH**

**Buccaneer MOVIES 1-2-3** MOVIES ARE GREAT FUN!  
756-3307 Greenville Square Center

**Hold Over Shows:**  
1:15-3:15-5:15  
7:15-9:15

**PG** **BILL MURRAY**  
**MEATBALLS**  
Shows Daily: 1-3-5-7-9

**The greatest cowboy who ever rode into the wild west... from Poland.**  
**Gene Wilder • Harrison Ford**  
in  
**"The Frisco Kid"**  
*The Frisco Kid*  
Now Showing At 2:00-4:30-7:00-9:30

## GOREN BRIDGE

BY CHARLES H. GOREN AND OMAR SHARIF  
1979 by Chicago Tribune

East-West vulnerable. North deals.

**NORTH**  
♦ A Q J 4  
♥ J 8 6  
♦ Q 4  
♣ K Q 7 6

**WEST EAST**  
♦ 8 6 3 ♦ K  
♥ 9 7 ♥ A K Q 5 4 3  
♦ K 8 7 6 5 ♦ J 10 3  
♦ 10 9 8 ♦ 5 3 2

**SOUTH**  
♦ 10 9 7 5 2  
♥ 10 2  
♦ A 9 2  
♣ A J 4

The bidding:  
**North East South West**  
1 ♦ 1 ♥ 1 ♣ Pass  
2 ♦ Pass 3 ♦ Pass  
4 ♦ Pass Pass Pass  
Opening lead: Nine of ♠.

When you are unable to squeeze any more tricks out of your cards, you can always hope that the opponents will misguess the location of a key card. If they seem headed along that path, a little push might prove effective. But if you can't tell a plausible lie, you might at least make an effort to conceal the truth!

East gave the show away in an extraordinarily simple manner on this hand. South became declarer at a contract of four spades after routine bidding, and West naturally led the top of his doubleton in partner's suit.

East won the queen of hearts and continued with the ace and king. Declarer naturally ruffed this trick with the ten of trumps, which held the trick. The play was very illuminating. Since East

was now marked with the king of trumps (West would have overruffed had he held the monarch), that finesse could not win. Declarer's only hope, therefore, was that the king was singleton, so declarer quite properly led a trump to the ace.

East might as well have shown declarer his hand when he led a third heart. It should have been evident that declarer would ruff with some trump high enough to prevent West from overruffing, thus exposing East's trump holding.

East's best play at trick three would have been a diamond. West would win with the king to complete the defensive book. Declarer would then have to guess the spade situation to make his contract. If he were able to divine why East did not continue with a third round of hearts, he might still guess to drop the king of spades. But if he does, he is entitled to the applause of the pundit.

What East must not do is force declarer to make the right play. Make him work for his money.

**Rubber bridge clubs throughout the country use the four-deal bridge format. Do they know something you don't? Charles Goren's "Four-Deal Bridge" will teach you the strategies and tactics of this fast-paced action game that provides the cure for unending rubbers. For a copy and a scorepad, send \$1.75 to "Goren-Four Deal," c/o this newspaper, P.O. Box 259, Norwood, N.J. 07648. Make checks payable to NEWS-PAPERBOOKS.**

## TV Log

For complete TV programming information, consult your weekly TV SHOWTIME from Sunday's Daily Reflector.

### WNCT-TV — Ch. 9

WEDNESDAY	
7:00 Dating	12:30 Search For
7:30 Jokers	1:00 Young and
8:00 Featherstone	1:30 World Turns
8:30 Good Times	2:30 Guiding
9:00 People's	3:30 M*A*S*H
11:00 News	4:00 Razzamalazz
11:30 Movie	4:30 Merv
	5:30 Brady Bunch
	6:00 9/Alive News
	6:30 News
THURSDAY	
5:30 Carolina	7:00 Dating
8:00 Morning	7:30 Jokers
9:00 Kangaroo	8:00 Waltons
10:00 Magazine	9:00 Hawaii 5-0
10:35 News	10:00 B Jones
11:00 Price Is	11:00 News
12:00 News	11:30 Movie

### WITN-TV — Ch. 7

WEDNESDAY	
7:00 Tic Tac	11:00 Rollers
7:30 Donna Fargo	11:30 Wheel of
8:00 Real People	12:00 News Noon
9:00 The Rebel	1:00 Our Lives
11:00 News	2:00 Doctors
11:30 Tonight	2:30 Another Wild
1:00 Tomorrow	4:00 Battle of
2:00 News	4:30 McHales
	5:00 Hogan's
	5:30 Silvers
	6:00 News
	6:30 NBC News
	7:00 Tic Tac
	7:30 Nashville
	8:00 Project
	8:25 News
	9:00 Ms. Columbo
	11:00 News
	11:30 Tonight
	10:00 Card Sharks
	1:00 Tomorrow
	10:30 All Star
	2:00 News

### WCTI-TV — Ch. 12

WEDNESDAY	
7:00 Sanford	12:00 Love Expert
7:30 Feud	12:30 Ryan's
8:00 Eight Is	1:00 Children
9:00 Ch. Angels	2:00 One Life
10:00 Vegas	3:00 Hospital
11:00 News	4:00 Tom & Jerry
11:30 P. Woman	5:00 Emergency
1:45 Maverick	6:00 News
2:45 Edition	6:30 News
	7:00 Sanford
THURSDAY	
5:55 Tidings	7:30 Gong Show
6:00 PTL Club	8:00 Mork &
7:00 America	8:30 Laverne
7:25 News	9:00 B. Miller
8:30 Today	9:30 Carter
9:00 Shore	10:00 20/20
10:00 Douglas	11:00 News
11:00 Laverne &	11:30 Starsky &
11:30 Family	1:45 Maverick
	2:45 Edition

### WUNK-TV — Ch. 25

WEDNESDAY	
7:00 Like It	5:00 Mr. Rogers
7:30 Report	5:30 Elect. Co.
8:00 Search	6:30 Studio See
9:00 Word Is	6:30 Ratsop
	7:00 Conference
	7:30 Report
THURSDAY	
3:00 Lillias	8:00 Nat. Geo.
3:30 Over Easy	9:00 Paradise
4:00 Sesame St	10:00 Masterpiece

**264 PLAYHOUSE INDOOR THEATRE**  
6 Miles West Of Greenville On U.S. 264 Farmville Hwy.

Showing Only The Finest In Adult Entertainment

**ENDS TONIGHT (ALL NEW)**

A Real Adult Love Match



**HOT RACKETS**

CANDIDA ROYALLE  
DEBBIE CLEARBRANCH  
JON MARTIN

Call For Showtime Anytime  
Valid I.D. Required  
Doors Open 5:45  
Showtime 5:00  
756-0848



Put **31** in your fun!

There's no end to the ways you can enjoy the rich, creamy taste of our ice cream

And let the good times roll!

Visit Us At

Greenville Square Shopping Center  
**OPENING SOON**  
AT  
**CAROLINA EAST MALL**

**BASKIN-ROBBINS ICE CREAM STORE**

GREENVILLE SQUARE SHOPPING CENTER



**STEWART & EVERS THEATRES**

**2ND FUN WEEK!**

...the fastest fun in the west!

**the Villain**

SHOWS DAILY  
3:15-5:10  
7:05-9:00

**Plaza 756-0088**

**ENDS THUR!** PITT-PLAZA SHOPPING CENTER **THUR.**

IT'S THE CANINE COMEDY CAPER OF THE CENTURY!

**WALT DISNEY'S 101 DALMATIANS**  
TECHNICOLOR

SHOWS 2-4-6-8

**BRUCE LEE'S LAST FILM**

**BRUCE LEE GAME OF DEATH**

Special Guest Star  
**KAREEM ABDUL-JABBAR "Hakim"**

SHOWS TODAY & THUR.  
5:00-7:00-9:00

**PARK UPTOWN GREENVILLE**  
752-7649

**ENDS THURSDAY!**

**BORN A MAN... LET ME DIE A WOMAN**

SHOWS 3:30-7:10-9:00

CHILDREN'S MATINEES TODAY & THUR. 1 & 3 P.M.

"PIPI ON THE RUN" (G)

CINEMA 3 ALL SEATS \$1.00

**20¢ off No nonsense makes a good value even better**



At No Nonsense, we think good value means high quality at a reasonable price. It doesn't mean cheap. It just means a very good product.

And No nonsense® are very good panty hose. They're made of a sheer clingy fabric. They have a soft knitted-in waistband. And they have the No nonsense ventilated cotton-lined crotch panel for cool comfort.

There are six basic styles—Regular, Sheer to the Waist, Queen Size, Knee Highs (in Sandalfoot and Reinforced Toe), Control Top (in Sandalfoot and Reinforced Toe) and Super Sheer Comfort Stride® (also available in Sheer to waist and Reinforced Toe). There is also "Easy to be me®" panties and hose all-in-one, which features comfortable panties of soft, Air-Knit® fabric.

If you haven't tried No nonsense, now is the time to do it. Because now we're offering twenty cents off your next purchase. And that makes a good value even better.

**No nonsense fit and comfort at a no nonsense price.™**

**20¢ STORE COUPON**

**"No nonsense panty hose."**

**Save 20¢ on your next No nonsense® purchase.**

TO THE RETAILER: No Nonsense Fashions Inc. will reimburse you for the face value of this coupon plus 5¢ handling if you receive it on the sale of the specified product and if upon request you submit evidence thereof satisfactory to No Nonsense. Coupon may not be assigned or transferred. Customer must pay any sales tax. Void where prohibited, taxed or restricted by law. Good only in U.S.A. Cash value: 1/20¢. Coupon will not be honored if presented through outside agencies, brokers or others who are not retail distributors of our merchandise or specifically authorized by us to present coupons for redemption. For redemption of properly received and handled coupons, mail to: NO NONSENSE FASHIONS INC., P.O. Box 1042, Clinton, Iowa 52734. Limit one coupon per purchase. This coupon good only on purchase of product indicated. Any other use constitutes fraud. **Coupon expires December 31, 1979**

**20¢ 48000 STORE COUPON**

© 1979, No Nonsense Fashions Inc.



Miscellaneous

CUSTOM MADE trailer hitch for Z-car, \$50. Ask for Mike, 756-5868 or 752-7597.

QUALITY USED FURNITURE for sale, individual returning to ECU full time. Everything must be sold, call 752-8296 after 8:15 p.m. or 756-8974 anytime.

GOT GOLD FEVER? Ask me about Sarah Coventry 14 karat Plumb Gold! Brand new. Call 756-6641.

5000 BRICKS Triangular, #1001, 756-2331 after 6.

VISIT THE Oriental and area rug gallery for a complete selection of rugs. Now at special savings. Larry's Carpetland, 3010 East Tenth.

AUGUST WHITE SALES offers special savings on Fieldcrest sheets and towels. Hurry in this week to The Linen Closet, 3008 East Tenth Street.

MATCHING SOFA and end chair, Lawson style, 3 pillow reversible. Good condition. \$250. Call 756-6097 after 5 p.m.

REFRIGERATOR with ice maker, frost free, washing machine, both year old, harvest gold, Kimbal organ, Swinger 100, 2 book shelves, bed, 756-4395 or 756-5727 ask for Buddy.

WEDDING DRESS, Size 7, Priscilla Boston, \$100. Call 756-7838.

FREE WOOD if you buy a Stihl or Poulan chain saw at Warren's Farm Supply, Highway 903, Stokes, Call 758-4578 for details.

HOT PINK, padded, double bed headboard, matching bench, end tables, platform rocker, Magna stereo and small appliances. Call 756-1463 between 6 and 11:30 p.m.

NAUGHAHYDE sofa for sale. Telephone 752-4266.

2 KEYSTONE slots disc mag rims with adjusters and cups. Excellent condition. Best offer, 752-2627.

1 SET OF DRUMS. Approximately 3 years old. Good set for beginners. 756-4874.

INCLUDE THE PRICE for quicker results when you advertise items for sale in Classified.

MATCHING WHITE crib and dressing chest, \$75; oak captain's bed, \$100. 756-5945.

MAN'S DIAMOND ring, Size 9, 14 karat, white gold, 752-2889, 758-9071.

LAPIDARY equipment. Must sell. 756-6134.

STEREO, Garrard turntable, 8 track, decca, 26 speakers, \$100. 756-8974 or 752-8296.

12 X 12 RUG; Oval braided rug; Panasonic turntable with speakers; vinyl recliner. 756-9156.

WANT TO BUY 3 lighted display cases. Call 455-9164.

PLAYPEN, \$10; walker, \$2; backpack, \$5; dishwasher, \$250. 752-0477.

DITCH-WITCH 52800. 756-4624 days.

WANTED INFORMATION on true hauntings and other related psychic phenomena. Contact Psychic Research Group, P.O. Box 976, Greenville, NC. Include name, address and phone number.

TWO AIR conditioners, 5000 and 6000 BTU. \$250 for both. 758-3065.

17 CUBIC foot, frost-free, upright freezer, \$160. 752-2448.

MOVING! Must sell! Round, solid wood table (needs refinishing), \$75; 3 antique night stands, \$15 each; Akai amp (35 watts per channel) and 2 ultra-linear speakers, \$200/best offer; Ross stereo unit including turntable, 8-track and speakers, \$75; small storage chest, \$10. 752-5301.

ELECTROLUX waxer; polisher. Call 756-1770.

IRISH POTATOES for sale. 746-6947.

WHITE ELECTRIC STOVE, 4 burners, \$100. 758-1866 after 6. 756-2948 anytime.

OFFICE FURNITURE, 50" X 30" executive desk with walnut finish, swivel chair, three filing cabinets. \$450 for all. 752-5207.

9 X 12 OBLONG braided rug; sofa-bed, \$25; one boy's and one girl's bicycle; record player, \$15; 5 lamps; Avon bottles. 756-4382.

60 INSTRUCTION

PRIVATE piano, guitar, banjo, mandolin and dobro lessons. Piano-Organ Warehouse, 756-2032.

LEARN TO SAIL/Sailboat rides. Save this number, 756-2873.

MOBILE HOMES

4 Mobile Homes For Rent

2 AND 3 BEDROOM mobile homes. Air conditioned, good location. No pets. 752-3286 days; 825-5391 nights.

CLEAN, 2 bedroom mobile home with central air conditioning, located in Azalea Gardens for couples only; also new, one bedroom, furnished apartment for singles or couples. Located in Azalea Gardens. Contact J. T. or Tommy Williams at Azalea Mobile Homes, 620 West Greenville Boulevard, 756-7815.

MOBILE HOMES and lots for rent. Call 756-4413 between 8 and 5.

2 BEDROOMS. No pets. No children. 752-0098 after 5 p.m.

5 MINUTES FROM ECU campus. 12 X 60, 2 bedrooms; fully carpeted with air. Also 2 bedroom mobile homes available for fall semester. August 15 - 12 X 60, 3 bedrooms, washer, dryer, air. No pets. No children. 758-3644.

2 BEDROOM, furnished mobile home on private lot. Married couple preferred. 756-0264.

2 BEDROOMS, furnished, air conditioning. No pets. Married couples only. 756-0173.

2 BEDROOM, completely furnished. Buck's Trailer Park, 752-0196.

2 BEDROOM, trailer, washer, air, furnished. 756-2497.

12 X 40. Very nice, 2 bedroom trailer on private lot with washer, dryer, air conditioning and outside storage building. Call 758-1659 after 5 p.m.

100 CLASSIFIED DISPLAY

Brown-Wood Has Daily Rental Cars Available. Call Brown-Wood, Inc. 752-7111

100 CLASSIFIED DISPLAY

ROOFING STORM WINDOWS DOORS & AWNINGS Remodeling, Room additions, etc. C. L. LUPTON CO. 752-6116

GREAT EXPECTATIONS HAIRCUTTERS In Carolina East Mall A nationwide chain, needs experienced and licensed haircutters and assistants. Good weekly pay plus commission. Call 756-3298 anytime and ask for Lou.

NO JOB TOO LARGE OR TOO SMALL We Will Do It All On Call 24 Hours Daily GENERAL SERVICES COMPANY Home Remodeling And Restoration Brick and Stone Work Carpentry - Driveways - Painting - Signs 7 Ft. Macon Rd. Atlantic Beach, N.C. 752-4266

Mobile Homes For Rent

2 BEDROOMS. No pets. Married couple only. No pets. 756-5891 or 752-3318.

66 Mobile Homes For Sale

GOOD SELECTION on used trailers at Azalea Mobile Homes. Ask for Tommy Williams.

WHY PAY RENT? Own your own home from Azalea Mobile Homes. See Tommy Williams.

WE BUY used mobile homes. Tommy Williams, 756-7815, 752-5482.

1972 TAYLOR 12 X 40, 2 bedrooms, one bath, completely furnished, central air, \$5995. See Tommy Williams, Oakwood Mobile Homes.

8 X 40 TRAILER, \$1200. 756-4275 or 756-0879.

10 X 55, 2 bedrooms. Air conditioner and furnishings. Excellent condition. \$3000. 756-7376, 746-6929.

1440 SQUARE FEET, 3 bedrooms, 2 baths, dishwasher, disposal, central air. Completely set up. \$16,500. 756-1276, 746-6929.

1978 OAKWOOD 14 X 60, 2 bedrooms, 2 full baths, completely furnished, all appliances, 753-3956.

1975 12 X 56, 2 bedrooms, air conditioner. Call after 6 p.m. 753-2349.

8 X 40 Refrigerator, stove, ideal for office or beauty parlor. 756-1168.

1974, 12 X 40 Westchester, 2 bedrooms, furnished, including washer and dryer, air. In excellent condition. \$4500. 746-6463.

100 CLASSIFIED DISPLAY

TO BUY OR SELL a business in conjunction with contact J. T. Snowden, Jr. at The Marketplace, Inc., Business Brokers, 401 West First Street, telephone 752-3666.

AVAILABLE NOW Unlimited high earnings opportunity. Top company with 55 years experience in sales and service. 756-3861. Equal Opportunity Employer.

ANTIQUES. Golden opportunity for small investment. All stock and contacts. 752-6022.

LIKE TO OWN your own business? I am being promoted and have an established lot route that covers Greenville and Kininston. Profits of over \$18,000 already this year. Investment of under \$25,000. For additional information, call Felton Cook, 522-0596 (Kininston).

73 Commercial Property

FOR LEASE

Office or commercial buildings located in contact J. T. Snowden, Jr. 1400 Block W. 14th St. Four 900 sq. ft. and one 1200 sq. ft. 756-1306.

1100 Block Hamilton St. Three 1200 sq. ft. 756-1306.

3000 Block E. 10th St. 700 ft. office building and 800 ft. block office building

These buildings can be finished within 30 days for occupancy and finished to suit tenant. New construction Contact J. T. or Tommy Williams 756-7815

SHOP/OFFICE space for lease. 1000 square feet. Neighborhood commercial zone. Hooker Road. Call 752-1733 days. 756-7614 nights.

526 SOUTH Cotanche Street (directly across from ECU campus). 5500 square feet for rent. Available late fall. J. J. Edwards, Jr., 758-2616.

OFFICE COMMERCIAL space for lease. 3000 square feet. 913 Dickinson Street. Formerly Edwards Hardware. 3 nice offices. Contact Cliff Edwards, 756-8500.

STORE FOR RENT. Corner of Dickinson Avenue and Picklen Street. 752-3585.

5 ACRES of light industrial area. Across from Carolina East Mall. \$50,000. Clark-Branch, Realtors, 756-6336.

ON 264 BUSINESS, 440 square feet of office space plus warehouse. fenced rear area. Excellent condition. Office partially leased. Some owner financing available. \$80,000. Clark-Branch, Realtors, 756-6336.

COMMERCIAL PROPERTY, \$172,600. Located on Memorial Drive and being known formerly as Pitt Marline Sales. P.H. County Realty, Inc., 756-1306.

COMMERCIAL PROPERTY, \$85,000. Located at Greene and Highway 133. Approximately 5000 square feet. P.H. County Realty, Inc., 756-1306.

COMMERCIAL PROPERTY, Three story brick building, located corner Main and Railroad Street, Robertsville, NC. Call for more details. \$12,500. Mavis Butts Realty, 758-0655; Kaye Montiehl, 758-4750; Mavis Butts, 752-7073.

74 Farms For Sale

87 ACRES on New Bern Highway, 15 miles from Greenville. 35 acres cleared, long road frontage, no allotments, Aldridge & Southernland, 756-3500; nights, Don Southerland, 756-5260.

16.70 ACRES, 620 foot road frontage. Near hospital on Allen Road, State Road 1203, \$6000 per acre. Bill Williams Real Estate, 752-2615.

100 CLASSIFIED DISPLAY

Houses For Sale

IN GRIFTON. Large 2 bedroom home with fireplace, heat pump, screened porch, new carpet throughout. McLawhorn Realty, 524-5474.

TWIN OAKS. New homes available in a modern setting. Mild 30's to low 40's. Variety of floor plans available and builder will build to suit your needs. D. G. Nichols, 752-4012.

TWO NEW condominiums, Yorktown Square, 2 bedroom flats, 2 full baths, living room, modern kitchen, close to patio, fireplace available. Prices at \$44,500 and \$44,900. Only two left. D. G. Nichols, 752-4012.

100 CLASSIFIED DISPLAY

Houses For Sale

110 GREENBRIAR Drive, 4 bedrooms, 3 baths, wooded corner lot, 2208 square feet, living area plus 700 square feet, paneled garage, \$56,500. Bill Williams Real Estate, 752-2615.

BY OWNER. In Stokes, 1 1/2 acre lot, 3 bedrooms, air and heat. 752-7890 between 5:30 and 6:30.

JUST LISTED. Club Pines, 4 bedroom contemporary, 2 1/2 baths, dining room, eat-in kitchen, 2 car garage, \$83,500. Call Peggy at Aldridge & Southernland, 756-3500.

FRESHLY PAINTED and ready for you to move into. Brick, 3 bedroom ranch. One bath, self-cleaning oven, storage room and detached storage area. Located on large, country lot, Winterville school district, \$28,900. David Heniford, 746-4838. Steve Evans, 756-7698 or 758-0934; Laura Meyer, 756-6575; Heniford & Evans, Inc., Realtors, 756-1111.

INCOME PROPERTY. Located in Marlinton, Ohio, \$59,000. Will trade for local residential property. 1-356-2273.

HOUSES for \$30,000 are a rarity! Buy Matchmaker has cut prices, 3 bedroom ranch with living room, eat-in kitchen, bath and large yard for only \$30,000. Down payment as little as \$1000. Call us quick, this house won't last. Hignite & Company, Inc., 758-6666 anytime.

NEW RANCH under construction in Montclair II. Don't bother looking at this home if you aren't serious about buying because we'll immediately fall in love with the great room, the patio, fireplace, carpet, etc. Contact Matchmaker, Hignite & Company, Inc., 758-6666 anytime.

NEW CEDAR ranch just nearing completion! We can move you into this new ranch in 30 days! The large sunken great room will delight you, plus the formal dining room is perfect for entertaining! Three bedrooms, two full baths, central utility. Priced in the low 50's. Call Matchmaker, Hignite & Company, Inc., 758-6666 anytime.

THINKING ABOUT selling your home? Call Matchmaker, Hignite & Company, Inc., 758-6666 anytime.

\$37,900. Open house on Oakdale Subdivision. Three bedrooms, living room, kitchen, 1 1/2 baths, garage, big corner lot and no city taxes. Pitt County Realty, Inc., 756-1306.

\$36,000. Farmville. Four bedrooms, 1 1/2 baths, with fireplace, kitchen and lots more. Pitt County Realty, Inc., 756-1306.

\$35,000. House in a commercial area, would be ideal for office or real estate office off Ninth Street. Close to downtown area. Pitt County Realty, Inc., 756-1306.

\$34,900. Home in Washington. Possible Farmers Home financing available. Three bedrooms, 1 1/2 baths, sunken great room and living room. Call us now for a showing. Pitt County Realty, Inc., 756-1306.

NEWEST ADDITION. When you have a home, you need a home that's another. This property is located in one of Greenville's finest areas and is located in Rose High school district. Three bedrooms, two full baths, den with fireplace, kitchen with eat-in area, living room and large living room. Landscaping is exquisitely done and this home is priced to sell. Give us a call for an exclusive showing. Pitt County Realty, Inc., 756-1306.

\$64,900. This home is located outside the city limits and has three bedrooms, two full baths, modern appliances and eat-in area. The den is complimented with a nice fireplace and wood paneling. Double car garage, big yard with new chain link fence. Storage house and big guest house with separate self-contained kitchen, living room, bath and bedrooms. Both have central heating and air conditioning. Please call on J. W. Tadlock for a showing! Pitt County Realty, Inc., 756-1306.

\$42,900. Open House in Farmville. 124 Green Pine Road in Marlboro Forest. Three bedrooms, 1 1/2 baths, living room, kitchen with eat-in area and a sunken family room with fireplace and thick shag carpet. Pitt County Realty, Inc., 756-1306.

BY OWNER in Belvedere Subdivision. 3 bedrooms, 2 full baths, den with fireplace, eat-in kitchen, carpet. Low utilities. 756-0937.

LAKE GLENWOOD. A very pretty, very comfortable and neat new Williamsburg. Spacious tree covered lot. Three bedrooms, two baths, elegant and large great room with fireplace, formal dining room, kitchen. Really nice. \$63,500. Duffus Realty, Inc., 756-5395.

2 STORY BRICK DUPLEX. 3 bedroom apartment and a 1 bedroom apartment. 411 East 4th Street to be shown by appointment only. 752-6186, Jimmy Brewer or Skip Bright; Hooker and Buchanan, Inc.

GRIFTON 2 story brick home features entrance hall, living room, dining room, kitchen, 4 bedrooms, 2 baths, and double garage. Call for more details. \$55,000. Mavis Butts Realty, 758-0655; Kaye Montiehl, 758-4750; Mavis Butts, 752-7073.

EXTRA! Extra! Read all about it - This 3 bedroom brick home has it all - privacy of its wooded lot, 2 water systems, space for garden plot, sunken den with fireplace, air conditioning, hardwood floors and more. Call Jonathan today for more details. Century 21 Lenco Realty, 756-5868; nights, 756-1616.

100 CLASSIFIED DISPLAY

Houses For Sale

SPECTACULAR VIEW

From the balcony of this extraordinary home on the water, 2418 sq. ft.; formal rooms, den, recreation room, four bedrooms, three baths, fireplace openings in three rooms, \$120,000.

LIKE GOLF?

Build on this heavily wooded lot bordering the 14th fairway. Located at cul-de-sac. \$6,000

Ginger Hackett, Realtors 756-7986 or 758-0050

CLARK-BRANCH SELLS TWO HOMES A WEEK SOMETIMES THREE

COUNTRY In Fairfield, 3 bedrooms, 2 full baths, great room with fireplace, kitchen, FHA VA financing available. Move in for \$1650. Offered at \$43,000.

COUNTRY It's new and nearly complete with 3 nice bedrooms and 2 full baths, single garage and large kitchen area. Heatilator fireplace in the great room. See this excellent floor plan with FHA-VA financing available at \$44,700.

NEW OFFERING With large family in mind, 5 bedrooms, 3 1/2 baths, 3100 square feet. Screened in porch, fenced in back yard. Well constructed home on Greenville Boulevard. Reasonably offered at \$68,500. Call today for details.

UNDER CONSTRUCTION Wooded On Stanionsburg Road, \$6,500 East Of Greenville, \$6,500

CLARK-BRANCH, INC. REALTORS 756-6336

On Call: Collette Dillworth 756-9987 Ed Meyer 756-6493 Connally Branch 756-0046

On Call: Sharon Lewis 756-9987 Mary Chapin 756-8431 Gio Clark 756-0046

An Equal Housing Opportunity

100 CLASSIFIED DISPLAY

CRAFT WOOD STOVES

Fireplace insert with NEW FRONT BLOWER

Tar Road Antiques Winterville, N.C. 756-9123

100 CLASSIFIED DISPLAY

CORDON LANDSCAPING

Grading and seeding, lot clearing, crawler work and dirt hauling. Will demolish old houses. Desire to start working out of Greenville. Free Estimates. Call Collect - Sonny Cordon 964-4709.

100 CLASSIFIED DISPLAY

CUTTER

Multi-apparel manufacturing company needs an experienced cutter. Immediate opening. Excellent benefits and salary. Please send letter to:

PLANT MANAGER P.O. Box 537 Snow Hill, N.C. 28580

Equal Opportunity Employer.

100 CLASSIFIED DISPLAY

SPECIAL HAVE FLEAS?

Let Us Help You Rid Your Home Of These Pests With Our Special Discount Rate Only \$30

Call Efird's Pest Control 752-6440

ARMY - NAVY STORE 1501 S. Evans St.

100 CLASSIFIED DISPLAY

Greenville's Finest Cars!

1976 Olds Omega 4 door. Light blue with white vinyl top. Fully equipped with sports console. \$3495

1976 Pontiac Grand Prix White with red landau roof and red interior. Fully equipped. \$3950

1977 Olds Cutlass Supreme Ginger with buxskin landau roof and buxskin interior. Fully equipped, 6 cylinder. \$4650

1977 Pontiac Grand Prix LJ Ginger in color. Loaded. Immaculate with 23,000 miles. \$4895

1976 Ford Thunderbird Light yellow in color, loaded. \$3450

1976 Mercury Cougar XR-7 Medium green, landau top, power steering and brakes, air, sports console, sport wheels, stereo. \$3995

1976 AMC Hornet 2 door coupe. Automatic transmission. 6 cylinder. \$1950

1977 Buick Century 4 door. Power steering and brakes, air conditioning. \$3250

1972 Ford Pinto Wagon Automatic transmission, 66,000 miles, new tires. \$1450

Bob Barbour HONDA VOLVO 117 West Tenth St, Greenville 758-7200

Houses For Sale

CLARK-BRANCH SELLS TWO HOMES A WEEK SOMETIMES THREE

NEW OFFERING Duplex for sale. Excellent location, 2 bedrooms, 1 bath in each. \$56,000. Loan assumption available. Rental income \$450 monthly.

NEAR SHIMPSON Reasonably priced. FHA-VA available. Cape Cod style on 1/2 acre wooded lot. 3 bedrooms, 2 full baths. Over 1300 square feet heated area. Convenient living in the country. Priced in the mid 40's. Under construction. Call today and select your own decor.

BETHEL One of the finer homes in this area with 3800 square feet, detached storage barn and 1/2 acre garden lot off rear. Includes four bedrooms, two fireplaces and large covered porch area, excellent landscaping and new oil furnace. This brick one and a half story has charm you must see to appreciate. Mid 50's.

NEW OFFERING Miniature Billmore Estate describes this beautiful estate approximately 14 miles south of Greenville. Nearly 5000 square feet on over 5 acres of land in a magnificent setting including stables and rolling terrain. The contemporary home itself is enhanced by a wall of glass in the front giving you a preview of what's within. 5 bedrooms, huge dining room, cathedral ceiling, large kitchen with brick floor and well built study and endless special features. Please call for your private showing. \$100's.

CLARK-BRANCH, INC. REALTORS 756-6336

On Call: Collette Dillworth 756-9987 Sharon Lewis 756-9987 Ed Meyer 756-6493 Connally Branch 756-0046

On Call: Mary Chapin 756-8431 Gio Clark 756-0046

An Equal Housing Opportunity

100 CLASSIFIED DISPLAY

REMODELING ROOM ADDITIONS, ETC. C. L. LUPTON CO. 752-6116

100 CLASSIFIED DISPLAY

RENTALS

RENT A beautiful Currier Spinnet piano for only \$22 per month, as long as you like. First 9 months rent applies toward purchase. Piano-Organ Warehouse, 730 Greenville Boulevard, 756-2032.

100 CLASSIFIED DISPLAY

82 Resort Property For Sale

12 X 55 TRAILER at Blounts Cove. 100 X 200 foot lot, screened in porch, 1/2 mile from river. \$2200. 757-6441 between 8 a.m. and 5 p.m.

**86 Apartments For Rent**

**EASTBROOK AND VILLAGE GREEN APARTMENTS**

327 one, two and three bedroom garden and townhouse apartments with heat, air conditioning, carpet, kitchen appliances, garbage disposals, nice laundry facilities, 3 swimming pools, 2 tennis courts, heat and hot water furnished in some units, and Cable TV. No pets or loud parties allowed. Rent from \$150-\$225 per month.

**STRATFORD ARMS APARTMENTS**  
The Happy Place To Live  
FREE MASTER ANTENNA  
Office Hours 10 a.m. to 5 p.m. Monday through Friday. Call us 24 hours a day at 756-4800

**LOVE TREES?**

Experience the unique in apartment living with nature outside your door. Quality construction, fireplaces, heat pumps (heating costs 50% less than comparable units), dishwasher, washer/dryer hook-ups, wall-to-wall carpet, thermal windows, extra insulation.

**COURTNEY SQUARE APARTMENTS**  
Arlington Blvd. 756-5067

**OAKMONT SQUARE APARTMENTS**  
Two bedroom townhouse apartments. 1212 Redbanks Rd. Dishwasher, refrigerator, range, disposal included. We also have Cable TV. Very convenient to Pitt Plaza and University. Also some furnished apartments available. 756-4151

**TAR RIVER ESTATES**

1401 Willow Street 752-4223  
1,2 and 3 bedrooms, washer-dryer hook-ups, cablevision, pool, carport house. Only 5 blocks from East Carolina University.

Check everywhere else first  
**Ultimate In Apartment Living**

**ONE BEDROOM apartment.** Furnished, utilities included. Short term lease. 756-5555.

**Kings Row Apartments**

One and two bedroom garden apartments. Fully carpeted, furnishing range, refrigerator, dishwasher, disposal and cable TV. Conveniently located to shopping center and schools. Located just off 10th Street. Call 752-3519

**AZALEA GARDENS**

Greenville's newest and most unique furnished one bedroom apartments.

- All electric energy efficient designed.
- Queen size beds and studio couches
- Washers and Dryers optional
- Free water and sewer and yard maintenance
- All apartments on ground floor with porches
- Frost free refrigerators

Located in Azalea Gardens near Brook Valley Country Club. Shown by appointment only. Couples or singles - no pets.  
Contact J. T. or Tommy Williams 756-7815

**Bryton Hills Apartments**  
River Bluff Rd.

Spacious brand new 2 bedroom apartments. Furnished kitchens, carpet, air condition. Convenient location. Nice deck or patio in each apartment. 758-3311 or 758-2994

**RENTER'S INSURANCE**

Call: Earl Thompson  
3101 S. Evans Street  
Across from Union Carbide  
Phone 756-3422

State Farm Fire & Casualty Company  
**LEASING BY owner.** Windy Ridge townhouse, 3 bedrooms, 2 1/2 baths, glassed dining room overlooking large patio. Pool and club house privileges. Available September. \$385. 923-8221.

**2 APARTMENTS.** 1 duplex. New. 2 bedrooms. Available about September 1. \$250. No pets. Call Jim Veeder. 756-2753 or Lily Richardson. Gallery of Homes. 756-2570.

**4 BEDROOM.** 2 bath duplex. 1310A Myrtle Avenue. Will rent to a family or to students. Call 787-0203 in Raleigh after 6 or see owner on premises Saturday, August 4 after 10-30 a.m.

**88 Houses For Rent**

**EXCEPTIONALLY nice home.** \$450 a month. Year's lease required. 3 bedrooms, 2 tile baths, 1950 square feet central air, wooded lot. Call Mrs. Faser, Blount & Ball Realty, Inc., 756-3000, 752-4499 (home).

**BRICK COUNTRY home near Greenville.** 3 bedrooms, 2 baths, garage, 1800 square feet. On 2 acres. Married family only. Lease required. \$300. Call Louise Hodge at Aldridge & Southerland Realty, 756-3500 or 756-5005.

**100 CLASSIFIED DISPLAY**

WE INSTALL ALUMINUM AND VINYL SIDING  
Remodeling, Repainting, Siding  
**C. L. LUPTON CO.**  
752-6116

**RIGHT NOW! TAKE COMMAND AND CHANGE YOUR WORLD FOR THE BETTER**  
Our training will prepare you for a management position in your locality within 6 months.

\*Earn \$15,000-\$25,000 while training  
\*Guaranteed income to start, 2 weeks training in school, expenses paid.  
\*Training in the field selling and servicing established accounts

Must be 21 or over and ambitious. Benefits include major medical and outstanding profit sharing plan.  
—Call for an appointment  
**Ron Cutler**  
527-2171

Equal Opportunity Employer M/F

**86 Apartments For Rent**

**HOUSES, apartments and trailers.** 746-3284 or 524-4239.

**2615 MEMORIAL Drive.** 3 bedrooms, 1 1/2 baths, air conditioning. Nice neighborhood. No dogs. Lease and deposit. \$250 month. Marrieds only. 756-6208, 9-5 weekdays.

**SHAMROCK TERRACE** 3 bedrooms, 1 1/2 baths. No pets. Lease and deposit. \$280. 756-0070 after 7 p.m.

**3 BEDROOMS** with living room, dining room and enclosed back porch. Near ECU. \$225 per month. 1217 Evans Street. 758-5299.

**FURNISHED DUPLEX.** Two bedrooms, bath, living room, breakfast area. \$340 month/lease required. Duffus Realty, Inc., 756-5395.

**FOUR BEDROOMS,** two baths, living room, dining room, family room with fireplace, garage. \$395 month. Duffus Realty, Inc., 756-5395.

**3 BEDROOM HOUSE.** Located convenient to schools, churches and businesses in Bethel. Reasonably priced. 825-4831.

**NICE 3 BEDROOM house** in Ayden. Reasonable. Call 746-3674.

**88 Houses For Rent**

**NEAR UNIVERSITY.** 3 bedrooms, 2 baths, large den, living room, dining room, spacious attic, central air. \$325. 756-7472.

**90 Lots For Rent**

**SPAIN'S MOBILE Home Park.** Single wide. \$37.50 a month. First month's rent free. 3 miles southeast of Greenville. 746-6575.

**91 Office Space For Rent**

**SHOP/OFFICE space** for lease. 1000 square feet. Neighborhood commercial zone. Hooker Road. Call 752-1733 days. 756-7614 nights.

**CLASSIFIED ADS** will go to work for you to find cash buyers for your unused items. To place your ad, phone 752-6166

**OFFICE OR retail space** available. 1000 or 2000 square feet. Will remodel to suit tenant or lease as is. Located beside Larry's Carpetland. 758-2300.

**5000 SQUARE FOOT office building** located 264 Bypass West with 46 paved parking spaces. Call 758-2300 days. 758-1742 nights.

**91 Office Space For Rent**

**OFFICE SPACE** for rent. Call Joe Bowen. 752-7194.

**92 Resort Property For Rent**

**ATLANTIC BEACH, NC.** Weekly summer rentals. Efficiency apartments. Second row with good ocean view. 2 bedroom, \$145; 3 bedroom, \$195. Call Century 21 Whale Creek Realty, (919) 726-2541.

**93 Rooms For Rent**

**ONE BEDROOM** with private bath, in private home. Share den, kitchen and living room. 758-2493 after 5.

**COLLEGE STUDENTS.** 2 persons to share one large room and all house privileges. 752-9275.

**94 WANTED**

**HOUSE ACROSS** from ECU. Prefer graduate student or professional. Tony 752-7278.

**FEMALE ROOMMATE** wanted. Responsible persons only. Call Sharon at 757-7221 or 758-2910 after 7.

**95 Roommate Wanted**

**WORKING FEMALE** wanted to share apartment. 758-2054 after 6.

**96 Wanted To Buy**

**STANDING TIMBER.** Any type, top prices paid. Call Carolina Union Timber Company. Call Goldsboro. 1-736-0344.

**WANTED.** Late model 4x4 or one ton Ford truck with utility body or F-150 Van. Top money for right truck. 756-2254 after 6.

**CAMPER TOP COVER** for 8' bed pickup. Call Dora at 758-1991 anytime.

**99 Wanted To Rent**

**FEMALE COLLEGE student** desires house or apartment to rent. Preferably unfurnished. Call collect 728-2131 between 8 a.m. and 5 p.m. or 726-4737 after 5 p.m.

**ROOM or apartment** near campus wanted by serious female art student. (803) 438-3016 collect.



Could You Make Two Mortgage Payments Without Being In A Financial Bind? We Can Buy Your Home At "Matchmaker".  
**HIGNITE & COMPANY, INC.**  
758-6666 Anytime

Buying or Selling. For Best Results Try Our "Personal Service".  
**D. G. Nichols Agency**  
752-4012 Anytime

**New Offering**

**Attention Investors**  
One year old duplex. Excellent location. 1 bath, 2 bedrooms, living room and front and rear decks on each side. \$56,000. Currently rented. Income \$450 per month. Assumable 10 1/2% loan. Call today!

**CLARK-BRANCH, INC.**  
**REALTORS**  
756-6336

Or Call **Ed Meyer**  
Listing Agent  
756-6695

**The Real Estate Corner**

**NEW — ADDITIONS**  
**INVESTMENT PROPERTY — UNIVERSITY AREA**  
Older 4 Unit Apartment House Just Off Campus. Good Condition, Fully Rented, All Utilities By Tenants. Projected Annual Income \$7,440 - Price \$65,000 with some owner financing.  
Excellent First Investment - Or Tax Shelter  
**PITT COUNTY REALTY INC. 756-1306**  
(Exclusive) Call For Details

**REASONABLY PRICED**

Approximately 1750 sq. ft., two years old and located in one of Greenville's newest and most stable neighborhoods. Decorated with the most tasteful blues and earthtones. Crown molding throughout (even the bathrooms) with the most beautiful walnut stain you've ever seen. Selective wall-coverings in most rooms. All formal areas including large family room with fireplace. Solid, hardwood doors throughout, three bedrooms and two baths. Best described as ROOMY. Reasonably priced - you bet! \$57,900

**SUPER SIGN**

**OVERTON & POWERS**  
758-4585

**Pitt County Realty, Inc.**  
THE NEWEST ADDITION TO OUR FAMILY OF HOMES

We are proud to introduce our new listing to you. This property is located in one of Greenville's finest areas and is ideal for almost any family priced in low 60's. This home must be seen to appreciate with one of the prettiest yards around. Three bedrooms, two full baths, kitchen, set in area, living room, den with fireplace, and garage, and all the small things that make a home desirable. Call on us for an Exclusive Showing Pitt County Realty, Inc.  
756-1306 756-1306

**BULL RITTER REALTORS**  
756-5458 (Office)  
758-6000 (Home)

**SIGNED, SOLD, DELIVERED.**

When it's time to sell your house, you need the security of professional help. Your CENTURY 21 Neighborhood Professional can give you that security because our name and reputation are recognized by millions. So it's not hard for us to attract the right buyers for your house. When it's time to sell, call your Neighborhood Professional. Then you can relax while your house is signed, sold and delivered.

**Century 21 WE'RE THE NEIGHBORHOOD PROFESSIONALS.**  
**WHITLEY'S HOUSE STATION**  
756-6050

**BROOK VALLEY**

**Living Room**  
**Dining Room**  
**Kitchen And Breakfast Area**  
**Fireplace**  
**Rear Deck**  
**Yard And Golf Course**

This Beautiful Four Bedroom, 2 1/2 Bath Home is Perfectly Located On A Quiet Street And On The Golf Course in Brook Valley. The Rear Of This Elegant Home Has A Full Wooden Deck, A Very Private Patio And Is Nicely Landscaped. When Relaxing With Your Friends On The Deck, The View Of The Yard, Trees And Golf Course is Extremely Impressive. The Living Room And Dining Room Are Perfect For Formal Entertaining. The Kitchen Area Features An Informal Dining Area And Breakfast Bar. The Center Of Attraction In The Cozy Family Room is The Large Fireplace And Very Handy Bookshelves.  
**\$87,000**

**Duffus Realty, Inc.**  
MEMBER  
**756-5395** **RELO**

**MAVIS BUTTS REALTY**  
105 West Third Street  
758-0655

**LOTS OF BEAUTY AND A LOT OF VALUE** - Is what you will have when you buy our new listing. Featuring entrance hall, living room, den with fireplace, sewing room, kitchen with eat-in area, 4 or 5 bedrooms, 3 1/2 baths, double paneled garage, and patio. Offers much more. \$69,000

**THE ANSWER TO YOUR DREAMS** - Ideal home has exceptionally large dining room, living room, entrance hall, den with fireplace, kitchen with eat-in area, 5 bedrooms, 2 baths, and carport with storage. In excellent condition. \$65,000

**HOME AND INCOME** - Will be yours when you buy our new listing. Four apartments, 2 downstairs and 2 upstairs. Home has aluminum siding, separate garage with storage, large lot, and owner will consider financing. Call for more details. \$35,000

**Mavis Butts, GRI, CRS**  
752-7073

**Kaye Montieth**  
758-4750

**Home-Finders**  
RELOCATING AMERICANS SINCE 1962

Join Us Today In Lovely Englewood. Do You Need A 3 Bedroom Brick Home With Office Space? This Fine Home Features Just That And Much More. It is Located in Eimhurst School District. In Addition This Home Has Two Ceramic Baths, Double Carport, Country Kitchen And A Great Room With A Fireplace. Call Us Today For An Appointment. Priced To Sell At \$52,500. No. 101.

Get Away From The City Life In Beautiful Walstonburg. This Brick Home Has 3 Bedrooms, 2 Baths, Kitchen/Dining Combo And Best Of All Low Utility Bills. An Added Plus Is The 24' X 32' Out Building Which Can Be Used As An Office Or Apartment. \$49,600. No. 102.

Tucker Estates. 3 Bedrooms, 2 Baths, Formal Living Room And Dining Room, Carpeted Throughout, Heat Pump And Just 3 Years Old Describes This Brick Ranch Home On A Beautiful Shaded Lot In The City. Extras Include Crown Molding Throughout, Chair Railing, Wallpaper And Large Fireplace In The Den. An Exceptional Home For \$72,600. No. 103.

Commercial Property. Owner Financing Available On This One Acre Lot Located On Dickinson Avenue. Property Includes Two Buildings With Over 11,000 Sq. Ft. \$60,000. No. 104

Farm For Sale. Located In Falkland, It Contains Approximately 7 Acres Of Cleared Land. Included In The 7 Acres Is 1 Acre Of Tobacco Allotment. Offered At \$24,900. No. 105.

Lots Available In Candlewick Estates. Prices From \$8,900 To \$8,500. No. 106

Charm, location and convenience - You had better come running on this one. Here is your chance to find that quiet location on a cul-de-sac. Located close to shopping. Extra large master bedroom with dressing area plus formal living and dining, eat-in kitchen, den with fireplace. \$49,900. No. 107

Williamsburg (Cherry Oaks). Under construction on wooded lot is this 3 bedroom, 2 1/2 bath executive home. Many features include formals, 2 bay windows, den with fireplace, screened porch and much, much more. Buy today and do your own decorating. \$81,500. No. 108

**Our Office Open Today**  
9 A.M. To 8 P.M.

**Dees Whitley** ..... 758-0816  
**Judd Richardson** ..... 758-6051  
**Gene Quinn** ..... 756-6037  
**Evelyn Rouse** ..... 756-6052  
**Larry Tyndall** ..... 756-6050

## Solar House Business Is Looking Up

By CHARLES S. TAYLOR  
ATLANTA (UPI) — After several false starts, businessmen selling solar energy systems believe the outlook is good for sales to homeowners, small businesses and industries, apartments, motels and to government agencies.

Federal tax credits have helped the small solar energy systems market, they say. Some states also are beginning to give tax credits. Those in the business of manufacturing and selling solar energy equipment believe that if low interest loans were made available to individuals who want to buy a solar-heating-cooling system, the market would really take off.

They also say that as the cost of gasoline, fuel oil and electricity go up, solar energy will become much more competitive.

These opinions were expressed by businessmen and other solar advocates attending the recent International Solar Energy Society's 25th anniversary meeting in Atlanta. The session attracted representatives from 63 countries and 400 papers on solar energy were presented.

George White, 50, of Asheville, N.C., heads a firm, Whiteline, that manufactures 300 solar collectors a month for homes and small businesses. His sales extend to 15 states and include home installations, hotels, restaurants, car washes and retirement homes. His most recent sale was to a contractor who bought 560 solar collectors for installation on the roof of a college in Sylva, N.C.

"What we need," he said, "is a system of low cost loans. If we can get money at the cost of municipal bonds — which is what many utility companies get it for — we could cover the country with solar equipment."

White has a letter from a motel owner in Asheville who wrote that he saved 2,183 gallons of heating oil over a seven-month period after installing White's solar energy equipment. Total savings on oil and electricity costs amounted to \$1,600. The cost of the solar energy system was \$8,500.

White says his system's cost for a 2,000 square foot home would be about \$10,000 installed at present-day prices. It would supply 70 percent of the home's heating needs and 95 percent of the hot water requirements.

"Solar energy systems are not going to get cheaper," White says. "Solar is just a combination of old techniques, using well known materials like copper and aluminum. Unless the price of these metals comes down, solar systems costs will not come down."

Larry Scott, a Casper, Wyo., contractor, has installed solar hot water systems at 128 car wash businesses. He's negotiating to sell his solar heating equipment to a nationwide car wash company.

Scott says owners of exploratory oil wells in Wyoming had to stop operations because of a diesel oil shortage and contacted him about installing solar-powered equipment. He says high temperature collectors that generate up to 600 degrees will be needed. Solar energy collectors capable of producing these temperatures were being displayed at the meeting.

Five years ago, Scott said, "there was a bunch of garbage in this business. There's still some garbage but now there are some very good things."

Joseph Farber, president of Solar Research Systems, Costa Mesa, Calif., predicts there will be booming solar energy market in California in about a year and in the country as a whole in 2-3 years.

Farber manufactures solar heat collectors and a special kind of heat pump for swimming pools. He says it costs about \$1,000 a year using gas to heat a swimming pool year-round in California. A \$2,500 solar heating system cuts that cost by 50 percent and with a California tax credit, a pool owner can regain his investment cost in 2½ years.

Walter Shropshire Jr., assistant director of the International Solar Energy Society, believes solar energy eventually could supply 10 to 20 percent of U.S. energy needs. He said some members of the society think the energy of the sun could satisfy all energy requirements "but I think that's nonsense."

**RETURNING WEAPONS**  
SAN JOSE, Costa Rica (AP) — Costa Rica has announced it will return weapons borrowed from Venezuela and Panama now that the Nicaraguan civil war and dictator Anastasio Somoza has fled.

# SPAIN'S

STORE HOURS:  
MON.-THURS. 8 A.M. TO 8 P.M.  
FRI. & SAT. 8 A.M. TO 8:30 P.M.  
CLOSED SUNDAYS

1414 CHARLES BLVD.

QUANTITY RIGHTS RESERVED

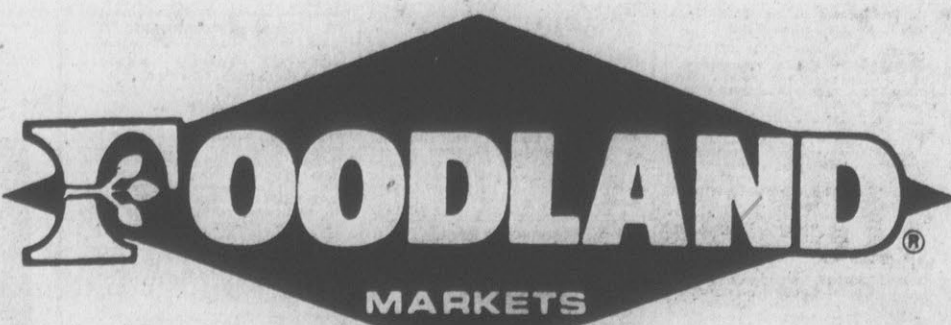

MEMBER OF THE FOODLAND SYSTEM

PRICES EFFECTIVE: GROCERY AND PRODUCE  
AUG. 2 THRU AUG. 8, 1979  
MEATS-AUG. 2, 3, 4

# SHOP-EZE

STORE HOURS:  
MON.-SAT.  
8:30 A.M. TO 9 P.M.  
OPEN SUNDAY 12:30 P.M.-5:00 P.M.  
WEST END SHOPPING CENTER

NONE SOLD TO DEALERS

GIBB'S  
**PORK N' BEANS**  
2½ CAN  
**49¢**

ROLLER CHAMPION SELF-RISING  
OR PLAIN  
**FLOUR**  
5 LB. BAG  
**79¢**

LIBBY  
**VIENNA SAUSAGE**  
5 OZ. CAN  
**39¢**

WHITE/DECORATOR, ASSORTED,  
OR DESIGNER  
**BOUNTY**  
TOWELS  
JUMBO ROLL  
1 ROLL PKG.  
**65¢**

USDA INSPECTED  
**FRYERS**  
WHOLE LB. LIMIT 4 PLEASE  
**38¢**

HEAVY WESTERN STEER FULL CUT  
**ROUND STEAK**  
LB.  
**\$1.69**

HEAVY WESTERN STEER TOP  
**ROUND STEAK** LB. **\$1.99**  
PEANUT CITY COUNTRY  
**HAMS** WHOLE LB. **\$1.29**  
(SLICED FREE) HALF LB. **\$1.39**  
HEAVY WESTERN STEER  
**CUBED STEAK** LB. **\$2.09**

HEAVY WESTERN STEER  
FRESH LEAN  
**GROUND BEEF** LB. **\$1.39**  
SMITHFIELD, SMOKED  
**SAUSAGE** 10 LB. BOX **\$9.95**  
FROZEN  
**CHITTERLINGS** 10 LB. BUCKET **\$3.49**  
GWALTNEY, SLICED  
**BACON** 1 LB. PKG. **99¢**

FRESH  
**PORK STEAK** LB. **\$1.19**  
FRESH PORK  
**BOSTON BUTTS** LB. **89¢**  
FROSTY MORN  
**FRANKS** 12 OZ. PKG. **89¢**

**MAXWELL HOUSE**  
COFFEE  
2 LB. CAN **\$5.67**  
**COKES** 2 LITRE BOTTLE **79¢**  
EXTRA ABSORBENT  
**PAMPERS** 24 CT. BOX **\$2.79**

**TIDE**  
DETERGENT  
10¢ OFF 49 OZ. BOX  
LIMIT 1 WITH 7.50 FOOD ORDER  
**\$1.19**

DEL MONTE CUT  
**GREEN BEANS** 3 303 CANS **\$1.00**  
DEL MONTE GOLDEN WK OR CREAM STYLE  
**CORN** 3 303 CANS **\$1.00**

WHITE, PINK/GREEN, OR YELLOW/BLUE  
**CHARMIN**  
TOILET TISSUE  
4 ROLL PKG. **79¢**

**NESTEA** 3 OZ. JAR **\$1.99**

DEL MONTE SLICED OR HALVES  
**PEACHES** 2½ CAN **69¢**

**KOZY KITTEN** 4 15 OZ. CANS **89¢**

SAUER'S  
**BLACK PEPPER** 8 OZ. BOX **\$1.49**

DEL MONTE ALL VARIETIES  
**PINEAPPLE** 1½ CAN **49¢**

NABISCO  
**OREO'S** 19 OZ. PKG. **\$1.29**

FOODLAND SLICED  
**CHEESE** 12 OZ. PKG. **\$1.19**

KRAFT  
**MACARONI & CHEESE**  
DINNER  
3 7¼ OZ. BOXES **89¢**

NABISCO  
**RITZ CRACKERS** 16 OZ. BOX **89¢**

DEL MONTE  
**CATSUP**  
24 OZ. BOTTLE **59¢**

KRAFT  
**ORANGE JUICE**  
HALF GALLON  
LIMIT 1 WITH 7.50 FOOD ORDER  
**99¢**

KRAFT  
**ORANGE JUICE**  
HALF GALLON  
LIMIT 1 WITH 7.50 FOOD ORDER  
**99¢**

**FROZEN FOODS**

MINUTE MAID PLAIN OR PINK <b>LEMONADE</b> 12 OZ. CAN <b>49¢</b>	PET WHIP <b>TOPPING</b> 9 OZ. CTR <b>69¢</b>
DULANY <b>BROCCOLI SPEARS</b> 10 OZ. PKG. <b>59¢</b>	PET RITZ <b>PIE SHELLS</b> 2 PER PKG. <b>49¢</b>
<b>EGGO WAFFLES</b> 11 OZ. BOX <b>69¢</b>	

**PRODUCE DEPT.**

FRESH WHITE <b>POTATOES</b> 10 LB. BAG <b>79¢</b>	FRESH YELLOW <b>CORN</b> EAR <b>10¢</b>
FRESH CRISP <b>CARROTS</b> 1 LB. PKG. <b>29¢</b>	FRESH <b>CANTALOUPE</b> EACH <b>59¢</b>

## Wilderness Filled With 96 Trailers

By ANDREW SCHNEIDER  
Associated Press Writer  
YORK HARBOR, Maine (AP) — Using flashlights in the misty darkness, Gerald and Helen Harper pitched their tent along the rocky Maine coast. They spent the night anticipating the uncluttered beauty of a coastal sunrise.

When the sun finally rose, they found a forest of metal blocking their view. Their small piece of wilderness was crammed with 96 trailers and three trees.

"The guidebooks said, 'Come to Maine to get away from it all,' but we woke up and found it's all still here," moaned Harper, a stockbroker from New York City. "I can see more of the great outdoors in Central Park."

"We thought we could save money and get away from the crowds by going camping," his wife said. "But after paying more than \$1,000 for what the clerk called the 'bare essentials,' we get here to find we're camping in a parking lot with more New Yorkers than we left in Manhattan."

Though the Harpers may not have considered their night in Libby's Campground "roughing it in the wilderness," many of the others in the four-acre field said they had found just what they wanted.

The Harpers' \$228 canvas tent was dwarfed, both in size and price, by the transportable homes that surrounded it.

"Explorer," "Woodsman," "Adventurer," "Deep Woods," "Savage," and other brand names on their metal sides offered the only hint that they had something to do with the outdoors.

Costing as much as \$30,000, the motor homes and trailers carry all the luxuries of home, and sometimes more. Sometimes parked just inches apart, they serve as home base for the visitors attracted to the area's beaches, theaters and vistas.

"I've got a microwave oven, shag carpeting and even a waterbed which I fill up when I get to the campground," said George Domain of Bridgeport, Conn., as he proudly patted his \$26,000 motor home. "I don't mind spending money for this because, contrary to popular belief, you can take it with you — if it's on wheels."

On the rear bumper of Domain's camper was a sticker reading, "Camping — Roughing it is the first step to adventure."

An insurance salesman from Manchester, N.H., stood on the roof of his modest \$11,000 Winnebago and tried to fix his bent antenna. Two of the hefty seagulls that patrol the camp had used it for a roost.

The salesman didn't want his name published because he didn't want his friends, who think he's "camping beside some isolated river in northern Maine," to know where he really was.

"I actually went to the north woods one year," he said. "But I was eaten alive by bugs, got the camper stuck in the mud and was chased by a moose. When I was through I really needed a vacation. This is right better."

"The outdoors is great except for the damn seagulls who sit on my antenna."

## Broken Mercury Lamp Dangerous

CHICAGO (UPI) — A broken mercury vapor high-intensity discharge lamp can be dangerous to everyone in the room with the lamp, according to a report in a recent issue of the Journal of the American Medical Association.

Dr. William Halperin of the New Jersey Department of Health noted that an envelope surrounding the inner light source of such lamps cut its ultraviolet radiation output 4,000-fold, but any hole in that envelope permits radiation to escape. Halperin reported that such an incident in a New Jersey high school gymnasium where 81 girls were present resulted in eye damage to 49 girls and skin rashes on 68.

Most of the injuries were not serious but four girls still had burning and tearing of the eyes three months later.

Shop our spacious showrooms for tremendous savings. We must make room for Fall Merchandise now arriving. Sale starts Thursday morning 8:30 a.m. through Saturday. Open all day Saturday til 5:30.

# Taft's Storewide DOLLAR DAY SALE

**Solid Brass Beds**  
Queen size Headboard & Footboard With Rails  
Reg. \$619.99 ..... Sale **\$419<sup>00</sup>**

**Brass Plated Queen Size Beds**  
Head & Foot With Rails  
Reg. \$329.00 ..... Sale **\$239<sup>00</sup>**

**4 Pc. Pecan Finish Bedroom Suite**  
Triple dresser with mirror, 5 Drawer Chest, Panel Bed & Foot With Night Stand  
Reg. \$889.00 ..... Sale **\$629<sup>00</sup>**

**Pine Student Desk**  
With Mar-Resistant Top  
Reg. \$169.00 ..... Sale **\$119<sup>00</sup>**

**4 Pc. Cherry Bedroom Suites**  
By American Drew Chest On Chest, Double Dresser & Mirror, Chairback Bed & 2 Drawer Night Stand  
Reg. \$1279.00 ..... Sale **\$895<sup>00</sup>**

**4 Pc. Allegro II Bedroom Groups**  
By Thomasville Bamboo Styling Yellow or Brushed Finishes White Double Dresser & Mirror Chest, Chair, Back Headboard And Night Stand  
Reg. \$1349.00 ..... Sale **\$899<sup>00</sup>**

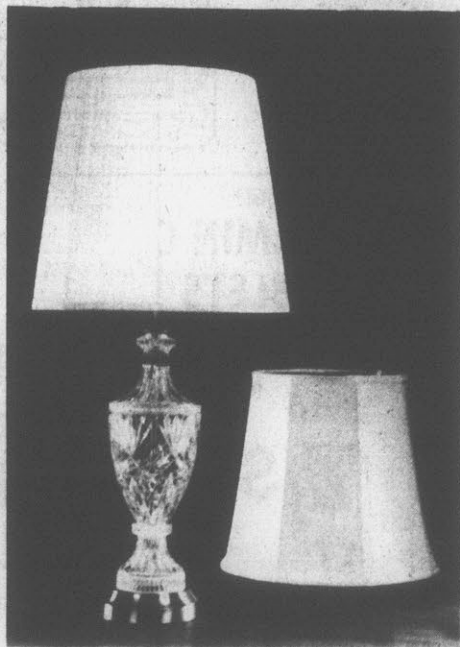

All Lamps, Pictures & Mirrors  
**25% Off**

All End Tables, Cocktail Tables and Sofa Tables  
**25% Off**

**4 Pc. Pine Bedroom Suites**  
Triple dresser With Hutch Mirror, Large Chest, Spindle Bed With Foot, and Night Stand  
Reg. \$879.00 ..... Sale **\$599<sup>00</sup>**  
(Only 3 to Sell)

**Lane Cedar Chest**  
With Tray in Top Pine Or Maple  
Reg. \$199.00 ..... Sale **\$129<sup>00</sup>**

**Maple Student Desk**  
Reg. \$129.00 ..... Sale **\$99<sup>00</sup>**

**Maple Bunk Beds**  
With Guard Rail & Ladder  
Reg. \$199.00 ..... Sale **\$139<sup>00</sup>**

**7 Pc. Bamboo Style Dining Room Suite**  
Oval Table with 6 Cane Back Chairs Pecan Finish  
Reg. \$1149.00 ..... Sale **\$789<sup>00</sup>**

**9 Pc. Dining Room Suites**  
Table, 6 Chairs and Light China French Provincial or Contemporary Styling  
Reg. \$969.00 ..... Sale **\$699<sup>00</sup>**

**7 Pc. Queen Anne Cherry Dining Room Suite**  
Oval Table & 6 Chairs  
Reg. \$969.00 ..... Sale **\$699<sup>00</sup>**

**7 Pc. Maple Dinettes**  
By Cochrane Planktop Oval Tables and 6 Mates Chairs Matching Hutches On Sale  
Reg. \$749.00 ..... Sale **\$549<sup>00</sup>**

**Solid Maple Corner Cabinets**  
Reg. \$359.00 ..... Sale **\$269<sup>00</sup>**

**7 Pc. Pine Dining Room Suite**  
By Thomasville Oval Plank Table with 6 Thick Seat Pilgrims Chairs  
Reg. \$995.00 ..... Sale **\$689<sup>00</sup>**

**Glass Front Lighted Curio Cabinets**  
Pecan or Pine Finish  
Reg. \$239.95 ..... Sale **\$149<sup>95</sup>**

**Early American High Back Swivel Rockers**  
Nylon Covers in Green, Rust, Brown or Blue.  
Reg. \$189.00 ..... Sale **\$129<sup>00</sup>**

**One Group Occasional Early American Pine Drop Leaf End Tables**  
Reg. \$99.00 ..... Sale **\$49<sup>95</sup>**



**Berklene WALLAWAY RECLINER AND ROCKER RECLINERS.**  
This sleek and handsome vinyl recliner by Berklene reposes in stud-detailed elegance but takes just 3 inches of back space for full reclining pleasure and puts a handy "kangaroo" pouch on the side for instant retrieval of reading materials.  
Over 150 to Choose From. Large Selection of Styles & Fabrics.  
Prices Start as low as **\$169<sup>00</sup>**

**QUEEN ANNE WING CHAIR**

Reg. \$259.00 ..... Sale **\$199.00**

**SEWING ROCKERS WITH PADDED SEAT AND BACK**

reg. \$79.95 ..... Sale **\$39<sup>95</sup>**

**2 PC. EARLY AMERICAN PILLOW ARM SOFA & CHAIR**  
Cover: Solid Green Nylon

Reg. \$659.00 ..... Sale **\$489.00**

**PINE GUN CABINETS WITH DOOR LOCKS**  
Holds 6 Guns

Reg. \$249.00 ..... Sale **\$189.00**

**KNEEHOLE DESKS WITH 7 DRAWERS**  
Pecan Finish

Reg. \$279.95 ..... Sale **\$199.00**



**90" Blue Velvet Sofa**

Reg. \$659.00 ..... Sale **\$489<sup>00</sup>**

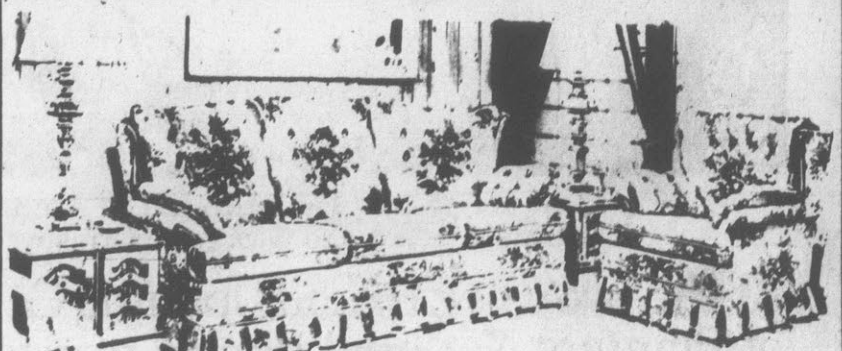

**2 Pc. Chair (Sofa & Chair)**

100% Nylon Cover Floral Print With Green, Rust, & Blue.

Reg. \$759.00 ..... Sale **\$519<sup>00</sup>**

**BASSETT CRIBS WITH FOAM RUBBER MATTRESS**  
Finish: Pine, Maple, or White

Reg. \$199.00 ..... Sale **\$149.00**

**BENTWOOD ROCKERS WITH WALNUT FINISH**  
Heavy Weight

Reg. \$129.00 ..... Sale **\$89.95**

**IMPORTED LEAD CRYSTAL LAMP**  
With White Pleated Silk Shade

Reg. \$129.00 ..... Special **\$68.88**

# Twelve Walked On Moon: Where Are They Now?

WASHINGTON (AP) — Twelve men, all Americans, have walked on the moon. They came back as heroes and, for most, with fleeting fame.

Neil Armstrong earned a place in history 10 years ago when he became the first human to stir the ancient lunar dust. Few recall the others, their names only dim memories.

The role, in order, Armstrong, Aldrin, Conrad, Bean, Shepard, Mitchell, Scott, Irwin, Young, Duke, Cernan and Schmitt.

Each was affected profoundly by his visit to another planet. The view from a quarter-million miles away gave each a greater awareness of the Earth

and its relative place in the Universe.

"My impression was of the importance of that small, fragile, remote blue planet," Armstrong reported. "People everywhere have, by television and photographs, shared that perspective and shared our concern for the security of our globe."

On return to Earth, some had difficulty readjusting. But most have carved successful second careers.

Seven are business executives, one a millionaire; one is a U.S. senator, one a college professor, one an evangelist. Two remain astronauts.

Here is a glance at the members of that exclusive club: Neil A. Armstrong ... raised

in a small Ohio town ... flew 78 combat missions Korea ... X-15 test pilot ... commanded Gemini 8, aborted shortly after executing the first docking of two vehicles in space ... first man to walk on the moon ... since 1971 professor of aerospace engineering at the University of Cincinnati ... director of several companies.

Edwin E. Aldrin Jr. ... son of a general ... West Point honor graduate ... fighter pilot in Korea ... Gemini 12 space walker ... landed on the moon with Armstrong on Apollo 11 ... passed over for promotion to brigadier general by the Air Force ... suffered mental depression and bouts with alcohol ... recovered from both ... divorced ... now president of his

own Los Angeles-based firm, Research & Engineering Consultants.

Charles Conrad Jr. ... engineering degree from Princeton ... Navy test pilot ... eight days in space aboard Gemini 8 ... commanded Gemini 11 ... commanded Apollo 12 moon landing ... daring space walks helped save crippled Skylab space station ... now a vice president of McDonnell Douglas Corp.

Alan L. Bean ... aeronautical engineer ... Navy test pilot ... holder of 11 world records in space and aeronautics ... landed on the moon with Conrad ... commanded 56-day Skylab 2 mission ... remains an astronaut.

Alan B. Shepard Jr. ... Naval Academy graduate ... carrier

and test pilot ... in America's first group of seven Mercury astronauts ... first American in space, a 15-minute suborbital flight in 1961 ... grounded for several years by an ear disorder ... commanded Apollo 14 moon landing ... several busi-

ness interests, including a beer distributorship in Houston, have made him a millionaire.

Edgar D. Mitchell ... doctorate of science from MIT ... Navy carrier and test pilot ... developed rendezvous techniques for Gemini spacecraft ... landed on the moon with Shepard ... on return he was divorced and concentrated on research into psychic phenomena ... director of three human resources management companies.

David R. Scott ... fifth in West Point class ... master of science from MIT ... Air Force test pilot ... flew with Armstrong on the aborted Gemini 8 flight ... command module pilot on earth-orbiting Apollo 9 mission ... commanded Apollo 15 moon landing ... Scott and crewmates James B. Irwin and Alfred B. Worden admitted carrying 400 unauthorized stamps to the moon which they planned to sell ... all three were removed from astronaut status ... Scott became director of NASA's Flight Research School and now is with an engineering

consulting firm, Scott-Preys Associates, in Los Angeles.

James B. Irwin ... Naval Academy graduate ... Air Force test pilot ... with Scott, drove first lunar car on the moon ... viewed his Apollo 15 moon journey as an oven over-

powering religious experience ... founded High Flight, an interdenominational evangelistic foundation, headquartered in Colorado Springs, Colo. ... slowed by a 1973 heart attack, but resumed religious crusades.

John W. Young ... Georgia Tech graduate ... commanded Gemini 10 ... orbited the moon on Apollo 10 and landed there as commander of Apollo 16 ... presently chief of the astronaut office and assigned to command the first space shuttle flight next year.

Charles M. Duke Jr. ... Naval Academy graduate ... master of science from MIT ... Air Force test pilot ... landed on moon with Young ... now an executive of Campbell and Duke Investments, San Antonio, Texas.

Eugene A. Cernan ... degree in electrical engineering from

Purdue University ... Navy fighter pilot ... Gemini 9 space-walker ... flew within 10 miles of the moon's surface on Apollo 10 ... commanded Apollo 17, last Apollo moon-landing mission ... helped plan joint U.S.-Russian manned flight ... now a vice president with Crown Petroleum, Houston ... served with U.S. Geological Survey's Astrogeology Branch ... instructed astronauts in geology before joining the corps ... first geologist on the moon, on Apollo 17 ... now a Republican U.S. senator from New Mexico.

consulting firm, Scott-Preys Associates, in Los Angeles.

James B. Irwin ... Naval Academy graduate ... Air Force test pilot ... with Scott, drove first lunar car on the moon ... viewed his Apollo 15 moon journey as an oven over-

powering religious experience ... founded High Flight, an interdenominational evangelistic foundation, headquartered in Colorado Springs, Colo. ... slowed by a 1973 heart attack, but resumed religious crusades.

John W. Young ... Georgia Tech graduate ... commanded Gemini 10 ... orbited the moon on Apollo 10 and landed there as commander of Apollo 16 ... presently chief of the astronaut office and assigned to command the first space shuttle flight next year.

## Breathing Club Meeting Set

The Better Breathing Club will meet at 1 p.m. Thursday at the Willis Building, corner of First and Reade Streets.

Camille Harris, psychiatric nurse with the Pitt County Mental Health Center, will speak on "How You and Your Family Can Cope With Your Lung Disease." Family members are encouraged to attend.

The club is sponsored by the American Lung Association of North Carolina and Pitt Memorial Hospital. It is designed for persons who experience difficulty with their respiratory health.

The club, which meets once a month, is free of charge and is funded by Christmas Seal contributions. For more information, call 752-5093 Monday - Friday, between 8:30 a.m. and 4:30 p.m.

**OPPOSING GUIDELINES**  
WASHINGTON (AP) — The AFL-CIO is asking the Supreme Court to reconsider its decision upholding President Carter's right to deny federal contracts to companies that violate his anti-inflation wage-price guidelines.

## Ripping The Veil From Testing Service Field

By DAVID BIRD  
Associated Press Writer  
PRINCETON, N.J. (AP) — For more than two decades, Educational Testing Service has operated in strict secrecy at its quiet campus near this university town.

ETS is responsible for most of the tests used in deciding who goes to what college and who is admitted to law or medical schools.

Questions and answers for the estimated 7 million exams administered annually by the firm are guarded like classified government documents. The \$80-million-a-year non-profit operation will take legal action against anyone suspected of leaking test information.

But a New York "truth-in-testing" law signed by Gov. Hugh Carey earlier this month has caused a rip in ETS' veil of secrecy that threatens to affect testing programs across the nation.

Under the law, answers and forms for every standardized test given in New York after Jan. 1 must be made public after 30 days. Test makers also are required to explain how the exams were devised and what they are designed to measure.

The standardized testing industry, which devises exams for everyone from golf-shop managers to gynecologists and Peace Corps volunteers to CIA agents, has come under increasing criticism in recent years.

Consumer groups argue that the public has a right to see their tests and studies on the validity of exam questions. Minority spokesmen accuse test makers of cultural biases that favor the white middle-class.

ETS officials dispute the charges, contending the firm has been accountable to the academic community. They say the New York disclosure law will force them to create a battery of new tests to replace those that must be taken out of circulation as a result of making the information public.

Now, questions are often repeated from one set of exams to another, to save the expense of preparing new questions and to provide a basis for comparison among different groups of test takers.

"The effect of the law is that a test given in New York can never be given again — anywhere," said ETS spokeswoman Mary Churchill.

The sharpest reaction to the law has come from an organization representing the nation's 125 medical schools and 60 dental schools.

Test administrators for the Association of American Medical Colleges and the American Dental Association said they would stop giving admission exams in New York rather than comply with the law.

"There is a limit to the number of relevant questions that can be used in the Medical College Admission Test," said Dr. John Cooper, president of the medical college association.

The decision would affect about 5,000 prospective medical students and 1,000 prospective dental students in New York.

ETS officials also say the quality of testing may be compromised.

"It's a little like the Environmental Protection Agency," ETS Vice President Robert Solomon said of the disclosure law. "The EPA passes acts in the interest of people, but it costs something to have scrubbers in smokestacks."

The costs of extra test preparation are expected to boost testing fees by as much as 50 percent.

## Experimenting With Fare Cuts

MADRID (UPI) — RENFE, the Spanish national railway system, is experimenting with ways to cut fares.

RENFE said that on 306 "blue days" a year it will lower the price of tickets between Madrid and Barcelona and allow sleeping car passengers to take their spouses with them for only \$9 extra.

The railroad also is simplifying its system of sleeping car charges so that long-distance passengers will pay 10 to 30 percent less for tickets.



**The right vitamin at the right price? Naturally, it's Rexall.**

It's time now to see the complete line of guaranteed Rexall vitamins at your Rexall Drug Store ... naturals, synthetics, in tablets, capsules and chewable tablets! If you're not completely satisfied, return where purchased for full refund!

# Dollar Day Sale

Prices Effective Wednesday, Aug. 1 Through Saturday, Aug. 4

Open Every Day Of The Year To Serve You!



**Rexall Natural Gelatin 100's**  
Reg. \$3.07  
**\$2.02**  
Sale



**Rexall Vitamin B-2**  
25 Mg. 100's  
**\$1.15**  
Reg. \$1.75



**GER-RITE™**  
HIGH POTENCY IRON AND MULTIVITAMIN SUPPLEMENT  
100 Tablets  
Reg. \$3.32  
**\$2.19**  
Compare price and quality with GERITOL!



**VITAMIN C TABLETS**  
For the extra Vitamin C protection you're looking for.  
500 Mg. 100's  
Reg. \$2.10  
**\$1.39**



**Rexall Cod Liver Oil**  
16 Oz.  
Reg. \$2.80  
**\$1.85**



**TREOFER® IRON TABS**  
(325 mg. Ferrous Sulphate)  
250's  
Reg. \$3.82  
**\$2.59**



**Rexall Natural WHEAT GERM OIL** 14 Minim, 100 Capsules  
Reg. \$3.50  
**\$2.31**



**Rexall Natural COD LIVER OIL**  
100 Capsules  
Reg. \$2.17  
**\$1.43**

# Hollowell's

**DRUG STORES, Inc.**

Quality • Competitive Prices • Service

911 Dickinson Ave. 752-7105      6th St. & Memorial Drive 758-4104

**AGRICULTURE:**  
PCA covers it.  
...with a PCA loan.



**Pitt-Greene Production Credit Assn.**  
Greenville  
758-1512

## Come Meet Fred, Dot, Connie & Georgette



Left to right are Fred Alcock, Dot Avera, Connie Heath and Georgette Ormsby.

At the two week Grand Opening Celebration of Planters National Bank's newest Greenville location—

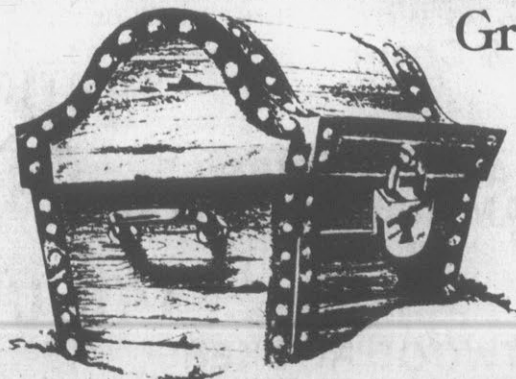

**Carolina East Mall**

August 1, 1979 through August 15, 1979

Get Your Free Gift And Play Our Treasure Chest Game

**PLANTERS NATIONAL BANK**

Member FDIC

# Haughty Traveler Found A Place She Might Live

By Dr. H. G. JONES  
**For The Associated Press**  
**CHAPEL HILL, N. C. (AP)** — When Mrs. Anne Newport Royall traveled through North Carolina 150 years ago, she brought along her intense prejudices against members of organized religious groups, particularly the Presbyterians whom she called "Blue-skins."

Despite her intemperate characterization of many citizens with whom she came into contact, her journal furnishes vivid word pictures of the places she visited.

Born in Maryland in 1769, Anne Newport was brought up by a wealthy Virginia planter, William Royall, who married her. Upon his death, she moved to Alabama.

After a 10-year legal battle over his estate, Anne was left virtually penniless and was forced to begin writing travel books for a living.

Her vituperativeness antagonized so many that in 1829 she was charged and convicted in Washington of the charge of common scold — "communis rixatrix."

Shortly thereafter, she began her trip through North Carolina, hitching rides on mail stagecoaches and accepting the free hospitality of those who were willing to receive the caustic traveler.

Her first stop in the Tar Heel was at Milton, "a flourishing village... a romantic site, on elevated ground, and commands an extensive view."

She wrote of Caswell County, "... the produce is principally tobacco and corn; children and chickens abound, the cattle are

very small, and scarce, sheep and hogs are plenty, and look well."

The people, she said, were stout and healthy, and the black slaves were well clothed, clean, and neat, and "seemed to work with great spirit and energy."

At the tavern in Milton, Mrs. Royall for the first time dined on guinea fowl and found it a delicacy. The night was spent in an excellent tavern at Caswell Courthouse (now Yanceyville).

Proceeding westward, she passed Sen. Bedford Brown's home and went on to Lenox

Castle, "nothing more than a common plain stone building, built many years ago... adorned with a grove of China trees, and handsome shrubberies and lawns."

Approaching Greensboro, the stage passed near the site of the Revolutionary War battle of Guilford Courthouse. She wrote, "My husband was in this battle! Imagine my feelings as I traveled upon the same road he traveled with his men!"

Greensboro was, she recorded, "a considerable village, and like all our towns infested by Presbyterians..."

In this town of perhaps 5,000,

she stayed at the tavern of Christopher Moring, whom she described as a convert to "whisky and Presbyterianism, a great red-faced sot." She thought he belonged to the "Intemperate Society."

Moring also owned the stage line from Milton to South Carolina, a circumstance that led Mrs. Royall to conclude that the Presbyterians were conspiring to control the taverns, post offices, and stage lines.

"There are, however, several fine people in Greensboro," she admitted.

The presence of the notorious Mrs. Royall was quickly com-

municated across the town, and a number of gentlemen called upon her, including editor William Swaim, "a free, generous, liberal man, I believe a (Henry) Clay man; but I underrate no man for his opinion — he might underrate me for the same reason."

Mrs. Royall was particularly impressed by Alexander Murphey, described as "quite a boy in years, but a man in manners and principle; he is the most amiable and promising youth perhaps in the State."

Despite her opinion of Moring, Mrs. Royall was pleased with his tavern. She wrote, "He

has constructed several small neat huts, united in one row, one story high, where the traveler is much more comfortable than when cooped up in a small room in a house surrounded by other rooms and annoyed by noise. I should be pleased to see this plan universally adopted."

Near Jamestown, she was taken by a Quaker by the name of Hodginson on a tour of a gold mine. Her description of the extraction of gold is one of the best early accounts of gold mining in the United States.

At Hillsborough, too, Mrs. Royall found herself on the spot

where her late husband had served during the Revolution. She recounted that he and his men had demanded food and drink from a local resident, and later became violently ill.

The Tory had poisoned the milk that the soldiers drank. She dined with Archibald Murphey, whom she described as "a tall, spare man, with a keen, thin Ciceronian face, and a very mild countenance; but nothing can equal the sweetness of his manners."

Hillsborough was characterized as a delightful town, and she said "some of the handsomest country seats in the Un-

ion appear in the neighborhood of Hillsborough."

At last, the haughty traveler had found a place she liked.

**SHERLOCK'S**  
**RESTAURANT**  
 & Sunday In The Park  
 Go Together  
 118 E. 5th St. - Downtown  
 Sun. Hours 5-9

## The Problem Kids Helped At Center

ALBUQUERQUE, N.M. (AP) — "We get a lot of tough child-abuse cases here," said Dr. Brian Grodner, psychologist at the Peanut Butter and Jelly Pre-School, Infant and Family Center. "Many of the cases we get are referred to us by agencies who can't handle them."

The Peanut Butter and Jelly Pre-School was founded in 1972 by Grodner's wife, Angela, a teacher of emotionally and mentally retarded children, and her partner, Christine Boyd, who had had 20 years of experience in working with pre-school children.

The center offers help to families with pre-school children and infants who are not developing normally or are in extremely high-risk situations.

"Some of these children are called emotionally disturbed, developmentally delayed, abused, neglected or autistic," said Mrs. Grodner. "But we prefer not to put labels on them."

The reason that Peanut Butter and Jelly staff members try hard to avoid labels is that they believe kids and families can be helped and that all things are possible.

"While we know that we can provide abused infants or children the kinds of emotional and educational support that will help them to grow and advance their skills, we feel that the advances that the kids make won't last unless we work with the parents," Grodner said.

"We need to get them where they can see that they possess the answers to their own problems. We try to get them to sit down and look at themselves objectively and to determine what it is that they want out of life."

A case in point is that of Maria Sanchez, 24, and her 4-year-old son Roberto (not their real names).

"Roberto was in a foster home when he was referred to us. He was 2 years old, hydrocephalic, very slow developmentally, shy and withdrawn," said Grodner.

"Married him out of wedlock, had abused him and didn't know what to do with him. Maria's mother had been married nine times. Maria had lived for a while with a step-mother whom she feared and simply had little concept of what a parent should be. On top of that, when we first met her she was using drugs quite heavily."

Thus, although Roberto remained in a foster home, the Peanut Butter and Jelly staff began working with Roberto and counseling and instructing Maria in parenting techniques.

## KINGS

FAMOUS BRANDS for Less

use your master charge or visa

never a service charge with our convenient lay-a-way plan!

GREENVILLE BLVD.  
 264 BY-PASS  
 OPPOSITE PITT PLAZA  
 NEW STORE HOURS  
 10 A.M. TIL 10 P.M. weekdays

### nylon or vinyl soft side luggage

22 inch carry-on **15.99** OUR REG 19.99

OUR REG 24.99, 24" pullman ..... 19.99

OUR REG 29.99, 28" tourist with wheels ..... 24.99

OUR REG 34.99, 28" overseas with wheels ..... 31.99

Choose from all vinyl in saddle tan or black nylon with tan vinyl trim. Both have lightweight steel frame, padded handle and deluxe front flap closure.

OUR REG 18.99,  
 30" x 16" x 12" vinyl trunk . 12.99

### water pik® Instapure® water filter

**17.99**

Makes your water taste, look & smell better. Removes organic chemicals & suspended particles without removing fluoride.

replacement filter ..... 1.99

### 4-drawer metal file cabinet

**44.99**

Furniture grade steel with scratch-resistant finish on baked enamel. Black/wood-grain color combination.

pkg of 48 legal size file folders ..... 2.99

### 3 piece desk set

**2.99**  
set

Includes memo box with paper, matching pen plus pen holder.

### water pik® super saver™ shower massage

**15.99**

wall mount model  
Save water & energy while soothing tired muscles! Uses less than half the water of a regular shower head.

hand held model ..... 24.99

### package of 10 fineline markers

**2** pkgs of 10 \$1

Assorted colors for every writing & drawing need.

perfect with pants or skirts

wool blend blazers

34.99

OUR REG 39.97

The perfect topper for cool fall days in warm blends of wool/polyester/acrylic. Real suede elbow patches, stitched yoke trim. Patch pocket & notched collar detail. In grey or beige.

sizes 5 to 15, 6 to 16

## midsummer savings!

sale starts wed, aug 1, ends sat, aug 4

plush velour  
fashion tops

10.99

Long or short sleeve styles with v-necks, turtlenecks, cowls or collars in solids, shiny iridescents, stripes or sculptured looks. Poly/cotton & poly/acrylic blends.

sizes S-M-L

pre-washed  
straight leg  
fashion jeans

10.99

The straight leg jean is here to stay with great novelty pocket treatments both front & back! Some belted styles in the group. 100% cotton denim in navy.

sizes 5 to 15, 6 to 20

famous brand  
exquisite form  
fashion bras

1.96 and 2.96

Choose from three great styles - cotton/polyester blend stitched undercup, double knit contour style or circle support style. Sizes 34 to 42B, 34 to 44C, 36 to 46D.

for the larger figure  
lightweight

"pucker knit"  
girdles

2.88

Comfortable, lightweight panty girdles and girdles with extra support front panels. In white.

sizes 34 to 46

# No Time To Write, But 'Shorty' A Pen Collector

By BOB HALLMAN  
The Gastonia Gazette  
Member Exchange Feature  
CRAMERTON, N.C. (AP) — Straight from the pages of Damon Runyan walked a red-capped, wrinkled-faced, white-haired gent, who wanted it plainly understood that he "never writes nothing unless I have to because I have no time to write."

Shorty Crowe is doing the talking, but strangely, it's pens and pencils he collects for a hobby.

He was just hanging around his service station at Cramerton Crossroads when some fellow crossed to him and shoved a ball point pen or two at him. That's the way it started in 1945 and that's the way it has been ever since.

"I ain't never bought a pen and I don't intend to," says Shorty, whose real name is Evona.

He has long pens, short pens, thin pens, old-fashioned fountain pens, round pens, square pens, pens that light up and pens that offer a headache pill if the going gets too tough. Shorty also has square carpenter's pencils, big, round, and thin pencils, pearl-bottomed mechanical pencils, felt tip pens and one made in the shape of a sledge hammer with the eraser as the sledge.

His prizes have come from every nook and cranny of the U.S. and have advertising messages that tout items ranging from life insurance to grits and from nuts, bolts and screws to bread.

But the most unusual conversation piece of his entire collecting career was stolen by some wag who wanted it more than Shorty. The red and white pen bore this message: "Mabel's Whorehouse - Satisfaction Guaranteed."

Shorty doesn't know where that little gem came from but he reckons that the sender

might have been ashamed to put his name on it. He was able to figure out that it came out of Baltimore.

He and his wife, Velma, are proud of the collection. When it's unpacked from boxes in trunks and nesting places at their home north of McAdenville, a kitchen table becomes a solid mass of pens and pencils, and this by no means shows the entire collection.

Once a year he and Velma, "who gives him his orders," go through the writing in-

struments, clean them and apply some kind of lubricant to keep them from getting rusty.

Plastic won't rust, will it Shorty?

"No, but it builds up a site of mildew."

When the average householder finds those confounded ballpoints stuck away in dresser drawers, they usually hit the garbage can because they won't write.

Not Shorty.

"All ya hafta do to loosen one up is to stick it into a bucket of hot water. If the ink ain't all

dried up, it will write," he says.

Evona Crowe came out of Oconee County, S.C., not too far from where Duke Power's nuclear plant is located. Now 5-foot-4 and 62-years-old, Shorty peers from behind horned-rimmed specs and wears a hearing aid. From the day he was born until he came to Cramerton in 1941 to work for Burlington Industries, he says "I slept."

The reference is to life on the farm, where the living was sometimes easy. He put in 18 years with Burlington and sev-

eral more with an air systems company in Charlotte before finding that he and his wife could earn their living running a service station. And that's the way it has been ever since.

Then came that day in 1945 when he was set afire by the idea of collecting writing instruments. A salesman for Moore & Stewart Co. of Gastonia gave him a mechanical pencil.

"Why not collect pens for a hobby?" Shorty said. And he started collecting pens from Mexico, Germany, England,

and any other place in the world where he could get them. He told his friends he was a collector and they brought him pens. These friends told other people and they mailed him pens.

Pens and pencils rolled in by the hundreds and the problem became where to keep them. When one box filled up, Shorty and Velma found another. Then a strange thing happened. The pens quit coming in and Shorty wondered why. As best as he can ascertain, a thing called inflation dried up his sources.

"When I was gittin' pens from all around they was costing about 3 cents apiece per thousand. Today the same type of pens are costing 25 cents apiece and I don't know if that is by the thousand or by the million. I guess it is a simple matter of overhead being too high to continue giving them away," he reasons.

He knows some of his collection is valuable, but he really doesn't know how much it is worth.

"A man offered me five dollars for that old Moore & Stew-

art mechanical pencil and I told him his money stunk," said Shorty.

But one thing is sure. The pens and pencils will remain in the family because he has it written into his will that his twin granddaughters will inherit them.

"If there are two pens alike they can divide them," he said. "If they don't want any of them they can just pitch 'em out into the yard."

But that's a thought that Shorty won't "write off" very lightly.

SAVE GAS!  
SAVE TIME!  
SAVE MONEY!

## ECKERD'S

...your little neighborhood department store.

PEOPLE TRUST  
ECKERD'S FOR  
QUALITY  
PRESCRIPTION  
SERVICE at low,  
low prices!

NESTEA®  
INSTANT  
TEA

3-oz. jar of 100% tea. Reg. 2.09

1.69



LISTERMINT  
MOUTHWASH & GARGLE

12-oz. bottle. Reg. 1.35 Limit 1

89¢



ARRID SPRAY  
DEODORANT

4-oz. Extra Dry Scented or Unscented & 4-oz. XX Dry. Reg. 1.59 Limit 1

89¢



PLAYTEX DEODORANT  
TAMPONS

Box of 28 Regular or Super. Reg. 2.17 Limit 1

1.69



JOVAN  
WRINKLES AWAY™

Smooth away wrinkles in minutes. Lasts most of the day or night. Reg. 7.50

5.99



CUTEX  
POLISH REMOVER

6-oz. with cuticle conditioners. Reg. 79¢

59¢



LADIES'  
TERRY SCUFFS

Choice of plain terry cloth scuffs or rose design. Assorted colors & sizes. Reg. 2.99

1.79



MAGLA  
LAUNDRY BAG

Large, durable laundry bag. No. 1840 Reg. 1.68

99¢



MAGLA  
IRONING BOARD  
PAD & COVER

Fits standard ironing boards. No. 6334 Reg. 1.68

99¢



ECKERD  
GLASS CLEANER

19-oz. spray can. Reg. 87¢

59¢



TY-D-BOL  
SOLID

Solid automatic toilet bowl cleaner. 9-oz. regular or pine. Reg. 89¢

59¢



LAZY-TRAY  
FOLDING LAP TRAY

Ideal as a bed or lap tray. Legs fold for easy storage. No. 356 Reg. 3.99

2.88



"ART" PLANTERS

Attractive planters with detachable water drainage trays. Earthtone colors and pastels.

5 1/4-IN. 6 1/4-IN. 7 1/4-IN.  
Reg. 1.19 Reg. 1.69 Reg. 1.99

89¢ 1.19 1.49

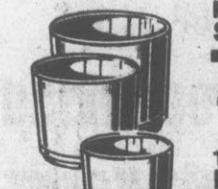

RAID  
HOUSE & GARDEN  
BUG KILLER

13 1/2-oz. spray can. Reg. 2.29

1.66



## BACK TO SCHOOL NEEDS

5-SUBJECT WIREBOUND  
NOTEBOOK

200 ruled sheets & dividers. Reg. 2.39

1.19

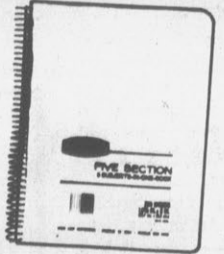

THE ORGANIZER,  
DATA CENTER or  
TRAPPER KEEPER

All include clipboard, ruled pads, pockets & more. By Mead Reg. 4.19

2.49

YOUR CHOICE

SPEEDI INDEX  
DICTIONARY

Wirebound Webster's dictionary with over 40,000 entries. Reg. 2.19

99¢

FLAIR  
QUICK SILVER

New! Rolling ball liquid ink pen. Blue or black. Reg. 98¢

2/98¢

KEN-TECH  
ELECTRONIC ALARM  
CLOCK

Smartly-styled digital alarm clock. Blue LED display. No. T2095 Reg. 17.99

14.88

JULIETTE  
AM CLOCK RADIO

Digital clock radio with illuminated leaf-type numerals. No. ADC-325 Reg. 17.99

14.88

PLASTIC  
SWEATER BOX

Clear plastic storage box. Reg. 2.49

1.66



POLAROID PRONTO  
SONAR ONESTEP

The simple instant camera. No. EDP-2156 Reg. 84.99

74.99

14" x 14" HIBACHI

Table top grill with deep bowl. Reg. 10.99

7.99

STP GAS  
TREATMENT

8-oz. Reg. 1.09

59¢



CONSTRUCTION  
PAPER

9" x 12". Pack of 42 sheets. Assorted colors. Reg. 98¢

49¢

BULLETIN  
BOARD

18" x 24" cork bulletin board. Reg. 3.99

2.99

BIC  
SUPER SAVER  
10-PACK

Super saver pack of 10 Bic Pens. Reg. 1.79

88¢

TEXAS INSTRUMENT  
MEMORY  
CALCULATOR

Electronic calculator with memory, 8-digit readout. Battery not included. No. TI-1025 Reg. 10.99

8.99

LLOYD'S DESK TOP  
CALCULATOR

No. E-680-2 Reg. 29.99

24.99

CLAIROL  
KINDNESS 3-WAY  
HAIRSETTER

Gives a deep conditioning mist set, water and mist-set, or dry set. No. K-420-5 Reg. 27.99

23.99

PLASTIC  
SHOE BOX

Clear plastic with lid. Reg. 89¢

66¢

FOUNTAIN SPECIAL  
ICE CREAM  
CONE

10¢ PER SCOOP

THURS., AUG 2 THRU SUN., AUG 5

We're in the neighborhood

America's Family Drug Stores  
**ECKERD  
DRUGS**

## Sandy Water A Factor

HONOLULU, Hawaii (AP) — Water in the lungs is not the only danger to near-drowning victims, say radiologists at Tripler Army Medical Center here.

They warn that if a victim is near a beach where waves break and mix with sand, it's possible that there is sand, as well as water, in the lungs and breathing passages.

The sand, easily seen on X-ray studies, must be quickly washed out to avoid complications, or even death, in those near-drowning victims, advise Dr. Jaime Bonilla-Santiago and Dr. William L. Fill.

They say they were alerted to such "sand drownings" when X-ray studies of a 23-year-old drowning victim showed pronounced definition ("marked opacity") of the windpipe and bronchus. The autopsy showed these were packed with sand.

In another case, a 20-year-old man was struck by a wave and pulled under but was rescued. His breathing had stopped for only a minute and mouth-to-mouth resuscitation revived him.

He was totally alert and breathed normally but a chest radiograph showed inflammation indicating sand in the bronchus. A bronchoscope was used to wash the area with a saline solution, small amounts of sand were removed, and the man recovered.

## A Live Boa In The Stolen Car

SAN FRANCISCO (AP) — Car thieves who stole a two-door, white-and-blue sport sedan in the city's Mission District may have got more than they bargained for.

The car's owner, who asked not to be identified, said a live boa constrictor was in the back seat of the auto when it was taken Saturday night.

He urged anyone who comes near the car — thieves included — to "use caution as there is a scared, live, 4 1/2-foot boa constrictor running around inside it."

### ECKERD'S FAMOUS PHOTO OFFER

**TWICE THE PRINTS** Get an extra set of prints with every roll of color or black and white print film developed and printed. TODAY AND EVERYDAY.  
**TWICE THE FILM** Get two rolls of print film for the price of one Kodacolor or black and white, when you have your film processed at Eckerd's. TODAY AND EVERYDAY.  
**GUARANTEE** Buy only the prints you want. No hassle - even if the goof was in the picture taking.

PRICES GOOD THRU SAT., AUG. 4th

WE RESERVE THE RIGHT TO LIMIT QUANTITIES

Pitt Plaza Shopping Center  
Rivergate Shopping Center

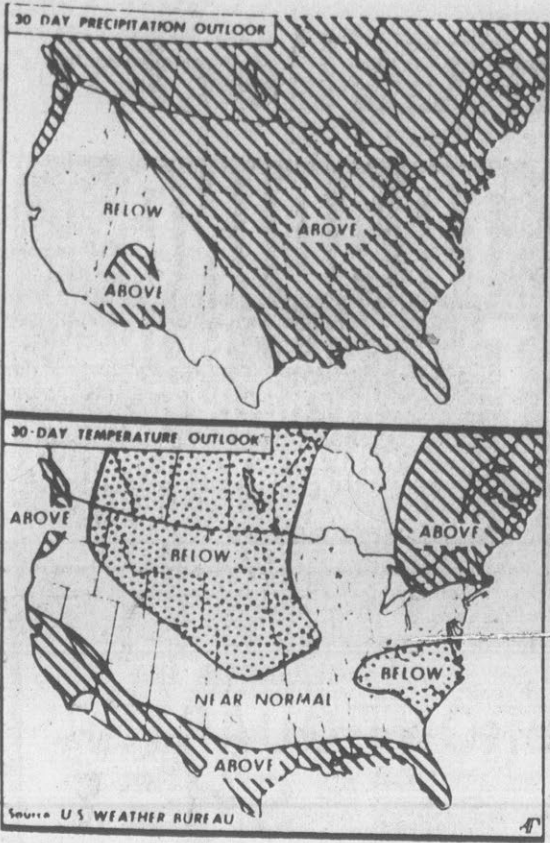

**THIRTY-DAY FORECAST** — This is the 30-day weather forecast in terms of precipitation and temperature, according to the National Weather Service. (AP Laserphoto)



Fern

## Hanging Baskets



Now **2** For  
**\$5.00**  
Or  
**\$2.88** Ea.

Large

## Houseplants



3 Gal.

Now **\$8.88**

Up To 16.95 Values

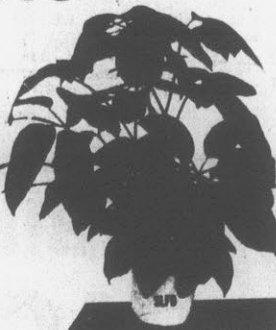

While Supply Lasts  
Blooming

## Hanging Baskets

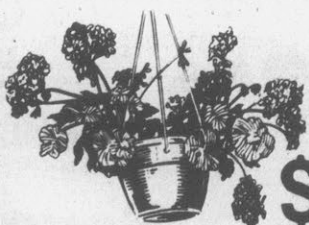

Now

**\$2.88**

Ea.



## Special Discounts

### On All Hammocks And Gas Grills



**20%**

To

**50% Off**

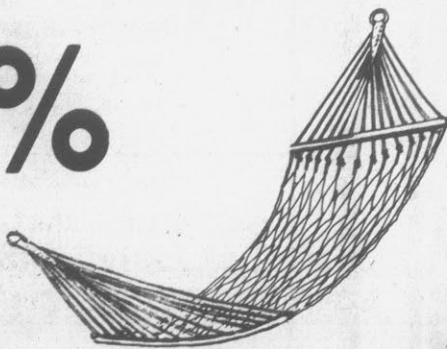

# sunshine

LOCATED 1 1/2 MILES SOUTH  
OF T.V. STATION  
ON EVANS ST. EXTENSION  
TEL. 756-2629

## Repairing Loss Due Vandals

By VICTOR L. SIMPSON  
Associated Press Writer

ROME (AP) — Under the gaze of thousands of summer tourists, a small army of workmen is repairing Campidoglio Square, the stately Roman city hall complex designed by Michelangelo that was ravaged by a terrorist bomb blast three months ago.

Rome's Communist-led administration has turned the damaged site atop Capitoline Hill into a showcase of art restoration.

A web of metal scaffolding has grown like ivy on the walls of the Palazzo Senatorio, Rome's city hall, and the twin buildings on each side of it.

Green netting encloses the famed bronze equestrian statue of Marcus Aurelius in the center of the square. The statue was not damaged by the 10-pound dynamite bomb but was suffering the ravages of air pollution.

Signs in five languages put up by the city on corrugated metal fencing tell tourists the restoration is "the consequence of a serious fascist attempt the night of April 19-20."

The bombing, two months before the Italian general election, was a bold strike at the political and cultural heart of the city, built over the ancient Tabularium that housed the Roman archives.

Mayor Giulio Carlo Argan, a Marxist and one of Italy's leading art historians, insisted on holding a city council meeting amid the rubble hours after the blast to show the city was not intimidated.

The Revolutionary Armed Nuclei — identified by police as a right-wing terrorist group — claimed responsibility for the bombing in telephone calls to the news media. Police say no arrests have been made. A few months before, the same group carried out an armed attack on five feminists during a talk show at a leftist radio station.

The city administration estimates it will cost the equivalent of \$1.2 million to repair the damage. Nearly half of it will go to restore the double-stairway and entrance of the Senatorial Palace, whose facade was built in 1592 according to a masterplan for the square drawn up by Michelangelo.

The city and national governments are footing the bill, and city officials say the work will take at least six months to a year to complete.

Also heavily damaged in that building were the walls and ceilings of the Julius Caesar Hall, the city council's meeting

hall. Experts found the blast opened cracks in the twin stone palaces that flank the city hall and damaged the ceiling of the "wedding room," a plush, red-velvet-lined chamber in the Palazzo dei Conservatori, where civil marriages are conducted.

A total of 237 marble and masonry pieces were collected after the explosion. Some were hurled as high as the bell tower atop city hall.

Since the bombing, police have tightened up security. Uniformed guards man wooden barricades at the foot of the hill and bar cars from the area, which is now guarded around the clock. The city is also studying a plan to require employees to carry identification cards to gain admittance to municipal offices atop the hill.

## More Chemical Engineers Seen

NEW YORK (AP) — During the next few years record numbers of new chemical engineers are expected to be seeking jobs in chemical process industries, according to Chemical Engineering magazine.

Luring students to enroll at U.S. chemical engineering schools are high starting salaries and plentiful job opportunities, says the publication.

It says the survey found that demand for chemical engineers will continue strong for the next three years but will not keep pace with the "onslaught of graduates."

## Big Black Bear Is Red-Faced

PHILLIPS, Wis. (AP) — A red-faced black bear is prowling Wisconsin's north woods — and the coloring is caused by more than just embarrassment.

While keeping two Department of Natural Resources foresters treed for two hours recently, the 250-pound beast spray-painted his face crimson when he bit open a paint can and rolled in the mess.

The foresters, David Bailey and Roy Gilge, both 29, were spray-painting the boundaries of a DNR timber sale in the Flambeau State Forest here when the bear appeared.

The bear wandered off eventually and the men made a dash to their pickup truck.

## Have You Missed Your Daily Reflector?

First Call Your Independent Carrier.  
If You Are Unable To Reach Him  
Call The Daily Reflector

**752-3952**

Between 6:00 And 6:30 P.M. Weekdays  
And 8 'Til 9 A.M. On Sundays.

# CAMERA *Angles*

By IRVING DESFOR  
AP Newsfeatures

This column is in collaboration with my son, Donald M. Desfor, who recently earned his doctorate in human behavior after a comprehensive survey on how people react to photographs.

He re-emphasizes that photography is a particularly significant and vital visual force in the world today.

"Pictures are everywhere," he says. "They are framed and displayed at home and at work. They hang on walls, lockers and auto visors. Pictures are taped and pinned on bulletin boards, doors, closets, posts and windows. They are crammed into cartons, dumped into drawers, enclosed in envelopes, shoved into shoe boxes and wadded into wallets.

"Similarly, cameras have become a common artifact of American life and our society. They appear everywhere and are used by everyone. Guests and bystanders with cameras rub shoulders with professionals at weddings, graduations, opening nights and public events. We're all aware that our travel and vacation experiences must be documented with photographic evidence. In



A RESEARCH STUDY on how people react to photographs, conducted by Donald Desfor of Long Beach, Calif., included this photo. His conclusion was that people generally express an opinion based on some visual clues but which cannot be substantiated as fact. Photos deserve more searching study and thought before evaluation.

most cases, the trip is deemed a success or failure depending on how the pictures turn out.

"Out of the deluge of billions of pictures from millions of cameras, what is the impact

that photographs have on us. What do they mean to us?"

To get some answers, Don conducted a research study in 1978. His subjects were men and women between the ages of 17 and 50 who lived in southern California and in the greater New York City area but who represented many areas of the country. They were a cross section of varied ethnic, social, occupational and educational backgrounds.

The subjects were asked to look at four photographs and freely give their response to each one without any prompting. Then Don probed their responses to find what motivated their thoughts. All the interviews were tape recorded, studied and evaluated.

All the freely given responses were classified into one of six categories: Deductive, Evaluative, Subjective, Photographic, Objective and Reflective.

A Deductive response is a factual statement that can be deduced from one or more visual cues in the photograph. The statement could be substantiated as to whether it was true or false. An example: "This is a mother and her son and daughter."

An Evaluative statement expresses a value, opinion or judgment stimulated by one or more visual cues in the photo but which cannot be substantiated as fact.

Example: "The girl looks happy and the boy looks hostile."

A Subjective response also expresses a value, opinion or judgment but it isn't based on visual clues or substantiated as a fact. An example: "The picture was taken at Easter." In this case, there was no basket, flowers or special attire that would indicate the picture was taken at Easter time.

A Photographic response made a technical or aesthetic statement about the photograph itself rather than about the subject content. An example: "It's a sharp, properly exposed print with good depth of focus."

An Objective response is rare. It's a statement that is detached, impersonal, free of commentary, evaluation and prejudice, and is visually verifiable. An example: "This photograph has three figures in it."

In the sixth and last category, a Reflective response might be one of two types — either personal or philosophical. A visual clue in the photo might evoke a personal response like, "She reminds me of my mother." Or the statement might contain a generality such as, "Family groups like this one are good for the

country." After evaluating all the responses, Don found only one category which included all persons interviewed: Eval-

uative. That's the one in which an opinion is expressed guided by clues in the photo but which cannot be substantiated visually. As a matter of fact, the

preponderance of all responses tended to be evaluative. In contrast, there were extremely few Objective responses, a conclusion that was all

the more noticeable because of the overwhelming number of interpretive statements.

# BARWICK'S TRADING POST

OPEN MONDAY THRU SATURDAY 8 A.M. TO 6 P.M.

TELEPHONE 758-2277

LOCATED BEHIND FRED WEBB'S GRAIN ELEVATOR

OWNED AND OPERATED BY L. ALLEN BARWICK

HOME OF QUALITY CUTS OF MEAT "AS GOOD AS THE BEST... BETTER THAN THE REST"

WE ACCEPT FOOD STAMPS ALL MEATS N.C.D.A. INSPECTED

PRICES GOOD WED. THRU SAT.

SWIFTS PREMIUM CHUCK ROAST \$1.29 LB. (BONE-IN)

SWIFT'S PREMIUM WESTERN FRONT QUARTERS \$1.25 LB. CUT & WRAPPED FREE

SWIFTS PREMIUM RIB STEAK \$1.99 LB.

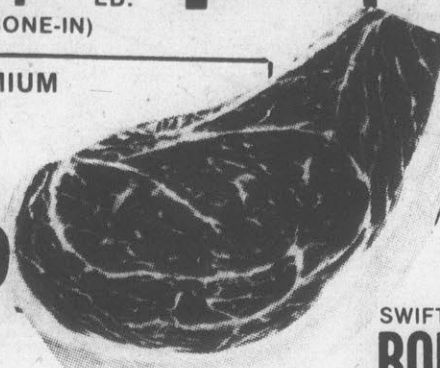

SWIFTS PREMIUM CHUCK STEAK \$1.39 LB. SWIFTS PREMIUM RIB STEW \$11.90 10 LBS. FOR

SWIFTS PREMIUM BONELESS CHUCK ROAST \$1.59 LB.

SWIFTS PREMIUM RIB EYE STEAKS \$3.49 LB.



SMOKED PICNICS 69¢ LB. SHOULDER ROAST \$1.49 LB.

PORK CHOPS 10 LBS. FOR \$11.90

COFFEE-MATE NON-DAIRY CREAMER 3-OZ. .33¢ 6-OZ. 55¢ 11-OZ. 99¢

A-1 SAUCE 10-OZ. SIZE 89¢

VAN CAMPS PORK & BEANS 16 OZ. SIZE 99¢

CAMPBELL'S CHUNKY SOUP 19 OZ. CAN 59¢

SWIFTS PREMIUM HAMBURGER \$14.90 10 LBS. FOR

## TAFT FURNITURE CO.'S Dollar Days

SALE ON SEALY MATTRESSES & BOXSPRINGS NOW THRU SATURDAY

SEALY REST PARAMOUNT Save \$20.00

All this quality at a first-time-ever reduced price! Rich satin cover multi-quilted through Sealyfoam\*. Hundreds of coils. Patented extra firm foundation. Save \$50 on Queen Size! 60" x 80" 2-pc. set \$279.95 Save \$60 on King Size! 76" x 80" 3-pc. set \$379.95 54" x 75" Dbl. Size \$99.95 ea. pc.



Now Twin \$79.95 ea. pc.



Sealy Anniversary Classic

Same Firm innerspring found at \$10 to \$20 more!

Get all the benefits of firm Sealy support for far less than you'd expect. Hundreds of exclusive Dura-Flex coils and patented Dura-Gard foundation. Plus deep-quilted cover. QUEEN SIZE 60x80" 2-pc. set \$189.95

54" x 75" Dbl. Size \$79.95 ea.

NOW \$59.95 Twin Ea. Pc.

Sealy Posturepedic

Never "sale-priced" but always your best value

This is the one that promises no morning backache from sleeping on a too-soft mattress. Designed in cooperation with leading orthopedic surgeons for firm support. Choose Extra Firm or Gently Firm.

\$129.95

Twin Ea. Pc.

Full Size 54" x 75" \$159.95 ea. Queen Size 60" x 80" 2-pc. set \$379.95 King Size 76" x 80" 3-pc. set \$529.95



## Blue Bell's Back-To-School BACK-TO-SAVINGS SALE

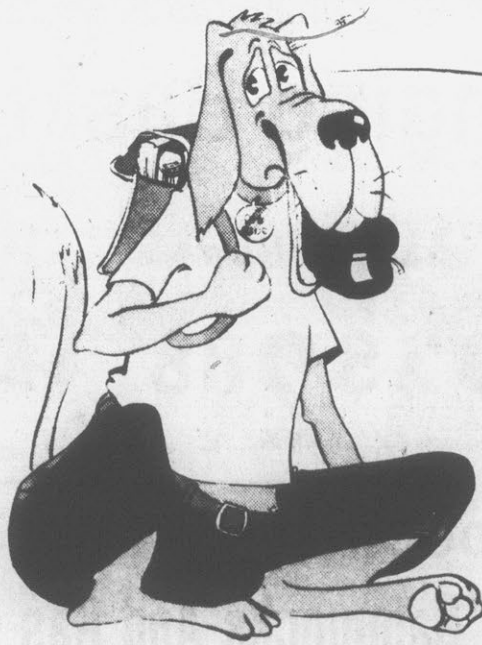

Ole Blue Says "Bite into some real sweet savings."

Save 30% to 60% Jeans, Sportswear Kidswear

Men's 1st quality denim jeans Only \$8.88 A \$15.00 value.	Boy's & Student's denim & corduroy jeans. Only \$8.84 A \$13.00 value. Straight leg and flare.	Junior Miss Fashion Jeans Only \$6.86 A \$15.00 value.
Men's 1st quality Oxford shirts Only \$7.88 A \$13.00 value.	Boy's long sleeve knit shirts. Only \$4.84 A \$9.00 value. Turtle neck, crew and placket front.	Junior Miss assorted blouses. Only \$3.84 An \$8.00 value.

\*First Quality & Irregulars

**Blue Bell Factory Outlet**



Blue Bell Factory Outlet 703 Greenville Square Shopping Ctr., Greenville, N.C. (919) 756-0337 Mon. - Fri. 10:00 AM - 9:00 PM Sat. 10:00 AM - 6:00 PM



Also in Goldsboro, New Bern, and Rocky Mount

## Taft Furniture Co.

535 Dickinson Ave. Phone 752-5161 Downtown Greenville

90 Day Cash Plan—Free Delivery Up To 100 Miles

"80 Years of Continuous Service to Eastern North Carolina"



**MAKING A SPLASH** - The recently-crowned Miss Universe for 1979, Maritza Sayalero of Venezuela, dips her foot into a pool in New York's Rockefeller Plaza and finds the water quite chilly. Miss Sayalero, who won the Miss Universe title on July 19 in Perth, Australia, is currently visiting New York. (AP Laserphoto)

**Save \$1020!! 51% Off Cherry With Elm In Sets. Chippendale 6 Piece Bedroom Group By Desota. Final Clearance.**

List Price \$2015. 7 Drawer Triple Dresser, Framed Verticle Mirror, Chest on Chest, Queen Size Canopy Bed & Two Drawer Nite Stand.

**\$995<sup>00</sup>**

**55% Off List Price. You Save \$745.00 Thomasville Allegro II 6 Piece White & Yellow Bamboo Bedroom Group**

6 Drawer Double Dresser, Lingerie Chest, Framed Plate Glass Mirror, Twin Bennett Bed & Bennett Frame.

**\$595<sup>00</sup>**

**SHOWROOM OPENS AT 8:00 A.M. SHARP THURSDAY MORNING**

**\$\$\$\$\$\$\$\$\$\$\$\$**  
**DAY SALE. SAVINGS OF 40% TO 70% STOREWIDE**



List Price \$20.00 <b>Twin White Vinyl Headboard</b> <b>\$5<sup>00</sup></b> Sale Price Tufted Back Only 1 to Sell	List Price \$130.00 <b>Singer Pine Captain's Chairs</b> <b>\$49<sup>00</sup></b> Sale Price Only 6 to Sell Honey Pine Finish	List Price \$65.00 <b>7 Play All Steel Gym Sets</b> <b>\$25<sup>00</sup></b> Sale Price Sold in Box Only Only 4 to Sell	List Price \$150.00 <b>White Wicker Patio Chair</b> <b>\$75<sup>00</sup></b> Sale Price Upholstered Seat - Only 1 to Sell	List Price \$82.50 <b>Rattan End and Coffee Tables</b> <b>\$35<sup>00</sup> Each</b> Sale Price Only 4 to Sell Formica Top	List Price \$325.00 <b>White Wicker Loveseat Sofa</b> <b>\$162<sup>00</sup></b> Sale Price Upholstered Seat Only 1 to Sell
--	--	---	---	--	--

**FINAL CLOSE OUT ON BEDROOM PIECES ...SAVE \$40.00 TO \$400.00 NOW!!!**

List \$480.00 Singer Pine Chest on Chest . . . . . Sale Price <b>\$240<sup>00</sup></b>	List \$200.00 Singer Pine Queen Cannonball Headboard . . . . . Sale Price <b>\$100<sup>00</sup></b>
List \$800.00 Singer Door Triple Dresser With Martha Washington Twin Mirrors . . . . . Sale Price <b>\$400<sup>00</sup></b>	List \$165.00 Lea Oak Queen Size Bar Bed. . . . . Sale Price <b>\$82<sup>50</sup></b>
List \$110.00 Lea Door Oak Modular Cabinet. . . . . Sale Price <b>\$55<sup>00</sup></b>	List \$80.00 Kemp Mahogany Spindle Bed . . . . . Sale Price <b>\$40<sup>00</sup></b>
List \$150.00 Lea Oak Modular Bookcase. . . . . Sale Price <b>\$75<sup>00</sup></b>	List \$180.00 Singer Pine Galley Nitestand . . . . . Sale Price <b>\$90<sup>00</sup></b>
List \$115.00 Lea Oak Modular 3 Drawer Chest . . . . . Sale Price <b>\$57<sup>50</sup></b>	List \$340.00 Singer 6 Drawer Pine Chest. . . . . Sale Price <b>\$170<sup>00</sup></b>

**SOFAS...CHAIRS...SLEEPER SOFAS ...SAVE \$56.00 TO \$305.00 NOW!!!**

List Price \$400.00 - Broyhill Curved Front Traditional Sofa.. Green & Gold Fabric . . . . . <b>\$190<sup>00</sup></b>	List \$450.00 Naugahyde Sofa & Matching Club Chair-Shopworn and 1 Group . . . . . <b>\$200<sup>00</sup></b>
List Price \$600.00 Lawson Style Pillow Back Sofa..Blue Naugahyde Fabric. 3 Cushions . . . . . <b>\$250<sup>00</sup></b>	List Price \$400.00 Kroehler Contemporary Sofa - Slightly Used Loose Pillow Back . . . . . <b>\$90<sup>00</sup></b>
List Price \$105.00 Rattan Club Chairs Floral Print Fabric . . . . . <b>\$49<sup>00</sup></b>	List \$240.00 La-Z-Boy Swivel Rocker - Used . . . . . <b>\$25<sup>00</sup></b>
List Price \$625.00 Serta Queen Size Early American Sleep Sofa. Tan Nylon Fabric. . . . . <b>\$250<sup>00</sup></b>	List \$600.00 Kroehler Colonial Sofa - Nylon Floral Print Fabric - Wood Galley Rail - Only 1 . . . . . <b>\$295<sup>00</sup></b>
List \$200.00 Fairfield Colonial Swivel Rocker . . . . . <b>\$90<sup>00</sup></b>	List \$200.00 Broyhill Colonial Swivel Rocker . . . . . <b>\$90<sup>00</sup></b>

**Speaking of Your Health...**  
Lester L. Coleman, M.D.

**Readers Ask About Bursitis**

**Q:** What causes a sudden attack of bursitis in an otherwise healthy person?  
**A:** Repeated injuries, exposure to drafts, lifting a heavy weight, off-balance swinging of a golf club or ax, straining the shoulder at tennis, can all cause an attack of this painful condition.  
**Q:** Does bursitis occur only in the shoulders?  
**A:** No. It is estimated that there are 150 bursae in the body. They may lie in the hip, the heel, the knee, the elbow. The shoulder does seem to be the most susceptible, however. About 75 percent of all bursitis cases occur in the shoulder joint.  
**Q:** What is a bursa and what is its purpose?  
**A:** A bursa is a flat sac that normally contains a slippery, lubricating fluid. The name originates from the Latin, meaning "money bag." And a bursa resembles a small, empty change purse. Bursae are the lubricating, ball-bearing system of the body. Bones, joints, tendons and muscles that constantly move are protected against the irritation of friction by these well-placed bursae.  
**Q:** Does one attack of bursitis make a person susceptible to more attacks?  
**A:** Unless the underlying cause is removed, recurring bouts of bursitis can be expected. Tiny calcium deposits, which may lead to stones in the bursa, further complicate the problem of bursitis. Gout

is sometimes overlooked as the real culprit in attacks of bursitis. Uric acid stones, rather than calcium, may be deposited in the bursae.  
**Q:** Why is the pain so severe with shoulder bursitis?  
**A:** The agonizing pain is nature's way of demanding that the shoulder be kept at complete rest. For any further motion irritates the bursa, makes it swell, and sends shooting pains down the arm.  
**Q:** What's the best way to relieve this pain?  
**A:** "Freezing" the shoulder is very effective. An ice bag applied to the tender spot brings welcome comfort. Note well: Ice, not heat. Most important is the fact that the joint must have absolute rest. It can be held in place with splints or slings until the inflammation subsides. There are now a number of very effective anti-inflammatory and pain-killing drugs that can afford great comfort. When pain persists, doctors will inject cortisone or ACTH and the pain-killing drug, "procaïne," into the joint. Besides drugs, X-rays are also used in some cases. Only occasionally is surgery necessary. Under no circumstances should a bursitis be "worked out" with heavy exercise. Manipulation and massage must be avoided, since it is absolutely essential that the joint be kept in a fixed, rigid position, in order to help reduce the inflammatory process.

**Home Filled By 65,000 Relics**

DENVER (AP) - John Kendra, 41, began collecting religious relics when he was only 14 years old. He now has more than 65,000. Most of them are in a 12-foot by 14-foot bedroom of the Kendras' mobile home in west Denver. A collection of Madonnas is kept in the living room. Kendra, who works in the mailroom at Ryall Electric, has crosses, crucifixes, statues, pictures, medals, an altar, rocks, pieces of saints' coffins and particles of hair and bones from saints. The bodily relics, Kendra says, are "first class" relics and most are in small locket-like cases and sealed with a bishop's seal or the seal of the coat of arms of a religious order or congregation. "Second-class" relics include tiny portions or threads from vestments that belonged to saints or some artifact belonging to saints. These include pieces of stone from a tombstone or bits of dirt from a

saint's grave. Kendra has collected relics and religious mementos from various trips in this country and Israel. There he obtained a piece of the Walling Wall and a stone from the garden of agony. He also has a menorah which burns in memory of the 6 million Jews who lost their lives in the Holocaust. Many of the other relics have come from monasteries and religious orders. Kendra says he has relics of the Holy Apostles, Mary's tunic, St. Joseph's tunic, the "true cross," and Jesus' crib, as well as those from several saints. Mrs. Kendra says the relics fill the bedroom, sitting on dressers and tables and hanging on the walls. There are also two storage chests full of relics. None was bought, and, according to Mrs. Kendra, "we would be excommunicated if we bought or sold relics." The Kendras have, however, spent a lot of money on postage.

Compare At \$260.00 <b>Twin Size Perfect Sleeper Mattress &amp; Box Springs</b> <b>\$160<sup>00</sup> Set</b> Sale Price Only 1 to Sell - Discontinued Model	List Price \$500.00 <b>Pillow Back Colonial Sofa</b> <b>\$200<sup>00</sup></b> Sale Price Orange Plaid Herculon Fabric	List Price \$210.00 <b>Colonial Wing Back Chair</b> <b>\$90<sup>00</sup></b> Sale Price Gold Nylon Tweed Fabric	List Price \$200.00 <b>Fairfield Pine Colonial Rocker</b> <b>\$119<sup>00</sup></b> Sale Price Nylon Tweed Seat & Back	List Price \$260.00 <b>Velvet Queen Anne Wing Chair</b> <b>\$130<sup>00</sup></b> Sale Price Green & Gold Cut Velvet Fabric	List Price \$600.00 <b>Duncan Phyfe Sofa</b> <b>\$300<sup>00</sup></b> Sale Price By Sugg & Harris Tapestry Cover
List Price \$80.00 <b>White Wicker Round End Tables</b> <b>\$40<sup>00</sup> Each</b> Sale Price 4 to Sell At This Low, Low Price	List Price \$620.00 <b>Singer Pine Buffet &amp; China</b> <b>\$290<sup>00</sup></b> Sale Price Grill in Deck Drawers & Doors in Buffet	List Price \$675.00 <b>Serta Colonial Sleeper Sofa</b> <b>\$295<sup>00</sup></b> Sale Price Blue & Brown Herculon Plaid Fabric	List Price \$160.00 <b>Traditional Club Chair</b> <b>\$65<sup>00</sup></b> Sale Price Herculon Plaid Fabric. Only 1 to Sell.	List Price \$240.00 <b>Wing Back Colonial Chair</b> <b>\$90<sup>00</sup></b> Sale Price Green Herculon Plaid Fabric	List Price \$250.00 <b>Broyhill Pillow Back Club Chair</b> <b>\$99<sup>00</sup></b> Sale Price Green & Brown Herculon Plaid Fabric.

WE WELCOME  
USDA FOOD  
STAMPS

BIG  
STAR'S ...

# STAR SAVER PRICES BRING

**BIG  
STAR  
FOODS**

Reader's Digest  
75th  
August Issue

**Pitt Plaza  
Shopping Center  
Open Mon. Sat. 8-10  
Sundays  
9 to 9**

**PILLSBURY  
BUTTERMILK BISCUITS**  
7.5-OZ. SIZE ..... **94¢**

**MAXWELL HOUSE  
COFFEE**  
1-LB. BAG ..... **\$2.69**

**KRAFT  
MAXI-CUP  
MARGARINE** 18 OZ. **94¢**  
**KRAFT  
MIRACLE  
MARGARINE** 16-OZ. CARTON **74¢**  
**PILLSBURY BIG  
COUNTRY  
BISCUITS** 12-OZ. SIZE **42¢**

**SUPER STAR SAVER**  
U.S. CHOICE BEEF  
**WHOLE  
RIB EYES**  
9 TO 12 LB. AVG.  
CUT INTO STEAKS  
& TRIMMINGS  
FREE!  
**\$2.98**  
LB.

**SUPER STAR SAVER**  
HICKORY MOUNTAIN  
OLD FASHION AIR DRIED  
NORTH CAROLINA  
**COUNTRY  
HAMS**  
12 TO 15 LB. AVG.  
WHOLE **\$1.28**  
SLICED FREE LB.  
HICKORY MOUNTAIN  
COUNTRY STYLE  
**HAM** HALF LB. **\$1.38**

**SUPER STAR SAVER**  
FRESH PORK  
ROAST  
**WHOLE  
PICNICS**  
LB. **68¢**

**OSCAR MAYER**  
**SLICED BACON** 1-LB. PKG. **\$1.58**  
**SPICED LUNCHEON MEAT** OR **COTTO SALAMI** 8-OZ. PKG. **\$1.08**  
• PICKLE-PIMIENTO LOAF  
• LIVER CHEESE  
• BOLOGNA N' CHEESE  
• OLIVE LOAF  
8-OZ. PKG. **98¢**  
**MORTON'S FRIED CHICKEN** 2-LB. PKG. **\$1.98**

LAND O' FROST WAFER SLICED LUNCH MEAT ALL 2 1/2-3 OZ. CELEBRITY BRAND  
• SLICED COOKED HAM 12-OZ. PKG. **\$2.48**  
• SLICED COOKED PICNIC 12-OZ. PKG. **\$2.28**  
**U.S. CHOICE BEEF**  
BONELESS CHUCK POT ROAST ..... LB. **\$1.88**  
BONELESS SHOULDER ARM ROAST ..... LB. **\$2.18**  
BONELESS CHUCK STEAK ..... LB. **\$1.98**  
BONELESS SHOULDER ARM STEAK ..... LB. **\$2.38**  
FARM BRAND PURE PORK SAUSAGE 1-LB. PKG. **98¢**  
SLICED SMOKED PICNICS WHOLE OR Half Lb. **78¢**

**SUPER STAR SAVER**  
U.S. CHOICE BEEF  
FAMILY PAK  
**RIB EYE  
STEAKS**  
6 STEAKS **\$3.88**  
OR MORE LB.

**SPECIAL STAR SAVER**  
FAMILY PAK  
ASSORTED  
**PORK  
CHOPS**  
CENTER & END CUTS  
8 LBS. OR MORE LB. **\$1.18**

**SPECIAL STAR SAVER**  
OSCAR MAYER  
PEAR OR PULLMAN SHAPE  
**CANNED  
HAMS**  
3-LB. CAN **\$6.98**

**SPECIAL STAR SAVER**  
OSCAR MAYER  
• **WEINERS** 1-LB. PKG. **\$1.58**  
• **BEEF FRANKS** 1-LB. PKG. **\$1.68**

**START YOUR COLLECTION TODAY**  
STAINLESS FLATWARE BY **ONEIDA**  
LAY-A-WAY CERTIFICATES ONLY **99¢** EACH WITH EACH \$5.00 PURCHASE  
20-pc. Service for Four ONLY **\$18.81**  
A AMERICAN BAROQUE B GLEN COVE  
SAVE **\$1.00** ON THESE COMPLETE PIECES  
SAVE-A-DOLLAR WITH THIS COUPON **4 SEAFOOD FORKS**  
REG. \$3.39 - ONLY \$2.39 WITH THIS COUPON  
COUPON VOID AFTER AUG. 4, 1979

Save 40¢ WITH THIS COUPON WHEN YOU BUY A 10 OZ. JAR OF  
**Maxwell House**  
INSTANT COFFEE  
**KRAFT PARKAY 1/4'S MARGARINE** 1-LB. **72¢**  
**KRAFT PARKAY SOFT MARGARINE** 2-8-OZ. BOWLS **88¢**

ASS'T. BETTY CROCKER **CAKE MIXES** 18-OZ. BOX 2 FOR **\$1.00**  
ASS'T. BETTY CROCKER **CAN FROSTING** 16 1/2-OZ. CAN **88¢**  
MRS. FILBERT'S QUARTERS **MARGARINE** 1-LB. **48¢**  
ASS'T. • REG. • SMOKEY • ONION FIESTA **BAR-B-Q SAUCE** 20-OZ. JAR **59¢**

**VANITY FAIR**  
100-CNT. • LUNCH NAPKINS 55¢  
50-CNT. • DINNER NAPKINS 2 FOR \$1.00  
134-CNT. • FACIAL TISSUE 49¢  
**SUNRIPE JELLY**  
• APPLE 16-OZ. JAR 49¢  
• GRAPE 16-OZ. JAR 59¢  
STRAWBERRY PRESERVES 16 OZ. JAR **69¢**

**MAXWELL HOUSE** COFFEE 1-LB. CAN **\$2.85**  
**LAY'S** NEW 1 POUNDER POTATO CHIPS **\$1.59**

INSTANT **MAXWELL HOUSE** COFFEE 6-OZ. JAR **\$2.99**

**SPECIAL STAR SAVER**  
**ARGO CUT GREEN BEANS**  
4 16-OZ. CANS **\$1.00**

**SPECIAL STAR SAVER**  
**VAN CAMP'S PORK & BEANS**  
4 16-OZ. CANS **\$1.00**

**SPECIAL STAR SAVER**  
**LUCKY LEAF APPLE SAUCE**  
4 16-OZ. CANS **\$1.00**

**SPECIAL STAR SAVER**  
17-OZ. ROSE DALE WHOLE KERNEL **GOLD CORN**  
16-OZ. PINE CONE **TOMATOES**  
16-OZ. RED GATE WHOLE **WHITE POTATOES**  
4 FOR **\$1.00**

# YOU WALL TO WALL SAVINGS!

U.S. CHOICE BEEF

**SUPER STAR SAVER**  
MARKET STYLE SLICED  
**BACON**  
2-LBS. OR MORE LB. **88¢**



**SUPER STAR SAVER**  
**COCA-COLA**  
8 PK. 16 OZ.  
**99¢**  
PLUS DEPOSIT

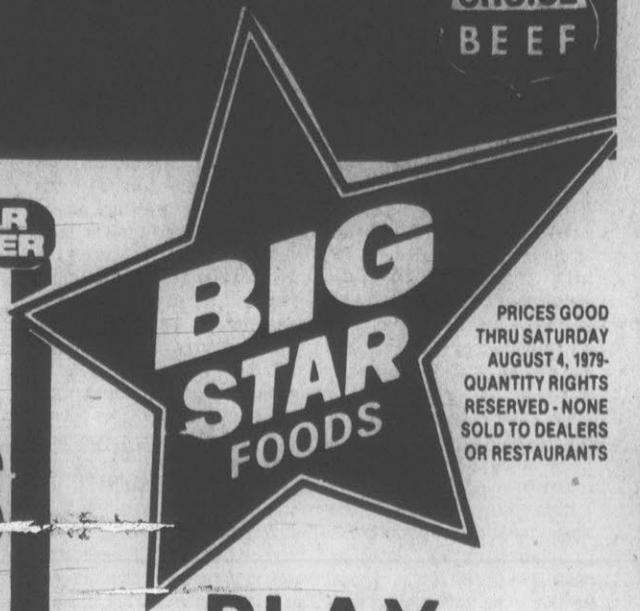

**SUPER STAR SAVER**  
SWEET WESTERN  
**CANTALOUPE**  
JUMBO SIZE  
**69¢**

PRICES GOOD THRU SATURDAY AUGUST 4, 1979. QUANTITY RIGHTS RESERVED - NONE SOLD TO DEALERS OR RESTAURANTS

**PLAY Instant Vegas**

**NOW AT BIG STAR**  
**WIN UP TO \$5,000.00**

ODDS TO WIN . . .

ODDS CHART EFFECTIVE JULY 1, 1979

PRIZES	NUMBER OF PRIZES	ODDS FOR ONE GAME TICKET	ODDS FOR 10 GAME TICKETS	ODDS FOR 25 GAME TICKETS
\$5,000.00	1	1 to 25,000	1 to 2,500	1 to 1,000
\$1,000.00	5	1 to 5,000	1 to 1,000	1 to 400
\$500.00	10	1 to 1,000	1 to 200	1 to 100
\$250.00	20	1 to 500	1 to 100	1 to 50
\$100.00	50	1 to 200	1 to 40	1 to 20
\$50.00	100	1 to 100	1 to 20	1 to 10
\$25.00	200	1 to 50	1 to 10	1 to 5
\$10.00	500	1 to 25	1 to 5	1 to 2
\$5.00	1000	1 to 10	1 to 2	1 to 1
TOTAL PRIZES	2106	1 to 25,000	1 to 2,500	1 to 1,000

**PICK UP YOUR FREE GAME TICKET TODAY!**

**JUBILEE MILD PIMIENTO**  
•CHEESE SPREAD (SAVE 20¢) 15 OZ. CUP **89¢**  
•CHICKEN SALAD 7-OZ. CUP **69¢**  
•FREEZER QUEEN MEAT ENTREES  
•BEEF PATTIES W/MUSHROOM GRAVY  
•BEEF PATTIES W/ONION GRAVY  
•SALISBURY STEAK  
•GRAVY N' SLICED TURKEY  
•TURKEY CROQUETTES  
2-LB. PKG. **\$1.38**  
•COOK N' POUCH ALL VARIETIES 5-OZ. Pkg. **38¢**  
SINGLETON'S GOLDEN FLEET PEELLED SALAD SHRIMP 12-OZ. PKG. **\$2.49**  
MRS. PAUL'S COMBINATION SEAFOOD PLATTER **\$1.39**  
9-OZ. PKG. GORTON'S BATTER FRIED FISH PORTIONS 12-OZ. PKG. **\$1.59**  
CAPT. JOE'S DEVILED CRABS 3 OZ. EA. **39¢**

HEINZ TOMATO **CATSUP** 32-OZ. BOTTLE **78¢**  
PACKER'S LABEL WHITE **PAPER PLATES** 100 CNT. PKG. **78¢**  
ASS'T. PRINGLE'S **POTATO CHIPS** 2 PAK **88¢**  
20¢ OFF LABEL DISH LIQUID  
**JOY DETERGENT** 32 OZ. BOTTLE **99¢**  
**PEPSI COLA** 6 PK. 12-OZ. CAN **\$1.28**  
VANITY FAIR **BATH TISSUE** 4 PAK **69¢**

WESTERN ICEBERG **LETTUCE** LARGE HEAD 3 For **\$1**  
FRESH GREEN **CABBAGE** LB. **15¢**  
THOMPSON SEEDLESS WHITE **GRAPES** LB. **89¢**  
GENUINE IDAHO BAKING **POTATOES** 4 LBS. **\$1.00**  
GOLDEN RIPE **BANANAS** LB. **29¢**

**SUPER STAR SAVER**  
PICK-OF-THE-NEST GRADE 'A' **LARGE EGGS** **63¢** DOZ.

**SUPER STAR SAVER**  
**HANOVER FROZEN**  
•SHOEPEG CORN  
•WHOLE OKRA  
•CUT OKRA  
16-OZ. BAG. **59¢**  
•BABY LIMAS 16-OZ. BAG **69¢**

**SPECIAL STAR SAVER**  
**GATORADE** CITRUS OR ORANGE **DRINK** 32-OZ. BOTTLE **48¢**

**SPECIAL STAR SAVER**  
**SEVEN SEAS SALAD DRESSING**  
•FRENCH  
•1000 ISLAND  
•ITALIAN  
8-OZ. BOTTLE 2 FOR **\$1.00**

**OUR PRIDE**  
BUTTERMILK **BREAD** 3 24 OZ. LOAF **\$1.09**  
HOT DOG & HAMBURGER **BUNS** 3 8-CNT. PKGS. **\$1.00**  
BUTTER TOP **BREAD** 24-OZ. LOAF **49¢**  
ALL SHION **BREAD** 16-OZ. LOAF **29¢**

FARM CHARM ICE CREAM **SANDWICHES** 6 CNT. BOX **78¢**  
FARM CHARM REG. OR LOW FAT **COTTAGE CHEESE** 24 OZ. CARTON **\$1.09**  
IDAHOAN INSTANT **POTATOES** 16-OZ. SIZE 2 FOR **\$1.00**  
PACKER'S LABEL SHOESTRING **POTATOES** 20-OZ. BAG 3 FOR **\$1.00**  
VALU PLUS **BLEACH** 1 GAL. **59¢**

FARM CHARM ICE CREAM 1/2 GAL. **\$1.09**  
OUR PRIDE ASS'T. POTATO CHIPS 2 PAK **68¢**  
•PEPPERONI•SAUSAGE•HAMBURGER **JENO'S PIZZAS** 12 OZ. **\$1.09**  
BIG STAR **TEA BAGS** 100-CNT. SIZE **\$1.29**  
WESTINGHOUSE PREMIUM EYE SAVER •60 •75 •100 WATTS BUY ONE GET ONE FREE!  
SUPER SUDS **DETERGENT** 40 OZ. BOX **78¢**

SAVE ON HEALTH & BEAUTY **AIDS!**  
8-CNT. SCHICK SUPER II **RAZOR BLADES** **\$1.99**  
15-CNT. SCHICK PLATINUM PLUS **INJECTOR BLADES** **\$1.99**  
12-OZ. LISTERINE **MOUTHWASH** **\$1.18**  
400-CNT. **Q-TIPS SWABS** **\$1.25**  
**BUFFERIN TABLETS** 60 CNT. **\$1.38**  
ASS'T. CREST **TOOTHPASTE** 8-OZ. TUBE **\$1.25**

**MAXWELL HOUSE COFFEE** 2-LB. CAN **\$5.69**

**KRAFT ORANGE MARMALADE** 18-OZ. JAR **\$1.03**

**FOLGER'S COFFEE** ASS'T. 1-LB. BAG **\$2.69**

**RITZ CRACKERS** 16-OZ. BOX **97¢**

**SPECIAL STAR SAVER**  
**OUR PRIDE MACARONI & CHEESE** 4 7 1/4-OZ. PKGS. **\$1.00**



**SPECIAL STAR SAVER**  
**TEXAS PETE HOT DOG CHILI** 4 10 1/2-OZ. CANS **\$1.00**



**SPECIAL STAR SAVER**  
14 3/4-OZ. FRANCO AMERICAN **SPAGHETTI**  
16-OZ. POCOHONTAS **FIELD PEAS**  
16-OZ. MORAGA VALLEY **GREEN LIMAS**  
4 OF YOUR CHOICE **\$1.00**

**SPECIAL STAR SAVER**  
32-OZ. WHITE HOUSE **APPLE JUICE**  
14 3/4-OZ. FRANCO-AMERICAN **SPAGHETTI & MEATBALLS**  
15-OZ. FRANCO-AMERICAN **BEEF RAVIOLIOS**  
46-OZ. SEALD SWEET NATURAL **GRAPEFRUIT JUICE**  
4 FOR **\$1.09**



# How Tar Heel Representatives, Senators Voted

**Roll Call Report Service**  
WASHINGTON — Here's how area Members of Congress were recorded on major roll call votes July 19 through July 25.

**HOUSE**  
**AMTRAK** — The House rejected 197 for and 214 against, an amendment to continue the full 27,500-mile Amtrak passenger train network for another year. The amendment was proposed to HR 3996, a bill authorizing Amtrak operations in fiscal 1980 and beyond. As later passed and sent to the Senate, the bill cuts Amtrak to 22,000 miles in order to stem its massive financial losses.  
Rep. Albert Gore, Jr., D-Tenn., the sponsor, said that due to shortages of gasoline, passenger train service should be kept intact for at least another year.  
Rep. James Florio, D-N.J., an opponent, said that in preserving Amtrak's least-productive routes the House invites the failure of the entire system.

Members voting "yea" wanted to keep Amtrak at its present size during the fiscal year that begins Oct. 1.  
Reps. Walter Jones, D-1, Ike Andrews, D-4, Charles Rose, D-7, and W.G. Hefner, D-8, voted "yea."  
Reps. L.H. Fountain, D-2, Charles Whitley, D-3, Stephen Neal, D-5, Richardson Prever,

D-6, James Martin, R-9, James Broyhill, R-10, and Lamar Gudger, D-11, voted "nay."  
**STAFF INCREASE** — The House voted 214 for and 120 against, to allow House members to enlarge their staffs by up to four part-time or temporary positions. This raises the present ceiling of 18 aides that a member can have on his personal (as opposed to committee) staff. It leaves unchanged the \$288,000 limit on salaries for a member's personal staff. The measure (H Res 359) does not require Senate concurrence and takes effect Aug. 1.  
Rep. Carroll Campbell, R-S.C., a supporter, said the staff enlargement will give members "some flexibility for dealing with situations in their offices, such as a maternity leave, such as the need for a temporary employee to bring special expertise..."

Rep. Lucien Nedzi, D-Mich., an opponent, said the hike "will guarantee more staff proliferation and, in its train, a requirement for more space, more furniture, more parking, and more telephone."  
Rep. John Buchanan, R-Ala., an opponent, said: "The Constitution should never be amended in such a light and cavalier fashion. Would we rewrite the Bill of Rights on the floor of the House on the basis of one of two hours of debate?"

Members voting "nay" either favored busing or felt that amending the Constitution was an inappropriate response to the problems of busing.  
Jones, Neal, Martin, Broyhill and Gudger voted "yea."  
Fountain, Whitley, Andrews, Prever, Rose and Hefner voted "nay."

## Navy Gig Has Emergency Role

**CHARLESTON, W. Va. (AP)** — Its last assignment was carrying naval officers between a giant cruiser and the French Riviera. Its next task will be to carry local emergency crews to scenes of river disasters.  
"We've been looking for years for something like this for water rescue," said Richard Gray, chief of emergency services for Charleston and Kanawha County, of the retired captain's gig.  
Gray has a crew of 15 volunteers who have taken a U.S. Coast Guard course in boat handling and will be able to man the 28-foot vessel.

Members voting "yea" wanted larger personal staffs.  
Jones, Fountain, Whitley, Andrews, Neal, Prever, Rose, Broyhill and Gudger voted "yea."  
Martin voted "nay."  
Hefner did not vote.

**SCHOOL BUSING** — By a vote of 209 for and 216 against, the House failed to achieve the two-thirds majority needed to approve a proposed "neighborhood schools" constitutional amendment. The measure was designed primarily to outlaw court-ordered busing to integrate schools.  
Rep. Ronald Mottl, D-Ohio, the sponsor, said court-ordered busing "is a social policy imposed by an activist judiciary, and it is a mistaken social policy that is leading to the virtual destruction of public education at neighborhood schools in cities where it is used."

Rep. John Buchanan, R-Ala., an opponent, said: "The Constitution should never be amended in such a light and cavalier fashion. Would we rewrite the Bill of Rights on the floor of the House on the basis of one of two hours of debate?"

Members voting "nay" either favored busing or felt that amending the Constitution was an inappropriate response to the problems of busing.  
Jones, Neal, Martin, Broyhill and Gudger voted "yea."  
Fountain, Whitley, Andrews, Prever, Rose and Hefner voted "nay."

## SENATE ELECTION COMMISSIONER

The Senate confirmed 73 for and 25 against, President Carter's nomination of Frank Reiche, a New Jersey Republican, to the Federal Election Commission.  
Reiche was opposed by many Seante Republicans who doubted that he was a sufficiently partisan Republican and dislike his refusal to oppose public financing of congressional campaigns. The FEC, which enforces

federal election laws, has three Democratic and three GOP commissioners.  
Sen. Mark Matfield, R-Ore., a supporter, criticized "those who lead people to believe they represent true Republicanism..."  
Sen. Orrin Hatch, R-Utah, an opponent, said that if Reiche proves to be "not a partisan Republican" the Democratic Party point of view could prevail on the FEC.

Senators voting "nay" opposed the nominations.  
Sens. Robert Morgan, D, and Jesse Helms, R, voted "nay."  
**ABORTION** — The Senate adopted 57 for and 42 against, a more conservative position on the abortion issue. The language was included in an appropriations bill (HR 4389) later passed and sent to conference with the House. It permits federally-funded abortions when (1) the mother's life is endangered, (2) the pregnancy is the result of rape or incest, or (3) two doctors say the pregnancy will harm the mother's health.

This vote puts the Senate more in harmony with the harder-line House, thus diminishing the chance of another months-long congressional standoff on the abortion issue.  
Sen. Birch Bayh, D-Ind., a supporter, said that due to the House's hard line the language "is about the best we can do under the circumstances."  
Sen. Robert Packwood, R-Ore., an opponent, said taking a harder line against federally-funded abortions "only denies to poor women equal access to this medical service."

Senators voting "yea" were anxious to compromise with the House on the abortion issue.  
Morgan voted "yea."  
Helms voted "nay."

**SAVE GAS ON AIR**  
**NEW YORK (AP)** — A recent survey by the Illinois Institute of Technology found that 50 to 70 percent of tires checked were underinflated during the summer and 60 to 80 percent had the same deficiency during the winter.  
Not only is proper inflation crucial to the performance and safety of tires, says Firestone's director of consumer affairs Jack B. Scarliff, it also helps lower gas consumption, since underinflation increases rolling resistance.

from your neighborhood ASSOCIATED DRUGGISTS

## A SCHOOL DAZE SALE August 1-7, 1979

<b>GAVISON ANTACID</b> 100 Tablets Mfg. List \$6.11 <b>\$3.37</b>	<b>CREST TOOTH PASTE</b> Regular or Mint 9 oz. Mfg. List \$2.49 <b>\$1.19</b>	<b>VASELINE INTENSIVE CARE</b> Baby Oil 16 oz. Baby Powder 24 oz. Baby Shampoo 16 oz. Mfg. List \$1.91 Ea. <b>\$ .99</b>
<b>STAYFREE MAXI-PADS</b> Regular or Super 12's Mfg. List \$1.59 <b>\$.99</b>	<b>PEPSODENT TOOTHBRUSHES</b> Hard or Soft Mfg. List \$1.99 Ea. <b>3/\$1.00</b>	<b>SECRET</b> Regular or New Unscented 2.5 oz. Mfg. List \$1.59 <b>\$.89</b>
<b>FLEX SHAMPOO</b> Normal or Oily or FLEX CONDITIONER Regular or Extra Body 16 oz. Mfg. List \$2.60 <b>\$1.39</b>	<b>SANKYO CLOCK RADIO</b> AM-FM Deluxe Digital Woodgrain Finish Mfg. List \$24.95 <b>\$24.88</b>	<b>BAND-AID BRAND</b> Adhesive Bandages Sheer or Plastic 70's Mfg. List \$2.19 <b>\$1.29</b>
<b>SECRET</b> Regular or New Unscented 2.5 oz. Mfg. List \$1.59 <b>\$.89</b>	<b>KNEE HI HOSIERY</b> Ass 1 Colors Mfg. List \$1.29 <b>\$.99</b>	<b>BAND-AID BRAND</b> Adhesive Bandages Sheer or Plastic 70's Mfg. List \$2.19 <b>\$1.29</b>
<b>SURBEX-T</b> Vitamin B Complex With Vitamin C 100's Mfg. List \$8.95 <b>\$6.19</b>	<b>BABY BEN ALARM CLOCK</b> By Weston Key Wind with Day & Date Mfg. List \$15.19 <b>\$9.88</b>	<b>SOFF COSMETIC PUFFS</b> By Johnson and Johnson 100's Triple Size Mfg. List \$1.29 <b>\$.69</b>
<b>RAVE HAIR SPRAY</b> Regular 1 oz. Aerosol Mfg. List \$1.85 <b>\$.97</b>	<b>CONAIR HAIR BLOWER</b> Two Temperature Control One Year Warranty 1000 Watts Mfg. List \$18.99 <b>\$11.88</b>	<b>COTTON SWABS</b> By Johnson and Johnson 300's Mfg. List \$2.16 <b>\$1.19</b>
<b>AYD'S CANDY</b> Reducing Plan Vanilla or Chocolate 2.75 oz. <b>\$1.59</b>	<b>CONAIR LOTS'A CURL</b> Dry Curling Iron Dry Hair Warranty Mfg. List \$7.99 <b>\$4.88</b>	<b>ROSE MILK SKIN CREAM</b> With Free 2.75 oz. Travel Size 12 oz. Mfg. List \$2.59 <b>\$1.49</b>
<b>JOHNSON'S ODOR EATERS</b> Regular or Ladies' Brown Mfg. List \$1.59 <b>\$.88</b>	<b>CONAIR LOTS'A CURL</b> Dry Curling Iron Dry Hair Warranty Mfg. List \$7.99 <b>\$4.88</b>	<b>PLAYTEX DEODORANT TAMPONS</b> Regular or Super 28's Mfg. List \$2.99 <b>\$1.77</b>

WE RESERVE THE RIGHT TO LIMIT QUANTITIES AT SALE PRICES.

**Biggs Drug Store**  
300 Evans On-The-Mall  
Opposite Courthouse  
Greenville, N.C.

**Hargett's Drug Store**  
2500 S. Charles St.  
Greenville, N.C.

## 160 taste-tingling glasses in one jar.

No kidding. There are 160 8-oz., cold, taste-tingling, ice-crackling glasses of real tea in every 4-oz. jar of Nestea® Instant 100% Tea. That's a lot of refreshment. A lot of taste. And a lot of economy. And with the coupon below, it's even more economical. So use it.



**105¢**

**STORE COUPON**

### SAVE 18¢

on any size jar or canister of Nestea® or Down Home™ Lemonade.

**TO THE DEALER:** This coupon will be redeemed only as follows: For amount specified plus 5¢ for handling, provided coupon is received from customer or purchase of listed merchandise. Proof of purchase of sufficient stock of merchandise to cover coupons submitted must be shown on request. Failure to comply may void all coupons submitted for redemption. Redemptions not limited through brokers or other outside agencies. Coupons are non-transferable and void if use is prohibited, taxed, restricted or in excess of required. Customer must pay any sales tax. Cash redemption value: 1.00¢.

**FOR REDEMPTION MAIL TO THE NESTEA COMPANY, INC., P.O. BOX 1500, ELM CITY, N.C. 27826. OFFER GOOD ONLY IN THE U.S.A. LIMIT ONLY ONE COUPON MAY BE RECEIVED PER UNIT OF PRODUCT PURCHASED. GOOD ONLY ON NESTEA® PRODUCTS LISTED IN THIS COUPON. ANY OTHER USE CONSTITUTES FRAUD. EXPIRES OCTOBER 31, 1979.**

577501

© 1979 The Nestlé Co., Inc.

## TAKE THE NESTEA PLUNGE!

# SUMMER SAVINGS



## SAVE 60¢

**Secret® Strong enough for a man but made for a woman.**

**Wondra® Takes the day's work right out of your hands.**

**The Prells. For fresh full-looking hair.**

9677SE TAKE THIS COUPON TO YOUR STORE

### SAVE 15¢ On NEW Secret Unscented Anti-Perspirant Spray

(or any other type or size Secret)

LIMIT ONE COUPON PER PURCHASE

TO THE CONSUMER: CAUTION: Don't embarrass your dealer by asking him to redeem coupons without making the required purchase. He must redeem coupons properly to get his money back. REMEMBER: coupons are good only on the brands listed. For any other use, consult your dealer.

TO THE DEALER: You are authorized to act as our agent for the redemption of this coupon. We will reimburse you for the face value of this coupon. A coupon can be for free merchandise in this coupon for reimbursement you represent that you redeemed a purchase to these terms. Any failure to enforce these terms shall not be deemed a waiver of any of the conditions. TERMS OF COUPON OFFER: This coupon must be redeemed by a consumer at the time of purchase of the brand or brands listed on the face of the coupon being deducted from the dealer's retail selling price. This coupon is non-transferable and may not be reproduced. The consumer must pay any sales tax on the purchase of the merchandise. Proof of purchase of sufficient stock of merchandise to cover coupons presented must be shown upon request and for all coupons submitted for redemption. Redemptions not limited through brokers or other outside agencies. Coupons are non-transferable and void if use is prohibited, taxed, restricted or in excess of required. Customer must pay any sales tax. Cash redemption value: 15¢.

PROCTER & GAMBLE 343250

9679W0 TAKE THIS COUPON TO YOUR STORE

### SAVE 25¢ when you buy one 6 oz., 10 oz., or 15 oz. size Wondra® SKIN CONDITIONING LOTION

LIMIT ONE COUPON PER PURCHASE

TO THE CONSUMER: CAUTION: Don't embarrass your dealer by asking him to redeem coupons without making the required purchase. He must redeem coupons properly to get his money back. REMEMBER: coupons are good only on the brands listed. For any other use, consult your dealer.

TO THE DEALER: You are authorized to act as our agent for the redemption of this coupon. We will reimburse you for the face value of this coupon. A coupon can be for free merchandise in this coupon for reimbursement you represent that you redeemed a purchase to these terms. Any failure to enforce these terms shall not be deemed a waiver of any of the conditions. TERMS OF COUPON OFFER: This coupon must be redeemed by a consumer at the time of purchase of the brand or brands listed on the face of the coupon being deducted from the dealer's retail selling price. This coupon is non-transferable and may not be reproduced. The consumer must pay any sales tax on the purchase of the merchandise. Proof of purchase of sufficient stock of merchandise to cover coupons presented must be shown upon request and for all coupons submitted for redemption. Redemptions not limited through brokers or other outside agencies. Coupons are non-transferable and void if use is prohibited, taxed, restricted or in excess of required. Customer must pay any sales tax. Cash redemption value: 25¢.

PROCTER & GAMBLE 343250

9681PR TAKE THIS COUPON TO YOUR STORE

### SAVE 20¢ when you buy one Imperial Size Pell® 16 oz. LIQUID, or 7 oz. CONCENTRATE, or 2 any other size

LIMIT ONE COUPON PER PURCHASE

TO THE CONSUMER: CAUTION: Don't embarrass your dealer by asking him to redeem coupons without making the required purchase. He must redeem coupons properly to get his money back. REMEMBER: coupons are good only on the brands listed. For any other use, consult your dealer.

TO THE DEALER: You are authorized to act as our agent for the redemption of this coupon. We will reimburse you for the face value of this coupon. A coupon can be for free merchandise in this coupon for reimbursement you represent that you redeemed a purchase to these terms. Any failure to enforce these terms shall not be deemed a waiver of any of the conditions. TERMS OF COUPON OFFER: This coupon must be redeemed by a consumer at the time of purchase of the brand or brands listed on the face of the coupon being deducted from the dealer's retail selling price. This coupon is non-transferable and may not be reproduced. The consumer must pay any sales tax on the purchase of the merchandise. Proof of purchase of sufficient stock of merchandise to cover coupons presented must be shown upon request and for all coupons submitted for redemption. Redemptions not limited through brokers or other outside agencies. Coupons are non-transferable and void if use is prohibited, taxed, restricted or in excess of required. Customer must pay any sales tax. Cash redemption value: 20¢.

PROCTER & GAMBLE 343250

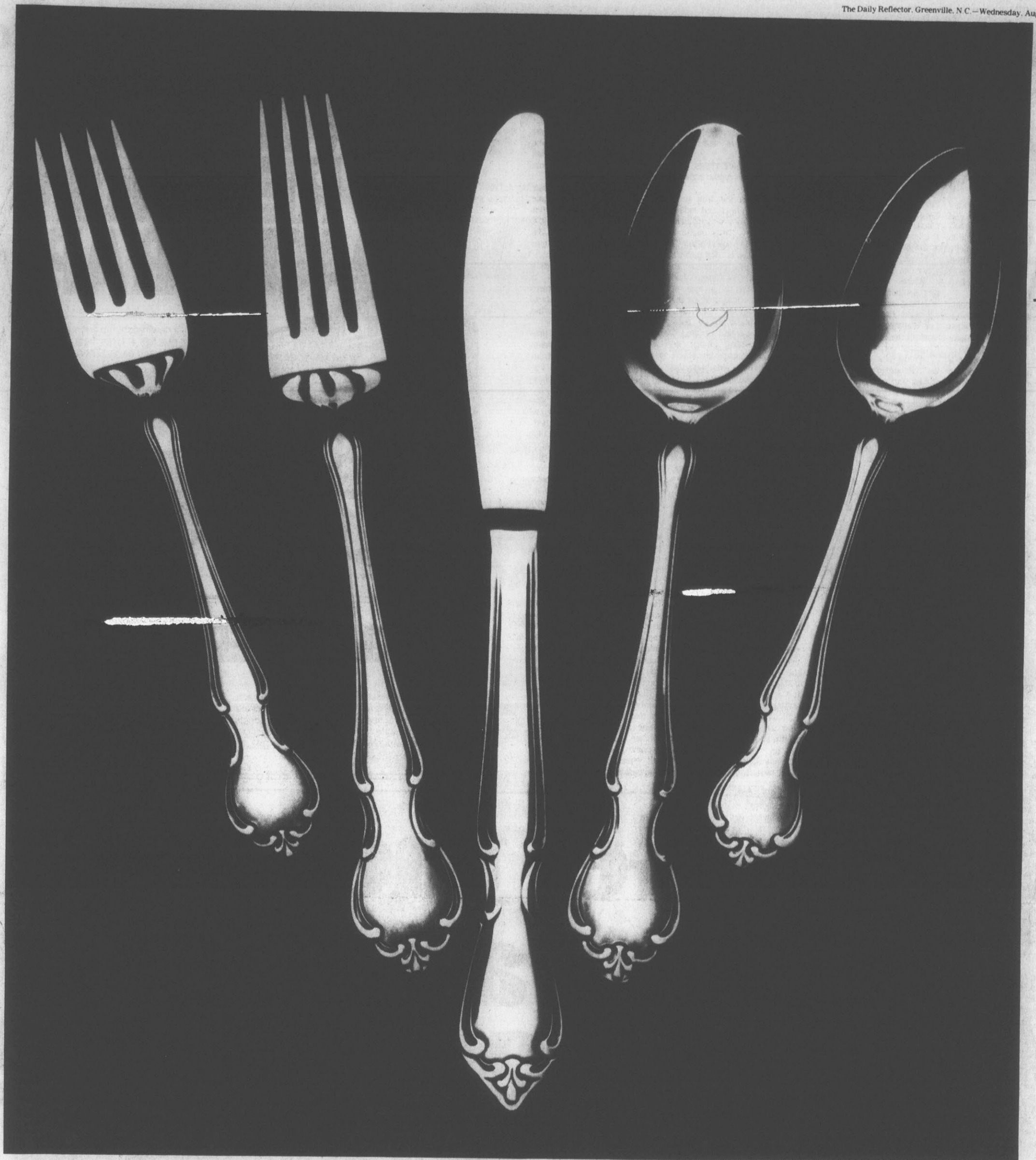

# FREE STAINLESS WITH THE NEWEST SAVINGS RATES A BANK CAN PAY.

Great news for savers. Planters now offers you the newest and the highest interest rates allowed any bank by law.

And something more.

Outstanding stainless flatware, free or at a special savings when you make the qualifying deposits.

There's the new 5 1/4% rate on regular savings, just part of our exclusive All-American Savings program.

Plus the brand-new, four-year Certificate of Deposit with interest at 1 1/4% below the average four-year yield for U.S. Treasury securities. The rate is set at purchase.

PLANTERS ALL-AMERICAN SAVINGS		
RATE	MATURITY	STAINLESS OFFER
NEW 5 1/4%	REGULAR SAVINGS	FREE 5-piece place setting with \$100 deposit. Additional \$25 deposits purchase additional settings and accessories at \$3.95 each.
5 1/2%	90 DAYS	
6%	1 YEAR	
6 1/2%	2 1/2 YEARS	
PLANTERS CERTIFICATES OF DEPOSIT		
RATE	MATURITY	STAINLESS OFFER
7 1/4%	4 YEARS	Complete 50-piece service for eight is only \$39.95 with a \$5,000 deposit. \$43.95 for a \$1,000-\$4,999 deposit. And \$49.95 for a \$500-\$999 deposit.
7 1/2%	6 YEARS	
7 3/4%	8 YEARS	
Phone For Current Rate	NEW 4 YEAR 6 MONTHS	

Substantial interest penalty required for early withdrawal, except for regular savings.

And to help you celebrate your first-rate earnings, top-rate stainless flatware from International Silver.

Available in classic Empress (shown) or striking Serenata. They're made of the highest-grade stainless and their quality and styling truly have to be seen and handled to be appreciated.

Take a look at our chart, then call or drop by the Planters Bank nearest you. You'll earn the newest savings rates a bank can pay.

And you'll get beautiful stainless, that's a steal.

**A PRACTICAL APPROACH TO MONEY.**

**PLANTERS NATIONAL BANK**

Member FDIC.

# How Tar Heel Representatives, Senators Voted

**Roll Call Report Service**  
WASHINGTON — Here's how area MEMBERS of Congress were recorded on major roll call votes July 19 through July 25.

**HOUSE**  
**AMTRAK** — The House rejected, 197 for and 214 against, an amendment to continue the full 27,500-mile Amtrak passenger train network for another year. The amendment was proposed to HR 3996, a bill authorizing Amtrak operations in fiscal 1980 and beyond. As later passed and sent to the Senate, the bill cuts Amtrak to 22,000 miles in order to stem its massive financial losses.

Rep. Albert Gore, Jr., D-Tenn., the sponsor, said that due to shortages of gasoline, passenger train service should be kept intact for at least another year.

Rep. James Florio, D-N.J., an opponent, said that in preserving Amtrak's least-productive routes the House invites the failure of the entire system.

Members voting "yea" wanted to keep Amtrak at its present size during the fiscal year that begins Oct. 1.

Reps. Walter Jones, D-1, Ike Andrews, D-4, Charles Rose, D-7, and W.G. Hefner, D-8, voted "yea."

Reps. L.H. Fountain, D-2, Charles Whitley, D-3, Stephen Neal, D-5, Richardson Prever,

D-6, James Martin, R-9, James Broyhill, R-10, and Lamar Gudger, D-11, voted "nay."

**STAFF INCREASE** — The House voted, 214 for and 120 against, to allow House members to enlarge their staffs by up to four part-time or temporary positions. This raises the present ceiling of 18 aides that a member can have on his personal (as opposed to committee) staff. It leaves unchanged the \$288,000 limit on salaries for a member's personal staff. The measure (H Res 359) does not require Senate concurrence and takes effect Aug. 1.

Rep. Carroll Campbell, R-S.C., a supporter, said the staff enlargement will give members "some flexibility for dealing with situations in their offices, such as a maternity leave, such as the need for a temporary employee to bring special expertise."

Rep. Lucien Nedzi, D-Mich., an opponent, said the hike "will guarantee more staff proliferation and, in its train, a requirement for more space, more furniture, more parking, and more telephone."

## Navy Gig Has Emergency Role

CHARLESTON, Va. (AP) — Its last assignment was carrying naval officers between a giant cruiser and the French Riviera. Its next task will be to carry local emergency crews to scenes of river disasters.

"We've been looking for years for something like this for water rescue," said Richard Gray, chief of emergency services for Charleston and Kanawha County, of the retired captain's gig.

Gray has a crew of 15 volunteers who have taken a U.S. Coast Guard course in boat handling and will be able to man the 28-foot vessel.

Members voting "yea" wanted larger personal staffs.

Jones, Fountain, Whitley, Andrews, Neal, Preyer Rose, Broyhill and Gudger voted "yea."

Martin voted "nay." Hefner did not vote.

**SCHOOL BUSING** — By a vote of 209 for and 216 against, the House failed to achieve the two-thirds majority needed to approve a proposed "neighborhood schools" constitutional amendment. The measure was designed primarily to outlaw court-ordered busing to integrate schools.

Rep. Ronald Mottl, D-Ohio, the sponsor, said court-ordered busing "is a social policy imposed by an activist judiciary, and it is a mistaken social policy that is leading to the virtual destruction of public education at neighborhood schools in cities where it is used."

Rep. John Buchanan, R-Ala., an opponent, said: "The Constitution should never be amended in such a light and cavalier fashion. Would we rewrite the Bill of Rights on the floor of the House on the basis of one of two hours of debate?"

Members voting "nay" either favored busing or felt that amending the Constitution was an inappropriate response to the problems of busing.

Jones, Neal, Martin, Broyhill and Gudger voted "yea."

Fountain, Whitley, Andrews, Preyer, Rose and Hefner voted "nay."

**SENATE ELECTION COMMISSIONER** — The Senate confirmed, 73 for and 25 against, President Carter's nomination of Frank Reiche, a New Jersey Republican, to the Federal Election Commission.

Reiche was opposed by many Senate Republicans who doubted that he was a sufficiently partisan Republican and dislike his refusal to oppose public financing of congressional campaigns. The FEC, which enforces

federal election laws, has three Democratic and three GOP commissioners.

Sen. Mark Matfield, R-Ore., a supporter, criticized "those who lead people to believe they represent true Republicanism."

Sen. Orrin Hatch, R-Utah, an opponent, said that if Reiche proves to be "not a partisan Republican" the Democratic Party point of view could prevail on the FEC.

Senators voting "nay" opposed the nominations.

Sens. Robert Morgan, D, and Jesse Helms, R, voted "nay."

**ABORTION** — The Senate adopted, 57 for and 42 against, a more conservative position on the abortion issue. The language was included in an appropriations bill (HR 4389) later passed and sent to conference with the House. It permits federally-funded abortions when (1) the mother's life is endangered, (2) the pregnancy is the result of rape or incest, or (3) two doctors say the pregnancy will harm the mother's health.

This vote puts the Senate more in harmony with the harder-line House, thus diminishing the chance of another months-long congressional standoff on the abortion issue.

Sen. Birch Bayh, D-Ind., a supporter, said that due to the House's hard line the language "is about the best we can do under the circumstances."

Sen. Robert Packwood, R-Ore., an opponent, said taking a harder line against federally-funded abortions "only denies to poor women equal access to this medical service."

Senators voting "yea" were anxious to compromise with the House on the abortion issue.

Morgan voted "yea."

Helms voted "nay."

## 160 taste-tingling glasses in one jar.

No kidding. There are 160 8-oz., cold, taste-tingling, ice-crackling glasses of real tea in every 4-oz. jar of Nestea® Instant 100% Tea. That's a lot of refreshment. A lot of taste. And a lot of economy. And with the coupon below, it's even more economical. So use it.



105LLS STORE COUPON

**SAVE 18¢**

on any size jar or canister of Nestea® or Down Home™ Lemonade.

TO THE DEALER: This coupon will be redeemed only as follows: For amount specified plus 1¢ for handling, provided coupon is received from customer on purchase of listed merchandise. Proof of purchase of sufficient stock of merchandise to cover coupons submitted must be shown on request. Failure to comply may void all coupons submitted for redemption. Redemptions not honored through brokers or other outside agencies. Coupons are nontransferable and void if date is prohibited, taxed, restricted or license is required. Customer must pay any sales tax. Cash redemption value: 1.00¢.

FOR REDEMPTION, MAIL TO THE NESTLE COMPANY, INC., P.O. BOX 13000, EMERYVILLE, N.C. 27838. OFFER GOOD ONLY IN THE U.S.A. LIMIT ONE COUPON PER UNIT OF PRODUCT PURCHASED. GOOD ONLY ON NESTEA® PRODUCTS LISTED IN THIS COUPON. ANY OTHER USE CONSTITUTES FRAUD.

EXPIRES OCTOBER 31, 1979.

577501

© 1979 The Nestlé Co., Inc.

### TAKE THE NESTEA PLUNGE!

from your neighborhood ASSOCIATED DRUGGISTS

## A SCHOOL DAZE SALE

August 1-7, 1979

<b>GAVISCAN ANTACID</b> 100's Mg. List \$6.11 <b>\$3.37</b>	<b>CREST TOOTH PASTE</b> 9 oz. Mg. List \$2.49 <b>\$1.19</b>	<b>VASELINE INTENSIVE CARE</b> Baby Oil 16 oz. Baby Powder 24 oz. Baby Shampoo 16 oz. Mg. List \$1.91 Ea. <b>\$.99</b>
<b>STAYFREE MAXI-PADS</b> Regular or Super 12's Mg. List to \$1.59 <b>\$.99</b>	<b>PEPSODENT TOOTHBRUSHES</b> Hard or Soft Mg. List \$ .89 Ea. <b>3/\$1.00</b>	<b>FOSTEX CAKE</b> For Ache and Dry Skin 3.75 oz. Mg. List \$1.65 <b>\$.97</b>
<b>FLEX SHAMPOO</b> Normal or Dry or <b>FLEX CONDITIONER</b> Regular or Extra Body 16 oz. Mg. List to \$2.60 <b>\$1.39</b>	<b>SANKYO CLOCK RADIO</b> All Day Alarm Digital Woodgrain Finish Mg. List \$34.95 <b>\$24.88</b>	<b>SCHICK DOUBLE EDGE</b> Plus Platinum Blades 5's Mg. List \$2.19 <b>3/\$1.00</b>
<b>SECRET Anti-Perspirant</b> Regular or New Unscented 2.5 oz. Mg. List \$1.89 <b>\$.89</b>	<b>KNEE HI HOUSIERY</b> Ass 1 Color Pkg. of 3 Pair Mg. List \$1.29 <b>\$.99</b>	<b>BAND-AID BRAND Adhesive Bandages</b> Sheer or Plastic 10's Mg. List \$2.19 <b>\$1.29</b>
<b>SURBEX-T</b> Vitamin B-Complex With Vitamin C 10's Mg. List \$8.95 <b>\$6.19</b>	<b>BABY BEN ALARM CLOCK</b> Key Wound With Day & Date Mg. List \$15.19 <b>\$9.88</b>	<b>SOFF COSMETIC PUFFS</b> By Johnson and Johnson 10's 1/2 Size Mg. List \$1.29 <b>\$.69</b>
<b>RAVE HAIR SPRAY</b> 1/2 gal. 7 oz. Aerosol or Regular 4 oz. Pump Mg. List \$1.85 <b>\$.97</b>	<b>CONAIR HAIR BLOWER</b> Two Temperature Control One Year Warranty 1000 Watts Mg. List \$18.99 <b>\$11.88</b>	<b>COTTON SWABS</b> By Johnson and Johnson 300's Mg. List \$2.16 <b>\$1.19</b>
<b>AYD'S CANDY</b> Reducing Plan Vanilla or Chocolate 12.75 oz. <b>\$1.59</b>	<b>CONAIR LOTS'A CURL</b> Reducing Plan One Year Warranty Mg. List \$7.99 <b>\$4.88</b>	<b>ROSE MILK SKIN CREAM</b> With Free 2.75 oz. Travel Tube 12 oz. Mg. List \$2.59 <b>\$1.49</b>
<b>JOHNSON'S ODOR EATERS</b> Regular or Leather Brown Mg. List \$1.59 <b>\$.88</b>	<b>PLAYTEX DEODORANT TAMPONS</b> Regular or Super 28's Mg. List \$2.99 <b>\$1.77</b>	

WE RESERVE THE RIGHT TO LIMIT QUANTITIES AT SALE PRICES

**Biggs Drug Store**  
300 Evans On-The-Mall  
Opposite Courthouse  
Greenville, N.C.

**Hargett's Drug Store**  
2500 S. Charles St.  
Greenville, N.C.

THESE ARE SUGGESTED SELLING PRICES. OPTIONAL WITH PARTICIPATING STORES.

# SUMMER SAVINGS

**Secret® Strong enough for a man but made for a woman.**

**Wondra® Takes the day's work right out of your hands.**

**The Pella® For fresh full-looking hair.**

98775E TAKE THIS COUPON TO YOUR STORE

**SAVE 15¢** On NEW Secret® Unscented Anti-Perspirant Spray (or any other type or size Secret)

LIMIT ONE COUPON PER PURCHASE

TO THE CONSUMER: CAUTION: Don't embarrass your dealer by asking him to redeem coupons without making the required purchase. He must redeem coupons properly to get his money back. REMEMBER: Coupons are good only on the brands listed for. Any other use constitutes fraud.

TO THE DEALER: You are authorized to act as our agent for the redemption of this coupon. We will reimburse you for the face value of this coupon or 1/2 of the face value of this coupon for free merchandise we will reimburse you for such free goods plus 5¢ for handling, provided that you and the consumer have complied with the terms of this coupon offer. By submitting this coupon for reimbursement you represent that you received it pursuant to these terms. Any failure to enforce these terms shall not be deemed a waiver of any of the conditions. TERMS OF COUPON OFFER: This coupon must be redeemed by a consumer at the time of purchase of the brand and size indicated in the coupon. Proof of purchase of sufficient stock of our brands to cover coupons presented must be shown upon request and may be voided if all coupons submitted for reimbursement for which no proof of products purchased is shown. Properly redeemed coupons will be accepted for reimbursement if identified by the retail distributor of our merchandise who redeemed them in connection with sales to the consumer of the goods and/or services for which the coupons have been redeemed who has by written agreement with Procter & Gamble agreed to accept financial responsibility for the redemption of the coupons. COUPONS SHOULD BE SHIPPED AT OUR EXPENSE TO PROCTER & GAMBLE, 2350 SULLYBROOK DRIVE, CINCINNATI, OHIO 45221.

PROCTER & GAMBLE 343250

9879W0 TAKE THIS COUPON TO YOUR STORE

**SAVE 25¢** when you buy one 6 oz., 10 oz., or 15 oz. size Wondra® SKIN CONDITIONING LOTION

LIMIT ONE COUPON PER PURCHASE

TO THE CONSUMER: CAUTION: Don't embarrass your dealer by asking him to redeem coupons without making the required purchase. He must redeem coupons properly to get his money back. REMEMBER: Coupons are good only on the brands listed for. Any other use constitutes fraud.

TO THE DEALER: You are authorized to act as our agent for the redemption of this coupon. We will reimburse you for the face value of this coupon or 1/2 of the face value of this coupon for free merchandise we will reimburse you for such free goods plus 5¢ for handling, provided that you and the consumer have complied with the terms of this coupon offer. By submitting this coupon for reimbursement you represent that you received it pursuant to these terms. Any failure to enforce these terms shall not be deemed a waiver of any of the conditions. TERMS OF COUPON OFFER: This coupon must be redeemed by a consumer at the time of purchase of the brand and size indicated in the coupon. Proof of purchase of sufficient stock of our brands to cover coupons presented must be shown upon request and may be voided if all coupons submitted for reimbursement for which no proof of products purchased is shown. Properly redeemed coupons will be accepted for reimbursement if identified by the retail distributor of our merchandise who redeemed them in connection with sales to the consumer of the goods and/or services for which the coupons have been redeemed who has by written agreement with Procter & Gamble agreed to accept financial responsibility for the redemption of the coupons. COUPONS SHOULD BE SHIPPED AT OUR EXPENSE TO PROCTER & GAMBLE, 2350 SULLYBROOK DRIVE, CINCINNATI, OHIO 45221.

PROCTER & GAMBLE 343250

9881PR TAKE THIS COUPON TO YOUR STORE

**SAVE 20¢** when you buy one Imperial Size Pella® 16 oz. LIQUID, or 7 oz. CONCENTRATE, or 2 any other size

LIMIT ONE COUPON PER PURCHASE

TO THE CONSUMER: CAUTION: Don't embarrass your dealer by asking him to redeem coupons without making the required purchase. He must redeem coupons properly to get his money back. REMEMBER: Coupons are good only on the brands listed for. Any other use constitutes fraud.

TO THE DEALER: You are authorized to act as our agent for the redemption of this coupon. We will reimburse you for the face value of this coupon or 1/2 of the face value of this coupon for free merchandise we will reimburse you for such free goods plus 5¢ for handling, provided that you and the consumer have complied with the terms of this coupon offer. By submitting this coupon for reimbursement you represent that you received it pursuant to these terms. Any failure to enforce these terms shall not be deemed a waiver of any of the conditions. TERMS OF COUPON OFFER: This coupon must be redeemed by a consumer at the time of purchase of the brand and size indicated in the coupon. Proof of purchase of sufficient stock of our brands to cover coupons presented must be shown upon request and may be voided if all coupons submitted for reimbursement for which no proof of products purchased is shown. Properly redeemed coupons will be accepted for reimbursement if identified by the retail distributor of our merchandise who redeemed them in connection with sales to the consumer of the goods and/or services for which the coupons have been redeemed who has by written agreement with Procter & Gamble agreed to accept financial responsibility for the redemption of the coupons. COUPONS SHOULD BE SHIPPED AT OUR EXPENSE TO PROCTER & GAMBLE, 2350 SULLYBROOK DRIVE, CINCINNATI, OHIO 45221.

PROCTER & GAMBLE 343250

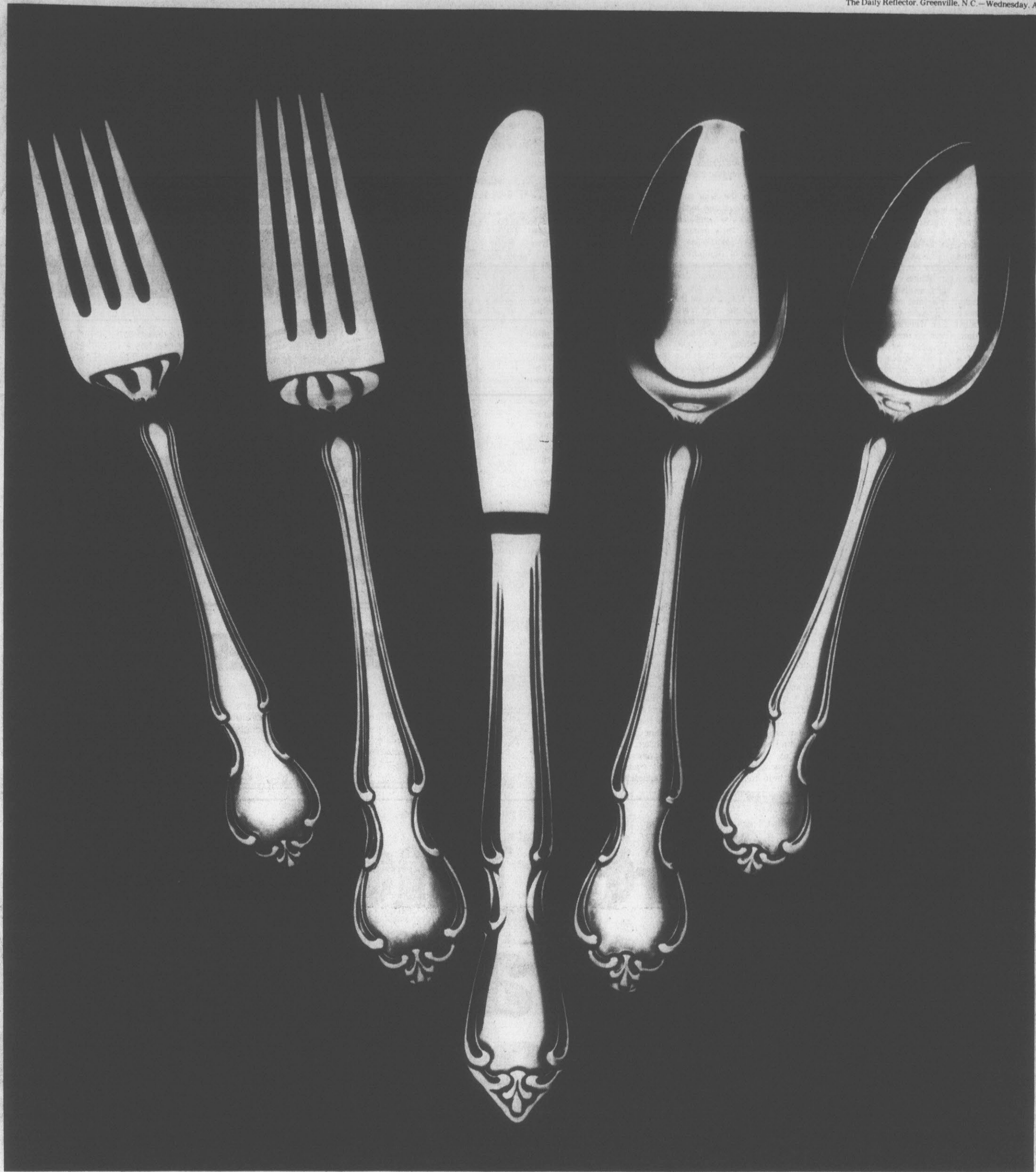

# FREE STAINLESS WITH THE NEWEST SAVINGS RATES A BANK CAN PAY.

Great news for savers. Planters now offers you the newest and the highest interest rates allowed any bank by law.

And something more.

Outstanding stainless flatware, free or at a special savings when you make the qualifying deposits.

There's the new 5 1/4% rate on regular savings, just part of our exclusive All-American Savings program.

Plus the brand-new, four-year Certificate of Deposit with interest at 1 1/4% below the average four-year yield for U.S. Treasury securities. The rate is set at purchase.

PLANTERS ALL-AMERICAN SAVINGS		
RATE	MATURITY	STAINLESS OFFER
NEW 5 1/4%	REGULAR SAVINGS	FREE 5-piece place setting with \$100 deposit. Additional \$25 deposits purchase additional settings and accessories at \$3.95 each.
5 1/2%	90 DAYS	
6%	1 YEAR	
6 1/2%	2 1/2 YEARS	
PLANTERS CERTIFICATES OF DEPOSIT		
RATE	MATURITY	STAINLESS OFFER
7 1/4%	4 YEARS	Complete 50-piece service for eight is only \$39.95 with a \$5,000 deposit. \$43.95 for a \$1,000-\$4,999 deposit. And \$49.95 for a \$500-\$999 deposit.
7 1/2%	6 YEARS	
7 3/4%	8 YEARS	
Phone For Current Rate	NEW 4 YEAR 6 MONTHS	
Substantial interest penalty required for early withdrawal, except for regular savings.		

And to help you celebrate your first-rate earnings, top-rate stainless flatware from International Silver.

Available in classic Empress (shown) or striking Serenata. They're made of the highest-grade stainless and their quality and styling truly have to be seen and handled to be appreciated.

Take a look at our chart, then call or drop by the Planters Bank nearest you. You'll earn the newest savings rates a bank can pay.

And you'll get beautiful stainless, that's a steal.

A PRACTICAL APPROACH TO MONEY.

**PLANTERS  
NATIONAL  
BANK**

Member FDIC.

# Black Druggist Says Economics Now Battlefield

By RICHARD H. GROWALD  
UPI National Reporter  
CLARKSDALE, Miss. (UPI) — Once upon a time, before Martin Luther King, before the overcoming, before black was beautiful, white was white and black was black and the railroad tracks were the border.

Above the tracks downtown Clarksdale was white and manners and mores operated as in olden days when cotton first came to this flat delta country. Blacks had such titles as Mister and Missus only below the tracks, in black Fourth Street.

Then came the civil rights struggles of the past generation. Martin Luther King visited Fourth Street. Hubert Humphrey, the onetime Minnesota pharmacist, spent much of a day behind the counter in Aaron Henry's Fourth Street drugstore.

And now, today, in the delta where integration once seemed as distant as snow, the railroad tracks are a fuzziy border. Oh, it may look the same. Fourth Street, from Goon's Store down to the Sunflower River, is still all black. The sidewalk loungers in front of

the second hand stores and the drugstore are all black. But there is a difference.

Philip Sherman, a young and husky white man running for reelection as county attorney, stops and chats with a black man with a political style that knows today's Mississippi ballot box is color blind. And across the tracks, in what had been the white heartland, there are blacks on the police and firefighting forces, there are black city officials and through the bank's front window a black teller can be seen.

"Whites are now courteous and southern gentle manners are what once they were only supposed to be," said Willie Lee Watkins, 44, soda jerk and clerk in the Henry drugstore in Fourth Street.

"Whites now say 'Yes, sir' and 'No, sir' to us in the stores and no longer are we the last in line to be served," he said.

Watkins and his brothers and sisters can ride up front in the bus. The separate drinking fountains are long gone. The schools are integrated. But Watkins mashed a ball of chocolate ice cream 'maybe harder than needed into a cone. He was showing emotion.

"But I don't feel equal," he said.

"I can apply for a job but being black, my chances may not be too good at getting it. And blacks are not being promoted."

"We've got civil rights. The battle now is economic rights," Watkins said.

The walls of the drug store speak of yesterday and today. Five photographs of President John Kennedy. Three pictures of President Lyndon Johnson. A colored display of Humphrey's smile. A framed picture of an unsmiling Jimmy Carter. And each wall has a picture of Martin Luther King and, on the counter, beside the cash register, is an almost lifesize, gold-painted plaster bust of King.

The plaster King gives an Old Testament prophet's stare at a display of civil rights literature and signs reading "Be A First Class Citizen — Pay Your Poll Tax!" and "Register Now — Voting Means Freedom."

Behind the counter Clarence Cummings, 40, Henry's manager and pharmacist, pats the King bust. "People say I look just like King. They're wrong; Martin Luther King had more hair," he said.

Cummings, native of Clarksdale, once chopped cotton in delta fields for \$3 a day. His mother and father had moved to town in search of an education for their children — "We were real rural and didn't know what kind of tomorrow the children would have without an education today," his mother, Mrs. John Cummings, 65, said.

Cummings measured some pills into a thumb-sized bottle and said, "I found a program the State of Mississippi had going; they'd pay college costs if I'd just go to school outside of Mississippi."

"I went to Xavier College in New Orleans and Mississippi paid me \$300 to \$400 a semester to do that. I became a pharmacist. It was 1964 and I didn't want to return here.

"I couldn't work in New Orleans then. They didn't hire black pharmacists then. You almost had to pay them to let you work. I went to Newport News, Va." Last year he suffered a marital separation and an auto crash and came home to Clarksdale.

"I earn about \$9,000 a year here. I guess I could make \$20,000 back in Virginia. But I'm living with my folks and I told Aaron Henry I would take the pay cut so he could be free for his politics."

Henry is Mississippi's NAACP leader and is a candidate for the legislature. Cummings said, "Clarksdale is integrated. But a little on the token side."

"The money for black projects is not coming from private sources but from government funds. Ah, but I'm no politician. Just a pharmacist."

Watkins, over beyond the counter of candy and newspapers and cameras, laughed. "Yes, just a pharmacist like Hubert Humphrey."

Cummings said, "Civil rights has a way to go. Progress now depends on how hard blacks work. We got a foot in the door. Education will get both feet in."

"It's economic, really. And the measure of success will be when a white man won't think nothing of working for a black. And when nothing but the railroad track separates Fourth Street from downtown."

Cummings paused for lunch. He went home. In the living room was a saying painted onto a piece of pottery: "God grant me the serenity to accept the things I cannot change; the courage to change the things I can; and the wisdom to know the difference."

His mother asked Cummings what he had been talking about. He told her.

She shooed him into the kitchen with his nieces and nephews. She said, "I always felt equal. I feel equal now. Maybe I feel equaler."

# INTRODUCING THE REAL-KILL ROACH TRAP



Real-Kill's new roach trap has a built-in attraction for roaches. It lures them in and wipes them out. Quickly and easily. There's no mess, no poison.

And Real-Kill Roach Traps are more economical, too. Compare Real-Kill's 3-trap box to the other's 2-trap box.

Try Real-Kill Roach Traps.

## SPECIAL OFFER!

Get 7 Gillette products worth over \$4.00, free! Just send us two proof-of-purchase stickers from Real-Kill Roach Traps or any other Real-Kill product along with the special "Free Gillette Products" certificate from a Real-Kill display at participating stores.

# Simplicity In Good Life

By TAD BARTIMUS  
Associated Press Writer  
TAYUJICA, Costa Rica (AP) — When the skies open and the gods cry, farmer Marco Tulio Corrales sits on his porch and watches the rain.

He has no broken machines to repair. No creditors to worry him. His tool is his brain. His bank is his mattress.

Corrales used to be a man of the city. Like thousands of other Costa Ricans, he went to San Jose looking for the good life.

Instead he found dirty air, noisy streets, high prices, loneliness and a confusion country folk never have to face.

He returned to the land.

Now he enjoys an easy pace. He has time to teach his sons what a farmer should know about tilling and planting and looking after coffee bushes and garden vegetables and loyal animals.

He lives without electricity, automobile or tractor. Water comes from rain or a nearby creek. His privy has a jungle view.

He and his wife Norma built their frame house with their own hands. With three sons already, it is time to add a room.

Corrales is a new breed of "campesino" — peasant, man of the field.

Unlike his father's father, he can read. He writes poetry. He has traveled far beyond his birthplace and came home again.

Ben Franklin would have liked the Corrales family's habits. They rise before sun-up, are asleep by twilight. They are healthy, moderately wealthy, and wiser than most of their former neighbors in the city.

In 1970, when Corrales was 21 and his bride 16, they left their home ground and moved 90 miles southwest to the capital.

"We went because we thought the work wouldn't be as hard as on the farm," he recalled. "I got a job in a refrigerator assembly plant. Soon I was making service calls, working weekends and nights."

"The first two boys were born. There was never enough room. We spent extra money on movies, a vice that isn't worthwhile. Instead of finding a place with a nice ambience, we found a contaminated society."

"My father had a chance to buy this land, but he said he needed help to work it. I was wasting my time in the city anyway, so we came home."

Corrales is the oldest of four boys. He and Norma and their sons Marco Jr., now 9, and Henry, now 6, moved in with his brothers until they could build a house on the 80 acres his father financed for him.

The house cost \$1,250. It sits on stilts to catch the breeze and stymie the termites. Rain falls off the tin roof and cool breezes waft into the two bedrooms, living room and big kitchen.

Norma made all the bedspreads, utatins, and pillow cushions. She sews all of her family's clothes.

The Corraleses spend about \$70 a month for food, half on staples and the rest on fresh and timed meat. They raise many of their own vegetables,

and the jungle provides much of their fruit — bananas, papaya, mango, wild berries. Their chickens give them eggs and on special occasions wind up in the pot. At Christmas they butcher a pig. The cow gives them butter, cream, cheese and yogurt.

"We are almost self-sufficient. The only drawback is being so far away from a doctor without having a car," Norma says. She walks two miles to the store and to church, but the doctor is in Turrialba, 45 minutes by car, and villagers now charge \$20 for the ride because gas is so high.

"But I love it here, and I never want to leave," she says.

Besides raising coffee and sugar cane, Corrales works parttime as foreman on a pine tree farm up the mountainside.

The extra money goes for the family's big purchases. After every harvest they invest in one major item.

Since he came back in 1975, Corrales has been able to buy a new cow or ox every two years. Each costs about \$450. Every time a neighbor wants to use his finely curried oxen, they pay \$9 a day.

Corrales, his father and his brothers contribute to a general family fund kept for emergencies or fast investments.

"Last year we had a chance to buy a car," says Corrales, "but we had a meeting and decided to stick with what we know best — we bought another cow."

Costa Rica is a democracy firmly rooted in its middle-class majority. Corrales and hundreds of thousands like him vote for their president, elect their Legislative Assemblyman, read uncensored newspapers, send their children to good schools, get free medical care, have plenty to eat and live in adequate houses.

"We feel we have control over our daily lives," he said, sipping a steaming cup of coffee while he sat on the porch watching the rain water the gardenias, bougainvillea, begonias, roses, jasmine, frangipani, hibiscus and poppies in Norma's flower garden.

"A lot of people like us have gone to the cities, but more and more they are going back to the farm as they find out they were happier there. Most of us have graduated from the sixth grade. For some, a college education can give a better way of life in San Jose."

"But for most young campesinos, the land is where they belong, and the land is where they'll stay."

# Get the best. Buy any 5 and get \$2.00 back!



**COUPONS, TOO!** Just buy any five Skinner products and send us the cooking instructions from each package as proof of purchase. We'll send you \$2.00, plus three 15¢ coupons for Skinner Dumplings, Twirls and Vermicelli.

That's \$2.45 in cash and coupons just for buying Skinner — the same brand you've been buying and trusting for over 60 years.

If you take pride in your pasta, get the best, get Skinner. And now, get two bucks back, too!

## \$2.00 SKINNER REFUND

Enclosed are five cooking instructions from Skinner products. Please send me \$2.00 refund and 45¢ in coupons to:

NAME \_\_\_\_\_

ADDRESS \_\_\_\_\_

CITY \_\_\_\_\_ STATE \_\_\_\_\_ ZIP \_\_\_\_\_

Offer limited to one coupon per family or customer. This certificate must accompany your request. This certificate cannot be mechanically reproduced or duplicated in any way, shape or form. Offer expires November 15, 1979. GR-8/1/9 Mail to: Skinner Macaroni Company • Box 75, Downtown Station • Omaha, NE 68101

**DEEDS**

Cherry Oaks Inc. to Merritt Jerome Howard no stamps  
 Furling V. Coggins to Pat McLawhorn Coggins no stamps  
 Eastwood Realty & Dev. Co. Inc. to Roy F. Choquette at 43.00  
 Francis L. Garner to F.L. Garner Inc. no stamps  
 H & H Dev. Corp. to Robert E. Taylor at 36.00  
 E.L. Harrington Jr. al to Harry E. Wilson no stamps  
 Dorothy Branch Ipock to Ephraim Smith at 6.00  
 Mary B. Jones to Robert C. Dunn al no stamps  
 Maynard E. Porter al to Naegle Outdoor Advertising Co. of Kinston 180.00  
 Wiley N. Stancill Jr. al to Ricky Lee Moore al 10.00  
 Dillon F. Watson to Watson Assoc. of G'ville Inc. \$45.00  
 Watson Assoc. of G'ville Inc. to Ridgewood Owners Assn. Inc. no stamps  
 Associated Realtors Inc. to Rice Const. Co. Inc. 24.00  
 Joseph P. Echel Jr. al to Fred A. Mercer al 36.00  
 Joseph S. Gaddie al to Carl W. King al 70.00  
 Greenbrier Realty Co. Inc. to Earl Spain 11.00  
 Leon Parker Lupton al to John Edward Pollock al 37.00  
 Real Estate Broker of G'ville Inc. to Alywin E. Klutz al 59.00  
 Jimmy Andrew Shaver al to The Equitable Life Assurance Society of U.S. 27.00  
 James A. Tripp al to Ronald R. House al 1.00  
 Rick W. Wise al to Daniel J. Pfeifer al 77.50  
 Blount & Ball Realty Co. Inc. to Robert Stephen Porter al 78.50  
 Bowser Const. Co. Inc. to Robert O. Edwards 12.00  
 Leland John Porter al to William Earl Reese al no stamps  
 Wayland Porter Excr. al to William Earl Reese al no stamps  
 William Earl Reese al to Leland John Porter no stamps  
 Thelma Proctor Rouse to Peggy E. Rowlette al no stamps  
 Frances H. Wiley to Wesley L. Wiley no stamps  
 Darrell V. Worthington al to Glen E. Stewart al 23.50  
 Mary A. Smith to Harold E. Harris al 10.00  
 William E. Draper al to Allen Rappaport al 33.50  
 Clara Smith Hart al to Alfred S. Wand al 17.00  
 Tommie L. Little & Assoc. Inc. to Robert S. McCants III al 35.00  
 James L. Mathis al to Dirk S. Dixon al 26.50  
 Robert E. Pittman al to Michael W. Yorke al 22.00  
 Shamrock Realty Co. of Pitt Co. Inc. to Thomas K. Olschner al 41.50  
 A.J. Speight al to James L. Mathis al 7.50  
 H. Dean Whitehurst to Robert Lee Sutton al 3.50  
 Hayden C. Turner al to John C. Rood Jr. al 10.00  
 Janice Buck Benton to James F. Buck al 75.00  
 Richard D. Campbell al to Stuart Weir al 34.00  
 Bill Clark Const. Co. Inc. to Lucille D. Whitfield 33.00  
 Emma B. Conleton to Austin B. Parker 29.00  
 Phillip Ray Dixon al to Gerald R. Haskins al 43.00  
 Johnnie F. Edwards Jr. al to Jay M. Collie al 84.00  
 Alan Gibbons al to Paul Wilson Dowell al 24.50  
 Oscar C. Haddock al to Joseph W. Albea Jr. al 40.00  
 Linwood J. Hardee al to William A. Waggoner al no stamps  
 Carl G. Hudson al to William E. Holloman al no stamps  
 Carl Willis King al to Grant W. Somes al 76.00  
 M. Donovan Phillips al to City of Greenville 6.50  
 Blount & Ball Realty Co. Inc. to Roy O. Dunbar al 22.50  
 Thomas C. Carson Jr. to Barbara D. Carson no stamps  
 William H. Collier III al to Tommie L. Little & Assoc. 65.00  
 Walter Thomas Dail al to David M. Merritt al 51.00  
 Stanley C. Daughtridge al to Rodney L. Buchman al 4.50  
 John M. Gray to Marvin Taylor Barnhill al no stamps  
 Herbert W. Lee al to Scott B. Hungate al 67.00  
 Dianne H. Leonard to John R. Leonard no stamps  
 John R. Leonard to Dianne H. Leonard no stamps  
 John R. Leonard to Dianne H. Leonard no stamps  
 Tommie L. Little & Assoc. Inc. to Williams H. Collier al 22.50  
 Shamrock Realty Co. of Pitt Co. Inc. to Annie G. Streeter al 15.00  
 Clifton Ray Stokes al to James Albert Hayes Jr. al 74.50  
 Shenandoah Development Co. Inc. to Oscar Holloman al 11.50



• PRICES GOOD THRU SAT., AUG. 4TH  
 • NONE TO DEALERS  
 • WE RESERVE THE RIGHT TO LIMIT QUANTITIES

ALL STORES OPEN SUNDAYS  
 9 A.M. 'TIL 8 P.M.

**PRODUCE PATCH**

WHITE SEEDLESS, RED OR BLACK

**GRAPES**  
 LB. **78**<sup>c</sup>

• SWEET & JUICY PEACHES 3 LBS. \$1.00  
 • GOLDEN RIPE BANANAS 3 LBS. \$1.00

U.S. #1 WHITE **POTATOES**  
 20-LB. VENT VUE BAG **179**<sup>c</sup>

U.S. #1  
 • YELLOW ONIONS 3-LB. BAG \$1.19  
 • GREEN PEANUTS 2 LBS. \$1.00  
 • FLORIDA LIMES DOZ. 69c

SWEET & JUICY  
 • NECTARINES  
 • PLUMS

**82**<sup>c</sup> LBS. **100**

**FROZEN FOODS**

THRIFTY MAID

**ICE MILK**  
 (ALL FLAVORS)  
 HALF-GAL. CARTON **88**<sup>c</sup>

• SANDWICHES PKG. OF 12 \$1.29  
 COZY KITCHEN CARROT, COCONUT OR GERMAN  
 • CHOCOLATE CAKES 24-OZ. SIZE \$1.29  
 SUPERBRAND FUDGE BARS OR  
 • TWIN POPS PKG. OF 12 88c  
 MOSTON CREAM TASTE-O-SEA BATTER OPT 14-LB. \$1.19  
 PIES 16-OZ. CASE 69c. FISH & CHIPS 14-LB. \$1.19  
 DODDANA HONEYBUNS 2 16-OZ. PCKGS. \$1.00. FISH FILLETS 12-OZ. PKG. \$1.19

**DAIRY DEPT.**

SUPERBRAND U.S.D.A. GRADE 'A' WHITE LARGE **EGGS** DOZ. **69c**

PELLERINI BUTTERMILK BISCUITS 4 7 1/2-OZ. CASE 79c • YOGURT 3 8-OZ. CUPS \$1.00  
 SUPERBRAND COTTAGE CHEESE 2 3-LB. CUP \$1.39 • MARGARINE 14-LB. BOWL 69c

**CHOIR UNION**  
 AYDEN—The Pitt-Greene Interdenominational Choir Union will meet Saturday at 7:30 p.m. at Morning Star Holiness Church here.  
 Members of the union are Little Creek Disciple Choir No. 2, Elm Grove Senior Choir, Selvia Chapel Gospel Chorus and Morning Star Senior Choir.

**AUTUMN COLLECTION STONEWARE**

**CEREAL/SOUP BOWLS ON SALE THIS WEEK!**

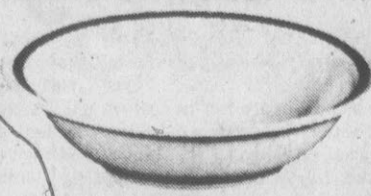

**39**<sup>c</sup>

THIS IS SERVICEABLE YET ELEGANTLY DESIGNED QUALITY STONEWARE. OVEN TO TABLE, DISHWASHER AND MICROWAVE OVEN SAFE.

EACH ONLY

WITH EVERY \$5.00 PURCHASE



YOU SAVE 82c PER LB.

BRAND U.S. CHOICE BEEF WHOLE BONELESS **SIRLOIN TIPS** LB. **77**<sup>c</sup>

BONELESS SIRLOIN TIP  
 • ROASTS **\$2.49**  
 • STEAKS **\$2.69**

9-11 LBS. AVG.

CUT INTO STEAKS, ROASTS & TRIMMINGS AT THIS PRICE

Special  
 YOU SAVE 60c PER LB.  
 BRAND U.S. CHOICE BEEF **SHOULDER ROASTS** LB. **199**<sup>c</sup>

BRAND U.S. CHOICE BONELESS STEW BEEF LB. \$1.99

Special  
**FRESH PORK SALE**  
 COUNTRY-STYLE **RIBS** LB. **149**<sup>c</sup>

COUNTRY-STYLE BACKBONES LB. \$1.39  
 PORK LOIN SIRLOIN ROASTS LB. \$1.39  
 U.S. CHOICE "UNTRIMMED" BEEF WHOLE TENDERLOINS LB. \$3.97 SLICED AT THIS PRICE

Special  
**SMOKED HAM SHANK PORTIONS** LB. **99**<sup>c</sup>

• BUTT PORTIONS LB. \$1.09  
 • CENTER SLICES LB. \$1.99

Special  
 HOLLY FARMS **CHICKEN FRANKS** 1-LB. PKG. **99**<sup>c</sup>

MATLAWS  
 • STUFFED CLAMS  
 • SHRIMP EGG ROLLS PKG. EA. **219**<sup>c</sup>

Special  
 BRAND SLICED (REGULAR OR THICK) **BOLOGNA** 1-LB. PKG. **139**<sup>c</sup>

• BRAND BEEF BEEF FRANKS 12-OZ. PKG. \$1.19  
 TYSON'S BRAND CORNISH HENS 34-OZ. PKG. OF 3 \$1.49  
 • BRAND SLICED SPICED LUNCHEON OR SALAMI 1-LB. PKG. \$1.59

DELI  
**HOT FROM THE OVEN!**

WHOLE B.B.Q. FRYERS LB. \$1.69  
 YOU SAVE \$1.50 PER LB.  
 SLICED TO ORDER BONELESS COOKED HAM LB. \$2.49  
**BAKERY DEPT.**  
 FRESH BAKED FRENCH BREAD 2 LOAVES \$1.00  
 FRENCH CREAM CHEESE CAKES 43-OZ. SIZE \$3.49  
 PLEASE CALL FOR SPECIAL ORDERS:  
 SHOPPERS MART 756-2956  
 RIVERGATE 756-6880

SUNNYLAND GOODTIMER FRANKS 12-OZ. PKG. 99c

HEAT & SERVE FISH STICKS 2-LB. BOX \$1.99

BRAND IMPORTED SLICED COOKED PICNIC 12-OZ. PKG. \$2.49



YOU SAVE 46c  
**ARROW**  
 • BLUE • WHITE • COLDWATER DETERGENT

49-OZ. BOX **77**<sup>c</sup>

WITH \$7.50 OR MORE ORDER (LIMIT TWO)

HOLLY FARMS **MIXED FRYER PARTS**

LB. **39**<sup>c</sup>

Special  
 BUY A CASE & SAVE \$1.30  
 12-OZ. CANS ASSORTED FLAVORS **CHEK DRINKS** CASE OF 24 **299**<sup>c</sup>

THRIFTY MAID DINNERS 4 7 1/2-OZ. BOXES \$1.09

Special  
 ASTOR ALL-PURPOSE **SHORTENING** 3-LB. CAN **169**<sup>c</sup>

PERSONAL SIZE IVORY SOAP PKG. OF 4 79c

Special  
 GOLD MEDAL **FLOUR** 5-LB. BAG **89**<sup>c</sup>

LITTLE FRISKEYS (CHICKEN OR FISH) CAT DINNERS 12-OZ. SIZE \$1.89

DIXIE DARLING **PRESTIGE BREAD** 3 24-OZ. LOAVES **109**<sup>c</sup>

WHITE HOUSE **CIDER VINEGAR** 64-OZ. JUG **119**<sup>c</sup>

KLEENEX EXTRA ABSORBENT DISPOSABLE DIAPERS BOX OF 24 **249**<sup>c</sup>

CHILDREN'S STRAINED BABY FOOD 5 4 1/2-OZ. JARS 95c • ENFAMIL LIQUID 13-OZ. CAN 59c  
 THRIFTY MAID  
 • BEETS (16-OZ. CANS)  
 • SAUERKRAUT (16-OZ. CANS)  
 • FRENCH GREEN BEANS (16 1/2-OZ. CANS)  
 • GREEN LIMAS (16-OZ. CANS)  
 3 MIX OR MATCH! **89**<sup>c</sup>

DONALD DUCK **ORANGE JUICE** 64-OZ. SIZE **129**<sup>c</sup>

THRIFTY MAID  
 • HOT DOG CHILI (10 1/2-OZ. CAN)  
 • PORK & BEANS (16-OZ. CAN)  
 • POTTED MEAT (3-OZ. CAN)  
 • PINEAPPLE JUICE (15-OZ. CAN)  
 4 MIX OR MATCH! **100**<sup>c</sup>

# Part Of Job: Telling Parents A Child Might Die

By MARIAN FOX  
Associated Press Writer  
MEMPHIS, Tenn. (AP) — When Michael Farmer tumbled down the stairs five years ago, the boy's parents took him to a hospital to find out why his bruises wouldn't heal. They learned their son might die.

Within a year, St. Jude Children's Research Hospital doctors told Lynn and Robert Farmer their only daughter Leisa, like their son, has a rare, incurable blood disease. Telling parents their child might die — and telling the child — is part of a doctor's job at St. Jude.

"They don't lie to you," Mrs. Farmer said. Mike, now 12, and Leisa, 11, are still alive, and the 35-year-old housewife has learned to cope with the lethal illnesses of two of her three children. "At first it seems unspeakably cruel," she said, "but you learn to appreciate the truth. Knowing makes it somehow less frightening."

The hospital has treated more than 5,000 youngsters from around the world without charge since it opened 17 years ago. It was founded by entertainer Danny Thomas and is supported by grants and charity.

The children's illnesses — leukemia and other cancers, neuromuscular disorders and blood diseases — are catastrophic or the children wouldn't be there. St. Jude's doctors

treat only children with potentially terminal illnesses. They try to keep the youngsters alive in hopes that cures may be found and they help the children — who've hardly lived — to face death.

There is no formula, but the preparation begins with the truth. "If you do not tell the patient what's really happening, then he cannot make the best of his situation," explained Dr. Morris Powazek, a clinical psychologist.

But dealing openly with death doesn't lessen the pain, so the seven professionals in the psychology-psychiatry department try to help the family cope.

Generally when a child is

brought to St. Jude, the parents know he is seriously ill, clinical social worker Janet Payne said. Tests are run to confirm the referring doctor's diagnosis. Then, usually on the second day, the doctor tells the parents and child. It's never easy.

"I felt like somebody hit me in the face with a brickbat," Mrs. Farmer said. "They are as kind as possible but it's there in black and white. I felt like my whole world was collapsing."

On the third day "when some of the numbness has worn off," Mrs. Payne said, the parents are told of the psychiatric services. More than half seek help, she said.

"Losing a child is such a special agony that there's not much anyone can do to ease it," said Mrs. Payne, 35, the mother of an infant daughter. "We try to provide support for the parents and kids and we support each other."

The explanation of death is tailored to each child, Powazek said, because a child's concept of death varies with his age.

"A very young child from 1 year to about 6 ... sees death as a separation, like being away on vacation," he said. "The child between 6 and 10 experiences the idea of death emotionally and sees it as a form of desertion by his parents."

"The child of 9 or 10, however, begins to think of death as adults do, understanding the finality ..."

Play and parental counseling usually work with younger children.

"Although young children can't put their feelings into words, they will express fear and anger in games and drawings," Powazek said. The counselors' offices are lined with children's art.

Parents receive as much attention as the child. "Young children identify strongly with their parents," Powazek said.

"Children have problems when their parents experience emotional difficulties. We try to help parents ventilate their feelings in a private and safe

## Woman Welder Likes Her Work

By MICHAEL DONAHUE  
Memphis Press-Scimitar  
MEMPHIS, Tenn. (AP) —

The war that inspired the song "Rosie the Riveter" was over before Lisa Croft was born, but Miss Croft and Rosie have a lot in common. They liked to work with metals.

"When I was little, most girls had dolls," Miss Croft said. "I

had locks and hammers and tools."

Miss Croft, who was wearing coveralls, a cap and a few grease smudges on her face, is a 22-year-old welder and riveter, the only woman working alongside four men at Collier-ville Welding and Supply.

"I do body work, pack wheels, carpentry, a little bit of everything that needs to be done. We have an aluminum welder I'm learning to use. I can use just about any machine in the shop."

A farmer's daughter, Miss Croft said she was offered the welding job recently while she was having some work done on her trailer.

She said she used to help repair the machinery on her father's 500-acre farm. "I learned how to fix it up, tear it up and get it back in running order. I figured if I could do it free at home, I could get paid somewhere else."

Welding takes patience and skill, she said.

"If you rush it, you'll spend all day trying to get it down to look slick. You have to measure, cut and angle it right. There's a fine hairline between two metals. The more space you leave between them, the harder it is to weld, to get the work stationary and do your welding."

Miss Croft said her mother isn't too pleased with her daughter's current vocation, but there may be something in welding's favor.

"Before I did this, I rode bulls in rodeos, so I guess this is an improvement," she said. She also used to tie goats in rodeos, but her mother wasn't in favor of that, either.

"She was dead set against me goat tying, but when she found out I was bull riding, she told me to go back to goat tying."

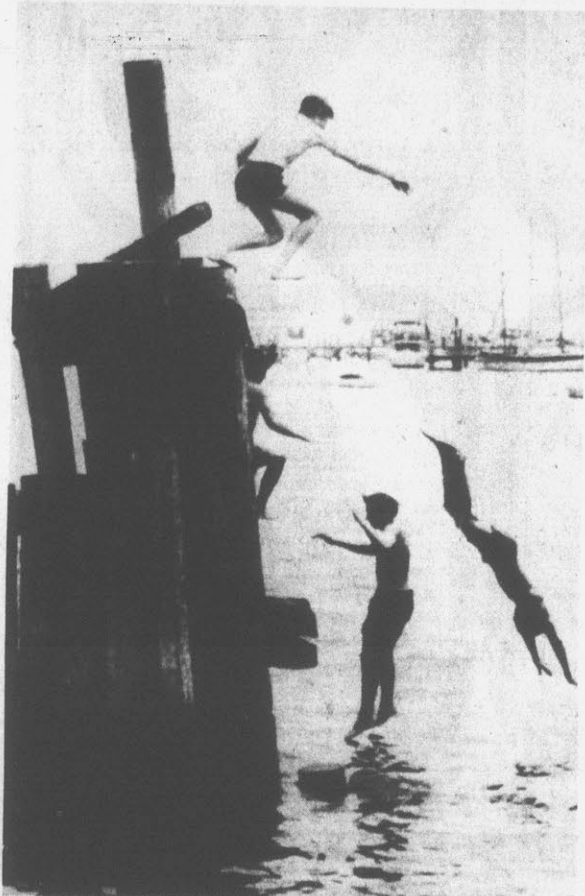

**PILE DIVING** — Youngsters beat the heat by taking to the water via an old ferry slip piling in the Thames River in New London, Conn. Water conditions have been ideal lately, resulting in swimming and sunbathing becoming the order of the day. (AP Laserphoto)

### Pay less now. And see how Crest's long-lasting protection pays off in the end.

9640CS TAKE THIS COUPON TO YOUR STORE

**SAVE 20¢** ON ANY SIZE MINT OR REGULAR **Crest**

LIMIT ONE COUPON PER PURCHASE

TO THE CONSUMER: CAUTION: Don't embarrass your dealer by asking him to redeem coupons without making the required purchase. He must redeem coupons properly to get his money back. REMEMBER: Coupons are good only on the brands as set forth. Any other sale constitutes fraud.

TO THE DEALER: You are authorized to act as our agent for the redemption of this coupon. We will reimburse you for the face value of this coupon or 20¢ per coupon as for free merchandise. This coupon is non-transferable and non-cashable. It is subject to the terms and conditions of our coupon offer. This coupon is not to be redeemed by a consumer at the time of purchase of the brand size indicated in the face value. It is void where prohibited, taxed or restricted by law. Good only in U.S.A., Puerto Rico and U.S. Gov't. install. Cash value: 1/20¢. Coupon will not be honored if presented through outside agencies, brokers or others who are not retail distributors of our merchandise or specifically authorized by us to present coupons for redemption. For redemption of properly received and handled coupon, mail to: PROCTER & GAMBLE, P.O. Box 103, Kankakee, IL 60901. This coupon good only on purchase of product indicated. Any other use constitutes fraud. Offer expires January 31, 1980. LIMIT—ONE COUPON PER PURCHASE.

PROCTER & GAMBLE 343250



### Somehow, it's just not a coffee break without a great-tasting cup of Maxwell House® Coffee.



#### MAIL-IN CERTIFICATE How to start your Maxwell House® Coffee Times Collection

\*First remove the inner seal from any 6-, 10- or 14-ounce jar of Maxwell House® Instant Coffee. This is your proof of purchase. Then fill in the information on the bottom of this certificate. Now just mail the completed certificate and one inner seal for each book ordered to the address below, and we'll send you the first booklet in our new Maxwell House Coffee Times series. It's packed with useful coffee ideas and delicious recipes.

Mail to: Coffee Break Recipe Offer,  
P.O. Box 4149, Kankakee, Ill. 60901

Name \_\_\_\_\_  
Address \_\_\_\_\_  
City \_\_\_\_\_ State \_\_\_\_\_ Zip \_\_\_\_\_

Please allow 6-8 weeks for delivery. Good only in U.S.A. Offer expires 1/31/80. This certificate must accompany request.



#### STORE COUPON Here's a 50¢ break on Maxwell House Instant Coffee

Save **50¢**

when you buy any size jar of Maxwell House® Instant Coffee



To the retailer: General Foods Corp. will reimburse you for the face value of this coupon plus 5¢ for handling if you receive it on the sales of the specified product and if upon request you submit evidence of purchase thereof satisfactory to General Foods Corp. Coupon may not be assigned, transferred or resold. Customer must pay any sales tax. Void where prohibited, taxed or restricted by law. Good only in U.S.A., Puerto Rico and U.S. Gov't. install. Cash value: 1/20¢. Coupon will not be honored if presented through outside agencies, brokers or others who are not retail distributors of our merchandise or specifically authorized by us to present coupons for redemption. For redemption of properly received and handled coupon, mail to: General Foods Corp., P.O. Box 103, Kankakee, IL 60901. This coupon good only on purchase of product indicated. Any other use constitutes fraud. Offer expires January 31, 1980. LIMIT—ONE COUPON PER PURCHASE.

GENERAL FOODS CORPORATION

## Western Sizzlin Steak House The Family Steak House

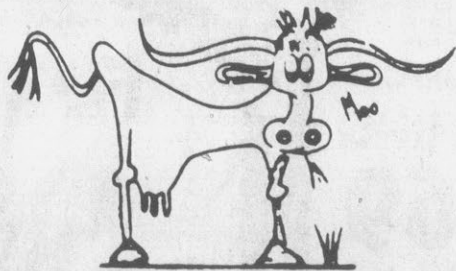

### THURSDAY & FRIDAY LUNCH AND DINNER SPECIAL

**\$ 1.00 OFF**

### 8 OZ. RIBEYE STEAK

Complete With Idaho King Baked Potato  
Texas Toast And Whipped Butter

**\$ 3.39**

REG. \$4.39

NOW

PARTY FACILITIES AVAILABLE

CALL 758-2712



# Piggly Wiggly's Values Make a Big Splash For Summer Savings

PRICES EFFECTIVE AUG. 1-4  
We reserve the right to limit quantities.  
None sold to dealers or restaurants.  
We gladly accept USDA Food Stamps.

MARTIN COUNTY OR PEANUT CITY

**COUNTRY HAMS** \$1.29  
SLICED FREE LB. WHOLE

Swiss Premium Protein BEEF

FULL CUT BONE IN

**ROUND STEAK** 2.29

**SIRLOIN STEAK**  
FINE FOR COOKOUTS  
LB. **2.69**

**SIRLOIN TIP OR RUMP ROAST**  
BONELESS & TENDER  
LB. **2.79**

FULL CUT BONELESS LB. **2.39**  
Round Steak

TOP BONELESS LB. **2.49**  
Round Steak

FINE FOR COOKOUTS LB. **2.79**  
T-Bone Steak

SIRLOIN BONELESS LB. **2.89**  
Tip Steak

FRESH MIXED LB. **39¢**  
FRYER PARTS

FRESH CHOICE PARTS LB. **79¢**  
Combination Pk.

FRESH REGULAR CUT UP LB. **47¢**  
FRYERS

FRESH CUP UP (COUNTRY STYLE) LB. **51¢**  
FRYER 13 Pieces

FRYER BREAST (Fine for Cookouts) LB. **57¢**  
QUARTERS

FRYER LEG AND THIGH (FINE FOR GRILLING) LB. **57¢**  
QUARTERS

FRESH SPLIT WHOLE (FINE FOR BAR-B-QUE) LB. **57¢**  
FRYERS

DINNER BELL 12 OZ. PKG. EA. **99¢**  
FRANKS

LUNDY'S **\$1.09**  
BACON LB.

JAMESTOWN FRESH **79¢**  
SAUSAGE LB.

OSCAR MAYER (Regular or Beef) **1.59**  
Franks your choice LB.

OSCAR MAYER VARIETY PACK 12 OZ. PKG. **1.59**  
Luncheon Meat EA.

WHOLE OR SHANK HALF SMOKED **83¢**  
HAM 19-23 lb. avg. LB.

SHANK **75¢**  
PORTION LB.

BUTT **79¢**  
PORTION LB.

BUTT **89¢**  
HALF LB.

CENTER SLICES OR HAM **1.49**  
ROAST LB.

U.S.D.A. GRADE "A" FRESH WHOLE **39¢**  
FRYERS LB.

TWO PER BAG

OSCAR MAYER REGULAR OR BEEF **89¢**  
BOLOGNA 8 OZ. PKG. YOUR CHOICE

**PEPSI**  
**MT. DEW**  
**DIET PEPSI**  
TWO LITRE NON-RETURNABLE BOTTLES  
**79¢**

**COCA-COLA**  
**8**  
16-OZ. BOTTLES  
**\$1.09**  
PLUS DEPOSIT

COCA-COLA, MELLO YELLO, TAB, SPRITE, MR. PIBB, CRUSH & SUGAR FREES  
**6 \$1.19**  
12-OZ. CANS

DUNCAN HINES **69¢**  
CAKE MIX 18½ OZ. BOX

**DAWN** 32 OZ.  
**99¢**  
LIMIT ONE AT THIS PRICE, PLEASE

**DOWNY** 33 OZ.  
**99¢**

KRAFT MACARONI & CHEESE **4/1.00**  
DINNER 7¼ OZ.

**WISK** LAUNDRY DETERGENT  
GALLON JUG **\$4.99**

GOLDEN BEST **99¢**  
TEA BAGS 100's  
Limit One With \$7.50 Food Order

RED BAND SELF-RISING **79¢**  
FLOUR LB. BAG

MAXWELL HOUSE INSTANT **4.89**  
COFFEE 10 OZ.

MAXWELL HOUSE INSTANT **3.29**  
COFFEE 6 OZ.

LUNDY'S **\$1.79**  
LARD 4 LB. PAIL

PET RITZ 14 OZ. **69¢**  
CREAM PIES

WALDORF BATHROOM **69¢**  
TISSUE 4 ROLL  
LIMIT ONE 4-ROLL PACK

KRAFT ½ GAL. **1.19**  
ORANGE JUICE

PIGGLY WIGGLY QUART **88¢**  
MAYONNAISE  
LIMIT ONE, PLEASE

DEL MONTE 24 OZ. **69¢**  
CATSUP

PIGGLY WIGGLY ½ GAL. **99¢**  
ICE CREAM

PIGGLY WIGGLY 1½ LB. LOAF **3/1.09**  
BREAD

BANQUET FRIED **2.79**  
CHICKEN 2 LB.

PIGGLY WIGGLY WHIP BOWL **65¢**  
MARGARINE LB.

KRAFT SOFT **79¢**  
PARKAY LB.

MERITA SWEET SIXTEEN **2/1.00**  
DOUGHNUTS

MAHISCO **89¢**  
RITZ LB.

KRAFT FRENCH **69¢**  
DRESSING 8 OZ.

KRAFT CREAMY CUCUMBER **69¢**  
DRESSING 8 OZ.

KRAFT LOW-CALORIE 1000 ISLAND **59¢**  
DRESSING 8 OZ.

KRAFT JET-PUFF **3/1.00**  
Marshmallows 10 OZ.

KRAFT JET-PUFF **59¢**  
Marshmallows LB.

PET RITZ **1.49**  
PIE SHELLS 8.

KEEBLER YOUR CHOICE **79¢**  
HONEY GRAHAMS 16 OZ.  
CINNAMON CRISP 14 OZ.  
KEEBLER TUC 10 OZ.

PINE STATE **89¢**  
MILK ½ GAL. (PAPER CARTON)

Piggly Wiggly World of **PRODUCE**  
the Freshest Buys In Town!

SWEET AND JUICY **\$1**  
PEACHES 3 LBS. FOR

GREEN PASCAL **29¢**  
CELERY EA.

NEW CROP WHITE **79¢**  
GRAPES LB.

IMPERIOR GREEN **69¢**  
BROCCOLI EA.

LOCAL **\$1.79**  
WATERMELONS EA.

**PIGGLY WIGGLY**

GERBER STRAINED **15¢**  
BABY FOOD JAR EA.

WE GLADLY ACCEPT W.I.C. FOOD VOUCHERS

PINE STATE CHEERIO **2 \$1**  
ICE CREAM BARS 6-CT. PKGS.

2105 DICKINSON AVE.  
Open Monday thru Saturday 8 to 8  
Open Sundays 9 to 6

# McKim, Mead & White Was Prolific Partnership

By MARLENE AIG Associated Press Writer  
NEW YORK (AP) - The oft-told tale about the odd-looking townhouse on East 77th Street is that architect Stanford White built it for his mistress, actress Evelyn Nesbit.

But a rental agent showing apartments in another townhouse also assures prospective tenants that White built THAT house for Miss Nesbit.

It is undoubtedly true that linking White's name to a residential building today enhances its romance, to say nothing of its value. But the truth is that White built neither.

White, the best-known member of the architectural firm of McKim, Mead & White, did have a notorious affair with Miss Nesbit, known as the girl on the red velvet swing. But he

never built her a townhouse. Perhaps he might have one day, but her husband, Harry Thaw, fatally shot White during one of her performances at the old Madison Square Garden, an edifice White certainly did build.

It was one hundred years ago, in 1879, that White joined Charles Follen McKim and William Rutherford Mead in a partnership that was to become one of the most prolific in American architectural history.

Their commissions dot the landscape from Maine to California, from Montreal to Texas. They designed the Rhode Island State Capitol, the Boston Public Library and renovations for the White House in 1902.

They laid out the town of Naugatuck, Conn., built the Walker Art Gallery at Bowdoin

College in Brunswick, Maine, the main office of the Bank of Montreal, the Boston Symphony Hall, and an exposition hall in San Francisco.

But the greatest treasury of their work is here in New York City where the firm was based. There are some 72 buildings still standing, none of which were designed for mistresses.

They include the recently saved Villard Houses on Madison Avenue, the octagon-shaped Low Library at Columbia University, the elegant Morgan Library and the massive General Post Office with its imposing entrance adorned by a row of twenty 53-foot-high columns.

They designed the arch in Washington Square and Judson Memorial Church on the opposite side of the square.

Such is the reputation of the

firm that a century after its founding the New York City Landmarks Preservation Commission still gets calls from well-meaning citizens who believe they've found another MM&W.

"You'd be amazed," said commission spokeswoman Patricia Rich, "at how many calls and letters we still get saying, 'Designate this building, it's by McKim, Mead & White.'"

One reason the firm holds the imagination of Americans, particularly New Yorkers, is because the three founders were not just architects, says architectural historian Henry Hope Reed Jr. They were, he says, "men of distinction who cared about their city and their time."

McKim was a Pennsylvania native trained at Harvard and at L'Ecole Des Beaux Arts in Paris, where the classical tradition was reborn in the latter part of the 19th century.

Mead hailed from Brattleboro, Vt. The most level-headed and quietest of the three, Mead used to say he spent most of his time keeping his partners from "making damn fools of themselves."

That description most often fit White, the youngest and most flamboyant member of

the firm. The son of a New York literary critic, White had versatile talents that spun out designs for everything from buildings to necklaces, picture frames to magazine covers.

White was 26, Mead was 33 and McKim was 32 when their partnership was created. The architecture and lifestyle they gave America was one based on classical Rome. It was an architecture fitting for an America reveling in the culmination of Manifest Destiny and bursting with pride at the marvels its new unity was producing.

Their period was known as the American Renaissance. To celebrate, the country turned - as Europe had during its renaissance - to an older world to express its triumph.

"We were trying to imitate our betters," says critic Brendan Gill, who is working on a biography of White. "We were considered uncouth and were looking for a culture to imitate. So, we turned back."

And so the glory that was Rome became America's too.

McKim, Mead & White adorned their sturdy structures with classical columns, intricately delicate ornamentation, heavy decorative cornices, majestic entrances, dramatic flourishes and flights of artistic fancy that brought Italian pa-

lazzi to Fifth Avenue.

And the three envisioned cities as well-planned communities. Thus, the imposing entrance to the General Post Office was once more effective when it was balanced by Penn Station, considered to be McKim, Mead & White's masterpiece.

Before it was razed in 1963, the station's high archways,

massive columns and soaring ceiling greeted travelers for over 50 years.

Ironically, it was the destruction of Penn Station that aroused preservationists to save what was left. The wrecker's ball already had taken such other McKim, Mead & White works as the W.K. Vanderbilt Jr. mansion, the old Madison Square Garden and

the Herald Building.

With the newfound appreciation of the city's architectural heritage, it seems unlikely that such destruction will continue.

The firm built in a monumental manner, aiming "for eternity" as England's great architect Christopher Wren once said it should. There is a chance the firm may yet succeed.

## Builds Own Highway, Sees Long Road Ahead

WRIGHT, Minn. (AP) - Retired dairy farmer Gordon Bushnell has to travel along dirt washboard roads, avoiding potholes and sand pockets, to reach the "highway" he's single-handedly building to shorten the trip from Duluth to Fargo-Moorhead.

He's 5-foot-6 and weighs 125 pounds, but the 79-year-old Bushnell can pick up a 100-plus-pound log and sling it over his shoulder as if it were kindling.

Then he carries that log 70 yards and climbs a quivering, 4-foot-high pile of logs and brush, surefooted as a mountain goat despite muddy gashes.

"I'm doing it because I think it should be done," he declares. "I thought if I just got it open once and people started using it, they'd demand more work be done on it."

It has taken him 17 years to build about nine miles of road. He expects to finish it in 20 years, when he's 99.

He works on the highway

from 5 a.m. to noon using a wheelbarrow, a mason's hoe, a saw, a pitchfork and sometimes a shovel. So far it's a dirt track that few vehicles could get through.

Bushnell's highway would run between and roughly parallel to U.S. 2 and Highway 210, John Pawlak, engineer for the Duluth District of the Minnesota Department of Transportation, said the department studied Bushnell's proposal four or five years ago but concluded there would be no real economic advantage to that area in building it.

Bushnell moved to the Wright area, about 50 miles southwest of Duluth, in 1918. He bought 80 acres of land and cleared it by hand.

He started trying to get his highway built 40 years ago, as one of the founders of the Cross-State Highway Association. Many of the original members of the group now are dead.

Bushnell, who was wearing

red cotton gloves, jeans a checked shirt and plaid cap, lays the 55-foot tree trunks along the road bed, piling trimmed branches and smaller logs on top. Then he plasters the pile with dirt from the ditches he's dug on either side of road.

The whole thing settles into a ramp, resting atop cast-off culverts he's installed for drainage.

Observers may be skeptical, but Bushnell's work is a source of pride that keeps him healthy and busy.

"A few years back, I had this pain in my side. The doctor said I had to have my gall bladder out," he recalled.

"Well I said, 'nothin' doing.' If I had my gall bladder out I wouldn't be able to finish my road. Well, the more I dug, the better I felt. I work winter and summer.

"Sure, it keeps me young. I like to be doing something constructive. I couldn't quit now if I wanted to."

### Expect Capping

#### Of Oil Spill

CORPUS CHRISTI, Texas (AP) - A Mexican official helping monitor oil drifting from a runaway well off the Yucatan Peninsula says the flow has been cut by a third and the well should be capped by Sept. 16.

"The spill has been reduced from 30,000 barrels a day to 20,000 to 21,000 barrels a day," navy Capt. Jose H. Orozco of Mexico City said Monday.

"That's by direct methods - pumping in special mud (trying to clog the well). We are still working on two relief wells."

He said relief wells will take the pressure off the well, which blew out June 3, "and eventually stop the flow. Sept. 16 is the target date." Orozco joined the U.S. team Sunday as a liaison officer.

# SHOP HOLT

Why? Because

We Trade Closer On All Our Deals

## Holt Olds-Datsun

101 Hooker Rd.

756-3115

# American aim Independent Markets

We Gladly Accept U.S.D.A. FOOD STAMPS

We Aim To Please!  
No Alcoholic Beverages  
Or Pornography Sold.  
1212 North Greene Street  
Greenville, N.C. 27834

FRESH GROUND BEEF  
\$1.29  
3 LBS. OR MORE



RICHFOOD BACON  
\$1.09  
LB. PACKAGE



FULL CUT BONE IN ROUND STEAK  
\$1.79  
LB.

RICHFOOD SAUSAGE  
99¢  
LB. PACKAGE

FIRST CUT PORK CHOPS  
99¢  
LB.

RICHFOOD CATSUP  
32 OZ. JUG  
59¢  
LIMIT 2

FOX PIZZA'S  
CHEESE, HAMBURGER SAUSAGE, PEPPERONI  
11.5 OZ.  
79¢

EVERYDAY LOW PRICES  
RICHFOOD TOWELS  
49¢

WALDORF BATHROOM TISSUE  
4 ROLLS  
79¢

MORTON POT PIES  
8 OZ. 3 FOR \$1

CHAMP DOG FOOD  
25 LB. BAG  
\$3.39

BOUNTY TOWELS  
JUMBO ROLL  
49¢  
LIMIT 1

RICHFOOD GRADE "A" SMALL EGGS  
DOZ.  
39¢

CROWN POPSICLES  
79¢

RICHTEX SHORTENING  
42 OZ. CAN  
\$1.39  
LIMIT 1

PRODUCE NEW WHITE POTATOES  
10 LB. BAG  
79¢

RICHFOOD COLA, ORANGE, GRAPE  
64 OZ.  
79¢

TREND LAUNDRY DETERGENT  
GIANT 42 OZ. BOX  
99¢

YELLOW RIPE BANANAS  
4 LBS.  
\$1.00

RICHFOOD MACARONI & CHEESE  
4 FOR \$1

PEPSI COLA  
2 LITER  
79¢



CALIFORNIA NECTERINES  
3 LBS.  
\$1.00

RICHFOOD CANNED VEGETABLES  
Pork & Beans  
Cut Green Beans  
Fresh Sliced Beans  
Whole Or Sliced Potatoes  
Whole Kernel Corn  
Cream Style Corn  
3 FOR \$1

RICHFOOD BLEACH  
GAL. JUG  
49¢  
LIMIT 1

EVERYDAY LOW PRICES  
RICHFOOD LAUNDRY STARCH  
32 OZ.  
33¢



SCOTT 100 YEARS STORE COUPON

15¢ OFF TWO PACKAGES SAVE 15¢ ON 2 PACKAGES OF Scott Towels (BIG ROLL OR TWIN PACK)

15¢ OFF TWO PACKAGES

15¢ OFF TWO PACKAGES

15¢ OFF TWO PACKAGES

15¢ OFF TWO PACKAGES

The good value towel

THE USE, RESERVATION OR HANDLING OF COUPON NOT ACCORDING TO ITS TERMS CONSTITUTES FRAUD. ONLY ONE COUPON PER TWO PACKAGES PURCHASED. MECHANICAL REPRODUCTION OF COUPON PROHIBITED.

# HARRIS

SUPER MARKETS, INC.  
 Where Shopping Is A Pleasure  
 PRICES GOOD THURS., FRI., SAT.  
 GREENVILLE-AYDEN-Tarboro

# DOLLAR DAYS Sale

## COOKOUT SPECIALS

WHOLE (FINE FOR BAR-B-QUE)

**PIGS** 40 LBS. AND UP

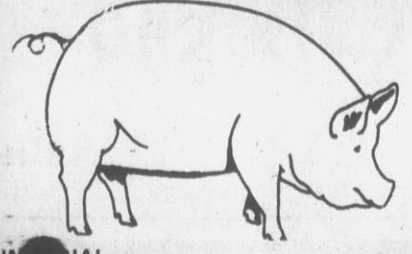

**59** LB.

WHOLE WESTERN BEEF

## RIB EYES

10-14 LB. AVG. CUT INTO STEAKS FREE

**2.99** LB.



## PRODUCE

DOLLAR DAYS SPECIAL

GOLDEN RIPE BANANAS 4 LBS. FOR **\$1.00**

FLORIDA ORANGES 5 LB. BAG **\$1.19**

LARGE CRISP LETTUCE 3 HEADS FOR **\$1.00**



CHARCOAL 20 LB. BAG **\$2.29**

GULF CHARCOAL STARTER . . . QUART **79c**

HEINZ 57 STEAK SAUCE. . . 10 OZ. SIZE **99c**



VAN CAMPS BEANEE WEENEE 2 8-OZ. SIZE FOR **79c**

## FELTS COUNTRY HAMS

WHOLE

**1.19** LB.

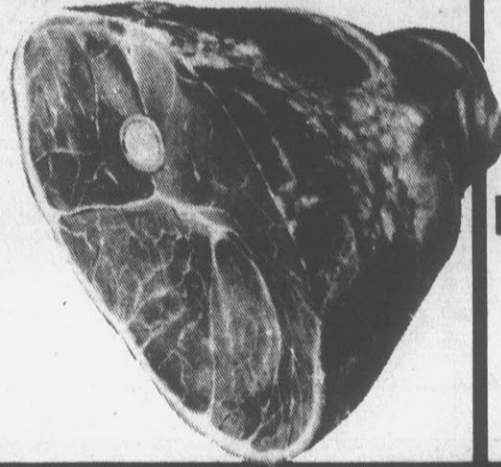

## SIRLOIN TIP ROAST

BONELESS

**\$1.69** LB.



## NABISCO SALE

SESAME WHEAT CRACKERS . . . **79c**

NUTTER BUTTER COOKIES . . . 15-OZ. SIZE **\$1.05**

OREO COOKIES . . . 19-OZ. SIZE **\$1.35**

OREO DOUBLE STUFF COOKIES 15-OZ. SIZE **\$1.05**

RITZ CRACKERS 16-OZ. SIZE **99c**



## HARRIS SLICED BACON

DOLLAR DAY SPECIAL

12-OZ. PKG

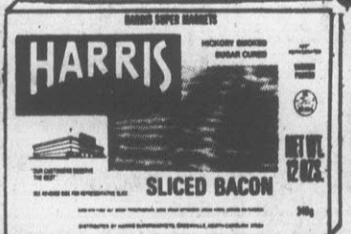

**\$1.00**

## WHOLE PORK LOINS

**\$1.09** LB. 8 TO 14 LBS.



## DUNCAN HINES BUTTER RECIPE GOLDEN CAKE MIX

18-OZ. SIZE

**59c**

LIPTON TEA BAGS 100 COUNT

**\$1.79**



- COUNTRY HAM HOCKS . . . 10 Lb. Box **\$7.99**
- SNOW WHITE FAT BACK . . . 10 Lb. Pkg. **\$3.99**
- PORK LIVER . . . 10 Lb. Pail **\$2.99**
- QWALTNEY ROLL SAUSAGE . . . 10 Lb. Box **\$9.99**
- CATES SALAD CUBES . . . **59c**
- KRAFT (DOLLAR DAY) MACARONI & CHEESE DINNERS . . . 4 7 1/2 Oz. Size For **\$1.00**
- ARMOUR VIENNA SAUSAGE . . . 2 5-Oz. Size For **\$1.00**
- ARMOUR POTTED MEAT . . . 4 3-Oz. Size For **\$1.00**
- WELCHES GRAPE JELLY OR JAM . . . 2 Lb. Size **99c**

## WILSON HOT DOGS

12-OZ. PKG

**99c**

**50c** COUPON Towards Purchase Of Any Size RAINBOW WHITE DETERGENT 32 Oz.-69¢ With Coupon 1.19 Without 64-Oz. 1.19 With Coupon 1.69 Without Expires 8/4/79

## CANDY SALE

### MILKY WAY, SNICKERS 3 MUSKETEERS

4 PACK FOR (25¢ BARS)

**69c**

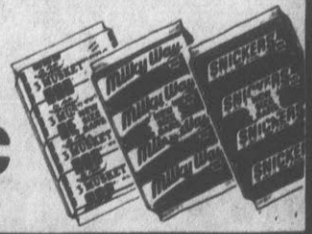

## DAIRY FOODS

SEALTEST SOUR CREAM

8-OZ. SIZE 2 FOR **\$1.00**

## CHARMIN TISSUE



NEW! SOFTER SCENT Charmin 2 4-Roll Packages For **\$1.69**

## DR PEPPER

2 LITRE DRINKS

**89c**



## FROZEN FOODS

COCONUT, GERMAN CHOCOLATE

COZY KITCHEN CAKES **\$1.39**

## FROSTY MORN SALE

DOLLAR DAYS SPECIAL HOT DOGS 12-OZ. PKG **\$1.00**

DOLLAR DAYS SPECIAL BOLOGNA 12-OZ. PKG **\$1.00**

HONEYGOLD SAUSAGE 12 OZ. PKG **\$1.00**



## DEL MONTE SALE

PINEAPPLE/ORANGE JUICE DRINK 46 OZ. SIZE **59c**

SLICED PINEAPPLE 15 1/2 OZ. SIZE 2 FOR **\$1.00**

CHUNK PINEAPPLE IN NATURAL JUICE 2 FOR **\$1.00**

CUT GREEN BEANS 2 303 CANS FOR **77c**

CUT GREEN BEANS IN NATURAL JUICE CRUSHED PINEAPPLE 15 1/2 OZ. SIZE 2 FOR **\$1.00**



PET RITZ BANANA, COCONUT, LEMON OR CHOCOLATE CREAM PIES . . . 14-Oz. Size **59c**

COUNTRY FRESH ICE CREAM (ALL FLAVORS) HALF GAL. **89c**



COUNTRY FRESH LOWFAT

MILK **\$1.69**

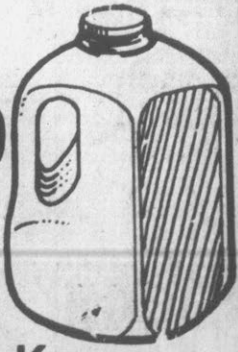

PILLSBURY BUTTERMILK BISCUITS 4 PACK 8 OZ. CANS **69c**



# GRADE "A" WHOLE FRYERS

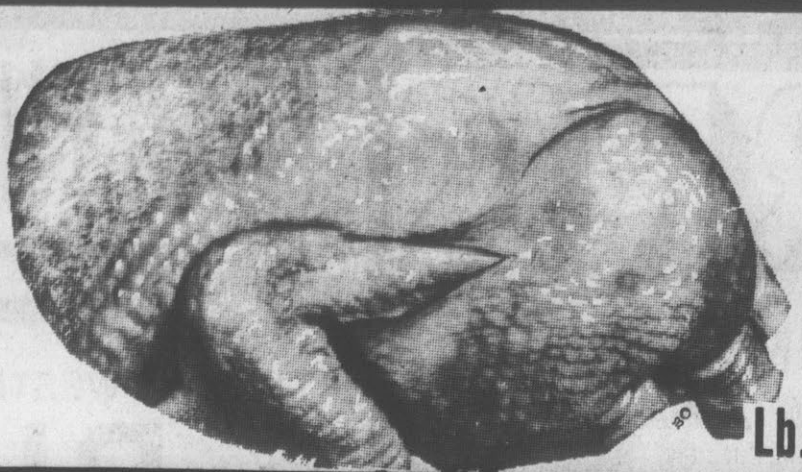

Lb.

# 39¢

**GWALTNEY BACON** 12 Oz. Pkg. **99¢**

**OVERTON'S FINEST GROUND BEEF** 3 Lb. Pkg Or More **\$1.59** Lb.

**MORRELL PRIDE FULL-CUT JOHN MORRELL ROUND STEAK** **\$1.89** Lb.

TREE-RIPENED **Peaches** **28¢** Lb.

FRESH SLICED 7-9 CHOPS **1/4 PORK LOINS** **\$1.49** Lb.

- "FAMILY PAK" SPECIALS OF THE WEEK
- PORK CHOPS..... 5-7 Lbs. \$1.45 Lb.
  - NECK BONES..... 10 Lbs. \$4.90
  - SMOKED SAUSAGE..... 10 Lbs. \$9.90
  - CHITTERLINGS..... 10 Lbs. \$4.90
  - GROUND BEEF PATTIES..... 10 Lbs. \$15.90

PRICES EFFECTIVE WEDNESDAY-SATURDAY



GOLDEN **BANANAS** **18¢** Lb.

DAWN **DISHWASHING LIQUID** Quart Bottle **98¢**

Quantity Rights Reserved Home Of Greenville's Best Meats 211 Jarvis Street - 2 Blocks From ECU Phone: 752-5025

BETTY CROCKER Your Choice **HAMBURGER HELPER** 2/\$1 6 Oz. Pkg. Spaghetti - Beef Noodle - Lasagna

4-ROLL PKG. **Charmin** **78¢**

RED, RIPE **WATERMELONS** 22 Lb. Avg. **\$1.59**

16 OZ. CARTON OF 8 - Plus Deposit **Coca-Cola** **98¢**

DUNCAN HINES DELUXE II **YELLOW CAKE MIX** YELLOW ONLY 17 Oz. Pkg. **68¢**

CALIFORNIA **BROCCOLI** Large Bunch **78¢**

CALIFORNIA VINE-RIPENED **CANTALOUPE** **68¢**

KRAFT **MIRACLE WHIP** Quart Jar **98¢**

CLIP THIS COUPON 5 LB. BAG **Dixie Crystals** **98¢**

With this coupon and \$7.50 food order excluding advertised specials. Without coupon \$1.18. Limit one coupon per customer. Expires August 4. (Please have coupons clipped separately)

CALIFORNIA THOMPSON SEEDLESS **WHITE GRAPES** Lb. **68¢**

CALIFORNIA SNOW WHITE **CAULIFLOWER** Large Head **88¢**

CLIP THIS COUPON JUMBO ROLL **Bounty** **48¢**

With this coupon and \$7.50 food order excluding advertised specials, without coupon 88¢. Limit one coupon per customer. Expires August 4. (Please have coupons clipped separately)

WESTERN **LETTUCE** Large Head **3/\$1.00**

KRAFT **ORANGE JUICE** Half Gal. Jug **\$1.08**

No stamps, no games, no gimmicks...just our promise to save you money on your total food bill.

WIGWAM **APPLE SAUCE** 303 Size Can **4/\$1**

CLIP THIS COUPON QUART BOTTLE **HEINZ TOMATO KETCHUP** **68¢**

With this coupon and \$7.50 food order excluding advertised specials. Without coupon 88¢. Limit one coupon per customer. Expires August 4. (Please have coupons clipped separately)

White Potatoes Lb. **8¢** Bell Peppers Each **8¢** Green Cabbage Lb. **8¢**

CLIP THIS COUPON GIANT BOX **Cheer** **98¢**

With this coupon and \$7.50 food order excluding advertised specials. Without coupon \$1.18. Limit one coupon per customer. Expires August 4. (Please have coupons clipped separately)

# THE REFLECTOR Shoppers Guide

BULK RATE  
U.S. POSTAGE  
PAID  
PERMIT NO. 306  
GREENVILLE  
N.C. 27834

POSTAL PATRON  
LOCAL

Vol. 10 No. 31

Wednesday, August 1, 1979

Greenville, North Carolina

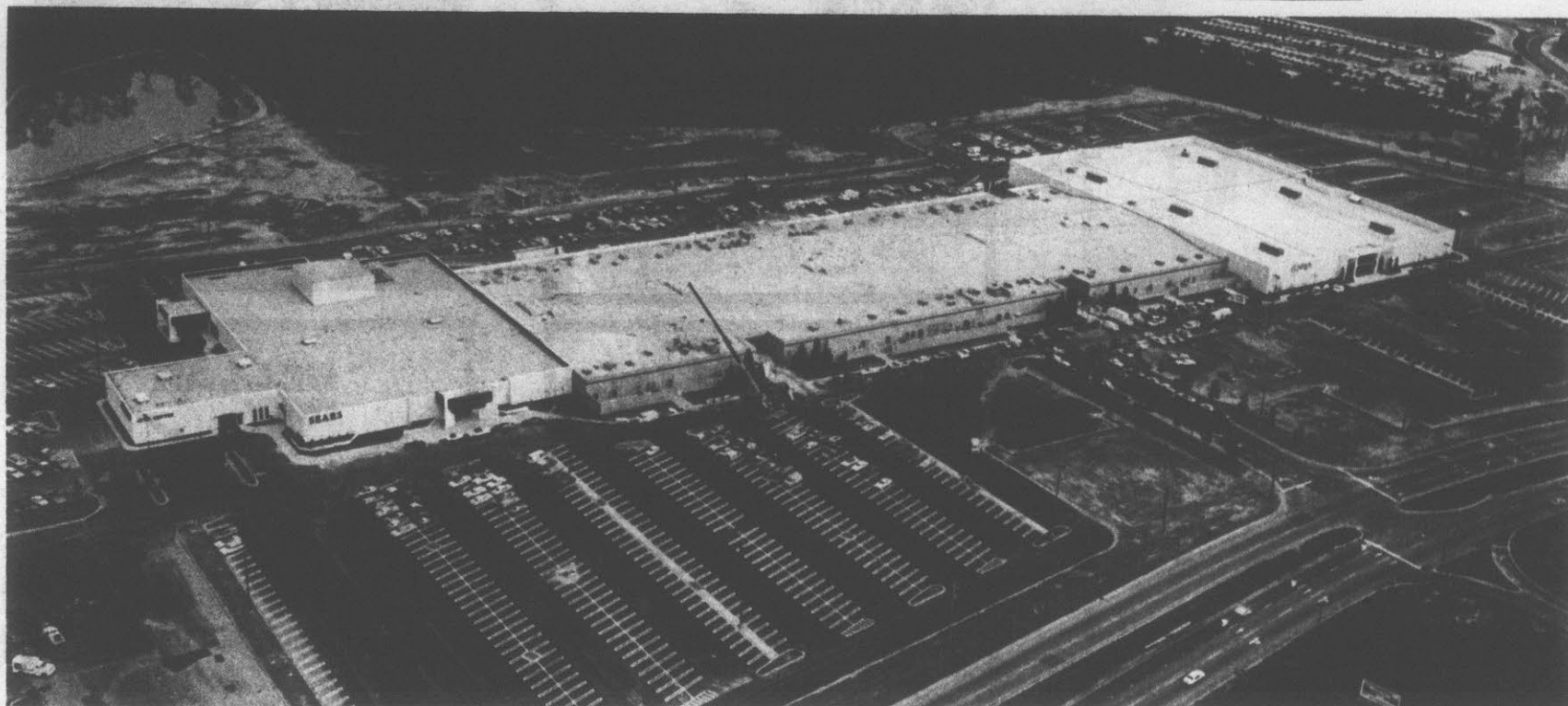

## Mall Opens Today

**AERIAL VIEW OF CAROLINA EAST** — The sprawling Carolina East Mall in Greenville with 64 stores holds its formal opening today (August 1) with entertainment and events for children.

The 130,000 square foot Belk-Tyler store is regarded as one of the mall's anchor units. Managerial officers of the mall forecast a substantial financial impact on Pitt County as well as Greenville, indicating that when all 64 stores in the present

enclosed mall are in operation approximately 368 people will be employed throughout the year with more during peak seasons. It is projected that 4.5 million people a year will visit the mall to shop, eat and brouse.



# Okay Annexation Proposals

The Joint City-County Planning and Zoning Commission voted last week to recommend to the City Council that a petition be approved for the annexation of some 46 acres on the southern fringe of the city limits.

The commission gave its unanimous endorsement of the petition by J. H. Blount Jr. and F. L. Blount III to have Section II of Pinewood Forest development annexed into the city.

The property, staff planner Skip Browder pointed out, is located south of Lynndale Subdivision and east of Section I of Pinewood Forest. The acreage involved in the petition is contiguous to the city limits.

Browder reported that an annexation study has been completed and the city staff found very few concerns or

objections regarding the property as a possible addition to the city land area.

Utilities have been installed, the planner said, and no problems were cited by the engineering or planning departments of the city.

Browder said that an area designated for recreational use in the development is needed and would involve some two acres or four lots. The Recreation Commission concurs in the need for the tract.

At full development, he noted that 77 single family homes are projected and the section would add an estimated \$3,650,000 to the city's tax base.

He added that the area meets all of the annexation criteria.

In other business on the joint agenda, commissioners

voted to defer action on the revised final plat of Section I of Oakgrove Estates, located on State Road 1417, until the Recreation Commission has been consulted on the possibility of purchasing two lots in the development for recreational use.

It was explained that initially it was proposed that two lots in the development be designated for possible recreational usage. Bobby Roberson, the city's director of planning, pointed out, however, that options on the two lots have expired.

Roberson recommended that the planning board approve the plat subject to the Recreation Commission deciding whether to purchase the lots.

Commissioner William Gibbs said that some five months ago the question of

recreational areas in Greenfield Terrace came up and plans then called for Greenfield Terrace residents to use the Oakgrove Estates recreational site.

Gibbs said that he would like for the Recreation Commission to give some indication as to whether it has interest in the designated lots before any action is taken on the final plat. Gibbs said the decision will have an impact on the Greenfield Terrace section.

Browder recalled that the Oakgrove land designated for possible recreational use was one of five areas set aside by the recreation board several years ago as sections in need of playground or park developments. Options have not been exercised on the designated parcels in Oakgrove, he said.

A spokesman for the developers of Oakgrove noted that other lots in the subdivision have been sold and the owner is interested in marketing the two remaining lots, whether they be to the Recreation Commission or another purchaser.

The Recreation Commission will be consulted regarding the Oakgrove property.

Joint board commissioners also endorsed the long range maintenance schedule of streets and thoroughfares, based on the Thoroughfare Plan, including three recommendations made by the Engineering Department. The long range plan will be considered by the Council.

Roberson said the maintenance schedule is a joint agreement that will be adopted by the city and the N.C. Department of

Transportation.

City Engineer Ron Sewell explained that the three areas recommended in the maintenance format include: the inclusion of 14th Street, from Dickinson Avenue out to the southern extension, on the state's maintenance schedule; the inclusion of the proposed Arlington Boulevard segment, from Memorial Drive out to the Highway 43 area, by the hospital, on the state schedule; and the assumption by the city for maintenance of Reade Street from Colaniche Street to First.

Commissioners also endorsed, with new member Bill Mitchum voting against, a proposal submitted by the Citizens Bikeway Committee for a bike loop around the city designed to connect the

(Continued on page 6)

# Dollar Day

## Thursday Aug. 2nd

**Rexall**  
**Quiet Nite**  
NIGHT TIME COLD MEDICINE



The cold medicine you take at bedtime...  
6 oz. **\$1.79**  
Dollar Day!

**Hollowell's**  
DRUG STORES, Inc.

Quality • Competitive Prices • Service  
911 Dickinson Ave 752-7105 6th St. & Memorial Dr. 758-4104

# DOLLAR DAY

## Quality Ladies Summer Shoes

Values to \$60<sup>00</sup>

**\$9 to \$15**

Palizzio, Amaffi, Red Cross, Joyce, Pappagallo

**Brody's**  
DOWNTOWN PITT PLAZA

SAVE LIKE NEVER BEFORE WITH OUR

# DOLLAR DAY

Thursday Thru Saturday

SHEER DRAPERY MATERIAL 45" wide **\$1.00** yd

Ladies Pull-On SLACKS **\$2.00** pair

Printed 45" wide DRAPERY MATERIAL **\$1.29** yd

One Lot 54" wide UPHOLSTERY MATERIAL **\$1.29** yd

**Mill Outlet Cloth**  
2727 East Tenth Street  
Colonial Heights Shopping Center  
Greenville, N.C.  
Open 9:30 A.M. - 5:30 P.M.  
Monday Thru Saturday

# Dollar Day

Maternity Wear  
Dresses • Slacks • Tops  
Shorts • Bathing Suits

**1/2 Price**

1/2 Price  
Girls  
Dresses • Bathing Suits  
Boys  
Shorts • Shirts • Play Clothes

Children's Pajamas... **30% off**

**The Stork's Nest**  
113 W. 4th Street  
Downtown Greenville



# DOLLAR DAY

## 15% OFF ALL FRAMING ORDERS

Taken On Dollar Day!

One Group  
**Prints Reduced**

**"THE FRAMING SHOP"**  
ERNEST AND KNOTT GLASS CO.  
FOR DICKINSON & CLARK  
GREENVILLE, N.C.  
752 2133 752 2134



# Dollar Day

Thursday Only

All In Stock

## Carpet

**10% off**

**Eastern Carpets, Inc.**  
264 By Pass  
Greenville, N.C.  
756-1944

Next to Kentucky Fried Chicken on the ByPass



# DOLLAR DAY Sale

758-2452

LARGE DIAMOND CLUSTER LOOK,  
SMALL DIAMOND PRICE!

*The Sparkler*

QUALITY DIAMONDS

SALE PRICE **\$99.50**

**Floyd G. Robinson Jewelers Inc**  
407 Evans Mall  
Downtown Greenville  
Greenville's Seiko Headquarters  
"If it don't tick, Tock to us"  
Open 8:30-5:30 Monday-Saturday



# dollar day

TAKE A LITTLE TV WHEREVER YOU GO!

**ZENITH**  
9" Jet-set III  
BLACK & WHITE  
AC/DC/BATTERY TV

COMPACT LIGHTWEIGHT  
1 WAY PLAYING VERSATILITY

\*AC HOME CURRENT-For use whenever electricity is available.  
\*12-VOLT DC AUTO ADAPTER-Plugs into car or rec-vehicle cigarette lighter for DC operation.  
\*Battery Pack Optional

The Jet Set III-L092-Featuring Zenith 100° solid-state chassis for outstanding performance and dependability. Quick-on sunshine picture tube provides sharp picture detail. Solid-state tuning system, detachable sunshield and private listening earphone. Choose Ebony, White, or Poppy Red color.

Big Viewing Enjoyment for only **\$129<sup>95</sup>**

**V.A. MERRITT & SONS**  
207 Evans Street  
Downtown Greenville  
752-3736



*Dollar Day*

**Thursday**

**Aug. 2nd**

**DOLLAR DAYS**

**WOMEN'S SHOES**  
VALUES TO \$30.00

- FLORSHIEM
- MISS WONDERFUL
- EMMA JETTICKS
- VITALITY
- HUSH PUPPLIES

**\$10**

SHOE STORE  
*Parry's*

- Quality
- Fit
- Service

ON THE MALL  
DOWNTOWN GREENVILLE  
OPEN AT 9 A M

**DOLLAR DAY BUYS!**

ALL WHIRLPOOL  
**APPLIANCES**  
ZENITH, RCA AND SONY  
TELEVISION SETS AND STEREO  
REDUCED FOR DOLLAR DAY,  
THURSDAY, AUGUST 2ND STOP  
BUY AND SEE THESE VALUES.

**BOB'S T.V. & Appliance**

108 E 2nd St  
Avden N C  
Telephone 746 4021

1702 W 5th St  
Greenville, N C  
(Near Pitt Mem. Hosp.)  
Telephone 752 6248

**Stretch-a-Buck**  
ON DOLLAR DAY

Playmobile  
Reduced **25%**  
Oak  
Swings & Ladders  
**1/2** Price



Selected  
Dolls  
**25% to 50% OFF**

**HAPPILY EVER AFTER**

Downtown Mall Greenville  
"Toys For All Ages"

**DOLLAR DAY**

All In Stock  
Merchandise  
**15% Off**

Grab Table  
Up  
To **40% Off**

*The Linen Closet*

3008 E 10th Street

**DOLLAR DAY**

Selection  
**Paperback & Hardback Novels**

Including Art Books, Fine Art Reproductions  
Books, Better Homes & Gardens, Assorted Craft  
Books, Large Group Novels, Including Classics.

From **25¢** up

**Central News & Card Shop**

Open 7 Days 9AM to 9PM  
On The Mall Downtown Greenville

Master Charge VISA

**DOLLAR DAYS**  
**JANIE**

**LADIES SUMMER FOOTWEAR**

Sandals-Casuals  
Dress Shoes  
Formerly \$8<sup>99</sup> to 19<sup>99</sup>  
NOW ALL REDUCED

**\$3<sup>00</sup> - \$4<sup>00</sup>**  
**\$5<sup>00</sup> - \$6<sup>00</sup>**

HUNDREDS OF  
PAIRS ON SALE



**Whites**  
DOWNTOWN SHOPPING CENTER  
FREE PARKING

**DOLLAR DAY**

I would like to thank you for your patronage  
in the past and would appreciate it in the future.  
I will still remain in my present location in the  
University Arcade, 218 E. East 5th Street.

All  
Jewelry... **1/2** Price

Some Discontinued  
Cosmetic Items... **1/2** Price

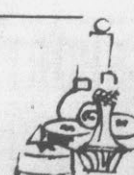

**MERLE NORMAN COSMETIC STUDIO**  
University Arcade—218 E. East 5th St. 752-3895

**DOLLAR DAY**  
**Special**

**THURS., AUGUST 2nd ONLY**

Close-Out On  
SCRUBBABLE,  
STRIPPABLE  
PRE-PASTED  
**WALLCOVERINGS**  
**\$1<sup>00</sup>**

Per Single Roll  
(Values to \$11.95 per roll)  
LIMITED QUANTITIES!  
SHOP EARLY



**CREATIVE WALLCOVERINGS**  
1207 West Fourteenth St. Phone 758-9318



# Looking For Involvement

The Pitt and Martin Involvement Councils are participating in a reimbursement grant program through the Governor's Office of Citizen Affairs to develop information and referral services for the counties. The amount of Pitt County's grant is \$3,570 and Martin County's is \$2,500.

This grant will facilitate the effective operation of the entire Involvement Council concept. Started in May 1978, at the urging of Governor James B. Hunt Jr., and administered on the state level by the Governor's Office of Citizen Affairs, the Involvement Councils are designed to serve as a local clearinghouse where citizens can go to get help as well as to give help.

Involvement Councils have several distinct functions. They are designated by County Commissioners to locate community services and try to link volunteers with area projects they might be interested in. They support existing services by added exposure, and attempt to bring together various groups around common concerns. In addition, many Involvement Councils encourage community programs in reading, crime prevention and other areas. There are presently Involvement Councils in over 50 North Carolina counties.

# Working As Interns

BOONE — Two Greenville natives who are students at Appalachian State University are working this summer as interns with business and industry in a special academic program in ASU's Walker College of Business.

Working in the Internship-in-Industry program are David King, a senior insurance and real estate major and John Sheppard, a junior management major.

The program is designed to provide students with practical experience prior to graduation in the field where they plan to work. Some 150 students at ASU work as interns each year, with each receiving six semester hours of academic credit.

King is the son of Mr. and Mrs. Roscoe L. King of 1757 Beaumont Rd., Greenville. He is working for First People's Savings and Loan Association, Raleigh.

Sheppard, the son of Mr. and Mrs. Moses Sheppard, 207 Nichols Dr., Greenville, is working in management at Williams Cleaners, Wilmington.

# DOLLAR DAY

## Thursday Aug. 2

On Dollar Day we disregard the cost of merchandise. Most items on this sale are priced at only a fraction of the manufacturer's cost. We almost give it away to make room for fall merchandise.

COME EARLY AND STAY LATE

One Table About 700 Yds <b>POLYESTER INTERLOCK PRINTS</b> Reg. 3.99 And 4.99 <b>\$1.00</b> <small>\$ Day Yd</small>	One Table <b>BLUE DENIM</b> Short Lengths <small>\$ Day</small> <b>\$1.00</b> <small>2 Yds</small>	One Table <b>COTTON TEE-SHIRT KNITS</b> 50-72 Inches Wide Reg. 2.99 Yd <b>\$1.00</b> <small>\$ Day 2 Yds</small>	One Group-Only 28 <b>FITTED CHAIR COVERS</b> Reg. 9.95 \$ Day <b>\$2.00</b> <small>Each</small>
PLACE MATS Cloth Foam Back Reg. 69¢ \$ Day <b>\$1.00</b> <small>4 For</small>	Odd Lot <b>DRAPERIES</b> Values to 12" <b>\$5.00</b> <small>\$ Day Each</small>	RUGS Size 18x30 Reg. 2.00 \$ Day <b>\$1.00</b> <small>Each</small>	CURTAINS Tier And Valance Sets 4 and 30 Inches Long (Ideal For Mobile Homes) <b>\$1.00</b> <small>\$ Day Set</small>
One Group <b>LACE DRAPERIES</b> Reg. 3.99 \$ Day <b>\$2.00</b>	One Rack Girl's Summer <b>Dresses</b> Sizes 2/6x-Reg. 7.99 to 11.99 - \$ Day <b>\$5</b> 7/14 Reg. 11.95 to 13.95 - \$ Day <b>\$6</b>	21 Only <b>LADIES PANT SUITS</b> Reg. 22.95 \$ Day <b>\$10.00</b>	One Group Ladies <b>SATIN SHORT &amp; TOP SETS</b> Reg. 7.99 \$ Day <b>\$5.00</b> <small>Each</small>
One Group Ladies <b>POLYESTER &amp; COTTON GOWNS</b> Reg. 3.99 \$ Day <b>\$2.00</b>	34 Pair <b>GIRLS BLUE DENIM JEANS</b> Reg. 7.99 Sizes 7/14 <b>\$2.00</b> <small>\$ Day</small>	One Rack <b>LADIES POLYESTER KNIT DRESSES</b> Values From 15.95 to 22.95 <b>\$5.00</b> <small>\$ Day Each</small>	
One Rack <b>LADIES TOPS</b> Shortsleeves And Sleeveless \$ Day Reg. 4.99 <b>\$2.00</b> <small>Each</small>	One Group <b>GIRLS TOPS</b> Sizes 7/14 \$ Day Reg. 3.99 <b>\$1.00</b> <small>Each</small>	One Group Ladies-Long Ang Short Sleeve <b>BLOUSES</b> Reg. 7.99 to 13.95 \$ Day <b>\$3.00</b> <small>Each</small>	One Rack <b>LADIES SLACKS</b> Reg. 9.00 \$ Day <b>\$3.00</b> <small>Each</small>
One Group <b>LADIES DRESSES</b> Reg. 12.95 to 15.95 \$ Day <b>\$2.00</b>	One Group Ladies Sun Top <b>DRESSES</b> Reg. 7.00 \$ Day <b>\$3.00</b> <small>Each</small>	One Group Ladies Large Size <b>BLOUSES</b> Short And Long Sleeves Sizes 44 to 52 Reg. 9.95 and 10.95 \$ Day <b>\$5.00</b> <small>Each</small>	18 Only <b>LADIES BLAZERS</b> Reg. 12.95 \$ Day <b>\$5.00</b> <small>Each</small>
Boys Short Sleeve <b>SPORT SHIRTS</b> \$ Day 2 For Reg. 4.99 <b>\$5.00</b> <small>Knits And Broadcloths</small>	One Group Boys Blue Denim <b>WRANGLER JEANS</b> \$ Day Sizes 8 to 18 - Values to 11.95 <b>\$5.00</b>	Size 3 to 7 Boys <b>SHIRT AND SHORT SETS</b> \$ Day Values to 6.99 <b>\$2.00</b>	11 Only Size 2 to 6 <b>BOYS SUITS</b> Reg. 27.95 \$ Day <b>\$10.00</b> <small>No Lay-A Ways</small>
28 Only Size 8 to 18 <b>BOYS SUITS</b> Reg. 10.55 \$ Day <b>\$19.00</b> <small>No Lay-A Ways</small>	2 For Values to 2.99 <b>\$3.00</b>	29 Only Mens Straw <b>DRESS HATS</b> \$ Day Reg. 10.95 to 14.95 <b>\$2.00</b> <small>Reg. to 7.99</small>	One Group Mens <b>KNIT SHIRTS</b> Reg. 10.95 to 14.95 \$ Day <b>\$5.00</b>
Mens Screen Print Front <b>TEE SHIRTS</b> Values to 2.99 \$ Day <b>\$1.00</b>	For Men And Women <b>SEA GRASS HATS</b> Reg. 1.99 \$ Day <b>\$1.00</b>	Mens Dacron & Cotton <b>KNIT SHIRTS</b> \$ Day Reg. 4.99 Crewneck & Placket Styles <b>\$2.00</b>	\$ Day Sale <b>LADIES SUMMER FOOTWEAR</b> Dress-Casuals-Sandals Formerly 8.99 to 17.95 Now All Reduced <b>\$3-\$4-\$5-\$6</b> <small>Hundreds Of Pairs On Sale Med And Wide Widths</small>
Mens Summer <b>PAJAMAS</b> \$ Day Reg. 7.99 Short Sleeve With Short Or Long Legs <b>\$3.00</b>	Reg. 2.49 <b>JELLO SANDALS</b> \$ Day Childrens And Ladies Sizes <b>\$1.00</b>	One Group Misses <b>DRESS SHOES &amp; SANDALS</b> \$ Day Values to 6.99 <b>\$3.00</b>	One Group <b>MENS SLACKS AND JEANS</b> Values to 16.95 \$ Day <b>\$7.00</b>
43 Only Mens <b>SUMMER SUITS</b> 3 Pc. Vested Styles \$ Day <b>\$35</b> <small>No Lay-A Ways No Alterations Reg. to 99.95</small>	Terrific Group <b>CHILDREN'S SPORTSWEAR</b> 2 Pc. Sets And Separates One Group Values to 3.99 <b>\$1.00</b> One Group Values to 5.99 <b>\$2.00</b> One Group Value to 7.99 <b>\$3.00</b>		Entire Stock Ladies <b>SUMMER HANDBAGS</b> \$ Day Sale Reg. to 8.95 <b>\$3.00</b> Reg. to 12.95 <b>\$5.00</b>
Mens Canvas <b>Converse Pro-250 Basketball Shoes</b> Hi And Low Tops Reg. 17.95 Values \$ Day <b>\$8</b>	Childrens 2 to 4 <b>GYM SHORTS</b> \$ Day Reg. 1.99 <b>\$1.00</b>	One Group-Odd Lot <b>MENS SHOES</b> Dress-Casual-Work \$ Day <b>\$4</b>	One Group-Childrens <b>POLO SHIRTS</b> 2 For Reg. to 2.99 Value to 1.99 <b>\$1.00</b>

**Whites**  
 DOWNTOWN SHOPPING CENTER  
 401-407 DICKINSON AVENUE  
 FREE PARKING

## Annexation....

(Continued from page 1)

recreational and cultural centers of the city.

The proposed 9.4 mile route would utilize existing corridors, including the bike path on Arlington Boulevard between Evans Street and Hooker Road, and would be designated by signs. Eventually, it is hoped that a system of links would be added to connect all parts of the city.

The Greenville planning board gave its approval to the preliminary and final plats of Section I of the J. F. Arthur property, located north of Arlington Boulevard between Evans Street and Seaboard Coast Line Railroad.

It was pointed out that the matter was tabled at the last meeting in order to study the Pitt Street situation and it was decided by the city staff that Pitt should be recommended for stoppage at Deck Street.

Attorney Fred Mattox, representing adjoining property owners, said that his clients opposed the proposal to stop Pitt Street at Deck and said that his clients believe good planning dictates that Pitt be extended on through.

Mattox said that if a public right-of-way is not provided, an area will exist with no north-south access. He asked why Arlington Boulevard should be four-laned and improved if traffic was not going to be routed to it.

Attorney Mickey Herrin, representing the Arthur developers, said that since the plat meets the checklist he feels said that since the plat met the checklist, he felt it should be approved.

Roberson said that the city feels Pitt should not be extended and he noted that Pitt is not seen as a major corridor for traffic on long range plans. He said that if it is extended, it would serve as a collector street and would be contrary to the Thoroughfare Plan.

Roberson added that the extension of Pitt to Arlington Boulevard would require signalization at the intersection and that would not be favorable. He said that the city felt the traffic volume should utilize Evans Street which is designated for four-laning.

Other business on the agenda included:

— Approval of the final plat of Patrick Blount property located between McClellan Street and Seaboard Coast Line Railroad and north of Deck Street.

— Tabling of action on the preliminary plat of Whichport Subdivision located on US 264 Bypass, adjacent to Nichols Shopping Center.

— Approval of the final plat of Section II of Whichport Subdivision on the bypass adjacent to Nichols.

— Approval of the final plat of Fairlane Farms, Block B, located on Hooker Road adjacent to Carolina Telephone

# Group Sues Pitt-Greene PCA

A group of 19 Pitt County residents have filed suit against Pitt-Greene Production Credit Association, seeking to recover more than \$84,000 from the Pitt-Greene Farmers Reserve Fund and \$500,000 in punitive damage.

In addition to the half-million dollars in punitive damages and the \$84,370 the group is seeking to recover from the reserve fund, the plaintiffs are asking to recover, "treble damages" for all damages awarded by the jury, an amount that possibly could exceed \$252,000.

The complaint was filed with the Clerk of Superior Court, June 26, by Milton C. Williamson and Mickey A. Herrin, attorneys for plaintiffs, who include Mr. and Mrs. Bobby E. Cannon, Mr. and Mrs. James Marion Cannon, Samuel Ira Cannon, Mr. and Mrs. Walter Gaskins, Mr. and Mrs. Tony A. Hardee, Mr. and Mrs. Noah T. Hardee, Mr. and Mrs. Sidney M. Harrell, Mr. and

Mrs. Henry Rex Lewis, Mr. and Mrs. John Tripp, G. W. Hamill and Dorothy Hamill.

The complaint alleges that the plaintiffs have on deposit in the PCA's Farmers Reserve Fund more than \$84,000; that the plaintiffs have demanded that PCA deliver the money...plus interest to the "plaintiffs but PCA has refused to deliver said money...even though PCA has no right whatsoever to hold the plaintiffs' money;" and that PCA representatives, "made misleading and fraudulent statements... with the plaintiffs being told that they were putting

money in a type of savings account that could be used by each of the plaintiffs in the event the plaintiffs needed that money which was being placed in the fund to pay on loans obtained by the plaintiffs from PCA."

Alleging that the agreement under which the plaintiffs placed the money in the fund, "is invalid," the complaint charges that the, "PCA discriminated against each of the plaintiffs in requiring," them to sign an agreement and place money into the fund, "in that other citizens and residents of Pitt County borrowed money from PCA without

having to sign said agreement and without having to place money in the reserve fund."

The suit also charges that, "PCA failed and refused to comply with their terms of said contract in delivering money to those plaintiffs who complied with the terms of said 'Agreement' regarding a request of a refund of the money which they had in the fund," and that, "requiring the plaintiffs to sign said 'Agreement' and contribute to the 'fund' are beyond the bounds allowable by law to PCS and said acts were solely to allow PCA to make loans greater that would

have been necessary to the plaintiffs and to collect interest over and above that which would ordinarily have been due from the plaintiffs..."

Finally, the complaint charges that, "the actions of the defendant...constitutes an unfair method of competition and unfair or deceptive act or practice in the conduct of trade or commerce and are in violation and contradiction of North Carolina General Statutes..."

The amounts allegedly on deposit in the fund and being sought by the plaintiffs range from \$22,173 to \$4,021.94.

## PCC Starting Two Classes

Two classes will begin in the near future at Pitt Community College.

"Sewing Crafts for Bazaars" will begin Thursday, August 2, and will be held from 9-11 a.m. "Plaster Crafts" will begin Tuesday, August 7, and will be held from 7-10 p.m. For more information on these classes, call PCC, 756-3130, extensions 238 or 266. The courses are free to senior citizens with a general fee of \$5.

**NAMED TO DEAN'S LIST**  
CULLOWHEE — Harold E. Garland of Greenville and Carolyn Huff of Vanceboro have been named to the Dean's List for spring semester at Western Carolina University.

Co. — Approval of the revised final plat of Elizabeth Heights Subdivision located on Evans Street Extension across from Pinewood Forest.

— Approval of the sedimentation control plan for Fairlane Farms; and

— Tabling of action of the preliminary plat of Brooklea Subdivision located on the proposed Brownlea Drive just north of Kingsbrook Road.

In a final item, commissioners voted to recommend to the Council that the subdivision regulations be amended to reflect a change in minimum street frontage requirements from 60 to 50 feet. The recommended amendment would clarify some present conflicts in regulations, it was pointed out.



## Stay On Top of the News

There's something for everyone  
in every issue of

# THE DAILY REFLECTOR

Up-to-the-minute news

Thought provoking editorials

Exciting pictures

Special features

Thrilling sports

Syndicated columns

Entertaining comics

Advertising messages

Call 752-6166 for home delivery

# Everything Clicked On County Tour

"Here in Pitt County, things clicked along pretty smooth," said assistant agricultural agent Gaylon Ambrose of last week's 2-day visit of the Agricultural Extension Service's Tobacco Research on Wheels tour.

A tour of the Speight Seed Farm near Winterville kicked off the 21st annual event Monday night, with people in all facets of the tobacco industry gathering for a tour of the farm and a pig picking, as well as for "tobacco talk."

"The rain deterred some visits to various plots on the farm, but people seemed to have a good time," said Ambrose.

Tuesday morning, participants gathered at the Lynn Raymond Hardee farm near Simpson to view use of mechanization in tobacco farming, with viewers impressed by Hardee's production.

"Everything couldn't have been better," said Ambrose of the farm visit. "Different types of machinery were displayed, with two different types of bulk curing shown. I think the tour group was probably impressed."

A tour of Farmer's Tobacco Warehouse followed, with viewers able to view the hustle and bustle of opening day on the Eastern Market. Ambrose noted that some of the tour participants, some from as far away as Jamaica, Brazil and Venezuela, had never been in the market atmosphere before.

Following the warehouse tour, participants moved to the Oliver Smith farm in Lenoir County to study the use of different fumigants in the fields, then to the Horace Phillips farm in Jones County for a display of chemical use on control of Granville Wilt. After a lunch break at a Kinston restaurant, two more tours followed in Duplin and Cumberland Counties before "The Pride In Tobacco" dinner in Lumberton.

Tours on the Border Belt were scheduled for today, with a visit to the Border Belt Tobacco Research Station. Tonight, the Research On Wheels banquet will be held in Benson, with a special program on WRAL-TV and the Tobacco Radio Network.

The tour will wind up Thursday in Wake County at the Sidney Fish farm for another discussion on control of Granville Wilt.

Ambrose seemed pleased with the results of the tour in Pitt County and the participants' interest in the tobacco industry.

"Approximately 100 cars left Pitt County yesterday, all with the research tour," the agricultural agent noted. "We had really good participation."

# HARRIS

SUPER MARKETS, INC.

Where Shopping Is A Pleasure

PRICES GOOD THURS., FRI., SAT.  
GREENVILLE-AYDEN-TARBORO

# DOLLAR DAYS Sale

## COOKOUT SPECIALS

WHOLE (FINE FOR BAR-B-QUE)

# PIGS

40 LBS. AND UP

# 59¢

LB.



WHOLE WESTERN BEEF

# RIB EYES

10-14 LB. AVG. CUT INTO STEAKS FREE

# 2.99

LB.



## PRODUCE

DOLLAR DAYS SPECIAL

GOLDEN RIPE BANANAS 4 LBS FOR \$1.00

FLORIDA ORANGES 5 LB BAG \$1.19

LARGE CRISP LETTUCE 3 HEADS FOR \$1.00



IMPERIAL CHARCOAL 20 LB. BAG \$2.29

GULF CHARCOAL STARTER . . . QUART 79¢

HEINZ 57 STEAK SAUCE . . . 10 OZ. SIZE 99¢

VAN CAMPS BEANEE WEENEE 2 8-OZ SIZE FOR 79¢



## FELTS COUNTRY HAMS

WHOLE

# 1.19

LB.



## SIRLOIN TIP ROAST

BONELESS

# 1.69

LB.



## NABISCO SALE

SESAME WHEAT CRACKERS . . . 79¢

NUTTER BUTTER COOKIES . . . 15-OZ. SIZE \$1.05

OREO COOKIES . . . 19-OZ. SIZE \$1.35



HARRIS SLICED BACON

DOLLAR DAY SPECIAL

12-OZ. PKG

# 1.00



WHOLE PORK LOINS

# 1.09

LB. 8 TO 14 LBS.



DUNCAN HINES BUTTER RECIPE GOLDEN CAKE MIX 18-OZ. SIZE 59¢

LIPTON TEA BAGS 100 COUNT \$1.79



OREO DOUBLE STUFF COOKIES 15-OZ. SIZE \$1.05

RITZ CRACKERS 16-OZ. SIZE 99¢



COUNTRY HAM HOCKS . . . 10 LB. \$7.99

SNOW WHITE FAT BACK . . . 5 LB. \$3.99

POOR LIVER . . . 5 LB. \$2.99

SAUSAGE (WALNUT HULL) . . . 5 LB. \$9.99

SALAD CUBES (PART-DOLLAR) . . . 59¢

MACARONI & CHEESE DINNERS . . . 4 \$1.00

VIENNA SAUSAGE . . . 2 \$1.00

POTTED MEAT . . . 4 \$1.00

JELLY OR JAM . . . 2 99¢

WILSON HOT DOGS 12 OZ PKG 99¢

COUPON: 50¢ Toward: Purchase Of Any Size RAINBOW WHITE DETERGENT

32 Oz - 69¢ With Coupon 1.19 Without  
64 Oz - 1.19 With Coupon 1.69 Without

## CANDY SALE

MILKY WAY, SNICKERS 3 MUSKETEERS

4 PACK FOR (25 BARS) 69¢



## DAIRY FOODS

SEALTEST SOUR CREAM 8-OZ. SIZE 2 FOR \$1.00



## CHARMIN TISSUE

NEW! SOFTER SCENT

3 Roll Packages for \$1.69



## DR PEPPER

2 LITRE DRINKS 89¢



## FROZEN FOODS

COCONUT GERMAN CHOCOLATE

COZY KITCHEN CAKES \$1.39



COUNTRY FRESH LOW FAT MILK \$1.69

Gallon Jug

PILLSBURY BUTTERMILK BISCUITS 4 1/2" x 4" CANS 69¢



## FROSTY MORN SALE

DOLLAR DAYS SPECIAL

HOT DOGS 12-OZ. PKG \$1.00

BOLOGNA DOLLAR DAYS SPECIAL 12-OZ. PKG \$1.00

HONEY GOLD SAUSAGE 12-OZ. PKG \$1.00



## DEL MONTE SALE

PINEAPPLE ORANGE JUICE 59¢

SLICED PINEAPPLE 2 \$1.00

CHUNK PINEAPPLE 2 \$1.00

CUT GREEN BEANS 2 77¢

CRUSHED PINEAPPLE 2 \$1.00

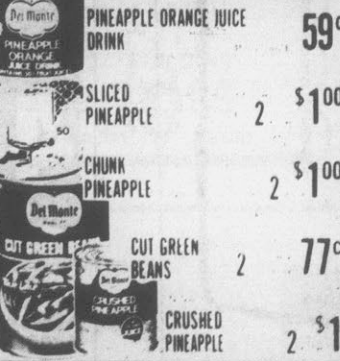

PET RITZ BANANA LEMON OR CHOCOLATE CREAM PIES . . . 11 OZ. SIZE 59¢

FRESH ICE CREAM - ALL FLAVORS! HALF GAL 89¢



# Farm Scene



Of all the dozens of vegetables in eastern North Carolina, the tomato is perhaps the most coveted of all summertime garden produce. For most people, the summer has not arrived until the first ripe tomato is picked and consumed. Gardeners really get anxious when it nears time for tomatoes to ripen.

Tomatoes can be grown in small spaces and still bear prolifically. A good tomato plant can yield as much as 50 pounds of tomatoes for a period of two to three months or longer. This is a distinct advantage for gardeners with limited space. There are numerous varieties of tomatoes on the market that are bred specifically for small gardens or even hanging baskets.

Tomato growers are faced with perplexing problems in some years. Many of these problems are caused by largely unknown factors, but some are due to well-known causes. Many tomato problems are insect and disease related, but there are several problems that are caused by physiological or environmental problems.

The most common complaint from home gardeners concerns blossom-end rot, or the sunken, rotted lesion on the blossom end of the fruit. This condition is brought on by a combination of factors. Fluctuating soil moisture, lack of available calcium and heavy suckering all tend to promote end rot. When plants are growing rapidly with adequate soil moisture, and then are subjected to 90 degree and higher temperatures with drought conditions, there is a good chance of the leathery blossom end rot appearing. Adequate moisture and properly limed soils will supply the necessary moisture and calcium. It is not necessary to

remove all the suckers (new stems and leaves that arise from the junction of the leaves and main stem.) The widespread practice of pinching out all suckers may accomplish very little except make blossom-end rot worse. It may also make the fruit more likely to sunscald and have a shorter life span.

Another problem with tomatoes is fruit cracking. Cracks in the fruit are caused by rapid growth. Periods of drought followed by hot wet weather are likely to spur growth and cause fruit to crack.

Cool and cloudy weather causes several tomato problems. Abnormal pollination, mishappen fruit, "cat-facing" and poor blossom set are all related to cool temperatures. Abnormal pollination can cause lopsided fruits, hollow fruits and elongated fruits. Mishappen fruit is often caused by the blossom sticking to the young tomato fruit, resulting in puckering and scarring. The cavities produced may go all the way to the center of the fruit.

Tomatoes often drop their blossoms and the net result is lowered yields of fruit. The cause of blossom rot is closely related to night temperatures. Most varieties of tomatoes will set fruit only in a narrow range of night temperatures. For the most part, night temperatures should be between 55 and 75 degrees. Temperatures below or above this range inhibit fruit set, or rather cause the blossoms to drop. The end result is often a lush vine with no tomatoes. This condition is frequently blamed on too much nitrogen fertilizer, when it is an environmental condition that is to blame.

Tomatoes are easy for some gardeners to grow and impossible for others.

SAVE! SAVE!  
SAVE! A&P'S  
SUMMERTIME

# 88¢ SALE!



SWIFT HOSTESS 4 LB OR A&P QUALITY 5 LB  
**CANNED HAM**

SLICED FREE  
EACH ONLY  
**\$788**  
YOUR CHOICE!

ADVERTISED ITEM POLICY

Each of these advertised items is required to be readily available for sale at or below the advertised price in each A&P Store except as specifically noted in this ad.

PRICES EFFECTIVE THRU SAT AUG 4 AT A&P IN GREENVILLE, N.C.  
ITEMS OFFERED FOR SALE NOT AVAILABLE TO OTHER RETAIL DEALERS OR WHOLESALEERS

CHECKERBOARD BRAND YOUNG  
**BASTED TURKEYS**  
10 TO 14 LB. AVG. WT.  
**88¢**  
LB.  
OLD WICKERY FARM BARBECUE \$188

A&P QUALITY  
**SMOKED HAM**  
SHANK PORTION  
**88¢**  
LB.  
MARKET STYLE SLICED BACON 88¢

A&P QUALITY HEAVY WESTERN GRAIN FED BEEF  
**ROUND STEAK**  
FULL CUT (BONE IN)  
**\$188**  
LB.  
24 TO 32 LB. BONE IN WHOLE BEEF RIBS \$188

A&P QUALITY HEAVY WESTERN GRAIN FED BEEF—WHOLE BEEF  
**BOTTOM & EYE ROUND**  
25 TO 35 LB. AVG. WT.  
**\$188**  
LB.  
CUT FREE INTO BOTTOM ROUND STEAK, ROAST EYE ROUND STEAK, EYE ROUND ROAST, RUMP ROAST AND GROUND ROUND. \$188

Greenville Square Shopping Center  
Greenville, N.C.  
Store Hours For Your Convenience  
Open Monday 7:00 A.M. To Saturday 12 Midnight  
Sunday 7:00 A.M. To 10:00 P.M.

HURRY! COMPLETE YOUR SET NOW!!!  
**Hearthside Garden Festival**  
HANDPAINTED STONWARE GOES OFF SALE SATURDAY NIGHT AUG 4

A&P COUPON  
10¢ OFF LABEL  
**CHEER** LAUNDRY DETERGENT  
YOU PAY ONLY **88¢**  
SAVE 61¢  
49 OZ PKG  
LIMIT ONE WITH COUPON AND ADDITIONAL \$3.50 ORDER  
A&P STORES THROUGH SAT AUG 4 AT A&P IN GREENVILLE, N.C.

YOU'LL DO BETTER WITH A&P'S grocery products

A&P QUALITY  
**SALTINE CRACKERS**  
**2 88¢**  
16 OZ PKGS.

PRIZE  
**POTATO CHIPS**  
**59¢**  
8 OZ. FOIL PACK

DEXOLA PURE  
**VEGETABLE OIL**  
**\$188**  
48 OZ BOTTLE

A&P QUALITY  
**LUNCHEON MEAT**  
**88¢**  
LIMIT ONE PER PERSON  
12 OZ CAN

ANN PAGE  
SALAD DRESSING 88¢  
COFFEE CREAMER 88¢  
FIG BARS 88¢  
KOSHER DILLS 88¢

A&P COUPON  
**DONALD DUCK ORANGE JUICE**  
SAVE 37¢  
GALLON BOTTLE  
**88¢**  
LIMIT ONE WITH COUPON AND ADDITIONAL \$3.50 ORDER  
A&P STORES THROUGH SAT AUG 4 AT A&P IN GREENVILLE, N.C.

A&P COUPON  
ANN PAGE VEGETABLE (IN OILS)  
**MARGARINE**  
SAVE 47¢  
1 LB PKGS  
**3 88¢**  
LIMIT ONE WITH COUPON AND ADDITIONAL \$3.50 ORDER  
A&P STORES THROUGH SAT AUG 4 AT A&P IN GREENVILLE, N.C.

**SHASTA COLA**  
78¢  
HEAVY OR ORANGE OR GRAPE

better health & beauty aids  
FABERGE  
**ORGANIC SHAMPOO**  
(REG \$1.89)  
15 OZ BTL  
**\$1.09**  
FABERGE  
**ORGANIC CONDITIONER**  
15 OZ BTL  
**\$1.09**

**THE FARM**  
AT A&P  
GOLDEN RIPE  
**BANANAS**  
**4 88¢**  
LBS. ONLY  
OUTSTANDING QUALITY  
**YELLOW CORN**  
**8 88¢**  
LARGE EARS ONLY  
BULK UNTRIMMED  
RED PLUMS 2 88¢  
CUCUMBER 88¢  
SEEDLESS GRAPES 88¢  
ROMAIN LETTUCE 88¢

better frozen foods  
ANN PAGE  
**LOOK FIT ICE MILK**  
**88¢**  
1/2 GAL CTN.  
ANN PAGE PIZZAS 88¢

better dairy products  
ANN PAGE 2%  
**LOWFAT MILK**  
**88¢**  
GRADE A  
1/2 GAL CTN.  
ANN PAGE YOGURT 3 88¢

**Printing**  
PHONE: 752-2878  
**Jimmy Smith Printing Co., inc.**  
511 COTANCHE STREET  
GREENVILLE, NORTH CAROLINA 27834  
•BUSINESS FORMS  
•BROCHURES  
•BOOKLETS  
•LETTERHEADS  
•STATEMENTS  
•ADVERTISING  
•WEDDING INVITATIONS  
If it's printing let us help you...  
Thanks

# Medication Could Also Be Harmful

Many medications in common use — both prescription and over-the-counter — can cause temporary or even permanent damage to the eyes.

Improper dosage and ignoring of warning labels can cause problems, reports the American Association of Ophthalmology.

Cold remedies which abound and drug stores and shopping centers contain belladonna derivatives, which act like atropine, a potent nerve-blocker chemical, and may cause acute glaucoma in some susceptible individuals, warns Kenneth R. Fox, M. D. of Falls Church, Va.

Non-prescription sedatives and sleeping pills can cause temporary slowing of nerve conduction, including the nerves around the eye, often causing the double vision which can be extremely dangerous while driving.

While double vision from overindulgence in alcohol or marijuana has been experienced by many, alcohol also may seriously damage the optic nerve which carries visual impulses from the retina in the back of the eye to the brain.

"Although the cannabis in marijuana is currently being used experimentally as a new treatment for certain types of glaucoma, other effects on the eyes from this drug are unknown."

"The pill," popularly used for birth control, can cause occasional serious damage to the blood vessels in the retina of the eye in susceptible women, as well as possible damage to other blood vessels, Dr. Fox said. Also, some users of "the pill" find that their eyes are extremely sensitive to contact lenses. Such patients should check with an ophthalmologist.

Vitamin A, necessary for the health of both the cornea and the retina of the eye, can cause an inflammation of the optic nerve and severe loss of vision, if taken in massive quantities. Vitamin D, if taken in large doses, can cause an accumulation of calcified plaque in the cornea, called "bank keratopathy."

# Scholarship For Local Student

Thomas C. Bolt of Greenville has received a scholarship to the University of Delaware Freshman Honors Program for academic achievement.

The University will offer a unique honors program for selected freshman students. Many of these students have elected to begin their work as "early admission" candidates and they begin the honors program before completing high school. Qualified, regular age students who have completed high school and wish to be part of the program will also be participating.

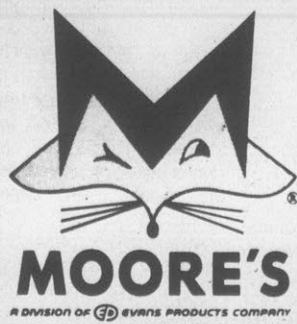

ORANGE

# MILLION DOLLAR TAG SALE

SALE  
Today  
thru  
Saturday

LOOK FOR  
THE  
ORANGE TAGS  
FOR  
SUPER BUYS

UP  
TO

# 75% OFF

OUR FORMER RETAIL PRICE ON SELECTED MERCHANDISE

ODD LOTS  
SOME SLIGHTLY  
DAMAGED  
SCRATCH  
& DENT

NO RAIN  
CHECKS AT  
THESE LOW  
LOW PRICES  
SHOP EARLY  
FOR BEST  
SELECTION!

**CELOTEX  
INSULATED  
SHEATHING**

**222**  
4 x 8 x 1/2

UP  
TO

# 40% OFF

OUR REGULAR LOW PRICES ON  
A SELECTED GROUP OF  
LIGHT FIXTURES

**CUT-TO-SIZE  
PONDEROSA PINE  
SHELVING BOARDS**

	4'	6'	8'
1 x 4	.99	1.88	2.49
1 x 6	1.99	2.88	3.88
1 x 8	2.49	3.78	4.99
1 x 10	2.99	4.88	6.49
1 x 12	3.49	5.49	7.69

PRICED BELOW OUR COST!

**PLASKOLITE  
SHOWER  
STALL**

**99<sup>95</sup>**

- Easy to assemble
- Includes grab rail, curtains & fittings
- #82771
- HIGH BASE UNIT
- #82787 ..... 129.95

**Door Mirrors** Your Choice

15 X 55 Reg \$9.99 Sale \$7.49  
15 X 55 Brass Frame Reg \$14.99 Sale \$9.49

**Single Glazed Wood Window**

2/8 X 6/2 1/2 Lite Sale \$65.00  
Reg \$89.99 One Only

**Entrance Double Door**

5/0 X 6/8 Style PD-2 Perma Door Reg \$299.99 Sale \$239.95 One Only

**Sink Chopping Block**

14 X 12 X 18  
Reg \$5.49 Sale \$3.99

**Heater Wall With Fan**

120 Volts No. 115022  
Reg \$22.88 Sale \$19.99

**10' X 7' Garage Door**

Wood with Hardboard Panels, Track & Hardware included

Reg \$199.95 Sale \$149.95

**Garage Doors 8' X 8'**

Wood with Hardboard Panels, Tracks & Hardware Included  
Reg \$299.99  
Sale \$245.00  
Two Only

**Gold Acrylic Tub**

Right Hand \$104.95  
Reg \$124.95 Sale

**19" Self-Rim Round Lavatory**

Choice Of Gold Or Marble  
Reg \$45.95 Sale \$29.95

**4 1/2 Ft. Tub Enclosure**

For Owens Corning Fiberglas Tub Clear Tempered  
Reg \$49.95 Sale \$35.95

**White Evanstyle Blinds**

81  
Reg \$25.39 Sale \$16.99

## STORAGE BUILDINGS TO FIT YOUR NEEDS

**NORTHPORT™  
10 x 9 SHED**

**119<sup>95</sup>** each KD

- 451 cu. ft. of storage space
- 340034

**CAMBRIDGE™  
HIGH ROOF 10 x 9 SHED**

**169<sup>95</sup>** each KD

- 527 cu. ft. of walk around space
- 340059

**NO SAWING REQUIRED**

**AMERICAN™ 8 x 8  
REAL WOOD BUILDING**

**289<sup>95</sup>** each KD

- Precut barn style storage building
- 301606

**ALL WOOD & METAL  
FENCING**

SAVE **30% OFF** REG. PRICE

**PREFINISHED  
WHITE ALUM.  
GUTTER**

8' SECT. **2<sup>99</sup>** each

• 036962

# 50% OFF

OUR REG. LOW PRICE

**TUB SURROUND KIT**

GILLESPIE DEKA  
• 630038 • 630061  
• 630103 • 630111

**1948** REG. 38.95

**PICK UP TOOL BOX**

Fits standard full width truck beds

**78<sup>88</sup>** each



Limited  
Quantities

OPEN 8-8 MONDAY thru FRIDAY  
8-5:30 SATURDAYS

329 Greenville Blvd Phone 756-5187



# Solar Energy Applied To Pig-Raising Facility

**GARDNERSVILLE** — With the rising costs of energy, Don and Ann Wilcox decided to harness the sun's energy for heating purposes. However, the heating's not for their house, it's for their self-contained feeder pig production facility, located outside of Gardnersville on State Road 1725.

The solar heating will be used primarily in the farrowing and nursery areas, where warm temperatures are needed the most. Their new operation, dubbed the "Pig Palace" by Nutrena Feeds, is housing 42 sows, with hopefully 8.8 pigs to

be marketed per litter. Wednesday, Nutrena Feeds, a division of Cargill Company, Slade and Harrell Feed of New Bern, and Jensen Solar Inc. of Goldsboro hosted a dinner and demonstration tour of the Wilcox operation. Approximately 50 persons, many of them hog producers, came to a local restaurant to hear about the benefits of solar heating used in an agricultural environment.

Jack Jensen, the eastern North Carolina representative for Nutrena Feeds, explained to the producers that the company

was interested in promoting the new concept as part of keeping in the forefront of new developments in the swine industry. Slade and Harrell officials also wanted to give the producers a chance to talk with the Wilcoxes and see the operation.

Jack Jensen of Jensen Solar Inc. noted that Wilcox had approached him concerning the use of solar heating in his new feeder pig building. According to Jensen, the solar system will supply approximately two-thirds of the building's heating needs, and reduce the need for conventional gas heating.

"This is the first time our company has worked with an agricultural energy problem," said Jensen. "We have installed solar units in residential homes, but nothing like this before."

"Energy is expensive and it's going to get more so," continued Jensen. "Solar isn't the answer to every energy problem, but it doesn't pollute, and it doesn't get more expensive."

Jensen noted that there are several different methods of hog production, and asked interested hog producers to work with him on an individual solar heating system.

"Let us help you define your problem," he noted. "Don't try to copy a system. It has to be engineered to individual needs."

"Some folks say that solar power is the energy of the future," Jensen continued. "Well, that's not so. The energy is here right now."

According to Jensen, the Wilcox's production building has 51 solar panels angled at 90 degrees on the roof top, providing 1,100 square feet of collection area. Heat collected from the sun warms the liquid in the 2,000 gallon storage tank. A backup gas heating system maintains the constant temperature in the storage tank.

Jensen explained that the panels were angled toward providing the best heat during the winter months, catching the longer rays.

## Energy Technology Program Planned

Pitt Community College will begin a new, two-year Energy Technology training program in September, fall quarter. The associate degree program has been developed over a two year period through research and development in conjunction with the N.C. Department of Community Colleges and the Energy Division of the N.C. Department of Commerce.

The purpose of the new program is to provide trained personnel who are capable of assisting business, industry, governmental agencies, utilities and homeowners in coping with the energy problems and crisis. Program emphasis is upon energy management and conservation with additional experiences provided in solar energy and other alternate energy sources.

Employment prospects for energy technology graduates are bright and appear to be increasing daily. One national survey conducted at Baylor University stated that there would be more than 7,000 energy related jobs to be filled in the United States during the next ten years, and that over half of these would require trained energy technologists.

Statewide energy manpower research conducted by Pitt Community College has already identified more than 630 current energy jobs in North Carolina and established a projected need for energy technologists at 650 by 1990.

Graduates of the program will be able to perform numerous tasks including: conducting energy audits, assisting in the designing of more energy efficient structures, monitoring facilities and operations for energy efficiency, operating and servicing energy management systems and conducting energy/benefit analyses.

Pitt Community College is currently accepting applications for admission to the program. For further information, interested prospects should write or call Marcus King, chairman, Department of Energy Technology, Pitt Community College, P.O. Drawer 7007, Greenville, N.C. 27834.

## Listed As Outstanding

The Board of Advisors for the Outstanding Young Men of America Awards Programs have announced that 24 Pitt County men have been included in the 1979 edition of the "Outstanding Young Men of America."

These men were selected from nominations received from various governmental and civic leaders, including the United States Jaycees, who endorse the program.

Greenville nominees are as follows: Michael Lee Aldridge, Jeffrey Earl Allen, Charles Manuel Asbell, Jr., Richard Wooten Briley, Jr., Jerry Neal Creech, Paul deVendel Davis, Ronald Lane Hartis, Jeffrey Lee Miller, Ernest Cordell Avery, Paul Breitman, James Michael Bumgarner, Phillip Howard Cummings, Duard Francis Fleming Jr., Richard Lee Kerns, Jeffrey Dale Manning, James Gilbert Moore, Donald Wayne Newman, Dale Richard Rice, Etheridge Hubert Ricks, Bobby Ray Taylor, Douglas Park Williams, Warren Keith Stroud Sr., and Joseph Leigh Taylor.

David Kent Allen of Winterville was included in the 1979 edition.

## Ten Pitt Youth At '79 4-H Congress

Ten Pitt County young people attended the 1979 4-H Club Congress last week and were awarded a certificate for their participation in several county blood collection drives.

Brenda Roberson, formerly of the Bethel Golden Eagles 4-H Club, was tapped for inclusion in the 4-H Honor Club, one of 42 4-H'ers selected from across the state. She is currently enrolled as a sophomore at North Carolina State University.

Amy Tyson of the Bushwackers 4-H Club from Ballards Crossroads performed in the Thursday Talent Show with 14 other 4-H club acts from across the state. She performed a ventriloquist act.

Cynthia Lilley of the Grifton Pioneers 4-H Club, and Jeff and Tim Johnson of the Fountain Trailblazers chapter competed in statewide contests in beef char-grill, electric demonstrations and senior archery competitions respectively.

Gloria Hinson, Melanie Bell, Guy Dixon, Gladys Roberson and Linda Peele also attended the congress from Pitt County.

4-H leaders from Pitt County who served as chaperones and coordinated various activities were as follows: Mrs. Nancy Allen, Mrs. Rene Thompson, Mrs. Gladys Avery, Mrs. Jessie Glen Shaw, Mrs. Doris Tyson, and Mrs. Rachel Albritton. Members of the East Carolina University Collegiate 4-H Club in attendance were as follows:

John Ward, Dasha Effird, and Melody Loughran. Dasha Effird greeted Governor Jim Hunt as part of her duties as 1979 State Council Secretary-Treasurer and presided over the Wednesday session.

Jean Johnson, Pitt County 4-H Program Assistant, accompanied the delegation on Tuesday, and Dale Panaro, Pitt County 4-H Agent, attended the week-long congress.

## Deadline For Veterans On Pension Plan

**WINSTON-SALEM** — Veterans Administration Regional Director Kenneth E. McDonald reminds veterans who are eligible for the improved pension plan that October 1, 1979 is the deadline for qualification of retroactive benefits.

The improved plan offers substantially higher pension rates than the old program, but changes in some income counted under the new plan may make it advisable for certain veterans to remain under their current plan.

In establishing the improved plan, Congress stipulated that veterans may switch before Oct. 1 if they wish the higher rates it provides to take effect retroactively to Jan. 1, 1979.

Detailed explanations were given on "tuning," whereby the optimum heat is gained coming out of the storage tanks. Three valves and a thermometer regulate the flow, obtaining a heat of around 130-150 degrees Fahrenheit for maximum BTU's.

Jensen quoted a base figure of approximately \$14,000 for installation of a solar unit, but cautioned pork producers that each unit would differ, depending methods of operation.

After the talk, producers proceeded in a caravan fashion to the Wilcox farm to see the new building and to hear more about the solar unit. As Don Wilcox walked through the building, he explained how he had decided on using solar heating:

"I just decided by myself that the idea would be a good one," he said. "I looked in the telephone directory for solar installers. It's got to work as long as the sun shines."

For the Wilcoxes, who've moved around the United States for approximately 15 years in the pork production business, the solar collectors will help keep down the costs of overhead and provide warmth for the first litter of pigs to born in the new facility, sometime in the middle of August.

### 78 Houses For Sale

**CLARK-BRANCH SELLS TWO HOMES A WEEK SOMETIMES THREE**

**NEW OFFERING**  
Duplex for sale. Excellent location. 2 bedrooms, 1 bath in each. \$56,000. Loan assumption available. Rental income \$450 monthly.

**NEAR SIMPSON**  
Reasonably priced. FHA-VA available. Cape Cod style on 1/2 acre wooded lot. 3 bedrooms, 2 full baths, over 1300 square feet heated area. Convenient living in the country. Priced in the mid \$40's. Under construction. Call today and select your own decor.

**BETHEL**  
One of the finer homes in this area with 2800 square feet, detached storage barn and 1/2 acre garden lot off rear. Includes four bedrooms, two fireplaces and large covered porch area, excellent landscaping and new oil furnace. This brick one and a half story has charm you must see to appreciate. Mid \$50's.

**NEW OFFERING**  
Miniature Blithmore Estate describes this beautiful estate approximately 14 miles south of Greenville. Nearly 5000 square feet on over 4 acres of land in a magnificent setting including stables and rolling terrain. The contemporary home itself is enhanced by a wall of glass in the front giving you a preview of what's within. 5 bedrooms, huge den, playroom, extremely large kitchen with brick floor and wet bar, study and endless special features. Please call for your private showing. \$100's.

**CLARK-BRANCH, INC. REALTORS 756-6336**

On Call: Colette Dilworth 756-8380 Sharon Lewis 756-9987

Ed Meyer 756-6695 Mary Chapin 756-8431

Connally Branch 756-1549 Glo Clark 756-0046

An Equal Housing Opportunity

**TO PLACE YOUR Classified Ad,** just call 752-6166 and let a friendly Ad-Visor help you word your Ad.

### 100 CLASSIFIED DISPLAY

**WE INSTALL ALUMINUM AND VINYL SIDING**  
Remodeling, Room additions, etc.  
**C.L. LUPTON CO.**  
752-6116

**ROOFING**  
STORM WINDOWS  
DOORS & AWNINGS  
Remodeling, Room additions, etc.  
**C.L. LUPTON CO.**  
752-6116

**WANT TO SELL YOUR HOUSE?**  
For fast action, list with us:  
**CENTURY 21**  
Real Estate Brokers  
756-2121

**WE REPAIR SCREENS & DOORS**  
Remodeling, Room additions, etc.  
**C.L. LUPTON CO.**  
752-6116

Army tents—back packs, sleeping bags, canteens, work and casual apparel, foot wear, cloths-outs, camping and sporting goods, plus new and used G.I. surplus  
**ARMY - NAVY STORE**  
142LS Evans St

**Betty's Personnel Service**  
208 E. Greenville Blvd.  
"Let us help you with your employee needs. Satisfaction Guaranteed."  
(Budget Fees)  
Betty Evans, Owner  
**756-3404**

## CLASSIFIED ADS

**12 Cadillac**  
**CADILLAC** 1976 Sedan DeVille. 40,000 miles, one owner. Perfect condition. Loaded. 756-5365.

**56 Miscellaneous**  
**4 PIECE**, 1 place breakfast setting. 179; Recycled jeans, \$3.95; Work pants, \$2.50; Shirts, \$1.75; plus over 400 different GI items. Army-Navy Store, 1501 South Evans Street.

### 78 Houses For Sale

**CLARK-BRANCH SELLS TWO HOMES A WEEK SOMETIMES THREE**

**COUNTRY**  
In Fairfield 3 bedrooms, 2 full baths, great room with fireplace, kitchen. FHA-VA financing available. Move in for \$1650. Offered at \$43,000.

**COUNTRY**  
It's new and nearly complete with 3 nice bedrooms and 2 full baths, single garage and large kitchen area. Heatilator fireplace in the great room. See this excellent floor plan with FHA-VA financing available at \$44,700.

**NEW OFFERING**  
With large family in mind. 5 bedrooms, 3 1/2 baths, 3100 square feet. Screened in porch, fenced in back yard. Well constructed home on Greenville Boulevard. Reasonably offered at \$68,500. Call today for details.

**UNDER CONSTRUCTION**  
On Stantonsburg Road. Approximately 1300 square feet, wooded lot. 3 bedrooms and double carport. \$45,000. Excellent location and convenient floor plan. Come see the plans on this country home today.

**LOTS AVAILABLE**  
Wooded On Stantonsburg Road ..... \$6,500  
East Of Greenville ..... \$6,500

**CLARK-BRANCH, INC. REALTORS 756-6336**

On Call: Colette Dilworth 756-8380 Sharon Lewis 756-9987

Ed Meyer 756-6695 Mary Chapin 756-8431

Connally Branch 756-1549 Glo Clark 756-0046

An Equal Housing Opportunity

# TV LOG

PEPSI-COLA, "PEPSI" AND "MOUNTAIN DEW" ARE REGISTERED TRADEMARKS OF PepsiCo, INC.



Hello  
Sunshine  
Hello  
Mountain  
Dew



BOTTLED BY PEPSI-COLA BOTTLING COMPANY OF GREENVILLE, INC.,  
1809 DICKINSON AVENUE, GREENVILLE, NORTH CAROLINA  
UNDER APPOINTMENT FROM PepsiCo, INC., PURCHASE, N.Y.

**WNCT**  
Channel 9

**WITN**  
Channel 7

**WCTI**  
Channel 12

**THURSDAY**  
WNCT-Ch. 9

5:30 Carolina	4:00 Razzmatazz
8:00 Morning	4:30 Merv
9:00 Kangaroo	5:30 Brady Bunch
10:00 Magazine	6:00 9/Alive News
10:55 News	6:30 News
11:00 Price Is	7:00 Dating
12:00 News	7:30 Jokers
12:30 Search For	8:00 Waltons
1:00 Young and	9:00 Hawaii 5-O
1:30 World Turns	10:00 B. Jones
2:30 Guiding	11:00 News
3:30 M*A*S*H	11:30 Movie

**WITN-Ch. 7**

5:30 Adam 12	2:30 Another Wid
6:00 Almanac	4:00 Battle of
7:00 Today	4:30 McHales
7:25 News	5:00 Hogan's
7:30 Today	5:30 Silvers
8:25 News	6:00 News
8:30 Today	6:30 NBC News
9:00 Shore	7:00 Tic Tac
10:00 Card Sharks	7:30 Nashville
10:30 All Star	8:00 Project
11:00 Rollers	9:00 Ms. Columbo
11:30 Wheel of	11:00 News
12:00 News Noon	11:30 Tonight
12:30 Squares	1:00 Tomorrow
1:00 Our Lives	2:00 News
2:00 Doctors	

**WCTI-Ch. 12**

5:55 Tidings	4:00 Tom & Jerry
6:00 PTL Club	5:00 Emergency
7:00 America	6:00 News
7:25 News	6:30 News
8:25 News	7:00 Sanford
9:00 Donahue	7:30 Gong Show
10:00 Douglas	8:00 Mork &
11:00 Laverne &	8:30 Laverne
11:30 Family	9:00 B. Miller
12:00 Love Expert	9:30 Carter
12:30 Ryan's	10:00 20/20
1:00 Children	11:00 News
2:00 One Life	11:30 Starsky &
3:00 Hospital	1:45 Maverick
	2:45 Edition

**FRIDAY**  
WNCT-Ch. 9

5:30 Carolina	3:30 M*A*S*H
8:00 Morning	4:00 Love of
9:00 Kangaroo	4:30 Merv
10:00 All In	5:30 Brady Bunch
10:30 WHEW	6:00 9/Alive News
10:55 News	6:30 News
11:00 Price Is	7:00 Dating
12:00 9/Alive News	7:30 Joker's
12:30 Search For	8:00 Special
1:00 Young and	9:30 Ebony and
1:30 As the World	11:00 News
2:30 Guiding Light	11:30 Movie

**WITN-Ch. 7**

5:30 Adam 12	2:30 Another Wid
6:00 Almanac	4:00 Battle of
7:00 Today	4:30 McHales
7:25 News	5:00 Hogan's
7:30 Today	5:30 Silvers
8:25 News	6:00 News
8:30 Today	6:30 NBC News
9:00 Shore	7:00 Tic Tac
10:00 Card Sharks	7:30 M. Robbins
10:30 All Star	8:00 Different
11:00 Rollers	8:30 Rockford
11:30 Wheel of	10:00 Eddie Capra
12:00 News Noon	11:00 News
12:30 Squares	11:30 Tonight
1:00 Days Of	1:00 Midnight
2:00 Doctors	2:30 News

**WCTI-Ch. 12**

5:55 Tidings	2:00 One Life
6:00 PTL Club	3:00 Hospital
7:00 America	4:00 Tom & Jerry
7:25 News	5:00 Emergency
8:25 News	6:00 News
9:00 Donahue	6:30 News
10:00 Douglas	7:00 Sanford
11:00 Laverne &	7:30 Muppet
11:30 Family	8:00 Beatles
12:00 Pyramid	9:00 Movie
12:30 Ryan's	11:00 Cystic
1:00 Children	Telephone

**MONDAY**  
WNCT-Ch. 9

5:30 Carolina	4:00 Love of
8:00 Morning	4:30 Merv
9:00 Kangaroo	5:30 Brady Bunch
10:00 All In	6:00 News
10:30 WHEW	6:30 News
10:55 News	7:00 Dating
11:00 Price Is	7:30 Joker's
12:00 News	8:00 White Sha
12:30 Search	9:00 M*A*S*H
1:00 Restless	9:30 WKRP
1:30 World	10:00 Lou Grant
2:30 Light	11:00 News
3:30 M*A*S*H	11:30 Movie

**WITN-Ch. 7**

5:30 Adam 12	2:30 Another Wid
6:00 Almanac	4:00 Battle of
7:00 Today	4:30 McHales
7:25 News	5:00 Hogan's
7:30 Today	5:30 Silvers
8:25 News	6:00 News
8:30 Today	6:30 News
9:00 Shore	7:00 Tic Tac
10:00 Card Sharks	7:30 Kingdom
10:30 Secrets	8:00 Little House
11:00 Rollers	9:00 Movie
11:30 Wheel of	11:00 News
12:00 News Noon	11:30 Tonight
12:30 Squares	1:00 Tomorrow
1:00 Days of	2:00 News
2:00 Doctors	

**WCTI-Ch. 12**

5:55 Tidings	2:00 One Life
6:00 PTL Club	3:00 Hospital
7:00 America	4:00 Tom & Jerry
7:25 News	5:00 Emergency
8:25 News	6:00 News
9:00 Donahue	6:30 News
10:00 Douglas	7:00 Get Smart
11:00 Laverne &	7:30 Dance Fever
11:30 Family	8:00 Baseball
12:00 Pyramid	11:00 News
12:30 Ryan's	11:30 Police
1:00 Children	1:40 Maverick
	2:40 Edition

**TUESDAY**  
WNCT-Ch. 9

5:30 Carolina	3:30 M*A*S*H
8:00 Morning	4:00 Razzmatazz
9:00 Kangaroo	4:30 Merv
10:00 All In	5:30 Brady Bunch
10:30 WHEW	6:00 9/Alive News
10:55 News	6:30 News
11:00 Price Is	7:00 Dating
12:00 9/Alive News	7:30 Jokers
12:30 Search For	8:00 CBS News
1:00 Young and	9:00 Movie
1:30 World Turns	11:00 News
2:30 Guiding Light	11:30 Movie

**WITN-Ch. 7**

5:30 Adam 12	2:30 Another Wid
6:00 Almanac	4:00 Battle of
7:00 Today	4:30 McHales
7:25 News	5:00 Hogan's
7:30 Today	5:30 Silvers
8:25 News	6:00 News
8:30 Today	6:30 NBC News
9:00 Shore	7:00 Tic Tac
10:00 Card Sharks	7:30 Name That
10:30 All Star	8:00 Runaways
11:00 Rollers	9:00 Big Event
11:30 Wheel of	11:00 News
12:00 News Noon	11:30 Tonight
12:30 Squares	1:00 Tomorrow
1:00 Days of	2:00 News
2:00 Doctors	

**WCTI-Ch. 12**

5:55 Tidings	4:00 Tom & Jerry
6:00 PTL Club	5:00 Emergency
7:00 America	6:00 News
7:25 News	6:30 News
8:25 News	7:00 Sanford
9:00 Donahue	7:30 When Havoc
10:00 Douglas	8:00 Happy Days
11:00 Laverne &	8:30 Laverne &
11:30 Family	9:00 Three's
12:00 Pyramid	9:30 Taxi
12:30 Ryan's Hope	10:00 Starsky
1:00 Children	11:00 News
2:00 One Life	11:30 Movie
3:00 Hospital	1:10 Maverick
	2:10 Edition

**SATURDAY**

WNCT-Ch. 9	WITN-Ch. 7	WCTI-Ch. 12
7:00 Gilligan's	6:30 Better Way	5:45 Teletory
7:30 Laurel and	7:00 Treehouse	6:00 Marble
8:00 Popeye	7:30 Bay City	6:30 Hot Fudge
9:00 Bugs/runner	8:00 Alvin	7:00 Animals
10:30 Tarzan	8:30 Fantastic	7:30 Marlo
12:00 Space	9:00 Godzilla	8:00 Fang Face
12:30 Puff Puff	10:30 Daffy Duck	8:30 Scooby's
1:00 Juke Box	11:00 Fred &	10:00 Challenge
1:30 Film	11:30 Jetsons	11:30 Big Foot
2:00 Pop Goes	12:00 Bulford &	12:00 Panther
2:30 Honey's	12:30 Funnies	12:30 Bandstand
3:00 Concerts	1:00 Wrestling	1:30 Soul Train
4:00 Sports	2:00 Baseball	2:30 Nashville
4:30 Sports	2:15 Baseball	3:00 Last Wild
6:00 News	5:00 AAU Jr.	3:30 Sports
6:30 News	6:30 News	5:00 PGA
7:00 Pre-Season	7:00 Lawrence	7:00 Wrestling
8:00 Bad News	8:00 Chips	8:00 Battlestar
10:00 ELVIS	9:00 Love Boat	9:00 Love Boat
11:00 News	10:00 Supertrain	10:00 Fantasy
11:30 Movie	11:00 News	11:00 Red Eye
	11:30 Night Live	
	1:00 Closeup	
	1:15 News	

**SUNDAY**

WNCT-Ch. 9	WITN-Ch. 7	WCTI-Ch. 12
7:00 Revival	7:00 Club	6:00 Journey
7:30 Falwell	8:00 Day of	6:30 Gospel
8:30 O. Roberts	8:30 Viewpoint	7:00 Dimensions
9:00 Sunday	9:00 Swagart	8:00 Grace
10:30 PTL Club	9:30 Humbard	8:30 Revival
11:30 Tomorrow	10:30 The Answer	9:00 Schuller's
12:00 Face the	11:00 Angley	10:00 J. Falwell
12:30 Together	11:30 Tempo 79	11:00 Baptist
1:00 Movie	12:00 Hospitality	11:30 A. Campbell
3:00 Football	1:00 Movie	12:00 Issues &
4:00 Sports	2:30 Sports	12:30 First Sunday
6:00 Sportsman	4:00 SportsWorld	1:00 Life Style
6:30 News	5:30 Great Teams	1:30 Cinema
7:00 60 Min	6:00 Meet the	3:00 PGA
8:00 All In	7:00 Disney	4:00 Love
8:30 One Day	8:00 Alice	4:30 Merv
9:00 Movie	9:30 Jeffersons	5:30 Brady Bunch
10:00 News	10:00 Moses	6:00 9/Alive News
11:00 News	11:00 News	6:30 News
11:15 Late Movie	11:30 Whittington	7:00 Dating
	12:00 Ironside	7:30 Jokers
		8:00 Dorothy
		8:30 Big Nine
		9:00 Movie
		11:00 News
		11:30 Your Turn
		12:00 late movie

**WEDNESDAY**

WNCT-Ch. 9	WITN-Ch. 7	WCTI-Ch. 12
5:30 Carolina	5:30 Adam 12	5:55 Tidings
8:00 Morning	6:00 Almanac	6:00 PTL Club
9:00 Kangaroo	7:00 Today	6:00 PTL Club
10:00 All In	7:25 News	7:00 America
10:30 WHEW	7:30 Today	7:25 News
10:55 News	8:25 News	8:25 News
11:00 Price Is	8:30 Today	8:30 Today
12:00 9/Alive News	9:00 Shore	9:00 Donahue
12:30 Search For	10:00 Card Sharks	10:00 Douglas
1:00 Young and	10:30 All Star	11:00 Laverne &
1:30 World Turns	11:00 Rollers	11:30 Family
2:30 Guiding Light	11:30 Wheel of	12:00 Pyramid
4:00 Love	12:00 News Noon	1:00 Children
4:30 Merv	12:30 Squares	2:00 One Life
5:30 Brady Bunch	1:00 Our Lives	3:00 Hospital
6:00 9/Alive News	2:00 Doctors	4:00 Tom & Jerry
6:30 News	2:30 Another Wid	5:00 Emergency
7:00 Dating	4:00 Battle of	6:00 News
7:30 Jokers	4:30 McHales	6:30 News
8:00 Dorothy	5:00 Hogan's	7:00 Sanford
8:30 Big Nine	5:30 Silvers	7:30 Feud
9:00 Movie	6:00 News	8:00 Eight is
11:00 News	6:30 NBC News	9:00 Ch. Angels
11:30 Your Turn	7:00 Tic Tac	10:00 Veggs
12:00 late movie	7:30 Donna Fargo	11:00 News
	8:00 Real People	11:30 P. Woman
	9:00 The Rebel	1:45 Maverick
	11:00 News	2:45 Edition
	11:30 Tonight	
	1:00 Tomorrow	
	2:00 News	

# HRD Class Will Begin On Aug. 9

The next class in Human Resources Development (HRD) at Pitt Community College will begin Thursday, August 9. According to Charles Dickens, HRD coordinator at the College, 21 students will be selected to participate in the class.

The primary objective of the HRD program is to help citizens of the Greenville - Pitt County area who are unemployed, underemployed, and/or recipients of public assistance become gainfully employed tax-paying individuals. Another objective is to develop within the individuals a more positive self-image of themselves. The program also strives to place graduates in wage-earning capacities.

The program consists of two curriculum components, academic and orientation/motivation. The academic consists of studies in English, social studies, science literature and mathematics, with students able to take the General Educational Development test.

The orientation/motivation component deals with training the graduates how to cope with the working world.

The program is state-funded sponsored through the community college system of the State Board of Education. Local and federal funds are utilized only when necessary. The Comprehensive Education and Training Act (CETA) allocated funds from HEW through the state Employment Security Commission allows some students to be awarded stipends based on economic need.

Enrollees receiving AFDC and/or other forms of public assistance are ordinarily eligible to receive a stipend, daily travel reimbursement plus a small dependents' allowance. Enrollees not receiving public assistance may also qualify for stipends based on need. Each case is personally reviewed and decided on its own merit by the HRD program coordinator or staff appointee.

Interested individuals may apply for enrollment by contacting the HRD program, 756-3130, or writing P. O. Drawer 7007, Greenville, NC.

## Awards Go To Med Students

Three third-year medical students at the East Carolina University School of Medicine recently received awards for scholastic achievement and community service.

Eugene D. (Dave) Day Jr. of Durham received the Vivian Neal Barnes Memorial Award for academic achievement in pharmacology. The award was established in memory of the mother of Dr. Donald W. Barnes of the ECU Department of Pharmacology.

<p>GRADE "A" WHOLE <b>FRYERS</b> <b>39</b> Lb.</p>	
<p><b>GWALTNEY</b> <b>BACON</b> 12 Oz. <b>99c</b> Pkg.</p>	<p><b>OVERTON'S</b> FINEST <b>GROUND BEEF</b> <b>\$1.59</b> 3 Lb. Pkg Or More Lb.</p>
<p><b>Peaches</b> <b>28</b> Lb.</p>	<p><b>MORRELL PRIDE FULL-CUT</b> <b>JOHN MORRELL</b> <b>ROUND STEAK</b> <b>\$1.89</b> Lb.</p>
<p><b>Tree-Ripened</b> <b>1/4 PORK LOINS</b> <b>\$1.49</b> Lb.</p> <p>FRESH SLICED 7-9 CHOPS</p> <p>"FAMILY PAK" SPECIALS OF THE WEEK</p> <p>PORK CHOPS ..... 3.75 Lb. \$1.45 Lb. NECK BONES ..... 10 Lb. \$4.90 SMOKED SAUSAGE ..... 10 Lb. \$9.90 CHITTERLINGS ..... 10 Lb. \$4.90 GROUND BEEF PATTIES ..... 10 Lb. \$15.90</p> <p>PRICES EFFECTIVE WEDNESDAY-SATURDAY</p> <p><b>Overton's</b> Supermarket, Inc.</p> <p>Quantity Rights Reserved Home Of Greenville's Best Meats 211 Jarvis Street - 2 Blocks From ECU Phone: 752-5025</p>	
<p><b>DAWN</b> <b>DISHWASHING LIQUID</b> Quart Bottle <b>98c</b></p>	<p><b>BETTY CROCKER</b> Your Choice <b>HAMBURGER HELPER</b> <b>2/\$1</b> 6 Oz. Pkg. Spaghetti - Beef Noodle - Lasagna</p>
<p><b>4-ROLL PKG.</b> <b>Charmin</b> <b>78</b> Discover Softer softness Luxuriously soft</p>	<p><b>RED. RIPE</b> <b>WATERMELONS</b> <b>\$1.59</b> 22 Lb Avg</p>
<p><b>DUNCAN HINES/DELUXE II</b> <b>YELLOW CAKE MIX</b> YELLOW ONLY 17 Oz. <b>68c</b> Pkg.</p>	<p><b>CALIFORNIA</b> <b>BROCCOLI</b> Large Bunch <b>78c</b></p>
<p><b>CLIP THIS COUPON</b> <b>5 LB. BAG</b> With this coupon and \$7.50 food order excluding advertised specials. Without coupon \$1.18. Limit one coupon per customer. Expires August 4. Please have coupons clipped separately.</p> <p><b>Dixie Crystals</b> <b>98</b> pure cane sugar</p>	<p><b>CALIFORNIA VINE-RIPENED</b> <b>CANTALOUPE</b> <b>68</b></p>
<p><b>CLIP THIS COUPON</b> <b>JUMBO ROLL</b> With this coupon and \$7.50 food order excluding advertised specials without coupon \$1.18. Limit one coupon per customer. Expires August 4. Please have coupons clipped separately.</p> <p><b>Bounty</b> <b>48</b> Absorb Like Magic! TOWELS</p>	<p><b>CALIFORNIA THOMPSON SEEDLESS</b> <b>WHITE GRAPES</b> Lb. <b>68c</b></p>
<p><b>KRAFT</b> <b>ORANGE JUICE</b> Half Gal Jug <b>\$1.08</b></p>	<p><b>CALIFORNIA SNOW WHITE</b> <b>CAULIFLOWER</b> Large Head <b>88c</b></p>
<p><b>CLIP THIS COUPON</b> <b>QUART BOTTLE</b> With this coupon and \$7.50 food order excluding advertised specials. Without coupon \$1.18. Limit one coupon per customer. Expires August 4. Please have coupons clipped separately.</p> <p><b>HEINZ</b> <b>TOMATO KETCHUP</b> <b>68</b></p>	<p><b>WESTERN</b> <b>LETTUCE</b> Large Head <b>3/\$1.00</b></p>
<p><b>CLIP THIS COUPON</b> <b>GIANT BOX</b> With this coupon and \$7.50 food order excluding advertised specials. Without coupon \$1.18. Limit one coupon per customer. Expires August 4. Please have coupons clipped separately.</p> <p><b>ALL TEMPERATURE</b> <b>cheer</b> <b>98</b></p>	<p><b>WIGWAM</b> <b>APPLE SAUCE</b> 303 Size Can <b>4/\$1</b></p>
<p><b>White Potatoes</b> <b>8</b></p>	<p><b>Bell Peppers</b> <b>8</b></p>
<p><b>Green Cabbage</b> <b>8</b></p>	

# TOP TEN

Below Are Our  
10 Best Values

**LOWE'S**

We Challenged Our Marketing People To Come Up With 10 Of The Best Buys Available Anywhere. We Think You'll Agree: They Did!



Regularly \$1.99... Save \$1.00  
AC Exterior Plywood Precut  
To Convenient 2'x2'x1/4" Size

**99¢**

Each  
It's Lowe's best quality plywood, precut in a size for less waste and work in small do-it-yourself projects. Already sanded on one side for painting or staining. #11766



Lowest Price In Over A Year  
"Dale Bunyan" Economy 2x4's  
For A Variety of Projects

**79¢**

Each  
Use these handy, economical studs to build non-load-bearing partitions and similar items that are not governed by building codes. (Ask about delivery, too.) #07002

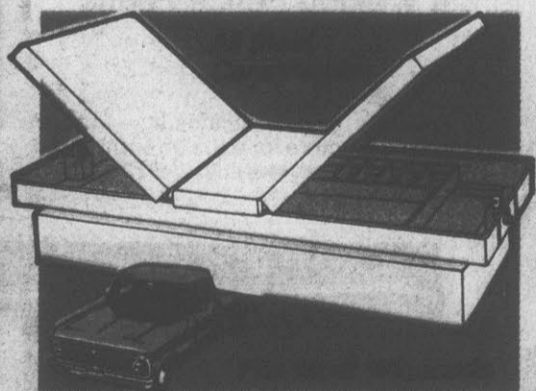

Lowest Price In Over 2 Years  
All-Steel Pickup Truck Utility  
Box In A Variety Of Sizes

**\$69<sup>88</sup>**

Protects your tools from theft and bad weather. Has positive pushbutton/key lock. All-steel construction with baked enamel finish and SureSeal overlapping lids. Removable tray for a variety of small items. And a price that was almost history. #92402



Our Lowest Price Ever  
Alarm Clock/Calculator For  
Home, School Or The Office

**\$16<sup>97</sup>**

With Batteries  
If you've been looking for a new calculator, this is it. If you've been looking for an alarm clock this is it, too. Desktop model with easy-to-read 1/2" LCD display. And (lo & behold) batteries are included. #55170



Regularly \$5.99. Advertised in  
July at \$4.49 "Spanish Moss"  
5/32"x4'x8' Wall Paneling

**\$3<sup>39</sup>**

Panel  
Add a great new look to the den, playroom etc. with this thrifty panel. Has light green tracings throughout the woodgrain for a cool, distinctive look. Simulated pattern on wood fiberboard. See it today! #13883

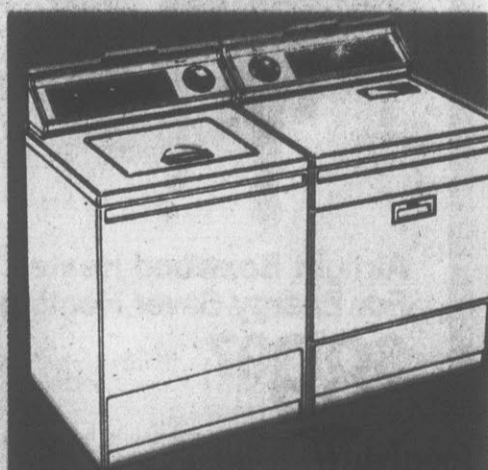

Regularly \$629.78, Save \$100.  
Lowe's Best Whirlpool  
Washer And Dryer Pair

**\$529<sup>78</sup>**

Washer has 5 cycle choices: Super Wash, Normal, Permanent Press, Gentle and Knit. Plus 2 wash & 2 spin speeds. Dryer has 5 temperature choices and cool-down care for perm press and knit fabrics. Buy Washer alone for \$309.87 and save \$50. Buy Dryer for \$239.91 & save \$30. #51360, 51510



Regularly \$32.49, Save \$12.52  
Choose One Of These 5-Light  
Chandeliers With Brass Finish

**\$19<sup>97</sup>**

Fixture at left has clear glass chimneys and white candle covers. It's 18" wide and 13 1/2" high. Fixture at right has crystal-etched glass chimneys & glass column. It's 18" wide and 12" high. Both models are perfect for the foyer, the dining room and more. Light bulbs not included. #74725, 30

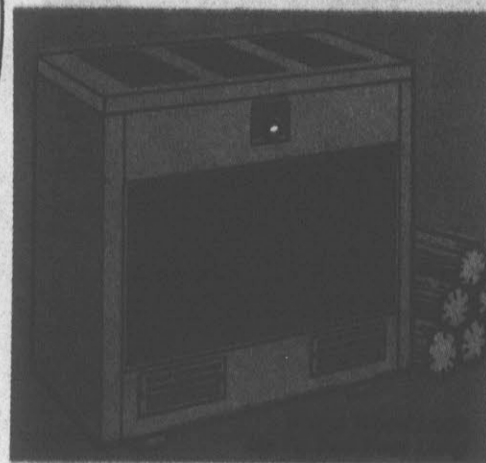

Same Price For 3rd Year  
Circulating Wood Heater Has  
An Adjustable Thermostat

**\$199<sup>97</sup>**

Blower Available  
For This Model.  
\$49.87... #37372

Cut your heating costs with this firebrick-lined heater. Has cast iron grate and adjustable thermostat that lets you set the combustion level to your comfort. #37370

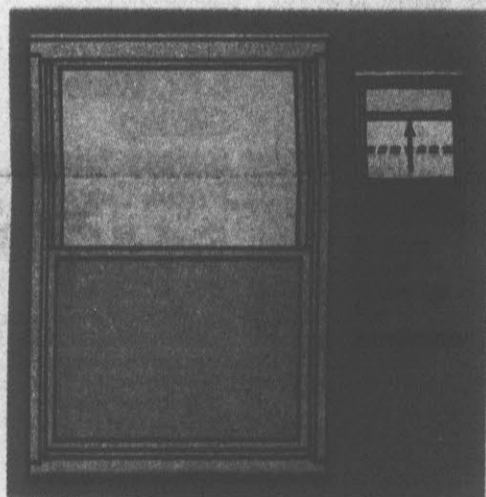

Preseason Truckload Sale!  
Aluminum Storm Window In  
All Standard Stock Sizes

**\$13<sup>99</sup>**

All The Windows  
You Need... At  
Lowe's Low Price!

Each  
Save energy this winter with storm windows at Lowe's low price. Predrilled and ready to install with just a screwdriver. Seals leaks & insulates to save you money. #1500 Header



Preseason Truckload Sale!  
6" Thick Unfaced Insulation.  
In 15" Or 23" Wide Batts

**19¢**

All The Insulation  
You Need... At  
Lowe's Low Price!

Each  
Has an R-value of 19! Excellent add-on to existing insulation, or for "first time" use (with suitable vapor barrier). Sold in complete bundles only. Take advantage of Lowe's low price and insulate now—before the winter winds arrive. #13585, 6

**LOWE'S**

AUG. '79 (CR)

2728 South Memorial Drive • Phone: 756-6560  
Greenville, N.C.

SUPPLEMENT TO: The Daily Reflector & The Reflector Shoppers Guide

We Guarantee To Hold  
The Prices Of Our  
Top Ten Values Until  
August 18th, 1979

The Other Prices In This  
Publication Are Guaranteed  
Through August 8th, 1979



Free Store-Front Parking.  
Convenient Location.  
Check Our Store For  
Unadvertised Specials

**You Can Own  
A Piece Of  
American  
History!**



**Used Railroad Cross Ties**

**\$6.99**  
Each

Real cross-ties. Approximately 7"x9"x8'6". With the rustic charm and durability that made 'em legendary. Cresote treated. #05203

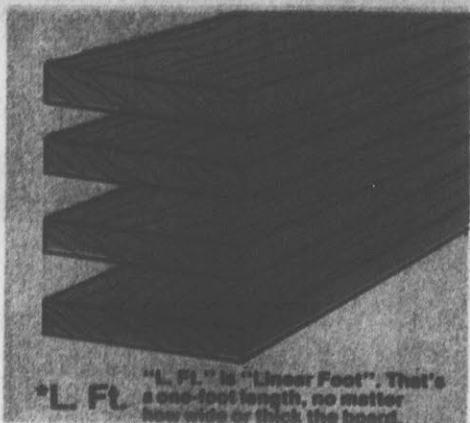

"L Fl." is "Linear Foot". That's a one-foot length, no matter how wide or thick the board.

**Be Chairman of the Boards  
With Lowe's Shelving Wood**

- |                               |     |         |
|-------------------------------|-----|---------|
| 1x4 #3 Ponderosa Pine #01185  | 22¢ | L. Fl.* |
| 1x6 #3 Ponderosa Pine #01200  | 28¢ | L. Fl.* |
| 1x8 #3 Ponderosa Pine #01250  | 37¢ | L. Fl.* |
| 1x10 #3 Ponderosa Pine #01300 | 45¢ | L. Fl.* |



**Landscaping Treated Timbers**  
**\$3.39**  
Each

Approximate size is 3 3/4"x5"x8". Resists rot, insects. #05207



**Pressure Treated 4x4x8 Posts**  
**\$4.29**  
Each

Pressure-treated for use in decks, docks, etc. Our best. #05290



**Real Redwood 4x4x8 Posts**  
**\$6.99**  
Each

Finished on all four sides. Good-looking. Heavy-duty. #04001



**Particleboard Shelving**  
**\$2.48**  
Each

1x12x8' boards have a knot-free, smooth surface. #01381



**Wood Shutters With Hardware**  
**\$16.99**  
Pair

For windows 25" to 28" W & 17" to 20" H. Paint or stain. #12802



**Mediterranean Style Turning**  
**99¢**  
2"x12"

Use as supports for bookcases, etc. Unfinished. #12430



**Handy 1x2 Furring Strips**  
**7¢**  
L. Fl.\*

Wood strips can be used to install paneling. #11782



**All Purpose 2x2 Lumber**  
**13¢**  
L. Fl.\*

For light support use in shelving and other home projects. #04160



**6 Ft. Wide Sliding Safety Glass Patio Door**  
**\$149.99**

Double-pane insulated safety glass lets the view in but keeps the heat and cold out. Has top-mounted safety-lock for your security. Aluminum finish. #13017



**Save \$5.00  
Oak Finish Vinyl Fold Door**  
**\$30.88**  
Regularly \$35.88

Add a door; enclose a closet; combine them to divide a room. They're adjustable to fit 24" to 29" opening. Do it yourself. #11313

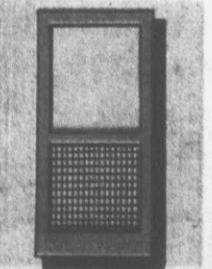

**Screen Door With Grill**  
**\$36.95**

3' wood frame door is ready to paint or stain. With protective kickplate grill. #11203



**Beige Vinyl Folding Door**  
**\$5.99**

An economical door. 2'8" x 6'8" size. With hardware and sliding track. #10962

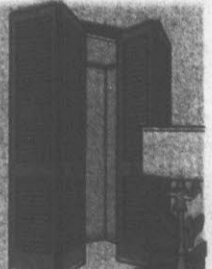

**Louvered Wood Bifold Door**  
**\$34.98**  
Single Door

Single folding door of unfinished pine. 2'8" x 6'8" size. Ready to paint, stain. #10537

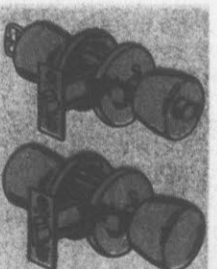

**Entrance Lock And Key Set**  
**\$7.49**

Brass finish lock has pushbutton inside and key outside. #60858  
Passage Latch #0002 \$3.88



**Blowing Or Pouring Insulation 30 Pound Bag**  
**\$3.49**

Cellulose add-on attic insulation. Can be poured from the bag or blown with use of a machine. Covers about 45 sq. feet with 3 1/2" layer. #12578

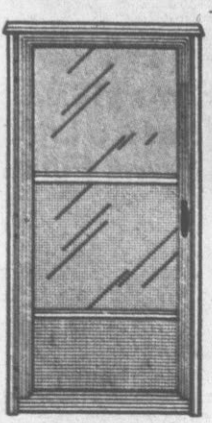

**2'8" Aluminum Combination Storm Door/Screen Door**  
**\$44.99**

Conserve energy with this prehung aluminum door. Has slide-up glass panel for summertime ventilation. With safety glass, latch & closer. #11131



**16 Oz. Spray Can Foam Insulation**  
**\$6.89**

Easily fills cracks & cavities around doors, windows, etc. Can be painted over. #13617



**Energy Saving Insul-Pane Panel**  
**\$5.49**

Works like a storm window from inside the house. 24"x36". With molding. #11221, 5



**Reflecto-Shield Blocks The Sun**  
**\$7.99**

Reduce solar glare in campers, boats, cars with this 28"x5" roll in silver color. #11365



**6-Pack Multi-Purpose Panels**  
**\$3.99**

Use 13"x48" panels to insulate behind wallboard. 3/4" thick. Polystyrene. #15350



**Lowest Price Ever!  
Lowe's Beautiful  
Random Shakes**  
*now only \$1.39* 12"x48" Section

Use Inside or Outside for a rich, rustic texture at an excellent price. Use it on a wall in your den. Or entirely remodel your home's exterior. Beautiful, Natural Wood Shake Look with deep-embossed weathered graining on durable, 7/16" thick unprimed hardboard with random edge. Can Be Painted, Stained or Sealed to beautifully complement your home's interior or exterior. Stop by Lowe's today for full details. #15833  
Galvanized 2 1/2" Siding Nails #12100 ..... 89¢ LB.

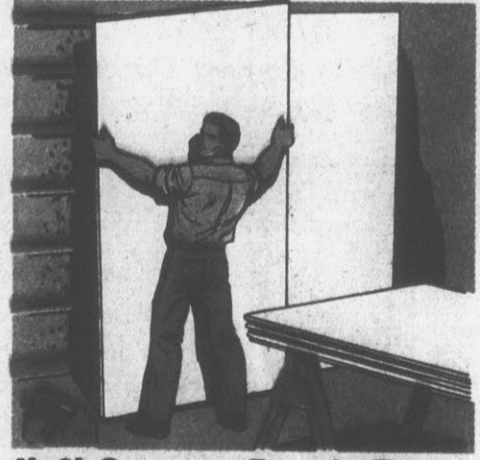

**4'x8' Gypsum Panels For Building Walls or Ceilings**  
**\$2.99**  
Each

Adding on or finishing in? Here's what you need for sturdy walls and ceilings. 3/8" thick. Use nails or adhesive. #11725  
Joint Compound (12 Lbs.) ..... \$2.50

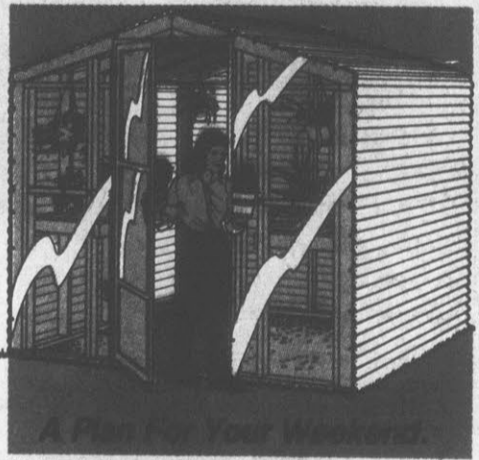

**You Can Build This 8'x8' Green House**  
**\$299** ALL MATERIALS, BLUEPRINT AND INSTRUCTIONS

This price includes the lumber, nails, storm door, redwood stain—everything you need. With blueprint & step-by-step illustrated instructions. Come see. #00023



**Airtight Boxwood Heater For Energy Saver Heating**  
**\$89.97**

Has extra-deep firebox with front draft control for longer logs and fires. All cast iron, finished in satin black. 12 1/2" wide. 20" deep and 25" high. #37365

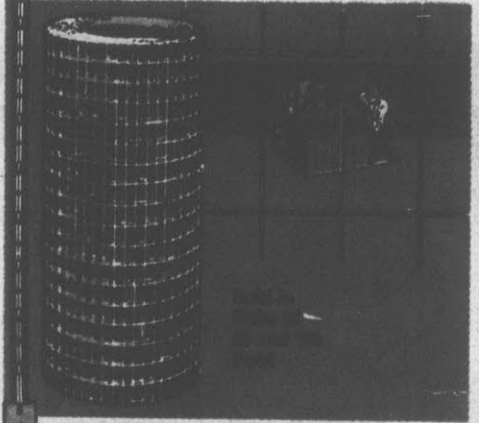

**4 Ft. High 12 1/2 Gauge Welded Fence Fabric**  
**39¢**  
Foot

A durable, galvanized fencing—welded at each juncture for extra strength. For the garden, backyard, etc. #92280, 88  
6 Ft. Steel Post #0000 ..... \$2.35

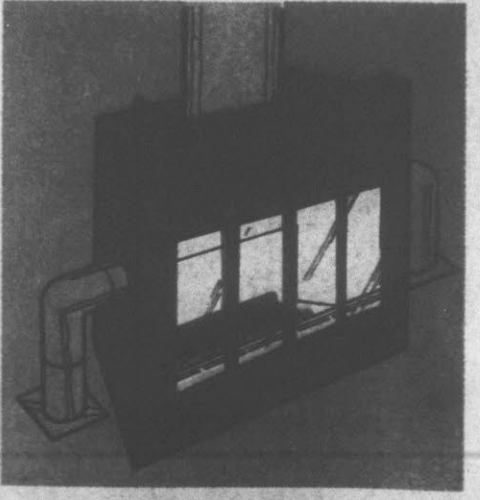

**8x7 4-Section Roll-Up Wood Garage Door**  
**\$119.99**

Has four windows and comes with all the hardware, including track and springs for easy counterbalanced action. #11042

**36" Energy Efficient Fireplace With Glass Doors**  
**\$399.97**

Draws in outside air for combustion instead of robbing your heated room air. Zero clearance for installation directly against studs. Chimney kit extra. #37052

**Lowe's Installment Credit Terms**  
Your credit must be satisfactory. Lowe's Cash Price doesn't include sales tax. Deferred Payment Price includes sales tax at 4%. If sales tax in your area differs, Deferred Payment Price and Monthly Payment will vary slightly. Life insurance is available, but not required or included in our figures. Delivery charges, if any, are not included. The Annual % Rate for Pa. stores is 15%, so payment's a bit lower.  
Installment Terms above are separate from our Credit Card Terms.

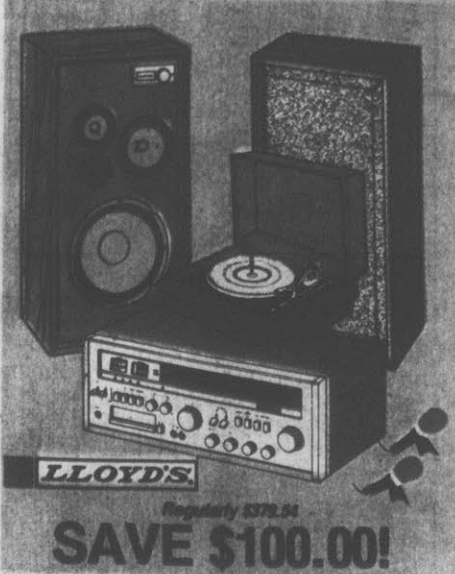

**Component Stereo  
With 8-Track Recorder**  
**\$279<sup>54</sup>**

AM/FM/FM-Stereo receiver with built-in 8-track; Garrard automatic changer; and 3-way speaker system. See it. #54225,6,7  
Cassette Stereo (Like Above) #54224,6,7... \$289.54  
No Down Payment. Monthly Payment Of \$14.30 For 24 Months.  
Deferred Payment Price \$343.20  
Annual Percentage Rate 16.42%.

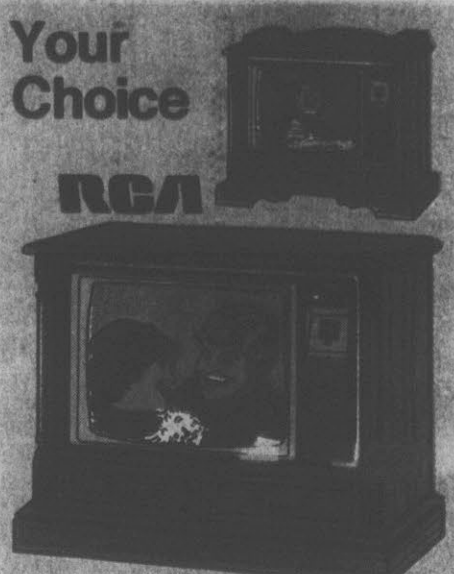

**Your Choice**  
**25" Diagonal ColorTrak  
Color Console TV**  
**\$669<sup>98</sup>**

Choose either Mediterranean or Early American cabinetry. Both models have electronic tuning, room light sensor & 100% solid state chassis. #54671,2  
No Down Payment. Monthly Payment Of \$24.57 For 36 Months.  
Deferred Payment Price of \$894.52.  
Annual Percentage Rate 16.24%.

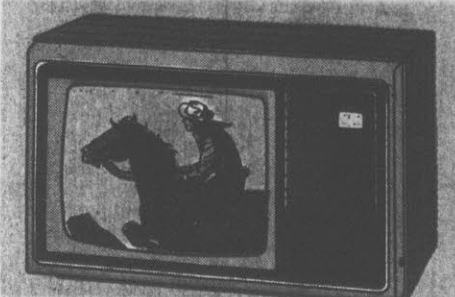

**Fingertip Remote Control**  
**13" Diagonal Solid State Color TV**  
**\$389<sup>97</sup>**

Remote unit lets you turn the set on & off, adjust volume and select all 82 VHF and UHF channels from across the room. See it today. #54602



**15" Diagonal Black  
and White TV**  
**\$99<sup>97</sup>**

Has "set and forget" volume control. VHF/UHF tuning & molded-in carry handle. #54474

**Perfect for Office or  
Back to Campus  
Beautiful Woodgrain  
Decorator Styling**

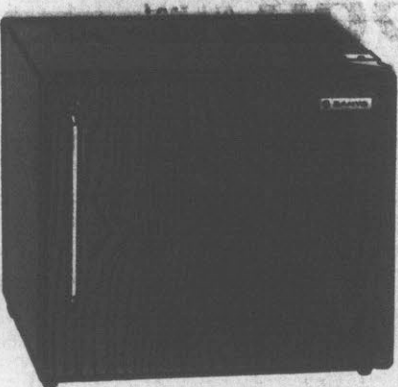

18 1/2" High by 19 1/4" Wide by 16 1/2" Deep

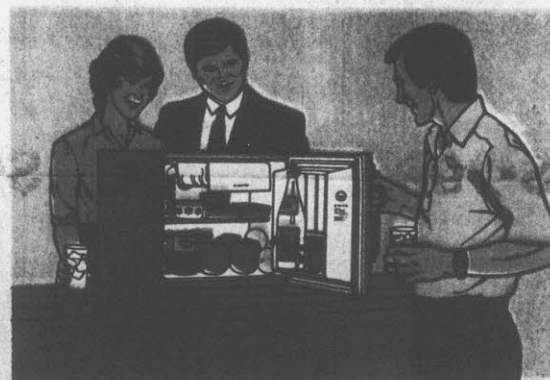

**Cube Refrigerator  
With Freezer Section**

**\$99<sup>96</sup>**

- Temperature Control
- Bottle Rack On Door
- Two Ice Cube Trays
- Slide-Out Shelf
- Quiet Compressor

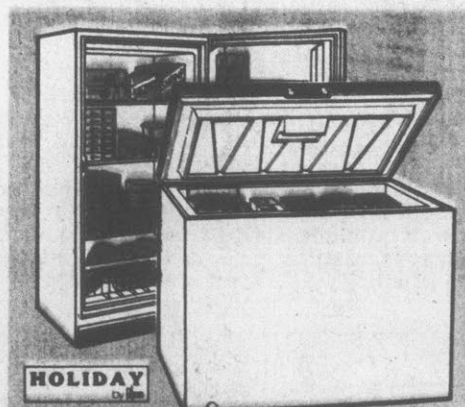

**One Low Price! Your Choice!**  
**Chest or Upright Freezer**  
**\$269<sup>93</sup>**

Chest freezer has 14.8 cu. ft. of storage; Upright has 15.2. Both models have eject-a-key lock for safety and convenient drain tube. Thick foam insulation. #50817,60

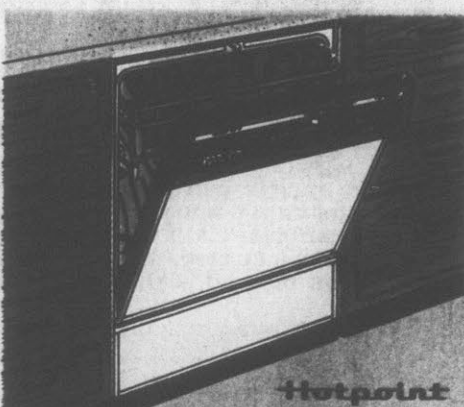

**Lowe's Best Hotpoint  
Undercounter Dishwasher**  
**\$259<sup>86</sup>**

Regular price \$299.86. 7 cycle choices, including Power Scrub, Normal Soil, Short Wash, Rinse & Hold and energy-saving optional settings. Rinse dispenser. #51018



**Family Size Electric Range &  
Continuous Cleaning Oven**  
**\$279<sup>87</sup>**

Porous ceramic oven liner partially absorbs and helps burn off spills and splatters. Automatic oven timer and clock with minute timer. Colors are \$10.00 extra. #52805

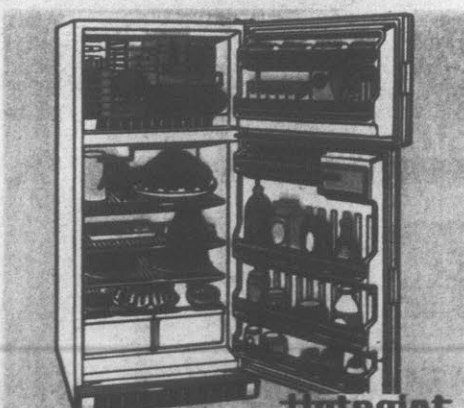

**15.7 Cu. Ft. Refrigerator  
Never Needs Defrosting**  
**\$389<sup>74</sup>**

Has two Easy Release™ ice trays, adjustable shelves, covered butter bin, egg tray. And has wheels for easy roll-out cleaning. Energy Saver switch. Colors \$10.00 extra. #53530



**Tired Of Taking  
Those Cold Showers?**  
**Lowe's 40-Gallon  
Electric Water Heater**  
**\$89<sup>97</sup>**

Double immersion-type heating elements provide fast recovery. Has adjustable thermostat and pressure relief valve. #26322

40 Gallon Energy Saver #26302 ... \$119.97  
(Required in Va. By State Building Codes)



**Decorate Your Bath With  
The Look Of Antique Brass**

- A. Tumbler And Brush Holder #25118 ..... \$3.40
- B. Wall Mount Soap Dish #25119 ..... \$3.40
- C. Tissue Paper Holder #25120 ..... \$5.97
- D. 18" Towel Bar #25121 ..... \$5.97
- E. 4" Center Faucet Set #24931 ..... \$28.97

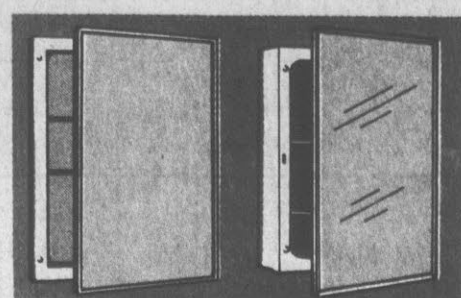

**Your Choice! Flush Mount or  
Surface Mount Bath Cabinet**

Both cabinets feature all-steel construction and enameled soft-tone finish. Surface model is 14" x 20". Recessed is 12" x 16". #23670,2

**\$12<sup>97</sup>**  
EACH

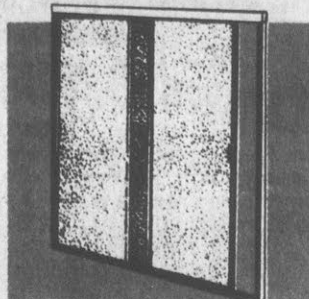

**Tub Enclosure**  
**\$39<sup>97</sup>**

Tempered safety glass panels and aluminum frame with self-draining track. 5' wide. #26757



**1/2 HP Sump Pump**  
**\$47<sup>88</sup>**

Has automatic on/off. Pumps 2,700 gallons per hour at 10 feet lift. 1 1/2" outlet. #25777

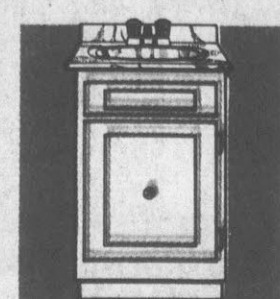

**Vanity Package**  
**\$59<sup>97</sup>**

Includes 19" x 17" cultured marble top and dual control faucet. Single door. #20804



**4" Center Faucet**  
**\$11<sup>88</sup>**

Durable acrylic handles, pop-up drain assembly & good-looking chrome finish. #24912

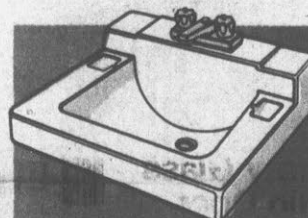

**19" x 17" Lavatory**  
**\$19<sup>97</sup>**

Smooth, vitreous china finish and concealed front overflow. Faucet not included. #20050

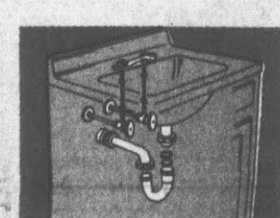

**Vanity Hookup Kit**  
**\$11<sup>88</sup>**

Kit to hook up water supply to faucet & drain to wall. With instructions. #25103



**66" Base Cabinet**  
**\$79<sup>88</sup>**

Great for the kitchen, playroom, etc. Has four doors and two drawers. Sink, faucet & butcherblock countertop extra. #29021  
Butcher Block Top For Above #29022... \$28.97



**Stainless Steel Sink**  
**\$54<sup>97</sup>**

For just one low price you get a 33" x 22" self-rimming stainless steel sink, dual control washerless faucet, maple chopping block and 2 basket strainers. #26021



**SAVE \$2.00!**  
**1/4" Paneling**  
**\$9<sup>99</sup>**

4x8 Panel Regular price \$11.99. "Fawn Driftwood," simulated on lauan 1/4" plywood. #13942

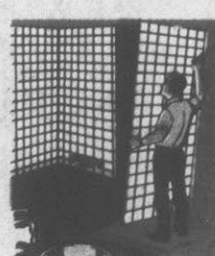

**Washable White  
Tileboard**  
**\$8<sup>79</sup>**

Big 4' x 8' panels of durable melamine for most any room of the home. #16605

**20% OFF! "Saxony" Style  
Kitchen Cabinets**  
When Ordered Thru Lowe's Catalog Sales.



**WAREHOUSE  
EXPRESS**  
Catalog Sales

This Item Is Available Through Lowe's Exclusive Fast Ordering System: Warehouse Express Catalog Sales. We have centrally located warehouses in N.C., Miss. and Tenn. We'll place your order for you, call you when it arrives, and work out arrangements for delivery. It's that simple.

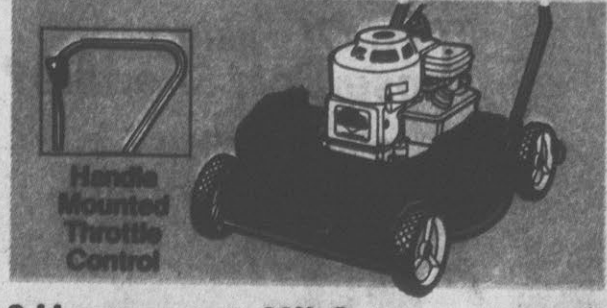

**Handle Mounted Throttle Control**

**3 Horsepower, 20" Cut Power Lawn Mower..... \$74<sup>99</sup>**

Convenient handle-mounted control lets you vary the power according to the job. Also has manual cutting-height adjustment and dependable Briggs & Stratton engine with easy-spin recoil starter. #95106



**\*12-Volt Electric Key Start • Briggs & Stratton Engine**

**Murray** **Ask About Credit**

**11 Horsepower, 36" Cut Riding Lawn Mower..... \$749<sup>99</sup>**

This rugged workhorse has 3 forward speeds and 1 reverse; twin blades, mounted in a floating deck to help prevent scalping; adjustable cut; foot-pedal disc brake; and twin headlights. Come see! #95196



**10x9 Storage Building Has Lots Of Floor Space..... \$119<sup>99</sup>**

It's made to take it: Has triple-ribbed wall panels; galvanized base rails and roof rafters; and it's coated with epoxy-polyester bonded enamel. Inside is 9' 6 3/4" wide, 8' 3 1/8" deep & 6' 1 1/4" high. #92735

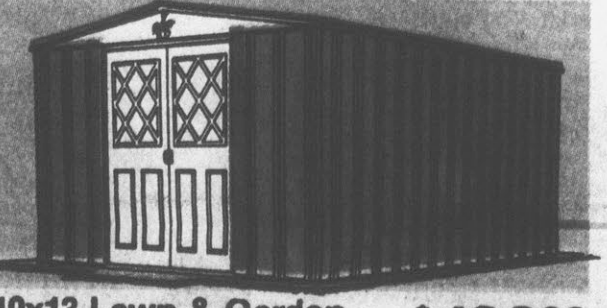

**10x13 Lawn & Garden Steel Storage Building..... \$199<sup>99</sup>**

Fully galvanized Perma-Plate finish. Mid-wall brace for extra support. Double roof beams at ridge for extra strength. Big 51" wide door opening. Inside is 9' 7 1/4" wide, 12' 10 3/4" deep and 6' 7 3/4" high. #92736

**ENTERPRISE Paint**  
**Nobody Makes It Better**

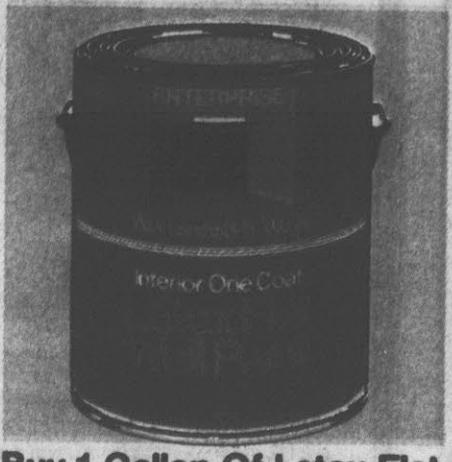

**Buy 1 Gallon Of Latex Flat Wall Paint At Our Regular Price Of \$10.99 And Get A 2nd Gallon For Only \$2.00!**

It's warranted to cover any color in 1 coat, and to be washable, colorfast, stain resistant & durable. Easy water cleanup. In white & colors. #47608-42

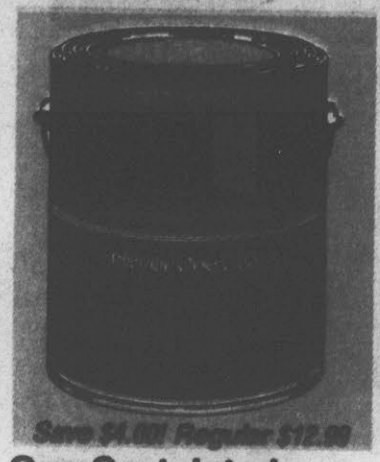

**One-Coat, Interior Latex Semi-Gloss \$8<sup>99</sup>**  
Gallon

For interior trimwork. Warranted 1-coat, scrubable, colorfast, stain resistant and durable. In white and off-white. #47764, 80



**Save \$2.00! Regular \$8.99**

**Protect It With Wood Preservative \$4<sup>59</sup>**  
Gallon

Penta ingredient minimizes swelling and shrinkage. Prevents decay, kills termites and repels water. And you can paint right over it! #47255



**Save \$2.00! Regular \$8.99**

**White Latex Flat Exterior House Paint \$6<sup>99</sup>**  
Gallon

Warranted non-yellowing for 4 years. Dries quickly to a flat white finish. And cleans up easily with water. Stop by Lowe's today & save! #48534

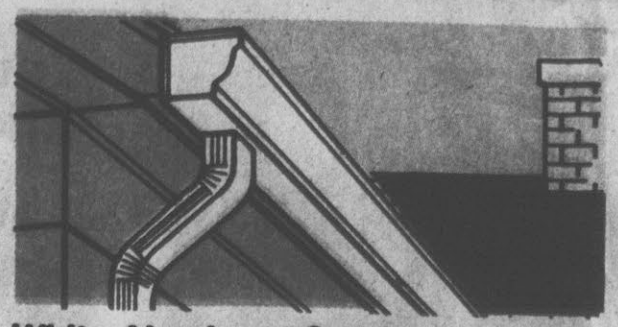

**White Aluminum Guttering \$3<sup>99</sup>**  
In 10-Foot Sections.....

Are your gutters showing their age? Leaking, peeling, rusting? If so, we've got the perfect replacement. Pre-painted aluminum gutters that are lightweight and rustproof. All accessories are available, too. #11550

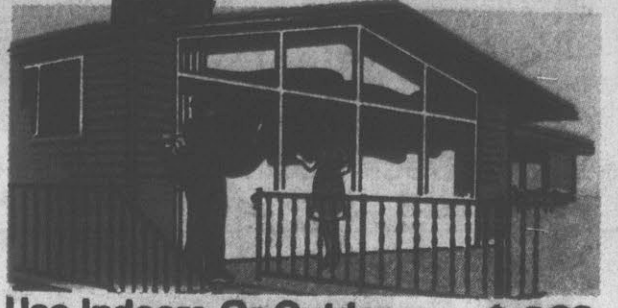

**Use Indoors Or Outdoors \$4<sup>29</sup>**  
4' Length Iron Railing.....

Sturdy, good-looking, and ready to add a smart new look to your home. Use it indoors as a room or area divider; or outdoors on porches, decks, etc. Primed with a flat black sealer. Rails are 1" wide. #14215



**Galvanized Skirting For Mobile Homes \$3<sup>59</sup>**  
28" x 80" Piece

Beautifies your home site and increases protected storage area. Installs easily on frame of 2x4's. Handsome rockface style. Can be reused, too. #60762

Accessories Below:  
Mobile Home Anchors 650-S..... \$3.39 Each  
Mobile Home Aluminum Roof Bracket..... \$2.88 Each  
Mobile Home 35' Roof Straps..... \$5.19 Each  
Mobile Home S-Buckles For Strap..... \$3.35 Each



**AMF**  
**Roadmaster® The Uncommonly Uncomplicated Moped**

**It's Fun, Simple To Drive, and Costs Just Pennies A Mile!**

**AMF Moped Lets You Beat The High Cost Of Gasoline \$299<sup>99</sup>**

How does 170 miles per gallon strike you? That's the top m.p.g. for a 150-lb. rider on this terrific moped. Not to mention the expanding drum brakes, sealed headlight, electric horn, luggage rack and dependable McCulloch 2-cycle engine with durable friction drive. #94844

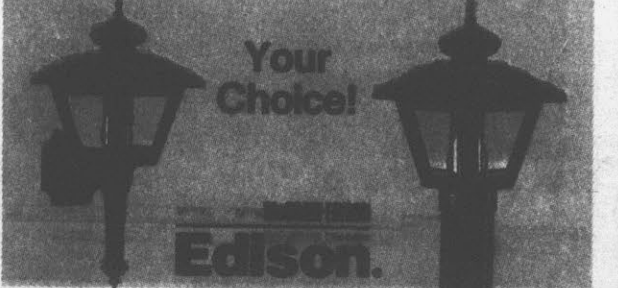

**Your Choice!**  
**Edison**

**Outdoor Lanterns For Wall \$12<sup>97</sup>**  
Or Post Mounting..... Each

Rugged polymer construction for long life. With brass-framed, clear bevelled panels of tough acrylic. Matte black finish will never need painting. Post lantern fits 3" diameter post (not included). #73105, 8



**39" Black or White Vinyl Shutters \$9<sup>99</sup>**  
Pair

Forget about painting with these sturdy vinyl shutters. Also resist warping, splitting and denting. #12852, 60



**Aluminum Roof Vent \$3<sup>88</sup>**

Cools Your Attic

Add extra ventilation to your attic with one or more of these easy-care, self-flashing roof vents. No-rust! #17156

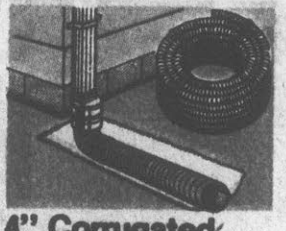

**4" Corrugated Drain Pipe \$2<sup>35</sup>**  
3 Foot

Solve drainage problems with our flexible plastic pipe. Resists freezing and thawing. And bends to fit contours. #24112



**WEED EATER**

**Electric String Trimmer \$12<sup>88</sup>**

Lightweight for 1-hand operation. Trims grass and light weeds. Cuts an 8-inch path. #91588 Replacement Line (10100) \$1.99



**Black & Decker**

**This Jig Saw Can Handle The Job \$9<sup>99</sup>**

For straight, curved & scroll-cuts in wood, metal & plastics. It's double-insulated. With blade for wood. #91781

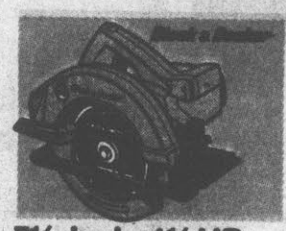

**7 1/2 inch, 1 1/2 HP Circular Saw \$24<sup>77</sup>**

Has two handle surfaces for steady control, and power lock-off button to guard against accidental starts. See it! #91844



**30 Foot Roll Camper Tape \$2<sup>99</sup>**  
30' Roll

1 1/4" wide and 3/16" thick self-adhesive foam tape. Seals out water, dust and noise. Also reduces road vibration. #61664



**100 Foot Outdoor Extension Cord \$9<sup>97</sup>**

Heavy-duty, 16-gauge cord with ground. Ideal for electric trimmer, chain saw, lawn mower, etc. UL listed. #70372



**Propane Torch For Home Repairs \$7<sup>97</sup>**

Fix a leaky gutter, thaw out a pipe—you name it. Solid brass burner. Clog-proof filter. And it's UL listed. #23498



**Yard and Garden Cordless Sprayer \$8<sup>88</sup>**

Control weeds and pests, fertilize and feed your plants, etc. Has 1-quart capacity and adjustable spray nozzle. #92490

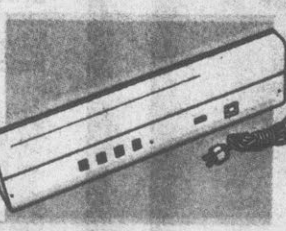

**Fluorescent Light Just Plug It In! \$5<sup>99</sup>**

Has fingertip on/off & comes with fluorescent tube & mounting screws. Mounts flush to wall or under counter. #74611

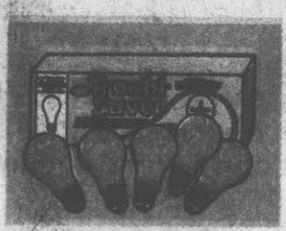

**60 or 100 Watt 5-Pack Bulbs 99¢**  
5-Pack

Long-life, frosted bulbs with corrosion-resistant bases. #75225, 6 (By the way, be sure to see our lighting fixtures, too!)

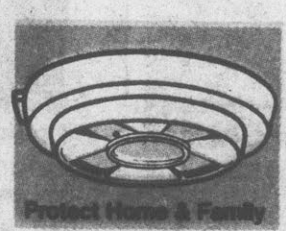

**Battery Operated Smoke Detector \$10<sup>97</sup>**

Alarm sounds before smoke is even visible. Solid state. UL listed. With a 9-volt alkaline battery. #73060, 54

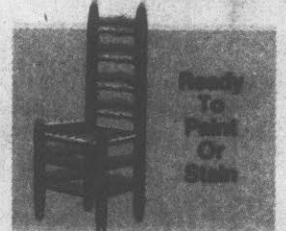

**Unfinished Ladderback Chair \$16<sup>88</sup>**

Do-it-yourself and save! Add the finishing touch to this 43"-high chair of sturdy hardwood. Woven fiber seat. #86003

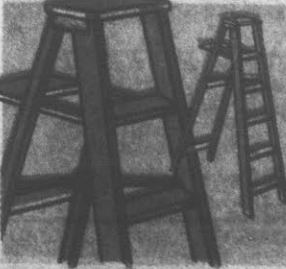

**6-Foot Wooden Stepladder \$19<sup>99</sup>**

From painting a room to changing a light bulb, there's nothing handier than this well-made ladder with utility shelf. #92508

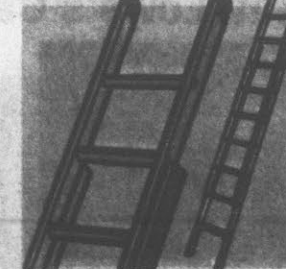

**16-Foot Aluminum Extension Ladder \$29<sup>99</sup>**

Painting? Cleaning out gutters? Here's what you need. 13-foot working height, with gripper-feet and grooved steps. #92530

LOWE'S VISA Just Say "Charge"

**LOWE'S**

**Here's Our Raincheck Policy**

If we sell out of an advertised item, we'll issue you a raincheck. When we restock, you'll be notified so you can buy at the previously advertised price. (Except on any products marked "Limited Quantities.") It's that simple.

Our smaller stores may not stock all advertised items. But every item shown in this publication can be ordered for you.



**Be Prepared! 5 Gallon Gas Can \$5<sup>67</sup>**

Has a built-in goose-neck spout and poly vent. Semi-dome top design allows for fuel-air expansion. Bright red & yellow finish. #92373



**Hundreds Of Uses! Pump And Sprayer \$9<sup>99</sup>**

Hand-operated, self-priming pump for gas, water, etc. Can be used as a sprayer, too. Comes complete with hoses. See it! #93705

# Kroger Sav-on

Supplement To: The Greenville Daily Reflector

FOOD, DRUG, GEN. MDSE. STORES

The store that brought you  
**SOOPER COST CUTTER SAVINGS** OF UP TO **40%**

### ADVERTISED ITEM POLICY

Each of these advertised items is required to be readily available for sale in each Kroger Sav-on, except as specifically noted in this ad. If we do run out of an advertised item we will offer you your choice of a comparable item when available, reflecting the same savings or a raincheck which will entitle you to purchase the advertised item at the advertised price within 30 days.

Prices Effective  
 Sunday, July 29  
 Through Saturday,  
 Aug. 4, 1979.

# Now 6,188 More Prices slashed offering COST CUTTER SAVINGS throughout THE STORE



**STARTING SUNDAY JULY 29**

- LIGHT BULBS** **DISCOUNTED 30%** OFF MFR. SUG. RETAIL
- TIMEX WATCHES** **DISCOUNTED 20%** OFF MFR. SUG. RETAIL
- LADIES HOSIERY** **DISCOUNTED 20%** OFF MFR. SUG. RETAIL
- MAGAZINES & PAPERBACKS** **DISCOUNTED 10%** OFF MFR. SUG. RETAIL
- FRUIT OF THE LOOM UNDERWEAR** **DISCOUNTED 20%** OFF MFR. SUG. RETAIL
- CANNON TOWELS** **DISCOUNTED 20%** OFF MFR. SUG. RETAIL
- RUBBERMAID PRODUCTS** **DISCOUNTED UP TO 20%** OFF MFR. SUG. RETAIL
- LITTLE DEBBIE SNACK CAKES** **DISCOUNTED UP TO 10%** OFF MFR. SUG. RETAIL
- BABY FORMULA** **SOLD BY THE CASE AT OUR INVOICE COST**

- GREETING CARDS** **DISCOUNTED 25%** OFF MFR. SUG. RETAIL
- COSMETICS & FRAGRANCES** **DISCOUNTED UP TO 20%** OFF MFR. SUG. RETAIL
- RECORDS & TAPES** **DISCOUNTED 30%** OFF MFR. SUG. RETAIL
- BAGGED CHIPS & SNACKS** **DISCOUNTED UP TO 10%** OFF MFR. SUG. RETAIL
- CORNINGWARE PRODUCTS** **DISCOUNTED 20%** OFF MFR. SUG. RETAIL
- BAGGED NUTS** **DISCOUNTED UP TO 10%** OFF MFR. SUG. RETAIL
- POUCH PACKS SAUCES & GRAVY MIXES** **DISCOUNTED UP TO 10%** OFF MFR. SUG. RETAIL
- MOTOR OIL** **SOLD AT OUR INVOICE COST**

NONE SOLD TO DEALERS **OPEN 7 AM TO MIDNIGHT** MON THRU SAT **OPEN SUNDAY 9 AM TO 9 PM** **600 Greenville Blvd.-Greenville** Phone 756-7031

LOOK FOR THIS SIGN OF EVERYDAY SAVINGS ON HUNDREDS OF PANTRY STAPLES

SOOPER COST CUTTER

SUNGOLD HOT DOG OR Hamburger Buns 8-CL Pkg. **33¢**

KROGER **Sandwich Bread** **\$1.41** 24-Oz. Loaves

COST WEAVER'S SPECIAL SOOPER COST CUTTER

# SAVE UP TO 40% ON

- PLAYGROUND Peanut Butter ~~77¢~~
- EMBASSY Grape Preserves ~~79¢~~
- AVONDALE Shortening ~~\$1.09~~
- KROGER Sugar ~~99¢~~
- PLAIN OR ICED KROGER Salt ~~18¢~~
- KROGER Instant Tea ~~\$1.59~~

EMBASSY **Mayonnaise** **89¢** 32-Oz. Jar

- MISSY Dish Detergent ~~39¢~~
- MISSY Fabric Softener ~~88¢~~
- FAMILY PRIDE Deodorant Soap ~~77¢~~
- FLEECE Napkins ~~46¢~~
- HOME PRIDE Aluminum Foil ~~33¢~~
- SOLO 9-OZ. Foam Cups ~~54¢~~

**BAKED GOODS**

AUNT FANNY'S Pecan Twirls 3 **\$1.19** 6-Oz. Pkgs.

KROGER WESTERN TEXAS SLICED OR Rye Bread 2 **88¢** 16-Oz. Loaves

MULTI GRAIN Brown & Serve 2 **88¢** 12-Oz. Pkg.

COUNTRY OVEN Angel Food Cake 1 **\$1.09** 16-Oz. Pkg.

CHEE-TOS Cheese Puffs 1 **79¢** 8-Oz. Pkg.

BIG VALUE Sandwich Cookies 24 **69¢** 24-Oz. Pkg.

CRACKERS Kroger Zips 16 **77¢** 16-Oz. Box

KROGER WESTERN Texas Sliced Bread 2 **88¢** 16-Oz. Loaves

KROGER **Pork & Beans** **23¢** 15-Oz. Can

- KROGER BEEF RAVIOLI ~~49¢~~
- KROGER—WITH MEAT BALLS Spaghetti ~~49¢~~
- OLD EL PASO Taco Shells ~~49¢~~
- AVONDALE Vegetable Oil ~~\$1.22~~
- ENRICHED Gold Medal Flour ~~79¢~~
- KROGER FRENCH STYLE Green Beans ~~29¢~~

KANDU **Laundry Detergent** **88¢** 42-Oz. Box

COUNTRY CLUB GALLON **Ice Cream** **99¢** One Gallon Carton

LIMIT 1 WITH 7.50 OR MORE ADDITIONAL PURCHASE

- KROGER Pineapple Juice ~~78¢~~
- KROGER Apple Juice ~~55¢~~
- KROGER PINK Grapefruit Juice ~~53¢~~
- AVONDALE Mandarin Oranges ~~39¢~~
- KROGER Potted Meat ~~19¢~~

KROGER **Applesauce** **24¢** 16-Oz. Can

- HOME PRIDE Paper Plates ~~79¢~~
- TRIX Dog Food ~~16¢~~
- Jergens Soap ~~19¢~~
- S.O.S. STEEL WOOL Soap Pads ~~66¢~~
- CLEANER Spic & Span ~~\$1.59~~
- Lysol Spray ~~89¢~~

EMBASSY **Tea Bags** **\$1.19** 100-Ct. Box

- KROGER Spinach ~~29¢~~
- KROGER Tomato Sauce ~~29¢~~
- KROGER Sauerkraut ~~29¢~~
- BUSH'S Baked Beans ~~33¢~~
- KROGER Frosted Flakes ~~88¢~~
- KROGER Catsup ~~66¢~~

AVONDALE **Long Grain Rice** **79¢** 4-Lb. Bag

**FROZEN FAVORITES**

AVONDALE CRINKLE CUT French Fries 2 **88¢** 2-Lb. Pkgs.

KROGER Fried Chicken **\$1.99** 2-Lb. Box

KROGER Deep Dish Pie Shells 2 **66¢** 12-Oz. Pkg.

KROGER Lemonade 1 **89¢** 6-Oz. 6-Pkg.

FREEZER PLEEZER ICE MILK BARS OR Fudge Bars 12 **89¢** 12-CL. Pkg.

KROGER Corn-On-The-Cob 4 **88¢** 4-Ear Pkg.

KROGER FROZEN Whole Strawberries 20 **99¢** 20-Oz. Pkg.

10" SAUSAGE, CHEESE, PEPPERONI, OR HAMBURGER Jeno's Pizza 12 **99¢** 12-Oz. Pkg.

## COST CUTTER

GREAT NORTHERN OR **Lucks Pinto Beans** **3 \$1** 17-Oz. Can For WAS 45¢ EA.

- |   | WAS                | NOW    |
|---|--------------------|--------|
| SHOWBOAT OR BUSH'S Pork & Beans                 | 14 1/2-Oz. Can 27¢ | 488¢   |
| RED Hawaiian Punch                              | 64-Oz. Bot. \$1.03 | 88¢    |
| MRS. FIBBERT'S Mayonnaise                       | 32-Oz. Jar \$1.39  | \$1.09 |
| CARNATION Coffee Mate                           | 16-Oz. Jar \$1.29  | \$1.18 |
| KROGER CREAM OF CHICKEN OR Chicken & Stars Soup | 10 1/2-Oz. Can 28¢ | 4/\$1  |

- |                                  | WAS                | NOW   |
|----------------------------------|--------------------|-------|
| KELLOGG'S Special K Cereal       | 11-Oz. Box 95¢     | 82¢   |
| BUSH'S Cut Green Beans           | 15 1/2-Oz. Can 39¢ | 3/88¢ |
| SHOWBOAT CUT Sweet Potatoes      | 20-Oz. Can 71¢     | 2/\$1 |
| BUSH'S KIDNEY OR Chili Hot Beans | 16-Oz. Can 3/\$1   | 3/88¢ |
| BUSH'S Chopped Spinach           | 15-Oz. Can 36¢     | 3/\$1 |

DISH DETERGENT **Lux Liquid** **79¢** 22-Oz. Bottle WAS 99¢

**Fleece Paper Towels** **38¢** Jumbo Roll

10 OFF LABEL **Waldorf Bathroom Tissue** **79¢** 4-Roll Pkg. WAS 99¢

- |                                     | WAS                  | NOW |
|-------------------------------------|----------------------|-----|
| KRAFT TANGY Bar-B-Que Sauce         | 7 1/2-Oz. Jar \$1.12 | 99¢ |
| HUNT'S Tomato Paste                 | 16-Oz. Can 33¢       | 29¢ |
| KLEENEX Paper Towels                | 16 1/2-Oz. Box 73¢   | 55¢ |
| GLAD HEAVYWEIGHT LARGE Garbage Bags | 10-CL. Box 99¢       | 88¢ |
| LAUNDRY DETERGENT Rinso             | 16-Oz. Bot. \$1.25   | 99¢ |

# SOOPER COST CUTTERS

KANDU  
**Liquid Bleach**  
SOOPER COST CUTTER  
**55¢**  
Gallon Jug

COMPARED TO OTHER BRANDS\* AT SAV-ON  
Here Are Just A Few Of The Hundreds Of Everyday Sooper Cost Cutter Prices — A Complete Store.\* For Some Sooper Cost Cutters, No Other Brands Are Stocked.

SOOPER COST CUTTER  
**Avondale Tomatoes**  
**24¢**  
16-Oz. Can

- KROGER Small Whole Potatoes... 16-oz. Can **24¢**
- AVONDALE Whole Kernel Corn... 17-oz. Can **24¢**
- AVONDALE Cream Style Corn... 16-oz. Can **24¢**
- KROGER Green Lima Beans... 16-oz. Can **49¢**
- AVONDALE Pinto Beans... 15-oz. Can **26¢**
- BUSH'S Blackeyed Beans... 15-oz. Can **26¢**

EMBASSY  
**Ground Coffee**  
SOOPER COST CUTTER  
**\$1.89**  
1-Lb. Bag

- KROGER Colby Long Horn Cheese... 14-oz. Pkg. **\$1.49**
- KROGER—WITH ONIONS, Barbecue Sauce... 16-oz. Jar **49¢**
- Kroger Mustard... 32-oz. Jar **55¢**
- EMBASSY Salad Dressing... 32-oz. Jar **69¢**
- 1000 ISLAND Kroger Dressing... 16-oz. Jar **44¢**
- SUNGOLD Saltines... 16-oz. Box **43¢**

REFRESHING  
**Pepsi-Cola**  
SOOPER COST CUTTER SPECIAL  
**69¢**  
2-Ltr. N.R. Btl.  
Limit 2 With \$7.50 Or More Additional Purchase  
Pepsi-Cola 6 12-Oz. Cans **\$1.25**

SOOPER COST CUTTER  
CHUNK LIGHT  
**Kroger Tuna**  
**59¢**  
6 1/2-Oz. Can

- KROGER WHITE OR YELLOW Cake Mix... 16-oz. Box **48¢**
- KROGER Vienna Sausage... 5-oz. Can **35¢**
- PACKERS LABEL Mackerel... 15-oz. Can **49¢**
- KROGER Raisin Bran... 20-oz. Box **99¢**
- KROGER INDIVIDUALLY WRAPPED & SLICED Cheese Food... 16-oz. Pkg. **\$1.48**
- KROGER Pimento Spread... 14-oz. Can **\$1.09**

SOOPER COST CUTTER  
**Avondale Sweet Peas**  
**24¢**  
16-Oz. Can

**BEER AND WINE**

PREMIUM <b>Busch Beer</b> <b>6</b> 12-Oz. Cans <b>\$1.89</b>	CHIANTI, RHINESKELLER OR <b>Colony Rose</b> 1.5-Liter <b>\$2.09</b>
LEONARD KREUSCH <b>Liebfraumilch</b> 1.5-Liter <b>\$2.09</b>	<b>Cella Bianco</b> 1.5-Liter <b>\$3.89</b>

- KROGER Grapefruit Sections... 16-oz. Can **39¢**
- AVONDALE Fruit Cocktail... 16-oz. Can **47¢**
- JIFFY Corn Muffin Mix... 8 1/2-oz. Pkg. **18¢**
- KROGER SELF RISING Corn Meal... 5-Lb. Bag **77¢**
- EMBASSY Tea Bags... 100-CL. Box **\$1.19**

AVONDALE  
**Cut Green Beans**  
SOOPER COST CUTTER  
**24¢**  
16-Oz. Can

- ASSORTED FLAVORS Kroger Gelatin... 3-oz. Box **16¢**
- KROGER ASSORTED VARIETIES Pot Pies... 6-oz. Pkg. **27¢**
- KROGER 12 COUNT Glazed Donuts... 14-oz. Box **59¢**
- KROGER Whipped Topping... 13 1/2-oz. Tub **59¢**
- AVONDALE Orange Juice... 12-oz. Can **69¢**
- PERSONAL SIZE Ivory Soap... 4 3/4-oz. Bar **59¢**

SOOPER COST CUTTER SPECIAL  
KROGER GRADE A  
**Large Eggs**  
SAVE 20¢ Doz.  
**49¢**  
Doz.  
Limit 2 Doz. With \$7.50 Or More Additional Purchase  
MARKET BASKET Black Pepper 4-Oz. Can **59¢**

## BONUS BUYS

	WAS	NOW
ORIG. STYLE Pringles Potato Chips	\$1.09	97¢
BUSH'S BEST Chop Turnip Greens	29¢	4/\$1
Love My Carpet.	\$2.19	\$1.99
TWIN PACK Scot Towels	91¢	83¢
FRISKIES CHICKEN Cat Food	29¢	4/88¢

SOOPER COST CUTTER BUY  
**Wesson Oil**  
**\$1.59**  
38-Oz. Btl.  
WAS \$1.89

ALUMINUM FOIL  
**Reynolds Wrap**  
SOOPER COST CUTTER BUY  
**37¢**  
Was 37¢ Ea.

	WAS	NOW
PURE NATURAL Sioux Bee Honey	\$1.79	\$1.49
VIETTI Hot Dog Sauce	39¢	3/\$1
Purina Dog Chow	\$1.39	\$9.49
KRAFT French Dressing	67¢	55¢
BASIN, TUB, TILE AERO Lysol Cleaner	\$1.22	99¢

KRAFT AMERICAN SINGLES <b>Cheese Slices</b> 1-Lb. Pkg. <b>\$1.78</b>	ALL NATURAL <b>Esprit Yogurt</b> 3 6-Oz. Cup <b>\$1</b>
KRAFT GRATED Parmesan Cheese... 3-oz. Can <b>69¢</b>	KROGER English Muffins... 13-oz. Pkg. <b>37¢</b>
KRAFT PARKAY Maxi-Cup Margarine... 1-Lb. Pkg. <b>69¢</b>	KRAFT VELVEETA Cheese Spread... 1-Lb. Box <b>\$1.49</b>
KROGER Cottage Cheese 24-Oz. Cup <b>99¢</b>	MOUNTAIN MAN REGULAR OR BUTTERMILK <b>Kroger Biscuits</b> 10-Oz. Pkg. <b>4 88¢</b>

	WAS	NOW
MAZOLA Corn Oil	\$2.59	\$2.49
SKIPPY CREAMY Peanut Butter	\$1.19	\$1.09
FRUIT DRINK Welchade	69¢	59¢
QUAKER Corn Bran Cereal	99¢	87¢
Heinz 57 Steak Sauce	\$1.19	\$1.09

SOOPER COST CUTTER BUY  
**Hunt's Ketchup**  
**66¢**  
24-Oz. Btl.  
WAS 79¢

SOOPER COST CUTTER  
KROGER 1/2%  
**Lowfat Milk**  
**\$1.49**  
Gallon Jug  
QUARTERS Clover Valley Margarine 1-Lb. Can **33¢**

**Serving You Comes First**  
in the  
**Kroger Sav-on Garden**

In the Kroger Sav-On garden our fresh fruits and vegetables are in bulk displays as opposed to pre-packaged, as many stores have. You can choose one green pepper or 5, one lemon or a dozen, and YOU pick and choose the one you want. Then take your choice to the "Gardener" for weighing and pricing. Your Kroger Sav-On "Gardeners" will be pleased to answer your questions about any of the hundreds of fresh fruits and vegetables we have here for you.

Green Broccoli  
Bunch **58¢**

NEW CROP ROUND

**White Potatoes**

10 Lb. Bag

**99¢**

SAVE 30¢ Off Reg. Price

**ORIENTAL VEGETABLES**

FRESH Egg Roll Wrappers	1-lb. Pkg.	<b>99¢</b>
FRESH Bok Choy	Lb.	<b>49¢</b>
FRESH Nappa	Lb.	<b>49¢</b>

Fresh Plums lb. **59¢**

FRESH CRISP

**Green Cabbage**

Lb.

**10¢**

LUSCIOUS Sweet Nectarines

**49¢** Lb.

JUMBO 4 SIZE  
**Honeydew Melons**  
**\$1.29**

Ea.

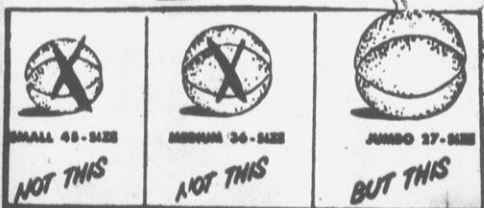

27 SIZE  
**Jumbo Cantaloupes**

**59¢** Ea.

GREEN TOP Bunch Carrots	3 Bunches	<b>\$1</b>	FRESH Egg Plant	Each	<b>39¢</b>
GREEN TOP Bunch Radishes	4 Bunches	<b>\$1</b>	NORTHWEST Bing Cherries	Lb.	<b>99¢</b>
FRESH Red Leaf Lettuce	3 Each	<b>\$1</b>	DECORATIVE HANGING Baskets	10-inch	<b>\$4.99</b>
CRISP Green Onions	4 Bunches	<b>\$1</b>	CROOKNECK Yellow Squash	Lb.	<b>39¢</b>
FRESH Limes	6 For	<b>49¢</b>	FRESH Collard Greens	3 Bunches	<b>\$1</b>

FIRST of the season

FRESH YELLOW  
**Sweet Corn**

In Husk Ear

**12¢**

# Kroger Sav-on Market

## COST CUTTER



HOLLY FARMS GRADE A MIXED FRYER PARTS OR

**Whole Fryers**

**39¢** Lb.

LIMIT 3 PACKAGES

Holly Farms is the chicken to buy. It's bred and fed to be plump and juicy. It's always U.S.D.A. Inspected. And every piece is always Grade A (or it doesn't reach our store). Shipped chilled, frozen or packed in ice you're not paying for absorbed water. It's dated for freshness right on the package.

BULK PACKAGED COUNTRY STYLE, ANY SIZE PACKAGE  
Sliced Bacon... Lb. **98¢**  
COUNTRY CLUB Canned Ham... 3-lb. Can **\$4.99**

PORK FEET, TAILS OR

**Pork Neck Bones**

Fine For Seasoning

Lb.

**38¢**

SHANK HALF  
**Smoked Ham**

**98¢** Lb.

SMALL MEATY  
**Pork Spare Ribs**  
**\$1.38** Lb.



SEASONING MEAT DRY SALT-END CUT  
Pork Bellies... Lb. **69¢**  
DRY SALT Fat Back... Lb. **59¢**

CHUB PAK OR REGULAR STORE PAK

**Ground Beef**

Any Size Pkg. **\$1.28**

Lb.

FRESH  
**Ground Chuck**  
**\$1.48** Lb.

ARMOUR  
**Pork Sausage** Lb. **98¢**



A FINE BLEND OF BEEF VEGETABLE PROTEIN COMBINATION

BREAKFAST  
**Beef Sausage**

**2\$1.98** Lb. Roll

GREAT ON THE GRILL  
CHOPPED  
**Beef Steak**

**\$1.98** Lb.

"KROGER'S"  
**Patty M**

Any Size Pkg. Lb. **99¢**

**NEW** A new food product that looks, cooks and tastes like Ground Beef!

Kroger Sav-on brings you 6,188

**MORE PRICES SLASHED** throughout the Store

**COSMETICS AND FRAGRANCES**

**DISCOUNTED UP TO 20%**  
OFF MANUFACTURER'S SUGGESTED RETAIL

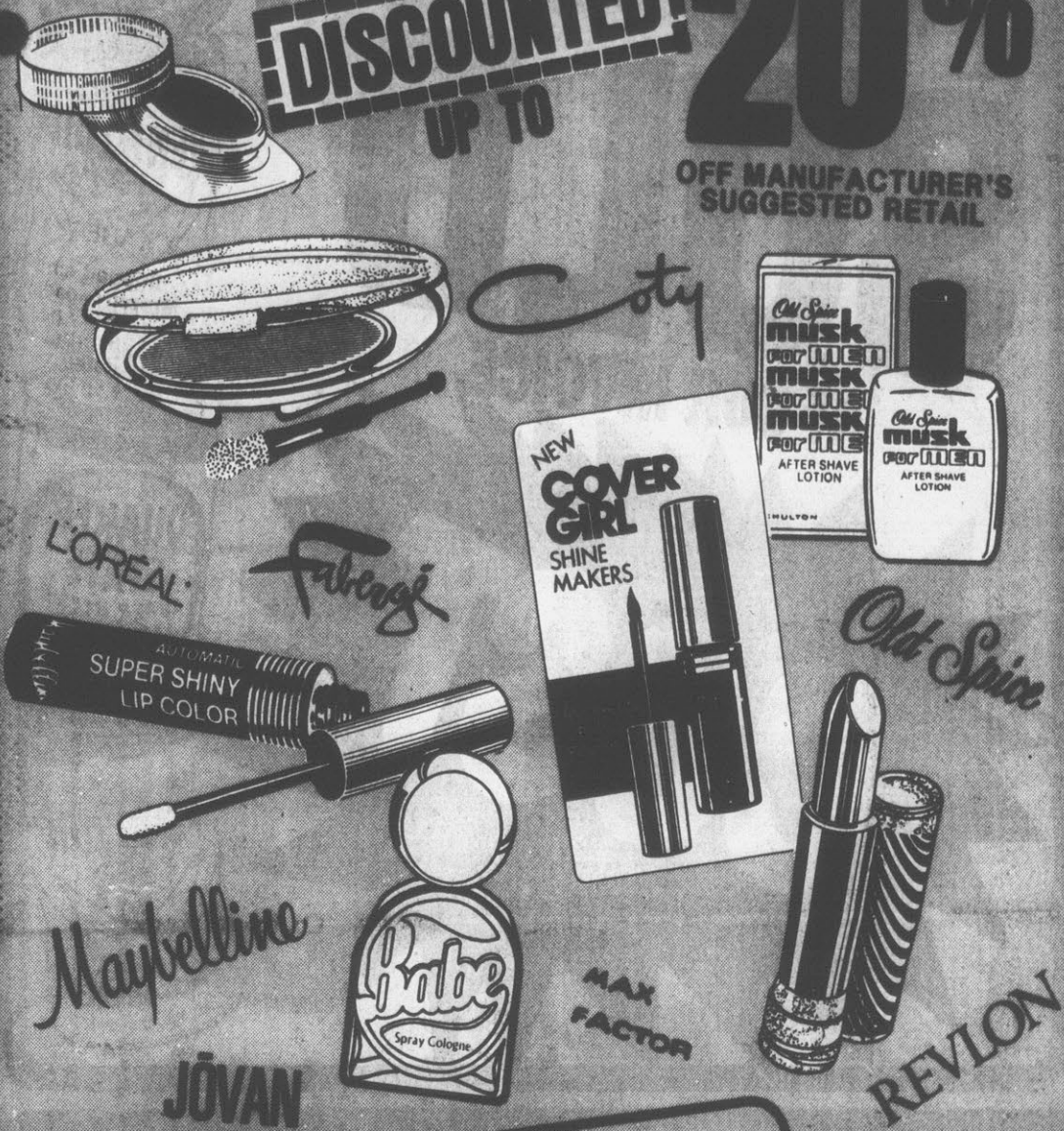

**CORNINGWARE PRODUCTS**

**DISCOUNTED 20%**  
OFF MANUFACTURER'S SUGGESTED RETAIL



**VARIETY and SELECTION**  
Looking for total variety and selection in groceries, meats, produce and general merchandise? Looking for first quality foods at lowest possible prices?  
**THEN LOOK AND SHOP KROGER SAV-ON AND DON'T SETTLE FOR ANYTHING LESS**  
We're a whole lot more than just one store!

**RECORDS AND TAPES**

**DISCOUNTED 30%**



**LADIES HOSIERY**

**DISCOUNTED 20%**  
OFF MANUFACTURER'S SUGGESTED RETAIL



No nonsense\*

**GREETING CARDS**

**DISCOUNTED 25%**  
OFF IMPRINTED PRICE

REG. PRICE	OUR PRICE	REG. PRICE	OUR PRICE
.15	ONLY .11	1.00	ONLY .75
.25	ONLY .19	1.25	ONLY .94
.30	ONLY .23	1.50	ONLY 1.13
.35	ONLY .26	2.00	ONLY 1.50
.40	ONLY .30	2.50	ONLY 1.88
.50	ONLY .38	3.00	ONLY 2.25
.60	ONLY .45	5.00	ONLY 3.75
.75	ONLY .56		

# Kroger Sav-on

Brings you **10% 20% 30%**

**DISCOUNTS**

ON **6,188**

Items throughout the Store

All Brands  
**Light Bulbs**

**DISCOUNTED**

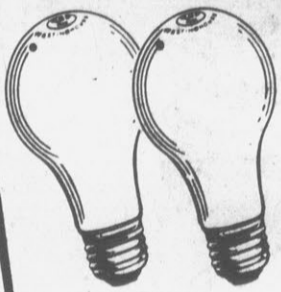

**30%**

OFF MFD. SUGG. RETAIL

## EXPRESS CHECK CASHING

We cash checks! It's a service you expect in any food store. For really fast service sign up for a Kroger Sav-on Courtesy Card and simply present proper identification for the amount of purchase at the courtesy desk prior to checking out.

All Brands

# Motor Oil

# SOLD

AT OUR INVOICE



All Brands  
**Baby Formula**



# SOLD BY THE CASE AT OUR INVOICE COST

**DISCOUNTED**

# 10%

OFF MFR. SUGG. RETAIL

## Magazines and Paperback Books



## Little Debbie Snack Cakes

**BAGGED**  
Chips and Snacks

**BAGGED NUTS AND SAUCES & GRAVY MIXES**  
POUCH PACK

**DISCOUNTED**

# 10%

OFF MFR. SUGG. RETAIL

**FRUIT of THE LOOM**  
Men's Underwear  
Cannon Towels  
Rubbermaid



**DISCOUNTED**

# 20%

OFF MFR. SUGG. RETAIL

## We're a whole lot more than just one store.

# EAT PRICES SLASHED!

HOLLY FARMS WITH WING  
**Fryer Breast Quarters**  
Lb. **89¢**

HOLLY FARMS SPLIT  
**Fryer Thighs**  
Lb. **\$1.09**

HOLLY FARMS FRYER  
**Leg Quarters**  
Lb. **79¢**

FRESH WHOLE  
**Picnic Style Pork Roast**  
Lb. **78¢**

QUARTER PORK LOIN CUT INTO  
**Pork Chops**  
Lb. **\$1.38**

CENTER CUT  
**Pork Chops**  
Lb. **\$1.88**

TYPE  
**Ribs** Lb. **\$1.48**

S.D.A. CHOICE "HEAVY"  
FRN BEEF CHUCK ROAST OR  
**Chuck Steak**  
Lb. **\$1.58**

SAVE 30¢ lb. Off Reg. Price  
COST CUTTER SPECIAL  
WHOLE GLENDALE "OLDE SMOKEY" OR FARMLAND MAPLE RIVER  
**Boneless Ham**  
**\$1.48**  
Lb. 7 To 9-lb. Avg.



KROGER (12-OZ. PKG. 99¢)  
**Meat Wieners**  
Lb. Pkg. **\$1.18**  
SERVE N SAVE Wieners 12-Oz. Pkg. **89¢**

ALL MEAT  
**Kahn's Franks** 1-Lb. Pkg. **\$1.58**

OSCAR MAYER  
**Sliced Bacon** 1-Lb. Pkg. **\$1.68**

ALL MEAT  
**Kahn's Bologna** 9-Oz. Pkg. **98¢**

OSCAR MAYER  
**Sliced Bologna** 9-Oz. Pkg. **98¢**

ALL MEAT  
**Boneless Top Sirloin Steak** 8 Oz. Avg. Wt. Steaks Total Weight 5-lbs. or More (\*2.97 lb.) **\$11.88**

ALL MEAT  
**Boneless Rib Eye Steaks** 8 Oz. Avg. Wt. Steaks Total Weight 4-lbs. or More (\*4.47 lb.) **\$17.88**

ALL MEAT  
**Boneless Sirloin Tip Steak** 10 Oz. Avg. Wt. Steaks Total Weight 5-lbs. or More (\*2.78 lb.) **\$13.88**

## FREEZER BEEF SALE

Processed The Way You Want It And Wrapped Free U.S.D.A. Choice "Heavy" Western Beef

<p>WHOLE BONELESS <b>Top Sirloin Butt</b> CUT INTO <b>Boneless Steak</b> <b>\$2.38</b> Lb. (Avg. Wt. 15- To 22-Lbs.)</p>	<p>CHOICE WHOLE BEEF LOIN CUT INTO <b>Porterhouse, T-Bone or Sirloin Steaks</b> <b>\$2.18</b> Lb. 48- To 55-Lb. Avg.</p>
--	--

Please Allow 3 Days For Preparation

## Let the Deli Do it

EXTRA LEAN SLICED TO ORDER  
**Boiled Ham**  
**\$1.99**  
Lb.

SAVE \$1.50 Off Reg. Price

Let The Deli Do It... PARTY TRAYS FOR SPECIAL PARTIES—Kroger party trays make special occasions more special. Choose from ham, turkey, roast beef, cheese, shrimp or colorful combinations — they're a delight to see, delicious to taste and surprisingly economical. Stop by or phone ahead so we have time to do our very best for you!

## IN STORE BAKERY

FRESH FRIED DAILY  
**Sour Cream Cake Donuts**  
Doz. **99¢**

SAVE 50¢ Off Reg. Price

JUMBO — CHOCKED FULL OF CHIPS  
**Chocolate Chip Cookies**  
Dz. **\$1.19**

In our bakery you'll find a friendly hostess or assistant to help fill your order from our service displays of tempting cakes, donuts, pies, cookies and other delights. Many of these favorites are baked right in the modern ovens built into the store. Here is where you also place your order for birthday, anniversary or other special occasion cakes.

## IN STORE RESTAURANT

Breakfast Served 7:00 A.M.

DAILY  
**Plate Lunch Special**  
**\$1.49**  
Ea.

Includes Meat, 2 Vegetables, Roll And Butter

SAVE 50¢ Off Reg. Price

Fresh — never frozen — that's our secret — fresh made pizza. Made the way you like with your choice of the freshest ingredients available — pepperoni, sausage, green and red peppers, mushrooms, shredded mozzarella and provolone cheese. You fix it fresh from your own oven with no mess or extra work. Take one home today for an all natural fresh treat for your family. Have a pizza made your way today!

FRESH WHOLE OR BUTT HALF  
**Lamb Legs**  
**\$2.19**  
Lb.

WHOLE LAMB Shoulder Roast Lb. **\$1.59**  
FRESH VEAL Rib Chops Lb. **\$4.39**

Fresh Seafood Available Fri., and Sat., Only  
**Fresh Dressed Flounder** Lb. **\$1.69**  
**Fresh Dressed Perch Fillets** Lb. **\$2.19**

FRESHORE FISH N BATTER Portions 10-oz. Pkg. **\$1.29**  
FRESHORE Fish N Chips Lb. **\$1.29**  
FRESH FROZEN Turbot Fillets Lb. **\$1.58**

KROGER CHUNK STYLE  
**Bologna** Lb. **\$1.19**  
SERVE N SAVE, ASSORTED VARIETIES  
**Lunch Meats** 1-Lb. Pkg. **\$1.28**  
KROGER (Lb. PKG. \$1.39)  
**Beef Wieners** 12-oz. Pkg. **\$1.09**

KROGER MEAT (BEEF Lb. \$1.40)  
**Dinner Franks** 1-Lb. Pkg. **\$1.39**  
KROGER REGULAR OR DELUXE VARIETY PAK  
**Lunch Meat** 12-oz. Pkg. **\$1.79**  
HOLLY FARMS  
**Chicken Franks** 1-Lb. Pkg. **98¢**

# Kroger **SAVES** 6,188

Sav-on **SAVES**

**CHEF'S PRIDE**  
**Charcoal**  
10 **88¢**  
-Lb. Bag



**QUAKER STATE**  
**Super Blend**  
Motor Oil  
Quart **57¢**



**IGLOO**  
**Playmate**  
Cooler  
Keeps 18 cans of beverage icy cold all day long. Tough Plastic.  
**\$9.99**

**Igloo**  
**1-Gal. Cooler**  
Only **\$5.99**



8 Quarts  
**Potting Soil**  
**2 \$1**  
Bags For

12-INCH  
**Clay Pots**  
**2 For \$5**



**PATTON 12-INCH**  
**Circulating Fan**  
**\$34.88**



**LIMITED EDITION**  
**Daiwa Rod & Reel Combo**  
Only **\$39.99**

Limited Edition Daiwa Saltwater Spinning Reel with engraved spool and teakwood spool and teakwood knob matched with a 9 Ft. 2 Piece Daiwa Regal Surf Rod with ceramic guides and soft cushioned handles.



**Zebco '33' Reel**  
Only **\$8.99**

- Polished stainless steel covers
- Wide range drag
- America's favorite spincast reel.



**WD-40**  
Lubricating Spray  
9-Oz. Can Only **99¢**

- Stops Squeaks
- Protects Metal
- Loosens Rusted Parts
- Freezes sticky mechanisms



**Daiwa Spinning Rods**  
Your Choice **\$8.99**

Your choice of 6 1/2' or 7' Spinning Rod. 2 Piece hollow fiberglass rods with top quality ceramic guides.

**SPALDING TOP FLITE XED OUT Golf Balls**  
Doz. **\$5.99**

**MANN'S Jelly Worms**  
Choice of Bass Fishermen everywhere. Available in 4", 6", and 8" lengths.  
**2 Pkgs. \$1**



**SPALDING TOP FLITE 1300C Daiwa Reel**  
**\$13.99**

Medium Freshwater Spinning Reel. High speed right or left hand retrieve.



**RUBBERMAID Filter Funnel**  
**99¢**

**RUBBERMAID Flexible Funnel**  
**\$1.19**

**Rubbermaid Car Litter Basket**  
**\$1.19**



**Jubilee**  
2-PACK  
**Panty Hose**  
OR  
4-PACK  
**Knee-Hi's**  
Your Choice **\$1.00**



**UNO Card Game**  
UNO FAMILY CARD GAME WITH TRAY & SCORE PAD  
**\$4.99**



**NO MORE PANTY LINES!**  
**Hanes Underalls**  
PANTY & HOSE IN ONE  
Only **99¢**



**STURDY CANVAS**  
**School Tote Bag**  
Only **\$3.29**



**22" HIGH PLAY Shopping Cart**  
**\$3.97**



**BOYS' T-Shirts Or Briefs**  
Your Choice **\$2.47**



# MORE PRICES

Offering Cost-Cutter Savings throughout the store

COST WEEK CUTTER SPECIAL

**20% OFF!**  
**TIMEX WATCHES**

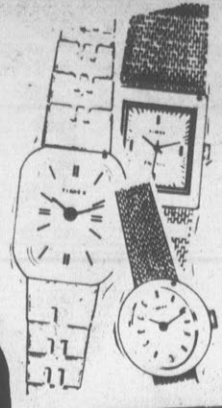

**Light Bulbs**

• 33% LONGER LIFE  
• 60, 75 & 100 WATT

**4 Bulbs For \$1**



#7018  
**TOMY Blip Game**  
Only **\$11.99**

It's player against player when you blip it with a friend. Or player against machine if you dare play against Blip itself.

Tomy #7034 **Digital Derby**

How many laps can you race before the time runs out? Steer and shift, racing against other cars to avoid accidents. Try it today.

Only **\$15.88**

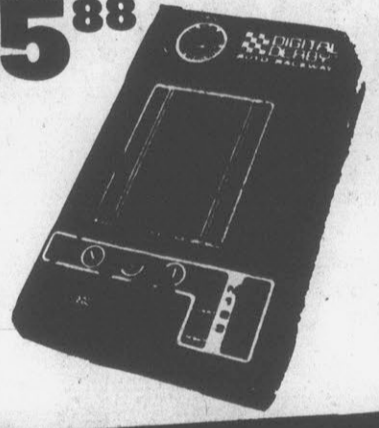

**G.E. Flip Flash II**

**\$1.27** Each

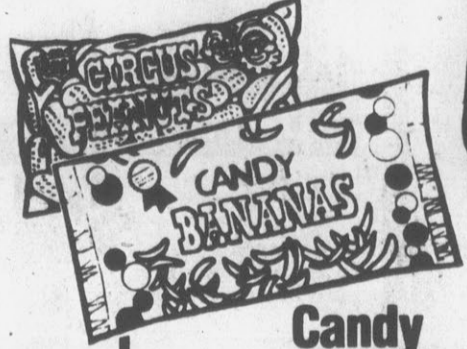

**Candy Bananas or Circus Peanuts**

Your Choice **66¢**

**SPORT CRAFT Croquet Set**

Only **\$14.99**

Four player set complete with hardwood mallets, balls, stakes and wickets.



## Home Canning Supplies



### CANNING JARS

REGULAR Pint Jars . Doz.	<b>\$2.39</b>	WIDEMOUTH Pint Jars . Doz.	<b>\$2.66</b>
REGULAR Quart Jars . Doz.	<b>\$2.66</b>	REGULAR Jelly Jars . Doz.	<b>\$2.66</b>

2-QUART **Mixer Pitcher**

Only **\$1.59**

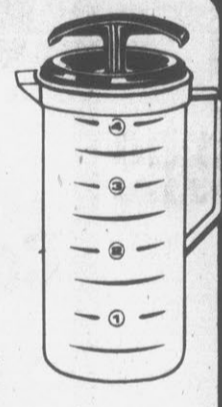

2-Quart Serving Decanter **\$1.27**



**Souptime Mugs**

Decorated With Various Graphics **\$1.99** YOUR CHOICE



**FRAMED PICTURES**  
All with glass.

Your Choice **\$3.99**

### RUBBERMAID SALE THIS WEEK

**1/2 OFF** MFG. SUG. RETAIL

Dependable Rubbermaid quality in items for all through the house!



- A. 10 1/2" High Wastebasket Rectangular **\$2.74**
- B. Wastebasket **\$1.89**
- C. Swing Top Wastebasket **\$4.57**
- D. Vanity Wastebasket **\$8.99**
- E. Toilet Bowl Brush Set **\$1.24**
- F. Bathtub Mat **\$9.99**
- G. Laundry Basket **\$2.24**



**Cutlery Tray**  
Separate cushioned compartments for flatware, cutlery. **74¢**



**Strainer-Colander**  
Thaw frozen food! Twin spouts. Dishwasher safe. **74¢**

GILLETTE 11-OZ. — WITH FREE RAZOR

**Trac II Shave Cream . . 99¢**

COCONUT SHAVE CREAM

Gillette Foamy . . . . . 11-Oz. **97¢**

MAX FACTOR PANCAKE OR Panstik Makeup . . . . . Each **\$1.59**

KROGER FAMILY PRIDE Baby Shampoo . . . . . 16-Oz. Btl. **73¢**

REVLON Formula II Blusher . . . . . 1/2-OZ. **\$2.97**

REVLON FOR EYES Color-Up Stick . . . . . **\$2.67**

# Kroger Sav-on CLASHES 6,188 PRICES

**Kroger Sav-on**  
Wants you to meet  
*Our Friendly*  
**Pharmacists**

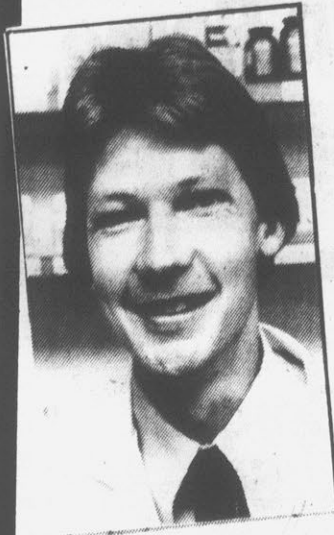

JEFF TUGWELL

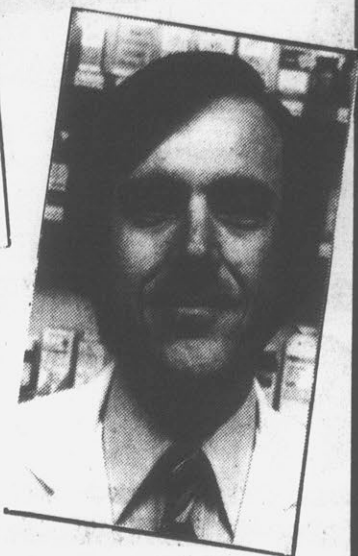

CHARLES CARTER

They are here to give you their professional advice and assistance. When you dial 756-7393 in Greenville a registered pharmacist answers promptly, to serve you.

**COST CUTTER SAVINGS**  
THROUGHOUT THE STORE



ORIGINAL **Alka-Seltzer**  
Box Of 25 Tablets **67¢**

*Greatest Variety of Health & Beauty Aids in Greenville*



BRONZE **Right Guard**  
**\$1.47**  
10-Oz. Can

**Kroger Sav-On, Your Health & Beauty Aid Store**  
Stocked with a complete selection of national brands, and nationally advertised products to assure you, our shopper, that you are getting the best brands at lowest possible prices.



COLGATE **Shave Cream**  
**\$2.11**  
11-Oz. Cans



WITH FLUORIDE **Colgate Toothpaste**  
**99¢**  
9-Oz. Tube



GILLETTE **Atra Shaving Cartridges**  
**\$1.89**  
Pack of 10

**COST CUTTER COUPON**

**FREE**

To 360 Persons While They Last

ORAL OR RECTAL — BECTON-DICKINSON **Fever Thermometer**

Regular \$1.49 Value  
Bring this completed coupon To one of our pharmacies.

NAME \_\_\_\_\_  
ADDRESS \_\_\_\_\_  
CITY \_\_\_\_\_ ZIP \_\_\_\_\_

Limit One Coupon Per Family.

Coupon Good Thru Wed., Aug., 8, 1979.

SUBJECT TO APPLICABLE STATE & LOCAL TAXES.

COUPON MUST ACCOMPANY ORDER



**COST CUTTER COUPON**

**FREE Prescription (New Or Transferred)**

Up To **\$3.00** At The Sav-On Pharmacy

Limit One Coupon Per Family.

Coupon Good Thru Wed., Aug., 8, 1979.

SUBJECT TO APPLICABLE STATE & LOCAL TAXES.

COUPON MUST ACCOMPANY ORDER



LOREAL **Ultra Rich Conditioner** 16-Oz. Bottle **\$1.57**

LOREAL **Ultra Rich Shampoo** 16-Oz. Bottle **\$1.19**

CLAIROL **Condition Shampoo** 16-Oz. Bottle **\$1.09**

CLAIROL **Condition Treatment** 2-Oz. Tube **\$1.17**

JOHNSON & JOHNSON **Bandaids** Value Pack 70 Strips **\$1.09**

SPECIALLY DESIGNED **Reach Toothbrush** **77¢**

ANTI-PERSPIRANT **Right Guard** 4-Oz. Can **\$1.09**

ANTI-PERSPIRANT **Soft & Dri** Can 4-Oz. **\$1.27**

GILLETTE **The Dry Look** 8-Oz. Pump **\$1.57**

DIAPARENE **Baby Wash Cloths** Dispenser of 70 **99¢**

COLOR AND CONDITIONER **Clairese** Only **\$1.88**



**WEDNESDAY...  
A NEW SHOPPING EXPERIENCE  
IS DAWNING IN  
GREENVILLE!  
CAROLINA EAST MALL**

**Sears**

**GRAND  
OPENING!**

**WEDNESDAY 10 A.M.**

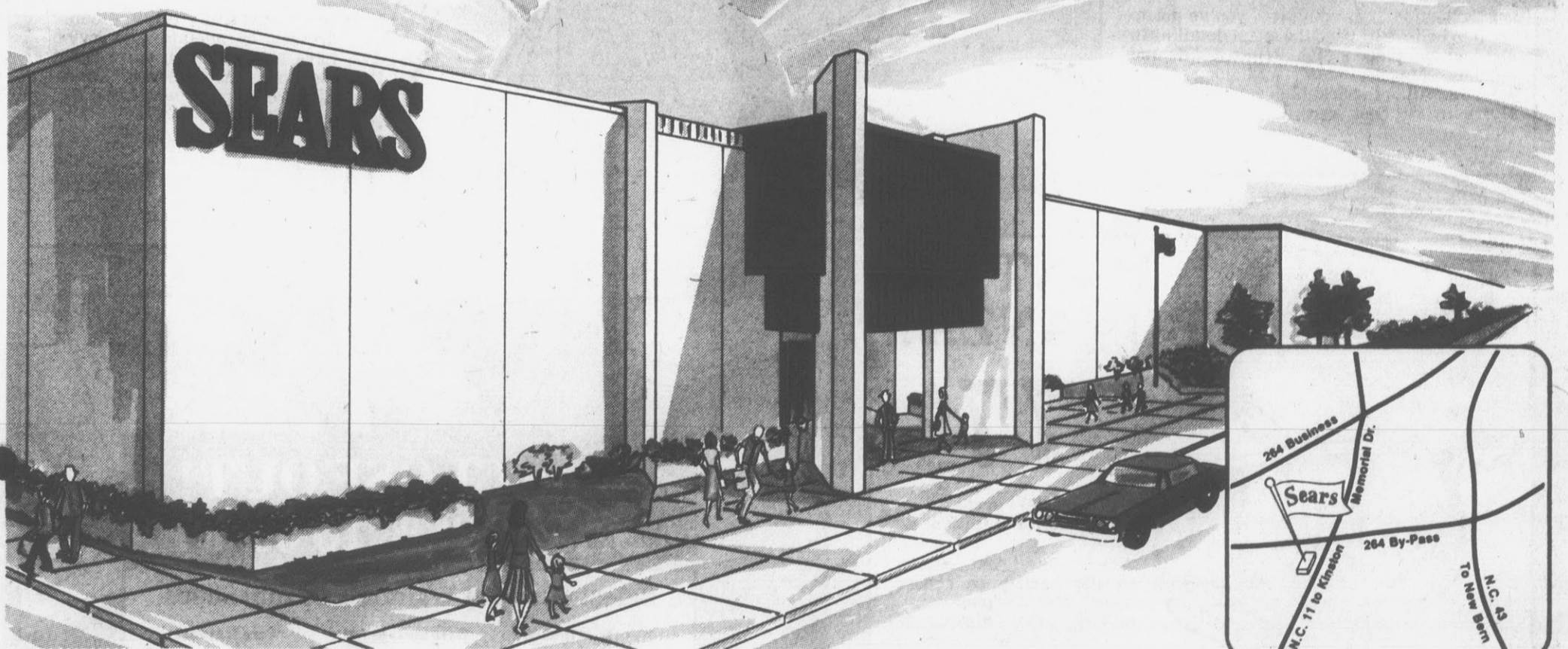

You're just minutes away from your new Sears!

**Join in the Ribbon Cutting  
Ceremony at Main Mall Entrance  
Wednesday at 10 a.m.!**

**An Exciting NEW Store  
With So Much More,  
Just for YOU!**

**Greenville and Eastern Carolina are  
getting a new Sears Like never before!**

- Wide aisles for your shopping convenience!
- A large selection of Appliances — Pick the One that's right for you!
- Big Auto Center for All Your Automotive Needs!
- In short, more selection, more service, more value!

**HEY KIDS!  
Winnie-the-Pooh  
Will Be Here!**

© Walt Disney Productions

Here is Winnie's schedule:  
 Wednesday, Aug. 1: 10 a.m., 1 p.m., 4:30 p.m., 7 p.m.  
 Thurs.-Fri.-Sat. Aug. 2-3-4: 11 a.m., 1 p.m., 4:30 p.m., 7 p.m.

**Sears**  
SEARS, ROEBUCK AND CO.

Where America shops  
for Value

Satisfaction Guaranteed or Your Money Back

**CAROLINA EAST MALL**  
PHONE: 756-9700

Supplement to the Greenville, N.C.  
Daily Reflector and Shopper's Guide

**Sears Pricing Policy . . .** If an item is not described as reduced or a special purchase, it is at its regular price. A special purchase, though not reduced, is an exceptional value.  
Most items at reduced prices

Sears

# Grand Opening

## SAVE 20%-25%

### Cool, Classic Sportswear

Misses' solids

**5<sup>99</sup>**

Reg. Price \$10 will be in effect after Aug. 4

Misses' pants

**7<sup>99</sup>**

Reg. Price \$8 will be in effect after Aug. 4

A classic updated with a fashionably small collar. So versatile it can go with practically anything. Of polyester knit that's silky smooth. Get several in solids and prints. Misses' sizes.

Reg. Price \$10 will be in effect after Aug. 4. Misses' print shirt..... 7.99  
Reg. Price \$11 will be in effect after Aug. 4. Women's print shirt, sizes 38 to 44..... 8.49  
Reg. Price \$9 will be in effect after Aug. 4. Women's solid shirt, sizes 38 to 44..... 6.99

### Soft Styles in Terry Bouclé for Juniors

While Quantities Last

**19<sup>99</sup>**

Our beautiful terry boucle dresses of acetate and nylon have a texture you can't resist touching and a lovely sheen. They're machine washable, too. In Junior sizes.

JR *Bazaar*

### Dresses and Skirtsets that Go 'Most Anywhere!

**14<sup>99</sup>**

Sears Price  
Limited Quantities!

Our collection is dazzling... you've got to see it to believe it! Find the latest detailing in one and two piece styles. Prints, solids and combos. Muscle, short and long sheer sleeves. All of packable polyester knit. Hurry in for best selection! Misses' and Half-sizes.

Ask about Sears Credit Plans

### PANTY BONANZA!

ONLY

**77¢**

each

Special Purchase  
Quantities Limited!

What a buy! And what a terrific variety to choose from. You'll find great-looking brief, hiphugger and bikini styles... are all soft, comfortable, and smooth fitting. Machine wash and tumble dry. Assorted trims. Prints and solids.

Sunglasses not available  
in Greenville, NC

**30% - 50%  
OFF!**

### Sunglasses

Fashion styles for men and women! SunSensor™ lenses, gradient lenses with metal and plastic frames. You're bound to find the look you're looking for. Come in and take a look-see. Why not buy several pair!

Sunglasses not available in Danville, Florence, Jacksonville, Rocky Mt., Gastonia, Rock Hill, and Greenville, N.C.

### Shoe CLOSEOUT! SAVE 28% to 60%!

#### Select Group of Women's Casual Shoes

Were \$6.99 to \$9.99      Were \$10 to \$13.99      Were \$14 to \$22

SAVE **3<sup>97</sup>**      SAVE **5<sup>97</sup>**      SAVE **9<sup>97</sup>**  
43% to 60%!      40% to 57%!      28% to 54%!

#### Select Group of Men's Casual Shoes

Were \$17.99 to \$22.99      Were \$22.99 to \$28.99

SAVE **9<sup>97</sup>**      SAVE **13<sup>97</sup>**  
44% to 56%!      39% to 51%!

In men's sizes 7½-11, 12D.

#### SAVE 50%-57%! Family Canvas Shoes

Were \$6.99 to \$17.99

**2<sup>97</sup> to 8<sup>97</sup>**

In children's, women's and men's sizes.

#### SAVE 50%! Select Group of Children's Shoes

Were \$15.99  
to \$16.99

**7<sup>99</sup> to 8<sup>49</sup>**

Original prices from Fall 1978 to Spring 1979 styles.

Sears

# Grand Opening

FIRST TO SEARS  THEN TO SCHOOL

ASK ABOUT SEARS CREDIT PLANS

## SAVE 20%

### Sears Best Underwear and Socks for Kids

Here are some reasons you'll reach for Sears Best:

- Strength • Softness • Shape Retention

This underwear is made of a durable, shrink-resistant blend of Dacron® polyester, cotton and DuPont nylon. Bigger girls' slips are of nylon, too. See them all today!

- \$3.79 Little boys' T-shirts, pkg. of 3..... 3.03
- \$3.79 Little girls' vests, pkg. of 3..... 3.03
- \$3.79 Little girls' panties, pkg. of 3..... 3.03
- \$1.19 Little girls' knee-highs, S,M,L,XL..... 95¢ pr.
- 99¢ Little girls' knee-highs, S,M,L,XL 79¢ pr.
- \$1.99 Little boys' tube socks, pkg. of 3... 1.59
- \$4.49 Bigger boys' briefs or T-shirts, pkg. of 3..... 3.59
- \$1.19 Bigger boys' crew socks, M,L,XL..... 95¢ pr.
- \$1.29 Bigger boys' sport tube socks, M,L,XL..... 1.03 pr.
- \$5.99 Bigger boys' sport tube socks, pkg. of 6..... 4.79
- \$3.69 Bigger girls' panties, pkg. of 3..... 2.95
- \$3.69 Bigger girls' vests, pkg. of 3..... 2.95
- \$1.19 Bigger girls' knee-highs, S,M,L . 95¢ pr.
- \$1.49 Bigger girls' knee-highs, S,M,L 1.19 pr.
- \$3.49 Bigger girls' full slip..... 2.79

Regular prices shown above will be in effect after Aug. 4

## BIG BUY!

### Sportshirt Prices You Shouldn't Miss

# 3<sup>97</sup>

While Quantities Last

Button-front shirts in an assortment of solids and patterns. But quantities are limited, so do your shopping now!

## 15% OFF

### Rustle up Savings on Fall Westernwear

Shirt or Jeans  
Reg. Price \$9.99 will be in effect after Aug. 4

# 8<sup>49</sup>

each

#### Western Heavyweight Jeans

They're 100% cotton denim with 4 pockets, metal bartacks for strength. Semi-flare leg gives easy fit.

#### Western Chambray Shirt

Tailored for strength in a polyester and cotton blend. The authentic western details give that casual look.

MEN'S  
WORK 'N' LEISURE  
CLOTHING

### Our Lowest-Priced Mens' Knit Slacks

# 9<sup>85</sup>

Sears Price

That's right! Now you can purchase a great pair of knit slacks at an even greater price! Polyester doubleknit Perma-Prest® slacks in solid colors.

Ask about Sears Credit Plans

## SAVE \$5

### Steel Toe, Cushioned Insole Work Shoes

Cushioned heel-to-toe for comfort. Black leather uppers. Goodyear welt construction. Gas, oil and grease resistant rubber soles and heels. Hurry! Sale ends August 7.

Reg. Price \$33.99 will be in effect after Aug. 7

# 28<sup>99</sup>

Oxfords

Reg. Price \$40.99 will be in effect after Aug. 7

# 35<sup>99</sup>

6-in. Shoe



Heel-to-toe insoles are cushioned and ventilated for cool comfort



CONSIDER SEARS WORTHWHILE MAINTENANCE AGREEMENTS!

Sears Maintenance Agreements Let You Buy Tomorrow's Service at Today's Prices . . . and Sears is Nationwide!

Sears

Sears Pricing Policy . . . If an item is not described as reduced or a special purchase, it is at its regular price. A special purchase, though not reduced, is an exceptional value.

# Grand

SAVE \$30

BIG BUY

SAVE \$50

SAVE \$20

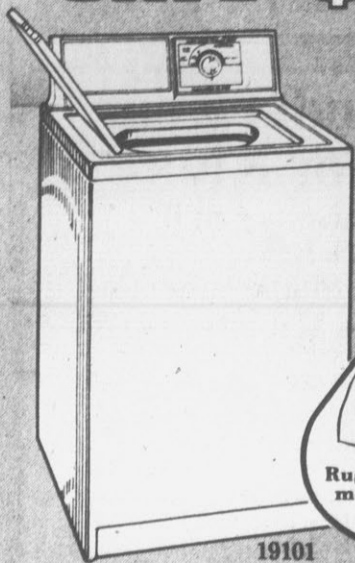

Rugged heavy-duty motor is built for durability

19101

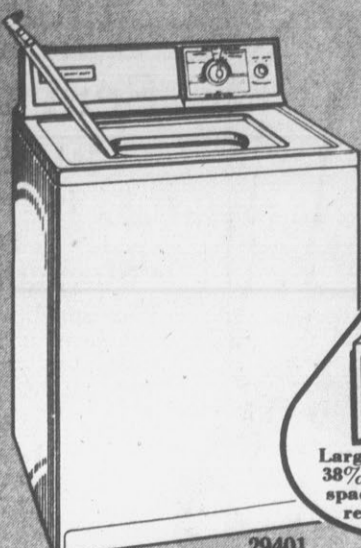

Large capacity—38% more wash space than our regular size

29401

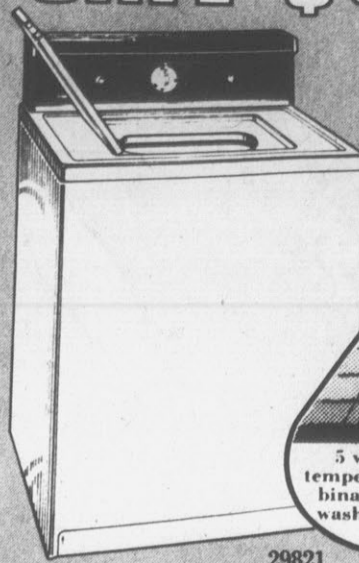

5 wash/rinse temperature combinations for all washable fabrics

29821

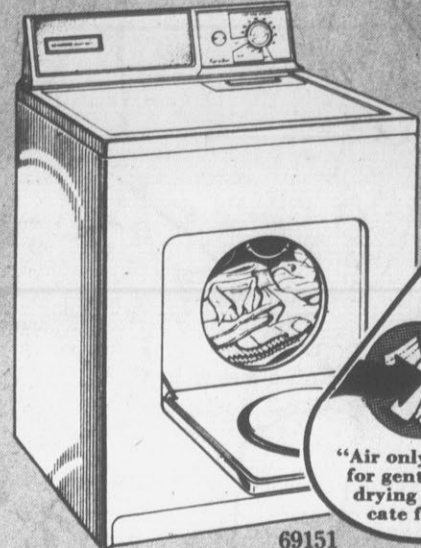

"Air only" option for gentle fluff-drying of delicate fabrics

69151

Space-Saving Washer

Reg. Price \$229 will be in effect after Aug. 4

**\$199**

2 pre-set water temp. combinations.

Kenmore Permanent Press Washer

Sears Price

**\$269**

Normal and permanent press cycles.

Large-Capacity 5-Cycle Washer

Reg. Price \$399.95 will be in effect after Aug. 11

**349<sup>95</sup>**

Sale ends Aug. 11

Settings for knits, delicates, permanent-press. Self-cleaning lint filter.

Budget-Priced Kenmore Dryer

Reg. Price \$179 will be in effect after Aug. 4

**\$159**

Heavy-duty dryer. Standard capacity.

BIG BUY

BIG BUY

BIG BUY

SAVE \$100



69401



All-frostless convenience! No frost build-up, no defrosting jobs.

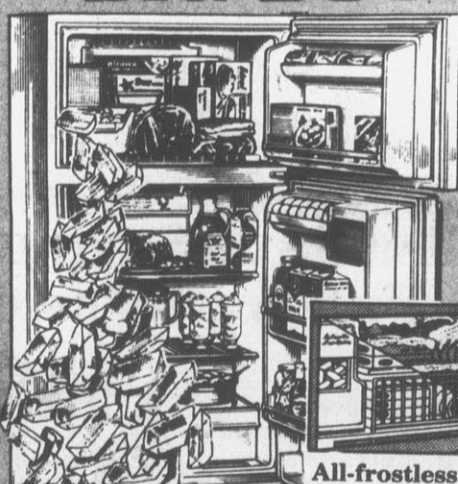

69701/8050



All-frostless convenience! No frost build-up, no defrosting jobs.



69021



All-frostless convenience! No frost build-up, no defrosting jobs.

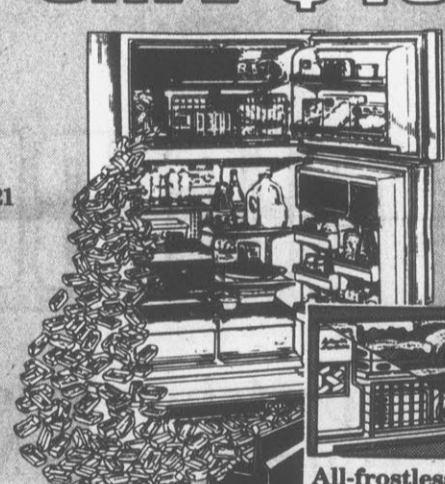

69931



All-frostless convenience! No frost build-up, no defrosting jobs.

Kenmore 14.3 cu.ft. Refrigerator-Freezer

Sears Price

**\$369**

Has twin crispers and door shelves.

17.0 cu.ft. Ice Maker Refrigerator-Freezer

Sears Price

**\$459**

Twin crispers and cold control.

19.1 cu.ft. Frostless Side-by-Side

Sears Price

**\$499**

Has meat keeper and door shelves.

19.0 cu.ft. Ice Maker Refrigerator-Freezer

Reg. Price \$749.95 will be in effect after Aug. 4

**649<sup>95</sup>**

Adjustable shelves, Humidrawer®.

BIG BUYS

\$50 - \$70 OFF

BIG BUY

BIG BUY

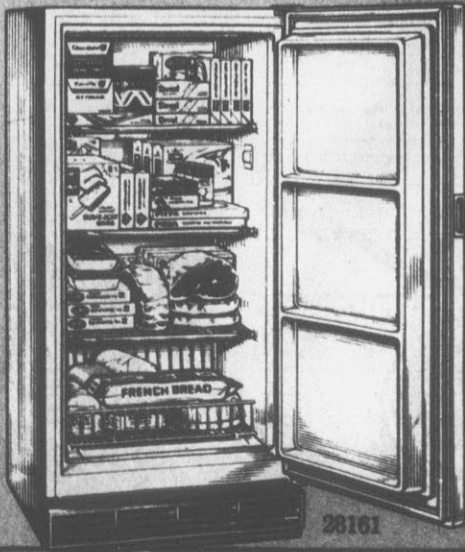

28101



39205

Sale ends Sept. 1

19235

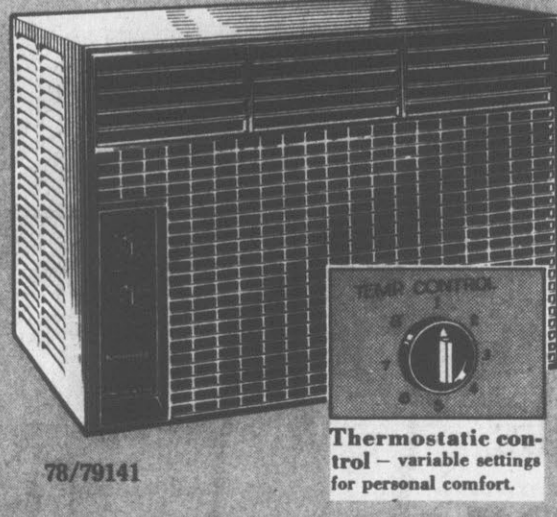

78/79141



Thermostatic control—variable settings for personal comfort.

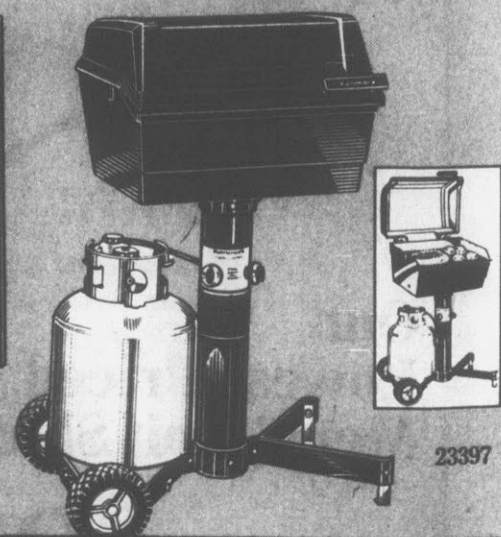

23397

16.0-cu.ft. Upright Freezer

Sears Price

**\$299**

Big capacity, 3 grille-type shelves.

19.6-cu.ft. Upright or 23.1-cu.ft. Chest

Reg. Prices \$549.95 to \$569.95 will be in effect after Sept. 1

**499<sup>95</sup>**

Each Your Choice

Frostless upright or conventional chest.

14,000 BTUH Air Conditioner

Sears Price

**\$329**

Model	BTUH Capacity	Sears Price
79071	7,500	\$229
79042	4,000	\$149
79181	18,000	\$399

Gas Grill with Dual Controls

Sears Price

**159<sup>95</sup>**

253-sq. in. grill with tank, hose, cart.

Dryer and range cords sold separately

Each of these advertised items is readily

# Opening

NOW AVAILABLE . . . QUICK SERVICE WHILE YOU WAIT!

For Most Sears Mowers and Major Appliances at our Repair Shop!

- Includes mowers, TV's, stereos, vacuums, sewing machines, more.
- We'll repair, give an estimate, or order parts not carried in our inventory.
- Expert technicians provide dependable, professional service backed by Sears.
- Quick service repairs limited to jobs of 30 minutes or less.

SAVE \$20

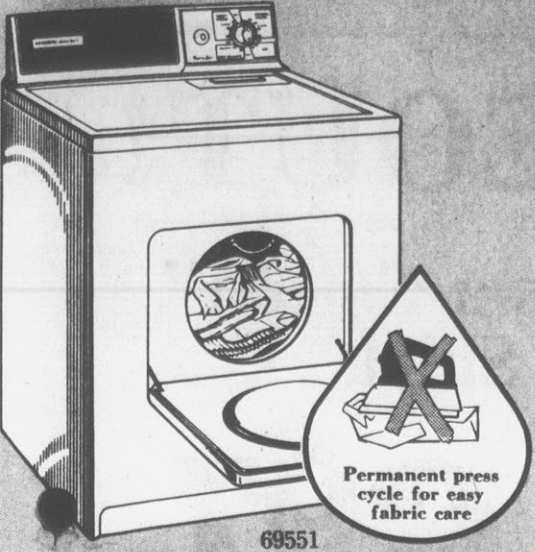

69551

Permanent press cycle for easy fabric care

SAVE \$30

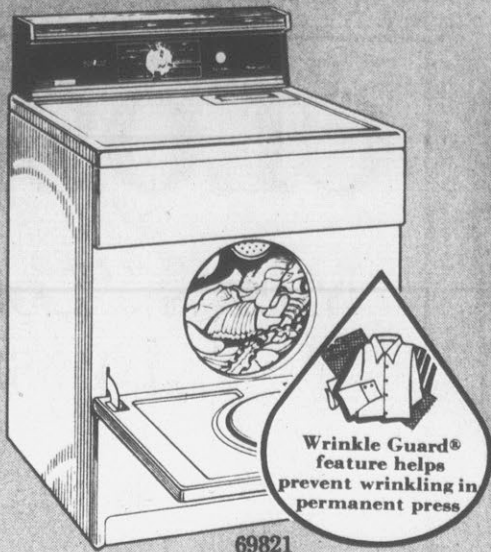

69821

Wrinkle Guard® feature helps prevent wrinkling in permanent press

\$50 OFF

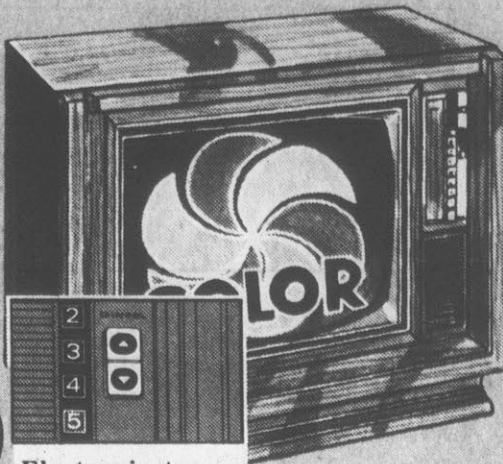

Electronic tuner with easy Sensor Scan channel selector.

44561

SAVE \$40



Chromix® black matrix picture tube aids picture color quality.

41703

## Permanent-Press Electric Dryer

Reg. Price \$219.95 will be in effect after Aug. 4

**199<sup>95</sup>**

Cycles for permanent press, delicates.

## Large-Capacity All-Fabric Dryer

Reg. Price \$279.95 will be in effect after Aug. 11

**249<sup>95</sup>**

Sale ends Aug. 11

4-cycles, automatic termination.

## CLOSEOUT! TV with Sensor Scan Selection

Reg. Price Was \$649.95 in Spring 1979 Catalog

**599<sup>95</sup>**

25-in. diagonal measure picture. While Quantities Last!

## Table Top Color TV

Reg. Price \$339 will be in effect after Aug. 4

**\$299**

19-in. diagonal measure picture.

SAVE \$100

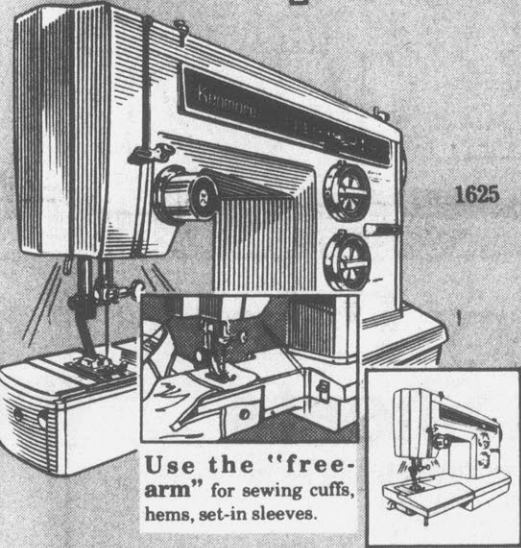

1625

Use the "free-arm" for sewing cuffs, hems, set-in sleeves.

\$70 OFF

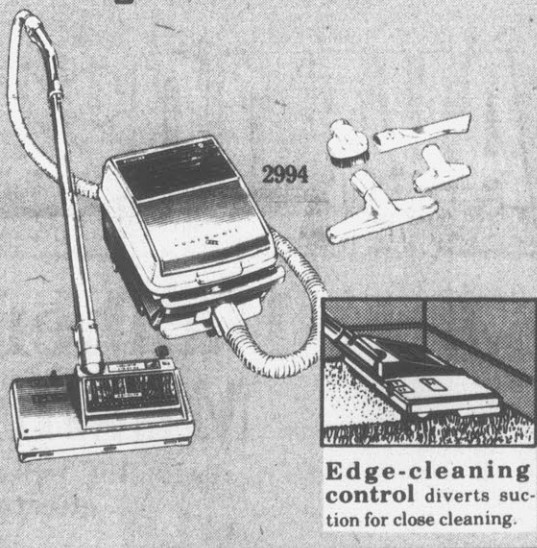

2994

Edge-cleaning control diverts suction for close cleaning.

SAVE \$10



3960

Edge-cleaning control diverts suction for close cleaning.

BIG BUYS

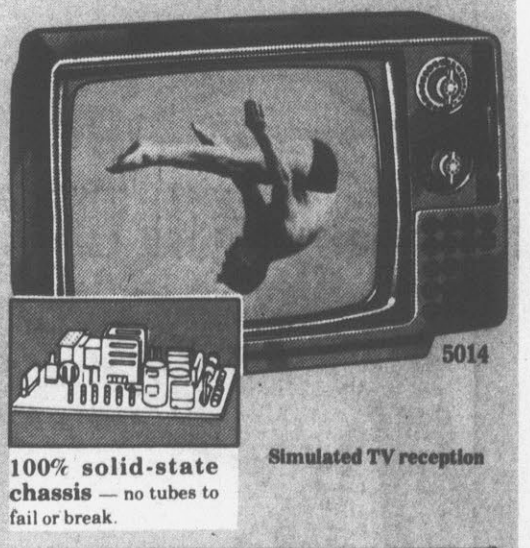

5014

100% solid-state chassis — no tubes to fail or break.

Simulated TV reception

## Convertible Free-Arm Sewing Head

Reg. Price \$299.95 will be in effect after Aug. 4

**199<sup>95</sup>**

Thru Aug. 3

6 stretch stitches. Built-in buttonholer.

## CLOSEOUT! Powermate® Vacuum

Reg. Price Was \$264.95 Spring 1979 Catalog

**199<sup>95</sup>**

While Quantities Last

Concealed tool storage in canister top.

## Kenmore Upright Vac

Reg. Price \$79.95 will be in effect after Aug. 25

**69<sup>95</sup>**

Thru Aug. 25

18-ft. cord winds on hooks.

## Black and White Portable TV Set

Sears Price

**79<sup>95</sup>**

12-in. diagonal measure picture TV.

SAVE \$30



91261

Porcelain enameled cooktop. Easy clean, resists scratches.

BIG BUY

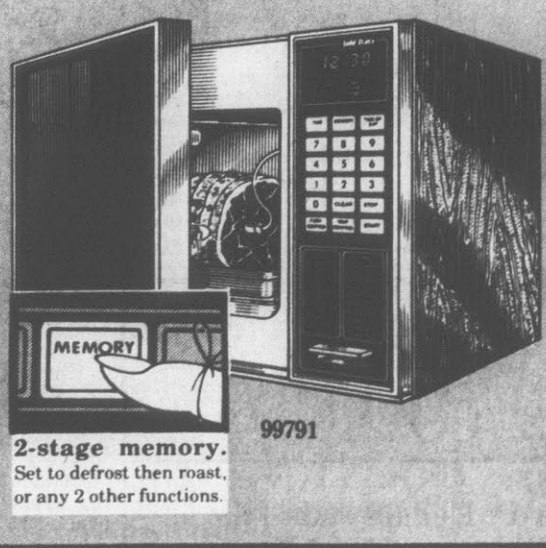

99791

2-stage memory. Set to defrost then roast, or any 2 other functions.

SAVE \$50



91931

## 8-Track and Cassette Stereo

Reg. Price \$249.95 will be in effect after Sept. 1

**199<sup>95</sup>**

Thru Sept. 1

AM/FM stereo receiver, record changer, 2 speakers.

BIG BUYS



2391

38062 An FCC license is required to operate CB equipment.

2430

2168

Your Choice

Clock Radio, Portable Radio, Cassette Recorder, Reg. Price \$79.95 will be in effect after Sept. 1

**59<sup>95</sup>**

each Thru Sept. 1

38062 CB radio, Sears Price . . . . . 59.95

## Electric Range with Lift-up Cooktop

Reg. Price \$249 will be in effect after Aug. 4

**\$219**

Porcelain-enameled oven. 30-in. range.

## Deluxe Microwave

Sears Price

**399<sup>95</sup>**

Multipower with temperature probe.

## 8-Track and Cassette Stereo

Reg. Price \$249.95 will be in effect after Sept. 1

**199<sup>95</sup>**

Thru Sept. 1

AM/FM stereo receiver, record changer, 2 speakers.

Your Choice

Clock Radio, Portable Radio, Cassette Recorder, Reg. Price \$79.95 will be in effect after Sept. 1

**59<sup>95</sup>**

each Thru Sept. 1

38062 CB radio, Sears Price . . . . . 59.95

**Sears**

# Grand Opening



**\$3 - \$5 OFF!**

**CLOSEOUT!**

**Men's "Lots-a-Cotton"  
Dress Shirt**

**6<sup>97</sup>**

Reg. Price \$9.99 to \$11.99  
Fall 1978 General Catalog

Now's the time to stock your closet with shirts, shirts, shirts! All come in a comfortable, easy-care blend of 60% cotton, 40% polyester. Styled with spread collars, one straight-hemmed pocket and long sleeves in a wonderful assortment of patterns and colors.

While Limited Quantities Last  
Ask about Sears Credit Plans

**SAVE 10% - 14%!**



## Danberry Print Muslin Sheets

Twin, Reg. Price \$2.79 each will be in effect after Aug. 4

**2 for \$5**

Flowery fresh sheets of cotton and polyester muslin for ease of care. Just machine wash and tumble dry. In blue or rose colors. Hurry and save!

Reg. Price \$3.99 will be in effect after Aug. 4,  
Full size ..... 2 for \$7  
Reg. Price \$3.49 will be in effect after Aug. 4,  
Pillowcases ..... 2.99 pair

**Mattress Pad**  
Twin size  
Sears Price **3<sup>89</sup>**  
Full size ..... 4.89

**Daybreak Bath Rug**  
21x36-in.  
Sears Price **2<sup>99</sup>**

**Acrylic Blanket**  
Twin/Full  
Sears Price **4<sup>99</sup>**

**Shower Curtain**  
Sears Price **1<sup>77</sup>**

**Pillow**  
Reg. Price \$2.65 will be in effect after Aug. 4  
**2 for \$5**

**Bath Scales**  
Sears Price **4<sup>99</sup>**

**SAVE \$3**

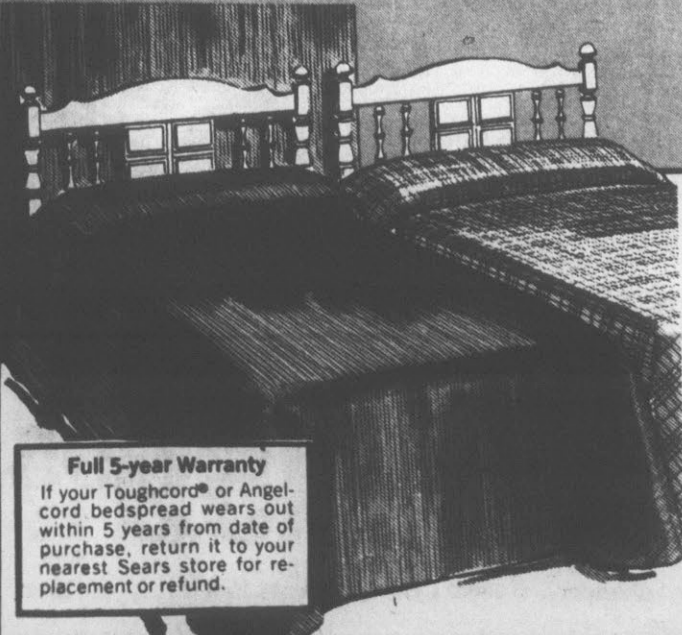

**Save on Toughcord® Bedspreads—So Rugged They're Warranted for 5 Years**

Need a ribbed Perma-Prest® spread that's made to stand up to rough wear? Want a choice of bright, cheery colors? Toughcord fills the bill! Made of easy-care polyester and rayon blend.

Reg. Price \$11.99 will be in effect after Aug. 18

**8<sup>99</sup>**  
Bunk Size

Reg. Price \$12.99 will be in effect after Aug. 18 **9<sup>99</sup>** Reg. Price \$14.99 will be in effect after Aug. 18 **11<sup>99</sup>**

Sale ends August 18

**Full 5-year Warranty**  
If your Toughcord® or Angelcord bedspread wears out within 5 years from date of purchase, return it to your nearest Sears store for replacement or refund.

**Sheer Panel Curtains**  
Sears Price **2<sup>49</sup>**  
Machine washable rod-pocket sheer panel. 40x81-in.

**Cape Cod Cafe Curtain**  
Sears Price **1<sup>89</sup>**  
Delta 60x24-in. 60x36-in. size.... 2.87

**Light Filtering Window Shade**  
37 1/4-in. x 6-ft. **1<sup>58</sup>**  
Sears Price

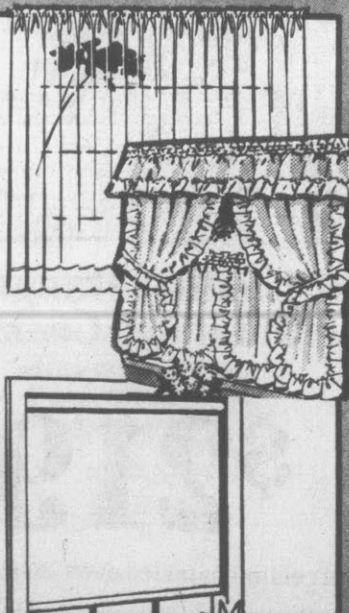

Sears

# Grand Opening

## SAVE A BIG \$20!



### 26-in. 10-Speed Adult Bike

Our easy-pedaling yellow 10-speed racer will help conserve your leg power. Side-pull caliper hand brakes with dual levers allow braking in either upright or racing positions. Stem-mounted gear shifter. 10-speed derailleur.

Reg. Price \$109.99 will be in effect after Aug. 4

**89<sup>99</sup>**

Ask about Sears Credit Plans

### HELP SAVE ENERGY—SWITCH TO TWO WHEELS!



Sears Bike Shop  
• Expert service  
• Expert assembly  
• Parts in stock  
Available at additional cost



### 16-in. Single-Speed Convertible Bike

Sears Price  
Adjustable all-steel blue and white frame. Convert from boy's to girl's bike.

**49<sup>99</sup>**



### Boy's or Girl's 20-in. High Rise Bike

Sears Price  
Single-speed bike has sturdy all-steel blue frame, coaster brakes. Banana style saddle.

**59<sup>99</sup>**



### Men's or Women's 27-in. 10-Speeds

Reg. Price \$139.99 will be in effect after Aug. 4  
Stem-mounted shift levers can be used from standing or touring position. Dual hand brake. Unassembled.

**109<sup>99</sup>**

### \$20 OFF! Boys' and Girls' 24-in. 10-Speed Bike

Reg. Price \$109.99 will be in effect after Aug. 4  
Sears Best youth size 10-speed racer features dual-position center pull caliper brakes, stem mounted shifter.

**89<sup>99</sup>**

**\$30 OFF!**

## SAVE \$15

## SAVE \$100



### Sears Best Vanity with White China Top

**89<sup>99</sup>**

Reg. \$104.99 20-inch

Adds beauty and storage space with this moisture resistant white finish vanity and white china top. Traditional and Country styles available at similar savings.

- \$39.99 Single Lever Lavatory Faucet . . . 31.99
- \$9.99 Neat Seat Toilet Seat . . . . . 7.99
- \$64.99 Matching Storage Cabinet . . . . . 54.99
- \$64.99 White China Toilet . . . . . 54.99
- \$89.99 Tub Door Enclosure . . . . . 79.99

Regular prices shown above will be in effect after Aug. 4



**\$8 OFF**  
Washerless Kitchen Faucet  
Reg. Price \$39.99 will be in effect after Aug. 4 **31<sup>99</sup>**  
Reg. Price \$44.99 will be in effect after Aug. 4. Faucet with rinse spray . . . . . 36.99

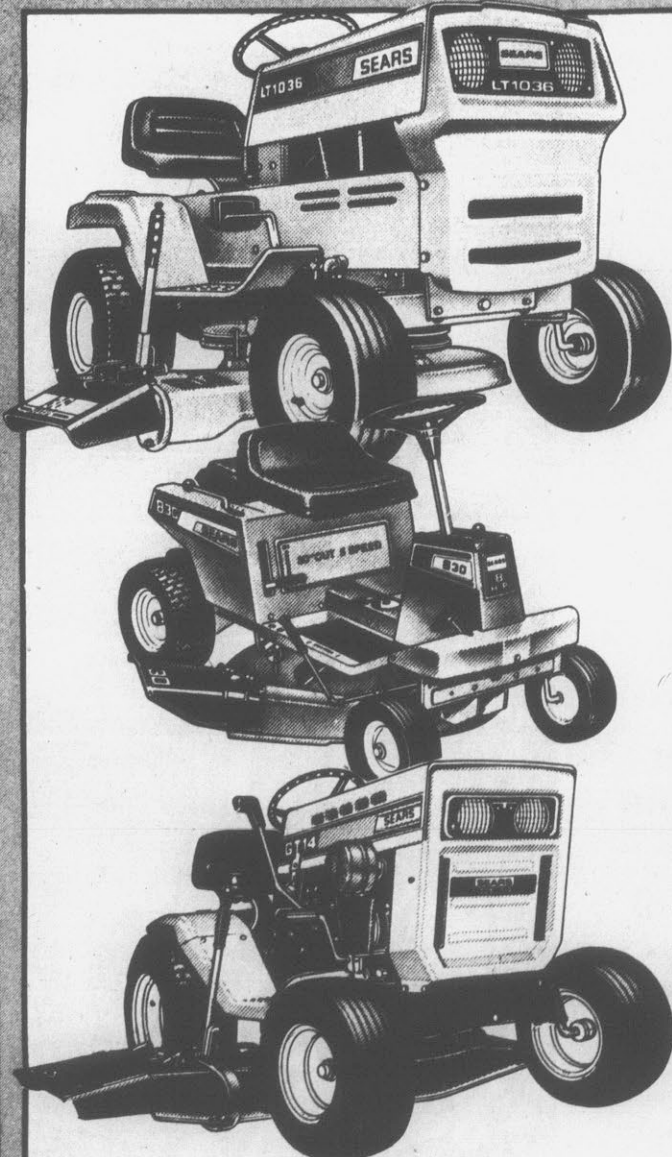

### 3-Speed 10-HP Lawn Tractor

Reg. Price \$949 will be in effect after Aug. 18 **\$849**

Lawn tractor has 3 speeds forward plus reverse. Electric start. ISO-VIB engine mounts dampen vibration. 36-in. cut. mower deck. Handles optional attachments.

### 8-HP 5-Speed Riding Mower

Reg. Price \$749 will be in effect after Aug. 18 **\$649**

Recoil start riding mower has 5 speeds forward plus reverse. ISO-VIB engine mounts dampen vibration. 30-in. cut mower deck. Optional grass catcher.

### SAVE \$200!

### 14-HP 3-Speed Garden Tractor

Reg. Price \$1599 will be in effect after Aug. 18 **\$1399**

Vari-drive means convenience and maneuverability. Electric start engine with 3 speeds forward plus reverse. ISO-VIB engine mounts dampen vibration.

All attachments are extra.

Tractor and Mower Sale ends August 18

## SAVE 20%

### Wynnewood II or Brookside Cabinets for a "Custom Look" in Your Kitchen

Create a lovely and functional new kitchen! Pick either Wynnewood II or Brookside kitchen cabinets (from our Cabinet Maker Collection). Many sizes and styles from which to choose. We can help you plan your kitchen free of charge!

Sink, faucet, countertop, appliances and installation extra. Kenmore® ranges require a connector sold separately. Professional installation available at an extra cost. Built-in cook units are sold on special order basis. Continuous cleaning ovens have specially coated oven interiors.

- Reg. Price \$339.95 will be in effect after Aug. 25, Built-in Dishwasher, 7973 . . . . . 289.95
- Reg. Price \$259.95 will be in effect after Aug. 11, Compactor, 40706 . . . . . 239.95
- Reg. Price \$339.95 will be in effect after Aug. 21, 24-in. Continuous Cleaning Oven, 42289 . . . . . 309.95
- Reg. Price \$349.95 will be in effect after Aug. 21, 36-in. Ceramic Glass Cook Top Unit, 43391 . . . . . 299.95
- NOT SHOWN:
- Reg. Price \$489.95 will be in effect after Aug. 21, 24-in. Continuous Cleaning Double Oven . . . . . 439.95
- Reg. Price \$689.95 will be in effect after Aug. 21, 30-in. Smooth Top Drop In Range, 45699 . . . . . 619.95
- Reg. Price \$79.95 will be in effect after Aug. 25, Kenmore® "200" Disposer, 6653 . . . . . 69.95

Each of these advertised items is readily available for sale as advertised.

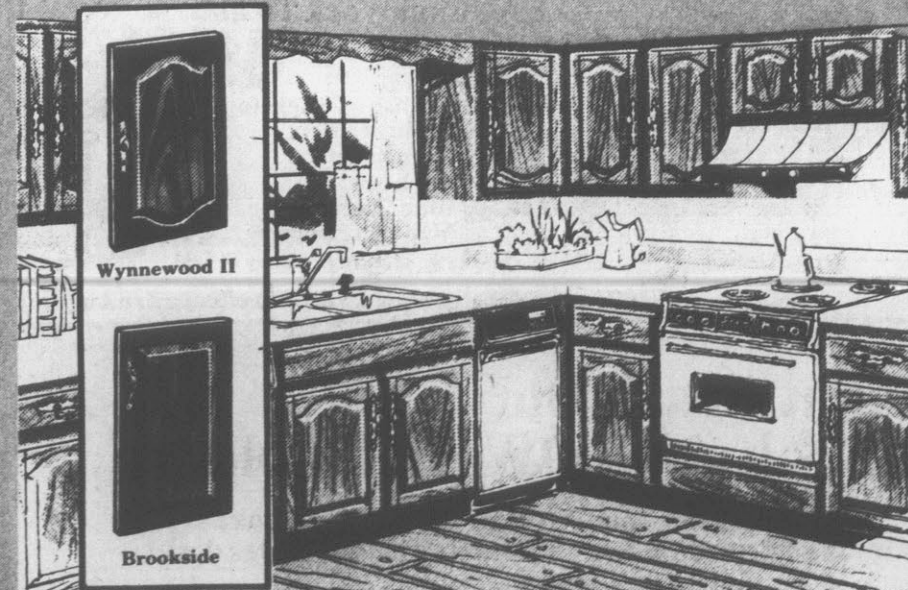

Sears

# Grand Opening

## SAVE \$4

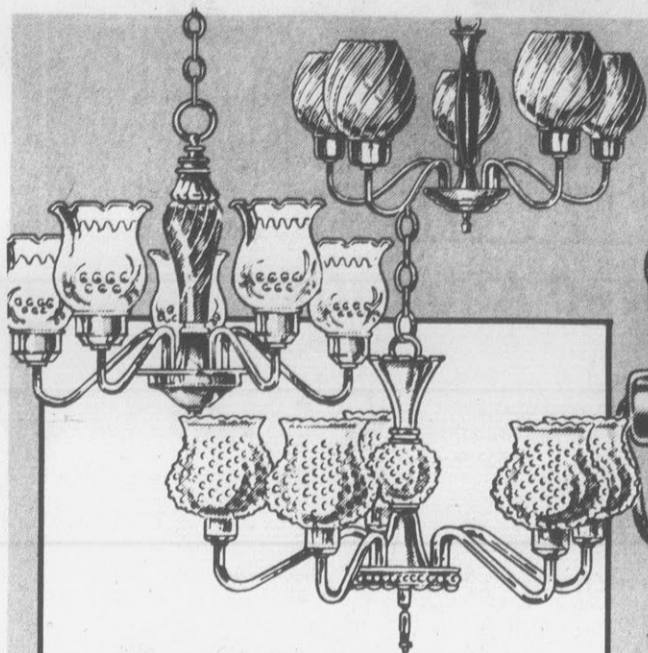

### SAVE \$10 on Chandeliers!

Reg. Price \$44.99 will be in effect after Aug. 4

**34<sup>99</sup>** each

Choose from 3 attractive styles, sure to suit most any decor. All feature brass or black finish metal arms and graceful formed glass shades—see them today!

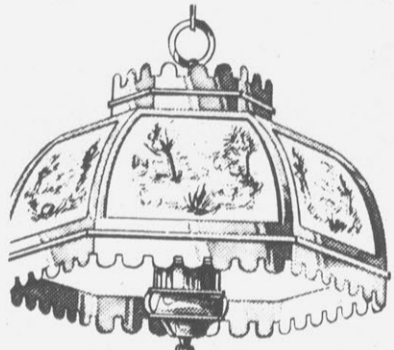

### \$10 OFF! Currier and Ives Print Fixtures

Reg. Price \$54.99 will be in effect after Aug. 4

**44<sup>99</sup>** Pendant

Choose from 3 styles, framed with antique-brass metal trim.

Reg. Price \$54.99 will be in effect after Aug. 4 Swag ..... 44.99  
Reg. Price \$47.99 will be in effect after Aug. 4 Ceiling ..... 37.99

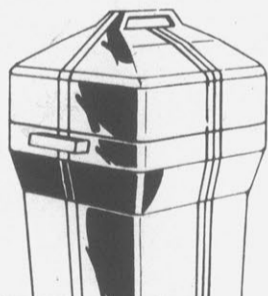

**Full 6-year Warranty**  
If, within 6 years from the date of purchase, this Super Permanex® plastic container or lid cracks or breaks, we will, upon return, replace it free of charge.

### \$4 OFF 32-Gal. Super Permanex® Trash Can

Sears Best container resists freeze cracking and heat warping from -20°F to +150°F. Sale ends Aug. 18.

Reg. Price \$17.99 will be in effect after Aug. 18

**13<sup>99</sup>**

**SAVE \$3!**

### Heavy-Duty Laundry Detergent

Reg. Price \$10.99 will be in effect after Aug. 18

**7<sup>99</sup>** 24-lb. box

Removes more soil than the nation's leading detergent! 1/2-cup cleans family washload.

Reg. Price \$5.49 will be in effect after Aug. 18.  
1-gal. liquid detergent ..... 3.99  
Sale ends August 18



For one-coat results, all Sears one-coat paints must be applied as directed.



90005



77005



90955



72005



83005

### 1-Coat Latex Paint

#### Weatherbeater Exterior Flat Paint

Sears Best. 1-coat coverage, washable, non-yellowing, stain resistant. No chalk washdown. Many colors. Reg. Price \$13.99 will be in effect after Aug. 18

**9<sup>99</sup>** gal.

Paint Sale ends August 18

### Flat or Semi-Gloss Latex

Interior Flat Reg. Price \$11.99 will be in effect after Aug. 18 **7<sup>99</sup>** gal. Semi-Gloss Reg. Price \$12.99 will be in effect after Aug. 18 **8<sup>99</sup>** gal.

One-coat coverage, washable, colorfast, spot resistant, non-yellowing and durable.

Reg. Price \$11.99 will be in effect after Aug. 4 Ceiling Paint ..... 7.99 gal.

#### Interior Semi-Gloss

Sears Price **6<sup>99</sup>** gal. One-coat coverage at a reasonable price.

#### Interior Flat Latex Paint

Sears Price **5<sup>99</sup>** gal. Comes in 14 beautiful colors. One-coat coverage.

### \$120 OFF! Air Compressor

Reg. Price \$349.99 will be in effect after Aug. 18

**229<sup>99</sup>**

Delivers 6.9 SCFM at 40 PSI, 100 PSI max. pressure. 12 gal. tank, safety valve. Sale ends Aug. 18.

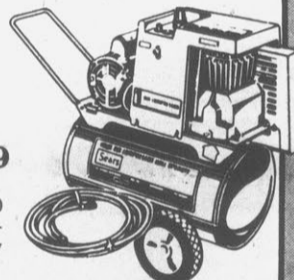

## SAVE \$35

### Heavy-Duty Router

**44<sup>99</sup>**

Reg. Price \$79.99 will be in effect after Aug. 4

Has power enough to cut into hard wood and the control to cut intricate designs. 1-HP motor generates shaft speed of 25,000 rpm.

### \$25 OFF! Circular Saw

**44<sup>99</sup>**

Reg. Price \$69.99 will be in effect after Aug. 4

Develops maximum 2 HP, no-load speed of 5400 rpm. Permanently lubricated ball and roller bearings. Cuts up to 2 1/4-in. wood at 90°. External blade clutch. Hurry and save!

#### Router Table

Reg. Price \$39.99 will be in effect after Aug. 4

**34<sup>99</sup>**

#### Router Crafter

Reg. Price \$59.99 will be in effect after Aug. 4

**54<sup>99</sup>**

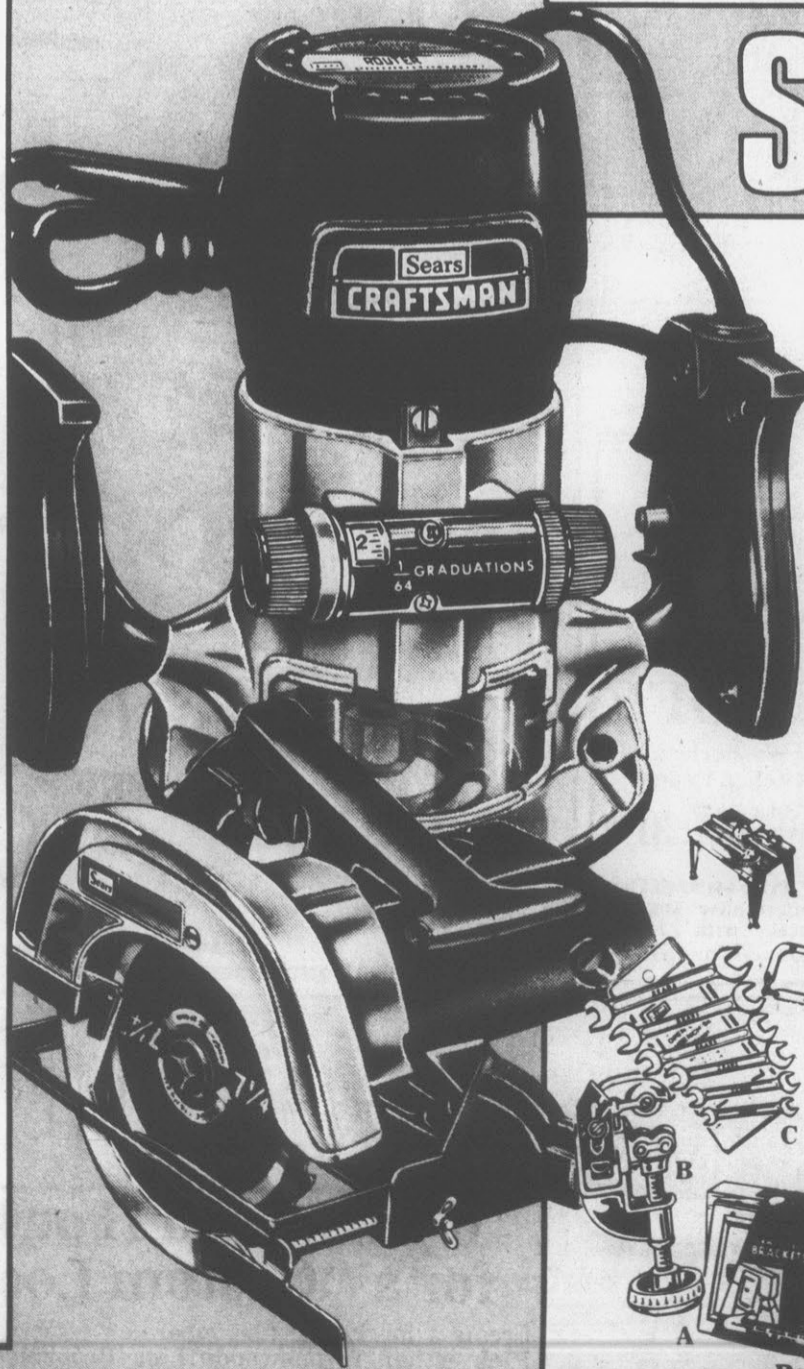

### SAVE on Work Tools!

Your Choice **4<sup>44</sup>** each

- A. \$6.99 Sawhorse brackets . . . . . 4.44
- B. \$5.99 Tubing Cutter . . . . . 4.44
- C. \$4.99 Wrench Set . . . . . 4.44
- D. \$5.49 Hacksaw . . . . . 4.44
- E. \$5.99 Glue Clamp . . . . . 4.44
- F. \$4.79 Mag. Screwdriver . . . . . 4.44
- G. \$5.99 "C" Clamp . . . . . 4.44

Regular prices shown above will be in effect after Aug. 4

## Limited Quantities of Our 1979 Fall/Winter Big Book are NOW Available!

- You can get one for just \$2!
- And you'll get a certificate worth \$2 off any \$10 order from this Fall/Winter Big Book!
- So get your copy now at any catalog sales desk!



Sears

# Grand Opening

**\$4 OFF!**

## Heavy-Duty Plus Shocks

Reg. Price \$9.99 will be in effect after Aug. 4

**5<sup>88</sup>** each

**INSTALLED . . . 9.88**

Wiper ring helps keep dirt and water out of shock and seal area. Has chrome-plated piston rod for long shock life. For most cars, pickup trucks, vans.

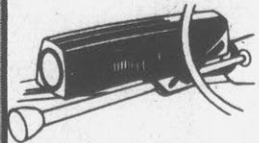

### Electronic Speed Control

Reg. Price \$99.99 will be in effect after Aug. 11

**89<sup>99</sup>**

Sale ends August 11

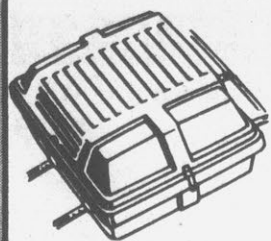

### X-Cargo Luggage Carrier

Sears Price **79<sup>99</sup>**  
Adds 16.8 cu.ft. luggage space. A great buy!



10W-40 Spectrum Oil  
Reg. Price 79¢ will be in effect after Aug. 18

**59¢** qt.

### Dual Oil Filter

Reg. Price \$2.99 will be in effect after Aug. 18

**2<sup>54</sup>**

Sale ends Aug. 18

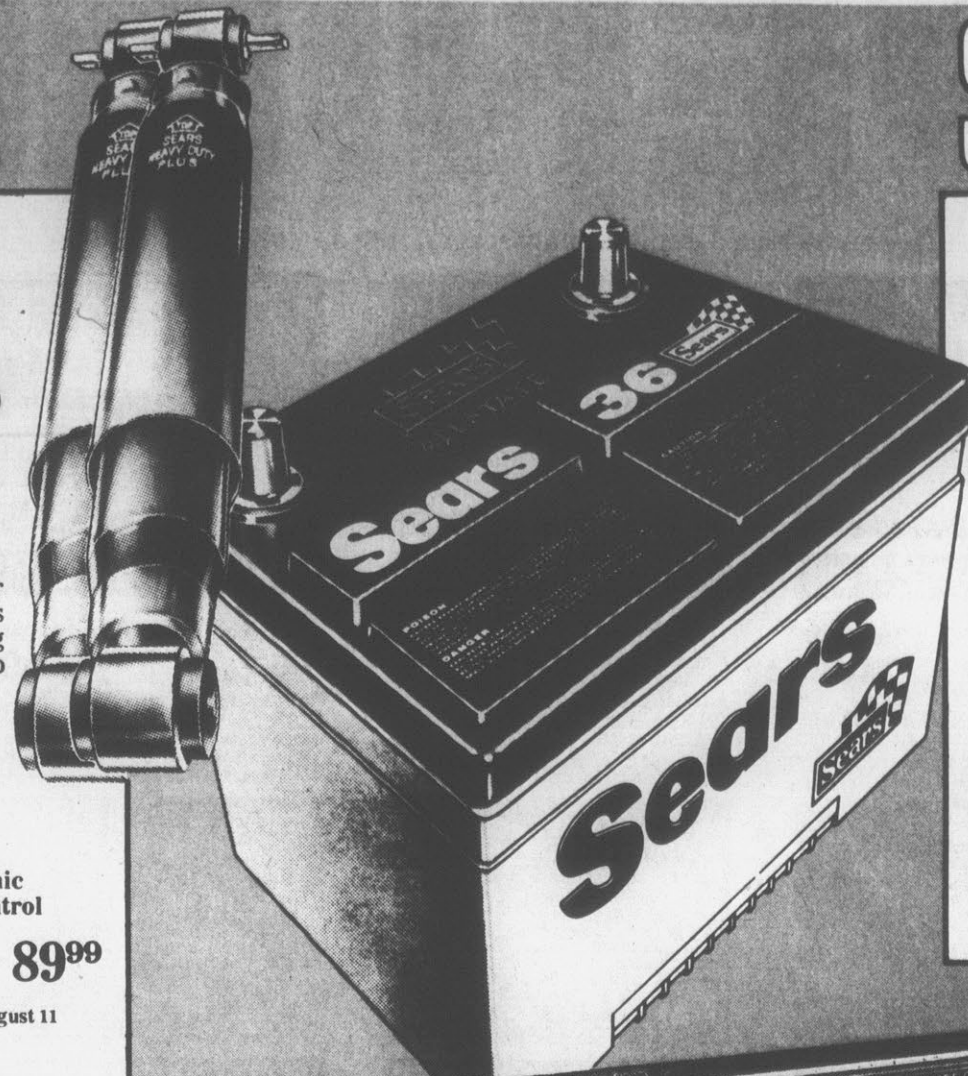

**SAVE \$5**

## on Sears 36 Maintenance-Free Battery

Reg. Price \$39.99 will be in effect after Aug. 4 with exchange

**34<sup>99</sup>** with trade-in

350 amps cold cranking power, 80 minutes reserve capacity. Group 24C. Top or side terminals. For most American-made cars and many imports.

Reg. Price \$59.99 to \$69.99 will be in effect after Aug. 11 with exchange Marine Die Hard Batteries now on sale for \$54.99 to \$62.99 with trade-in.

Maintenance-free means water is not added under normal operating conditions.

Ask about Sears Credit Plans

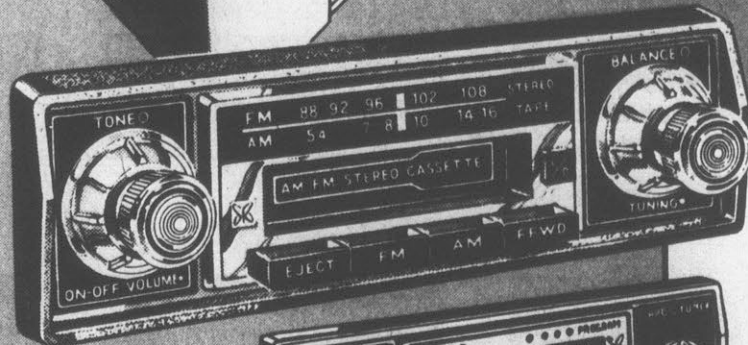

**\$20 OFF**

## AM/FM Stereo with Cassette or 8-Track

Reg. Price \$109.99 will be in effect after Aug. 4

**89<sup>99</sup>**

Your Choice

Fits indash of most cars. Balance and full-range tone controls. Local/distant FM switch. AFC for FM. Cassette player with automatic loading, fast-forward and automatic stop at end of tape. 8-track has channel selector and indicator lights. Save \$20!

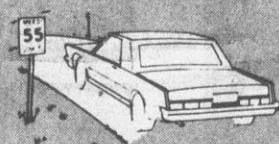

**SAFE, HAPPY DRIVING STARTS AT SEARS!**



dashmate  
Professional Installation Available on Complete Stereo Systems



### Coaxial Speaker Kit

Choice of 6x9-in. or 4x10 inch round speakers with wiring, instructions. Reg. Price \$37.99 will be in effect after Aug. 4

**29<sup>99</sup>** pair

## Automotive center

### Wheel Alignment and Front Wheel Balance

We'll set caster/camber and toe, inspect front end and adjust steering. Includes air conditioned cars. Torsion bar adjustment when required.

Reg. Price \$23.49 will be in effect after Aug. 4

**19<sup>88</sup>**

### Brake Job

We'll replace shoes or disc pads, brake fluid, brake springs and front oil seals. Turn and true drums or rotors. Rebuild cylinders or calipers. We'll also repack front bearings.

**99<sup>88</sup>**

Disc or Drum  
Brake service not available in Anderson, Danville, Florence, Gastonia, High Point, Jacksonville, Lynchburg, Rocky Mount, Greenville, N.C.

### Installed Muffler

The Muzzler® muffler... sold only at Sears! Fits most American-made cars. Clamps, if needed, are 99¢ each. Additional parts, if needed are extra. Hurry in!

**22<sup>99</sup>**

Sears Price

Above services for most American made cars, and some imports. Not available in Shelby.



## SAVE 10%!

Typhoon Steel Dish Wheels

13-in. 14-in. 15-in.

Reg. Prices shown here will be in effect after Aug. 18. Reg. \$32.99 ea. Reg. \$36.99 ea. Reg. \$38.99 ea.

**29<sup>99</sup> 33<sup>99</sup> 35<sup>99</sup>**

Available at larger stores through Aug. 18

**SAVE \$28-\$60**

## on Steel-Belted Radials in Sets of Four

165-13 Steel Belted Radial and old tire

Reg. Price \$46.95 will be in effect after Aug. 18

**39<sup>88</sup>** Plus \$1.76 F.E.T.

Save big on pairs and single tires, too. Twin steel belts resist impact and fight tread squirm for long tire mileage. Two radial plies help give quick responsive handling. Save now!

Sears Steel Belted Radial and old tire	also fits	Reg. Price as shown will be in effect after Aug. 18	Sale price on whitewall	plus F.E.T.* each
165-13	AR78-13	46.95	39.88	1.76
175-13	BR78-13	53.95	44.88	1.96
185-14	ER78-14	63.95	53.88	2.26
195-14	FR78-14	68.95	57.88	2.39
205-14	GR78-14	72.95	61.88	2.46
215-14*	HR78-14	79.95	67.88	2.79
165-15*	6.00R-15	53.95	44.88	1.98
205-15	GR78-15	76.95	64.88	2.73
215-15	HR78-15	79.95	67.88	2.86
225-15	JR78-15	85.95	72.88	3.28
235-15	LR78-15	95.95	80.88	3.45

\*Available in larger stores only

## 4-Ply Polyester Guardsman

A78-13 blackwall and old tire

**17<sup>88</sup>** plus \$1.62 F.E.T.

Guardsman. Our lowest-priced 4-ply tire, yet built to exacting standards.

Sears Guardsman and old tire	Sears price each blackwall	plus F.E.T. each
A78-13	17.88	1.62
B78-13	20.88	1.73
C78-14*	23.88	1.88
E78-14	25.88	2.10
F78-14	27.88	2.22
G78-14	30.88	2.38
560-15	23.88	1.66
G78-15	30.88	2.44
H78-15	32.88	2.66

\*Size available in larger stores only.

## SAVE on Small-Car Radials

155-12 blackwall and old tire Reg. Price \$42.95 will be in effect after Aug. 18

plus \$1.36 F.E.T.

**32<sup>88</sup>**

Steel Belted Sport Radial. Save on pairs, too. 2 belts, radial design. 155-12 to 165.15.

Steel Belted Sport Radial and old tire	Reg. Price as shown will be in effect after Aug. 18	Sale price each blackwall	Plus F.E.T. each
155-12	38.95	32.88	1.36
155-13	40.95	33.88	1.41
165-13	43.95	36.88	1.56
175-14	50.95	42.88	1.93
*165-15	50.95	42.88	1.74

Tires available at Sears Retail Store Through Aug. 18

Sears

# GRAND OPENING!

Each of these advertised items is readily available for sale as advertised

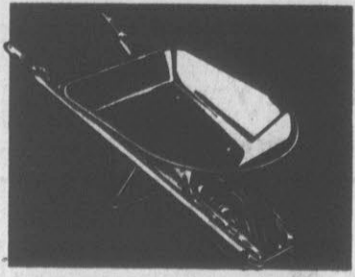

**SAVE \$10!**

**4.0 cu. ft. Wheelbarrow**  
Reg. Price \$49.99  
will be in effect  
after Aug. 4  
**39<sup>99</sup>**  
Holds up to 300 lbs. Rounded tray  
and durable hardwood handles.

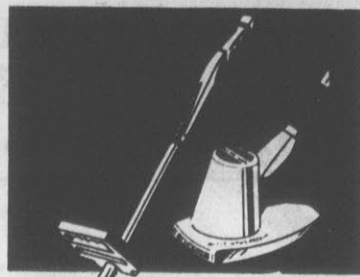

**SAVE \$5!**

**Weedwacker™ Trimmer**  
Reg. Price \$44.99  
will be in effect  
after Aug. 4  
**39<sup>99</sup>**  
Trims in tight areas. Has 3/8-HP  
permanent magnet motor.



**SAVE \$2!**

**50-ft. Rubber Hose**  
Reg. Price \$16.99  
will be in effect  
after Aug. 4  
**14<sup>99</sup>**  
Craftsman reinforced rubber gar-  
den hose. 5/8-in. inside.

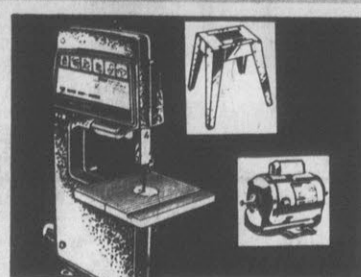

**\$54 OFF!**

**Band Saw/Sander Outfit**  
Reg. Sep. Price  
\$344.93 will be  
in effect after Sept. 1  
**289<sup>99</sup>**  
Versatile outfit with motor and leg  
set. Partly assembled.

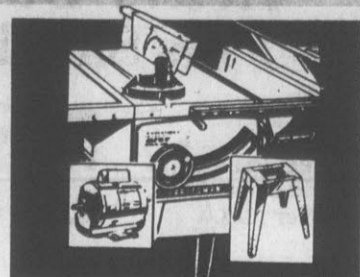

**\$130 OFF!**

**10-in. Table Saw Outfit**  
Reg. Sep. Price  
\$429.92 will be in  
effect after Sept. 1  
**299<sup>88</sup>**  
1-HP motor develops 2-HP, 1-  
extension. Partly assembled.

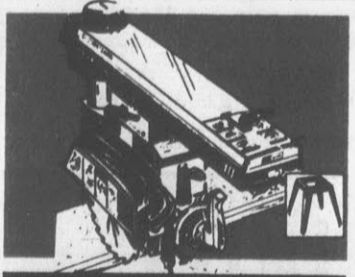

**\$115 OFF!**

**10-in. Radial Saw Outfit**  
Reg. Sep. Price  
\$414.94 will be  
in effect after Sept. 1  
**299<sup>88</sup>**  
Sears Best. 1 1/2-HP motor develops  
2 1/2-HP. Partly assembled.



**AUTO VALUE!**

**Champion Spark Plugs**  
Sears Price  
Regular type. Helps engine perform.  
Resistor type. . . . . 99¢ ea.  
**79¢** ea.

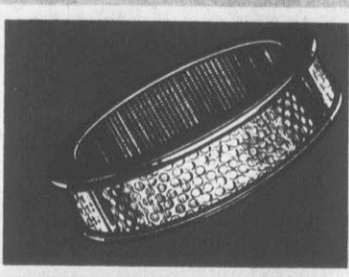

**AUTO VALUE!**

**Sears Air Filter**  
Sears Price  
Traps dirt and grime. Lets  
carburetor "breathe" easy!  
**233**

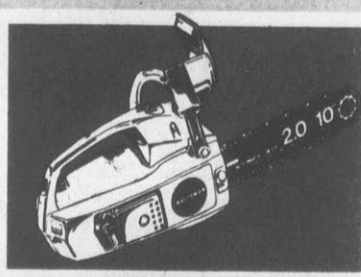

**GREAT BUY!**

**Gas Chain Saw**  
Sears Price  
Low profile chain, bar and  
handguard unattached.  
**79<sup>99</sup>**



**GREAT BUY!**

**Chain Saw Engine Oil**  
Sears Price  
Four 8-oz. cans. For all air-cooled  
chain saw engines.  
**199**

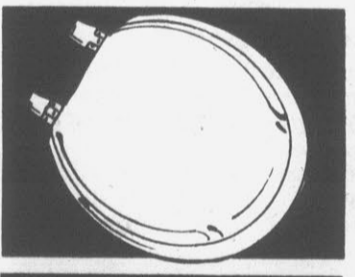

**For The Bath!**

**White Wood Toilet Seat**  
Sears Price  
Economy-priced seat is standard  
size. Enamel finish.  
**399**

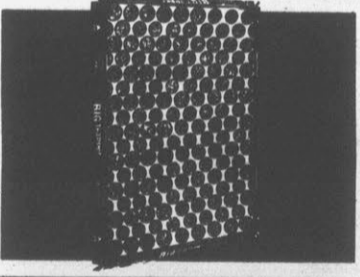

**GREAT BUY!**

**Furnace Filters**  
Sears Price  
Clean filters help furnace efficiency.  
Package of six 1-in. sizes.  
**339**

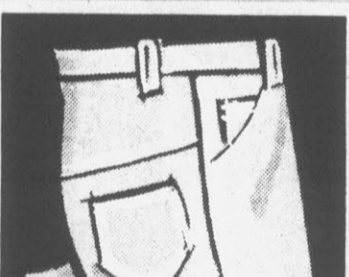

**25% OFF!**  
**Little Kids'  
Cotton Jeans**

Reg. Price \$3.97  
will be in effect  
after Aug. 4  
**297**

A great way to start them  
back to school! Sturdy jeans  
with yoke back, 4 pockets. In  
navy. Regular and slim  
sizes, 3-6x.

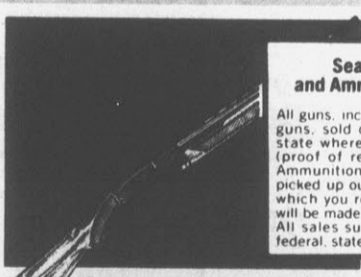

**Sears Firearm  
and Ammunition Policy**  
All guns, including BB and Pellet  
guns, sold only to residents of  
state where purchase is made  
(proof of residence required).  
Ammunition may be ordered or  
picked up outside of the state in  
which you reside. No deliveries  
will be made outside of the store.  
All sales subject to applicable  
federal, state and local laws.

**SAVE \$30!**

**Model 300 Semi-Automatic**  
12-ga. or 20-ga.  
Reg. Price \$239.99  
will be in effect  
after Aug. 4  
**209<sup>99</sup>**  
ce. Walnut stock,  
forearm. Deluxe recoil pad.

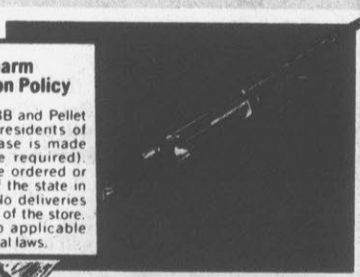

**SAVE \$20!**

**Model 200 Pump-Action**  
Reg. Price \$209.99  
will be in effect  
after Aug. 4  
**189<sup>99</sup>**  
Fires 2 3/4 or 3-in. standard or  
magnum shells. 12 or 20 ga.

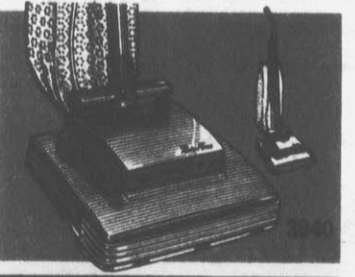

**KENMORE!**

**Upright Vacuum**  
Sears Price  
Twin-fan action for strong pickup. 3-  
position handle.  
**\$49**

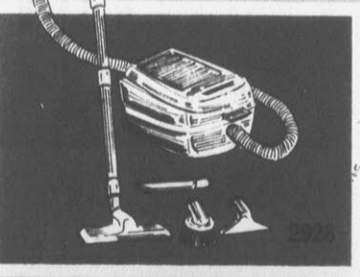

**VAC VALUE!**

**Handy Canister Vac**  
Sears Price  
1-speed, single-fan motor with 1.2-  
HP (peak). Includes attachments.  
**\$39**



**BIG BUY!**

**CLOSEOUT LP Gas Grill**  
Sears Price  
Has grill, cart and LP gas cylinders.  
Great for apartments.  
**49<sup>95</sup>**

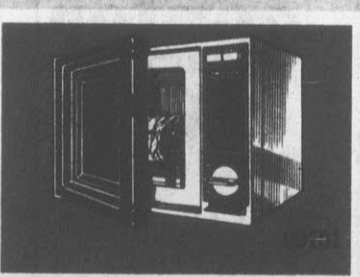

**Cook and Defrost!**

**Microwave Oven**  
Sears Price  
Two power levels to rush foods from  
freezer to table. Timer.  
**\$199**

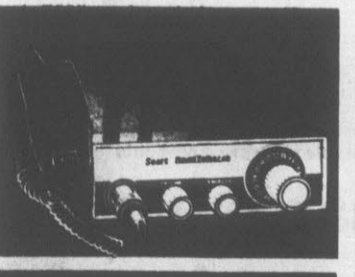

**CLOSEOUT!**

**40-Channel CB Unit**  
Limited  
Quantities  
Has features like noise limiter,  
volume and squelch controls.  
**39<sup>95</sup>**

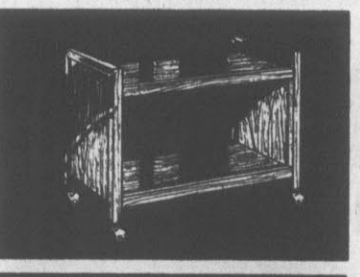

**SAVE \$5!**

**TV Cart with Shelf**  
Reg. Price \$24.99  
will be in effect  
after Aug. 4  
**19<sup>95</sup>**  
For 19-in. diag. meas. picture TV  
set. Ready to assemble.



**FREEZER BUY!**

**6.0 cu. ft. Freezer**  
Sears Price  
Walnut-look, counter-balanced lid.  
Compact to fit small areas.  
**\$229**

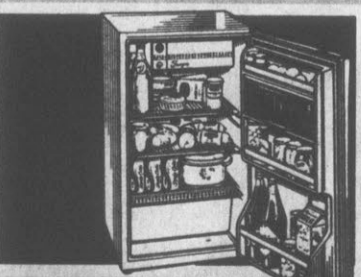

**SAVE \$20!**

**6.0 cu. ft. Refrigerator**  
Reg. Price \$259.95  
will be in effect  
after Sept. 1  
**239<sup>95</sup>**  
Fresh food section with crisper.  
Handy freezer. In brown color.



**BIG BUY!**

**Men's Work Shoes**  
Sears Price  
Cushioned insole. Top grain leather  
uppers, rubber soles, heels.  
**29<sup>99</sup>**

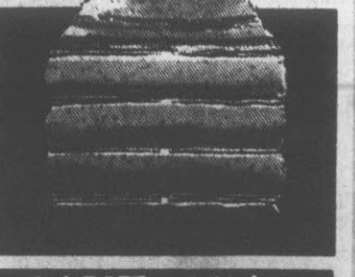

**SAVE 16%!**

**Daybreak Bath Towels**  
Reg. Price \$1.49 ea.  
will be in effect  
after Aug. 7  
**4 for \$5**  
Hand Towel . . . . . 99¢ each  
Washcloth . . . . . 59¢ each

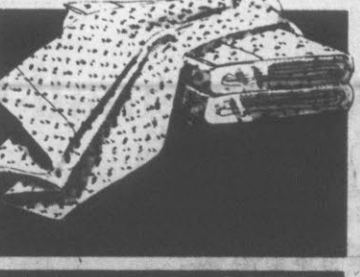

**10% to 14% OFF!**

**Danberry Muslin Sheets**  
Twin Reg. \$2.79  
ea. will be in  
effect after Aug. 4  
**2 for \$5**  
\$3.99 Full size . . . . . 2 for \$7  
\$3.49 Pillowcases . . . . . 2.99 pr.



**BIG BUY!**

**Leisure Breakfast Coats**  
Sears Price  
Easy-into breakfast coats in sunny  
solids. Handy pockets. S,M,L.  
**750**

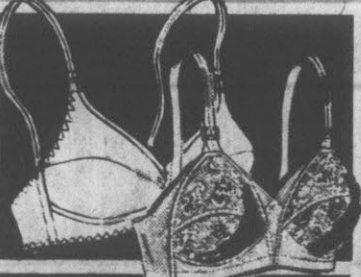

**BODY FASHIONS**

**Natural and Contour Bras**  
Sears Price  
Both natural and contour cups give  
firm support.  
**195**

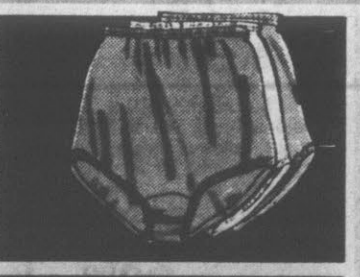

**BODY FASHIONS**

**Pkg. of 3 Nylon Briefs**  
Sears Price  
Nylon tricot, double fabric crotch.  
Extra-size briefs, pkg of 3 . . . . . 2.47  
**197**

**LA-Z-BOY®  
RECLINA-ROCKER®  
CHAIR SPECTACULAR!**

Hurry in today while every famous, comfortable, La-Z-Boy® Reclina-Rocker® is on SALE!

A. Magnificent Reclina-Rocker®  
In Lush, Leather-like Vinyl Cover.

**\$188** SAVE \$111

B. Traditional Reclina-Rocker®  
Upholstered in 100% Nylon Velvet.

**\$269<sup>95</sup>** SAVE \$130

C. "Tallman's" Reclina-Rocker® In Durable Vinyl With Thickly Padded Arms.

**\$299<sup>95</sup>** SAVE \$100



**\$188**



**\$269<sup>95</sup>**

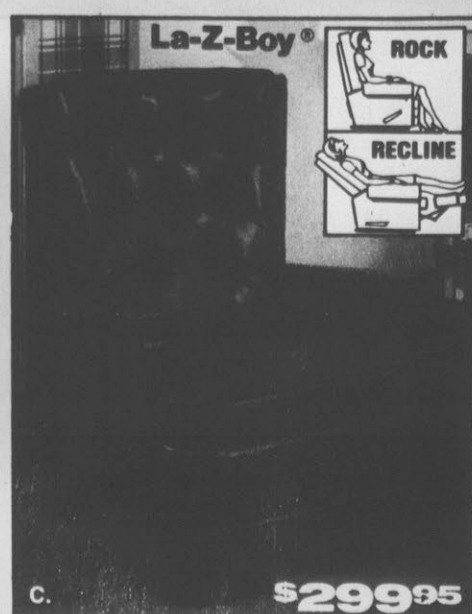

**\$299<sup>95</sup>**



**A. VERSATILE, STYLISH TABLES**

- Concealed Storage
- Working Doors
- Mar-resistant Tops

YOUR CHOICE (Hex, Square, or Cocktail)

**\$69<sup>95</sup>** SAVE \$30 ea.

**B. COMPLETE, DELUXE 3 PIECE WALL SYSTEM!**

- Each Unit Is 18" Deep & 72" High
- Accommodates Most TV's & Stereo Components
- Concealed Storage Space Behind Doors

ENTIRE 3 PC. WALL UNIT (AS SHOWN)

**\$399<sup>95</sup>** SAVE \$179.95

Available Separately: Open Unit \$149.95, 2 Door Unit \$169.95

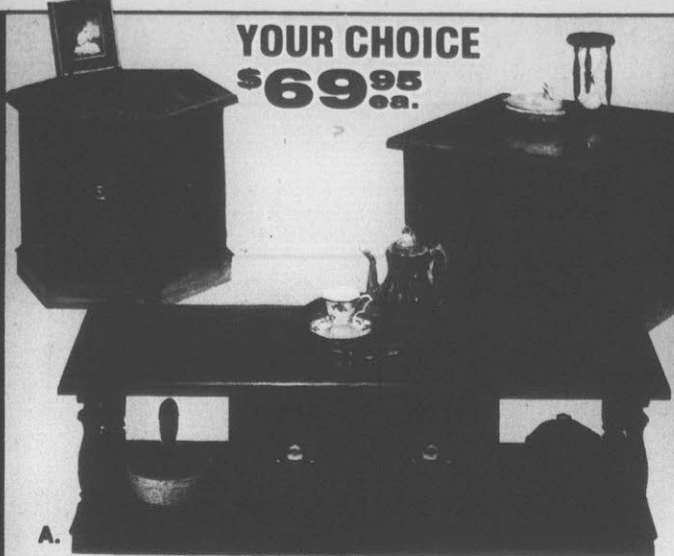

**A.**

**YOUR CHOICE**

**\$69<sup>95</sup>**

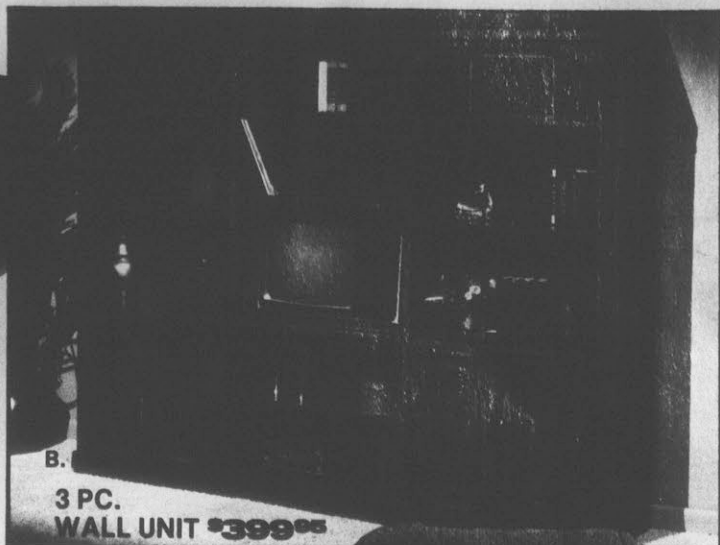

**B.**

**3 PC. WALL UNIT \$399<sup>95</sup>**

**SENSATIONAL RECLINER WITH BUILT-IN VIBRATOR AND HEATER.**

IT WARMS-IT VIBRATES IT RESTS-IT RELAXES AND RECLINES

- X-tra High Back & Wide Seat
- Built-in Vibrator & Heating Pad Back
- Your Choice of Durable Herculon® or Leather-like Vinyl Covers
- 130 Store Buying Power Makes This Tremendous Offer Possible

SPECIAL PURCHASE PRICE **\$168** SAVE \$51.95

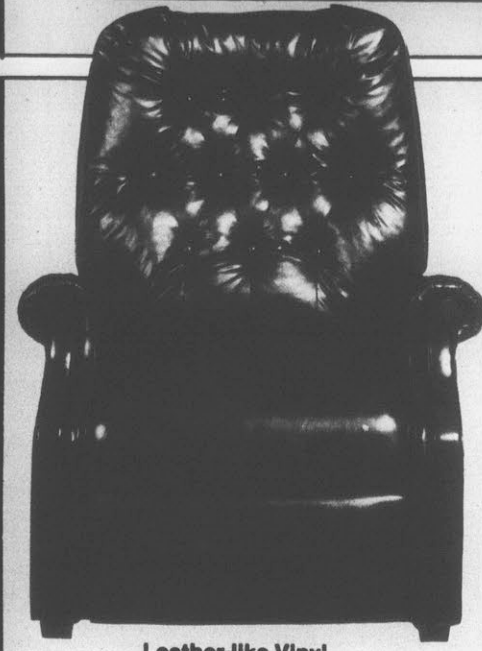

Leather-like Vinyl

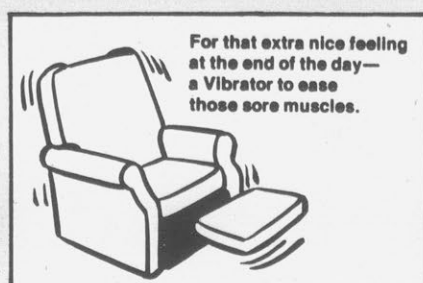

For that extra nice feeling at the end of the day—a Vibrator to ease those sore muscles.



Soothing Heat adds to the comfort of this man-size recliner!

Action Lane®

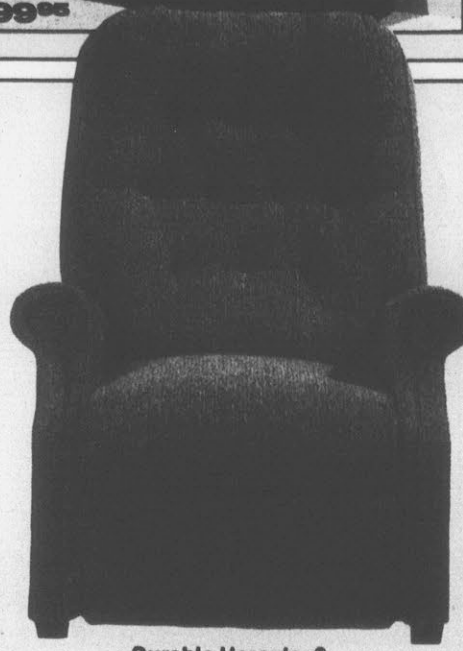

Durable Herculon®

**THE PERFECT GROUP FOR YOUR LIVING ROOM, FAMILY ROOM OR DEN!**

Look at this massive solid-pine frame collection featuring thick pine wood, loose cushions (that are reversible, too) and durable Herculon® fabric.

SOFA ONLY **\$248** SAVE \$101.95

- Loveseat..... **\$198**
- Chair (Not Shown)..... **\$148**
- Ottoman..... **\$ 98**
- Rocker..... **\$168**
- End Table..... **\$ 88**
- Cocktail Table..... **\$ 88**



SOFA ONLY **\$248**

**FAMOUS NAME EARLY AMERICAN DINETTES**

Each group features laminated stic tops for easy care and matching warm maple finish on hardwood table legs and chairs.

A. Robust Family Size Set. 42" Round Table Opens to 66" with Leaves. 6 High Spindle-back Chairs. ALL 7 PCS.

**\$399<sup>95</sup>** SAVE \$160

B. 5 Piece Colonial Dinette. 42" Round Table Extends to 66" and 4 Mates Chairs. ALL 5 PCS.

**\$199<sup>95</sup>** SAVE \$79.80

C. Big 7 Piece Dinette. 42" Round Table Extends to 66" 4 Mates Chairs and 2 Captains Chairs. ALL 7 PCS.

**\$299<sup>95</sup>** SAVE \$89.70



**A.**

**\$399<sup>95</sup>**

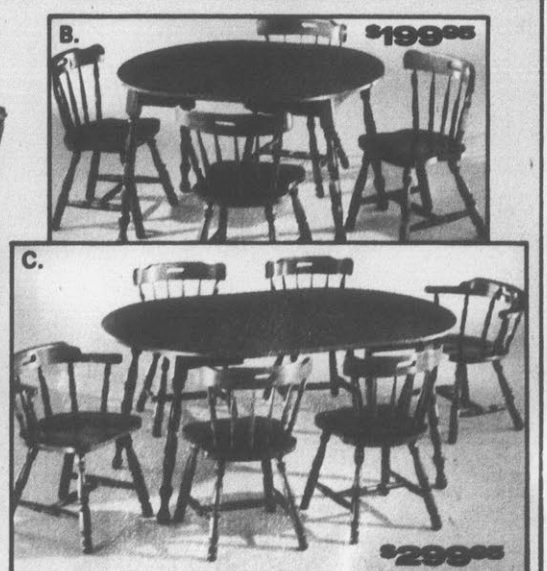

**B.**

**\$199<sup>95</sup>**

**C.**

**\$299<sup>95</sup>**

**CHOOSE CONTEMPORARY OR EARLY AMERICAN QUEEN-SIZE SOFA-SLEEPERS**

A. Contemporary 77" Queen-Size Sofa-Sleeper Covered In A Smart, Blue Olefin Matching Stripe Fabric.

**\$299<sup>95</sup>** SAVE \$60

B. Early American 79" Queen-Size Sofa-Sleeper Covered In a 100% Nylon Center Print (shown) or Olefin Plaid. Extra-high Attached Back. Fully Upholstered Wings. Reversible Seat Cushions for Twice the Wear.

**\$399<sup>95</sup>** SAVE \$70

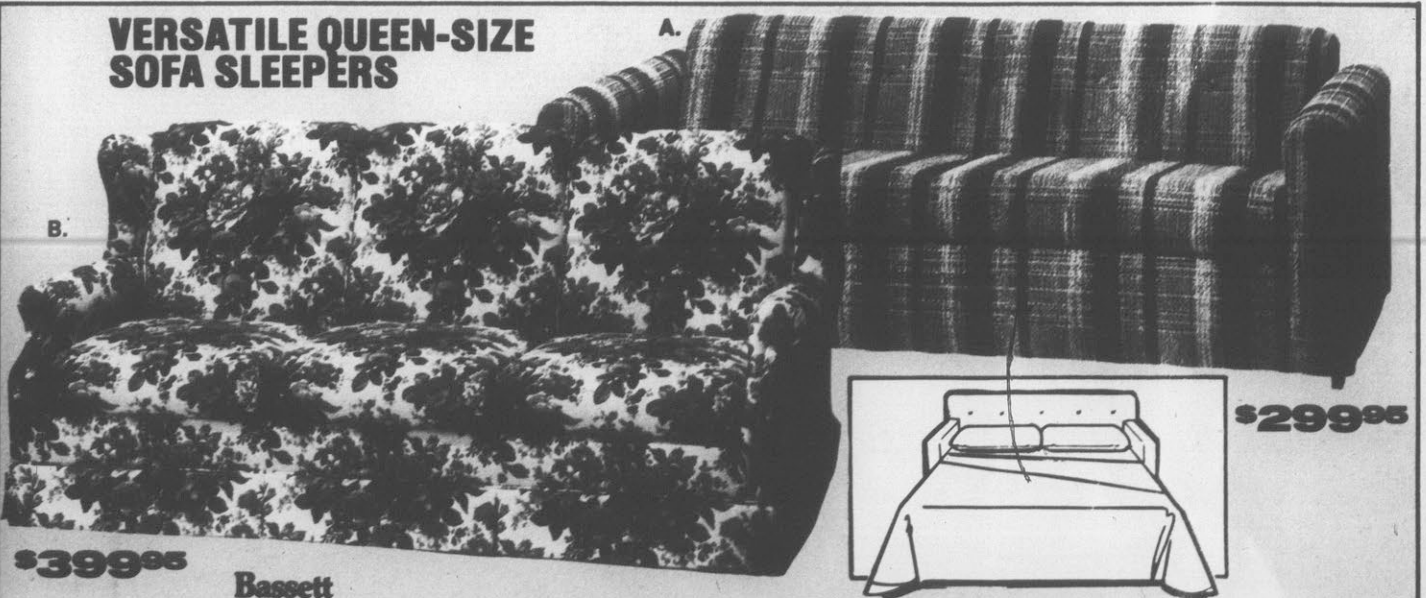

**A.**

**\$299<sup>95</sup>**



**B.**

**\$399<sup>95</sup>**

Bassett

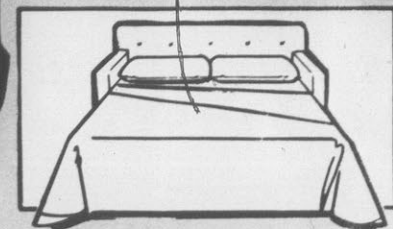

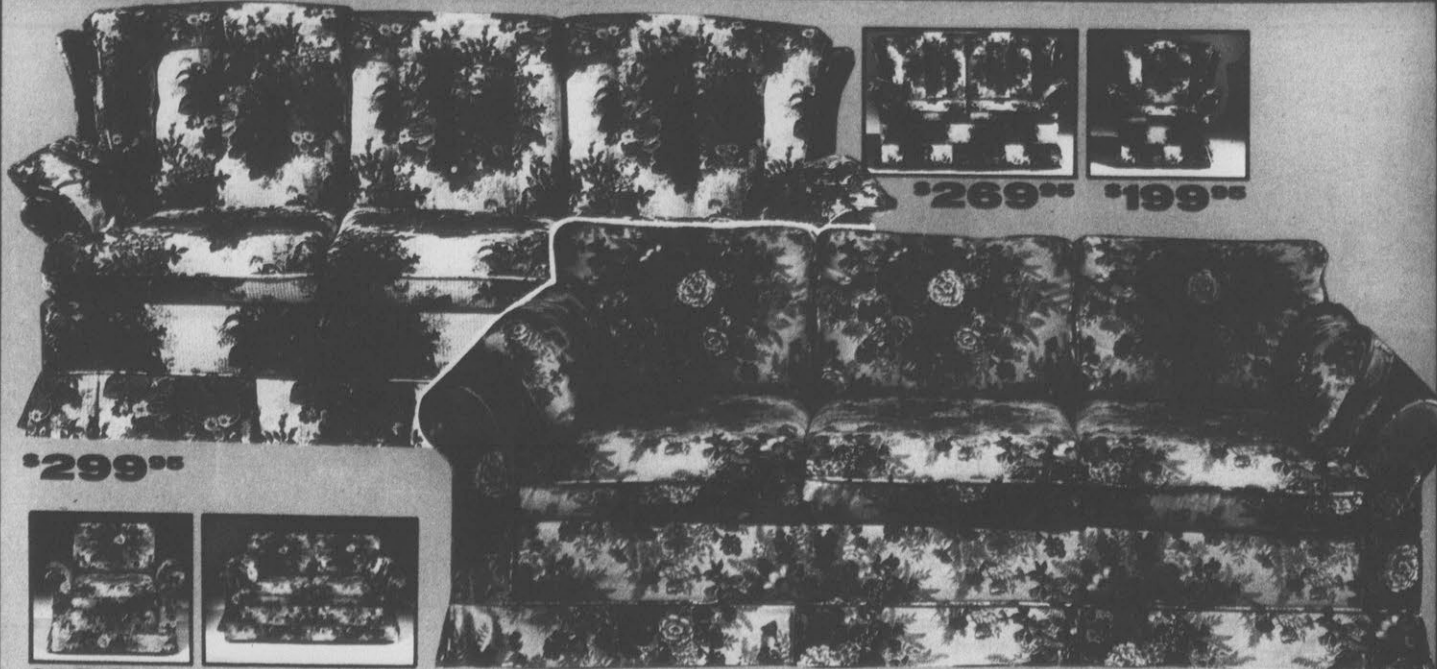

**MAXWELL'S NEW DECORATOR COLLECTION!**

8 beautiful living room groups in 2 exciting styles! Your choice of 4 different fabrics with each style—guaranteed quick delivery! Be your own decorator! Choose the style, then custom order the upholstery from our special fabric collection.

Quick Delivery for each of the 2 groups in the covers shown. Guaranteed 3 week delivery for any of the 6 alternate fabrics.

YOUR CHOICE OF SOFAS  
**\$299<sup>95</sup>** SAVE UP TO \$150  
 ea.

**LUSH PIT SECTIONAL**

In Your Choice of 4 Beautiful Decorator Fabrics!  
**ENTIRE 5 PIECE PIT SECTIONAL**  
 (2 sofas, 1 armless loveseat, 2 ottomans)  
**NOW ONLY**

**\$799<sup>95</sup>** SAVE \$199.80

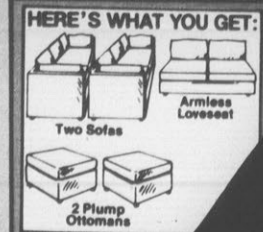

**LUSH PIT SECTIONAL**

ENTIRE PIT ONLY  
**\$799<sup>95</sup>**



Trend Line Furniture  
 SOFA ONLY **\$299<sup>95</sup>** SAVE \$100

**MAXWELL'S HAS IT!**

A superb quality genuine wood group with all the impressive features offered to you at an unbelievably low price.

This group has all the quality features you've been looking for but couldn't afford - now you can! Solid pine wings shaped in two directions; full knuckle arms carved on both sides; dual density cushions; soft edge; covered in durable, carefree Herculon fabric. Quality... style... Affordable Price!

**YOUR CHOICE**

Sofa & Loveseat or Sofa, Chair & Ottoman  
**\$499<sup>95</sup>** SAVE \$199.90



**COMFORTABLE SEATING BY DAY-SOUND SLEEPING BY NIGHT!**

**SPECIAL BONUS!**  
 All sleepers include comfortable, back-supporting "TV positions"



*Claude Gable*

FULL-SIZE & LOVESEAT SLEEPER  
 2 SLEEPERS FOR ONLY **\$499<sup>95</sup>** SAVE \$129.95 ON THE PAIR

**ENJOY THE LUXURY OF AN EXTRA BEDROOM WITHOUT PUTTING A DENT IN YOUR BUDGET**

Imagine-beautifully concealed beds in sofas and loveseats like these! Sofa hides a full-size mattress and loveseat hides a twin-size mattress. Both are upholstered in durable Olefin plaid fabric and have reversible seat cushions.

LOVESEAT SLEEPER **\$239<sup>95</sup>** SAVE \$40

FULL-SIZE SLEEPER **\$269<sup>95</sup>** SAVE \$60

Queen-size Sleeper (Not Shown)-\$299.95



**PRESENTING... LUXURIOUS COMFORT, THE LOOK AND FEEL OF LEATHER AT LESS THAN HALF THE PRICE!**

SOFA ONLY **\$399<sup>95</sup>** SAVE \$150

Loveseat..... **\$349.95**

Chair..... **\$249.95**

Ottoman..... **\$99.95**

Recliner..... **\$299.95**

Cocktail Table..... **\$129.95**

End Table..... **\$129.95**

**COVERED IN NEW NAUGA-PLUS LONG WEARING VINYL!**

It's New... It's Long Wearing... It's made by Famous Uniroyal. You've known and loved the durability and leather-like qualities of Naugahyde Vinyls for many years. New Nauga-Plus is even better. Come to Maxwell's for full details on New Nauga-Plus.

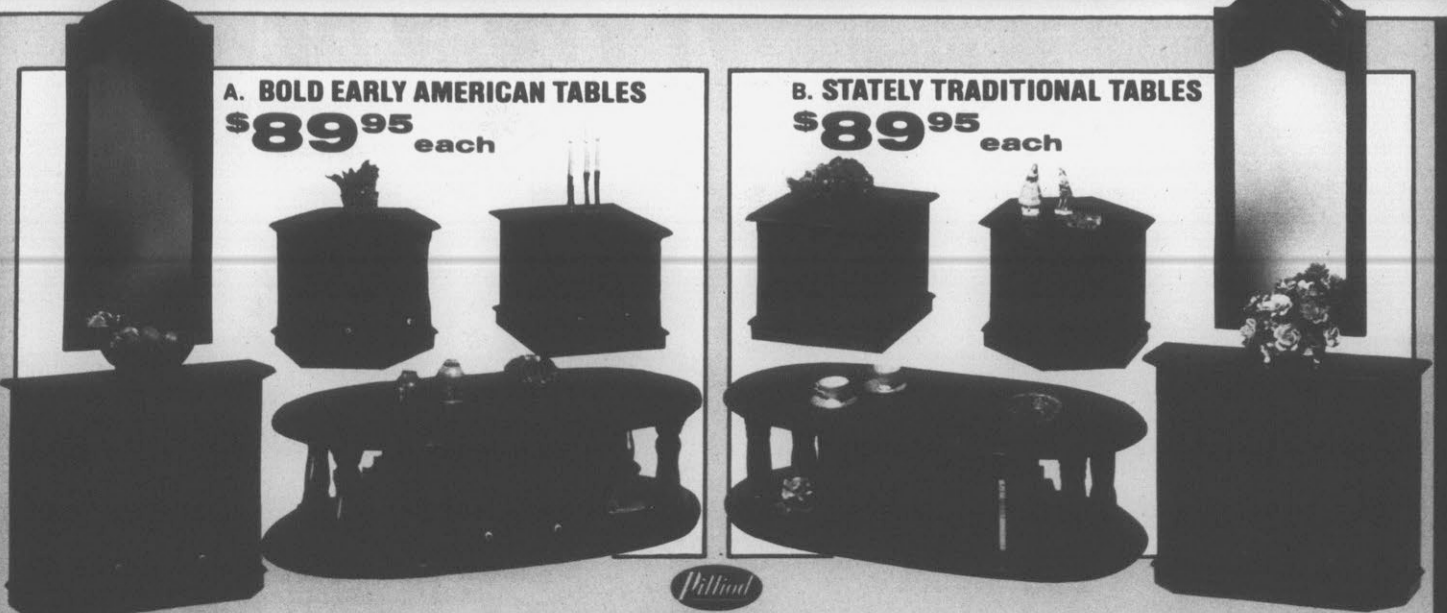

**A. BOLD EARLY AMERICAN TABLES**  
**\$89<sup>95</sup>** each

**B. STATELY TRADITIONAL TABLES**  
**\$89<sup>95</sup>** each

**YOUR CHOICE OF ANY TABLE (Cocktail, Hex or Square Commode) OR CREDENZA!**

YOUR CHOICE **\$89<sup>95</sup>** SAVE \$30 ea.-EACH

Matching Mirrors Only-\$49.95 ea.

**A. Warm Pine Finished Tables and Credenza with Antiqued Hardware. Massive Pillaster Post Motif and Accenting White, Porcelain-look Drawer Pulls.**

**B. Rich Pecan Finish Tables and Credenza with Burl-look Insets, Tear Drop Antiqued Hardware and Stately Traditional Styling.**

## YOUR CHOICE OF PIECES

- Large Hutch • Small Hutch
- Corner Desk • Chair
- Night Stand

**\$66** EACH PIECE SAVE \$13.95 TO \$73.95

OTHER PIECES SHOWN LISTED BELOW:

- A. (Left to right)
- Pedestal Desk—**\$99.95**
  - 3 Drawer Chest—**\$89.95**
  - Single Dresser—**\$99.95**
  - Mirror—**\$39.95**
  - 4 Drawer Chest—**\$99.95**
- B. Panel Bunk Bed with Guardrail & Ladder (mattresses not included) **\$139.95**
- C. Full Size Panel Bed (mattress & boxspring not included)—**\$66**

ALL PIECES SHOWN FEATURE HIGH PRESSURE LAMINATED, MAR-RESISTANT TOPS.



## EXCITING 4 PIECE EARLY AMERICAN BEDROOM GROUP

Lovely Pine Finish on Pine Engraved Wood Products.

YOU GET:

- Large 9 Drawer Triple Dresser
- Mirror
- 4 Drawer Chest
- Full/Queen-size Headboard

ALL **\$399.95** 4 PCS. SAVE \$89.95

2 Drawer Night Stand Priced Separately at \$79.95  
Bed Frame also Priced Separately



ALL 4 PIECES **\$399.95**

## DINE IN STYLE!

- A. 5 Pc. Chrome Pedestal Set Features 48" Oval Table Which Opens to 60" with Leaf. 4 Pedestal Caster Equipped Vinyl Chairs.

ALL **\$299.95** 5 PCS. SAVE \$80

- B. 7 Piece Family Size Set Features 42" Square Table Which Opens to 60" with Leaf. 6 Vinyl Chairs Included.

ALL **\$199.95** 7 PCS. SAVE \$60

- C. 5 Pc. Set Features 36" Round Table Which Opens to 48" with Leaf. 4 Vinyl Chairs.

ALL **\$99.95** 5 PCS. SAVE \$40



## YOUR CHOICE OF CHROMCRAFT PEDESTAL CHROME DINETTES

- A. 5 Piece Set Features 42" Round Table and 4 Chrome & Vinyl Chairs.

- B. 5 Piece Set Features 48" Rectangular Table Which Opens to 60" with Leaf. 4 Chrome and Vinyl Chairs.

YOUR CHOICE

**\$399.95** ea. SAVE FROM \$120 to \$130



- A. High, Flair Back With Button Accent And Cane Inset Arms Covered In Warm Rust Velvet. **\$99.95** SAVE \$40

- B. Deep Button Tufted High Back With Shaped Ski Arms. Contoured Hardwood Frame. Center Welting Loose Seat Cushion Covered In Rust or Blue Velvet. **\$139.95** SAVE \$50

- C. 33" High, Attached Pillow Back With Deep Button Accent, Cane Inset Arms With Softly Padded Arm Tops, Reversible Seat Cushion. Covered In Gold Or Rust Stria Velvet. **\$149.95** SAVE \$30



**\$99.95**



**\$139.95**



**\$149.95**

Charisma® Chairs

## RELAX 'TIL YOUR HEART'S CONTENT!

- A. This High-back Swivel Rocker Features a Tufted Back, Reversible "T" Seat Cushion, and Skirted Base. Covered in Elegant Scotchguard™ Nylon Velvet. Available In Rust Or Gold.

A LOW **\$129.95** SAVE \$50

- B. Lush Swivel Rocker And Ottoman Are Both Covered In Long-wearing Herculan Olefin Fabric. BOTH PIECES

**\$99.95** SAVE \$49.95



A.

B.

**\$129.95**

BOTH PIECES **\$99.95**

**\$169<sup>95</sup>**  
SAVE \$80



**MAXWELL'S BRINGS YOU SAVINGS!**

- Black & White Sets
- Color Sets
- Portables
- Consoles
- Some With Roll-about Stands
- Some One-Of-A-Kind
- All On Sale Now So Hurry As Quantities Are Limited!

**\$399<sup>95</sup>**  
SAVE \$100

SIMULATED RECEPTION

**\$799<sup>95</sup>**  
SAVE \$300

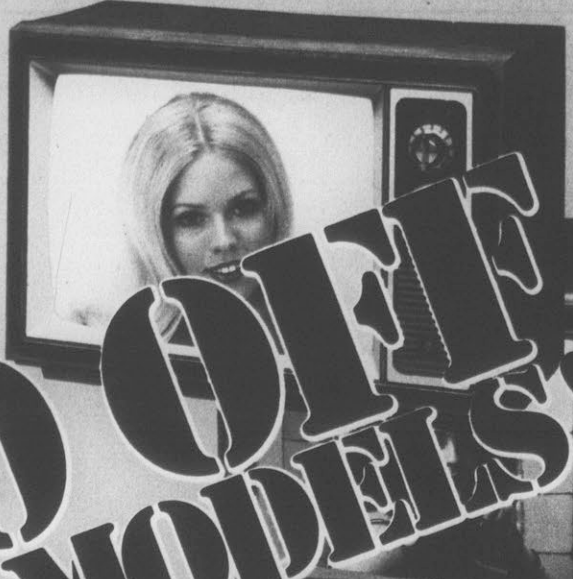

**\$60-\$300 OFF!**  
**ALL G.E. 1979 MODELS!**

**\$599<sup>95</sup>**  
SAVE \$300

**\$89<sup>95</sup>**  
SAVE \$60



SOME ITEMS MAY NOT BE AVAILABLE AT ALL STORES!



SIMULATED RECEPTION



**\$349<sup>95</sup>**  
SAVE \$100

WASHER & DRYER SHOWN IN NEW ALMOND FINISH

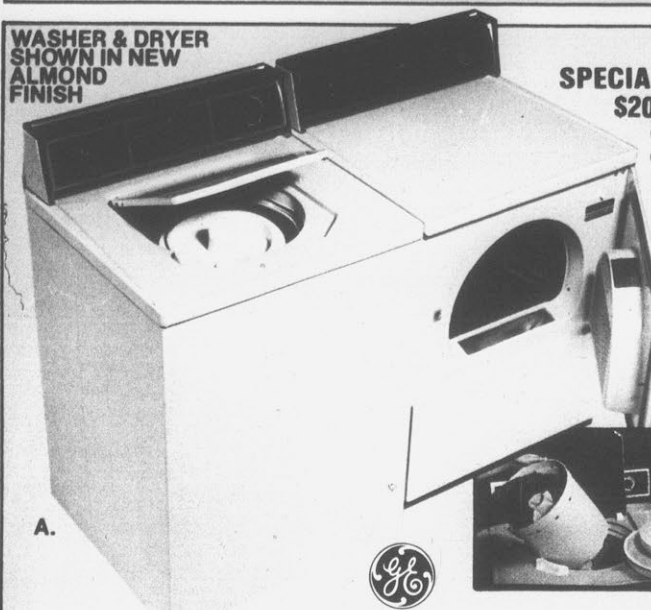

**SPECIAL \$20 REBATE!**

G.E. Factory to Customer \$20 Rebate On Washer if Purchased by August 31, 1979.

B.

**EXCLUSIVE Mini-Basket Tub** made for small loads and delicate fabrics. Uses less detergent and 30% less hot water.

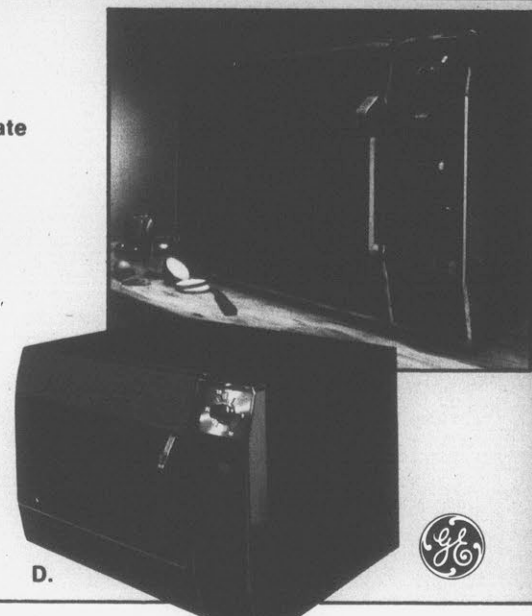

D.



**A.G.E. AUTOMATIC WASHER WITH MINI BASKET™ TUB**  
• 4 Water Selections • 2 Cycles  
• 3 Wash/Rinse Temperatures  
• Bleach Dispenser & More!

**\$369<sup>95</sup>** SAVE \$30

**B.G.E. AUTOMATIC DRYER**  
• 2 Cycles — Regular & Permanent Press • 3 Drying Selections

**\$269<sup>95</sup>** SAVE \$80

**C.GE DELUXE MICROWAVE OVEN With Automatic Chef™**  
Temperature Sensor  
• Digital Timer • 3 Power Levels

**\$499<sup>95</sup>** SAVE \$100

**D.GE MICROWAVE OVEN With Defrost Cycle**  
• Dual Power Levels

**\$299<sup>95</sup>** SAVE \$70

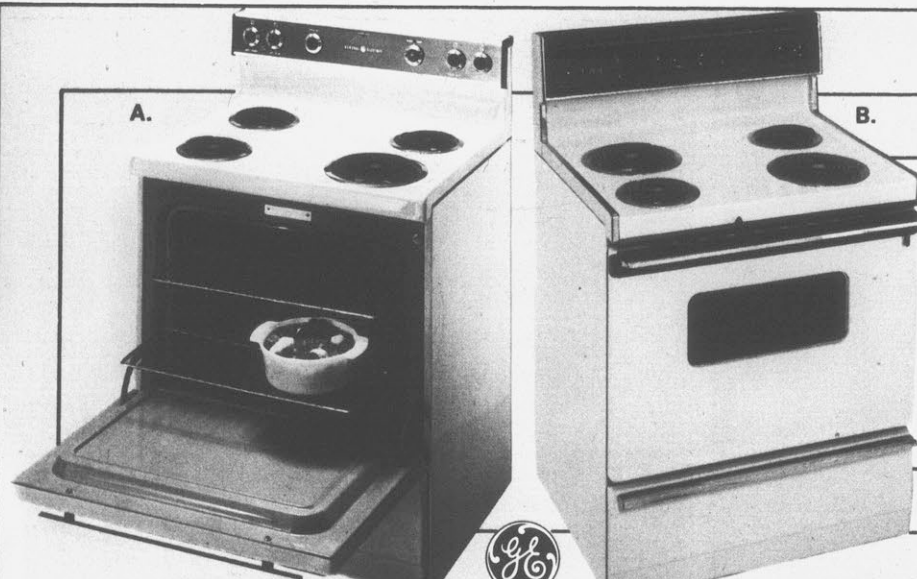

A.

B.

**SPECIAL \$40 REBATE!**  
GE Factory to Customer \$40 Rebate On This Range If Purchased by August 31, 1979



**CHEF'S DELIGHT!**

**A.GE'S EASY CLEAN, WORK SAVING ELECTRIC RANGE**  
• 30" Range With Easy-Clean Oven • Removable Oven Door  
• Tilt Lock Surface Controls  
• Full Width Storage Drawer

**\$299<sup>95</sup>** SAVE \$50

**B.GE'S SELF CLEANING ELECTRIC RANGE**  
• 30" Range With "Picture Window" Removable Oven Door • Tilt Lock Surface Unit Controls • Full Width Storage Drawer • Digital Clock

**\$599<sup>95</sup>** SAVE \$70

**MAXWELL'S BEST REFRIGERATOR BUY!**  
(Shown in New Almond Finish)



**G.E. DELUXE 20.7 cu. ft. ICE DISPENSER REFRIGERATOR In New Natural Almond Finish!**

- Dispenses Crushed Ice or Cubes • 30½" Wide, 66" High Fits Most Kitchens
- Huge 6.83 cu. ft. Freezer
- 13.89 cu. ft. Fresh Food Capacity • Super Cold Zone for Quick-chilling Beverages and Desserts

**\$799<sup>95</sup>** SAVE \$100



**ICEMAKER**  
Fills Removable Storage Bin Automatically



**ADJUSTABLE SHELVES**  
Of Strong Tempered Glass



**PORTA-BINS**  
For Door Storage Flexibility, Adjustable and Portable

**ICE DISPENSER**  
Delivers Crushed Ice or Cubes... Right to your Glass



**MAXWELL'S DINING ROOM SPECTACULAR!**

**3 EXCITING STYLES**

- Elegant French
- Classic Traditional
- Warm Early American

**YOUR CHOICE OF A 5 PIECE GROUP**

(Table and 4 Side Chairs) or a Lighted China

**\$399<sup>95</sup>**

Matching Arm Chairs \$69.95 ea.  
**MAXWELL'S 130 STORE BUYING POWER IN ACTION!**

5 Piece Group (Table and 4 Side chairs) or Lighted China - ONLY \$399.95

**3 EXCITING GROUPS TO CHOOSE FROM!**



ELEGANT FRENCH STYLING.

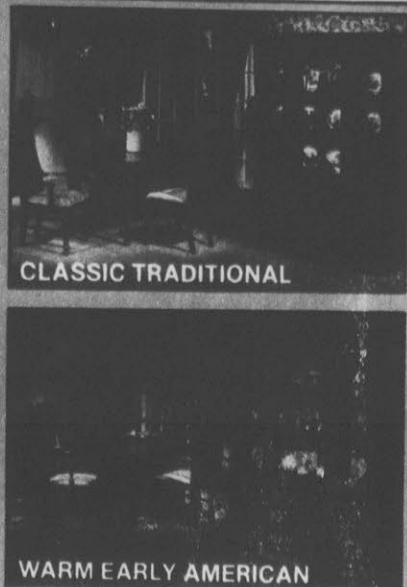

CLASSIC TRADITIONAL

WARM EARLY AMERICAN

**ALL WOOD 4 PIECE BEDROOM GROUP WITH HUTCH MIRROR IN WARM HONEY PINE FINISH**

- Includes:
- 7 Drawer Triple Dresser
  - Hutch Mirror
  - 5 Drawer Chest
  - Queen/Full-size Headboard

**\$499<sup>95</sup>**

SAVE \$219.85  
Night Stand Available for \$99.95  
Bed Frame Priced Separately



4 PIECE BEDROOM  
**\$499<sup>95</sup>**

**Broyhill**

**FAMOUS EARLY AMERICAN BEDROOM GROUP WITH BEAUTIFUL HUTCH MIRROR!**

Warm Oak Finish on Oak Engraved Wood Product and Selected Oak Solids.

- 4 PIECE GROUP INCLUDES:
- 7 Drawer Triple Dresser
  - Hutch Mirror
  - 5 Drawer Chest
  - Queen/Full-size Headboard

ALL 4 PCS. **\$599<sup>95</sup>** SAVE \$229.85

2 Drawer Night Stand Priced Separately at \$99.95  
Bed Frame Priced Separately

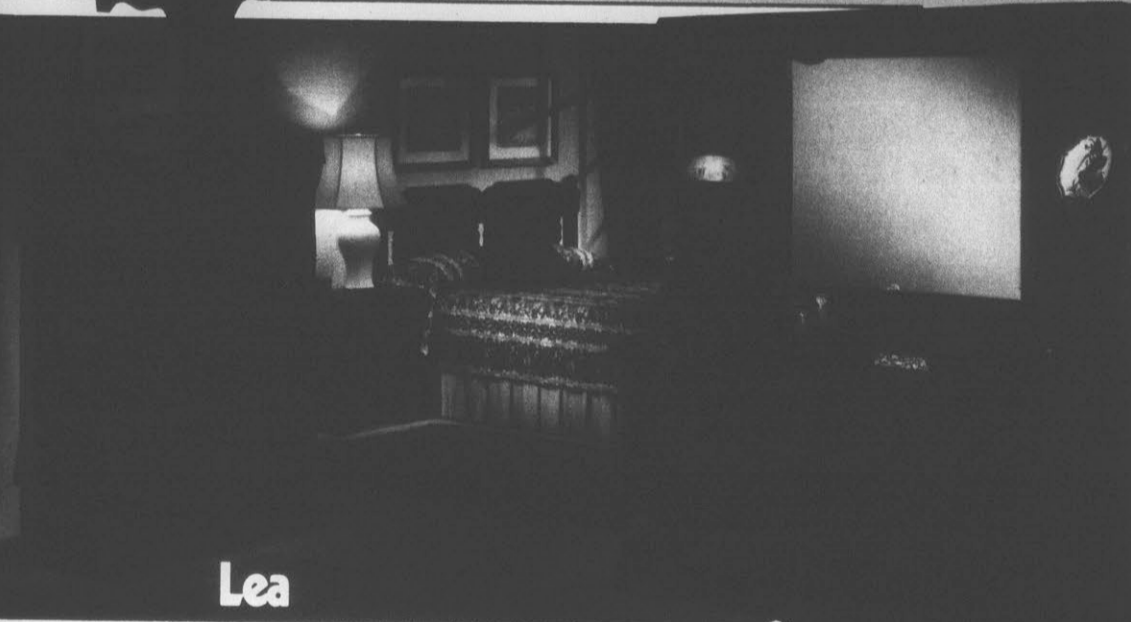

**Lea**

ALL 4 PIECES  
**\$599<sup>95</sup>**

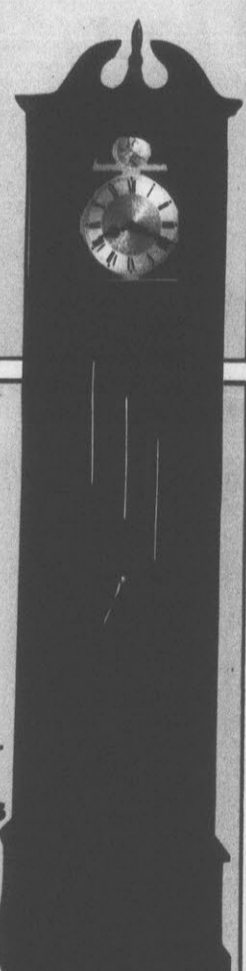

**ROCK YOUR CARES AWAY!**

A. Beautiful Oak Finish Rocker with Cane Insert.

**\$149<sup>95</sup>** SAVE \$40

B. Nostalgic Bentwood Rocker. America's most popular bentwood rocker complements any decor. Dark Walnut finish with woven cane seat and back lets you rock in comfort. Easy to assemble.

**\$69<sup>95</sup>** SAVE \$50



A. **\$149<sup>95</sup>**

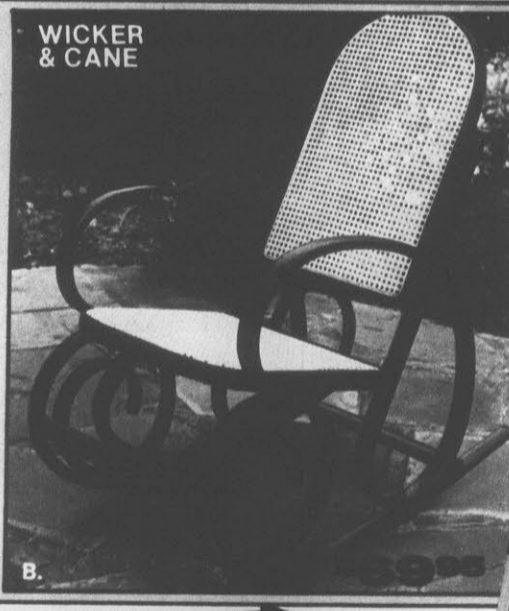

B. **\$69<sup>95</sup>**

**FULL-SIZE TRADITIONAL GRANDFATHER CLOCK**

- Cabaret Finish
- Glass Side Panels
- West German Movement
- Big Ben Gong Strikes Hourly
- Brass Weights & Pendulum
- Westminster Chimes on 1/4 Hr.
- Stands a Full 77" Tall

**\$399<sup>95</sup>** SAVE \$200

**Ridgeway**

**A. ROLL-TOP DESK IN CANDLELIGHT PINE FINISH**

**\$269<sup>95</sup>** SAVE \$130

**NEW HOME ORGANIZER...**

- Ultimate in Versatility
- Desk for Home Office
  - Refreshment Bar/Server/Butlet
  - Sewing Table • Stereo Console

**\$99<sup>95</sup>** SAVE \$70

**C. FAMOUS HOOVER UPRIGHT**

- Steel Agitator Beats...Sweeps.
- Cleans from Low, Normal, High to Shag • Zip-close Vinyl Bag
- Free Attachments

**\$79<sup>95</sup>** SAVE \$20

**D. FAMOUS HOOVER CANISTER**

- Compact and Lightweight
- Powerful Motor • Powermatic Nozzle
- Free Attachments

**\$199<sup>95</sup>** SAVE \$70

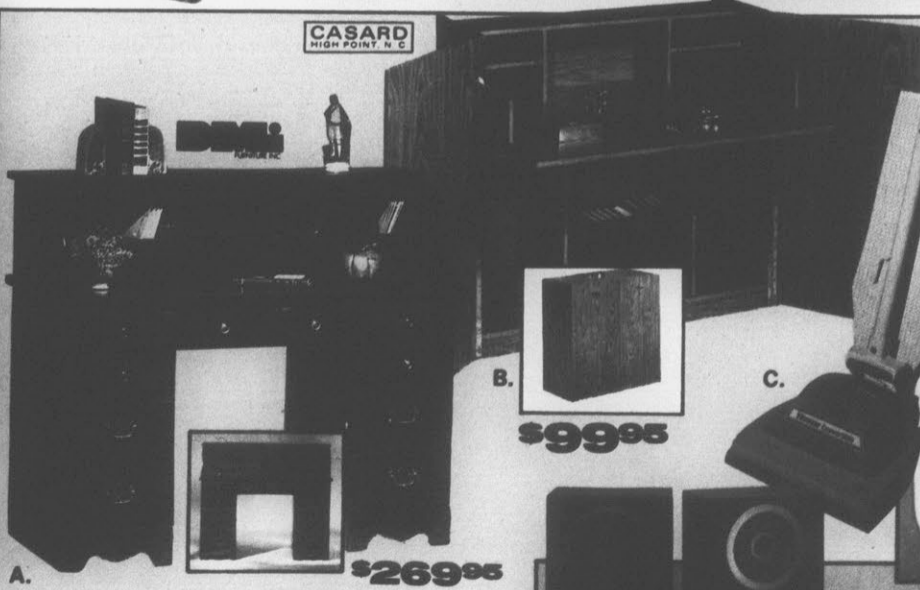

A. **\$269<sup>95</sup>**

B. **\$99<sup>95</sup>**

C. **\$79<sup>95</sup>**

D. **\$199<sup>95</sup>**

**A. HOME ENTERTAINMENT CENTER**

- 8 Track Tape Player / Recorder
- AM/FM Stereo Receiver • Record Changer • Fast Forward and Pause Control

**\$249<sup>95</sup>** SAVE \$20

**B. BIG SOUNDS FOR A SMALL PRICE**

- 8 Track Tape Player / Recorder
- AM/FM Stereo Receiver
- Automatic Record Changer
- Fast Forward & Pause Control

**\$199<sup>95</sup>** SAVE \$30

**C. HI-FI COMPONENT SYSTEM**

- 8 Track Tape Player / Recorder
- AM/FM Stereo Receiver
- Full Size BSR Turntable
- Fast Forward & Pause Control

**\$399<sup>95</sup>** SAVE \$100



**\$249<sup>95</sup>**



**\$199<sup>95</sup>**



**\$399<sup>95</sup>**

**NOW YOU CAN AFFORD YOUR OWN RECORDING STUDIO!**

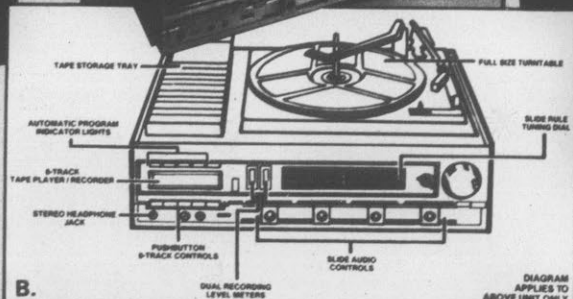

**SOUNDESIGN**



# ★★ SAVINGS EXTRA ★★

### K mart® ADVERTISED MERCHANDISE POLICY

Our firm intention is to have every advertised item in stock on our shelves. If an advertised item is not available for purchase due to any unforeseen reason, K mart will issue a Rain Check on request for the merchandise to be purchased at the sale price whenever available or will sell you a comparable quality item at a comparable reduction in price. Our policy is to give our customers "satisfaction always."

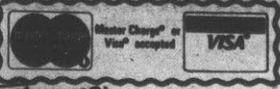

4 DAYS ONLY

66¢

Our Reg. 97¢ Carton  
**Candy Malted Milk Balls**  
Real old fashioned malted milk candy with crunch! 14½-oz. \* pkg. \* Net Wt.



97¢

Our Reg. 1.78  
**Pkg. of 80 Paper Plates**  
Extra deep, rigid 9" plates. Plastic-coated. Deeptone green, yellow.

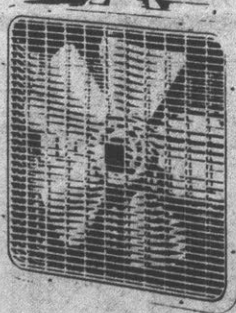

15<sup>88</sup>

Our Reg. 19.70  
**Breeze Box Fan**  
20", 3 speed fan has plastic blades, safety grid. Save



**THE SAVING PLACE**  
OPEN MON-SAT 9:30-9:00  
WED. THRU SAT. SALE



- White
- Eggshell
- Brown

At home with  
**DUPONT DACRON**

2<sup>33</sup>

Our Reg. 3.12 Ea. 40x81"  
**Panels of Dacron®**  
Puff-dot open weave polyester.  
Our Reg. 2.77 48x63" Panel ..\$2  
\*DuPont Reg. TM

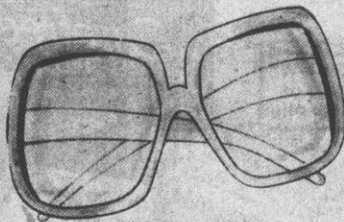

\$1

Our Reg. 1.97  
**Adult Sunglasses**  
Assorted styles, plastic frames, lenses.



Our Reg. 1.09  
7 Oz. Crest **69¢**  
Fluoride Toothpaste. Regular or Mint.



Our Reg. 78¢ **2 For \$1**

**Knee High Hose**  
2 pr pk of wide band knee high hose.



6 For **\$1**

Our Reg. 3 for 67¢  
**Assorted Candy Bars**  
Choose among a big selection of everybody's favorite bars. mounds, Hersheys, Reeses and others.



**SALISBURY STEAK DINNER 1.77**  
WITH 10-OZ. \* COKE®  
\*Fl. Oz. \*Coke Cola and Coke are registered trade-marks which identify same product of The Coca Cola Co.



Our Reg. 1.03 **77¢**

**Super Glue**

Instantly bonds china, plastic, rubber, 3 gram.

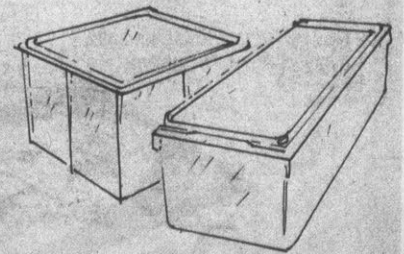

1.88

Our Reg. 3.78-2.49  
**Food Savers**  
Air tight plastic food storage for fruits, vegetables, breads and pastries.



97¢

Our Reg. 1.24  
**8 Qt. Potting Soil**  
General purpose potting soil. Odorless, sterile.



CORNER OF GREENVILLE AND ARLINGTON BOULEVARDS

# HEALTH AND BEAUTY AID<sup>s</sup> AT EXTRA SAVINGS

4-day Sale **1.18**  
Our Reg. 2.38

•Rose Milk® lotion. 12-oz.\* Skin care cream. Save.  
\* Fl. oz.

4-day Sale **1.28**

•L'Oreal® Preference® shampoo in 7-ounce\* size.  
\* Fl. oz.

**67¢**  
Our Reg. 83¢

•Aqua Net® hair spray in 10-ounce\* size. Save now!  
\* Net wt.

**42¢**

Box of 200 Facial tissues. 2-ply, 8.25x9.75" sheets.

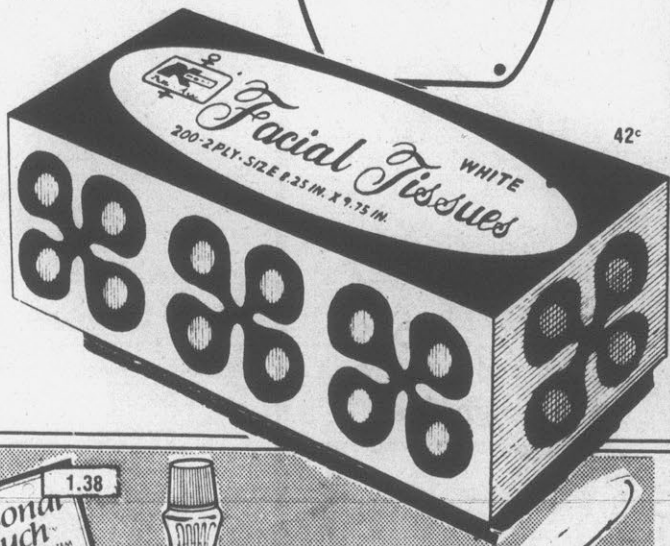
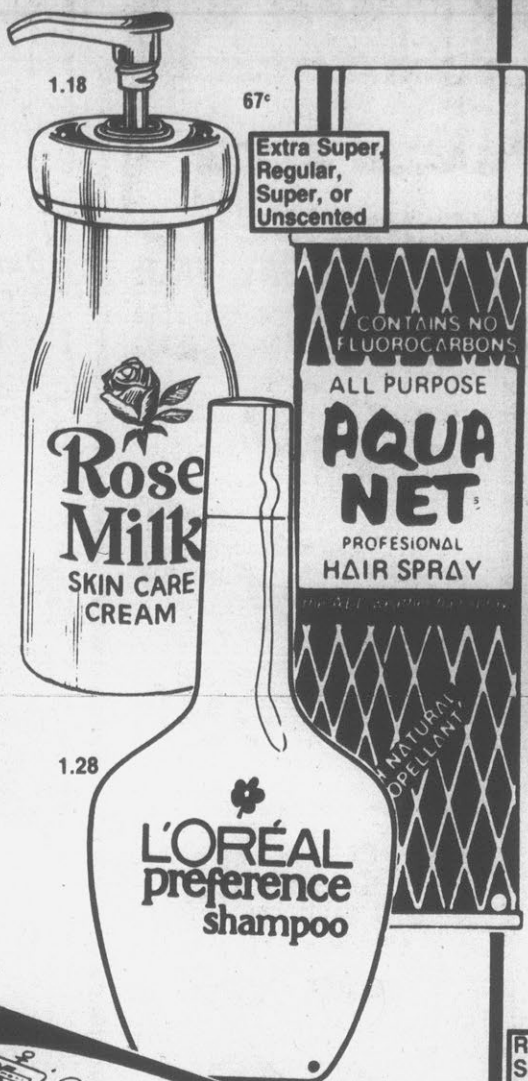

•Adorn® non-aerosol hair spray. 8-oz.\*  
\* Fl. oz. **1.47**  
Scented or Unscented

N.P. 27® Lotion For Athletes Foot. 2.25 Oz. **97¢**  
•Unguentine® spray **1.38** for sunburn, cuts.  
\* Net wt.

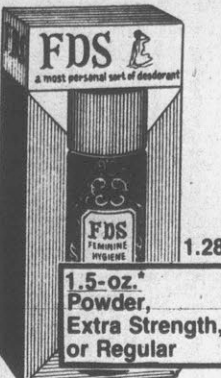

•FDS® feminine deodorant spray. **1.28**  
\* Net wt. **1.28**  
•Wet Ones® moist towelettes for baby. **77¢**



Zest® Deodorant Soap. 5.5 Oz. Bar. **29¢** Each  
Ben Gay® Greaseless, Stainless Muscle Rub. 3 Oz. **1.69**



•Tampax® tampons in box of 40. Save. **1.59**  
•Carefree® panty shields. Box of 30. **1.23**

•Stay Free® mini-pads. Box of 30. **1.48**  
•Stay Free® regular maxi-pads. Box of 30. **2.11**



Personal Touch® Twin Blade Shaver For Women. **1.38**  
Cutex - Polish Remover. 4 Oz. Size. **2 For \$1**  
Pepsodent® Toothbrush Soft, Medium And Hard Bristle. **42¢** Each

Purse Size Nylon Bristle Hairbrush. Save. **3 For \$1**



Nice 'N' Easy® Shampoo In Haircolor By Clairol. **1.88** 1 Application  
Hair Painting® Brush On High Lighting Kit. **2.97**

Plastic Cosmetic Organizer **1.37**  
Balm Barr® 8 Oz. Rich Cocoa Butter Lotion For Hands And Body. **1.13**

OPEN MON.-SAT. 9:30-9:00

WED.-SAT. SALE

# Kmart

THE SAVING PLACE

## YARD GOODS CLEARANCE



Poly/Cotton Eyelet Fabric  
In White And Colors

**\$2** Yd.  
Our Reg. 2.37 Yd.

T-Shirt Fabrics, Stretchy  
Knits

**150** Yd.  
Our Reg. 2.27 Yd.

Light, Textured Poly/Cottons  
In Pastel Shades

**150** Yd.  
Our Reg. \$2.67 Yd.

Print Gauze  
Coordinates

**150** Yd.  
Our Reg. 2.67 Yd.

Childrens Prints In  
Poly/Cotton Blend

**\$1** Yd.  
Our Reg. 2.25 Yd.

Dan River® Plaid In  
Light Poly Cotton

**\$1** Yd.  
Our Reg. 2.44 Yd.

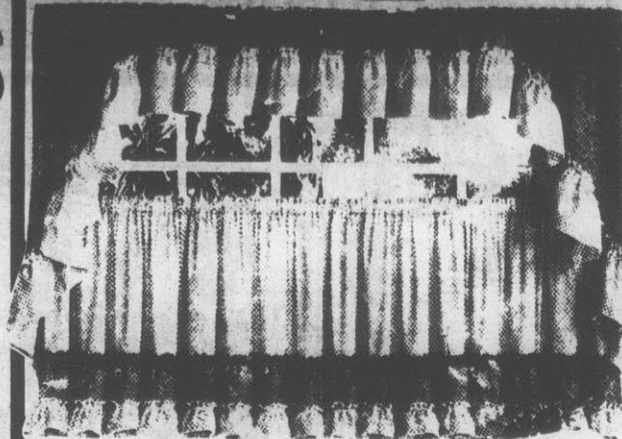

TATTERSALL TIERS  
**347**

Our Reg. 4.37  
OUR 4.96 60" X 30" PR. .... 3.97  
OUR 5.77 SWAG TOPPER ..... 4.66  
OUR 3.57 VALANCE ..... 2.96  
Green, Melon, Brown And Gold. No Rainchecks Please.



5-PC.  
BATH SET  
**1077**

Our Reg. 13.37  
Polyester Bath Ensemble In  
Several Patterns.



POLYESTER PANELS  
**224**

Our Reg. 2.78  
40" X 81"  
Sheer Panels In White, Gold Green And Ivory  
Our 2.48 40" X 63" Pr. .... \$2

CARPET RUNNERS  
**327**

Our Reg. 4.27  
23 X 60  
Polypropylene Carpet Runners. In Col-  
ors

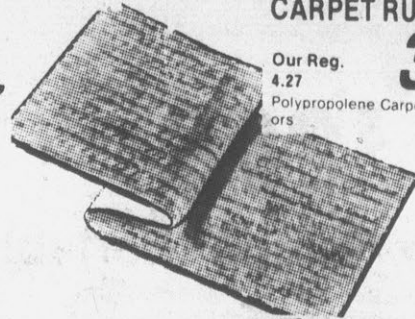

TEXTURED BATH TOWELS  
**311**

Our Reg. 3.87  
Luxurious Towels In Geometric Pattern. White, Colors, Save.

Our 1.27 Washcloth ..... \$1  
Our 2.67 Hand Towel ..... 2.17

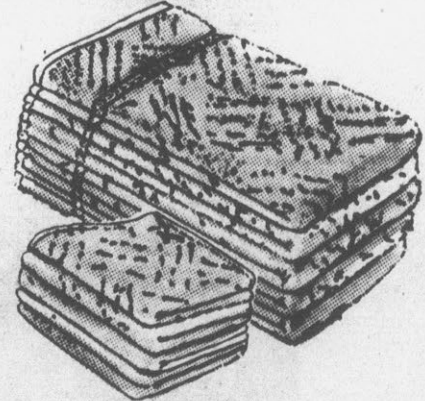

## PHARMACY DEPARTMENT

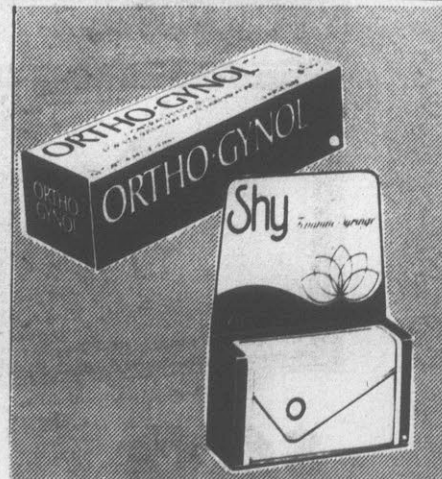

VISALENS  
**89c**

Our Reg. 1.80  
2 Oz.  
Wetting Solution For Hard Contact Lenses.  
NO RAINCHECKS

TINACTIN CREAM

Our Reg. 2.89  
**239**

For Athletes Foot, Jock Itch.

Ortho-  
Gynol

Our Reg. 4.96  
**388** 4.44 Oz.

Contraceptive Jelly.

Shy  
Syringe

Our Reg. 4.50  
**329**

Compact Douche Kit.



500 ASCRIPTIN

Our Reg. 7.24  
Pain Reliever With  
Maalox®

**577**

•100 MY-A-MULTI®

4 Days  
Only  
Diet Supplement.

**297** Save!



Our Reg. 2.89

# Kmart

THE SAVING PLACE

# ★★ SAVING

**\$399**

• **Chromacolor® II**

Our Reg. \$419 High contrast, natural color by Zenith®. Reliable solid-state video tuning system. Save.

SAVINGS EXTRA  
SAVE \$20



\$299

**\$229**

• **NTC 1300**

Our Reg. \$249.00 13" Solid State Portable T.V. LifeLike Color. Shop And Save.



**\$288**

• **Sampo® Portable**

Our Reg. \$299 Solid-state dependability and black stripe picture tube deliver true-to-life color. Save at Kmart.



KMC1978  
\$288

SAVINGS EXTRA  
SAVE \$11

SAVINGS EXTRA  
SAVE \$10

149.88

SAVINGS EXTRA  
SAVE \$10



\$69

**\$69**

• **12" Portable B/W Television Set**

Our Reg. \$79 Features UHF and VHF channels with dial type tuning. Compact and lightweight for traveling.

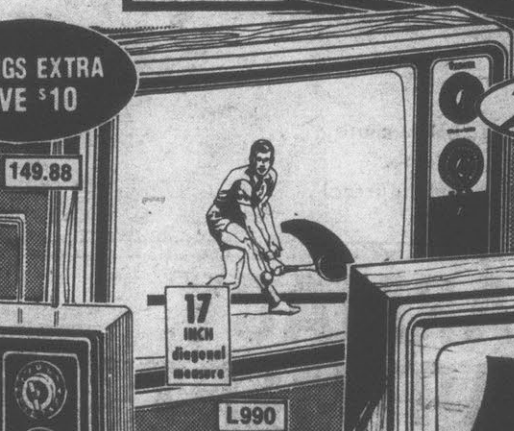

L990

SAVINGS EXTRA  
SAVE \$19

**139<sup>88</sup>**

• **Big-screen B/W Zenith®**

Our Reg. 149.88 Solid-state chassis for long set life. Blanking circuits prevent diagonal lines. Save.



\$358

L3710

**\$358**

• **Zenith® Trim-line Color Portable**

Our Reg. \$377. Ideal set for use wherever space is limited. Tri-focus picture tube delivers great color. Save at Kmart.

Ready to Assemble

All Tables Hold up to 19" Sets

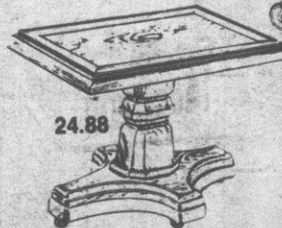
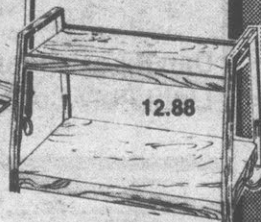
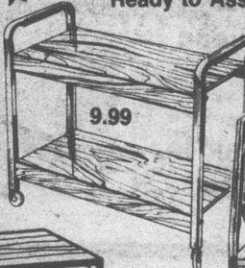

**TV Table Sale**

- Our Reg. 11.88 Walnut-tone vinyl laminate; casters. **9<sup>99</sup>**
- Our Reg. 16.97 Wood-like, plated steel legs, casters. **12<sup>88</sup>**
- Our 29.88. Wood look polystyrene model, casters. **24<sup>88</sup>**

# SAVINGS EXTRA\*\*

- HOME DELIVERY INCLUDED WITH MOST MAJOR APPLIANCE PURCHASES
- SECOND YEAR SERVICE CONTRACT ONLY \$10



## \$439

### 17.6 CU. FT. MODEL

No-Frost Refrigerator With 4.67 Cu. Ft. Top Freezer. Energy Saver Helps Reduce Operating Cost. With 2 Ice 'N' Easy Trays, Generous Door Storage And Adjustable Meat Keeper. White Only.

Model TBF18VW  
\$439

**\$55 SAVINGS ON PAIR**  
Save \$20 Plus \$20 Rebate

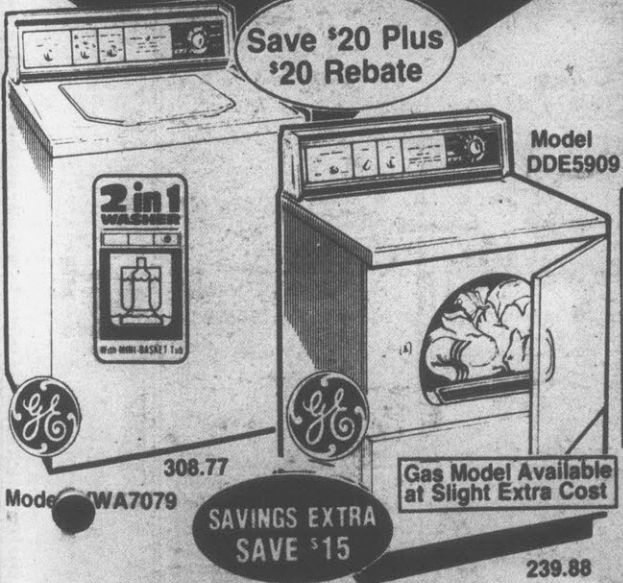

Model WA7079 308.77  
SAVINGS EXTRA SAVE \$15  
239.88  
Gas Model Available at Slight Extra Cost

Our Reg. 328.77  
Less GE<sup>®</sup> Rebate \$20  
Your Net Cost **288.77**  
• 2-in-1 Washer  
2-cycle washer with Mini-Basket<sup>®</sup> tub. Save \$7 Additional for Color

**239.88** Our 254.88  
• Electric Dryer Sale  
Standard-capacity dryer, has automatic sensor control. \$7 Additional for Color

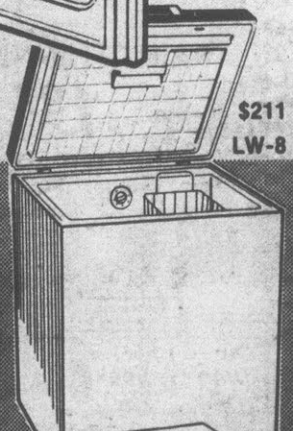

\$211  
LW-8

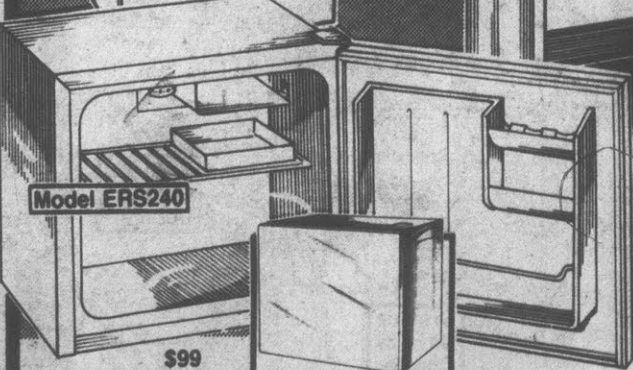

Model ERS240  
\$99

**\$99** Take With Price  
• 2.2 Cu. Ft. Refrigerator  
Compact refrigerator includes freezer compartment, ice cube tray, handy bottle rack on door.

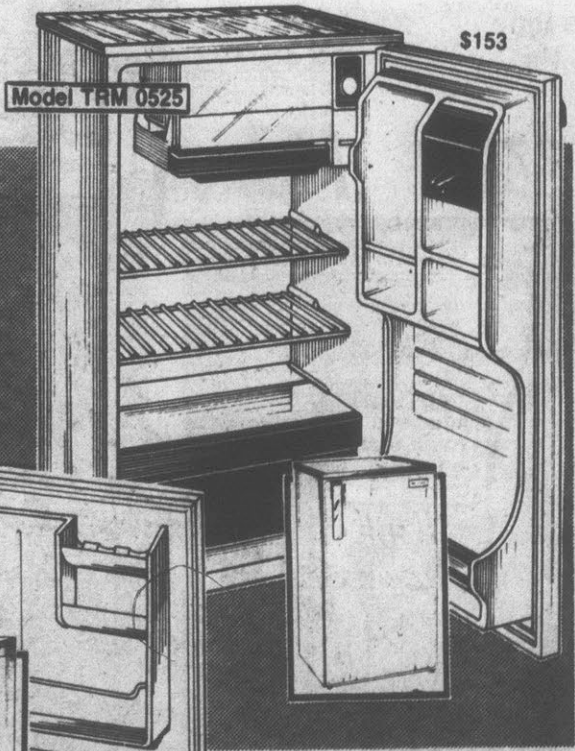

Model TRM 0525  
\$153

**\$211** Take With Price  
• 8.23 Cu. Ft. Chest Freezer  
Model features top storage basket, key-eject lock. 5 Cu. Ft. Model .... \$188

**\$153** Take With Price  
• 5 Cu. Ft. Refrigerator  
Walnut grain finish on top and door. Includes freezer, bottom crisper, shelf storage. Shop at Kmart.

**Kmart**  
THE SAVING PLACE

OPEN MON. THRU SAT. 9:30-9:00  
WED. THRU SAT. SALE

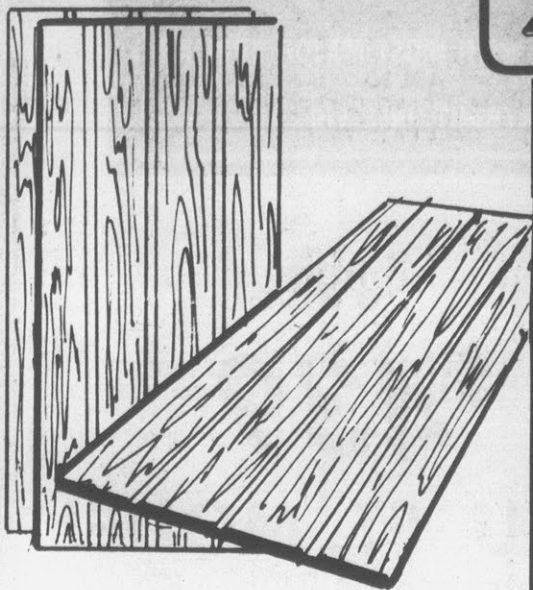

**EXTERIOR SIDING**

Our Reg. 15.97 **13<sup>97</sup>** 4' X 8'  
5/8" Reverse Board And Batten Pine Siding. Save.

<b>White Pine</b> 2 X 4's 8' Long Our Reg. 1.57 <b>1<sup>27</sup></b>	<b>YELLOW PINE</b> 2 X 4's 8' Long Our Reg. 1.27 <b>1<sup>17</sup></b>
---	--

SAVE 3.10

**WARRANTED 8-Years**  
EXTERIOR • ONE COAT  
**LATEX HOUSE PAINT**

White and Tinted Colors

**Big Bucket**  
ONE COAT  
**LATEX**  
INTERIOR  
FLAT WALL PAINT

**PAINT THINNER**

**The Fresh Look**  
9-YEAR DURABILITY  
One Coat Interior  
**LOW LUSTRE LATEX ENAMEL**

**The Fresh Look**  
Interior  
**FLAT**

**BIG BUCKET FLAT**  
Our Reg. 6.46 **4<sup>46</sup>** 5 Qt.  
Economy Size One Coat Latex Wall Paint.

**PAINT THINNER**  
Our Reg. 2.52 **1<sup>97</sup>** GAL.  
Our Reg. 1.16 Qt. Paint Thinner 97¢

**LATEX ENAMEL**  
Our Reg. 10.88 **7<sup>88</sup>** GAL.

**INTERIOR LATEX**  
Our Reg. 8.44 **7<sup>88</sup>** GAL.

**SAVE \$3**

**K mart LIMITED WARRANTY**  
8-year durability warranted when applied over properly prepared surface or K mart's obligation shall be limited solely to refund of the purchase price.

**6<sup>88</sup>** Gal.  
Our Reg. 9.78

**Our Latex House Paint**

Easily applied in one fast coat and lasts up to 8 full years. Color-fast paint is durable and chalk resistant too. Easy clean-up. Save at Kmart.

Sold in Sporting Goods Dept.

**12.96**

**Adult and Youth Sizes in Sporty Colors**

**10.96**

**12<sup>96</sup>** AND **10<sup>96</sup>**  
Adult Youth  
Our Reg. 17.88 Our 14.88  
**Lightweight Nylon Warm-Up Suits**  
Participating or lounging. Here's a quality nylon 2-pc. suit with multi-stripes. Zip-front jacket, zippered back pocket on pants. Save at Kmart.  
Children's Sizes .....8.96

Youth sizes 7-11  
Adult sizes 9-17

Our **1.66-1.97**,  
Tube Socks\*  
.....**1.27-1.47**

**4.88**

Size and Color Choice

**1.97**

Gray or Navy in Choice of Sizes

**5<sup>96</sup>** Our Reg. 7.97  
**Hood Sweatshirt**  
Hand-warmer pocket. Cotton/Creslan<sup>®</sup> acrylic with fleecy lining.

**1<sup>97</sup>** Our Reg. 2.88  
**V-leg Shorts**  
Perm-press polyester. Elastic waist. Save.  
**Deluxe Shorts...4.88**

**21.88**

Sold in Sporting Goods Dept.

**13.88**

**17.88**

**8.44**

Our 9.96, Tote ...8.44  
Our 16.96, 21" ...13.88  
Our 21.96, 25" ...17.88  
Our 26.96, 27" ...21.88

**8<sup>44</sup>** TO **21<sup>88</sup>** Our Reg. 9.96-26.96  
**'Softsider' Luggage Choice**  
Soft-sided so you can pack in just a little more. Extra-heavy expanded vinyl, steel frame in bottom\*, easy-action nylon zipper. Save at Kmart.  
\*Except in tote bag

# Kmart

FOR AUTO SERVICE DIAL 756-5953

## THE SAVING PLACE

**Kmart AUTO SERVICE POLICY**  
Kmart's policy is to perform only needed services. For your benefit, Kmart auto services are necessarily conditioned on Kmart's right to decline any service, whether advertised or not, where a car has related deteriorated or worn parts which create or continue an unsatisfactory or unsafe driving condition, unless the customer gives Kmart a written waiver of replacement of such needed parts. Needed brake system parts may not be waived by customer; Kmart may in its judgment refuse to perform any partial brake job where your safety is at stake.



SIZES	REG.	SALE	F.E.T.
B78x13	24.88	4/92	1.73
C78x14	27.88	4/104	1.88
E78x14	28.88	4/108	2.10
F78x14	30.88	4/116	2.22
G78x14	31.88	4/120	2.38
G78x15	31.88	4/120	2.44
H78x14	33.88	4/128	2.61
H78x15	35.88	4/132	2.66
L78x15	41.76	4/160	2.96

### "OUR BEST" 4-PLY BLACKWALLS

Our Reg. 22.88-A78x13

**4 FOR \$80**

Plus 1.62 F.E.T. Each

Whitewalls 2.88 more each  
All Tires plus F.E.T. Each

Whitewalls only

MOUNTING INCLUDED—NO TRADE-IN REQUIRED



### "OUR BEST" STEEL BELTED RADIAL WHITEWALLS

Our Reg. 51.88 BR78x13

**35<sup>88</sup>**

Plus 1.98 F.E.T. Each  
All Tires Plus F.E.T. Each

SIZES	REG.	SALE	F.E.T.
ER78x14	58.88	47.88	2.38
FR78x14	61.88	52.88	2.55
GR78x14	65.88	56.88	2.65
GR78x15	65.88	56.88	2.73
HR78x14	69.88	59.88	2.95
HR78x15	71.88	63.88	2.96
LR78x15	75.88	68.88	3.30

## auto service

SHOP HOURS  
9 A.M. TO 8 P.M. MON. THRU SAT.  
OFFICIAL N. CAROLINA STATE INSPECTION STATION  
SALE DAYS, WED., THURS., FRI., SAT.



INSTALLED

### Kmart 4/48 SEALED BATTERY

With Exchange **47<sup>88</sup>**  
Our 54.88

Maintenance-free. Calcium lead. Fits most U.S. cars.

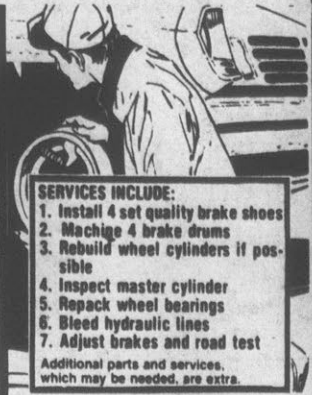

- SERVICES INCLUDE:
1. Install 4 set quality brake shoes
  2. Machine 4 brake drums
  3. Rebuild wheel cylinders if possible
  4. Inspect master cylinder
  5. Repack wheel bearings
  6. Bleed hydraulic lines
  7. Adjust brakes and road test
- Additional parts and services, which may be needed, are extra.

### FOUR-WHEEL BRAKE SERVICE

Sale Price **58<sup>88</sup>**

Service for most cars. Disc brakes at a higher price.



YOUR CHOICE

### MAJOR BRAND OIL FILTERS

Our Reg. 3.47 **2<sup>33</sup>** Ea.

Spin-on type oil filters fit most G.M.\* Chrysler\*, Ford\* cars.



CARRY-OUT 5.88 EA.

### DELUXE SHOCKS INSTALLED

Sale Price **8<sup>88</sup>** Ea.

Heavy-duty shocks to fit most U.S. cars. 1 3/16" piston.

## BODY REPAIR SPECIALS



5-OUNCE\* SPRAY PAINT  
Sale Price **1<sup>47</sup>**

Dupli-color\* to match most cars. Save.  
\*Net wt.



13-OZ.\* RUST NOT PAINT  
Sale Price **1<sup>77</sup>**

Easy-on spray with rust inhibitor. Colors.  
\*Net wt.



YOUR CHOICE

### AUTO BODY REPAIR KITS

Our Reg. 4.17-4.77 **2<sup>99</sup>** Each

With plastic filler. 48-oz.\* White Knight, qt. Black Knight.  
\*Net wt.



Pkg. of 5

### AUTOMOTIVE SANDPAPER

Our Reg. 88¢ **67¢** Pkg.

5" discs, various grits or 3x11" for rough finishing.

Pkg. of 6

### HANDY CAR CONSOLE

Our Reg. 4.97 4 Days Only **3<sup>88</sup>**

Space For Tissues. Change Cups. End Car Clutter.

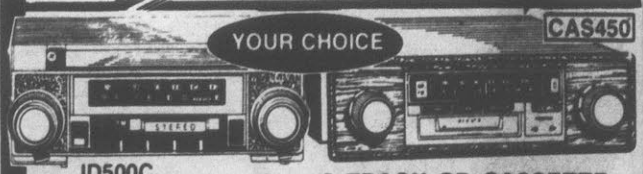
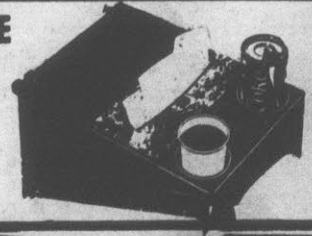

YOUR CHOICE

ID500C

### 8-TRACK OR CASSETTE AM/FM INDASH PLAYER

Our Reg. 148.88 **119<sup>88</sup>** Ea.

Stereo 8-track, AM/FM pushbutton radio or automatic reverse cassette.

### 3-SPEAKER STEREO UNIT

Our Reg. 68.88 - 4 Days **58<sup>88</sup>** Pr.  
6x9" rear deck speaker. Handles 25-watts steady.

SK6900

# ★/★ SAVINGS EXTRA ★★



**ICEE**

**MEDIUM ICEE**

Our Reg. 40¢ **33¢**

Cola Or New Strawberry Batch. Save.

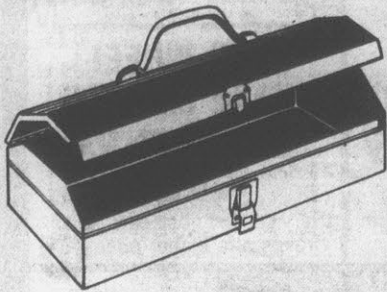

Our Reg. 3.97 **2.77**

**Utility Tool Box**  
Metal with baked hammertone finish. 15" x 6" x 3 1/2". Sturdy handle.

SAVE \$3



Double Insulated

**21.88** Our 24.88

**7 1/4" Circular Saw**  
1 1/3 HP. General-purpose saw. Combination blade included.



Our Reg. 7.47 **5.97** GAL.

**LIQUID WEED KILLER**

Top kills weeds and grasses along fences, trees, walks. **SAVE NOW.**



OPEN MON-SAT  
9:30-9:00

WED. THRU SAT. SALE



8X10

Our Reg. 97¢-1.17 **2 For \$1**

**Picture Frames**  
Goldtone Metal Frames With Hinged Easel. Glass. 8" x 10" and 5" x 7".

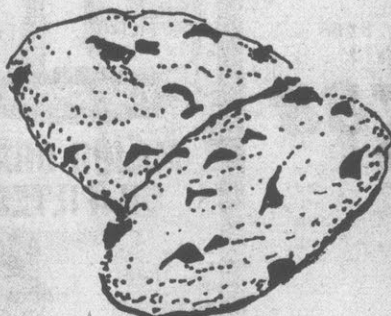

**97¢**

Our Reg. 1.37 **1 1/4 lb. Chocolate Chip Cookies**

Great for snacks or lunch packing. Shop and save.



**48¢**

Our Reg. 74¢ **Instant Gatorade**

For camping, hiking, picnics. Each packet makes 2 quarts of delicious thirst quencher. Orange or Lemon-Lime.



**68¢**

Our Reg. 83¢ **Mallow Cookies**  
6 oz. of delicious marshmallow cookies. Fudge, stripe or sprinkles.

**K mart® ADVERTISED MERCHANDISE POLICY**

Our firm intention is to have every advertised item in stock on our shelves. If an advertised item is not available for purchase due to any unforeseen reason, K mart will issue a Rain Check on request for the merchandise to be purchased at the sale price whenever available or will sell you a comparable quality item at a comparable reduction in price. Our policy is to give our customers "satisfaction always."

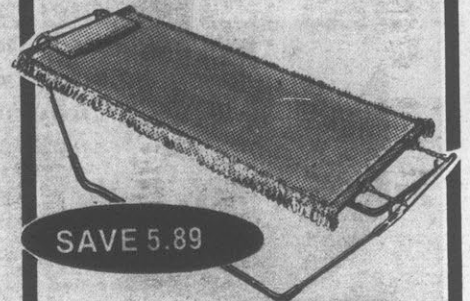
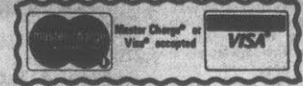

SAVE 5.89

Our Reg. 20.57 **15.88**

**HAMMOCK WITH PILLOW**  
Steel frame. 34x76". Made of polyester. **NO RAINCHECKS PLEASE**

Mildew-resistant

**3.77**

Our Reg. 5.37



**20 Gal. Trash Can**

Sturdy galvanized can with handles, tight fitting lid. Shop now.

**RURAL METAL MAIL BOX**

**4.47**

Our Reg. 6.47 **Standard mailbox with aluminum finish, red flag.**

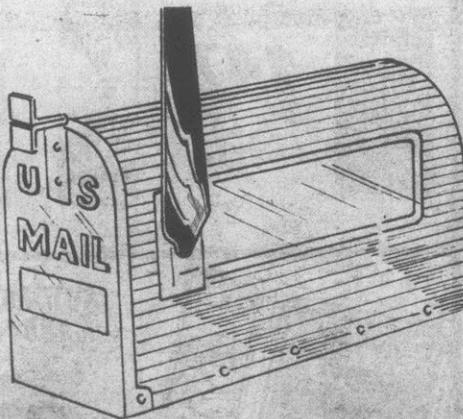

**9.97**

Our Reg. 13.37

**Parakeets**

Beautiful young birds make delightful pets.



CORNER OF GREENVILLE AND ARLINGTON BOULEVARDS

SUPPLEMENT TO: ARINGDON WASHINGTON CTY. NEWS, ANDERSON INDEPENDENT-MAIL, ANOSKIE HERALD, BOONE WATAUGA DEMOCRAT, BRYSON CITY SMOKY MOUNTAIN TIMES, CHAPEL HILL VILLAGE ADVOCATE, CHARLOTTE OBSERVER, CHESTER NEWS & REPORTER, CHINA GROVE SOUTH ROWAN TIMES, CONWAY FIELD & HERALD, DILLON HERALD, DUNN DAILY RECORD, DURHAM HERALD-SUN, EDENTON CHOWAN HERALD, ELIZABETH CITY DAILY ADVANCE, ELIZABETHTOWN BLADEN JOURNAL, FAIRMONT TIMES-MESSENGER, FAYETTEVILLE OBSERVER-TIMES, FORT MILL TIMES, FUQUAY-VARINA INDEPENDENT, GARNER NEWS, GEORGETOWN TIMES, GOLDSBORO NEWS-ARGUS, GREENVILLE DAILY REFLECTOR, HAMLET NEWS, HAVELOCK PROGRESS, HENDERSON DAILY DISPATCH, HENDERSONVILLE TIMES-NEWS, HILLSBOROUGH NEWS OF ORANGE CTY., KINGSTREE NEWS, KINGSTON DAILY FREE PRESS, LAKE CITY NEWS, LAURINBURG EXCHANGE, LOUISBURG FRANKLIN TIMES, LUMBERTON EXCHANGE, MANNING TIMES, MARION STAR, McCAYS-

VILLE CITIZEN-ADVANCE, MONROE ENQUIRER-JOURNAL, MOREHEAD CITY CARTERET CTY. NEWS, MULLINS ENTERPRISE, MURPHY CHEROKEE SCOUT, MYRTLE BEACH SUN-NEWS, NEWBERRY OBSERVER, NORTH MYRTLE BEACH TIMES, OXFORD PUBLIC LEDGER, PLYMOUTH ROANOKE BEACON, RAEFORD NEWS-JOURNAL, RALEIGH NEWS & OBSERVER, ROANOKE RAPIDS DAILY TELEGRAM, ROCK HILL EVENING HERALD, ROCKINGHAM DAILY JOURNAL, ROXBORO COURIER-TIMES, SAFFORD DAILY HERALD, SMITHFIELD HERALD, SOUTHERN PINES PILOT, STATESVILLE RECORD & LANDMARK, TARBORO DAILY SOUTHERNER, UNION DAILY TIMES, WADESBORO ANSON RECORD, WALLACE ENTERPRISE, WARRENTON WARREN RECORD, WILSON DAILY TIMES, WINNSBORO NEWS-HERALD & FAIRFIELD INDEPENDENT, BREVARD PENNSYLVANIA TIMES, KANNAPOLIS DAILY INDEPENDENT, WEDNESDAY, AUGUST 1, 1979.



**ADVERTISED ITEM POLICY** Each of these advertised items is required to be readily available for sale at or below the advertised price in each A&P Store, except as specifically noted in this ad.

PRICES GOOD THROUGH SAT. AUG. 4 IN ALL A&P STORES IN NORTH CAROLINA AND SOUTH CAROLINA EXCEPT AIKEN & BEAUFORT, S.C.

# SUMMERTIME 88¢ SALE!

**CHARMIN**  
BATHROOM TISSUE  
WHITE, YELLOW OR BLUE  
**4** ROLL PKG. **88¢**

YOUR CHOICE — SLICED FREE!  
4-LB. SWIFT HOSTESS OR 5-LB. A&P BRAND  
**CANNED HAM**  
**\$7.88**  
EACH ONLY



ANN PAGE

**VEGETABLE MARGARINE**  
IN QUARTERS

**3** 1-LB. PKGS. **88¢**

LIMIT 3 PKGS. WITH COUPON BELOW & ADDITIONAL \$7.50 ORDER



A&P

**SALTINE CRACKERS**

**2** 16-OZ. PKGS. **88¢**



DONALD DUCK

**ORANGE JUICE**

½ GALLON BOTTLE

**88¢**

LIMIT ONE WITH COUPON BELOW & ADDITIONAL \$7.50 ORDER



10¢ OFF LABEL

**CHEER**

LAUNDRY DETERGENT

YOU PAY ONLY 49-OZ. PKG.

**88¢**

LIMIT ONE WITH COUPON BELOW & ADDITIONAL \$7.50 ORDER

A&P COUPON

ANN PAGE VEGETABLE

**MARGARINE**

**3** 1-LB. PKGS. **88¢**

LIMIT 3 PKGS. WITH THIS COUPON & ADDITIONAL \$7.50 ORDER  
LIMIT ONE COUPON. GOOD THROUGH SAT. AUG. 4 IN ALL A&P STORES IN N.C. & S.C. EXCEPT AIKEN & BEAUFORT.

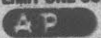

A&P COUPON

DONALD DUCK

**ORANGE JUICE**

**88¢**

LIMIT ONE WITH THIS COUPON & ADDITIONAL \$7.50 ORDER  
LIMIT ONE COUPON. GOOD THROUGH SAT. AUG. 4 IN ALL A&P STORES IN N.C. & S.C. EXCEPT AIKEN & BEAUFORT.

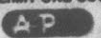

A&P COUPON

10¢ OFF LABEL

**CHEER** LAUNDRY DETERGENT

**88¢**

LIMIT ONE WITH THIS COUPON & ADDITIONAL \$7.50 ORDER  
LIMIT ONE COUPON. GOOD THROUGH SAT. AUG. 4 IN ALL A&P STORES IN N.C. & S.C. EXCEPT AIKEN & BEAUFORT.



ITEMS OFFERED FOR SALE NOT AVAILABLE TO OTHER RETAILERS OR WHOLESALERS

# A&P'S SUMMERTIME



**ADVERTISED  
ITEM POLICY**

Each of these advertised items is required to be readily available for sale at or below the advertised price in each A&P Store, except as specifically noted in this ad.

DEC., ASSTD. OR ARTS & FLOWERS



**SCOTTOWELS**

**BIG ROLL 67¢**

**A&W ROOT BEER**  
REGULAR OR SUGAR FREE

**6 \$1.29**  
12-OZ. CANS

MARVEL SANDWICH SLICED

**WHITE BREAD**

**3 \$1.09**  
24-OZ. LOAVES

JANE PARKER

**HAMBURGER ROLLS**

**2 88¢**  
12-CT. PKGS.

ANN PAGE 2%

**LOW FAT MILK**

**88¢**  
½ GAL. CTN.

ANN PAGE LOOK FIT

**ICE MILK**



**88¢**  
½-GAL. CTN.

A&P FROZEN DESSERT TOPPING

**HANDI WHIP**

**2 88¢**  
9-OZ. BOWLS

SURE FRESH FROZEN

**STRAWBERRIES**

**3 88¢**  
10 OZ. PKGS.

SLICED BEEF, SLICED TURKEY OR SALISBURY STEAK

**FREEZER QUEEN**

**3 88¢**  
5-OZ. PKGS.

A&P FROZEN REGULAR OR CRINKLE CUT

**FRENCH FRIES**

**2 88¢**  
1-LB. PKGS.

ANN PAGE FROZEN

**POT PIES**

- BEEF
- CHICKEN
- TURKEY

**3 88¢**  
8-OZ. PKGS.

SEALTEST

**ICE CREAM BARS**

**88¢**  
6-CT. PKG.

ANN PAGE PEPPERONI, SAUSAGE OR CHEESE

**FROZEN PIZZAS**

**88¢**  
12-OZ. PKG.

ANN PAGE

**YOGURT**

ASSORTED FLAVORS • SWISS STYLE OR FRUIT ON THE BOTTOM

**3 88¢**  
8-OZ. CARTONS

A&P HOMESTYLE OR BUTTERMILK

**BISCUITS**

**6 88¢**  
10-CT. 8-OZ. CANS

ANN PAGE SMALL OR LARGE CURD

**COTTAGE CHEESE**

**88¢**  
16-OZ. CTN.

ANN PAGE

**SOUR CREAM**

**88¢**  
16-OZ. CTN.

DIET OR REGULAR

**SHASTA COLA**

OR REGULAR ORANGE OR GRAPE

**78¢**  
2 LITER BOTTLE

PRICES GOOD THRU SATURDAY AUG. 4 IN ALL A&P'S IN NORTH CAROLINA & SOUTH CAROLINA EXCEPT AIKEN & BEAUFORT.

# 88¢ SALE!

88¢ SPECIALS IN EVERY DEPARTMENT!

**DEXOLA OIL**  
48-OZ. BOTTLE  
**\$1.88**

A&P BRAND  
**LUNCHEON MEAT**  
12-OZ. CAN  
LIMIT ONE, PLEASE  
**88¢**

ASSORTED FLAVORS  
**FIRESIDE COOKIES**  
8-OZ. PKGS.  
**2.88¢**

ANN PAGE  
**KOSHER DILLS**  
48-OZ. JAR  
**88¢**

ANN PAGE  
**SALAD DRESSING**  
32-OZ. JAR  
**88¢**

FIRESIDE  
**FIG BARS**  
2-LB. PKG.  
**88¢**

A&P DRY ROASTED  
**PEANUTS**  
12-OZ. JAR  
**88¢**

IN POUCH  
**BISQUICK BAKING MIX**  
ANN PAGE  
4 5½-OZ. PKGS.  
**88¢**

PLAIN, SELF-RISING OR UNBLEACHED  
**PILLSBURY FLOUR**  
5-LB. BAG  
**88¢**

ANN PAGE WASTEBASKET  
**BAGS**  
20-CT. PKG.  
**88¢**

ANN PAGE  
**ELBOW MACARONI**  
16-OZ. PKGS.  
**2.88¢**

WHOLE OR SLICED  
**GREEN GIANT MUSHROOMS**  
2 2½-OZ. JARS  
**88¢**

GOLD OR WHITE DEODORANT—5c OFF LABEL  
**DIAL SOAP**  
YOU PAY ONLY 3 3½-OZ. BARS  
**88¢**

HORMEL  
**VIENNA SAUSAGE**  
2 5-OZ. CANS  
**88¢**

EIGHT O'CLOCK  
**NON DAIRY CREAMER**  
16-OZ. JAR  
**88¢**

10c OFF LABEL  
**DAWN LIQUID**  
YOU PAY ONLY  
• 22-OZ. BOTTLE  
**88¢**

ANN PAGE ASSORTED FLAVORS  
**GELATIN**  
3 6-OZ. PKGS.  
**88¢**

A&P COUPON  
OUR OWN WITH LEMON & SUGAR  
**ICED TEA MIX**  
LIMIT ONE WITH THIS COUPON  
LIMIT ONE COUPON  
SAVE 30c  
24-OZ. JAR **\$1.39**  
GOOD THROUGH SAT., AUG. 4 IN ALL A&P STORES IN N.C. & S.C. EXCEPT AIKEN & BEAUFORT.

DAILY MEAT, FISH, LIVER OR CHICKEN  
**DOG FOOD**  
3 26-OZ. CANS  
**88¢**

LONG GRAIN  
**A&P RICE**  
3 LB. PKG.  
**88¢**

SUNSHINE 12-OZ.  
**SUGAR WAFERS**  
OR • 12-OZ. CHIP-A-ROOS  
• 11-OZ. PEANUT BUTTER WAFERS  
YOUR CHOICE  
EA. PKG. **88¢**

KEEBLER 16-OZ.  
**HONEY GRAHAMS**  
OR • 14-OZ. CINNAMON CRISP  
• 10-OZ. TUC CRACKERS  
YOUR CHOICE  
EA. PKG. **88¢**

NABISCO  
**RITZ CRACKERS**  
16-OZ. PKG.  
**88¢**

JANE PARKER  
**PECAN TWIRLS**  
6-OZ. PKGS.  
**2.88¢**

PRIZE  
**POTATO CHIPS**  
8-OZ. FOIL PACK  
**59¢**

ITEMS OFFERED FOR SALE NOT AVAILABLE TO OTHER RETAIL DEALERS & WHOLESALERS.

# The Butcher Shop

# A&P

with supermarket prices

**ADVERTISED ITEM POLICY** Each of these advertised items is required to be readily available for sale at or below the advertised price in each A&P Store, except as specifically noted in this ad.

PRICES GOOD IN ALL A&P STORES IN NORTH CAROLINA & SOUTH CAROLINA EXCEPT AIKEN & BEAUFORT, S.C. PRICES GOOD THROUGH SAT. AUG. 4



# SUMMER

At A&P we don't display selections and then guess which cut is the Stroganoff or how long you need to serve six.

We're so proud of our butchers that we're sure you make the right choice.

That's why the A&P Butcher Shop has you with all the answers to your questions... when you ask the man who knows.

**A&P is a smoked meat shop**

A&P QUALITY

## SMOKED HAM

SHANK PORTION

LB.

# 88¢

MARKET

## SLICED BACON

LB.

# 88¢

**A&P is a country farm pork shop**

BONELESS RIB PORTION

## PORK ROAST

LB.

# \$1.88

CENTER CUT RIB

### PORK CHOPS

LB.

# \$1.88

LEAN 'N MEATY

### PORK BACK RIBS

LB.

# \$1.88

**A&P is a seafood shop**

MRS. PAUL'S FROZEN LIGHT BATTER

### FISH FILLETS

16-OZ. PKG.

# \$1.88

MRS. PAUL'S FROZEN FAMILY

### PERCH FILLETS

14-OZ. PKG.

# \$1.88

A&P FROZEN BATTER DIP

### FISH STICKS

8 1/4-OZ. PKG.

# 88¢

A&P QUALITY HEAVY WESTERN GRAIN-FED BEEF

# ROUND STEAK

FULL CUT BONE IN

# \$1.88

LB.

A&P QUALITY HEAVY WESTERN GRAIN-FED BEEF

## WHOLE BEEF RIBS

24 TO 30 LB. AVG. BONE IN CUT FREE INTO RIB STEAK, ROAST AND TRIMMINGS

# \$1.88

LB.

A&P QUALITY HEAVY WESTERN GRAIN-FED BEEF

## RIB EYE STEAKS

LB.

# \$3.88

### BONELESS RIB STEAKS

LB.

# \$2.88

### ROUND OR CHUCK CUBED STEAK

LB.

# \$2.88

### BONELESS CHUCK BEEF STEW

LB.

# \$1.88

A&P QUALITY HEAVY WESTERN GRAIN-FED BEEF

## BONELESS

## & EYE ROAST

25 TO 35-LB. AVG. WT.

CUT FREE INTO BOTTOM ROUND STEAKS OR ROAST, EYE ROUND STEAKS OR ROAST, RUMP ROAST AND GROUND ROUND

LB.

FRESHLY

## GROUND ROAST

CHECKERBOARD

## BASTED YACHTS TURKEY

10 TO 14 LB. AVERAGE

# 8

LB.

U.S.D.A. INSPECTED FRESH

### FRYER QTRS.

BREAST OR LEGS

ITEMS OFFERED FOR SALE NOT AVAILABLE TO OTHER RETAIL DEALERS OR WHOLESALERS.

# WIMMERTIME 88¢ SALE!

Display all of our fine beef when leave you alone to the right one for your best how many pounds you'll

our beef that we want to be the right decision.

P Butcher Shop provides answers to your beef questions ask our Butcher ... the

HEAVY WESTERN BEEF—WHOLE

S BOTTOM ROUND

**\$1.88**

ROUND LB. **\$1.88**

ARD BRAND

YOUNG KEYS

**88¢**

**88¢**

YOUR CHOICE! SLICED FREE  
4-LB. **SWIFT HOSTESS**

OR

5-LB. **A&P BRAND**

**CANNED HAM**

EACH CAN ONLY

**\$7.88**

OLD HICKORY PORK

**BARBECUE**

TAKE SOME HOME TONIGHT!

**\$1.88**

1-LB. CUP

A&P BRAND FRESH

**PORK SAUSAGE**

**88¢**

MILD OR HOT

1-LB. PKG.



**Oscar Mayer**  
WEEK AT A&P!  
FAMOUS FOR QUALITY

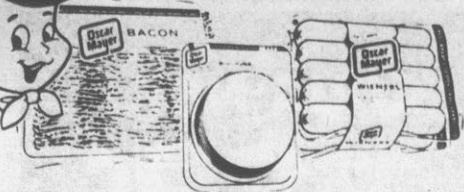

OSCAR MAYER

**SLICED BACON**

**\$1.58**

1-LB. PKG.

OSCAR MAYER

**SKINLESS WIENERS**

**\$1.58**

REGULAR OR BEEF

1-LB. PKG.

OSCAR MAYER

**SLICED BOLOGNA**

**\$1.48**

REGULAR OR BEEF

12-OZ. PKG.

CLAUSSSEN PICKLES

**PICKLES**

**\$1.18**



QT. JAR

ALLGOOD BRAND

**HOT DOGS**

**88¢**

12-OZ. PKG.

CAROLINA PRIDE

**SLICED BOLOGNA**

**88¢**

12-OZ. PKG.



**HURRY! FINAL WEEK TO COMPLETE YOUR SET!**  
**Hearthside Garden Festival**

**HANDPAINTED STONEWARE GOES OFF SALE SATURDAY AUGUST 4th**

**ADVERTISED ITEM POLICY**

Each of these advertised items is required to be readily available for sale at or below the advertised price in each A&P Store, except as specifically noted in this ad.

PRICES GOOD THROUGH SAT., AUG. 4 IN ALL A&P STORES IN NORTH CAROLINA & SOUTH CAROLINA EXCEPT AIKEN & BEAUFORT

REGULAR · UNSCENTED · SUPER HOLD

**AQUA NET**

HAIR SPRAY **88¢**

10-OZ CAN

**BRUT 33**

SPLASH ON LOTION **\$1.88**

7-OZ BOT

TABLETOP

**PICNIC GRILL**

EACH ONLY **\$1.88**

VINYL

**PLAYBALLS**

9 1/2" SIZE EACH ONLY **88¢**

MULTICOLOR ALUMINUM CHAIR

FLAT ARM **\$5.88**

EA. ONLY

MULTICOLOR ALUMINUM CHAISE LOUNGE

**\$10.88**

EA.

**OIL OF OLAY**

LOTION **\$2.88**

4-OZ. BOT.

MENNEN

**SPEED STICK**

DEODORANT **88¢**

2.5 OZ. SIZE

COFFEE FILTERS

**MR. COFFEE**

2 50-CT. PKGS. **88¢**

**ECONOMY CORNER**

ECONOMY CORNER

**STRAWBERRY PRESERVES**

2-LB. JAR **85¢**

**GOOD PRODUCTS**

**LOWEST PRICES**

ECONOMY CORNER

**DRY DOG FOOD**

25-LB. BAG **\$2.99**

ECONOMY CORNER

**PEANUT BUTTER**

28-OZ. JAR **\$1.29**

- ECONOMY CORNER **MACARONI AND CHEESE DINNER** 7 1/4-OZ. PKG. **23¢**
- ECONOMY CORNER CUT **GREEN BEANS** 15 1/2-OZ. CAN **29¢**
- ECONOMY CORNER **SWEET PEAS** 16 1/2-OZ. CAN **29¢**
- ECONOMY CORNER **SLICED BEETS** 16-OZ. CAN **29¢**
- ECONOMY CORNER **TOMATOES** 16-OZ. CAN **31¢**
- ECONOMY CORNER **DRY ROASTED PEANUTS** 12-OZ. JAR **89¢**

- ECONOMY CORNER CANNED **DOG FOOD BEEF FLAVOR** 15 1/2-OZ. CAN **17¢**
- ECONOMY CORNER DRY LAUNDRY **DETERGENT** 49-OZ. PKG. **99¢**
- ECONOMY CORNER LIQUID DISH **DETERGENT** 32-OZ. BOTTLE **45¢**
- ECONOMY CORNER **TRASH BAGS** 20-CT. PKG. **\$1.39**
- ECONOMY CORNER **FACIAL TISSUE** 200-CT. PKG. **45¢**
- ECONOMY CORNER **PAPER TOWELS** BIG ROLL **49¢**

- ECONOMY CORNER **GRAPE JELLY** 32-OZ. JAR **65¢**
- ECONOMY CORNER **TOMATO KETCHUP** 14-OZ. BOT. **37¢**
- ECONOMY CORNER **LIQUID BLEACH** 128-OZ. BOT. **57¢**
- ECONOMY CORNER **FABRIC SOFTENER** 128-OZ. BOT. **79¢**
- ECONOMY CORNER **PAPER NAPKINS** 140-CT. PKG. **47¢**
- ECONOMY CORNER **BATHROOM TISSUE** 4-ROLL PKG. **69¢**

ITEMS OFFERED FOR SALE NOT AVAILABLE TO OTHER RETAIL DEALERS OR WHOLESALERS.



# BACK TO SCHOOL



## TEXAS INSTRUMENTS INCORPORATED



### THE LITTLE PROFESSOR™ – for kids 5 and up.

- 16,000 math problems
- Four levels of difficulty.
- Addition, subtraction, multiplication, or division.
- "The Little Professor"™ asks the questions, the child keys the answer.
- If the correct answer is not given in three tries "The Little Professor"™ will display the correct answer.
- Automatic scoring
- Activity Book



Suggested Retail \$15.00  
**NOW ONLY \$11.99**

### FIRST WATCH™

– new concept for helping boys & girls learn to tell time.

- TI Digital Watch
- "Hands of Time" Learning Dial Facilitates learning to read time on any kind of clock or watch.
- "How To Tell Time Both Ways" book.



Suggested Retail \$16.95  
**NOW ONLY \$14.99**

### DATAMAN™ – for kids 7 and up.

- Provides exciting practice drills and games:

**ANSWER CHECKER  
ELECTRO FLASH  
MISSING NUMBER  
NUMBER GUESSER**



Suggested Retail \$22.00  
**NOW ONLY \$18.99**

#### WIPE OUT:

A stadium-type scoreboard light show signals top scores. The better the score, the bigger the light show.

- 24-page activity book
- Memory bank for quizzes you design yourself.
- Battery-saver feature.
- Large, vacuum fluorescent display.

### TI-30 STUDENT MATH KIT

- 224-page "Great International Math on Keys" book.
- TI-30 slide-rule calculator.
- Carrying Case
- Functions . . . percent, parentheses, constant, roots, powers, reciprocals, logarithms, degree/radan modes, and trigonometric functions.
- Memory • Automatic on/off
- Scientific • 8-digit LED readout. notation



Suggested Retail \$22.00  
**NOW ONLY \$14.99**

### LADIES WATCHES

Beautiful, Compact, Lightweight.  
New LCD Quartz digital watches for women.



- Liquid crystal display shows time continuously.
- 5-functions (hours, minutes, seconds, month, date)
- Calendar automatically adjusts for short & long months.
- No moving parts – never needs cleaning or winding.
- Years of dependable service.

TI-651-10 BLACK  
TI-651-20 BROWN

Suggested Retail \$19.95  
**SALE PRICED AT \$15.99**

### MEN AND BOYS WATCHES



TI-552-10 BLACK  
TI-552-20 BROWN

- Rugged watch for an active lifestyle
- Remarkable precision, durability and quality for the money
- 5-function (hours, minutes, seconds, month, date)

Suggested Retail \$14.95  
**SALE PRICED AT \$12.99**



TI-526-10  
BLACK WITH  
METALLIC  
OVERLAY



Suggested Retail \$12.95  
**SALE PRICED AT \$7.99**

### PORTABLE ELECTRONIC CALCULATOR

- 5-function calculator – Adds, Subtracts, Multiplies, Divides and Percent Key.
- Ideal for shopping



TI-1000  
Suggested Retail \$10.00  
**SALE PRICED AT \$6.99**

### PORTABLE ELECTRONIC CALCULATOR WITH MEMORY

- 5-function calculator plus memory – Adds, Subtracts, Multiplies, Divides, Automatic constant and Percent Key.
- 4-key memory.
- Easy-to-read green display



TI-1025  
Suggested Retail \$12.00  
**SALE PRICED AT \$9.99**

ALL CALCULATORS USE 9 VOLT BATTERY (NOT INCLUDED)

# A&P's SUMMERTIME THE FARM 88¢ SALE!



Where do you go for the freshest fruits and vegetables? To the farm, of course. So A&P brings The Farm to you.

Somewhere in the world, it's harvest time. And that's exactly where A&P's eagle-eyed produce buyers are right now—gathering the pick of the crop and getting it rushed to The Farm in your nearby A&P store.

Their demanding standards and their ability to buy in large quantities means you get exceptional value whenever you buy produce at A&P.

So come take a fresh look at The Farm at A&P and get to know the Farm Manager. He's so proud of his fine fruits and vegetables, you'd think he grew them all himself! And he'll help you find exactly what you need to be equally proud when you serve it to your family!

**ADVERTISED  
ITEM POLICY**

Each of these advertised items is required to be readily available for sale at or below the advertised price in each A&P Store, except as specifically noted in this ad.

JUICY THOMPSON SEEDLESS

## GRAPES

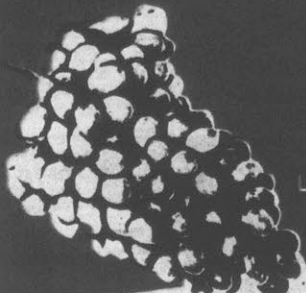

LB **88¢**

SPECIALLY SELECTED FOR OUTSTANDING QUALITY

## YELLOW CORN



BULK UNTRIMMED  
8 LARGE EARS ONLY **88¢**

FOR OUR FEATHERED FRIENDS

### BIRD SEED

5-LB. BAG **88¢**

COUNTRY STAND FRESH WHITE

### MUSHROOMS



8-OZ. BOX **88¢**

EASTERN WHITE

### POTATOES

U.S. #1 ALL PURPOSE

5 LB. BAG **88¢**

BEAUTIFUL—FULL BLOOM

### VIOLETS



3 INCH POT **88¢**

A&P BRAND

### PEANUTS

SALTED IN SHELL 12-OZ. BAG **88¢**

FRESH CRISP

### CUCUMBERS

OR GREEN PEPPERS

4 FOR ONLY **88¢**

JUICY RED

## PLUMS

2 **88¢**

LBS

GOLDEN RIPE

## BANANAS

4 **\$1.00**

LBS ONLY

FRESH CRISP

## ROMAINE LETTUCE

2 **88¢**

LARGE BUNCHES

PRICES GOOD THROUGH SAT., AUG. 4 IN ALL A&P STORES IN NORTH CAROLINA AND SOUTH CAROLINA EXCEPT AIKEN & BEAUFORT, S.C. ITEMS OFFERED FOR SALE NOT AVAILABLE TO OTHER RETAIL DEALERS OR WHOLESALERS.

SALE STARTS AUGUST 1st... SALE ENDS AUGUST 4th

# Back to School

THAT WON'T LET YOU SHOP ANYWHERE ELSE ...



# Savings

Due to the nature of certain purchase of merchandise ... we will be unable to issue RAINCHECKS since there will not be any merchandise available to reorder. These items will carry a No Raincheck notation.

**Men's Famous Name Jeans At A Super Value**

**888**  
PAIR

The name has been removed but you'll recognize the outstanding quality. 100% cotton denim jeans for men in sizes 28 to 38 in blue. Priced so fantastic, you'll want several pair.

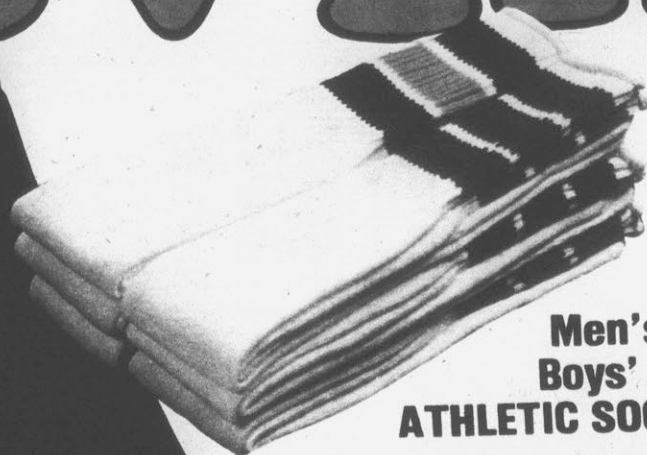

**Men's or Boys' ... ATHLETIC SOCKS**

6 PAIRS TO EACH PACK

Orlon® Acrylic and Nylon Athletic Socks for active men and boys. White with color trim. Boys' sizes 6-8½ and 8-11. Men's size 9-14. 6 pairs to a package.

**477**  
PACK  
REG. TO 5.77 PACK



**Unisonic**  
Model LC-110

**Unisonic® Pocket Calculator**

Unisonic® pocket size calculator is the tiny unit that does big things. Has 8 digit readout, electronic memory with automatic shut-off, carry case and more.

**1288**



**Canvas Totes in Several Styles**

Large canvas tote bags in navy, black, tan or brown. Several styles with lots of pockets, zipper pouches and easy grip handles.

**297**  
EACH



**4-Ounce Sure Spray**

Regular and unscented 4-oz. (net wt.) Sure anti-perspirant or deodorant. **97¢** EA. LIMITS NO RAIN CHECK



**8-Oz. Final Net Non-Aerosol Hair Spray**

**147**  
REG. 1.87

Non-aerosol Final Net Hair Spray in 8 fl. oz. pump bottle. Concentrated formula for longer lasting hold. Regular and Ultra-Hold formulas. LIMIT 2

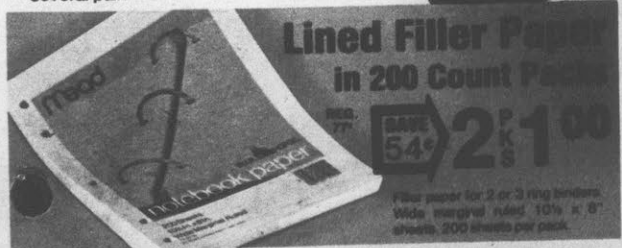

**Lined Filler Paper in 200 Count Packs**

**2100**  
REG. 77 **SAVE 54¢**

Filler paper for 2 or 3 ring binders. Wide marginal ruled 10½ x 8" sheets. 200 sheets per pack.



**G.E.® Folding Handle Dryer**

**1588**  
REG. 17.97 SAVE 2.09

Compact 1200 watt pistol style dryer with folding handle. Has 4 heat/speed settings. Includes concentrator attachment.

**MULTIPLY YOUR OPTIONS  
HOODED, BELTED, POCKETED  
FASHIONS THAT GIVE YOU  
FASHIONABLE SAVINGS**

REG.  
34.97

**29<sup>97</sup>**  
EACH

**RAIN COATS . . .  
Great Looking Over All  
In Jr. and Misses Sizes**

Rain coats with the style, flare and quality you'd expect to pay a lot more for. Choose from our assortment of trench and streamer styles with eye-catching details. Made of easy-care polyester and cotton poplin. Sizes 5 to 15 and 6 to 16.



REG.  
20.97

**17<sup>97</sup>**  
EACH

Look good . . . Feel good . . . in campus leaders specially designed for junior sizes 3 to 13. Printed dresses with color matching vest in a collection of styles that let you know you'll always look your best. Plus the poly/cotton blend assures you of care-free comfort all day long.



**THE JUNIOR SCENE ...**

**CAMPUS COLLECTIONS THAT**

**SAVE YOU MONEY**

**Back-to-School Basics for the**

**Good Times of Fall . . . The**

**Mix-and-Match-Ability is Perfect . . .**

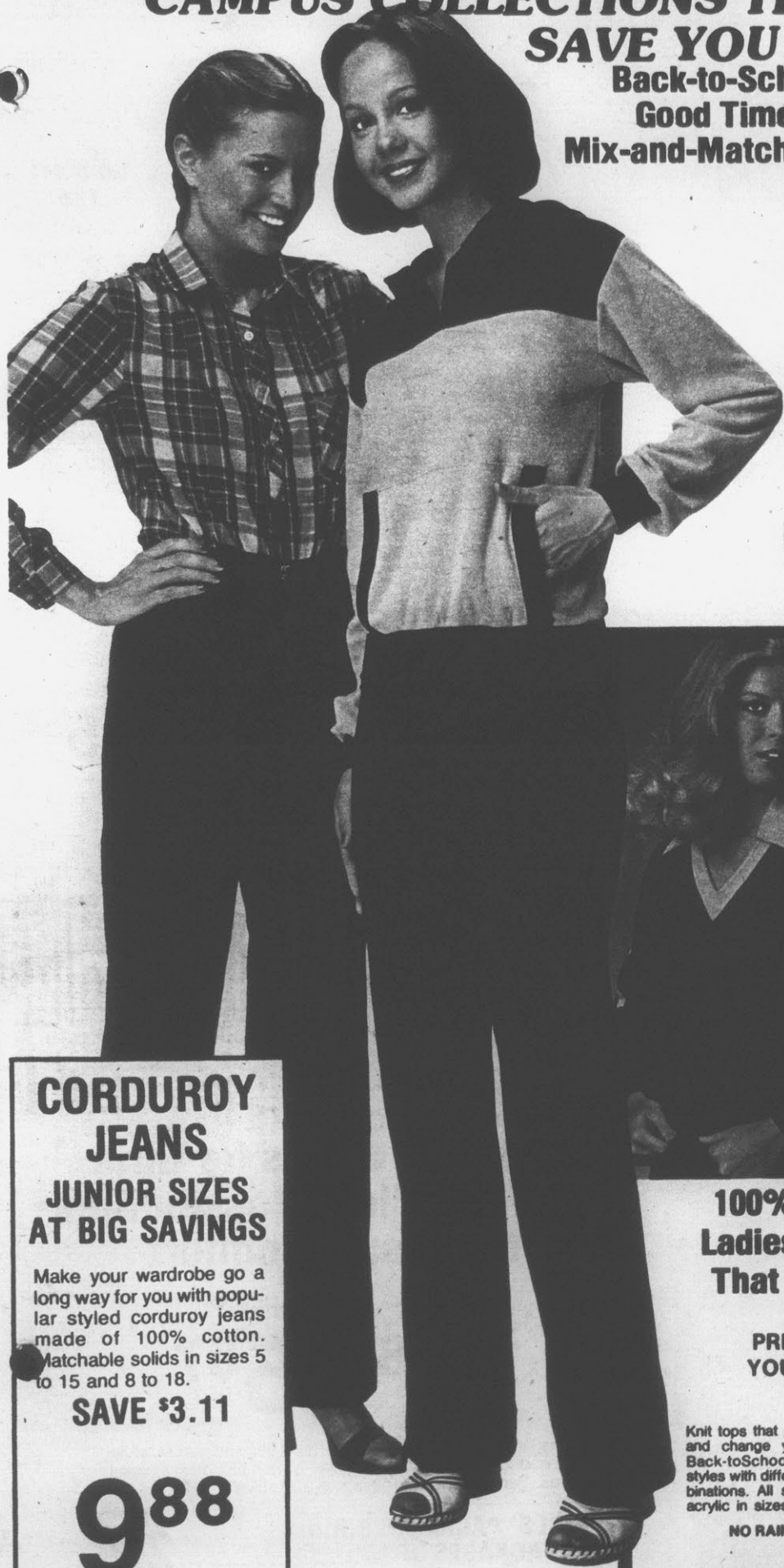

**JR. BLOUSES**

Long sleeve blouses for multiple matchability. Styled with round collar and four button front. Cotton and polyester blend in sizes small to large

**7<sup>44</sup>**  
REG. 8.99

**DENIM JEANS**

Priced just right for your Back-to-School Budget. All styles made for great versatility. 100% cotton in sizes 5 to 15 and 8 to 18. Belt not included.

**9<sup>88</sup>**  
REG. 12.99

**JR. TERRY TOPS**

Popular terry knit tops are just the thing this year whether you're on or off campus. Hooded styles with pouch pockets. Great colors in sizes small to large.

**9<sup>44</sup>**  
REG. 10.99



**CORDUROY JEANS**

**JUNIOR SIZES AT BIG SAVINGS**

Make your wardrobe go a long way for you with popular styled corduroy jeans made of 100% cotton. Matchable solids in sizes 5 to 15 and 8 to 18.

**SAVE \$3.11**

**9<sup>88</sup>**

**100% Acrylic Tops for Ladies . . . New Arrivals That Fit Your Style . . .**

**PRICED SO FANTASTIC! YOU'LL WANT SEVERAL!**

Knit tops that provide the mix and change you'll need for Back-to-School. Separate styles with different color combinations. All styles of 100% acrylic in sizes small to large.

**NO RAIN CHECK**

**5<sup>88</sup>**  
EACH

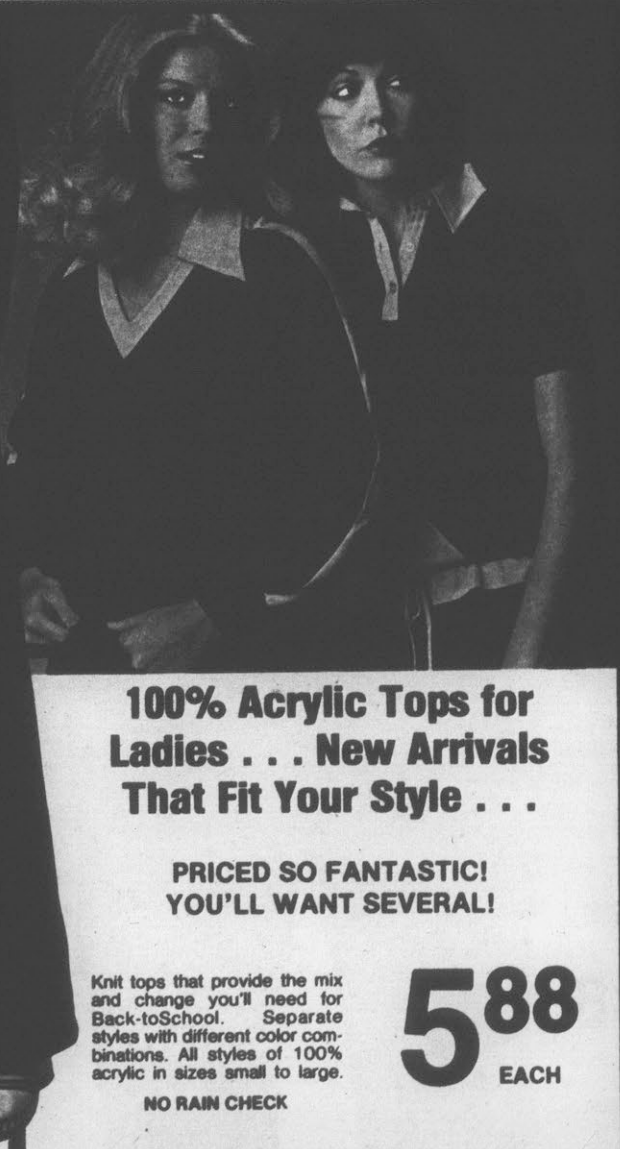

7-14 KNOT TOPS **4<sup>34</sup>** REG. 6.47

7-14 CASEROSE SLACKS **6<sup>48</sup>** REG. 8.48

Start her off right with fashion's one's look and feel good in. Short sleeve V-neck Tops of brushed poly/cotton stripes. Banded bottom and sleeve. Caserose Slacks are of textured polyester. Straight legs in several styles and colors. Both in sizes 7 to 14.

# NEW DIRECTIONS FROM NECESSITIES TO ACCESSORIES ... THAT LET YOU POCKET THE SAVINGS



**Ladies LCD Watches**  
... In Several Styles

Ladies LCD quartz watches in gold or silvertone. Lovely mesh bands for today's appeal. Features time, month, date, seconds and lighted dial.

Men's or Ladies

**17<sup>88</sup>** EACH



**Clutch or Shoulder Style Handbags ...**  
For Ladies of All Ages

Six styles on handbags for ladies of all ages. Choose clutches and shoulder bags of vinyl and canvas. Many fall colors to compliment your wardrobe.

**3<sup>88</sup>** EACH

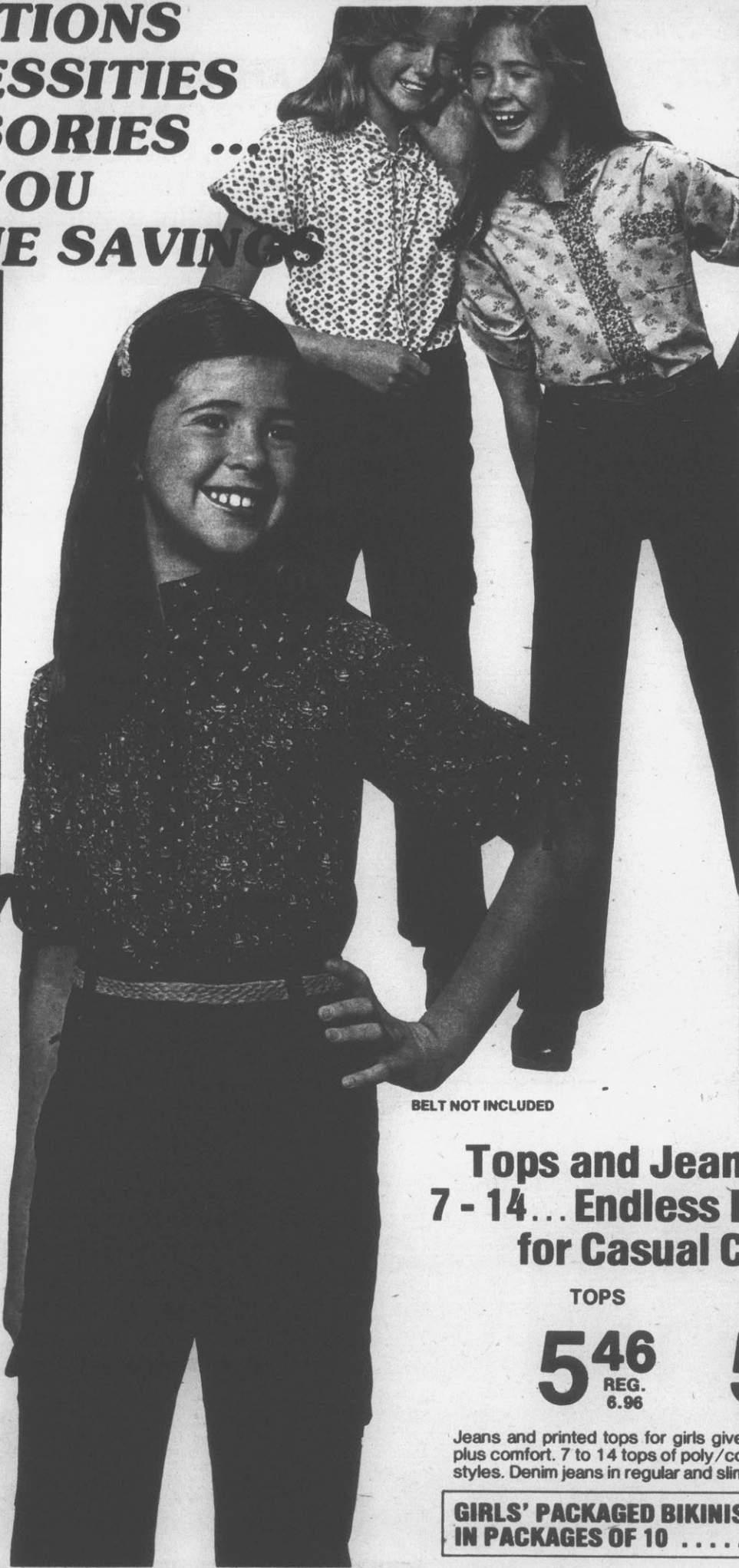

BELT NOT INCLUDED



**Pom-Pom Sneaker Socks**

**88¢**

Ladies pom sneaker sock in sizes medium and large. White sock with colored pom.



**Comfort Top Knee-Hi's**

**4 FOR \$1**

Pack of four, sandal foot knee-hi's in popular shades. One size.



**Multi-Purpose Organizer Bag**

Ladies' vinyl organizer shoulder bag has multi-pockets and zipper compartments. Several solid colors. NO RAIN CHECK

**5<sup>88</sup>** EACH



**Knee-Hi Socks or Ladies Panty Hose**

Colorful knee-hi socks in solid and stripe colors. Sizes 8-8 1/2 and 9-11. Ladies first quality panty hose of 100% nylon. One size in several colors.

**2<sup>99</sup>** S

## Tops and Jeans for Girls 7 - 14... Endless Possibilities for Casual Comfort

TOPS

**5<sup>46</sup>**  
REG. 6.96

JEANS

**5<sup>87</sup>**  
REG. 7.87

Jeans and printed tops for girls give your little miss style plus comfort. 7 to 14 tops of poly/cotton blends in several styles. Denim jeans in regular and slim sizes 7 to 14.

**GIRLS' PACKAGED BIKINIS**  
IN PACKAGES OF 10 ..... **2<sup>99</sup>** PK.

**MAN SIZE QUALITY  
FOR DRESS OR SPORT AT  
SAVINGS ... YOU CAN'T  
AFFORD NOT TO BUY**

**Men's 100% Cotton Denim Jeans  
and Western Shirts . . .**

**The Answer to  
Your Active Times**

**MEN'S WESTERN SHIRT**

Western shirts styled to put you on top of any fashion scene. Designed with full snap front and snap button pockets. Vibrant plaids in polyester and cotton blend.

REG. 8.99 **788**  
EACH

**MEN'S JEANS**

Fashion jeans made by Rump®. Traditionally styled with contrasting stitching and unique pocket treatments. All styles made of 100% cotton for comfort. Sizes 29 to 38 in blue only.

REG. 9.88 **888**  
PAIR

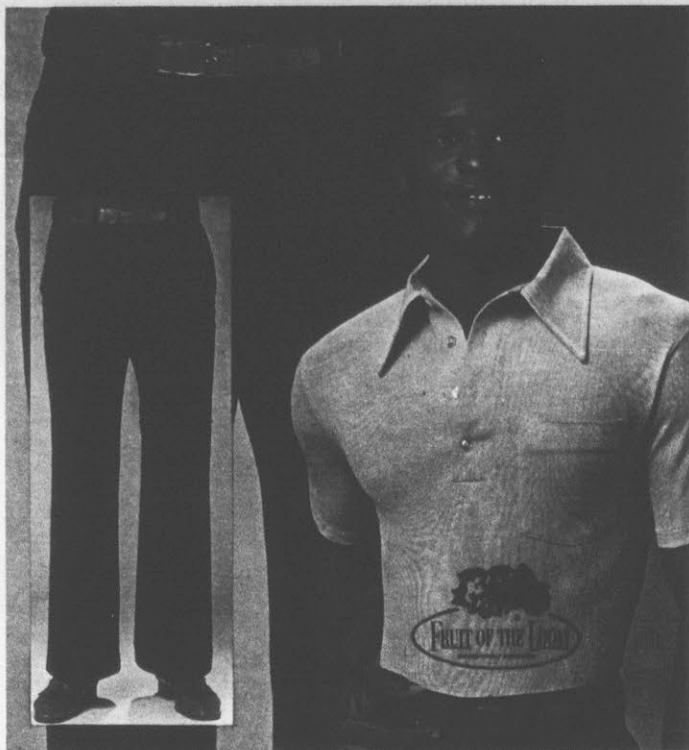

**Poly/Cotton Knit Shirts and  
Belted Slacks for Men . . .  
The Leisure Look Goes Full Force**

**MEN'S KNIT SHIRT**

Lacoste knit shirts from Fruit-of-the-Loom®. Four button placket front styling with front pocket and pointed collar. Short sleeve styling in poly/cotton blend. Sizes S to XL.

REG. 5.99 **488**  
EACH

**MEN'S BELTED SLACKS**

Neat, crisp looking slacks complete with matching belt. Slightly-flare leg styling in polyester and cotton blend. Navy, brown, blue, or tan in sizes 30 to 42.

REG. 13.97 **1188**  
PAIR

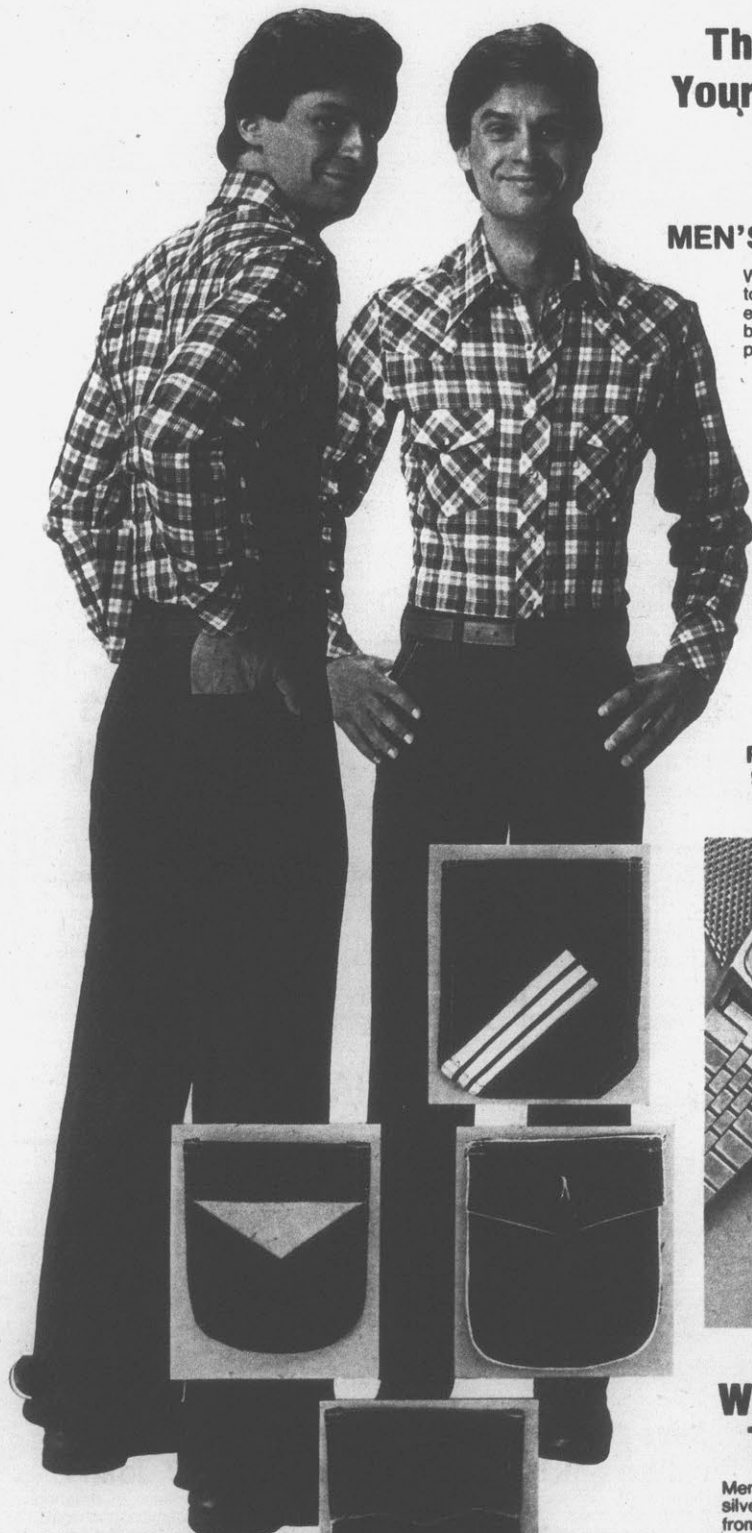

**A POCKET  
TO FIT YOUR  
FANCY**

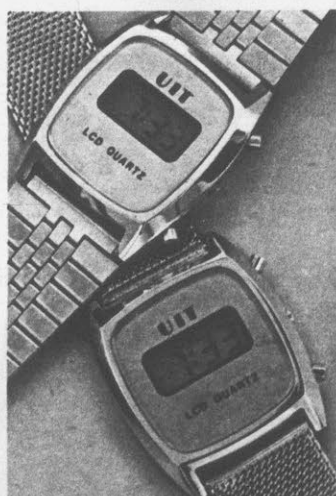

**Men's LCD  
Watches Give the  
Time Instantly**

Men's quartz LCD watches in gold and silver-tone. Attractive styles to choose from. Gives time, month, day, seconds and has back-up light.

**1788**  
EACH



**Men's Nylon  
Jacket with 100%  
Cotton Lining**

Men's nylon snap front jacket with side pockets. 100% cotton lining provides extra warmth without bulk. Sizes S - XL in several solid colors.

REG. 8.97 **688**  
EACH



**Men's Pull-over  
Knit Shirt with  
Open Front**

Men's pull-over short sleeve shirt with open front. Poly/cotton blend in sizes small to extra large. Colors: midnight, natural, broom straw and brown.

**788**  
EACH

# THE ABC'S OF BOYS' FASHIONS THAT GET MOM'S DOLLAR SAVINGS STAMP OF APPROVAL

Rugged  
Boys . . .  
**JEANS  
OF 100%  
COTTON**



**SAVINGS  
YOU CAN POCKET!**

**788**  
PAIR

Rump® jeans for boys, sizes 8 to 18. Styles with eye-catching back pocket designs. All pre-washed for softness; 100% cotton for comfort.



## Poly/Cotton Western Sport Shirts for Boys 8 - 18

Priced to Give You a  
Pocketful of Savings

Neat looking western styled sport shirts for boys, sizes 8 to 18. Designed with printed yoke and solid shambre body. Poly/cotton blend for total comfort and easy care.

**499**  
EACH



**CHARGE IT!**



**Matchables**  
for school  
. . . Made to take  
the tough wear  
he'll give them

## Western Shirt

Western sport shirts for junior boys styled just like the big boys. Printed yoke with solid shambre body. Poly/cotton blend in sizes 4 to 7.

**388**  
EACH  
REG. 4.44

## Fashion Jeans

Denim jeans made tough to take lots of wear. Poly/cotton blend in a choice of several styles. Sizes range from 4 to 7.

**599**  
PAIR

## Boys 8 - 18 JEANS

**488**  
PAIR

Traditionally styled boys jeans in sizes 8 to 18. Solid color or polyester and cotton blend in denims, twills or brushed styles. Choice of colors.

**SPECIAL PRICE**

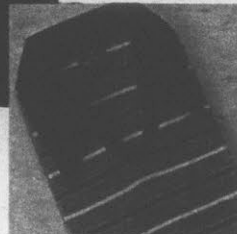

## Boys Pull- over Shirts

Short-sleeve stripe design with pointed collar. Polyester and cotton blend in boys sizes 8 to 18.

REG. 3.99  
**347**  
EACH



## Boys 8 - 18 Western Shirts

Western print broadcloth sport shirts for boys. Sizes 8 to 18 in several colorful print patterns. Poly/cotton blend.

**588**  
EACH



## Boys Nylon Football Shirts

100% nylon mesh football jerseys in sizes 8 to 18 for boys. Has team name and numbers on jersey. Several colors.

REG. 4.99  
**397**  
EACH



## Jr. Boys 4 - 7 Jeans

Jr. Boys jeans in brushed denims, denims and twills. Sizes 4 to 7 in solid colors. Easy care blends wear comfortably.

**388**  
EACH

# PACE SETTING FOOTWEAR

## Men's, Boys' and Youths' Low-Top Boots of Suede

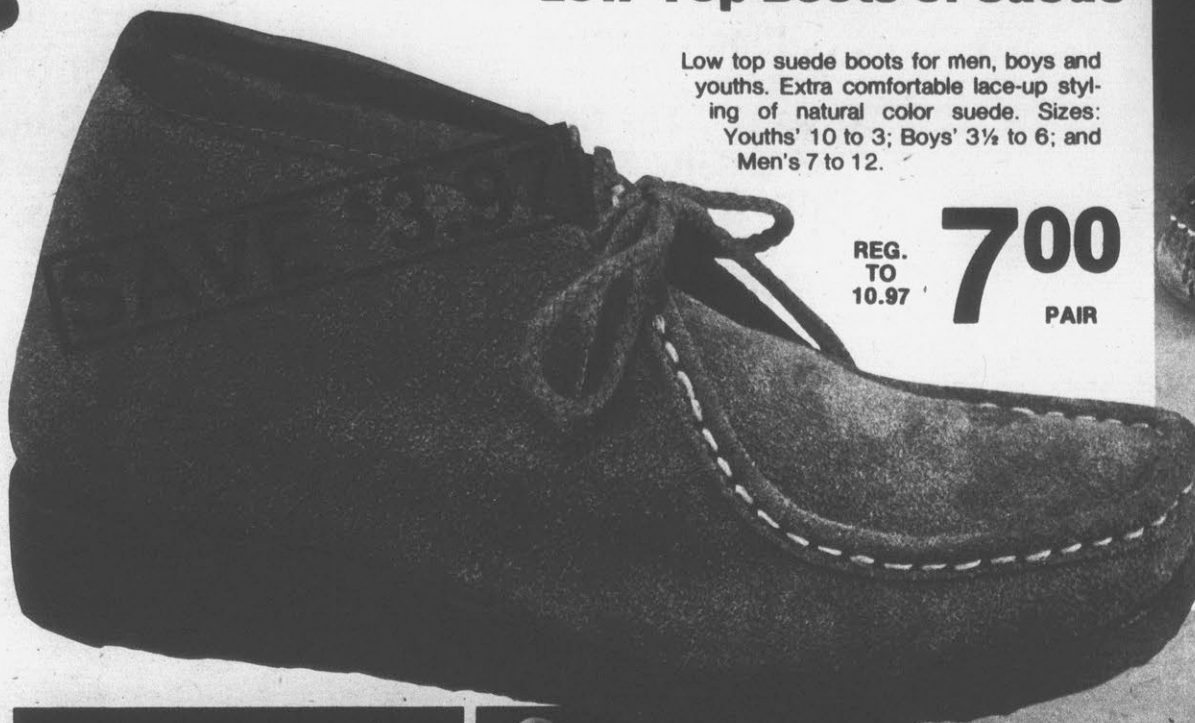

Low top suede boots for men, boys and youths. Extra comfortable lace-up styling of natural color suede. Sizes: Youths' 10 to 3; Boys' 3½ to 6; and Men's 7 to 12.

REG.  
TO  
10.97

**7.00**  
PAIR

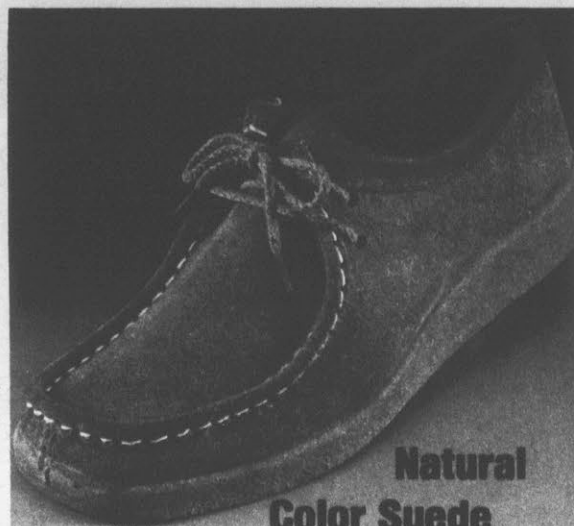

Natural  
Color Suede

Lace-Up Oxfords for Ladies

SAVE 2.97

**6.00**  
REG.  
8.97

Casual styled suede oxfords for ladies that are terrific for school, work or everyday wear. Lace-up style of natural color suede. Sizes 6 to 10.



Lace-Up  
Basketball Shoes

Lace-up basketball shoes with canvas uppers and acid resistant soles. Sizes: Youths' 10½ to 2; Boys' 2½ to 6; and Men's 7 to 12. Carolina Blue or Navy.

**3.66**  
REG.  
4.97

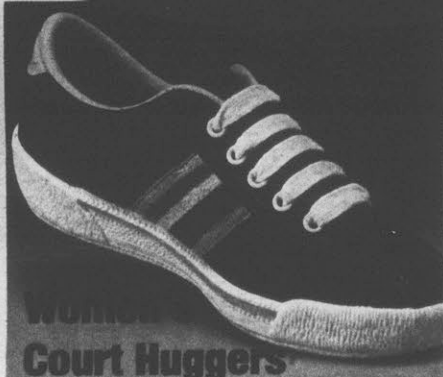

Women's  
Court Huggers

Rugged Court Huggers for ladies that feature multi-color stripes and contrasting stitching. Sizes 5 to 10 in white or navy with stripes.

**4.44**  
REG.  
5.97

Rugged Nylon Joggers  
for Ladies with  
Sporty Stripe Trim

SAVE 2.53

**5.44**  
REG.  
7.97

Ladies' joggers that are styled for active feet. Has kick up toe and heel for added durability. Made of lightweight nylon with stripe trim. Sizes 5 to 10 in beige.



Two Styles of Ladies' Fashionable  
High Stepping Sandals

You'll be sure to step in style with these fashionable sandals. Quarter strap sandal is a combination of polyurethane and suede. Sizes 5½ to 10 in wine or black. High heel polyurethane sandal in sizes 6 to 10 in wine or camel. Both colors at most Roses stores.

SAVE  
TO  
4.20

**8.77**  
REG. TO  
12.97

ROSES

# AFFORDABLE ADDITIONS TO FAMOUS BRANDS AT UNHEARD OF PRICES ... BACK TO SCHOOL

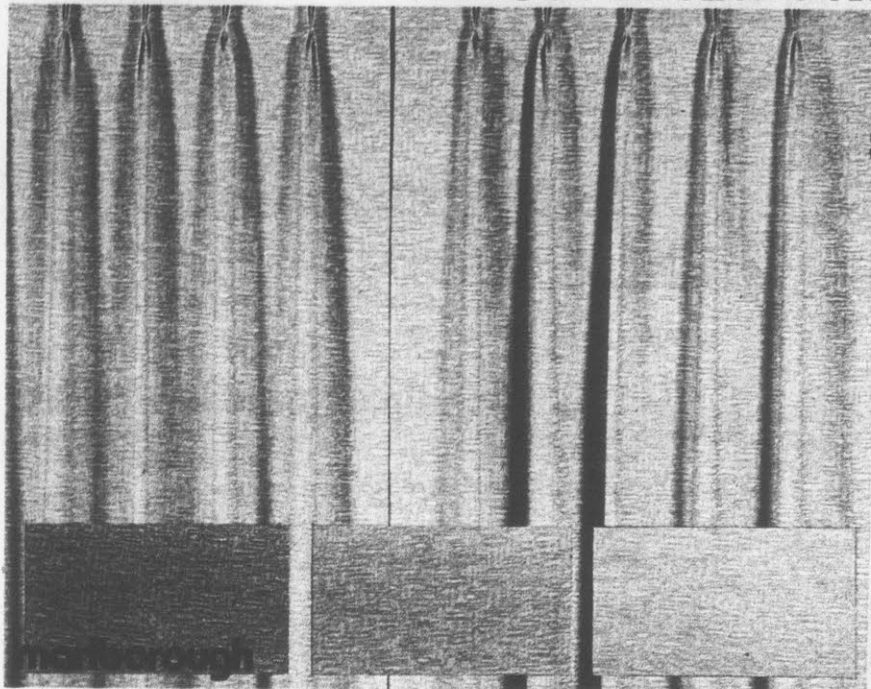

... Pinch Pleated  
Drapes in Two  
Sizes ... The Best  
of Quality at a  
Price You Would  
Expect to Pay  
More For ...

63"  
REG. 11.47  
SAVE 2.00

9<sup>47</sup>

84"  
REG. 13.47  
SAVE 2.00

11<sup>47</sup>

Rich, nubby textured with foam back.  
Superb quality Livingston Drapes in  
50 x 63" or 50 x 84" sizes. Cotton and  
polyester blend in beige, lettuce, wedg-  
ewood or nugget colors.

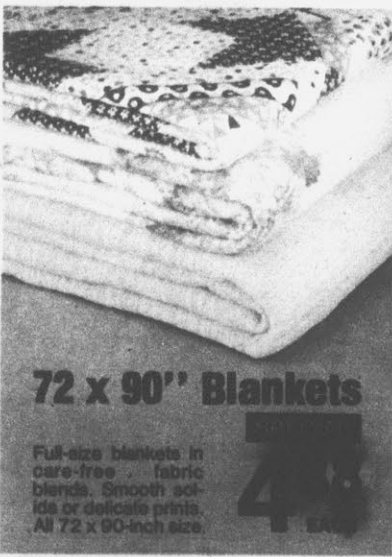

72 x 90" Blankets

Full-size blankets in  
care-free fabric  
blends. Smooth soli-  
ds or delicate prints.  
All 72 x 90-inch size.

4<sup>47</sup>



... 100%  
Nylon  
Tweed  
Room Size  
Rug

SPECIAL PRICE 23<sup>88</sup>

Features sure grip waffle rubber back  
for safety. Covers almost 100 sq. ft. of  
floor space. Measures 8½ x 11½ ft.

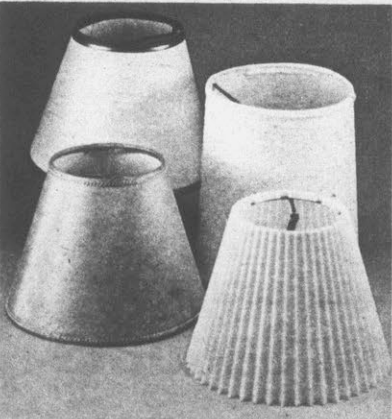

BOUDOIR SHADES

REG.  
1.47

SAVE 47¢ 1<sup>00</sup>

Large selection of boudoir shades in a collection of styles, fabrics, designs and colors to fit any decor.

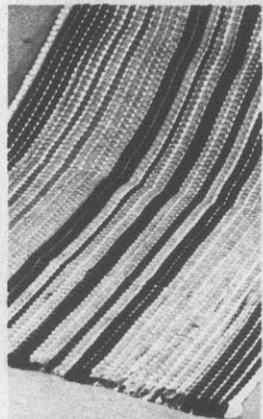

MULTI-COLOR RUG

SPECIAL PRICE 1<sup>00</sup>

Colorweave utility rug, useful in any room. Reversible and machine washable. Approximate size 21 x 36-inches.



CHAIR PADS

REG. 1.77 SAVE 50¢ 1<sup>27</sup>

Cotton Hopsack filled with solid foam. Americana print in gold, green or red. Measures 16 x 14 x 1-inches.

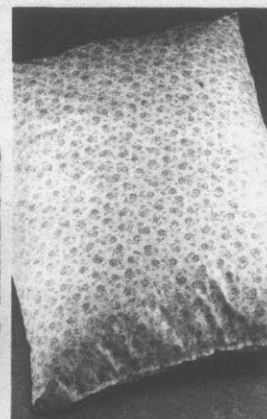

BED PILLOW

REG. 1.88 EACH SAVE 38¢ 2<sup>50</sup> OR 3<sup>00</sup>

Odorless bed pillows foam filled for softness and printed outer coverings. Measures 18 x 26-inches.



POLY FIBER

SPECIAL PRICE 1<sup>00</sup> EACH

100% polyester fiber in 16-oz. (net wt.) bags. Ideal for stuffing toys, pillows, and other crafts. White.



SELF-ADHESIVE

REG. 1.27 SAVE 27¢ 1<sup>00</sup>

Easy-on-Brand self-adhesive plastic in 3-yard x 18-inch rolls. Choose clear, black or assorted colors.

# THROUGHOUT YOUR HOME

HOOL SAVINGS THAT PLEASE EVERYBODY'S POCKET BOOK



Set Comes Complete With It's Own Matching Trash Basket

## "Ultra-Soft" BATH SET ENSEMBLE

Bath set tucked neatly in its own trash basket. All pieces made of ultra soft nylon pile. Set contains tank top, tank cover, lid cover, contour rug, bath mat.

**SPECIAL PRICE 9<sup>97</sup>**



### Matching Bedspread . . . The loveliest of all additions . . .

Elegant full-size bedspread flows richly to the floor. Cotton/poly blend is scattered with delicate blue or gold bouquets with a soft white background. Totally machine washable and permanent press.

**SAVE 4 09**

**21<sup>88</sup>** REG. 25.97

### . . . Poly/Cotton Blend at an Unbeatable Price Per Yard . . .

**66¢** YD.

Polyester and cotton blends in 45-inch widths. Create your own wardrobe in a marvelous selection of rich-looking solids or vibrant prints.

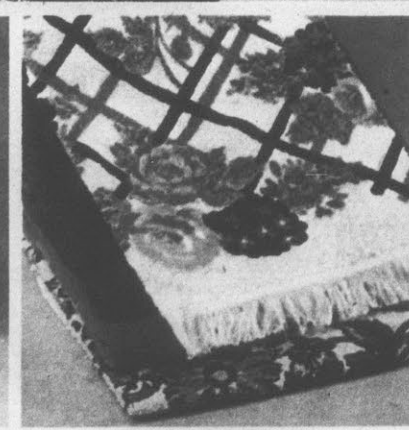
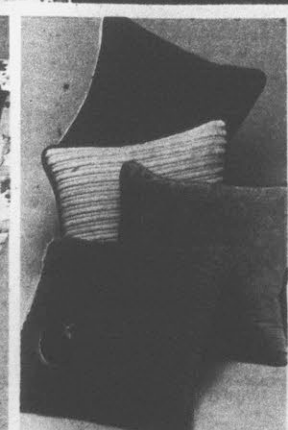
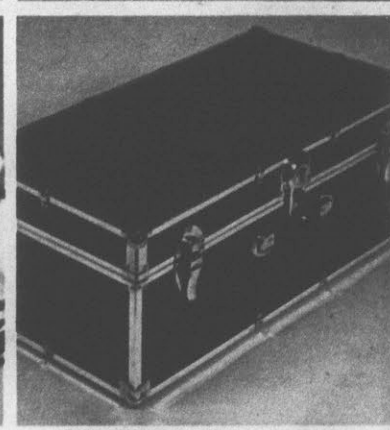

### THROW PILLOWS

**SPECIAL PRICE 2<sup>F</sup> \$5<sup>R</sup>**

Solid, colorful 14-inch pillows in pinwale, medwale, or wide wale corduroy

### FRAMES

**SPECIAL PRICE 1<sup>00</sup> EACH**

All-purpose frames with Thermoplastic Safety Glass. 8 x 10" in green, red, blue, yellow or white frames.

### FRAMED PICTURES

REG. 7.97 **SAVE 2<sup>00</sup> 5<sup>97</sup>**

Beautiful pecan framed pictures under glass. Choose from 12 different subjects, each 16x20".

### BATH TOWELS

**SPECIAL PRICE 2<sup>F</sup> \$3<sup>R</sup>**

Standard size cotton/polyester bath towels with hemmed or fringed ends in solids or prints. Slightly irregular.

### VINYL FOOTLOCKER

REG. 15.97 **SAVE 4<sup>00</sup> 11<sup>97</sup>**

Wood box construction with tongue and groove closures. Brass plated hardware with vinyl covering. Black or blue.



# ENTERTAINMENT SAVINGS THAT YOU NOT ONLY HEAR BUT SEE ...

Home Entertainment Center for Your Listening Pleasure

## \$94

Features AM/FM stereo radio, indicator light, rotary control, headphone jack, stereo 8-track player, full size BSR automatic record changer, speakers and more.



G. E.<sup>®</sup> Black and White Portable Television

REG. 88.00



\$79

G.E.<sup>®</sup> black and white, 12" portable television has 100% solid state chassis, VHF "Pre-Set" fine tuning, daylight bright picture tube, up front controls, built-in antenna and more.



Slim Pocket RADIO 777

Has fingertip tuning and volume controls, telescopic FM antenna, wrist strap and operates on 9-volt battery. NO BAIN CHECK



4-Shelf Metal Room Divider

SPECIAL 777 EACH

Easy to assemble 4-shelf metal room divider. Measures 9 1/2" W x 36" L x 36" H. Decorative and useful. NO BAIN CHECK



Bean Bag Chair for Relaxing

1288 REG. 14.99

Bean bag chair is ideal for bedroom or den. Comes in several colors. Conforms to any shape.

Polaroid



Polaroid's<sup>®</sup> One-Step Camera

SAVE 5.08

2688 REG. 31.96

Polaroid's<sup>®</sup> One Step Camera lets you enjoy fast and simple photography. Just load the camera, aim and shoot. In minutes you'll have a sharp color picture. Capture your favorite moments on the One-Step.

Polaroid

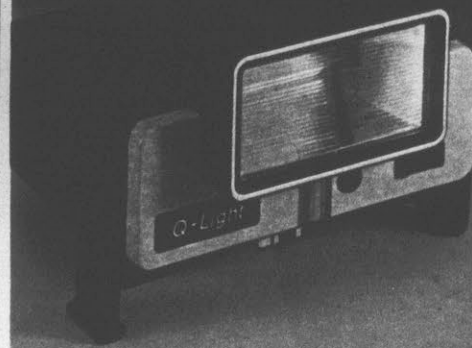

1988 REG. 24.88

Never use a flashbar again. Use Polaroid's<sup>®</sup> Q-Light on the One-Step Camera. Give the correct amount of light each time.



Polaroid<sup>®</sup> SX-70 Instant Color Film

533 REG. 5.97

Polaroid

Polaroid<sup>®</sup> SX-70 color film has 10 exposures to a pack. Easy to use.



G.E.<sup>®</sup> Flashbar

G.E.<sup>®</sup> Flashbar II has 10 flashes to a bar. Improved for better light.



177 REG. 1.97



Eveready<sup>®</sup> Batteries 9 VOLT 99c PK. AA 188

Dependable alkaline Eveready<sup>®</sup> batteries. Choose 1 9-volt or 4 AA size batteries.

### EVERYDAY LOW PRICES ...

C-125	1.99	C-125-35	7.99
C-125-20	4.99	135, 125, 110 (20-exp. slides)	1.91
C-110-12	5.99	Super 8 or Reg. 8 Movies	1.91
C-130-20	4.99	5 x 7 Color Enlargement	1.15
C-135-24	5.99	6 x 10 Color Enlargement	2.40

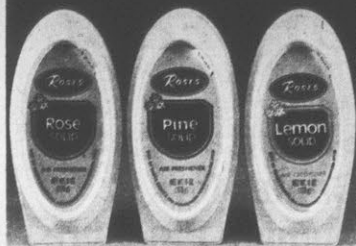

### Solid Air Fresheners

6-oz. (net wt.) Solid Air Fresheners in Rose, Pine, Herbal, Lemon or Powder Room scents.

SAVE 44¢  
**3<sup>F</sup> \$1<sup>R</sup>**  
 REG. 49¢

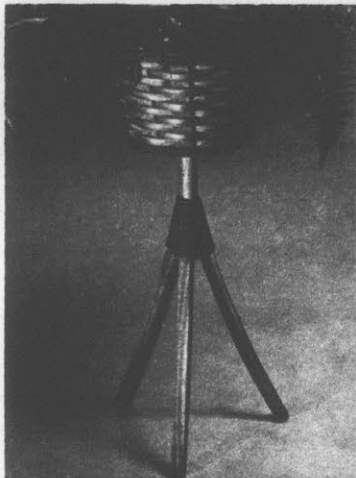

### 28" Tall Planter

Basket on stand is 28-inches tall. Has 10 1/2-inch basket for plants. Gives growing plants room to spread.  
 PLANT NOT INCLUDED

SAVE 100¢  
**3<sup>F</sup> 97**  
 REG. 4.99

BECAUSE QUALITY MEANS SO MUCH  
 WE ALSO LET YOU SAVE!

CLAIROL



## Clairol® Instant Hair Setter Has 3 Size Rollers

Clairol® Instant Hair Setter is safe and easy to use. Set has 20 curlers in 3 sizes. Curlers are designed to hold heat longer. Gives you a lasting hair style in minutes.

**17<sup>F</sup> 76**  
 REG. 21.97  
 SAVE 4.21

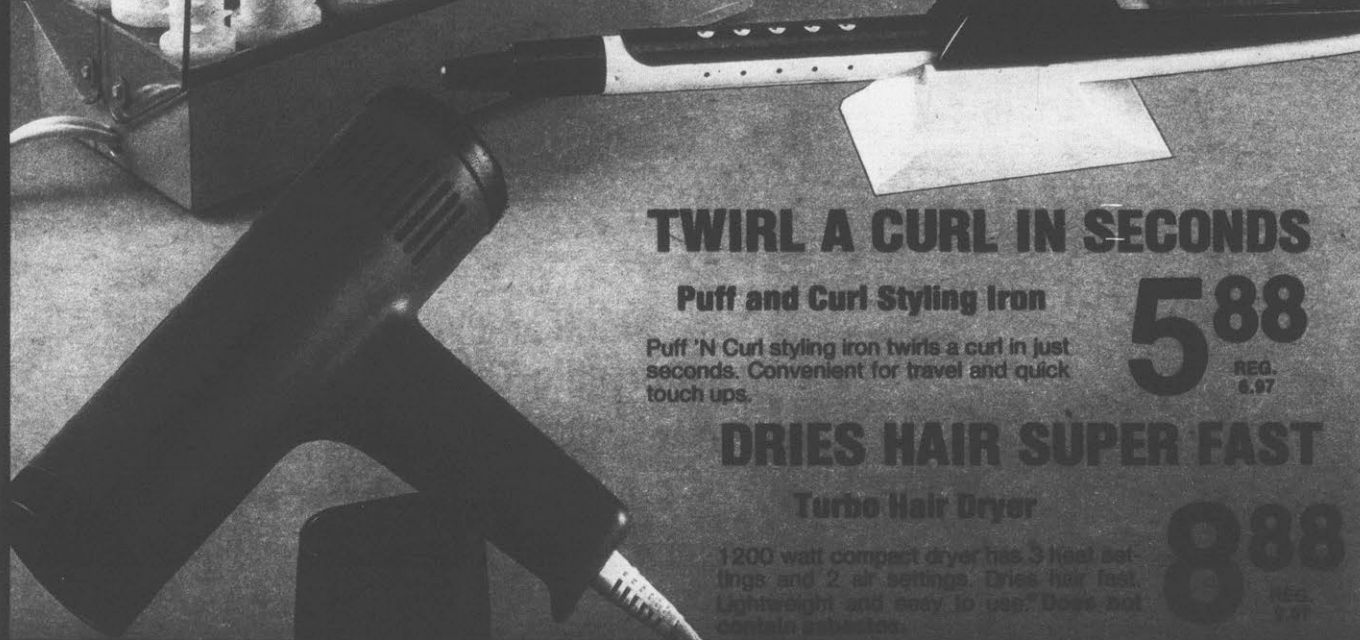

## TWIRL A CURL IN SECONDS

### Puff and Curl Styling Iron

Puff 'N Curl styling iron twirls a curl in just seconds. Convenient for travel and quick touch ups.

**5<sup>F</sup> 88**  
 REG. 6.97

## DRIES HAIR SUPER FAST

### Turbo Hair Dryer

1200 watt compact dryer has 3 heat settings and 2 air settings. Dries hair fast. Lightweight and easy to use. Does not contain asbestos.

**8<sup>F</sup> 88**  
 REG. 11.97

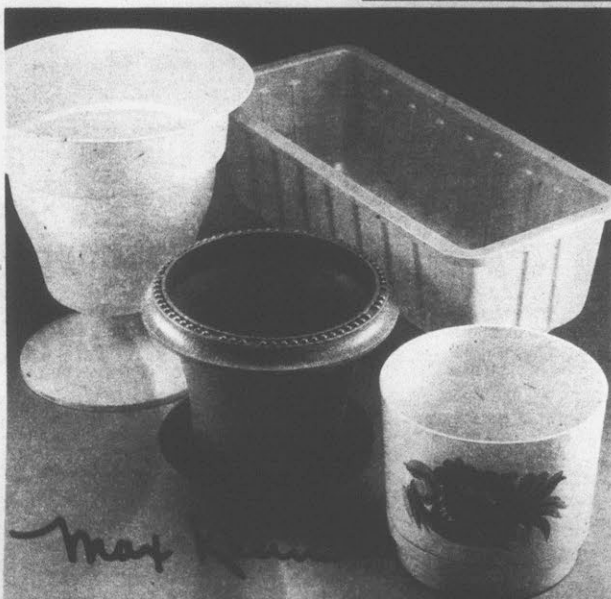

## Decorative Planter Pots In Several Styles

Decorative planter pots in four sizes. Use indoors or looks great on patio or porch. Several styles available for all type plants.

SPECIAL PRICE

**1<sup>F</sup> 77**



## Mirro Cookware Set of Even-Heating Aluminum

7-piece cookware set of even-heating aluminum. Polished exterior with decorative design. Set includes 1, 2, and 4-qt. covered sauce pans and 8-inch fry pan.

SAVE 2.00  
**9<sup>F</sup> 88**  
 REG. 11.88



## Multi-Purpose Selection of Bake-Ware . . . Can Be Used in a Microwave Oven

Jeannette ovenware is versatile and can also be used in a microwave. Choose 1-qt. covered oval casserole, 2-qt. covered oval casserole, 1-qt. round covered casserole, 8-in. sq. cake dish, 4-qt. mixing bowl, 1 1/2-qt. utility dish or 1 1/2-qt. deep loaf pan.

YOUR CHOICE

**2<sup>F</sup> \$3<sup>R</sup>**

LIMIT 2 EACH NO RAIN CHECK

**CLEANERS, ORGANIZERS  
OR PLASTICS...  
SO LITTLE...  
BUYS SO MUCH.**

**Utility Plastics that  
Do So Much for  
So Little Price**

SAVE TO 1.59

**388**  
REG.  
TO  
5.47

Rugged trash cans that are built to last. Choose Avocado 20-gallon trash can, Gold 44-quart swing top bin, or Almond 44-quart lift top bin.



**Handy Household Plastics**

YOUR CHOICE

Useful plastics you'll use every day. Available in several colors. Choose utility tub, dish pan, bowl brush and holder, wastebasket, laundry basket and handled utility pail.

Utility Tub  
Dish Pan  
Wastebasket  
Laundry Basket  
Handled Pail  
Brush & Holder

**\$1** EA.

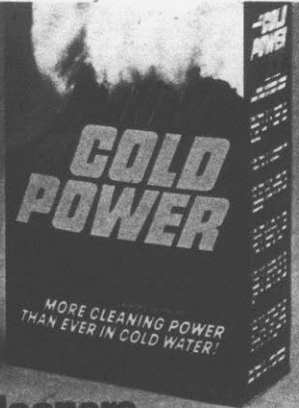

**Laundry Cleaners . . .  
64-Oz. Dynamo or  
84-Oz. Cold Power**

64-fl. oz. Dynamo cleans all fabrics in hot, warm or cold water. 84-ounce (net wt.) Cold Power gives you strong cleaning performance in cold water.

**227**  
EACH

LIMIT 2 EACH NO RAIN CHECK



**Trash Bags or  
Kitchen Bags**

**133**  
REG.  
1.77

Strong and durable plastic bags with self-twist ties. Choose 20 trash bags or 30 kitchen can bags.

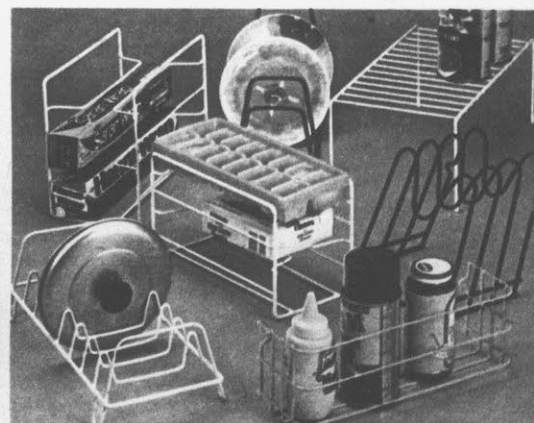

**Space Savers of Heavy  
Duty Vinyl Covered Wire**

Useful organizers of heavy duty vinyl covered wire. Choose cabinet shelf, plate rack, lid rack, wrap rack, paper bag rack, cleaner rack or ice tray rack. Items available in most Ross stores. NO RAIN CHECK

**88¢** EA.

**Bissell**

**Bissell®  
Whisk-it-Broom  
with Removable  
Dust Pan**

**988**  
EACH

Bissell® Whisk-it-Broom comes with removable dust pan that is completely washable. Sectional handle for less bending.

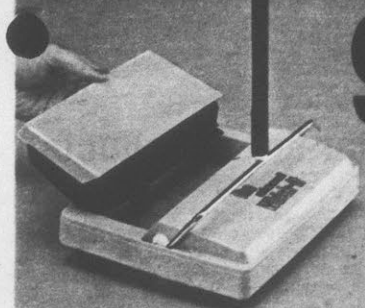

**120 Day Automatic  
BOWL CLEANER**

14-Oz. (net wt.) bowl cleaner, automatically deodorizes and sanitizes toilet bowl water.

**234**  
REG.  
3.74



**Useful  
KITCHEN BRUSHES**

Choose scourer, dish and vegetable, scrubber, pot and pan, pastry or dish mop brushes.

**57¢** EA.



**9-Ounce  
Carpet Fresh  
or 40-Ounce  
Clorox II**

**100**  
REG. TO  
1.54

40-oz. (net wt.) Clorox II is safe for all washable fabrics. 9-oz. (net wt.) Carpet Fresh deodorizes your rug and room.

LIMIT 2 EACH

NO RAIN CHECK

# PRACTICAL AND VERSATILE AT SUPER PRICES.

... SAVE \$14.12 on ...  
The "Ace" of Bikes  
Men's 26" 10-Speed  
from Huffy® ..

**69<sup>88</sup>**  
REG.  
84.00

Huffy's® Strider, men's 10-speed bike has hi-ho silver finish. Features 10-speed derailleur gearing system, maes bend handlebars, dual caliper handbrakes and racing style saddle.

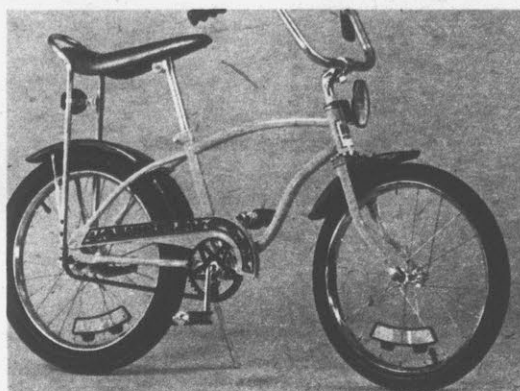

**HUFFY**

... SAVE \$12.12 on ...  
Single-speed Huffy®  
Hi-Rise Bikes ...

**49<sup>88</sup>**  
REG.  
62.00

Huffy® 20" hi-rise bikes, Star Princess for girls and Rangler for boys. Single speed bikes with coaster brakes, hi-rise handlebars, polo saddle, reflective pedals and full length chainguard.



**HUFFY**

**5-Ton Hydraulic Jack**

**14<sup>88</sup>**

Heavy duty jack easily lifts 10,000 lbs. Constructed of durable material for lasting use.

**Chain Lock**

**SAVE 10¢ → 1<sup>97</sup>**  
REG. 2.99

3-digit combination lock with 36" chain with vinyl sleeve. Heavy duty.

**Light-weight Fire Extinguisher**

**6<sup>88</sup>**  
REG. 8.99

Lightweight 3½-pounds (net wt.) fire extinguisher is compact enough for use in kitchen, car, boat or garage.

**ELMER'S GLUE ALL**

**78¢**  
REG. 1.17

Dries clear, fast and strong. Bonds paper, cloth, wood and more. 8-fluid ounces.

**BORDEN**

**Krazy Glue**

**51¢ → 97¢**  
REG. 1.49

Bonds in seconds. One drop holds a ton. .07-fl. oz. tube.

**TEXACO**

**Super-Premium All-Temperature HAVOLINE**

**SAVE 22¢ → 64¢**  
REG. 86¢

All-temperature Havoline in quart size cans. Super-premium formula assures you the best performance.

LIMIT 8 QUARTS

**Wet-Dry VAC**

**36<sup>88</sup>**

Powerful 2-gallon Wet and Dry Vac has flexible hose with snap lock and extension tubes with snap lock ends, floor nozzle with brush, shoe rug plate with brush and nozzle and much more.

**Star brite Products**

Clean, shine and protect with Star Brite paste wax in 10-oz. (net wt.) cans or Star Brite car polish in 16-fl. oz. bottles.

**2<sup>44</sup>**  
REG. 10.77

# HOME IMPROVEMENTS OFFER BIGGER SAVINGS

## ROSES PAINTS



### WALL PAINT

Rose's quality paint for your walls in gallon sizes cans. Goes on smooth and dries in 30 minutes. Available in white, oyster white and beige.

**3.44**  
REG. 4.44

### HOUSE PAINT

Rose's latex exterior house paint is blister resistant, lead free, requires just one coat and dries in 30 minutes. Available in gallon cans in white only.

**3.97**  
REG. 4.97



### PAINT BRUSH

Handy four-inch paint brush for interior or exterior use. For all type surfaces.

**1.99**

### PAN AND ROLLER SET

Paint roller set with 9" roller and pan. Easy to use with all paints. Quickest way to paint with little clean-up mess.

SAVE 52¢

**1.47**  
SET

REG. 1.99



SAVE \$2

### WORK LIGHT

**10.88**  
REG. 12.88

Easy to install 7 x 48" workshop light comes with two Fluorescent tubes and all mounting hardware.

**Creslite**

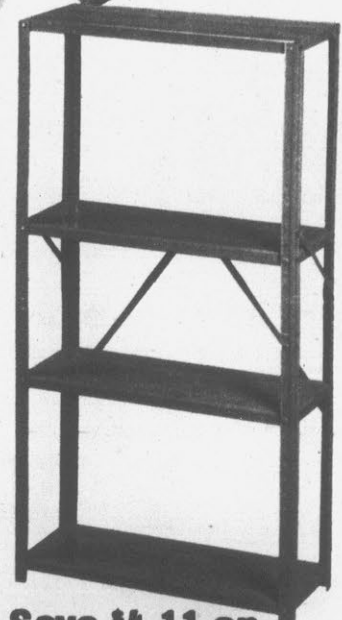

### ... Save \$4.11 on ... METAL SHELVING UNIT

Metal shelving unit gives lots of storage area in a small space. Has 4 shelves that hold many items. Each unit measures 60 x 12 x 30".

**9.88**  
REG. 13.99

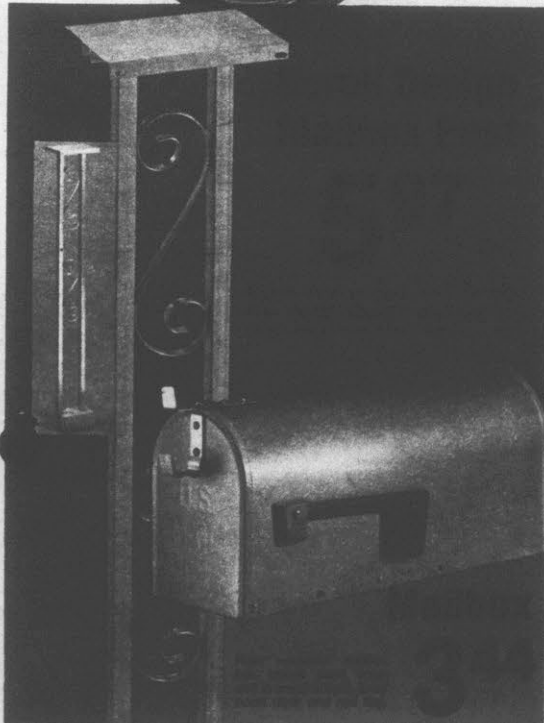

### KRYLON SPRAY PAINT

**1.57**  
REG. 1.99

Krylon spray goes on quick and dries fast. For indoors or outdoors. Many colors.

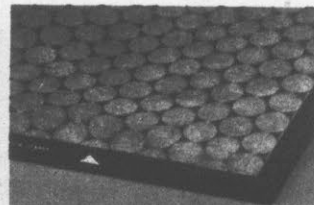

### Furnace Filters

Easy to install furnace filters are your best investment to save money. Several popular sizes.

**2 FOR 88¢**



### Latex Caulk

1-1/2 oz. latex caulk is so quick and easy to use.

**99¢**  
REG. 1.34

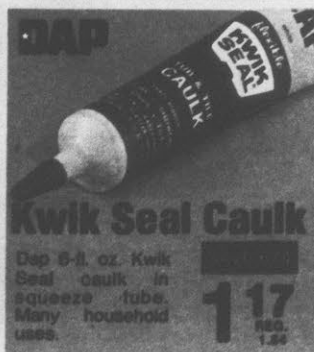

### Kwik Seal Caulk

Dep 6-1/2 oz. Kwik Seal caulk in squeeze tube. Many household uses.

**1.17**  
REG. 1.34



### Masking Tape

REG. 77¢ EA.

**2.17**

Multi-purpose masking tape measures 3/4" x 60-yards.

**ROSES**

**Back to School**

**Savings**



**Roses Quality Products**

COMPARE AND SAVE YOUR CHOICE

Roses brand toiletries are quality items at everyday low prices. Choose 14-oz. (net wt.) Baby Powder, Twin Blades (5 to a pack), 16-fl. oz. each Baby Oil, Baby Shampoo, Balsam Conditioner, Balsam Shampoo and Special Lotion.

**77¢ EACH**



**LUNCH KITS**

**2.97**  
REG. 3.97

Metal and plastic lunch boxes with unbreakable thermos bottles. Choose Holly Hobby, Cracker Jack, Incredible Hulk and Super Heroes.



**TAMPONS OR NOXZEMA**

**1.47**  
REG. TO 1.97

Box of 40 Tampax Tampons are easy and safe to use. Choose regular, super or super plus sizes. 10-oz. (net wt.) Noxzema is greaseless and medicated.

LIMIT 2 EACH NO RAIN CHECK



**Listerine**

32-fluid ounce Listerine mouthwash and gargle. Leaves a fresh, minty taste. **1.67** SPECIAL EACH



**efferdent®**

Fast acting efferdent® light denture plaque, 96 tablets per box. **1.97** SPECIAL BOX



**Head & Shoulders Shampoo**

Head and Shoulders dandruff shampoo, 7-fl. oz. lotion or 4-oz. (net wt.) tube. **1.17** SPECIAL EACH



**Extra Strength Tylenol**

Extra Strength Tylenol. Choose box of 60 tablets or box of 50 capsules. **1.77** SPECIAL EACH



**The Clear Plastic Wraps Saran Wrap or Handi-Wrap**

SAVE 66¢ **2 FOR \$1** REG. TO 83¢

Clear plastic wraps that keep foods fresher longer. Choose 50-ft. rolls of Saran Wrap or 100-ft. rolls of Handi-Wrap.

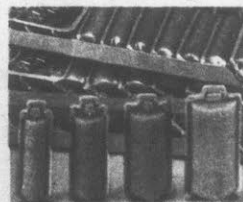

**Foam Rollers**

Easy to use foam curlers in small, medium, large and x-large sizes. **88¢** PK.

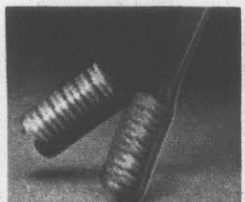

**Toothbrushes**

Peppermint adult size toothbrush in soft medium or hard. **2.67¢** LIMIT 2



**Play-Doh**

Play-Doh is clean and non-toxic. 4 cans to a pack. 24-oz. (net wt.) total. **1.00** REG. 1.27



**Comb. Lock**

Combination lock is easy to use. Has strong multi-spring security. **1.44** EACH



SUPPLEMENT TO: The Virginian-Pilot/Ledger Star, Southwest Progress, Daily News Record and Page News & Courier, News Virginian, Daily Press and Times Herald, Laurinburg Exchange, Reidsville Review, Courier-Tribune, Fayetteville Observer-Times, High Point Enterprise, The Times, Kinston Daily Free Press, Sampson Independent, Daily News (Jacksonville, N.C.), The Pointer, The Durham Morning Herald-The Durham Sun, Daily Times-News, Wilson Daily Times, Winston-Salem Journal-Sentinel, Daily Reflector & Reflector Shopper's Guide, Salisbury Post, Shopper's Guide, Enquirer-Journal, Henderson Daily Dispatch, Tri County Shopping Guide & South Hill Enterprise, The Dispatch, News & Observer and Raleigh Times, Village Advocate, Asheville Citizen and Asheville Times, Carteret County News Times, Sun Journal, The Shopper, Daily Advance, Danville Advocate Messenger, Commonwealth Journal and Lake County Shopper, Daily News (Bowling Green, Ky.), Logan Leader, Green River Republican, Tri County Shopping Guide, Money Bag Messenger, Daily Herald, Merchant's Advocate, Cookeville Herald-Citizen & Plus, Daily Post Athenian, Etowah Enterprise, Monroe County Advocate, Tri County Observer, Cleveland Daily Banner, Daily Sentry-News and St. Tammany News-Banner, The Clarion Ledger-Jackson Daily News, Hattiesburg American, Enterprise Journal, Tallahassee Advertiser and TV Guide, Mobile Press Register, Chickasaw Herald, Spartanburg Journal and Spartanburg Herald, Tavares Citizen, Eustis News and Triangle Shopping Guide Inc., DeLand Sun News, DeBary/Deltona Enterprise, Blanket Shopper, Daytona Beach Morning Journal, Florence Morning News, Alton Standard, Times and Democrat, LaGrange Daily News, Moultrie Observer, Colquitt Shopper, Cook County Shopper, Daily Tifton Gazette & Gazette Shopping Guide, Augusta Chronicle, Augusta Herald, Macon Telegraph & News, Albany Herald, Gwinnett Daily News, Barnesville News-Gazette, Griffin Daily News, Thomaston Times, Sentinel Star (Orlando, Florida), The Wilmington Morning Star, The Mountaineer

**WE RESERVE THE RIGHT TO LIMIT QUANTITIES ON ANY ITEM. ALL SPECIALS WILL BE SOLD ON FIRST COME BASIS.**

**YES  
YOU CAN**

# CLARKS

Sale ends Saturday,  
August 4th.  
We reserve the right  
to limit quantities.

Save during our

## Handyman's



# Sale



**60¢**

Reg. 75¢  
**STP Gas Treatment**  
8 oz. Protects  
your car's engine  
against wear,  
sludge and rust.



**2.27**

Reg. 2.59  
**Raid Yard Guard**  
Outdoor fogger.  
Rids area of  
annoying insects.  
Child guard actuator.



**12¢**  
ft.

Reg. 17¢ ft.  
**12/2 romex with ground**  
NEMA approved. 12 gauge / 2 wire with ground.  
Non-metallic sheathed cable. (13040)



**79¢**

Reg. 99¢  
**Men's jersey  
work gloves**  
White canvas  
work gloves  
Reg. 95¢ ..... 79¢



**2.25**

Reg. 2.80  
**Woodhill Glue-  
matic** Tough  
breaks easy  
to fix. (GM1)



**1.50**

Reg. 2.29  
**Krylon spray  
paint** 13 oz.  
In ass't. colors.



**99¢**

**Gillette Atra**  
Invitation razor  
Twin blade.

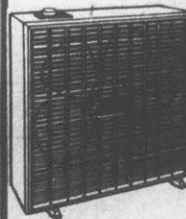

**16.88**

Reg. 21.95  
**Lasko Galaxy**  
20" breeze  
box fan (3713)



**79.79**

Reg. 95.79  
**Skil 12" gas  
chain saw** Light-  
weight. Solid  
state electronic  
ignition. (1612)

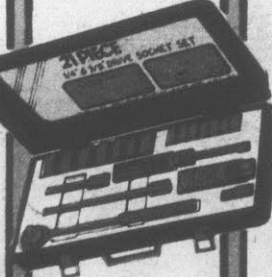

**4.99**

Reg. 9.99  
**21-pc. socket set**  
S.A.E. 1/4" and  
3/8" drive.  
Chrome alloy  
steel. (T221)



**1.00**

Reg. 1.55  
**Woolite liquid**  
16 oz. Cold  
water wash.

**YES  
YOU CAN**

# Find great savings on top quality tools

**10.99** Reg. 15.57

**11-pc. wrench set**  
Combination box and open end.  
From 3/8" to 1". Drop forged  
alloy steel. (9200)

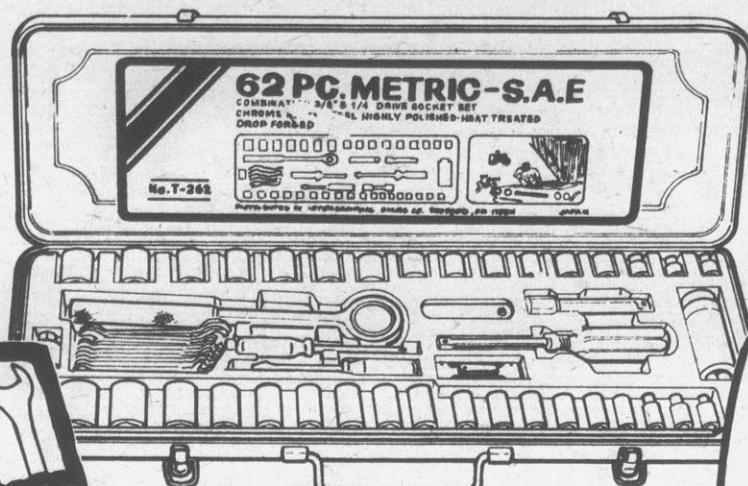
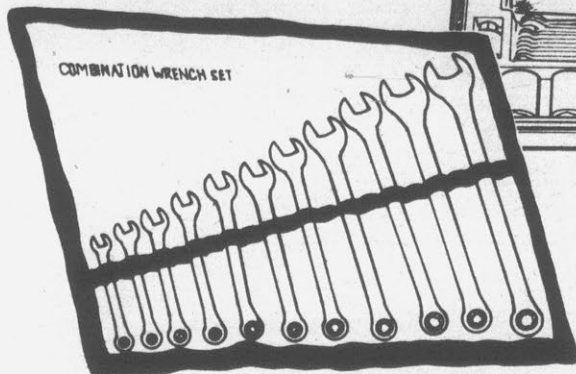

**14.99** Reg. 21.39

**62-pc. socket set**  
1/4" and 3/8" drive. S.A.E. and metric.  
Chrome alloy steel, drop forged and heat  
treated. (T262)

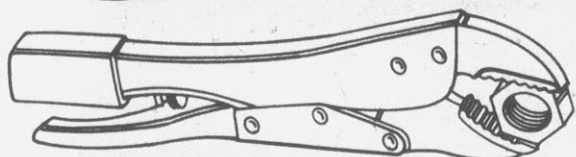

**4.99** Reg. 6.25

**Leverage 10" lever wrench**  
One hand operation, pressure  
selection. (10)

**6.99** Reg. 10.00

**Torque wrench**  
1/2" drive with specially hardened vanadium  
steel body. (A4000)

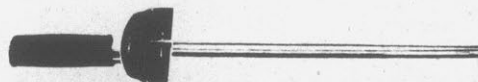

**10.79** Reg. 13.69

**Spitfire brazing torch kit**  
Instruction book incl.  
(303-01)

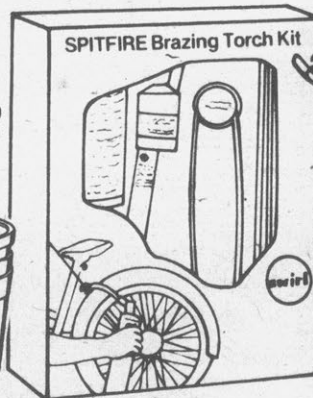

**24.99** Reg. 29.00

**Burgess airless electric  
paint sprayer**  
Applies oil paint,  
latex paint, insecticides  
and much more. (870)

**19.99** Reg. 25.99

**Black & Decker Value Plus™ variable  
speed reversible lock drill** With infinite  
speed lock. 1/3HP, 13 amps, 6' cord.  
0-1200 RPM. UL approved (7190)  
Limit one.

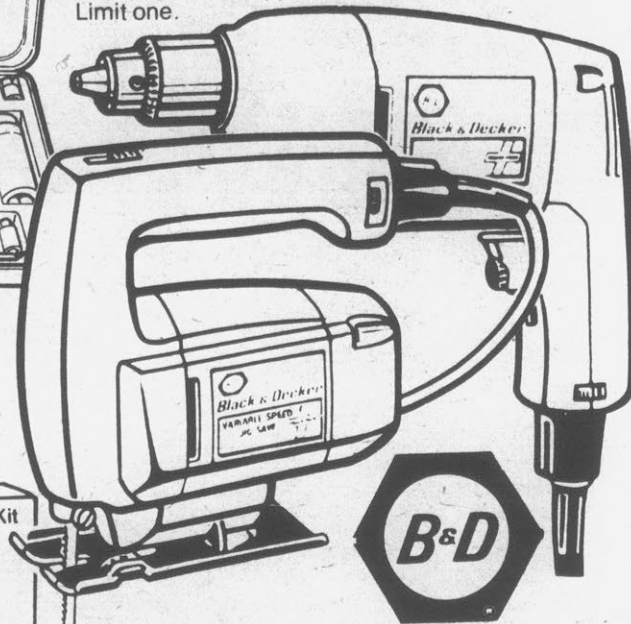

**19.99** Reg. 24.99

**Black & Decker Value Plus™  
variable speed jigsaw** 1/3HP.  
Double insulated. Detachable 6' cord  
and slide control switch. 3 amps,  
0-3200 RPM. UL approved. (7580)  
Limit one.

**14.99** Reg. 18.75

**Portalign precision  
drill guide**  
Gives portability and  
drill press accuracy  
to power hand drill.  
Drill not incl. (101A)

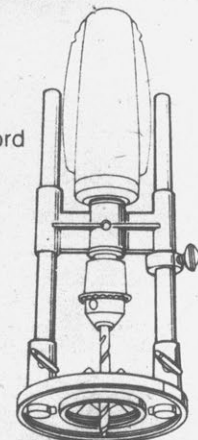

**4.99** Reg. 6.49

**8-pc. deep well socket set**  
3/8" drive, drop forged. (T208)



**2.49**

Reg. 3.89  
**Wrecking bar**  
3/4"x30". High  
carbon steel,  
(4WB)



**4.99**

Reg. 6.85  
**Impact driver  
wrench kit**  
(2500)

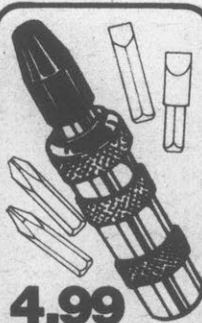

your choice  
**89¢**  
ea.

Reg. 1.17-1.33  
**Irwin Speed Bore®  
electric drill  
wood bits**  
3/8"-7/8"

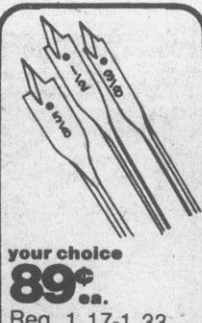

your choice  
**1.99** Reg. 2.59

**7 1/4" circular saw blades**  
Choose from cross cut, rip and  
combination.

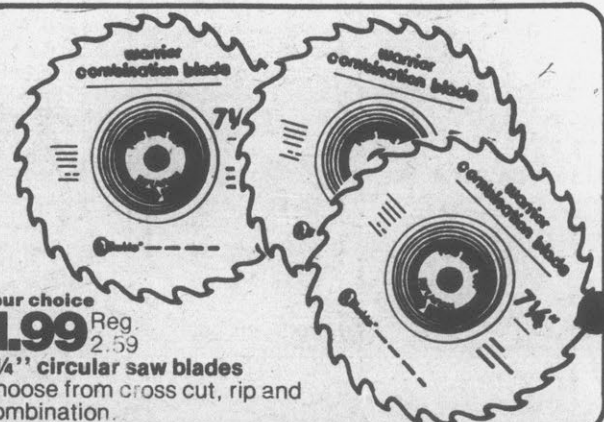

**YES  
YOU CAN**

# Fix-it-up and save

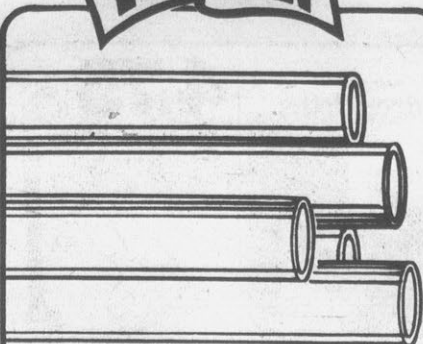

**1.25** Reg. 2.00  
**1/2" x 10' CPVC pipe**  
 For hot or cold water installation. Sold in 10' lengths only. (50005)

**2.99** Reg. 3.99  
**1/2" CPVC water line stop**  
 (530151)

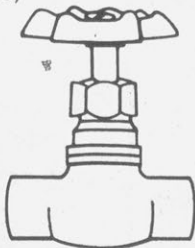

**8¢** Reg. 10¢  
**1/2" CPVC 90° ell**  
 (50705)

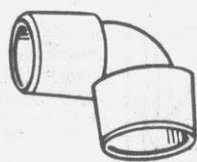

**10¢** Reg. 13¢  
**1/2" CPVC coupling**  
 (50105)



**13¢** Reg. 16¢  
**1/2" CPVC tee**  
 (51405)

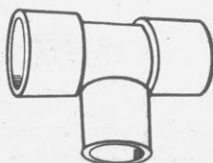

**18.99** Reg. 24.49  
**Lighted medicine cabinet**  
 Measures 21 3/4" x 15" x 5". Double strength mirrors, one shelf. Bulbs not incl. (15)

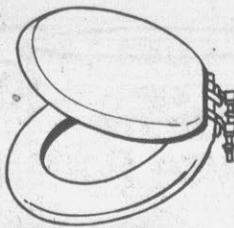
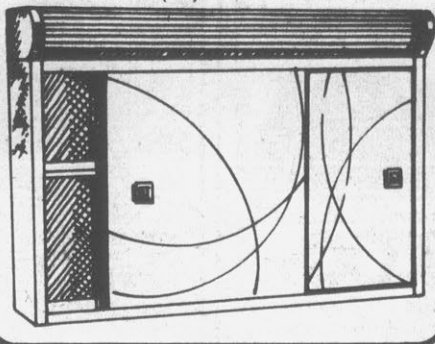

**3.99** Reg. 5.65  
**White enameled toilet seat** Wood composition. (M100)  
**18.99** Reg. 25.75  
**Peerless washerless lavatory faucet** 2 handle. 5-year limited warranty. (9620)

**38.99** Reg. 52.99  
**A grade closet combination**  
 Vitreous china. Includes ballcock. Seat not incl. (81018)



**3.25** Reg. 4.45  
**Fluidmaster silent ballcock** (200)

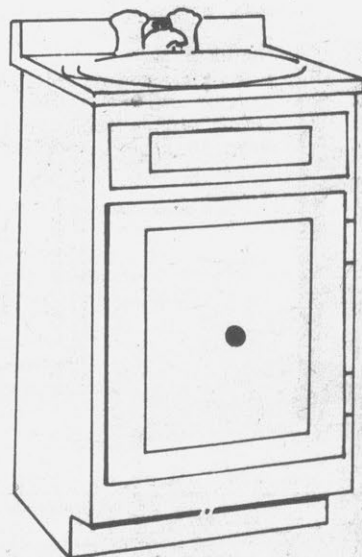

**32.99** Reg. 39.99  
**Decorative space saver vanity** 17" x 19" with marbella top. Easy to assemble. Faucet not included. (1900)

your choice  
**3.95** Reg. 4.95  
**4" x 10' solid or perforated sewer and drain pipe**  
 (40040, 40041)

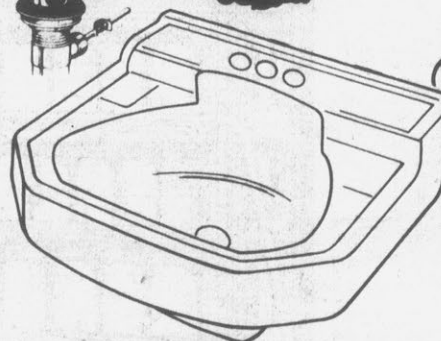

**13.99** Reg. 18.39  
**19" x 17" vitreous china sink**  
 B grade Faucet not incl. (81150)

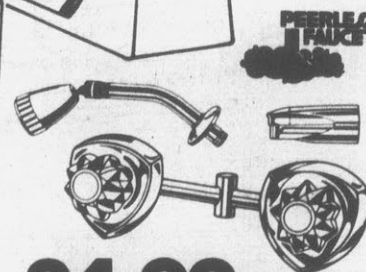

**34.99** Reg. 42.00  
**Peerless 2 handle tub faucet** (9730)

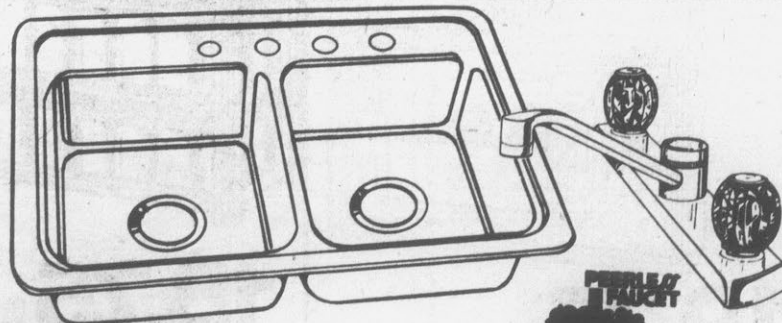

**26.99** Reg. 37.79  
**Stainless steel double sink** 22" x 33". Self edging. (81480)

**15.99** Reg. 21.75  
**Peerless washerless, 2 handle kitchen faucet** (9210)

**YES  
YOU CAN**

Get it all together with these low prices



**6.50** Reg. 9.50  
**Lucite rustic stain**  
 Protects and high-  
 lights. Gal.



**9.50** Reg. 11.95  
**Lucite exterior enamel**  
 Tough medium gloss  
 finish. Gal.



**9.25** Reg. 10.95  
**Lucite house paint**  
 Dries in 1 hr.  
 Gal.



**8.00** Reg. 9.50  
**Lucite floor paint**  
 Durable low gloss  
 finish. Gal.



**5.75** Reg. 7.50  
**Padco paint kit**  
 (2800)



**20¢** Reg. 30¢  
**9'x12' plastic drop**  
**cloth (TEX105)**



**4.75** Reg. 6.20  
**Poly pro 4" brush**  
 100% polyester.  
 (12812)

**2.25** Reg. 3.65  
**2" angle brush**  
 100% nylon.  
 (12452)

**22.75** Reg. 29.95

**Music Center**  
 Simulated wlnut finish. 47 3/4" x 15 3/4" x  
 30 1/2". Ready to assemble with pull  
 out shelf. (948)  
 Accessories not included.

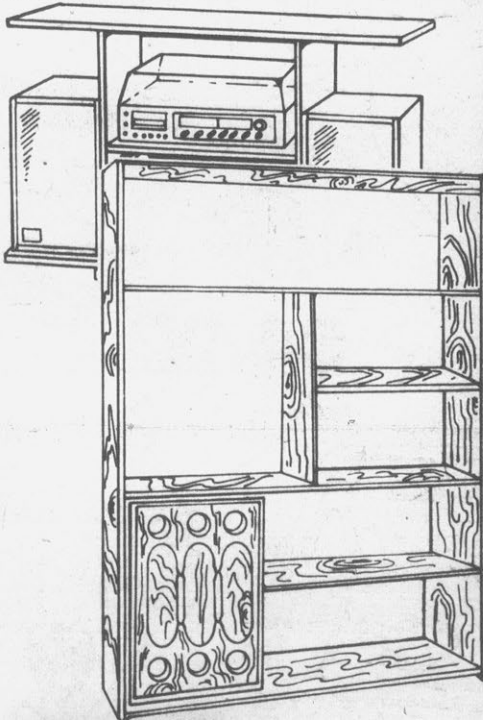

**49.75** Reg. 74.95  
**American walnut finish wall unit**  
 Measures 48" x 11 3/4" x 65" H.  
 Assembly required. Perfect for all  
 your needs. (4850)

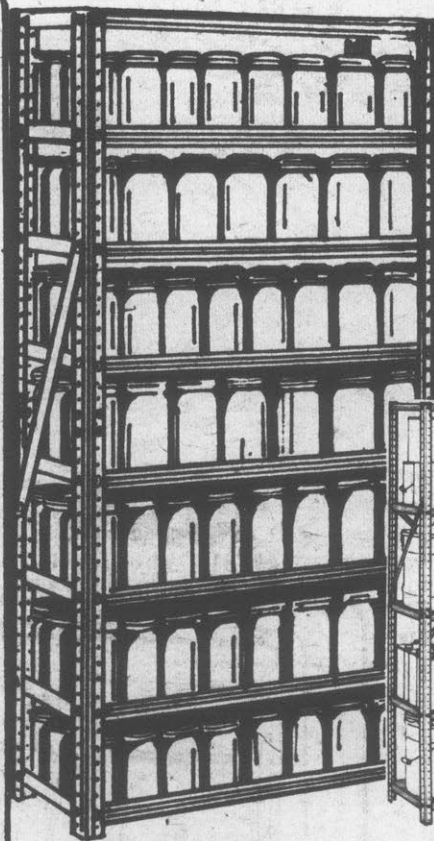

**18.75** Reg. 27.50  
**Home canning center**  
 Measures 12" x 30" x 60".  
 Includes 8 shelves, posts and  
 supports of grey enameled  
 Steel. (TL820)  
 Jars not included.

**8.75** Reg. 11.50

**4-shelf heavy duty storage shelving**  
 12" x 30" x 60".  
 Strong wobble free con-  
 struction. (TL420)

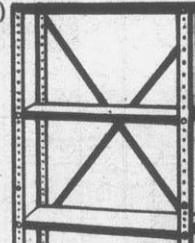

**12.75** Reg. 17.50  
**5-shelf heavy duty storage**  
**shelving** Measures 12" x 36" x  
 72". In grey. (TL526)

**14.75** Reg. 19.95  
**5-shelf heavy duty shelving**  
 Measures 16" x 36" x 72".  
 In grey. (TL566)



**1.25** Reg. 1.89  
**Borden tile grout**  
 Ready to use, starts  
 white and stays white. (E873)

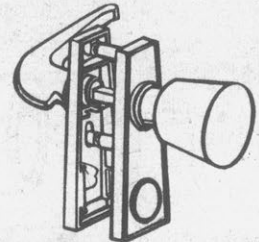

**4.50** Reg. 5.96  
**Ideal security latch**  
 Tulip knob. For use on  
 wood or metal, storm  
 or screen doors. (SK15)



**2.50** Reg. 3.40  
**Door closer**  
 Quiet and adjustable.  
 Installation hardware incl.  
 (SK85)

**YES  
YOU CAN**

# Keep your car at its best

your choice

**1.00**

Reg. 1.19-2.00  
DuPont chrome polish, Simoniz rubbing compound. Snap tire black, Turtle bug and tar remover, Turtle Zip Wax car wash, 10" wisk broom, wash dust mitt, terry shemie towels or air conditioner fuses. All at one low price.



your choice

**79¢**

Reg. 1.20 and 1.35  
Belt dressing, silicone spray or carburetor and choke cleaner

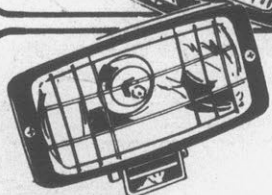

**9.50** Reg. 14.40  
Blazer quartz drive or fog lights (QR23, QR21)

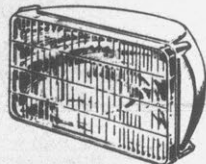

**8.85** Reg. 9.98  
Halogen sealed beam headlamps  
Improves visibility for night time driving.

**3.95**

Reg. 4.65-6.74  
Perfection flexible tube  
From 1 3/4" to 2 1/4"

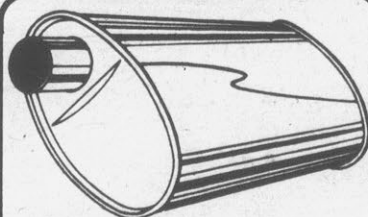

**10.99** Reg. 15.49  
Trimline muffler  
Installation hardware incl.



**8.88** Reg. 10.99  
Big Daddy Hi Performance muffler  
Aluminized for longer life. Easy to install.

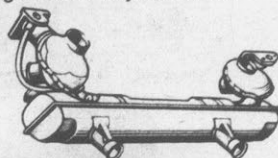

**14.99** Reg. 19.75  
VW muffler (0531)



**1.00 to 1.50**

Reg. 1.15-2.00  
Fram gas filters  
Sizes to fit most cars.

**6.99** Reg. 8.29  
5 gal. gas can

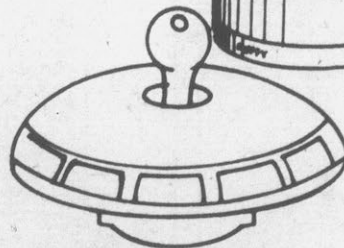

**2.99 to 4.99**

Reg. 4.20-6.30  
Locking gas caps  
Why take the chance? Protect your gas. Sizes to fit most cars.

**1.50** Reg. 2.05  
Kravex Vac siphon pump (945)



**9.85** Reg. 15.40 and 15.70  
Robert Jr. west coast or truck and camper mirror (706, 727)

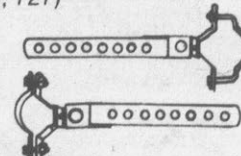

**59¢** Reg. 86¢  
Universal tail pipe hanger

**YES  
YOU CAN**

# Stock up and save on assorted plastics

**2.25** Reg. 3.00  
Octagonal laundry basket  
1 1/2 bu. 23" x 18" x 10".  
In yellow and green.

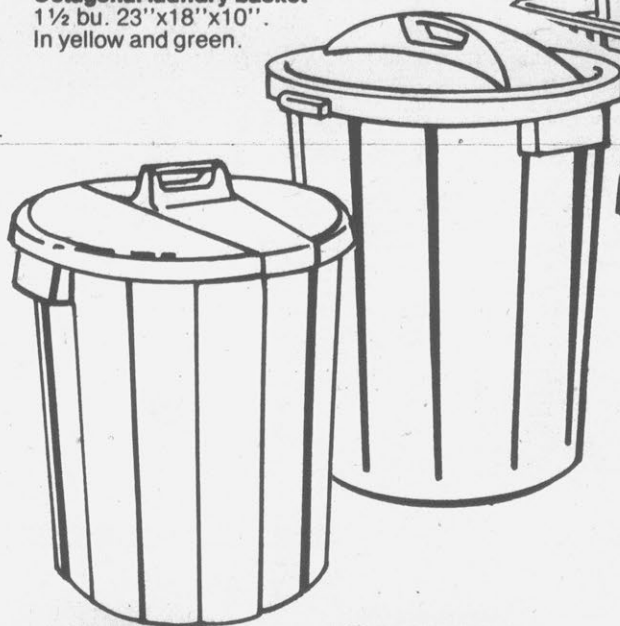

**4.00** Reg. 6.00  
20 gallon trash can  
Snap locks hold lid  
on tightly. Measures  
20" x 19-3/8" x 24".  
Avocado. (7200)



**7.00** Reg. 10.50  
32 gallon trash can  
Snap locks hold lid  
on tightly. Measures  
22-5/8" x 22" x 30".  
Avocado. (5207)

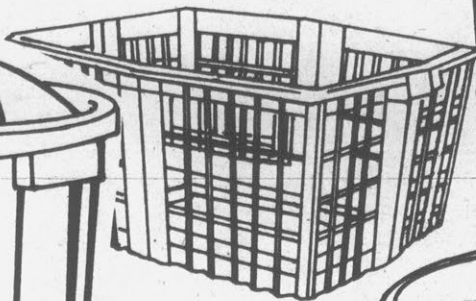

**1.25** Reg. 1.75  
10 quart pail  
9 3/4" dia. x 9 1/2" H.  
Choose from green and  
gold. (8100)

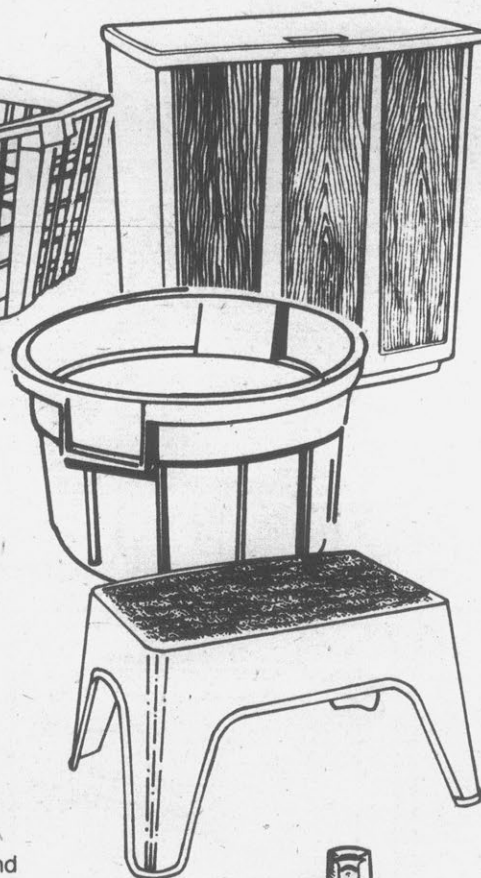

**4.00** Reg. 5.25  
40 quart hamper  
In caramel only. (4443)

**75¢** Reg. 95¢  
Cutlery tray  
Measures 12 1/2" x 9 1/2" x 1 3/4".  
In avocado and gold.  
(8188)

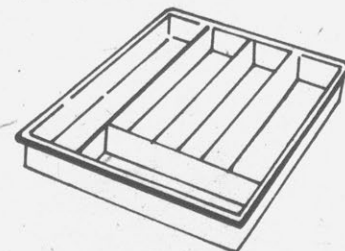

your choice  
**2.50** Reg. 3.50  
and 4.50  
Handi textured surface  
stool or round 32 qt.  
utility tub  
(4691, 2232)

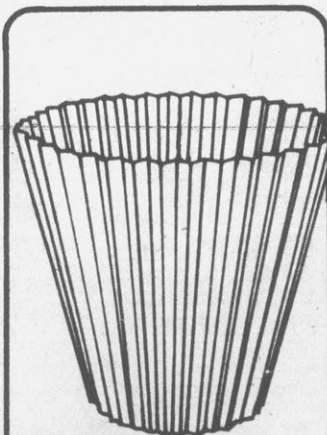

**1.25** Reg. 1.60  
11 qt. pleated waste  
basket 11" dia. x  
10 1/2" H. Comes in  
white and chocolate. (4836)

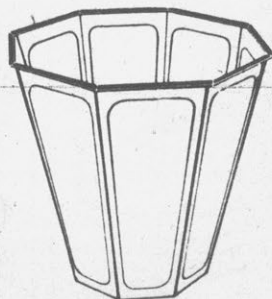

**2.00** Reg. 2.50  
10 qt. vanity waste  
basket A nice touch  
for your bathroom. In  
avocado, chocolate and  
gold. (5196)  
19-qt. kitchen waste basket  
Reg. 2.00 ..... 1.50  
28-qt. rect. kitchen basket  
Reg. 2.50 ..... 2.00



**1.25** Reg. 1.80  
Floral bowl brush  
& holder White and  
gold to choose from.  
(8965)



your choice  
**85¢** Reg. 1.09  
ea. and 1.20  
Lysol spray (6 oz.)  
or Lysol Basin,  
Tub & Tile cleaner  
(17 oz.)

your choice  
**1.09** Reg. 1.39  
and 1.49  
Lysol deodorizing  
cleaner (28 oz.) or  
Lysol disinfect-  
ant (12 oz.)

**Brighten up your home  
with these accessories**

**25% off  
inflatables**

**19.99** Reg. 24.95

**Ceiling light**  
Easy to install and maintain.  
48" in length. UL listed. (5024)



**7.99** Reg. 12.95

**Screw-in fluorescent converter**  
Screws into incandescent bulb  
fixture. Bulb incl. Helps save  
on electricity. (7722)

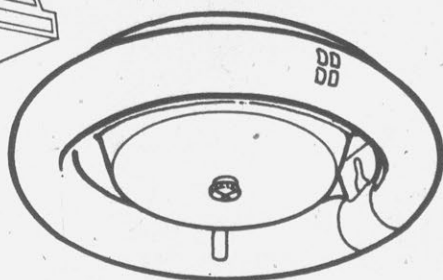

**9.99** Reg. 14.95

**48" shoplight**  
Ideal bench or plant light.  
Economical to purchase and maintain.  
Includes two 40 watt bulbs.  
Prewired for your convenience.  
UL listed. (4924L)



**9.99** Reg. 16.99

**Folding step stool**  
Multi-use with  
cushioned seat  
and deluxe safety tread.  
Overall height 30".  
Chocolate. (4256)

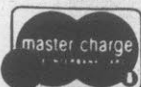

**7.39** Reg. 9.88

**Canvasette French air mattress**  
78"x28" super heavy duty vinyl  
with tufted I-beam construction  
and self-seal valves. Repair  
kit included. (7970)

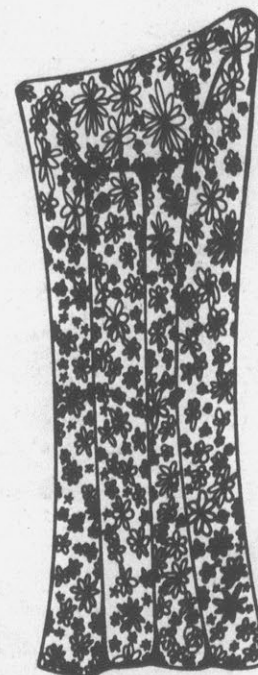
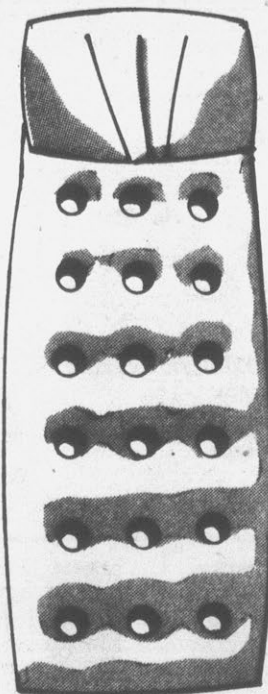

**2.75** Reg. 3.69

**Heavyweight vinyl air mattress**  
74"x30". Brightly printed with  
pillow. Self-sealing valve. Includes  
self-stick repair patch. (7913)



**1.59** Reg. 2.19

**Heart shaped jumbo split ring**  
32" with Love Boat motif. Self-seal  
valve. Great fun for the beach  
or backyard pool. (7936)



**73¢** Reg. 99¢

**Ziggy® swim aids**  
8"x18". Proven best way  
for little ones to learn  
to swim. Safety self-seal  
valves. (7943)

**YES  
YOU CAN**

# Save plenty on health & beauty



**99¢**

**Breck shampoo**  
The beautiful hair shampoo.  
Choose dry, normal or  
oily formulas.  
11 oz. bottle.



**79¢**

**Aqua-Fresh toothpaste**  
6.4 oz. tube. Fights cavities  
and freshens breath.

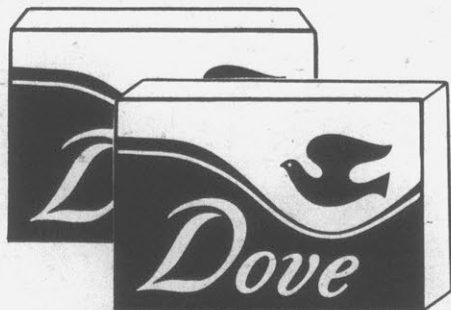

**2 for 2.79¢**

**Dove soap**  
4.75 oz. bar. White or pink.



**89¢**

**Scope mouthwash**  
12 oz. bottle.



**99¢**

**Wet Ones disposable  
towelettes** Convenient for  
travel and outdoor living.  
70 ct.

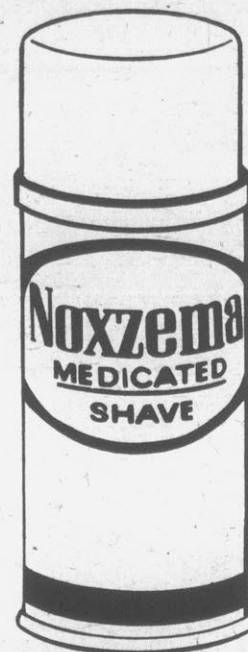

**79¢**

**Noxzema shave cream**  
11oz. Lime, menthol,  
regular or wild forest.



**79¢**

**Brut 33 Stick deodorant**  
2.75 oz.



**1.69**

**Brut 33 After Shave**  
5 oz.

**Rexall**

**1.99**

**Rexall  
Vitamin E**  
200 I.U.,  
100 capsules.  
(V-3042)



**69¢**

**Curad Bandage**  
The ouchless bandage.  
Plastic or transparent.  
80 ct. box.

**BIC**

**2 for 89¢**

**Bic disposable  
lighter** You get  
thousands of  
lights for one  
low price.

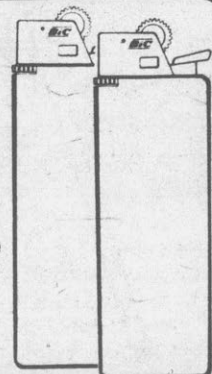

**1.59**

**Extra strength Tylenol**  
60 ct. Fast pain relief.  
Contains no aspirin.

**YES  
YOU CAN**

**Come to us for all your needs**

**Scotch  
Carpet  
Tape**

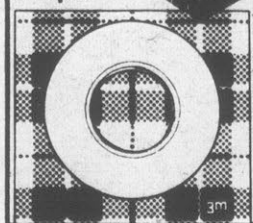

**1.99** Reg. 2.89

**Carpet tape**  
With 2 way stick. 1 1/4" x 300"

**your choice**

**2 for 1.00** Reg. 69¢ and 79¢

**Double stick tape, electrical tape or mounting squares**  
Good for all your needs.

**Scotch  
Patch &  
Repair  
Tape**

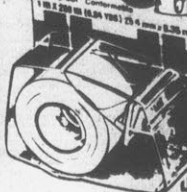

**Scotch  
Freezer  
Tape**

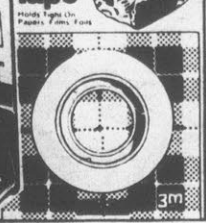

**your choice  
99¢** Reg. 1.25 and 1.49

**Patch 'n Repair Tape  
or Freezer tape**

**Scotch  
Double  
Stick  
Tape**

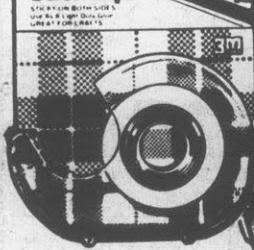

**Scotch  
Electrical Plastic Tape**

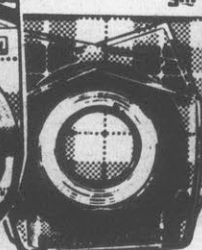

**Scotch  
Mounting Squares**



**2.49** Reg. 2.99

**Car bar**  
Sturdy, hangs from clothes hooks in car. Chrome bar extends from 2 1/2' to 4 1/2' to fit all cars.

**your choice  
99¢** Reg. 1.39 and 1.69

**Tie and belt hanger or set of 3 lacquered hardwood trouser hangers**

**3.95** Reg. 4.95

**Travel suit bag**  
22" x 40". Holds 3-6 suits. Protects clothes from water and dust.

**1.50** Reg. 1.99

**Contour suit hangers**  
Hardwood with pants bar. Set of 3.

**1.00** Reg. 1.69

**Multiple slack rack**  
Holds 5 pairs of pants plus shorts and belts.

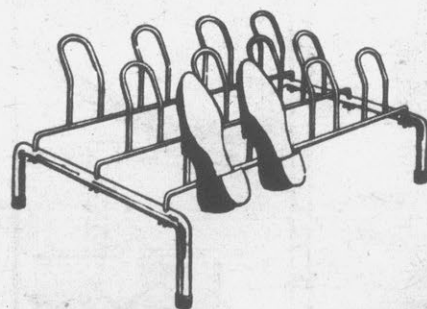

**4.00** Reg. 5.19

**Men's shoe keeper**  
Holds 6 pairs of shoes. Wedge-lock construction with chrome plating.

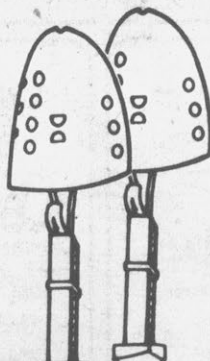

**1.77** Reg. 2.29

**Men's shoe tree**  
All steel construction. Keeps shoes looking good so they'll last longer.

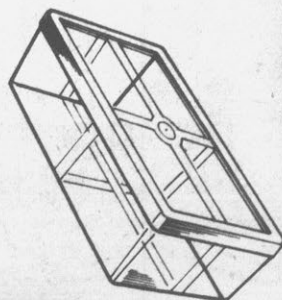

**66¢** Reg. 89¢

**Plastic shoe box**  
Measures 12 1/2" x 6 3/4" x 3 3/4". Crystal clear lid. Keeps shoes safe and in order.



**2 for 1.00** Reg. 60¢ ea.

**Kiwi paste shoe polish**  
1-1/8 oz. can. Colors to match all types of shoes.

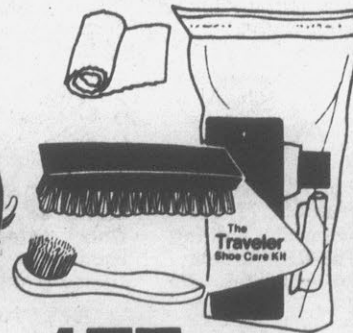

**1.77** Reg. 1.99

**The Traveler shoe care kit**  
Includes brush dauber and shine cloth. Everything you'll need to keep your shoes looking good.

**YES YOU CAN**

Find great savings without looking far



**25% off Dr. Denton winter sleepers**

**3.36 to 4.49** Reg. 4.49-5.99

2-pc. chemical-free, flame resistant. Non-skid plastic soles. Sizes 1-4. (Available in 1-pc./gripper front, 6-18 mo.)



**25% off infants & toddlers Garanimals**

**2.62 to 5.62** Reg. 3.50-7.50

Mix, match and save. Choose from a wide selection of new fall coordinating tops and bottoms for your little ones.



**77¢** Reg. 1.09

Spencer undershirts Snap side or pullover. 6-30 mo.



**5.29** Reg. 7.29

Chix® prefolded diapers Super absorbent. Pkg. of 12.



**55¢** Reg. 72¢-79¢

Spencer training pants Interlock or terry knit. 1-6.



**2.79** Reg. 3.79

Chix® fitted crib sheets Fits standard mattress.



**1.77** Reg. 2.29-2.59  
Spencer gowns and kimonos Up to 12 mos.



**99¢** Reg. 1.49 and 1.69  
Waterproof pants



**25% off infants' clothing sets**

**2.69 to 6.49** Reg. 3.69-8.49

Boys' and girls' diaper sets, dresses or angel top sets in easy care fabrics. Assorted trims and appliques to choose from.

**8.33** Reg. 9.97

Ladies' plus sizes V-neck shirts Ass't. short sleeve solids and prints. Sizes 38-44.



**4.44** Reg. 5.57

Ladies' plus size pull-on pants Ass't. colors Sizes 32-38. Missy sizes 8-18 Reg. 4.47 ..... 3.33

**4.88** Reg. 6.27

Ladies' woven plaid shirt Short sleeve, in sizes S, M, L.



**7.88** Reg. 9.97

Ladies' denim wrap skirt Back wrap styling. 5/6-15/16.

**5.88** Reg. 7.47

Ladies' pant tops 3 styles in comfortable brushed cotton. S, M, L.



**7.77** Reg. 8.97

Missy 2-way stretch pants Elastic front, cinch back. Ass't. colors. 8-18. Plus size 32-40 Reg. 10.47 ..... 8.88



**99¢** Reg. 1.17-1.27  
Fashion knee-hi's Ladies' 9-11, girls' 7-8½. Not all styles in all stores.



**66¢** Reg. 79¢  
Straight-up nylon knee-hi's Ladies' 9-11, girls' 6-8½. Colors. Turn-down cuff. .... 77¢



**3.88** Reg. 4.97  
Canvas handbags Ass't. colors with graphic designs.



**88¢** Reg. 1.09  
Ladies' bikini panties Nylon. Sizes 5, 6, 7. Nylon briefs (5-10) Reg. 1.19 & 1.29 ..... 99¢

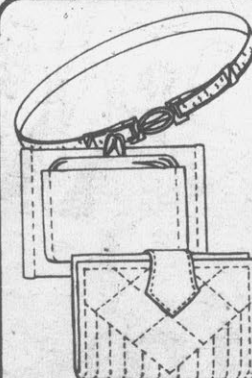

your choice **1.88** Reg. 2.27  
Ladies' belts or wallets In a large assortment of styles and colors.

**YES  
YOU CAN**

# Be prepared for everything and save

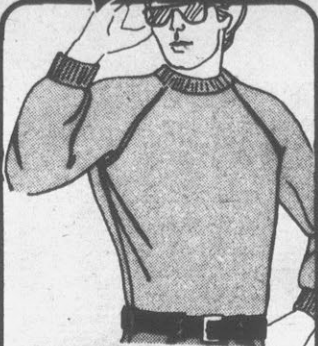

**4.95** Reg. 5.95  
**Men's flannel shirts**  
 Long sleeve in assorted  
 plaids. Sizes S-XL.  
 Boys' sizes 8-18  
 Reg. 4.95-5.25 ..... 4.25

**5.00, 6.50**  
 Reg. 6.00 and 7.50

**Boys' matching vest or jeans**  
 Prewashed blue denim. 65% cotton/  
 35% poly. Jeans sizes 8-18.  
 Vest sizes S,M,L. In  
 regulars and slims.

**4.50** Reg. 5.50  
**Men's long sleeve crew  
 neck sweatshirts**  
 Raglan sleeve. Sizes S-XL.  
 Boys' sizes 10-16  
 Reg. 4.50 ..... 3.95



Hanes

**2 pkg. 8.00** Reg. 5.29 ea.  
**Men's Hanes underwear**  
 Your choice of either  
 T-shirts or briefs. 100%  
 cotton, white in pkg. of 3.  
 T-shirts S-XL, briefs 30-44.



vest jeans  
**8.99, 9.99**  
 Reg. 10.00 and 12.00  
**Men's fashion jeans and  
 matching vest** Prewashed  
 blue denim. 100% cotton.  
 Jeans 29-38, vest S-XL.

**11.00, 13.00**

Reg. 14.00-16.00  
**Men's work boots**  
 Durable 6" or 8" work  
 boots. Sizes 7-12.



**18.66, 19.66** Reg. 22.99  
 and 24.99  
**Men's 6" or 8" leather work boots**  
 Quality leather uppers. Stitching  
 reinforced. Men's sizes 7-12.



**14.88** Reg. 19.99  
**Men's leather oxfords**  
 Sturdy leather construction  
 with thickly padded  
 insoles and cushioned  
 arches. Sizes 7-12.

**13.66** Reg. 19.99  
**Men's suede leather alpine  
 boots** Sturdy construction.  
 Men's sizes 7-12.

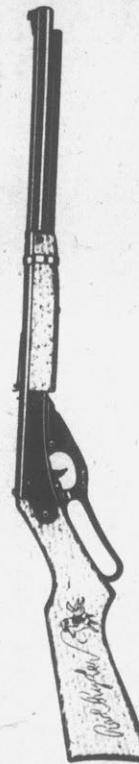

**19.88** Reg. 23.95  
**Daisy Red Ryder BB air rifle**  
 Featuring controlled muzzle velocity:  
 270' per second. Length-35" (7938)  
 Daisy BB shot tube (530). . . Reg. 49' . . . 35'

**23.88** Reg. 25.99

**Coleman lantern**  
 Features maintenance-free operation  
 with easy-lite valve and striped frosted  
 globe that reduces glare. (275-710)  
 Coleman lantern case (275-764)  
 Reg. 9.99 ..... 8.88

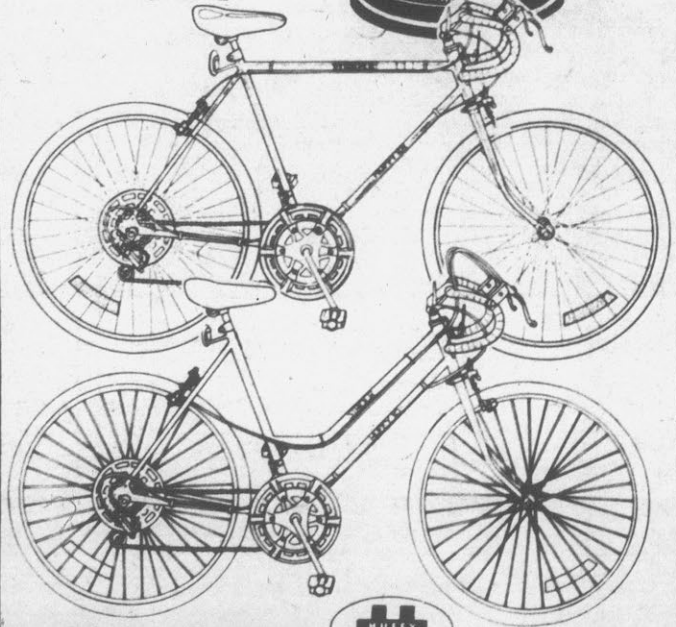

**69.88** Reg. 79.95  
**Men's or women's 26" 10-speed bikes**  
 Top quality with dual caliper hand brakes,  
 reflective rat trap pedals and a racing  
 style saddle. A great way to stay in shape  
 or simply have fun. (26869, 26879)



**YES  
YOU CAN**

# CLARK'S

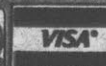

Find a large selection of quality merchandise

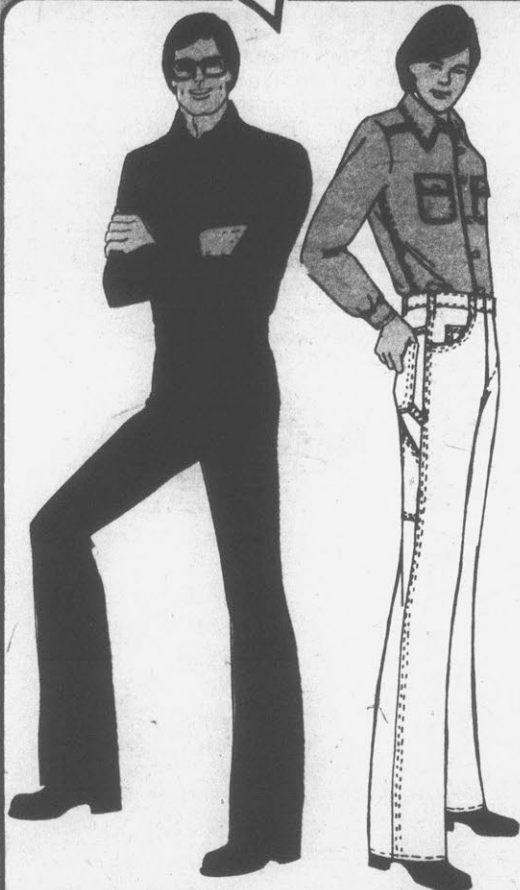

**6.88** Reg. 7.99

**Men's Big Yank work shirts** Sizes 14/14½-17/17½. 32" x 35" sleeve lengths.

**7.88** Reg. 8.99

**Men's Big Yank work pants** Sizes 30-42. S, M, L, XL lengths.

Big Yank overalls	Reg. 16.00	12.88
Work aprons	Reg. 2.35 & 3.00	2.00 & 2.50
Bandanas (pkg. of 2)	Reg. 1.28	99¢
Work caps	Reg. 2.00	1.75
Work belts	Reg. 3.00	2.50
Work hosiery	Reg. 2.95-3.45	2.29-2.99

**5.88** Reg. 6.50

**Men's chambray work shirt** Poly/cotton blend. Sizes S-XL.

**8.88** Reg. 10.00

**Men's painter pants** For work or casual. 100% cotton. White. Sizes 30-38.

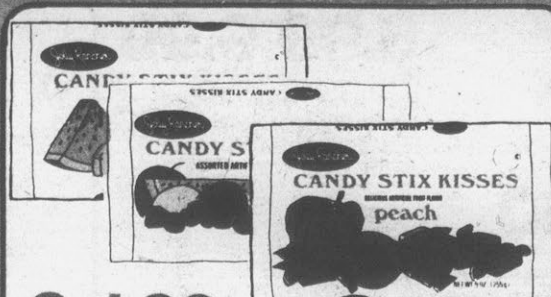

**2 for 1.00** Reg. 59¢ ea.

**Jolly Rancher stix kisses** 9 oz. Choose watermelon, peach or assorted flavors.

**1.00**

Reg. 1.50  
**Clorox 2 All Fabric bleach**  
40 oz. box.



all fabric bleach



**28.88** Reg. 34.75

**Norelco mercury vapor light**

For dusk to dawn use. 175 watt. UL approved. (34011)



Newborn 60's

**2.99** Reg. 3.95

**Disposable diapers**

Pinless and absorbent. No waterproof pants needed.

Daytime 60's, Toddler 40's or

Daytime Extra 48's

Reg. 4.29 ..... 3.55

**8.88** Reg. 14.99

**Walker/jumper**

Sturdy construction and high back easily teach baby to walk. Deep tray for feeding. (4335)

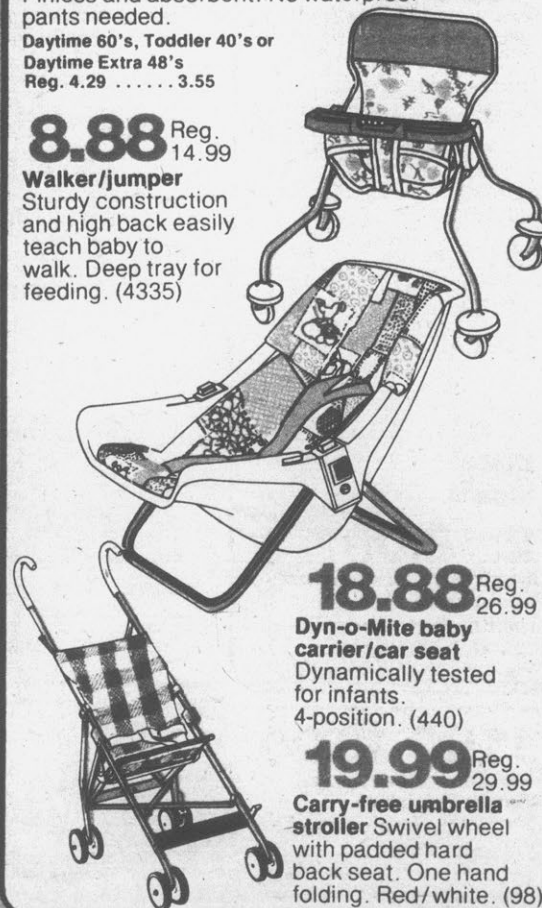

**18.88** Reg. 26.99

**Dyn-o-Mite baby carrier/car seat**

Dynamically tested for infants. 4-position. (440)

**19.99** Reg. 29.99

**Carry-free umbrella stroller**

Swivel wheel with padded hard back seat. One hand folding. Red/white. (98)

## RAINCHECK

if we sell out of any advertised specials\* you will receive a written order "Raincheck" which entitles you to buy the item at the advertised price when our stock is replenished. (excluding clearance items)

Memorial Dr. & Farmville Hwy.  
West End Shopping Center  
Greenville, North Carolina

U.S. Highway 58 and Theatre Ave.  
Roanoke Road, North Carolina

Highway 70 & 17  
New Bern, North Carolina

710 North Broadway  
Peru, Indiana

661 East Main Street  
Bradford, Pennsylvania

Broad Street-U.S. Highway 76 & 378  
Sumter, South Carolina

Highway 52 & Maybert Street  
Portsmouth, Ohio

207 South Dawson Street  
Thomasville, Georgia

814 Memorial Blvd.  
Murfreesboro, Tennessee



Just say "CHARGE-IT"

# FAMILY DOLLAR 20th anniversary sale

SAVINGS JUST IN TIME FOR BACK TO SCHOOL



## Ladies' Fall Fashion Separates

- Blouses - Choose a smocked neck blouse with ruffle sleeve or tunic with crocheted neckline. Sizes S,M,L.
- Pants and Skirts - New narrow waist cinch back pants and skirts. Sizes 8 to 16. Easy care polyester.

Your Choice

**\$5**



## Boys' Western Jeans

**3.99**

Heavy all cotton blue denim jeans with Western 5-pocket styling. Regular and slim. Sizes 4 to 18.

Novelty Tee Shirts  
Sizes 6-16..... 1.99

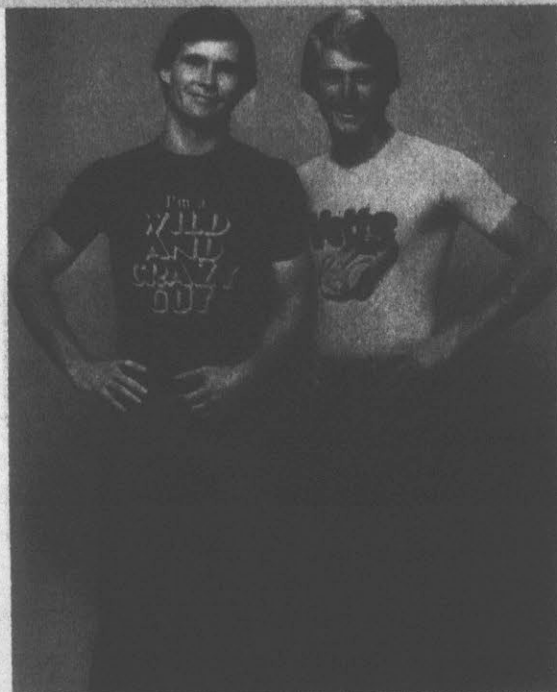

## Ladies' "Disco" Hi-Heel

**4.88**

Soft leather upper on a dressy polyurethane high heel sole. Ladies sizes 5-10.

## Men's Screen Print Tees

Tee shirts in a wide selection of print designs and colors. Full cut. Sizes S,M,L,XL.

**2.44**

## Men's Denim Jeans

Straight leg 4-pocket jeans in regular, brushed and soft pre-washed denim. Sizes 28-38.

**5.99**



## Metric/Standard 40-Pc. Socket Set

**8.99**

Handy 1/4-in. and 3/8-in. combination with metal case.



## Mobil All Seasons Motor Oil

**2 Qts. \$1.00**

Premium quality 10W30. Buy now! Limit 6 quarts.

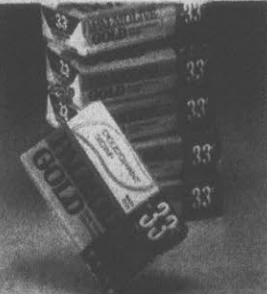

## Palmolive Gold Deodorant Soap

**4 5-oz. Bars 1.00**

Deodorant protection in big 5-oz. bars. Limit 4.



## Bic Disposable Razors or Lighters

**2 For 1.00**

Get 2 Bic lighters or 2 packs of 4 Bic razors.



## Wintuk Knitting Yarn

**69¢ Skein**

Choose 3 1/2-oz. solid colors or 3-oz. ombres. 100% Orion®



## Fruit-of-the-Loom® Men's Crew Socks

**2 Pr. 1.00**

Bulky acrylic crew socks in dark colors. Fits 10-13.

Sale Now In Progress Through Saturday, August 4 Or Sunday, August 5 For Stores Open On Sunday. Quantities Limited On Some Merchandise. Lay-Away Now!



### Men's & Boys Action Casuals

The newest in casual shoes for men and boys. Sueded or smooth vinyl with action soles. Sizes 3½ to 6 and 7 to 10.

**7.00**



### Suede Leather Casuals

Made in Spain using soft split suede leather. Sand color only. Men's 7 to 12.

Ladies' 5 to 10 ..... 5.88

**6.88**



### Basketball Oxfords Or Hi-Tops

Perfect court shoes with non-slip soles in both oxford and high tops style. Navy or black. Sizes 11-2, 2½-6, 6½-12.

**3.88**



### Rugged Children's Shoes For School Or Play

Your choice of casual styles in tough vinyl or imitation suede. The season's best looks and colors with longwearing action soles. Sizes 5½ to 8 and 8½ to 3.

**4.00 Pr.**

Big boys' 3½ to 6 and ladies' 5 to 10..... 5.00



5.66

### Save On Joggers For The Entire Family!

Children's Joggers

**5.66**

Men's & Boys Vinyl Joggers

**5.66**

Boys' & Ladies Nylon Joggers

**6.66**

Men's Nylon Joggers

**7.66**

Your choice of popular styles with rugged, lightweight uppers, soles designed for comfort and traction, padded ankle collars and cushioned insoles. For sport or casual wear.



### Ladies' Fashion Dresses

**20th anniversary sale**

**6.88**

Choose tie sleeve elastic waist, short sleeve scoop neck tee shirt or long sleeve smocked waist dress. Solids and prints. All polyester. Sizes S,M,L.



### Pant Suits Or Skirt Sets

**20th anniversary sale**

**6.99**

Cardigans, pullovers, blousons, tunics and more with matching skirts or pants. Skirt sets 8-16, pant suits 8-18. All polyester.

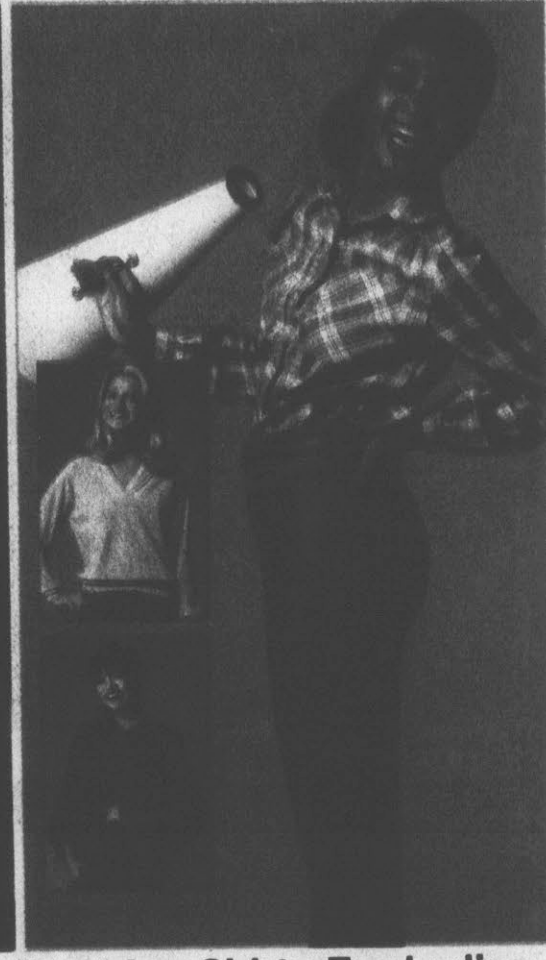

### Fashion Shirts For Ladies

Woven plaids, checks and stripes in assorted styles and colors. 100% cotton. S,M,L.

**5.99**

Terry & chenille fashion tops... 6.99

### Ladies' Straight Leg Jeans

Fashion jeans with great back pocket details. All cotton denim. Sizes 5/6 to 15/16.

**7.99**



### Ladies' Fashion Handbags

Seal frame and zipper closing blazer bags in fall fabrics and colors.

**2.99**

Vinyl bags including multicompart-ment styles in popular earth tones.

**4.00**

Canvas handbags..... 4.99



### Ladies' Dorm Shirts

**3.00**

Sleep shirts and long gown in baseball motif. Sizes S,M,L.



### Bra & Bikini Set

**2.99**

Nylon with lace trim. Nude, mauve, black or white.



### Regular Or Queen Size Pantyhose

**99¢**

All nude, reinforced toe, panty pantyhose in four shades. Control top pantyhose..... 1.59

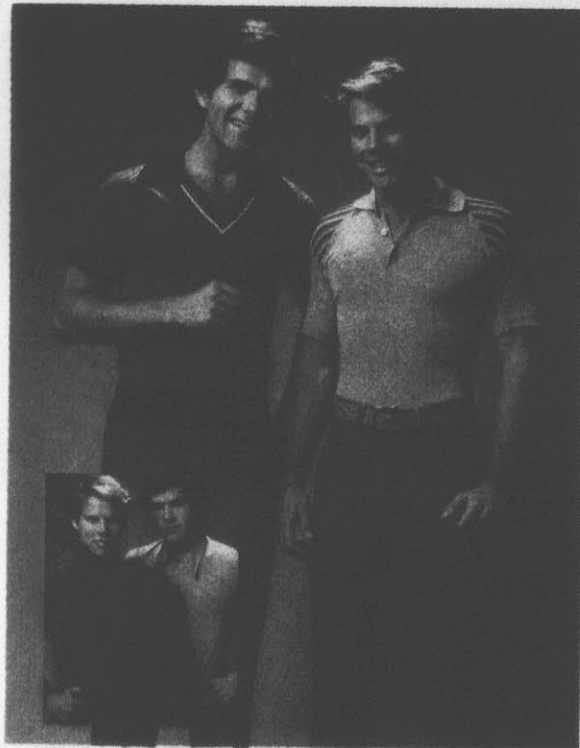

### Men's Knit Shirts

V-necks, crews, and collar styles with long or short sleeves. Solids and stripes. S, M, L, XL.

**3.99**



### Men's Sport Shirts

Long sleeve polyester sport shirts in prints and solids. Sizes S,M,L,XL.

**5.99**

### Men's Fashion Jeans

Straight leg or flare leg jeans with fashion pockets and styling. Sizes 28 to 38.

**7.99**

### Men's Dress Slacks

Double knit slacks in tan, green, navy blue and brown. Sizes 30 to 42.

**7.99**

**FAMILY DOLLAR 20th ann**  
SAVINGS JUST IN TIME



### Boys' Novelty Tees

Popular transfers on cotton or poly/cotton tee shirts. Sizes 6-16.

**1.99**



### Boys' Collar Knit Shirts

Short sleeve shirts in solids and patterns. Fall shades. Sizes 4-16.

**2.99**

### Boys' Fashion Jeans

Dark and light blue denim styles in regular and slim.

Sizes 8 to 18 . . . . . 5.99

**4.99**

Sizes 4-7

### Boys' Dress Slacks

Many styles in bright and dark shades. Sizes 4-18 reg. and slim.

Sizes 8 to 18 . . . . . 6.99

**5.99**

Sizes 4-7



**SALE!**

Men's And Boys Fruit-of-the-Loom Underwear

**3.50**

Men's 3-Pack

Famous quality all cotton tee shirts, S,M,L,XL, or briefs, 24-42.

**2.50**

Boys 3-Pack

Stock up now! Boys 100% cotton tee shirts and briefs, sizes 4-16.

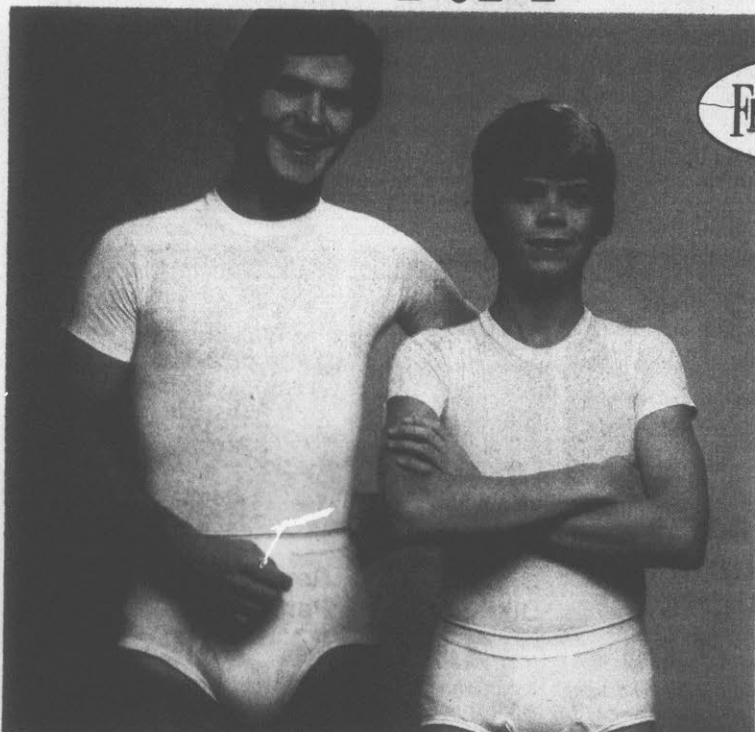

### Men's Football Shirts

**3.88**

With screen printed numerals on front and back. 100% cotton PAKNIT®. Popular fashion colors. S,M,L, XL.



### Tube Socks

**1.69** Pk.

Men's 2-pack or boys' 3-pack. White with striped tops.

First To Family Dollar . . . Then Back To School . . .

# Anniversary sale

IT'S TIME FOR BACK TO SCHOOL



## Special Purchase! Girls' School Dresses

Sizes 4-6x **4.99** Sizes 7-14 **5.99**

Plaids, solids, two-tones and novelties for big and little girls. Pretty fall colors in polyester and poly/cotton blends.



Knee Socks  
**99¢ Pr.**

Girls' and misses' knee socks from famous maker. Light and dark shades.

## Infants & Toddlers' Tops And Jeans

Tops **1.99**

Jeans **2.39**

Classic and novelty short sleeve tops. Solid color jeans with full elastic waist band.



## Mix 'N Match Fall Coordinates for Girls

Tops **4.99** Skirts **5.99** Slacks **6.99**

A smart selection of skirts, slacks and new fashion tops just in time for back-to-school. Easy care polyester and cotton blends. Sizes 7-14.

Girls 4-6x: Tops . . . . . 3.99 Skirts . . . . . 4.99 Slacks or Jumper . . . . . 5.99



## Girls' Fashion Pant Suits

**20th sale** **6.99**

Short and tunic length tops with matching pants in new fall fashion shades. Sizes 7-14.

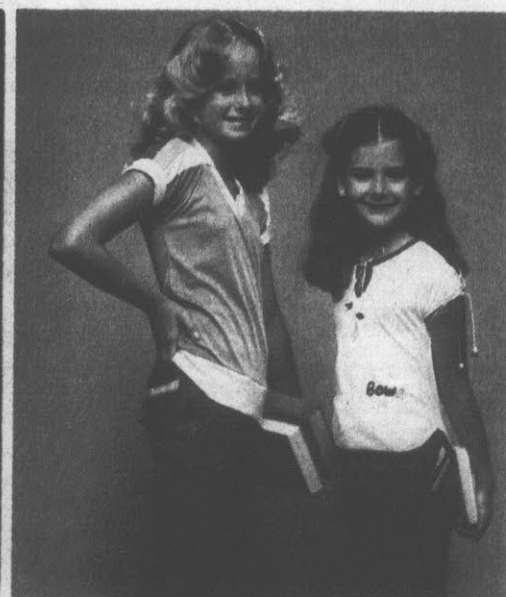

## Girls' Knit Tops and Jeans

• Hooded, V-neck and novelty tops in terry and poly/cotton blends. **1.99**  
4-14

• Fashion jeans in brushed or pre-washed denim. Assorted trims and details. **5.99**  
7-14  
Sizes 4-6x . . . . . 4.99

Hurry In Now And Save . . . Lay-Away Now!



### Cannon Bath Towels

**20<sup>th</sup> anniversary sale**

**1.99**

Heavyweight Cannon® Santa Cruz bath towels in attractive solid colors. Sculptured border design. Slightly irregular.

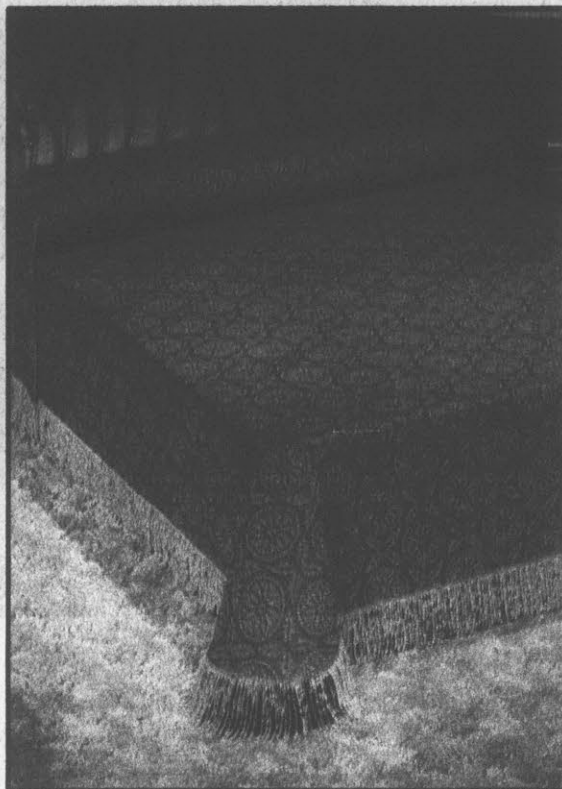

### Woven Textured Bedspreads

**20<sup>th</sup> anniversary sale**

**7.99**

Special purchase! A no-iron bedspread that doubles as an extra blanket at night. Full or twin size.

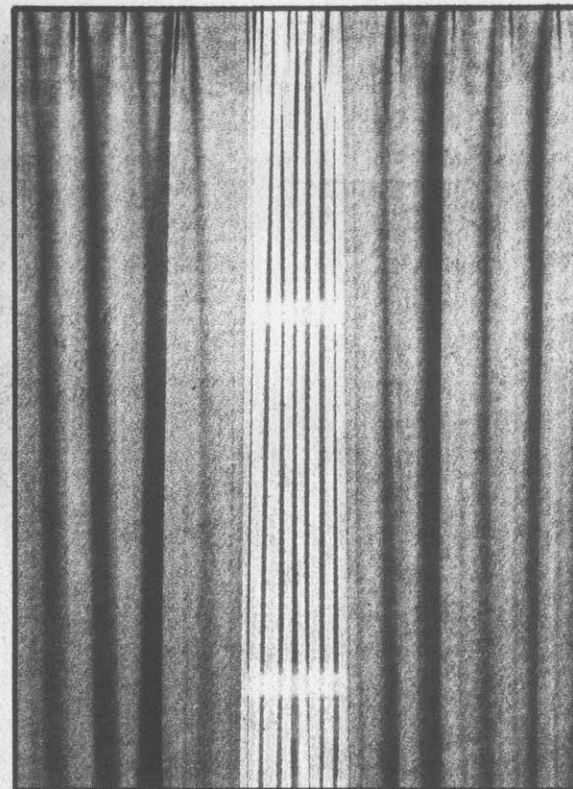

### Antique Satin Draperies

**20<sup>th</sup> anniversary sale**

**7.99 Pr.**

Permanent press Celanese® with insulated backing. Solid colors. Choose 48"x63" or 48"x84". Dacron® Ninon Panel, 60"x63" or 60"x81" . . . . 2.99ea.

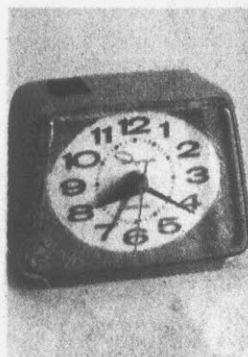

### Electric Alarm Clock

**4.99**

Quiet electric movement with lighted dial and repeat buzzer alarm.



### 5-Pc. Bath Mat Set

**20<sup>th</sup> sale**

**7.99**

Includes bath rug, contour rug, lid cover, tank cover and tank top cover. Soft pile. Washable.



### Solid Or Print Blankets

Solids **3.49**

Prints **4.99**

For full or twin size beds. Machine washable. Buy now and save!

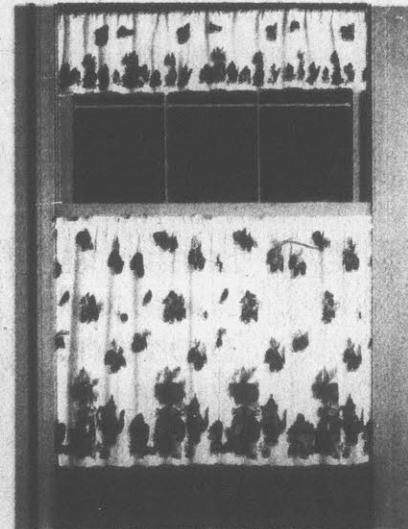

### Tier And Valance Set

**20<sup>th</sup> sale**

**3.99**

Pair of 36" tiers with matching valance.  
Single curtain rod . . . . . 77c  
Double curtain rod . . . . . 1.39



### Airwick Carpet Fresh

**1.39**

Room and rug deodorizer in 14-oz. container. Airwick Stick Ups . 69c



## Decorator Ceramic Lamps

**20<sup>th</sup> anniversary sale** **8.99**

Incredible savings! Large ceramic base lamps in many styles and colors. Approximately 25" tall. Not all styles or colors available at every store.

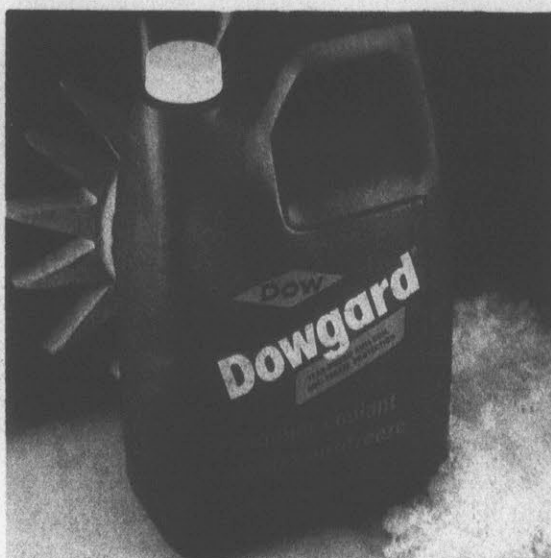

## Dowgard Antifreeze/Coolant

**20<sup>th</sup> anniversary sale** **2.99 Gal**

For year-round protection against boil-overs and freezing temperatures. Winterize your car now and save!

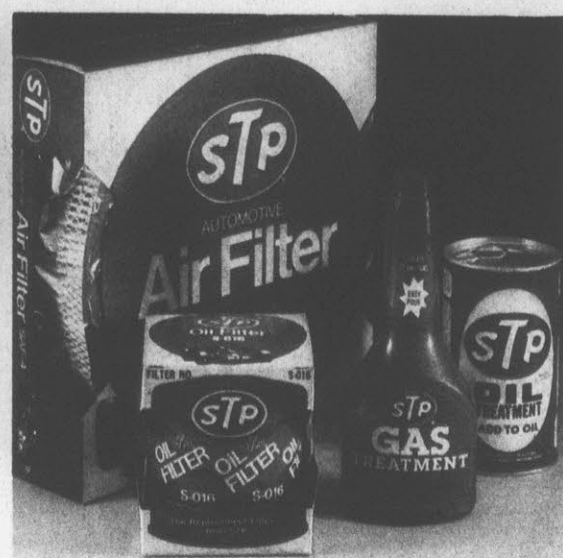

## Save Now On STP Products

Gas Treatment, 12-oz.	<b>99¢</b>
Oil Treatment, 15-oz.....	<b>2.22</b>
Single Oil Filter.....	<b>2.99</b>
Air Filter.....	



## Assorted Housewares

Your Choice **1.00**

- Laundry basket
- Pack of 10 12-oz. tumblers
- 7-pc. salad serving set
- Pack of 8 cereal bowls

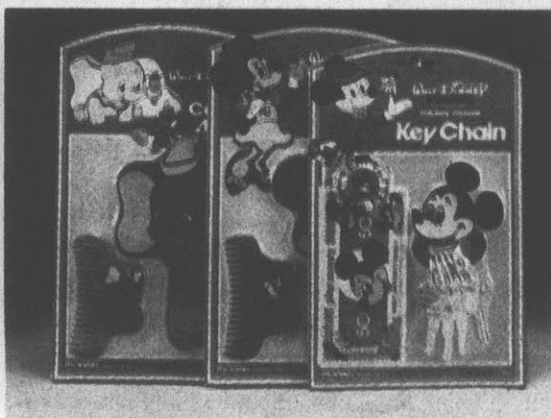

## Toys For Boys And Girls

Your Choice **1.00**

Choose from a wide selection of toys for boys and girls. Made to sell for much, much more.



## Cheryl Ladd Or Slime Monster

By Mattel. Popular Slime Monster game or Cheryl Ladd doll.

**3.99**



**Set of 4  
Steak Knives**  
**1.00**

Sharp stainless steel blades with plastic wood grain handles.



**Parsons  
Tables**  
**2.99**

Sturdy plastic, stackable Parsons Tables. Choose white, yellow, or black.



**Light Bulbs**  
**2 Pks. 1.00**

Sylvania 60, 75 or 100 watt light bulbs, inside frost. Pack of 2.

**Soil Or Planter**  
Your Choice **88¢**

8-qt. bag of potting soil or 8-in. hanging planter.

You Get More For Your Dollar From Family Dollar During Our Great 20th Anniversary Sale!

# FAMILY DOLLAR 20th anniversary sale

SAVINGS JUST IN TIME FOR BACK TO SCHOOL

SUPPLEMENT TO: Sandersville Progress, The Charlotte Observer, Burlington Times-News, Sanford Daily Herald, Wilmington Morning Star, Lenoir-News-Topic, Sun-News, Evening-Herald, The Gastonia Gazette, Mount Airy News, The Dispatch, The News-Herald, Richmond County Journal, Hamlet News, News Leader, Roanoke Times-World News, Courier-Tribune, The Lancaster News, The Evening & Sunday Telegram, Daily Citizens-News, Greensboro Daily News-Record, High Point Enterprise, Martinsville Bulletin, Bessemer City Record, Easley Progress, The Gaffney Ledger, Laurens County Advertiser, News & Reporter, Newberry Observer, Buena Vista News, The Pilot, Kinston Daily Free Press, Sun Journal, Washington Daily News, Mooresville Tribune, Shelby Daily Star, North Myrtle Beach Times, The Tribune, Marlboro Herald-Advocate, The Eden News, Smithfield Herald, The Daily Southerner, Tabor City Tribune, The News Reporter, Union Daily Times, Village Advocate, Lincoln Times-News, Galax Gazette, Smyth County News, Spartanburg Herald, Transylvania Times, McDowell News, Altavista Journal, Bristol Herald Courier and Virginia-Tennessean, Field & Herald, Jackson Herald-Banks County News, The Commerce News, Anderson Independent/Daily Mail, The Mountaineer, Stanly News & Press, Carteret County News-Times, The Daily Independent, The Daily Reflector, Daily Advance, Camden Independent, Athens Banner-Herald, The Windsor News, Belmont Banner & Mt. Holly News, Toccoa Record, The Robesonian, The State, Goldsboro News-Argus, Seneca Journal, Sumter Daily Item, The Franklin Times, The True Citizen, Cheraw Chronicle, The Enquirer-Journal.

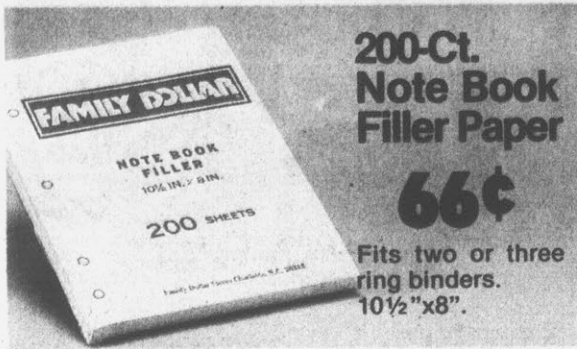

**200-Ct.  
Note Book  
Filler Paper**

**66¢**

Fits two or three  
ring binders.  
10 1/2"x8".



**Sale! School Supplies**

Your Choice **3 For 1.00**

- Lepages school glue
- Lepages 1/2"x1,000" tape
- Lepages mucilage
- Lepages white paste
- Pedigree 6-pack erasers
- Empire 8-pack pencils
- 3-ring pencil case
- Weavever retractable pen



**Thermos  
School  
Lunch Kits**

**2.99**

Colorful, popular  
movie and T.V.  
character designs.  
Pint Thermos bottle . . . 1.99  
Qt. Thermos bottle . . . 2.99



**3-Ring Binders**

Canvas or vinyl  
three ring style.  
1 1/2 inch rings.

**1.44**

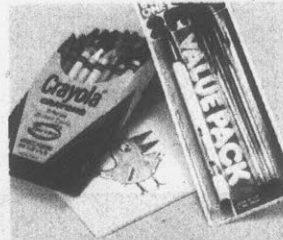

**Pens or Crayons**

Your choice of Bic  
Value Pack Pens or  
24 Crayola Crayons.

**59¢**



**60-Page  
Composition  
Book**

**59¢**

Wire bound. Made to  
fit all 2 and 3 ring  
binders.



**Assorted  
Health And  
Beauty Aids**

**2 For \$1**

Choose Lander baby  
powder, skin cream,  
stick deodorant,  
bubble bath, petro-  
leum jelly and more.



**Wella Balm**

Shampoo or  
conditioner.  
Your choice!  
8 oz. **1.00**  
Ea.



**Queen Helene**

Cocoa butter  
lotion or creme. **1.00**  
Henna shampoo  
or conditioner. **1.49**



**Delta  
Paper  
Towels**

**39¢**

Strong absorbent towels  
with colorful border  
trims. 125 sheets per  
roll.



**Intensive Care Lotion**  
**89¢** Ea.

Extra strength, regular or  
herbal. 10-oz.



**Auto**

**Flicker Ladies' Shaver**  
**5 blades 99¢**

Personna Auto blades,  
fits Atra razor, 5-Pk. **89¢**



**Regency Drink Mix**  
Makes **8 Qts. 99¢**

Grape, cherry, lemonade  
and fruit punch. By Borden.



**Munch King Snacks**  
**2 For 1.00**

Corn chips, cheese curls,  
pork rinds and cheese balls.

Shop Family Dollar Now for Back-to-School Savings . . . Use Our Convenient Lay-Away!



good old fashioned

# DOLLAR DAYS

where a dollar buys more

Your Choice **250**

**Fun Totes For Girls**  
Our Reg. 3.44

Rayon/canvas. With attached coin purse.

**\$2**

**Bedford Cord Boxers**  
Our Reg. 2.97

A favorite for boys 2-4. Polyester/cotton.

**\$2**

**Fashion Tees In Soft Cotton**  
Our Regular 2.96

Classic styling with fashion's newest necklines...basics for any wardrobe.  
Not all colors in all Stores

**K mart® ADVERTISED MERCHANDISE POLICY**  
Our firm intention is to have every advertised item in stock on our shelves. If an advertised item is not available for purchase due to any unforeseen reason, K mart will issue a Rain Check on request for the merchandise to be purchased at the sale price whenever available or will sell you a comparable quality item at a comparable reduction in price. Our policy is to give our customers "satisfaction always."

Men's and Boys' Belts in Stock **20% OFF** Reg. Price

**\$6**

**Men's Western Denim Jeans**  
Our Regular \$7

A tradition in casual wear fashioned in popular indigo cotton denim.

**\$4**

**Western-style Jeans For Boys**  
Our Regular 5.97

Solid-color polyester/cotton denim or twill tailored with that authentic look.

GREENVILLE, N. CAROLINA GREENVILLE BLVD. AT ARLINGTON BLVD.

**Kmart**  
THE SAVING PLACE

Good  
Old-Fashioned

**DOLLAR DAYS**



Master Charge® or  
Visa® Accepted  
in Most Areas

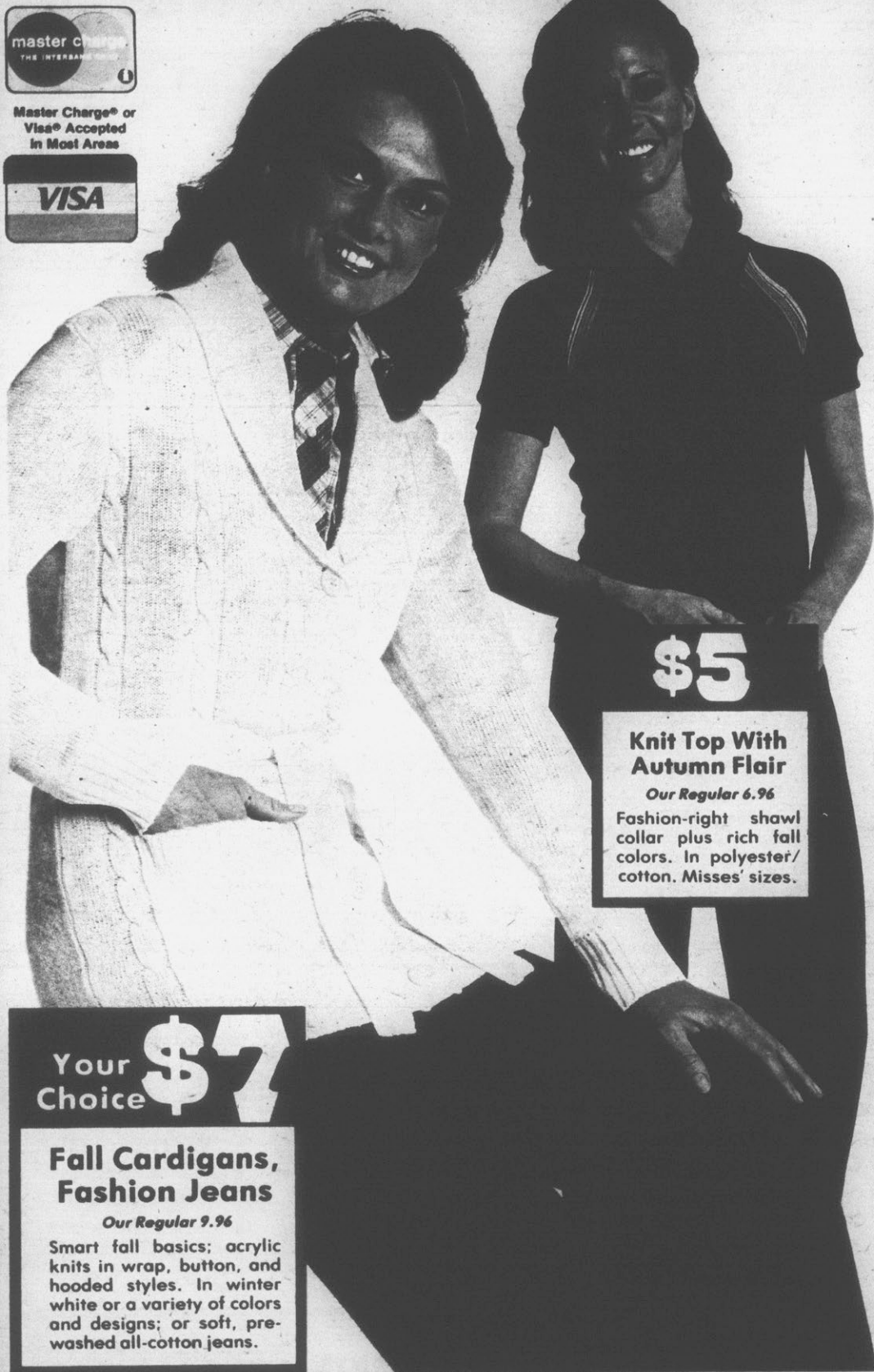

**\$5**

**Knit Top With  
Autumn Flair**

*Our Regular 6.96*

Fashion-right shawl  
collar plus rich fall  
colors. In polyester/  
cotton. Misses' sizes.

Your  
Choice

**\$7**

**Fall Cardigans,  
Fashion Jeans**

*Our Regular 9.96*

Smart fall basics; acrylic  
knits in wrap, button, and  
hooded styles. In winter  
white or a variety of colors  
and designs; or soft, pre-  
washed all-cotton jeans.

**\$3**

**Soft Brushed  
Sleep Gowns**

*Our Regular 3.96*

Cozy warmth in  
soft acetate/nylon  
gowns; trims, colors.

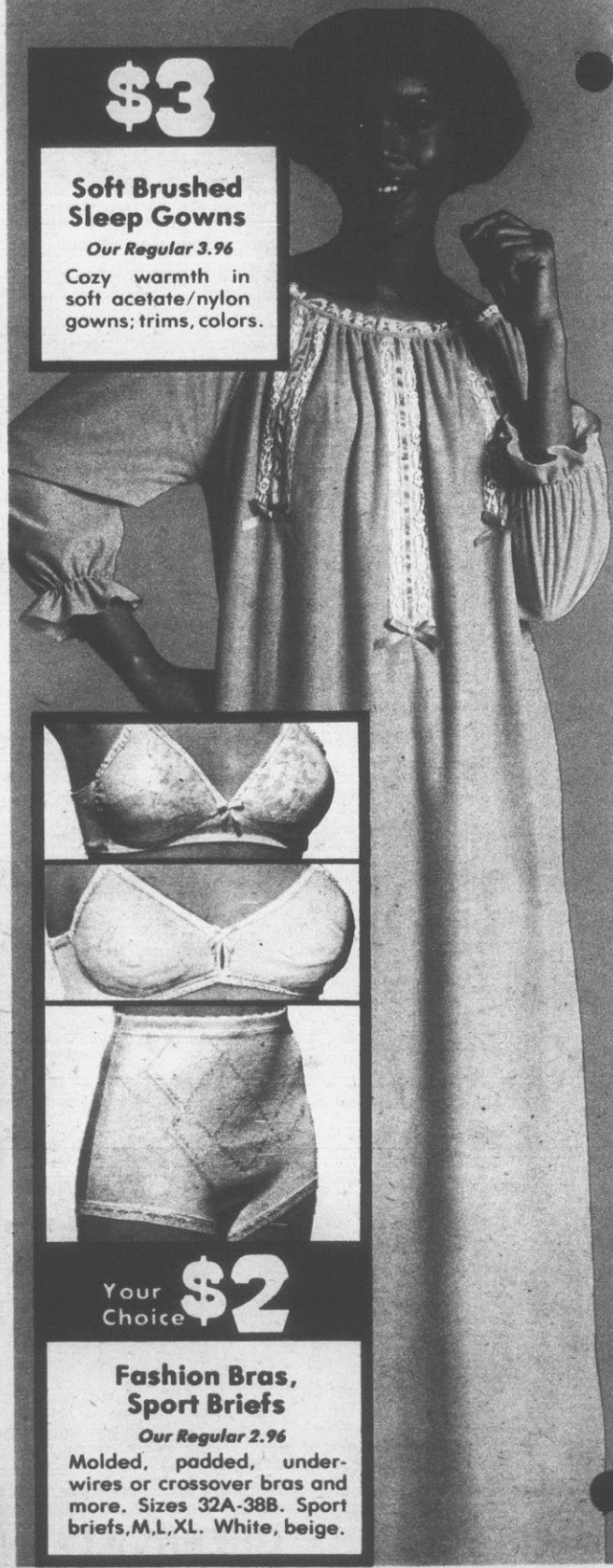

Your  
Choice

**\$2**

**Fashion Bras,  
Sport Briefs**

*Our Regular 2.96*

Molded, padded, under-  
wires or crossover bras and  
more. Sizes 32A-38B. Sport  
briefs, M, L, XL. White, beige.



**\$8**

**Smart Dresses In Full Figure Sizes**

*Our Regular 9.96*

Lovely 1- and 2-piece polyester dresses in fall prints and solid colors. Half-sizes 14½-24½.



\$6  
Sizes  
7-12

**\$6**

**Pretty Styles For School**

*Special Purchase*

Charming dresses in soft polyester knits and woven polyester/cotton.

**\$5**

**Fashions For Little Girls**

*Special Purchase*

New fall dresses in polyester knits or woven polyester/cotton blends. 4-6X.

\$5  
Sizes  
4-6X



4.50  
Sizes  
7-14  
Many  
Other  
Styles

**4.50**

**Western-style Plaid Shirts**

*Our Regular 5.96*

Casual flair for girls, shirts of colorful polyester-cotton. Sizes 7-14. Not all plaids in all stores

**\$5**

**Fashion Pants In Fall Colors**

*Our Regular \$6*

Smartly tailored girls' pants of woven polyester. 7-14. Our \$5, 4-6X, \$4

\$5  
Sizes  
7-14

**3.50**

**Novelty Tees Just For Fun**

*Our Regular 4.57*

Bright sayings\* on colorful tops. Polyester/cotton. 7-14. Our 3.96, 4-6X, \$3

\*Not all sayings in all stores

**5.50**

**Pre-washed Cotton Jeans**

*Our Regular 6.96*

Blue cotton denim jeans, pre-washed for soft comfort. Our 5.96, 4-6X, 4.50

5.50  
Sizes  
7-14



3.50  
Sizes  
7-14

**Kmart**  
THE SAVING PLACE

Good  
Old-Fashioned

**\$6** Each

**Embroidered  
Knit Shirts**

*Our Regular 6.97*

Men's short-sleeve  
classics with tulip,  
snap or zip neck.  
Polyester/cotton.

Your  
Choice

**\$10**

**Great Looks In  
Fashion Jeans**

*Our Regular 14.97*

Style-right "Leggs"  
and "Tailfeathers"  
jeans in cotton  
denim. Men's.



Boys **2\$5**  
Pkgs.

Men's **2\$7**  
Pkgs.

**Cotton Briefs  
Or Tee Shirts**

*Our Reg. 3.38-4.48*

Combed-cotton  
comfort in white.  
Package of 3 briefs  
or 3 tee shirts.

Jr. **\$3** Boys'  
Boys' **\$4**

**Knit Sport Shirts  
With Embroidery**

*Our Regular 4.44-5.44*

Embroidered for the look  
boys go for. Polyester/  
cotton knit. Jr. boys'  
4-7 and bigger boys' sizes.



Jr. **\$5**  
Boys'

**Western-style  
Denim Jeans**

*Our Regular 6.97*

The authentic look  
with safety-stitched  
seams. Polyester-  
cotton. 4-7.

# DOLLAR DAYS



**\$6**

Boys

### Fashion Jeans With Boot-cut

*Our Regular 7.97*

For the casual scene. Cotton denim. Boys' regular, slim sizes. Trend-setting style.

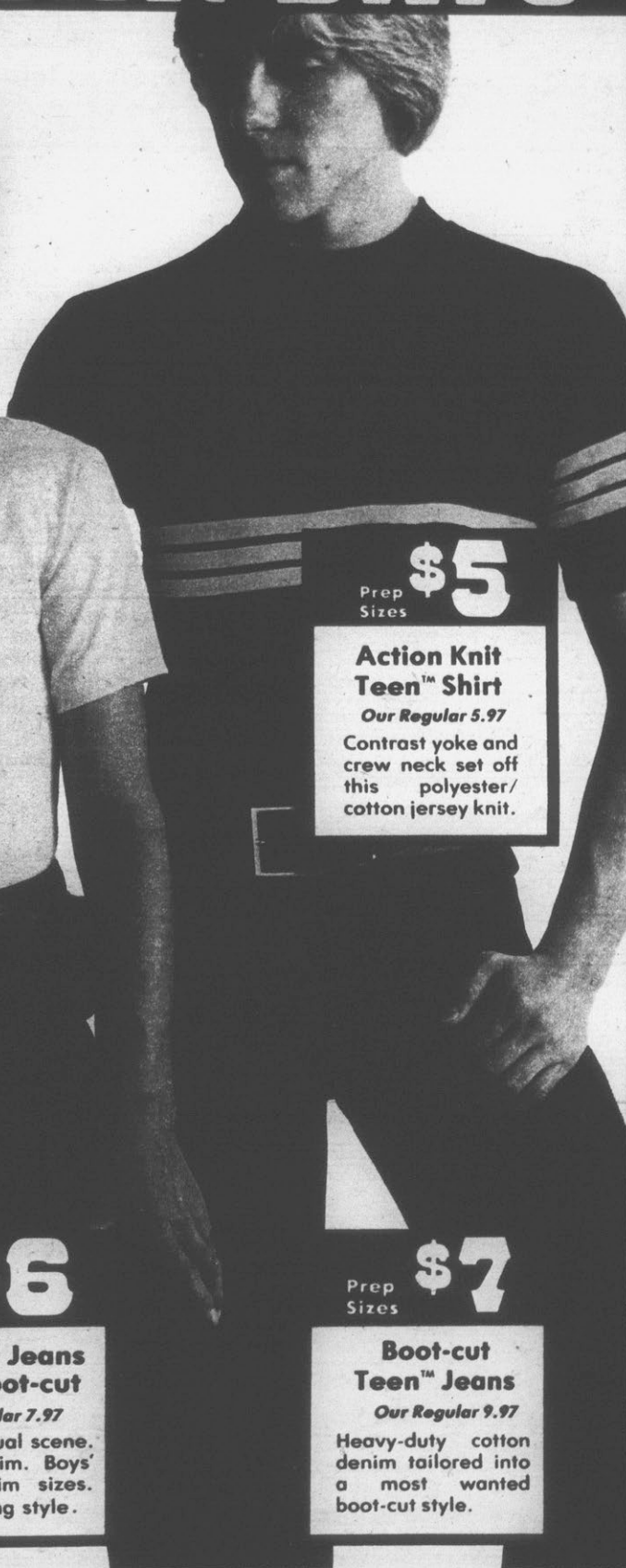

Prep  
Sizes **\$5**

### Action Knit Teen™ Shirt

*Our Regular 5.97*

Contrast yoke and crew neck set off this polyester/cotton jersey knit.

Prep  
Sizes **\$7**

### Boot-cut Teen™ Jeans

*Our Regular 9.97*

Heavy-duty cotton denim tailored into a most wanted boot-cut style.

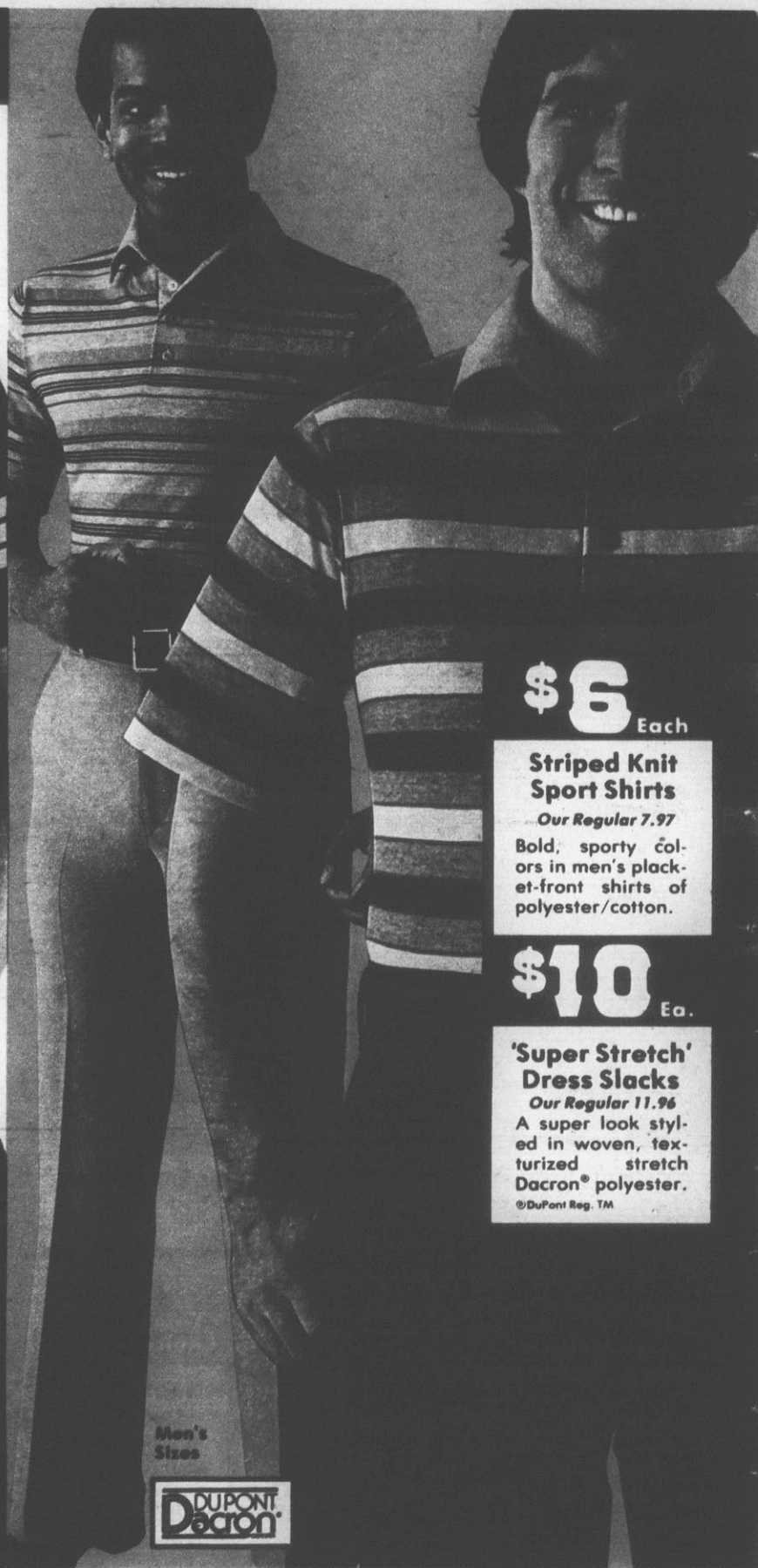

**\$6** Each

### Striped Knit Sport Shirts

*Our Regular 7.97*

Bold, sporty colors in men's placket-front shirts of polyester/cotton.

**\$10** Ea.

### 'Super Stretch' Dress Slacks

*Our Regular 11.96*

A super look styled in woven, textured stretch Dacron® polyester.

©DuPont Reg. TM

Men's  
Sizes

DUPONT  
Dacron

"Blossom"



Our Reg. 14.88 **\$10**

**Soft Curl Wig**

Kanekalon® modacrylic in natural shades. Easy style.

"The Lady"



Our Reg. 18.88 **\$15**

**Versatile Wig**

Kanekalon® Elura® modacrylic. In natural shades.



Our Reg. 2.94 **\$2**

**Rain Or Shine Cap**

Super admiral style. Water-repellent cotton. New!



Our Reg. 4.97 **\$4**

**Rain Or Shine Hat**

Easy-pack cloche in water-repellent cotton. Save now!



Your Choice **\$4**

**Neat Clutch Handbags**

Our Reg. 4.97  
Sophisticated!  
Bags with strap  
or handle. Vinyl.



**2 \$3**  
For

**Infants' Tops**

Our Reg. 2.97  
Long sleeves, snap shoulder. Cotton knit. 9-24 months.

**Infants' Pants**

Our Reg. 2.57  
Cotton/polyester corduroy, for boys' and girls' 9-24 mos.

**Tots' Knit Tops**

Our Reg. 3.33  
Girls' long sleeve cotton/polyester top. Sizes 2-4.

**\$2** Each

**Girl Tots' Boxer Slacks**

Our Reg. 3.33  
Twill, cord, denim in cotton/polyester, three styles. Color choice. 2-4.



**2 \$5**  
For

**Toddler Girls' New Nightwear**

Our Reg. 3.27  
Cuddly brushed nylon pajamas and gowns in darling styles and colors for her. Sizes 2-4.

**\$1**  
Pair

**Boys' Over-calf  
Tube Socks**

Our Regular 1.27  
"Sta-dry" Orlon®  
acrylic/stretch  
nylon; striped top.  
Fit sizes 9-11.  
© Du Pont Reg. TM

**\$1**  
Pair

**Men's "Sta-dry"  
Tube Socks**

Our Regular 1.47  
Over-the-calf  
style of Orlon®  
acrylic/stretch  
nylon. 10 to 13.  
© Du Pont Reg. TM

**2 \$1**  
Pairs

**Nylon Panty Hose  
In Two Styles**

Your Choice - Our 64'  
Stretch nylon. Regular  
style with reinforced  
panty or sheer top-to-  
toe style. Basic colors.  
In sizes S/M-MT/T.

**2 \$1**  
Pairs

**Crew Socks  
For The Family**

Our Regular 58¢-74¢  
Orlon® acrylic/  
stretch nylon crews  
in solid colors.  
7-8½, 9-11, 10-13.  
© Du Pont Reg. TM

**6 Pr. \$1**  
Pack

**Sheer Nylon  
Knee-Highs**

Our Regular 1.37  
Sheer stretch ny-  
lon knee highs,  
with non-bind top,  
fit sizes 8½-11.

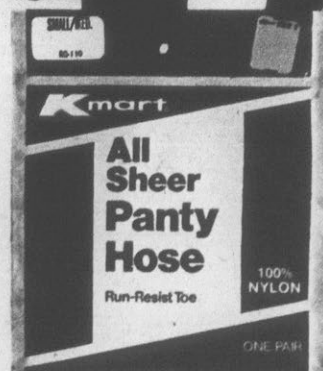

**Kmart**  
THE SAVING PLACE

Good  
Old-Fashioned

**DOLLAR DAYS**

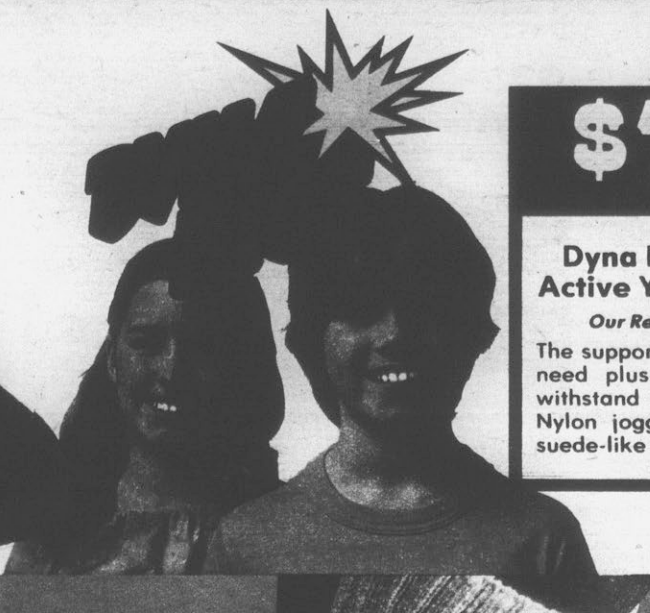

**\$7** Pair

**Dyna Kids™ For  
Active Youngsters**

*Our Regular 10.97*

The support growing feet need plus durability to withstand rugged action. Nylon joggers rich with suede-like trim. 12½-3.

**Trax**®  
QUALITY ATHLETIC  
FOOTWEAR  
ONLY AT K mart

**\$12** Pair

**Men-on-the-go  
Sure Go For Trax®**

*Our Regular 16.97*

Joggers in suede-trim nylon with flexible rubber sole for the ultimate sports look. Padded and cushioned for comfort.

**Trax**®  
QUALITY ATHLETIC  
FOOTWEAR  
ONLY AT K mart

**\$10** Pair

**Women Love Trax®  
Style and Comfort**

*Our Regular 15.97*

Contrasting colors of nylon, suede leather and vinyl combine for outstanding sportswear fashion, Texon® innersole.

