

## Weather

Partly cloudy through Thursday with chance of afternoon and evening showers.

# THE DAILY REFLECTOR

## INSIDE READING

Page 15 — How they voted  
Page 16 — Obituaries  
Page 22 — The Assembly

TRUTH IN PREFERENCE TO FICTION

98TH YEAR NO. 129

GREENVILLE, N.C.

WEDNESDAY AFTERNOON, MAY 30, 1979

112 PAGES—8 SECTIONS PRICE 15 CENTS

## Marathon Operation Separated Hansen Twins

SALT LAKE CITY (AP) — Siamese twins Lisa and Elisa Hansen, joined at the tops of their heads since birth 19 months ago, were successfully separated today in pioneering surgery that lasted over 16 hours.

"It's done and it's a success. They're awake and crying," said John Dwan, spokesman for the University of Utah Medical Center. He said the twins were separated at 1:19 a.m. EDT.

He said the tops of the twins' heads were closed at 5:05 a.m. EDT. Two teams of surgeons, one for each twin, participated in the marathon operation.

Dwan said the twins were in "critical but stable condition and their prognosis is unknown."

The parents, David and Patricia Hansen of Ogden, were "very grateful and very tired," Dwan said. The Hansens and several close members of the family kept a vigil at the hospital during the surgery, which began at 12:40 p.m. EDT Tuesday.

Working in shifts through the night, teams of surgeons tied off shared blood vessels and cut apart the girls' skulls. Before the surgery, the twins faced the same direction.

When they were wheeled out of the operating room today, it was the first time in their lives they had independent movement.

Dr. Stephen Minton, a spokesman for the medical team, said recently that separation of this type had never before been

completed successfully. Other attempts had ended in death or severe mental retardation, he said.

Asked if either of the twins may have suffered brain damage during the grueling surgery, Dwan declined comment. He said doctors would hold a news conference at 3 p.m. EDT today.

Newsmen were not allowed near the operating theater, but Dwan compared the lengthy, delicate operation to a ballet. He said the operating room was very noisy and very busy as up to 11 doctors conferred and worked in teams.

Before the operation, Minton had described Lisa and Elisa as healthy children who were perfectly normal, both physically and mentally, except for their being joined together.

During the surgery, Dwan said doctors — including neurosurgeons, plastic surgeons, anaesthesiologists and pediatricians — worked more slowly for a time because they encountered scar tissue from four previous operations which set the stage for final separation.

However, he said doctors were able to accelerate their pace during other stages of the operation, which doctors had predicted could last 20 hours.

Doctors have said the girls' brains were separate, although touching. They had shared veins carrying blood away from their brains, and their skulls were fused together, but there was a slight indentation where Lisa's head stopped and Elisa's began.

## Grounding Disrupts World Air Travel

By The Associated Press  
Thousands of passengers scrambled for new flights or cooled their heels in airport lounges and hotels as a U.S. government-ordered grounding of all DC-10 jumbo jets disrupted world air travel.

Some DC-10s were called back in mid-flight Tuesday, and on the ground passengers

were bused hundreds of miles to catch substitute flights or lodged overnight until an available seat turned up.

Sir Freddie Laker's Skytrain was derailed. It uses six DC-10s for its cheap-fare flights between England and the United States.

Many took the inconvenience philosophically, mindful the inspections were

prompted by the crash of an American Airlines DC-10 that killed at least 273 people in the nation's worst air disaster.

"It's better to be safe on the ground rather than go 'Oh! Oh!' in midair," said singer Pat Boone, who had a reservation for a DC-10 flight from New York to Los Angeles.

The Federal Aviation Administration's decision to ground the three-engine jets pending new checks of their engine assemblies left about 40,000 DC-10 seats empty on U.S. carriers alone — about 12 percent of domestic capacity, the industry estimated.

The order followed discovery of "grave and potentially dangerous deficiencies" in the engine assemblies. An engine fell off the ill-fated American plane on Friday.

Eight U.S. carriers have 134 DC-10s in operation. Foreign airlines have at least that many, and while they were not bound by the FAA order, many grounded their jets.

Joseph Scott, an American spokesman in Chicago, estimated about 17,000 persons nationwide were bumped from DC-10s. About 3,200 persons were bumped in Chicago, he said.



SAFETY AWARDS PRESENTED — Kenneth Buck, left, chairman of Tuesday's safety awards banquet, looks on as North Carolina Commissioner of Labor John Brooks, right, presents safety certificates to Steve Perry, second from right, plant manager of

Union Carbide Corporation, Battery Products Division, and Tom Bullock, personnel manager of Collins and Aikman Corporation, Bangor Division, Farmville Plant. (Reflector Photo by Tommy Forrest)

## REFLECTOR

### HOTLINE

752-1336

Hotline gets things done for you. Call 752-1336 and tell your problem or your sound-off or mail it to Hotline, The Daily Reflector, Box 1967, Greenville, N.C. 27834.

Because of the large numbers received, Hotline can answer and publish only those items considered most pertinent to our readers. Names must be given, but only initials will be used. Transcribing is done once a day.

## Assassin Of Judge Hunted By 40 Agents

By JACK KEEVER  
Associated Press Writer  
SAN ANTONIO, Texas (AP) — An army of federal agents commanded by the FBI's top criminal investigator has been called in to search for the assassin who gunned down U.S. District Judge John H. Wood Jr., known as "Maximum John" because of his stiff sentences for drug offenders.

"We cannot have a country where judges are assassinated or killed," said U.S. Attorney General Griffin Bell, himself a former federal judge. "We don't intend to leave a stone unturned."

Wood, 63, was shot once in the lower back Tuesday morning as he was getting into his car in the parking lot at his apartment. He was pronounced dead on arrival at a San Antonio hospital.

The judge was the second federal official involved in West Texas drug investigations to be the target of gunfire in the last seven months. He was believed to be the first federal judge ever assassinated.

Bell assigned James Ingraham, whom Bell described as the FBI's foremost investigator, to

direct a team of 40 agents in the case. He also sent federal marshals to protect four federal judges in the San Antonio area.

The FBI said Wood was apparently shot with a small-caliber rifle. Although the judge's wife and the son of a fellow jurist arrived at the scene only moments after the shooting, there was no report they saw the assassin.

Last November, assistant U.S. Attorney James Kerr, one of the prosecutors in the investigation, narrowly escaped death when his car was riddled by gunfire. Wood was put under protective guard but ordered it discontinued three weeks ago.

Wood had often alluded to the danger posed by his drug cases, which included that of Jimmy Chagra, a professional gambler charged with conspiracy to possess, import and distribute cocaine and marijuana.

Chagra's lawyers asked at an April pretrial hearing in Midland that Wood remove himself from the case, scheduled to be tried July 23, but Wood refused, saying he would be unbiased.

## Safety Records Honored At Annual Awards Event

By REBECCA BUFFALO  
Reflector Staff Writer  
Approximately 100 persons from 50 Pitt County plants, businesses and service establishments attended the Tuesday safety awards

banquet sponsored by the Greenville Area Chamber of Commerce and the North Carolina Department of Labor.

Companies qualified for the safety certificates by main-

taining perfect safety records during the calendar year, or by recording an occupational injury incidence rate of at least 50 percent below the statewide rate for their particular industry.

Master of ceremonies for the event was Kenneth M. Buck, GACOC Safety Awards Banquet chairman. Douglas Starr, vice chairman of the Chamber's Economic and Industrial Development Council, introduced the featured speaker, North Carolina Commissioner of Labor John C. Brooks.

Brooks, a Greenville native, commended those present "for a job well done." He pointed out that good safety records increase productivity and are successful in controlling spiraling inflation. Brooks spoke of the need for North Carolina high skilled craftsmen, and noted that community colleges and technical institutes should be authorized to implement more high skilled programs in their curricula.

"Industries will not choose to come to North Carolina if there are not enough high skilled craftsmen," said Brooks. He noted that the low number of high skilled craftsmen, such as sheet metal workers and carpenters, cause higher increases in craftsmen's pay.

Commissioner Brooks presented awards to the business representatives. Union Carbide Corporation,

(Continued on page 16)

## Public Employee Union Ban Argued At Hearing

RALEIGH, N.C. (AP) — Enacting into law a bill that would prohibit public employees from joining certain unions and from striking will only make public employees more inclined to join unions, opponents of the bill told legislators Tuesday.

In a public hearing called after several of the state's labor leaders implied the General Assembly was trying to rush the bill through without public airing, opponents said it would only increase the discontent felt by those employees now.

"If you don't want public-employee unions in North Carolina representing state, city and county public employees," said Barbara Brown, president of the N.C. Federation of Teachers, "you are going to have to upgrade quickly your treatment of public employees..."

Several dozen speakers spoke against the proposal, which was introduced by Sen. I. Beverly Lake Jr., D-Wake, and Rep. Hartwell Campbell, D-Wilson.

A smaller number, including former state Sen. Lawrence Davis of Winston-Salem, spoke in favor of it.

Davis' Winston-Salem law firm represents that city in litigation stemming from successful union organization of several departments there.

"We have in North Carolina today no law relating to what unions public employees can join," Davis said.

"Virtually every state has an appellate court case or a statute saying public employees cannot strike," Davis said. "We have not needed it.

But that can change and change rapidly."

Another Winston-Salem official agreed.

"We need the limitations on public employees' union membership and activities this bill provides in order to ensure our continued economic well-being, as well as protect the health, safety and welfare of all the citizens of the state," said Richard Stockton, president of the Greater Winston-Salem Chamber of Commerce.

But opponents warned the bill would prompt public employees to seek union representation.

"Yes, poor public employees in this state are just

ripe for organizing. Winston-Salem proves just that," Ms. Brown said. "By outlawing public employee unions, you are just going to make them look more enticing."

The bill would prohibit public employees from becoming members of unions that use strikes as bargaining tools and require members to participate in authorized strikes. It would also prohibit police officers from joining a union that represents any employees in private industry in the same municipality.

The Senate and House committees handling the bill are expected to act on it this week.

PRETTY RED BLOSSOMS... on scarlet runner running green bean vines planted at a local residence have attracted a hummingbird every day since Saturday. (Reflector Staff Photo)

### HUMMINGBIRD ATTRACTERS

I would like to know some plants to plant that would attract hummingbirds. My children have never seen one and it's been years since I have. L. T.

There's a book at Sheppard Memorial Library titled, "Hummingbirds and Their Flowers." This would give a good idea of the kinds of plants that would be likely to draw hummingbirds. Some locally-easy-to-grow examples might be scarlet runner green beans, columbines, trumpet vines, and tiger lilies.

Another possible hummingbird attracter is a "store-bought" hummingbird feeder, which can be hung from a tree limb and filled with red soft-drink mix or sugar water colored red. The price at most local garden supply stores is \$3 or thereabouts.

## Rent Subsidy

GREENSBORO, N.C. (AP) — The federal government will help pay the rent on nearly 1,000 apartments in North Carolina this year at a cost of nearly \$2.8 million.

The program, which will be funded by the U.S. Department of Housing and Urban Development, is a new project designed to encourage landlords of deteriorating housing to renovate their property. The landlords will also be urged to help low-income families find places to live.

The incentive will be the ability to charge the fair-market rent, which is usually much higher than the rent landlords could expect for deteriorating structures.

Under the program, landlords owning deteriorating housing must renovate their property to standards acceptable to a housing-authority inspector. If acceptable, the authority will provide tenants who will pay about 20 percent of their income for rent and utilities with the government paying the rest.

To be eligible for the subsidized rent, the maximum income a family of four can earn is \$12,600. HUD said it must receive applications by July 23.

## Found Locked In Attic

BUFFALO, N.Y. (AP) — Police responding to a call for first aid in suburban West Seneca found a naked, emaciated 69-year-old man who they said may have been locked in an attic for half a century.

West Seneca Police Chief Bruce Manning said Erwin Moll was found Monday lying in a fetal position in a second-floor attic of the home occupied by his brother and sister.

"The man was found in very poor condition," Manning said Tuesday. "More or less a Howard Hughes-type condition. Emaciated, you know."

"Officers at the scene said he had very long toenails, was lying naked in a fetal position, twisted grotesquely and apparently in an advanced state of malnutrition," Manning said.

He said Moll had been apparently locked in the attic for some time by his sister Agnes. "His sister said he had been mentally in-

competent for the last 50 years," Manning said.

Police were trying to determine whether Moll had been confined in the attic for the entire half-century, Manning said. The Erie County Medical Center reported Moll in fair condition.

The police chief said Miss Moll called police, but officials had not been able to determine what caused her to seek assistance. The residence did not contain a telephone, and family members could not be reached for comment.

Manning said no charges had been filed, but an investigation was under way.

He said investigators have found that Miss Moll and her 72-year-old brother Raymond were both receiving Social Security benefits, but Erwin had never been registered in the Social Security system.

# Miss Gipson, Mr. West Exchange Vows Sunday

AYDEN — The Ayden Christian Church was the scene of the wedding ceremony Sunday afternoon at three o'clock of Betty Lucille Gipson and Frederick Ormand West Jr.

The Rev. Ralph Messick, Greenville, former pastor of the bride, performed the double ring ceremony. A program of wedding music was presented by Tommy Manning, Ayden, organist, and Mrs. Jimmy Lee, Greenville, vocalist.

Mr. and Mrs. Paul Gipson Sr. of Ayden are parents of the bride and the bride was given in marriage by her father. The bridegroom's parents are Mrs. Ray Hardison of Grifton and Mr. Frederick O. West Sr. of Florida. The bridegroom's stepfather served as best man.

Letty Koonce of Greenville, twin sister of the bride, was honor attendant and bridesmaids were Cathy Gipson, sister of the bride, of Greensboro, Kathy Stox of Ayden, and Wanda West of Greenville, sister of the bridegroom.

Paul Gipson Jr., brother of the bride, and Wallace Koonce, brother-in-law of the bride, both of Greenville, and Tim Odham of Ayden were ushers.

The bride was attired in a formal length gown by Milady of white qiana over peau de soie designed with an open Queen Anne neckline outlined in white floral silk Venise lace that extended over the empire bodice. The long fitted sleeves were enhanced by appliques of silk Venise lace and the modified A-line skirt and attached chapel train were trimmed at the hemline with the coordinating silk floral Venise lace. She chose a matching bridal hat to complete her attire and carried a cascade of pink roses and white Jack Frost pom poms.

The honor attendant wore a formal length gown of sheer silesta print of dusty Panama with blue and green floral design over blue taffeta designed with an open portrait neckline edged in piping with miniature tie bows

## Shower Given Couple Saturday

Miss Tammie Haddock and Perry Hardee, whose marriage will take place in July, were honored at a floating bridal shower Saturday night at the home of Mr. and Mrs. Larry Hardee.

Assisting hostesses were Mrs. Hardee, Mrs. Patsy Rollins, sister of the bridegroom-elect, and Mrs. Dorothy Hudson, aunt of the bridegroom-elect.

The honoree was given a corsage of yellow roses with blue ribbon. Mothers of the couple were given corsages of yellow roses with white ribbon.

Mrs. Hardee assisted in displaying gifts on a table covered with a white cloth draped with yellow streamers. Mrs. Rollins greeted guests and the register table was decorated with red roses.

Refreshments were served by Mrs. Hudson. The refreshment table was covered with a white linen and lace cloth centered with a candelabra of white daisies and candles.



MRS. FREDERICK ORMAND WEST JR.

at shoulders, short split sleeves, blouson bodice and full flared skirt. She wore a headpiece of pink carnations and baby's breath and carried a nosegay of pink carnations, white pom poms and pink ribbon streamers.

Bridesmaids were dressed like the matron of honor.

After the ceremony, a reception was given by the bride's parents in the church fellowship hall.

The couple will live in Greenville after a wedding trip to Myrtle Beach, S.C.

Both the bride and bridegroom graduated from Ayden-Grifton High School. She attended Pitt Technical Institute and works at Pitt Memorial Hospital. He

works at Grady-White Boats.

The bridegroom's parents entertained at a rehearsal dinner Saturday night at the Three Steers for members of the wedding party and out-of-town guests.

On Friday night, Mrs. Eliza Richardson and Robie Richardson entertained in the church fellowship hall at a floating miscellaneous shower. Mrs. David Stox and Mrs. Rudy Robinson gave a bridesmaids luncheon at the Ramada Inn Saturday.

A miscellaneous shower was held at the Bethel Christian Church given by Mrs. J. W. Rouse and Mrs. J. W. Efrid.

## Class Reunion Held Saturday

The Belvoir class of 1949 held its 30th reunion at the Western Steer Steak House Saturday night. Beatrice Little greeted guests, presenting them name scrolls.

Jane Anderson, toastmistress, gave the welcome and recognized special guest, Fodie Hodges of Kinston principal at the school in 1949. Joseph Whitehurst gave the invocation. Juanita Lewis presented gifts to various members and Hodges.

The group's next reunion will be held in five years.

Tribute was paid to deceased class members, Jimmie Spain, Estell Dunn Smith, L. B. Venters and Hilda Allen Holland.

Attending were Lynden and Jane Clark Anderson, James Robert and Mattie Harrell Bullock, Charles and Juanita Dickerson Lewis, Thomas and Beatrice Coggins Little and Grace and Norman Pollard, all of Greenville, Rosa Bibbs Brow of Mississippi, Norman and Earline Stocks Butts, Robert and Irene Pollard Walston, Tarboro.

Hardy and Frances Little Cobb, Linwood and Joyce Peaden, Falkland, Edna C. Corbett, Fountain, Bennie and Peggy Cullipher, Chesapeake, Va., Hank and Janet Parker Forvendel, Winston-Salem, Willard and Adeline Gurganus, Washington, Joseph and Joan Whitehurst, Snow Hill.

Good-byes were said by Mrs. Lewis and Mrs. Anderson.

## Adoption

Mr. and Mrs. F. Bruce Sauter of Greenville announce the adoption of a daughter, Laura Elizabeth, on May 25, 1979.

## GEMS BIG

PARIS (AP) — Fall will not be the season for quiet, simple jewelry if French designers have their way.

At the recent showing of the fall collections, big, attention-getting pieces were the rule.

## Homemaker's Haven

By Addie Gore  
Pitt Home Agent

### What Causes Food Price Increases?

Food price increases result mainly from general inflation in the economy and changes in farm level commodity prices, according to economists with the U. S. Department of Agriculture (USDA).

A year-long study of food prices by USDA economists indicates reducing food price inflation will require the same long-term effort necessary for curbing inflation in the rest of the economy.

Recent fluctuations in food prices primarily responsible for the higher than normal food price increases. But the underlying rate of food price increases closely corresponds to changes in marketing costs which reflect inflationary pressures in the economy.

Rapid food price increases in 1973 and 1978 were due largely to higher farm-level commodity prices. In contrast, higher marketing costs accounted for most of the food price increases from 1973 to 1977, USDA economists said.

Changes in consumer lifestyles, particularly the increasing demand for food services, have also increased food prices. Sales by fast food outlets, for example, have risen faster than any other part of the market since the sixties — six-fold between 1967 and 1977. Growth in consumer purchases of frozen and partly prepared foods, costs of providing nutritional and ingredient information, and restrictions on pesticide and chemical use also have pushed up costs of producing and marketing food.

The formation of grain

reserves and pursuit of international trade agreements help to bring stability to the commodity markets. USDA economists say emphasis on other aspects of the food system may have a greater potential to reduce inflation in the years ahead.

Actions that government, the food industry and consumers could take to reduce food price increases include: monitoring merger activity and encouraging price competition in farm input supply, food manufacturing and food retailing industries; improving public knowledge of nutrition for better food purchase decisions; and encouraging adoption of available technology by the food industry and discouraging forces that impede technological adoption.

## Births

### Mersereau

Born to Dr. and Mrs. John Mersereau, Brooklyn, N. Y., a daughter, Amanda Ruth, on May 19, 1979. Mrs. Mersereau is the former Patricia Worthington of Greenville.

### Hardee

Born to Mr. and Mrs. Tony Alan Hardee, Rt. 7, Greenville, a son, Mark Alan, on May 28, 1979, in Pitt Memorial Hospital. Mrs. Hardee is the former Joy Roberson of Robersonville.

### Golden Indian Bread

No Preservatives Added

Diener's Bakery

815 Dickinson Ave.

## FRAME-IT-YOURSELF SHOPPE

156 Trade St. Phone 756-7454

OPEN TONITE UNTIL 9 P.M.

Coming To...  
United Figure Salon...  
3rd Anniversary Special

It's Almost Too Good To Be True!

One Full Year Only \$100<sup>00</sup>

Call Today For Your Appointment!  
Offer Good June 1 thru June 4

United Figure Salon  
756-2820 Red Oak Plaza

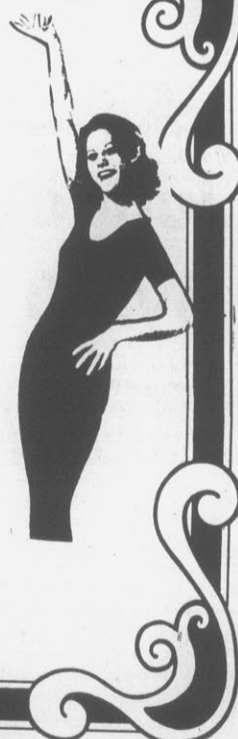

## Cooking Is Fun

By CECILY BROWNSTONE  
Associated Press Food Editor

DINNER FOR FOUR

Baked Chops Potatoes

Okra and Corn

Coconut Cake

BAKED PORK CHOPS

Adapted from Puerto Rican cuisine.

4 pork rib chops (about 2 pounds)

2 tablespoons lime juice

1 teaspoon salt

1/4 teaspoon pepper

2 to 3 teaspoons dried oregano leaves, crushed

2 teaspoons crushed garlic

1 egg, slightly beaten

1/2 cup (about) fine dry bread crumbs

If necessary, trim some (but not all) fat away from around chops. Stir together the lime juice, salt, pepper, oregano and

garlic; spread over chops. One at a time, dip chops in egg, then in crumbs, pressing crumbs down firmly. Place in a shallow greased baking pan (lined with foil) into which they just fit. Bake, uncovered, in a preheated 350-degree oven until browned on bottom side — about 30 minutes; turn and continue baking, uncovered, until very tender and well browned — 30 to 45 minutes longer. Serve at once. Makes 4 servings.

## MIRACLE PILL

A recent article in a well-known national newspaper revealed the thoughts of doctors who hailed the attributes of the safe, natural L-TRYPTOPHAN, that can virtually eliminate stress, depression and sleeping problems, and is available without prescription.

It is not a drug. According to medical experts in the article, L-TRYPTOPHAN can calm you down by relieving nervousness and stress. It can pick you up when you are blue, and help you to sleep like a baby. L-TRYPTOPHAN has been tested and can replace Valium, Tranquilizers, and Anti-Depressants. It is the first safe non-barbiturate, non-toxic sleeping pill that leaves you with a clear head in the morning. It is better than tranquilizers because it is non-habit forming.

L-TRYPTOPHAN is available at:

**NATURE'S HARVEST**

108 E. 5th Street  
Greenville, NC  
752-9336  
MONDAY-SATURDAY  
10:30-6:00

## SPECIAL INTRODUCTORY SALE

# WHAT'S 25 to 50% OFF\* BUT 100% NEW?



**American Tourister Casual Series 2500**

with combination locks

What's new? The combination lock — first time ever on Verilite® softside luggage. Plus the soft flexible handle. And the elegant textured panels. Available in nine his or her styles in strong, scuff-resistant vinyl. Combination lock not available on totes or car bags.

Choose blue, gold or natural.

### SAMPLE SAVINGS

A. 26" Pullman  
Style #2526  
Regularly \$85.00  
Sale Price \$63.75  
Save \$21.25

C. 24" Pullman  
Style #2524  
Regularly \$75.00  
Sale Price \$54.00  
Save \$21.00

B. Shoulder Tote  
Style #2511  
Regularly \$55.00  
Sale Price \$27.50  
Save \$27.50

D. Ladies Car Bag  
Style #2590  
Regularly \$80.00  
Sale Price \$60.00  
Save \$20.00

\*suggested retail price



**Brody's**  
DOWNTOWN  
PITT PLAZA

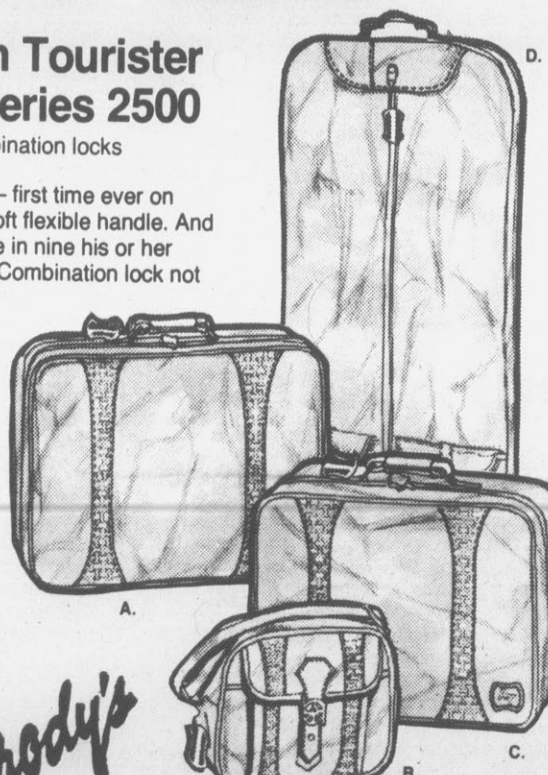

- Infants wear
- Preteens
- Toddlers Boys
- Toddler Girls
- Boys
- Girls 4 to 6X
- Girls 7 to 14
- Accessories

**Brody's**  
Children's Department

New Location Next To Balentines Pitt Plaza  
Sorry! No Layaways!

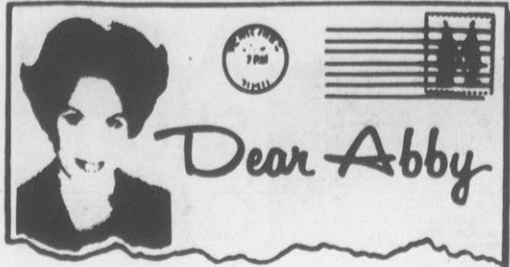

## Retardation— Not a Dead End, Only a Detour!

By Abigail Van Buren

© 1979 by Chicago Tribune-N.Y. News Synd. Inc.

DEAR ABBY: Enclosed please find my check for \$1 and a long, stamped (28 cents), self-addressed envelope for your booklet "How to Have a Lovely Wedding."

This wedding has to be specially lovely, because it is for a special daughter and a special young man. Both were labeled retarded as children, but have overcome their handicap and grown into mature, capable people. (She is 31 and he is 29.) Both work and are able to manage their own affairs with a little assistance from both sets of parents.

Friends and relatives are so happy that this beautiful couple found each other. If they were growing up today I'm sure they would not be labeled retarded, but would be considered to have "learning disabilities." They will be married in a church because their religion means so much to both of them.

This is my first letter to Dear Abby, and the only advice I need is how to make this wedding one of the loveliest our family has ever had.

REJOICING IN N.Y.

DEAR REJOICING: Thank you for a beautiful letter bearing a message of hope for all "special" children and their families. May the happy couple enjoy all of God's blessings.

DEAR ABBY: Frannie asked if birth control pills were deductible, and you replied, "Only if they don't work."

Cute answer, but for your information, according to Internal Revenue ruling 73-200, birth control pills are deductible whether they work or not—if prescribed by a physician.

NEIL WITH THE IRS

DEAR NEIL: Thanks for the info. Who am I to argue with the IRS? They're the nice people who know you can't take it with you—so they remove the temptation.

DEAR ABBY: I have two big, good-looking sons. One is 18 and the other is 16, but he's as big as his older brother. These boys have been fighting each other ever since they were old enough to swing their arms.

The 18-year-old just bought himself a secondhand car with his savings. He drove past his brother walking down the road and wouldn't even give him a lift.

The younger brother keeps his clothes in better shape, so the older one helps himself to his brother's clothes without asking. These boys fight and cuss like a couple of mule skinner.

Why can't they act like brothers?

TENNESSEE MOM

DEAR MOM: They do. Cain and Abel.

DEAR ABBY: Today I received a note which read, "Please give Suzie another week to pay for the social studies books she lost as we are making her pay for it out of her baby-sitting money."

Abby, if more parents taught that kind of responsibility at home, our job would be a great deal easier!

A JUNIOR HIGH TEACHER  
ALVIN, TEXAS

DEAR TEACHER: Amen!

DEAR ABBY: Why do fellows say, "I'll call you," and then you never hear from them again?

This has happened to me and a lot of my girlfriends so often it's not even funny.

HURT IN KOKOMO

DEAR HURT: Some fellows say, "I'll call you," because they think that's what most girls want to hear. And they're right. But it has about as much meaning as, "See you around," or, "Let's get together sometime."

The next time a fellow says, "I'll call you," if you want to shake him up, say, "Terrific. When?"

DEAR ABBY: Please settle an argument between my husband and me. He says that my sister's husband is HIS brother-in-law. I say that my sister's husband is MY brother-in-law, but he isn't my husband's brother-in-law. He is my husband's sister-in-law's husband. Who's right?

SAN CLEMENTE

DEAR SAN: Webster defines "brother-in-law" as follows: 1) the brother of one's husband or wife; 2) the husband of one's sister; 3) the husband of the sister of one's wife or husband. So your husband is right.

## Gap Is Bridged By Translators

NEW HYDE PARK, N.Y. (AP) — How do you ask, "How do you feel today?" in Turkish or Tagalog?

Whatever the patient's language, from Arabic to Yiddish, chances are an employee of the Long Island Jewish-Hillside Medical Center can ask the question in the patient's native tongue and translate the answer.

"It is a trying enough experience to be ill and in a hospital, but when the patient doesn't even speak English a sense of loneliness and isolation further compounds the problem," says Dr. Abe Lurie, Director of Social Services at the medical center.

To cope with this situation the center has created an Interpreters' Bureau made up of employees who speak two and even three and four languages.

The Emergency Room, the admissions office, nursing stations and other strategic areas are supplied with a directory of translators' names and the languages they speak so that they can be called at a moment's notice.

"Finding someone who can communicate with the patient contributes to the quality of care he or she will receive," says Dr. Lurie. "Talking in his native tongue, the patient can discuss not only his physical state but his anxieties about himself or his worries about his family."

"A lot of tension is relieved this way," he adds.

For example, Helen Mavroidis, an employee manager who speaks Greek fluently, is

called to the kidney dialysis unit where a woman in her 30s is under treatment for kidney failure.

Mrs. Mavroidis spends an hour with the Greek woman and talks to her about her most serious worry, her three young children. The patient also talks of her apprehension over her own condition and her concern over the cost of treatment.

Mrs. Mavroidis recounts all of this to a social worker who maintains close contact with the patient through the interpreter and helps her work through some of her problems.

On another day, Mrs. Mavroidis is called to the Emergency Room when a Greek restaurant worker arrives by ambulance following an accident. The man breathlessly tells the interpreter about his allergies, concerned that he might be given some medication he cannot tolerate.

Still another incident draws on the language ability of a pediatric resident named Dr. Jeffrey Phillips who attended medical school in Spain and Mexico and who speaks Spanish as though it were his mother tongue. A baby, en route from Lisbon to the midwest, has become ill on arrival at Kennedy Airport and has been whisked by ambulance to LIJ-HMC.

The physician becomes the liaison between the baby's parents and hospital personnel.

## Tags Will Tell Energy Cost

NEW YORK (UPI) — Energy-use tags are expected to be available on some home appliance tags, starting this summer, says Hada de Slosser of Cornell University's Cooperative Extension Service Consumer Education Office.

The new tags being designed by the Federal Trade Commission will estimate operating costs in energy based on standard tests. An estimate will indicate monthly operating costs in dollars and cents. The tags are designed to help prospective buyers compute costs for their locales, based on area utility rates.

Tags will give a range of energy costs for similar models. Appliances using hot water will be tagged for costs based on different types of fuels.

## It Hurt When He Turned 40

TOLEDO, Ohio (AP) — When Bob Cready turned 40 recently, his family didn't forget his birthday; and they didn't let him forget it either.

His children Mikki and Travis wore T-shirts that read, "My Dad is Really Old," and his wife, Bonnie, wore one saying "I Prefer Older Men."

What really hurt, though, Cready said, were the bumper stickers that read "Life Begins at 40 — When Your Wife Is In the 20s."

Mrs. Cready explained that within a month she'd be in her 30s and wanted to make the most of her youth while she could.

learning the pertinent facts about the child quickly from the family and feeding back information on the infant's condition.

"If these parents had suddenly found themselves with a very sick baby, and no one to tell them what was going on, they would have been extremely apprehensive, but Dr. Phillips, with his fluent Spanish, was able to allay their fears," Dr. Lurie points out.

Three hundred and fifty interpreters at the medical center cover the globe, linguistically, even to Urdu and Hindi, should the occasion ever arise.

"The Interpreters' Bureau has proven so helpful, other hospitals may want to consider the same service, even if they must reach beyond their own employee ranks to the community; people get a great deal of gratification out of helping," Dr. Lurie says.



DISCO AND BALLROOM  
BY INVITATION

RALEIGH

GREENVILLE

**Belk Tyler**  
downtown greenville

Thurs., Fri. and Sat. Only!

American Tourister Soft Side  
Luggage - Casual Series 9000

25% OFF

Reg. 42.50 To 80.00

The Casual Series 9000 Is Casual Luggage That Features Soft Flexible Side Panels, Soft Flexible Handles. It Is In Scuff Resistant Vinyl For Strength And Durability And With A Fastening Assembly That Has A Fingertip Touch-Lock Release. In Blue, Grey And Palomino. Be Sure To Shop Early For Best Selection And Incredible Savings! Take The Savings And Take A Trip!



Shoulder Tote

31.88

Regular 42.50

22" Carry-All

39.38

Regular 52.50

24" Pullman

46.88

Regular 62.50

26" Pullman

54.38

Regular 72.50

29" Overseas

60.00

Regular 80.00

50" Car Bag

41.25

Regular 55.00

**Belk Tyler**  
downtown greenville



save 20%  
on all 'Heiress' panties  
3 days only

THURSDAY, FRIDAY & SATURDAY

Replenish your stock of 'Heiress' panties now! For 3 days only, all our famous 'Heiress' briefs, bikinis and hipbudders are yours at 20% savings. Cool cotton, soft nylon tricot or tummy-controlling nylon/spandex, all with cotton crotch. Lots of breezy prints, pretty solids, plus white or nude.

- a. Nylon hipbudder, reg. 2.50 ..... sale 2.00
- b. Nylon bikini, reg. 2.25 ..... sale 1.80
- c. Nylon bikini, reg. 1.39 ..... sale 1.11
- d. Cotton hipbudder, reg. 1.75 ..... sale 1.40
- e. Nylon brief, reg. 2.50 ..... sale 2.00
- f. Nylon/spandex brief, reg. 2.50 ..... sale 2.00

**nautilus** NAUTILUS OF EASTERN CAROLINA

THE FITNESS CLUB for men and women

**Special Summer Fitness Program Offered To High School Students!**

Supervised Physical Fitness Program Conducted By Responsible Dedicated Professionals. For Young Men And Women Of High School Age, 16 Years Or Over.

Hey, Parents! Beat The High Cost Of Summer Camp By Sending Your Son Or Daughter To Nautilus' Special Physical Fitness Program Right Here In Greenville.

Completely Supervised Physical Workouts For Young Men, Weight Control And Body Development For Young Women.

3 MONTHS PROGRAM FOR YOUNG WOMEN **\$40.00**

3 MONTHS PROGRAM FOR YOUNG MEN **\$60.00**

For Full Details See Or Call 758-9584, Nautilus of Eastern Carolina, Greenville, N.C.

1002 EVANS ST. GREENVILLE, N.C.

Shop Monday Through Wednesday and Saturday 10 a.m. Until 6 p.m., Thursday and Friday 10 a.m. Until 6 p.m. - Phone 766-2176

# Obscure Factors Guide Lives

It is difficult to absorb the American Airlines DC-10 jet crash in Chicago which became the nation's worst air tragedy in taking 273 lives.

The sudden crash brought sudden terror and then sorrow to hundreds of families and friends of victims whose charred bodies lay scattered across a field near O'Hare International Airport.

Hardly had the agony of the disaster begun to unfold before National Transportation Safety Board investigators moved on the scene. They knew from eyewitness accounts that an engine had wrenched loose and fallen to the run-way.

During the weekend they found out why. One of the bolts which held the engine to the wing, had

failed from metal fatigue. The broken bolt was located in the grass after an exhaustive search.

The investigators emphasized that the bolt was not necessarily the cause of the crash since the plane was designed to fly with the two remaining engines.

Still it appears likely that the engine's tearing away from the plane set in motion other failures which caused the plane to lose power.

It was a horrible twist of fate, of course, that a lone bolt failed on this particular flight and 273 people died. Yet at times all our lives depend on something equally obscure.

## Important To Filling Hospital Needs

The Project Review Committee of the Eastern Carolina Health Systems Agency last week approved a certificate of need for a new bed tower at Pitt County Memorial Hospital.

The recommendation must go to the full HSA board but it is an important step forward in allow-

ing the construction of the 166 additional beds... and they are badly needed because of the regional nature of the hospital.

We are pleased that this important action has been taken.

THIS AFTERNOON

# The Tail Wags The Dog

By BILL NOBLITT  
RALEIGH — Has the bureaucratic tail wagged the legislative dog?

A cross-section of leadership in the 1979 session of the North Carolina General Assembly agrees wholeheartedly with the blunt assessment rendered by the veteran chairman of one of the most powerful committees: "Oh, absolutely."

The Legislature this session has moved a step closer on the inexorable road toward becoming, itself, a bureaucracy bent more to self-perpetuation and self-protection than much of anything else.

Supposed to be, by Constitution and definition, the Board of Directors for the State Corporation, legislators are supposed to function as the bosses, overseers, supervisors, critics and gadflies of the governmental bureaucracy... and most especially the governor and his administration.

Two quick illustrations serve to describe how that hasn't worked.

Raises

That tragicomic exercise in legislative leadership trying to outdo one another in

how much of a raise to give state employees and the infighting over who got the increase the first demonstrates how much the General Assembly waltzes to the orchestrations of state employees and teachers.

The fact that best estimates show half the bills introduced this session were written by state agencies; another big number produced by the administration of Gov. Jim Hunt; and a relative handful originated from the minds and pens of members of the General Assembly — and those have been typically ill-fated — proves the power of outside influence on the lawmakers.

What is happening? The answer is complex, and derives from a number of legislators who see things from varying perspectives.

Here, in overview drawn from a number of conversations, the scene:

Intent on winning reelection every two years, legislators are intimidated by the organized numbers of state employees and teachers. "They may not guarantee you will win, yet. But they sure threaten you can be beat... and they're

right", says a legislator.

Freshman legislators are heavily courted by employee organizations, agency representatives, and special interest lobbies like banks and utilities and local governments. Isolated in legislative glamour, they are quickly roped and branded. Most bills introduced with the

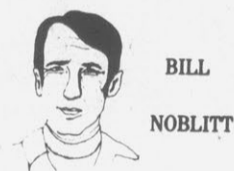

BILL NOBLITT

name of a sponsor on the top were presented by the influence group.

Advocate

Assigned to committee, a legislator tends to become an advocate for the causes put forth by state agencies or special interest groups affected by the particular committee.

Too much is going on to keep track, so a legislator must develop limited fields of interest and skill, and in doing so becomes a recognized

"expert" to whom his colleagues defer. After enough time, the lawmaker becomes a "legislative leader" whose yea or nay in a particular area is enough to determine the outcome of the vote.

As legislative salaries and fringes improve — and as lawmakers become pampered, fed, wined and entertained — more and more decide they enjoy Raleigh more than the office or store back home. Much of this is ego factor. The net, however, is an increased "professional" flavor to the assembly rather than a "citizen assembly" at which those serving do as they think best without regard for next year or next election.

When this session of the General Assembly is viewed from the perspective of the months ahead, it will be seen as one which strained mightily to satisfy demands of the bureaucracy, to reward the banks and savings and loans people with whatever they wanted, to produce higher raises for state employees than most Tar Heels will enjoy, and to rubber stamp a stack of administration proposals without truly understanding them.

THE INSIDE REPORT

# N. Y. Blues For Jimmy

By ROWLAND EVANS and ROBERT NOVAK  
NEW YORK — President Carter's rapid political deterioration here can be measured by the fact his political agents will be forced into a bruising confrontation this week to undo a new state primary election plan custom-made for Sen. Edward M. Kennedy.

That Kennedy-style primary was tentatively approved by a 24-member delegate selection committee, blithely overriding White House wishes. It was to have been finally approved May

24, but the meeting was cancelled after backstage urgings by the president's men. That sets a showdown in which, whatever the outcome, efforts to undo the Kennedyized primary rules will leave Democratic blood on the floor — some of it Jimmy Carter's.

The New York primary will not decide the Democratic presidential nomination. But events here have exposed Carter's astonishing weakness in New York. Lacking committed backers, he depends on elected officials and regular party leaders

who see him as the source of federal funds and patronage (support with all the ardent generally expected from mercenaries).

While left-wing Democrats here chastise the president on ideological grounds, this is not Carter's basic problem in a state no longer so liberal. "Not that I approve of the things Ted Kennedy is saying and doing," one politician long associated with the Kennedys told us, "but I have to be for him because Carter is so weak a leader." Accustomed to assertive leaders, New Yorkers find the Carter style unappealing.

But mostly, Democratic politicians view Carter as a loser. Andrew Stein, the fiercely ambitious Manhattan borough president who is eyeing the 1980 Senate race, sees himself as a surrogate for all Democratic candidates who don't want to run with Carter. While Kennedy is the overwhelming choice, politicians believe somebody

will beat Carter in New York even if Kennedy finally refuses to run.

The president also has suffered here from political fumbling of a kind chronic in his White House. Carter's interests in revising the state's 1980 delegate procedures have been represented by his campaign committee's legal counsel, 31-year-old Tim Smith, one of Carter's 1976 "campaign kids."

Smith has been working closely with the state Democratic party's counsel: Melvin Schweitzer, lawyer for a Park Ave. firm which formerly employed Smith. Some two months ago, the White House tapped Schweitzer to head the General National Mortgage Assn. (Ginnie Mae), but he withdrew when Housing Secretary Patricia Harris was unenthusiastic.

Smith and Schweitzer worked up a delegate plan

(Continued on page 5)

## Strength For Today

A GREAT SAINT  
St. Francis of Assisi was one of the greatest Christians that ever lived. The church in which he prayed and from which he conducted his missionary efforts, now stands within the great Assisi Chapel, in Italy.

The son of wealthy parents, Francis as a young man lived the worldly life of his day. But on one occasion he was returning home at night with gay and singing companions, he fell behind and saw a heavenly vision. He thenceforth dedicated his life completely

to the service of his fellow men. So great was his devotion and so contagious his personality that others joined with him, and the Franciscan Order became one of the great religious bodies of the church.

Francis is the ideal of every Christian whose confidence in unseen things is complete and whose dedication to God is without qualification. And Francis is not a man of a single age. Every age, as well as every branch of the Church, can claim him.

Elisha Douglass

### JUST A NEW SET OF CHAINS!



By ART BUCHWALD

## Commencement Speech

WASHINGTON — Every graduating class has the same problem, and that is to find a speaker who will bring honor and as much money for the school as possible.

Very few people realize how graduation speakers are chosen.

This is how it goes: In January, the president calls in the senior class committee and says, "Whom have you chosen as your speaker?"

"We had an election and the senior class has decided it wants Woody Allen."

The president blanches.

"Yes, he would make a very good speaker though I'm not sure he would be available. Do you have a second choice?"

"Garry Trudeau, who draws 'Doodles'."

"And your third choice?"

"Jane Fonda."

"Those are all excellent suggestions and I'll do everything in my power to see if we can get them. You'll be hearing from me in a short while."

In April, the senior class committee returns and the

## Public Forum

Letters submitted for Public Forum should be limited to 300 words. The editor reserves the right to edit longer letters.

To the editor:

After reading some of the recent letters in the Public Forum, I feel compelled to share some thoughts concerning the Greenville Rescue Squad.

1. Greenville Rescue Squad is the "World Champion" at "Heavy Duty" rescue, NOT basic first aid, where they spend 99 percent of their time.

2. Out of the whole world, only two other teams competed against G. R. S. for the world title. One team was volunteer and the other an oil company team. G. R. S. placed third in first aid in a field of only six teams. Where was Los Angeles, Calif., and all the other famous teams?

3. Part of the competition team was volunteer, not the paid men you see every day. One of the volunteers is a reporter for The Daily Reflector, and writes most of the paper's unbiased articles about the squad.

4. The training level of G. R. S. is "E.M.T." The same E.M.T. as the newly trained firemen we have heard so much about. A bit more polished, perhaps, but still just plain E.M.T.

5. G. R. S. will go in another squad's territory at will. This situation has improved since Chief Allen has taken over, but it still happens regularly. Evidently the leadership of G. R. S. wants the extra number of calls in the county for statistical purposes so they can ask the county for more money.

6. G. R. S. apparently as a squad policy, will make an injured or sick person wait for an available truck instead of calling for assistance from a county squad when G. R. S. units are busy. This is not championship quality service to people who think they are receiving it.

Tony Day, E.M.T.  
Winterville

To the editor:

June 8th is a very important day for the students of Greenville City and Pitt County Schools. On that day, concerned citizens will have an opportunity to vote for a \$9 million bond issue for the improvement of both school systems.

These funds will be utilized to build classrooms in overcrowded schools, to replace outdated, crowded lunchroom facilities, to provide media facilities which meet state standards and to make many other improvements in the city and county schools.

The children of Pitt County are our most important product. The future of these children is dependent upon the education they receive in our schools. How can we afford to vote "No" for such an important bond issue? Won't you join me and my family in voting "Yes" for the school bond issue on June 8th?

Jean Averette



ART BUCHWALD

# A Vast Slice Of Life

By HUGH A. MULLIGAN  
AP Special Correspondent  
CLASSIFIED INFORMATION  
NEW ORLEANS (AP) — Those orderly rows of classified ads at the back of the nation's newspapers can sometimes sandwich an awesome slice of life in the space of four or five lines.

"Never worn. White wedding dress. Petite size."

That two-line message in the New Orleans Times-Picayune with a phone number attached conjures up enough imaginary emotional wallop for a mini TV series. What happened to the little lady? Jilted? Died? Changed her mind? Left him waiting at the church? Decided to go groupie?

If that wedding ever does come off, it might be just the occasion to enlist the classified services, offered on the same day of "Sam, the video man, Weddings video-taped professionally."

"Wanted to Buy," beseeched a classified advert in the Frederick (Md.) Post a few Saturdays ago. "1976 Linganore High School Year Book. Doesn't matter if autographed."

Surrounded by all those "I will not be responsible for any debts other than those contracted by me" notices, someone in Barbara Fritchie's home town was trying to get a handle on the past, not forget it.

The Frederick paper that day featured a number of "In Memoriam" ads, with sad, simple and very moving bits of verse to dear departed friends and relatives.

There was one to "Nellie who left us four years ago" that crammed a lot of love and heartache into the space of a half dozen lines:

"Memories, memories, the hurt is always there,  
Loneliness and sadness, more than we can bear.  
We look at your pictures and tears always fall.

(Continued on page 5)

## 40 Years Ago Today

May 30, 1939  
Eleven men clung throughout Sunday night and part of Monday to the wreckage of the pleasure cruiser Dixie, as it literally went to pieces under them and drifted into Pamlico Sound.

Buffed by storms and high winds, four of the party finally left the ill-fated craft and rowed a lifeboat for six hours to get help.

The 11 survivors gave their story as they were landed safely at Englehard last night from a fishing boat that had completed the rescue about 5:15 yesterday.

Members of the party included J.H. Waldrop, J. Howard Moye, G.J. Woodard, H.J. McGinnis, E.C. Hollar, J.R. Gullledge, Dr. W.I. Wooten of Greenville, J.A. Staton of Bethel, Elijah Edwards, Captain Jesse Keech and Victor Ruark of Belhaven. Capt. Keech and Ruark were the crew of the ill-fated craft.

Despite their harrowing experience, their exhaustion and terrible sunburn, the survivors are recuperating at their respective homes today.

— Stuart Morgan

## Playing Down The Guidelines

By R. GREGORY NOKES  
Associated Press Writer  
WASHINGTON (AP) — Faced with growing evidence that the wage and price guidelines aren't working, the Carter administration has begun to play down their importance.

It has little choice, since the only other option may soon be to admit failure, and politicians and bureaucrats are loathe to admit they have failed at anything.

Alfred Kahn, the president's chief inflation adviser, scarcely mentioned the guidelines during a speech to the National Association of Homebuilders last week in which he gave a detailed explanation of the administration's efforts to control inflation.

He acknowledged that he had given the guidelines

"shortshrift" in his remarks. But he said he didn't want to exaggerate their importance because they never were intended to play anything but a minor role in the anti-inflation effort.

Kahn had said previously that if the guidelines didn't show results by the beginning of summer, he would personally consider them to have failed.

The time for such a judgment is almost at hand. Summer is less than a month away, and inflation hasn't abated significantly yet.

Indeed, President Carter said last week he expects "serious, adverse" inflation figures for the next two to three months. Prices increased at an annual rate of nearly 14 percent during the first four months of the year.

Kahn admitted last week,

after the government reported another 1.1 percent increase in consumer prices in April, that the government can't do much about the worse current causes of inflation, rising oil, housing and food prices.

Both Kahn and Treasury Secretary W. Michael Blumenthal now say consumer prices will increase at least 8.5 percent this year, up from an original target of 7.4 percent, and could easily be higher. Prices increased 9.2 percent last year.

Rather than declare the guidelines a failure, Kahn told the home builders that anyone who thought the guidelines could by themselves restrain inflation was afflicted with "economic illiteracy."

Kahn stressed the importance of other steps being

taken to restrain inflation, especially fiscal policies to slow government spending and monetary policies to tighten the money supply and raise interest rates. Blumenthal has adopted a similar stance.

The administration will be reluctant to drop the guidelines entirely anytime soon.

In fairness, the guidelines never were supposed to be the end-all solution to controlling inflation, but the administration had hoped they would contain the upward spiral of prices for a time until fiscal and monetary policies had a chance to work.

The guidelines ask business to hold price increases one-half of one percentage point below the average increases during the 1976-77 period.

**The Daily Reflector**  
INCORPORATED  
209 Cotanche Street, Greenville, N.C. 27834  
Established 1882  
Published Monday Through Friday Afternoon and Sunday Morning  
DAVID JULIAN WHICHARD, Chairman of the Board  
JOHN S. WHICHARD — DAVID J. WHICHARD  
Publishers  
Second Class Postage Paid at Greenville, N.C. (USPS 145-400)

MEMBER OF ASSOCIATED PRESS  
The Associated Press is exclusively entitled to use for publication all news dispatches credited to it or not otherwise credited to this paper and also the local news publications herein. All rights of publications of special dispatches here are also reserved.

SUBSCRIPTION RATES  
Payable in Advance  
Home Delivery By Carrier or Motor Route Monthly \$3.50  
MAIL RATES (Prices include tax where applicable)  
Pitt And Adjoining Counties \$3.50 Per Month  
Elsewhere in North Carolina \$3.85 Per Month  
Outside North Carolina \$5.00 Per Month

UNITED PRESS INTERNATIONAL  
Advertising rates and deadlines available upon request. Member Audit Bureau of Circulation.

**Evans-Novak . . . Mulligan Col. . .**  
(Continued from page 4) (Continued from page 4)

geared to keeping Kennedy out of New York: early primary date, early filing deadline, arduous requirements to get delegates' names on the ballot, voting for delegates instead of presidential candidates. But there was one little problem. It had no support. Regular county leaders wined and dined at the White House of late did nothing for the president's cause.

The delegate selection committee tentatively adopted a scheme pushed by the state's Kennedyite faction, headed by state Attorney General Robert Abrams. It was Carter's plan in reverse: late primary date (April 29), late filing deadline (10 days before the primary), lenient requirements for petition signatures, the name of the presidential candidate — not his delegates — on the ballot.

With no voiced opposition, the New Yorkers were moving toward a system that would give Kennedy a late, late chance for president, with a predictably overwhelming win in New York. "The White House will go crazy," Schweitzer predicted at the meeting. Democratic state chairman Dominic Baranello later informed Schweitzer that he was not supposed to be representing the White House.

But White House pressure, probably filtered through Gov. Hugh Carey, was surely the cause when Baranello suddenly cancelled the May 24 meeting to pin down the new plan. At the rescheduled meeting (perhaps this week), representatives of Gov. Carey and Mayor Edward Koch will seek a primary plan closer to Carter's specifications, particularly an earlier filing deadline for Kennedy.

Now it is the Kennedy forces who "will go crazy," forcing a confrontation disastrous for the president to lose and dangerous to win. Winning it would be risky because Carter's advocates are not with him for the long haul. Koch's aides tell friends the mayor is backing the president, only temporarily, because his city depends on federal largesse.

Is there no prominent New York Democrat backing Carter as a believer, not as a mercenary? No, say the politicians. But there may be one who qualifies: Lt. Gov. Mario Cuomo, who last week in the midst of the president's troubles telephoned Carter aide Gerald Rafshoon to avow faith in Jimmy Carter and to pledge support. That this is worthy of mention shows why the White House now must apply naked pressure to make less devastating a primary he seems incapable of winning.

Remembering how good you were to us all. Mom, we miss you. Your devoted family."

Around Memorial Day and All Souls Day, memorial poems and remembrances fill page after page in the classified sections of both New Orleans papers, as befits a city where the dead rest above ground, the saints are on the street signs and at the Superdome, and heaven, the Elysian Fields, is just a bus ride from Canal Street.

Almost every day in the Picayune and the State-Item, classified ad buyers are thanking their favorite saints for answered prayers:

"Thanks to Our Lord, His Blessed Mother, St. Jude, St. Anthony, St. Lucy, Padre Pio and Mother Seton for favors granted."

The Vatican hasn't got around to canonizing him yet, but St. Expedite has a big following in New Orleans. Hagiographers, as saint students are called, would have a difficult time tracing his claim on a halo since he was actually born of a printer's devil. Long ago, a customer in a hurry to thank his heavenly patrons wrote "expedite" on his classified ad form and the printer somehow included the name in the litany of saints. Now St. Expedite, with his French sounding name, appears often in the classified columns of this bilingual town.

# Brody's Remodeling Sale!



We are remodeling our Pitt Plaza Store enlarging to make a bigger and more attractive store! Workmen will soon be busy in each department and in order to make room for them, we are having a Remodeling Sale. Please pardon the inconvenience. The Remodeling Sale prices will be the same at our Downtown Store, too! Yes, right now as Summer begins, Brody's gives you fashion savings up to 33 1/3%!

**Brody's**  
Children Dept.

Now Located Next To Balentines at Pitt Plaza

SAVE DURING OUR REMODELING SALE

On Entire Stock Of Children's Fashions!

You'll Be Glad You Did!

**New Fashion Dresses Reduced!**  
You Can Choose From Hundreds Of Your Favorite Styles.

Reduced **20% to 33 1/3%**

**Jewelry Group Of Chains**  
**\$2<sup>59</sup> to \$3<sup>29</sup>**

All Stick Pins **1/2 Price**

**Hundreds And Hundreds Of Your Favorite Shoe Fashions!**  
All Name Brands Reduced  
**20% to 33 1/3%**  
\*Every Handbag Reduced!

**Junior Sportswear!**  
Wear Now & Through The Summer. Everything Has Been Marked Down.  
Giving You Savings Of **20% to 33 1/3%**

**Better Blouses!**  
Reg. 30.00 Now **\$19<sup>90</sup>**  
Cotton-Long And Short Sleeves Sizes 6 to 16.

**Missy Sportswear!**  
Just About Everthing On Sale! Size 6 to 20.  
Save **20% to 33 1/3%**

**Better Sportswear!**  
Choose From Jones, Emily, Harve' Benard, John-Meyer, And Others.  
Save **20% to 33 1/3%**

**All Alice Carol Tee-Shirts**  
Save **20%**

**Lingerie Department!**  
Save On Every Summer Robe, Gown And Pajamas-Special Group Of Lingerie.  
Save **20% to 33 1/3%**

**Half-Size Fashions! Dresses - Sportswear**  
Size 12 1/2 to 24 1/2  
Save **25%**

**14 Kt. Gold Bracelettes**  
Single Reg. \$16.00 Now **\$9<sup>90</sup>**  
Double Reg. \$27.00 Now **\$17<sup>90</sup>**

**Luggage On Sale!**  
Save Up To 53% On American Tourister Soft Side Luggage In Scuff-Resistant Vinyl.

Save On **Childrens Shoes**  
**20% to 30%**

**Suburban Propane** ...there's **plenty!**

Call it **LP-Gas** or Call it **Propane** or Call it **Bottled Gas** but... **Call Suburban Propane for Quality Service!**

Suburban Propane Saves Money in water heating, space heating, cooking, clothes drying.

732 Greenville Blvd. Beside Sweet Carolines Greenville 756-2242

Get your share of these fashions before the season begins at Brody's. The remodeling sale prices for Pitt Plaza are the same Downtown at Brody's.

# Jerry Creech Awarded Senatorship By Jaycees

Jerry Creech, who served during the past year as president of the Greenville Jaycees, was recently awarded a Jaycee In-

ternational Senatorship, the highest honor given to a Jaycee by the organization.

Creech received the JCI Senatorship, which provides him with a lifetime membership in the Jaycees, at the recent installation banquet of the local chapter.

Creech became only the sixth Greenville Jaycee to receive a JCI Senatorship in the chapter's

The international designation is given to individuals who work and perform on a local, state or national Jaycee level. Recipients must also exemplify the meaning and purpose of the Jaycees and enhance the overall Jaycee movement.

Jaycee International is a federation of Jaycees in 80 countries.

A Benson native, Creech graduated from Benson High School and attended East Carolina University. He is associated with Creech & Jones Business Machines in Greenville.

He has served as director and state director during his membership tenure with the local chapter, in addition to his term as president. Creech also chaired the Boys' Home football game in 1977.

Creech is married to the former Sue Sykes of Mebane and the couple has two children.



JERRY CREECH

history as he joined Billy Laughinghouse, Gene Prescott, Tom Reese, Don Brady, and Hal Smith as local recipients.

## Office Complex For Charlotte

CHARLOTTE, N.C. (AP) — Plans were unveiled Tuesday for a \$50 million office complex in southeast Charlotte.

Developers said work is scheduled to begin on two of the six buildings in the complex, to be called The Park, within the next two weeks.

The 65-acre complex, to be built in the SouthPark area, includes two major corporate headquarters, a shopping center and a 150-room hotel. The hotel was announced in November by golfer Arnold Palmer and associates.

A new \$2.5 million building, to house the Travelers Insurance Co.'s Charlotte offices, will be the next structure in the complex.

Buildings occupied by Equitable Life Assurance Society and the Gold Bond Building Products are already on the tract.

A spokesman for the project said the new offices will provide about 665,000 square feet of rentable space.

# Khomeini Has Foes In Iranian Arabs

KHORAMSHAHR, Iran (AP) — Iranian Arabs set fire to government buildings and battled troops of Iran's revolutionary regime today in Khoramshahr, the country's largest port and the center of the Khuzestan oil region. Official sources said armed Arab tribesmen were moving toward Khoramshahr from all over Khuzestan province.

The Arabs, renewing their fight for the autonomy which both Shah Mohammad Reza Pahlavi and Ayatollah Ruhollah Khomeini have denied them, attacked the naval base and the district governor's office and set fire to the main police station, the post office and the government tobacco factory.

Officials said at least 11 Arabs were killed and dozens more wounded. A huge column of black smoke hung over the city from at least a dozen burning buildings, including several supermarkets and a warehouse of the National Iranian Oil Co.

Radio Tehran said Adm. Ahamad Madani, the governor general of Khuzestan province and the head of the Iranian navy, proclaimed a state of emergency in the city of 100,000 at the head of the Persian Gulf and advised residents to stay indoors.

Troop reinforcements

rushed to the city after the fighting broke out at dawn and set up sandbag barricades on all the main streets. Heavy gunfire continued into the afternoon.

But oil industry officials said there was no interruption in operations at the world's largest oil refinery at Abadan, across the Karoun River from Khoramshahr.

In the holy city of Mashhad in northeastern Iran, meanwhile, a revolutionary firing squad executed four more of the shah's soldiers, raising to 239 the number shot since February, newspapers reported. They said the four, ranging from a lieutenant to a colonel, were convicted of killing and wounding innocent people.

## Workshop For City Council

A workshop meeting by members of the City Council will be held at 7:30 p.m. tonight in the first floor conference room at city hall.

The purpose of the workshop is to study the 1979-80 budget proposals for the City of Greenville.

## Shooting Still Being Studied

Chief Glenn Cannon said officers are continuing their investigation of a shooting incident here Sunday morning.

Cannon said William A. Smith, 38 of 1604 Henry St. told officers he had been shot while riding along Greene Street in his car.

The chief said officials at a local motel later reported that blood and what appeared to be bullet holes had been found in a room.

Investigators said Smith, wounded in the right arm and shoulder, had allegedly rented the room under another name and charged the room on a credit card.

## Arrest Man In Shooting Case

Greenville Police yesterday arrested Russell L. Anderson, 32 of 808A Bancroft Ave. on charges of assault with a deadly weapon following investigation of an 11:30 p.m. Monday shooting at 811A Bancroft Ave.

Chief Glenn Cannon said Anderson allegedly shot Edward Leroy House of Greenville in the left shoulder with a .22 caliber pistol following an argument connected with a card game.

## EXTENDED WEATHER OUTLOOK FOR N.C.

Widely scattered showers mainly in the southern portion Friday, tapering off during the weekend. Lows in the 60s with some 50s in the mountains. Highs in the 80s except some 70s in the mountains.

We've Made A Special Purchase Of Exquisite 14 Karat Italian & Domestic Gold Chains

...and we're passing the savings on to you!

# Save 50%

Values from \$23.65 to \$159.95  
Now \$11.82 to \$79.97

It's one of the largest collections of fine-quality 14 karat gold chains we've ever assembled. Neckchains and bracelets in the most popular styles: serpentine, rope and foxtail. A wide choice of weights and lengths. A gigantic assortment of styles available in the special purchase group — plus other outstanding selections from our regular stock. All at unbelievable low prices!

Shop Now For Graduation... And Save!

CARLYLE & Co.

Established 1922

Formerly Jewel Box

410 EVANS STREET • 758-2189



Downtown Greenville's most exciting summer sales event is here. 54 downtown Greenville businesses have joined together to bring you 3 days of gigantic savings and a chance to win over \$1200.00 worth of prizes. Shop downtown this Thursday, Friday, and Saturday for yourself and your family and especially remember to shop for Father's Day, too. You'll find a wider variety of merchandise, friendly-courteous sales clerks and free parking.

Register for over \$1200.00 in valuable prizes given away by the following businesses. No purchase necessary and you do not have to be present to win. Drawing Saturday afternoon.

## GRAND PRIZE! \$100.00 in Gift Certificates

- Apple Records—Record
- Art & Camera Shop—\$20.00 Gift Certificate
- Bigg's Drug—Free Prescriptions month of July
- Bissette's—Presto Burger
- Blount-Harvey—\$25.00 Gift Certificate
- Book Barn—\$15.00 Gift Certificate
- Brody's—\$25.00 Hand Bag
- Carolina Office Equipment—Cross Pen
- Central News—2 \$5.00 Gift Certificates
- Coffman's—Corbin Slacks
- Coffman's 10/20—Knit Shirt
- College Shop—\$25.00 Gift Certificate
- Clothes Horse—Clothes Horse T Shirt
- Curry Copy Center—100 Sets Personalized Stationary
- D.A. Kelly's—\$25.00 Gift Certificate
- Diener's Bakery—Decorated Layer Cake
- C. Heber Forbes—\$25.00 Gift Certificate
- Friendly Wig Shop—\$25.00 Wig
- Giant Discount—GE Tape Recorder
- Gazebo—Beach Mat Carryall
- Globe Hardware—Watta Pizzeria
- Happily Ever After—Electric Train, \$50.00 Value
- Harmony House South—Portable Cassette Recorder
- Harris Cash & Carry—FFV Country Ham
- H.L. Hodges—Nike Waffle Running Shoes
- Hollowell's Drug No. 1—Waring Push Button Blender
- Hollowell's Drug No. 2—Waring Push Button Blender
- Home Furniture Store—\$25.00 Gift Certificate
- House of Hats—Hand Bag
- I-Sue-Jan—\$25.00 Gift Certificate
- Carlyle & Co.—\$50.00 Man's Bulova Caravelle Watch
- Lord's Jewelry—Lady's or Man's Watch
- Marie's—\$15.00 Gift Certificate
- MarKay's—2 \$10.00 Gift Certificates for Jewelry
- Mushroom—\$5.00 Gift Certificate
- Man's Room—Man's or Lady's Cologne Set
- V.A. Merritt & Sons—GE Portable Mixer
- Morgan Printers—Personalized Stationary
- Newby's Sub Shop—
- Park Theatre—10 Movie Passes, Value \$25.00
- Pipeline Restaurant—Luncheon For Two
- Proctor's LTD—Gift Certificate
- Pugh's Tire Service —Oil Change
- Pitt Theatre—6 Month Movie Pass
- Ridgeway's—\$35.00 Gift Certificate
- Riggan's Shoe Repair—Leather Belt
- Robinson's Jewelry—Lady's Diamond Dinner Ring
- Sherlock's Restaurant—\$10.00 Gift Certificate
- The Silver Thread—Plant Hanger
- Smith Electric—GE Alarm Clock
- Snooty Fox—\$20.00 Gift Certificate
- Steinbeck's—Sans-A-Belt Trousers
- Stork's Nest—\$10.00 Gift Certificate
- Taff Office Supply—Sheaffer Pen and Pencil Set
- Western Auto Assoc. Store—Oil Change, Filter Change, Lube Job
- White's Store—5 \$10.00 Gift Certificates
- Wise Fashions - \$20.00 Gift Certificate



## Attention Men

Make Way For Savings On All Men's Florshiem Shoes And Boots.

# 25% OFF

Men's Rand And Hushpuppies

# 25% OFF

Many Sale Shoes Are Placed On Racks For Convenient Selection

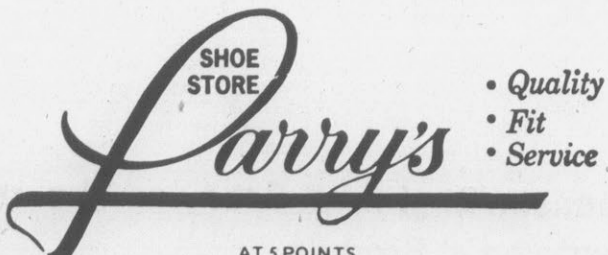

AT 5 POINTS  
OPEN DAILY 9 A.M. - 6 P.M.  
Downtown Greenville On The Mall



Downtown Greenville Association, Inc.  
Post Office Box 333  
Greenville, North Carolina 27834

# Carter Now Expects No Election-Year Tax Cut

By JERRY ESTILL  
Associated Press Writer  
WASHINGTON (AP) — President Carter is joining leading congressional taxwriters in predicting the traditional election-year tax cut will go by the wayside in 1980 as federal officials concentrate on trying to balance the national budget.

"I doubt very seriously that we'll have any tax cut in 1980," Carter said Tuesday at a news conference.

"If we have the option between substantial reductions in the deficit and controlling inflation on the one hand, and having tax reductions for the American people in an election year on the other, I would fore-

go the tax reduction and insist upon controlling inflation and cutting the deficit."

Similar sentiments have been expressed by the two most influential tax experts on Capitol Hill — Sen. Russell Long, D-La., chairman of the Senate Finance Committee, and Rep. Al Ullman, D-Ore., chairman of the House Ways and Means Committee.

"The top priority is to control expenditures and balance the budget," Ullman said last week. "That pre-empts any tax cut, unless the country is dropping into an obvious recession."

Carter and administration economists insist no recession is on the horizon.

Long told a U.S. Chamber of Commerce seminar recently he also believes balancing the budget over the next two years should take priority over tax cuts. "I don't think a...tax cut should keep us from balancing the budget," Long said.

The historic tendency is for Congress to approve tax cuts in election years, largely because it's a politically painless vote to cast. With inflation pushing taxpayers into ever-higher tax brackets, dollars flow into the federal treasury in ever-larger amounts. Legislators can thus

vote to cut the tax rate every few years without reducing the funds available to pay for government programs.

That phenomenon, often called "taxflation" by government taxwriters, is working overtime now and could yet provide a way for Carter and Congress to balance the 1981 budget and approve a tax cut at the same time.

With federal tax receipts now pouring in in much greater amounts than previously estimated, some private and government economists have sug-

gested a tax cut and balanced budget may both be possible by 1981.

Tax legislation applying to the 1981 fiscal year, beginning Oct. 1, 1980, would come next year — just in time for the fall elections.

On other matters Tuesday, Carter:

—Signed an executive order delegating some of his authority over gasoline sales to the nation's governors. The action authorizes governors to do such things as order odd-even rationing plans, regulate gas station operating hours and set min-

imum purchases.

But the president warned that any plan making gasoline shortages less painful does nothing to solve "a long-term chronic problem in obtaining adequate energy supplies....It is necessary to stop aggravating the problem by blaming one another and by seeking out scapegoats," he said. "The fact is that the oil-producing countries are holding down supply while the rest of the world has increased demand."

—Said the United States will give Egypt and Israel a chance

to resolve questions dealing with the Palestinians and other Israeli neighbors before offering any U.S. suggestions.

—Insisted that his anti-inflation program, including its wage and price guidelines, eventually will be successful in stemming inflation. But he acknowledged it probably will take a long time.

—Said he will wait until a new bi-racial government takes office in Rhodesia to decide whether to lift the U.S. trade embargo against the African nation.

—Reiterated his desire to

eliminate nuclear weapons from the world and defended pending development of the new MX nuclear missile as necessary to maintain the military balance between the Soviet Union and the United States while negotiations aimed at reducing nuclear arms continue.

—Expressed confidence that Congress eventually will approve legislation implementing treaties turning the Panama Canal over to Panama. Failure to do so, he said, would leave the United States powerless to protect its interests after the transfer takes place.

## Install Officers Of Secretaries

At the annual installation banquet of the Greenville Chapter of the National Secretaries Association held Monday night, Betty Thompson was installed as president for the 1979-80 year.

Ms. Thompson, who served previously as vice-president of the board of directors and as vice-president of the Secretaries Week Committee, was also

chairman of the CPS Education Committee for the 1978-79 year. For her role in developing and organizing review courses for certification of professional secretaries exam, in April she was elected the outstanding member of the Greenville Chapter.

Currently a secretary with Pitt Pathologists, Ms. Thompson is a graduate of Lee's-McRae Junior College with an associate arts degree. She served her internship year as a medical secretary at N. C. Memorial Hospital, Chapel Hill, and has had 13 years experience in secretarial work.

Active in workshops and seminars of the chapter, she completed the CPS exam in Raleigh the first of this month. She is married to Bill Thompson and the couple has two children.

Other officers installed at the Monday night banquet are: Mary Kittrell, vice president; Barbara Evans, recording secretary; Betty Andrews, corresponding secretary; Myrtle McRoy, treasurer; and Carolyn Evans, Yvonne Hardee and Amy Mills were elected to the board of directors.



BETTY THOMPSON

## Amtrak-Crescent Could Yet Survive

GREENSBORO, N.C. (AP) — The Amtrak Crescent — better known as the Southern Crescent — may still have a chance of survival, an aide to Rep. Richardson Preyer, D-N.C., says.

Preyer's aide said Tuesday that the Crescent's ridership has increased since Feb. 1, when the federally operated Amtrak system took over the Crescent from Southern Railways.

However, Amtrak's operation of the train has been so brief that federal officials are having difficulty deciding whether the increase in ridership has real meaning.

The aide said the Crescent's best chance for survival passed last week when both Houses of Congress declined to overturn Transportation Secretary Brock Adams' plan for reducing the nation's passenger rail network.

Adams announced in February that he would eliminate 43 percent of the nation's passenger trains Oct. 1 in an effort to save \$1.4 billion during the next five years. The House had until May 22 to veto Adams's decision, the Senate until May 23. Neither House took action on the issue.

Preyer's spokesman said the only chance left for the Crescent is separate legislation now pending in Congress. An appro-

priations bill would set up a new funding formula intended to save a few passenger lines on which ridership is increasing.

Criteria for each train's eligibility for continued existence won't be known until the House and Senate complete work on the bill.

The new formula is based on passenger miles and not just the total number of people who ride the train. Passenger miles are based on how far the average rider rides.

## Motorcyclist Is Injured In Crash

Michael Wayne Tyson, 20 of 101 North Bubba Blvd. was reported injured when the motorcycle he was driving collided with a car driven by Tonda Marie Thering of Merry Hill, about 9:20 p.m. yesterday at the intersection of Memorial Drive and Greenfield Boulevard.

Officers estimated damage from the collision at \$300 to the Thering car and \$800 to the Tyson motorcycle.

**IS BUSTIN' OUT ALL OVER**  
DOWNTOWN GREENVILLE  
MAY 31, JUNE 1 & 2

**FREE \$25 Gift Certificate**

Be sure to register for a \$25.00 Gift Certificate. Also register for \$100 in Gift Certificates Grand Prize. No purchase necessary. You do not have to be present to win.

Don't Miss The Savings!  
**25 TO 50% Off**

Special Group Of  
**Kenrob Sportswear**  
**1/2 Price**

**Group Of Prestige & Other Famous Brands**  
**1/3 off**

**IS BUSTIN' OUT ALL OVER**  
DOWNTOWN GREENVILLE  
THURS.-FRI.-SAT.

PRICES EFFECTIVE THURSDAY FRIDAY SATURDAY

Register To Win  
Free General Electric Tape Recorder To Be Given Away Saturday.  
(No Purchase Necessary. Do Not Have To Be Present To Win.)

Cutex Polish Remover (All Kinds) 4 oz. ONLY <b>44¢</b>	Clairol Condition Shampoo 16 oz. ONLY <b>\$1.17</b>	Bayer Aspirin 24 Tablets 2 Bottles <b>\$1.00</b>	Ban Roll-On Antiperspirant 2.5 oz. Limit 2 Please Only <b>99¢</b>
Scope 24 oz. Only <b>\$1.77</b>	Gillette Disposable Twin Blade Razors Good News! 2 Pkgs. of 2 <b>\$1</b>	Miss Breck Hair Spray 3 oz. Only <b>77¢</b>	Gillette Right Guard Bronze 3 oz. Only <b>77¢</b>
Crest Toothpaste 7 oz. Regular or Mint Only <b>88¢</b>	Ultra Sheen Conditioner And Hair Dressing 2 oz. Only <b>77¢</b>	White Alcohol 16 oz. Only <b>24¢</b>	

A Selection Of  
**Misses And Half Size Dresses**  
Reg. \$36 To \$80  
Now **\$24.50 To \$53.60**

Good Group Of  
**Better Dresses**  
Reg. \$45 To \$100  
Now **\$30 To \$66**

A New Group Of  
**Alex Garay Suits And Dresses**  
Just Received  
Reg. \$60 To \$75  
Now **\$45 To \$56.25**

**GIANT**  
Discount, Inc. Quantity Rights Reserved.  
429 Evans Mall Downtown Greenville

**Blount-Harvey**  
Downtown Greenville & Carolina East Mall Soon  
Free Parking Downtown Shop Daily 10 A.M. to 5:30 P.M.

# Suggests Primitive Living Is An Answer To Energy Crunch

By KAY LYNCH  
HONOLULU (UPI) — Jan Newhouse believes population pressures and the energy crisis have triggered a decline in living standards that will force a return to primitive living. Hoping to teach people how to live without the energy luxuries, he is beginning an experiment on a Polynesian atoll. "The U.S. Statistical Yearbook says per capita energy consumption has been declining worldwide since 1973," Newhouse said. "It means we have had less energy available each year since 1973. Energy avail-

bility means standard of living. "In Hawaii we'll all be living like primitives 100 years from now, because when the oil runs out, all this will be gone." He raised a tanned arm toward urban Honolulu. So he has taken leave of the chairmanship of the University of Hawaii's General Science Department for his project in the Tuamotu Archipelago of French Polynesia. He hopes to pool technical information with information from people who still have the skills that enabled their island ancestors to subsist.

group will list all its plant and animal life, fresh water resources, rate of replenishment by rainfall, and how it all can handle various standards of living. "You figure out how much pie there is, and then you figure how you're going to cut it up. This is something industrialized nations don't do nowadays."

"But the early Hawaiians and Tahitians did this. Island peoples have always done this. They have said, 'Not only do we want to eat, but we do not want to spend all our time just gathering food or planting or catching fish. We would also like to have time to make canoes and make love and sing and have festivals.' "They calculated their resources and divided their time, and they reached a particular standard and they held it. We don't do that. We continue to

expand and are getting less and less pie worldwide."

"One important thing is to get away from the idea that we should duplicate the crops of the western world," he said. "Instead, we'll work with some of the things that have been time-tested over 2,000 years on atolls... Things like breadfruit, banana, papaya, pandanus and taro."

The project will draw on technology in working out systems for obtaining fresh water, preserving food and providing a small, temporary electricity supply, but will aim to avoid metals in the long run. His project may not appeal the islanders now but, he said, "when the boat stops coming and the store shelves are bare... then they may say, 'Hey, that looks better than the sloppy conditions I'm living in now.'"

## Radiation Is Halted

MOSCOW (AP) — The Soviet Union, in what was seen as an attempt to improve relations before the upcoming Carter-Brezhnev summit, has stopped bombarding the U.S. Embassy with microwave radiation, an embassy spokesman said today. President Carter and Soviet President Leonid I. Brezhnev will meet in Vienna, Austria next month to sign the SALT II nuclear arms accord.

Since the mid-1960s Washington had repeatedly protested the Soviet radiation bombardment. The exact purpose of the activity never has been clear. U.S. officials theorized that the microwaves could have been intended either to jam American electronic intelligence-gathering equipment or to trigger Soviet surveillance devices planted within the embassy.

During the past 3½ years the Soviet beams had been aimed at the embassy's upper floors from transmitters located east and south of the 10-story structure on Tchaikovsky Street. However, the embassy spokesman said, "Neither the east nor the south signal has operated since the end of April. Hence we have detected no radiation since that time from those sources."

**DRUNK DOGS**  
SYDNEY, Australia (AP) — When a truck loaded with champagne and wine crashed near Sydney recently, dogs came from miles around to lap up the liquor flowing through the streets, says driver Colin Bennett.

"Finally they fell over dead drunk," he said, "and we had to drag them to the sidewalk to let them sleep it off."

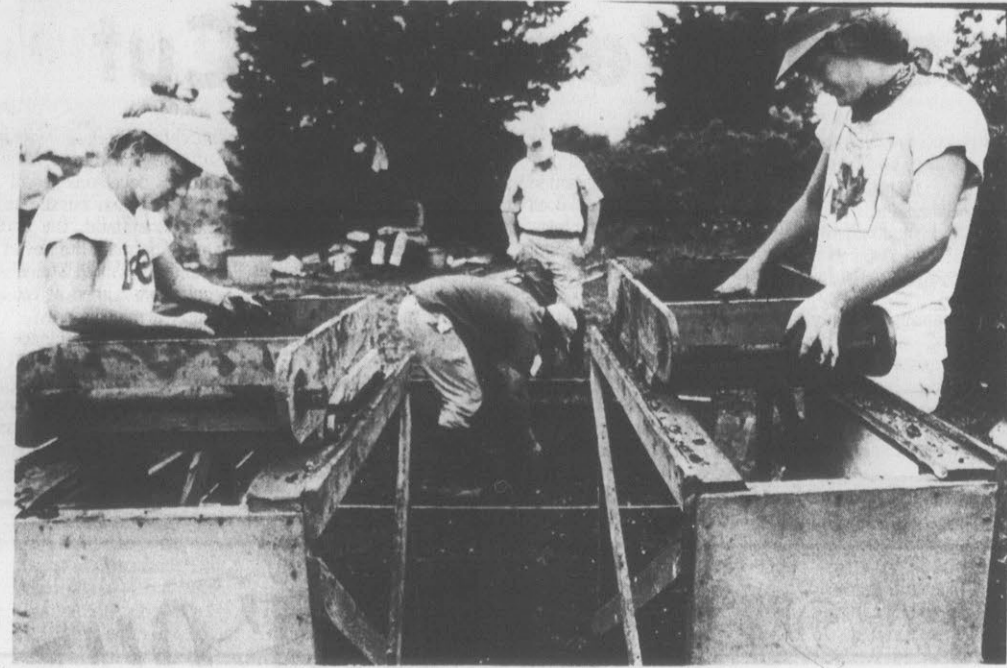

**WANCHESE EXCAVATIONS** — A group of eight students from East Carolina University are spending five weeks on Roanoke Island excavating the site of a 2,000 year old Indian camp in Wanchese. Dr. David S. Phelps heads the group excavating an area of two or three acres of marshland in Wanchese first discovered in 1895 by Talcott Williams, a historian looking for the site of the

Lost Colony. In the first week of digging, the ECU group has found large deposits of oyster shells, bone and pottery fragments and a human tooth. They are attempting to find evidence of changes in cultures, including the Algonquin Indians who occupied Roanoke Island long before English settlers appeared on the scene. (Photo by J. Foster Scott, Dare County Tourist Bureau)

## Special Summer Camps Helpful To Kids With Health Problem

By JO-ANNE BYRNE  
MINNEAPOLIS (UPI) — Camp is a magic word for kids. It can mean fun in the sun, swimming, horseback riding, a dizzy world of delights after a long cooped-up winter.

But most camps don't accept all children because some have health problems such as diabetes or asthma, or physical disabilities ranging from speech and hearing impairment to crippling disorders. Others are mentally retarded. Those children must rely on specialty camps. They have one thing in common — an interest

in providing a camping experience for kids who need it more than most.

At Camp Needlepoint, which accepts diabetic children, "it was the first time I realized I wasn't the only diabetic in the world," said Mo Farrell, a former camper and now assistant camp director.

Needlepoint is one of about 60 camps for diabetic children across the country. It is held at Camp St. Croix in Hudson, Wis., and accepts 125 to 130 children from the ages of 7 to 16.

Dr. Don Eitzwiler, medical director, said diabetic children frequently suffer from psychological problems as well as diabetes-related restrictions and their parents suffer guilt feelings. In many cases, the children are overprotected.

Needlepoint gives the child an opportunity to take part in a group experience and to learn while doing it. "Once you've learned how to test your urine in the woods behind the bushes," Miss Farrell said, "you don't have too many apprehensions."

Eitzwiler has seen an increased need for the camping experience in older age groupings and has begun a wilderness challenge program for young adults, 16 to 18. Three groups of eight or nine teenagers will backpack and canoe this summer in the Boundary Waters Canoe Area in northern Minnesota, Michigan's Isle Royale National Park and the Big Horn Mountains in Wyoming.

Camp Courage near Maple Lake, Minn., is one of those for physically disabled children and adults and retarded child who can be "mainstreamed."

The camp, and a second in northern Minnesota, serve over 900 persons a summer aged 7 through senior citizen. The emphasis is on as much physical involvement as is possible for each individual.

"If they can benefit intellectually and are able to sit in a

wheelchair a certain number of hours each day, they are appropriate for camp," said camp director Bob Pollard.

The camp also has a program for persons with speech, hearing and language disorders.

Among camps for the mentally retarded is Camp Friendship at Annandale, Minn.

"It is basically a recreational and leisure period for campers," said Judy Morris, program director. She called it an opportunity for these individuals, two-thirds of whom come from state institutions and residential group homes, to spend a whole week outside.

"Asthma is a scary word for lots of camp directors," Dr. Richard Cushing said.

Camp Superkids, near Loretto, Minn., where Cushing is the medical director, is one of 10 camps for asthmatics in the country.

Campers learn breathing exercises, how to take medication and how to cope with and avoid asthmatic attacks.

"Parents of asthmatic children are in a conflicted situation," Cushing said. "They are very protective and also very tired. Camp gives them a chance to free themselves and their children from the constant problem."

Camp Superkids has served as a model for a number of camps in Illinois, Nebraska, Indiana and Michigan. "We've proven our point and have a system that works," Cushing said.

## 208 Telephone Books For Him

DECATUR, Ill. (AP) — Buddy Melnik believes in efficiency, but decided Illinois Bell went too far when it began charging him for calls to directory assistance in other central Illinois cities.

So Melnik told telephone-company officials if they expected him to look up the numbers they should provide the phone books — 208 of them. And they agreed to do so.

Illinois Bell said they would be happy to provide any customer with the telephone books he needed for towns in the same area code. "If you're too lazy to look the number up, you should be penalized," said Melnik. "But, they don't normally provide you with those books and that's the only way we have to get the numbers without paying."

Melnik operates a wholesale heating and air conditioning company, and says he frequently makes calls to other cities in the 217 area code, which includes a large section of central Illinois.

Early this year, Illinois Bell began charging its customers 20 cents a call for directory information. The first eight calls a month are free, and customers may get two telephone

numbers per call. Melnik said he had not realized that the charge would apply to calls made outside Decatur, and did not think other people realized that either.

He had a Decatur phone book and used it. But when he needed an out-of-town number, he called directory assistance.

Terry Henkle, manager of the Illinois Bell office in Decatur, said every customer got 25 cents taken off his bill because of the new directory assistance charge.

Henkle said Illinois Bell had paid \$900,000 to customers in February, while collecting \$950,000 in directory assistance charges. The phone company contends that the people who use directory assistance should pay for it, instead of spreading the cost over everyone's bills.

Henkle said the number of calls for information had dropped 19 percent in February, compared with a year earlier, and that the new program could result in a decrease in labor costs for the utility.

"We are willing to give each customer a reasonable number of directories so he can place the calls he needs," said Henkle.

Thursday, Friday, Saturday  
May 31, June 1, 2, 1979

**JUNE IS BUSTIN' OUT ALL OVER...**

Pants, Shorts ... 10% Off  
EARLY SPRING  
Dresses ..... 1/2 Price  
One Group  
Summer Tops .... 1/2 Price

Register For \$20 Gift Certificate To Be Given Away.  
No Purchase Necessary. Do Not Have To Be Present To Win.

Plenty Of Free Parking.

*Sweetie*

203 East Fifth Street

**Make this Father's Day unforgettable with the amazing Seiko Quartz Memory Bank Calendar watch.**

Truly a gift for remembering. Simply pre-program in dates to remember for the next 12 months. When the appropriate date comes along, this remarkable watch flashes a reminder both in the time mode and the calendar mode. It also features a continuous readout of the time, day and date, as well as an instant display of any full month calendar from January 1930 to December 2009.

All with the incomparable accuracy and dependability of world-famous Seiko Quartz. And amazingly simple to operate. This LC Digital in stainless steel with a blue panel, \$225. Also available in yellow with a black panel, \$275. Seiko Quartz. **SA**

Register For Ladies Diamond Dinner Ring To Be Given Away Saturday, June 2. No Purchase Necessary.

**SEIKO**  
**Floyd G. Robinson Jewelers**  
407 EVANS MALL • 758-2452 GREENVILLE, N.C.  
"YOUR INDEPENDENT JEWELER"  
FREE PARKING IN DOWNTOWN GREENVILLE.

**JUNE IS BUSTIN' OUT ALL OVER...**  
DOWNTOWN GREENVILLE  
Thursday-Friday-Saturday

Pre-Natal Bras 1/2  
Nursing Bras 1/2  
Leisure Bras 1/2

Boys and Girls  
Bathing Suits

20% Off  
All Yellow  
Tag Items

1/3 Off

**The Stork's Nest**  
113 W. 4th St.  
Downtown Greenville  
Plenty Of Free Parking

**JUNE IS BUSTIN' OUT ALL OVER...**  
DOWNTOWN GREENVILLE  
MAY 31, JUNE 1 & 2

**FREE \$25.00 Gift Certificate**

Register For Our FREE \$25.00 Gift Certificate And Also The \$100.00 Grand Prize Gift Certificate To Be Given Away. No Purchase Necessary. You Do Not Have To Be Present To Win!

We've been saving one for Dad!

**famous Barcalounger® recliners**  
at savings up to \$100<sup>00</sup>

...Traditional styling and the space-saving Pop-Up mechanism...

"SIR CHARLES"™  
Antique brass nailheads trim and adjustable headrest.

Special Orders Available For FATHER'S DAY Delivery. Most Styles Available.

Many Styles To Choose From.

Buy a Barcalounger...It's a Comfortable feeling!

**Home Furniture Store**  
Downtown, Dickinson Ave. At  
Eight Street  
Phone 752-2879

# Extension Of Insurance Law Hits Senate Snag

By SHARON BOND  
Associated Press Writer  
RALEIGH, N.C. (AP) — A bill that would extend indefinitely the controversial 1977 insurance law ran into a snag on the Senate floor Tuesday over a House amendment that would place a 6 percent limit on annual rate increases on all lines of so-called essential insurance.

The Senate refused to concur in the House amendment by a 26-23 vote, meaning the bill will now have to be sent to a conference committee composed of senators and representatives in an effort to resolve the differences.

The bill would extend the law enacted by the 1977 Legislature that allows insurance companies to raise rates on some auto and casualty insurance policies without the prior approval of the state insurance commissioner.

It was approved first by the Senate, and it contained a 6 percent cap on annual increases on automobile liability and collision insurance rates.

The House extended that ceiling to cover workers' compensation and fire insurance.

The head of the Senate Insurance Committee, Sen. Carolyn Mathis, D-Mecklenburg, urged the full Senate to refuse to concur with that amendment, saying the 6 percent cap on workers' compensation could cause trouble because of other pending legislation on workers' compensation benefits.

But she said her refusal to go along with the House action did not mean she was opposed to workers' compensation rate hikes being limited annually.

She said the Legislature must determine how those benefits will figure in the 6 percent annual rate increase. If it doesn't, she said, the insurance companies might successfully challenge the ceiling on workers' compensation.

they budgeted last year.

Knott told the commissioners that they should stay firm on their demands. "Our position is akin to a man's head in a lion's mouth and trying to figure out how to get it out without losing it," he said.

The commissioners also met with their counties' legislators. Most commissioners said after that the legislators were sympathetic but gave no assurances that the General Assembly could help them.

Eight counties have said they cannot meet their Medicaid obligations for the remainder of the fiscal year, which ends June 30. The counties are Alamance, Anson, Burke, Stanly, Sampson, Jones, Buncombe and Washington.

Medicaid is a federally mandated program that picks up the cost of health care for poor persons.

**KILLER HURRICANE**  
NEW DELHI, India (AP) — The hurricane that lashed the southern Indian state of Andhra Pradesh early this month killed 607 persons, destroyed the homes of 2.5 million and did \$850 million in property damage, state Revenue Minister Janardhan Reddy reports.



READY TO ROLL — Jean Hopcraft of Melbourne, Australia, gets ready for the latest import from America - Disco Roller Skating. She is the manager of a city disco and keeps well ahead of the fashion in her skimpy but well protected gear. (AP Laserphoto)

# Told Medicaid Formula Stands

RALEIGH, N.C. (AP) — Gov. Jim Hunt told county commissioners from across the state Tuesday that it's too late to change the formula for Medicaid contributions.

Each county is required to contribute a certain portion towards paying its county residents' Medicaid bills. A number of county officials have said the portion is too high and that they are unable — or unwilling — to pay all of their share.

The North Carolina Association of County Commissioners held a special meeting Tuesday morning to discuss financial problems caused by last year's change in the formula used to determine each county's share of the cost of the Medicaid program.

The change was designed to encourage counties to place more people in less-expensive rest homes, rather than in skilled-care nursing homes. It reduces the amount the state pays for skilled care.

Hunt told J.T. Knott, president of the association, after its meeting that Medicaid funding isn't only the biggest drain on county budgets, it also accounted for the largest single increase in the state's budget this year.

During Tuesday morning's meeting, many of the commissioners said their counties' share of the Medicaid expenses has doubled over the amount

# Courses For The Camper

CULLOWHEE, N.C. (AP) — A series of 20 vacation courses called Camper College will be offered this summer by Western Carolina University.

The program is designed to help visitors to the Great Smoky Mountains National Park "experience more than a wind-shield view of the area," said a college spokesman.

Courses offered through the school's division of continuing education include backpacking, fly-fishing, woodcarving, clogging, soapmaking and dulcimer playing.

"We look upon Camper College as an expanded dimension of our efforts to interpret the park's significance and consider it a rich opportunity for visitors to enhance the quality of their park experience," said Merrill D. Beal, superintendent of the park.

The courses are to be taught by a 15-person staff and will last two days each. Camper College begins June 25 and will offer courses through Aug. 11.

The teachers are considered experts in their subjects. Cherokee Indians will teach the art of Cherokee cooking, Indian pottery and woodcarving. The park is next to a Cherokee reservation.

Tuition is \$25 for each course. Families may enroll in a course for a rate of \$25 for the first family member and \$10 for each additional member.

Advance registration is requested. Information is available from the continuing education division at the school in Cullowhee.

**JUNE IS BUSTIN' OUT ALL OVER...**  
DOWNTOWN GREENVILLE  
THURSDAY-FRIDAY-SATURDAY

Register For A Free General Electric Portable Mixer To Be Given Away Saturday Afternoon. No Purchase Necessary.

**NOW ZENITH SYSTEM 3**  
-the best Zenith ever-  
comes to 17" COMPACT TABLE TV

**Electronic Power Sentry**  
energy-saving voltage regulating system

The BROOKDALE • L1740W  
Simulated Walnut wood-grained finish. Durable polystyrene cabinet. Earphone. Detachable VHF and UHF Antennas.

**A GREAT VALUE!**  
**\$429<sup>95</sup>**

**SYSTEM 3**

<b>TRI-FOCUS PICTURE TUBE</b> The sharpest Zenith picture ever!	<b>TRIPLE-PLUS CHASSIS</b> Designed to be the most reliable Zenith ever!	<b>COLOR SENTRY</b> Automatic picture control system!
--	---	--

**ELECTRONIC VIDEO GUARD TUNING SYSTEM**  
Tuners have no internal moving parts to corrode, wear or cause picture problems.

- One-Knob VHF and UHF Channel Selector
- VHF/UHF Deluxe Spotlight Panel
- Automatic Fine-tuning Control
- Picture Control

**V.A. Merritt & Sons**  
207 Evans Street Downtown Greenville  
752-3736 Plenty Of Free Parking

compensation insurance and cause the ceiling on the other three types of insurance to be declared invalid also.

"I don't think either body would like to see a situation without any cap at all," she said.

A number of senators disagreed with Mrs. Mathis. Charles Vickery, D-Chatham, was one.

He said the 6 percent cap should be kept on all four lines of insurance in order to ensure the constitutionality of the bill.

"If we tamper with it and put it on auto insurance but not workmen's compensation, then

the companies will take it to court and we won't have any cap," he said.

After the Senate's action, Gov. Jim Hunt released a statement saying he was disappointed by that body's refusal to accept the cap on increases in workers' compensation insurance rates.

"As I have said before, I believe we need to take strong action to protect consumers against inflationary increases in rates on essential lines of insurance," Hunt said. "I hope the Senate will reconsider its action and vote to place a cap on all the essential lines ..."

**Kmart THE SAVING PLACE**

## CORRECTION

The tent shown below was incorrectly priced in our advertisement that appears in the Wednesday, May 30th edition of The Reflector's Shopper's Guide and The Daily Reflector. A correct price is shown below.

**9'8" x 7'2" CAMP TENT**

Roomy Fire Retardant Tent With 7' Center Height. 2 Zippered Windows. Aluminum Frame. Save Now.

# \$119

**BISSETTES DISCOUNT CENTER**

**JUNE IS BUSTIN' OUT ALL OVER...**  
DOWNTOWN GREENVILLE  
THURSDAY, FRIDAY & SATURDAY

**THERMOS JUG/COOLER COMBO**

Rustproof, plastic 35 qt. Cooler and 1 gal. Spout Jug. Both urethane insulated to keep foods fresh and beverages cold all day. Rugged molded construction. Now Only...

# \$12<sup>99</sup>

**SUPER SAVING COUPON**

FOR MEN AND LADIES!  
Shape up the easy, effortless way...just 10 minutes a day can make a leaner, healthier you!

**FIRM UP...TRIM DOWN...IT'S EASY "BODY TONER" EXERCISER**

Can be used anywhere anytime ... just faster to any door knob.

Now In Stock! **3.99** Value **77¢**

We Regret The Delay  
Limit 1 With This Coupon

**RAINWAVE LAWN SPRINKLER**  
Waters Area Up To 2200 Sq. Ft.

# \$3<sup>77</sup>

Reg. \$5.77

**Gillette TRAC II**

**TRAC II BLADES**

9's **\$1<sup>39</sup>**

Reg. \$2.09

**TIMEX® WATCHES**  
NEW STYLES—ELECTRIC OR WIND-UP

WORLD FAMOUS FOR  
• QUALITY  
• ACCURACY  
• ECONOMY

Regular \$12.95 To \$49.95

# 20% Off

**RIGHT GUARD® DEODORANT STICK**  
2.5 OZ.  
REG. \$1.18  
ONLY **88¢**

Lime Or Regular

Especially Formulated For Blow Dryer Users.

**ULTRA MAX® SHAMPOO**

• Normal or Dry Hair  
• Oily Hair

7-Oz. Reg. 99¢

# 77¢

**Alkaline Power Cells**

**EVEREADY**

• 2 Pack C Or D Cell  
• 2 Pack AA Penlight

# 99¢

**VALUABLE COUPON**

# 50¢ OFF

On the purchase of ANY REVLON LIPSTICK

Choice of shades and formulations WITH COUPON

**BISSETTES**

**VALUABLE COUPON**

# \$1 OFF

On the purchase of REVLON FRAGRANCE PRODUCT

IN Jontue, Charlie Or Intimate. WITH COUPON

**BISSETTES**

**Here's the Instant for you**

Come in and see the KODAK COLORBURST 50 Instant Camera. It's for you because it's an aim-and-shoot instant camera that leaves more time for fun. It's for you because it gives you beautiful instant color by Kodak with an elegant SATINLUXE™ Finish. It's for you because it's instantly affordable. See it today.

**\$44.50 Value ONLY**

# 34<sup>95</sup>

KODAK Instant Print Film PR10

**Kodak** PRODUCTS

**COUPON SPECIAL**

**Color Reprints 6 FOR \$1.19**

WITH THIS COUPON From your same size Kodacolor, GAF or Fuji color negatives.

Good Thru Sat. June 2, 1979

**BISSETTES**

# His Model House Hobby Began In Pre-TV Years

## ECU Faculty Members Appeared On Programs

**ECU News Bureau**  
Several faculty members of East Carolina University's professional schools appeared on programs at recent national and regional professional meetings.

Dr. John Eatman of the ECU School of Business economics faculty spoke on "A Simulation Study of the Use of Ordinal Data in Regression" at the Boston, Mass. meeting of the American Institute for Decision Sciences.

Eatman and Drs. Jerry Hunt and Robert Angell also appeared at the Washington, D.C. Meeting of the Eastern Finance Association.

Eatman and Hunt presented a report of their research, "Regulatory Influence on Growth in the Savings and Loan Industry," and Hunt and Angell reported on their project, "Efficient Markets and Underwriting Performance in Small Stock Offerings."

Dr. Charles Snow and Patricia McMahon of the ECU School of Home Economics spoke at the annual conference of the Southern Association on Children under Six in Birmingham, Ala. Both are members of the child development and family relations faculty.

Snow's topic was "Personal Development and Sources of Support for Child Development Programs," and Ms. McMahon discussed the results of her research project, "Stimulating Imagination and Creativity in Young Children."

Dr. Norman Pendered of the ECU School of Technology spoke at the eighth international conference of the American Industrial Arts Association in San Antonio, Texas, on organizing, financing and publishing state newsletters.

Two members of the School of Education faculty presented papers at the first annual Urban Affairs Conference at UNC-Chapel Hill.

Dr. Frank Fuller, chairman of the Department of Counselor Education, discussed "Utilizing the Expertise of Members of the University Community in Helping to Improve Conditions of Living in the City."

Dr. Clinton Downing of the administration and supervision faculty spoke on "Developing and Implementing a Functional School-Community Relations Program for the Urban School Community."

Dr. Dennis Davis of the School of Allied Health and Social Professions directed a session on "Pain Management Using Modalities of Physical Therapy and Acupuncture Points" at a

meeting of the South Carolina Physical Therapy Chapter.

The Davis presentation was based on procedures and techniques he worked with at a San Francisco symposium on the uses of acupuncture.

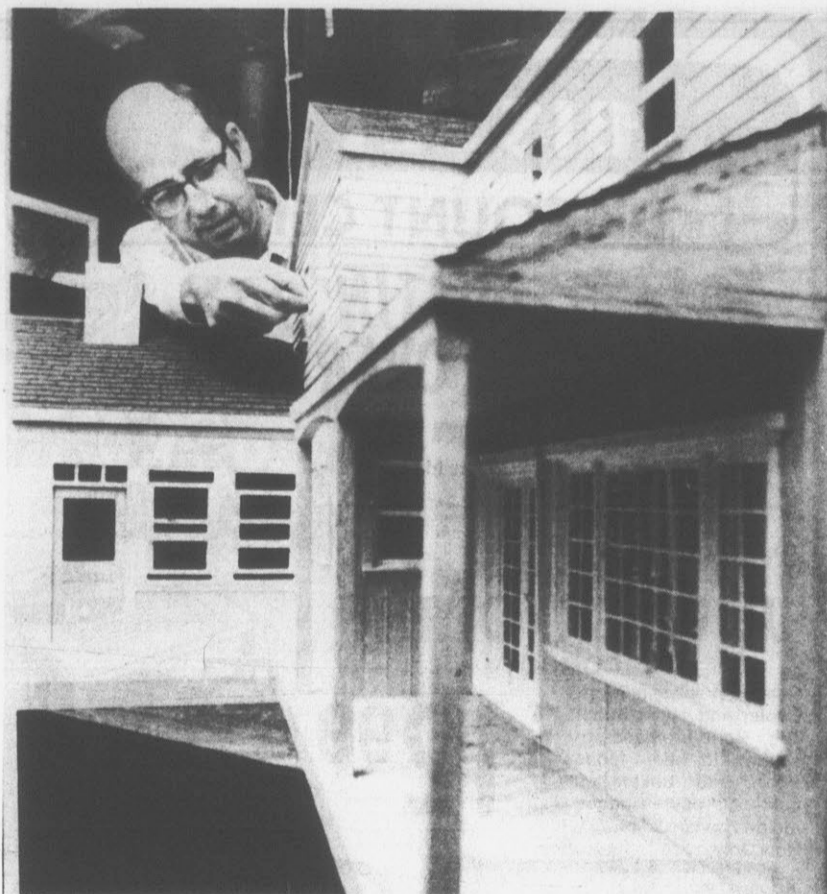

**STILL BUILDING HOUSES** — Bob Stein works on the latest of his houses in the basement of his home. When he was a boy he built model houses instead of model planes. (AP Laser-photo)

By JULES LOH  
AP Special Correspondent  
MIDDLETON, Wis. (AP) —

In the generation before TV antennas forested the land, the popular pastime for boys was making model airplanes. Few kitchen tables survived the stains of airplane glue.

The rage, however, never caught the fancy of Bob Stein. Instead, he built model houses — and hid them away. They might, he considered ruefully, be thought of as, egad, doll houses.

One day his mother embarrassed him by entering a model he had built in a crafts contest at school. It was a model of his own home and it won first prize. His mother still has it.

Now past 40, Bob Stein still builds model houses as a hobby but they are a far cry from the rude efforts of his youth.

Indeed, they are in such demand by people who have gotten word of his skills that he is battling the urge to let go his career as a landscape architect and pursue his hobby full time.

"I had no idea of the popularity of doll houses," he said. "People are spending fortunes on them, decorating them, furnishing them. My wife, Beth, bowls with a lady who just laid out \$250 for a couch. A couch for a doll house. When they put that kind of money in them they want a good house to start with."

Bob Stein no longer has boy-

ish misgivings about making doll houses, but the term is inadequate to describe what he makes.

Just now, for example, he is working on a scale model of an actual mansion, room for room, fireplace for fireplace, staircase for staircase; an exact replica built from the blueprints of the mansion on a scale of an inch to a foot. Slide away a section of wall, or lift a hinged roof, and every interior room opens to view.

"I have a hunch the lady I'm building it for is going to sell her house," he said.

"It's a beautiful place and must hold many memories for her. Her children are grown

and gone. I think she wants a replica so she can at least keep the memories."

Bob Stein's workbench is a miniature itself: tiny table saws, knives, clamps. He cuts and shapes with the precision of a jeweler.

The workbench is in the basement of a house which, not surprisingly, he built himself — full scale, of course. The house snuggles into the side of a steep, wooded hill on a lot commercial builders rejected because of the difficulty of building on it.

Besides doing landscaping, Bob Stein put his hobby to use at one architectural firm he worked for and made miniatures of proposed buildings.

That's how he got started making doll houses. An associate, whose wife worked in a toy store, suggested he make some for sale.

"Beth and I drove around looking at houses, looking for ones that were interesting but simple enough to become doll houses. We found three. I measured them and duplicated them."

"I build about 30 of those a year, not counting the custom made jobs for people with their own plans. Beth makes the titles, the deeds. She prints them up."

Titles? Deeds? "Sure. A person buys a little house, he ought to have a little deed."

### May Be Losing A Sweet Tooth

WASHINGTON (AP) — America may be losing its sweet tooth.

The Commerce Department says U.S. confectionery manufacturers produced 3.174 billion pounds of candy last year, which was a 2.5 percent decline from 1977. Consumption dropped 3.2 percent in 1978 to 14.9 pounds per person, the department said. That places candy consumption at the 1935 level, the figures show. Despite the decline, manufacturers' shipments were valued at \$3,337,000 last year, a 9.1 increase over 1977.

**JUNE IS BUSTIN' OUT ALL OVER**  
DOWNTOWN GREENVILLE  
MAY 31, JUNE 1 & 2

**COMPARE AND SAVE!** SMART SHOPPERS RELY ON REXALL FOR THE HIGHEST QUALITY VITAMINS AT THE LOWEST COST!

USE GERITOL? COMPARE PRICE AND FORMULA WITH

**Rexall GER-RITE™**  
IRON AND MULTIVITAMIN SUPPLEMENT  
**\$3<sup>32</sup>**  
100 TABLETS

Each tablet provides:  
VITAMIN B-1 (THIAMINE) 5mg  
VITAMIN B-2 (RIBOFLAVIN) 5mg  
VITAMIN C 75mg  
NIACINAMIDE 30mg  
VITAMIN B-12 10mg  
PANTOTHENIC ACID 10mg  
IRON 50mg

Show loved ones how much you care by taking good care of yourself. Get plenty of exercise, eat the right foods and take REXALL GER-RITE High Potency Iron and Multivitamin supplement daily to be sure you're getting all the nutrients your body needs to function properly.

USE OS-CAL? COMPARE PRICE AND FORMULA WITH

**Rexall NATURAL OYSTER SHELL CALCIUM & VITAMIN D**  
100 TABLETS  
**\$2<sup>22</sup>**

This rich, natural source of calcium helps in the repair of bones and teeth. It also helps regulate certain body processes such as normal nerve behavior, muscle tone and blood clotting.

ONE TABLET THREE TIMES DAILY PROVIDES:  
VITAMIN D 375 I.U.  
CALCIUM 750 mg

USE FLINTSTONES? COMPARE PRICE AND FORMULA WITH

**Rexall CHILDREN'S CHEWABLE MINUTEMAN® MULTIPLE VITAMINS**  
100 TABLETS  
**\$2<sup>25</sup>**

New improved formula! Each tasty, fruit-flavored tablet contains 10 vitamins essential for growing children PLUS IRON.

Each tablet contains:  
VITAMIN A 5,000 I.U.  
VITAMIN D 400 I.U.  
VITAMIN E 15 I.U.  
VITAMIN C 80 mg  
FOLIC ACID 0.4 mg  
THIAMINE 1.7 mg  
RIBOFLAVIN 1.7 mg  
NIACIN 20 mg  
VITAMIN B-6 2 mg  
VITAMIN B-12 8 mcg  
IRON 18 mg

USE ALLBEE WITH C? COMPARE PRICE AND FORMULA WITH

**Rexall HIGH POTENCY B COMPLEX CAPSULES WITH VITAMIN C**  
100 CAPSULES  
**\$4<sup>13</sup>**

A healthful combination of high potency B Complex vitamins and 300 mg. of Vitamin C!

Each capsule provides:  
VITAMIN C 300 mg  
THIAMINE 15 mg  
RIBOFLAVIN (VITAMIN B-1) 15 mg  
VITAMIN B-2 50 mg  
NIACIN 50 mg  
VITAMIN B-6 5 mg  
PANTOTHENIC ACID 10 mg

SPECIAL BONUS-PAK OFFER! **Rexall SUPER PLENAMINS® MULTIVITAMIN/MULTIMINERAL SUPPLEMENT**

Whether you're a SUPERSTAR — a busy mother with active kids, or a businessman or woman on the go, you don't always get the food that supplies the nutrients you need. That's why REXALL SUPER PLENAMINS tablets contain 11 essential vitamins and 8 important minerals — so you can live your busy life in good health.

And remember — REXALL unconditionally guarantees all their nutritional products to be unsurpassed for quality and freshness.

If you're not completely satisfied we'll refund your money!

**36 TABLETS FREE WITH 72!**  
**\$4<sup>76</sup>**

### Register To Win!

Don't Forget To Register At Both Our Hollowell's Locations For A FREE Waring Blender. We Will Be Giving Away A Blender At Each Location. Also Register For The \$100 Grand Prize.

No Purchase Necessary. You Do Not Have To Be Present To Win!

**Hollowell's**  
DRUG STORES, Inc.

Quality • Competitive Prices • Service  
No. 1 911 Dickinson Ave. 752-7105 No. 2 6th St. & Memorial Drive 758-4104

Be Sure To Vote June 8

### June Is Bustin' Out All Over' With Savings At D.A. Kelly's...

Large Group Spring And Summer Fashions

25-50% Off

Register For \$25 D.A. Kelly's Gift Certificate

No Purchase Necessary.

### BUSTIN' OUT "Special"

Buy Shorts Or Romper At Regular Price Receive A Beach Cover-Up Sleeper Absolutely Free!!



**D.A. Kelly's**

409-A Evans St. Mall Greenville Phone: 752-8965



**AT LAST A VETERAN** — Oleda Christidas, 82, is finally a certified World War I veteran. The Marine City native and other telephone operators who served with the Army Signal Corps have been declared veterans after a 60-year battle with Pentagon officials. She is pictured here with her husband Chris. (AP Laserphoto)

**JUNE IS BUSTIN' OUT ALL OVER...**

See Us For Expertly Printed Wedding Invitations

**MORGAN PRINTERS, Inc.**  
211 WEST 9th ST. ★ PHONE 752-5151

# Some Southerners Claim The First Memorial Day

By Dr. H.G. JONES  
For The Associated Press  
CHAPEL HILL, N.C. (AP) — The grinch may have stolen Christmas, but the Yankees stole Memorial Day.

Or at least that's what a lot of Southerners think.

Ironically, it was a Southerner, President Lyndon Johnson, who issued a proclamation in 1967 crediting Waterloo, N.Y., with holding the first Memorial Day observance on May 5, 1866.

Well, now, let's see about that.

Boalsburg, Pa., claims that in October 1864, Emma Hunter and a neighbor decorated the graves of their father and son, respectively, who had been killed in the Union Army. The two women were said to have pledged to repeat the ceremony each year.

Southerners have several competing claims for being first. For instance, on April 26, 1865, the ladies of Vicksburg, Miss., placed flowers on the graves of Confederate soldiers; in Charleston, S.C., on May 30, 1865, Negro children strewed flowers on four trenches that held Union dead, and on June 9, 1865, the women of Petersburg, Va., decorated the graves of their soldiers.

There is also evidence that the Ladies Memorial Association of Columbus, Ga., decorated the graves of Confederate soldiers on April 26, 1866, ten days before the date that the New York village defends.

We have no proof as to when the first decoration of graves occurred in North Carolina, but we do know that on May 10, 1866 — only four days after the Waterloo ceremony — a large number of women of Raleigh, "in accordance with the pre-

vious announcement," gathered in the Senate chamber "with flowers, festoons, and evergreens, whence they proceeded to the City Cemetery and the other places where our brave dead lie sleeping, and dedicated their hallowed graves."

The Raleigh Sentinel noted that business ceased for the day and that the women also "festooned with flowers the grave of Andrew Johnson's father, to testify their respect for the President and their gratitude for the magnanimous policy when he has adopted towards our unhappy section."

Two years later, the Sentinel reminded its readers, "the usu-

al memorial day ceremonies will be observed to-day at 4 o'clock p.m. at the Memorial Cemetery, under the auspices of the ladies of the Memorial Association." This was Saturday, May 9, chosen because the proper date — the anniversary of the death of Stonewall Jackson — fell on Sunday.

Then, only three weeks later, the Sentinel carried this note:

"In accordance with orders from the headquarters of the Grand Army of the Republic, the members of the order and such others as are disposed to participate, will observe me-

morial ceremonies at the Cemetery, near this city to-day."

Added the editor, "Approving, as we do, most heartily, the annual memorial ceremonies for the loved, and these lost, and the brave among the Confederate dead, we cannot withhold our entire approval of similar observances in behalf of the Federal army ..."

In that statement in 1868 the newspaper confirmed that "annual memorial ceremonies" for the Confederate dead were firmly established in Raleigh. It also recognized the advent of two separate memorial days —

one to honor the Confederates, the other the Federals.

As the years passed, Confederate Memorial Day in the South became a time for remembering the lost cause through parades, band concerts, eloquent addresses, veterans' reunions and the decoration of graves.

On May 10, 1879, for instance, the holiday was observed around the state. Bands, fire companies, police, school and college students and faculties, organizations, state guard, governmental officers and the veterans themselves joined in the

ceremonies. By 1904, some of the bitterness had faded, and the News and Observer noted that at Federal Memorial Day exercises in Raleigh, representatives of the Confederate Veterans Association were in attendance. The glory of the Union soldier was also the glory of the Confederate, the speaker said.

During the next 50 years, May 30 gradually was transformed into a National Memorial (or Decoration) Day for the dead from all wars, and as a federal holiday, it gained as-

pendancy over Confederate Memorial Day in all but a few Southern states.

Until 1971, state employees in North Carolina received a day off on May 10. That year the State Personnel Department quietly changed the holiday to May 30. To test the sentiment of the public, the News and Observer interviewed 20 persons, only two of whom knew the significance of May 10.

The Yankee victory was complete. But, just as Southerners were getting adjusted to May 30 as a common observance, Congress stepped in and

changed the calendar, making Memorial Day the fourth Monday in May.

**SHERLOCK'S**  
118 East 5th  
**We Cater Pig Pickin's**  
Call Freddie Somers at 758-1991

## Two Earn Doctorates

ECU News Bureau

Two faculty members of the East Carolina University School of Music received doctoral degrees during the 1978-79 academic year.

Daniel Mellado, a violoncellist and a member of the instrumental faculty, was awarded a PhD degree from Michigan State University. He holds the bachelor of music degree from the University of Texas at El Paso and the master of music from the University of Colorado.

Brett Watson, conductor of ECU's Concert Choir, and a member of the theory-composition and choral departments, received the doctor of musical arts degree in choral music from the University of Southern California.

Dr. Watson is an ECU alumnus and received the master of music degree from the Eastman School of Music in Rochester, N.Y.

## Among Club Winners

RALEIGH — Students of Aycock Junior High and the Bear Grass Schools were among award winners in the annual Tar Heel Junior Historians clubs meeting and competition held recent at Meredith College in Raleigh.

In the regular (above elementary grades) category, Aycock students took first place in the Individual Literary division with their project, "A Pictorial History of the Greenville Rescue Squad."

Bear Grass students, who have for several years been award winners, were in the top achievement level again this year with a first place in the Special Achievement category for student Derek Price's "Scale Model of a Brig, Sailing Ship."

Bear Grass students also took second place for a group project in the Bloombury Book Awards for "Weird Tales of Martin County."

A total of 53 entries were made in the annual competitions, cosponsored by the N. C. Museum of History of the Dept. of Cultural Resources and the N. C. Literary and Historical Association.

## Paper Sale By Shriners

Pitt County Shriners will be out Friday and Saturday, June 1 and 2, participating in the First Annual Sudan Temple "Shrine Paper Sale," according to Hugh T. Hardee Jr., president of the Pitt County Shrine chapter.

The local Shriners are offering their newspapers to raise funds to operate the Shriners' Hospitals for children.

According to Sudan Potentate John R. Godwin, it took in excess of \$46 million to operate the 18 orthopedic Hospitals and three Burns Institutes in 1978.

More than a quarter million children have benefited from the treatment centers since they were begun in 1922 by the Shriners. No government funds support the hospitals and 100 percent of funds raised by Shriners for the hospitals go toward that purpose.

**JUNE IS BUSTIN' OUT ALL OVER**  
DOWNTOWN GREENVILLE  
Thursday-Friday-Saturday

**All Early American Den Suites**  
Large Selection of 2 Piece Suites in Prints, Solids, or Plaids. Colors: Rust, Green, Gold & Brown.  
**Reduced 25% To 50%**

**Berkline Recliner Sale -**  
Entire Group On Sale-Over 150 In Stock-Save Up To \$100.00 Large Selection of Wall-A-Ways and Rocker Recliners.

One Group  
**Loose Pillow Back Sofas**  
In Cotton Prints or Corduroy.  
Reg. \$669.00 ..... Sale **\$469<sup>00</sup>**

One Group **Bassett End Tables & Cocktail Tables**  
Pecan, Maple or Pine Finish. Door Cocktail Tables And Door End Table.  
Reg. \$129.00 ..... Sale **\$89<sup>00</sup>** Each

**Sofa Tables With Glass Top Insert**  
Oak Contemporary Finish  
Reg. \$159.00 ..... Sale **\$78<sup>88</sup>**

"at home"  
**DINING FURNITURE**

Solid Maple And Solid Oak Dinette Suites  
By Cochrane  
Large Selection Of Chairs, Tables & Hutches  
**Reduced 25% To 50%**

**Colony 13**

**Big 3 Day Sales Event**  
**Thursday-Friday-Saturday**  
**Storewide Sale - Save 25% to 60%**  
Store Hours 8:30 A.M. to 5 P.M.  
Use Our 90 Day Cash Plan With No Finance Charge, Or use Our Convenient Revolving Charge And Take Months To Pay.

**Maple Or Pine Gun Cabinets**  
Holds 6 Guns With Door Locks  
Reg. \$259.00 ..... Sale **\$189<sup>00</sup>**

One Group  
**Queen Anne Wing Chairs**  
In Vinyls or Velvets.  
Reg. \$249.00 ..... Sale **\$189<sup>00</sup>**

**Bentwood Rockers**  
Heavyweight-Extra Sturdy  
Reg. \$129.00 ..... Sale **\$88<sup>88</sup>**

**5 Pc. Maple Dinettes**  
42" Table With One Leaf and Four Chairs  
Reg. \$259.00 ..... Sale **\$179<sup>00</sup>**

**4 Pc. Pine Bedroom Suite**  
By Thomasville  
Triple Dresser With Lighted Hutch Mirror, Chest On Chest, Cannonball Bed And Night Stand.  
Reg. \$1995.00 ..... Sale **\$599<sup>00</sup>**

**All Bassett Baby Furniture**  
**Reduced 25%**  
Includes Cribs, Dressing Tables, Chest & Rockers.

**9 X 12 Oriental Rugs.** 100% wool. Medallion or Indian design.  
Colors: Blue, beige, or red. Reg. \$399.00 ..... Sale **\$299<sup>00</sup>**

**All Lamps, Pictures, & Mirrors 25% off**

**Sealy Mattresses & Boxsprings**  
Firm Support, Quilted Top  
Double Size Reg. 99.95 ..... Sale **\$79.95**  
Twin Size Reg. 69.95 ..... Sale **59.95**  
Queen Size Reg. 229.00 ..... Sale **\$189.00**

**Taft Furniture Co.**  
535 Dickinson Ave.  
Downtown Greenville  
752-5161  
**"80 Years of Continuous Service To Eastern North Carolina"**  
Use our 90 day cash plan, (no finance charge), or our easy revolving charge and take months to pay. Free delivery up to 100 miles.



**OUT OF THE PAST** — Ten-year-old Karol Wojtyla, first at right in the second row, is photographed with his father (first at left in the second row) a non-commissioned officer of the Polish Army who died in 1941, and some schoolmates. This photo was made May 26, 1930 during a trip to Wieliczka. Karol Wojtyla, now Pope John Paul II, returns to native Poland on June 2 and on June 7 visits his birthplace Wadowice. (AP Laserphoto)

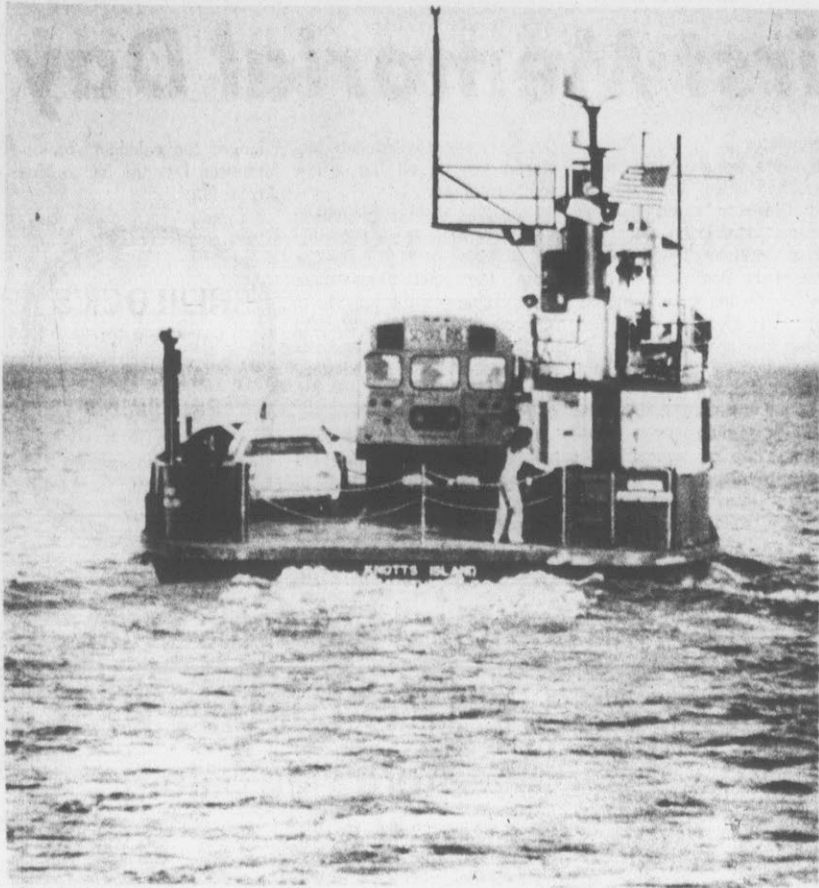

**FERRIED BUS** — Students from Virginia, aren't just bused to school — their bus is ferried, too. (AP Laser-photo)

## Taking Ferry Is Daily Routine For Students

**KNOTT'S ISLAND, N.C.** (AP) — Tourists take the ferry ride to relax and feed the seagulls.

But for 22 high school students on Knott's Island, just below the Virginia border and lying between the Outer Banks and the mainland, it's routine, everyday stuff.

The ferry was started in 1962 to transport children from the island across Currituck Sound to attend high school on mainland Currituck County.

The drive from the island to Currituck County High School is two hours long, and the only possible land route goes through Virginia. No insurance would cover North Carolina buses travelling in that state, officials said.

The school ferry — which takes both the students and their bus aboard — is one of two such ferries in the country. The other is in Michigan.

"I just wish we would go faster," said Mark King, a freshman, of the 50-minute ferry ride. It's only 4 1/2 miles from the Knott's Island ferry dock to the mainland; but the ferry travels at a leisurely — some say lethargic — four mph.

"It's really bad for athletics and dating," said Janet Wil-

liams, a senior who says she plans to leave the island after graduating. "There can be no school participation in anything at night."

The boat leaves Knott's Island at 7 a.m. and returns the students at 4:35 p.m. Only high school students make the trip.

Most of the students say they like the ferry, despite their complaints about the lengthy cruise.

"It's better than riding in a car, and you can get up and talk to your friends," one said.

A bridge would "mess up" the wildlife, they say.

"It'd just mean more trash and traffic if a bridge was built ... and all the tourists would come here. I think we should keep the island the way it is," said Debbie Brumley, a sophomore.

The students pass the ferry ride by doing homework, sleeping, playing cards and chasing each other around the deck.

"They're a pretty good bunch of kids," said Gilbert Brickhouse, a ferry crew member.

## Davis Papers For Collection

**ECU News Bureau**  
The East Carolina Manuscript Collection has acquired the personal papers of Captain Louis Poisson Davis, U.S.N. (1883-1978). Captain Davis, a native of Wilmington, N.C., was the son of attorney Junius Davis and grandson of eminent Confederate statesman George Davis.

A 1905 graduate of the U.S. Naval Academy, Davis served on or commanded the U.S.S. KEARSARGE, GALVESTON, DELAWARE, PANTHER, MINNESOTA, JARVIS, TEXAS, ALABAMA, MARYLAND, RINGOLD, WOODBURY, and COLORADO during 30 years of active duty. He participated in the "Great White Fleet," a flotilla of 16 new battleships dispatched by Theodore

Roosevelt to circumnavigate the globe in a demonstration of U.S. naval might.

The papers, which consist of personal and military correspondence, financial papers, orders, pamphlets, personal military records, diaries, and photographs, were donated by Davis' widow, Edna S. Davis of Washington, D.C., and his sons Louis P., Jr., George J., Shethar, and Thomas Walker, II.

Three of the Davis sons graduated from the Naval Academy and all four received commissions in the Navy during World War II. Researchers interested in the Davis Papers may visit the Collection, located in ECU's Joyner Library, between the hours of 8 a.m. and 5 p.m., Monday through Friday.

## The Total Look ...totally Americana ...totally affordable!

Cocktail table \$80<sup>00</sup>

**YOUR CHOICE \$80<sup>00</sup>**

Designed for today's "authentic look" ... and casual living. Antiqued finish on select maple veneers and hardwoods. Tops are protected with the newest high pressure laminate... no worry about spills and stains! Tremendous buy at this price!

Drawer end commode... \$80<sup>00</sup>

Po commode \$80<sup>00</sup>

**Broyhill OCCASIONAL**

AT BOSTIC-SUGG  
JUST SAY "CHARGE IT"



30-60-90 DAY CASH PLAN  
PERSONALIZED REVOLVING  
CHARGE PLAN

**Bostic-Sugg FURNITURE INC.**  
401 WEST 10th STREET, GREENVILLE, N.C. PHONE 758-1729 or 758-2513

# PINE FOR YOUNG AMERICANS

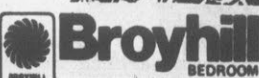

**PINEDALE**

\$145.00 Off Honey Pine Four Piece Master Bedroom Group

Large 7 Drawer Double Dresser, Frame, Plate Glass Landscape Mirror, Double Queen Cannonball Headboard and Spacious 5 Drawer Chest... Matching Nitstand Only \$82.50

Showroom Hours  
8:00 A.M. to 5:30 P.M.  
Monday thru Saturday  
& 'Til 9:00 Friday Nites

**\$450<sup>00</sup>**

## Pic 'n Pay Shoes

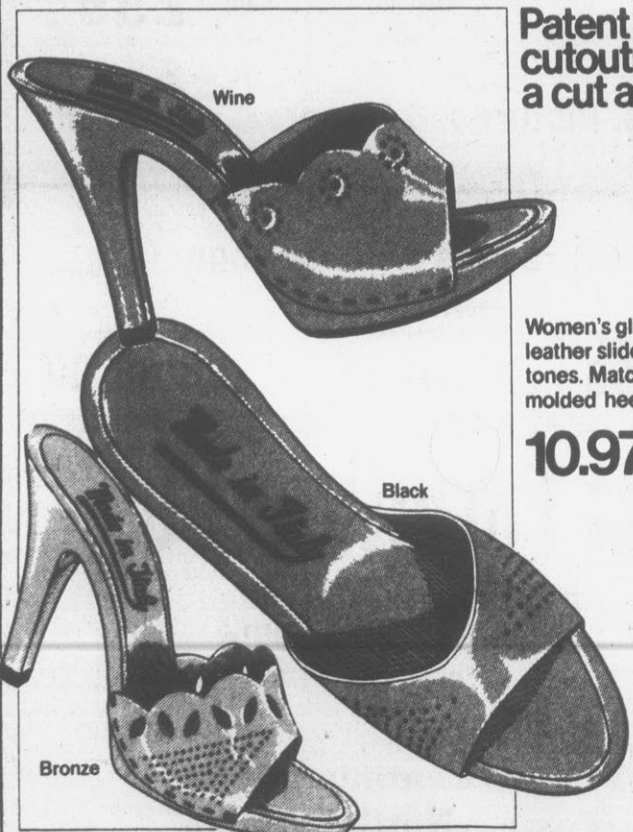

Patent Leather cutouts... a cut above.

Women's glistening patent leather slides in jewel tones. Matching high, molded heels and soles.

**10.97**

**264 BY-PASS** ACROSS FROM NICHOLS DISCOUNT CITY

Open Monday thru Thursday 10 to 9, Friday 9 to 9, Saturday 9 to 8.

Master Charge or Visa. Open evenings

# Glenn Turner Still Motivates

By PAULA SCHWED CASSELBERRY, Fla. (UPI) — Glenn W. Turner sometimes jokes that he and the caped crusader from Krypton have a lot in common.

"Sometimes I think I was dropped in from another planet, like Superman," Turner says. "Cause nothin' bothers me, nothin' worries me. I have become a symbol of keeping your head."

The 44-year-old salesman is back in the motivation business with a new pitch called "Challenge to America."

Fraud litigation toppled the \$300 million pyramid sales empire and ended the "Dare to Be Great" motivation courses that inspired and misled thousands. It turned business associates against Turner. It landed him in jail, briefly. It also left him penniless, forcing him to depend on his children for money.

But Turner says now, "I haven't had it bad. I came from so far down, it all looks like up to me. Even in jail they feed you three meals a day — which is more than I had as a kid."

Turner constantly refers to his early years in Marion, S.C., and the ridicule he suffered as the harelipped son of a sharecropper. He uses the stories to prove that losers, dropouts and has-beens can succeed beyond their wildest dreams with positive thinking.

He enjoys telling about the customer who could not keep her eyes off his mangled upper lip in the days when he was selling sewing machines door-to-door.

"That's just something I put on every morning so's people will notice me," he told the woman in his nasal voice.

Turner never has been the kind of man who goes unnoticed. At the height of his glory he used to leap from his own Learjet — flanked by twin midgets — before crowds of cheering disciples.

He owned 180 pairs of boots and too many red suits to count. He used to autograph \$100 bills and hand them out to every hard-luck case he came across.

Turner ordered construction of his own \$3.5 million white stone castle complete with helicopter landing pad and a bathtub big enough for 10 people. It now stands empty and unfinished on the banks of Bear Gulley Lake, 10 miles north of Orlando.

Turner lives above the stable with his wife and his youngest child. Several hundred yards away in a boathouse is the office of Ed Rector, who heads the company that markets "Challenge to America" motivational courses.

Turner is billed as a consultant to the courses because his attorneys still are trying to settle with the IRS on

the issue of back taxes and penalties. He claims any income of his would be seized. The flamboyant salesman never has admitted wrongdoing, he merely pleaded no contest to federal misdemeanor charges stemming from his business deals which the FTC said in 1973 left "a staggering human toll — money borrowed, jobs quit, homes mortgaged and even personal bankruptcy for some who dared to be great."

Rector says the marketing approach of "Dare to Be Great" and Koscot Interplanetary Inc., a cosmetics company, that was attacked by the

government as fraudulent, has been eliminated from "Challenge to America."

The two former businesses operated on the principle of a chain letter. Those who wanted to induce others to take the motivation course or sell Koscot cosmetics first had to buy their way in. The idea was to bring a few friends, and let them bring a few friends — for a hefty commission.

"The government saw that as selling people, not selling a product," said Rector. Turner's former bodyguard, "Selling the right to re-sell. With Challenge to America, they have to sell the courses to move up. But

they don't have to buy the course in order to sell it. They may not be too proficient in selling it, but there's no requirement to buy in order to sell or to sell in order to buy." Besides that and a 30-day, money-back guarantee, "Challenge to America" sounds identical to "Dare to Be Great."

"Much of it is the same material that skyrocketed thousands to success, assembled in a different way," Rector said. "It's still based on belief in yourself. It's still Mr. Turner's secrets of success. We just didn't feel like we could

improve on the course of instruction, although we have added to it. Some of it is exactly alike." Rector and Turner are expecting government opposition.

"I think we'll be tested in some states and have to prove ourselves," Rector said.

"I've told them to run it so clean that the Girl Scouts will look like Mafia. The government would like to fix it so I can't do anything except go back to South Carolina and drive mules," Turner said.

"The only way they're going to stop me is to pass a law against harelips."

### Great New Look...

### Same Great Taste.

Jeffreys Beer & Wine Co.



# FAMILY DOLLAR

### \$2,000,000 SPORTSWEAR

### SAVINGS SPECTACULAR!

### Purchase of Manufacturer's '79 Summer Overstocks!

## 2<sup>99</sup>

Your Choice!

Sizes S,M,L

Ladies' tank tops, camisole tops or pull-on shorts at one low price!

### Ladies' Poplin Shorts Selection

Sizes 7/8 to 15/16

## 4<sup>99</sup>

### Ladies' Cotton Knit Tops

Sizes S,M,L,XL

## 2<sup>00</sup>

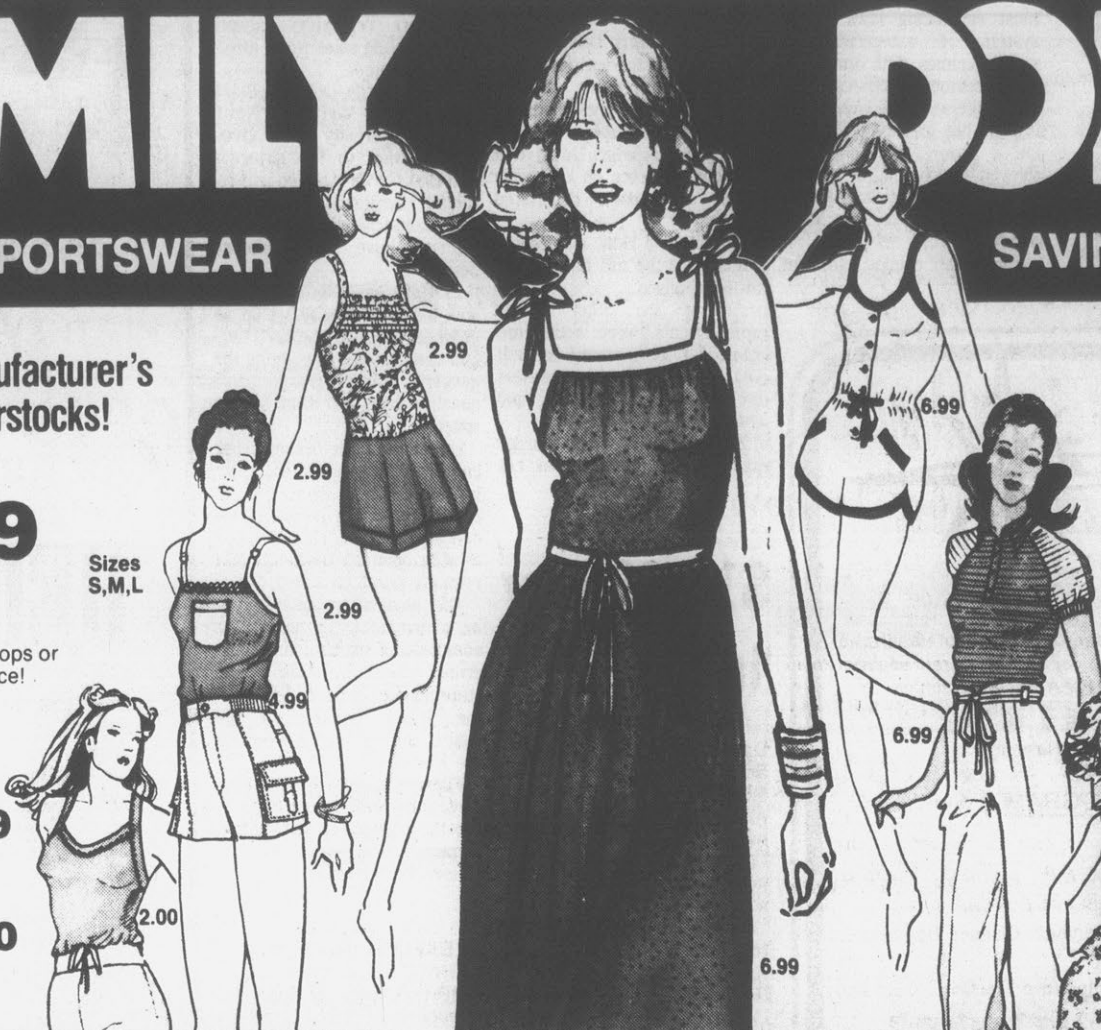

### Dresses, Blouses, Tops, Jeans, Slacks, Shorts!

This Year's Fashion Favorites

## 6<sup>99</sup>

Your Choice!

Ladies' tee shirt dresses or Terry rompers at one low price.

### Selection Of Ladies' Blouses, Slacks And Jeans

Blouses ..... 4.99  
Slacks ..... 6.99  
Jeans ..... 7.99

### Ladies' 1 & 2 Pc. Dresses

Sizes 8-18 **7.99 & 8.99**



### Girls' Or Toddlers' Shorts And Tops

## 1<sup>00</sup>

Super summer playwear! Girls' fashion tops and jogging shorts, sizes 4-6x and 7-14. Toddlers' mix n' match tops and shorts, sizes 2-4.

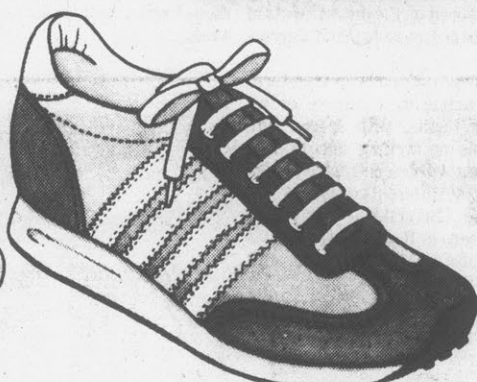

### Men's And Ladies' Action Nylon Joggers

Men's **7<sup>66</sup>** Ladies' **6<sup>66</sup>**

Lightweight nylon and leather joggers with thick cushion insole for added comfort. Blue and white and other colors. Men's 7-12, ladies' 5-10.



### Ladies' Disco Hi-Heel Slide

**4<sup>88</sup>** Pair

Soft vinyl uppers with the newest "disco" fashion heel. White, black or tan. Sizes 5-10.



### Summer Fashion Accessories For Ladies

Handbags **4<sup>99</sup>** Scarves **1<sup>00</sup>**  
Hats

Canvas handbags with contrasting vinyl and canvas trims. Also, straw and sea grass hats, and assorted scarves.

## Train Depot In Backyard

IVANHOE, Calif. (AP) — Howard Morris, an insect exterminator who demolishes buildings in his spare time, has merged his collection of architectural memorabilia into a house he saved from destruction.

Incorporated into the home's design are turn-of-the-century street lampposts now used as roof pillars.

Redwood beams from a nearby town's train station grace the living-room ceiling. Bricks that cover the front of the house were originally used in a general store that served as the first post office in this small Central California community.

The 2,000-square-foot building started out as a triplex apartment in 1926, and later housed an employment agency and a Girl Scout headquarters before being moved to the Morris property.

Bits and pieces of old hotels and commercial buildings that Morris helped demolish also have found their way into the home. Brass doorknobs and other hardware, including hand-hammered brass chandeliers, will be added before the house is complete.

His interest in the history of the area prompted him to assemble the unusual house, Morris said.

"I've been an antique collector for years and years. I know most people don't care about history, but someday this house might mean something to somebody."

The project was begun nine years ago and has taken so long partly because of the time required to repair the components.



### Pampers Diapers

## 2<sup>39</sup>

Box of 24 Extra Absorbent. To keep baby drier.



### Hollywood Candy Bars

## 79<sup>c</sup>

Pack of 5

Playday Zero, Hollywood, Big Time, Butternut, or Milkshake.

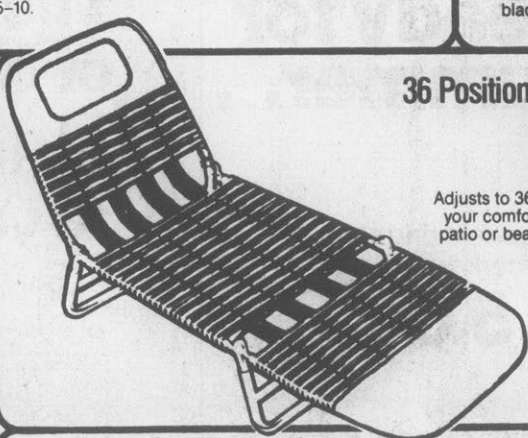

### 36 Position Lounger

## 8<sup>99</sup>

Adjusts to 36 positions for your comfort. Perfect for patio or beach! Measures 22" x 72".

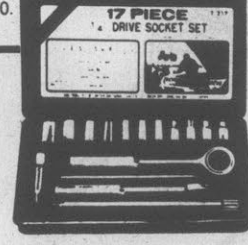

### 17-Pc. Socket Set

## 5<sup>99</sup>

With ratchet, extenders and 11 sockets for American made cars. Great Father's Day gift!



### 50-Ft. Water Hose

## 2<sup>00</sup>

Tough vinyl hose measures 3/8" x 50". Compare and save!



### Crest Toothpaste

## 79<sup>c</sup>

Regular or mint flavor Crest in big 7-oz. tube.



### Secret Spray Deodorant

## 89<sup>c</sup>

Choose anti-perspirant or deodorant in 4-oz. cans.

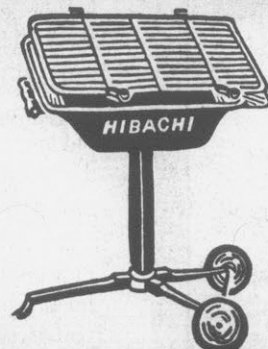

### Cast Iron Hibachi

## 6<sup>88</sup>

Hibachi grill on stand, or with chrome plated legs and wheels for easy moving. For patio or picnics. 12" x 16" grid.



### 2-Qt. Bag Potting Soil

## 3 Bags \$1

It's re-potting time! Special blend for house plants.



### Artificial Flowers

## 1<sup>22</sup>

Plastic flowers in bouquet. Choose roses, carnations or mums.



### Irish Spring Soap

## 5 Bars \$1

Irish Spring deodorant soap in 3.5-oz. bars. Limit 5.



### Scotch Pine Cleanser

## 3 For \$1

Cleans and disinfects. 15-oz. size.



### Mod Dish Detergent

## 3 For \$1

Choose pink or lemon. Mild to hands. 32-oz.



### Kitchen Assortment

## 88<sup>c</sup>

Choose 2-pack Terry towels, 3-pack waffle dish cloths or 2-pack Terry dish cloths.



### Work Socks For Men

## Pack Of 3 Pair 1<sup>49</sup>

Fully cushioned with no-bind stay up top. 10-13. White.



### Fashion Sunglasses

## 2<sup>99</sup>

A great selection! Hurry in while quantities last. Corning Sunscreeners ..... 4.99

PRICES GOOD AT ALL FAMILY DOLLAR STORES THROUGH THIS WEEKEND. QUANTITIES LIMITED ON SOME MERCHANDISE.

HARRIS SHOPPING CENTER, MEMORIAL DRIVE  
OPEN MONDAY THRU THURS 9 AM — 7 PM  
OPEN FRIDAY AND SATURDAY 9 AM — 9 PM

# Uniform Sentencing Bill Moves Toward Passage

By WILLIAM M. WELCH  
Associated Press Writer  
RALEIGH, N.C. (AP) — A uniform-sentencing bill pushed by Gov. Jim Hunt as a way to reduce the wide disparity in prison terms handed out for the same crimes neared passage

Tuesday when the House voted overwhelmingly to give it tentative approval.  
Hunt, who has made the bill one of his top priorities during the current legislative session, said he was "gratified" by the 102-8 House vote. Final House

action was expected today.  
Rep. Jim Ezzell, D-Nash, floor leader for the legislation, said the measure would increase the certainty of punishment facing criminals and reduce the broad differences in prison terms defendants receive for similar crimes. But he said it would not cause an increase in the population of the state's already over-crowded prisons.

"The intent behind this bill is to bring sentences that are being issued by judges closer together, so that a sentence in one section of the state will be pretty near that imposed in another section of the state," he said.

Called "fair sentencing" by Hunt, the bill would replace most sentencing laws with a system of categories that match crimes with maximum and presumed sentences.

A judge would be expected to impose the presumed sentence for a given crime unless he showed aggravating or mitigating circumstances and entered them into the written court record.

For most crimes, the bill

would also replace the paroles system. In the system's place, inmates would be given one day off their sentences for each day served on good behavior, so a prisoner could expect to serve one-half the sentence imposed. In addition, an inmate could earn earlier release with "gain time" for work release and other accomplishments.

Only one legislator, Rep. William McMillan, D-Iredell, opposed the measure, saying it would clog the courts with more delays, create more appeals of sentences and inhibit plea bargaining.

"It's going to take more judges; it's going to take more prosecutors; it's going to take more public defenders," McMillan said.

Rep. Al Adams, D-Wake, said he supported the legislation because of committee changes that reduced the presumed sentences for a number of crimes and allowed judges to give a reduced sentence on the basis of a defendant's negotiated plea.

Adams said Hunt and Senate backers of the bill had agreed to the changes.

Among the other House amendments were reductions from four to three and one-half years the presumed sentences for larceny and breaking and entering.

First-degree rape and murder were kept at life in prison, but

the paroles system was retained for persons convicted of those offenses, permitting their release after 20 years instead of after 40 years, as approved by the Senate.

The bill does not alter the death penalty as a possible sentence for first-degree murder.

It narrows the wide range of sentences possible for other

crimes, such as second-degree murder. That offense is now punishable by anywhere between two and 20 years in prison, which would be changed un-

der the bill to a presumed sentence of 16 years — or eight years with good-behavior time.

Rep. Henry Frye, D-Guilford, said he was reluctant but voted

for the measure. Frye sponsored a similar bill in 1977 but said he believed the Hunt version contained sentences that were still too harsh.

## New Dino Theory

BERKELEY, Calif. (AP) — A lethal bombardment of cosmic radiation from an exploding star may have blanketed the Earth 65 million years ago, wiping out the dinosaurs and paving the way for man's evolution, University of California researchers say.

The new theory, based upon radiological testing of the rare element iridium, is another attempt at explaining the relatively rapid disappearance of the huge reptiles who once ruled their steamy environment, the researchers say.

University geologist Walter Alvarez, who presented a report on the group's findings Monday to an American Geophysical Union conference in Washington, D.C., called it "the most dramatic event involving the most dramatic animals ever seen."

"And it had tremendous implications," he said. "It gave the early mammals scope for evolution. Had the dinosaurs not become extinct, we might not be here."

### RAYNEZ



1960 - 1979

Twentieth year of progressive aquatic activities.

Director: Ray H. Martinez, B.S., M.S., Ph. D. Professor, Department of Health and Physical Education, E. C. U. Coach of Swimming for 14 years (retired from coaching in 1968), AAU Kiputh Award Recipient and NCAA Master Coach.

Coordinator: Mrs. Inez N. Martinez, R.N., B.S., M.A. Ed. Associate Professor, E.C.U. School of Nursing

#### TOTAL SWIMMING PROGRAM

Infants - Individual Instruction - By Appointment.

Children - Hour Long Classes At 11:00 A.M., 1:00 P.M., 2:00 P.M., 3:00 P.M. Classes Begin June 11, June 25, July 9, July 23, August 6.

Adults - Two Hour Classes. Mon, Wed., & Fri. Evenings. Classes Begin Mon. June 11, June 25, July 9, July 23, Aug. 6.

Resident Competitive Program - For Advance Competitive Training - Girls and Boys, 10 to 16.

Recreation By Membership - Beginning Tues., June 5 - Individual or Family Membership.

#### FACILITIES

•Heated pool, 75' by 36'  
•Bathhouse •Parking area

#### CONTACT:

Ray or Inez Martinez

Phone 756-2667  
(or at the pool,  
756-4900)

## \$18,395 For Inmate Use

RALEIGH — The N. C. Department of Cultural Resources has been awarded \$18,395 by the Law Enforcement Assistance Administration for a model arts program for the N. C. Correctional Center for Women, according to Secretary Sara W. a Hodgkins.

The funds are coming through the American Correctional Association's project CULTURE (Creative Use of Leisure Time Under Restrictive Environments), and will be jointly sponsored by the departments of Cultural Resources and Correction.

The project calls for long-term instruction in a number of artistic media, with special emphasis on writing and drama. Artists will be contracted to conduct the different courses.

The Correctional Center for Women, in Raleigh, was chosen because it is the main such facility in the state.

Implementation of the project is expected to begin immediately.

## Unaffected By Orders

RALEIGH, N.C. (AP) — President Carter's order giving governors regulatory powers over gasoline sales won't affect North Carolina.

State Energy Director Brian M. Flattery said that North Carolina already had given such powers to the governor and that Carter's action will establish similar measures for the 19 states whose governors did not have the regulatory power.

Flattery said North Carolina was the first state to set up an emergency plan. The 1977 Legislature passed a law giving the governor certain powers over gasoline sales and other energy sources.

Under the plan, the governor can regulate gasoline sales, alternating daily from odd to even license tag numbers. He can also direct certain stations to stay open on weekends and regulate purchase sizes.

The governor's powers may be overruled by a committee composed of the lieutenant governor, president pro tem of the state Senate, majority leader of the Senate, speaker of the House and speaker pro tem of the House.

Flattery said he did not think Gov. Jim Hunt would have to use the emergency powers this summer.

#### EXECUTIONS STAYED

KINGSTON, Jamaica (AP) — The Privy Council has stayed the executions of four murderers condemned to be hanged. Two of them were scheduled to die this week.



Our furniture has a past and a future.

## HERITAGE HOUSE

Special Invitation June 1 & 2

See a restored home furnished completely in hand-crafted Early American furniture. We have a complete line of Brass, copper, wood, crystal and China accessories. Unique gifts for all ages. Come browse and reflect on heirloom pieces of today and tomorrow. Eastern Carolina's finest selection of handcrafted treasures. Open 10:00 a.m. to 4:00 p.m. and by special appointment. Turn left at the corner of Main St. and Van Norden. 115 Van Norden Street, Washington, N.C. PH. 946-0880.

## Pic 'n Pay Shoes

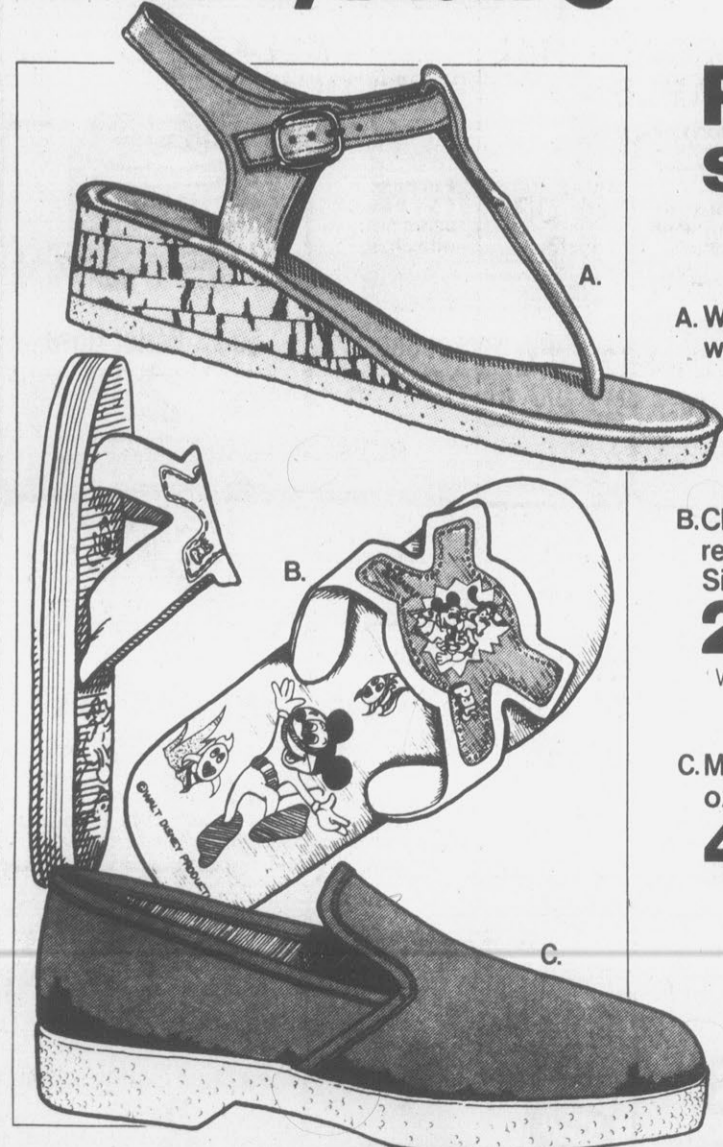

## Ready for summer...

A. Women's thong sandal with cork wedge.

**5.00** Reg. \$6.97

B. Children's Disney Pals™ reflector sandal. Sizes S-M-L.

**2.00** Reg. \$2.97  
Walt Disney Productions.

C. Men's canvas casuals in oxford and slip-on styles.

**4.00** Reg. \$5.47

■ All Canvas Handbags 20% off regular price with purchase of any pair of shoes.

■ Pom-pom socks in assorted colors. **75¢**

264 BY-PASS ACROSS FROM NICHOLS DISCOUNT CITY

Open Mon. thru Thurs. 10 to 9, Fri. 9 to 9, Sat. 9 to 8

Master Charge or Visa. Open evenings



## The Holsum Seal of Nutritional Value.

### It's important to you and us.

Bread has been recognized as a valuable source of nutrition and food energy in the daily diet, by the Senate Select Committee on Nutrition and Human Needs in their report, "Dietary Goals for the United States."

The HOLSUM Seal of Nutritional Value is our pledge to continue baking the finest bread for you and your family.

It's your assurance of Holsum nutrition and quality—available to you at a very reasonable price.



Holsum Bread

# How Tar Heel Congressmen And Senators Voted

**Roll Call Report Service**  
WASHINGTON — Here's how area Members of Congress were recorded on major roll call votes May 17 through May 23.

**HOUSE**  
**PANAMA CANAL** — The House approved, 200 for and 198 against, the parliamentary rules under which it will debate legislation to implement the treaties turning over the Panama Canal to Panama by the year 2000.

Rep. John Murphy, D-N.Y., who wanted to debate the legislation, said: "The time to vote for or against the treaties was two years ago, not today."

Rep. George Hansen, R-Idaho, an opponent, said the House should postpone treaty debate until the CIA provides "firm assurances that Panama is not a mainland-based Cuba-type revolutionary operation rampantly exporting terrorism among its neighbors with the money they get from the Panama Canal."

Most members voting "nay" don't want to relinquish the Panama Canal.

Reps. Charles Whitley, D-3, Ike Andrews, D-4, Stephen Neal, D-5, Richardson Preyer, D-6, Charles Rose, D-7, and W.G. Hefner, D-8, voted "yea."

Reps. Walter Jones, D-1, L.H. Fountain, D-2, James Martin, R-9, James Broyhill, R-10, and Lamar Gudger, D-11, voted "nay."

**DISASTER LOANS** — The House rejected, 174 for and 232 against, an amendment to lower the interest rate on government loans that compensate for damage inflicted on homes and personal property by natural disasters. The amendment sought to lower from three to one per cent the rate on the first \$10,000 loaned. The vote came during debate on HR 4011, later passed with a proposed rate of

three per cent on the first \$55,000. A House-Senate conference now has the bill.

Rep. Jon Hinson, R-Miss., the sponsor, said: "This is not a spending amendment. There is nothing inflationary about restoring the economy of a disaster-stricken area."

Rep. Neal Smith, D-Iowa, an opponent, said "probably it will not do any good anyway" to vote for the lower interest rate, because the Senate was firmly against the one per cent figure.

Members voting "yea" wanted to lower the interest rate to one per cent on certain federal disaster-assistance loans.

Martin and Broyhill voted "yea."

Jones, Fountain, Whitley, Andrews, Neal, Preyer, Rose, Hefner and Gudger voted "nay."

**SMALL BUSINESSES** — By a vote of 192 for and 216 against, the House rejected an amendment to limit the size and scope of the Small Business Development Center (SBDC) program. The vote came during debate on a Small Business Administration bill (HR 4011) later passed and sent to conference with the Senate.

The program in question has set up, on a pilot basis, 11 centers designed to counsel small businessmen on federal regulations, tax matters, new technology and other matters. Rejection of this amendment cleared the way for possible expansion of the program beyond its pilot basis, at a fiscal 1980 cost of \$18 million.

Rep. Ken Kramer, R-Colo., who supported the limiting amendment, called the SBDC program "a classic case of the government giving more help than the people who are getting the help really need."

Rep. Neal Smith, D-Iowa, an opponent of the amendment,

said "I have talked to many small businesses who need just a bit of help in the way of what we might call adult education...."

Members voting "yea" either were opposed to or had doubts about the federal program (SBDC) intended to advise small businessmen.

Broyhill and Gudger voted "yea."

Jones, Fountain, Whitley, Andrews, Neal, Preyer, Rose, Hefner and Martin voted "nay."

**SENATE**  
**TURKEY** — The Senate adopted, 64 for and 32 against, an amendment providing Turkey with a grant, rather than a loan,

of \$50 million in U.S. military aid. The vote came during debate on HR 3173, a foreign aid bill that was passed and sent to conference with the House. Altogether, Turkey is slated to receive more than \$400 million in U.S. economic and military aid this fiscal year.

Sen. Robert Byrd, D-W.Va., the sponsor, said: "The U.S. is not alone. Greece (and) the NATO countries and our friends in the Middle East also have a profound stake in a sound and stable Turkey."

Sen. Claiborne Pell, D-R.I., an opponent of the grant, said: "In addition to Turkey's poor per-

formance regarding Cyprus, we are also witnessing a Turkish sabotage of Greece's efforts to return to the integrated military command of NATO."

Senators voting "yea" wanted a \$50 million military outlay for Turkey to be a grant rather than a loan.

Sens. Robert Morgan, D, and Jesse Helms, R, voted "yea."

**NARCOTICS** — The Senate voted, 65 for and 29 against, to increase by \$16.6 million the fiscal 1980 outlay for narcotics-control programs in Colombia. This brought to \$54.4 million the amount in the new foreign military-aid bill for supporting

Colombian government efforts to slow the flow of Colombian cocaine and marijuana into the U.S. The bill (HR 3173) was passed and sent to conference with the House.

Sen. Dennis DeConcini, D-Ariz., the sponsor, said: "My personal belief is that we are essentially unable to control the supply of illicit narcotics once it has entered into the U.S. Therefore, the principle of moving as close to the source as possible is our only alternative to controlling this insidious problem."

No senators spoke against adding the \$16.6 million. Senators

voting "nay" opposed the additional outlay for the Colombian government's "narcotics inter-

vention" program. Morgan and Helms voted "yea."

Joseph R. Smith II, D.D.S., P.A.

Announces The Relocation Of His

Dental Office

to

James Street, Bethel

Office Hours  
By Appointment

Telephone  
825-1131

## 'Crazy' Girl Scout Project Is Timely

By JO-ANNE BYRNE  
ST. PAUL, Minn. (UPI) — Four years ago the people of St. Paul thought the girl scout project was crazy.

Along came the energy crunch and at its dedication this month, it was hailed as a unique achievement in energy conservation.

The project is the Program Center for the Girl Scout Council of St. Croix Valley. It is unusual because it is a public building built to incorporate many of the known ways to conserve energy. It is expected at the outset to produce up to 65 percent of its own heating and cooling.

The center is constructed partially below ground to utilize soil insulation. It has a solar system and a heat-pump which draws warmth from the air and increases the efficiency of the solar system. South-oriented windows aid the solar collectors.

An experimental vertical-axis wind mill funded by the Minnesota Energy Agency also will be put into use.

An internal waste-disposal system — Swedish Clivus Multrum — will produce compost during an 18-month cycle to be used in an atrium in a ramp area connecting the building's two floors.

Task lighting designed to provide illumination only when and where it is needed will save on electricity.

The roof of the center will be soil-covered for insulation and planted with prairie grass and wildflowers. Plants in the building are designed to help

control the humidity. All energy systems employed will be color-coded so that four groups can be instructed on their use.

The building was planned to express the concern of a branch of the national Girl Scout organization about natural resources and their proper utilization.

"Any parent with teen-agers has to be concerned about the environment," said Mrs. Thea Childs, executive director of the 11-county Girl Scout council.

The center will be used for indoor camping, she said, and also for meetings by the state energy agency and groups such as the Sierra Club. Up to 32 Scouts using sleeping bags can be accommodated overnight in the second-floor program center.

Financing for the building was secured through a fund raising campaign and a variety of grants and gifts.

Delano Erickson, an architect who worked on the project, said the building cost \$725,000, the total project, more than \$1 million.

**KING'S SALOON**  
LONDON (AP) — A 1936 Lancashire saloon, once owned by King George VI, was recently sold at an auction for about \$3,600.

But the auction house reported that two other royal cars on the auction block were not sold because bids did not meet the reserve prices.

**Bare Footin' (Almost)**

Mens  
THONG SANDAL for Mens... Sizes 7-12, Blue and Black. 90¢

Ladies & Girls  
WOODEN CLOG with hand-carved sides. Velvety soft thong. Ladies 5-10, Girls 13-4. Ladies Reg. 6.99 5.00  
Girls Reg. 5.99 4.00

Ladies  
SANDAL with Craple Soles for extra flexibility. Reg. 8.95 6.00

SHOE SHOW

Greenville Square Shopping Center  
Open 10 A.M. - 9 P.M. Monday thru Saturday  
"SHOE SHOW IS YOUR SHOE STORE"

# Maxwell FURNITURE

In our big 1/3 OFF SALE, choose from our entire furniture stock — Imagine... Pick what you want from thousands of beautiful pieces of furniture... ALL NOW AT 1/3 OFF the regular retail price, except appliances, electronics, and bedding which are also available at great savings!

ONE OF THE GREATEST SAVING EVENTS IN OUR HISTORY!

**SAVE OVER 1/3 OFF ON THIS SENSATIONAL RECLINA-ROCKER FROM LA-Z-BOY®**

- Easy Going Rocking
- Ultimate Reclining Positions
- Covered in Luxurious Velvet

NOW ONLY \$199<sup>95</sup>  
Reg. \$369.95

LIMITED QUANTITIES

**3 DAYS ONLY!**



# 1/3 OFF!

<p><b>ALL SOFAS</b> REDUCED A BIG</p> <p>Choose from hundreds of beautiful sofas as low as \$169!</p> <p><b>1/3 OFF</b></p>	<p><b>ALL CHAIRS</b> REDUCED A BIG</p> <p>Choose from hundreds of luxurious chairs as low as \$89!</p> <p><b>1/3 OFF</b></p>
<p><b>ALL OCCASIONAL TABLES</b> REDUCED A BIG</p> <p>Choose from hundreds of elegant occasional tables, consoles, side in all styles and finishes!</p> <p><b>1/3 OFF</b></p>	<p><b>ALL BEDROOMS</b> REDUCED A BIG</p> <p>Example: 4 pc. transitional bedroom suite with chest - \$333</p> <p><b>1/3 OFF</b></p>
<p><b>ALL DINETTES &amp; DINING ROOMS</b> REDUCED A BIG</p> <p>Example: 5 pc. famous name suite - \$293!</p> <p><b>1/3 OFF</b></p>	<p><b>ALL LIVING ROOMS</b> REDUCED A BIG</p> <p>Choose from the very best names! Sofas, occasional low seats &amp; chairs!</p> <p><b>1/3 OFF</b></p>
<p><b>ALL ODDS &amp; ENDS</b> REDUCED A BIG</p> <p>Choose from our entire selection of accessories, lamps, and more!</p> <p><b>1/3 OFF</b></p>	<p><b>ALL RECLINERS</b> REDUCED A BIG</p> <p>Choose from hundreds of rocker-recliners in all styles!</p> <p><b>1/3 OFF</b></p>

**HURRY! SALE STARTS TODAY!**

**Maxwell FURNITURE**

604 Greenville Blvd.  
Greenville, N.C. 27834  
Open 9 A.M. - Until 6 P.M.  
Monday Through Saturday  
And Friday Nights Until 9.

Phone 756-3142  
Convenient Credit Terms  
Free Delivery & Set-Up  
Huge Selection  
Competitive Prices

3 WAYS TO SAY "CHARGE IT!"

**\$1,000 INSTANT CREDIT**

You may qualify for \$1,000 instant credit if you have one of these cards:  
• MASTER CHARGE • VISA • AMERICAN EXPRESS

## Stock And Market Reports

NEW YORK (AP) — Energy worries helped keep the stock market in retreat today.

The Dow Jones average of 30 industrials dropped 2.85 to 829.70 in the first half hour.

Gainers trailed losers by about a 4-3 margin in the early tally of New York Stock Exchange-listed issues.

Analysts said concern over rising gasoline prices and uncertainty about fuel supplies continued to set the mood on Wall Street.

Texaco and Gulf announced Monday they would reduce further in June the amount of gasoline they supply to service stations.

Meanwhile, Libya was reported Monday to have raised its official price for crude oil by \$2.30 a barrel to \$21.31, topping the previous high of \$21 set by Algeria and Nigeria last week.

Today's early volume leaders included Inco Ltd., up 3/4 at 21; Great Western Financial, off 1/4 at 19 3/4, and MGIC Investment, unchanged at 20 1/2.

On Tuesday the Dow Jones industrial average slipped 3.73 to 832.55.

Declines outnumbered advances by a 5-4 spread on the NYSE.

Big Board volume came to 27.04 million shares against 27.81 million in the previous session.

The NYSE's composite common-stock index lost .08 to 56.53.

At the American Stock Exchange, by contrast, the market value index gained 2.04 to a new high of 187.49.

Following are selected 11 a.m. stock market quotations:

Burroughs	69 1/2
United Telecommunications Prd.	23 1/2
Heublein	27
Jiff Pilot	32 1/2
Tri South	31 1/2
Wicks	13 1/2
Wachovia Realty	5 1/2
Eckerd's	25 1/2
Central Soya	13 1/2
Hardens	14 1/2
Integon	21 1/2
Fieldcrest	36 1/2
Hatteras Income	14 1/2
Vendo	12 1/2
Eaton	38 1/2
John Deere	33 1/2
P & G	80 1/2
Piedmont Aviation	11 1/2
Conner Homes	9 1/2
McGraw Edson	25 1/2
OVER THE COUNTER	
Combined Insurance	18 1/2-18 3/4
NCNB	12 1/2-12 3/4
Planters Bank	16 1/2-17 1/4
Low	16 1/2-17 1/4
Little Mint	1-1 1/8

RALEIGH (AP) (NCDA) — Hogs: at N.C. buying stations. Wilson 44.00 per hundred pounds. Rocky Mount 43.50. Clinton, Fayetteville, Dunn, Elizabethtown, Pink Hill, Pine Level, Chadbourne, Ayden, Laurinburg, and Benson 44.00. Salisbury 42.00. Kinston 44.00. Spiveys Corner 41.00-42.00 (325-600 lb sows) 32.00-35.50. Fayetteville (sows 400 lbs up) 36.50.

RALEIGH (AP) (NCDA) — Cattle: (weekly auction sale) - N. Wilkesboro 313 head of cattle, and 9 hogs. Slaughter cows: utility and commercial 50.75-55.75, canner and cutter 45.75-53.00. Vealers (150-250) choice 104.00-107.00, good 97.00-101.00. Calves (250-325) good and choice 91.00-101.00, (325-550) good 85.00-94.00. Bulls (1000 lb up) utility and commercial 65.75-71.50. Feeder steers: (300-400) standard and good 82.00-106.00. (500-600) few good 86.00-96.00. Feeder heifers (300-500) good 77.00-89.00, (500 up) good 67.00-73.00. Feeder bulls (200-300) choice 116.00-126.00, good 99.00-110.00, (300-550) good 87.00-107.00. Baby calves 81.00-120.00.

RALEIGH (AP) (NCDA) — N.C. broilerfryers: Market steady. Supply adequate. Demand good. N.C. Dock weighted average price is 49.18 cents

per pound this week for small purchases of plant grade broilers picked up at processing plants. Estimated slaughter today totaled 1,579,000 head and average live weight 3.94 pounds per bird on May 25.

RALEIGH (AP) (NCDA) — N.C. Hens: market weaker for heavy type hens. Supply moderate. Demand light. Prices paid for hens over seven pounds at the farm too few.

RALEIGH (AP) (NCDA) — N.C. eggs: market steady on large, fractionally lower on medium, fractionally higher on small. N.C. weighted average price for small sales of consumer grade A eggs in cartons delivered to retail stores: 61.82 cents per dozen for large white, medium 52.42, small 43.25.

RALEIGH (AP) (NCDA) — Graded feeder pig sales: Statesville 570 head, 50 lb. No. ones and twos 66.69 per cwt., No. threes 50.25. 50-60 lbs. No. ones and twos 55.79. No. threes 48.00. 60-70 lbs. No. ones and twos 50.00. No. threes 45.25. Wallace-Chadbourne 2,932 head, 40-50 lbs. No. ones and twos 68.06 per cwt., No. threes 57.75. 50-60 lbs. No. ones and twos 59.00. No. threes 51.50. 60-70 lbs. No. ones and twos 54.16. No. threes 46.75. Smithfield 737 head, 40-50 lbs. No. ones and twos 72.00 per cwt., No. threes 60.34. 50-60 lbs. No. ones and twos 77.14. No. threes 52.25. 60-70 lbs. No. ones and twos 69.25. No. threes 45.75.

RALEIGH (AP) (NCDA) — Cabbage: (Eastern N.C. fob) market weaker. Demand moderate to good. Supply good. Quality good. Green 1 3/4 bushel crates 3.50, 50-pound bags 3.00.

David Voorhes, the bank customer shot during a robbery of the First Citizens Bank and Trust Company at Long Leaf Mall in Wilmington yesterday, is employed by a Greenville firm.

Witnesses said the robbers, wearing ski masks and black gloves, were so thoroughly disguised that they could not identify their race.

An FBI spokesman said the robbery was characterized by vulgar language.

"They were doing a lot of talking," the agent said. "There was a lot of vulgarity, which is typical of what you'd expect from stickup men."

Reports said both suspects were between 5 feet 5 inches and 5 feet 7 inches tall and slim.

A \$2,000 reward has been offered by the North Carolina Bankers Association for information leading to the arrest and conviction of the robbers.

## Shot In Holdup, Recovery Seen

WILMINGTON, N.C. (AP) — A New Hanover County man was in serious condition after he was shot Tuesday during a holdup of a Wilmington bank.

David Voorhes, 32, of Castle Hayne, was in the First Citizens Bank and Trust Co. branch at Long Leaf Mall on an errand for his employer when the robbers shot him in the abdomen, police said. Authorities say the man apparently didn't respond quickly enough to orders to lie on the floor.

According to witnesses and police reports, the robbery occurred at about 9:15 a.m. when two gunmen, wearing ski masks and gloves, stormed into the bank and ordered everyone to lie on the floor. There were two customers and five bank employees in the office at the time.

Police Sgt. Fred Law said the two bandits stuffed an undisclosed amount of money into a pillow case and fled in a green pickup truck.

Witnesses said the robbers, wearing ski masks and black gloves, were so thoroughly disguised that they could not identify their race.

An FBI spokesman said the robbery was characterized by vulgar language.

"They were doing a lot of talking," the agent said. "There was a lot of vulgarity, which is typical of what you'd expect from stickup men."

Reports said both suspects were between 5 feet 5 inches and 5 feet 7 inches tall and slim.

A \$2,000 reward has been offered by the North Carolina Bankers Association for information leading to the arrest and conviction of the robbers.

David Voorhes, the bank customer shot during a robbery of the First Citizens Bank and Trust Company at Long Leaf Mall in Wilmington yesterday, is employed by a Greenville firm.

Witnesses said the robbers, wearing ski masks and black gloves, were so thoroughly disguised that they could not identify their race.

An FBI spokesman said the robbery was characterized by vulgar language.

"They were doing a lot of talking," the agent said. "There was a lot of vulgarity, which is typical of what you'd expect from stickup men."

Reports said both suspects were between 5 feet 5 inches and 5 feet 7 inches tall and slim.

A \$2,000 reward has been offered by the North Carolina Bankers Association for information leading to the arrest and conviction of the robbers.

David Voorhes, the bank customer shot during a robbery of the First Citizens Bank and Trust Company at Long Leaf Mall in Wilmington yesterday, is employed by a Greenville firm.

Witnesses said the robbers, wearing ski masks and black gloves, were so thoroughly disguised that they could not identify their race.

An FBI spokesman said the robbery was characterized by vulgar language.

"They were doing a lot of talking," the agent said. "There was a lot of vulgarity, which is typical of what you'd expect from stickup men."

Reports said both suspects were between 5 feet 5 inches and 5 feet 7 inches tall and slim.

A \$2,000 reward has been offered by the North Carolina Bankers Association for information leading to the arrest and conviction of the robbers.

David Voorhes, the bank customer shot during a robbery of the First Citizens Bank and Trust Company at Long Leaf Mall in Wilmington yesterday, is employed by a Greenville firm.

Witnesses said the robbers, wearing ski masks and black gloves, were so thoroughly disguised that they could not identify their race.

An FBI spokesman said the robbery was characterized by vulgar language.

"They were doing a lot of talking," the agent said. "There was a lot of vulgarity, which is typical of what you'd expect from stickup men."

Reports said both suspects were between 5 feet 5 inches and 5 feet 7 inches tall and slim.

A \$2,000 reward has been offered by the North Carolina Bankers Association for information leading to the arrest and conviction of the robbers.

David Voorhes, the bank customer shot during a robbery of the First Citizens Bank and Trust Company at Long Leaf Mall in Wilmington yesterday, is employed by a Greenville firm.

Witnesses said the robbers, wearing ski masks and black gloves, were so thoroughly disguised that they could not identify their race.

An FBI spokesman said the robbery was characterized by vulgar language.

"They were doing a lot of talking," the agent said. "There was a lot of vulgarity, which is typical of what you'd expect from stickup men."

Reports said both suspects were between 5 feet 5 inches and 5 feet 7 inches tall and slim.

A \$2,000 reward has been offered by the North Carolina Bankers Association for information leading to the arrest and conviction of the robbers.

David Voorhes, the bank customer shot during a robbery of the First Citizens Bank and Trust Company at Long Leaf Mall in Wilmington yesterday, is employed by a Greenville firm.

Witnesses said the robbers, wearing ski masks and black gloves, were so thoroughly disguised that they could not identify their race.

An FBI spokesman said the robbery was characterized by vulgar language.

"They were doing a lot of talking," the agent said. "There was a lot of vulgarity, which is typical of what you'd expect from stickup men."

Reports said both suspects were between 5 feet 5 inches and 5 feet 7 inches tall and slim.

## Safety ...

(Continued from page 1)

Battery Products Division, Greenville, was honored for 14 consecutive years of perfect safety records.

The following businesses were honored:

FIRST YEAR WINNERS: Town of Bethel; Boyd Associates Inc., Greenville; Brown and Wood, Inc., Greenville; Burroughs Wellcome Company, Greenville; Town of Farmville; Free Will Baptist Press Foundation, Ayden; City of Greenville Fire Department; Bill Haddock Chrysler Plymouth, Inc., Greenville; Hoke Contracting Company Inc., Greenville; Holt Oldsmobile-Datsun, Greenville; Roy H. Park Broadcasting Inc., Greenville; Pugh's Tire and Service Center, Greenville; Regional Storage and Transport, Inc., Greenville; Tom Togs Inc., Conetoe.

SECOND CONSECUTIVE YEAR — F & D Motor Company, Inc., Bethel; City of Greenville, City Hall and Recreation and Parks Dept.; Pitt County Memorial Hospital, Inc., Greenville; Pitt and Greene Electric Membership Corporation, Farmville.

THIRD CONSECUTIVE YEAR — Dixie Supply Company, Greenville; Eaton Corporation, Industrial Truck Division, Greenville; Fieldcrest Mills, Inc., Karastan Worsted Mill, Greenville; Garner Wynne Manning Inc., Greenville; E. R. Lewis Construction Company, Inc., Bethel; National Printing Company, Inc., Greenville; White Concrete Company, Greenville; Wickes Lumber Company, Farmville Center.

FOURTH CONSECUTIVE YEAR — ABC Moving and Storage, Inc., Greenville; Berce Inc., Ayden; Brody's Inc., Greenville; Coastal Chemical Corporation, Greenville; Coca-Cola Bottling Company, Inc., Greenville; Daniel International Corporation, P&G Project, Greenville; East Carolina University, Greenville; Eastern Lumber and Supply Company Inc., Winterville; Hastings Ford Inc., Greenville; H. A. Haynie Company, Inc., Greenville; J. H. Hudson Inc., Greenville; Sunnyside Eggs Company, Inc., Greenville; Tri-County Feed Mills, Inc., Bethel; Wynne's Inc., Bethel.

FIFTH CONSECUTIVE YEAR — Blue Bell Inc.,

Bethel Plant; Fountain Apparel Inc.; Walter B. Jones Alcoholic Rehabilitation Center, Greenville; North State Garment Company Inc., Farmville; Prepsport Manufacturing Corporation, Greenville; and Procter and Gamble Paper Products Company, Greenville.

SIXTH CONSECUTIVE YEAR — Collins and Aikman Corporation, Bangor Division, Farmville Plant.

FOURTEENTH CONSECUTIVE YEAR — Union Carbide Corporation, Battery Products Division, Greenville.

RALEIGH (AP) (NCDA) — Graded feeder pig sales: Statesville 570 head, 50 lb. No. ones and twos 66.69 per cwt., No. threes 50.25. 50-60 lbs. No. ones and twos 55.79. No. threes 48.00. 60-70 lbs. No. ones and twos 50.00. No. threes 45.25. Wallace-Chadbourne 2,932 head, 40-50 lbs. No. ones and twos 68.06 per cwt., No. threes 57.75. 50-60 lbs. No. ones and twos 59.00. No. threes 51.50. 60-70 lbs. No. ones and twos 54.16. No. threes 46.75. Smithfield 737 head, 40-50 lbs. No. ones and twos 72.00 per cwt., No. threes 60.34. 50-60 lbs. No. ones and twos 77.14. No. threes 52.25. 60-70 lbs. No. ones and twos 69.25. No. threes 45.75.

RALEIGH (AP) (NCDA) — Cabbage: (Eastern N.C. fob) market weaker. Demand moderate to good. Supply good. Quality good. Green 1 3/4 bushel crates 3.50, 50-pound bags 3.00.

David Voorhes, the bank customer shot during a robbery of the First Citizens Bank and Trust Company at Long Leaf Mall in Wilmington yesterday, is employed by a Greenville firm.

Witnesses said the robbers, wearing ski masks and black gloves, were so thoroughly disguised that they could not identify their race.

An FBI spokesman said the robbery was characterized by vulgar language.

"They were doing a lot of talking," the agent said. "There was a lot of vulgarity, which is typical of what you'd expect from stickup men."

Reports said both suspects were between 5 feet 5 inches and 5 feet 7 inches tall and slim.

A \$2,000 reward has been offered by the North Carolina Bankers Association for information leading to the arrest and conviction of the robbers.

David Voorhes, the bank customer shot during a robbery of the First Citizens Bank and Trust Company at Long Leaf Mall in Wilmington yesterday, is employed by a Greenville firm.

Witnesses said the robbers, wearing ski masks and black gloves, were so thoroughly disguised that they could not identify their race.

An FBI spokesman said the robbery was characterized by vulgar language.

"They were doing a lot of talking," the agent said. "There was a lot of vulgarity, which is typical of what you'd expect from stickup men."

Reports said both suspects were between 5 feet 5 inches and 5 feet 7 inches tall and slim.

A \$2,000 reward has been offered by the North Carolina Bankers Association for information leading to the arrest and conviction of the robbers.

David Voorhes, the bank customer shot during a robbery of the First Citizens Bank and Trust Company at Long Leaf Mall in Wilmington yesterday, is employed by a Greenville firm.

Witnesses said the robbers, wearing ski masks and black gloves, were so thoroughly disguised that they could not identify their race.

An FBI spokesman said the robbery was characterized by vulgar language.

"They were doing a lot of talking," the agent said. "There was a lot of vulgarity, which is typical of what you'd expect from stickup men."

Reports said both suspects were between 5 feet 5 inches and 5 feet 7 inches tall and slim.

A \$2,000 reward has been offered by the North Carolina Bankers Association for information leading to the arrest and conviction of the robbers.

David Voorhes, the bank customer shot during a robbery of the First Citizens Bank and Trust Company at Long Leaf Mall in Wilmington yesterday, is employed by a Greenville firm.

Witnesses said the robbers, wearing ski masks and black gloves, were so thoroughly disguised that they could not identify their race.

An FBI spokesman said the robbery was characterized by vulgar language.

"They were doing a lot of talking," the agent said. "There was a lot of vulgarity, which is typical of what you'd expect from stickup men."

Reports said both suspects were between 5 feet 5 inches and 5 feet 7 inches tall and slim.

A \$2,000 reward has been offered by the North Carolina Bankers Association for information leading to the arrest and conviction of the robbers.

David Voorhes, the bank customer shot during a robbery of the First Citizens Bank and Trust Company at Long Leaf Mall in Wilmington yesterday, is employed by a Greenville firm.

Witnesses said the robbers, wearing ski masks and black gloves, were so thoroughly disguised that they could not identify their race.

An FBI spokesman said the robbery was characterized by vulgar language.

"They were doing a lot of talking," the agent said. "There was a lot of vulgarity, which is typical of what you'd expect from stickup men."

## Obituaries

### Baptist

FARMVILLE — Ms. Mary Louise Baptist, a Farmville resident, died Tuesday in Greenville Villa Nursing Home. Ms. Baptist was the mother of Albert Earl and Evon Baptist, both of Farmville. Arrangements are incomplete at Joyner's Mortuary, Farmville.

### Harrison

Funeral services for Mrs. Alice Bell Harrison of 204 Smith St., Greenville, will be held Friday at 3 p. m. at Bibleway Holiness Church, Williamston, by Elder D. A. Carter, pastor. Burial will be in the Odd Fellows Cemetery, Williamston.

Mrs. Harrison was a Martin County native who spent most of her life in the Williamston and Robersonville communities. She was a member of Bibleway Holiness Church, which she served as a member of the Mothers' Board.

Surviving her are a daughter,

Mrs. Gertrude Ebron of the home; two grandchildren and seven great grandchildren.

The family will receive friends Thursday from 8 to 9 p. m. at Flanagan Chapel in Robersonville.

### Price

Mr. Ernest Mabry Price, formerly of the Fort Barnwell community of Craven County, died at King's County Hospital, Brooklyn, N. Y. Tuesday. Funeral arrangements are incomplete at Mitchell's Funeral Home, Winterville.

### Randolph

Miss Mary Eva Randolph, 19, 310 Conley St., Greenville, died Tuesday in Pitt Memorial Hospital. She was the granddaughter of Mrs. Lucille Randolph and the twin sister of Miss Teresa (Terry) Randolph of the home. Funeral arrangements are incomplete at Hardee's Funeral Home.

## Dogs Turn On Five-Year-Old

BASEL, Switzerland (AP) — Four Saint Bernards bit a 5-year-old boy to death even though the child had been playing nicely with the big dogs for months, police said today.

They said the boy, Daniel Lesser, was playing with the dogs when he was bitten in the neck and then lay helpless as they continued to attack him, severing a main artery.

The dogs were put to death. Their 66-year old owner, who neighbors said treated the boy as his only human friend, disappeared after the incident, apparently in shock, but reported to police today.

He was being investigated for possible negligence.

DAILY LUNCH SPECIALS ..... \$1.95  
 DOG OR BURGER ..... 45¢  
 Breakfast Served All Day!  
**CAROLINA GRILL**  
 ORDERS TO GO!

## Recruiters Told 'Stay'

CHARLOTTE, N.C. (AP) — Some Army recruiters under investigation in connection with allegations of fraudulent recruiting locally have been ordered to remain at their posts and not take leave or accept transfers until the investigation is ended, according to the Charlotte News.

The paper said in its Tuesday editions that at least 10 recruiters are being investigated in connection with allegations that recruiters coached enlistees so they could pass Army entrance examinations.

None of the 10 has been charged.

"It doesn't mean the 10 are guilty of anything," an unidentified Army source told the News. "It just means that there have been accusations of malpractice leveled against them, and they're under investigation."

Lt. Col. Edward Walker, head of the Charlotte recruiting command, which covers 47 counties with 50 recruiters, confirmed that some persons have been ordered to remain at their posts during the investigation.

"It's not a serious action," he said. "It's just to insure that the folks are available for questioning."

Walker would not say how many recruiters have been ordered to remain at their jobs.

## Area Graduates At Wesleyan

ROCKY MOUNT — The following area students received degrees Saturday during commencement exercises at Wesleyan College:

GREENVILLE — Lionel E. Andrews, B. S., Fish and Wildlife Management; Ronald Linwood Clark Jr., B. S., Technology, Police Science.

WILLIAMSTON — Martha Elizabeth Peel, B. S., Elementary Education; Milton B. Wynne Jr., B. S., Fish and Wildlife Management.

Bethel Plant; Fountain Apparel Inc.; Walter B. Jones Alcoholic Rehabilitation Center, Greenville; North State Garment Company Inc., Farmville; Prepsport Manufacturing Corporation, Greenville; and Procter and Gamble Paper Products Company, Greenville.

SIXTH CONSECUTIVE YEAR — Collins and Aikman Corporation, Bangor Division, Farmville Plant.

FOURTEENTH CONSECUTIVE YEAR — Union Carbide Corporation, Battery Products Division, Greenville.

Dr. Alan Gibbons

IDS INVESTMENTS/INSURANCE

IDS Marketing Corporation, a wholly owned subsidiary of Investors Diversified Services.

IDS Life Insurance Company  
 Minneapolis, Minnesota  
 P.O. Box 7381  
 We Help People Manage Money.

B. Gail Hester

401 West First St. 752-1370

## Offer Course In Calligraphy

Beginning Thursday, May 31, Pitt Technical Institute will offer an introductory class in calligraphy. The class will meet Monday and Thursday nights, 7-9:30 p.m., for five weeks.

The course will include introduction to basic hand lettering skills and application of hand lettering techniques. Registration fee is \$5, with those age 65 and older exempted from payment. Persons must be 18 years of age or older and out of high school to enroll.

For more information, contact the Continuing Education Division of PTI, 756-3130, Extension 238 or 266.

## CHOLERA VICTIMS

JAKARTA, Indonesia (AP) — Twenty persons have died of cholera in the West Java district of Astana Anyar, the Antara news agency reported today.

## Serves As Page In Hunt Office

RALEIGH — Michael A. McLawhorn of Ayden, son of Mr. and Mrs. J. A. McLawhorn, 705 W. Eighth St., served as a page last week in Governor Jim Hunt's offices.

Michael is a junior at Ayden-Grifton High School.

## Two Classes To Washington

Two personal improvement classes sponsored by Pitt Technical Institute toured Washington, D. C. Friday.

Class members were accompanied by William Crandol and Mrs. Verna Thompson, class teachers.

## A Four-Gospel Rally Sunday

There will be a four-gospel rally at Mayo Chapel Baptist Church, Sunday, June 3, 7:30 p.m.

Orioles Snap Ten-Game Losing Streak



Out At Second Texas Ranger second baseman Bump Wills holds up the ball after tagging out Boston Red Sox Jerry Remy on an attempted steal in the first inning of

their game in Arlington Stadium last night. Remy can't believe the call by umpire Bill Kunkel. The game was halted in the top of the third due to rain. (AP Laserphoto)

By HERSCHEL NISSENSON AP Sports Writer

The Baltimore Orioles survived a 10-count and flattened the Kansas City Royals Tuesday night.

One night earlier, the Orioles dropped their 10th consecutive game in Royals Stadium. But Tuesday evening, Ken Singleton, Rich Dauer, Gary Roenicke and Lee May unloaded haymakers and the Orioles pounded the Royals 8-1, their first success in Kansas City since June 4, 1977.

Says Bird Will Sign

BOSTON (AP) — Celtics owner Harry Mangurian has stepped into negotiations for Larry Bird and plans to sign the Indiana State star to a National Basketball Association contract on Wednesday, the Boston Herald American reported.

"Harry is up here to sign Bird. We'll have him under contract tomorrow," a source close to Mangurian told the newspaper Tuesday night.

Terms of the contract were not reported.

Mangurian, Celtics president Red Auerbach and Bob Woolf, attorney for the Celtics' No. 1 draft choice in 1978, were scheduled to meet at 10:30 Wednesday morning.

"Hell, does this feel good," exclaimed Manager Earl Weaver. "You get to wondering what the hell you have to do. Last year it was 100 percent Kansas City and last night (Monday's 5-4 16-inning loss) we had plenty of chances but still couldn't win."

In other American League action, the Milwaukee Brewers trimmed the New York Yankees 7-3, the California Angels downed the Seattle Mariners 6-4, the Detroit Tigers edged the Toronto Blue Jays 9-8 and the Chicago White Sox shaded the Cleveland Indians 4-2. The Oakland-Minnesota and Boston-Texas games were rained out.

Baltimore ace Jim Palmer, making his first start in 10 days since complaining of soreness in his right arm, retired 13 Kansas City batters in a row between the first and the fifth. He allowed five hits, struck out three and walked two before Tippy Martinez relieved in the eighth when Palmer's forearm tightened again.

Brewers 7, Yankees 3 Cecil Cooper slammed a pair of bases-empty homers and

Robin Yount added a two-run double as Milwaukee handed winless Catfish Hunter his fourth setback. Cooper's 11th homer of the year and second of the game broke a 2-2 tie in the sixth inning and three infield hits and Yount's double, which right fielder Reggie Jackson misplayed, helped the Brewers to three more runs in the seventh. Milwaukee's Moose Haas scattered seven hits, including home runs by Jackson and Graig Nettles.

Angels 6, Mariners 4 Bobby Grich collected three hits and drove in three runs while Jim Barr scattered eight hits before needing help from

Dave LaRoche in the eighth as the Angels posted their fourth consecutive triumph. Barr replaced scheduled starter Nolan Ryan, who remained behind in California with his injured son and then was delayed by the grounding of a DC-10. Grich delivered a two-run double in the seventh inning. In the fifth, his single scored Brian Downing all the way from first. Ruppert Jones and Bob Stinson homered for Seattle.

Tigers 9, Blue Jays 8 Lance Parrish snapped an 8-8 tie with a run-scoring single in the eighth inning following a two-out intentional walk to Jason Thompson. Lou Whitaker opened the eighth with a single and was sacrificed to second. After Rusty Staub fied out, Thompson was purposely passed, but Parrish spoiled the strategy with his game-winning hit. The Tigers also got a two-run single from Alan Trammell and a two-run double from Jerry Morales and Parrish had an RBI double. Rookie Dave Tobik earned his first major league victory with one inning of relief.

White Sox 4, Indians 2 Bill Nahorodny doubled home two runs and Richard Wortham blanked Cleveland on four hits for eight innings. Nahorodny's double came in the fourth inning off loser Eric Wilkins after Alan Bannister singled and Lamar Johnson walked. The White Sox scored two more runs in the sixth on RBI singles by Milt May, making his debut with Chicago, and Rusty Torres.

Sonics Remember Last Year, Nip Bullets, 114-112, Lead 3-1

By TOM SEPPY AP Sports Writer SEATTLE (AP) — Dennis Johnson says the Seattle SuperSonics only have to remember last year to keep from squandering their lead in the National Basketball Association championship playoffs against the Washington Bullets. "Everybody on this team is remembering last year," said Johnson after the Sonics defeated the Bullets 114-112 in overtime Tuesday night to go ahead 3-1 in the best-of-seven finals. "We had the lead then and relaxed. The next thing we knew, we were being blown out."

Last year, the Sonics led in the final series 3-2, but got pas-

ed in Game Six in Washington, 117-82, and the Bullets went on to win the championship. The next game in this series will be played Friday in Landover, Md., with Game Six, if necessary, here on Sunday and Game Seven in Landover next Wednesday. Dennis Johnson also said it doesn't mean a thing that the Bullets were down 3-1 against San Antonio in the Eastern Conference finals and came back to win the series, only the third time in NBA history such a comeback was made in the playoffs. It has never been done in the championship round.

"We're not the Spurs," said Johnson, who tipped the last Bullets shot into the hands of teammate Jack Sikma with three seconds remaining in the overtime. "We don't get all the publicity that the Spurs do, but they don't play defense like us. We aren't your average team. We're not going to lose the 3-1 lead."

Dennis Johnson and Gus Williams, the two Sonics guards, once again paced Seattle. They got 32 and 36 points, respectively. They got lots of help inside from Sikma, who had 20 points, 17 rebounds, five blocked shots and aided in getting Washington's three big men — Elvin Hayes, Bobby Dandridge and Wes Unseld — to foul out of the game. Washington Coach Dick Motta was angered about those foul calls, claiming San Antonio Coach Doug Moe set the stage for them when he criticized the referees after the final game of the Eastern Conference playoffs.

Otis Melvin Goes For NCAA 800-Meter Crown

For East Carolina sprinter Otis Melvin the time is right. After three straight weeks as a winner in the 200 meters he took last away from competition and trained for this weekend's NCAA championship meet at Illinois.

that prepared me well for this outdoor season," Melvin said. "I met the qualifying standard and I've won my last three races, so I'm in a great frame of mind and looking forward to this meet more than any I've ever entered before.

curve now I bring my right arm across my body while my left arm stays on that side. It helps me to put more effort into running the curve while holding my balance better and helping me to run the shortest distance to the finish line."

The slender 6-2 junior from Fayetteville won meets in Richmond, Va., Pittsburgh, Pa., and Knoxville, Tenn., in his last three outings and appears primed for a sterling NCAA performance. Melvin ran a 20.6-second hand-timed effort at Pittsburgh to qualify for this weekend's track carnival and hopes to become the third Pirates all-American in as many years in the 200 meters. Teammate Calvin Alston earned the honor the past two years. "I had a good indoor year and

"I feel good physically, too. I've shortened my workouts some and done a lot of work on the curves so I'll be ready if I'm in lane one or on the outside. "It's an advantage for a tall runner like me to be in the outside lane because it's a lot straighter, while the inside lane requires a different running technique. I have to prepare for them all because I never know where I'll be running."

Melvin participated in an Olympic development camp in Colorado last summer. He spent a lot of time there working on running the turns and he believes that it has made him faster this year. "I changed my style for running the inside lanes because of what I learned at the Olympic development camp," Melvin said. "Most of the time a runner's hands and arms both do the same thing, but when I run a

Sports Calendar

- Today's Sports Baseball Midway at Jamesville (8 p.m.) Little League Lions vs. Coca-Cola Pepsi-Cola vs. Wellcome American Legion Greenville at Washington (8 p.m.) Babe Ruth League Home Builders vs. Action Movers Coca-Cola vs. Pepsi-Cola Softball City League Sunnyside Eggs vs. Home Savings Whitts vs. Carolina Music Philippians vs. Pantana Bob's Silkcreens vs. Johnny's Mobile Homes Pair Electronics vs. Ervins Industrial League Eaton vs. Grady-White Greenville Square vs. Burroughs-Wellcome Carolina Leaf vs. Fire Department Union Carbide vs. Daniel Construction East Carolina vs. Public Works Empire Brushes vs. Fieldcrest Women's League Flamingo Disco vs. Blount-Harvey Pitt Memorial Hospital vs. Stroth's Thursday's Sports Track NCAA at Illinois Baseball Little League Kiwanis vs. Jaycees Moose vs. First Federal Babe Ruth League Wachovia Bank vs. Planters Bank Prep League Dr. Pepper vs. Cox Realty Softball Industrial League Winn-Dixie vs. Fieldcrest Church League Arlington Street vs. First Presbyterian Memorial vs. St. Paul Oakmont vs. University Trinity vs. Faith First Christian vs. Mt. Pleasant Grace vs. Black Jack First Pentecostal-Holliness vs. First Free Will Women's League Flamingo Disco vs. Pepsi-Cola Village Groomer vs. Pitt Memorial Hospital Blount-Harvey vs. Western Steer

Sampson Choice Set Thursday

HARRISONBURG, Va. (AP) — Ralph Sampson, the 7-foot-3 3/4-inch basketball star who is the hottest prospect left on the recruiting market, will announce Thursday where he'll play college ball, although he hasn't decided on his choice yet. Roger Bergey, who coached the star center at Harrisonburg High School, said Tuesday that Sampson will hold a news conference at 7 p.m. Thursday in the high school gymnasium to reveal his plans. Bergey said Sampson apparently has not yet reached a final decision, "but he's pretty close."

Sampson attended an athletic banquet at Strasburg High School Tuesday night and remained vague about his college plans. He made no reference to the Thursday night news conference and said only that he'd make up his mind "in a week or two."

Meisel Improved

East Carolina University swimmer Kevin Meisel, a sophomore from Orlando, Fla., continues to make progress in the Duke University Hospital after having his right arm almost severed in an accident with a train April 28. A reimplantation team at Duke worked to save the arm. He has had skin grafted from his left leg to his arm and faces another similar operation, probably this week. "I'm looking forward to going home soon," Meisel said this weekend. "If I have the next graft soon, then I might be able to go home the second weekend in June."

He is no longer confined to his bed and therapists have begun to move his arm and fingers through their range of motion.

Waltrip Is New Leader

DAYTONA BEACH, Fla. (AP) — Darrell Waltrip's racing luck turned for the better and Bobby Allison's turned for the worse. Result: Waltrip won the World 600 at Charlotte and replaced Allison on top of the Grand National stock car racing point standings. Allison finished 22nd. Rookie Dale Earnhardt, who was fifth in the race, is the sixth driver to top \$100,000 in winnings this year. After 13 races of the scheduled 31, Waltrip has 2,066 points, Allison 2,013, Cale Yarborough 1,897, Richard Petty 1,887.

Sampson narrowed his list of schools to four — North Carolina, Virginia, Virginia Tech and Kentucky. He has visited only those four schools and East Tennessee State. Bergey said Sampson plans to notify the college he chooses only a short time before the news conference and that the chosen coach isn't expected to be present for the announcement. At least two of the four coaches plan to be on hand,

BOB'S TV '79' SPECIAL

RCA 19" COLOR TV

- 100% Solid State •Extended Life Chassis •Woodgrain Finish •Energy-Saving Chassis

NEW LOW PRICE \$378.00



Price Includes Service and Parts Warranty C. L. Lupton Bldg. Memorial Dr. Greenville, N. C. 752-6248

Model FC443 RCA XL-100 19" diagonal

108 E. 2nd St. Ayden, N. C. 746-4021 BOB'S TV

SAAD'S SHOE SHOP QUALITY SHOE REPAIRING Located at College View Cleaners 113 Grande Avenue "Parking In Front"

FRIDAY'S 1890 Seafood Thursday Night Family Special All You Can Eat Trout Or Perch... \$2.29 Flounder... \$3.25 Shrimp... \$4.50 Oysters... \$4.50 Seafood Platter... \$4.95 Fried Chicken \$2.75

HOD WANTS YOU TO COME IN AND TEST DRIVE A NEW CAR TODAY!! HOLT OLDSMOBILE DATSUN, INC.

# Parker Sparks Pittsburgh To Victory

**By KEN RAPPOPORT**  
AP Sports Writer

Dave Parker is starting to shake out of his "slump." You know it when he tells you so.

The Pittsburgh Pirate star never hesitates to blow his own horn, as many know, and that's exactly what he did Tuesday night after helping his team blow out the Chicago Cubs 8-0.

"It's about time for me to put something together," said Parker after hitting two doubles and a home run and driving in three runs.

In the other NL games Tuesday night, the Montreal Expos routed the Philadelphia Phillies 9-0; the Houston Astros nipped the Cincinnati Reds 2-1; the New York Mets turned back the St. Louis Cardinals 6-2; the Los Angeles Dodgers edged the San Francisco Giants 6-5 and the San Diego Padres swept a

double-header from the Atlanta Braves, 6-3 and 3-2.

Pittsburgh took a 2-0 lead in the first inning with the aid of a throwing error by pitcher Ken Holtzman and a run-scoring single by Willie Stargell. Phil Garner led off the Pirate second with his third homer. Parker clouted his seventh homer with two out in the seventh, and then doubled in two more runs in a four-run Pirate eighth.

Don Robinson and Grant Jackson combined on a five-hitter for the Pirates, who turned in only their second shutout this season.

**Expos 9, Phillies 0**  
Ellis Valentine's three-run homer capped a five-run, fifth inning and Steve Rogers pitched a six-hitter as Montreal beat Philadelphia. Rogers triggered the fifth-inning outburst

with a lead-off single and Warren Cromartie later delivered a two-run double before Valentine's fifth homer of the season.

The Expos had provided Rogers with a 2-0 lead in the second inning when Chris Speier doubled in two runs. Perez and Valentine both hit RBI doubles in the seventh to stretch the Montreal lead to 9-0.

**Astros 2, Reds 1**  
Pinch-hitter Denny Walling's run-scoring single with the bases loaded in the ninth inning led Houston over Cincinnati. Craig Reynolds and Cesar Cedeño started the decisive Houston ninth with singles off loser Paul Moskau. Reliever Doug Bair then intentionally walked Jose Cruz to load the bases, setting the stage for Walling's winning hit. Randy Niemann, recalled from the minors earlier this month, scattered eight

hits for his first major league victory.

**Mets 6, Cardinals 2**  
John Stearns and Steve Henderson belted run-scoring doubles to highlight a four-run rally in the seventh inning and lead New York over St. Louis. Lee Mazzilli's double, one of 14 New York hits, triggered the New York uprising off St. Louis right-hander Pete Vuckovich.

An inning later, the Mets added an insurance run on two singles and Richie Hebner's sacrifice fly in support of Pat Zachry, 4-0, who yielded nine hits in 71-3 innings.

**Dodgers 6, Giants 5**  
Dusty Baker's fly ball single to deep center field drove in the winning run as Los Angeles rallied for three runs in the ninth inning to defeat San Francisco.

twice in the ninth and had the bases loaded with one out and Baker hitting against San Francisco reliever Dave Roberts. Baker lofted a fly ball over the head of Giants center fielder

Bill North for the game-winning hit.

Run-scoring singles by Reggie Smith and Steve Yeager gave the Dodgers their first two runs of the inning.

**Padres 6-3, Braves 3-2**  
Dave Winfield homered and Gene Tenace cracked a two-run triple to help Gaylord Perry record his 27th career victory as San Diego defeated Atlanta

in the first game of their double-header.

The Padres completed their sweep as Ozzie Smith's run-scoring single broke a tie in the eighth inning.

## Perry Closes Out May With 4th Victory After Long Drought

SAN DIEGO (AP) — "I hope number five is not as hard coming as number four," Cy Young Award winner Gaylord Perry said of a personal drought that finally ended during a San Diego doubleheader sweep over Atlanta.

Perry struck out 10, allowing seven hits in the Padres' first game victory by a 6-3 score. Shortstop Ozzie Smith ended his dry spell at bat with an eighth inning RBI single to give San Diego a second game 3-2 victory over the Braves.

"The last was May 1 in New York. I remember 'em all," Perry said of the long passage between victories No. 270 and 271 of his career.

Now 44 for the season, he had a good April before hitting the sour streak. During May he had three losses and two "no decision" starts, although most of his games were well pitched.

It looked like another of those nights when Atlanta got three unearned first inning runs, but Perry shut out the Braves the rest of the way.

"It was great to have some runs to work with," the 40-year-old Perry said. "When you're

going bad you've got to face it, and fight it, and keep going."

The victories gave San Diego its first three-game win streak of an otherwise troubled season — but not quite as troubled as the Atlanta fortunes.

"A loss is a loss," said the losing pitcher in the second game, Phil Niekro, now 5-8. "I think it hurts a little more because with the win, we'd have been in the same position with the Padres as we were when we came into town (tied for last in the National League West). Now that puts us two back."

"Niekro pitched a good ballgame and he lost," said Atlanta Manager Bobby Cox. "He's got almost 190 losses in his career, and 140 have been just like that one."

"We're always close to winning. We never get blown out of games and we're always in them, but one thing after another keeps happening," Cox said.

San Diego left fielder Jerry Turner had two doubles, a triple and a homer in the doubleheader, after being moved to cleanup.

"I have no gripes about where I hit, if I'm producing. This is my first year playing as a regular. I've been hitting third all of my career."

Padres' Manager Roger Craig, doesn't think the switch of Winfield to third and Turner to fourth as important as the switch of shortstop Smith to second in the order.

"Ozzie batting second is a psychological thing," Craig said. "It showed I had confidence in him. Ozzie really wants to hit second." Smith came into the doubleheader hitting .161.

Then his average dropped near his weight of 150 with an 0-for-6 night before his game winning single in the second game. But Smith also had sacrificed two runners into scoring

position and both eventually scored.

In the Padre eighth with one out, winning pitcher Bob Owhinko, 2-1, got a single. Following a walk to Gene Richards, Owhinko left the game for pinch-runner Bill Almon, who scored the winning run on Smith's hit.



### Rose Award Winners

These five athletes were among those honored at the Rose High School All-Sports Banquet last week. From left to right are: Robin Edwards, Most Valuable in softball; Mike Williams, Hustler

Award in baseball and Kiwanis Cup for Outstanding Senior Athlete in Sportsmanship; Lindsay Winstead, Most Improved in baseball; Kenny Barnes, Most Valuable in junior varsity baseball; and Curtis Little, Dixon Cup as Outstanding Senior Athlete. (Reflector Photo)

## Long Shadow Of Ali Still Hides Unknown Champ, Larry Holmes

**By WILL GRIMSLEY**  
AP Special Correspondent

The best heavyweight fist fighter in the world stands in an isolated corner, talking in subdued tones with a couple of newsmen and a handful of the curious.

Meanwhile, there is a shoving, six-deep mob around a handsome, mustachioed Californian of Mexican extraction, Carlos Palomino, a former welterweight champion. Outside on the patio, a pack of ring buffs struggles to get within conversation distance of Jersey Joe Walcott, a colorful throwback to the Joe Louis era.

For Larry Holmes, unbeaten in 30 bouts and holder of half of the world heavyweight boxing crown but rightful owner of all, it's a lonely, frustrating existence.

The long shadow of Muhammad Ali continues to block him from the public view.

"Until that man officially re-

tires or fights me, nobody will know I exist," says Holmes, who accepts his fate placidly. "I have fought everybody who is willing to fight me. What else do they want me to do?"

Holmes can walk the length of 5th Ave. without once being asked for an autograph. It's the same when he strolls the Champs Elysees in Paris or pauses to admire the scenery on London's Trafalgar Square.

He is the forgotten champion — boxing's "Mr. X."

"I have the same trouble at home," Holmes said at a press conference Tuesday aimed at hyping his June 22 bout in Madison Square Garden against a little-known ex-Marine, Mike "Hercules" Weaver.

"I go home and ask my 11-year-old daughter, Missy, if I am her champion," Holmes said.

"She says, 'Yes, daddy.' I ask her, 'Am I the best fighter in the world?' She says, 'I don't

know, daddy.' I ask her, 'Can I beat Muhammad Ali?' She replies, 'I don't know, daddy.' I ask her if I am going to knock out Weaver. She says, 'I don't know, daddy.'"

Holmes, recognized as world champion by the World Boxing Council, is risking his \$3 million purse for a scheduled September fight against tough Earnie Shavers by going against a fighter who has lost eight times and is No. 8 among heavyweight challengers.

All, who lost and then regained the World Boxing Association title against Leon Spinks, is capitalizing on his auspicious time formally to retire from the ring.

He has insisted — and almost everybody believes him — that he will never fight again. Certainly, he wants no part of a younger, stronger, more dedicated Holmes, who once was his sparring partner.

Holmes will be fighting Weaver for practically nothing, repaying a debt to Promoter Don King, who befriended him in his struggling early days.

The TV networks spurned the fight, insisting it would be one-sided and lacking in appeal. His back to the wall, the ingenious King had to scrounge around for an attractive supporting cast, including Palomino against Roberto Duran.

"When I first came up, I couldn't get on TV," Holmes said. "They said I wasn't good enough. Now TV doesn't want me because they say I am too good. Once ABC told me they'd use my fight if I scored a knockout. I won by decision. They never took the film out of the can."

Holmes, 29, a onetime truck

driver, is an impressive gladiator — 6-foot-3, 214 pounds with massive neck, shoulder and arms. He is reminiscent of Ali in his speed and ring finesse. Tender knuckles keep him from being a murderous puncher.

But he is unquestionably the finest heavyweight now in action and a man destined to rule the division for perhaps another five years — not, let us hope, in virtual anonymity.

"I can't get famous for not going into the service or for becoming a Muslim," the modest, low-key champ said. "Ali was known for what he was and what he did and all the people around him. I'm not Muhammad Ali. I don't expect to be. I came into the world as Larry Holmes. I will go out as Larry Holmes."

## Nobles Aids Brave Effort

AYDEN — Rod Nobles, a junior at Pembroke State University, was a member of the school's mile and 440-yard relay teams that placed nationally at the 28th National Association of Intercollegiate Athletics track and field championships.

The NAIA meet was held in Abilene, Texas.

The Braves' mile relay team was nationally ranked sixth going into the meet with a time of 3:13.3, and they finished the championship meet in fifth place with a 3:11.2 time. Nobles ran the third leg on the relay, and had a split time of 48.3 seconds.

In the 440, the team finished seventh, with a time of 41.0 seconds. Nobles again ran the third leg, but his split was not available.

During the regular season, he also ran the 220-yard dash, posting the top time of 21.4 for the year.

The son of Mr. and Mrs. Leroy

Nobles of 1209 Fleming Street in Ayden, Nobles is a graduate of Ayden-Grifton High School. He is a business administration major at Pembroke State.

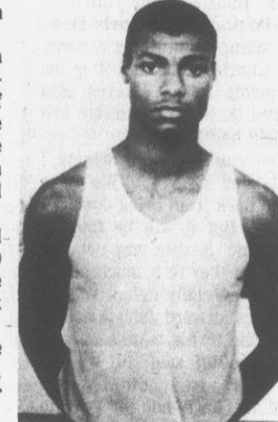

Rod Nobles

## Kemper Bowling Out In N.C.

CHARLOTTE, N.C. (AP) — There's a certain sense of nostalgia to this week's \$350,000 Kemper Open Golf Tournament.

It is the last to be played at the 7,160-yard, par-72 Quail Hollow Country Club. Despite an extremely successful 11-year run in Charlotte, the tournament next year will be moved to the famed Congressional Country Club in Bethesda, Md.

It isn't unusual for tourna-

ments and or cities to disappear from the PGA Tour schedule. In the last 10 years, more than two dozen events have dropped off the circuit.

But there was a difference. In those cases, the tournaments had problems of one type or another. They'd be played this year, then quietly drop off the schedule the next, without fanfare or announcements. They'd just be gone.

Holmes, 29, a onetime truck

**Announcing The Opening Of**

**NICK'S ROOFING COMPANY**

Leaks Repaired • Gutters Repaired • New Roofs & Gutters Installed  
• Slate Roof Repairs • Slag Roofs • Tin Roofs Painted • No Job Too Small

Call 758-7129 7 Days A Week, Day Or Night

Licensed • Insured • All Work Guaranteed In Writing  
We Respond Promptly • Let Us Be Your Roofers

**15% DISCOUNT 'TIL JUNE 1ST**

**The best person to see about your LIFE INSURANCE may be your car, home and health agent! See or call:**

**Bill McDonald**

East 10th Street Ext.  
Phone 752-6680  
Greenville, N.C.



Like a good neighbor, State Farm is there.

**STATE FARM**  
INSURANCE

STATE FARM LIFE  
INSURANCE COMPANY  
Home Office: Bloomington, Illinois

# SAFE!



Even Joe DiMaggio's 39 home runs couldn't help the Yanks that year. They finished two games out in the losing column.

But, Cleveland came on strong after clinching the American League title in a playoff with the Red Sox. The Tribe's pitching took the Series 4-1 from the National League's Boston Braves and Bob Elliot's powerful bat.

1948.

Russia moved tanks into Berlin and the threat of war loomed. The experts hid the knowledge that Russia probably had the A-bomb.

Times were not safe.

But, if you had money in Home Savings, it was safe. Because 1948 was the year that Home Savings began insuring deposits with the Federal Savings and Loan Insurance Corporation. Home Savings had already been around 42 years. Their customers' money had always been safe. But they wanted to add an extra measure of protection.

So Home Savings got FSLIC, so they could continue to protect your money. With federal insurance.

Since 42 years before Stan Musial batted .376 to win the National League batting title.

Your money is safe at Home.



**HOME SAVINGS**  
Greenville, Bethel, Plymouth.

MEMBER  
**FSLIC**  
FEDERAL SAVINGS  
LENDER

# New Owner For Lakers

By TOM HARRIGAN  
Associated Press Writer  
INGLEWOOD, Calif. (AP) — The House that Jack Built — and household names like Kareem, Magic and Marcel — are being bought by Los Angeles real estate man Dr. Jerry Buss.

The purchase for about \$67 million of the 16,000-seat Forum, pro basketball's Lakers and the pro hockey Kings from Jack Kent Cooke gives Los Angeles a homegrown sports entrepreneur.

Until now the baseball O'Malleys from New York, former Canadian Cooke and football franchise owners moving from the East have controlled the pro sports market in the Los Angeles area. One exception was formation of baseball's Angels by former movie cowboy Gene Autry.

The 46-year-old Buss, who holds a doctoral degree in physical chemistry from the University of Southern California, showed the necessary financial muscle when he bankrolled a great deal of the struggles of World Team Tennis for five years.

He owned the Los Angeles Strings, putting Ilie Nastase and Chris Evert together to win a WTT title last year. Buss also was a part owner of the San Diego, Anaheim and Indiana franchises before the 10-team WTT folded last fall.

Winning the WTT trophy only cost him "a couple of million," he joked. He has estimated his fortune in 20 years of real estate has grown to \$350 million. He quit a research job with an aircraft company in 1958 and sunk his entire savings into one apartment building — the first of very many with 5,000 units in Los Angeles and another 5,000 in other cities.

The 66-year-old Cooke and Buss made separate announcements Tuesday that they are fi-

nalizing the package deal, the largest transaction in sports history. In addition to the Lakers, the Kings and the 11-year-old Forum, the sale also includes Cooke's Ranjon, a 13,000-acre ranch in the California Sierra.

"I am elated," said Buss in a statement released by spokesman Bob Steiner. "It is something I have wanted for a long period of time. It is like a dream come true. It's very exciting for me to work with people like Kareem Abdul-Jabbar and Marcel Dionne. And I'm excited about the arrival of Dale McCourt."

To add to Laker center Abdul-Jabbar, a five-time NBA most valuable player, and high-scoring Kings center Dionne, the Lakers recently signed Earvin "Magic" Johnson, who led Michigan State to the national collegiate championship. And the Kings won an appeals court verdict in the struggle over young center McCourt of Detroit.

Calling Cooke's Forum "The House that Jack Built" recalled the importance of Babe Ruth 40 years earlier for Yankee Stadium — "The House that Ruth Built."

Cooke built the Forum for \$16 million in 1967 following disagreements with the Los Angeles Coliseum Commission over conditions for use of the Sports Arena by the Lakers and Kings.

National Football League Commissioner Pete Rozelle had urged Cooke to divest himself of other sports interests if he desired to stay affiliated with that league's Washington Redskins.

Cooke was given time to settle a divorce suit. Two months ago an agreement was reached giving his former wife, Barbara, one-half of his holdings which were estimated at \$100 million.

# Youth Ball

## Little League

### Big Value Drugs 8, Moose 4

Big Value Drugs rolled to an 8-4 victory over the winless Moose yesterday in the Tar Heel Little League.

Big Value is now 6-1 on the year, while the Moose have yet to win in seven starts.

The Moose scored first, getting a run in the first inning. Charlie Littleton walked and scored when Daryl Perkins tripled. Two more came over in the third, as Perkins hit a home run with one on. The other Moose run came in the fifth.

Big Value scored twice in the fourth. Kevin Lang sing-

ed and Matthew Saieed doubled. Gene Leggett walked, loading the bases and an error on Mike Herrin's ball allowed Lang and Saieed to score.

After getting another in the fifth, Big Value came back to score five in the sixth to win it. Eric Jarman singled and Steve Wall doubled. Sterling Edwards reached on an error that scored both Jarman and Wall. Les Turner followed with a homer, scoring Edwards. Lang then hit another homer to close out the scoring.

Wall, Edwards, Turner and Lang each had two hits, while Saieed led the way with three for Big Value. Perkins had both of the two hits allowed by Jarman to the Moose.

## Legion Game Is Cancelled

The American Legion baseball game between Pitt County and Snow Hill scheduled for last night was cancelled. The Pitt County team will resume play tonight at Washington in an 8:00 contest.

### Union Carbide 15, Kiwanis 1

Union Carbide pushed over ten runs in the first inning and went on to record a 15-1 victory over the Kiwanis in the North State Little League yesterday.

The results left both teams with 2-5 records. Union Carbide put it away with its ten in the first inning.

Jeff Howard singled and Steve Rhodes walked. Duane Roeser also walked, loading the bases. Walks to Dwight Smith and Frederick Hurt brought in two runs. Tim West, Billy Overton, and Bill Hall also walked, forcing in three more. Howard reached on an error, scoring West, and Rhodes singled in Overton. Roeser walked to score Hall, and a double by Smith brought in Howard and Rhodes to close out the scoring in the inning.

Union Carbide added two in the second and three more in the fourth.

The lone Kiwanis run came in the bottom of the first. Van Alston singled and moved up on two wild pitches. He scored on an out.

Rhodes led the Union Carbide hitting with two, while no one had more than one for the Kiwanis, who got only three off Tim West.

## Prep League

### Auto Specialty 4, Gr. Hardware 3

Auto Specialty held off a Greenville Hardware rally last night and claimed a 4-3

Prep League victory. The win boosted Auto Specialty to 2-3, while Greenville Hardware fell to 2-2.

Greenville Hardware scored first, getting a run in the top of the first. Hunter Bost reached on an error and stole second. He came around on errors.

Auto Specialty came back with one in the bottom of the first. David Jester reached on an error and moved up on a stolen base and a passed ball. He was sacrificed in by Mike Kinley.

Auto Specialty added one in the second and another in the third. Greenville Hardware came back with one in the fourth.

Auto Specialty then scored the winning run in the fifth. Mont Brown singled and stole second. He took third on an out and scored on a balk.

The other Greenville Hardware run came in the seventh, and the tying run was left in scoring position.

Greenville Hardware got only three hits off Kinley, while Auto Specialty got four off Billy Godley, two of them by John Rovoris.

## Senior Babe Ruth

### Kiwanis 4, Robersonville 3

The Kiwanis opened the Senior Babe Ruth season with a 4-3, ten-inning victory over Robersonville last night.

Robersonville scored first, getting two in the opening inning. Steve Wallace reached on an infield single and scored when Jesse Matthews singled. Matthews advanced on the throw-in, took third on an out and scored on a wild pitch.

The Kiwanis came back to tie it up with two in the sixth. Arthur Fletcher walked as did Mac Stokes. Walks to Kenny Barnes and Charles Daise forced in Fletcher, and Stokes scored when Jeff Worthington hit into a fielder's choice.

It stayed that way until the tenth, when Robersonville scored to regain the lead, 3-2. But the Kiwanis came back with two in the bottom of the tenth to win it.

Stokes reached on an error and Barnes walked. Daise reached on a fielder's choice.

and another, by Worthington, scored both Stokes and Barnes for the win.

The Kiwanis got only one hit off two Robersonville pitchers, Clay Roberson and Matthews. Street Lee had two hits to lead Robersonville.

### Clifton Ins. 4, Farmville 3

FARMVILLE — Bill Clifton Insurance gained a 4-3 victory over Farmville last night in Senior Babe Ruth League play. It was the first game of the year for both teams.

Todd Galloway hurried the victory, allowing only two Farmville hits. He also led the Clifton hitting, getting two, including a three-run homer that proved the difference in the fourth inning.

North Pitt 8, Ayden-Grifton 6  
LITTLEFIELD — North Pitt gained an 8-6 win over Ayden-Grifton in Senior Babe Ruth action last night.

The win evened North Pitt's record at 1-1, while Ayden-Grifton was opening its season. No details were available.

# SCOREBOARD

## Recreation Ball

**Church League**  
First FWB 040 402-10  
First Presby 040 103-8  
Leading hitters: FF, Carl Belch 4-4; James Woodard 3-4; FP, Greg Sasser 4-4, Bobby Sasser 3-4.

**Mt. Pleasant** 000 000 0-0  
**Black Jack** 454 211 x-21  
Leading hitters: MP, Howard Stocks 1-4, John Simpson 1-2; BJ, Tal Adams 3-5, HR, J T Mills 3-3.

**Arlington** 000 043 1-8  
**First Pentecostal** 020 311 2-9  
Leading hitters: A, Sam Harrell HR, Joe Betterham 3-4; FP, John Raeford 2-3, Jim Thornton 2-3.

**Trinity** 000 000 0-0  
**Memorial** 303 000 x-6  
Leading hitters: T, Stewart Jones 3-3, Lee Cherry 2-3; M, Chuck Odum 2-3, Woody Simpson.

**First Christian** 010 040 01-6  
**Grace** 100 001 x-14  
Leading hitters: FC, Bryant Honeycutt 3-3, Tom Lughill 2-3; G, Russell Paige 3-4, Wayne Bailey 2-4.

St. Pauls defeated First Pentecostal 4-0.

**Industrial League**  
PIH Hospital 000 100 2-3  
Eaton 525 101 x-14  
Leading hitters: PH, Ty Curtis 3-3, David Nelson 2-3; E, Sam McDonald 2-3, Roscoe Howard HR.

## Pro Baseball

AMERICAN LEAGUE				
EAST				
	W	L	Pct.	GB
Baltimore	30	17	.638	-
Boston	26	18	.591	2 1/2
Milwaukee	27	22	.551	4
New York	25	22	.528	5
Detroit	20	21	.488	7
Cleveland	20	26	.435	9 1/2
Toronto	12	36	.250	18 1/2

**Tuesday's Games**  
Detroit 9, Toronto 8  
Chicago 4, Cleveland 2  
Milwaukee 7, New York 3  
Oakland at Minnesota, p.p.d., rain  
Boston at Texas, p.p.d., rain  
Baltimore 8, Kansas City 1  
California 6, Seattle 4

**Wednesday's Games**  
Detroit (Wilcox 3-2) at Toronto (Huffman 2-1), (n)  
Oakland (Minetto 1-0) at Minnesota (Hartzell 1-3), (n)  
Cleveland (Waits 6-2) at Chicago (Baumgarten 5-1), (n)  
New York (John 9-1) at Milwaukee (Caldwell 5-4), (n)  
Boston (Torrez 4-3) at Texas (D. Ellis 1-3), (n)  
Baltimore (Flanagan 6-3) at Kansas City (Leonard 4-1), (n)  
California (Ryan 5-3) at Seattle (Honeycutt 2-5), (n)

**Thursday's Games**  
Oakland at Minnesota  
Detroit at Toronto, (n)  
New York at Milwaukee, (n)  
California at Seattle, (n)  
Only games scheduled

NATIONAL LEAGUE				
EAST				
	W	L	Pct.	GB
Montreal	26	15	.634	-
Philadelphia	27	18	.600	1
St. Louis	22	19	.537	4
Pittsburgh	21	21	.500	5 1/2
Chicago	19	23	.452	7 1/2
New York	16	26	.381	10 1/2

**WEST**  
Cincinnati 26 20 .565 -  
Houston 27 23 .540 1 1/2  
San Francisco 24 26 .476 4  
Los Angeles 24 26 .476 4  
San Diego 21 29 .420 7  
Atlanta 18 28 .391 8

**Championship Finals**  
Best of Seven Series  
Game 1  
Washington 99, Seattle 97  
Game 2  
Seattle 92, Washington 82  
Game 3  
Seattle 105, Washington 95  
Tuesday's Game  
Seattle 114, Washington 112, OT  
Friday's Game  
Seattle at Washington, (n) Sunday's Game  
Washington at Seattle (Coliseum), if necessary.  
Wednesday, June 6  
Seattle at Washington, (n), if necessary.

## NBA

**AMERICAN LEAGUE**  
BATTING (100 at bats)—Smalley, Min. 390; Kemp, Det. 385; Carew, Cal. 356; A. Bannister, Chi. 345; Remy, Bsn. 344.  
RUNS—GBrett, KC. 39; LeFlore, Det. 36; Otis, KC. 36; Lynn, Bsn. 35.  
C. Washgn. Chi. 35; Smalley, Min. 35.  
RBI—Baylor, Cal. 47; Lynn, Bsn. 41; Cooper, Mil. 39; Porter, KC. 39; Nettles, N.Y. 36; Horton, Sea. 36.  
HITS—Smalley, Min. 67; Remy, Bsn. 65; GBrett, KC. 64; Carew, Cal. 62; Cooper, Mil. 61; Baylor, Cal. 61.  
DOUBLES—Lemon, Chi. 15; Bonds, Cle. 13; C. Washgn. Chi. 13; GBrett, KC. 13; McRae, KC. 13; Otis, KC. 13; BBell, Tex. 13.  
TRIPLES—GBrett, KC. 6; Griffin, Tor. 5; A. Bannister, Chi. 4; Wilson, KC. 4; 10 Tied With 3.  
HOME RUNS—Lynn, Bsn. 14; Singleton, Bal. 12; Cooper, Mil. 11; Thomas, Mil. 11; L. May, Bal. 10; Smalley, Min. 10; Horton, Sea. 10.  
STOLEN BASES—LeFlore, Det. 21; Wilson, KC. 19; Otis, KC. 17; J. Cruz, Sea. 17; Willis, Tex. 16.  
PITCHING (5 Decisions)—Kern, Tex. 6-0, 1,000, 1.19; John, N.Y. 9-1, 900, 1.95; Baumgrtn, Chi. 5-1, 833, 2.35; D. Martinez, Bal. 7-2, 778, 2.95; Koonsman, Min. 7-2, 778, 3.52; Palmer, Bal. 6-2, 750, 2.80; Jenkins, Tex. 6-2, 750, 3.44; Marshall, Min. 8-4, 647, 2.05.  
STRIKEOUTS—Ryan, Cal. 66; Guidry, N.Y. 61; Jenkins, Tex. 61; Kravec, Chi. 49; Koonsman, Min. 49.

**NATIONAL LEAGUE**  
BATTING (100 at bats)—Rose, Phi. 365; Brock, St. L. 360; Winfield, SD. 349; Murphy, Atl. 348; Mazzilli, N.Y. 339.  
RUNS—Lopes, LA. 41; Concepcion, Cin. 35; North, SF. 34; Puhl, Htn. 33; Schmidt, Phi. 32; Parker, Pgh. 32.  
RBI—Murphy, Atl. 36; Kingman, Chi. 35; Schmidt, Phi. 34; Winfield, SD. 34; Foster, Cin. 33; Garvey, LA. 33.  
HITS—Winfield, SD. 68; Russell, LA. 66; Rose, Phi. 65; Garvey, LA. 62; Concepcion, Cin. 59.  
DOUBLES—Rose, Phi. 18; Parrish, Mil. 15; 9 Tied With 13.  
TRIPLES—Scott, St. L. 7; Moreno, Pgh. 5; Winfield, SD. 5; Buckner, Chi. 4; Dawson, Mil. 4; J. Cruz, Htn. 4; Lopes, LA. 4; Metzger, SF. 4.  
HOME RUNS—Schmidt, Phi. 15; Kingman, Chi. 14; Murphy, Atl. 13; Dawson, Mil. 11; Matthews, Atl. 11.  
STOLEN BASES—Moreno, Pgh. 18; Scott, St. L. 15; Cabell, Htn. 14; Lopes, LA. 14; Taveras, N.Y. 13.  
PITCHING (5 Decisions)—LaCoss, Cin. 5-0, 1,000, 2.51; Lamp, Chi. 4-1, 800, 4.26; Reed, Phi. 4-1, 800, 3.94; Welch, LA. 4-1, 800, 3.91; J. Nietero, Htn. 4-2, 750, 2.44; Rogers, Mil. 5-2, 714, 2.56; Knipper, SF. 5-2, 714, 3.17; Ruthven, Phi. 6-3, .667, 3.20.  
STRIKEOUTS—Richard, Htn. 81; Carlton, Phi. 55; Perry, SD. 55; P. Nietero, Atl. 54; Hooton, LA. 52.

**Transactions**  
National Football League  
CINCINNATI—Pooled, running back DENVER—Broncos—Signed Jim Turner, placekicker.  
ST. LOUIS CARDINALS—Signed Nate Henderson, tackle; Ricky McBride, linebacker; and Ken Stone, defensive back.

**COLLEGE**  
EASTERN WASHINGTON—Named Ron Raver athletic director.  
MISSOURI VALLEY CONFERENCE—Named David Price commissioner.  
STANFORD—Announced the resignation of Anne Gould, women's tennis coach, at the end of the season.

# \$30 Off Men's 26" Superstar

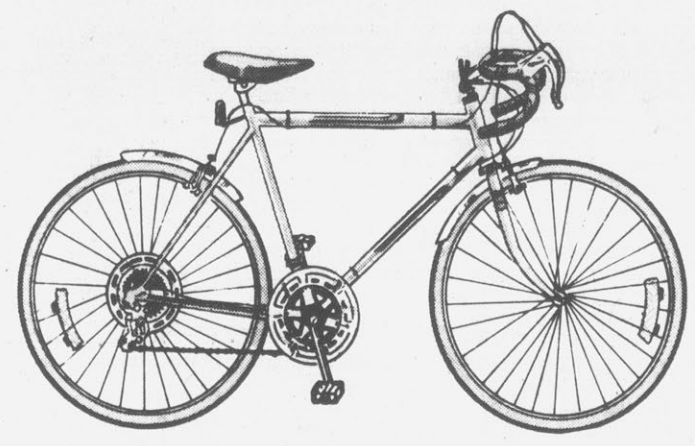

**Sale 94.99**  
Reg. 124.99. Men's 26" 10-speed Superstar racing style bike.  
**Sale 94.99 Reg. 124.99. Women's 26" Superstar.**  
**Sale 94.99 Reg. 114.99. Boy's and girl's 24" Superstar.**

# Save \$5 On Our Finest Exterior Paint.



**Save \$4**  
Reg. 13.99 a gal. Sale 9.99.  
Eight year limited warranty. One & Only interior flat latex with low luster finish. One coat coverage gives enamel-like durability.

**Save 3.50**  
Reg. 13.49 a gal. Sale 9.99.  
Four year limited warranty. One Coat Plus semi-gloss exterior latex is durable and fade resistant. One coat coverage. Washable.

**Save 3.50**  
Reg. 12.49 a gal. Sale 8.99.  
Four year limited warranty. One coat leveling latex paint has a smooth finish. Dripless and washable.

**Save \$3**  
Reg. 10.99 a gal. Sale 7.99.  
Latex floor, porch and patio paint has a low-gloss finish that's great for wood, cement or linoleum. Rolls on easily, dries quickly and is completely washable.



**Sale 99.99**  
Reg. 119.99. Push mower has a 3 1/2 HP Briggs & Stratton engine, 20" steel cutting deck and quick height-of-cut adjustment. Side bagger available.

This is JCPenney  
Shop 10 A.M. 'til 9 P.M.  
Phone 756-1190

# Save \$20 to \$32 on four fiberglass belted tires.

**Sale \$29** Reg. \$34, plus fed. tax, ea. Size A78-13  
El Tigre 278s. Wide 70 and 78 series profile feature a 2 polyester ply body with 2 fiberglass belts. Metric sizes in blackwall only.

Tire size	Reg.	Sale*
A 78 X 13	34.00	29.00
E 78 X 14	44.00	35.00
F 78 X 14	46.00	37.00
G 78 X 14	48.00	38.00
H 78 X 14	50.00	40.00
G 78 X 15	49.00	39.00
H 78 X 15	53.00	42.00
L 78 X 15	57.00	46.00
165-13	35.00	30.00
155-15	35.00	30.00
165-15	35.00	30.00

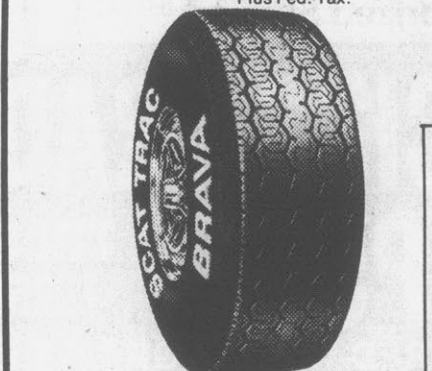

# Save \$40 on four RV tires.

Rugged RV tire designed for off/on road use. Deep biting tread to keep you moving. Tough nylon cord body with raised white letters. Tubeless.

Tire size	Reg.	Sale*
11-15	79.00	69.00
12-15	89.00	79.00



**\$10 off air shocks. Sale 44.99 pr.**  
Reg. 59.99. Increase your car's load carrying capacity by 1,100 lbs. with air shocks. Adjust as easily as filling a tire for changing loads or road conditions.

**Gould Action Pack™ batteries. Sale 50.95**  
Reg. 64.95 Deep cycle battery made for hours of continuous use and many re-charges conventional batteries can't handle. 105 amp/hour. Complete with handy wing-nut terminals and carrying handles.  
Sale 42.95 Reg. 54.95 80 amp/hour

JCPenney Auto Center  
Shop 8:30 A.M. 'til 9 P.M.  
Phone 756-1190 EXT 251

# Ancient Ghetto Of Venice Now Being Restored

By SAMUEL KOO

VENICE, Italy (AP) — Venice's long-neglected Jewish quarter, the home of Shakespeare's Shylock and where the word "ghetto" originated, is being restored, supported partly by American benefactors.

The ghetto, a three-block area once inhabited by more than 5,000 Jews, derives its name from the old Venetian word "geto" meaning foundry, so called because it was built on the site of an abandoned foundry for casting iron.

Here for centuries, ever since the colony was created in 1516, the Jews lived their segregated and unequal life, apart from the rest of the city, surrounded by walls, but with their synagogues, schools and traditions.

"Venice's ghetto represents a unique experience in the history of the Jewish people," says Colombo Vitaliano, the cantor at the Spanish Synagogue. "It's an interesting example of the possibilities for living — in the heart of a pluralistic society — of a minority that had been able to preserve intact its faith and customs."

"It was a Jewish melting pot," says Mark Harris, a Uni-

versity of Manchester student writing a doctoral dissertation on the Jewish community in Venice.

"Jews from different countries, with entirely different customs, traditions and languages, were thrown in together bound by one faith," he says. "It was not unlike a Chinatown, but with exaggerated difficulties and elements of repression thrown in."

In "Merchant of Venice," Shakespeare portrays a relentless moneylender named Shylock operating in the Renaissance ghetto.

Fewer than 20 Jewish families now live in the area, built around a large square and isolated by canals. Impoverished families, mostly those of migrant workers, occupy the rest of the slum buildings. Most apartments do not have baths, and many rooms, especially on upper floors, are barely four feet high.

Fusetti Leda, who runs a third-generation jewelry shop, says her business is good, but her children do not want to live in the ghetto.

"They all left for comfortable places," says Mrs. Leda, who

was born here 46 years ago. "Maybe someday if we can at least redo the interiors of these buildings — some people say they can make attractive duplexes or triplexes out of them — then, maybe, they may return."

Many of the Jewish specialty stores that used to dot the slum streets have disappeared. A snack bar with a big star of David on the window is serving ham-and-swiss sandwiches. A souvenir shop selling Jewish artifacts is run by a non-Jewish family.

But Columbo insists the ghetto remains the center of Jewish life in Venice. He points out that it still holds the synagogues, the rabbi's office, a rest home with kosher restaurant, the ritual bath and a bakery for unleavened bread.

On Saturdays and holidays, the Jews from Venice as well as Jewish tourists come to worship at two of the slum's five synagogues, all built within slum buildings presumably not to embarrass the dogs, the Renaissance rulers of Venice, who had barred their construction.

Considered exquisite exam-

struments.

They can perceive polarized light and ultraviolet light, which enables them to locate the sun even on a partly cloudy day, and helps them understand the lay of fog-covered terrain.

There are theories, some of which have been in and out of favor, that they can orient themselves by hearing thunderstorms or the pounding of surf at distances of thousands of miles; that some may smell their way home from the sea; that keen perception of barometric pressure gives them advance warning of weather fronts; that they are helped by a feeling for the earth's magnetic field or for the force generated by its rotation; and that young birds follow the lead of wise elders while journeying south in the fall.

This last lacks universal truth, quite obviously, because adult puffins, among others, desert their half-feathered offspring, who follow later as best they can.

It is considered quite likely that various birds rely on not just one set of skills but on two or more, giving them backup systems for various weather and other conditions. Even so, millions come to grief each year and sink into the sea, slam into lighted buildings, plate-glass windows and radio towers, or die in unseasonal weather.

At best the navigational systems merely supply compass directions, for the most part. What mental chart or road map do the lonely voyagers use to guide them to the little plots of land they call their own? No researchers can say.

built in the early 16th century, they have undergone repeated renovations.

They are the Schola Tedesca, the Schola Canton, the Schola Italiana, the Schola Levantina and the Schola Spagnola. The Schola Levantina and the Schola Spagnola are open for services, and the other three are used as museums.

The Chicago chapter of the International Fund for Monuments took part in the restoration of the Schola Canton and America's Save Venice Inc. in that of the Schola Levantina.

Work on the Schola Tedesco was supported by private German donors, and Italian organizations have contributed to the restoration of the Schola Italiana.

But the entire ghetto still needs a lot of work, and American and Italian groups are now preparing an international program for students to do volunteer work in the ghetto during their vacations.

## Bird Migration Still Mystery

By JOE WING  
For AP Newsfeatures

A single swallow returning this spring to nest under the eaves of a barn almost anywhere in the United States poses a mystery that some of the world's keenest scientists have yet to solve.

How does this familiar, 7-inch bundle of feathers find its way each year from South America to the very same farmyard in which it nurtured a brood the year before?

Not only barn swallows, but hundreds of other migrant species making up most of North America's five or six billion birds, pose the same basic question.

Even if they could speak, as birds do in fairy tales and folklore, they could hardly explain to mankind their extraordinary navigational skills, which must be more complex, and more baffling to the human mind, than the highly sophisticated ones worked out by engineers.

Ornithologists, such as those in the world's largest bird orientation research program at Cornell University, continue to experiment and sift reams of data, but the key to the inner door of the migration mystery eludes them, even as it did Aristotle, who thought 2,300 years ago that many birds dive into marshes, come fall, and hibernate like frogs.

There are plenty of clues to the mystery. It is known that on occasion some birds fly from landmark to landmark, but that seems an unlikely method for those, like the indigo bunting, that make their journeys at night.

Some seem to take their directions at all hours of day or night from sun or stars, in which case they must harbor in their tiny bodies a system as complicated as a whole battery of navigational tables and in-

## SPRING TIRE SALE!

**S.P.D. POLY**

Full 4-Ply Polyester with Specified Performance Design. Whitewalls only.

**\$24.95** A78-13

Values up to 20% off!

TIRE SIZE	SALE PRICE	PLUS F.E.T.
A78-13	24.95	1.62
B78-13	25.95	1.73
E78-14	29.75	2.10
F78-14	29.75	2.22
G78-14	32.75	2.38
H78-14	32.75	2.61
F78-15	31.75	2.41
G78-15	34.75	2.44
H78-15	34.75	2.66
J78-15	37.75	2.91
L78-15	37.75	2.96

\*All prices plus sales tax.

**DIRECTOR 120**

2 + 2 Belted Polyester and Fiberglass Whitewalls only.

**\$29.95** B78-13

TIRE SIZE	SALE PRICE	PLUS F.E.T.
B78-13	29.95	1.86
E78-14	36.85	2.21
F78-14	36.85	2.34
G78-14	39.85	2.53
H78-14	39.85	2.76
G78-15	41.85	2.59
H78-15	41.85	2.82
J78-15	44.85	3.06
L78-15	44.85	3.11

**MARK 74 RADIAL**

Polyester with 2 Steel Belts Whitewalls only.

**\$44.95** BR78-13

TIRE SIZE	SALE PRICE	PLUS F.E.T.
BR78-13	44.95	1.98
ER78-14	53.95	2.38
FR78-14	53.95	2.55
GR78-14	58.95	2.65
HR78-14	61.95	2.95
GR78-15	61.95	2.73
HR78-15	64.95	2.96
JR78-15	64.95	3.14
LR78-15	64.95	3.30

**FCX**

GREENVILLE Line & Chestnut Streets 919-758-3173  
FARMVILLE South Fields Street Ext. 919-753-3482  
WILLIAMSTON Jamesville Road 919-792-7086  
BELHAVEN West Main Street 919-943-3136  
WASHINGTON 132 West 5th Street 919-946-8048

**SALE ENDS JUNE 2**  
FREE MOUNTING AND OFF-CAR BALANCING — NO TRADE-IN REQUIRED

**FREE**

With purchase of any set of 4 sale-priced tires.

**Litton**  
21-piece Litton socket set 1/4" and 3/8" drive. \$12.99 value.

Limited supply — rainchecks if supplies run out.

**Jenn-Air's Grill-Range makes creative cooking easy with convertible cooktops.**

The extraordinary Jenn-Air Grill-Range puts the gourmet touch right at your fingertips with a variety of easy-to-handle, easy-to-clean convertible cooktops. Conventional electric or glass-ceramic cooktops lift out easily to accommodate an exclusive range of interchangeable accessories that let you griddle, shish-kebab, spit-roast. And bring outdoor flavor indoors every day of the year with the famous Char-Flavor grill. Smoke and cooking odors are whisked quietly away by the powerful built-in surface ventilation system.

**JENN-AIR**



**Ariane Clark**  
custom kitchens

329 Arlington Blvd.  
Greenville, N.C.

**Jenn-Air • Sub-Zero**  
Factory Authorized Service

## BARWICK'S TRADING POST

OPEN MONDAY THRU SATURDAY 8 A.M. TO 6 P.M. TELEPHONE 758-2277

LOCATED BEHIND FRED WEBB'S GRAIN ELEVATOR

OWNED AND OPERATED BY L. ALLEN BARWICK

HOME OF QUALITY CUTS OF MEAT "AS GOOD AS THE BEST... BETTER THAN THE REST"

WE ACCEPT FOOD STAMPS ALL MEATS N.C.D.A. INSPECTED PRICES GOOD WED. THRU SAT.

PORK LIVER	LB.	33¢
PIG FEET	10 LB. PKG.	\$3.50
PIG TAILS	10 LB. PKG.	\$3.90
NECK BONES	10 LB. PKG.	\$3.90



**EDGEMONT TENDERIZED HAMS 89¢**

**SLICED PORK LOIN \$1.39**

10 To 12 Lb. Avg. LB.

**SMOKED PICNICS 75¢**

SLICED ..... LB. 79¢

KOZY KITTEN CAT FOOD	15 OZ.	19¢
FRISKIES DOG FOOD	14 OZ.	29¢
KELLOGG'S CORN FLAKES	12 OZ.	2/\$1.00
KELLOGG'S SUGAR FROSTED FLAKES	20 OZ.	99¢
SOFT N' PRETTY BATHROOM TISSUE	4 ROLL PKG.	89¢

**"IT'S COOK-OUT TIME" ...AND WE CAN SAVE YOU MONEY!**

**KINGSFORD CHARCOAL**

10 LB. BAG \$1.79 / 20 LB. BAG \$3.49

**CHARCOAL LIGHTER**

PINT 59¢  
QUART 79¢  
HALF GAL. \$1.49



## SAVE UP TO \$3.25 ON KLEENEX® SUPER DRY DIAPERS

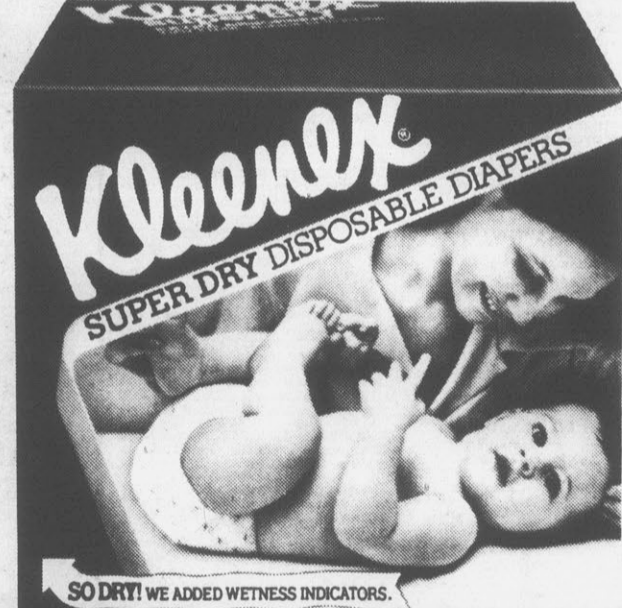

Now Kleenex Super Dry (the diaper with wetness indicators) offers you two special ways to save money and keep your baby really dry.

First. A 25¢ off coupon.

Second. A refund offer worth up to \$3.00. (See below for details.)

**SO DRY! WE ADDED WETNESS INDICATORS.**

**STORE COUPON**

890297 0009E **SAVE 25¢** 25¢

on any size of Kleenex Super Dry diapers

Dealer: For prompt payment, send this coupon to: Kimberly-Clark Corporation, Box #2, Clinton, Iowa 52734. For each coupon you accept as our agent, we will pay you face value plus 5¢ handling charge, provided you and your customer have complied with the terms of this coupon. Any other use constitutes fraud. Invoices showing purchases of sufficient stock to cover all coupons submitted must be shown upon request. Limit one coupon per package. Void where prohibited or restricted. Your customer must pay any sales tax involved.

Offer good only in the U.S. Cash value 1/20 of 1¢. OFFER EXPIRES August 31, 1979.

36000 182083

25¢

**Get \$3.00 worth of coupons or \$2.00 in cash.**

TO ORDER: Send this Official Order Form/Rebate Certificate with twelve (12) Product Code Symbols, complete with numbers, from any size Kleenex Super Dry disposable diaper cartons.

7. Limit of one request per family, group or organization. Duplicate requests constitute fraud.

8. OFFER EXPIRES October 31, 1979.

**CHECK REBATE DESIRED:**

- \$3.00 Coupons (12 — 25¢ coupons)
- \$2.00 Cash

MAIL TO: Kleenex Diaper Rebate Offer Box 551 — KS Neenah, WI 54956

Mail My Selection to:

Name \_\_\_\_\_

Address \_\_\_\_\_

City \_\_\_\_\_ State \_\_\_\_\_ Zip \_\_\_\_\_ (Required)

**MAIL IN OFFER**



Tune up for savings and  
**Liven Up Your Menus with**

**DISCO SPECIALS**

PRICES EFFECTIVE MAY 30 - JUNE 2  
We reserve the right to limit quantities.  
None sold to dealers or restaurants.  
We gladly accept USDA Food Stamps.

PIGGY WIGGLY  
**WAFFLES**  
5 OZ.

**4/1<sup>00</sup>**

PIGGY WIGGLY  
**BISCUITS**  
4's 10 CT.

**4/67¢**

U.S.D.A. "Grade A"  
Fresh Whole  
**FRYERS 49¢<sub>lb.</sub>**  
(Two Per Bag)



**LUX**  
LIQUID  
32 OZ.  
**99¢**

**SWIFT'S PREMIUM PRO-TEN BEEF**

BLADE CUT  
**CHUCK ROAST**  
LB. **1.29**

CENTER CUT Chuck Roast	1.39	LB. BONE IN	Shoulder Steak	1.89
BONELESS Chuck Roast	1.59	LB. BONELESS	Shoulder Steak	2.19
BONE IN Shoulder Roast	1.59	LB. BONE IN	RIB STEAK	2.29
BONELESS Shoulder Roast	1.69	LB. CUBED	Chuck Steak	2.09
BONE IN Chuck Steak	1.59	LB. LEAN & MEATY	SHORT RIBS	1.19
BONELESS Chuck Steak	1.79			

**WISK**  
½ GAL.  
**1.99**

LIMIT ONE AT THIS PRICE, PLEASE

RED BAND  
SELF-RISING OR PLAIN  
**FLOUR**  
5 LB.  
**58¢**  
LIMIT ONE WITH \$7.50 FOOD ORDER

**BOUNTY TOWELS**  
JUMBO  
**69¢**

CHARMIN  
BATHROOM  
**TISSUE**  
4 ROLL  
**89¢**

HEINZ  
**KETCHUP**  
24 OZ.  
**69¢**  
LIMIT ONE WITH \$7.50 FOOD ORDER

KRAFT MIRACLE WHIP  
**Salad Dressing**  
QT.  
**88¢**  
LIMIT ONE WITH \$7.50 FOOD ORDER

PIGGY WIGGLY  
**MACARONI AND CHEESE DINNER**  
7½ OZ.  
**4/1<sup>00</sup>**

KRAFT ORANGE  
**JUICE**  
½ GAL.  
**1.09**

PARKAY  
**MARGARINE**  
1-LB. QUARTERS  
**2/1<sup>00</sup>**

PIGGY WIGGLY  
**APPLESAUCE**  
303 SIZE  
**4/1<sup>00</sup>**  
LIMIT FOUR AT THIS PRICE, PLEASE

PINE STATE  
**ICE CREAM**  
½ GALLON (ALL FLAVORS)  
**99¢**

WHOLE  
**BEEF RIBS**  
(25-30 LB. AVG.)  
(SLICED FREE)  
LB. **1.79**

HAMS  
**SHANK PORTIONS**  
LB. **79¢**

SMITHFIELD BACON	1.29
SMITHFIELD FRANKS 12 OZ. PKG.	99¢
VIRGINIA SMOKED LINK SAUSAGE	1.09
BIG TOP FRANKS 12-OZ.	59¢
BIG TOP BOLOGNA PKG.	79¢

WHOLE SMOKED OR SHANK HALF (19-22 LB. AVG.)	89¢
HAMS	89¢
BUTT HALF	89¢
Butt Portion	83¢
CENTER SLICES OR HAM ROAST	1.09
SLICED PORK LIVER	43¢

SMITHFIELD  
**HAM SAUSAGE**  
12 OZ.  
**1.39**

SMITHFIELD  
**Bar-B-Que**  
12 OZ. CUP  
**1.59**

COLONIAL ACRE FARMS  
GRADE A MEDIUM  
**EGGS 2 \$1<sup>00</sup>**  
DOZ. FOR

KRAFT DRESSINGS  
FRENCH 16 OZ.  
**1.19**  
CATALINA 16 OZ.  
**1.29**  
THOUSAND ISLAND 16 OZ.  
**1.19**

**DOWNY**  
FABRIC SOFTENER  
32-OZ.  
**99¢**

MAXWELL HOUSE  
**COFFEE**  
1 LB. BAG  
**2.29**

MAXWELL HOUSE  
**COFFEE**  
INSTANT 6 OZ.  
**2.89**

JIFFY CORN  
MUFFIN MIX  
8½ OZ. **5/ \$1.00**

PINESTATE  
CHERRIO ICE CREAM BARS  
6-PKS. **2/99¢**

PIGGY WIGGLY Pancake Syrup  
24 OZ. **69¢**

PIGGY WIGGLY Pancake Mix  
2 LB. BOX **69¢**

SMUCKER'S Grape Jelly  
2 LB. JAR **99¢**

KRAFT Mayonnaise  
QT. **\$1.29**

**PEPSI-COLA**  
6 32 OZ. BOTTLES  
**\$1.89**  
PLUS DEPOSIT

**MELLO-YELLO**  
MR. PIBB  
ORANGE CRUSH  
GRAPE CRUSH  
6 10-OZ. BOTTLES  
**59¢**  
PLUS DEPOSIT

**COCA-COLA**  
MELLO YELLO  
SPRITE & TAB  
TWO LITRE BOTTLES  
EA. **79¢**

**PIGGY WIGGLY'S WORLD OF PRODUCE**  
the Freshest Buys in Town!

FRESH, LOCAL **SALAD 29¢<sub>lb.</sub>**

LEMONADE LEMONS	6/69¢
FRESH YELLOW CORN	6 EARS 89¢
PIGGY WIGGLY WHITE POTATOES	10 LBS. FOR \$1.09
LARGE FANCY PINEAPPLES	EA. 89¢

NABISCO FLEX BAG SNACK ALL FLAVORS **69¢**

KEEDLER ZESTA SALTINES 2 LB. BOX **1.29**

KEEDLER ELFWICH 14 OZ. **79¢**

**PIGGY WIGGLY**

GERBER STRAINED **BABY FOOD 15¢<sub>EA.</sub>**

WE GLADLY ACCEPT **WIC FOOD VOUCHERS**

CHARLES' CHIPS **POTATO CHIPS 89¢<sub>8-OZ. BAG</sub>**

2105 DICKINSON AVE.  
Open Monday thru Saturday 8 to 8  
Open Sundays 9 to 6

# Execution By Injection Fails In Committee Vote

RALEIGH, N.C. (AP) — A bill that would make lethal injection of drugs the method of execution in North Carolina failed to pass a committee vote Tuesday, but supporters said they would try again Thursday to send the measure to the full House.

The legislation would make a lethal dose of drugs replace the use of Central Prison gas chamber, which has gone unused since 1961. It is sponsored by Rep. John Gamble, D-Lincoln, a physician and supporter of the death penalty, and has drawn opposition from legislators who are against the death penalty in any form.

Gamble's measure failed to pass when the House Judiciary II Committee deadlocked 6-6 on a motion to approve it.

Committee chairman Rep. Parks Helms, D-Mecklenburg, cast the decisive vote against the measure, forcing the tie. But the committee did not kill the proposal. And Helms, who opposes the death penalty, said he would bring it up in the committee again Thursday.

Gamble told the committee that the use of drugs is a more humane way to execute a person and that the drugs would put the condemned criminal to sleep before killing him.

Gamble also contends his bill would save the state the expense of constructing a new gas chamber when the present one is demolished. Central Prison is being replaced with a modern facility on the same site near downtown Raleigh. But Helms said making the

condemned person more comfortable in death would only soothe the conscience of legislators who enact the death penalty.

"If we pass it, we're not really doing that for the prisoners' comfort," Helms said. "I believe we're doing that to soothe our own conscience."

"It will interfere with our ability to see that the death penalty is wrong, that killing people is immoral," he added. "This legislation tends to make us feel better about what we're doing."

Some committee members said they expected an effort on Thursday to send the bill to the House floor for debate "without prejudice," or without a recommendation.

## Minimum Wage

A bill that would increase the state minimum wage from \$2.50 per hour to \$2.75 per hour in July and raise it another 15 cents an hour next July won tentative approval in the Senate.

The House-passed bill advanced on a 44-2 vote with little discussion or debate and was expected to be up for final consideration today.

The measure would cover state employees, and according to its sponsor, Sen. Jack Childers, D-Davidson, would primarily affect cafeteria workers in the state's schools.

## Firing

A House-passed bill that would make it illegal for an employer to fire a worker solely because he filed a workers' compensation claim gained final approval in the Senate.

Now the measure must go back to the House for concurrence on an amendment added in the Senate that says

the burden of proof for the claim as the basis for firing is on the employee.

## Credit Cards

Another House-passed bill that would strengthen the law against credit-card fraud gained final approval in the Senate. It revises the fraud laws to cover illegal use of new debit cards in electronic banking.

It must also be returned to the House for concurrence on amendments.

## Insurance

A bill raising the minimum amount of automobile liability insurance motorists must have was approved in the House and returned to the Senate for concurrence on amendments.

The bill, when enacted, will cause a small increase in automobile liability premiums, supporters said.

## Community Colleges

A Senate-passed bill that would remove the state com-

munity college system from control of the state Board of Education was approved by the House Higher Education Committee. The measure now goes to the full House.

The committee amended the bill by increasing the size of the new community college board from 17 to 19 members. It also ensures the board and system president would have complete authority over top-level personnel in the statewide

system. Odometer Rollback Legislation strengthening the state law prohibiting automobile owners from rolling back the odometers on their vehicles was enacted when the House voted to go along with Senate amendments to the bill.

Supporters say the new law will allow easier prosecution of persons who have sold cars and are suspected of having changed the mileage indicator.

Campus Cops A bill that would give arrest powers to college and university police forces was approved by the House and sent to the Senate. However, the House amended the bill to require that campus police be subject to the same training requirements as regular police officers.

The bill would not prohibit city police and other local law enforcement agencies from making arrests on campuses.



A DECORATOR'S TOUCH — A nesting bird couple in a tree on the grounds of "The Daily Reflector" evidently liked the bright yellow color of perforator tape used in the newspaper's operations. Or maybe it was simply handy at the time of construction. Whatever

the birds' reason for using the tape in their nest construction, the bright tape interwoven with more conventional dark twigs create an unusual, colorful contrast. (Reflector Photo by Jerry Raynor)

## Galifianakis Case Delayed

WASHINGTON (AP) — A federal judge Tuesday delayed until June 5 any further proceedings in the case against former U.S. Rep. Nick Galifianakis, D-N.C., who has been charged with perjury.

The delay, by U.S. District Judge Charles R. Richey, came after Galifianakis' lawyer said he was having trouble getting information from the House ethics committee.

Galifianakis was indicted last month on a charge that he lied to the House committee about an alleged \$10,000 contribution from Korean businessman Tongsun Park.

The former 4th District congressman, who is from Durham, pleaded innocent April 17.

Barry W. Levine, Galifianakis' lawyer, told Richey that he had asked the committee to give the defense copies of lie detector tests given Park, Park's diary and other documents on the Korean influence-buying scandal. However, he told Richey Tuesday that the panel had not given him the documents.

Richey said the court "will not look with favor" if the committee tries to withhold the documents.

Richey told Levine to "tell the clerk (of the House) that

the court expects his cooperation — and promptly."

Under the Speedy Trials Act, the government has 70 days to bring the case to trial from the time the defendant is arraigned. If the deadline is not met, the indictment could be dismissed.

Park and Barbara Fletcher, a former aide to the congressman, told the House ethics committee that Park gave Miss Fletcher \$10,000 in \$100 bills for Galifianakis' unsuccessful 1972 Senate campaign against Republican Jesse Helms.

Miss Fletcher and another aide, Margaret Suggs, told the grand jury that indicted Galifianakis that he knew of the donation.

If convicted of the perjury charge, Galifianakis could be sentenced to five years in prison and be fined \$2,000.

## BONANZA'S FAMOUS

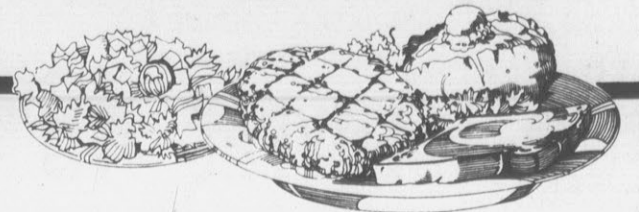

**LUNCHEON  
CHOPPED STEAK  
\$2.49**

Imagine, this delicious steak plus a steaming hot baked potato or french fries and a slice of grilled Texas toast. And salad you can pile a mile high as often as you like... fresh greens and vegetables from our famous "Discovery" Salad Bar. What a treat!

## BONANZA'S FAMOUS LUNCHEON CHOPPED STEAK

**\$2.49**

Coupon valid Monday through Friday, 11 a.m. to 4 p.m. at participating Bonanza Restaurants



From the World's Largest Family of Steak Restaurants

# The "Double Buck Back" Special



## Save \$2.00 on Real-Kill

Send us this Buck Back Refund Certificate along with proofs-of-purchase from two Real-Kill products, and get a buck back. If you also enclose the special Double Buck Back Refund Certificate from a Real-Kill display at a participating retailer, you'll get two bucks back.

And to make the deal even nicer, here's 10¢ off on your initial purchase of any REAL-KILL bug killer.

10¢ **REAL-KILL** 10¢

To the Dealer: For each coupon you accept as our authorized agent we will pay you face value plus 5¢ handling charges, provided you and your customer have complied with the terms of this offer. Any other application of this coupon constitutes fraud. Invoices showing purchase of sufficient stock to cover all coupons redeemed must be made available upon request. Your customer must pay any sales tax. Cash value 1/20th of one cent. Void where prohibited by law. Redeem by mail to: Real-Kill Corporation, P.O. Box No. 1689, Clinton, Iowa 52734. Offer good only in USA and expires December 31, 1979.

Coupon good on all Real-Kill Products

**STORE COUPON**

70116 100010

**Real-Kill Buck Back Refund Certificate**

To get your cash refund, check the appropriate box below, fill out this certificate and send it with required proofs-of-purchase to:  
Double Buck Back, P.O. Box NB052, El Paso, Texas 79977

\$1.00 REFUND should be sent to me. I am enclosing the proof-of-purchase stickers from any 2 Real-Kill products.

\$2.00 REFUND should be sent to me. I am enclosing the proof-of-purchase stickers from any 2 Real-Kill products along with the special Double Buck Back Store Certificate from a Real-Kill display.

Name \_\_\_\_\_  
Address \_\_\_\_\_  
City \_\_\_\_\_ State \_\_\_\_\_ Zip \_\_\_\_\_

Offer good only in U.S.A. Void where prohibited by law. This refund certificate may not be reproduced and must accompany your refund request. Only one refund per household, group or organization. Offer expires September 30, 1979.



The only thing nicer than our gentle white lining is our cold hard cash.

**15¢/2** 15¢ off two packages of Aurora or Soft Prints 2-Pack. **15¢/2**

**TO OUR CUSTOMER:** Please be sure to redeem this coupon only with the purchase of the brand and size offered. Any other use constitutes fraud. Misredeemed coupons can be and are rejected by the manufacturer and may cause embarrassment and financial loss to your dealer.

**TO OUR DEALER:** As a legitimate retail distributor of the brand and size(s) indicated, you are authorized as our agent to redeem this coupon. We will reimburse you for the face value of this coupon, or, if coupon calls for free merchandise, we will reimburse you for such free goods, plus 5¢ for handling, provided that you and the consumer have complied with the terms of our coupon offer. Any failure to enforce these terms shall not be deemed a waiver of any of the conditions.

**TERMS OF COUPON OFFER:** This coupon must be redeemed by a consumer at the time of purchase of the brand size(s) indicated with the face value of the coupon being deducted from the dealer's retail selling price. Meet condition and gang-cut coupons (coupons not circulated to and redeemed by the consumer) will not be redeemed. This coupon is non-assignable, void if presented by outside agents, and may not be reproduced. Customer must pay any sales tax involved. Invoices proving purchase of sufficient stock to cover coupons presented must be shown upon request and failure to do so may, at our option, void all coupons. Coupon void if taxed, prohibited, or legally restricted. Cash value 1/20¢. Good only in the U.S.A., its territories, and Puerto Rico. For redemption of properly received and handled coupons mail to: AMERICAN CAN COMPANY, P.O. BOX 1115, CLINTON, IOWA 52734.

Expiration Date: March 31, 1980

**SOFT PRINTS** **AURORA**

Softness. Aurora lays it on thick.

**STORE COUPON**

# Area Graduates From East Carolina Univ. Listed

The 1979 graduation class at East Carolina included some 2,565 undergraduate and graduate students who were conferred degrees during the commencement exercises May 11. Local area graduates include:

GREENE — Valerie Joan Wood, BA; Jacqueline Denise Suggs, BS; Walter McNeil Hooker, BS; Cynthia Joyce Harrell, BS; Donna Rose Pettaway, BS; Jeffrey Lynn Priddy, BS; Jerry Alan Carraway, BSBA; Lynette Harvey Ginn, BS; Mary Jo Creech, BS; Rachel Elaine Butts, BA; Magna Cum Laude; Sherri Darlene Howell, BS; Gretchen Leah Holloman, BS; Margaret Diane Diddy, BS; Donald Carey Allen, BSBA; Anna Lanette Harper Liles, BSBA; Melody Lois Harrison, BFA; Deborah Lynn West Gay, BSBA; and Marion Edwards, BSBE; Martha Ann Bowen Moye, MAE; Bettie Marie Scott Lane, BSBA; Claudia Kathleen Hardison Stalls, MAE; Malcolm Stuart Smith, BA; Peggy Ann Cobb Warren, MAE; Sara Lillian Suggs Giles, MAE; Dan Harvey Artis, BSBA; Harper Lee Shackelford Jr., BS; Timothy Marshall Corbett, MAE.

MARTIN — Milton Douglas Council, MAE; Carla Jo Manning, BS; Cum Laude; Katrina Lynn Telfertton, BS; Donna Marie Roebuck, BSBA; Emma Jean Vanderford, BSN; Lorey Hiram White, Jr., MS; Lula Mae Harper Council, M.S.; Patsy A. Roberson, m MAE; Reuben Forest Boone, BSBA, Magna Cum Laude; William Thomas Brown, Jr., MSRC; Angela Yvonne Bowen, BS, Magna Cum Laude; Carol Lynn Tice, BSBA; Cathy Lynn Taylor, BS; Charley Ann Peele Hopkins, MM; Ernest Andrew Brooks, MAE; Henry Alonzo Peel, BS; Jack Barnes Ritter, BSBA; Linda Kay Roberson, MSS; Mavis Lynn Revels, BS; Sherry Rose Roberson, BS; Susan Carol Hight, BSBA; Ann Savage, BS; William Phillip Hodges, BS; Clifton Scott Harrell, BA; Jennifer Kay Hyman, BA; Joseph Robert Ayers, BSBA; Nancy Faye White, BS; Teresa Jane Williamson Donovan, BS; Betty L. Harris Roberts, BS; Joyce Anne Cowan Ward, BS; Cum Laude; Nancy Sue Moore Williams, BS; Paula Ruth Godard, BSBA; Randy Stephen Stall, BA; Richard Leonard Gay, BS; Sharon Jeanne Coltrain, MAE; Sylvia Green Newell Ingram, MAE; Frank Wallace Neal, MAE; Phyllis Sue Modlin Price, MAE; Nancy Earle Tyson, BS; Emma Lou Vanderford, Crawford, MAE; Larry Gene Eileen Stokes, BS; James Carroll Smith, BS; Nettie Alma Tyson, BSN, Cum Laude; William Lawrence May, BA; Lois Ann Crawford, BSBA; Belinda Ann Minn-Bryant, MM; John Michael Edmondson, MAE; John Randall Bryant, MM; Lynette Haislip Bowers, MAE; Herbert Pennell Norf, Jr., MA; Kathy Colene Suggs, BA; Magna Cum Laude; Melonie Ann Bobbitt Messer, MAE.

Shelton P. Chesson, BFA; Sheri Lynn Vonschritz, BSBA; Sheryl Rose Eason, BS, Magna Cum Laude.

Wanda Lynn Little, BS; Albert Bradshaw Walls, MS; Alexander Carl Fiore, BS; Allan Franklin Brooks, MA; Allison Turnage Peaden, BS; Ann Bentley Halgwood, BSBA; Barbara J. Jamieson Mallory, MAE; Benjamin Hampton Jenkins, MFA; Benny Lee Ferguson, MM; Betty Jo Nowell Ryan, BFA; Magna Cum Laude; Betty Kay Carroll Crisp, MAE; Bobbie Credie Austin, MAE; Bonnie Ray Harrell, BS.

Bradley Wayne Miller, BSBA; Brenda Dalton Wood, BSBA; Bruce Hebra King, Jr., BS; Carol Ann Smith, BS, Cum Laude; Catherine Carol Daughrey, BS; Catherine Jane Maley Mills, BSN, Cum Laude; Catherine E. Downing Adams; Charles Merriman King, Jr., MBA; Charles Michael Waters, BSBA; Christopher Wells Hargett, BA; Cynthia Ann Pettus, BS; Cynthia Dawn Boyd Leazer, BS; Cynthia Jane Anderson, BS; Magna Cum Laude; Daisy Durene Short, MSHE; Danny Arthur Harrington, BSBA, Magna Cum Laude.

David Elliot Mattheis, BS; David Glenn Hahn, BS; David Howard Blackwood, BS; David John Barbe, BS; David Lafayette Perry, BFA; David Michael Quinn, BS; David Neal Mitchell, BA; Deborah Ann Gunn Bunn, BSBA; Magna Cum Laude; Deborah Paulette Joyner, BA; Donald Louis Sargent, MA; Donald Winston Minges, BSBA.

Edwin John Thorne, MS; Elbert Gale Thornton, BSN; Eleanor Catherine Barrett, BS; Elisabeth Hulsey Spruell Beverly, BSBA; Eleanor Elizabeth Louise Davis Smart, BM; Ella Kathleen Edmondson Crisp, BS; Ernest Franklin Sline, Jr., BS; Magna Cum Laude; Frank James Hooper, MBA; Gail Lynn Porter, BSBA; George Anthony King, BM; George Sherrick, Jr., BA; Gerald Thomas Wichard, BS.

Gregory James Mazur, BS; Harry Lee Moore, BSPT; Harvey Deskins Bradshaw, Jr., BS; Haven Elizabeth Morrison, BS; Helen Marie Waldrop, BS; Jack A. Lucido, ED; Jackie Lynn Roberson, BS; Jacqueline Jaye Stancill Brown, MS; James Aaron Kleiner, Jr., BS; James Darvin Asbell, BA; James Kevin Dill, BS; James R. Baker, Jr., BS; Jane Grey Lawrence, BFA; Janet Gaye Herron Horton, BSN; Janet Lynn Dunn, BS; John Fisher Jones, BA; John Martin, BA; John Richard Laupus, MA; Julian Robert Vainright, Jr., BS; Magna Cum Laude; Julie Ann Miller, BSBA; Julie Ann Sharpe Martin, BSBA; Karen Jean Krenn, BSBA; Mills, BS; Karen Louise Brewer Bream, BA; Karen Sue Silverman Warren, MSHE; Katherine Marie Shill, BS; Kenneth Strayhorn, BS; Kim Lee Paez, BS; Linda Marie Laura Kathleen Brann, BSBA; Laura Virginia Boone, BSN; Leon Welton Deshields, Jr., BS; Leslie Gail Parsons, BS; Linda Joann Brown Gambill, BS; Magna Cum Laude; Linda Lee Paez, BSBA; Linda Ree Braddy, BSMT; Linda Sue Blackwell, BS; Lynn Ellen Caverly, BSBA; Madhavan Balachandran, MBA; Manuel Michael Chaknis, MA; Marcia Sue Fiering, BSBA; Marianne Linn Dill, BS; Mark Patrick Macari, BSBA; Mark Steven McCoy, BS; Cum Laude; Mark Steven Stroud, BS; Marvin Thomas Adams, MAE; Mary Charles Stevens, BFA; Mary Edwina Harris, BSBA.

Mary Elizabeth Cherry, BS; Michah David Ball, BSBA; E Michael Heaton Carter, BSBA; Mildred Helen Meredith, MAE; Myrna Lee Dove Smalls, BS; Nancy Fleming Edwards, BS; Nicholas Van Slyck Mumford, III, MBA; Noria M. Smiley Jennings, BS; Ola Jean Stroud Stroud, BS; Olivia June McMahan Wyrick, BSBA; Pamela Marie Robinson, BS; Paul David Prewitt, BS; Paul Ernest Pajak, BSBA; Paul Gerard Comas, MS.

Paul Ronald Scervc, MAE; Paula Frances Alsop, MS; Phillip Woodford Telfertton, BSBA; Phyllis Sue Alderman, BS; Priscilla Wynne Matthews; Prvette, MAE; Ralph Lee Scott, MA; Ralph T. Barnes, III, MBA; Regina Ann Kear, MA; Rex Alan McKinney, BSBA; Richard Marvin Baker, III, BSBA; Richard Thomas Clark, BA; Robbie Estelle Riddle, MBA; Robert Russell Lee, BSBA; Robert Speight Melton, Jr., BSBA, Magna Cum Laude.

Robert Wayne Smith, BA; Roberta Anne Fountain, BA; Robin Smith, BSN; Ronny Gene Brown, BS; Rose Ann Smith, BS; Samuel Allen Mills, BSBA; Sandra Faye Hoggard Curry, BSN; Sarah Elizabeth Dixon, MS; Sherree Marie Meigs Vann, BSN; Magna Cum Laude; Sheri Lynn Buck, BSBA; Stephen Richard Ward, MSSL; Steven Edward Reed, MS.

Susan Linda Corda, BS, Cum Laude; Teresa Elaine Leggett, MM; Thomas Stephen Elmo, MBA; Harold Crump, BS; Tommy Joe Payne, BSBA; Vicky Lynn Adams Allen, BSN; Vivian Sue Dillingham Weaver, BS; Wanda Cox, BSBA; Wesley Garrett Alford, BSBA; Wilda White Rhodes, BS; William Arthur Bream, BFA; William Charles Clodfelder, MSRC; William Emory Mills, BSBA; William Griffin Garner, BSBA; Summa Cum Laude; William Kurt Salomon, MBA; William Lyle Barlow, Summa Cum BSBA; Summa Cum Laude; Willie Malva Williams, BS; Wanda Sue Smith, BSBA; Karen Jane Howes, BS; Kathryn Marie Lamm, BSN; Kay Lynn Teeter Cox, BS; Billy Ray Dawson, BS; Robert Francis Matthews, BA; Clara Margaret Burns Worthington, BS; John Milton Worthington, MAE; Amanda Gail Caldwell Austin, BSN, Cum Laude; Cheryl Lannette Riggs, BS; Diane Harper Liles, BS; Joanna Lynn Chitty Webb, BSN; Parks Edward Britt, BSBA.

Rusty Levon Lewis, BS; Steven Oakley Fuller, BSBA; Donna Leutgen Martin, MA; Thomas Jennings Henderson, MA; David Robert Henford, BSBA; Nanelle Edmondson Congleton, MAE; Noel Thomas Manning, BS; Joseph Mark Hensgen, BSBA; Linda E. McLahorn, MAE; Mary Gwendolyn Wilson, BSN; Adrienne Illione Wood Koehler, BS; Cum Laude; J. Javeri, MBA; Alan Wayne Ferguson, BSBA; Ara Edison Midgett, BFA; Augustine Okechukwu Chine, BSBA; Barbara Ann Lewis, BS, Magna Cum Laude; Barbara Ann Plummer, MM; Barbara Dempsey Bumgarner, BSBA; Belinda Ellen Temple Lee, MSN; Betsy Deborah Boswell, MAE; Betty Sue Godwin Gay, MSN; Brenda Lou Rogers Speight, BSBA; Carol Meissa Glover, BS; Earl Winston Page, BS; Edna Jan Kleinert, BFA; Edward Dunn Chadwick, BS; Edward Earl Holland, Jr., BS; Edward Sheldon Slagle, MS.

Elizabeth C. Javeri, MAE; Susan Jane Arnaud Turcotte, MAE; Swati Akshay Javeri, MBA; Sylvia Jane Thigpen Brown, MSN; Taylor Greg Potter, BSBE; Teresa Ann Stokes, BSN; Teresa Lewis, BS; Thomas Edward Johns, BS; Thomas Elbridge Hodgins, BS; Willard E. Bryant Jr., MAE; William Atwood Gurganus Jr., BSBA; Cynthia Ann Herzog Brown, BA; Joan Carol Rogerson Vanderford, MAE; Joel Keith Harrison, BA, Magna Cum Laude; Bruce Elliot Gray, MAE; Catherine Lynn Barnes Skinner, BS; Cum Laude; George Robert Franke, MAE; Margaret Laude, Michael Floyd Gooding, BSBA; Nancy Lou Buck, MAE; Pamela Marie McLawhorn, BS.

Vanlora Finch Teel, BS; Barbara Harde Kinsie; Gorrod, MAE; Christina Surrency Drye, MAE; Donna Wilene Stancill Lofin, BS, Magna Cum Laude; Martha Victoria Westbrook, BS; Wanda Dale Adams Hudson, BS; William Lawrence May, BSBA; Leslie Camille Dickens, BA; High White Thompson, BA; Jackie Paulette Carpenter Wooten, MAE; Lynette Haislip Bowers, MAE; Rita Lewis Andrews, BSBE; Ann Clough Basnight, MSHE; Mary Kathryn Owens, MAE; Roger Lee Mooring, MAE; Adrienne Illione Wood Koehler, BS; Alan Leroy Mobley, CAE; Albert Bradshaw Walls, MS; Alan Ernest Price Jr., BSBA; Alvin Wright Barrett, Jr., BSBA.

Amy Camardo Andersen, MAE; Amy Malene Leggett, BFA; Andy Chukwuma Adiele Jr., BS; Anne Marie Schiesel, BFA; Anthony Myles Carreffe, BSBA; Arlene D. Menning Patterson, MAE; Barbara Ellen Peoples, BA; Barbara Jean Mills Small, MLS; Betsy Deborah Boswell, MAE; Betty Jo Nowell Ryan, BFA; Brenda Louise Harper Cherry, MAE; Bruce Cleaveland Abbott, BSBA; Bruce Edward Field, MA; Butler Wendell Lewis, BA; Carlyle Lorain Lupton Jr., BSBA; Carolyn Jean Allen Garis, MAE; Carolyn Jane Seelers Herring, BS; Caryll Mae Archibald Graham, MS; Gaswell Michael Edmondson, MAE.

Christine Mary Geisser, BA; Clifton M. Carey, MS; Cynthia Ann Hart, MAE; Cynthia Marie Elizabeth Buehler, BSBA; Arlene D. Menning, CAS; David Clifton Briley Jr., MAE; David Cranford Plyler, MSRC; David Creswell Gupton, MBA; David McLawhorn, MAE; Debra Batton Epps, BA; Don J. Marcus, MA; Donald Fitch Quinn, BS; Donald Woodard Dixon Jr., MS; Dudley Carroll Vann, MAE; Edward Joseph Morris, MBA; Edward Sheldon Slagle, MS; Elizabeth Ann Buchanan, MS; Elizabeth Lou Yates Price, BS.

Elizabeth Shannon Stoney, BA; Elizabeth Sue Bartlett, BS; Emily Louise Bredin Egerton, BS; Erhard Paul Shiffel III, MAE; Gail Marie Davis Stancil, BM; Gail Marie Stancil, MAE; George Anthony Whitehurst, BSBA; George Michael McCormick, MS; Gino Michael Abbessino, MAE; Glenda Rose Hardee Carawan, MAE; Gobind Sharan Singh, BSBA, Magna Cum Laude; Gregory Robert Moll, BFA; Harold Thelbert Leary, BSP; Hassie Wilder Solomon, BSBA; Jack A. Lucido, MAE; Jack Donald Childress Jr., BS; James David Christman, BA; James Edwin Holmes, MBA; James Jay Jester, BA.

James Marvin Harris, MBA; James Michael McCluskey, MA; James Wayne Brown, MAE; Jane Phyllis Walker Conner, MSHE; Jeff Gregory Rollins, BA; Jena Leigh Gurganus Kerns, MAE; Jennifer McLoughlin Lang, BSN; John Eldridge Williams Jr., BS; John Michael Brady, BFA; John Richard

Laupus, MA; John Walter Maye, Jr., MAE; Jonathan Gray Blount, BS; Joseph Carmen Testa, MAE; Joseph Eugene Hatch, BS; Joyce Lynn McFarland Buck, BSBA; Julia Anne Hughes, MAE; Katharine J. Blackburn, BSBA; Katharine Crowell Talbert, MAE; Katherine T. Wright Pratt, BSN.

Kathleen Jean Luze, BS; Kathryn Elaine Denny, MSRC; Kathryn Elaine Johnston, BS; Kay Hasbrook Allen, BS; Kimberley Jo Miller, BS; Kirby Elwood Patterson, MAE; Kyle Jeffrey Toothman, BS; Laroly Seegers, MA; Larry Edward Paul, BS; Laurie Ann Spencer Bruton Young, BA; Leslie Camille Dickens, BS; Lucy Mary Powell, BA; Lynne Mather Petterson, MA; M. Kaye Priddy Crook, MA; Manuel Michael Chaknis, MA; Margaret Frances Walker Stalon, MAE; Mark Edward

Fackrell, BA; Mark Warren Ayers, MS; Marshall Craig Simpson, BS; Martha Jean Guzman, MAE; Mary Susan Ward Mills, BS; Mary Helen Willhite Bradshaw, MA; Michael Lee Roberson, BS; Michael Ray Stancill, BSBA; Mitchell Erwin White III, MS; Mural Lee Warren Lanier, MAE; Myron Franklin Civils, MS; Norman H. Tadlock Jr., BSBA; Pamela Rose Sasser Floyd, BSBA, Magna Cum Laude; Parvin Jafari, MA; Patricia Joan Williams Kinney, BA; Patrick Lee Smith, MAE; Paul David Osman, BSBA, Magna Cum Laude; Paul Gerard Conar, MS; Ralph Lee Scott, MA; Randall Lathan Forrest, BSBA; Rebecca Ellen Rice Hughes, BS; Regina Ann Kear, MA.

Richard Barclay Ransom, BSN; Richard Glenn Hudson, MSRC; Roger David Crook, MLS; Ronald David Miller, BS; Ronald Lee Hinant, MAE; Roosevelt Roberson, MAE; Rosalind G. Gallops Thompson, MFA; Roseanna Irwin McDougald, MAE; Sally Lindsay Salmon Howard, MSRC; Samuel Harvey Williams Jr., MAE; Sara Christine Wilkerson, MAE; Sarah Anne Bailey Lessiter, MLS; Sara Elizabeth Dixon, MS; Scarlet Glenn Murphy Farmer, BS; Sharon Farrior Ashley, BS; Sharon Virginia Flanagan, MAE; Stanford Rudolph Hill, MAE; Stephen B. Benton, MS; Stephen Richard Ward, MSSL.

Stephen Warren Aldridge, BSBA; Steven Edward Reed, MS; Sui Ki Li, BFA; Susan Holden Dixon, MAE; Theresa Elaine Dewar Carson, MAE; Thomas Barrett Klingman, MA; Thomas B. Speight, Jr., MS; Thomas Elbridge Hodgins, BS; Tom K. Marsh, MAE; Tommy Harold Crump, BS; Valerie McKinney Cox, BS; Victoria Judith Vulte, MAE; Walter Anthony Murray, BSBA; Walter Cleo Blount, MAE; Wanda Dawn Hardister Cherry, BS; Wanda Lee Stancill, BS; Wilbur John Lynch, MAE; Willard E. Bryant Jr., MAE; William Blount Butler, BS; William Kent Worthington, MAE; Yasmin Hussain, MA; Charles Ray Craft, BSBA; Cheryl Sue Barnes, BS; Amanda Rae Grimes Nobles, MAE; David C. Harrison, BS; Katherine Yvonne Haddock, BS; Robert Johnson Dunn, BS.

OUT OF COUNTRY — Elisabeth Juliana Hofvath, BSN; Patrick James Seymour, MAE; Nassau Bahamas; Nooraini Binli Mohamed Ismail, MA, Singapore; Young-Kai Park, MS, Sung, Korea; Zulaiha Mohamed Ismail, MAE, Malaysia; Marcelle Mathieu, MA, Ste-Julie PQ.

Volunteers Donate Time And Materials For A New Home

## Volunteers Donate Time And Materials For A New Home

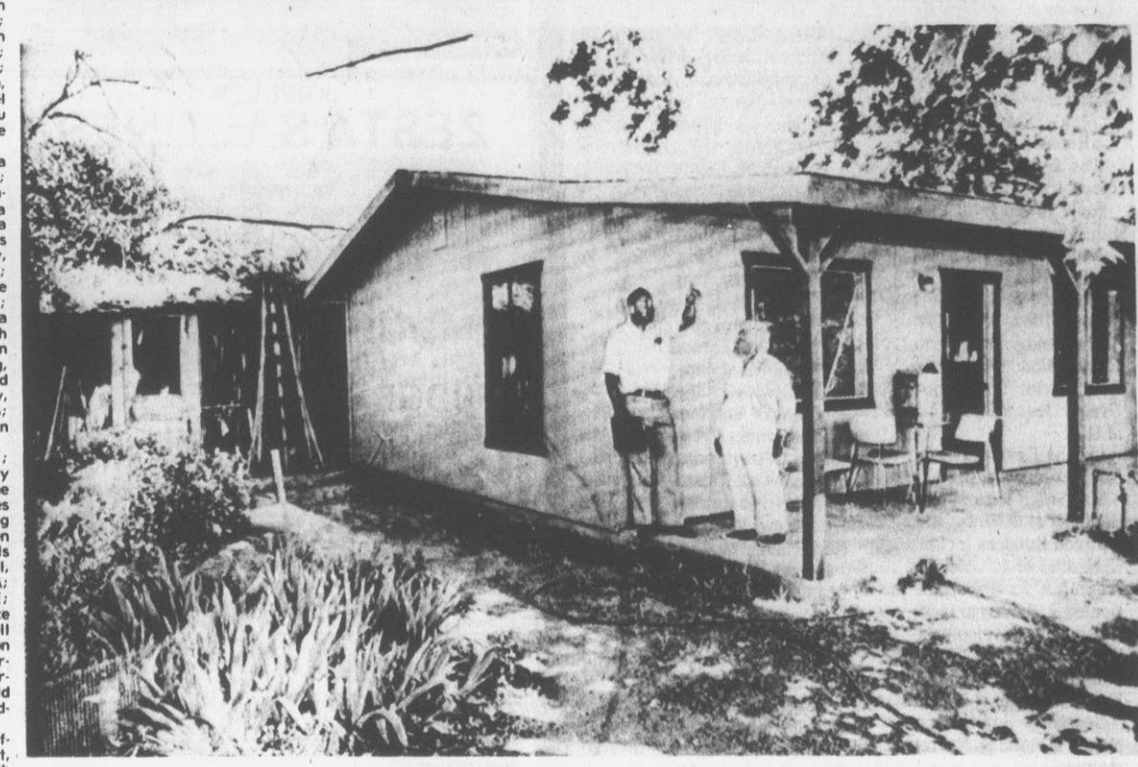

BUILT BY VOLUNTEERS — Emma Traylor, 75, stands on the porch of her new home built with volunteer help and donated materials to replace her

leaking cottage, at left rear, that had been her residence. With Mrs. Traylor is Darrel Dietrich who organized the project. (AP Laserphoto)

CLOVIS, Calif. (AP) — When Darrel Dietrich saw the elderly woman's crumbling home, he was shocked. So he started a drive to get it repaired. Before the utility company official was done, 145 people had donated their time and materials to build 75-year-old Emma Traylor a new home valued at \$25,000. "I didn't know what to say," Mrs. Traylor recalled Monday. "I didn't believe it."

But this past weekend Mrs. Traylor moved from her 240-square-foot cottage with its leaky roof into the new 600-square foot cottage complete with indoor bathroom. "It's beyond words," said Mrs. Traylor as she surveyed

her new home. Dietrich, Pacific Gas & Electric Co. manager in this central California city, said he happened on Mrs. Traylor's home while checking a broken utility pole. He found shingles on the roof crumbling and aluminum foil tacked to the ceiling to keep out the rain. The one-room home was heated by a propane oven; the bathroom was outside — a converted chicken coop. Dietrich said he first got \$100 in donations from fellow Rotary Club members to fix Mrs. Traylor's electrical service, but an electrician in the group volunteered to do the work for free. Then, Dietrich suggested the Rotarians pay to have a new roof and siding built on the old house. He found that was impractical because the structure was riddled with termites and dry rot. So, he suggested building a new house and began organizing volunteers. Members of the local carpenter's union local built the structure on weekends. Sheet metal workers donated a natural gas wall heater. The move also was handled by volunteers with Mrs. Traylor doing only the supervising because of her age and high blood pressure. Next weekend, the volunteers will tear down Mrs. Traylor's old cottage. In the meantime, she wants to get used to her new surroundings. "I just want to get settled, that's the main thing," she said. "I don't remember the last time I moved, but this time's the last, that's for sure."

## Nat'l Recognition For 3 Of Faculty

ECU News Bureau  
Three members of the East Carolina University School of Music faculty have recently been awarded national recognition.

### No Choice But Learn To Cope

HARTSVILLE, S.C. (AP) — Elias Joe, Jr., who lost both his arms in a textile industry accident in 1967 says, "You have no choice. You have a handicap and you have to learn how to deal with it." Joe, 36, dealt with it by finding an occupation "that you could do without hands." After years of rehabilitation and study, he became South Carolina's first black licensed auctioneer.

He attended the Missouri Auction School in Kansas City. He was the first black graduate.

nial term as governor of Phi Mu Alpha Sinfonia fraternity's Province 20. He will be one of 38 provincial governors who act as liaisons between campus chapters and regional and national Phi Mu Alpha directors.

Dr. Rodney Schmidt, a violinist, has been chosen to perform in Zurich, Switzerland from June 25-July 7 in a select master class directed by famed violinist Nathan Milstein.

The class will be held at the Muraltegut in Zurich, meeting daily for a four-hour session in which each participant will perform concertos and sonatas for Milstein's criticism and comments.

Herbert Carter, chairman of the school's instrumental department, was awarded a citation of excellence from the National Band Association. The honor is given to persons who have "set an example of excellence in musicianship, leadership and dedication to bands and band music."

## Captain's Table

THUR., FRI., SAT. SPECIAL TROUT OR LOUNDER \$2.99 PER PERSON ALL YOU CAN EAT (NOT FILLET)

COUPLES SPECIAL 12 OZ. RIB EYE STEAK \$7.95 COUPLE Includes Extra Place Setting For Your Mate (Split Steak) Salad Bar, Baked Potato And Tea For Two. (SUNDAY NIGHT ONLY 5 P.M. 'TIL CLOSING)

29 Item Salad Bar 746-2601 TRY OUT TAKE OUT SERVICE

Restaurant Seafood-Steaks 1113 Third St. Ayden (AT HARRIS SHOPPING CENTER) NEW HOURS SUN.-THURS. 11-9 FRI.-SAT. 11-10

## pace academy

Pace Academy is an Independent Day School for boys and girls of average and above average ability that have no learning disabilities.

The Academy provides a traditional learning environment with structured classes and stress on phonetics, English grammar, writing, and a step-by-step development of mathematical and reading skills. Emphasis is placed on social studies and science by special teachers.

An excellent physical education program has been developed for the children featuring gymnastics, folk dancing, basketball, softball, and many other activities to help with physical and social development of Academy children.

Conversational French is an added advantage in grades K-5. In grades 6 and 7, French culture is emphasized with a visual, oral, and written approach to the language and people. This in depth study of French culture prepares the student for French I in the eighth grade.

High standards of conduct and maximum effort on the part of students are essential at Pace Academy.

Extra curricular activities include: an optional trip to Europe, boy's basketball, girl's basketball, student government, and cheerleading.

All teachers hold North Carolina "A" certificates or Masters degrees in education. Each is carefully selected for their position at the Academy.

Emphasis is placed on small classes with not more than 25 students per class. All children must pass an entrance test before entering Pace Academy.

The Academy is now accepting applications in grades 1-8. We invite you to come out and visit our Academy if you are concerned about your child's education.

Notice of Nondiscriminatory Policy As to Students

Pace Academy admits students of any race, color, national or ethnic origin to all the rights, privileges, programs, and activities generally accorded or made available to students at the school. It does not discriminate on the basis of race, color, national and ethnic origin in administration of its educational policies, admissions policies, scholarship and loan programs, and athletic and other school administered programs.

pace academy P. O. Box 1766 Greenville, N. C. or Telephone 756-2244

Is Your Daily Reflector Delivery Okay?  
We take particular pride in the efficiency of our carriers who deliver The Daily Reflector to your home.  
If the daily delivery of your Daily Reflector is less than satisfactory, please tell us about it. Call our Circulation Department and we will do our best to work out the problem.  
752-3952  
Between 8:30 A.M. and 6:30 P.M. Weekdays and 8 'til 9 A.M. On Sundays

pace academy P. O. Box 1766 Greenville, N. C. or Telephone 756-2244

# Deeds

F.L. Blount III al to Ethel L. Jenkins 3.50  
 Crudie Odie Bradley al to James F. Robinson al 46.00  
 Leroy Carraway to James A. Carraway no stamps  
 LaRue McLawhorn Castelloe to Thomas E. Castelloe al no stamps  
 Bill Clark Const. Co. Inc. to William H. Collins Jr. al 61.00  
 Bill Clark Const. Co. Inc. to Nelda H. Holland 33.00  
 Margaret Brown Fleming to Charles A. Overton al 18.00  
 Harrington Manufacturing Co. Inc. to Gregory A. Watkins al 53.00  
 Edna Braxton Lane to City of Greenville 13.00  
 Tommie L. Little & Associates Inc. to John Michael Nuckolls al 6.00  
 Lyndale Development Co. of Greenville to Bill O'Neal Associates Inc. 12.00  
 John M. Nuckolls al to Gary A. Galloway al 37.50  
 Larry G. Oakley al to Farley D. Ebron no stamps  
 Farley D. Ebron al to Farley D. Ebron no stamps  
 James Henry Ebron al to Bennie Roundtree no stamps  
 The Evans Co. of Greenville Inc. to Irene B. Donson 3.00  
 Lelia S. Higgs al to Anne B. Buchanan no stamps  
 Lelia S. Higgs to Elizabeth H. Buchanan no stamps  
 Clarence F. Little to Rubelle Dixon Little al no stamps  
 The Landgrant Corp. to James Rayvon Haddock 4.00  
 Lyndale Develop. Co. of Greenville to William W. Gaston al 11.00  
 Charles Ervin Smith to Walter Ray Davenport al 12.50  
 May Smith Taylor al to Fred J. Faulkner al 19.50  
 Tipton Builders Inc. to Peggy E. Heath 5.00  
 Cynthia P. Wilkinson al to Ronald R. Bunzey al 16.50  
 Lyndale Development Co. to W.W. Grainger Inc. 132.00  
 Milton Altschuler to Charles Edward Cobb al 11.50  
 George W. Stokes, Excr. al to Nancy Holland S. Everett al no stamps  
 George W. Stokes, Excr. al to William F. Stokes al no stamps  
 George W. Stokes, Excr. to Emma Pearl S. Brewer al no stamps  
 George W. Stokes, Excr. to Sylvia S. Bailke al no stamps  
 George W. Stokes, Excr. to Jenning B. Stokes, Jr. al no stamps  
 George W. Stokes, Excr. to Mabel Louise S. King al no stamps  
 George W. Stokes, Excr. to Alma Clark S. Mills al no stamps  
 George W. Stokes Excr. al to Esther Earl Tyson al no stamps  
 George W. Stokes, Excr. al to Elbert R. Stokes al no stamps  
 George W. Stokes, Excr. al to George Washington Stokes al no stamps  
 Charles G. Autry to Cathy M. Autry no stamps  
 Joe W. Brunson al to Frankie S. Hardee al 35.50  
 Elizabeth H. Buchanan to Lelia S. Higgs no stamps  
 Bill Clark Construction Co. Inc. to Charles S. McGaw al 67.00  
 Bill Clark Construction Co. Inc. to Charles K. McKenzie al 32.00  
 Bill Clark Construction Co. Inc. to Marjorie K. Malvaso 32.00  
 Willie Hathaway al to James C. Anderson al 38.50  
 Betty Tyson Ligon to Ben Devon Quinn 12.50  
 Lyndale Development Co. to Bowser Construction Co. 12.00  
 Lyndale Development Co. to Rice Construction Co. Inc. 47.00  
 Thomas Earl Marshburn al to William Sloan Farrior al 20.50  
 Linwood P. Moore al to Kizer D. Morgan Jr. al 10.50  
 Louise H. Moye al to James E. Durham al 4.00  
 Willie B. Petteway al to James T. Willoughby al no stamps  
 Laurena Pitt to Milton G. Foreman al no stamps  
 Rice Construction Co. Inc. to James A. Nickelsen al 120.00  
 George W. Stokes, Excr. al to James Hardee Stokes al no stamps  
 Leslie T. Dixon al to James Henry Corey al 13.00  
 Leslie T. Dixon al to Wayne E. Elks al 15.00  
 Elsie M. Haddock to Gayle Cannon Dennis 2.50  
 Marie M. Jackson to Stephanie L. Jackson no stamps  
 Marie M. Jackson to Troy Rhyan Jackson Jr. no stamps  
 Lyndale Development Co. to Ernest Harvey Holt II al 18.50  
 Lyndale Development Co. to Tommie L. Little & Assoc. Inc. 85.00  
 Lyndale Development Co. to Tommie L. Little & Assoc. Inc. 37.50  
 Lyndale Development Co. to Tommie L. Little & Assoc. Inc. 53.00  
 Turnage Farms Inc. to Kings Cross Roads FWB Church no stamps  
 Murie C. Berry al to Lloyd James Chapman no stamps  
 Lloyd James Chapman to Murie C. Berry al no stamps  
 John P. Davanzo al to David E. Archibald al 25.00  
 Robert G. Deyton Jr. al to William D. Whitley al 6.00  
 Barbara R. Campbell al to Marion Lee Barnes no stamps  
 Leroy T. Cherry to James E. Merritt 11.00  
 William H. Clark al to Prever Eugene Rose 6.00  
 Charles S. Davenport al to Davenport Brothers no stamps  
 Addie Maynie B. Dixon al to Eunice Dixon no stamps  
 F.L. Garner to Haywood McKay Phthisic al 77.50  
 H. & H Development Corp. to Levi Gary McGowan 39.00  
 JF Co. to John F. Moye Jr. no stamps  
 William D. Rogers Const. Co. Inc. to John L. Causey Sr. no stamps  
 Randolph Enterprises of Pitt Co. Inc. to Howard Eugene Lee III 61.50  
 Singletree Inc. to The Evans Co. of G'ville Inc. no stamps  
 Alfred Howel Watson al to William H. Waters Jr. 39.00  
 Matthew Dixon to Addie M. B. Dixon no stamps  
 Candlewick Estates Inc. to Dees Whitley al no stamps  
 Candlewick Estates Inc. to C. Harold Creech al no stamps  
 Candlewick Estates Inc. to Margaret M. Spain no stamps  
 Candlewick Estates Inc. to Earl Spain no stamps  
 Candlewick Estates Inc. to Robert Williams no stamps  
 Candlewick Estates Inc. to Ed N. Warren no stamps  
 Candlewick Estates Inc. to J. Ed Clement no stamps  
 Candlewick Estates Inc. to Robert G. Deyton Jr. no stamps  
 Candlewick Estates Inc. to Ed N. Warren no stamps  
 Candlewick Estates Inc. to Earl Spain al no stamps  
 Dorsey E. Baker al to Douglas R. Baker 47.00  
 Bernice C. Branch al to Silk Screens Unlimited Inc. 5.00  
 John Louis Braxton Jr. al to Bonnie Ray Bunting al 5.00  
 Amy Edwards al to H & H Development Corp. 262.00  
 Patricia T. Lawrence to Arlie E. Lawrence no stamps  
 Lyndale Development Co. to F.L. Garner 11.00  
 Arthur Gray Mayo al to Margaret Holmes Baker 4.50  
 Richard H. Morin al to Robert Allen McMillen 47.50  
 Herbert B. Randolph al to Danny L. Williams al 4.50  
 Herbert B. Randolph al to Ernest B. Dunn al 4.50  
 Paul S. Randolph to Randolph Enterprises of Pitt Co. no stamps  
 Powell T. Speight al to Philip Lester Brackins al no stamps  
 Faye B. Bowen to J. C. Bowen al no stamps  
 Denny N. Branch to Jacquelyn B. Goodson al no stamps  
 Bill Clark Construction Co. Inc. to Janie G. Harris 5.50  
 Bill Clark Construction Co. to Charles H. Winstead al 33.50

# Truck Runs On Propane

FAYETTEVILLE, N.C. (AP) — While soaring gasoline costs have forced many motorists to curb fuel consumption, a Fayetteville man drives his truck on a cheaper gas substitute.  
 When Jim McElroy wheels up to the pumps, it's to a propane pump.  
 "If you're paying 75 to 85 cents a gallon for gasoline and you can convert your car and pay 57 cents a gallon for propane, the savings in fuel alone, in time, will pay for the equipment needed to convert the engine," he says.  
 McElroy, a Fayetteville propane distributor, says that in addition to the low cost of the fuel, extra benefits include fewer tune-ups and oil changes and longer engine life. He said the \$1,000 cost of a conversion kit will, in time, be outweighed by fuel cost savings.  
 McElroy said his truck is proof of the success of the conversion kit. He said it registers 131,000 miles on propane fuel and still starts with just a flick of the key.  
 Gas dealers say mileage for propane-operated cars is lower for city driving compared to gasoline, while highway mileage is much better.  
 McElroy said the \$1,000 kit can be removed and attached to another vehicle when it's time to trade the car.  
 The kit includes the fuel tank, priced about \$400, hoses and the carburation system.  
 McElroy said that until two months ago he got few, if any, calls about converting cars to propane. But, since the price of gasoline has been soaring he's getting between one and five calls a day.  
 Already, he has 15 propane conversion kits on order, and they won't be delivered until September.

# HARRIS

## SUPER MARKETS, INC.

Where Shopping Is A Pleasure

PRICES GOOD THURS., FRI., SAT.  
 Greenville-Ayden-Bethel -Tarboro

# CHECK T FANTAS FOOD SPE

SMITHFIELD

## HOT DOGS SLAB BACON

12 OZ. PKG. **99¢** LB. **79¢**

SMITHFIELD

## FULLY COOKED DUCHESS HALF

# PICNICS

KEEBLER

## ZESTA SALTINES

2 LB. **\$1.29**

KEEBLER

## DOUBLE NUTTY VANILLA OR FUDGE CREME COOKIES

12 OZ. **79¢**

FFV COUNTRY

## HAMS

WHOLE **\$1.29** LB.

SLICED **\$1.39** LB.

## BARREL OF FRYING CHICKEN

# 4

LIPTON TEA

## MIX OR MATCH SALE

100 CT. TEA BAGS, 3 OZ. INSTANT TEA, OR 36 OZ. TEA MIX

**\$1.79** Ea.

COUPON

## VANITY FAIR BATHROOM TISSUE

**\$1.00**

2 For Without Coupon 89¢ Ea. Coupon Expires 6/2/79 Limit 2 Per Family 1 Coupon Only

SMITHFIELD

## SLICED BACON

12 OZ. PKG. **99¢**

FOLGER'S

## FLAKE COFFEE

IN BAG 13 OZ. **\$1.79**

FOLGER'S BAG COFFEE ALL GRINDS **\$2.19** 1 LB.

COUPON

## VANITY FAIR JUMBO ROLL TOWELS

**\$1.00**

3 For Without Coupon 65¢ Ea. Coupon Expires 6/2/79 Limit 3 Per Family 1 Coupon Only

## 1/4 SLICED PORK LOINS

2 LITRE

## COCA COLA

**79¢** Ea.

DINNER BELL

## FULLY COOKED BONELESS DELUXE HAMS

2 TO 3 LB. AVG. **\$2.29** LB.

## WESTERN WHOLE BEEF RIB EYES

## FROZEN FOODS

MORTONS

## POT PIES

CHICKEN, BEEF OR TURKEY **4/\$1**

CAROLINA DAIRIES SHERBET, ORANGE, PINEAPPLE & LIME

## ICE CREAM

QUARTS **59¢**

PET WHIP TOPPING **59¢** 9-OZ. SIZE

## 10 LB. SALE

10 LB. V.C. SMOKED SAUSAGE . . . **\$7.99**  
 10 LB. VIRGINIA SMOKED SAUSAGE. . . **\$9.99**  
 10 LB. H.C. LINK SAUSAGE . . . **\$11.99**  
 10 LB. PORK CHITTERLINGS . . . **\$3.99**  
 10 LB. PIG EARS. . . **\$2.99**  
 10 LB. PORK NECK BONES . . . **\$4.99**

# THESE STIC ECIALS

2 TO 3 LB. AVG.

\$1.49 LB.



5 LB.



CONTAINS 22 PIECES  
8 PC. THIGHS  
3 PC. DRUMSTICKS  
3 PC. BREASTS  
4 PC. BACKS  
4 PC. NECKS

## JAMESTOWN ROLL SAUSAGE

89 LB.



## IT'S SALADTIME

LARGE CRISP  
LETTUCE 3 HEADS \$1.00 FOR

VINE RIPE  
TOMATOES LB. 59¢

LONG GREEN 100 COUNT  
CUCUMBERS EA. 12¢



SOUTHERN BISCUIT  
FLOUR 5 LB. 59¢



SELF RISING  
WITHOUT COUPON 89¢  
LIMIT 1 PER FAMILY  
WITH 1 COUPON ONLY  
EXPIRES 6/2/79

ON SALE NOW! WEEKLY SAVINGS ON FAMOUS BAR SOAPS



THIS WEEK'S SPECIAL

CAMAY SOAP

2/79¢

ZEST SOAP

4/\$1.00

IVORY SOAP

4/69¢

STOCK UP AND SAVE!

## DR. PEPPER

1 LITRE  
6 PAKS

\$1.45 PLUS DEPOSIT



19

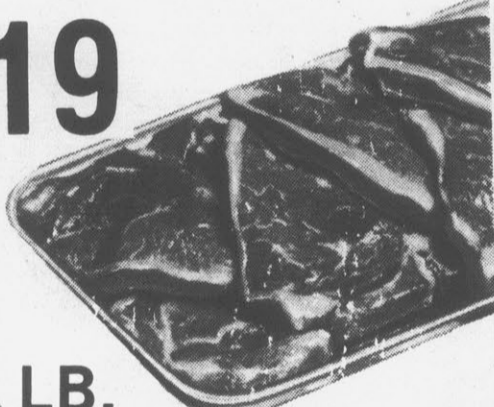

LB.

## JOY

DISHWASHING LIQUID

22 OZ.  
10¢ OFF  
89¢



## CHATHAM DOG FOOD RATION

25 LB.

\$3.29



### CANNED GOODS SALE

ARGO GREEN LIMA BEANS. . . . . No. 303	3/\$1.00
DOUBLE LUCK CUT GREEN BEANS. . . . . No. 303	3/\$1.00
WIGWAM GOLDEN CREAM STYLE CORN . . . . . No. 303	3/\$1.00
WIGWAM WHOLE KERNEL GOLDEN CORN. . . . . No. 303	3/\$1.00
WIGWAM MIXED VEGETABLES . . . . . No. 303	3/\$1.00
WIGWAM SWEET PEAS. . . . . No. 303	3/\$1.00

## PLEDGE FURNITURE POLISH

REGULAR, LEMON OR NATURAL WOOD

7 OZ. SIZE 89¢



## BEAUTY AIDS SALE

CREST TOOTH PASTE . . . . . 7-OZ. SIZE	\$1.19
WONDRA SKIN CONDITIONING LOTION . . . . . 10-OZ. SIZE	\$1.19
LIQUID PRELL SHAMPOO . . . . . 11-OZ. SIZE	\$1.74
SECRET SPRAY DEODORANT . . . . . 4-OZ. SIZE	\$1.22
SECRET SPRAY UNSCENTED . . . . . 4-OZ. SIZE	\$1.27
SECRET ROLL ON DEODORANT . . . . . 2 1/2-OZ. SIZE	\$1.55

## DAIRY FOODS

SEALTEST (6¢ OFF) DIP . . . . . 8-OZ. SIZE	2/\$1.00
SHEDD'S SPREAD MARGARINE . . . . . 1 LB.-IN QUARTERS	3/\$1.00
HOMESTYLE BISCUITS . . . . . 9 OZ. SIZE	39¢

## 'Dirty Post Card' Display



PARISIAN SCENE—A stroller takes a look at the post cards on display at bookseller's stand along the embankments of the Seine, in Paris. In the background, on the other side of the Seine, stands the cathedral of Notre Dame.

By MARCUS ELIASON Associated Press Writer  
PARIS (AP) — With hardcore pornography comfortably settled in Paris, "le dir-tee post card" seems no naughtier than the stockinged leg of a can-can dancer. But the post card as art or history retains its humble corner in the pantheon of French passions.

The capacity of the post card to evoke laughter, nostalgia or distaste is being artfully displayed at a museum in Paris' Bois de Boulogne.

Each of the thousands of post cards on display is a captured splinter of time, bringing to life a faded world of handlebar mustaches, horse-drawn carts, shoeshine stands, billowing bonnets, thatched roofs, organ grinders and knee-length swimsuits.

There were days, these cards remind us, when people wrote with goose feathers, sculpting the "M" of a Mademoiselle with a zestful flourish.

French post cards were born in the 1870 Franco-German war. Bismarck had captured Strasbourg from Napoleon III.

So the city's Red Cross printed small message cards that could be carried to Paris by balloon. Homing pigeons were taken along in case the balloon didn't make it.

The balloons and pigeon post have vanished along with the sleazy hawkers who would tug the tourist's sleeve and hiss the oft-parodied line, "Do you want to buy a dirty post card?"

Today an old post card, whether it pictures a plump half-nude Victorian woman or a long-forgotten prime minister, is a collector's item to be rummaged for in the used-books stalls along the Seine River.

With the appearance in 1889 of the first picture post card, portraying the newly built Eiffel Tower, a major industry was born. By 1909, the Reunies Co. in France was printing half a million cards a day.

Some cards show little has changed in a hundred years. One portrays a policeman with a dog on a leash watching a park for hoodlums.

Another depicts a healthy young man with beard and shoulder-length hair scything garden weeds. He looks like a graduate of the 1960s back-to-the-land movement, and indeed, the post card's message is: "Sun, Earth, Work, Peace."

World War I made the post card a propaganda tool. Kaiser Wilhelm was pictured entwined in snakes.

There were post cards which, pasted together, formed lifesize portraits of Napoleon Bonaparte.

Another vogue was the series of post cards which told a story. These ranged from simple boy-meets-girl yarns to the 1890s' trial of army captain Alfred Dreyfus, an espionage case with anti-Semitic overtones that became a sort of French Watergate.

There were post cards for the social conscience — breadlines in 1906, street demonstrations in 1910 — and others portraying Mata Hari doing a belly dance.

The great poster designers did not disdain the post card as an art form, and cards by Alfons Mucha, Jules Cheret and Leonetto Cappiello sell today to collectors for hundreds of dollars each.

The French remain avid senders, as well as collectors, of post cards. The exhibit includes a model of a bistro bedecked with the 200 post cards the owner receives every summer from her vacationing customers.

## HSA Meets On June 13

The Eastern Carolina Health Systems Agency will meet June 13 at 7:30 p.m. at the Ramada Inn.

Included on the HSA agenda will be the consideration of the agency's Project Review Committee's recommendation for approval of the construction of a bed tower at Pitt County Memorial Hospital.

The 166-bed addition, and the conversion of 20 existing beds to intensive care unit status are part of the clinical training program of the East Carolina University School of Medicine program at the hospital.

Construction of the bed tower will be funded by the State as part of the medical school program.

In addition to other Project Review Committee reports, the HSA board will consider the annual implementation plan and review the preliminary fiscal 1980 budget.

## George Is Still Most Popular

NEW YORK (AP) — Father Time may be catching up to the Father of Our Country. The greatest American Father of them all is still George Washington, according to an informal survey by Hallmark Cards, but his margin of victory was not as large as might be expected.

Twenty percent of the cross-section participating in the poll named Washington as their favorite father, while 17 percent selected Abraham Lincoln and 14 percent picked Bing Crosby.

The solid fourth-place finisher was "my own father," who received 8 percent of the vote. Other favorite fathers surfacing in the survey included Joseph Kennedy, John Wayne, Henry Ford, Ernest Hemingway, and "me."

## Will Graduate From Academy

CHATHAM, VA. — Cadet 1st Lt. Bryan Butler of Raleigh, a former Greenville resident, will be among the 36 seniors at Hargrave Military Academy who will receive their diplomas during commencement exercises Saturday, June 2.

Cadet 1st Lt. Butler is the son of Mrs. Elizabeth M. Butler of Raleigh. He is a member of the Beta Club, Rifle Team and Sabre Club at Hargrave.

He holds the rank of 1st Lieutenant in the Cadet Corps and is company executive of Company Delta. He plans to attend the U. S. Naval Academy.

# Struggling For Mary Pickford, First Movie Rating In News Star Of America, Is Dead

By PETER J. BOYER  
AP Television Writer  
LOS ANGELES (AP) — About three years ago ABC relinquished its place as the laughing stock of network television when, through clever promotion and programming moves, it displaced CBS as the No. 1 network.

But ABC News carried on the tradition of No. 3. The estimable CBS Evening News with Walter Cronkite was top-rated, getting about 30 percent of the viewers. NBC was garnering about 27 percent.

ABC, ever last here, could only attract 18 percent of the audience.

ABC decided to fix things. The network's first attempted remedy was the highly publicized acquisition of Barbara Walters from NBC as co-anchor of the evening news program. Typical ABC move, detractors said. If you can't be good, be gaudy.

Viewers tuned in for a couple of nights just to see what a million-dollar-a-year anchor person did. They promptly returned to

Cronkite and Brinkley and "I Love Lucy" reruns.

Next, ABC announced that Rooney Arledge, the successful sports director, would be made chief of the news division, too. More typical ABC, rang the chorus. This will be the first network-level happy-talk news show.

It wasn't. In the 11 months since Arledge introduced the "World News Tonight," the show has climbed into a virtual second-place tie with NBC's evening news show. And for the first time in history, ABC News is holding its audience gains.

Arledge, a personable and forthright fellow, talked about his undertaking in an interview. "Well, the first objective was to not do what ABC has always done in the past — go for a quick-fix gimmick of some sort, with a superstar or something. I mean, they've always in the past thought they could change things just by buying Barbara Walters or Harry Reasoner or Jim Haggerty or whoever."

"I said that what we had to do was build a news department, that we had to make a product that, when we could get people to look at it, they would return to it...."

"First of all, I had to get rid of every one of the executives that had been here before, or reassign them...."

Then, he said, he wanted to get ABC's documentaries back to where they should be and also to use "Good Morning America" as a vehicle for people to see ABC News in a good showcase....

The "World News Tonight," was switched to a multi-anchor concept with anchormen in London, Washington and Chicago.

Arledge has spent 60 percent of his time working with the news division, and it has paid off.

"In the past," he says, "ABC has had so many problems that their priorities, understandably, did not include news on a very serious level... But we're making progress. I think we've gotten to the point where the public understands that ABC is serious about news."

By BOB THOMAS  
Associated Press Writer  
HOLLYWOOD (AP) — Mary Pickford, who reigned as America's Sweetheart during the colorful, formative period of American movies, is dead at 86 after 13 years of seclusion in her legendary home, Pickfair.

Her death Tuesday was attributed to a cerebral hemorrhage suffered last Friday.

The journey to the hospital was one of the few times Miss Pickford, whose golden curls and spunky innocence won her the adulation of millions, had emerged from the mansion since she withdrew from public life in 1966.

In 1976, she appeared before

cameras at Pickfair to accept an honorary award "in recognition of her unique contribution to the film industry and the development of film as an artistic medium" from the Academy of Motion Picture Arts and Sciences, which she helped found.

Miss Pickford was perhaps the first great international screen idol. In an era of such stars as Greta Garbo and Gloria Swanson, she was the first to have her name in marquee lights and the first to command thousands of dollars a week. She was box office gold for such movies as "Pollyanna" and "Poor Little Rich Girl."

The romance of the Pickford name grew when she married the screen's most dashing hero, Douglas Fairbanks Sr., in 1920. Even five years later, 300,000 people went to a Moscow train station to see them.

Miss Pickford was known around the world as "America's Sweetheart," a title that

## 'Coincidence'

RALEIGH, N.C. (AP) — The North Carolina Symphony's top administrator resigned Tuesday to accept a position with the Detroit Symphony.

Ralph O. Guthrie, 58, said his resignation was not related to the announcement Monday that conductor John Gosling would step down next year.

"It's just a coincidence. I don't know how you're going to convince people that the orchestra is not collapsing, but it's not," Guthrie said.

Guthrie came to North Carolina in 1975 as vice president and general manager of the state symphony. He said that he had planned to stay in North Carolina, but "Detroit made me an offer I absolutely could not refuse... they're paying me almost twice what I'm getting here."

Sesame Street To Washington

WASHINGTON (AP) — One of the world's most famous thoroughfares is moving to the nation's capital this summer.

To commemorate its 10th anniversary, "Sesame Street," the internationally-viewed children's educational television show, will be the subject of a three-month-long exhibition through Sept. 3 at the Smithsonian Institution's National Museum of History and Technology.

In the free show are parts of the original Sesame Street set, including the door and steps of 1-2-3 Sesame Street; a 60-foot-long section of "the street" containing Big Bird's nest and Oscar the Grouch's trash can.



KING OF SWING IS 70 — Benny Goodman "The King of Swing" turns 70 today. He is shown here in a recent picture in his New York apartment. Decades after being recognized as the world's greatest jazz clarinet player, Goodman typically is taking nothing for granted. He practices daily, maintaining "every note counts." Goodman advises "you can't do it by memory. You have to work at it. Your fingers have to be limber. Your body has to be in shape." (AP Laserphoto)



MARY PICKFORD — at left in 1925 photo; at right, pictured in 1978. (AP Laserphotos)

completely satisfied with anything I did. But my public accepted me at last as not only an adult, but an adult that has an illicit affair."

"Coquette" won her the Oscar as best actress. After the 1932 film, "Secrets," she quit acting. "I knew it was time to retire. I wanted to stop before I was asked to stop," she said.

Miss Pickford remained active in the film industry. She retained ownership in United Artists, which she had founded in 1920 with Fairbanks, Chaplin and Griffith. She produced movies, starred on radio and helped found the Motion Picture Relief Fund.

Fairbanks and Miss Pickford divorced in 1936 and the following year she married Charles "Buddy" Rogers, who had been her co-star in the 1927 "My Best Girl." They had two foster children, Ronald Pickford Rogers and Roxanne Pickford Rogers.

Her fortune was estimated at \$50 million.

Funeral services were pending.

## TV Log

WNCT-TV Ch. 9	
WEDNESDAY	12:00 News
7:00 News	12:30 Search For
7:30 Jokers	1:00 Young and
8:00 Jeffersons	1:30 World Turns
8:30 Good Times	2:30 Guiding
9:00 Movie	3:30 M*A*S*H
11:00 News	4:00 Love of
11:30 Movie	4:30 Merv
	5:30 Dating
	6:00 9/Alive News
THURSDAY	6:30 News
5:30 Carolina	7:00 News
8:00 Morning	7:30 Jokers
9:00 Kangaroo	8:00 Waltons
10:00 Magazine	9:00 Hawaii 5.0
10:55 News	10:00 Barnaby
11:00 Price Is	11:00 News
	11:30 Movie

## WITN-TV Ch. 7

WEDNESDAY	11:00 Rollers
7:00 Tic Tac	11:30 Wheel of
7:30 Dennis Fargo	12:00 News Noon
8:00 Real People	12:30 Squares
9:00 Novels	1:00 Our Lives
11:00 News	2:00 Doctors
11:30 Tonight	2:30 Another Wid
1:00 Tomorrow	4:00 Battle of
2:00 News	4:30 Superman
	5:00 McHale's
THURSDAY	5:30 F-Troop
5:30 Adam 12	6:00 News
6:00 Almanac	6:30 NBC News
7:00 Today	7:00 Tic Tac
7:25 News	7:30 Nashville
7:30 Today	8:00 Ann Murray
8:25 News	9:00 Quincy
9:00 Shore	10:00 TBA
10:00 Card Sharks	11:00 News
10:30 All Star	11:30 Tonight
	1:00 Tomorrow
	2:00 News

## WCTI-TV Ch. 12

WEDNESDAY	11:30 Family
7:00 Sanford	12:00 Love Expert
7:30 Feud	12:30 Ryan's
8:00 Eight Is	1:00 Children
9:00 Ch. Angels	2:00 One Life
11:30 P. Woman	3:00 Hospital
1:45 Nitelite	4:00 Tom & Jerry
2:45 Edition	5:00 Bicent Women
	6:00 News
THURSDAY	7:00 Sanford
5:55 Tidings	7:30 Gong Show
6:00 PTL Club	8:00 Monk &
7:00 America	8:30 Angie
7:25 News	9:00 Inflation
8:25 News	10:00 20/20
9:00 Donahue	11:00 News
10:00 Douglas	11:30 Starsky &
11:00 Laverne &	1:45 Nitelite
	2:45 Edition

## WUNK-TV Ch. 25

WEDNESDAY	12:15 Nipples
7:00 Assembly	12:30 Elect. Co.
7:30 Report	1:00 Word Shop
8:00 Search	1:15 Inside/Out
9:00 Dance	1:30 Readalong
10:00 Estampa	1:40 Images
THURSDAY	2:00 Readalong
8:10 Weather	2:10 Nipples
8:30 Contract!	2:30 Myth
8:50 Readalong	3:00 Lillas
9:00 Sesame St.	3:30 Over Easy
10:00 Dusting off	4:00 Sesame St
10:30 Readalong	5:00 Mr. Rogers
10:40 Metric	5:30 Elect. Co.
11:00 Word Shop	6:00 Studio See
11:15 Thinkabout	6:30 Making
11:30 Media	7:00 Assembly
11:45 Liberty &	7:30 Report
12:00 Poetry	8:00 Nova
	9:00 Views of
	10:00 Masterpiece

**264 PLAYHOUSE INDOOR THEATRE**  
4 Miles West Of Greenville On US 264 (Farmville Hwy.)

SHOWING ONLY THE FINEST IN ADULT ENTERTAINMENT

**ENDS TONIGHT**  
Eastern N.C.'s First Showing

"JACK 'N JILL is fun from the top of the hill to all points below."  
—ESCAPEE MAG.

**Jack 'n Jill**  
A COLORFUL GUIDE TO SWIMMING

Starring  
SAMANTHA FOX • JACK WRANGLER  
in EASTMANCOLOR

Valid ID Required  
Doors Open 5:45 Showtime 6:00

Call For Showtime Anytime  
**756-0848**



MARIE AND FIANCE — Marie Osmond poses with her fiance 23-year-old Jeff Crayton. The couple became engaged at the Osmond Studio in Orem on Monday. They plan to be married in the Salt Lake Temple in mid-August. Miss Osmond met Crayton at a party in Hollywood in 1978. He returned from a Latter Day Saints mission in Spain on May 5. (AP Laserphoto)

STEWART & EVERETT THEATRES

**Plaza cinema 1-23** 756-0081  
PITT-PLAZA SHOPPING CENTER

HURRY!  
ENDS THURSDAY!  
•CHUCK NORRIS•  
•JENNIFER O'NEILL•

**A FORCE OF ONE**

SHOWS DAILY AT  
3:15-5:10-7:05-9:00

**Plaza cinema 1-23** 756-0083  
PITT-PLAZA SHOPPING CENTER

N-O-W!  
ENDS THURSDAY!  
JON VOIGHT • FAYE DUNNWAY

**THE CHAMP**

SHOWS 2:30-4:45-7-9:15

**PARK**  
UPTOWN GREENVILLE  
752-7649

ENDS THURSDAY!

**GREASE**

PG-13- SHOWS 3-7-9

**STARTING FRIDAY CINEMA 3 "STAR CRASH" PG**

**Buccaneer MOVIES 1-2-3**  
756-3307 Greenville Square Center MOVIES ARE GREAT FUN!

IF YOU FORGOT WHAT **TERROR** WAS LIKE... IT'S BACK *The Original* **JAWS**

PG — MAY BE TOO INTENSE FOR YOUNGER CHILDREN

Shows: 2:00-4:20-6:50-9:15

The original theatrical version of the spectacular television film.

**Battlestar GALACTICA**

Shows: 2:00-4:30 7:00-9:20

Before her fate is sealed by the deep, the superliner Poseidon will reveal one last secret...

**BEYOND THE POSEIDON ADVENTURE**

Shows: 1:00-3:00 5:00-7:00-9:00

Accepted For **Piano Studies**

ECU News Bureau

Pianist Alisa Wetherington of Kinston, a graduate student in the East Carolina University School of Music, has been accepted for four weeks of study at the Aspen Summer Music Festival.

She will be involved in an intensive series of classes with Prof. John Perry, a music faculty member of the University of Texas at Austin.

Perry is a well-known teacher and performer and a regular member of the Aspen Festival faculty.

A student of Nelms McKelvain of the ECU keyboard faculty, Ms. Wetherington has been a winner in several statewide piano competitions. She currently holds a graduate teaching assistantship at ECU.

**Pitt**  
DOWNTOWN  
"HOOPER"  
7:30-9:15

**MEADOWBROOK**  
DRIVE IN • OPPOSITE ASPEN  
Now Thru Thur. "INVASION OF THE BODY SNATCHERS"  
PG Shows 8:30-10:30 P.M.

**TICE**  
DRIVE IN • AYDEN HIGHWAY  
Now Thru Thur. "EVERY WHICH WAY BUT LOOSE"  
PG Shows 8:30-10:30 P.M. Flea Market Sat. & Sun.

**ARABIC DANCE**  
"Authentic Belly Dancing"  
"Shape Up For Summer"  
Donna Whitley, former teacher in Casablanca and California, announces registration of her summer classes.  
Call 752-0928

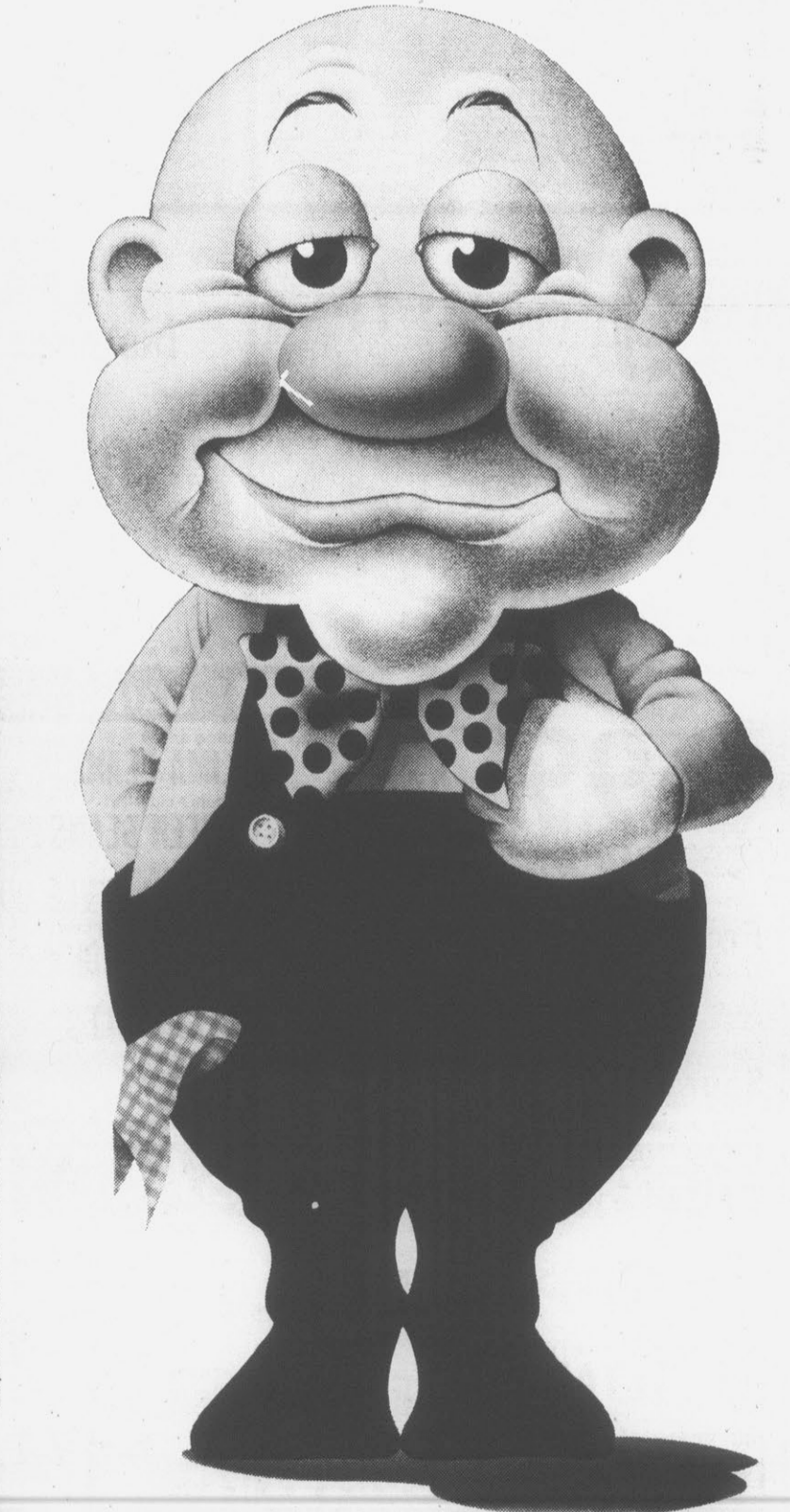

**Ever wonder who makes thunder?**

This little Doozy does it, of course. He's one of the amazing little people who work under the earth to make the top of the earth work.

They push up crops to give us food. They dance on drums to give us thunder. And they make children laugh to give us joy.

Don't believe it? Then bring your family to the all-new Lost World at Kings Dominion and see for yourself. You see, The Lost World isn't just a new ride. It's three new adventures — and a whole new world.

**It's a whole new world at Kings Dominion.**  
20 miles north of Richmond on I-95.



BIG STAR'S ...



PRICES GOOD THRU SAT. JUNE 2, 1979. QUANTITY RIGHTS RESERVED. NONE SOLD TO DEALERS OR RESTAURANTS.

# STAR SAVER PRICES BRING YOU WALL TO WALL SAVINGS!

PITT PLAZA SHOPPING CENTER  
OPEN MON.-SAT. 8-10  
SUNDAYS 9 TO 9

PLAY.... *Instant Vegas*

PICK UP YOUR FREE GAME TICKET TODAY!

**SUPER STAR SAVER**

U.S. CHOICE BEEF!

**TENDER LEAN WHOLE RIB EYES**

10 TO 12 LB. AVG. **\$3.18** LB.

**USDA CHOICE CUT FREE!**

**SUPER STAR SAVER**

HOLLY FARMS

**"FAMILY PAK" MIXED FRYER PARTS**

U.S. GRADE 'A' **48¢** LB.

LIMIT 4 PLEASE

**SUPER STAR SAVER**

**COCA-COLA**

16 OZ. RET. BOTTLE

8 PAK **98¢**

PLUS DEPOSIT

**SUPER STAR SAVER**

**SWEET FLORIDA YELLOW CORN**

EAR **10¢**

**STAR SAVER PRICES SAVE YOU MONEY**

**SUPER STAR SAVERS.** Deep cut weekly specials - the very biggest savings.

**SPECIAL STAR SAVERS.** When we make extra good buys, we pass the extra savings on to you while the supply lasts.

**STAR SAVER VALUES.** Low prices that stay low. Look for them all over the store.

All Star Savers are very good deals for your family. You can spot them easily by the three colors that identify Star Saver Prices.

HORMEL'S LEAN BONELESS CURE '81' HAMS **\$2.79** LB.

HORMEL'S BREAKFAST SAUSAGE LITTLE SIZZLERS **\$1.09** 12 OZ. PKG.

MARKET STYLE SLICED 2 LBS. OR MORE

**BACON** **98¢** LB.

LEAN TENDER SMOKED WHOLE OR HALF

**SLICED PICNICS** **98¢** LB.

HOLLY FARMS FRESH

**CHICKEN LIVERS** **78¢** LB.

U.S. CHOICE BEEF...FAMILY PAK (6 OR MORE)

**RIB EYE STEAKS** **\$3.98** LB.

"FAMILY PAK" ASSORTED...CENTER & END CUTS

**PORK CHOPS** **\$1.38** 8 LBS. OR MORE

**JESSE JONES** HOT OR MILD PURE PORK

**SAUSAGE** **\$1.68** 1-LB. PKG.

**SLICED BOLOGNA** **\$1.68** 1-LB. PKG.

**FRANKS** **\$1.58** 1-LB. PKG.

**ARMOUR STAR**

**SLICED BACON** **\$1.28** 12 OZ. PKG.

**REG. OR BEEF HOT DOGS** **\$1.28** 12 OZ. PKG.

U.S. CHOICE BEEF!

**BONELESS BOTTOM ROUND ROAST** **\$2.38** LB.

**BONELESS EYE STYLE ROUND ROAST** **\$2.48** LB.

TENDER LEAN **CUBED STEAK** **\$2.78** LB.

U.S. CHOICE BEEF!

**WHOLE BOTTOM ROUNDS** **\$1.88** 22 TO 28 LB. AVG. LB.

CUT FREE!

FRESH GREEN **CABBAGE** **15¢** LB.

SEALTEST **ORANGEADE OR LEMONADE** **49¢** HALF GALLON CARTON

**TOMATOES** **49¢** 1-LB. PKG.

RED RIPE SALAD

**SPECIAL STAR SAVER**

SILVER LABEL **COFFEE** **\$1.78** ASST. 1-LB. CAN

LIMIT 1 WITH \$10 ORDER OR MORE

**SPECIAL STAR SAVER**

FARM CHARM **ICE MILK** "ALL FLAVORS" **78¢** HALF GALLON

**SPECIAL STAR SAVER**

CITRUS OR ORANGE **GATORADE DRINK** **48¢** 32 OZ. BOTTLE

**SUPER STAR SAVER**

BETTY CROCKER ASSORTED **CAKE MIX** **\$1.00** 2 18 OZ. PKGS.

**SPECIAL STAR SAVER**

MRS. FILBERT'S **QUARTERS MARGARINE** **48¢** 1-LB. PKG.

**SUPER STAR SAVER**

**MOTOR OIL GULFPRIDE** **65¢** CASE OF 24 30 HD QUART

**73¢** CASE OF 24 10W30 QUART

FIESTA ASST. BBQ SAUCE **59¢** 20 OZ. BOTTLE

FIESTA "ALL FAVORS" ICE CREAM **99¢** 1/2 GAL.

BETTY CROCKER CAN Frosting **88¢** 16 1/2 OZ.

FARM BEST Asst. Pops **69¢** 12 OZ.

FARM CHARM Sour Cream **45¢** 8 OZ.

SEALTEST LIGHT 'N' LIVELY COTTAGE CHEESE **\$1.19** 24 OZ.

DOVE DISHWASHING DETERGENT **98¢** 32 OZ. BOTTLE

VANITY FAIR BATH TISSUE **69¢** 4 ROLL PAK

PEPPERONI, SAUSAGE OR HAMBURGER **G & W PIZZA** **79¢** 11 1/4 OZ. SIZE

TONY...ASSORTED FLAVORS **DOG FOOD** **\$1.00** 6 15 OZ. CANS

SEVEN SEAS (1000 ISLAND, FRENCH OR ITALIAN) **SALAD DRESSING** **\$1.00** 2 8 OZ. BOTS.

LIGHT CHUNK TUNA IN OIL **STAR-KIST** **59¢** 6 1/2 OZ. CAN

VANITY FAIR (134 CNT.) **FACIAL TISSUE** **49¢** BOX

VANITY FAIR LUNCH NAPKINS **55¢** 100 CNT.

VANITY FAIR 50 CNT. DINNER NAPKINS **\$1.00** 2 FOR

BIG STAR **TEA BAGS** **\$1.29** 100 CNT.

OUR PRIDE TWIN PAK **POTATO CHIPS** **68¢** 8 OZ.

OVEN KRISP PLACE PAK **COOKIES** **\$1.00** 3 10 OZ. PKGS.

SUN RIPE

- APPLE JELLY..... 16 OZ. 49¢
- GRAPE JELLY..... 16 OZ. 59¢
- STRAWBERRY PRES. .... 16 OZ. 69¢

OUR PRIDE BUTTERMILK **BREAD** **\$1.09** 3 24 OZ. LOAVES

**ENGLISH MUFFINS** **49¢** 12 OZ. PKG.

SOUR DOUGH & HONEY WHEAT

OLD SOUTH **PIE SHELLS** **\$1.00** 3 10 OZ. PKGS.

SHOP BIG STAR FOR BEER!

**MILLER LITE BEER** **\$1.55** 7-OZ. NON RETURNABLE BOTTLES 8-PAK

THE NEW WOMAN'S DAY **ENCYCLOPEDIA OF COOKERY** **69¢** VOLUME 1 ONLY

VOLS. 2-22 ONLY \$2.69 EACH! VOLUME 23 FREE WITH PURCHASE OF VOLUME 2.

**SPECIAL STAR SAVER**

10.5 OZ. GARNER'S "TEXAS PETE" **HOT DOG CHILI**

16 OZ. RED GATE WHOLE **WHITE POTATOES**

7 1/4-OZ. OUR PRIDE **MACARONI & CHEESE**

"MIX 'EM OR MATCH 'EM"

**4 FOR \$1.00**

**SPECIAL STAR SAVER**

"YOUR CHOICE"

17 OZ. GREEN GIANT W/K **GOLDEN CORN**

16 OZ. PINE CONE **TOMATOES**

16 OZ. LUCKY LEAF **APPLE SAUCE**

16 OZ. VAN CAMP'S **PORK & BEANS**

**4 OF YOUR CHOICE \$1.00**

**SPECIAL STAR SAVER**

14.7 OZ. FRANCO-AMERICAN **SPAGHETTI**

17 OZ. ARGO CUT **GREEN BEANS**

16 OZ. ARGO **GREEN LIMAS**

16 OZ. ARGO **SWEET PEAS**

"MIX 'EM OR MATCH 'EM"

**4 FOR \$1.00**

**SPECIAL STAR SAVER**

"YOUR CHOICE"

15 OZ. FRANCO-AMERICAN **BEEF RAVIOLIO'S**

14.7 OZ. FRANCO-AMERICAN **SPAGHETTI & MEATBALLS**

46-OZ. SEALED-SWEET NATURAL **GRAPEFRUIT JUICE**

32-OZ. WHITE HOUSE **APPLE JUICE**

**2 OF YOUR CHOICE \$1.09**

### Crossword By Eugene Sheffer

- ACROSS**  
 1 Hindu or low caste  
 5 Harvest goddess  
 8 Scram!  
 12 Solar disk (var.)  
 13 Aswan, for one  
 14 English composer  
 15 Visual disorder  
 17 Toddlers  
 18 Dogma  
 19 Expunges  
 21 Peasant of India  
 24 Abstract being  
 25 Denomination  
 28 Passport endorsement  
 30 Nocutrnal creature  
 33 Sense organ  
 34 African river  
 35 Broad sash  
 36 WWII area
- DOWN**  
 2 Hindmost  
 22 Roman poet  
 23 Big cat  
 25 Bishopric  
 26 Consume  
 27 Kind of saw  
 29 Antitoxins  
 31 Sleeveless garment  
 32 Gratuity  
 34 Swelling  
 38 Felt  
 40 River in France  
 42 A fuel  
 44 Attitudinize  
 45 Flat-bottomed boat  
 47 Charles Lamb  
 48 School session  
 49 Degree  
 52 Narrow inlet  
 53 Ancient
- Answers to yesterday's puzzle:**  
 1. TAPU  
 2. RAM  
 3. MOTE  
 4. EDAM  
 5. EPT  
 6. AVID  
 7. CALUMETS  
 8. LIME  
 9. SAD  
 10. SUDDEN  
 11. ARRET  
 12. VISE  
 13. LIES  
 14. CALENDAR  
 15. ETA  
 16. HOLES  
 17. AML  
 18. CALCULUS  
 19. STUN  
 20. OGLE  
 21. STARK  
 22. TRALEE  
 23. CHA  
 24. HERO  
 25. CALABASH  
 26. ANER  
 27. TRI  
 28. LIEU  
 29. TOSS  
 30. SAP  
 31. ERNE

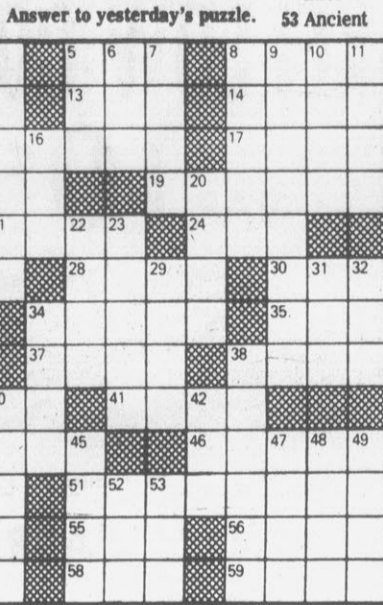

CRYPTOQUIP 5-30

TFKWHCURNBUH TRKGBGRNHW TFC-KHCHG FOOPKHKNW

Yesterday's Cryptiquip - WOULD THE BEST BULL DARE WOO THE SACRED COW?

Today's Cryptiquip clue: W equals S

The Cryptiquip is a simple substitution cipher in which each letter used stands for another. If you think that X equals O, it will equal O throughout the puzzle. Single letters, short words, and words using an apostrophe can give you clues to locating vowels. Solution is accomplished by trial and error.

© 1979 King Features Syndicate, Inc.



## Speaking of Your Health...

Lester L. Coleman, M.D.

### Longtime Drinker Fears Liver Damage

I'm not a heavy drinker, but I have drunk alcohol over a long period of time. When a friend of mine, who is really a heavy drinker, developed cirrhosis of the liver, I began to worry about myself. Even though I'm in good health, is there a way of finding out if I'm heading for trouble? — Mr. C.O., Mass.

Dear Mr. O.:

You are very wise to give consideration to the state of your health, and especially to your liver since you do have a history of prolonged alcoholic intake.

Doctors have observed for a long time that people react with tremendous anxiety when a friend or relative comes down with a heart, liver or lung condition, or other severe medical problems. Their anxiety mounts until they seek the medical attention that they probably have avoided up to that point.

Yes, it is possible to study your liver and to learn if it is functioning properly. The so-called "liver profile" is a series of chemical tests which, with remarkable accuracy, reflects the health of the liver and its capacity to function. There are probably about 15 complicated and sophisticated tests included in these liver function studies. These should be done in your case, mostly to give you the assurance that you obviously need.

My 4-year-old daughter was left with two scars on her face after a bout of chicken pox. Our concern is whether these will eventually go away when she gets older. If not, can anything be done about it later on? — Mrs. R.E., Va.

Dear Mrs. E.:

Facial scars due to chicken pox, acne and injury can be removed in a number of ways. Small ones can often be eliminated by a process known as "dermabrasion." It is a simple procedure and is often done in the doctor's office. After anesthetizing the skin, a high-speed rotary abrasive brush removes the outer layer of skin. Then,

when healing follows, a smooth surface replaces the pitted marks. The crust that appears remains on the skin for about 10 days. In carefully selected cases, this procedure is very effective.

Only in some isolated cases is plastic surgery resorted to.

We hope to make a trip to India in the fall with two of our young children. I know they will resent injections and I'd like to cut them down to a minimum. What tests are absolutely essential for safety? — Mr. J.R., N.M.

Dear Mr. R.:

Most European countries have excellent control over their water and milk supplies. This is not always true in tropical, sub-tropical and Far Eastern countries. The United States Health Department, the Armed Forces and local health officials are constantly kept abreast of the need for inoculations for visitors to foreign lands. Typhoid, paratyphoid, yellow fever, cholera and smallpox inoculations are essential for travelers to India and neighboring areas.

### Principal Also School's Cook

ANDOVER, Conn. (UPI) — The principal is also the cook at the Andover elementary school.

David Kravet makes french toast or pancakes and bakes zucchini muffins every Friday for as many as three dozen children who eat breakfast at school five mornings a week.

Kravet's breakfast program is one of several projects he began after heading up the 250-student school five years ago.

He also organized the school's vegetable garden, using a U.S. Department of Labor program to hire two local high school youths as gardeners. The U.S. Department of Agriculture helps pay for both programs.

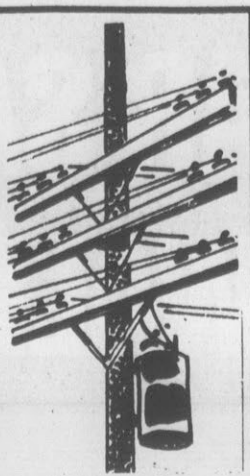

There are lots of ways to send a message. When you need to find a buyer, a renter or an employee, send your message with a Classified Ad.

### 01 PUBLIC NOTICES

**NOTICE**  
 STATE OF NORTH CAROLINA  
 COUNTY OF PITT  
 The undersigned having qualified on the 24th day of April, 1979, as Co-Executors of the Estate of Virginia R. Wright, deceased, this is to notify all creditors of said estate to file their claim against the same on or before the 15th day of December, 1979 or this notice will be pleaded in bar of any recovery. All persons in-

### PEANUTS



### B.C.



### NUBBIN



### BLONDIE



### BEEBLE BAILY



### PHANTOM



### FRANK AND ERNEST



### PRIME TIME

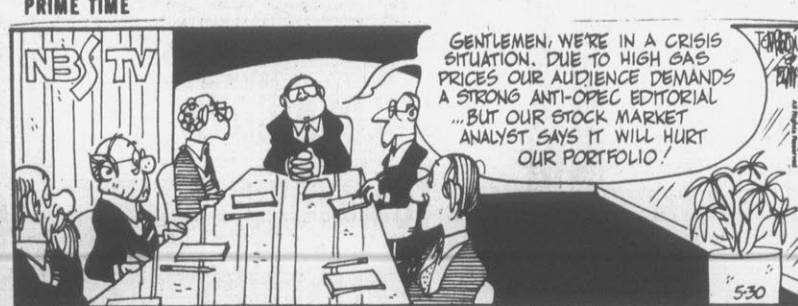

### FUNKY WINKERBEAN



### 01 PUBLIC NOTICES

debted to said estate will please make immediate payment to the undersigned.

This the 24th day of April, 1979, Martin H. Sugg and Dan H. Wright, Co-Executors of the Estate of Virginia R. Wright, deceased, 1801 Azalea Drive, Wilmington, N.C. 28403, May 9, 16, 23, 30, 1979.

**NOTICE TO CREDITORS**  
 NORTH CAROLINA  
 COUNTY OF PITT  
 The undersigned, having qualified as Administratrix of the Estate of Johnnie J. Johnson, late of Pitt County, this is to notify all persons, firms and corporations having claims against said Estate to present them to the undersigned on or before the 15th day of November, 1979, or this Notice will be pleaded in bar of their recovery.

All persons indebted to said Estate will please make immediate payment to the undersigned. This the 7th day of May, 1979. Mrs. Rosa B. Darden, 421 Bonner Lane, Greenville, North Carolina 27834. Administratrix of the Estate of Johnnie J. Johnson, Deceased. Robert J. Johnson, 807 W. 5th Street, Greenville, N.C. 27834. (919) 758-2123. May 9, 16, 23, 30, 1979.

**NOTICE TO BIDDERS**  
 Filled proposals addressed to the Mid-East Regional Housing Authority for the following contract for construction will be received from bidders in the office of the Mid-East Regional Housing Authority at 809 Pennsylvania Avenue, Washington, North Carolina 27889 at 10:00 a.m. local time on June 19, 1979. At which time the bids will be publicly opened and read. The contract shall be for 20 units of public housing located on 4th Street in Fountain, North Carolina. H.U.D. Project No. N 19-R000-022.

Contract documents including drawings and project manual may be inspected on or after May 28, 1979, at the City Clerk's Office, North Carolina, H.U.D. Project No. N 19-R000-022. Contract documents including drawings and project manual may be obtained from Gresham & Smith, Architects, 8740 North Park Blvd., Charleston, South Carolina 29405. A plan deposit of \$200 will be required for all bidders requesting a set of contract documents refundable upon return of

### 01 PUBLIC NOTICES

documents after bid opening to all but successful bidder.

Any contract or contracts awarded under this invitation to bid are expected to be funded in part by Federal Housing Administration of the United States Department of Housing and Urban Development and will be subject to all regulations and promulgations by these agencies including but not limited to the prevailing wage rate and equal opportunity regulations that are provided by the contract documents.

All bidding will be conducted in accordance with the laws, policies, and procedures of the Mid-East Regional Housing Authority and the State of North Carolina. William I. Cochran, Jr., Executive Director. May 30, 1979.

**NOTICE OF PUBLIC HEARING ON THE QUESTION OF THE ADOPTION OF AN ORDINANCE AMENDING CHAPTER 28 OF THE CITY CODE ENTITLED SUBDIVISION GENERAL REQUIREMENTS: WHEN PERFORMANCE AGREEMENT**

**SURETY BOND REQUIRED**  
 Pursuant to Chapter 160A, Section 381 et. seq. of the General Statutes of North Carolina, notice is hereby given that the City Council of the City of Greenville, North Carolina will conduct a public hearing in the City Council Chambers of the Municipal Building, located on the corner of West Fifth and Washington Streets, Greenville, North Carolina, on Thursday, June 14, 1979 at 8:00 P.M. on the question of the adoption of an ordinance amending Chapter 28, Article IV, Section 28-21 of the Code of the City of Greenville entitled "Subdivisions Physical Improvements - General Requirements" when performance agreement or surety bond required. A copy of the proposed amendment is on file in the City Clerk's Office and may be examined by any interested person between the hours of 8:00 A.M. and 5:00 P.M., Monday through Friday. Any person interested is requested to be present at the public hearing aforementioned at which time they will be afforded an opportunity to be heard. BY ORDER OF THE CITY COUNCIL: Lois D. Worthington, City Clerk. May 30 and June 6, 1979.

### 01 PUBLIC NOTICES

**NOTICE**  
 NORTH CAROLINA  
 COUNTY OF PITT

Having this day qualified as Administratrix C. T. A. of the estate of John Columbus Stilton, late of Pitt County, this is to notify all persons having claims against said estate to present them to the undersigned Administratrix C. T. A. on or before November 16, 1979, or this notice will be pleaded in bar of their recovery. All persons indebted to said estate please make immediate settlement. This the 11th day of May, 1979. Laura S. Murphy, Administratrix C. T. A., 808 E. High Street, Rocky Mount, North Carolina 27801. W. I. Wooten, Jr., Attorney Greenville, North Carolina 27834. May 16, 23, 30, June 6, 1979.

**NOTICE**  
 Having qualified as Executor of the estate of Robert L. Kirtrell late of Pitt County, North Carolina, this is to notify all persons having claims against the estate of said deceased to present them to the undersigned Executor within six (6) months from date of the first publication of this notice or same will be pleaded in bar of their recovery. All persons indebted to said estate please make immediate payment. This the 14th day of May, 1979. Mrs. Lillian Kirtrell, 2929 Dickinson Avenue, Greenville, N.C. 27834. W. I. Wooten, Jr., Attorney Greenville, North Carolina 27834. May 16, 23, 30, June 6, 1979.

**NOTICE**  
 BUDGET HEARING  
 TOWN OF WINTERVILLE  
 The tentative budget for the fiscal year beginning on June 1, 1979 of the Town of Winterville was on May 29, 1979 presented to the Board of Commissioners. It is available for public inspection in the office of the Town Clerk. A public hearing will be held in the Municipal Building, at which time any persons who wish to be heard on the budget may appear.

Interested persons are requested to be present at the public hearing aforementioned at which time they will be afforded an opportunity to be heard. BY ORDER OF THE CITY COUNCIL: Lois D. Worthington, City Clerk. May 30 and June 6, 1979.

### AUTOMOTIVE

**09 Autos For Sale**  
 HASTINGS FORD has daily rentals at reasonable prices. Call 758-0114.  
 WE BUY nice, used cars. Grant Bulk Mazda, Inc., 756-1877.

**10 AMC**  
 AMC 1975 Pacer. \$2,000. 758-2637.

**11 Buick**  
 BUICK 1975 Electra 225. 4 door, loaded, only 45,000 miles. Good condition. Owner will sacrifice. \$2700. 756-3088; 752-3366.  
 BUICK REGAL 1976. Full power, extra clean. 756-3877, days. 756-8023, evenings.

**13 Chevrolet**  
 CHEVELLE 1971 Needs motor. Days until 2:30. 758-3274; after 2:30. 752-9497.  
 CHEVELLE 1970. Good condition. 756-2424.  
 CHEVELLE 1970 Malibu 2 door hardtop. Vinyl roof, automatic. \$500 asking price. 752-3400.

**14 Chrysler**  
 CHRYSLER 1970 Newport. Power steering, air, and power brakes. Excellent condition. \$500. Call 756-3686; night, 752-8998.

**15 Dodge**  
 DODGE 1975 Charger. Extra clean. Financing available. 752-5818.

**16 Ford**  
 MUSTANG 1971. Good gas mileage. Very good condition. \$1100. 752-6185.  
 MUSTANG 1970. Excellent condition. New tires, good gas mileage. \$650 firm. 752-1157 after 6.  
 ELITE 1976. Automatic, air, sport color, 15,000 miles. \$3000. Excellent condition. 756-2424.

**17 Lincoln**  
 LINCOLN 1977 Town Coupe. All extra. Call 756-5383.  
 LINCOLN 1973 Continental. Extra clean, low mileage, one owner. Financing available. Call 752-5818.

**18 Mercury**  
 CAPRI 1973. V-6, air conditioned, AM/FM Cassette, new radial tires, good condition, good gas mileage, \$1500. Call 752-7278.

**19 Oldsmobile**  
 OLDSMOBILE 442, 1969. One owner. Automatic, air, low mileage. Has all original papers. Needs paint. \$1495. Call Buddy at 756-3115; 756-2899 after 6 p.m.

**20 Plymouth**  
 ROADRUNNER 1974, 1975 Chrysler, 1974 Duster. By owner. 752-8850.

**21 Pontiac**  
 PONTIAC 1977 Grand Prix. Bucket seats, electric windows, stereo radio, cruise control, tilt wheel, 12,000 miles. Like new. \$3995. Call Holt Oldsmobile, 756-3115.

**BONNEVILLE 1977** 301 Economy engine, 36,000 miles, cruise, power windows, tilt wheel, all. AM/FM, 33 miles per gallon. 5600. Call 758-0361.

**PONTIAC 1972** 2 door, power steering and brakes, air. Good condition. \$825 or best offer. 758-2920 between 7 a.m. and 3 p.m.; 746-2417 after 6 p.m.

**PHOENIX LJ 1980** Air, power steering and brakes. AM/FM. 33 miles per gallon. 5600. Call 758-0361.

**JENSEN HEALEY 1973** Excellent condition. 752-4147.

**TOYOTA 1975** Celica GT. 5 speed, extra clean, excellent condition, 8 track stereo. 758-2852 after 6 p.m.

**TOYOTA 1979** Corolla Deluxe. 4000 miles. Moving, must sell. 756-8476.

**TOYOTA 1979** Corona Station Wagon. Air, AM/FM, automatic, power steering and brakes. 5000 miles. Moving, must sell. 756-8476.

**DATSUN B-210 GX 1978** AM/FM, 4 speed, air. 753-3524.

**38 MILES PER GALLON** Mazda 1978 GLC. 4 door, hatchback, 5 speed, radio, in-dash, AM/FM, cassette stereo. Excellent condition. Asking \$4150. 756-7295.

**AUDI 1973** LS 100. 2 door, good gas mileage. Needs some body work. 752-4132 before 5:30 (ask for Randy). 756-8305 after 6.

**TOYOTA 1976** SR-5. Low mileage, good condition. 756-8793 evenings. 757-6074 days.

**29 Boats For Sale**  
 1977 GRADY WHITE 21' Gulf Stream. Excellent condition, fully loaded. 756-5365.  
 19' BONITA, 115 HP Mercury motor (power trim), galvanized trailer. 758-4576; 758-4645.  
 BEARING BUDDYS. \$795/pair. Quality boat trailer parts and service. Price Designs. Grifton. 524-5790.  
 15' GLASTON with 85 HP Mercury and Cox trailer. Ideal ski boat. 756-1113.  
 22' STARCRAFT Inboard/Outboard, 235 OMC. Cuddy cabin, CB, tilt canvas top, portable sink, porta-pot. Sleeps 6. 72 hours running time. 752-2203 until 7 p.m.  
 14' FIBERGLASS boat with motor and trailer. \$450. 756-9987.  
 20' SAILBOAT. Used one season. Being transferred - must sell immediately. First reasonable offer. Call 792-5603.  
 SAVE GAS. Catalina 27' sailboat, in-board engine, 4 sails. Sleeps 5, galley, head, lots of extras. 758-4881 anytime.  
 1974, 9.9 HP Johnson motor. Excellent condition. 758-2817.  
 1977, 140 Johnson motor (power trim and tilt). \$3000. 758-4897.



## Even Small Businessmen Have Cash Flow Problems

Your Daily Reflector carrier depends on his collections each month to pay his bill, whether or not he has received payment from his customers. When he doesn't get paid, he has to dip into his pocket to make up the difference.

You can help keep a small businessman from going under if you pay your carrier each month when he calls to collect. Thank You.

# THE DAILY REFLECTOR

Phone 752-6166

**35 Cycles For Sale**

1974 YAMAHA 500, 9000 miles, new tires. Good condition. \$695 negotiable. 756-9036.

1978 KAWASAKI LTD. Kerker 4 into 1 headers, carburetors properly jetted, engine guards, newly painted tank, 6000 miles. Extremely good condition. 746-3798.

1977 YAMAHA 350. Brand new, 300 miles, under warranty. 758-4801.

1978 HONDA CX 500. Less than 2500 miles. \$1595 firm. 758-4009 after 7 p.m.

1975 BMW 900S. Windjammer, sad die bags. Big road bike. 13,000 miles. \$2000. Serious calls only. 758-1608 days. 756-2787 nights.

**MOTORBIKES** for sale. 1977 Honda Express and 1978 Honda Hobbit. Excellent condition. 758-0354.

1975 HONDA 360-CB. 6000 miles. \$495. 752-3109 days. 758-5363 nights.

1977 HONDA CB-400. 4 stroke. 5900. 758-5473.

**37 Trucks For Sale**

1978 TOYOTA. Long bed. 33,000 miles. 32 miles per gallon. Excellent condition. \$3900. Call East Carolina Builders. 752-7194.

1978 CHEYENNE. 4 wheel drive, completely loaded, 8000 miles. 752-0001 after 6 and weekends.

1971 FORD Pickup. 1/2 ton. V-8 automatic transmission, power steering and brakes, white spoke rim. Extra clean. 752-7743.

**CLASSIFIED ADS** are as close as your telephone. Just dial 752-6166 and ask for a friendly Ad Visor.

TOYOTA LONG BED 1978, tool box, 16,000 miles. Good condition. \$4500. 752-0001.

FORD VAN 1972. 8 cylinder. Carpeted, paneled and insulated. Excellent condition. 758-2731.

1979 FORD F-150 (4 wheel drive, 6 cylinder, speed), assume loan. 1973 Ford Econoline 300 Van (good condition). \$1695. All types of drywall equipment. 758-3254.

**40 DOGS & PETS**

AKC DOBERMAN puppies. Females only. Tails docked and dewormed. Black and rust. \$65. 758-1005 after 3 p.m.

AKC REGISTERED German Shepherds and Boston Terriers. Also Beagle, not registered. 8 weeks old. Appointment at night. 756-6153. Sale days: Sunday, Monday, Tuesday.

AKC OLD English Sheepdogs. 6 weeks old June 2. \$175. 756-7593.

AKC OLD English Sheepdog pups. Adorable shaggy dogs. 758-0951.

PEK-A-POO PUPPIES. 7 weeks old. Call 756-2837 after 6 p.m.

MINIATURE Dachshund puppies. Females only. \$125. Call 756-3267 after 5.

TWO FEMALE AKC Cocker Spaniel puppies. Champion bloodline. Buff colored. 752-1710 after 4.

**PUPPIES FOR SALE.** Siberian Husky, Nowegian Elkhound, Pekinese, Cocker Spaniels, Eskimo Spitz, German Shepherds, South Seas Pet Shop, in the corner, Greenville Square. 756-9222.

SIBERIAN HUSKY Puppies. AKC. Blue eyed, outstanding markings. Call after 5 p.m. 566-3853. LaGrange.

FREE KITTENS. 756-7286 after 6 p.m.

2 AKC MALE German Shepherds. Championship bloodline. \$75 apiece. 752-5419.

FREE KITTENS. 756-7258.

PART CAIRN Terrier female. 8 months old. 752-3322.

**EMPLOYMENT**

**42 Help Wanted**

AUTO MECHANIC'S helper. Good pay and good benefits. Regional Auto Parts, Inc., Highway 264 West, Frog Level. Contact M. E. Porter. 756-1100.

AUTO MECHANIC. At least 2 years experience and tools. Good pay and good benefits. Regional Auto Parts, Inc., Highway 264 West, Frog Level. Contact M. E. Porter. 756-1100.

DENTAL ASSISTANT. Night employment. Monday through Thursday 5 to 9 p.m. No less than 6 months experience. 752-1337.

REAL ESTATE salespersons for real estate firm. Part time, temporary, leading to full time. Must be available Sundays from 2 till 5 to show model home. Also evening work. License preferred. Write Box 79 Greenville, S.C.

CARPET AND VINYL installers needed for immediate employment. \$3.50 to \$4.50 an hour plus fringe benefits, paid vacations and insurance. Experience required. Carpets by George. 756-5718.

SECRETARY for established Greenville legal firm. Send resume to Secretary, P. O. Box 1967, Greenville, NC 27834.

ELECTRICIAN NEEDED. 756-8970 anytime.

PLUMBER NEEDED. 756-8970 anytime.

CREDIT COUNSELOR. Telephone or general office experience required. Equal Opportunity Employer. Apply from 8:30 till 5:30 at Greenville Collection Service, Wilcar Executive Center, 219 West Tenth Street.

**42 Help Wanted**

SALESPERSON for tractors and farm equipment. Call 756-2845 for appointment. Eastern Tractor & Equipment Company, 264 By pass, Greenville, NC 27834.

YARD MAINTENANCE Person. Must be accurate and type 50 words by letter to P.O. Box 3078, Greenville, NC.

EXPERIENCED dental receptionist needed. Reply to Receptionist, P. O. Box 1967, Greenville, NC.

CLERK/TYPIST. Need clerk/typist for position in purchasing office. Must be accurate and type 50 words per minute. Call 752-2111 for appointment.

WELDERS. Experienced, with ability to read blueprints. \$4.25-\$5.25 per hour, depending on experience. Call Employment Security Commission. 756-2686.

COIL WINDERS. Use of winding machine, hydraulic press, threading machine. Work from blueprints. \$3.60-\$5.25 per hour, depending on experience. Call Employment Security Commission. 756-2686.

TRANSFORMER ASSEMBLER. Must read blueprints. \$4.25-\$5.25 per hour, depending on experience. Call Employment Security Commission. 756-2686.

PUMP OPERATOR. 3 years experience repairing electric motor pumps. \$175 per week. Call Employer. 756-2686.

CARPENTER. Experienced. \$4.50 per hour. Call Employment Security Commission. 756-2686.

SYSTEMS ANALYST II. BS in computer science and 3 years experience. \$1540 per month. Call Employment Security Commission. 756-2686.

**Working Foreman**

Concrete and steel experience required. Also needs commercial carpenter's contact.

Miller & Davis Associates  
758-7474  
For Appointment

**FINANCIAL PLANNER**

Major corporation has openings for two individuals interested in professional sales career with advancement opportunities. Call Mr. Brown at 527-8866 between 11 and 1 on Monday and Wednesday.

HIGH SCHOOL juniors and seniors. Summer jobs: openings available for young persons on the food service staff of a restaurant on the coast of NC. Good salary plus room and board. Excellent opportunity for friends to work together. Limited amount of time for sailing, motor boating, swimming, water skiing, and sports. Early June through mid-August. Must be at least 17 years of age and have completed high school. No experience is necessary. Only ambition and good references required. Quick answer upon receipt of a letter of application. Address inquiries to: Lloyd Griffin, Assistant Director, Camp Sea Gull, Arapahoe, NC 28510 or call (919) 249-1111.

NEED ATTRACTIVE person for digitized position. Must have and know Greenville and surrounding areas well. For info/interview, call Robert Baker. 758-3401 from 4 p.m. till 8 p.m. only.

SALES CAREER. Will train aggressive person for exceptional career opportunities. Substantial starting salary plus incentive increases as earned. Sales experience helpful but not essential. Write or send resume to TSS, P. O. Box 2279, Raleigh, NC 27602. Equal Opportunity Employer. Male/Female.

ROOFER WANTED. Must be all around roof and gutter man. Above wages for this area. Able to take charge of jobs. Only experienced roofing mechanic need apply. Call Nick at 442-6234.

WANTED. ACTIVITIES Director to work on a long term care atmosphere. Experience preferred. Contact Mr. Massey at University Nursing Center. 758-7100.

**WELCOME WAGON**

Seeks additional personnel in Greenville area. Flexible hours, good earnings, car required. A special opportunity. Call 625-4185 or write Charlotte Patton, 627 Redding Rd., Asheville, N.C. 27203. An Equal Opportunity Employer.

STRONG HELPER wanted in crabbing and fishing. Good salary plus living quarters. (919) 964-4917 after 8 p.m.

INSURANCE AGENT to service and collect insurance debts. Good training. Contact Mr. Massey at University Nursing Center. 758-7100.

SALESPERSON. Outside. Aggressive and free to travel 40 mile radius of Greenville. High commission plus. 758-6018.

**100 CLASSIFIED DISPLAY**

**SWIMMING POOLS**

Greenville Pool & Supply, Inc.  
2725 E. 10th St.  
Greenville, N.C.  
758-6131

**42 Help Wanted**

FAMILY PERSON. I want someone who cares for his/her family. Car helpful. \$2000 week earning potential. Outgoing personality. Call 756-3861. Equal Opportunity Employer.

**MAXWELL FURNITURE**

Has position open in sales in Greenville. Furniture sales experience preferred. Good benefits include retirement plan, paid vacation, hospital and dental insurance, good working conditions. For interview, call 756-3142 or apply at Maxwell Furniture, 604 Greenville Blvd., next to Kroger Sav-On.

**"ATTENTION" HIGH SCHOOL SENIORS AND GRADUATES**

For a short period of time the North Carolina National Guard is offering a \$1500.00 Enlistment Bonus to High School Seniors and Graduates. Many other benefits are available including College Tuition Assistance. To find out if you qualify come by the National Guard Armory on Highway 13 North, or call SFC George Pleasants at 752-5693 or SFC Mack Tripp at 752-0855. After 6:00 P.M. call SGT Roy Nash at 753-2273.

LINE CONSTRUCTION personnel wanted for power line work. Experience necessary. Call 752-7006.

AVON. Earn good money, part-time, selling world famous Avon products. For details, call 752-7006.

HELP WANTED for farm supply store, driving truck and general work. Full time. Write, giving name, address and phone number, to Farm, P. O. Box 1967, Greenville, NC.

**IMMEDIATE OPENING**

For Credit Manager in large retail operation. Person selected must have good background in credit/office management. Resume will be handled in confidence. Benefits are numerous, including excellent salary program. Respond to:

**CREDIT MANAGER**

P. O. Box 1967  
Greenville, N.C. 27834

**44 Work Wanted**

REPAIR WORK. Carpentry, roofing, masonry. Call James Harrington. 752-7765 after 6.

SEPTIC TANK installation, lot clearing, landscaping, backhoe/dredger work. Call Sonny Cox. 746-2348 or 746-3414.

FOR PAINTING. Large or small. Work 100 miles out. Call June White. 752-5448.

WOULD LIKE to keep toddlers in my home, also school age children for summer. Located at Frog Level. Call 756-1996.

PROFESSIONAL carpet installation. Reasonable rates. 10 years experience. David Tripp. 756-5173.

WOULD LIKE to keep children in my home, near Simpson and Hardee Acres. Christian home. 752-9397.

PROCRUSTATOR'S handyman. What you put off, I'll do. Ray. 758-2199.

STUDENTS WILL cut grass, do yard work, etc. Contact Employment Security Commission. 756-2686.

EXPERIENCED painter will do all types of painting. Interior, exterior, spraying or brushing. 758-3336.

HOUSE PAINTING by conscientious worker (ECU student). Call Tim. 758-6718 after 3:30.

WILL KEEP children in my home for working mothers. Live between Stokes and Greenville. 758-0356.

EXPERIENCED MOTHER. Would like to keep children in my home. Monday through Friday. age 3 months to 3 years. Excellent references. 752-4754.

WOULD LIKE to babysit in my home for working mothers. Route 6 area. 758-4465.

**46 FOR SALE**

**48 Farm Equipment**

FARMALL 140, 1975 with disc, drag, breaking plow, cultivators, with plows, fertilizer, sewers. Mccan sewers, tobacco sifter and sprayer. 752-0001 after 6 and weekends.

FARMALL CUB tractor and equipment. 758-2625.

**100 CLASSIFIED DISPLAY**

**COW MANURE For Sale 753-3227**

**MANAGER**

Earn from \$1200 - \$1400 monthly managing a modern service station and convenience store in Greenville, N.C. Guaranteed salary plus commissions. Blue Cross - Blue Shield group insurance available. Must be able to supervise other employees. If interested apply in person at:

**Dodge's Store**  
3209 S. Memorial Dr. Greenville, N.C.  
See Mr. Eubanks

**48 Farm Equipment**

CREEPER GEAR for Super A 100 and 140 Farmall tractor. Ideal for use with riding tobacco primer. 752-0001 after 6 and weekends.

MASSEY FERGERSON Combine. Both heads, model 300. Diesel, air condition, with cab. Used one season. Excellent condition. 746-2611 after 6 p.m.

**FARM MACHINERY AUCTION SALE**

Tuesday, June 5 at 10 A.M. 125 Tractors, 300 Implements. We Buy And Sell Used Equipment Daily

**WAYNE IMLEMENT AUCTION CORP.**  
P. O. Box 233, Hwy 117 South Goldsboro, N.C. 27530  
NC License No. 188  
734-4234

**50 Garage-Yard Sale**

**THE BARGAIN HOUSE**

Indoor Flea Market  
Open Saturday 9:00 A.M. to 5:00 P.M. Closed Sunday. Dealers welcomed. Located at the New Fairground Building 264 By-pass. Rental space: inside \$3.00; Outside \$2.00. Farm produce, free church and non-profit items. Antiques, new and used furniture, plants, jewelry, woodwork items, clocks, picture frames, toys, junk.

YARD SALE 2307 East Fourth Street, Saturday, June 2.

GARAGE SALE Saturday, June 2, 9 until 2, 3001 East Tenth.

**100 CLASSIFIED DISPLAY**

Army tents, back packs, sleeping bags - canteens work and casual apparel foot wear, close-outs, camping and sporting goods, plus new and used G.I. surplus.

**ARMY - NAVY STORE**

1501 S. Evans St.

**54 Livestock**

GENTLE PLEASURE horse. (Rebel) From Jenn-Lorr stables. Will guarantee. 756-146.

PALOMINO COLT (one year old). \$300; gentle riding Pinto horse, \$225 (completely outfitted, \$265). 749-2801 after 6:30 p.m.

**56 Miscellaneous**

AIR CONDITIONER (7.5 BTU, like new), \$150; 19" black and white TV, \$35; desk type calculator, \$35. 756-9987.

USED 5000 BTU air conditioner, \$150; 110 pound set of barbells, \$20. 746-3019.

PONTIAC 1969 (air, radials), \$375; Chevrolet 1967 Convertible (new motor, 4 speed), \$400; VW parts; Toshiba stereo 8-track player/recorder, \$50. 747-2902 after 5.

PUERTO RICANS. Jewel potato plants. L. E. Sugg. 746-6277.

GE refrigerator/freezer, 17.6 cubic feet, frost-free, 4 years old, white. Good condition. 750-746-2632.

ONE REFRIGERATOR and one new guitar. 746-4760.

BERKLINE RECLINER. Great condition. \$75 firm. 756-6736.

**100 CLASSIFIED DISPLAY**

**Sales Director Needed**

Hotel is looking for ambitious self-starting individual to make sales calls on area firms and organizations. Good starting pay. Must have own transportation. Send resume to:

**Holiday Inn**  
US 70 & 258  
Kinston, N.C. 28501

**HELP WANTED**

Moulder Operator Assistant—Must Have Some Experience In Feeding Or Operating A Planner Or Moulder. Further Training Available.

Plastic Laminator—Experienced In Making Up Plastic Counter Tops For Cabinet Work.

Modern Equipment Working 45 Hours Per Week. Good Wages And Excellent Fringe Benefits.

**STEPHENSON MILLWORK CO., INC.**  
Box 345—Wilson, N.C. 27893

**STUDENTS AVAILABLE**

For Part Time Or Temporary Jobs.

We Also Have Students For Permanent Part Time Jobs. Call 756-2686.

Job Service  
3201 Bismarck St.  
Greenville, N.C.

**JOB SERVICE**

**56 Miscellaneous**

RINSE & VAC. \$10 a day. Shampoo not included. Whitehurst Carpet Center.

LARGE LOADS of sand, topsoil, field dirt and rock. Also lot clearing. Jim Hudson. 756-4742.

CEMENT STEPS, horse trailers, utility barns, campers and truck shells. Call 946-0311.

PIANO RENTAL, as low as \$15 per month. Cha-Rich Music, 756-1212.

AMAZING NEW wireless home or office security system. Call 756-1944 for free demonstration.

NEED FURNITURE? We have 111 Brands you'll recognize. Financing available to fit your needs. Home Furniture Store, 701 Dickinson Avenue.

CENTPEDE SOD. 752-4994.

CLEAN CARPETS last longer and look better. Rent the best—rent Steamex. Call 758-2300. Larry's Carpetland, 3010 East Tenth Street.

TOP SOIL fill dirt, sand, rocks, landscaping and bulldozer work. Call Henry Worthington. 746-3461.

FILL DIRT, builder sand, top soil and rock. Call J. McDaniel, day. 752-2229 (mobile unit); 756-2351 residence.

**100 CLASSIFIED DISPLAY**

**56 Miscellaneous**

STOVE, stereo, TV. 752-2713 after 6.

KEY MACHINE for cutting keys (will sacrifice); also potato sprouts. Home and Auto Supply, 718 Dickinson Avenue.

KING SIZE water bed, \$800 value, must sacrifice, \$450. 752-4818.

RESTAURANT furniture for sale. Free standing tables and chairs, also tables that mount to wall, wall plaques and inside trash can planters. For more information, call 756-6707.

USED 14" Hotpoint freezer. 752-1869 after 6 p.m.

GOING OUT of fish aquarium accessories. 75% discount. gravel, 10¢ pound; 25¢ off fishing tackle. Home & Auto Supply, 718 Dickinson Avenue.

VEGETABLES YOU PICK. Heritage Farm, 1 mile south of Oronokeville. Hours, 7 a.m. to noon, 4 until dark. Closed Saturday afternoon and Sunday. 746-4642.

SUN DECKS/porches. 7 x 12 feet, already built. Ideal for mobile homes. \$100 each. 746-4837 after 5 p.m.

11 CUBIC FOOT Sears refrigerator, 2 electric ranges. 752-7236 after 4 p.m.

**100 CLASSIFIED DISPLAY**

**56 Miscellaneous**

NEED FURNITURE? We have 111 Brands you'll recognize. Financing available to fit your needs. Home Furniture Store, 701 Dickinson Avenue.

BOOTLEG PRICES: Men's knit slacks and jeans, \$9.99; sportcoats, \$19.95; lady's pantsuits, \$12.95; slacks, \$5.99; tops, \$4.99. Large selection. Mill Outlet Clothing, 264 Bypass (across from Nichols), Greenville.

SMALL LOADS pinebark, sand, top soil and stone. Also driveway work. Call Charles Tice. 758-3013.

**100 CLASSIFIED DISPLAY**

**WE REPAIR SCREENS & DOORS**

Free Pick-up and delivery for homeowners in Pitt County.

**METAL WOOD, INC.**  
758-0404

**100 CLASSIFIED DISPLAY**

**M & W'S USED CAR SPECIALS**

- 1979 Pontiac Trans AM  
Black. Loaded, 13,000 miles ..... **\$7695**
- 1978 Cadillac Coupe De Ville  
D'elegance. Loaded. 15,000 miles. Light blue with blue Cabriolet top. .... **\$8695**
- 1977 Pontiac Firebird  
Silver with carmine interior, power steering and brakes, air ..... **\$5195**
- 1976 Mercury Marquis Brougham  
2 door. Power steering and brakes, air, power windows and seat, stereo radio with tape, 47,000 miles, one local owner. White on white ..... **\$3695**
- 1976 Chevrolet Leguna  
Silver. Black bucket seats, console, power steering and brakes, air. .... **\$3295**
- 1976 Chevrolet Caprice  
4 door. One owner, power windows, power steering and brakes, air. Silver with burgundy vinyl top, 42,000 miles ..... **\$3495**
- 1976 Ford Elite  
Blue with dark blue vinyl top, Was \$4295. .... Now **\$3695**
- 1972 Volkswagen Bus  
3 rear seats ..... **\$1595**
- 1977 Chevrolet Cheyenne Pickup  
4 wheel drive. Short Air condition, power steering and brakes. Brown and Santa Fe Tan, 50,000 miles ..... **\$6295**
- 1977 Ford Crew Cab Pickup  
Red, V-8, 4 speed, power steering, one owner, 37,000 miles ..... **\$4395**
- 1976 Jeep CJ-5 Renegade  
New soft top, 39,000 miles, 6 cylinder. Was \$4295 ..... Now **\$3995**
- 1975 Chevrolet Silverado Pickup  
Beige and white, air, power steering and brakes ..... **\$4395**
- 1974 Dodge Tradesman Van  
V-8, automatic, CB radio, customized, shag carpet, 2 rear bucket seats ..... **\$2295**
- 1974 Chevrolet Pickup  
1/2 ton. 3 speed, power steering ..... **\$2395**
- 1973 GMC Van  
6 cylinder, 3 speed ..... **\$895**

**Station Wagon Specials**

- 1977 Ford Country Squire Wagon  
White with woodgrain panels, one owner, 29,000 miles, power windows, power door locks, cruise control ..... **\$5295**
- 1977 Ford LTD Wagon  
One owner, 63,000 miles, power steering and brakes, air ..... **\$4295**
- 1974 Chevrolet Impala Wagon  
Air, power steering and brakes, luggage rack, light green, white top. .... **\$1695**
- 1974 Chevrolet Caprice Estate Wagon  
One owner, low mileage ..... **\$2995**
- 1972 Chevrolet Caprice Wagon ..... **\$1195**
- 1971 Plymouth Wagon  
Automatic, power steering and brakes, air ..... **\$795**

See One Of Our Courteous Salesmen



Julian White, Owner Jay Mills, Sales Mgr. Rex Wainwright



Tommy Cooke Nicky Harris Jule White

**M & W'S CHEVROLET**

Ayden, N.C. 746-3141

**Morris Blueberry Farm**

LOCATED: 1 mile North of New Bern on U.S. 17.  
Open 7 Days A Week.

Pick Your Own Container

Bring Your Own Container

**40c Lb. BLUEBERRIES**

637-6896  
637-6630  
637-3709

**WICKES LUMBER**

Greenville Store Only  
756-7144

**APPLIANCE CLOSE-OUT SPECIALS**

Brand Names Below Dealer Cost

**WHOLESALE TO PUBLIC**

Holt Olds Is Overstocked In Used Cars And Is Drastically Reducing The Inventory During A Tremendous

**SED CAR SALE**

Special Note: We Have Several 4 Wheel Drive Vehicles In Stock Including A Wagoner And Blazer.

If You Are In The Market For A Used Car, Shop Holt. There May Never Be A Better Time To Buy Than Right Now!

**Holt Olds-Datsun**

101 Hooker Rd. 756-3115

56 Miscellaneous

WHIRLPOOL 15 cubic foot chest freezer, \$300. Royce model 1-682 mobile CB transceiver, \$100. Call 795-4135 after 6.

STEREO SYSTEM Sansui 8080 receiver, cassette recorder, belt-drive turntable, pair Advent speakers. Reasonable. 825-0538.

HOME-STYLE pinball machine, \$150; ping pong table, \$45; electric wall model fireplace, \$50. 752-0677 before 5:30 p.m.

ONE LARGE modern safe. Would like smaller modern fe. A trade could be arranged. 752-8559.

PIANO Good condition. 758-3815 after 4.

8000 BTU air conditioner, \$45; Penn's car air conditioner, \$30; Fiberglass shower, \$18. 758-5571 after 6 p.m.

8 TRACK TAPE player. Good condition. \$20.00 756-2906 after 6 p.m.

RS277US Cassette deck, Dolby and automatic reverse. 758-3646 or 752-2855.

MISCELLANEOUS odds and ends. Ladies handbags, shoes, sweaters, coats, and gowns. Other items include kitchen curtains, fabric clothes, scarves, rugs, glassware, electric blankets, artificial flowers, wall plaques, and lots of other things. 756-7182 after 6 p.m.

LATHE BELT driven 24" gap bed, 9" between centers, 20" jaw chuck. Good condition. 756-3269 after 5 p.m.

60 INSTRUCTION

SUMMER TUTORING service taught by certified teacher in reading and math. Grades 1-3. Call Carol Quente, 758-0488 for more information.

JOYFUL LEARNING. Tutoring by certified teacher with Master's. Students, grades K-8. All areas. 758-8974.

REAL ESTATE School. The Bacon School has taught more people the real estate business than any other in N.C. Next Kingston course starts Monday, June 18 at 7 p.m. Course qualifies you to take the NC Licensing Exam. Classes meet two nights a week for 5 1/2 weeks. Credit cards accepted. Call today to reserve your seat. Enrollment is limited. Contact Steve Suttton, Hill Realty, Kingston, 527-5179; 523-9877 nights.

ENGINEERING student would like to tutor grades 8-12. Math, English, Sciences. 758-5248.

SUMMER TUTORING available for students, grades 4-9, by certified teacher with master's. All subject areas. 752-0377 after 4 p.m.

PIANO LESSONS offered to residents of Winterville. 746-4634.

BOOKS & BUTTERFLIES tutorial service. Certified teachers, reasonable rates, all subject areas. K-12, education consultant available. 756-8770.

PIANO AND Guitar lessons daily afternoons. Richard J. Knapp, B.A. (degree-music) 756-2563.

TUTORING, reading, math. Grades 1-3. Al Braxton, Shady Knoll, 758-6799.

62 LOST AND FOUND

LOST. 3 month old black puppy wearing red collar. Answers to Bear. 758-0269.

\$50 REWARD for lost cat. Grey tabby, lost near 13th Street. 752-8920.

WHEN YOU CALL to place a Classified ad, a friendly Ad-Visor will help you with the wording. Call 752-6166.

LOST IN VICINITY of Old County Home. Plott Hound female, brindle in color. Finder please call collect, 946-1647 Ota Forbes, Chocowinity.

MOBILE HOMES

64 Mobile Homes For Rent

2 AND3 bedroom mobile homes. Washer, air and carpet. No pets. 756-0792 or 752-4111.

55' 2 BEDROOMS, washer, dryer, air. No pets. 756-7912 after 5 p.m.

100 CLASSIFIED DISPLAY

WE INSTALL ALUMINUM AND VINYL SIDING C. L. LUPTON CO. 752-6116

64 Mobile Homes For Rent

2 AND 3 BEDROOM mobile homes. Air conditioned, good location. No pets. 752-3286 days; 825-5391 nights.

CLEAN, 2 bedroom mobile home with central air conditioning, located in Azalea Gardens for couples only; also new, one bedroom, furnished apartment for singles or couples (located in Azalea Gardens). Contact J. T. or Tommy Williams at Azalea Mobile Homes, 620 West Greenville Boulevard, 756-7815.

12 X 60, 3 bedrooms, fully carpeted with air conditioning, 2 bedrooms with air; also available June 1, 12 X 60, 3 bedrooms with washer, dryer and air conditioning. No pets. No children. 758-3644.

3 BEDROOMS, air, washer/dryer, shag carpet. Also 1 bedroom. Both real nice. 756-9225 or 756-1900 after 3 p.m.

2 BEDROOMS, furnished; washer and air. No pets. Deposit required. 752-4008.

2 BEDROOM mobile home for rent. 752-0078 after 4 p.m.

2 BEDROOMS in country. 752-0864.

40', 2 bedrooms, furnished, air, washer, central heat, covered patio. No children or pets. 752-5907.

2 BEDROOMS, fully carpeted, washer and dryer, fully air conditioned. Available June 1. No pets. 758-2679.

EXTRA NICE, 2 bedrooms, central air, washer, dryer, furnished. Convenient to ECU. 758-1366.

SOMEONE IS looking for your unused power mower. Why not advertise it with a low cost Classified Ad?

2 BEDROOMS, furnished, air conditioned. Good location. 756-0175.

2 BEDROOM mobile home. Furnished, central heat. \$145. 752-3839.

66 Mobile Homes For Sale

ONE VERY inexpensive. For the river or beach. 10 X 50 with air conditioning. Delivered for only \$2995. \$300 down. 756-0191.

THREE 2 bedrooms, two 12 X 65, one 12 X 60. Very nice. 756-0191.

ONE 3 BEDROOM, 1974, 12 X 65. Will provide furniture. 756-0191.

1975 MOBILE HOME, 3 bedrooms, central heat and air, 1 1/2 baths, new appliances. 752-5452 or 752-4955.

1975 CHAMPION. Unfurnished, doublewide. After 6. 752-1608.

1973, 12 X 65, 2 bedrooms, den with sliding glass doors and deck, washer and dryer, air, tool shed. 752-0171.

BAYWOOD MODULAR doublewide. 24 X 60. Excellent condition. Central air, underpinned, single sides and roof. \$2000 cash and assume mortgage of \$195 a month. Call 752-7275.

OAKWOOD 1979 Bonita. Sale price, \$10,025. Serial number 9788. All our homes on sale through June 30. Call or see Jimmy Langston, 756-5434. Oakwood Mobile Homes, 626 West Greenville Boulevard.

1973, 12 X 64, unfurnished, 2 bedroom home with appliances and air. Excellent condition. Perfect for first home. 756-8605 after 5 p.m.

DOUBLEWIDE 3 bedrooms, 2 baths, central air, unfurnished. Excellent condition. Equity and assume loan. 752-0221.

1975, 12 X 40. Excellent condition. 756-5436.

1968 GREAT LAKES 12 X 50, 2 bedrooms, front kitchen, completely furnished. No down payment, only take up payments of \$83.76 monthly, 752-2534.

BY OWNER, 1973 — nice, 2 bedrooms, furnished. \$3995. Located: Branch's Estates. 756-1914.

TRAILER FOR sale. \$200 down and take up payments of \$117.29 per month. Call 752-5953.

100 CLASSIFIED DISPLAY

SALES CAREER IN EASTERN CAROLINAS LEADING HOME FURNISHING SHOWROOM

WE HAVE OPENINGS FOR TWO SALES PERSONS. PAID VACATION, FULL BLUE CROSS HOSPITAL INSURANCE. EXCELLENT WORKING CONDITIONS. WE WILL TRAIN YOU. BIG EMPLOYEE DISCOUNTS. OUR PEOPLE KNOW OF THIS AD. SALARY COMMENSURATE WITH QUALIFICATIONS AND EXPERIENCE. WRITE P.O. BOX 3314 GREENVILLE, N.C.

COX

WHY DO WE WORK WITH 12 OF 26 COUPLES MOVING TO GREENVILLE EACH WEEK?



We're Experts At Handling Business And Industry Employee Transferees

A Move To A New Distant City Becomes An Emotional Event And We Are Sensitive To The Needs Of Relocating Employees. The Transition Is Made Easier Because Jeannette Cox Agency Is Sensitive And Provides The Most Professional Service Available.

Jeannette Cox Agency, Inc.

756-1322

Jeannette Cox CRB, CRS, GRI Only Realtor In Greenville With 3 Residential Designations

Betty Bland Barbara Hart, GRI

66 Mobile Homes For Sale

1977 RAYNELL by Ritzcraft, 12 X 65. Make down payment and assume loan. With or without furniture. 758-0100 anytime.

1974, 12 X 66 Oakmont Totally electric, air conditioning, 2 bedrooms with large master bedroom, one bath. Includes all appliances (washer and dryer negotiable), some furniture. Located in Highland Trailer Park, \$6300. 758-5782.

1972, 12 X 60 Ritzcraft. Furnished with washer and dryer. Excellent condition. Set up and ready to move in at Shady Knoll. 752-7982 or 758-6100.

1960, 10 X 56, 3 bedrooms. Good condition. Greenville. Will take best offer. Call Tony at 746-3092.

1977 VISCOUNT 12 X 65, 3 bedrooms, 2 baths, central heat and air. Excellent condition. Assume loan. Call 827-4836 after 6.

A FANTASTIC BUY 1974, 2 bedroom possession. Only one, \$450 transfer fee, take up payments. 756-0191.

ONLY ONE, 1974, very clean, 2 bedrooms. Going fast at \$3995. 756-0191.

ONE GREAT LAKES 12 X 64, 3 bedrooms, air conditioners. \$5995. Better hurry! 756-0191.

68 OPPORTUNITY

SMALL BUSINESS for sale. Call 758-3602 between 6 and 9 p.m.

SOLAR ENERGY

Golden opportunity with new solar product. High profits and protected dealership. Solar energy is the energy source for the future. Small investment required. Call 1-867-0457. Solar Applications Unlimited.

70 PROFESSIONAL

COMMERCIAL and residential painting. Call Gwaltney Paint Company, Inc., 527-1990.

72 REAL ESTATE

WANT TO BUY 10 plus acres near Washington. Suitable for horse pasture. Road frontage not necessary. Please call 946-9926 evenings.

WANT TO RENT, with option to buy, 6 room house (or more) in ECU area or in country, within 8 miles of city. New or old. \$30,000-\$40,000 range. No realtors, please. 752-0275.

73 Commercial Property

ARLINGTON BOULEVARD, 1500 square feet for lease. 107 (between Annie's Bridal and Moseley in surplus). Call I. J. Edwards, Jr., 758-2616 or 756-5024.

SHOP/OFFICE space for lease. 1000 square feet. Neighborhood commercial zone. Hooker Road. Call 752-1733 days. 756-7614 nights.

FULLY RENTED \$800/month office building for sale in Oakmont Professional Plaza. \$72,000 with possible financing. Call John Jackson, 756-3791 office; 756-4360 home.

FOR LEASE. Up to 1000 square feet prime office space in Oakmont Plaza. Will arrange to suit. Ginger Hackett Realtors, 756-7986, 758-0050.

100 CLASSIFIED DISPLAY

ROOFING

STORM WINDOWS DOORS & AWNINGS C. L. LUPTON CO. 752-6116

73 Commercial Property FOR LEASE

Office or commercial buildings located.

1400 Block W. 14th St. Four 900 sq. ft. and One 1800 sq. ft.

1100 Block Hamilton St. Three 1200 sq. ft. and One 2400 sq. ft.

3000 Block E. 10th St. 700 ft. office building and 800 ft. block storage building.

These buildings can be finished within 30 days for occupancy and finished to suit tenant. New construction.

Contact J. T. or Tommy Williams 756-7815

YOU CAN SAVE money by shopping for bargains in the Classified Ads.

74 Farms For Sale

69 ACRE FARM in Pitt County. Call 746-3287.

78 Houses For Sale

2915 ROSE, 3 bedrooms, family room with fireplace, swimming pool with filter, (16 X 32), \$29,500. Bill Williams Real Estate. 752-2615.

IN GRIFTON. Large 2 bedroom home with fireplace, heat pump, screened porch, new carpet throughout. McLawhorn Realty, 524-5474.

TOWN'N COUNTRY LIVING. Grimesland, 3 bedrooms, 1 1/2 baths. No down payment for veterans or \$1150 down for FHA loan. Closing costs paid by seller. Aldridge & Southernland Realty, 756-3500.

\$47,500. A special home on corner lot with beautiful lawn and shrubs. 3 bedrooms, 2 baths, carport, heat pump. Call Louise Hodge at Aldridge & Southernland Realty, 756-3500 or evenings, 756-5005.

NEW LISTING. Cambridge. Priced to sell, this home offers 3 bedrooms, 2 baths, great room with fireplace. Many extras. \$44,900. Century 21, Whitley's House Station, 756-6050.

2 BEDROOM frame house on approximately one acre. Must see to appreciate. Route 8, Greenville, \$22,500. Kea-Manning Realty, call collect, 443-2516 or 443-1410.

NEW HOME in Grifton, 1400 square feet. Wooded lot, heat pump, extra insulation, fireplace, will trade. By builder, 524-5474.

NEW LISTING. University area. 2000 square foot, 2 story home with 3 bedrooms, 2 baths, formal rooms, study, screened porch. Completely remodeled. New kitchen appliances, heating system. Must see to appreciate. \$54,500. Blount & Ball Realty, 756-3000; evenings, Richard Lane, 752-8819.

100 CLASSIFIED DISPLAY

HARDWARE CLERK

Free hospitalization. 5 day week. Pension plan. Call Joe Melton at 753-3169.

Farmville Hardware Co. Farmville, N.C.

Over 300 cars must go during our biggest sale ever ... a Pitt County record! Super-strong savings!

# MAY TARHEEL TOYOTA SHOW

Open Till Midnight 6 Days!

These Savings Good Thru May Sale Only!

**\*SAVE FROM \$800 TO \$1800**

On Every Total Deal Toyota In Stock

\*Amount Depending On Which Toyota You Select

The Time To Buy Is Now, Because Our Prices Will Never Be Lower!

**TODAY'S GREAT USED CAR DEALS!**

We're turning our back on high profit to turn over these trade-ins as fast as we can!

1978 TOYOTA CELICA LIFTBACK  
White with blue vinyl interior. Automatic transmission, air condition, AM-FM stereo, rear window defogger. **\*\$6198**

1978 CHEVROLET CAPRICE CLASSIC  
Medium green metallic with green cloth interior, automatic, air condition, power steering and brakes, tilt wheel, cruise control, power door locks, AM-FM radio. **\*\$4998**

1978 FORD F-150 4 X 4  
Silver with blue vinyl interior. Automatic transmission, power steering, AM-FM stereo with tape, 17,000 miles. **\*\$5398**

1978 MERCURY COUGAR XR-7  
Light blue with dark blue vinyl roof and blue landau roof. Automatic transmission, air condition, power steering and brakes, power windows, AM-FM stereo, 17,000 miles. **\*\$4998**

1978 FORD PINTO RUNABOUT  
White with green vinyl interior. 4 speed transmission, air condition, AM-FM radio, 18,000 miles. **\*\$3998**

1978 MERCURY MONARCH  
Red with burgundy vinyl roof and burgundy vinyl interior. Automatic transmission, air condition, AM radio, 18,000 miles. **\*\$4998**

1977 DODGE CHARGER SE  
Medium green metallic with black landau vinyl top and green vinyl interior. Automatic, air condition, power steering and brakes, AM-FM stereo, power windows, glass T-top. **\*\$4398**

1977 CHEVROLET NOVA  
Medium blue metallic with blue vinyl interior. Automatic transmission, air condition, power steering and brakes, radio. **\*\$3698**

1977 CHEVROLET LUV PICKUP  
Red with tan vinyl interior. 4 speed transmission, long bed, step bumper, radio. **\*\$3698**

1976 CHEVROLET MONTE CARLO  
Silver metallic with burgundy landau roof and burgundy cloth interior. Automatic transmission, air condition, power windows, power sun roof, tilt wheel, cruise control, bucket seats. **\*\$3698**

1976 VOLKSWAGEN RABBIT  
Blue with black vinyl interior, 4 speed transmission, radio, rear defroster. **\*\$2398**

1976 TOYOTA COROLLA  
Yellow with tan vinyl interior. 4 speed transmission, radio, rear defroster. **\*\$2798**

1975 CHEVROLET IMPALA  
White with blue vinyl roof and blue vinyl interior. Automatic transmission, air, AM-FM radio. **\*\$2098**

1975 FORD MAVERICK  
Light blue with dark blue vinyl roof and blue vinyl interior. Automatic, air condition, power steering and brakes, radio. **\*\$2498**

1975 FORD THUNDERBIRD  
White with white vinyl top and white vinyl interior, automatic, air condition, power steering and brakes, AM-FM stereo, power seat, power windows. **\*\$3495**

1975 CHEVROLET MALIBU WAGON  
Tan with tan vinyl interior, automatic transmission, air condition, power steering and brakes, radio, 38,000 miles. **\*\$2298**

1975 TOYOTA CELICA  
Red with black vinyl interior. 4 speed transmission, air condition, AM-FM radio. **\*\$3398**

1974 DODGE CHARGER SE  
White with black landau roof and black vinyl interior. Automatic transmission, air condition, power steering and brakes, AM-FM stereo, mag wheels. **\*\$1598**

1974 AMC MATADOR WAGON  
Medium brown metallic with tan vinyl interior, automatic, air condition, power steering and brakes, radio. **\*\$1298**

1973 DATSUN 240-Z  
Bright orange with black vinyl interior. Automatic, air, AM-FM radio. Clean!! **\*\$3998**

Transportation Specials

1973 Olds Delta 88	*998
1973 Pontiac Catalina	*798
1973 Olds Cutlass	*698
1973 Plymouth Fury	*698
1972 Ford LTD	*498
1968 Plymouth Satellite	*498

TODAY'S DEALER TODAY with the promise of tomorrow

# TARHEEL TOYOTA

109 Trade St. Greenville  
Phone 756-3228

Open 8 a.m. 'til the last customer has been served, Monday thru Saturday

Houses For Sale

HOMEOWNER'S POLICY
Earl Thompson
3101 S. Evans Street
Across From Union Carbide
Phone 756-3422

State Farm Fire & Casualty Company

Practically no upkeep with this brick and aluminum siding home, convenient to shopping and schools, home offers living room, dining room, paneled kitchen, two bedrooms, central air, \$42,900.

LOAN ASSUMPTION available on this pretty brick ranch in Ayden with living room, den, kitchen with eat-in area, 3 bedrooms, 2 baths, paneled garage, patio and fenced backyard.

LOAN ASSUMPTION available on this nice brick ranch home with living and dining combination, 3 bedrooms, 1 1/2 baths, pantry, off kitchen, garage and patio.

UNFURNISHED by tall trees, this brick ranch in Ayden with living room, den, kitchen with eat-in area, 3 bedrooms, 2 baths, paneled garage, patio and fenced backyard.

CLARK-BRANCH SELLS TWO HOMES A WEEK SOMETIMES THREE

COLONIAL RANCH priced in the low \$40's at Fairfield conveniently located, 3 bedrooms as good floor plan. Kitchen with bar, formal dining room plus great room with fireplace.

JUST COMPLETED contemporary near the new shopping center. Stone and siding on the exterior, 3 bedrooms, 2 1/2 baths, central air, FHA VA.

COUNTRY south of Greenville near Ayden. This bedroom ranch should catch your eye at \$25,200. Separate utility room, attic storage, 1/2 acre lot and carport.

NEW OFFERING this immaculate 3 bedroom, 2 1/2 bath contemporary home needs to be seen in order to appreciate its beauty and quality. Some special features include heater/air conditioner in both the great room and master bedroom, two wet bars, deck and double car garage.

CLARK-BRANCH, INC. REALTORS 756-6336

Mary Chapin Ed Meyer
756-8431 756-6695
Colette Dilworth Sharon Lewis
756-8380 756-9987
Connally Branch Glo Clark
756-1549 756-0046

CLARK-BRANCH SELLS TWO HOMES A WEEK SOMETIMES THREE

CHERRY OAKS loan assumption. That's right, that 1/2% loan assumption you've been waiting for is here! \$13,000 equity and total payments of \$433.00. Three bedrooms, two full ceramic baths, plus air conditioned garage. Beautiful fenced in back yard for summer activities.

OAKDALE \$37,500. Just listed, this handsome Oakdale home has all the features you want. Antique brick fireplace in den, formal living room, big special kitchen, three bedrooms and possible loan assumption. Call today!

CLARK-BRANCH, INC. REALTORS 756-6336
Mary Chapin Ed Meyer 756-8431 756-6695
Colette Dilworth Sharon Lewis 756-8380 756-9987
Connally Branch Glo Clark 756-1549 756-0046

CLARK-BRANCH SELLS TWO HOMES A WEEK SOMETIMES THREE

GREENBRIAR Pretty as a picture. Here is a neat five brick home that would be mighty cozy for the young family looking for a good neighborhood with convenience to shopping areas. This home is beautifully landscaped and would win the Good Housekeeping Seal of Approval inside. Three bedrooms, 1 1/2 baths, living room, kitchen-dining room combination and carport with storage area. The spacious backyard is completely fenced. Only \$39,900!

LAKE ELLSWORTH Immaculate 3 bedroom ranch including fireplace, deck, workshop, separate utility and not to mention 1882 square feet. Conventional loan assumption available priced at \$56,900. Compare this value and you'll see what we mean by this special buy.

COUNTRY Under construction near Pitt Tech. This 3 bedroom ranch offers a lot for \$44,000. 2 full baths, plenty of storage. Select your own decor and take advantage of 9 1/2% FHA-VA financing.

NEAR WINTERVILLE 3 bedrooms, 1 1/2 baths. Nearly 1100 square feet. FHA financing available. \$37,000. Under construction. You can select your own decor.

CLARK-BRANCH, INC. REALTORS 756-6336
Mary Chapin Ed Meyer 756-8431 756-6695
Sharon Lewis Colette Dilworth 756-9987 756-8380
Connally Branch Glo Clark 756-1549 756-0046

ALMOST NEW contemporary. Large den and fireplace, 3 or 4 bedrooms, well equipped, low utilities. \$45,500. Ginger Hackett Realtors, 756-7986, 758-0050.

100 CLASSIFIED DISPLAY

INSTRUCTION Drivers employed by large trucking companies had annual average earnings of about \$18,300.

in 1974 as quoted by the U.S. Dept. of Labor, Bureau of Labor statistics, bulletin No. 1875.

Revo Tractor Trailer Training, Inc. RALEIGH 919-828-1752

Consider a Professional Career Driving a "BIG RIG." We are a Private Training School offering a PART TIME or FULL TIME Training Program. If you are working, Don't Quit Your Job, attend our Weekend Training Program or at attend our 3 Week FULL Time Resident Training.

Houses For Sale

\$48,500. Cedar split level with 3 bedrooms, 2 1/2 baths, great room with cathedral ceiling, rustic family room with fireplace, many luxury touches. Nicely landscaped half acre lot in Stonebrook, between Greenville and Farmville. Call East Carolina Builders, Inc., 752-7194 anytime.

RED OAK Subdivision. By owner, 3 bedrooms, brick, with garage. Up per 30's. 756-5157 after 5.

UNIVERSITY Condominium, 2 bedrooms, 1 1/2 baths, living room, kitchen with breakfast area. Swimming pool and many extras. Own your own home for less than \$26,000. Call today, Phil Partin, 752-0689; Home Showcase, 752-5522.

80 Lots For Sale

ZONE O AND I. Oakmont, 756-3333.

WOODED LOT in country, 1.2 acres on State Road 1538. Includes septic tank, 300 foot deep well, circular brick, 1400 square foot garage, all newly installed. 1400 square foot brick foundation, 200 feet off road with septic area. Landscaped with perfect southern exposure, ideally suited for building. \$11,000. Call 752-4965.

LOT FOR SALE, 10 1/2 miles east of Greenville, off Highway 264, \$500 down. Call John Jackson, 758-3790 office, 756-4360 home or Kent Worthington, 756-2474.

WESTWOOD. Developed lot for sale, 100 x 150. Curbing and sewage system. 756-7100.

IN COUNTRY in Candlewick Estates. Large, wooded lot (100 x 200) in restricted neighborhood. Lot has been cleared of all underbrush. Has been approved for septic tank, is on community water system and is ready for builder to start construction immediately. Lot is located on well-drained, paved, state maintained street; swimming pool and tennis courts are located nearby, only 3 miles from hospital city limits. For more information, call Century 21 Real Estate Brokers, 756-2121.

RIVER HILLS. All remaining subdivision lots are now available for purchase or construction. All city services, in county, \$8500 up. Ginger Hackett Realtors, 756-7986, 758-0050.

82 Resort Property For Sale
12 X 65 TRAILER at Camp Hardce. Central heat and air, underpinned. 12 X 30 screened porch with excellent view of Pamlico River. Excellent condition. Common usage of pier and beach area. \$11,000. Call 758-2900 days, 758-1742 nights.

WATERFRONT model home on Bogue Sound, 4 bedrooms, 2 1/2 baths, many many luxury features, panoramic view. Developer's cost, \$120,000. Call 758-1742 nights.

WATERFRONT residential lot on Bogue Sound, near Atlantic Bch. Wooded, 100 x 320, Waldo Gray, Broker, 726-2621 or 726-8787 nights.

100 CLASSIFIED DISPLAY

RENTALS

RENT A beautiful Currier Spinnet piano for only \$22 per month, as long as you like. First 9 months rent applies toward purchase. Piano-Organ Warehouse, 730 Greenville Boulevard, 756-2032.

4 BEDROOM apartment in town, 2 bedroom trailer and 2 bedroom apartments in country, 746-3284.

BUILDING FOR RENT in Simpson, 4 miles east of Greenville, \$170 a month, 752-7982 or 758-6100.

TAR RIVER ESTATES

1401 Willow Street 752-6225. 1, 2, and 3 bedrooms, washer-dryer hook-ups, cablevision, pool, club house. Only 5 blocks from East Carolina University.

Check everywhere else first Ultimate In Apartment Living

ONE BEDROOM apartment. Furnished, utilities included. Short term lease. 756-5553.

Kings Row Apartments One and two bedroom garden apartments. Fully carpeted, furnishing disposal and cable TV. Conveniently located to shopping center and schools. Located just off 10th Street. Call 752-3519

ONE BEDROOM apartment. Excellent location, near university. Heat, air conditioning and water furnished. No pets, \$165 per month. Call Buchanan Real Estate, Inc., 752-3696.

3 BEDROOM duplex on Stencil Drive, five blocks from university. Marrieds, \$195, 756-7480 after 6 p.m.

SUBLET 2 bedroom apartment. Heat pump, central air, washer/dryer hook-up. Near everything in Greenville, 756-8415.

5 ROOM furnished apartment with one bedroom. New furniture. Call 752-6233.

2 BEDROOM duplex apartment. Central air, kitchen appliances, washer and dryer. \$200, 752-1572 after 5:30 p.m.

GRADUATE STUDENT needs roommate to share expenses, 2 bedrooms, fully carpeted, air, full kitchen. Call 758-4317.

100 CLASSIFIED DISPLAY

86 Apartments For Rent

STRATFORD ARMS APARTMENTS The Happy Place To Live FREE MASTER ANTENNA Office Hours 10 a.m. to 5 p.m. Monday through Friday. Call us 24 hours a day at 756-4800

LOVE TREES? Experience the unique in apartment living with nature outside your door. Quality construction, fireplaces, heat pumps (heating costs 50% less than comparable units), dishwasher, washer/dryer hook-ups, walk-in closets, extra insulation.

COURTNEY SQUARE APARTMENTS Arlington Blvd. 756-5987

CARRIAGE HOUSE Apartments, new Section II, 8 apartments for rent. May 1. All electric, 2 bedrooms, unfurnished with cable TV. Call Manager, 756-3450.

NEW DUPLEX APARTMENTS IN COLONIAL VILLAGE Two carpeted bedrooms, large carpeted living room, kitchen with dining area and plenty of cabinets. Appliances furnished. Brick veneer construction fully insulated. Heat pump. Across from Burroughs-Wellcome near school, \$500 per month. Call 758-2558

GEORGETOWN APARTMENTS, 2 bedroom townhouses for rent, furnished. Located just off 10th Street, 752-7101 days, 758-1188 nights.

OAKMONT SQUARE APARTMENTS Two bedroom townhouse apartments, 1212 Redbanks Rd. Dishwasher, refrigerator, range, disposal included. We also have Cable TV. Very convenient to Pitt Plaza and University. Also some furnished apartments available. 756-4151

2 BEDROOM apartment, 4 blocks from campus. Heat included. Pets allowed. \$225. Home Showcase, 752-5222; nights, 756-2770.

2 BEDROOM apartment with washer and dryer hookups, cable TV, fully carpeted, 5 blocks from college. 752-0180, 756-2766.

DUPLEX apartment for rent. New. Colonial Village, across from Burroughs Wellcome, 2 bedrooms, \$200 per month, 756-5830.

3 ROOM apartment. Located near university, 756-0528.

WE REPAIR SCREEN & DOORS C.L. LUPTON CO.

86 Apartments For Rent

AZALEA GARDENS Greenville's newest and most unique furnished one bedroom apartments. All electric energy efficient designed. Queen size beds and studio couches. Washers and Dryers optional. Free water and sewer and yard maintenance. All apartments on ground floor with porches. Frost free refrigerators.

Located in Azalea Gardens near Brook Valley Country Club. Shown by appointment only. Couples or singles, no pets, \$175 per month. Contact J. T. or Tommy Williams 756-7815

UNIQUELY DESIGNED 2 bedroom apartments at Cedar Village. Solar assisted utilities. Air conditioning, carpet, furnished kitchens, one bath. Attractive decks. \$225 per month. Call Simmons & Harris at 752-1872.

BRYTON HILLS APARTMENTS River Bluff Rd. Spacious brand new 1 and 2 bedroom apartments. Furnished kitchens, carpet, air conditioning. Dishwasher and living room drapes included. Convenient location. Nice deck or patio in each apartment. 752-1872

2 BEDROOM apartment, 4 blocks from campus. Heat included. Pets allowed. \$225. Home Showcase, 752-5222; nights, 756-2770.

2 BEDROOM duplex, \$135 month. Available June 1, 758-2225 after 6.

DUPLEX ON JARVIS Street. Appliances furnished. Central air and heat. 752-0864.

ONE UNFURNISHED duplex. Colonial Village. Appliances including washing machine and dishwasher. \$215, 756-3165. After 5, 756-3789 or 756-0209.

2 BEDROOM, unfurnished duplex. Married couples. No pets. 1303 East Second Street, \$175, 752-4717.

100 CLASSIFIED DISPLAY

86 Apartments For Rent

GreeneWay Large 2 bedroom garden apartments, carpet, drapes, dishwasher, pool. On Country Club Dr. adjacent to Greenville Country Club, 756-6869. WE HAVE CABLE TV

CHERRY COURT Luxurious 2 bedroom townhouses and 1 bedroom apartments. Carpet, drapes, compactors, washer-dryer hook ups, pool, sauna, tennis court, clubhouse, etc. 752-1557.

EASTBROOK AND VILLAGE GREEN APARTMENTS 327 one, two and three bedroom garden and townhouse apartments with heat, air conditioning, carpet, kitchen appliances, garbage disposal, nice laundry facilities, 3 swimming pools, 2 tennis courts, heat and hot water furnished in some units and Cable TV. No pets or loud parties allowed. Rent from \$150-\$225 per month. Eastbrook - Eastbrook Drive off 264 By-pass, Village Green - 800 Heath Street off E. 10th Street Call 752-5100.

ROOMMATE NEEDED to share 2 bedroom apartment, \$170 a month plus utilities. 752-1477.

2 BEDROOM duplex, \$135 month. Available June 1, 758-2225 after 6.

DUPLEX ON JARVIS Street. Appliances furnished. Central air and heat. 752-0864.

ONE UNFURNISHED duplex. Colonial Village. Appliances including washing machine and dishwasher. \$215, 756-3165. After 5, 756-3789 or 756-0209.

2 BEDROOM, unfurnished duplex. Married couples. No pets. 1303 East Second Street, \$175, 752-4717.

86 Apartments For Rent

FOR RENT OR sale, 2 bedroom, condominium at Yorktown Square. End unit with carpet, central heat and air, and all appliances. Call 756-9949.

SUBLEASE AVAILABLE on one bedroom, unfurnished apartment at Riverbluff. Available June 1, \$150, 758-6162.

ONE BEDROOM apartment at Cedar Lane Apartments, \$130, 756-3811 or 756-2926.

3 ROOM APARTMENT for a single person located in front of Cliff's Steak House, 3 miles out on 33. If interested stop in and see lot.

APARTMENTS South of Greenville, 524-5507.

SIX ROOM house about 10 miles from Greenville. Call 746-4560.

OAKDALE, 3 bedrooms, 1 1/2 baths, 225 lease and deposit, 756-5706.

AVAILABLE July 1, 3 bedrooms, 2 baths, fireplace, fenced backyard. Lease and security deposit, \$330 a month, 756-4851.

ACROSS FROM ECU, 758-7048.

SOMEONE WANTED to share house from June 30-August, 752-1653 or stop by 409 East Third Street.

BRENTWOOD, Available July 15, 3 bedrooms, 2 baths, central air, fireplace, deck. Plenty of storage. Deposit and lease required, \$350. Omni Realty, 758-6900, 756-5456, 756-6171.

3 BEDROOMS, unfurnished or partially furnished, appliances, carpet. Married or family, \$200, 752-6092.

MALE ROOMMATE wanted for summer to share 2 bedroom house. Fully equipped. 752-8408 after 6 p.m.

3 BEDROOMS, living room, dining room, and kitchen (completely furnished). Location, Rt. 1 on the Stanfordsburg Road. Call 752-6444, William Teel.

EASTWOOD Large 3 bedroom brick ranch on quiet circle. One yr lease. Available July 1, \$375 a month. Aldridge & Southerland, 756-3500; nights, 756-7871.

3 BEDROOM, 2 1/2 baths, large family room with fireplace, formal living room and formal dining room. Large lot. Detached garage. One year lease and deposit required. \$425 a month. Call, 756-3677.

86 Houses For Rent

EQUAL OPPORTUNITY. Immediate opening. Two female, monogamous, gay couples wanted for roommates for 3 bedroom wooden house beside Tar River. Quiet, liberal neighborhood. \$60 a month plus 1/6 of utilities, which are approximately \$6 for 7 months and \$14 for 5 months. Houseowner is 31, single female. We will set up house rules (minimal) together. Call 758-6225, Rachel Kirkpatrick, 210 North Harding Street, Greenville, NC.

3 BEDROOMS, 1 1/2 baths, fireplace, living room, dining room, den and activity room, kitchen, central heat, 22 miles north of Greenville, off Highway 11, 1/2 mile left on Highway 42, \$192 month, 759-2486 after 6 p.m.

FEMALE TO share 3 bedroom house, 2 blocks from campus, 1/2 rent plus utilities. Summer only. 206 South Summit Street.

91 Office Space For Rent OFFICE SPACE for rent. Call Joe Bowen, 752-7194.

OFFICE or retail space available, 1000 or 2000 square feet. Will remodel to suit tenant or lease as is. Located beside Larry's Carpetland, 758-2300.

SHOP/OFFICE space for lease, 1000 square feet. Neighborhood commercial zone. Hooker Road, Call 752-1733 days, 758-614 nights.

EXECUTIVE OFFICE space for rent. Convenient location. New building. All services provided. 756-6186, ask for Steve Umstead.

8000 SQUARE FOOT office building located 264 Bypass West with 46 paved parking spaces. Call 758-2300 days, 758-1742 nights.

WANTED NEED NICE LOOKING, female companion for all expense paid vacation to Las Vegas, Nevada, June 7-10. Call Sonny, 522-4980 after 5 p.m., May 25 through June 5.

Wanted To Buy WANT TO BUY mobile home lot. Approximately 4 miles from Burroughs-Wellcome. Enough footage to build house later. Fair price. 758-1997.

Greenville's Finest Used Cars!

1976 Olds Omega 4 door. Light blue with white vinyl top. Fully equipped with sports console. \$3495

1976 Pontiac Grand Prix White with red landau roof and red interior. Fully equipped. \$3950

1977 Olds Cutlass Supreme Ginger with buckskin landau roof and buckskin interior. Fully equipped, 6 cylinder. \$4650

1977 Pontiac Grand Prix LJ Ginger in color. Loaded. Immaculate with 23,000 miles. \$4895

1978 Pontiac Trans AM Black with buckskin interior. \$5950

1974 Chevrolet Vega Hatchback. Blue with blue vinyl top. Air condition, automatic. \$1695

1977 Buick Century 4 door. Air condition, automatic transmission, power steering. \$3395

1977 Honda Civic Red, 4 speed. \$3695

1975 Ford Pinto Squire Wagon Tan, automatic transmission, power steering, air, AM-FM radio. Very low mileage at only 30,445 miles. \$2695

Bob Barbour HONDA VOLVO 117 West Tenth St., Greenville 758-7200

GRANT BUICK, INC. 603 Greenville Blvd., Greenville, N.C.

1978 Toyota Corolla SR-5 - Air, stereo, CB radio \$5298

1977 Mazda GLC - Air, automatic, AM-FM \$3998

1977 Chevrolet Caprice Classic - Loaded, like new \$4298

1976 AMC Jeep Renegade - Nice, perfect condition \$3998

1974 Ford Econoline Van - V-6, air, economical \$2998

1977 Plymouth Volare Wagon - Extra clean, one owner \$4298

1977 Pontiac Grand Prix - Sharp, one owner \$4698

1978 Dodge Magnum XE - T-top, like new \$5698

1974 Buick Century Wagon - Perfect for vacation \$2698

1977 Chevrolet Nova - Power windows, air, nice \$4298

Super Savings Specials 1974 Chevrolet Impala \$998

1973 Chevrolet Monte Carlo \$1098

1973 Chevrolet Impala \$598

Low Prices And High Quality Go Together With Us

Bill Grant Garry Singleton Jack Mewborn Al Wainwright Tom Dickens Jim Gantz

SUPER SIGN OVERTON & POWERS 758-4585

ROBERT C. DUNN CO. ROOFING & SHEET METAL WORKS

A New Offering OAKDALE Wanted. A family for this well kept brick three bedroom home.

CLARK-BRANCH, INC. REALTORS 756-6336

COUNTRY HOMES JUST WEST OF GREENVILLE A Beautiful, Extra Special Contemporary Not Far From Greenville.

EASTERN PINES Country Living At Its Best And At A Very Affordable Price.

SIMPSON AREA Look At All You Can Have For The Price! Three Acres Of Beautiful Trees.

WE BUY HOMES Call MATCHMAKER for more information. Hignite & Co., Inc. 758-6666 Anytime

Buying or Selling, For Best Results Try Our "Personal Service" D. G. Nichols Agency 752-4012 Anytime

Mavis Butts realty 105 West 3rd St. Greenville 758-0655

MAVIS BUTTS - GRI, CRS 752-7073 KAYE MONTIETH 758-4750

THE NIFTY FIFTIES 52,500-CAMBRIDGE. Echoes of yesteryear in this home's Williamsburg styling.

53,900 FAIRLANE ROAD. Four bedrooms for less than \$54,000! With large living room, dining room, entry hall, fireplace, flooded attic, one-car garage, and a 90% assumable loan.

55,800-ENGLEWOOD. On a beautifully manicured lawn, this pretty ranch home will offer lots more besides just a place to call home.

57,500-EAST 10TH STREET. Need a nice office or business location? There's lots you can do with this property which is zoned Highway Commercial.

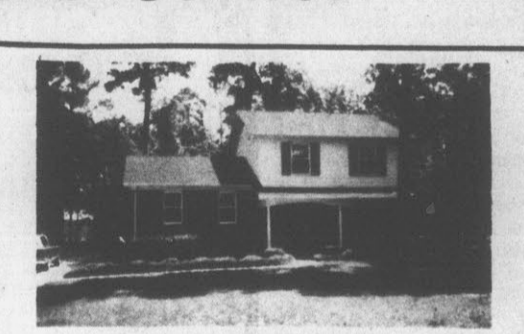

For Sale By Owner Tucker Estates. 3 bedrooms, 2 1/2 baths, den with built-ins, office or sewing room. Large wooded lot. \$55,000. Shown by appointment only. Call 756-3374 Days 756-6020 Evenings

Mavis Butts realty 105 West 3rd St. Greenville 758-0655

MAVIS BUTTS - GRI, CRS 752-7073 KAYE MONTIETH 758-4750

THE NIFTY FIFTIES 52,500-CAMBRIDGE. Echoes of yesteryear in this home's Williamsburg styling.

53,900 FAIRLANE ROAD. Four bedrooms for less than \$54,000! With large living room, dining room, entry hall, fireplace, flooded attic, one-car garage, and a 90% assumable loan.

55,800-ENGLEWOOD. On a beautifully manicured lawn, this pretty ranch home will offer lots more besides just a place to call home.

57,500-EAST 10TH STREET. Need a nice office or business location? There's lots you can do with this property which is zoned Highway Commercial.

### Pitt Tech Honor Roll For Quarter

The following area students were named to the Pitt Technical Institute Honor Roll for the Spring Quarter:

AYDEN — Louis M. Dail, Timothy L. Grimsley, Sherri L. Harris, Melvin W. King, Linda L. Mewborn, Larry C. Morton, Olivia D. Pate, Diane D. Taylor, Marietta Williams and Diane F. Young.

BELL ARTHUR — Joanne E. Stoddard.  
BETHEL — Geraldine Brown and Julia A. Purvis.

FARMVILLE — Sheila D. Cox, Roy L. Davis, Martha S. Gay, Valerie A. Joyner, William K. Linton, Terry A. Mashburn, Audrey J. Vines and Roy M. Williams.

GREENVILLE — Jasper W. Anderson, George E. Andrews, Burtis L. Atkinson, John J. Bakerman, Cindy J. Baltezare, Delphia A. Beacham, Bobby P. Boseman Jr., James R. Brown, Kay A. Brown, Martha S. Capel, Mitzi L. Cheek, Carlette F. Cherry, Jennifer H. Cherry, George C. Clark Jr., Suzanne L. Commander, John C. Curlings, Dorothy J. Daniels, Lois A. Daniels, Susan W. Dickerson, Jarvis R. Everett, Jane A. Fox, Leslie R. Gaddy.

James W. Hardy, Helen I. Haynes, Carolyn J. Hill, Cecelia A. Hurwitz, Siamaek Ishaniafoosi, William E. Jones, Steven R. Jordan, Cynthia A. Kandrotas, Charles E. Kavanaugh, Carolyn F. King, Carol S. Lappin, Haywood J. Latham Jr., Wanda S. Leonard, Karen W. Maye, Lou N. McLawhorn, Stephen H. Mehan, Donna M. Moore, Robin D. Moore, Barbara A. Murray, Frank E. Northern, Margie S. Osborn, Debora A. Oxley, Connie F. Palmer, Helen M. Parks, Shirley T. Payne, Thelma G. Perry, Dorothy F. Pickett, Doris W. Potter, Gloria S. Roach, Linda L. Rouse, Lizzie M. Savage, Lula G. Scherer, Sharon B. Shiple, Steve R. Shipley, Cheryl L. Smith, Lydia R. Smith, Ronald H. Smith, Samuel N. Stykes, Constance G. Tavasso, Marian Thigpen, Mavis C. Vines, Glenn T. Warren, Michael D. Welch and Linda B. Whitehurst.

GRIFTON — Deborah H. Jones, Michael O. Mewborn, James O. Moore, Joyce A. Rosenboro and Kermit M. Suggs.

GRIMESLAND — William S. Davenport, Frank J. Haddock, Theresa G. Hines and Barry J. Swain.

JAMESVILLE — Randy K. Holliday.  
PLYMOUTH — Patti A. Williams.

ROBERSONVILLE — Deborah L. Roberson.  
SNOW HILL — Russell F. Brann, Harry A. Brinkley, Ben G. Edmundson, Winnifred H. Hill and Donald A. Wooten.

WALSTONBURG — Linda L. Barnes, Ronnie L. Heath and Teresa J. Tugwell.  
WILLIAMSTON — Billie M. Harrison.

WINTERVILLE — Patricia A. Buck, Annie L. Carmon, Lillie M. Coward, Gail E. Crunk and Teresa C. Martin.

### Facilities Open June 1

RALEIGH — Swimming facilities and refreshment stands in North Carolina state parks and recreation areas will open for the summer season on Friday, June 1.

Bathhouses and refreshment stands will operate daily from 10 a.m. to 6 p.m. at the following eastern North Carolina parks — Cliffs of the Neuse near Goldsboro; Jones Lake north of Elizabethtown; Fort Macon near Morehead City; and Hammocks Beach southeast of Swansboro.

The free passenger ferry service to Hammocks Beach, an island state park, will begin running its daily schedule on June 1. The ferry boat leaves the mainland every hour on the half hour beginning at 9:30 a.m., and departs from the island on the hour with the last ferry leaving at 6 p.m.

Swimming areas are supervised by lifeguards.  
Summer park hours for camping, hiking, picnicking, and other year round activities are 8 a.m. until 9 p.m. daily.

OUT OF DETENTION  
KARACHI, Pakistan (AP) — The widow and daughter of executed former Prime Minister Zulfikar Ali Bhutto have been released from detention in a police camp near Islamabad and flown here, the government says.



SERIES 314

## INSTANT TWIN WINN BINGO

80 WAYS TO WIN!

Get your FREE Game Ticket and Collector Folder (with handy Collector Pocket) at the store.



## STORE MANAGERS' SALE!

ALL STORES  
**OPEN SUNDAYS 10-7**

WINN-DIXIE  
CLIP & SAVE 40c

**DUKE'S MAYONNAISE** QT. JAR **79c**

LIMIT ONE WITH COUPON & \$7.50 OR MORE ORDER  
GOOD THRU SAT., JUNE 2ND

USDA U.S. CHOICE  
**YOU SAVE \$1.00 PER LB.**  
U.S. CHOICE BEEF WHOLE  
"UNTRIMMED" BONELESS (9-11 LBS. AVG.)  
**SIRLOIN TIPS** LB. **1.59**

CUT INTO STEAKS, ROASTS & TRIMMINGS AT THIS PRICE

BONELESS SIRLOIN TIP  
• ROASTS LB. \$2.89  
• STEAKS LB. \$2.99

Winn-Dixie BRAND U.S. CHOICE  
**YOU SAVE \$13.90**  
BRAND U.S. CHOICE  
**15-LB. BEEF SPECIAL**

• 5 LBS. SIRLOIN TIP STEAKS \$  
• 5 LBS. SIRLOIN TIP ROASTS \$  
• 5 LBS. SIRLOIN TIP STEW BEEF \$

**29<sup>95</sup>**

**PRODUCE PATCH** Harvest Fresh  
U.S. #1 IDAHO  
**BAKING POTATOES**  
15-LB. POLY BAG **1.69**

RED, RIPE (28 LBS. AVG.)  
• **WHOLE WATERMELONS** EA. \$2.79 (SLICED LB. 13c)

SWEET & TENDER YELLOW CORN 6 EARS 99c • GREEN CORN 3 BCHS. \$1.00  
HARVEST FRESH BROCCOLI BUNCH 79c • HARVEST FRESH BROCCOLI BUNCH 79c  
VINE RIPENED JUMBO HONEYDEWS EA. \$1.39 • U.S. #1 YELLOW ONIONS 3-LB. BAG 79c

VINE RIPENED  
**CANTALOUPE (JUMBO)** Harvest Fresh  
EA. **69c**

**FROZEN FOODS** YOU SAVE 21c  
SUPERBRAND  
**SHERBET OR ICE CREAM**  
HALF-GAL. CTN. **98c**

SUPERBRAND FUDGE BARS OR TWIN POPS PKG. OF 12 88c  
MORTON'S (EXCEPT HAM OR BEEF) T.V. DINNERS EA. 59c • MORTON'S HONEYBUNS 2 PKGS. \$1.00  
MORTON'S COUNTRY TABLE DINNERS 18-OZ. SIZE 99c • MORTON'S CHEESE CAKES 6-OZ. SIZE 69c  
MORTON'S CREAM PIES 14-OZ. SIZE 69c • MORTON'S MINI DONUTS 10-OZ. PKG. 69c  
MORTON'S FAMILY PAK DONUTS 13-OZ. PKG. 69c • MORTON'S FRIED CHICKEN 2-LB. BOX \$2.49

**DAIRY DEPT.**

YOU SAVE 24c ON  
• PILLSBURY BUTTERMILK BISCUITS 4 8-OZ. CANS 69c  
• MARGARINE 3 1-LB. CTNS. \$1.29  
• ALL-NATURAL YOGURT 3 8-OZ. CUPS \$1.00  
• COTTAGE CHEESE 3 2-LB. CUPS \$1.49  
• PIMENTO CHEESE 1-LB. CUP \$1.29  
• CHEESE SPREAD (18 SLICES) 12-OZ. PKG. \$1.19

**YOU SAVE \$2.00 ON GRAVY BOAT**

Redeem this coupon worth \$2.00 toward the purchase of this item.

Regular Discount Price \$10.99  
Coupon Savings \$2.00  
Price (With Coupon) \$8.99

Check the Pattern of your Choice  
 Winsford  Floral Generation  
 Spring Bouquet  Golden Autumn

COUPON GOOD THRU WEDNESDAY, JUNE 6TH

**VALUABLE DISCOUNT COUPON**

Winn-Dixie U.S. CHOICE  
**YOU SAVE 40c PER LB.**  
BRAND U.S. CHOICE BEEF BONELESS  
**CUBED STEAKS** LB. **2.99**

BRAND U.S. CHOICE BEEF MEATY  
• CHUCK STEAKS LB. \$1.99  
• RIB ROASTS LB. \$2.49

**YOU SAVE 10c PER LB.**  
HOLLY FARMS  
**FRYER QUARTERS**  
• LBS. PORTIONS LB. 69c  
• BREAST PORTIONS LB. 79c

CLAUSSEN'S  
REFRIGERATED WHOLE, SLICED OR ICICLE  
• PICKLES 32-OZ. JAR \$1.19

**FRESH PORK SLICED QUARTER** \$1.49

• LOINS LB. \$1.39  
• BACKBONES COUNTRY-STYLE LB. \$1.49  
• RIBS LB. \$1.49

SUNNYLAND  
GEORGIA BRAND PORK  
• SAUSAGE 2-LB. ROLL \$2.99

**YOU SAVE 20c PER LB.**  
SMOKED **HAM**  
• SHANK PORTIONS LB. 99c  
• BUTT PORTIONS LB. 1.09

DIXIE BEEF  
"FINE FOR MEAT LOAF, HAMBURGER, CHILI, ETC."  
• PATTY MIX 3-LB. ROLL \$2.99

**BRAND MEAT PRODUCTS SALE!**  
REGULAR OR DINNER  
• **FRANKS** 1-LB. \$1.49 PKG.

REGULAR OR THICK  
• **SLICED BOLOGNA** 1-LB. \$1.39 PKG.

SPICED LUNCHEON, SALAMI, BOLOGNA, 8-OZ. PKG. 99c  
• OLIVE OR HAM & CHEESE 8-OZ. PKG. 99c  
• BRAUNSCHWEIGER LB. 79c  
• IMPORTED SLICED COOKED HAM OR PICNIC 12-OZ. PKG. \$2.49  
• SALAMI, SPICED LUNCHEON OR PICKLE & PIMENTO 1-LB. PKG. \$1.59

SLICED VARIETY PACK 12-OZ. PKG. \$1.39  
FULLY COOKED SMOKED SAUSAGE 5-LB. PKG. \$7.99  
WHOLE HOG PORK SAUSAGE 1-LB. ROLL \$1.49  
WHOLE HOG SAUSAGE PATTIES 12-OZ. PKG. \$1.19

**YOU SAVE UP TO 58c**  
THRIFTY MAID  
SLICED OR HALVES  
• **YELLOW CLING PEACHES**  
• BARTLETT PEARS  
2 29-OZ. CANS **\$1.00**

WITH \$7.50 OR MORE ORDER (LIMIT 4 OF CHOICE)

**YOU SAVE 37c**  
2-PLY JUMBO  
**BOUNTY PAPER TOWELS**  
2 100-SHEET ROLLS **\$1.09**

WITH \$7.50 OR MORE ORDER (LIMIT TWO)

DIXIE DARLING SANDWICH  
**BREAD**  
3 24-OZ. LOAVES **\$1.00**

PLAIN OR PEANUT BUTTER & M&M CANDY 7-OZ. PKG. 99c  
THRIFTY MAID STUFFED OLIVES 2-OZ. JAR 49c  
LIFEBREAD TEA BAGS BOX OF 100 \$1.89

**YOU SAVE 70c**  
ASTOR  
**COFFEE**  
1-LB. CAN **1.59**

WITH \$7.50 OR MORE ORDER (LIMIT 1)

DEEP SOUTH B.B.Q. SAUCE 2 16-OZ. BTL. \$1.19  
THRIFTY MAID GRAPEFRUIT JUICE 46-OZ. CAN 59c  
DOWNEY FABRIC SOFTENER 64-OZ. JUG \$1.98

DELI-BAKERY  
SLICED-TO-ORDER BONELESS  
• **COOKED HAM** LB. \$2.49

FRESH CRISP CHEF SALADS EA. **1.69**

TAKE-OUT SPECIAL  
• 2 LBS. TURKEY & DRESSING  
• 1 QT. GREEN BEANS  
• 1 QT. YAMS  
• 1 DOZ. ROLLS  
ALL FOR **\$7.99**

FRESH FROM OUR IN-STORE BAKERY!  
• STRAWBERRY PIES EA. \$2.89  
• FRENCH BREAD 2 1-LB. LOAVES \$1.00

PLEASE CALL FOR SPECIAL ORDERS: Shopper Mart 756-2655 Rivergate 758-0888

SUPERBRAND U.S.D.A.  
**GRADE 'A' WHITE LARGE EGGS**  
DOZ. **59c**

THRIFTY MAID PORK & BEANS 5 16-OZ. CANS \$1.00  
ARROW BLUE DETERGENT 192-OZ. PAR. \$5.49

**YOU SAVE 16c**  
MAZOLA  
**CORN OIL**  
32-OZ. BTL. **1.69**

DONALD DUCK ORANGE JUICE 64-OZ. JUG \$1.19  
**YOU SAVE 10c ON SPAM** 12-OZ. CAN \$1.19

PILLSBURY'S FLOUR  
• FLOUR 5-LB. BAG 89c  
• LAYER CAKE MIXES 18½-OZ. BOX 69c

ASSORTED FLAVORS FIGURINES 7-OZ. PKG. \$1.43

READY-TO-SPREAD FROSTINGS 16½-OZ. CAN \$1.09

HUNGRY JACK PANSHAKES 7-OZ. BOX 53c

# Author, 70, Chops Wood To 'Relax'

By PHIL THOMAS  
AP Books Editor

NEW YORK (AP) — When Wallace Stegner tires of writing, he chops wood. "It relaxes me," says Stegner.

"My wife and I live outside of San Francisco. We've got three acres and there are a lot of trees that need pruning or cutting. So, after I write for maybe four hours, I stop and become a handyman. I've got a real Vermont woodpile in California. We live among the wild-life and the woodpile, very quietly."

Stegner has spent much of his 70 years on the move — living in Iowa, North Dakota, Washington, Saskatchewan, Montana, Utah, Nevada and California.

"It was like living in a covered wagon," he recalls with a smile. "I did a lot of roaming, but now I've decided to settle down."

The West plays a major part in some of his more than 20 fiction and non-fiction books, but Stegner says, "I wouldn't like to be tagged as a Western writer, the West is the country I know and like the best. But my feeling is that while I write about people who happen to live in the West, these people would be legitimate anywhere."

His latest novel, "Recapitulation," is set in Salt Lake City. "I went to high school and college there," he says. "I worked my way through the University of Utah driving a delivery truck for a rug and linoleum house. Driving a truck is a splendid way to learn a town, you go all over the place, and I drew on the knowledge I acquired back then for this book."

After taking his doctorate in 1935 in American literature, Stegner continued with a teaching career that lasted until 1971.

While teaching he sold short stories and finished a short novel. The book, "Remembering Laughter" won a publishing house competition in 1937 and earned him a prize of \$2,500. "After that," he says, "there was no going back, there was no alternative."

Stegner says that during his later teaching years he would combine history writing with teaching because "you feel you are getting something done by going to the library for a couple of hours and taking necessary notes."

Fiction was different. "I wrote my novels while on vacation. You can't work on a novel for a couple of hours and then quit. You have to submerge yourself in your story and stay under..."

He says he was a teen-ager when he decided to be a writer. But it wasn't, he says, until he won the National Book Award and the Pulitzer prize that "my not very confident suspicion that I was a novelist was reassured..."

Stegner won the NBA for "The Spectator Bird" in 1977 and the Pulitzer for "Angle of Repose" in 1972.

Stegner says he quit teaching 1971 and "was glad to be done with it. All my life I had been doing two jobs, and it was a relief to get back to one — writing."

"Besides, I had a sense of time passing, of hearing time's chariot drawing just a little closer. I figured I had a few more years to write books and I'd better make the most of it."

## Child Hazard In Roasted Nuts

SACRAMENTO, Calif. (AP) — Keep nuts — especially roasted nuts — away from children under 5 years old, says Dr. Leslie Bernstein.

Bernstein, chairman of the University Medical Center's Department of Otorhinolaryngology, says he and other doctors in his department treat many people who have accidentally inhaled solid particles such as nuts, many of them children.

A child died recently because peanuts accidentally became lodged in his breathing passages, he said.

What if, despite all precautions, an accident happens? "If a child is choking, try to have someone call an ambulance — or do it yourself if no one else is around," he said. "Then hold the child upside down and slap him on the back sharply several times."

"If the child turns blue and stops breathing you should consider mouth-to-mouth resuscitation."



MEMBER OF THE FOODLAND SYSTEM

**"BANK YOUR SAVINGS BY SHOPPING FOODLAND TODAY" "THAT'S THE FOODLAND WAY"**

USDA INSPECTED

# FRYERS

WHOLE **49¢**  
LB. LIMIT  
4 PLEASE  
CUT UP (PAN READY) LB. **59¢**

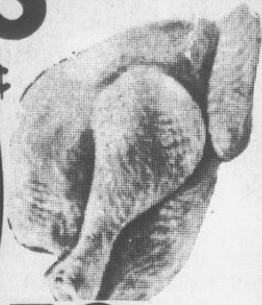

FOODLAND GRADE A MEDIUM WHITE EGGS DOZ. **57¢**

SMITHFIELD 12 OZ. PKG. FRANKS **99¢**

GWALTNEY SLICED BACON **\$1.19**  
1 LB. PKG.

SMITHFIELD SMOKED SAUSAGE **\$9.90**  
10 LB. BOX

# PORK CHOPS

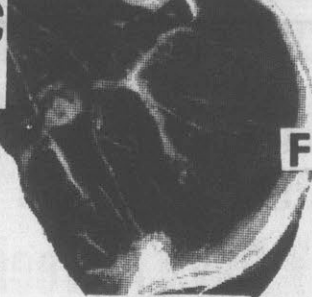

CENTER RIB **\$1.39**  
LB.

FRESH FIRST CUT LB. **99¢**  
CENTER LOIN **\$1.49**  
LB.

HEAVY WESTERN STEER RIB STEAK **\$2.19**  
BONE IN LB.

FRESH PORK CHITTERLINGS **\$3.99**  
10 LB. BOX

SMOKED TENDERIZED HAM **79¢**  
WHOLE OR SHANK PORTION LB.  
BUTT PORTION **89¢**  
CENTER SLICES **\$1.39**  
LB.

PORK CHOPS **\$1.29**  
1/4 LOIN LB.  
WHOLE OR RIB HALF LB. (SLICED FREE) **\$1.19**

FRESH BRUSSELS SPROUTS **79¢**  
1 PKG.

FRESH GREEN CABBAGE **12¢**  
LB.

FRESH YELLOW ONIONS **49¢**  
3 LB. BAG

FRESH CATALOUPES **69¢**  
18 CT. EA.

DUKE'S MAYONNAISE **89¢**  
32 OZ. JAR  
LIMIT 1 WITH 7.50 FOOD ORDER

ARMOUR POTTED MEAT **\$1.00**  
4 3 OZ. CANS

ARMOUR VIENNA SAUSAGE **89¢**  
2 5 OZ. CANS

SAUER'S BLACK PEPPER **69¢**  
3 OZ. BOX

OLD EL PASO TACO DINNERS **\$1.19**  
10 1/2 OZ. BOX

LYSOL SPRAY **\$1.19**  
6 OZ. CAN

FORMULA 409 **89¢**  
22 OZ. BOTTLE

JOY LIQUID DETERGENT **99¢**  
20" OFF  
32 OZ. BOTTLE

LIPTON TEA BAGS **99¢**  
48 CT. BOX

WHITE HOUSE VINEGAR **\$1.79**  
GALLON SIZE

PUSS N BOOTS **\$1.49**  
6 15 OZ. CANS  
CAT FOOD (ALL FLAVORS)

LOG CABIN BUTTERED SYRUP **\$1.29**  
24 OZ. BOTTLE

SPIC & SPAN **\$1.69**  
54 OZ. BOX

BOUNCE FABRIC SOFTNER **\$1.99**  
40 CT. BOX

SAFEGUARD SOAP **59¢**  
7 OZ. BAR

VIVA TOWELS **59¢**  
1 ROLL PKG.  
WHITE/ASSORTED, OR DECORATOR

COKE'S **79¢**  
2 LITRE BOTTLE

LOG CABIN COUNTRY KITCHEN SYRUP **\$1.09**  
24 OZ. BOTTLE

KRAFT GRATED PARMESAN **\$1.69**  
8 OZ. CAN

KEEBLER ZESTA SALTINES **\$1.25**  
2 LB. BOX

COMET CLEANSER **35¢**  
14 OZ. CAN

UNCLE BEN'S RICE **59¢**  
1 LB. BOX

KEEBLER CLUB CRACKERS **85¢**  
16 OZ. BOX

ERA DETERGENT **\$1.39**  
32 OZ. BOTTLE

JACK & BEANSTALK CUT GREEN BEANS **\$1.00**  
3 303 CANS

DULANY BROCCOLI SPEARS **59¢**  
10 OZ. PKG.

FOODLAND ICE MILK (ALL FLAVORS) **89¢**  
HALF GALLON

FROZEN FOODS: OLD SOUTH ORANGE JUICE **69¢**  
12 OZ. CAN

CHATHAM 25 LB. BAG (DOG FOOD) **\$2.99**  
4 LB. BAG (CAT FOOD) **\$1.29**

KRAFT-AMERICAN, WHITE, OR PIMENTO SINGLES CHEESE **\$1.19**  
12 SLI. PKG.

MORTONS HONEYBUNS **59¢**  
9 OZ. BOX

BANQUET CHICKEN & NOODLES, CHICKEN & DUMPLINGS, CHICKEN CHOW MEIN, SPAG. & MEATBALLS, BEEF STEW, SALISBURY STEAK, OR SLICED TURKEY DINNERS **\$1.49**  
2 LB. BOX

MAXWELL HOUSE COFFEE **\$2.19**  
1 LB. BAG  
**\$4.97**  
2 LB. CAN

SPAIN'S 1414 Charles Blvd.

Store Hours  
Mon.-Thurs. 8 A.M. To 8 P.M.  
Fri. & Sat. 8 A.M. To 8:30 P.M.  
Closed Sundays



Store Hours:  
Mon.-Sat.  
8:30 A.M. To 9 P.M.  
Open Sunday 12:30 P.M.-6:00 P.M.

SHOP-EZE West End Shopping Center

# Pitt Tech Honor Roll For Quarter

The following area students were named to the Pitt Technical Institute Honor Roll for the Spring Quarter:

**AYDEN** — Louis M. Dail, Timothy L. Grimsley, Sherri L. Harris, Melvin W. King, Linda L. Mewborn, Larry C. Morton, Olivia D. Pate, Diane D. Taylor, Marietta Williams and Diane F. Young.

**BELL ARTHUR** — Joanne E. Stoddard.

**BETHEL** — Geraldine Brown and Julia A. Purvis.

**FARMVILLE** — Sheila D. Cox, Roy L. Davis, Martha S. Gay, Valerie A. Joyner, William K. Linton, Terry A. Mashburn, Audrey J. Vines and Roy M. Williams.

**GREENVILLE** — Jasper W. Anderson, George E. Andrews, Burtis L. Atkinson, John J. Bakerman, Cindy J. Baltezone, Delphia A. Beacham, Bobby P. Boseman Jr., James R. Brown, Kay A. Brown, Martha S. Capel, Mitzi L. Cheek, Carlette F. Cherry, Jennifer H. Cherry, George C. Clark Jr., Suzanne L. Commander, John C. Curlings, Dorothy J. Daniels, Lois A. Daniels, Susan W. Dickerson, Jarvis R. Everett, Jane A. Fox, Leslie R. Gaddy.

James W. Hardy, Helen I. Haynes, Carolyn J. Hill, Cecelia A. Hurwitz, Siamack Ishaniafossi, William E. Jones, Steven R. Jordan, Cynthia A. Kandrotas, Charles E. Kavanaugh, Carolyn F. King, Carol S. Lappin, Haywood J. Latham Jr., Wanda S. Leonard, Karen W. Maye, Lou N. McLawhorn, Stephen H. Mehan, Donna M. Moore, Robin D. Moore, Barbara A. Murray, Frank E. Northern, Margie S. Osborn, Debra A. Oxley, Connie F. Palmer, Helen M. Parks, Shirley T. Payne, Thelma G. Perry, Dorothy F. Pickett, Doris W. Potter, Gloria S. Roach, Linda L. Rouse, Lizzie M. Savage, Lula G. Scherer, Sharon B. Shipley, Steve R. Shipley, Cheryl L. Smith, Lydia R. Smith, Ronald H. Smith, Samuel N. Stykes, Constance G. Tavasso, Marian Thigpen, Mavis C. Vines, Glenn T. Warren, Michael D. Welch and Linda B. Whitehurst.

**GRIFTON** — Deborah H. Jones, Michael O. Mewborn, James O. Moore, Joyce A. Rosenboro and Kermit M. Suggs.

**GRIMESLAND** — William S. Davenport, Frank J. Haddock, Theresa G. Hines and Barry J. Swain.

**JAMESVILLE** — Randy K. Holliday.

**PLYMOUTH** — Patti A. Williams.

**ROBERSONVILLE** — Deborah L. Roberson.

**SNOW HILL** — Russell F. Brann, Harry A. Brinkley, Ben G. Edmundson, Winnifred H. Hill and Donald A. Wooten.

**WALSTONBURG** — Linda L. Barnes, Ronnie L. Heath and Teresa J. Tugwell.

**WILLIAMSTON** — Billie M. Harrison.

**WINTERVILLE** — Patricia A. Buck, Annie L. Carmon, Lillie M. Coward, Gail E. Crunk and Teresa C. Martin.

## Facilities Open June 1

**RALEIGH** — Swimming facilities and refreshment stands in North Carolina state parks and recreation areas will open for the summer season on Friday, June 1.

Bathhouses and refreshment stands will operate daily from 10 a.m. to 6 p.m. at the following eastern North Carolina parks — Cliffs of the Neuse near Goldsboro; Jones Lake north of Elizabethtown; Fort Macon near Morehead City; and Hammocks Beach southeast of Swansboro.

The free passenger ferry service to Hammocks Beach, an island state park, will begin running its daily schedule on June 1. The ferry boat leaves the mainland every hour on the half hour beginning at 9:30 a.m., and departs from the island on the hour with the last ferry leaving at 6 p.m.

Swimming areas are supervised by lifeguards.

Summer park hours for camping, hiking, picnicking, and other year round activities are 8 a.m. until 9 p.m. daily.

**OUT OF DETENTION**  
**KARACHI, Pakistan (AP)** — The widow and daughter of executed former Prime Minister Zulfikar Ali Bhutto have been released from detention in a police camp near Islamabad and flown here, the government says.



SERIES 314

# INSTANT Twin WINN BINGO

80 WAYS TO WIN!

Get your FREE Game Ticket and Collector Folder (with handy Collector Pocket) at the store.

NO PURCHASE NECESSARY Adults Only



# STORE MANAGERS' SALE!

- PRICES GOOD THRU SAT., JUNE 2ND
- NONE TO DEALERS
- WE RESERVE THE RIGHT TO LIMIT QUANTITIES

ALL STORES

OPEN SUNDAYS 10-7



CLIP & SAVE 40c

**DUKE'S  
MAYONNAISE** QT. JAR **79c**

LIMIT ONE WITH COUPON & \$7.50 OR MORE ORDER  
GOOD THRU SAT., JUNE 2ND

## PRODUCE PATCH

U.S. #1 IDAHO  
BAKING POTATOES  
15-LB. POLY BAG **\$1.69**

RED, RIPE (28 LB. AVG.)  
• **WHOLE WATERMELONS** EA. \$2.79 (SLICED LB. 13c)

SWEET & TENDER YELLOW CORN 6 EARS 99c • GREEN ONIONS 3 BCHS. \$1.00

HARVEST FRESH BROCCOLI BUNCH 79c • HARVEST FRESH BROCCOLI Bunch 79c

VINE RIPENED JUMBO HONEYDEWS EA. \$1.39 • U.S. #1 YELLOW ONIONS 3-LB. BAG 79c

VINE RIPENED  
**CANTALOUPE (JUMBO)**  
EA. **69c**

## FROZEN FOODS

YOU SAVE 21c  
SUPERBRAND  
**SHERBET OR ICE CREAM**  
HALF-GAL. CTN. **98c**

SUPERBRAND  
• FUDGE BARS OR TWIN POPS PKG. OF 12 88c

MORTON'S (EXCEPT HAM OR BEEF)  
T.V. DINNERS EA. 59c • MORTON'S HONEYBUNS 2-OZ. PKG. \$1.00

MORTON'S COUNTRY TABLE DINNERS 18-OZ. SIZE 99c • MORTON'S CHEESE CAKES 6-OZ. SIZE 69c

MORTON'S CREAM PIES 16-OZ. SIZE 69c • MORTON'S MINI DONUTS 10-OZ. PKG. 69c

MORTON'S FAMILY PAK DONUTS 13-OZ. PKG. 69c • MORTON'S FRIED CHICKEN 2-LB. BOX \$2.49

## DAIRY DEPT.

YOU SAVE 24c ON  
• PILLSBURY BUTTERMILK BISCUITS 4 8-OZ. CANS 69c

SUPERBRAND  
• MARGARINE 3 1-LB. CTNS. \$1.29

SUPERBRAND  
• ALL-NATURAL YOGURT 3 8-OZ. CUPS \$1.00

SUPERBRAND  
• COTTAGE CHEESE 2-LB. CUP \$1.49

PALMETTO FARM  
• PIMENTO CHEESE 1-LB. CUP \$1.29

SUPERBRAND  
• CHEESE SPREAD (18 SLICES) 12-OZ. PKG. \$1.19

YOU SAVE \$2.00 ON  
**GRAVY BOAT**

Redeem this coupon worth \$2.00 toward the purchase of this item.

Regular Discount Price \$10.99  
Coupon Savings \$2.00  
Price (With Coupon) \$8.99

- Check the Pattern of your Choice
- Winsford  Floral Generation  
 Spring Bouquet  Golden Autumn

COUPON GOOD THRU  
WEDNESDAY, JUNE 6TH

VALUABLE DISCOUNT COUPON

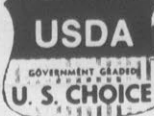

U. S. CHOICE

YOU SAVE \$1.00 PER LB.  
U.S. CHOICE BEEF WHOLE

"UNTRIMMED"  
BONELESS  
(9-11 LBS. AVG.)  
**SIRLOIN TIPS** LB. **\$1.59**

CUT INTO STEAKS, ROASTS & TRIMMINGS AT THIS PRICE

BONELESS SIRLOIN TIP  
• ROASTS LB. \$2.89  
• STEAKS LB. \$2.99



U. S. CHOICE

YOU SAVE \$13.90

BRAND U.S. CHOICE  
15-LB. BEEF SPECIAL

- 5 LBS. SIRLOIN TIP STEAKS  
5 LBS. SIRLOIN TIP ROASTS  
5 LBS. SIRLOIN TIP STEW BEEF

ALL FOR **\$29.95**



U. S. CHOICE

YOU SAVE 40c PER LB.

BRAND U.S. CHOICE BEEF BONELESS  
**CUBED STEAKS** LB. **\$2.99**

BRAND U.S. CHOICE BEEF MEATY  
• CHUCK STEAKS LB. \$1.99  
• RIB ROASTS LB. \$2.49

YOU SAVE 10c PER LB.

HOLLY FARMS  
FRYER QUARTERS  
• LB PORTIONS **69c**  
• BREAST PORTIONS **79c**

CLAUSSEN'S  
REFRIGERATED WHOLE, SLICED OR ICICLE  
• PICKLES 32-OZ. JAR **\$1.19**

FRESH PORK

SLICED QUARTER

• LOINS LB. **\$1.49**  
COUNTRY-STYLE  
• BACKBONES LB. \$1.39  
COUNTRY-STYLE  
• RIBS LB. \$1.49

SUNNYLAND  
GEORGIA BRAND PORK  
• SAUSAGE 2-LB. ROLL **\$2.99**

YOU SAVE 20c PER LB.

SMOKED  
**HAM** 99c  
• SHANK PORTIONS LB. **99c**  
• BUTT PORTIONS LB. **1.09**

DIXIE BEEF  
"FINE FOR MEAT LOAF, HAMBURGER, CHILI, ETC."  
PATTY MIX 3-LB. **\$2.99**

BRAND MEAT PRODUCTS SALE!

REGULAR or DINNER

**FRANKS** 1-LB. **\$1.49**  
PKG.

- SPICED LUNCHEON, SALAMI, BOLOGNA, 8-OZ. PKG. 99c
- OLIVE OR HAM & CHEESE 8-OZ. PKG. 99c
- CHUNK BRAUNSCHWEIGER LB. 79c
- IMPORTED SLICED COOKED HAM OR PICNIC 12-OZ. PKG. \$2.49
- SALAMI, SPICED LUNCHEON OR PICKLE & PIMENTO 1-LB. PKG. \$1.59

REGULAR or THICK

**SLICED BOLOGNA** 1-LB. **\$1.39**  
PKG.

- SLICED VARIETY PACK 12-OZ. PKG. \$1.39
- FULLY COOKED SMOKED SAUSAGE 2-LB. PKG. \$7.99
- WHOLE HOG PORK SAUSAGE 1-LB. ROLL \$1.49
- WHOLE HOG SAUSAGE PATTIES 12-OZ. PKG. \$1.19

YOU SAVE UP TO 58c

THRIFTY MAID  
SLICED OR HALVES

• YELLOW CLING PEACHES  
• BARTLETT PEARS  
2 29-OZ. CANS **\$1.00**

WITH \$7.50 OR MORE ORDER (LIMIT 4 OF CHOICE)

YOU SAVE 37c

2-PLY JUMBO  
**BOUNTY PAPER TOWELS**

2 100-SHEET ROLLS **\$1.09**

WITH \$7.50 OR MORE ORDER (LIMIT TWO)

DIXIE DARLING SANDWICH

**BREAD** 3 24-OZ. LOAVES **\$1.00**

PLAIN OR PEANUT M&M CANDY 7-OZ. CUPS 99c  
THRIFTY MAID MUFFINS 2-OZ. JAR 49c  
LIFTOPS BOX OF 100 \$1.89

YOU SAVE 70c

ASTOR COFFEE

1-LB. CAN **\$1.59**

WITH \$7.50 OR MORE ORDER (LIMIT 1)

- DEEP SOUTH SAUCE 2 18-OZ. BTL. \$1.19
- THRIFTY MAID GRAPEFRUIT JUICE 44-OZ. CAN 59c
- DOWDY FABRIC SOFTENER 64-OZ. JUG \$1.98

DELI-BAKERY

SLICED-TO-ORDER BONELESS

• **COOKED HAM** LB. \$2.49

FRESH CRISP CHIEF SALADS EA. **\$1.69**

TAKE-OUT SPECIAL  
• 2 LBS. TURKEY & DRESSING  
• 1 QT. GREEN BEANS  
• 1 QT. YAMS  
• 1 DOZ. ROLLS

ALL FOR **\$7.99**

FRESH FROM OUR IN-STORE BAKERY!  
FULL OF FRUIT  
• STRAWBERRY PIES EA. \$2.89  
FRESH BAKED  
• FRENCH BREAD 2 1-LB. LOAVES \$1.00

PLEASE CALL FOR Shopper Mart Riverdale  
SPECIAL ORDERS: 756-2666 756-0888

SUPERBRAND

U.S.A  
**GRADE 'A' WHITE LARGE EGGS** DOZ. **59c**

THRIFTY MAID PORK & BEANS 5 16-OZ. CANS \$1.00  
ARROW BLUE DETERGENT 192-OZ. PAL \$5.49

YOU SAVE 16c

MAZOLA  
**CORN OIL** 32-OZ. BTL. **\$1.69**

DONALD DUCK ORANGE JUICE 64-OZ. JUG \$1.19

YOU SAVE 10c ON  
• SPAM 12-OZ. CAN \$1.19

PILLSBURY'S

FLOUR 5-LB. BAG 89c  
LAYER CAKE 18 1/2-OZ. BOX 69c

ASSORTED FLAVORS  
• FIGURINES 7-OZ. PKG. \$1.43

READY-TO-SPREAD  
• FROSTINGS 16 1/2-OZ. CAN \$1.09

HUNGRY JACK  
• PANSHAKES 7-OZ. BOX 53c

# Author, 70, Chops Wood To 'Relax'

By PHIL THOMAS  
AP Books Editor

NEW YORK (AP) — When Wallace Stegner tires of writing, he chops wood. "It relaxes me," says Stegner.

"My wife and I live outside of San Francisco. We've got three acres and there are a lot of trees that need pruning or cutting. So, after I write for maybe four hours, I stop and become a handyman. I've got a real Vermont woodpile in California. We live among the wild-life and the woodpile, very quietly."

Stegner has spent much of his 70 years on the move — living in Iowa, North Dakota, Washington, Saskatchewan, Montana, Utah, Nevada and California.

"It was like living in a covered wagon," he recalls with a smile. "I did a lot of roaming, but now I've decided to settle down."

The West plays a major part in some of his more than 20 fiction and non-fiction books, but Stegner says, "I wouldn't like to be tagged as a Western writer, the West is the country I know and like the best. But my feeling is that while I write about people who happen to live in the West, these people would be legitimate anywhere."

His latest novel, "Recapitulation," is set in Salt Lake City. "I went to high school and college there," he says. "I worked my way through the University of Utah driving a delivery truck for a rug and linoleum house. Driving a truck is a splendid way to learn a town, you go all over the place, and I drew on the knowledge I acquired back then for this book."

After taking his doctorate in 1935 in American literature, Stegner continued with a teaching career that lasted until 1971.

While teaching he sold short stories and finished a short novel. The book, "Remembering Laughter" won a publishing house competition in 1937 and earned him a prize of \$2,500. "After that," he says, "there was no going back, there was no alternative."

Stegner says that during his later teaching years he would combine history writing with teaching because "you feel you are getting something done by going to the library for a couple of hours and taking necessary notes."

Fiction was different. "I wrote my novels while on vacation. You can't work on a novel for a couple of hours and then quit. You have to submerge yourself in your story and stay under..."

He says he was a teen-ager when he decided to be a writer. But it wasn't, he says, until he won the National Book Award and the Pulitzer prize that "my not very confident suspicion that I was a novelist was reassured..."

Stegner won the NBA for "The Spectator Bird" in 1977 and the Pulitzer for "Angle of Repose" in 1972.

Stegner says he quit teaching in 1971 and "was glad to be done with it. All my life I had been doing two jobs, and it was a relief to get back to one — writing."

"Besides, I had a sense of time passing, of hearing time's chariot drawing just a little closer. I figured I had a few more years to write books and I'd better make the most of it."

## Child Hazard In Roasted Nuts

SACRAMENTO, Calif. (AP) — Keep nuts — especially roasted nuts — away from children under 5 years old, says Dr. Leslie Bernstein.

Bernstein, chairman of the University Medical Center's Department of Otorhinolaryngology, says he and other doctors in his department treat many people who have accidentally inhaled solid particles such as nuts, many of them children.

A child died recently because peanuts accidentally became lodged in his breathing passages, he said.

What if, despite all precautions, an accident happens? "If a child is choking, try to have someone call an ambulance — or do it yourself if no one else is around," he said. "Then hold the child upside down and slap him on the back sharply several times."

"If the child turns blue and stops breathing you should consider mouth-to-mouth resuscitation."

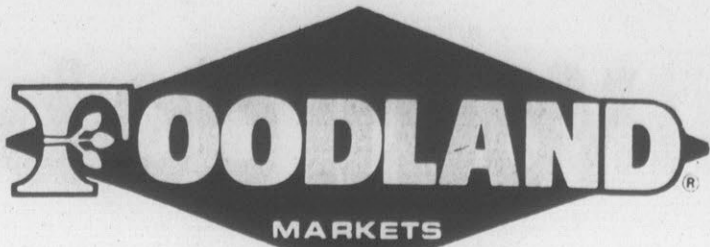

MEMBER OF THE FOODLAND SYSTEM

**"BANK YOUR SAVINGS  
BY SHOPPING FOODLAND TODAY"  
"THAT'S THE FOODLAND WAY"**

USDA INSPECTED  
**FRYERS**  
WHOLE **49¢**  
LB. LIMIT  
4 PLEASE  
CUT UP (PAN READY) LB. **59¢**



FOODLAND GRADE A MEDIUM WHITE  
**EGGS** DOZ. **57¢**  
SMITHFIELD 12 OZ. PKG.  
**FRANKS** **99¢**  
GWALTNEY SLICED  
**BACON** **\$1.19** 1 LB. PKG.  
SMITHFIELD  
**SMOKED SAUSAGE** **\$9.90** 10 LB. BOX

FRESH  
**PORK CHOPS**  
**99¢**  
FIRST CUT LB.  
CENTER RIB **\$1.39** LB.  
CENTER LOIN **\$1.49** LB.



PRICES EFFECTIVE-GROCERY AND PRODUCE-MAY 31 THRU JUNE 6, 1979  
MEATS-MAY 31, JUNE 1, 2  
QUANTITY RIGHTS RESERVED-NONE SOLD TO DEALERS

HEAVY WESTERN STEER  
**RIB STEAK**  
**\$2.19**  
BONE IN LB.

FRESH PORK  
**CHITTERLINGS**  
**\$3.99**  
10 LB. BOX

SMOKED TENDERIZED  
**HAMS**  
WHOLE OR SHANK PORTION **79¢** LB.  
BUTT PORTION **89¢** LB.  
CENTER SLICES **\$1.39** LB.

**PORK CHOPS**  
**\$1.29**  
¼ LOIN LB.  
WHOLE OR RIB HALF LB. (SLICED FREE) **\$1.19**

FRESH  
**BRUSSELSPROUTS**  
**79¢**  
1 PKG.

FRESH GREEN  
**CABBAGE**  
**12¢**  
LB.



FRESH YELLOW  
**ONIONS**  
**49¢**  
3 LB. BAG



FRESH  
**CATALOUPES**  
**69¢**  
18 CT. EA.



DUKE'S  
**MAYONNAISE**  
**89¢**  
32 OZ. JAR  
LIMIT 1 WITH 7.50 FOOD ORDER

ARMOUR  
**POTTED MEAT** 4 **\$1.00** 3 OZ. CANS  
ARMOUR  
**VIENNA SAUSAGE** 2 **89¢** 5 OZ. CANS  
SAUER'S  
**BLACK PEPPER** 3 OZ. BOX **69¢**



OLD EL PASO  
**TACO DINNERS** 10½ OZ. BOX **\$1.19**  
**LYSOL** **\$1.19** 6 OZ. CAN  
**FORMULA 409** 22 OZ. BOTTLE **89¢**

**JOY**  
LIQUID DETERGENT  
**99¢**  
20¢ OFF  
32 OZ. BOTTLE



LIPTON  
**TEA BAGS**  
**99¢**  
48 CT. BOX

WHITE HOUSE  
**VINEGAR** **\$1.79** GALLON SIZE  
**PUSS N BOOTS** 6 **\$1.49** 15 OZ. CANS  
CAT FOOD (ALL FLAVORS)  
**LOG CABIN BUTTERED SYRUP** 24 OZ. BOTTLE **\$1.29**



**SPIC & SPAN** 54 OZ. BOX **\$1.69**  
**BOUNCE** **\$1.99** 40 CT. BOX  
FABRIC SOFTNER  
**SAFEGUARD** **59¢** 7 OZ. BAR  
SOAP

WHITE/ASSORTED, OR DECORATOR  
**VIVA**  
TOWELS  
**59¢**  
1 ROLL PKG.



**COKES**  
**79¢**  
2 LITRE BOTTLE

LOG CABIN COUNTRY KITCHEN  
**SYRUP** 24 OZ. BOTTLE **\$1.09**  
KRAFT GRATED  
**PARMESAN** 8 OZ. CAN **\$1.69**  
KEEBLER  
**ZESTA SALTINES** 2 LB. BOX **\$1.25**



**COMET CLEANSER** 14 OZ. CAN **35¢**  
**UNCLE BEN'S RICE** 1 LB. BOX **59¢**  
**KEEBLER CLUB CRACKERS** 16 OZ. BOX **85¢**

**ERA**  
DETERGENT  
**\$1.39**  
32 OZ. BOTTLE



JACK & BEANSTALK CUT  
**GREEN BEANS**  
**\$1.00**  
3 **303** CANS



DULANY  
**BROCCOLI SPEARS** 10 OZ. PKG. **59¢**  
FOODLAND  
**ICE MILK** (ALL FLAVORS) HALF GALLON **89¢**



FROZEN FOODS:  
OLD SOUTH  
**ORANGE JUICE**  
**69¢**  
12 OZ. CAN

**CHATHAM**  
25 LB. BAG **\$2.99** (DOG FOOD)  
4 LB. BAG **\$1.29** (CAT FOOD)



KRAFT-AMERICAN, WHITE, OR PIMENTO SINGLES  
**CHEESE**  
**\$1.19**  
12 SLI. PKG.

MORTONS  
**HONEYBUNS**  
**59¢**  
9 OZ. BOX



BANQUET-CHICKEN & NOODLES, CHICKEN & DUMPLINGS, CHICKEN CHOW MEIN, SPAG. & MEATBALLS, BEEF STEW, SALISBURY STEAK, OR SLICED TURKEY  
**DINNERS**  
**\$1.49**  
2 LB. BOX



**MAXWELL HOUSE**  
COFFEE  
1 LB. BAG **\$2.19**  
2 LB. CAN **\$4.97**



**SPAIN'S**  
1414 Charles Blvd.

Store Hours  
Mon.-Thurs. 8 A.M. To 8 P.M.  
Fri. & Sat. 8 A.M. To 8:30 P.M.  
Closed Sundays



Store Hours:  
Mon.-Sat.  
8:30 A.M. To 9 P.M.  
Open Sunday 12:30 P.M.-6:00 P.M.

**SHOP-EZE**  
West End Shopping Center

# University Helps Ease Prison Life

By GEORGE TIBBITS  
Associated Press Writer  
SALT LAKE CITY (AP) —  
Some University of Utah students can pick up three credit hours this summer in how to get along in prison.

One student who's taken the course, David Savard, said it had taught him more about himself, although the prerequisite was a little tough. In his case, a 1-to-15 year term for armed robbery.

Created and taught by university Division of Health Science professors Gerald Braza and Bryan Smith, the course helps inmates cope with physical and emotional strains of confinement at the Point of the Mountain prison. The class is offered through an inmate education program under a Division of Corrections contract with the university.

Braza said inmates were encouraged to take more responsibility for their health and behavior by learning methods of solving problems, handling stress and dealing with emotions.

The weekly class, first taught last summer, also teaches better personal health care and fitness, he said. As a result, some students have given up the traditional prison exercise of weightlifting to become joggers.

Weightlifting is popular because inmates can readily see results in the mirror. But "inmates often overdo it with weights and pay scant attention to other components of good health," Braza said.

He started some of the inmates running, and it's been so successful the prison now holds a semi-annual five-mile race.

Savard, 42, was one of about 25 medium and maximum security inmates in the course last fall. He said it had boosted his self-esteem and sense of responsibility and had made life easier "not only at the prison but in the sense of what I want to do when I leave here."

He credits the class with moving him toward a Utah degree in psychology, with a goal of going into alcohol counseling and therapy.

"When I started this program, it was like a dream — 'What the hell, I would try for it,'" he said of his major. "The class has made it a reality. In five quarters I'm halfway home to a bachelor's degree."

Assignments include keeping diaries and carrying out behavior-change projects, such as losing weight, stopping smoking or reducing tension.

"Confinement, by its very nature, creates a lot of stress and tension, which a lot of inmates have difficulty understanding and handling," Braza said. "We had a lot of discussions on controlling tempers and reducing anxieties in a prison environment."

Braza said some students, after release to half-way houses, had gone on to do well as full-time university students. "I'd say about 75 percent were affected by the class, one way or the other," Savard said.

"I gained a lot from working with the prisoners since I no longer have a stereotype on what a prisoner is like," Braza said. "Their needs are just the same as others'."

## Seek Alumnae Of Vardell Hall

RED SPRINGS — The Vardell Hall Alumnae Association Inc. is seeking to contact every woman who attended Vardell Hall Girls' School, which operated here from 1964 through 1973.

Every Vardell Hall alumna interested in belonging to the Association is asked to send her address, phone number, years she attended Vardell Hall, plus information about other classmates to Mrs. Mary Moye Lowe, 3243 Linda Drive, Winston Salem, N. C. 27106, or Mrs. Eulene S. Paris, 214 N. Edinborough St., Red Springs, N. C. 28377.

The annual reunion date for the Association is the second Saturday of April, except when that date falls on Easter weekend, in which year the reunion will be held the third Saturday of April.

LANDSLIDE KILLS 23  
JAKARTA, Indonesia (AP) — Heavy rains caused a landslide which killed 23 persons in the central Java village of Cihayang and injured six others, the government newspaper Suara Karya reports.



### ADVERTISED ITEM POLICY

Each of these advertised items is required to be readily available for sale at or below the advertised price in each A&P Store, except as specifically noted in this ad.

PRICES EFFECTIVE THRU SAT., JUNE 2 AT A&P IN GREENVILLE, N.C.  
ITEMS OFFERED FOR SALE NOT AVAILABLE TO OTHER RETAIL DEALERS OR WHOLESALERS

**Greenville Square Shopping Center**  
Greenville, N.C.  
**Open 24 Hours A Day**  
**7 Days A Week**

**Hearthside Garden Festival** ON SALE THIS WEEK  
HANDPAINTED STONWARE CEREAL BOWL EACH ONLY **59¢** WITH EACH \$5 PURCHASE

ANN PAGE  
**ORANGE JUICE** 1/2 GAL. CTN. **88¢**

A&P GRADE "A" NORTH CAROLINA  
**MEDIUM EGGS**  
Limit 2 Dozen Please **\$1.00**  
2 DOZEN ONLY

YOU'LL DO **better** WITH A&P'S frozen foods

A&P FROZEN REGULAR <b>PIE SHELLS</b> 2 CT. PKGS. <b>288¢</b>	FARM FARE FROZEN <b>FRENCH FRIES</b> 2 LB. PKG. <b>49¢</b> CRINKLE CUT
A&P DESSERT TOPPING <b>HANDI-WHIP</b> 1 1/2 OZ. BOWL <b>69¢</b>	SEALTEST <b>FUDGE BARS</b> 6 CT. PKG. <b>69¢</b>

YOU'LL DO **better** WITH A&P'S **ECONOMY CORNER**

ECONOMY CORNER <b>BATHROOM TISSUE</b> 4 ROLL PKG. <b>69¢</b>	ECONOMY CORNER <b>GRAPE JELLY</b> 32 OZ. JAR <b>65¢</b>
--	---

YOU'LL DO **better** WITH A&P'S **action prices**

KRAFT <b>BARBECUE SAUCE</b> PLAIN · HOT · SMOKED 18 OZ. JAR <b>69¢</b>	<b>SHASTA SOFT DRINKS</b> REGULAR OR DIET 6 12 OZ. CANS <b>\$1.19</b>
ANN PAGE <b>PORK N' BEANS</b> 4 16 OZ. CANS <b>\$1.00</b>	CYCLE (ALL VARIETIES) <b>DOG FOOD</b> 3 14 OZ. CANS <b>\$1.00</b>

# You'll do better

**DUKE'S MAYONNAISE**

QT. JAR **79¢**

LIMIT ONE WITH COUPON ON RIGHT PAGE AND ADDITIONAL 7.50 ORDER



**CLOROX LIQUID BLEACH**

GAL. JUG **49¢**

LIMIT ONE WITH COUPON ON RIGHT PAGE AND ADDITIONAL 7.50 ORDER

PURE VEGETABLE  
**WESSON OIL**  
24 OZ. BTL. **99¢**

ANN PAGE WAFFLE & PANCAKE SYRUP  
12 OZ. Jug **49¢**

CASTLEBERRY'S  
**HOT DOG CHILI**  
10 OZ. CANS **3 \$1.00**

PURE VEGETABLE CRISCO SHORTENING 3-LB. CAN **\$1.99**  
OUR OWN WITH LEMON AND SUGAR ICED TEA MIX 24 OZ. PKG. **\$1.79**  
A&P FROZEN CHOPPED BROCCOLI 10 OZ. PKG. **35¢**  
ANN PAGE PRINT PAPER TOWELS 2 JUMBO ROLLS **\$1.00**

LUCK'S WITH PORK  
**PINTO BEANS**  
OR · NAVY · GREAT NORTHERN  
17 OZ. CANS **3 \$1.00**

A&P FROZEN  
**BROCCOLI SPEARS**  
2 10 OZ. PKGS. **88¢**

FROZEN  
**G&W PIZZA**  
PEPPERONI · SAUSAGE · HAMBURGER  
10 OZ. PKG. **89¢**

SEALTEST  
**LIGHT N'LIVELY ICE MILK**  
1/2 GAL. CTN. **\$1.19**

FREEZER QUEEN  
**FROZEN ENTREES**  
BEEF PATTIE · BEEF PATTIE W MUSH GRAVY · SLICED TURKEY · TURKEY CROQUETTES · SPAG. & MT. BALLS · SALISBURY STEAK  
2 LB. PKG. **\$1.49**

YOU'LL DO **better** AT **THE FARM AT A&P**

OUTSTANDING QUALITY — RIPE

**CANTALOUPE** LARGE SIZE EACH ONLY **69¢**

**FRESH PEACHES** SWEET RIPE FIRST OF THE SEASON LB. **69¢**

FRESH TENDER **GREEN BROCCOLI** LARGE BUNCH **77¢**

SWEET, RED, RIPE **STRAWBERRIES** 3 PINT BASKETS **\$1.69**

RED RIPE **SALAD TOMATOES** 3 CT. PKG. **59¢**  
A&P FRESH **ROASTED PEANUTS** 24 OZ. BAG **\$1.29**

TENDER GREEN **CABBAGE** LB. **15¢**

REFRESHING PERSIAN **FRESH LIMES** EACH ONLY **10¢**

CRISP FIRM **CUCUMBERS** LARGE SIZE ONLY **22¢**

# With Super Summer Savings

## Pitt Tech Dean's List Announced

The following area students were named to the Pitt Technical Institute's Dean's List for the Spring Quarter:

**AYDEN** — Kevin R. Adkins, Robert A. Arnold, Thomas E. Arnold, Lillian L. Blaylock, Joseph P. Echel, Randy C. Haddock, Donna J. Harrington, Robert G. Harris, Alan C. Jones, Teresa F. Martin, Wanda J. Mills and Edward A. Taylor.

**BELVOIR** — Thomas E. Spencer.

**BETHEL** — Bruce A. Copeland, Patricia E. Kilcoyne, Charlie A. Purvis, Yvonne T. Richards, Charles B. Rogister Jr. and Kenneth L. Smith.

**FALKLAND** — Carol L. Garis.

**FARMVILLE** — Sharon A. Cox, Audrey C. Darden, Jessie C. Heizer, Judith G. Mewborn, Rose H. Shirley, Kimberly D. Tugwell and Allen J. Tyson.

**FOUNTAIN** — Dennis L. Peaden.

**GREENVILLE** — Anne C. Ashley, Edward A. Barnette, Emiley A. Beamon, William J. Bell Jr., Robert B. Bergstedt, Lu A. Black, Jesse M. Braddy, Beverly C. Browder, Annette Cogdell, Lynne D. Cox, Ronald E. Crisp, Nancy Croll, Sheryl L. Croston, Ralph E. Dalton, Thomas N. Dalton, Shirley J. Daniels, Judy A. Dezeam, Patsy P. Emerson, Beverly M. Foreman, Deborah S. Francis, Teresa Y. Gargis, Obie D. Godley, William G. Haynie, Bruce W. Hedreen.

James R. Hill, Valerie E. Hill, Debra L. Jackson, Jamie S. Jacobson, Mary M. Kruger, Richard M. Langston, Timothy G. Manning, Dale H. McCann, Susan C. McKenzie, Mary T. Mercer, Pamela H. Messner, Pearl L. Mills, Raymond T. Mills, Rhonda P. Mills, John A. Moore, Linwood E. Mooring, Alfred J. Newkirk, Brenda J. Newsome.

Christine S. O'Neal, John M. Panaro, Joyce R. Parrisher, Hugo L. Pascale, India J. Pierce, Clara P. Pleasant, Carolyn J. Powell, Lottie O. Purvis, Vivian L. Purvis, Kathryn A. Raines, Melinda S. Rossi, George L. Sadler, Vickie L. Sautler, Cathy J. Sawyer, Joseph B. Schulken Jr., Bobby G. Simpkins, Deborah M. Smith, Ethelene Teel, Tien T. Tran, Janice A. Tripp, Robert Walters, Elaine P. Warshauer, Dana L. Webster, Sandra R. Wilkins, Nancy F. Williams, Sherry E. Williams, Lillian F. Williamson, and Rachel S. Woods.

**GRIFTON** — Kelvin E. Conner, Horace R. Dunn, Melinda C. Jones, Linda R. Slate and Jean W. Tripp.

**GRIMESLAND** — Louise D. Boseman, Johnny E. Hardy, Donna H. Hudson, James B. Little, Jewell L. Lloyd, and Jasper J. Whitehurst.

**MACCLESFIELD** — Sandra S. Edwards.

**PLYMOUTH** — James C. Hardison, Linda P. Jackson, David G. Miller and Dwayne D. Tetterton.

**ROBERSONVILLE** — Wallace R. Bullock Jr., Sam H. Rawls, Lisa G. Roberson.

**SIMPSON** — Clarence E. Hamilton.

**STOKES** — Beverly J. Mullins.

**WALSTONBURG** — William E. Tuten.

**WINTERVILLE** — James P. Beebe, Doris M. Boyd, Frankie C. Cash, Juanita L. Cash, Rhuberna Knox, Audrey J. Perry, Sandra F. Shepard and Sally R. Wolinsky.

U.S.D.A. INSPECTED FRESH

# WHOLE FRYERS

BOX-O-CHICKEN LB. 49c

2 TO A BAG  
LIMIT 2 BAGS  
PLEASE

# 49c

LB.



PRICES EFFECTIVE THRU SAT., JUNE 2 AT A&P IN GREENVILLE, N.C. ITEMS OFFERED FOR SALE NOT AVAILABLE FOR OTHER RETAIL DEALERS OR WHOLESALERS

A&P COUPON  
DUKE'S

## MAYONNAISE

# 79c

QT. JAR

LIMIT ONE WITH THIS COUPON AND ADDITIONAL \$7.50 ORDER

SAVE 40c

LIMIT ONE COUPON GOOD THRU SAT., JUNE 2 AT A&P IN GREENVILLE, N.C.

U.S.D.A. INSPECTED FRESH FRYING

## CHICKEN LIVERS

5 LB. BOX \$2.99

# 68c

LB.

U.S.D.A. INSPECTED FRESH WHOLE

## FRYER LEGS

BREAST FAM. PKG. 10 LBS. OR MORE \$1.08

FAMILY PKG. 10 LBS. OR MORE

# 88c

LB.

A&P QUALITY HEAVY WESTERN GRAIN-FED BEEF

## WHOLE BONELESS SIRLOIN TIPS

CUT FREE INTO SIRLOIN TIP ROAST, STEAKS, AND TRIMMINGS

9 TO 13 LB. AVG. WT.

# \$1.98

LB.

A&P COUPON

## CLOROX LIQUID BLEACH

# 49c

GAL. JUG

LIMIT ONE WITH THIS COUPON AND ADDITIONAL \$7.50 ORDER

SAVE 34c

LIMIT ONE COUPON GOOD THRU SAT., JUNE 2 AT A&P IN GREENVILLE, N.C.

A&P COUPON

## EIGHT O'CLOCK INSTANT COFFEE

CONTAINS RICH BRAZILIAN COFFEES

# \$2.99

10 OZ. JAR

LIMIT ONE WITH THIS COUPON

SAVE 40c

LIMIT ONE COUPON GOOD THRU SAT., JUNE 2 AT A&P IN GREENVILLE, N.C.

You'll Do Better With A&P'S SEAFOOD SHOP

A&P BATTER DIPPED FISH STICKS 14 OZ. PKG. \$1.39

A&P QUALITY FISH CAKES 2 12 OZ. PKGS. 89c

A&P BATTER DIPPED FISH PORTIONS 24 OZ. PKG. \$2.19

A&P QUALITY HEAVY WESTERN GRAIN FED BEEF

## SIRLOIN TIP ROAST

BONELESS

# \$2.58

LB.

A&P QUALITY HEAVY WESTERN GRAIN-FED BEEF

## SIRLOIN TIP STEAK

BONELESS

# \$2.78

LB.

•IN THE DELICATESSEN•

## FRIED CHICKEN

SNACK PACK (2 PIECES) EA. PKG. 99c

INSTORE FRESH BAKED PEACH PIES EA. ONE \$1.49

KAISER ROLL SANDWICH ROAST BEEF EA. ONLY 89c

A&P QUALITY CORN-FED WHOLE PORK

## SMOKED PICNIC

4 LB. TO 8 LB. WT. AVG.

# 88c

LB.

A&P QUALITY CORN-FED FRESH

## PORK STEAK

BOSTON BUTT ROAST \$1.18 LB.

# \$1.28

LB.

GREAT FOR GRILLS

HOLLY RIDGE BRAND

## SLICED BACON

1 LB. PKG.

# \$1.28

YOU'LL DO better WITH A&P'S health & beauty aids

SHOWER TO (REG. \$1.65) • REGULAR • HERBAL \$1.29

SHOWER DEODORANT BODY POWDER 8 OZ. SIZE

7c OFF LABEL (REG. \$1.19)

ALKA SELTZER YOU PAY ONLY 25 CT. BTL. 99c

REG. \$2.49

LISTERINE ANTISEPTIC MOUTHWASH 32 OZ. BOTTLE \$2.19

REG. \$3.19

EFFERDENT DENTURE CLEANSER 96 CT. BTL. \$2.49

BALSAM & PROTEIN

SUAVE SHAMPOO AND CONDITIONER 28 OZ. BTL. 99c

You'll Do Better With A&P'S COUNTRY FARM PORK SHOP

CENTER CUT RIB

## PORK CHOPS

LOIN PORK CHOPS LB. \$2.08

# \$1.98

LB.

SIRLOIN CUT PORK CHOPS LB. \$1.78

BONELESS RIB PORTION PORK ROAST LB. \$1.98

FRESH BACK PORK RIBS LB. \$1.98

GWALTNEY BRAND

## GREAT DOGS

1 LB. PKG. \$1.18

OSCAR MAYER SLICED BACON 1 LB. PKG. \$1.98

OSCAR MAYER CHEESE WIENER OR WIENERS ALL MEAT 1 LB. PKG. \$1.78

HORMEL BRAND SLICED—ALL VARIETIES COOKED HAM 4 OZ. PKG. 98c

You'll Do Better With A&P'S SAUSAGE SHOP

A&P QUALITY

## FRANKS

MEAT OR BEEF 12 OZ. PKG. \$1.18

OSCAR MAYER "ALL MEAT" SLICED BOLOGNA 8 OZ. PKG. 98c

A&P WAFER THIN SLICED LUNCHEON MEATS 3 OZ. PKG. 59c

CRICKET LIGHTER

By Gillette Disposable Butane 2 FOR ONLY \$1.00

MAXWELL HOUSE COFFEE (ALL GRINDS) 1 LB. BAG \$2.39

JOY LIQUID DISH DETERGENT 10c OFF LABEL 22 OZ. BTL. 79c

25c OFF LABEL WISK LIQUID LAUNDRY DETERGENT YOU PAY ONLY 64 OZ. BOTTLE \$2.50

A & P CHARCOAL 10 LB. BAG \$1.39

LUX BEAUTY SOAP 4 5 OZ. BARS \$1.00

ELECTRIC PERK FOLGER'S COFFEE 1 LB. CAN \$2.79

ALL GRINDS FOLGER'S COFFEE 1 LB. BAG \$2.39

YOU'LL DO better WITH A&P'S dairy products

A&P BUTTERMILK OR HOMESTYLE BISCUITS 6 10 CT. 8 OZ. CANS 89c

ANN PAGE—LEMON, ORANGE, GRAPE, PUNCH FRUIT DRINKS GALLON JUG 89c

## Speed Reading Course Is Set

ECU News Bureau "Speed Reading" will be offered Tuesdays and Thursdays, June 12-July 5 from 7 to 9 p.m. through the ECU Division of Continuing Education.

Course instructor is Homer Yearick of the ECU social work faculty, an experienced speed reading instructor who has taught reading improvement to college students and business personnel.

Further information is available from the Office of Non-Credit Programs, Division of Continuing Education, ECU, phone 757-6143.

**GREECE JOINS**  
ATHENS, Greece (AP) — Premier Constantine Caramanlis has signed Greece up for membership in the European Economic Community, declaring his country "the outpost of the European frontier and the Mediterranean balcony of the Common Market!"

# COUPONS Beat the High Cost of Eating! COUPONS

## FRYERS

Grade "A" Whole

**48**

Lb.

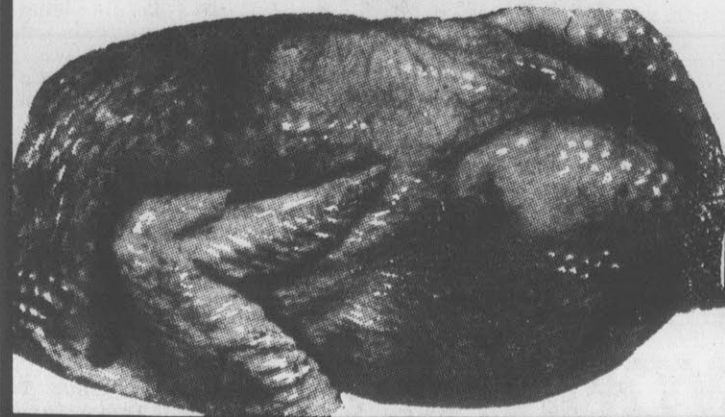

## COUNTRY HAMS

PEANUT CITY  
Half  
Or  
Whole

**1.45**

Lb.

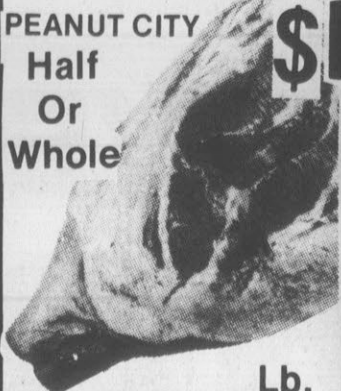

No stamps, no games, no gimmicks, no thrills. Check these prices—they are super hot! Plus "Clip the Coupons" and really save.

MORRELL PRIDE  
**ROUND STEAK FULL CUT** \$1.89

Lb.



KRAFT ORANGE JUICE

Half  
Gallon  
Jug

Limit 2  
With \$7.50  
Food Order

**98**

OVERTON'S FINEST  
**GROUND BEEF** \$1.59

3 Lb. Pkg.  
Or More  
Lb.



JOHN  
MORRELL

MORRELL PRIDE  
First-Cut

**Chuck Roast** Lb. \$1.29

**Center-Cut  
Chuck Roast** Lb. \$1.49

**Shoulder Roast** Lb. \$1.69

GWALTNEY  
**BACON** 12 Oz. Pkg. \$1.09

"FAMILY-PAK" SPECIALS OF THE WEEK

**PORK CHOPS** 5-7 Lbs. \$1.39 Lb.  
**NECK BONES** 5-7 Lbs. 49¢ Lb.  
**GROUND BEEF PATTIES** 10 Lbs. \$15.90

FRESH SLICED 7-9 CHOPS  
**1/4 PORK LOINS** Lb. \$1.49

16 Oz. Carton Of 8



Plus Deposit

**78**

WIGWAM  
**APPLE SAUCE** 303 Size Can 4/\$1.00

4-ROLL PKG.



**78**

Prices Effective Wednesday-Saturday



Quantity Rights Reserved

211 Jarvis Street - 2 Blocks From ECU  
Home of Greenville's Best Meats Phone 752-5025



SWIFT'NING  
**SHORTENING** 42 Oz. Can \$1.38

DIXIE CLASSIC ICE MILK

Half Gallon  
Carton

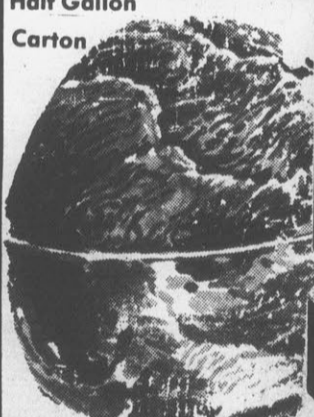

**58**

CHEF BOY-AR-DEE  
**FROZEN PIZZA** Cheese, Hamburger, Or Pepperoni 13 Oz. 88¢

YELLOW  
**CORN** 10/Ears \$1.00

BLUEBIRD  
**ORANGE or GRAPEFRUIT JUICE** 7 Oz. 6-Pack 98¢

CLIP THIS COUPON

With this coupon and \$7.50 food order excluding advertised specials. Without coupon 78¢. Limit one coupon per customer. Expires June 2. (Please have coupons clipped).

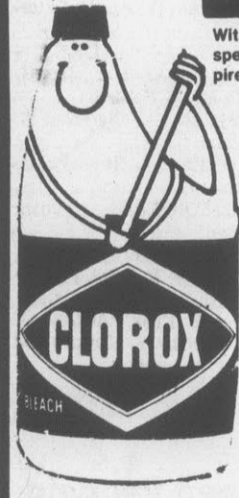

Gallon  
Jug

**58**

WESTERN  
**LETTUCE** (Head) 3/\$1.00

GREEN (Inflation Fighter)

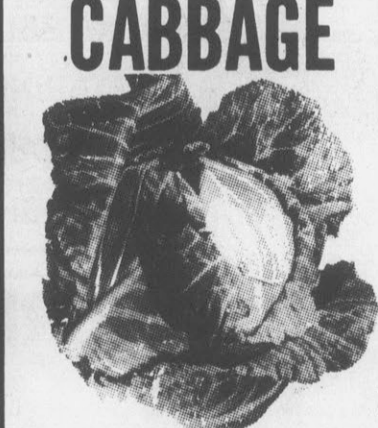

Lb.

**9**

CLIP THIS COUPON

With This Coupon And \$7.50 Food Order Excluding Specials Advertised. Without Coupon 88¢. Limit One Coupon Per Customer. Expires June 2. (Please Have Coupons Clipped).



Giant  
Size  
22 Oz.

**68**

SEALD-SWEET  
**FROZEN ORANGE JUICE** 6 Oz. Can 3/\$1.00

GOLDEN  
**BANANAS** 5 Lbs. /\$1.00

SHOWBOAT  
**PORK 'N BEANS** 300 Size Can 5/\$1

Tide Or Fab  
Laundry Detergent

CLIP THIS COUPON

Giant Size

With This Coupon And \$7.50 Food Order Excluding Specials Advertised. Without Coupon \$1.08. Limit One Coupon Per Customer. Expires June 2. (Please Have Coupons Clipped).

(Your Choice)

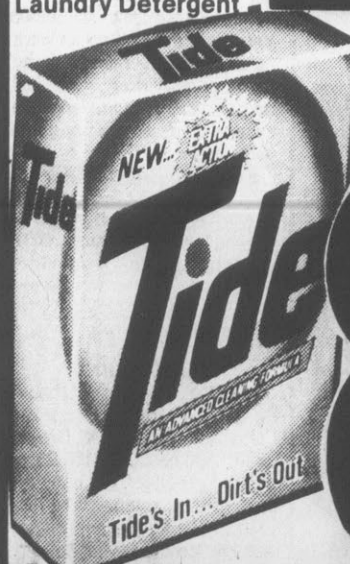

**88**

CLIP THIS COUPON

**WHITE POTATOES**

10 Lb. Bag

With This Coupon And \$7.50 Food Order Excluding Advertised Specials. Without Coupon 88¢. Limit One Coupon Per Customer. Expires June 2. (Please Have Coupons Clipped).



**68**

CLIP THIS COUPON

Bounty or Marcal Towels  
Giant Roll (Your Choice)

With This Coupon And \$7.50 Food Order Excluding Advertised Specials. Without Coupon 88¢. Limit One Coupon Per Customer. Expires June 2. (Please Have Coupons Clipped).

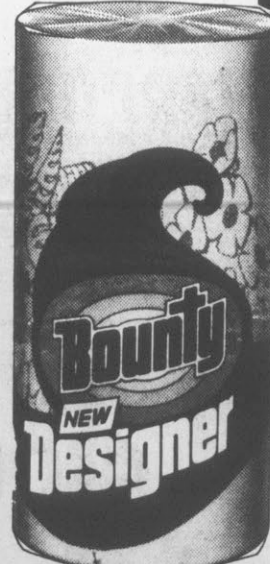

**48**

# When Your Money Matters, Lowe's Makes The Difference

With great home values in appliances, lumber, lawn & garden equipment, interior decorating products and much more (including the kitchen sink!)



100%  
Solid  
State  
Chassis

**Color Portable TV**  
Has Large 19" Diagonal Picture  
Custom Picture Control,  
in-line black matrix picture  
tube and Automatic Color  
Control. VHF/UHF. #54522

**\$319<sup>87</sup>**



Protects  
Blacktop  
Driveways

**Asphalt  
Driveway Sealer**

**\$5<sup>99</sup>**

5 Gallons

Protects against gas, oil,  
grease, etc. Seals against  
moisture & helps prevent  
frost damage. #10272

Asphalt Driveway Crack Filler,  
One Gallon (#10273) ..... \$3.99

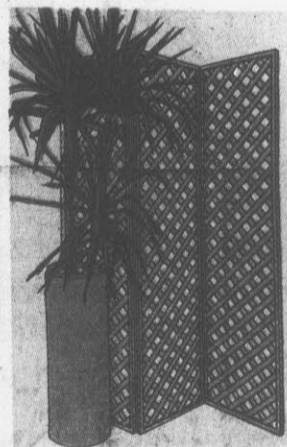

A Decorative  
Touch At An  
Economy Price

**Northern Pine  
Folding Lattice  
Panels**

**\$29<sup>88</sup>**

51"x72" hinged lattice  
section can be used as a  
divider, decorator accent,  
and more! Just add sealer,  
paint or stain. #10644

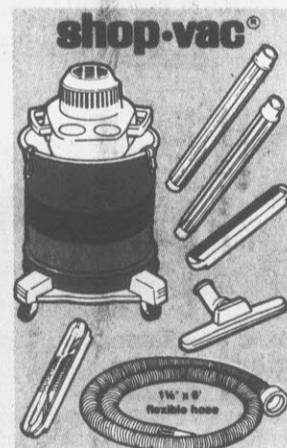

shop-vac®

Makes Cleanup  
Chores Quick  
And Easy

**Powerful Shop  
Vacuum Has  
6 Attachments**

**\$37**

It's an all-purpose vacuum  
that sucks up water as  
easily as it gobbles up  
dirt! Can also be used as  
an air blower. #98690

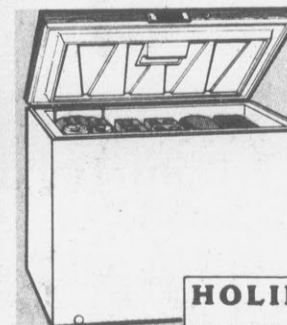

Stock Up On  
Grocery Specials

HOLIDAY  
by Lowe's

**Holiday 14.8 Cubic Ft. Chest  
Freezer With Safety Lock**

Has drain tube for easy  
defrosting. And the lid  
is counterbalanced for  
extra convenience. #50817

**\$269<sup>93</sup>**



859 5738 169 528 1

BILL GRADY

05/79

**Introducing The New  
Lowe's Credit Card.  
The Handy Card For  
Handy People ...  
Like Yourself! See  
Details Below.**

That's right. Whether you're handy at  
sawing a board, mowing a lawn,  
decorating a room or just plain  
enjoying life, Lowe's makes it all a  
little easier with our new Credit Card.  
Just stop by and pick up an application.  
If you want to charge something while  
you're in the store, your application  
may be approved in a minimum amount  
of time..... Or you can take it home  
with you and mail it back to us. Either  
way, it's worth looking into. Because  
our new Credit Card will make it faster  
(no hassle) and easier (no down payment)  
for you to get the products & services  
you need...from a new TV to a truck-  
load of lumber. Stop by the store today!

Prices Guaranteed Through June 6th

<p><b>4" Corrugated Drain Pipe</b> <b>21<sup>c</sup></b> Per Ft. Solve drainage problems with flexible plastic pipe. Resists freezing. #24112</p>	<p><b>Edison. 2-Speed Fan</b> <b>\$19<sup>97</sup></b> 20" portable with tough plastic grill and high &amp; low fan speeds. #39574</p>
---	--

<p><b>16' Extension Ladder</b> <b>\$29<sup>88</sup></b> Sturdy aluminum ladder has gripper feet. Extends to 13' full working height. #92430</p>	<p><b>Metal Sawhorse Brackets</b> <b>\$1<sup>88</sup></b> Pair Need a sawhorse? Just put 2x4's into these brackets and nail them tight. #61725</p>
---	--

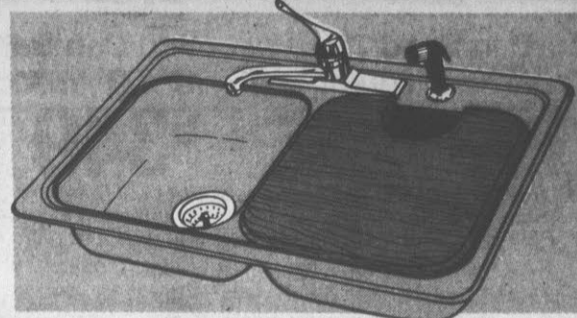

**Stainless Steel Sink Unit With  
Faucet, Chopping Block, More**

33"x22" sink with single  
lever faucet & spray, solid  
maple chopping block and  
2 basket strainers. #26024

**\$69<sup>97</sup>**



Helps Save  
On Cooling  
Expenses

**Roof Mounted  
Power Ventilator  
Saves Energy**

**\$34<sup>88</sup>**

Ventilates up to a 2,000  
sq. ft. attic, and reduces  
air conditioning costs by  
up to 30%. Has adjustable  
thermostat, too. #30985



Great For  
Handyman  
Projects

**Dale Bunyan  
Economy  
2x4 Studs**

**89<sup>c</sup>**  
Each

For use in home projects  
not governed by building  
codes, such as doghouses  
and other light framing  
work. Thrifty price! #07002

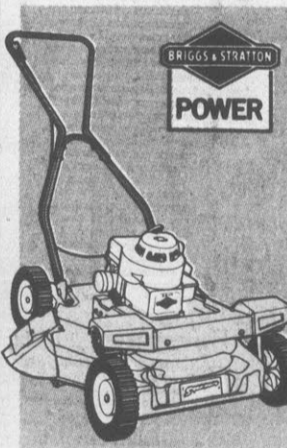

Cut Your  
Lawn Down  
To Size

**Self-Propelled  
3.5HP Mower  
Has 22" Cut**

**\$139<sup>99</sup>**

Fingertip control engages  
the front wheel drive to  
make your mowing a lot  
easier. Handle-mounted  
throttle control. #95152

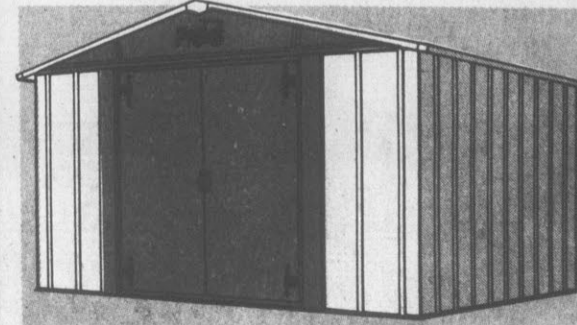

**Roomy 10x9 Lawn and Garden  
Steel Storage Building**

Interior measures 9'6 3/4"  
wide, 8'3 1/8" deep and 6'1 1/4"  
high. Triple-ribbed wall  
and roof panels. #92735

**\$124<sup>99</sup>**



Rockwell International

**Cordless Trimmer**  
Battery lets you  
trim up to 45  
minutes without  
recharge. #91594

**\$39**

**Cordless Sprayer**  
Electric sprayer  
for gardens, etc.  
With adjustable  
nozzle. #92490

**\$8<sup>88</sup>**

Convenient Location - Store-Front Parking June 7th (1) or  
**LOWE'S**

2728 South Memorial Drive • Phone: 756-6560  
Greenville, N.C.

SUPPLEMENT TO: The Daily Reflector & The Reflector Shoppers Guide

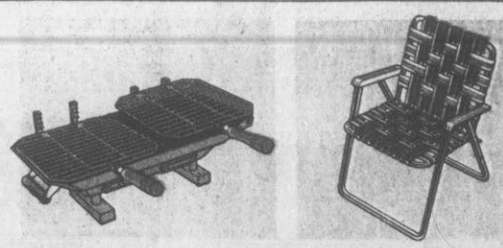

**Hibachi Grill**  
Cast iron grill  
with adjustable  
cooking grates.  
A value! #97296

**\$4<sup>99</sup>**

**Webbed Lawn Chair**  
Folding chair  
with a durable  
aluminum frame.  
Come see! #96506

**\$5<sup>99</sup>**

# When Your Money Matters, Lowe's Makes The Difference

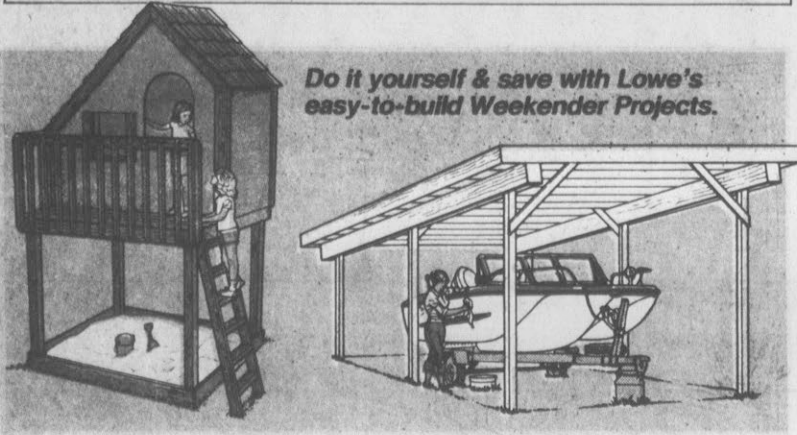

Do it yourself & save with Lowe's easy-to-build Weekender Projects.

You Can Build This "Treeless" Treehouse **\$199** Includes Materials, Blueprint And Instructions

Has sandbox base & 6'x4' treehouse with railed deck. Real cedar shake roof. Plus finishing stain. #00024

You Can Build This 12'x24' Wood "Cover" **\$349** Includes Materials, Blueprint And Instructions

For boat, camper, etc. And includes your choice of in-stock #240 asphalt shingles and paint or stain. #00023

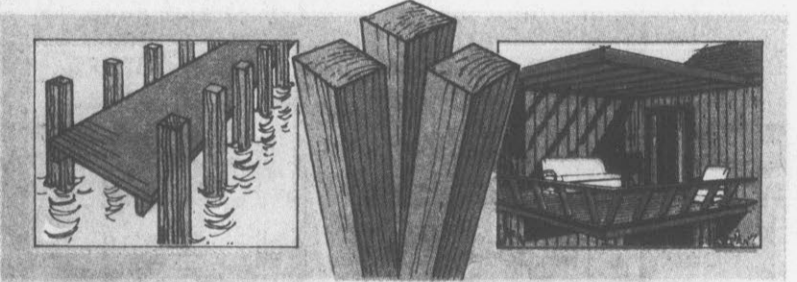

Pressure Treated 4x4x8' Posts **\$429** Each

Can be used to build decks, docks, porches, steps, etc. They're Lowe's best! Size is nominal. #05290

We also have Pressure Treated Lumber for your deck or dock

2x4x8' Treated Southern Yellow Pine #05261 ..... \$1.99 Each  
2x6x8' Treated Southern Yellow Pine #05266 ..... \$3.19 Each  
2x6x12' Treated Southern Yellow Pine #05269 ..... \$4.79 Each

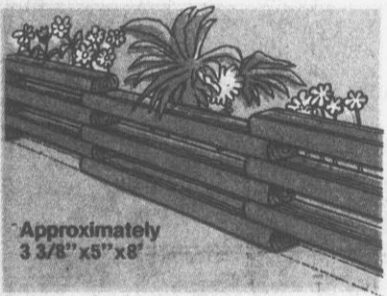

Pressure Treated Landscape Timbers **\$339** Each

For walls, steps, borders and more. Treated to resist rot, decay and insects. Rustic & rugged. #05202



5/8"x4'x8' Particleboard **\$449** Each

An underlayment grade panel with two smooth sides. Strong & durable. Can be used under carpet. #12259

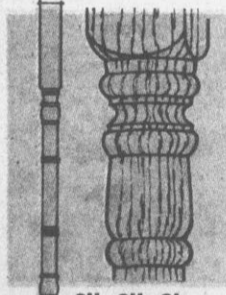

6"x6"x8' Wood Post **\$3688**

Solid wood post can be used indoors or out. It's unfinished. #10486



Use 1x2 Furring To Install Paneling

7¢ L. Ft. Linear Foot: a 1' length, no matter how wide or thick. Use our furring strips on masonry walls to apply the paneling. #11782

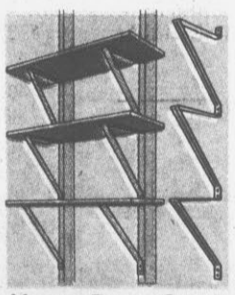

Heavy Duty, Steel Shelving Bracket **99¢**

Continuous bracket for three shelves. Installs in minutes. #61724

# When Your Money Matters, Lowe's Makes The Difference



Your Choice!  
3/8" Drill Press Or  
6" Bench Grinder  
**\$5500**

Drill Press has variable speed (700-1800rpm) and safety on-off switch. Bench Grinder has 1 fine & 1 coarse grit wheel. #91726,7

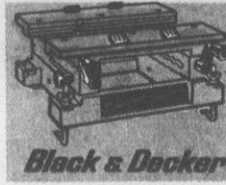

Bench Top Workmate **\$2999**

Swivel grips hold odd shapes and lumber up to 12 1/2" wide. Surface tilts 15°, 30° and 45°. #91991



Router/Saw Table **\$1599**

Converts your portable router or saber saw to a "stationary" tool. Frees both hands. #91791



Workbench/Shelf **\$2288**

36"x20" work surface, six clear plastic bins, steel tool rack & heavy-duty bracing. #62455

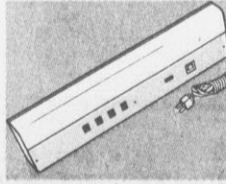

18" Fluorescent **\$599**

Mounts flush to wall or under counter or shelf. Has on-off switch and fluorescent tube. #74611



Workbench Light **\$997** Just Plug It In!

Easy-to-assemble light uses two fluorescent tubes (not included). It's 4 feet long! #74665



Pump & Sprayer **\$999**

Hand operated. Pumps water, gas, oil—and it even sprays! Self-priming, too. #93705



100' Outdoor Extension Cord **\$997**

Heavy-duty, 16/3 cord for use with electric lawnmowers, edgers, power tools & lighting. UL listed. #70372



Items In This Section Are Available Through Lowe's Exclusive Fast Ordering System...

Warehouse Express We have centrally located warehouses in North Carolina, Mississippi and Tennessee. We'll place your order for you, call you when it arrives and work out arrangements for delivery. It's a great way to buy. Come see.

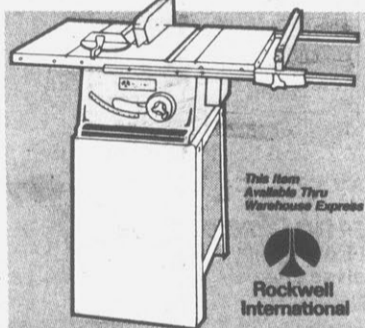

10 Inch Table Saw **\$234**

Cuts 3 1/4" deep. Rips 24". Has upfront controls and high torque motor, thermal overload protected. Ball bearing equipped. #91957

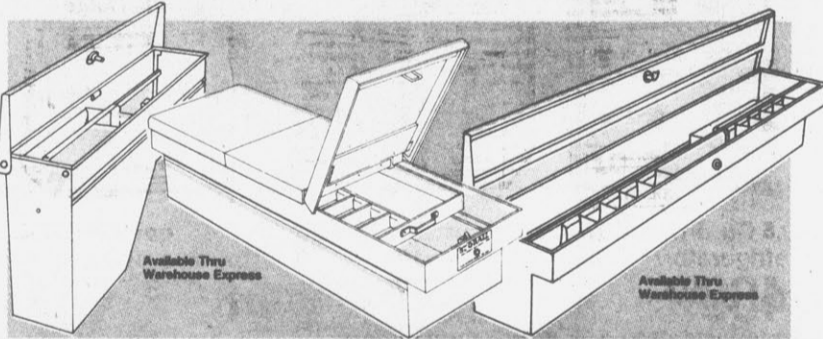

Over-Wheel Utility Box **\$5995** Save \$20 Reg. \$79.95

Has a lift-out tray and chrome-plated T-handle lock with 2 keys. Heavy duty steel construction & enamel finish. #92408

Behind-Cab Utility Box **\$7897** Save \$10 Reg. \$88.97

Dual, overlapping lids for easy access. Heavy duty steel construction. Pushbutton/key lock. Interior tray. #92402,4,6

Side-Rail Mount Utility Box **\$12995** PAIR Reg. \$169.95

Heavy duty steel, with a lift-out tray and a strip compartment that features movable dividers. With pushbutton lock. #92410

# When Your Money Matters, Lowe's Makes The Difference

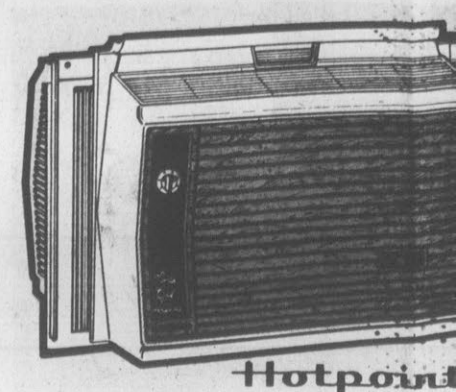

4,000 BTU, Portable Room Air Conditioner **\$13900**

This model's light weight and expandable sides let you put cool air where it's needed. Has an adjustable thermostat "set and forget" automatic cooling volt operation. Come see it! #50149

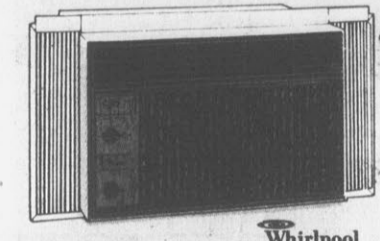

7,500 BTU, Portable Room Air Conditioner **\$24994**

Adjustable thermostat, 2-speed fan, air changer (exhaust) and 2-way air direction control. #50003



Blowing or Pouring Cellulose Insulation **\$349**

30 Lb. Bag Covers an approximately 45 sq. ft. area with a 3 1/2" thick layer. Makes a good add-on insulation. #12578

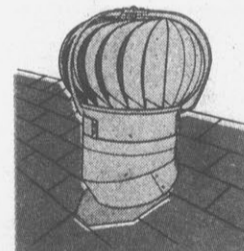

Wind-Powered Attic Ventilator **\$1997**

Unit & Base Costs nothing to operate & reduces air conditioning expense! #30996 or 97

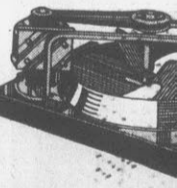

Deluxe 2-Speed 30 Inch Attic Fan **\$11997**

Has 1/2 HP motor for cooling. Plus 2-speed switch. Come see

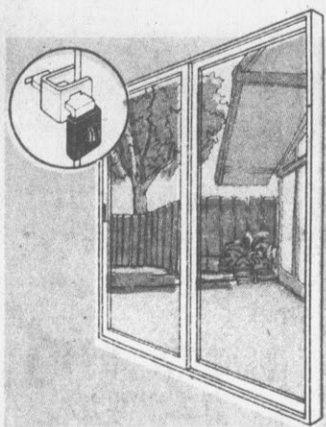

6' Sliding Glass Patio Door Has Safety Glass **\$14999**

Double-pane safety glass forms an insulating barrier against heat and cold. Has high-mounted latch & tough aluminum frame. #13017

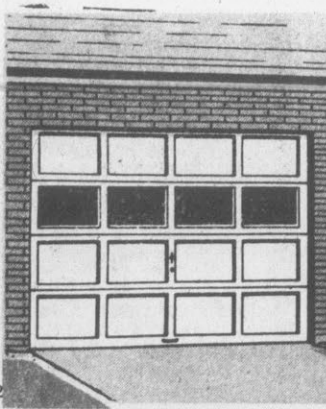

4-Section Roll-Up 9x7 Wood Garage Door **\$13995** Hardware Included

1 3/8" thick door with four windows. Predrilled and sanded. With all hardware, including matched springs for counterbalance. #11030

# When Your Money Matters, Lowe's Makes The Difference



Edison

Choose A Light For The Wall Or For The Post

Your Choice!  
Wall Or Post Outdoor Lantern **\$797** Each

Both fixtures have tough polymer housings that won't rust. Flat black finish. With easy access for quick bulb changes. Lamp post extra. #73103,9

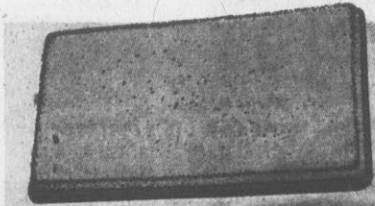

Protect Your Floors 14"x24" Cocoa Mat **\$229**

This tough fiber mat helps scrape off dirt & debris and absorbs water. #16110

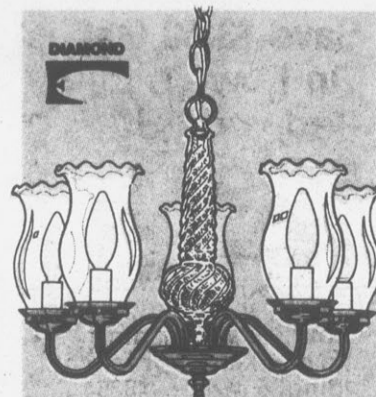

Polished Brass 5-Light, Hanging Chandelier **\$2197**

Shed some new light on things with this graceful model. Has clear glass chimneys and is 18" wide, 13 1/2" high. #74730

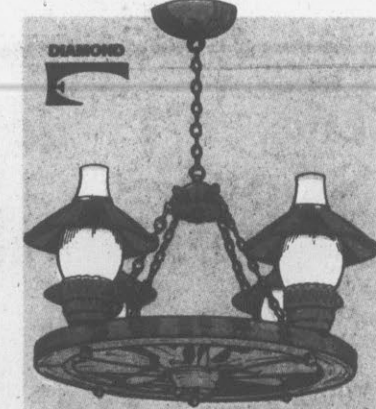

4-Light Model Rustic Wagon Wheel Fixture **\$4997**

Add a touch of the Old West with this 23" wide fixture. Has an antique copper finish and 3/4" frosted chimneys. #74735

# When Your Money Matters, The Difference



**18,600 BTU Air Conditioner \$379<sup>94</sup>**  
 Expandable unit's most thermostat for cooling. 115-volt. 115-0149.  
 8-position thermostat. 3 cooling & "fan only" speeds. 230-volt. #50174

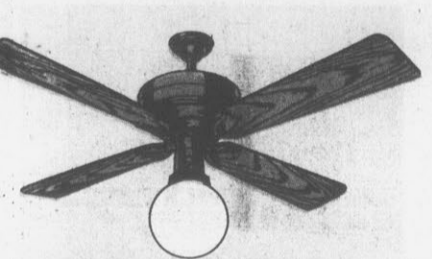

**"Casablanca" 36 Inch Fan In White Or Brown \$88<sup>88</sup>**  
 This Price Does Not Include Light  
 Simulated woodgrain blades in white or brown. Variable speed control. UL listed. With hardware. #30791,6



**Whole House 30 Inch Attic Fan \$89<sup>97</sup>**  
 Also See Deluxe Fan Below  
 Installs in your ceiling. 1/2HP, 30" fan circulates outside air through your home. Shutters extra. #31220

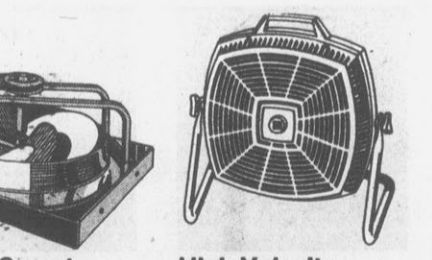

**High Velocity 3-Speed Fan \$34<sup>88</sup>**  
 13" fan has adjustable tilt. Use it on the floor, in window, etc. #39584

# When Your Money Matters, Lowe's Makes The Difference



**40 Gallon, Energy Saving Water Heater \$119<sup>97</sup>**  
 Extra-thick insulation holds in the heat, so less electricity is needed to keep the water hot. Adjustable thermostat. UL listed. #26302



**Heavy-Duty 2-Speed Washer \$259<sup>59</sup>**  
 Includes three wash/rinse temps & perm press/poly knit cycle. #51224,5  
 You Can Charge It! No Down Payment. 24 Monthly Payments of \$13.27 Per Month. Deferred Payment Price is \$318.48. Annual Percentage Rate 16.42%.



**8.2 Cubic Foot Chest Freezer \$199<sup>83</sup>**  
 Has eject-a-key lock for safety and tamper-proof temp control. #50814



**12 Cubic Foot Upright Freezer \$239<sup>86</sup>**  
 Eject-a-key lock, three refrigerated shelves and bulk storage bin. #50858

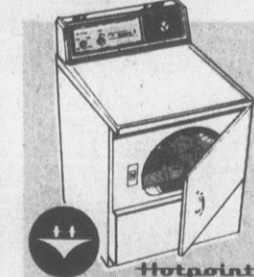

**4 Drying Temperature Electric Dryer \$179<sup>86</sup>**  
 Has automatic Sensi-Dry™ cutoff, plus timed drying. Perm press, too. #51420

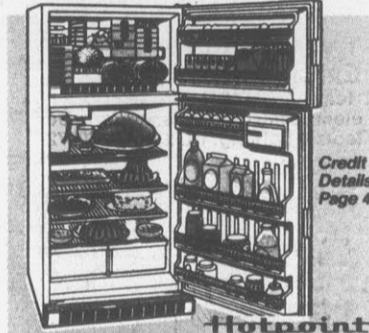

**15.7 Cu. Ft. Refrig/Freezer \$379<sup>77</sup>**  
 It's frost free! With 3 adjustable shelves and twin crispers. #53530  
 You Can Charge It! No Down Payment. 36 Monthly Payments of \$13.92 Per Month. Deferred Payment Price is \$501.12. Annual Percentage Rate 16.24%.



**30" Electric Range \$279<sup>77</sup>**  
 Porous ceramic oven liner helps absorb & burn off spills. #52806  
 You Can Charge It! No Down Payment. 24 Monthly Payments of \$14.30 Per Month. Deferred Payment Price is \$343.20. Annual Percentage Rate 16.42%.



**19.6 Cu. Ft. No-Frost Refrigerator/Freezer \$469<sup>98</sup>**  
 Has textured steel doors, adjustable shelves, twin sealed crispers. #53683



**Microwave Oven Cuts Cooking Time \$259<sup>87</sup>**  
 Variable power control, 35-minute oven timer & sealed in shelf. #51746



**12" Diagonal AC/DC Portable Black & White \$89<sup>96</sup>**  
 Runs on house current or 12V car lighter. 100% solid state chassis. #54555



**AM/FM In-Dash Stereo 8-Track or Cassette \$67<sup>76</sup>**  
 Both of these great units have balance & tone controls. #55134,5



**FREE Micro Menus Cookbook Included!**  
**Plugs Into Your Car's 12 Volt Cigarette Lighter!**

# When Your Money Matters, Lowe's Makes The Difference

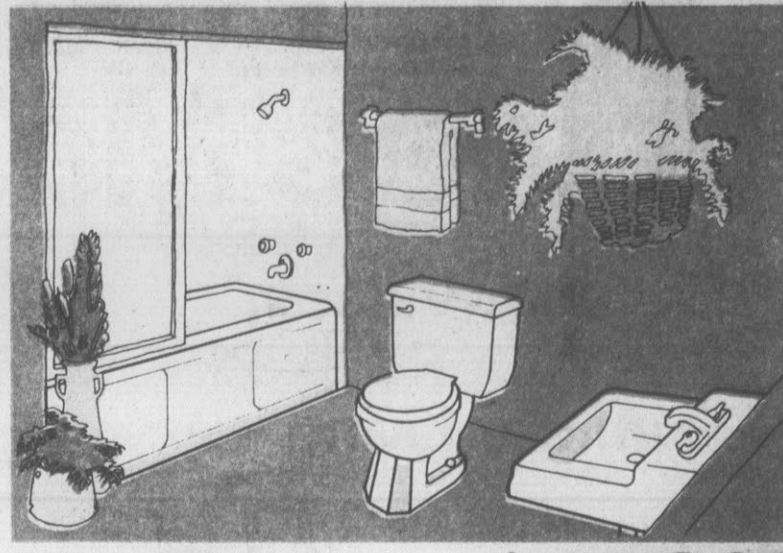

**3 Piece Bath Includes Commode, Lavatory And Tub \$129<sup>97</sup>**  
 3-piece white bath group includes a water-saving commode, 19"x17" wall-hung lavatory and 5-foot enameled steel tub. Faucets extra. Commode seat extra. #20050, 20091, 2, 20333, 4

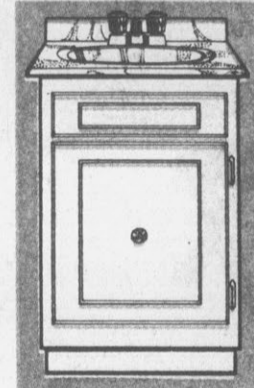

**Washerless Faucet \$19<sup>99</sup>**  
 4" centerset has pop-up drain & acrylic handles. Come see. #24932



**Easy To Install White Tub/Wall Kit \$49<sup>97</sup>**  
 A 5-piece kit of acrylic and ABS plastic. Installs in minutes with trim knife & caulking gun. #20133



**Bath Vanity With Top And Faucet \$59<sup>97</sup>**  
 19"x17" single-door vanity has a cultured marble top and dual-control faucet. Nice trim. #20804

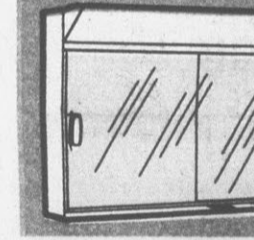

**Surface-Mounted Bath Cabinet \$23<sup>97</sup>**  
 All-steel construction with baked enamel finish. A removable glass shelf. Light fixture. #23716

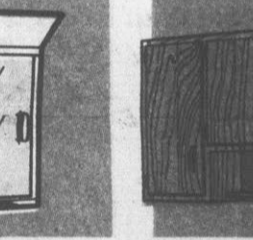

**66" Wide Pecan Wall Cabinets \$74<sup>88</sup>**  
 Pecan-finish unit measures 66" wide, 30" high and 12" deep. For family room, den, etc. #29026

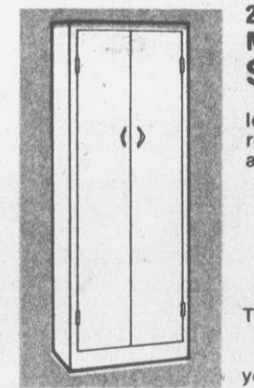

**22" Wide x 60" High Metal Utility Cabinet \$29<sup>88</sup>**  
 Ideal for the kitchen, laundry room, etc. Has three shelves and a baked enamel finish. #26122



**4'x8' Wallboard For Most Rooms \$89<sup>99</sup>**  
 These easy-care melamine panels resist stains & scratches. Great for the kitchen, the playroom — you name it. Gold-on-white. #16628

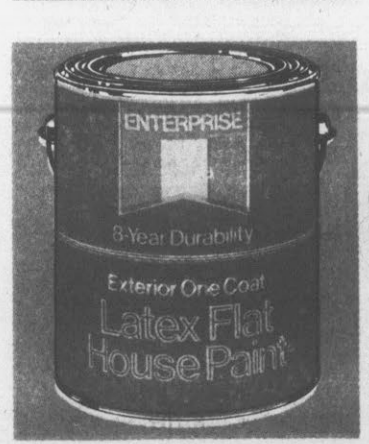

**Save \$3.50 Gallon On Lowe's Latex Redwood Stain \$2<sup>99</sup>**  
 Reg \$6.49! One Gallon  
 Lends a rich redwood color to any wood, inside or out. Resists fading and cracking. For fences, siding, & more. #48664

**Save \$4.00 Gallon On Lowe's 1-Coat Latex Flat Exterior \$8<sup>99</sup>**  
 Reg \$12.99! One Gallon  
 Warranted to cover any color in one coat. Has 8-year durability rating. Easy cleanup with water. White & colors. #48514,28,32

# When Your Money Matters, Lowe's Makes The Difference

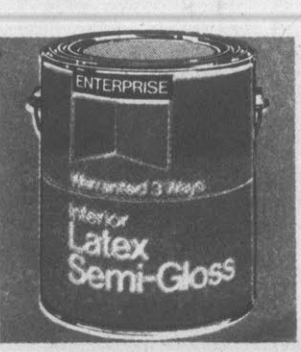

**Save \$3.00 Gallon On Lowe's White Latex Flat Wall \$5<sup>99</sup>**  
 Reg \$8.99! One Gallon  
 Warranted to cover any color in one coat and to be washable and fade resistant. Easy cleanup with water. White only. #47662

**Save \$3.00 Gallon On Lowe's White Latex Semi-Gloss \$7<sup>99</sup>**  
 Reg \$10.99! One Gallon  
 It's warranted scrubable, fade resistant and stain resistant. For kitchen, bath and woodwork. Easy cleanup. White only. #47784

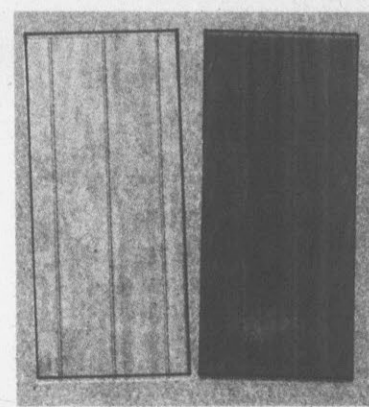

**Your Choice! 4x8 Caribbean Or Country Pecan Panels \$6<sup>99</sup>**  
 Each  
 Both of these handsome panels look great, with rich warm tones realistically simulated on 3mm thick lauan plywood. #13926, 7

**Prefinished Molding Special! 12"x12" Cork Tiles \$1<sup>49</sup>**  
 4-Pack  
 Buy an 8-foot length of cove molding at the regular price and get a 7-foot length of casing molding for 1/2 price! #01454, 63, 82, 93, 01503  
 From a bulletin board to a tabletop, these 12"x12" dark cork squares make a great decorator item. Apply with adhesive (extra). #10940

# When Your <sup>Outdoor</sup> Money Matters, Lowe's Makes The Difference

## Outdoor Values For Your Relaxed Summer Living



**A. Multi-Position Reclining Lounge**  
Has sturdy vinyl webbing and built-in cushioned headrest. Plus four comfortable positions. Relax in style this year! #96558

**\$999**

**B. Brown and White Lawn Chair**  
Deluxe folding chair with 2 1/2" wide copolymer strapping and color-matched armrests. #96509

**\$899**

**C. 6 Ft. Picnic Table With 2 Benches**  
Made of western wood, redwood-stained for durability. Great for the porch, patio or backyard. Some assembly required. #96806

**\$3499**

Both These  
Rugged  
Riders Have  
Engines By  
BRIGGS &  
STRATTON



**A. Rugged Rider Mower Features  
8HP Engine With 32" Cut**

**\$629<sup>77</sup>** CHARGE IT\*  
See Details Below

You'll get key ignition, rear discharge cutting deck, 3 forward speeds and 1 reverse, shock-mounted engine with heavy-duty gear drive and disc brake. At Lowe's #95188

No Down Payment. Monthly Payment of \$23.09  
For 36 Months. Deferred Payment Price Of \$1017.00.  
Annual Percentage Rate of 16.24%.

**B. Powerful 11HP Rider Mower  
Has 3 Speeds And 36-inch Cut**

**\$769<sup>99</sup>** CHARGE IT\*  
See Details Below

Includes synchro-balanced engine with transaxle, electric start with alternator, disc brake, three forward speeds and one reverse. Comfort-firmed seat. See it! #95196

No Down Payment. Monthly Payment of \$26.25  
For 36 Months. Deferred Payment Price Of \$1017.00.  
Annual Percentage Rate of 16.24%.

## Give Your Home An Exciting New Look This Year!

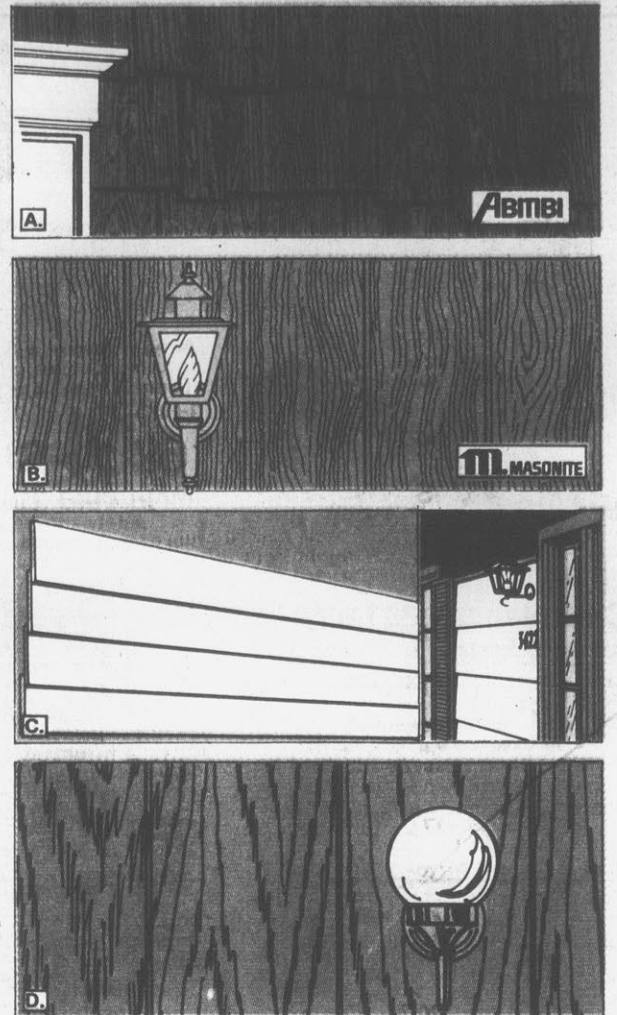

**A. Rustic Textured Random Shakes**  
**\$169** CEDAR SHAKE LOOK  
Each

7/16" x 12" x 48" hardboard panel has the look of real wood shakes. Just add paint or stain to achieve the appearance you like best. See it in person, at Lowe's. #15633

**B. Masonite "Woodman Plank" Siding**  
**\$1295** NATURAL WOOD LOOK  
4x8 Ft. Sheet

7/16" thick hardboard panel has an embossed rough cedar texture, with 3/4" grooves on 8" centers. It's a great way to remodel your home's exterior this summer! #15614

**C. Primed Hardboard Lap Siding**  
**\$499** PRIMED FOR PAINTING  
1x16 Ft. Length

7/16" thick hardboard panels let you add the traditional look of horizontal siding to your home. They're already primed to save time and expense. See 'em today! #15602

**D. Pine Plywood Woodgrain Siding**  
**\$1639** BEAUTIFUL WOODGRAIN  
4x8 Ft. Sheet

5/8" thick panel of real pine plywood, in a reverse board & batten pattern. Just add paint or stain. #12936  
2 1/2" Galvanized Siding Nails #12100 . . . . .8¢ Per Pound



Do It Yourself  
Just Add Water

When You Build, Build It To Last.  
Use Quality Quikrete Masonry  
Products For A Good Foundation.

- Do-It-Yourself Concrete Mix #10388 . . . . . \$149 40 Lb. Bag
- Do-It-Yourself Sand Mix #10389 . . . . . \$199 90 Lb. Bag
- Do-It-Yourself Mortar Mix #10391 . . . . . \$199 60 Lb. Bag
- Mixing Box For Quikrete Products, Holds 2 Bags #10386 . . . . . \$159 Each



Patch Up Your  
Driveway Problems  
The Quikrete Way

**Black-Top  
Patching**  
**\$349**  
Bag

Premixed and ready to pour from bag. Tamps tightly into place. Won't shrink. 60-lb. bag. #10394

**Concrete  
Patcher**  
**\$299**  
Pail

Seals and repairs cracks in concrete drives & walkways. Just add water. 7-lb. pail. #10390

## GIVE YOUR KIDS DAYS OF PLAY THIS SUMMER



**Kids Gym Set  
Has 3 Rides,  
Plus a Slide**  
**\$4999**

Includes two swings, a sky glide and slide with steps. Unassembled. #99718



**Regular \$10.97!  
24 1/2" Diameter  
Adjustable Grill**  
**\$899**

Has 380 sq. in., 5-position cooking grid. Tubular steel legs for strength. #97284

SHOP LOWE'S FOR ALL YOUR  
OUTDOOR SUMMER NEEDS

**\*Lowe's Installment Credit Terms**  
Your credit must be satisfactory. Lowe's Cash Price doesn't include sales tax, Deferred Payment Price includes sales tax at 4%. If sales tax in your area differs, Deferred Payment Price & Monthly Payment will vary slightly. Life insurance is available, but not required or included in our figures. Delivery charges, if any, are not included. The Annual % Rate for Pa. stores is 15%, making payments slightly lower. The installment terms above are completely separate from the terms of Lowe's Credit Card Accounts.

# LOWE'S

### Raincheck Policy

If we sell out of an advertised item, we'll issue you a raincheck. When we restock, you'll be notified so you can buy at the previously advertised price. (Except on any products marked "Limited Quantities.") It's just one more way we serve you, at Lowe's. Our smaller stores may not stock all advertised items. But every item shown here can be ordered.

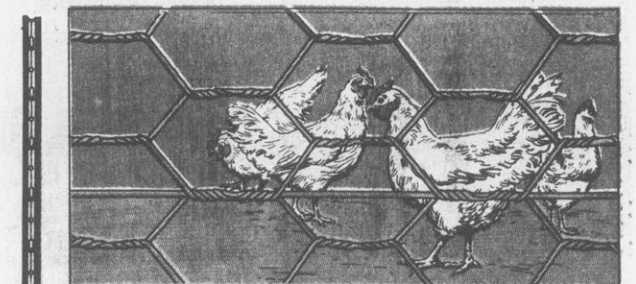

**20-Gauge Poultry Netting**  
**\$1195** Lots Of Uses For  
The Home & Farm  
36' x 50' Roll

This sturdy netting can be used to keep rabbits out of your garden or the family pet out of the neighbor's backyard. Galvanized, too. #92302  
5' Steel Fence Post, #92064 . . . . . \$1.29



**White Painted  
Aluminum  
Gutter Section**  
**\$399**

10-Ft. Section  
Lightweight and rustproof gutter section is pre-painted and ready to install. #11550

LOWE'S STOCKS A COMPLETE  
LINE OF GUTTER FITTINGS

OPEN MON.-SAT. 9:30-9:00

SALE DAYS, WED., THURS., FRI., SAT.

**WARRANTY ADVERTISING MERCHANDISE POLICY**  
 Our store is authorized to sell merchandise advertised in this publication. Merchandise is sold on the basis of the advertisement. The advertiser is responsible for the accuracy of the information in the advertisement. The advertiser is not responsible for the accuracy of the information in this publication. The advertiser is not responsible for the accuracy of the information in this publication.



# SUNSHINE SALE



**CANNING JARS**  
 Our Reg. 3.23-3.73  
**277**  
 Qt. Size

Case Of 12 Wide Mouth Or Regular Mason Jars. Bands And Lids Included. 12 Pint Jars Wide Mouth Or Regular W/ Bands And Lids.....



**ALUMINUM FOIL**  
 Our Reg. 3.17  
**4 for \$1**



**KITCHEN HELPERS**  
 Our Reg. 1.17  
 2-qt. measuring, 2-qt. 14- or 18-oz. food storage bowl.  
**64¢**

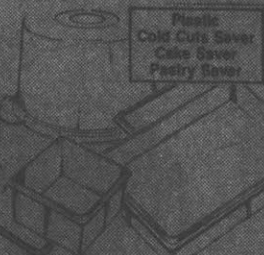

**HANDY FOOD SAVERS**  
 Our Reg. 2.74-3.86  
 Many plastic styles  
 Our 1.97 Patcher, 2 1/2-qt. .... 1.88  
**188**  
 Each



**PLASTIC HELPERS**  
**2 for \$1**

Laundry Basket, Pail, Foot Tub And More.



**EMBLEM VISOR CAP**  
 Our Reg. 2.83  
**197**



**BOXED ENVELOPES**  
 Our Reg. .84  
**2 \$1 FOR**  
 Legal, letter or note size. Some security tinted inside.



**SAUCE PAN SET**  
 Our Reg. 3.53  
**288**  
 1/2 Qt., 1 Qt., 1 1/2 Qt.  
**5" STRAINER**  
**88¢**  
 Clearance Special No Returns Please.



**16-OZ. WOOLITE**  
 Our Reg. 1.78  
**96¢**  
 Cold water wash for all fine washables.  
 \* 11 Oz.



**BATH SCALE**  
 Our Reg. 8.82  
**466**  
 Decorative steel bath scale in white or attractive colors.

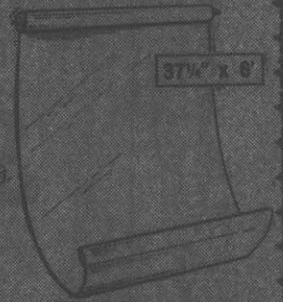

**WINDOW SHADE**  
 Our Reg. 3.23  
**197**  
 White vinyl room-darkening.

**CAFETERIA SPECIALS:** 8-OZ. CHOPPED STEAK DINNER, 2 VEGETABLES ROLL & BUTTER **219** FRI. SAT. **HOT FUDGE SUNDAE 48¢**



**dill pickles**  
 Our Reg. 1.24  
**97¢**  
 Large 46-oz. size of fresh pack Polish dills or Kosher dills. Save at Kmart.



**SALAMI SAUSAGE**  
 Our Reg. 1.24  
**97¢**  
 8-oz. roll beef salami sausage.  
 \*Net Wt.



**AIR BONS CANDY**  
**2 for 87¢**  
 Puff balls in four favorite flavors. 6 oz. bag.



**TOASTY TREATS**  
 Our Reg. .87  
**73¢**  
 Toasted coconut marshmallows 12oz.  
 \*Net wt.



**Pickled Salad Mix**  
 Our Reg. 1.27  
**97¢**  
 Assorted Pickled Vegetable Mixes 32 Oz. Save.



**2-LB. CAN HAM**  
 Our Reg. 5.15  
**466**  
 Tasty Danish canned ham, natural juices.  
 \*Net Wt.



OPEN MON.-SAT.  
9:30-9:00  
WED., THURS.,  
FRI., SAT.



**GIRLS' MIDRIFF TOPS**  
Special Purchase **1<sup>77</sup>** Save!

Pert midriiffs are tops! Prints\* and solid colors. Polyester/cotton. Sizes 4-14.  
\*Not all prints in all stores

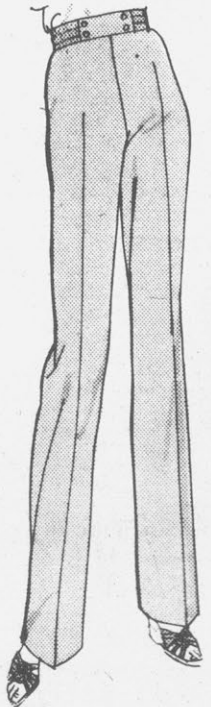

**FASHION PANTS**  
Our Reg. 5.57  
**3<sup>88</sup>** Save!  
Great fitting. Newest colors. Polyester in misses' sizes.

# Cool 'N' Comfortable Savings



**SMART NEW DRESSES**  
Our Reg. 9.96  
**7<sup>96</sup>** Junior, Misses

Fashions says this is the summer of the dress, and we have plenty for you at your price. Cottons, polyester/cotton and polyesters in colors and styles galore. Prints and stripes.

**"BARELY THERE TUBE" TOPS**  
Our Reg. 2.96  
**2<sup>33</sup>** Save!  
Polyester tubes in super colors and styles. Some with straps Misses' sizes.

**WOVEN POLYESTER SHORTS**  
Our Reg. 4.77  
**2<sup>96</sup>** 4 Days Only  
Tailored to perfection in new colors. Many styles to please you. Misses' sizes.



**TERRY TANK TOPS**  
Our Reg. 3.57  
**2<sup>57</sup>** 4 Days Only

Spun polyester terry with diagonal knit weave. Colors. Misses' sizes.

**WOMEN'S SURFERS**

For warm weather easy-living and chic. In colors to delight — red, blue or gold with multi-colored sole. Nylon grosgrain thong with neat suede overlay. Women's sizes. Save now!

Specially Priced **2<sup>50</sup>** Pair





### MEN'S WORK SHIRTS

**5<sup>97</sup>**  
Our Reg. 7.49

Durable polyester/cotton.

### MATCHED WORK PANTS

**6<sup>97</sup>**  
Our Reg. 8.49

Deluxe twill fabric. Colors.

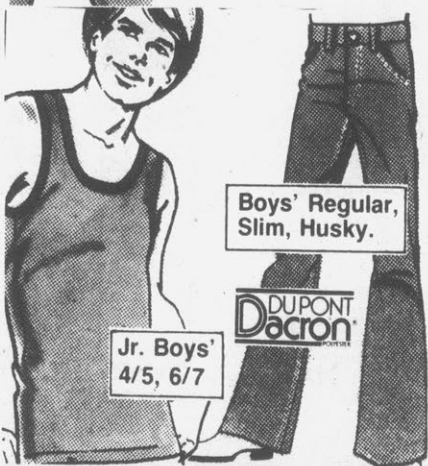

Boys' Regular, Slim, Husky.

DUPONT Dacron

Jr. Boys' 4/5, 6/7

### BRUSHED TWILL JEANS

Our Reg. 7.77-7.97  
Dacron cotton; colors. **\$6**

Our 5.77-5.97... JR BOYS \$4

\*Reg. TM E.I. duPont

### BOYS' TANK TOPS

Our Reg. 2.77 **1<sup>97</sup>**  
Cotton/polyester. Save.

Our 2.27... JR BOYS 1.66

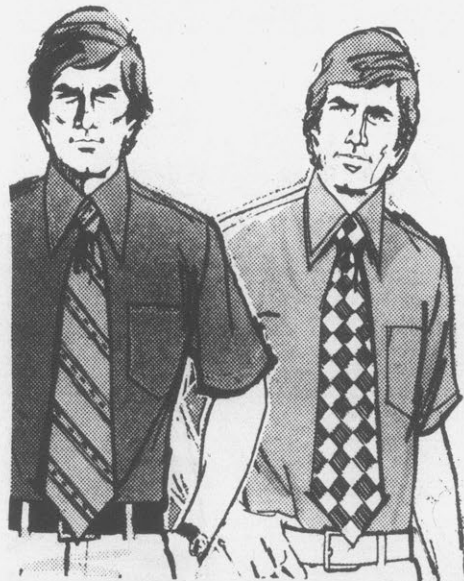

### SHORT SLEEVE DRESS SHIRTS

Our Reg. 9.66 **\$8**

Men's Quiana Knit Shirts In White And Pastel Colors.

## DISCO WEAR

### FASHION SHIRTS

Our Reg. 13.97 **11<sup>97</sup>**

Mens Fashion Disco Shirts In Many Styles And Fabrics.

### FOGLEY SLACKS

Our Reg. 16.97-14.97 **12<sup>97</sup>**

Mens Dress Or Disco Slacks In Solids And Pinstripes. Save.



## RAIN COATS

FOR MEN AND BOYS

Our Reg. 2.97 **\$2**

BOYS

Durable Vinyl Raincoats Will Not Crack Or Stiffen. Heat Sealed Seams.



Our Reg. 3.33 **2<sup>57</sup>**

MEN'S



### KNIT SHIRTS

Our Reg. 6.96 **4<sup>88</sup>**

Placket styles in polyester/cotton. Men's sizes.

### MEN'S SUMMER SPORT SHIRTS

**\$5**

Save!

Cool polyester/cotton sport shirts in solid colors or your choice of patterns.

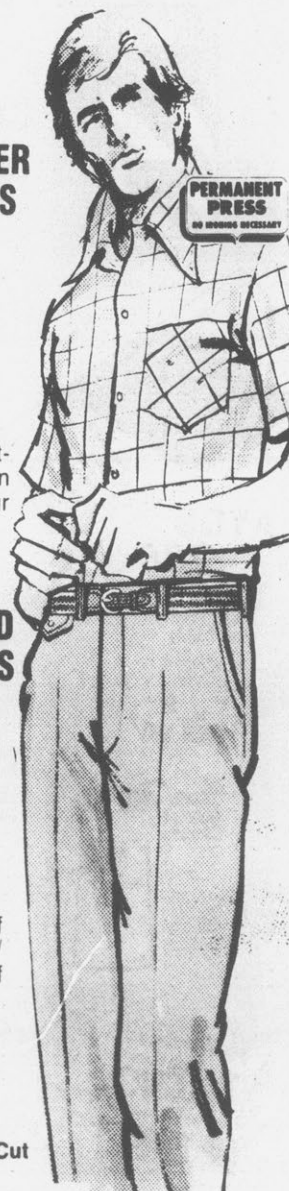

PERMANENT PRESS NO IRONING NECESSARY

### MEN'S BELTED DRESS SLACKS

Our Reg. 14.96

**11<sup>96</sup>**

Save!

Neat pincords of woven polyester/cotton in choice of colors.

Trim or Mature Cut

# Kmart®

## THE SAVING PLACE

OPEN MON.-SAT. 9:30-9:00  
WED., THURS., FRI., SAT.



**MENNEN  
DEODORANT**

**97¢**

Regular, Herbal, Spice 2.5 Oz.



**• COTTON SWABS**  
4 Days Only  
300 swabs; with  
safe, flexible stems. **63¢**

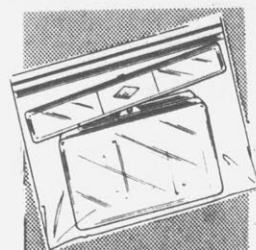

**TRAVEL KIT**  
**37¢**

3 Pc. Kit. Soap, Dish,  
Toothbrush Holder, Carry  
Case.

**OIL OF OLAY**  
**247**

4 Oz. Skin Care Lotion.

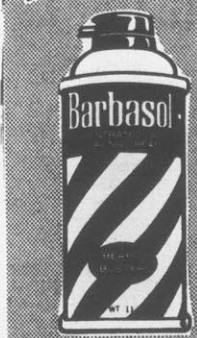

**BARBASOL SHAVE**

**2 for 88¢**

Regular, Menthol Or Lemon  
Lime.

**BAN ROLL-ON**  
**188**

3.5 Oz. Deodorant.

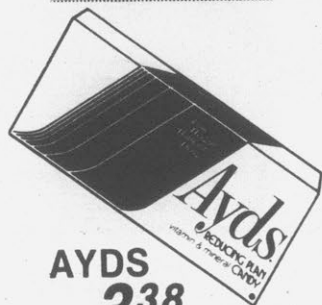

**AYDS**  
**338**

1 1/2 Lb. Box. Reducing  
Plan Candy.



**CALADRYL LOTION**

**158**  
6 Oz.

For Rashes, Insect Bites.

**• BABY CLOTHS**  
**188**  
4 Day Sale  
150 pre-moistened pop-up  
wash cloths with lanolin.

**• 70 WASH 'N' DRI**  
**77¢**  
Save now!  
Disposable, flushable size  
5 1/2 x 9" sheets. Shop now.

**12 OZ. MYLANTA**  
**143**

Antigas, Ant Acid.  
**CHILDRENS TYLENOL**

**88¢**

Chewable Tablets.  
**ALLERGY RELIEF**

**148**

24 Triaminic Allergy Tablets.



**TANNING OIL**

**117**  
8 Oz.

K-Mart Hawaiian Blend.



# HAIR CARE SPECIALS



**AGREE SHAMPOO**

Regular, Oily  
Or Extra  
Gentle Formula. **138** 12 OZ.



**rave home  
permanent**  
**427**

Gentle Soft Perm, No Odor. Save  
Now.

**PROTEIN 21  
HAIR SPRAY**  
**108**

9 Oz.  
Regular Unscented, Extra  
Body.



K 2 78 DW

**CONDITIONER**  
**87¢**

K-Mart Brand Balsam  
Conditioner.

**BABY SHAMPOO**  
**108**

K-Mart Brand. Save.



**BODY ON TAP**

Beer Enriched  
Shampoo Regular  
Oily, Dry. **153**

11 Oz.

**SHORT 'N' SASSY**  
**97¢**  
7 Oz.

Normal, Oily, Dry Formula Shampoo.

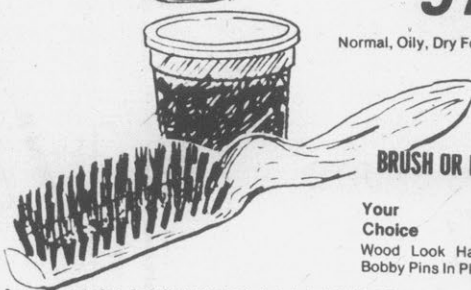

**BRUSH OR BOBBY PINS**  
**68¢**

Your  
Choice  
Wood Look Hairbrush Or 300  
Bobby Pins In Plastic Container.

# Kmart

THE SAVING PLACE

## SPORTING GOODS

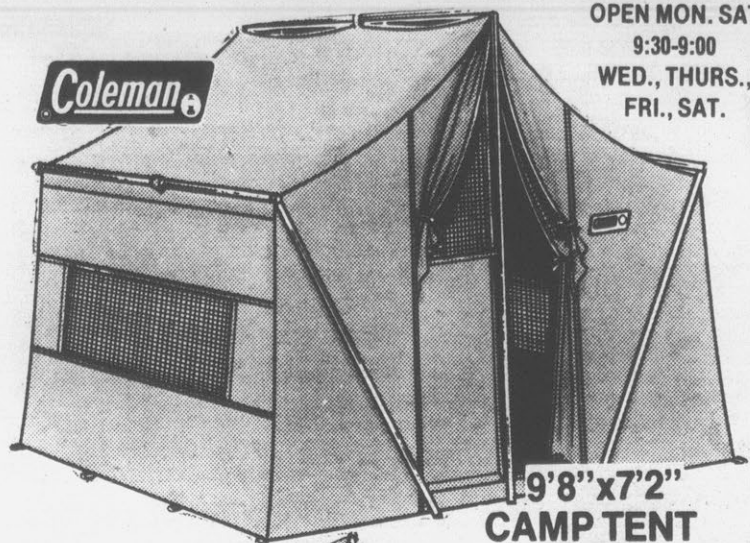

OPEN MON. SAT  
9:30-9:00  
WED., THURS.,  
FRI., SAT.

9'8" x 7'2"  
**CAMP TENT**  
**\$119**

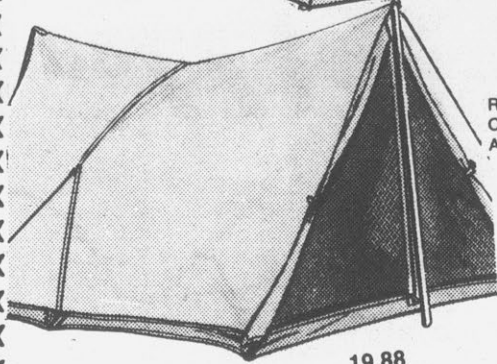

Roomy Fire Retardant Tent With 7' Center Height. 2 Zippered Windows. Aluminum Frame. Save Now.

**2-PERSON NYLON TENT**  
**19<sup>88</sup>**

Our Reg. 29.88  
5'x7' floor area, 42" center height. Sewn-in floor.  
\*Net wt.

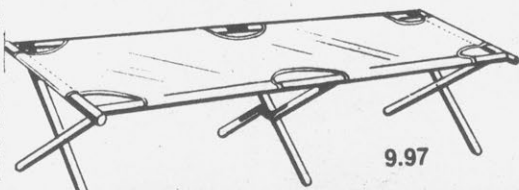

19.88

**WOODEN FOLDING CAMP COT**  
Our Reg. 11.88  
Hardwood frame, canvas top. Folds completely for storage.  
**9<sup>97</sup>**

Our Reg. 2.22 Wood Camp Stool **1<sup>88</sup>**



1.88



2.96  
Our Reg. 3.88 Mini Rucksack **2<sup>96</sup>**  
Our 2.66 Cutter Spray **1<sup>97</sup>**

86 QT. COOLER  
**48<sup>88</sup>**

Our Reg. 54.88  
Rust And Chip Resistant  
Our 9.97 2-Gal. Jug 8.88



**POLYESTER-FILLED SLEEPING BAG**

3 lbs.\* polyester fill provides lightweight warmth and comfort. Red nylon cover, lined with cotton flannel. 33x77" finished size. Shop K mart.  
Ray-O-Vac® Lantern, 6-volt Battery. 2.97

Sale Ends Saturday  
**16<sup>88</sup>**

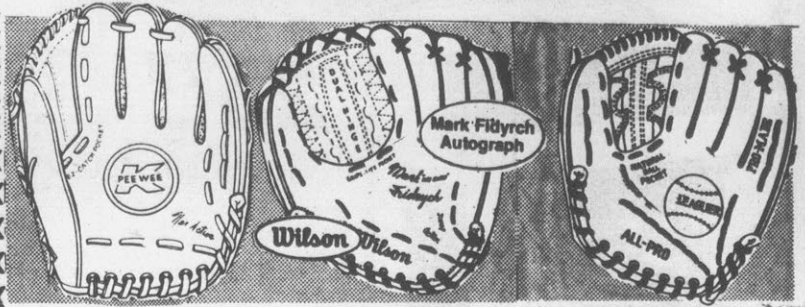

**LEATHER GLOVES**  
Our Reg. 6.96 **5<sup>44</sup>** Save  
Fielder's model. Right, left hand.

**MARK FIDRYCH GLOVE**  
Our Reg. 14.96 **12<sup>97</sup>**  
Fielder's Leather Glove With Dual Hinge Pocket.

**ALL PRO LEAGUER GLOVE**  
Our Reg. 13.96 **9<sup>97</sup>**  
Top Quality Leather Gloves Right Or Left Hand. Save.



U.S.C.G. Approved

17.88

12.88

**STEARNS SAILOR'S VEST**

Our Reg. 21.97 **17<sup>88</sup>**  
Urethane-coated nylon. Heavy-duty.  
Our 14.97 Child's Vest, 2-9, 12.88

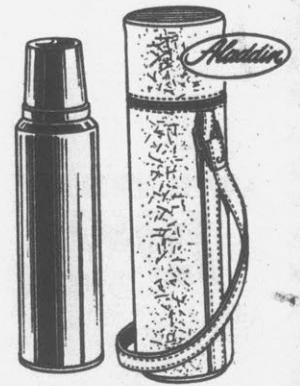

**STANLEY® KIT**  
Our Reg. 24.88 **19<sup>97</sup>**  
Sale Ends Sat.

Quart steel vacuum bottle in leather-like adjustable-strap vinyl case. Save.

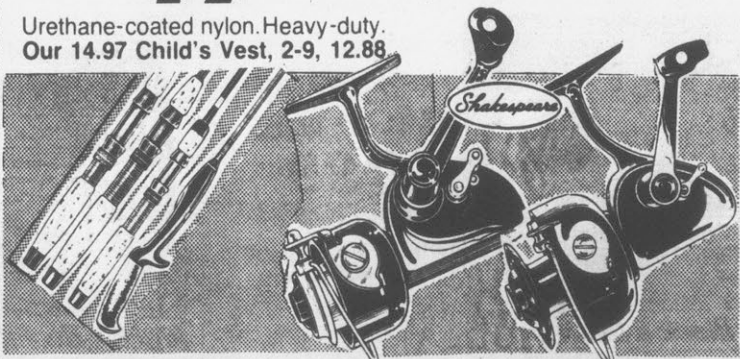

**SHAKESPEARE® REELS, RODS**

Ultra-light spinning reels with ballbearing mechanisms, disc drag. Ultra-light, spinning, spin-cast or worm rods of 1- or 2-pc. fiberglass. Save now at K mart.

Your Choice  
**9<sup>97</sup>**  
Each

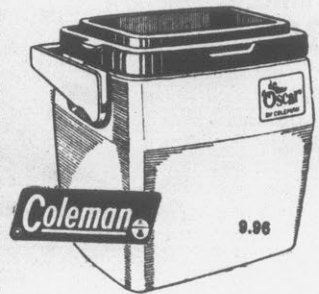

**4-GAL. OSCAR COOLER**

Our Reg. 11.88

**9<sup>96</sup>**

Sturdy Plastic Cooler With Built In Drink Holder On Flip Side Of Lid. Rust Proof, Chip Resistant.

# Kmart

THE SAVING PLACE

OPEN MON.-SAT.  
9:30-9:00  
WED., THURS., FRI., SAT.

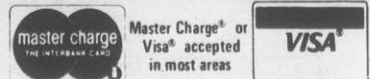

MR. COFFEE®  
**25<sup>77</sup>** Save!  
10-cup, 'Coffee Saver'  
Our 83¢, 100 Filters, 57¢



CRAZY CURL  
Our Reg. 13.90  
**10<sup>88</sup>**  
Quick Curls Gentle Steam Heat.



PLAYER/RECORDER STEREO  
Our Reg. 199.97  
Tri-mode AM/FM  
stereo, cassette, re-  
cord changer, 2  
mikes.  
**177<sup>88</sup>** Save!

GE® 3-WAY  
SPEEDSETTER  
Our Reg. 24.88  
**21<sup>88</sup>**

Style hair with mist, con-  
ditioner or dry. With 20  
tangle-free rollers.



AM/FM PORTABLE  
**19<sup>97</sup>** Save!

Uses AC or battery\*.  
3" speaker.  
\*Batteries not included.



BLACK AND WHITE  
PORTABLE SET

Our Reg. 79.88  
**69<sup>88</sup>**

12" Diagonal T.V. Features Earphone  
Jack. Earphone Included.



12  
INCH  
diagonal  
measure

CREDIT TERMS  
AVAILABLE  
ON MAJOR PURCHASES

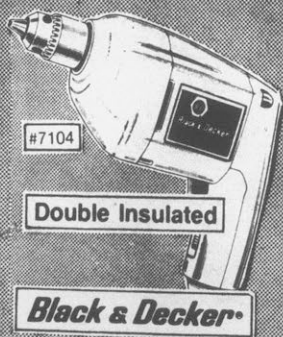

B&D® 3/8" DRILL  
**9<sup>99</sup>** Save!

General purpose for  
home workshop use.

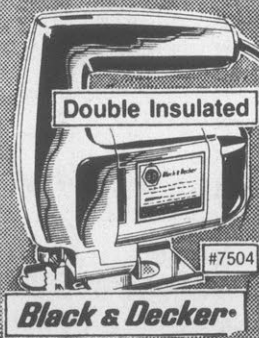

1-SPEED JIG SAW  
**8<sup>37</sup>** Save!

2.1-amp motor. Comes  
complete with blade.



COMPACT 5 1/2" SAW  
**16<sup>87</sup>** Save!

Compact, 5 1/2" blade,  
4000 RPMs, 5-amps.

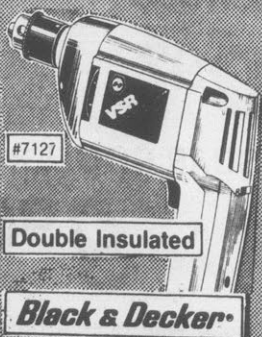

REVERSING DRILL  
**15<sup>88</sup>** Save!

3/8" variable speed  
Handyman special.

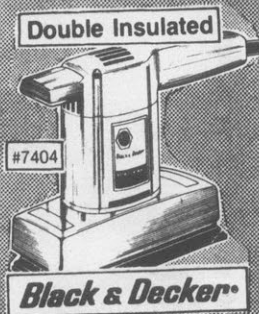

FINISH SANDER  
**14<sup>97</sup>** Save!

10,000 OPM speed,  
lightweight. 1.6-amps.

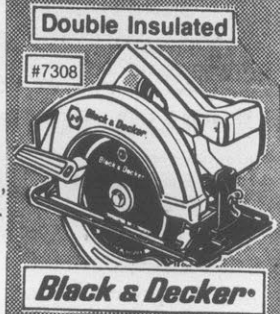

7/4" CIRCULAR SAW  
**22<sup>88</sup>** Save!

5300 RPM speed saw,  
combination blade.

OPEN MON.-SAT. 9:30-9:00

OFFICIAL N. CAROLINA INSPECTION STATION

WED., THURS., FRI., SAT.

FOR AUTO SERVICE DIAL 756-5993

# Kmart

# auto center

THE SAVING PLACE

**K mart AUTOMOTIVE SERVICE POLICY**  
K mart's policy is to perform only need of services for your benefit. K mart auto services are necessarily conditioned on K mart's right to decline any service, whether advertised or not, when a car has related deteriorated or worn parts which create or contribute to an unsatisfactory or unsafe driving condition, unless the customer gives K mart a written waiver of replacement of such needed parts. Needed brake system parts may not be waived by customer. K mart may, in its judgment, refuse to perform any general brake job where your safety is at stake.

Master Charge® or Visa® accepted in most areas



**Complimentary TIRE MAINTENANCE**  
EVERY 5,000 MILES FOR THE LIFE OF YOUR K mart TIRE. ANY K mart STORE WHICH SELLS K mart BRAND Tires will perform WITHOUT CHARGE THESE MAINTENANCE SERVICES:

1. Properly Rotate Tires
2. Thoroughly Inspect Tires
3. Check Air Pressure
4. Tire Puncture Repair
5. Check Valve Stems
6. K mart Safety Inspection

Maintenance Free!



**INSTALLED**

"OUR BEST" 6/72 BATTERY

Our Reg. 71.88 **61.88** With Exchange

Calcium-lead construction. For most cars and light trucks.

**DISC/DRUM BRAKE JOB**

Sale Price — 4 Days **63.88**

Disc drum brake special for most American cars. Additional parts and services may be needed at extra cost. Save.

**SERVICES INCLUDE:**

1. Install quality front brake pads and brake linings on rear wheels
2. Resurface rotors and turn drums
3. Inspect front calipers
4. Rebuild rear wheel cylinders (if possible)
5. Repack inner and outer bearings
6. Bleed hydraulic system and refill
7. Inspect master cylinder
8. Adjust brakes and road test

**HEAVY-DUTY SHOCK SALE**

Sale Price **5.96** Each

1 1/4" size piston, 1 1/2" shaft. Sizes for most American cars.



**KM 78 — BLACKWALLS**

Our Reg. 22.88 — A78x13

SIZES	REG.	SALE	F.E.T.
878x13	24.88	<b>21.88</b>	1.73
C78x14	27.88	<b>24.88</b>	1.88
878x14	30.88	<b>25.88</b>	2.10
178x14	30.88	<b>27.88</b>	2.22
678x14	31.88	<b>28.88</b>	2.38
878x15	31.88	<b>29.88</b>	2.44
878x14	33.88	<b>30.88</b>	2.61
878x15	35.88	<b>31.88</b>	2.66
178x15	41.77	<b>39.76</b>	2.96

**19.88** Plus F.E.T. 1.62 Each

- ✓ 7 Multi-siped Tread Ribs
- ✓ "78" Series Tread Design
- ✓ 4-Ply Polyester-cord Body

All tires plus F.E.T. each  
Whitewalls 2.88 More Each

\*Whitewalls only

**MOUNTING INCLUDED — NO TRADE-IN REQUIRED**

**BALL JOINTS AND ALIGNMENT, SAVE**

Sale Price 4 Days **48.88**

For most U.S. compact, standard cars. Cars with ball joint, control assembly higher.

**SERVICE INCLUDES:**

1. Replace upper or lower ball joints
2. Align front end
3. K mart safety inspection



**HANDY CAR CONSOLE**

Our Reg. 4.97 4 Days Only **3.88**

A snack tray, litter basket, tissue holder plus a roomy miscellaneous compartment. In colors.



**STEEL-BELTED RADIAL**

**KM RADIAL 225 WHITEWALLS**

Our Reg. 43.88 AR78x13

SIZES	REG.	SALE	F.E.T.
C878x14	49.88	<b>35.88</b>	2.15
878x14	51.88	<b>38.88</b>	2.38
878x14	54.88	<b>41.88</b>	2.55
878x14	58.88	<b>44.88</b>	2.65
878x14	62.88	<b>47.88</b>	2.95
878x15	47.88	<b>36.88</b>	2.09
878x15	58.88	<b>44.88</b>	2.73
878x15	62.88	<b>47.88</b>	2.96
1878x15	66.88	<b>51.88</b>	3.30

**29.88** Plus F.E.T. 1.86 Each

- ✓ 2 Radial Plies Polyester Cord
- ✓ 2 Steel Belts
- ✓ Exclusive K mart 5-Rib Tread Design

All Tires Plus F.E.T. Each

**MOUNTING INCLUDED • NO TRADE-IN REQUIRED**

**AUTO SOUND SPECIALS**

**ID500C SAVE \$21** TRYVOX20

Variable Tone Control, Stereo Indicator Light, Balance Control, Volume Program Selector, 5 AM FM Pushbutton Selectors, Manual Tuner.

**6x9" WOOFER TWEETER MIDRANGE**

**SAVE \$10**

**DELUXE AM/FM/8-TRACK INDASH PUSHBUTTON**

Our Reg. 148.88 — 4 Days **127.88**

AM FM radio with local-distance reception switch Plus 8-tr. player. Adjusts for most U.S. cars.

**6x9" TRIPLE-PLAY STEREO SPEAKERS**

Our Reg. 58.88 4 Days Only **48.88** Pair

High fidelity, full-range 3-speaker-in-1, with 20-oz magnet. Up to 50-watts peak power.

**GREASE GUNS SAVE \$8**

Our Reg. 6.37 **4.44** Each

Mini-pack with refill cartridge or lever-action gun.

**AIR PUMP SALE**

Our Reg. 4.88 **3.77**

High pressure hand pump inflates tires and toys.

**DIGITAL CLOCK**

Our Reg. 24.88 **16.88**

Fits on, under or in the dash. Shows hour, minute, second.

**YOUR CHOICE**



**GAS CAN SPECIAL**

Our Reg. 2.47 **\$2** ONE GALLON CAN

Our Reg. 6.47 **\$4** 2 1/2 GALLON CAN

Our Reg. 7.47 **\$5** FIVE GALLON CAN

Features Seal-tite Leak-Resistant Spout



**Kmart's Advertised Merchandise Policy**

Our Best Merchandise is the Best Kmart Merchandise. Items in this section are available in limited quantities. Items in this section are available in limited quantities. Items in this section are available in limited quantities.

# Kmart

THE SAVING PLACE

OPEN MON.-SAT.  
9:30-9:00  
SALE DAYS  
WED., THURS.,  
FRI., SAT.

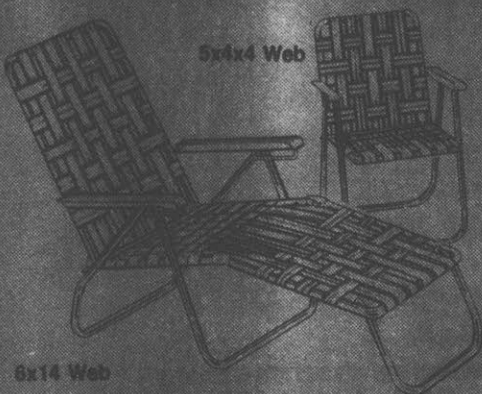

5x4x4 Web

**LAWN CHAIR AND CHAISE**

Our Reg. 5.53 **4<sup>88</sup>** Chair

Our Reg. 12.88 **10<sup>88</sup>** Chaise

Sturdy chair or 5-position chaise lounge with multi-color web. Aluminum frame, waterfall arm.

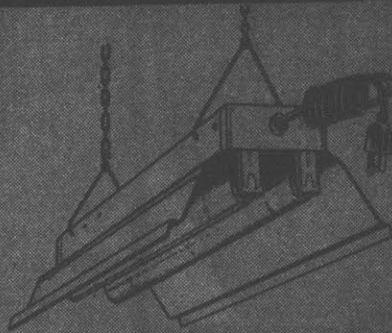

**FLUORESCENT FIXTURE**

Our Reg. 15.95 **11<sup>88</sup>**

Easy assembly; with cord chain, bulbs 4-ft.



**100' OUTDOOR CORD**

Our Reg. 16.88 **12<sup>88</sup>**

100' Heavy Duty All Purpose Cord 3 Wire Grounded.



**20 QT. POTTING SOIL**

Our Reg. 2.14 **1<sup>88</sup>**

Ready To Use, Odorless Soil, Prepared For All Plants. Save Now



**39-FT. LAWN FURNITURE WEDGING**

Our Reg. .79

**66<sup>c</sup>** 4 Days

Polystyrene, 1/2" x 1/2" x 39-1/2" long. 100% Satisfaction Guaranteed.



**HOUSE HOLD HELPERS**

**2. SOFT SCRUB**

Our Reg. 1.53

**\$1**

28 Oz. Gentle Liquid Abrasive Cleaner

**b. K-MART BATHROOM CLEANER**

Our Reg. .97

**2 for \$1**

Foaming Cleaner Disinfects, Deodorizes.

**c. 22 OZ. WINDEX**

Our Reg. 1.37

**\$1**

For Sparkling Clean Glass

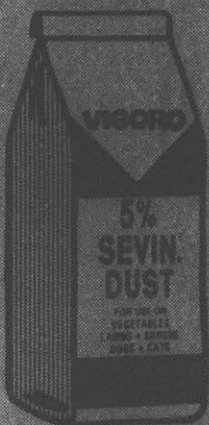

**SEVIN DUST**

Our Reg. 4.37

**3<sup>47</sup>**

4 lb.

Insecticide For Vegetables, Lawns, Shrubs, Pets.



**50' SPRINKLER HOSE**

Our Reg. 5.17

**4<sup>17</sup>**

3 Tube Sprinkler Hose in Green Vinyl With Brass Couplings.



**8<sup>66</sup>**

Our Reg. 9.96

**PLASTIC TRASH CAN**

Wooden - look 30-gal. size, with tight cover.



**15 GAL. TUB**

Our Reg. 8.27

**4<sup>97</sup>**

Galvanized Tub With 2 Handles.



**KITCHEN LADDER**

Our Reg. 16.27

**7<sup>88</sup>**

Sturdy Aluminum Ladder, 27" High, Light Weight, Folds For Storage.

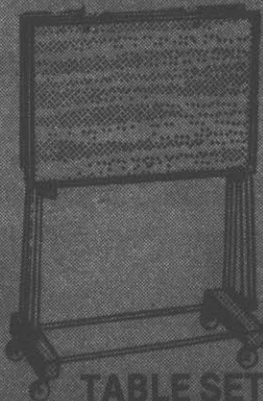
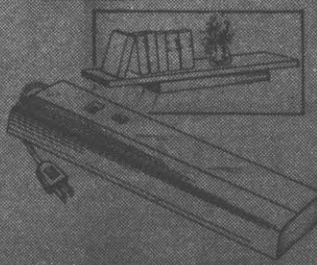

**TABLE SET**

Our Reg. 31.36

**19<sup>96</sup>**

Deluxe 5 Pc. Set 4 Tables, Rolling Rack. Choice Of Styles. Our 13.33 4 Pc. Table Set..... 18.36



**LIGHT FIXTURE**

Our Reg. 6.85

**5<sup>96</sup>**

18" fluorescent under-cabinet fixture. Plastic housing. Save

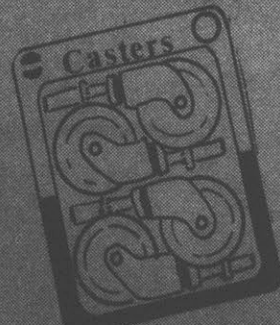

**CASTER SET**

Our Reg. 2.37

**1<sup>97</sup>**

4 Casters With 2" Wheels.

# Kmart

THE SAVING PLACE

CORNER OF GREENVILLE AND ARLINGTON BOULEVARDS

COPYRIGHT 1973 KROGER SAV-ON  
QUANTITY RIGHTS RESERVED  
NONE SOLD TO DEALERS

Supplement to the Greenville Daily Reflector.

# Kroger Sav-on

FOOD, DRUG, GEN, MDSE.

**ADVERTISED ITEM POLICY**  
Each of these advertised items is required to be readily available for sale in each Kroger Sav-On Store, except as specifically noted in this ad. If we do run out of an advertised item, we will offer you your choice of a comparable item, when available, reflecting the same savings or a raincheck which will entitle you to purchase the advertised item at the advertised price within 30 days.

PRICES EFFECTIVE WED., MAY 30 THRU  
SUNDAY, JUNE 3

**SAVE UP TO 40%  
COST CUTTERS**

COMPARED TO OTHER  
BRANDS AT KROGER  
SAV-ON.

**PRICES GOOD  
THROUGH  
SUNDAY**

KROGER SAV-ON  
GLADLY WELCOMES  
FEDERAL FOOD  
STAMPS

**SOOPER COST CUTTERS**  
ARE EVERYDAY LOW PRICES ON  
HUNDREDS OF PANTRY STAPLES  
YOU USE EVERY WEEK.

HOLLY FARMS  
GRADE "A" MIXED  
FRYER PARTS OR

**Whole Fryers**

**48¢**  
Lb.

Limit  
3 Fryers

Save  
11¢ Lb.

Save  
20¢

KROGER  
**2% Milk**  
**\$1.59**  
Gal.  
Plastic  
Jug

Save  
51¢

DUKES  
**Mayonnaise**

Qt. **68¢**

Limit One With \$7.50  
or More Additional Purchase



**Kroger Sav-on SOOPER COST CUTTER SAVINGS SHEET**

ITEM	UNIT	SAVINGS	ITEM	UNIT	SAVINGS
<b>BAKING SUPPLIES</b>					
...	...	...	...	...	...
<b>BREAD AND BAKERY</b>					
...	...	...	...	...	...
<b>CANDY</b>					
...	...	...	...	...	...
<b>CANNED FISH</b>					
...	...	...	...	...	...
<b>CANNED FRUIT</b>					
...	...	...	...	...	...
<b>CANNED MEAT</b>					
...	...	...	...	...	...
<b>CANNED VEGETABLES</b>					
...	...	...	...	...	...
<b>CONDIMENTS &amp; SPREADS</b>					
...	...	...	...	...	...
<b>COOKIES &amp; CRACKERS</b>					
...	...	...	...	...	...
<b>DESSERTS</b>					
...	...	...	...	...	...
<b>DRESSINGS</b>					
...	...	...	...	...	...
<b>DRINK MIXES</b>					
...	...	...	...	...	...
<b>PROSTINGS</b>					
...	...	...	...	...	...

CHECK THIS LIST  
AVAILABLE AT  
KROGER SAV-ON  
TAKE IT HOME OR TO ANY  
STORE AND SEE FOR YOURSELF  
HOW SOOPER COST CUTTERS  
CAN HELP YOU CUT YOUR  
FOOD COSTS

SOOPER  
COST  
CUTTER

COST  
CUTTER  
SPECIAL

**OPEN 7 AM TO MIDNIGHT**  
OPEN SUNDAY 9 AM TO 9 PM

MON.  
THRU  
SAT.

**600 Greenville Blvd.**

Phone 756-7031

# SAVE UP TO 40% WITH

**SOOPER COST CUTTER**

**KROGER FROZEN Lemonade**

6-Pk. 6-Oz. Cans **89¢**

**FRIENDLY PERSONAL SERVICE**

Our aim is to be neighborly to make you feel at home when you visit KROGER...with manners, cheerful smiles, and careful attention to you and your purchases. We want your shopping trip just as pleasant as we can possibly make it.

**COST WEEK!**

**REFRESHING Coca-Cola**

6 32-Oz. Rtn. Btls. **\$1.89**

Plus Deposit **Save 66¢**

Save \$1.18

**Dr. Pepper**

6 1-Ltr. Rtn. Btls. **\$1.39**

Plus Deposit

**COST WEEK!**

**CUTTER SPECIAL**

**KROGER 2% Milk**

Gal. Plastic Jug **\$1.59**

**KROGER 1/2% Lowfat Milk**

Gal. **\$1.49**

**Save 20¢**

**DAIRY DELIGHTS**

Shop Kroger for all your dairy items, located in our dairy department. Look for everyday low prices, plus our weekly specials that are priced to save you money on your every day needs.

## COST CUTTER BONUS BUYS

	WAS	NOW
GIANT Tide..... 48-Oz. Box	\$1.49	\$1.39
INSTANT Lipton Tea..... 3-Oz. Jar	\$2.09	\$1.88
ARMOUR Vienna Sausage ... 8-Oz. Can	87¢	76¢

**SPAM Luncheon Meat**

12 Oz. Can **\$1.09**

JUST REDUCED WAS \$1.19

	WAS	NOW
ARMOUR Beef Stew ..... 24-Oz. Can	\$1.29	\$1.15
DEL MONTE Fruit Cocktail ..... 17-Oz. Can	59¢	2/\$1
SLICED DEL MONTE Peaches... 18-Oz. Can	59¢	2/\$1

**INSTANT Maxwell House Coffee**

10 Oz. Jar **\$3.77**

JUST REDUCED WAS \$4.45

	WAS	NOW
KRAFT Bar-B-Q Sauce ..... 16-Oz. Btl.	75¢	66¢
KRAFT 1000 Island Dressing 8-Oz. Btl.	67¢	57¢
CREAM STYLE Green Giant Corn ... 17-Oz. Can	43¢	3/\$1

**HIC Fruit Drinks**

46 Oz. Cans **2 \$1**

WAS 53¢

	WAS	NOW
LEMON/LIME OR ORANGE Gatorade ..... 32-Oz. Btl.	53¢	2/\$1
PET Evaporated Milk ... 13-Oz. Can	39¢	37¢
SHOWBOAT Pork & Beans ..... 14 1/2-Oz. Can	27¢	4/\$1

**12 OZ. CAN REG. CUT GREEN BEANS OR GREEN GIANT Niblets Corn**

16 Oz. Cans **3 \$1**

JUST REDUCED WAS 37¢

	WAS	NOW
MACARONI & CHEESE Kraft Dinner ..... 7 1/4-Oz. Box	35¢	3/\$1
CHEF BOY AR DEE Spaghetti & Meat Balls 15-Oz. Can	59¢	56¢
CONTADINA Tomato Sauce ... 8-Oz. Can	2/51¢	21¢

**PETER PAN Peanut Butter**

6-Oz. Jar **29¢**

JUST REDUCED WAS 49¢

	WAS	NOW
CHEESE Chef Boy Ar Dee Pizza 15-Oz. Box	\$1.08	92¢

**COUNTRY OVEN Potato Chips**

POTATO CHIPS

**59¢** Twin Pack

**SOOPER COST CUTTER**

UNSWEETENED Drink Aid Drink Mix ..... 1/4-Oz. Pkg.	6¢
KROGER GRANULATED Sugar ..... 5-Lb. Bag	99¢
ZANY ZOO Freezer Pops ..... 24-Ct. Pkg.	79¢
WITH LEMON & SUGAR-KROGER Tea Mix ..... 24-Oz. Jar	\$1.09

**BIG K CANNED Soft Drinks**

6 12-Oz. Cans **89¢**

**SOOPER COST CUTTER**

SPOTLIGHT Bean Coffee ..... 1-Lb. Bag	\$1.89
KROGER Evaporated Milk ..... 13-Oz. Can	33¢
AVONDALE Coffee Creamer ..... 22-Oz. Jar	99¢
HERSHEY'S Chocolate Syrup ..... 16-Oz. Can	55¢

**KROGER Catsup**

32-Oz. Btl. **66¢**

**SOOPER COST CUTTER**

KROGER Flaked Coconut ..... 14-Oz. Bag	89¢
KROGER Orange Breakfast Drink .. 27-Oz. Jar	\$1.09
KROGER Apple Juice ..... 32-Oz. Btl.	55¢
KROGER Grape Juice ..... 40-Oz. Btl.	\$1.15

**FLEECE Bathroom Tissue**

4-Roll Pkg. **66¢**

**SOOPER COST CUTTER**

# SOOPER COST CUTTERS

**COMPARED TO OTHER BRANDS\* AT SAV-ON**  
 HERE ARE JUST A FEW OF THE HUNDREDS OF EVERYDAY SOOPER COST CUTTER PRICES A COMPLETE LIST IS AVAILABLE AT THE STORE  
 \*For Some Sooper Cost Cutters, No Other Brands are Stocked

**BUSH Baked Beans**  
 16-Oz. Can **33¢**

- |  |             |            |
|--|-------------|------------|
| KROGER SLOPPY JOE Sandwich Sauce ..... | 15½-Oz. Can | <b>55¢</b> |
| KROGER Corned Beef Hash .....          | 15-Oz. Can  | <b>69¢</b> |
| AVONDALE Sliced Peaches .....          | 29-Oz. Can  | <b>59¢</b> |
| KROGER IN JUICE Pineapple .....        | 20-Oz. Can  | <b>57¢</b> |

**EMBASSY Tea Bags**  
 100-Ct. Box **\$1 19**

- |                                    |             |               |
|------------------------------------|-------------|---------------|
| AVONDALE Great Northern Beans .... | 15½-Oz. Can | <b>26¢</b>    |
| KROGER Pinto Beans .....           | 2-Lb. Bag   | <b>47¢</b>    |
| AVONDALE Long Grain Rice .....     | 4-Lb. Bag   | <b>79¢</b>    |
| KROGER Instant Potatoes .....      | 32-Oz. Box  | <b>\$1 32</b> |

**POWDERED DRINK MIX Drink Aid**  
 24-Oz. Can Makes 8-Qts. **\$1 22**

- |                              |             |            |
|------------------------------|-------------|------------|
| KROGER Egg Noodles .....     | 16-Oz. Pkg. | <b>49¢</b> |
| KROGER Spaghetti .....       | 48-Oz. Bag  | <b>99¢</b> |
| KROGER Spaghetti Sauce ..... | 32-Oz. Btl. | <b>88¢</b> |
| KROGER Tuna Magic .....      | 8-Oz. Box   | <b>55¢</b> |

**AVONDALE Vegetable Oil**  
 38-Oz. Btl. **\$1 22**

- |  |             |            |
|--|-------------|------------|
| EMBASSY Salad Dressing .....                 | Qt. Jar     | <b>69¢</b> |
| KROGER Blue Cheese Dressing .....            | 8-Oz. Btl.  | <b>54¢</b> |
| KROGER ITALIAN OR 1000 Island Dressing ..... | 16-Oz. Btl. | <b>88¢</b> |
| KROGER Worcestershire Sauce .....            | 10-Oz. Btl. | <b>66¢</b> |

**KROGER Applesauce**  
 16-Oz. Can **29¢**

- |                              |             |            |
|------------------------------|-------------|------------|
| KROGER Mustard .....         | 32-Oz. Btl. | <b>55¢</b> |
| KROGER Sandwich Spread ..... | 16-Oz. Jar  | <b>58¢</b> |
| KROGER Bar-B-Q Sauce .....   | 28-Oz. Btl. | <b>76¢</b> |
| KROGER Gelatin .....         | 3-Oz. Box   | <b>16¢</b> |

**BIG VALUE Sandwich Cookies**  
 24-Oz. Box **69¢**

- |                                   |                   |               |
|-----------------------------------|-------------------|---------------|
| PERSONAL SIZE Ivory Soap .....    | 3½-Oz. 4-Bar Pack | <b>59¢</b>    |
| STEEL WOOL S.O.S. Soap Pads ..... | 18-Ct. Box        | <b>66¢</b>    |
| CLEANER Spic & Span .....         | 54-Oz. Box        | <b>\$1 59</b> |
| BRIGHT Bleach .....               | Gal. Jug          | <b>55¢</b>    |

**KANDU Bleach**  
 1-Gal. Jug **55¢**

**FLEECE Paper Towels**  
 Jumbo Roll **38¢**

KROGER SAV-ON GLADLY WELCOMES FEDERAL FOOD STAMPS

**KROGER Sandwich Bread**  
 24-Oz. Loaves **\$1 3**

Save 63¢

**FRESH BAKED FOODS**  
 For variety, freshness, and quality, you will find it hard to beat Kroger for baked foods. We especially recommend our own brand. They are all fresh baked in our very own bakerys, where we can control quality from ingredients...and each package is clearly dated to assure freshness.

**DUKES Mayonnaise**  
 32-Oz. Jar **68¢**

Limit One With \$7.50 or More Additional Purchase

Save 51¢

# FROZEN VALUES



MORTON  
**Fried Chicken**

2-Lb.  
Pkg.

**\$2.29**



KROGER CRINKLE CUT  
OR REG. CUT  
**French Fries**

2-Lb.  
Pkg.

**59¢**



MORTON  
**Pot Pies**

8-Oz.  
Pkg.

**29¢**

BIRDSEYE CAULIFLOWER  
WITH CHEESE SAUCE OR

**Broccoli**

10-Oz.  
Pkg.

**69¢**

FRUIT 'N CREME BARS 12-CT. PKG.  
OR FREEZER PLEEZER

**Fudge Sundae  
Bars**

10-Ct.  
Pkg.

**\$1.19**

BREYERS  
**Ice Cream** ..... ½-Gal. **\$2.29**  
Ctn.

KROGER  
**Orange Juice** ..... 16-Oz. **88¢**  
Can

MAN PLEASER  
**Banquet Dinners** ..... 18-Oz. **\$1.19**  
Pkg.



KROGER PEPPERONI, SAUSAGE  
OR HAMBURGER

**Pizza**

13-Oz.  
Pkg.

**\$1.19**

# DAIRY SPECIALS

BLUE BONNET QUARTERS  
**Margarine**

1-Lb.  
Pkgs.

**2 \$1**

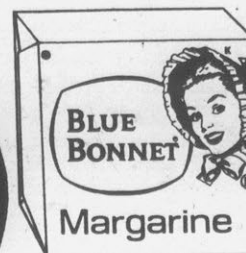

KROGER GRADE A  
**Large Eggs**

Doz.

**65¢**

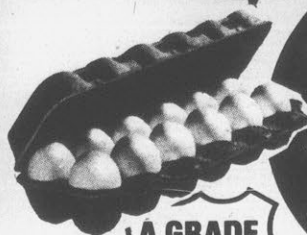

A GRADE  
LARGE

KROGER SLABCUT OR FULL MOON  
**Colby Long Horn Cheese** ... 14-Oz. **\$1.49**  
Pkg.

WHIPPED  
**Parkay Margarine** ..... 1-Lb. **69¢**  
Ctn.

KROGER SOUR CREAM OR  
**French Onion Dip** ..... 16-Oz. **69¢**  
Cup

SEALTEST  
**Cottage  
Cheese**

24-Oz.  
Pkg.

**\$1.19**

YUBI  
**Yogurt**

**3** 8-Oz. **\$1**  
Cups

MOUNTAIN MAN HOMESTYLE  
OR BUTTERMILK

**Merico  
Biscuits**

10-Ct.  
Pkg.

**39¢**



KROGER  
**Orange Juice**

½-Gal.  
Jug

**\$1.09**

# BAKED FOODS

SUNGOLD HOT DOG OR  
**Hamburger Buns** ..... 8-Ct. **33¢**  
Pkg.

KROGER LIGHT OR DARK  
**Special  
Formula Bread**

**2** 16-Oz. **88¢**  
Loaves

BRAN, RYE, WHEAT,  
ITALIAN, BUTTER-  
CRUST WHEAT  
**Kroger Variety  
Bread Special** ..... 2 16-oz. **\$1.19**  
Loaves

KROGER GOLDEN, LEMON,  
ORANGE, BANANA NUT, 19-Oz. **\$1.19**  
**Pound Cake** ..... Pkg.

NABISCO WHEAT THINS  
(16-OZ.) OR  
**Triscuits** ..... 13-Oz. **\$1.09**  
Pkg.

# WINE & BEER

BLACK LABEL  
**Carlings  
Beer** ..... 6 12-Oz. **\$1.39**  
N.R. Btls.

BEER  
**Tuborg  
Gold** ..... 6 12-Oz. **\$1.75**  
Cans or N.R. Btls.

**Schlitz  
Beer** ..... 12 12-Oz. **\$3.69**  
Cans

BEER  
**Miller  
Lite** ..... 6 12-Oz. **\$2.22**  
Cans

BLUE RIBBON  
**Pabst  
Beer**

12  
12-Oz.  
Cans

**\$3.19**

# LET THE DELI DO IT!

## THE KROGER DELI BAKERY

Wonderful specialties and ready to serve foods for last minute meals is what awaits you at the Kroger Deli/Bakery. Many kinds of ready to enjoy salads and desserts ... fresh sliced lunchmeats and cheese ... as well as many gourmet treats not found in your average supermarket.

In our bakery you'll find a friendly hostess or assistant to help fill your order from our service displays of tempting cakes, donuts, pies, cookies and other delights. Many of these favorites are baked right in the modern ovens built into the store. Here is where you also place your order for birthday, anniversary or other special occasion cakes.

EXTRA LEAN  
SLICED AS YOU LIKE IT

**Roast Beef**

Save 40% **\$3.79** LB.

COST WEAVER CUTTER SPECIAL

LOW CHOLESTEROL-LOW FAT

**Lorraine Swiss Cheese**

Save 50c **\$2.99** LB.

SPICY AND GOOD

**German Potato Salad**

Save 20c **69¢** LB.

SLICED THICK OR THIN

**Hard Salami** ..... Save 30c **\$2.99** LB.

**FRENCH Onion Dip** ..... Save 20¢ **69¢** LB.

## In-Store RESTAURANT

INCLUDES 1 LB. COLE SLAW,  
HUSH PUPPIES

**9 Piece Fish Dinner** ..... Save 50¢ **\$4.99**

MADE IN OUR DELI FRESH DAILY

**Pepperoni Pizza** ..... **\$2.19**

INSTANT PICNIC

**Fried Chicken**

**\$4.99** Save \$1.00

12 Piece With 1 Lb. Cole Slaw, 1 Lb. Potato Salad & Dinner Rolls

HEAPED ON A FRESH BUN

**Roast Beef Sandwich** ..... Save 50¢ **99¢**

BREAKFAST SPECIAL WITH SAUSAGE OR BACON

**French Toast** ..... Save 30¢ **99¢**

**Professional Cake Decorating**  
Ask Our Deli Clerk For Details

## FOR HAPPY GRADS—Let the Deli Do It!

Graduation days are party time for families, classmates and friends. Your gathering will be more fun with good things to eat from the Deli...elegant party trays, complete buffet dinners, luscious desserts—even specially decorated cakes. Let the Deli do it for you!

A NEW TASTE TREAT  
CHOCOLATE FILLED

**Eclairs**

Save 10c **2 For 69¢**

FOR YOUR PICNIC NEEDS

**Hamburger Buns**

**8 For 69¢**

LIGHT AND FLUFFY  
FRESH

**Angel Food Cake**

Save 20¢ **\$1.19**

FRESH FROM OUR OVEN  
HOME STYLE

**White Bread**

**2 24-Oz. Loaves** **98¢** Save 19¢

TOPPED WITH WHIPPED CREAM  
FRESH  
**Strawberry Pie** **\$2.79**



**Kroger Sav-On...A Whole Lot More Than Just One Store**



WHOLE PORK LOIN  
CUT INTO

**Pork Chops**

**\$1.28**

Lb.

14-17-Lb.  
Avg. Wt.

Save  
40¢ Lb.



**SLICED PORK  
WITH NATURAL PROPORTIONS  
OF CENTER CUTS  
FOR PRICE ... FOR  
KROGER SAV-ON MEATS**

Sliced pork loins with natural proportions of center cuts. What some stores call "sliced quarter pork loin" is all skimpy first cuts at "a hot price" because the choice center cuts will go at a premium price. Never at Kroger Sav-On. When you buy a pork loin (sliced) the package will contain a natural proportion of center cuts and first or end cuts. That seems fair and right to us. We're sure it does to you!

FRESH FROZEN 3-5-LB. AVG.

**Spare Ribs**

30-Lb. Box  
\$34.99

**\$1.28**

COUNTRY CLUB

**Canned Ham**

3-Lb.  
Can

**\$4.99**

CHUB PAK OR STORE PAK

**Ground Beef**

**\$1.68**

KAHN'S ALL MEAT

Franks ..... 1-Lb. Pkg. **\$1.68**

PORK

Neck Bones ..... Lb. **58¢**

SERVE N' SAVE

Wieners ..... 12-Oz. Pkg. **89¢ Ea.**



SHANK HALF

**Smoked Ham**

8-10-Lb.  
Avg. Wt.

**88¢**

Lb.

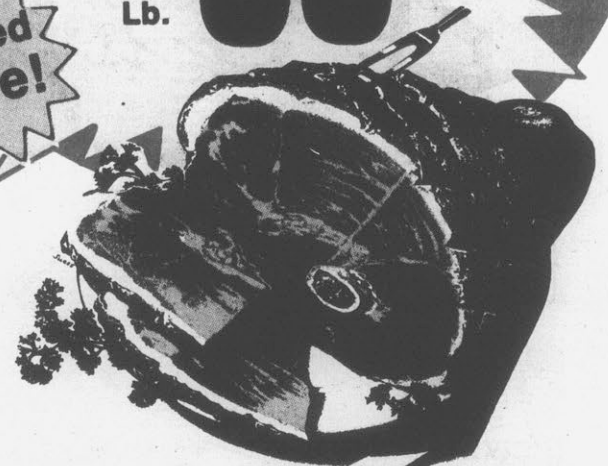

**CHOICE BEEF ROUND SALE**

U.S. Gov't. Graded Choice Semi-Boneless  
Whole Beef Round Processed The Way You Want It



**Round Steaks,  
Round Roasts,  
or Ground Round**



Save  
20¢  
Per Lb.

48-55  
Lb. Avg.  
Wt.

**\$1.68**

Lb.

GLENDALE 4-6-LB. AVG. WT.

**Boneless Ham**

**\$1.78**

PORK FEET OR  
**Pork Livers**

**68¢**

HILLSHIRE  
**Smoked Sausage**

**\$2.28**

U.S.D.A. CHOICE "HEAVY" WESTERN BEEF  
BONELESS ROUND

**Swiss Steak**

**\$2.18**

U.S.D.A. CHOICE "HEAVY" WESTERN BEEF  
TOTAL WT. 4-LBS. OR MORE-BONELESS

**Top Sirloin Steak**

**\$12.88**

U.S.D.A. CHOICE "HEAVY" WESTERN BEEF  
TOTAL WT. 4-LBS. OR MORE-BONELESS

**Rib Eye Steaks**

**\$16.88**

U.S.D.A. CHOICE "HEAVY" WESTERN BEEF  
CENTER CUT

**Round Steak**

**\$2.18**

U.S.D.A. CHOICE "HEAVY" WESTERN BEEF  
TOTAL WT. 5-LBS. OR MORE-BONELESS

**Sirloin Tip Steak**

**\$13.88**

CHUNK STYLE

**Kroger Bologna**

**\$1.19**

CHUNK STYLE KROGER

**Braunschweiger**

**99¢**

# PORK LOINS PROPORTIONS LARGER CUTS FOR VALUE, MEANS BETTER MEAT



**COST CUTTER SPECIAL**

HOLLY FARMS  
GRADE "A" MIXED  
FRYER PARTS OR

**Whole Fryers**

**48¢**

Lb. **Limit 3 Whole Fryers**

**Save 11¢ Lb.**

**Holly Farms CHICKEN**

HOLLY FARMS GRADE "A" CUT-UP

**Mixed Fryer Parts** ..... Lb. **48¢**

HOLLY FARMS CUT-UP

**Whole Fryers** ..... Lb. **69¢**

HOLLY FARMS COUNTRY STYLE

**Fryers** ..... Lb. **73¢**

HOLLY FARMS SPLIT FRYER BREAST OR

**Drumsticks** ..... Lb. **\$1.18**

HOLLY FARMS

**Leg Quarters** ..... Lb. **79¢**

MARVAL FRESH WHOLE

**Turkeys** ..... Lb. **99¢**

HOLLY FARMS WITH WING

**Breast Quarters** ..... Lb. **99¢**

RIB HALF LOIN CUT INTO

**Pork Chops** ..... Lb. **\$1.38**

COUNTRY STYLE

**Pork Spare Ribs** ..... Lb. **\$1.48**

FRESH PICNIC STYLE

**Pork Roast** ..... Lb. **98¢**

BULK PACKAGED COUNTRY STYLE

**Sliced Bacon** ..... Lb. **\$1.18**

HOLLY FARMS

**Chicken Franks** ..... 1-Lb. Pkg. **\$1.09**

GENUINE

**Ground Chuck** ..... Lb. **\$1.88**

BREAKFAST BEEF

**Sausage** ..... 2-Lb. Roll Each **\$2.18**

FRESH BOSTON BUTT

**Pork Steak** ..... Lb. **\$1.38**

CENTER CUT RIB

**Pork Chops** ..... Lb. **\$1.88**

SWIFT HOSTESS

**Canned Ham** ..... 4-Lb. Ham **\$8.99 Ea.**

GWALTNEY BONED-N-TENDER 2-3-LB. AVG. WT.

**Ham** ..... Lb. **\$2.88**

SERVE 'N' SAVE

**Sliced Bacon** ..... Lb. **\$1.39**

SWIFT'S

**Sizzlean** ..... 12-Oz. Pkg. Ea. **\$1.78**

GUNNOES HOT OR MILD

**Pork Sausage** ..... 1-Lb. Pkg. **\$1.58**

KAHN'S ALL MEAT

**Bologna** ..... 8-Oz. Pkg. Ea. **98¢**

SERVE 'N' SAVE-ASSORTED VARIETIES

**Lunch Meat** ..... 1-Lb. Pkg. **\$1.39**

WHOLE OR BUTT HALF

**Lamb Leg** ..... Lb. **\$2.09**

WHOLE OR HALF SQUARE CUT LAMB

**Shoulder Roast** ..... Lb. **\$1.59**

## SEAFOOD

**COST CUTTER SPECIAL**

FRES-SHORE

**Fish N' Batter**

**\$1.29**

10-Oz. Portions

**Save 50¢ Pkg.**

FRES-SHORE

**Fish and Chips** ..... 1-Lb. Pkg. Ea. **\$1.29**

FRES-SHORE

**Perch Fillets** ..... 1-Lb. Pkg. Ea. **\$2.09**

FRESH FROZEN

**Turbot Fillets** ..... Lb. **\$1.58**

### FRESH SEAFOOD

AVAILABLE  
FRIDAY & SATURDAY  
ONLY

FRESH DRESSED

**Flounder** ..... Lb. **\$1.69**

FRESH DRESSED

**Perch Fillets** ..... Lb. **\$2.19**

Self-Contained,  
No TV Set  
Needed!

## ENTEX Electronic Baseball

- One player or two.
- Electronic sound effects.
- LED indicators.
- Exclusive remote control pitching.

**\$29<sup>79</sup>**

Uses 3  
"AA" Batteries  
Not Included.

COST  
WEEK!  
CUTTER  
SPECIAL

## RUBBERMAID Ice Cube Trays

2  
For  
**88¢**

RUBBERMAID  
Ice Bucket  
**\$5<sup>88</sup>**

7410

COST  
WEEK!  
CUTTER  
SPECIAL

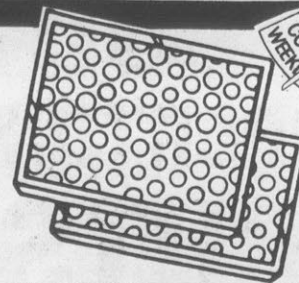

## ASSORTED SIZES Air Filters

1" Air Filters  
To Fit Most  
Central Air  
Systems.

**2 \$1**  
For

COST  
WEEK!  
CUTTER  
SPECIAL



DID  
YOU  
KNOW

## COMMON NAMES

### CAN SAVE YOU MONEY?

Ask your doctor about prescribing drugs by their generic or "common" names. These chemically identical drugs generally cost much less than their brand-name counterparts. And, on brand-name or generic drugs, we will meet...or beat...our competitors' prices.

NOTHING TO JOIN BUT A GROUP  
OF SATISFIED CUSTOMERS

MediMET



PAID  
PRESCRIPTION

**PCS**

Call Your  
Nearest **Pharmacy**

**CHARLOTTE**  
• Tryala Rd. 527-3159  
• Eastway Dr. 597-8154  
• Freedom 399-0075  
• Albemarle Rd. 568-2880

**COLUMBIA**  
• Bush River Rd. 799-9901  
• Dozier Rd. 799-3620

**CHARLESTON**  
• Main Dr. 554-9042  
• Savannah Hwy. 556-8998

**GREENVILLE**  
756-7393

**SAVANNAH**  
354-7431

**WILMINGTON**  
392-1959

**FAYETTEVILLE**  
864-3449

**FLORENCE**  
662-9147

**SUMTER**  
775-0115

**HICKORY**  
329-3058

**SALISBURY**  
636-8432

COST  
WEEK!  
CUTTER  
SPECIAL



## Health & Beauty Aid Savings

BALSAM & PROTEIN <b>Flex Conditioner</b> .....	16-Oz. Bottle	<b>\$1<sup>37</sup></b>
BALSAM & PROTEIN <b>Flex Shampoo</b> .....	16-Oz. Bottle	<b>\$1<sup>17</sup></b>
NATURE-GLO <b>Cocoa Butter Lotion</b> .....	16 Ozs.	<b>99¢</b>
MICRO SMOOTH GILLETTE <b>Atra Razor</b> .....	Each	<b>\$2<sup>97</sup></b>
FOR THE IMPOSSIBLE SHAVE <b>Atra Cartridges</b> .....	Pack of 5	<b>97¢</b>
OGILVIE <b>Soft Body Perm</b> .....	One Appl.	<b>\$2<sup>97</sup></b>
BAND AID LARGE <b>Sheer Strips</b> .....	Box of 50	<b>99¢</b>
OGILVIE HAIR REPAIR <b>Shampoo</b> .....	Oz. Btl.	<b>\$2<sup>47</sup></b>
NEW-DESIGN TOOTHBRUSH <b>Reach</b> .....	Each	<b>67¢</b>
TOOTHPASTE-30¢ OFF LABEL <b>Pepsodent</b> .....	6.4-Oz. Tube	<b>67¢</b>
JOHNSON'S <b>Dental Floss</b> .....	5 Yards	<b>77¢</b>



**GREAT-LASH** MASCARA

CONTAINS  
PROTEIN

from *Maybelline*

Builds, thickens, colors & curls

**\$1<sup>37</sup>**

**COST WEEKLY CUTTER SPECIAL**

COMFORTABLE NEW  
**Wedge Slippers**  
**\$3.47** Pair

**COST WEEKLY CUTTER SPECIAL**

EXPLORER RUBBER  
**Mask & Snorkle Set**  
**\$2.99**

THIS PRODUCT MADE OF QUALITY RUBBER

**SERGEANT'S PET PRODUCTS**

CREME, ANTI-TANGLE OR  
**Skip-Flea Shampoo 77¢**  
Your Choice .....

KILLS FLEAS, REDUCES ODORS  
**Skip-Flea Soap 67¢** .....

NYLON ONE SIDE  
OTHER SIDE METAL  
**Combo Brush 67¢** .....

FINE METAL  
**Slicker Brush \$1.07** .....

METAL-FINE & LARGE TOOTH  
**Pet Comb \$1.07** .....

**SATISFYING SOUNDS!**

**THE STATLER BROS**  
*The Originals*

MERCURY

**KENNY ROGERS & DOTTIE WEST**  
Classics

Including: All I Ever Need Is You  
You Needed Me • Midnight Flyer  
Just The Way You Are

UNITED ARTISTS

**VILLAGE PEOPLE**  
Go West

PACKED IN THE NAVY

Includes GIANT FULL COLOR POSTER

CASABLANCA  
STEREO LPS 8-TRACK TAPES  
& CASSETTES SERIES 898

**5.99**

**MILLIE JACKSON**  
A Moment's Pleasure

SPRING

**ARISTA**

Includes: DISCO NIGHTS (ROCK FREAK)  
MAKE MY DREAM A REALITY / SPIRIT

STEREO LPS  
8-TRACK TAPES  
& CASSETTES  
SERIES 798

ARISTA

**4.99**

PICTURED ITEMS ONLY.

ORIGINAL SOUNDTRACK RECORDING  
**HAIR**

RCA

RCA

STEREO LPS 8-TRACK TAPES  
& CASSETTES SERIES 1498

**10.49**

**COST WEEKLY CUTTER SPECIAL**

**WHAM-O**  
**Fun Fountain \$10.99**

**Volley Ball \$3.99**

**DELUXE Lawn Darts \$4.99**

**RUBBER Horseshoes Set \$4.99**

**H&G Monkey Swing \$2.99**

**SWIMMING Foam Ring \$1.49**

COST WEEK!  
CUTTER SPECIAL

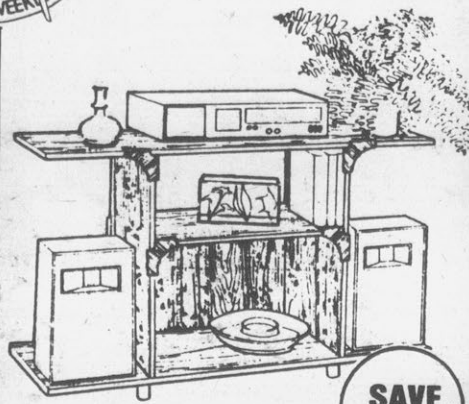

SAVE  
\$5<sup>07</sup>

### Roomy Home Entertainment Center

Only

Beautiful and functional describes our new Entertainment Center. Features loads of room for portable TV, stereo components and speaker cabinets. Lots of record storage space at the bottom, too.

**\$24<sup>88</sup>**

free offer



### 1-GALLON Pitcher

- With Kool-Aid
- Dishwasher safe
- Flip-top, no drip spout
- Secure twist-lock cover
- Assorted colors

**\$1<sup>37</sup>**

COST WEEK!  
CUTTER SPECIAL



SAVE  
\$4<sup>98</sup>

Simulated Walnut Finish

### Deluxe Etagere

14x37<sup>3</sup>/<sub>4</sub>x62" Tall

Here's a strikingly handsome unit that goes in both directions and features both vertical and horizontal space. It's a perfect room divider or wall unit.

**\$29<sup>97</sup>**

COST WEEK!  
CUTTER SPECIAL

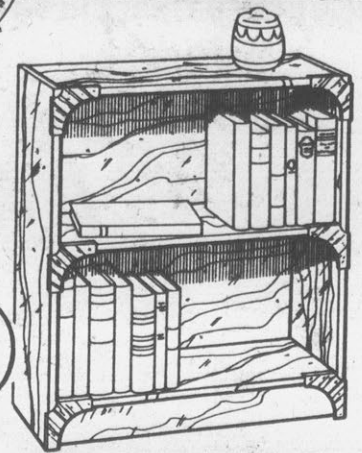

SAVE  
\$5<sup>07</sup>

### Encyclopedia Bookcase

Only

Enhance any room decor with our handsome new lifestyle Bookcase. Generous shelf space for all of your books, or even a complete set of encyclopedias. Finished in rich 'Rustic Malibu'. Solid-core construction.

**\$24<sup>88</sup>**



### Certificate Frames

- Choice of walnut or black

5x7" ..... **68¢**  
8x10" ..... **88¢**  
11x14" .... **\$1<sup>59</sup>**



SAVE  
\$5<sup>07</sup>

### HAND OPERATED 5-Qt. Ice Cream Freezer

Simulated Wooden Tub

With heavy gauge 5-qt. tinned steel cream can and flexible dasher.

**\$13<sup>88</sup>**

COST WEEK!  
CUTTER SPECIAL

### SIMULATED Walnut Finish

SAVE  
\$3<sup>00</sup>

### Plant Stand

**\$24<sup>88</sup>**

5<sup>1</sup>/<sub>2</sub>" Tall

Tall, open and with plenty of circular shelves. The stylish and functional design provides maximum exposure to the sun and air and makes plant care easy and plant display beautiful. It's ready to assemble.

Charge It!



COST WEEK!  
CUTTER SPECIAL

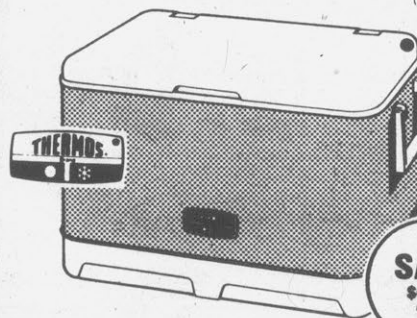

SAVE  
\$2<sup>83</sup>

### Thermos 42-Qt. Cooler

Only

**\$19<sup>95</sup>**

For food and beverages that are still cold and fresh when you get where you're going.

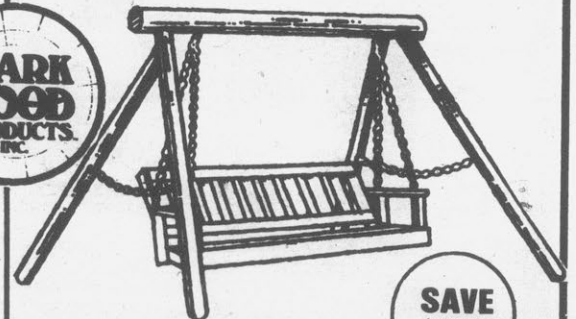

SAVE  
\$18<sup>23</sup>

### Rugged Ozark Lawn Swings

Durable, rustic beauty and free-swinging comfort for the lawn with a purpose.

**\$69<sup>77</sup>**

Only



Great  
18" Grill  
Value

SAVE  
\$1.00

18" BBQ Grill  
**\$3.99**

With adjustable grid.  
22 inches high.



Spaulding  
Golf Balls

Box of 12

**\$3.99**



WILSON  
Tennis  
Balls

3 Balls For **\$1.88**



WOOD OR  
ALUMINUM

Tennis Rackets

Your Choice

**\$2.99**  
Each

Nylon strung tennis rack-  
ets are ideal for the be-  
ginner.



Starbrite  
Car Care Products

- Car Wash 16-Oz. Bottle ..... **\$1.47**
- Vinyl Shampoo 16-Oz. Bottle ..... **\$1.47**
- Vinyl Brite 8-Oz. Bottle ..... **\$2.19**
- Car Polish 16-Oz. Bottle ..... **\$2.66**

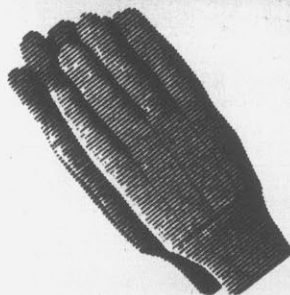

MEN'S BOSS

Work  
Gloves

**66¢**  
Pr.

8-oz. white  
canvas.



Starbrite  
Pre-Softened  
Paste Wax  
**\$2.66**

- Cleans • Shines
- Protects

**ROD RIOT!**

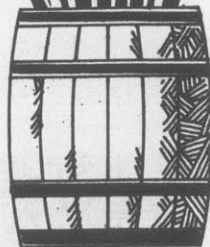

OLD PAL  
Tackle Box

**\$5.99**

Three tray tackle box with  
23 compartments for  
lures. Plenty of space un-  
der tray for reels, line  
and other tackle.

FAMOUS BRAND  
Fishing Rods

Special Group At This Low Price

**\$6.99**  
Each

Choose from spinning, spincast,  
fly and boat rods. Select from  
such famous brands as: Daiwa,  
Berkeley, Olympic, True Temper,  
Zebco and more.

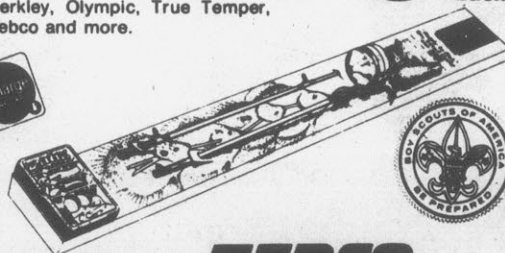

**ZEBCO**

Boy Scout  
Fishing Combo

**\$9.99**

Includes Zebco 202 reel  
with line, 4 1/4' rod, tack-  
le box with lures, weights  
and hooks.



3/4" x 50'  
Freeze  
Flex  
Garden  
Hose  
**\$6.99**

Moore  
75150



DR. SCHOLL'S  
Exercise Sandals

**\$10.88**

- Exclusive toe grip
- High quality



# Kroger Sav-on

WHERE SERVING YOU  
COMES FIRST

**FIRST**  
of the season

## garden

FIRST OF THE SEASON  
CALIFORNIA  
**Bing Cherries**

Lb. **99¢**

WHOLE  
RED RIPE  
**Watermelon**  
**\$2.99**  
AVG.  
WT.  
20 LBS.

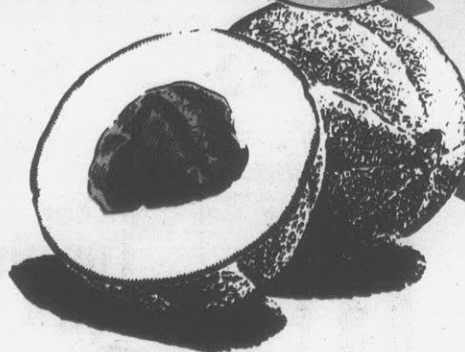

NEW CROP  
TEXAS  
**Honeydew  
Melons**  
**\$1.29**  
Ea.

NEW CROP  
TEXAS

**Cantaloupe**

Ea. **69¢**

SAVE  
30¢

In the Kroger Sav-On garden most of our fresh fruits and vegetables are in bulk displays as opposed to pre-packaged, as many stores have. You can choose one green pepper or 5, one lemon or a dozen, and YOU pick and choose the one you want. Then take your choice to the "Gardener" for weighing and pricing. Your Kroger Sav-On "Gardener" will be pleased to answer your questions about any of the hundreds of fresh fruits and vegetables we have here for you.

### Plant Shoppe



BEAUTIFUL  
**Zebra Plants**  
3 \$3.99  
Inch

ASSORTED  
**Ferns**  
1 \$1.37  
Inch

AVAILABLE THURS. THRU SATURDAY

IMPORTED <b>Granny Smith Apples</b> .....Lb.	<b>49¢</b>
NEW CROP SWEET JUICY <b>Peaches</b> .....Lb.	<b>69¢</b>
FRESH BUNCH <b>Spinich</b> .....Bunch	<b>49¢</b>
IDAHO <b>Baker Potatoes</b> .....5 Lbs.	<b>\$1</b>

RED RIPE  
CALIFORNIA

**Strawberries**

Qt. **99¢**



FLORIDA  
YELLOW OR WHITE  
**Sweet Corn**  
5 Ears  
In Husk **79¢**

FRESH  
**Limes**.....3 For **49¢**

FRESH  
**Broccoli**.....Ea. **69¢**

TROPICANA  
**Fruit  
Drinks**.....4 For **\$1**

FRESH  
**Green Cabbage**.....Lb. **19¢**

FRESH  
**Artichokes**.....2 For **\$1**

CALIFORNIA  
**Avocados**.....2 For **\$1**



### HEARTY CHEF'S SALAD

Another all-time  
FAVORITE RECIPE from **McCall's**

- 1/2 cup salad oil
- 1 cup red-wine vinegar
- 1 1/2 teaspoons salt
- 1 1/2 teaspoons dry mustard
- 1 1/2 teaspoons sugar
- 1 teaspoon pepper
- 1 small avocado, cubed
- 1 cup thinly sliced raw mushrooms
- 1 quart crisp bite-size pieces Boston lettuce
- 1 quart crisp bite-size pieces romaine
- 1 cup chopped watercress
- 1 bunch scallions, sliced
- 1/4 pound ham, cut into thin strips
- 1/4 pound Swiss cheese, cut into thin strips

- 1/4 pound cooked chicken, cut into thin strips
- 2 hard-cooked eggs, cut into quarters

1. In a pint jar with tight-fitting lid, combine oil, vinegar, salt, mustard, sugar, and pepper. Shake vigorously.

2. Coat avocado and mushrooms, each in a small bowl, with dressing. Refrigerate rest of dressing and all salad ingredients.

3. Just before serving: In large bowl, toss greens and tarragon. Arrange other ingredients over top of greens. Toss dressing; pour over salad; toss to mix well. Serves 6.

FOR OTHER RECIPES SEE McCALL'S ON SALE AT KROGER.

Copyrighted material by permission.

### Salad Fixin's

Unusual variety is not unusual at Sav-On. Shop "the Garden" for a complete variety of lettuce and salad fixin's.

FRESH CROP  
**Romaine Lettuce**  
FRESH  
**Red Leaf Lettuce**  
FRESH ENDIVE OR  
**Escarole Lettuce**  
CRISP TENDER  
**Boston Lettuce**

Your  
Choice

**38¢**  
Ea.

GREEN TOP  
**Bunch Carrots**....3 For **\$1** GREEN TOP  
**Bunch Radishes**...4 For **\$1**

# ECKERD'S

# Summer Savings

## REDWOOD AND ALUMINUM OUTDOOR FURNITURE

Attractively styled with durable redwood slats & double tubular aluminum arms, curved for comfort. Chaise has 7 positions.

**CHAIR**  
Reg. 14.99

**10<sup>88</sup>**

**CHAISE**  
Reg. 28.99

**22<sup>88</sup>**

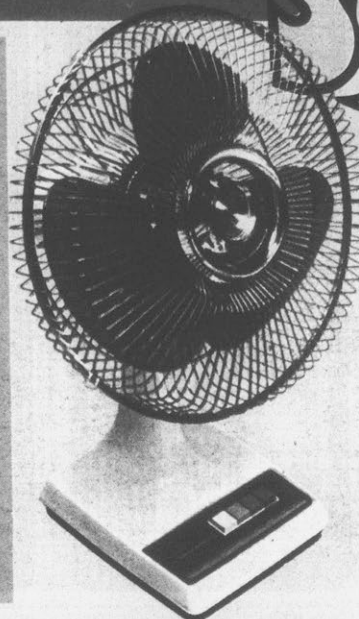

## GALAXY 12-INCH OSCILLATING FAN

3 speed fan with quiet operation. Gives maximum air with minimum energy consumption. No. 2150 Reg. 29.99

**24<sup>99</sup>**

CUT ON DOTTED LINE

CUT ON DOTTED LINE

Valuable Coupon



## CREST TOOTHPASTE

7-oz. tube. Regular or Mint. Price reflects 25¢ off label. Limit 1

**79¢**

Coupon Good Thru Sat. June 9

ECKERD DRUGS

Valuable Coupon



## OIL OF OLAY BEAUTY LOTION

4-oz. Moisturizing lotion for your skin. Limit 1

**2<sup>39</sup>**

Coupon Good Thru Sat. June 9

ECKERD DRUGS

Valuable Coupon



## PALMOLIVE LIQUID

22-oz. For clean dishes & soft hands. Limit 1

**79¢**

Coupon Good Thru Sat. June 9

ECKERD DRUGS

Valuable Coupon



## DIAL BATH SOAP

Deodorizing bath bar for the whole family. Limit 4

**4 / 1<sup>00</sup>**

Coupon Good Thru Sat. June 9

ECKERD DRUGS

Valuable Coupon



## ECKERD TOILET TISSUE

Economy pack in white or colors. Reg. 1.39 Limit 1

**6 / 88¢**

Coupon Good Thru Sat. June 9

ECKERD DRUGS

CUT ON DOTTED LINE

CUT ON DOTTED LINE

SALE PRICES GOOD THRU SAT., JUNE 9TH. WE RESERVE THE RIGHT TO LIMIT QUANTITIES.

CUT ON DOTTED LINE

SAVE \$ Valuable Coupon SAVE \$



### BAYER ASPIRIN

Bottle of 100 for relief of minor pain. Limit 1

**97¢**

Coupon Good Thru Sat. June 9

SAVE \$ ECKERD DRUGS SAVE \$

CUT ON DOTTED LINE

SAVE \$ Valuable Coupon SAVE \$

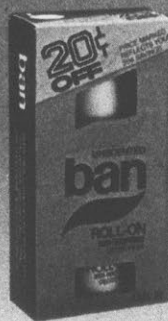

### BAN ROLL-ON

1.5-oz. Price reflects 20¢ off label. Limit 1

**69¢**

Coupon Good Thru Sat. June 9

SAVE \$ ECKERD DRUGS SAVE \$

CUT ON DOTTED LINE

SAVE \$ Valuable Coupon SAVE \$



### BARBASOL SHAVE CREAM

11-oz. aerosol. Your choice of types. Limit 1

**39¢**

Coupon Good Thru Sat. June 9

SAVE \$ ECKERD DRUGS SAVE \$

CUT ON DOTTED LINE

SAVE \$ Valuable Coupon SAVE \$



### CUTEX POLISH REMOVER

4-oz. With cuticle conditioners. Limit 1

**39¢**

Coupon Good Thru Sat. June 9

SAVE \$ ECKERD DRUGS SAVE \$

CUT ON DOTTED LINE

SAVE \$ Valuable Coupon SAVE \$



### VASELINE INTENSIVE CARE LOTION

10-oz. For summertime dry skin. Limit 1

**89¢**

Coupon Good Thru Sat. June 9

SAVE \$ ECKERD DRUGS SAVE \$

CUT ON DOTTED LINE

CUT ON DOTTED LINE

CUT ON DOTTED LINE

### CLAIROL NICE 'N EASY HAIR COLOR

Shampoo-in hair color in popular shades. Limit 1

**1.69**

### ECKERD COSMETIC PUFFS

Bag of 300 soft multi-purpose puffs. Limit 1

**49¢**

### MASSENGILL DISPOSABLE DOUCHE

6-oz. Convenient & easy to use. In your choice of 3 types. Limit 2

**33¢**



### VASELINE INTENSIVE CARE BABY POWDER

24-oz. family size shaker canister. Limit 1

**99¢**

### VISINE EYE DROPS

½-oz. For tired, irritated eyes. Limit 1

**89¢**

### MYLANTA ANTACID

12-oz. pleasant tasting liquid antacid. Limit 1

**1.29**



### GILLETTE TRAC II BLADES

9 Microsmooth™ blades. Limit 1 pack

**1.59**

### CURAD PLASTIC BANDAGES

60, ¾" adhesive bandages. Limit 1

**49¢**

### TEK ADULT TOOTHBRUSH

Soft, medium or firm. Limit 4

**19¢**

CUT ON DOTTED LINE

SAVE \$ Valuable Coupon SAVE \$



**FINAL NET  
HAIR SPRAY**

12-oz. non-aerosol hair spray. Limit 1

**1.39**

Coupon Good Thru Sat. June 9

SAVE \$ **ECKERD DRUGS** SAVE \$

CUT ON DOTTED LINE

SAVE \$ Valuable Coupon SAVE \$



**COTY  
EMERAUDE  
SPRAY**

1.8-oz. cologne spray. Reg. 5.00 Limit 1

**2.99**

Coupon Good Thru Sat. June 9

SAVE \$ **ECKERD DRUGS** SAVE \$

CUT ON DOTTED LINE

SAVE \$ Valuable Coupon SAVE \$



**VIDAL SASSOON  
SHAMPOO**

8-oz. Enriched with conditioners. Limit 1

**1.39**

Coupon Good Thru Sat. June 9

SAVE \$ **ECKERD DRUGS** SAVE \$

CUT ON DOTTED LINE

SAVE \$ Valuable Coupon SAVE \$

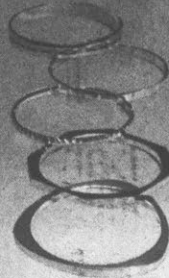

**BANGLE  
BRACELETS**

Gold or silver. Wear 1 or an armfull! Reg. 2.50

**1.59**

Coupon Good Thru Sat. June 9

SAVE \$ **ECKERD DRUGS** SAVE \$

CUT ON DOTTED LINE

SAVE \$ Valuable Coupon SAVE \$

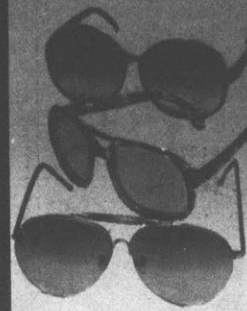

**FOSTER GRANT  
SUNGLASSES**

Fashionable styles for sun shading. Reg. 6.00 and 7.00

**3.99**

Coupon Good Thru Sat. June 9

SAVE \$ **ECKERD DRUGS** SAVE \$

CUT ON DOTTED LINE

CUT ON DOTTED LINE

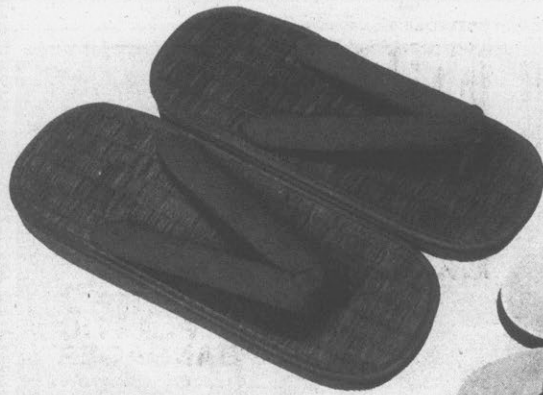

**MEN'S or LADIES'  
TATOMIS**

**99¢** Casual sandals with woven straw sole & V-strap. Reg. 1.99

**SOFT TOUCH  
LATEX  
GLOVES**

**2 / 1.00** Protective household gloves with non-slip grip. Reg. 99¢ pair



**ZORRIE  
SANDALS**

V-strap sandals in men's, ladies' & children's sizes. Reg. 69¢

**44¢**

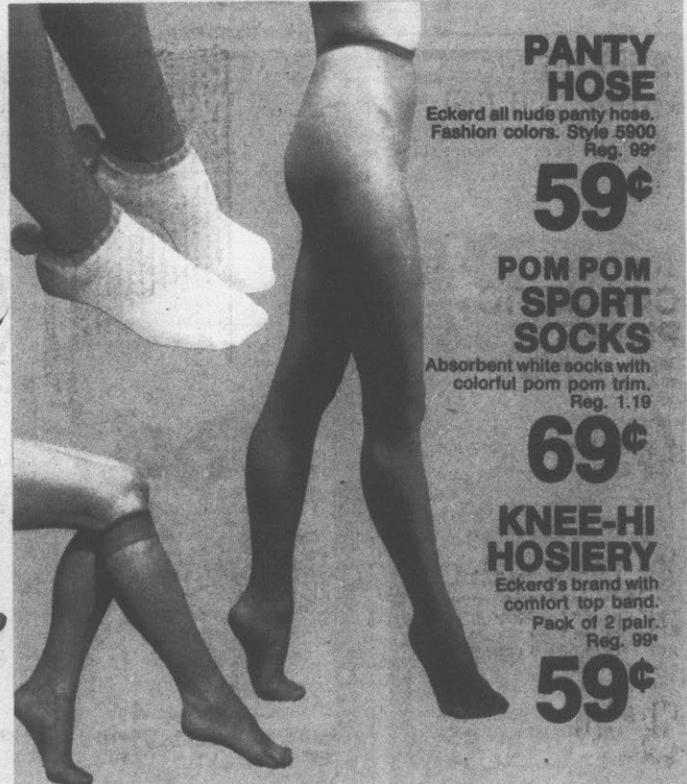
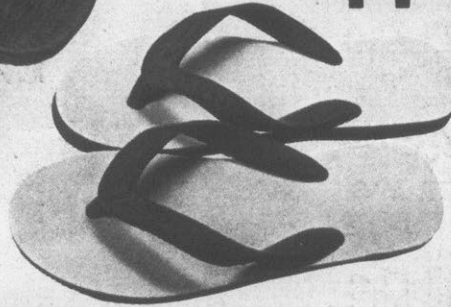

**PANTY  
HOSE**

Eckerd all nude panty hose. Fashion colors. Style 5900. Reg. 99¢

**59¢**

**POM POM  
SPORT  
SOCKS**

Absorbent white socks with colorful pom pom trim. Reg. 1.19

**69¢**

**KNEE-HI  
HOSIERY**

Eckerd's brand with comfort top band. Pack of 2 pair. Reg. 99¢

**59¢**

## BRADLEY DUAL BURNER GAS BARBEQUE GRILL

With automatic igniter & dual controls to light one side or both. Has 14" x 22" cooking surface, 20-lb. LP tank (gas not included) & stainless steel twin burners (15,000 BTU's each side). Reg. 149.99

# 119<sup>88</sup>

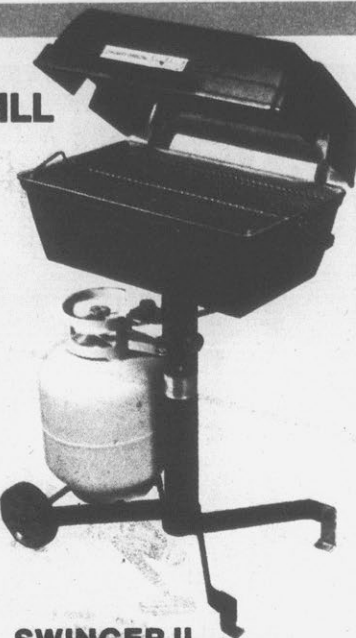

## SWINGER II SMOKER GRILL

18" x 18" grid with 4 height adjustments, baked enamel fire bowl & tilt-away hood with vents. Reg. 42.99 (Available in green only)

# 29<sup>99</sup>

## WEB & ALUMINUM LAWN CHAIR

**5<sup>88</sup>** Features polished aluminum arms & rugged polypropylene webbing. Reg. 7.99



## MULTI-POSITION COMBI LOUNGER

Tote to beach, pool or patio. Bright vinyl strapping on cadmium plated steel frame. Adjusts for total comfort. Reg. 12.88

# 9<sup>88</sup>



CUT ON DOTTED LINE

CUT ON DOTTED LINE

SAVE \$ Valuable Coupon SAVE \$

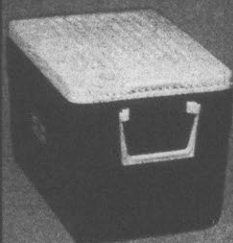

## 35-QUART THERMOS COOLER

Urethane foam insulation & hinged lid. Reg. 14.99

# 11<sup>88</sup>

Coupon Good Thru Sat. June 9

SAVE \$ ECKERD DRUGS SAVE \$

SAVE \$ Valuable Coupon SAVE \$

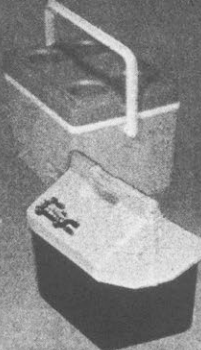

## THERMOS SUNPACKER or SIXPACKER

11-qt. Sunpacker or 12-qt. Sixpacker. Reg. 11.99

# 8<sup>99</sup>

Coupon Good Thru Sat. June 9

SAVE \$ ECKERD DRUGS SAVE \$

SAVE \$ Valuable Coupon SAVE \$

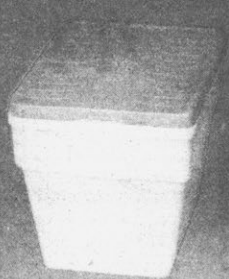

## 30-QUART ICE CHEST

Molded foam with molded handles.

# 1<sup>19</sup>

Coupon Good Thru Sat. June 9

SAVE \$ ECKERD DRUGS SAVE \$

SAVE \$ Valuable Coupon SAVE \$

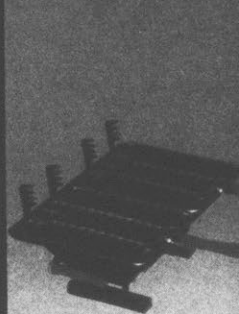

## HIBACHI GRILL

10" x 17", cast iron with adjustable grids & vents.

# 5<sup>88</sup>

Coupon Good Thru Sat. June 9

SAVE \$ ECKERD DRUGS SAVE \$

SAVE \$ Valuable Coupon SAVE \$



## CHARCOAL STARTER

1-qt. Gulf Lite. Quick & odor-free. Reg. 89¢

# 69¢

Coupon Good Thru Sat. June 9

SAVE \$ ECKERD DRUGS SAVE \$

CUT ON DOTTED LINE

CUT ON DOTTED LINE

CUT ON DOTTED LINE

CUT ON DOTTED LINE

CUT ON DOTTED LINE

CUT ON DOTTED LINE

CUT ON DOTTED LINE

CUT ON DOTTED LINE

**MEN'S OR BOY'S SWIMWEAR**  
Assorted styles & colors in men's & boy's sizes. Reg. 5.99 **3<sup>99</sup>**

**LADIES' 2-PIECE SWIMSUITS**  
Colorful swimsuits in fashion styles. Assorted sizes. Reg. 8.99 **6<sup>99</sup>**

**MEN'S GOLF SPORT SHIRTS**  
Choose from a colorful assortment of leisure looks. Short sleeve knit styles. Reg. 5.99 **3<sup>99</sup>**

**SWIM GOGGLES**  
Protect eyes from chlorine or salt water. Thick foam padding. No. DS60G Reg. 2.59 **1<sup>59</sup>**

**ZEBCO 404 REEL & ROD COMBO**  
Fresh/salt water reel with spring loaded drag & medium action 2-piece fiberglass rod. Reg. 10.98 **7<sup>99</sup>**  
COMPLETE WITH LINE

**ZEBCO 840L/730G REEL & ROD COMBINATION**  
Reel has self-positioning bail & silent anti-reverse. Super Rod. Reg. 26.98 **18<sup>99</sup>**  
COMPLETE WITH LINE

**DAIWA 7290 REEL & ROD COMBO**  
Medium weight reel features corrosion resistant anodized metal spool. Teamed with 6 1/4-ft. No. E160 Super Rod. Reg. 15.98 **9<sup>99</sup>**  
COMPLETE WITH LINE

CUT ON DOTTED LINE

Valuable Coupon

**FOAM CUPS**  
Pack of 51, 6.4-oz. hot/cold cups. Reg. 59\* **39<sup>¢</sup>**

Coupon Good Thru Sat. June 9

SAVE \$ **ECKERD DRUGS** SAVE \$

CUT ON DOTTED LINE

Valuable Coupon

**CHINA FOAM DISPOSABLE PLATES**  
Stronger than paper, disposable tool. Reg. 59\* ea. **2/69<sup>¢</sup>**

Coupon Good Thru Sat. June 9

SAVE \$ **ECKERD DRUGS** SAVE \$

CUT ON DOTTED LINE

Valuable Coupon

**SWIM MASK & SNORKEL SET**  
Quality snorkel & mask set. No. 1425 Reg. 2.79 **1<sup>99</sup>**

Coupon Good Thru Sat. June 9

SAVE \$ **ECKERD DRUGS** SAVE \$

CUT ON DOTTED LINE

Valuable Coupon

**AUTO SEAT CUSHION**  
19" x 34" for driving comfort. Reg. 3.79 **2<sup>49</sup>**

Coupon Good Thru Sat. June 9

SAVE \$ **ECKERD DRUGS** SAVE \$

CUT ON DOTTED LINE

Valuable Coupon

**SPALDING TENNIS BALLS**  
For all court surfaces. Vivid yellow. Reg. 2.18 **CAN OF 3/1<sup>88</sup>**

Coupon Good Thru Sat. June 9

SAVE \$ **ECKERD DRUGS** SAVE \$

CUT ON DOTTED LINE

Valuable  
Coupon
**ASSORTED  
PLANTERS  
SNACKS**

 Various tasty snacks in re-  
seal canisters. Reg. 79¢ ea.

**2/1.00**  
FOR

Coupon Good Thru Sat. June 9

 SAVE \$ **ECKERD** SAVE \$  
DRUGS

CUT ON DOTTED LINE

Valuable  
Coupon
**NESTEA  
100% TEA**

 3-oz. With real tea  
taste. Reg. 2.09

**1.69**

Coupon Good Thru Sat. June 9

 SAVE \$ **ECKERD** SAVE \$  
DRUGS

CUT ON DOTTED LINE

Valuable  
Coupon
**6-PACK  
THERMAL  
COASTERS**

 To keep your drinks  
cold longer. Reg. 1.19

**88¢**

Coupon Good Thru Sat. June 9

 SAVE \$ **ECKERD** SAVE \$  
DRUGS

CUT ON DOTTED LINE

Valuable  
Coupon
**50-FT. OUTDOOR  
EXTENSION  
CORD**

 Orange, U.L. listed cord  
with ground. Reg. 9.98

**5.49**

Coupon Good Thru Sat. June 9

 SAVE \$ **ECKERD** SAVE \$  
DRUGS

CUT ON DOTTED LINE

Valuable  
Coupon
**4-QUART  
POTTING  
SOIL**

 Ready to use for most  
plants. Reg. 69¢ ea.

**3/1.00**  
FOR

Coupon Good Thru Sat. June 9

 SAVE \$ **ECKERD** SAVE \$  
DRUGS

CUT ON DOTTED LINE

**SURF RIDER**
**6.88** 29" x 48" in sturdy  
PVC. Rope handle.  
Reg. 8.99

**BEACH  
TOWEL**

 28" x 58". Assorted  
bright designs.  
Reg. 3.99

**2.88**

**FIRESIDE  
CREME  
COOKIES**

 7-oz. pack of creme filled  
cookies. Assorted  
flavors. Reg. 39¢ ea.

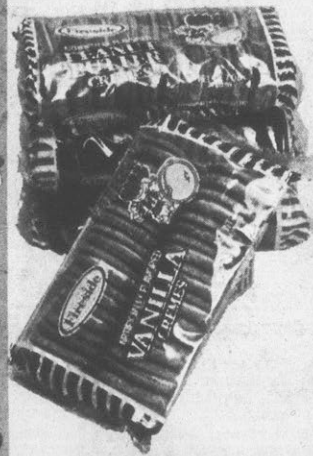
**4/1.00**  
PACKS

**WELCH'S  
GRAPE  
JELLY**

 2-lb. jar. Old fashion  
flavor. Reg. 1.19

**89¢**

**ECKERD  
DRY ROASTED  
PEANUTS**

 16-oz. No oil or sugar  
added. Reg. 1.49

**99¢**

**DIAMOND  
ALUMINUM  
FOIL**

 12-inch x 25-foot roll. For  
storing & cooking.  
Reg. 43¢ ea. Limit 3

**3/89¢**  
ROLLS

CUT ON DOTTED LINE

SAVE \$ Valuable Coupon SAVE \$



### GARDENING HAND TOOLS

Transplanter, cultivator or trowel. Reg. 79\*

**59¢**

Coupon Good Thru Sat. June 9

SAVE \$ **ECKERD DRUGS** SAVE \$

CUT ON DOTTED LINE

SAVE \$ Valuable Coupon SAVE \$

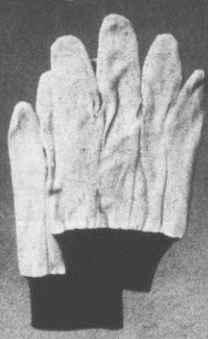

### MEN'S or LADIES' WORK GLOVES

8-oz. canvas gloves to protect hands. Reg. 99\*

**58¢**

Coupon Good Thru Sat. June 9

SAVE \$ **ECKERD DRUGS** SAVE \$

CUT ON DOTTED LINE

SAVE \$ Valuable Coupon SAVE \$



### MELNOR PULSATING SPRINKLER

Covers up to 75-ft. Sled base. No. 9570 Reg. 6.99

**4<sup>99</sup>**

Coupon Good Thru Sat. June 9

SAVE \$ **ECKERD DRUGS** SAVE \$

CUT ON DOTTED LINE

SAVE \$ Valuable Coupon SAVE \$



### FAN SPRAY NOZZLE

Fits on hose. With shut-off control. Reg. 99\*

**77¢**

Coupon Good Thru Sat. June 9

SAVE \$ **ECKERD DRUGS** SAVE \$

CUT ON DOTTED LINE

SAVE \$ Valuable Coupon SAVE \$

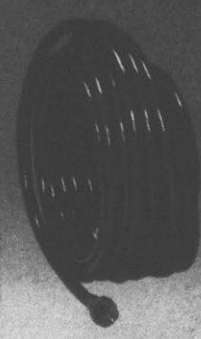

### 1/2-IN. x 50-FT. GARDEN HOSE

2-ply lightweight vinyl garden hose. Reg. 2.99

**1<sup>99</sup>**

Coupon Good Thru Sat. June 9

SAVE \$ **ECKERD DRUGS** SAVE \$

CUT ON DOTTED LINE

CUT ON DOTTED LINE



### ORTHO MALATHION

**3<sup>88</sup>** General purpose insecticide for fruits, vegetables & ornamentals. 1-pint. Reg. 4.98

### ORTHO SEVIN DUST

**1<sup>19</sup>** 4-lb. bag. Insecticide for vegetables & fruits. Kills fleas & ticks too. Reg. 1.98



### GOLDEN BOY ELECTRIC MONOFILAMENT TRIMMER

**14<sup>99</sup>** 1/4 HP with automatic line feed. Lightweight yet powerful to cut 9" area. No. 300 Reg. 17.99

### 5/8-IN. x 50-FT. GARDEN HOSE

Reinforced with nylon tire cord for excellent burst resistance. Reg. 9.99

**7<sup>88</sup>**

### OSCILLATING SPRINKLER

With high impact case, brass jets & aluminum sled base. No. 69 Reg. 7.99

**5<sup>99</sup>**



### 22-INCH SELF-PROPELLED POWER MOWER

3.5 HP Briggs & Stratton engine, easy spin recoil starter & manual height adjustment. Reg. 159.99

**138<sup>88</sup>**

**PROCTOR  
SILEX  
10-CUP  
COFFEE  
MAKER**

With Brew-For-Two coffee saver basket. Automatically switches from brew to warm. No. A301N

**17<sup>99</sup>**

**NORTHERN  
DOUBLE  
BURGER  
COOKER**

Cooks burgers, sandwiches & more. With non-stick surface. Reg. 9.99

**7<sup>77</sup>**

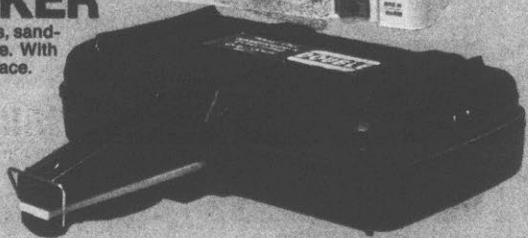

● **NORTHERN FOLDING DRYER**

1200 watts with 2 heats & 2 speeds. Handle folds up for storage or travel. Dryer stands by itself for 2-handed drying. Reg. 11.99

● **HAMILTON BEACH  
CAN OPENER**

Knife sharpener tool With detachable cutting unit & lid magnet. No. 831 Reg. 11.99

● **PROCTOR SILEX  
TOASTER**

2-slice toaster with color control & snap-open crumb tray. No. 6208 Reg. 12.99

● **VIP PRO DRYER**

1250 watts with 2 speeds, 4 heat settings & pro nozzle. Reg. 11.99

● **GENERAL  
ELECTRIC  
STEAM/DRY  
IRON**

25 steam vents for even distribution & heat selector dial. No. F-63 Reg. 11.99

**YOUR  
CHOICE**

**9<sup>99</sup>**  
EACH

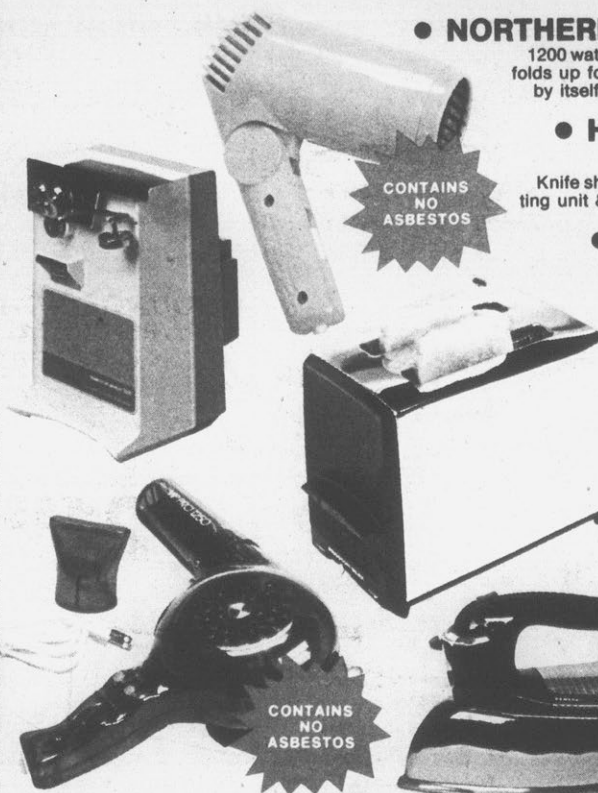

CUT ON DOTTED LINE

CUT ON DOTTED LINE

SAVE \$ Valuable Coupon SAVE \$

**MEN'S & LADIES' FAMOUS BRAND WATCHES**  
Many brands & styles with assorted bands. Reg. 29.99

**24<sup>88</sup>**

Coupon Good Thru Sat. June 9

SAVE \$ ECKERD DRUGS SAVE \$

SAVE \$ Valuable Coupon SAVE \$

**ECKERD "C or D" BATTERIES**  
To power flashlights, toys & more! Reg. 63¢ pack

PACK OF 2/ **39¢**

Coupon Good Thru Sat. June 9

SAVE \$ ECKERD DRUGS SAVE \$

SAVE \$ Valuable Coupon SAVE \$

**WESTCLOX ALARM CLOCK**  
Keypound alarm with large numerals. Reg. 4.99

**3<sup>49</sup>**

Coupon Good Thru Sat. June 9

SAVE \$ ECKERD DRUGS SAVE \$

SAVE \$ Valuable Coupon SAVE \$

**INTERMATIC VARIABLE TIMER**  
WITH SPECIAL REBATE OFFER\* Turns on/off at varying times. No. D-711 Reg. 7.99

SALE PRICE ..... **5<sup>99</sup>**  
LESS MFG. MAIL-IN REBATE\* ... **-1<sup>00</sup>**  
FINAL COST AFTER REBATE ..... **4<sup>99</sup>**

Coupon Good Thru Sat. June 9

SAVE \$ ECKERD DRUGS SAVE \$

SAVE \$ Valuable Coupon SAVE \$

**SHARP L.C.D. MEMORY CALCULATOR**  
8-digit pocket calculator with sq. rt. & 1/2 keys. No. EL-206

**7<sup>88</sup>**

Coupon Good Thru Sat. June 9

SAVE \$ ECKERD DRUGS SAVE \$

CUT ON DOTTED LINE

CUT ON DOTTED LINE

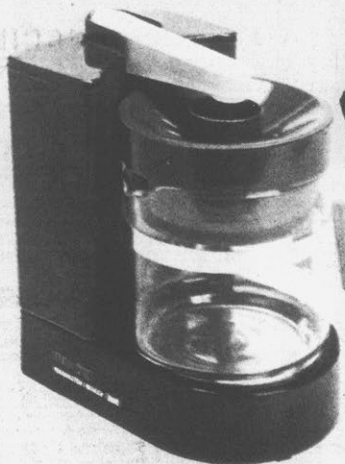

### HAMILTON BEACH MINI DRIP COFFEEMAKER

Brews up to 4 cups in 7 minutes.  
Heats water for tea, soup or  
instant coffee. Reg. 14.99

**12<sup>99</sup>**



### HAMILTON BEACH SLOW COOKER

4-qt. with thick crockery  
cooking vessel & see-  
thru lid. No. 443

**8<sup>88</sup>**

### SOUNDESIGN AM/FM DIGITAL CLOCK RADIO

Wake to AM, FM or alarm.  
Lighted leaf-type numerals,  
slide rule tuning & snooze  
switch. No. 3545 Reg. 24.99

**21<sup>99</sup>**

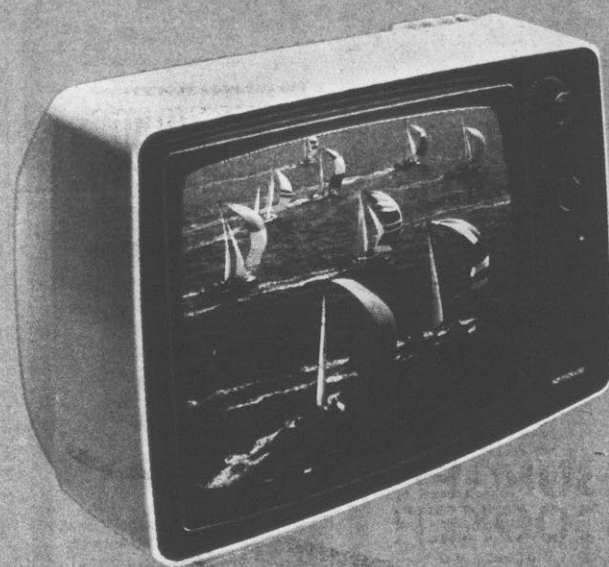

### SEVILLE 12-INCH DIAGONAL BLACK & WHITE TELEVISION

**69<sup>99</sup>**

100% solid state with automatic gain control,  
VHF & UHF detent tuners, rotary controls &  
earphone jack. No. C379 Reg. 84.99

CUT ON DOTTED LINE

CUT ON DOTTED LINE

Valuable  
Coupon



### MR. COFFEE FILTERS

Pack of 100 fluted  
paper filters. Reg. 99¢

**59¢**

Coupon Good Thru Sat. June 9

ECKERD  
DRUGS

Valuable  
Coupon

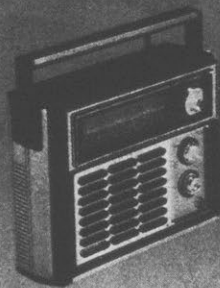

### GRAN PRIX MULTI-BAND RADIO

AM/FM/Police/Weather/  
Air. No. 210 Reg. 19.99

**17<sup>99</sup>**

Coupon Good Thru Sat. June 9

ECKERD  
DRUGS

Valuable  
Coupon

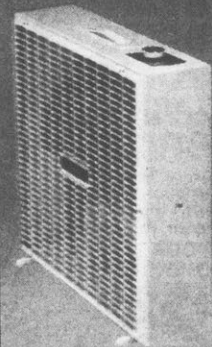

### GALAXY 20-IN. FAN

3 speed model with mesh  
grill. No. 6713 Reg. 22.99

**19<sup>99</sup>**

Coupon Good Thru Sat. June 9

ECKERD  
DRUGS

Valuable  
Coupon



### VIP PRO CURLING IRON

Teflon rod, hi/lo heat &  
safety tip. Reg. 6.95

**5<sup>99</sup>**

Coupon Good Thru Sat. June 9

ECKERD  
DRUGS

Valuable  
Coupon



### GENERAL ELECTRIC HAND MIXER

3-speed model with  
eject. No. M-24 Reg. 12.99

**10<sup>88</sup>**

Coupon Good Thru Sat. June 9

ECKERD  
DRUGS

CUT ON DOTTED LINE

CUT ON DOTTED LINE

CUT ON DOTTED LINE

CUT ON DOTTED LINE

CUT ON DOTTED LINE

CUT ON DOTTED LINE

CUT ON DOTTED LINE

CUT ON DOTTED LINE

CUT ON DOTTED LINE

Valuable  
Coupon**QUAKER STATE  
MOTOR OIL**

Quart can of 10W30 Super Blend oil. Reg. 83¢ Limit 6

**59¢**

Coupon Good Thru Sat. June 9

ECKERD  
DRUGS

CUT ON DOTTED LINE

Valuable  
Coupon**WD-40  
LUBRICANT**

9-oz. aerosol. Stops rust &amp; squeaks. Reg. 1.69

**99¢**

Coupon Good Thru Sat. June 9

ECKERD  
DRUGS

CUT ON DOTTED LINE

Valuable  
Coupon**SUPER  
GLUE 3**

3-gram tube. Super fast &amp; strong. Reg. 1.69

**89¢**

Coupon Good Thru Sat. June 9

ECKERD  
DRUGS

CUT ON DOTTED LINE

Valuable  
Coupon**CAT  
LITTER**

10-lb. bag. Absorbent &amp; deodorizing. Reg. 89¢

**58¢**

Coupon Good Thru Sat. June 9

ECKERD  
DRUGS

CUT ON DOTTED LINE

Valuable  
Coupon**ECKERD  
PLAYING  
CARDS**

For bridge, pinochle or poker. Reg. 49¢ deck

**3  
DECKS / 99¢**

Coupon Good Thru Sat. June 9

ECKERD  
DRUGS

CUT ON DOTTED LINE

CUT ON DOTTED LINE

**TRASH  
BAGS**

20 trash for up to 20-gal. can or 30 kitchen for up to 13-gal. can. Reg. 1.79

**99¢****PARSONS  
LEMON or SUDSY  
AMMONIA**

28-oz. all purpose cleaning ammonia.

**3  
FOR / 1.00****VAPORETTE  
DOG or CAT  
FLEA  
COLLAR**

Kills fleas for up to 3 months. Reg. 99¢ ea.

**2  
FOR / 1.00****AUTO SPECIALS!****STAR  
BRITE  
POLISH  
or VINYL  
BRITE**

16-oz. to polish exterior, clean vinyl top or interior. Reg. to 3.49

**YOUR  
CHOICE****2.29****QUAKER STATE  
OUTBOARD  
MOTOR  
OIL**

32-oz. with top power &amp; performance. For most 2 cycle engines. Reg. 1.19

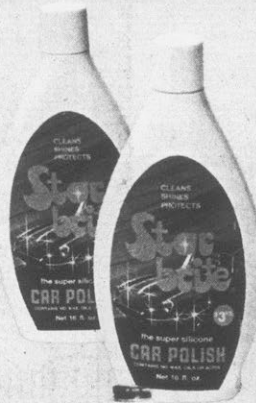
**83¢****TRANSMISSION  
FLUID**

32-oz. For use in most transmissions. Reg. 63¢

**47¢****STP  
OIL  
TREATMENT**

Use when you change oil or add oil for better performance. 15-oz. Reg. 1.39

**99¢**

CUT ON DOTTED LINE

SAVE \$ Valuable Coupon SAVE \$



### BOXED ENVELOPES

100, 6½" or 50, 9½".  
White only. Reg. 69¢ ea.

2/ **88¢**  
BOXES

Coupon Good Thru Sat. June 9

SAVE \$ ECKERD DRUGS SAVE \$

CUT ON DOTTED LINE

SAVE \$ Valuable Coupon SAVE \$



### RENUZIT SOLID AIR FRESHENER

6-oz. Assorted scents.  
Reg. 49¢ ea. Limit 3

3/ **1.00**  
FOR

Coupon Good Thru Sat. June 9

SAVE \$ ECKERD DRUGS SAVE \$

SAVE \$ Valuable Coupon SAVE \$



### GENERAL ELECTRIC LIGHT BULBS

Choose 60, 75 or 100  
watt Soft White.

PACK OF 4/ **1.29**

Coupon Good Thru Sat. June 9

SAVE \$ ECKERD DRUGS SAVE \$

CUT ON DOTTED LINE

SAVE \$ Valuable Coupon SAVE \$



### AJAX CLEANSER

14-oz. Gets out tough  
food stains. Reg. 35¢ ea.

3/ **79¢**  
FOR

Coupon Good Thru Sat. June 9

SAVE \$ ECKERD DRUGS SAVE \$

SAVE \$ Valuable Coupon SAVE \$



### MASKING TAPE

¾-in. x 60-yd. Many uses.  
Reg. 65¢ ea. Limit 2

2/ **77¢**  
ROLLS

Coupon Good Thru Sat. June 9

SAVE \$ ECKERD DRUGS SAVE \$

CUT ON DOTTED LINE

CUT ON DOTTED LINE

### RAID ANT & ROACH KILLER

**1.39** 16-oz. aerosol with  
penetrating vapor.  
Reg. 1.79

### SHELL NO-PEST STRIP

Kills flies &  
mosquitos  
indoors.  
Reg. 2.19

**1.69**

### OFF INSECT REPELLENT

6-oz. Long lasting spray  
to keep mosquitos away.  
Reg. 1.69

**99¢**

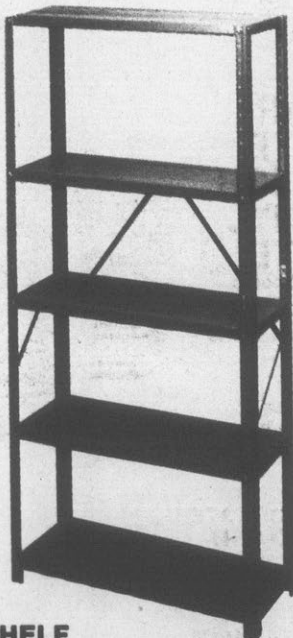

### 5-SHELF STEEL SHELVING

**9.88** 12" x 30" x 66". Sturdy utility  
shelving that assembles  
easily. Reg. 13.99

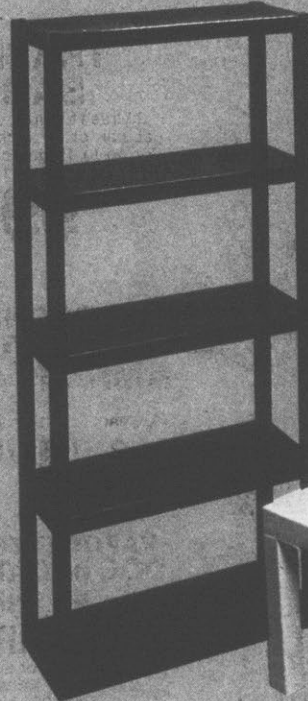

### 5-SHELF PLASTIC ETAGERE

12" x 30" x 66". Assembles  
easily. In white, almond or  
brown. Reg. 26.99

**19.99**

### PLASTIC PARSONS TABLES

16" square. Easy to as-  
semble. In white or brown.  
Reg. 4.99 ea.

2/ **7.00**  
FOR

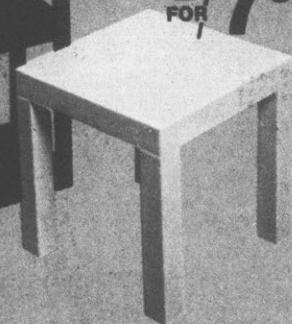

## POLAROID ONE STEP CAMERA

The aim & shoot camera with motorized print ejection. Gives sharp, clear pictures. Reg. 34.99

# 28<sup>99</sup>

PURCHASE A POLAROID ONE STEP AND RECEIVE A MAIL-IN MFG. COUPON GOOD FOR A FREE BOX OF SX-70 FILM AND A FLASHBAR!



## KEYSTONE XR106 POCKET CAMERA

With built-in electronic flash, color corrected lens & 400 speed capability. No. 106 Reg. 29.99

# 19<sup>99</sup>

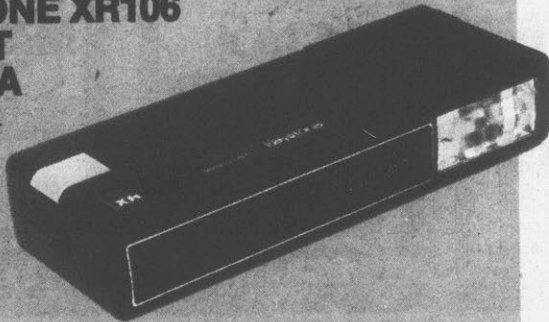

Supplement to: Aiken Standard, Albermarle Stanley News & Press, Anderson Independent, Ashboro Courier Tribune, Augusta Chronicle & Herald, Asheville Citizen/Times, Boone Watuga Democrat, Bristol Daily Times News & Bristol Virginia-Tennessean, Burlington Daily Times-News, The Village Advocate, The Enterprise, Charleston News & Courier, Charlotte Observer, Sampson Independent, Sampson County Shopping Guide, The Columbia State, Concord Tribune, The Horry Shopper, The Dunn Daily Record, Durham Morning Herald & Sun, Elizabethton Star and Star Weekly, Fayetteville Observer, Florence Morning News, Gastonia Gazette, Georgetown Times, Goldsboro News-Argus, Greensboro Daily News & Record, Greenville Daily Reflector & Reflector Shoppers Guide, Greenville News-Piedmont, Greenwood Index-Journal, Henderson Daily Dispatch & Tri-County Shopping Guide, Hendersonville Times-News, Hickory Daily Record, High Point Enterprise, Thomasville Times, Jacksonville Daily News,

Kannapolis Daily Independent, Kingsport Times-News, Kinston Daily Free Press, Lenoir News Topic, Lexington Dispatch, The Robesonian, McDowell News, Monroe Enquirer-Journal, Carteret County News-Times, Morganton News Herald, The Mount Airy News, The New Bern Sun-Journal, The North Wilkesboro Journal-Patriot, Norton Coastfield Progress, Oconee County Shopper, Orangeburg Times & Democrat, Raleigh News & Observer, Reidsville Review, Roanoke Rapids Sunday Herald, Rock Hill Evening Herald, Richmond County Daily Journal, The Rocky Mount Telegram, Sanford Daily Herald, Salisbury Post, Savannah News-Press, Shelby Daily Star, Smithfield Herald, Southeast News, Spartanburg Herald-Journal, Stateville Record & Landmark, Sumter Daily Item, The Pilot, Waynesville Mountaineer, Wilmington Morning Star, Wilson Daily News, Winston-Salem Journal, Rutherford County News & The Enterprise, (Section C), Wednesday, May 30, Thursday, May 31, Friday, June 1 or Sunday, June 3, 1979.

ECKERD'S RAIN CHECK POLICY: We try our best to have sufficient quantities of sale merchandise in every store. If, for any reason, we should run out of an advertised special before the sale ends, we will offer a similar item in an equivalent brand at comparable savings. Or, if you prefer, we'll give you a rain check which entitles you to the advertised price as soon as we receive another shipment. Clearance sale, special purchases and "while they last" items excluded.

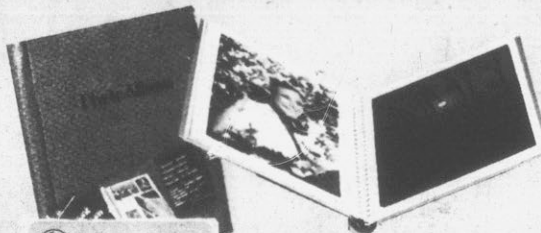

## 10-PAGE PHOTO ALBUMS

2 / 3<sup>00</sup> Dry-mount; no glue or corners needed. Reg. 2.49 ea.



## GENERAL ELECTRIC FLASHBAR II

169 10 flashes in handy, compact unit. Reg. 2.59



## KODAK PR-10 INSTANT PRINT FILM

For 10 color prints that develop before your eyes.

# 5<sup>39</sup>

CUT ON DOTTED LINE

CUT ON DOTTED LINE

Valuable Coupon



## SWEET 'N LOW

100 packets of sugar substitute. Limit 1

# 59¢

Coupon Good Thru Sat. June 9

ECKERD DRUGS

Valuable Coupon



## REVLON FLEX CONDITIONER

16-oz. in your choice of types. Limit 1

# 1<sup>19</sup>

Coupon Good Thru Sat. June 9

ECKERD DRUGS

Valuable Coupon



## LISTERINE ANTISEPTIC

12-oz. mouthwash & gargle. Limit 1

# 89¢

Coupon Good Thru Sat. June 9

ECKERD DRUGS

Valuable Coupon



## GATORADE THIRST QUENCHER

32-oz. refreshing Gatorade.

# 2 / 88¢

Coupon Good Thru Sat. June 9

ECKERD DRUGS

Valuable Coupon



## GILLETTE CRICKET LIGHTER

Disposable butane lighter. Reg. 79¢ ea.

# 2 / 69¢

Coupon Good Thru Sat. June 9

ECKERD DRUGS

CUT ON DOTTED LINE

CUT ON DOTTED LINE

SALE PRICES GOOD THRU SAT., JUNE 9TH. WE RESERVE THE RIGHT TO LIMIT QUANTITIES.

Supplement to: Greenville Daily Reflector & Shoppers Guide, New Bern Sun Journal, Roanoke Rapids Daily Herald, Emporia Independent, Mt. Messenger, Sumter Daily Item, Thomasville Times Enterprise

Sale ends Tuesday, June 5th. We reserve the right to limit quantities.

# CLARK'S

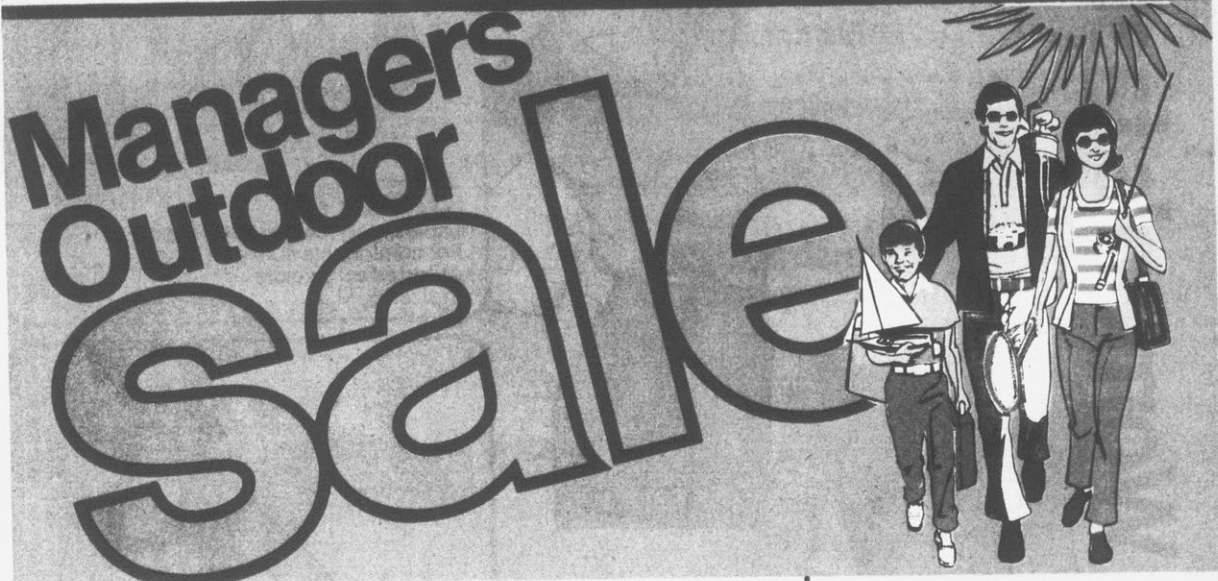

**3 for 1.00**  
 Reynolds Aluminum Foil  
 12" x 25' standard.  
 Keeps food fresh.

**99¢**  
 Rinso Detergent  
 49 oz. box.

**Prestone's \$2.00 rebate with 2 gallon purchase!**

**6.50** You pay for 2 gallons  
**-2.00** Less Prestone mail-in rebate  
**4.50** Your cost after rebate

Reg. 7.78 for 2 gallons  
**Prestone Anti-Freeze**  
 For summer or winter protection. Gal.

**PRESTONE**

**2 for 1.00**  
 Reg. 2 for 1.54  
**Ladies' footie sport socks**  
 Ass't. colors.  
 Fits 8 1/2-11.

**99¢** Reg. 1.25  
**Charcoal briquets**  
 10 lb. bag.

**2 for 79¢**  
 Reg. 50¢ ea.  
**Comet cleanser**  
 Bleaches and disinfects. 21 oz.

**1.59**  
**Listerine Mouthwash**  
 32 oz. bottle.

**2 for 1.00**  
 Reg. 65¢ ea.  
**Mead envelopes**  
 100-ct. (3-5/8" x 6 1/2") or 50-ct. (4-1/8" x 9 1/2").

**2 pkg. 2.25**  
 Reg. 1.40-1.75 ea.  
**Cannon banded goods**  
 Dish towels, utility or dish cloths.

# Women's fashions



**25% off**  
**2.22 to 8.55**

Reg. 2.87-11.50  
**Ladies' summer tops**  
Choose from a large selection of ladies' summer tops. In a wide variety of styles and colors.  
Plus sizes 40-46  
Reg. 4.97-7.25... 3.70-5.40



**3.55** Reg. 4.67  
**Ladies' poly/cotton tank tops**  
For comfortable summer living.  
Assorted solid colors.  
In sizes S, M, L.



**4.88** Reg. 6.27  
**Ladies' sleeveless chenille tops**  
Elastic blouson, shirred shoulder and juliet neckline. Available in ass't. solid colors. Sizes S, M, L.



**4.88** Reg. 6.27  
**Ladies' poly/cotton camisoles**  
A great topping for jeans and shorts. Eyelet trim, tie shoulder. Assorted plaids and florals. Sizes S, M, L.  
Plus sizes 38-44  
Reg. 6.97 ..... 5.22



**2.88** Reg. 3.47-3.97  
**Ladies' tank tops**  
Choose from 100% polyester or terry. Contrasting trims. Assorted solids and prints. Sizes S, M, L.  
Plus sizes 40-46  
Reg. 4.50 ..... 3.44



**3.88** Reg. 5.27  
**Plus size ladies' tees and tanks**  
Choose from a wide assortment of sleeveless cotton knits. Variety of solids and prints. Sizes XL-XXL.

# TABLE OF VALUES

Women's fashions . . . . .	2,4-5	Lighting . . . . .	22
Men's & boys' fashions . . . . .	6-8	Utilities & sundries . . . . .	23,26
Shoes . . . . .	9	Paint . . . . .	26
Sports equipment . . . . .	10,11	Home improvement . . . . .	27,28
Health & beauty . . . . .	12-15	Hand tools . . . . .	29,30
Notions . . . . .	16	Electrical . . . . .	31,32
Domestics . . . . .	17	Plumbing . . . . .	33
Appliances . . . . .	18-21	Lawn & garden . . . . .	34-37
Housewares . . . . .	20-21	Automotive . . . . .	38-40

### RAINCHECK

If we sell out for any advertised specials,\* you will receive a written order, "Raincheck" which entitles you to buy the item at the advertised price when our stock is replenished. \*(excluding clearance items)

Highway 52 & Maybert Street  
Portsmouth, Ohio

661 East Main Street  
Bradford, Pennsylvania

710 North Broadway  
Peru, Indiana

U.S. Highway 158 & Theater Ave  
Roanoke Rapids, North Carolina

Highway 70 & 17  
New Bern, North Carolina

Memorial Dr. & Farmville Hwy.  
West End Shopping Center  
Greenville, North Carolina

814 Memorial Blvd.  
Murfreesboro, Tennessee

207 South Dawson Street  
Thomasville, Georgia

Broad St.-U.S. Hwy 76 & 378  
Sumter, South Carolina

Just say,  
"CHARGE IT!"



Reg. 5.59-5.99 **4.44**  
**Girls' sundress and panty set**  
2-pc. set, Assorted prints. Sizes 4-6x and 7-14.



Reg. 3.99 **2.69**  
**Girls' terry tank tops**  
Cool cotton/polyester.  
Screen prints. Sizes 7-14.

Reg. 3.59 **2.69**  
**Girls' denim shorts**  
Comfortable prewashed jean  
styled shorts. Poly/cotton.  
Sizes 7-14.



**2.99** Reg. 3.99  
**Toddler Super Heroes short sets** 2 pc.  
tank top and short set.  
100% polyester.  
Spiderman or Superman.  
Sizes 2-4.



**16.44** Reg. 23.00  
**Infant car seat**  
Tubular steel construction.  
Custom upholstered. Supple  
vinyl foam padded seat  
and back. Exceeds Federal  
Motor Vehicle safety  
standards. Black  
and white. 213

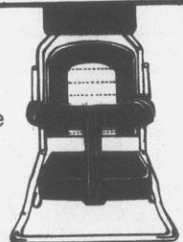

**2.99** Reg. 3.95  
**Newborn 60's disposable diapers**  
**3.55** Reg. 4.29  
**Daytime 60's, Toddler 40's, Overnight 40's, or Daytime Extra 48's**



# 20% off coordinates

20% off our entire stock of spring & summer coordinates

**3.17 to 11.97**

Reg. 3.97-14.97  
Take advantage of our super savings on fashionable coordinating tops and bottoms. Polyesters, seer-suckers, terry and cotton knits.



20% off our entire swimwear collection

**5.57 to 10.37**

Reg. 6.97-12.97  
Choose from a variety of styles. Fashion colors, prints and solids. Sizes 6-16.



**4.88** Reg. 6.97

**Ladies' short set**  
100% cotton jersey cap-sleeve top and jogging shorts with side stripe. Assorted colors. Sizes S, M, L.



your choice  
**5.88** Reg. 7.97

**Ladies' fashion pants or wrap skirt**  
Choose from fashion pants made of assorted fabrics or back wrap skirt. Both come in a variety of colors.



your choice  
**2.88** Reg. 3.47-3.97

**Ladies' jogging or jamaica shorts**  
Terry jogging shorts with side stripe, sizes S, M, L or 100% polyester pull-on jamaicas, sizes 10-20. Plus sizes jamaicas, sizes 32-38  
Reg. 3.97..... 3.22

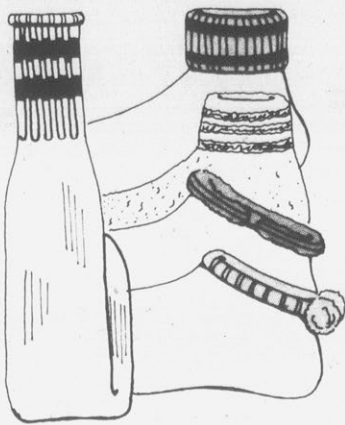

**88¢** Reg.

1.07-1.27

**Ladies' sport socks by the score!**

Choose from a selection of fashion poms, roll tops, ankle hi's and cuffed tops. Sizes 9-11.

Ladies' tubes... Reg. 97¢ ..... 77¢



**20% off L'eggs\***

**1.18 to 4.00** Reg. 1.49-5.00

Many styles and shades of pantyhose to choose from. Regular and queen size.

\*Suggested retail price



**2.27 to 2.77** Reg.

2.99-3.69

**Full figure bras**

Lace cup, full figure bras. In white only. Sizes 36-42B, 36-44C and 36-44D.

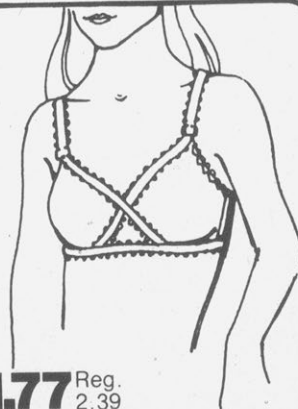

**1.77** Reg.

2.39

**Cross-your-heart seamfree or seamfree plunge bras**

In white or beige. Sizes 34-36A, 32-38B, 34-38C.

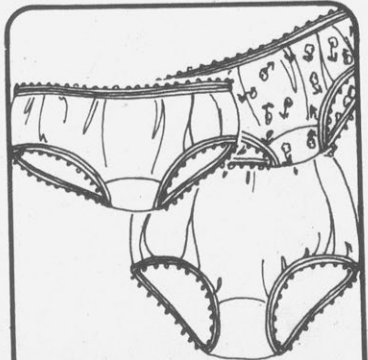

**79¢ to 99¢** Reg.

1.09-1.39

**Cotton briefs and bikinis**

Choose from solid white briefs, sizes 5-10 or white and floral bikinis, sizes 5-7.

**25% off all hats and visors**

**88¢ to 1.15** Reg.

1.19-1.57

**Ladies' sun visors**

Choose from terry, straw or cotton visors. In a variety of colors.



**1.00 to 1.85** Reg.

1.37-2.47

**Ladies' fashion summer hats**

Choose from straw, visor and tennis hats. In a variety of colors.



**1.00** Reg.

1.37

**Ladies' terry belts**

Made of stretch terry. In an assortment of styles and summer colors.

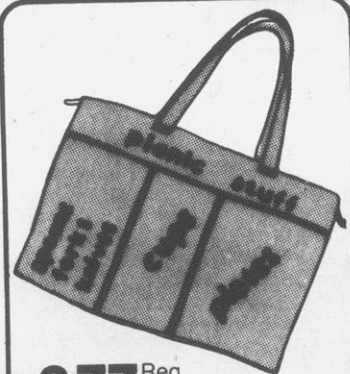

**3.77** Reg.

4.97

**Canvas picnic tote**

Just in time for summer fun. Choose from an array of sayings and colors.

# Men's and boys' fashions

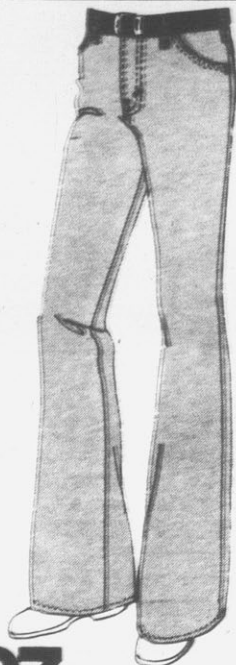

**7.97** Reg.  
9.99

**Men's prewashed western jeans**  
14 oz. 100% cotton with boot flare.  
Sizes 28-42. S, M, L lengths.

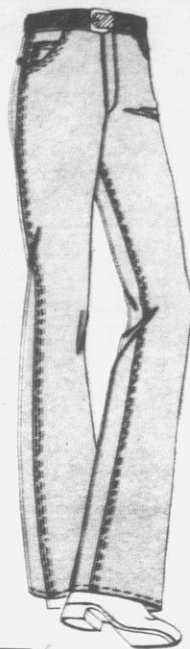

**6.97** Reg.  
8.99

**Men's brushed denim jeans**  
100% cotton fashion jeans.  
Assorted styles and colors.  
Sizes 28-42.

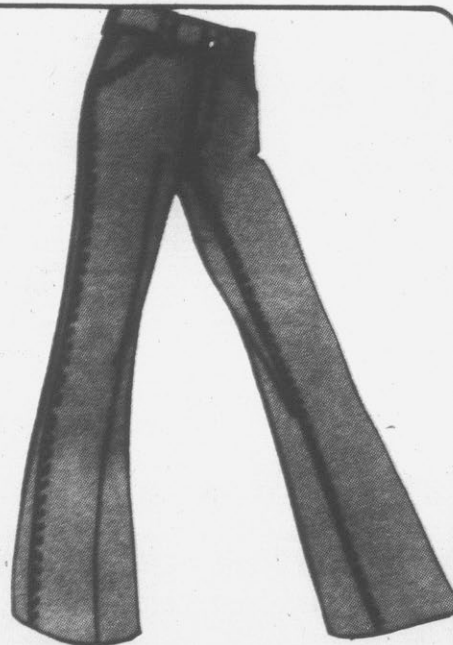

**4.77** Reg.  
6.00

**Boys' brushed denim jeans**  
Stylish jeans made of 100% cotton.  
Assorted colors. Sizes 8-18.

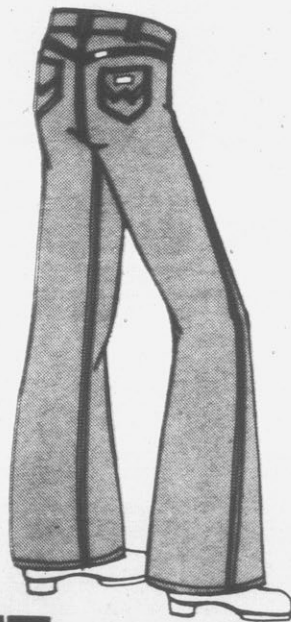

**6.77** Reg.  
7.99-9.50

**Boys' Wrangler jeans**  
For the casual look. Prewashed denim in  
ass't. styles. 50/50 cotton/poly blend.  
Twill or navy denim.  
Sizes 8-18, reg. or slim.

# 20% off men's selected knit shirts



**4.40 to 7.16**

Reg. 5.50-8.95  
For casual, comfortable summer living. Various short sleeve styles. Poly/cotton, perma press fabrics. Variety of colors. Sizes S-XL.

# 20% off all men's lightweight spring jackets



**6.40 to 12.75**

Reg. 8.00-15.95  
The perfect jackets for those cool spring nights. Styles include poplin, golf and more. Assorted colors. Sizes S-XL.



**1.95** Reg. 2.95

**Men's tank tops**  
Top it off in style. Body fitting. Assorted solids and stripes. Sizes S-XL.  
Boys' sizes 4-18. .Reg. 2.25-2.50 ..... 1.75



**5.95** Reg. 6.50-8.95

**Men's jean shirts**  
Choose from short or long sleeve. Assorted plaids with the style and fit to make you look good. Sizes S-XL.



**3.95** Reg. 4.95-5.95

**Men's swimwear**  
Popular volleyball, pocket and zip front boxer styles. Sizes S-XL.  
Boys' sizes S-L. . . . . Reg. 4.50 ..... 3.50

Reg. 4.99 **3.97**  
**Boys' tank sets**  
 Cool and comfortable boys' Superman tank top and shorts set. Ass't. colors. Sizes 4-7.



pkg. of 3  
**2 for 6.00**  
 Reg. 3.65-3.95  
**Men's Fruit-of-the-Loom underwear**  
 Choose T-shirts or briefs. 100% cotton. White. Sizes S-XL.  
 Boys' sizes (pkg. of 3)  
 Reg. 2.85-2.95 . . . . .  
 . . . . . 2 for 4.00



pkg. of 6 pr.  
 Reg. 5.95 **4.98**  
**Men's over-the-calf tube socks**  
 White with stripe top. One size fits 10-14.  
 Boys' tube socks (pkg. of 6 pr.)  
 Reg. 4.95 . . . . . 3.98



**1.49**  
**Men's industrial logo caps**  
 Variety of colors. S, M, L.



Reg. 6.50 **5.00**  
**18" gym bag**  
 Constructed of durable vinyl. Extra strong handle and ID plate. Black, brown and blue.



**6.77** Reg. 8.50  
**Men's double knit dress slacks** Comfortable and casual. 100% polyester in assorted colors. Sizes 28-42.



**3.50** Reg. 3.95-4.95  
**Boys' knit shirt**  
 A natural value for comfort and good looks. Ass't. stripes and solids. Sizes 8-18.



**11.00 to 28.00**

Reg. 14.95-35.95  
**Luggage with wheels**  
 Continental styling, light and durable. Constructed of mellow toned vinyl with leather like finish. 16" to 50". Tan or blue.  
**Luggage carrier (C90)**  
 Reg. 9.75 . . . . . 7.88

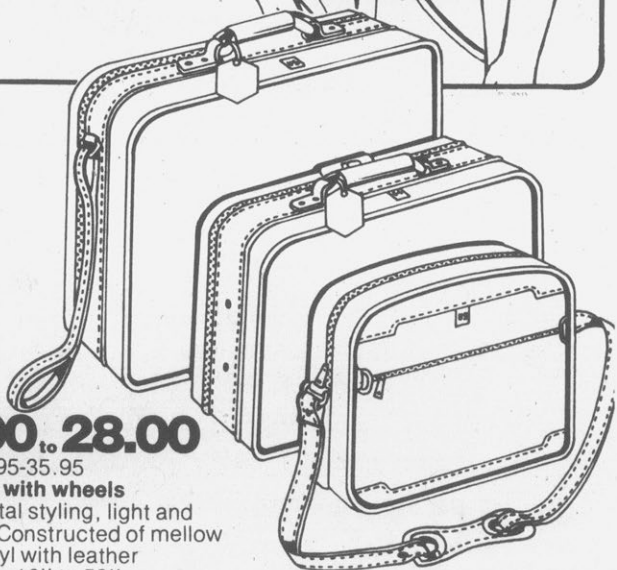

# Shoes

Reg. 9.99 **5.88**

## Leather Disco Shoes

Step out in beautiful dress shoes. Fashioned of genuine leather. High heels and sleek bottoms. Women's sizes 5½-10.

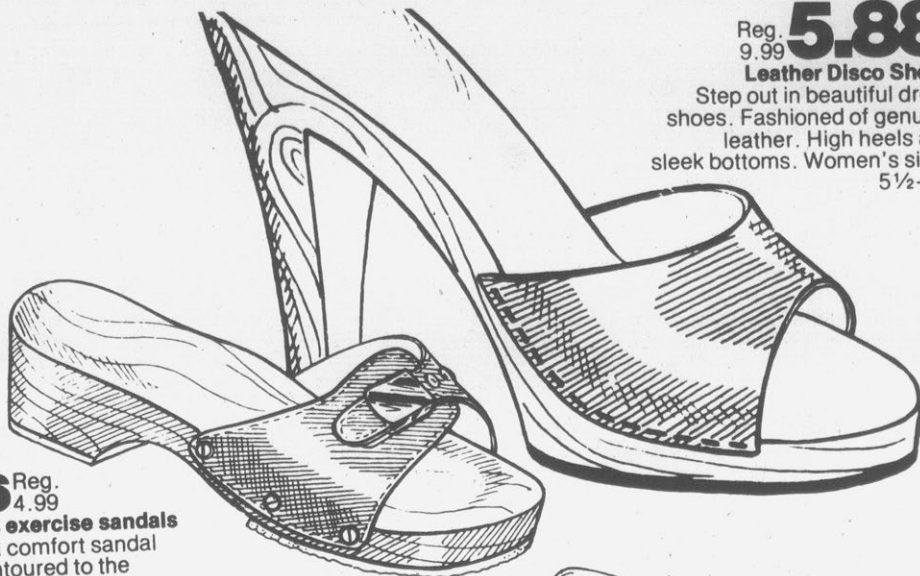

**3.66** Reg. 4.99

## Women's exercise sandals

Slip into a comfort sandal that's contoured to the shape of your foot. Front buckle adjusts for perfect fit. Women's sizes 5½-10.

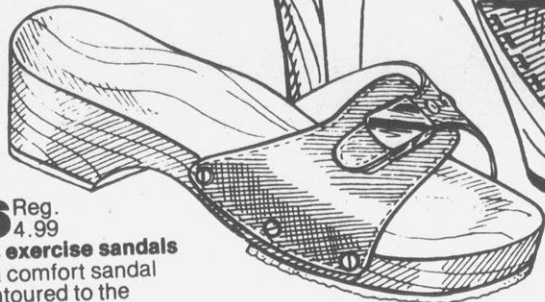

Reg. 2.00 **1.44**

## Women's beach thongs

Cool, comfortable and flexible. Great for beach or pool. Multi-stripped bottoms. Women's sizes 5½-10.

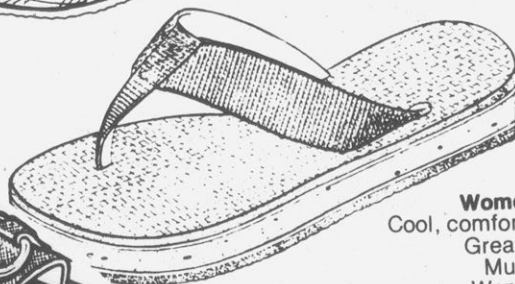

**5.22** Reg. 6.99

## Men's H-Band sandals

Cool and casual summer sandals. Adjustable heel strap for custom fit. Cushioned soles. Men's sizes 7-12.

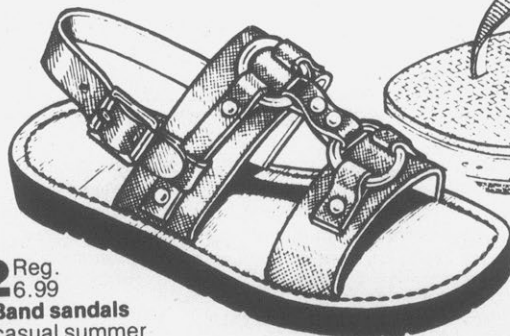

Reg. 2.00 **1.44**

## Girls' sandals

The perfect summer shoe that's waterproof, too. T-strap styling, flexible soles. Girls' sizes 5-12.

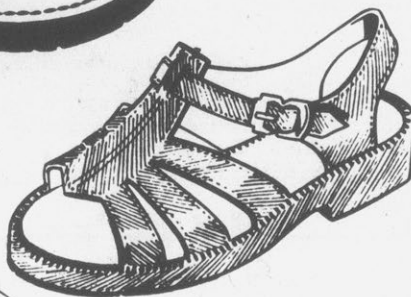

**2.88** Reg. 3.99

## Children's sneakers

Adorable sneakers for your little athlete. Canvas uppers with protective toe caps. Non-skid soles. Children's sizes 5½-10.



Reg. 5.99 **4.22**

## Men's and boys' baseball shoes

Durable canvas sneakers. Reinforced eyelets and protective toe caps for long wear. Men's sizes 7-12. Boys' sizes 11-2, 2½-6.



# Sports equipment

**3.49** Reg. 4.39

**Adirondack bat**

Northern white ash. Natural finish wood softball bat. 131

Softball bat SB0

Reg. 9.99 ..... 8.88

**3.49** Reg. 4.19

**Little League baseball bat**

Natural finish wood ash bat.

For younger players. 100LL

Little League bat LL1

Reg. 9.99 ..... 8.88



Reg. 2.69 **2.22**

**Rawlings Little League baseball**

Alum-tanned leather cover, cushioned cork center and double stitched seams. LLBR

Softball (G-12)

Reg. 2.45 ..... 1.88



Reg. 24.95 **19.88**

**Regent softball glove**

Top grain leather lining with finest quality rawhide lacing.

Reg. 13.75-14.75 **11.00**

**Converse shoes**

Strong, loose-lined uppers with durable cushioned insoles. Stop/start traction.

Reg. 24.95 **19.88**

**Backboard and goal set**

36" x 48" x 3/4" fiberboard with 5/8" goal iron with net. 9149-72

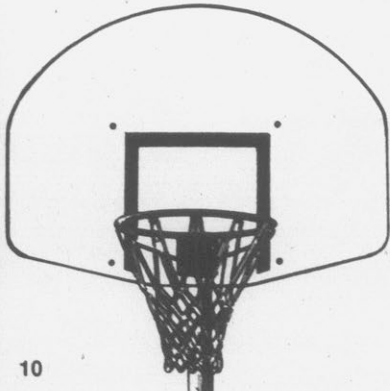

**3.88** Reg. 4.97

**Lantern camplight**

Designed for durability. High impact polyethylene. Steel ring for carrying or hanging. 16

Ray-O-Vac 6 volt

battery (941)

Reg. 1.75 .... 1.50



**3.99** Reg. 4.99

**4 player badminton set**

Include 4 steel shaft rackets, 2 shuttlecocks 18 ft. net with guide ropes, stakes and metal poles. B6S



**6.50** Reg. 7.95

**Swisher basketball**

Rugged nylon sheeting construction. Molded rubber cover. 61-275



**26.88** Reg. 29.95

**Crossman 760 Powermaster rifle**

.177 caliber pneumatic pump power source. 4 lbs. 6 oz. 36" long. BB-177

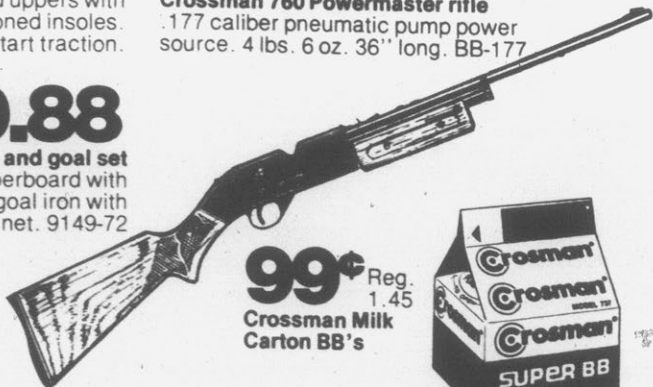

**99¢** Reg. 1.45

**Crossman Milk Carton BB's**





**1.88** Reg. 2.49

**Landing net**

1" heavy duty embossed aluminum handle. 1/2" heavy duty aluminum hoop. Hoop size 14"x16". 620P

**10.88** Reg. 12.99

**Magnum tackle box**

Ideal all-around 2-in-1 box with 30 movable dividers. 1146



**4.88** Reg. 5.89

**Adventurer tackle box**

Molded of rugged copolymer. Rustproof. 2 trays with built in tray supports. Ass't. colors. PA102

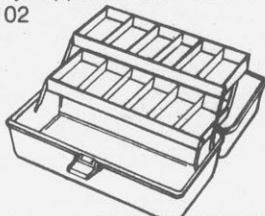

**2.44** Reg. 2.99

**3-piece vinyl storm suit**  
Sizes S-XL. Style 1210.

**4.88, 5.88**

Reg. 5.79 and 6.79

**Assorted boat paddles**

Slim and sleek. Made from select wood with urethane finish. Choose 4', 4 1/2', 5' and 5 1/2' lengths.

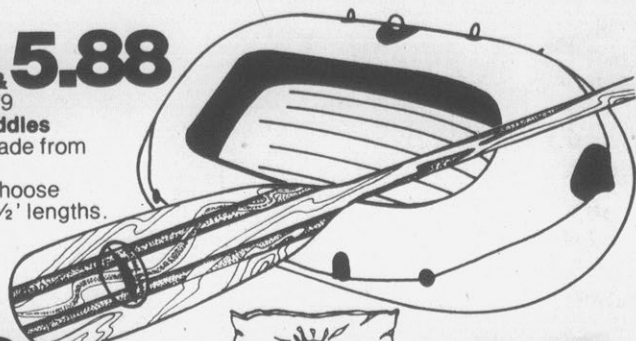

**13.88** Reg. 15.99

**Two man vinyl boat**

Constructed of heavy vinyl with inflatable bottom. Multiple separate air chambers, wrap around tow rope. Includes repair kit and vacuum adapter. Size: 78" x 46". 6478

One man boat (6545)  
Reg. 10.99 ..... 8.88

your choice

**9.88** Reg. 9.99-12.99

**Zebco spincast reel with selective anti-reverse (33), Daiwa spincast (308RL) or Olympic spincast reel (1200RL)**

your choice

**4.88** Reg. 6.95-6.99

**Spinning and spincast rods**

Lightweight action. Chrome plated with stainless steel guides.



**38.88** Reg. 43.95

**Portable toilet**

Small 2-piece portable camping toilet. Made of sturdy, easy to clean plastic. Lightweight and easy to carry. 153

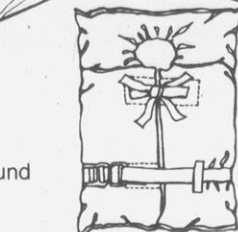

Reg. 4.99 **3.88**

**Kapok life vests**

U.S.C.G. approved type II.

Child, S, 30-50 lbs.  
Med., 50-90 lbs.  
Adult, over 90 lbs.

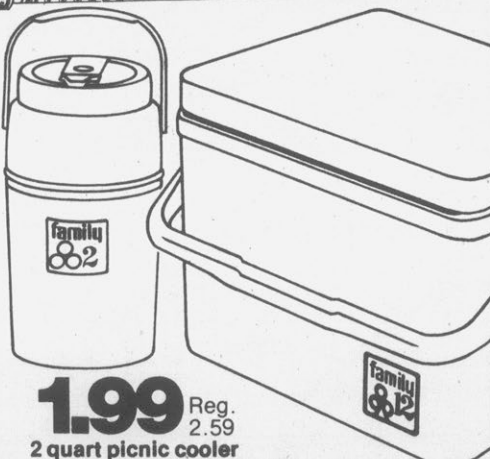
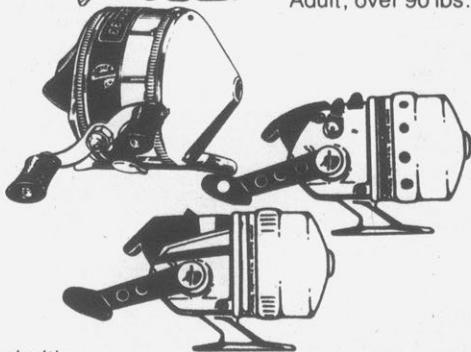

**1.99** Reg. 2.59

**2 quart picnic cooler**

Made of high density polyethylene. Wide mouth for easy filling and cleaning. 011

**9.95** Reg. 11.95

**The Lite Cooler**

12 quart capacity. Polyurethane insulation seals in cold. 036

# Health & beauty

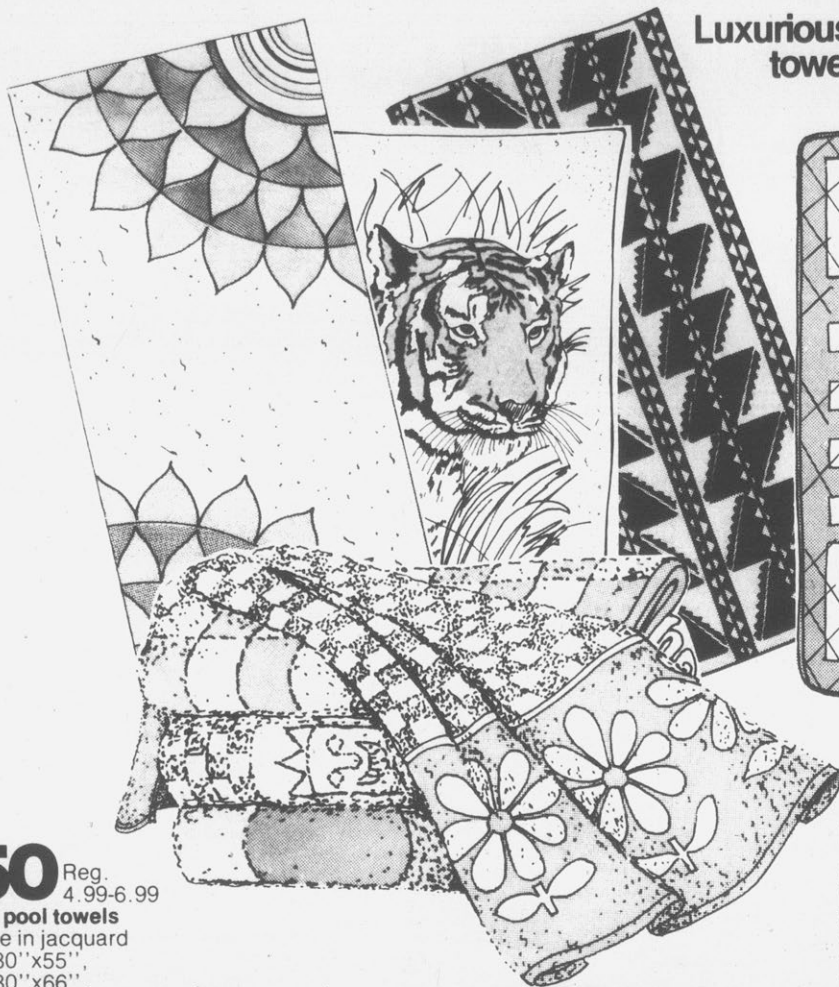

Luxurious heavyweight towels to wrap you after a swim



**4.50** Reg. 4.99-6.99

**Beach and pool towels**

Your choice in jacquard or velour. 30" x 55", 30" x 60", 30" x 66".

**4.99**

**Beach Bums**

Vinyl bag includes 35" x 70" beach blanket. Comes in red, blue and green. Drawstring top with inside lining.



**6.00** Reg. 8.95

**Sunsensor sunglasses**

The lens changes from dark to light and back again depending on sunlight intensity. Metal or plastic frames.

**Make the most of your summer. Get the best tan ever!**



your choice

**1.95**  
Tropical Blend lotion or oil 8 oz.

**1.59**  
Solarcaine Aerosol, 3 oz.

**3.39**  
Hawaiian Tropic Royal Blend 8 oz. For that dark native tan.

**3.95**  
Even-Up tanning blanket  
Helps you put the sun where you need it.

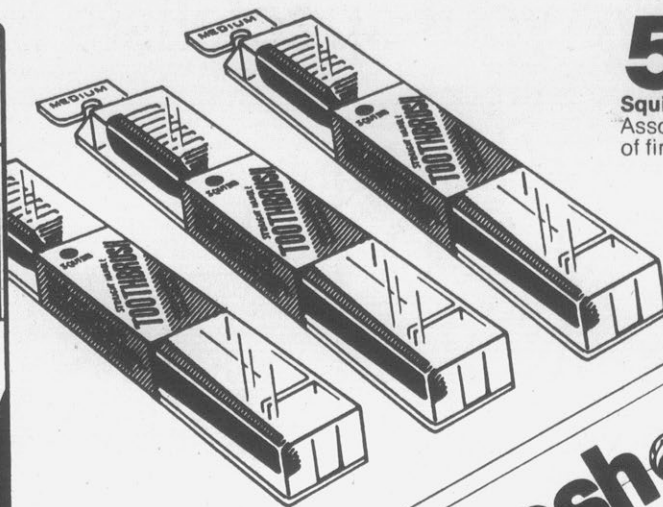

**5 for 1.00**

Squibb toothbrushes  
Assorted. Your choice  
of firm, gentle or medium.



**79¢**

Aqua-Fresh toothpaste  
6.4 oz. tube.



**2 for 1.00**  
Barbasol Shave Cream  
Your choice of lime,  
menthol or  
regular. 11 oz.

**2 for 1.00**  
Gillette Good News  
Razor 3 razors  
per package.



3 Disposable Twin Blade Razors



**69¢**  
Suave Shampoo  
Your choice of  
Balsam Protein,  
Cologne Earth or  
Cologne Fresh. 16 oz.

**99¢**  
Clairmist Hair Spray  
Reg. or unscented. 8 oz.

# We're your specialists in savings



**3.49** Reg. 4.49  
**Rexall Super Plenamins Bonus Pak**  
 72 ct., plus 36 free.

**99¢**  
**Tums tablets**  
 75 tablets.  
 Regular or flavored.

**1.29**  
**Excedrin Tablets**  
 100 ct.

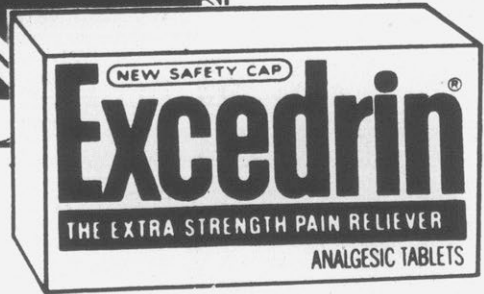

**1.39**  
**Secret Roll-On**  
 2.5 oz. Regular or unscented. Strong enough for a man but made for a woman.

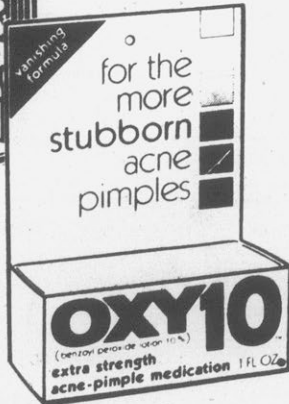

**2.39**  
**Oxy-10 Acne Cream**  
 1 oz. For help in clearing acne pimples.



**3 for 1.00**  
**Cutex Polish Remover**  
 4 oz. Regular or lemon.



**8 for 1.00**

Stayfree Mini-Pads  
Deodorized.  
Trial size box of 5.



Buy one at  
**1.19**

Get the second one  
**FREE!**

Vaseline Intensive  
Care Lotion  
10 oz. For silky  
smooth skin.

**2 for 1.00**

La Cross emery boards  
12 per package.

**2 for 88¢**

Reg. 60¢ ea.  
Kiwi Shoe Polish  
Regular size - 1-1/8 oz.  
Black, brown or natural.

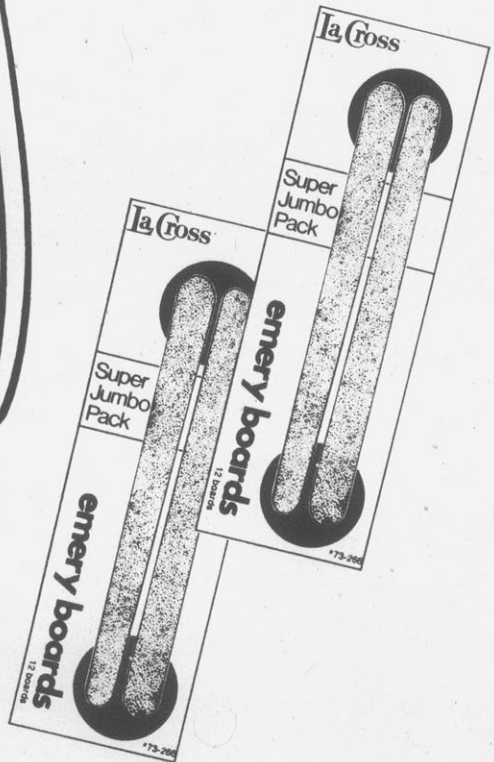

# Notions

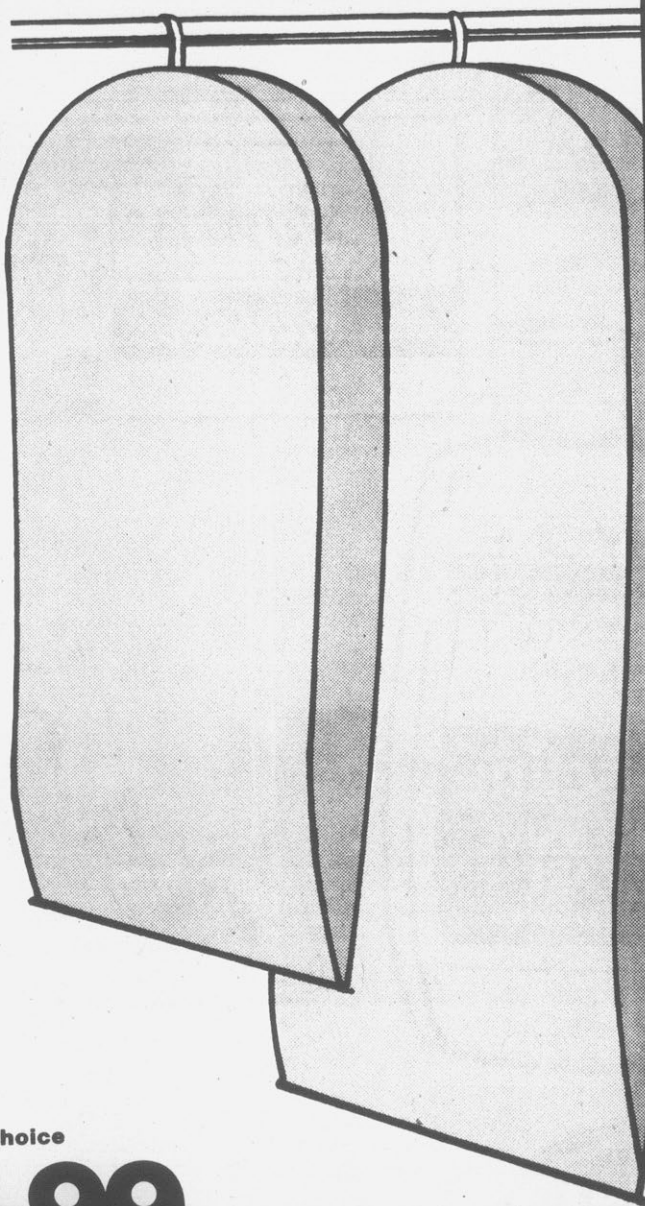

your choice

**3.99**

Reg.  
4.95

**Travel suit or dress bag**

Heavy duty, protects clothes from water and dust. Full length zipper. Ladies' 22"x50" holds 3-6 dresses. Men's 22"x40" holds 3-6 suits.



**19.95**

**Men's and women's Texas Instruments watch**  
Bracelet styling. Silvertone.  
459-31, 759-31

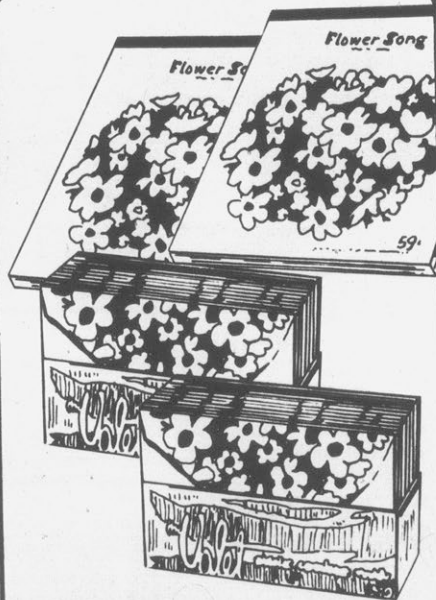

your choice

**2 for 88¢**

Reg. 60¢

**Mead tablets or envelopes**

Ass't. matching tablets or envelopes. 14 ct. envelopes or 26 ct. tablet.

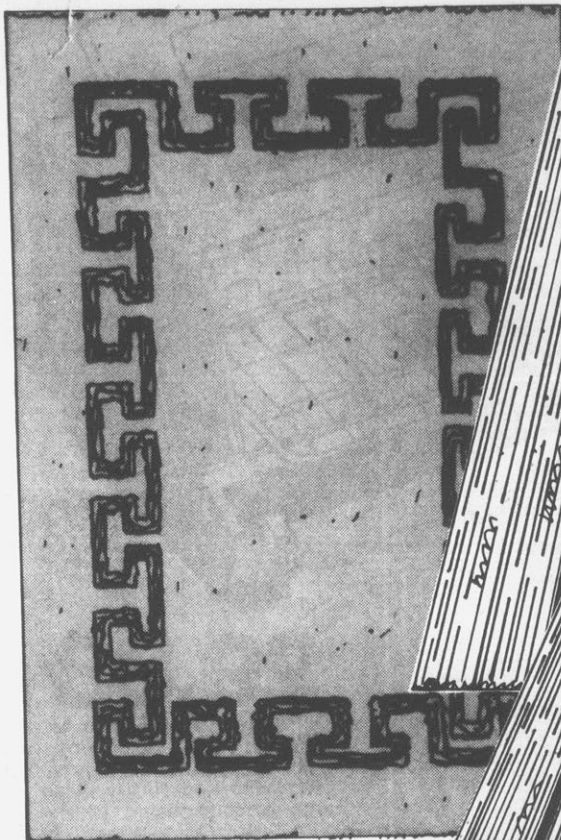

**2.60** 21" x 34"  
Reg. 3.25

**Corey Cut-n-Loop area rug**

Choose from many different square and rectangle patterns. Assortment of colors.

26" x 44" ..... Reg. 4.95 ..... 3.96  
24" x 70" ..... Reg. 7.95 ..... 6.36

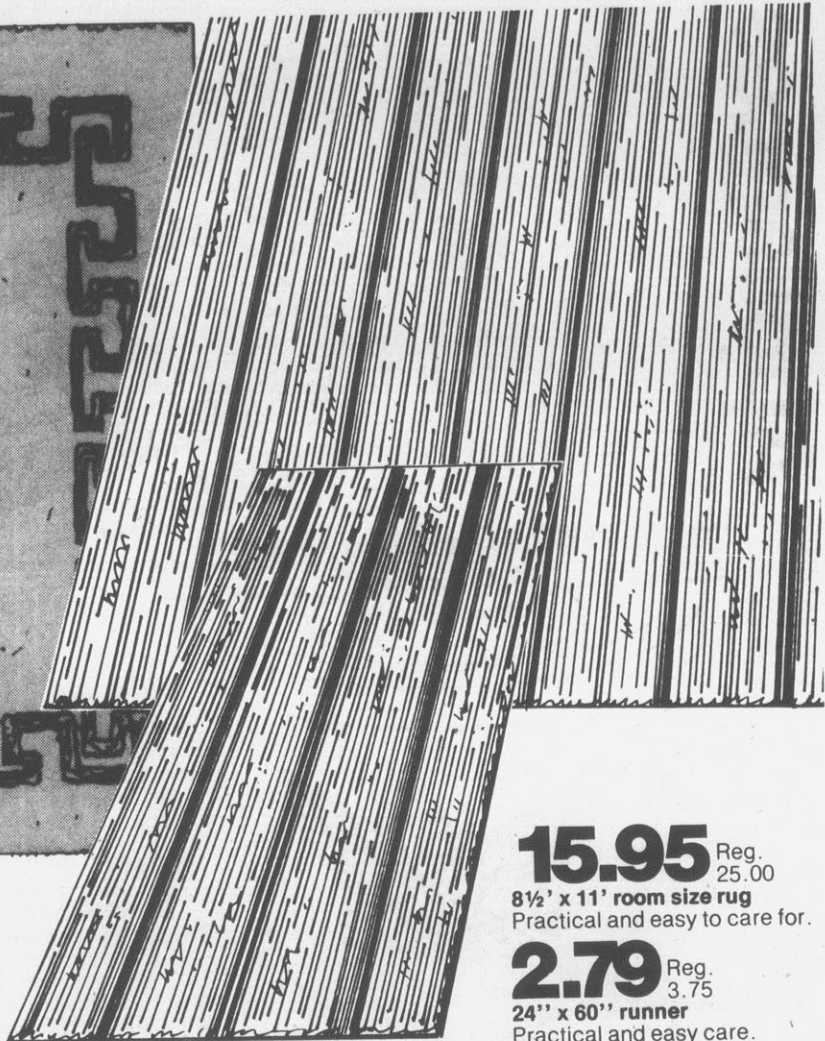

**15.95** Reg. 25.00

**8½' x 11' room size rug**

Practical and easy to care for.

**2.79** Reg. 3.75

**24" x 60" runner**

Practical and easy care.



**1.09** dish towel  
Reg. 1.39

**Solid color kitchen ensemble** Thick and absorbent. Comes in an ass't. bright kitchen colors.

Dish cloth  
Reg. 75¢ ..... 59¢  
Pot holder  
Reg. 75¢ ..... 59¢  
Oven mitt  
Reg. 1.39 ..... 1.09



**1.99** Reg. 3.00

**Hemp door mats**

Reversible. Great mud catchers. Your choice of Indian mesh, Indian sennet or Indian lover's knot.

# Appliances

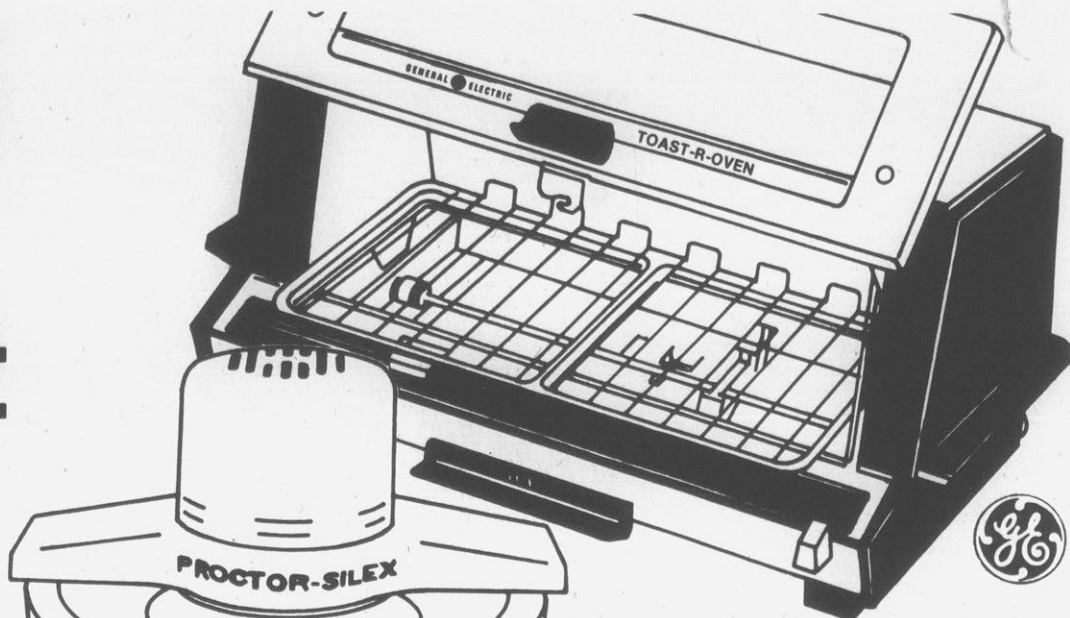

**29.88** Reg. 32.95

**GE Deluxe Toast-R-Oven toaster**  
It toasts, bakes and browns. Door opens automatically when food is finished. Richly styled with compact design. T93B



**PROCTOR-SILEX**

**11.88** Reg. 14.95

**Proctor Ice Cream Parlor**  
4 qt. electric ice cream maker. Easy to operate with power packed motor. Bright kelly green with spirited American eagle design. Free recipe book. F007A



**8.88** Reg. 9.95

**Mirro Colonial Style 8-cup coffee perk**  
Molded in durable polypropylene that won't chip, crack or fade with normal use. Brews 4-8 cups. Built-in warmer. 0199-43.

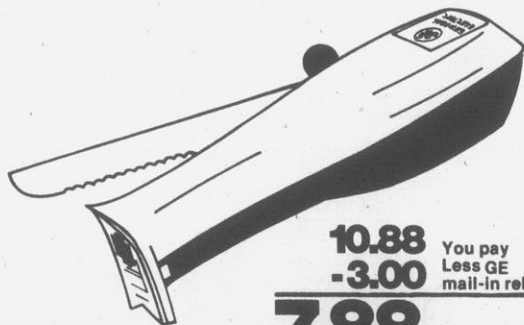

**10.88** You pay  
**-3.00** Less GE  
mail-in rebate

**7.88** Your cost  
after rebate

Reg. 13.95  
**GE electric knife**  
Features 9" hollow ground stainless steel slicing blades with serrated cutting edges. 6' detachable cord for easier storage. EK15



# 149.88

Reg. 169.95

**GE 4,000 BTU air conditioner**

2 fan speeds/2 cooling speeds/  
10 position thermostat. Features  
energy efficiency ratio,  
dehumidification and save  
energy range tilt out  
filter. AT604

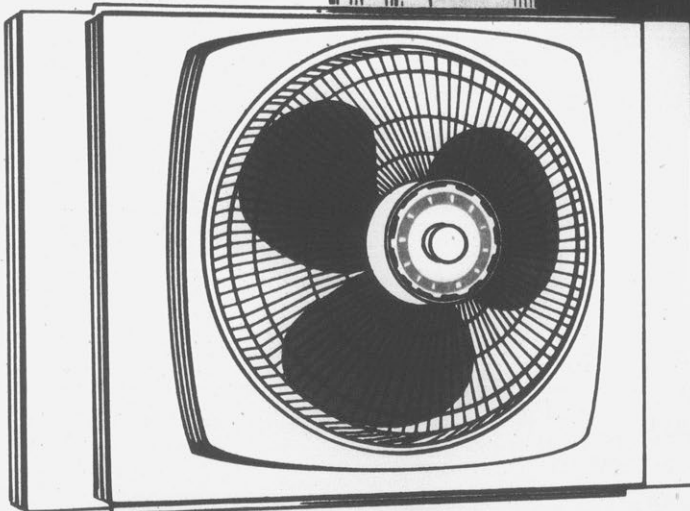
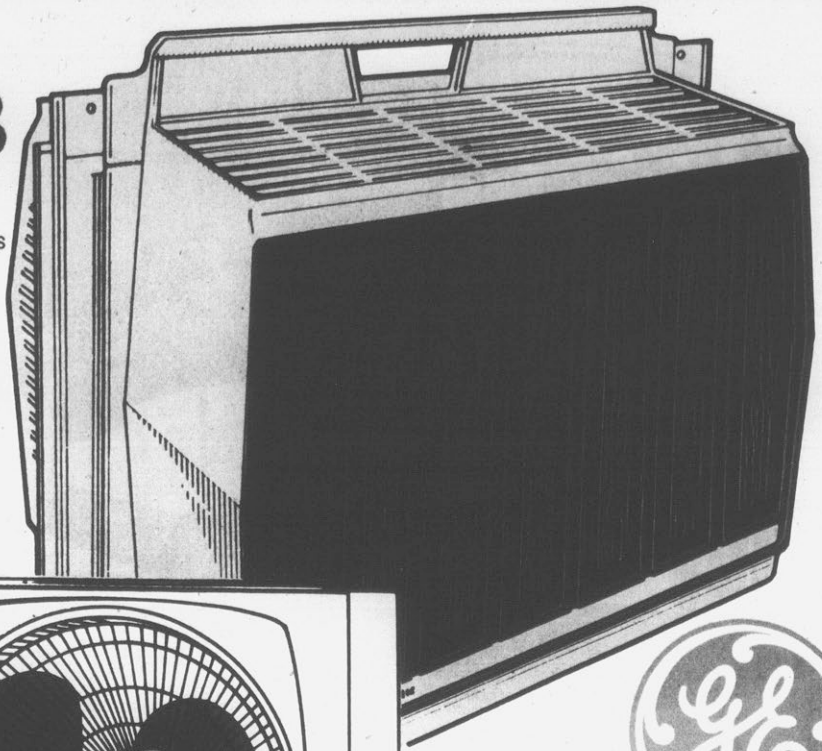

# 35.88

Reg. 48.95

**Lasko 3-speed fan**  
16" adjustable window fan.  
Will adapt to more  
window sizes than most.  
3 intake/3 exhaust  
speeds. 2155



# 31.88

Reg. 33.95

**Norelco Tripleheader  
rotary razor** New  
sleek styling for closer,  
smoother shaves.  
Convenient thumb  
control on/off switch.  
HP1132

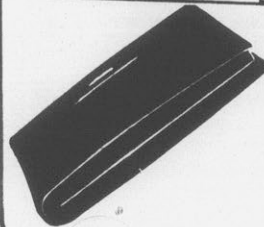

# 23.88

Reg. 29.95

**Super Thin Pocket Calculator**  
8 digit LCD FEM type.  
Accu. memory/percent and  
square root keys. 4  
basic arithmetic functions.  
Operates on 2 watch  
batteries. EL8036

**11.99** Reg. 17.50

**7-pc. aluminum cookware set**

Set consists of 1 qt. and 2 qt. covered saucepans, 10" open fry pan and 6 qt. covered sauce pot. Teflon II interior. Comes in chocolate or pineapple.



**1.44**

**7" open fry pan**  
Teflon II interior for cooking with ease.

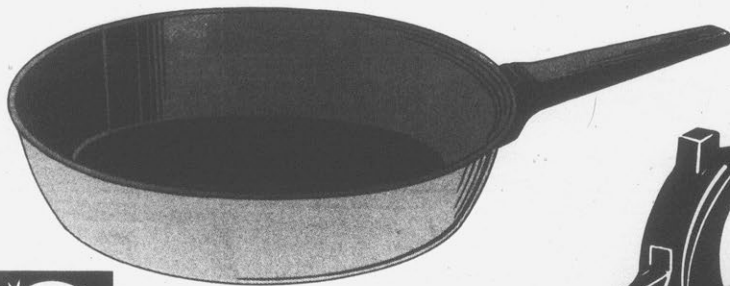

**2.99**

**Whistling tea kettle**  
2½ qt. aluminum with acrylic finish and open end handle. Assorted colors.

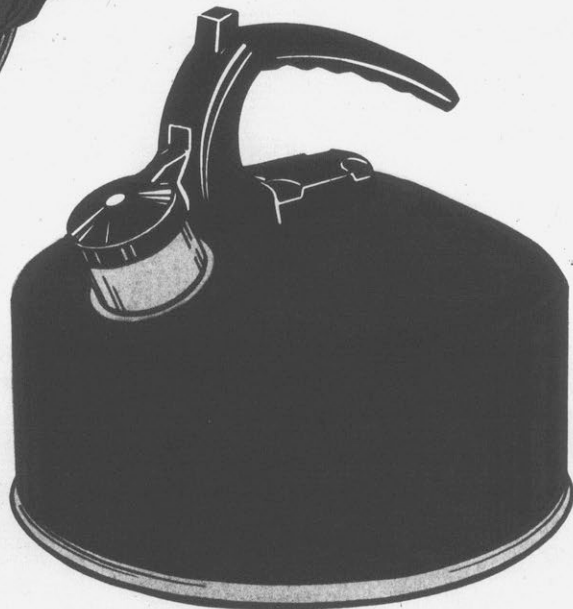



**7.49** Reg. 9.75

**16-pc. Melamine dinnerware**  
 Set includes: 4 each -  
 10" dinner plates, pedestal  
 mugs, soup/cereal bowls  
 and bread and butter plates.  
 In Wildflower, Dover,  
 Buttercup or Strawberry  
 patterns.

For those hot summer days-  
**Swirl Iced Tea Glassware**

**1.25**

80 oz. Swirl pitcher

**3 for 1.00**

25 oz. Swirl cooler

**4 for 1.00**

17 oz. Swirl cooler

**Libbey**

your choice

**2 for 3.00**

**Superseal Clears**

1½-qt. round, 44 oz.

flat, 80 oz. flat

or 68 oz. oblong.

Keeps food fresh.

your choice

**4 for 3.00**

**Superseal Clears**

1-pt. round, 16 oz.

oblong or 32 oz.

oblong. Keeps

food fresh.

# Lighting

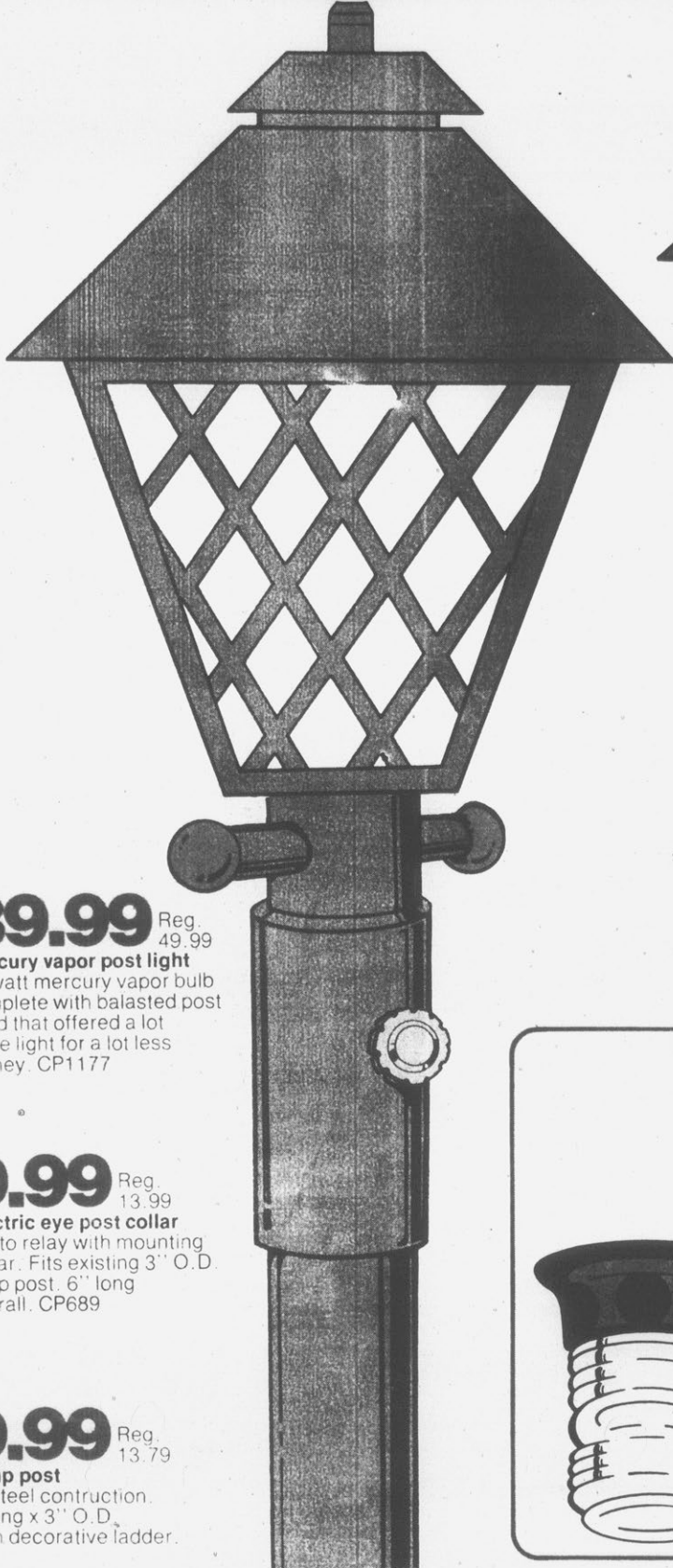

**39.99** Reg. 49.99

**Mercury vapor post light**  
50 watt mercury vapor bulb complete with ballasted post head that offered a lot more light for a lot less money. CP1177

**9.99** Reg. 13.99

**Electric eye post collar**  
Photo relay with mounting collar. Fits existing 3" O.D. lamp post. 6" long overall. CP689

**9.99** Reg. 13.79

**Lamp post**  
All steel construction. 7' long x 3" O.D. With decorative ladder.

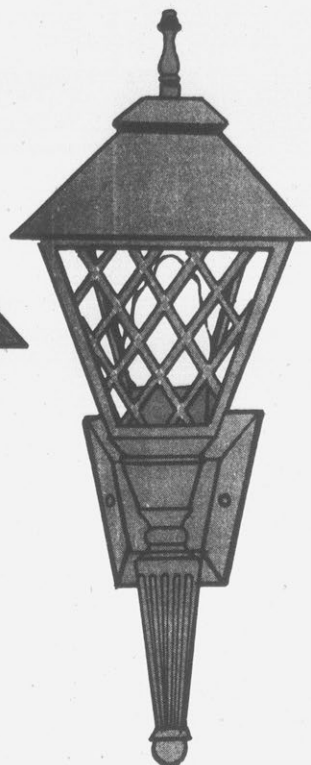

**9.99** Reg. 11.49

**Wall mount lantern**  
Wall mount unit compliments both contemporary and colonial. 8" sq. x 18" high x 9" extension for wall. 60 watt incandescent. Cp-182-CL



your choice  
**2.49** Reg. 3.25

**Entry light or overhead light**  
Black with clear shaped glass. PT-783, PT-784

# Utilities & sundries



**1.39** Reg. 1.65  
**Dishwasher All**  
 50 oz.

Reg. 1.60  
**1.29**  
**Woolite Liquid**  
 16 oz. Cold water wash.

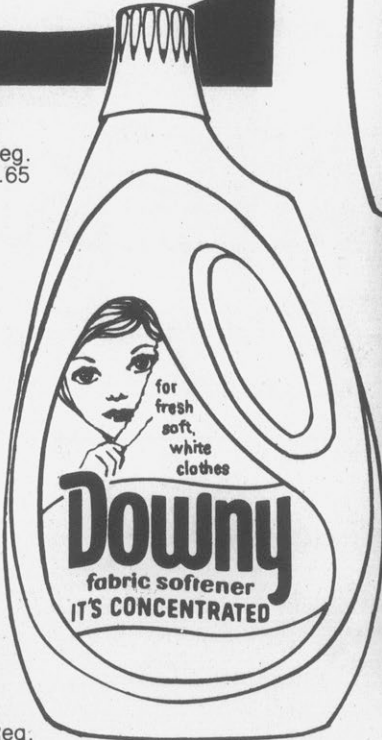

**2.19** Reg. 2.75  
**Downy Fabric Softener**  
 96 oz.

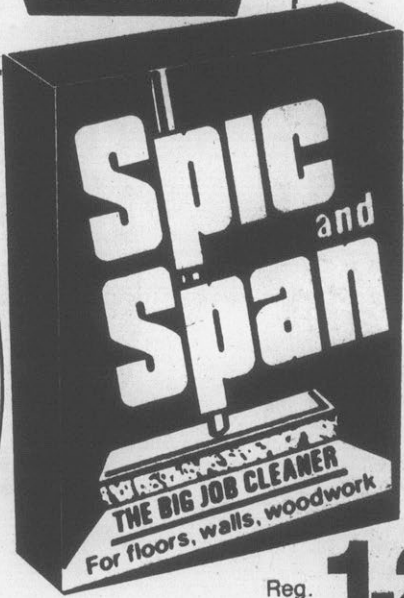

Reg. 1.75  
**1.29**  
**Spic & Span**  
 54 oz.

**69¢** Reg. 1.00

**Dove for Dishes**  
22 oz.



Reg. 1.50 **99¢**

**Mr. Clean**  
28 oz.

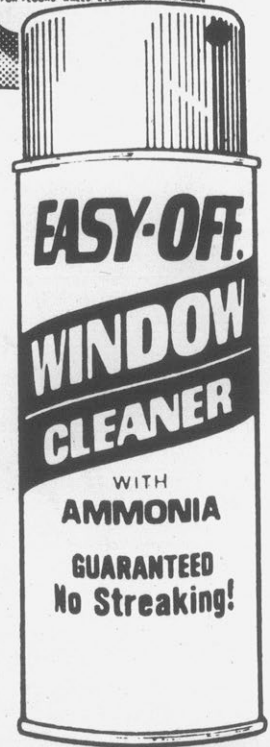

**88¢** Reg. 1.15

**Wizard Owl**  
They'll never know it's  
an air freshener.

**99¢** Reg. 1.50

**Top Job**  
With ammonia. 28 oz.

Reg. 80¢ **66¢**

**Easy Off Window  
Cleaner 18 3/4 oz.**

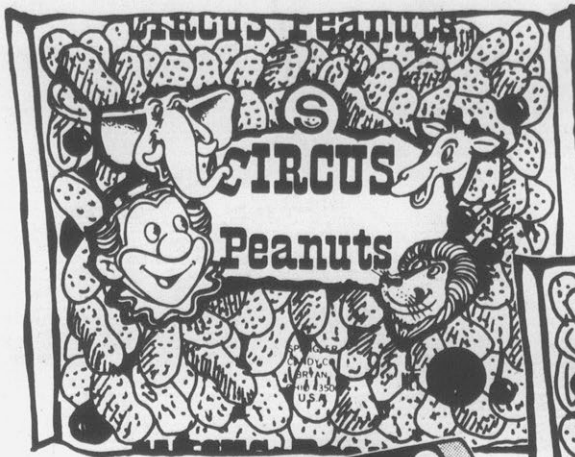

your choice  
**49¢**

Spangler's Circus Peanuts (10 oz. bag)  
 or colored Circus Peanuts (9½ oz. bag)  
 Marshmallow circus peanuts.

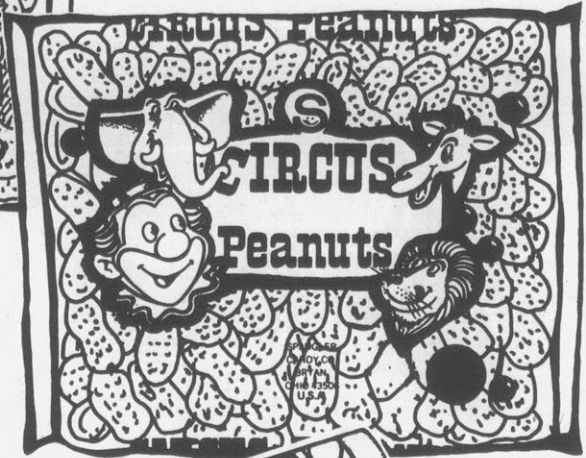

**10 for 90¢**  
 Smiles Candy Rolls  
 Mix and match your  
 favorites. Assorted flavors.

**PHOTO  
 COUPON**

Color print film  
 developing & printing

**2.19** up to  
 12 exp.

**3.19** up to  
 20 exp.

35mm  
**3.49** up to  
 24 exp.

Beautiful borderless color  
 prints. Good on Kodak or  
 Kodak competitive film.  
 Coupon must accompany order.  
 Coupon expires 6/6/79.



**9.99** Reg. 13.50  
**Bissell Zoom Broom**  
 Lightweight. Easy and convenient to use for quick pick-ups. Removeable dust pan.



**1.79** Reg. 2.10  
**Bissell Rug Shampoo**  
 32 oz.  
 1/2 gal. size Reg. 3.85 ..... 3.49

**1.99** Reg. 2.25  
**Bissell Upholstery Shampoo Kit**  
 14 oz. aerosol shampoo with reusable sponge brush applicator.

# Paints



**5.50** Reg. 8.95  
**Carefree exterior latex house paint**  
 Ideal for wood or masonry. Easy soap and water clean-up. Gal.



**4.75** Reg. 6.95  
**Dripless flat wall paint**  
 For wall and ceilings. Easy to apply, dries quickly. Soap and water clean-up. Gal.

**3.50** Reg. 5.95  
**White latex ceiling paint**  
 Covers in one coat. 1 hour drying. Soap and water clean-up. Gal.

**3.50** Reg. 5.20

**Bondex joint cement**  
1 gal. Easy sanding.  
Smooth seams.



**1.50** Reg. 1.89

**Tile grout**  
6 oz. tube. Ready to use, starts white, stays white. Resists shrinking, cracking, staining and mildew. E873



**95¢** Reg. 1.50  
**Sanding block**  
H131



**85¢** Reg. 1.20

**Joint tape**  
75 ft. Excellent for reinforcing all board joints. Angle silvered for adhesion and strength.



**3.50** Reg. 5.00  
**Brass finished Nite Latch**  
Brass cylinder. Standard American. Keyway, 2 brass keys and 5 pin tumbler. H67



**95¢** Reg. 1.35  
**Krazy Glue**  
.07 oz. Works on glass, metal, rubber, china and many other materials. 200BK



**75¢** Reg. 98¢  
**Peghook assortment**  
52-pc. set of sturdy pegboard hooks. H143

# Home improvement

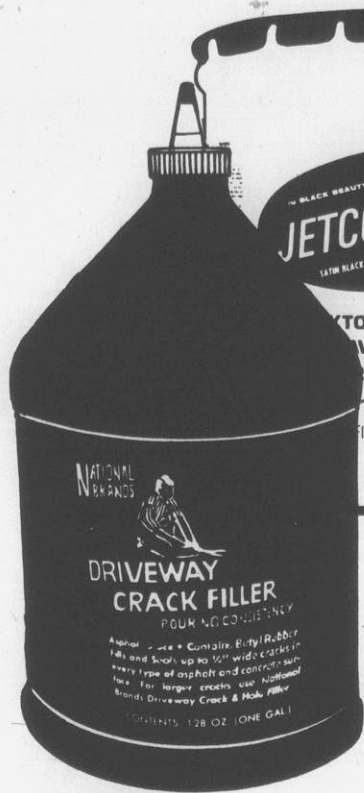

**3.50** Reg. 4.75

**Liquid crack filler**  
1 gal. Squeeze bottle fills and seals hairline cracks up to 1/4" wide. Fills approx. 15 ft. of 1/8" cracks. CFL-1

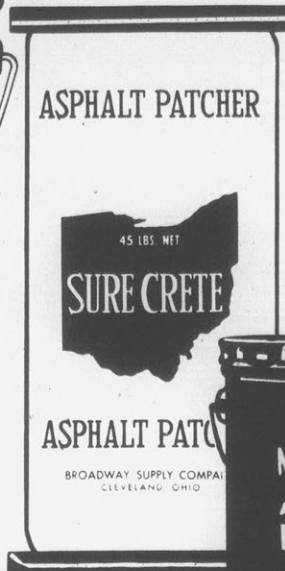

**6.95** Reg. 9.25  
**Jetcoat 727 blacktop sealer**  
Provides driveway with water resistant surface. Fills in most surface imperfections. Covers approx. 400 sq. ft. JCH-5

**2.95** Reg. 3.75  
**Black top patch**  
45 lbs. Quick setting patch for large potholes in drives and walks. Waterproofs and is self airing. BP-45



**1.20** Reg. 1.65

**Macco tub & tile caulk**  
Flexible latex compound. Ideal for sealing and waterproofing around bath tubs and sinks. TC-10

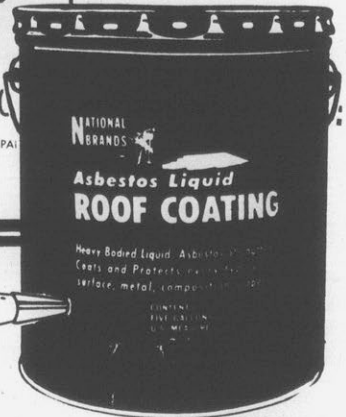

**6.50** Reg. 8.75

**Roof coating**  
5 gal. Provides an new protective surface to any flat asphalt roof. RC-5

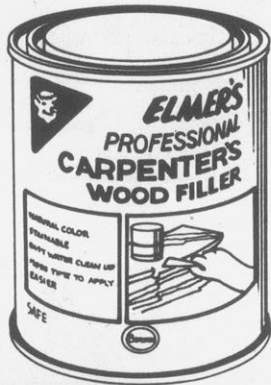

**1.50** Reg. 1.99

**Wood filler**  
1 pint. Can be sanded, drilled, nailed and cut. Accepts all stains and varnishes. Easy water clean up. Non flammable, non toxic. E833



**1.75** Reg. 2.85

**Bondex Quick Plug hydraulic cement**  
3 lb. A fast setting cement used for stopping running leaks. Seals cracks, keeps basements dry.



**1.75** Reg. 2.70

**Spachtling paste**  
1 quart. Ideal for patching small holes and cracks in drywall and plaster. 51084

# Hand tools

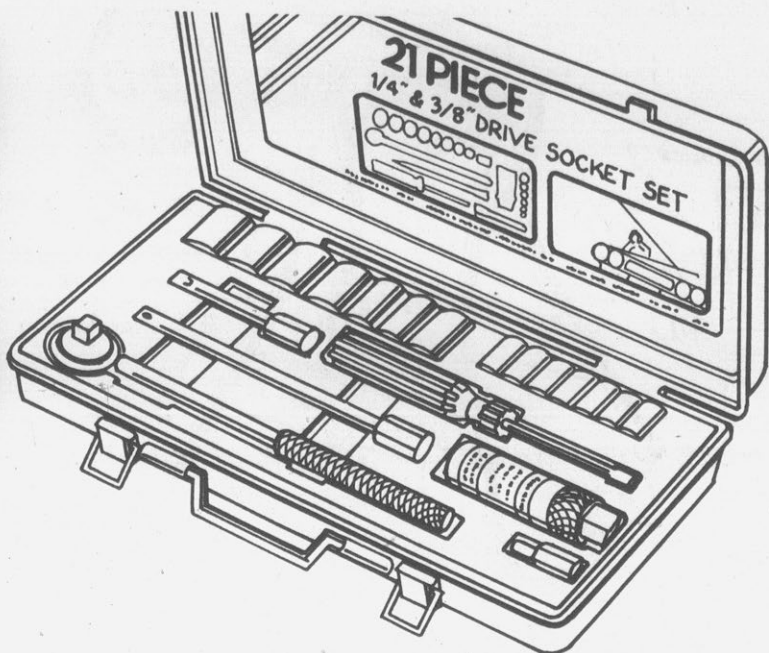

Reg.  
9.99

# 5.99

**21-piece socket set**  
S.A.E. sizes. 1/4" and 3/8"  
drives. Chrome alloy steel.  
T21

**8.65** Reg.  
10.65

### 7" adjustable block plane

For smoothing, trimming. 1-5/8" wide adjustable cutter. 220D

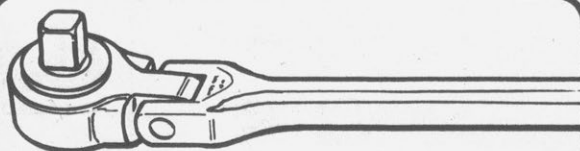
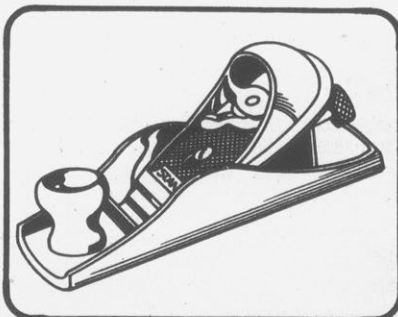

**3.99** Reg.  
5.29

### 3/8" drive flex head ratchet

10 1/2" long. Chrome plated with knurled handle. T206

**3.49** Reg.  
4.59

### 7-pc. wood handle screwdriver set

Ass't. sizes. T199

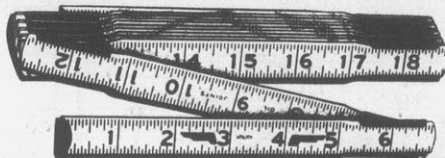
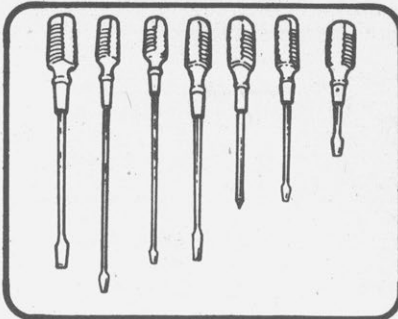

**1.69** Reg.  
2.39

### Durall 6' extension rule

Hard maple, lifetime joints, rustproof. X25C

**DURALL**

**5.99** Reg.  
7.25

### Arrow staple gun

Light duty for household chores. Steel construction, baked enamel finish. Safety handle lock. JT21

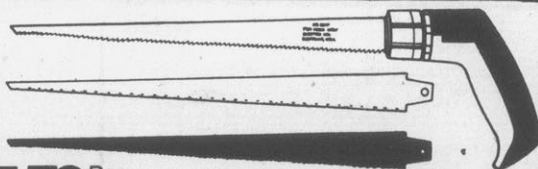
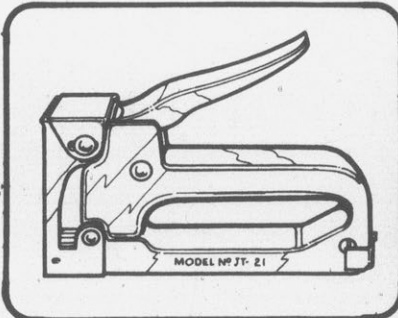

**5.79** Reg.  
7.79

### Disston Twist-n-Lock saw set

Cuts in 12 different positions. Easy blade change. Set includes handle, rip, crosscut and metal cut blades. 101

**DISSTON**

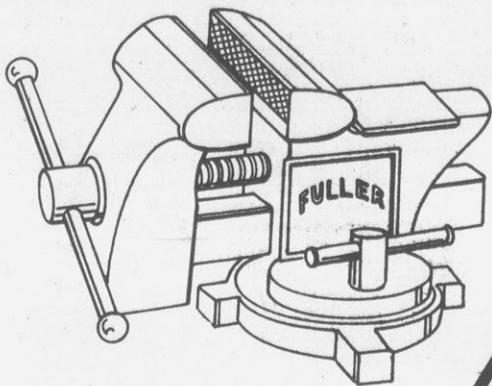

**6.47**

Reg.  
8.47

**3½" bench vise**  
11½ lbs. Made of unbreakable ductile steel. Replaceable hardened faces. Permanent pipe jaws. Swivel base. 1773



Reg.  
47.99

**38.99**

**Black & Decker Workmate**  
Single height base of sturdy steel. Folds for easy storage.

**your choice**  
**9.99** Reg. 13.59  
**True Temper cutter or pick mattocks**  
5 lb. head. Cutter - 16" in length. Pick - 19" in length.  
Handles available.

**8.99**

Reg.  
12.39

**True Temper boys' axe**  
Long handled sports axe for light chopping. Fire engine red poll.

**TRUE TEMPER.**

**8.99**

Reg.  
12.29

**True Temper axe with sheath**  
Sturdy forced steel with a keen cutting edge and 14" fire-hardened handle.

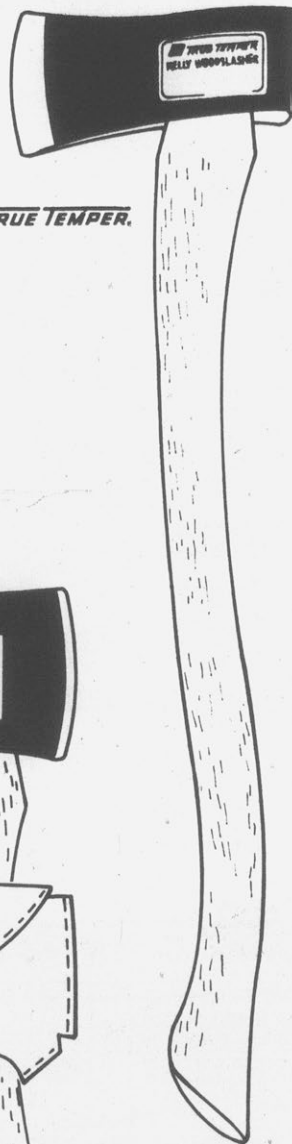

**1.29** Reg. 1.75  
**Saw horse bracket**  
Use with 2x4's.

**TRUE TEMPER.**

**24.99** Reg. 31.00  
**One Ton Power Pull**  
1 ton capacity winch/puller. Safety tested, built for rugged service. Operates in any position. 144S-6

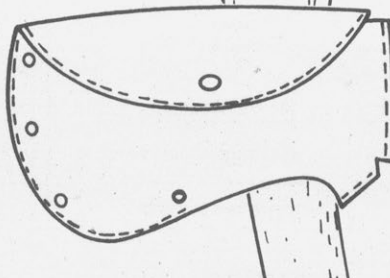

# Electrical

**16¢** Reg. 23¢  
 ft. 23¢  
 12/2 UF with ground  
 12 gauge/2 wire.  
 Underground wire for  
 direct burial. NEMA  
 and UL approved.

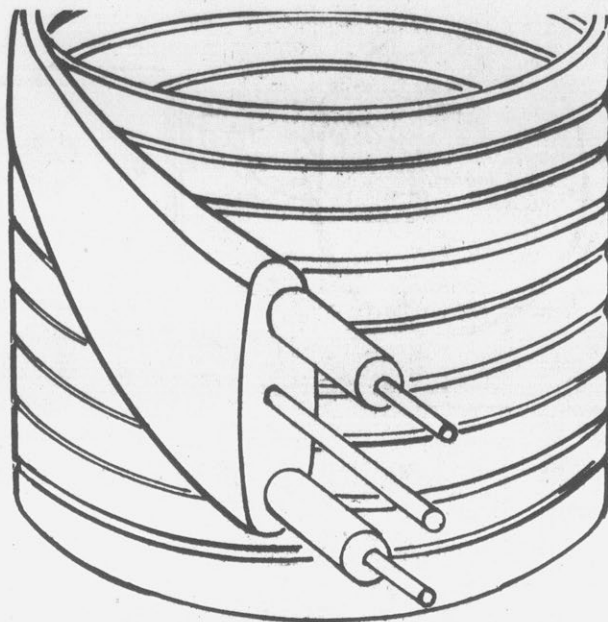

**3.79** Reg. 4.99

**Outdoor stake light**  
 Includes 6' cord,  
 weatherproof adjustable bracket.  
 Die cast. (Bulb not incl.)  
 PAR 22/3

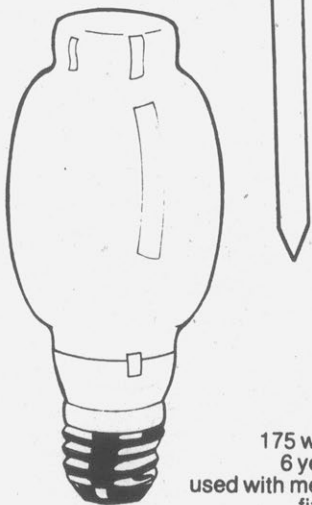

Reg. 1.99 **1.49**

**Flood bulb holder**  
 Cast aluminum with gasket.  
 Fits any medium base outdoor  
 flood bulb. 1/2" threaded  
 connection with locknut.



Reg. 12.75 **9.75**

**Mercury vapor bulb**  
 175 watt replacement bulb.  
 6 year average life. To be  
 used with mercury vapor ballasted  
 fixtures. H39KC-175DX

**1.99** Reg. 2.45  
**Weatherproof  
 outlet box.**  
 11T11-1

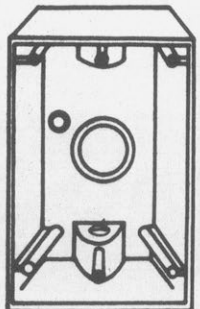

**1.49** Reg. 1.99  
**Weatherproof  
 outlet cover**  
 1181-C

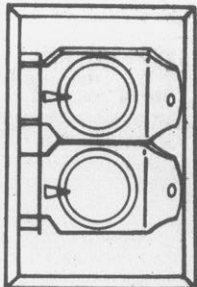

**1.99** Reg. 2.55  
**Weatherproof  
 single pole  
 switch**  
 11W1

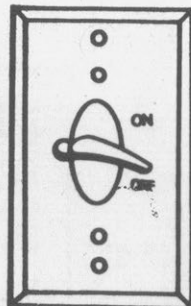

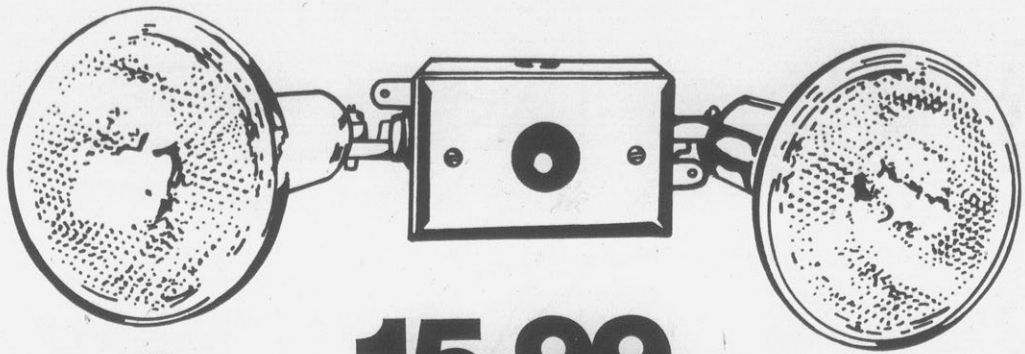

**15.99** Reg. 19.99

**Dusk to Dawn security light**  
Photoelectric cell turns lights on and off automatically. Adjustable lamp holders. (Bulbs not incl.) TL200

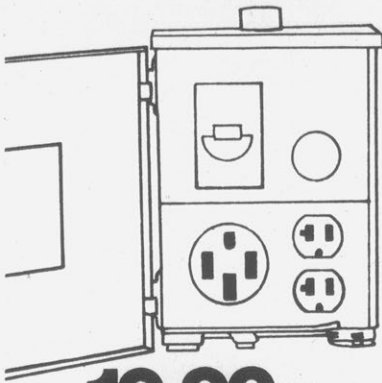

**19.99** Reg. 25.69

**Trailer electric box**  
For mobile homes and recreational vehicles. 50 amp capacity. 125/250 volt. Ground: 20 amp/125 volt. Duplex.

**13.49** Reg. 17.50

**Rain tight electrical safety switch** 30 amp/250 volt. Fusible. DW-143R

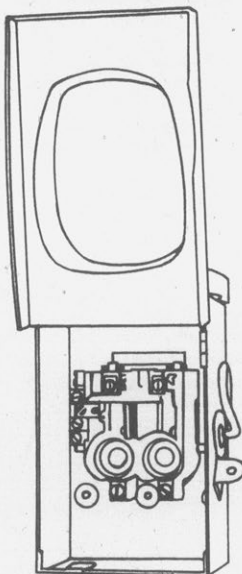

**8.99** Reg. 11.49

**24 hour automatic plug in timer**  
Provides night and day protection for your home while you're away. Multiple on/off programs. D811

**6.99** Reg. 9.75

**Super Cop 24-hour timer**  
Turns on and off lights and appliances automatically at different times each day. D711B



Reg. 33.39 **26.99**  
**Ground fault receptacle**  
Electric code requirement in any area where there is heavy moisture. UL approved. 6198-I

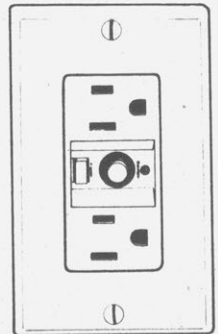

**67.99** Reg. 87.99

**24" vanity**

Features a distinctive marbella top. Easy to assemble. White. (Faucet not incl.) V24E

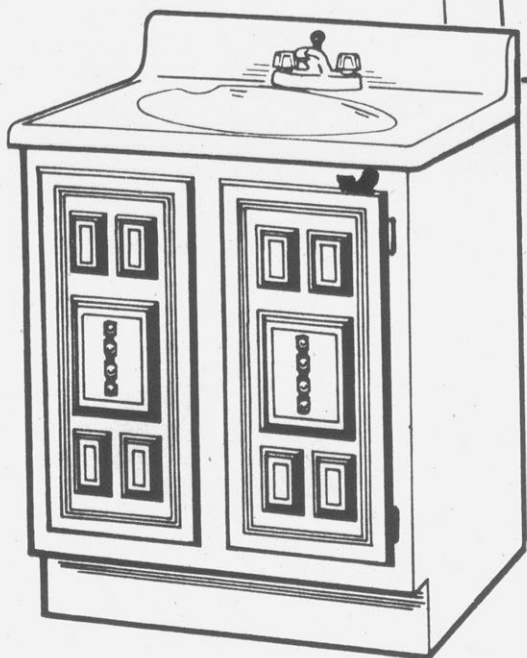

Reg. 42.99 **32.99**

**Decorator color toilets**

Vitreous china in gold, blue, sand and avocado. Includes ballcock. (Seat not incl.)



**Plumbing**

Reg. 5.65 **3.99**

**Toilet seats**

Baked enamel. Wood composition. Top mount hinges. Assorted colors. M100

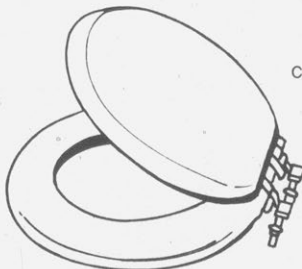

Reg. 14.99 **9.99**

**4" x 10" schedule 40 pipe**

Polyvinyl chloride for drain, waste and vent. Accepted by F.H.A. Approved by B.O.C.A. 70041

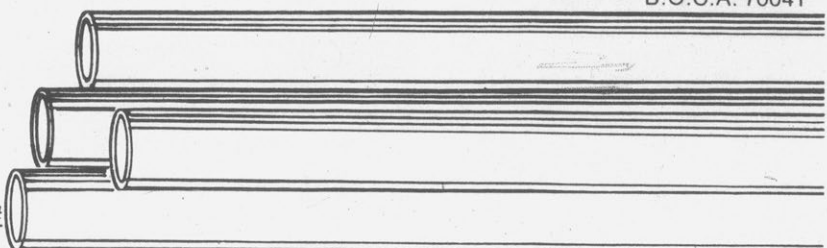

Reg. 3.89 **2.89**

**1 1/2" x 10' schedule 40 pipe**

Polyvinyl chloride for drain, waste and vent. Accepted by F.H.A. Approved by B.O.C.A. 70011



your choice

**1.79** Reg. 2.49

My-Ro tub 'n floor crack seal (1 1/2" x 5 1/2" cove - 30), seal 'n wall cove (2" x 72" - 20) or seal-a-crack tub 'n wall (15" x 3/4" with 2 corners - 15)

**PEERLESS FAUCET**



**34.99** Reg. 42.00

Peerless washerless tub and shower faucet Two handle bath valve. Shower head and tub filler with diverter. 5 year warranty. 9730

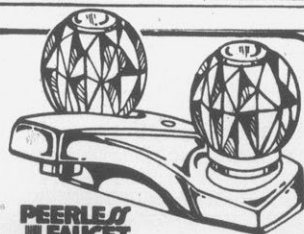

**PEERLESS FAUCET**

**18.99** Reg. 25.75

Peerless washerless lavatory faucet 2 handle, clear duralac knobs. No drip. 5 year limited warranty. 9620

# Lawn & garden

**Turco**  
MANUFACTURING COMPANY



**88.00** Reg. 99.00

**Turco 30,000 BTU Gas Grill**  
Stainless steel hemmed single burner. 268 sq. in. cooking surface. Heavy duty nickel chrome plated cooking grid. 20 lb. LP tank. 4900

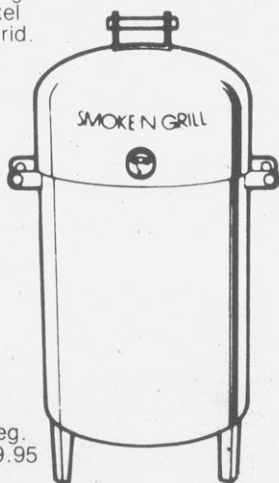

**39.99** Reg. 49.95

**Charcoal smoker grill**  
Double grill. 50 lb. capacity. Roasts or barbeques. Black finish. 5201

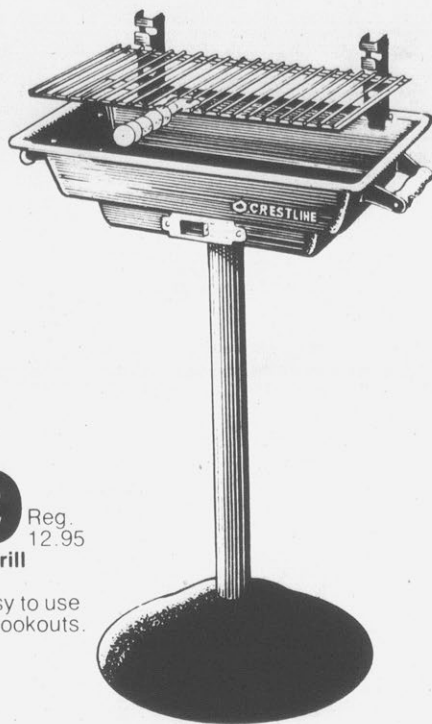

**9.99** Reg. 12.95

**Crestline hibachi grill**  
Comes with stand. Convenient and easy to use for those summer cookouts.

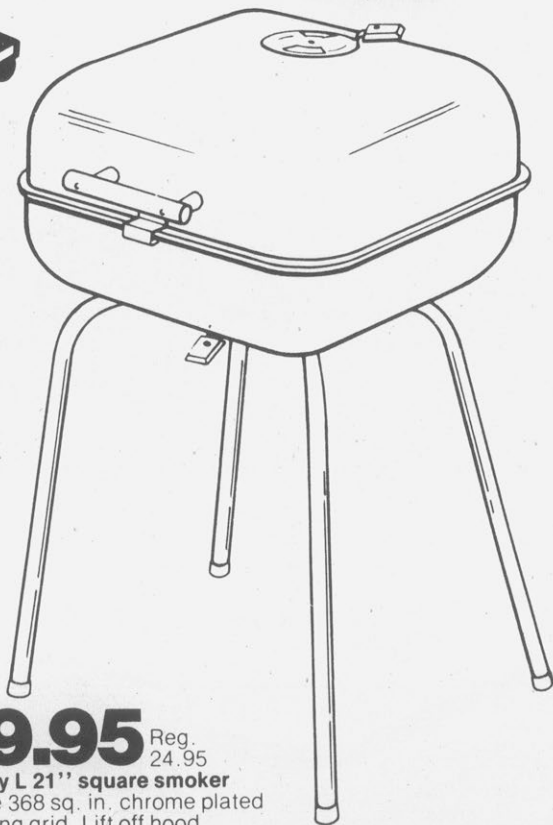

**19.95** Reg. 24.95

**Buddy L 21" square smoker**  
Large 368 sq. in. chrome plated cooking grid. Lift off hood. Hangs on side when not in use. 21" L x 36" H x 25" D. Black finish. 8008

**27.77** Reg. 34.95

**Macon table umbrella**

Maconized aluminum pole, guaranteed rust proof. Touch-a-matic tilting device. 6½ ft. spread. Nylon and vinyl laminate. Floral pattern inside, solid color outside. (Stand not incl.). 606

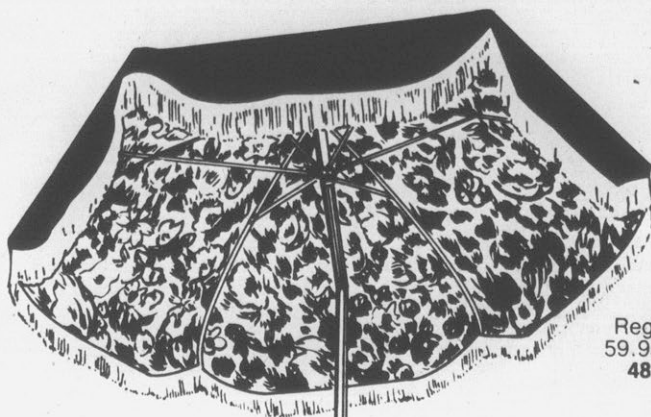

Reg. 59.95 **47.88**

**48" octagonal umbrella table and benches**  
Table measures 48" dia. x 30"H. Benches measure 2'Lx11½"Wx17"H. Redwood stained. Made of 2" stock lumber. (Umbrella not incl.) 8190-4

**12.88** Reg. 14.95

**Director's chair**

Comfortable. White metal frame with yellow, green or orange cover. 30W



12.88

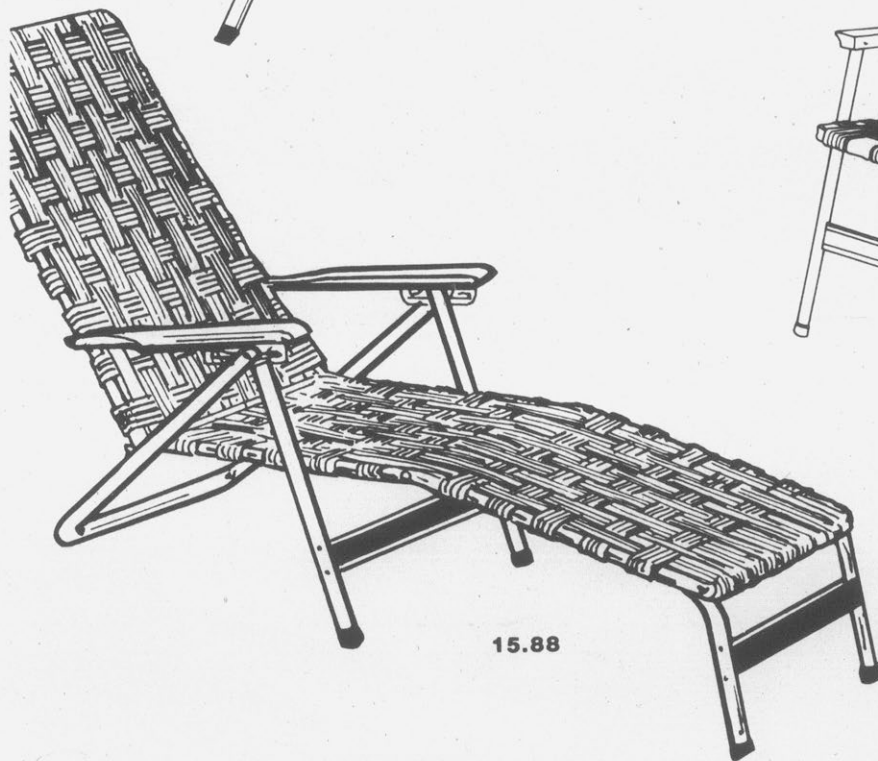

15.88



11.88

**11.88** Reg. 13.95

**Folding chair**  
Measures 37"H x 26"W. Multi-colored webbing. Aluminum tubular frame and hardwood arms. F62

**15.88** Reg. 19.95

**Chaise lounge**  
Measures 76"L x 28"W. Multi-colored webbing. Aluminum tubular frame and solid hardwood arms. F62

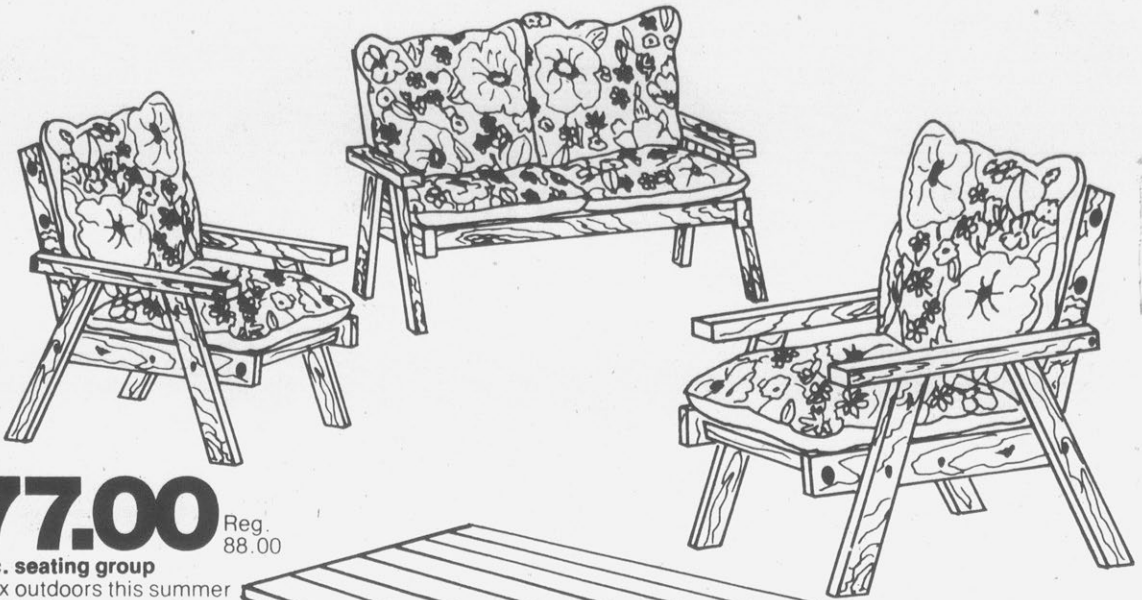

**77.00** Reg. 88.00

**3-pc. seating group**

Relax outdoors this summer with this 3 pc. redwood stained set. Includes settee and 2 chairs. Bright floral cushions. 987



**29.99** Reg. 39.95

**6' picnic table and benches**

Rustic, heavy duty and redwood stained. Made from 2" stock lumber. Table measures 29½" Wx 72" Lx30" H. Benches measure 11½" Wx72" Lx17" H. 8150-6

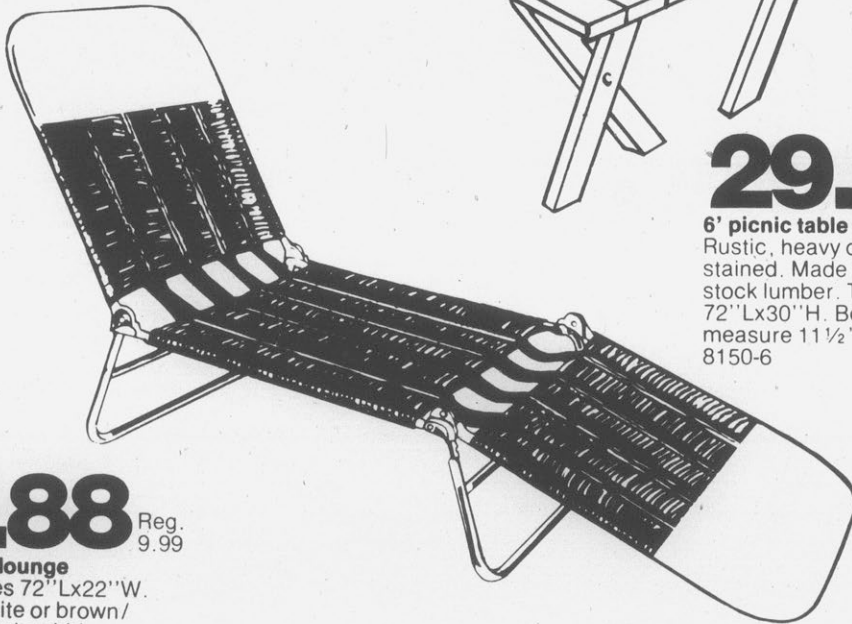

**8.88** Reg. 9.99

**Folding lounge**

Measures 72" Lx22" W. Mint/white or brown/white vinyl webbing.

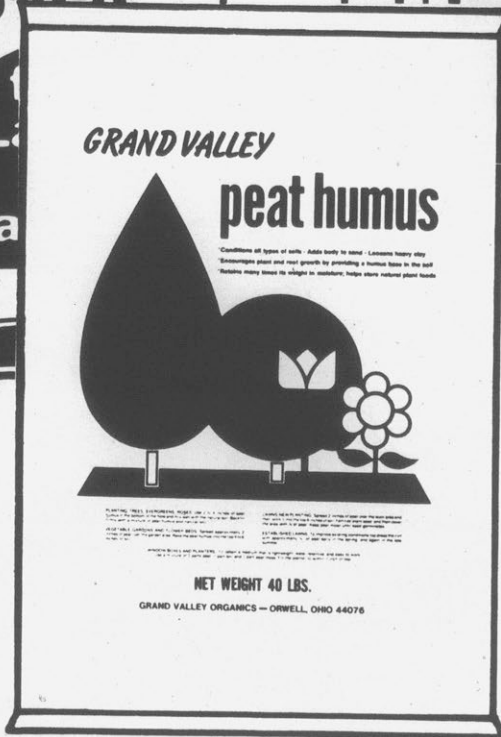
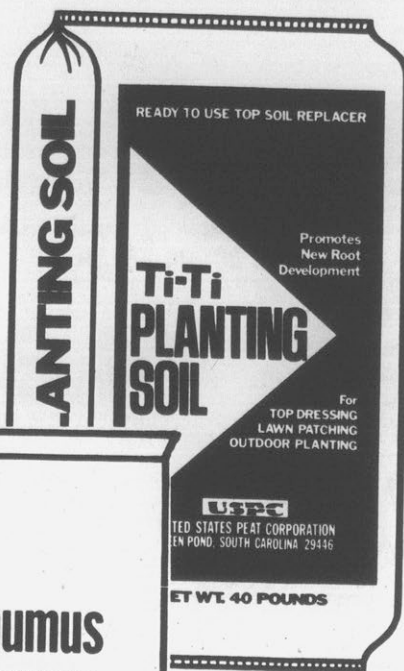

**2.66** Reg. 2.99  
**Swift 8-8-8 fertilizer**  
 For lawn and garden.  
 703868

**99¢** Reg. 1.15  
**Top soil**  
 40 lb. bag. A peat moss and sandy loam composted blend. Ideal for new plantings.

**99¢** Reg. 1.15  
**Peat humus**  
 40 lbs. For lawns, gardens, greenhouses and potted plants.



# Automotive



**4.89** Reg. 5.79  
Lever grease gun  
7091

**7.39** Reg. 13.00

2 ton hydraulic jack  
A2000  
3-ton hydraulic jack (A3500)  
Reg. 19.25 ..... 11.88  
5-ton hydraulic jack (A5000)  
Reg. 23.00 ..... 14.88  
8-ton hydraulic jack (A8000)  
Reg. 27.95 ..... 22.88

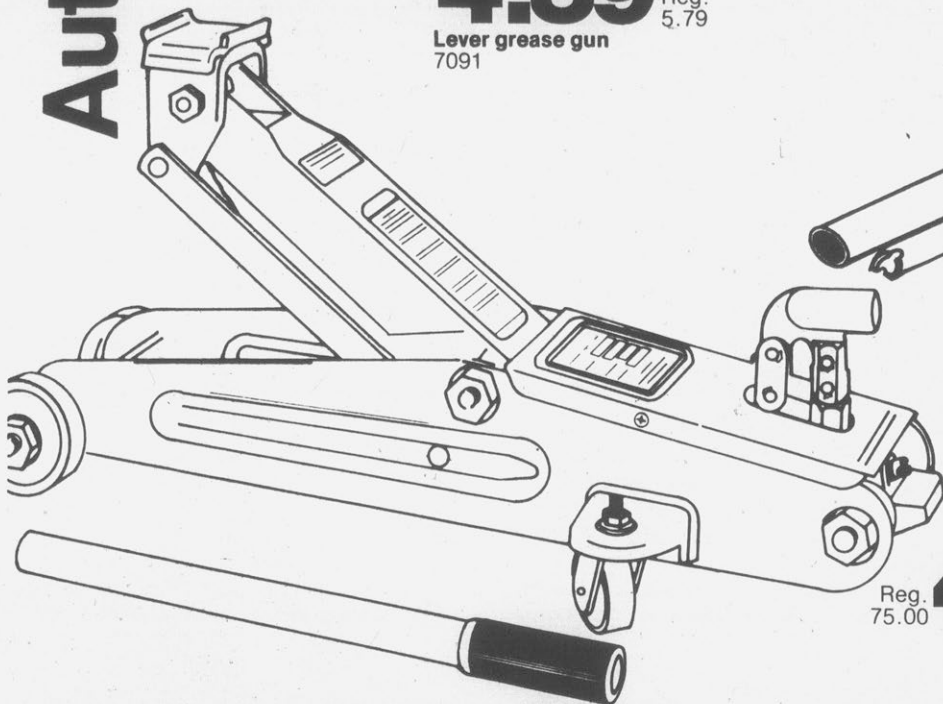
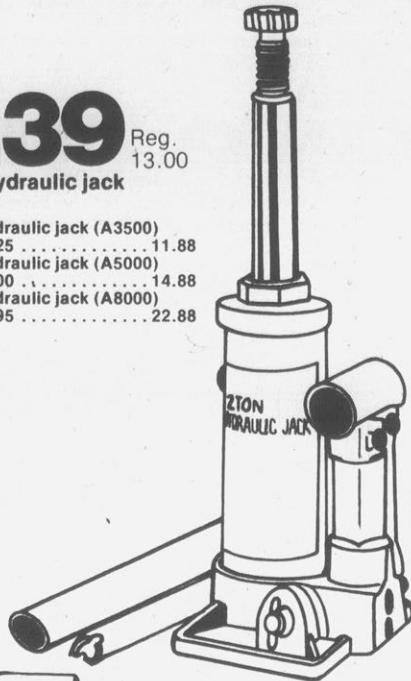

Reg. 75.00 **49.85**  
1 1/2-ton floor jack  
Sturdy steel construction.  
A3001



**3.99** Reg. 6.44  
Auto air conditioner  
recharge and leak  
detection kit  
Easy to use. Will service  
all auto air conditioners. ARD-6



**98¢** Reg. 1.20  
Snap brake fluid  
S-262

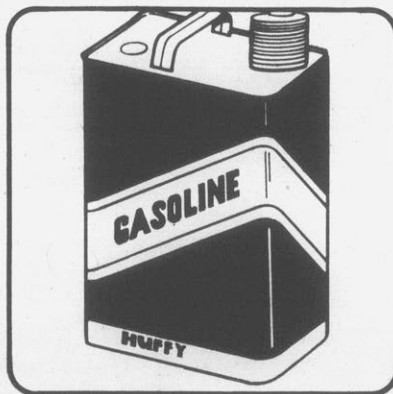

**2.49** Reg. 3.50  
2 gallon gas can  
4624

**DUPONT**

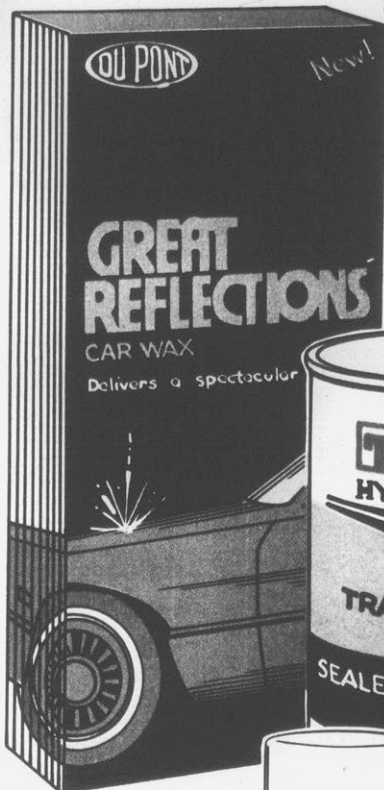

**4.75** Reg. 5.80  
**DuPont Great Reflections Car Wax**

**5.99** Reg. 7.49  
**Vinyl Top Renew**  
Everything you need to make your car's vinyl top look new again. Black, white or blue.



**39¢** Reg. 53¢  
**Tradco Transmission Fluid 1 quart.**

**99¢** Reg. 1.55  
**Gumout Jet Spray**

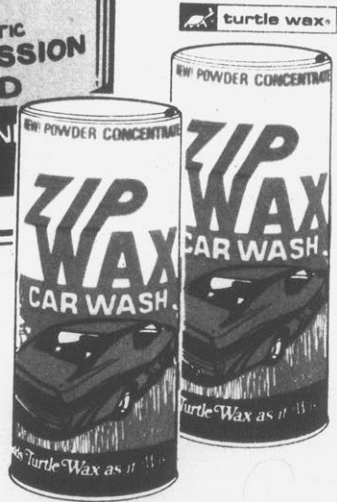

**1.15** Reg. 1.39  
**Turtle Wax Zip Car Wash** Get a wax while you wash.

**2.00** Reg. 2.50  
**Starbrite Vinyl Brite**  
New life for old vinyl tops and interiors. Restores color and softness.



## Starbrite Sweepstakes



**WIN!**  
**Grand Prize!**  
A 1979 Mercury Bobcat!

**WIN!**  
•30 Second Prizes: Digital watch  
•50 Third Prizes: Calculator with case  
•150 Fourth Prizes: Starbrite gift pack

No purchase necessary and you need not be present to win. Licensed drivers only may enter. Contest will end June 1, 1979 and a random selection from all entries will be used to select winners. Cook United Inc. and Starbrite employees and their families are not eligible. Sweepstakes void where prohibited.

Name \_\_\_\_\_  
Address \_\_\_\_\_  
City \_\_\_\_\_ State \_\_\_\_\_  
Phone \_\_\_\_\_ Zip Code \_\_\_\_\_



# CLARKS

## Managers Outdoor **sale**

**45.88**

Reg.  
70.95

**Clam Shell Top Carrier**  
Designed for your traveling  
convenience. 736

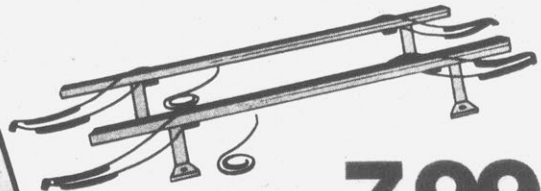
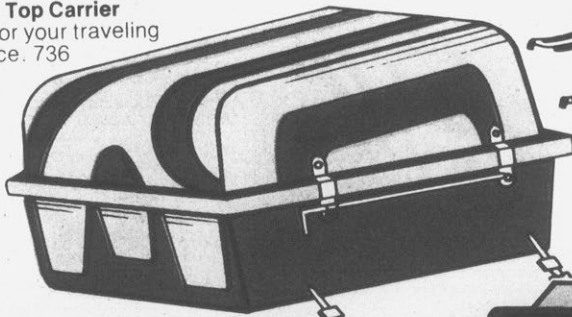

Reg.  
11.35

**7.99**

**45'' steel carry bars**  
Mounted on steel feet.  
Complete with adjustable  
lashing straps. Fits all  
cars with or without raingutters.

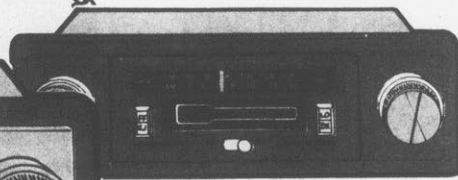

your choice

Reg.  
79.95

**64.85**

**8-track in-dash AM/FM stereo (SR200) or  
cassette in-dash AM/FM stereo (SR300)**



**4.99**

Reg.  
6.70

**Rubber Queen Textura**  
2-pc. rear car mats

**5.99**

Reg.  
8.95

**Rubber Queen Textura**  
2-pc. front car mats



**1.75**

Reg.  
2.15

**Westinghouse headlamps**

A name brand you can count on.  
Model no. 6014

