

# Weather

Clear tonight, variable cloudiness Thursday. Lows tonight mostly 40s, Thursday highs in low 70s.

# THE DAILY REFLECTOR

INSIDE READING  
Page 7 — The Assembly  
Page 15 — Opportunity in open door  
Page 33 — How they voted

98TH YEAR NO. 69

GREENVILLE, N.C.

TRUTH IN PREFERENCE TO FICTION

WEDNESDAY AFTERNOON, MARCH 21, 1979

7 SECTIONS—82 PAGES

PRICE 15 CENTS



## Spring Meets Deadline

SPRING IS HERE — Spring finally arrived today with a warm welcome from Pitt County citizens. Jay Deonna, of Haddenfield, N. J.,

makes use of the spring-like day on the Town Commons on First Street. Temperatures were expected to be in the lower 70's today. (Reflector Photo by Tommy Forrest)

## Schools' Calendar Decisions Put Off

By JERRY RAYNOR  
Reflector Staff Writer  
Action on the school calendar for school year 1979-80 has been deferred until April. The calendar, scheduled for adoption at the March action meeting of the Greenville Board of Education, called for a first pupil full day on Wednesday, August 29, 1979 and a final/graduation date of Tuesday, June 10, 1980.

At the continuation meeting Tuesday night of the Monday night recessed school board meeting, school board members directed

Superintendent Glenn Cox to prepare a second calendar, one that would give a final day/graduation date of Friday, June 6.

Among possible rearrangements available to shorten the calendar are: beginning school one or two days earlier, shortening the week-long Easter holiday, or reshuffling one of days designated as teacher work day/student holiday.

Also delayed until the April meeting was action on considering an off-campus lunch hour for students at Rose

High. This was due to the fact that students could not attend last night's meeting to provide input due to activities they were already committed to.

A bid of \$21,617 was awarded to Howard Williams Roofing Company of Greenville for phase 2 of roof repairs and resaturation at Rose High School. The overall project has a base bid of \$19,450; a design fee of \$1,167; and contingency fee of \$1,000. Two other bids were received on the roofing project, one from Lan-Way Contractors, Inc. at \$28,450; and Service Roofing & Sheet Metal Co., \$22,500.

North Carolina National Bank (NCNB) was approved as the bank for the 1979-1981 Systemwide Funds Depository. One member, Miles Frost, abstained from voting, citing a conflict of interest. Cox said five local banks had submitted bids for the service. "It boiled down to two banks on which no substantial difference existed on services offered," Cox said. The bid policy calls for the board to make a judgement in case of two or more banks offering identical services.

The accounting firm of John C. Proctor & Co. was approved as the auditing firm for the accounts of the city schools. The contract for the 1978-79 funds is for a fee of \$4,300.

The lingering question of the format for agendas of the two scheduled monthly school board meetings was resolved.

(Continued on page 18)

## Profit Report Stirs Dismay

WASHINGTON (AP) — The government's report that business profits increased a whopping 26.4 percent last year is heating the already fiery debate over the effectiveness of the nation's efforts to stem inflation.

"We will take steps to deal with it," promised President Carter's principal assistant, Hamilton Jordan.

"Profits data cannot be used as a scapegoat for bad government policies that are

causing inflation," countered Chamber of Commerce economist Jack Carlson.

AFL-CIO President George Meany, one of the harshest critics of the president's anti-inflation program, was expected to give his views today on the profits report.

The focus of the debate is the Commerce Department's Tuesday announcement that before-tax profits during the fourth quarter of 1978 were at an annual rate of \$225.3

billion, a gain of \$19.9 billion over the third quarter and \$47 billion or 26.4 percent over the final three months of 1977.

After-tax profits rose \$26.3 billion against the previous fourth quarter, an increase of 25.2 percent.

The increase in both before-tax and after-tax profits was the largest since 1950.

(Continued on page 3)

## Indicative UNC Board 'Bypassed'

RALEIGH, N.C. (AP) — A Department of Health, Education and Welfare official apparently bypassed University of North Carolina officials and went directly to a legislator in a push for a compromise over UNC's desegregation plan.

A legislative appropriations committee chairman raised the possibility Tuesday of spending \$60 million to \$80 million to help upgrade the five predominantly black colleges in the system, apparently at the suggestion of the official, who was not identified.

Sen. Jim Edwards, D-Caldwell, asked UNC President William C. Friday Tuesday what his reaction to such a plan would be and Friday said, "It would have to be written down somewhere and signed."

Friday said if the legislature approved \$60 to \$80 million in new expenditures for the black campuses, he doubted that it would be willing to spend any more money on the remaining 11 campuses in the UNC system.

He said that HEW secretary Joseph Califano wants North Carolina to spend \$120 million over the next six years to upgrade

the black campuses. The state proposed spending \$21 million over four years, he said. Edwards' caller suggested spending \$60 million to \$80 million over eight years.

Edwards is chairman of the Senate Appropriations Committee on Education, before which Friday appeared Tuesday.

Edwards said the legislature might be able to appropriate the compromise amount if such an action would avoid a court suit.

Edwards said the contacts prompted him to question Friday when he appeared before the panel.

He said the HEW representative hadn't informed university system officials or Gov. Jim Hunt's office of the new strategy.

Friday said he did not know of the direct appeal to Edwards until the committee meeting. He declined comment on the calls to Edwards, saying he didn't know what the calls might mean.

Edwards said he thought HEW realized that the legislature, not the university administration, controls the purse strings.

"I just think HEW

(Continued on page 3)

## Officers Are Elected At Memorial Hospital Meeting Of Trustees

By CAROL TYER  
Reflector Staff Writer  
New officers were chosen last night for the Pitt County Memorial Hospital Board of Trustees.

Elected by acclamation were G. Henry Leslie as chairman; James T. Cheatham III as vice chairman; Ephraim Smith as secretary; Norfleet Sugg as treasurer; and Mildred Indorf as assistant treasurer.

Named to the executive committee were the chairman, vice chairman and secretary, plus Glenn Strickland, Billy Phillips, Albert C. Martin and Dr. John L. Wooten.

Thomas J. White Jr. was welcomed as a new appointee. A Kinston attorney, he is a UNC appointee.

Reappointed were Albert C. Martin and Harvey E. Beech, both of Kinston. Based on a charter revision of some time ago, the board is gradually being shrunk in size to 20 members. The membership now stands at 24.

Recognized as retiring members were Mrs. Martha Walston, with three years service, and Otis Stokes, Roscoe Bell and Eugene James, each with 12 years service, the maximum any board member can serve.

The Board heard a presentation by John Larson of Howell, Larson and Associates Health Care Consultants, a Virginia firm that has spent some months compiling "a blueprint for fulfilling the future role of Pitt County Memorial Hospital as a regional medical center."

The study was accepted by the board, with one nay vote, that of Mildred Indorf, who expressed indignation, saying that she had believed, upon reading the report, that it was a rough draft, because it is, in her opinion, so poorly written.

Approval was given for Hospital Director Jack Richardson to accept a hospital administration resident from the Medical College of Virginia to begin work here in August. This residency program would cost the hospital about \$12,000 a year,

he indicated. \$2,000 was approved for the cost to be incurred during this fiscal year, which ends Sept. 30.

Finance Committee Chairman Norfleet Sugg said the hospital's net income is running \$251,000 over budget so far this year. He praised Finance Officer Warren McRoy's money management, saying all excess funds are earning money. He asked for and received approval for the retention of Michael

Grady of Lowrimore Warwick and Company accounting firm here at a cost of \$40 per hour, not to exceed 45 hours, to review hospital finance reporting procedures and forms "to see if the finance committee is receiving the best possible information on which to base management decisions."

Several board members expressed indignation at the

(Continued on page 18)

## Education Officials Tour Local Schools, See Improvement Needs

By STUART SAVAGE  
Reflector Staff Writer

The chairman of the State Board of Education, Dr. David Bruton, and the State Superintendent of Public Instruction, Dr. Craig Phillips, visited schools in Greenville and Pitt County today as part of a three-day visit to Eastern North Carolina.

The officials attended a breakfast meeting with Greenville Board of Education members, city school principals and members of the city's central office staff, then toured the Greenville Middle School and Farmville Central High School where they talked with staff and students.

At the breakfast session, Bruton and Phillips responded to questions and asked questions. The topics ranged from energy costs, and capital needs to bond issues, and reading programs, and maintenance.

Phillips said, "We're out visiting...to look first hand at what needs to be done."

He added that by visiting local school systems, talking with administrators, teachers and students, and seeing facilities at the grass roots level, "we can do a better job."

Bruton said the tour started Sunday with a visit to Ocracoke, and has included

(Continued on page 3)



ON SCHOOL TOUR ... Greenville Board of Education chairman Ed Carter and city school superintendent Glenn Cox talk with State Board of Education

chairman Dr. David Bruton and State Superintendent of Public Instruction Craig Phillips following breakfast meeting this morning.

## Exemptions To Open Meetings Law Pushed

By WILLIAM M. WELCH  
Associated Press Writer

RALEIGH, N.C. (AP) — Pleas by local governments and the Council of State for more exemptions in open meetings legislation would only weaken the proposed new law, representatives of the state's newspapers and broadcast stations told a Senate panel Tuesday.

The House-passed measure that would revise the state's open meetings act is now before the Senate Judiciary III Committee, and was the subject of a public hearing Tuesday.

"If we ask everybody who's covered by this bill if they favor open meetings, they'd say 'yes, but we don't want our meetings to be covered by the law,'" Wade Hargrove, attorney for the N.C. Association of Broad-

casters, said. "On the close calls, I hope you'll opt for openness."

The bill was generally praised during the sparsely-attended session, but lobbyists for the N.C. Hospital Association, the N.C. League of Municipalities and the N.C. Association of County Commissioners each asked for broader exemptions that would allow their groups to meet in secret.

"We all want to get with the times and have government in the open," said W.C. "Buck" Harris, representing the hospitals. "However, there are certain areas where in our opinion it is essential that we give protection to certain meetings."

Harris' group is asking for an exemption to allow hospital boards of trustees to vote in secret on disciplining other doctors. The bill

presently allows the boards to discuss the action in private but vote in public.

The bill would strengthen the existing open meetings law, provide certain civil suit sanctions against violations and make more specific the reasons a public board can go into executive session.

Other changes requested by the local governments would allow complete exemptions for taking action to acquire land, and removal of the bill's main sanction. Under that provision, a judge who found that a public board held an illegal secret meeting could order the government to pay legal fees to the plaintiff.

William Lassiter, representing the N.C. Press Association, urged the committee not to comply with a request last week by Secretary

of State Thad Eure that the Council of State be granted a full exemption from the law.

Eure said the elected officials of the council have historically met in secret because they discuss what he said were sensitive matters such as buying and selling of property and emergency appropriations.

"It appears to me the members of the Council of State have not read the bill," Lassiter said. "If the Council of State is made a part of this, there are already provisions to allow them to consider acquisition of property in executive session."

Lassiter asked for removal of a provision added in the House, which requires that a judge find an open meetings violation to be "willful" before he can access attorney fees.

### REFLECTOR

## HOTLINE

752-1336



Hotline gets things done for you. Call 752-1336 and tell your problem or your sound-off or mail it to Hotline, The Daily Reflector, Box 1967, Greenville, N.C. 27834.

Because of the large numbers received, Hotline can answer and publish only those items considered most pertinent to our readers. Names must be given, but only initials will be used. Transcribing is done once a day.

### HOUSE BURNED

The house occupied by Earlene Locke, her brother, Danny Ray Locke, and her son, Jumar, three, burned in late February.

Almost everything in the house was either burned or smoke- or water-damaged. The Lockes are repairing and repainting the house and continuing to live in it, but are in need of furnishings and other household goods for it. The house is located near Dell's Grocery and Grill in the Bell's Fork community off Highway 43 south of Greenville. Danny Locke is a construction worker for Pitt County.

Bell's Chapel Church pastor, Thomas Dixon, says Ms. Locke is a member of his church and he has asked Hotline to appeal for help for her and her brother and son. Contributions may be made in care of the church treasurer: Bell's Chapel Church, Mrs. Mabel Jenkins, treasurer, 306 Collins St., Greenville, N. C. 27834. Gifts also may be sent directly to the Lockes or taken to the house, Rt. 2, Box 195-A, Greenville. Inquiries may be made by calling a neighbor, 756-0133.

Sizes of the family members as follows: Earlene, women's 14; Danny Ray, 32 long pants and medium shirt; and Jumar, boys' size four.

# The Little Girl Image Doesn't Work Any More

**By BRUCE MEYER**  
**United Press International**  
 For some reason, it's always a surprise when a child star grows up. It's a natural enough thing to happen, of course; it happens to all of us. But for millions of movie-goers, Shirley Temple will always have golden curls and a bow in her hair — and Judy Garland will never grow out of those ruby slippers. Musicians don't get age-cast as readily as movie stars, but the pattern is similar. It took a lot of fans years to figure out that Little Stevie Wonder had grown up. He had acquired the image of a precocious kid and

while that gave him a head start in the business it forced him to prove himself all over again for the audience as he matured.  
 Now Tanya Tucker is going through that same difficult process.  
 Most people will probably remember Tanya as a 13-year-old country singing sensation, a little cutie with a big, powerful voice and stage presence that never failed to startle the audience. Her first record, "Delta Dawn," was a smash and she followed that with a string of impressively sophisticated country hits.

But now she's 20 years old; that little girl image just doesn't work any more. And with her new album, "TNT" (MCA Records), she has declared her independence from her past in a fashion almost as startling as when she first appeared.  
 Tanya Tucker is now a rock 'n' roller — and she's got the skin-tight black leather jeans to prove it.  
 "When I first came to Nashville," she says, "I was real happy to be there. I was 13 and, of course, my roots were in country music. It was all I ever listened to, back home in Wilcox, Ariz. — Jimmy Rogers, Hank Williams. But I went to high school in Vegas and started listening to rock 'n' roll. I liked the way it felt, liked the way I could move to it."  
 Anyone who has seen Tanya in concert can attest to the fact that she moves to it very well indeed. And the new record demonstrates once and for all that she can rock in the studio just as well as she does on stage.



## Engagement Announced

MISS SYLVIA ANN BARRETT... is the daughter of Mr. and Mrs. Floyd Barrett of Rt. 1, Greenville, who announce her engagement to Steven Russell Boyd, son of Mr. and Mrs. Russell Boyd of Winterville. The wedding will take place June 9.

## Pitt Insurance Women Receive Regional Awards

The National Association of Insurance Women, International, Region II, held its 33rd annual conference in Richmond, Va., Friday through Sunday.  
 States represented were North Carolina, Virginia, West Virginia, Delaware, Maryland and the District of Columbia which comprise Region II. The conference was held at the Richmond Hyatt House.  
 The Pitt County Association of Insurance Women was represented by Mrs. Joyce Mills, CPIW, and Mrs. Audrey Stillwell, CPIW, delegate. All Certified Professional Insurance Women were honored at a luncheon Friday and was attended by Mrs. Mills and Mrs. Stillwell. Workshops were held Friday afternoon, prepared by regional committee chairmen. Mrs. Stillwell, region chairman for ACORD prepared an information table and gave a report Saturday morning.  
 Club presidents, past regional directors and national officers were honored at the Saturday luncheon which was also attended by Mrs. Stillwell. Regional awards were also presented. First place in legislation was awarded to the Pitt County women with Mrs. Stillwell accepting for Chairman Sophia Sumner, CPIW. First place in safety was received by the club.

## Miss Murray Entertained

Miss Nancy Ruth Murray, whose marriage to Charles E. Mayo Jr. will take place April 7, was honored at a kitchen shower held last week at the home of Mrs. Wade Jordan.  
 Upon arrival the honoree was presented a white mink corsage. Guests were welcomed and presented to the bride-elect, her mother, Mrs. William M. Murray, and Mrs. Charles E. Mayo Sr., mother of the bridegroom-elect by Mrs. Jordan.  
 A spring basket of jonquils and greenery flanked by two lighted tapers centered the refreshment table.  
 Approximately 20 guests were present for the shower. Hostesses, Mrs. Curtis L. Hardee Sr. and Mrs. Jordan, remembered the bride-elect with a gift.

Produced by the decidedly non-country Jerry Goldstein of Far Out Productions, "TNT" mixes rock standards like Buddy Holly's "Not Fade Away" and Elvis' "Heartbreak Hotel" with some newer material, including a fine version of "Texas (When I Die)," a tune that proves she isn't about to forget her established country audience.

The band is tight and there are a variety of guests on the clean, well-produced album, including John Prine and Seals and Crofts.  
 The whole thing may seem sudden to anyone who was still thinking of Tanya as a kid — but she doesn't see it that way.  
 "It's just a growing experience — I'm growing up in my music. And people that are close to me don't think it's such a drastic change. My stage presence hasn't changed, it's just that now people who buy my records will have a better idea of what I'm like in concert."

There's one good word for Tanya, both on stage and on record: hot. And she still has all the time in the world.

## Rescue Members Give Program

Two members of the Greenville Rescue Squad gave the program at the meeting of the Lake Ellsworth Garden Club held at the home of Mrs. Arlene Kraus. Mrs. Sonia Dickerson was assisting hostess.  
 Capt. D. R. Daniels and D. B. Preast talked on choking, severe bleeding and heart attacks.  
 Mrs. Hilda Weathers presided at the business meeting and reminded members of the silent plant auction to be held by the Greenville Garden Club.  
 Members will hold their Lake Ellsworth annual spring yard and bake sale Saturday, May 5, which will be the club's major project for the spring.



## Daughter Still Needs Mother's Approval

**By Abigail Van Buren**  
 © 1979 by Chicago Tribune-N.Y. News Synd. Inc.

**DEAR ABBY:** My mother lives in another town. She keeps asking me to visit her, but it's such a drag I seldom go, so she comes to visit me.  
 I am 28, female and married. For years I avoided visiting mother because her sister lives in the same town and I always had to go to see her, too. The minute I walked through my aunt's door she would "weigh" me with her eyes, then start in on me about how I should lose some weight. Now my mother has started to do the same thing.  
 Abby, I have tried every diet there is and none has worked. So I've decided to accept myself as I am, and as long as my husband is satisfied, to heck with everyone else!  
 When mother left, she asked when I was coming to visit her, so I wrote her a letter (which I haven't mailed yet) and told her that I would visit her after I shed 50 pounds.  
 Am I being overly sensitive and unable to accept criticism, or am I justified in my feelings of irritation?  
**HEAVY PROBLEM**

**DEAR HEAVY:** Yours is a heavier problem than shedding 50 pounds. It's shedding the role of a little girl who desperately needs mama's approval.  
 I'm sure your mother means well, but she must be told that you are now an adult in charge of your own life, and until she quits treating you as a child, you will not visit her.

**DEAR ABBY:** Karen is my best friend. We are both 15. Karen spends a lot of time at my house. When my father is home, he has a habit of kissing Karen on the lips whenever she arrives and goes home. Do you consider this proper behavior for a 38-year-old man?  
 Also, my father is always trying to get Karen to sit on his lap. Sometimes she does and sometimes she doesn't. I don't know if this is embarrassing to Karen or not. As a daughter it doesn't bother me, but I sure wouldn't want Karen's father kissing me on the lips or asking me to come sit on his lap.  
 What is your opinion?  
**DADDY'S DAUGHTER**

**DEAR DAUGHTER:** I think Karen is a little too OLD to be kissed on the lips by your father. And your father is too YOUNG to have a 15-year-old girl on his lap.

**DEAR ABBY:** About artificial insemination: When a man's sperm count is low and he wants to father a child, why not ask the sperm bank to combine his sperm with the sperm of an anonymous donor? Then when pregnancy occurs from the mixed sperm insemination, there is always the possibility that one of his sperm made it after all!  
**CHUKMAH**

**DEAR CHUK:** Why not, indeed? My insemination experts tell me that technique has been used often.

**CONFIDENTIAL TO "WILMA IN COUNCIL BLUFFS":** Is this the poem?  
 "So many gods, so many creeds,  
 So many paths that wind and wind,  
 While just the art of being kind  
 Is all this sad world needs."  
**ELLA WHEELER WILCOX**

If you put off writing letters because you don't know what to say, get Abby's booklet, "How to Write Letters for all Occasions." Send \$1 and a long, stamped (28 cents), self addressed envelope to Abby: 132 Lasky Drive, Beverly Hills, Calif. 90212.

Spring Fashion Headquarters  
 Sportswear By J.G. Hook Cargo Point Of View  
 Contemporary Styles In Sizes 4 To 16  
**C.H.F.**  
 C. HEBER FORBES  
 Evans Mall—Downtown Greenville

Spring fashion excitement  
 Stop by and see our two new bags for Spring. Lady Bug and Jenie. Our Spring fabrics include Linen & Dotted Swiss.  
 Compare Prices  
 Lady Bug  
 Lady Bug Covers Available in All Sizes & Colors.  
 Complete Monogramming Service Jenie  
**Creative Handbags And Accessories**  
 West End Shopping Center-756-5685 Next To Sears

## Homemaker's Haven By Addie Gore Pitt Home Agent

**Don't Know Beans About Beans? Here's All The Information You Need**  
 As prices for red meats, fish and other main dish protein foods have risen, many people have become aware that dry beans are an excellent alternative source of protein. However, they may not know how to shop for them or prepare them.  
 So, here are a few tips about dry beans which are now in especially heavy supply.  
**Buying Tips**  
 Try to buy your beans, peas or lentils in cellophane bags or other "see through" types of packages such as cardboard boxes with a cellophane window. Then, consider these factors:  
**BRIGHTNESS OF COLOR:** Beans, peas, and lentils should have a bright, uniform color. Loss of color usually indicates long storage, lack of freshness, and a product that will take longer to cook. Eating quality, however, is not affected.  
**UNIFORMITY OF SIZE:** Look for beans of uniform size. Mixed sizes will result in uneven cooking, since smaller beans cook faster.  
**VISIBLE DEFECTS:** Cracked seed coats, foreign material and pinholes caused by insect damage are signs of a low quality product.  
**Storage Tips**  
 Dry beans, peas and lentils should be kept in tightly covered containers and stored in a dry, cool place (50 to 70 degrees F is ideal). Stored in this manner, they will keep their quality for several months.  
 After opening a package, don't mix the contents with that of other packages bought at separate times, particularly several months apart. Mixing packages will result in uneven cooking since older beans take longer to cook than fresher ones. Keep the product in the original package until opened. Then store it in a glass or metal jar or container with a tight fitting lid.  
**Preparation Tips**  
 Wash beans, peas and lentils first.  
 Dry beans should be soaked before cooking to reduce the time required for cooking.  
 A quick and effective way to soak beans is to start by boiling them in water for two minutes. Remove from heat, soak for one hour, and then they are ready to cook.  
 If soaked overnight, it is still advantageous to start with the two-minute boil because this will mean fewer hard skins. If the beans are to be soaked overnight in a warm room, the brief boil will keep them from souring.  
 One teaspoon of salt for each cup of dry beans will suit most tastes. For special flavor, add onions, herbs or meat. Add salt and flavoring only after soaking since salt toughens the surface of the beans and increases cooking time.  
 Boil gently and stir very little in order to prevent the breaking of skins.  
 Always remember to allow for expansion of beans when

cooking. For example, depending on the type used, one cup of dry beans yields 2 to 2-3/4 cups of cooked beans.  
 Now that you have mastered the basics, get out your cookbooks and look for interesting ways in which to prepare dry beans. You'll find an astonishing variety, as almost every ethnic group has created dishes around them — from, the French cassoulet to Boston baked beans. And they're all delicious. So start including beans in your menus with tonight's dinner.

## Wedding Invitation

Mr. and Mrs. Lewis Sellers Lawrence request the honor of your presence at the marriage of their daughter, Catherine Ruth, to Stephen Norwood Sprull, on Saturday, March 31, at 1:00 p.m. in the Falkland Presbyterian Church. A reception will follow the ceremony.

**Cakes Decorated For All Occasions**  
**Diener's Bakery**  
 815 Dickinson Ave.

the Kitchen Cupboard  
 Greenville Square Greenville, N.C.  
**THIS WEEK'S DEMONSTRATION**  
**THE ART OF NAPKIN FOLDING**  
 Friday At 2:00 And 8:00 P.M.

from your neighborhood ASSOCIATED DRUGGISTS

**Savings on the March**  
 March 21-27, 1979

|  |  |   |
|--|--|---|
| <b>NOVAHISTINE DMX</b><br>Decongestant Cough Formula 4 oz. Mfg. List \$2.99<br><b>\$1.77</b>                   | <b>ICY HOT ANALGESIC BALM</b><br>3.5 oz. Mfg. List \$3.09<br><b>\$1.99</b>                       | <b>PEPTO BISMOL</b><br>Liquid 8 oz. Mfg. List \$1.89<br><b>\$1.19</b>                                   |
| <b>NOVAHISTINE ELIXIR LIQUID COUGH MEDICINE</b><br>4 oz. Mfg. List \$1.99<br><b>\$1.39</b>                     | <b>CHLORASEPTIC ANTISEPTIC W/SPRAYER</b><br>Menthol 6 oz. Mfg. List \$2.03<br><b>\$1.17</b>      | <b>LILT HOME PERMANENT</b><br>Special or Body Wave 3.75 oz. Mfg. List \$2.93<br><b>\$1.09</b>           |
| <b>SINE-OFF SINUS SPRAY</b><br>ONCE A DAY SINUS SPRAY 1.5 oz. Mfg. List \$2.09<br><b>\$.99</b>                 | <b>VASELINE PETROLEUM JELLY</b><br>7.5 oz. Mfg. List \$1.49<br><b>\$.87</b>                      | <b>TEGRIN MEDICATED SHAMPOO</b><br>Herbal or Original Lotion 3.75 oz. Mfg. List \$2.25<br><b>\$1.19</b> |
| <b>BLISTEX-BLISTIK</b><br>Lip Ointment or Lip Balm Mfg. List \$5.99 ea<br><b>3/\$1.00</b>                      | <b>Q-TIP COTTON SWABS</b><br>170 ea. Mfg. List \$1.59<br><b>\$.77</b>                            | <b>BARNES-HIND WETTING SOLUTION</b><br>For Hard Contact Lenses 2 oz. Mfg. List \$2.79<br><b>\$1.69</b>  |
| <b>MISS BRECK HAIR SPRAY</b><br>Repair or Super Hold 9 oz. Mfg. List \$1.97<br><b>\$1.07</b>                   | <b>CUTEX POLISH REMOVER</b><br>Regular or Lemon 4.2 oz. Mfg. List \$1.85<br><b>2/\$.88</b>       | <b>NOXZEMA SKIN CREAM</b><br>10 oz. Jar Mfg. List \$2.65<br><b>\$1.59</b>                               |
| <b>MASSENGILL DISPOSABLE DOUCHE</b><br>Herbal or Country Flowers 4.2 oz. Mfg. List \$1.73 ea<br><b>2/\$.88</b> | <b>COTTON BALLS</b><br>By Johnson & Johnson 100% Sterile 130's Mfg. List \$1.89<br><b>\$1.04</b> | <b>COUPON</b><br>BAYER ASPIRIN Adult 325's Mfg. List \$1.79<br><b>\$1.09</b>                            |
| <b>COUPON</b><br>ALKA SELTZER BLUE FOIL 36 ea. Mfg. List \$1.90<br><b>\$1.19</b>                               | <b>COUPON</b><br>SCHICK SUPER II CARTRIDGES 5 ea. Mfg. List \$1.79<br><b>\$.99</b>               | <b>COUPON</b><br>Super II 3-27-79   |

THESE ARE SUGGESTED A.D. PRICES OPTIONAL WITH PARTICIPATING STORES

**Biggs Drug Store**  
300 Evans On-The-Mall Opposite Courthouse Greenville, N.C.

**Hargett's Drug Store**  
2500 S. Charles St. Greenville, N.C.

WE RESERVE THE RIGHT TO LIMIT QUANTITIES AT SALE PRICES

# Knesset Debates Treaty

JERUSALEM (AP) — Israel's Parliament moved ahead today toward final ratification of the peace treaty with Egypt, and Prime Minister Menachem Begin's latest rejection of a Palestinian state and the return of East Jerusalem to the Arabs was not expected to delay the signing of the pact next week.

A large majority of the Knesset, the Israeli Parliament, was expected to approve the treaty at the conclusion of its two-day debate tonight or early Thursday. In Washington, House Speaker Thomas P. O'Neill said President Carter told him Begin, Egyptian President Anwar Sadat and Carter would sign the treaty at 2 p.m. Monday in the U.S. capital.

Begin opened the Knesset debate with the vow that Israel would never permit the division of Jerusalem again, would never allow a Palestinian state to be established west of the Jordan River and would never return to the borders it had before the 1967 Arab-Israeli war.

Egyptian Prime Minister Mustafa Khalil, who provoked Begin's statement by saying last week that the peace agreement provided for the eventual return of East Jerusalem to the Arabs, said Begin's reply "spoils the atmosphere" of the peace process. But when asked if it might block the treaty signing, he said: "No, I don't think so."

Begin's declaration, reiterating a stand endorsed by most Israelis, was made to placate right-wing hawks demanding assurances that the autonomy promised by the treaty to the Palestinians in the West Bank of the Jordan River and the Gaza Strip would not lead to Palestinian statehood or to the weakening of Israel's military presence in the territories it seized in the 1967 war.

Left-wing hecklers frequently interrupted Begin's two-hour speech,

# Profit Report...

(Continued from page 1)

A Commerce Department analyst said profit breakdowns for individual industries would not be ready before next month.

The announcement came as the Carter administration is working hard to get labor to continue to comply with its voluntary guidelines calling for a limit of 7 percent on wage increases despite this year's double-digit inflation rate.

Reaction was swift. Alfred Kahn, the president's chief inflation fighter, said in a statement: "At a time when we are asking all segments of society to exercise restraint, and have seen a real demonstration of restraint by labor, the large increase announced...puts business on trial in the eyes of the American people."

Presidential aide Jordan told a gathering at the National Press Club that "we think profits are inordinately high." He promised the administration would "deal with it" but did not explain how.

Lyle E. Gramley, a member of the president's Council of Economic Advisers, said in an interview he would "use the word embarrassing to describe it: embarrassing for the administration and embarrassing for the business community."

The Chamber of Commerce argued in response that government, not business, is to blame for the economy's woes.

"The acceleration in inflation has been, and continues to be, federal budgets too high for economic conditions, tardy monetary policy which was adding to inflation last year instead of fighting it, and federal government cost-push inflationary policies, such as increases in the federal minimum wage, Social Security taxes and costly regulations," the chamber's Carlson said in a statement.

charging that the treaty ignores Palestinian rights. But ratification was assured when Shimon Peres, head of the opposition Labor Party, declared his 31 members would vote for the treaty.

# Potholes On The Market

WELLSTON, Ohio (AP) — For the person who has everything — including a spare \$10 — the city of Wellston has a unique offering: genuine potholes.

The southeast Ohio community has 6,000 residents, and with the disappearance of winter snow, some 10,000 king-sized potholes.

What the town doesn't have is the \$60,000 to \$70,000 needed to patch the potholes and make the 44 miles of city streets passable again.

"Our street repair fund is at a deficit," Wellston Mayor Harold Souders said Tuesday.

The pothole sale started as a joke, the mayor said. It was suggested, tongue in cheek, during an informal meeting Monday on the city's pothole problem.

The next day, however, the Athens Messenger ran a front-page story about the plan.

Shortly after the newspaper hit the streets, "a woman walked in with a check for two potholes. Then another woman came in, and then another came in," Souders said.

By late Tuesday afternoon, four potholes had been sold. What the investor gets for \$10 is a certificate, issued and signed by the city clerk, stating that the bearer owns a pothole in a Wellston city street.

The certificate also guarantees that the owner's pothole will be repaired.

But it doesn't say when the pothole will be fixed.

By RICHARD LOWE

Associated Press Writer

NASHVILLE, Tenn. (AP) —

Country music singer Porter Wagoner today sued buxom blonde Dolly Parton for management fees and royalties he said should total at least \$3 million.

In a suit filed in Chancery Court, Wagoner, known for his rhinestone-studded costumes, contends Miss Parton owes him millions of dollars under an agreement he says was signed by the two in 1970.

Wagoner wants 15 percent of Miss Parton's net income from June 1974 through June 1979.

Under the agreement, he said, he was to be Miss Parton's manager for five years

after she left the "Porter Wagoner Show" and receive 15 percent of her net income.

Wagoner offered no estimate of what the 15 percent demand would bring, but he says that if that demand is denied she should pay him at least \$3 million.

Miss Parton, selected in October as the Country Music Association's entertainer of the year, worked with Wagoner from 1968 until 1974, when she left the television show amid

reports of quarreling and squabbling.

Since swapping her country-flavored warble for the more financially fruitful pop sound, Miss Parton's career has skyrocketed with such hits as "Here You Come Again."

Beverly Magid, director of the music department of Solters & Roskin Inc., Miss Parton's public relation's firm, said in a telephone interview from Los Angeles that the firm had no comment on the suit.

# OLGA NOW A MOTHER

MOSCOW (AP) — Olga coaches, is the mother of a 7-year-old boy, the former Olympic pommel horse, the Soviet Sports Federation says.

# FRAME-IT-YOURSELF AND SAVE!

48-HOUR CUSTOM PICTURE FRAMING

OPEN MON. & WED. NITE 'TIL 9 P.M.

# Frame-It Yourself Shoppe

Mon & Wed 10-9, Tues-Thru Sat 10-5, 136 Trade St. Bank Cards Welcome Phone 756-7451

# Belk Tyler

downtown greenville

# save 20%

on underwear for the entire family

3 days only

THURSDAY, FRIDAY & SATURDAY

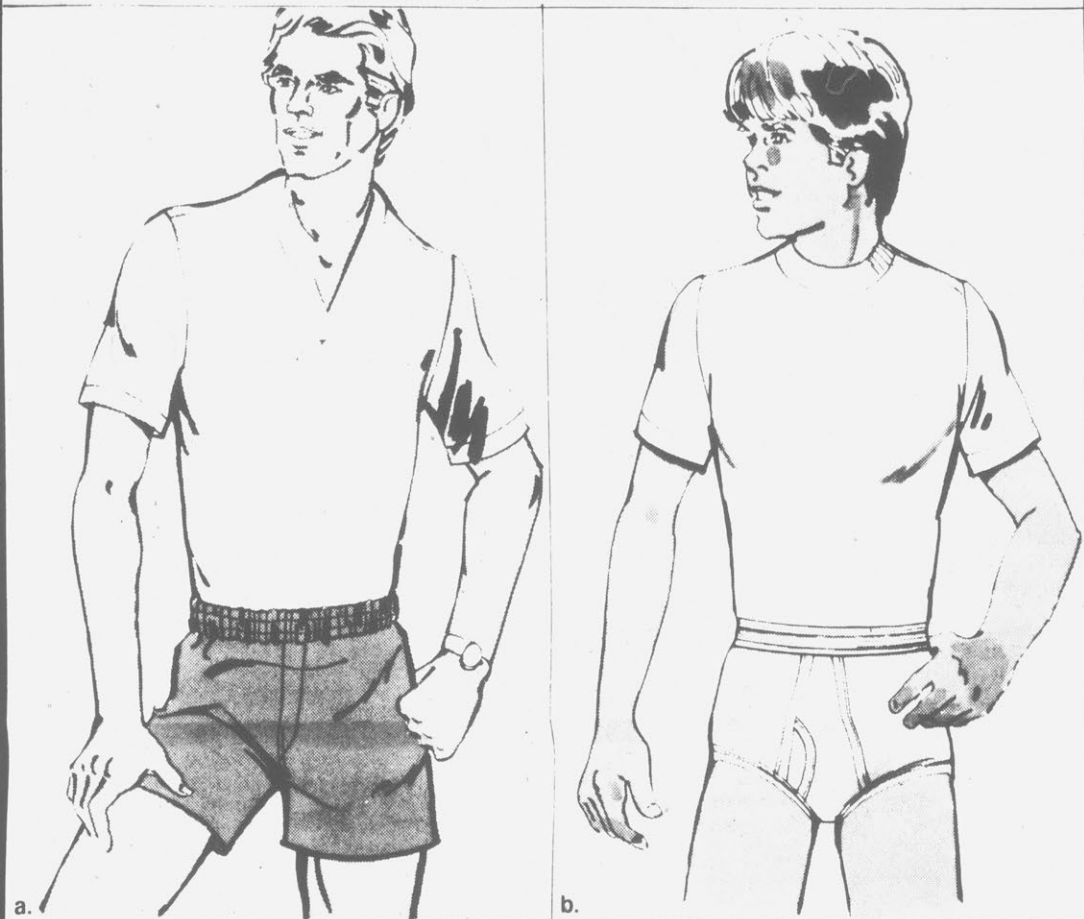

Our best-selling underwear in your choice of styles and colors

| a. Men's 'Andhurst' underwear:                             |     | reg.   | sale     | b. Boys' 'Andhurst' underwear:                             |     | reg.   | sale     |
|--|-----|--------|----------|--|-----|--------|----------|
| Nylon tricot briefs, boxer shorts, undershirts or t-shirts | ea. | \$2.75 | ea. 2.20 | Poly/cotton briefs or t-shirts                             | 3/  | \$3.59 | 3/2.87   |
| Poly/cotton t-shirts or briefs                             | ea. | \$2.75 | ea. 2.20 | Poly/cotton t-shirts or briefs                             | 3/  | \$2.99 | 3/2.39   |
| Poly/cotton t-shirts or briefs                             | ea. | \$2.50 | ea. 2.00 |  |     |        |          |
| Cotton undershirts, t-shirts or briefs                     | 3/  | \$5.25 | 3/4.20   | c. Women's 'Heiress' panties:                              |     |        |          |
| Cotton boxer shorts, boxer grippers or v-neck t-shirts     | 3/  | \$6.25 | 3/5.00   | Cotton/nylon/Lycra <sup>®</sup> briefs, sizes 5, 6, 7      | ea. | \$1.75 | ea. 1.40 |
| Poly/cotton briefs, t-shirts or undershirts                | 3/  | \$5.25 | 3/4.20   | briefs, sizes 8, 9, 10                                     | ea. | \$2.00 | ea. 1.60 |
| Poly/cotton boxer shorts or boxer grippers                 | 3/  | \$7.25 | 3/5.80   | hipsters, sizes 5, 6, 7                                    | ea. | \$1.75 | ea. 1.40 |
| trim boxer shorts  | ea. | \$2.50 | ea. 2.00 | d. Girl's 'Bugoff' panties:                                |     |        |          |
|  |     |        |          | Nylon tricot bikini, cotton crotch, prints or solid colors | ea. | 89¢    | ea. 71¢  |
|  |     |        |          | Crepeset nylon hip-hugger, cotton crotch                   | ea. | 99¢    | ea. 80¢  |

Shop Monday Through Wednesday And Saturday 10 A.M. Until 6 P.M., Thursday And Friday 10 A.M. Until 9 P.M. - Phone 758-2176

# Bypassed...

(Continued from page 1)

doesn't want a confrontation with North Carolina but that it won't be possible to resolve the problem if it can't get the money from us," Edwards said. "They're just saying even if UNC and the governor agree to something, it won't work without the money. The man who called me just said he felt the problem might be negotiated by extending the time if there was a commitment for the money."

# No Big Problem

RALEIGH, N. C. (AP) —

North Carolina currently is running 4 to 5 percent short of expected gasoline supplies, but Brian Flattery, director of the state's energy office, has told a legislative committee it's no big problem.

"We have no crisis now; we can handle 5 percent very easily," he told a joint appropriations committee. Even with a more serious shortfall, one not necessitating rationing, "we could probably get by," he said.

Flattery told the committee that the possibility of federally imposed Sunday closing of service stations, with negligible gas savings, could cost the state \$15 million per week.

# School Tour...

(Continued from page 1)

schools from Elizabeth City to Washington and Beaufort County.

"It's the first time," Phillips said, "that the chairman of the State Board of Education has been able to take the time to see for himself," what is going on in the field.

"We like what we see," Phillips said, adding however that "we've seen a lot of things that need to be improved."

Phillips noted that, "over the past several years," he has visited 1,300 of the 2,000 schools in the state.

# Belk Tyler

downtown greenville

our all-new 'sew-easy shop'



spring's new fashion fabrics 1.99 to \$5 yard

This spring fashion takes bold new directions, and we want you to be first to know. Start with the silhouettes: wider at the shoulder, narrow at the waist. Feel the fabrics: at once sheer and marvelously luxuriant. Crunchy textures, fluid knits, nostalgic prints. New ways with color, too: sun-ripened banana yellow, soft sun-baked pastels with the accent on lilac, lavender. Sizzling blues: nautical navy, making news combined with red and white. Delicate tints, ranging from sky blue to seafoam green. It's all here, in one easy-to-shop spot. Fashion's multiple choice that you put together your way to create an exciting spring wardrobe with a signature that is uniquely you.



Simplicity 8788



McCall's 6397



Simplicity 8738

Shop Monday Through Wednesday And Saturday 10 A.M. Until 6 P.M., Thursday And Friday 10 A.M. Until 9 P.M. - Phone 758-2176

# Still Fertile Area For Study

Electric utilities get plenty of criticism in this time of rising cost, and much of it should be heeded. T. Justin Moore, Jr., chairman of the board of Veeco, however paid tribute to Greenville Utilities as one "recognized across the nation as one of the most efficiently run municipal electric systems." Customers, disgruntled with high electric bills might not agree . . . but it should be recognized that GUC was a pioneer in development of energy conservation programs. Its Beat-the-Peak program has been highly successful in leveling out the electric load, which

saves money. At the same time it has meant a return during the summer months to participating customers. There are other approaches to load management, of course, some of them quite radical as compared to previous formulas for distributing and pricing electricity. We hope GUC will continually study new methods of load management with an eye toward further savings. Efficient use of electricity can do more at this point toward easing our energy problems than any other one thing. It is still a fertile area for study.

# Least Number Of Students Affected

The city school board, faced with racially balancing schools again, decided on a plan which will move the least number of students.

move 78 students to achieve the desired racial balance. There were other plans advanced, some with merit, but we think the plan which will disrupt the least number of students is the best.

THIS AFTERNOON

# Juvenile Court Reforms

By BILL NOBLITT  
RALEIGH — Juvenile courts could take the lead in communities across North Carolina in demanding that up-to-date treatment and analysis programs are quickly put into operation.

then the court could order the county government to put these things into place—in a short time period—or threaten that they would be held in contempt of court and fined \$1,000 a day for so long as such alternatives are not provided.

evidence and due process must be followed. Yet few juvenile court officials know how to implement this change.

workers, and others trained in child behavior and development to enter the juvenile justice system after the trial has been completed.

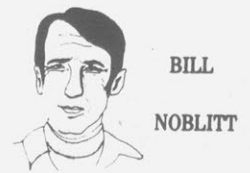

BILL NOBLITT

He sees the process as divisible into two parts—the adjudication process in which all rules of evidence and due process can be followed carefully and the defendant can be represented by an attorney.



"Frankly, I'm a little concerned . . . the Republicans are already calling it 'Peanutgate!'"

By ART BUCHWALD

# Hydrogen Bomb Lobby

WASHINGTON — As soon as it was revealed that a reporter for Progressive Magazine had discovered how to make a hydrogen bomb, a group of firearm

zealots formed the National Hydrogen Bomb Assn., and they are now lobbying against any legislation to stop Americans from owning one.

# Relief Revolt 'Alive'

By WALTER R. MEARS  
AP Special Correspondent  
WASHINGTON (AP) — The tax revolt is alive, flourishing and apparently about to pay dividends to taxpayers in states across the nation. Tax relief and restraint were the common themes as governors from A for Alabama to W for Wyoming presented their agendas to legislatures and voters.

Those are politically popular items, a fact not lost on a Congress that still is trying to handle the increasing pressure for a balanced federal budget. There is talk of scaling down aid to the states on grounds that while they lecture Washington on austerity, they balance their own ledgers with federal assistance.

According to the Council of State Governments, tax relief is likely in most of the states if legislatures follow the recommendations of the governors.

In California, which produced Proposition 13 in the first place, Gov. Edmund G. Brown Jr. has proposed a \$1 billion state income tax cut and the elimination of 5,000 state jobs.

Brown is trying to build a Democratic presidential campaign around his advocacy of a constitutional amendment to require a balanced federal budget. He also wants the state constitution amended to limit state and local spending.

In Illinois, says Gov. James R. Thompson, they are "practicing what the nation preaches," with a conservative, balanced budget and with proposals to limit the future size and cost of government.

Thompson does not have a tax cut to offer; in fact, he says there will have to be an increase in the state gasoline tax. But he is proposing amendments to the state constitution to limit future spending and to make it easier for the voters to block state tax increases.

Various tax and spending limits also have been proposed in Kansas, Minnesota, Montana, Nevada, Rhode Island, South Carolina, Texas, Wisconsin and Wyoming.

Property tax relief, in one form or another, is on the agenda in at least 30 states.

Another tax relief proposal with widespread support: a change in state income tax laws to index taxes for inflation. (Continued on page 5)

As it is, most juvenile court officers and other concerned parties simply bemoan the absence of treatment alternatives and local government officials claim there isn't sufficient money to provide them.

As it is, no one is now provoking local officials to move," says Streit.

This situation is compounded by removal of status offenders from the juvenile criminal proceedings and the training schools. Status offenses are those (truancy, running away, undisciplined behavior) which, if done by an adult, would not result in criminal charges.

Upon conviction the disposition would take over, and the interdisciplinary team would attempt to study the individual case and devise a formula to seek correction.

# Public Forum

Letters submitted for Public Forum should be limited to 300 words. The editor reserves the right to edit longer letters.

To the editor:

Like a lingering sore, the remnants of racial segregation remain within the structure of higher education in North Carolina. Even our Governor concedes this reality.

The issue which faces UNC and the Dept. of HEW is the manner through which the deficiencies will be corrected and improved.

Historically, the predominantly Black institutions were created as "separate, but equal" schools in which Blacks could be educated, whereas the predominantly white institutions were created to educate the white race.

The major asset of UNC, State, ECU and other predominantly white institutions has been their financial resources. Federal grants, industrial endowments and gifts from illustrious alumni have tremendously assisted their growth and development. At issue, however, is the equitable use of state monies. When N. C. appropriates its taxpayers' monies unjustly and biasedly, then there must be pressure exerted to correct these ills.

The major asset of the predominantly Black institutions has been, and hopefully continues to be, the care, sacrifice and inspiration of faculty and staff. Even though UNC could hire the Harvard Ph. D., the A/T instructor could motivate his students to educational heights and professional levels with the "system of higher education" stacked against Blacks. It must be deduced, therefore, that "the real teaching" was done on the Black campus.

Until the federal government intervened in Little Rock, the pattern of racial segregation did not desist. HEW, the NAACP and the Black colleges and universities have been categorized as culprits in this battle for the proper and just use of state money.

Blacks in N. C. fear that the techniques implemented to destroy the Black high school are presently being used to close the Black colleges. It is incumbent upon Blacks and compelled whites to join in this intense political struggle to insure that the Black schools survive.

The political and educational resolution to the fight between HEW and UNC will be decided soon. Remember Frederick Douglass's words: "Power concedes nothing without a demand."

John W. Maye Jr.



ART BUCHWALD

# 40 Years Ago Today

March 21, 1939

"The National Hydrogen Bomb Assn. hopes to spend a good portion of its dues on educating people in the safe handling of this type of weapon. We are instructing owners to keep the bomb in a locked closet and the fuse separately in a drawer. We also will hold classes in how to take care of his bomb there is no danger to himself or his family."

"Some people consider the hydrogen bomb a very lethal weapon which could kill somebody."

The spokesman said, "Hydrogen bombs don't kill people-people kill people. The bomb is for self-protection and it also has a deterrent effect. If somebody knows you

(Continued on page 5)

It has been announced today that a drive for the sale of Easter seals, the proceeds of which will be used to aid crippled children, will be inaugurated in the business district of Greenville Thursday.

Mrs. E. W. Evans, Jr., chairman of the Woman's Club Citizenship Department, which is sponsoring the campaign, appealed to local businessmen for their support. No canvass will be made of the residential districts, but workers will call on local businesses and urge them to buy the seals and place them on their monthly statements.

"The cooperation of the merchants and other business houses is absolutely necessary to make the campaign a success," declared Mrs. Evans, in urging support for the drive.

Ninety-five percent of all money received from the sale of the seals will be retained locally.

WASHINGTON DATELINE

# The Environmental Altar

In 1978, by Executive Order, President Carter bypassed the Congress and set aside 56 million acres of "Monuments" (wilderness, parks, etc.) in Alaska. Similarly, Interior Secretary Andrus withdrew another 55 million acres of land under the Federal Land and Management Act, and Secretary of Agriculture Berglund withdrew approximately 8 million acres. Caribou and a few hearty backpackers have now been handed a hunting and hiking land mass equal to five times the state of Ohio! Fortunately for the caribou, the energy shortage won't affect them. However, few Americans will be able to afford the trip.

"represents an opportunity to protect immense tracts of unspoiled, pristine wilderness of great beauty and variety" and that Alaska contains "untrammelled wilderness" in a "subcontinent blessed with natural values and splendors of surprising international significance on this planet". Phrases such as "ecological heritage", "a new consciousness", "obligation of stewardship" have filled Congressional hearings, bloated Congressional debate and been over-represented as the main issue in the media coverage of the Alaska land question. In the months ahead, we can anticipate more of the same.

lives of Americans. This issue is the mineral wealth of Alaska.

Alaska more than a visual feat, more than a vast wildlife habitat — it is a treasure chest of mineral wealth — both fuel and non-fuel. We cannot afford to have it barred from exploration. The time of our need for that wealth is now.

Alaska has tremendous potential for the development of oil and gas. Prudhoe Bay already supplies 1.2 million barrels of oil daily to the nation. Current estimates place that reserve at 10 billion barrels of oil and 26 trillion cubic feet of natural gas. Yet the same geologic formation which created Prudhoe Bay extends across much of the northslope, with some 30 million acres of potential oil and gas fields.

sent drilling season. Initial plans in 1976 called for 26 wells to be drilled. Now the Interior Department plans to stop at 19 despite the fact that oil and gas have been found in nearly every hole drilled thus far. The Alaska lands bill proposed by Rep. Udall (D-Ariz.) would create an additional 7 million acres of wildlife refuge within the Petroleum Reserve. Also, Udall wants the Arctic Wildlife Range to be designated wilderness, thus preventing oil exploration. The Alaskan snowshoe rabbit should be grateful.

Elsewhere in Alaska, little oil exploration has taken place, leaving a huge information gap. Yet of the sedimentary basins in Alaska which may contain oil and gas, some 40 million acres would be in conservation units under the Udall bill. One-third of these would be classified as wilderness, thus prohibiting exploration.

Knowing the potential of this area, and knowing the present near-crisis in the international oil market, the Administration's position is one which strains belief. The Administration wants to end the exploratory drilling in the National Petroleum Reserve at the end of the pre-

(Continued on page 5)

# Small Savers Feel Victimized

By JOHN CUNIFF  
AP Business Analyst

NEW YORK (AP) — As some small savers see it, they are victims of a caste system that limits them to a minimal return on investment, while big savers earn several percentage points more.

Not merely prejudicial treatment, they say, but a caste system, one that effectively limits their ability to ever get a shot at higher rates, the rates that go to those who already have a hunk of capital.

The passbook savings rate, for example, is 5.25 percent in savings institutions, 5 percent in commercial banks. But if an individual can commit \$10,000 for six months, he or she can earn nearly 9.5 percent.

The difference is more than a few points of interest; for the small saver it can mean

lending at a loss. At inflation of 9 percent, as prevailed from December 1977 to December 1978, the loss is significant.

Even discounting inflation, the effect is to widen the gap between small and big saver. At 5.25 percent interest, the face value of money doubles in 14 years; at 9.5 percent it doubles in less than eight.

While conceding the disparity, not everyone believes something should be done about it.

They explain that there's a reason, that funds of small savers support home mortgages, and that home mortgage rates must be kept low. Home-buying, it is said, is socially desirable and should be supported.

In theory, the money of larger savers generally goes into commercial banks and is

then lent out on higher cost commercial loans, on which there are few limitations except those imposed by market conditions.

Such an explanation seems to offer small savers little solace, to say nothing of the affront to their sense of justice. And they aren't without support. Some savings industry people share their view.

Some of the latter, in fact, fear that their very existence could be endangered. They see would-be savers disillusioned by the low return available to them, and find them becoming spenders instead.

What this country needs today, say the latter, is less consuming and more savings. Savings feed capital investment, which helps restrain inflation. Spending, in contrast, supports in-

flation, our No. 1 enemy.

The U.S. League of Savings Associations, by far the largest trade group of mortgage lenders, feels small savers should get immediate attention.

It proposes that the lower limit of deposits accepted for higher-paying, longer term savings certificates — those in which funds must be left for at least a year — be lowered to \$100 from \$1,000.

That, at least, would permit small savers to obtain interest rates of up to 8 percent, even if they had to leave the funds on deposit for as much as 8 years.

An opportunity for an interest rate that high least offers the distant hope to small savers that some day, if inflation is brought under control, they might become big investors.

**The Daily Reflector**  
INCORPORATED  
209 Cotanche Street, Greenville, N.C. 27834  
Established 1882  
Published Monday Through Friday Afternoon and Sunday Morning  
DAVID JULIAN WHICHARD, Chairman of the Board  
JOHN S. WHICHARD — DAVID J. WHICHARD  
Publishers  
Second Class Postage Paid at Greenville, N.C. (USPS 145-400)

MEMBER OF ASSOCIATED PRESS  
The Associated Press is exclusively entitled to use for publication all news dispatches credited to it or not otherwise credited to this paper and also the local news published herein. All rights of publications of special dispatches here are also reserved.

SUBSCRIPTION RATES  
Payable in Advance  
Home Delivery By Carrier or Motor Route Monthly \$3.50  
MAIL RATES  
(Prices include tax where applicable)  
Pitt And Adjoining Counties \$3.50 Per Month  
Elsewhere in North Carolina \$3.85 Per Month  
Outside North Carolina \$5.00 Per Month

UNITED PRESS INTERNATIONAL  
Advertising rates and deadlines available upon request.  
Member Audit Bureau of Circulation.

# Strength For Today

AN INCONVENIENCE — BUT PROGRESS

Few things are more discouraging than to encounter on the highway a sign which reads, "Road Under Construction".

Recently a traveler came upon a sign which read somewhat differently — "Road Under Construction, Sign of Progress." This statement was obviously true. Roads under construction are certainly inconvenient for travelers, but they are nevertheless signs of progress.

Reconstruction in our lives

and improvement of any kind involves very much the same process. We must break up a lot of highways over which we were quite content to pass in former days. It means going over huge mountains, and sometimes even tunneling under them. Old ideas, prejudices, jealousies, bitter memories, have to be shoved aside. It is not possible to lay the new road until the old one has been disposed of.

Roads under construction mean inconvenience, but they also mean progress.

Elisha Douglass

**Buchwald Col. ...**  
(Continued from page 4)

have a nuclear weapon in your house, they're going to think twice about breaking in."  
"But those who want to ban the bomb for American citizens claim that if you have one locked in the closet, with the fuse in a drawer, you would never be able to assem-

ble it in time to repulse an intruder."  
"That's garbage put out by the antinuclear weapon people. We are only advocating ownership of hydrogen weapons by law-abiding citizens. If someone commits a crime with one, he should get a stiff jail sentence."  
"Another argument against allowing people to own a bomb is that at the mo-

ment it is very expensive to build one. So what your association is backing is a program which would allow the middle and upper classes to acquire a bomb while poor people will be left defenseless with just handguns."  
"That's pure propaganda put out by the bleeding hearts. In a year or two there will Saturday Night Hydrogen Bomb Specials

costing less than a hundred dollars. It's worth that to protect your family."

**CHOIR MEETING THURSDAY**  
The Mt. Calvary Senior Choir will hold a rehearsal and business meeting Thursday, March 22, 7:30 p.m. All members are asked to attend, according to president Rachel Williams.

"Would your association be willing to permit the registration of bombs by their owners?"  
"Absolutely not. If we ever go to war the Communists will have a list of everybody in this country who owns the bomb. They could disarm us overnight. The strength of this nation is still in a citizens' army, and our members are pledged to fight

to the last man."  
"Do you plan to use the bomb for hunting?"  
"Only for big game. We're not going to use it on a rabbit or a duck because that would be overkill. But it's a perfect weapon for knocking down an elk or a bear."  
"A recent Gallup survey has indicated that 78 percent of the people polled said they were in favor of banning the

hydrogen bomb in private hands. What is your response to that?"  
"Our recent survey indicates just the opposite," he replied. "People favor keeping the bomb out of the hands of criminal elements, and believe that if you carry one around in your pocket you should have a license. But it's nobody's damn business what you do with one at home."

**SHERLOCK'S**  
(Formerly The Old Towne Inn)  
Now Available To Cater Your Dinners & Parties  
Call 758-1991 For Details

**Mears Col. . . .**  
(Continued from page 4)

flation, so that increased pay reflecting a higher cost of living does not automatically push a wage earner into a higher tax bracket.  
In Alabama, Gov. Fob James called for repeal of the sales tax on food and medicine, and said he will present a tax relief package to the Legislature in April.  
At the other end of the alphabet, Wyoming Gov. Ed Herschler said all property taxes should be cut by one-third. Herschler said that would be financed with a 5 percent increase in the state severance tax on minerals.

**Dateline...**  
(Continued from page 4)

discoveries from the strictly controlled offshore oil and gas exploration may never reach the market place.  
America now imports a higher percentage of its oil needs than during the 1973 embargo. We had a trade deficit last year of \$28.5 billion dollars, much of it due to oil importation. Our leaders consider sending troops to the Persian Gulf while we blithely take steps to lock up what could well be our greatest domestic source of oil. Little wonder that America's stock has fallen so low in the world.  
Hopefully, the critical needs of our entire nation will not be sacrificed on the altar of environmental worship. — Rep. Steven D. Symms (R-Idaho), member of House Interior Committee.

**Offer Course In Auctioneering**

**KINSTON** — An auctioneering course will be offered through the Continuing Education Division of Lenoir Community College beginning Tuesday, April 3, in building 71 of the Kinston Jetport. The class will meet from 7-10 p.m. on Tuesdays and Thursdays for 14 weeks, as well as bid  
Mrs. Josie Graves will serve as instructor, having taught the course for approximately four years at LCC. Auctioneers in various fields will also make classroom appearances.  
Interested persons 18 years and older and not enrolled in public school should call the College at 527-6223, extension 222, or write Lenoir Community College, P. O. Box 188, Kinston, N. C. 28501, for more information.

**Floral Ass'n Meeting Held**

The Pitt County Floral Association met Monday, with members from Greenville, Farmville, Ayden and Bethel in attendance.  
Marie Cox of Cox Floral Service gave the program at the meeting, held at the Three Steers Restaurant. Association members noted the recent death of fellow member Lena Tyson, who had served as a member for many years.

**START TODAY... LOSE WEIGHT BY FRIDAY WITH EXTRA STRENGTH SLENDER-X CAPSULES**

For over 15 years, thousands have been losing weight with Slender-X Tablets. NOW...we are offering you a New Time-Release EXTRA STRENGTH SLENDER-X CAPSULE. Try our amazing, improved formula. We guarantee it to help the pounds drop off or your money back.

**Big Value Discount Drugs**  
2814 East 10th St. Greenville  
West End Shopping Center Greenville  
1192 West 3rd St. Ayden

**Belk Tyler**  
downtown greenville

**An Incredible Low Price On Junior and Misses' Spring Coats!**

**29.88**  
If Perfect Up to 75.00

**We Have Bought The Entire Stock of Coats From A Top North Carolina Manufacturer**

Fabulous new spring coats . . . the newest styles . . . the newest colors. In fact, it's the entire stock of a top North Carolina manufacturer. Polished poplins . . . unlined. Street lengths . . . belted, buttoned, single and double-breasted. And an array of sleeve and collar accents. And the colors. Black, tan, oyster, covert, cinnamon and more. But you'll have to hurry to take advantage of this low price. Not all colors in all styles. Slight imperfections will not affect wear. Misses' sizes from 8 to 18 and junior sizes from 5 to 15.

**Shop Monday Through Wednesday And Saturday 10 A.M. Until 6 P.M., Thursday And Friday 10 A.M. Until 9 P.M. - Phone 758-2176**

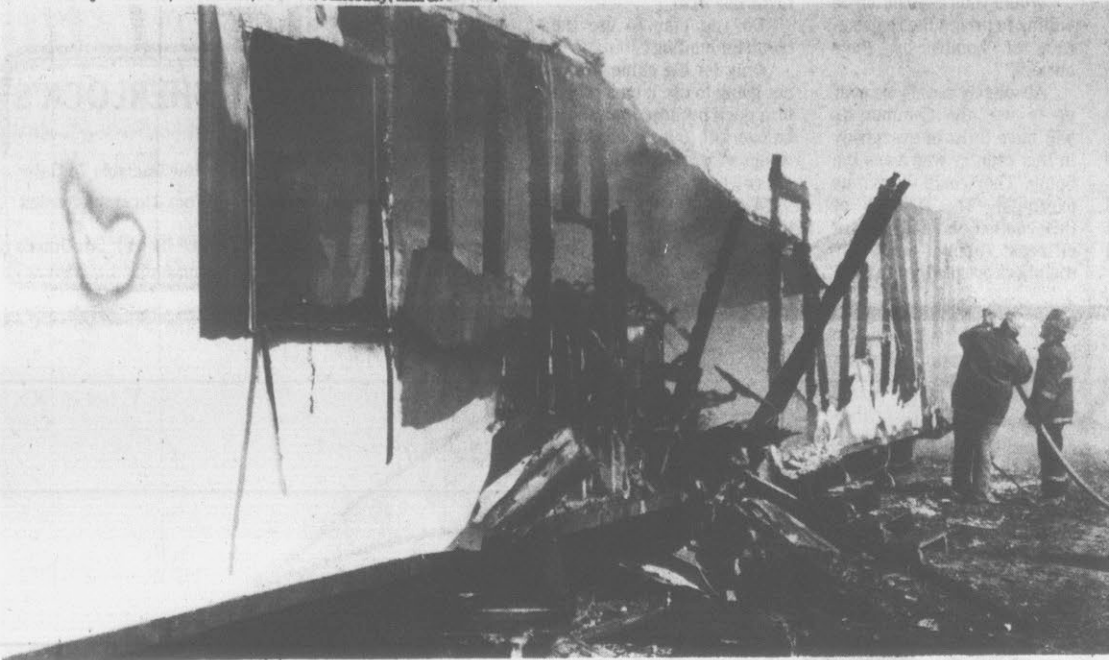

**MOBILE HOME BURNED.** The home of Johnny Murphy in the Belvoir Trailer Park on Highway 33 one and a half miles east of Greenville was reported burning at 1:52 p. m. yesterday. The Belvoir Fire Department was assisted by the Falkland and Staton

House Fire Departments in preventing the flames from being spread by wind to four adjacent mobile homes. The fire was reported rekindled at 4:53 the same afternoon and Belvoir again responded. (Reflector Photo By Tommy Forrest)

## Thirteen-Year-Old Prodigy Has A Good Start At Salem College

WINSTON-SALEM, N.C. (AP) — Sheri Johnson is the type of student whose teachers used to give her workbooks on the condition that she not finish them in one night.

She is, in the words of her classmates, a child prodigy.

At 13-years-old, the Doylestown, Pa., resident is more than halfway through a successful freshman year at Salem College in Winston-Salem — successful at least to an observer. Miss Johnson is not completely satisfied with the A's and B's she got last semester.

"I sat down after I got my grades and thought awhile," said Miss Johnson, peering out from under the bottom bunk in her dorm room at the college. "And I decided that I worked and had done okay but I hadn't done as much as I could."

"Grades aren't as important as how much you get out and whether you were trying," she said. "This semester I'm putting more in. I'm more systematic."

Miss Johnson has been ahead of her age group for a long time. So, looking back over a

year that's often traumatic for people five years her senior, she says the first semester at college "was pretty much what I expected. I put in a little more than in high school, but it's not as hard as their little sisters chalk it up to be."

She may have assimilated to college life fairly easily, but for some of her classmates it's hard to forget Miss Johnson is the same age as their little sisters back home.

"It blew my mind," said Laverne Hales, Miss Johnson's dorm adviser, "because I have a sister who's 14. At the time I kept thinking what kind of environment this was for a 13-year-old. Some of the 17- and 18-year-olds have to do a lot of thinking about the problems they have to deal with."

But Miss Hales said she thinks Miss Johnson has adjusted very well.

A music and psychology major, Miss Johnson not only spends lots of time studying, but also practicing voice and piano. She also has time to go to dances and out to dinner, but her social life is necessarily dif-

ferent because of her age. For example, she is excluded from campus parties where beer is served.

As for her roommates, they say it's not hard to relate to Miss Johnson or to imagine her

it up to be.

She may have assimilated to college life fairly easily, but for some of her classmates it's hard to forget Miss Johnson is the same age as their little sisters back home.

"It blew my mind," said Laverne Hales, Miss Johnson's dorm adviser, "because I have a sister who's 14. At the time I kept thinking what kind of environment this was for a 13-year-old. Some of the 17- and 18-year-olds have to do a lot of thinking about the problems they have to deal with."

But Miss Hales said she thinks Miss Johnson has adjusted very well.

A music and psychology major, Miss Johnson not only spends lots of time studying, but also practicing voice and piano. She also has time to go to dances and out to dinner, but her social life is necessarily dif-

ferent because of her age. For example, she is excluded from campus parties where beer is served. As for her roommates, they say it's not hard to relate to Miss Johnson or to imagine her it up to be.

She may have assimilated to college life fairly easily, but for some of her classmates it's hard to forget Miss Johnson is the same age as their little sisters back home.

"It blew my mind," said Laverne Hales, Miss Johnson's dorm adviser, "because I have a sister who's 14. At the time I kept thinking what kind of environment this was for a 13-year-old. Some of the 17- and 18-year-olds have to do a lot of thinking about the problems they have to deal with."

But Miss Hales said she thinks Miss Johnson has adjusted very well.

A music and psychology major, Miss Johnson not only spends lots of time studying, but also practicing voice and piano. She also has time to go to dances and out to dinner, but her social life is necessarily dif-

## Opposition To Mixed Drink Sales Organizing

A group of some 45 local businessmen and clergy leaders met Monday night to organize their campaign against the issue of mixed drink sales in Pitt County, which is scheduled for a June 8 referendum.

The Rev. J. M. Bragg, pastor of People's Baptist Temple, said that the group, which met at his church, adopted the name Christian Action League of Pitt County for the organization.

Bragg, who was named publicity co-chairman, indicated that the Christian Action League will be waging an "active campaign" against the mixed beverage issue. He said that the group feels that the recent rejection by Wilson County of mixed drink sales will help the Pitt organization in its campaign.

The minister said the organization will be making an effort to encourage voter turnout for the referendum in Pitt County, contending that a heavy turnout will be to the group's benefit in its opposition stand.

He added that the group will be meeting again next Monday night, March 26 at 7:30 p.m. to continue its organizational efforts.

Frank Steinbeck Sr. of Steinbeck's Men's Shop was elected chairman of the organization, while three co-chairmen were named, including the Rev. David Hammond, pastor of Phillip Baptist Church; Ernest Harris, chairman of the school board of Greenville Christian Academy; and the Rev. Richard Kennedy, pastor of Temple Free Will Baptist Church.

Other officers named included:

publicity co-chairman, the Rev. Van Dale Hudson, pastor of

Trinity Free Will Baptist Church; transportation chairman, James Glisson, retired businessman; registration chairman, the Rev. Roger Tripp, pastor of Grace Free Will Baptist Church; secretary, Lloyd Johnston, director of the Red Cross; and treasurer, Guy Mayo, area businessman.

## Festival To Need Hands

GRIFTON — Workers are still needed for the drink and hot dog wagons, as well as the games and pancake supper events for the Grifton Shad Festival April 20-22, it was announced at a recent meeting of a Shad planning meeting.

Workers are also needed to work with co-chairmen Bobby and Jean McLawhorn for the annual parade line-up. According to the McLawhorns, there is still time for ordering professional floats for the parade.

According to Tommy Sugg, Festival chairman, Linwood Moore has been named as Games Chairman. Janet Oglesby will chair the "Shad-O" event, aided by the Grifton Service League.

Another planning session will be held Monday, March 26, 7:30 p.m., at the Grifton Library. All interested persons are welcome to attend and offer ideas for the upcoming festival.

### ATTENDED LAYMEN'S SEMINAR

TULSA, OKLA. — Mr. and Mrs. Sutton Austin, 403 Greenfield Blvd., Greenville, recently attended a laymen's seminar on the campus of Oral Roberts University, featuring ORU founder and president Oral Roberts as speaker. Nearly 3,000 persons from across the nation and Canada were University guests for the four-day event. The Austins made a short visit to Chicago, Ill. after the seminar.

### Jamestown OKs Mixed Drinks

JAMESTOWN, N.C. (AP) — Jamestown voters approved mixed-drink sales by a vote of 293-190 Tuesday, according to election officials.

The turnout among the town's 1,161 registered voters was about what had been predicted, the officials said.

The drive for mixed-drink sales in the Guilford County town was initiated last fall by Sadie May, who owns an Italian restaurant on Main Street. Mrs. May conducted a personal drive for mixed drinks, using her own money to place radio ads and distribute campaign material.

CHOIR SPONSORS PROGRAM GRIMESLAND — The Senior Choir of White Oak Baptist Church will sponsor Shirley Hansley and the Eight Specialists Sunday, March 25, 4 p.m. The public is invited to attend, according to Monroe Rountree, president.

# FAMILY DOLLAR

ASK ABOUT OUR CONVENIENT LAY-AWAY



**Men's Screen Print Tee Shirts**  
**\$2.50**

A wide selection of print designs and colors. Sizes S,M,L,XL.



**Men's Western Jeans**  
**\$5.00**

Full cut, 5-pocket jeans for men in all cotton navy blue denim. Sizes 29-38.



**Men's Tube Socks**  
**\$3.00**

Famous Fruit of the Loom tube socks with color stripe tops.



**Ladies' Nylon Gowns**  
**\$2.00**

Waltz length gowns in pastel pink, blue and green with lace trimmed neckline. Sizes S,M,L.



**Ladies' Pantyhose**  
**3 Pair \$1**

All nude or reinforced toe in five shades. One size fits all. Pack of 3.



**Girls' Shirts & Skirts**  
**\$1.99 \$3.99**

Two- and three-tier spring skirts in solids and prints. Short sleeve and sleeveless tops. Sizes 4-14.



**Tier And Valance Set**  
**\$2.99**

Special purchase! Pair of 36" tiers with matching valance. Window Shades... \$1.57



**Tasty Cookies**  
**4 Packs \$1**

All your favorites, "kitchen fresh."



**Aim Toothpaste**  
**59c**

Fluoride Toothpaste in 4.6 oz. tube.



**Arrid Deodorant**  
**99c**

Extra Dry XX. Light Powder or Reg. 4-oz.



**Trend Detergent**  
**3 For \$1**

Trend detergent in 17-oz. box. Limit 3.



**Lux Beauty Bar**  
**5 For \$1**

Five big 5-oz. bars. Limit 5.



**Planter & Soil**  
**\$1.00**

Each Stoneware planters or 8-qt. potting soil. 50' sisal rope... \$1

PRICES GOOD AT ALL FAMILY DOLLAR STORES THROUGH THIS WEEKEND. QUANTITIES LIMITED ON SOME MERCHANDISE.

HARRIS SHOPPING CENTER, MEMORIAL DRIVE  
OPEN MONDAY THROUGH SATURDAY  
9:00 A.M. Until 9:00 P.M.



## Clean up, Paint up, Fix up Sale



**LUCITE Wall Paint**  
NO STIR • NO MESS • 1/2 HOUR DRY • WATER CLEAN-UP

Regular Price — \$9.97  
Sale Price — 8.97  
Less Du Pont STORECHECK\* — 1.00  
**YOUR NET COST 7.97**  
After STORECHECK\*

In appreciation of your purchase of LUCITE® Paint # 000000

**\$1.00 STORECHECK\***  
PER GALLON

From Du Pont  
On every gallon of Lucite you buy!

**SAVE \$1.00, \$3.00, \$5.00 or more!**



**LUCITE House Paint**  
BUILT-IN PRIMER • DRIES IN AN HOUR • WATER CLEAN-UP

Regular Price — 12.88  
Sale Price — 10.88  
Less Du Pont STORECHECK\* — 1.00  
**YOUR NET COST 9.88**  
After STORECHECK\*

## Big Savings! No Limit!

You Save on every gallon of LUCITE® Paint you purchase. from Our Store, 1.00 STORECHECK\*, from Du Pont.



**21" Step Stool**  
Reg. 4.44 **3.66** SAVE 78¢

21" High For Those Hard To Reach Places. Wood Construction.



**Masking Tape**  
**2 \$1**

Economical 3/4" By 80 Yards.



**Paint Brush**  
**1.97**

100% Golden Polyester Bristles. 4" Wide.



**Paint Pan & Roller Set**  
Reg. 1.47 **99c** SAVE 48¢

9" Roller With Steel Tray. A Real Buy.

**Pitt Plaza Shopping Center**  
Open Daily 9:30 A.M. - 9:00 P.M.  
Prices Effective Thurs. - Fri. - Sat.

# Senate-House Panels Hold Insurance Hearing

RALEIGH, N.C. (AP) — Insurance purchasers spoke out at a public hearing Tuesday in favor of restoring the power of prior approval of insurance rates to the insurance commissioner's office.

On the other hand, representatives of the insurance industry called for retention of the current file-and-use system that allows insurance com-

panies to file rates through the North Carolina Rate Bureau and implement them while the commissioner's rejection is being appealed.

The public hearing was called by the Senate and House Insurance committees, which are considering opposing bills on how insurance rates should be set in North Carolina.

"Since the commissioner's

power was curtailed, we have received a slap in the face to the tune of \$107 million," said Joseph Reinckens, legislative director of the Raleigh chapter of the American Association of Retired People.

Tom Lominac, a spokesman for Carolina Action, a statewide consumer group, spoke in favor of a bill filed by Rep. Ernest Messer, D-Haywood, that would

restore the commissioner's prior-approval power, which was taken away by a controversial law enacted by the 1977 General Assembly.

"We have seen liability insurance rates go up in the years since the commissioner's role was diminished," he said.

Industry spokesmen spoke in favor of a second bill, filed by Rep. Hartwell Campbell, D-Wilson, that would retain the file-and-use system.

"House Bill 425 (Campbell's bill) will continue the progress made in establishing a balance between the needs of the citizens of North Carolina and a financially sound insurance industry," said Edward L. Jennings, an official of Nationwide Insurance Co.

Industry leaders and sponsors of the 1977 legislation said under the prior-approval system, too many rate cases ended up in court on appeal after being disapproved by Ingram. They contend the file-and-use system promotes competition and keeps rates down.

In other legislative business: **UNC Appropriations**

William Friday, president of the University of North Carolina, said UNC's highest priority on a list of supplemental budget requests is an additional \$9.5 million for construction.

Friday said the additional money which UNC is requesting from the state General Fund would cover capital improvements that the university's Board of Governors wants finished, including improvements on some of the state's traditionally black campuses.

Friday asked members of the Joint Appropriations and Base Budget Committees to "go as far as you can" in meeting the request.

During the fiscal year beginning July 1, the university requested supplementary allocations totaling \$30 million, including a \$7.9 million supplement for expanding current op-

erations. Any supplemental funds approved by the General Assembly would be money above the amount already earmarked for the university in the proposed state budget for the coming year.

The university has asked for an additional \$22 million for expanding current operations for the second year of the budget biennium.

The other requests are for \$11.1 million in capital improvements for North Carolina Memorial Hospital and \$1.2 million for current operations in agricultural programs.

**Blue Light Rapes**

A Senate judiciary committee approved a bill that would make it a misdemeanor to have a blue light installed in a private car. The bill was initiated after several so-called blue light rapes and rape attempts, in which the attacker used a blue light to force the victim to the side of the road.

The bill was amended by the Senate Judiciary II Committee to set a mandatory 90-day jail sentence without parole or pro-

bation for persons installing the lights.

**Hazards**

The Senate Agriculture Committee approved a state hazardous substances act that would set up testing facilities in the state Agriculture Department. The facilities would allow department officials to deal with merchants over the removal of hazardous products from store shelves.

The measure must now go to the Appropriations Committee.

**Employees Insurance**

The House unanimously approved a committee substitute for a Senate bill that would set up a separate insurance commission to accept bids for coverage of public employees. Supporters of the bill said it would make insurance for the employees less expensive since companies would bid before the commission and offer insurance to the employees as a group.

An amendment which would

have included school board employees in the bill was defeated, 34-75.

**Handicapped**

A bill that would enforce enforcement of parking spaces for the handicapped was approved by the Senate Transportation Committee and sent to the full chamber. The bill would allow a \$10 fine for violations, and allow police officers to go onto private property, when requested, to ticket cars illegally parked in spaces set aside for the handicapped.

**Schools**

A Senate judiciary committee approved a bill that would exempt private schools not affiliated with churches from administering the state competency tests. The bill would also exempt the schools from other state regulations.

The bill now goes to the Senate, where it will be considered along with a bill that would exempt church-related schools from regulations.

**Juries**

The Senate gave tentative approval on a 47-0 vote to a bill that would allow Superior Court judges to empanel two grand juries within a county at the same time.

**Alimony**

A bill filed in the House would allow a judge to order the termination of alimony payments if the spouse receiving the alimony "openly cohabitates with a member of the opposite sex." Rep. Martin Lancaster, D-Wayne, filed the bill.



**FIRST LADY'S BIKE TOUR** — Rosalynn Carter bicycled through a subdivision of solar-heated homes with developer Mike Corbett during a visit to Davis, California Tuesday where she later told the community they are setting

an example for the nation. Davis claims to be one of the nation's most energy-conscious communities. Its 35,000 residents have an estimated 25,000 bicycles. (AP Laserphoto)

## Rose Grad Is On Dean's List

Michael A. Williams, a senior art major at Saint Augustine College, Raleigh, was named to the school Dean's List for the fall semester.

A 1975 graduate of J. H. Rose High School, Williams is the son of Mr. and Mrs. Preston Williams of Greenville.

## Two Collisions Here Tuesday

An estimated \$3,900 property damage resulted from two collisions investigated by Greenville Police yesterday.

Officers reported heaviest damage resulted from an 11:45 a.m. collision at the intersection of Greenville Boulevard and Hooker Road involving cars driven by Pamela Dee Norman of Roper, and Ann Mills Sutton of Route 2, Greenville.

Police, who estimated damage at \$2,000 to the Norman car and \$1,000 to the Sutton auto, charged Mrs. Sutton with failing to stop for a stop light.

Cars driven by Socrates Richard Gliarmis of Wilson and Paul Frederick Lincke III of Kinston, collided about 6:53 p.m. at the intersection of Tenth and Cotanche Streets, resulting in an estimated \$400 damage to the Gliarmis car and \$500 damage to the Lincke vehicle.

## Co-Op Elects Woman To Bd.

TARBORO — Some 300 members of the Edgcombe-Martin Electric Membership Corp. attended the annual meeting of the co-op here Saturday, and elected the first woman ever to serve on the board of directors.

Mrs. Alice E. Wilson of Tarboro, was one of three persons elected to the Board of Directors of the co-op.

Elected as officers of the board for the coming year were: president H. M. Britt Jr. of Route 1, Tarboro; vice-president Noel Lee Jr. of Route 3, Washington; secretary M. V. Scott of Pinetops; and treasurer M. D. Wilson of Robersonville.

**ALPHA TECHNICAL DRAFTING And PRINTING**  
ELECTRICAL-MECHANICAL HVAC-STRUCTURAL SCREEN PRINTING ADVERTISEMENT 756-8918

**REVIVAL Black Jack Free Will Baptist Church**  
Each night this week at 7:30  
Rev. Joseph H. Ingram, Evangelist  
Nursery & Children's Church Provided

## Boy's Easter suits.

\$5 deposit will put any boy's suit on Layaway.

Boys suits made of polyester and cotton. Solids, stripes, and plaids made for an exciting spring selection. Sizes 4 through 20 regulars, slim and huskies.

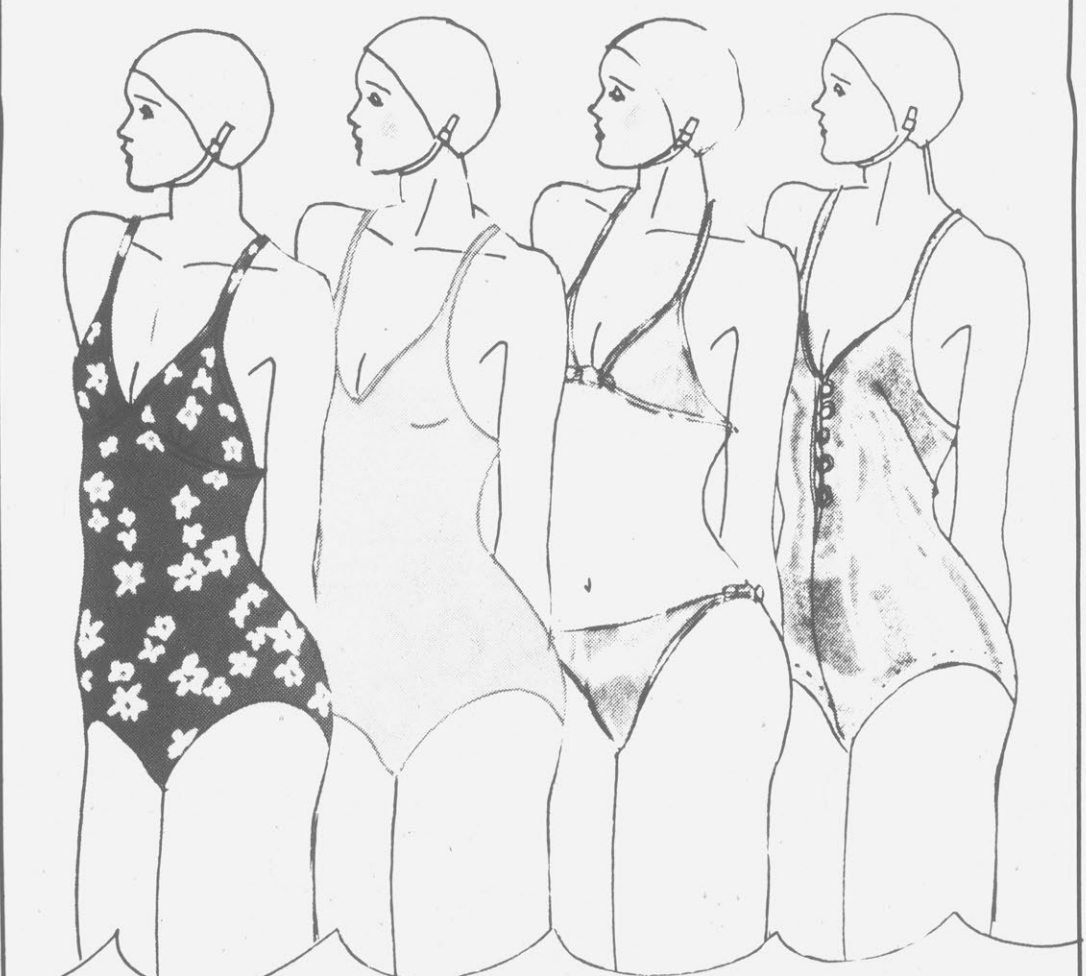
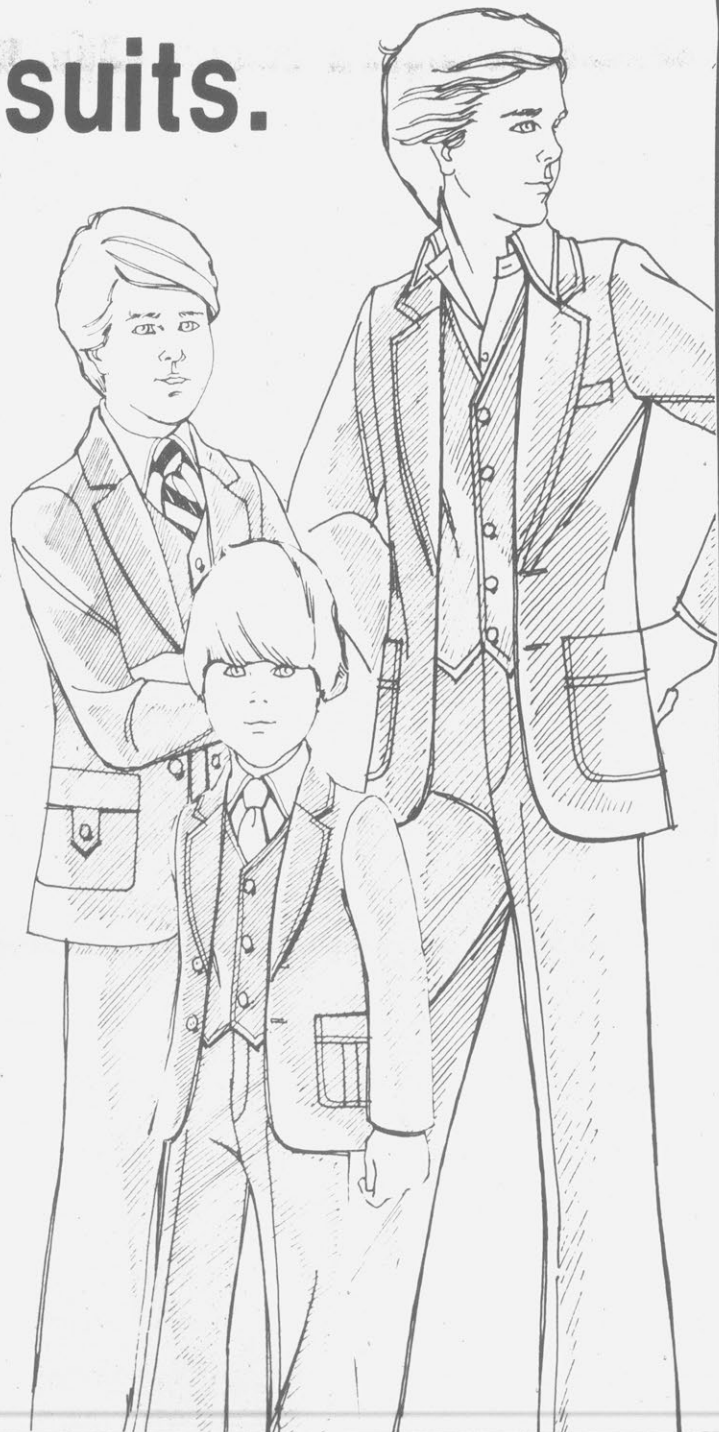

## Splashdown '79 25% off all of our own swimwear. Sale 8.25 to 25.50

Reg. \$11 to \$34 Get into the savings swim and snap up some of the prettiest beach scenery around. Take your pick of teeny bikinis, maillots, boylegs, and much more in nylon/Lycra® spandex blends, polyester prints, solids and stripes. Hurry. They'll go fast. Misses' and junior sizes. Sale does not include famous-make swimwear.

This is JCPenney

•Shop 10 A.M. 'til 9 P.M.  
•Phone 756-1190

This is JCPenney

•Shop 10 A.M. 'til 9 P.M.  
•Phone 756-1190

# Homemakers Spectacular.

## \$10 off 7-pc. cookware sets. Sale 42.99

Reg. 52.99. 7-pc. aluminum cookware set made for us by Wear-Ever Aluminum. Almond porcelainized enamel. Silverstone™ cooking surface. 1½ and 3-qt. covered saucepans, 5-qt. covered Dutch oven, 10" fry pan. Sale 6.49 Reg. 8.49 8" saute pan Sale 8.69 Reg. 10.69 10" saute pan Sale 10.79 Reg. 13.79 12" saute pan Sale 9.69 Reg. 11.69 10½" square griddle

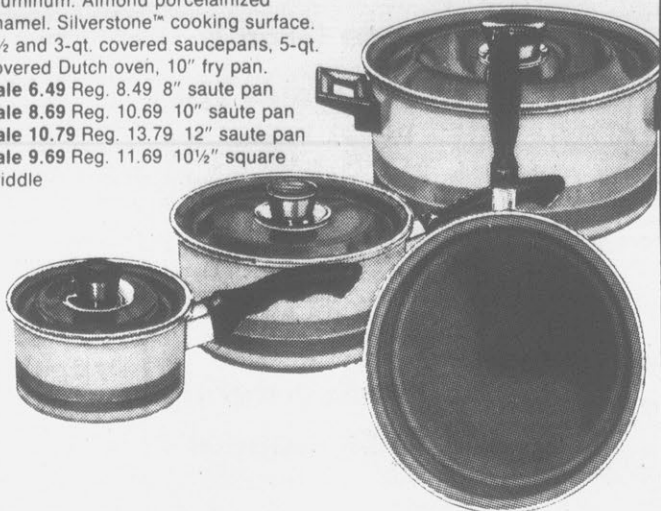

## Sale 29.99

Reg. 39.99. 7-pc. striped porcelain enamel cookware set imported from Italy by Moneta®. Dishwasher and oven safe. Includes 1 and 2-qt. covered saucepans, 5-qt. covered Dutch oven, 10" open frypan.



## Sale 64.99

Reg. 74.99\* If purchased separately as open stock in catalog would cost 132.35. Heavy cast aluminum cookware has scratch-resistant non-stick DuPont® SilverStone™ interior porcelain-clad exteriors. Kitchen tested and approved by Betty Crocker.® Includes 1 and 2-qt. covered saucepans; 11" open pan; 5½-qt. covered Dutch oven. Cover fits 11" fry pan. 8¾" omelet pan, 10.95



## \$5 to \$10 off JCPenney small appliances with full one year warranty.

Within one year of purchase, we will replace this JCPenney appliance, if defective in material or workmanship, with one of equal value. Just return it to the nearest JCPenney facility for prompt service.

### Sale 39.99

Reg. 48.99. Toaster/broiler oven with automatic shut-off toasts 6 slices of bread; broils steaks and chops, bakes 9" pie, and more.

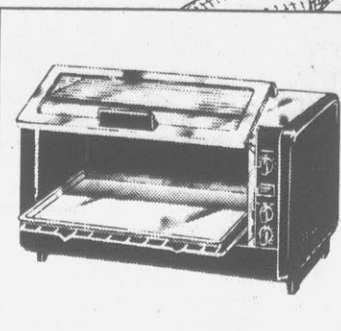

### Sale 14.89

Reg. 19.89. Deluxe hand mixer with 5 mixing speeds. Burst of power helps to beat through heavy batter. Sale prices effective through Saturday.

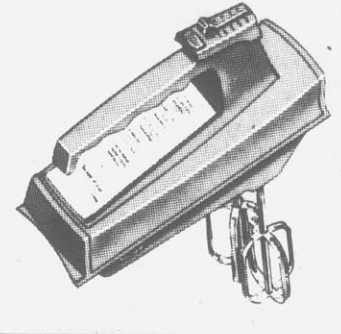

### Sale 54.99

Reg. 64.99. Food processor with powerful direct drive motor. Includes unbreakable workbowl; 3 stainless steel blades for chopping, slicing, shredding; plastic mixing blade; spatula; cookbook. Stainless steel french fry blade. 5.99 (Not shown.)

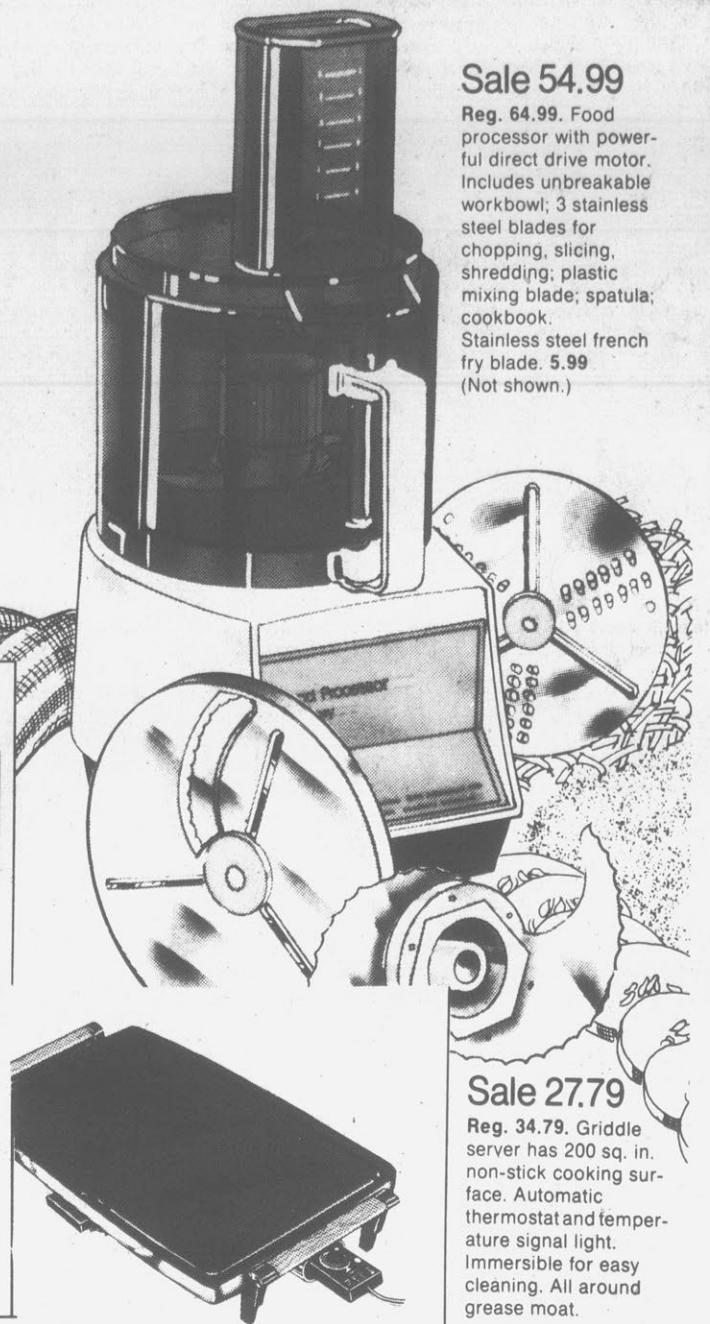

### Sale 27.79

Reg. 34.79. Griddle server has 200 sq. in. non-stick cooking surface. Automatic thermostat and temperature signal light. Immersible for easy cleaning. All around grease moat.

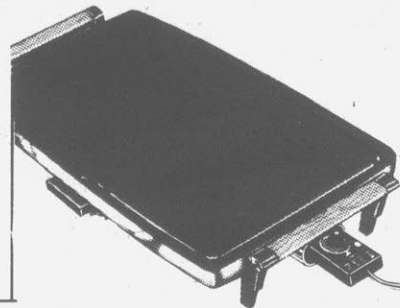

## Sale 15.75

Reg. \$21. 8" covered skillet.

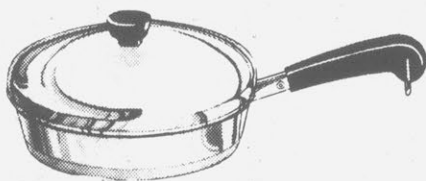

## Bright savings. \$15 off fashion lamps

### Sale 29.99

Reg. \$45. Brass-finished cast-metal candlestick table lamps are at home in any decor. Choose from four classics. All with beige-textured fabric over vinyl shades. 32" high: Pillared candlestick. Triple font candlestick. Hexagonal font candlestick. Ball font candlestick.

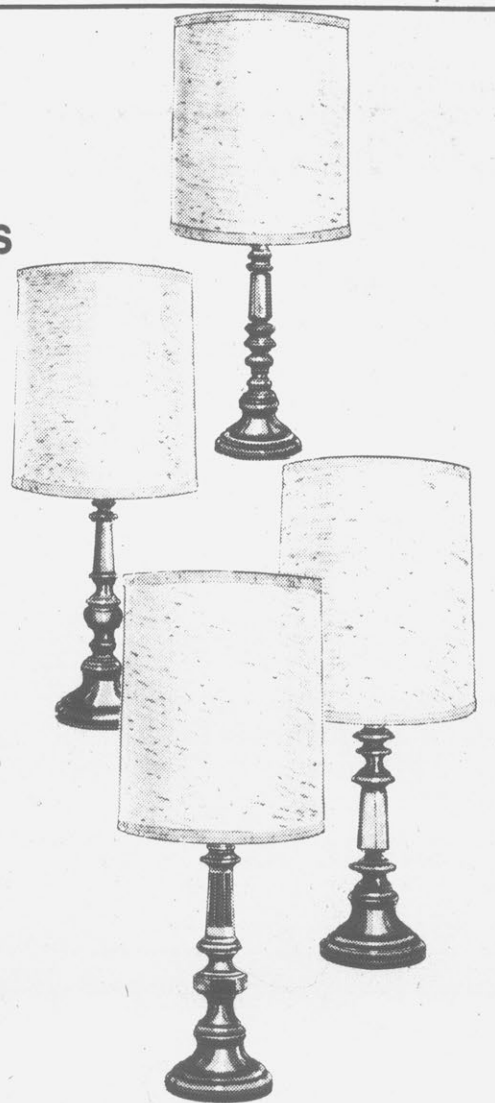

# Save 25% on all dinnerware and flatware

## \$30 to \$60

Reg. \$40 to \$80 Beautiful ways to set a table. Choose from our entire stock of ironstone and stoneware. Including famous name Mikasa. All are chip and crack resistant, dishwasher and detergent safe. Go easily from freezer to conventional oven or microwave. Corningware Corelle® not included.

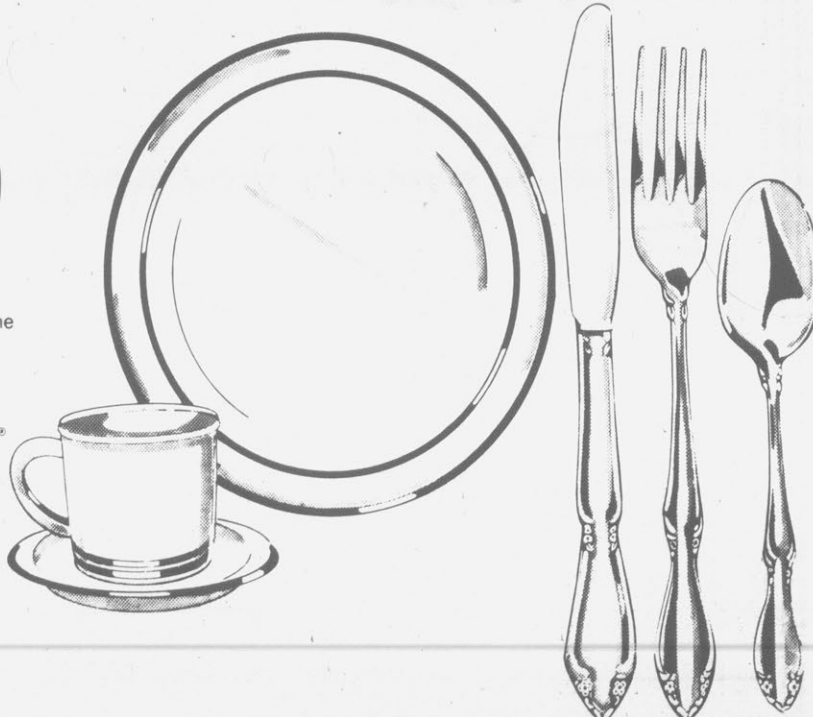

## Sale 14.25 to \$39

Reg. \$19 to \$52 Save on our entire line of shiny stainless steel flatware, including patterns by Onieda. Choose from a wide selection of designs, from classic to contemporary. All are dishwasher and detergent safe. Tarnish and rust resistant. Some with serving pieces.

## 20% off Sale 15.20

Reg. \$19. Wooden Butcher block clock.

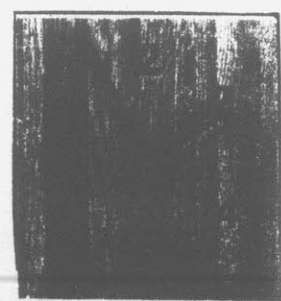

This is JCPenney

Auto Center  
•Shop 8:30 a.m. 'til 9 P.M.  
•Phone 756-1190 Ext. 251

•Shop 10 a.m. 'til 9 p.m.  
•Phone 756-1190

Catalog  
•Shop 10 a.m. 'til 9 p.m.  
•Phone 756-2146



**TRIAL GOES TO JURY** — Mary Vincent, the 15-year-old Nevada girl who had her arms chopped off by a rapist, shows the dexterity she has learned with her artificial limbs during lunch break Tuesday from the trial of her alleged attacker, Lawrence Singleton. The trial is due to go to the jury today. (AP Laserphoto)

## School Fees A Usual Practice

RALEIGH, N.C. (AP) — Only 10 of the state's 145 school systems did not collect instructional fees last year. But if a Superior Court ruling Monday in Greensboro is applied across the state, the other 135 schools may join the ranks of those who don't charge students for such things as pencils, gym shorts and elective courses.

On Monday, a Superior Court judge ruled unconstitutional a 1955 law permitting schools to levy fees. Although the ruling affects only the Greensboro city schools, chances are it will be appealed and the appeals court ruling would affect the entire state.

Some officials at schools currently collecting fees are worried about where funds will come from if that source of revenue is curtailed.

"If the money didn't come from the state or the county commissioners, we would just have to tighten our belts," said Wilson County Superintendent W.O. Fields. Fields' system charges a \$4.50 instructional fee for all students and collects about \$60,000 a year.

A Department of Public Instruction survey reports that 68 school systems charged instructional fees last year, ranging from 75 cents in the Beaufort city schools to \$16 in western Ashe County.

Ninety-seven systems charged additional fees for elective courses in junior high and high school, ranging from 50 cents in Beaufort to \$18 for business courses in several systems.

Rocky Mount, Chapel Hill, Columbus County, Durham city, Franklinton and Hoke County are among the schools that do not charge fees. Administrators at other schools said they would be happy to do away with the fees, if there was some way to compensate for the revenue the fees bring in.

"Without it, we can't operate," said Wake schools superintendent John A. Murphy about a \$3.25 instructional fee in that county.

"I've always been opposed to

charging fees of any kind," Murphy said. "This is supposed to be a free public school system."

Andrew A. Vanore, the state deputy attorney general, said Tuesday courts in other states generally had ruled against laws allowing schools to require fees.

## Shad Parade

GRIFTON — Plans are underway for the Grifton Shad Festival Parade, to be held Saturday, April 21, beginning at 10 a.m.

Trophies will be given to the best motorized and non-motorized floats. Cash prizes will also be given for the best decorated bicycle.

Bands from across eastern North Carolina will also participate in the event. One hundred dollars will be awarded to the best band.

Parade chairman Jean McLawhorn urges anyone interested in entering horses, old cars, or any other item in the parade to call her at 524-4565, after 5:30 p.m.

## Vice Crackdown Nets 25 Men

RALEIGH, N.C. (AP) — A Raleigh patrolwoman arrested 25 men on charges of aiding and abetting prostitution during a one-week undercover operation, according to Det. Lt. K.J. Johnson.

Johnson, who supervises the police department's vice and drug section, said a patrolwoman who posed as a prostitute on Hillsborough Street made the arrests. Johnson said the woman, whose name was not released, was approached by the accused and given money. After receiving the money, the patrolwoman told the suspect he was under arrest and used a radio to call her backup officer, Johnson said.

# Home Improvement Month.

**Save \$20**  
on this 64-pc. socket set.

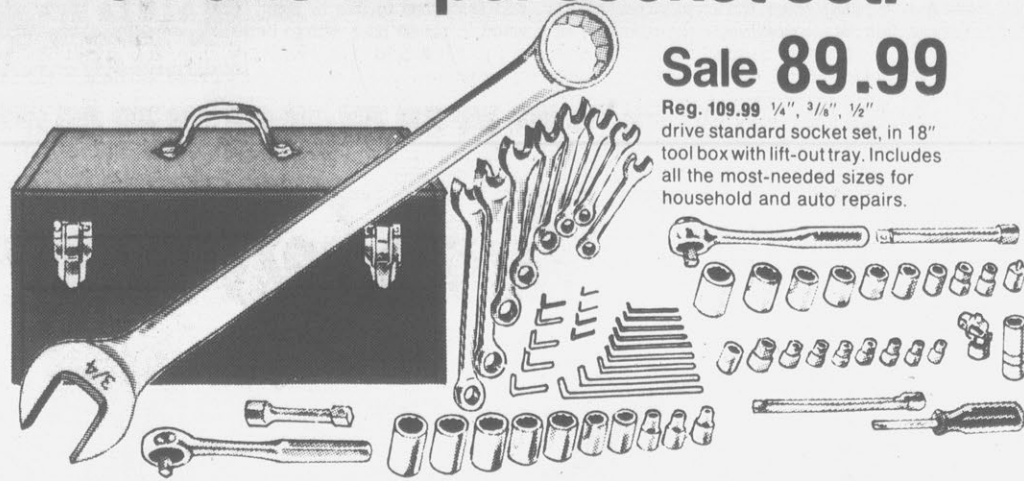

**Sale 89.99**

Reg. 109.99 1/4", 3/8", 1/2" drive standard socket set, in 18" tool box with lift-out tray. Includes all the most-needed sizes for household and auto repairs.

**6 drawer chest**  
**84.99**

**Save \$35**

Reg. 119.99 Sale 84.99 Six-drawer heavy duty tool chest provides 2616 cubic inches of storage for the handyman or hobbyist. Features lift-out divided tray, lift-up top, side carry handles, cylinder lock with two keys. Sturdy metal with black wrinkle finish.

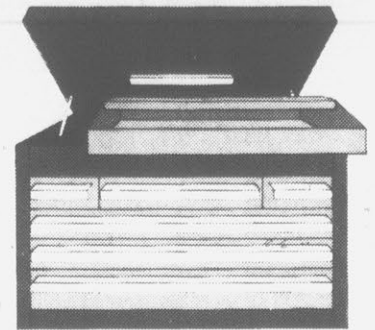

Would cost 90.80 if purchased separately.

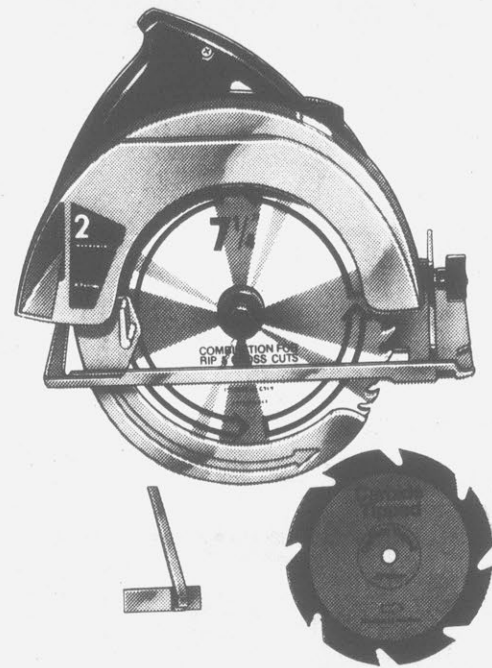

**Special 49.97**  
7 1/4" circular saw kit.

Would cost 90.80 if purchased separately. Includes 2.0 HP, 10 amp circular saw with ball bearing construction; carbide tip blade, handy saw case.

Your choice

**4.99** ea.

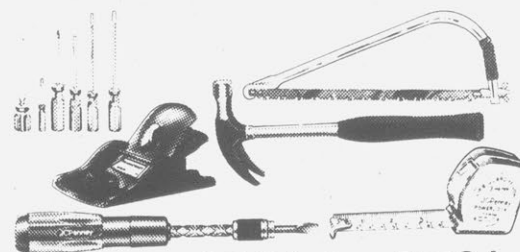

**Save 16% to 37%**  
Your choice, 4.99

Choose from a wide assortment of hand tools that are musts for the handyman.

- Reg. 6.49 16 oz. claw hammer
- Reg. 7.99 6-pc. screwdriver set
- Reg. 6.49 10" spiral ratcheting screwdriver
- Reg. 6.49 3 meter/10' tape rule
- Reg. 6.29 10" vise grip
- Reg. 6.99 6 1/2" block plane
- Reg. 6.99 21" bow saw

**Full No Time Limit Warranty**  
If any JCPenney hand tool ever fails to give complete satisfaction we will replace it, free of charge, with a new one of equal value. Just return it to the nearest JCPenney facility for prompt service.

**Line trimmer**

**39.99**

**Save \$10**

Reg. 49.99. Sale 39.99. Toro 3.5 amp line trimmer. Automatic line feed, double insulated and lightweight with adjustable support handle.

Sale prices effective through Saturday.



**Save \$5**  
on our most popular interior flat paint.

**Sale 8.99** gal.

Reg. 12.99 Five year limited warranty. One Coat Plus interior flat latex paint. Easy, smooth one coat coverage that's durable, washable, stain and fade-resistant. Clean up with just soap and water.

Sale 9.99 Reg. 13.99 gal. One Coat Plus interior semi-gloss

Limited warranty: If this JCPenney paint fails to cover in one coat when applied according to label instructions or if it fails because of a defect in materials within the specified number of years, we will replace it or refund your purchase price. Application of replacement paint is excluded. Just contact the nearest JCPenney facility for prompt service.

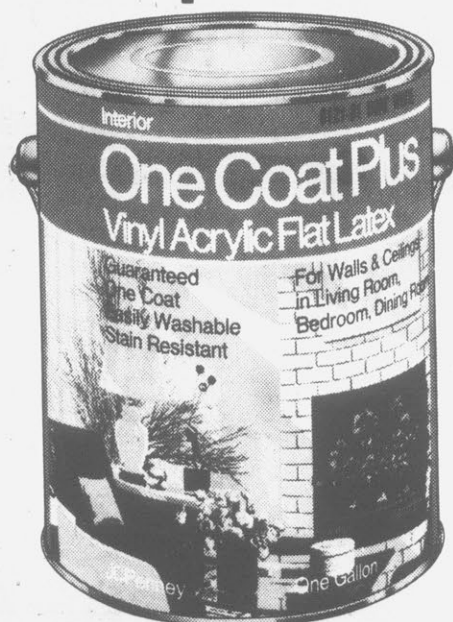

**Save \$4**

Reg. 12.99 gal. Sale 8.99 Limited four year warranty. One Coat Plus exterior flat latex, our most popular exterior flat paint. Resists blistering, fading.

**6 Ga. wet/dry shop vacuum.**

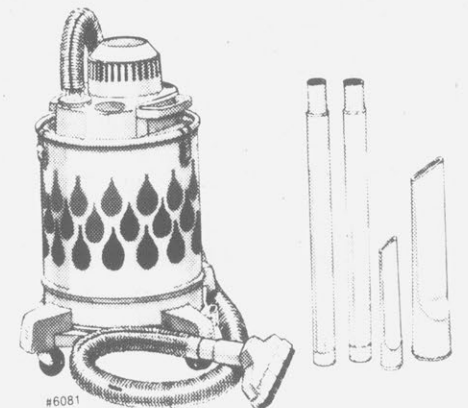

**47.99**

6 gallon wet/dry shop vacuum is great for indoor or outdoor clean-ups. Includes hose, nozzle, squeegee shoe, 4 wheel dolly, more.

## 'Great Decisions'

Another in the "Great Decisions" lectures, a program sponsored nationally by the Foreign Policy Association, will be held at 7:30 p.m. Thursday, March 22 in Room 210 of the Belk Building (Allied Health Center), East Carolina University.

Professor Luis Acevez, of the Department of Foreign Languages, ECU, will be the speaker, and his topic will be "The U.S. and Latin America: Facing New Facts of Power."

The sponsoring association is a non-profit, non-partisan institution founded to promote a more informed public on foreign affairs issues, and East Carolina University is the regional coordinator for the program.

There is no admission charged and the public is invited to attend. The program is due to end by 9 p.m.

## TOWN OF WINTERVILLE NOTICE OF PUBLIC HEARING TO CONSIDER ADOPTION OF THE TOWN OF WINTERVILLE FY 1978 COMMUNITY DEVELOPMENT URBAN RENEWAL PLAN

NOTICE IS HEREBY given that at 7:00 P.M. on April 2, 1979 in the Town of Winterville Municipal Building, the Town of Winterville Board of Commissioners will conduct a public hearing to consider the adoption of a FY 1978 Community Development Urban Renewal Plan. That plan sets forth the property acquisition, property disposition and relocation procedures of the FY 1978 Community Development Program. The Urban Renewal Plan establishes the FY 1978 Community Development Area as a "blighted area" in need of Urban renewal and redevelopment. A copy of the Winterville Urban Renewal Plan is on file in the Winterville Town Advisor's Office and is available for public review during all normal office hours. Comments may be submitted in writing to the Winterville Town Advisor's Office at any time prior to the April 2, 1979 public hearing. The public is encouraged to attend the public hearing and comment on the Urban Renewal Plan.

TOWN OF WINTERVILLE BOARD OF COMMISSIONERS P.O. BOX 431 WINTERVILLE, N.C. 28590

This is **JCPenney**

•Shop 10 a.m. 'til 9 p.m.  
•Phone 756-1190

### Meet Friday

The Board of County Commissioners will meet Friday at 10 a.m. in the Law Library in the Pitt County Court House to consider introduction of the bond order for a proposed \$9 million school bond referendum, and to approve an application to the Local Government Commission for approval to issue the bonds.

Other business is also included on the agenda.

### Thief Takes City Buses

NEW YORK (AP) — Officials of the Riverdale Transit Co. were not terribly surprised when one of their buses turned up missing from the Manhattan terminal.

Tuesday was the fifth time in five weeks it had happened, either at the Manhattan terminal or at the company's huge bus barn in Yonkers.

The 40-foot-long, \$90,000 buses just vanish while the regular driver is grabbing a bite of lunch.

But they always turn up, and the one stolen Tuesday was no exception. Police found it several hours later at Eighth Avenue and 141st Street, minus the unscheduled driver.

It also was minus an undetermined amount of fare cash, as the bus thief, as usual, had smashed the fare box and emptied it before taking off.

George Bernacchia of Riverdale Transit is convinced the bus capers are carried out by one man, and that before abandoning the buses, he picks up passengers along the regular route to sweeten his take.

"He's one of our best bus drivers," said Bernacchia. "He's someone who knows the route, knows the procedures for checking out buses, knows all the schedules."

"We think we know who he is," he added.

**CLUB SPONSORS LECTURE**  
The Christian Women's Fellowship Club of Philippi Church of Christ will sponsor the third in a series of four Lenten lectures Wednesday, March 21, 7:30 p.m., on "Living the Word." Eldress Shirley Daniels will give the lecture. The public is invited.

## Former Raleigh Attorney Is Sentenced In Heroin Dealings

GOLDSBORO, N.C. (AP) — John D. McConnell Jr., a former Raleigh attorney and civic leader, was sentenced Tuesday to five years in prison for helping launder money from a large-scale heroin ring.

"I was an absolute fool," the 38-year-old McConnell told Superior Court Judge Forrest A. Ferrell as he choked back tears. "I'm gravely sorry for the things I have done."

McConnell, charged with being an accessory after the fact to possession of heroin with intent to sell, will be eli-

gible for parole as soon as he begins serving the sentence. He was ordered to surrender June 1.

McConnell was the first person to plead guilty last year when proceedings began against those accused of being part of a heroin operation masterminded by Leslie "Ike" Atkinson and Frank Lucas.

In the four-hour sentencing hearing in Wayne Superior Court Tuesday, it was revealed that McConnell was approached in 1974 by a Northwestern Bank officer who coached him on how to slip money out of the country into a tax-free haven

on Grand Cayman Island in the Caribbean.

A month later McConnell began transporting money for the Atkinson-Lucas ring, according to defense attorney Roger Smith.

Smith made a two-hour emotional plea that McConnell be placed on probation rather than be sent to prison. He said the former attorney is living on borrowed money and charity.

McConnell has already served a federal prison sentence on a perjury conviction in connection with testimony before a grand jury in New York. Smith said that five days after

McConnell's release from prison, Raleigh police were advised that a \$50,000 contract had been put on his life.

McConnell was the latest person to be sentenced among a group of people — most of them members of Ike Atkinson's family — who were indicted by a Wayne County grand jury last March. All of them have received prison sentences.

On Monday, Edward Atkinson, 60, brother of Ike Atkinson, was sentenced to five to eight years in prison on a charge of conspiracy to possess and deliver heroin.

### Will Speak On Hang-Gliding

Ralph Buxton, a representative from Kitty Hawk Kites, Inc., Nags Head, will visit East Carolina University Thursday, March 22, to discuss hang gliding and show a film on the subject.

Buxton will also be interested in seeking out persons interested in employment with Kitty Hawk Kites.

The event is open to the public and sponsored by the Parks, Recreation and Conservation Society of ECU. All persons should plan to attend. The event will be held in Room 244, Mendenhall Student Center, at 7:30 p.m.

### Retirees Plan Luncheon Meet

A Pitt County Retired Teachers and School Personnel Luncheon will be held Wednesday, March 28, 12 noon, at the Red Oak Christian Church, Highway 264 Bypass West.

Tickets will be \$3.50, with reservations to be made by Friday, March 23. Interested persons should call Irene Fleming, 752-2972, by Thursday night for reservations.

### SHARING GROUP

The Greenville Advisory Committee for Exceptional Children will sponsor a sharing group meeting Thursday, March 22, 7:30 p.m., at St. James United Methodist Church. Interested persons are welcome.

**INVENTORY REDUCTION SALE**



Model LFE 3000

## WHIRLPOOL DRYER

•Large 5.9 cu. ft. drum •Permanent press cycle  
•Extra large lint screen •Finish of high temperature baked enamel.  
Price includes delivery up to 20 miles, service and parts warranty.

**NEW LOW PRICE \$178<sup>00</sup>**

**Whirlpool**

**BOB'S TV & APPLIANCE**

AYDEN, N.C. GREENVILLE, N.C.

# Green Thumbs

## Lawn & Garden Specials



# 1<sup>¢</sup>

## SALE

### EVERGREENS

Azaleas & Camellias in 1 Gallon Containers. 60 Varieties. Thousands Available.

Buy One At Regular Price (From \$2.49-\$5.95) And Get The Second Plant For Only 1<sup>¢</sup>

## Red Geraniums

IN 4" POTS  
SAVE 1/3  
REG. \$1.49 . . .

# 99<sup>¢</sup>



## Primroses

Hardy Perennials In Assorted Colors. Potted In 4" Containers. Save 33 1/3% Reg. \$1.49

# 99<sup>¢</sup>

## FLOWERING DOGWOODS

4 To 7 Feet Tall. Red, White Or Pink Colors Available.

Save 33 1/3% - Reg. \$14.95

# \$9<sup>88</sup>

Now Unconditionally Guaranteed Until July 1, 1979. Planted in 3 And 7 Gallon Containers.

## FLOWERING TREES



Buy 2, Get 1 Free (Priced From \$9.95 To \$19.95)



Save \$2.00

### PINE BARK NUGGETS

No Limit

3 Bags \$6<sup>97</sup>



Bulk Sales Minimum Of 2 Lbs. Per Customer

### Centi-Seed

The original Centipede Grass Seed

\$15<sup>95</sup> Per Lb.

SAVE \$4.00 Lb.



8-8-8 Pelletized Fertilizer

4 50-Lb. Bags

### \$11<sup>88</sup>



Cabbage Plants

Per Bunch

### 99<sup>¢</sup>



ONION SETS

Quart

### 99<sup>¢</sup>

## Kmart

THE SAVING PLACE

### Our Personality Portrait Package



**\$10.95** total package price

95¢ deposit

Package Includes:  
1-8x10  
3-5x7's  
15-Wallets  
4-Color Portrait Chams

The perfect Color Portrait Package for the entire family at a super Kmart price, and in a variety of poses and backgrounds. One sitting per subject. No additional charge for groups. Poses our selection. Satisfaction always or deposit cheerfully refunded.



**SHOOTING DATES**

Thurs., March 22  
Fri., March 23  
Sat., March 24  
Mon., March 26  
Tues., March 27  
Wed., March 28  
Thurs., March 29  
Fri., March 30  
Sat., March 31



**PHOTOGRAPHER ON DUTY**

10 A.M. TO 8 P.M. DAILY

Get Growing Now!

# sunshine

Spring And Summer Hours Mon.-Sat. 8-6 Open Sundays 1-6

GARDEN CENTER  
Located 1 1/2 Miles South Of T.V. Station  
On Evans St. Extension  
Telephone 756-2629

# As In All Big Cities, Moscow Has Street Crimes

By NIKKI FINKE  
Associated Press Writer  
MOSCOW (AP) — Muggings, murders, looting, rape, burglaries, grand larceny and — of course — the age-old crime of prostitution.

Like every major city, Moscow has a crime problem. It is less visible than in big American cities, and the Soviet press tries to perpetuate the image that the capital is almost crime-free.

But many Western diplomats and tour groups that run trips here are now urging foreign tourists to start taking more precautions against Moscow street crime, especially since more than 300,000 foreigners, by Russian estimates, will visit here during the 1980 Olympics.

Several months ago, a woman on a U.S. university exchange program here was walking home from the subway stop near Moscow State University late one night. Because of Moscow's reputation as a "safe" city, she felt little fear about traveling without a friend.

Then a middle-aged man attacked her and tried to force her to the ground. She began screaming, and the man fled — but not before he bashed her in the mouth and stole her pocketbook.

"It was a mugging, just like you'd find in New York," she said.

Despite such incidents, crime in Moscow is nowhere as prevalent as in similar-sized cities in the United States, partly because of a strong police presence to look after juvenile delinquents, drunks and other anti-social elements in the population of 7.8 million.

U.S. Chief Justice Warren Burger was told during a trip here that there is one uniformed policeman for every 3,000-4,000 people. And some 8 million people around the country are so-called "public order volunteers" who aid police and have powers to arrest.

The traffic cop can be found on almost every Moscow street corner during the day. But, like most big cities, a policeman is hard to find late at night except for the occasional patrol car. There is an emergency police number that Muscovites can telephone for help — 02 — and get a swift response.

The government-controlled Moscow media rarely report crime stories except occasional cases aired to warn citizens away from anti-social behavior. Each article contains the stiff punishment meted out by the courts to the criminal.

But it is the philosophy here that violent crime is an example of the class struggle in capitalist societies only. Asked to compare crime statistics for New York and Moscow, city head Vladimir Promyslov told a Soviet interviewer not too long ago:

"Comparison is practically impossible ... There is a whole range of crimes, though widespread in capitalist society, including the United States — New York in particular — which is simply impossible in the U.S.S.R. The very nature of the socialist system has eliminated such crimes as bank robbery, kidnapping people for ransom and a few other crimes."

He noted, however, that "Moscow has not eliminated cases of hooliganism, misappropriation of socialist property, arson and other offenses against the law."

Many Western analysts here believe Moscow's rapid urbanization has led to a significant rise in crime in recent years.

But it is impossible to verify,

since Soviet crime statistics are hard to come by — partly because none was kept from the 1930s to the 1950s under orders of Soviet leader Josef Stalin. It wasn't until the 1960s that records were kept of "negative behavior."

According to official statistics obtained from various sources: property crimes and hooliganism make up 60 percent of all crimes; some 63 percent of all crimes are committed by drunks; and crimes against

persons — murder, rape and assault — accounted for 15 percent of the 835,000 convictions logged in 1970.

One Soviet sociologist pointed out that seven out of 10 murders here are committed in apartments, showing what she said was an "alarming" tendency towards more crimes in every-day places.

And when crimes come so close to home, Muscovites get nervous. Signs have begun appearing in some Moscow apart-

ment buildings urging residents to take turns "guarding" the houses. This would have been an unheard-of request 10 years ago, residents say.

But a recent newspaper article reported that a burglary ring robbed more than 20 apartments around Moscow before the three thieves were caught and sentenced to seven years' hard labor.

An unprecedented instance of looting also took place recently. Residents of one Western Mos-

cow district told The Associated Press that looters moved in after 3,000 people were evacuated from their apartments because of no heat or hot water during a severe cold wave.

Petty theft is common around Moscow. Many Western residents are initiated when they find that the windshield wipers, sideview mirrors and tape-decks from the cars have been swiped.

But grand larceny also is around. A recent tour story re-

ported that two men were sentenced to death after one of them shot and killed a female cashier at the Moscow Institute of Chemical Machine-Building on payroll day. The killer was carrying a "homemade" gun.

Nor is Moscow without its sensational crimes — a 1969 assassination attempt on three cosmonauts, a 1976 terrorist subway explosion, last May's hostage-taking at the Finnish airline office.

The bloodiest attack on for-

eign visitors in recent years took place last June when a 24-year-old Soviet night watchman axed to death three Swedish tourists outside the Intourist Hotel here.

And a recent bizarre murder has come to the attention of Westerners here. Six weeks ago, police reportedly found a woman's torso stuffed in a suitcase abandoned on a Moscow tramcar. Another suitcase was found, containing the woman's other remains.

OPENING  
MARCH 26TH.



## KING'S

FAMOUS BRANDS for Less



milton bradley's simon  
electronic skill game  
Test your concentration and try to repeat the random sequence of sounds and flashing lights. It's tricky!  
**22<sup>90</sup>**

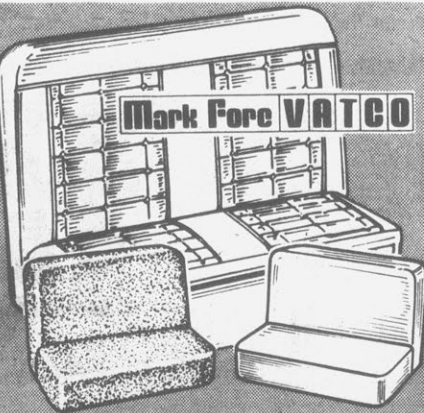

auto seat covers  
in three styles  
our reg 6.49  
to 7.49 **4<sup>99</sup>** ea

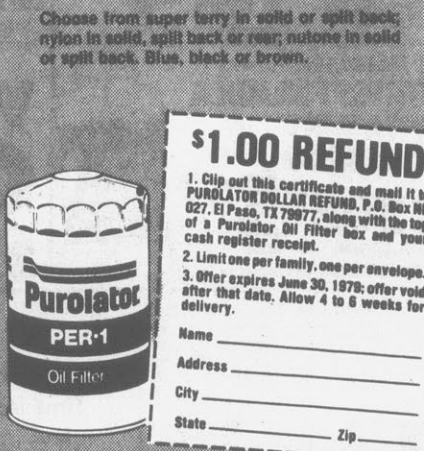

\$1.00 REFUND  
1. Clip out this certificate and mail it to PUIROLATOR DOLLAR REFUND, P.O. Box 807, El Paso, TX 79877, along with the top of a Purolator Oil Filter box and your cash register receipt.  
2. Limit one per family, one per envelope.  
3. Offer expires June 30, 1979; offer void after that date. Allow 4 to 6 weeks for delivery.  
Name \_\_\_\_\_  
Address \_\_\_\_\_  
City \_\_\_\_\_  
State \_\_\_\_\_ Zip \_\_\_\_\_

\$1 refund when you buy a purolator® oil filter  
our reg price ... 3.49  
our sale price ... 2.00  
less mfr's rebate 1.00  
your cost after rebate **\$1.00**

### Petrochemical Plants To China

TOKYO (AP) — Four Japanese firms have completed a \$200-million deal to export four petrochemical plants to China, where they will produce materials for making plastics and man-made fibers.

The four firms involved are Mitsui Petrochemical Industries Ltd., Mitsui Engineering and Shipbuilding Co., C. Itoh and Co., and Kosho Corp.

### Now They Know; Lake Has Leak

KEYNES PARK, England (AP) — The local sailing club couldn't figure out why so many experienced yachtsmen were running aground. Now they know — their lake is leaking. The water level has dropped more than three feet in the past year.

GREENVILLE BLVD.  
264 BY-PASS  
OPPOSITE PITT PLAZA  
OPEN DAILY 10 'TIL 9

sale starts wed, march 21  
sale ends sat, mar 24

charge it with  
visa or mastercharge



spring's newest!  
dressy fashion  
coordinates  
blouses color-cued to  
skirts and slacks!

our reg 10.99  
to 12.99 **7<sup>99</sup>** ea

Solid and print blouses in v-neck and mandarin collar styles. Matching solid color skirts and slacks with elasticized waistbands for easy fit. 100% polyester and poly/cotton blends. In rains.

sizes 5/6 to 15/16



made in u.s.a.



childrens  
basketball oxfords  
sold elsewhere **\$2**  
for 2.99

Rugged cotton canvas upper with full cushion insole, non-slip sole, bumper toe. Assorted colors. Sizes 5 to 10 1/2.



mens knit  
shirts from a  
top notch maker

made to sell for much more!

**6<sup>90</sup>**

Short sleeve knits in nylon and polyester blends featuring collar and placket detail. In solids and fancies. Sizes S-M-L.



decorator toss pillows

antique satin **\$2** our reg 2.99  
corduroy or velour **\$3** our reg 3.99  
crewl or fringed **\$4** our reg 4.99

Choose colorful antique satins, midwale corduroys or plush velour piles in 15" squares. Or luxury crewel wool embroidery looks and Indian-style hand tied fringe looks in natural, stripes, plaids or tweeds.

2 and 3 piece styles!  
spring skirt sets

our reg 21.97  
**14<sup>90</sup>**

Junior styles feature notched-collar blazer, front pleated skirt. Misses, Womens 3-piece styles with 4-button vest, blazer, straight skirt. 100% suretane polyester in the newest spring colors.  
sizes 5 to 13, 10 to 16, 14 1/2 to 24 1/2

\*3 mail-in rebate  
from regina® on  
their 3-speed  
electrikbroom®

our reg price ... 34.99  
our sale price ... 29.99  
mfr's mail-in  
rebate ... 3.00

your cost  
after rebate **26<sup>90</sup>**

Features exclusive dirt cup, 4-setting rug pile dial, swivel nozzle that gets under furniture.

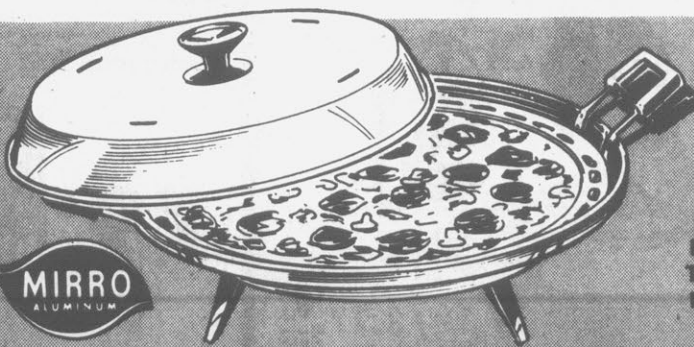

save \$13...save energy, too! mirro's  
watta pizzeria™ for pro-style pizza

Bake frozen pizza, ready-made or make it from scratch using 70% less energy than a gas or electric range oven unit. Even-heating 12" diameter aluminum pan with easy-care acrylic enamel exterior finish. Directions, recipes included.

our reg 19.99  
**6<sup>99</sup>**

UP TO  
**70%**  
HEAT SAVINGS

Save Up To 70%  
Energy Compared  
To Electric Or Gas  
Range Oven Units



1200 watt  
welco pro hair dryer

2 speeds, 3 heat settings plus air concentrator for spot drying, styling. Contoured handle, convenient hang-up ring.  
**9<sup>97</sup>**

# Jury Unable To Reach Plug-Pulling Verdict

By **THERESA HUMPHREY**  
Associated Press Writer  
BALTIMORE (AP) — The jury in the mercy-killing trial of nurse Mary Rose Robaczynski stood 10-2 for acquittal during most of its deliberations before a mistrial was declared, says the jury forewoman.

The six-man, six-woman jury deliberated 19 hours over two days before Judge Robert Karwacki decided late Tuesday that a verdict could not be reached.

Mrs. Robaczynski, 24, a former nurse at Maryland General Hospital, was accused of unplugging the respirator of Harry Gessner, a 48-year-old Baltimore cab driver who was in a coma.

A city grand jury indicted her last year on murder charges in the deaths of Gessner and three other comatose patients. She acknowledged disconnecting the respirators of Gessner, Catherine Womack, and Louvenia Reed because she thought they were dead. However, she denied pulling the plug on Markene Smith.

Mrs. Robaczynski still faces trial in connection with the other deaths. Assistant State's Attorney Howard B. Gersh said after the mistrial that it was "too premature" to tell if he would seek a retrial in Gessner's death.

"The biggest issue was whether or not he was dead," said jury forewoman Beverly A. Stokarski. "There was so much speculation on the part of the doctors' testimonies."

One juror who held out for a guilty verdict said emotions played a big part in the deliberations.

"It was too much to ask a jury to decide," said Cleo E. Anderson Jr., who said he held out for a guilty verdict. "It was useless."

The judge called the jury back to the courtroom at 11:20 p.m. Tuesday and asked Ms. Stokarski, "Do you think continued deliberation would not be fruitful?"

"Yes," she replied.

The jury was told Monday it could acquit Mrs. Robaczynski, or convict her of first-degree murder, second-degree murder, or involuntary manslaughter.

During deliberations, prosecutor Gersh said he heard jurors screaming about whether or not Gessner was dead when his respirator was disconnected.

Gessner's time of death was an important factor in the case. Prosecutors argued that he was alive when Mrs. Robaczynski unplugged the respirator, but the defense said that by legal definition he was already dead.



**MISTRIAL — Mary Rose Robaczynski, a former nurse accused of murdering a patient by disconnecting his respirator, and her attorney George Helinski, leave court after the jury could not reach a unanimous verdict. (AP Laserphoto)**

# Appeals Court Concurs Secrecy Was Violated

RICHMOND, Va. (AP) — Former CIA agent Frank W. Snapp broke his secrecy agreement with the agency when he published his controversial book about the 1975 U.S. evacuation of Vietnam, a federal appeals court says.

But the 4th U.S. Circuit Court of Appeals ruled Tuesday that a lower court's punishment — forfeiting all his profits from the book — was too severe.

The court said that imposing thousands of dollars in damages would be proper only if Snapp had disclosed classified information, which the government did not charge. Snapp's earnings from his book, "Decent Interval," are approaching \$100,000.

Snapp is a former Charlotte, N. C., resident who makes his home in Arlington, Va. His father is Superior Court Judge Frank W. Snapp Jr., of Charlotte, a former North Carolina legislator.

The decision came on Snapp's appeal of last summer's ruling by U.S. District Judge Oren Lewis of Alexandria, Va.

In his ruling, Lewis denied

Snapp any profits from the book and ordered him to clear all CIA-related material with the agency before any future publication.

In arguments last November before the appeals court here, Snapp's lawyer, Mark Lynch, argued that his client did not violate any secrecy agreement with the publication of the book.

He said an agreement signed by Snapp when he left the CIA in 1976 merely barred him from disclosing classified information.

Snapp argued he was singled out by the agency because his book cast the CIA in an unfavorable light.

The appeals court, in its decision, also reaffirmed an earlier opinion that the CIA's secrecy agreement does not violate First Amendment free speech rights.

The judges said they agreed with Lewis' ruling that Snapp violated the secrecy contract by not submitting his manuscript so the agency could determine if it contained secrets.

They also said that the gov-

ernment was entitled to punitive damages from Snapp but not as high as those imposed.

**NEED A TAX BREAK?**  
CALL 756-1377  
**WATSON ASSOCIATES OF GREENVILLE, INC.**  
Duplexes, Quadrplexes and Apartments are being developed and are for sale  
Call For An Appointment Today  
Dillon F. Watson  
Etsell S. Gordon  
N.C. Contractors License No. 8029

**NEED MONEY?**  
**\$ TOP CASH PRICE \$**  
**PAID ON THE SPOT FOR**  
Class Rings  
Wedding Bands  
Diamond Rings  
Pocket Watches  
Sterling Silver

**Convert Your Old Coins & Scrap into CASH!!**

Bronson Matney  
Silver Coins-50¢, 25¢, 10¢ - (1964 and older)  
Clad Half Dollars-(1965-1969)  
Silver Dollars-(1935 and older)  
Old Coins- 1/2 cent, 2 cent, 3 cent, Indian 1' and others  
(Please no Buffalo nickels or wheat pennies)

**GOLD Coins — Absolute Top Dollar Paid In Cash!**  
Complete Coin Collections-

We specialize in buying estate jewelry, sterling silver, and coin collections. If you cannot come down, call Mr. Matney at 752-3651 for a personal appointment at your home. All transactions done in strictest confidence.

"Coin & Ring Man" from Harmony House South  
ON THE MALL DOWNTOWN GREENVILLE 752-3651

# Spring Signals Clean-Up Drive

GRIFTON — Mayor Dave Bosley of Grifton signed a proclamation Wednesday designating the first day of spring as Grifton's Ninth Annual Grifton Clean-Up Campaign kick off day.

Grifton residents will meet Saturday, March 24, 9 a.m., at the Grifton Water Tower for the first of three Saturday-morning sessions to pick up trash and beautify the roadsides and public areas in the town.

Each Saturday for the next

three weeks, March 24 and 31, as well as April 7, workers will meet to form work crews and receive instructions. At 12 noon, all workers will be treated to hot dogs and drinks, which will be donated.

The Keep Pitt County Clean and Beautiful Committee has designated Grifton's annual clean up campaign as a model for other small towns in the county. The Committee is also sponsoring a county-wide clean up in April.

Older teenagers and adults are especially needed to supervise groups of younger children and to work on the highway approaches to Grifton. Children will not be allowed to clean near the highways. Also, donations are also being asked for large plastic or strong paper bags for garbage.

A special effort is being made to beautify the town before the annual Shad Festival, April 20-22.

# Funds Offered To Fire Depts.

WASHINGTON — Wayne Harris, local government coordinator for the Mid-East Commission, said today that \$78,000 has been made available to North Carolina to provide assistance to rural fire departments.

The funds have been released by the Department of Agriculture through the U.S. Forest Service, according to Harris, to provide financial assistance to communities with no fire protection which wish to establish and organize fire departments.

Harris said grant funds may also be used to aid recently organized departments, and departments that have little or no equipment.

The local government coordinator said too, that in addition to the grant money, fire departments may receive federal excess vehicles on an indefinite loan basis, provided they be converted to a pumper within a specified time. The vehicles, he noted, are available through the N.C. Department of Natural

Resources and Community Development.

Harris said in order to qualify for grant money, the population served by the rural fire department must be less than 10,000, and answer all fire calls without discrimination. The department, he added, must agree to furnish at least 50 per cent of the funds required to purchase equipment.

Further information on the grant program may be secured by calling Harris at 946-8043.

# Resurfacing City Streets

The city reported that work is underway on resurfacing some 15,745 linear feet of local streets.

Streets scheduled for resurfacing include: Country Club Drive, from Memorial Drive westerly past the clubhouse; Woodstock Drive; Martinsborough Road, from Tar Road to Queen Anne Road; Hillside Drive, from Elm Street easterly to the end;

Crestwood Drive, from S. Overlook Drive to Beaumont Drive; Beaumont Circle; E. Wright Road, from Ragsdale Road to Tenth Street; Tryon Drive, from Jefferson Drive to Cedar Lane; and Airport Road, from Memorial Drive westerly.

Work on the streets, contracted by Barrus Construction Co., should be completed in the next three to four weeks with the exception of Martinsborough Road, which will be delayed to allow time for completion of sewer line installations.

The work, according to the city, represents the first resurfacing program of local streets since 1976.

# Demonstration In Crafts Work

Mrs. Lyles W. Russell of Winterville gave a basket demonstration to students in Aycock's Library recently. Her appearance was arranged by Mrs. Sue May, Home Economist for the Pitt County Extension Service.

In addition to basketweaving, other crafts she demonstrated and displayed were hand made yarn dolls, nut head dolls, felt animals, monkeys made from pairs of socks, and an antique egg/gizzard basket.

MID-ATLANTIC CHAMPIONSHIP **THURS. MARCH 22**  
**WRESTLING**  
8:15 P.M. 8:15 P.M. 8:15 P.M.  
**ROANOKE H.S. GYM**  
SPONSORED BY MONOGRAM CLUB  
**FOR WORLD'S TAG TEAM CHAMPIONSHIP**  
**PAUL ORNDORFF**  
AND  
**JIMMY SNUKA**  
•VERSUS•  
**RIC FLAIR** AND  
**ERNIE LADD**  
SKIP YOUNG PEDRO MORALES  
•VS•  
MOOSE MOROWSKI SGT. JACQUES GOULET  
DAVID PATTERSON VS. HERB GALLENT CHARLIE FULTON VS. TERRY SAWYER  
Admission: \$5.00 Ringside \$4.00 General Admission.

**JOGGER SALE**  
MENS, BIG BOYS, YOUTHS  
White Vinyl with Blue or Green Stripes. (Also Sueding in Boys Sizes)

CHILDS 8½-3 **4.77** Reg. 6.99  
Mens 6½-12 B. Boys 3½-6 **5.77** Reg. 8.95 & 7.99  
Youths 5½-8 **3.77** Reg. 5.99

**SNEAKER SAVER 175**  
**TUBE SOCKS 99¢**

Greenville Square Shopping Center  
Hours: Monday thru Saturday 10 A.M.-9 P.M.

"SHOE SHOW IS GOING TO BE YOUR FAVORITE SHOE STORE"

**Spring "2 FOR" SALE**  
Sale Ends Sunday, March 25

**REXALL Vitamin E** (V-3043) 400 I.U., 100 Capsules **2 For \$5.99**

**REXALL GER-RITE** (V-2040) High Potency Iron & Multivitamin Supplement 100 Tablets **2 For \$4.98**

**REXALL High Potency STRESS FORMULA VITAMINS PLUS ZINC** (V-2045) 60 Tablets **2 FOR \$5.97**

**REXALL High Potency STRESS FORMULA VITAMINS PLUS IRON** (V-2035) 60 Tablets **2 FOR \$5.47**

**REXALL Vitamin C** (V-3024) 500 mg., 100 Tablets **2 FOR \$2.79**

**REXALL NATURALIST™** Natural laxative for the treatment of constipation. 14 oz. **\$2.79**

**REXALL PERMATHENE-12** Time Release Capsule Reducing Plan. For all-day appetite control! Follow the diet plan included for fastest weight loss results. 48's **\$4.99**

**CO-TYLENOL GOLD FORMULA** 24's Reg. \$1.29 **\$1.89**

**Vinyl Shopping Bag** heavy duty floral designs 20" x 15" **79¢**

**Party Picks** for hor's d'overs 2 Pkgs. For **79¢**

**Plate Holders** 2 in a package for picnics asst colors **79¢**

**Hollowell's DRUG STORES, Inc.**  
FREE Hospital & City-Wide Delivery  
Quality • Competitive Prices • Service  
Open Every Day Of The Year To Serve You!

No. 1—911 Dickinson Ave. 752-7105  
No. 2—6th St. & Memorial Drive 758-4104

# Freeze-Dry Process Has Saved Books

BY NADINE JOSEPH  
Associated Press Writer  
PALO ALTO, Calif. (AP) — More than half of 45,000 books Stanford University librarians feared were lost to a flood will be back on the shelves next month — saved by a freeze-dry process usually reserved for coffee.

"The results have been exciting, when you consider we had masses of pulpy paper and it looked hopeless," said Sally Buchanan, a Stanford librarian in charge of the book restoration project.

Ms. Buchanan said 65 percent of the books will be returned to the graduate library after dirt and mud have been removed and 25 percent of the books will need rebinding. The rest — 10 percent — need extensive repairs and a small number will be replaced.

"We may lose some covers, but the paper has come out beautifully," Ms. Buchanan said. The books were soaked when a water main broke and flooded the basement stacks of the Stanford library on Nov. 4. Most of the damaged books were classics, religion, art, music, philosophy and architecture books.

After the accident, the books were immediately frozen, among vegetables and fruit, at Modern Ice & Storage in San Jose, Calif., which is owned by a Stanford alumnus.

The books remained there until Lockheed Inc. volunteered to freeze-dry them in a vacuum chamber that had been used in training for space ventures.

It took three days to freeze-dry each load of 5,000 books. The process began Feb. 5 and was completed March 12, Ms. Buchanan said.

The books were first subjected to mild heat in the stainless steel vacuum chambers, which measured 18-by-18-by-35 feet.

Through a physical reaction called sublimation, the ice crystals turned to vapor without getting the books wet. The vapor collected on a special cold panel in the form of ice and the books came out "dry and brittle," Ms. Buchanan said.

Before they are returned to the shelves April 1, the books are being kept in a high humidity environment so that they absorb moisture.

A similar process was used to restore smaller numbers of books from the Corning Glass Museum and Library in Corning, N.Y., the Klein Law Library at Temple University, in Philadelphia, and the Federal Record Center in St. Louis.

"There was no way to get 45,000 books dry before they mildew and rot," said Ms. Buchanan. "The books were guinea pigs for this new freeze-dry process. But we're not complaining. It worked."

Sale ends Saturday, March 24th. We reserve the right to limit quantities.

# CLARKS

**2.88 and 3.88**  
Reg. 4.00 and 5.50  
**Ladies' U-neck and U-neck collared T-shirts** Short sleeves in assorted solid colors. Sizes S, M, L.  
Plus-size (42-46) polyester T-shirts . . . Reg. 4.97 . . . 3.88

**2.88** Reg. 3.95  
**Ladies' polyester pull-on pants** Assorted fashion colors for spring. Missy sizes 8-18.  
Plus-sizes 32-38. . . Reg. 5.00 . . . 3.88

**7.88** Reg. 9.97  
**Ladies' denim wrap skirt** With 2 roomy pockets. Missy sizes 5/6-15/16.



**20% off**  
**all No-Nonsense hosiery**  
**90¢ to 2.15**  
Reg. 1.15 to 2.70  
Enjoy No-Nonsense fit and 20% off our low everyday prices on all styles, colors and sizes of No-Nonsense knee-hi's and pantyhose.

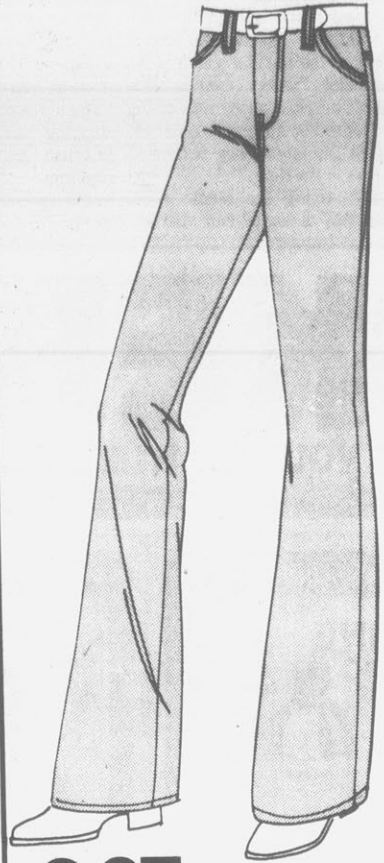

**6.97** Reg. 8.50  
**Men's brushed denim western jeans** 100% cotton in assorted colors. Sizes 28-42.



**3.95** Reg. 4.95  
**Men's long sleeve sweatshirts** Crewneck with raglan sleeves in ass't. colors. S-XL.



**59¢** Reg. 79¢  
**Men's orlon crew socks** Ass't. colors. Fits 10-13. Boys' crew socks. . . . . 55¢



**Special savings on Cannon® towels**

**3.49** bath Reg. 4.50-4.75  
Choose Cannon's Keystone or Ecstasy patterns. Assorted decorator colors.

|                     |                           |                    |                          |
|---------------------|---------------------------|--------------------|--------------------------|
| KEYSTONE Hand towel | Reg. 3.00 . . . . . 2.49  | ECSTASY Hand towel | Reg. 3.25 . . . . . 2.49 |
| Wash cloth          | Reg. 1.50 . . . . . 1.19  | Wash cloth         | Reg. 1.50 . . . . . 1.19 |
| Bath sheet          | Reg. 11.75 . . . . . 9.49 |                    |                          |

CANNON.



**your choice**

**9.88** Reg. 11.95  
**Texas Instruments 8 digit calculator with memory (TI-1025) or Sunbeam Mixmaster hand mixer (3-11)**



**2 for 5.00** Reg. 2.95 ea.  
**Dreemel pillow** All cotton solid ticking with polyester fill. 21"x27".



**3.00** 20"x30" Reg. 4.75  
**Braided rugs** Early American charm in earth tones. 30"x50" . . . . . Reg. 10.50 . . . . . 8.75

## Possibly Old Slave Refuge

COLLINSVILLE, Ill. (UPI) — Historians are trying to determine whether the old Bethel Baptist Church was part of the "Underground Railway" used by fleeing slaves in the Civil War.

The church contains a trap door that leads to an area where some believe runaway slaves were hidden.

The church founder, James Lemen, was a friend of Elijah P. Lovejoy, the abolitionist Alton newspaperman murdered by a pro-slavery mob while defending his printing press.

The church was founded in 1806 and is thought to be the oldest organized Protestant church in Illinois.

## New Center For Psoriasis Opens

NEW YORK (UPI) — To help individuals who normally require hospitalization due to psoriasis, the itchy, scaly skin disease suffered by six to eight million Americans annually, Presbyterian Hospital here has opened the first ambulatory psoriasis treatment center on the East Coast. The new facility enables patients to return home during the final week of the special three-week treatment period.

**MOVING PLIGHT**  
BIRMINGHAM, England (AP) — Widow Minnie Giles, 68, stands four feet, 5 inches tall, and this poses a problem. She recently had to move from her ninth-floor flat because she couldn't reach the ninth-floor button in the elevator.



**3 for 2.00** Reg. 1.00 ea.  
**Rubbermaid shelf liner** 12"x10" or 22"x5". Ass't. floral and solid colors.



**75¢**  
**Mr. Muscle oven cleaner** Self-scouring. 16 oz. aerosol can.

**\$1.00 rebate** from Sylvania with the purchase of 2 packages of Magicubes



**1.49** Reg. 1.60  
**Sylvania Magicubes** 3 cubes, 12 flashes.



**1.69** Reg. 2.19  
**Hershey's Kisses or Miniatures** 14 oz. bag.



**65¢**  
**Close-Up toothpaste** 4.6 oz.



**2 for 3.00**  
**"Gee Your Hair Smells Terrific" shampoo** Normal, dry or extra body. 16 oz.

**COUPON**

Instant reprints from Kodak or Polaroid instant prints  
**39¢** ea.  
☆☆☆  
**Slide and movie film processing**

**1.25** 20 exp. color slides, super-8 or 8mm movies  
Good on Kodak or Kodak competitive film only.  
☆☆☆  
**Coupon must accompany order. Coupon expires 4/3/79.**



**22.88** Reg. 26.95  
**Norelco Lickety Split ice cream maker** Makes 2 different kinds of frozen dessert at the same time. HB1114



**8.88** Reg. 10.95  
**Sunbeam Mist Stick Curling Iron No. 54-53**



**6.50** Reg. 7.95  
**Swisher basketball** Rugged nylon construction with molded rubber cover.



**14.90** Reg. 17.95  
**Roll bag** Double reinforced handles and detachable shoulder strap.



**5.00** Reg. 6.99  
**All purpose sports shoe** Wipes clean, lightweight and long wearing.

**RAINCHECK**  
If we sell out of any advertised specials, you will receive a written order, "Raincheck" which entitles you to buy the item at the advertised price when our stock is replenished.  
(\*excluding clearance items)

**WEST END SHOPPING CENTER, GREENVILLE**  
MON. thru SAT., 9:30 A.M. to 9:30 P.M.



# Jewelry Carries Medical Information

By MICHAEL J. CONLON  
WASHINGTON (UPI) — Ed Asner, better known as TV's "Lou Grant," has been going around the country dangling his right wrist in front of photographers, reporters, television cameras and almost anyone else who will listen.

He's showing off a gold bracelet he thinks could save his life some day, or at least make it easier for doctors to decide how to help him if he were found unconscious.

The bracelet is from Medic Alert. Another 1.3 million Americans wear similar jewelry. The bracelets alert doctors to serious medical conditions or allergies — to drugs, for example — and other problems they should be aware of before treating an unconscious patient.

In Asner's case, no such allergies or medical conditions exist.

That's the very reason why the actor thinks everyone should wear such a bracelet.

"... the doctor, should I be found unconscious, can go ahead and do anything he wants," Asner said in an interview. "(The bracelet) also

carries my blood type. Mine is O-positive, so they could immediately start blood without having to refer."

Medic Alert was founded in Turlock, Calif., in 1956 as a non-profit organization by a doctor whose daughter was almost killed because he was out of town, and the physician who treated her for a wound did not know she had a severe allergy to tetanus injections.

The doctor-father subsequently made a bracelet for his daughter so others who treated her would know of her problem. He then decided to offer the service to anyone who needed

it. For a one-time fee of \$10, anyone can register his or her vital information with the foundation. The bracelet contains a toll-free number a doctor can call if necessary to obtain blood type, medical and other information.

Asner, who agreed to serve voluntarily as national chairman of the foundation, says the bracelet "works against that great horrible anonymity of the collapsed or unconscious person when the emergency personnel come in the door."

By calling the Medic Alert number, a doctor can also get

information on the wearer's personal physician, medical records.

A similar system in Europe has a cooperative arrangement with the California organization to help American members of Medic Alert when they become ill abroad.

"One in every five persons has a medical problem that would warrant being placed on a band like this," Asner said. "The resistance occurs in wearing one, thereby being branded as someone with a problem."

"So our task is preaching the utility (of the bracelet) to the

problem bearer as well as the non-problem bearer. To make it a habit, a widely used habit. To make it an occasion where the great majority of citizens don't pay attention to it or give it a second thought.

"Our basic effort is to make it just a casual piece of jewelry to the wearer that will save lives and certainly ease the burden of medical personnel."

Long distance runners, for instance, might need the bracelets to alert doctors that they have a low pulse rate common from that form of exercise. Joggers who run without other identification

could rely on the bracelet for help if they should collapse. Asner says no other organization offers the same computer record keeping service to back up the bracelet information.

Free information and forms can be obtained by writing to Medic Alert, Box 1009, Turlock, Calif., 95380. In addition to the initial \$10 fee, there is a \$3 charge if you update your medical record during the year. The \$10 fee gets you a stainless steel bracelet. Silver and gold models are available for slightly higher prices, and a necklace version is also available.

## PUBLIC HEARING

The City Council of the City of Greenville has scheduled a public hearing for Tuesday, April 3, 1979, at 7:30 P.M., in the City Council Chambers on the third floor of City Hall, on the corner of Washington and Fifth Streets for the purpose of discussing the:

### THOROUGHFARE PLAN FOR THE CITY OF GREENVILLE, N.C.

# ECKERD'S BONUS

... a name you can trust.

## Sticking To Country Life

MAYS LICK, Ky. (AP) — Truman Ritchie and his commuter friends would rather commute 170 miles round-trip to work every day than live in the city.

At age 51, Truman Ritchie has spent the past 20 years commuting from his home here to the General Motors Assembly Division plant in Norwood, Ohio.

"It's like driving to the grocery store," he exaggerated, adding that he sleeps better because it's quieter in the country, although he doesn't get as much time to sleep.

When he first started with GM, Ritchie took an apartment in Norwood.

"I couldn't stand the noise," he said. "I like to lie down and have my quiet. We lived near some railroad tracks."

In a couple of weeks, Ritchie was back living in the country. Back then, there wasn't another job to be had in his area. Now, he can't afford to leave General Motors.

So he gets up at 3 a.m., in order to be at work by 5:36 a.m. He often works nine hours a day, six days a week. He leaves work at 3:30 p.m. and it's time to make the trip back home.

"I get three or four hours (of sleep) and take off," he said. "They say when you get older, you need more sleep, but it doesn't seem to bother me."

Ritchie alternates driving with four other men so each one has to drive only one day a week, unless there's overtime. Like Ritchie, the other men want to keep their homes in the country.

The car takes the river route along the Ohio River. Although it's usually too dark to see in the morning, the ride is nice on the way home.

## Phi Beta Kappa Will Honor 10

ECU News Bureau  
Ten top-ranking senior students in the East Carolina University College of Arts and Sciences will be honored by the Eastern Carolina Alumni Chapter of Phi Beta Kappa honor society.

The 10 will be guests at an April 11 reception in the VanLandingham Room of the home economics building. Each will be presented a gift in recognition of outstanding academic achievement.

The honorees are Edward Tyer of Washington, Linda Kraus of Shippensburg, Pa., Sheryll Eason of Farmville, Joel Harrison and James Bryant of Greenville, Emily Taylor of Robersonville, Joyce Dunn of Warsaw, Bernard Lambe of Goldsboro, Edith Dixon of Alexandria, Va. and Ramon Davis of Winterville.

## Neighbors Balk At A Pet Lion

WEST MALLING, England (AP) — Patricia Alcorn is appealing a council's ruling which revoked her license to keep a pet.

Neighbors have been complaining about the roaring of Shane, her 4-year-old lion.

|   |   |   |  |
|---|---|---|--|
| <p>Valuable Coupon</p> <p><b>LISTERINE ANTISEPTIC</b><br/>12-oz. bottle mouth-wash &amp; gargle. Limit 1</p> <p><b>89¢</b></p> <p>Coupon Good Thru Sat. March 24</p> <p><b>ECKERD DRUGS</b></p> | <p>Valuable Coupon</p> <p><b>Colgate MFP</b><br/>10¢ OFF</p> <p><b>COLGATE TOOTH PASTE</b><br/>5-oz. Price reflects 10¢ off label. Limit 1</p> <p><b>69¢</b></p> <p>Coupon Good Thru Sat. March 24</p> <p><b>ECKERD DRUGS</b></p> | <p>Valuable Coupon</p> <p><b>VASELINE INTENSIVE CARE LOTION</b><br/>10-oz. rich lotion for dry skin and hands.</p> <p><b>79¢</b></p> <p>Coupon Good Thru Sat. March 24</p> <p><b>ECKERD DRUGS</b></p> | <p>Valuable Coupon</p> <p><b>KLEENEX FACIAL TISSUES</b><br/>Box of 200 in white or assorted colors. Reg. 75¢ ea.</p> <p><b>2/88¢</b></p> <p>BOXES</p> <p>Coupon Good Thru Sat. March 24</p> <p><b>ECKERD DRUGS</b></p> |
|---|---|---|--|

|  |  |  |   |
|--|--|--|---|
| <p><b>LIFE SAVERS BUNNY BOOK CANDY</b><br/>Delicious treat for your Easter basket. Reg. 1.29</p> <p><b>99¢</b></p> | <p><b>LADIES' BANDANA or FASHION SCARVES</b><br/>Assorted styles. Reg. to 1.39</p> <p><b>88¢</b></p> | <p><b>JET X PRESSURE WASHER</b><br/>Sprays on suds, rinses off dirt. No. 116 Reg. 7.99</p> <p><b>5.99</b></p>              | <p><b>BATHROOM SCALE</b><br/>White, gold or chocolate. Counselor No. 86. Reg. 5.99</p> <p><b>3.99</b></p>           |
| <p><b>BUNTE JELLY BIRD EGGS</b><br/>1 1/2-lb. bag. A great treat. Reg. 99¢</p> <p><b>77¢</b></p>                   | <p><b>WIREBOUND NOTEBOOK</b><br/>70 sheets. Great for theme papers. Reg. 89¢</p> <p><b>59¢</b></p>   | <p><b>SUPER GLUE 3</b><br/>3-gram tube. Reg. 1.69</p> <p><b>88¢</b></p>  | <p><b>AKRO FLOOR MAT</b><br/>24" x 44". 100% nylon face with non-slip vinyl base. Reg. 10.99</p> <p><b>7.99</b></p> |
| <p><b>FRAMED PICTURES</b><br/>12" x 16" with wooden frames. Reg. 10.99</p> <p><b>8.88</b></p>                      | <p><b>SILVER DUCT TAPE</b><br/>2" x 60-yards for many sealing jobs. Reg. 4.99</p> <p><b>2.99</b></p> | <p><b>GENERAL ELECTRIC BRIGHT STIK</b><br/>Easy to install fluorescent lighting fixture. Reg. 10.99</p> <p><b>7.99</b></p> |   |

# THE MORE YOU CLIP..

|   |   |  |  |  |  |  |
|---|---|--|--|--|--|--|
| <p>Valuable Coupon</p> <p><b>CONTAC</b><br/>12-HOUR RELIEF</p> <p><b>99¢</b></p> <p>Coupon Good Thru Sat. March 24</p> <p><b>ECKERD DRUGS</b></p> | <p>Valuable Coupon</p> <p><b>LEE NAILS</b><br/>Brush-on artificial fingernail kit. Easy to apply. Reg. 6.49</p> <p><b>4.99</b></p> <p>Coupon Good Thru Sat. March 24</p> <p><b>ECKERD DRUGS</b></p> | <p>Valuable Coupon</p> <p><b>ANACIN TABLETS</b><br/>100 tablets for fast relief of minor pain. Reg. 1.64 Limit 1</p> <p><b>1.29</b></p> <p>Coupon Good Thru Sat. March 24</p> <p><b>ECKERD DRUGS</b></p> | <p>Valuable Coupon</p> <p><b>TUSSY DEODORANT</b><br/>Your choice of roll-on, cream or stick.</p> <p><b>2/1.00</b></p> <p>Coupon Good Thru Sat. March 24</p> <p><b>ECKERD DRUGS</b></p> | <p>Valuable Coupon</p> <p><b>ULTRA MAX SHAMPOO</b><br/>7-oz. in your choice of oily or normal formula. Prepriced at 99¢ ea.</p> <p><b>69¢</b></p> <p>Coupon Good Thru Sat. March 24</p> <p><b>ECKERD DRUGS</b></p> | <p>Valuable Coupon</p> <p><b>PERSONNA BLADES</b><br/>Double II in pack of 5 cartridges. Reg. 1.47 Limit 1</p> <p><b>69¢</b></p> <p>Coupon Good Thru Sat. March 24</p> <p><b>ECKERD DRUGS</b></p> | <p>Valuable Coupon</p> <p><b>MAALOX ANTACID</b><br/>12-oz. liquid for relief of indigestion. Reg. 1.58 Limit 1</p> <p><b>1.29</b></p> <p>Coupon Good Thru Sat. March 24</p> <p><b>ECKERD DRUGS</b></p> |
|---|---|--|--|--|--|--|

|  |   |  |   |  |  |  |
|--|---|--|---|--|--|--|
| <p>Valuable Coupon</p> <p><b>NEW FREEDOM MAXI PADS</b><br/>Box of 30 for maximum protection. Reg. 2.62 Limit 1</p> <p><b>1.69</b></p> <p>Coupon Good Thru Sat. March 24</p> <p><b>ECKERD DRUGS</b></p> | <p>Valuable Coupon</p> <p><b>MASSENGILL DISPOSABLE DOUCHE</b><br/>6-oz. Regular. Herbal or Vinegar/Water. Reg. 63¢ Limit 2</p> <p><b>33¢</b></p> <p>Coupon Good Thru Sat. March 24</p> <p><b>ECKERD DRUGS</b></p> | <p>Valuable Coupon</p> <p><b>ONE-A-DAY PLUS IRON VITAMINS</b><br/>100 multiple vitamins with iron. Reg. 3.44 Limit 1</p> <p><b>2.29</b></p> <p>Coupon Good Thru Sat. March 24</p> <p><b>ECKERD DRUGS</b></p> | <p>Valuable Coupon</p> <p><b>ORAL B TOOTHBRUSH</b><br/>Your choice of No. 35, 40 or 60. Reg. 99¢ Limit 3</p> <p><b>59¢</b></p> <p>Coupon Good Thru Sat. March 24</p> <p><b>ECKERD DRUGS</b></p> | <p>Valuable Coupon</p> <p><b>BARNES-HIND WETTING SOLUTION</b><br/>2-oz. solution for contact lens. Reg. 2.29 Limit 1</p> <p><b>1.39</b></p> <p>Coupon Good Thru Sat. March 24</p> <p><b>ECKERD DRUGS</b></p> | <p>Valuable Coupon</p> <p><b>ST. JOSEPH ASPIRIN FOR CHILDREN</b><br/>Bottle of 36 with safety top. Reg. 53¢ Limit 1</p> <p><b>27¢</b></p> <p>Coupon Good Thru Sat. March 24</p> <p><b>ECKERD DRUGS</b></p> | <p>Valuable Coupon</p> <p><b>GILLETTE "THE DRY LOOK"</b><br/>8-oz. Non-aerosol hair control for men. Reg. 2.29</p> <p><b>1.69</b></p> <p>Coupon Good Thru Sat. March 24</p> <p><b>ECKERD DRUGS</b></p> |
|--|---|--|---|--|--|--|

It's easy to have your prescription filled at Eckerd Drugs...even if it's now being filled somewhere else. Bring in any new prescription and we'll fill it...or if you've been having your prescription filled somewhere else, simply bring us the bottle and we'll easily arrange to have your prescription transferred to Eckerd's.



**ECKERD'S FAMOUS PHOTO OFFER**  
**TWICE THE PRINTS**  
Get an extra set of prints with every roll of color or black and white print film developed and printed...TODAY AND EVERYDAY.  
**TWICE THE FILM**  
When you pick up your developed film and prints, buy two rolls of Kodacolor or black and white print film for the regular price of one...TODAY AND EVERYDAY.

**TWICE THE GUARANTEE**  
1. You don't pay for it.  
2. You don't pay for it.

# Missionaries See Opportunities Opening In China

By LINDA MORRIS  
Wilson Daily Times

WILSON, N.C. (AP) — The Carter administration began 1979 with a bold diplomatic move of both stunning and surprising importance to the United States. The formal recognition of Communist China opened up whole new vistas of opportunity for Americans, spiced with the excitement of discovering an unknown people and culture.

Few North Carolinians watched the progress of those negotiations more avidly than Lou Spencer, a Pentecostal wellness nurse and missionary

who spent the past two years among the Chinese in resettlement camps located in the British colony of Hong Kong.

And if Ms. Spencer's observations are any guide, most Americans will be both pleased and perplexed by the Chinese people and their way of life.

Now working as a nurse in Wilson, Ms. Spencer traveled to Hong Kong, seated periously on the southern tip of China, in May 1976. She had been assigned by the missions board to serve as a nurse supervisor at a clinic run by the Pentecostal Holiness Church in the Tsz Wan Shan District, a ferry's ride

across the bay from the main island of Hong Kong.

"Three days after I arrived there, they gave me a welcoming feast," she remembers well. "They served a dish called bird's nest soup that had boiled pigeon eggs and other things floating around in it. I had always been a finicky eater, but I was determined to jump right in there and become Chinese all in one day."

It wasn't until several days later that she learned those "other things" floating around in the soup were indeed pieces of an authentic bird's nest.

Despite that less than delectable

beginning, Ms. Spencer did become fond of the Chinese cuisine and the impressive feasts they considered a necessity. "You'll have people living in these resettlement areas on salaries that are ridiculously low by American standards. But they won't think twice about going to a nice restaurant and paying good money to throw a feast," she said.

Chicken and fish are their favorites and are always served with both head and tail displayed on the platter. "If you're the guest of honor, they place the head so that it's facing you. You feel awfully jolly

eating a chicken while it's still looking at you!"

The resettlement areas that these Chinese — refugees from the Communist regime on the mainland — call home can range from shabby squatters huts to more modern high-rise dormitories.

A family of six or eight would live, sleep and eat in a room not much larger than an average American den. "Some of the Chinese kids had seen pictures of an average American home. These were like 18-year-old kids, and one of them looked at me with the most serious expression one day and said,

"But don't you get lonely living in a house like that all by yourself?"

The Chinese cook on open air balconies, no matter what the weather, and hang their washed clothes on bamboo poles on their balconies, she said. Few Chinese have beds, but sleep instead on bamboo mats on the floor.

But what of the Chinese character itself? "They have the keenest minds I've ever seen," Ms. Spencer observed, coupled with memories that were phenomenal.

It was not uncommon for tourists who may have visited

Hong Kong 10 or 12 years ago to be greeted by a merchant who remembers their names, where they're from and how long since their last visit, she said.

The Chinese also rank as the world's most avid seekers of knowledge, Ms. Spencer observed. "They study everything! Even the little kids study constantly. The Chinese are always carrying around books and reading. The ones who worked in the clinic with me wanted me to teach them English, even though they could speak it fairly well already. They were willing to come to

my apartment every night that I would let them just to learn."

Child abuse most often resulted from parents severely punishing their children because they weren't studying hard enough, she said.

Religiously, the Chinese have little concept of Christianity, she said, and consider Jesus Christ just another god to add to their long list of deities. They don't fear their children being exposed to Christianity, Ms. Spencer said, because they figure, what harm could another god do?

Most Chinese coming to the clinic had the same type ailments Americans seek treatment for, including common colds, abrasions and infections, she said. The Chinese are especially susceptible to nose and throat cancer because of the large amounts of dried fish they eat, many medical observers feel, Ms. Spencer said.

But probably the most difficult cultural difference for Americans to adjust to would be the Chinese penchant for fresh air, regardless of the season or temperature.

"We had to keep the front door at the clinic standing open all the time to let the Chinese know we were open," she said. In addition many times patients would open up the windows too.

"Seventy-degree buildings? Poppycock!" Ms. Spencer said. "The Chinese would rather have the fresh air!"

# Coupon Savings!

Valuable Coupon

**VIENNA SAUSAGE**  
5-oz. can Armour Star brand. A great snack or lunch treat.

**2 FOR 79¢**

Coupon Good Thru Sat. March 24

**ECKERD DRUGS**

Valuable Coupon

**PINE SOL CLEANER**  
15-oz. Cleans, disinfects & deodorizes. Kills household germs fast. Reg. 1.09

**69¢**

Coupon Good Thru Sat. March 24

**ECKERD DRUGS**

Valuable Coupon

**AJAX CLEANER**  
14-oz. Gets out even toughest stains. Price reflects 4¢ off label. Limit 2

**2 FOR 49¢**

Coupon Good Thru Sat. March 24

**ECKERD DRUGS**

Valuable Coupon

**KODAK COLOR FILM**  
Your choice of 126 or 110 film in 12 exposure drop-in cartridge. Reg. 1.65

**99¢**

Coupon Good Thru Sat. March 24

**ECKERD DRUGS**

**HOUSE-IN-BLOOM PLANT FOOD**  
Your choice of flowering foliage or African Violet. Reg. 1.19

**88¢**

**McGRAW EDISON HEDGE TRIMMER**  
13" double edge hedge trimmer with carbon steel blades. No. G974311 Reg. 24.99

**18<sup>88</sup>**

**IGLOO "LUNCHMATE" COOLER**  
Rugged exterior with push-button top release. With tray. Reg. 9.99

**7<sup>77</sup>**

**COOKIN CAJUN WATER SMOKER GRILL**  
Charcoal-water smoker also barbecues. Black or red. Reg. 59.99

**49<sup>88</sup>**

**SOUNDESIGN POCKET RADIO**  
Rotary tuning dial & ferrite bar antenna. No. 1177 Reg. 5.99

**3<sup>99</sup>**

**SEVILLE 12" TELEVISION**  
Solid state black & white. Reg. 84.99

**62<sup>88</sup>**

**CLAIROL CRAZY CURL**  
Twirl a curl in 10 seconds. Great for touch-ups. Reg. 15.99

**11<sup>99</sup>**

**G.E. STEAM/DRY IRON**  
25 steam vents for better distribution. No. F-63

**9<sup>99</sup>**

**VAN WYCK HAND MIXER**  
5 speed with push button beater eject. No. 402 Reg. 11.99

**8<sup>88</sup>**

**HAMILTON BEACH CAN OPENER**  
With knife sharpener. Cutting unit detaches to clean. No. 831 Reg. 11.99

**9<sup>99</sup>**

# THE MORE YOU SAVE!

Valuable Coupon

**NESTLE CRUNCH**

**NESTLE CANDY BARS**  
Milk Chocolate or Nestle's Crunch. Reg. 59¢ ea.

**3 FOR 88¢**

Coupon Good Thru Sat. March 24

**ECKERD DRUGS**

Valuable Coupon

**PEANUTS**

**ECKERD DRY ROASTED PEANUTS**  
24-oz. jar. Always fresh & delicious.

**1<sup>29</sup>**

Coupon Good Thru Sat. March 24

**ECKERD DRUGS**

Valuable Coupon

**PLANTERS Potato Chips**

**PLANTERS POTATO CHIPS**  
Triple pack of stacked potato chips. Reg. 1.39

**99¢**

Coupon Good Thru Sat. March 24

**ECKERD DRUGS**

Valuable Coupon

**PEANUT BRITTLE**

**SOPHIE MAE PEANUT BRITTLE**  
10-oz. box loaded with peanuts. Reg. 79¢

**49¢**

Coupon Good Thru Sat. March 24

**ECKERD DRUGS**

Valuable Coupon

**ALADDIN QUART SIZE BOTTLE**  
Aladdin Vanguard. Rust & dent proof. Model No. 43-D Reg. 3.79

**2<sup>44</sup>**

Coupon Good Thru Sat. March 24

**ECKERD DRUGS**

Valuable Coupon

**WIZARD OWL AIR FRESHENER**  
Herbal, powder or rose scents. Reg. 1.19

**77¢**

Coupon Good Thru Sat. March 24

**ECKERD DRUGS**

Valuable Coupon

**20-PAGE PHOTO ALBUM**  
Spiral bound dry mount album. Reg. 3.49

**1<sup>99</sup>**

Coupon Good Thru Sat. March 24

**ECKERD DRUGS**

Valuable Coupon

**FANTASTIK SPRAY CLEANER**  
32-oz. all purpose household cleaner. Reg. 1.49

**89¢**

Coupon Good Thru Sat. March 24

**ECKERD DRUGS**

Valuable Coupon

**HEFTY PLASTIC TUMBLERS**  
Your choice of 18, 9-oz or 16, 10-oz. Reg. 59¢ pack

**3 FOR 99¢**

Coupon Good Thru Sat. March 24

**ECKERD DRUGS**

Valuable Coupon

**THERMOS 1-GALLON JUG**  
With spout. Lightweight & rustproof. Model 7784

**3<sup>66</sup>**

Coupon Good Thru Sat. March 24

**ECKERD DRUGS**

Valuable Coupon

**2-GALLON GAS CAN**  
Metal can is easy to use. With spout. Reg. 1.99

**1<sup>66</sup>**

Coupon Good Thru Sat. March 24

**ECKERD DRUGS**

Valuable Coupon

**VISUAL SCENE SUN GLASSES**  
Assorted styles for men & ladies. Regs. to 15.97

**1/3 OFF**

Coupon Good Thru Sat. March 24

**ECKERD DRUGS**

Valuable Coupon

**SHARP THIN MEMORY CALCULATOR**  
8 digit with audible input check. Fits pocket. No. 8130 or 8036. Reg. 29.95

**24<sup>88</sup>**

Coupon Good Thru Sat. March 24

**ECKERD DRUGS**

Valuable Coupon

**TEXAS INSTRUMENTS WATCHES**  
Black or brown. Models 552-10/-20. Reg. 14.99

**11<sup>99</sup>**

Coupon Good Thru Sat. March 24

**ECKERD DRUGS**

## Bustard Is Endangered

By RAMESH C. PANDE  
NEW DELHI, India (UPI) — The great Indian bustard, a game bird once hunted to the verge of extinction by maharajahs and nabobs, is once more an endangered species.

Indian wildlife lovers and protective societies have protested against the Indian government's tacit permission to well-heeled Arab sportsmen to hunt the bustard.

A party of Arab nobles, including a Saudi Arabian prince, recently camped in the Great Thar desert of Western India, which still boasts a few coveys of bustards and so-called "imperial sandgrouse" — also a prized game bird. The Arabs hunt birds with trained falcons.

The bustard, which looks like a crane, is an ungainly bird and a poor flier. The challenge isn't shooting it but finding it.

The visiting Arab princes, accustomed to hunting the bustard and other rare desert birds on the Pakistan side of the Thar desert, have had no success there recently, according to news reports, so they asked permission to try their falcons in Indian territory.

In New Delhi, students recently marched around the city with placards reading, "Eat custard, not bustard."

Jaja Mangal Singh, a well-known sportsman from central India, said, "We are told the Indian government has exempted the Arabs because it might help us get more oil from Saudi Arabia. That is just like inviting Jimmy Carter to shoot our tigers in exchange for enriched uranium."

## Trading Stamps Remain Popular

NEW YORK (UPI) — Consumer attitudes toward trading stamps remain highly positive, according to a national public opinion poll.

More than 24 million households save trading stamps, and new stamp savers are increasing, says William F. Penwell, senior vice president of marketing for S&H Promotional Services.

Other findings:

- 59 percent of the new stamp savers are 35 or under.
- The higher the income, the more likely a household is to save stamps. Thirty-four percent of those with family incomes of \$25,000 were strong savers, compared with only 30 percent of those with \$20,000-\$24,999 incomes, and 26 percent with \$15,000-\$19,999 incomes.
- The 1978 study was the 20th in a series by leading research firms for Penwell's company. It was made by Opinion Research Corp., Princeton, N.J.

Shop Our 2 Convenient Locations

Pitt Plaza Shopping Center  
Rivergate Shopping Center

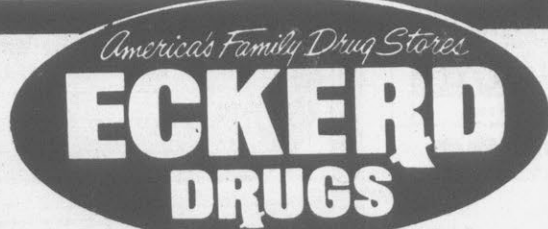

PROBLEMS INCREASE  
TOKYO (AP) — The number of minors taken into police custody for juvenile delinquency hit a post-World War II record in 1978, according to a recent government report.

# Vocalist 'Crippled' By Stage Fright

By MARY CAMPBELL  
AP Newsfeatures Writer  
NEW YORK (AP) — Many people who have heard Anita Ellis sing think her career could have been as big as Ella Fitzgerald's or Peggy Lee's if she had pursued it. She didn't, because for more than 25 years she's been fighting stage fright.

"It's not just stage fright," Miss Ellis says. "It's more than that. It's really crippling. It's kept me from my own gifts. It just stops me cold. I don't sing."

Miss Ellis, 58, has sung on the radio, in commercials, dubbed voices in movies, made a few records. The first, cut in 1953, sells today to collectors for \$100.

She can sing with technical people around; it's just an audience — even thinking about an audience — that puts her, as she describes it, "in traction." She's never sung with a band. When she had to make a living, she auditioned for a Broadway show — to be an understudy.

Since 1960, when she married Dr. Mortimer Shapiro, a New York neurologist, she has taken refuge in not having to make a living. Since then, she has sung "live" just eight weeks.

She gave the first concert of her life on Feb. 4 to a sold-out house in Lincoln Center's 1,096-seat Alice Tully Hall. The only indication this tiny, curly-haired woman gave of nerves was starting five of 26 songs again, saying she thought she could do better.

She says that before the concert she was terrified. But, she adds: "When I walked on stage, I was holding myself together. I had to do my work and my work became dominant." After her one encore, she mouthed the words, "I made it."

Afterwards — again for the first time — she thought of ways to do better next time instead of ways to say no to offers. Now, she says, the next time, she won't start songs over. The next time, she'll get more in tune with the musicians, the audience and the songs. The next time, she'll pick more songs that reflect her love of nature.

She's working on an album with pianist Ellis Larkins and

plans to make the talk show and disc jockey circuit — one-to-one communication is easy — "putting the album out there to speak for me."

"I'm not looking for fame and fortune now, at 58. Just to sing. Just homage to song. It is taking all my courage to try and do it."

In the 1950s, she saw a psychiatrist. "We hit on this clue," she says. "My mother was such a beautiful singer. My father thought it wasn't right for a woman to sing in public, so she wasn't allowed. The doctor and I thought I was telling myself, if I sing in public I'll lose a man's love and I'll lose my parents' love."

But even when with that insight, she couldn't cure stage fright.

So she left therapy to dub songs for Jeanne Crain in "Gentlemen Marry Brunettes." She had already done five Rita Hayworth films plus "Three Little Words" and "Belle of New York" for Vera-Ellen, which had duets with Fred Astaire.

Jazz critic Whitney Balliett described Miss Ellis' voice as "a muscular soprano, capable of endless colors and timbres; beautiful pianissimo phrases capped with silken vibratos; sudden sustained fortissimos that take on a reedy, breaking quality; brave jubilant middle notes; high clarion tones and low reverential asides. Her crystalline diction says, these words are important — listen. When she finishes, her songs don't end they subside."

She was born Anita Kert in Montreal, oldest of four children. Her younger brother Larry, an actor, is rehearsing now for the title role in a show about Al Jolson. The family moved to Hollywood when Anita was 10. She went to school there, then to the College of Music in Cincinnati, and in 1941 became a singer on radio station WLW.

In 1943, she married Frank Ellis, two weeks before he left for the Air Force. When Ellis returned, the marriage withered and they divorced in 1946, remaining friends until he died in 1957.

Miss Ellis returned to radio and movies in Los Angeles. Stage fright first showed up in

1951, when she auditioned in New York for "Your Show of Shows" with Sid Caesar, Imogene Coca and Mel Brooks.

"At the first rehearsal, I was terrific," she says. "Then I walked out there for the dress rehearsal and the theater was full of people. Nothing came out of my mouth. I didn't know that would happen to me. Mel Brooks walked me around the block. There was another dress rehearsal the next day. I couldn't sing."

Her psychiatrist suggested she try again, so she hooked up with pianist Luther Henderson and was booked into La Vie en

Rose, a tiny, red velvet place in New York.

"The day I opened, I started with 'Someone To Watch Over Me' — a Freudian slip choice. I started singing the verse but I couldn't go on stage. Larry — my brother is a rock of Gibraltar — jumped up from the audience, waited until the chorus and pushed me on. People thought that was a dramatic, brilliant way to open."

Club work got no easier. In 1958, Oscar Hammerstein persuaded Miss Ellis to audition for "Flower Drum Song," so she tried out for understudy to the two female leads. "I was

very frightened but I accepted my fate. I was learning about theater. After awhile it wasn't as frightening. You sing the same way every night; you do the same thing; the other people are like a family. It's almost impossible to forget anything; you had to be there every night and there were rehearsals twice a week."

Then, in 1960, she married Shapiro and became a full-time wife.

In 1974, a friend died — a reporter who had urged her to return to singing. Later that year — for him — she sang in person for the first time since 1960,

for eight weeks at Michael's Pub in New York.

She's making her current comeback primarily for that friend, for her mother, who died last March, and because she used being "very married" as an excuse for not singing for the last 19 years. Her husband hasn't pushed her, though he prefers classical music to jazz.

Miss Ellis says, "I think it would have been more honest if I'd been singing all the time. But I've liked my life. I liked the rules I had. I don't think every minute is supposed to be happy. I have a gift. I just feel very fortunate."

## PIPE LINE

Serving Daily Mon.-Sat.  
Lunch: 11:30-3 P.M.  
Dinner: 5:30-11 P.M.

### Wine Of The Month

Only **\$2.50** Full Bottle  
With Two Dinners  
March Selection Paul Mason "Rabbon"  
For Reservations Call: 752-2320

A Contemporary Restaurant With Continental Flair

## Maxwell FURNITURE END OF THE MONTH BUYS!

# ATTENTION BARGAIN HUNTERS: SAVE 12%, 20%, 60% & MORE

LAST OPPORTUNITY YOUR CHOICE OF 3 SOFAS! **\$199** Reg. \$399.95 each

**COLONIAL EARLY AMERICAN**  
LOVELY DUPONT ANTRON NYLON BY MALDEN

**TRANSITIONAL TRADITIONAL**  
GORGEOUS DUPONT ANTRON NYLON BY MALDEN

**SUMPTUOUS CONTEMPORARY**  
STUNNING GEOMETRIC DESIGNED DUPONT ANTRON NYLON BY MALDEN

**HURRY! TEST THE COMFORT**  
NOTE THE BEAUTIFUL DESIGN—THE LUXURIOUS DURABLE COLORS

**\$15 per month with 10% down**

COVERED IN DUPONT ANTRON NYLON® BY MALDEN

**MATCHING LOVESEATS AND CHAIRS ALSO AT GREAT SAVINGS!**

### A NEW ALL WOOD 4 PIECE BEDROOM

- Mellow Pine Finish
- Sunburst Headboard

4 PIECE GROUP INCLUDES: Dresser, Mirror, Full or Queen-size Sunburst Headboard & Night Stand

**\$398** Reg. \$549.95

5 Drawer Chest Priced Separately at **\$168** Reg. \$199.95

**\$21 per month with 10% down**

### MAXWELL'S IS FIRST IN THE NATION TO OFFER THIS NEW MAGNIFICENT RECLINA-ROCKER® FROM LA-Z-BOY®

- Easy-going Rocking or Full Reclining Comfort • Handle Control • Stylish Wrap-Over Arms
- Lush, Leather-Like Naugahyde® Vinyl

**\$188** Reg. \$299.95

HURRY! OFFER GOOD FOR A LIMITED TIME

**\$14 per month with 10% down**

| CASH PRICE   |        | NORTH CAROLINA |         | TOTAL DEFERRED PAYMENTS |        |
|--------------|--------|----------------|---------|-------------------------|--------|
| DOWN PAYMENT | AMOUNT | MO. 1          | MO. 2   | MO. 3                   | A.P.R. |
| 118          | 12.00  | 11.00/11       | 6.52/1  | 139.52                  | 21.86  |
| 138          | 14.00  | 10.00/14       | 14.47/1 | 168.47                  | 21.93  |
| 188          | 19.00  | 14.00/14       | 14.42/1 | 229.42                  | 21.94  |
| 199          | 20.00  | 15.00/14       | 15.11/1 | 228.11                  | 21.92  |
| 398          | 40.00  | 21.00/23       | 18.84/1 | 533.84                  | 21.98  |
| 598          | 60.00  | 32.00/23       | 17.52/1 | 813.52                  | 21.98  |

Amount Financed includes estimated 4% sales tax, optional life and property insurance. If Tax differs or insurance is not included, terms and totals can vary slightly.

### GRANDFATHER'S CLOCK

- 6 ft. tall • Accurate electric movement
- Simulated Brass weights

**\$98**

**BRASS PLATED HALL TREE**  
• 66" tall  
**\$28.88**  
Reg. \$49.95  
Limit 2 per customer

### STEREO COMPONENT SYSTEM

- 8-track tape
- AM/FM Radio
- BSR record changer (diamond stylus)
- Twin 4-speaker system
- Tape play-back

**\$138** Reg. \$169.95  
ONLY 10 TO SELL!

**\$10 per month with 10% down**

### OVAL OR RECTANGULAR MIRRORS

- Pittsburg plate glass
- Bronze gold finish

**YOUR CHOICE \$24.88**  
Reg. \$39.95

TWIN FULL QUEEN KING

### BRASS-PLATED HEADBOARDS.

A touch of nostalgia for your bedroom

**YOUR CHOICE OF \$38.88** ANY SIZE ONLY

**\$11 per month with 10% down**

### ELEGANT FRENCH PROVINCIAL TESTER BED

Canopy priced separately

**\$118** Reg. \$159.95

### FABULOUS 3 PC. WALL UNITS

- Pecan finished wall units for storage or display

**ALL 3 UNITS \$98** Reg. \$134.85  
Easy to Assemble

## Hike-Bike For Retarded Set

Margo Sherman has been named chairman of the 1979 Hike-Bike for Retarded Citizens, according to Ronald E. Rice, president of the Pitt Co. Association for Retarded Citizens.

Mrs. Sherman is assistant director of the Pitt County Adult Developmental Activity Program.

part are asked to contact the Pitt Co. Assn. for Retarded Citizens, 758-1683. A satellite hike-bike will be held in Farmville Saturday, May 5. For more information on this event, one should contact Jackie Atkinson, 753-4742.

"Saturday, Apr. 21," Mrs. Sherman said, "residents of Greenville and Pitt County will have an opportunity to join in the Hike-Bike, either as a participants or sponsors. The Hike-Bike calls on volunteers to hike or bike over a measured course and on businesses and individuals to pledge so much per mile for each mile walked or ridden by a particular participant."

"The event will begin at 9:30 a. m., with hikers and bikers gathering at Aycock Junior High School. Checkpoints will be set up at intervals along the route to clock miles walked or ridden."

Persons interested in taking

## Holding Bible Convention

Approximately 1,000 Jehovah's Witnesses are expected to attend a two-day Bible convention March 24-25 at Fayetteville's Cumberland County Memorial Auditorium.

According to Charles L. Corey, local minister, more than 100 persons from the Pitt County area are expected to attend the event, with the featured lecture, "A cleansed Earth- Will You Live to See It?"

SELECTED BY THE U.S. OLYMPIC COMMITTEE

# Theragran®

high-potency vitamin formula

Higher levels of seven essential vitamins compared to the leading family supplement

**SPECIAL NOW—\$4.49** Theragran® 'Thrift Pack' 30 with 100

**\$4.49** Theragran-M® 'Thrift Pack' 30 with 100

**ECKERD DRUGS**  
Pitt Plaza Shopping Center

**Maxwell FURNITURE**

604 Greenville Blvd. Greenville, N.C. 27834  
Open 9 A.M. Until 6 P.M. Monday Through Saturday And Friday Nights Until 9.

Phone 756-3142  
Convenient Credit Terms  
Free Delivery & Set-Up  
Huge Selection  
Competitive Prices

3 WAYS TO SAY "CHARGE IT!"  
MasterCard CREDIT VISA

**\$1,000 INSTANT CREDIT**

You may qualify for \$1,000 instant credit if you have one of these cards: MASTER CHARGE • VISA • AMERICAN EXPRESS

# Sailing Ship's Voyage Is Adventure For Young

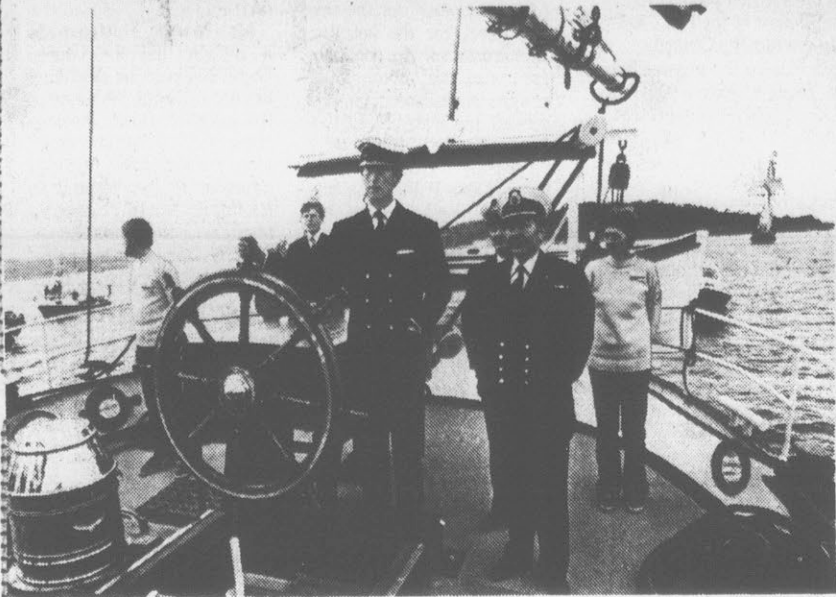

WITH PRINCE CHARLES at the tiller, and Capt. Patrick Collis at his side, the brigantine "The Eye of the Wind" sails out of Plymouth harbor in England on a round-the-world expedition. The prince, who disembarked later, is serving as patron of "Operation Drake," a two-year round-the-world voyage with an international crew of young explorers.

By GENE SCHROEDER  
AP Newsfeatures Writer  
NEW YORK (AP) — Some 400 years after Sir Francis Drake sailed his galleon around the world, another British sailing ship has set forth on a voyage which also will circumnavigate the globe.

But this time the goal is scientific exploration rather than discovery.

The vessel, a 150-ton brigantine named "The Eye of the Wind," sailed out of Plymouth, England, last October on a two-year voyage linking a series of land-based expeditions in Panama, Papua New Guinea, the Galapagos Islands, Indonesia and the Red Sea.

At the tiller for a few hours as the ship left the same harbor from which Drake sailed in 1577 was Prince Charles, patron of "Operation Drake," as the modern-day voyage has been dubbed.

"The prince is very much interested in the project and is keeping close watch on its progress," said a spokesman for the British Information Service in New York.

Described as the most ambitious seafaring adventure of its kind ever launched, "Operation Drake" was conceived to provide young explorers from various walks of life with a chance to experience, as Prince Charles expressed it, "some of the challenges of war in a peacetime situation."

The adventure, estimated to cost about \$1 million, is being underwritten by various sponsors, including the Explorers Club of New York, Walter H. Annenberg, former U.S. ambassador to England, contributed \$100,000.

Commenting on the project, Prince Charles said: "Many young people, I believe, long to have the chance of lasting adventure, of achieving something through personal endeavor or simply giving service where it is needed."

"Operation Drake will help bring to fruition a number of scientific and community projects in several parts of the world, but it will also provide many young explorers with the adventure of a lifetime."

The voyage will link up with a series of land-based projects studying such diverse subjects

as rare animals, birds and flowers, a sunken treasure ship, and the rapid spread of an infamous coral-eating starfish.

According to a spokesman, the young explorers will tackle "rushing rivers never before navigated and dense jungle seldom penetrated."

The steel-hulled brigantine serves as a floating laboratory base at each anchorage. It is fitted out for diving purposes and carries a number of inflatable craft for inshore work. A modern quartz navigation clock was supplied by Bulova Watch Co., official timekeeper of the expedition.

During each of nine three-month phases, an international crew of some two dozen youths will serve aboard.

Each crew will be made up of adventurers ranging in age from 17 to 24 under the command of an experienced master and watch leaders. The youths were selected from applicants in several countries, including about 70 from North America.

At each stop, the youths will be joined by others on a number of scientific projects, including archaeological digs. Ultimately, "Operation Drake" will

involve several hundred persons.

The first major stop was Panama's Caledonia Bay, where the young adventurers are probing the site of an ill-fated, 17th-century Scottish colony named New Edinburgh.

The Panama phase also calls for a diving team to search for the wreck of the "Maurepas," a 42-gun French merchantman that sank on Christmas Eve, 1698, with a cargo of silver coins valued now at an estimated \$16 million.

Later this spring, the vessel is scheduled to leave Panama for the Galapagos Islands, where the emphasis will be on marine biological research and community aid projects.

The "Eye of the Wind" will stop in turn at Fiji, New Guinea, Indonesia, Singapore and Port Sudan on the Red Sea, where the explorers will take part in a project attempting to discover the reasons behind the enormous increase in coral-eating starfish, which threaten to destroy many coral reefs of the world.

The voyage is scheduled to end back at Plymouth in October 1980.

The expedition's leader is a world-famous explorer, Lt. Col. John Blashford-Snell, whose experiences have included being bitten by a vampire bat in Central America and watching one of his boats on an African adventure being eaten by a hippopotamus.

## Legendary Bird Became Bunny

KANSAS CITY, Mo. (UPI) — The egg and bunny illustrations on today's Easter cards have ancient origins, says creative director George L. Parker of Hallmark Cards.

Legend says the rabbit originally was a large and handsome bird, a pet of Eostre, Teutonic goddess of spring. One day Eostre changed the bird into a rabbit. That, supposedly, is why the Easter bunny builds nests and fills them with colored eggs.

The egg was seen by Egyptians, Greeks and Romans as a symbol of the universe and a token of spring and rebirth. Early Christians stained eggs red to represent Christ's blood, says Parker. Since then, coloring eggs at Easter has become traditional in many countries.

## Walls Provided Graffiti Work

IMPERIA, Italy (AP) — Authorities in this Riviera city have installed blank panels on public walls in the hope that graffiti artists will concentrate their efforts "in an orderly way," and keep public places cleaner.

"Anyone, Italian or not, who wants to display publicly in writing his thoughts or feelings can now do it in an orderly way," a city spokesman said.

The panels were nailed to walls at a height within everybody's reach.



# SPRING SALE

Prices Effective  
March 22-24



**DRY IDEA**  
ROLL-ON ANTI-PERSPIRANT

IT GOES ON DRY!  
1.5 Oz.  
\$2.10 Value  
**99¢**

protein  
**21**  
shampoo

Available in normal oily and dry formulas  
7 OZ. ONLY  
**88¢**

Enter THE GREAT  
TONI MAKEOVER CONTEST

TONI SILKWAVE COLLECTION

TONI SILKWAVES with NEW Quick 'n Easy... Applicator

- Gentle
- Regular
- Super
- Body

**\$1.88**  
Regular \$3.39

**Pepsodent** TOOTHPASTE

2.8 OZ.  
ONLY **39¢**

**Vitalis** V7

GROOMS HAIR WITHOUT GREASE  
4 OZ. \$1.79 Value  
**99¢**

**close-up**

TOOTHPASTE AND MOUTHWASH IN ONE  
6.4 Oz. Only **87¢**

**EVEREADY**  
E93 BP2C OR E 95 BP 2D

\$2.00 Value  
**\$1.17**

**ANACIN**

100 Tablets  
Reg. \$2.79 Value  
**\$1.58**

**Massengill** DISPOSABLE DOUCHE

6 Oz. Single Package  
3 For **\$1**

**A.R.M. ALLERGY RELIEF MEDICINE**

20 Tablets \$2.19 Value  
**\$1.17**

**Gillette Good News!**

3 Pack Regular 90¢  
2 For **\$1**

**DRISTAN** DECONGESTANT TABLETS

COLDS HAY FEVER SINUS CONGESTION  
24 Tablets Or Aspirin Free  
Reg. \$1.99  
**\$1.17**

FOR BACKACHE RELIEF

**Doan's** PILLS

24's Only **99¢**

FAST PAIN RELIEF

**BAYER ASPIRIN**

200 Tablets  
Regular \$3.12 Value  
**\$1.99**

**ultra ban**

1.5 Oz. Reg. \$1.79 Value  
**96¢**

**PROTEIN 21**

4 Oz. \$1.35 Value  
**79¢**

**Secret Deodorant** Or **Anti-Perspirant**

2.75 Oz. Or 2.5 Oz.  
Only **88¢**

**PREPARATION H**

1 Oz. \$2.29 Value  
**\$1.17**

**Excedrin P.M.** THE NIGHT TIME PAIN RELIEVER

30 Tablets \$1.79 Value  
**99¢**

**FREE DOG COMB OR JEWEL CAT COLLAR OFFER**

When you buy any **Sergeant's** FLEA & TICK COLLAR  
\*See display at store  
Only **\$2.29**

**Vaseline** INTENSIVE CARE

FOR OVER-DRY SKIN  
10 Oz. \$2.09 Value  
**99¢**

**Denorex**

4 Oz. \$2.45 Value  
Only **\$1.38**

**condition**

2 Oz. Tube \$1.89 Value  
**\$1.17**

**Old Spice** Aerosol 4 Oz. Or Stick 2.5 Oz.

Only **99¢**

**Pk 'n Pay Shoes**

Only you'll know how little you paid.

A. Women's sleek fashion slide with graceful heel and platform. Simply beautiful.  
**12.00**

B. Women's wood bottom sandal has classic styling and scooped wedge. Assorted colors.  
**9.00**

Bamboo & canvas clutch bags in assorted colors.  
**5.00** Reg. \$6.97

Comfort-top knee hi hose. 4 pairs **\$1.00** Reg. 49¢

Master Charge or Visa welcome. Open evenings

**264 BY-PASS** Across From Nichols Discount City  
Open Mon.-Thurs. 10-9, Fri. 9:30-9, Sat. 9 to 8

# GIANT

Discount, Inc.  
429 Evans Mall  
Downtown Greenville  
Quantity Rights Reserved

## Stock And Market Reports

Following is a summary of market prices and conditions of North Carolina farm products as reported by the Federal-State Market News Service of the N. C. Department of Agriculture:

**RALEIGH (AP) (NCDA) — Cattle:** (weekly auction sales) North Wilkesboro - 562 head cattle and 4 hogs. Slaughter cows: utility and commercial 49.75-55.25, canner and cutter 43.00-48.75; Dairy type: utility few 47.50-53.00; Vealers: (150-250) choice 98.00-106.00, good 88.00-96.00; Calves: (250-325) good and choice 83.00-102.00 (325-550) good 74.50-84.50; Heifers: (850 up) few standard 52.25-55.00; Bulls: (1000 up) utility and commercial 62.00-66.75; Feeder steers: (300-400) good 92.50-100.00; (400-500) choice 98.00-107.00, good 93.00-100.00; (500-600) good 84.00-91.00; (600-800) good 71.00-79.00; Feeder heifers: (200-300) good 81.50-92.00 (300-400) good 78.50-86.50 (400-500) good 73.00-79.00; (500 up) good 62.25-72.00; Feeder bulls: (200-300) few choice 110.00-118.00 good 93.50-110.00 (300-400) choice 100.00-110.00, good 89.00-102.00 (400-550) good 75.00-92.00; Cows: feeder and replacements 48.75-67.00; Baby calves: 49.00-93.00. Hillsborough - 253 head cattle and 92 hogs. Slaughter cows: utility and commercial 50.00-56.50; Vealers: (150-250) good few 93.00-99.00; Calves: (325-550) good few 76.00-78.00; Bulls: (1000 up) utility and commercial few 60.00-66.00; Feeder steers: (300-400) few good 91.50-94.50 (400-500) good few 82.00-88.50; Feeder heifers: (500 up) few good 72.00-74.50; Feeder bulls: (200-300) few good 95.00-101.00 (300-400) good 90.00-96.00 (400-550) few choice 91.50-93.00, good 85.00-90.00; Cows: feeder and replacements few 52.50-55.99. Baby calves: 45.00-90.00 per head; swine: (180-240) few 46.50-48.10; Sows: (300-600) 43.00-44.75.

**RALEIGH (AP) (NCDA) — N.C. broilers:** Market steady. Supply moderate. Demand moderate. N.C. dock weighted average price is 46.19 cents per pound this week for small purchases of plant-grade broilers picked up at processing plants. Estimated slaughter Tuesday totaled 1,510,000 head and average live weight 4.03 pounds per bird on March 16.

**RALEIGH (AP) (NCDA) — N.C. hens:** Market steady for heavy type hens. Supply moderate. Demand good. Prices paid per pound for hens over seven pounds at farm (Monday and Tuesday slaughter) 28 cents.

**RALEIGH (AP) (NCDA) — State farmer market:** (wholesale prices) Apples - tray pack cartons 10.00-14.00; Snap beans - bushels 10.50; Cabbage - 50-pound bags 11.00-11.50; Collards

- bushels 5.00-5.50; Corn - crates 7.50-8.50; Cucumbers - bushels 12.50-13.00; Oranges - cartons 6.25-6.50; Grapefruits - cartons 4.00-5.00; Greens - bushels 5.00-5.50; Lettuce - cartons 7.00-8.00; Peppers - bushels 13.00-16.00; Irish potatoes - 50-pound bags 3.50-5.50.

**RALEIGH (AP) (NCDA) — New York broilerfryers:** Buying interest for delivery this week is irregular and centers on shipments for end of the week. Spots loads are fully adequate to ample with sales ranging from 44-46 cents per plant grade, depending on processing areas. Current movement is light to fair with advanced inquiry noted as fairly active in some quarters.

**NEW YORK (AP) — Stock prices:** continued to decline in early trading today extending the market's slide into a second session.

The Dow Jones average of 30 industrials fell 2.34 to 847.97 in the first half hour of trading on the New York Stock Exchange. Losing issues outnumbered gainers by a 3-2 margin.

Trading volume was moderate in the early going.

Analysts said a number of concerns seemed to be weighing on the market. Among them reports that profit or wellhead taxes on oil companies are being considered as part of a White House proposal to decontrol domestic oil prices. Also, there were indications that the White House may step up its anti-inflation program in light of the 26 percent surge in 1978 corporate profits which the Commerce Department reported Tuesday.

Some oil issues continued to slip in early trading today. Standard Oil of California declined 1/4 to 48 3/4; Atlantic Richfield fell 1/2 to 61 3/4; Occidental Petroleum fell 3/4 to 20 3/4. But Texaco was unchanged at 26 3/4.

Eastman Kodak was among stocks which bucked the downward trend. Kodak rose 1/2 to 62 1/2 after unveiling a new high-speed instant color film and several new camera models on Tuesday. K Mart, which reported a 28 percent earnings gain in its latest quarter, rose 1/4 to 24.

On Tuesday, the Dow Jones average of 30 industrials fell 7.28 to 850.31. Declines outnumbered advances by a 9-5 spread on the New York Stock Exchange.

Big Board volume came to 27.18 million shares against 34.62 million in the previous session.

The NYSE's composite common-stock index sank .29 to 56.85.

At the American Stock Exchange, the market value index fell .84 to 173.02.

**EASTERN STAR MEETING:** Pride of the East, No. 524, Order of the Eastern Star, will hold a regular meeting Thursday, 8 p.m. All members are urged to attend.

Alice F. Frewington, Worthy Matron  
Vanessa Sanders, Sec'y

## School Board...

(Continued from page 1)

Unanimous approval was given to limiting the informational meetings on the second Monday nights of each month to presentation of information from the school's administration to the board. Items of non-agenda public expression and "old and new business" will be limited to the agenda of the action meeting of the board on the third Monday night of each month.

Cox said he felt this arrangement would be far more effective as "it will, for example, give time to discuss predetermined items at length." Cox also emphasized this decision does not shut out anyone who seeks to have an item put on the action meeting agenda as the channel of requesting such action is still the same — contacting the superintendent or the chairman of the board five days or more in advance of the action meeting.

Board member Theresa Shank, commenting on limiting the informational meeting, said "the time had come when we had to do something about these long meetings."

Cox presented to the board a final tabulation of construction costs of the Greenville Middle School. Grand total for the project amounted to \$2,087,838.74.

Of this total, \$1,797,654.20 was for contract — general, plumbing, heating, electrical, etc. work; \$89,282 for site preparation work, \$5,421.90 for fencing; \$177,323.23 for the design fee; and \$18,157.41 for contingency.

The original awarding base bid was for \$2,117,000.

To date, a total of \$948 has been spent on landscaping, and considerable work needs to be done to the area, according to Cox.

Mrs. Shank urged that early action be taken to firm up the grounds so that grass seeds can be sown and have a chance to take root.

Approval was given the Greenville Utilities commission for an easement cover-

ing the installation of guy wires and the right to trim trees on school property at Third Street School. This work will involve the removal of three pecan trees and trimming of several other trees in the area.

Changes in the wording of the proposed "Equal Employment Opportunity/Affirmative Action Plan" centered primarily on wording that includes males as a minority group in the kindergarten/elementary field, along with other minority defined groups.

This policy paper will be considered for adoption at a later date.

In relation to the new state policy for retirement at age 70 instead of the former 65 age, the board voted to bring the retirement policy of the schools into line with the state law, and to seek legal counsel in the wording of the local policy. Concern was expressed that assurances be included that would make it possible to deal with older teachers on the same basis of performance as any other teacher, to include an evaluation process of performance.

The board unanimously voted to extend the current contract of attorney Phillip Dixon for the remainder of this school year and for the school year 1979-80. A request was also made that a letter be sent to Dixon expressing the board's appreciation for his outstanding service he has provided to date.

Action will be taken in the near future to survey student and staff to determine the need for measles immunization. Dr. Robert Ehinger, of the Director of the Pitt County Health Dept. will work with the schools in this project.

At the conclusion of last night's meeting, Cox revealed he would be in Raleigh today "as the sole opponent to the new state math-science high school. I was told I'd be the token opposition at the legislative committee meeting," Cox commented.

## Airport Bill

**RALEIGH —** A bill has been introduced in the North Carolina House of Representatives to expand the membership of the Pitt-Greenville Airport Authority.

The bill changing the make-up of the authority was introduced by Rep. Horton Rountree at the request of the Pitt County Board of Commissioners and the Greenville City Council.

If approved, the legislation would expand the present five-member board to eight members. Three members would be appointed by the Board of County Commissioners while three would be appointed by the city council. In addition, each of the governing bodies would designate one of its members to serve on the authority.

At present, each of the governing boards appoints two members to the commission, which in turn, elect a fifth member. One member of the city council and one commissioner serve as non-voting ex-officio members of the authority.

## Hospital Bd....

(Continued from page 1)

amount of "busy work" that must be done for each new endeavor at the hospital now. The case in point was the recent submission of "certificate of need" for the new bed tower for the hospital. Richardson said he could not estimate the number of worker hours spent on this project, but Board Chairman Leslie called the effort "colossal." ECU Medical School Dean William Laupus said one person from his organization, Dr. Walter Sheppard, spent "at least four full weeks" on the project.

The board members resolved to individually contact state legislators about general feeling of opposition against a state-level Rate Review Commission to monitor hospital charges. Its their opinion, they indicated, that the greater the degree of regulation, the greater the cost to the patient, as all costs must, of course, be reflected in patient day charges.

Chief of Staff Dr. Billy Bost observed that the staff now must employ three full-time secretaries to keep up with documentation of staff activities alone. He estimated that paperwork costs the patient \$15 to \$17 a day.

Dr. Bost presented some by-law changes of the medical staff. He offered for the board's approval promotion of the following to full staff membership: Diane Meelheim, RN, family nurse practitioner; Dr. Lawrence S. Harris, forensic pathology; Dr. James R. Markello, pediatrics; Dr. William E. Tripp Jr., consulting privileges in dentistry; Dr. Arthur Kopelman, pediatrics and neonatology; Dr. Jarlath Mackenna, obstetrics and gynecology and perinatology; Dr. Donald D. Weir, rehabilitation medicine; and Dr. Frank Fleming, internal medicine and neurology.

Board members were ad-

vised of a number of continuing education meetings and were invited to the groundbreaking for the ECU School of Medicine Medical Education Building to be held Friday.

Mrs. Martha Walston made a motion that the County Commissioners be prevailed upon the change the name of the complex which includes the hospital, EAHEC, Family Practice and other facilities adjacent to the hospital to Eastern North Carolina Medical Center. She got a second, but then an overwhelming no vote. Eugene James expressed the view that Pitt County taxpayers are entitled to have their hospital continue to be called Pitt Co. Memorial.

## Revival Series Is Underway

**BELVOIR —** Revival services are being held this week at Brown's Chapel Holiness Church. The speaker is Pastor Raymond A. Griswold.

Services begin at 7:30 nightly. Quarterly meeting will be held Sunday and communion Sunday night. The pastor will be the speaker. Services will start at noon and 7:30 p.m.

The public is invited to attend.

**ARREST 9 SUSPECTS**  
SAN SEBASTIAN, Spain (AP) — Police say they have arrested nine alleged members of the Basque separatist organization (ETA), who had been charged with a number of terrorist activities in Spain's northern Basque region.

|                           |        |
|---------------------------|--------|
| DAILY LUNCH               | \$1.95 |
| SPECIALS                  | .....  |
| DOG OR BURGER             | 45¢    |
| Breakfast Served All Day! |        |
| <b>CAROLINA GRILL</b>     |        |
| ORDERS TO GO!             |        |

## Obituaries

**Clark**

Graveside services for Demetrius Lee Clark, infant son of Mr. and Mrs. LeRoy Clark, 304 Paige Dr., Greenville, will be held Thursday, 4 p.m., at Brownhill Cemetery, by the Rev. Matthew Best of Simpson Chapel, Simpson.

Survivors include his parents of the home; two brothers, Shawn Speight and Anthony Knight, both of the home; his paternal grandmother, Mrs. Jessie Mae Paige of Chicago, Ill.; his maternal great-grandmother, Mrs. Lucy Clark of Greenville.

Services are being handled by

Hardie's Funeral Home, Greenville.

**Lewis**

Funeral services for Ms. Elizabeth Lewis, who died Sunday at her home, 1016 Colonial Ave., will be held Friday, 4 p.m., at York Memorial A. M. E. Zion Church by the Rev. Luther Brown Sr., pastor. Burial will be in the Brownhill Cemetery.

Ms. Lewis was a native of Pitt County and spent most of her life in Greenville. She was a member of York Memorial A. M. E. Zion Church.

Surviving her is Francis Anderson of the home.

Family visitation will be Thursday, from 7-8 p.m., at Flanagan Funeral Chapel.

**West**

## Farmville Club Is Broken Into

**FARMVILLE —** The Farmville Country Club was broken into during the night, it was reported to Farmville Police this morning at 8:45.

Farmville Police Chief Ron Cooper said investigating officer, Sgt. Jenny Childers, was still on the this morning. Entry appeared to have been gained through a locker room window, he said, and items known taken so far include a portable color television set and some beer.

## MASONIC NOTICE

There will be a stated communication of Crown Point Lodge No. 708 A. F. / A. M. Thursday at 7:30 p. m. All Master Masons are invited.

E. J. Eatman, Master  
Wyle S. Christy, Secretary

## Mother Of Five Killed In Crash

**ST. PAUL'S, N.C. (AP) —** A 34-year-old mother of five and her 10-year-old daughter died in a single-car crash early Tuesday, according to the Highway Patrol. Virginia Lee Powell and her daughter, Kelley Ann Powell, died shortly after 1 a.m. when their compact station wagon crashed into a bridge abutment on Interstate 95 two miles north of St. Pauls, said Trooper E.B. Jackson.

The family was apparently moving from Macon, Ga., to Smithfield where Mrs. Powell's husband, Dr. Matthew J. Powell, was to begin practice Tuesday as an emergency room doctor at Johnson Memorial Hospital.

Powell and the couple's four other children were driving ahead of Mrs. Powell in the family's camper and were unaware of the accident until they were located at a rest stop near Fayetteville, Jackson said.

He said the cause of the accident is under investigation.

## Seniors' Club Project Planned

Forty-six members attended the Thursday meeting of the Town and Country Senior Citizens, held at St. Paul's Episcopal Church.

The Club will hold a baked goods and fancy work booth on the Evans St. Mall, March 31. All articles and baked goods should be delivered to the Mall by 9:30 a.m., according to Sarah Ashton, president.

It was announced that 46 members will attend the Easter Story program at the Morehead Planetarium, Chapel Hill, on April 11. Also, a luncheon will be held at the American Legion building in May.

Marguerite Cooke provided musical accompaniment for the group during a singing session. Refreshments were served by Eloise Smith, Lorraine House, Williamson George, Helen Snyder, Lena Laughinghouse, Katherine Lofquist and Henry Lofquist. The Rev. Henry Lofquist closed the meeting.

## The Meeting Place

**WEDNESDAY**  
6:30 p.m. — Kiwanis Club meets  
6:30 p.m. — REAL Crisis Intervention meets  
7:00 p.m. — Winterville Jaycees meet at Winterville Grill  
8:00 p.m. — Pitt County Al-Anon Group meets at AA Bldg. on Farmville Hwy. Telephone 752-7606  
8:00 p.m. — Pitt County Ala-Teen Group meets at AA Bldg., Farmville Hwy. Telephone 756-2501 or 752-5284

**THURSDAY**  
2:00-5:00 p.m. — Game day at Women's Club  
6:30 p.m. — Jaycees meet at Greenville Jaycee Bldg.  
6:30 p.m. — Exchange Club meets  
7:00 p.m. — Winterville Kiwanis Club meets at community bldg.  
8:00 p.m. — Chapter 1308 of the Women of the Moose  
8:00 p.m. — VFW Auxiliary meets at Post Home

**Home Savings Money Market Certificates\***

**9.483% Per Annum**

Effective March 22-28

Earn a high rate of interest on the Money Market Certificate with a minimum deposit of \$10,000 and a 26-week term.

\* A substantial interest payment penalty is required for early withdrawal.

**HOME SAVINGS**  
Greenville, Bethel, Plymouth.

MEMBER **FSLIC**

**+22/4**

Simple Arithmetic about Money

Now is the time to put something aside for your financial future. See your IDS representative for money accumulation plans.

**IDS INVESTMENTS/INSURANCE**  
IDS Marketing Corporation, a wholly owned subsidiary of Investors Diversified Services.  
IDS Life Insurance Company  
Minneapolis, Minnesota  
P. O. Box 7381  
We Help People Manage Money.

401 West First St. 752-1370

# Thank You, Greenville.

In 1978 more people all over North Carolina did business with NCNB than any other year in our history. Naturally, we're pleased about that, and we know that we couldn't have done it without the support of the people who do business with us here. So we thank you.

And we can assure you that we'll keep doing all we can to make NCNB "the best bank in the neighborhood," in every neighborhood we're in. Because the closer NCNB comes to being just that, the better job we do for our community.

## Members Of Your Greenville City Board.

|  |  |   |
|--|--|---|
| <b>M.W. ALDRIDGE, DDS</b><br>Periodontist  | <b>J.H. HUDSON</b><br>President<br>J.H. Hudson, Inc.                                       | <b>HAROLD L. THOMAS</b><br>Owner<br>Brook Valley Country Club                   |
| <b>ALTON R. BARRETT</b><br>Treasurer<br>Blount Fertilizer Co.                          | <b>JOHN B. KITTRELL, JR.</b><br>President & Treasurer<br>J.B. Kittrell & Co., Inc.         | <b>DONALD H. TUCKER, M.D.</b><br>President<br>Quadrangle Internal Medicine      |
| <b>W.S. BOST</b><br>Retired  | <b>DR. RAY D. MINGES</b><br>Retired  | <b>ERCELL S. WEBB</b><br>Retired  |
| <b>JAMES T. CHEATHAM, JR.</b><br>Attorney<br>Everett & Cheatham                        | <b>JANET STOUGHTON</b><br>President<br>Quikote Travels                                     | <b>J. FRED WEBB</b><br>President<br>Fred Webb Elevator, Inc.                    |
| <b>LESLIE H. GARNER</b><br>President<br>Garner-Wynne-Manning, Inc.                     | <b>*B. BRUCE SUGG, JR.</b><br>Retired  | <b>JOHN S. WHICHARD</b><br>Co-Publisher & Vice President<br>The Daily Reflector |
| <b>HOWARD L. HODGES</b><br>President<br>H.L. Hodges & Co.                              | <b>JAMES E. SUTTON</b><br>President<br>Sutton's Service Center                             | <b>ALEX J. WHITE, JR.</b><br>Owner<br>White Concrete Co., Inc.                  |
| <b>DURWARD M. HARRIS</b><br>President<br>Harris Super Markets, Inc.                    | <b>R. EUGENE TAYLOR</b><br>City Executive & Vice President<br>North Carolina National Bank | <b>WOODROW W. WOOTEN</b><br>Owner<br>W.W. Wooten Farm Supplies                  |
| <b>CHARLES W. HOWARD, JR.</b><br>President & Treasurer<br>Greenville Tobacco Co., Inc. |  |   |

\*Chairman

**NCNB**  
Member FDIC

WEDNESDAY AFTERNOON, MARCH 21, 1979

## Pirates Back Britt For 6-1 Victory



Bird With A Katz In Hand

Indiana State's All-American basketball whiz, 6-9 Larry Bird, towers over diminutive Flora Katz of New York City Tuesday outside Gallagher's Restaurant in New York. The two bumped into each other outside the restaurant after Bird had been presented with the award as college basketball's player of the year. (AP Laserphoto)

## Woods Closes Out Sports Club's Year

By WOODY PEELE  
Reflector Sports Editor  
Jim Woods, sports director of WNCT-TV and the "voice of the Pirates," was the guest speaker for the Greenville Sports Club's final regular meeting of the year

### Sports Calendar

**Today's Sports**  
**Baseball**  
Eastern Connecticut at East Carolina (7:30 p.m.)  
**Tennis**  
East Carolina at Atlantic Christian (2 p.m.)  
**Softball**  
Williamston at Plymouth (4 p.m.)  
Conley at Washington (4 p.m.)  
**Track**  
Ayden-Grifton, North PIH at Southern Nash (3:30 p.m.)  
Farmville Central, Greene Central at Southwest Edgecombe (3:30 p.m.)  
Conley, C.B. Aycock at North Lenoir (3:30 p.m.)  
Fike, Hunt at Rose girls  
**Thursday's Sports**  
**Swimming**  
NCAA at Cleveland  
**Baseball**  
UNC Charlotte at East Carolina—2 (6 p.m.)  
Lawrence at Martin (4 p.m.)  
**Tennis**  
Greene Central at North Duplin (3 p.m.)  
Ahoskie at Williamston (3:30 p.m.)  
Plymouth at Roanoke  
**Track**  
Roanoke Rapids at Williamston boys and girls (3 p.m.)  
Roanoke at Tarboro boys and girls (3 p.m.)  
Rose, Northern Nash at Hunt (3:30 p.m.)  
**Softball**  
Conley at North PIH (4 p.m.)  
North Lenoir at Greene Central (4 p.m.)  
Farmville Central at Ayden-Grifton (4 p.m.)  
Lawrence at Martin (2:30 p.m.)  
**Golf**  
East Carolina at Furman Invitational  
Farmville Central at Wayne County Day (1:30 p.m.)

**ANNUAL AT MADISON SQUARE GARDEN**  
**NIT National Invitation Tournament**  
**College Basketball's Oldest, Most Prestigious Tournament**  
**9 LIVE**  
WNCT-TV GREENVILLE  
WEDNESDAY MARCH 21 9-11 P.M.

By WOODY PEELE  
Reflector Sports Editor  
Mickey Britt seems to have a thing about giving up unearned runs in the first inning of the games he pitches.  
Last night, against Eastern Connecticut State, he did it again. But this time, he got some solid support from his teammates as he recorded his second win in four decisions, 6-1.  
Britt was tagged with the run, although it didn't affect his earned run average, after leadoff

batter Jim Silva reached on a single and came around on to score on a two-out error that would have ended the inning.  
The Pirates, who went down in order in the first, came back to blast starting hurler Briant Murphy for five second inning runs, including back-to-back home runs by Mike Sage and Jerry Carraway.  
Britt, in going the distance, allowed just four hits, none after the fourth inning. He struck out three and walked two. Only one

man reached base in the last four innings, and he was erased in a ninth-inning double play, one of two pulled off by the Pirates during the evening.  
"They (Eastern Connecticut) have a good club," ECU Coach Monte Little said. "They made some good plays against us."  
"But we had some outstanding defensive plays, too. (Mike) Sorrell played a fine game for us at shortstop."  
Little felt the Pirates hit the ball better in the game than they have all season. "And we did it when we had to. If we continue to play good defense, we have the people who can swing the bats. Once we get our hitting going, I think we're going to be okay. If we can win this next one (tonight), I think we'll be on the right track. We're not taking them for granted, of course. They've got a good club, and I think their reliever (Russ Allen) did a fine job for them. He challenged us by throwing curve balls for strikes when he got behind."

Little added that Butch Davis, a usual starter, did not see action due to a slight ankle sprain suffered in an exhibition game Sunday. "He should be back late in the week," the coach said.  
Eastern Connecticut got things started in the top of the first, scoring its only run. Silva's single came off the top of the glove of leaping second baseman Bob Neff. He then stole second and moved to third on an infield out. Bob Cressotti hit a routine grounder to third that Jerry Carraway errored, allowing Silva to score his unearned run.  
After that, only one other ECU player reached second base. That came in the third when Phil Smythe reached on a bad-hop single at second and moved up on Mark Riemer's single with two outs.  
After going down in order in

the first, the Pirates drove in five second inning runs before Connecticut could chalk up an out. Macon Moye led off with a single to right and Rick Derechallo followed with a double to left. Tim Hardison singled Moye over, and a pickoff attempt that went astray scored Derechallo and moved Hardison to second.  
Sage followed that with a home run over the left center fence, driving in Hardison. Carraway then lofted a ball over the wall in right for a second straight homer, making it 5-1.  
Except for a walk, the Pirates didn't get another runner until the fifth. Billy Best led off the fifth with a bunt single down the third base line that he easily beat out. Raymie Styons followed with a double to left, moving Best to third. Moye hit a long sacrifice fly to center, scoring Best for the 6-1 lead.  
It marked the final Pirate threat of the evening.  
Styons and Carraway led the Pirate hitting with two each.

The two teams meet again tonight at 7:30 p.m. at Harrington Field. Eastern Connecticut then travels to Wilmington for several games before returning here Saturday afternoon for the third game of the series.

|              |    |    |   |    |               |    |   |   |    |
|--------------|----|----|---|----|---------------|----|---|---|----|
| E.Conn.      | ab | r  | h | rb | ECU           | ab | r | h | rb |
| Silva,cf     | 4  | 1  | 1 | 0  | Sorrell,ss    | 3  | 0 | 0 | 0  |
| Sullivan,ss  | 3  | 0  | 0 | 0  | Best,cf       | 4  | 1 | 1 | 0  |
| Riemer,3b    | 4  | 0  | 1 | 0  | Styons,c      | 4  | 0 | 2 | 0  |
| Cressotti,1b | 4  | 0  | 0 | 0  | Moye,r        | 3  | 1 | 1 | 1  |
| Gilka,r      | 3  | 0  | 1 | 0  | Derechallo,dh | 3  | 1 | 1 | 0  |
| Wills,ph     | 0  | 0  | 0 | 0  | Hardison,l    | 3  | 1 | 1 | 0  |
| Perun,dh     | 3  | 0  | 0 | 0  | Sage,1b       | 4  | 1 | 2 | 1  |
| Castello,ph  | 1  | 0  | 0 | 0  | Cway,3b       | 4  | 1 | 2 | 1  |
| Glynn,2b     | 2  | 0  | 0 | 0  | Neff,2b       | 3  | 0 | 1 | 0  |
| Reynolds,l   | 3  | 0  | 0 | 0  |               |    |   |   |    |
| Smythe,c     | 3  | 0  | 1 | 0  |               |    |   |   |    |
| Totals       | 38 | 14 | 8 | 0  | Totals        | 31 | 4 | 8 | 5  |

## Lady Pirates Split Openers

PEMBROKE — East Carolina split its first doubleheader of the softball season with Pembroke State yesterday afternoon. The Braves defeated the Pirates 4-3 in the first game, but ECU came back to win the second 3-2.

The hosts scored four unearned runs in the first inning of the opener, aided by four Pirate errors.

East Carolina got runs by Janis Parlon and Addie Carter in the first and a run from Teresa Whitley in the fourth, but could not overcome Pembroke's early lead.

In the second game, Donna LaVictoria singled to left in the third and scored on an infield out. Then, trailing 2-1 in the seventh, Pirate shortstop Mary

Powell smashed a home run to deep center field and Jo Carol Barrow scored after a double when Cindy Meekins reached on an error to give ECU the win.

Powell, LaVictoria and Jan McVeigh were all 3-6 for the day for the Pirates.

|   |                  |
|---|------------------|
| First Game                                |                  |
| E. Carolina                               | 200 100 0-3 10 4 |
| Pembroke                                  | 400 000 0-4 3 3  |
| Carlyle and McVeigh: Little and McMillan. |                  |
| Second Game                               |                  |
| E. Carolina                               | 001 000 2-3 7 1  |
| Pembroke                                  | 101 000 0-2 9 2  |
| Carlyle and McVeigh: Little and McMillan. |                  |

## No Word On Coach

There will be no announcement of the new basketball coach at East Carolina University today, it was learned.

An announcement, however, could be anticipated later in the week.

Reportedly, work on deciding on the new coach is coming to an end today, and university officials will make their decision by Thursday, with a possible announcement on Friday morning.

Four people are believed to be among those under consideration. They include assistant coach Terry Kunze, ex-UNC player Dick Grubar, Virginia aide Richard Schmidt, and Wake Forest assistant Dave Odom.

yesterday.  
The club will hold its annual spring banquet on Saturday, April 7, at the Greenville Golf and Country Club.

Maryland basketball coach Charles "Lefty" Driessell will serve as the guest speaker for the occasion.

Tickets for the banquet are \$10 each for members and their escorts, and \$15 for non-members and guests. In addition, those who join the club for the coming year will be allowed to purchase at member prices.

"Anyone who is not involved in sports in some way, either as a participant or a spectator is missing something," Woods told the group. "You learn a lot in athletics: teamwork, how to lose and bounce back, things like that that will carry over into the business world."

He added that it also was a chance for people to let off steam from pent-up emotions.

Woods was asked what was the most excited events he had covered, and he mentioned two.

"One of them came this year, and both of them were in basketball. When East Carolina went up to Io this year and beat a very

fine team, actually a superior team by one point right at the very end, after being down by 15 at the half, has to rank as one of the biggest I've seen. And the win in the Southern Conference tournament over Furman for the championship on a last-second shot in overtime is the other. They rank right together."

Woods was asked too about the prospects for conference membership for East Carolina.

"Well, there is no chance of getting into the ACC," he said. "I don't think they'd have even taken in Georgia Tech if not for the Atlanta advertising and television market."

He noted that there has been some talk about seeking membership in the Metro Seven. "Not being in a conference hurts all the sports except football. Football at this stage can stand on its own."  
"East Carolina has gotten on the bowl list, by playing in the Independence Bowl, and they were impressive there. I would think that if they had a good year this season, they'd have a chance to move up to a bigger bowl, like the Liberty or the Peach."

**FREE ESTIMATES**  
Don't You Really Wish You Had A Fence?  
  
Chain Link  
**SPECIAL**  
If You Buy NOW You Get A FREE Walk Gate (Chain Link)  
Guaranteed Professional Quality At Lowest Prices  
**EVERETT FENCE BUILDERS**  
Greenville  
Call 756-6388  
Lester Everett

**Pk 'n Pay Shoes**  
  
Children's **Battlestar Galactica™** sport shoe made of canvas with illustrated sole. Sizes 5-3. Blue. Reg. \$7.97 & \$8.97 **6.00**  
1978 Universal City Studios, Inc.  
  
Men's casual oxford in rust suede with padded collar, stitched sides, and action sole. Reg. \$17.97 **13.00**  
Only you'll know how little you paid.  
**264 BY-PASS** Across From Nichols Discount City  
Open Mon.-Thurs. 10-9, Fri. 9:30-9, Sat. 9 to 8  
Master Charge or Visa welcome. Open evenings

**GENERAL TIRE SPRING**  
**Tire-Thon**  
**Save on Glass Belted Radials \$37.95**  
size BR78-13 tubeless Jet Radial whitewall plus \$1.90 Fed. Ex. Tax  
The General Jet Radial features a polyester cord body, two tough fiberglass belts for stability and a wide 5-rib tread for traction.  
**Whitewalls**

| Tire Size | Reg. Price | Sale Price | Fed. Ex. Tax |
|-----------|------------|------------|--------------|
| DR78-14   | \$46.95    | \$41.95    | \$2.15       |
| ER78-14   | \$50.95    | \$45.95    | \$2.27       |
| FR78-14   | \$52.95    | \$47.95    | \$2.38       |
| GR78-14   | \$57.95    | \$51.95    | \$2.57       |
| HR78-14   | \$60.95    | \$54.95    | \$2.75       |
| FR78-15   | \$54.95    | \$49.95    | \$2.39       |
| GR78-15   | \$57.95    | \$52.95    | \$2.66       |
| HR78-15   | \$61.95    | \$55.95    | \$2.84       |
| JR78-15   | \$64.95    | \$58.95    | \$3.01       |
| LR78-15   | \$65.95    | \$59.95    | \$3.13       |

Sale ends March 24th  
**SPRING Tire-Thon**  
**Polyester Cord Whitewall Buy**  
Value Priced! **\$24.95**  
size A78-13 tubeless whitewall plus \$1.63 Fed. Ex. Tax  
The General Poly-Jet features a smooth riding polyester cord body and a wide, flat traction tread. A great tire at a popular price! Larger sizes comparably priced!

**Electronic Ignition Engine Tune-Up \$28.88**  
This week only!  
Includes up to six new spark plugs installed, inspect belts and hoses, adjust dwell, timing and carburetor as needed. Standard ignition, 8 cylinder engines, resistor spark plugs and any other additional parts or service cost extra if needed. Most U.S. cars and light trucks.  
**Passenger Tire Air Gauge 99¢ EACH**  
Featuring an easy to read white nylon bar, 6 to 50 pound range and metal cylinder. Properly maintained tire pressure is important.

RAIN CHECK: Should our supply of some sizes or lines run short during this event, we will honor any orders placed now for future delivery at the advertised price.  
**Bill's Amoco SERVICE**  
310 E. GREENVILLE BLVD.  
756-4766  
OPEN 7 A.M.-8P.M.  
7 DAYS A WEEK  
**Suttons SERVICE CENTER**  
1105 DICKINSON AVE.  
752-6121  
OPEN MON.-FRI. 7 'TIL 6  
SAT. 7 'TIL 4  
**GENERAL TIRE**  
Sooner or later, you'll own Generals

# Barrett's Homer Keys Rose Victory

By JIM KYLE  
Reflector Sports Writer  
Locked in a classic pitchers'

duel, Rose High's baseball team was tied with Goldsboro 1-1 as the Rampants came to bat in the

bottom of the seventh inning. As the leadoff batter, right fielder Will Barrett, strode to the

plate, someone in the stands shouted, "Go ahead and hit a home run, Will." Rose coach Ronald Vincent recalled later.

Barrett, who had gotten the Rampants' only hit of the game, an infield hit in the second inning, watched the first two pitches go by, both balls. The third was a letter-high fastball and Barrett tagged it. Almost as soon as it was hit, it was evident the game was over. The Rampants cleared out of their dugout in jubilation as the ball cleared the left field fence for a 2-1 victory.

Barrett's heroics nearly overshadowed the brilliant efforts of both pitchers. Goldsboro's Ron Pennington gave up only two hits, while Rose's Mike Williams allowed only one. Only nine bat-

ters in the entire game reached base.

Williams, now 2-0 on the season, had a no-hitter going until the fifth when, with two outs, second baseman David Frederick got a clean single to center field. Pennington's no-hit bid ended early as Barrett hit a ground ball in the second that neither the pitcher nor the short-stop could get to in time.

Williams walked three and struck out 10, while Pennington walked just one and struck out five. Both teams came up with some great defensive plays to back up their pitchers. It was truly a game that neither team deserved to lose.

"I'm sort of disappointed with our hitting today," Vincent said after the game. "But I'm very pleased with our defense. Defense like that is what we're going to have to do to win games this year."

Vincent said it was the best his infield has looked this season. Third baseman Junior Neal was especially busy and left fielder Joey Mattheis had the catch of the day in the second as he made a great play moving to his right on a fly ball.

"Williams looks like he's getting in shape," Vincent grinned. "His control is much better and

he stayed ahead of the hitters. He got a little bit tired at the end, though."

Vincent also praised the hitting of Barrett, saying he is "probably hitting the ball as well as anybody on the team right now." It was the second game in a row in which Barrett came up with a timely hit. His two-run double against Kinston last week broke open a tie game for Rose.

Barrett was the first man to reach base in the game with his infield hit in the second. He stole second and moved to third on a wild pitch, but was left stranded. Both pitchers walked batters in the third, but Goldsboro's Tim Huffman was caught stealing and Rose's Robert Morehead was left at second after stealing.

Williams gave up his only hit in the fifth. With two away, Frederick looped a hit over second base for a single, but the next batter struck out.

The Rampants put their first run on the scoreboard in the sixth. Leadoff batter Mike Campbell reached when his ground ball was fumbled by the third baseman. Pinch runner Charles Daise stole second and went to third on a sacrifice bunt by Morehead. Mark Shank hit a fly ball to left field and Daise tagged up. The throw was in

time, but the catcher dropped the ball, allowing Daise to score.

With one away in the top of the seventh, David Searles walked for the Cougars. Pinch runner Tim Simpson stole second and made it to third on an infield out by Craig Brown. He scored when Williams threw an 0-2 pitch into the dirt and Rose catcher Mark Shank was unable to handle it.

Williams struck out the next batter to end the inning and Barrett was the leadoff man in the top of the seventh.

The Rampants are now 2-0,

while Goldsboro dropped to 2-2. Rose travels to Kinston Friday.

| Goldsboro     | ab | r | h | rb | Rose         | ab | r | h | rb  |
|---------------|----|---|---|----|--------------|----|---|---|-----|
| Strows, 3b    | 2  | 0 | 0 | 0  | WHead, cf    | 1  | 0 | 0 | 0   |
| Martin, rf    | 3  | 0 | 0 | 0  | Shank, c     | 3  | 0 | 0 | 0   |
| Pennington, p | 3  | 0 | 0 | 0  | Chapman, ss  | 3  | 0 | 0 | 0   |
| Searles, lf   | 2  | 0 | 0 | 0  | Barrett, 1b  | 3  | 1 | 2 | 1   |
| Simpson, pr   | 0  | 1 | 0 | 0  | Neal, 3b     | 2  | 0 | 0 | 0   |
| Brown, cf     | 3  | 0 | 0 | 0  | Sanford, lb  | 2  | 0 | 0 | 0   |
| Frederick, 2b | 3  | 0 | 1 | 0  | Mattheis, lf | 2  | 0 | 0 | 0   |
| WHead, p      | 2  | 0 | 0 | 0  | Williams, p  | 2  | 0 | 0 | 0   |
| Huffman, dh   | 1  | 0 | 0 | 0  | Campbell, 2b | 2  | 0 | 0 | 0   |
| Walker, c     | 0  | 0 | 0 | 0  | Daise, pr    | 0  | 0 | 0 | 0   |
| Searles, ss   | 2  | 0 | 0 | 0  | Totals       | 21 | 1 | 8 | 2   |
|               |    |   |   |    | Goldsboro    |    |   |   | 2-2 |
|               |    |   |   |    | Rose         |    |   |   | 2-1 |



## Jumping Throw

Boston Red Sox' shortstop Julio Valdez (11) jumps and throws for a double play in the second inning of an

exhibition game at Winter Haven, Fla. yesterday. Cincinnati Reds' left fielder Dave Collins tried to break up the double play. (AP Laserphoto)

## Rampettes Take Win

KINSTON — Rose High School's girls' softball team gained its first victory of the season yesterday, downing Kinston, 14-7.

Rose pushed over two runs in the second, but saw Kinston come back with one in the bottom of the inning and two in the third. Rose added four in the fifth, then broke it open with seven in the sixth and one more in the seventh.

Kinston added one each in the fifth and seventh and two in the sixth.

Christia Dunn was the winning pitcher for Rose. Debra Wingate led Rose's hitting with three, while Sherri Helms had two, including a double.

Redding had a two-run homer for Kinston in the third. Now 1-2, the Rampettes travel to Washington on Friday.

|         |     |     |      |   |
|---------|-----|-----|------|---|
| Rose    | 020 | 047 | 1-14 | 9 |
| Kinston | 012 | 012 | 1-7  | 5 |

# Minnesota Bombs New York In 15-7 Victory

By The Associated Press

All right, so the Minnesota Twins have lost Rod Carew and Dan Ford, their two most productive hitters of 1978.

Does that mean they won't score many runs this year?

No...not if their 15-7 bombardment of the New York Yankees, winners of the last two World Series, is any indication.

"The sad fact is this was a lousy ballclub last year with Rod Carew (the seven-time American League batting champion)," Twins Manager Gene Mauch philosophized Tuesday after Minnesota's impressive exhibition triumph. "You've got to have a reason to come to the ballpark and we didn't have one."

The reason they lacked the incentive was the fact they had little chance at winning the American League West title. They wound up the season with a 73-89 record, in fourth place, 19 games behind division champion Kansas City.

After the season, Carew and Ford were traded to the California Angels in separate deals.

Despite the loss of Carew, of whom Mauch was very fond, the manager feels the Twins are a better team.

"There are only two things that could have happened if we still had Rod this year and both of them are bad," said Mauch. "One, all the attention on this team would have gone to him in regard to his imminent departure, and that would have hurt morale. And two, if he stayed for this season, he would

have played out his option and we'd have gotten nothing in return for him."

One of the players the Twins received in the deals with the Angels was first baseman Ron Jackson, who hit .297 for California last year.

Jackson lashed two doubles and a single as the Twins tattooed four Yankees' pitchers for eight hits.

Starter Ken Clay was the easiest target for the Minnesota hitters. He was raked for 10 hits and 10 runs in 22-3 innings, including a grand slam home run by Roy Smalley and a three-run shot by Glenn Adams. Rookie Dan Graham added a two-run homer and Willie Norwood had a solo blast.

"If my first three hitters in the batting order have any kind of year at all, there's no way Jackson won't drive in 100 runs," Mauch said. "The guy can hit. You can hear it just by the sound of his bat."

The loss was the 11th in 13 games for the struggling Yankees.

In other exhibition games, Jamie Quirk rapped three hits in Kansas City's 13-hit attack and Dennis Leonard pitched five-hit ball for seven innings as the Royals whipped the Atlanta Braves 9-2.

Terry Kennedy, Roger Freed and Ken Reitz slammed consecutive home runs in the fifth inning and Mike Tyson drove in three runs with a double and a homer, powering the St. Louis Cardinals to a 7-2 victory over the Toronto Blue Jays.

Art Howe's run-scoring double highlighted a four-run Houston fifth inning against Montreal's Bill Lee and helped the Astros beat the Expos 6-4.

Doubles by Bobby Brown and Butch Benton keyed a seven-run eighth inning that carried the New York Mets to an 8-3 triumph over the Pittsburgh Pirates at Bayamon, Puerto Rico. Jack Clark and Tom Heinzelman each had two hits and two RBI as the San Francisco Giants downed the San Diego Padres 6-4.

Carl Yastrzemski's double and Dwight Evans' run-producing single in the 10th inning lifted the Boston Red Sox to a 4-3 decision over the Cincinnati Reds.

Lee May's second homer in two days triggered a three-run Baltimore second inning as the Orioles topped the Philadelphia Phillies 4-1.

Dave Rozema's six scoreless innings helped the Detroit Tigers blank the Chicago White Sox 2-0.

And three games were rained out — Chicago Cubs-California, Oakland-Cleveland and Seattle-Milwaukee.

Meanwhile, Baltimore pitching ace Jim Palmer, sidelined with a pulled groin muscle, said he would be out "...until they pay me what I'm worth. This could be a three-year injury."

And Seattle reacquired catcher Larry Cox from the Chicago Cubs for outfielder Luis Delgado.

**The best person to see about your LIFE INSURANCE may be your car, home and health agent! See or call: Bill McDonald**  
East 10th Street Ext. Phone 752-6680 Greenville, N.C.



Like a good neighbor, State Farm is there.



STATE FARM LIFE INSURANCE COMPANY  
Home Office: Bloomington, Illinois

# POWERAMA

Come on over... try them out... join us for live demonstrations, big displays and great savings!

WEST END SHOPPING CENTER, GREENVILLE, N.C.  
STARTS WEDNESDAY, MARCH 21, 1979

**CUT \$100**  
8-HP 5-speed riding mower  
**\$639**

5 speeds forward, 1 reverse, 30-in. 2-blade mower deck included.

**CUT \$130**  
11-HP vari-drive lawn tractor  
**\$949**

Multiple speeds in each of 3 gears. 36-in. rear-discharge mower deck.

**CUT \$15**  
Craftsman 3.5-RP Eager-1® mower  
**\$129**

No-adjust carburetor. Key-lock starter. 5 heights. 20-in. cut.

**2-HP Front-tine Chain-drive Cultivator**  
9-inch diameter tines dig 10 or 15-inch wide swaths  
**\$157<sup>99</sup>**

2-HP Craftsman engine by Briggs & Stratton®. Four-cycle horizontal shaft with "Easy-Spin"® recoil design. Chain-drive transmission with 2 chains.

**10-HP Lawn Tractor** with 36-in. side-discharge mower, 3-speed transaxle drive

**400 Lb.-4 Cu. Ft. GARDEN CART**  
3.50 X 10.25 In. Semi-Pneumatic Tires 32A26133N, 53 Lbs.  
**\$74<sup>99</sup>**

4-cu. ft. capacity Cart

**Gas-Powered 2-HP Edger**  
**\$105<sup>99</sup>**

ENGINE: Briggs & Stratton® 100-cc. (7.5-cu. in.), 2-HP engine. Recoil starter, 4 cycles.

**CULTIVATION ATTACHMENTS and 3-pt. Hitches for Sears Tractors**

Electric 3-point Tractor Hitch    Manual 3-point Tractor Hitch

These Items Readily Available  
• Prices are catalog prices, shipping extra • Prices from our "T" and "B" catalog supplements • Sears has credit plan to suit most every need  
Satisfaction Guaranteed or Your Money Back

WEST END SHOPPING CENTER  
OPEN DAILY 9 A.M. - 6 P.M.

PHONE 756-2111    SEARS, ROEBUCK AND CO.

## Western Sizzlin Steak House

The Family Steak House

U.S. Choice Beef Cut Fresh Daily!

### LUNCH & DINNER SPECIAL

MONDAY THRU WEDNESDAY

No. **1** 8 oz. Sirloin Steak **\$2<sup>99</sup>**  
Served With King Baked Potato And Hot Toast With Butter.

WESTERN SIZZLIN

### Now Offers Business Man's Lunch

11 A.M.-2 P.M. Daily. Plus Exciting New Salad Bar Selections.  
Party Facilities For Lunch & Dinner Available, Call 758-2712  
11 A.M. To 10 P.M. Sunday Thru Thursday, 11 A.M. To 11 P.M. Friday & Saturday

# Basketball More Than Sport In Indiana

INDIANAPOLIS (AP) — The stereotype of a lanky Indiana farm boy with a straw hat on his head, a carburetor tucked under one arm and a basketball in the other hand just isn't true.

They don't all tinker with automobiles. And the hat would fall off in a game of one-on-one.

But basketball? Well, it's more than a sport in Indiana. It's a way of life that begins in early childhood and ends when...well, it never really ends.

It's no coincidence that the Hoosier State has produced a nearly unbroken string of outstanding players and coaches at every level, from Johnny Wooden in the 1920s to Larry Bird a half-century later.

And it's no coincidence that the Hoosier faithful that Indiana and Purdue will play each other tonight for the championship of the National Invitation Tournament — already renamed by some newspapers as the "National Indiana Tournament."

Or that top-ranked and unbeaten Indiana State, led by the marvelous Bird, has reached the Final Four of the NCAA tournament. Or that Notre Dame, the fourth Indiana college in the national spotlight this spring, reached the finals of the NCAA Midwest regional tournament.

While not every player from these college teams was weaned on Hoosier high school ball, the prominence of Indiana teams and players is undeniable. Frenzied crowds fill not only college arenas but also the high school gyms — some of them, such as New Castle High School's 9,300-seat facility, larger than most colleges have.

Market Square Arena, site of last week's NCAA Midwest tour-

namment and next year's NCAA finals and the home of the Indiana Pacers of the National Basketball Association, will be filled with a sellout crowd approaching 17,000 on Saturday for the finals of the state high school tournament. The month-long tournament will draw an estimated 1 million fans.

It's known as Hoosier Hysteria and it's especially strong in the smaller communities, where all civic activity is centered on the high school. It brought the townspeople together, and it promoted natural rivalries with the surrounding communities.

"In the early days of basketball, starting with when Naismith put it all together and established some common rules, schools of all sizes participated in basketball," says Ward Brown, commissioner of the Indiana High School Athletic Association.

But what makes Indiana dif-

ferent? Surely other states had — and still have — similar situations.

"No. 1, we have a system that's unique," Brown said. "There are only two other states that have no class basketball (separate programs for schools of different sizes). This goes back to the early days of basketball, where you had 10 or 12 high schools in each county. Now (because of consolidations) several counties have only one school."

"But our system of one-class basketball makes them (the players) equally sought after by colleges because they've had to demonstrate themselves in a one-class tournament with all the other athletes. You know you can't force recruiters to come out."

Wooden, remembered more for his coaching achievements at UCLA, played on an Indiana high school championship team at Martinsville and was an All-

America at Purdue. Perhaps best-known among the other Hoosier products are Oscar Robertson and George McGinnis, both of whom played on state championship teams in

Indianapolis, then went on to national prominence in the college and professional ranks. But there are many others, including Bobby Leonard, Clyde Lovellette, Tom and Dick Van

Arsdale, Jimmy Rayl, Rick Mount, Dave Schellhase and Terry Dischinger. And current pros Louie Dampier, Kent Benson, Jim Price, Steve Green, Tom Abernethy, Bob Wilkerson,

Larry Steele and McGinnis. The focus for Hoosier Hoosiers each year, naturally, is the state tournament.

Four years ago, when Indiana University was defeated and ranked No. 1 in college basketball, an Indianapolis television station decided against live coverage of the Hoosiers' NCAA game against (Continued On Page 22)

## Rams Defeat Jaguars, 7-3

SNOW HILL — Greene Central came up with four runs in the third and then held off Farmville Central in the late innings for a 7-3 baseball victory over the Jaguars yesterday afternoon.

The Rams scored first in the game with a single run in the first, but Farmville got runs in the second and third for a 2-1 lead.

In the bottom of the third, Cohen Cox walked for the Rams,

Greg Holmes reached on a fielder's choice on a sacrifice bunt and the two runners moved up on a sacrifice by Jimbo Fulghum. Al Murray walked to load the bases and Donald Shaw hit a three-run triple. Shaw scored on Walt Tyndall's infield out.

Farmville added a run in the fourth and threatened in nearly every inning after that, but was unable to score again. The Rams scored two more in the sixth.

No Farmville batter had more than one hit, while Shaw was 2-2 and Jeff Scott 2-3 for Greene Central. Murray had a home run in the first inning.

Farmville 011 100 0-3 7 2  
Greene Cent. 104 002 x-7 8 4  
Eason and Gordon, Johnson, Goff (3) and Cox.

## Aycock Tops Conley By 5-2

PIKEVILLE — D. H. Conley fell to its third loss of the young baseball season yesterday as C. B. Aycock took a 5-2 victory over the Vikings.

Aycock scored in the first on a home run by Dave Thomas, but Conley got two in the top of the second. Ben Wilson and Curtis Spencer singled, moved up on Micah Dixon's sacrifice and scored on base hits by Roy Lassiter and Mike Edens.

Aycock tied the game in the bottom of the inning as Jackson

doubled and scored on Pittman's single. In the third, Best walked and moved up on a wild pitch for Aycock and scored on Satterfield's double. The Falcons scored two more runs in the fourth.

Conley, now 2-3, was held to four hits with now batter getting more than one. Aycock also didn't have a batter with more than one hit.

Conley 020 000 0-2 4 3  
Aycock 111 200 x-5 5 1  
Allen and Spencer; Hare and Taylor.

## Beddingfield Rips Tigers

STANTONSBURG — Wilson Beddingfield High School rolled to a 10-1 victory over Williamston High School yesterday.

Williamston got its only run in the top of the first inning. Jeff Odom walked and Chuck Rogerson singled. Randy Ellis then singled in Odom.

Beddingfield tied it up with one in the second. Jim Barnes reached on an error and was sacrificed up. Terry Ellis tripled him in.

The Bruins pushed over three in the third for a 4-1 lead. David

Lawson singled and Kenneth Thorne got a hit. Mike Smith walked and a wild pitch brought in Lawson. Tim Barnes then singled in two runs.

Beddingfield added five more in the fourth and one in the sixth. Rogerson led the Williamston hitting with four, while Barnes had two for Beddingfield.

The two teams meet again on Friday in Williamston. The Tigers are now 1-2 on the year.

Williamston 100 000 0-1 8 4  
Beddingfield 013 201 x-10 8 3  
Wilhelm, Rogers (3), Williams (4), Clemens (6) and Peaks; David and Smith.

## Tigers In Victory

EDENTON — Williamston High School dropped the first two singles matches, then went on to record a 6-3 victory over Edenton High School yesterday.

The Aces managed only to win the number one doubles match during the rest of the afternoon.

Williamston plays host to Ahoskie on Thursday.

Summary:  
Bobby Ashley (E) defeated Gary Bateman, 6-0, 6-0.  
Billy Whichard (E) defeated Duke Douglas, 6-4, 2-6, 6-3.  
Tim Rogers (W) defeated Tommy Bass, 7-6, 2-6, 6-4.  
Kent Perry (W) defeated David Hoggard, 6-4, 6-2.  
Ben Selby (W) defeated Craig Stefan, 7-6, 6-4.  
Jeff Hartman (W) defeated Alan Downing, 6-4, 3-6, 6-1.  
Ashley-Whichard (E) defeated Bateman-Steve Bunch, 8-6.  
Rogers-Douglas (W) defeated Bass-Hoggard, 8-6.  
Selby-Perry (W) defeated Stefan-Downing, 8-2.

## Ram Netters Are Beaten

SNOW HILL — West Carteret's tennis team defeated Greene Central 7-2 yesterday.

The loss dropped the Rams' record to 1-5 on the season. They will play at North Duplin on Thursday.

Details of yesterday's match were not available.

Our finest tire! Our best warranty!

\$60 to \$80 off

# 4 Aramid belted radials.

Sale \$45 ea.

Reg. \$60. Plus fed. tax.\* Size BR78-13.

Premium passenger tire constructed of 2 polyester radial plies and 2 Aramid belts. Aramid, the pound-for-pound, stronger-than-steel synthetic cord with gentle ride. Added sidewall stabilizers and 7-rib tread design. No trade-in required. Tires mounted at no extra charge.

| Tire size | Reg.  | Sale* |
|-----------|-------|-------|
| BR78-13   | \$60  | \$45  |
| DR78-14   | \$67  | \$54  |
| ER78-14   | \$73  | \$56  |
| FR78-14   | \$77  | \$60  |
| GR78-14   | \$82  | \$65  |
| HR78-14   | \$91  | \$73  |
| GR78-15   | \$84  | \$65  |
| HR78-15   | \$93  | \$73  |
| LR78-15   | \$102 | \$82  |

\*Plus fed. tax from 1.90 to 3.13 per tire.

Wheel alignment 12.88

Wheel alignment to factory specifications. Most U.S. and foreign cars.



Full 2 year protection

Plus, additional coverage providing Road hazard protection

Protection against defects in material and workmanship

Wearout protection

JCPenney ARAMID BELTED RADIAL TIRE WARRANTY

**FULL TWO YEAR WARRANTY**  
If this JCPenney Aramid Belted Radial Tire becomes unserviceable within 2 years from date of purchase because of defects in material and workmanship, we will replace it free. Tires that become unserviceable because of wearout, misalignment, improper inflation or misuse are excluded. This warranty applies only to tires used on private passenger cars and other non-commercial vehicles. Just return it to the nearest JCPenney facility for prompt service.

**FULL REPLACEMENT WARRANTY FOR FIRST 10% OF TREAD DEPTH**  
If this JCPenney Aramid Belted Radial Tire becomes unserviceable due to road hazard during the first 10% of the original usable tread, we will replace it free. This warranty applies only to tires used on private passenger cars and other non-commercial vehicles. Just return it to the nearest JCPenney facility for prompt service.

**LIMITED ADDITIONAL WARRANTY FOR DEFECTS IN MATERIAL AND WORKMANSHIP BETWEEN 24 MONTHS OF USE AND THE LAST 2/32 INCH OF TREAD REMAINING AND FOR ROAD HAZARDS AFTER THE FIRST 10% OF ORIGINAL USABLE TREAD AND BEFORE THE LAST 2/32 INCH OF TREAD DEPTH**

If this JCPenney Aramid Belted Radial Tire fails due to defects in material or workmanship after 24 months or fails due to road hazards after the first 10% of original usable tread, we will, at our option, repair or replace it, charging only the portion of the then current selling price that represents original tread used (plus total Federal Excise Tax on the replacement tire). Failure caused by misalignment, improper inflation or misuse is excluded. The warranty is no longer effective when the tread indicators appear in the tire showing that only 2/32" of tread remain. This warranty applies only to tires used on private passenger cars and other non-commercial vehicles. Just return it to the nearest JCPenney facility. To help us serve you better, please return this document with the tire.

**LIMITED ADDITIONAL WARRANTY ON TREAD WEAR FOR 44 MONTHS**

If this JCPenney Aramid Belted Radial Tire wears down to the tread indicators that appear when only 2/32" of tread remains before 44 months of use, we will make an adjustment as shown in the chart below. Wearout caused by misalignment, improper inflation or misuse is excluded. In return for the tire, we will provide a new tire, charging the then current selling price, less the following allowance (plus total Federal Excise Tax on the replacement tire). Just return it to the nearest JCPenney facility. To help us serve you better, please return this document with the tire. This warranty applies only to tires used on private passenger cars and other non-commercial vehicles.

| WARRANTY PERIOD | ALLOWANCE |
|-----------------|-----------|
| 44 Months       | 30%       |

The following is a part of each of the above warranties:

For the addresses of JCPenney facilities in your area, refer to your local telephone directory. If there is no JCPenney facility in your area, write to Carole Winstowe, J.C. Penney Co., Inc., Product Service Department, 1301 Avenue of the Americas, New York, New York 10019.

This warranty gives you specific legal rights, and you may also have other rights which vary from state to state.

Special buy on air adjustable shocks.

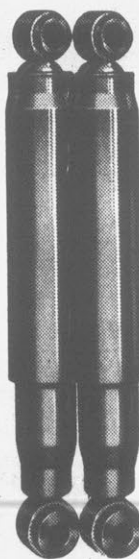

39.88 pr. Increase your car's load-carrying capacity by 1000 lbs. with air shocks. Adjust as easily as filling a tire. Merely add or bleed air for changing loads or road conditions. Great for towing trailers, campers, etc. 49.88 pr. installed

40% off our heavy duty shock absorbers. Sale 5.99 ea.

Reg. 9.99. Great for all normal driving and road conditions. Bigger than original factory replacement equipment by 40%. Has 20% more fluid, too. Fade resistant, stable ride and reliable control. 16.50 ea. The JCPenney shock absorber.



Heavy duty muffler installed. Only

19.88

This heavy duty muffler is designed to provide a quiet ride and dependable performance. It fits most American made cars, and we'll install it now at this great low price.

Keystone sunspoke wheel 4 for \$169

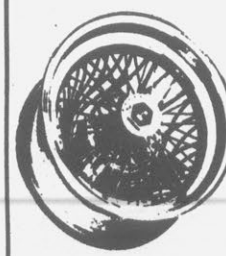

**Sunspoke**  
• All steel, wire wheel.  
• Features K-Lug fit applications. Use special Keystone Sunspoke lugs and washers.  
• Accommodates disc brakes without using special adaptors.  
• Guaranteed leak-proof for tubeless tire applications.

## The Bargain House

Greenville's Newest & Largest INDOOR Flea Market

Saturdays 9:00 A.M.-5:00 P.M.  
Sundays 1:00-5:00

RENTAL SPACES (10' x 10')—\$5.00 Per Day  
ELECTRICAL OUTLETS AVAILABLE ON EACH SPACE  
FARM PRODUCE SPACES \$3.00 PER DAY  
FREE SPACES FOR CHURCH GROUPS & NON-PROFIT ORGANIZATIONS  
CONCESSION STAND (food & drink available)  
OPEN FRIDAY AFTERNOON 2:00 TO 5:00 FOR EARLY SET-UPS

Come On Down To The **NEW** Fairground Building  
Located On Industrial Boulevard  
(Between Burroughs Wellcome & Hastings Ford)

SALE EVERY SATURDAY & SUNDAY

Reply To:  
P.O. Box 194, Greenville, N.C.

# JCPenney Auto Center

•Shop 8:30 a.m. til 9 p.m.  
•Phone 756-1190 Ext. 251

# Sicksers Get Well, Get Win

By The Associated Press  
Things had gotten so bad recently for the Philadelphia 76ers that they were being called the "Sicksers."  
Tuesday night, the "Sicksers" got well...against the San Antonio Spurs, beating the National Basketball Association's Central Division leaders 124-120.  
After San Antonio tied the score 112-112 with 2:06 remaining, Julius Erving hit a layup, giving Philadelphia the lead for good. Then Doug Collins, who returned to action last week after missing 25 games because of foot surgery, clinched the victory with six straight free

throws in the final 14 seconds.  
In other NBA games, the Washington Bullets blitzed the New Orleans Jazz 126-107, the Denver Nuggets whipped the Golden State Warriors 113-102, the Atlanta Hawks downed the Cleveland Cavaliers 115-109, the New York Knicks topped the Milwaukee Bucks 118-110, the New Jersey Nets defeated the Detroit Pistons 117-110, and the Portland Trail Blazers stopped the San Diego Clippers 115-109.  
Bullets 126, Jazz 107  
Washington, despite the absence of starters Bob Dan-dridge and Kevin Grevey plus reserve Mitch Kupchak — all sidelined with injuries — buried

the Jazz by outscoring New Orleans 39-25 in the third quarter for a 101-84 advantage. Elvin Hayes paced the Bullets with 32 points, as Washington raised its record to 48-22, best in the league.

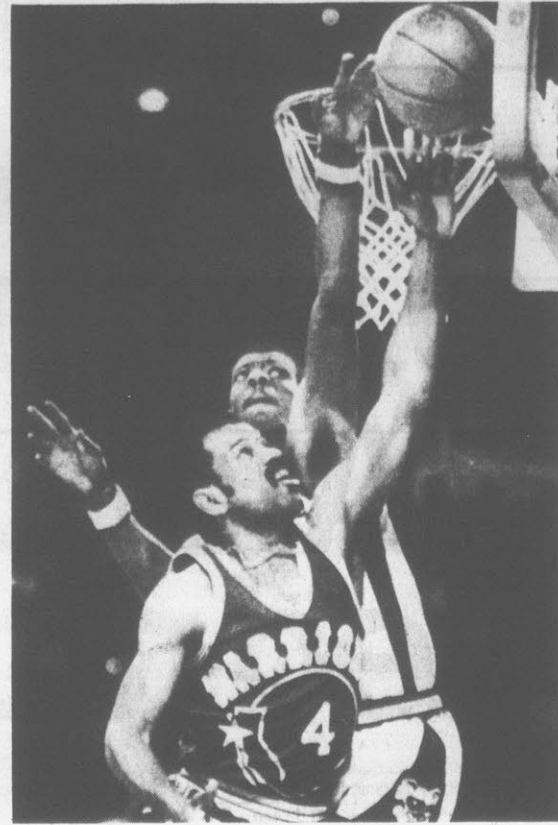

**Block It!**  
Denver Nuggett Charlie Scott (11) blocks a driving layup shot by Golden State Warrior John Lucas during action in last night's National Basketball Association game in Denver. (AP Laserphoto)

Jordan had 29. Bob Lanier topped the Pistons with 26.  
Trail Blazers 115, Clippers 109  
Mychal Thompson's 27 points, including a clutch field goal with 11 seconds remaining, and Maurice Lucas' 24 points, including four free throws in the final 42 seconds, enabled Portland to get past San Diego and move within one game of the Clippers and Denver in the battle for the final two Western Conference playoff berths.  
San Diego's Randy Smith led all scorers with 28 points, but was blanked in the final quarter.

Nuggets 113, Warriors 102  
David Thompson scored 19 of his game-high 27 points in the first half, helping Denver beat Golden State and move within 3½ games of first-place Kansas City in the Midwest Division.  
George McGinnis collected 21 points for the Nuggets, while Dan Issel had 18 points and 11 rebounds. Purvis Short paced Golden State with 20 points.  
Hawks 115, Cavaliers 109  
John Drew's 33 points, 14 in the fourth period, and Dan Roundfield's 30 helped the Hawks win their 12th straight home game and their 30th of the season in the Omni, tying a club record.

The victory ended a four-game Atlanta losing streak, while the setback extended Cleveland's losing streak to six.  
Campy Russell led Cleveland with 27 points and Austin Carr scored 23.  
Knicks 118, Bucks 110  
Earl Monroe and Marvin Webster equaled their season highs with 28 and 23 points, respectively, as the Knicks overcame a 15-point first-quarter deficit and handed the Bucks their 29th road loss in 35 games this season. Webster, suffering from tendonitis in his right knee, also had a game-high 12 rebounds and five assists.  
Marques Johnson tallied 24 points for Milwaukee and Junior Bridgeman scored 21.  
Nets 117, Pistons 110  
Reserve Harvey Catchings scored all 15 of his points in the fourth quarter as the Nets rallied to beat Detroit and end a five-game losing streak.  
John Williamson led New Jersey with 35 points and Eddie

# Kinston Nips Ayden-Grifton

KINSTON — Kinston High School outlasted Ayden-Grifton yesterday, gaining a 8-7 baseball victory.  
Ayden-Grifton scored first, getting a run in the top of the first. Ed Coley singled and moved up on a passed ball. He scored when the relay on a long fly was errored.  
Kinston came back with three runs in the bottom of the first, taking a 3-1 lead. Pittman walked, as did Bailey. Both moved up on a passed ball and Gooding singled in Pittman. A balk scored Bailey, and Cole reached on an error, scoring Gooding.  
The Chargers got another run in the second. Chris Phillips singled and came around on a pair of errors.  
Kinston came back with two more in the bottom of the second. Goodwin singled and scored on a home run by Pittman.  
Both teams scored twice in the third and Ayden-Grifton added a

single run in the fifth and two in the sixth to tie it at 7-7.  
But in the bottom of the sixth, Kinston pushed over the winning run. Hill singled and moved up on a wild pitch. Gooding doubled in Hill.  
Ayden-Grifton 112 012 0-7 10 4  
Kinston 322 001 x-8 8 3  
Daily: Ricciarelli (2), Teachey (4) and Coley; Holder, Hill (5) and Gooding.

# Lady Rams Top Jags

FARMVILLE — Greene Central's softball team romped over Farmville Central yesterday for a 29-3 victory.  
The Lady Rams had 19 hits in the game, led by Melody Ham with three and a host of others with two each. Shackelford was the winning pitcher.  
Greene Cent. (11) 111 408 4-29 19  
Farmville 000 002 1-3 10

# Basketball...

(Continued From Page 21)  
archival Kentucky and showed a high school tournament game instead. Last year, basketball games were played although many schools were closed because of the energy crisis induced by a nationwide coal strike.  
Even the blind drawing for first-round pairings is televised live statewide. This time there is extra interest because of small-town favorite Argos, a tiny school from northern Indiana with an enrollment of

just 271.  
Since little Milan wrote itself into Indiana folklore by winning the state championship 25 years ago, only a handful of small schools have reached the finals. None have won it.  
Now, everyone in Argos is caught up in the basketball madness. Gov. Otis R. Bowen, from nearby Bremen, was in the stands last Saturday when Argos advanced to the finals with a victory over big-school power Marion, which has more students than Argos has citizens.  
For Saturday's final round, Argos gets about 1,700 tickets — enough for every man, woman and child in town.  
"We eat it, drink it and sleep it," says Rosie O'Dell, mother of two starting players for the Argos Dragons. "It's been that way since we were young. We're basketball crazy."  
One of her brothers is the athletic director and soccer coach at the high school. Another brother is basketball coach at nearby Plymouth High School; another is basketball coach at Bremen High School.  
Her nephew plays on the Bethel College team at Mishawaka, Ind. She was a cheerleader in high school herself, and her husband, Darrell, played on the Argos team in the 1950s. Their 20-month-old daughter Stephanie is the unofficial mascot for the current team.  
"We don't smoke or drink or go out that much," she says. "We go to ball games five nights a week. That's our fun."

# Pant-HERS Are Beaten

STANHOPE — Southern Nash High School rolled to a 12-4 softball victory over North Pitt yesterday.  
The Lady Firebirds pushed over four runs in the first inning, then saw North Pitt come back with three in the top of the third. But Southern then added six more in the bottom of the third for a 10-3 lead.  
The Birds added single runs in the fifth and sixth, while the Pant-HERS picked up one more in the fifth.  
Boone and Brenda Brown each had three hits for Southern Nash, while Sandra Brown had three for North Pitt.  
The Pant-HERS, now 0-2, play host to Conley on Thursday.  
North Pitt 003 010 0-4 18  
Southern Nash 406 011 x-12 25

# Jamesville In 13-1 Victory

JAMESVILLE — Jamesville's Bullets romped to a 13-1 victory over Belhaven Friday in Beaufort-Hyde-Martin Conference play.  
Belhaven got its only run in the top of the first and it staked them to a short lead. C. Young singled and D. Gibbs walked. James Freeman then singled in Young.  
Jamesville came back with three in the bottom of the first. Toby Holliday walked and Keith Modlin doubled him in. Tommy DiNardo also doubled, scoring Modlin. A single by Greg Sullivan brought in DiNardo for

a 4-1 lead.  
Another run came in the second. Alan Frazier walked and Victor Lilley singled. Danny Lilley walked, and Trent Ange reached on a fielder's choice, scoring Frazier.  
Jamesville went on to add four in the third and five in the fourth. Ange hurled the victory, allowing just two hits. He struck out eight and walked three.  
The Bullets are now 2-1, and travel to Aurora on Friday.  
Belhaven 100 00-1 2 5  
Jamesville 314 5x-13 10 1  
Edward and Cox; Ange and Holliday.

## \$500 REWARD

For information leading to the arrest and conviction of person or persons responsible for the breaking and entering of Regional Auto Parts, Inc., Thursday night, March 8, taking a 12 gauge Remington pump gun, a 32 revolver pistol, and several hundred dollars worth of mechanic hand tools.

Information will be kept confidential.

**Contact: M.E. Porter**

**Regional Auto Parts**  
**756-1100 and 756-2361**

# The Incredible Paint Savings



**From Lowe's!**

**Incredible Low Prices!**

**Giant Savings!**



**Half Price!**

**Warranted**

**Interior One Coat Latex Flat Ceiling White**

**It's a hulking half price sale on flat ceiling paint!**

This ceiling white is warranted to cover any color in just one coat. It also resists yellowing... is dripless... fast drying... easy to apply... and cleans up quickly and easily in plain water. #47612

**\$549**

Gallon... Regularly \$10.99

**Choose Either and Save \$3.00**



**Huge \$6.00 Savings**



**Enterprise latex house paint**

NON-YELLOWING  
5 GALLONS (17.57 LITERS)  
1 1/2 IN. DIA. CAN

**This latex flat house paint has a 4 year durability rating.**

This exterior latex is warranted to be non-yellowing for a full 4 years. It's also fast drying and cleans up in plain water. #48558

**\$10<sup>99</sup>** 2 Gal. Pail  
Reg. \$16.99

**\$599** Gal... Reg. \$8.99

**2728 S. Memorial Dr. Greenville, N.C. 756-6560**

Convenient Location • Store Front Parking

Master Charge • VISA

**\$699** Gal... Reg. \$9.99

**Basement-Dri paint is warranted to waterproof. Use on interior or exterior masonry. #48280**

**\$599** Gal... Reg. \$8.99

**2728 S. Memorial Dr. Greenville, N.C. 756-6560**

Convenient Location • Store Front Parking

Master Charge • VISA

**Store Hours: Open 7:30-6 Mon.-Fri.; Sat. 8-4**

**Prices Good Thru Saturday**

# LOWE'S



# WE'RE SITTING ON A GOLD MINE.

Maybe you never thought of your home as a gold mine. Maybe you should. Because, with a Homeowner's Loan from Planters, you're borrowing on the equity you've built into your home. And that can mean a bigger, more flexible loan than you'd ever imagine.  
If you need money for remodeling, vacations, any worthwhile purpose, see us for details.

**PLANTERS NATIONAL BANK**  
Member FDIC

WE STILL KNOW THE VALUE OF YOUR DOLLAR.

# Indiana, Purdue Battle For NIT Title

NEW YORK (AP) — The name is NATIONAL Invitation Tournament and the last four games still are held at Madison Square Garden in the heart of New York, but tonight's title game for college basketball's oldest postseason championship really is just a regular mom and apple pie civil war.

The Big Ten Conference has this season's bragging rights as the No.1 college basketball

area, with seven teams in the Top 20 at one time or another, Michigan State in the NCAA Final. Four and three teams reaching the semifinals of the 42nd NIT. So who outside the state of Indiana cares that Purdue and Indiana meet at 9 p.m. EST for the NIT title?

Nearly 15,000 showed up for Monday night's semifinal doubleheader that saw Purdue, 27-17, beat Alabama 87-68 and In-

diana, 21-12, defeat Big Ten rival Ohio State 64-55. A similar turnout is expected tonight when the Boilermakers and Hoosiers meet for the third time this season, each team having won once.

It will be the first time two teams from the same conference have reached the NIT final and the second time teams from the same state have

played for the championship. Xavier, Ohio beat Dayton 78-74 in overtime in 1958.

The Big Ten doesn't have a bigger booster than Hoosiers' Coach Bobby Knight.

"Since 1939, every team in the Big Ten except Northwestern and Minnesota have made the Final Four," he said Tuesday. "I did a survey three years ago and the Big Ten had 48 players in the pros, the Pac-

8 (now Pac-10) had 25 and the Atlantic Coast Conference 15. I don't think there's any question that some of the 24 teams in the NIT are better than some of the 40 in the NCAA.

"We have to play Purdue in the finals, but if I had any control over it, we'd be playing Rose Poly."

The focus of the game should be on whether Knight's swarming defense can stop Joe Barry

Carroll, Purdue's 7-foot-1 center.

"There'll be five guys on Joe Barry at times — like bees on a honeycomb," said Purdue Coach Lee Rose. "He might as well warm up on the Indiana side because they're going to be around him all night."

Carroll, who Rose says has not spoken to newsmen in three years at Purdue, scored 42

points on 16-of-19 shooting against Alabama.

"He's not necessarily shy," said Rose. "He wants his ball-playing to do his talking for him."

"I'd like to think they would use Carroll as a decoy, but I don't think they will," said Knight.

Rose said his biggest worry is not how Indiana would handle Carroll, but the status of

6-7 forward Arnette Hallman, his best defensive player, who suffered an injured ankle against Alabama.

"Arnette did a super job on Mike Woodson (Indiana's leading scorer who paced the Hoosiers with 20 points Monday night) this season," said Rose.

"Right now he can barely walk, and the ankle is worse than it was last night."

**Sale 27.99**

Reg. 32.99. 5'x7' nylon wall tent with 3-way zip screen door, tie back storm flap, rear window. 4'9" center height. Poles, stakes, guy ropes and stuff bag included.

Sale prices effective through Saturday.



**Great savings for the great outdoors.**

**Sale 26.99**

Reg. 34.99. Rectangular Hollofil® II polyester 3 lb. nylon sleeping bag with flannel liner. 33"x75".

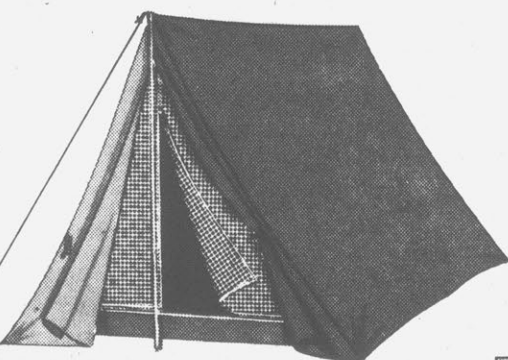
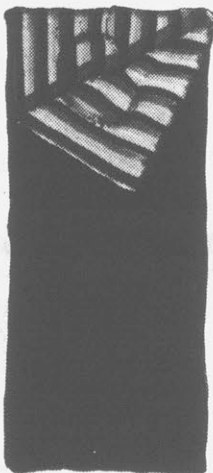

**Sale 19.99**

Reg. 22.99. 5'x7' two-man nylon pup tent with 3-way zip screen door, tie back storm flap, rear window. 3'6" center height. Poles, stakes, guy ropes and stuff bag included. 9.99, 7'x7 1/2' nylon tent fly

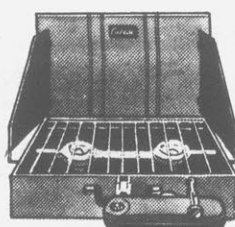

**Sale 25.99**

Reg. 34.99 Coleman deluxe two burner gas stove. 3 1/2 pint fuel capacity with approximate BTU input of 25,600 BTU's.

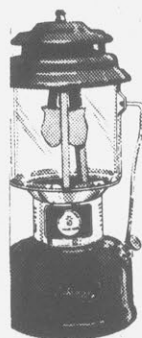

**Sale 21.99**

Reg. 25.99 Coleman deluxe double mantle gas lantern. Eight hour burning time.

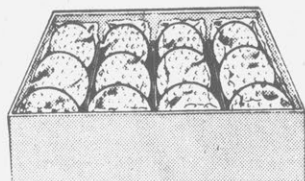

**6.88 Doz.**  
Top Flite xed out golf balls.

**\$10 to off family bikes.**

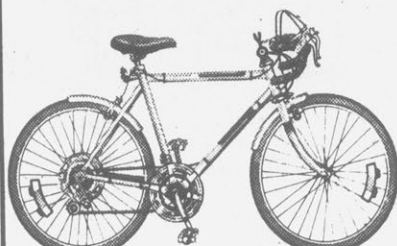

**Save \$20**

Reg. 109.99 Sale 89.99 Men's or women's 26" 10-speed Superstar™ racing style bike. Features the Positron™ derailleur system and dual caliper center pull brakes. Straw finish.



**Save \$15**

Reg. 89.99 Sale 74.99 Boy's 24" 10-speed bike features brake extension levers. Blackwall tires. Silver finish with black seat.

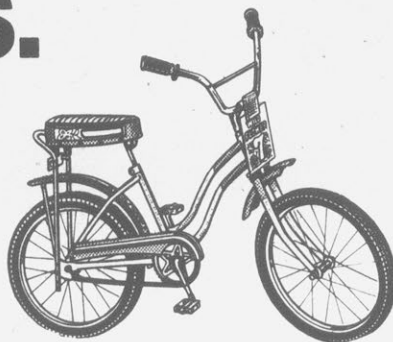

**Save \$10**

Reg. 89.99 Sale 79.99. Girl's Wildflower bike. Cross-braced handlebars, rat trap pedals, coaster brake. White with pink lollipop finish.

Bicycles come unassembled. Sale prices effective through Saturday.

**Save 20% on colorful pro-look tennis coordinates.**



**Sale \$8**

Sale \$10. The mature men's short sleeve shirt is crisp polyester/cotton knit with button placket and chest pocket. For on court or off. Sizes S-M-L-XL.

**Sale \$8**

Sale \$10. Trim tennis shorts are full-cut for comfort with Ban-Rol® waist, adjustable side tabs. Styled with front pockets, one back pocket. In Kodol™ polyester/cotton. Color-trimmed white and fashion pastels for 28-42.

Sale prices effective through Saturday.

This is JCPenney

•Shop 10 A.M. 'Til 9 P.M.  
•Phone 756-1190

This is JCPenney

•Shop 10 A.M. 'Til 9 P.M.  
•Phone 756-1190

# Jack Gives Warning: He's Ready Now

JACKSONVILLE, Fla. (AP) — It was a grimly determined — and slightly annoyed — Jack Nicklaus who intoned:

"I can assure you, I'll play better this week than I have the last two. It's time, past time, to start putting some numbers on the board. It's time to do it instead of talking about it."

Nicklaus' failure to bring his game around, and the emergence of a new wave of winners and contenders have served as the outstanding trends on the Professional Golfers Association tour this year.

The slump could come to an abrupt end this week in the \$440,000 Tournament Players Championship, an ambitious

event that Nicklaus calls "the most significant tournament on the tour." It's the richest event in the game and, more importantly, offers the finest field of the season.

## Tarboro Downs Roanoke Netters

TARBORO — Tarboro High School rolled up an 8-1 tennis victory over Roanoke High School yesterday.

The lone Roanoke victory came in the number two singles where Dean Burns took a win.

The loss dropped the Redskins to 0-5. They play host to Plymouth on Thursday.

Summary:  
Eddie Hurst (T) defeated Ricky

The quality of the field, including all of golf's great performers, and the severity of the tough Sawgrass links — in the three years the TPC has been played here, par 72 has not yet

been broken — strongly indicate that an established player is the most likely winner of the \$72,000 first prize in the event that begins Thursday.

Nicklaus is the defending champion and has won three of the five titles since the TPC has come into being.

Generally acknowledged as the greatest player the game has ever known, the mighty Golden Bear has had his problems this year, however. It's probably the poorest start he's ever had. He hasn't broken par in 10 rounds. He hasn't had a

top 10 finish this season. His scoring average is 72.12 and he ranks a distant 78th on the year's money-winning list.

He insists, however, his game is not that bad.

"Two weeks ago, at Bay Hill, I played about as poorly as I can remember," he said. "But last week wasn't bad at all. I was hitting the ball pretty well and my putting was coming around. I simply wasn't scoring."

Although he had announced a cutback in his playing schedule, his problems have prompted

him to add to his schedule. This will mark his fourth consecutive tournament. It's the first time since his early days on the tour that he's played four in a row.

Should he fail to execute a turnaround in his performance, the strongest lineup in golf is poised for a stab at the title in the tournament that ranks as the annual championship of the game's touring pros.

Among them are Tom Watson, the Player of the Year the last two seasons; and South African Gary Player, the Masters

champion who is opening his 1979 American campaign; and John Mahaffey, the current PGA and World Cup champ.

Portions of the final two rounds will be televised nationally by CBS.

of action for more than a month with a damaged hand.

## McIntyre & Gerry Inc.

ACCOUNTING & TAX RETURNS  
200 West 4th St. Phone 752-2998  
Across from Wachovia Bank's main office  
Open Monday-Saturday 9:00 a.m.-7:30 p.m.

## Rose Takes Net Win

Rose High School's tennis team gained a 7-2 victory over Farmville Central yesterday.

Rose lost the number two and three doubles events to Farmville after sweeping the singles.

The Rampants are now 3-1 overall, while Farmville Central falls to 2-1. Rose travels to Northern Nash on Friday, while Farmville Central plays host to C.B. Aycock on Tuesday, April 3.

Summary:  
Fred Matney (R) defeated Roy Richardson, 6-0, 6-1.

Jeff Quinn (R) defeated Lonnie Pierce, 6-1, 6-0.

Scott Bailey (R) defeated David Dunn, 6-1, 7-5.

Brian Kiczyne (R) defeated Bobby Patterson, 6-1, 6-0.

Larry Talbert (R) defeated Steve Morgan, 6-3, 6-3.

Chuck Blake (R) defeated Billy Sugg, 6-3, 6-0.

Danny Elmer-Bert Singleton (R) defeated Richardson-Pierce, 8-5.

Dunn-Patterson (FC) defeated Scott Taylor-Tom Messick, 8-4.

Morgan-Mark Owens (FC) defeated Chris Lalik-Bobby Gantt, 8-4.

## Knight Bow In Opener

SHARPESBURG — Greenville Christian Academy opened the 1979 baseball season yesterday, bowing to NEW Academy, 6-3.

The hosts pushed over three runs in the bottom of the first to take the lead for good. Benny Hicks reached on an error and Jimmy Joyner singled. Tommy Dorce walked, loading the bases. A Triple by Paul Davis brought in all three runners.

The Knights came back with two in the top of the second. Patrick Langley walked and Troy Hudson singled. Both came in when Sammy Harris singled.

What proved to be the winning run crossed in the bottom of the third for NEW. Joyner singled and came in when Andy Webb reached on an error.

NEW added two in the fourth, while GCA picked up one in the same inning.

Joyner led the NEW hitting with two, while George Griner, Huston, Chuck Allen and Harris each had two for GCA.

The Knights play host to NEW on Friday in their first home game.

GCA 020 100-3 8 4  
NEW 301 20x-6 4 0  
Smith and Allen; Webb, Joyner (5) and Edwards.

# scoreboard

### Recreation Ball

Winterville Jr. League  
Boys Club 15 19-34  
16 11-27  
Leading scorers: W. Glenn Clemons 17, Johnny Harper 12; BC, Hildred Gilbert 15.

Winterville League  
Swift 17 12-29  
Home Savings 9 15-24  
Leading scorers: S. Lexanne Keeter 13, Patricia Breck 13.

Hardee Farms 24 44-68  
Worthington Farms 27 53-70  
Leading scorers: HF, J. Harris 14, R. Harris 14, J. Boyd 14; WF, W. Hawkins 17, O. Lewis 16.

### NBA

| Eastern Conference                |    |      |      |        |
|-----------------------------------|----|------|------|--------|
| Atlantic Division                 |    |      |      |        |
| W                                 | L  | Pct. | GB   |        |
| Washington                        | 48 | 22   | .686 | —      |
| Philadelphia                      | 38 | 33   | .535 | 10 1/2 |
| New Jersey                        | 34 | 37   | .479 | 14 1/2 |
| New York                          | 31 | 43   | .419 | 19     |
| Boston                            | 27 | 47   | .391 | 20 1/2 |
| Central Division                  |    |      |      |        |
| San Antonio                       | 42 | 30   | .583 | —      |
| Houston                           | 40 | 30   | .571 | —      |
| Atlanta                           | 40 | 33   | .548 | 2 1/2  |
| Detroit                           | 28 | 43   | .394 | 13 1/2 |
| Cleveland                         | 28 | 44   | .389 | 14     |
| New Orleans                       | 22 | 51   | .311 | 20     |
| Western Conference                |    |      |      |        |
| Midwest Division                  |    |      |      |        |
| Kansas City                       | 43 | 29   | .597 | —      |
| Denver                            | 40 | 33   | .548 | 3 1/2  |
| Milwaukee                         | 33 | 40   | .452 | 10 1/2 |
| Indiana                           | 30 | 41   | .423 | 12 1/2 |
| Chicago                           | 26 | 45   | .366 | 16 1/2 |
| Pacific Division                  |    |      |      |        |
| Seattle                           | 44 | 27   | .620 | —      |
| Los Angeles                       | 42 | 30   | .583 | 2      |
| Phoenix                           | 42 | 30   | .583 | 2 1/2  |
| San Diego                         | 40 | 33   | .548 | 5      |
| Portland                          | 38 | 33   | .535 | 6      |
| Golden State                      | 32 | 41   | .438 | 13     |
| Tuesday's Games                   |    |      |      |        |
| New York 118, Milwaukee 110       |    |      |      |        |
| Atlanta 115, Cleveland 109        |    |      |      |        |
| New Jersey 117, Detroit 110       |    |      |      |        |
| Philadelphia 124, San Antonio 120 |    |      |      |        |
| Washington 126, New Orleans 107   |    |      |      |        |
| Denver 113, Golden State 102      |    |      |      |        |
| Portland 115, San Diego 109       |    |      |      |        |
| Wednesday's Games                 |    |      |      |        |
| Detroit at Atlanta                |    |      |      |        |
| New York at Washington            |    |      |      |        |
| Chicago at Indiana                |    |      |      |        |
| San Antonio at Kansas City        |    |      |      |        |
| Philadelphia at Houston           |    |      |      |        |
| San Diego at Golden State         |    |      |      |        |
| Portland at Los Angeles           |    |      |      |        |
| Thursday's Games                  |    |      |      |        |
| Indiana at Cleveland              |    |      |      |        |
| Boston at Seattle                 |    |      |      |        |

### Patrick Division

N.Y. Islanders 45 13 12 102 321 187  
N.Y. Rangers 38 24 9 85 289 246  
Philadelphia 34 22 14 82 240 213  
Atlanta 37 27 7 81 286 251

Chicago 25 23 12 62 209 252  
Vancouver 21 40 10 52 198 273  
St. Louis 17 43 10 44 224 307  
Colorado 14 48 9 27 187 303

Wales Conference  
Boston 39 20 12 90 282 233  
Buffalo 30 25 15 75 238 230  
Toronto 30 30 11 71 231 225  
Minnesota 25 33 11 61 230 243

Norris Division  
x-Montreal 45 15 10 100 297 181  
Pittsburgh 31 28 10 72 245 247  
Los Angeles 31 28 10 72 254 254  
Washington 21 36 14 56 243 298  
Detroit 19 35 16 54 229 260

x-clinched division  
Tuesday's Games  
NY Rangers 2, Washington 2, tie  
Detroit 5, Chicago 3  
Los Angeles 4, Atlanta 3

Wednesday's Games  
Washington at Pittsburgh  
Detroit at Toronto  
New York Rangers at Chicago  
Philadelphia at Minnesota  
Buffalo at Colorado  
St. Louis at Vancouver

Thursday's Games  
Pittsburgh at Boston  
New York Islanders at Montreal  
St. Louis at Los Angeles

### NIT

Semifinals  
Monday's Games  
At New York  
Purdue 87, Alabama 86  
Indiana 64, Ohio St. 55

Finals  
Wednesday's Games  
At New York  
Championship  
Purdue (27-6) vs. Indiana (21-12), (n)  
Third Place  
Alabama (22-11) vs. Ohio St. (19-11) (n)

### NCAA

Regional Championship  
Saturday's Games  
Midwest  
At Cincinnati  
Indiana St. 73, Arkansas 71

West  
At Provo, Utah  
DePaul 95, UCLA 91  
Sunday's Games  
East  
At Greensboro, N.C.  
Penn 64, St. John's 62

Midwest  
At Indianapolis, Ind.  
Michigan St. 80, Notre Dame 68

National Semifinals  
March 24  
At Salt Lake City  
Penn (25-5) vs. Michigan St. (24-4)  
Indiana St. (32-0) vs. DePaul (25-5)

National Championship  
March 26  
At Salt Lake City  
Penn-Michigan St. winner vs. Indiana St.-DePaul winner.

### Pro Baseball

Tuesday's Games  
Houston 6, Montreal 4  
Chicago (N) vs. Atlanta 2  
St. Louis 7, Toronto 2  
Boston 4, Cincinnati 3, 10 innings  
Detroit 2, Chicago (A) 0  
Minnesota 15, New York (A) 7  
San Francisco 6, San Diego 4  
Chicago (N) vs. California, p.p.d., rain  
Oakland vs. Cleveland, p.p.d., rain  
Seattle vs. Milwaukee, p.p.d., rain  
Baltimore 4, Philadelphia 3  
New York (N) 8, Pittsburgh 3

Wednesday's Games  
Houston vs. Montreal at Cocoa, Fla.  
Baltimore vs. Atlanta at West Palm Beach, Fla.  
St. Louis vs. Toronto at Dunedin, Fla.  
Los Angeles vs. New York (N) at St. Petersburg, Fla.  
Philadelphia vs. Texas at Pompano, Fla.  
Minnesota vs. Cincinnati at Tampa, Fla.  
Kansas City vs. Chicago (A) at Sarasota, Fla.  
San Francisco vs. California at Palm Springs, Calif.  
Cleveland vs. Seattle at Tampa, Ariz.  
Chicago (N) vs. San Diego at Yuma, Ariz.  
Boston vs. Detroit at Lakeland, Fla. (n)

Thursday's Games  
Detroit vs. Houston at Cocoa, Fla.  
Los Angeles vs. Atlanta at West Palm Beach, Fla.  
Minnesota vs. Pittsburgh at Bradenton, Fla.  
Cincinnati vs. Chicago (A) at Sarasota, Fla.  
Kansas City vs. Toronto at Dunedin, Fla.  
Baltimore vs. Texas at Pompano, Fla.  
New York (A) vs. Boston at Winter Haven, Fla.  
California vs. Cleveland at Tucson, Ariz.  
Milwaukee vs. Oakland at Scottsdale, Ariz.  
Chicago (N) vs. San Diego at Yuma, Ariz.  
Seattle vs. San Francisco at Phoenix, Ariz.  
St. Louis vs. New York (N) at St. Petersburg, Fla., (n)

### Transactions

BASEBALL  
American League  
BOSTON RED SOX—Sent Bobby Sprol, Steve Schneck, Burke Suter and Win Remmerswaal, pitchers; Glenn Hoffman and Julio Valdes, infielders, to Pawtucket of the International League.

CALIFORNIA ANGELS—Sent Bob Slater, infielder; Stan Cizub, Brian Harper and Mark Noccoio, catchers; Dennis Gilbert, outfielder; Ralph Botting, Joel Crider, Mike Heaton, Charlie Phillips, Dave Steck and Rick Foley, pitchers, to their minor league camp for reassignment.

CHICAGO WHITE SOX—Sent Fred Howard and Lamar Hoyt, pitchers; A.J. Hill and Dave White, infielders, to their minor league camp for reassignment.

MILWAUKEE BREWERS—Traded Jack Heidemann, infielder, to the Seattle Mariners' Spokane team of the Pacific Coast League, for a player to be named later.

SEATTLE MARINERS—Acquired Larry Cox, catcher, from the Chicago Cubs for Luis Delgado, outfielder.

FOOTBALL  
CLEVELAND BROWNS—Traded Barry Barrow, offensive tackle, to the New Orleans Saints for an undrafted 1980 draft choice.

Canadian Football League  
MONTREAL ALOUETTES—Signed Joe Scannella, head coach, to a contract extension through 1981. Named Joe Galati special teams and linebacker coach.

Soccer North American Soccer League  
SAN DIEGO SOCKERS—Acquired rights to Ty Keough, defender, from Tulsa Roughnecks in exchange for John Rowlands, defender, and cash.

American Soccer League  
CLEVELAND COBRAS—Signed Mike Nikolic, midfielder.  
INDIANAPOLIS DAREDEVILS—Signed George Perry, defender, and Colin McLocklan, forward.

COLLEGE  
ALFRED UNIVERSITY—Signed Ron Frederes, head basketball coach, to a one-year contract.  
MEMPHIS STATE—Named Dana Kirk head basketball coach.

PEPPERDINE—Named Jim Harrick head basketball coach.



We put over 20 million Custom Polysteel Radials on the road in just 4 years. Now we're putting them ON SALE for just 6 days.

Even at their full price, Goodyear Custom Polysteel Radials are an excellent value. Their two steel cords, wide tread grooves and radial construction provide a stable, smooth ride. You get road-hugging traction even in wet weather. Now they're sale priced. So now Goodyear Polysteel Radials are an even better value. There will never be a better time to buy the tire millions of people ride on with confidence.

Sale prices in effect through March 27th.

| Custom Polysteel Whitewall Sale                   |      |                    |
|---|------|--------------------|
| AR78-13<br>(7 Rib)                                | \$54 | Plus \$1.86 F.E.T. |
| GR78-15<br>(7 Rib)                                | \$73 | Plus \$2.73 F.E.T. |
| HR78-15<br>(5 or 7 Rib depending on availability) | \$78 | Plus \$2.96 F.E.T. |

NO TRADE NEEDED

Lube & Oil \$6.88

Includes up to five quarts major brand 10/30 oil. Oil filter extra if needed.

Front-End Alignment \$17.88

Parts and additional services extra if needed. Front-wheel drive and Chevetttes excluded.

RAIN CHECK — If we sell out of your size we will issue you a rain check, assuring future delivery at the advertised price. Just Say "Charge It" Goodyear Revolving Charge Account. Use any of these 7 other ways to buy: Our Own Customer Credit Plan • Master Charge • Visa • American Express Card • Carte Blanche • Diners Club • Cash.

# GOODYEAR

BUY IT WITH CONFIDENCE. DRIVE IT WITH CONFIDENCE.

SEE YOUR INDEPENDENT DEALER FOR HIS PRICE AND CREDIT TERMS. PRICES AS SHOWN AT GOODYEAR SERVICE STORES IN ALL COMMUNITIES SERVED BY THIS NEWSPAPER. SERVICES NOT AVAILABLE AT STARRED LOCATIONS.

Goodyear Is Open Til 5 P.M. on Saturdays For Your Convenience

## WE SERVICE NATIONAL ACCOUNTS

# GOODYEAR SERVICE STORES

729 Dickinson Ave. Open Mon.-Fri. 7:30 to 6, Sat. 7:30 to 5. Phone 752-4417. Johnny Joyner, Mgr.

## CLIFF'S Seafood House and Oyster Bar

Washington Highway (N.C. 33 Ext.) Greenville, North Carolina  
Phone 752-3172

**Thursday Special**  
**(CLIFF'S SHRIMP NIGHT)**  
Regular Fried Shrimp REG. \$3.95 **\$3.10**



**PYRAMID-STYLE STORAGE** — Sacks of groundnuts, a major source of foreign earnings for Nigeria, are stacked outdoors in pyramid style storage structures. A proposal has been made in the country to coordinate a system of

nationally held and internationally coordinated food stocks, attempting to assure the world enough to eat in times of widespread shortages. (AP Laserphoto)

## Italians Have Retained A Vast Artistic Hoard

By JULIUS B. HUMI  
FLORENCE, Italy (UPI) — Napoleon and Hermann Goering had agents in their invading armies plunder the art works of Italy, and no wonder. Art is the nation's most valuable but often neglected patrimony.

Figures released by the Ministry of Culture and Art recently reveal that the nation owns some 4.6 million items of "historic and artistic value," ranging from old and contemporary paintings and sculptures to relics and archaeological finds, manuscripts and other collections.

Of this number, only about 358,000 are on display in the country's 142 museums, 71 art institutes and 1,985 exhibition sites.

The rest of the vast collection lies in museum vaults, storage rooms and other depositories.

Only 500,000 items of this stored treasure ever have been properly catalogued.

The ministry figures do not include the Vatican museum in Rome nor the few remaining collections still in private hands in Italy.

Most of the works carried away by the French at the start of the 19th century were returned to Italy after the fall of Napoleon and the formation of the Italian state after the Congress of Vienna.

Most, but not all, the art works stolen by the Nazis, mainly on behalf of Reichsmarschall Goering, were retrieved and returned after World War II. Some are still surfacing at auctions in England and the United States, watched by Italian arts ministry agents.

It is impossible to estimate the value of the works of art exhibited in famous museums like the Uffizi and Pitti in Florence, the Accademia in Venice and Brera in Milan.

Ministry figures show Italy spends \$327.5 million to maintain the paintings, sculptures, manuscripts and antiquities shown in the museums, exhibitions and excavation sites, less than one percent of total national spending.

Italy's art treasures have for centuries been the fountainhead of art collections all over the world. Its primitive and Renaissance paintings, together with classical sculptures of the ancient Roman and Greek empires, formed the nucleus of practically every major museum from the National Galleries in London and Washington to the Museums of Leningrad and Leipzig.

Their treasures were acquired, often illegally, by wealthy foreign collectors during the 18th and 19th centuries and even the beginning of the 20th, when the families descendant from the rulers of Italy's wealthy 15th and 16th century city-states who were patrons of the great artists of the time were losing their fortunes.

Only at the start of the present century, and more particularly after World War II, has the Italian government made the export of art works illegal, thereby encouraging an increasing market in stolen and illegally exported art.

The ministry estimates that more than 500 paintings and sculptures have been spirited out of Italy in the last 10 years, not always following clamorous thefts. Most of the really famous art works stolen are recovered by the police.

The countless treasures now on show to the millions of tourists who crowd Italy's museums each year came into national ownership mostly by donation.

One of these was the biggest single donation ever recorded

in history.

In 1742 Anna Maria Ludovica, the last of the Medici dynasty which had ruled Florence since the 15th century, bequeathed the entire Medici art collection to Tuscany, then an independent state, with the proviso "that none of it should ever be removed from Florence, and that it should be there for the benefit of all nations."

The duchess, then 72 and married to the German Elector Palatine of the Rhine, gave to the state a treasure which included the works of Michelangelo, Botticelli, Donatello, Angelico, Lippi and many others. Any one of these would today be the centerpiece of a museum.

The donation also included the Laurentian Library, one of the most valuable collections of ancient manuscripts, gathered by agents of the immensely wealthy Medici rulers during the Renaissance.

Italy's two most famous museums, the Uffizi and Pitti galleries here, consist almost entirely of some Medici treasures presented by the last of their line.

Her bequest contributed towards making the Italian tourist industry one of the country's most profitable.

The just-published Culture and Art Ministry study is designed to remind Italians of their most important heritage, one more admired — and often coveted — by foreigners than by the natives of the land which saw the flowering of the Renaissance, the beginning of all art appreciation as it is now known.

## A NEW BOUNCE IN COMFORT.

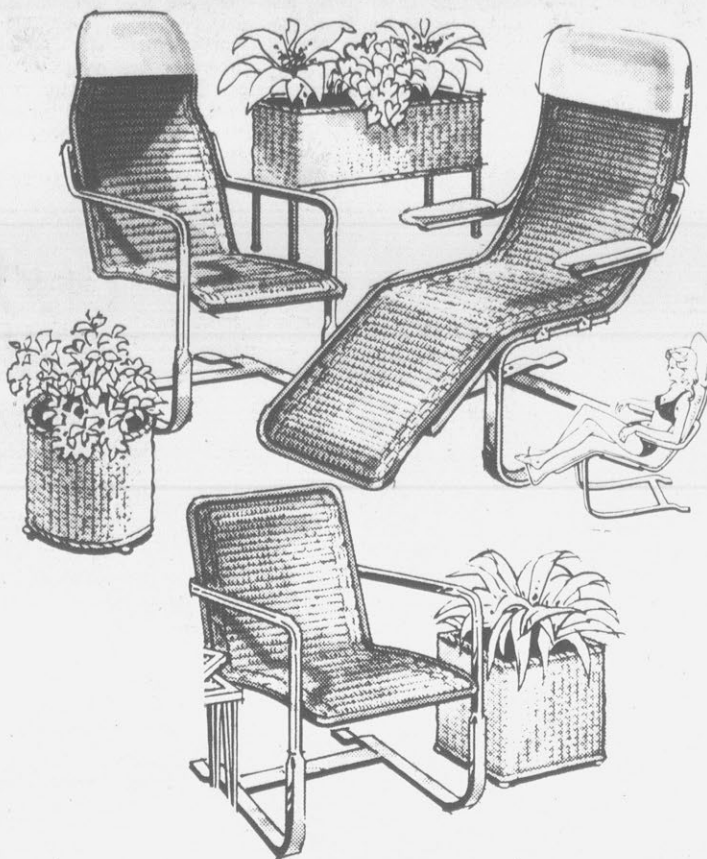

Save \$18.35 To \$36.95 Now At Bostic-Sugg  
**LLOYD SPRING-BASE CHAIRS.**

- List \$58.35 Spring Base Rocker ..... \$40.00
- List \$71.00 Tall Back Spring Base Rocker ..... \$50.00
- List \$136.90 Tall Back Chaise Lounge Rocker ..... \$100.00

## Bright Days! For A Shady Corner



\$146.25 CUT ON LLOYD  
5 PIECE UMBRELLA  
TABLE PATIO GROUP

42 Inch Round Umbrella  
Table Plus Four Comfortable  
Arm Side Chairs. .... Now Only  
**\$175<sup>00</sup>**

### Select One Of Bostic-Sugg's Budget Pay Plans



- VISA •Master Charge
- 30-60-90 Day Cash Plan
- Revolving Charge Plan

Bostic-Sugg's Show Room Hours  
8 A.M. To 5:30 P.M. Monday Thru  
Saturday. Open Til 9 P.M. Friday  
Nites.



## PRICES MAY NEVER BE THIS LOW AGAIN on La-Z-Boy Reclinas

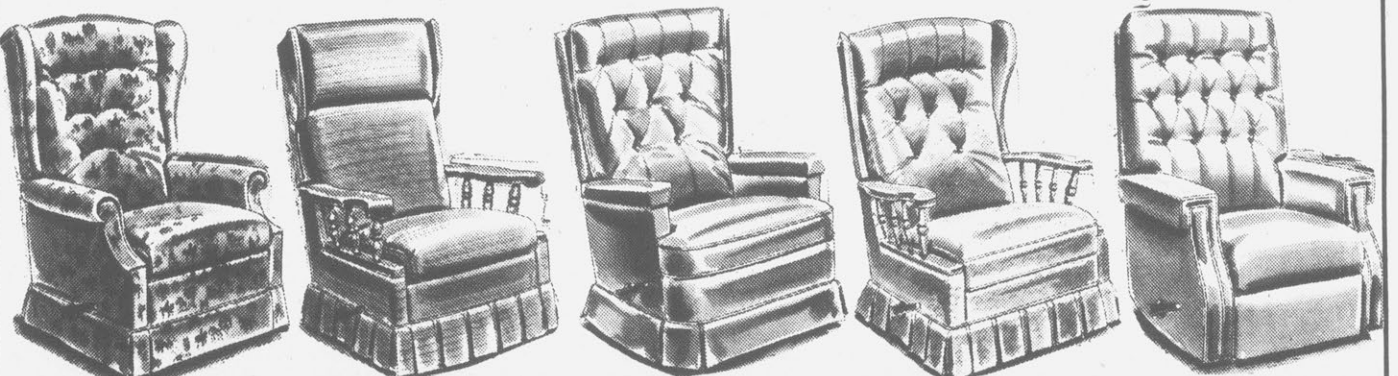

- \$117.50 Off! List \$340.00  
**Wing Back**  
Colonial La-Z-Boy  
**\$222<sup>50</sup>**
- \$115.00 Off! List \$380.00  
**Colonial Pillowback**  
La-Z-Boy  
**\$265<sup>00</sup>**
- \$134.00 Off! List \$374.00  
**Big Man's**  
La-Z-Boy  
**\$240<sup>00</sup>**
- \$134.00 Off! List \$374.00  
**Maple Trim-**  
Colonial La-Z-Boy  
**\$240<sup>00</sup>**
- \$132.00 Off! List \$338.00  
**Tall Back**  
La-Z-Boy  
**\$189<sup>00</sup>**

## Final Date For 'Friends'

Saturday, March 24 is the final date for the membership drive for Friends of the College, the largest concert series of its kind in the country.

Mrs. Mae Gates is the membership chairman for Greenville, and is accepting season memberships for \$10. Membership includes admission to a number of entertainment events scheduled for the 1979-80 series at N. C. State University in Raleigh.

Attractions for the series are: The Black Watch, Scotland's senior Highland Regiment band; the Moscow State Symphony Orchestra; the Norman Luboff Choir; Ballet West; the Cincinnati Symphony Orchestra; and a quartet of Metropolitan Opera stars in concert.

Interested persons can contact Mrs. Gates at 758-1420.

**OLYMPIC STORY**  
HOLLYWOOD (UPI) — Wayne Rogers and Elke Sommer will costar in Paramount's "Top of the Hill", a 1980 Winter Olympics story to be filmed in Lake Placid, N.Y. The four-hour television series is novelist Irwin Shaw's first original story for television.



## Speaking of Your Health...

Lester L. Coleman, M.D.

### Persistent Fever: A Perplexing Problem

Our 14-year-old daughter has had fever for the past eight months. Usually, it's about 100 to 101 degrees. Rarely does it go above 102. The doctor has not been able to find the cause. We can't send her to school with fever. It's interfering with all her progress. — Mrs. J.D., Ky. Dear Mrs. D.:

Fever of unknown origin is one of the most baffling and frustrating problems that a physician has to deal with. Sometimes, the answer is elusive even after the most exhaustive tests have been made.

Normally, fever is a remarkable phenomenon. It is a great indicator of the body's reaction to invading bacteria, to inflammation and to infection. Fever indicates that the body forces are at work and, in fact, it represents the body's constant effort to overcome infections and other diseases.

Persistent fever demands the tireless coordinated efforts of the doctor and patient. When first confronted by such a perplexing problem, doctors tabulate all the possibilities and then proceed to rule them out, one at a time.

There are many possibilities that are always considered by doctors when they try to track down persistent fever of unknown origin. Rheumatic fever, typhoid fever, typhus, amebic dysentery, vascular diseases, liver disease, malaria, tuberculosis, tropical diseases, intestinal parasites and hepatitis are but

some of the conditions that must be ruled out. It would be a monumental task to list every possible cause of persistent fever.

When the cause of fever completely eludes the physician, blood samples are often sent to the Communicable Disease Center in Atlanta. There, the blood is studied for some of the more unusual types of infection. It takes great courage and perseverance to pursue all the studies necessary to finally find the cause of uninterrupted fever. Eventually, this will occur because the facilities for studying the blood are now extensive and effective in the pursuit of the cause of fever.

My aunt has a cancer and is seriously sick. My wife is so afraid of cancer that I can't get her to visit. She is sure cancer is contagious. I need your extra help to convince her that she is wrong. — Mr., E.E., Okla. Dear Mr. E.:

The fear of cancer is so great in so many people that it is difficult to reason with them or to separate them from their anxiety.

Cancers are not contagious. Cancers are not infectious. Cancers cannot be transmitted from one person to another, even when they are intimately in contact.

DR. COLEMAN welcomes letters from readers. Please write to him in care of this newspaper.

©1979 King Features Syndicate, Inc.

## Thomasville NATIONALLY ADVERTISED Collector's Cherry

Thomasville designers have researched the formal motifs of Early American furniture for a collection of faithful reproductions. Many of the pieces reflect the hallmarks of New England Queen Anne designs which were so popular in the finer colonial homes. Exceptional bedroom reproductions include the Queen Anne high boy, the shaving mirror, the vertical mirror with its flowing broken pediment, a substantial cannonball bed and a graceful canopy bed in

An unusual adaptation of Early American design for 20th century storage requirements is the master's chest with drawer and door storage. These designs have graced the interiors of fine homes for more than 200 years. Thomasville makes them available now, scaled for today's rooms, in the Early American beauty and with the Thomasville quality your home deserves.



Bostic-Sugg Saves You Hundreds Of Dollars On Authentic Colonial Styled Hand-Rubbed

### Thomasville Collector's Cherry Bedroom Group

**35% To 40%**

Off Retail  
Price List

Now You Can Own Quality  
Thomasville Bedroom Groups  
At Prices You Never Thought  
Possible.

Largest Savings Ever On Col-  
lector's Cherry Group

# Chinese Are Astute In Their Business Bargaining

BY WILLIAM J. HOLSTEIN  
HONG KONG (UPI) — American and European businessmen going into China in a flush of good will are finding the Chinese can be tough customers.

Businessmen attempting to sell airplanes, hotels, television sets and other commodities often find themselves at a distinct disadvantage in dealing with their Chinese counterparts. Most foreign businessmen suffer from the "Marco Polo Complex" — a fascination with China and an eagerness to do business there. The Chinese, keenly aware of this, are not above taking advantage of it with gamesmanship tactics.

"The Chinese play a really neat cat and mouse game," said one American consultant specializing in helping small U.S. firms do business in China. "Most Americans don't understand it. That's one reason why the Japanese have done so well. They do understand it."

For the Chinese, bargaining is an art that requires great skill and patience. Westerners, particularly Americans, tend to view it as a somewhat distasteful task that should be completed as quickly as possible.

"What is extremely frustrating to an American is to go half-way around the world and sit down and the Chinese won't talk business," the consultant said. "I've gone in there and by the third meeting I still haven't talked business. I wanted to take my fist and punch these guys out."

In some cases, the Chinese appear to drag out negotiations because they recognize that time is on their side: the foreign businessman is staying in a strange hotel, eating strange food, seeing strange things. He misses his wife. He wants to conclude his business and go home.

Realizing this, the Chinese may act pessimistic about purchasing a salesman's goods and draw out the talks by asking about his house, his children and the like.

Several frustrated Americans have checked out of their hotels in despair and gone to the airport to leave China — only to get a phone call at the last minute saying, "Come back. We want to talk."

In addition, few Western businessmen understand the Chinese tradition of "using the barbarians against the barbarians." For hundreds of years the Chinese have been masters at getting foreigners to compete with each other — which drives down the price for the Chinese.

John Kamm, Hong Kong representative of the National Council for U.S.-China Trade, believes the bargaining atmosphere is improving for the Western businessman, but he acknowledges the Chinese can "throw you a few wrinkles."

"In a negotiation, they are

able to get companies to compete against each other for a particular project on terms very favorable to themselves," he said. "They are sharp businessmen. They have a long, long history of commerce. They are very skilled at negotiating."

The scramble by Western banks to lend the Chinese huge sums of money is one example

of the Chinese skill. The West Germans, Italians, Canadians, Americans and Japanese all are opening new bank branches in Hong Kong, establishing correspondent relations with the Bank of China and gearing up to make loans.

Although no major loans actually have been made, the interest rates that the Chinese are likely to pay are minimal

— in the range of 7 to 8 percent, banking sources say. "We're actually going to lose money on these first few loans," one Chase Manhattan official acknowledged. "We all just want the status of being the first bank to get in there."

Another standard Chinese bargaining ploy is to assemble a large group of officials to

bargain with only a small number of foreign businessmen. "You walk into the room and there are 27 of them and only four or five of you," said a representative of a major American tire company who has traveled to Peking. "They work in shifts and by the time it's over with, you've been worn down."

A final Chinese negotiating

strategy might be called the "shell trick." "Say the Chinese are most interested in buying Product A," one China trade expert said. "They might talk to you for days about products B and C and only at the last minute do they even bring up what they're most interested in. It's a way of drawing you off balance."

Although the foreigner has few defenses against a crafty Chinese negotiator, he can take some steps that may help him: —Include an elderly man in your group. The Chinese respect age and may deal more graciously with you if they believe senior officials are present.

—Take your own translator,

especially to assist you in technical discussions. —Never say anything in the bargaining room you don't want the Chinese to understand. Some of the Chinese negotiators are likely to speak excellent English. —Have a plentiful supply of patience and never show signs of frustration or anger, which is considered a loss of face.



AT PARTICIPATING  
PIGGLY WIGGLY STORES

CHOOSE FROM TWO  
BEAUTIFUL PATTERNS!

# FREE STAINLESS FLATWARE

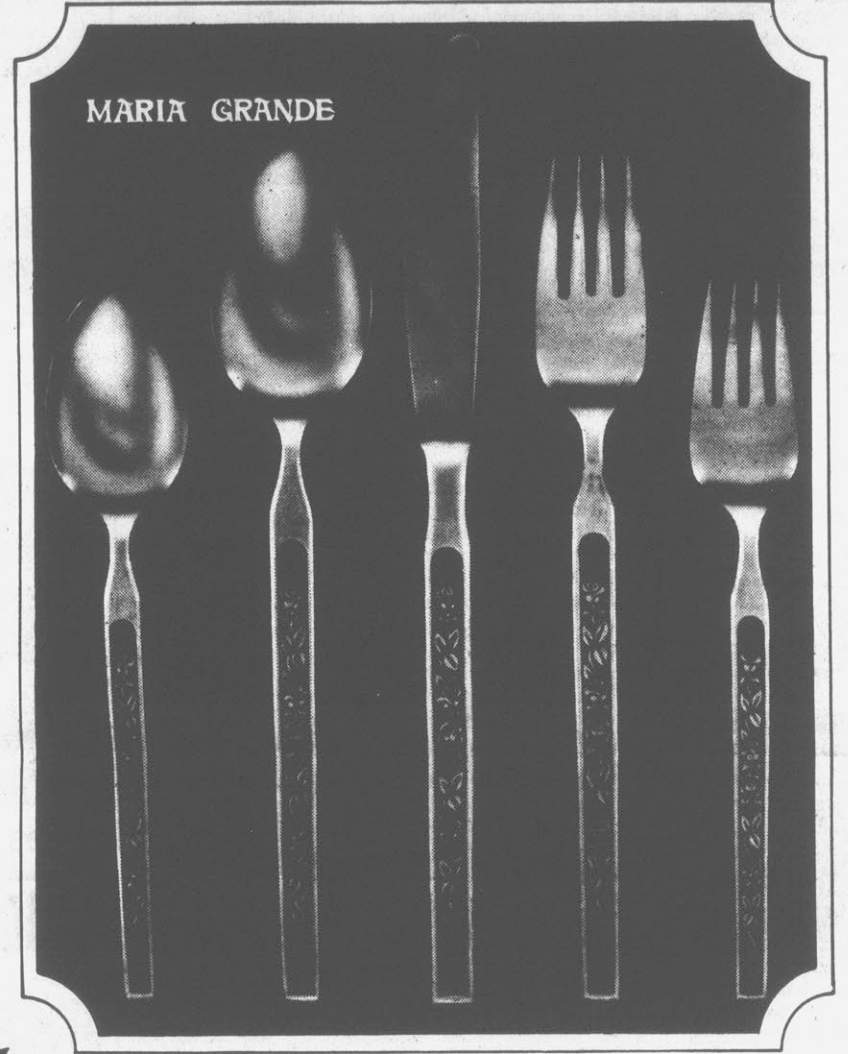
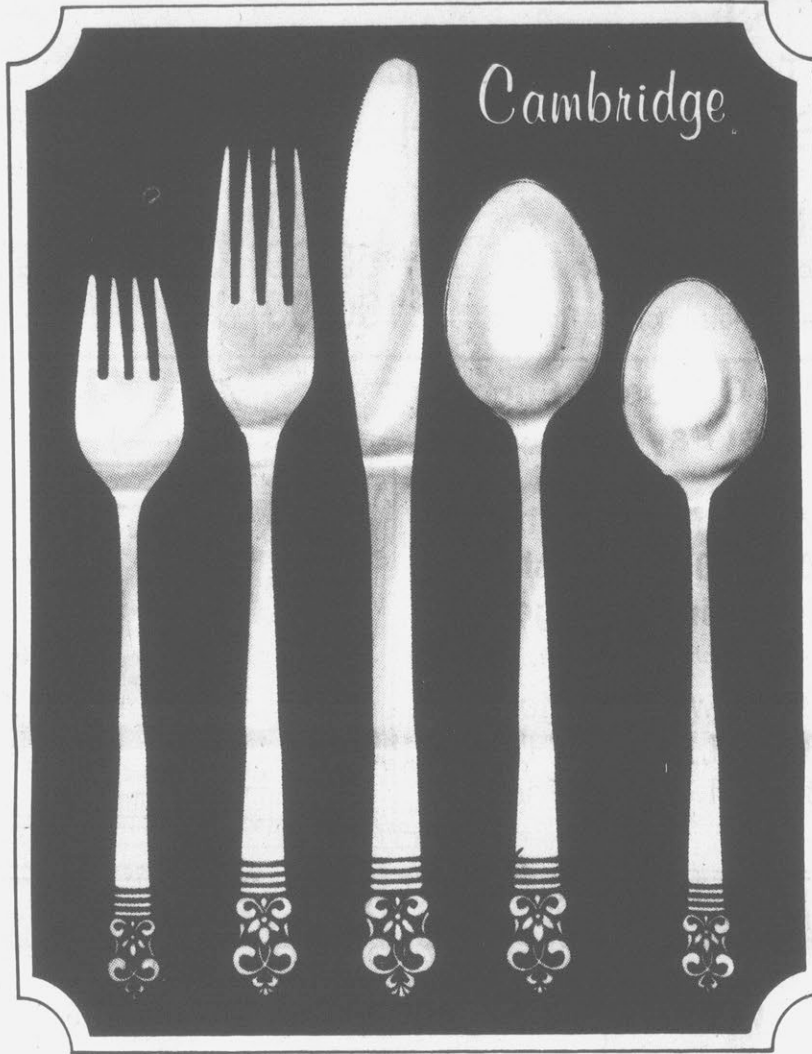

## Conference On Nutrition

ECU News Bureau  
The East Carolina University School of Medicine will hold a conference on "Infant Nutrition: A Foundation for Lasting Health" Wednesday, March 28.

The conference is sponsored by the ECU Department of Pediatrics and Mead Johnson's Nutritional Division as a special program celebrating the International Year of the Child.

Featured speaker for the afternoon program will be Dr. Donough O'Brien, professor of pediatrics at the B.F. Stolsky Research Laboratories, University of Colorado. O'Brien will discuss the psychological and nutritional needs of infants during the first year of life and contrast these needs with current feeding practices.

He will also review the short and long-term consequences of infant feeding practices as they relate to obesity, hypertension and cardiovascular disease. Two 40-minute films will supplement his presentation.

Also participating in the program will be Dr. William E. Laupus, dean of the medical school, and Dr. Jon B. Tingelstad, professor and chairman of pediatrics.

The conference will be held at 1:30 p.m. in the Teaching Addition Auditorium at Pitt County Memorial Hospital.

LATE WISH  
GLOUCESTER, England (AP) — Peter and Betty Meadows were celebrating their 34th wedding anniversary when a postcard arrived from Betty's sister wishing Betty good luck on her engagement.

The card had been stuck in a mailbox since 1945.

FEATURE-OF-THE-WEEK  
**FREE**  
WITH EACH \$10.00 MINIMUM PURCHASE.  
LIMIT ONE PER CUSTOMER.

- ELEGANT STAINLESS FLATWARE WITH THE GLEAMING HIGH POLISH OF FINE SILVER... STYLED TO PLEASE THE MOST DISCRIMINATING TASTE!
- HANDCRAFTED QUALITY... DISTINCTIVE DESIGN...
- SUPERB FLATWARE TO GRACE THE FINEST TABLE... DISHWASHER SAFE AND DETERGENT PROOF.
- HEAVYWEIGHT, FOR LASTING FAMILY USE AND GRACEFUL ENOUGH FOR THE MOST FORMAL ENTERTAINING.

These accessory sets are on sale during the entire program. No purchase requirement!

ADDITIONAL FEATURE  
PIECES ONLY

4 ICED TEA  
SPOONS

\$2<sup>49</sup>

1 COLD MEAT FORK  
2 TABLESPOONS

\$2<sup>99</sup>

1 CAKE SERVER  
1 GRAVY LADLE

\$2<sup>99</sup>

1 PIERCED  
SERVING SPOON  
1 SUGAR SPOON  
1 BUTTER KNIFE

\$2<sup>99</sup>

**39¢** EACH  
NO PURCHASE  
REQUIREMENT!  
NO LIMIT!

| FEATURE-OF-THE-WEEK               |              |  |
|-----------------------------------|--------------|--|
| FIRST, SIXTH AND ELEVENTH WEEK    | TEASPOON     | SPECIAL PRICE<br><b>FREE</b><br>With \$10.00 minimum purchase. Limit one per customer.<br>ADDITIONAL FEATURE PIECES ONLY<br><b>39¢</b> EACH<br>NO PURCHASE REQUIREMENT!<br>NO LIMIT! |
| SECOND, SEVENTH AND TWELFTH WEEK  | DINNER FORK  |  |
| THIRD, EIGHTH AND THIRTEENTH WEEK | DINNER KNIFE |  |
| FOURTH, NINTH AND FOURTEENTH WEEK | SALAD FORK   |  |
| FIFTH, TENTH AND FIFTEENTH WEEK   | SOUP SPOON   |  |

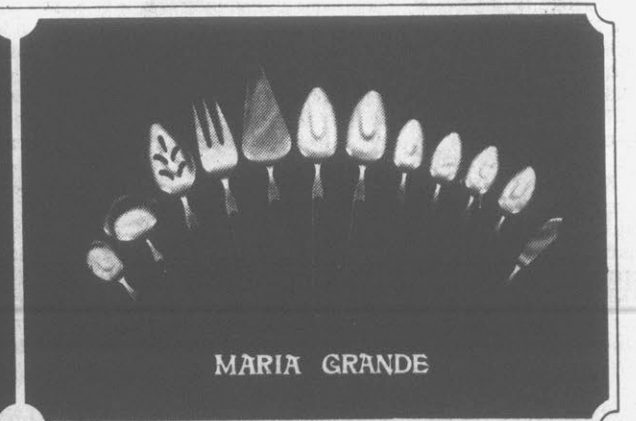
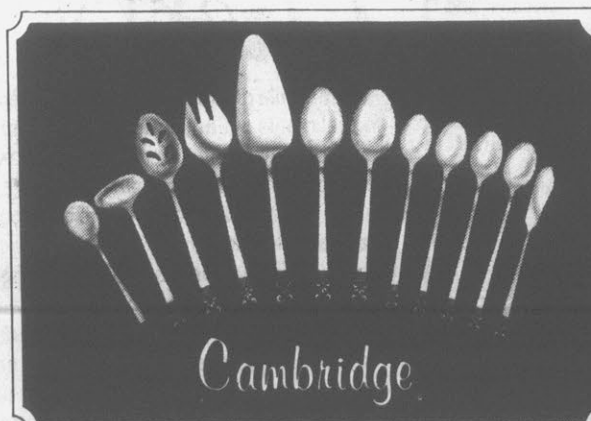

START COLLECTING YOUR  
BEAUTIFUL NEW FLATWARE  
TODAY!



**PRICES EFFECTIVE MARCH 21-24**  
 We reserve the right to limit quantities.  
 None sold to dealers or restaurants.  
 We gladly accept USDA Food Stamps.



SWIFT  
**NEW**

HOMEMADE  
**Soup Starter**  
 7 OZ.

**QUALITY FOODS 89¢**  
**at Budget Pleasin' Prices**

Shop  
**PIGGLY WIGGLY**

PIGGLY WIGGLY  
**FRESH PORK SALE**

WHOLE OR RIB HALF  
**PORK LOIN**

SLICED FREE

LB. **1.29**

WHOLE SLAB  
**SPARERIBS**

LB. **1.29**

SLICED.....LB. 1.39

BOSTON BUTT  
**PORK ROAST**

LB. **99¢**

FRESH WHOLE  
**PORK PICNIC**

LB. **89¢**

(SLICED 99¢ LB.)

QUARTER  
**SLICED PORK LOIN** LB. 1.39  
**PORK CHOPS (CENTER CUT)** LB. 1.69  
**PORK CHOPS (WAFER THIN)** LB. 1.79  
**PORK ROAST (SLICED 1.50)** LB. 1.49  
**BACK BONE** LB. 1.39  
**PORK CHOPS (BLADE CUTS)** LB. 1.39  
**Chitterlings** 10 LB. CARTON **4.99**  
**SLICED PORK STEAK** LB. 1.09  
**FRESH PORK LIVER (SLICED)** LB. 39¢

OSCAR MAYER REGULAR **BOLOGNA** 8 OZ. PKG. **99¢**  
 OSCAR MAYER BEEF **BOLOGNA** 8 OZ. PKG. **99¢**  
 OSCAR MAYER REGULAR **BOLOGNA** 12 OZ. PKG. **1.49**  
 OSCAR MAYER BEEF **BOLOGNA** 12 OZ. PKG. **1.49**  
**SWIFT'S PREMIUM BACON** 12 OZ. PKG. **1.19**  
**SWIFT'S (ALL MEAT) FRANKS** 12 OZ. PKG. **1.19**  
**LUNDY'S SLICED BACON** LB. **1.29**

**Fastest 1/2 Hour on TV!**



**"Let's Go to the Races"**

RACE TICKET GREEN NO. 2052 RACE 3/26/79

WIN YOUR SHARE OF **\$143,000.00** PRIZE MONEY  
 WIN UP TO **\$1,000.00**

ODDS CHART - WINNING POSSIBILITIES

| AWARD  | NO. OF WINNERS | 1 STORE VISIT PER WEEK |         | 2 STORE VISITS PER WEEK |        |
|--------|----------------|------------------------|---------|-------------------------|--------|
|        |                | T                      | in      | T                       | in     |
| \$2    | 1,000          | 1                      | 215     | 1                       | 72     |
| \$5    | 100            | 1                      | 2,150   | 1                       | 720    |
| \$10   | 50             | 1                      | 4,300   | 1                       | 1,433  |
| \$100  | 5              | 1                      | 43,000  | 1                       | 14,334 |
| \$1000 | 2              | 1                      | 107,500 | 1                       | 35,834 |

Your chance of winning a prize are 1 in 186. There is a total of \$143,000 prize money available during this 26 week program. A total of 30,082 winning game pieces. 1 in 186 are winning game pieces. This game is being played in 42 Piggy Wiggle Stores throughout central and eastern North Carolina. Game will be terminated March 26, 1979. Get complete details from the participating Piggy Wiggle Store in your area.

"LET'S GO TO THE RACES"

**TV SCHEDULE**

**\$1,000.00 WINNERS**  
 DAVID MITCHELL HORNE  
 Autryville, N. C.  
 BRENT SCOTT  
 New Bern, N. C.

**\$100.00 WINNERS**  
 MRS. W. M. JONES  
 Clinton, N. C.  
 MARTHA CHAVIS  
 Rowland, N. C.  
 EVELYN M. BASS  
 Creedmore, N. C.

EACH MONDAY NIGHT  
 WECT-TV Channel 6  
 4:30 p.m. to 5:00 p.m.  
 WNCT-TV Channel 9  
 5:00 p.m. to 5:30 p.m.  
 WCTI-TV Channel 12  
 7:00 p.m. to 7:30 p.m.

**DOVE**

22 OZ. LIQUID

**59¢**

**DOWNY**

FABRIC SOFTNER  
 96 OZ.

**2.39**

JIFFY  
**CORN MUFFIN MIX**  
 8 1/2 OZ.

**5/1<sup>00</sup>**

PIGGLY WIGGLY BUTTER-ME-NOT  
**Biscuits**  
 9 OZ.

**3/1<sup>00</sup>**

LIPTON  
**Tea Bags**  
 24 CT.

**1.29**

KRAFT  
 MACARONI AND CHEESE  
**DINNER**  
 7 1/4 OZ.

**4/1<sup>00</sup>**

LIMIT FOUR WITH \$7.50 FOOD ORDER

PILLSBURY  
 PLAIN OR SELF-RISING  
**FLOUR**  
 5 LBS.

**69¢**

LIMIT ONE WITH \$7.50 FOOD ORDER

KRAFT  
 MARGARINE  
**PARKAY**  
 LB.

**2/89¢**

Spring Savings  
**PINE POWER SPRAY** 28 OZ. **1.09**  
**WASH** 22 OZ. **1.29**

GLASS PLUS FANTASTIK 22 OZ. **89¢**  
**59¢**

ICE CREAM SANDWICHES 6 CT. PK. **69¢**

PIGGLY WIGGLY BROWN & SERVE ROLLS **3/1.09**  
 PIGGLY WIGGLY ANGEL FOOD CAKE **89¢**

Cambridge  
**MARIA GRANDE**

Exquisite Flatware  
**FREE!**  
 This Weeks Feature  
**Teaspoon**

YOUR CHOICE **FREE**  
 WITH \$10.00 MINIMUM PURCHASE.  
 ADDITIONAL FEATURE PIECES ONLY **39¢** EACH  
 NO PURCHASE REQUIREMENT!  
 NO LIMIT!

U.S.D.A. GRADE "A"  
 FRESH WHOLE  
**FRYERS**  
 TWO PER BAG

LB. **46¢**

PEANUT CITY  
**COUNTRY HAMS** LB. **\$1.49**

**MELLO-YELLO**  
 SOFT DRINKS  
 6 10-OZ. BOTTLES **59¢** PLUS DEPOSIT

OR  
**PEPSI MOUNTAIN DEW**

8 16-OZ. BOTTLES **\$1.29** PLUS DEPOSIT

PIGGLY WIGGLY'S WORLD OF  
**PRODUCE**  
*the Freshest Buys in Town!*

BRIGHT CELLO RED RADISHES 6 OZ. PACKAGES **2 FOR 29¢**

GOLDEN RIPE BANANAS LB. **23¢**  
 FANCY SLICING CUCUMBERS EA. **10¢**  
 PIGGLY WIGGLY RED POTATOES 5 LB. **79¢**  
 SAMPSON COUNTY SWEET POTATOES 4 LBS. FOR **\$1**

SUNSHINE KRISPY CRACKERS LB. PKG. **2/\$1**

SUNSHINE CHEEZ-IT CRACKERS LB. **79¢**

BROCK 8 OZ. Fruit Basket **2/1.00**  
 BROCK 8 OZ. Sugar Lumps **2/1.00**  
 BROCK 11 OZ. Orange Slices **2/1.00**  
 BROCK 11 OZ. GUM DROPS **2/1.00**  
 BROCK 9 OZ. Jelly Beans **2/1.00**  
 STARLIGHT MINTS 7 OZ. **2/1.00**  
 ALL STAR (Orange, Pineapple and Lime) SHERBET QT. **59¢**

**FRESH START**  
 POWDER  
 GIANT

**99¢**

LIMIT ONE WITH \$7.50 FOOD ORDER

It's here!  
 The wildest encyclopedia ever!

Now, Funk & Wagnalls brings you an encyclopedia made up of the kinds of things everybody goes for: things that roar, chirp, hop, soar, swim, glide and flutter. Funk & Wagnalls Wildlife Encyclopedia.

Try Volume 1 for just 49¢ and Volume 2 for \$1.49 at any of our super-markets. Then, each week when you shop, pick up a volume or two for just \$2.49 each and complete the set.

**2.49**

Funk & Wagnalls Wildlife Encyclopedia

KEEBLER CINNAMON CRISPS 14 OZ. **85¢**

KEEBLER HONEY GRAHAM 16 OZ. **85¢**

**PIGGLY WIGGLY**

GERBER STRAINED BABY FOOD Ea. **15¢**

WE GLADLY ACCEPT W.I.C. FOOD VOUCHERS

IRISH SPRING SOAP 3 BATH SIZE BARS **\$1.00**

STORE HOURS:  
 Mon. Thru Thurs. 8 To 7 Friday 8 To 8  
 Saturday 8 To 8, Sunday 9 To 6.

**2105 DICKINSON AVE.**

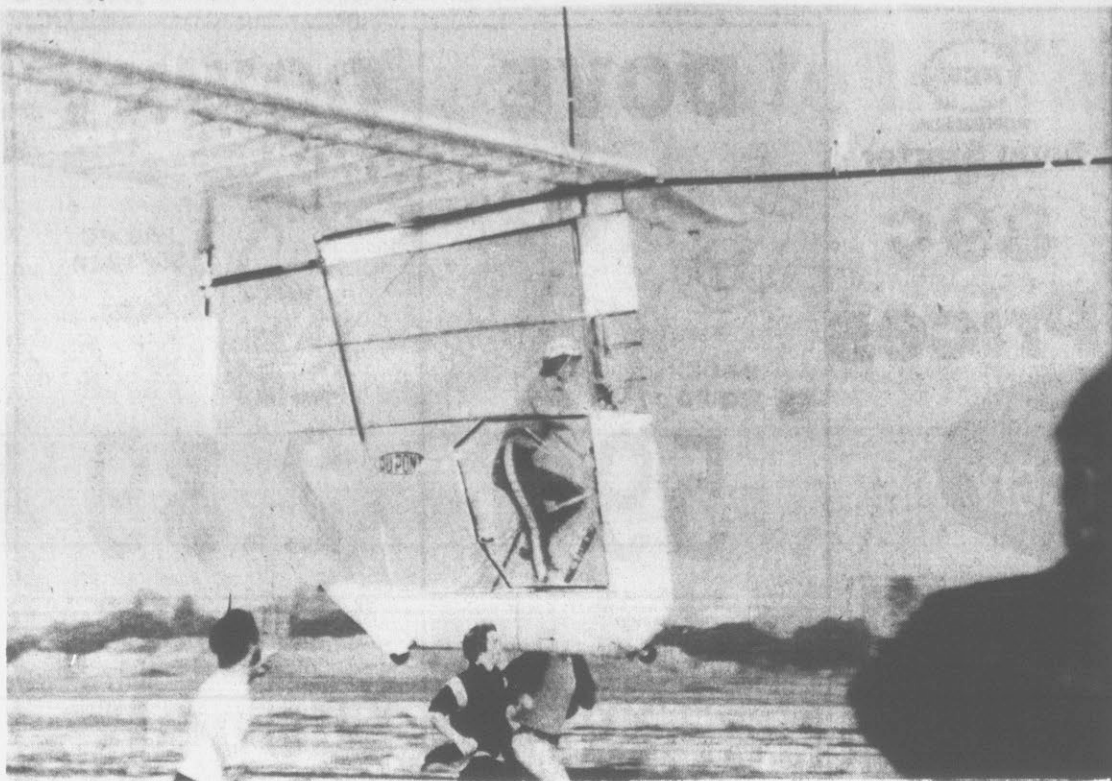

**CHANNEL-CROSSING GOAL** — The Gossamer Albatross, an aircraft powered solely by human-power, lifts off the ground in a recent test. The plane, whose sister ship the Gossamer Condor was the first successful human-powered plane to negotiate a prescribed course, will attempt to cross the English Channel, from

Dover, England, to Cape Gris Nez, France. Designer Dr. Paul Cready says it should take the 55-pound craft more than two hours to cross the channel, powered by an experienced bicyclist at 11 mph. (AP Laserphoto)

## Precautions For Lightning

NEW YORK (AP) — Back in 1752, Benjamin Franklin invented the lightning rod to intercept a lightning bolt and lead it harmlessly into the ground, leaving the house untouched.

But more than 200 years later, American homes are still suffering damage from lightning, says Lee Meyer, president of the Independent Insurance Agents of America.

More than 50,000 homes in the United States are hit, directly or indirectly, each year by some 90 million lightning bolts, he says. Of the total hit, he adds, about 15,000 to 20,000 homes suffer significant damage, some 30,000 have less serious losses to wiring, appliances and plumbing, and some 1,500 homes burn to the ground.

Lightning is one of nature's worst destroyers, causing 500 deaths, 1,500 injuries and some half-billion dollars-worth of property loss each year, say members of Meyer's group, local agents who counsel on homeowners' insurance.

They offer this advice in the area of lightning:

—Evaluate your home's need for lightning protection. If it is surrounded by other houses on level land, it won't be the primary target it would be if it were alone on a hilltop. Then, too, your chances of being struck by lightning vary from place to place. Some parts of Florida have 10 times as many electrical storms as California.

—Since lightning starts fires, you'll want to question how far your home is from fire protection. When you evaluate the location of your home, its closeness to fire protection, perhaps even your own fear of lightning, you may find that lightning rods that are properly grounded and installed by an approved electrician will be well worth the cost.

—To protect yourself during a storm:

—Do not use the telephone or television set.

—Keep away from open doors and windows. Lightning can strike an indirect, but powerful, blow.

—Don't run outside to close the windows of the car or to take the bikes in.

—Do not have any contact with plumbing, which means do not take a bath or wash the dishes during an electrical storm.

—If you are caught outside, avoid lone trees. Even if the tree you are under is not struck by lightning, a nearby strike may follow the tree's roots, thereby electrifying a wide ground area.

—If you are caught out on the golf course, sacrifice your equipment for the time being and get as far away as possible from metal golf clubs and the spikes in golf shoes. Stay low.

—If caught in the woods, seek out a small tree among several larger ones.

## Cox School Honor Lists

WINTERVILLE — The following students were named to the A. G. Cox School Honor Roll for the fourth marking period: Ed Daughtridge, Cheryl Lanzo, Jeff McCallum, Brian Joyner and Bertha Tien, fourth grade; Karen Adams, Gayle Dibbell, Phillip Dickerson, Carl Dunn, Cherry Flake, Pattie Jean Keeter and Michelle Waters, fifth grade; Hope Clark, sixth grade; Susanna Hudson and Ragan Spain, seventh grade; Amy Gibbs, Robert Adams, Albert Tien and Janet Little, eighth grade.

The following students were named to the Principal's List: Lisa Anderson, Mitzi Benfield, Michael Collins, Lori Conger, Deborah Craft, Jo-Ann French, Lynn Hazelton, Jay Joyner, Robin Ratcliff and Chris Sams, fourth grade; Karen Andrews, Dia Baker, Bryan Forrest, Darby Fulford, Fred Hampton, Beth Gurganus, Michelle Halby, Randy Simpson, Roy Lewis, Lisa Macomber, John Kerr, and Mitzi Roberts, fifth grade.

Stephanie Creech, Todd Cochran, Sherrie Rudy, Carla Snow, Kelley Marie King, and Deborah Little, sixth grade; Todd Hudson, Angela Hardy, Sheila Spain, Nathan Tripp, Lisa Flanagan, Lisa Evans, Gloria Artis, and Kim Carraway, seventh grade; Loretta Grantham, Penny Joyner, Rene Mobley, Beth Darden, Lisa Allen, Dallas Braxton, Tina Byrd, Darlene Cannon and Elaine Smith, eighth grade.

## Honor Students At Pace Are Listed

The following students were named to the Pace Academy honor roll for the fourth marking period, according to Patsy Galloway, principal: Amanda Robinson, ninth grade; Gigi Edwards, and Amanda Manning, seventh grade; Lesley Holloway, Mary Jon May, Rebecca Pace, Jody Ross, Angela Smith, and Marty Welch, sixth grade; Chris Guiffre, Tracey O'Bannon and Jill Whitehurst, fifth grade.

Cisse Davenport, Tammy Huggins, Scott Newton, Elizabeth Pollard, and Angela Robbins, fourth grade; Alex Ferguson and Stefanie Unverferth, third grade; Anna Harrington, Anjali Katari, Lee Nisbet and Cindy Ross, second grade; Ashley Meyer, Jason Newton, Heath Nisbet, Fran Smith, and Laura Young, first grade.

The following students were named to the Achievement list: Sue Ellen Allen, ninth grade; David Davenport, eighth grade; Beth Kopelman, Richard Pace, and Walter Perkins, seventh grade; Lee Allen, Mary Helen Allen, Duane Mills, Joe Rhea, Ginny Robbins, Lewis Robbins, Michelle Savage and Nancy Sneed, sixth grade. Hank Briley, Patrick Casey, Paula Freeman, Robert Hag-

gard, Trey Harrington, Leslie House, Carla Hudson, Will Pope, Martha Taylor, and Christy Tyler, fifth grade; Sammy Cox, Suzanne Elmer, Stuart Mercer, Marshall Moore, Jennifer Newton, Julian Perkins, Mike Swinson, and Manu Verma, fourth grade; Lee J. Ball, Gray Blount, Caroline Crawford, Lillian Gordley, Paige Holloway, Laura Newton, Gentry Pinkham, Scottie Smith and Jay Surles, third grade.

Kelly Briley, Mark Cox, Christy Davenport, Nelson Galloway, Jeffrey Granoff, Jennifer Harris, Franklin Huggins, Michelle Johnston, Cameron Melvin, Janelle Moore, Chris Pittman, Charles Swinson and Allison Waters, second grade; Thomas Barfield, Hunter Blount, Jasha Cox, Jonathan Granoff, Ashlee Roll and Gwendolyn Tyndall, first grade.

## Crop Seeing 5 Changes

Five basic changes have been made in the tobacco program that will affect growers' 1979 decisions, according to Stacy Evans of the Pitt County ASCS office.

The five changes are as follows:

—The final date to lease and transfer tobacco for the spring will be May 1. No transfers can be accepted between May 1 and June 14. Fall leasing will begin after June 14.

—A change in the fall leasing and transfer (after June 14) is no farm that overplants the effective allotment will be eligible to lease.

—There will be no delivery of tobacco that is produced in excess of 110 percent of the effective farm quota to be processed for storage. This means that a farm operator will have to store and keep any tobacco that he is unable to market.

—All farm operators will be required to report their carryover tobacco at the end of the marketing season.

—The four-leaf program will mean that a producer who participates can plant 110 percent of the effective allotment if he signs an agreement not to harvest the four bottom leaves. This agreement must be filed at the county office by April 7.

Persons having any questions on these changes are asked to call the county office, 752-6112, for more information.

### CANNIBAL SHARKS

WASHINGTON (AP) — Sand tiger sharks are cannibals even before they are born, according to the National Geographic Society.

The eggs hatch within the female shark's uterus, where the young remain until sufficiently developed to enter the ocean.

The first baby hatched feeds on its weaker brothers and sisters as they emerge from other eggs, scientists have noted.

## Brazilian Signs Railroad Deal

TELEPHONE SHOCK SUVA, Fiji (AP) — Shopkeeper Kester Yee was shocked when he received his monthly bill from the government telecommunications department. The bill was for \$4,550 (Fijian). After lengthy hassles with the department, he was finally told the account was incorrect and was asked to pay \$4.50.

RIO DE JANEIRO, Brazil (AP) — A Brazilian construction firm has signed a \$1.5-billion contract with the government of Iraq to construct a railway network linking Baghdad to the southern part of the country. The firm, Mendes Junior, says the project is expected to be completed by 1983.

It's That Time Again!  
**Designate #530**  
Designation Dates Mar. 5-Apr. 6  
**GROWER'S WAREHOUSE**  
300 Moore St., Greenville N.C. 756-6558  
J.L. Tripp Tom Morris Frank D. Dall

**Fleming's Furniture & Appliance Corp.**  
1024 Dickinson Ave. 752-3609

**SYLVANIA Spring Special**

**Model CL9216P**  
SYLVANIA GT-MATIC™ COLOR SYSTEM

- 25" diagonal Black Matrix color picture tube
- Deluxe GT-300™ chassis... 100% solid-state
- Sylvania GT-Matic™... Self Adjusting Color System
- Exclusive ASC Circuitry (Automatic Sharpness Control)
- Room Light Monitor... adjusts contrast and color level when room lighting changes
- Mediterranean styling in a cabinet of Pecan grain finish on hardboard

**\$599<sup>95</sup>**

Limited Supply Financing Available

5 ways you can save 20¢ on Scope. Pick one.

The attached coupon saves you 20¢ when you buy any bottle of Scope®. That's an outstanding buy on an outstanding mouthwash. Because while Scope gets breath clean like the leading antiseptic mouthwash, it leaves your breath smelling minty fresh. Not mediciney.

Use the 20¢ coupon and get Scope. You'll wind up with a good buy—and good breath. Scope fights bad breath without giving you medicine breath.

9665 SC TAKE THIS COUPON TO YOUR STORE

**SAVE 20¢** when you buy **SCOPE** 20¢ ANY SIZE

LIMIT ONE COUPON PER PURCHASE

TO THE CONSUMER: CAUTION! Don't embarrass your dealer by asking him to redeem coupons without making the required purchase. He must redeem coupons properly to get his money back. REMEMBER: coupons are good only on the brands called for. Any other use constitutes fraud. You are authorized to act as our agent for the redemption of this coupon. We will reimburse you for the face value of this coupon or, if coupon calls for free merchandise, we will reimburse you for such free goods, plus 5¢ for handling, provided that you and the consumer have complied with the terms of our coupon offer. By submitting this coupon for reimbursement you represent that you redeemed it pursuant to these terms. Any failure to adhere to these terms shall not be deemed a waiver of any of the conditions. TERMS OF COUPON OFFER: This coupon must be redeemed by a consumer at the time of purchase of the brand size indicated with the face value of the coupon being deducted from the dealer's retail selling price. This coupon is non-assignable and may not be reproduced. The consumer must pay any sales tax involved. Invoices proving purchase of sufficient stock of our brands to cover coupons presented must be shown upon request and failure to do so may, at our option, void all coupons submitted for reimbursement for which no proof of purchase is shown. Properly redeemed coupons will be accepted for reimbursement. If identified by the retail distributor of our merchandise who redeemed them in connection with sales to the consumer, or the supplier of the products on which the coupons have been redeemed who has by written agreement with Procter & Gamble agreed to accept financial responsibility, or to a holder of our Certificate of Authority acting for them, COUPONS SHOULD BE SHIPPED, AT OUR EXPENSE, TO PROCTER & GAMBLE, 2102 SUNBELT DRIVE, CINCINNATI, OHIO 45221. Cash redemption value 1/20 of 1¢.

©1978, The Procter & Gamble Company

WE ACCEPT  
FEDERAL  
FOOD  
STAMPS!

PRICES GOOD THRU SAT.,  
MARCH 24, 1979—QUANTITY  
RIGHTS RESERVED—  
NONE SOLD TO OTHER  
DEALERS OR  
RESTAURANTS.

TALMADGE  
FARMS  
FRANKS  
12-OZ. PKG.  
**58¢**

**BIG  
STAR  
FOODS**

*The New Woman's Day*  
**Encyclopedia of Cookery**

VOLUME 1 only **69¢**

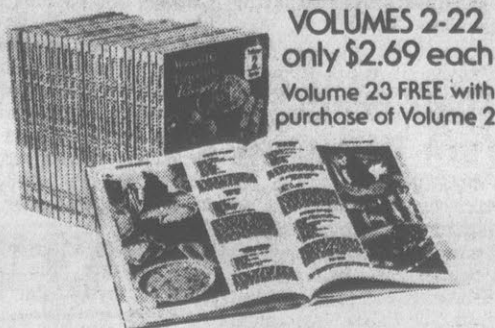

It's all the cookbook you'll ever need.

VOLUMES 2-22  
only \$2.69 each  
Volume 23 FREE with  
purchase of Volume 2

FINAL SALES WEEK!

**Wexford**  
BEVERAGEWARE by ANCHOR HOCKING

THE FOLLOWING  
ITEMS ARE  
REDUCED TO ... **59¢** EACH

- ☆ ICED TEA
- ☆ ON THE ROCKS
- ☆ TABLE TUMBLER
- ☆ FOOTED SHERBET
- ☆ FOOTED WINE/JUICE

COMPLETE YOUR SETS TODAY!



**TERMINATION NOTICE!**

Our "Instant Vegas" Game has a scheduled termination date of March 31, 1979. However, due to the popularity of the game, we expect to run out of tickets a little sooner. This will be on or about March 24. Some stores may run out sooner or later. When your store runs out of tickets, the game is officially terminated for your store, and no more Saver Discs can be exchanged. All cash winners must be claimed by April 7.

**HOLLY FARMS WHOLE FRYERS**

U.S. GRADE 'A'  
"THE ONE TO PICK TO BE SURE"

**48¢** LB.

Limit 4

**HOLLY FARMS U.S. GRADE 'A' FAMILY PAK MIXED FRYER PARTS**

**47¢** LB.

LIMIT 4

**MARKET STYLE SLICED BACON**

2 LBS. OR MORE **\$1.08** LB.

**Thorn Apple Valley BRAND EXTRA LEAN SEMI-BONELESS SMOKED HAMS**

6 TO 8 LB. AVG. **\$1.68** LB.

- U.S. CHOICE BEEF...BONELESS TOP **ROUND STEAK** LB. **\$2.68**
- U.S. CHOICE BEEF **CUBED STEAK** LB. **\$2.78**
- U.S. CHOICE BEEF...BONELESS BOTTOM **ROUND ROAST** LB. **\$2.38**
- HOLLY FARMS **FRESH FRYER LIVERS** SKINLESS & DEVEINED LB. **78¢**
- SLICED BEEF LIVER** LB. **98¢**

- JESSE JONES HOT OR MILD PURE **PORK SAUSAGE** 1-LB. PKG. **\$1.68**
- JESSE JONES **SLICED BOLOGNA** 12-OZ. PKG. **\$1.28**
- ARMOUR STAR REGULAR OR BEEF **HOT DOGS** 12-OZ. PKG. **\$1.18**
- ARMOUR STAR **SLICED BACON** 12-OZ. PKG. **\$1.28**

- OLD FASHION FRESH CUT **MILD DAISY CHEESE** LB. **\$1.78**
- CELEBRITY BRAND SLICED **COOKED HAM** 12-OZ. PKG. **\$2.48**
- CELEBRITY BRAND SLICED **COOKED PICNIC** 12-OZ. PKG. **\$2.18**
- GORTON'S BATTER FRIED **FISH PORTIONS** 12-OZ. **\$1.59**
- GORTON'S **COOKED FISH STICKS** 15-OZ. **\$1.59**
- GORTON'S BATTER FRIED **FLOUNDER** 12-OZ. PKG. **\$1.79**
- SINGLETON'S **DEVILED CRABS** 15-OZ. **\$1.99**
- SINGLETON'S BR. **SHRIMP PCS.** LB. PKG. **\$1.99**
- MRS. PAUL'S SUPREME **LIGHT/BATTER FISH FILLET** 7 1/2-OZ. **\$1.19**

- RED RIPE SLICING **TOMATOES** LB. **49¢**
- EVERYDAY LOW PRICE! GOLDEN RIPE **BANANAS** LB. **24¢**
- CRISP CRUNCHY **RADISHES** 2 6-OZ. PKGS. **29¢**
- TASTY SPRING **ONIONS** BUNCH 2 FOR **29¢**

**FOLGER'S "MTN. GROWN" FLAKED COFFEE**

13-OZ. BAG **\$1.88**

LIMIT 1 PLEASE!

16-OZ. IDAHOAN INSTANT **POTATOES**

32-OZ. LUCKY LEAF **APPLE JUICE**

"MIX 'EM OR MATCH 'EM"

**2 FOR \$1.00**

- ROYAL PINK **SALMON** 7.7-OZ. **69¢**
- BLUE BONNET QUARTERS **MARGARINE** 1-LB. PKG. **49¢**
- DELTA WHITE **PAPER TOWELS** SAUSAGE OR HAMBURGER JUMBO ROLL **39¢**
- G & W PIZZA** 11 1/4-OZ. SIZE **79¢**
- DETERGENT **SUPER SUDS** 40-OZ. PKG. **78¢**

WASHINGTON STATE **APPLES**

"EXTRA FANCY" RED OR GOLDEN

☆ DELICIOUS

☆ WINESAP

LB. **39¢**

- FARM CHARM "ALL NATURAL!" ASSORTED FLAVORS **ICE CREAM** HALF GALLON **\$1.58**
- PACKER'S LABEL FROZEN **SHOESTRING POTATOES** 5 LB. BAG **99¢**
- CHUNK LIGHT IN OIL **STAR-KIST TUNA** 6 1/2-OZ. CAN **59¢**
- PLAIN OR SELF-RISING **RED BAND FLOUR** 5 LB. BAG **64¢**
- VANITY FAIR **BATH TISSUE** 4 ROLL PAK **69¢**

SAVE ON SUN RIPE!

- APPLE JELLY 28-OZ. **69¢**
- GRAPE JELLY 28-OZ. **79¢**
- STRAW. PRESERVES 28-OZ. **89¢**

**"NEW" BUSCH PREMIUM BEER**

CTN. OF SIX 12-OZ. CANS **\$2.11**

- FACIAL TISSUE **KLEENEX** 3 100 CNT. PKGS. **\$1.00**
- VANITY FAIR PAPER **TOWELS** JUMBO ROLL **49¢**
- VALU-PLUS **LIQUID BLEACH** GAL. **59¢**
- VANITY FAIR LUNCH **NAPKINS** 100 CNT. PKG. **55¢**
- VANITY FAIR DINNER 50 CNT. **NAPKINS** 2 FOR **\$1.00**
- GAINES GRAVY TRAIN **DOG FOOD 25** LB. BAG **\$5.07**
- FARM CHARM **ASST. YOGURT** 8-OZ. CTN. **27¢**

- FARM BEST
- ☆ POPS ☆ FUDGE BARS
- ☆ ICE MILK BARS
- 12 PAK **88¢**
- OUR PRIDE BAKERY PRODUCTS
- BUTTERMILK **BREAD** 3 24-OZ. LOAVES **\$1.09**
- WHOLE WHEAT REG. OR SANDWICH **BREAD** 16 OZ. LOAF **49¢**
- OVEN FRESH **PECAN TWIRLS** 7 OZ. **49¢**

16-OZ. LUCKY LEAF **APPLESAUCE**

16-OZ. RED GATE **TOMATOES**

14-OZ. CAN AJAX **CLEANSER**

"MIX 'EM OR MATCH 'EM"

**4 FOR \$1.00**

14.7 OZ. FRANCO-AMERICAN **SPAGHETTI-O'S**

16-OZ. VAN CAMP'S **PORK & BEANS**

16-OZ. BUSH'S FRESH **BLACKEYE PEAS**

"MIX 'EM OR MATCH 'EM"

**4 FOR \$1.00**

17-OZ. DEL MONTE W/K **GOLDEN CORN**

15.5-OZ. DOUBLE LUCK CUT **GREEN BEANS**

"MIX 'EM OR MATCH 'EM"

**4 FOR \$1.00**

15-OZ. HUNT'S **TOMATO SAUCE**

16-OZ. RED GATE **LIMA BEANS**

16-OZ. LUCK'S **PINTO BEANS**

"MIX 'EM OR MATCH 'EM"

**3 for \$1.00**

# Life Of Crime Began Early For Doomed Prisoner

By KENDAL WEAVER  
Associated Press Writer  
ATMORE, Ala. (AP) — John Louis Evans III didn't pay much notice when newspapers headlined the firing squad execution of Gary Gilmore in Utah on Jan. 17, 1977.

Evans was too busy. He had shot a pawn shop owner to death in Alabama 12 days earlier. He and cohort Wayne Ritter were robbing food stores, pizza parlors, fried chicken take-outs, hardware outlets and

small shops. When Gilmore was executed, says Evans, "I read it in the paper. I thought, 'Big deal. The guy got what he wanted.'"

Then Evans and Ritter headed for Disney World in Florida to celebrate Ritter's 27th birthday.

Now Evans sits in a small, dim cell awaiting an April 6 electrocution that might have been scripted by Gilmore. Like the Utah killer who wanted to

die, Evans has forsworn any final appeals. He repeats almost wearily that he wants death and wants it soon.

His scheduled electrocution would make him the first person since Gilmore — and only the second in 12 years — to be executed in the United States.

"I'll be glad when it's over," says Evans, 29, of Beaumont, Texas. "Knowing the date you're going to die, it's kind of weird. But I don't dwell on it all the time...I've come to grips with death."

He also seems to have come to grips with his life. By his own account, it was "a wasted life," full of crime and with no one to blame but himself.

"I was a rotten kid," said

Evans. "It had nothing to do with my family. I would pull stuff just to see if I could get away with it. And then when I'd get away with it, I'd just feel so good for days."

"And then I'd just have to go out and do something a little bit bigger.... I knew where I was headed."

Evans, his chained hands lifting cigarettes, spoke easily during an interview in the death row witnesses' chamber next to Alabama's electric chair at Holman Prison.

It didn't seem to bother him that he was so near the chair, which is painted a gaudy yellow. At one point Evans stood up and looked at it and laughed. "I just wish it was painted a different color," he said.

Recounting the events that led him to death row, Evans

said he was 16 when he pulled his first armed robbery.

"I was more scared than the guy was," he said. "But when it was all over, I was thinking, wow, all this money, you know, for 30 seconds work. And that's when I decided right then and there it was the easy way to go."

But it wasn't easy. He was repeatedly in trouble with the law and eventually ended up in an Indiana prison on a bad check charge. When he was ready to get out, he said, "I looked back on my life and it had been pretty wasted. I thought, 'I'm not getting anywhere. It's the same old treadmill, over and over again.'"

He and Ritter — whom he had met in the Indiana prison — then struck out on their two-month crime spree that included the murder of pawn shop owner Eddie Nassar in Mobile, Ala. Nassar's two young daughters were in the shop and saw their father left mortally wounded.

Captured in Little Rock, Ark., by FBI agents, the two admitted to 30 armed robberies and nine kidnappings during the crime rampage. Evans said in court that he had shot Nassar in the back, and Ritter said he would have done so if Evans hadn't.

Both said repeatedly they wanted a hurry-up death sentence, but Ritter later changed his mind. More court proceedings are scheduled to determine if his death sentence should be maintained.

Evans said he has known love and has a woman friend who now is "not discussable." But he said he rejected love because it would interfere with his criminal habits, which he rejected his white, Roman Catholic, middle-class home life.

"I knew me too good," he said. "You hurt the people you love. When it comes down to it, I'm a pretty selfish person. If I want to do something, I do it. No matter who gets hurt. So I figured, well, it's better not to get into anything" that might involve love.

"It's been a wasted life, sure," he said. "But I'm not down on myself, I'm just a

realist. I was a rotten kid, I knew I was a rotten kid, I liked being a rotten kid...I was going down society's wrong road and I didn't care."

On death row, Evans said he finds little or no pleasure in his routine, which mostly involves sleeping, writing letters, watching a hall television, listening to the radio and playing chess.

Alabama's 42 death row inmates get 30 minutes of exercise outside each day, but Evans said he has skipped the exercise period all but one day in the past month. He said it

hurts to see "all the freedom out there" beyond the prison fence.

Asked if he has considered suicide, Evans replied, "Not me, brother...What are you going to do? Cut your wrists and lay there for 20 minutes? Psychologically, that's got to be one of the most cruel ways to go."

"Or do you make a little rope out of your sheets and hang there 30 minutes kicking around? That's a hard way to go...I'm doing it the easy way."

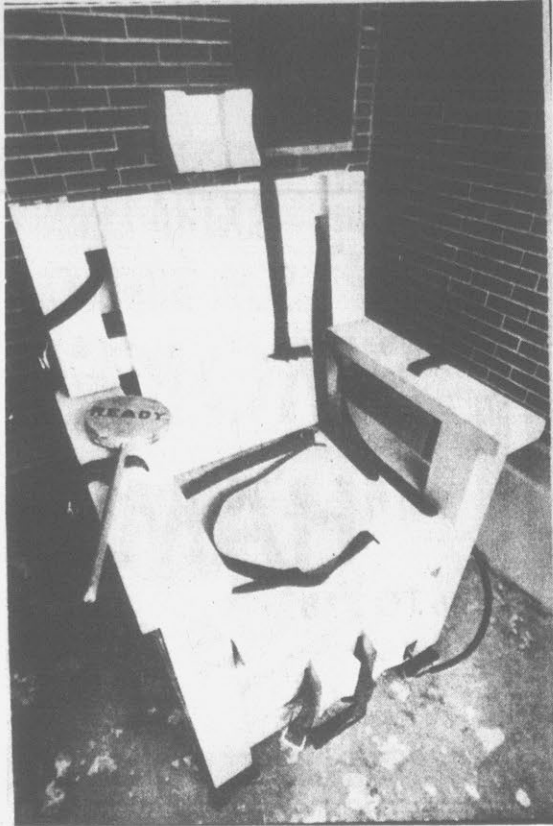

— AND WAITING — The "Ready Stick" rests on the arm of Alabama's electric chair in Atmore where Johnny Louis Evans III is scheduled for electrocution on April 6. (AP Laserphoto)

## Pepper-Picking Is By Machine

By JOANNA FIRESTONE  
EAST LANSING, Mich. (UPI) — Peter Piper's paydays may be imperturbed by progress in the pepper picking business at Michigan State University.

Pepper growers, processors and equipment manufacturers from across the nation attending a vegetable convention recently inspected an automated pepper picking machine that could revolutionize the pepper business.

The mechanical pepper harvesting machine was the brainchild of Dale E. Marshall, an agricultural engineer at MSU.

"Traditionally, peppers for processing have been picked by hand, but recent labor shortages and increasing harvesting costs have almost made mechanization essential," Marshall said.

The cost of hand-picking peppers eats up as much as 65 percent of the price received by growers, he said.

Nationwide, more than 680,000 tons of peppers are produced annually, with a value of nearly \$170 million.

Marshall's machine will be particularly welcome in Michigan, which ranks seventh among the states in pepper production. In 1977, Michigan growers produced 10.5 million pounds of peppers.

Marshall used the results of previous mechanical harvesting (AP) — The Netherlands, experiments from Canada, Italy, Hungary, Bulgaria, Israel and the U.S. to produce his harvester, which has been tested on more than 20 varieties and peppers of different sizes and

shapes. The self-propelled, one-man-operated machine can gather tons of peppers each day, he said.

The harvesting portion of the machine consists of two inclined double helixes, rotating out-of-phase, that shake and strip the plants. The peppers are carried on a conveyor belt to a cleaning bed, then sorted and placed in storage boxes.

Now that pepper picking has been improved, agricultural scientists will be concentrating on another aspect of the industry: The quest for the perfect pepper to maximize the picker.

The mechanical harvester can recover about 80 percent of the peppers of many varieties, and the recovery level could be improved for other varieties by improving the basic product itself.

The ideal pepper plant, Marshall said, would stand erect — more than two-feet tall — and have no fruit close to the ground where an automatic picker misses.

Although the perfect pepper for mechanical picking doesn't yet exist, jalapeno and serrano chili peppers come the closest.

### NEW CHEESE

AMSTERDAM, Netherlands (AP) — The Netherlands, known for its Edam, Gouda and Leyden cheeses, recently began exporting a new variety called Holland. It is sold in rectangular blocks and is made from partly-skimmed milk.

**INVENTORY REDUCTION SALE**

**ZENITH 25" COLOR TV**  
Model K2504

- Automatic Color Button
- 100% Solid State
- Easy-Roll Casters
- Energy-Saving Chassis

**NEW LOW \$558**  
PRICE

Price includes Service and Parts Warranty

**BOB'S TV & APPLIANCE**  
GREENVILLE, N.C.  
2 blocks from Pitt Memorial Hospital in the C. L. Lupton Bldg.

**Start your day with a new drier spray.**

**Here's 20¢ off to get you started.**



**20¢ STORE COUPON**

**SAVE 20¢ ON NEW DRIER SPRAY SECRET**  
(or any other type or size Secret)

LIMIT ONE COUPON PER PURCHASE

**20¢**

PROCTER & GAMBLE

16269 343250 8992 SE

## Try Folger's in bags and save 35¢

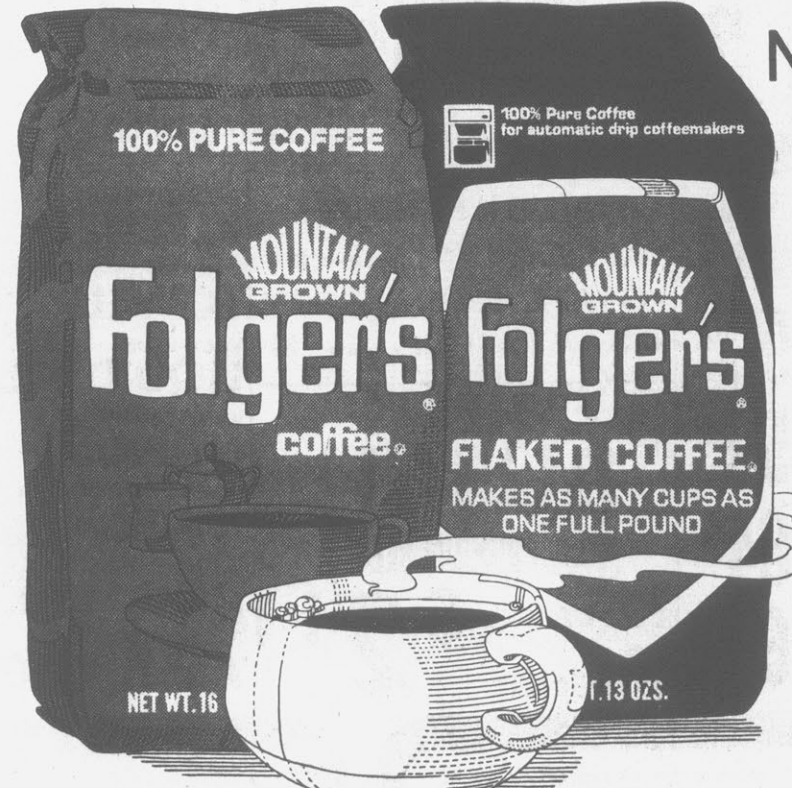

Now delicious Folger's comes in bags as well as cans!

Delicious Mountain Grown Folger's. Just taste it and you'll know why it's the best-selling ground coffee in America. Try Folger's, in cans or bags, and see how delicious coffee can be.

Folger's Coffee is available in different grinds, one just right for your coffeemaker. And Folger's is mountain grown. That's the richest, most aromatic kind of coffee. The cool mountain air and gentle sunshine let coffee ripen slowly so it builds up rich flavor.

Folger's Flaked Coffee is specially designed for automatic drip coffeemakers. It's the same delicious Mountain Grown Folger's. But it's flaked to release more rich flavor, so you use less. That's why the 13 ounce bag of Folger's Flaked Coffee makes as many cups as a full pound bag of ordinary coffee.

**PUBLIC NOTICE**

Pitt County will open sealed bids on Friday, March 23, 1979, at 10 o'clock A.M. in the Pitt County Manager's office at the Pitt County Courthouse for the following items:

- 1978 Silver Plymouth 4-door (wrecked) Automobile
- 1976 Brown Dodge 4-door (wrecked) Automobile
- 1969 Blue Chevrolet Van 90 (wrecked)
- 1963 Army Surplus 3/4 ton cargo Jeep

All vehicles may be inspected from 8:00 A.M. to 5:00 P.M. Monday through Friday, at the County Garage on the 264 by pass. Each item will be sold to the highest bidder in their present condition with no stated or implied warranty or promise of performance.

All bids should be on the appropriate bid form which may be obtained at the County Manager's Office, or by contacting Don Davenport at 752-2934. The completed bid forms should be mailed to: The Pitt County Manager, Sealed Bids, P.O. Box A, Greenville, N.C. 27834.

All Bids must be sealed and in possession of the County Manager prior to 10:00 A.M. on March 23, 1979.

H.R. Gray  
County Manager

Take this coupon to your grocer and save **35¢** on Folger's in cans or bags.

9633 CF TAKE THIS COUPON TO YOUR STORE

**Save 35¢** on any size **Folger's** 100% Pure Coffee Regular or Flaked

LIMIT ONE COUPON PER PURCHASE

**35¢**

FOLGER COFFEE CO. 343250

CUT ALONG DOTTED LINE

© The Folger Coffee Company, 1979

**Spring SPECTACULAR**

LIMIT 4 PLEASE

GRADE "A" WHOLE FRYERS **45¢** LB.

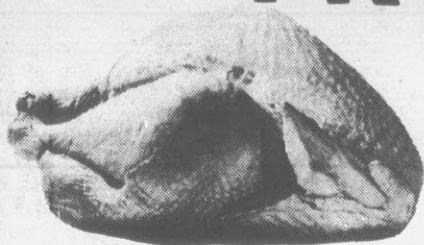

**PRODUCE**

GOLDEN YELLOW CORN **6 EARS FOR 69¢**

NEW RED POTATOES **10 LB. BAG 99¢**



**BATH SIZE IVORY**

4¢ OFF 3 BAR PACK **59¢**



SMITHFIELD SMOKED **PICNICS WHOLE**

**79¢** LB.

SLICED **89¢** LB.



**CHUCK STEAK**

**\$1.39** Lb.



BONELESS **CHUCK ROAST**

**\$1.49** Lb.



**DOWNY FABRIC SOFTNER**

96-Oz. Size **25¢ Off**

**\$2.49**



DINNERBELL PURE PORK **Smoked Sausage** **\$1.69** Lb.

GOLDEN GRAIN 7 1/2 OZ. **Macaroni & Cheddar** **\$1.00** 4 Cheese Dinners

CHEF BOY AR DEE **Spaghetti & Meat Balls** **59¢** 4

Dixie Dew Syrup . . . 24 Oz. Size **69¢**

MARTINDALE CUT **Sweet Potatoes** . . 2 1/2 Size **69¢**

GIBBS **Pork & Beans** . 4 16 Oz. Size For **\$1.00**

LOG CABIN COMPLETE **Pancake Mix** . 2 Lb. Size **79¢**

**Pepsi Cola** . . 8 Pack 16-Oz. **\$1.39**

WESTERN BONELESS **SIRLOIN-TIP ROAST** **\$1.89** Lb.



**FOLGERS COFFEE**

1 Lb. Bag **\$2.19**

13 Oz. Bag Flaked **\$1.79**

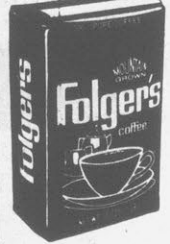

VALUABLE COUPON

DINNERBELL **HOT DOGS** 12-Oz. Pkg. **99¢**

WITH THIS COUPON EXPIRES 3/24/79 WITHOUT COUPON \$1.19 PKG.



VALUABLE COUPON

WHITING **FISH** 5 Lb. Box **\$2.99**

WITH THIS COUPON WITHOUT COUPON \$3.99 COUPON EXPIRES 3/24/79

CARNATION **FRISKIES DINNERS** 3 For **\$1.00**

14-Oz. Size MEAT STEW, BEEF LIVER EGG & BACON

CHICKEN OF THE SEA **TUNA** 6 1/2 OZ. SIZE **69¢**



VALUABLE COUPON

OSCAR MAYER **FRANKS** 1 Lb. Pkg. **\$1.39**

WITH THIS COUPON WITHOUT COUPON \$1.69 EXPIRES 3/24/79



VALUABLE COUPON

LARGE ROLL **BRAWNY TOWELS** 2 ROLLS FOR **\$1.00**

WITH THIS COUPON WITHOUT COUPON 69¢ LIMIT TWO ROLLS WITH 7.50 FOOD ORDER EXPIRES 3/24/79



**HOT DOG WAGON**

MEMORIAL DR. STORE FRI. & SAT. 3/23 & 24 11 A.M. - 11 P.M. **HOT DOGS 4 For \$1.00**

With Mustard Ketchup & Onions. Help ESA Sorority Raise Money



VALUABLE COUPON

SHOWDRIFT **SHORTENING** 3 Lb. Can **\$1.49**

WITH THIS COUPON WITHOUT COUPON \$1.79 EXPIRES 3/24/79



VALUABLE COUPON

JAMESTOWN ROLL **SAUSAGE** 1 Lb. Pkg. **89¢**

WITH THIS COUPON WITHOUT COUPON \$1.19 EXPIRES 3/24/79



VALUABLE COUPON

FROSTY MORN SLICED **BACON** 1 Lb. **\$1.29**

WITH THIS COUPON WITHOUT COUPON \$1.49 PKG. EXPIRES 3/24/79



VALUABLE COUPON

KRAFT **MIRACLE WHIP SALAD DRESSING** Quart Size **89¢**

WITH THIS COUPON WITHOUT COUPON \$1.39 LIMIT 1 WITH 7.50 FOOD ORDER EXPIRES 3/24/79



**FROZEN FOODS**

CRINKLE CUT **POTATOES** 2 Lb. Size **49¢**

BIRDS EYE **COOL WHIP** 9 Oz. Size **59¢**

SUN SLICED **STRAWBERRIES** 10 Oz. Size **39¢**

COUNTRY FRESH **ICE MILK** Half Gal. **79¢**



**DAIRY FOODS**

HARRIS **LOW FAT MILK** Gal. **\$1.59**

BALLARD **BUTTERMILK BISCUITS** 4 Pack For **69¢**



HARRIS **MADERITE BREAD** 3 1/2 Lb. Loaves For **\$1.17**

**HARRIS SUPER MARKETS, INC.**

"Where Shopping Is A Pleasure"

Greenville-Ayden-Bethel PRICES GOOD THURS. THUR SAT.



## Crossword By Eugene Sheffer

**ACROSS**  
 1 Soak flax  
 4 Modern discussion  
 7 Profit's companion  
 8 Storage edifices  
 10 Hesitation  
 11 Evident  
 13 Sometimes candied  
 16 Those in office  
 17 Hindu guitar  
 18 Undivided  
 19 Strong desires  
 20 German admiral  
 21 Brag  
 23 Dean Martin dish  
 25 Dagger  
 26 Roman historian  
 27 Quick-wink  
 28 Struck

**DOWN**  
 1 Bounders  
 2 Being  
 3 African flies  
 4 Lariat  
 5 Place of sacrifice  
 6 Shelley, for one  
 7 Fine fabric  
 8 Blemishes  
 9 Pries nosily  
 10 Greek letter  
 12 Dogma

Average solution time: 26 min.

SCAR BAR WANE  
 PONE OLE ARES  
 AVES GOODNEWS  
 RETINUE OTATE  
 DIS IDE  
 TENET GOODMAN  
 AGE PAN APO  
 GOODIES ASTER  
 OCA ELM  
 IGLLOO ASPERSE  
 GOODNESS LAHR  
 OBOL ELE TRIG  
 RIPE LIAD SEPS

3-21  
 Answer to yesterday's puzzle.

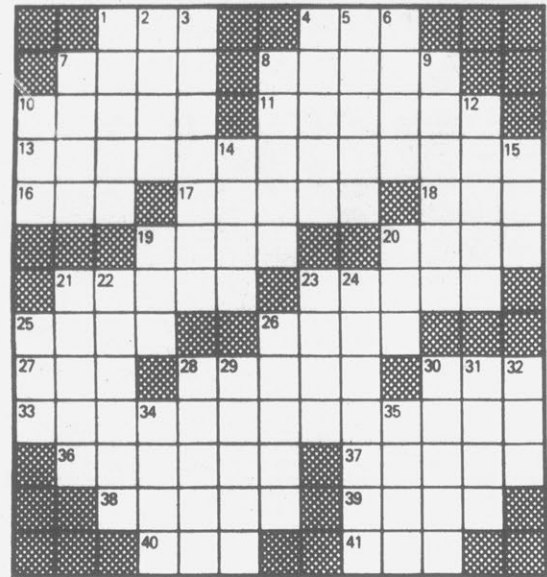

DVZKUY NFGCPYWGN IWGCZY SU  
 WCPNFE SE DVPKUF'I UPY

Yesterday's Cryptquip — CANDID CAMERA PUT COMMUNITY PARTY ON RECORD.  
 Today's Cryptquip clue: G equals O

The Cryptquip is a simple substitution cipher in which each letter used stands for another. If you think that X equals O, it will equal O throughout the puzzle. Single letters, short words, and words using an apostrophe can give you clues to locating vowels. Solution is accomplished by trial and error.

## Friars To Honor Johnny Carson

HOLLYWOOD (UPI) — The Friars Club will honor Johnny Carson as Entertainer of the Year May 6 with a black-tie dinner at New York's Waldorf-Astoria hotel with Bob Hope as the evening's roastmaster. Joining Hope, a long-time friend of Carson, in roasting the talk-show host will be Lucille Ball, Kirk Douglas, George Burns, Mike Wallace, Ruth Gordon and Johnny's sidekick Ed McMahon.

## TV Log

**WNCT-TV Ch. 9**

WEDNESDAY  
 7:00 Newlywed  
 7:30 Jokers  
 8:00 Billy G.  
 9:00 NIT Bkb  
 11:00 News  
 11:30 Movie

THURSDAY  
 6:00 Carolina  
 8:00 Morning  
 9:00 Kangaroo  
 10:00 All In  
 10:30 Magazine

**WITN-TV Ch. 7**

WEDNESDAY  
 7:00 Hogan's  
 7:30 Donna Fargo  
 8:00 Super Train  
 9:00 Movie  
 11:00 News  
 11:30 Tonight  
 1:00 Tomorrow

THURSDAY  
 5:30 Arthur Smith  
 6:00 Almanac  
 7:00 Today  
 7:25 News  
 7:30 Today  
 8:25 News  
 9:00 Shore  
 10:00 Card Sharks  
 10:30 Hollywood  
 11:00 Rollers

**WCTI-TV Ch. 12**

WEDNESDAY  
 7:00 Sanford  
 7:30 Fund  
 8:00 Eight is  
 9:00 Angels  
 10:00 20/20  
 11:00 News  
 11:30 P. Woman  
 1:45 Nitelife

THURSDAY  
 5:55 Tidings  
 6:00 PTL Club  
 7:00 America  
 7:25 News  
 8:25 News  
 9:00 Shore  
 10:00 Donahue  
 10:00 Douglas  
 11:00 Happy Days

**WUNK-TV Ch. 25**

WEDNESDAY  
 7:00 Assembly  
 7:30 Report  
 8:00 Shakespeare

THURSDAY  
 8:15 AM Weather  
 8:30 Contract  
 8:50 Readalong  
 9:00 Sesame Street  
 10:00 Living Bill  
 10:30 Readalong  
 10:40 Mtrc  
 11:00 Word Shop  
 11:15 Celebrate  
 11:30 Two Plus  
 11:45 Liberty  
 12:00 Stepping  
 12:15 Ripples  
 12:30 Elect. Co.

# Shows Lost To The 'Ad Hoc Network'

By PETER J. BOYER  
 AP Television Writer  
 LOS ANGELES (AP) — TV viewers in Sacramento, Calif., might be wondering about that extravagant NBC flop, "Supertrain." That is, they might be wondering why they've never seen it on their local NBC station.

Viewers in Boston might be wondering why "The Incredible Hulk" suddenly disappeared from their local CBS outlet and then, just as suddenly, reappeared. Similar mysteries might have stirred the curiosities of viewers in Milwaukee, Denver, Cleveland and other cities.

The mysteries are created by a fourth network, the so-called "ad hoc network" run by Mobil Oil. It's not really a network, just a cheaper way of television advertising that has had the curious side-effect of prompting some network-affiliated local stations to dump a network program in favor of the Mobil Oil show.

Mobil's current offering is "Edward the King," which runs on Wednesday nights in most towns in the United States. It's part of the "Mobil Showcase" series, started by the oil company three years ago when it struck someone that TV advertising would be cheaper if the advertiser just skipped past the network and went straight to the local stations with a program.

Independent local stations — usually stuck with reruns, sports and movies in prime time — find the Mobil plan a relatively cheap way to get fine original programming that can compete with network programming. But some network

affiliates have begun to bite the Mobil bait, too, much to the vexation of the networks.

In Sacramento, for example, NBC affiliate KCRA has been doing quite well with "Edward the King" in place of NBC's "Supertrain."

When CBS moved "Incredible Hulk" to Wednesday night, CBS affiliate WNAC stuck with "Edward the King," and Boston viewers just had to do without the Hulk until CBS moved the show back to Friday nights.

Although the stations get to keep more of the advertising revenue from "Edward the King" than they would from a network show, more than economics is involved.

"Money is not the primary concern here," says KCRA station manager Don Saraceno.

It's a chance to get better programming on the air. We were not at all pleased with what NBC was doing at 8 o'clock on Wednesday. We did what we had to do, and I'd do it again."

Of the 49 stations that opted for Mobil's "Edward the King," 11 were ABC affiliates, eight were CBS affiliates, and 20 were NBC affiliates. That latter number represented about 10 percent of the CBS network.

The bitter irony for CBS is that it once owned "Edward the King." It bought the property for \$2.5 million and shelved the project, before selling the rights to Mobil.

When critics gripe about mediocre, mindless pap, nothing much comes of it. When a station manager does, though, well, we'll see.

## Overhauls Get Nowhere

NEW YORK (AP) — NBC-TV has overhauled its prime-time schedule several times since September, and nothing seems to work.

The troubled network listed only one program among the first 22 in the A.C. Nielsen Co.'s ratings for the week ending March 18, and that's no way to compete with ABC, which had seven of the top 10.

While ABC ran away with the ratings race for the 10th week in a row, NBC remained mired in last place for the fifth consecutive week. NBC's rating was 13.6, lowest of the season for any network and nearly 10 points behind ABC's 22.2. CBS was runnerup at 17.7.

The networks say that means in an average prime-time minute during the week, only 13.6 percent of the homes in the country were tuned to NBC.

As failure seems to follow failure at NBC, ABC continues to build on successful series. "Three's Company" was the week's most-watched program, followed immediately in the ratings by the premiere episode of a spinoff from the successful series, "The Ropers."

The rating for "Three's Company" was 38.5. Nielsen says that means of all the homes in the country with TV, 38.5 percent saw at least part of the show.

NBC's best for the week was 14th-rated "Little House on the Prairie," followed by the most successful of its new programs, "Diff'rent Strokes," No. 23.

NBC has been least successful with new entries. In fact, several programs introduced since the start of the season were clustered near the bottom

## GOREN BRIDGE

BY CHARLES H. GOREN AND OMAR SHARIF  
 © 1979 by Chicago Tribune

Neither vulnerable. South deals.

**NORTH**  
 ♠ Q 8 3  
 ♥ J 10 9 5  
 ♦ K 9 2  
 ♣ Q 10 6

**WEST EAST**  
 ♠ K 9 6 4 2 ♠ 7  
 ♥ 7 3 ♥ 8 4 2  
 ♦ 10 7 ♦ 6 5 4  
 ♣ A 8 4 2 ♣ K J 9 7 5 3

**SOUTH**  
 ♠ A J 10 5  
 ♥ A K Q 6  
 ♦ A Q J 8 3  
 ♣ Void

The bidding:  
 South West North East  
 1♦ 1♠ 1NT Pass  
 3♥ Pass 4♥ Pass  
 5♣ Pass 5♦ Pass  
 7♥ Dble. Pass Pass  
 Pass

Opening lead: Ace of ♣.

West ventured into the auction for no good reason and steered declarer away from a natural line into an unusual one that succeeded as the cards lay.

South elected to open one diamond rather than two diamonds to make it easier to probe for a 4-4 major fit, and West gaily overcalled one spade — hardly a recommended action with such a weak suit and hand. His adventure was partly successful, for South, after hearing North cue-bid the king of diamonds, decided to gamble that his partner held the king of spades as well, which would allow West's queen to be finessed. South's bold leap to seven hearts was greeted by another strange bid from West — a penalty double without a defensive trick.

West led the ace of clubs, and declarer ruffed in his hand with the queen. There was obviously no point in trying the spade finesse — that was sure to lose. The only alternative was a dummy reversal.

Rubber bridge clubs throughout the country use the four-deal bridge format. Do they know something you don't? Charles Goren's "Four-Deal Bridge" will teach you the strategies and tactics of this fast-paced action game that provides the cure for unending rubbers. For a copy and a scorepad, send \$1.75 to "Goren-Four Deal," c/o this newspaper, P.O. Box 259, Norwood, N.J. 07648. Make checks payable to NEWS-PAPERBOOKS.



MUDDY SPECIAL — Actress Cheryl Ladd holds out her hands as she tussles with actors in a mud pen during the taping of her ABC special "The Cheryl Ladd Special" in Los Angeles Tuesday. The show will air April 9 in conjunction with the Academy Awards. (AP Laserphoto)

## Robert Preston Back On Screen

HOLLYWOOD (UPI) — Robert Preston, long away from movie screens and TV shows, will star with Rosemary Harris in "The Chisholms," a series about a close-knit pioneer family's trek from Virginia to Fort Laramie, Wyoming. Twice a Tony-winner on Broadway — in 1958 for "The Music Man" and 1967 for "I Do! I do!" — Preston will be seen in the role of patriarch Hadley Chisholm beginning March 29 on four consecutive Thursdays.

**BILLY GRAHAM INTERNATIONAL CRUSADES**  
 A One-Hour TV Special From...

**POLAND**

It was an unprecedented experience in evangelism those 11 days in Poland, where Billy Graham preached in six major cities.

In Katowice, the largest church in Poland was filled with townspeople and students; in Warsaw, people stood in the aisles, others in an overflow room and many were outside where loudspeakers carried the message.

During those 11 days Mr. Graham spoke to more than 25 thousand people while the Team preached in other Polish cities.

**Tonight 8:00 P.M. WNCT-TV CH. 9**

Read Billy Graham's new book — "Holy Spirit" available in bookstores.

**RICHARD PRYOR**  
 NOW SHOWING!  
 LIVE IN CONCERT  
 FUN FOR ADULTS  
 SHOWS DAILY  
 3:30-5:20-7:10-9:00  
 Plaza 756-0088  
 cinema 1-2-3  
 PITT-PLAZA SHOPPING CENTER  
 ENDS THUR!

**WHO KILLED THE GREAT CHEFS OF EUROPE?**  
 A Delicious Mystery  
 PG  
 SHOWS DAILY  
 2:45-4:30-6:55-9:00  
 Plaza 756-0088  
 cinema 1-2-3  
 PITT-PLAZA SHOPPING CENTER  
 ENDS THURS.

**THE DRINKS JOB**  
 PG  
 SHOWS 3:15-5:15-7:15-9:15

**PARK UPTOWN GREENVILLE 752-7649**  
 NOW SHOWING!  
**Real Bruce Lee**  
 — BRUCE LEE  
 3:00-7:00-9:00 (R)

**STARTS FRIDAY! PLAZA CINEMA'S**  
 "THE WIZ"  
 "MOMENT BY MOMENT"

"One night when you come home, you'll find me inside waiting... and that will be the night you'll wish you'd never been born..."

**ELLIOTT GOULD**  
**CHRISTOPHER PLUMMER**  
**SUSANNAH YORK**  
 NOW SHOWING  
 SHOWS: 12:30-2:40  
 4:50-7:00-9:10

**Buccaneer MOVIES 1 2 3**  
 Greenville Square Shopping Center

**GABE KAPLAN'S HAVING A BALL!**  
 His dream team's got a preacher, a jailbird, a pool shark, a musician. And the best guy on the team is a girl.  
**FASTBREAK**  
 Shows: 12:50-2:55  
 5:00-7:10  
 9:20

**DUSTIN HOFFMAN VANESSA REDGRAVE**  
 SHOWS:  
 1:15  
 3:15  
 5:15  
 7:15  
 9:15

**Agatha**

**Buccaneer MOVIES 1 2 3**  
 Greenville Square Shopping Center

Catch the Thrill of Breaking Free

**Drift**

GO FOR IT

Featuring Parnelli Jones, Rick Mears, Mickey Thompson, Bobby Ferro and Malcolm Smith

**STARTS FRIDAY**

# How Tar Heel Senators And Congressmen Voted

**By Roll Call Report**  
Washington — Here's how the Members of Congress were recorded on major roll call votes March 8 through March 14.

**HOUSE**  
**BUDGET CUTS** — The House approved, 336 for and 73 against, a one-year budget of \$167,500 for a special six-person task force of the Education and Labor Committee. The unit deals with legislation affecting private and public pension plans. Although it is the equivalent of a subcommittee, the task force's budget is in addition to the Education and Labor Committee's \$2.25 million annual budget.

Rep. Frank Thompson, D-J., supporter, said the task force is "the only unit in ex-

istence" that can answer congressmen's questions about the complex pension laws.

Rep. William Dannemeyer, R-Calif., an opponent, noted that the \$167,500 outlay is 53 per cent above last year's task force budget, and questioned "why we should vote to approve an increase...of a magnitude of better than 50 per cent in just one year for this one committee."

Members voting "nay" opposed the expenditure for the special task force.

Reps. Walter Jones, D-1, Charles Whitley, D-3, Ike Andrews, D-4, Stephen Neal, D-5, Richardson Preyer, D-6, Charles Rose, D-7, W.G. Hefner, D-8, James Broyhill, R-10, and

Lamar Gudger, D-11, voted "yea."  
Rep. James Martin, R-9, voted "nay."  
Rep. L.H. Fountain, D-2, did not vote.

**TAIWAN** — The House rejected, 149 for and 221 against, an amendment to establish an unofficial defense treaty between the U.S. and Taiwan. The pact would have, in effect, continued the formal Mutual Defense Treaty with Taiwan that will expire as a result of the U.S. establishing diplomatic relations with the People's Republic of China. This vote came during consideration of the bill (HR 2479) establishing a new basis for Taiwan-U.S. relations. The bill was later passed and sent to conference with the Senate.

Rep. Ken Kramer, R-Colo., the sponsor, said his amendment states "that a threat to the security of Taiwan constitutes a threat to the peace and stability of the West Pacific area and hence to the interests of the U.S."

Rep. Stephen Solarz, D-N.Y., an opponent, said the amendment would "scuttle the entire policy of normalization" with Peking and that if adopted U.S. Ambassador Leonard Woodcock "would be given his walking papers the day after news of it had arrived in Peking."

Members voting "yea" favored the strongest possible U.S. defense commitment to Taiwan.

Martin and Broyhill voted "yea."  
Fountain, Whitley, Andrews, Neal, Preyer, Hefner and Gudger voted "nay."  
Jones and Rose did not vote.

**QUEMOY AND MATSU** — The House defeated, 146 for and 256 against, an amendment to define the islands of Quemoy and Matsu as part of Taiwan in the bill (HR 2479; see above vote) establishing a new basis for Taiwan-U.S. relations. The effect of this amendment would have been to commit the U.S. to support the two islands to the same extent it will support Taiwan.

Rep. Mickey Edwards, R-Ola., the sponsor, said: "To exclude the two islands of Quemoy and Matsu from this act is an open invitation to Peking to attack these islands without so much as a suggestion from us that it might be of some concern to the U.S."

Rep. Clement Zablocki, D-Wisc., an opponent, asked: "Does the U.S. want to regard the shelling of (Quemoy and Matsu) as 'grave security' to our country?"

Members voting "yea" wanted the U.S. to regard the future of Quemoy and Matsu as vital to the U.S. national interest.

government of China and retain a security commitment to another part of China."  
Senators voting "yea" wanted the equivalent of an unofficial defense treaty with Taiwan.

Sen. Jesse Helms, R, voted "yea."  
Sen. Robert Morgan, D, did not vote.

**BUDGET CUTS** — The Senate killed, 42 for and 55 against, a move to spend \$33.6 million in health money. The \$33.6 million is to be cut out of the fiscal 1979 budget for various nursing, medical, veterinarian and dental school programs. This vote was an attempt to keep the already-appropriated money from being "rescinded" from the current budget.

Sen. Edward Kennedy, D-Mass., supporter of the move to spend the money, said what was at issue was the ability of the federal government to uphold its financial commitment to the various health school.

Sen. Pete Domenici, R-N.M., an opponent, said: "We have to

send a signal to the American people and to the entire world that we in the Senate are serious about spending restraint in these extremely inflation-ridden times."  
Senators voting "yea" opposed the budget cut.  
Morgan and Helms voted "yea."

**Have You Missed Your Daily Reflector?**

First Call Your Independent Carrier. If You Are Unable To Reach Him Call The Daily Reflector

**752-3952**

Between 6:00 And 6:30 P.M. Weekdays  
And 8 'Til 9 A.M. On Sundays.

## Electricity Soaring In Mill Households

KANNAPOLIS, N.C. (AP) — The 1,600 households that have depended on Cannon Mills for electricity since the 1920s are in for some changes now that Duke Power Company has taken over the company's power distribution system.

When electricity bills are mailed late next month, customers who have relied on the expensive Cannon system will probably see their bills triple. That's because Cannon deliberately kept its rates lower than

average during the energy-crisis years of the 1970s, a company official said.

Cannon charged its customers — less than 10 percent of the households in Kannapolis — an average of 1.25 cents for every kilowatt hour of power. That compares with Duke's average of 3.6 cents a kilowatt hour that its 19,000 regular customers in Kannapolis have been paying.

"Both Cannon and Duke are quite concerned about the impact this is going to have on these people," Paul Briggs, Duke's Kannapolis plant manager said Tuesday. "It'll be a very significant increase..."

To make matters worse, Briggs said the new customers have relatively high consumption rates and will have to start thinking about conservation measures to hold down their power bills.

In the early 1920s, Cannon Mills began distributing electricity to residences and businesses within a one-mile radius of its main plant in Kannapolis. But over the last several years, the company has been negotiating with Duke to sell the private system.

Tuesday, the \$400,000 sale was made official.

"It became quite apparent over the years that the system needed to be upgraded and expanded," said Ed Rankin, Cannon public relations vice president. "It is far more complicated than in years past and Cannon didn't believe it had the expertise or the equipment to keep the system modern for the future."

The Cannon system also serves about 200 businesses that will be switched over to Duke's system in the coming months.

## Clash Over Milk Pricing

RALEIGH, N.C. (AP) — Proponents and opponents of state regulation of wholesale and retail milk prices clashed at a public hearing Tuesday sponsored by the N.C. Milk Commission.

Representatives of grocery store chains and a consumers group told the commission that regulation would hurt consumers, farmers, retailers and others involved in the dairy business.

But supporters of the milk pricing plan said they believed it would help the dairy industry and the consumer by ensuring a steady supply of high-quality milk.

"We call on the Milk Commission to establish fair and equitable prices at all levels, and to assure the supply of high-quality milk for the state's consumers," said Charles Colard, speaking for the plan on behalf of the Cooperative Council of North Carolina.

On the other hand, Lillian Boo, director of the Consumers Center of North Carolina, said price-setting would mean higher retail prices and decreased milk consumption.

B.W. Thomas, a representative of the Charlotte-based Harris Teeter food stores, added that the proposal "would completely eliminate competition at the producer level."

Currently, the commission sets only the price processors pay dairy farmers for milk, although it has the legal authority to set prices on the wholesale and retail levels as well.

Commission members called the hearing after retail milk prices rose sharply in some areas of the state in January after the commission gave dairy farmers a 6.5-cent-per-gallon increase.

Most of the sentiment expressed during Tuesday's hearing was against further regulation of the milk industry in North Carolina.

average during the energy-crisis years of the 1970s, a company official said.

Cannon charged its customers — less than 10 percent of the households in Kannapolis — an average of 1.25 cents for every kilowatt hour of power. That compares with Duke's average of 3.6 cents a kilowatt hour that its 19,000 regular customers in Kannapolis have been paying.

"Both Cannon and Duke are quite concerned about the impact this is going to have on these people," Paul Briggs, Duke's Kannapolis plant manager said Tuesday. "It'll be a very significant increase..."

To make matters worse, Briggs said the new customers have relatively high consumption rates and will have to start thinking about conservation measures to hold down their power bills.

In the early 1920s, Cannon Mills began distributing electricity to residences and businesses within a one-mile radius of its main plant in Kannapolis. But over the last several years, the company has been negotiating with Duke to sell the private system.

Tuesday, the \$400,000 sale was made official.

"It became quite apparent over the years that the system needed to be upgraded and expanded," said Ed Rankin, Cannon public relations vice president. "It is far more complicated than in years past and Cannon didn't believe it had the expertise or the equipment to keep the system modern for the future."

The Cannon system also serves about 200 businesses that will be switched over to Duke's system in the coming months.

## Revival Series Is Conducted

The Rev. Eustace A. Riggs is conducting a revival at Belvoir FWB Church through Thursday of this week.

The services start at 7:30 each night.

Rev. Riggs, a West Virginia native, is pastor of the First FWB Church of Russellville, Ala. He has previously been in full-time evangelistic work for 13 years and conducted revivals through the south and midwest. He has pastored churches in Alabama, Tennessee, Missouri, and Kansas, having been preaching since he was 16. He is a graduate of the Free Will Baptist Bible College in Nashville, Tenn.

The public is invited, says the pastor, the Rev. John C. Moran.

## FORECAST FOR THURSDAY, MARCH 22, 1979

### Your Daily HOROSCOPE

from the CARROLL RIGHTER INSTITUTE

**GENERAL TENDENCIES:** You have a certain amount of cleverness in now being able to arrange all of the usual routines of everyday living so that a larger amount of efficiency will be in effect.

**ARIES (Mar. 21 to Apr. 19)** Seek out a bigwig you know and get the advice you need in order to make your own life more substantial. Take more interest in community affairs.

**TAURUS (Apr. 20 to May 20)** Seek information you need from new contacts who are progressive and improve your lot in life. A new adjunct to present philosophy could help to add to present stature you enjoy.

**GEMINI (May 21 to June 21)** Find a better way of handling both payments and collections so that you need not worry so much in the future. Improve romantic life.

**MOON CHILDREN (June 22 to July 21)** Discuss with allies how to improve a project that is not working out well and be more successful with it. A situation arises that can prove beneficial for you.

**LEO (July 22 to Aug. 21)** Use more up-to-date methods in some work in which you are currently engaged and get better results. A fellow worker has a good idea that you should follow.

**VIRGO (Aug. 22 to Sept. 22)** Plan early to have more time for amusements later in the day. Gain the goodwill of a bigwig you know. Don't overspend.

**LIBRA (Sept. 23 to Oct. 22)** Try to agree with kin regarding changes that should be made at home and have more harmony there. Entertain at home in the evening. Take no risks with credit and reputation.

**SCORPIO (Oct. 23 to Nov. 21)** Discuss career affairs with those who can be of assistance to you. Changing perspective somewhat is wise. Make a better impression on others by taking a new stance.

**SAGITTARIUS (Nov. 22 to Dec. 21)** Plan how to add to present abundance via new ideas, systems that can be helpful to you. Study financial reports and get interesting information. Be more willing to cooperate at home.

**CAPRICORN (Dec. 22 to Jan. 20)** Go after a personal aim from a different angle and get good results. Be wiser in business matters. Be with congenials in the evening.

**AQUARIUS (Jan. 21 to Feb. 19)** Study new information and come up with the right answers to problems. Do not confide in others. An expert can be of assistance to you if you contact early.

**PISCES (Feb. 20 to Mar. 20)** You have personal aims that can be helped by advice from an older person. Be more willing than usual to go out socially in the evening and meet interesting personalities.

**IF YOUR CHILD IS BORN TODAY...** he or she will want to get started on a career and will study hard to make something of himself or herself. There is ability at inventions here. Teach early the proper tenets under which to live.

"The Stars impel, they do not compel." What you make of your life is largely up to you!

© 1979, McNaught Syndicate, Inc.

**PEANUTS**  
THERE...I MOVED FIVE SQUARES..NOW IT'S YOUR TURN...ROLL THE DICE!  
IN THE TWENTY-EIGHTH CHAPTER OF EXODUS, IT TELLS OF URIM AND THUMMIM... SOME SCHOLARS SAY THESE WERE SMALL STONES LIKE DICE  
THESE DICE WERE USED TO OBTAIN THE WILL OF GOD WHEN DECISIONS HAD TO BE MADE, AND...  
ROLL THE DICE!  
THAT'S A GOOD DECISION

**B.C.**  
MEDICAL SCIENTISTS TODAY ANNOUNCED NEW FINDINGS ON A POSSIBLE LINK BETWEEN CAFFEINE AND THE INNER EAR.  
WHICH COULD EXPLAIN WHY YOU CAN'T TALK TO SOME PEOPLE IN THE MORNING TILL THEY'VE HAD THEIR COFFEE.

**NUBBIN**  
PIERRE HAS THE SNIFFLES, DOCTOR.  
WELL, SEE HE STAYS WARM AN' GETS PLENTY OF REST.  
GOOD! I'LL GET TO WEAR MY JAMMIES WITH THE FOOTIES.

**BLONDIE**  
WOW! IT'S REALLY LATE! I WONDER IF I CAN SNEAK UPSTAIRS WITHOUT WAKING BLONDIE?  
GEE, HONEY, YOU LOOK BEAUTIFUL STANDING THERE  
HONEST, HONEY...YOU LOOK BEAUTIFUL!

**BEETLE BAILEY**  
WHAT A LIFE THIS IS!  
UP AT FOUR EVERY MORNING...COOKING ALL DAY LONG...  
TRYING TO PLEASE 200 SOLDIERS WHO DON'T KNOW THE DIFFERENCE BETWEEN FINE FOOD AND SLUDGE  
OF COURSE, THAT'S WHAT SAVES ME

**PHANTOM**  
I'VE STUDIED THIS... I HAD A COURSE AT THE CLINIC...I'M PREPARED.  
HMM... DOES IT WORK?  
IT'S WORKED FOR THOUSANDS OF YEARS. HOW DO YOU THINK YOUR ANCESTORS, ALL 20, WERE BORN?  
I'VE OFTEN WONDERED.  
I KNOW, DON'T WORRY, I'LL BE ALRIGHT.

**FRANK AND ERNEST**  
PSYCHIATRIC CLINIC  
HOW ABOUT THAT! SOMEBODY'S KIDNAPPED DR. CORNWELL, THE KLEPTOMANIA SPECIALIST!

## Forward-Swept Wing Studied

Aeronautics and Space Administration to determine the potential of highly forward-swept wings, according to Aviation Week and Space Technology magazine. (AP Laserphoto)

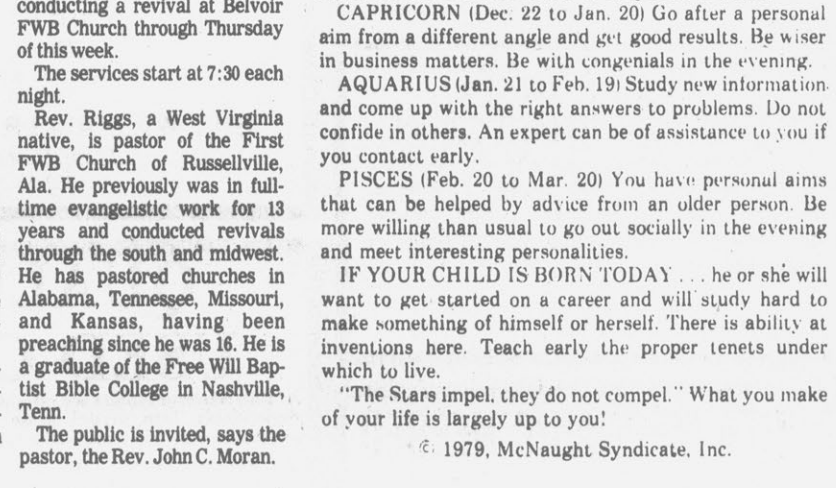

WASHINGTON — This is a full-scale engineering mockup of Rockwell International's forward-swept wing fighter. The Defense Advanced Research Agency is the lead organization in a project with the U.S. Air Force and the National

Aeronautics and Space Administration to determine the potential of highly forward-swept wings, according to Aviation Week and Space Technology magazine. (AP Laserphoto)

**PHANTOM**  
I'VE STUDIED THIS... I HAD A COURSE AT THE CLINIC...I'M PREPARED.  
HMM... DOES IT WORK?  
IT'S WORKED FOR THOUSANDS OF YEARS. HOW DO YOU THINK YOUR ANCESTORS, ALL 20, WERE BORN?  
I'VE OFTEN WONDERED.  
I KNOW, DON'T WORRY, I'LL BE ALRIGHT.

**FRANK AND ERNEST**  
PSYCHIATRIC CLINIC  
HOW ABOUT THAT! SOMEBODY'S KIDNAPPED DR. CORNWELL, THE KLEPTOMANIA SPECIALIST!

**PHANTOM**  
I'VE STUDIED THIS... I HAD A COURSE AT THE CLINIC...I'M PREPARED.  
HMM... DOES IT WORK?  
IT'S WORKED FOR THOUSANDS OF YEARS. HOW DO YOU THINK YOUR ANCESTORS, ALL 20, WERE BORN?  
I'VE OFTEN WONDERED.  
I KNOW, DON'T WORRY, I'LL BE ALRIGHT.

**FRANK AND ERNEST**  
PSYCHIATRIC CLINIC  
HOW ABOUT THAT! SOMEBODY'S KIDNAPPED DR. CORNWELL, THE KLEPTOMANIA SPECIALIST!

**PHANTOM**  
I'VE STUDIED THIS... I HAD A COURSE AT THE CLINIC...I'M PREPARED.  
HMM... DOES IT WORK?  
IT'S WORKED FOR THOUSANDS OF YEARS. HOW DO YOU THINK YOUR ANCESTORS, ALL 20, WERE BORN?  
I'VE OFTEN WONDERED.  
I KNOW, DON'T WORRY, I'LL BE ALRIGHT.

**FRANK AND ERNEST**  
PSYCHIATRIC CLINIC  
HOW ABOUT THAT! SOMEBODY'S KIDNAPPED DR. CORNWELL, THE KLEPTOMANIA SPECIALIST!

**PHANTOM**  
I'VE STUDIED THIS... I HAD A COURSE AT THE CLINIC...I'M PREPARED.  
HMM... DOES IT WORK?  
IT'S WORKED FOR THOUSANDS OF YEARS. HOW DO YOU THINK YOUR ANCESTORS, ALL 20, WERE BORN?  
I'VE OFTEN WONDERED.  
I KNOW, DON'T WORRY, I'LL BE ALRIGHT.

**FRANK AND ERNEST**  
PSYCHIATRIC CLINIC  
HOW ABOUT THAT! SOMEBODY'S KIDNAPPED DR. CORNWELL, THE KLEPTOMANIA SPECIALIST!

01 PUBLIC NOTICES

NOTICE OF PUBLIC HEARING ON THE PROPOSED AMBULE HOME... Public notice is hereby given that the City Council of the City of Greenville...

ADVERTISED FOR BIDS Sealed proposals will be received by the Board of Trustees, P.H.T. Technical Institute, Greenville, N.C. in the Conference Room of the Administration Building...

ADVERTISING FOR BIDS Sealed proposals, so marked, will be received in the office of the Director of Greenville Utilities Commission, Greenville Utilities Building, 300 West Fifth Street, Greenville, N.C. 27634...

ADVERTISING FOR BIDS Sealed proposals, so marked, will be received in the office of the Director of Greenville Utilities Commission, Greenville Utilities Building, 300 West Fifth Street, Greenville, N.C. 27634...

ADVERTISING FOR BIDS Sealed proposals, so marked, will be received in the office of the Director of Greenville Utilities Commission, Greenville Utilities Building, 300 West Fifth Street, Greenville, N.C. 27634...

ADVERTISING FOR BIDS Sealed proposals, so marked, will be received in the office of the Director of Greenville Utilities Commission, Greenville Utilities Building, 300 West Fifth Street, Greenville, N.C. 27634...

ADVERTISING FOR BIDS Sealed proposals, so marked, will be received in the office of the Director of Greenville Utilities Commission, Greenville Utilities Building, 300 West Fifth Street, Greenville, N.C. 27634...

ADVERTISING FOR BIDS Sealed proposals, so marked, will be received in the office of the Director of Greenville Utilities Commission, Greenville Utilities Building, 300 West Fifth Street, Greenville, N.C. 27634...

ADVERTISING FOR BIDS Sealed proposals, so marked, will be received in the office of the Director of Greenville Utilities Commission, Greenville Utilities Building, 300 West Fifth Street, Greenville, N.C. 27634...

ADVERTISING FOR BIDS Sealed proposals, so marked, will be received in the office of the Director of Greenville Utilities Commission, Greenville Utilities Building, 300 West Fifth Street, Greenville, N.C. 27634...

ADVERTISING FOR BIDS Sealed proposals, so marked, will be received in the office of the Director of Greenville Utilities Commission, Greenville Utilities Building, 300 West Fifth Street, Greenville, N.C. 27634...

ADVERTISING FOR BIDS Sealed proposals, so marked, will be received in the office of the Director of Greenville Utilities Commission, Greenville Utilities Building, 300 West Fifth Street, Greenville, N.C. 27634...

ADVERTISING FOR BIDS Sealed proposals, so marked, will be received in the office of the Director of Greenville Utilities Commission, Greenville Utilities Building, 300 West Fifth Street, Greenville, N.C. 27634...

ADVERTISING FOR BIDS Sealed proposals, so marked, will be received in the office of the Director of Greenville Utilities Commission, Greenville Utilities Building, 300 West Fifth Street, Greenville, N.C. 27634...

ADVERTISING FOR BIDS Sealed proposals, so marked, will be received in the office of the Director of Greenville Utilities Commission, Greenville Utilities Building, 300 West Fifth Street, Greenville, N.C. 27634...

ADVERTISING FOR BIDS Sealed proposals, so marked, will be received in the office of the Director of Greenville Utilities Commission, Greenville Utilities Building, 300 West Fifth Street, Greenville, N.C. 27634...

ADVERTISING FOR BIDS Sealed proposals, so marked, will be received in the office of the Director of Greenville Utilities Commission, Greenville Utilities Building, 300 West Fifth Street, Greenville, N.C. 27634...

ADVERTISING FOR BIDS Sealed proposals, so marked, will be received in the office of the Director of Greenville Utilities Commission, Greenville Utilities Building, 300 West Fifth Street, Greenville, N.C. 27634...

ADVERTISING FOR BIDS Sealed proposals, so marked, will be received in the office of the Director of Greenville Utilities Commission, Greenville Utilities Building, 300 West Fifth Street, Greenville, N.C. 27634...

ADVERTISING FOR BIDS Sealed proposals, so marked, will be received in the office of the Director of Greenville Utilities Commission, Greenville Utilities Building, 300 West Fifth Street, Greenville, N.C. 27634...

ADVERTISING FOR BIDS Sealed proposals, so marked, will be received in the office of the Director of Greenville Utilities Commission, Greenville Utilities Building, 300 West Fifth Street, Greenville, N.C. 27634...

ADVERTISING FOR BIDS Sealed proposals, so marked, will be received in the office of the Director of Greenville Utilities Commission, Greenville Utilities Building, 300 West Fifth Street, Greenville, N.C. 27634...

ADVERTISING FOR BIDS Sealed proposals, so marked, will be received in the office of the Director of Greenville Utilities Commission, Greenville Utilities Building, 300 West Fifth Street, Greenville, N.C. 27634...

ADVERTISING FOR BIDS Sealed proposals, so marked, will be received in the office of the Director of Greenville Utilities Commission, Greenville Utilities Building, 300 West Fifth Street, Greenville, N.C. 27634...

ADVERTISING FOR BIDS Sealed proposals, so marked, will be received in the office of the Director of Greenville Utilities Commission, Greenville Utilities Building, 300 West Fifth Street, Greenville, N.C. 27634...

ADVERTISING FOR BIDS Sealed proposals, so marked, will be received in the office of the Director of Greenville Utilities Commission, Greenville Utilities Building, 300 West Fifth Street, Greenville, N.C. 27634...

21 Pontiac

GRAND PRIX 1978. Under warranty, V-6, EPA 19-27, air, AM/FM. Excellent condition. \$3995. 746-4609 after 6.

22 Foreign

DATSUN 2802 1978. Demonstrator, turbo, chrome, sunroof, 2000 miles. Hot Oldsmobile-Datsun, 101 Hooker Road. 756-3115.

SUPER BEETLE 1971 with air. Good condition. \$1100. Call after 6 p.m. 756-0488.

VW 1971. Clean. Price negotiable. Call 756-2749.

Bicycles For Sale GIRL'S SCHWINN Fair Lady bike. Good condition. 756-3970.

Boats For Sale AQUASPORTS. Bajas, Cruise boats, Galaxies, Lucrafts, Manatees, Regals, Evrinore motors, OMC, Stern drive motors, etc. Best Prices in North Carolina.

1974 FIBERFRONT 115 Johnson with trim and tilt, stainless steel propeller. Cox galvanized tilt trailer. \$2500. 756-4981.

1977, 31' Grady White Gulf Stream. 75 HP OMC galvanized trailer. Depth finder. CB, rod holders. \$8500. 752-5308 after 5.

1973 SPORTCRAFT (16'). 55 HP motor. trailer. \$1250. 752-1061.

1971 RENKIN open bow boat, 115 HP motor. CB galvanized tilt trailer. 756-9577 after 5.

BOAT, MOTOR and trailer. New condition. 85 HP. 756-0895.

18' DIXIE, 85 HP Johnson. Long trailer. 1975 Johnson outboard. 15 HP. Marine compass, CB, anchors and accessories included. Mint condition. \$4000. 756-1155.

31 Campers For Sale CONVERTED VANS. All makes. Sasser's Camping Center. All types of camping equipment. North 117 Business. 756-0771.

14' SCOTTY CAMPER and 18' Friendship Camper. Call 752-0657 after 6 p.m. daily.

1969, 29' HOLIDAY Rambler with penthouse. Fully equipped. 20 cubic feet. awning, crash bar and stabilizers. Immaculate condition. \$4799. 746-1132 days. 792-3786 nights.

1971 COX camper. Good condition. Best reasonable offer. 756-0771.

8 FOOT BED CAMPER with paneling, insulation. Only \$275. 758-8023.

CAMPER SHELL. Like new. Best reasonable offer. 752-2530. 758-2542.

30 FOOT COBRA. Rear bedroom, bath with tub and shower, rear house type mattress. Fully equipped. Set up at Satter Path. Ocean front. \$3500 firm. 756-4496.

35 Cycles For Sale 500 HONDA 1977. 8,000 miles. lug gear, rack bar, crash bar and helmet. Black and chrome. Like new. \$1200. 746-6535.

1978 YAMAHA 500. 1800 miles. lug gear, rack bar, crash bar and helmet. Like new. \$1400. 758-0738.

1974 YAMAHA 650. Electric with trailer. Mint condition. 3800 miles. 756-7535.

1979 HARLEY DAVIDSON Sportster. 1600 miles. Excellent condition. \$2900 firm. 524-4814.

1966, 650cc Triumph street chopper plus original frame. 752-7661.

1978 HONDA GL-1000. 756-1485 after 6 p.m.

MINI-TRAIL. Excellent condition. \$150. Call 746-2397 after 7 p.m.

37 Trucks For Sale 1974 DODGE CLUB V-8, power steering and brakes, AM/FM radio, manual transmission. 37,000 miles. \$3500. Call 752-3609 or see Fleming's Furniture & Appliances, 2100 North Carolina Avenue or call 756-7510 nights.

1979 WAGONER LIMITED. Brown. Almost new. Great machine. Need car. Call 756-8608 or 756-2166.

1968 FORD RANGER with bins. Call 752-2540.

1974 FORD F-100. Extra clean, power steering and brakes, V-8, automatic, camper shell. 752-2542.

1972 CHEVY BLAZER. 4 wheel drive, automatic, air, oversized tires. \$3300. 854-0844.

1972 GMC SPRINT. New paint, new tires. Excellent condition. \$1895. 756-7707 after 6.

1976 JEEP WAGONER. Excellent condition. All the bells and whistles. Call Monday-Friday, 8 to 5. 756-7555.

1974 CHEVY BLAZER. 350, 4 barrel, automatic, power steering and brakes, air, AM/FM, CB. Asking \$4150. 758-1626.

42 Help Wanted

EXPERIENCED meat cutter. Kroger Sav-On, Greenville Boulevard. Apply in person from 8 a.m. to 5 p.m. Monday-Friday. Equal Opportunity Employer.

EXPERIENCED CARPET or vinyl installer for immediate employment at Carpets By George. 756-7178.

PEKING CLIPPER Beauty Salon to open soon. Owner Torrie Hair, formerly of La Kosmetique, has opening. Please call 756-1505 or 758-2774.

JOB OPPORTUNITY. Up to \$1500 monthly income starting. Company with 25 years experience. Insurance. P.O. Box 533, Greenville, NC.

SHEETROCK HANGERS and finishers wanted. Apply in person for appointment. Call 756-0055.

DENTAL ASSISTANT. 5 days a week. Experienced. Good salary. 752-1337.

EARN EXTRA money. Choose your own hours. Call 752-3681.

RECENT COLLEGE graduate. Career position marketing property, casualty and life insurance programs to business accounts. Salary, commission, fringe benefits, pension and excellent fringe benefits. Must be able to travel. Business persons comfortably have past sales experience and live in the area. Call 756-1505 or 758-2774.

PRODUCTION SUPERVISOR. Looking for person to come in on the entry level of management in a production environment. Need person with 1-2 years experience and related experience. Call 752-2111 for appointment.

RNOR LPNs. Full time, 7:11 a shift with 15 minutes break off. Contact Mrs. Brannon, 758-4121.

WANTED. Housewives Special. Fill in for absences and vacationing persons. All phases of light, clean production work. First and second shifts. Entry level opportunity for sales, clerical, and industrial. Silkcreens. 758-0517 for interview and sign-up.

NEEDED IMMEDIATELY. Experienced in V.A.S. and industrial machinery helpful. Special training in electrical and pneumatic control systems. Must be able to travel. Salary negotiable. Profit sharing. Vehicle and tools provided. Call for appointment. (919) 851-5762. 756-0264.

IF YOU'RE LOOKING for a good used car at a good price, be sure you look at the many cars offered for sale today. Call 756-0771.

DATA PROCESSING Manager. Individual should have experience with IBM system 111, model 8 or 10; extensive knowledge of data processing design and programming. Supervisory experience a must. Excellent salary. Send resume to Data Processing Manager, P.O. Box 1967, Greenville, NC 27634.

BRODY'S has full time opening for a new retail store. Good company benefits. Apply to Ms. Flye at Brody's, P.H. Plaza.

PART-TIME WEEKEND help wanted for V.A.S. and industrial machinery helpful. Special training in electrical and pneumatic control systems. Must be able to travel. Salary negotiable. Profit sharing. Vehicle and tools provided. Call for appointment. (919) 851-5762. 756-0264.

WANTED. Person with experience in curing tobacco with Roanoke tubs and some maintenance ability. 758-0530 days.

UNUSUAL OPPORTUNITY For local person in this area to sell customized lubricants for a nationally known oil company. Permanent full-time position. \$10,000 annually high commissions, opportunity for advancement. Knowledge of V.A.S. and industrial machinery helpful. Special training in electrical and pneumatic control systems. Must be able to travel. Salary negotiable. Profit sharing. Vehicle and tools provided. Call for appointment. (919) 851-5762. 756-0264.

INSURANCE INVESTIGATOR National firm seeking mature, responsible person for interesting work in a growing field. Investigator. Pitt-Martin-Green and Lenoir Counties. Sent resume with photo.

ATTN: MANAGER Raleigh, N.C. 27606 system design and programming. Supervisory experience a must. Excellent salary. Send resume to Data Processing Manager, P.O. Box 1967, Greenville, NC 27634.

SALES. Outside. Several experienced salespeople for a six county area surrounding Greenville. Must be ambitious, self-motivated and willing to travel. Drawn commission forming potential of \$20,000 per year and up. Reply to Sales, P.O. Box 469, Greenville, NC 27634.

MEDICAL SOCIAL WORKER. Master's Degree in Social Work and one year experience in health care field. Deadline for applications: March 26. Apply Greene County Health Care, P.O. Box 657, Snow Hill, NC 27581.

PNEUMATIC CONTROL SUPERVISOR. Immediate opening for industrial control systems. Must have experience in pneumatic controls. Good salary and benefits. Contact Office of Personnel, P.H. Plaza, 756-4479.

AVON. Earn good money part-time. Selling world famous Avon products. For details, call 752-7000.

SALES - INSURANCE GREENVILLE, N.C. AREA LIFE EXPERIENCE PREFERRED LEADS FURNISHED COMMISSIONS ANNUALIZED AND ADVANCED Call 803-243-3412

IMMEDIATE OPENING for heavy equipment operator. Packer firm. Send resume to Mechanic, 400 North Memorial Drive, Greenville, S.C. 29601.

BARMAID needed for Saturday night. Call Louie's Lounge, 752-1493.

TWO PERSONS to show Celebrity Fashion jewelry to their friends. Top commission to delivery. Fast advancement. 752-1201.

KEYPUNCH. Temporary. Must have good references. Betty's Personnel, 756-3404.

TOPLESS DANCER or topless waitress. 20 years experience. Police record. 400 a week for the right person. Apply at 33 Club on Bypass. Interview from Riverbluff (behind Fast Fare).

REAL ESTATE agency is expanding and seeks successful-oriented persons for all our equipment. Maxine Ginger Hackett Realtors, 756-7996, 758-0050.

CERTIFIED dental assistant or dental hygienist. 525-2253 nights; 525-4313 days. 525-2253 nights; 525-4313 days.

MECHANIC. Immediate opening for mechanical aptitude. Prefer experience in heating and air conditioning. Must be able to rotate all shifts. Call Pitt County Memorial Hospital, 757-4479.

100 CLASSIFIED DISPLAY

42 Help Wanted

BLOODMOBILE Assistant. Pleasant personality, ability to learn to deal with donor reactions. Must drive and maintain two ten vehicle within 100 mile radius of Greenville, variable hours, weekdays only. Responsible to Bloodmobile head nurse. Good salary and benefits. Call 756-7178.

EXPERIENCED WAITRESSES. Apply between 6 in mornings and 10 in evenings. Waffle House, 306 Greenville Boulevard, Southeast.

CASHIER and GENERAL office worker qualified to operate computer terminal. Must be accurate typist. Benefits include profit sharing, major medical and dental plan. Apply in person at Maxwell Furniture, 404 Greenville Boulevard.

ELECTRICIAN's helper wanted immediately. Welding job site, off 264 Bypass, Langdon Court, Greenville. Apply to Mike Wilson.

REPAIR WORK CARPENTRY, roofing, masonry. Call James Harrington. 752-7765 after 6.

SEPTIC TANK installation. lot clearing, landscaping, backhoe/bulldozer work. Call Sonny Cox. 746-2348 or 746-3414.

COMPLETE LAWN maintenance, including tree service. Tony Brown's Services. 756-4735.

COMPLETE FURNITURE upholstery and large assortment of fabrics. 758-4643 or 758-1803, ask for Sue.

INDIVIDUAL with BA in Business Administration desires work as manager trainee or other similar position. Has past managerial experience. 752-7209 after 6 p.m.

NO JOB TOO SMALL. Remodeling and roofing work on houses and mobile homes. Will also do cabinet work, roof work, concrete work and tile. Call 756-1505 or 758-2774 anytime.

YOUNG MOTHER would like to keep child in her home, 2 years and 3 months old. Call after 5 p.m. 756-9379.

WOULD LIKE to custom build your home at cost plus, 20 years experience with work guaranteed. Also additions or repairs. 756-3821 or 756-0264.

WE CLEAN out gutters, put up gutters and do painting. 752-3076.

EXPERIENCED lawn work and maintenance. Trimming, raking, etc. 758-5928 after 5:30.

WANTED. Part-time secretarial position. Approximately 30 hours per week. Must be experienced, shorthand and bookkeeping. Call Betty's Personnel, 756-3404.

46 FOR SALE AYC 1974 GREMLIN (4 cylinder, AM/FM cassette stereo, radials, great mileage per gallon). \$2000. 1959 El Camino (fire truck made). \$1500. 1977 Oldsmobile Royale (87,000 miles, loaded). \$4500. Call 756-3276 or 756-3776.

54 Livestock ONE STALL available. Private barn. Four miles past hospital. Board negotiable. 752-6498 after 6 p.m.

56 Miscellaneous FILL DIRT, builder sand, top soil. Call Charles L. McDaniel, 758-7608 days. 756-2351 after 3:30 p.m.

BOOTLEG PRICES: Men's knit slacks and jeans, \$9.99; sportcoats, \$19.95; women's blouses, \$12.95; mail qualifications, nite, address, and phone number to John Tanquary, Dept. D, P.O. Box 47843, Dallas, Texas 75247.

SMALL LOADS pinebark, sand, top soil and stone. Also driveway work. Call Charles L. McDaniel, 758-7608 days. 756-2351 after 3:30 p.m.

RINSE & VAC 310 van, Shampoo not included. Whitehurst Carpet Center.

LARGE LOADS of sand, topsoil, fill dirt, gravel, etc. Call 758-2300.

FIREWOOD FOR SALE. Call J. P. Stencil, 752-6331.

LITTLE'S NURSERY. Fruit trees, pecan trees, most other trees, shrubs, yucca and palms. Free estimates here. Little's Nursery, 3 miles west of Greenville on 264. 756-3626.

COMPLETE AUTO, furniture and boat upholstery. All furniture repairing and refinishing. Complete line of materials. Free pickup and delivery. Testimonials. Jackson's Cleaning & Upholstery Service, 758-3276.

WANTED. Consignment antiques, furniture and miscellaneous items. Will take any goods on consignment at Tar Road Antiques, 756-9123.

TWO SLIP-COVERED chairs, \$10 and \$15; oak and table, \$15; small carpet's desk, \$15. 756-6201.

AMAZING NEW wireless home or office security system. Call 756-1944 for free demonstration.

NEED FURNITURE? We have 111 Brands you'll recognize. Financing available to fit your needs. Home Furniture Store, 701 Dickinson Avenue.

PORTABLE dishwasher, \$100; Hot-point stove, \$100; 10,000 BTU air conditioner, \$100. Call 752-3899.

100 CLASSIFIED DISPLAY

56 Miscellaneous

USED SUN TUNE-UP machine and other various equipment. Contact Johnny Joyner at Goodyear. 752-4411.

ONIONS POTATOES BROCCOLI PLANTS LETTUCE PLANTS EARLY GARDEN SEEDS PANSY PLANTS Fertilizer and other garden supplies

PECCAN TREES 20% off KITTRELL'S GREENHOUSES 2531 Dickinson Ave. Ext.

TOP SOIL, fill dirt, sand, rocks, landscaping, bulldozer work and lot clearing. Call Henry Worthington, 746-3464.

PIANO RENTAL, as low as \$15 per month. Cha-Rich Music, 756-1212.

NOW OPEN DAILY, 10 to 5. Antiques and stuff, 2 miles west of Chocowinity, Choco Fiesta Market.

SYSTEM PHASE SHIFTER. Lee Paul custom job. Gold plated. Call 752-3424.

ANTIQUE STEINWAY Grand. Beautifully restored. \$4500. Exclusively carved. 752-1387.

PITT TILE COMPANY is now carrying wallpaper. Introductory offer, 10% above cost through April 15. Colonial Heights, Shopping Center. Call 752-3424.

STEREO SYSTEM (one year old). Sony STR-5000SD receiver (55 watts per channel), Sony PS-1700 automatic tuner, Bose 901 Series II speaker system, \$1200 original value. Call 746-4430.

FURNITURE STRIPPING and refinishing. Tar Road Antiques, 758-9123.

HAMMOND M-3 organ. Leslie model #125, #710, #145. Like new. Call 749-2641 weekdays; 753-2534 nights and weekends.

ANTIQUE BEDROOM SET, \$250; living room set, \$250; large utility cabinet and miscellaneous. 758-1674.

ICE CREAM FREEZER, \$300. Call 756-0999.

FRONT-END loader and forklift. Bush hog, landscape, cut trees; yard, garden work. 752-7611.

MATCHING CHAIR and sofa by Burlington House. Excellent condition. Moving and need to sell. Call 756-4242 anytime.

BEAUTIFUL 27' Magnavox color TV. Nice wood finish. Great picture. 1958. 758-4960.

WHIRLPOOL portable, convertible, avocado, deluxe dishwasher. Cutting board top, like new. \$175. 756-4970 after 6 p.m.

AMC 1974 GREMLIN (4 cylinder, AM/FM cassette stereo, radials, great mileage per gallon). \$2000. 1959 El Camino (fire truck made). \$1500. 1977 Oldsmobile Royale (87,000 miles, loaded). \$4500. Call 756-3276 or 756-3776.

PHILCO REFRIGERATOR, used 10 months, 15 cubic feet, \$125; automatic washer, \$35; couch and chair, \$100; 1978 Buick and box springs, \$25. 756-5945.

IBM EXECUTIVE typewriter. Extra long carriage, cover and manual. Excellent condition. 758-3510.

35mm CAMERA. Yashica TL. Electro. 55mm F.1 lens. 758-3510.

UMPIRE EQUIPMENT. Complete set. Second-hand but brand new. 758-2300.

5 HP GILSON garden tiller with attachments. 756-9577 after 5.

COMBO ORGAN. Cordova model with tone in Moog synthesizer. \$995. 758-1984 after 6 p.m.

DINING ROOM suite. Dark pine. 6 chairs, china closet. \$500. 242-4814.

2 NEW BURROUGHS cash registers. 14 inch Burroughs cash registers in good condition. Call 756-2350.

SEARS REFRIGERATOR (gold, 15 cubic foot, frost-free); wedding dress (size 8-10, lace with matching veil). 756-0909.

ROYAL PORTABLE electric typewriter. \$75. 752-6243.

62 LOST AND FOUND

LOST OLDER GRAY CAT, East Third Street (near Overton's). 752-2179 after 6 p.m.

LOST MALE yellow Labrador. Reward. Call 756-1146.

100 CLASSIFIED DISPLAY

64 Mobile Homes For Rent

2 BEDROOM MOBILE HOME for rent. Furnished, washer, central air and heat. Call 752-3839.

3 BEDROOM mobile home. Air conditioned, good location. No pets. 752-3286 days; 825-5391 nights.

12 X 46, 2 bedrooms, 2 baths, washer, dryer, air. Nice large lot

**78 Houses For Sale**

**200 SQUARE FOOT HOME**, 3 bedrooms, 2 baths, living room with marble fireplace, eat-in kitchen, den. Located in convenient part of town on an enclosed wooded lot. Priced to sell, \$55,000. The Home Showcase, 752-5522; Phil Parlin, 752-0689; Bill Barbre, 752-2770.

**HARDE ACRES**, 3 bedrooms, 1 1/2 baths, family room, kitchen and dining room with all appliances on 1/2 acre. Owner, woodwork, carpeting. The Home Showcase, 752-5522; Phil Parlin, 752-0689; Bill Barbre, 752-2770.

**PERFECT STARTER HOME** or great investment. New carpet, aluminum siding, 2 bedrooms, 1 bath, living room and eat-in kitchen plus an extra lot currently producing an income. Now only \$25,500! Phil Parlin, 752-0689; Bill Barbre, 752-2770; The Home Showcase, 752-5522.

**TWO BLOCKS** from campus. This home near ECU has a most attractive 2 bedroom apartment upstairs. The interior of this home has been completely remodeled. It has a kitchen, dining room, living room, fireplace, den, 2 bedrooms and a bath. On a corner lot with a heated square feet. Call us today! The Home Showcase, 752-5522; Phil Parlin, 752-0689; Bill Barbre, 752-2770.

**UNDER CONSTRUCTION**, Fox Run, 3 bedrooms, 1 1/2 baths. Priced at \$34,900. Call Ritter & Evans, Inc. at 756-1111; David Heniford at 756-4838; Steve Evans at 756-6721; Bull Ritter at 756-6000.

**ANTIQUE BRICK** fireplace, brick patio, barbecue grill, fenced-in backyard for the kids and pets and lots of home to live in. 2 years old. \$34,500. Call Ritter & Evans, Inc. at 756-1111; David Heniford at 756-4838; Steve Evans at 756-6000 or Steve Evans at 756-6721.

**FOR SALE BY OWNER**

Brick home. Located 5 miles east of Greenville on wooded lot. Has fireplace, central air, electric heat, central vacuum, dishwasher, trash compactor, 2 baths, 3 bedrooms, 4 years old.

Call 752-6947  
NO REALTORS PLEASE

**BY OWNER**, 1400 square foot home, 3 miles east of Greenville. Central air, electric heat, lots of extras. Call 752-6947 after 6.

**COUNTRY**

It's new, south of Greenville behind Pitt Tech with about 1300 square feet, 3 bedrooms and 2 full baths. Builder pays points for VA, FHA, Low \$40's.

**COUNTRY**

South of Greenville near Ayden. This 2 bedroom ranch should catch your eye at \$25,200. Separate utility room, attic storage, 1/2 acre lot and carport.

**NEW OFFERING**

Belvedere, 3 1/2 lots, low assumption, \$6700 equity required. Immaculate 3 bedroom ranch on Woodstock Drive. Owner is moving soon and would like to close as soon as possible. Payments under FHA 245 plan in 1st year. Call today. It won't last long.

**WINTERVILLE**

Catch this one under construction and select your decor, \$35,500 regular FHA points paid by builder. Three bedroom ranch with 1 1/2 baths. Brick veneer construction. Call today.

**CLARK-BRANCH, INC.**

**REALTORS**

Connally Branch 756-1549  
Glo Clark 756-0046  
Coleette Dilworth 756-8380  
Sharon Lewis 756-9987

**An Equal Housing Opportunity**

**100 CLASSIFIED DISPLAY**

**BEGINNING AND ADVANCED**

**STAINED GLASS CLASSES**

Starting Soon

**CONTACT SKIP WHITE**

**Mixed Media**

758-2127

**78 Houses For Sale**

**BY BUILDER**, 2 new homes in Grifton. Large family rooms with fireplaces, wooded lots, heat pumps, deck, 1350 to 1400 square feet. High 20's to low 40's. \$24-5274.

**BRICK RANCH** home with carport and garage. Huge great room with fireplace, fenced yard, \$43,900. Call Louise Hodge, Realtor, at Aldridge & Southerland Realty, 756-3500; nights, 756-5005.

**LOT 8, GRIMESLAND**, 3 bedroom, 1 1/2 bath ranch. Reduced to \$32,500. We pay points and closing costs. Aldridge & Southerland Realty, 756-3500.

**101 PINEWOOD ROAD**, 4 bedrooms, 3 baths, central air, family room with fireplace, corner wooded lot. Bill Williams Real Estate, 752-2615.

**CLUB PINES**. You will love this stylish Freire Provincial home on pretty wooded lot, 3 bedrooms, 2 baths, 2 car garage plus many extras. \$44,900. Call Louise Hodge at Aldridge & Southerland Realty, 756-3500 or nights, 756-5005 for appointment.

**BY OWNER IN GRIFTON**, \$4200 and assume payments. Call 524-5289 anytime.

**GREEN FARMS**, 3 bedrooms, 1 1/2 baths, living room, kitchen/dining combination, sliding glass doors lead to patio, \$34,500. The Home Showcase, 752-5522; Phil Parlin, 752-0689; Bill Barbre, 756-2770.

**FARMVILLE**. Great neighborhood, great yard, great family room with fireplace (22 x 17), 3 bedrooms, 1 1/2 baths, 1700 square feet. Mid 40's. The Home Showcase, 752-5522; Phil Parlin, 752-0689; Bill Barbre, 756-2770.

**STANTONS ROAD**

Home prices got you down? \$22,000 buys this 1500 square foot mobile home, double garage and lot located on the Stantons Hwy. Centipede lawn, walk-in closets, 2 full baths, separate 12 x 17 living room and 12 x 16 den are just a few of the features. Call Ware and get the complete package!

**TUCKER ESTATES**

Stone fireplace with great room and three good sized bedrooms. Decor has been selected and awaits your approval. Good buy in this exclusive area. 1700 square feet, \$63,000.

**CLUB PINES**

Tucked away on Amber Lane. This farm house has what you've been waiting for in convenient living. 1700 square feet plus deck and porch areas. See this home for only \$64,000.

**MEADOWBROOK**

Budget minded or rental income. This 2 bedroom charmer may fit the bill. Oil heat. Appliances and air condition negotiable. Seller pays points for FHA. Freshly painted and waiting for an owner with low monthly payments in mind. \$17,950. CLARK-BRANCH, INC.

**REALTORS**

Connally Branch 756-1549  
Glo Clark 756-0046  
Coleette Dilworth 756-8380  
Sharon Lewis 756-9987

**An Equal Housing Opportunity**

**BY OWNER**, Brick home on approximately one acre. Call 756-5097 after 6 p.m.

**BY OWNER** in Belvedere, 3 bedrooms, living and dining room, den, 2 baths, 2 car garage. Corner lot. Private yard. High 50's. 757-7341 days, 756-1111 nights.

**GRACIOUS LIVING** with formal rooms plus den, 2 baths, fully landscaped lot, \$48,000. Charlotte Fianapa-Glenn, Hackett Realtors, 756-7986, 756-7192.

**80 Lots For Sale**

**ZONE O AND I**, Oakmont, 756-3333.

**ROOM TO ROOM**, 7 1/2 acres with 22 x 48 building, pond stocked with fish, two septic tanks and wells, 15 miles from city limits, \$22,500 or will divide in two parcels for \$11,300 each. Call Realty Company, 752-6058; nights 752-3661.

**CHAIN LINK** and split rail, 100 x 150, Quail Ridge, corner lot, 758-7449 days, 756-9725 nights.

**3.33 ACRES** near MacGregor Downs, 75% wooded. Suitable for division into two lots, \$12,000. Omni Realty, 758-6900, 756-6171 or 756-5456.

**BUSINESS LOT** in Ayden, 110' frontage, \$6000. Omni Realty, 758-6900, 756-5456, 756-6171, 756-4364, 758-3078.

**BROOK VALLEY**, Well drained 1/2 acre lot on cul-de-sac, \$15,900. Omni Realty, 758-6900, 756-5456, 756-6171, 758-3078, 756-4364.

**100 CLASSIFIED DISPLAY**

**80 Lots For Sale**

**MOBILE HOME** lots, \$4350. Omni Realty, 758-6900, 756-5456, 756-6171, 756-4364, 758-3078.

**WOODED LOT**, Nearly one acre. Area already cleared for house. Water and sewer has been run into house site. Perfect for building. \$12,500. Omni Realty, 758-6900, 756-6171, 756-5456.

**3/4 ACRE WOODED**, 6 miles from Greenville near Simpson, 2000 sq. ft. Home Showcase, 752-5522; Phil Parlin, 752-0689; Bill Barbre, 756-2770.

**VACANT LOT**, 1206 Chestnut Street. Call 1-726-4950.

**RIVER HILLS**. All remaining subdivision lots are now available for purchase or construction. All city services in county, \$8500 up. Ginger Hackett Realtors, 756-7986, 756-4665.

**82 Resort Property For Sale**

**WATERFRONT HOME** near Bath Marina, 3 bedrooms, living room, dining room, kitchen and bath. All appliances and most furniture included in the price of \$45,900. The Home Showcase, 752-5522; Phil Parlin, 752-0689; Bill Barbre, 756-2770.

**LARGE WATERFRONT**, heavily wooded lot with 50' pier and trailer on Pamlico, near Bath, \$29,800. Bennie Eastwood, Ginger Hackett Realtors, 756-7986, 756-8883.

**UNFURNISHED** oceanfront condominium for sale, owners Smugglers Cove, Atlantic Beach. This top floor condominium also has commanding view of the sound. Owner will finance 75% for 20 years at 10 1/2%. \$82,000. Linwood Mercer, Farmville, N.C., 753-3788, days, 753-4807 nights and weekends.

**84 RENTALS**

**RENT A beautiful Currier Spinnet piano** only \$22 per month, as long as you like. First 9 months rent applies toward purchase. Piano-Organ Warehouse, 730 Greenville Boulevard, 756-2032.

**86 Apartments For Rent**

**GreeneWay**

Large 2 bedroom garden apartments, carpet, drapes, dishwasher, pool. On Country Club Dr. adjacent to Greenville Country Club. 756-6869.

WE HAVE CABLE TV

**CHERRY COURT**

Luxurious 2 bedroom townhouses and 1 bedroom apartments. Carpet, drapes, compactors, washer-dryer hook ups, pool, sauna, tennis court, club house, etc. 752-1557.

**EASTBROOK AND VILLAGE GREEN APARTMENTS**

327 one, two and three bedroom garden and townhouse apartments with heat, air condition, carpet, kitchen appliances, garbidge disposal, nice laundromat facilities, 3 swimming pools, 2 tennis courts and heat and hot water furnished in some units. No pets or loud parties allowed. Rent from \$145-\$215 per month. Eastbrook — Eastbrook Drive off 264 By-pass, Village Green — 800 Heath Street off E. 10th Street Call 752-5100.

**STRATFORD ARMS APARTMENTS**

The Happy Place To Live FREE MASTER ANTENNA

Office Hours 10 a.m. to 5 p.m. Monday through Friday. Call us 24 hours a day at 756-4800

**LOVE TREES?**

Experience the unique in apartment living with nature outside your door. Quality construction, fireplaces, heat pumps (heating costs 50% less than comparable units), dishwasher, washer/dryer hook-ups, wall-to-wall carpet, thermopane windows, extra insulation.

**COURTNEY SQUARE APARTMENTS**

Arlington Blvd. 756-5067

**CARRIAGE HOUSE** Apartments, new Section 11, apartments for rent January 1. All electric; 2 bedrooms; unfurnished with cable TV. Call Manager, 756-3450.

**Kings Row Apartments**

1 and 2 bedroom garden apartments. Furnishing drapes, stove, refrigerator, dishwasher, disposal and Cable TV. Centrally located just off E. 10th Street.

Call 752-3519

**NEW APARTMENTS**, 4 new 2 bedroom townhouse apartments, all electric. Contact Bill Williams Real Estate, 752-2615.

**2 BEDROOM** apartment with washer and dryer hookups, cable TV, fully carpeted. Near university. 752-0180, 756-2766.

**100 CLASSIFIED DISPLAY**

**86 Apartments For Rent**

**2 BEDROOM DUPLEX**, near downtown and ECU. Carpet, central heat and air. Call 752-7101 9 to 5.

**REDWOOD APARTMENTS**, 802 East Third Street. One bedroom, furnished apartment. Heat, air condition, hot and cold water furnished. No pets. Call 756-0889.

**NEW DUPLEX APARTMENTS IN COLONIAL VILLAGE**

Two carpeted bedrooms, large carpeted living room, kitchen with dining area and plenty of cabinets. Appliances furnished. Brick veneer construction fully insulated. Heat pump. Across from Burroughs-Wellcome near school. \$200 per month. Call 758-3558

**AZALEA GARDENS**

Greenville's newest and most unique furnished one bedroom apartments.

- \* All electric energy efficient designed
- \* Queen size beds and studio couches
- \* Washers and Dryers optional
- \* Free water and sewer and yard maintenance
- \* All apartments on ground floor with porches
- \* Frost free refrigerators

Located in Azalea Gardens near Brook Valley Country Club. Shown by appointment only. Couples or singles - no pets. \$175 per month.

Contact J. T. or Tommy Williams 756-7815

**FOREST VILLAGE APARTMENTS**

In Farmville 13 Miles from Greenville

- 1 Bedroom from \$128
- 2 Bedroom from \$140
- 3 Bedroom from \$160

Water Included

ENERGY EFFICIENT HEAT & AIR

Carpeting, range, refrigerator, disposal, central heat pump, Smith Walking Distance to Shopping

753-3026

Off Highway 264 Across From Monk

**GEORGETOWN APARTMENTS**, 2 bedroom townhouses for rent. 752-7101, days; 758-1188 nights.

**NEW APARTMENTS**, 4 new 2 bedroom townhouse apartments. All electric. Contact Bill Williams Real Estate, 752-2615.

**OKMONT SQUARE APARTMENTS**

Two bedroom townhouse apartments, 1212 Redbanks Rd. Dishwasher, refrigerator, range, disposal included. We also have Cable TV. Very convenient to Pitt Plaza and University. Also some furnished apartments available.

756-4151

**NEW 1 AND 2 BEDROOM** carpeted apartments. Heat and air by economical heat pump. Smith Insurance and Realty, 752-2754.

**DUPLEX AVAILABLE** April 15. The Woods, 2 bedrooms, \$265 month; with fireplace, \$285 month. New and tastefully decorated. No pets. 756-6091.

**DUPLEX**, 5209A East Third, 3 bedrooms, central air, Close to Wahl-Coates, washer/dryer hookups, yard, large attic. Utilities not included. Monthly preferred. \$210. 758-0502, 5-8 p.m.

**2 BEDROOM DUPLEX**, 300 Lewis Street. Central heat and air. Appliances. Couples only. No pets. \$175. April; 752-3282.

**100 CLASSIFIED DISPLAY**

**WE REPAIR SCREEN & DOORS**

**C.L. LUPTON CO.**

**Bryton Hill**

All new Spacious 1 & 2 Bedrooms, Wood Deck or Patio, Heat Pumps - AC Laundry Room in each building From \$185

Left off 10th Street beyond River Gate Mall onto River Bluff Road

**Simmons & Harris** PROFESSIONAL MANAGEMENT 215 Commerce Street 756-0331

**You might like real challenge.**

Some people don't. But we've got plenty for those who do. In Construction, Law Enforcement, Electronics, Medicine. Or even in the sky. All you have to do is qualify for training. We'll provide all the challenge you want. Join the people who've joined the Army.

Call Army Opportunities

**Sgt Marlon Haddock** At 752-4826

**100 CLASSIFIED DISPLAY**

**100 CLASSIFIED DISPLAY**

**100 CLASSIFIED DISPLAY**

**100 CLASSIFIED DISPLAY**

**100 CLASSIFIED DISPLAY**

**100 CLASSIFIED DISPLAY**

**100 CLASSIFIED DISPLAY**

**100 CLASSIFIED DISPLAY**

**100 CLASSIFIED DISPLAY**

**100 CLASSIFIED DISPLAY**

**100 CLASSIFIED DISPLAY**

**100 CLASSIFIED DISPLAY**

**100 CLASSIFIED DISPLAY**

**100 CLASSIFIED DISPLAY**

**100 CLASSIFIED DISPLAY**

**100 CLASSIFIED DISPLAY**

**100 CLASSIFIED DISPLAY**

**100 CLASSIFIED DISPLAY**

**100 CLASSIFIED DISPLAY**

**100 CLASSIFIED DISPLAY**

**100 CLASSIFIED DISPLAY**

**100 CLASSIFIED DISPLAY**

**100 CLASSIFIED DISPLAY**

**100 CLASSIFIED DISPLAY**

**100 CLASSIFIED DISPLAY**

**100 CLASSIFIED DISPLAY**

**100 CLASSIFIED DISPLAY**

**100 CLASSIFIED DISPLAY**

**100 CLASSIFIED DISPLAY**

**100 CLASSIFIED DISPLAY**

**100 CLASSIFIED DISPLAY**

**100 CLASSIFIED DISPLAY**

**100 CLASSIFIED DISPLAY**

**100 CLASSIFIED DISPLAY**

**100 CLASSIFIED DISPLAY**

**100 CLASSIFIED DISPLAY**

**100 CLASSIFIED DISPLAY**

**100 CLASSIFIED DISPLAY**

**100 CLASSIFIED DISPLAY**

**100 CLASSIFIED DISPLAY**

**100 CLASSIFIED DISPLAY**

**100 CLASSIFIED DISPLAY**

**100 CLASSIFIED DISPLAY**

**100 CLASSIFIED DISPLAY**

**100 CLASSIFIED DISPLAY**

**100 CLASSIFIED DISPLAY**

**100 CLASSIFIED DISPLAY**

**100 CLASSIFIED DISPLAY**

**100 CLASSIFIED DISPLAY**

**100 CLASSIFIED DISPLAY**

**100 CLASSIFIED DISPLAY**

**100 CLASSIFIED DISPLAY**

**100 CLASSIFIED DISPLAY**

**100 CLASSIFIED DISPLAY**

**86 Apartments For Rent**

**TAR RIVER ESTATES**

1401 Willow Street 752-4225

1,2, and 3 bedrooms, washer-dryer hook-ups, cablevision, pool, club house. Only 5 blocks from East Carolina University.

Check everywhere else first

**Ultimate In Apartment Living**

**DUPLEXES** in Colonial Village, across NC 11 from Burroughs Wellcome. Brand new, two bedrooms, patio, lawn, air conditioning. \$200. Call J. L. Harris & Sons, Realtors, 758-4711.

**NICE, 2 BEDROOM**, unfurnished apartment available for sublease, beginning May 1, 758-7729.

**ONE BEDROOM APARTMENT**, Utilities included. Near university. \$145 per month. Must take on four month lease. Call 756-3734.

**RENTERS INSURANCE**

Call: Earl Thompson 3101 S. Evans Street Across From Union Carbide Phone 756-3422

State Farm Fire & Casualty Company

**CARPETED**, 2 bedrooms with patio. Appliances, water and sewer furnished. \$225. 756-4412 after 7 p.m.

**NEW DUPLEX ON Hooker Road**, 2 bedrooms, fully equipped kitchen, carpet, central heat and air, deck off living room. Call 756-3666.

**3 BEDROOM** apartment available April 1. Unfurnished. Married couples only. 104 Stancill Drive. 756-5963.

**100 CLASSIFIED DISPLAY**

**100 CLASSIFIED DISPLAY**

**100 CLASSIFIED DISPLAY**

**100 CLASSIFIED DISPLAY**

**100 CLASSIFIED DISPLAY**

**100 CLASSIFIED DISPLAY**

**100 CLASSIFIED DISPLAY**

**100 CLASSIFIED DISPLAY**

**100 CLASSIFIED DISPLAY**

**100 CLASSIFIED DISPLAY**

**100 CLASSIFIED DISPLAY**

## Small Town Folks Prove Compacent

WEBSTER, N.C. (AP) — It doesn't take much to run this tiny Jackson County town. In fact, the folks in Webster are so complacent, they're just as apt to leave the voting at election time up to those who are running for office.

"We can't hardly get anybody to come out and vote for us," said Alderman Claude Cowan. "If we didn't vote for each other we wouldn't have a board."

Running the town of Webster is an uncomplicated task for the mayor and five aldermen. The board meets "whenever the notion strikes us," one alderman said, which averages three or four times a year.

The town government is conducted in much the same way that Webster residents live their lives — quietly, peacefully and leisurely. According to the Institute of Government in Chapel Hill, Webster is probably the smallest active, incorporated town in western North Carolina with a population hovering around 180, not counting pets.

"If we counted all the dogs in the population, we'd have a good-sized town," Mayor Jim Simpson joked.

Because there are no city taxes, the aldermen only have to oversee the town's street lights and water. Residents pay a flat rate of \$3 per month for water, which comes from one well.

Because there is no town hall, the board meets in Simpson's home or in former mayor Roy Baker's upholstery shop next door. It is the only retail business in town.

The town has only three streets within its two square-mile radius: Main Street (N.C. 116), Cemetery Road and a residential street no one ever got around to naming.

The crime rate in the quiet town is zero, which is fortunate, since there is no police department. There is no fire department either. In fact, there is no town payroll. The town's operating funds come from revenue-sharing money.

And despite the fact that the surrounding area, including neighboring Sylva and Western Carolina University, is growing, Webster residents aren't worried their tranquil town will be upset by development. They put an end to their worries in 1974 by approving an ordinance prohibiting the use of land for any purpose other than residential.

Life in Webster wasn't always so slow and peaceful.

From 1853 to 1913, Webster was the Jackson County seat with a population of 1,000 at the turn of the century. It was a bustling place with shops, a bank, the county courthouse and what is believed to be the first sidewalks in Jackson County.

But the activity ended one day in 1910 when a fire leveled most of the buildings in town. The killing blow fell in 1913 when a railroad track was laid to Sylva instead of Webster, and businesses left to follow the railroad ties.

No one seems to mourn for the Webster of the past. The aldermen said they remain in the community for the peace, satisfaction and close fellowship that a small town provides.

"I've lived here for 35 years and we've been like one big family," Cowan said.

## Expert Will Be Featured

ECU News Bureau "The African Horn: Realities and Future Prospects" is the topic of this year's African-Asian Symposium at East Carolina University. The event is scheduled for March 22-23.

Featured speaker is Dr. Abraham Demoz, director of African studies at North western University, an internationally known expert on Ethiopia. His presentation will begin at 10 a.m. Friday in Brewster Building, C-103, and will be followed by a panel discussion by Dr. Ralph Birchard of the ECU geography faculty, Dr. Avatar Singh of the sociology faculty and Dr. Robert Bunker of the anthropology faculty.

Drs. Bunker and Singh will present a slide lecture, "Perspectives on Africa and Japan" at 7:30 p.m. Thursday, March 22, at the Greenville Woman's Club Building.

Both events are free and open to the public.

The symposium is sponsored by the ECU African and Asian Studies Committee, with support from the South Atlantic States Association for Asian and African Studies.

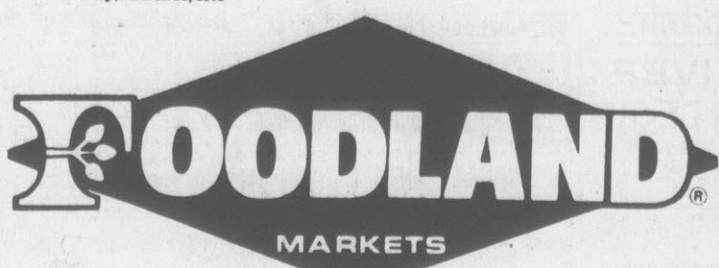

MEMBER OF THE FOODLAND SYSTEM

"THOSE FOODLAND BOYS HAVE THAT OLD FASHIONED SERVICE AND EVERYDAY LOW PRICES." "SHOP FOODLAND TODAY" "THAT'S THE FOODLAND WAY."

U.S.D.A. Inspected  
**FRYERS**  
WHOLE **45¢**  
LIMIT 4 PLEASE  
LB.



SMITHFIELD SLICED FRESH PORK  
**LIVER** LB. **39¢**

BONELESS  
**RUMP ROAST** LB. **\$1.99**

**EYE OF ROUND** LB. **\$2.19**

FRESH  
**GREEN BEANS** LB. **49¢**



PEANUT CITY  
**COUNTRY HAMS**  
Sliced Free  
LB. **\$1.49**

GOLDEN RIPE  
**BANANAS** LB. **19¢**

FRESH FLORIDA  
**ORANGES** 5 LB. BAG **99¢**

FRESH CRISP  
**CELERY** STALK **29¢**  
FOODLAND WHITE  
**BREAD** 3/\$1.09  
1½ LB. LONG LOAVES

DEL MONTE SLICED OR HALVES  
**PEACHES** 2½ CAN **59¢**  
SAVE 10¢

SUPERFINE  
CUT GREEN BEANS, GOLDEN WK CORN, OR MIXED VEGETABLES **\$1.00**  
4 303 CANS SAVE 8¢

**WESSON OIL** 48 OZ. BOTTLE **\$1.89**  
SAVE 26¢

WHITE, PINK/GREEN, YELLOW/BLUE  
**CHARMIN** TOILET TISSUE 4 ROLL PKG. **79¢**  
SAVE 18¢  
LIMIT 2 WITH 7.50 FOOD ORDER

**KRAFT ORANGE JUICE** HALF GAL. **99¢**  
LIMIT 1 WITH 7.50 FOOD ORDER

HUNT'S **TOMATO PASTE** 3 6 Oz. Cans **\$1.00** SAVE 2¢  
HUNT'S **TOMATO SAUCE** 3 15 Oz. Cans **\$1.00** SAVE 16¢

MORTON-PLAIN OR IODIZED **SALT** 5 26 Oz. Boxes **\$1.09** SAVE 5¢  
FOODLAND **EVAPORATED MILK** 3 Tall Cans **\$1.09** SAVE 3¢

**COLD POWER** DETERGENT 15¢ OFF 49 OZ. BOX **\$1.19** SAVE 31¢

**KRAFT VELVEETA CHEESE** 2 LB. BOX **\$2.99** SAVE 20¢

**LIPTON TEA BAGS** 24 Ct Box **\$1.29**  
**DREAM WHIP** 6 Oz. Box **\$1.19** SAVE 18¢

SAVE 6¢  
**SUPERFINE ALL GREEN LIMAS** 303 Can **39¢**  
**STERNO FIRE LOGS** 3 Hour **99¢**

20¢ OFF  
**PALMOLIVE** LIQUID DETERGENT 32 OZ. BOTTLE **\$1.19** SAVE 10¢

FRANCO AMERICAN  
**SPAGHETTI** 15 OZ. CANS **4/\$1.00** SAVE 5¢

**CRUNCH N' MUNCH** 7 Oz. Box **59¢**  
**CHEF BOY-AR-DEE BEEF RAVIOLI** 15½ Oz. Can **59¢**

**NABISCO HONEY GRAHAMS** 1 Lb. Box **79¢**  
**NABISCO BAG SNACKS** Your Choice **69¢**  
CHIPSTERS, DIGGERS, FLINGS, KORKERS, & NACHO'S

**IRISH SPRING** SOAP 25¢ PP REG. SIZE BAR **25¢** EVERYDAY LOW PRICE

**PEPSI** 8 16 OZ. BOTTLES **\$1.29** PLUS DEPOSIT

**OLD SOUTH ORANGE JUICE** 12 Oz. Can **69¢** SAVE 10¢  
**WINTER GARDEN COCONUT** 12 Oz. Pkg. **89¢** EVERYDAY LOW PRICE

**FROZEN FOODS: COOL WHIP** 9 Oz. Ctr **69¢** SAVE 10¢  
**DULANY TINY GREEN LIMAS** 10 Oz. Pkg. **59¢** EVERYDAY LOW PRICE

**PAMPERS** 2 24 CT. BOXES **\$4.99** SAVE 40¢ ON EACH BOX

**MAXWELL HOUSE COFFEE** 1 LB. BAG **\$1.99** EVERYDAY LOW PRICE  
**INSTANT COFFEE** 6 OZ. JAR **\$2.79** EVERYDAY LOW PRICE

**SARA LEE POUND CAKE** 10¼ Oz. Box **\$1.19** SAVE 16¢

**BANQUET** - SAVE 40¢  
Chicken & Noodles, Chicken & Dumplings, Salisbury Steak, Spaghetti & Meatballs, Beef Stew, Or Sliced Turkey **\$1.29** 2 Lb. Pkg.

**SPAIN'S** 1414 Charles Blvd.

Store Hours  
Mon.-Thurs. 8 A.M. To 8 P.M.  
Fri. & Sat. 8 A.M. To 8:30 P.M.  
Closed Sundays



Store Hours  
Mon.-Sat. 8:30 A.M. To 9 P.M.  
Open Sunday 12:30 P.M. - 4:00 P.M.

**SHOP-EZE** West End Shopping Center

# money-saving food prices!

PRICES EFFECTIVE-GROCERY AND PRODUCE-MARCH 22 THRU MARCH 28, 1979

MEATS-MARCH 22, 23, 24

QUANTITY RIGHTS RESERVED-NONE SOLD TO DEALERS

HEAVY WESTERN STEER FRESH, LEAN

**GROUND BEEF** **\$1.39** LB.

GWALTNEY SLICED **BACON** **\$1.19** 1 LB. PKG.

GWALTNEY **FRANKS** **99¢** 12 OZ. PKG.

HEAVY WESTERN STEER

**ROUND STEAK** FULL CUT **\$1.79** LB.



HEAVY WESTERN STEER BONELESS **TOP ROUND** LB. **\$1.99** CUBED.....LB. **\$2.19**

HEAVY WESTERN STEER **SIRLOIN TIP ROAST** BONELESS LB. **\$1.89**

HEAVY WESTERN STEER **ROUND ROAST** BONELESS LB. **\$1.79**

FRESH **GREEN BEANS** LB. **49¢**

GOLDEN RIPE **BANANAS** LB. **19¢**

FRESH FLORIDA **ORANGES** 5 LB. BAG **99¢**

FRESH CRISP **CELERY** STALK **29¢**  
FOODLAND WHITE **BREAD** 3/\$1.09  
1½ LB. LONG LOAVES

DEL MONTE SLICED OR HALVES  
**PEACHES** 2½ CAN **59¢**  
SAVE 10¢

SUPERFINE  
CUT GREEN BEANS, GOLDEN WK CORN, OR MIXED VEGETABLES **\$1.00**  
4 303 CANS SAVE 8¢

**WESSON OIL** 48 OZ. BOTTLE **\$1.89**  
SAVE 26¢

WHITE, PINK/GREEN, YELLOW/BLUE  
**CHARMIN** TOILET TISSUE 4 ROLL PKG. **79¢**  
SAVE 18¢  
LIMIT 2 WITH 7.50 FOOD ORDER

**KRAFT ORANGE JUICE** HALF GAL. **99¢**  
LIMIT 1 WITH 7.50 FOOD ORDER

HUNT'S **TOMATO PASTE** 3 6 Oz. Cans **\$1.00** SAVE 2¢  
HUNT'S **TOMATO SAUCE** 3 15 Oz. Cans **\$1.00** SAVE 16¢

MORTON-PLAIN OR IODIZED **SALT** 5 26 Oz. Boxes **\$1.09** SAVE 5¢  
FOODLAND **EVAPORATED MILK** 3 Tall Cans **\$1.09** SAVE 3¢

**COLD POWER** DETERGENT 15¢ OFF 49 OZ. BOX **\$1.19** SAVE 31¢

**KRAFT VELVEETA CHEESE** 2 LB. BOX **\$2.99** SAVE 20¢

**LIPTON TEA BAGS** 24 Ct Box **\$1.29**  
**DREAM WHIP** 6 Oz. Box **\$1.19** SAVE 18¢

SAVE 6¢  
**SUPERFINE ALL GREEN LIMAS** 303 Can **39¢**  
**STERNO FIRE LOGS** 3 Hour **99¢**

20¢ OFF  
**PALMOLIVE** LIQUID DETERGENT 32 OZ. BOTTLE **\$1.19** SAVE 10¢

FRANCO AMERICAN  
**SPAGHETTI** 15 OZ. CANS **4/\$1.00** SAVE 5¢

**CRUNCH N' MUNCH** 7 Oz. Box **59¢**  
**CHEF BOY-AR-DEE BEEF RAVIOLI** 15½ Oz. Can **59¢**

**NABISCO HONEY GRAHAMS** 1 Lb. Box **79¢**  
**NABISCO BAG SNACKS** Your Choice **69¢**  
CHIPSTERS, DIGGERS, FLINGS, KORKERS, & NACHO'S

**IRISH SPRING** SOAP 25¢ PP REG. SIZE BAR **25¢** EVERYDAY LOW PRICE

**PEPSI** 8 16 OZ. BOTTLES **\$1.29** PLUS DEPOSIT

**OLD SOUTH ORANGE JUICE** 12 Oz. Can **69¢** SAVE 10¢  
**WINTER GARDEN COCONUT** 12 Oz. Pkg. **89¢** EVERYDAY LOW PRICE

**FROZEN FOODS: COOL WHIP** 9 Oz. Ctr **69¢** SAVE 10¢  
**DULANY TINY GREEN LIMAS** 10 Oz. Pkg. **59¢** EVERYDAY LOW PRICE

**PAMPERS** 2 24 CT. BOXES **\$4.99** SAVE 40¢ ON EACH BOX

**MAXWELL HOUSE COFFEE** 1 LB. BAG **\$1.99** EVERYDAY LOW PRICE  
**INSTANT COFFEE** 6 OZ. JAR **\$2.79** EVERYDAY LOW PRICE

**SARA LEE POUND CAKE** 10¼ Oz. Box **\$1.19** SAVE 16¢

**BANQUET** - SAVE 40¢  
Chicken & Noodles, Chicken & Dumplings, Salisbury Steak, Spaghetti & Meatballs, Beef Stew, Or Sliced Turkey **\$1.29** 2 Lb. Pkg.

**DEEDS**

A. J. Speight al to Larry C. Whitlow 100.00  
 A. Louis Singleton, Sub-Tr. to Unity Inc. 5.00  
 Blount & Ball Realty Co. Inc. to William S. Brown al 1.00  
 Linda H. Cayton to Jesse Cayton Jr. al no stamps  
 William E. Dinkins to Ruby F. Dinkins no stamps  
 Elmer Bill Dixon al to John R. Jackson al 15.00  
 John B. Lewis, Com'r al to Harry J. Hastings al 32.00  
 John S. Melvin al to Tommie L. Little & Assoc. 65.00  
 C. Austin Robbins Sr. al to Norma D. R. Gibson no stamps  
 J. B. Hudson al to Wilmer A. Warren al no stamps  
 The Plad Corp. to Douglas C. Smith al 41.00  
 A. T. Venters al to Wayne D. Walls 6.00  
 David N. Worthington al to Shamrock Realty Co. of Pitt Co. 12.00  
 David N. Worthington al to Shamrock Realty Co. of Pitt Co. 8.00  
 Leroy Winstead Jr. al to Robert L. Johnson al 34.50  
 Earl Spain al to Van C. Fleming Jr. al 95.00  
 Jimmy Bright al to Samuel C. Winchester Jr. al 100.00  
 Robert J. Briley al to Yvonne B. Briley no stamps  
 Bill Clark Const. Co. Inc. to Leland F. Troutman 42.50  
 Lucille E. Fleming al to Larry J. Early Sr. no stamps  
 Robert L. Lane Jr. al to Joe's Branch FWB Church 4.00  
 Riverhills Inc. to Darrell E. Rudisell 38.00  
 Jean M. Stocks to James R. Stocks no stamps  
 Willie Austin al to T. G. Worthington no stamps  
 Eleanor C. Drawdy al to George Saad 135.00  
 The Evans Co. of Greenville to Jesse D. Roberts al 34.00  
 Howard Fulford al to Leonard Scott Peele no stamps  
 Dallas W. McPherson al to Douglas E. McPherson 22.00  
 Bill Clark Const. Co. Inc. to Paul L. Thompson al 32.00  
 J. David Duffus, Tr. to First State Bank no stamps  
 Lynndale Develop. Co. of Greenville to Stanley D. Peaden Inc. 18.50  
 Lynndale Develop. Co. of Greenville to Kenneth Neil Walker al 10.00  
 Lynndale Develop. Co. of Greenville to Robert Ingram Barnes Jr. al 12.00  
 George E. Naff al to John Paul McAleer al 52.00  
 Donnie Ray Paramore al to Robert Hill Const. Co. Inc. no stamps  
 Robert P. Pierce al to James Ward al no stamps  
 Irvin Lee Thigpen al to City of Greenville 5.50  
 F. Roosevelt Tripp al to Willie G. Murphy al 22.00  
 Tipton Builders Inc. to Sinnie T. Barrett 4.50  
 Tipton Builders Inc. to Mark A. Suggs al 5.00  
 Ed N. Warren al to Gorman W. Ledbetter Jr. 13.50  
 Ola Dale Lee Wilson al to George W. Huntley al 14.00  
 Linwood O. Casper al to Cathy Skinner Casper no stamps  
 W. W. Carson al to David T. Massenburg 5.00  
 William H. Clark al to the Evans Co. of Greenville Inc. 4.50  
 Charles R. Flanagan to Cordelia M. Bates 43.50  
 Robert Hill Const. Co. Inc. to Donald H. Willoughby al 4.00  
 Pitt Co. Tobacco Com. to A. C. Monk, Jr. al 29.00  
 Vicky Mae Shoffner to Warren A. McAllister 21.00  
 W. Douglas Starr Jr. al to Timothy W. G. Smith 4.50  
 Bobby Sutton al to Charlie J. Dixon no stamps  
 Plummer A. Taylor Jr. al to Charles W. Kesler al 38.00  
 Benjamin T. Webb al to Bill Clark Const. Co. Inc. 3.50  
 Mary T. Williamson to Patrick A. Thomas al 28.50  
 Manuel M. Chaknis al to Louise E. Jordan 31.00

Announcing Our  
**Grand Opening**  
 5th  
**BIG  
 WEEK**

**IN RIVERGATE SHOPPING CENTER**  
 AT THE INTERSECTION OF HWY. 264 & 264-A GREENVILLE, N.C.



**Come In And Shop One Of This Area's Most Modern Food Stores!**

**STORE HOURS:**  
 Open 8 A.M.-10 P.M.  
 Monday Thru Saturday  
 10 A.M.-7 P.M. Sundays



Our New Rivergate Store  
 Features A Complete  
 Delicatessen & Bakery For  
 Your Shopping Convenience.

12 OZ. CANS  
**PABST BLUE RIBBON  
 BEER**  
 Ctn. \$ **3<sup>49</sup>**  
 Of 12

2 LITRE  
**PEPSI COLA**  
 Ea. **69**  
 Limit 2 Please

**HOLLY FARMS MIXED  
 FRYER PARTS**  
 LB. **49<sup>c</sup>**

**SUPERBRAND  
 MARGARINE**  
 4 1 Lb. \$ **1<sup>00</sup>**  
 Ctns.  
 With \$7.50 Or More  
 Order. Limit 4

Above Items Good Thru Wed., March 28th In Both Greenville Stores

**The Smart Place To Go For Good Things To Eat!**

Below Items Good Thru Wed., March 28th. In New Store Only

**THRIFTY MAID  
 PORK -N-  
 BEANS**  
 16 Oz. Can  
**FREE**  
 BUY ONE  
 & GET ONE  
 Limit 1 Free

12 Oz. Box  
**CORN CHEX  
 CEREAL**  
**FREE**  
 BUY ONE  
 & GET ONE  
 Limit 1 Free

**Two Inventions  
 Played Big Role**

WASHINGTON (AP) — Two inventions patented in November helped create new industries that employed hundreds of men and women, according to a study by Intellectual Property Owners, Inc. (IPO), a non-profit group dedicated to preserving the patent system as an incentive to innovation and creativity.  
 The first clock factory in the nation was founded in 1800 when Eli Terry switched from making hand-crafted clocks to mass production by using water power to drive his machines. This method helped him turn out 10 to 20 clocks at a time.  
 Some 100 years later, on Nov. 11, 1930, Nobel physicist Albert Einstein and Leo Szilard obtained a patent for producing refrigeration. This led to the first gas refrigeration system produced in the United States.

## Sees Touchy Period For Polish Role

By GEORGE W. CORNELL  
AP Religion Writer  
NEW YORK (AP) — The U.S. ambassador to Poland, William E. Schaefe Jr., says the fact that Pope John Paul II is from Poland indicates a strengthening of the church's position in that Communist country.

But he adds the situation also makes for a time of touchy readjustments.

"The struggle of the Polish church will continue but the presence of a Polish pope is more strengthening than usual," he told a meeting of the Council on Religion and International Affairs.

"Church and state are going to have to find some kind of changed modus vivendi. Very possibly, there will be some concessions to the church, although they may be begrudging. But the church still will have to cope with the realities of Poland's policies and its geographic position (adjoining Russia)."

Schaefe offered the analysis in a two-hour discussion with theologians, foreign affairs experts and church leaders.

He noted that Polish Communist Party Secretary Edward Gierek has met with the pope, and that the pope has life-long, first-hand knowledge in dealing with Communist officials and in church resistance to atheism.

The church has several principal demands, he said, including:

—Some kind of legal status, which all churches in Poland now lack.

—Some church access to the media. Polish radio and television are state controlled and the first time any church service was allowed on the air was at the installation of the new pope.

—Availability to the church of paper and printing materials so it can put out its own literature.

—Agreement from the state not to draft seminary students, giving them exemptions — now denied — parallel to those given students in state universities.

In regard to the pope's coming visit to Poland, Schaefe observed that "certain brinkmanship" had gone on in the negotiations, eventuating in a compromise.

The pope had wanted to go in mid-May on the 900th anniversary of the martyrdom of the nation's patron saint, St. Stanislaus, whom legend says was beheaded for challenging the authority of the king.

"The symbolism of that is not lost on anybody in Poland today," Schaefe said. "Poles think of it as a challenge to secular authority, which accounts for the government's resistance to that particular visit."

He added, "I'm sure the pope will not remain silent about St. Stanislaus even if it comes late."

Noting that the Polish church involves 95 percent of the people, has always been at the forefront of Polish nationalism and has fought vigorously to retain its prerogatives, Schaefe added:

"The church is not about to disappear. It cuts across a complete cross-section of the people, old and young, workers and intellectuals. Communist party officials take their children to the back door to be baptized. They just don't go to church themselves."

## Commuting On A 'Brain Train'

SWINDON, England (AP) — The train speeding toward London is teaching Spanish, French, German and economics to commuters every weekday morning.

The new "Brain Train" special, one of several operated by Britain's national railway, helps travelers pass the time usefully and pleasantly.

Passengers can join a special coaching car where three instructors hold classes.

## Rediscovered

### 'Extinct' Fish Is

SUVA, Fiji (AP) — A species of commercial fish previously believed to be extinct in Fijian waters has been rediscovered.

The bech-de-mer, also known as the plum flower fish, used to be sold at high prices in Southeast Asia.

Biologist Mark Gentle said he had found dense beds of the species on reefs near Suva.



• PRICES GOOD THRU SAT., MARCH 24TH  
• NONE TO DEALERS • WE RESERVE THE RIGHT TO LIMIT QUANTITIES

## FREE APPLIANCES

HURRY! COMPLETE YOUR REGISTER TAPES FOR FREE APPLIANCES.

OFFER EXPIRES MARCH 28TH!

### BEST BUYS IN OUR PRODUCE DEPT.

FRESH JUICY FLORIDA

- ORANGES
- GRAPEFRUIT (WHITE OR PINK)

5-LB. BAG **99¢**

### HARVEST FRESH

LARGE BUNCH BROCCOLI OR LARGE HEAD CAULIFLOWER EA. **69¢**

WESTERN RED OR GOLDEN DELICIOUS APPLES 1-B. 49¢ (REDS LOOSE) 6 FOR 99¢

U.S. #1 IDAHO BAKING POTATOES 15-LB. BAG \$1.79

HARVEST FRESH CRISP CARROTS 2-LB. BAG 49¢

HARVEST FRESH JUMBO CELERY 2 STALKS \$1.00

RUSKIN'S FRENCH SLAW OR COLE SLAW 5-OZ. BAG 39¢

U.S. #1 YELLOW ONIONS 2-LB. BAG 59¢

HARVEST FRESH ICEBERG LETTUCE HEAD 59¢

### BEST BUYS IN FROZEN FOODS

YOU SAVE 20¢ ON THRIFTY MAID

ICE MILK (ALL FLAVORS) HALF-GAL. CTN. **79¢**

YOU SAVE 40¢ ON KOUNTRY FRESH

ALL-NATURAL PRESTIGE ICE CREAM HALF-GAL. CTN. **\$1.59**

TASTE-O-SEA FISH STICKS 1-LB. PKG. \$1.19

TASTE-O-SEA BATTER DIPPED FISH FILLETS 12-OZ. PKG. \$1.19

TASTE-O-SEA BATTER DIPPED FISH & CHIPS 1-LB. PKG. 99¢

ONE IDA TATER TOTS 2-LB. PKG. 89¢

SUPERBRAND SUPER WHIP TOPPING 2 9-OZ. CUPS \$1.00

DELANA CUT OR WHOLE OKRA 2 10-OZ. PKGS. 89¢

### BEST BUYS IN OUR DAIRY DEPT.

PALMETTO FARM PIMENTO CHEESE 1-LB. CTN. **\$1.19**

YOU SAVE 20¢

SUPERBRAND COTTAGE CHEESE 1-LB. CUP 79¢ 2-LB. CUP \$1.39

MRS. FILLBERT'S MARGARINE 2 1-LB. CTNS. \$1.00

SUPERBRAND SWISS-STYLE YOGURT 4 8-OZ. CUPS \$1.00

SUPERBRAND SOUR CREAM 1-LB. CUP 69¢

SUPERBRAND SLICED CHEESE SPREAD 12-OZ. PKG. \$1.19

# THE BEEF PEOPLE

## part of a great tradition.



YOU SAVE UP TO \$1.28

- ASTOR FRUIT COCKTAIL
- THRIFTY MAID BARTLETT PEARS
- THRIFTY MAID PEACHES

**6** \$ **1.99**

16-OZ. CANS

WITH \$7.50 OR MORE ORDER (LIMIT 6 OF CHOICE)

YOU SAVE 50¢

ASTOR COFFEE

**179**

1-LB. CAN

WITH \$7.50 OR MORE ORDER (LIMIT ONE)

BUMBLE BEE CHUNK LIGHT TUNA 6½-OZ. CAN 65¢

YOU SAVE 6¢

DAWN LIQUID DISH DETERGENT

**119**

32-OZ. BTL.

YOU SAVE 20¢

THRIFTY MAID SUGAR

**89**

5-LB. BAG

WITH \$7.50 OR MORE ORDER (LIMIT ONE)

THRIFTY MAID LONG GRAIN RICE 5-LB. BAG \$1.39

YOU SAVE 14¢

DUKE'S MAYONNAISE

**99**

QT. JAR

BLUE BAY PINK SALMON 15½-OZ. CAN \$1.49

THRIFTY MAID TOMATOES OR CUT GREEN BEANS

**2 88**

28-OZ. CANS

AUNT JEMIMA COMPLETE PANCAKE MIX 32-OZ. BOX 83¢

CORONET 2-PLY BATHROOM TISSUE

**159**

8-ROLL PKG.

SOUP STARTER SOUP MIX 6-OZ. SIZE 89¢

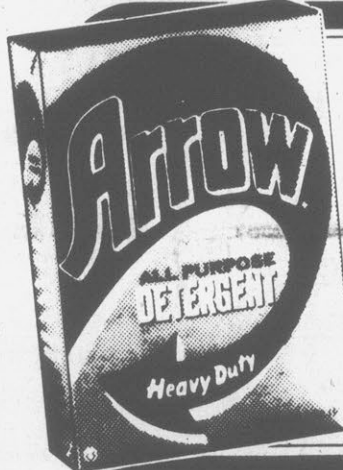

YOU SAVE 50¢

KING SIZE ARROW DETERGENT

**159**

- BLUE
  - COLDWATER
- 84-OZ. BOX
- WITH \$7.50 OR MORE ORDER (LIMIT ONE)

YOU SAVE 10¢

THRIFTY MAID ORANGE JUICE

**79**

46-OZ. CAN

FOLGER'S COFFEE

- FLAKE 26-OZ. CAN \$4.99
- FLAKE 13-OZ. BAG \$2.09
- FLAKE 13-OZ. CAN \$2.25
- 1-LB. CAN \$2.59

HUNT'S

- KETCHUP 32-OZ. BTL. 89¢
- SAUCE 2 15-OZ. CANS 88¢
- TOMATO PASTE 3 6-OZ. CANS \$1.00
- TOMATO PUREE 3 10½-OZ. CANS \$1.00
- CORN 30-OZ. JAR \$1.59

THRIFTY MAID LUNCHEON MEAT 12-OZ. CAN 99¢

THRIFTY MAID EVAPORATED MILK 3 12-OZ. CANS \$1.09

TASTER'S CHOICE FREEZE-DRIED COFFEE

**479**

8-OZ. JAR

- ASTOR SMALL PEAS 3 17-OZ. CANS \$1.09
- THRIFTY MAID & GREEN LIMAS 3 16-OZ. CANS \$1.09

JERGEN'S LOTION

**99**

10-OZ. BTL.

CREST TOOTH PASTE

**99**

7-OZ. TUBE

YOU SAVE 24¢

YOU SAVE 80¢

CONTAC CAPSULES

**199**

BOX OF 20

YOU SAVE 40¢

HEAD & SHOULDERS (4-OZ. TUBE • 7-OZ. LOTION) SHAMPOO

**139**

EA.

PREPARATION H OINTMENT

**189**

1-OZ. TUBE

LISTERINE

**179**

18-OZ. BTL.

**WINN DIXIE** **CLIP & SAVE!**  
**CRISCO OIL**  
 48-OZ. BTL. **\$1.79**  
 LIMIT ONE WITH COUPON & \$7.50 OR MORE ORDER. GOOD THRU SAT., MARCH 24TH

**WINN DIXIE** **CLIP & SAVE!**  
**CHEK <sup>W6</sup> COLA**  
 2-LITER (67.6-OZS.) NO DEPOSIT PLASTIC BTLs. **59¢**  
 LIMIT ONE WITH COUPON & \$7.50 OR MORE ORDER. GOOD THRU SAT., MARCH 24TH

**WINN DIXIE** **CLIP & SAVE!**  
**BRAND 100% PURE GROUND BEEF**  
 1-LB. HANDI-PAK **99¢**  
 LIMIT ONE WITH COUPON & \$7.50 OR MORE ORDER. GOOD THRU SAT., MARCH 24TH



### Three Films Favored In Oscar Race

By VERNON SCOTT  
 HOLLYWOOD (UPI) — The 51st Annual Academy Awards April 9 may boil down to a contest between Warren Beatty and the Vietnam War, according to Hollywood insiders.  
 Beatty and his "Heaven Can Wait" romantic comedy is up against two powerful dramas of the Vietnam conflict, "The Deer Hunter" and "Coming Home," for best picture of the year.

The three films are heavily favored in the race for the Oscar over the other two nominated pictures, "Midnight Express," a prison picture set in Turkey and "An Unmarried Woman," the drama of wife adjusting to life when her husband leaves home.

Beatty, like his picture, is in against heavyweights. He has been nominated for best actor, playing an athlete who dies and returns to earth in the person of a multimillionaire eccentric.

His prime opposition comes from Robert De Niro in "The Deer Hunter" as a heroic combat veteran who returns in triumph from Vietnam, and Jon Voight who plays a paraplegic victim of the Southeast Asia war.

Also in the running, but given less chance for the Oscar, are Laurence Olivier in "The Boys From Brazil" and Gary Busey in "The Buddy Holly Story."

Beatty, even if he does not win, distinguished himself as considerably more than just an actor in his film. He received a total of four nominations — acting, directing, writing and producing — an achievement equaled only by Orson Welles, who did the same thing in 1941 with "Citizen Kane."

In the race for best actress, it is Jill Clayburgh, who starred in the title role of "An Unmarried Woman," against a field of veterans, all of whom have been nominated at least four times in the past.

Ingrid Bergman, in the running for her role in Ingmar Bergman's "Autumn Sonata," has been nominated for best actress five times previously. She won Oscars in "Gaslight" (1944) and "Anastasia" (1956), and as best supporting actress, "Murder on the Orient Express" (1974).

Jane Fonda, in the running for her role as the unfaithful wife in "Coming Home," has been nominated three times in the past, winning in 1971 for her performance in "Kluge."

Ellen Burstyn was nominated for "Same Time, Next Year." A veteran of three Oscar nominations, she won the award in 1974 for "Alice Doesn't Live Here Anymore."

Geraldine Page is enjoying her sixth nominations — for "Interiors" — having three times won nominations for supporting actress and twice for best actress. She has never won an award.

The winners will be announced April 9 at the Los Angeles Music Center when the awards presentations are made with Johnny Carson as master of ceremonies on the nationally telecast program.

Nominated for best supporting actor: Bruce Dern ("Coming Home"), Richard Farnsworth ("Comes A Horseman"), John Hurt ("Midnight Express"), Christopher Walken ("The Deer Hunter"), Jack Warden ("Heaven Can Wait").

Best supporting actress nominees: Dyan Cannon ("Heaven Can Wait"), Penelope Milford ("Coming Home"), Maggie Smith ("California Suite"), Maureen Stapleton ("Interiors"), Meryl Streep ("The Deer Hunter").

### Holdup Didn't Unnerve Clerk

GRAND RAPIDS, Mich. (AP) — A man described as in his early 20s entered a Grand Rapids grocery, keeping his right hand in his pocket as if holding a gun.

"This is a holdup," he announced to a clerk, according to the police. "Open the cash register."

The 52-year-old clerk studied the man and shook his head. "No way am I going to open it up," he said.

"Do you want to die?" the man asked.

The clerk thought about it briefly and shrugged. "We all got to die some time," he said.

The man stared back at the clerk in disbelief, then grabbed a bag of potato chips, slapped a quarter on the counter and left, police said.

**YOU SAVE 30c PER LB.**  
**WHOLE SMOKED PICNICS**  
**89¢**  
 (6-8 LBS. AVG.) LB. **SLICED LB. 99c**

• PRICES GOOD THRU SAT., MARCH 24TH  
 • NONE TO DEALERS • WE RESERVE THE RIGHT TO LIMIT QUANTITIES

**EKCO INTERNATIONAL**  
*Exquisite Fine China*

**\$2.00 OFF**  
 on this week's featured item

**14" MEAT PLATTER**  
 Redeem this coupon worth \$2.00 toward the purchase of this item.  
 Regular Discount Price \$12.99  
 Coupon Savings \$2.00  
 Price (With Coupon) \$10.99

Check the Pattern of your Choice  
 Winsford  Floral Generation  
 Spring Bouquet  Golden Autumn

COUPON GOOD THRU WEDNESDAY, MARCH 28TH  
**VALUABLE DISCOUNT COUPON**

**YOU SAVE 80c PER LB.**  
 BRAND U.S. CHOICE BEEF "NATURALLY AGED"  
**SIRLOIN STEAKS**  
**\$2.49**  
 LB.

**YOU SAVE 20c PER LB.**  
**HOLLY FARMS FRYER THIGHS OR DRUMSTICKS**  
**99¢**  
 LB.  
 SUNNYLAND GOODTIMER FRANKS 12-OZ. PKG. 99c

**TASTE O'SEA**  
**SEAFOOD SPECIALS!**  
 FILLET OF PERCH LB. **1.69** (5-LB. BOX \$6.99)  
 FILLET OF TURBOT LB. **1.59** (5-LB. BOX \$6.99)  
 H&G WHITING FISH LB. **75¢** (5-LB. BOX \$3.49)

**YOU SAVE 20c PER LB.**  
**FRESH PORK BLADE**  
 • ROASTS **\$1.39**  
 LB.  
 • STEAKS **\$1.49**  
 LB.  
 GUALTHERY'S SLICED HAMWICHES 6-OZ. PKG. \$1.29

**YOU SAVE 30c**  
 BRAND REG. • THICK • BEEF SLICED  
**BOLOGNA**  
**\$1.29**  
 1-LB. PKG.  
 BRAND FRESH PORK BREAKFAST LINK SAUSAGE 12-OZ. PKG. \$1.39

**USDA**  
**YOU SAVE 40c PER LB.**  
 U.S. CHOICE BEEF WHOLE "UNTRIMMED" BONELESS  
**BOTTOM ROUNDS**  
 20-25 LBS. AVG. **\$1.69**  
 LB.  
 CUT INTO STEAKS, ROASTS & TRIMMINGS  
 VALLEYDALE FRANKS 2-LB. PKG. \$2.49

**WV D BRAND**  
**GOVERNMENT GRADED U.S. CHOICE**  
**YOU SAVE 50c PER LB.**  
 BRAND U.S. CHOICE BEEF  
**CHUCK ROASTS**  
**\$1.39**  
 LB.

**BEST BUYS IN OUR BAKERY DEPT.**  
**DIXIE DARLING <sup>W6</sup>**  
**PRESTIGE BREAD**  
**3 24-OZ. LOAVES \$1.09**

NATURAL FIBER BREAD 2 16-OZ. LOAVES 89c  
 RAISIN, PECAN OR FRUIT CINNAMON BUNS 2 11-OZ. PKGS. \$1.19  
 HALF ROUND POUND CAKES EACH 79c  
 DAINTY DINNER ROLLS 3 8-OZ. PKGS. \$1.09

**BEST BUYS IN OUR DELI DEPT.**  
**YOU SAVE 54c**  
**WHOLE (1 1/4 LB. AVG.) B.B.Q. FRYERS**  
**\$1.99**  
 EA.  
**PLATE LUNCHES**

4 OZS. MEAT LOAF OR 4 OZS. SMOKED SAUSAGE WITH 2 VEGS. & ROLL EA. **\$1.69**  
**BAKERY DEPARTMENT**  
**SUPERMAN CARTOON CAKES** EA. **\$5.99**  
 • HARD ROLLS PKG. OF 12 79c  
 • GLAZED DONUTS DOZ. **\$1.39**  
 PLEASE CALL FOR SPECIAL ORDERS:  
 Shopper's Mart Deli: 756-2956  
 Rivergate Deli: 758-6880

**YOU SAVE 30c PER LB.**  
**TALMADGE FARMS COUNTRY CURED SLICED QUARTER HAMS**  
**\$2.49**  
 LB.  
 COUNTRY CURED SIDE MEAT LB. \$1.39

**YOU SAVE 60c PER LB.**  
**LUTER'S BONELESS DUCHESS PICNICS**  
**\$2.29**  
 3-LB. AVG. LB.  
 BRAND U.S. CHOICE BEEF BONELESS SIRLOIN TIP ROASTS LB. \$2.59

**YOU SAVE 60c PER LB.**  
 BRAND U.S. CHOICE BEEF "NATURALLY AGED"  
**T-BONE STEAKS**  
**\$2.79**  
 LB.  
 BRAND U.S. CHOICE BEEF BONELESS SIRLOIN TIP STEAKS LB. \$2.69

**SUMMER'S EVE**  
**DOUCHE**  
**\$1.09**  
 9-OZ. SIZE

**YOU SAVE 36c**  
**CHILDREN'S LIQUID TYLENOL**  
**99¢**  
 2-OZ. BTL.

**YOU SAVE 50c**  
**TARNOFF SILVER CLEANER**  
**\$1.79**  
 8-OZ. SIZE

**YOU SAVE 40c**  
**SURE ROLL-ON DEODORANT**  
**\$1.49**  
 2.5-OZ. SIZE

**YOU SAVE 20c**  
**FABERGE' AQUA NET HAIR SPRAY**  
**79¢**  
 10-OZ. CAN

• GRAVY TRAIN DOG FOOD 25-LB. BAG \$5.79  
 • WELCH'S TOMATO JUICE 32-OZ. BTL. 59c  
 • NEW FREEDOM MAXI PADS BOX OF 30 \$1.69  
 • NEW FREEDOM MINI PADS BOX OF 30 \$1.69  
 • KLEENEX FACIAL TISSUE 240-CT. BOX 89c  
 • JIM DANDY DOG RATION 25-LB. BAG \$5.29  
 • MINUTE RICE 14-OZ. BOX 69c • WINDIX 30-OZ. BTL. 63c  
 • DRANO 32-OZ. BTL. 93c • NEW FREEDOM OF 30 \$2.39  
 • ARMOUR'S VIENNA SAUSAGE 2 E-CAN CASE \$1.00

# BIGGER, BETTER FOOD BUYS

That's what you get each time you shop Overton's. Everyday low prices on over 300 food items plus clip the coupon specials and deep-cut advertised specials. No stamps, no games, no gimmicks, no thrills, just our promise to save you money wherever possible. We put money we would have spent on games, etc. back in your pocket, that way everybody wins. PS...The extra clean store, the friendly personnel and the number one service is all free of charge. Come see why more and more people start shopping Overton's everyday—the supermarket with personal service.

## T-BONE-SIRLOIN STEAK

MORRELL PRIDE

## Grade "A" FRYERS Whole

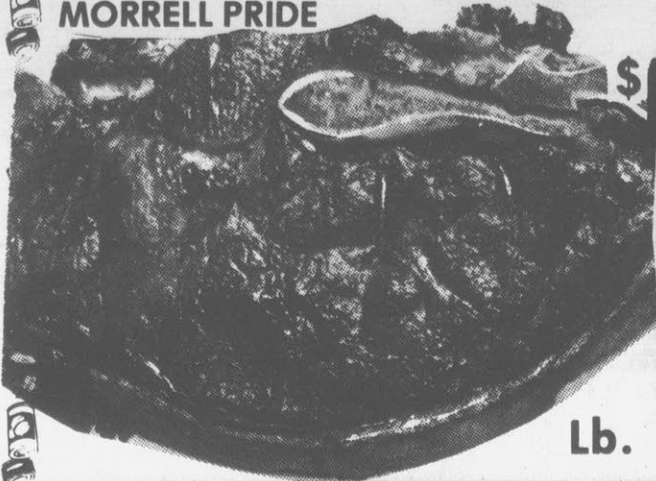

Lb.

# 1.99

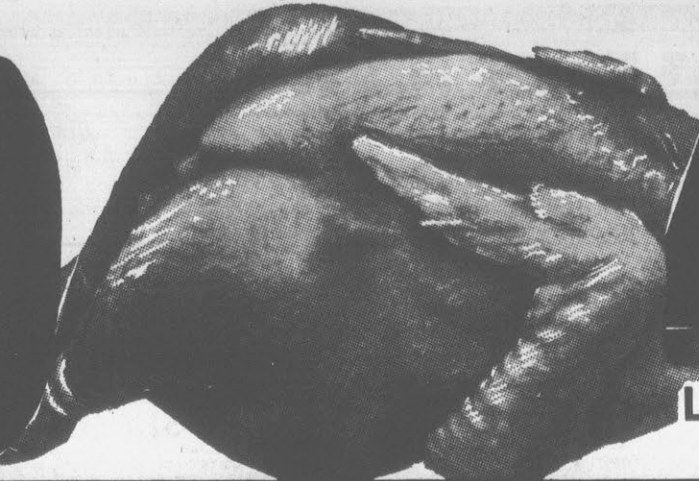

Lb.

# 4.45

SLICED 7-9 CHOPS  
**1/4 PORK LOINS** Lb. \$1.39

MORRELL PRIDE FULL-CUT  
**ROUND STEAK** Lb. \$1.89

OVERTON'S FINEST  
**GROUND BEEF** 3 Lb. Pkg. Or More \$1.39 Lb.

4-ROLL PKG.  
**White Cloud**  
NEW!  
**78¢**

GWALTNEY  
12 Oz. **BACON** Or  
**HOT SAUSAGE** \$1.09 Ea.  
(Hot Or Mild)  
Lb. Roll

GWALTNEY  
**FRANKS**  
12 Oz. Pkg. **99¢**

QUART JAR  
**KRAFT REAL Mayonnaise**  
**98¢**  
Limit one with \$7.50 food order.

WISHBONE  
**THOUSAND ISLE DRESSING** 8 Oz. Bottle **38¢**

**Campbell's**  
CONDENSED  
cream of  
**Mushroom SOUP**  
10 Oz. Can  
**1.18**  
Limit 6 Cans With \$7.50 Food Order.

**OVERTON'S INC SUPERMARKET**  
3rd AND JARVIS ST.  
Prices Effective Wednesday-Saturday  
VISA master charge

"FAMILY-PAK" SPECIALS OF THE WEEK  
PORK CHOPS..... 5-7 Lbs. \$1.45 Lb.  
GROUND BEEF PATTIES..... 10 Lbs. \$14.90  
NECK BONES..... 5-7 Lbs. 69¢ Lb.  
CHITTERLINGS..... 10 Lbs. \$4.99  
SMOKED SAUSAGE..... 10 Lbs. \$9.90

MRS. FILBERT'S  
**MARGARINE** Lb. **2/\$1** Pkg.

10 LB. BAG  
**KINGSFORD Charcoal Briquets**  
**98¢**  
Lighter Fast and Easy

DEL MONTE  
**KETCHUP** Quart Jug **78¢**

KOUNTY KIST  
**CUT GREEN BEANS-WHOLE KERNEL GOLDEN CORN** 303 Can **4/\$1**  
CREAM STYLE GOLDEN CORN

Giant Box **CLIP THIS COUPON**  
With This Coupon And \$7.50 Food Order Excluding Specials. Without Coupon \$1.18. Limit One Coupon Per Customer. Expires March 24.  
**LEMON FRESHENED BORAX**  
**Fab 98¢**  
ALL TEMPERATURE LAUNDRY DETERGENT

TRUCKLOAD  
**CALIFORNIA PRODUCE SALE**  
NICE SIZE  
**ADVOCADOS**  
**3/\$1**

Jumbo Roll **CLIP THIS COUPON**  
With this coupon and \$7.50 food order excluding specials. Without coupon 68¢. Limit one coupon per customer. Expires March 24.  
**Bounty**  
**48¢**  
NEW! EXTRA ABSORBENT

FRESH CALIFORNIA  
**CELERY HEARTS** Large Pkg **2/\$1**

CALIFORNIA  
**FRESH CELERY** 3 Stalks **\$1.00**

CALIFORNIA FRESH  
**BROCCOLI** Large Bunch **2/\$1.00**

JUICY CALIFORNIA  
**LEMONS** Dozen **69¢**

WHITE HOUSE  
**APPLE SAUCE** 303 Can **3/\$1.00**

**CLIP THIS COUPON**  
NEW FLORIDA  
**RED POTATOES**  
10 Lb. Bag  
**78¢**  
With this coupon and \$7.50 food order excluding specials. Without coupon 98¢. Limit one coupon per customer. Expires March 24.

CRISP CALIFORNIA  
Large Head  
**LETTUCE**  
**36¢**  
Each

**CLIP THIS COUPON**  
**PEPSI COLA**  
2 LITER PLASTIC BOTTLE  
With this coupon and \$7.50 food order excluding specials. Without coupon 98¢. Limit one coupon per customer. Expires March 24.  
**78¢**



SUPPLEMENT TO THE GREENVILLE  
DAILY REFLECTOR ON WEDNES-  
DAY, MARCH 21, 1979



**There Are  
Many Reasons  
Why You'll  
Do Better  
At A&P**

**ADVERTISED  
ITEM POLICY**

Each of these advertised items is re-  
quired to be readily available for sale  
at or below the advertised price in  
each A&P Store, except as specifi-  
cally noted in this ad.

PRICES EFFECTIVE THRU SAT., MAR. 24 AT A&P IN GREENVILLE

CONVENIENTLY LOCATED AT  
**703 GREENVILLE BLVD.**  
(GREENVILLE SQUARE SHOPPING CENTER)  
**GREENVILLE, N.C.**

**OPEN 24 HOURS  
7 DAYS A WEEK!!!**

ANN PAGE



**ICE  
CREAM**  
OR SHERBET

LIMIT ONE WITH COUPON  
ON PAGE 2 AND ADDITIONAL  
7.50 ORDER

1/2 GAL.  
CTN. **69¢**

**LOOK WHAT'S  
NEW AT A&P!**

SMALL FAMILY? SMALL PACKAGES?  
NEED ONLY TWO STEAKS? TWO CHOPS?  
SMALL SIZES?

SHOP YOUR A&P MINI-MEAL MEAT  
SECTION. A COMPLETE SELECTION  
OF STEAKS, CHOPS, GROUND BEEF,  
CHICKEN, AND ROAST!

PLUS ALL AT A&P's GREAT MONEY  
SAVING PRICES!

CRISP TASTY ICEBERG

**LETTUCE**

EACH  
HEAD  
ONLY **39¢**

A&P NORTH CAROLINA GRADE "A"

**LARGE  
EGGS**

LIMIT ONE DOZEN WITH  
COUPON ON PAGE 2  
AND ADDITIONAL  
\$7.50 ORDER

DOZEN  
ONLY **58¢**



A&P QUALITY FRESH

**PORK  
LOIN**

WHOLE OR  
RIB HALF

**\$1.28**

LB.

MOUNTAIN DEW, OR

**PEPSI**

CTN. OF  
**8** 16 OZ.  
BOTTLES **\$1.39** PLUS  
DEPOSIT

WHITE OR ASSORTED

**CHARMIN  
BATHROOM TISSUE**

LIMIT ONE WITH  
COUPON ON PAGE 2  
AND ADDITIONAL  
\$7.50 ORDER

**4** ROLL  
PKG. **69¢**

U.S.D.A. INSPECTED FROZEN

**BAKING  
HENS**

GREAT FOR STEWING

4 LB. TO 7 LB.  
AVG. WT. **69¢**

LB.

ANN PAGE HOMOGENIZED

**MILK**

**\$1.69**

GALLON  
JUG

**PLAY SUPER CASH BINGO**

**\$201,743  
IN CASH  
PRIZES**

**46,019  
CASH PRIZE  
WINNERS!**

**57,825  
FOOD PRIZE  
WINNERS!**

**NO PURCHASE  
NECESSARY!**

**WIN \$1, \$5,  
\$10, \$25, \$50,  
\$100 OR \$1000!**

**\*ODDS CHART EFFECTIVE MARCH 18, 1979**

| Number of<br>Winners | Winning<br>Amount       | Odds 1<br>Visit | Odds 13<br>Visits | Odds 26<br>Visits | Total     |
|----------------------|-------------------------|-----------------|-------------------|-------------------|-----------|
| 25                   | \$1000                  | 233,800         | 17,985            | 8,993             | \$ 25,000 |
| 193                  | 100                     | 30,285          | 2,330             | 1,165             | 19,300    |
| 411                  | 50                      | 14,221          | 1,094             | 547               | 20,550    |
| 788                  | 25                      | 7,418           | 571               | 286               | 19,700    |
| 2002                 | 10                      | 2,920           | 225               | 113               | 20,000    |
| 2801                 | 5                       | 2,087           | 161               | 80.5              | 14,005    |
| 39,799               | 1                       | 147             | 12                | 6                 | 39,799    |
| 57,825               | AP Products or 75¢ each | 101             | 8                 | 4                 | 43,369    |
| 103,844              |                         | 56              | 4.3               | 2.2               | 201,743   |

The Super Cash Bingo game is available at 129 Great Atlantic & Pacific Tea Co. stores located in North Carolina, South Carolina, Florida, Georgia, and Washington, D.C. Original. This promotion is scheduled to run from April 15, 1979. Super Cash Bingo will only be available where game tickets are distributed.



# 4 Big Ways

## ADVERTISED ITEM POLICY

Each of these advertised items is required to be readily available for sale at or below the advertised price in each A&P Store, except as specifically noted in this ad.

### 1★ SUPER CASH BINGO

### 2★ WEEKLY SPECIALS

PRICES EFFECTIVE THRU SAT., MAR. 24 AT A&P IN GREENVILLE

**CHARMIN BATHROOM TISSUE**  
WHITE OR ASSORTED

LIMIT ONE WITH COUPON BELOW AND ADDITIONAL \$7.50 ORDER

**4 ROLL PKG. 69¢**

**A&P COUPON**  
WHITE OR ASSORTED CHARMIN BATHROOM TISSUE

LIMIT ONE WITH COUPON AND ADDITIONAL \$7.50 ORDER  
LIMIT ONE COUPON

**4 ROLL PKG. 69¢** #659

GOOD THRU SAT., MAR. 24 IN GREENVILLE

A&P NORTH CAROLINA GRADE "A"

**LARGE EGGS**

LIMIT ONE DOZEN WITH COUPON BELOW AND ADDITIONAL \$7.50 ORDER

**DOZEN ONLY 58¢**

**A&P COUPON**  
A&P NORTH CAROLINA GRADE "A" LARGE EGGS

LIMIT ONE DOZEN WITH COUPON AND ADDITIONAL \$7.50 ORDER  
LIMIT ONE COUPON

**DOZEN ONLY 58¢** #660

GOOD THRU SAT., MAR. 24 IN GREENVILLE

HEARTY & VIGOROUS

**OUR OWN TEA BAGS**

LIMIT ONE WITH COUPON BELOW AND ADDITIONAL \$7.50 ORDER

SAVE 40¢

**100 CT. PKG. \$1.59**

**A&P COUPON**  
HEARTY & VIGOROUS OWN OUR TEA BAGS

LIMIT ONE WITH COUPON AND ADDITIONAL \$7.50 ORDER  
LIMIT ONE COUPON

SAVE 40¢ **100 CT. PKG. \$1.59** #661

GOOD THRU SAT., MAR. 24 IN GREENVILLE

**GREEN GIANT CREAM STYLE OR WHOLE KERNEL GOLDEN CORN 3 17 OZ. CANS \$1.00**

**GREEN GIANT KITCHEN SLICED OR FRENCH STYLE GREEN BEANS 3 16 OZ. CANS \$1.00**

GREEN GIANT

**SLICED MUSHROOMS**

OR WHOLE MUSHROOMS

**2 2½ OZ. JARS \$1.00**

FROZEN—IN BUTTER SAUCE

**LE SUEUR PEAS**

10 OZ. PKG. **59¢**

GREEN GIANT—NIBBLER'S

**CORN ON THE COB**

6 CT. PKG. **69¢**

ANN PAGE UNSWEETENED

**GRAPEFRUIT JUICE**

46 OZ. CAN **59¢**

TEXAS PETE

**HOT DOG CHILI**

3 10 OZ. CANS **\$1.00**

BETTY CROCKER

**HAMBURGER HELPER**

BEEF NOODLE 6½ OZ.  
LASAGNA 7½ OZ.  
CHILI TOMATO 7½ OZ.  
CHEESEBURGER 8 OZ.

EACH ONLY **69¢**

ANN PAGE

**ICE CREAM OR SHERBET**

LIMIT ONE WITH COUPON BELOW AND ADDITIONAL \$7.50 ORDER

**½ GAL. CTN. 69¢**

**A&P COUPON**  
ANN PAGE ICE CREAM OR SHERBET

LIMIT ONE WITH COUPON AND ADDITIONAL \$7.50 ORDER  
LIMIT ONE COUPON

**½ GAL. CTN. 69¢** #667

GOOD THRU SAT., MAR. 24 IN GREENVILLE

PILLSBURY

**BUTTERMILK BISCUITS**

4 10 CT. 7½ OZ. CANS **79¢**

A&P QUALITY

**SOFT MARGARINE**

2 1 LB. BOWLS **\$1.00**

SEALEST LIGHT 'N LIVELY YOGURT  
3 8 OZ. CUPS **\$1.00**

# To Save

3 ★ ACTION PRICES

4 ★ ECONOMY CORNER



SWIFT'S HOSTESS HAM

4 **\$7.99**  
LB. ROUND CAN  
LIMIT ONE WITH ADDITIONAL \$7.50 ORDER

A&P QUALITY FRESH

**PORK LOIN**

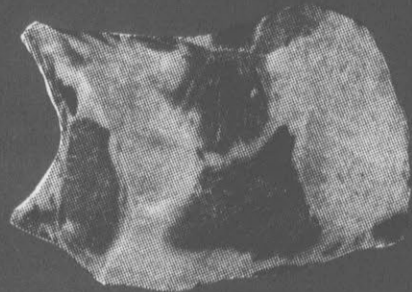

WHOLE OR RIB HALF

**\$1.28**  
LB.

A&P QUALITY FRESH

**PORK SAUSAGE**

HOT OR MILD

1 LB. PKG.

**98¢**

FAMILY PACKAGE

**PORK CHOPS**

(10 LBS. AND UP) CONTAINS EQUAL NUMBER CENTER AND END CHOPS

LB.

**\$1.28**

HORMEL—FULLY COOKED

**CURE 81 HAM**

BONELESS

LB.

**\$2.99**

A&P QUALITY CORN FED

**PORK ROAST**

SIRLOIN PORTION

LB.

**\$1.48**

U.S.D.A. INSPECTED FRYING

**CHICKEN LIVERS**

5 LB. BOX

ONLY **\$2.49**

LB.

**59¢**

U.S.D.A. INSPECTED FRESH

**FRYER LEG QTRS.**

BREAST QTRS.

LB. **78¢**

LB.

**68¢**

U.S.D.A. INSPECTED FROZEN

**BAKING HENS**

GREAT FOR STEWING!

U.S.D.A. A GRADE

4 TO 7 LB. AVG. WT.

LB.

**69¢**

A&P QUALITY HEAVY WESTERN GRAIN FED BEEF

**WHOLE SEMI-BONELESS BEEF ROUNDS**

35 LB. TO 45 LB. AVG. WT.

CUT FREE INTO FAMILY PKG. OF—EYE OF ROUND, ROUND STEAKS, AND ROUND ROAST

**\$1.78**  
LB.

A&P QUALITY HEAVY WESTERN GRAIN FED BEEF

**RIB STEAKS**

BONELESS

LB.

**\$2.98**

A&P QUALITY HEAVY WESTERN GRAIN FED BEEF

**RIB ROAST E-Z CARVE**

BONE IN

LB.

**\$2.38**

A&P BUTTER BASTED OR SWIFT

**BUTTERBALL TURKEYS**

10 LBS. AND UP

U.S.D.A. A GRADE

LB.

**88¢**

A&P QUALITY HEAVY WESTERN GRAIN FED BEEF

**GROUND CHUCK**

3 LBS. AND UP

**\$1.58**  
LB.

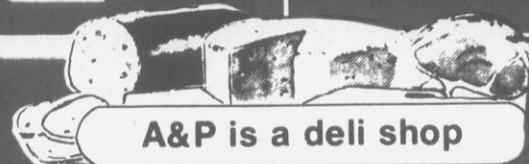

A&P is a deli shop

2 PIECE SNACK PAK

**FRIED CHICKEN**

ONLY

**99¢**

SLICED TO ORDER

**BEEF BOLOGNA**

LB.

**\$1.89**

CUSTOM SLICED GOURMET

**TURKEY BREAST**

LB.

**\$3.29**

CREAMY

**POTATO SALAD**

LB.

**69¢**

7 INCH ROUND TWO LAYER

**CHERRY CAKE**

ONLY

**\$2.49**

GOOD ONLY AT GREENVILLE A&P



There are lots of reasons why You'll do better at A&P

- ★ SUPER CASH BINGO
- ★ WEEKLY FEATURES
- ★ ECONOMY CORNER
- ★ ACTION PRICES

**PLUS** At A&P We Offer You The Opportunity to Select Your Own Size, Color, Shapes, and Quantities Of Fresh Fruits And Vegetables To Your Own Personal Satisfaction!

**ADVERTISED ITEM POLICY**

Each of these advertised items is required to be readily available for sale at or below the advertised price in each A&P Store, except as specifically noted in this ad.

PRICES EFFECTIVE THRU SAT., MAR. 24 AT A&P IN GREENVILLE

FLORIDA GROWN

**RED OR WHITE GRAPEFRUIT**

LARGE SIZE

**4 ONLY \$1.00**

GARD-N-PATH POTTING SOIL 8 QT. BAG **88¢**

FLAVORFUL

**FRESH LEMONS**

**3 FOR ONLY 39¢**

MILD TENDER YELLOW ONIONS LB. **22¢**

**GREAT FOR SALADS!**

FRESH

- ★ GREEN PEPPERS OR FIRM CRISP
- ★ CUCUMBERS

YOUR CHOICE!

EACH ONLY **22¢**

FRESH TASTY CRISP CARROTS 1 LB. BAG **33¢**

CRISP TASTY ICEBERG

**LETTUCE**

EACH HEAD ONLY **39¢**

U.S. #1 BAKING RUSSET

**POTATOES**

10 LB. BAG **99¢**

JANE PARKER FRESHLY BAKED

**WHOLE WHEAT BREAD**

2 16 OZ. LOAVES **88¢**

JANE PARKER OLD FASHIONED

**WHITE BREAD**

2 24 OZ. LOAVES **79¢**

BETTY CROCKER—SUPER MOIST

**CAKE MIXES**

- YELLOW BUTTER • WHITE
- DEVIL'S FOOD • YELLOW

BETTY CROCKER READY-TO-SPREAD FROSTING 16½ OZ. CAN **89¢**

18½ OZ. PKG. **59¢**

MORTON'S FROZEN

**FRIED CHICKEN**

2 LB. PKG. **\$1.99**

FARM FARE FROZEN

**FRENCH FRIES**

CRINKLE CUT

2 LB. PKG. **49¢**

BANQUET FROZEN

**COOKIN' BAGS**

- CHICKEN A LA KING
- SALISBURY STEAK
- SLICED BEEF
- CREAMED CHIP BEEF
- TURKEY
- MACARONI & CHEESE

3 5 OZ. PKGS. **\$1.00**

A&P FROZEN

**MACARONI & CHEESE**

3 8 OZ. PKGS. **89¢**

now...it's  
something  
else!

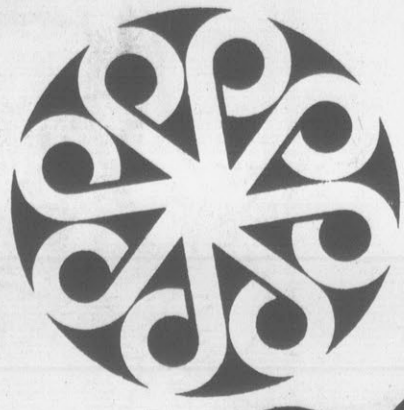

# parkwood mall

more food...



more fashion...



more selection



and a spacious  
new mall!



For many years Parkwood has served the shoppers of Wilson. But Wilson has grown and so has the need for a more sophisticated, more complete, more all-encompassing center for shopping. Today, the exciting new Parkwood offers the "something else" you may have been missing. A spacious enclosed mall combines year-round, springtime comfort and nature's greenery. Specialty shops, big department stores, restaurants and businesses all coverage under one roof to bring you an endless variety of merchandise and services. Come for our Grand Opening 9:30 Thursday morning, enjoy the special entertainment and take time to look around our beautiful new mall. You'll discover that Parkwood is indeed, "something else"!

MALL HOURS: 10 A.M. TO 9 P.M. MON.-SAT.  
AND 1 TO 6 P.M. SUNDAY

## Grand Opening Thursday, March 22

WARD BOULEVARD AT N.C. 42 IN WILSON

KORET  
SEPARATE  
IMPRESSIONS®



**Koret Separate Impressions® are self-expressions.** The put-together sportswear. You match it up to say all the women you are. In unique Comfort Stretch Sharkskin of 100% **Today's Dacron®** polyester, woven by **Klopman**. You're the well-groomed executive in this side-elastic pant and classic blazer. The French toile print soft shirt adds a delicate touch. The same pant worn with an unconstructed jacket gives a country club flair to your look. This time the shirting is a meadow bright bouquet print. See these and many other styles by Koret Separate Impressions®. The fit and quality are from Koret of California®. The self-expression is all up to you.

- A. Jackets — White, Willow, Navy And Apricot. 55  
 B. Blouse — Willow & White, Navy & White And Apricot & White. 25  
 C. Pants — White, Willow, Navy And Apricot. 25  
 D. Blouse — Multi-Colors Navy, Green And Tan. 24



PARKWOOD MALL



# Sylvia's

Announces  
The Opening Of  
A New Division

## THE STOUT SHOP

"Where Fashion Is Queen"

Sizes  
14½-32½ 38-52

The Biggest Little  
Store In Town

NOW IN  
PARKWOOD  
MALL

NOW OPEN TO SERVE YOU:

## FIRST CITIZENS BANK'S NEW TELLER WINDOW OFFICE INSIDE THE PARKWOOD MALL.

We now offer you a big extra in banking convenience. In addition to our full-service Parkwood drive-in office, you can now bank within the Mall at our handy new teller window office. It's designed to give you the best in all-weather, time-saving banking service. Come in soon. We want to serve you.

Take Advantage of our  
**FREE BLANKET OFFER.**  
Available only at our teller window office.

Open or add \$100 or more to a First Citizens savings account and one of these famous Chatham blankets is yours absolutely free. Only one blanket per customer, please.

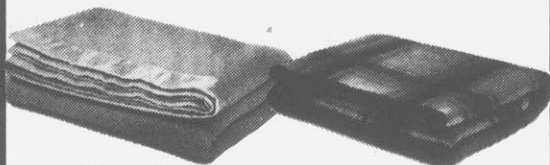

Esmond® Horizon® fiberwoven® blanket in various colors is virgin acrilan® and acrylic blend with nylon binding. Practical 72" x 90" size.

The gad-about, all purpose 50" x 64" vacation blanket in exciting plaids by Chatham. Comes with zippered heavy vinyl carrying case. Made of 100% acrylic and firm-lok whipstitched all around.

Register for bags of money.

**First Citizens.**  
**The Can Do Bank.**

Member FDIC. © 1979 First Citizens Bank & Trust Company

1958-211-8

## B. Dalton is spreading stories at the new Parkwood Mall Wilson, N. C.

You've never seen a bookstore like the new B. Dalton. You'll find over 25,000 different titles to choose from. Plus special services like special orders, gift wrapping, personal assistance, mailing, gift certificates and the convenience of using your major credit cards. You're going to like the new B. Dalton. Come see us!

*B. Dalton*

America's Favorite Book Seller

PHONE 291-7103

OPEN

MON.-SAT. 10 A.M.-9 P.M.

SUNDAY 1 P.M.-6 P.M.

## Career Club



### woven satin stripes

right for every occasion! handsome, elegant, white ground woven satin stripings, superbly tailored by Career Club in a carefree silky blend of Dacron® polyester and cotton, it's the "just right" shirt for that well dressed look. come in today for the best selection!

\$13.50



NATURAL BLEND™



### all-time classic... the button-down oxford

very much in the fashion picture, and mellowed with tradition, tailored by Career Club in a comfortable "natural blend" of 60% cotton and 40% Fortrel® polyester, permanent press, of course. select your favorite colors today.

\$12.50

**MOSS & CO. INC**

OF PARKWOOD

MEN AND BOYS STORE

## GRAND OPENING

# Stride Rite®

OF WILSON INC.

## Something New For Wilson Shoes

Exclusively  
For  
Children



Complete Line Of Stride Rite  
Children's Shoes,  
Including Prescription Shoes.

  
parkwood  
mall  
1980 WILSON, N. C. 27157

RED HAWLEY, Manager

"NOW'S THE TIME TO SEW EASIER  
WITH SINGER - AND SAVE!"  
POLLY BERGEN

# SALE A THON

Parkwood  
Mall  
Grand  
Opening  
Special

**SAVE \$40** OFF REG. PRICE

**ON THIS SINGER\* FREE ARM MACHINE. NOW ONLY \$169<sup>95</sup>**

This *Stylist\** machine converts from flat bed to free arm to make hard-to-reach places (like armholes and sleeves) easy to sew. And to make sewing everything else easy, it has built-in zig-zag, stretch, blind hemstitches and a built-in buttonholer. Model 543.

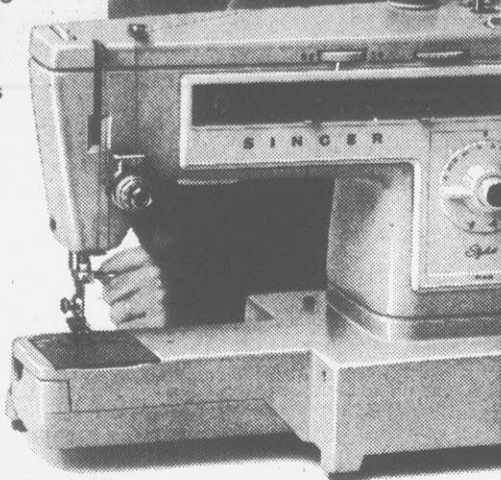

**SAVE \$20** OFF REG. PRICE **ON THIS ZIG-ZAG MACHINE. NOW ONLY \$119.95**

With this *Fashion Mate\** machine, you can select from seven interchangeable stitches (including elastic and blind hemstitches) at the touch of a lever. It even has a built-in buttonholer. (This machine available only at company-owned stores. See your local independent Singer dealer for comparable offer.) Model 360.

**STILL A GREAT BUY. ONLY \$99<sup>95</sup>**

This *Fashion Mate* zig-zag machine is perfect for beginners. With all the basics you need including 11 interchangeable *Fashion\** stitches, front drop-in bobbin, blind hemstitch and snap-on presser feet. (This machine available only at company-owned stores. See your local independent Singer dealer for comparable offer.) Model 368.

**SAVE ON CABINETS & VACS**

**10% OFF REG. PRICE ON SEWING CABINETS.** A variety of selected *Singer\** cabinets that will fit almost any *Singer\** machine you have.

**SAVE \$20<sup>95</sup> OFF REG. PRICE (NOW ONLY \$149)** on a *Singer\** Upright Vacuum that has an 8-position, dial-operated pile selector. Model U-69.

**OR SAVE \$16<sup>95</sup> OFF REG. PRICE (NOW ONLY \$98)** on a Canister Vacuum that's perfect for above-the-floor cleaning jobs. Model C-16.

**100 MILLION PEOPLE SEW EASIER WITH SINGER**

Prices optional at participating dealers.  
Polly Bergen is a member of The Singer Board of Directors.

\*A Trademark of The Singer Company  
Carrying case or cabinet extra on all models.



## REED'S

# Grand Opening DIAMOND SALE 20% TO 50% OFF



All  
Diamond  
Merchandise

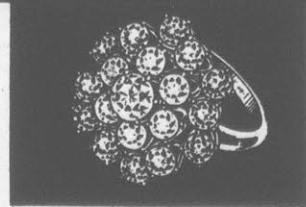
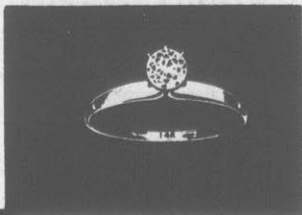

## 14 Karat Gold Chain & Bead Sale

All Gold Chains

**20% off**



Beads ..... 3mm - \$1.48 ea.  
Beads ..... 4mm - \$1.98 ea.  
Beads ..... 5mm - \$2.08 ea.  
Beads ..... 6mm - \$2.48 ea.  
Beads ..... 7mm - \$2.88 ea.

LIMITED SUPPLY ON CHAINS FOR BEADS,  
SO SHOP EARLY



## REED'S

Fine Jewelers and Diamond Importers  
PARKWOOD MALL

MIKE STUCKEY, Manager

DONNIE R. WATSON, Asst. Manager

On Premise Diamond Appraisal and Inspection

5 CONVENIENT WAYS TO BUY: OUR CUSTOM CHARGE PLAN, AMERICAN EXPRESS,  
VISA, MASTER CHARGE OR LAYAWAY

# Barshay's

## A new shape, a new era — An old tradition

*Pink is femininity — Femininity is Barshay's*

*Enter the doors of our beautiful pink exterior, and you'll enter our thrilling new world of fashion — a new world preceded by a 40 year tradition which has made our name synonymous with top quality and great variety in the fashion field. Enter our new world, and let us share with you our enthusiasm and our personal, courteous service which has made you our loyal and treasured customer.*

A TOUR

*On our main level browse through our incredible and ever-expanding selection of sportswear, our famous blouse bar, our hosiery and handbag departments, and our fabulous accessory arena. Then prepare for another treat as you visit our four elegantly designed lower level departments — lingerie, dresses, coats, and our brand, new uniquely exciting designer shop — Chez Bar. We're waiting to take you on the grand tour!*

Parkwood Mall

Open Mon.-Sat. 10:00 'Til 9:00

# Belk Tyler

parkwood mall wilson

# grand opening sale

**THURSDAY,  
FRIDAY AND  
SATURDAY**

Selected Group of  
Junior Dresses  
at a 1/3 Savings

**1/3 OFF**  
ORIGINAL PRICES

Selected groups of famous brand names dresses. Polyester/cotton, linens, acrylics in solids and fancies. New spring colors. Sizes 3 to 15.

Sale! Add-A-Bead Chain with Gold Bead  
**7.88**

Originally 10.95

One 7MM gold bead on an 18" gold filled curb chain. Additional beads available with no charge for stringing. A perfect gift for any occasion.



**A Big 25% Off  
on Selected  
Girls' Dresses**

**25% OFF**  
ORIGINAL PRICES

Beautiful group of spring styles in pastel solids, checks and patterns. Famous brands in polyester and polyester/cottons. Sizes 7 to 14, 3 to 6X. Shop early for best selection.



5.12 Savings on Junior Sweaters  
**12.88**

Regular 18.00

Entire group of Collage sweaters in acrylic/nylon blends. Tans, lavender, brown and many other solid colors in sizes small, medium, and large.

Savings of Up to  
3.12 on New Spring  
Skirts in 5 Styles

**12.88**

Regular \$14 and \$16

Polyester/cotton blend in solids and patterns. Navy, black, brown, peach, khaki and other in pastels. Sizes 5/6 to 15/16.



A Big 5.12 Savings  
on Ladies' Sweaters

**12.88**

Regular 18.00

Lightweight acrylics and mohair in many spring solids. By British Vogue. Sizes S, M, L, XL.



Jr. Knit Tops Up  
to a 2.12 Savings

**7.88**

Regular \$9 and \$10

Cottons, polyester/cottons in many solid colors. Sizes S, M, L. By a famous maker.

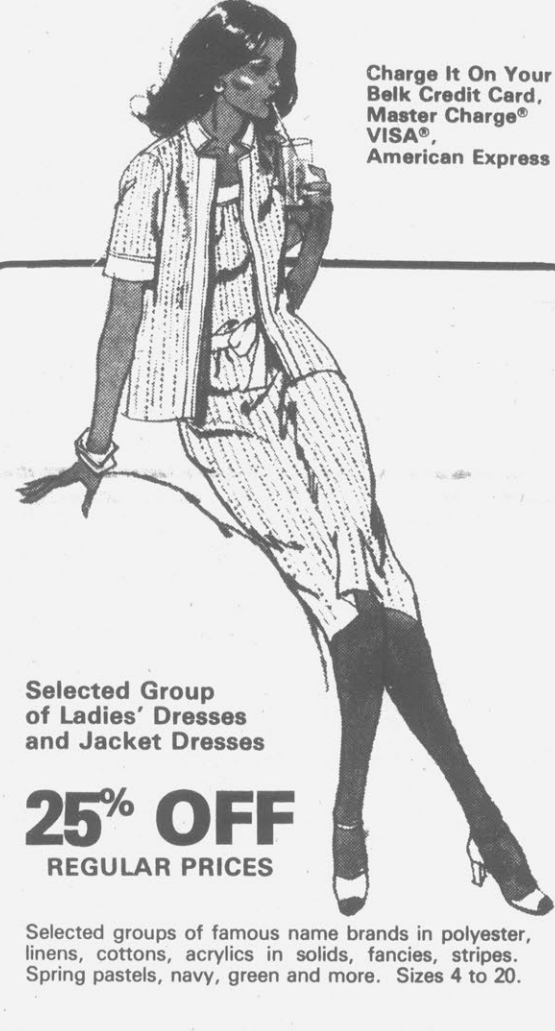

Charge It On Your  
Belk Credit Card,  
Master Charge®  
VISA®,  
American Express

Selected Group  
of Ladies' Dresses  
and Jacket Dresses

**25% OFF**  
REGULAR PRICES

Selected groups of famous name brands in polyester, linens, cottons, acrylics in solids, fancies, stripes. Spring pastels, navy, green and more. Sizes 4 to 20.

Low, Low Prices on Ladies' Name Brand Coats

**1/3 OFF** ORIGINAL PRICES

Choose your favorite styles from this selected group of polyester and polyester/cotton blends. Lots of new spring pastel solid colors too. In sizes 6 to 20. A great time to buy that new spring coat and save at the same time. Stop in early before quantities are gone and make your purchase.

Special Low Price on Girls'  
Size 7 to 14 LEVI'S® Jeans

**11.88**

Belk Tyler Low Price

An easy-care blend of polyester and cotton in navy and blue denim colors. Sizes 7 to 14. Levi's® ... a name you can depend on for quality and price.



Jr. Dresses  
at 7.12 Off!

**12.88**

Regular 20.00

Famous name brand group of 100% cotton denim styles. Denim blue solid. Sizes 5 to 13. Shop early!

Ladies' Designer  
Jeans at an 8.12 Savings

**26.88**

Regular 35.00

100% cotton in solid denim blue only. A most sophisticated look by a famous designer. Looks terrific with any tops you put on. In sizes 4 to 14.

Super But on Candie's  
Shoes in Four Styles!

**9.88**

Originally \$15 and \$16

Four very stylish shoes. Over 400 pair to sell. All made in Italy. Choose from mocha, dusty rose, moss, brick, black, rust and brown. Sizes 5 to 10 (no halves).

Sale on Charlies' Angels Jeans

**19.88**

Regular \$24 and \$26

100% cotton jeans in solid blue denim. Terrific looking jeans in junior sizes 3 to 13.

Bangle Bracelets or Fashion Combs

**1.88**

Originally 3.00

18 combs or bracelets in a package in pastel colors or dark colors. A color to coordinate with your entire wardrobe.

Select Group! Ladies' Sunglasses

**3.88**

Originally \$6 to \$8

A super selection on several styles of frames in colors to go with almost any outfit. Buy several pair while the price is low.

Sale on Pre-Fold Baby Diapers

**5.88**

Regular 7.29 and 7.59

One-dozen of gauze diapers in white. 21 x 40", 14 x 20" sizes.

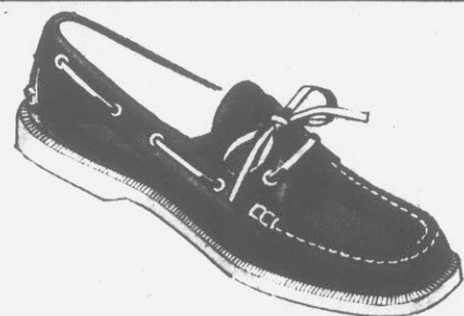

10.12 Savings on Men's and  
Ladies' Sperry Top-Siders®

**28.88**

Orig. 39.00

Brown leather moccasin, two-eyelet tie style. Ladies' sizes 6 to 10 slim, 5 to 10 medium. Men's sizes 7 to 12 slim, 6-1/2 to 13 wide. A bargain, so shop early!

Shop Daily 10 a.m. Until 9 p.m. and Make Us Your "Sunday Place" . . . Shop Sunday 1 p.m. Until 6 p.m. — Phone 291-2355

# Belk Tyler

parkwood mall wilson

Special Purchase Price  
On Select Picture Frames

**2.88 to 5.88**

Originally 4.50 to 15.00

Sizes 3" x 4", 5" x 7", 8" x 10" in single, double or triple fold. Collage or arrangement styles. Mats also available in styles and sizes.

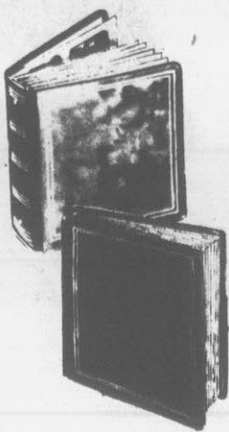

Sale! Photo Albums

**4.88**

Compare at 12.00

20 self-adhesive refillable pages. Fits all size photos. Brown, white, red, or green.

Refills available for 1.50 a package.

Special Buy! Novus Calculator

**12.88**

Belk Tyler  
Low Price

Model 6020 'Financier'. With memory. Adds, subtracts, multiplies, divides. Only 20 left to sell at this price.

Low Price on Versatile Aprons

**1.00**

Compare at 1.79

Choose from a big selection of aprons in several colorful patterns and styles. Very versatile too!

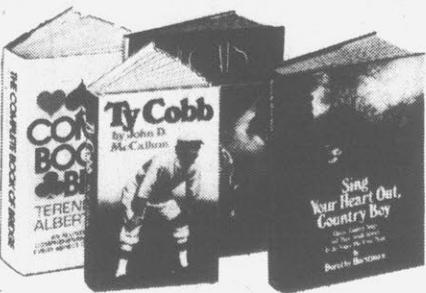

On Sale Now! Our Entire  
Stock of Paperback Books

**15% OFF**

Manufacturer's  
Suggested  
Prices!

Visit our new book department and choose from a multitude of interesting and informative books on almost any subject. There are best seller, novels, fiction and more all just waiting for you!

Special on Set of 4 Placemats

**47¢**

Set  
of 4

Belk Tyler  
Low Price

Vinyl top with non-skid foam backing. Floral motif in delightful colors. A great buy so stock up and get a complete set of eight for your entire table.

Four Hand Made Doilies With  
A \$10 Table Linen Purchase

**FREE WITH  
PURCHASE**

With any 10.00 purchase of table linens, you'll receive a set of four doilies Free. Hand made in China.



Save 31¢ on Red Heart® Knitting Yarn

**88¢**

Skein

Regular 1.19

Red Heart® . . . a name you'll recognize for top quality knitting yarn. Easy to work with and it comes in a super choice of colors.

Super Low Reduction on Men's and  
Ladies' Selected Groups of Luggage

**40% OFF**

ORIGINAL PRICES

Our selection includes American Tourister®, Samsonite® and many other name brands of hard side and soft side. . . and they're all reduced to help you save money. Stop in today and get the first choice.



Save Up to 52¢ On A Selected  
Group of Spring Fabric Remnants

**97¢**

Yd.

Reg. 1.39 and 1.49 Yd.

45" polyester/rayon prints, 45" polyester/cotton, rayon/cotton, 100% cotton striped fabrics, print fabrics with eyelets in polyester/cotton and polyester/cotton solids, 100% white polyester, 45". One to ten-yard pieces.

A Savings of 54¢ On A Selected  
Group of Knit Fabric Remnants

**1.44**

Yd.

Reg. 1.98 Yd.

One to six-yard pieces of 100% polyester interlock knit in solids and prints. All 60" wide. A great bargain just in time for all your spring and summer sewing needs.

# grand

**THURSDAY,  
FRIDAY AND  
SATURDAY**

GE Food Processor at a 11.10 Savings

**48.88**

Reg. 59.88

Shreds, slices, grates, grinds, minces, chops, mixes, mashes and purees. On/Off switch for continuous operation and Pulse-On button for momentary on-off operation. Heavy duty motor. Cover interlock system. Model FP1. A handy kitchen helpmate that makes your cooking a breeze. A gift any gourmet or homemaker would be happy to receive.



10.07 Savings on a  
7-Piece Cookware Set!

**39.88**

ALUMINUM CLAD  
Regular 49.95

Stainless steel with aluminum clad bottom. Set includes: 1-1/2, 3 and 8-qt. covered saucepans, 10-1/2" fry pan. By Farberware®. Open stock value to 79.95. A super buy!

Save on a 45-Pc. Set  
of Ironstone Tableware

**79.88**

SPECIAL PURCHASE!  
Compare at 230.00

Beautiful, versatile ironstone by Wedgewood from their Midwinter Collection. Choose from Night, Day, Spring patterns.

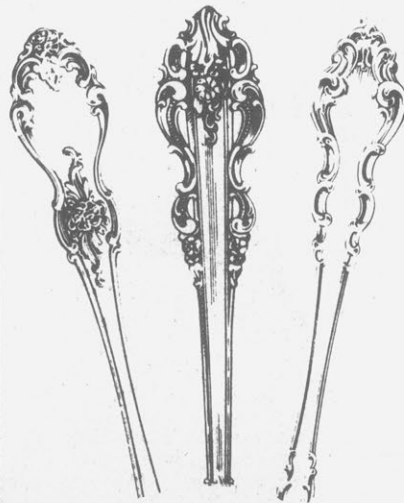

Half Price Reductions on  
Our Entire Stock of Famous  
Name Brand Silver Tableware

**50% OFF**

MANUFACTURER'S SUGGESTED PRICES

Choose from names like Gorham, Reed and Barton, Towle, International Silver and others. You can save a big 50% on knives, forks, spoons and serving pieces during this giant sale!

Savings For Home,

Charcoal Grill at a

Regular 12.99

Chrome plated cooking grill with 5" easy roll wheels. 28"H x 31"W Green.

Healthy Azaleas at

Regular 1.99

Choose from 10 varieties of evergreen azaleas. In one-gallon containers.

Lawn Chairs at

Regular 7.49

Easy-clean polypropylene webbing inum arms. Fold for easy storage. than one.



Shop 10 A.M. Until 9 P.M.  
'Sunday Shopping Place' . . . Shop Sunday

# Opening Sale

Special Low, Low Price! 'Pot 'n Fry'

SPECIAL PURCHASE!

**13.88**

Copper clad, versatile 'Pot 'n Fry' by Revere Ware®. Handy 3-qt. size.

Low Price on Magic Hostess Slow Cooker

Compare at 27.99  
SPECIAL PURCHASE!

**19.88**

Four-quart family size slow cooker with removable crockery for cleaning.

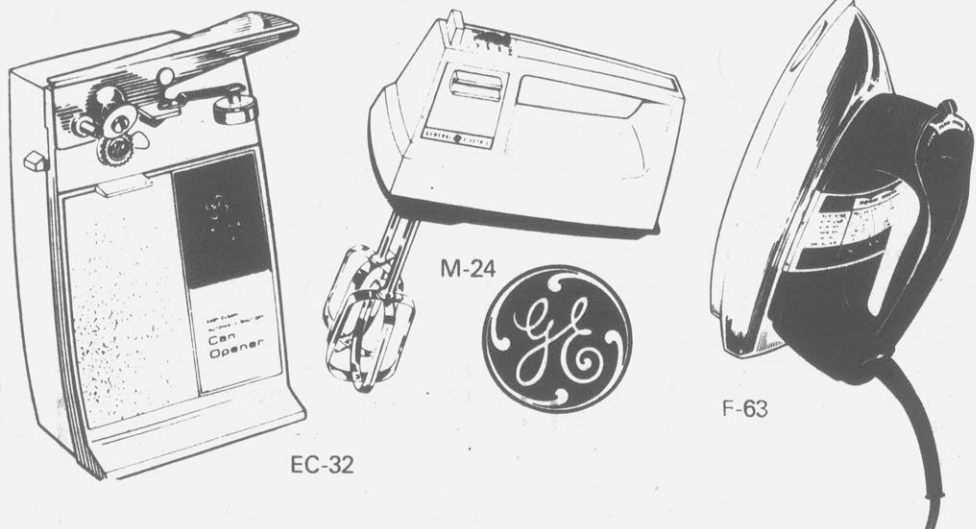

EC-32

M-24

F-63

A Savings of Up to 2.10 on Handy, Helpful GE Can Opener, Hand Mixer and Iron. . . A Great Buy!

YOUR CHOICE

Regular 11.98 and 12.98

**10.88**

Automatic can opener opens and shuts off when lid is cut. Easy to clean cutting assembly and pierce lever removes. White, avocado, harvest. 3-speed fingertip control hand mixer with beater clips for storing beaters. Up-front beater ejector. White, avocado, harvest. Steam and dry iron with 25 steam vents for even, overall heat distribution. Double non-stick coated soleplate. Cordset can't fray.

Garden and Patio. . . And Just In Time For Spring Too!

a 3.11 Savings

**9.88**

with four position adjustment. 23" W. Fold for easier storage.

Save 2.00 on Foliage Houseplants

**7.99**

Regular 9.99

10" pot sizes. Choose from Scheffleras, Ficus Benjamina, Philodendron, Seloum and Arboricola. Healthy, green plants.

and Evergreens

**1.17**

green shrubs and 7 varieties liners ready for planting.

Foliage Houseplant With Purchase

**FREE** WITH PURCHASE

With any purchase from our Garden Shop you will receive your choice from 10 varieties, of any 2-1/2" potted houseplant.

at 2.61 Savings

**4.88**

coming with non-rusting aluminum. 23" W x 32" H. Buy more

Save on 50-Foot Garden Hose

**2.68**

Regular 3.85

Two-ply opaque green vinyl hose with all brass couplings. 1/2" diameter. By Tuff-Lite. Such a low price you'll want two.

'Royal Classic' Towel Ensemble by Cannon®

BATH  
Regular 5.00

**4.44**

HAND  
Regular 3.50

**2.88**

WASHCLOTH  
Regular 1.50

**1.27**

Choose from a large selection of colors to coordinate the bath. Thick, thirsty and absorbent towels of 100% cotton. A good chance to stock up now and save later! Shop early for these and other great bargains!

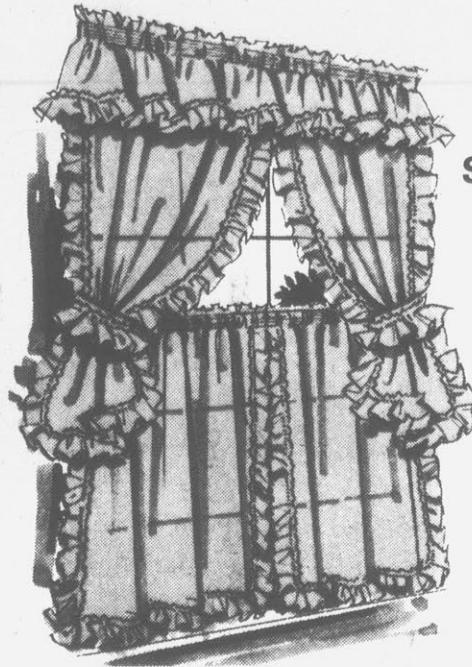
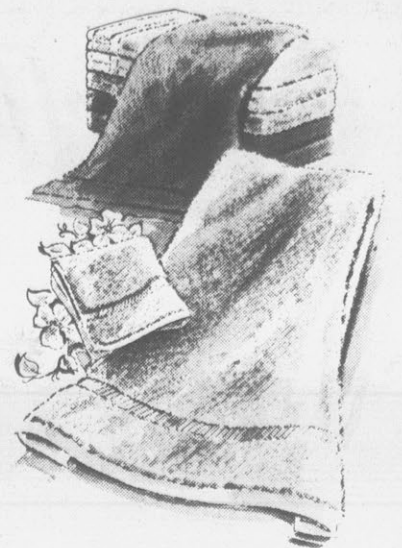

Special Low Prices on Statepride® Curtains

54" x 11" VALANCE  
Regular 2.50

**1.88**

60" x 36" CURTAIN  
Regular 3.50

**2.88**

It's our own Statepride® 'Cape Cod' style curtains in white, yellow or natural. For use in the bedroom, kitchen or den. Easy-care polyester and cotton that's machine washable. Buy several pair now and save!

Save on Statepride® Dacron® Ninon Sheers

80" x 63"  
Regular 6.88

**5.88**

80" x 84"  
Regular 8.00

**6.88**

Machine washable 100% Dacron® polyester sheers that let in light but still afford some privacy. Also adds beauty to your already existing window treatment. In several lovely decorator colors.

FREE Monogram on Any Towel Priced From 5.00 and Up. . . 3 Days Only! Hurry!

During this three day sale you will receive a FREE monogram on any towel purchased from our stock that is valued at 5.00 or more. Select from a beautiful and large group of decorator towels. These would make a lovely gift so don't delay.

Remember. . . 3 DAYS ONLY!

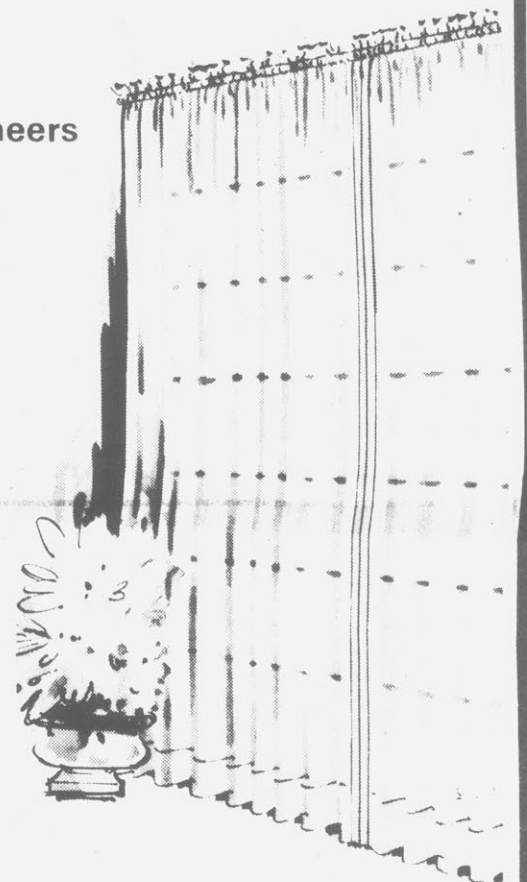

Save Up to 4.12 On Our Statepride® 'Regal Rose' Bedsread in Full Size Only! Hurry!

**18.88**

Regular 23.00

A bedsread that adds charm to any bedroom decor. Beautiful woven mattelasse design of 100% cotton with matching ball fringe trim. easy-care, machine washable and tumble dry too. In white, natural, gold, blue and avocado.

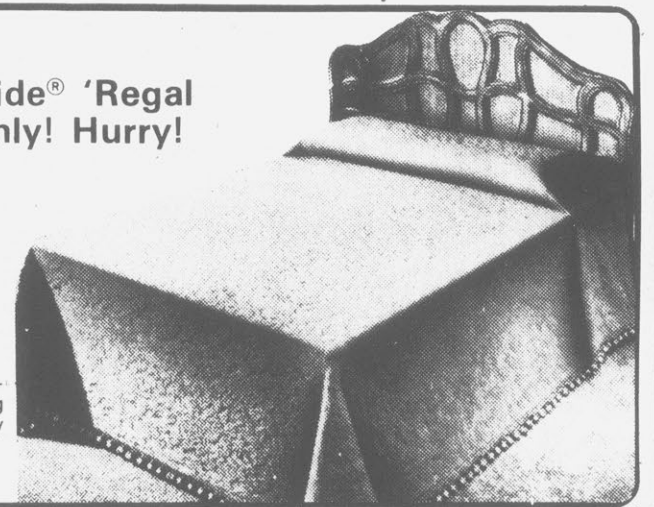

'George Washington's Choice'® Bedsreads on Sale in 4 Sizes

TWIN  
Regular 69.99

**49.88**

FULL  
Regular 79.99

**54.88**

QUEEN  
Regular 96.00

**64.88**

KING  
Regular 105.00

**79.88**

In stately colonial mansions, beds bore themselves like born aristocrats. . . the major point of pride being the treasured handwoven counterpart. Today's treasure is its perfect counterpart, so authentic Bates® registers it in the owner's name. Reversible, wash and dry by machine. A contemporary classic. Antique, snow white.

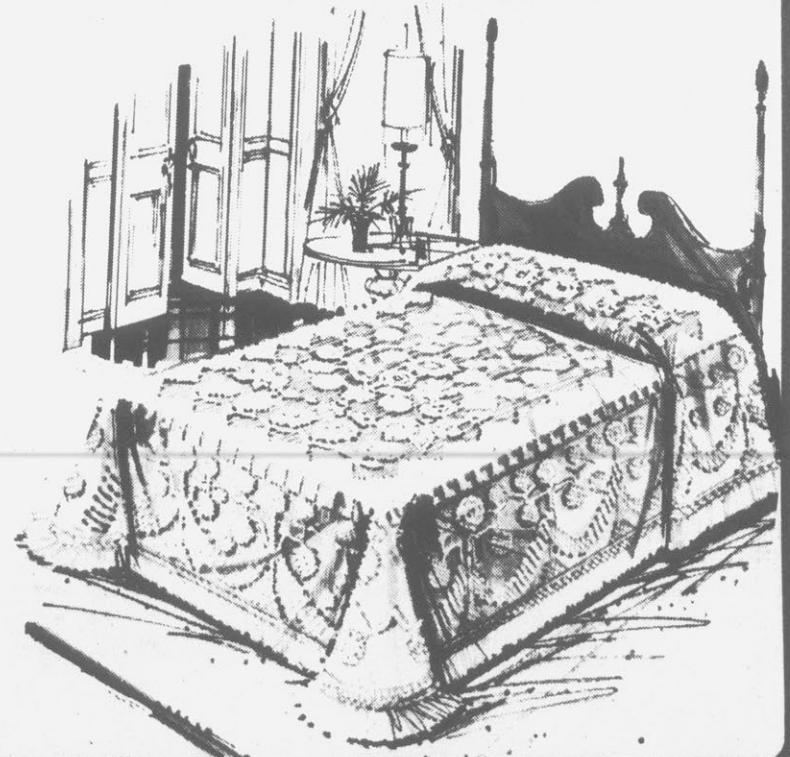

P.M. and Make Us Your

Day 1 P.M. Until 6 P.M. — Phone 291-2355

# Belk Tyler

parkwood mall wilson

# grand opening

# sale

**THURSDAY,  
FRIDAY AND  
SATURDAY**

Big Savings on Boys' Suits!

**20% OFF**  
ORIGINAL PRICES

Our selection includes polyester and polyester/cotton blends in spring solids, stripes and plaids. They're famous name brands too in sizes 4 to 7. Shop early!



Charge It On your Belk Credit Card, Master Charge®, VISA® and American Express

Special Buy on Boys' LEVI'S® Denim and Corduroy Jeans!

**11.88**

Belk Tyler Low Price

Straight leg styles in denim blue and navy, beige, cream, rust, royal, light blue corduroys. Sizes 8 to 20.

Low Price on Men's Jogging Shorts

**2.97**

Belk Tyler Low Price

Polyester/cotton blend in solid white, red, kelly, orange, light blue, navy, tan, yellow with contrast trim. Split side legs in sizes S, M, L, XL.



Men's Three-Piece Suits at 30.12 Off!

**69.88**

Regular 100.00

A perfect year 'round weight of 100% texturized polyester with hard finish. Solids or black, navy, steel blue. Sizes 38 to 44 regulars, and 40 to 46 longs. Shop early for best selection!

Save 10.12 on Our 'Manstyle' Men's Three-Piece Suits!

**59.88**

Regular 70.00

Handsomely styled coat, vest and pants of 100% texturized polyester with hard finish for longer wear. Perfect all year 'round weight. Navy, tan, brown, medium blue solids. Sizes 38 to 46 regulars, longs.



Versatile Men's Four-Piece Suits 21.12 Off!

**69.88**

Regular 90.00

Reversible vest, matching slacks, contrast slack and coat of 100% texturized polyester. Tan, brown, navy, medium blue solids in sizes 38 to 46 regulars, 39 to 46 longs.

Men's Tube Socks Special

Belk Tyler Low Price **6 Pr. for 5.88**  
One size fits all socks in white with contrasting colored trimmed tops. Six per package so stock up now and save!

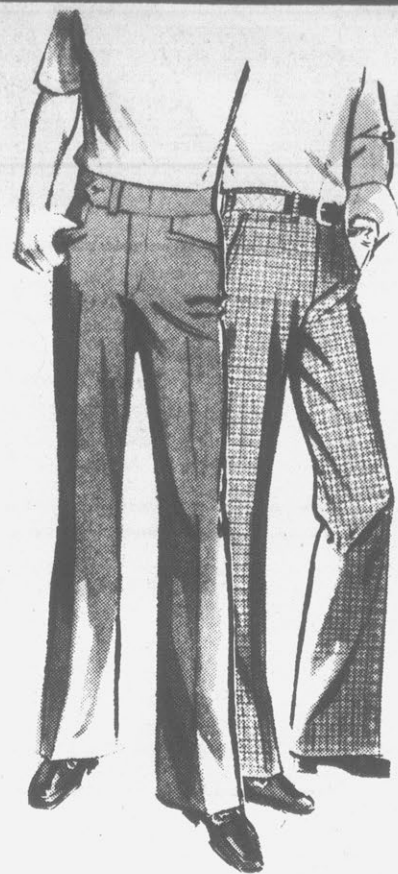

Men's Slacks 10.12 Off!

**19.88**

Reg. \$30

100% polyester of famous name brands in black, grey, navy, tan, brown, rust, light blue solids in belt loop and beltless Self-Sizer™ waistband. Sizes 32 to 44.

2.12 Savings on a Group of Boys' Denim Jeans!

**6.88**

Reg. \$10

Easy-care machine washable polyester and cotton blend in denim color only. Sizes 4 to 7.



Men's Arrow® Dress Shirts With Savings Up to 6.12!

**9.88**

Reg. \$15 and \$16

Famous Arrow® quality of long and short sleeve styles in handsome solids and interesting patterns of easy-care fabrics that need little or no ironing. Sizes 15 to 18. Buy several and save later!



'The Bold One' Men's Knit Shirts on Sale!

**7.88**

Reg. \$10

Polyester/cotton knit with short sleeve styling, short collar, banded sleeve, long tail in red, yellow, kelly green, pink, melon. Sizes small, medium, large, extra large.



Special on Hot Press Caps

Belk Tyler Low Price **4.00**  
Buy a cap and get an emblem put on for Free. Sizes small, medium, large, extra large.

T-Shirt and Hot Press Emblem

Belk Tyler Low Price **3.25**  
Buy a 100% cotton T-shirt and get a hot press emblem of your choice put on Free. Sizes S, M, L, XL. Solid colors.

Shop Daily 10 a.m. Until 9 p.m. and Make Us Your "Sunday Place". . . Shop Sunday 1 p.m. Until 6 p.m. — Phone 291-2355

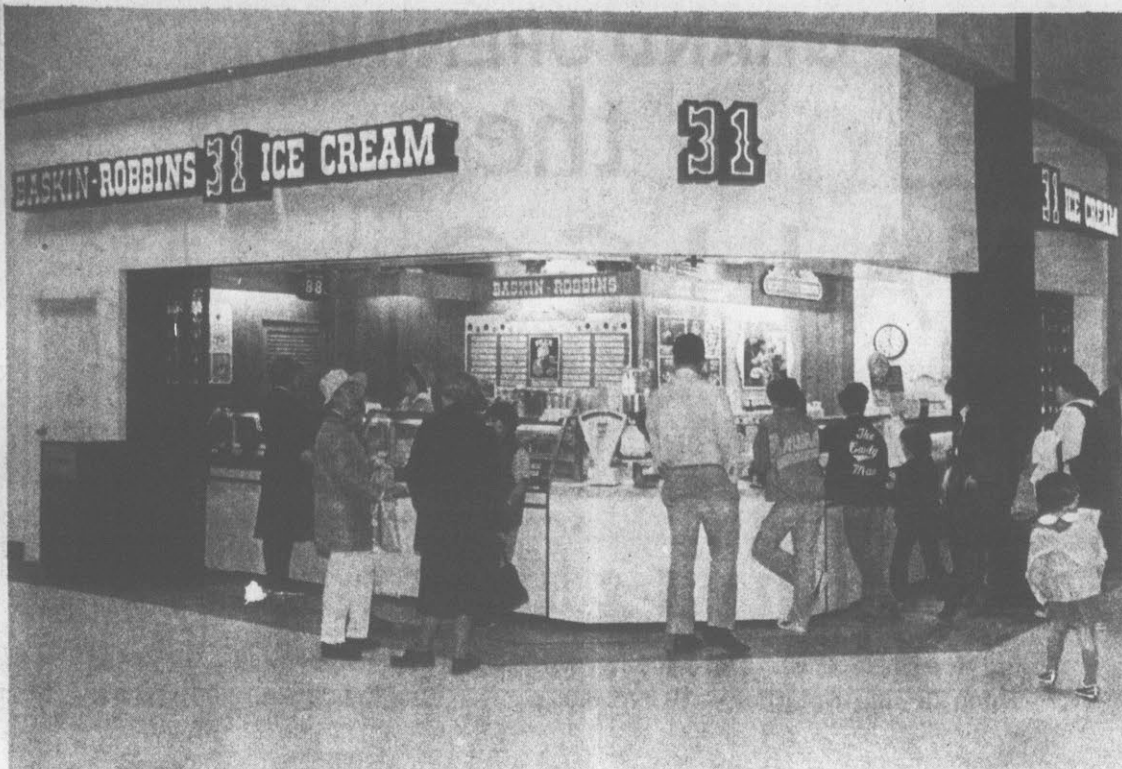

BASKIN-ROBBINS 31 flavor ice cream parlor located on the center court of Parkwood Mall, features ice cream, sundaes and a variety of party treats made to order. (Photo by Mickey Driver)

**More Than Convenient Shopping ...**

**Community Events Planned At Parkwood**

Parkwood Mall will offer the Wilson community a lot more than convenient shopping, says Roger Melton, Promotional Director for the mall. Numerous community activities have been planned for the months ahead, and Melton would like to schedule still more.

"We say that Parkwood Mall is something else, and I believe that something else is community involvement," said

Melton. The Promotional Director is planning an arts and crafts fair through the Wilson Arts Council, and an antique show for the fall, coordinated with the Wilson Sertoma Club.

Two charity bazaars for non-profit organizations have been scheduled, along with several Diabetes Association events. Parkwood will also be spon-

soring another Christmas party for deaf children, complete with a "signing" Santa and free photographs.

For Senior Citizens Day, Parkwood Mall will have entertainment and refreshments, and various activities are planned for Boy Scout Week and Girl Scout Week.

"We want the people of Wilson to feel a part of the mall," Melton said. "Before, we were

limited in our facilities, but now we feel that our facilities are exceptional. We want to make them available to the community any way we can."

Melton advised that Parkwood's calendar of community events is far from complete, and that mall officials welcome the opportunity to work with any non-profit civic organization in Wilson.

**Landscaping Completed At Parkwood**

The landscaping at Parkwood Mall has been designed as much for safety and practicality as for beauty.

As a safety measure, the use of shrubbery has been minimized so as not to block the site lines.

Geoffrey McLean & Company, landscape architects for the mall, have instead made more extensive use of trees. Rows of deciduous hardwoods line the entranceways much like the trees on an avenue. Upon installation, the trees are ten to

twelve feet tall with a 2½ inch caliper, but they will grow much larger.

At least part of the periphery of the mall is irrigated for maintenance in case of drought.

The landscaping has been planned to create an effect of progression approaching the mall. Closer to the mall, the trees become smaller and the arrangement is more organized. The walkway areas have been

designed with features for pedestrians such as benches and small shade trees. Most of the trees in this area are American Holly and Crepe Myrtle.

The interior of the mall contains Palms and other semi-tropical material which is native to Florida. All are types which can survive the consistency of climatic conditions within the mall. Most will be located in the center court.

**Parkwood Is A New 'First' For Wilson**

Fifty years ago, it seemed like science fiction—a small "city" of stores completely enclosed under one roof—where technology makes sure that it never rains, snows, gets too hot or too cold. Perhaps today such modern miracles are taken for granted much more than they were fifty years ago, but the first climate-controlled mall in Wilson County is still a long-anticipated, exciting event.

Parkwood Mall now has 65 very different tenants and services grouped together to provide convenience and variety. Because of the well designed, attractive environment, shopping at Parkwood will be an adventure. Shoppers can find everything from hardware and fur coats to Raggedy Ann dolls and diamond rings. The crisp smell of new clothes mingles with the smells of popcorn and perfume, as customers stroll in a climate carefully controlled at comfort level. In the summer, the temperature does not fall below 78 degrees F., and in the winter it does not exceed 68 degrees F. Parkwood has three units for air conditioning and heating to

ensure maximum flexibility and reliability.

For safety, there are sophisticated smoke alarm devices and a 24 hour security patrol.

Parkwood has a natural, earth-toned interior, complete with a fountain and lots of greenery. All the stores, including the existing ones, have brand new fronts.

Outside the mall, benches are strategically located beneath crepe myrtle trees. Inside, seating and conversation areas provide pleasant places to relax. Parkwood's atmosphere is warm and inviting.

Americans have been said to spend more time in shopping centers than anywhere else except their homes and places of work. Maybe it's the convenience of one-stop shopping and the shelter from the weather. Maybe it's the free parking and the accessibility of dining and entertainment. Or maybe it's all the sights and smells, and the brightly colored merchandise beckoning from all the different stores—a fantasy world that even grownups are allowed.

**Fashion Comes Alive At The New Lerner**

Fashion comes alive at the new Lerner now open in Parkwood Mall. Gals will love the adventure of shopping at this bright, new fashion ce, which is the 569th link in a nationwide chain dedicated to bringing exciting, but very affordable styles to their customers.

The Parkwood Mall Lerner offers all the latest concepts in design, and is a modern showcase for the presentation of today's great young looks. All the fashion finds for career, school and campus are right there in a fresh array of young Spring-Easter looks. All styled with you in mind. Your figure, your lifestyle, your budget, because that's what today's Lerner shops are all about. See everything that's now and new for the every mood of you. Elegant, refined looks! Daring looks! School stuff and fun styles for every day of your life.

There's a sensational selection of "free-to-be-you" sports-separates that run the gamut from sassy to dress-up, and

everything in-between. You can choose from a wide, wide world of tops and bottoms you'll delight in now, and for a long time to come, as well as a choice of breezy dresses styled to match your every mood and move.

Lerner takes great pride in providing services that make shopping easy, pleasant and comfortable. Accommodations include the Lerner Charge Plan, VISA, as well as a liberal layaway schedule. Also offered, is the unique facility which enables shoppers to exchange, or refund purchases made at the Parkwood Mall store in any other Lerner.

Corporate Headquarters are in New York City and seven Branch Offices, and Distribution Centers operate in Atlanta, Jacksonville, Denver, Los Angeles, Chicago, Dallas and Pittsburgh. This regional alignment enables Lerner Shops to merchandise the stores in each area with the latest fashions based on local demand.

**Special Parkwood Mall Grand Opening SALE!**



Zales and Friends make wishes come true.

Also available, Zales Revolving Charge.

**ZALES**  
The Diamond Store

Sale prices effective on selected merchandise. Entire stock not included in this sale. Original price tags shown on every item. All items subject to prior sale. Items illustrated not necessarily those on sale.

**Wachovia**  
Looks Forward  
To Joining  
The Wilson  
Community  
Summer Of  
1979

**Wachovia**  
Bank & Trust

Office Location  
Parkwood Mall

**RICE'S**  
OF WILSON

In Wilson Since 1947 -  
In Parkwood Mall Since  
1972 - Re-Modeled And  
Ready To Serve You  
In The Very Finest And  
Latest Men's Clothing  
For The Short, Regular,  
Tall And Big Man.

You're Invited To See  
Our Spring & Summer  
Lineup From These  
Famous Makers:

- Hart Schaffner & Marx
- Palm Beach
- Crickateer
- Penn State
- Hardwick
- Stanley Blacker
- 3 F's
- Gant
- Arrow
- Manhattan
- Hickok
- Jantzen
- Munsingwear
- Izod
- London Fog
- Berle
- Higgins
- After-Six
- Lord West
- Hang Ten
- Lord Jeff

"You'll Look The Nicest . . .  
When You Shop At Rice's!"

2 LOCATIONS TO SERVE YOU BETTER  
Parkwood Mall And  
Blvd. Plaza Shopping Center

**GRAND OPENING**

Our store and our footwear collection have been designed with you in mind — both are as versatile, as tailored, as feminine, as you can be. Please stop by soon: You'll not only enjoy the merchandise, you'll treasure the surroundings and the expert help. Connie Shoes — a beautiful way of shopping!



Colors:  
Black Patent,  
Bone &  
White  
**\$26**

**connie**<sup>®</sup>  
Parkwood Mall



Parkwood's Camelot Music Store Shown

## Camelot Complements Motif Of Mall With Tastefully Decorated Interior

From its modern exterior, to its tastefully decorated interior, each Camelot Music store utilizes the latest fixtures, color schemes and graphics to complement the motif of the mall.

The store is characterized by a well-conceived floor plan that provides ample aisle space, unobstructed customer flow and complete accessibility to stereo albums, tapes and accessories.

The philosophy of each Camelot store is to make it appealing to every member of the family, young and old. Dramatically lit and furnished interiors are accented by colorful displays and huge inventories that provide an inviting environment for people of all ages.

Camelot's family appeal carries the widest variety of inventories to please a diverse range of musical tastes. Classifications include Country, Rock, Classical, Quad, Religious, Ethnic,

Childrens, Educational and import recording. In addition, a complete selection of stereo album and tape accessories, sheet music and music books and over 300 different titles in current 45 r.p.m.'s and oldies round out the inventory mix.

The broad selection is designed to appeal to consumers of all ages, all of musical preferences. It includes not only current history of the day, but the perennial standards not found in the typical record and tape store. An extra added feature that Camelot has initiated is a customer special order service, where the customer would like to order a particular album or tape that is not stocked in their vast inventory. Camelot will order this particular merchandise at no extra charge to the customer.

Camelot store locations span 22 states and will be over 80 stores strong at the end of 1978.

## Expansion Has Economic Impact On Area

The expansion of Parkwood Mall will significantly affect Wilson's economy in many areas other than retail.

will create jobs, pay taxes, and provide its own essential maintenance services."

"The mall will have a definite impact," said Mark Pitney of North Hills, Inc. "Besides supplying retail needs, the mall

However, the most obvious impact will occur in the area of retail sales. The results of a 1977 Chamber of Commerce survey on Wilson's shopping habits

indicated that available retail merchandise was not keeping pace with the city's buying power. Although 90.6 percent of those surveyed reported that they did look first in Wilson for their shopping needs, approximately a fourth of them went "out of town" for items in

the clothing and dining-entertainment categories.

The population and income increases combined with the survey results convinced North Hills, Inc. that Parkwood must be expanded in order to meet the retail needs of the community.

GRAND OPENING

# the CALICO BARN

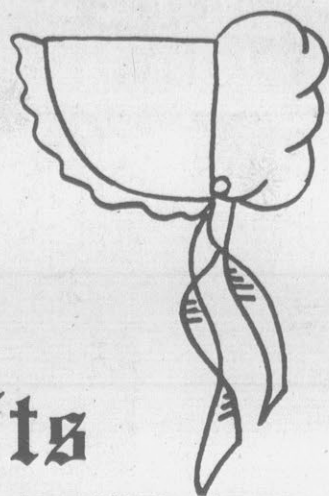

## Antiques & Gifts

Spring Hope, N. C. Hwy. 64, 478-5052 — Wilson, N. C. Parkwood Mall — 291-9584  
Open Monday-Saturday — 10 a.m.-9:00 p.m. — Sunday 1:00 p.m.-6:00 p.m.



Antiques and Reproductions

Quilts and Coverlets

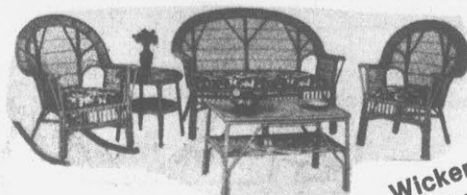

Wicker, Wicker Old & New

Calico Fabrics, Ribbon and Soap, Wooden Toys, Pretty Dolls and A Jumping Rope,

Potpourri, Brass, Candlesticks and Tin — Apples, Eggs and Little Wire Hens — Placemats and Napkins, Candles and Such.

Can't List It All It's Much Too Much —

Houses For Birds and Bunnies Of Yarn — We Welcome You Warmly To

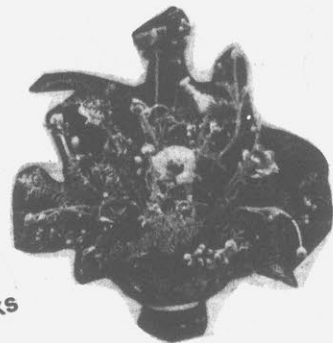

The Calico Barn

And Silks

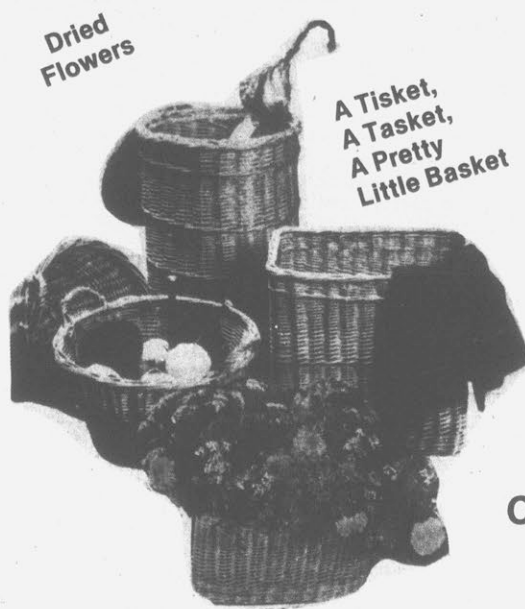

Dried Flowers

A Tisket, A Tasket, A Pretty Little Basket

# Grand Opening



## FLORSHEIM®

### IMPERIAL

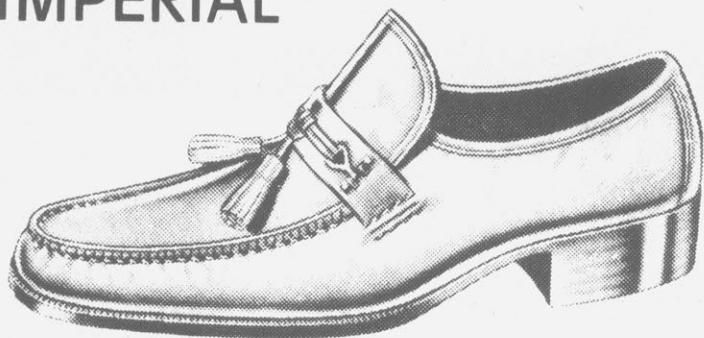

Top quality leathers teamed with comfortable support. A fine blend of Florsheim styling and craftsmanship for the man who appreciates fashion at its finest.

Colors — Brandy, Gold, And Black

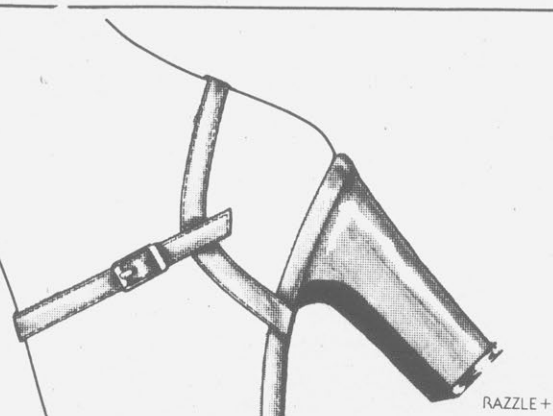

RAZZLE+

Just try and go unnoticed in this eye-catching sandal!

It's the little sandal that forgot to be demure—baring heels and toes for all to admire! A foot caught in the snares of these slender straps will intrigue every eye. Get noticed! Get this dainty sandal today!

|            |           |      |        |
|------------|-----------|------|--------|
| N          | M         | W    | NO 10½ |
| 6½-10 & 11 | 5-10 & 11 | 5½-9 |        |

SOCIALITES

Black, Bone, White, Navy

\$29<sup>95</sup>



"Serving The Surrounding Area Since 1937!"

# Flowers' Shoe Store, Inc.

108 S. TARBORO STREET — WILSON — PARKWOOD MALL



**Mall  
Grand  
Opening!**

# Spectacular!

**Mall  
Grand  
Opening!**

Save 20% on  
selected swimwear.



**Sale**  
**11<sup>20</sup>**  
to  
**\$20**

**Reg. \$14 to \$25.** Get into the savings swim and snap up some of the prettiest beach scenery around. Take your pick of teeny bikinis, maillots, boylegs and much more. In nylon/Lycra® spandex blends, polyester prints, solids and stripes. Hurry. They'll go fast. Misses' and junior sizes.

Sale prices effective thru Saturday.

Save 20% on colorful pro-look tennis coordinates.



**Sale \$8**

**Sale \$10.** The mature men's short sleeve shirt is crisp polyester/cotton knit with button placket and chest pocket. For on court or off. Sizes S-M-L-XL.

**Sale \$8**

**Sale \$10.** Trim tennis shorts are full-cut for comfort with Ban-Rol® waist, adjustable side tabs. Styled with front pockets, one back pocket. In Kodol™ polyester/cotton. Color-trimmed white and fashion pastels for 28-42.

**Special \$15**



On court or off, Terry is tops when it comes to looking like a pro. And feeling like a champion. Terry 3 piece set in S, M, L all of polyester.

**Sale**  
**5.99**

**Orig. \$14.** Polyester baby cord trouser with slash pockets.

**Special**  
**2.99**

Women's athletic short in great colors.



**20% off athletic shoes.**

**Sale \$12**

**Reg. 14.99.** Men's and boys' leather/nylon sport shoe is padded where it counts: collar, tongue, insole. Molded sponge rubber adds arch support. The sole is a multi-surface, sawtooth/suction cup rubber design. In red, blue, brown and gold.

**Sale 9.60**

**Reg. 11.99.** The vinyl sport shoe for men is reinforced with leather at the toe and heel. Plus plenty of padding at the collar, insole and arch. Rugged rubber herringbone design sole turns up at toe and heel. White with blue stripes.



**Special**  
**2.99**

Ladies tops in solids and stripes.

**Sale**  
**3.99**

**Orig. \$10.** Ladies poly/cotton tennis shirts.

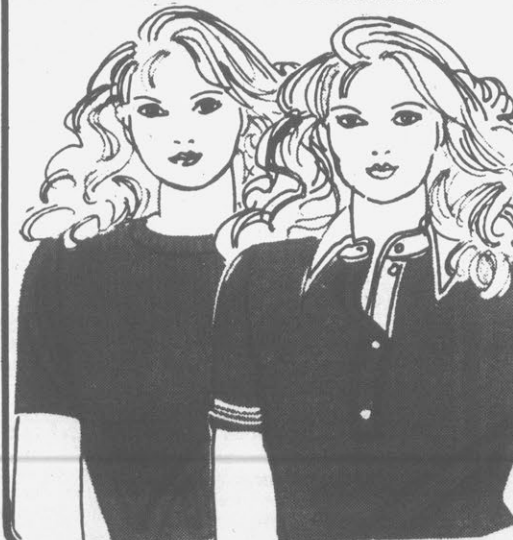

**Save 20%**  
**7.99**

**Reg. 9.99.** Best buy solid and fancy dress slacks.

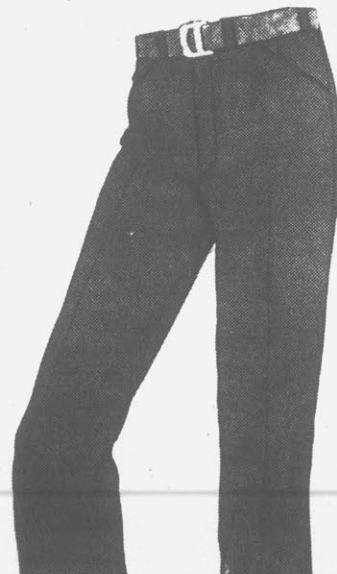

**20% off men's 3-piece suit.**  
**\$72**

**Reg. \$90.** Great selection of vested solids and patterns. All with terrific fashion details. In regular and long.



**This is JCPenney**

Located in Parkwood Mall — Open Mon.-Sat. 10 a.m.-9 p.m. — Sun. 1-6 p.m.

**Mall  
Grand  
Opening!**

# Spectacular!

**Mall  
Grand  
Opening!**

**Save \$230**  
on our MCS Series® 33-watt receiver,  
two 3-way speakers, plus a JCPenney  
warranty unsurpassed  
by any hi-fi manufacturer.

**Modular Component Systems MCS Series® warranty**  
• Full 5 year warranty on speakers  
• Full 3 year warranty on receivers and turntables  
Within 5 years of purchase of speakers or 3 years of purchase  
of receivers and turntables of this Modular Component  
System, we will, at our option, repair or replace these items  
if defective in material or workmanship. Just return it to  
the nearest JCPenney facility.

**Sale \$349**

Reg. 579.85. Our MCS Series® 33 watt component  
package includes receiver with tape monitor,  
tuning and signal strength meters; plus speakers  
with 12-in. woofer, midrange, tweeter.

33 watts RMS minimum per  
channel, two channels driven  
a 8 ohms, 20-20,000 Hz with  
not more than 0.8% total  
harmonic distortion.



**Save \$30**

Reg. 129.95. Sale \$99. MCS Series®  
belt drive turntable with Audio Technica®  
magnetic cartridge, strobe. #6502  
31.95 Koss stereo headphone (not  
covered by MCS Series® warranty)

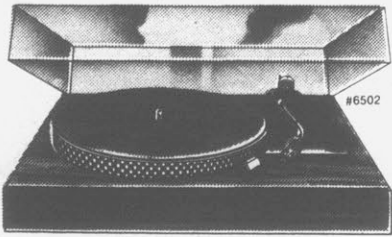

**Sale 429.95**

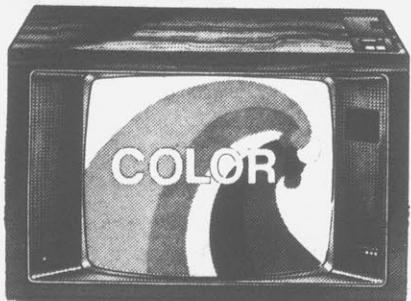

Reg. 479.95. Accu-Scan™ color TV with 19-in.  
screen (meas. diag.). #2033  
• Accu-Scan™ automatic color for lifelike tones  
• Chroma-Brite™ black matrix picture tube

**Sale \$249**

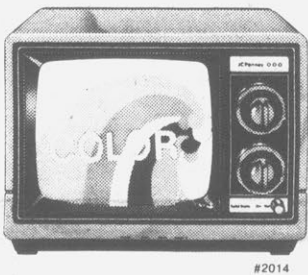

Reg. \$279.  
Color  
TV with 10-in.  
screen (meas.  
diag.). #2014  
• Automatic fine  
tuning  
• Memory VHF  
fine tuning  
Sale prices effective  
through Saturday.

**Sale  
27.99**

Reg. 32.99. 5'x7' nylon wall  
tent with 3-way zip screen  
door, tie back storm flap, rear  
window. 4'9" center height.  
Poles, stakes, guy ropes and  
stuff bag included.  
Sale prices effective  
through Saturday.

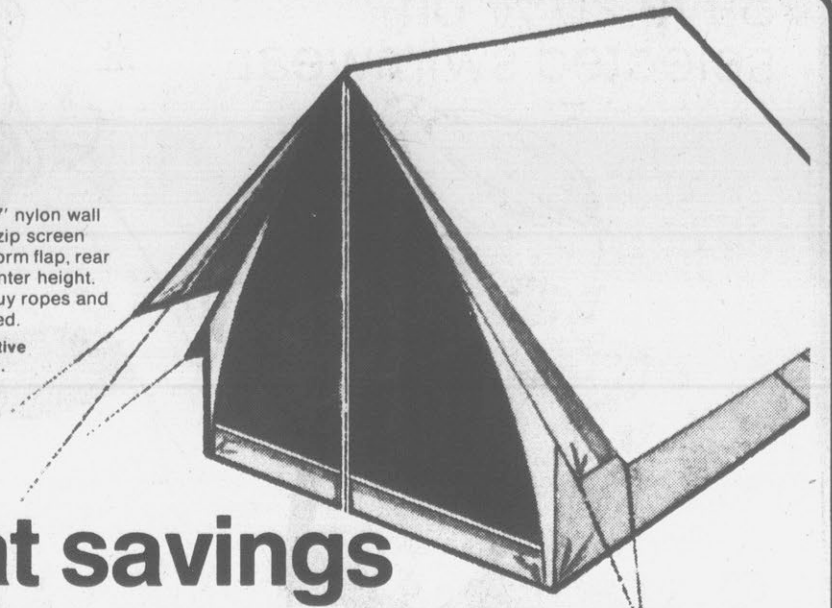

**Great savings  
for the great outdoors.**

**Sale 23.99**

Reg. 29.99. Mummy style  
2 1/2 lb. Hollofil® II poly-  
ester sleeping bag with rip-  
stop nylon lining. 33"x78".

**Sale 26.99**

Reg. 34.99. Rectangular  
Hollofil® II polyester 3 lb.  
nylon sleeping bag with  
flannel liner. 33"x75".

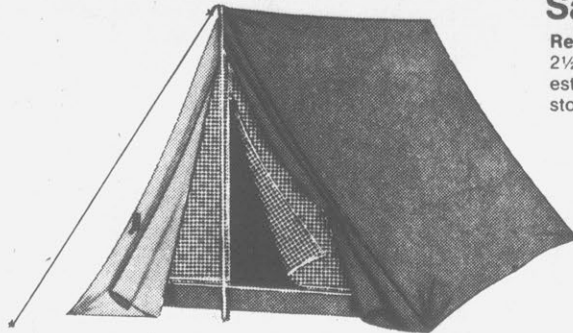

**Sale 19.99**

Reg. 22.99. 5'x7' two-man nylon pup tent  
with 3-way zip screen door,  
tie back storm flap, rear window.  
3'6" center height. Poles,  
stakes, guy ropes and stuff bag included.  
9.99. 7'x7 1/2' nylon tent fly

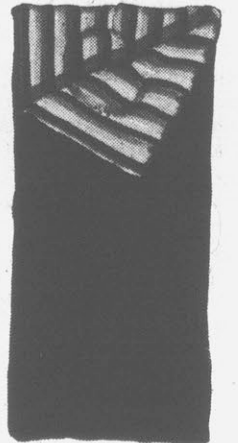

**22.99**

Coleman  
double mantle  
propane lan-  
tern. Up to  
20 hours  
burning time  
on low flame.  
Adaptable to  
bulk tank.



**25.99**

Coleman de-  
luxe double  
mantle gas  
lantern. Eight  
hour burning  
time.

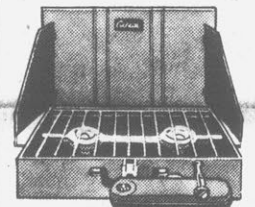

**29.99**

Coleman  
deluxe two burner gas  
stove. 3 1/2 pint fuel  
capacity with approxi-  
mate BTU input of  
25,600 BTU's.

**Save \$35**

Reg. 179.99. Sale 144.99.  
3 1/2 HP 21" push mulching  
mower with Briggs &  
Stratton engine. Vertical  
pull starter, single lever  
height adjustment.  
Sale prices effective  
thru Saturday.



**Save \$20**

Reg. 119.99. Sale 99.99. Push  
mower features a 3 1/2 HP Briggs &  
Stratton engine, 20" steel cutting  
deck and height-of-cut adjustment.  
Throws grass to the side.  
Sale prices effective  
thru Saturday.



**Save \$10**

Reg. 49.99. Sale 39.99. Toro  
3.5 amp line trimmer. Auto-  
matic line feed, double insu-  
lated and lightweight  
with adjustable support  
handle. Or, the Toro  
cordless line trimmer  
with recharger.



**Special  
6.88**

A Dozen  
Top Flight X-outs.

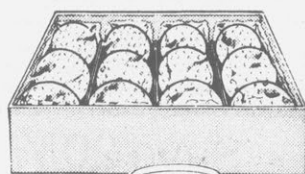

**1.99**

Wilson Match  
Point Tennis Balls.

**Save 50% on  
one coat interior  
flat latex.**

**Sale 5.49**

Reg. 10.99  
**Save \$4**  
Reg. 10.99. Sale 6.99 gal.  
Limited 4 year warranty.  
One coat semi-gloss interior  
latex. Washable.



**Save 3.50**

Reg. 12.49. Sale 8.99 gal.  
Custom Color interior semi-  
gloss in over 700 colors.  
Sale 7.99. Reg. 11.49. Custom  
color interior flat.

**Save \$3**

Reg. 10.99. Sale 7.99 gal.  
Limited 3 year warranty.  
One coat flat exterior latex.  
2.29 qt. Gloss-off  
2.29 qt. Paint remover

**\$10 to \$30 off  
family bikes.**

**Save \$30**

Reg. 119.99. Sale 89.99. Men's deluxe 26" racing  
style bike features Shimano Positron III derailleur  
shift, 8 sprocket cluster with 12-speed gear ratio.  
Metallic blue finish.

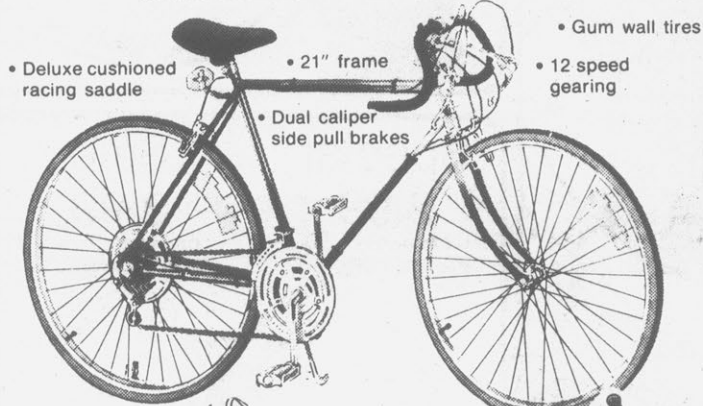

• Deluxe cushioned racing saddle  
• 21" frame  
• Dual caliper side pull brakes  
• Gum wall tires  
• 12 speed gearing



**Save \$10**

Reg. 89.99. Sale 79.99. Boy's  
20" motocross styled bike features  
coaster brake, padded tank, knobby  
tires, front and side number plates.



**Save \$20**

Reg. 119.99. Sale 99.99. Men's  
or women's 26" 10-speed  
Superstar™ racing style bike.  
Features the Positron™ derailleur  
system and dual caliper center  
pull brakes. Straw finish.



**Save \$10**

Reg. 89.99. Sale 79.99. Girl's  
Wildflower bike. Cross-braced  
handlebars, rat trap pedals,  
coaster brake.

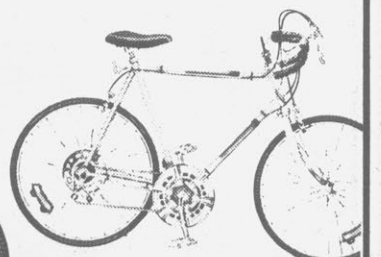

**Save \$15**

Reg. 99.99. Sale 84.99. Boy's  
24" 10-speed bike features  
brake extension levers. Blackwall  
tires. Silver finish with black seat.

**This  
is JCPenney**

Located In Parkwood Mall — Open Mon.-Sat. 10 a.m.-9 p.m. — Sun. 1-6 p.m.

Sunday at  
Parkwood Mall is  
something else  
...AN EXTRA DAY  
FOR SHOPPING!

the  
Sunday  
Place

shop 1 to 6

The new Parkwood Mall wants to make it as CON-  
VENIENT for you to shop as it is easy to find what  
you want when you get here. Our 10 a.m. to 9 p.m.  
hours, Monday through Saturday, will satisfy most  
people, but, for those who find it difficult to shop  
on weekdays, PARKWOOD MALL STORES WILL BE  
OPEN SUNDAY 1 P.M. TO 6 P.M. You can depend  
on Parkwood for "something else" in shopping ...  
EVERY DAY OF THE WEEK!



parkwood mall

it's something else!

WARD BOULEVARD AT N.C. 42 IN WILSON

Now open in  
Parkwood Mall

Rosenbloom-Levy... a name long associated in  
eastern North Carolina with fashion flair and  
impeccable taste in men's and women's clothing,  
opens tomorrow in Wilson's Parkwood Mall.  
This latest edition to the Rosenbloom-Levy  
family of stores has been innovatively designed  
to give the feel of a stylish boutique specializing  
in thoughtful, personalized service.  
Rosenbloom-Levy is proud to be in Wilson,  
and warmly invites you to visit our store to see  
the most dazzling display of springtime  
fashions and accessories ever!

Visa and Mastercharge welcome.

Rosenbloom-Levy

PARKWOOD MALL WILSON

TARRYTOWN MALL ROCKY MOUNT

ONES NEW YORK

CHRISTINE VON LUMBE

IZOD

CORBIN, LTD.

Southwick

St. Raphaël

Calvin Klein

Breckenridge

BILL BLASS FOR PBM

**Saslow's and  
Parkwood**  
Two Great Names!



14K GOLD BALL  
PENDANT  
ONLY  
\$12.88

14K CHAIN 14K 7MM BALL

Famous Value From  
**SASLOW'S**

**14k Serpentine Chains!**

Start with a 14K gold neckchain and add a ray of sunshine to whatever you're wearing. A glint of gold to make a fashion impact in 15" or 18" lengths.



SALE  
ENDS  
MARCH 31st

15-INCH LENGTH  
**\$18<sup>88</sup>**

Then, circle your wrist with gold. Our wonderfully wispy 7", 14K gold bracelet is a delicate finish to any look.

AVAILABLE IN ALL LENGTHS

**\$11<sup>88</sup>**

VISA, MASTER CHARGE  
OR USE SASLOW'S OWN CHARGE PLAN

**SASLOW'S**

Jewelers  
229 PARKWOOD MALL  
WILSON  
PHONE 291-7016

**William's  
Ltd.**

**"YOUR  
PERSONAL  
SHOP  
FOR  
GREAT  
LOOKING  
CLOTHES!"**

**OPEN  
MONDAY-SATURDAY  
10:00 A.M.-9:00 P.M.**

LOCATED AT —



**William's Ltd.**

Parkwood Mall  
Wilson, N. C.  
Phone: 291-5625

**Becky's**



Stop For A Quick Meal When Shopping The Mall  
Ham And Sausage Biscuits, Sandwiches, And Homemade Soup  
OPEN MONDAY-SATURDAY 8 A.M.-9 P.M.

**Becky's**  
PARKWOOD MALL

**Mitchell's**

HAIRSTYLING

Invites you to visit  
our new location

The Latest In Hair Fashion  
For Men, Women and Children  
We offer fantastic new hours

Mon.-Fri. 8 a.m.-9 p.m. — Sat. 8 a.m.-6 p.m.

Our staff of 10 stylists have just finished an  
advanced class in the latest hair cutting techniques

**GRAND OPENING SPECIAL**

Frosting

\$17<sup>50</sup>

Reg. 25.00

Offer Good March 22-31  
No Appointment Necessary

Body Wave

\$19<sup>50</sup>

Reg. \$30.00

Given By Selected Stylist  
Phone 237-5221

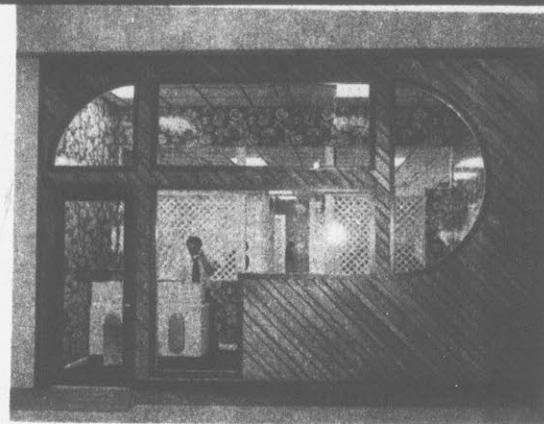

**Young is the look,**

is the mood, is the  
style at Lerner.

NOW OPEN  
**PARKWOOD MALL**

Ward Boulevard at N.C. 42

Free and thoroughly female, your  
fashion sights are set on the  
looks that mirror the mood  
you're in. Fashion with pizzazz.  
Getting it together in your  
inimitable way. We're on to you.  
And we've got your style.

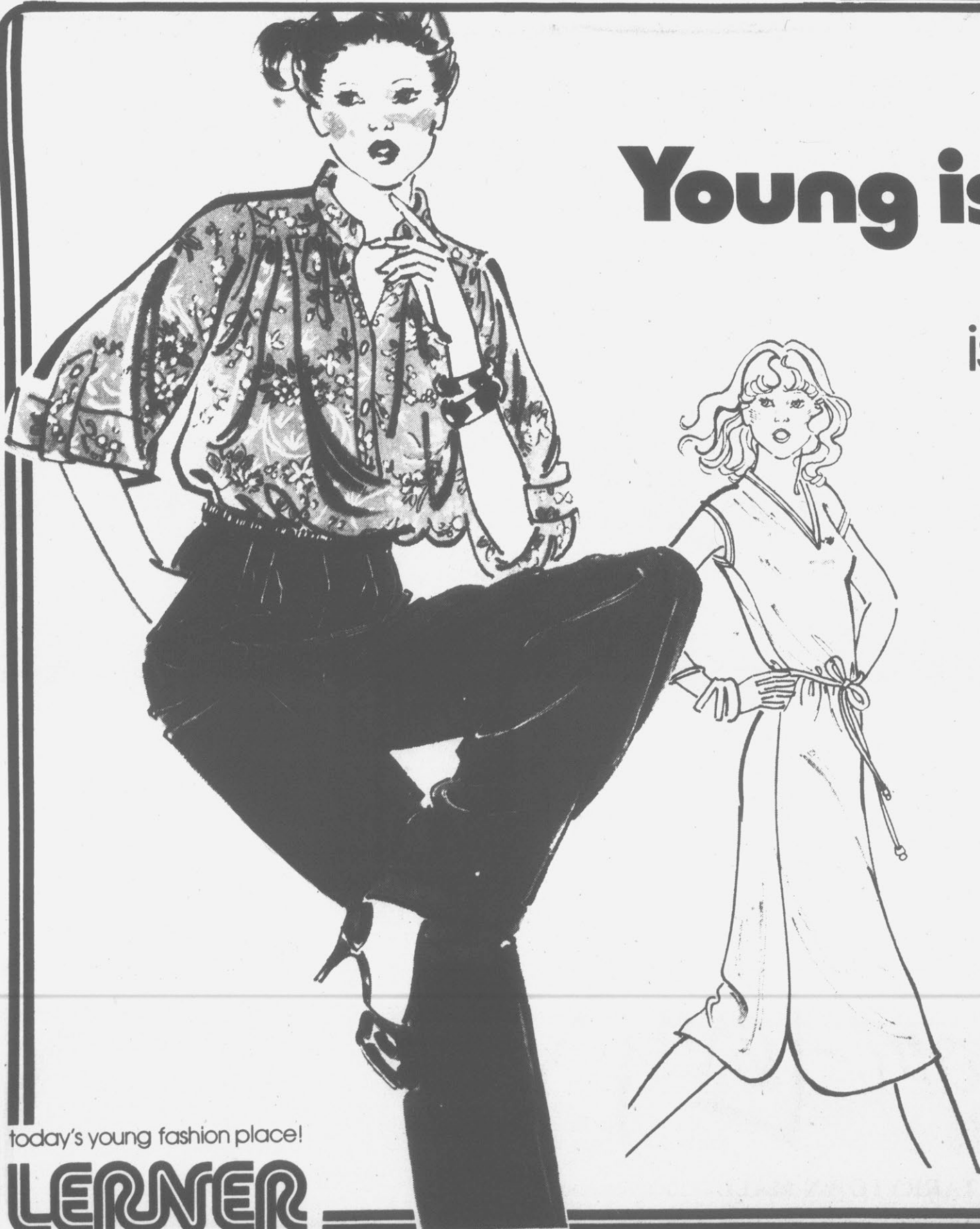

today's young fashion place!

**LERNER**

# Hackney's

is now open in Wilson's new Parkwood Mall with  
the finest famous maker sports equipment and sportswear  
... great labels for people who play.



Come in ...  
browse through our selections  
and meet our friendly folks...

... a knowledgeable staff to answer your questions,  
to recommend the best equipment for your particular sport ... to introduce you  
to famous maker sportswear from hats to shoes and sports equipment from  
tennis to backpacking, from racquetball to basketball.



Shop 10 to 9 Monday-Saturday/1 to 6 Sundays in Wilson's Parkwood Mall Phone 291-9407



Becky's of Parkwood Mall features fast food at its finest, serving 100 percent all meat products, hot dogs, Becky Burger, ham biscuits, sausage

biscuits, homemade soup, coffee and soft drinks, and is open Monday through Saturday from 8 a.m. to 9 p.m. (Photo by Micky Driver)

## Special Events Scheduled At Parkwood

In the next few weeks, Parkwood Mall will be the site for some exciting public events.

Probably the most exciting of all will be the Mall's grand opening celebration, which will last from March 22 until March 25. There will be clowns on hand for the celebration, and a huge "Parkwood" cake, made with a recipe which calls for 800 eggs.

Lots of surprises and fun for everyone are on schedule.

Spring Fashion Days will be the focus March 29-31. To get everyone's mind on spring, the mall will be beautifully decorated for Easter. This is the best opportunity to get a first look at the very latest fashions for spring; all the stores at Parkwood will be putting out

their brand new spring merchandise.

Parkwood brings a little magic to Wilson April 7 and 8 in the form of Franklin and Company. Franklin and Company is comprised of the husband and wife magic act, Mr. and Mrs. Ted Franklin. They put on an extremely professional and exciting show.

For the first time, on April 8, Parkwood will have its Easter egg hunt within the mall. Officials plan to put down straw on the mall floor for the hunt. Parkwood's special guest for the event will be the Easter Bunny, who reportedly has quite a few candy eggs to distribute at the mall. Prizes for the hunt will be contributed by Parkwood merchants.

Area civic or non-profit organizations are invited to sell home-made or hand-crafted items inside the mall at the Spring Charity Bazaar. The bazaar will take place April 12-14.

The Parkwood Hobby Show is slated for April 26-28. This will be a combination exhibit and sale event, with the emphasis on the exhibit. Area coin, stamp and other hobby displays will create an interesting exhibit for the mall. Parkwood extends an invitation to all local hobbyists.

The first Sunday in May is traditionally the day of the Wilson Arts Council's Sunday in the Park. This year "Sidewalk Sam," the sidewalk art exhibit, is on May 6, and Parkwood will again sponsor a free bus to and from the park.



CALICO BARN is a new addition to Parkwood Mall, featuring candles, wicker, antiques and reproduction and bathroom accessories. (Photo by Mickey Driver)

# GRAND OPENING

REGISTER FOR:

COUNTRY HAM, HANOVER F.D. DRESS SHOES, #713 WALKER WORK BOOTS, LADIES HAND MADE LEATHER POCKETBOOK, SHOE SHINE KITS, #4684 ACME WESTERN BOOTS TO BE GIVEN AWAY MARCH 24th — DRAWING WILL BE HELD 6 P.M.



WORLD'S LARGEST BOOTMAKER

**20% OFF ENTIRE LINE WESTERN BOOTS FOR THE FAMILY**



#2417  
"Children's" Rust Driftwood Cowhide Foot With Matching Man Made Shaft  
Sizes 5 1/2-3  
Reg. \$21.95  
**NOW \$17.95**  
Sizes 3 1/2-6  
Reg. \$22.95  
**NOW \$18.95**



#2418  
"Children's" Antique Tan Brazil Cowhide Foot And Shaft  
Sizes 5 1/2-3  
Reg. \$25.95  
**NOW \$20.95**  
Sizes 3 1/2-6  
Reg. \$28.95  
**NOW \$22.95**



#607  
"Ladies" Rust Driftwood Cowhide Foot And Shaft  
Sizes 6-8 1/2 C  
Reg. \$49.95  
**NOW \$39.95**



#666  
"Ladies" Antique Glove Cowhide Foot With Peanut Brittle Lizard Shaft  
Size 6C-8C  
Reg. \$44.95  
**NOW \$35.95**



**JOEL HENDRIX**  
Sales Representative  
With Acme Boot Co.  
Will Be On Hand With \$35,000 Worth of Western Boot Samples And Will Take Special Orders With A Small Deposit. Joel Will Be On Hand **MARCH 22 10 A.M.-6 P.M.**



#4956  
"Mens" Brown-Orange Antique Cowhide Foot And Shaft  
Sizes 8-11D  
Reg. \$49.95  
**NOW \$39.95**

#5612  
"Mens" Antique Brown-Orange With Air Cord Stitching 100% Cowhide Foot And Shaft  
Sizes 8-11D  
Reg. \$49.95  
**NOW \$39.95**



#4914  
"Mens" Brandy Mod-Tek Cowhide Foot And Shaft  
Sizes 8 1/2-11 EW  
Reg. \$44.95  
**NOW \$35.95**



#5789  
"Mens" Tan Oil Retan Cowhide Foot And Shaft  
Sizes 8-11E  
Reg. \$49.95  
**NOW \$39.95**



#4684  
"Mens" Peanut Brittle Lizard Foot With Man Made Patchwork Shaft  
Sizes 8 1/2-11 1/2 D  
Reg. \$39.95  
**NOW \$31.95**



acme

DAN POST

dingo

**Golden Retriever**  
BOOTS & SHOES

The best pair in the field.

A QUALITY AMERICAN PRODUCT FROM WALKER SHOE CO.

**SAVE 20% ON ALL WALKER SHOES & BOOTS**

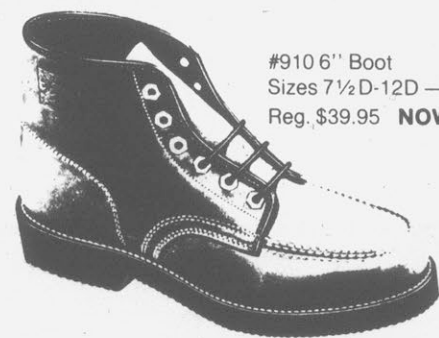

#910 6" Boot  
Sizes 7 1/2 D-12 D — 8-11 EE  
Reg. \$39.95 **NOW \$31.99**



#900 Oxford  
Sizes 8-12 D — 8-11 EE  
Reg. \$39.95 **NOW \$31.99**

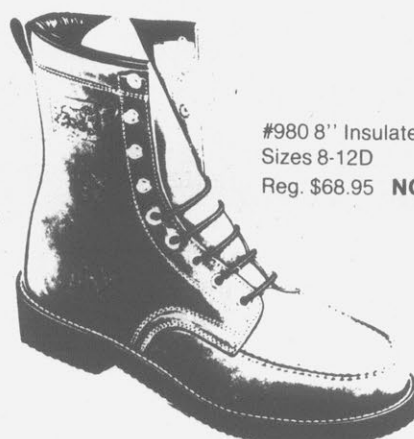

#980 8" Insulated Boot  
Sizes 8-12 D  
Reg. \$68.95 **NOW \$54.95**



#940 8" Boot  
Sizes 8-12 D  
Reg. \$49.95 **NOW \$39.95**

980  
8" Explorer Insulated boot, Rosewood Lumberjack full grain leather upper, embossed moc toe, crepe sole, full Marigold cowhide leather wrapped cushion insole, steel shank, waterproof treated fiber counter, inside cowhide leather rolled and padded top, full Marigold cowhide leather lined and insulated with Uniroyal Ensollite® insulation.

940  
8" Viking boot, Rosewood Lumberjack full grain leather upper, embossed moc toe, crepe sole, full leather cushion insole, steel shank, waterproof treated, purified fungus-resistant vamp lining.

"WHERE COMFORT FITS"

**THOMPSON SHOES AND REPAIR SHOP**

MEN'S WESTERN BOOTS — WORK BOOTS — DRESS CASUAL — FACTORY DAMAGE

PHONE 237-7236

PARKWOOD MALL

the **Color Center**

PARKWOOD MALL — PHONE 237-4115

YOUR COMPLETE PAINT, FRAMING, HOBBY & CRAFT CENTER

### CRAFTS

- MACRAME
- STRING ART
- DECOUPAGE
- SAND ART
- LATCH HOOK
- NYLON FLOWERS
- CANDLE MAKING

### WALLPAPER

- OVER 400 BOOKS TO CHOOSE FROM IN NUMEROUS STYLES, COLORS & PATTERNS

### PAINT DEPARTMENT

- COLONY PAINTS
- PROFESSIONAL CUSTOM MIXING OF COLORS
- BRUSHES
- LADDERS
- TOOLS

### ART DEPARTMENT

- OILS
  - ACRYLICS
  - WATERCOLORS
  - BRUSHES
  - EASELS
  - CANVAS
  - PAPERS
- EVERYTHING FOR THE ARTIST

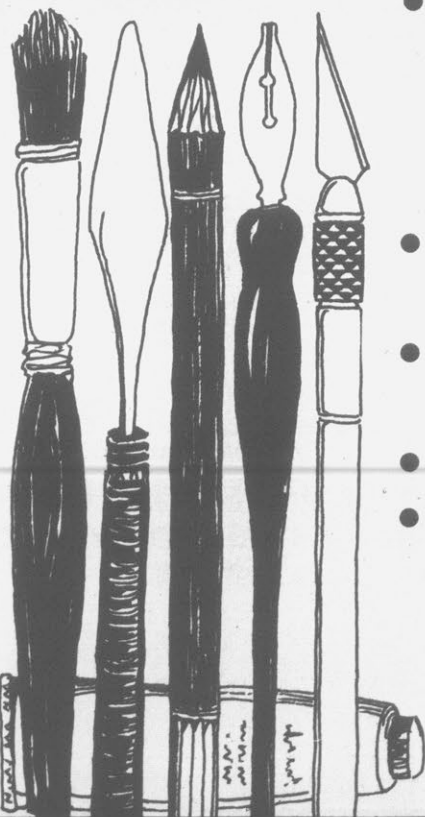

### HOBBY SUPPLIES

- DREMEL TOOLS
- MODELS — PLASTIC & WOOD
- ROCKETS
- RADIO CONTROL CARS AND PLANES



**LAKE BOONE CAMERA SHOP** carries everything from large format cameras to instamatic models. The store additionally stocks supplies and ac-

cessories for all major camera lines, as well as slide projectors and binoculars.

## Mall No Longer Strictly Retailing Center

A meeting place, a cultural center, an opportunity for community involvement — all these phrases describe today's shopping malls. Already, Parkwood Mall officials are busy planning community events, with everything on schedule for a Senior Citizens Day to Arts and Crafts fairs and antique shows. The shopping mall created solely for retailing is a thing of the past.

### Teen-ager Meeting Place

Teen-agers, especially, are finding malls the perfect place to meet and socialize — a practice that is not discouraged by mall officials. A recent survey conducted by the international Council of Shopping Centers revealed that shopping center managers rate teen behavior in shopping centers positively, finding the teens to be friendly, responsible, considerate and cheerful. Parents, too, appreciate the fact that enclosed malls are a safe and pleasant place for young people to congregate.

### Modern Village Green

Shopping malls have become the modern equivalent of the village green. A trip to the mall can be a pleasant family outing that encompasses shopping, dinner and movie. Older citizens appreciate the controlled climate and can find companionship in the malls. Housewives enjoy the convenience and time-saving aspects of mall shopping, along with the added bonus of mall events and exhibits.

Mindful of the shopping mall's function as a community center, North Hills, Inc. has developed Parkwood with the intention of fulfilling as many community needs as possible.

### Community Service

"Of course we want people to shop at Parkwood," said Bob Hughes, a spokesman for North Hills, Inc. "But we want Parkwood Mall to be much more than just a place to shop. We're interested in serving the community in many ways. The mall really belongs to the people of Wilson, and we want them to enjoy it and benefit from it."

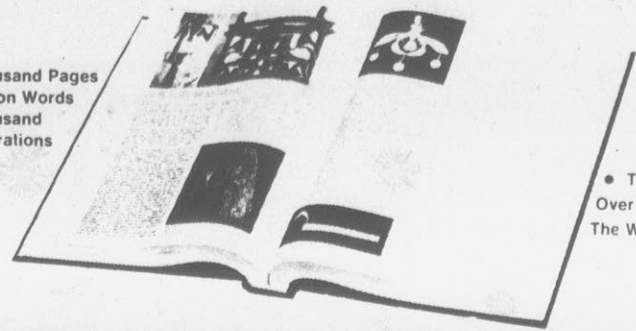

- 33 Thousand Pages
- 43 Million Words
- 23 Thousand Illustrations

• The Work Of Over 5 Thousand Of The World's Best Minds

## Win A Magnificent 30-Volume Set Of The New Encyclopaedia Britannica 3



## Free Registration For The Grand Prize Drawing During Parkwood Mall's Gala Grand Opening Event!

Here's a chance to make your family's dream come true at **Parkwood Mall**. In honor of our **Gala Grand Opening**, The **Parkwood Mall Merchants Association** is giving lucky shoppers a fabulous chance to win a valuable addition to your home library. Every family that comes to **Parkwood Mall** during this celebration is eligible to register for our **Grand Prize** give-away of the exciting new 30-Volume **Encyclopaedia Britannica 3**. Every family has an equal opportunity to win because there's nothing to buy and no contest to enter. It's easy! Just fill out this Free registration form and deposit it at the **Encyclopaedia Britannica Information Booth** in the **Parkwood Mall** before 7 p.m., **Sat., March 24**.

**Register Now Thru Sat., March 24 At The Parkwood Mall Encyclopaedia Britannica Information Booth!**

### PARKWOOD MALL

Free Registration Form For The **ENCYCLOPAEDIA BRITANNICA** Grand Prize Drawing **Sat., March 24**

Name \_\_\_\_\_  
 Address \_\_\_\_\_  
 City \_\_\_\_\_  
 State \_\_\_\_\_ Zip \_\_\_\_\_  
 Phone Number \_\_\_\_\_  
Children under 18 years of age are not eligible to enter.

*We Invite You To Visit The Newest Shoe Salon In Wilson. Come Meet Mrs. Dora Williams And Let Her Show You The Finest Collection Of Designer Shoes For Spring.*

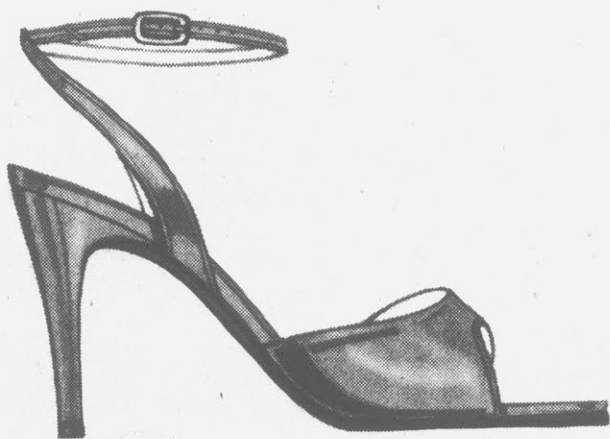

S.R.O.'s FLIRTY DISCO SANDAL IS HIGH ON STYLE. BLACK, WHITE, WINE, JASMIN KIDSKIN ..... \$40.

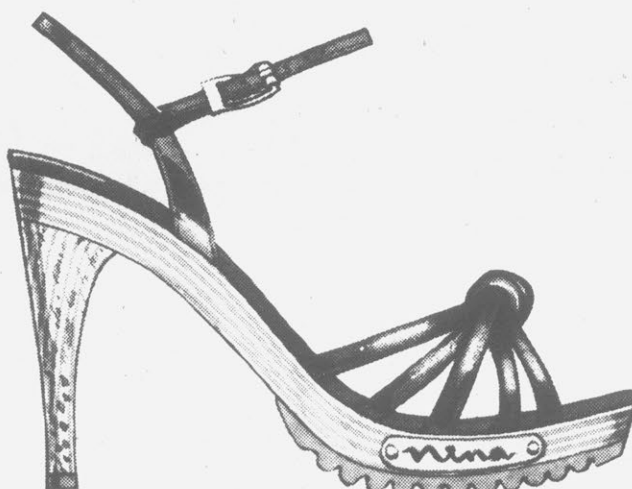

NINA'S NEW TUBULAR STRAP SANDAL . . . OUTSTANDING IN SHADES OF BONE AND WHITE KIDSKIN. ALSO BLACK PATENT ..... \$40.

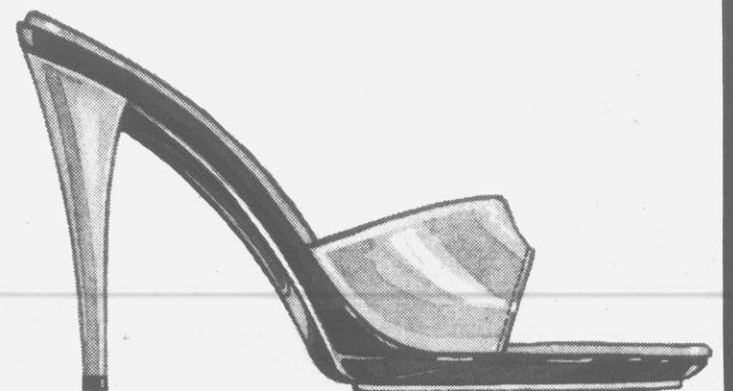

FROM THE **MADEMOISELLE** GALLERIA COLLECTION . . . THE #1 FASHION SILHOUETTE OF THE SEASON. WHITE, BLACK, CAMEL, BONE, WINE, TAUPE ..... \$42.



**MRS. DORA WILLIAMS**  
Shoe Dept. Mgr.  
With Over 14 Years Experience.

Dora Invites You To Come By And Let Her Show You The New Burton's Shoe Salon And All The New Shoes For Spring.



PARKWOOD MALL



Kerr Drug, with a large entrance to the mall area, also has an entrance from the parking lot and features a complete line of drug and sundry items

and is open nightly and Sunday. (Photo by Mickey Driver)

## Here's Summary Of Parkwood Expansion

Most of the construction activity at Parkwood has come to a close, leaving Wilson with a considerably expanded mall. The original Parkwood opened with nineteen tenants. The newly expanded Parkwood Mall has sixty-five.

The activity at Parkwood was

not limited to expansion. Most of the existing stores have done extensive remodeling and redecorating, and nine of them have new locations in the mall. The stores which have moved are Flowers Shoes, Singer, Barshay's, Kerr Drugs, Burton's, The Color Center, Mit-

chell's, Lynn's Hallmark Shop and Winn Dixie.

The new Winn Dixie is almost twice the size of the old store. The original Winn Dixie was 15,602 square feet; the new store is 27,720. Now, the store is one of the largest in the state. Winn Dixie was the first to open under

the recent expansion.

J. C. Penney's is still in the process of expanding and redecorating, but when construction is complete, the store will be 87,062 square feet, and will feature several new departments.

Roses has not undergone expansion (the original store is 42,750 square feet), but has instead concentrated efforts on extensive remodeling. Roses has also added new departments.

The new Belk-Tyler at Parkwood is designed to be a model store, and the most unique in the state. The total square footage of the new Belk's is 88,328.

When shoppers come to Parkwood Mall, they won't find any parking problems. The new mall has 2,944 spaces.

But just as important as the actual expansion is the number of new faces and ideas the mall will contribute to the community.

"Parkwood has attracted some very interesting and exciting new stores," said Paul DelaCourt. "They will each be bringing something new to Wilson.

# GRAND OPENING SPECIAL!

## Levi's

# 20%

OFF ALL LEVI'S  
**PRE-WASHED  
BASIC DENIM JEANS**

3 DAYS ONLY

### THE JUNCTION

PARKWOOD MALL

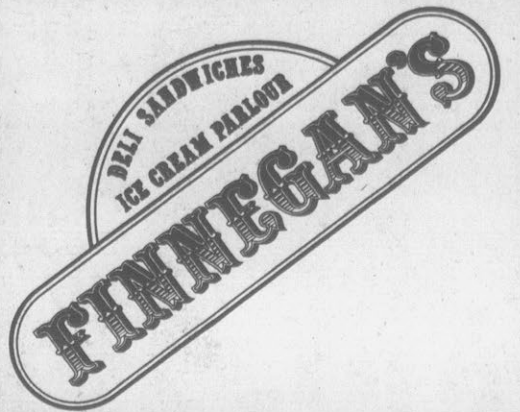

## GRAND OPENING

- 50 Great Sandwiches
- A Fantastic Salad Bar &
- Fabulous Ice Cream Creations

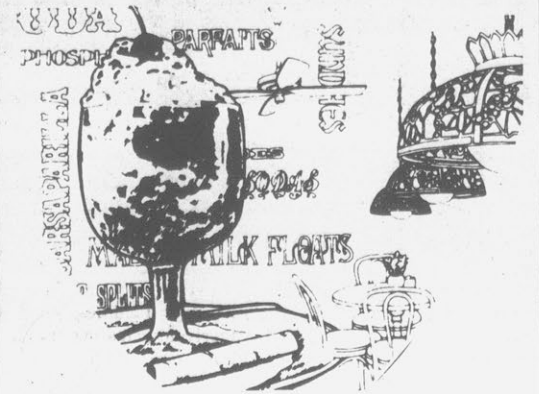

NEW HOURS:  
11:00-11:00  
Sun. Thru Thurs.  
11:00-12:00  
Fri. & Sat.

Corner Ward Blvd. & Tarboro St.  
Parkwood Mall



KARMELKORN features popcorn, karmelkorn and several varieties of candy and specialty confectionery items. (Photo by Mickey Driver)

**Parkwood  
Grand Opening**

# IT'S SPRING TIME FLOWERS FOR EASTER

Beautiful Potted Plants



**COME SEE  
OUR LARGE  
SELECTION  
OF SPRING  
ARRANGEMENTS**

**DESIGNED JUST  
FOR YOU BY**

**Lillie Mercer  
M.G. Bardin  
Aileen Mercer  
Sharon Liles  
Connie Harrison**

**Delivered Free  
Of Course**

**PARKWOOD  
FLORIST  
Phone 291-0222**

**Crunch...  
or munch  
a bunch...**

the  
**peanut  
shack**  
...For Peanut Lovers

Parkwood Mall  
Wilson, N. C.



**WE START  
FRESH  
EVERYDAY**

OPENING SOON!

## Wendy's

Parkwood Mall  
Ward Blvd. At N.C. 42 In Wilson

Copyright © 1977 by Wendy's International, Inc. All rights reserved.

**Grand  
Opening  
At  
Parkwood  
Mall**

**A 31<sup>ST</sup> BIRTHDAY BONUS.**

Save ten  
of these...



It's our 31st birthday! And participating stores are celebrating by giving you a Birthday Bonus Coupon with each 1 lb. 8 oz. purchase of handpacked ice cream, sherbet or ice. Save 10 coupons and get a delicious gift... a 1 lb. 8 oz. carton of your favorite handpacked flavor... the coolest deal in town! It's our way of saying, "Thank you for 31st birthday years."

**BASKIN-ROBBINS  
ICE CREAM STORE**



© 1976 Baskin-Robbins Ice Cream Co.



THOMPSON SHOE STORE specializes in men's shoes, including western boots, work shoes, casual shoes, dress shoes, plus Hanover Factory damaged dress shoes, boots and casual shoes, ranging in price from \$19.95 for the casuals, \$24.95 for dress shoes, \$27.95 Chucka boots, and \$29.95 for zip-up

dress boots. These shoes are all leather and compare to other shoes in the \$44.95-\$69.95 price range, plus a full line shoe repair shop offering one-day service. Open from 9:30 a.m. to 9 p.m. Monday through Saturday and 1-6 p.m. Sunday. (Photo by Mickey Driver)

*'Wilson Has Needed This For A Long Time'*

## Mayor Benton Cites Need For Expansion

"Wilson has needed this for a long time," agreed Mayor H. P. ("Red") Benton Jr. He added that while his wife was looking forward to the expanded shopping facilities, he was eagerly anticipating trying out the new cafeteria.

As for the economic impact of new jobs, it is estimated that a shopping mall creates one full time job for every 500 square

feet of its gross leasable area. Based on these figures, Parkwood Mall will employ approximately 1,100 employees.

Parkwood Mall will also be a major source of secondary employment, providing an impressive number of part-time jobs for students, housewives, and teens.

"The mall will provide increased employment for many more people in Wilson," said David Hacker, manager of J. C. Penney's and President of the Parkwood Merchants Association. "It will also make Wilson more attractive to new industry," he added.

Although construction is over and the mall is completed, the economic benefits of Parkwood will continue for years to come. Parkwood Mall — the only enclosed, air conditioned mall in the county — is officially a part of Wilson, ready to make its increased contribution to the city.



STRIDE RITE of Wilson is a special edition to Parkwood Mall, featuring Stride Rite shoes for children exclusively. "Red" Hawley is store manager and has over 20 years experience in fitting children with regular and prescription type shoes. (Photo by Mickey Driver)



DOWNTOWN  
PHONE 237-0824  
Open Tues.-Sat.  
7 a.m.-5 p.m.

PARKWOOD  
Phone 291-5054  
Open Mon.-Sat.  
10 a.m.-9 p.m.

- Cookies
- Cupcakes
- Brownies
- Cream Puffs
- Donuts
- Pies
- Lady Fingers
- Cheese Straws
- Jelly Rolls



- Chocolate Cream Roll
- Rolls
- Biscuits
- Chicken Pastry
- Birthday Cakes
- Wedding Cakes
- Anniversary

All Occasions  
Party Supplies

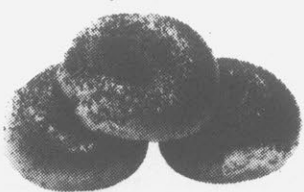

# KERR

KERR HAS  
SOMETHING  
FOR  
EVERYONE!

## Discount Drug Stores

Celebrating Parkwood Mall's GRAND OPENING.  
Join Us Today at Kerr's for the Grand Opening SAVINGS and EXCITEMENT!

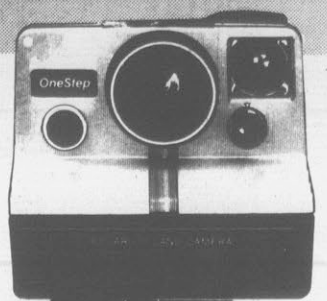
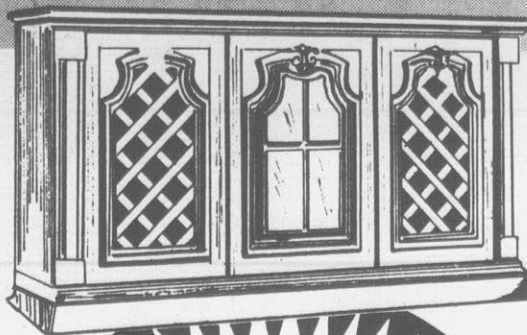

AT KERR'S  
**FREE . . .**  
Magnavox® Console Stereo  
to be given away at Kerr Drugs  
Saturday, March 24, at 4 p.m.  
Register Today at Kerr's.

Stereo is console model with AM/FM radio, turntable, record storage, 8-track play/recorder, tape deck built-in. No purchase necessary . . . you do not have to be present to win.

**Polaroid is coming**

The Polaroid camera demonstrator will be in our store to show you Polaroid's exciting line of instant picture cameras and film.

- March 23  
Friday at Kerr . . . 10 a.m.-5 p.m.
- March 24  
Saturday . . . 11 a.m.-5 p.m.



Northern 4 pack  
Bathroom Tissue

Grand Opening Price **67¢** PK.

SAVE TODAY at  
Kerr Discount Drugs.



**Dove**

only Dove is 1/4 moisturizing cream

Dove can't dry your skin the way soap can. Dove helps keep your skin younger looking.

**43¢** BAR



**Dove** dishwashing liquid

Regular **39¢** Each

Dove's famous mildness leaves your hands soft and smooth.  
SAVE TODAY AT KERR'S!



Brawny Paper

TOWELS  
**2** Rolls For Only **\$1**

Grand Opening  
Specials at Kerr!



**Wisk** laundry detergent

Grand Opening Price **\$1.99** 1/2 Gal.

Gets your whole washload ring-a-round the collar clean.  
1/2 Gallon bottle.



**Final Touch** fabric softener

Regular \$1.69 **\$1.49** Bottle

Without our whitener we'd be just another fabric softener.



SAVE 46¢ on 2 Boxes!  
Kleenex Tissues 200's

**2** Boxes For **\$1**  
Regular 73¢ Box



Sprite, Coke or Tab, 28-oz.

Your Choice  
**3** For Only **\$1**  
No Deposit. No Return

**TODAY through SUNDAY!**

THERE IS A KERR DRUG STORE NEAR YOU . . . Low, Low Prescription Prices

# PARKWOOD MALL

# Camelot Music

PARKWOOD MALL — PHONE 291-8423  
 OPEN MON.-SAT. 10 A.M.-9 P.M. — SUNDAY 1 P.M.-6 P.M.  
 MASTER CHARGE — VISA WELCOME

Save 20% Off our regular prices on new Capitol hits by Kate Bush, Desmond Child & Rouge, Marshall Hain, Gonzalez, Amil Stewart, Tavares, McGuinn, Clark & Hillman, Barooga Bandit, plus 20% Off on older catalog Albums, 8-Tracks & Cassettes by the Beatles, Beach Boys, Ferrante & Teicher or any other Capitol/United Artists merchandise in stock.

ASK OUR COURTEOUS & KNOWLEDGEABLE SALES CLERKS TO ASSIST YOU IN MAKING YOUR ALBUM & TAPE SELECTIONS.



BOB WELCH  
"Three Hearts"



THE BEATLES  
"Sgt. Pepper's Lonely Hearts Club Band"



CRYSTAL GAYLE  
"When I Dream"

\* SPECIAL BONUS \*  
**\$4.99**  
 EACH

PRICES GOOD  
 THRU MARCH 31st

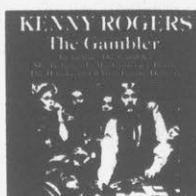

KENNEY ROGERS  
"The Gambler"



LITTLE RIVER BAND  
"Sleeper Catcher"



ANNE MURRAY  
"New Kind Of Feeling"

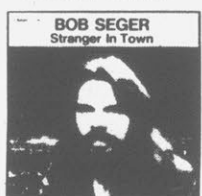

BOB SEGER  
"Stranger In Town"

## CAPITOL - UNITED ARTISTS CATALOG SALE

# 20%

OFF REG. PRICE

ALBUMS+8-TRACKS+CASSETTES



WINGS  
"Greatest Hits"



THE STEVE MILLER BAND  
"Greatest Hits 1974-78"

**\$5.99**  
EACH

SALE MERCHANDISE NOT ELIGIBLE  
 FOR 20% OFF

Angel Classics SERAPHIM

20% OFF REG. PRICE  
 ANGEL & SERAPHIM CLASSICS  
 IN STOCK

DeBOST/  
BEETHOVEN  
Variations for Flute

PREVIN/  
LONDON  
Tchakovsky: Swan Lake

Dont Forget — Classical Club Members receive an extra 10% OFF on Classical purchases with your Membership Card.

Capitol.  
 MEANS BUSINESS!

20% OFF REGULAR PRICE  
 CAPITOL BLANK RECORDING  
 TAPE IN STOCK

## Parkwood's expanding . . . AND So Are We!!

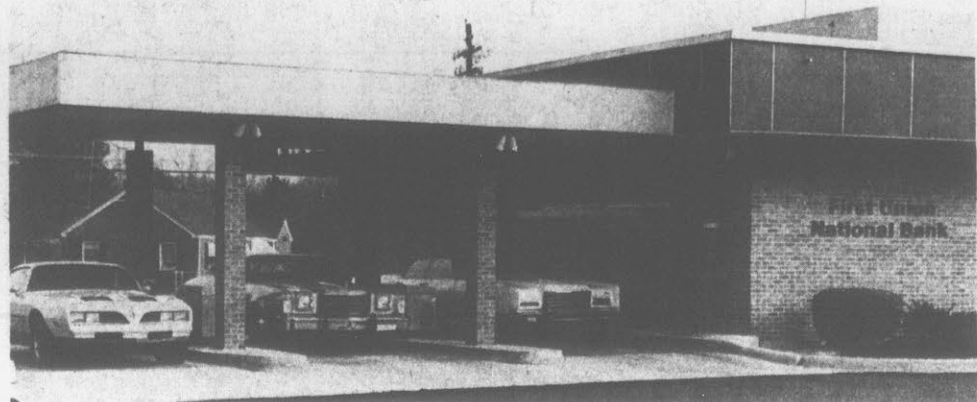

Yes, Parkwood's expanding, and First Union is right there offering the best in banking facilities to the Parkwood area!

We've just added our 3rd drive-in express lane to give you faster, more efficient service with all of your banking needs. Stop by and try one of our two express lanes or our regular window for easy, convenient banking service. Transactions requiring more than 2 or 3 minutes should continue to be made inside the bank.

PARKWOOD OFFICE

# FIRST UNION

MEMBER FDIC

## grand opening sale!

# FASHION DENIM JEANS \$9.99

For Guys and Gals  
 Originally \$15-\$17

**NOW**

# MEN'S KNIT SHIRTS \$7.99

Originally \$12-\$14  
**NOW**

# GAL'S TOPS \$4.99

"V" and "Sloop" necks—Solid colors, Half-sleeves—Sizes small, medium, large  
 Originally \$7.00  
**NOW**

# just\* pants

VISA

PARKWOOD MALL, WILSON, N.C.

master charge

Weights About 884 Pounds

## Cake-Cutting Ceremony Scheduled At Parkwood

It's not exactly your average, run of the mill cake. This cake weighs approximately 884 pounds, and its recipe calls for 145 pounds of flour, 406 pounds of sugar, 166 pounds of shortening and over 1,000 eggs. It's the Parkwood Grand Opening cake, baked especially for the event by John and Marie Shealey of Shealey's Bake Shoppe at Parkwood.

"It's going to be some cake!" said Marie Shealey. "This is the largest one I've ever worked on — 9½ feet long and 32 inches

wide."

The logistics of making such a cake call for quite a bit of planning. The cake will be basically constructed at Shealey's, sheets of it will be placed on slabs of plywood, and the finished product with its final decorating touches will be assembled within the mall. The cake will be made in the shape of Parkwood, from J. C. Penney's to Belk Tyler. It will be beige with a dark beige trim, and will feature a ribbon made of icing which will be cut at the Grand Opening ceremony scheduled for 10:00 a.m., March 22.

Mr. Shealey will be doing the actual baking of the Grand Opening cake, while Mrs. Shealey will take care of the decorating and assembling.



Roger L. Melton, marketing promotions director and executive secretary for the Parkwood Merchants Association, is a Rocky Mount native and married to the former Teresa Herring, also of Rocky Mount. They have one son, Toby Sean, two years of age. Melton is a graduate of Rocky Mount Senior High School. He attended N.C. State University and completed courses in marketing at Michigan State University. He plans to sit for his A.S.P.D. degree this fall. Melton was most recently employed by the Wilson J.C. Penney Store where he held the post of advertising manager for nine years. During much of this time he also carried out the duties of marketing director for Parkwood on a part-time basis. The Meltons attend Peace Free Will Baptist Church. Melton is a Wilson Jaycee and a member of the local TPA. They reside at Route 3, Elm City.

**PARKWOOD MALL MANAGER:** Johnny Weaver is married to the former Dianna Carlton of Alton, Illinois. They have two sons, John Jr. and Scott. They reside at Route 2, Kenly. He graduated from high school at Glendale in Johnston County and attended Louisburg College in Louisburg and North Carolina State University in Raleigh. He worked with the Raleigh Police Department from 1965 through 1968. He started with North Hills, Inc. at North Hills Mall in Raleigh in January, 1968 as chief security officer. He was transferred to Parkwood in October, 1976. He is a member of Holly Springs Free Will Baptist Church and is the Sunday school superintendent.

# Sylvia's



Spring Means  
Easy Casual  
Put-Togethers And  
Your Favorites Like —

- John Meyer
- Intuitions
- Gant
- Emily
- Cargo
- Young Edwardians
- Jody & J. T. Dress
- Jerrell
- Strait Lane
- Applause
- Sweet Baby Jane
- Organically Grn.
- Esprit DeCorp To Make Up

"The Best Look In Town"

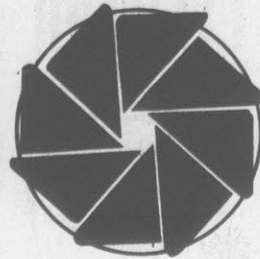

Experience  
The Lake Boone  
Camera Store

## Lake Boone Camera Store

Lake Boone Shopping Center  
Raleigh  
782-7433

Parkwood Mall  
Wilson  
291-3303

PRICES GOOD AT BOTH  
LOCATIONS  
MARCH 22-31

ALL ITEMS SUBJECT TO PRIOR SALE

AUTHORIZED DEALER FOR:

NIKON • OLYMPUS • CANON • MINOLTA  
PENTAX • POLAROID • KODAK • HOYA • MAMIYA  
BESELER • OMEGA • METZ • DURST • BOGEN  
ILFORD • UNICOLOR • VIVITAR • SUN PAK  
• BOLEX • SANKYO • BRONICA • GITZO • ETC.

### IT'S HERE!

**MINOLTA XD-II**  
THE WORLD'S FIRST COMPACT,  
MULTI-MODE 35mm SLR.



W/50mf 1.7 Lens  
SALE \$389.95 Less  
\$35.00 Factory Rebate  
Equals \$354.95

Switch from aperture to shutter-priority to metered-manual operation.  
Override automatic exposure system plus or minus two full stops.

MD Series lenses, specially designed for multi-mode operation. All other Minolta lenses operate in both aperture-priority and manual modes.  
Smallest, lightest, quietest auto winder you can own! Optional Auto Winder D advances film for single shots, sequences as fast as 2 frames a second. Unprecedented creative freedom! It gives you your choice of aperture or shutter-priority automation or metered-manual operation at the flip of a switch. Easy handling, too! ONLY

**Minolta XG-7. The easy-does-it 35mm SLR with an exclusive combination of features!**



1. Feather-touch shutter button.
2. Optional Auto Electro-flash 200X.
3. LED flash-ready signal in viewfinder.
4. Over-exposure prevention.
5. Flashing electronic self-timer.
6. Optional Auto Winder G for continuous pictures at about 2 frames per second.

W/50mf 1.7 Lens

SALE PRICED AT \$279.95  
LESS FACTORY REBATE \$25.00  
EFFECTIVE COST \$254.95

COMPARE OUR PRICES

"Get the Minolta Pocket Autopak® 450E. The camera that says yes to all kinds of pictures." — Doug Henning, the Magic Showman

Fully automatic. Built-in stop-action pop-out electronic flash. Built-in lens for close-ups at 19 inches. Full-information extra-bright viewfinder. Quality Rokkor lens.

Only \$74.95



PENTAX SYSTEM 10.

IT'S MORE THAN A  
POCKET CAMERA.  
IT'S A  
POCKET SLR SYSTEM.



The System 10 Major Components Kit includes the most important parts of the world's first complete 110 SLR system:

- Pentax Auto 110 camera. The smallest SLR ever, with easy cartridge loading and programmed auto exposure.
- Three Pentax 110 interchangeable lenses.
- Pentax Winder 110.
- Pentax Auto Flash AF 130 P.
- Carrying pouches.

PENTAX SYSTEM 10

KIT > \$434.95

CAMERA & STANDARD LENS \$189.95

CAMERA, LENS, FLASH & WINDER \$339.95

WE'RE THE ONE'S TO SHOW YOU THE OM-1N WONDERFUL



**OLYMPUS OM-1**  
The World's Largest Selling 35mm SLR.

No wonder the OM-1 is so popular. It's a small wonder with big features. The OM-1 is 35% smaller than most ordinary 35mm SLRs. Its viewfinder image is 30% larger and 70% brighter than most conventional 35mm SLRs. And it's incredibly quiet and virtually shock-free, due to the air dampers on the mirror which reduce shock and vibration. Plus it's the beginning of the complete OM system of over 200 accessories. Stop in today and see it. You'll wonder how you lived without it.

\$279.95  
For NEW OM-1N

- Flash L.E.D. Now In The View Finder
- Has New Accessory Shoe 4
- Shorter Stroke
- Takes The New T-20 Flash

OM-1N  
With 50mf 1.8 Lens  
\$279.95

## GRAND OPENING SPECIAL

Hallmark  
TINS  
50¢ EACH  
with \$1.00 purchase

LIMIT ONE TIN PER CUSTOMER

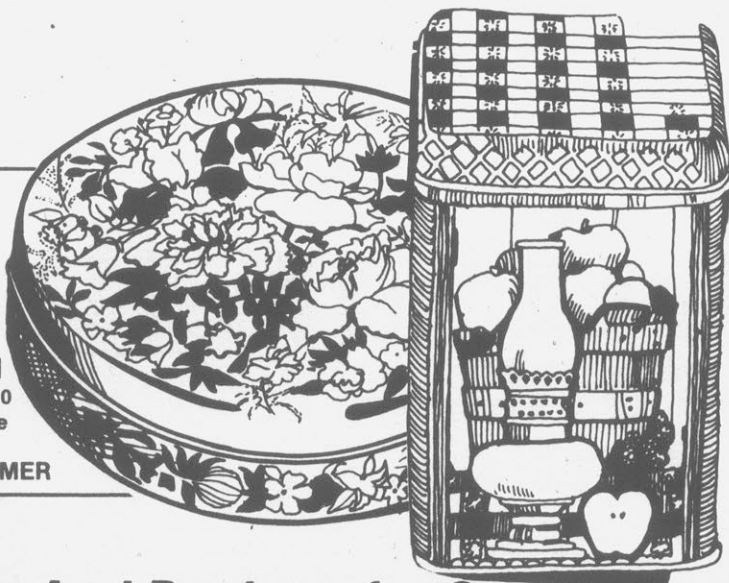

Come In And Register for Our  
ANGUS BARN GIFT CERTIFICATE (\$25.00)

DINNER-FOR-TWO • DRAWING WED., MARCH 28

• NO PURCHASE REQUIRED • WINNERS WILL BE NOTIFIED

parkwood mall  
WILSON BOULEVARD AT N.C. 42

Lynn's  
Hallmark shop

PARKWOOD MALL, WILSON, N.C. OPEN 10:00 A.M. - 9 P.M. Mon.-Sat.

Phone 291-1565

1:00 P.M. - 6:00 P.M. Sundays

## CASH REBATES direct from Nikon on NIKKOR LENSES



LOOK AT THESE TYPICAL SAVINGS!

| LENS            | REBATE |
|-----------------|--------|
| 24mmf 2.8       | \$30   |
| 28mmf 2.8       | \$40   |
| 28mmf 3.5       | \$30   |
| 35mmf 2.8       | \$25   |
| 105mmf 2.5      | \$40   |
| 135mmf 2.8      | \$40   |
| 200mmf 4        | \$40   |
| 500mmf 8 Reflex | \$70   |
| 55mmf 3.5 Micro | \$20   |

Nikkor lenses by Nikon featuring Nikon Integrated Coating are world famous for incomparable sharpness, precision and color fidelity. They are made to bring out the best in your Nikon or Nikkormat camera, every time. This is just one of 32 superb Nikkors on which you can get cash rebates of \$25 to \$150 (depending on lens) direct from Nikon. Offer ends April 30, 1979. Come in today for complete details and best selections!

See the automatic camera that does it all

## THE NEW NIKON FE AUTOMATIC

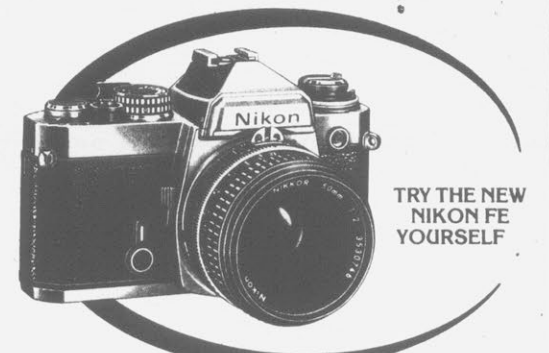

TRY THE NEW  
NIKON FE  
YOURSELF

Automatic on-the-button exposures are only the beginning. This fast-handling, light and compact precision "35" also offers:

- World-famous Nikon precision
- Reliable exposure automation with more than 55 Nikkor lenses and many accessories
- Electronically timed shutter, 8 seconds to 1/1000th
- Full information viewfinder with interchangeable viewing screens
- Special creative controls including multiple exposures
- Facilities for "programming" automatic flash
- Accepts motor drive for up to 3.5 shots per second.

FE W/50mf 2.0 LENS  
SALE PRICED \$469.90  
LESS FACTORY REBATE 40.00  
YOUR EFFECTIVE COST IS \$429.90



RIBBON-CUTTING ceremony at Parkwood Shopping Center in 1966 is shown in picture. Left to right are S. M. Cozart, E. B. Pittman, Mayor of Wilson in 1966, and E. N. Richard, chairman of the board, North Hills, Inc.

Since 1966

### Parkwood Has Grown From Center To Mall

In 1966 when Parkwood Shopping Center had its grand opening, Wilsonians obviously enjoyed the special atmosphere created by attractive landscaping and interesting architectural features. It was the only shopping center of its kind in Wilson, a strip center containing 170,000 square feet of store floor space.

Today parkwood is transformed even further — into the climate controlled, enclosed Parkwood Mall. The transformation was anticipated at the beginning, with enclosed mall conversion features incorporated into the initial construction.

"It was not normally done that way at the time," according to Paul DelaCourt, President of North Hills, Inc., "but we knew we were in a market that would be growing. Other centers have been later converted into malls, but the layout is superior when you plan at the onset for conversion."

Parkwood's plans for expansion and conversion were more than justified by Wilson's subsequent growth. In 1966 there were approximately 57,000 people in the Wilson area. By 1976 this figure had more than doubled, and per capita income also showed an increase of 87 percent. But at the same time, a Wilson Chamber of Commerce study showed that more and more of this increased population were making "out of town" purchases. This was an indication that retail needs were not being met. The results of the Chamber of Commerce study in conjunction with the demographic studies conducted by North Hills, Inc. convinced the ownership that the right time was right for Wilson.

"We're building because the need has developed," DelaCourt explained. "We're responding to a demand — we don't create the demand. This keeps the vitality of the town."

DelaCourt believes that the new mall will have definite impact on the economy of Wilson County.

"A shopping mall creates jobs in necessary employment areas. A mall is one of the biggest utilizers of part-time help, including teens and working women — persons who traditionally have a hard time finding jobs. It also attracts and keeps retail dollars in the community. People no longer have to go out of town to make purchases.

## FASHION EYEWEAR



### Announcing The Opening Of PARKWOOD OPTICIANS

At

231 PARKWOOD MALL

We will feature the latest in fashion eyewear and prompt, accurate prescription service.

We will have two licensed opticians to serve you with combined experience of more than fifty years in all phases of optical dispensing.

- Frame Repairs
- Lenses Duplicated
- Adjustments
- Sunglasses
- Hearing Aids

**HARRY TOLAR, Manager**  
Telephone 291-0767

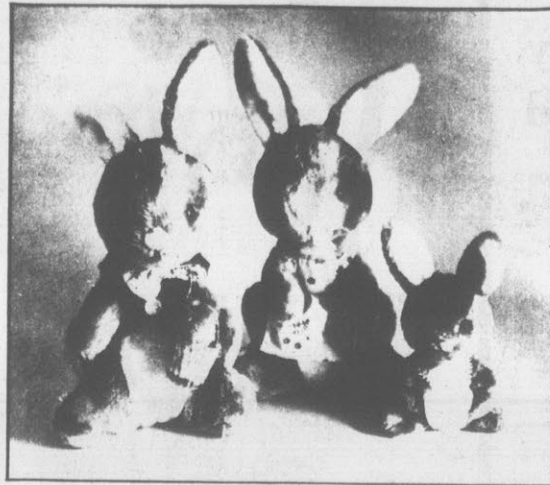

## PLUSH EASTER ANIMALS

Famous DAKIN quality, plush Easter animals will delight any child. Choose from our large selection of DAKIN Easter bunnies, baby ducks, and lambs covered with cuddly acrylic plush in cheerful Spring colors.



PARKWOOD MALL—WILSON

*Dotty Lewis*

NOW OPEN IN  
**parkwood**

- For The Finest In
- Infants Clothing
  - Children's Clothing
  - Teens Clothing

While Shopping In  
Downtown Wilson,  
Visit Our Store Located  
At 213 W. Nash St.



We'd like your family to be in our shoes!



Come to the  
Endicott Johnson  
Grand Opening  
Celebration  
Today thru March 31  
Parkwood Mall

**50% off**  
**2nd pair**

Buy one pair of shoes at regular price,  
get the second pair of equal value  
at just half-price!

You'll find all the latest dress, casual  
and athletic footwear for men, women  
and children in our new store.  
And you'll sure be happy with the  
money you save, too!

So come on over—bring your family,  
bring your friends—let's get  
acquainted!

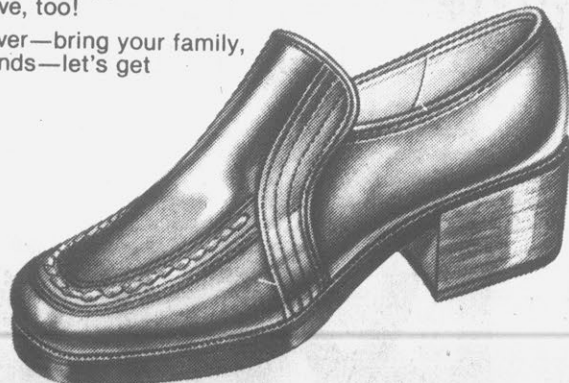
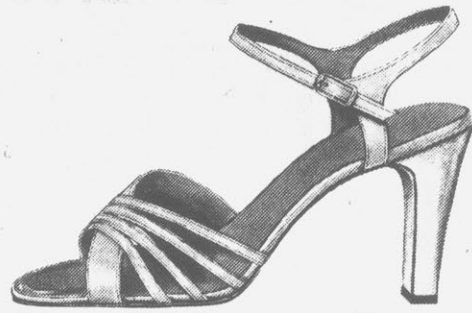
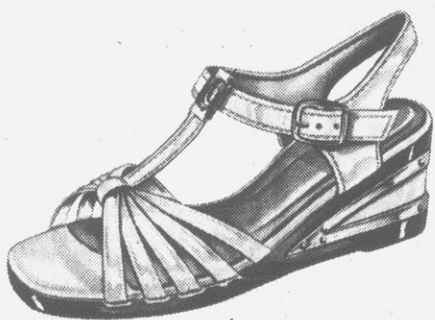

Handbags  
**1/2 PRICE**  
with purchase of shoes  
\$12.99 or more

**FREE HOSIERY**  
Buy three pair of men's,  
women's or children's  
hosiery and get three  
pair of equal value FREE!

**Endicott Johnson**

Parkwood Mall, Wilson





# IN THE BEAUTIFUL NEW PARKWOOD MALL

ROSES COMPLETELY RE-MODELED STORE



# GRAND OPENING

FREE! FREE! WHILE QUANTITY LAST Balloons — Pens — Yard Sticks



## MISS BRECK HAIR SPRAY

Choose Regular — Super Hold  
Or Unscented Super Hold In  
Nine Ounce Cans.  
NEW — IMPROVED  
The Natural Way To Spray...

ROSES  
SPECIAL  
PRICE **77¢** CAN  
LIMIT 2 CANS

## TRUCKLOAD SALE OF QUALITY KIMBERLY- CLARK PRODUCTS

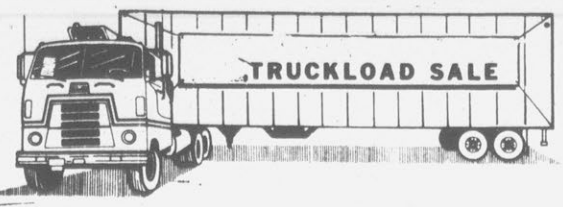

## 4 ROLL PACKAGE HI-DRI BATHROOM TISSUE

4 Roll Package Of Super-Soft  
Bathroom Tissue From Kimberly-Clark  
A REAL VALUE AT A BUDGET PRICE

ROSES  
SPECIAL  
PRICE **68¢** PKG.



## TRUCKLOAD SALE



2 LITER SIZE  
**PEPSI  
MT. DEW  
DIET PEPSI**  
No Deposit Bottle

ROSES SPECIAL PRICE  
**69¢** EA.  
LIMIT 1 CASE



## NEW FREEDOM MAXI PADS

BOX OF 30

ROSES  
SPECIAL  
PRICE **\$1.82**



## KOTEX STICK TAMPONS

NEW — 35% MORE ABSORBENT  
BOX OF 30 TAMPONS  
CHOOSE REG. OR SUPER

ROSES  
SPECIAL  
PRICE **\$1.38**



## CIGARETTES BY THE CARTON

Choose Regulars Or Kings In Your  
Favorite Brands

ROSES  
SPECIAL  
PRICE **\$3.44** CARTON  
LIMIT 2 CARTONS



## KLEENEX TOWELS

102 2-PLY TOWELS  
STRONG AND ABSORBENT

ROSES  
SPECIAL  
PRICE **2 FOR 88¢**



## NEW FREEDOM MINI PADS

BOX OF 30

ROSES  
SPECIAL  
PRICE **\$1.48**



## QUAKER STATE MOTOR OIL

Choose Quart Size Cans  
Of 30 Weight High-Detergent Or  
30 Weight Regular

ROSES SPECIAL PRICE  
**2 QTS. \$1.00**  
LIMIT 6 QTS.



## KLEENEX TISSUES

BOX OF 200 TISSUES  
CHOOSE WHITE OR COLORS

ROSES  
SPECIAL  
PRICE **2 FOR 99¢**



## KLEENEX FAMILY NAPKINS

140 COUNT FACIAL SOFT  
DINNER NAPKINS

ROSES  
SPECIAL  
PRICE **2 FOR 88¢**



## QUAKER STATE SUPER BLEND MOTOR OIL

Limit 6 Qts.

ROSES  
SPECIAL  
PRICE **62¢** QT.

# Parkwood Mall... something for everyone!

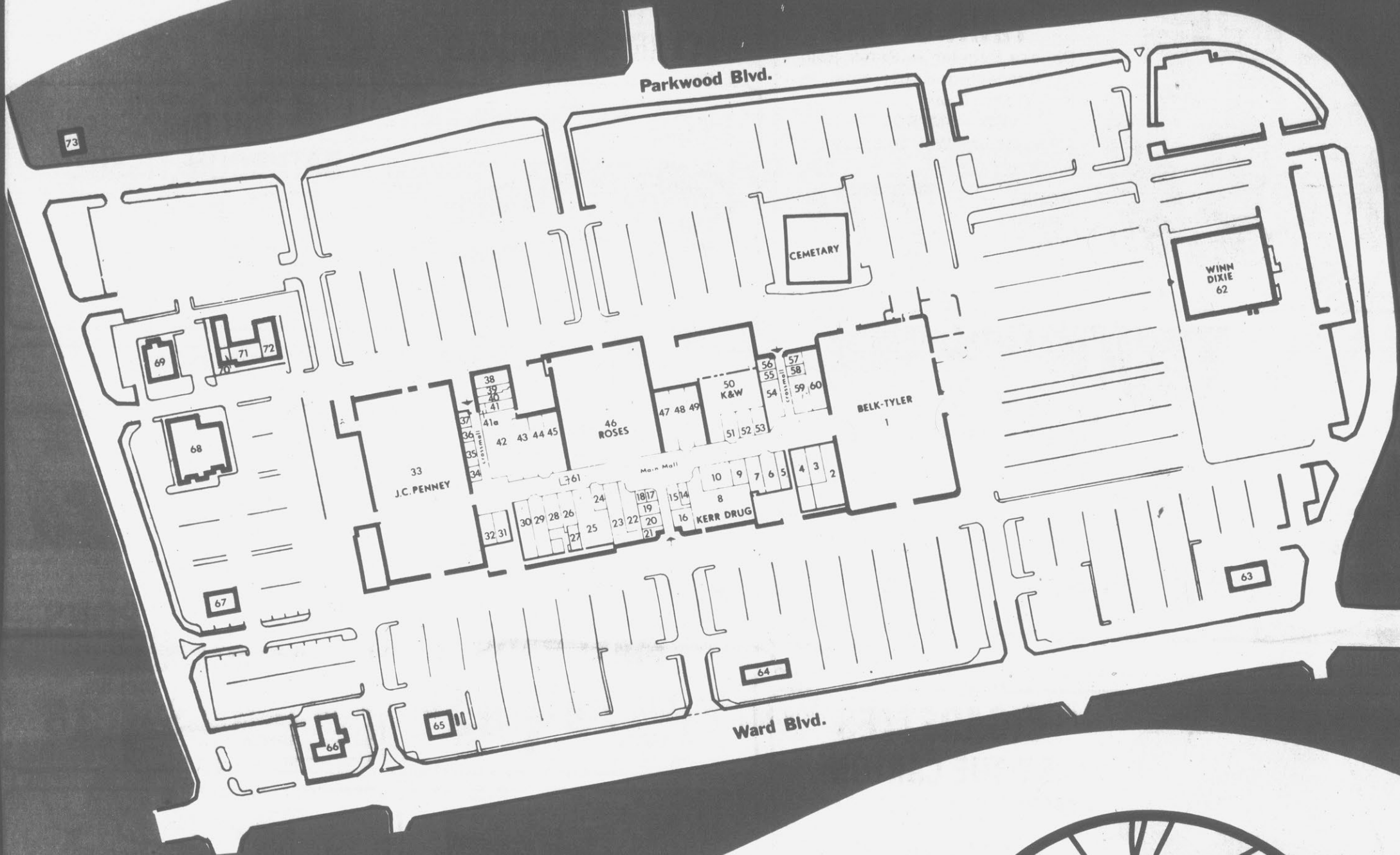

**Mall Businesses (in alphabetical order):**

- 38. A.B.C. Store
- 2. Barshay's
- 17. Baskin-Robbins
- 31. Becky's Fast Food
- 1. Belk-Tyler
- 48. Brook's Fashions
- 25. Burton's
- 10. Calico Barn
- 7. Camelot Music
- 30. Color Center
- 24. Connie Shoes
- 29. Dotty Lou's
- 47. Endicott Johnson
- 44. Fancy This
- 55. First Citizens Bank
- 54. Flowers Shoes
- 28. General Nutrition
- 49. Hackney's
- 6. Hallmark Cards
- 3. Junction
- 5. Just Pants
- 59. K&K Toys
- 50. K&W Cafeteria
- 34. Karmelkorn Shoppe

- 8. Kerr Drug
- 45. Kinney Shoes
- 21. Lake Boone Camera Store
- 23. Lerner Shop
- 41. Mall Offices
- 32. Mitchell's Hairstyling
- 60. Moss Men's Wear
- 9. Orange Bowl
- 18. Orange Julius
- 27. Parkwood Barber Shop
- 39. Parkwood Florist
- 19. Parkwood Opticians
- 14. Peanut Shack
- 33. J. C. Penney
- 40. Dr. Perry, Optician
- 41A. Public Rest Rooms
- 51. Reed's Jeweler
- 43. Rice's Mens Store
- 22. Roscoe Griffin Shoes
- 42. Rosenbloom - Levy
- 46. Roses
- 20. Saslow's Jewelers
- 58. Shealy's Bake Shoppe
- 53. Singer Sewing Center
- 56. Stout Shop

- 57. Stride-Rite Bootery
- 26. Sylvia's
- 35. Thompson Shoe & Repair
- 61. Tiara
- 52. Williams Ltd.
- 15. Zales Jewelers
- 16. TBA
- 36. TBA
- 37. TBA

**Free-standing Businesses, outside Mall:**

- 71. Fast Fare
- 66. Finnegan's
- 67. First Citizens Bank
- 65. First Union National Bank
- 72. Mitchell's Hairstyling Academy
- 73. NCNB
- 68. Parkwood Cinema I & II
- 70. Dr. Wayne Riddout, Dentist
- 69. U. S. Post Office
- 63. Wachovia Bank
- 64. Wendy's Hamburgers
- 62. Winn-Dixie Food Store

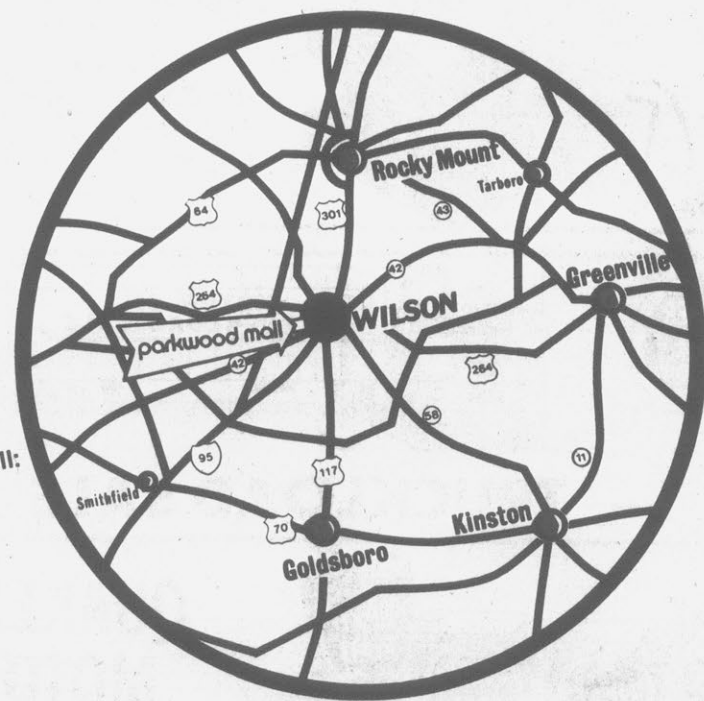

Parkwood Mall is easy  
to get to from wherever you  
live in Wilson County  
... or surrounding towns.

Mall Open Mon.-Sat. 10 a.m. To 9 p.m. ... Sunday 1 to 6 p.m.



# parkwood mall

it's something else!

WARD BOULEVARD AT N.C. 42 IN WILSON

# Kroger Sav-On

COPYRIGHT 1979 KROGER SAV-ON  
QUANTITY RIGHTS RESERVED  
NONE SOLD TO DEALERS

Supplement to the Greenville Daily Reflector.



**FOOD  
DRUG**  
Pharmacy  
Appliances

PRICES IN THIS AD ARE GOOD THROUGH SATURDAY,  
MARCH 24, 1979 IN GREENVILLE, NORTH CAROLINA.

**ADVERTISED ITEM POLICY**

Each of these advertised items is required to be readily available for sale in each Kroger Sav-On Store, except as specifically noted in this ad. If we do run out of an advertised item, we will offer you your choice of a comparable item, when available, reflecting the same savings or a raincheck which will entitle you to purchase the advertised item at the advertised price within 30 days.

**COST WEEK CUTTER SPECIAL**

WHOLE OR SHANK HALF  
**Smoked Ham**

Sliced Free  
**98¢**  
Lb.

- WHOLE Smoked Picnic ..... Lb. **98¢**
- 3-5-LB. AVG. FRESH FROZEN Pork Spare Ribs ..... Lb. **\$1.48**
- PORK FEET OR Pork Liver ..... Lb. **58¢**
- FRESH FROZEN Pork Neck Bones ..... Lb. **68¢**
- WHOLE OR HALF SQUARE CUT LAMB Shoulder Roast ..... Lb. **\$1.59**
- LAMB Loin Chops ..... Lb. **\$3.99**
- SWIFT SIZZLEAN Bacon Strips ..... 12-Oz. Pkg. **\$1.58**
- GUNNOE HOT OR MILD Pork Sausage ..... Lb. **\$1.68**

- BREAKFAST Beef Sausage <sup>2-Lb. Roll</sup> ..... **\$1.98**
- WHOLE SLICED BUTT Pork Roast ..... Lb. **\$1.48**
- LOIN END SLICED Pork Roast ..... Lb. **\$1.68**
- FRESHLY SLICED Pork Steak ..... Lb. **\$1.58**
- COUNTRY STYLE Spare Ribs ..... Lb. **\$1.58**
- SWIFT'S HOSTESS Canned Ham <sup>4-Lb. Can</sup> ..... **\$9.68**

QUARTER PORK LOIN SLICED INTO  
**Pork Chops**

**\$1.58**  
Lb.

FRESH PICNIC STYLE  
**Pork Roast**

**98¢**  
Lb.

**COST WEEK CUTTER SPECIAL**

U.S.D.A. CHOICE "HEAVY WESTERN" BEEF CENTER CUT BLADE

**Chuck Steak**

**\$1.38**  
Lb.

U.S.D.A. CHOICE "HEAVY WESTERN" BEEF CENTER CUT BONELESS  
**Chuck Roast**

**\$1.98**  
Lb.

CHUB PAK OR STORE PAK  
**Ground Beef**

**\$1.48**  
Lb.

HOLLY FARMS CUT-UP MIXED  
**Fryer Parts**

**59¢**  
Lb.

HOLLY FARMS GRADE "A"

**Whole Fryers**

**55¢**  
Lb.

- U.S.D.A. CHOICE "HEAVY WESTERN" BEEF BONELESS ROLLED OR **Flat Briskets** ..... Lb. **\$2.18**
- U.S.D.A. CHOICE "HEAVY WESTERN" BEEF 12-15 LB. AVG. BONELESS (Cut And Wrapped Free) **Beef Strip Loin** ..... Lb. **\$2.98**
- U.S.D.A. CHOICE "HEAVY WESTERN" BEEF BONELESS-TOTAL WT. 4-LBS. OR MORE 8 (\$3.22 Lb.) 8-Oz. Steaks **Top Sirloin Steak** ..... **\$12.88**
- U.S.D.A. CHOICE "HEAVY WESTERN" BEEF BONELESS-TOTAL WT. 4-LBS. OR MORE 8 (\$3.97 Lb.) 8-Oz. Steaks **Rib Eye Steaks** ..... **\$15.88**
- U.S.D.A. CHOICE "HEAVY WESTERN" BEEF BONELESS-TOTAL WT. 5-LBS. OR MORE 10 (\$2.57 Lb.) 8-Oz. Steaks **Sirloin Tip Steaks** ..... **\$12.88**

- KROGER **Chunk Bologna** ..... Lb. **\$1.09**
- KROGER CHUNK **Braunschweiger** ..... Lb. **79¢**
- MEAT OR BEEF **Gwaltney Franks** ..... 12-Oz. Pkg. **\$1.18**
- KROGER MEAT OR BEEF **Jumbo Dinner Franks** ..... 1-Lb. Pkg. **\$1.68**
- ASST. VARIETIES OLDE VILLAGE **Smoked Sausage** ..... Lb. **\$1.99**
- GWALTNEY **Sliced Bacon** ..... 1-Lb. Pkg. **\$1.78**

BULK PACKAGED COUNTRY STYLE  
**Sliced Bacon**

**\$1.29**  
Lb. (2-Lbs. or More) (Less Than 2-Lbs. \$1.39 Lb.)

SERVE 'N SAVE SLICED  
**Luncheon Meats**

**\$1.29**  
1-Lb. Pkg.

TASTY SERVE 'N SAVE  
**Wieners**

**79¢**  
12-Oz. Pkg.

**COST WEEK CUTTER SPECIAL**

FRESH FROZEN  
**Baking Hens**

**58¢**  
Lb.

**COST WEEK CUTTER SPECIAL**

ASSORTED FLAVORS COUNTRY CLUB  
**Ice Cream**

1/2-Gal. Ctn. **58¢**

Limit 1 With \$7.50 or More Additional Purchase

Addl. Ctn. **89¢**

**COST WEEK CUTTER SPECIAL**

KROGER  
**Homogenized Milk**

**\$1.69**  
Gal. Jug

KROGER 1/2% Low Fat Milk  
Gal. Jug **\$1.49**

**COST WEEK CUTTER SPECIAL**

REFRESHING  
**Pepsi Cola**

**\$1.19**

8 16-Oz. Returnable Bottles Plus Deposit

Save 50¢

Limit 2 Ctns. With \$7.50 or More Additional Purchase

**LENTEN SEAFOOD**

IN BIG SUPPLY TO MEET YOUR NEEDS THROUGHOUT THE SEASON!

It's fun to observe Lent, even when you're not an official Lenten observer, with Kroger's terrific variety of Lenten foods most everyone likes. Thanks to Kroger's huge volume and low profits, we can pass big savings on to you through lower prices like these Lenten Specials.

- FROZEN **Turbot Fillets** ..... Lb. **\$1.29**
- FROZEN FRES-SHORE 1-Lb. **P perch Fillets** ..... **\$1.39**
- FRES-SHORE PORTIONS 12-Oz. **Fish-N-Batter** ..... **\$1.29**
- VAN 'de KAMP 12-Oz. **Fish Fillets** ..... **\$1.88**
- FRES-SHORE PORTIONS 24-Oz. **Fish-N-Batter** ..... **\$2.49**

We also have a wide variety of seafood including lobster, shrimp and scallops available in our frozen dept.

**FRESH SEAFOOD** AVAILABLE FRIDAY AND SATURDAY ONLY

- FRESH **Dressed Sea Trout** ..... Lb. **\$1.59**
- FRESH **Ocean Perch** ..... Lb. **\$2.09**
- FRESH DRESSED **Flounder** ..... Lb. **\$1.59**

**OPEN 7 AM TO MIDNIGHT**  
OPEN SUNDAY 9 AM TO 9 PM

MON. THRU SAT.

**600 Greenville Blvd., Phone 756-7031**

# SOOPER

SAVE WITH

KROGER GRADE A  
**Large Eggs**

**68¢**

Dozen

Addit. Doz  
**89¢**

Limit 2 Dozen With \$7.50 or More Additional Purchase

KROGER HOMOGENIZED  
**Whole Milk**

**\$1.69**

Gal. Jug

KROGER 1/2%  
**Low Fat Milk**

Gal. Jug **\$1.49**

KROGER SA  
**White**

**3**

## SOOPER COST CUTTERS

HERE ARE JUST A FEW OF THE HUNDREDS OF SOOPER COST CUTTERS AT KROGER SAV-ON. A COMPLETE LIST IS AVAILABLE AT YOUR NEAREST KROGER SAV-ON STORE.



GRANULATED  
**Kroger Sugar**

5-Lb. Bag **99¢**

BIG K CANNED Soft Drinks ..... 12-Oz. Can **6/\$1**  
WITH LEMON & SUGAR Kroger Tea Mix ..... 24-Oz. Jar **\$1.09**  
KROGER ORANGE Breakfast Drink ..... 27-Oz. Jar **\$1.09**  
KROGER Grape Juice ..... 32-Oz. Btl. **68¢**  
KROGER Tomato Juice ..... 46-Oz. Can **58¢**

KROGER SINGLES  
**American Cheese Food**

12-Oz. Pkg. **\$1.18**

FLEECE Bathroom Tissue ..... 4-Roll Pkg. **66¢**  
HOME PRIDE Aluminum Foil ..... 25-Ct. Roll **33¢**  
HOME PRIDE Sandwich Bags ..... 80-Ct. Box **39¢**  
KROGER WHOLE KERNEL Golden Corn ..... 12-Oz. Can **28¢**  
AVONDALE Tomatoes ..... 16-Oz. Can **29¢**

COUNTRY OVEN TWIN PK.  
**Potato Chips**

8-Oz. **59¢**

EMBASSY Pancake Syrup ..... 24-Oz. Btl. **66¢**  
KROGER Pancake Flour ..... 2-Lb. Box **55¢**  
ARM & HAMMER Baking Soda ..... 16-Oz. Box **33¢**  
KROGER Corn Meal ..... 5-Lb. Bag **77¢**  
CHOCOLATE Hershey's Syrup ..... 16-Oz. Can **55¢**

KROGER  
**Pinto Beans**

2-Lb. Bag **47¢**

KROGER Prune Juice ..... 40-Oz. Btl. **86¢**  
EMBASSY Mayonnaise ..... 32-Oz. Jar **89¢**  
KROGER Tomato Catsup ..... 32-Oz. Btl. **66¢**  
KROGER French Dressing ..... 16-Oz. Btl. **88¢**  
KROGER Luncheon Meat ..... 12-Oz. Can **89¢**

BEAN  
**Spotlight Coffee**

1-Lb. Bag **\$1.89**

KROGER Mixed Vegetables ..... 16-Oz. Can **28¢**  
KROGER Tomato Paste ..... 12-Oz. Can **47¢**  
AVONDALE Cut Green Beans ..... 15 1/2-Oz. Can **28¢**  
AVONDALE Pinto Beans ..... 15 1/2-Oz. Can **26¢**  
KROGER Hamburger Magic ..... 6-Oz. Box **55¢**

FLEECE  
**Paper Towels**

Jumbo Roll **38¢**

KROGER Instant Puddings ..... 3 1/2-Oz. Box **21¢**  
AVONDALE Coffee Creamer ..... 22-Oz. Jar **99¢**  
PERSONAL SIZE Ivory Soap ..... 3 1/2-Oz. Bar **4/59¢**  
HOME PRIDE SOLID Air Fresheners ..... 6-Oz. Pkg. **33¢**  
MISSY Fabric Softener ..... Gal. Jug **88¢**

KROGER  
**Apple Juice**

32-Oz. Bottle **55¢**

KROGER Vienna Sausage ..... 5-Oz. Can **35¢**  
KROGER Instant Potatoes ..... 16-Oz. Pkg. **66¢**  
KROGER Instant Rice ..... 28-Oz. Box **\$1.18**  
KROGER (MEDIUM OR WIDE) Noodles ..... 12-Oz. Pkg. **36¢**  
KROGER Cup-O-Soup ..... 1.4-Oz. Pkg. **39¢**

KROGER  
**Applesauce**

16-Oz. Can **29¢**

KROGER Ravioli ..... 15-Oz. Can **49¢**  
KROGER Apple Butter ..... 28-Oz. Jar **66¢**  
CLOVER VALLEY Grape Jelly ..... 32-Oz. Jar **58¢**  
MARKET BASKET Black Pepper ..... 4-Oz. Can **59¢**  
KROGER 10X OR Lt. Brown Sugar ..... 1-Lb. Box **37¢**

LIQUID  
**Kandu Bleach**

Gal. Jug **55¢**

BRIGHT Cleanser ..... 14-Oz. Can **17¢**  
STEEL WOOL S.O.S. Soap Pads ..... 18-Ct. Box **66¢**  
PLAIN OR IODIZED Kroger Salt ..... 26-Oz. Box **18¢**  
PLAIN OR SELF RISING Kroger Flour ..... 5-Lb. Bag **77¢**  
KROGER Potted Meat ..... 3-Oz. Can **19¢**

CHUNK LIGHT  
**Kroger Tuna**

6 1/2-Oz. Can **59¢**

KROGER Tomato Soup ..... 16 1/2-Oz. Can **18¢**  
KROGER Quick Oats ..... 18-Oz. Box **49¢**  
KROGER Toaster Treats ..... 11-Oz. Pkg. **49¢**  
KROGER Barbecue Sauce ..... 16-Oz. Jar **49¢**  
KROGER WHOLE Dill Pickles ..... 32-Oz. Jar **79¢**  
YELLOW OR WHITE Kroger Cake Mix ..... 16 1/2-Oz. Box **48¢**  
AVONDALE Shortening ..... 48-Oz. Can **\$1.09**

KROGER  
**Tomato Sauce**

15-Oz. Can **29¢**

KROGER Pure Vanilla ..... 2-Oz. Btl. **55¢**

KROGER PINK Grapefruit Juice ..... 46-Oz. Can **53¢**

FROZEN FOOD  
AVONDALE French Fries  
5-Lb. Bag **99¢**  
PET RITZ Fruit Cobblers  
AVONDALE Orange Juice  
CHEESE, PEPPERONI SAUSAGE OR HAMBURGER  
Jeno's Ritz  
13-Oz. Pkg. **89¢**  
PET RITZ Pie Shells  
FREEZER PLEEZER Ice Cream Sandwiches  
CHICKEN, BEEF, TURKEY, MAC. & CHEESE  
KROGER Pot Pies  
8-Oz. Pkg. **27¢**  
CHOCOLATE, JELLY OR CINNAMON  
Everfresh Donuts  
MCKENZIE VEGETABLE OR GUMBO  
Soup Ladle  
BAKED FOOD  
AUNT FANNY'S Pecan Twists  
**3** 6-Ct. Pkgs. **\$1.18**  
KROGER Multi Grain Bread  
BIG VALUE Sandwich Cookies  
BROWN & SERVE Kroger Biscuits **3**

COMPARE SOOPER COST CUTTERS WITH WHAT YOU PAY

# COST CUTTERS

**SANDWICH OR**  
**Bread**  
**\$1**  
 10-Oz. Loaf

**COST CUTTER WEEKLY SPECIAL**

REFRESHING  
**Pepsi Cola**  
**\$1.19** **Save 50¢**  
 8 16-Oz. Returnable Bottles Plus Deposit

LIMIT 2 CTNS. WITH 7.50 OR MORE ADDITIONAL PURCHASE

**COST CUTTER WEEKLY SPECIAL**

ASSORTED FLAVORS  
**COUNTRY CLUB Ice Cream**  
**58¢** **Add'l. Ctn. 89¢**  
 1/2-Gal. Ctn.

LIMIT 1 WITH 7.50 OR MORE ADDITIONAL PURCHASE

**DAIRY FOODS**

**MARGARINE QUARTERS**

**Parkay**  
**2 1-Lb. Pkgs. \$1**

**COST CUTTER WEEKLY SPECIAL**

**WHIPPED 6-STICK Parkay Margarine** 1-Lb. Pkg. **59¢**

**WHIPPED MARGARINE Blue Bonnet** 1-Lb. Bowl **69¢**

**HUNGRY JACK Biscuits**  
**4 5-Ct. Cans \$1**

**COST CUTTER WEEKLY SPECIAL**

**PHILADELPHIA Cream Cheese** 8-Oz. Pkg. **72¢**

**DELUXE AMERICAN SLICED Kraft Cheese** 12-Oz. Pkg. **\$1.39**

**KROGER Cottage Cheese**  
**2 12-Oz. Cups \$1.09**

**COST CUTTER WEEKLY SPECIAL**

**LIGHT & LIVELY COTTAGE CHEESE OR Yogurt Dip** 8-Oz. To 12-Oz. Pkg. **66¢**

**KROGER Yubi Yogurt** 3 8-Oz. Cups **99¢**

**WINE & BEER**

**BEER Tuborg Gold**  
**6 \$1.69**

**COST CUTTER WEEKLY SPECIAL**

**CARLINGS BLACK LABEL GOLD, PINK OR RUBY Colony Chablis** 750 ML. **\$1.07**

**YAGO Sangria** 1/5th **\$1.82**

**LAMBRUSCO Giacobazzi** 1.5 Lt. **\$3.88**

## COST CUTTER BONUS BUYS

**GROUND Folgers Coffee**  
 1-Lb. Bag **\$2.19** **JUST REDUCED**  
 WAS \$2.59

|   | WAS    | NOW    |
|---|--------|--------|
| J.F.G. Mayonnaise..... 32-Oz. Jar         | \$1.29 | 99¢    |
| KROGER Rice Puffs Cereal... 6-Oz. Bag     | 49¢    | 3/\$1  |
| INSTANT COFFEE Maxwell House... 6-Oz. Jar | \$2.87 | \$2.79 |
| TENDER LEAF Tea Bags..... 100-Ct. Box     | \$2.09 | \$1.89 |
| DOUBLE O Pink Salmon.... 15 1/2-Oz. Can   | \$1.89 | \$1.66 |

|  | WAS    | NOW    |
|--|--------|--------|
| CONTADINA Tomato Paste... 8-Oz. Can    | 33¢    | 3/89¢  |
| CONTADINA Tomato Sauce... 8-Oz. Can    | 2/51¢  | 4/89¢  |
| CAMPBELL'S Pork & Beans... 28-Oz. Can  | 59¢    | 55¢    |
| LUCKS Black Eye Peas..... 17-Oz. Can   | 47¢    | 2/79¢  |
| PANCAKE Log Cabin Syrup... 36-Oz. Btl. | \$1.79 | \$1.66 |

**PURE VEGETABLE Crisco Shortening**  
 3-Lb. Can **\$1.79** **JUST REDUCED**  
 WAS \$1.89

**MACARONI & CHEESE Kraft Dinners**  
**3 7 1/4-Oz. Boxes \$1** **JUST REDUCED**  
 WAS 35¢

|  | WAS    | NOW    |
|--|--------|--------|
| ARMOUR Vienna Sausage..... 5-Oz. Can         | 49¢    | 39¢    |
| CHUNK LIGHT Starkist Tuna..... 6 1/2-Oz. Can | 89¢    | 68¢    |
| LIGHT DIGESTIBLE Crisco Oil..... 24-Oz. Btl. | \$1.17 | \$1.09 |
| GALA Decorator Towels.... Jumbo Roll         | 71¢    | 66¢    |
| FACIAL Kleenex Tissue..... 200-Ct. Box       | 63¢    | 53¢    |

|  | WAS    | NOW    |
|--|--------|--------|
| PLAIN OR SELF RISING Martha White Flour... 5-Lb. Bag | \$1.09 | 77¢    |
| PLAIN OR IODIZED Morton Salt..... 28-Oz. Box         | 23¢    | 21¢    |
| PILLSBURY Fudge Brownie Mix... 22 1/2-Oz. Pkg.       | \$1.15 | \$1.05 |
| NESTLES Cocoa Mix..... 12-Oz. Pkg.                   | \$1.19 | \$1.12 |
| MILK MATE Chocolate..... 20-Oz. Btl.                 | \$1.45 | \$1.35 |

**BATHROOM TISSUE White Cloud**  
 4-Roll Pkg. **88¢** **JUST REDUCED**  
 WAS 99¢

**DETERGENT Ivory Liquid**  
 32-Oz. Bottle **\$1.29** **JUST REDUCED**  
 WAS 1.45

|  | WAS    | NOW    |
|--|--------|--------|
| TONY Dog Food..... 14 1/2-Oz. Can                            | 19¢    | 18¢    |
| PURINA Cat Chow..... 22-Oz. Box                              | 63¢    | 57¢    |
| DOG FOOD Gravy Train..... 25-Lb. Bag                         | \$5.69 | \$4.77 |
| FABRIC SOFTENER (50¢ OFF) Sta Puf Concentrate... 96-Oz. Btl. | \$2.58 | \$1.99 |
| SCALLOPED OR AU GRATIN French's Potatoes.... 5 1/2-Oz. Box   | 73¢    | 66¢    |

|  | WAS    | NOW    |
|--|--------|--------|
| TOPPING Dream Whip..... 6-Oz. Pkg.     | \$1.29 | \$1.15 |
| AUNT SUE Raw Honey..... 16-Oz. Jar     | \$1.19 | \$1.09 |
| HEINZ Tomato Ketchup..... 14-Oz. Btl.  | 53¢    | 47¢    |
| KRAFT Barbecue Sauce..... 19-Oz. Btl.  | 75¢    | 64¢    |
| REAL LEMON Lemon Juice.... 16-Oz. Btl. | 57¢    | 2/\$1  |

**INSTANT Nescafe Coffee**  
 10-Oz. Jar **\$3.88** **JUST REDUCED**  
 WAS \$4.49

**Health & Beauty Aids SOOPER COST CUTTERS**

|   |     |   |        |  |        |
|---|-----|---|--------|--|--------|
| FAMILY PRIDE Baby Shampoo..... 16-Oz.     | 66¢ | FAMILY PRIDE ROLL-ON Deodorant..... 2.5-Oz. | 69¢    | FAMILY PRIDE BLADES 10'S Double Edge.....        | 59¢    |
| FAMILY PRIDE Herbal Shampoo..... 16-Oz.   | 59¢ | FAMILY PRIDE Creme Rinse..... 16-Oz.        | 59¢    | FAMILY PRIDE MINT AND REG. Toothpaste..... 7-Oz. | 63¢    |
| FAMILY PRIDE Nail Polish Remover... 6-Oz. | 43¢ | FAMILY PRIDE Aspirin 100's.....             | 29¢    | INSIDE FROSTED 60W 75W 100W G.E. Bulbs 4 Pk..... | \$1.48 |
| FAMILY PRIDE Petroleum Jelly..... 16-Oz.  | 79¢ | FAMILY PRIDE BLADES 9'S Twin Cartridge..... | \$1.19 | HARTZ Two In One Collar.....                     | \$2.29 |

**YOU'VE BEEN PAYING AT ANY STORE IN TOWN!!**

It's *Springtime* At Your *Kroger Sav-on* garden  
 WHERE SERVING YOU COMES FIRST



Kroger Sav-on gardeners take special pride in every item they sell. They'll be happy to help with your selection, tell you new ways to serve your favorites, and introduce you to new ones you haven't tried yet. And when you've made your choices, they'll weigh and price them with a smile.



In Store **BAKERY**

- FRESH FROM OUR IN-STORE OVEN
- Homestyle White Bread** ..... 2 Lvs. **98¢**
  - 2-LAYER- 8" **Coconut Cake** ..... **\$2.99** (Save 70c Ea.)
  - A SWEET BREAKFAST TREAT **Cinnamon Raisin Rolls** ..... **89¢** (Save 30c 1/2 Doz.)
  - 4 FLAVORS IN EACH BAG **Variety Rye Rolls** ..... **99¢** (Save 20c Doz.)
  - FRESH BAKED DAILY **Apple Pie** ..... **\$1.69** (Save 30c Ea.)

**DELICATESSEN...**



- SHAVED FOR EXTRA FLAVOR
- Chopped Ham** ..... **\$1.69** (Save 30c Lb.)
  - SLICED AS YOU LIKE IT YELLOW OR WHITE **American Cheese** ..... **\$2.29** (Save 20c Lb.)
  - SLICED OR ORDER EXTRA LEAN-BAKED **Virginia Ham** ..... **\$2.99** (Save 90c Lb.)
  - FRESH FROM OUR KITCHEN **Cole Slaw** ..... **69¢** (Save 20c Lb.)
  - A CREAMY DESSERT DELIGHT **Tahitian Salad** ..... **\$1.29** (Save 20c Lb.)

Cafeteria Style... **RESTAURANT...**

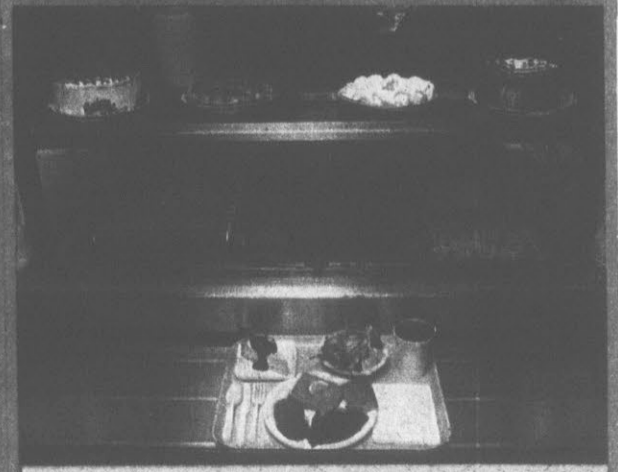

- SPICY GOOD FIXED FRESH DAILY
- Whole BBQ Chicken** ..... **\$1.19** (Save 50c Lb.)
  - WITH 9 ROLLS • 12-PIECE FAMILY PACK **Fried Chicken** ..... **\$4.49** (Save \$1.00 Ea.)
  - WITH POTATO SALAD & PICKLE SPEAR SWISS CHEESE & **Shaved Ham Sandwich** ..... **\$1.29** (Save 20c Ea.)
  - FRESH MADE DAILY **Cheese Pizza** ..... **\$1.69** Ea.

1ST OF THE SEASON FRESH TENDER **Asparagus** **99¢** Lb. (FIRST of the season)

RED RIPE **Watermelon** **25¢** Lb.

FRESH **Mushrooms** **\$1.29** Lb.

FRESH **Pineapples** **89¢** Each

- U.S. NO. 1 **White Potatoes** ..... **\$1.69** (20-Lb. Bag)
- INDIAN RIVER #0 SIZE **Grapefruit** ..... **5¢** For
- WASHINGTON STATE RED **Delicious Apples** ..... **15¢** (130 Size Ea.)
- CALIFORNIA **Avocados** ..... **3¢** For
- EGGROLL OR **Won Ton Wrappers** ..... **99¢** (1-Lb. Pkg.)
- IMPORTED WHITE **Seedless Grapes** ..... **\$1.29** Lb.
- SELECT **Idaho Bakers** ..... **4¢** For
- FRESH **Lemons** ..... **10¢** For
- FRESH CROOKNECK **Yellow Squash** ..... **49¢** Lb.
- FLORIDA NEW CROP **Red Potatoes** ..... **5¢** Lb.

SPRING FRESH **Cherry Red Rhubarb** **59¢** Lb.

- SALAD FIXINS**
- FRESH TENDER **Boston Lettuce** ..... **2** Heads **\$1**
  - FRESH **Green Onions** ..... **4** Bunches **\$1**
  - GREEN TOP **Bunch Carrots** ..... **3** Bunches **\$1**
  - GREEN TOP **Bunch Radishes** ..... **4** Bunches **\$1**

FIRST OF THE SEASON **Cantaloupes** **88¢** Ea. (FIRST of the season)

Quantity Rights Reserved  
None Sold To Dealers

# Kroger Sav-on

## Outdoor Living

# SALE



FOOD  
DRUG



Copyright Kroger Sav-On 1979  
Prices Effective Wed., Mar. 21 Thru Sat., Mar. 24

### ADVERTISED ITEM POLICY

Each of these advertised items is required to be readily available for sale in each Kroger store, except as specifically noted in this ad. If we do run out of an advertised item, we will offer you your choice of a comparable item, when available, reflecting the same savings or a rain-check which will entitle you to purchase the advertised item at the advertised price within 30 days.



### Starter Fertilizer

**\$7.88**  
5,000 Sq. Ft. Bag

Special root-building formula for use whenever seeding grass, sprigging or laying sod.



Folding Aluminum Chaise  
**\$11.67**  
Model K-12

Rust resistant aluminum frame with rugged vinyl webbing. Multi-colored.

'Charge It'

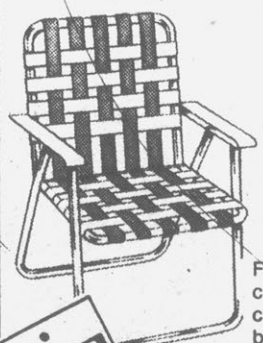

Webbed Aluminum Lawn Chair  
**\$5.67**  
Model K-11

Folding aluminum chair with multi-colored vinyl webbing.

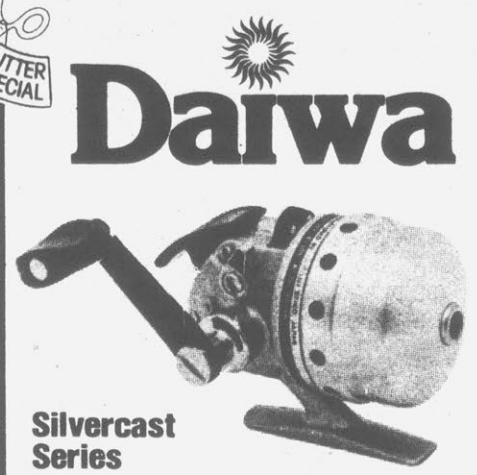

Silvercast Series

**Spinning Reel**  
Silvercast Model 208RL  
Medium/light freshwater  
• Gear ratio: 4.1 to 1  
• Pre-wound line 75 Yds., 8 lbs.  
• Weight: 7.8-oz.  
• Complete owner's manual  
**\$7.99**

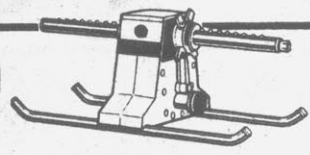

FLUIDIC Lawn Sprinkler  
**\$11.88**  
Model 372

- Avoids over/under watering
- Hundreds of settings
- Up to 3,500 sq. ft.
- Plus water where it counts

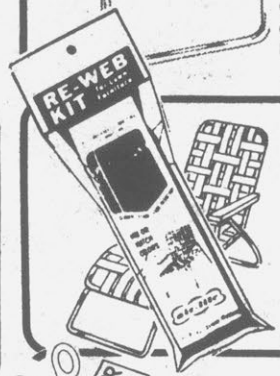

Re-Web Kit  
**99¢** Ea.

Renew your lawn furniture with this sturdy vinyl kit. Includes 72-ft. of webbing.

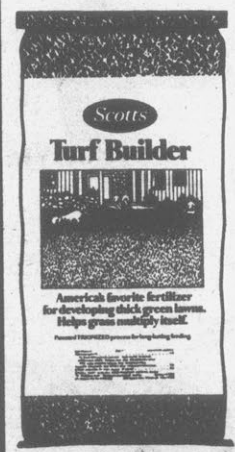

Turf Builder  
6,000 Sq. Ft. Bag  
**\$11.88**

Non burning, slow release formula for developing thick, green lawns. Helps grass multiply itself.



HOODED Swinger Grill  
**\$32.99**

Beauty! Performance! Compact Construction! This sleek Swinger II smoker grill features a big 18"x18" cooking grid. Unique one piece tilt-away hood allows full access to cooking area.



Model 4400



Swifts 8-8-8 Fertilizer  
**\$2.49**  
50-Lb. Bag

Swift Lawn and Garden Fertilizer. Fast acting fertilizer for lawns, shrubs, trees and vegetables.

**Kroger Sav-On...A Whole Lot More Than Just One Store**

COST WEEKLY CUTTER SPECIAL



### ZEBCO 202 Rod and Reel Set

Ready To Fish!

- Spring-loaded power drag
- Filled with premium Zebco line

**\$3<sup>99</sup>**  
Set

COST WEEKLY CUTTER SPECIAL



### Grow Shrubs and Trees

Sustains vigorous growth and beauty of shrubs, trees and ground cover.



Your Choice **\$1<sup>77</sup>**  
2½-Lbs.



### Grow Flowers

Helps give flower seeds and transplants a strong start.

COST WEEKLY CUTTER SPECIAL

### Hirsch Plant Tree Stand

**\$10<sup>88</sup>**

Decorator plant stand holds 3 plants. Black metal hangers, famous Hirsch quality.





**Silvercast Series Spinning Reel**  
Silvercast Model 208. Medium/light freshwater. Gear ratio: 4.1 to 1.  
**\$7<sup>99</sup>**



**RUBBER Horseshoe Set**  
Complete Outdoor Set  
**\$5<sup>99</sup>**



**1½ GALLON UTILITY Tanksprayer**  
**\$12<sup>88</sup>**



**Extension Cord**  
100 Feet  
**\$8<sup>88</sup>**



**DAIWA Rod Riot**  
Spinning, Spincast, Worm Rod  
**\$10<sup>99</sup>**  
Your Choice Ea.



**Men's or Ladies 26" 3-Speed Bikes**  
Training Lightweights  
**\$69<sup>95</sup>**

- Men's frame size 21"
- Women's frame size 19"
- 3-speed gearing system with trigger controlled shifter
- 26x1 1/2" blackwall tires
- Chrome touring style handlebars
- Dual caliper handbrakes

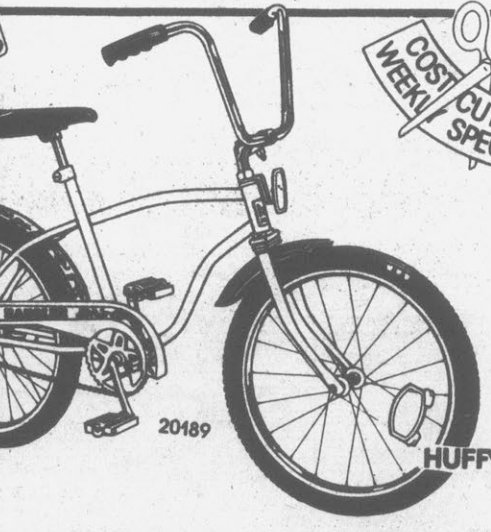

**Boy's or Girl's 20" Hi-Rise Bikes**  
Boy's Rangler or Girls' Cactus Flower Models  
**\$49<sup>95</sup>**

- Single speed, coaster brake
- 20x1.75" blackwall tires
- Huff® Hi-Rise handlebars
- Hot Fudge extra wide, lightweight fenders
- Custom polo style saddle
- Reflective pedals



EMERSON SOLID STATE AM/FM  
**Digital Clock Radio**

- Lighted clock movement with hour/minute second display
- Wake to music
- Target AM/FM tuning dial

**\$17<sup>88</sup>**

master charge  
THE INTERBANK CARD

VISA

COST  
WEEKLY  
CUTTER  
SPECIAL

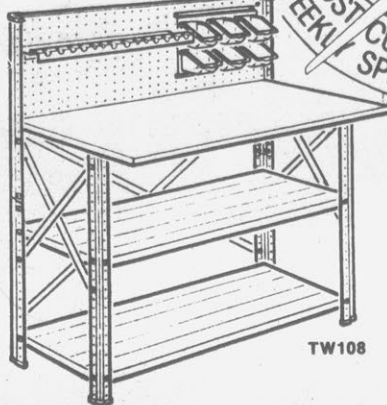

TW108

**Hirsh Work and  
Hobby Bench**  
Sturdy All Steel Frame

Complete workshop for the home hobbyist. 20"x36" work surface is thick compressed high-impact board. Legs are steel, formed in a rigid conformation for maximum strength. Two 36" wide x 16" deep bottom shelves provide additional storage capacity.

**\$17<sup>88</sup>** Ea.

COST  
WEEKLY  
CUTTER  
SPECIAL

**Hirsh  
HEAVY-  
DUTY**

**Storage Shelving**  
4-Shelf Unit

**\$9<sup>97</sup>**

Only

Super-strong, wobble-free construction with heavy-duty back and side braces. Posts are heavy-gauge steel, formed in an extra-rigid conformation for maximum strength.

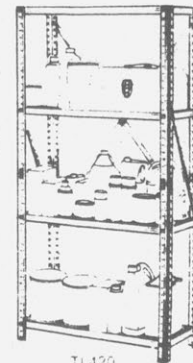

TL420

VISA

master charge  
THE INTERBANK CARD

COST  
WEEKLY  
CUTTER  
SPECIAL

4-INCH  
**Paint Brush**  
100% Polyester

**\$2<sup>29</sup>** Ea.



50-FOOT  
**Garden  
Hose**

5/8"  
Diameter

**\$6<sup>99</sup>**

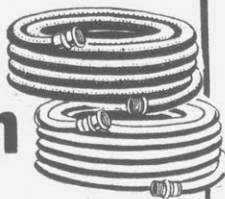

RAINWAVE  
**Sprinkler**  
**\$3<sup>49</sup>**



ALKALINE  
**Duracell  
Batteries**

C & D Size  
Pack of 2  
9-Volt  
Pack of One

**88¢** Pk.



DU PONT

**LUCITE Wallpaint**

- Fast drying
- Easy water clean-up

**\$7<sup>77</sup>** Gal.



**LUCITE  
House Paint**

- Built-in primer
- Water clean-up

**\$8<sup>99</sup>** Gal.

PLASTIC  
Drop Cloth  
**29¢**

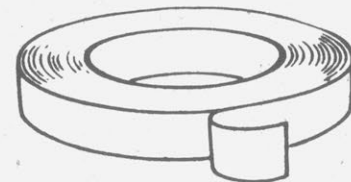

3/4" WIDE  
**Masking Tape**

**49¢**

60-Yard Roll

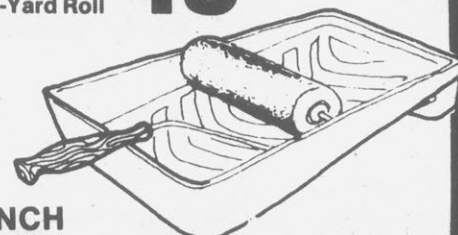

9-INCH  
**Paint Tray & Roller**

**\$1<sup>99</sup>** Set

COST  
WEEKLY  
CUTTER  
SPECIAL

# Kroger Sav-on Outdoor Living SALE



FOOD  
DRUG

**Kroger Sav-on HAS**

## LOW PRESCRIPTION PRICES

**DID YOU KNOW YOUR DOCTOR'S PRESCRIPTION BELONGS TO YOU?**

You have the right to have it transferred from one pharmacy to another. If you feel you are paying too much elsewhere, ask your friendly Kroger Sav-on Pharmacist to tell you how much you can save at Kroger Sav-on.

**Call Your Nearest Pharmacy**

|                           |                     |
|---------------------------|---------------------|
| <b>CHARLOTTE</b>          | <b>WILMINGTON</b>   |
| • Tyvola Rd. 527-3159     | 392-1959            |
| • Eastway Dr. 597-8154    |                     |
| • Freedom 399-0975        | <b>FAYETTEVILLE</b> |
|                           | 864-3449            |
| <b>COLUMBIA</b>           | <b>FLORENCE</b>     |
| • Bush River Rd. 798-6901 | 662-9147            |
| • Decker Rd. 788-3620     |                     |
| <b>CHARLESTON</b>         | <b>SUMTER</b>       |
| • Mall Dr. 554-5042       | 775-0115            |
| • Savannah Hwy. 556-6956  |                     |
| <b>GREENVILLE</b>         | <b>HICKORY</b>      |
| 756-7393                  | 328-3058            |
| <b>SAVANNAH</b>           | <b>SALISBURY</b>    |
| 354-7431                  | 636-8432            |

SHAVING CARTRIDGES

**Gillette Atra**  
97¢

Pack of 5



**3/4" BAND-AID BRAND Sheer Strips**  
59¢

60-Count Box

EXTRA STRENGTH

**Datril 500**  
\$1.27

50 Tablets

**Datril 500** Extra Strength



**ANTI-PERSPIRANT Secret Spray**  
\$1.33

4-Oz.

CLAIROL HAIR SPRAY

**Final Net**  
\$1.37

8-Oz.



**CLAIROL AFTER SHAMPOO Condition II**  
\$1.29

16-Oz. Bottle

CLAIROL SHAMPOO

**Herbal Essence**  
\$1.39

15-Oz.



LOTION

**Polish Remover**  
69¢

3-Oz.  
From Vaseline Intensive Care

DARK TANNING OIL

**Hawaiian Tropic**  
\$2.87

8-Oz.



**POND'S CREAM & Cocoa Butter Lotion**  
\$1.29

12-Oz.

SUNTAN OIL OR LOTION

**Coppertone**  
\$1.69

Your Choice

4-Oz.



**SHAMPOO FORMULA Miss Clairol**  
\$1.77

With Color Hold

FLUORIDE TOOTHPASTE

**Crest**  
73¢

5-Oz. Tube



**CLAIROL Frost & Tip Kit**  
\$3.49

One Application

**COST CUTTER COUPON**

**5"x7" Color Enlargement**

**49¢** Each

From Your Favorite Color Slide Or Color Negative

Limit One Coupon Per Family  
Coupon Good Thru Saturday, Mar. 24, 1979  
Subject to Applicable State & Local Taxes

910

**Kroger Sav-On...A Whole Lot More Than Just One Store**

# Kmart®

THE SAVING PLACE

**EMART ADVERTISED MERCHANDISE POLICY**  
 All items advertised in this section are available in all Kmart stores. Some items may be available in select stores only. All items are subject to change without notice. All items are sold as shown. All items are sold as advertised. All items are sold as shown. All items are sold as advertised. All items are sold as shown. All items are sold as advertised.



OPEN MON.-SAT.  
9:30-9:00

# MARCH MONEY SAVERS

WED., THURS., FRI., SAT.  
SALE DAYS



TABLE TOP GRILL  
**344**

18" Portable Grill For Picnics, Apartments.

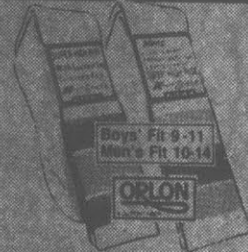

'SUPER HI-RISE'

Our Reg. 1.27-1.47  
Your Choice **\$1** Pr.

Orlon® acrylic/stretch nylon socks in white/stripes.



PAPER TOWELS

Our Reg. **56¢**

Gala® 2-ply 11x14 towels 100 sq. ft. Color choice.



• **THIN STEREO HEADPHONES**  
Our Reg. 19.97 **15.84**  
20 - 15,500 Hz response. Ear cushions. Save.



TERRY BATH TOWELS

Our Reg. 2.67 **1.97** 22oz

Cotton/polyester terry in floral or diagonal stripe.



DACRON® BED PILLOW

Our Reg. 2 \$7 **4.27** FOR

Dacron® polyester filled; print ticking 20x26



28-OZ. COOKIES

Our Reg. \$4.99 Your Choice **83¢** Pkg.

Vanilla, Chocolate or Assorted Sandwich Creams



BOOK SELECTION

Our Reg. 2.99 Your Choice **1.97** Each

Hard cover, draft, nature, animal or cook books in color.



RUG HOOK KIT

Our Reg. 7.99 **\$6**

Pre-cut yarn, cones, directions. Size 20x27"



PRE-FOLDED DIAPERS

Our Reg. 4.97 **4.44** Dozen

Pkg. of 12 birdseye pre-folded reusable diapers.



NEW FREEDOM

1.47 4 Days

30 bedless Mini Pads Save. 20 Maxi Pads ..... 1.00



ENAMELLED TOILET SEAT

**4.67** Our Reg. 6.67

Wood construction, top-mounted hinges. Save now.



FLAT ENAMEL WALL PAINT

Our Reg. 2.47

**5.96** Gal.

6-way interior latex one coat for wall and woodwork. Lead-free 'n' baby safe. Color fast. Save now.

ENAMEL SPRAY PAINT

Our Reg. 1.57

Interior/exterior epoxy enamel high gloss paint. **97¢**



SAVE 2.44

CHECK FILE

Our Reg. 8.88 **6.44**

Check file with monthly index.



HAND HELD PRINT CALCULATOR

Our Reg. 82.97 **64.97**

10-digit green readout with memory.



80 PAPER PLATES

Our Reg. 1.78 Pkg. **1.38** 4 Days

9" plastic-coated plates. Yellow or green. Save now.



SAVE \$4 EACH

6-WAY LATEX SEMI-GLOSS

Our Reg. 9.47

**6.96** Gal.

Interior semi-gloss enamel latex wall paint in white and custom tinted colors. Washable. Save at Kmart.

#14-OZ. PROTEIN 21®

Sale Price **1.47** 4 Days

Normal or oily. 14-Oz. 11.0z.

SHORT N SASSY SHAMPOO

**97¢** 9 Oz. Size



COLOR FILM

**99¢** Ea. Focal® 110/20, 126/20, or 135/20 color print film.\*



OIL FILTER

Our Reg. 1.94 **1.27** 4 Days

Top quality filters fit most U.S. foreign cars.



**4.78**  
Elegant polyester shawls of delicate designs with long fringe ends. Save at K mart.

**3.97**  
Canvas "body-bags" for spring... with pockets, pouches, coin purses. Save now.

**3.97**

**478**  
Our Reg. 5.78 4 Days

**397**  
Our Reg. 5.88 4 Days

Black, White, Beige, Pastels

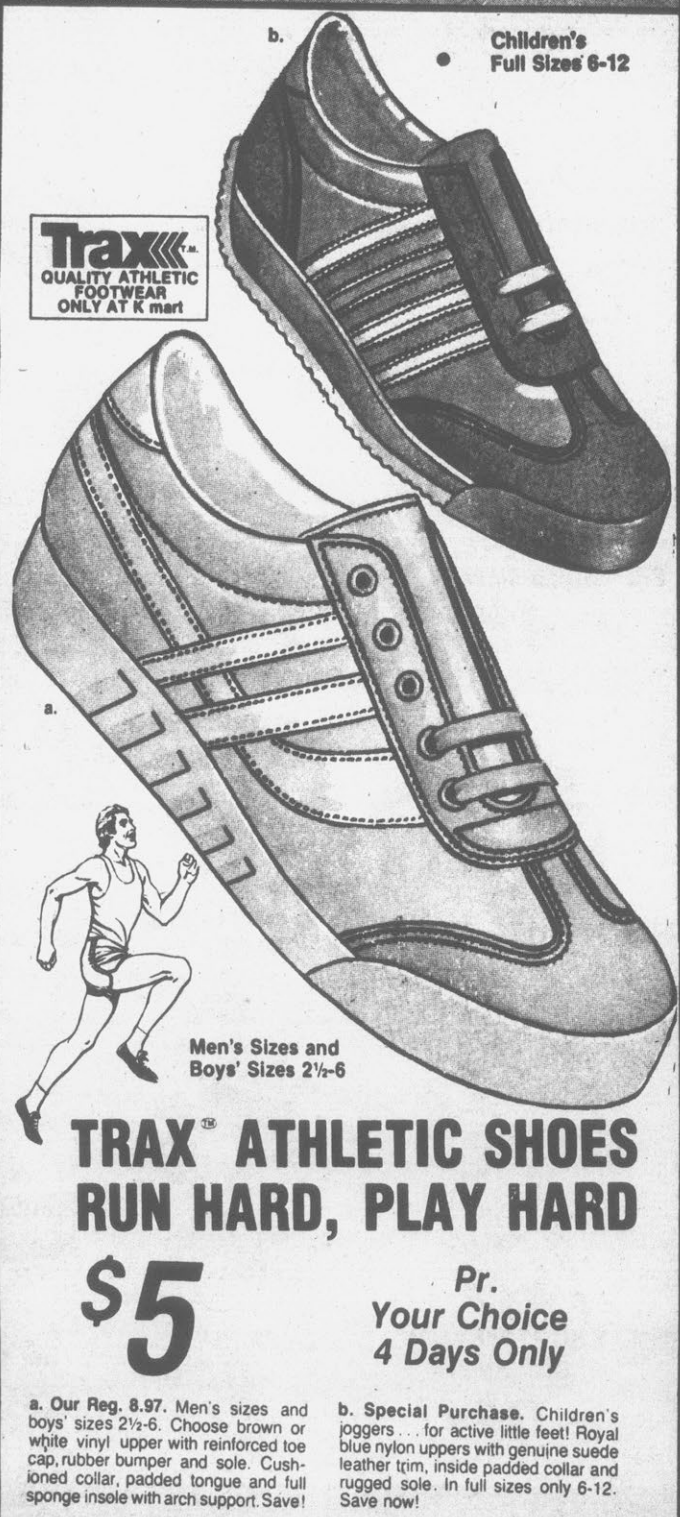

**Trax** QUALITY ATHLETIC FOOTWEAR ONLY AT K mart

**Children's Full Sizes 6-12**







**Men's Sizes and Boys' Sizes 2 1/2-6**

**TRAX™ ATHLETIC SHOES**  
**RUN HARD, PLAY HARD**

**\$5** Pr. Your Choice 4 Days Only

a. Our Reg. 8.97. Men's sizes and boys' sizes 2 1/2-6. Choose brown or white vinyl upper with reinforced toe cap, rubber bumper and sole. Cushioned collar, padded tongue and full sponge insole with arch support. Save!

b. Special Purchase. Children's joggers... for active little feet! Royal blue nylon uppers with genuine suede leather trim, inside padded collar and rugged sole. In full sizes only 6-12. Save now!

|  |   |
|--|---|
| <p><b>100 TRI-BEC B COMPLEX</b><br/><b>1.97</b><br/>200 I.U. 1.97</p> <p>VITAMIN SUPPLEMENT<br/>200 I.V.</p>  | <p><b>WETTING SOLUTION</b><br/><b>1.57</b></p> <p>Barnes-Hind® for hard contact lenses. Save.<br/>*Fl. oz.</p>     |
| <p><b>LAXATIVE</b><br/><b>1.79</b></p> <p>LIMIT 2 PLEASE</p> <p>Vegetable-type. 14-oz. *Net wt.</p>           | <p><b>42 PILLS DIUREX</b><br/><b>1.87</b></p> <p><b>20 CAPSULES PROCNINE</b><br/><b>1.97</b></p>                   |
| <p><b>16-OZ. * PROTEIN POWDER</b><br/><b>3.97</b></p> <p>Enriched instant protein *Net wt.</p>                | <p><b>1.3-GAL. VAPORIZER</b><br/><b>6.17</b></p> <p>Adds moisture to air, helps relieve congestion. Save now.</p>  |
| <b>HEALTH 'N BEAUTY AIDS</b>   |   |
| <p><b>36 ALKA-SELTZER</b><br/><b>1.08</b></p> <p>ANTACID HEARLBURN RELIEF.</p>                              | <p><b>ROSEMILK</b><br/><b>1.18</b></p> <p>SOOTHES DRY SKIN 12 OZ.</p>   |
| <p><b>20 CONTAC</b><br/><b>1.88</b></p> <p>LONG ACTING NASAL SPRAY<br/><b>1.07</b></p>                      | <p><b>FORMULA 44</b><br/><b>1.68</b> 6 OZ.</p> <p><b>FORMULA 44D</b><br/><b>2.18</b> 6 OZ.</p>                   |
| <p><b>BAYER ASPIRIN</b><br/><b>2.34</b></p> <p>300 PURE ASPIRIN TABLETS.</p>                                | <p><b>100 BUFFERIN®</b><br/><b>1.24</b> 4 Days</p> <p>Analgesic tablets helps relieve pain.</p>                  |
| <p><b>NOXEMA</b><br/><b>1.34</b></p> <p>10 OZ. SIZE</p>   | <p><b>30 TAMPONS</b><br/><b>1.08</b></p> <p>REGULAR OR SUPER</p>   |
| <p><b>100 TABLETS COMTrex</b><br/><b>3.28</b></p> <p><b>COMTrex LIQUID</b><br/><b>1.57</b> 6 OZ.</p>        | <p><b>OXY 5</b><br/><b>1.47</b></p> <p>1 OZ. FOR ACNE</p>    |

OPEN MON.-SAT. 9:30-9:00

WED. THRU SAT. SALE

# Kmart

THE SAVING PLACE



SAVE \$2

Misses' Half-Size, Full-Figure (14½ to 24½)

SAVE \$2

### PANTSUITS

Our Reg. 9.96

**7.96**  
Save

Fashion's perennial favorite updated for spring. Many styles in new-look tops with smart-fitting pull-on pants in two-toned, printed or solid-color fuss-free polyester. Flattering! Save now at K mart.



### PRETTY GOWNS

Our Reg. 3.96

**2.88**

Save  
Waltz-length nighties polyester cotton. Prints or solid colors. Save.



SAVE \$2

SAVE \$2

### FASHION SHIRTS

Our Reg. 9.96

**7.96**  
Misses'

Soft and sheer polyester/rayon voile superbly tailored with the newest, tiny point collar, detailed front and back yoke. All in the prettiest prints for springtime. Save at K mart.



SAVE \$2-\$3

### GIRLS' PANTSUITS NEED NO IRONING

Our 11.96-12.96

**9.96**  
4 Days

Many styles in polyester or polyester cotton. 7-14. Save Our 10.96-11.96, 4-6 X... 8.96

### GIRLS' BABYDOLL PAJAMAS ON SALE

Our 11.96-12.96

**2.22**  
4 Days

Adorable tops with matching bikini panty in printed or solid-color polyester. 4-14. Save now

### EASTER DRESSES FOR LITTLE GIRLS

Our 7.96

**6.44**  
4 Days

She'll be pretty as a princess in her fashion-perfect dress. Polyester in Easter egg colors. 4-6



\$4

\$5

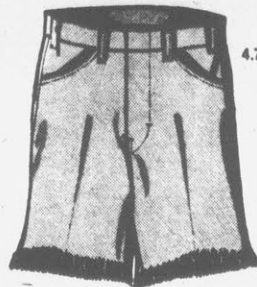

4.77

### FRAYED-LEG SHORTS

Our Reg. 6.97  
In blue cotton denim Western cut. Save!

**4.77**  
Men's



\$1

### SPORTY VISOR CAPS

Our Reg. 1.88 2-tones or solid colors. Elastic band and cotton lining.

**\$1**

### WORK SHIRT

Our Reg. 5.48

**\$5**

Men's blue chambray work shirt in polyester/cotton. Made with banded collar, tail bottom, chest pocket.

### DENIM JEANS

Our Reg. 8.97

**\$5**

Men's blue cotton denim work jeans made with hammer loop, tool pocket, belt loops and metal buttons. Save!

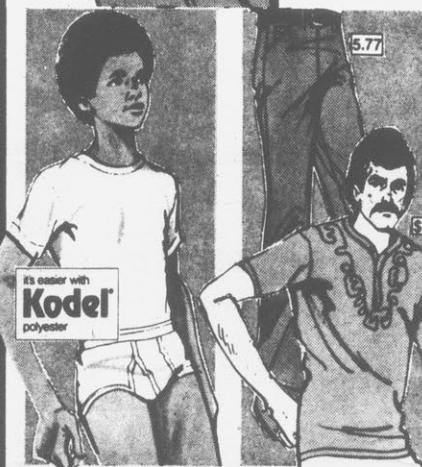

It's easier with **Kodel** polyester

5.77

\$5

### BOYS' BRIEFS OR TEE-SHIRTS

Our Reg. 3.88 Pkg. of 3

**2.97**

Comfort-styled tee shirts or briefs in white Kodel<sup>®</sup> polyester/cotton. XS-SL.

### KNIT SHIRTS

Our Reg. 6.96

**\$5**

Placket styles in polyester/cotton. Men's sizes.

### WESTERN JEANS

Our Reg. \$7

**5.77**

Men's blue cotton denim, 4-pocket flare jeans. Save.



\$5

Our 3.57 Jr. Boys Acrylic Shirts, Sizes 4-7... 2.77

### MEN'S V-NECK KNIT SHIRTS

Our Reg. 5.96

**\$5**

Men's knit shirts in soft polyester/cotton. Comfortable for leisure or sports. SX-L.

OPEN MON.-SAT.  
9:30-9:00

# WEDNESDAY

## DISCOUNTS

**K mart® ADVERTISED MERCHANDISE POLICY**

Our first intention is to have every advertised item in stock on our shelves. If an advertised item is not available for purchase due to any unforeseen reason, K mart will issue a Rain Check on request for the merchandise to be purchased at the sale price whenever available or will sell you a comparable quality item at a comparable reduction in price. Our policy is to keep our customers' "satisfaction always."



**2" x 4" x 8' STUDS**

Our Reg. 1.77  
**1.57**

White Pine 2 x 4's for construction.

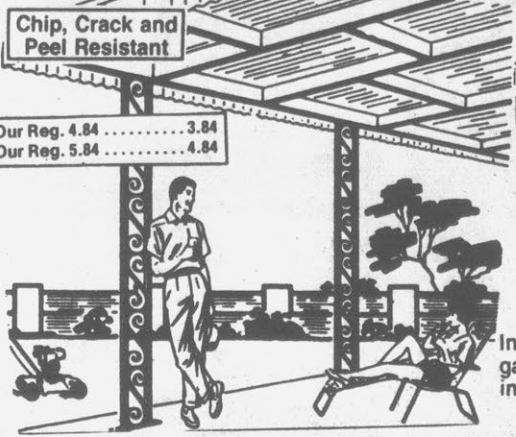

Chip, Crack and Peel Resistant

Our Reg. 4.84 ..... 3.84  
Our Reg. 5.84 ..... 4.84

**26" x 8-FT. FIBERGLASS PANELS**

Our Reg. 3.84  
**2.84**

Indoor-outdoor corrugated fiberglass panels in white or green.

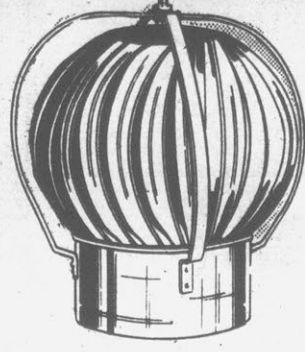

**12" TURBINE VENTILATOR**

Our Reg. 26.86 4 Days

No operating costs. Save. **24<sup>88</sup>**

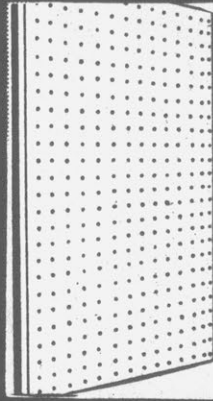

**1/8" PEGBOARD**

Our Reg. 4.88  
**3.88**

End garage clutter. Organize tools, garden equipment.

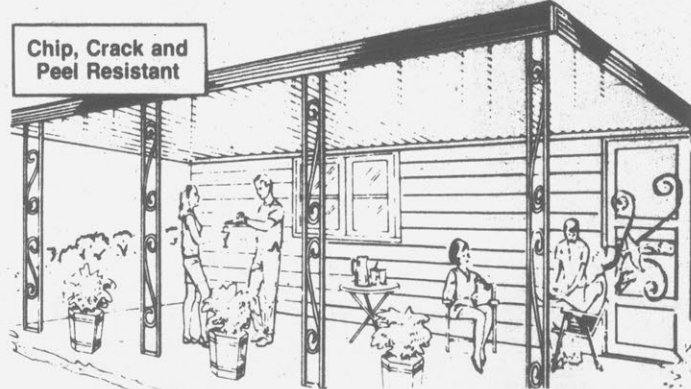

Chip, Crack and Peel Resistant

**BIG 10x20-FT. WHITE ALUMINUM PATIO COVER**

Our Reg. 338.88 - 4 Days Only

**298<sup>88</sup>**

With 4 Posts

White acrylic-baked enamel cover with four ornamental columns and built-in gutters.

16 x 8

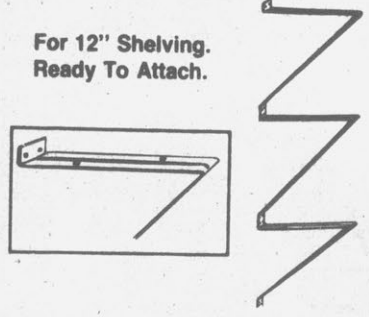

For 12" Shelving. Ready To Attach.

**STEEL 3-SHELF BRACKET**

1-pc. "Z" bracket made for 12" shelving. Fastens easily. **97<sup>c</sup>**

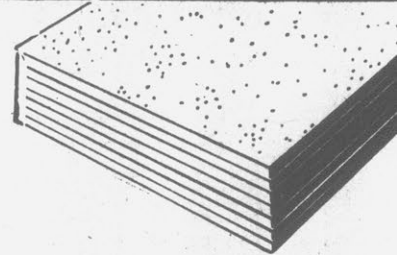

**4 x 8 PARTICLE BOARD**

Our Reg. 6.27  
**5.27**

Versatile particleboard is easy to use and ideal for...

**MERCURY VAPOR LAMP**

Our Reg. 39.88

**32<sup>88</sup>**

Security lamp for dusk-to-dawn lighting. Powerful 250-W. photoelectric bulb. Ready to install.

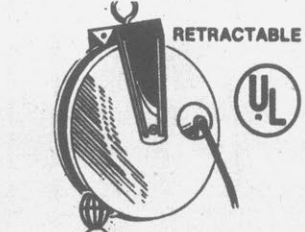

RETRACTABLE



OUTLET

BULB NOT INCLUDED

**QUALITY ELECTRIC LIGHT REEL**

Our Regular 14.88

**10<sup>88</sup>**

Includes fixture 20 ft. 3 wire cord and retractable reel.

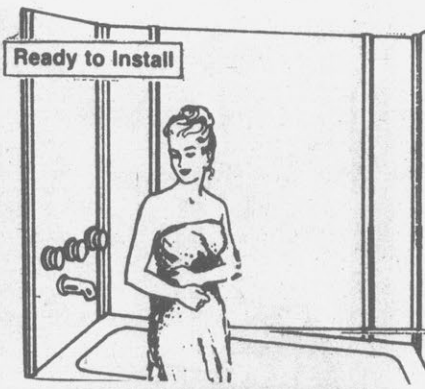

Ready to Install

**SHOWERMATE® 5-PIECE KIT**

Our Reg. 78

Pre-cut solid white acrylic panels fit around standard 4 1/2'-5' tub. Seamless corners.

**49<sup>88</sup>**

THURS., FRI., SAT.

**Smart**  
SAVING PLACE

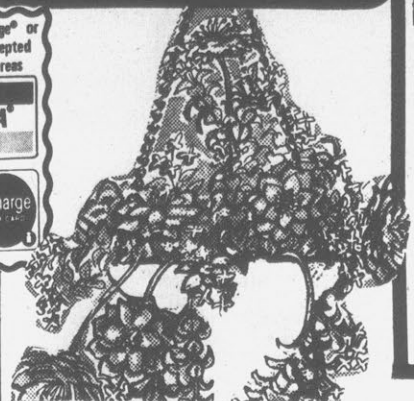

**HANGING PLANTS**  
Our Reg. 6.77 **5.96**

Blooming vines or foliage in 8" hanging baskets. Ideal indoors on porch or patio.



**GLADIOLUS BULBS**  
**1.33**  
Jumbo  
Our Reg. 1.67  
Mammoth size. Mixed colors. New stock. Save.

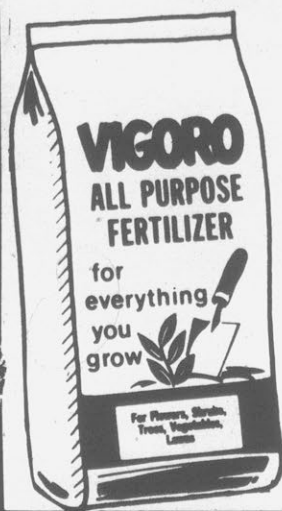

**VIGORO**  
LAWN AND GARDEN PRODUCTS

|              |             |
|--------------|-------------|
| 50 Lb. Size  | 20 Lb. Size |
| <b>10.88</b> | <b>3.66</b> |

|   |   |
|---|---|
| 24*4*12 Lawn Fertilizer covers 10,000 sq. ft. .... 10.88      | 6*10*4 All purpose fertilizer . . 3.66                    |
| 12*5*7 Weed control fertilizer covers 5000 sq. ft. .... 10.88 | 4*10*10 Azalea, Camellia and Rhododendron food. .... 3.66 |
| Vigoro Crabgrass Preventer covers 5000 sq. ft. .... 10.88     | 6*9*5 Rose food. .... 3.66                                |



**GOLDEN VIGORO**  
LAWN FERTILIZER  
**GREENS YOUR LAWN FAST!  
KEEPS IT GREEN!**

50' x 1/2"  
**GARDEN HOSE**  
Our Reg. 2.66 **2.37**

Sturdy hose in green vinyl for lawn and garden.

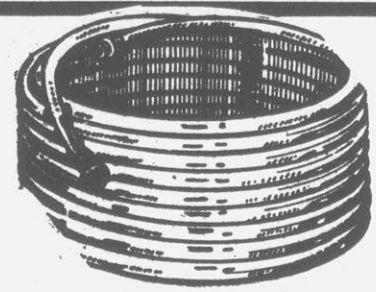

**K-GRO LIQUID**  
Our Reg. 2.57 **2.17**  
12-6-6 fish-base formula liquid plant food. Quart.

**GARDEN TOOLS**  
4 Days Only **4.17** Your Choice

Special sale for gardeners on bow rakes, garden hoes and long-handled shovels.

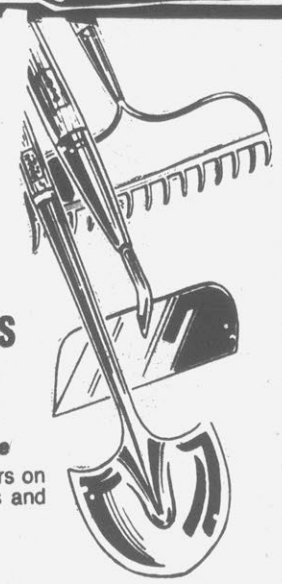

# green 'n growing discounts



**BARK NUGGETS**  
Our Reg. 3.17 **1.97** Save!  
3-cu.-ft. bags of large, medium or small chunks.  
Our Reg. 2.27  
Bark Mulch ..... 1.77



**ORGANIC PEAT MOSS**  
Our Reg. 1.14 **1.08**  
Encourages healthy lawns, gardens and shrubs. 40-lb.\* Save.  
\*Not wt.

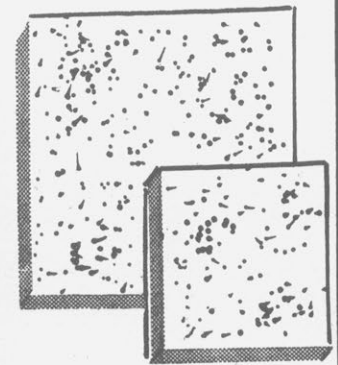

**PATIO BLOCKS**

|                           |      |
|---------------------------|------|
| 12" x 12" Red             | 97¢  |
| 12" x 12" White           | 87¢  |
| 18" x 18" White           | 1.84 |
| 18" x 18" Red             | 1.97 |
| 18" Round White           | 1.84 |
| 18" Round Red             | 1.97 |
| Scalloped Lawn Edge White | 93¢  |
| Scalloped Lawn Edge Red   | 97¢  |

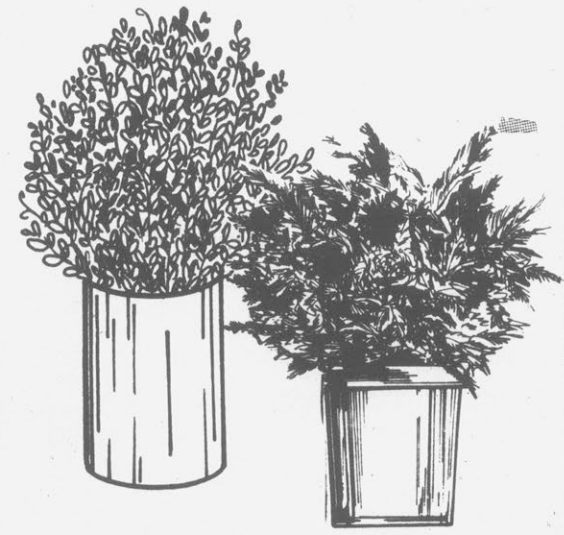

**LANDSCAPE SHRUBS**  
**1.88**  
Choose from Azalea, Boxwood Evergreen and other popular varieties. In 1 gallon cans.



• 10-CUP MR. COFFEE®  
**25<sup>64</sup>**  
Save

Automatic drip brewer with "Coffee Saver", 24 filters. Save. 100-Pack Kmart® Filters, 2/\$1

• 7-SPEED BLENDER®  
**19<sup>85</sup>**  
Save

8 pushbuttons, 7 exact speeds. "Power Pitcher" glass jar with removable assembly for cleaning.

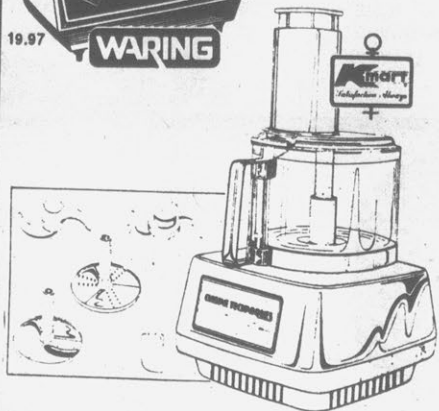

• K mart® FOOD PROCESSOR  
**45<sup>97</sup>**

Chops, grinds, slices, shreds and grates. 2 disks, knife, mixing blades, pusher, spatula. Save.

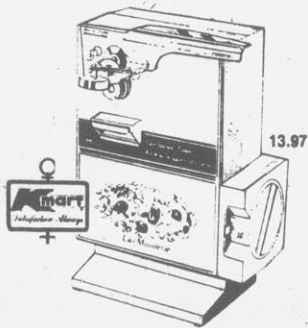

• VERSATILE CAN OPENER  
**13<sup>97</sup>**  
Save

Automatic can opener, knife/scissors sharpener and all-purpose timer. Removable cutter. Save.



AM/FM DIGITAL RADIO **24<sup>97</sup>**

Wake-to-music. AM/FM radio plus drop-leaf digital clock. 24-hour timer. Save.



TENDER TWEEZE  
**12<sup>44</sup>**

The gentle automatic tweezer by Clairol



PORTABLE AM RADIO  
**7<sup>97</sup>**

Slide-rule tuning. 3-inch speaker.

Batteries not included

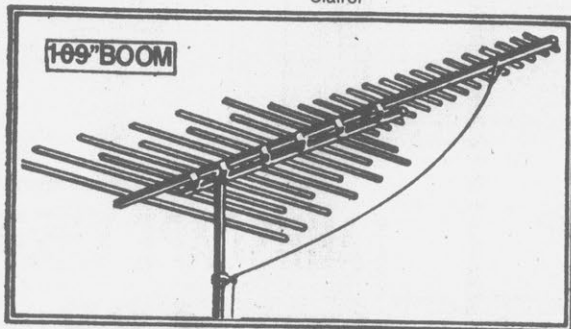

FRINGE ANTENNA

Our Reg. 36.97

**29<sup>97</sup>**

UHF-VHF-TV antenna for excellent color, black/white and FM reception. Save now.

OPEN MON.-SAT. 9:30-9:00

WED. THRU SAT. SALE

**Kmart**  
THE SAVING PLACE

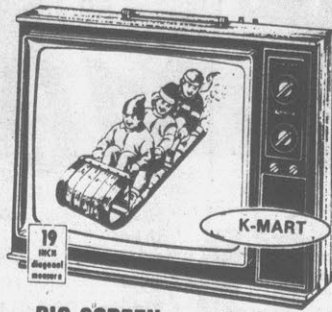

BIG-SCREEN B/W SET **\$119**

Our Reg. 149.88. Black-and-white portable with solid-state reliability... quick-on tube delivers clear, bright pictures. Save at K mart.



PORTABLE COLOR TV **\$299**

Our Reg. \$328. Great performance and reliability from this solid-state Solarcolor® TV... the deluxe features at an easy price.



• SPORTABLE® TV Black and white. New **\$99**

Vista 100 VHF/UHF tuner.

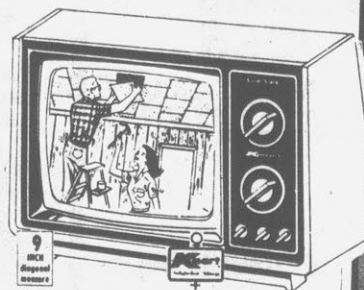

PERSONAL B/W PORTABLE **\$68**

Our Reg. 89.88. Kitchen, bedroom, workroom or college dorm... this handsome black-and-white, personal-size set fits right in.

CREDIT AVAILABLE ON MAJOR PURCHASES



STEREO CONSOLE

**\$179**

Colonial Style Console Features AM/FM, 8 Track Tape Player Phonograph.

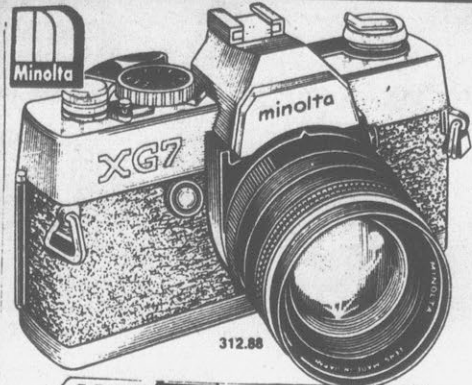

**SAVE \$37**  
**MINOLTA' XG7**  
**35 MM CAMERA**  
**279<sup>88</sup>**

Features 1.7 lens. Electronic. Easy to use. Minolta quality. Save now!  
 Our 399.88 XG735 MM Camera / 1.4 Lens, 359.88

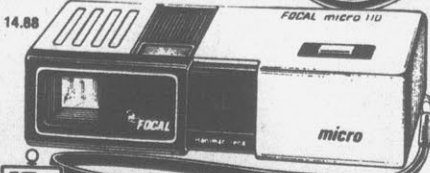

**SAVE \$4**  
**FOCAL' 110**  
**POCKET CAMERA**  
 Our Reg. 18.88  
**14<sup>88</sup>**

Single stroke pull/push action. Uses flip flash, and 110 cartridge film.



**SAVE \$8**  
**MINOLTA' 440E**  
**POCKET PAK**  
 Our Reg. 66.88  
**58<sup>88</sup>**

Built-in electronic flash and close-up lens. Beautiful slides, snapshots.

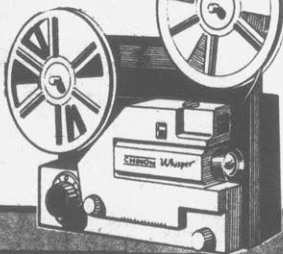

**SAVE \$11**  
**DUAL 8 PROJECTOR**  
 Our Reg. 89.88  
**78<sup>88</sup>**

Automatic threading, f1.5 zoom lens; forward, reverse, still; speed control.

**MARCH MONEY SAVERS**  
 WED. THRU SAT.

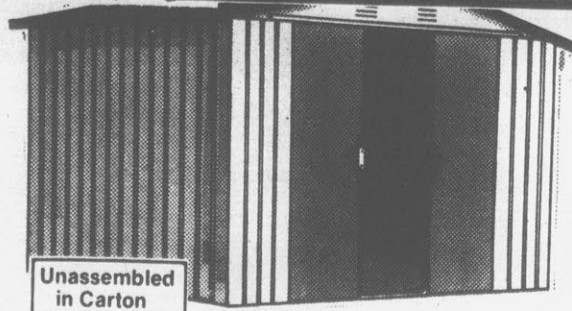

Unassembled in Carton

**9X10' METAL STORAGE SHED**  
**\$137**

End yard clutter! Sturdy metal shed has 51" door opening, 71 1/4" inside height. Front gable roof. Save! \*Interior dimensions.

**L.P. GAS GRILL WITH MOBILE MOUNT**

Our Reg. \$99  
**85<sup>88</sup>**

Aluminum Body  
 Stainless Steel Burner.  
 308 Sq. In Of Cooking Space  
 20 Lb. Tank Included.



With Front Wheel Drive  
**3 1/2-HP ROTARY**  
 Our Reg. 129.87  
 22" mower is self-propelled.  
**\$120**

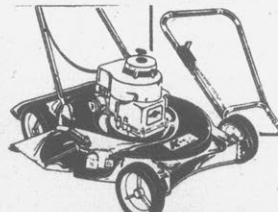

**3-HP ROTARY**  
 Our Reg. 79.87  
 20" side-discharge mower.  
**\$75**

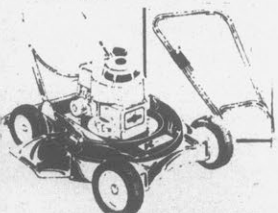

**22-IN. MOWER**  
 Our Reg. 89.87  
 3 1/2-HP recoil-start rotary.  
**\$85**

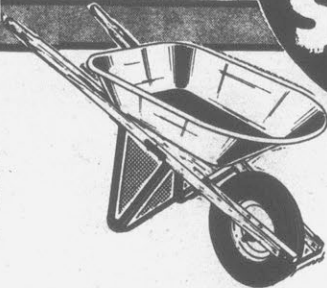

**4 CU. FT. WHEEL BARROW**  
**36<sup>97</sup>**

Sturdy Construction For Heavy Duty Jobs Save Now.

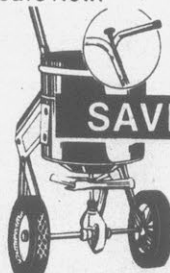

**BROADCAST SPREADER**  
 29.97  
**24<sup>97</sup>**

Easy-rolling unit with 50-lb. capacity hopper. Nylon gears adjust area coverage from 4' to 8'. Save.



**REDWOOD PICNIC SET**  
**27<sup>88</sup>**

Beautiful 6 Ft. Redwood Color Lable Comes With Two Matching Benches.

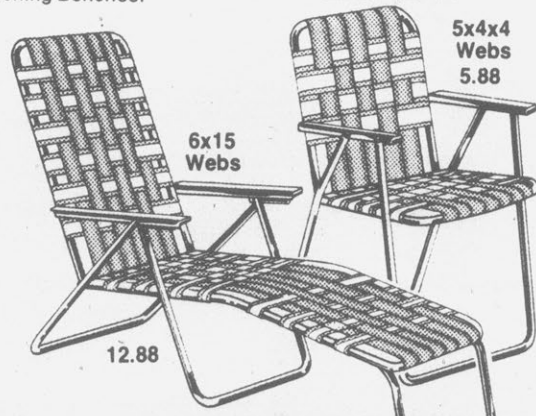

**OUTDOOR FURNITURE**  
**12<sup>88</sup>** Chaise **4<sup>88</sup>** Chair

Comfortable chair and adjustable chaise. Aluminum frame and arms, polypropylene web.

OPEN MON.-SAT. 9:30-9:00

WED. THRU SAT. SALE



**SPORTING  
GOODS**

**Sale**

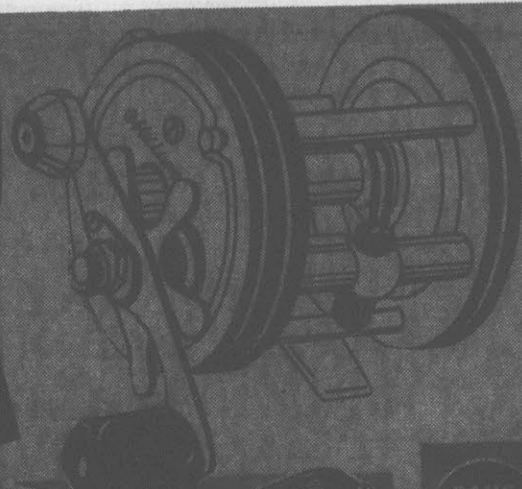

**BAITCAST  
REEL SALE**

Sale Price

**49<sup>97</sup>**  
Save!

Millionaire® baitcasting reel. 5-to-1 high-speed retrieve. Has power handle ball bearing. Spool capacity 165 yds. #15 mono line.

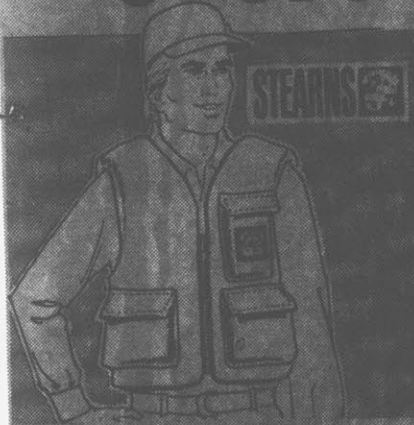

**DENIM SPORTSVEST**

Sale Price **16<sup>96</sup>**  
4 Day Sale

Ensolite® fill with denim shell. Has 3 pockets and velcro closure. Shop at K mart.



**SNOW-LITE® COOLER**

Sale Price **26<sup>88</sup>**  
Save!

Extra large 13½-gal. cooler with recessed handle end and light fitting lid. Save now.

**LANTERN 'N BATTERY**

Our Reg. 4.65 **2<sup>97</sup>**  
Save!

Ray-O-Vac® floating lantern and 6-v battery. Waterproof, rustproof. Save now.



SAVE \$5

**SPORTSMASTER® KIT**

Our Reg. 27.88 **22<sup>88</sup>**

All-steel quart thermos bottle with cup in soft vinyl case and adjustable strap.

**6-CYL. ENGINE TUNE UP**  
Sale Price — 4 Days Only  
Deluxe tune-up for most U.S. cars. Save now. **4<sup>99</sup>**

**RADIAL TIRE SHOES**  
Sale Price — Carry Out Only  
Premium shock absorbers for cars with radial tires. **10<sup>99</sup>**

**AUTO JACK STANDS**  
Our Reg. 5.95  
Adjustable stands with locking pins. **5<sup>99</sup>**

**TRAYWAY® 48' AUTO BATTERY**  
Reg. 42.97 — With Exchange  
Calcium lead construction. Fit most U.S. cars. **38<sup>88</sup>**

**FRONT DISC BRAKE SPECIAL**  
Sale Price 4 Days  
Front only. Additional parts or services extra. For most U.S. cars. **43<sup>88</sup>**

**W/T & W/OIL SOCKET SET**  
Our Reg. 14.95  
21-pc. wrench set included box. **10<sup>99</sup>**

**auto center**

**Steel Belted Radial**

**OUR BEST 4-PLY POLYESTER CORD 'KM-100' WHITEWALLS**

Our Reg. 21.91 — 878112

| SIZE | REG.  | SALE  | SAV. |
|------|-------|-------|------|
| 1300 | 24.95 | 21.91 | 3.04 |
| 1400 | 26.95 | 23.91 | 3.04 |
| 1500 | 28.95 | 25.91 | 3.04 |
| 1600 | 30.95 | 27.91 | 3.04 |
| 1700 | 32.95 | 29.91 | 3.04 |
| 1800 | 34.95 | 31.91 | 3.04 |

**4 FOR \$100**

Plus P.E.T. 1.75 Each

| SIZE | REG.  | SALE  | SAV. |
|------|-------|-------|------|
| 1300 | 45.00 | 35.88 | 9.12 |
| 1400 | 47.00 | 37.88 | 9.12 |
| 1500 | 49.00 | 39.88 | 9.12 |
| 1600 | 51.00 | 41.88 | 9.12 |
| 1700 | 53.00 | 43.88 | 9.12 |
| 1800 | 55.00 | 45.88 | 9.12 |

Our Reg. 51.98 — 877812 **35<sup>88</sup>**

Plus P.E.T. 1.25 Each

All Tires Plus P.E.T. Each

ALL TIRES PURCHASED AT K-mart INCLUDE MOUNTING. NO TRADE-IN REQUIRED.

**SOUND SYSTEM SPECIAL**

**DELUXE AM/FM/8-TRACK IN-DASH PLAYER**  
Our Reg. 148.99 — 4 Days Only **118<sup>88</sup>**

In-dash stereo with push-button AM/FM radio, tape player. Adjustable for most U.S. cars.

**3-SPEAKER STEREO UNIT**  
Our Reg. 68.99 — 4 Days Only **53<sup>88</sup>**

6x9" rear deck speaker. Handles 25-watts steady, up to 60-watts. Home-like stereo for car or van.

**PROFESSIONAL CREEPER**  
Our Reg. 13.99 **9<sup>88</sup>**

Deluxe 42x17" creeper. Comes with 2 steel casters.

**DELUXE AUTO SEAT COVER**  
Our Reg. 14.99 **11<sup>77</sup>**

Stain resistant polyester for 2- or 4-door models. Colors.