

Weather

Clouds moving in tonight with chance of showers on Thursday.

THE DAILY REFLECTOR

INSIDE READING Page 5 - City Council agenda Page 16 - Obituaries Page 34 - How they voted

98TH YEAR NO. 57

GREENVILLE, N.C.

TRUTH IN PREFERENCE TO FICTION

WEDNESDAY AFTERNOON, MARCH 7, 1979

62 PAGES-6 SECTIONS

PRICE 15 CENTS

Cautious Over Peace Gamble By Carter

By FRANK CORMIER Associated Press Writer WASHINGTON (AP) - U.S. officials are being consistently cautious about President Carter's peace gamble in the Middle East despite more optimistic assessments in Israel and Egypt.

American sources, even when talking privately, emphasize the pitfalls that could again derail the signing of an Egyptian-Israeli peace treaty - Carter's unspoken goal as he sets out tonight for Cairo on the first leg of a journey that will last at least a week.

A White House official who asked not to be identified cautioned late Tuesday that

at best it will be impossible to conclude all formal action on a treaty during Carter's trip.

The closest thing to public optimism from a U.S. leader came Tuesday when House Speaker Thomas P. O'Neill said, "I truly believe that he (Carter) not only hopes for success but he feels success is there."

Israeli Prime Minister Menachem Begin, who was leaving New York today to prepare for Carter's Saturday night arrival in Jerusalem, told reporters:

"There is euphoria, not only in this country, but in Jerusalem and Cairo and throughout the world. Now we must be very careful. I am hopeful."

Egyptian officials, led by Prime Minister Mustafa Khalil, were equally positive about the treaty outlook.

In Cairo, President Anwar Sadat met Tuesday with U.S. National Security Adviser Zbigniew Brzezinski to hear the outline of Carter's proposals. Sadat's reaction was not immediately known, but Egyptian officials said Carter's trip may mean "the final sprint" to a peace treaty.

Because of Carter's absence from Washington, Vice President Walter F. Mondale is canceling a six-day Latin American trip next week. He was to have attended presidential inaugurations in Brazil and Venezuela.

Carter will devote most of his time to business during the trip, but does plan to see Egypt's pyramids.

And a White House official said Carter is seriously considering a train trip Friday from Cairo to Alexandria in anticipation of drawing a large crowd to demonstrate Egyptian support for a peace treaty.

There were also reports in Cairo that Carter might address a special session of the Egyptian Parliament Saturday before leaving for Israel.

Plans have already been announced for him to address the Israeli parliament.

U.S. officials maintained a tight secrecy lid on the treaty

suggestions broached by Carter to Begin last Sunday - proposals that broke a

stalemate threatening collapse of peace efforts. However, a White House

official who asked not to be identified confirmed Tuesday that Carter discussed "in

passing" the possibility of a U.S.-Israeli mutual defense treaty with Begin.

Pitt School Bd. Adopts Snow Make-Up Schedule

By REBECCA BUFFALO

Reflector Staff Writer

The Pitt County Board of Education voted Tuesday for county children to go to school a half day March 9 and April 27, with a full day April 13, Good Friday.

Superintendent Ott Alford noted that children will be released from school after lunch on the half days, with the other half of the days to be used as teacher workdays. Children will have April 16, Easter Monday, as a holiday, with teachers utilizing the day for work. June 15, formerly noted as a vacation day, will be used by teachers for a teacher workday. Children will not attend

school June 15.

The change in the school calendar was made to make up for the three school days lost to the snow conditions.

After hearing a report made by board members Dr. J. O. Carson, Jim Black and Beverly Congleton, the board voted to uphold its decision that all racial balances be erased as to academic honors, such as marshals and graduation speakers.

Superintendent Alford explained that as of now, the board will expect principals to do away with racial quotas in other areas, such as selection of cheerleaders, club officers and homecoming queens.

The board, in its decision, has entrusted the principals to work out their own timetables in erasing such balances, with all uses of quotas to be extinct by 1983. The board also added that as of now, no racial balances will be noted in the middle schools.

The committee had studied the racial balance question after a request was made by a group of Pitt County prin-

cipals to reinstate some form of quota in county schools.

Bill Wiggins, principal at Ayden-Grifton High School, told board members that he personally felt that Ayden-Grifton could work with the phasing of quotas, rather than abolishment. He added that he didn't want any race to feel "ostracized" from school activities.

Energy Control Officer George Laws reported to the board concerning efforts toward better energy conservation in the school. After discussion, the board voted to abolish all interior night lighting at all county schools, with exterior lights to be extinguished at night at 12 schools.

It was noted that lights would not be cut off when activities were held at school at night.

The board voted approval of a 25-year lease for school property incorporated in the county Community Schools Program. Alice Keene, program coordinator, explained to the board that federal monies could not be obtained until approval of the lease

was made. She also noted that schools utilizing Community Schools monies would be able to use new facilities when community-related activities were not scheduled.

Assistant Superintendent Leck Keeter reported on the Wednesday, March 7, county-wide vaccination for red measles in county schools. He told board members that state officials had found a few more cases in schools where children needed to have red measles vaccinations.

Board member Carson stated that those students who had just found out this week that they needed vaccinations may need an extension on getting the needed treatment.

The board had voted Feb. 27 to deny school entrance to those had not received the vaccination as of Thursday, March 8.

The board, however, voted Tuesday to give an extension until Thursday, March 15, for students to either get vaccinations from the county health department or private

(Continued on page 11)



READY FOR CARTER - A Tel Aviv gift shop owner paints her shop window with a four-language greeting for President Carter who arrives in Israel

this weekend. The window reads "Welcome Carter" in Hebrew, Arabic, French and English. (AP Laser-photo)

NATO's Secrets Go East?

BERLIN (AP) - East Germany claims a defector from the NATO secretariat staff in Brussels brought the Communists war plans of the North Atlantic Alliance.

A NATO spokesman at the North Atlantic Treaty Organization's headquarters in the Belgian capital confirmed that Ursel Lorenzen, a West German employed by NATO for 11 years, defected on Monday. He refused to say how much access she had to the alliance's secrets but reported that she worked in the Office of Council Operations and Communication, which he said helps prepare for military exercises.

Officials will meet this week "to assess what damage she could do," the spokesman said.

ADN said Miss Lorenzen decided to defect because of stepped-up NATO "war preparations," including plans for an "atomic attack against the socialist camp" during the Wintex-Cimex exercise now being held by NATO.

But the NATO spokesman said the exercise is "a paper exercise, involves no troops at all," and will conclude in about two weeks.

The East German news agency ADN said Miss Lorenzen decided to defect because of stepped-up NATO "war preparations," including plans for an "atomic attack against the socialist camp" during the Wintex-Cimex exercise now being held by NATO.

But the NATO spokesman said the exercise is "a paper exercise, involves no troops at all," and will conclude in about two weeks.

ADN said another factor in the woman's decision to defect was her learning of the "fascist past" of NATO Secretary-General Joseph Luns, who last month was listed as a member of the Dutch wing of Hitler's National Socialist movement from 1933-36.

Luns, NATO's top civilian official, was foreign minister of the Netherlands for 19 years after World War II. He acknowledged he is listed in Nazi membership archives at the Dutch government's War Documentation Center in Amsterdam. But he claimed the listing was a mistake and that he was never an active member of the Dutch party.

There was no indication the defection was related to the recent roundup of at least 12 East German spies in West Germany.

REFLECTOR

HOTLINE

752-1336



Hotline gets things done for you. Call 752-1336 and tell your problem or your sound-off or mail it to Hotline, The Daily Reflector, Box 1967, Greenville, N.C. 27834.

Because of the large numbers received, Hotline can answer and publish only those items considered most pertinent to our readers. Names must be given, but only initials will be used. Transcribing is done once a day.

GARDEN SOIL CONTAMINATED?

We have a garden in the vicinity of the Coastal Chemical fire site and I wonder if there is any danger involved in planning a garden for the summer and eating the vegetables from the garden. Should the soil be tested? B. W.

Pitt County Health Department Director Dr. Robert Ehinger said you have absolutely nothing to fear. Any chemicals released into the air at the time of the fire has long since been biodegraded, he said. This would be true, anyway, he said, but is all the more definite because of the large amount of precipitation the Greenville area has had during the past two weeks. The chemicals that may have fallen onto the soil in your garden will do you no harm nor will they kill bugs and weeds for you now or in the months to come, he indicated.

WITNESS?

I had my car, a maroon and gray Monte Carlo Chevrolet, parked in the front parking lot of Pitt County Memorial Hospital the morning of Monday, Feb. 23. I was parked right beside the handicapped parking space. When I came out from visiting my grandfather in the ICU unit, I found that someone had sideswiped my car, leaving no name or anything. The security guard told me the parking lot company carries no insurance on customers' cars, so I'd just have to file with my insurance company. I have a \$131 body work bill, \$50 deductible, which someone should feel obligated to help me pay. If anyone saw someone hit my car that morning or if the person who hit it has had pangs of conscience, I'd like to know it. M. D.

Anyone who has information about this accident is asked to contact M. D. at 753-3395.

Martin County Allots Money To Courthouse

WILLIAMSTON - Surplus funds amounting to \$2 million dollars have been approved by Martin County Commissioners to be applied to the cost of constructing a new courthouse in Williamston.

The board at its March meeting voted unanimously to transfer the surplus money to a specially designated fund. At the same time, commissioners named a nine-member committee to study the acquisition of land and plans for a better facility.

For more than ten years commissioners have sought a source of federal and/or state funds for the construction of a new courthouse, but has been unable to come up with a source.

The action to designate surplus funds for this purpose, a spokesman noted, should quell long-standing criticism that has been directed at the commissioners for the size of the county's surplus fund.

Synanon Suing For \$40 Million

SAN FRANCISCO (AP) - Synanon Foundation has filed suit in federal court seeking at least \$40 million in damages against Marin County, the board of supervisors and the grand jury for libel and conspiracy to violate civil rights.

The alternate lifestyle group contends the investigations by the defendants resulted in decreased values on some of its Marin County properties and threatened civil actions against its members because of their religious activity.

Chemical Link Said Difficult

HOUSTON (AP) - Studies at two chemical plants where vinyl chloride was produced show 15 employees have died from brain tumors, but federal investigators say it is difficult to link the disease with the chemical because the tumors take about 20 years to appear.

A complaint by a Union Carbide plant worker resulted in the discovery of 10 deaths by federal investigators between 1962 and 1978. A spokesman for the nearby Monsanto plant said a study revealed five such deaths. George Pettigrew, regional director of the National Institute for Occupational Safety and Health, said about 10,000 past and present employees are being studied.

DECISION REVERSED

MONROE, N.C. (AP) - Voters in Monroe on Tuesday reversed an earlier decision and approved a \$4.5-million bond issue for water and sewer facilities.

Rountree Considering Bid For Speakership In 'Alternative' Role

RALEIGH, N.C. (AP) - The third member of the state House to show an interest in the post of speaker floated a trial balloon for his candidacy this week.

"I might run. I might very well run," said Rep. Horton Rountree, D-Pitt. "But I've got to make a decision in the next week or two."

Rountree, now in his second term as speaker pro tem, wrote a letter to all members of the House this week, urging them to keep their options open in supporting candidates in upcoming speaker's races.

Two state representatives are already running for speaker in the next two legislatures.

The House speaker is elected by majority party members of each House session. Rep. Carl Stewart, D-Gaston, a close ally of Rountree, is now serving an unprecedented second term.

Rountree didn't say so in

his letter, but he told The Associated Press in an interview that he may offer himself as an alternative candidate for speaker in the 1981 session.

Rep. Liston Ramsey, D-Madison, is generally acknowledged to be the front-runner in the speaker's race in 1981, and Rountree's letter was widely interpreted as an attempt to derail Ramsey's campaign.

In his letter to House members, Rountree said he did not believe it wise for future speakers to serve more than one term. Ramsey has acknowledged he will probably seek a second term if he wins the first one.

Ramsey is being challenged by Rep. Parks Helms, D-Mecklenburg, who is seeking commitments for the speakership during the 1983 session. Rountree said he believed Helms might find stiff opposition from those

who do not want a second speaker from the Charlotte-Gastonia region.

Rountree said if he does seek the speakership, it would be for the 1981 session only. "After that, I'll go home and practice law," he said.

Rountree praised Stewart in his letter for opening the legislative process to more representatives and warned - in a veiled reference to Ramsey - that another speaker might put the real power of the House in the hands of a few.

"The chair should never be controlled by a few but should be open to the entire membership," he said.

In the interview, Rountree said during the 1975 session, Lt. Gov. Jimmy Green was House speaker and that power was in the hands of a clique that included Ramsey.

"Under Green, there was a cabinet that ran the whole show," Rountree said.

Farmville Board OK's Two Zoning Changes

By CAROL TYER

Reflector Staff Writer

FARMVILLE - Approval was given last night during the Farmville Commissioners' meeting for two zoning changes.

The W. R. Duke Jr. property on South Main Street in the block where Lee's Warehouse used to be was changed from light industrial to general business on the Main Street frontage and residential (R-5) in the portion facing Walnut Street.

The F. M. Davis heirs land on Highway 264 across from Fields Street was changed from light industrial to highway business.

Administrator Patrick Thomas reported that the

town will be seeking exemption from the Environmental Protection Agency's requirement for development of a pretreatment program for industrial waste. If this effort is not successful, considerable engineering and lab work will be necessary, he indicated.

The refuse collection-transfer site on Highway 121 just outside Farmville to the north is now operable and the last day of operation of the town landfill on State Road 1200 will be Friday.

An ordinance was adopted requiring attendance by a Planning Board member of at least half of the meetings in a calendar year to retain membership.

Confirmation was made of

several street improvement assessment rolls drafted in the summer of 1974. This was a technical matter, because the record of the action at that time was unclear, it was pointed out.

Discussion was made of the need to move a pole placed within the Downtown revitalization area near the railroad by the phone company. The Commissioners indicated they did not feel the town should pay for the removal, but agreed that it should be moved. They asked the administration to contact the railroad about the running of underground lines in its right of way.

The Commission resolved (Continued on page 14)



EPSDT PROGRAM...started in Pitt County.

## Child Screening Program Started

"Good health is the greatest gift children can have", might be the motto of the new Child Screening Program begun in Pitt County recently.

Pitt County is participating in the preventive EPSDT (Early and Periodic Screening, Diagnosis and Treatment) Program. EPSDT is one aspect of the Medicaid program which provides health care for low income persons. EPSDT concentrates on serving children and is a cooperative effort through the Department of Social Services and the Pitt County Health Department.

Entry into the EPSDT program is available only to Medicaid eligible children through a referral from the Pitt County Department of Social Services or Health Department school nurses. After referral, the EPSDT staff visits the home of the child where they explain the program, set up an appointment for the child at a screening clinic, and advise about the child's health.

The next step is for the child to be screened. Many health problems, if caught in time, can save needless suffering and prevent permanent impairment or disability. Among the health signs checked at the clinic are dental, visual and hearing problems, anemia, sickle cell trait, tuberculosis, immunization record, physical and emotional development and many others as correct for the child's age. Because no additional charges are made for receiving the program it is easy for low income parents to take this step toward improving their child's health.

If problems are found during the screening, the child is referred to the correct source of medical care. In the Pitt County program, most common problems found among children requiring further medical care are dental work and evaluation of heart murmurs. The medical care is paid for through Medicaid to participating private doctors, dentists and optometrists. The parent or guardian chooses the source of medical provider from those participating in the program.

The child is scheduled for a return visit and screening at least once a year. Parents are encouraged to provide their own transportation for screening and medical treatment but emergency transportation is provided if needed. If a child misses an appointment, a new appointment is made. If the second appointment is missed, a visit is made to the home. Seventy-five percent of all EPSDT referrals based on national studies result in the child receiving diagnostic and treatment services.

There is a 50 percent higher rate of disabilities for lower income people based on national estimates. This is a major reason for the amending of the Medicaid program in 1967 to include preventive health services for children. The target group for the EPSDT program is all Medicaid eligible children under the age of 21. One of the most important reasons for EPSDT is that it makes available medical care for these children. By carrying out early screening and providing needed health care early, children will get off to a good start. They will generally be better able to contribute productively to the economy of the community where they live. One study of low income 18-year-olds rejected by Selective Service found 33 percent of their health conditions could have been prevented or corrected before age 15. EPSDT has also been found to improve the efficient use of health services and reduce the use of hospital care, physicians' services and prescription drugs thus lowering the overall Medicaid cost to the public.

For further information, contact the EPSDT Department, 752-4141.

## Miss Freeman, Mr. Dillahunt Wed

MAURY — Miss Loraine Freeman and Mark Randall Dillahunt were united in marriage Sunday, Feb. 25, in Maury Chapel Church. The Rev. J. E. Reddick officiated at the double ring ceremony.

The bride is the daughter of Mr. and Mrs. Earl Freeman of Maury. The bridegroom is the son of Mr. and Mrs. Plummer Webster Dillahunt Sr. of Grifton.

A program of nuptial music was presented by Mrs. Dolly Bryant of Snow Hill, organist, a trio by Pevrella Barfield, Ann Miller and Faye Edwards and Clarence Hicks, soloist.

The bride, given in marriage by her parents and escorted by her uncle, Averon Olds. She wore a white gown of organza and alencon lace fashioned with a Queen Anne neckline, empire bodice trimmed with seed pearls, long bishop sleeves and alencon lace trimmed cuffs. The full skirt, with sun burst pleats and matching lace, flowed into a chapel train. Her headpiece was bameleau alencon lace crystal and seed pearls attached to tiers of silk illusion trimmed with lace. She carried a Bible decorated with red and white carnations.

Mrs. Linda Corbett, sister of the bride, was matron of honor and Miss Teresa Gooding, cousin of the bride, was maid of honor. Bridesmaids included Sandra Freeman of Maury, sister of the bride, Renee and Kaye Barfield of Maury, cousins of the bride, Gail Dillahunt of Grifton, sister of the bridegroom, Sandra Dillahunt of Durham, sister-in-law of the bridegroom, Cheryl Grant of Brown Town, and Iva Smith of Snow Hill.

Kimberly Dillahunt of Grifton, sister of the bridegroom, and Tamara Gaskins of Washington, D. C., cousin of the bridegroom, were junior bridesmaids. Meloney Reeves of Temple Hill, Md., and Nicha Coward of Upper Marlboro, Md., cousins of the bridegroom, were flower girls. Rico Smith of Snow Hill was ring bearer.

Plummer W. Dillahunt Jr. of Durham, brother of the bridegroom, was best man. Ushers included Willie and Jesse Freeman of Maury, brothers of the bride, Curtis Strayhorn of Kinston, cousin of the bride, Freddie Mills of Winterville, cousin of the bridegroom, Edward Huggins of Fort Barnwell, Douglas Olds of Washington, D.

C., uncle of the bride, Frank Croom of Hookerton, cousin of the bride, and Donald Bryant of



Mrs. Mark Randall Dillahunt

Snow Hill.

Mothers of the couple were presented long-stemmed red silk roses at the end of the ceremony by the bridal couple.

Following the ceremony, the bride's parents entertained at a reception at the K and W Cafeteria, Kinston. Georgia Lanier presided at the bride's book, which was placed on a table with a portrait of the bride.

The bride's table was covered with an English lace cloth and centered with a silver bowl holding red and white carnations and gypsophilia flanked by white tapers in silver candelabra. Assisting in serving were Levenia Becton, Fannie Comings and Mr. and Mrs. Joe Randolph.

The couple will live in Grifton after a wedding trip to unannounced points.

The bridal couple is attending Lenoir Community College, Kinston.

## Programs Given At Chapter Meets

The Eta Delta Chapter of Beta Sigma Phi held its meetings for February at the homes of Cindy Hart and Joyce Sawyer.

Programs were given by Kathy Shepherd on "Love" and Ron Jones of Garner-Wynne-Manning on "Biorhythms." Cindy Lewis, social chairperson, reported on the rush social held at the Holiday Inn. Further plans for casino night were given by Jackie Brown, coordinator. It will be held March 17 at the Ayden Golf and Country Club with proceeds going to the United Cerebral Palsy Developmental Center here.

President Jackie Gehrlein read a thank you note from the Prenatal Clinic for the donation of blankets. A surprise bridal shower was given for Carol Glover.

## Cooking Is Fun

By CECILY BROWNSTONE  
Associated Press Food Editor

TEEN PARTY  
Hamburgers on Buns  
Ginger Punch Cookies

GINGER PUNCH  
A non-alcoholic blend given on request.

3 cups unsweetened grapefruit juice  
2 cups unsweetened pineapple juice  
1 large bottle (about 1 quart) ginger ale, chilled

Mix fruit juices and chill. Just before serving, stir in the ginger ale. Makes 16½-cup servings.

## Yard Selection Is Announced

WINTERVILLE — The Winterville Jaycees and Jaycettes announce that Mr. and Mrs. Bobby R. Crawford of 519 Lee St. are displaying the Yard of the Month sign during March.

## Dr. Morrow To Be Keynote Speaker

"Government Policies: The Need to Examine and Involve" will be the topic discussed by government officials on the county, state and national level at a one-day conference Thursday.

Charles P. Gaskins, Pitt County commissioner, Senator Vernon White and Congressman

Walter B. Jones will served as panel participants and Mrs. Tenella Gross will act as moderator.

The conference will be held on the East Carolina University campus.

The keynote address "Resources for Enhancing the Quality of Life in North

Carolina" will be presented by Dr. Sarah Morrow, Department of Human Resources secretary. Dean Miriam Moore, School of Home Economics, will conclude the program by discussing "Future Directions: Effective Public Policy."

Workshop sessions directed at various aspects of quality living will be conducted by the following: Mort Conleton, deputy

secretary, Council on Aging; Dr. Malene Irons, Developmental Evaluation Clinic, ECU; Miss Addie R. Gore, home economics extension agent, Pitt County; Ms. Lynn Gardner, nutrition consultant, Department of Human Resources; Ms. Isabelle Buckley, extension specialist in aging, N. C. State University, Raleigh;

Dr. Lilla Hosley, School of Home Economics, ECU; Mrs. Charlotte Purvis, extension specialist in human development, A & T University, Greensboro; and Dr. Mel Markowski, child development and family relations, School of Home Economics, ECU.

The conference will be in the School of Home Economics building beginning with registration at 8:30 a.m. Sponsors are Pitt County Agricultural Extension Service, School of Home Economics and Division of Continuing Education, ECU.

Interested persons are invited to attend.



## Wedding Strife: Dad's New Wife

By Abigail Van Buren

© 1979 by Chicago Tribune-N.Y. News Synd. Inc.

DEAR ABBY: I am planning my wedding and need some advice. My parents were divorced four years ago. Dad married again last year. Mom is still single and has a lot of bitterness toward Dad, although I must say in all fairness that she nagged him so much he did well to stay married to her as long as he did.

Also, Dad didn't meet Joyce (his present wife) until his divorce was final, so no one can say she broke up his marriage.

Abby, I want my wedding to be perfect. I want Dad to give me away, and I want Mom and Dad to be there as a couple on that day. Mom doesn't want to face Dad's new wife, and if Dad brings her it will spoil everything for Mom.

My minister says I should invite Dad and Joyce. Should I? Deep down, I hope Joyce will be wise enough to let Dad come alone, but what if she decides to come with him?

Please help me.

IN BETWEEN

DEAR IN: If you're old enough to be married, you're old enough to accept the fact that your parents are divorced and your father has another wife. Quit living in the past when you mother and father were a couple, and get on with the business of living life as it is. Invite your father and Joyce, and let them decide whether Joyce stays home or accompanies her husband.

DEAR ABBY: I have on occasion found the man I date sucking his thumb while watching TV or napping. He is 41. This shocked me, so I called his attention to it. He became very defensive and quite irritated, and an argument ensued.

Abby, do other adults regress to this kind of infantile behavior? Is this serious enough to require professional help?

WONDERING

DEAR WONDERING: Yes, other adults have been known to regress to thumb-sucking when they're tired or in need of relaxation and comfort. Aside from the humiliation and teasing they might suffer if this babyish habit is discovered, there's no harm done. If your friend is mature in other ways, overlook it.

DEAR ABBY: To GRANNY, whose grandchildren never send thank-you notes for the gifts she sends:

Don't blame the kids. It's their parents' fault!

I never knew if my grandson received my gifts since he never bothered to thank me for them. One day while talking on the phone with my son, I asked, "Did Jamie ever get the present I sent him?"

My son called out, "Hey, Jamie, did you ever get Grandma's present?"

Then I heard someone yell, "Yeah. Tell her thanks." Well, that did it. Now I send greeting cards. And if the subject ever comes up, I will explain why.

FED UP WITH BAD MANNERS

DEAR FED UP: I'm sure your cards conveyed the message.

Problems? You'll feel better if you get them off your chest. For a personal reply write to Abby, Box 69700, Los Angeles, Cal. 90069. Please enclose stamped, self-addressed envelope.

## ADK Members Have Fashion Show Thursday

A fashion show and new hairstyles were shown at the meeting of Alpha Nu Chapter of Alpha Delta Kappa Thursday evening.

The fashion show was coordinated by Thelma Flye, manager of Brody's, Pitt Plaza. The hairstyles were by Tori Hair of La Kosmetique Beauty Salon. Carol Brewer, Peggy Conleton, Sue Creech and Cleve Wallace, sorority members, were models.

Guests for the meeting included Brenda Roebuck and Rose Rowe, ADK members-at-large, Leslie Brinson, and Edsil Gordon, "Carolina Today" panelist, was moderator for the fashion show.

President Evelyn Finch presided at the business meeting and the April state convention was discussed.

**100% Whole Wheat Bread**  
**Diener's Bakery**  
815 Dickinson Ave.

**START TODAY... LOSE WEIGHT BY FRIDAY WITH EXTRA STRENGTH SLENDER-X CAPSULES**

For over 15 years, thousands have been losing weight with Slender-X Tablets. NOW...we are offering you a New Time-Release EXTRA STRENGTH SLENDER-X CAPSULE. Try our amazing, improved formula. We guarantee it to help me pounds drop off or your money back.



**Big Value Discount Drugs**  
2814 East 10th St., Greenville  
West End Shopping Center Greenville  
1102 West 3rd St., Ayden

**Arabic Dance "Belly Dancing"**  
"Shape Up For Summer"  
An excellent way of exercising for women from 9 to 90  
Donna Whitley announces the registration of her spring classes  
Call 752-0928  
Experienced performer & teacher in Casablanca, Morocco & California

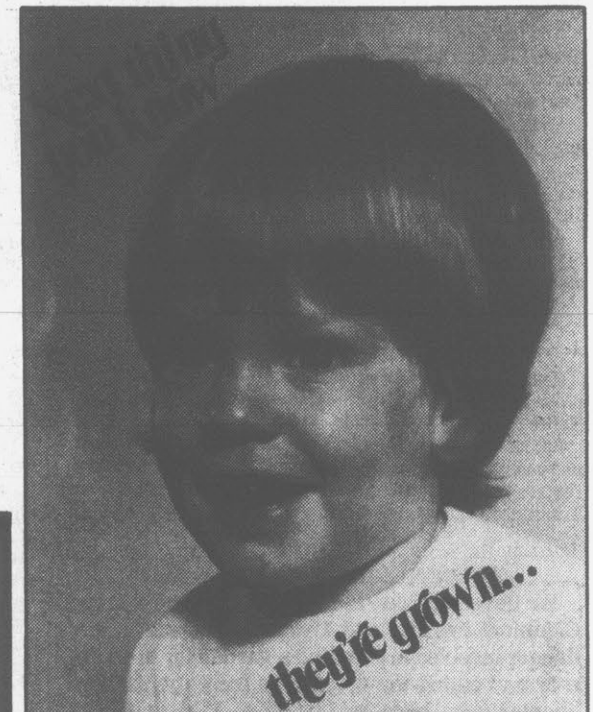

**A professional 8x10 color portrait for 88¢**

Choose from our selection of 8 scenic and color backgrounds. You may select additional portraits offered at reasonable prices, with no obligation. See our large Decorator Portrait. Satisfaction always, or your money cheerfully refunded.

**A Great Way to Remember Those You Love**

THESE DAYS ONLY: THURS FRI SAT  
MARCH: 8 9 10

DAILY: 10AM - 8PM

West End Shopping Center, Greenville

**CLARKS**

One sitting per subject—\$1 per subject for additional subjects, groups, or individuals in the same family. Persons under 18 must be accompanied by parent or guardian.

**TOMMIE WILLIS BYRD, PRESIDENT OF TOMMIE WILLIS INC. WOULD LIKE TO ANNOUNCE THAT SHE IS NOW THE SOLE STOCK OWNER OF THE CORPORATION.**

I WOULD LIKE TO THANK ALL OF MY MANY FRIENDS AND CUSTOMERS FOR THEIR PATRONAGE OVER THE PAST 17 YEARS. I LOOK FORWARD TO SERVING YOU IN THE FUTURE. PLEASE COME BY AND TALK TO OUR STAFF FOR ALL OF YOUR DECORATING NEEDS.

**Tommie Willis, Inc.**

THANKS, TOMMIE

**SPRING CLEANING SALE**  
**Kitchen Cupboard**  
**20-40% OFF**

Add to your gourmet collection- cookware, cutlery, gadgets, bakeware, & accessories-

Now's your chance to get the selective items you've always wanted. Let Betty, Jane, or Sylvia show the many items used in the classes and demonstrations.

**MARCH 12-18**

Kitchen Cupboard  
Greenville Square  
Greenville, N.C.  
919-756-1310

# University Tuition Hike Not Yet Out Of Picture

RALEIGH, N.C. (AP) — Action Tuesday by a joint appropriations committee lifted, at least temporarily, the threat of a tuition increase for the students enrolled in the University of North Carolina system.

But a tuition increase is not definitely out of the picture. The legislator who headed the tuition subcommittee that recommended the increase said she has no plans to bring the matter up again.

"I don't know about the rest of the subcommittee members," said Sen. Carolyn Mathis, D-Mecklenburg. "Some of those people might be interested in doing it in the full appropriations committee."

Mrs. Mathis' subcommittee had recommended that tuition at the 16-campus system be increased by 10 percent for in-state students, beginning next fall, and that tuition for out-of-state students be boosted 5 percent next fall, to be followed by a second 5 percent increase the next year.

The subcommittee also recommended the budget for a tuition remission program for talented students be cut in half, from \$3 million to \$1.5 million for the next two years.

But the Joint Appropriations Committee on Education rejected all three suggestions after appeals from UNC President William Friday, university students and several committee members.

"The tuition increase will affect those least able to pay," Friday said. "The out-of-state rates now in North Carolina are the second-highest in the nation and the highest in the Southeast."

And Friday said cutting the budget for tuition remission to

talented students would severely handicap university research. That money is used to pay graduate assistants who also teach in the research programs and by athletic departments on the UNC campuses.

In other legislative action: A House committee held up a bill that would make North Carolina's Department of Revenue a collection service for bad debts which have not been paid to other state agencies. The action was taken after some members said they doubted the constitutionality of the measure.

The bill, introduced by Rep. Dan Lilley, D-Lenoir, would require a group of agencies, including the University of North Carolina and state-run hospitals, to send records of their uncollected accounts to the revenue department.

The bill would then require the department to deduct the amounts from any state income tax refunds the debtors stood to receive.

"I frankly don't think it's constitutional," said Rep. George Miller, D-Durham. "De-

spite all the good intentions, I just don't think this is a good bill."

Committee support for the measure was widespread, but Miller warned that it could be unconstitutional because it would enforce debt collections without the debtors having a reasonable opportunity to challenge the state's claim.

Jim Lore of the state attorney general's office said debtors could appeal to Superior Court and said a similar law had been upheld in Oregon. The bill was recommended

by a legislative study commission. The committee postponed action on the bill until next week.

A bill that would set up separate regulations for the state's fundamentalist Christian schools, removing them from the stricter state Board of Education regulations, was filed in the Senate Tuesday.

Sponsored by senators Ollie Harris, D-Cleveland, and Harold Hardison, D-Lenoir, the bill would allow the schools to give their own competency test instead of the state version and would exempt them from having to hire certified teachers.

It would also exempt them from certain parts of the board's required annual reports. Since January of last year, the schools have waged a court fight over filing the reports, saying they interfered with their freedom of religion.

The bill would require the Christian schools to send the state notice of their intent to operate and to provide the names and addresses of the schools and the names of owners and chief administrators.

It would also require them to maintain annual attendance and disease-immunization records for students and to meet health, fire, and safety standards.

But the bill says the schools would not be required to comply with any other provision of

the laws relating to education. Harris said last week he doesn't think there are any Christian schools in his home county. But he said he agreed to sponsor the legislation because the dispute between the state and the schools is something the General Assembly ought to take up.

**Substitutes**  
The House Education Committee unanimously approved and sent to the House a resolution authorizing the state to increase the pay for substitute teachers by using surplus education appropriations. Under the measure, which has been passed by the Senate, pay for qualified substitute teachers would be increased from \$20 to \$30 a day.

The measure would authorize higher pay immediately. But state budget analysts have warned there may not be enough money for the increased pay to last until the end of the school year.

**Open Meetings**  
A Senate judiciary committee took up a House-passed bill that would revise the state's open meetings law. Sen. Henson Barnes, D-Wayne, chairman of the committee, scheduled a public hearing for Tuesday, March 20, at 3:30 p.m. in the Legislative Building, on the measure.

**Sales Tax**  
The House will take a final

vote on a bill which exempts from the state sales tax personal property purchased in North Carolina for use abroad, as long as it is exported within 90 days.

Rep. Aaron Plyler, D-Union, said the purpose of the bill is to encourage the shipment of goods through the state ports of Wilmington and Morehead City instead of through Charleston, S.C., and Norfolk, Va.

**SHERLOCK'S**  
(Formerly The Olde Towne Inn)

Now Available To Cater  
Your Dinners & Parties  
Call 758-1991 For Details

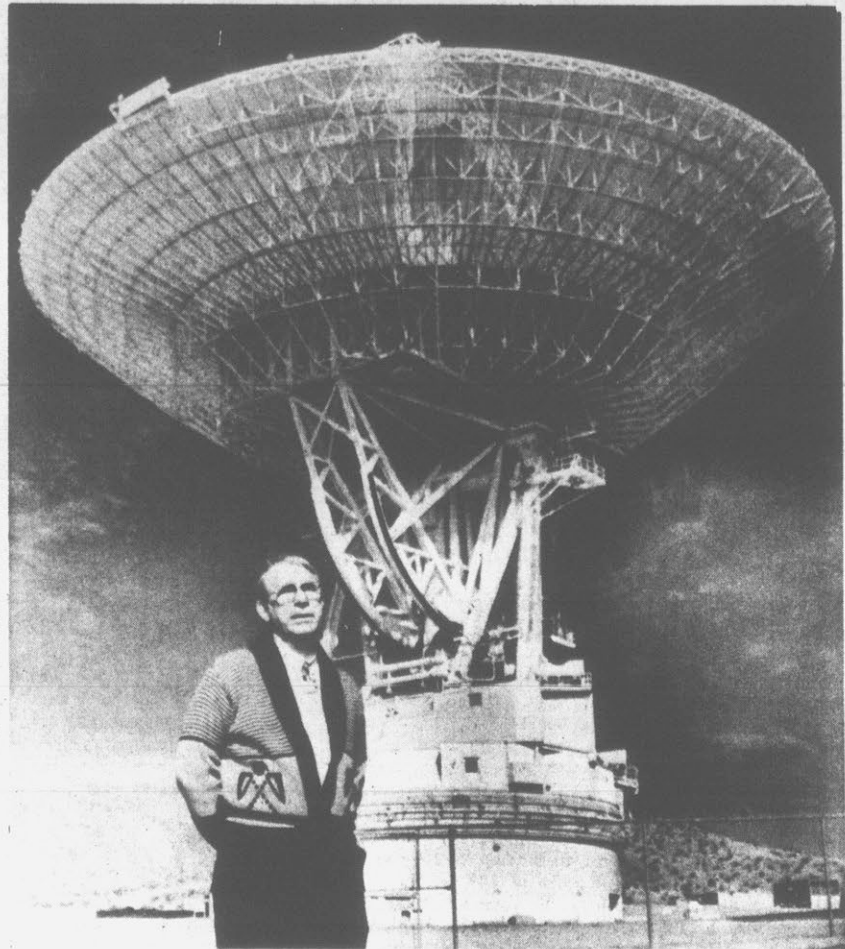

**WHISPERS FROM SPACE** — Mars station antenna, known as "giant ears", looms over operations manager Charles Koscielski. The spectacular photos of the planet Jupiter taken by Voyager 1 are being received by the antenna northeast of Los Angeles. The giant "ears" are enormous antennas that receive radio signals every day of the year from several unmanned spacecraft. (AP Laserphoto)

## McKissick In Hospital

DURHAM, N.C. (AP) — Floyd McKissick, a civil rights leader and founder of Soul City, was admitted to a hospital here Tuesday following a car accident in which he suffered head injuries, according to the state Highway Patrol.

A spokesman at Durham County General Hospital said McKissick was in stable condition early today. He underwent surgery for a fractured shoulder and for cuts on his skull, the spokesman said.

Trooper E.D. Wright said late Tuesday that the accident occurred about 6:15 p.m. about four miles north of Durham.

Wright said McKissick was pinned in his car about 45 minutes after it went off a bridge on Interstate 85 and landed on the road below.

The cause of the accident was under investigation, Wright said.

McKissick was head of the civil rights group Congress of Racial Equality for several years.

He and several others began organizing Soul City, one of a number of federally financed "new towns," about 10 years ago.

McKissick is a native of Asheville and practiced law in Durham for many years. He

was the first black to attend the University of North Carolina law school and was active in desegregation cases involving a number of public schools.

## Sadie Saulter PTA To Meet

The Sadie Saulter Elementary School PTA will meet Thursday, March 7 at 7:30 p.m. in the multipurpose room of the school. Charles Crumpler, physical education instructor, has prepared a program to be presented by students at the meeting.

Selections for the annual Book Fair will be on display, and the League of Women Voters will have a table offering voter information on the upcoming School Bond Issue.

**SAVE-Order Now Before Price Increase March 12th**

If you have an over or undersized or one-of-a-kind fireplace, order your enclosure now to insure delivery before March 12th price increase. Bring us your fireplace measurements today for Custom or Stock sizes.

**How To Measure:**

If you have an arched fireplace, please bring an accurate drawing of your arched opening also.

Let Us Help Make Your Fireplace Special!

**756-4651**

Open Mon.-Fri. 10 a.m. till 6 p.m.  
Sat. 10 a.m. till 5 p.m.  
284 Bypass West-Greenville (Red Oak Shopping Center)

**100 YEAR GUARANTEE!**

Prices from \$795.  
to \$4,995.

**Carrier**  
Your best PIANO investment!

9 MONTHS

RENT APPLIES TO PRICE!

**SALE PIANO-ORGAN WAREHOUSE**

726 Greenville Blvd.  
Beside Panney's Auto Center  
Pitt Plaza  
756-2832

Thinking About A Quick,  
Easy Way To Cook Meals?  
**Think Microwave!**

Attend The Amana Radarange  
**Cooking School**  
THURSDAY NIGHT, MARCH 8TH.  
FROM 7:00 P.M. UNTIL 9:00 P.M.

Now You Have The Opportunity To Learn  
The Quick, Easy Way To Prepare Meals  
For Your Family With A Minimum Of Effort,  
Delicious To The Taste And Nourishing Too!

Come In Thursday From 7 Until 9 P.M. For  
A Demonstration!

MODEL RR-10

**GREENVILLE TV & APPLIANCE**  
200 GREENVILLE BLVD. MALCOLM C. WILLIAMS, JR. VICE PRES.

**Belk Tyler**  
downtown greenville

**limited time sale!**  
now through March 17

Fine usually \$17

Webb usually \$19

**'Heiress' shoes with that open-air feeling**

**14.88**  
usually \$17 and \$19

Such a smart way to step into beautiful spring! Three variations on the free-and-easy sandal theme. The accent is on open toes, open backs, and heels that tower or are mid-high. Whatever your choice (at this price you'll want all three!) our Heiress brand is your assurance of forward-looking fashions plus that special comfort that's a treat for your feet. Right now is your time to save on already-low Heiress prices. Women's sizes.

\*Webb' with novelty interlaced vamp, molded heel with eye-catching see-thru.

\*Fine' with slim straps.

\*Judy' criss-cross vamp, towering heel.

Judy usually \$19

Shop Monday Through Wednesday And Saturday 10 A.M. Until 6 P.M., Thursday And Friday 10 A.M. Until 9 P.M. - Phone 758-2176

# Pursued To Ultimate Depths

A royal "We are not amused" reaction to suits brought by former live-in partners, seeking monetary compensation for past "services and companionship" is appropriate. It is no joke.

However... If one were to pursue the theme to an ultimate pinnacle (or depth), we might one day see a lawyer representing a cat down to its ninth life, in a court of law.

The complaint is that after giving four of its best years as a companion, solace, and only friend of a

struggling young reporter; to be evicted when said reporter became rich and his fame extended one block in each direction of his modest residence.

The jury is called upon to decide whether said cat is now entitled to share in that newfound wealth and fame or continue to subsist on plate-scraps and the nonentity of life at a house three doors down the block.

Never happen! you say? Don't bet on it. There is no sure thing in today's world.

# Thankfully, Tuition Hike Turned Down

Thankfully a joint appropriations committee in the Legislature has voted to reject a subcommittee recommended tuition increase for the UNC system.

In-state tuition would have risen by \$27 to \$36 and out-of-state by \$87 to \$109.

No doubt the tuition increases were tempting to

legislators who are hard pressed to find funds to meet all state needs.

Nevertheless young people trying to go to college are hard pressed, too. Everything from housing to books is soaring. Thus holding the line on tuitions can mean a lot to the university students and their families.

THIS AFTERNOON

# Total Health Care Vision

By BILL NOBLITT  
RALEIGH — There is much more to good health care in a community than just a hospital. But lack of thoughtful planning, and the hindrances of local, state and federal bureaucratic fragmentation stand in the way of change.

That is the conclusion of a retired physician from Vermont who settled in Sanford at a time when that community was deeply involved in making decisions about a new hospital.

Dr. Robert L. Richards feels that Sanford made some good moves as local citizens were involved in site selection and structural design of the hospital. But, he believes, "goals and vision are limited", and can be applied to many North Carolina locations.

Richards makes a major point from experiences: "The more continuing medical education, physical therapy, rehabilitation and preventive services are privately financed and provided outside of hospitals, the less hospital care will cost."

Emerging from his study of the Sanford hospital is a

blueprint for a total health community, largely privately owned and operated.

Locate the hospital near an interstate highway, and make it the nucleus of health activities: a convalescent home and/or nursing facility so residents can have close medical supervision and be at the hospital for emergencies, lab work or admissions; nearby housing, apartments, and a motel should be available; as well as a "general store, drug store, auto service station, recreation center surrounded by communal garden plots (for) retirees with space for craft center and occupational therapy and physical therapy for handicapped patients recovering from injury, surgery or strokes," are all in Richards' vision.

Nearby, he suggests, a day care center, or kindergarten, where retirees might offer special skills and serve as surrogate grandparents would serve the community and hospital staff.

Equally important, the hospital should be a center of activity as health agencies, medical lectures, community college or nursing school classes, public school

students, civic groups, and citizens come together to learn about public and private health issues.



BILL NOBLITT

"The problem is that industrial and public health includes mental health, health education in schools and welfare aid to dependent children, home health care by visiting nurses, family planning... convalescent homes and housing for the aged, food stamp programs that should include nutritional and dietary services — all of which are administered and funded by federal, state and local governments and private agencies.

Conflict "There is imperfect cooperation and coordination of and often duplication of services due to conflicting laws and regulations that control these various agencies and hospitals," Richards says.

He envisions a "general services corporation" to

direct nursing services, home health aides, housekeepers, baby sitters, craftsmen to teach, and to provide part-time employment to high school students and others to do chores for retirees, the disabled, and others confined at home. Welfare recipients could be hired as companions for the elderly or disabled, and to deliver meals, etc.

As for prevention, which so many experts agree is a key to good health, Richards suggests an "industrial, health service corporation" to provide smaller business operations with nurses, physical exams, periodic checks for blood pressure, overweight, diabetic, heart problems; early attention to pregnant women; information on health and nutrition; and individual assistance in diagnosing problems and locating the proper treatment.

"With a little imagination and private initiative," Richards is convinced, "Sanford... could lead the U.S.A. in health care services without dependence on federal and state bureaucracies." Other communities might consider some of his ideas, as well.

## CHOOSING HIS FRIENDS!

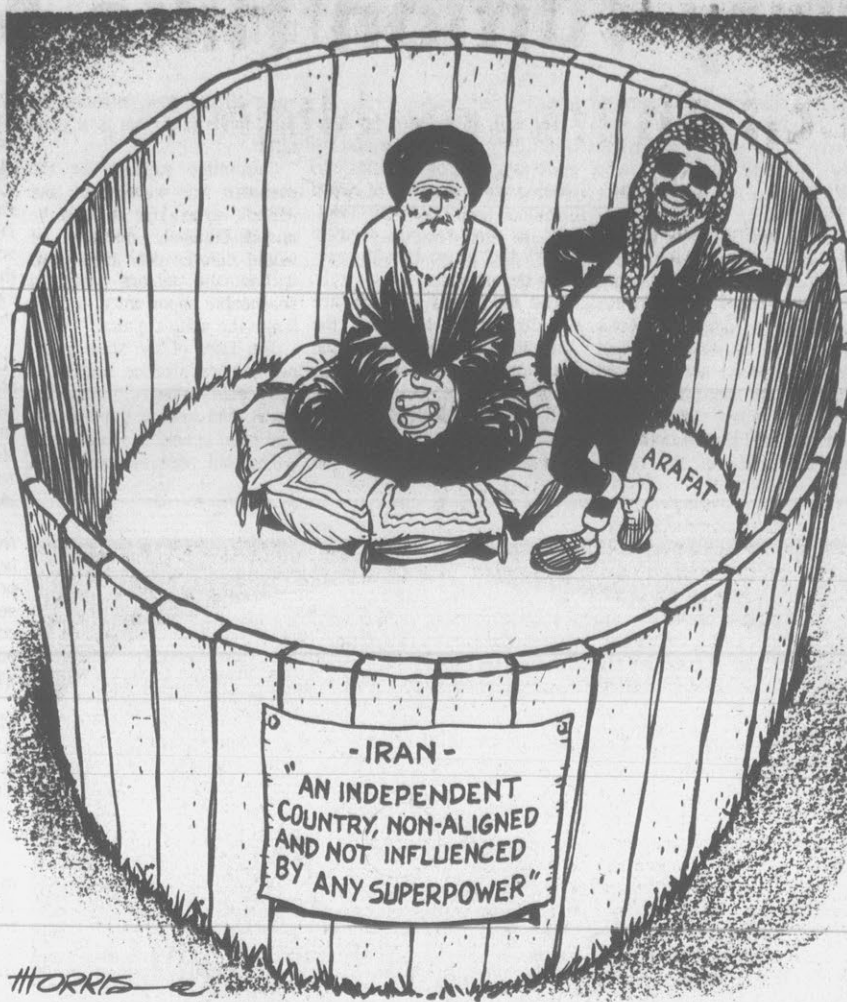

By ART BUCHWALD

# Who Failed In Chicago?

WASHINGTON — There is a bitter debate now going on in Washington as to who lost Chicago. The downfall of Mayor Bilandic and the Daley machine came as a shock to the White House, which had been assured by the CIA that Bilandic, backed by a powerful Department of Sanitation, had no chance of being overthrown. The CIA had told the President that the stories of unrest emanating from Chicago had been planted by reformers and opposition leaders in downstate Illinois.

When Bilandic was thrown out, President Carter was

furious and demanded to know why he had been so misled.

Chicago analysts, in retrospect, now say that Bilandic tried to modernize Chicago too fast, and the Chicagoans could not absorb all the changes in such a short span of time.

They also said that Bilandic was far more interested in purchasing every new snow removal piece of hardware that came on the market, despite the fact that no one in the city was capable of knowing how to use it.

Although American snow removal companies had sent

technicians to Chicago to train Bilandic's people in the use of this equipment, most of it sat in garages for the lack of personnel who knew how to drive them.



ART BUCHWALD

As one Chicago-watcher put it, "We gave them bulldozers when most of them were just getting used to shovels. Bilandic had delusions of grandeur and dreamed of Chicago becoming a major city in one generation."

"He was encouraged in this thinking by officials in Washington, who gave the mayor any advanced snow removal equipment he asked for and talked themselves into thinking that Bilandic was capable of handling any blizzard that came along."

"When push came to shove, Bilandic's people could neither push nor shove the snow off the streets. And the writing was on the wall." Henry Kissinger blames Carter for the downfall of the Daley machine. He told a reporter from "The Economist": "We did not give Bilandic the support he needed when he was in trouble. We should have sent in the 82nd Airborne Snow Plow Brigade from Fort Bragg, and ice breakers from the Sixth Fleet to show that we were behind him. When the Chicago voters realized that the United States would not do anything to help him, they were encouraged to go out into the streets."

Kissinger was asked if he thought Carter's human rights policies had played any part in Bilandic's downfall? "Absolutely," he said. "Chicago's standards of human rights may not have been everything we wanted

# There Is No Crisis

By WALTER R. MEARS  
AP Special Correspondent  
WASHINGTON (AP) — Take it from the White House: there's no energy crisis right now.

President Carter said the other day that the current oil price and supply situation is serious but not critical.

He said the other month that energy shortages could become catastrophic, threatening raging inflation and unemployment.

That's the way it's been on the government's energy fever chart, up one season, down the next. Those changing diagnoses may account, at least in part, for the evident public confusion and suspicion about the causes and handling of energy shortages.

One winter, factories are closed and people are shivering for lack of natural gas. This year, natural gas is abundant and Secretary of Energy James Schlesinger says it should be used wherever possible.

Carter has asked, again, for voluntary energy conservation. He said Tuesday that the situation is not serious enough to warrant mandatory moves now. Schlesinger said Wednesday that before summertime, the government may have to order weekend closings of gasoline stations and order fuel-saving thermostat setting in public buildings.

That hardly sounds like the moral equivalent of war, the slogan Carter adopted in proposing energy legislation nearly two years ago.

At the time, Carter ordered the accelerated buildup of a billion-barrel strategic oil reserve, as insurance against emergency shortages. According to the National Journal, the government so far has managed to stockpile 72 million gallons, little more than one quarter of what was supposed to be in storage by now.

U.S. oil imports run to about 8 million barrels a day. Carter said in his original energy pro-

(Continued on page 5)

# 40 Years Ago Today

March 7, 1939

The N.C. House of Representatives in Raleigh today refused by a 56 to 52 vote to place a tax on "illegal punch boards."

Last night, the representatives voted to license slot machines used for purposes of amusement only, with proponents of the levy arguing it would not license slot machines that "pay off" while opponents argued "it opens the gate wide open for any kind of slot machine."

The finance committee proposed a \$1 tax on "illegal punch boards" and estimated the state could get \$40,000 a year in revenue from the tax.

Rep. Cherry of Gaston County, who led the unsuccessful assault on the slot machine section, had better luck on punch boards after he told the house "there is absolutely no moral or legal justification for this section in the revenue act."

"If you are going to do that, let's put in horse races and license bawdy houses," he added. "Let's get the big boys and not play around with three by four punch boards."

McBryde of Cumberland County offered the amendment which struck the tax completely from the bill.

— Stuart Morgan

# Public Forum

Letters submitted for Public Forum must be limited to 300 words.

To the editor:

Thanks for the support you gave to the recently organized Pitt County Court Monitoring Program. As you pointed out in your editorial of Mar. 1, it is our purpose to provide a public presence in the courtroom to facilitate justice for all defendants.

We have established a Speakers Bureau to inform area residents of the CMP's objectives and methods. Any club or group may arrange for a speaker by calling Mary Cochran, 756-3863, or Roy Schaal, 758-4895.

The initial need is for citizens to serve as volunteer court monitors. Those with a few hours a week free time to volunteer for this project are asked to sign up with Carroll Webber, 758-4906. This is one positive way in which citizens can "be involved" and contribute to the smooth operation of the democratic process.

Elaine Warshauer, Chairman  
Pitt Co. Court Monitoring Program

To the editor:

We wonder where we have gone wrong in raising our children. We pray, we teach, we carry them to Sunday School and church. We try the best way we can to raise them to be ladies and gentlemen when they grow up. Sometimes we make it and sometimes we fail.

TV is no help. If we try to look at our own station, Channel 9, after housework and dinner are over, we're faced with "Newlyweds." Why can't the manager run this show at a later time? And while he is at it, why not carry "The Dating Game" along with it?

We have no control over what is on, but he does. Are we going to have to stop supporting our own station? I'm not the only one who is kicking these shows.

Selina Jamison  
Rt. 8, Greenville

(Continued on page 5)

THE INSIDE REPORT

# Unwelcome Soviet Guest

By ROWLAND EVANS and ROBERT NOVAK

WASHINGTON — Just when Soviet broadcasts were raising anti-American passions among Marxist guerrillas in Tehran to highest pitch, the No. 2 Soviet diplomat here was invited to be an unprecedented guest at a routine, two-hour staff meeting of the State Department's Bureau of Soviet Affairs on the department's sixth floor.

Vladilen Vasev, minister-counselor under Soviet Ambassador Anatoly Dobrynin, arrived at the 9 a.m. staff meeting with one aide on Feb. 2. Before he left, he treated the 20-odd U.S. diplomats and a half-dozen officials from the Commerce

Department and the United States Information Agency to a standard, wholly predictable anti-U.S., anti-Carter administration lecture.

With other developments in Jimmy Carter's confused handling of his Soviet problem, this strange invitation unintentionally symbolizes a State Department compulsion to prove to the Kremlin that, no matter what anyone else is saying, it is really and truly loved in Carter's Washington. "But what is transmitted to Moscow," one American long skilled in dealing with the Russians told us, "is not love but obsequiousness and even fear, and that is bad."

The extraordinary invitation to Vasev was specifically

approved by Dr. Marshall Shulman, Secretary of State Cyrus Vance's Soviet adviser, and at least one other top official. It caused a furious reaction among the few insiders who found out about it in the Carter administration, particularly in the Pentagon and Dr. Zbigniew Brzezinski's National Security Council staff.

Indeed, we found no officials anywhere — including experienced Soviet experts — who, when informed of Vasev's attendance at the staff meeting, were not astonished and angered. William Shinn, chief of the Soviet desk, told us it was simply an experiment in diplomacy with no sequel planned.

U. Alexis Johnson, who was the department's top career diplomat and Shinn's boss in arms control talks with the Russians a few years ago, said he had "enormous regard" for career diplomat Shinn. Now retired, Johnson told us: "I simply cannot understand this."

That lack of understanding goes to the heart of Vance-

Shulman diplomatic management of the frayed U.S.-Soviet connection. The invitation to Vasev seems clearly tied to the Vance-Shulman policy — often but not always echoed by Carter — of putting the brightest face on a clearly deteriorating picture: in this case, despite incendiary anti-American broadcasts in Iran, show Vasev how hard Carter is trying to get along, and the Soviets will follow suit.

To much of official Washington beyond the panelled chambers of Messrs. Vance and Shulman, that policy invites not reciprocity but but Soviet audacity. Worse, it betrays a kind of diplomatic masochism that lies just under the administration's surface attitude of occasional hard-headed diplomacy.

This ambivalence reinforces the Carter-Vance-Shulman refusal to link strategic arms talks (SALT II) to Soviet expansion throughout Africa and South Asia; it informs the Kremlin that the more successful it is

(Continued on page 5)

# Strength For Today

SOUL'S REAL ENEMY

Moral compromise is often a major obstacle to living an upright life. Occasionally we are overcome by some great temptation. Usually, however, we descend from higher to lower ideals by an incline which is sometimes so gradual that we are not conscious of the fact that we are on the way down. Some little moral compromise, almost unnoticed at the time it is made, results later in a transgression of such size and significance that our whole lives may be shaken to their foundations.

In the course of this des-

cent, many admirable moral qualities are subtly corrupted. For example, thrift becomes avarice. Striving grows into self-centered ambition which dominates and warps the lives of others. Little grudges, never put out of mind, become inveterate hatreds with the passing of time. Evil thoughts establish a mental pattern hard to change.

And the whole transformation often begins by the little moral compromises which are such deadly foes of the soul.

Elisha Douglass

# Sees Timidity In Investment

By JOHN CUNNIFF

NEW YORK (AP) — Americans are not by nature timid souls, but sometimes they may act that way, says William Batten, head of the New York Stock Exchange. They avoid risk-taking; they seek security, he suggests.

Batten's focus, of course, is the stock market, where risk is the name of the game, a game at which fewer and fewer individuals seem to participate. It is from this specific that his generality develops.

The chairman may have a firm handle on the subject. Stock ownership that rose to 31 million in 1970, a reflection of the post-World War II investment aggressiveness, has now fallen to 25 million or

less.

Much of the market participation today is through intermediaries rather than directly, with individuals giving their money to pension funds and mutual funds, and leaving investment decisions to them.

This practice, it has been observed by independent students of the marketplace, can sometimes be considered a copout. Fearful of decisions, it is said, the individual turns the matter over to others.

And what do the recipient institutions do? Well, sometimes they do the same thing. That is, rather than buying equities, which entail risk, they put the money into fixed-return bonds or other

debt instruments.

In January, which is the same month the Investment Company Institute chose to reprint a Batten speech on the subject of timidity, mutual funds bought \$948 million of stocks — but sold \$1.23 billion.

That was not the extent of it either. They bought \$923 million of low-risk, non-stock securities, they announced, but sold only \$749 million of the same. Riskless investments, that is, were more attractive.

Timidity? If it is, it is not isolated. Batten speaks also of the big corporations that avoid start-up risks by buying existing concerns — concerns that by luck or expertise already have overcome the

odds.

But in his speech, given before an Opinion Research Corp. group shortly after it had done a census for the exchange, he reminds us that timidity did not build the nation. It was risk-taking that did, he says.

"Our early captains of industry and the venture capitalists who helped finance ideas and enterprises that often must have seemed extravagant were not — whatever their other faults — timid souls."

"The key trait that helped build this nation was boldness — boldness tempered by sound judgment of what was possible, and a willingness to take risks to make things happen."

**The Daily Reflector**  
INCORPORATED  
209 Cotanche Street, Greenville, N.C. 27834  
Established 1882  
Published Monday Through Friday Afternoon and Sunday Morning  
DAVID JULIAN WHICHARD, Chairman of the Board  
JOHN S. WHICHARD — DAVID J. WHICHARD  
Publishers  
Second Class Postage Paid at Greenville, N.C. (USPS 145-400)

MEMBER OF ASSOCIATED PRESS  
The Associated Press is exclusively entitled to use for publication all news dispatches credited to it or not otherwise credited to this paper and also the local news published herein. All rights of publications of special dispatches here are also reserved.

SUBSCRIPTION RATES  
Payable in Advance  
Home Delivery By Carrier or Motor Route Monthly \$3.50  
MAIL RATES  
(Prices include tax where applicable)  
Pitt And Adjoining Counties \$3.50 Per Month  
Elsewhere in North Carolina \$3.85 Per Month  
Outside North Carolina \$5.00 Per Month

UNITED PRESS INTERNATIONAL  
Advertising rates and deadlines available upon request.  
Member Audit Bureau of Circulation.

# 31-Item Agenda To Confront City Council Thursday Night

A 31-item agenda, including several public hearings, is scheduled for consideration Thursday at the City Council's 8 p.m. meeting at city hall.

Items scheduled under "old business" include: appointments to boards and commissions; public hearing on a petition for annexation of Section II of North River Estates located south of Greenfield Terrace, along State Road 1419;

Public hearing on rezoning property on the north side of Sixth Street west of Hollowell's Pharmacy from Medical Arts to Downtown Commercial Fringe; public hearing on rezoning property on the north side of US 264 Bypass West from RA-20 to R-6 and R-9;

Public hearing on rezoning property south of Greenville Boulevard, adjoining Belvedere Subdivision, from R-9 to R-6; public hearing on the closing of an unnamed dirt street south of Farmers Warehouse on N. Green Street;

Consideration of guidelines for naming recreation facilities; authorization for the submission of the 1979-80 Community Development hold-harmless application; and applications for

renewal of mobile home permits.

"New business" on the agenda includes: applications for mobile home permits; consideration of a request to erect crypt tombs in Greenwood Cemetery; authorization to apply for transit planning grants revisions; consideration of an agreement for architectural services for the Public Works facility;

Consideration of an amendment to the engineering contract for 14th Street improvements; resolutions approving the sale of disposal parcels in Southside; requests by Greenville Cable TV Inc. regarding a resolution approving a capital stock exchange and an amendment to the ordinance relative to the transfer of control;

Consideration of budget amendments; Traffic Commission recommendations; application for beer and wine privilege license; scheduling of rezoning requests for public hearings; receipt of the semi-annual reports of the local planning boards;

Submission of an application for a Historic Preservation Inventory Grant; consideration of

extension of the extraterritorial limits to conform with the Utilities Commission water district line;

Scheduling of a public hearing on the Thoroughfare Plan; con-

sideration of tax releases and refunds; request for a building permit refund; consideration of police uniform bids; and review of Greenville Utilities budget amendments.

## Death-Ray Is Nearer Reality

WASHINGTON (AP) — "Death rays," used by generations of science fiction warriors to zap each other, are moving closer to being real-life battlefield weapons, says a new Defense Department report.

The report, filed by a Pentagon research agency to support its request for more money, provides these other glimpses into weapons development:

### Mears Col. . . .

(Continued from page 4)

gram that the imports should be reduced to 6 million or 7 million by 1985. Schlesinger has since said that won't be possible and that, in fact, oil imports will be up to 9 million or 10 million barrels a day by then.

—Work is proceeding on "spy in the sky" satellites that could gather intelligence, track potential targets with pinpoint accuracy whatever the weather and defend themselves with energy beams.

Under Richard M. Nixon's all-but-forgotten Project Independence, 1985 was supposed to be the year the United States ended its dependence on foreign oil.

—Researchers are developing a gun using electricity rather than explosives to fire projectiles at hypersonic — or faster than supersonic — speeds and a weapon designed to wipe out tank squadrons massed behind enemy lines.

Varying signals may be one of the reasons Americans give Carter low marks on his handling of energy problems.

What few details are given on any of the programs are largely couched in language that only superficially resembles English. But the report, prepared by the Pentagon's Advanced Research Projects Agency and released by a House Armed Services subcommittee, does provide a look at the kinds of weapons Uncle Sam hopes to one day have in his arsenal.

An Associated Press-NBC News poll taken before the Iranian oil cutoff became a major concern showed 33 percent rate Carter's performance on energy as poor.

The report says the United States is far ahead of its potential adversaries in computer technology.

Only 19 percent rated it good to excellent, while 44 percent called it only fair. Four percent of the 1,600 people in the nationwide survey said they weren't sure.

This ability to store massive amounts of information and computing functions on small silicon chips gives the United States "the option of pulling significantly ahead of our adversaries in capabilities for surveillance, target acquisition and homing guidance," the report says.

The AP-NBC News survey and other polls have found the public skeptical of government and industry explanations of energy shortages. Generally, the polls find that people suspect energy shortages are ploys to force up prices.

When it comes to lasers and charged particle beams, however, "It is not as clear that we have a unique technology base," the report says.

A survey in December showed that 85 percent believed gasoline shortages were only a cover for price increases.

The report says substantial progress has been made in demonstrating a high-efficiency chemical laser — the possible precursor of a "death ray."

## Evans-Novak . . . Buchwald Col. . .

(Continued from page 4)

in weakening U.S. influence in the world, the harder the U.S. will try to make a deal with Moscow. Examples are numerous:

Item: Despite severe presidential protests over Soviet treatment of Anatoly Shcharansky (jailed as an alleged American spy) along with trials of other Soviet dissidents last year, not a single piece of drilling equipment from the controversial Dresser industries deal on down has been cancelled. Yet, hundreds of noisy hours were consumed in top-level meetings to arrange legal procedures to halt some of these technology sales, creating a hard-line public image.

Item: The White House removed the usual net assessment of U.S.-Soviet military strength from the first draft of the Joint Chiefs of Staff annual "posture" statement in January. It showed bad deterioration in relative military strengths over the year and might therefore have acted as a further prod to higher defense spending, offending Moscow, history's greatest weapons procurers.

them to be. But it is unfair to impose our standards on an entirely different culture. By insisting Chicago stop voting in dead people more than once, we undermined the government of one of our strongest allies in the Midwest.

Item: Inadvertently or not, in his Feb. 27 press conference Carter junked the careful formulation of U.S. displeasure for Vietnam's Soviet-backed "invasion" of Cambodia and China's "frontier penetration" into Vietnam. Those were Carter's words on Feb. 20 at Georgia Tech and Brzezinski's on the March 1 CBS "Morning Show". But in his press conference, Carter equated the two events with the same language, thus muting the anti-Soviet signal.

The biggest mistake we made, according to Kissinger, was emasculating the CIA's covert capabilities in the Windy City. "When the CIA was forced to give up its domestic operations, the opposition was not afraid to challenge the Daley machine."

George Ball disagrees strongly with the Kissinger analysis. He blames Nixon and Kissinger for making Bilandic believe he was unbeatable.

"There wasn't anything Washington could have done to prevent Ms. Byrne from taking over once the snow started falling," said Ball.

The big question now being asked in the capital is whether Washington can live with the new Chicago government. President Carter said he was sending his son Chip Carter to talk with the new leaders and assure them that with or without the Daley machine we wanted their friendship.

When asked if he thought he had done enough to prevent a Bilandic defeat, the President angrily replied, "The United States cannot be the policeman of the world."

## Set Open House At Pope AFB

FAYETTEVILLE — The annual open house at Pope Air Force Base this year will be held on Saturday, April 7 and will celebrate the base's 60th anniversary.

aircraft, a parachuting demonstration by the Army's Golden Knights, a repelling demonstration by the Pope Combat Control Team, and numerous aircraft displays — to include more than a dozen different versions of the C-130 aircraft.

Highlights of the day will be an aerial demonstration by F-15

## Devilish Pleasures.

Enjoy the down-to-earth goodness of a devilish good doughnut. Earth Grains Old Fashioned Devil's Food Doughnuts.

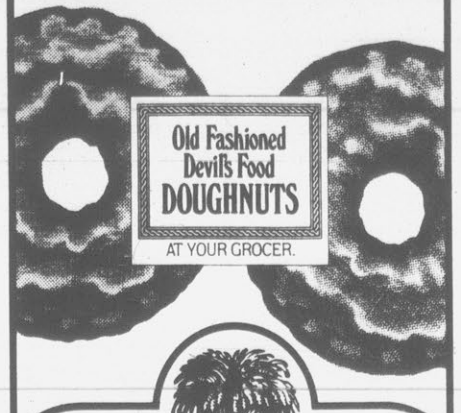

Old Fashioned Devil's Food DOUGHNUTS

AT YOUR GROCER.



DOWN TO EARTH GOODNESS.

© 1979 BEL-ART ADVERTISING, INC.

**OUR LEASE IS OUT**

AT

## MUSIC ARTS

PITT PLAZA  
GREENVILLE

HOME OF THE LOWREY ORGAN

LAST DAY OF BUSINESS

Doors Close Tonight At 8 P.M.

ALL PIANOS AND ORGANS  
WILL BE SOLD  
AT  
CLOSE-OUT PRICES

All Merchandise Is Under Warranty And Will Be Serviced Through Music Arts Of Washington Square Mall. Financing Available To 60 Months

**MUSIC ARTS PITT PLAZA 756-3522**

Open 10 A.M. To 8 P.M. Daily



**Peaches, Greenville's Adult Disco Is Proud To Announce "The Best Is Getting Better"!**

**Peaches will be closed Sunday, March fourth through Monday, March twelfth.**

But it'll be worth it. We will reopen Tuesday, March thirteenth with a face lift and an all new system to make convenience for you a key word in our operation. The all new management places the emphasis on service with the introduction to Eastern Carolina of the total tab system. The beauty of this setup is that each individual will have to pay only once prior to leaving Peaches at the end of the evening. More time to do other things you'd rather be doing at Peaches.

More changes! Peaches will be open a new night beginning in March. Introducing Backgammon night, Sundays with the emphasis on easy listening music, good conversation, (you supply), a relaxed atmosphere, and of course, backgammon. Peaches will have backgammon boards available, but we encourage you to bring your own. See you Sundays at seven P.M.

Peaches will also be continuing the tradition of Beach Nite on Tuesdays. Our oldies D.J., Collins Cooper, plays some of the best 50's & beach music around, so you won't want to miss the fun every Tuesday at 8:00 P.M.

Of course, Foxy Lady Night every Thursday Nite 8:00 P.M. and 10:00 P.M.

## PEACHES DISCO

GREENVILLE SQUARE GREENVILLE

## INVENTORY REDUCTION SALE

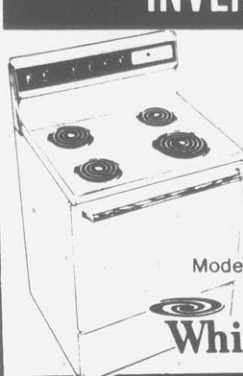

Model RDE3000

**Whirlpool**

### 30" WHIRLPOOL RANGE

•One Piece Lift-Up Top•Plug-In Surface Units•Removable Oven Door•Infinite Heat Controls.

Price includes delivery up to 20 miles, service and parts warranty.

NEW LOW PRICE **\$198<sup>00</sup>**

## BOB'S TV & APPLIANCE

AYDEN, N.C. GREENVILLE, N.C.

7 BLOCKS FROM PITT MEMORIAL HOSPITAL IN THE C.L. LUPTON BLDG.

## FAMILY DOLLAR DOLLAR DAYS



**Genuine Suede Casuals Made In Spain**

**\$6<sup>00</sup>** Pair

A classic go-with-anything shoe styled in natural suede leather. Men's, women's and boys' sizes.

**New Fashion Tops For Ladies**

**\$2<sup>00</sup>**

Choose tunics, blouses, jackets and vests in solids and stripes. Long or short sleeves. Sizes S,M,L and 8-20.



**Ladies' Pre-Washed Straight Leg Jeans**

**\$6<sup>00</sup>**

Straight leg denim jeans in indigo or faded blue. Great pocket and waist details. Sizes 5/6-13/14.

Save Now During Family Dollar's Spring Paint Sale!



**Hair Spray**

**2 For \$1**

All Weather super unscented. 11-oz.



**Super-Glo Latex Paint**

**\$2<sup>00</sup> gal**

Dripless flat indoor paint in six decorator colors.



**Acrylic Latex Paint**

**\$4<sup>00</sup> gal.**

Super hiding latex wall paint. Seven colors.



**Skin Care Cream**

**83<sup>c</sup>**

Intensive Care, 10-oz. or Rose Milk, 8-oz.



**Kleenex Tissues**

**2 For \$1**

Decorator box with 200 soft tissues.

**Family Dollar Spray Paint**

**\$1<sup>00</sup>**

**Set of 4 brushes**

**2 Sets \$1**

**9" roller and paint tray set**

**\$1<sup>00</sup>**



**Scour Pads & Cloths**

**2 For \$1**

Pack of 3 copper puffs or scour cloths. Rubber gloves . . . 2 Pr. \$1



**Dennis Snacks**

**3 For \$1**

Cheese Snaps, Hot Fries, Popcorn and more!

**Striped Tube Socks**

**\$1<sup>99</sup>**

Pack Of 3 Pair Men's and boys' over-the-calf socks. White with striped tops.

**Scatter Rugs**

**\$1<sup>00</sup>**

Excellent selection with jute backing. 18x27".

**Purex Bleach**

**2 For \$1**

Money-saving gallon size. Limit 2.

**Depend-O Cleaner**

**2 For \$1**

Depend-O toilet cleaner, 12-oz. Limit 2.

PRICES GOOD AT ALL FAMILY DOLLAR STORES THROUGH THIS WEEKEND. QUANTITIES LIMITED ON SOME MERCHANDISE.

HARRIS SHOPPING CENTER, MEMORIAL DRIVE  
OPEN MONDAY THROUGH THURSDAY  
9:00 A.M. UNTIL 7:00 P.M.  
OPEN FRIDAY AND SATURDAY 9:00 A.M. UNTIL 9:00 P.M.

## South Africa Bars Change In Election

JOHANNESBURG, South Africa (AP) — The U.N. peace plan for South-West Africa was threatened anew today by South African raids on guerrilla bases in Angola and the South African government's rejection of alleged modifications favorable to the guerrillas.

South Africa has agreed to the U.N. proposal for a cease-fire in the territory March 15 provided the guerrilla South-West Africa People's Organization "undertakes to stop violence ..."



**BORDER RAID** — Map locates the Angola-Namibia border where South African troops supported by warplanes struck Tuesday. (AP Laserphoto)

But the government ordered strikes against the guerrilla bases Tuesday because it said SWAPO was stepping up raids and there were new interpretations to the U.N. plan for South-West Africa, also known as Namibia.

Under the U.N. plan, a peace-keeping force of up to 7,500 troops and administrators would supervise the cease-fire, universal voter registration among the territory's 1 million inhabitants and establishment of an independent government.

The plan also calls for all but 1,500 of the estimated 30,000 South African troops in the territory to pull out, while those remaining would be confined to bases monitored by the United Nations.

But Prime Minister Pieter W. Botha told Parliament in announcing the raids, "If there are others who wish to deviate from the plan, they must bear the consequences. Our position remains unchanged."

South Africa says its objections to the latest proposals by U.N. Secretary General Kurt Waldheim are that SWAPO guerrillas would be permitted to occupy bases inside the territory once the cease-fire begins March 15.

## Serving Divorce Papers Saturday At 10,000 Feet

ANTIOCH, Calif. (AP) — Gene Ballard is bailing out of his marriage but his divorce plans are up in the air.

Ballard is to serve divorce papers on his wife, Lynda, on Saturday at about 10,000 feet.

Ballard, a carpenter, and his wife plan to skydive one last time together — for old times' sake. They are friends and have been separated for four years. The divorce is uncontested but the in-the-sky ceremony will include Ballard's at-torney.

And if things go as planned, Ballard says, he'll give his soon to be ex-wife a kiss as they open their chutes at 4,000 feet above the Antioch Airport, about 40 miles east of San Francisco.

"There have been a lot of marriages in the air, but as far as I know this is the first time divorce papers will be served like this," said fellow skydiver Steven Schlosser.

## Held Up Store To Pay His Fine

CASPER, Wyo. (AP) — Wyoming law officers are looking for an armed robber who stuck up a Casper liquor store to raise money to pay a fine in Gillette.

The gunman walked into the liquor store Monday night and demanded \$125 — no more, no less, Casper authorities told Campbell County Sheriff D.B. "Spike" Hladky.

The robber told the clerk he needed \$125 to pay a fine in Gillette or go to jail. He took only \$125 and left the rest of the money, the lady said Tuesday.

# Belk Tyler

downtown greenville

Sale Ends Saturday

# 3 day Sale

**DOORBUSTER**  
**Misses' 'Lady Manhattan' Blouses**  
**At Incredible Low Prices! Hurry!**  
 Regular \$26 to \$30 ..... **13.88 and 18.88**  
 Qiana® de Chine® of 100% nylon and polyester crepe. In solids of beige, strawberry, gold and wine. Long sleeves, mandarin and shirt collar styles. 8 to 16.

**DOORBUSTER!**  
**A Fabulous Low Price On A Group of Misses' Knit Shells On Sale!**  
 Regular 5.99 ..... **4.88**  
 Choose from turtle necks and jewel neck. Sleeveless, short and long sleeve styles. In navy, black brown, red, white and tan. Sizes S, M, L, XL.

**DOORBUSTER!**  
**Ladies' Famous Maker Lingerie On Sale At Fantastic Low Prices!**  
 Regular Up to 20.00 ..... **25% off**  
 Choose from slips, gowns and panties from Vanity Fair®, Shadowline®, Vassarette® and Maidenform®. Not all sizes, styles and colors in all sizes.

**DOORBUSTER!**  
**An Unbelievable Low Price On A Group of Junior Spring Dresses!**  
 Regular \$20 to \$28 ..... **19.88**  
 Blouses, floats and T-shirt looks. Three-quarter, short and cap sleeves. Solids and prints. Such a selection, you'll have trouble deciding. Sizes 5 to 13.

**DOORBUSTER!**  
**A Group of Junior Tailored Shirts On Sale At A Savings of 2.12!**  
 Regular 9.00 ..... **6.88**  
 From Stuffed Shirt. A polyester/cotton oxford cloth. In light blue. Styled with long sleeves and button-down collar. Sizes from 5/6 to 13/14.

**DOORBUSTER!**  
**A Large Group Of Ladies' Spring Dresses At A Great Low Price!**  
 Regular \$22 to \$24 ..... **19.88**  
 Polyester sheers in assorted prints. Short and long sleeve styles. Fabulous spring colors to delight you. Misses' sizes from 10 to 18 and half-sizes 14½ to 24½.

**DOORBUSTER!**  
**One Great Low Price On A Group of Misses' Slacks and Blouses!**  
 Compare at \$14 to \$18 ..... **10.22**  
 Choose from long sleeve print blouses, short sleeve tunic tops, three styles of fashion slacks all in fashion spring colors. Sizes 8 to 18.

**DOORBUSTER!**  
**Special Purchase On A Group of Ladies' Bangle Bracelets on Sale!**  
 Belk Tyler Low Price ..... **1.88**  
 Eighteen hot colored bangle bracelets in a rainbow collection. It's a must for your total spring look. Be sure to shop early for selection and savings!

**Ladies' Fashion Dress Sandals On Sale And At A Savings of 5.12!**  
 Regular 24.00 ..... **18.88**  
 Self-covered heel, fully braested with a leather upper. In black patent and camel. AA and B widths. A must for the new spring fashions.

**Junior and Misses' Dresses for Spring On Sale For 3 Days At Great Low Prices!**  
 Regular Up To \$32 ..... **24.88**  
 Regular Up To \$40 ..... **32.88**  
 Regular Up To \$50 ..... **38.88**  
 Soft fluid fashions to ease you into the spring season...and go easy on your budget. Easy-care polyesters in beautiful floral prints or subtle solids to suit any taste. Junior and misses' sizes.

**Misses' Shirts At Low Prices!**  
 Regular \$16 and \$19 ..... **13.88 and 15.88**  
 Short or long sleeves styles with the option of the roll-up cuffs. Button-front with placket collars. Tone-on-tone colors. Misses' sizes 8 to 18.

**Misses' Fashion Skirts For Spring**  
 Regular \$14 to \$16 ..... **12.88**  
 Solids and prints. Choose from wraps, button-fronts, slit fronts and styles with tie belts. In the newest spring colors. Shop for selection.

**LEVI'S® Jeans For Girls On Sale!**  
 Regular 13.50 ..... **10.88**  
 Rinsed denim jeans in a coarse weave of 65% cotton and 35% Dacron® polyester. In navy. Sizes from 7 to 14. Shop for best selection.

**Ladies' Shadowline Slips On Sale!**  
 Regular 11.00 ..... **8.88**  
 Taffase in Antron® III. Full slip for underlining knits and sheers. Lace trimmed bodice and skirt. In white. Sizes 34 to 42 average and tall.

**Pechglo® Panties From Vanity Fair®**  
 Belk Tyler Low Price ..... **3.00**  
 Pechglo® panties in a plain style. Cotton crotch for more comfortable wear. In white only. Shop early for selection.

**Ladies' All-Weather Coats On Sale!**  
 Regular 30.00 ..... **24.88**  
 Dacron® and cotton blended poplin. The trench coat with a shirt look. It's a must for this spring season. Shop early for selection.

**Ladies' Spring Sweaters On Sale!**  
 Regular \$16 to \$18 ..... **13.88**  
 Acrylic cardigans...your choice of a popcorn stitch or a pineapple stitch. In off white. Just great for those cool nights.

**Girls' Fashionable Button Front Skirts At A Savings!**  
 Regular 7.00 ..... **5.88**  
 From our Bugoff® collection. A polyester/cotton blend with a Shirred front and tab extension waist. Two front scoop pockets. In tan, melon, aqua and light blue. Sizes from 7 to 14.

**A Large Selection of Girls' Carrousel Dresses for Spring On Sale and At A Savings!**

**20% OFF**  
 Regular \$14 to \$18  
 Skirt sets and peasant look dresses just waiting for spring to appear. In subtle solids and magnificent floral prints. In sizes from 4 to 6X and 7 to 14. Your little girls will just love the look!

Shop Monday Through Wednesday and Saturday 10 a.m. Until 6 p.m...Thursday and Friday 10 a.m. Until 9 p.m...Telephone: 758-2176



**Belk Tyler**  
downtown greenville

**3 day  
Sale**

**SALE  
ENDS  
SATURDAY!**

**A Selected Group of Men's and Boy's  
LEVI'S® Jeans At Great Low Prices!**

**10.88 11.88**

**Boys' Sizes** Regular 12.50 and 14.50  
**Men's Sizes** Regular 14.50 to 16.50

Choose from boys' Saddleman denim boot jeans or the basic denim jeans. Sizes from 8 to 12 in regulars and slims and prep sizes 25 to 30. The men's jean is the ever popular basic style. Shop for selection.

**Men's Famous Arrow® Shirts On Sale  
and At A Very Special Low Price!**

**8.88**

Compare at \$15

Short sleeve woven dress shirts to begin your spring wardrobe with. They're from the Kent collection. Choose from white-on-white and tone-on-tones. Polyester/cotton blend.

**Men's Classic Izod® Shirts for Spring**

**Belk Tyler Price** ..... 19.00  
The classic LaCoste® shirt with the alligator emblem. 2-button placket front with banded sleeves and extra long tails. Short sleeves. 100% cotton. Sizes S, M, L.



**Suits With Executive  
Qualities . For Men  
From Palm Beach®!**

**\$ 155**

**Royal Palm® Beach Collection**

A three-piece vested suit that speaks with an executive tone. The Warfield pattern in a blend of 85% polyester and 35% Viscose® rayon. In solid navy or a navy pinstripe. Coat, vest and slacks complete the outfit.

**Sale! Save  
7.12 On Men's  
Tassel Slip-On  
Loafers for Spring!**

**Regular \$35 ..... 27.88**

Brown tassel slip-ons that go dress or casual. Styled with leather uppers and soles, the inside has quarter leather linings, too. From our own Andhurst collection.

**A Selected Group of Boys' Suits  
for Spring On Sale! Save 6.12!**

**Regular \$45 ..... 38.88**

100% texturized woven polyester. In assorted solids. Single breasted coat with center vent and welt pockets. Vest and 4-pocket slacks. Sizes from 14 to 20.

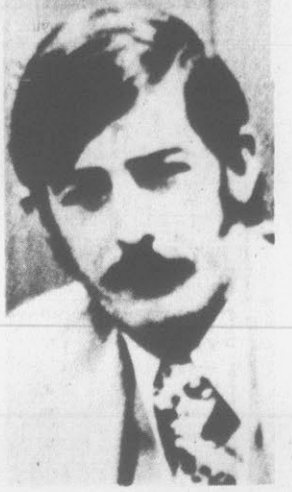

**TO BE EXECUTED** — John Louis Evans III, 29, is scheduled for electrocution at Holman Prison in Alabama on April 6. The warden of the prison said Tuesday he is trying to find someone to throw the switch on the electric chair where the convicted triple slayer is scheduled to die. (AP Laserphoto)

**Immolation  
By Gasoline**

ERIE, Pa. (AP) — A Chicago man bought a gallon of gasoline at a service station, doused himself with it, struck a match "and just blew up in flames," a witness says.

The man, identified as Kenneth Ziemba, 31, was listed in critical condition early today at St. Vincent Health Center with burns over 98 percent of his body, a hospital spokesman said.

Police said the incident occurred Tuesday at a service station along U.S. 20 in Millcreek Township.

The station attendant, Bill Whiteford, said he sold the man a gallon of gasoline in a can.

"I thought he had just run out of gas. That's what people usually come in for," said Whiteford.

"He started walking towards the road. Then he poured the gasoline on himself.

"He tried to light one match. It didn't work. He lit another match and just blew up in flames."

The man then ran across the highway and threw himself into a pile of road salt at a Pennsylvania Department of Transportation storage area, police said.

Passing motorists stopped and tried to extinguish the flames. Police arrived quickly, responding to an earlier call that the same man had been seen trying to jump in front of autos along the highway.

**Illegal Animal  
Pelts Seized**

WASHINGTON (AP) — Nearly 18,000 wild animal pelts, apparently destined for sale in Europe, have been seized by the U.S. Fish and Wildlife Service.

Agency officials placed the value of the seized pelts Tuesday at \$1.1 million, representing the largest fur haul in the agency's history. Among the seized skins were those of Mexican bobcats, coyotes, badgers, raccoons, gray foxes and skunks. The animals were believed killed in Mexico and smuggled across the border to Texas. Agency official Clark Bavin said the skins apparently were to be sold in Europe and made into fur coats.

**Blames Skipper  
For Collision**

WASHINGTON (AP) — The Coast Guard's commandant says the skipper of the ill-fated cutter Cuyahoga was "lulled by the good weather and good visibility" the night the craft collided with an Argentine freighter in the Chesapeake Bay. Eleven men died in the October crash.

Adm. John B. Hayes told a House panel Tuesday that "it is quite clear where the responsibility for this casualty lies ... command was the crucial element." Warrant Officer Donald K. Robinson was commander of the Cuyahoga when it collided with the Santa Cruz II. Hayes' testimony represented the Coast Guard's first public assessment of fault in the accident.

**PARTNERSHIPS**  
WARSAW, Poland (AP) — The Polish government is going to allow foreign firms to go into business with Polish partners on a small scale, the state television service reports.

**DOORBUSTER!**  
**Men's Tube Socks On Sale!**  
Regular \$1.25 ..... **98¢**  
Super-Pro sport socks. 85% Orlon® acrylic and 15% stretch nylon. White with top color band trim.

**An Incredible Savings On Famous Nike® Shoes!**  
Men's styles: Bruin, Wimbledon, Blazer Hi-Top and All Court. Women's sizes: Racquette and Racquette II and for the children...the Curt pattern.  
**20% OFF**  
Regular \$12 to \$34

**DOORBUSTER!**  
**Men's Famous Jogging Suits!**  
Regular \$48 ..... **19.88**  
56% nylon/44% cotton. Zip front jacket. Stripe on pant and jacket sleeve. In navy, light blue and yellow. Sizes S, M, L, XL.

**DOORBUSTER!**  
**Sale! Men's Knit Shirts!**  
Regular \$14 ..... **8.88**  
Short sleeve shirts with a horizontal stripe design. Bold colors with a contrasting collar. In a 50% polyester/50% cotton blend.

**DOORBUSTER!**  
**Men's Bold One Tennis Shorts**  
Regular \$11 ..... **8.88**  
In navy, white, khaki and yellow, light blue, green and red. 100% cotton, and blends. Two front pockets and one back pocket. 28 to 42.

**DOORBUSTER!**  
**Men's Archdale Underwear!**  
Regular \$3.99 and 4.39 ..... **20% OFF**  
Choose from T-shirts and briefs. In 50% polyester/50% combed cotton. Longer lasting, smoother fitting. "No Chafe" leg openings.

**DOORBUSTER!**  
**Boys' Tube Socks On Sale!**  
Belk Tyler Low Price... **6 for 4.88**  
Over the calf or athletic socks. In a blend of 80% Orlon® and 20% nylon. Package of 6. In white with color banded tops.

Shop Monday Through Wednesday and Saturday 10 a.m. Until 6 p.m...Thursday and Friday 10 a.m. Until 9 p.m...Telephone: 758-2176

# JCPenney Days Sales.

**20% off**  
Casual  
slacks for  
mature  
men.  
Sale \$12

Reg. \$15. The JCPenney  
slack is Dacron® polyester  
with stretch Ban-Roi® waist-  
band, self locking nylon zip-  
per and slightly flared, hem-  
med legs. Terrific fashion  
solids for sizes 28-42.

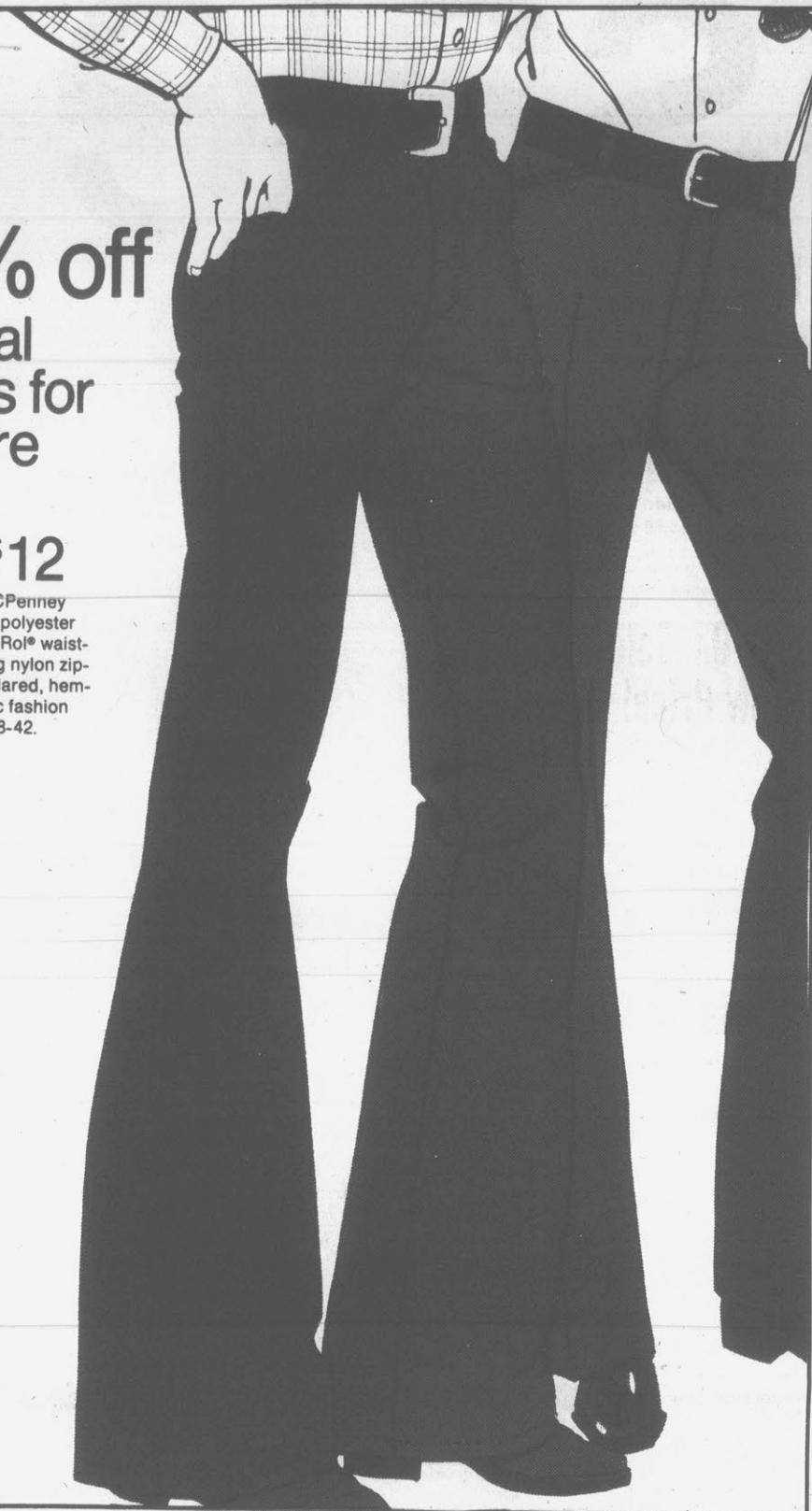

**20% off**  
"First  
Edition"  
pants for  
women.

First Edition pant.

**Sale \$8**

Reg. \$10. 100% polyester pull-on pant  
with fly front and stitched crease. Basic  
and fashion colors. Misses' petite, and  
average

**Sale 11.20**

Reg. \$14. The trouser with self belt and  
high waist detailing is the newest  
look for juniors. All woven polyester.  
Petite, average, tall.

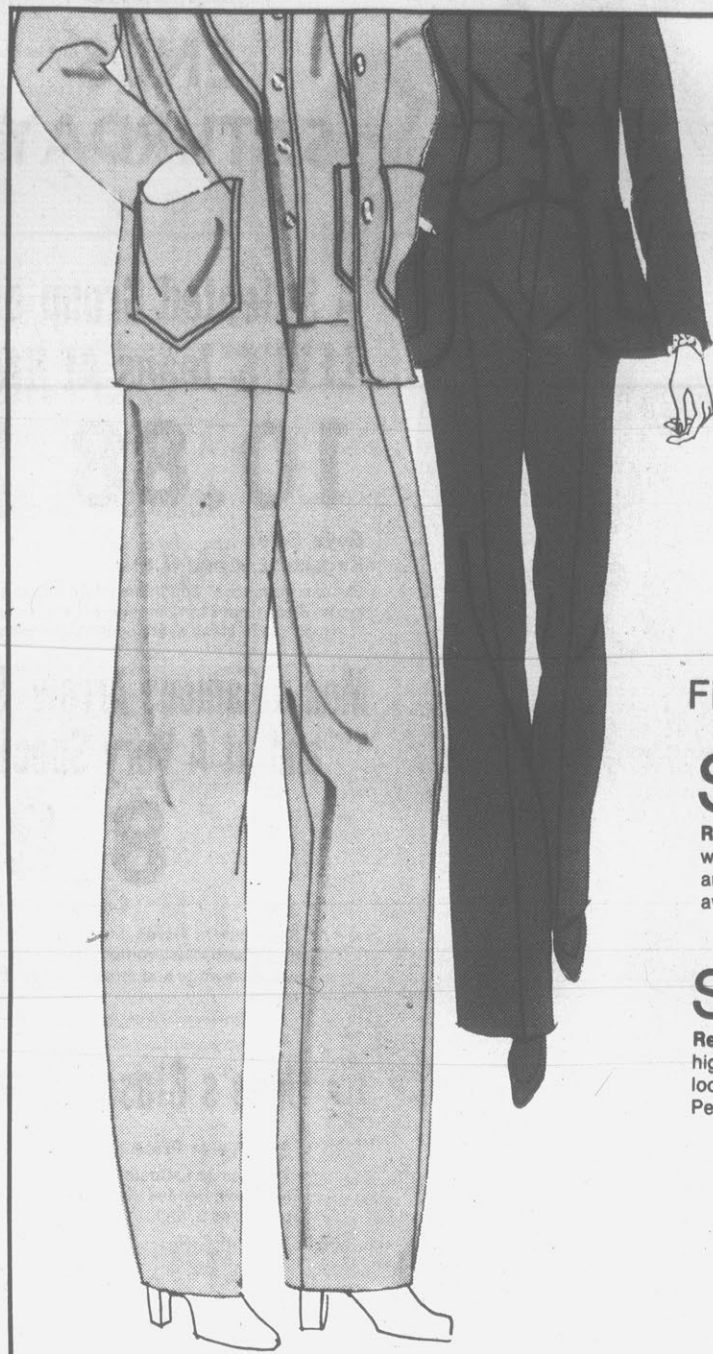

Sale prices effective through Saturday.

**30% off**

**Women's  
spring dresses.**  
Sale 16.80 to \$35

Reg. \$24 to \$50. A select group of long  
and short sleeve spring dresses. One  
and two piece prints and solids in  
sheers, polyester, poly/cotton in  
junior, misses and half-sizes.



**20% off women's  
wood-look shoes.**



**Sale 13.59**

Reg. 16.99. Wood-look cut-out heels with  
wishbone or love-knot front. Urethane in  
women's sizes.



**Sale 11.99**

Reg. 14.99. Strappy urethane sandal with  
wood-look platform heel. Spring shades in  
women's sizes.

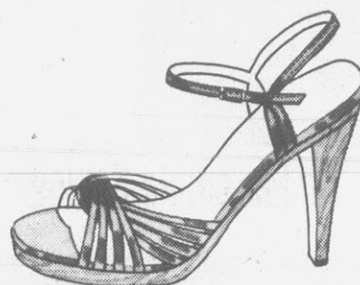

**Sale 13.59**

Reg. 16.99. Slender straps knot to make the  
prettiest spring sandals. Choose pastels of  
urethane. Women's sizes.



**Sale 13.59**

Reg. 16.99. Side-knot sandal with wood-look  
heel in lustrous urethane shades. Women's sizes.

This is **JCPenney**

**Auto Center**  
•Shop 8:30 A.M. - 9 P.M.  
•Phone 756-1190 Ext. 251

•Shop 10 A.M. - 'til 9 P.M.  
•Phone 756-1190

**Catalog**  
•Shop 10 A.M. - 'til 9 P.M.  
•Phone 756-2146

# Home Improvement Month.

## Save 50% One coat interior flat latex. Sale 5.49

Reg. 10.99 gal. Limited 3 year warranty. Our lowest priced One Coat interior paint. Easy one coat coverage in washable, stain resistant latex.

**Limited Warranty:** If this JCPenney paint fails to cover in one coat when applied according to label instructions, or if it fails because of a defect in materials within the specified number of years, we will replace it or refund your purchase price. Application of replacement paint is excluded. Just contact the nearest JCPenney facility for prompt service.

In custom paint mixes, because color intensity differs, the volume of paint per can may, in some cases, be slightly less than a full gallon.

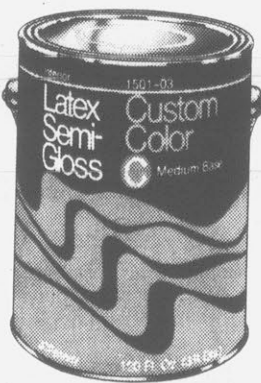
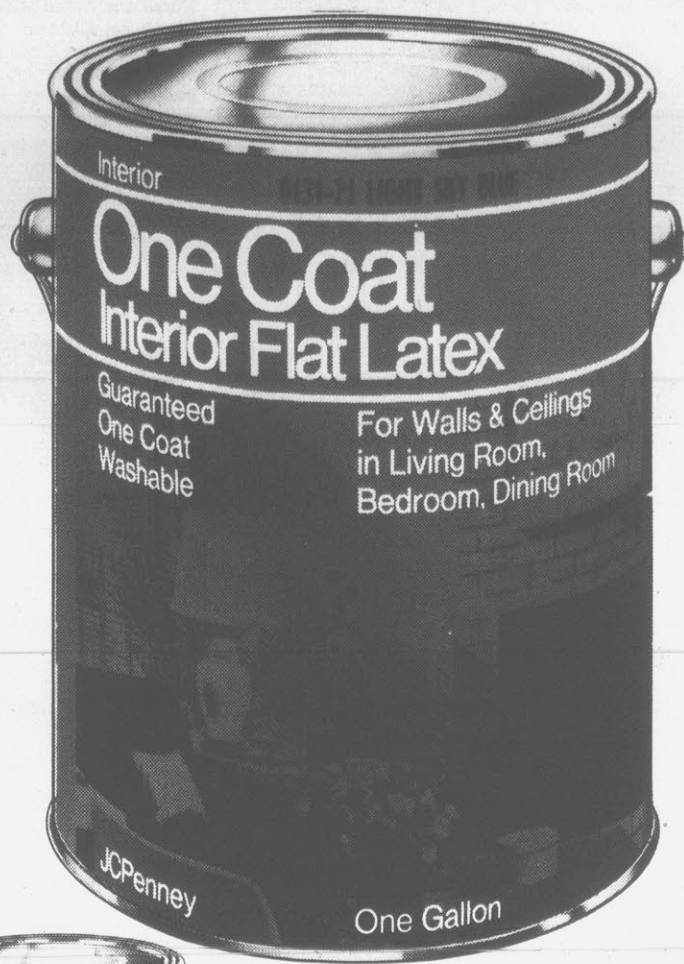

**Save 3.50**  
Reg. 12.49. Sale 8.99 gal.  
Custom Color interior semi-gloss in over 700 colors.



**Save 3.50**  
Reg. 11.49. Sale 7.99 gal.  
Custom Color interior flat latex in over 700 colors.



**Save \$4**  
Reg. 11.99 Sale 7.99 gal.  
Limited 4 year warranty.  
One coat semi-gloss interior latex. Washable.  
2.29 qt. Brush and roller cleaner



**Sale \$3**  
Reg. 10.99 Sale 7.99 gal.  
Limited 3 year warranty.  
One coat flat exterior latex.  
2.29 qt. Gloss-off  
2.29 qt. Paint remover

## Save \$5 on aluminum ladders.

Reg. 28.99. Sale 23.99. 6' sturdy aluminum step ladder is ideal for indoor painting, repairs and more. UL listed. No. 4007.

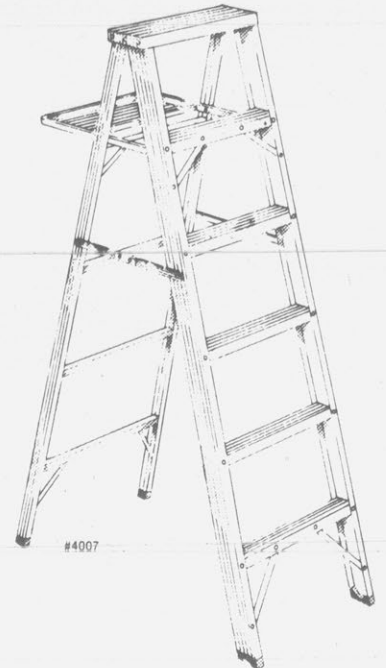

## Save \$20

Reg. 169.99 Sale 149.99 1/2 HP single cylinder compressor tank operates a wide variety of air tools. Great for home workshop, garage.

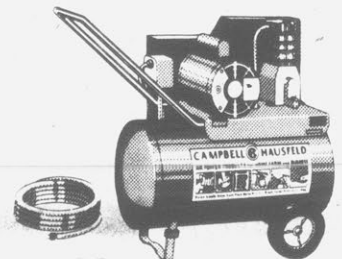

Sale prices effective through Saturday.

## Save 16% to 38% on hand tools.

Your  
Choice **3.99**

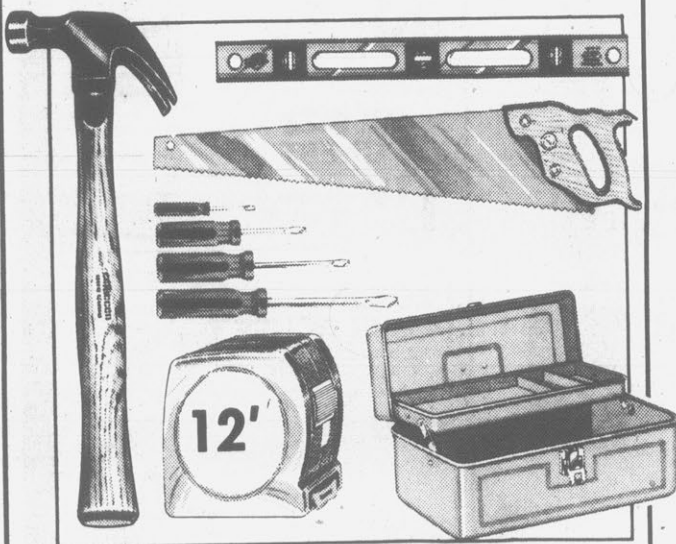

A large selection of reliable hand tools for the do-it-yourselfer.

Reg. 6.49 13 oz. curve claw hammer

Reg. 5.99 4-pc. standard screwdriver set

Reg. 5.99 4-pc. Phillips® screwdriver set

Reg. 4.79 Tape rule

Reg. 5.49 24" economy level

Reg. 5.49 13 1/2" tool box

Reg. 4.99 26" 8-point cross cut saw

**Full No-Time-Limit Warranty for JCPenney Hand Tools.** If any JCPenney hand tool ever fails to give complete satisfaction we will replace it, free of charge, with a new one of equal value. Just return it to the nearest JCPenney facility for prompt service.

Sale prices effective through Saturday.

## Your choice 24.99

### Save \$5

Reg. 29.99. Two-speed sabre saw. #1015  
• 2.5 amp  
• Heavy steel base tilts 45° to left or right  
• Rip guide and blade included  
2.49 6-pc. blade assortment

### Save \$10

Reg. 34.99. High speed finishing sander. #2300  
• Delivers 10,000 orbits per minute  
• Contoured handle  
• Double insulated  
• Sheet of sandpaper included  
6.99 Molded utility case

**Full One Year Replacement Warranty for JCPenney Power Tools.** Within one year of purchase, we will replace this JCPenney portable power tool if defective in material or workmanship, with a new one of equal value. Just return it to the nearest JCPenney facility for prompt service.

### Save \$10

Reg. 39.99 Sale 29.99 Deluxe 20" mechanic's tool box with three drawers. Cylinder lock and two keys. Black and red. #8044

### Save \$10

Reg. 39.99. Sale 29.99. 21-pc. 3/8" standard drive socket set. Includes ratchet, extension bars, universal and spark plug socket. 15 sockets, carrying box. #3011  
Sale 29.99 Reg. 39.99 21-pc. metric socket set

Sale prices effective through Saturday.



## Save \$5

Reg. 29.99. 3/8" variable speed reversible drill. #0220  
• 0-1300 RPM (no-load speed)  
• Reversible action for backing out bits, removing screws  
• Speed-Loc knob  
• Trigger lock for continuous operation  
4.99 7-pc. drill-bit set w/case

## Save \$10

Reg. 34.99. 5" bench grinder. #2025  
• Wheels rotate at 3500 RPM (no-load speed)  
• Adjustable tool rests, eyeshields  
• One coarse, one fine wheel included



## 8.99

24-drawer steel parts cabinet holds screws, nuts, bolts and more. A perfect addition for your home workshop. #8023

# This is JCPenney

**Auto Center**  
•Shop 8:30 a.m. 'til 9 P.M.  
•Phone 756-1190 Ext. 251

•Shop 10 a.m. 'til 9 p.m.  
•Phone 756-1190

**Catalog**  
•Shop 10 a.m. 'til 9 p.m.  
•Phone 756-2146

# Gems, Rare Treasures Lavished On Elizabeth II

By GRAHAM HEATHCOTE  
Associated Press Writer  
LONDON (AP) — Queen Elizabeth II is home from the shores of Araby with a fortune in gems, but Buckingham Palace says her loyal subjects may not get a glimpse of them.

The queen, already one of the world's richest women, reportedly was astounded by the splendor of the presents showered on her by oil-rich rulers in the Persian Gulf during her 18-day tour of seven countries which ended last Friday.

But a palace spokeswoman, asked Monday about suggestions that everyone would be delighted to have a peep at the wonders, said cautiously: "We haven't heard that there is to be a show."

The queen brought some of the gifts home with her by plane. "The heavier ones are coming on Britannia, the royal yacht," the palace said.

The 45 journalists accompanying the queen said she frequently was overwhelmed and even embarrassed by the munificence of her hosts. Every day when she returned to the Britannia, more treasure had been added to the trove of precious stones, gem-encrusted ornaments and rich carpets.

Queen Victoria, the famous great-great-grandmother of Elizabeth, didn't travel much. In her day, as paintings of the period confirm, princes of the far-flung empire came to London bearing gifts, and knelt before their empress to present them.

Nowadays, oil and other vital interests have reversed things. Elizabeth's tour was the first ever by a reigning British sovereign to Arabia, and the rulers showed their delight.

In Dubai the queen gasped. It happened when Sheikh Rashid presented her with a 2-foot square box containing a necklace of sapphires and surrounded by 300 diamonds, with matching earrings and a ring.

There also were two model camels sculptured in gold,

standing beside an 18-inch high golden palm tree with pearls and rubies for dates.

Nobody really knows the value of all the gifts. Reports talk of anything up to \$6 million, and the presents are the queen's personal property. She won't have to give a reckoning to the customs; Her Majesty's Customs says gifts from heads of state to the head of state aren't dutiable.

And "she wouldn't put jewelry into a museum unless it was utterly unwearable," Buckingham Palace said.

In Kuwait, the queen's first stop, Emir Sheikh Jaber launched the treasure train with three strands of pearls as big as marbles. The queen, reputedly worth a billion dollars and herself the owner of no mean jewel collection, put on the choker for dinner and said to her entourage, "Don't you think my pearls are lovely?"

The queen collects a lot of things on every trip. Past gifts

Emir Sheikh Khalifa of Qatar gave her a knee-length necklace of gold that an awed British reporter said looked "like chain-mail." Also: an oyster shell containing a huge pearl, a lapis lazuli fruit bowl supported by prancing golden horses studded with diamonds, a five-strand pearl and diamond necklace, a gold and diamond watch and a gold handbag.

The queen collects a lot of things on every trip. Past gifts

have included a 110-foot totem pole, a painting of a power station and a mink coat from Canada, a bronze cauldron and an umbrella from Australia, a Nepalese yak's hair fly-whisk, and talking-drums from Ghana. Everything is catalogued, stored and looked after so that it can be displayed whenever the donor visits England.

The queen gave her Arabian hosts silver salvers engraved with a picture of her yacht.

They reportedly cost \$30,000 each from Plante and Johnson, court silversmiths of Bury Street, St. James's, and the queen was said to have brought seven of them along. Sheiks' wives received signed photographs and other small gifts

and a book on Bedouin jewelry. Presenting a pendant to one Gulf princess, the queen said, "I'm afraid it's rather small."

"We know we can't compete," a royal official explained. "What a wonderful plus for

Great Britain," wrote Londoner Clive Phillips in a letter to the Evening Standard. "Almost all the jewelry given to the queen was made in London, paid for in valuable foreign currency, and given back forever to us free of charge."



**GIFTS FIT FOR A QUEEN** — Britain's Queen Elizabeth II smiles at girls in the national costume during a visit to the Bahrain Museum at Muharraq, Bahrain, last month. Officials presented the Queen with a pottery jar more than 4,000 years old as a

souvenir. The queen was reportedly astonished by the splendor of presents showered on her by rulers of the oil-rich states along the Persian Gulf. (AP Laser-photo)

## Pick 'n Pay Shoes

Only you'll know how little you paid.

A. Women's low heel walking sandal features fully cushioned insole, envelope vamp, and self-covered heel. Assorted colors.

**6.00** Reg. \$8.97

B. Women's dress heel for spring with molded, woodlike heel, and cushioned insole. White.

**12.00**

"Smooth as Skin" panty hose in assorted shades.

**65¢** Reg. 99¢

All Handbags 20% off regular price with purchase of any pair of shoes.

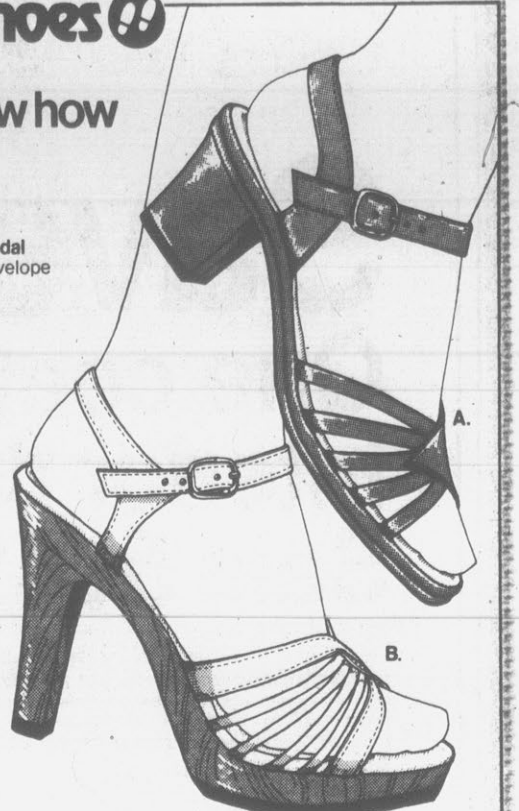

**264 BY-PASS**

Across From Nichols Discount City

Open Mon.-Thurs. 10-9, Fri. 9:30-9, Sat. 9 to 8

Master Charge or Visa welcome. Open evenings

# ECKERD'S

... a name you can trust.



## Need regular prescription refills?

Come to Eckerd Drugs. Compare our prescription price with what you are paying now. Yes, bring your prescription to Eckerd's, a name you can trust for quality and low, low prices.

## Treasure In Film Found

OTTAWA (UPI) — More than 500 reels of vintage film unearthed last summer in frozen tundra behind the Yukon's only legal gambling hall are being painstakingly restored.

Produced between 1903 and 1929, the movies include the lone surviving print of Samuel Goldwyn's "Polly of the Circus," a 1917 silent film starring Mae Murray, and "Wild Fire," a 1915 picture featuring Lionel Barrymore.

"So far, about one third of the collection has been restored. It will take another few months to complete the work," said Sam Kula, director of Canada's National Film Archives.

Most important is footage of World War I. Canada lost much of the filmed record of its role in the 1914-18 war in a warehouse fire in 1967.

"Some are official British and Canadian allied war releases. There is lots of news film from the 1920s," Kula said.

Unfortunately, the nitrate films are volatile and deteriorate rapidly. "We may have to destroy some of the originals, but we'll copy what we can," he said.

Kula said some reprints are being sent to Washington for the Library of Congress — "because they believe some of the film to be the sole surviving copies."

Distributors shipped film up to the Yukon for about 25 years starting in the early 1900s to entertain miners caught up in the gold rush. And because of shipping costs, distributors left the film there.

Eventually it was frozen at the bottom of a swimming pool that had been turned into a hockey rink behind Golden Tooth Gerby's gambling hall in Dawson City.

Workmen clearing a vacant lot for a recreation center uncovered the film last August.

Kula said that in a few weeks more than 500 reels were unearthed.

## Rats Can Sniff Out Explosives

TORONTO (AP) — Rats are far more effective than dogs in sniffing out explosives, says Dr. Sidney Weinstein, a U.S. Army researcher.

Weinstein, in Toronto to attend a seminar recently, said rats were also cheaper to buy and train than dogs "and you can take a rat just about anywhere."

**ANACIN TABLETS**  
Bottle of 100 tablets. Limit 1

**1.29**

**BAN ROLL-ON DEODORANT**  
1-ounce size. Regular. Limit 1

**57¢**

**FABERGE ORGANICS SHAMPOO**  
15-ounce bottle. For normal or oily hair. Reg. 1.99

**1.19**

**BIC DISPOSABLE SHAVERS**  
3-pack disposable shavers. Reg. 59¢. Limit 1 pack

**29¢**

**DePree SPRING VITAMINS Sale DePree**

<b>DePree VITAMIN C</b> The vitamin you need every day.	<b>DePree VITAMIN B-12</b> 100 mcg, 100 tablets. Reg. 3.98
100 250 mg. Vitamin C Reg. 1.98 1.48	<b>DePree VITAMIN A</b> Water miscible. 25,000 units. 100 capsules. Reg. 3.98
250 250 mg. Vitamin C Reg. 3.99 2.99	<b>DePree VITAMIN A</b> 100 tablets. Reg. 3.98
100 500 mg. Vitamin C Reg. 2.99 1.99	<b>DePree WHEATACOL TABLETS</b> 100 vitamin/mineral tonic. Reg. 4.98
250 500 mg. Vitamin C Reg. 5.98 3.99	<b>DePree FRUIT-PAK C</b> Chewable vitamin C in 3 fruit flavors. 100 tablets. 250 mg. 500 mg. Reg. 2.98 4.49 3.59
100 1000 mg. Vitamin C Reg. 5.99 3.99	<b>DePree B COMPLEX WITH C</b> B vitamins with 500 mg. vitamin C in each tablet. 40 TABS 100 TABS Reg. 2.55 Reg. 5.27 3.19 6.59
50 500 mg. Timed Release C Reg. 2.98 2.39	<b>DePree STRESS COMPLEX</b> B-complex, 600 mg. vitamin C, copper & zinc. 40 TABS 80 TABS Reg. 3.98 8.98 6.98
100 500 mg. Timed Release C Reg. 5.49 3.99	<b>DePree TREATS PLUS IRON</b> Chewable fruit-flavored multi-vitamin supplement with iron. 100 tablets. Reg. 3.98
100 500 mg. C with Rose Hips Reg. 4.49 3.39	<b>DePree PRO-PLAN CAPSULES</b> 24 capsules. Reg. 2.95
<b>DePree STRESS COMPLEX</b> B-complex, 600 mg. vitamin C, copper & zinc. 40 TABS 80 TABS Reg. 3.98 8.98 6.98	<b>DePree FAMILY FORMULA MULTI-VITAMINS PLUS IRON</b> A daily supplement for the entire family. 100 TABS 250 TABS Reg. 2.98 5.95 4.77 2.98 5.95 4.77
<b>DePree WHEATAVIMS</b> Balance of 12 vitamins, 7 minerals plus natural Wheat Germ. 60 TABS 150 TABS Reg. 3.83 9.98 7.98 4.79 9.98	<b>DePree THERAGARDS M</b> Therapeutic vitamin-mineral formula. 100 TABS 200 TABS Reg. 3.99 9.79 6.99 5.69 9.79

**QUEEN HELENE HAND & BODY LOTION**  
16-ounce size bottle. Reg. 1.79

**99¢**

**FABERGE ORGANICS HAIR SPRAY**  
10-ounce size. Reg. 1.59

**99¢**

**PLANTERS COCKTAIL PEANUTS OR SPANISH PEANUTS**  
12-ounce size. Reg. 1.29 Your Choice

**89¢**

**30-QT. SIZE ICE CHEST**  
30-qt. with molded handles. No. G7000 Reg. 1.49

**1.19**

**TONI PERM**  
Your choice of regular or gentle. Reg. 2.49

**1.59**

**CURAD PLASTIC BANDAGES**  
3/4" wide plastic bandages. Box of 60. Reg. 1.19 Limit 1

**44¢**

**LADIES' PLUSH SCUFF**  
Soft & comfortable slide-in scuff. Assorted colors. Reg. 3.49

**1.99**

**SPORT TUBE SOCKS**  
6-pair package. Reg. 4.99

**3.88**

**DePree VITAMIN E**  
Choose the strength you need.

100 200 I.U. Vitamin E Reg. 3.57 2.89	<b>DePree VITAMIN E SKIN OIL</b> Readily absorbed. moisturizer. 1-oz. Reg. 4.95
100 400 I.U. Vitamin E Reg. 5.98 3.98	<b>DePree DICALCIUM PHOSPHATE</b> Calcium, phosphorus & vitamin D. 100 tablets. Reg. 2.29
50 1000 I.U. Vitamin E Reg. 6.98 5.23	
200 400 I.U. Vitamin E Reg. 10.98 7.48	
100 200 I.U. Natural E Reg. 5.98 4.48	
100 400 I.U. Natural E Reg. 9.98 6.98	

**CORICIDIN-D TABLETS**  
Bottle of 25 tablets. Limit 1

**99¢**

**PEPTO-BISMOL**  
For Upset Stomach, Indigestion & Nausea. 8-oz. liquid. Limit 1

**1.09**

**DONALD ART DECORATIVE WALL PLAQUES**  
22" x 28" plaques. Animals or assorted scenes. Reg. 9.99

**7.77**

**BEN-GAY OINTMENT**  
1 1/4-oz. Greaseless. Reg. 1.34 Limit 1

**79¢**

**BIC PENS**  
Medium point Bic Pens. Your choice of black, blue and red. Reg. 25¢ ea.

**6/1.00** FOR

**STAR BRITE AUTO POLISH**  
Cleans & polishes. Removes surface rust. No hard rubbing. Reg. 3.49

**2.29**

# Farm Bureau Initiates Property Protection Plan

## VACATION BIBLE SCHOOL

Leaders, Teachers, Workers  
and all who love kids

You are invited to a workshop held at

### Ayden Bible & Bookstore

811 N. Lee Street 746-6128 Ayden

Friday, March 16, 1979  
7:00 P.M.

It is your opportunity to examine  
all - new graded materials  
for any denominational group

Crafts, Music, Visuals, Refreshments

Free VBS Banner for each church represented

The Pitt County Farm Bureau has initiated a property protection service designed to reduce the incidence of rural crime.

Farm Bureau president Atlas Wooten said the local effort is part of a state and national program in which participants are urged to mark all farm equipment and similar items with an individual identification number. The numbering system, which includes 10 characters, tells the state and county of residence and other information that can be used in tracing ownership.

Wooten said the identification number, which can also be used to mark household and personal items, can be obtained by contacting the Pitt County Sheriff's Department.

An identification manual, showing uniform locations for marking various pieces of machinery, as well as confetti for identifying grain, can be obtained from the Pitt Farm Bureau office.

According to Wooten, the coding system enables law enforcement officers anywhere in the United States to prove theft and to trace stolen items back to their rightful owner.

Wooten said, "we feel this program has the potential of reversing the rapid rise in rural crime. We therefore urge all rural peo-

ple in the county to participate."

The program is a cooperative effort involving the Farm Bureau, the Federal Bureau of Investigation, the N.C. Sheriff's Association, the Farm Equipment Dealers association, the N.C. Department of Crime Control and Public Safety, the N.C. Department of Justice, the N.C. Crime Prevention Officers Association, the N.C. Agricultural Extension Service, and the N.C. Department of Agriculture.

### NATIONALIST DIES

SAN JUAN, Puerto Rico (AP) — Andres Figueroa Cordero, a Puerto Rican nationalist who served 23 years in federal prison for his part in shooting up the U.S. House of Representatives in 1950 died today. Pres. Carter ordered his release in 1977 when he was reported gravely ill with cancer.

### LIBYAN SUPPORT

NAIROBI, Kenya (AP) — Libya is flying massive amounts of military equipment into Uganda in preparation for a Ugandan counterattack against Tanzanian invaders that could come in about a week, Western diplomats said today.

## Pitt School Bd....

(Continued from page 1)

physicians, or get medical documentation concerning immunization to show to school officials.

Keeter again pointed out that children who received the vaccination prior to age one would still have to have another shot according to state laws. The board noted that those who had not gotten their shots or received medical documentation of having the shot would be denied entrance to school as of Friday, March 16.

Representatives from the Stokes Advisory Council came before the board with a request to place Stokes Elementary on a priority list for renovation monies in the

upcoming school budget.

According to the advisory council members, Stokes school is in "critical" condition, and should be replaced. The board informed the members that priorities were being drawn up, and that further visits were being made to county schools to ascertain school needs.

According to a report given by Alice Keene, members of the Stokes community have requested to use the old Stokes High School building for Community Schools Program projects. Plans for the school would include using money to renovate the high school lunch room, with possible work to be done on the gym in the future.

The board voted for the Community Schools Program to allot approximately \$1,200 toward use of the old high school lunchroom, and agreed to send a county maintenance person to work on the electrical system.

Board member Beverly Congleton noted that use of the old high school might prevent further destruction of the building.

School Finance Officer Dan Thomas reported to the board on the school system's annual audit, noting that all school records had been found in good order, except for minor problems at Bethel Elementary and G. R. Whitfield. Thomas added that over \$1

million flowed through county schools during fiscal year 1977-78.

Assistant Superintendent Kathryn Lewis reported that the cultural arts program in the county was going well, but noted that cultural arts teachers were being over-extended in their use in different schools. According to Mrs. Lewis, one teacher presently serves 946 students in different schools.

Mrs. Lewis stated that meetings held with high school, middle school and elementary school principals were progressing smoothly, saying that principals enjoyed meeting with feeder school principals.

Mrs. Lewis addressed the problem of student pull-out, whereby students are "pulled out" of regular classrooms to attend remedial classes or cultural arts programs.

"Teachers feel like dispatchers," said Mrs. Lewis of the pull-out problem. She noted that she was not condemning special programs, but just wanted to point out to the board the growing pull-out situation.

Mrs. Lewis asked the board to allow her to work on assembling a middle school task force to work on the diversified programs offered at middle schools. The board gave Mrs. Lewis approval to work on the matter.

The board voted to revise the present county retirement policy so as to allow Pitt County Schools employees to work past the age of 65 if they wish to do so.

In other actions, the board made change in special legislation for allowance of eight board members in compliance with state laws. The board also agreed to seat new board members June 1 after May primaries rather than the first Monday in December as previously designated.

## Sees Small Risk

Dr. Robert Ehinger, Director of the Pitt County Health Department, has reported that a dike at the Coastal Chemical Company cleanup site broke some time between midnight and 8 a. m. Tuesday.

He said about 200,000 gallons of water were released and that he believes there is little danger involved since dilution has occurred because of the large amount of rain that has fallen recently. "The solution to pollution is dilution, they say," he commented, "and if so, we've gone a long way toward the solution recently with the amount of rain we've had. He added, however, that persons having cattle in the Fork Swamp area below the spill area should not allow them back into the swamp area till the weekend.

### ECKERD'S FAMOUS PHOTO OFFER

#### TWICE THE PRINTS

Get an extra set of prints with every roll of color or black and white print film developed and printed...TODAY AND EVERYDAY.

#### TWICE THE FILM

When you pick up your developed film and prints, buy two rolls of Kodacolor or black and white print film for the regular price of one...TODAY AND EVERYDAY.



### TEXAS INSTRUMENTS CALCULATOR

With full memory. Does addition, subtraction, multiplication, division & percentages. With floating decimal. No T11025 Reg. 9.99

7<sup>99</sup>

### POLAROID 108 FILM

Big sharp 3 1/4" x 4 1/4" pictures with brilliant colors that last. Reg. 5.19

4<sup>99</sup>

### CONAIR 1000 WATT HAIR DRYER

Lightweight with 2 temperature settings. No. 078 Reg. 14.99

9<sup>99</sup>

### NORTHERN MIST STYLING WAND

Easy to fill, with 15 mist vents, safety heel rest & swivel cord. No. 2302 Reg. 9.99

7<sup>99</sup>

### VAN WYCK CAN OPENER

Cutting unit removes for cleaning. With lid magnet. No. 104ALM Reg. 8.99

7<sup>99</sup>

### FUJI FILM YOUR CHOICE

126-12 or 110-12 print film. Reg. 1.29

69<sup>c</sup>

### VALIANT TRAVEL IRON

8-ft. cord, thermostat control & folding handle. No. 2319 Reg. 6.99

5<sup>88</sup>

### WORTH UP TO \$200 OFF

ON YOUR NEXT PRESCRIPTION FILLED AT ANY ECKERD DRUG STORE!

Bring this coupon with your next prescription and receive up to \$2.00 OFF! If your prescription is less than \$2.00, we'll fill it FREE! If it is more than \$2.00, we'll deduct \$2.00 from the price and you pay only the difference. Limit 1 prescription per customer.

Coupon Good Thru March 17, 1979

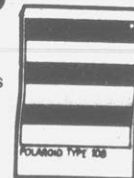

### ALUMINUM FOLDING CHAIR

Aluminum lawn chair with webbing for extra comfort. Square bent seat & back & full size waterfall arms. No. 774 Reg. 7.99

5<sup>88</sup>



### TIDE

49-oz. size with 10c off label. Reg. 1.59

1<sup>35</sup>



### PARSONS AMMONIA

28-oz. Your choice of lemon or sudsy. Reg. 39<sup>c</sup> ea.

3<sup>100</sup> FOR 1<sup>00</sup>



### HERSHEY'S LARGE SIZE CANDY BARS

Milk Chocolate Almond, Mr. Goodbar & Krackle. Reg. 79<sup>c</sup> each

2<sup>100</sup> FOR



### BRACH'S ASSORTED CANDY

Great assortment to choose from. Reg. 2/1.00

2<sup>77c</sup> FOR



### Gardening Specials!

#### Dura-Tred® RADIAL BELT REINFORCED GARDEN HOSE

Reinforced with nylon tire cord. Brass couplings. Reg. 14.99

10<sup>99</sup>



#### 22" SPRING BACK RAKE

Strong with 22 oil-tempered "spring back" tines. Reg. 4.99

3<sup>99</sup>



#### McGraw-Edison PASS THRU PRUNER

An exceptional value pass-thru pruner. Chrome plated cutlery steel. Model #503611.

1<sup>99</sup>



#### Village Blacksmith 21" LOPPING SHEAR

Plated metal handles with foam grips. No. G520111

3<sup>33</sup>

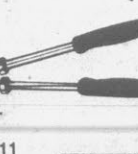

ECKERD'S...your complete headquarters for all gardening needs. Shop our broad selection of vegetable and flower seeds!

### 12-INCH x 16-INCH HIBACHI GRILL

Heavy duty cast iron with chrome plated grills. Adjustable grill height. Reg. 16.99

9<sup>99</sup>



### 18-INCH ROUND BRAZIER GRILL

Assembles with no tools. Plated 3 level grid and ribbed bowl for strength. Reg. 5.99 Model #118.

3<sup>99</sup>



### ALADDIN Pump-A-Drink

Press the pump-top for a smooth stream of beverage. Quart size. Reg. 10.99

7<sup>77</sup>



### LLOYD'S AM/FM RADIO

AC or battery operation. Telescoping antenna. No. N710 Reg. 19.99

15<sup>99</sup>



### GRAN PRIX AM/FM 8-TRACK MUSIC CENTER

Tape player, AM/FM radio & speakers. No. 4750 Reg. 84.99

64<sup>99</sup>



### KEYSTONE POCKET CAMERA

Extended range capability & built-in electronic flash. No. XR106 Reg. 29.99

22<sup>99</sup>



### WOOLITE COLD WATER WASH

32-oz. liquid for all fine washables. Reg. 2.79

1<sup>99</sup>



### KORDITE TRASH BAGS

6-bushel capacity. Box of 10. Reg. 1.79

99<sup>c</sup>



### 11" PLASTIC WICKER WASTEBASKET

White with assorted colored liners. Easy to clean. Reg. 2.79

1<sup>99</sup>



### WOODEN CLOTHES DRYING RACK

12-ft. of drying space. Reg. 5.99

3<sup>99</sup>



### 5-SHELF ETAGERE

59 1/2" high x 31 1/2" wide. Simulated hickory. Reg. 39.99

29<sup>99</sup>



### BASKETWEAVE PLANTER

Smartly styled for indoor or outdoor use. Compliments any decor. Reg. 2.99

1<sup>77</sup>



### FLAIR TIP BROOM

Libman polypropylene broom. Reg. 2.99

1<sup>99</sup>



Pitt Plaza Shopping Center  
Rivergate Shopping Center

America's Family Drug Stores

**ECKERD DRUGS**

## Amendment Action Due

RALEIGH, N.C. (AP) — Final Senate action is likely today on a proposed constitutional amendment, tentatively approved Tuesday, that would allow state legislators to face election every four years instead of every two years.

The Senate vote was 31-15 Tuesday, one vote more than the three-fifths majority required to approve amendments to the state constitution.

The proposed amendment would make future state representatives and senators serve four-year terms, rather than two-year terms. "The cost of running a campaign is increasing tremendously," said one of the bill's sponsors, Sen. Herson Barnes, D-Wayne. He said that campaigning every four years instead of every two was one way to cut those costs.

The bill received wide support when it was introduced by a freshman, Sen. Robert Davis, D-Rowan. Initially, 40 of 50 Senate members signed the measure indicating their support, but several said they had a change of heart by the time it came up for a vote.

## Secrets...

(Continued from page 1)

They were fingered by Werner Schiller, an East German security officer who defected in January from the East with a store of secret files. Authorities said another dozen operatives unmasked by the defector managed to elude police and cross into East Germany.

Schiller's information triggered a spy hunt in West Germany, Austria and France, but authorities say the hunt is concentrated in West Germany, where 3,000 Soviet Bloc spies are believed to be operating.

West Germany has arrested more than 100 Communist operatives since 1974, including a close adviser to Willy Brandt while he was chancellor. Defense Minister Georg Leber resigned under pressure last year after a spy ring was found in his department.

# Chicago Landmark Doomed

By ARTHUR H. ROTSTEIN  
Associated Press Writer  
CHICAGO (AP) — The Loop, perhaps Chicago's best known landmark, may be doomed.

For 82 years, trains have whooshed and roared around the elevated tracks that mark the borders of downtown. They lurch around 90-degree turns, third rail flashing, cement canyons magnifying shrill screech of metal on metal, assailing eardrums, smothering conversation.

The Loop has been as symbolic of Chicago's identity as Lake Michigan. It's a survivor, a utilitarian device uniquely delineating the city's business and financial hub and carrying the public there in unequalled numbers.

It's been loved and hated, its demise predicted since its inception. The latest threat: City Hall wants to tear down the two square miles — 11,000 tons — of 25-foot-high riveted plate steel. Merchants long have howled it's an eyesore, a nuisance, a blight, a deterrent to business.

The Chicago Urban Transportation District says the Loop is doomed. It will take about \$400 million to build a partial replacement, a subway businessmen insist will spur more than \$1 billion in new development west and northwest of the Loop.

And so the brouhaha: "The Elevated and the Loop are as much a part of Chicago as the cable car is to San Francisco," says architect Doug Schroeder.

"If anybody is interested in preservation of the elevated structure for historical purposes, we have some sections of it on 63rd Street I'm sure we could keep," says Mayor Michael Bilandic. "But downtown, clearly the best thing we could do is to take it down."

Since the Union Loop Elevated was completed by Charles Tyson Yerkes in 1897, an estimated 2.7 billion passengers have ridden the "iron collar" around a 7-by 10-block downtown area.

Yerkes devised the Loop, bringing rail lines from north, south, west into common circling trackage above the congestion. For real estate and businessmen, it meant more shoppers and land development.

But it brought dire warnings: of rush-hour trains stacking up at its ridiculous 90-degree curves, of packed behemoths plunging into streets teeming with pedestrians, cars, trolleys and trucks.

And it quickly brought complaints about light blotted out and noise that made thinking impossible. But Yerkes scoffed at replacing the elevated with subways.

Now merchants were complaining about the Loop. It stifled already-jammed streets, magnifying the tumult, and provided a haven for deadened pigeons.

In 1916, the Chicago Traction and Subway Commission was ordered to extend the transit system by elevated lines, noting, "A subway costs about four times as much per mile as an elevated railroad and will furnish no more passenger carrying capacity, speed or other advantages."

Business interests, and mayors — Ed Kelly, Richard J. Daley, Bilandic — said most of the Loop could or would be removed. But the general manager of the Rapid Transit Lines, predecessor of the Chicago Transit Authority, said in 1940: "The Loop occupies only 8½ percent of the street area in the downtown business center and is the greatest asset the other 91½ percent has. It is the greatest passenger pickup system in the world."

The present plan stems from a 1968 study that includes a \$750 million program for an underground replacement and an east-west line past major railroad terminals. The CUTD was set up in 1970 to carry it out. But there wasn't enough federal money, so the agency trimmed its plans to inter-

secting north-south and east-west axes.

At \$50 million to \$100 million a mile, there's enough money now only for one line.

Meanwhile, Harry Weese, an architect, nominated the Loop for the National Register of Historic Places. He contends it "ranks with the original Ferris Wheel and the Eiffel Tower in its rivets tracery, canopied stairs, railings, girders and laced columns." The Illinois Historic Sites Advisory Council rejected it, but the national Advisory Council on Historic Pre-

servation is studying alternatives to demolition.

Meanwhile, the Urban Mass Transit Administration is studying whether the service will be worth the estimated \$490 million. Subway projects in San Francisco and Washington have led to huge cost overruns and some transit experts now see subways as too costly.

The CUTD's environmental impact statement said a proposed subway on the downtown area's western edge, "would not be a significant catalyst to major new development" and

would bring "an increased reliance on motor vehicle transportation" with noise, pollution, accident and energy problems.

Defenders say the Loop has few marks against it. Although a crash in February 1977 killed 11 people and injured 189, the National Transportation Safety Board determined the cause was human error, not the structure. During January's blizzard, which disrupted most transportation, the Loop elevated functioned 24 hours a day.

Defenders say it could be up-

graded to lessen noise and restored for much less than constructing a subway. With hundreds of millions of dollars then remaining, additional service could be provided elsewhere.

They also point out that subway construction and dismantling the el could create havoc, noise and air pollution for 10 years.

"By God, you trifle with your urban images at your peril. We're not Des Moines or Kansas City; we're Chicago, and it's because of the lake and the Loop," Schroeder says.

**CLIFF'S**  
**Seafood House and Oyster Bar**  
Washington Highway (N.C. 33 Ext.) Greenville, North Carolina  
Phone 752-3172

**Thursday Special**  
**(CLIFF'S SHRIMP NIGHT)**  
Regular Fried Shrimp ..... REG. \$3.95 **\$3.10**

## KINGS

FAMOUS BRANDS for Less

sale starts wed, mar 7 ends sat, mar 10

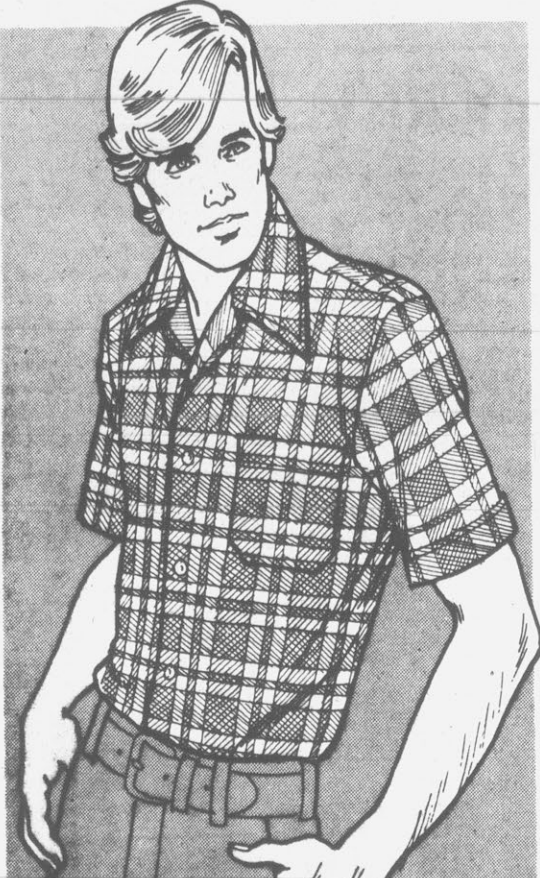

**famous maker mens sport shirts**  
**6.90**

Assorted solids and contrast stitch styles in easy-care cotton/poly blends. Sizes M-L-XL.



**infants & toddlers slack sets**

**3.99**

Shown are just some of our boys and girls styles featuring novelty short sleeve tops and pull-on pants in 100% polyester and poly/cotton blends.

sizes 9 to 24 months; 2 to 4T (some irregs in group)

## packaged sheet sets

(slight irregularities)

twin size **7.44** full size **9.44**

set includes:

flat and fitted sheets plus pillow case.

Mix and match solids and prints of no-iron 50% polyester/50% cotton in a wide array of colors.

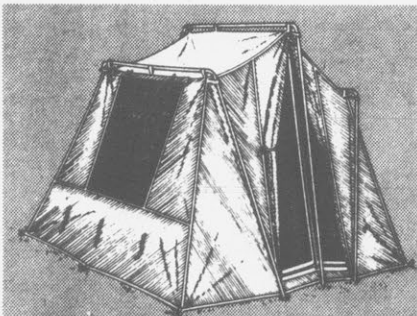

**famous camel nylon cabin tent**

our reg 79.99 **59.99**

8' x 10' size with side windows, screen door and storm flaps. Rip stop polyethylene floor, sturdy frame.

(All fabric is fire retarded to meet CPAI-84 specifications)

**8' x 12' Nylon Cabin Tent 69.99**

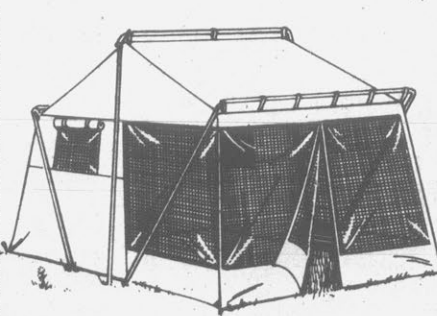

**sleeps six! poly duplex tent**

our reg 99.99 **79.99**

9' x 15' combination cabin tent and screenhouse! Roof and floor are mildew and rot resistant.

(All fabric is flame retarded to meet CPAI-84 specifications)

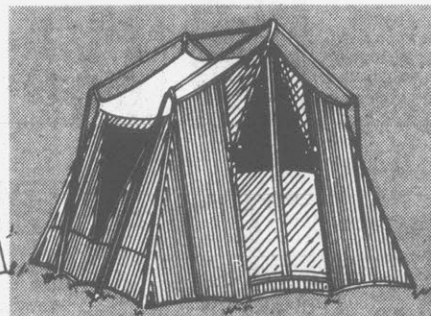

**camper's delight canvas cabin tent**

our reg 99.99 **79.99**

8' x 10' size with triangular windows providing cross ventilation. Inside zippered storm flaps, yoke style frame. 44" wide Dutch door.

(All fabric is flame retarded to meet CPAI-84 specifications)

**8' x 12' Canvas Cabin Tent 89.99**



**rival 3 1/2 qt crock pot**

Simmer delicious meals the easy "slow cooking" way. Includes cookbook. **9.99**

**rival 5-quart removable crock pot.....19.99**

**GRAND OPENING OF OUR GARDEN SHOP!**

**sturdy lightweight wheelbarrow**

The perfect homeowner's wheelbarrow for all those spring clean-up jobs.

3 cu ft size

**15.99**

**durable nylon hose** **steel hose hanger**

**4.22**

Nylon reinforced 50' hose, 1/2" inside diameter. All brass fittings.

**88¢**

Sturdy steel with green enamel finish. Keeps hoses neat, ready for use.



**garden hand tools**

your choice **68¢ ea**

- trowel • weeder
- transplanter
- cultivator

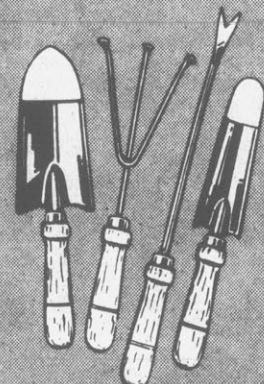

**lopping shears**

**4.99**

Rugged construction with rubber grips on handles for handling ease.

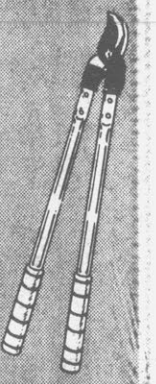

**dutch onion sets**

**54¢**

100 sets per bag. Just ready for planting!

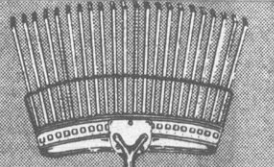

**metal rake**

**2.99**

Heavy metal broom rake for yard and garden work.

**long handled garden tools**

**1.88**

Heavy gauge English steel blades, genuine hardwood handles.

## See Microwave Hazard Growing

WASHINGTON (UPI) — Hazards from microwave radiation are increasing, says the General Accounting Office, which wants a performance standard set and enforced promptly for microwave medical diathermy machines to protect patients, operators and the public. In a recent report, the congressional investigative agency cited Food and Drug Administration estimates that 15,000 such machines are used in the United States anywhere from once a week to 12 times daily.

# Grizzlies Cause Controversy At Yellowstone Park

By JAMES R. SCHIFFMAN  
CHEYENNE, Wyo. (UPI)—Thousands of years before European man inched across the American West, there was the grizzly.

Scientists say the species at one time numbered in the hundreds of thousands and was found from California to South Dakota, from Arizona to Montana. Grizzlies perhaps came across the Bering Strait, possibly up to 30,000 years ago.

Gradually the bears were

pushed from their habitats by hunters and trappers and by a westward movement of people that crowded them into progressively more desolate country.

The grizzly found refuge in remote areas, including the region of forests, mountains and geysers where Yellowstone National Park, the nation's oldest, was created. Today the surviving bears roam in an 8,000-square-mile area that extends beyond the confines of

the park into the neighboring wilderness of Wyoming, Montana and Idaho.

Frank and John Craighead from the 1950s until the early 1970s gained fame as private researchers of Yellowstone grizzlies. Since leaving the park in an angry dispute over bear management policy, the Craigheads have been at loggerheads with the National Park Service.

The researchers loudly declared that Federal officials were too hasty during

the early 1970s in removing garbage dumps that for years had been feeding grounds for grizzlies. The practice, the Craigheads said, resulted in unnecessary killing of bears that did not quickly adjust and harassed park visitors. Part of the controversy that continues today concerned the actual number of grizzlies in the Yellowstone area.

"Our studies reveal probably not over 135 grizzlies in 1974 in the Yellowstone eco-system,"

Frank Craighead said from his home in Moose, Wyo., near the park. "There is no evidence that that population has increased."

"If not properly managed and their numbers continue to decline and the reproductive rate continues to decline, we may reach a point beyond which they cannot recover."

However, Richard R. Knight, the leader of a federally commissioned group called the Interagency

Grizzly Study Team, disputed — albeit with a qualification — Craighead's contention.

"There's no good solid scientific evidence," Knight said from his headquarters in Bozeman, Mont. "I think there are 300 to 350 grizzlies. The population is probably either stable or increasing a little bit, depending on how widespread the killing of bears is."

"Maybe the mortality that we don't know about (from poaching or killing by

sheepmen) may be fairly significant."

Craighead questioned results from "in-house" researchers, saying federal agencies tailor their findings to desires of superiors. But Yellowstone Park Superintendent John Townsley rejected the accusation and said the interagency team is independent.

"I have no desire, nor is there any record of anything going on in my park, to suggest what kinds of an-

swers we are looking for," Townsley said.

"The continuing disagreement among bear biologists is one that I don't view as being terribly helpful to the grizzly bear himself."

The Craigheads and the Knight group tracked grizzlies by trapping bears, placing radio-controlled collars on them, and returning them to the wilds. In addition, the interagency team has used aircraft to spot grizzlies.

Craighead advocates placing animal carcasses at strategic, remote locations throughout the park to attract grizzlies and keep them away from people. Townsley said he has seen no evidence suggesting that would help the situation.

"When you get into this business of proposing to feed bears, I would judge that during the time of year you have campers in Yellowstone, probably natural food is fairly abundant," the superintendent said.

The main effort, Townsley said, has been and should be to keep food carried by people away from bears. In recent years, a few "problem" grizzlies that consistently sought food at campsites have been shot to death.

Townsley said another problem is a dump at Cook City, Mont., outside the park, where bears feed on garbage left by people. "We're working toward the elimination of that dump," the superintendent said.

Dumps for bear feeding were common in Yellowstone until they were eliminated. In the 1920s and 1930s, stands were built for people to sit and watch the bears. Armed rangers stood by to protect against possible advances by aggressive bears.

"It was a real circus back then," said Bart Koehler, executive director of the Wyoming Outdoor Council, an environmental group. "It's amazing what they did in the parks in the early days."

Through all the years of study, the grizzly has remained an elusive animal. However, Knight said, a picture of an independent animal that follows the path of least resistance has emerged:

—Grizzlies may return to places they find food, but otherwise, there appears to be no pattern to their meanders. "They seem to be very independent. They pick up and go for no apparent reason," Knight said.

—Grizzlies generally are wary of people, a trait that may be passed from one generation to another via a learning process. However, they are dangerous. Contacts with humans are not making them domesticated.

—The hibernation period begins anywhere between late October and early December and runs until February, March or April, depending on the bear. Except for females with cubs, grizzlies hibernate alone and do not seem to have a particular preference for den locations.

—Cubs are born in the hibernation den, but, Knight said: "We've never witnessed a birth. All births anybody has any record on have taken place in zoos." Two is the most common number in a litter, but occasionally four will be born at one time.

—Grizzlies often rest during the heat of the day and set out at night. Except for females and cubs, they usually travel alone. "Very seldom will you find two adults traveling together. Occasionally it's seen, but we don't know what the connection is," Knight said.

—Bears like to follow trails as much as possible, which accounts for some of the encounters with people.

—Bears tend to eat whatever is easiest to find, whether it be meat, fish during spawning season, grasses or roots.

—Grizzlies in the wild will live about 20 years, some 10 years less than their counterparts in zoos.

Conventional wisdom has it that the best course of action when encountering a grizzly along the trail is to lie down and play dead. Climbing a tree is another possibility.

"Some of the grizzlies can climb trees," Knight said. "If he can climb a tree, too, you're just out of luck."

Knight gave the following advice:

"Stay calm and don't panic. Look the situation over. See if the bear's really going to do a thing first. You might be able to stare him down."



## healthy rose bushes & climbers

**select grade roses**  
Individually color wrapped with rose name and description.

**fancy grade roses**  
Our finest! Pink, white, red, yellow and variegated. Just waiting for spring!

**select grade 199**     **fancy grade 249**

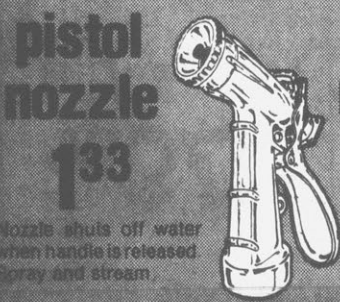

**pistol nozzle 133**

Nozzle shuts off water when handle is released. Spray and stream.



**flexible nylon hose 599**

Full 1/2" inside diameter, 50' long. All brass fittings.



**3-lb bag grass seed \$1**

Fast growing, rugged mixture. Good for patching or play areas.



**anvil pruner 266**

Chrome plated 8" size. Perfect for trimming shrubs, flowers.



**18-inch spreader 1199**

Sturdy steel construction with baked enamel finish. 40 lb capacity.



**plastic fence 58¢**

33" size with wood grain finish, self locking ends.



**long handled garden tools 299 ea**

Choice of straight rake, 4-prong cultivator, culti hoe or garden hoe.



**less than 1/2 price!**

**carefree skimmer flats**

teens and ladies     sold elsewhere for 3.67     **147**

Black or brown man-made uppers, long wearing molded sole, heel. Sizes 5 1/2 to 10.

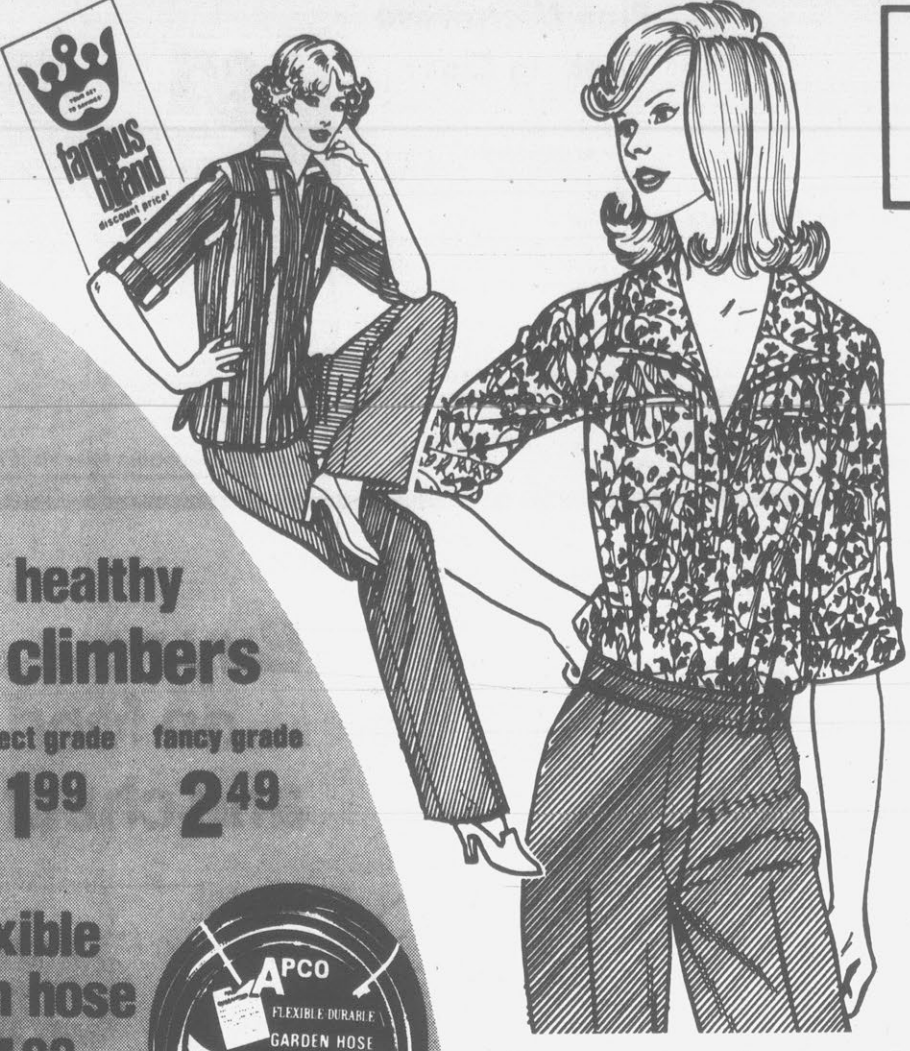

# KINGS

FAMOUS BRANDS for Less

GREENVILLE BLVD.  
264 BY-PASS  
OPPOSITE PITT PLAZA  
OPEN DAILY 10-9

## famous brand coordinates

**\$7 ea**

Short and long sleeve tops in stripes, plaids, florals to wear with solid color, fashion detailed slacks. All 100% polyester.

sizes 8 to 18

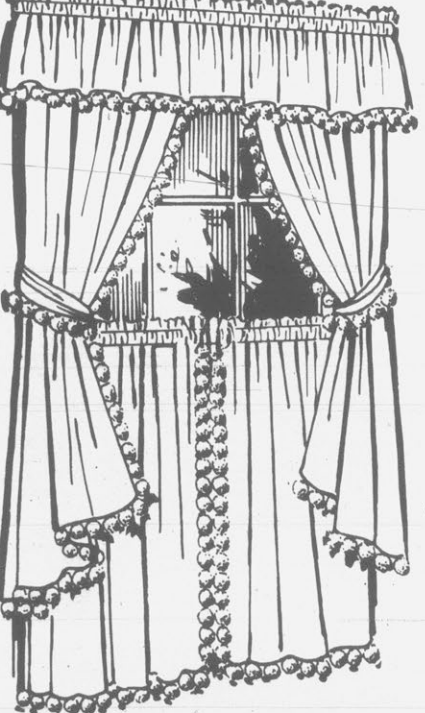

## misses 3-piece pant suits

all three pieces

**1397**

Lovely v-neck velour blouse in 50% Arnel®/50% acetate with removable 100% polyester dickey to wear over 100% polyester pull-on pants. Dickey and pants in eggshell; coordinating blouse in blue, rose or coral.

sizes 10 to 18



## ball fringe cape cod curtains

fortrel® for curtains

24" long our reg 3.97     **216**

● 30" long, our reg 4.18 ..... 2.66     ● 45" long, our reg 5.97 ..... 4.26

● 36" long, our reg 4.28 ..... 3.26     ● 63" long, our reg 6.97 ..... 5.26

● valance, our reg 2.48 ..... 1.76

Permanent press, machine washable Fortrel® polyester/Avril® rayon in white or beige.

Fortrel® Reg™ Fiber Ind Inc. Subsid Celanese Corp  
Avril® Reg™ American Viscose

**anacin tablets**  
bottle of 300     **299**

**sweetheart soap**  
5 oz bars     **5 for \$1**

**new freedom mini pads**  
pkg of 48     **159**

**eveready heavy duty batteries**  
your choice C or D cell     **2 2-pk \$1**



**burry cookies**  
9 oz pkgs ● mr. chips ● fudgetown ● gaucho     **2 for \$1**

**dial spray anti-perspirant**  
1 oz trial size     **4 for \$1**

**new freedom maxi pads**  
pkg of 48     **199**

## Farmville Board... City Counts

(Continued from page 1)  
that they intend to hold a public hearing concerning the construction of a drainage ditch for the block bordered by Williams, Thorne, Cameron and Bennett streets.

An ordinance was adopted governing conduct in the public parks of the town.

Considerable discussion was given to the need for safety measures at the intersection of Fields and Wilson streets. The Commissioners modified the Police Chief's recommendation for sight distance revision and decided to designate 30 feet from the intersection in each direction as a no parking area, with the exception of the area in front of Stencil's Garage, where no parking would extend to the driveway.

The administrator was directed to find out the Southern Railway's feelings concerning making the railroad right of way that has been used as a street on the north side of the railroad between S. Main and S. George streets into a more usable town-maintained street.

The Commissioners agreed to let it be known that the town plans to go ahead with water system improvements that would make use of State Clean Water funds currently allocated to the town in the amount of \$243,000. There was some discussion as to whether more wells or more water lines should be constructed with this matching money.

Preparation is being made for Farmville's participation in the May 23 Highway Improvements hearing. The Commissioners indicated they feel the four-laning of 264 is still No. 1 priority, but cited other needs, including the need for parallel service roads on existing 264 and possibly for the extension of Mandarin Drive to 264 to provide another outlet in that area of town. The Mandarin Drive extension idea was

turned over to the Planning Board for study.

David Shackelford and Albert Ellis were appointed by Mayor Sara Albritton to the Recreation Committee, replacing Clover Phillips and S. T. Collins, who have resigned.

The budget was amended to accommodate the town's \$2,700 solid waste planning grant.

Thomas was given the go-ahead to begin developing a proposal to seek funds for a 701 Planning and Management Assistance Grant. The deadline is Mar. 12. A 50 percent local match is required.

A newly drafted town charter was gone over and plans were made to submit it to the General Assembly by the Mar. 9 deadline for local bills. The new charter has only minor changes, but has a number of deletions of outdated processes such as election procedure, which is no longer handled by the town, and mayor's court, which is no longer in existence.

## Looking For A Creative Excuse

WARREN, Mich. (AP) — The Michigan policeman who comes up with the most outlandish excuse by a motorist caught speeding probably won't have to worry about making up an excuse if he's caught speeding.

Michigan's Fraternal Order of Police is holding a statewide contest during March to see who has heard the most "creative" excuse for speeding.

First prize, to be announced in June, is a device used to locate radar detection units before they detect speeders.

The contest is being held to put a little humor in an unpopular job, says Tony Malta of the Dale Corp., which publishes the FOA's semi-monthly magazine, "The Peace Officer," in which the contest was announced.

Creativity aside, says Malta, a speeder probably will get a ticket anyway.

## 2 Accidents

An estimated \$3,200 property damage resulted from two collisions investigated by Greenville Police yesterday.

Heaviest damage resulted from an 11:50 a.m. mishap at the intersection of Greene and Martin Streets involving a truck driven by Norman Earl Revel of Route 4, Greenville, and Benita Delcasse Ruffin of Route 4, Goldsboro.

Damage was estimated by officers at \$800 to the Revel truck and \$2,000 to the Ruffin car.

An estimated \$200 damage resulted to each of two cars involved in a 9:07 a.m. collision at the intersection of Fifth and Elm Streets.

Police identified the drivers of the vehicles as Danny Ray Short of 4008 Roundtree Dr., and M. Cooper Beland of 212 Shady Knoll Trailer Pk.

## Took His 'Coon

SILER CITY, N. C. (AP) — The Chatham County sheriff's office was looking for a raccoon — and two cans of shortening — and deputies were hoping to find all three in time for a birthday party today.

Colon Austin told deputies the raccoon had been skinned and dressed and was destined to be the main course for his 53rd birthday party. He said he and his wife returned home Sunday afternoon to find the house had been entered through a window.

The 22-pound raccoon was missing from the refrigerator where it had been soaking in preparation for cooking, and also missing was the shortening.

Mrs. Austin said a squirrel or rabbit might be substituted for the main dish, along with something additional to feed 26 grandchildren expected for the meal.

Austin, meanwhile, was still upset over the loss of his favorite meal. "Somebody done me a dirty deal," he said.

## Utilities Bonds Vote Supported By C-of-C

The promotion of proper and orderly growth is one of the major reasons the Greenville Area Chamber of Commerce is supporting the Greenville Utilities bond referendums, according to Jerry Powell, GACOC Chairman of the Board.

The Board of Directors of the Greenville Area Chamber of Commerce voted Feb. 15 to support the three utility bond referendums totaling \$24 million.

According to Powell, the Greenville Utilities Commission Committee of the Chamber studied information concerning the water, sewer and electric referendums and then recommended that the board support the referendums.

Advantages listed by the committee include the following:

passage of the three bond referendums will provide for orderly expansion of the utilities capacity for the Greenville area; passage of the referendums will insure a growth policy rather than a no-growth policy, increasing Greenville's ability to attract new industries; the general obligation bonds will be cheaper than revenue bonds which could be released to continue growth even if the referendums fail; passage will allow ex-

pansion for the future at a lower cost today; and passage of the bonds would not cause an elec-

tric rate increase.

The committee cited that the bond referendums will be affected by prevailing high interest rates, with water and sewer rates increased by bond passage as disadvantages to the issue.

According to the Chamber's Greenville Utilities Commission Committee Chairman, Charles Schwidde, the committee decided

that the real need for expansion is a present problem in the areas of water and sewer services.

The committee's report was also submitted to Charles Horne, Director of Greenville Utilities.

The Greenville Area Chamber of Commerce will assist the Utilities Commission in promoting the passage of the three bond referendums during the next few weeks.

## Church Service Planned Tonight

Services will be held at Brown's Chapel Holiness Church tonight at eight o'clock.

The guest speaker will be Elder Freddie Farmer, who will be accompanied by the youth choir of the church.

The public is invited to attend.

## Plan Microwave Cooking Class

SNOW HILL — The Greene County Unit of Lenoir Community College will sponsor a 30-hour class in Microwave Cooking beginning Tuesday, March 13 at the college unit in Snow Hill.

Mrs. Frankie Hardy will teach the class which will cover various topics, including safety techniques.

The non-credit class is open to anyone 18 or older. A tuition fee of \$5 will be charged except for those 65 or older, who can enroll free of charge.

For more information, call 747-2451.

**Supersonic Sale**

**WHILE SUPPLY LASTS**

**287** Reg. 6.99

**487** Reg. 7.99

Boys & Girls 8½-12  
Girls 12½-4  
Childs 5-8

**THE SHOESHOW**

SHOE SHOW IS GOING TO BE YOUR FAVORITE SHOE STORE

Greenville Square Shopping Center  
Open 10:30 A.M. - 9 P.M.  
Mon.-Sat.

from your neighborhood ASSOCIATED DRUGGISTS

**Savings on the March**

March 7-13, 1979

<b>GAVICON ANTACID TABLETS</b> 100's Mfg. List \$6.11 For Heartburn and Indigestion <b>\$3.39</b>	<b>CREDIT CARD CALCULATOR</b> 8 Digit Readout 4 Math Functions Automatic Shut-off Two Batteries - 1,000 Hours Complete with Credit Card Case <b>\$16.88</b> Mfg. List \$24.88	<b>ROBITUSSIN</b> Cough Formula 4 oz. Mfg. List \$1.43 <b>\$0.79</b>
<b>PHILLIPS MILK OF MAGNESIA</b> Regular or Flavored Mfg. List \$1.54 <b>\$1.07</b>	<b>LAWN &amp; TRASH BAGS</b> 100 Rolls - 17 1/2" x 20" 30 Gallon Capacity 15' x 15' Mfg. List \$1.49 <b>\$0.97</b>	<b>ROBITUSSIN DM</b> 6-8 Hour Cough Suppressant 4 oz. Mfg. List \$2.49 <b>\$1.23</b>
<b>LISTERINE</b> Mouthwash 16 oz. Mfg. List \$2.99 <b>\$1.47</b>	<b>VEGETABLE AND FLOWER SEEDS</b> Choice of Large Selection Mfg. List \$35.50 Packets White Quarters Lot Only <b>\$0.09</b> each	<b>TYLENOL TABLETS</b> Regular 100's Mfg. List \$2.99 <b>\$1.77</b>
<b>STAYFREE MAXI PADS</b> Regular 30's Mfg. List \$1.39 <b>\$2.39</b>	<b>KITCHEN TOWELS &amp; CLOTHS</b> Assorted Dish Towels, Dish Cloths, Wash Cloths, Dobby Cloths and Ply Headers Mfg. List \$4.99 each <b>3/\$1.00</b> Mix or Match	<b>TAMPAX TAMPONS</b> Regular or Super 40's Mfg. List \$2.49 <b>\$1.79</b>
<b>COUPON</b> <b>ORAL B TOOTHBRUSH</b> Adult #35, #40 or #60 18 oz. Mfg. List \$1.35 <b>\$0.63</b>	<b>COUPON</b> <b>GLEEM TOOTH PASTE</b> Family Size 7 oz. Mfg. List \$1.08 <b>\$0.97</b>	<b>COUPON</b> <b>SURE ANTI-PERSPIRANT</b> Regular or Unscented 3-1/2 oz. Mfg. List \$2.15 <b>\$1.19</b>

THESE ARE SUGGESTED A.D. PRICES OPTIONAL WITH PARTICIPATING STORES

**Biggs Drug Store**  
300 Evans On-The-Mall  
Opposite Courthouse  
Greenville, N.C.

**Hargett's Drug Store**  
2500 S. Charles St.  
Greenville, N.C.

**Buy now...save now ...on food bills and chest freezer!**

**Whirlpool**

17.2 cubic foot no-frost refrigerator-freezer.

**\$399<sup>97</sup>**

- twin vegetable crispers
- full door storage
- adjustable shelves
- egg tray
- covered butter bin
- all-purpose utility bin #53677

**Hotpoint**

30 inch electric range with continuous clean oven.

**\$269<sup>87</sup>**

- lift-up Calrod® units
- removable trim rings
- oven interior light
- glass oven door
- automatic oven timer
- surface unit "on" light #52806

8.2 cu. ft. freezer, #50814 ..... **\$199.91**

**LOWE'S**

2728 S. Memorial Dr.  
Greenville, N.C.  
Store Hours:  
Open 7:30-5 Mon.-Fri.; Sat. 8-4  
755-6500

**GE**

25 inch diagonal color console television with 100% solid state chassis & automatic fine tuning. #54540  
**\$479<sup>96</sup>**

**RCA**

19 inch diagonal color portable TV with XL-100 chassis. #54610  
**\$349<sup>84</sup>**

**LLOYD'S**

Stereo system complete with record changer, AM/FM stereo receiver w/8-trk recorder, 3-way speakers. #54225,6,7  
**\$299<sup>86</sup>**

**ROUNDER/IGN**

45 inch console stereo with AM/FM receiver and 8-trk. recorder. #54341  
**\$239<sup>76</sup>**

**17" diagonal portable color TV with 100% solid state chassis. #54517**  
**\$289<sup>98</sup>**

**12 inch diagonal black & white portable television. #54460**  
**\$79<sup>98</sup>**

**#5 Just Say Charge It!**

**Convenient Location Store Front Parking**

# Foreign Language Interest Still Weak

By DEAN REYNOLDS  
WASHINGTON (UPI) — It is coming increasingly clear that the average American doesn't know his unilaut from his tide and apparently doesn't care to.

Nine out of 10 Americans cannot speak, read or effectively understand any language but English and the President's Commission on Foreign Language and International Studies, at work since October, is trying to come up with ways to change that.

About 90 percent of all colleges today have no language requirement for admission. A quarter of all high schools do not teach a foreign language of any kind.

Oddly enough, it is the Helsinki Accords of 1975 that may trigger a renaissance of foreign language study in the United States. While much of the interest in the East-West pact boiled down to a peace-through-strength declaration, a bit of culture seeped through the agreement.

Rep. Paul Simon, D-Ill., points out a little known part of the accords that commits the nations who signed it to encourage the study of foreign languages and cultures. Simon is a member of the commission and also of a congressional panel that monitors observance of the Helsinki agreements.

"We are living in a new world economically just as we have moved into a new world militarily," Simon said in an interview.

All of a sudden we find this balance of trade deficit. We have to get out and sell. We have to communicate with others and part of this is the language thing. We're the only industrial nation in the world that does not require foreign language exposure by all students."

Simon thinks one way to influence colleges to expand their foreign studies curriculum is through federal grants.

If the commission came up with a program where we said, 'For every student you have enrolled in foreign language for at least three hours a semester, we'll pay you X number of dollars,' all of a sudden you're going to find a lot of places interested."

Here's a look at what the commission is up against.

Between 1968 and 1974 there was a drop of 15 percent in high school language studies. In 1975, only 24 percent of American high school students were studying a foreign language. In 1976, only four percent of the graduating students had two years of foreign language studies.

But there are incentives to change the situation.

For one thing, the commission has found that 100,000 jobs were probably lost to foreign

nationals because Americans cannot speak foreign languages. The Ford Foundation stated in a recent report, "The principal obstacle to the development of first class competence in the foreign and international field is the low level of language teaching in the United States."

But there has always been a kind of, "Let them learn English," attitude. Simon says this parochialism shocks scholars and businessmen of other nations "because they see us turning our backs on what could be a sure way of improving our image and position in the world."

"We are culturally isolated," Simon said. "There's just no question about it. And we suffer for it."

Some of the problems arising from the language barrier are humorous.

Simon said, "General Motors put out the Nova (car model) and they got into Latin America and it didn't sell at all until someone figured that 'no va' in Spanish means 'doesn't go.'"

Then there is the story of the Parker Pen Co. Simon said the company was running an advertisement throughout Latin America that had been mistranslated somehow, and "indicated that the pen had contraceptive benefits."

But there are just as many stories that are not funny.

"When the Vietnam War broke out," Simon said, "we did not have a single American-born specialist on Vietnam or Cambodia or Laos in any American university or the State Department — anyone who spoke the language or understood the environment."

"If we'd have had 10 academicians or people who understood Vietnam, maybe we would have saved 50,000 American lives and hundreds of billions of dollars."

"It's amazing. There are 300 million people on the face of the earth that speak Hindi, (yet) we have fewer than 300 students of Hindi in the United States."

Simon said he believes the commission is really calling for a "minor cultural revolution" in America.

## ECHSA Meet Slated Mar. 14

The monthly meeting of the Eastern Carolina Health Systems Agency will be held Wednesday, Mar. 14, at 7:30 p. m. in the Ramada Inn, Greenville.

Agenda items include, but will not be limited to, the following: action on by-laws revisions; project review reports on a six-bed addition to the existing facility at Edgecombe-Nash Mental Health Center; Medical Park Nursing Center; Children's Resources Services of Edgecombe-Nash Mental Health Center; Essential Services of the N. C. Department of Human Resources Migrant Health Program (continuation), and a continuation staffing grant for Wilson-Greene Mental Health Center.

The public is invited to this meeting.

"And it's important that we do it," he said. "It's important for our cultural enrichment, it's important for our economy, it's important for our security."

Simon and his fellow commission members are not kidding themselves. An attempt to win support by pushing the purely intellectual merits of bilingualism will fail, they believe.

So a different approach must be taken. That approach, like so much else today, targets the pocketbook. "This is a pocketbook issue," Simon said.

"The man on the street may not react immediately by

saying we've got to have foreign languages, but he or she is concerned about inflation. And about 1.5 percent of inflation last year was caused by the balance of trade deficit."

"I think the pocketbook issue has to sell it. The economic issue is the one that has the appeal."

For instance, said Simon, "One out of every three farm acres goes for farm exports." If a Brazilian is going to import farm products and the choice is between a Russian who can speak Portuguese or an American who can speak only

English, the American is at a distinct disadvantage, Simon said.

"You're just not likely to buy something from a guy you don't understand."

So what will the commission recommend. Probably not much beyond bringing the matter before the people.

There is talk of an advertisement campaign to make people aware of the need to acquire a second or third language. There may even be funding for some education acts that have been in limbo since passage by Congress.

The 1966 International Education act, for instance, has never been funded.

So while the commission busies itself with its monumental job of salesmanship, consider this amazing statistic that Simon has unearthed, and then think again about the need for foreign language study:

"There are more teachers of English in the Soviet Union than there are students of Russian in the United States."

Oh yes. A tilde is a diacritical mark written over "n" in Spanish. An unilaut is the two dots used in German to indicate a changed vowel.

## BANK NOTICE

Application of Peoples Bank and Trust Company, Rocky Mount, Nash County, N.C., for authority to change the location of its approved but unopened "Greenville Branch," Greenville, Pitt County, N.C., from Club Pines Drive and N.C. Highway 11 to Mail Drive and N.C. Highway 11, has been filed with this office.

The action of the Commissioner of Banks with respect to this application will be reviewed at a hearing by the State Banking Commission at its Regular Meeting to be held at 10 a.m. Wednesday, March 21, 1979, in Room 149, Crime Control Conference Room, First Floor, Dobbs Building, 430 North Salisbury Street, Raleigh, North Carolina.

All interested persons will be heard.  
JAMES S. CURRIE  
Commissioner of Banks

# Spring

... IT'S JUST THE BEGINNING



## LOOK WHAT'S SPROUTING

SPRING • GARDENING SPECIALS

## Wed.-Sun. Specials

Enjoy Great Buys Without The Crowds By Shopping Week Days Or Saturday Mornings.



Stark Trees Bear Fruit. Since 1816.

## STARK BROS. THE FINEST DWARF

Grow fresh fruit in your own backyard on world-famous Stark Bro's dwarf fruit trees.



BUY 2 GET 1 FREE!



YUCCA. Regular or Cane.



AGLAONEMA Pewter Variety



DIFFENBACHIA Tropic Snow.



DRACAENA "JANET CRAIG."



FICUS DECORA in 6" pot

## QUALITY IN DOOR PLANTS IN 6" POTS

Reg. \$5.95 Ea.

Buy 1st At Reg. Price Get 2nd For \$1.00

Bring A Friend Share The Cost



March Plantings Seed Crops 7th & 8th Root Crops 14th & 18th

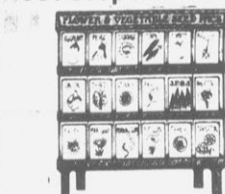

WEEKLY SPECIALS

Onions Sets ..... 88¢

Seed Potatoes .. 100 \$888



EXTRA EXTRA LARGE Hanging Baskets Plus 100's Of Regular Sizes

All 1/2 Price 6 Days Only

## Riped Into 20th Century

LITTLE COXWELL, England (AP) — When this tiny village was finally connected to main sewers, families were so relieved that they threw a party for the workmen who piped them into the 20th century.

The villagers even baked a cake topped with a model of a mechanical digger.

**\$5.00 OFF!** SPECIAL LIMITED TIME OFFER!



REXALL SUPER PLENAMINS Multi-Vitamins with Minerals

ECONOMICAL 365-TABLET SIZE REGULAR NOW \$18.95 \$13.95

Act NOW and save TWICE when you buy a years supply of Rexall Super Plenamins! The 365-tablet size is an economical way to buy one of America's most popular multi-vitamin-mineral products! Take an additional \$5.00 off the price and it becomes a bargain too good to miss! Rexall Super Plenamins contain 11 vitamins plus 8 minerals. Remember—they're guaranteed to satisfy or your money will be cheerfully refunded!

Hollowell's DRUG STORES, Inc. Quality • Competitive Prices • Service

911 Dickinson Ave. 6th St. & Memorial Drive 752-7105 758-4104



KENTUCKY 31 FESCUE SALE SPECIAL

50 LB. \$14.95 BAGS Ea.

2 50 Lb. Bags For \$26.88



8-8-8 FERTILIZER

50 Lb. Bags Reg. \$3.50 Bag Now

4 For \$11.88

ORTHO SPREADERS • Rugged structural polyethylene hopper — will not rust! • Hopper has 55-pound fertilizer capacity • Easy on-off action

Choose From Either Style Lawn Spreader Reg. \$34.95 Assembled-Ready To Use-Just \$29.95 In The Box-Easy To Assemble-Just \$22.95

## MIX OR MATCH AZALEAS OR CAMELIAS



Large 4 Litre Size Plants In Bud Or Bloom Reg. \$5.95



Buy 1st At Reg. Price Get 2nd For \$1.00

Lime 50 Lb. Bag 97¢



# sunshine

Located 1 1/2 Miles South Of T.V. Station On Evans St. Extension Telephone 758-2629

Spring And Summer Hours Mon.-Sat. 8-6 Open Sundays 1-6

## Stock And Market Reports

Following is a summary of market prices and conditions of North Carolina farm products as reported by the Federal-State Market News Service of the N. C. Department of Agriculture:

**RALEIGH (AP) (NCDA) — Cattle:** (weekly auction sales) North Wilkesboro - 360 head cattle and 8 hogs; slaughter cows; utility and commercial 50.25-55.50, canner and cutter 43.00-51.75; vealers: (150-250) good and choice 95.00-111.00; calves: (250-325) good 86.00-93.00; (325-550) good 78.00-85.00; heifers: (850 up) few good 57.50-60.50; bulls: (1000 up) utility and commercial 62.00-68.75; feeder steers: (300-400) few choice 109.00-121.00; (400-500) good and choice 93.50-97.00 (600-800) good 70.00-81.00; feeder heifers: (200-300) standard and good 70.00-93.00 (300-400) good 80.00-86.00 (400-500) good 74.00-79.50 (500 up) good and choice 68.50-77.50; feeder bulls: (200-300) good 110.00-128.00 (300-400) choice few 110.00-118.00, good 90.00-107.00 (400-550) few choice 101.00-107.00 (600-800) good 67.00-69.00; feeder heifers: (500 up) good 65.00-75.00; feeder bulls: (400-550) good 81.00-87.00; cows: feeder and replacements few 53.00-55.50; baby calves: 60.00-105.00; swine: (180-240) 51.20; sows: (300-600) 39.50-44.00.

**RALEIGH (AP) (NCDA) — North Carolina broilers:** market steady. Supply moderate. Demand very good. North Carolina dock weighted average price is 46.33 cents per pound this week for small purchases of plant grade broilers picked up at processing plants. Estimated slaughter Tuesday totaled 1,482,000 head and average live weight 4.04 Pounds per bird on March 2.

**RALEIGH (AP) (NCDA) — State farmers market:** (wholesale prices) apples - bushels 5.00-7.00, tray pack cartons 8.50-13.00; snap beans - bushels 15.00; cabbage - 50 pound bags 12.50-13.00; collards - bushels 5.00-6.00; corn - crates 7.00-8.00; cucumbers - bushels 11.00-13.00; oranges - cartons 6.00-7.00; grapefruits - cartons 4.00-4.75; greens - bushels 6.00; lettuce - cartons 12.50-15.00; peppers - bushels 8.00-11.00; Irish potatoes - 50 pound bags 3.50-4.50.

**RALEIGH (AP) (NCDA) — New York broiler-fryers:** truck-

lot buying interest has improved for end of the week needs. Fill-in loads have sold at 47 cents on plant grade and 48 cents on U.S. Grade A with shippers now becoming reluctant to sell additional product at these levels. Advanced interest is fairly good. However, current retail and distributive movement is light to fair.

**RALEIGH (AP) (NCDA) — N.C. eggs:** Market higher. Supplies moderate. N.C. weighted average price for small sales of consumer Grade A eggs in cartons delivered to retail stores: 73.62 cents per dozen for large white: medium 70.69; small 49.61.

**RALEIGH (AP) (NCDA) — New York eggs:** Prices advanced. The market is fully steady with most traders cautious. Inquiry exceeds available offerings as all levels of trading hold inventories with confidence. Major buyers that are featuring eggs are ordering very heavy. Cartoned-egg movement is fair to good. Prices to retailers, sales to volume buyers, consumer Grade A white eggs in cartons delivered store door: A extra large 72-75, A large 71-73; A medium 67-69.

**RALEIGH (AP) (NCDA) — Graded feeder pig sales:** Statesville: 685 head sold - 40-50-pound no. one and twos 116.00, no. threes 105.50; 50-60-pound no. one and twos 102.00, no. threes 94.25. Smithfield - 869 head sold: 40-50-pound no. one and twos 118.00, no. threes 115.50; 50-60-pound no. one and twos 107.00, no. threes 96.50. Wallace-Chadborn - 1,913 head sold: 40-50-pound no. one and twos 117.00, no. threes 114.00, no. threes 97.25.

**RALEIGH (AP) (NCDA) — Grain:** No. 2 yellow shelled corn slightly higher at 2.50-2.63, mostly 2.55-2.60 in the east and 2.52-2.65, mostly 2.55-2.65 in the Piedmont; no. 1 yellow soybeans higher at 7.39-7.64, mostly 7.54-7.63 in the east and 7.25-7.40 in the Piedmont; Wheat 3.50-4.07, Oats 1.13. Prices paid as of 4 p.m. Tuesday by location for corn and soybeans: Wilson (2.56-2.58), 7.54; Elizabeth City 2.56, 7.64; Goldsboro (2.58-2.63), 7.55; Selma 2.58, 7.63; Lumberton 2.50, (7.39-7.45); Snow Hill and Saratoga 2.57; Pantego 2.52, 7.59; Greenville (2.55-2.58), 7.59; Farmville 2.57; Raleigh, 7.63; Fayetteville, 7.63; Williamston 2.53, 7.56; Clinton 2.60; Mount Ulla, 7.40; Durham 2.60; Statesville 2.52, 7.25; Albemarle (2.55-2.60) 7.35; Monroe (2.60-2.65); Mocksville 2.60.

Following are selected 11 a.m. stock market quotations:

Burroughs	45 1/2
United Telecommunications Prd.	23 3/4
Heublein	28 1/4
Jeff-Pilot	30 1/2
Tri South	27 1/2
Wicks	13 1/2
Wachovia Realty	3 1/4
Veeco	24 1/2
Central Soya	13
Hardees	12 1/2
Integen	16 1/2
Fieldcrest	15 1/2
Hatteras Income	15 1/2
Veeco	13 1/2
Eaton	36 1/2
John Deere	25 1/2
F & G	8 1/4
Piedmont Aviation	7 1/4
Corner Homes	7 1/4
OVER THE COUNTER	
Combined Insurance	17 1/4
FDS Holding	31
NCHB	11 1/4
Little Mint	1 1/2
Love	19 1/4

**NEW YORK (AP) — Stock prices gained ground today amid hopes for a Middle East peace agreement.**

The Dow Jones average of 30 industrials rose 1.82 to 828.40 in the first half hour. Gainers took a 5-3 lead over losers among New York Stock Exchange-listed issues.

President Carter is due to leave this evening on his trip to Egypt and Israel seeking to help bring about a peace treaty.

Prime Minister Mustafa Khalil of Egypt said today he believed the chances for an agreement were "rather good in my opinion."

## Parent Volunteer Program Operating

A parent volunteer program is now in operation at Bethel Elementary School. All parents interested in becoming a volunteer must attend a workshop to prepare them for serving as a volunteer.

The program began operation on Wednesday, February 21. Topics discussed at the initial workshop included "How to Listen to a Student Read", by Mrs. Linda McLawhorn, reading resource consultant for Pitt County Schools; "Skills in Teaching a Student to Memorize Math Facts", by Mrs. Jane Huffman, math consultant for Pitt County Schools; "Proper Procedures in Performing Health Screening", by Mrs. Joanne Tetterton, social counselor of Pitt County Schools; "Ethics and Techniques Used in Assisting in a Classroom", by Mrs. Janie

Manning, principal of Bethel Elementary School; and "The Importance of a Parent Volunteer Program", by Ott Alford, superintendent of Pitt County Schools.

Schedules of parent volunteers vary according to the amount of time parents are serving as volunteers as well as to the time of day and number of days a week they choose to serve. Any interested parents or community persons may contact Bethel Elementary School.

## Nebraska Few Unemployed

WASHINGTON (AP) — Nebraska had the lowest average unemployment rate among the states last year, while Alaska had the highest, according to new government figures.

The Labor Department said Tuesday that Nebraska had a 2.9 percent unemployment rate while Alaska's was 11.2 percent. Among the four regions, the Northeast led last year with a 6.9 percent jobless rate, down from 8.4 percent in 1977. The Midwest had the lowest regional rate at 5.3 percent. Unemployment in the South averaged 5.6 percent last year, and 6.6 percent in the West.

## Carter Probe?

WASHINGTON (AP) — The Justice Department acknowledges there is a possibility a special prosecutor will be named to look into President Carter's family peanut warehouse business. But the department adds such an action would be "a rather extraordinary step."

Federal investigators have been investigating operations of the warehouse, including \$6.5 million in loans it obtained from the National Bank of Georgia in 1975 and 1976, when former Budget Director Bert Lance was president of the bank.

In a meeting Tuesday with Republican members of the House Judiciary Committee, Justice Department officials said they had received a lengthy FBI report on the case and would decide soon how to proceed with the case.

Terrence Adamson, department spokesman, said several possible options were listed for the legislators, including "the rather extraordinary step of appointing a special prosecutor."

But analysts said a good many stock traders seemed to be wary of becoming prematurely optimistic. They noted fears that the market might be vulnerable should Carter's mission not succeed.

Geosource was the early volume leader among NYSE issues, off 1/4 at 29. Polychrome climbed 1/4 to 25%. A bidding war between French and Japanese companies apparently ended when the Japanese concern's American subsidiary raised its offer from \$25 to \$26 a share.

On Tuesday the Dow Jones industrial average slipped .78 to 826.50.

Declines outnumbered advances by a 6-5 spread on the NYSE.

Big Board volume came to 24.49 million shares against 25.69 million in the previous session.

The NYSE's composite common-stock index lost .08 to 54.88.

At the American Stock Exchange, the market value index was down .34 at 164.15.

## PVM-Maker To Pay Civil Fine

WASHINGTON (AP) — The maker of the diet product, P.V.M., has agreed to pay a \$75,000 civil fine to settle a false advertising case, the Federal Trade Commission says.

FTC attorney Arthur B. Patrizio said Tuesday that ads run from December 1977 to May 1978 made it appear the product caused weight loss. "Instead, it was the diet, which limits calories, that caused the weight loss," he said. The fine is against J.B. Williams Company, Inc., and its ad agency, Parkson Advertising Agency, Inc. The firm did not acknowledge any wrongdoing in settling the case.

## MASONIC NOTICE

There will be a stated communication of Crown Point Lodge no. 708 A. F. and A. M. Thursday, March 8, at 7:30 p.m. All Master Masons are invited.

**EASTERN CONTRACTORS**  
New to Greenville  
Professional Painting  
Free Estimates  
Painting 12¢ Per Sq. Ft.  
Residential-Commercial  
Ph. 758-1005 Jim Hill

## Obituaries

**Becker**  
**BETHEL** — Florence Jane Becker, 76, retired secretary, died Tuesday. Services will be held Thursday, 8 p.m., from the Bethel United Methodist Church by the Rev. Ellis Bedsworth. Burial will be in the Arlington National Cemetery.

**Gay**  
Mr. James Gay died Tuesday afternoon in Pitt Memorial Hospital. He was the brother of Mrs. Willie Ruth Brown of 1610 Myrtle Ave. Funeral arrangements are incomplete at Hardee's Funeral Home.

**Gorham**  
**FARMVILLE** — Mr. Sterling Gorham of 415 S. George Street here died this morning in Pitt Co. Memorial Hospital. He was the father of Willie James and Glasgow Gorham. Funeral arrangements are incomplete at Joyner's Mortuary here.

**Hill**  
**ELIZABETH CITY** — Mr. Albert Clinton Hill, Sr., 81, died Sunday afternoon in Albemarle Hospital following a long illness.

Mr. Hill, a native of Tyrrell County, lived in Greenville and taught in the G. R. Whitfield School, Grimesland, for a number of years. He had made his home in Elizabeth City for the past several years.

Among survivors is a son, Albert Clinton Hill, Jr., of Greenville, a teacher at Sadie Sautler School.

A funeral service will be held Saturday at 1 p.m. at Cornerstone Baptist Church, Elizabeth City.

**McGowan**  
Mr. Jesse E. McGowan, 78, died in Bruce Hospital in Florence, S.C. Tuesday.

The funeral service will be conducted Thursday at 3:30 p.m. in the Wilkerson Funeral Chapel by the Rev. Cedric Pierce. Burial will be in Greenwood Cemetery.

Mr. McGowan, a Pitt County native, moved from Portsmouth, Va to Florence two years ago. He was a retired automobile mechanic.

Surviving him are his wife, Mrs. Orene Young McGowan; a daughter, Mrs. Joe Russell of Virginia Beach, Va.; a brother, E. W. McGowan Jr. of Greenville; a sister, Mrs. Mamie Cannon of Greenville; and two grandchildren.

at the funeral home tonight from 7 to 9 o'clock. At other times they will be at the home of Mr. and Mrs. E. W. McGowan Jr. of Portertown.

**Paris**  
**FOUNTAIN** — The funeral service for Mrs. Sadie Lilley Paris, 83, of Route 1, Fountain, who died Monday afternoon, will be held at 11 a.m. Friday at the Church Street Chapel of the Farmville Funeral Home. Rev. Luther Bisette will officiate, and burial will be in the Lilley Family Cemetery near Fountain.

**Rogers**  
**ROBERSONVILLE** — Funeral services for Mr. Willie Lee Rogers will be conducted Thursday at 2 p. m. in the Jenkins Chapel Church, Parmele, by Elder David Langley. Burial will be in the Council Cemetery.

Mr. Rogers was born and reared in the Robersonville community and served in the U. S. Navy during World War as steward's mate first class. He was a deacon of Jenkins Chapel Church.

Surviving him are his wife, Mrs. Adell Rogers of the home; two sons, Kenneth Briley of Washington, D.C. and Dwain Rogers of the home; a daughter, Miss Jennifer Rogers of the home; a brother, James Williams of New York; two sisters, Mrs. Hazel Modica of Robersonville and Mrs. Vernell Burns of Portsmouth, Va.

The family will receive friends Wednesday from 7 to 9 p. m. at Jenkins Chapel Church. The body will be taken from Phillips Brothers Mortuary to the church one hour prior to the visitation.

**VOTE MIXED DRINKS**  
**WINSTON-SALEM, N.C. (AP)** — Voters approved mixed-drink sales in the city by a margin of almost two-to-one Tuesday in a referendum that drew about 31 percent of the city's eligible voters.

**DAILY LUNCH SPECIALS** ..... \$1.95  
**DOG OR BURGER** ..... 45¢  
Breakfast Served All Day!  
**CAROLINA GRILL**  
ORDERS TO GO!

## Bad Day For 2 Pitt Families

Tuesday was a bad day for the families of two Pitt County Sheriff's Department deputies.

The wife of Deputy Jimmy Evans was hospitalized from injuries received in an 8:50 a.m. collision on Memorial Drive just South of the Greenville Boulevard intersection, and the 10-year-old daughter of Deputy Jimmy Harrell was injured when struck by a car near Black Jack about 5:30 p.m.

Highway Patrolman Wayne Taylor reported that Crystal Michele Harrell was injured when struck by a car driven by James C. Mills of Route 2, Greenville, as she crossed secondary road 1774 in front of her home.

Trooper Taylor said the child had crossed the roadway and

was returning to her home at the time of the mishap.

No damage resulted to the Mills car and no charges were made, he said.

Greenville Police reported that Linda Evans of Grifton was injured when her car struck the median on Memorial Drive, went out of control, flipped two times in the air, and came to rest against a car driven by Leonard Bostic of Ayden.

No charges were reported by officers who estimated damage at \$3,500 to the Evans car and \$300 to the Bostic auto.

## Whitfield Talks To Bethel Club

**BETHEL** — Carl E. Whitfield was guest speaker at the meeting of the Bethel Rotary Club last night.

"The Governor's Highway Safety Program: Its Objectives and Operations" was Whitfield's program topic. He is field representative, Governor's Highway Safety Program, eastern district.

The Governor's Highway Safety Program is the coordinating agency for federal, state and local traffic safety activities, he said.

"This program functions primarily as an administrative office to help state agencies and local political subdivisions obtain grant-in-aid funds. It provides technical assistance to cities and towns in establishing goals and in evaluating the results of safety projects implemented throughout the state," Whitfield added.

## Burned Her?

Clinton Earl Wilson, 19 of 1912 Norcott Cir. has been arrested by Greenville Police on charges that he caused malicious injury by the use of incendiary material, Chief Glenn Cannon said this morning.

Cannon said the charges against Wilson stemmed from an 8:30 p.m. incident at the home of Dorothy Matthews at 1206 South Pitt St. Monday.

The chief said Wilson allegedly poured kerosene on Ms. Matthews as she lay on her bed and set the fuel on fire.

Ms. Matthews, Cannon noted, suffered second and third degree burns over about 30 percent of her body.

Bond for Wilson was set at \$50,000 pending court action in the case.

**Announcing The Opening Of**  
**John R. Dupree Accountants**  
2723 E. 10th Street  
Colonial Heights - Greenville, N.C.  
**758-0681**

**The Meeting Place**  
WEDNESDAY  
6:30 p.m. — Kiwanis Club meets.  
6:30 p.m. — REAL Crisis Intervention meets.  
7:00 p.m. — Winterville Jaycees meet at Depot Grill.  
8:00 p.m. — Pitt County Al-Anon Group meets at AA building on the Farmville Highway, telephone 752-7608 or 752-5284.  
8:00 p.m. — PIH County Ala-Teen Group meets at AA building on Farmville Highway, telephone 756-2501 or 752-5284.  
8:00 p.m. — Matrons Club will meet with Lucille Sharp.  
THURSDAY  
2:00 p.m. — Game day at Woman's Club.  
6:30 p.m. — Jaycees meet at Greenville Jaycee building.  
6:30 p.m. — Exchange Club meets.  
6:45 p.m. — BPW Club meets.  
7:00 p.m. — Winterville Kiwanis Club meets at community building.  
7:00 p.m. — Disabled American Veterans Chapter No. 37 and Auxiliary meets at Parker's Restaurant.  
8:00 p.m. — Chapter 1308 of the Women of the Moose.

**Home Savings Money Market Certificates\***  
**9.665%** Per Annum  
Effective March 8 Thru 14  
Earn a high rate of interest on the Money Market Certificate with a minimum deposit of \$10,000 and a 26-week term.  
\*A substantial interest payment penalty is required for early withdrawal.  
**HOME SAVINGS**  
Greenville, Bethel, Plymouth.  
MEMBER  
**FSLIC**

**2 + 2 = 4**  
Simple Arithmetic about Money  
Now is the time to put something aside for your financial future. See your IDS representative for money accumulation plans.  
**IDS**  
INVESTMENTS/INSURANCE  
IDS Marketing Corporation, a wholly owned subsidiary of Investors Diversified Services.  
IDS Life Insurance Company  
Minneapolis, Minnesota  
401 West First St. P.O. Box 7381 752-1370  
We Help People Manage Money.

**Now you can whip up more breakfasts without getting wiped out.**

Oh boy. Get ready to start spreading Soft Whipped Blue Bonnet. And to keep on spreading, without spreading your budget too thin. Because now, with our 10¢-off coupon on a 1 lb. package of Blue Bonnet (or our 25¢-off on two 1 lb. packages), you'll find yourself spreading buttery Blue Bonnet everywhere. On piles of pancakes... mountains of muffins. You'll just go on spreading. Spreading the fresh, buttery taste and aroma that help make a scrumptious breakfast a bit more scrumptious. So cut out our coupon. For either a 10¢ or 25¢ saving on Soft Whipped Blue Bonnet Margarine.

**BLUE BONNET**

For 10¢ offer cut along solid line.

**10¢** 10¢ off on 1 lb. Soft Whipped BLUE BONNET Margarine (Bowl or Sleeve) **10¢**

**25¢** 25¢ off on 2 lbs. Soft Whipped BLUE BONNET Margarine (2 Bowls or 2 Sleeves) **25¢**

TO GROCER: Standard Brands will pay the face value plus 5¢ handling charge provided you and your customer have complied with the terms of this offer; any other application constitutes fraud. Invoices showing your purchase of sufficient stock to cover all coupons redeemed must be shown upon request. Void if prohibited, taxed or restricted. Good only in U.S.A. and APO/FPO locations. Customer must pay any sales tax. Cash value 1/20th of 1¢. Coupon will not be honored if presented through outside agencies, brokers or others who are not retail distributors of our merchandise or specifically authorized by us to present coupons for redemption. Redeem only through our representatives or by mailing to Standard Brands Incorporated, P.O. Box "C", Wilkes-Barre, Pennsylvania 18703.  
TO HOME/MAKER: This coupon is good only on the product indicated. Any other use constitutes fraud. LIMIT — ONE COUPON PER PURCHASE. COUPON EXPIRES SEPT. 30, 1979.  
REDEEM PROMPTLY.  
Another fine product of **Standard Brands** INCORPORATED.

## Exhibitions Open...

By **HERSCHEL NISSENSON**  
AP Sports Writer

The cry of "Play ball!" will be heard at five exhibition baseball locations today...but major league umpires won't be doing the shouting.

In fact, if the contract dispute between the 51 umpires and the two major leagues isn't settled by Friday, the Chicago Cubs' head groundskeeper at Ho Ho Kam Park in Mesa, Ariz., will help officiate the game against the Seattle Mar-

iners. "He can make up his own ground rules. Nobody will be able to argue with him," quipped General Manager Bob Kennedy.

The dispute, of course, is somewhat more serious than that. The umpires have authorized Richie Phillips, head of the Major League Umpires Association, to try and renegotiate individual contracts even though the union and baseball have a contract in force for a few more years.

"I see no possibility that this thing will be settled in time," Phillips said Tuesday from his Philadelphia law office. "Without individual contracts, the umpires will not work."

"It's an individual action on the part of 51 individuals who are unhappy. I'm not feeling any pressure to give in. In fact, the only pressure I'm getting is that some of the individuals are thinking of re-evaluating their situations to ask for more money."

Dick Butler, supervisor of umpires for the American League, said the exhibition games would be officiated by former minor league umpires and college baseball arbiters.

"We don't foresee any problem," Butler said. "Every town's got plenty of umpires. Most of these guys will have done umpiring for us before. They won't be as good as our guys, but the players probably won't notice. They're concentrating more on getting in shape and making the ballclub than on umpiring."

Only one of today's five scheduled exhibitions pairs two major league teams — the California Angels entertaining the San Diego Padres at Palm Springs, Calif.

Meanwhile, the world champion New York Yankees face Grambling State University at Grambling, La., the St. Louis Cardinals meet the University of Missouri at St. Petersburg, Fla., while Pittsburgh and Seattle oppose a couple of Japanese clubs — the Pirates against the Seibu Lions at Bradenton, Fla., and the Mariners vs. the Yakult Swallows at Tempe, Ariz.

The Yankees' weekly brouhaha involves, of all people, shortstop Bucky Dent, who never makes waves. The Yanks' postseason hero, who can become a free agent following the 1979 season, says he will do just that if he isn't signed by the start of the campaign.

"They don't want to talk before the season, then I don't want to talk at all," Dent said. "I just would rather not talk during the season. I'm not threatening; I just feel that way."

"I don't want to play out my option and leave New York. I like playing in New York. I have one thing on my mind and that's playing baseball during the season. I'll honor my contract and play as hard as I can."

The Los Angeles Dodgers, the Yankees' World Series victims the past two seasons, are far ahead of where they were last year at this time, according to

## ...But Without Umps Who Have Walked Out

By **FRED ROTHENBERG**  
AP Sports Writer

Job opportunity. Forty dollars a day, plus carfare, for three hours work in the sun. That's the glamorous part.

On the negative side there will be no overtime, even though there may be extra innings. And, of course, there will be plenty of chances to be abused by players, managers and fans.

With five games on tap, spring training exhibitions were to begin today — without major league umpires. But there should be no lack of replacements.

"We'll have ex-minor league umpires, college baseball umpires and the doctor around the corner," said Dick Butler, American League supervisor of umpires. "I think it will work out all right."

The reason for this call for pinch umpires is that the 51 regular arbiters won't be working because of a dispute over individual contracts. They want more money and their attorney, Richie Phillips, is bargaining to get it for them.

"I see no possibility that this thing will be settled in time," Phillips said Tuesday. "Without individual contracts, the umpires will not work."

Phillips, who has had meetings with American League President Lee MacPhail and National League President Chub Feeney, said the umpires want to reach parity with officials in other sports. He pointed out that an umpire with 10 years of major league experience would have a min-

imum salary of \$32,500 while a National Basketball Association referee is guaranteed \$45,000 after 10 years.

"It's an individual action on the part of 51 individuals who are unhappy," said Phillips by phone from his law office in Philadelphia. "I'm not feeling any pressure to give in. In fact, the only pressure I'm getting is that some of the individuals are thinking of re-evaluating their situations to ask for more money."

Baseball has been preparing for the possibility the umpires

## IOC After Chinese

LAUSANNE, Switzerland (AP) - The executive board of the International Olympic Committee will try again this weekend to get Mainland China into the Olympic Games.

But the closer the IOC gets to the 1980 Games in Moscow, the more formidable the Chinese puzzle becomes. China has said it will not compete unless the IOC drops Taiwan. And that is not as easy as it sounds.

Lance Cross, IOC member for New Zealand who led a three-man team to China this winter, is to report his findings to the executive board Friday and Saturday. The board could make a recommendation to the full session of the IOC, set for April 3-8 in Montevideo, Uruguay.

Lord Killanin, president of the IOC, newly home from a fact-finding tour of seven African countries, said: "All I can tell you is that the Chinese want to compete in Moscow. Beyond that I cannot begin to predict what might happen."

wouldn't be working today. A teletype has been sent from the two league offices, asking the clubs to make preparations to have local umpires available.

Another teletype was sent out Tuesday, informing the clubs that it didn't appear that the regular umpires would be working and that local officials would be needed to fill in.

Butler said the void would definitely be filled. "We don't foresee any problem," he said from Sarasota, Fla. "Every town's got plenty of umpires. So much college baseball is played down here and in Arizona, anyway."

Butler pointed out that when the major league teams play "B" or split-squad games, extra umpires are used. "Most of these guys will have done umpiring for us before," he said. "They won't be as good as our guys but the players probably won't notice. They're concentrating more on getting in shape and making the ballclub than on umpiring."

Phillips said he welcomed the fill-in umpires. "There's no problem at all with these other guys going to work. We urge them to work," he said. "The contrast would just emphasize the quality of our umpiring."

## Knights Take Tourney Win

KINSTON — Greenville Christian Academy's varsity and junior varsity joined the girls in the finals of the Bethel Academy Invitational Basketball Tournament with victories last night.

In the varsity game, Greenville rolled to a 61-53 victory over Mt. Calvary. The junior varsity downed Bethel, 46-23.

In the varsity game, Greenville built up a 15-10 lead over Mt. Calvary, then saw their opponent rally in the second period to take over the lead, 27-24, at the half.

Greenville regained control in the third period, moving into a 40-37 lead. Then, in the final period, the Knights outscored Mt. Calvary, 61-53.

Ben Haddock led Greenville with 22 points, while Steve Tyburski had 15 and Marshall Crumpler had 10. K. Letchworth led Mt. Calvary with 16, while Glenn Mitchell had 14 and Charles Taylor had 11.

The finals of the tournament will be played Thursday night. Bethel faces Greenville Christian in the girls' final, while Mt. Calvary and Greenville collide

for the junior varsity title. Greenville faces Bethel for the varsity championship.

Boys Game		GCA	
Mt. Calvary	53	61	53
Cahoon	4	1	9
Taylor	3	5	11
Jones	8	1	1
Tyson	0	2	2
Michell	6	2	14
Letchworth	7	2	16
S. Jones	0	0	0
Wood	0	0	0
Totals	30	13	52
Mt. Calvary	10	17	10
Greenville	15	9	16

## Kiwanis Golf Set

The annual Kiwanis Golf Tournament will be held April 20 at Brook Valley Golf and Country Club.

The tournament is open to all golfers, and information on the tournament, along with entry blanks can be obtained from any member of the Progressive City Kiwanis Club or from Paul H. Rasberry at 756-4181 at night.

Proceeds from the tournament and other projects of the club are for local community projects.

## Clemson Slips Past Pirates By 2-1

CLEMSON, S.C. — Clemson University won its sixth straight baseball game here Tuesday afternoon, defeating East Carolina University by a score of 2-1.

The Tigers are now 6-1 on the year, while the Pirates dropped to 1-2. The same two teams met

again this afternoon at 3 p.m. Righthander Mike Brown went recording his second win in three decisions. He let the Pirates down on four singles, struck out eight and walked two. Bobby Patterson, the East Carolina starter, hurled four innings and took the loss, evening his record at 1-1.

Brown lost his shutout in the fifth inning when Rick Derechallo walked to open the inning and went to third on two ground outs. Mike Sorrells drove the run in with a single.

Two singles and an error on a scarfie loaded the bases with two out in the seventh, but Brown got Tim Hardison on a pop up to second to end the threat.

The Pirates also threatened in the eighth, putting two on with none out, and loading the bases with two outs, but they failed to produce once again.

Tim Teufel opened the Clemson second with a single, stole second and rode home on Robbie Allen's single. The Tigers scored what proved to be the winning run in the fourth as Tony Masone singled to open the inning, stole second and came in when Robert

Bonnette singled. Allen singled again and Billy Weems walked, but Patterson got Dave Bufamoyer to pop up to short.

Allen and Bonnette each had two hits for the Tigers and Sorrells collected two of the Pirates' four hits. There was not an extra base blow by either team.

Following today's game, the Pirates move on to Charlotte to face the UNCC 49ers, then come to Greenville for their home opener against the University of Connecticut on Saturday.

East Carolina	ab	r	b	Clemson	ab	r	b
Hardison,lf	4	0	0	Buttmoyer,c	4	0	0
Bell,cf	4	2	0	Simons,cf	3	0	0
Davis,ss	4	0	0	Schroeder,dh	3	0	0
Shyons,3b	1	0	0	Masone,rf	4	1	0
Neff,ss	2	0	1	Teufel,2b	4	1	0
Moyer,rf	4	0	1	Bennett,3b	2	0	1
Derechallo,c	3	1	0	Youngman,lb	2	0	0
Sage,1b	4	0	0	Russ,ph	1	0	0
Carraway,ss	3	0	0	Gunn,lf	0	0	0
Raynor,dh	1	0	0	Allen,ss	3	0	1
Sorrells,2b	3	0	2	Weems,lf	2	0	0
Totals	30	4	1	Totals	28	2	2
East Carolina	0 0 0 1 0 0 0 0 x — 2						
Clemson	0 0 0 0 0 0 0 0 x — 1						
E — Youngman, Brown, Teufel, Shyons, Neff; DP — East Carolina 2; LOB — East Carolina 7; Clemson 6; SB — Teufel, Neff, Masone, Schroeder; S — Derechallo.							
Pitching (L, 1-1)	b b r r b b so						
Davis	4 1 0 0 1 2						
Brown (W, 2-1)	9 4 1 1 2 2						

**SAAD'S SHOE SHOP**  
PROMPT SERVICE  
Located at College  
View Cleaners  
113 Grand Avenue  
"Parking In Front"

**Your Equitable Agent knows about...**  
**INSURANCE PROTECTION FOR YOUR CHILDREN'S EDUCATION**

**Rob Powell**  
131 Oakmont Drive  
Greenville  
756-6126  
752-8669

The Equitable Life Assurance Society of the United States, N.Y. N.Y.

## Sports Calendar

- Today's Sports**  
Baseball  
East Carolina at Clemson (3 p.m.)  
Basketball  
Men's Recreation  
Grady-White vs. 9-Alive  
Cox Tires vs. Empire Brushes  
Bailey's vs. Greenville Utilities  
Azalea Mobile Homes vs. Eagles  
River Ox vs. PoBoys  
Pepsi-Cola vs. Rockets  
Softball  
Greene Central at North Lenoir (4 p.m.)  
Track  
Greene Central at Beddingfield (3 p.m.)  
Thursday's Sports  
Wrestling  
East Carolina at NCAA Tournament at Iowa State  
Baseball  
East Carolina at UNC Charlotte (3 p.m.)  
Conley at Williamston (3:30 p.m.)  
Indoor Track  
East Carolina at NCAA meet at Detroit  
Tennis  
Eastern Wayne at Greene Central (3:30 p.m.)  
Washington at Williamston (3:30 p.m.)  
Roanoke at Ahsokie  
East Carteret at Farmville Central (2:30 p.m.)  
Basketball  
Greenville Christian at Bethel Invitational  
Men's Recreation  
Aldridge & Southerland vs. Book Barn  
Clark-Branch vs. Prep Shirt  
Taff Office vs. Sportsworld  
Carolina Sales vs. Pitt Memorial Hospital  
Siroh's vs. Jarvis  
Sheltered Workshop vs. Integon

**FREE ESTIMATES**  
Don't You Really Wish You Had A Fence?

Chain Link

**SPECIAL**  
If You Buy NOW You Get A FREE Walk Gate (Chain Link)

Guaranteed Professional Quality At Lowest Prices

**EVERETT FENCE BUILDERS**  
Greenville  
Call 756-6388  
Lester Everett

**Norelco And Remington**

## SHAVER CLINIC

CLEAN, OIL, ADJUST **\$3.99**

—Factory Trained Experts—  
**ONE DAY ONLY**  
THURSDAY, MARCH 8, 1979—9:00 A.M. To 4:00 P.M.

**HARGETT'S DRUG STORE**  
2500 S. Charles St. Phone 756-3344

# DON'T JUST SAY BULL! STATE IT!

**SCHLITZ MALT LIQUOR**  
**SAY BULL!**  
(YOUR STATE NAME HERE)

**GET THIS UNIQUE "SAY BULL" ATHLETIC SHIRT CUSTOM-PRINTED WITH THE NAME OF YOUR STATE FOR ONLY \$5.50.**

Let everyone know the state you're in with a genuine Schlitz Malt Liquor athletic shirt. Featuring our Schlitz Malt Liquor Bull with royal blue 3/4 length sleeves and white shirt body. It's made of 70% cotton and 30% polyester. And it's 100% you, because we custom-print the name of your state right on the front.

So wherever you live, Schlitz Malt Liquor has a bull shirt to match. To order yours today, look for the special Schlitz Malt Liquor Jersey display at your favorite store. And while you're at it, order a Schlitz Malt Liquor, too. After all, if you're going to state your case, enjoy one, too.

**DON'T SAY BEER, SAY BULL! SCHLITZ MALT LIQUOR.**

## Defense Gets Praise After Spurs Trim New Jersey Club

By The Associated Press  
Who says the San Antonio Spurs don't play defense? Not Coach Doug Moe...or New Jersey Nets Coach Kevin Loughery.

"They have a great offense, but they also have one of the better defensive teams," Loughery said Tuesday night after the usually high-scoring Spurs defeated the Nets 103-99. "A lot of people look at the stats, but they play good defense. You have to play defense to win in this league."

That would be the National Basketball Association, where the Atlanta Hawks beat the Philadelphia 76ers 94-91, the Houston Rockets edged the Denver Nuggets 119-118 and the Portland Trail Blazers downed the New York Knicks 118-110 in other action Tuesday. San Antonio nailed down its

triumph when James Silas connected on a tie-breaking jump shot and two free throws in the final 25 seconds. The Nets led 85-76 entering the final quarter but the Spurs pulled even at 95 on George Gervin's jumper with 1:15 to play.

Gervin and New Jersey's Bernard King took scoring honors with 27 points apiece.

The contest included a fourth-quarter shouting match between Loughery and Allan Bristow of the Spurs. The San Antonio player claimed New Jersey's Winford Boynes spit on him while they were jockeying for position under the boards. Boynes declined to comment on whether he spit at Bristow.

**Hawks 94, 76ers 91**  
Despite their defeat, the third-place Nets remained just 1½ games behind Philadelphia in the Atlantic Division. Atlanta

turned back the 76ers when Tom McMillen sank a pair of free throws with 1:28 remaining for the Hawks' seventh consecutive victory and Philly's fifth straight loss.

Atlanta, paced by Eddie Johnson with 22 points and John Drew with 20, trailed only once — by one point in the third period. The Hawks got the lead back 64-63 on two free throws by Dan Roundfield and then got six more points, including a pair of baskets by Johnson.

**Rockets 119, Nuggets 118**  
Houston's Moses Malone blocked George McGinnis' shot attempt as the final horn sounded to preserve the Rockets' victory, their second in a week over Denver. With regular center Dan Issel out, Denver used Kim Hughes and Tom Boswell in the pivot. Malone finished with 26 points, but the

Denver duo helped keep the game close and it was tied 29 times.

An attempted slam dunk by Denver's David Thompson with 11 seconds left was pinned against the backboard by Houston's Robert Reid but goaltending was not called. Thompson finished with 33 points while McGinnis added 24. Calvin Murphy led Houston with 30.

**Trail Blazers 118, Knicks 110**

Injury-plagued Portland was led by Tom Owens' 34 points and moved within one-half game if San Diego in the race for the final Western Conference playoff spot despite the absence of Maurice Lucas and Lionel Hollins. The Trail Blazers blew an 18-point lead before Dave Twardzik threw in two long-range jumpers and added six free throws in the last four minutes to seal the victory. The Knicks suffered their 40th setback, one more than all last season. They still have 14 games remaining.

## National Invitation Tourney, Truly National, Begins Tonight

By HERSCHEL NISSENSON  
AP Sports Writer

The nation's oldest post-season basketball tourney, the 42-year-old National Invitation Tournament, gets under way tonight and, for a change, it is truly national in scope.

The NIT, which has been criticized in the past for loading up with Eastern teams when the entire tourney was held at New York's Madison Square Garden, has gone national in recent years, holding the first round or two at various sites around the country and bringing only the survivors to the Big Apple.

This year, the NIT boasts a 24-team field, including 16th-ranked Purdue. The Boilermakers will host Mid-American Conference runnerup Central Michigan in one of Thursday night's six opening-round games.

Tonight's six-game schedule features the meeting at Lexington, Ky., between Clemson (17-9) and fast-coming Kentucky

(19-11), which narrowly missed a chance to defend its 1977-78 NCAA crown by losing a 75-69 overtime thriller to Tennessee in the final game of last week's Southeastern Conference post-season tourney.

The rest of tonight's slate finds St. Joseph's (19-10) at Ohio State (17-10), Rhode Island (20-8) at Maryland (18-10), Northeast Louisiana (23-5) at Virginia (18-9), Nevada-Reno (20-6) at Oregon State (18-9) and Wagner (21-6) at Old Dominion (21-6).

On Thursday night, it's Central Michigan (19-8) at Purdue (19-7), Texas A&M (22-8) at New Mexico (19-9), St. Bonaventure (19-8) at Alabama (19-10), Indiana (18-12) at Texas Tech (19-10), Holy Cross (17-10) at Dayton (18-9) and Cinderella Alcorn State, one of the nation's two major unbeaten teams with a 27-0 mark, at Mississippi State (19-8).

Central Michigan "won" its NIT berth Tuesday night by

losing 72-65 to Toledo in a play-off at Ann Arbor, Mich., to decide the MAC champ. Both teams finished the regular season with 13-3 league records. The winners gained a berth in the NCAA Tournament, which begins Friday.

Toledo trailed 37-28 at half-time but Stan Joplin scored 15 points in the second half to spark the Rockets' comeback in which they outscored the Chipewas 14-3 over the final five minutes.

"We made mistakes on offense in the first half," said Toledo Coach Bob Nichols. "We weren't attacking the basket. In the second half, we did better going to the basket."

The regular season also came to an end Tuesday night when Tony Smith and Brett Vroman combined for 47 points to lead Nevada-Las Vegas to a 91-89 victory over Colorado State. Smith scored 27 points and Vroman added 20 as UNLV, 22-8, held on after leading by 16

points late in the first half.

The Rams, sparked by the 32-point performance of Barry Young, climbed within 90-89 with six seconds left before Smith hit an insurance free throw.

Kentucky climaxed what Coach Joe B. Hall called a rebuilding year by coming within an eyelash of winning the SEC tourney — and an automatic NCAA berth — after upsetting nationally ranked Louisiana State in the semifinals.

The Wildcats are led by guards Kyle Macy and Truman Claytor, a pair of long-range bombers, but will be hurt by the absence of lightning-quick freshman Dwight Anderson, their No. 2 scorer, who suffered a broken wrist in the opening second against LSU.

"To be picked for a national tournament at the end of the season is a compliment to the way this young club has come together," Hall said.



### Over For Two

Philadelphia 76ers Julius Erving reaches over the outstretched defensive arm of Atlanta Hawks' Dan Roundfield (32) for two points in their 94-91 loss to the Hawks Tuesday night in Atlanta. (AP Laserphoto)

Philadelphia 76ers Julius Erving reaches over the outstretched defensive arm of Atlanta Hawks' Dan Roundfield (32) for two points in their 94-91 loss to the Hawks Tuesday night in Atlanta. (AP Laserphoto)

## Defeats Haunt Vegas Coach Jerry Tarkanian

By FRED ROTHENBERG  
AP Sports Writer

LAS VEGAS, Nev. (AP) — "Pay attention," demanded Prof. Jerry Tarkanian between halves of Nevada-Las Vegas' game with San Diego State. "Maybe if we get our heads in the game we can go out and do it."

"I would love to see us play 20 full minutes of basketball. Dammit, you've got to get yourself ready to play."

This is Tarkanian's classroom. Nowhere else are his eyes so alive, his spirit so high and his personality so dominating.

The lecture wasn't inspirational Knute Rockne, and it wasn't very successful as UNLV lost to San Diego 94-91 last month for the third home loss of the season, the most games any Tarkanian-coached team had ever lost at home.

"This is an all-time low," moaned Tarkanian after the Rebels' record dropped to 17-7. Tarkanian, who has the highest winning percentage of any active coach, brought a major college career mark of 244-44 into the 1978-79 season. That's in five years at Long Beach State — where he never lost a home game — and five years at UNLV.

After the loss, Tarkanian was near tears. Constantly haunted by his troubles with the NCAA, Tarkanian used to be able to take solace in the fact his team was winning consistently.

"We've been through so much; I just don't know how much we have left to draw on," said Tarkanian's wife, Lois, who has been the coach's most vocal defender throughout his troubles with the NCAA because of alleged rules violations at Long Beach State and UNLV.

"I never was paranoid, but because of this NCAA thing, I think everyone's out to get me now," Tarkanian said.

Since Tarkanian became a major college coach, 12 of his

players have played in either the National or American Basketball Associations, although only Ricky Sobers and Reggie Theus have really starred in the pros. At UNLV, 14 of his players have been drafted. NBA scouts like his teams because they play a fast-paced game.

His Runnin' Rebels have been near the top of the team scoring charts all season, even though he says he doesn't have a good shooting club. In the 1975-76 season, UNLV set an NCAA record, averaging 110.5 points a game. The next season, the Rebels had at least 100 points in a record 12 straight

games, reached the Final Four of the NCAA Tournament and had a record six players drafted by the NBA.

At Long Beach, Tarkanian used a 1-2-2 zone and a power forward offense. He adapted his style to the personnel he inherited at Vegas in 1973, the Rebels became the Runnin' Rebels and Tarkanian became a believer. This fast town fell in love with the fast game and would scream if the Rebels tried a slow down. So Tark recruits greyhounds, most of whom happen to be black players who love to run and gun.

Another Tarkanian selling (Continued On Page 20)

## Hey!

It's time to get that 30% nitrogen on your small grain.

The people of Grimesland Fertilizer and Supply Co. have the know-how and equipment to spray 30% nitrogen on your small grain fields!



Call Or Come By



Liquid Fertilizer / Nitrogen Solutions / Pesticides

GRIMESLAND, N.C.

Days 758-9414

NIGHTS 946-0363

# Put your money where the MILEAGE is!

## DOUBLE BELTED Firestone Deluxe Champion\*

If you're looking for mileage as well as the extra protection of belts look no farther. For nearly 10 years this super tire has been providing long wear and a smooth ride to America's motorists!

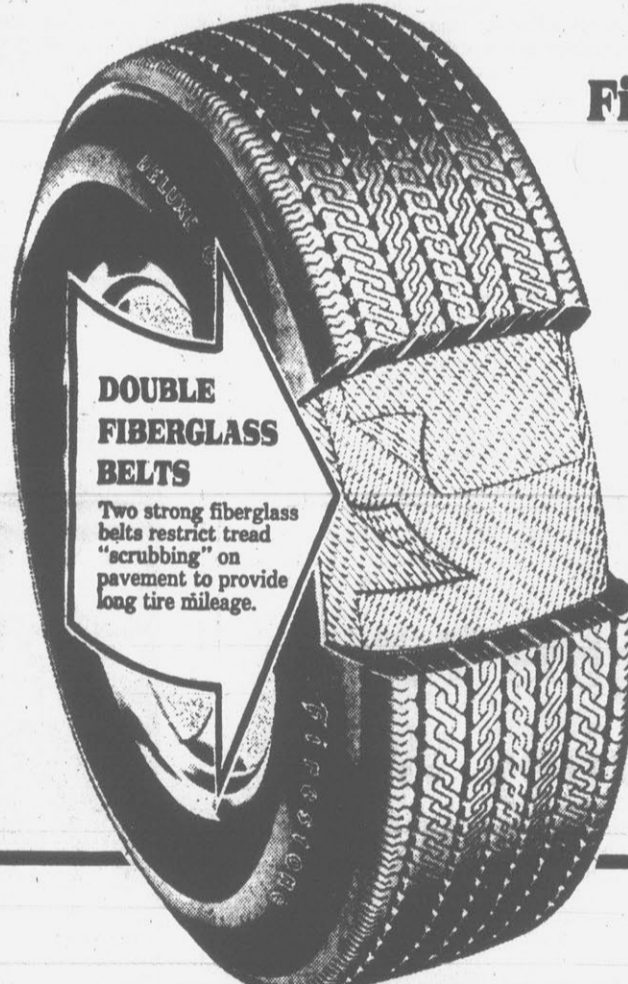

### DOUBLE FIBERGLASS BELTS

Two strong fiberglass belts restrict tread "scrubbing" on pavement to provide long tire mileage.

# \$32

A78-13 Blackwall Plus \$1.74 F.E.T. and old tire.

B, C, E78-14

# \$37

Plus \$1.94 to \$2.21 F.E.T.

F, G78-14; E, F78-15

# \$42

Plus \$2.33 to \$2.53 F.E.T.

H78-14, G78-15

# \$44

Plus \$2.59 to \$2.76 F.E.T.

H78-15, J78-15

# \$47

Plus \$2.82 to \$3.06 F.E.T.

L78-15

# \$51

Plus \$3.11 F.E.T.

All prices shown are for blackwalls, plus tax and old tire.

Whitewall add \$2 to \$5

Radial tire specially designed for import cars!

# \$36

155R-12, 155R-13 Blackwall Plus \$1.45 to \$1.65 F.E.T. and old tire.

STEEL-BELTED RADIAL CAVALLINO™

Super handling and a European-type tread design make the Cavallino the right tire for Audis, Datsuns, Fiats, MG's, Mazdas, Opels, Saabs, Toyotas, VW's and other import cars.

165R-13 Blackwall

# \$40

Plus \$1.81 F.E.T. and old tire. Whitewalls add \$4

165R-14, 155R-15, 165R-15 Blackwall

# \$47

Plus \$1.81 to \$2.10 F.E.T. and old tire. Whitewalls add \$4



### Compacts & Imports to Big Cars

AS LOW AS

# \$22

A78-13 Blackwall Plus \$1.89 F.E.T. and old tire. "A" size 8-16 design. Whitewall add \$4.

This tough polyester cord tire resists impacts, bruises and breaks and gives a smooth, quiet ride. Aggressive tread design for excellent traction. Handling and cornering ability.

Size	PRICE	F.E.T.
*6.00-12	24	1.42
*5.80-13	24	1.46
*P155/800-13	24	1.43
*6.00-13	25	1.50
878-13	26	1.77
C78-13	27	1.91
878-14	27	1.77
C78-14	27	1.93
*6.45-14	29	1.71
D78-14	29	2.01
E78-14	31	2.13
F78-14	33	2.26
G78-14	34	2.42
H78-14	36	2.60
*5.80-15	28	1.61
*6.00-15L	28	1.70
*6.85S-15	29	1.86
G78-15	35	2.48
H78-15	38	2.66
L78-15	40	2.93

All prices plus tax and old tire. Whitewalls add \$1 to \$4. \*Tread design different than shown.

# PUGH'S

TIRE & SERVICE CENTER

Corner of 5th & Greene Strs. Phone 752-6125

ROAD SERVICE • FARM & OFF-THE-ROAD SERVICE TRUCKS  
FRONT END ALIGNMENT • ELECTRONIC TUNE-UP • EXPERT BRAKE WORK

• Wash & Wax • Lube Jobs  
• Front End Alignments  
• Oil Changes  
**WE SERVICE NATIONAL ACCOUNTS**

Steel belted radial **Deluxe Champion**

# \$39.95

B78-13 Whitewall Plus \$1.89 F.E.T. and old tire.

Size	White stripe	F.E.T.
ER78-14	\$47.95	\$2.40
FR78-14	\$0.95	2.68
GR78-14	\$3.95	2.76
HR78-14	\$7.95	2.90
JR78-15	\$4.95	2.83
KR78-15	\$1.95	3.03
LR78-15	\$3.95	3.19
MR78-15	\$5.95	3.34

\*All prices plus tax and old tire.

# Jack Opens Inverrary Defense Amid Criticism Of His Playing

LAUDERHILL, Fla. (AP) — Jack Nicklaus, winner of the last two Jackie Gleason-Inverrary Golf Classics, not only is the defending champion, but also seems just a bit defensive coming into this week's chase for a \$54,000 first prize.

Nicklaus, winner of almost everything the game has to offer and generally considered the finest player golf has ever known, has been the subject of considerable criticism for the reduced schedule — if that's what it is — he's playing this year.

"Coming into this tournament, I've played as much golf this year as I did last," Nicklaus said before a practice session over the 7,127-yard, par-72 Inverrary Country Club course, site of the 72-hole test that begins Thursday.

That involves the late fall and early winter.

One tournament in question is the prestigious World Series of Golf in September. At the moment, it isn't on his schedule.

"I haven't yet qualified for it," Nicklaus pointed out. "Let's talk about it when and if

I qualify." Last year he commuted between the World Series in Akron, Ohio, and his home in Florida in order to watch his sons play high school football. And, again, he drew some criticism.

The same situation could exist this year and that, obviously, was in his mind when he said: "I don't want to go through that again."

Nicklaus has added one event to his schedule, the Tournament of Champions the week

following the Masters. Other additions are possible.

He has played twice coming into this event, but failed to finish in the top 10 in either the Bob Hope Desert Classic or last week's Bay Hill Citrus Classic. He moved into a contending position early in the final round, then blew to a fat 78 that took him out of it.

"Obviously, I didn't play very well," he said.

This week he's playing on one of his more productive courses, a layout on which he is unbeaten in three years. Not only has he won the last two Gleason's, he also won the 1976 Tournament Players Championship on the same course.

"Generally, I feel I'm playing pretty well, striking the ball pretty well. I just need some tournament competition," he said.

Six winners of 1979 titles — Ben Crenshaw, Lon Hinkle, Bruce Lietzke, Bob Byman, Lanny Wadkins and Fuzzy Zoeller — top the strong field that opposes Nicklaus.

Other standouts include Lee Elder, Ray Floyd, Hale Irwin, Gil Morgan, U.S. Open champ Andy North, Jerry Pate, Lee Trevino, Tom Weiskopf and Andy Bean. Tom Watson, John Mahaffey and Hubert Green are not competing.

CBS will provide national television coverage of portions of the final two rounds Saturday and Sunday.

# Hall Of Fame Vets Committee Sets Vote

TAMPA, Fla. (AP) — Three sluggers known for their muscle but who each finished distinguished careers with lifetime batting averages over .300 were the top possibilities when the Hall of Fame Veterans Committee met today.

Hack Wilson, Johnny Mize and Chuck Klein were overlooked by the writers in the Hall of Fame balloting, but they were expected to be strongly considered by the 18-member committee, comprised of six former players, six executives and six writers. The committee requires 75 percent

affirmative votes from the attending members for election.

Klein batted .320 and belted 300 homers in 17 seasons with Philadelphia, Chicago and Pittsburgh in the National League. In his first six seasons, he hit .360, .356, .386, .337, .348 and .368. With Philadelphia in 1929, the left-handed hitting outfielder slugged 43 homers, knocked in 145 runs and batted .356. The next year, he had 40 homers, 170 RBI and a .386 batting average.

Hack Wilson played 12 seasons for New York, Chicago,

Brooklyn and Philadelphia in the NL, finishing with lifetime marks of 244 homers and a .307 batting average. In 1930, the right-handed hitting outfielder had 56 homers, an alltime high 190 RBI and .356 average.

Mize, a left-handed hitting first baseman, played 18 seasons with St. Louis, the Giants and Yankees, finishing with a career total of 359 homers and a lifetime batting average of .313. In 1947, Mize belted 51 homers and knocked in 138 runs for the Giants.

# Save \$20 to \$32 on four fiberglass belted tires.

## Sale \$29 ea.

Reg. \$34, plus 1.74 fed tax, Size A78-13.

El Tigre 278s. Wide 70 and 78 series profile feature a 2 polyester ply body with 2 fiberglass belts. Metric sizes in blackwall only. No trade-in required. Tire mounted at no extra charge.

Sale prices effective through Saturday.

Tire size	Reg.	Sale	+ fed. tax
A78-13	34.00	29.00	1.74
E78-14	44.00	37.00	2.21
F78-14	46.00	39.00	2.34
G78-14	48.00	41.00	2.53
H78-14	50.00	43.00	2.76
G78-15	49.00	42.00	2.59
H78-15	53.00	45.00	2.82
L78-15	57.00	49.00	3.19

Sale prices effective through Saturday.

# Save \$40 on four Scat Trac Bravas.

Rugged RV tire designed for off/on road use. Deep biting tread to keep you moving. Nylon cord body with raised white letters. Tubeless. No trade-in required. Tires mounted at no extra charge.

Tire size	Reg.	Sale
11-15	79.00	69.00
12-15	89.00	79.00

F.E.T. Not Included.

# JCPenney Auto Center

•Shop 8:30 A.M. 'Til 9 P.M.  
•Phone 756-1190 EXT. 251

# 20% off men's golf gear.

## Sale 41.60

Reg. \$52. Power Stix Mark III set of 3 woods with low profile laminated heads.

## Sale 110.39

Reg. 137.99. Power Stix Mark III set of irons have investment cast heads.

## Sale \$48

Reg. \$60. Jack Nicklaus golden master set of 3 woods with Cyclocast inserts.

## Sale \$80

Reg. \$99.99. Jack Nicklaus Golden Master set of irons. Have deluxe propel shaft and thin sole design.

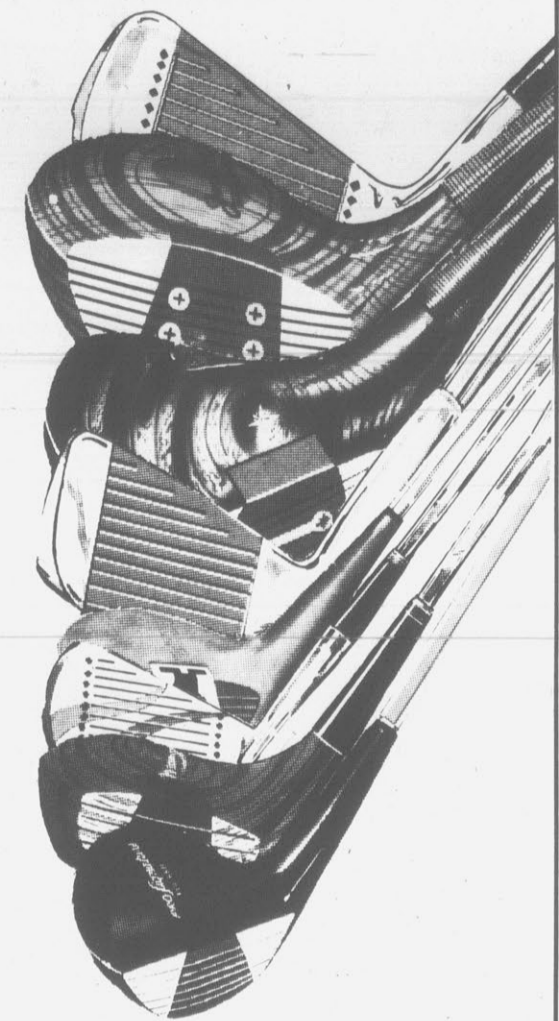

# 20% off golf shoes.



## Sale 15.99

Reg. 19.99. Men's wing toe oxford has vinyl uppers, cushion innersole and pvc outsole and heel. Men's sizes.

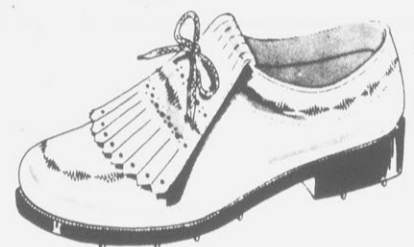

## Sale 13.59

Reg. 16.99. Women's multi-color stitch golf shoe has vinyl uppers, cushion innersole and pvc outsole and heel. Women's sizes.

Sale prices effective through Saturday.

# More sporting savings for the family.



## Sale 12.99

Reg. 15.99. Leach 'Charlie Brumfield' Personal racketball racket with quadriform head.

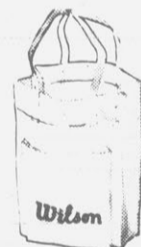

## 5.99

Women's Wilson® canvas tennis tote has outside racket pocket.

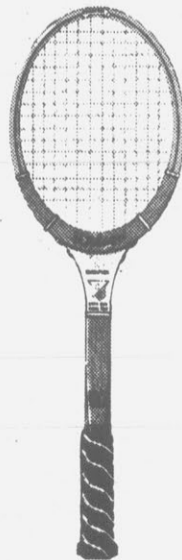

## Sale 7.99

Reg. 9.99 Wilson® Rosewall Champion wood tennis racket with leather grip.

## Sale 24.99

Reg. 29.99. Montini I aluminum frame tennis racket with 25% larger head.



## Sale 2.39

Reg. 2.79 Can of 3 Wilson® Championship tennis balls.

# This is JCPenney

•Shop 10 A.M. 'Til 9 P.M.  
•Phone 756-1190

# Defeats Haunt Tarkanian...

(Continued From Page 18)

point is his rapport with blacks. Many of his ex-players have become unofficial recruiters in black areas, spreading the word that Tark can be trusted. One coach likens Tarkanian to "a hoodlum priest. He knows some of his kids are bad, but he tries to build them into better people. Some of his kids are out-and-out punks but he'll protect them."

The two-year NCAA probation at UNLV — mostly for violations committed before Tarkanian came to Las Vegas — is supposed to end after this season. The probation prohibits the Rebels from playing in the NCAA Tournament that begins Friday and reduces their basketball scholarships to three a year.

The NCAA says one reason it has such a hard time getting the goods on Tarkanian is that his players are too loyal. Cash transactions aren't done in front of cheering crowds, either, the NCAA says.

"The boosters here will slip you something, just like everywhere else," said senior Eddie McLeod. "And when you go to the coach with a problem, he'll steer you to someone. Boosters know how to handle this type of thing. It's done privately."

Tarkanian says he's clean now. If a player asks for help, "I'll say 'you know people in this town as well as I do, keep

me out of it.'" Either way, Tarkanian's attitude is that he either cannot or does not want to turn off the flow of illegal booster activities.

"It's really uncontrollable, there are rabid people in any town," he said.

Tarkanian says he was aware of his players being helped at Long Beach, things like plane rides which were arranged by an assistant coach, Ivan Duncan. "I knew the players didn't walk," he said.

But his philosophy is that these are actions taken for humanitarian reasons. "If I were a mathematics professor and tried to help one of my students with a problem, then I would be considered a caring educator," he said. "But I am a basketball coach, and if I care about my players, the NCAA calls me a 'cheat.'"

Tarkanian says, however, he draws the line at buying recruits.

"You can't coach bought players. They don't have respect for you or themselves," he said. "We've been in the running with kids being offered \$50,000 (by another school) by selling them on having pride and dignity. But we don't usually get those kids. We have never gotten any of the superstar players to come here. Not one."

The AP interviewed a number of coaches who know Tar-

# Softballers To Be Improved

By WOODY PEELE  
Reflector Sports Editor

East Carolina University's women's softball team will be looking for a 20-game-plus winning season this year, despite the fact that only four regulars return from last season's 19-13 team.

Coach Alita Dillon said that while the team plays pretty much the same schedule as last year's, she looks for improvement from the Lady Pirates. "Nearly everyone else will be improved, too, but I'll still be disappointed if we don't win at least 20. I think we are capable of winning several more than we did last year."

While the women haven't had much time out on the field as yet, Dillon feels they've done well in practice so far. "They are not as far along as I'd like them to be, but I don't guess that they ever

are. They'll be back on campus for practice on Sunday, and we've got several days before we play a scrimmage game, and then a few more before we open the season."

The first game on the schedule is on Tuesday, March 20, against Pembroke State, last year's Division II state champion. The four returning regulars from last year's team include pitcher Mary Bryan Carlyle, first baseman Theresa Whitley; left fielder Donna LaVictorie and short fielder Robin Faggart.

"The outfield will be fairly experienced," Dillon said. "We have two returning, plus several others who played some last year. The infield lost a lot of people, but we have some who played some and some other good new people, so we should be all right here too. We're young in the infield, but the players have

a good background." Dillon is looking for a strong defense from the Lady Pirates, but hitting right now is a question mark. "If I had to put them into a batting order right now, it would be difficult," she said. "We just haven't had enough time on the field hitting yet. We lost several of our top hitters, although Whitley and LaVictorie are both good ones. We do have one or two newcomers who could be consistent long-ball hitters."

Jan McVeigh, who was the back-up at first base last year, has moved behind the plate this year to assume the catching duties. Carlyle will handle much of the pitching, but Dillon is hoping that Donna Eason, who is also slated for utility work, will come along as her backup.

Whitley returns to first base, while Cindy Meekins, who will also be a backup at third, behind her.

Janis Paron, a freshman, appears slated for second base, with Tricia Pearce behind her. Mary Powell will handle the shortstop duties. A transfer from Coastal Carolina College, she played as a freshman at UNC-Greensboro on the state championship team. "She and Mary Bryan played last summer on a team that went to the world tournament and finished fourth," Dillon added.

LuAnn Davis, who was a backup last year, takes over at third, with freshman Maureen Buck challenging her for the spot.

In left, LaVictorie returns, with freshman Kim Holmes as a backup. Shirley Brown, a freshman, and veteran Jo Carol Barrow are battling for the centerfield spot, while Addie Carter, who saw some action, will be in right.

"Lillian Barnes, who is coming off basketball, may challenge in the outfield once she gets acclimated to softball. She played a lot last year."

Faggart will handle the short field position, with Lynn Hurdle as backup, while Dawn Cayton could play any one of the outfield spots.

"I really think we have the makings of a good year," Dillon said. "Having our new field ready to play on, and having it on campus will help us a lot. I think interest in the sport will improve because of it. It won't be so hard for the students to come to games, and people passing by on Charles Blvd. will see us and maybe stop in. There won't be any admission charged."

"I really think we can have a good team," she said.

Purdue's football players were originally called either "Blacksmiths," "Rail Splitters" or "Boilermakers" and wound up settling for the last of those three.

—He is one of the best technical coaches in America.

—He does allow illegal things to go on with his players, but it's small scale compared to many other schools. Several of the coaches listed Kentucky, UCLA and USC as the biggest violators.

—The NCAA's punishment does not fit Tarkanian's crimes. He has been unfairly singled out by the NCAA.

—He genuinely cares about the welfare and pro aspirations of his players but is less concerned about their education.

Tomorrow: Tark the cheat?

## scoreboard

### Recreation Ball

Winterville League	
Peppi	14 22-36
Home Savings	8 16-24
Leading scorer: P. M. James 10	
Smith-Waldrop	
Winterville Ins.	21 33-54
Leading scorers:	SW, G. Warren
13; W. M. Vanlandingham 26	
Sheltered Workshop	
PH Hospital	25 22-47
Leading scorers:	SW, Carlos
Dawson 21; PH, Randy Allen 20;	
Herace Williams 10	
Integon	
Carolina Sales	20 21-41
Leading scorers:	L. Joe Butler-
worth 18; J. David Goetting 14	
Sportsworld	
Taff	29 20 6 9-64
Book Barn	24 25 6 4-61
Leading scorers: T. Kenneth	
Williams 20, James Anderson 14; BB,	
Blythe Clark 20, Don Edwards 16	
Sportsworld	
PH Hospital	20 41-61
Leading scorers:	S. Al Nichols 13,
John Kane 13; P. Wayne Grant 15	
Eaton vs. Ald. & Southerland	
suspended due to injury.	

Portland 118, New York 110	
Atlanta 94, Philadelphia 91	
San Antonio 103, New Jersey 99	
Houston 110, Denver 118	
Wednesday's Games	
Kansas City at Atlanta	
Boston at Philadelphia	
Seattle at Detroit	
Washington at Indiana	
New Jersey at Milwaukee	
Portland at New Orleans	
Houston at San Diego	
Cleveland at Golden State	
Thursday's Game	
Chicago at Phoenix	

S. Maine 70, Franklin Pierce 66
District 6
First Round
Cent. Wesleyan 71, Coastal Carolina 72
Winthrop 62, Lander 74
District 7
Championship
Grand Canyon 86, S. Utah 72
District 16
Championship
Drury 85, Rockhurst 61
District 17
Championship
Henderson St. 65, Hendrix 60
District 26
First Round
High Point 71, Winston-Salem St 49
Pfeiffer 58, Gardner-Webb 55
District 30
First Round
Xavier, La. 74, Miss. Valley 70
Louisiana Coll. 84, Wm Carey 73
NCAA
District 3
Championship
Bethel, Ind. 58, Grace 56

Transactions	
BASEBALL	
American League	
CLEVELAND INDIANS—Signed Len	
Barker, pitcher, to one-year contract.	
National League	
CINCINNATI REDS—Signed Dan	
Dumoulin, pitcher, to one-year contract.	
HOCKEY	
National Hockey League	
BUFFALO SABRES—Reactivated Jim	
Schoenfeld, defenseman, from the disabled	
list.	
VANCOUVER CANUCKS—Signed Veli-	
pekka Ketola, center.	
World Hockey Association	
NEW ENGLAND WHALERS—Sent	
Mike Antonovich and George Lyle, left	
wings, to Springfield of the American	
Hockey League.	
COLLEGE	
EASTERN MICHIGAN—Fired Ray	
Scott, head basketball coach.	
KENT STATE—Announced the	
resignation of Ted Boyle, swimming coach.	
LAWRENCE UNIVERSITY—Named	
Mike Gallus, men's basketball coach.	
Named Mary Heineke Paulson, women's	
basketball coach.	

Pro Hockey					
National Hockey League					
Campbell Conference					
Patrick Division					
W	L	T	Pts	GF	GA
N.Y. Islanders	40	12	10	90	282
Atlanta	35	23	6	76	256
N.Y. Rangers	34	21	8	76	257
Philadelphia	29	20	14	72	212
Smythe Division					
Chicago	24	27	12	60	194
Vancouver	19	35	10	48	185
St. Louis	16	40	8	40	197
Colorado	13	45	8	34	174
Wales Conference					
Adams Division					
Boston	36	17	11	83	255
Buffalo	26	24	13	65	204
Toronto	24	27	11	63	204
Minnesota	23	29	11	57	209
Norris Division					
Montreal	43	12	9	95	273
Los Angeles	28	27	9	65	229
Pittsburgh	27	26	9	63	220
Washington	20	34	11	51	223
Detroit	15	34	14	44	204
Tuesday's Games					
Philadelphia 5, Colorado 0					
Buffalo 3, N.Y. Islanders 2					
Wednesday's Games					
Colorado at N.Y. Rangers					
Los Angeles at Pittsburgh					
Vancouver at Toronto					
Chicago at Philadelphia					
Thursday's Games					
Chicago at Philadelphia					
Los Angeles at Buffalo					
Vancouver at Montreal					

College Scores	
SOUTH	
Clinch Valley 97, Bluefield St. 72	
FAR WEST	
Neu.-Las Vegas 91, Colorado St. 89	
TOURNAMENTS	
Mid-American Conference	
Championship	
Toledo 72, Cent. Michigan 65	
NAIA	
District 2	
Championship	
Oregon Tech 104, Hawaii-Hilo 74	
District 4	
Championship	
St. Mary's, Texas 71	
SW Texas 72, St. Mary's, Texas 71	
District 5	
Championship	
First Round	

NBA	
Eastern Conference	
Atlantic Division	
Washington	43 19 694
Philadelphia	34 29 540 9/2
New Jersey	32 30 516 11
New York	28 40 412 18
Boston	25 38 397 18 1/2
Central Division	
San Antonio	40 26 606
Atlanta	37 29 561 3
Houston	36 29 554 3 1/2
Cleveland	27 38 415 12 1/2
Detroit	24 39 381 14 1/2
New Orleans	21 45 318 19
Western Conference	
Midwest Division	
Kansas City	40 26 606
Denver	37 32 536 4 1/2
Milwaukee	28 38 424 12
Indiana	26 39 400 13 1/2
Chicago	23 41 359 16
Pacific Division	
Los Angeles	40 25 615
Seattle	39 26 600 1
Phoenix	38 27 585 2
San Diego	35 32 522 6
Portland	32 31 516 6 1/2
Golden State	30 37 448 11
Tuesday's Games	

Transactions	
BASEBALL	
American League	
CLEVELAND INDIANS—Signed Len	
Barker, pitcher, to one-year contract.	
National League	
CINCINNATI REDS—Signed Dan	
Dumoulin, pitcher, to one-year contract.	
HOCKEY	
National Hockey League	
BUFFALO SABRES—Reactivated Jim	
Schoenfeld, defenseman, from the disabled	
list.	
VANCOUVER CANUCKS—Signed Veli-	
pekka Ketola, center.	
World Hockey Association	
NEW ENGLAND WHALERS—Sent	
Mike Antonovich and George Lyle, left	
wings, to Springfield of the American	
Hockey League.	
COLLEGE	
EASTERN MICHIGAN—Fired Ray	
Scott, head basketball coach.	
KENT STATE—Announced the	
resignation of Ted Boyle, swimming coach.	
LAWRENCE UNIVERSITY—Named	
Mike Gallus, men's basketball coach.	
Named Mary Heineke Paulson, women's	
basketball coach.	

Transactions	
BASEBALL	
American League	
CLEVELAND INDIANS—Signed Len	
Barker, pitcher, to one-year contract.	
National League	
CINCINNATI REDS—Signed Dan	
Dumoulin, pitcher, to one-year contract.	
HOCKEY	
National Hockey League	
BUFFALO SABRES—Reactivated Jim	
Schoenfeld, defenseman, from the disabled	
list.	
VANCOUVER CANUCKS—Signed Veli-	
pekka Ketola, center.	
World Hockey Association	
NEW ENGLAND WHALERS—Sent	
Mike Antonovich and George Lyle, left	
wings, to Springfield of the American	
Hockey League.	
COLLEGE	
EASTERN MICHIGAN—Fired Ray	
Scott, head basketball coach.	
KENT STATE—Announced the	
resignation of Ted Boyle, swimming coach.	
LAWRENCE UNIVERSITY—Named	
Mike Gallus, men's basketball coach.	
Named Mary Heineke Paulson, women's	
basketball coach.	

In 1978, the New England Patriots were the first team in NFL history to have four 500-yard rushers, Sam Cunningham, Horace Ivory, Andy Johnson and quarterback Steve Grogan all topping that figure.

OPEN MONDAY THRU SATURDAY 9:30-9:00  
OFFICIAL N. CAROLINA INSPECTION STATION

# Kmart

FOR AUTO SERVICE DIAL 756-5953

## THE SAVING PLACE



**4-PLY POLYESTER CORD BLACKWALLS**

Our Reg. 21.88 Ea. — A78x13

### 4 FOR \$72

PLUS F.E.T. 1.69 EACH  
All Tires Plus F.E.T. Each  
Whitewalls 2.88 More Each



**STEEL BELTED**

Our Reg. 42.88  
AR78x13

### \$29

Plus F.E.T. 1.87 Each

All Tires Plus F.E.T. Ea.

ALL TIRES PURCHASED AT K mart INCLUDE MOUNTING • NO TRADE-IN REQUIRED

## AUTO SOUND SYSTEM

Model ID300A



EASY INSTALLATION

AM/FM STEREO INDASH RADIO

Our 127.84-134.84 — 4 Days Only

### \$96

Bring the sound of home stereo in your car. Original equipment styling in AM/FM push button indash radio, adjustable for most cars. 5 1/4" weather resistant indoor speaker with 6 1/4" grille or 6X9 rear deck speaker with air suspension woofers, 2" tweeters. 20 oz. magnets. Handles 25 to 50 watts of stereo output.

Our Reg. 69.93  
GR70x15

### 55<sup>88</sup>

Plus F.E.T. 3.50 Each

ALL TIRES PLUS F.E.T. EACH

Our Reg. 42.88  
AR78x13

### \$29

Plus F.E.T. 1.87 Each

All Tires Plus F.E.T. Ea.

Our Reg. 58.88  
With Exchange

### \$52

With Exchange

Sealed, maintenance-free '6/72' battery is lead-calcium constructed. Never needs water. Quality engineered to fit most large cars with many electrical appliances.



**'OUR BEST' BATTERY**

Our Reg. 58.88 With Exchange

### \$52

With Exchange

Sealed, maintenance-free '6/72' battery is lead-calcium constructed. Never needs water. Quality engineered to fit most large cars with many electrical appliances.

SERVICES INCLUDE:

1. Install new K mart points, rotor, condenser and major brand plugs (in stock)
2. Set dwell and carburetor
3. Tune engine
4. Diagnostic engine analysis

**6-CYLINDER TUNE-UP**

Air conditioned and 8-cyl. cars, \$2 more. 4 cyl. cars, \$2 less. Electronic ignition \$4 less. Additional parts and services extra. For most U.S. cars. Save.

### 31<sup>88</sup>

K mart AUTOMOTIVE SERVICE POLICY  
K mart guarantees a performance tune-up for 90 days. If any part of the tune-up fails to correct a problem, K mart will re-tune the engine at no charge. If any part of the tune-up fails to correct a problem, K mart will re-tune the engine at no charge. If any part of the tune-up fails to correct a problem, K mart will re-tune the engine at no charge.

**ARRESTOR**

CARRY-OUT ONLY 15.88

**H.D. MUFFLER INSTALLED**

Sale Price — 4 Days Only

### 17<sup>88</sup>

Arrestor® muffler is double wrapped against rust. Additional parts and services which may be needed are extra. Most U.S. cars.

SERVICES INCLUDE:

1. Replace front brake pads
2. Replace rotors
3. Inspect calipers
4. Bleed hydraulic system and refill
5. Inspect inner and outer bearings
6. Inspect rear linings for wear
7. Inspect master cylinder
8. Road test

Additional parts and services which may be needed are extra.

SERVICES INCLUDE:

1. Complete balance 2 front wheels
2. Align front end

**DISC BRAKE SPECIAL**

Sale Price 46<sup>88</sup>

**BALANCE AND ALIGNMENT**

Sale Price 14<sup>88</sup>

Front only work for most U.S. cars. Labor included. For Most U.S. Cars. Foreign Cars Excluded. Save.



## Kentucky Gentleman.

### A taste ahead of its price.

Pint \$3<sup>15</sup>

.75 Liter \$5<sup>00</sup>

1.75 Liter \$10<sup>75</sup>

### Sour mash. Sweet price.

You can see all the fascinating lore of whiskey-making at the Barton Distillery and Museum of Whiskey History in Bardston, KY. Make it a point to drop in if you're out our way.

© 1978. Kentucky Straight Bourbon Whiskey, 80 and 86 proof. Barton Distilling Co., Bardston, KY.

# Few Student Defaults Said 'Willfull'

By ELIZABETH LELAND  
Associated Press Writer  
The number of students who willfully default on federally-funded student loans is small, according to the executive director of the North Carolina Educational Assistance Authority.

"Many of the defaulters we run into are those who are having difficulty finding a job, or are underemployed, or are foolish enough to extend their credit beyond their ability," director Stan Broadway said Tuesday.

"So the student loan suddenly falls at the bottom of the priority heap," he said. "Unemployment, underemployment and inflation all work against students paying back their loans." Five North Carolina colleges are among 275 in the nation with default rates above 50 percent on National Direct Student Loans as of June 30, 1978, according to a list released Monday by the Department of Health, Education and Welfare. In all, more than 800,000 ex-students across the nation owe about \$702 million on loans that date back as far as 1959.

The amount of the loans outstanding from North Carolina was not available. North Carolina colleges with default rates above 50 percent are Durham College, 65 percent; Guilford Technical Institute, 56; North Carolina A&T, 52; North Carolina Central, 51; Roanoke-Chowan Technical Institute, 63, and Shaw University, 64. The average

rate in the state is 23 percent. Officials of at least one North Carolina college are so frustrated with the high default rate that they plan to discontinue participation in the NDSL program. Guilford Tech President J. James Owen said he believes there are other, more efficient ways of helping students. Other colleges are working on

ways to collect the outstanding debts — either by mailing payment requests to ex-students or by depending on the federal government's help in tracking down the former students. "We will consider whatever alternative is required to bring down the default rate," said Alberta Dalton, director of finan-

cial aid at North Carolina A&T in Greensboro. Five weeks ago, HEW Secretary Joseph A. Califano Jr. announced that he was stepping up a drive to improve the National Direct Student Loan collection rate. HEW plans to take over the collection of loans that have been in default the long-

est. The state attorney general's office, as lawyer for state schools, has taken students to court over the years in an effort to collect outstanding debts. But, as Blackwell put it, "We turn them (students) over to the attorney general and he has to decide whether to go after a drug trafficker or a loan defaulter."

It's That Time Again!  
**Designate #530**  
Designation Dates Mar. 5-Apr. 6  
**GROWER'S WAREHOUSE**  
500 Moore St., Greenville N.C. 756-6658  
J.L. Tripp Tom Morris Frank D. Dall

## Registration

Stokes Elementary School will hold pre-school registration Wednesday, March 28, from 8 a.m. to 12 noon.

Those children who live in the Stokes attendance area and will be five years old on or before Oct. 16, 1979 are asked to bring his/her birth certificate and shot record to the school. Children who enter kindergarten are required to have the following shots: three DPT's, three polio, one for rubella (German measles) and one for rubella (red measles).

## Community Funds

RALEIGH, N.C. (AP) — The town of Milwaukee no longer exists in North Carolina law, but its treasury is still in the bank.

The tiny Northampton County town of Milwaukee was chartered in 1915 and had its charter abolished in 1971. But the town's revenues have remained solid, growing with interest from less than \$2,000 to \$4,592.83 today.

So to do something with all that money, Rep. Guy Revelle, D-Northampton, introduced a bill in the General Assembly Tuesday. It would authorize the money, now in a bank in Woodland, N.C., to be given to the Bethany United Methodist Church.

The money may only be used, the bill says, for the upkeep of the old Milwaukee town cemetery, which the church is now maintaining.

"They've been after me for five years to get that money for them," Revelle said Tuesday. "I tried to get them to have that charter renewed. But there just isn't any leadership in the town."

There aren't many of the others, either. Revelle said the town population is now about 50 or 60 persons.

"They're all real good old country people," he said. Milwaukee, or what remains of it, is located three miles south of Conway on N.C. 35. In its better days, Revelle said, Milwaukee's main industry was a basket-manufacturing plant.

## Crossword By Eugene Sheffer

<b>ACROSS</b>	<b>DOWN</b>
1 Lively dance	1 Sword handle
5 Stripling	2 Melville
8 French town	3 Put to flight
12 Love god	4 Tapestry
13 Crude metal	5 Most lax
14 Exclamation	6 Fortify
15 Group of golfers	7 Supposes
17 Evangelist	8 Sullied
Roberts	9 Kind of
18 Finds the sum	10 Cordelia's father
19 Measuring devices	11 Nocturnal birds
21 Understand	12 Kind of dance
22 Glut	13 Ascend
23 Perform	14 Former VIP of Iran
26 Military decoration	15 Window section
28 Staircase post	16 Mine entrance
31 Cry loudly	17 Camper's need
33 Old weight for wool	18 Rim
35 A fruit	19 Education org.
36 To ponder	
38 Make lace	
40 Still	
41 Town in New Mexico	

**Answer to yesterday's puzzle.**

**Average solution time: 26 min.**

BRAN BAG SPAR  
EURE ALA LEDA  
SLIPACOG IRAN  
TED WOE SPURT  
SAN AIS  
HOLLY ANDORRA  
ALAIERN LOON  
TEMPERA DEWEY  
NAG GAS  
COROT ELM OCA  
OLIO SLIPSHOD  
ALAS AID AIRE  
TALE LAE PODS

**CRYPTOQUIP** 3-7

WSJQ VDXZVDRR VAWW CEZCDEZQ  
WSE WARR XZDXSJ

Yesterday's Cryptoquip — SLOPPY BOWLER BLOWS EASY SPARE.  
Today's Cryptoquip clue: J equals N

The Cryptoquip is a simple substitution cipher in which each letter used stands for another. If you think that X equals O, it will equal O throughout the puzzle. Single letters, short words, and words using an apostrophe can give you clues to locating vowels. Solution is accomplished by trial and error.

**JUST SAY "CHARGE IT" AT BOSTIC-SUGG**

**Bostic-Sugg FURNITURE INC.**  
401 WEST 10th STREET, GREENVILLE, N.C. PHONE 758-1729 or 758-2513

**Take Months To Pay With Bostic-Sugg's Personalized Revolving Charge Small Down Payment & Stretch Your Payments Over Many Months.**

**Bostic-Sugg's Interest Free 30-60-90 Day Cash Plan Simple As 1-2-3-4 Pay 1/4 On Purchase, Pay 1/4 30 Days, 1/4 60 Days, & 1/4 90 Days Just Like Paying Cash**

Logos for VISA and master charge.

## \$68.00 OFF LIBRA 4 PIECE MESH WROUGHT IRON SEATING GROUP

53 Inch Love Seat Sofa - 2 Arm Chairs & Cocktail Table Choice Of Pump Or White Suggested Retail Price \$247.00

**\$175<sup>00</sup>**

Save \$75.00 To \$80.00 On Contemporary 5 Piece Wrought Iron Dining Group

\$75.00 Off 42 Inch Umbrella Table & 4 Arm Chairs. List Price \$255.00. Choice of Yellow, White Or Pump. **\$180<sup>00</sup>**

\$80.00 Off 48 Inch Umbrella Table & 4 Arm Chairs. List Price \$280.00. Choice Of Yellow, White Or Pump. **\$200<sup>00</sup>**

## Save \$15.00 To \$22.50 On Solid Oak And Tuliptop Deacons Benches

List \$60.00 **44 Inch Deacons Bench .. \$45.00**

List \$80.00 **60 Inch Deacons Bench .. \$60.00**

List \$90.00 **72 Inch Deacons Bench .. \$67.50**

List Price \$400.00 \$100.00 Off!

**Maddox Solid Cherry Or Mahogany Queen Anne Writing Desk**

**\$300<sup>00</sup>**

Authentic Reproduction, Handrubbed Finish.

**For That Special Touch!**  
This will really make your eyes light up!

**Decorator Tilt Top Tables \$39<sup>00</sup>**  
List Price \$60.00

These unique solid hardwood tilt-top tables are that finishing touch for today's "lifestyle" home. Solid hardwood construction, finished in warm Antique Pine... with magnificent multi-colored hand-decoration. Sturdy pedestal base assembles simply with no special tools. Designed for extra strength and durability. These tables are that special plus touch to finish any room.

**MAPLE FLOOR LAMP WITH TRAY \$39<sup>00</sup>**  
Your Choice!

Shop Every Friday Night 'Til 9 P.M. 30-60-90 Days Same As Cash Plan.

Save **\$21<sup>00</sup>**  
Suggested Retail Price \$60.00

# How's The Weather?

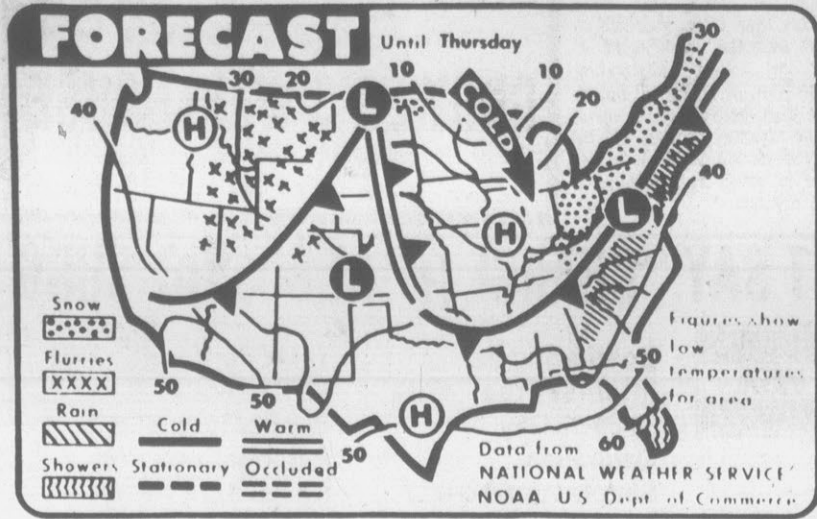

**WEATHER FORECAST** — Rain is expected in the forecast period until Thursday morning from Georgia to eastern New England. Snow is predicted for the Midwest, St. Lawrence Valley and western New England. Snow flurries are

# Airlines Are Curbing Service

**By The Associated Press**  
Fuel shortages have forced two additional air carriers — United and Delta — to cancel hundreds of flights, and airline industry officials are predicting the tight supply picture could endanger some cheap fares and plans to expand routes.

"The idea is to save fuel," said United's Williams. "Shell Oil has told us we can't get our normal supply of fuel temporarily, so we're cutting back through the end of the month."

He said the schedule reduction went into effect Saturday with no problems and future cancellations will be determined by bookings. "If we have several flights to the same city, we'll cancel one flight and try to book the passengers on an earlier or later one," he said.

United will not cancel service to cities with only one flight a day, or to locations where bookings are heavy, he said. Spokesmen for the Air Transport Association, which represents the nation's scheduled carriers, said the cancellations represent only a fraction of the 13,500 daily flights nationwide. "We expect adequate supplies with only spot shortages," said Daniel Henkin. "To date, we are experiencing only tempora-

ry problems. We've been able to meet more than 99 percent of our flights." Airline officials say it's too early to tell how long the tight fuel situation — precipitated by oil production slowdowns in Iran — will persist or what the ultimate impact may be. However, a Delta official said if the fuel picture doesn't improve, the airline could be forced to delay plans to add flights and routes to its system.

# Cemetery Vase Thefts Add Up

**GASTONIA, N.C. (AP)** — The value of bronze vases placed on graves has attracted the interest of thieves in Gaston County, according to officials.

A Gastonia police spokesman said the vases disappear from local cemeteries and never reappear on the local marketplace.

According to police records, 77 vases disappeared from Westview Cemetery in Gaston County in 1977, followed last December by 400 stolen from

Hillcrest Cemetery in Mount Holly.

But police say a considerably higher number of the vases, which have a wholesale value between \$30 and \$45, may have been taken.

The problem is nationwide, police say, but North Carolina and Florida have reported the largest number of cemetery-vase thefts.

Cemetery operators say many of the grave thefts go unreported in order to avoid publicity.

Many cemetery owners, including some on the N.C. Cemetery Commission, said they suspect an unscrupulous foundry operator is melting the vases and selling the bronze. Gaston County sources have said that the vases are reprocessed in West Virginia, the site of several small foundries.

But West Virginia police records show no cemetery-vase thefts, and police in that state said there have been no reports that foundries are receiving stolen vases to be melted down.

Marvin Kaiman, president of a scrap-processing facility in Pensacola, Fla., dismissed the theory of the foundry connection.

"In Florida, we've tracked the stolen vases to the flea markets, because they're worth more there than melted down," Kaiman said.

Meanwhile, North Carolina and Florida authorities are looking for a ring of professional thieves that moves its operation around the country taking cemetery vases.

## ANNIVERSARY SUNDAY

The Simpson Gospel Singers will celebrate their 10th anniversary Sunday at 2 p. m. at English Chapel F.W.B. Church.

The president, Thomas Best, invites the public.

Pursch, the head of the facility's alcohol and drug rehabilitation unit.

Pursch also was in charge of caring for Mrs. Ford in 1978 and Sen. Talmadge of Georgia earlier this year. Both suffered from alcoholism problems. In addition, the former first lady became dependent on drugs taken to relieve arthritic pain.

Medical experts consider the Long Beach facility's alcoholism treatment program one of the best in the country.

Lt. Cmdr. F.W. Ohnemus, officer of the day at the medical facility, said he could not say for certain under what authority the president's brother was brought to the hospital. But he added, "The secretary of defense can designate whoever he wants to be admitted, and I am assuming he was a secretary-designate."

As to who would pay the bill for Carter's treatment, Ohnemus said, "I assume he will receive a bill the same as any other civilian at the rate of \$266 a day. Whether he will pay it or an insurance company will pay it, I don't know at this time."

Carter was admitted only hours after leaving the Americus-Sumter County Hospital in Americus, Ga., where he underwent 10 days of treatment for bronchitis, hospital administrator James Griffith said.

The Washington Star reported last week that White House physician William Lukash had been seeking help for Carter from specialists in alcohol rehabilitation. At a recent press conference, President Carter said his brother was "seriously ill" but he did not elaborate.

**By The Associated Press**  
Drier air continued to move eastward across North Carolina today behind the cold front that brought the recent rains. This morning, the front was located just off the coast where showers lingered.

per plains area this morning and it should be moving across the mid-Atlantic states on Thursday. This could bring showers to North Carolina, possibly starting in the mountains tonight.

The scattered rain along the coast this morning was expected to be followed by consid-

erable cloudiness during the day, while some clearing was expected inland.

Temperatures were expected to climb to the 50s before dropping tonight to the 30s.

Friday is expected to be fair, with cloudy weather over the weekend.

# Billy Carter Admitted To Alcohol Abuse Care

**LONG BEACH, Calif. (AP)** — Billy Carter, the president's beer-guzzling brother, has been admitted to the alcohol abuse center where Betty Ford and Sen. Herman Talmadge underwent intensive treatment.

The 41-year-old Carter, who once said his beer drinking has been exaggerated but that "some days maybe I drink 20 to 25 beers," was spirited into the sprawling Long Beach Naval Hospital Tuesday evening

while reporters were kept away from the admitting area.

A brief statement released by the hospital said only that Carter "has been admitted as a voluntary patient" and was under the care of Dr. Joseph

## NOW AT FIRST FEDERAL MONEY MARKET CERTIFICATES

**9.665%**  
Per Annum Compounded Quarterly Rates good Thurs., Mar. 8 through Wed., Mar. 14

\$10,000 minimum deposit. Six month term. Penalty for early withdrawal. FSLIC insured.

**FIRST FEDERAL SAVINGS** FSLIC  
Greenville, Farmville, Grifton, Ayden



# Comet creates a rice mix that doesn't need a packet to give it flavor.

There's no packet to mix. Because flavor is steeped into each and every beautiful kernel. So all you have to do is cook up as much or as little as you like. (It only takes 15 minutes.) And enjoy. There are four delicious varieties. All with the flavor steeped in and the packet left out. Comet's new rice mixes. They're out of this world.

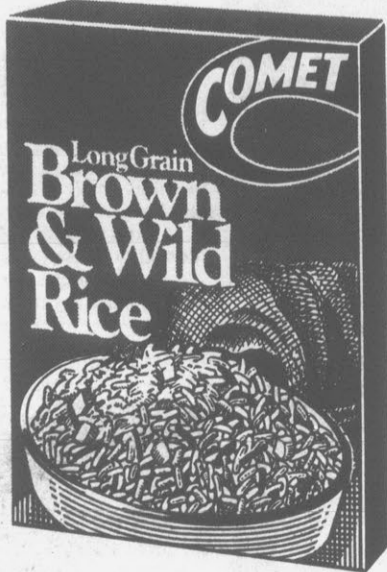

**10¢ off** on a box of any Comet Rice Mix.

### STORE COUPON



**TO DEALER:** For each coupon you accept from consumer at time of purchase of the specified product we will pay you face value (plus 5¢ handling) provided you and your customer have complied with the terms of this offer. Presentation for redemption without such compliance constitutes fraud. Invoices proving purchase of sufficient stock to cover coupons presented must be shown upon request. Coupon may not be assigned or transferred. Customer must pay any sales tax. Offer good only in U.S.A., void where prohibited, taxed or restricted by law. Coupons will not be honored if presented through unauthorized persons. Cash value 1/20 of 1¢. Unauthorized reproduction of this coupon is prohibited. Coupon is redeemable only if mailed to COMET RICE MILLS, INC., P.O. Box R-7028, El Paso, Texas 79975.

Limit one coupon per customer. Offer expires Dec. 31, 1979.

CRM-1B

# SAVE UP TO \$1.10



Soft-weve ... in soft pastels and pretty floral prints.

### ORDER FORM / NOT A STORE COUPON

**SAVE \$1.00 ON SOFT-WEVE® BATHROOM TISSUE**

GET 5 SOFT-WEVE COUPONS EACH WORTH 20¢ ON THE PURCHASE OF 2 PACKAGES. JUST SEND 6 "SEALS OF QUALITY" FROM SOFT-WEVE WRAPPERS TO:

SOFT-WEVE REFUND OFFER  
P.O. BOX 4221  
CHESTER, PA 19016

HURRY! OFFER EXPIRES JUNE 1, 1979.  
SCOTT PAPER CO., SCOTT PLAZA, PHILA., PA 19113

BE SURE TO INCLUDE THIS FORM

NAME \_\_\_\_\_  
ADDRESS \_\_\_\_\_  
CITY/STATE/ZIP \_\_\_\_\_

**IMPORTANT:** WE CANNOT GUARANTEE DELIVERY WITHOUT ZIP CODE. PLEASE ALLOW 6-8 WEEKS FOR DELIVERY. THIS ORDER FORM PLUS 6 SOFT-WEVE "SEALS OF QUALITY" MUST ACCOMPANY YOUR ORDER. FACSIMILES OF THIS ORDER FORM OR "SEALS OF QUALITY" WILL NOT BE ACCEPTED. VOID WHERE TAXED, RESTRICTED, OR PROHIBITED BY LAW.

**SAVE 10¢**

WHEN YOU BUY 1 PACKAGE OF Soft-weve BATHROOM TISSUE PRINTS OR PASTEL

**10¢ OFF ONE PACKAGE**

Retailer: If you receive this coupon in part payment on the retail sale of One Package of Soft-weve Bathroom Tissue to a consumer and if, upon request, you submit evidence thereof satisfactory to Scott Paper Company, we will reimburse you for the face value of the coupon plus 5¢ for handling. Mail properly received and handled coupon to SCOTT PAPER COMPANY, BOX 5000, CHESTER, PA 19016. Cash value 1/20¢. Coupon may not be assigned or transferred. Void where prohibited, taxed or restricted by law. Good only in U.S.A. Consumer must pay any sales tax. THE USE, REDEMPTION OR HANDLING OF COUPON NOT ACCORDING TO ITS TERMS CONSTITUTES FRAUD. ONLY ONE COUPON PER PACKAGE PURCHASED. MECHANICAL REPRODUCTION OF COUPON PROHIBITED.

STORE COUPON 06069

K-376

# Advices Learn Enough To Set Own Pace In Fitness

By FRED T. FERGUSON  
NEW YORK (UPI) — The average American is going to have to decide for him or herself what is a common-sense approach to fitness and health.

At least, that is the opinion of Dr. Robert Arnot. He'll be glad to provide a few tips along the way, as will lots of others. And he's pretty strong about what he believes.

But he says that when 300 doctors at a Boston marathon for the medical professions were asked how they would approach physical fitness last year, there were just about 300 different answers.

As for massive national funding and organized education on fitness, both of which he'd like to see, he says, "it just isn't going to happen, at least, any time real soon."

"There was a lot of talk about it at the Kennedy conference in Washington last fall, but when it came down to who was going to do it, there was just no one equipped or capable of tackling it," he said. Lacking a tremendous

number of trainers and enough of the kind of training centers and education on fitness to do the job in schools and out, he believes people probably are best off learning enough about fitness to plan their own exercise program.

The average general practitioner — and most other doctors, for that matter — is going to be "safe and conservative" but not necessarily right on how to go about getting fit, he says.

Because of this, he even suggests, if you lack the wherewithal for a fitness specialist, that you seek a doctor's advice only when they have an injury or health problem.

Who is this Arnot? He's just 30, looks younger. Handsome, dashing, debonair

## Can't Trust A Flippant Sign

ABINGDON, Va. (AP) — The boy insisted that the marquee he'd seen outside an office-supplies business here proclaimed "Only 150 More Shopping Days Until Easter," but his father didn't believe it.

The father was sure his son misread the sign, and that it probably had something to do with the number of shopping days until Christmas.

The father was wrong. It was not the first time the marquee, which has its message changed every week or so, had caused some confusion. When it said, "Welcome Greta Garbo," a woman called the business and became irate when she learned the actress was not coming after all.

Sam Guza, who runs the business, said he started putting flippant messages on the marquee simply for fun.

"It's becoming a problem to try and top myself," he admitted.

and a twinkling eye, dimpled smile. He must have been the idol of the girls when he was at Dartmouth and McGill, where he picked up degrees. He's also a world class cross-country skier.

More to the point, he is director of sports medicine for the U.S. Winter Olympics.

And he is a recognized authority in the field of clinical sports physiology, physician for the U.S. Ski Team, director of Lake Placid Sports Medicine, sports physiology consultant to Massachusetts General Hospital.

He's doing some exciting research at the moment on the effects of exercise stress on athletes and its utilization in designing individualized training programs.

Arnot says it's just fine that the number of fitness freaks has more than doubled since the '60s. But what's needed now is for those doing all this exercise to start really working on getting fit by picking up some knowledge about how to do it. Not that some don't, but that so many more could do it and avoid injury in the process.

Arnot delivered a drumfire lecture on some of the new developments of determining what an athlete can do and how he can best be trained at a conference to announce the findings of a Louis Harris Fitness in America poll for the Perrier bottled water company.

For example, "We've got to get away from the idea of running just to try to slim down."

The survey said 59 percent of all adult Americans are now into fitness in one way or another.

Arnot said the East Germans and the Russians, in whose sports medicine labs he has spent a lot of time studying, have demonstrated that the incidence of disease can be greatly reduced through massive fitness education and training programs.

Despite his belief that America's present approach to fitness is all wrong and the nation is "way behind the ball" when compared with other countries, he's hopeful. But he says this country needs to get with it quick.

He believes billions of dollars can be saved, social security and medical insurance programs protected and hospital costs and facilities alleviated if more Americans can find a way to achieve fitness.

Lacking a massive federal program emulating, say, the East Germans, he believes what is beginning to happen is that Americans are taking over their own fitness destiny.

"The general public is much smarter than it is given credit for," he says. "It's what they are going to do for themselves that will work."

"The Scandinavians say train

It would help, he says, if grade schools taught more about how the heart, lung and brain work and if the biology of human activity were taught more thoroughly in high schools. But barring that, "we can learn from commercial television and the press."

"What I say is that, if people are shown a very legitimate, scientific approach to fitness, then they will listen. What we want to encourage is a very slow, gradual approach to fitness, a change in lifestyle."

He gives an example. "Just about anyone can knock off five pounds pretty quick, but what good is it going to do for you? Most of it won't stay off."

"The safest way is to lose about a quarter of a pound a week, but not for how thin it's going to make you, for how fit you will be."

"I hope what the public will say is, 'I don't need any of this sophisticated equipment to get started on fitness for health.'"

"You can take a calorie book, figure out how many calories you eat each day and get a chart, figure out how many calories you use up running or doing some other exercise in an hour. The average American now eats about 3,500 calories a day. But after 21, most people use about 500 calories a day less than that. They need to use up those calories."

a lot, eat a lot." He tells of an Olympic weightlifter who eats 11,000 calories a day, of an oarsman who consumes 7,000. But they are in great shape because they work it all off. Not that he's suggesting the novice fitness freak do anything like that.

He notes everyone is different. Each program needs to be tailored to the individual. "It's a terribly individual thing."

From experience, most people find out how many calories they use up and can compensate with the appropriate amount of exercise.

The kind of exercise is another matter. He talks of muscle fiber studies which show some people are unsuited to, say, distance running while others will not achieve anything with weightlifting. To some extent, this becomes apparent by what you do best, although

for world class athletes there are scientific and complex tests that can be used.

What good will it all do? He likes to cite a Harvard study. "It shows you could start at 30, 35 even 45 and live longer. But the key really is how well you can perform."

"And it's clear to me that a certain amount of exercise correlates not only with better health but an improved mental fix and a feeling of well being."

## INVENTORY REDUCTION SALE



### ZENITH 25" COLOR TV

Model K2504

- Automatic Color Button
- 100% Solid State
- Easy-Roll Casters
- Energy-Saving Chassis

**NEW LOW \$558**

Price includes Service and Parts Warranty

### BOB'S TV & APPLIANCE

AYDEN, N.C. GREENVILLE, N.C.

108 East 2nd St. 2 blocks from Pitt Memorial Hospital in the C. L. Lupton Bldg.

## Consumption Of Wine Growing

NEW YORK (AP) — The consumption of wine will register the highest annual growth-rate among America's favorite beverages from now until 1990, according to an industry magazine.

Soft drinks, however, will continue to be the nation's top beverage, gaining from a per capita intake of 36 gallons in 1978 to 50 gallons by 1990, says the publication Impact.

Wines are expected to show an annual growth rate of 8 percent, enjoying benefits from increased social and mealtime usage, it was explained.

# Save 50¢ on new Lean'n Tasty.

Leave it to Oscar Mayer to make the great tasting leaner breakfast meat.

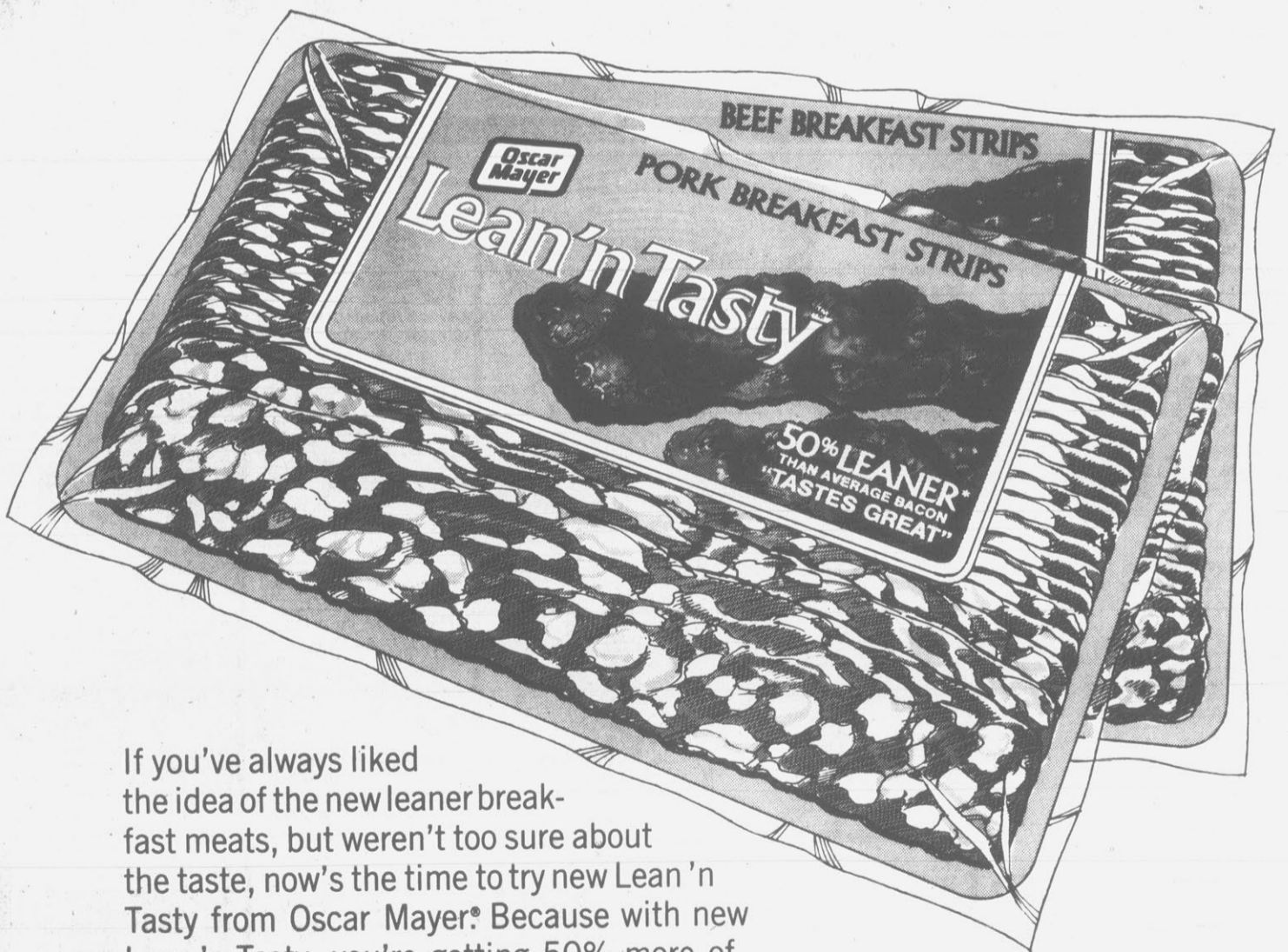

If you've always liked the idea of the new leaner breakfast meats, but weren't too sure about the taste, now's the time to try new Lean 'n Tasty from Oscar Mayer®. Because with new Lean 'n Tasty, you're getting 50% more of Oscar Mayer good lean meat than you get in regular bacon. Plus all that delicious Oscar Mayer hardwood smoking. No wonder we can't wait till you taste it.

REDEEM PROMPTLY

## Save 50¢

50¢ h0h50t 002hh

MR. DEALER: You are authorized to act as our agent for Oscar Mayer & Co., Inc. for redemption of this coupon for the face value plus 50¢ for handling if you receive it on the sale of Oscar Mayer Lean 'n Tasty breakfast strips. Coupon may not be assigned or transferred. Customer must pay any sales tax. Void where prohibited, taxed, or restricted by law. Cash value 1/20¢. Coupon will not be honored if presented through outside agencies, brokers or others who are not retail distributors of our merchandise or specifically authorized by us to present coupons for redemption. Proof of purchase of adequate supplies of Oscar Mayer® Lean 'n Tasty™ breakfast strips to cover coupon redemption must be furnished upon request. Failure to do so may, at our option, void any coupon submitted for redemption. Limit: One coupon per purchase of Oscar Mayer Lean 'n Tasty breakfast strips. For redemption of a properly received and handled coupon, mail to: Oscar Mayer & Co., Inc., P.O. Box 1621, Clinton, Iowa 52734. This coupon expires March 31, 1980.

Clip this coupon and take it along to your local supermarket. It's worth 50 cents off the regular price of new Lean 'n Tasty.

44700 105404

STORE COUPON

## FRIDAY'S 1890 Seafood Special Features

**Sunday-Couples Night:** 2 delicious seafood platters of Shrimp, Oysters, Fish, Cole Slaw, French Fries and our Famous Hush Puppies.  
**Only \$7.99 for 2**

**Monday-Shrimp-A-Roo:** A delicious entre' of Calabash Style Shrimp with French Fries, Cole Slaw and Hush Puppies.  
**All For Only \$2.99**

**Tuesday-Fish Fry:** All the Fried Fish (Trout or Perch) you can eat with French Fries, Slaw, and Hush Puppies.  
**Only \$2.25**

**Wednesday-Fried Oysters:** Golden Brown Fried Oysters with French Fries, Cole Slaw and Hush Puppies.  
**Only \$2.99**

**Thursday-Family Night:** Great Specials on Shrimp, Oysters Trout Or Perch,

Shrimp .....	<b>\$4.25</b>
Trout Or Perch .....	<b>\$2.25</b>
Oysters .....	<b>\$4.25</b>
Flounder .....	<b>\$3.95</b>

"All You Can Eat"

Hours: **Open 4:30 P.M. To 9 P.M.**  
**Sunday-Thursday 4:30 P.M.-10 P.M.**  
**Friday and Saturday**



Located On Evans Street Behind Sports World

# Pioneer Sub Heading For Final Berth

By DAN HALL

Associated Press Writer  
GROTON, Conn. (AP) —  
After a quarter-century without  
conflict, the world's first nuclear-  
powered submarine finds it-  
self in the midst of a battle  
over its final resting place.

Two of the leading site pro-  
posals for the USS Nautilus are  
Groton, where it first slid into  
the water 25 years ago on Jan.  
21, and Annapolis, Md., home  
of the U.S. Naval Academy. Lo-  
cations in California, South  
Carolina and Washington State  
also are being touted.

If Navy Secretary W. Gra-  
ham Claytor has made a deci-  
sion, he isn't saying what will  
happen to the sleek No. 571,  
which left a wake of records  
after paving the way for the  
nuclear underwater navy.

In fact, he said recently the  
Nautilus might be kept in ser-  
vice for another five years if the  
Navy Department decided to  
recondition older nuclear attack  
submarines as an economy  
move.

"Any decision on possible re-  
tention of the USS Nautilus will  
be made prior to her scheduled  
summer deactivation," he said  
in a statement.

But a former submariner who  
is leading the effort to bring  
the aging submarine back to its  
birthplace is skeptical.

"It's an iron coffin now. An-  
other five years..." said con-  
tractor and developer Frank  
Sheetz, who retired as a chief  
quartermaster 21 years ago.

He set up a nonprofit group  
to display the USS Croaker, a  
World War II submarine, and  
now wants to place the history-  
making Nautilus at the Croa-  
ker's Thames River mooring.

He has even leased his near-  
by restaurant to demonstrate  
that he wasn't interested in fi-  
nancial gain in bringing the  
Nautilus to Groton.

Meanwhile, another group in-  
cluding a number of admirals  
has created a USS Nautilus Na-  
tional Monument Committee  
that favors placing 571 in Anna-  
polis, said Melinda Hamilton,  
vice chairman of the group.

As a national monument, the  
submarine would have to go on  
a federal site and would be  
maintained by federal person-  
nel, much like the Revolution-  
ary warship Constitution in  
Boston Harbor.

Sheetz argues the taxpayers  
would have to bear the cost "in  
perpetuity." He said he would  
prefer the Nautilus be main-  
tained without cost to tax-  
payers, but would not oppose  
making it a national monument  
if that's what it takes to get it  
in Groton.

Retired Lt. Cmdr. Stuart N.  
Nelson of Norwich is a former  
Nautilus crew member who fa-  
vors the Annapolis proposal.

"I believe that that boat, like  
any other history-making part  
of this country, should be a na-  
tional monument," he said.  
"We have an institution for old  
airplanes, for civil war equip-  
ment. Why shouldn't we have a  
Smithsonian for submarines?"

At a Nautilus crew reunion in  
August, a majority also backed  
the Annapolis proposal, Nelson  
said.

Groups in Charleston, S.C.,  
Bremerton, Wash., San Diego  
and San Francisco also have  
put in bids for the Nautilus, the  
Navy says.

The interest isn't purely his-  
toric or patriotic. "Somebody is  
going to make money," Nelson  
said.

Unofficial predictions on the  
amount of tourist wealth that  
should come in on the Nautilus  
range up to \$60 million yearly.

## Fellowship For Satellite Plan

UNITED NATIONS, N.Y.  
(UPI) — Dr. John R. Pierce,  
the Des Moines, Iowa, scientist,  
who offered the first concrete  
proposals for satellite com-  
munications two years before  
the first satellite was launched,  
has been named winner of the  
fifth annual \$25,000 Marconi  
International Fellowship.

The award, named after  
Guglielmo Marconi, inventor of  
the wireless, will help finance  
new work of an international  
dimension that will benefit  
mankind, according to Intel-  
lectual Property Owners, a non-  
profit organization dedicated to  
the preservation of patents.

The fellowship was founded  
by Mrs. Gioia Marconi Braga,  
daughter of the Italian inven-  
tor, and is funded with \$500,000  
from 26 corporations and  
organizations from 10 different  
countries.

Sale ends Saturday,  
March 10th.  
We reserve the right  
to limit quantities.

# CLARKS

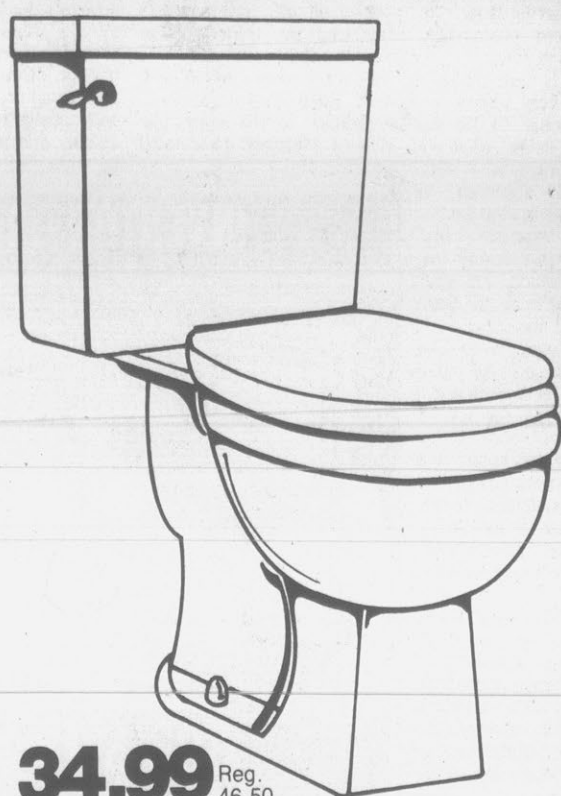

**34.99** Reg. 46.50

Grade "A" closet combination  
Made of vitreous china, includes  
ballcock. Seat not incl.

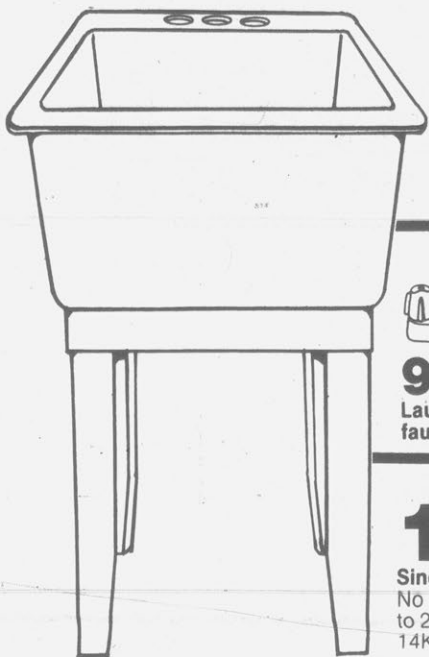

**9.99** Reg. 14.25  
Laundry tub  
faucet

**14.75** Reg. 18.00

Single laundry tub  
No rust construction, holds up  
to 24½ gallons. Faucet not incl.  
14K

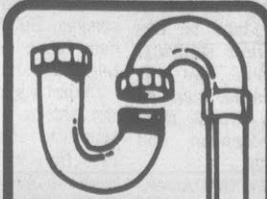

**5.49** Reg. 7.50  
1½" S trap  
Chrome plated

**2.49** Reg. 3.25  
1½" J bend  
Chrome plated.

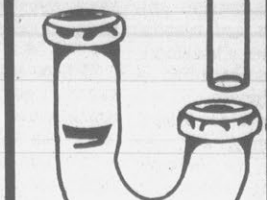

**3.49** Reg. 4.75  
1½" P trap  
Chrome plated.

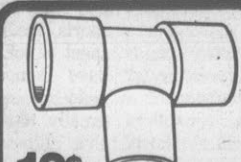

**13¢**  
Genova ½" CPVC tee



**8¢**  
Genova ½" CPVC 90° ell

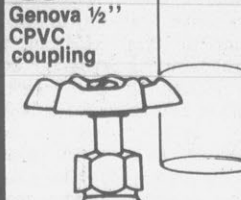

**10¢**  
Genova ½" CPVC coupling

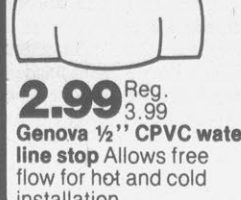

**2.99** Reg. 3.99  
Genova ½" CPVC water  
line stop Allows free  
flow for hot and cold  
installation.

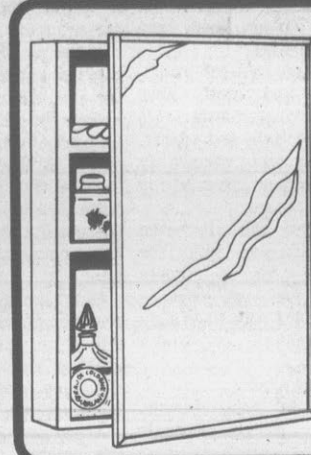

**9.99** Reg. 13.25  
Medicine/utility  
cabinet White  
enamel finish,  
single strength  
mirror.  
14"x18"x4-1/8"D



**12.99** Reg. 16.50  
Grade "B" vitreous  
china lavatory  
19"x17". Faucet not incl.



**8.49** Reg. 11.49  
Bedford Brass lavatory  
faucet Chrome plated  
brass with 4" centers.  
843-020

**1.29** Reg. 2.00  
Genova ½"x10"  
CPVC pipe For hot and  
cold water installation.

**2.55** Reg. 3.55  
Genova 1½"x10"  
PVC DWV pipe  
Schedule 40 pipe.

**9.49** Reg. 13.49  
Genova 4"x10"  
PVC DWV pipe  
Polyvinyl chloride  
for drain, waste  
and vent.

# Do it yourself and save!

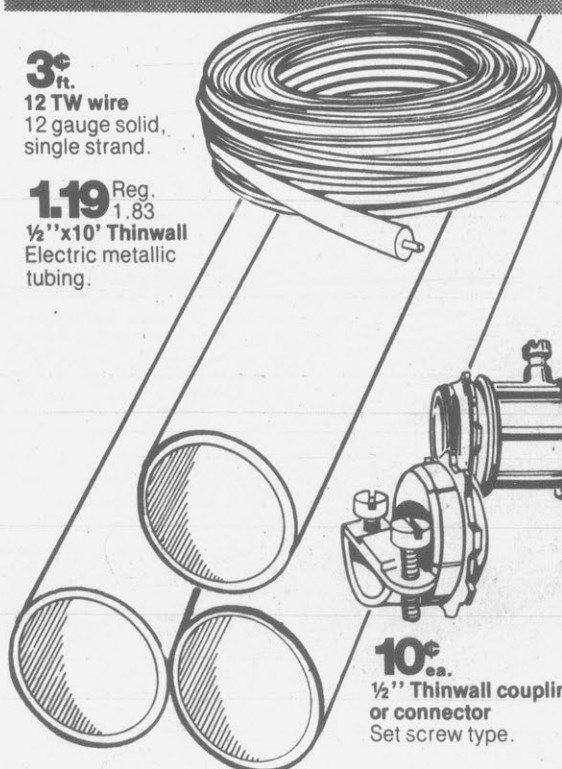

**3¢**  
12 TW wire  
12 gauge solid,  
single strand.

**1.19** Reg. 1.83  
½"x10' Thinwall  
Electric metallic  
tubing.

**10¢**  
½" Thinwall coupling  
or connector  
Set screw type.

**19¢**  
Leviton rubber grounding  
adaptor Converts 2  
prong outlet into  
3 prongs. 274

**20¢**  
Leviton ivory plug  
base Makes a socket  
into an outlet. 125-I

**32¢**  
Leviton ivory cube tap  
Plugs into any outlet.  
68-I

**37¢**  
Leviton ivory socket  
adaptor Turns an outlet  
into a socket. 61-I

Why rent a phone when you can own  
one and save money too. It's legal!



**3.99** Reg. 5.25  
25' standard to modular  
extension Modular plug  
on one end, standard  
jack on the other. S155

**2.99** Reg. 4.00  
Modular phone adaptor  
plug Converts 4 prong  
jack to new modular  
jack. S3566

**2.99** Reg. 4.25  
25' telephone extension  
cord With molded plug  
and jack. S149

**18.95** Reg. 24.95  
Desk telephone  
Rotary dial with ringer.  
Available in white or  
beige. 9666, 9668



**6.99** Reg. 9.25  
½" Thinwall Bender  
Heavy duty construction.

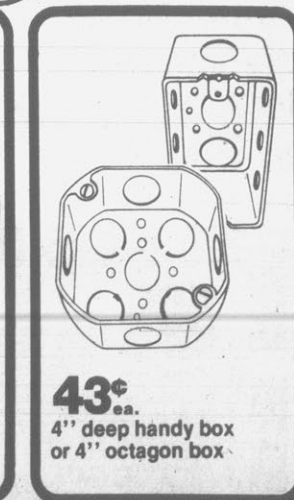

**43¢**  
4" deep handy box  
or 4" octagon box



**4.99** Reg. 6.70  
GE 2 place breaker  
panel Single phase.  
3 wire. UL listed.  
TL270



**16.99** Reg. 21.50  
GE 12 place main  
breaker panel 125 amp  
main lugs. TLM1212



**5.99** Reg. 7.95  
Safety switch Suitable  
for electric dryers.  
33NP

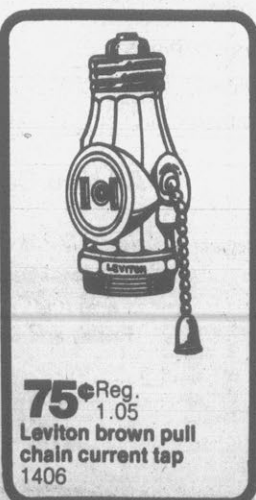

**75¢** Reg. 1.05  
Leviton brown pull  
chain current tap  
1406

RAINCHECK  
If we sell out of any advertised specials,  
you will receive a written order. "Rain-  
check" which entitles you to buy the item  
at the advertised price when our stock is  
replenished.  
(excluding clearance items)

WEST END SHOPPING CENTER, GREENVILLE

MON. thru SAT., 9:30 A.M. to 9:30 P.M.



Just say "CHARGE-IT"

Sale ends Saturday, March 10th. We reserve the right to limit quantities.

# CLARKS



## Fuel-Waste By Tractors In Capital

By PAMELA J. HUEY  
CHAMPAIGN, Ill. (UPI) — The American Agriculture Movement's tractorcade to the nation's capital is over but a flap goes on as to one aspect — fuel waste by the clanking vehicles.

President Carter's chief inflation fighter, Alfred Kahn, chided farm protestors for wasting fuel when they traveled to Washington to demonstrate.

But, an AAM member in Illinois argued that if leaders in Washington had done their job they would not have to worry about tractorcades or the demonstrating farmers.

"I would say that the tractors do not bode well for food prices, or even for energy consumption in the United States today," Kahn said in Washington.

"If government would have listened to us without this (the tractorcade) and enacted the 1977 farm bill, they could have saved the whole mess," retorted farmer Vince Klay in Illinois' Christian County.

Still, there has been criticism, both in government and from the general public, of some of the farmers' tactics — especially the use of large, expensive machinery to protest low farm prices.

Agriculture Secretary Bob Bergland said the demonstrations had been very damaging for the farmer in terms of public relations.

"They can't be all that bad off when they drive around on \$30,000 tractors," said one Champaign resident recently.

At the request of UPI, Royce Hinton, a University of Illinois farm management economist, calculated the cost of operating a 100-horsepower, \$30,000 tractor, taking into consideration fuel consumption, depreciation of the implement, repairs, tire wear and interest on the investment.

First, Hinton cautioned his cost figures applied to normal farm activities and not to driving on Interstate highways. For normal farm use and without considering fuel consumption, Hinton said such a tractor costs between \$9 and \$11 an hour to operate.

Assuming the farmer paid 60 cents per gallon for diesel fuel (figure includes tax on the fuel), and burned five gallons per hour, the farmer paid about \$3 per hour in fuel costs.

Hinton then added the \$3-per-hour fuel cost to the initial \$11 cost-of-operation figure, and calculated it would cost the farmer \$14 an hour to operate the tractor on his trip to Washington. If the farmer averaged 20 mph, the approximate cost would be 60 cents per mile.

Taking that one step further, if the farmer traveled from Springfield to Washington and back again — a distance of 1,516 miles — the travel cost would be \$909.60.

"It's not a very economical way to travel," Hinton said.

However, Klay said tractors make much better mileage traveling on interstate highways than they do in the field.

Klay, whose wife, Janet, traveled to Washington for the protest activities, said the farmer held the key to the nation's energy woes through the production of gasohol (a blend of 90 percent gasoline and 10 percent ethanol) and/or the production of just straight ethanol (grain alcohol).

If the federal government lifted present restrictions, farmers could build old-fashioned stills on their farms and become energy self-sufficient in no time, he said.

"Our big problem is the government is being manipulated by the large oil companies," Klay also disagreed with contentions the farmers had done more harm than good while protesting in Washington.

His wife told him reaction all the way had been positive and capital city residents offered to open their homes to the protesters.

As for the use of expensive tractors, Klay said, "The tractor is the tool of the farmer's trade. He must have good tools. It's not a prestige item."

**GAVEL**  
KANSAS CITY, Mo. (AP) — Wyandotte County District Court Judge John Mahoney has had his gavel stolen from the top of his bench.

Mahoney believes it disappeared a day before he discovered the loss, but he admits it could have been missing for as long as 10 days.

"I don't have much use for it to pound lawyers into submission," he said, chucking.

**1.49**  
Royal Baby Shampoo  
64 oz.

**2 for 1.00**  
Curad Bandages  
3/4" wide. Box of 60.



**3 for 57¢**  
Reg. 25¢ ea.  
Tic Tac

Orange, peppermint, spearmint and wild fruit flavors.

**59¢**  
Sophie Mae Peanut Brittle  
10 oz. box.



### Special savings on color print film developing & printing!

Valuable coupon

Borderless prints from 110 or 126 film. Good on Kodak or Kodak competitive film only. Coupon must accompany order. Coupon expires 3/20/79.

**1.99** up to 12 exposures

**2.99** up to 20 exposures

**35mm film**

**3.65** up to 24 exposures

**YOU PAY 32.88**  
Less Regina mail-in rebate  
Your cost after rebate

**29.88**  
Reg. 38.95  
Regina Electric Broom  
3 speeds with rug pile dial and edge cleaner.

**YOU PAY 14.88**  
Less First Alert mail-in rebate  
Your cost after rebate

**9.88**  
Reg. 17.95  
First Alert Smoke Detector  
Detects visible and invisible smoke particles. Uses 9-V battery.

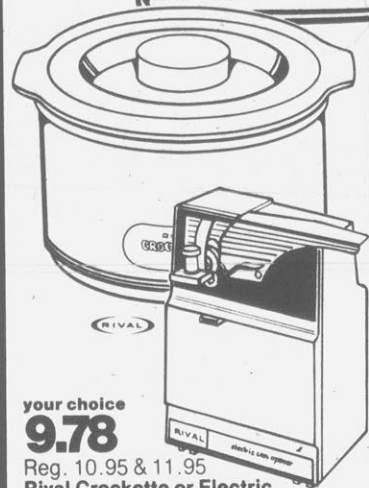

**your choice 9.78**

Reg. 10.95 & 11.95  
Rival Crockette or Electric Can Opener/Knife Sharpener  
Choose either 1-qt. slow cooker with removable stoneware liner or can opener/knife sharpener with click 'n clean action.

**1.15**  
Handle With Care  
Won't fade, shrink or stretch delicate fabrics. Softens, too. 16 oz.

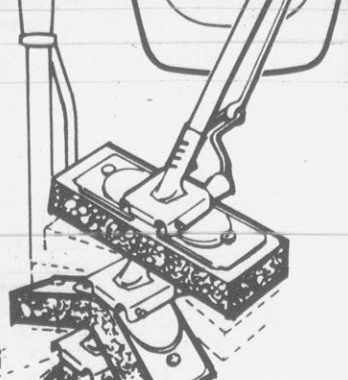

**Now! A mop that wrings itself out!**

**4.00**

Quickie Automatic Wet or Sponge Mop  
Your hands never touch water. Just rinse, push on the handle and Quickie wrings itself out. As seen on TV.

**America's Super Hero!**



**4.99** Reg. 6.00  
Superman Sheets  
Twin flat or fitted.

Pillowcases  
Reg. 2.75 ea. .... 2.29 ea.  
66x90 blanket  
Reg. 9.99 ..... 7.99  
Twin bedspread  
Reg. 15.99 ..... 12.99  
48x63 unlined drapes  
Reg. 14.99 ..... 12.99

**2.25** Reg. 4.50  
Room darkening shade

**1.20..**  
Quilted placemats  
Ass't colors and patterns.

21"x45"  
**7.00** Reg. 8.59  
Coronado Rug  
100% polyester.  
34" x 54" ..... 11.50  
48" x 68" ..... 21.50  
Reg. 23.79

## Build a warm weather wardrobe around these fashion values

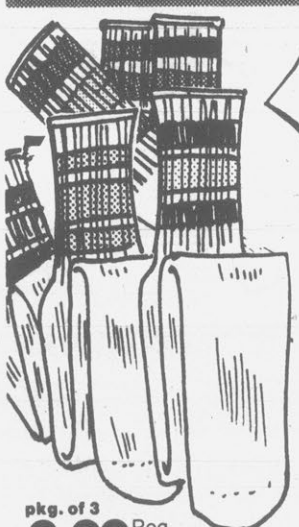

pkg. of 3  
**2.00** Reg. 2.75  
Men's 19" tube socks  
85/15 orlon/nylon.  
White with stripe top. Fits 10-13.

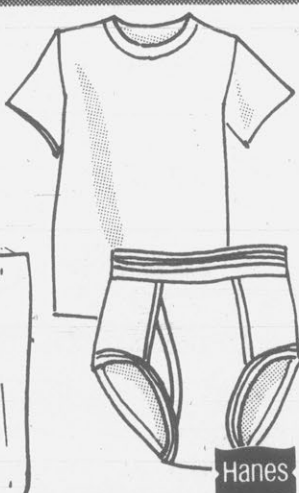

pkg. of 3  
**3.75** Reg. 4.75  
Men's Hanes briefs or T-shirts  
100% cotton.

**7.95** Reg. 9.99  
Men's 14 oz. prewashed western jeans  
100% cotton flare. Sizes 28-42.

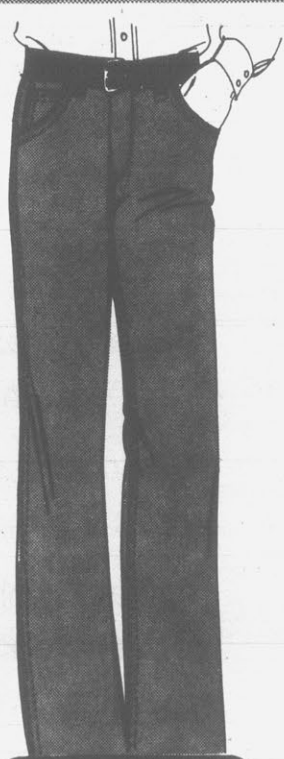

**6.95** Reg. 8.00 and 8.95  
Men's flannel lined jackets  
Nylon in ass't. colors. Sizes S-XL.  
Boys' sizes  
Reg. 6.95 ..... 5.95



**3.90** Reg. 4.75  
Ladies' terry tank top  
U-neck or V-neck. Solids in S, M, L. Plus sizes 40-46  
Reg. 5.97 ..... 4.90



**7.88** Reg. 9.97  
Ladies' woven poly pants  
2-way stretch in assorted colors. Sizes 8-18.



pkg. of 30  
**1.99**  
Newborn Pampers  
Toddler 12's ..... 1.55  
Daytime Extra 24's ..... 2.50

**2.88** Reg. 3.97  
Ladies' terry jogger shorts  
Side striped. In spring colors. S, M, L.



**8.95** Reg. 9.95 and 11.95  
Men's long sleeve western shirts  
Blue or natural with embroidered or plaid yoke. S-XL.



**1.95** Reg. 3.00  
Men's short sleeve polo shirts  
Solids and stripes in S-XL.  
Boys' sizes  
Reg. 2.50 ..... 1.75



**5.88** Reg. 8.00  
Ladies' pant tops  
Dotted Swiss peasant neck or gauze V-neck. Ass't. colors. S, M, L.



**6.88** Reg. 8.97  
Plus size blouse  
Shawl collar, button front and keyhole sleeves. 40-46.

**RAINCHECK**  
If we sell out of any advertised specials, you will receive a written order, "Raincheck" which entitles you to buy the item at the advertised price when our stock is replenished.  
(excluding clearance items)

WEST END SHOPPING CENTER, GREENVILLE

MON. thru SAT., 9:30 A.M. to 9:30 P.M.



Just say "CHARGE-IT"

# Oil-Pricing Makes Alternatives More Reasonable

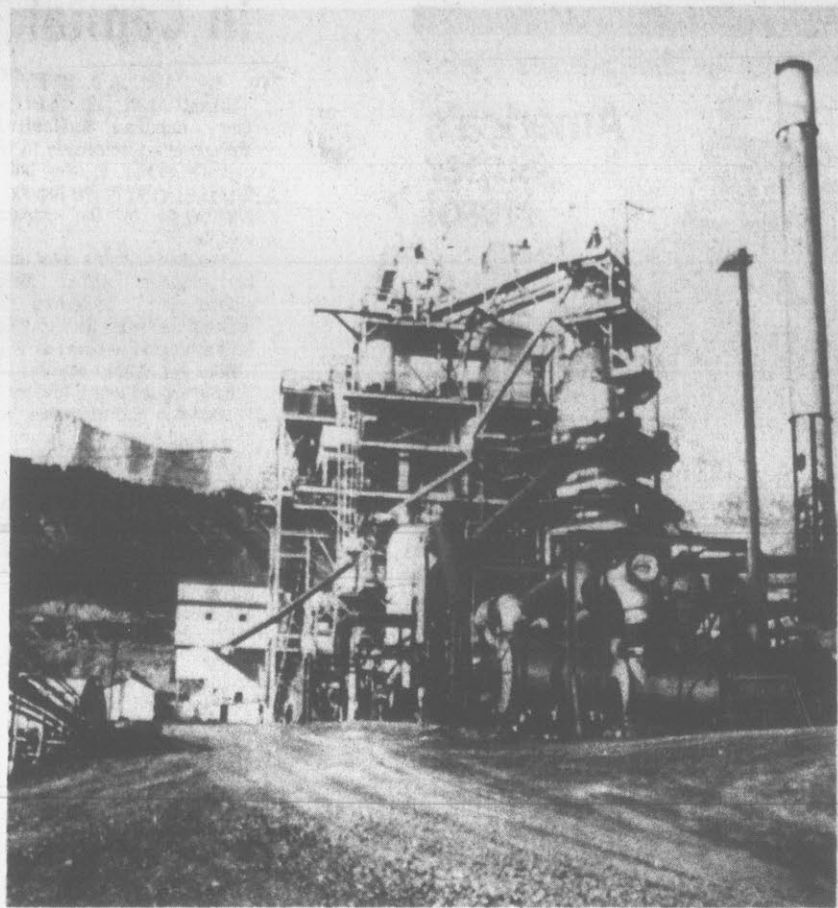

**OIL SHALE PLANT** — This is a 1977 file photo of the Paraho oil shale test plant at Anvil Points, Colorado. Extraction of oil from shale or tar sand is becoming more attractive with the high oil prices and spot shortages in the United States. (AP Laserphoto)

By MARK POTTS  
AP Business Writer

NEW YORK (AP) — Higher oil prices and spot shortages brought on by the shutdown of Iranian oil production are focusing interest on several alternate forms of supply that a few years ago were little more than dreams.

While commercial solar, wind and geothermal power are decades away, other alternate sources — like oil from tar sand and shale, and natural gas made from coal — may be practical in the next few years.

"The Iranian situation points up the United States' vulnerability," says Gary Ross, an analyst for the Petroleum Industry Research Foundation, an industry group. "Therefore, from both economic and political considerations, we have to look more favorably on alternate energy sources."

The sources of two of the three most practical sources are plentiful in the United States: oil shale and coal. And large deposits of tar sand lie just over the border in Canada.

Known in the trade as synfuels — short for synthetic fuels — the three processes involve producing ordinary types of crude oil and natural gas from unlikely sources. Shale oil production involves mining oil-bearing shale and using heat to squeeze the oil out of the rock. Experts estimate there is enough oil shale in Wyoming, Colorado and Utah to supply the United States' oil needs for nearly a century.

To get oil out of tar sand — also known as bitumen — the heavy, sticky sand is washed with hot water to separate the sand and oil. In coal gasification, the coal is smashed to bits and heated until it turns into a mixture of gases. The better quality gases can be mixed with natural gas to augment supply of that fuel. The low-quality gases produced can be used to power the gasification plant itself.

Although the technology for synfuels has been in place for several years — small-scale

coal gasification projects existed before World War II — the cost has been seen as prohibitive. The price tag on extracting crude oil from shale, for example, is estimated by most experts to be about \$20 a barrel.

That's 50 percent higher than the \$13.35 a barrel OPEC began charging Jan. 1. But the Iranian situation is narrowing the margin. Independent price increases by many oil-producing nations have raised their prices to nearly \$15 a barrel. And the Iranian-caused shortage of supply on the spot oil market has pushed some prices there up over \$20 a barrel. General crude-oil prices may not be far behind.

"If we end up in that range, it will send the right signals through the private sector and maybe we'll get some oil from shale out of the ground in about five years," said Arnold E. Saffer, an analyst at Irving Trust Co.

The cost of getting oil from tar sands is several dollars more per barrel than with shale. Gas produced from coal costs about \$5 per 1,000 cubic feet, some three times what natural gas now costs.

But Eugene Nowak, who analyzes energy for the Blyth Eastman Dillon brokerage house, feels these methods may be practical soon, too. "Every time the price of a major fuel like petroleum rises, it does bring us somewhat closer to development of other energy sources," he said. "At some point it could trigger a substantial effort in one of these fuels."

Opposition from some parts of the oil industry and a meager amount of encouragement from the Department of Energy, analysts say, has retarded growth in the technologies that could bring prices down still further.

And production of these forms of fuel on a full-scale commercial basis is still at least a decade away, although pilot plants are already in operation.

"It's a longer-term proposition," says Ross. "It can't help us today, but it can help us in the future."

Says Nowak: "We ought to be thinking about these things very hard very simply because of the long time lags involved." Nowak says that the large

amounts of capital involved in starting full-scale production of synfuels may be more than one company can bear. "One of the problems, of course, is that these are massive projects, these are billion-dollar projects," he says. So he suggests that it could take a consortium of companies — or government incentives — to bring synfuels into commercial production.

In addition to price constraints, synfuels have other problems, many of them environmental. Strip-mining to get at shale and tar sand is not looked on favorably by environmentalists, and the manufacturing processes for those fuels and coal gasification can cause pollution.

Similar, but more acute problems, are dooming a much more common fuel source, coal, which has been all but

written off by the energy industry and government as a long-term answer to energy problems.

But backers of synfuels think their problems are surmountable. And at the right price, analysts say, synfuels could play a significant part in the nation's energy picture. "It's just a matter of trying to get them out," says Nowak. "That costs money."

## Community Development Program

The Community Development Annual Grantee Performance Report for the 1975-1979 Program Years has been submitted to the Department of Housing and Urban Development for review and approval. Copies of the performance Report are available for public inspection in City Hall in the City Clerk's and City Manager's offices and the Sheppard Memorial Library and its branches.

City of  
Greenville



**IT PAYS TO SWITCH TO TWIN PET**

**Save 10¢**

**Premium Quality! Budget-lovin' Price!**

Put a smile on your dog's face... feed him new, IMPROVED Twin Pet. Your dog will love the taste... you'll love the low price of this PREMIUM QUALITY dog food. It's a complete balanced diet. Flavorful with all the nutrients he needs to run faster, play harder... regardless of age or size. Cut the coupon below and you'll smile even more!

**AVAILABLE IN BEEF, CHICKEN & LIVER FLAVORS, TOO**

NET WT. 15 OZ. 425 GRAMS  
Complete for growth and maintenance

**CLIP THIS COUPON AND TAKE IT TO YOUR GROCER**

**Save 10¢**

**GN 123**

**Offer Expires May 31, 1979**

TO THE GROCER: You are authorized to act as our agent for the redemption of this coupon. You will be reimbursed 10¢ plus 2¢ for handling, provided that you and the consumer have complied with the terms of our coupon offer. Any failure to comply with these terms shall not be deemed a warranty of any of the conditions.

TERMS OF COUPON OFFER: BY SUBMITTING THIS COUPON FOR REDEMPTION, DEALER REPRESENTS THAT HE RECEIVED IT PURSUANT TO THE TERMS OF THE COUPON OFFER. The consumer must pay any sales tax involved. This coupon is non-transferable. Invoices proving purchases of sufficient amount of our brand to cover coupons presented must be shown upon request and failure to do so may, at our option, void all coupons submitted for redemption for which no proof of purchase is shown. Property of our merchandise will be accepted for reimbursement if identified as being the property of the retail distributor of our merchandise who indicated them. Reimbursement will be made only to a retail distributor of our merchandise as shown on our Certificate of Authority listing for him. COUPONS MUST BE MAILED TO: ALLIED FOODS, INC., P.O. Box 9229, Atlanta, Ga. 30316. Cash redemption value of 1/20 of 1¢.

### Winners In Science Fair

Winners in four divisions and honorable mention winners of the Aycock Junior High Science Fair have been announced. These are:

— Biological Division, first place, Ishan Sehgal for "Bisexual Reproduction;" and second place, Catrina Logan and Jan Wheelers for "Marine Algae as a Food Source."

— Technological Division, first place, Jonathan McGee for "Solar Heating;" and second place, Leigh King and Beverly Tedder for "Cylinder Cement."

— Earth Science Division, first place only, Jay Holley and Bill O'Neal, "Paleontology."

— Physical Science Division, first place only, Stephen Johnson for "Rover the Robot."

Honorable mentions were awarded to Mary Vick for "Crystal;" Donald Whitaker, "Solar Food Dryer;" Bill Coffman, for "Canal Locks;" and Morad Rowshan-Araghi for "Aerodynamic Testing."

**ONE EXPLANATION**  
WASHINGTON (AP) — Commerce Department economists say a large increase in steel orders in January probably reflected an attempt to avoid price increases scheduled this spring.

## — DESIGNATE — Planters Tobacco Warehouse No. 512 753-3014

We are pleased with the outlook for the 1979 tobacco selling season.

Selection of the warehouse where you want to sell your crop is an important step facing you now!

We at PLANTERS # 512, ask that you designate with us. We have an experienced sales force working for the Top Dollar. We have an equal scheduling system. We have a comfortable place to sell.....Because we try harder and have your interests at heart. And most important of all is the Sincere Honesty and Integrity with which we always perform our service to you.

We make our living by satisfying you.....you, the tobacco producers, are our most important assets.

Thank you

Mark Mozingo

Micky Pegram

— Owners & Operators —

# DESIGNATE

## No.

# 512

**Saving is a Breeze!**  
**PIGGLY WIGGLY'S**  
**March Value Days**

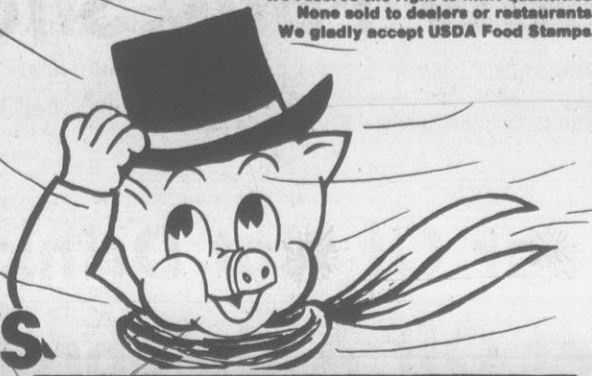

PRICES EFFECTIVE MARCH 7-10  
 We reserve the right to limit quantities.  
 None sold to dealers or restaurants.  
 We gladly accept USDA Food Stamps.

**SWIFT'S HEAVY WESTERN BEEF**

**CHUCK ROAST**

**1.19**

BLADE CUT LB.

<b>CENTER CUT</b> Chuck Roast <b>1.29</b>	<b>BONELESS</b> Chuck Steak <b>1.69</b>
<b>BONE IN</b> Chuck Roast <b>1.59</b>	<b>BONE IN</b> Shoulder Steak <b>1.59</b>
<b>BONE IN</b> Shoulder Roast <b>1.49</b>	<b>BONE IN</b> SHORT RIBS <b>1.09</b>
<b>BONE IN</b> Chuck Steak <b>1.29</b>	<b>BONE IN</b> RIB STEAK <b>2.19</b>
<b>SHOULDER BONELESS</b> Savoy Steak <b>1.69</b>	<b>STAR BRAND</b> CHICKEN SALAD <b>7oz. 49¢</b>

**CUBED CHUCK STEAK** **1.99** LB.

**WHOLE BEEF RIBS** **1.69** LB.  
 (20-25 LB. AVG.)  
 (CUT INTO STEAKS)

**SMOKED PICNICS** **79¢** LB.  
 SLICED LB. 89¢  
 WHOLE

**LUNNY BACON** **1.29** LB.

**FROSTY MORN FRANKS** 12 OZ. PKG. **89¢**

**STAR BRAND PIMENTO CHEESE** 7-oz. **49¢**

**FROSTY MORN BOLOGNA** LB. **1.39**

**OSCAR MAYER Lean'n Tasty Breakfast Strips** 12 OZ. **1.39**

REGULAR AND BEEF EA.

**PIGGLY WIGGLY POT PIES** **4/\$1.00**

**U.S.D.A. GRADE "A" FRESH, WHOLE FRYERS** **46¢** LB.

**PIGGLY WIGGLY WAFFLES** **4/\$1.00**

**SUNSHINE CHEEZ-ITS** 10 oz. **57¢**

**SUNSHINE Chip-a-roos** 12 oz. **69¢**

**KRAFT THOUSAND ISLAND DRESSING** 16 oz. **99¢**

**DEL MONTE Fruit Cocktail** 17oz. **2/1.00**

**PINE STATE ORANGE JUICE** **99¢** 1/2 Gal.

**PINE STATE FRUIT DRINK** **79¢** Gal.

**Fastest 1/2 Hour on TV!**

**Let's Go to the Races**

**RACE TICKET PURPLE NO. 2050 RACE 3/12/79**

**WIN YOUR SHARE OF \$143,000.00 PRIZE MONEY**

**WIN UP TO \$1,000.00**

ODDS CHART - WINNING POSSIBILITIES

AWARD	NO. OF WINNERS	1 STORE VISIT PER WEEK	2 STORE VISITS PER WEEK
\$2	1,000	1 in 215	1 in 72
\$5	100	1 in 2,150	1 in 720
\$10	50	1 in 4,300	1 in 1,433
\$100	5	1 in 43,000	1 in 14,334
\$1000	2	1 in 107,500	1 in 35,834

Your chance of winning a prize are 1 in 186. There is a total of \$143,000 prize money available during this 26 week program. A total of 30,082 winning game pieces. 1 in 186 are winning game pieces. This game is being played in 42 Piggy Wiggly Stores throughout central and eastern North Carolina. Game will be terminated March 26, 1979. Get complete details from the participating Piggy Wiggly Store in your area.

**"LET'S GO TO THE RACES" \$1,000.00 WINNERS**  
 MRS. VIRGIE ARMSTRONG  
 Southern Pines, N. C.

**\$100.00 WINNERS**  
 WANDA FAYE THOMPSON  
 Clinton, N. C.  
 JOHN WILLIAM CHATMAN  
 Franklinton, N. C.  
 CECIL HOBBS  
 Roseboro, N. C.

**GEORGE FURLOW**  
 Rose Hill, N. C.  
**J. GARLAND METTS**  
 Richlands, N. C.  
**WILLIAM H. PARKER**  
 Sanford, N. C.

**TV SCHEDULE**  
 EACH MONDAY NIGHT  
 WECT-TV Channel 6  
 4:30 p.m. to 5:00 p.m.  
 WNCN-TV Channel 9  
 5:00 p.m. to 5:30 p.m.  
 WCTI-TV Channel 12  
 7:00 p.m. to 7:30 p.m.

**DAWN** **99¢** 32 OZ.

LIMIT ONE WITH \$7.50 FOOD ORDER

**TREND** **69¢** 42-OZ.

LIMIT ONE WITH \$7.50 FOOD ORDER

**COCA-COLA** **89¢** Ea.  
**SPRITE** OR **TAB**

TWO LITER BOTTLES

BUY A CASE FOR ONLY **\$5.10**

**PIGGLY WIGGLY'S WORLD OF PRODUCE**  
*the Freshest Buys in Town!*

**PIGGLY WIGGLY WHITE POTATOES** 10 LB. **89¢**

**FLORIDA PINK GRAPEFRUIT** 5 LB. **1.09**

**BRIGHT RED CHERRY TOMATOES** PT. **89¢**

**DUPLIN COUNTY COLLARDS** **35¢** LB.

**WASHINGTON STATE FANCY RED DELICIOUS APPLES** LB. **39¢**

**PIGGLY WIGGLY**

**It's here!**  
**The wildest encyclopedia ever!**

Now, Funk & Wagnalls brings you an encyclopedia made up of the kinds of things everybody goes for: things that roar, chirp, hop, soar, swim, glide and flutter. Funk & Wagnalls Wildlife Encyclopedia.

Try Volume 1 for just **49¢** and Volume 2 for **\$1.49** at any of our super-markets. Then, each week when you shop, pick up a volume or two for just **\$2.49** each and complete the set.

**2.49**

Funk & Wagnalls Wildlife Encyclopedia

**MERITA HONEY BUNS** **4/\$1.00**

**PIGGLY WIGGLY CINNAMON ROLLS** **2/1.00**

**MABISCO Oreo Cremes AND DOUBLE Stuff Oreos** LB. **95¢**

**KEEBLER ZESTA SALTINES** 16 OZ. **67¢**

**Sing Out America**  
 Del Monte **HIT PARADE OF VALUES**

**DEL MONTE CATSUP** 14 OZ. **3/1.09**

**DEL MONTE FRENCH STYLE BEANS** 16 OZ. **3/1.09**

**DEL MONTE CUT GREEN BEANS** 16 OZ. **3/1.09**

**DEL MONTE CREAM STYLE YELLOW CORN** 17 OZ. **3/1.09**

**DEL MONTE WHOLE KERNEL CORN** 17 OZ. **3/1.09**

**DEL MONTE PEAS** 17 OZ. **3/1.09**

LIMIT SIX OF YOUR CHOICE WITH \$7.50 FOOD ORDER

**PIGGLY WIGGLY SUGAR** **99¢** 5-LB. Limit One Please With \$7.50 Order.

**SHOWBOAT PORK & BEANS** 29 OZ. **2/1.00**

**SHOWBOAT SPAGHETTI** 14 OZ. **4/1.00**

**PINE STATE ICE CREAM SANDWICHES** 6 CT. PKG. **59¢**

**PIGGLY WIGGLY BUTTERMILK** 10 CT. **2/1.09**

**RED BAND PLAIN OR SELF-RISING FLOUR** 5 LB. **69¢**

**PIGGLY WIGGLY SALT** 5 26-OZ. BOXES **\$1.00**

**WE GLADLY ACCEPT W.I.C. FOOD VOUCHERS**

**GERBER STRAINED BABY FOOD** Ea. **15¢**

**STORE HOURS:**  
 Mon. Thru Thurs. 8 To 7 Friday 8 To 8  
 Saturday 8 To 8, Sunday 9 To 6.  
**2105 DICKINSON AVE.**

FORECAST FOR THURSDAY, MARCH 8, 1979

# Your Daily HOROSCOPE

from the CARROLL RIGHTER INSTITUTE

**GENERAL TENDENCIES:** Forget the past and look forward to the future with courage and confidence. Think in terms of the biggest benefits you can envision and go after them for they are closer to you than you imagine and can be yours with a little more effort.

**ARIES (Mar. 21 to Apr. 19)** Study your finest talents and gain the backing you need to make them pay off handsomely. A little entertainment you get into can relieve tensions now.

**TAURUS (Apr. 20 to May 20)** Make your home more functional and harmonious and be happier there in the future. Steady new interests that will give you an added abundance.

**GEMINI (May 21 to June 21)** Plan how to expand in your career activities and become a more influential person. Communicate with others and get fine results. Rest and restore energies.

**MOON CHILDREN (June 22 to July 21)** Study your monetary status well and know how to improve it in the near future. Look to a most powerful individual for the advice you need.

**LEO (July 22 to Aug. 21)** Plan how to attain more personal aims and be happier. First get important work done. Later join with friends at some relaxation. Be happy and live a fuller life.

**VIRGO (Aug. 22 to Sept. 22)** Get the information you need to gain the backing you want from bigwigs. Take time for pleasure with a loved one. Show generosity but not extravagance.

**LIBRA (Sept. 23 to Oct. 22)** Attend social functions that give you a chance to enlarge your circle of friends. Go after a wish that means much to you. Be careful in travel, though.

**SCORPIO (Oct. 23 to Nov. 21)** Bigwigs can be of assistance to you if you have something worthwhile to offer. Make your career soar through proper activity. Show more devotion to family and to friends.

**SAGITTARIUS (Nov. 22 to Dec. 21)** Get into new projects that can help you to develop and grow more rapidly. Make plans now for a trip you want to take shortly. Make sure you do not spend money foolishly.

**CAPRICORN (Dec. 22 to Jan. 20)** Carry through with promises and contracts you have made with others. Pay more attention to detailed specifications. Socialize in the evening.

**AQUARIUS (Jan. 21 to Feb. 19)** Get in touch with an associate and gain cooperation for a joint project of importance to you both. Do whatever improves your image with the public. Be careful of strangers.

**PISCES (Feb. 20 to Mar. 20)** Be enthusiastic about work you have to do and it will go well with you. Show more cooperation with fellow workers. Take no risks with strangers and be safe.

**IF YOUR CHILD IS BORN TODAY . . .** he or she will want to look at everything from its largest scope and should have an education that teaches organization and how best to direct others. Give an opportunity to travel early and to study different philosophies of life for a fuller and richer life.

"The Stars impel, they do not compel." What you make of your life is largely up to you!

© 1979, McNaught Syndicate, Inc.

## GOREN BRIDGE

BY CHARLES H. GOREN AND OMAR SHARIF  
© 1979 by Chicago Tribune

Both vulnerable. West deals.

- NORTH**  
♦ Q J 10 8  
♥ Q J 10 7  
♦ A  
♦ A K 4 2
- WEST EAST**  
♦ A 4 ♦ 3 2  
♥ A K 8 4 ♥ 5 3 2  
♦ J 10 8 6 2 ♦ 9 7 5 4 3  
♦ Q 8 ♦ J 7 3
- SOUTH**  
♦ K 9 7 6 5  
♥ 9 6  
♦ K Q  
♦ 10 9 6 5

The bidding:  
West North East South  
1 ♦ Dbble. Pass 1 ♦  
Pass 2 ♦ Pass 4 ♦  
Pass Pass Pass  
Opening lead: King of ♣.

As a defender, your play at trick one simply shows whether or not you like partner's lead. However, third hand's signal is not an absolute command. On this hand, West could have defeated the contract had he ignored partner's disinterest. North showed his extra values for his takeout double by voluntarily raising partner's one spade response. Since South might have had nothing when, in fact, he was close to a jump response, he was fully justified in going on to game.

West led the king of hearts and East played the discouraging two. West dutifully shifted to the queen of clubs, won by the king. Dummy's queen of spades lost to the ace, and West continued with another club to the ace.

Declarer drew the outstanding trumps, then surrendered a trick to the ace of hearts. West had no more clubs, so he exited with a diamond. Declarer won in dummy, discarded two clubs from his hand on dummy's high hearts and claimed the contract.

Instead of blindly switching the attack after he received a discouraging signal on the opening lead, West should have considered ways to neutralize the threat posed by dummy's hearts.

East was virtually certain to have length in hearts, so declarer could not be prevented from getting one discard on the hearts. West's plan should have been to see that declarer did not utilize both of dummy's hearts.

All West had to do was to continue with the ace of hearts at trick two, and then lead a third round of the suit. Declarer can get one club discard, but he cannot take another before trumps have been extracted. But when declarer leads a trump, West wins the ace and returns a fourth round of hearts. East ruffs dummy's winner and South is forced to overruff. Now South still has three clubs in his hand, and try as he might, he cannot avoid surrendering a club trick for down one.

**COURSE ON WOMEN**  
CHICAGO (AP) — Significant contributions women have made to American life despite severe educational and social limitations will be among the topics explored in a course, "Women in American History," at Daley College, one of the City Colleges of Chicago.

**264 PLAYHOUSE INDOOR THEATRE**  
4 Miles West Of Greenville On US 264 (Farmville Hwy.)  
SHOWING ONLY THE FINEST IN ADULT ENTERTAINMENT  
**ENDS TONIGHT**  
Valid ID Required  
Doors Open 5:45 Showtime 6:00  
Call For Showtime  
Anytime **756-0848**

# MTM Show Falls Short In Ratings

NEW YORK (AP) — Mary Tyler Moore's first effort of the season, a comedy-variety show on CBS called "Mary," lasted only a few weeks. The extraordinary Miss Moore returned to prime-time Sunday, and the ratings for her new show were far from spectacular.

"The Mary Tyler Moore Hour" on CBS was 29th of 63 programs rated by the A.C. Nielsen Co. during the week ending March 4.

Indeed, another CBS show "Stockard Channing in Just Friends," did much better, 14th in the ratings.

CBS, in fact, had four shows

in the Top 15, including No. 5 "60 Minutes" and "All in the Family" in ninth place. But it was ABC, with seven of the week's 10 top-rated shows, that came in first over-all.

That's nothing new. ABC has been first eight weeks in a row, and 20 of 25 weeks this season.

The week was marked by a return to normal programming. February was perhaps the most competitive month in the medium's history, with programs like "Roots: The Next Generations" on ABC up against major miniseries, and first-run movies.

The week's top-rated show was ABC's "Three's Company," and the network's "Mork and Mindy," No. 1 the previous three weeks, dropped to fourth. ABC's rating for the week was 20.8, followed by CBS' 18.1 and NBC's 17.5.

The networks say that means in an average prime-time minute during the week, 20.8 percent of the TV-equipped homes in the country were tuned to ABC.

NBC scored a moderate success with a two-hour pilot, "Mrs. Columbo," but the first regularly scheduled episode in the comedy-mystery series finished 45th.

Both NBC and CBS had two programs among the bottom five in the ratings: CBS' "Kaz" was No. 59, followed by NBC's "Supertrain," "Makin' It" on ABC, "Leopard of the Wild" on NBC and "Boston and Kill-bride" on CBS.

Here are the week's Top 10 shows:

- "Three's Company," with a rating of 32.5 representing 24.2 million homes, "Laverne & Shirley," 31.4 or 23.4 million, "Happy Days," 29.7 or 22.1 million, and "Mork and Mindy," 29 or 21.6 million, all ABC; "60 Minutes," 27.9 or 20.8 million, CBS; "Eight is Enough," 27.4 or 20.4 million, "Angie," 27.3 or 20.3 million, and "Taxi," 27 or 20.1 million, all ABC; "All in the Family," 26.9 or 20 million, CBS, and "Little House on the Prairie," 26.4 or 19.7 million, NBC.

The next 10 shows: "M-A-S-H," CBS; "Barney Miller" and "Charlie's Angels," both ABC; "Stockard Channing in Just Friends," CBS; "Soap" and "Sunday Movie—The Ordeal of Patty Hearst," both ABC; "WKRP in Cincinnati," CBS; "Monday Movie—Mrs. Columbo," NBC, and "Fantasy Island" and "Vegas," both ABC.

## TV Log

### WNCT-TV Ch. 9

WEDNESDAY	10:00 All In
7:00 Newlywed	10:30 Magazine
7:30 Jokers	1:00 Basketball
8:00 Year	1:30 World Turns
9:00 One Day At	5:00 Brady
9:30 Jeffersons	5:30 Dating
10:00 KAZ	5:55 Weather
11:00 News	6:00 NBC Live News
11:30 Movie	6:30 News
	7:00 Newlywed
THURSDAY	7:30 Jokers
4:00 Carolina	8:00 Walkers
8:00 Morning	9:00 Awards
9:00 Kangaroo	11:00 News
	11:30 Movie

### WITN-TV Ch. 7

WEDNESDAY	11:30 Wheel of
7:00 Hogan's	12:00 News Noon
7:30 Donna Fargo	12:30 Passport
8:00 Super Train	1:00 Squares
9:00 Movie	1:30 Our Lives
11:00 News	2:30 Doctors
11:30 Tonight	3:00 Another Wild
1:00 Tomorrow	4:00 Sports Day
	4:30 Supermen
THURSDAY	5:00 Battle of
5:30 Arthur Smith	5:30 Alchales
6:00 Almanac	6:00 News
7:00 Today	6:30 NBC News
7:25 News	7:30 Nashville
7:30 Today	8:00 Little Women
8:25 News	9:00 News
9:00 Shore	10:00 Columbo
10:00 Card Sharks	11:00 News
10:30 Hollywood	11:30 Tonight
11:00 Rollers	1:00 Tomorrow

### WCTI-TV Ch. 12

WEDNESDAY	11:30 Family
7:00 Sanford	12:00 Love Expert
7:30 Report	12:30 Ryan's
8:00 Eight is	1:00 Children
9:00 Angels	2:00 One Life
10:00 Vegas	3:00 Hospital
11:00 News	4:00 Tom & Jerry
11:30 P. Woman	4:30 Six Million
	5:30 Three Sons
THURSDAY	6:00 News
5:55 Tidings	6:30 News
6:00 PTL Club	7:00 Sanford
7:00 America	7:30 Gong Show
7:25 News	8:00 Mork &
8:25 News	8:30 Studio
9:00 Donahue	9:30 Soap
10:00 Stepping	10:00 Family
11:00 Happy Days	11:00 News
	11:30 Sharks &
	1:45 Nitelite

### WUNK-TV Ch. 25

WEDNESDAY	12:30 Elect. Co.
7:30 Assembly	1:15 Inside/Out
8:00 Report	1:30 Readalong
9:20 Callas	1:40 Matter of
	2:00 Readalong
THURSDAY	2:10 Matter &
8:15 AM Weather	2:30 Design for
8:30 Contract!	3:00 Japan:
9:00 Readalong	3:30 Never Easy
9:00 Sesame Street	4:00 Sesame St
10:00 Justice	5:00 Mr. Rogers
10:30 Readalong	5:30 Elect. Co.
10:40 Metric	6:00 Studio
11:00 Word Shop	6:30 Review
11:30 Two Plus	7:00 Assembly
11:45 Liberty	7:30 Report
12:00 Stepping	8:00 Reunion
12:15 Ripples	9:10 Live

## Warns Chinese Are Puritanical

BOSTON (AP) — Male musicians in the Boston Symphony will fly off Monday for the orchestra's China tour armed with an opening line for approaching Chinese women and with advice that it probably won't work.

"China is a fairly puritanical society," advised Jan Berris, a University of Michigan China specialist. She briefed the 103 men and women of the orchestra Tuesday on their tour, the first by a major American musical organization since the U.S. and China established diplomatic relations.

"Chinese women find it difficult to cope with compliments," she said. "Tell a woman she is lovely and she finds it very embarrassing."

"If you want to compliment a woman, tell her what a lovely political ideology she has."

## Year Of Not Drinking Set Off A Celebration

NORTHAMPTON, Mass. (AP) — When Smith College sophomore Mary Dickinson won a \$2,500 bet that she could forego alcohol for a year, she celebrated with a midnight gulp of peppermint schnapps.

Then the real celebration began. Her small party in her dormitory room spread spontaneously from dorm to dorm as hundreds of "Smithies," some in nightgowns, cavorted across campus at 1 a.m. Tuesday.

Bell-ringing in the first dorm sparked the revelry. Women drank and danced on the quadrangle. They sent music blaring across the quad from stereo speakers in dorm

windows. "It was crazy. It was incredible. It was just terrific," said Ms. Dickinson, an economics and history major from Braintree, N.Y.

The ruckus awoke Jill Ker Conway, president of the 2,200-student college, and the revelers — recalling that Ms. Conway had missed the traditional Christmas caroling last year — serenaded her with "Silent Night."

The anything-but-silent night was the result of a bet made a year ago between the 20-year-old student and her mother, Eileen Dickinson.

The bet required Ms. Dickinson to go without booze for one year — her mother's way of showing her how to get along socially as a non-drinker.

"It was a really good experience," the daughter said Tuesday. "I don't feel like I need to have a drink to function socially."

She said the toughest challenge came last summer in Washington, D.C., where she worked as an intern in the office of Sen. Daniel Moynihan, D-N.Y.

The "Washington party circuit" provided strong temptation almost every evening, Ms.

## Will Launch Fund Drive

"The official kick-off of the Boys' Club of Pitt County Development Fund starts on Thursday, March 8," Austin Britt, campaign chairman, commented on the completion of a training program for volunteer solicitors.

More than 50 volunteer solicitors, Britt added, "are eager to start canvassing the Pitt County area, and will be working on the project which we hope will be completed by May 1."

The goal, Austin notes, "is \$500,000 and we are asking that businesses and individuals pledge their gifts over a five-year period." He added that "all donations to the campaign will be tax deductible."

Campaign funds will be used to build the new Boys' Club facilities, and none of the money raised will be used for salaries or operation of the club.

In another related event, members of the Progressive City Kiwanis Club of Greenville had as their guest speaker Chet Emerson, the Boys' Club executive director, at its Tuesday morning 7:30 a.m. breakfast meeting. Emerson discussed plans of the campaign to raise funds for the new building.

## Aged Actor Is Fatally Beaten

HOLLYWOOD (AP) — Charles Wagenheim, an 84-year-old character actor who appeared on such television shows as "Gunsmoke," "All in the Family" and "Baretta," has been found bludgeoned to death in his bedroom, police said.

Wagenheim's wife, Lillian, an invalid under the care of a nurse, was in the living room at the time of the attack Tuesday evening but heard nothing, Los Angeles police said.

The nurse had gone downstairs to the laundry room for 10 minutes and when she came back she found the body and called police, officers said.

Police Capt. Mark Kroeker said the bedroom window was found open.

In "Gunsmoke," Wagenheim played a sidekick to Festus, Dodge City's deputy marshal. In other shows, he generally played drunks or comic figures.

Investigators said there was no known motive for the attack. Funeral arrangements were pending.

However, the end of the year-long bet "was one hell of an excuse for a party," she said with a laugh.

The college president joined in the high spirits, coming out of her campus house and walking students back to their dorms.

Before parting with Ms. Dickinson, the president joined her in a ceremonial drink of tequila as students sang, "Goodnight, Ladies."

Ms. Dickinson, who has had a year to think about how she'll spend the \$2,500 she won from her mother, says the money will go toward a trip to Antigua later this month — and toward liquor for a "huge" campus party she'll throw this Thursday.

## 'Studs Lonigan' Good Fodder For 1979 TV

By PETER J. BOYER  
AP Television Writer  
LOS ANGELES (AP) — When James T. Farrell released a three-segment novel called "Studs Lonigan" in the early 1930s, it wasn't called "a classic American trilogy," as it is now. It was called trash in three parts.

"Lonigan" said much about urban America, its mores and its spiritual bonds of family and religion. They were powerful statements, not so much condemnation as illumination. And they were shocking enough to prompt a ban on the books in parts of the country.

Perfect fodder for a 1970s made-for-TV movie, NBC, the network of the novel, has learned that American books considered too bold in their day fit nicely into the miniseries format. The network proved it with the successful TV adaptation of "From Here to Eternity" and is trying again with the three-part "Studs Lonigan," both appearing in the "Novels for Television" series.

Of course, what was hot and controversial in 1932 can seem tepid in 1979, and NBC's "Lonigan," which begins tonight, could have been made into a quaint little period piece. But Farrell's story of a street-hardened Chicago youth trying to grow up in the World War I years transfers in this TV version quite nicely. And though

Studs' conflicts may seem a bit dated, the pain of making choices and living with wrong turns rings modern.

Studs is a young man fighting with himself; his father (Charles Durning) is the very personification of a repressive father. Studs tries to jibe the tough-guy image he projects to his peers with a vigilant conscience instilled by his Irish Catholic family. This duality makes Studs more than just a street punk, it makes him human, and the actions of his mundane life are made dramatic by the incessant raging of this inner war — boy vs. man.

Studs is every bit the swaggering hero when he leads a group of his pals to the seamy digs of a local harlot; but in the next scene, we see Studs wrestled to his knees by guilt, begging God's forgiveness.

And when Studs falls in love with the beautiful Lucy, he is angered and frightened by what he feels. A friend chastises him for behaving as though "being soft were some kind of disease or something" but Studs relents to the taunts of the street

**SATURDAY NIGHT FEVER**  
Catch it.  
7-9  
PITT

## FESTIVAL 79 ON UNC-TV

TV worth staying home for.

### "CHOREOGRAPHY BY BALANCHINE—PART 4"



A look at the New York City Ballet, under the direction of the world's foremost choreographer, George Balanchine.

Mikhail Baryshnikov and Patricia McBride are featured performers.

8:00 Tonight Channel 25

Also Tonight:

9:20 MARIA CALLAS

**MATINEES EVERY DAY**  
Bill's largest musical  
**RICHARD PRYOR**  
**RICHARD PRYOR**  
UNCENSORED  
LIVE IN CONCERT  
WARNING: This Picture Contains Harsh And Very Vulgar Language And May Be Considered Shocking And Offensive No Explicit Sex Or Violence Is Shown.  
FUN FOR ADULTS!  
SHOWS DAILY  
3:30-5:20-7:10-9:00  
Plaza cinema 1-2-3  
PITT-PLAZA SHOPPING CENTER  
ENDS THURSDAY!  
**Invasion of the Body Snatchers**  
PG  
SHOWS DAILY  
2:45-4:55-7:05-9:15  
Plaza cinema 1-2-3  
PITT-PLAZA SHOPPING CENTER  
NOW SHOWING!  
**Wolfman**  
starring  
Earl Owensby  
YOU CAN CATCH PG  
WOLFMAN  
DAILY AT 3:15-5:15-7:15-9:15  
PARK  
UPTOWN GREENVILLE  
753-7449  
ENDS THURSDAY!  
**THE DRAGON'S EXECUTIONER**  
SHOWS DAILY  
ACTION SHOWS AT  
3:00-7:10-9:00  
STARTS FRIDAY!  
CINEMA 3  
"TAKE DOWN" PG

# Crew Takes Over Ship During Labor Dispute

THPORT, N.C. (AP) — Sunny Point munitions terminal Egyptian crew of a Kuwaiti ship has taken over the ship in a labor dispute, it was reported Tuesday.

Col H.K. Stevenson, commandant of the terminal, said indications are that the captain has lost control of the ship and that he and the ship's first mate are being held on board the Kuwaiti Horizon.

The 550-foot freighter carrying tobacco had planned to load an assortment of armaments aboard at the terminal late last week when it was taken over by its 20-man crew last Friday, according to Stevenson and a State Department spokesman in Washington.

The spokesman, who was not identified, said the department had been informed of the takeover by the Coast Guard but that he had no further details.

The dispute is apparently over wages. WWAY, a Wilmington television station, reported that the crew was demanding at least \$100,000 in back and current wages.

Stevenson said negotiations were underway between the

crew and the ship's owner. The ship is owned by the National Maritime and Agency of Kuwait, according to William B. Harris III, attorney for the ship's owners in Wilmington. Kuwait is an oil-rich country on the Persian Gulf.

Harris said he was on board the freighter Friday, but he declined comment.

"This is a sensitive and delicate matter at this time," he said.

Stevenson said that as far as he knew, none of the crew had left the ship since it docked at Sunny Point last Thursday.

"As far as I know, it's purely a labor dispute," Stevenson said, adding that he has received no reports of injuries.

Stevenson denied reporters access to the Military Ocean Terminal, which is closed to the public. He said he wanted to give the owners a chance to settle the dispute without "any more publicity than necessary."

He said personnel at the terminal are taking precautions to see that the situation does not get out of hand. He declined to elaborate.

An FBI spokesman told the television station that it was not actively in the case but was researching the matter to see if any federal laws were involved.

The ship is reported based in Beirut, Lebanon, and was on its way to Singapore and to Bangkok, Thailand, when the incident occurred.

# Call For State To Act Quickly

RALEIGH, N.C. (AP) — Seven boards of county commissioners have urged the state to find a prompt solution to the PCB disposal problem.

The toxic chemical has lain

along 210 miles of roadway in those and eight other counties since August.

However, the seven governments had several different ideas about the best way to remove or treat the chemical, which is believed to cause cancer and other ailments in laboratory animals and in man.

The actions by the counties came after Warren County officials invited representatives of the state's other PCB-contaminated counties to Warren to ask them to exert pressure on the state.

The Warren board and the Region K Council of Governments have criticized the state proposal to bury an estimated 10,000 truckloads of contaminated soil in Warren County. They asked the state to instead haul the dirt to a federally approved dump in Alabama.

Herbert L. Hyde, secretary of crime control and public safety, said Tuesday that he hopes to recommend a solution to Gov. Jim Hunt within two weeks.

"I was hoping in two weeks to come up with something, I'm still trying to point to that, if it's at all possible... Lord knows, I want to get it over with as much as these county commissioners," Hyde said.

A check of the 10 boards of commissioners that sent representatives to Warren County found that seven of them adopted PCB resolutions Monday. Four of them — Chatham, Franklin, Granville and Person counties — essentially endorsed the Warren County stand.

Alamance and Halifax county commissioners supported a proposal to study treating the soil where it lies with activated carbon to neutralize the chemical.

"They felt like to pick it up from our roads and to move it would endanger other people's lives wherever it was moved," said Alamance County Manager Don C. Flowers of that county board's decision.

Wake County commissioners urged Hunt to seek a speedy solution but did not take a stand on what method should be used.

Three New York men have pleaded guilty to charges that they dumped PCB-laden oil along the roads, and two Raleigh men have pleaded innocent to related charges.

# Have You Missed Your Daily Reflector?

First Call Your Independent Carrier. If You Are Unable To Reach Him Call The Daily Reflector

# 752-3952

Between 6:00 and 6:30 P.M. Weekdays And 8 'Til 9 A.M. On Sundays.

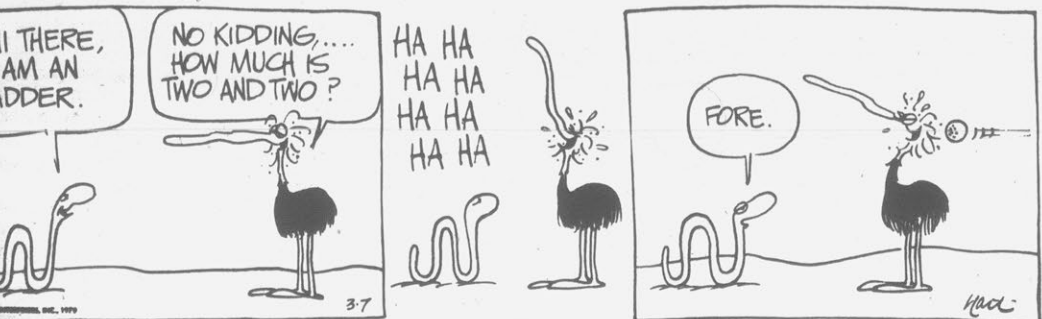

# Campus Is On Register

RALEIGH — St. Mary's College campus in Raleigh has been listed in the National Register of Historic Places, according to Dr. Larry Tise, Director of the state Division of Archives and History.

The listing includes the historic portion of the campus, most of which faces on Hillsborough Street. Among buildings included are Smedes Hall, a four-story Greek Revival brick building built in 1835-39; East Rock and West Rock, built in 1833-35 of stone discarded during the construction of the State Capitol; and St. Mary's Chapel, a simple, one-story board and batten Gothic Revival structure built in 1855. All four are Raleigh Historic sites.

CITE "EVIDENCE" WASHINGTON (AP) — The Pentagon says a \$100 million fighter plane sale to Thailand "will be viewed by friendly states in the region as evidence of continued U.S. support for the independence and territorial integrity of Thailand."

# 01 PUBLIC NOTICES

NOTICE OF PUBLIC HEARING ON THE QUESTION OF THE ADOPTION OF AN ORDINANCE ANNEXING TERRITORY TO THE CITY OF GREENVILLE, N.C.

The owners of the real property hereinafter described, the same being contiguous to the City of Greenville, have filed a petition requesting the City Council of the City of Greenville, North Carolina, to annex said property to the City of Greenville, pursuant to Article 36 of the Constitution of the State of North Carolina and the Statutes of North Carolina...

# 15 Dodge

FOR IMMEDIATE sale, 1973 Dodge Polara. Silver gray, cream vinyl top, air, automatic, power steering, 4 door, low mileage. Excellent condition. Owner asking \$1350 (negotiable). 756-0571.

# 16 Ford

PINTO 1974. Vinyl top, 4 speed transmission, radio, air, good tires. Excellent condition. Call 752-9275.

# 18 Mercury

COUGAR XR-7, 1978. White on white, 21,000 miles, loaded. 753-3557.

# 19 Oldsmobile

CUTLASS 1969 wagon. Power steering, air, tires in good condition. \$350. 746-4846.

# 20 Plymouth

PLYMOUTH 1974. Cuda. White with black stripes. 34,000 miles. Excellent condition. 758-6996.

# 21 Pontiac

PONTIAC 1977 Grand Prix. Bucket seats, electric windows, stereo radio, cruise control, 111 wheel, 12,000 miles. Like new. \$5995. Call Mot Oldsmobile, 756-3115.

# 22 Foreign

DATSUN 280Z 1978. Demonstrator, turbo charged, sunroof, 2000 miles. Holt Oldsmobile-Datsun, 101 Hooker Road. 756-2115.

# 23 Boats For Sale

35 HP EVINRUDE, 14' Pisces boat and trailer. Like new. \$2200. 746-6750 after 5 p.m.

# 31 Campers For Sale

CONVERTED VANS, all makes. Sasser's Camping Center. All types of camping equipment. North 117 Business, Goldsboro, 724-4616.

# 35 Cycles For Sale

1975 YAMAHA 175 ENDURO. 2000 miles. \$600. 756-2624.

# 01 PUBLIC NOTICES

NOTICE OF PUBLIC HEARING ON THE QUESTION OF THE ADOPTION OF AN ORDINANCE ANNEXING TERRITORY TO THE CITY OF GREENVILLE, N.C.

The owners of the real property hereinafter described, the same being contiguous to the City of Greenville, have filed a petition requesting the City Council of the City of Greenville, North Carolina, to annex said property to the City of Greenville, pursuant to Article 36 of the Constitution of the State of North Carolina...

# 01 PUBLIC NOTICES

Having qualified as Co-Executors of the estate of Rena Pollard Cobb late of Pitt County, North Carolina, this is to notify all persons having claims against the estate of said deceased Executor within (6) months from the date of the first publication of this notice or same will be pleaded in bar of their recovery...

# 01 PUBLIC NOTICES

Having qualified as Co-Executors of the estate of William A. Pollard, Jr., late of Pitt County, North Carolina, this is to notify all persons having claims against the estate of said deceased to present them to the undersigned Executor within (6) months from the date of the first publication of this notice or same will be pleaded in bar of their recovery...

# 01 PUBLIC NOTICES

Having qualified as Co-Executors of the estate of William A. Pollard, Jr., late of Pitt County, North Carolina, this is to notify all persons having claims against the estate of said deceased to present them to the undersigned Executor within (6) months from the date of the first publication of this notice or same will be pleaded in bar of their recovery...

# 01 PUBLIC NOTICES

Having qualified as Co-Executors of the estate of William A. Pollard, Jr., late of Pitt County, North Carolina, this is to notify all persons having claims against the estate of said deceased to present them to the undersigned Executor within (6) months from the date of the first publication of this notice or same will be pleaded in bar of their recovery...

# 01 PUBLIC NOTICES

Having qualified as Co-Executors of the estate of William A. Pollard, Jr., late of Pitt County, North Carolina, this is to notify all persons having claims against the estate of said deceased to present them to the undersigned Executor within (6) months from the date of the first publication of this notice or same will be pleaded in bar of their recovery...

# 01 PUBLIC NOTICES

Having qualified as Co-Executors of the estate of William A. Pollard, Jr., late of Pitt County, North Carolina, this is to notify all persons having claims against the estate of said deceased to present them to the undersigned Executor within (6) months from the date of the first publication of this notice or same will be pleaded in bar of their recovery...

# 01 PUBLIC NOTICES

Having qualified as Co-Executors of the estate of William A. Pollard, Jr., late of Pitt County, North Carolina, this is to notify all persons having claims against the estate of said deceased to present them to the undersigned Executor within (6) months from the date of the first publication of this notice or same will be pleaded in bar of their recovery...

# 01 PUBLIC NOTICES

Having qualified as Co-Executors of the estate of William A. Pollard, Jr., late of Pitt County, North Carolina, this is to notify all persons having claims against the estate of said deceased to present them to the undersigned Executor within (6) months from the date of the first publication of this notice or same will be pleaded in bar of their recovery...

# 01 PUBLIC NOTICES

Having qualified as Co-Executors of the estate of William A. Pollard, Jr., late of Pitt County, North Carolina, this is to notify all persons having claims against the estate of said deceased to present them to the undersigned Executor within (6) months from the date of the first publication of this notice or same will be pleaded in bar of their recovery...

# 01 PUBLIC NOTICES

Having qualified as Co-Executors of the estate of William A. Pollard, Jr., late of Pitt County, North Carolina, this is to notify all persons having claims against the estate of said deceased to present them to the undersigned Executor within (6) months from the date of the first publication of this notice or same will be pleaded in bar of their recovery...

# 15 Dodge

FOR IMMEDIATE sale, 1973 Dodge Polara. Silver gray, cream vinyl top, air, automatic, power steering, 4 door, low mileage. Excellent condition. Owner asking \$1350 (negotiable). 756-0571.

# 16 Ford

PINTO 1974. Vinyl top, 4 speed transmission, radio, air, good tires. Excellent condition. Call 752-9275.

# 18 Mercury

COUGAR XR-7, 1978. White on white, 21,000 miles, loaded. 753-3557.

# 19 Oldsmobile

CUTLASS 1969 wagon. Power steering, air, tires in good condition. \$350. 746-4846.

# 20 Plymouth

PLYMOUTH 1974. Cuda. White with black stripes. 34,000 miles. Excellent condition. 758-6996.

# 21 Pontiac

PONTIAC 1977 Grand Prix. Bucket seats, electric windows, stereo radio, cruise control, 111 wheel, 12,000 miles. Like new. \$5995. Call Mot Oldsmobile, 756-3115.

# 22 Foreign

DATSUN 280Z 1978. Demonstrator, turbo charged, sunroof, 2000 miles. Holt Oldsmobile-Datsun, 101 Hooker Road. 756-2115.

# 23 Boats For Sale

35 HP EVINRUDE, 14' Pisces boat and trailer. Like new. \$2200. 746-6750 after 5 p.m.

# 31 Campers For Sale

CONVERTED VANS, all makes. Sasser's Camping Center. All types of camping equipment. North 117 Business, Goldsboro, 724-4616.

# 35 Cycles For Sale

1975 YAMAHA 175 ENDURO. 2000 miles. \$600. 756-2624.

# 37 Trucks For Sale

1976 DODGE CLUB Cab. V-8, power steering and brakes. AM/FM radio, manual transmission. 37,000 miles. \$3500. Call 752-3609 or see at Flerning's Furniture & Appliances, Dickinson Avenue or call 756-7510 nights.

# 37 Chevrolet

CHEVELLE 1964 Malibu, 2 door, 307 automatic. Good condition. 746-6445.

# 37 Oldsmobile

CHEVROLET 1975 Caprice Classic, 2 door, excellent condition. Call 756-7571.

# You'll find all sizes, kinds and styles in today's Classified Ads. Check NOW!

**37 Trucks For Sale**  
1964 CHEVROLET truck. 756-6749 after 5 p.m.

**40 DOGS & PETS**  
FEMALE GERMAN SHEPHERD. 746-4398.

**EMPLOYMENT**  
**Help Wanted**  
3 MATURE PERSONS needed to service and sell our equipment. May mean doubling your income. Call 756-3861 for appointment. Equal opportunity employer.

**TOP NOTCH SECRETARY** Administrative Assistant for construction firm. Must be excellent typist, over 25, mature, serious minded and interested in growth position. Great opportunity for right person. Send resume, stating past salary and present salary requirements, to Box 79, Greenville, NC.

**BODY SHOP** repairman needed. Call manager at Hastings Ford, 758-0114.

**SALESPERSON NEEDED**. Excellent company benefits. Draw agent commission. Apply to Smith-Waldrop Motors, Dickinson Ave. Phone 756-4267.

**MATURE SALESPERSON** for national company. Good benefits and opportunity for advancement. All for appointment. 756-2242. Equal Opportunity Employer.

**SALESPERSON WANTED**. Excellent benefits, excellent pay plan. Prefer married person. Apply in person at 101 Oldsmobile, 101 Hooker Road, Greenville, NC.

**AVON**. Want to earn extra money but need to be home when your kids are home? Become an Avon Representative and sell Avon products. Avon representatives have hours that suit you best. For details, call 752-7006.

**SECRETARY/RECEPTIONIST** for financial institution. Requirements: attractive person with good secretarial skills, nice personality, pleasant telephone voice, ability to deal with people, able to type, ambitious with desire to advance with growing company. Excellent benefits, excellent pay plan, working atmosphere. Send resume to P. O. Box 1158, Greenville, NC.

**BOOKKEEPER** needed by local retail concern. Duties would include keeping books, writing checks, filing and other general bookkeeping of office duties. Must have excellent hospitalization, life insurance and vacation. Please reply, giving full resume, to Bookkeeper, P. O. Box 3333, Greenville, NC 27834.

**AGRICULTURAL SALES**  
**TRAINER**. Individual with farm background to build a business in agricultural sales business. Good benefits. Agri-Supply Company, Greenville, 752-3999.

**OUTSIDE SALES Representative**. Must be neat, aggressive and dependable with management potential. Commission and expense allowance. Apply in person only. The Singer Company, Pitt Plaza Shopping Center, Greenville, NC.

**SHOP FOREMAN** who is qualified in trouble shooting and quality control. Contact Herbert Powell, Holt Oldsmobile-Datsun, 101 Hooker Road.

**AVON**. Help make ends meet. Sell Avon. The more you sell, the more you earn. And flexible hours fit easily around work or home life. For details, call 752-7006.

**WANTED**. Dental Hygienist. Full or part-time. Send resume to Dental Hygienist, P.O. Box 1967, Greenville, NC.

**FULL TIME yard maintenance person** needed. Send resume to Yard Maintenance Person, 1509 Greenville Boulevard, Greenville, NC.

**CLORIMLT, ASCP REGISTERED** certified lab technician. Part-time employment that could lead to full time. Evening hours and on call duty. Blood bank. Free health insurance. For further details, call 758-1140, ask for Mr. Carney or Mrs. Frye.

**4 PERSONS NEEDED** for full or part-time work by Stanley Home Products. Car necessary. 752-5269, 752-9254, 752-3300.

**BECOME PART** of a growing industry. An international company has recently made it possible for individuals to build a business of their own and operate that business out of their home. There are no franchise fees and no territorial limitations. An investment which is secured by inventory is required. We provide training and do offer an excellent buy-back if you are not completely satisfied. To arrange an interview, write Home Business, P. O. Box 1967, Greenville, NC 27834.

**REGISTERED NURSE**. Available for immediate opening in Cross Phersis program. 2 years nursing experience and Phlebotomy experience necessary. Must be available for on call rotation. Starting salary range from \$11,800 to \$12,400. For flexible hours, call 758-1141 between 8:30 and 5, Monday-Friday, ask for Mrs. Creech or Mr. Carney.

**CARPENTERS NEEDED**. Call nights only. 752-1568 or 758-7462.

**GENERAL FARM** equipment shop. Agricultural sales business desires individual with farm background, familiar with agricultural equipment assembly and repairs, hand tools and some electrical equipment. Many fringes. Agri-Supply Company, Greenville, 752-3999.

**HOUSEKEEPER**. References. 6 hours daily, 5 days a week, \$2.90 per hour. Must drive. 756-0544 after 6, anytime weekends.

**MANAGEMENT POSITION**. Chemical distributor. Warehouse. National company needs individual to manage all phases of chemical distribution. Typing ability necessary. Good salary, excellent fringe benefits. Send resume to Management, P. O. Box 2633, Greenville, NC.

**WELDER**. Experienced. 45 hours a week. Farm repair and fabrication shop. Some mechanical knowledge helpful. 756-5989.

**WANTED**. Owner/Operators. Transit Homes, Inc., a nationwide transporter of mobile homes has immediate need for a few good owner/operators in the North Carolina area. Must own or be able to purchase a suitable truck for towing mobile homes. Drivers and truck must meet DOT requirements. Excellent earning potential, with extra pay for experience in hauling mobile homes. For more information, contact Operations Department, 1-800-845-0224.

**CRANE OPERATOR** with experience needed for local firm in Greenville. Send resume to Crane Operator, 405 North Memorial Drive, Greenville, NC.

**RN'S OR LPN'S**. Full time. 3 to 11. Call Mrs. Brannon, 758-4121.

**WANTED**. RN or LPN full time. Excellent pay. New 120 bed facility specializing in rehabilitative nursing. Contact Director of Nurses. 758-7100 between 8:30 and 5.

**PET LOVERS**  
Looking for a way to turn your spare time into extra income, or possibly a second career? I need key people to form a direct sales organization in your area. This is a chance to be your own paychecks and be your own boss. Pet-related products. For more information, write to Nancy Barber, P. O. Box 340, Jamestown, N.C. 27882.

**SALES PROFESSIONAL**  
Call on business owners only. \$21,750 to \$40,000 first year. AAUW 90 per hour. 20 years old. Call Mr. Scott at 1-800-247-2446.

**CHILD CARE NEEDED** for two boys, 3 and 4, Monday - Friday. 758-7099, 10 to 5:30; 758-4650, nights.

**POSITION OPEN** for full time experienced salesperson. Contact Miss Porter, Salsow's Jewelers, 406 Evans, on the mall, Greenville.

**42 Help Wanted**  
**SALES CAREER**. Will train aggressive person. Top exceptional career opportunities. Substantial starting salary plus incentive increases as earned. Sales experience helpful but not essential. Write or send resume to: S.S. P. O. Box 2279, Raleigh, NC 27602. Equal Opportunity Employer, Male/Female.

**EXCITING AND HIGHLY** rewarding career in advertising sales. \$2500 to \$30,000 a year income. Hospital and life insurance. Call or send resume to Mr. Zimmerman, 812 South Pine Street, Rocky Mount, NC 27801. 1-442-8704.

**NEWS & OBSERVER**. News & Observer dealership available in Greenville area. Call Don Tripp, 758-3354.

**IMMEDIATE OPENINGS** for first, second and third shifts. Cooks and waitresses. Experience needed. Apply between 6 a.m. and 5 p.m., Wal-Fie House.

**FULL TIME SECRETARY**. Available on Saturdays. Salary depends on ability. Please apply in person to Greenville TV, Greenville Blvd. 200 East Greenville Boulevard.

**REPAIR WORK**. Carpentry, roofing, masonry. Call James Harrington. 752-7765 after 6.

**SEPTIC TANK** installation. Lot Sealing and grading. Backhoe/boiler work. Call Sonny Cox, 756-2348 or 746-3414.

**NO JOB TOO SMALL**. Remodeling and painting. Also equipment and mobile homes. Will also do cabinet work. 752-3076 after 5.

**CARPENTER-WOODWORKER** with 20 years experience. Will do minor repair or readjustment. If interested, call 758-5972 after 5:30 p.m.

**STUDENT** would like to babysit and/or do housekeeping in your home after 2 p.m., Monday - Friday. 758-3316.

**RESPONSIBLE PERSON** would like to keep children in my home. 758-6679.

**YOUNG WOODWORKER** seeks work with local firm. 3 years experience in remodeling, repairs, and cabinet-making. Jim, 752-5786.

**FOR SALE**  
**48 Farm Equipment**  
**NURSE WAGON**. 1000 gallon tank on tandem with 112 pump. Complete with valves, cut-offs and hose. \$167.95. Agri-Supply Company, Greenville, 752-3999.

**A ROW AND A ROW**. Massey Ferguson corn planters with plates. One riding tobacco harvester. 756-6165 after 7 p.m.

**REGISTERED** Polled Hereford bulls, 12 to 15 months old. Excellent performance records. Phone L. S. Corbett, 827-4830, Macclesfield.

**REGISTERED QUARTER HORSE** 5 years old. Has been shown. 756-1660.

**CEMENT STEPS**, horse trailers, utility barns, campers and truck shells. Call 756-0311.

**FILL DIRT**, bulldozer, top soil and rock. Call Daniel, 758-7008.

**BOOTLEG PRICES**. Men's knit slacks and jeans, \$9.99, sportcoats, \$19.95; lady's sportcoats, \$12.95; slacks, \$5.99; tops, \$4.99. Large selection. Mill Outlet Clothing, 264 Bypass (across from Nichols), Greenville.

**SMALL LOADS** pinebark, sand, topsoil, etc. Call 756-0311.

**RINSE & VAC**. \$10 a day. Shampoo not included. Whitehurst Carpet 758-2679.

**LARGE LOADS** of sand, topsoil, fill dirt and rock. Also lot clearing. Jim Hudson, 756-4742.

**CEMENT STEPS**, horse trailers, utility barns, campers and truck shells. Call 756-0311.

**WOOD HAULED**, split, stacked. Oak, \$35; mixed hard, \$30; soft mixed, \$25. Green or dry. 752-7611.

**FIREWOOD FOR SALE**. Call J. P. Stancil, 752-6331.

**LITTLE'S NURSERY**. Fruit trees, pecan trees, most other trees, shrubs for immediate delivery. In Cross Phersis program. 2 years nursing experience and Phlebotomy experience necessary. Must be available for on call rotation. Starting salary range from \$11,800 to \$12,400. For flexible hours, call 758-1141 between 8:30 and 5, Monday-Friday, ask for Mrs. Creech or Mr. Carney.

**PIANO RENTAL-Purchase Plan**. \$25.00 private lessons included. Cha-Rich Music, 758-1212.

**COMPLETE AUTO**, furniture and boat upholstery. Also furniture repairing and refinishing. Complete line of materials. Free pickup and delivery. Free estimates. Jackson's Upholstery & Upholstery Service, 758-3278.

**KEEP CARPET CLEANING** problems small. Use Blue Lustre wall-to-wall. Rent your shampooer. Rental Tool Company, 758-0211.

**KIRBY SWEEPER**, shampooer and buffer. 746-3743 or 746-2188.

**WOOD HEATER** for mobile home. UL approved. HUD approved. Tar Road Antiques, 756-1212.

**LE STOVE** wood stove. Rated to heat 2000 square feet. Regularly \$399; on sale for \$349. Tar Road Antiques, 756-1212.

**WANTED**. Consignment antiques, furniture and miscellaneous items. Will take any goods on consignment at Tar Road Antiques. 756-1212.

**BEAUTY SHOP** equipment for sale. 752-4649 days, 758-0886 nights.

**USED SUN TUNE-UP** machine and other various equipment. Contact Johnny Joyner at Goodyear, 752-4417.

**IBM EXECUTIVE** typewriter. Excellent condition. 752-6888 tel. 5:30.

**COPIER**. A. B. Dick 475. Excellent condition. 752-6888 tel. 5:30.

**OAK FIREWOOD**. Get next year's wood at this year's prices. \$30 half cord; \$40 cord. 758-0211.

**NATIONAL CROWN** 20 column cigarette machine. \$300; Vendo VISA machine, \$350. 756-4505.

**SWEET POTATOES** and pecans. 2 miles west of Chocowinity. Choco Flea Market.

**ANTIQUES**, USED FURNITURE and much more. 2 miles west of Chocowinity. Choco Flea Market.

**USED SPINET** piano. Excellent condition. Music Arts, Pitt Plaza, 756-3522.

**ONIONS**, POTATOES, BROCCOLI PLANTS, LETTUCE PLANTS, EARLY GARDEN SEEDS, PANSY PLANTS, Fertilizer and other garden supplies. PECAN TREES 20% off. KITRELL'S GREENHOUSES, 2531 Dickinson Ave. Ext.

**56 Miscellaneous**  
**STEAM JEANIE**. Fairly new. Valued at \$400. Will sell for \$480. Call 758-8023.

**RUST COLOR** naugahyde sofa, chair, recliner and ottoman. 2 matching end tables with glass tops. Excellent condition. 756-0736.

**23 INCH SYLVANIA** color TV. Maple cabinet. Excellent condition. \$250. Call 746-6040 before 3 p.m.

**EXPERT shoe** repairing. Shiver's Surplus, 822 Dickinson Avenue, next to Cozart's Auto Supply.

**BLACK AND WHITE** couch and 2 chairs. \$100. Call 758-5989 after 5:30.

**SOOT YOURSELF!** Dirty chimneys are dangerous. Or through service and a no-mess guarantee, call Carolina Chimney Cleaners, 758-0174. Call us anytime.

**ZENITH ALLEGRO** stereo system. Phono, 8-track, AM/FM, 4 speakers. Excellent condition. 758-1365 days, 756-9088 nights (ask for Jerry).

**VINYL BARBEL SET**. 110 pounds in box, never used. \$10. 758-7665 after 6.

**BEAUTIFUL NEW CARPET**. Save 20% retail. 12 X 16, Bahama blue, 100% nylon. Saxony Plush. 756-7886.

**PEANUT HAY** for sale. \$1.40 per bale. Call 756-2889 after 5.

**3 PIECE LIVING ROOM**, dinette and 2 piece bedroom suite. Call 756-4892.

**NEW HARVEST GOLD** electric stove. \$200. 752-0905.

**ONE PIONEER SUPER** Tuner chassis player and two Jensen 8 1/2" coaxial speakers. All for \$110. 758-5072.

**KENWOOD 7600** stereo receiver with two Rempest Lab Three speakers. Wash and wax. Deposit required. 752-5262 or 752-4008.

**FOR SALE OR RENT**. 2 bedrooms, fully carpeted, central heat and air, washer and dryer, 1/2 baths. No pets. \$130. 756-0070 after 6 p.m.

**VERY QUIET**. Lots of space, large den and fireplace, sun kitchen, many built-ins. \$60,500. Charlotte Flamingo. Ginger Hackett Realtors, 756-7986, 756-7192.

**NEW RANCH**. Lots of room, separate living, dining room, plus 21' den and fireplace. In country. \$31,200. Sante Eastwood, Ginger Hackett Realtors, 756-7986, 756-8883.

**ALMOST NEW** contemporary, large den and fireplace, living room, fire alarm system. Price \$5695. Call 752-6655 days; 752-7982 nights.

**1972 AADISON**. 12 X 45, 2 bedrooms, den, sun deck, 1 bath, fully furnished, washer and dryer, central air, fire alarm system. Price \$5695, reduced to \$5495. Call 758-4723.

**1969 KNOX MOBILE HOME**. 12 X 30, very good condition. Furnished, air conditioning and central heat. Asking \$3695. Call 923-7541 in Bath.

**100 CLASSIFIED DISPLAY**  
**ARMY/NAVY STORE**  
1501 S. Evans St.  
B-15 Bomber, Field Deck, Flight, Snorkel Jackets, Peacoats, Parkas, Shoes, Combat Boots - New and Used Plus Surplus Of All Kinds.

**Trade your wheels for a 750-HP tank.**  
If you can handle it, you'll get your chance - after training in an Armored unit. You'll be part of a team handling an incredible 57-ton machine that challenges your strength, brains, and ability to work with other people. The feeling is great. So is the pay. Join the people who've joined the Army.  
Call Army  
**Sgt Marlon Haddock**  
at 752-4826

**Improve yourself.**  
"Drivers employed by large trucking companies had annual average earnings of about \$18,300 in 1974"  
As quoted by the U.S. Dept. of Labor Bureau of Labor Statistics bulletin, 1875.  
Start now to plan for a professional career driving a "Big Rig". Our private training school offers competent instructors, modern equipment and challenging training fields. Keep your job and train on part time basis (Sat. & Sun.) or attend our 3 week full time resident training. Call right now for full information.  
Revo-Tractor-Training, Inc.

**WE REPAIR SCREEN & DOORS**  
**C. L. LUPTON CO.**

**100 CLASSIFIED DISPLAY**  
**INSTRUCTION**  
**Improve yourself.**  
"Drivers employed by large trucking companies had annual average earnings of about \$18,300 in 1974"  
As quoted by the U.S. Dept. of Labor Bureau of Labor Statistics bulletin, 1875.  
Start now to plan for a professional career driving a "Big Rig". Our private training school offers competent instructors, modern equipment and challenging training fields. Keep your job and train on part time basis (Sat. & Sun.) or attend our 3 week full time resident training. Call right now for full information.  
Revo-Tractor-Training, Inc.

**100 CLASSIFIED DISPLAY**  
**WE REPAIR SCREEN & DOORS**  
**C. L. LUPTON CO.**

**100 CLASSIFIED DISPLAY**  
**WE REPAIR SCREEN & DOORS**  
**C. L. LUPTON CO.**

**100 CLASSIFIED DISPLAY**  
**WE REPAIR SCREEN & DOORS**  
**C. L. LUPTON CO.**

**100 CLASSIFIED DISPLAY**  
**WE REPAIR SCREEN & DOORS**  
**C. L. LUPTON CO.**

**100 CLASSIFIED DISPLAY**  
**WE REPAIR SCREEN & DOORS**  
**C. L. LUPTON CO.**

**100 CLASSIFIED DISPLAY**  
**WE REPAIR SCREEN & DOORS**  
**C. L. LUPTON CO.**

**100 CLASSIFIED DISPLAY**  
**WE REPAIR SCREEN & DOORS**  
**C. L. LUPTON CO.**

**100 CLASSIFIED DISPLAY**  
**WE REPAIR SCREEN & DOORS**  
**C. L. LUPTON CO.**

**100 CLASSIFIED DISPLAY**  
**WE REPAIR SCREEN & DOORS**  
**C. L. LUPTON CO.**

**100 CLASSIFIED DISPLAY**  
**WE REPAIR SCREEN & DOORS**  
**C. L. LUPTON CO.**

**100 CLASSIFIED DISPLAY**  
**WE REPAIR SCREEN & DOORS**  
**C. L. LUPTON CO.**

**100 CLASSIFIED DISPLAY**  
**WE REPAIR SCREEN & DOORS**  
**C. L. LUPTON CO.**

**100 CLASSIFIED DISPLAY**  
**WE REPAIR SCREEN & DOORS**  
**C. L. LUPTON CO.**

**100 CLASSIFIED DISPLAY**  
**WE REPAIR SCREEN & DOORS**  
**C. L. LUPTON CO.**

**100 CLASSIFIED DISPLAY**  
**WE REPAIR SCREEN & DOORS**  
**C. L. LUPTON CO.**

**100 CLASSIFIED DISPLAY**  
**WE REPAIR SCREEN & DOORS**  
**C. L. LUPTON CO.**

**100 CLASSIFIED DISPLAY**  
**WE REPAIR SCREEN & DOORS**  
**C. L. LUPTON CO.**

**100 CLASSIFIED DISPLAY**  
**WE REPAIR SCREEN & DOORS**  
**C. L. LUPTON CO.**

**66 Mobile Homes For Sale**  
1970, 12 X 40, Central air, all appliances, partly furnished. Good condition. \$4000. Call 752-6655 days; 752-7982 nights.

1972, 12 X 40, Central air, washer and dryer, fully furnished. \$4995. 758-4392 after 6.

DOUBLEWIDE 24 X 40, 3 bedrooms, 2 baths, den, \$11,000; with two 87 X 167 lots, \$19,000. 10 year owner financing with 20% down at 10% APR. 758-0506.

1978 REPOSESSION. 14 X 70, 5 bedrooms, 2 baths. Furnished. Assume loan. Call Johnny's Mobile Homes, 756-4667.

1974, 12 X 40, 2 bedrooms, completely furnished. \$3800 or \$600 down and take up payments of \$77.56 per month. 758-0736 anytime.

1973 PARKEET doublewide, 24 X 40. Extra clean, Central heat and air, new carpet. Priced to sell. Call 756-2109.

**70 PROFESSIONAL**  
**BEAUTY SHOP** booths for rent. 756-6411 days, 756-4866 nights.

**CHIMNEY SWEEP**. 20 years experience with fireplaces and chimneys. Call Gid Holloman, 752-3503 day or night.

**CHILD CARE** services. By the hour, day or week. Call 758-4734, 6:30 a.m. til 6 p.m.

**GENERAL HOME REPAIRS**. Carpets, patios, porches, driveways. No job too small. For free estimate, call Billy Whitehurst, 752-9274.

**PAINT WORK**. Inside and out. 25 years of experience. Call 752-5448.

**73 Commercial Property**  
**SHOP SPACE** available at reasonable price. Ideal for construction related operation. 752-1020.

**FOR LEASE**  
Office or commercial buildings located in Greenville.  
1400 Block W. 14th St. Four 900 sq. ft. and One 1800 sq. ft.  
1100 Block Hamilton St. Three 1200 sq. ft. and One 2400 sq. ft.  
3000 Block E. 10th St. 700 ft. office building and 800 ft. block storage building  
These buildings can be finished within 30 days for occupancy and finished to suit tenant. New construction.  
Contact J. T. or Tommy Williams  
756-7815

**PITT PLAZA RETAIL SPACE AVAILABLE**  
Excellent opportunity for experienced retailer in established location. Call J. M. Kane and Co. at 756-0842.

**STORE/OFFICE SPACE** available. 1000 square feet. New construction. Neighborhood commercial zone. Adjacent to Stop-N-Go, Hooker Road. Call 752-1733.

**BY BUILDER**. 2 new homes in Grifton. Large family room with fireplace, wood floors, heat pumps, deck and dining area. High 30's to low 40's. \$24-5474.

**UNUSUAL FIND**. 3 bedrooms, family room, bath, in quiet neighborhood, close to schools and shopping centers. Only \$39,900. For details call J. D. Real Estate, 756-1800 or 756-6782.

**4 BEDROOM CONDOMINIUM**. Formal living and dining areas. All extras in kitchen. Refrigerator, washer and dryer remain. Fireplace in den. 2 1/2 baths. Central Heat, 758-6900 or 756-5456; 756-6171.

**BCK RANCH** with 3 bedrooms, 2 baths, eat-in kitchen, full formal dining room, fireplace, heat pump. 756-4500 after 5 p.m.

**FARMVILLE**. Newly renovated inside and out. 2 story, 4 rooms and bath downstairs, 3 rooms and bath upstairs. Call 756-2206 after 5 p.m., weekdays or contact owner at 756-2112, 9 a.m. and 5 p.m. on Saturday or Sunday.

**VERY QUIET**. Lots of space, large den and fireplace, sun kitchen, many built-ins. \$60,500. Charlotte Flamingo. Ginger Hackett Realtors, 756-7986, 756-7192.

**Houses For Rent**

**IN FARMVILLE**, 207 East Church Street. Prefer couple. Call 752-6195.  
**BRICK HOME** near university. 2 bedrooms, sun room, one bath, nice yard. \$250. Call Louise Hodges Realtor, 756-3500 or 756-5005.  
**BRICK RANCH** home in College Court. 3 bedrooms, 2 baths, den with fireplace, deck, \$300. Call Louise Hodges Realtor, 756-3500 or 756-5005.  
**EXECUTIVE TYPE HOME**, 3 bedrooms, 2 1/2 baths, large family room with fireplace, formal living room and dining room, large lot, detached garage. One year lease and deposit required. \$425 per month. 756-3477.

**SELECT 1**

**BROOK VALLEY**, Four bedrooms, two baths, living room, family room, washer, dryer, refrigerator. Lease required. \$450.00  
**LAKE GLENWOOD**, Three bedrooms, two baths, living room, family room. \$395. Lease required.  
**DUPLEXES**, New. Two bedrooms, bath, refrigerator. \$200. Lease required.  
**DUFFUS REALTY, INC.**  
 756-5395

**BELVEDERE**, 3 bedrooms, 2 baths, screened porch. \$350 per month. Lease. 756-5120 after 5 p.m.  
**2 BEDROOMS**, central air and heat, carpet, refrigerator and stove. Washer/dryer hookups. \$195. 756-2787 after 5.  
**3 BEDROOM**, 1 bath brick house in Falkland. \$200, lease and security deposit. 758-2302 after 5.

**91 Office Space For Rent**

**OFFICE SPACE** available. Single suites, multiple suites. Also conference room available. All services provided. 752-1020.  
**OFFICE SPACE** for rent. Call Joe Bowen, 752-7194.

**OFFICES AVAILABLE** at Oakmont Plaza. Between \$100 and \$130 a month. Utilities included. New temporary office building. 756-4624 days, 756-5168 evenings.

**OFFICES**, \$30 per month up. Includes heating, air conditioning, janitorial service and parking. Grier Rental Agency, 752-3700 or 758-1076.

**OFFICE SPACE** with plenty of parking. \$2.50 per square foot. Call 758-2300 days; 758-1742 nights.

**TWO INDIVIDUAL OFFICES** with excellent view. Downtown across from courthouse. 300 square feet. \$150 per month. Call Clark Branch Realtors, 756-6336.

**100 CLASSIFIED DISPLAY**

**WE INSTALL ALUMINUM AND VINYL SIDING**  
**C. L. LUPTON CO.**  
 752-6116

**Immediate Opening**  
**OFFSET PRESS OPERATOR**  
 Phone 752-0331

**Grand Opening**  
 March 17th  
**The Bargain House**  
 Flea Market & Auction Sales  
 Greenville's Newest & Largest INDOOR Flea Market—10,000 Sq. Ft. Year Round  
 Saturdays—9 A.M. to 5 P.M.  
 Rental Spaces (\$9 x 19' 8" Per Day (Discount Available))  
 Come On Down To The NEW Fairground Bldg. Located On Industrial Blvd.  
**SALE EVERY SATURDAY**  
 Call 756-7721 or 782-2783 P.O. Box 194, Greenville  
 Auctioneer, Daniel M. Owens, N.C. St. Lic. No. 310

**91 Office Space For Rent**

**OFFICE SPACE** available in Duffus Building. Utilities, janitorial service, use of conference room included. Select 1, Duffus Realty, 756-5395.  
**AVAILABLE APRIL 1**, Store/office. Upstairs overlooking downtown mall. Mr. Lee, 756-5737, 756-2772.  
**DOWNTOWN**, just off mall, 160 square feet. Available now. Mr. Lee, 756-5737, 756-2772.  
**EXECUTIVE OFFICE** space, 2 upstairs offices for rent on Arlington Boulevard (with full utilities included). 325 square feet. \$230 per month. Immediate occupancy. Realty Industries, Inc., 201 East Arlington Boulevard. Call Larry Horton, (804) 359-9391.

**93 Rooms For Rent**

**FURNISHED ROOMS**. Excellent furniture, convenient location. Contact Grier Rental Agency, 752-3700 anytime from 9 a.m. till 3 p.m., Monday through Friday.  
**TO BUSINESS** person or serious student. Private bedroom and share other facilities in 3 bedroom modern home near ECU. (Don't read between the lines, for we are squares!) 752-6888 till 5:30.

**94 WANTED**

**WANTED TO BUY** mobile homes, 1970-1974. Will pay cash. Call 758-4392 after 6.

**ONE TO TWO ACRES** of land in vicinity of Winterville, Ayden or Grifton. Paved road frontage. 746-6571.

**98 Wanted To Lease**

**WANT TO LEASE** tobacco package. To be moved off farm. Will pay highest prices. 758-0332.

**TOBACCO WANTED**—20,000 to 30,000 pounds. 746-3914 or 746-3983.

**WANT TO LEASE** peanuts on or off land. 752-6496.

**100 CLASSIFIED DISPLAY**

**ROOFING**  
 STORM WINDOWS  
 DOORS & AWNINGS  
**C. L. LUPTON CO.**  
 752-6116

**BEGINNING AND ADVANCED**  
**STAINED GLASS CLASSES**  
 Starting Soon  
 CONTACT SKIP WHITE  
**Mixed Media**  
 758-2127

**How To Build An \$8100 Education Fund In 3 Years.**  
 It's easy in today's Army. If you save \$50 to \$75 a month under the Veterans' Educational Assistance Program, your money is matched \$2 for \$1 in three years, that comes to as much as \$8100 for education when you get out. Join the people who've joined the Army.  
 Call Army Opportunities  
**SGT. MARLON HADDOCK**  
 AT 752-4826

# The Real Estate Corner

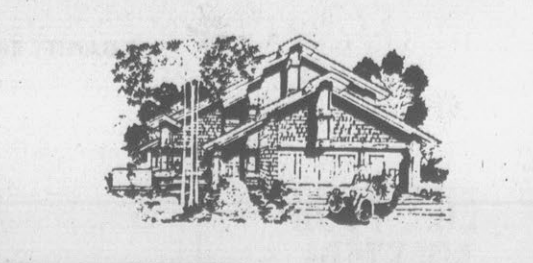

Buying or Selling. For Best Results Try Our "Personal Service"  
**D. G. Nichols Agency**  
 752-4012  
 Anytime



For Quality New Homes In Greenville's Finest Areas  
 Call The New Homes Specialists.

**GROUP 10 INC.**  
 756-6234

**OVERTON & POWERS**  
 758-4585

**NEW HOMES IN ORCHARD HILL SUBDIVISION**  
**\$39,950. to \$45,500.**

FHA Financing—Standard or Graduated  
 Payment plan  
 VA 100% Financing  
 Conventional Financing  
 Three Bedrooms  
 Two Full Baths  
 Living Room

Kitchen-Eating area  
 Garage  
 Den (Optional)  
 Fireplace (Optional)  
 Climatrol Heat Pump  
 City Water and Sewer  
 City School District

Contact  
**D.G. Nichols Agency**  
 752-4012

**LAKE BREEZES**  
 Flow thru this spacious 3 bedroom ranch. The quality and fine workmanship of this home speaks for itself. The bedrooms are all large and there's an abundance of closet space. Formal living & dining. Den with built-ins and fireplace, sliding doors open to porch which overlooks the lake. Family size kitchen, separate laundry room. 2 car garage and it's only \$59,900.

**Jeannette Cox Agency, Inc.**  
 756-1322

Jeannette Cox 756-2521  
 Anne Reese 758-4713  
 Barbara Hart 752-7806

**Mavis Butts Realty**  
 105 West 3rd St.  
 Greenville

**758-0655**

**NEW LISTING**—Be the first to see this pretty brick ranch home in Ayden, featuring living room, den, kitchen with eat-in area, 3 bedrooms, 2 ceramic baths, paneled double garage, utility, central air, fenced backyard and sliding glass doors to patio. Assumable loan. \$42,900.

**MAVIS BUTTS** 752-7073  
**NANCY WILSON** 758-5231  
**ANN BASS** 756-6666

**"OUR NEWEST MATCHABLE"**

How long have you been looking for a three bedroom, two bath ranch, with a fireplace in the Thirties? We have an excellent buy in a good neighborhood. Formal living and dining, kitchen with stove and dishwasher, den with fireplace, garage and large fenced in back yard. Only \$38,500. Call us now for an appointment to see this home.  
 LISTING BROKER: JANET HIGNITE (NIGHTS 756-5569)

**MATCHMAKER**  
 Matching people with homes...all over America!  
**Hignite & Company, Inc.**  
 758-6666 Anytime

**FOR SALE...**

- 2-story home, completely remodeled and painted in and out, 5 bedrooms, 2 baths, sun room, French doors open to screened porch, 2000 sq. ft. atop shaded, sloping lot. Reduced to \$36,500.
- Three-bedroom house on attractive lot in Village Grove, with living room and combination kitchen and dining room—an excellent buy. Reduced to \$14,500!
- One-bedroom bungalow on 45' x 85' lot near university-zoned CDF, good for present rental, future commercial use. Reduced to \$10,500!
- Site on Bonner's Lane, zoned IU, good for many business uses, \$14,000.
- Building site 4 blocks from downtown Mall, zoned R-6 Residential, perfect for duplex or multi-unit apartments or townhouses. See us today!

**NOTICE**

**Tommie Dail**  
 Pete McClung, President of Farmville Motors, Inc is pleased to announce that Tommie Dail has joined their staff as a sales representative. Tommie would like to invite all his many friends and customers to come by or give him a call today.

**FARMVILLE MOTORS, INC.**  
 201 N. Main St. Farmville, N.C. 753-3909

**A New Offering**

**AYDEN**  
 A Very Pretty And Well Kept Ranch Home. Four Bedrooms, Two Baths, Living Room, Kitchen With Dining Area, Family Room, Garage, Central Air, Heat Pump, Patio, Fenced Rear Yard. Definitely See This. \$44,900.

**Select 1**  
**DUFFUS REALTY, INC.**  
 756-5395

**Jack Duffus**  
 Listing Broker  
 756-5395

**CLARK BRANCH INC. Realtors**

**A NEW OFFERING**

**Westwood**  
**\$54,900**

The right price and the right size (1790 square feet) make this a dreamboat. Features double garage, covered patio, large swimming pool, three large bedrooms and two full baths, spacious den with built-ins and formal areas round out this well built home in private Westwood. Call today for an appointment. Loan assumption available. It won't last long.

**CLARK-BRANCH, INC. REALTORS**  
 756-6336

**FOR RENT OR LEASE...**

- Two-bedroom duplexes in Colonial Village; range, refrigerator, air-conditioning \$200 per month.
- Office suites, with parking and storage space, from \$85 to \$150 per suite.
- Two-bedroom house RENTED on N.C. 43, 12 mi. from Greenville.
- Office building, 2000 sq. ft., 4 offices, large storage area, adaptable. \$350 per month, lease only.
- Small office building (former drive-in bank) downtown, built-in desk, washroom facilities, drive-in window. \$150 per month.

We have customers with money to spend, and we provide a full range of professional real estate sales and management services—so let us sell, rent or lease your property for you!

**J. L. Harris & Sons**  
 204 W. 10th Street  
 758-4711

**QUALITY USED CARS**

At Bob Barbour Honda we offer you a better selection of dependable late model used cars than you'll find anywhere else. Here are some examples:

- 76 Pontiac Grand Prix, white with maroon landau top, fully equipped.
- 77 Chevy Monte Carlo Landau, silver, loaded, 13,000.
- 77 Olds. Cutlass Supreme, silver blue, rally wheels, landau roof, fully equipped.
- 77 Pontiac Grand Prix, ginger with buckskin landau roof, loaded with options, 22,000 miles.
- 78 Buick Regal, 3.8 litre turbo charged engine, tilt wheel, cruise, power windows and seats, power door locks, AM-FM stereo tape, landau roof, 15,000 miles.
- 77 Buick Electra 225. Gold with buckskin top, loaded.
- 78 Pontiac Trans AM, Black, power steering and brakes, air, AM-FM radio, tilt wheel.
- 78 T-Bird, black with dove grey landau roof & interior, fully equipped, incl. wire wheels, a beautiful car.

**SPECIAL!**  
 •78 Chevy Monte Carlos and Caprice Classics—six in stock, all fully equipped, your choice for only **\$4795**

**Bob Barbour HONDA**  
 117 West Tenth Street  
 Greenville / 758-7200

**DON'T LET 'EM SCARE YOU**

**WE CAN HANDLE THEM**  
**Jeannette Cox Agency Inc.**  
 756-1322

**Is Building In Your Future?**

Then let Tipton Builders, Inc. help you realize your dream come true. We can help with Loans, Lots, Blueprints and just about everything about building. We specialize in Farm Home Loans. No Job Too Big or Too Small.

For Appointment Call:  
**Tipton Builders Inc.**  
 234 Greenville Blvd.  
 756-7717

# Employment Picture In U.S. Shifts

INTERSTATE SECURITIES  
CORP.

Unemployment statistics are a widely followed, economic indicator. In earlier periods of economic expansion, this figure declined to relatively low levels: 3.6 percent in 1950-53 and 3.7 percent in 1966-69. Currently, the rate is at a high 5.8 percent, despite four years of economic growth and record levels of total employment.

For the ten years ended 1978, the U.S. labor force increased by almost 28 percent compared with total population growth of only 9 percent. Increased participation by women and the coming of age of the World War II "baby boom" are responsible for this growth in the work force, and may well make the four percent "full employment" standard: obsolete. A 6-6.5 percent rate may be much more realistic.

Sixty percent of adult women are working or seeking work today compared with 40 percent in 1965. Since 1968 alone, the growth rate of women in the work force has resulted in an additional seven million people looking for jobs or working.

Except for the World War II baby boom, the rate of growth of the U.S. population has been in a long term decline. But these baby boom individuals began entering the work force in the mid-60's, swelling the growth of the total work force.

These two factors have important implications for the future. The baby boom was followed by a decline in the number of births in the sixties and seventies. Thus, the 16-24 age group is expected to increase 19.6 percent for 1970-80, but only 10 percent from 1980-90. The maturing of baby boom workers is expected to result in 70 percent of the work force being in the 25-54 age bracket by 1990, compared to 61 percent today.

Women are expected to represent about 46 percent of the labor force in 1990 compared to 42 percent currently. This would represent a slowing in the growth rate of the proportion of women to total population.

The results of changing growth rates and age mix are several. Competition among younger workers should be reduced for entry level jobs and the gap between teenage jobless rates and those for older workers should narrow. This should lower the overall unemployment rate.

The greater percentage of more mature, experienced, better educated workers presents the potential for sharp gains in productivity. But it may also result in a lower number of workers seeking work in the trades, which would necessitate sharp increases in wages to avoid labor shortages. The increase in the proportion of women in the work force could also affect productivity, depending on how many seek only part time work and the willingness of employers to accommodate this segment of the labor force.

Changes in total population growth and in the age of that population will certainly affect unemployment rates in the next 10 years. Near term, however, the cyclical nature of our economy indicates that unemployment is likely to rise from now until the end of the year.

## 'Year Of Child' Stamps Ahead

NEW YORK (UPI) — With the United Nations designating 1979 as the "International Year of the Child," many countries are expected to issue special stamps commemorating the period, with Great Britain and the United States leading the way, according to Alain de Cadenet, consultant to the British Post Office.

The BPO also will mark the 100th anniversary of the death of Sir Rowland Hill, "father" of the postage stamp, with a set of four commemoratives, de Cadenet said.

The London International Stamp Exhibition is scheduled for May, 1980.

**FRENCH BREAD PANS**  
TERRE HAUTE, Inc. (UPI) — A housewares manufacturer has added French style bread pans to its line of Early American-style cast iron utensils for *range-top* and oven use. The boat-shaped baking pans come in single and double loaf size.

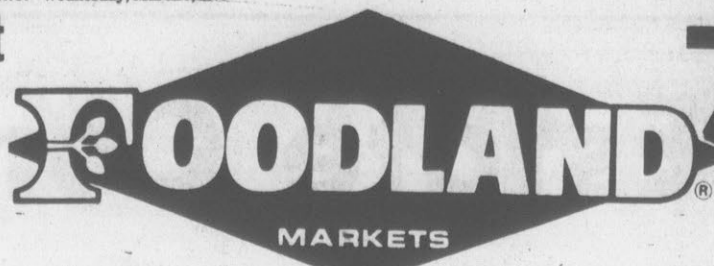

MEMBER OF THE FOODLAND SYSTEM

"THE PEOPLE THAT SHOP FOODLAND KNOW WHAT SAVINGS CAN BE HAD, PLUS QUALITY AND OLD FASHIONED COURTEOUS SERVICE." "SHOULDN'T YOU SEE FOR YOURSELF TODAY." "THAT'S THE FOODLAND WAY."

USDA INSPECTED  
**FRYERS**  
WHOLE **45¢**  
LB.  
LIMIT 4 PLEASE  
CUT UP LB. (PAN READY) **55¢**

**FILL YOUR FREEZER!**  
NECK BONES 10 LB. \$6.99  
PIG TAILS 10 LB. \$5.99  
PIG FEET 10 LB. \$5.99  
CHITTERLINGS 10 LB. \$4.99  
SMITHFIELD COUNTRY LINK SAUSAGE 10 LB. \$11.99  
SMITHFIELD SLICED BACON 1 LB. PKG. \$1.29  
SMITHFIELD FRANKS 12 OZ. PKG. 99¢

**FRESH LEAN PORK CHOPS**  
CENTER RIB LB. **\$1.39**  
CENTER LOIN LB. **\$1.49**

**COUNTRY HAMS**  
FFV OR PEANUT CITY  
LB. **\$1.49**

WHOLE HEAVY WESTERN STEER  
**RIB EYE**  
LB. **\$2.99**  
(CUT IN STEAKS FREE)

HEAVY WESTERN STEER  
**RIBEYE STEAK**  
BONELESS LB. **\$3.29**

**FRESH LEAN PORK CHOPS**  
1/2 LOIN OR PORK LOIN RIB HALF LB. **\$1.29**

**FRESH YELLOW CORN**  
EARS **3/49¢**

**GOLDEN RIPE BANANAS**  
LB. **19¢**

**RED, GOLDEN DELICIOUS OR WINESAP APPLES**  
3 LB. BAG **99¢**

**NEW FLORIDA RED POTATOES**  
5 LB. BAG **59¢**

**MEXICAN RIPE TOMATOES**  
32 OZ. BOTTLE **39¢**  
**HUNT'S KETCHUP**  
32 OZ. BOTTLE **69¢**  
LIMIT 1 WITH 7.50 FOOD ORDER

**ARMOUR VIENNA SAUSAGE**  
EVERY DAY LOW PRICE 3' OFF  
5 OZ. CANS **289¢**

**ARMOUR POTTED MEAT**  
5 3 OZ. CANS **\$1.00**

**WHITE, PINK/GREEN, YELLOW/BLUE WHITE CLOUD TOILET TISSUE**  
4 ROLL PKG. SAVE 18' **79¢**

**BUSH & SHOW BOAT PRODUCTS**  
5 CANS **\$1.00**

**FOODLAND-ORANGE, GRAPE, OR TROPICAL PUNCH DRINK**  
SAVE 4' 44 OZ. CAN **49¢**  
**NESTLE-REGULAR OR WITH MARSHMALLOW HOT COCOA**  
12-1 OZ. PKGS. **99¢**  
**NABISCO PREMIUM CRACKERS**  
1 LB. BOX **65¢**

**WHITE OR ASSORTED KLEENEX**  
SAVE 16' 200 CT. BOX **59¢**  
**CHUN KING CHICKEN CHOW MEIN**  
43 OZ. CAN **\$1.79**  
**CHUN KING CHOW MEIN NOODLES**  
3 OZ. CAN **39¢**

**10' OFF BOLD DETERGENT**  
49 OZ. BOX **\$1.49**  
SAVE 20'

**KRAFT-REG., HOT, HICKORY SMOKE, ONION BAR-B-Q SAUCE**  
18 OZ. **69¢**

**NABISCO OREO'S AND DOUBLE STUFF**  
YOUR CHOICE **95¢**

**CHUN KING SOY SAUCE**  
10 OZ. BOTTLE **69¢**

**IRISH SPRING SOAP**  
5' OFF BATHSIZE BAR SAVE 5' **39¢**

**DUNCAN HINES CAKE MIX**  
19 OZ. BOX **69¢**  
EVERYDAY LOW PRICE

**KRAFT REG. BAR-B-Q SAUCE**  
SAVE 26' 28 OZ. BOTTLE **99¢**  
**COMET LONG GRAIN RICE**  
SAVE 20' 42 OZ. BOX **79¢**

**TONY DOG FOOD ALL FLAVORS**  
5 15 OZ. CANS **\$1.00**  
**GIGI CAT FOOD**  
5 15 OZ. CANS **\$1.00**

**COKE'S**  
8 16 OZ. BOTTLES **\$1.29**  
PLUS DEPOSIT

**MAXWELL HOUSE COFFEE**  
EVERYDAY LOW PRICE 1 LB. BAG **\$2.29**

**PILLSBURY BUTTERMILK BISCUITS**  
44 OZ. ROLLS SAVE 20' **59¢**

**FRESH START DETERGENT**  
15' OFF 21 OZ. BTL. SAVE 5' **\$1.39**

**IDA TREET FRENCH FRIES**  
2 LB. PKG. **39¢**  
SAVE 14'

**BIRDSEYE AWAKE**  
12 OZ. CAN **59¢**  
EVERYDAY LOW PRICE  
**EDWARDS CHOCOLATE OR LEMON PIE**  
34 OZ. BOX **\$1.99**  
SAVE 60'  
**EGGO WAFFLES**  
11 OZ. BOX **69¢**  
SAVE 10'

**FROZEN FOODS:**  
**DULANY BROCCOLI SPEARS**  
10 OZ. PKGS. SAVE 14' **89¢**  
**CHEF BOY-AR-DEE-CHEESE, SAUSAGE, HAMBURGER, OR PEPPERONI PIZZAS**  
YOUR CHOICE **99¢**  
SAVE 20'

**PETER PAN SMOOTH OR CRUNCHY PEANUT BUTTER**  
18 OZ. JAR **69¢**  
SAVE 10'  
LIMIT 1 WITH 7.50 FOOD ORDER AND COUPON  
FOODLAND COUPON

**PRE-Spring SPECTACULAR**

LIMIT 4 PLEASE

GRADE "A" WHOLE FRYERS **44¢** LB.

WHOLE CUT-UP FRYERS **49¢** LB.



**IT'S SALAD-TIME**

- LONG GREEN (100 CL.) CUCUMBERS **10¢** Ea.
- RADISHES **10¢** Cello Pack
- LARGE POD GREEN (90 CL.) BELL PEPPERS **10¢** Ea.
- CARTON TOMATOES (3'S) **29¢** Cn.
- LARGE CRISP LETTUCE **49¢** Head



**OSCAR MAYER LEAN & TASTY**

BREAKFAST STRIPS  
12-OZ. PKG.

WITH COUPON FROM PAGE 23 OF TODAY'S PAPER

**89¢**

WITHOUT COUPON \$1.39 PKG.



**BONELESS CHUCK ROAST**

**\$1.39** LB.



**SMITHFIELD SMOKED PICNICS**

WHOLE **79¢** LB.

SLICED **89¢** LB.



**LEAN BONELESS STEWING BEEF** **\$1.59** LB.

**FRESH GROUND BEEF** **\$1.39** Lb.

3 Lbs. Or More Per Pkg.



**STOKELY CANNED FOOD SALE**

- CUT GREEN BEANS **3** 303 Cans For **\$1.00**
- WHOLE KERNEL GOLDEN CORN **3** 303 Cans For **\$1.00**
- CREAM STYLE GOLD CORN **3** 303 Cans For **\$1.00**
- GARDEN PEAS **2** 303 Cans For **79¢**
- PEAR HALVES **3** 303 Cans For **59¢**



- SLICED OR HALVES PEACHES **2** 303 Cans For **\$1.00**
- FRUIT COCKTAIL **2** 303 Cans For **\$1.00**
- TOMATO SAUCE **5** 8-Oz. Size For **\$1.00**
- VAN CAMPS PORK & BEANS **3** 300 Size For **\$1.00**
- VAN CAMP'S BEANEE WEENIE **3** 8-Oz. Size For **\$1.00**

**NABISCO SALTINES** 1 Lb. Box **69¢**

**NABISCO OREOS OR DOUBLE STUFF** **99¢** Ea.

**NABISCO FLEXIBLE BAG SNAKS** **69¢**



**ROLLER CHAMPION FLOUR** 5 Lb. Bag **79¢**

**GLOVE KID PEANUT BUTTER** 28 Oz. Size **\$1.59**



**ROYAL PINK SALMON** Tall Can **\$1.59**



**VALUABLE COUPON**

**FROSTY MORN BOLOGNA** 12-Oz. Pkg. With This Coupon **89¢**

Without Coupon 99¢ Pkg. Expires 3/10/79



**VALUABLE COUPON**

**CHATHAM BAR-B-QUE** 1 Lb. Pkg. With This Coupon **\$1.39**

Without Coupon \$1.69 Pkg. Expires 3/10/79

**VALUABLE COUPON**

**WHITE CLOUD TISSUE** 4 Roll Pack With This Coupon **89¢**

Without Coupon \$1.09 EXPIRES 3/10/79



**VALUABLE COUPON**

**OSCAR MAYER ALL MEAT OR BEEF FRANKS** 1 Lb. Pkg. With This Coupon **\$1.29**

Without Coupon \$1.69 Expires 3/10/79



**VALUABLE COUPON**

**DUNCAN HINES YELLOW CAKE MIX** With This Coupon **58¢**

Without Coupon 69¢ Expires 3/10/79



**VALUABLE COUPON**

**FRONTIER SMOKED SAUSAGE** 10 Lb. Box With This Coupon **\$7.99**

Without Coupon 8.99 Expires 3/10/79

**VALUABLE COUPON**

**SMITHFIELD HOT DOGS** 12 Oz. Pkg. With This Coupon **89¢**

Without Coupon \$1.19 Expires 3/10/79



**VALUABLE COUPON**

**LARGE ROLL BRAUNY TOWELS** With This Coupon **59¢**

Without Coupon 69¢ Expires 3/10/79



**VALUABLE COUPON**

**KINGSFORD CHARCOAL** 10-Lb. Bag With Coupon **99¢**

Without Coupon 1.69 Expires 3/10/79



**VALUABLE COUPON**

**HUNT'S KETCHUP** 32 Oz. Size With Coupon **69¢**

Without Coupon 89¢ Expires 3/10/79



**VALUABLE COUPON**

**GALLON PUREX BLEACH** With Coupon **49¢**

Without Coupon 79¢ Expires 3/10/79



**FROZEN FOODS**

- COZY KITCHEN CAKES** Carrot, Coconut, German Chocolate **\$1.39**
- WEIGHT WATCHERS FISH MEALS** 17-Oz. Size **\$2.29**
- WEIGHT WATCHERS MEAT MEALS** 16-Oz. Size **\$2.59**
- 6 PACK MOUSE, PINNOCHIO COL. CRUNCH** 6 Pack **99¢**



**DAIRY FOODS**

- LOW FAT MILK** Gal. Jug **\$1.59**
- SEALTEST SOUR CREAM** 16-Oz. Size **89¢**

**HARRIS MADE RITE BREAD** 1 1/2 Lb. Loaf **3 For \$1.17**

**HARRIS SUPER MARKETS, INC.**

"Where Shopping Is A Pleasure"

Greenville-Ayden-Bethel PRICES GOOD THURS. THUR SAT.



# How Tar Heel Senators And Congressmen Voted

**By Roll Call Report**  
**WASHINGTON** — Here's how area Members of Congress were recorded on major roll call votes Feb. 22 through Feb. 28.

**HOUSE**  
**\$2 BILLION CONGRESS?** — The House approved, 249 for and 121 against, a \$2.44 billion budget for the Banking, Finance and Urban Affairs Committee. This will fund committee operations during 1979, including salaries for the 100-plus staff members. The aggregate 1979 budget for all House committees will total more than \$75 million.

Rep. Frank Thompson, D-N.J., a supporter of the full \$2.44 billion banking committee outlay, said: "We are dealing with a \$3 trillion economy, and members up here (are) asking such absurd things, or making such absurd statements, as to say that we are in a never-ending upward spiral, that we have a billion dollar Congress. Maybe it ought to be a \$2 billion Congress, to operate a little bit more efficiently."

Rep. Ron Paul, R-Tex., an opponent, said: "If this Congress is serious about reducing bureaucracy, cutting waste, balancing the budget and reforming regulations, then let it

begin at home by slashing funds" from committee budgets. Paul favored cutting every committee budget by 25 per cent.

Members voting "yea" favored the higher budget for the banking committee.

Reps. L.H. Fountain, D-2, Charles Whitley, D-3, Ike Andrews, D-4, Stephen Neal, D-5, Richardson Preyer, D-6, Charles Rose, D-7, W.G. Hefner, D-8, James Broyhill, R-10, and Lamar Gudger, D-11, voted "yea."

Reps. Walter Jones, D-1, and James Martin, R-9, voted "nay."

**BALANCED BUDGET** — The House quashed, 222 for and 197 against, a budget-cutting gesture put forth by fiscal conservatives. With this vote, it refused to call up for debate an amendment which, if adopted, would have required the House to spell out "a method through which a balanced federal budget shall be required." Fiscal conservatives acknowledged that their balanced-budget language was mostly symbolic. The vote came during debate on HR 18964, a bill to increase the national debt ceiling above its soon-to-be-reached \$796 billion level. HR 18964 was later defeated.

Members who voted to quash the balanced-budget amendment wanted the fewest possible amendments to be offered to the debt-ceiling bill, which they favored. One of them, Rep. Richard Bolling, D-Mo., called the conservatives' amendment not germane to the debt ceiling bill and said "in the end it will be a futility."

Rep. John Rousselot, R-Calif., who voted "nay," said it is essential for the House "on the first important vote of the 96th Congress to demonstrate a real...commitment to the balanced budget concept so

widely supported by the American people."

Members voting "yea" opposed the balanced-budget language.

Jones, Whitley, Andrews, Preyer, Rose, Hefner and Gudger voted "yea."

Fountain, Neal, Martin and Broyhill voted "nay."

**SENATE**  
**FILIBUSTER** — The Senate voted, 78 for and 16 against, to make it more difficult for a minority of senators to tie up floor business with extended debate. This rules change put an end to the so-called "post-cloture

filibuster." Under that now-prohibited strategy, senators could keep a filibuster going even after its cloture had been voted, by means of introducing hundreds of amendments. The rule imposed by this vote in essence sets a limit of 100 hours debate after cloture has been voted.

Sen. John Stennis, D-Miss., a supporter, said: "I believe that this is the area of self-discipline, and we all have to discipline ourselves...We have got to do that lest we destroy the nature of this body."

Sen. James McClure, R-Idaho,

an opponent, said "our real problem is how do you accommodate the guarantee of rights for each individual member of the Senate and, at the same time, preserve the inviolability of the 100-hour cap?"

Senators voting "yea" favored tightening filibuster rules.

Sen. Robert Morgan, D, voted "yea."

Sen. Jesse Helms, R, did not vote.

**AVIATION FUEL** — The Senate failed, 34 for and 53 against, to postpone and possibly prevent the removal of federal price and allocation controls

from airplane fuel. This vote was on a motion to pry the Administration decontrol measure from the Energy Committee and send it to the floor, where it stood the possibility of being vetoed by the full Senate. Either the Senate or House may veto an Administration energy proposal such as this deregulation of both general and commercial aviation fuel. As a result of this vote and inaction by the House, the deregulation took effect Feb. 24.

Sen. Howard M. Metzenbaum, D-Ohio, a supporter of killing the decontrol plan, said decontrol would raise prices of other types of oil, and asked: "How can we possibly justify decontrolling an oil product at the same time we are giving serious thought to rationing?"

Sen. Bennett Johnston, D-La., said: "There is no reason to continue controlling a product when its users want it decontrolled, and when the ultimate beneficiaries, the airplane passengers, are certainly better off than the average American." Senators voting "nay" favored removing federal controls from aviation fuel.

Morgan voted "nay." Helms did not vote.

## Honor Roll At PTI Is Listed

The following students were named to the Pitt Technical Institute Honor Roll for the winter quarter:

**AYDEN** — Joyce Dawson, Robert Harris, Sherri Harris, Wanda Mills, Marilyn Pavey, Douglas Prayer, Edward Taylor, Linda Williams, and Marietta Williams.

**BELL ARTHUR** — Joanne Stoddard.

**BETHEL** — Brenda Lewis, Charlie Purvis and Sue Stancill.

**FALKLAND** — Carol Garris.

**FARMVILLE** — Tonya Carr, Martha Gay, Anna Mooring, Amelia Ross and Emma Strickland.

**GREENVILLE** — Cindy Baltezare, Charles D. Barbour II, Brenda Battle, James Bell, Arthur Best, Gurney Blake, Melva Buck, Paul Cano, Dany Canup, John Carpenter, Gene Carr, Lori Chamberlain, Mitzi Cheek, George Clark, Martha Clyde, Suzanne L. Commander, Lynne D. Cox, Patsy Emerson, Jane Fox, Daniel Gonzalez,

William Gouras, Patricia Graham, Donna Harris, Carolyn Hill, William Hudson, Steven Jordan, Carol Lappin, William Lewis, Charles Littleton, Wanda Locklear, Timothy Manning, Michael McGlohon, Mary Mercer, Pamela Messner, William Miller.

Barbara Mitchell, Celso Morejon, Laura Morrison, Cheryl Moyer, Brenda Newsome, Ruby Norris, Patrick O'Bryan, April Paschal, Charles Phillips, Julie Pruitt, Marilyn Rabey, Deborah Smith, Howard Speight, Bernard Spilman, Sanford Steinberg, Donald Taylor, Kristina Thornton, Terry Tolda, Susan Townsend, Janice Tripp, Marsha Ware, Michael Welch, Linda Whitehurst, Nancy Williams, Sherry Williams, Lillian Williamson, Mary Wooten.

**GRIFTON** — Karen Foss.

**GRIMESLAND** — Cleveland Edwards, Theresa Hines, Donna Hudson and Mary Ivy.

**SNOWHILL** — Winnifred Hill  
**VANCEBORO** — Gerelene Dixon.

**WINTERVILLE** — Frakie Cash, Lillie Coward, Olivia Evans, Betty Hines, Alice Moseley, Audrey Perry, Sandra Shepard, and Lenna West.

## Develop Train Without Wheels

**HAMBURG, Germany (UPI)** — A train without wheels, dubbed "The Float-Thing," will probably be the popular hit at the International Transport Exhibition in Hamburg June 8-July 1.

The train, known in technical circles as the "mag-lev train," (for magnetic levitation), "floats" on a magnetic "pillow" about one-half inch thick, which lifts it off the track and propels it forward. There's practically no sound, no air pollution and no bouncing during operation and the train can achieve speeds up to 250 miles an hour over longer stretches.

Exhibition visitors will at least get the feel of it at 50 mph on a three-quarter-mile stretch of track.

German developers think this may be the mass transit system of the future.

## 44 Is Standard Police Gear

**DALLAS (AP)** — Police in Dallas have adopted a new 44 as standard equipment. Its firing takes only a fraction of a second, and there's no noise.

Forty-four is the number of solid-state pushbuttons that control each of 10 sophisticated consoles in the new Dallas police communications center.

With the help of the pushbuttons from Honeywell, one console operator can coordinate mobile units, helicopters and a computer.

That's why the officer in the patrol car who stops you may know nearly as much about your car as your neighbors do.



**HAND EXERCISE** — A resident of Shanghai rotates two heavy steel balls in his hand, an exercise that strengthens the hands and improves health. He practiced this traditional Chinese activity during a walk on the Shanghai Bund, or waterfront. (AP Laserphoto)

# Maxwell FURNITURE

## Whirlwind of Special Purchases!

Sale Prices Good Thru March 17 While Quantities Last!

**TODAY'S MOST EXCITING CHAIR!**  
 Use for any room in your home or as a sensational dining or dinette chair.

Chrome With Cane Back & Thickly Padded Vinyl Seat

Easy to Assemble

**\$34<sup>99</sup>**  
 Reg. \$59.95

**ENTERTAINMENT CENTER**  
 • Just right for your stereo component system

Handsome Walnut Finish  
 • Pull-out Shelf  
 • 48" x 15 1/4" x 26 1/4"

**\$18<sup>99</sup>**  
 Reg. \$39.95

IN CARTON SAVINGS!

**COZY LOVESEAT \$198**

**END TABLE \$88**

**COCKTAIL TABLE \$88**

**COMFORTABLE ROCKER \$168**

**BEAUTIFUL LOUNGE CHAIR \$148**

**OTTOMAN \$98**

**A LIVING ROOM, FAMILY ROOM OR DEN FULL OF SAVINGS!**

Look at this massive Solid-Pine Frame collection featuring Thick Pine Wood, Loose Cushions (that are reversible too!), and Durable Herculon® Fabric!

Select The Pieces You Want Today and SAVE!

**SAVE \$101.95 ON SOFA**

**\$248**  
 Reg. \$349.95

HERCULON

**MAXWELL'S 81 STORE BUYING POWER MAKES THIS X-TRA SPECIAL PURCHASE POSSIBLE!**

QUALITY BEDDING SPECIALLY DESIGNED FOR MAXWELL'S BY FAMOUS

**Serta**

**PRESENTING THE NEW 1979 SERTA SUPERQUILT BEDDING SETS AT SUPER INTRODUCTORY SAVINGS!**

• THIS IS HIGH QUALITY BEDDING BUILT FOR COMFORT • BEAUTIFULLY QUILTED MATCHED BEDDING SETS • THIS IS BEDDING YOU WILL SEE IN 1979 AT MUCH, MUCH HIGHER PRICES!

**TWIN SETS ONLY \$98<sup>99</sup>** MATTRESS AND BOXSPRING

SAVE \$31.02 to \$61.07 per set

	REGULAR	SALE	SAVE
TWIN SET	\$139.90	\$98.88	\$41.02
FULL SET	\$159.90	\$128.88	\$31.02
QUEEN SET	\$239.95	\$178.88	\$61.07
KING SET	\$279.95	\$228.88	\$51.07

**CLASSIC TRADITIONAL**

**WARM EARLY AMERICAN**

**ELEGANT FRENCH STYLING**

• Broyhill

**MAXWELL'S 81 STORE BUYING POWER IN ACTION...**

3 EXCITING STYLES—WARM EARLY AMERICAN, CLASSIC TRADITIONAL OR ELEGANT FRENCH DINING ROOMS.

**\$388** YOUR CHOICE OF TABLE AND 4 SIDE CHAIRS OR LIGHTED CHINA Matching Arm Chairs \$68 ea.

**OUR 81 STORE BUYING POWER BRINGS YOU SPECIAL STEREO SAVINGS**

**\$30 - \$150 OFF**

ALL STEREO EQUIPMENT! CONSOLES, COMPONENT SYSTEMS JUKE BOXES AND MUCH, MUCH MORE!

**LIMIT 3 PER CUSTOMER**

**SPECIAL PURCHASE FRAMED PRINTS**

Now you can afford to bring your walls to life. Decorate with dazzling original reproductions. Large selection of colors and pictures available.

**\$1 SMALL \$2 MEDIUM \$3 LARGE**

**EARLY BIRD SPECIALS SAVE 25% OR MORE!**

**ON ALL SUMMER FURNITURE!**

**BUY NOW—SAVE MORE & ENJOY LONGER!**

Maxwell's is putting all Summer Furniture on Sale NOW with plenty of time for you to enjoy it. Wrought Iron, Mesh, Folding Cots, Umbrella Tables & More! NOT ALL ITEMS AVAILABLE AT ALL STORES

**3 WAYS TO SAY "CHARGE IT!"** Maxwell CREDIT VISA

**\$1,000 INSTANT CREDIT**

You may qualify for \$1,000 instant credit if you have one of these cards: \*MASTER CHARGE \*VISA \*AMERICAN EXPRESS

# Maxwell FURNITURE

604 Greenville Blvd. Greenville, N.C. 27634  
 Open 9 A.M. Until 6 P.M.  
 Monday Through Saturday  
 And Friday Nights Until 9.

Phone 756-3142  
 Convenient Credit Terms  
 Free Delivery & Set-Up  
 Huge Selection  
 Competitive Prices

# Ex-Farm Boy Tries Hand At Beefalo

By SAMUEL O. HANCOCK  
XENIA, Ill. (UPI) — A former Iowa farm boy has found a Southern Illinois home where the beefalo roam.

Chester Cooper, 65, who spent almost 40 years working in Chicago as an electrician, after forsaking farm life in southwestern Iowa, settled two years ago on a 40-acre Clay County farm he bought three years earlier.

He then became interested in beefalo — a cross between buffalo and domestic cattle.

Cooper said he probably will know about November whether his modest start in the beefalo business will prove to be more than "just a plaything as my wife says." He said he was encouraged by early prospects.

"One thing about it is nice — I don't have to depend on it for my next meal.

"They gain weight faster than domestic cattle and so far they have been immune to pink eye. I battled pink eye all last summer with my regular cows."

And even as the temperature dipped toward zero, Cooper said his beefalo ignored the comforts of a barn for the frigid outdoors.

"All they need is a little brush or a thicket for cover."

Cooper's beefalo "herd" numbers only three now. It began when "after much reading and research," he bought a beefalo cow with calf at auction in September 1977. A young male was born last April.

"One of the bulls is cream colored and one is coal black," said Cooper. "The mother is coal black. Her breeding is predominantly black angus."

Beefalo became a recognized breed 21 years ago, Cooper said, and is a hybrid of 3/4 buffalo and 1/4 domestic cattle.

"I found this place just like I discovered Chicago and a job there — just out driving," said Cooper. "I saw the white-faced cattle standing in lush grass up to their bellies and it was really beautiful."

Cooper said he met his wife, Phyllis, who "was secretary to my boss" in Chicago. She is a native of Crookston, Minn. "There's only a screen door between it and the North Pole," she said.

Cooper has 13 domestic cows which should have little beefaloes this spring and he expects to know by November how far he will go in the business.

"Today the market is for fast-growing beef," said Cooper.

Cooper became familiar with the cattle business while growing up on his father's farm near Red Oak, Iowa.

He tried farming on his own on his grandfather's farm near Red Oak starting in 1933 during the depression.

"It took me three years to go completely broke," Cooper recalled. "I sold corn for 13 cents a bushel and got 2 1/2 cents a pound for hogs."

"They can have their good old days, I'll settle for today."

# Announcing Our Grand Opening

**3rd BIG WEEK!**

**IN RIVERGATE SHOPPING CENTER  
AT THE INTERSECTION OF HWY. 264 & 264-A GREENVILLE, N.C.**



**Come In And Shop One Of This Area's Most Modern Food Stores!**

**STORE HOURS:**  
Open 8 A.M.-10 P.M.  
Monday Thru Saturday  
10 A.M.-7 P.M. Sundays



<b>THRIFTY MAID</b> ICE MILK <b>2 \$1</b> Half Gal. Ctns. With \$7.50 Or More Order (Limit Two)	<b>SUPER BRAND</b> MARGARINE (In Quarters) <b>4 \$1</b> 1-Lb. Ctns. With \$7.50 Or More Order (Limit Four)	<b>HOLLY FARMS</b> MIXED FRYER PARTS <b>39¢</b> LB.	No Return Btl. <b>COCA-COLA</b> <b>79¢</b> 2-Liter Size
<b>LESUEUR</b> PEAS <b>2 79¢</b> 17-Oz. Cans With \$7.50 Or More Order (Limit Two)	<b>KELLOGG'S</b> CORN FLAKES <b>89¢</b> 24-Oz. Box With \$7.50 Or More Order (Limit One)	<b>"FROM OUR BAKERY"</b> GLAZED DONUTS <b>99¢</b> DOZ.	<b>"FROM OUR BAKERY"</b> 22-Oz. Size <b>APPLE PIES</b> Buy One Get One <b>FREE</b>

Above Items Good Thru Wed., March 14th In Both Greenville Stores

Our New Rivergate Store Features A Complete Delicatessen & Bakery For Your Shopping Convenience.

**The Smart Place To Go For Good Things To Eat!**

## No Fine If In 'Magic Circle'

KANSAS CITY, Mo. (AP) — Municipal Judge Leonard Hughes Jr. scanned the traffic ticket of an elderly man recently and said, "You're in the magic circle. No fine, just the points."

With that, the man was directed out the main door of the courtroom, penalty points having been assessed against his license but his wallet no lighter.

The "magic circle?"

"Yeah," Hughes explained during a recess. "I don't fine anyone over 65. Not after all they've done for the community."

## Dental Program Aiding Elderly

NEW YORK (AP) — A pilot program, launched last June by the New York University College of Dentistry, is bringing dental treatment directly to the elderly residents of two Staten Island nursing homes.

Twice a week teams of senior dental students and their faculty supervisor travel to the homes, treating up to 40 geriatric patients a week while gaining experience in the problems of geriatric dentistry.

Below Items Good Thru Wed., March 14th In New Store Only

<b>10% OZ. CAN CAMPBELL'S</b> <b>TOMATO SOUP</b> Buy One & Get One <b>FREE</b> (Limit 1 Free)	<b>9-OZ. CANS CRACKLIN GOOD BUTTER-ME-NOTS</b> <b>BISCUITS</b> Buy One Get One <b>FREE</b>	<b>1 LB. PKG. TASTY BIRD</b> <b>CHICKEN LIVERS</b> Buy Two & Get One <b>FREE</b>
<b>8-OZ. BOX CRACKLIN GOOD</b> <b>SALTINES</b> Buy One & Get One <b>FREE</b> (Limit 1 Free)	<b>12-OZ. PKG. W-D BRAND REG. OR BEEF</b> <b>FRANKS</b> Buy Two & Get 12-OZ. PKG. W-D BRAND <b>BOLOGNA</b> <b>FREE</b>	<b>WINKY'S</b> <b>GELATIN SALADS</b> Buy One & Get One <b>FREE</b>

# Help Cities With Buried Bomb Legacy

By EDELGARD SIMON  
HAMBURG, West Germany (UPI) — Two thousand aerial photos of Hamburg's destruction after 213 Allied air raids during World War II may help save lives today.

Britain's Royal Air Force recently turned the pictures over to Hamburg, where they eventually will become part of the city archives.

"In addition to being a document of the destruction of Hamburg between 1940 and 1944, they will be a valuable aid in detecting left-over unexploded bombs in this city," said Volker Lange, Hamburg's senator for urban planning.

Specialists are poring over the pictures in an attempt to pinpoint areas where this potentially lethal legacy of World War II may be hidden in the ground.

"I would not say we are sitting on a powder keg, but some places come pretty close to it. Every German city that was heavily bombed during the war has duds buried somewhere," said Heinz Gaebler, head of Hamburg's bomb disposal team of five specialists and 25 assistants.

Most unexploded World War II left-overs turn up during excavation work on new building sites or during road construction.

Motorists often learn that they have driven over a live bomb for years, until it was found by chance.

In the Ruhr city of Rheine last year three people died, nine suffered serious injuries, and property damage came to nearly \$539,000 when a bulldozer nudged a bomb from its hiding place.

"The problem is that the longer they remain in the ground, the more dangerous they get," Gaebler explained.

Fuzes get rusty and may detonate a bomb at the slightest touch, he said.

Finds in Hamburg, including its port, total 4,363 high explosive bombs, 9,600 incendiary bombs, 207,000 grenades and shells, 5,300 hand grenades, 1,952 bazookas, and 371 tons of assorted ammunition.

According to Gaebler and other experts, West Germany will have to live with its old bombs for at least another 70 years.

Detecting and defusing them is especially difficult for the experts in Berlin, who have to deal with an international arsenal — British, American, Russian and old German Wehrmacht arms and ammunition.

Few records exist showing where the bombs hit in any one raid.

Hamburg had a headstart in removing the live bombs. A police office managed to save records, including reports by witnesses, showing the approximate position of 1,400 bombs that failed to go off.

Since 1956, a specially developed probe, the "Foerstersonde," has aided in detecting buried explosives. In 1962, the United States turned over a batch of aerial photos made after raids on Hamburg.

But the British pictures are of much better quality, permitting enlargement and processing for detailed study.

Hamburg owes much of its safety to Walter Merz.

In 1940, the then 34-year-old engineer was drafted and assigned to a demolition squad to "clean up" after air raids. When the war ended, he happened to be in Hamburg. He could have returned to his home in the Black Forest, left mostly untouched by the destruction of the war.

When Merz learned that in the first week after the end of the war, 40 children in Hamburg were killed and many seriously injured by live ammunition and bombs scattered in the ruins, he volunteered for more "clean up" work.

"I could not just run away," he once said. Merz retired in 1961, but until his death at 72 in December, he served as adviser and consultant to the city.

Merz once described his work this way:

"It was always the same. You turned over your papers and billfold to one of your assistants, somebody wished you luck and then the others ran for cover.

"You were totally alone. You knew that you would not feel much, if the thing went off.

"And then you concentrated on your work. Afterwards the sky looked bluer and the sun was brighter. You felt as if you had been born again."

Heinz Gaebler, who holds Merz' position today, says nothing has changed.



• PRICES GOOD THRU SAT., MARCH 10TH  
• NONE TO DEALERS • WE RESERVE THE RIGHT TO LIMIT QUANTITIES

WE GLADLY ACCEPT FOOD STAMPS

## FREE APPLIANCES

FREE APPLIANCES... everytime you collect '300, '400 or '500 worth of gold cash register tapes... you have a choice of 8 APPLIANCES

- THE HAND MIXER
- THE FAST COOKER
- THE HOT DOGGER
- THE JUICER
- THE OPENED SHARPENER
- THE DEEP FRYER
- THE POPCORN POPPER
- THE SLOW COOKER

COLLECT GOLD CASH REGISTER TAPES THRU MARCH 28, 1979

# THE BEEF PEOPLE

part of a great tradition.

YOU SAVE 44c

ARROW BLUE • WHITE • COLDWATER

# DETERGENT

# 79¢

49-OZ. BOX

WITH \$7.50 OR MORE ORDER (LIMIT ONE)

YOU SAVE 50c

ASTOR COFFEE

# 179

1-LB. CAN

WITH \$7.50 OR MORE ORDER (LIMIT ONE)

THRIFTY MAID EGG NOODLES 2 PKGS. \$1.09

YOU SAVE 46c

CRISCO CRISCO

# 149

3-LB. CAN

WITH \$7.50 OR MORE ORDER (LIMIT ONE)

YOU SAVE 24c

PILLSBURY FLOUR

# 69

5-LB. BAG

WITH \$7.50 OR MORE ORDER (LIMIT ONE)

CRACKIN' GOOD GEORGIA CRACKERS 2 12-OZ. BOXES \$1.09

## BEST BUYS IN FROZEN FOODS

YOU SAVE 30c

SUPERBRAND SHERBET OR ICE CREAM

# 89

HALF-GAL. CTN.

- SUPERBRAND SUPER WHIP TOPPING 2 12-OZ. CUPS \$1.00
- SALITO PARTY PIZZA 12-OZ. SIZE \$1.69
- SALITO SASSY & SPICY PIZZA 11-OZ. SIZE \$1.69
- TASTE-O-SEA FISH, PERCH OR FLOUNDER DINNERS EA. 79c
- DOXIANA GLAZED DONUTS 14-OZ. PKG. 69c
- McKENZIE VEGETABLE GUMBO 14-OZ. PKG. 69c
- MINUTE MAID 100% PURE LEMON JUICE 7 1/2-OZ. CAN 59c
- SHOESTRING POTATOES 3 20-OZ. PKGS. \$1.00

## BEST BUYS IN OUR PRODUCE DEPT.

U.S. #1 IDAHO BAKING POTATOES

# 159

15-LB. POLY BAG

- SAVE \$2.00 SHELLED (MEATS)
- WESTERN RED OR GOLDEN DELICIOUS WALNUTS 1-LB. PKG. \$1.49
  - RED APPLES 1/2 LB. 49c (LOOSE) 6 FOR 99c
  - RED RIPE STRAWBERRIES 3 PTE. \$1.59
  - HARVEST FRESH CAULIFLOWER HEAD 78c
  - HARVEST FRESH CUCUMBERS 5 FOR 99c
  - U.S. #1 YELLOW ONIONS 2 1/2-LB. BAG 59c
  - FLORIDA PINK OR WHITE GRAPEFRUIT 4 FOR 99c
  - CRISP JUMBO CELERY 2 STALKS \$1.00

FLORIDA

- ORANGES
- GRAPEFRUIT 5-LB. BAG 99c

YOU SAVE 20c

FOLGER'S "MOUNTAIN GROWN" COFFEE

# 229

1-LB. BAG

THRIFTY MAID SPAGHETTI 32-OZ. JAR 99c

BUY A CASE & SAVE \$1.01

12-OZ. CANS CHEK DRINKS

# 299

CASE OF 24

1-PLY LILAC NAPKINS 300-CT. PKG. 99c

YOU SAVE 16c

DIKIE DARLING LAYER CAKE MIXES

# 100

2 18 1/2-OZ. BOXES

DIKIE DARLING FROSTINGS 12 1/2-OZ. BOX 69c

YOU SAVE 30c

2-LITER (67.6-OZ.) PLASTIC NO RETURN BTLS.

# CHEK COLA

# 59

EA.

WITH \$7.50 OR MORE ORDER (LIMIT TWO)

YOU SAVE 21c

THRIFTY MAID DRINKS

# 88

2 46-OZ. CANS

THRIFTY MAID SPAGHETTI 3 1-LB. BOXES \$1.09

1-PLY SUNBELT PAPER TOWELS

# 88

2 160-SHEET ROLLS

THRIFTY MAID APPLE SAUCE 50-OZ. JAR 99c

STAR-KIST CHUNK LIGHT TUNA

# 65

6 1/2-OZ. CAN

ASTOR INSTANT POTATOES 1-LB. PKG. 79c

CURAD BONUS BOX PLASTIC BANDAGES

# 77

BOX OF 80

GENTLE TOUCH HAND & BODY LOTION

# 179

12-OZ. BTL.

BUFFERIN TABLETS

# 99

BTL. OF 36

COMPLETE DENTURE CLEANSER

# 89

2-OZ. TUBE

OLD SPICE AFTER SHAVE LOTION

# 259

4 1/2-OZ. BTL.

12-HOUR RELIEF CONTAC 12 HOUR CAPSULES

# 129

PKG. OF 10

**WINN DIXIE** **CLIP & SAVE!**  
**DEEP SOUTH**  
**SALAD DRESSING**  
 QT. JAR **49¢**  
 LIMIT ONE WITH COUPON & \$7.50 OR MORE ORDER. GOOD THRU SAT., MARCH 10TH

**WINN DIXIE** **CLIP & SAVE!**  
**HICKORY SWEET**  
**SLICED BACON**  
 1-LB. PKG. **99¢**  
 LIMIT ONE WITH COUPON & \$7.50 OR MORE ORDER. GOOD THRU SAT., MARCH 10TH

**WINN DIXIE** **CLIP & SAVE!**  
**SUPERBRAND**  
**GRADE 'A' LARGE EGGS**  
 DOZ. **59¢**  
 LIMIT ONE DOZ. WITH COUPON & \$7.50 OR MORE ORDER. GOOD THRU SAT., MARCH 10TH



**DEEDS**

Arthur J. Crowther al to Denry L. Carroll al 28.50  
 Herman B. Evans al to Donald E. Evans al Gift  
 Lewis Haddock al to Donald Haddock 1.00  
 Shirley Knight to City of Greenville 2.00  
 Emma J. Phillips to Ruby W. Jones no stamps  
 Redev. Comm. of Greenville to The Evans Co. of G'ville no stamps  
 George J. Saleeby al to Wade S. Adams al 3.50  
 Janice B. Buck to Percy L. Pair al 45.00  
 Bill Clark Const. Co. Inc. to Sandra M. Robinson 32.50  
 B.S. Correll al to Mark W. Mozingo no stamps  
 B.S. Correll al to Ralph C. Tucker Jr. no stamps  
 Robert Dorch al to George D. Sutton no stamps  
 Norma Forbes Hawkins to William C. Gildewell Jr. al 10.00  
 Mark W. Mozingo al to B.S. Correll al no stamps  
 Van C. Fleming al to W.L. Tripp al no stamps  
 William E. Fulford Jr. al to Maggie Moore al no stamps  
 H. Reginald Gray al to George E. Ward al 3.00  
 H. Reginald Gray al to Jeanette Bun 3.00  
 Curtis Hal Knox al to Wade Johnson Jr. al 37.00  
 National Realty Inc. to James Lloyd al 3.00  
 Rice Construction Co. Inc. to Dan M. Granoff al 118.00  
 Rusco Inc. to Richard C. Taft al 9.00  
 Earl Spain al to Wilber F. Harris 19.00  
 Joseph Edward Spivey to Daniel Worthington 1.50  
 Joseph Edward Spivey to Daniel Worthington 1.50  
 Peggy Wallace Willis al to Donald B. Freeman al 32.00  
 James Ray Crawford al to A.J. Speight 95.00  
 Redevel. Comm. of City of Greenville to The Evans Co. of Greenville no stamps  
 William D. Rogers Const. Co. Inc. to John L. Causey Jr. al 27.50  
 Berry D. Jackson al to Clauce R. Jenkins al no stamps  
 Edward L. Jones al to R.E. Deans Jr. 13.00  
 Elner Joyner Jones to Johnnie C. Brock al no stamps  
 Elner Joyner Jones to Johnnie C. Brock al no stamps  
 Fred T. Mattox Tr. to East Carolina Dental Spec. 90.00  
 National Realty Inc. to Helen L. Moore 1.50  
 Shamrock Realty Co. of Pitt Co. Inc. to Miller & Davis Assoc. 43.00  
 Shamrock Realty Co. of Pitt Co. Inc. to Dallas W. McPherson 43.00  
 Shamrock Realty Co. of Pitt Co. Inc. to James C. Lanier Jr. 43.00  
 Shamrock Realty Co. of Pitt Co. Inc. to Wesley F. Measamer al 43.00  
 Leland Bruce Whitaker to James T. Warren al 17.00  
 Cherry Oaks Inc. to DP Associates of Greenville 27.00  
 Bill Clark Const. Co. Inc. to J. Reginald Akin al 57.00  
 James W. Daniels al to Jesse Ray Daniels no stamps  
 The Evans Co. of Greenville Inc. to Robert A. Gurganus al 4.50  
 Willie Grice al to James M. Stokes al 23.00  
 William R. Parks to James G. Chrysson 6.00  
 Larry C. Worthington Jr. to Anne E. Northrop 48.50  
 Wilbur L. Worthington al to Milton W. Worthington al Gift  
 Emma J. Burnette to Paul R. Burnette al no stamps  
 Bill Clark Const. Co. Inc. to Jesse R. Laughinghouse al 42.50  
 Greenbrier Realty Co. Inc. to Donnie E. Spain al 10.00  
 Stuart Hardy al to Stuart Hardy Const. Co. Inc. 7.50  
 Arley Leggett Harris to S. Lawrence Davenport al no stamps  
 Wilbur F. Harris to S. Lawrence Davenport al 100.00  
 Thomas Earl Hemby al to Robert L. Bowen al 6.00  
 James A. Hicks al to Guy C. Evans Jr. al 11.00  
 Cass Hudson to J. Bryant Hudson al no stamps  
 Charles M. Hurst III al to Randy C. Highsmith al 34.50

**WVD BRAND** **U.S. CHOICE BEEF**  
**BONELESS CHUCK ROASTS** **1.79**  
 YOU SAVE 50c PER LB.  
 A SIZE FOR EVERY FAMILY!

• PRICES GOOD THRU SAT., MARCH 10TH  
 • NONE TO DEALERS  
 • WE RESERVE THE RIGHT TO LIMIT QUANTITIES

**EKCO INTERNATIONAL**  
*Exquisite Fine China*

**\$1.00 OFF**  
 on this week's featured item

**CREAMER**  
 Redeem this coupon worth \$1.00 toward the purchase of this item.  
 Regular Discount Price \$5.99  
 Coupon Savings \$1.00  
 Price (With Coupon) \$4.99  
 Check the Pattern of your Choice  
 Winsford  Floral Generation  
 Spring Bouquet  Golden Autumn  
 COUPON GOOD THRU WEDNESDAY, MARCH 14, 1979  
**VALUABLE DISCOUNT COUPON**

**WVD BRAND** **U.S. CHOICE BEEF**  
**BONELESS BOTTOM ROUND STEAKS OR ROASTS**  
**2.59**  
 YOU SAVE 30c PER LB.  
 BRAND U.S. CHOICE BEEF BONELESS CHUCK STEAKS LB. \$1.99

**WVD BRAND** **U.S. CHOICE BEEF**  
**OLD HICKORY CHOPPED PORK BARBECUE**  
**1.99**  
 YOU SAVE 50c  
 1-LB. CTN.  
 SHIMSON'S CORNED BEEF BRISKEETS OR ROUNDS (U.S. CHOICE) LB. \$2.29

**Oscar Mayer** **U.S. CHOICE BEEF**  
**LEAN 'N TASTY BREAKFAST STRIPS**  
**1.59**  
 YOU SAVE 10c  
 • PORK • BEEF  
 12-OZ. PKG.  
 SUNNYLAND FRESH PORK LINKS 20-OZ. PKG. \$2.19

**WVD BRAND** **U.S. CHOICE BEEF**  
**FRESH COUNTRY STYLE**  
**BACKBONE** **1.39**  
**RIBS** **1.49**  
 YOU SAVE 30c PER LB.  
 MATAM'S SHRIMP BOO ROLLS OR STUFFED CLAMS PKG. \$1.99

**TASTE O SEA** **U.S. CHOICE BEEF**  
**FISH FILLETS**  
 • PERCH **1.69**  
 • FLOUNDER **1.99**  
 • TURBOT **1.59**  
 YOU SAVE 30c PER LB.  
 LUTER'S SMITHFIELD COUNTRY HAM SAUSAGE 12-OZ. PKG. \$1.79

**WVD BRAND** **U.S. CHOICE BEEF**  
**15-LB. FREEZER SALE!**  
 • CHUCK ROASTS  
 • CHUCK STEAKS  
 • CHUCK STEW  
**2.69**  
 YOU SAVE \$7.00  
 ALL 15 LBS.

**WVD BRAND** **U.S. CHOICE BEEF**  
**FRESH RIB HALF OR WHOLE (14-17 LBS. AVG.)**  
**PORK LOINS** **1.29**  
 YOU SAVE 30c PER LB.  
 CUT INTO CHOPS, ROASTS & TRIMMINGS AT THIS PRICE.

**WVD BRAND** **U.S. CHOICE BEEF**  
**BONELESS RUMP ROASTS**  
**2.59**  
 YOU SAVE 30c PER LB.  
 BUDIN'S SLICED MEATS 2 2 1/2-OZ. PKGS. \$1.00

**WVD BRAND** **U.S. CHOICE BEEF**  
**ARMOUR STAR FRANKS**  
**1.49**  
 YOU SAVE 10c  
 1-LB. PKG.  
 LUTER'S JAMESTOWN PORK SAUSAGE 1-LB. ROLL 89c

**WVD BRAND** **U.S. CHOICE BEEF**  
**NEW YORK STRIP STEAKS**  
**2.99**  
 YOU SAVE 30c PER LB.

**BEST BUYS**  
**IN OUR BAKERY DEPT.**  
**DIXIE DARLING** **HOT DOG OR HAMBURGER BUNS**  
**4** **1.00**  
 11-OZ. PKGS.  
 SANDWICH  
 • BREAD NATURAL FIBER 3 24-OZ. LOAVES \$1.09  
 • BREAD HONEY 3 16-OZ. LOAVES \$1.00  
 • BUNS PECAN 2 9-OZ. PKGS. 99c  
 • TWIRLS 3 6-OZ. PKGS. \$1.00

**BEST BUYS**  
**IN OUR DAIRY DEPT.**  
**SUPERBRAND**  
**COTTAGE CHEESE**  
**1-LB. CUP 59¢** **2-LB. CUP 1.09**  
 SUPERBRAND (R) SOUR  
 • CREAM 1 1/2-LB. CUP 59c 2-LB. CUP \$1.09  
 SUPERBRAND (R) ALL-NATURAL  
 • YOGURT 4 8-OZ. CUPS \$1.00  
 OLD FASHIONED CHEDDAR  
 • HOOP CHEESE LB. \$1.99  
 SUPERBRAND (R) OLD FASHIONED CHEDDAR  
 • CHEESE SPREAD 12-OZ. PKG. \$1.19

**BEST BUYS**  
**IN OUR DELI DEPT.**  
 SLICED TO ORDER BONELESS  
 • COOKED HAM LB. \$2.99  
 JEWISH STYLE POTATO SALAD OR  
 • SHREDDED COLE SLAW LB. 79c  
**BAKERY DEPT.**  
 • HARD ROLLS 6 FOR 59c  
 • SUBMARINE ROLLS 4 FOR 59c  
 • DEVIL'S FOOD CAKES (WITH PEANUTS) 2-LB. SIZE \$3.99  
 PLEASE CALL FOR SPECIAL ORDERS: Shopper's Mart Deli: 756-2956 Rivergate Deli: 758-6880

**AMBESOL**  
**ANTISEPTIC**  
**1.33**  
 31-OZ. SIZE

**PREPERATION H**  
**SUPPOSITORIES**  
**2.19**  
 BOX OF 12

**AGREE**  
**SHAMPOO**  
**1.29**  
 8-OZ. SIZE

**SURE**  
**ANTI-PERSPIRANT**  
**1.29**  
 4-OZ. SIZE

**SCOPE**  
**MOUTHWASH**  
**1.49**  
 24-OZ. BTL.

PRIME VARIETY DOG FOOD 30-OZ. PKG. \$1.39  
 LOG CABIN COMPLETE PANCAKE MIX 24-OZ. BOX 89c  
 BUNGE QUICK GRITS 5-LB. 94c  
 WILCHADO PINEAPPLE 44-OZ. 75c  
 DRINK 14-OZ. 37c  
 SUPREME DICED BUTTERBAGS 16-OZ. 37c  
 SHAD TRASH BAGS 10-OZ. 19c  
 SHAD TRASH BAGS 16-OZ. 29c  
 SHAD TRASH BAGS 20-OZ. 39c  
 SHAD TRASH BAGS 24-OZ. 49c  
 SHAD TRASH BAGS 30-OZ. 59c  
 SHAD TRASH BAGS 36-OZ. 69c  
 SHAD TRASH BAGS 42-OZ. 79c  
 SHAD TRASH BAGS 48-OZ. 89c  
 SHAD TRASH BAGS 54-OZ. 99c  
 SHAD TRASH BAGS 60-OZ. 1.09  
 SHAD TRASH BAGS 66-OZ. 1.19  
 SHAD TRASH BAGS 72-OZ. 1.29  
 SHAD TRASH BAGS 78-OZ. 1.39  
 SHAD TRASH BAGS 84-OZ. 1.49  
 SHAD TRASH BAGS 90-OZ. 1.59  
 SHAD TRASH BAGS 96-OZ. 1.69  
 SHAD TRASH BAGS 102-OZ. 1.79  
 SHAD TRASH BAGS 108-OZ. 1.89  
 SHAD TRASH BAGS 114-OZ. 1.99  
 SHAD TRASH BAGS 120-OZ. 2.09  
 SHAD TRASH BAGS 126-OZ. 2.19  
 SHAD TRASH BAGS 132-OZ. 2.29  
 SHAD TRASH BAGS 138-OZ. 2.39  
 SHAD TRASH BAGS 144-OZ. 2.49  
 SHAD TRASH BAGS 150-OZ. 2.59  
 SHAD TRASH BAGS 156-OZ. 2.69  
 SHAD TRASH BAGS 162-OZ. 2.79  
 SHAD TRASH BAGS 168-OZ. 2.89  
 SHAD TRASH BAGS 174-OZ. 2.99  
 SHAD TRASH BAGS 180-OZ. 3.09  
 SHAD TRASH BAGS 186-OZ. 3.19  
 SHAD TRASH BAGS 192-OZ. 3.29  
 SHAD TRASH BAGS 198-OZ. 3.39  
 SHAD TRASH BAGS 204-OZ. 3.49  
 SHAD TRASH BAGS 210-OZ. 3.59  
 SHAD TRASH BAGS 216-OZ. 3.69  
 SHAD TRASH BAGS 222-OZ. 3.79  
 SHAD TRASH BAGS 228-OZ. 3.89  
 SHAD TRASH BAGS 234-OZ. 3.99  
 SHAD TRASH BAGS 240-OZ. 4.09

**T-Shirt Gallery**  
**Sees Success**

HAMBURG, Germany (UPI) — Art for art's sake it is not — but what might be the world's first T-shirt gallery in Hamburg seems to be catching on anyway.  
 Erwin Schulz, who opened the gallery about a year ago at Eppendorfer Weg, now holds chamber music nights and discussion sessions in the surroundings of T-shirt prints ranging from the Beatles to Kojak and Mickey Mouse.  
 T-shirts, says Schulz, can tell you a lot about the psychological make-up of the wearer, but they also provide clues to contemporary political, consumer and art trends.

# Sign Language Changes Life For The Retarded

By MARY A. DEMPSEY  
MONROE, Mich. (UPI) — For 21 years, guttural sounds and awkward gestures were my brother Michael's only means of communication. Sign language has changed all that. Michael has been severely retarded since birth and unable to speak because of a muscular disability. He lives at home and has been enrolled in special education classes since he was old enough for kindergarten. But until he began studying sign language — a speech alternative formerly the exclusive province of the hearing impaired — he was unable to

communicate with people outside the family. "The whole idea is, very new in the speech and language realm," said Katherine Zychowicz, Michael's speech teacher at the Monroe County Educational Center. "It's modifying the sign language of the hearing impaired population so it can be used for anyone with no oral communication. "It once was felt that using sign language impaired speech development because a person can't develop abstract ideas without speech," she said. "But it turns out just the opposite is true, and the new trend is

toward using any means available to communicate." While the 18-month experiment at the Monroe center has opened new vistas for Michael, the transition has been like trying to learn a foreign language, Ms. Zychowicz said. At first, Michael was self-conscious and easily frustrated. In the past he had communicated with his parents and six brothers and sisters with yes or no answers to their questions or an easily recognizable sound or gesture. Sometimes even those methods didn't work. For instance, there was the

time the family thought he had a stomach ache because he was rubbing his stomach. It turned out he was trying to let us know he wanted pizza. Now he can ask for it in sign language. Michael grew up reserved and quiet. He still is shy, but the sign language studies have made him more persistent in striving to be understood and to take part in family activities. "Now he wants to be a part of everything going on," his mother said. "What I like about it is that for the first time in his life he can ask questions. "He can ask where his brother is. He can inquire about things. "It's difficult for the rest of us to learn the signs because it isn't necessary. But the others have picked it up. His brothers make signs to each other to tease him, but he laughs. It makes him feel like part of the

group — for the first time in his life." Michael still sometimes accentuates his signs with guttural noises and, from time to time, has to be reminded of the newly found talents of his hands. But as he progresses, the sign language gestures are becoming more and more automatic. He is livelier and more eager to be with others. He becomes excited when his gesturing is understood. "No one ever said he wouldn't speak when he was a child," his mother said. "We always asked why he couldn't talk, but the doctors didn't have any answers. "It wasn't until he 16 that we found out about the muscle problems. Then we accepted the fact that he couldn't talk and we just adjusted to that. "Now at 21 years of age he

# Small Town Claims A Life Of Its Own

By CHARLOTTE PORTER  
Associated Press Writer  
PIERRE, S.D. (AP) — Living in a small town means the barber leaves his shop open when he goes to lunch. And he unlocks the cash register so people can make change for the pop machine while he's gone. "I've been here since 1952, and the only time I got burned was a kid a while back," says the barber. "And he paid me back." South Dakota is the 44th largest state in the union. Its capi-

tal town, Pierre — pronounced "peer" — has about 9,000 residents. And some consider it the best-kept secret since the Sun Belt. "I helped some people from New York with a home once," says Tom Farus of Pierre National Bank. "They couldn't believe what they discovered here. "They were writing to their friends and relatives," Farus says. "and I was telling them, 'Don't do that!'" What the New Yorkers found was a town in which volunteer firemen hear the fire siren and tune to the local radio station to find out where the fire is. The same siren sounds at 10

p.m., a gentle reminder that it's bedtime. A recent newspaper ad entitled "Please Save This Kitty" not only located the cat's owner, but 15 other people called to say they were willing to take the half-grown stray in. The governor's home telephone number is listed in the city directory, and his wife answers the phone. "Ann speaking." There is no fence around the mansion and a neighborhood basketball game is often in progress on the driveway. Asked to describe Pierre's last major crime, businessmen and community leaders have to stop and think a while. "There was a murder, let's see, in 1962," they'll tell you. "Well, no, there was a murder-suicide about two years ago in the motel. Then those out-of-staters who tried to cash the phony traveler's checks, they got caught."

# It's all the cookbook you'll ever need.



The New Woman's Day Encyclopedia of Cookery

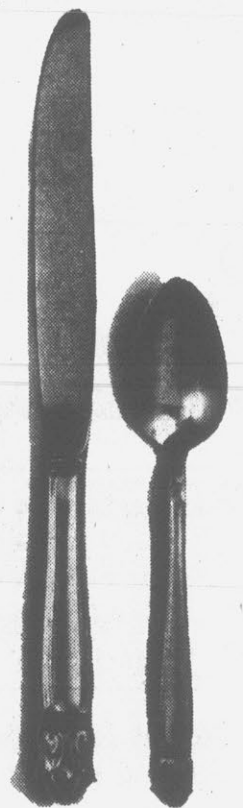
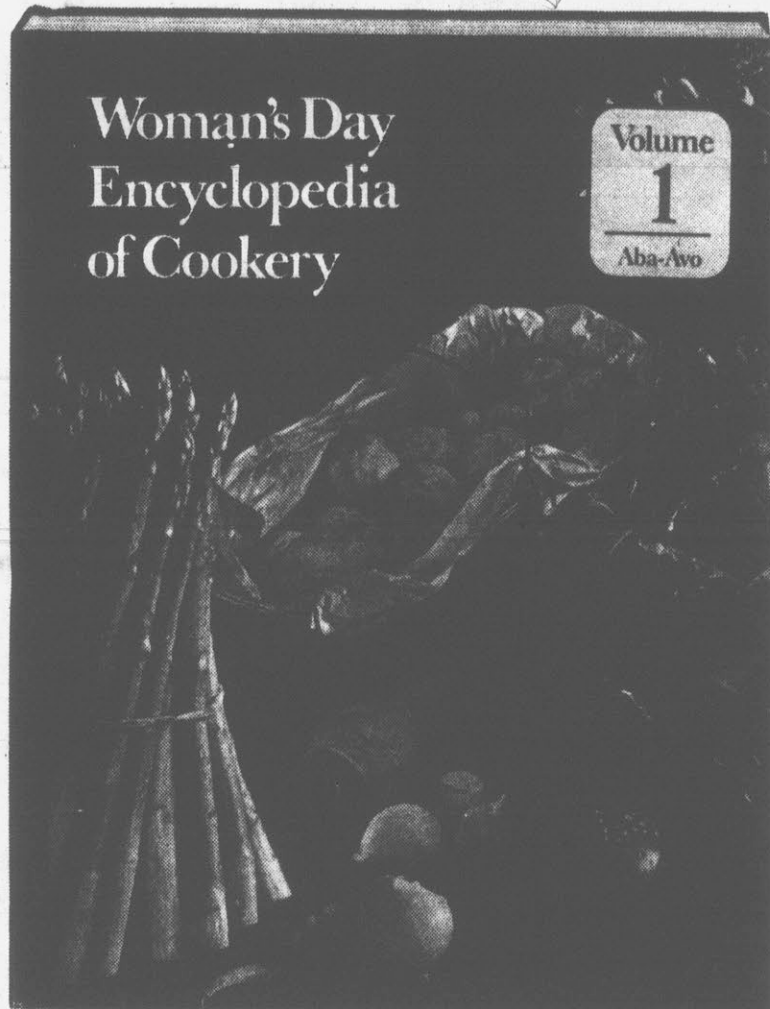
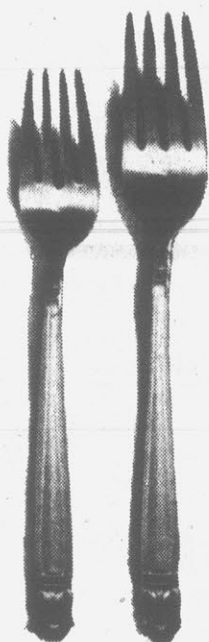

From basic to gourmet, there are 8,700 recipes and 1,100 menus.

It's as basic as hamburger. As gourmet as braised pheasant.

And so international, it includes special collections of recipes from more than 40 different countries.

The NEW *Woman's Day Encyclopedia of Cookery* is the whole world of cookery in 23 beautifully illustrated volumes. It's the history of food. Articles on diet. Nutrition. Entertaining. Menu Planning.

But, most important, it's 8,700 recipes and 1,100 menus. It's all the cookbook you'll ever need. In fact, with the NEW *Woman's Day Encyclopedia of Cookery*, you could cook up a storm every night for the rest of your days and never repeat a meal.

Be sure to look for our great display the next time you shop, and take advantage of our great introductory offer on Volume 1.

VOLUME 1 only  
**69¢**

VOLUMES 2-22  
only \$2.69 each

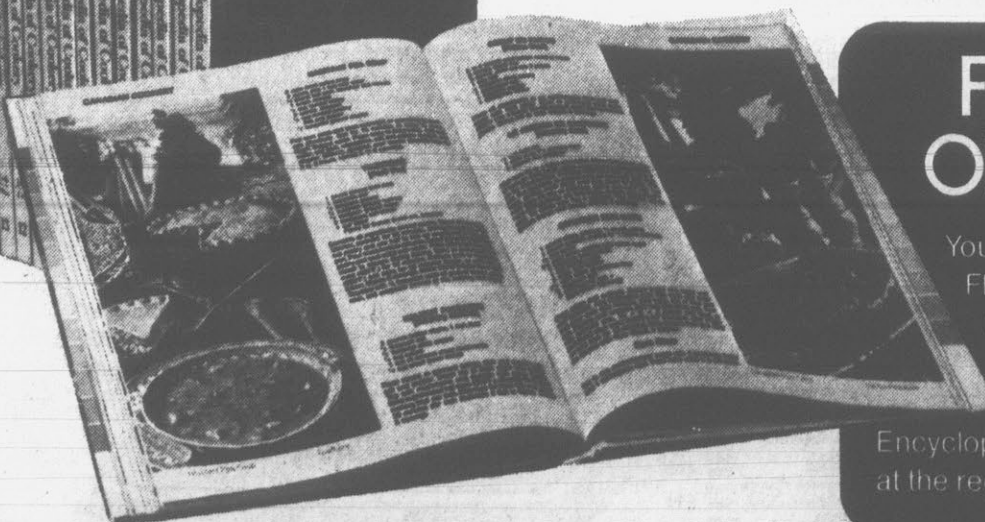

**FREE OFFER!**

You get Volume 23 FREE when you buy Volume 2 of the new *Woman's Day Encyclopedia of Cookery* at the regular price.



# BIG STAR'S GIGANTIC MEAT SPECTACULAR!

**BIG STAR FOODS**

PRICES GOOD THRU SAT., MARCH 10, 1979. QUANTITY RIGHTS RESERVED-NONE SOLD TO OTHER DEALERS OR RESTAURANTS.



**HOLLY FARMS U.S. GRADE 'A' FRYER LIVERS**

Lb. **78¢**

**U.S. CHOICE BEEF TENDER LEAN WHOLE RIB EYES**

9 To 12 Lb. Avg. **\$2.68** Lb.

Cut Into Steaks & Trimmings At No Extra Charge

**HOLLY FARMS U.S. GRADE 'A' FRYER LIVERS**

Lb. **78¢**

**GWALTNEY'S HOT OR MILD PORK SAUSAGE**

1-Lb. PKG. **\$1.08**

**FRESH PORK ROAST PICNICS**

WHOLE LB. **98¢**

**GWALTNEY'S REG. OR THICK SLICED BACON**

1-Lb. PKG. **\$1.38**

**HOLLY FARMS U.S. GRADE 'A' FAMILY PAK MIXED FRYER PARTS**

Family Pak - Chicken Parts

LB. **47¢**

**MARKET STYLE SLICED BACON**

2 LBS. OR MORE **\$1.08** LB.

**F.F.V. PEPPER COATED COUNTRY HAMS WHOLE**

SLICED FREE! **\$1.48** Lb.

HALF Lb. \$1.58

**Thorn Apple Valley BRAND**

•SEMI-BONELESS •EXTRA LEAN

**FULLY-COOKED SMOKED HAMS**

6 To 8 Lb. Avg. Lb. **\$1.68**

**HOLLY FARMS "TOP QUALITY" CHICKEN FRANKS**

35% LEANER

Franks 1-Lb. Pkg. **78¢**

Bologna 1-Lb. Pkg. **98¢**

**RIB ROAST . . . U.S. Choice Beef 7" Cut Bone In Lb. \$2.28**

**RIB EYE STEAK U.S. Choice Beef Family Pak-Lb. \$3.58**

**GWALTNEY FRANKS. 12-Oz. Pkg. \$1.08**

**GWALTNEY'S TOP QUALITY**

- Reg. Or Beef Sl. Bologna
- Spiced Luncheon Meat
- Cooked Salami
- Liver Cheese

Your Choice! **88¢** 8 Oz. Pkg.

**OSCAR MAYER'S REG. OR BEEF LEAN & TASTY BREAKFAST STRIPS. 12-Oz. Pkg. \$1.48**

**STUFFED FLOUNDER . . . Singleton's 8 Oz. Pkg. . 88¢**

**GORTON'S FISH STICKS . . . 2 Lb. Pkg. \$1.98**

**FISH PORTIONS . . . Gorton's Butter Fried 24-Oz. \$2.98**

**FISH FILLETS . . . Mrs. Paul's Buttered 10 Oz. \$1.38**

**SWEET FLORIDA ORANGES**

5 LB. BAG **98¢**



**NORTH CAROLINA CURED YAMS . . . . . Lb. 19¢**

**IMPORTED WHITE SEEDLESS GRAPES . . . . . Lb. 99¢**

**BANANAS . . . . . Golden Ripe Lb. 24¢**

**SWEET D'ANJOU PEARS . . . . . Lb. 39¢**

**COUNTRY STAND FRESH MUSHROOMS . . . . . 1-Lb. Pkg. \$1.49**

**TASTY CANADIAN RUTABAGAS . . . . . Lb. 19¢**

**MED. YELLOW ONIONS . . . . . 3 Lb. Bag 59¢**

**DR. PEPPER**

1-LITER RETURNABLE BOTTLE

SIX PAK **\$1.77** Plus Deposit

**PURE VEGETABLE WESSON OIL 38 Oz. Bottle \$1.48**

**PLAIN OR SELF-RISING RED BAND FLOUR 5 Lb. Bag 64¢**

**LIGHT CHUNK IN OIL STAR-KIST TUNA 6 1/2-Oz. Can 59¢**

**SWIFT'S BEEF STEW 24 Oz. Can 99¢**

**VANITY FAIR BATH TISSUE 4 Roll Pak 69¢**

**DELTA WHITE PAPER TOWELS Jumbo Roll 39¢**

**PEPPERONI, SAUSAGE OR HAMBURGER G & W PIZZAS 11 1/4-Oz. 79¢**

**PACKER'S LABEL FROZEN SHOESTRING POTATOES 3 20 Oz. Pkgs. \$1.00**

**DEL MONTE CATSUP 20-Oz. Bottle 39¢**

**MOTHER'S CREAMY SMOOTH MAYONNAISE**

Regular Qt. Jar **78¢** Diet Qt. Jar **68¢**

**KLEENEX Facial Tissue 3 100 Ct. Pkgs. \$1.00**

**BLUE BONNET MARGARINE 1/2 Lb. 49¢**

**VALU-PLUS LIQUID BLEACH Gal. 59¢**

**FARM CHARM SOUR CREAM 16 Oz. 69¢**

**OUR PRIDE BUTTERMILK BREAD 3 24 Oz. Loaves \$1.09**

**FIESTA ASSORTED FLAVORS ICE CREAM 1/2 Gal. 99¢**

**HANOVER FROZEN**

- \*BABY LIMAS . . . . . 16-Oz. Pkg. **78¢**
- \*SWEET PEAS \*CUT OKRA 16-Oz. **59¢**
- \*SOUP VEGETABLES . . . . . Pkg.
- \*GOLDEN CORN 16-Oz. **\$1**
- \*MIXED VEGETABLES . . . . . 2 Pkgs.
- \*WHOLE OKRA
- \*CUT BROCCOLI
- \*WHITE SHOEPEG CORN . . . . . 16-Oz. **65¢**

16-Oz. IDAHOAN INSTANT POTATOES

46-Oz. LIBBY'S TOMATO JUICE

32-Oz. LUCKY LEAF APPLE JUICE

MIX OR MATCH **2 For \$1.00**



**WEXFORD BEVERAGEWARE BY ANCHOR HOCKING THIS WEEK'S SPECIAL!**

"ON THE ROCKS" **59¢**

Special Savings Each Week On Featured Items!



**WIN \$5,000.00! PLAY.....**



**THE ODDS**

ODDS CHART EFFECTIVE FEB. 24, 1979

PRIZE VALUE	NUMBER OF PRIZES	ODDS FOR 1 GAME TICKET	ODDS FOR 5 GAME TICKETS	ODDS FOR 10 GAME TICKETS
\$1,500	20	1 in 141,946	1 in 28,389	1 in 7,097
500	61	1 in 46,540	1 in 9,308	1 in 2,327
50	435	1 in 6,524	1 in 1,305	1 in 326
5	1,790	1 in 1,586	1 in 317	1 in 79
2	6,702	1 in 424	1 in 85	1 in 21
1	52,534	1 in 54	1 in 11	1 in 2.7
TOTAL NO. PRIZES	61,542	1 in 46	1 in 9	1 in 2.3

ODDS are depending on number of game tickets you obtain. The more tickets you obtain, the better your chances of winning. Odds to obtain all nine (9) jackpot numbers and qualify for \$5,000.00 is 1 in 25. Odds to win \$500.00 will depend on the number of jackpot number winners.

This game is being played in 72 participating Big Star Foods and Colonial Stores located in North Carolina, Chesapeake, South Carolina, Virginia, West Virginia, and South Carolina. Prizes, game tickets, and Point-Of-Sale, Instant Vegas, and Point-Of-Sale, Instant Vegas promotional items of the promotion is March 31, 1979. However, instant Vegas prizes ends when all Game Tickets are distributed.

16-OZ. LUCKY LEAF APPLESAUCE

16-OZ. BUSH'S FRESH BLACK EYE PEAS

16-OZ. RED GATE TOMATOES

MIX OR MATCH **4 FOR \$1.00**



14.7 OZ. FRANCO-AMERICAN SPAGHETTI-O'S

16-OZ. VAN CAMP'S PORK & BEANS

14-OZ. CAN AJAX CLEANSER

MIX OR MATCH **4 FOR \$1.00**



17-OZ. DEL MONTE WHOLE KERNEL GOLDEN CORN

15.5-OZ. DOUBLE LUCK CUT GREEN BEANS

MIX OR MATCH **4 FOR \$1.00**



15-OZ. HUNT'S TOMATO SAUCE

16-OZ. RED GATE LIMA BEANS

17-OZ. LUCK'S PINTO BEANS

MIX OR MATCH **3 FOR \$1.00**



# BIGGER, BETTER FOOD BUYS

That's what you get each time you shop Overton's. Everyday low prices on over 300 food items plus clip the coupon specials and deep-cut advertised specials. No stamps, no games, no gimmicks, no thrills, just our promise to save you money wherever possible. We put money we would have spent on games, etc. back in your pocket, that way everybody wins. PS...The extra clean store, the friendly personnel and the number one service is free of charge!

# FRYERS

GRADE "A" WHOLE



Lb. **45**

FRESH HALF OR WHOLE

At Overton's You're Number One!

# PORK LOINS

CUT AND WRAPPED FREE



Lb. **129**

"PEANUT CITY" **COUNTRY HAM** Half Or Whole **\$1.49** Lb.

OVERTON'S FINEST **GROUND BEEF** 3 Lbs. Or More **\$1.39** Lb.

SLICED 7-9 CHOPS **1/4 PORK LOINS** **\$1.59** Lb.

GWALTNEY **SMOKED PICNICS**



6-8 Lb. Lb. **89**

GWALTNEY **FRANKS** 12 Oz. Pkg. **99**¢

GWALTNEY **BACON** 12 Oz. Pkg. **\$1.09**

MORRELL PRIDE FULL-CUT **ROUND STEAK** **\$1.89** Lb.

QUART JAR Limit one (1) with \$7.50 food order.



**98**

MAXWELL HOUSE **COFFEE** 10 Oz. Jar Instant **\$3.98** LIMIT ONE (1) WITH \$7.50 FOOD ORDER.



**OVERTON'S INC SUPERMARKET**

3rd AND JARVIS ST. 

JACK FROST **SALT** 26 Oz. Box **5/\$1.00**

GOLDEN **BANANAS**



Lb. **18**

"FAMILY-PAK" SPECIALS OF THE WEEK

- PORK CHOPS ..... 5-7 LBS. LB. \$1.55
- SPARE RIBS ..... 5-7 LBS. LB. \$1.39
- NECK BONES ..... 5-7 LBS. LB. 89¢
- CHITTERLINGS ..... 10 LBS. \$4.90
- SMOKED SAUSAGE ..... 10 LBS. \$9.90
- ROUND STEAK ..... 5-7 LBS. LB. \$1.79

RED **POTATOES**



10 Lb. Bag **98**

MORTON HOUSE **BEEF STEW** 24 Oz. Can **99**¢

PRICES EFFECTIVE WEDNESDAY-SATURDAY

KRAFT **MACARONI & CHEESE DINNER** 7 Oz. Box **3/\$1**

With this coupon and \$7.50 food order excluding specials. Without coupon \$1.18. Limit one coupon per customer. Expires March 10.

**CLIP THIS COUPON**

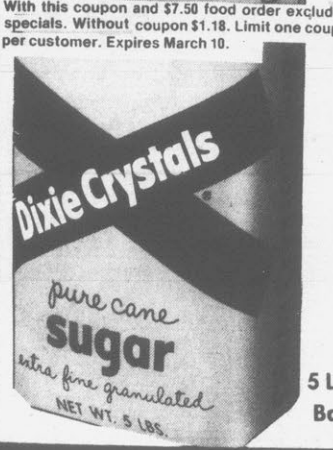

**98**

**WESTERN LETTUCE**



**58**¢ Each

4-Roll Pkg. **CLIP THIS COUPON**

With this coupon and \$7.50 food order excluding specials. Without coupon 88¢. Limit one coupon per customer. Expires March 10.



**68**

PARKAY **MARGARINE** Lb. Pkg. **2/\$1.00**

FLORIDA **ORANGES** 5 Lb. Bag **89**¢

PERFECTION **RICE** 2 Lb. Bag **2/\$1.00**

16 OZ. CARTON OF 8 **CLIP THIS COUPON**

With this coupon plus deposit and \$7.50 food order excluding specials. Without coupon \$1.08 plus deposit. Limit one coupon per customer. Expires March 10.



**88**



**IVORY LIQUID DETERGENT**



22 Oz. Bottle **78**

Giant Box **CLIP THIS COUPON**

With this coupon and \$7.50 food order excluding specials. Without coupon \$1.18. Limit one coupon per customer. Expires March 10.



**98**



SUPPLEMENT TO GREENVILLE  
DAILY REFLECTOR & REFLECTOR'S  
SHOPPING GUIDE ON WEDNESDAY,  
MARCH 7, 1979

**WE'VE  
TRIMMED  
PRICES!**



**ADVERTISED  
ITEM POLICY**

Each of these advertised items is re-  
quired to be readily available for sale  
at or below the advertised price in  
each A&P Store, except as specifi-  
cally noted in this ad.

PRICES EFFECTIVE THRU SATURDAY MARCH 10  
AT A&P IN GREENVILLE, N.C.

**LOOK WHAT'S  
NEW AT A&P!**

SMALL FAMILY? SMALL PACKAGES?  
NEED ONLY TWO STEAKS? TWO CHOPS?  
SMALL SIZES?

SHOP YOUR A&P MINI-MEAL MEAT  
SECTION. A COMPLETE SELECTION  
OF STEAKS, CHOPS, GROUND BEEF,  
CHICKEN, AND ROAST!

PLUS ALL AT A&P'S GREAT MONEY  
SAVING PRICES!

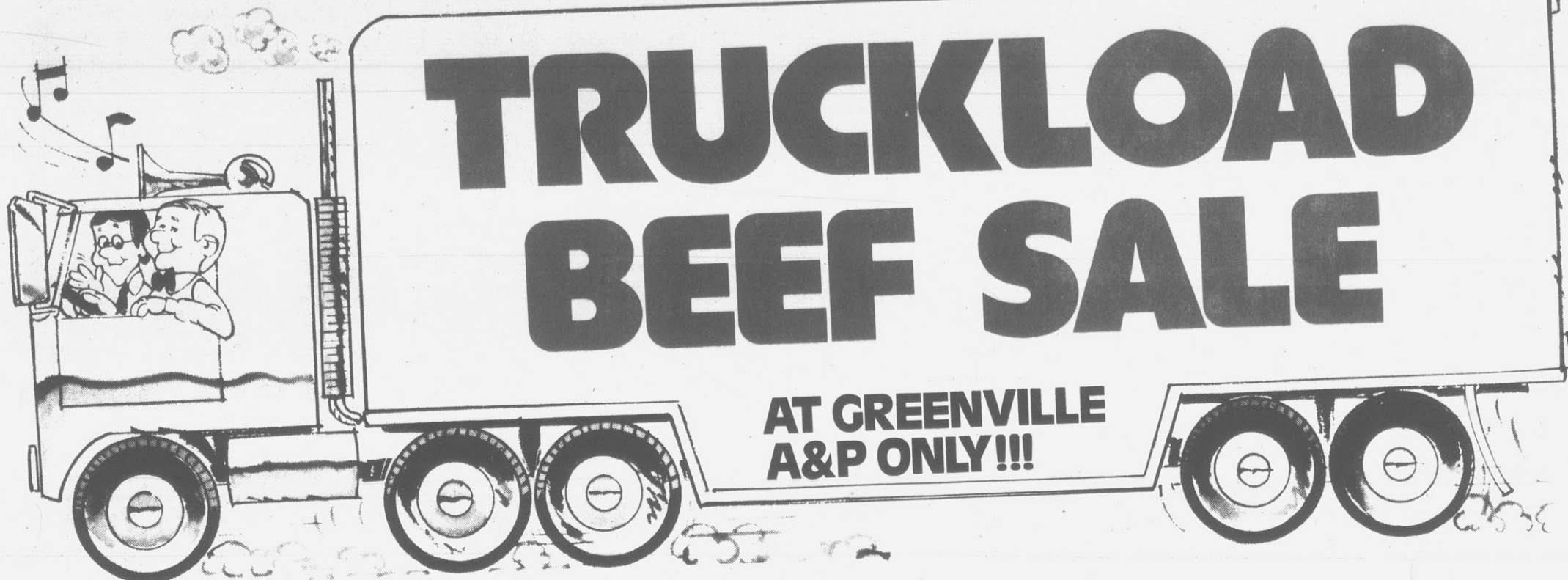

CONVENIENTLY LOCATED AT  
**703 GREENVILLE BLVD.**  
(GREENVILLE SQUARE SHOPPING CENTER)  
**GREENVILLE, N.C.**

**OPEN 24 HOURS  
7 DAYS A WEEK!!!**

A&P QUALITY HEAVY WESTERN GRAIN-FED BEEF

**BONELESS-WHOLE  
BOTTOM ROUNDS**

18 LB. TO 24 LB. AVG. WT.

CUT FREE INTO  
FAMILY PACK OF  
EYE OF ROUND,  
BOTTOM ROUND STEAKS,  
BOTTOM ROUND ROAST,  
AND TRIMMINGS

**\$1.78**

LB.

A&P QUALITY HEAVY WESTERN GRAIN-FED BEEF

**BONELESS ROUND  
SIRLOIN TIPS**

WHOLE 8 LB. TO 12 LB. AVG.

CUT FREE INTO  
FAMILY PACK OF  
BONELESS SIRLOIN  
TIP ROAST, STEAKS,  
AND TRIMMINGS

**\$1.88**

LB.

A&P QUALITY HEAVY WESTERN GRAIN-FED BEEF

**BONELESS-WHOLE  
TOP ROUNDS**

16 LB. TO 20 LB. AVG. WT.

CUT FREE INTO  
FAMILY PACK OF  
BONELESS TOP ROUND  
STEAKS, ROAST,  
AND TRIMMINGS.

**\$1.88**

LB.

A&P QUALITY HEAVY WESTERN GRAIN FED BEEF

**BONELESS-WHOLE  
TENDERLOINS**

LB. TO 6 LB. AVG. WT.

CUT FREE INTO  
FAMILY PACK OF  
FILET  
MIGNON  
STEAKS

**\$2.98**

LB.

A&P QUALITY HEAVY WESTERN GRAIN-FED BEEF

**BONELESS WHOLE  
STRIP LOINS**

8 LB. TO 12 LB. AVG. WT.

CUT FREE INTO  
FAMILY PACK OF  
BONELESS NEW  
YORK STRIP STEAKS

**\$2.88**

LB.

A&P QUALITY HEAVY WESTERN GRAIN FED BEEF

**BONELESS-WHOLE  
RIB EYES**

12 LB. TO 16 LB. AVG. WT.

CUT FREE INTO  
FAMILY PACK OF  
BONELESS  
RIB EYE  
STEAKS

**\$2.98**

LB.

**WOW! LOOK WHAT I GOT AT A&P!** WIN \$1, \$5,  
\$10, \$25, \$50,

- 1. ACTION PRICES**
- 2. WEEKLY SPECIALS**
- 3. ECONOMY CORNER**
- 4. SUPER CASH BINGO**

Plus I WON \$1000<sup>00</sup> 60 WAYS TO WIN CASH!

**\$221,110** CASH PRIZE WINNERS  
**50,662** IN CASH PRIZES  
**61,403** FOOD PRIZE WINNERS

NO PURCHASE NECESSARY! **\$100 OR \$1000!**

\*ODDS CHART EFFECTIVE MARCH 4, 1979

Number of Winners	Winning Amount	Odds 1 Visit	Odds 13 Visits	Odds 26 Visits	Total
29	\$1000	272,759	20,981	10,491	\$ 29,000
212	100	37,311	2,870	1,435	21,200
437	50	18,100	1,392	696	21,850
874	25	9,050	696	348	21,850
2,196	10	3,602	277	139	21,960
3,071	5	2,576	198	99	15,355
43,843	1	180	14	7	43,843
61,403	A&P products @ .75 each	129	10	5	46,052
112,065		71	5.5	2.75	221,110

The Super Cash Bingo game is available at 130 Great Atlantic & Pacific Tea Co. stores located in North Carolina, South Carolina, Florida, Georgia and Washington, D.C., Virginia. This promotion is scheduled to end on April 27, 1979. Super Cash Bingo will officially end, however, when all game tickets are distributed.

PLAYING **super cash bingo**

**START  
PLAYING  
TODAY!**



# 4 Big Ways

1★ SUPER CASH BINGO

2★ WEEKLY SPECIALS

### ADVERTISED ITEM POLICY

Each of these advertised items is required to be readily available for sale at or below the advertised price in each A&P Store, except as specifically noted in this ad.

PRICES EFFECTIVE THRU SATURDAY, MARCH 10 AT A&P IN GREENVILLE.

A&P CHILLED

## ORANGE JUICE

LIMIT ONE WITH COUPON BELOW AND ADDITIONAL \$7.50 ORDER

1/2 GAL. CARTON

# 68¢

A&P COUPON

A&P CHILLED

## ORANGE JUICE

LIMIT ONE WITH COUPON AND ADDITIONAL \$7.50 ORDER

1/2 GALLON CARTON

# 68¢

#653

A&P GOOD THRU SATURDAY, MARCH 10 IN GREENVILLE.

ANN PAGE

## MAYONNAISE

LIMIT ONE WITH COUPON BELOW AND ADDITIONAL \$7.50 ORDER

QUART JAR

# 68¢

A&P COUPON

ANN PAGE

## MAYONNAISE

LIMIT ONE WITH COUPON AND ADDITIONAL \$7.50 ORDER

QUART JAR

# 68¢

#654

A&P GOOD THRU SATURDAY, MARCH 10 IN GREENVILLE.

A&P GRADE "A" NORTH CAROLINA

## LARGE EGGS

LIMIT ONE DOZEN WITH THIS COUPON AND ADDITIONAL \$7.50 ORDER

DOZEN ONLY

# 48¢

A&P COUPON

A&P GRADE "A" NORTH CAROLINA

## LARGE EGGS

LIMIT ONE CTN. WITH THIS COUPON AND ADDITIONAL \$7.50 ORDER

DOZEN ONLY

# 48¢

#655

A&P GOOD THRU SATURDAY, MARCH 10 IN GREENVILLE.



DEL MONTE

## CREAM STYLE OR WHOLE KERNEL GOLDEN CORN

# 3 \$1.00

17 OZ. CANS



DEL MONTE

## CUT OR FRENCH STYLE GREEN BEANS

# 3 \$1.00

16 OZ. CANS

DEL MONTE—CHUNK, CRUSHED, OR

## SLICED PINEAPPLE

IN JUICE

# 2 \$1.00

15 1/4 OZ. CANS

MARVEL—YELLOW CLING

## SLICED PEACHES

ACTON PRICE

# 2 \$1.00

29 OZ. CANS

CONTAINS RICH BRAZILIAN COFFEE

## EIGHT O'CLOCK INSTANT COFFEE

CHECK AND COMPARE!

# \$3.39

10 OZ. JAR



A SUPERB BLEND, RICH IN BRAZILIAN COFFEES

## EIGHT O'CLOCK COFFEE

GROUND TO ORDER

# \$1.99

1 LB. BAG

FROZEN

## TOTINO'S PIZZA

• PEPPERONI 13 OZ.  
• HAMBURGER 13 1/2 OZ.

EACH ONLY

# 99¢



## COCA COLA

CTN. OF

# 6 \$1.99

32 OZ. RETURNABLE BOTTLES

PLUS DEPOSIT

LONG GRAIN

## MAHATMA RICE

ACTON PRICE

# 3 \$0.89

LB. BAG

TEXAS PETE

## HOT DOG CHILI

ACTON PRICE

# 3 \$1.00

10 1/2 OZ. CANS

# To Save

3 ★ ACTION PRICES

4 ★ ECONOMY CORNER

A&P QUALITY FRESH  
**PORK SAUSAGE**



1 LB. PKG.

**79¢**

A&P QUALITY HEAVY WESTERN GRAIN-FED BEEF

**BONELESS ROAST**

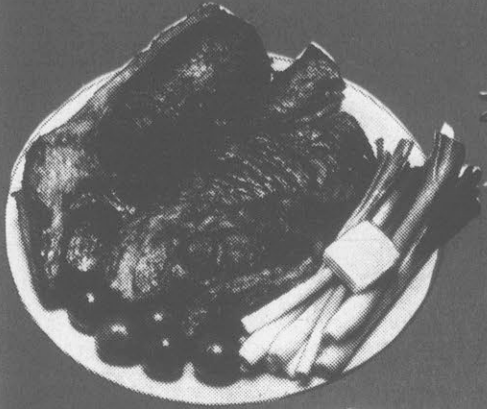

CUT FROM THE CHUCK

**\$148**

LB.

BONE-IN SHOULDER ROAST **\$148** LB.

A&P QUALITY HEAVY WESTERN GRAIN-FED BEEF

**WHOLE BEEF RIBS**

18 TO 24 LB. AVG.

BONE-IN

CUT FREE INTO RIB ROAST, RIB STEAKS, AND TRIMMINGS

**\$198**

LB.

10 LBS. OR MORE (CONTAINS EQUAL NUMBER CENTER AND END CHOPS)

A&P QUALITY CORN-FED—QUARTER LOIN SLICED

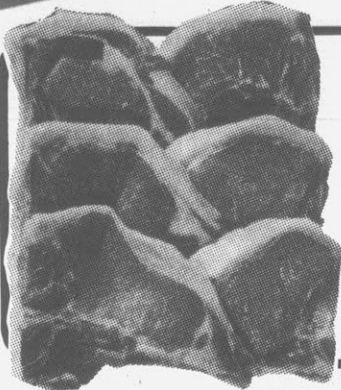

**PORK CHOPS**

LB.

**\$128**

QUARTER LOIN SLICED PORK CHOPS **\$148** LB.

MARVEL BRAND SLICED

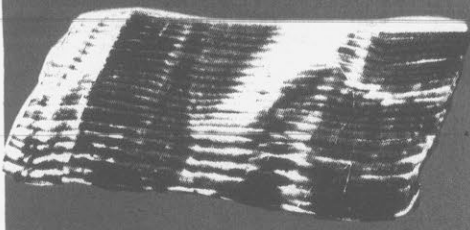

**BACON**

1 LB. PKG.

**99¢**

U.S.D.A. INSPECTED

**YOUNG TURKEYS**



10 LBS. AND UP

LB.

**78¢**

A&P QUALITY TENDER FULLY-COOKED—WHOLE

**SMOKED PICNICS**

4 TO 7 LB. AVG. WT.

LB.

**98¢**

FISHER BOY FROZEN

**FISH STICKS**

2 LB. PKG. **\$189**

8 OZ. PKG.

**49¢**

A&P QUALITY HEAVY WESTERN GRAIN-FED BEEF

**E-Z CARVE STANDING RIB ROAST**

BONE-IN

LB.

**\$228**

A&P QUALITY HEAVY WESTERN GRAIN-FED BEEF

**GROUND CHUCK**

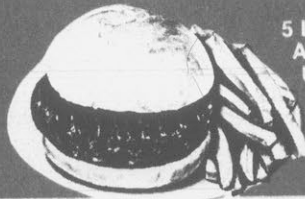

5 LBS. AND UP

LB.

**\$148**

SHENSON BRAND

**CORNERED BEEF BRISKET**

A&P SAUERKRAUT 1 LB. PKG. FREE! WITH PURCHASE OF ANY SIZE SHENSON CORNERED BEEF BRISKET

LB.

**\$199**

You'll Do Better With A&P's POULTRY SHOP

U.S.D.A. INSPECTED

**FRESH FRYER LEG**

**QUARTERS**

BREAST QTRS. LB. 78¢

**68¢**

LB.



A&P is a deli shop

CUSTOM SLICED

**GOURMET TURKEY BREAST**

LB.

**\$329**

PICKLE AND **PIMENTO LOAF**

LB.

**\$199**

TANGY SHARP **HOT PEPPER CHEESE**

LB.

**\$249**

FRESHLY MADE

**CREAMY POTATO SALAD**

LB.

**59¢**

2 PIECE SNACK-PACK

**FRIED CHICKEN**

2 PIECE SNACK PACK ONLY

**99¢**



There are lots of reasons why You'll do better at A&P

- ★ SUPER CASH BINGO
- ★ WEEKLY FEATURES
- ★ ECONOMY CORNER
- ★ ACTION PRICES

**PLUS** At A&P We Offer You The Opportunity to Select Your Own Size, Color, Shapes, and Quantities Of Fresh Fruits And Vegetables To Your Own Personal Satisfaction!

**ADVERTISED ITEM POLICY**

Each of these advertised items is required to be readily available for sale at or below the advertised price in each A&P Store, except as specifically noted in this ad.

PRICES EFFECTIVE THRU SATURDAY, MARCH 10 AT A&P IN GREENVILLE.

RICH IN VITAMINS—CRISP

**FRESH BROCCOLI**

LARGE BUNCH **69¢**

FRESH & TASTY RUTABAGAS LB. **19¢**

FRESH—LUSCIOUS

**RED RIPE TOMATOES**

LB. **59¢**

MILD & TENDER MEDIUM YELLOW ONIONS 3 LB. BAG **69¢**

IMPORTED FROM CHILE—WHITE

**SEEDLESS GRAPES**

LB. **99¢**

CRISP & TASTY RED RADISHES 6 OZ. BAG **12¢**

FULL OF FLAVOR—SWEET &

**JUICY ORANGES**

5 LB. BAG **99¢**

U.S. #1—BAKING

**RUSSET POTATOES**

10 LB. BAG **99¢**

JANE PARKER DELICIOUS CLOVERLEAF OR

**TWIN ROLLS**

BAKE 'N SERVE 3 12 CT. 11 OZ. PKGS. **\$1.00**

JANE PARKER FRESHLY BAKED

**CRACKED WHEAT BREAD**

2 16 OZ. LOAVES **79¢**

KRAFT

**1000 ISLAND DRESSING**

OR CATALINA DRESSING 8 OZ. BTL. **59¢**

BIRDS EYE FROZEN

**CORN-ON-THE COB**

8 CT. PKG. **99¢**

ALL NATURAL

**BREYER'S ICE CREAM**

1/2 GAL. CTN. **\$1.79**

A&P FROZEN DESSERT TOPPING

**HANDI-WHIP**

A&P QUALITY DEEP DISH PIE SHELLS 2 CT. PKG. **59¢**

13 1/2 OZ. BOWL **69¢**

ANN PAGE

**FACIAL TISSUE**

• WHITE  
• YELLOW  
• PINK

200 CT. BOXES **288¢**

ECONOMY CORNER

**BATHROOM TISSUE**

GOOD PRODUCTS LOWEST PRICES 4 ROLL PKG. **69¢**

ECONOMY CORNER BEEF FLAVOR **CANNED DOG FOOD** 15 1/2 OZ. CAN **17¢**

ECONOMY CORNER **PAPER TOWELS** JUMBO ROLL **49¢**

ECONOMY CORNER—DRY **LAUNDRY DETERGENT** 49 OZ. PKG. **99¢**

# Kroger Sav-On



**FOOD  
DRUG**

**SOOPER  
COST CUTTERS  
LEAD YOU TO  
GREATER  
SAVINGS**

PRICES IN THIS AD ARE GOOD THROUGH SATURDAY,  
MAR. 10, 1979 IN GREENVILLE, NORTH CAROLINA.

**ADVERTISED ITEM POLICY**

Each of these advertised items is required to be readily available for sale in each Kroger Sav-On Store, except as specifically noted in this ad. If we do run out of an advertised item, we will offer you your choice of a comparable item, when available, reflecting the same savings or a raincheck which will entitle you to purchase the advertised item at the advertised price within 30 days.

**COST WEEK CUTTER SPECIAL**

U.S.D.A. CHOICE "HEAVY WESTERN" BEEF CENTER CUT

## Sirloin Steak

**\$2.18**

Lb.

**USDA CHOICE**



KROGER GRADE A  
**Large Eggs**

**58¢**

Doz.

Limit 2 Doz. With 7.50 Additional Purchase Additional Doz. 69¢

**TURN PAGE FOR  
MORE SOOPER COST CUTTERS**

- U.S.D.A. CHOICE "HEAVY WESTERN" BEEF **T-Bone Steak** Lb. **\$2.48**
- U.S.D.A. CHOICE "HEAVY WESTERN" BEEF 12-15-LB. AVG. WHOLE BONELESS **Beef Loin Strips** CUT AND WRAPPED FREE Lb. **\$3.28**
- U.S.D.A. CHOICE "HEAVY WESTERN" BEEF 14-17-LB. AVG. WHOLE BONE-IN **Beef Loin Strips** CUT AND WRAPPED FREE Lb. **\$2.98**
- GENUINE **Ground Chuck** Lb. **\$1.78**
- BREAKFAST **Beef Sausage** 2 Lb. Roll **\$1.98**
- CHUB PAK OR STORE PAK **Ground Beef** Lb. **\$1.58**

- U.S.D.A. CHOICE "HEAVY WESTERN" BEEF TOTAL WT. 4-LBS. OR MORE - BONELESS **Top Sirloin Strips** (\$3.22 Lb.) 8 8-Oz. Steaks **\$12.88**
- U.S.D.A. CHOICE "HEAVY WESTERN" BEEF TOTAL WT. 4-LBS. OR MORE - BONELESS **Rib Eye Steaks** (\$3.97 Lb.) 8 8-Oz. Steaks **\$15.88**
- U.S.D.A. CHOICE "HEAVY WESTERN" BEEF TOTAL WT. 5-LBS. OR MORE - BONELESS **Sirloin Tip Steaks** (\$2.38 Lb.) 10 8-Oz. Steaks **\$11.88**
- U.S.D.A. CHOICE "HEAVY WESTERN" BEEF BEEF SHANKS OR **Beef Neck Bones** Lb. **\$1.18**

U.S.D.A. CHOICE

MILK FED **Veal** QUALITY TRIMMED **Lamb**

AVAILABLE IN MOST STORES  
SEE YOUR MARKET MANAGER

WHOLE OR HALF SQUARE CUT LAMB **Shoulder Roast** Lb. **\$1.59**

WHOLE OR BUTT HALF **Leg Of Lamb** Lb. **\$2.19**

**COST WEEK CUTTER SPECIAL**

CENTER CUT RIB

## Pork Chops

**\$1.78**

Lb.

- RIB END **Pork Chops** Lb. **\$1.58**
- FRESH SLICED **Pork Steaks** Lb. **\$1.58**

**COST WEEK CUTTER SPECIAL**

3-5 LB. AVG. FRESH FROZEN PORK

## Spare Ribs

**\$1.19**

Lb.

- 1/4 PORK LOIN FRESHLY CUT INTO **Pork Chops** Lb. **\$1.58**
- SLICED PORK LIVER OR **Pork Neck Bones** Lb. **58¢**
- "THE ROUND ONE" SWIFT'S **Hostess Canned Ham** (SLICED FREE) 4 Lb. Can **\$9.68**
- SHANK HALF **Smoked Ham** Lb. **\$1.08**
- ARMOUR SPEEDICUT **Boneless Ham** Lb. **\$2.49**
- KWICK KRISP **Sliced Bacon** 12-Oz. Pkg. **\$1.28**
- GUNNOE **Pork Sausage** 1-Lb. Pkg. **\$1.68**
- HOLLY FARMS **Leg Quarters** Lb. **79¢**
- HOLLY FARMS WHOLE **Cut-Up Fryers** Lb. **69¢**

**LENTEN SEAFOOD**

IN BIG SUPPLY TO MEET YOUR NEEDS THROUGHOUT THE SEASON!

It's fun to observe Lent, even when you're not an official Lenten observer, with Kroger's terrific variety of Lenten foods most everyone likes. Thanks to Kroger's huge volume and low profits, we can pass big savings on to you through lower prices like these Lenten Specials.

FROZEN

## Turbot Fillets

**\$1.19**

Lb.

- FROZEN **Fres-Shore Perch Fillets** 1-Lb. Pkg. **\$1.39**
- FRES-SHORE PORTIONS **Fish-N-Batter** 12-Oz. Pkg. **\$1.29**
- FRES-SHORE DIPT 'N' BATTER **Round Shrimp** 12-Oz. Pkg. **\$2.69**

We also have a wide variety of seafood including lobster, shrimp and scallops available in our frozen dept.



**FRESH SEAFOOD** AVAILABLE FRIDAY AND SATURDAY ONLY

- DELICIOUS **Country Club Canned Ham** (SLICED FREE) 3 Lb. Can **\$6.98**
- COUNTRY CLUB **Sauer Kraut** 2 Lb. Bag **69¢**
- QWALTNEY SLICED BOLOGNA, P & P LOAF, SPICED LUNCHEON OR **Cooked Salami** 8-Oz. Pkg. **99¢**
- QWALTNEY **Great Dogs** 1-Lb. Pkg. **99¢**
- KROGER **Chunk Style Bologna** Lb. **\$1.09**
- KROGER CHUNK STYLE **Braunschweiger** Lb. **79¢**

**COST WEEK CUTTER SPECIAL**

HOLLY FARMS GRADE "A"

## Whole Fryers

**56¢**

Lb.

HOLLY FARMS CUT-UP MIXED **Fryer Parts** Lb. **60¢**

- BULK PACKAGED COUNTRY STYLE **Sliced Bacon** (2-Lbs. or More) **\$1.29** (Less Than 2-Lbs. \$1.39)
- ALL VARIETIES SERVE 'N' SAVE **Luncheon Meats** 1-Lb. Pkg. **\$1.29**
- TASTY SERVE 'N' SAVE **Wieners** 12-Oz. Pkg. **79¢**

**OPEN 7 AM TO MIDNIGHT** MON. THRU SAT. **600 Greenville Blvd.,** Phone 756-7031  
OPEN SUNDAY 9 AM TO 9 PM

# SOOPER COST CUTTERS

**SAVE WITH**

**COST WEEK! CUTTER SPECIAL**

KROGER GRADE A  
**Large Eggs**  
Doz. **58¢**  
Limit 2 Doz. With \$7.50 Additional Purchase  
Additional Doz. 69¢

**SOOPER COST CUTTER**

FLEECE  
**Paper Towels**  
Jumbo Roll **38¢**

**COST WEEK! CUTTER SPECIAL**

KROGER HOMOGENEOUS  
**Whole Milk**  
Gal. Plastic Jug **1.18**

## SOOPER COST CUTTERS

HERE ARE JUST A FEW OF THE HUNDREDS OF SOOPER COST CUTTERS AT KROGER SAV-ON. A COMPLETE LIST IS AVAILABLE AT YOUR NEAREST KROGER SAV-ON STORE.

**SOOPER COST CUTTER**

AVONDALE FROZEN  
**Orange Juice**  
12-Oz. Can **73¢**

CLOVER VALLEY  
**Grape Jelly** ..... 32-Oz. Jar **58¢**  
COUNTRY OVEN  
**Marshmallow Pies** ..... 13-Oz. Box **2/\$1**  
KROGER  
**Chicken Noodle Soup** .... 10½-Oz. Can **22¢**  
SUNGOLD  
**Saltines** ..... 1-Lb. Pkg. **43¢**  
KROGER  
**Dutch Cocoa Mix** ..... 12-Oz. Box **89¢**

**SOOPER COST CUTTER**

GRANULATED  
**Kroger Sugar**  
5-Lb. Bag **99¢**

- KROGER **Spinach** ..... 15-Oz. Can **29¢**
- AVONDALE **Tomatotes** ..... 16-Oz. Can **29¢**
- KROGER **Apple Sauce** ..... 16-Oz. Can **29¢**
- KROGER **Sliced Carrots** ..... 16-Oz. Can **29¢**
- KROGER **Pork & Beans** ..... 16-Oz. Can **23¢**

**SOOPER COST CUTTER**

KROGER  
**Apple Juice**  
32-Oz. Btl. **55¢**

- HOME PRIDE **Aluminum Foil** ..... 25-Ft. Roll **33¢**
- HOME PRIDE HOT OR COLD **Styro Cups** ..... 50-Ct. Pkg. **39¢**
- BATHROOM **Swansoft Tissue** ..... 4-Roll Pkg. **77¢**
- UNSWEETENED **Big K Drink Mix** ..... 25-Oz. Pkg. **6¢**
- AVONDALE **Coffee Creamer** ..... 22-Oz. Jar **99¢**

**SOOPER COST CUTTER**

COUNTRY OVEN REG. OR DIP  
**Potato Chips**  
8-Oz. Twin Pack **59¢**

- KROGER **Grape Juice** ..... 24-Oz. Btl. **68¢**
- KROGER **Hamburger Magic** ..... 8-Oz. Box **55¢**
- KROGER **Tomato Sauce** ..... 15-Oz. Can **29¢**
- AVONDALE **Rice** ..... 4-Lb. Bag **79¢**
- KROGER **Vienna Sausage** ..... 5-Oz. Can **35¢**

**SOOPER COST CUTTER**

JIFFY  
**Corn Muffin Mix**  
8½-Oz. Box **18¢**

- KROGER WHOLE KERNEL VAC PAC **Vac Pac Gold Corn** ..... 12-Oz. Can **28¢**
- KROGER VEGETABLE **Juice Cocktail** ..... 46-Oz. Can **66¢**
- AVONDALE **Cut Green Beans** ..... 15½-Oz. Can **28¢**
- KROGER **Instant Potatoes** ..... 16-Oz. Box **66¢**
- KROGER **Flaked Coconut** ..... 14-Oz. Pkg. **89¢**

**SOOPER COST CUTTER**

AVONDALE  
**Vegetable Oil**  
38-Oz. Btl. **\$1.22**

- EMBASSY **Pancake Syrup** ..... 26-Oz. Btl. **99¢**
- OLD FASHIONED **Kroger Pancake Mix** ..... 2-Lb. Box **55¢**
- KROGER **Brownie Mix** ..... 22½-Oz. Box **89¢**
- KROGER **Stuffed Olives** ..... 7-Oz. Jar **88¢**
- KROGER **Sandwich Spread** ..... 16-Oz. Jar **58¢**

**SOOPER COST CUTTER**

BIG K  
**Soft Drinks**  
6 12-Oz. Cans **\$1**

- AVONDALE **Macaroni & Cheese** ..... 7¼-Oz. Box **21¢**
- MISSY **Fabric Softener** ..... Gal. Jug **88¢**
- LIQUID **Kandu Bleach** ..... Gal. Jug **55¢**
- S.O.S. STEEL WOOL **Soap Pads** ..... 18-Ct. Box **66¢**
- HOME PRIDE SOLID **Air Fresheners** ..... 6-Oz. Pkg. **33¢**

**SOOPER COST CUTTER**

EMBASSY  
**Mayonnaise**  
32-Oz. Jar **89¢**

- KROGER **Pure Vanilla** ..... 2-Oz. Bottle **55¢**
- GOLD CREST **Pecan Pieces** ..... 7½-Oz. Pkg. **\$1.49**
- AVONDALE **Shortening** ..... 42-Oz. Can **\$1.09**
- KROGER **Iodized Salt** ..... 26-Oz. Box **18¢**
- ARM & HAMMER **Baking Soda** ..... 16-Oz. Box **33¢**

**SOOPER COST CUTTER**

KROGER  
**Tomato Catsup**  
32-Oz. Btl. **66¢**

- KROGER **Bar B Q Sauce** ..... 18-Oz. Btl. **49¢**
- KROGER **Toaster Treats** ..... 11½-Oz. Pkg. **49¢**
- KROGER **Quick Oats** ..... 18-Oz. Box **49¢**
- KROGER **Instant Rice** ..... 28-Oz. Box **\$1.18**
- FRENCH SALAD **Kroger Dressing** ..... 9-Oz. Btl. **44¢**

**SOOPER COST CUTTER**

PINK BEAUTY  
**Pink Salmon**  
15½-Oz. Can **\$1.39**

- PERSONAL SIZE **Ivory Soap** ..... 3¼-Oz. 4-Pak. **59¢**
- TRIX **Dog Food** ..... 15-Oz. Can **15¢**
- KROGER **Instant Puddings** ..... 3½-Oz. Pkg. **21¢**
- KROGER **Honey Graham Crackers** .. 16-Oz. Box **59¢**
- LEMON **Bright Ammonia** ..... 64-Oz. Btl. **52¢**
- SPRAY **Bright Cleaner** ..... 21-Oz. Can **25¢**
- BRIGHT **Glass Cleaner** ..... 21-Oz. Btl. **55¢**

**SOOPER COST CUTTER**

AVONDALE  
**Fruit Cocktail**  
16-Oz. Can **47¢**

- KROGER **Peanut Butter** ..... 18-Oz. Jar **79¢**

- ALL GRINDS **Kroger Coffee** ..... 1-Lb. Can **\$2.38**

**FROZEN FOOD**

AVONDALE 3.5 Lb.  
**CRINKLE CUT**

**French Fries**  
2-Lb. Bag **39¢**

- BANQUET **Cookin' Bags** ..... 3
- KROGER **Pot Pies** ..... 8-Oz. Pkg.

**SAUSAGE, CHEESE, PEPPERONI OR HAMBURGER**

**Jeno's Pizza**  
13-Oz. Pkg. **89¢**

- KROGER **Glazed Donuts** ..... 12-Ct. Pkg.
- MAN PLEASER **Banquet Dinners** ..... 17-Oz. Pkg.

REGULAR T.V. ...

**Banquet Dinner**  
11-Oz. Pkg. **58¢**

MACARONI & CHEESE  
**Morton Casserole** ..... 20-Oz. Pkg.

SARA LEE  
**Pound Cake** ..... 10½-Oz. Pkg.

**BAKED FOOD**

BROWN & SERVE  
**Kroger Roll**  
3 11-Oz. Pkgs. **98¢**

- KROGER SANDWICH OR **Hot Dog Buns** ..... 3 8-Oz. Pkgs.
- LAY'S FRITOS **Corn Chips** ..... 10½-Oz. Bag
- MULTI-GRAIN **Kroger Bread** ..... 24-Oz. Loaf

**COMPARE SOOPER COST CUTTERS WITH WHAT YOU PAY ELSEWHERE**

# COST CUTTERS

**STERILIZED**  
**Low Fat Milk**  
**69¢**  
KROGER 1/2%  
Low Fat Milk  
Gal. Jug **\$1.49**

**KROGER**  
**Sandwich Bread**  
**3 \$1**  
24-Oz. Loaves

**REFRESHING**  
**Coca Cola**  
**6 \$1.89** **Save 66¢**  
32-Oz. Returnable Bottles  
Plus Deposit  
**Dr. Pepper \$1.59**  
6 1-Liter Returnable Bottles Plus Deposit

## DAIRY FOODS

**KROGER**  
**Cottage Cheese**  
**99¢**  
24-Oz. Ctn.

**BLUE BONNET**  
**Soft Margarine** ..... 28-Oz. Ctn. **72¢**  
**PHILADELPHIA**  
**Cream Cheese** ..... 3-Oz. Pkg. **29¢**

**KROGER SINGLES INDIVIDUALLY WRAPPED SLICES AMERICAN**  
**Cheese Food**  
**\$1.18**  
12-Oz. Pkg.

**BLUE BONNET 6 STICK**  
**Margarine** ..... 1-Lb. Pkg. **63¢**  
**WEIGHT WATCHERS**  
**Skim Milk** ..... 1/2-Gal. Ctn. **85¢**

**KROGER FULLMOON LONGHORN**  
**Colby Cheese**  
**\$1.49**  
14-Oz. Pkg.

**BUTTER-ME-NOT**  
**Kroger Biscuits** 3 10-CL. CANS **88¢**  
**DELICIOUS**  
**Yubie Yogurt** ..... 2 16-Oz. Ctns. **\$1**

**WINE & BEER**  
**RHINE, BURGUNDY OR CARLO ROSSI**  
**Chablis**  
**\$1.99**  
1.5 Liter Btl.

**GOLD Tuborg Beer** ..... 6 12-Oz. Cans or N.R. Btl. **\$1.69**  
**CHILLED LIGHT**  
**Colony Burgundy** ..... **\$2.39**  
**BURGUNDY, RHEINFEST OR**  
**Franzia Rose** ..... 3 **\$3.58**

## COST CUTTER BONUS BUYS

**DISH DETERGENT**  
**Ivory Liquid**  
**84¢**  
22-Oz. Btl. **WAS 99¢**

	WAS EVERYDAY LOW PRICE	NOW
TOMATO Heinz Ketchup .....	32-Oz. Btl. <b>83¢</b>	<b>89¢</b>
HUNTS Tomato Sauce ..	29-Oz. Can <b>83¢</b>	<b>74¢</b>
SHASTA Soft Drinks .....	12-Oz. Can <b>6/\$1.19</b>	<b>6/\$1.09</b>
WELCHADE Grape Drink .....	46-Oz. Can <b>66¢</b>	<b>61¢</b>
BUSH MUSTARD, COLLARD OR Turnip Greens ...	15-Oz. Can <b>31¢</b>	<b>28¢</b>

	WAS	NOW
GREAT NORTHERN OR Lucks Pinto Beans ...	17-Oz. Can <b>47¢</b>	<b>2/79¢</b>
VAN CAMP Pork & Beans ..	8-Oz. Can <b>2/55¢</b>	<b>4/\$1</b>
VAN CAMP CHILI OR NOODLE Beenie Weenies	8-Oz. Can <b>43¢</b>	<b>39¢</b>
ARMOUR Beef Stew .....	24-Oz. Can <b>\$1.23</b>	<b>\$1.15</b>
ARMOUR Vienna Sausage	5-Oz. Can <b>49¢</b>	<b>39¢</b>

**CHUNK LIGHT IN OIL OR WATER**  
**Star-Kist Tuna**  
**68¢**  
6 1/2-Oz. Can **WAS 89¢**

**BOLD 3 OR**  
**Tide Laundry Detergent**  
**\$1.37**  
49-Oz. Box **WAS \$1.49**

	WAS	NOW
WHOLE Hunts Tomatoes	28-Oz. Can <b>75¢</b>	<b>68¢</b>
3-OZ. REFILL Dixie Bathroom Cups	100-Cl. Pkg. <b>89¢</b>	<b>74¢</b>
PINE CLEANER Texize .....	28-Oz. Btl. <b>\$1.09</b>	<b>88¢</b>
WINDOW CLEANER REFILL Windex .....	20-Oz. Btl. <b>71¢</b>	<b>61¢</b>
PINK FABRIC SOFTENER Sta-Puf .....	Gal. Jug <b>\$1.09</b>	<b>99¢</b>

	WAS	NOW
ARMOUR Potted Meat .....	3-Oz. Can <b>24¢</b>	<b>4/88¢</b>
ORTEGA Taco Kits .....	7-Oz. Pkg. <b>\$1.05</b>	<b>97¢</b>
MUELLER'S Egg Noodles .....	8-Oz. Pkg. <b>45¢</b>	<b>39¢</b>
GREEN LABEL Karo Syrup .....	32-Oz. Btl. <b>\$1.29</b>	<b>\$1.22</b>
PURE VEGETABLE Crisco Shortening .....	3-Lb. Can <b>\$1.89</b>	<b>\$1.79</b>

**FRUIT**  
**Hi-C Drinks**  
**2 \$1**  
2 46-Oz. Cans **WAS 57¢**

**LIGHT DIGESTIBLE**  
**Wesson Oil**  
**\$2.07**  
48-Oz. Btl. **WAS \$2.17**

	WAS	NOW
CAT FOOD Tender Vittles .....	12-Oz. Pkg. <b>67¢</b>	<b>59¢</b>
TONY Dog Food .....	14 1/2-Oz. Can <b>19¢</b>	<b>18¢</b>
TENDER CHUNK DOG FOOD Ken-L Ration .....	5-Lb. Bag <b>\$1.69</b>	<b>\$1.49</b>
CHATHAM CHUNK Dog Food .....	25-Lb. Bag <b>\$3.59</b>	<b>\$3.29</b>
LOG CABIN COMPLETE Pancake Mix .....	32-Oz. Box <b>99¢</b>	<b>88¢</b>

	WAS	NOW
PILLSBURY Bundt Cake Mix .....	22 1/2-Oz. Box <b>\$1.39</b>	<b>\$1.27</b>
GELATIN Jello .....	8-Oz. Pkg. <b>45¢</b>	<b>42¢</b>
FLAKED Folgers Coffee ..	1-Lb. Bag <b>\$2.19</b>	<b>\$1.99</b>
BAGS Lipton Tea .....	48-CL. Box <b>\$1.19</b>	<b>\$1.05</b>
SMUCKERS Grape Jelly .....	3-Lb. Jar <b>\$1.79</b>	<b>\$1.49</b>

**LUNCHEON MEAT**  
**Armour Treet**  
**\$1.05**  
12-Oz. Can **WAS \$1.09**

### Health & Beauty Aids SOOPER COST CUTTERS

FAMILY PRIDE Baby Shampoo .....	16-Oz. <b>66¢</b>	FAMILY PRIDE ROLL-ON Deodorant .....	2.5-Oz. <b>69¢</b>	FAMILY PRIDE BLADES 10'S Double Edge .....	<b>59¢</b>
FAMILY PRIDE Herbal Shampoo .....	16-Oz. <b>59¢</b>	FAMILY PRIDE Creme Rinse .....	16-Oz. <b>59¢</b>	FAMILY PRIDE MINT AND REG. Toothpaste .....	<b>63¢</b>
FAMILY PRIDE Nail Polish Remover .....	6-Oz. <b>43¢</b>	FAMILY PRIDE Aspirin 100's .....	<b>29¢</b>	INSIDE FROSTED 60W. 75W. 100W G.E. Bulbs 4 Pk. ....	<b>\$1.48</b>
FAMILY PRIDE Petroleum Jelly .....	16-Oz. <b>79¢</b>	FAMILY PRIDE BLADES 9'S Twin Cartridge .....	<b>\$1.19</b>	HARTZ Two In One Collar .....	<b>\$2.29</b>

**YOU'VE BEEN PAYING AT ANY STORE IN TOWN!!**



WHERE SERVING YOU COMES FIRST

In Store **BAKERY**



Save 40¢  
**A NEW TASTE TREAT**  
**French Crumb Coffee Cake**...Ea. **99¢**  
 FRIED FRESH DAILY  
**Glazed Donuts**... Save 20¢ **12 For \$1.29**  
 CAKE OF THE WEEK  
 CREAMY RICH 8" 2-LAYER  
**German Chocolate Cake**... Save 40¢ Ea. **\$3.49**  
 FRESH FROM THE OVEN  
**Sandwich Buns**... Save 10¢ For **8 For 79¢**

**DELICATESSEN...**



SLICED TO ORDER-BAKED  
**Virginia Ham**... Save 90¢ **\$2.99** Lb.

FRESH FROM OUR KITCHEN  
**Creamy Cole Slaw**... Save 20¢ Lb. **69¢**

LOWER IN CALORIES  
**Lorraine Swiss Cheese**... Save 30¢ Lb. **\$3.19**

ALL MEAT - SLICED AS YOU LIKE IT  
**Jack & Jill Bologna**... Save 20¢ Lb. **\$1.29**

Cafeteria Style... **RESTAURANT...**



WITH 1 ENTREE, 2 VEGETABLES, ROLL & BUTTER  
**Daily Luncheon Plate Special**  
 Save 20¢ Ea. **\$1.79**

DELI FRESH  
**12 Pc. Fried Chicken**... Save \$1.00... Only **\$4.49**

A QUICK BREAKFAST TREAT  
**2 Sausage Biscuits & Coffee**... Save 16¢ Only **79¢**

WITH FREE 12-OZ. COCA COLA  
**Jumbo 1/4 Pounder Hot Dog**... Save 25¢ Only **99¢**

**RED RIPE Watermelon**  
 Lb. **23¢**

**LARGE 6 SIZE Pineapple**  
 Ea. **99¢**



IMPORTED WHITE

**Seedless Grapes**

Lb. **99¢**

**BROCCOLI ITALIENNE**

Another all-time FAVORITE RECIPE from **Better Homes and Gardens**

2 pounds fresh broccoli  
 1/2 teaspoon oregano, crushed  
 1/2 cup mayonnaise or salad dressing  
 1/4 cup shredded sharp process cheese  
 1 tablespoon milk

Cook broccoli until tender in boiling water with oregano; drain. In top of double boiler, mix mayonnaise, cheese and milk; heat over hot, not boiling, water, stirring until cheese melts and mixture is hot. Serve with broccoli. Makes 6 servings.

FOR OTHER RECIPES SEE BETTER HOMES & GARDENS ON SALE AT KROGER.



FRESH TENDER

**Broccoli**  
 Ea. **58¢**

DECORATIVE Hanging Basket **\$7.77**  
 10-Inch

ASSORTED VARIETIES Foliage Plants **2 \$1**  
 3 Inch For

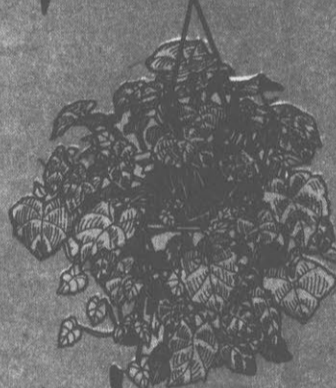

FLORIDA

**Juice Oranges**  
 5 Lb. Bag **99¢**

- CALIFORNIA Avocados... 3 For **\$1**
- SALAD SIZE Tomatoes... Lb. **49¢**
- IDAH0 Baker Potatoes... 4 Lbs. **\$1**
- FLORIDA PINK OR WHITE 40 SIZE Grapefruit... 5 For **\$1**
- NEW CROP Asparagus... Lb. **\$1.29**
- WASHINGTON STATE D'Anjou Pears... Lb. **49¢**
- WASHINGTON STATE RED OR GOLD Delicious Apples... 138 Size Ea. **15¢**
- FLORIDA Red Potatoes... Lb. **25¢**
- PURPLE TOP Turnips... Lb. **25¢**

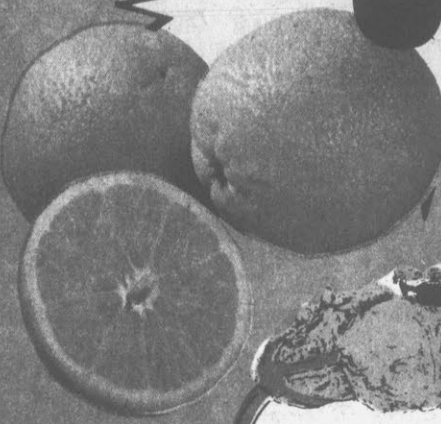

**SALAD FIXINS**

- GREEN TOP Bunch Radishes... 4 Bunches **\$1**
- FRESH CRISP ROMAINE Lettuce... 2 For **\$1**
- FRESH Green Onions... 4 Bunches **\$1**
- FRESH TENDER Spinach... Bunch **59¢**

**Cantaloupes**  
 FIRST OF THE SEASON  
**88¢** Ea.

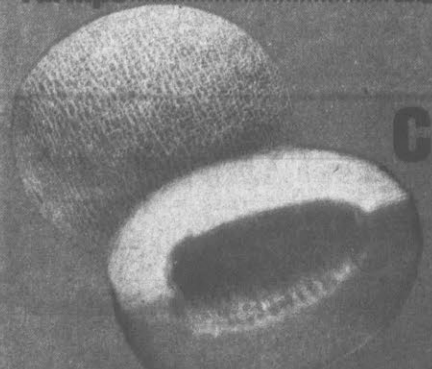

# Kroger Sav-on LET'S GET GROWING



**FOOD  
DRUG**

Copyright 1979 Kroger Sav-On Prices Effective  
Wed., Mar. 7 thru Sat., Mar. 10, 1979



**Scott's**

**Halts Crabgrass Preventer**

5,000 Sq. Ft. Bag **\$9<sup>79</sup>**

Stops crabgrass and 8 other problem weeds before they start. Apply now for best results.



**COST WEEK!**  
**CUTTER SPECIAL**

**Scott's**

**Turf Builder**

6,000 Sq. ft. Bag **\$11<sup>88</sup>**

Non burning, slow release formula for developing thick, green lawns.

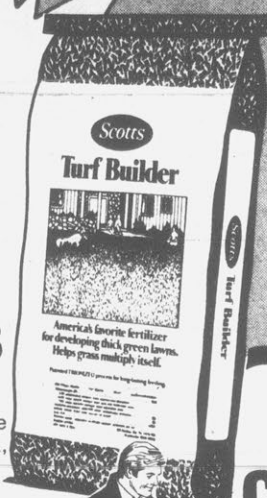

**ADVERTISED ITEM POLICY**  
Each of these advertised items is required to be readily available for sale in each Kroger store, except as specifically noted in this ad. If we do run out of an advertised item, we will offer you your choice of a comparable item, when available, reflecting the same savings or a raincheck which will entitle you to purchase the advertised item at the advertised price within 30 days.



**6-INCH Clay Pots**  
**2 For 89¢**

Great for repotting all your plants. Big 6" diameter pots.

**COST WEEK!**  
**CUTTER SPECIAL**



**COST WEEK!**  
**CUTTER SPECIAL**

**8-QUART BAG Potting Soil**  
**77¢**

Only **77¢**  
Ideal for all house plants. Sterile, won't burn. Odorless.



**Scott's**

**Lawn Spreader**

Only **\$29<sup>95</sup>**

Precision rate control spreader is calibrated to apply fertilizer and seed evenly and uniformly. Get yours today.

**TURN PAGE FOR MORE GREAT VALUES**

**Kroger Sav-On...A Whole Lot More Than Just One Store**

COST CUTTER SPECIAL

# INSTAMATIC Moisture Meter

• Great for house plants, lawns and vegetables



## \$5<sup>99</sup>

UPS-A-DAISY

# Hanging Plant Elevator

Only..... **\$3<sup>99</sup>**

COST CUTTER SPECIAL



# VAN WYCK Kitchen Appliances

Your Choice **\$6<sup>88</sup>** Ea.

- Hot Dogger • Can Opener
- Hand Mixer



COST CUTTER SPECIAL



# The Skin Machine By Clairol

- Leaves skin feeling fresh and alive
- Comes with two soft nylon complexion brushes
- Can be used with any soap or skin cleanser

## \$10<sup>88</sup>



# GILLETTE Promax Compact

- 3 heat/airflow settings
- Small and lightweight
- Turbo-flo design for high velocity airflow

Only **\$15<sup>88</sup>**

COST CUTTER SPECIAL



# PLANTERS DRY-ROASTED Peanuts

## 99¢

12-Oz. Jar

GENERAL ELECTRIC'S GRO & SHO

# Indoor Nursery

## \$24<sup>95</sup>

Only

- Adjustable light hood (4" to 19" high)
- Two 20 watt wide spectrum florescent plant lights
- Uses only 45 watts of power
- 6' cord and on and off switch



# KELLOGG-TAMDICO Bowl Brush

- Fashion handle
- Earth colors

## 2 \$1

For

COST CUTTER SPECIAL



ADULT  
SIZE

# Sleeping Bag

3-lb. polyfil, assorted colors. Nylon outer shell, tricot lined.

## \$9<sup>88</sup>

Ea.



# QUAKER STATE Motor Oil

Quart **57¢**

# QUAKER STATE Oil Filter

For Most Cars **\$1<sup>77</sup>** Ea.



# DO-IT YOURSELF AUTOMOTIVE SPECIALS!

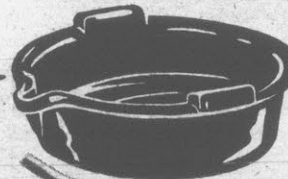

WEATHER-RESISTANT  
Oil Drain Pan  
Won't Rust Or Leak **\$1<sup>33</sup>** Ea.



ONE-HAND OPERATION  
Filter Wrench  
Heavy Duty **\$1<sup>77</sup>** Ea.



HEAVY DUTY  
Oil Spout **88¢**  
OIL DRAIN  
Plug Wrench  
Heavy Steel Construction **\$1<sup>47</sup>** Ea.

**VITAMIN B-6** 100 TABLETS  
100 MG. REG. 5.27  
**\$2.97**

**VITAMIN E** 60 CAPSULES  
100% NATURAL 400 I.U. REG. 6.65  
**\$3.99**

**ALFALFA TABLETS** 300 TABLETS  
NATURAL REG. 3.33  
RICH IN VITAMIN K, TRACE MINERALS  
AND OTHER NUTRIENTS. **\$2.33**

**VITAMIN B-12** 100 TABLETS  
250 mcg. REG. 4.63  
**\$2.59**

**Sunny Maid CHEWABLE VITAMIN C**  
GREAT TASTING ORANGE FLAVOR

250 MG. 100 TABLETS REG. 2.47  
500 MG. 100 TABLETS REG. 3.88  
**\$1.77** **\$2.77**

**VITAMIN C** 100 TABLETS  
with ROSE HIPS 250 MG. REG. 3.67  
**\$2.64**

**NUTRO-E**  
VITAMIN ENRICHED BEAUTY AIDS FOR HEALTHY SKIN & HAIR.  
**VITAMIN E OIL CONCENTRATE** 28,000 I.U. 1 OZ. REG. 4.99  
**\$2.98**  
**NATURAL PROTEIN SHAMPOO** 8 OZ. REG. 2.50  
**\$1.69**

RETAIL PRICES ARE MANUFACTURER'S SUGGESTED RETAIL.

*Nature Made* cold season  
**VITAMIN SALE**

**HIGH POTENCY LECITHIN**  
19 GRAINS  
EXCELLENT SOURCE OF CHOLINE & INOSITOL  
100 TABLETS REG. 4.43  
**NOW \$2.97**

**NEW AMAZING VITAMIN E**  
200 I.U. WITH 25 mcg. SELENIUM  
COMBINED FOR MAXIMUM BENEFIT  
60 CAPSULES REG. 4.48  
**NOW \$2.97**

**NATURAL DOLOMITE**  
CALCIUM MAGNESIUM SUPPLEMENT  
AS IN NATURE IN PERFECT BALANCE  
250 TABLETS REG. 2.99  
**NOW \$1.97**

**VITAMIN C 500 MG.**  
FOR THE COLD SEASON  
SAVE 100 TABLETS REG. 3.13  
**NOW \$1.79**

**SHAKE & SLIM**  
ALL IN ONE DIETARY AID TO WEIGHT LOSS...SEE YOUR PHYSICIAN WHILE DIETING AND READ LABEL CAREFULLY.  
PROTEIN POWDER WITH VITAMINS AND MINERALS.  
16 OZ. REG. 9.95  
**NOW \$5.97**

**VITAMIN E WATER SOLUBILIZED**  
400 I.U. PROVIDES OPPORTUNITY FOR MORE COMPLETE ABSORPTION  
100 CAPSULES REG. 7.99  
**NOW \$3.95**

**30 TABLETS FREE**  
**BONUS BOTTLE SUPER B COMPLEX**  
B-VITAMINS ARE NOT STORED BY THE BODY. THEY MUST BE CONSTANTLY REPLACED AS USED... ALL IN ONE TABLET.  
100 TABLETS REG. 6.59  
100 TABLETS PLUS 30 FREE ONLY **\$3.99**

**30 TABLETS FREE**  
**BONUS BOTTLE THERAPEUTIC M**  
HIGH POTENCY VITAMIN & MINERAL  
COMPARE TO THERAGAN M®  
100 TABLETS REG. 5.27  
100 TABLETS PLUS 30 FREE ONLY **\$3.99**

**Hartz 2-In-1 Collar For Dogs**  
**\$2.29**  
The white collar that kills both ticks and fleas.

**Storage Chest** 24"x13"x11"  
**Under Bed Chest** 27"x12"x6"  
Simulated all wood grain finish.  
**99¢**

**PAPER MATE**  
**Papermate Pens**  
2 For **\$1.00**

**cedar**  
**Angler Broom, Sponge Mop, Dust Mop, Rayon Deck Mop**  
LIGHT 'N EASY  
**YOUR CHOICE \$2.44 Each**

**Garbage Can** Rubbermaid 20 Gallon Roughneck  
**\$8.88 Each**  
• Avocado color  
• Premium quality  
**Stacking Pitcher 99¢ Each**  
Choose from avocado, burnt orange and gold.

# Kroger Sav-on March Value Days

## SALE!



FOOD  
DRUG

Kroger Sav-on HAS

# LOW

PRESCRIPTION PRICES

**DID YOU KNOW YOUR DOCTOR'S PRESCRIPTION BELONGS TO YOU?**

You have the right to have it transferred from one pharmacy to another. If you feel you are paying too much elsewhere, ask your friendly Kroger Sav-on Pharmacist to tell you how much you can save at Kroger Sav-on.

**Call Your Nearest Pharmacy**

<b>CHARLOTTE</b>	<b>WILMINGTON</b>
• Tyvola Rd. 527-3159	392-1959
• Eastway Dr. 597-8154	
• Freedom 399-0975	<b>FAYETTEVILLE</b>
	864-3449
<b>COLUMBIA</b>	<b>FLORENCE</b>
• Bush River Rd. 798-6901	662-9147
• Decker Rd. 788-3620	
<b>CHARLESTON</b>	<b>SUMTER</b>
• Mall Dr. 554-5042	775-0115
• Savannah Hwy. 556-6956	
<b>GREENVILLE</b>	<b>HICKORY</b>
756-7393	328-3058
<b>SAVANNAH</b>	<b>SALISBURY</b>
354-7431	636-8432

**Fluoride Aim Toothpaste**  
6.4-Oz. Tube **88¢**

**Balsam & Protein Flex Shampoo**  
16-Oz. Bottle **\$1.27**

**Balsam & Protein Flex Conditioner**  
16-Oz. Bottle **\$1.37**

**Hair Spray Flexnet**  
**\$1.48**

**Fluoride Gleem Toothpaste**  
5-Oz. Tube **63¢**

**Kaopectate**  
8-Oz. Bottle **\$1.17**

**Anti-perspirant Secret Roll-On**  
1.5-Oz. **97¢**

**Barnes-Hind Wetting Solution**  
2-Oz. Bottle **\$1.68**



**Medicated K.F.P. Skin Cream**  
16-Oz. **\$1.19**

**Lotion Formula Mitchum Roll-On**  
1.5-Oz. **\$1.48**

**Ointment Preparation H**  
2-Oz. Tube **\$2.49**

**24-Hr. Moisturizer Milk Plus 6**  
4-Oz. Bottle **\$1.97**

**Shampoo & Conditioner Milk Plus 6**  
5.75-Oz. Bottle **\$1.49**

**Shave Cream Noxzema**  
11-Oz. Can **97¢**

**Maybelline Lip-Eye Pencils**  
Ea. **\$1.19**

**Antacid Tablets Rolaid's**  
75-Ct. Bottle **\$1.09**

**COST CUTTER COUPON**

**NEW!** Print to Print **29¢** Each

• Prints of instant camera photo  
• No negatives required

Limit One Coupon Per Family  
Coupon Good Thru Saturday, Mar. 10, 1979  
Subject to Applicable State & Local Taxes

710

**Kroger Sav-On...A Whole Lot More Than Just One Store**

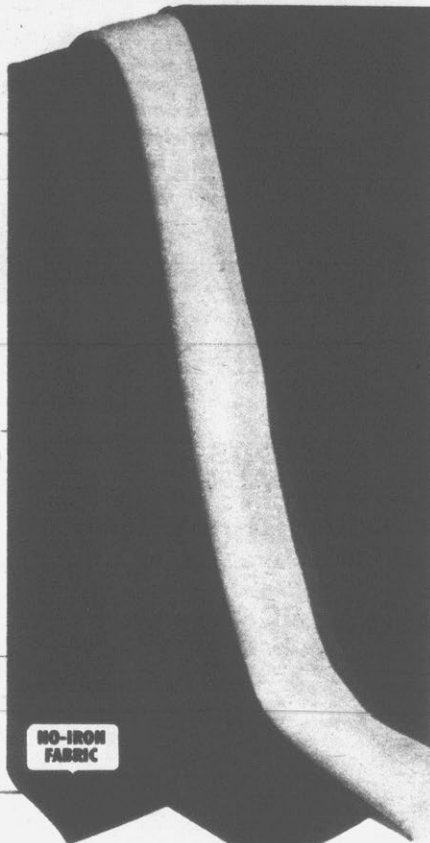

NO-IRON  
FABRIC

## No-iron Care

Our Regular 1.47 **\$1** Yd.

58"-60" Double-knit Polyester

Make your spring and summer wardrobe come alive with color and enjoy all the no-care qualities of this fabric.



# MARCH SALE

PERMANENT  
PRESS  
NO IRONING NECESSARY

## Wrinkle-resistant

Sparkling White Polyester/Cotton Sheets

Pure and simple...pure white invites a restful, soothing sleep...simple because these sheets never need ironing. 130 threads per square inch.  
Our Reg. 2.47 Standard Pillowcases...Pr. 1.97  
Our Reg. 3.97 Double Sheet, Flat or Fitted, 3.22  
Our Reg. 6.22 Queen Sheet, Flat or Fitted...4.97

Our Reg. 3.22

**2.57**  
Twin Flat  
or Fitted

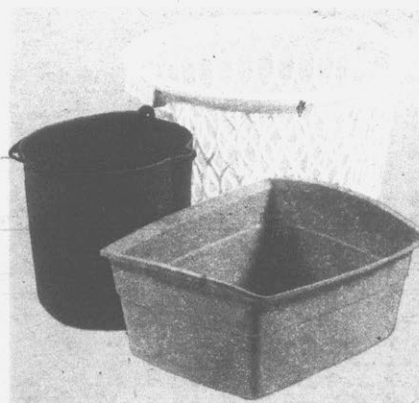

**Fesco® Brand**  
Plasticware  
17-qt. dishpan, 12-qt. pail with pour spout or 1-bu. laundry basket.

**96¢** Ea.  
Our Reg. 1.57



Save \$5  
Cookware Set  
Polished aluminum with non-stick SilverStone® interior.  
\*Du Pont Approved

**19.77**  
7-Pc. Set  
Our Reg. 24.77



**Proctor®**  
3-Way Iron  
Quality steam-dry iron has push-button "Spray Control."

**11.84**  
Sale Price

**K mart's Advertised Merchandise Policy**  
Our firm intention is to have every advertised item in stock on our shelves. If an advertised item is not available for purchase due to any unforeseen reason, K mart will issue a Rain Check on request for the merchandise to be purchased at the sale price whenever available or will sell you a comparable quality item at a comparable reduction in price. Our policy is to give our customers "satisfaction always."



Master Charge® or Visa® accepted in most areas.



3½-oz.\*\* Ombres  
4-oz.\*\* Solid Colors  
Not all colors in all stores

## Yarn Sale

Sale Price

**74¢** Skein

Orlon® Acrylic 4-Ply Wintuk® Yarn

For crochet or knitting, worsted-weight yarn is machine washable, dryable. Finished projects need no blocking.

\*Du Pont Certification Mark \*\*Du Pont Reg. TM \*\*\* Net wt.



**Glas-tile™**  
12" Mirror Tiles  
The clear, reflective beauty that makes any room look spacious.

**2\$1**  
For  
Box of 12, \$6

**Kmart**  
THE SAVING PLACE



## TERRIFIC TERRIES

So cool and comfortable for your summertime fun days. Softest polyester blends.

**T-Shirts** **2<sup>88</sup>**  
*Our Regular 3.77*

**Swimsuits** **6<sup>88</sup>**  
*Our Reg. 8.88*  
*Save \$2*

**Tank Tops** **2<sup>22</sup>**  
*Our Regular 2.96*

**Boxer Shorts** **2<sup>88</sup>**  
*Our Regular 3.57*

**Zip Jacket** **6<sup>96</sup>**  
*Our Regular 8.96*  
*Save \$2*



**Girls' Terry Shortalls**

*Our Reg. 3.57* **2<sup>88</sup>**  
*Sale Price*

Light and Carefree for Fun in the Sun  
Sassy shoulder ties, deep elastic waist  
inset. Cotton/polyester blends. 7-14  
*Our Reg. 2.96 Sizes 4-6x ..... 2.22*

Save 21% to 34%

Our Regular 4.96-5.96

Your Choice **3.88**  
Each

Knit Baby Dolls or Long Gowns

Soft knit sleepwear and styled for comfort! Big selection of gowns and baby doll pajamas in polyester/cotton with new-look screen print accents!

Misses' Sizes

3.88



3.88



Girls' Sizes  
7-14



Save 21% to 26%

Our Reg. **1.88** Our Reg. **3.88**  
Shorts Top

Fashion's Newest Terry Tops and Shorts  
All in soft, easy-care polyester terry. 7-14.  
Our 1.96 Terry Shorts, Sizes 4-6X ... 1.68  
Our 3.96-4.57 Similar Tops, 4-6x ... 2.88



Save 16%  
Our Reg. 5.97 **4.97**

Fashion-trim Canvas Handbags

So many styles to choose from! Body bags and top-handle designs, all in canvas with roomy front pockets and vinyl, macramé or canvas trims.



Save \$4 Each  
Our Reg. 19.88 **15.88**  
Each

Wigs in Curls of Fashion Beauty

Choose short'n fluffy, no-cap "Lady" or shoulder-length "Wildflower" for the disco look. Both are pre-styled modacrylic in a range of natural shades.



9.97



24.97



24.97

Save \$5  
Watches for Dress  
Fashion watch for women, calendar watch for men, Yellow or white finish.

**9.97**  
Our 14.97

Save \$10  
17-Jewel Watches  
Dependable timepieces, in silver- or gold-tone finish, for men, women.

**24.97**  
Our Reg. 34.97

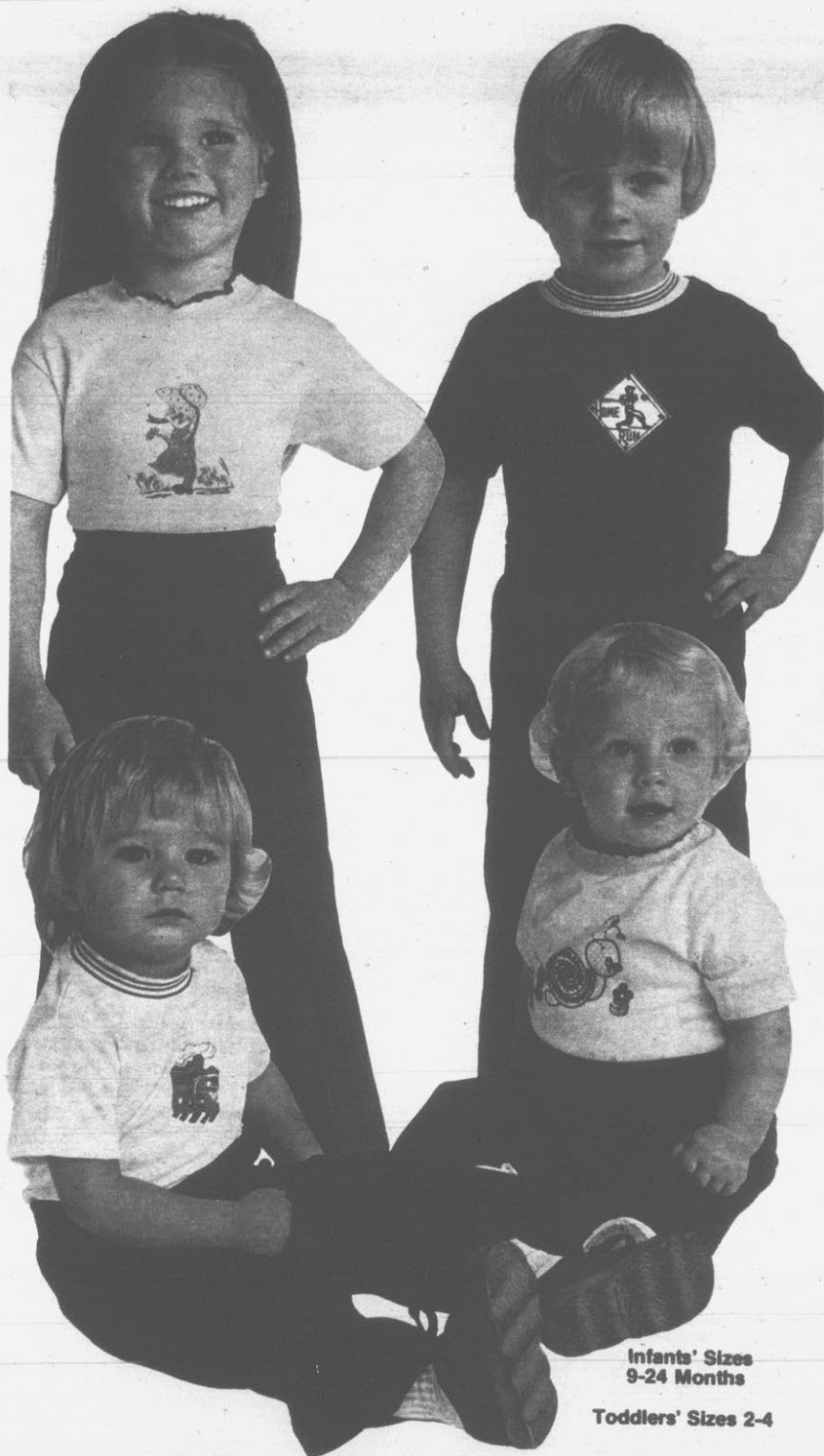

Infants' Sizes  
9-24 Months

Toddlers' Sizes 2-4

## Save 25% on Slack Sets

### Boxer Styles for Infants and Toddlers

Ready for fun and action. Short-sleeved knit tops sparked with colorful emblem, pattern or screen print. Paired with poplin slacks in snug-fitting boxer style to stay up. All of no-fuss polyester/cotton that machine washes and dries and is ready to go again with no ironing. Sizes 9-24 mos., 2-4.

Our Reg. 3.97

**2.97**

Your Choice



Save \$2

2-Pc. Warm-up Play Sets  
Zip-front baseball-style jackets  
in winning colors. Teamed with  
solid slacks. Polyester/cotton. 2-4.

Our Reg. 9.97

**7.97**

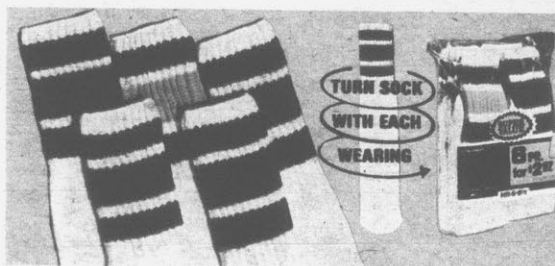

Save 20%

Our Regular 2.97

**6 Pr. 2.37**  
Pack

6 Pairs Tube Socks  
Creslan® acrylic/ stretch  
nylon. Stripes on white.  
Tots' sizes 4-5, and 6-8½.

\*American Cyanamid Reg. TM



Sale!

Our Reg. 2.17-2.67

**1.67**

Knit Tops for  
Infants, Toddlers

a. Double "B" in  
toddlers stripes by  
Buster Brown. 2-4.  
b. Carefree crew  
neck tops keep up  
with active kids.  
Polyester/cotton  
knits in solid colors  
and prints. All styles  
machine wash, dry.  
In 9-24 months.

**Kmart**  
THE SAVING PLACE

**Trax**  
QUALITY ATHLETIC  
FOOTWEAR  
ONLY AT K mart



Men's Sizes

Save 27%  
Our Regular 14.97  
**10.91** Pr.

**Suede Boots Go Casual**

A look that softly whispers comfort. But wait till you slip into them ... they're more comfortable than you ever dreamed. These suede leather boots, with crepe soles, are a timeless classic in men's casual wear. And now they're priced at classic savings.



Padded Collar

Padded Tongue

Rubber Sole

Cushion Insole

Save 22%  
Our Regular 9.90  
**7.70** Pr.

**Men's and Boys' Trax™ Joggers**

When the action's there and quality counts, you need Trax™! These joggers capture the active spirit, take rugged, grueling wear and give you unbelievable support and comfort. Lightweight nylon with suede leather and vinyl trim. Men's sizes and boys' sizes 3-6. Save now.

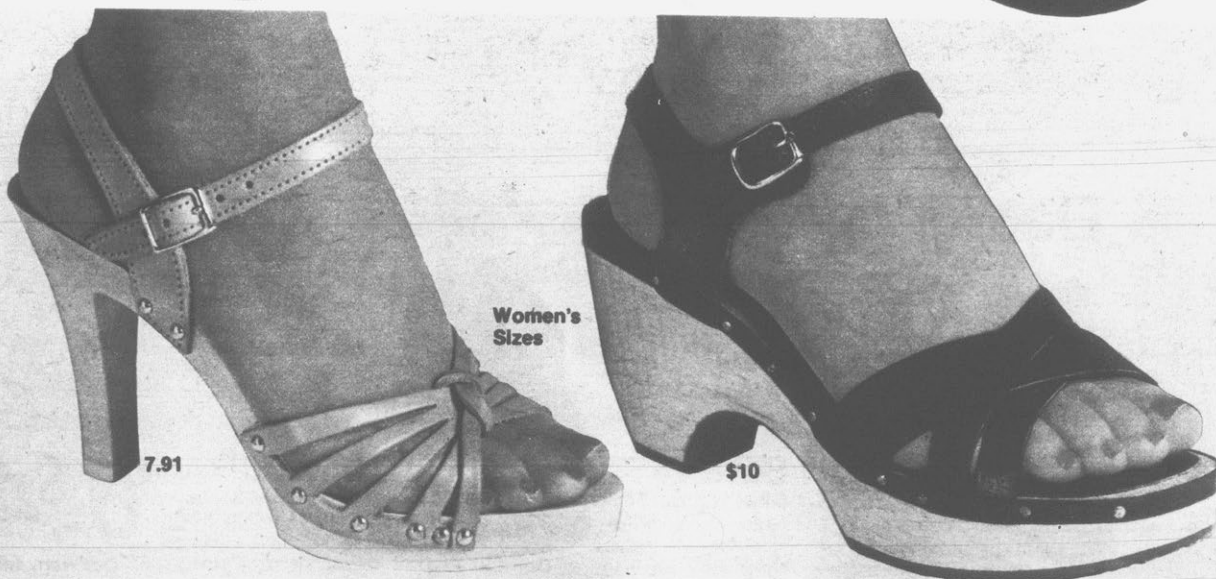

Women's Sizes

7.91

\$10

Save 28%  
Our Reg. 10.97  
**7.91** Pr.

**Leather Sandals For Dress**

A dainty and feminine open-toe sandal with luxurious genuine leather straps on a fashionable platform sole. Save.

Save 33%  
Our Reg. 14.97  
**\$10** Pr.

**Leather-and-Wood Casuals**

Refreshing simplicity! This winning look of fashion combines intertwining leather and uniquely sculptured wood.

**Ban-Lon®**  
**Short-sleeved Knit Shirts**  
 Sportswear classics, of Monsanto®  
 nylon knit, full cut for comfort.  
 Popular placket-and-collar style. **Our Reg. 5.96**  
 \*Joseph Bancroft and Sons Reg. TM

**\$4**

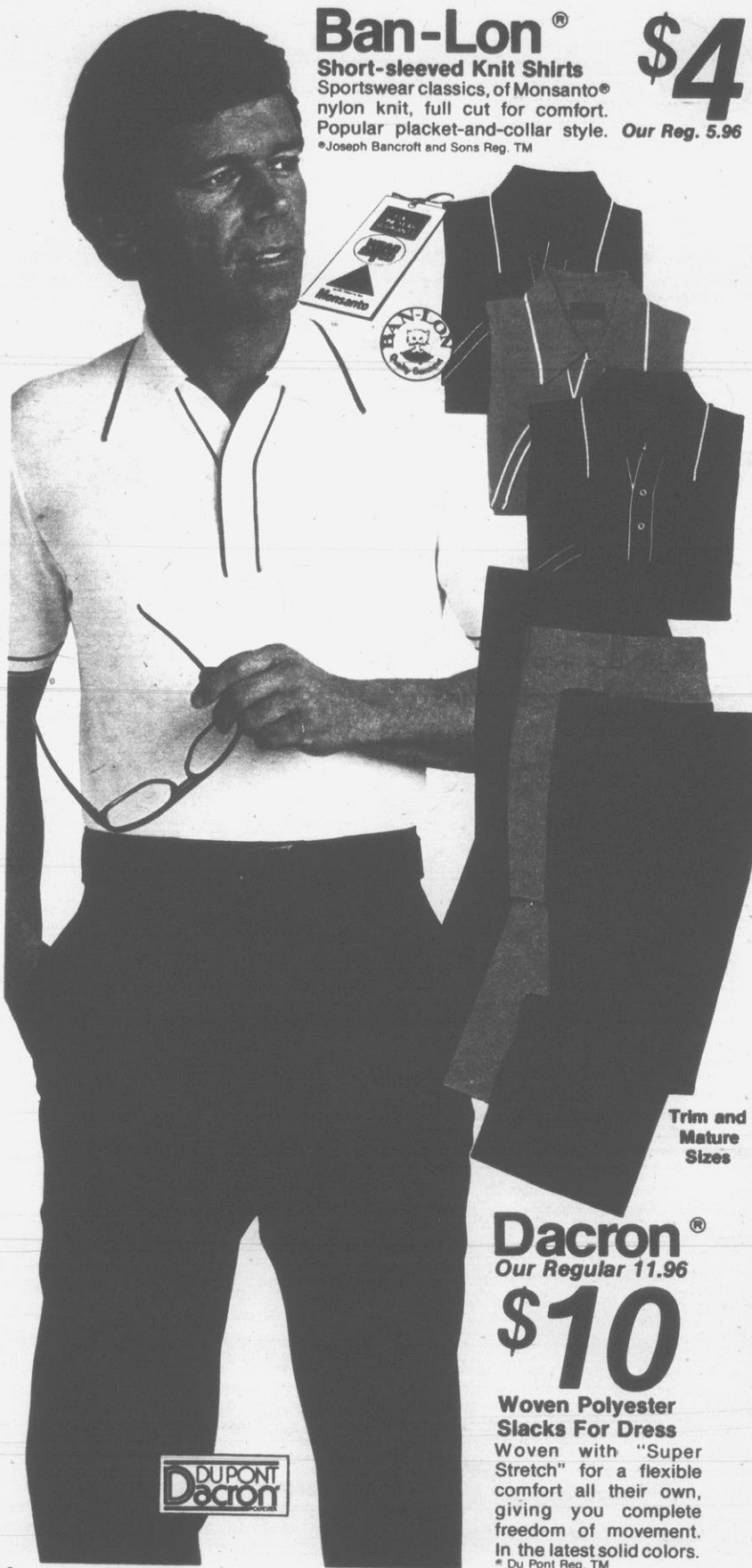

**Save 12% to 22%**

**Button-front Shirt With Spread Long-point Collar**

Vivid patterns woven in wrinkle-resistant polyester/cotton that stays neat and crisp all day and needs no ironing. Long tails stay tucked in. A spring absolute for any man's wardrobe.

**\$7**  
Ea.

Our 7.97-8.96

**Knit Shirt With Allen Sally® Placket and Collar**

Action-ready and striped for the sporty look in soft cotton/polyester knit. Bottom is hemmed so you can tuck it in or wear it out. Pure pleasure for play or just for relaxing.

Trim and  
 Mature  
 Sizes

**Dacron®**  
 Our Regular 11.96

**\$10**

**Woven Polyester  
 Slacks For Dress**

Woven with "Super Stretch" for a flexible comfort all their own, giving you complete freedom of movement. In the latest solid colors.  
 \*Du Pont Reg. TM

**DUPONT  
 Dacron**



**Save 26%**  
**Girls' 'n Boys' Socks**  
 Crew socks in Or-  
 lon® acrylic/stretch  
 nylon. Fit 7-8½, 9-11.  
 \*Du Pont Reg. TM

**3 Pr. 1.37**  
 Pkg.

Our 1.87 Pkg.

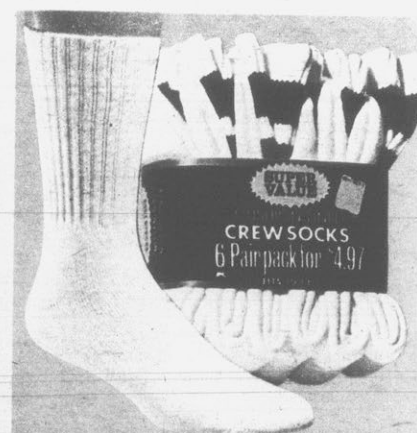

**Save 20%**  
**Men's Crew Socks**  
 Cotton/stretch nylon  
 socks with cushion  
 foot. Fit sizes 10-13.

**6 Pr. \$4**  
 Pkg.

Our Reg. 4.97

**Kmart**  
THE SAVING PLACE



**Sale! Save \$2**  
Our Regular 9.97  
Your Choice **7.97**

**Men's Western Jeans  
Take On A Variety Of Looks**  
Whether you want big bells in the pre-washed denim or flares in traditional indigo denim or solid-color broken bull, K mart has the jeans for you. All are of durable cotton, western styled jeans that are popular on the casual scene.



NO-IRON FABRIC

DUPONT  
Dacron

In Regular  
and Slim Sizes

**Save 20%  
to 25%**

Our Reg. 4.97-5.33

**\$4** Your Choice

**Boys' Knit Shirts  
or Western Jeans**

Thermal-look shirt (as shown) or box-stitched shirt with contrast piping, all in Dacron® polyester/cotton, team up happily with our flare or boot-cut western jeans in cotton denim.

\* Du Pont Reg TM

**Save 25%**

Our Regular 3.97

**2.97**

**Jr. Boys' Sport  
Shirts For Spring**

Short-sleeved comfort for the junior set. Print-happy shirts, tailored in wrinkle - resistant polyester/cotton, need no ironing. Sizes 4-7.

**Save 36%**

Our Regular 3.96

**2\$5** For

**Jr. Boys' Jeans  
In Twill or Denim**

Rugged jeans, in polyester/cotton, with all the western trappings. Seams are safety-stitched to resist rip-outs. Jr. boys' sizes 4-7

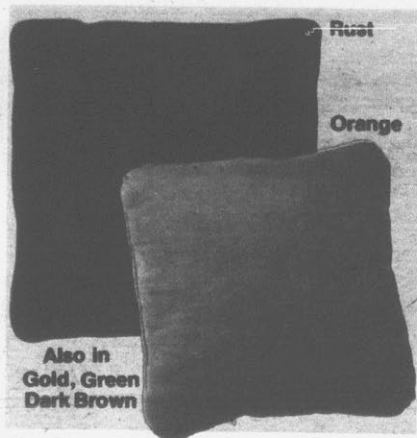

Also in  
Gold, Green  
Dark Brown

## Sofa Pillows

Soft Cotton Velveteen  
Luscious new decorator  
pillows with a fill of  
cotton/polyester/rayon.

**427**  
Each

Sale Price

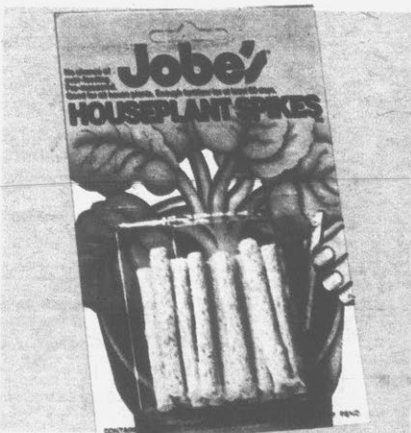

## Jobe's®

Houseplant Spikes™  
15-gram\* pkg. feeds 10  
plants in 4-in. pots for  
60 days. 10-4-5.

\*Net wt.

**57¢**

Sale Price



## It's Fesco®

22-Gallon Trash Can  
Plastic trash can and  
Cover with metal lock  
to keep lid on tight!

**488**

Sale Price

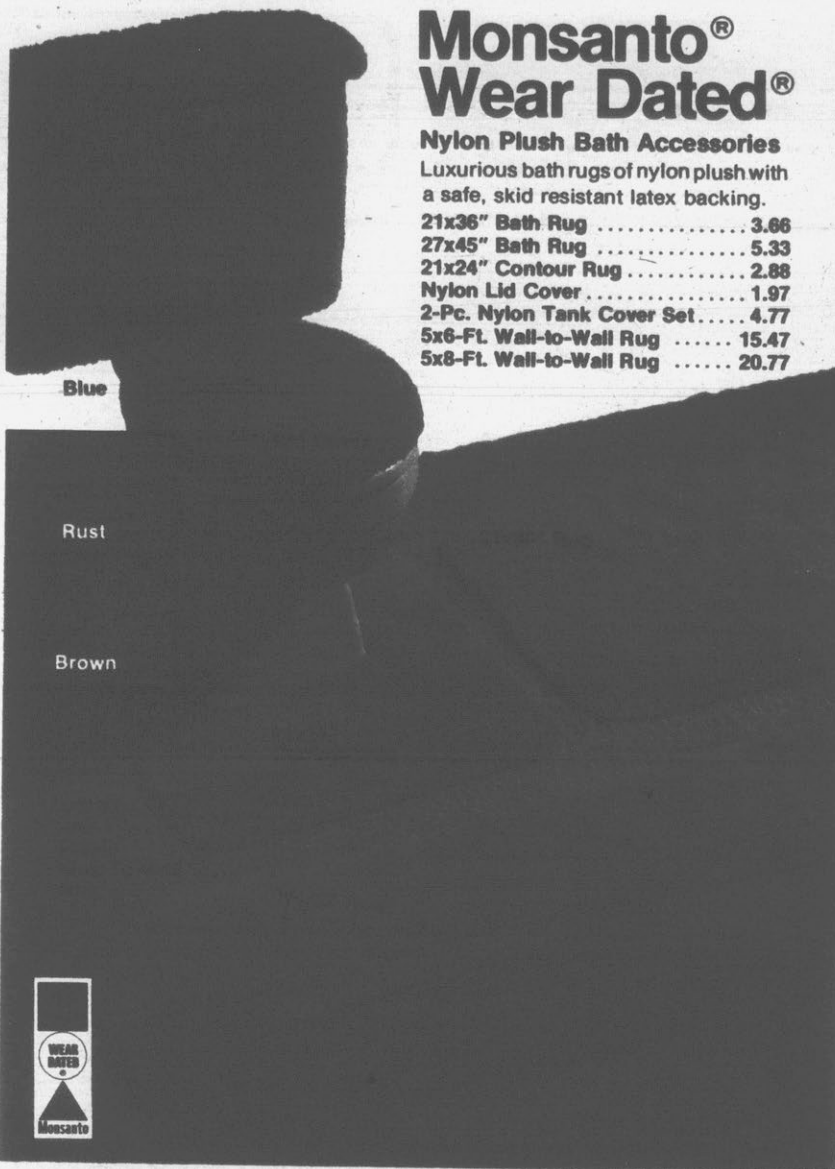

## Monsanto® Wear Dated®

### Nylon Plush Bath Accessories

Luxurious bath rugs of nylon plush with  
a safe, skid resistant latex backing.

21x36" Bath Rug .....	3.66
27x45" Bath Rug .....	5.33
21x24" Contour Rug .....	2.88
Nylon Lid Cover .....	1.97
2-Pc. Nylon Tank Cover Set .....	4.77
5x6-Ft. Wall-to-Wall Rug .....	15.47
5x8-Ft. Wall-to-Wall Rug .....	20.77

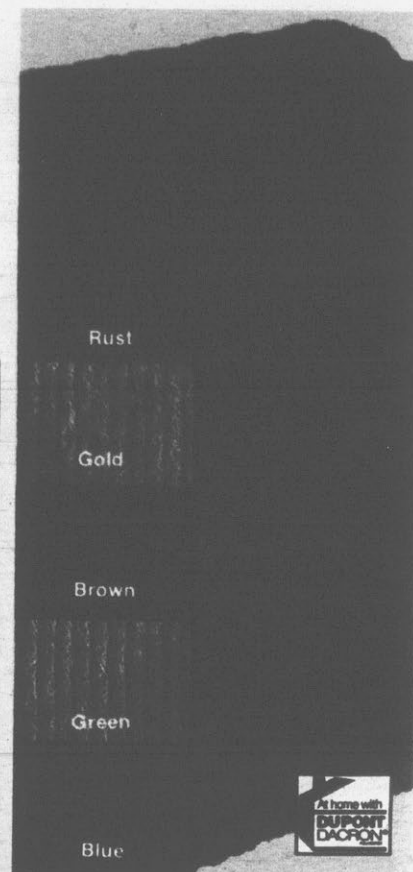

## DuPont Dacron®

Our Reg. 6.57 **557**

24x60-In. Hall Carpet Runner  
Protect your floors with good-looking  
carpet runners made of tough, soil-  
resistant Dacron® polyester. Decorator  
colors in a popular corduroy design.

©DuPont Reg. TM

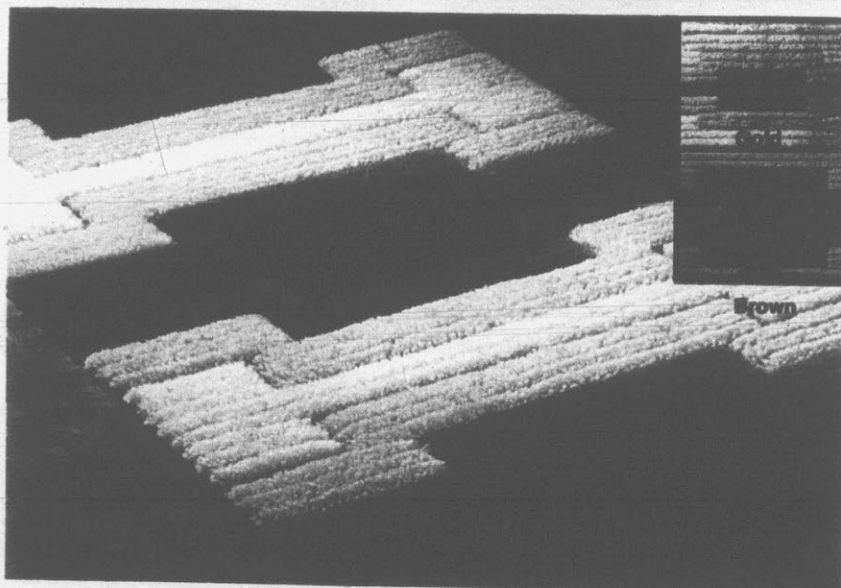

## Geometric Accent Rug

**327**  
21x33"

### 21x33-In. Fringed Scatter Rug In Colorful "Indian" Design

Add a bright fashion accent to your  
home with these delightful scatter rugs!  
Easy-to-clean polyester/nylon in 4-tone  
design with skid resistant latex backing.

26x43" Throw Rug .....	4.87
40x60" Area Rug .....	9.88

**Kmart**  
THE SAVING PLACE

**Sale! Save \$8**

Our Reg. 25.88

**17<sup>88</sup>**

23" Tall Ceramic Table Lamps  
Put Your Home in New Light  
Save on table lamps now, one lighter,  
brighter tomorrow. Hand-decorated  
in beautiful floral designs, our  
ceramic lamps come complete with  
fashionable polystyrene pleated  
shades and three-way lighting.

**CAFETERIA  
SPECIAL**

Available Only at  
Stores With Cafeteria

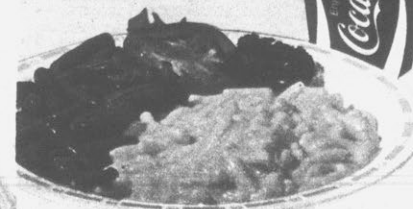

**With Coke\***

Trade-mark\*

Macaroni, Cheese, Coke\*  
Macaroni, cheese, vegetable,  
roll and butter. 10-oz. \*\*Coke\*.

**1<sup>33</sup>**

\*Coke and Coca Cola are registered trademarks of The Coca  
Cola Company. \*\*11 oz.

Gold

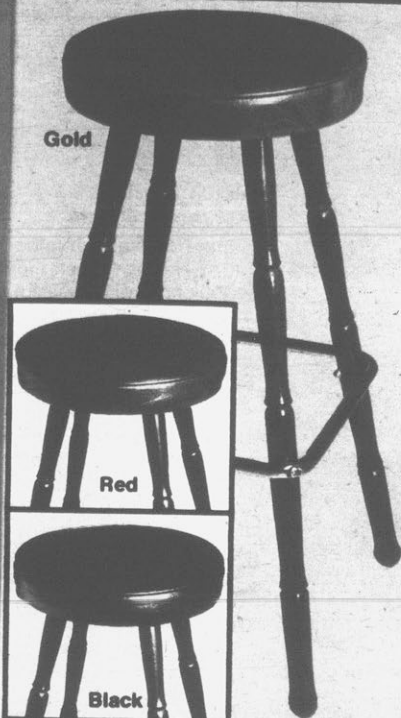

Red

Black

**Padded Seat**  
**13<sup>88</sup>**  
Unassembled

30" Stool for Counter or Bar  
With colorful, rugged 32-oz. expanded vinyl-  
upholstered seat, chrome-plated footrings  
and protective glides on furniture-style  
wooden legs. Simply outstanding savings!

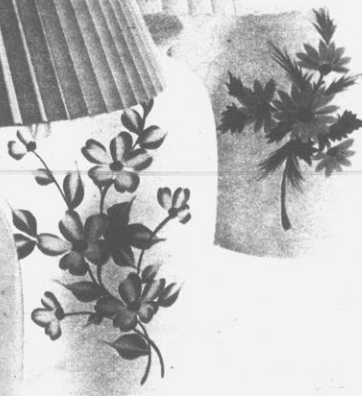

**3-Pc. Art  
Grouping**

Our Reg. 9.97

**7<sup>44</sup>**

Decorative and Distinctive  
3-Piece Picture Grouping.  
Pictures that can brighten any room  
are now on sale at terrific savings.  
This hinged 3-piece grouping of rural  
scenes comes in a handsome pine  
wood frame. Has two 6x14" panels,  
one 11x14" center frame.



**Candy Sale**

Delicious Confections  
Chunky® Original, Milk  
Chocolate Bar, Peanut  
Bar, Chocolate Peanuts.

**2\$1**  
For

Sale Price

\*Net wt.

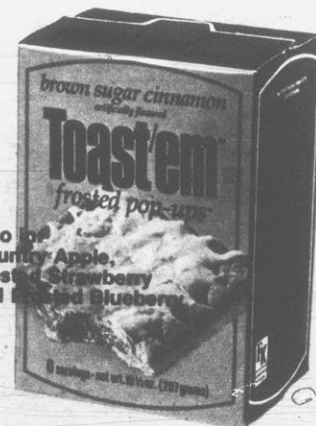

Also for  
Country Apple,  
Frosted Strawberry  
and Frosted Blueberry

**Toast 'Em®**  
Frosted Pop-Ups®

Taste treat for break-  
fast or lunch or snacks.  
Package of 6.10½-oz.\*

**2\$1**  
For

Sale Price

\*Net wt.

**Kmart**  
THE SAVING PLACE



**Sew and Save 32%**

Our Regular  
2.47 Yard

**167**  
Yd.

**"Calico Cupboard" and "Four Seasons" Cotton Prints**

Natural, color-bright cotton prints at their very best to bring a refreshing spring touch to your winter-weary wardrobe. Sew shirts and skirts, dresses and blouses, even decorator items of these enchanting cottons. Smooth-feeling, firm-textured, and permanent-pressed to keep their fresh look through repeated washings. 44"-45".



**Save 37%**

Our Regular 2.97 Yd.

**187**  
Yd.

**Mock Interlock  
Polyester Prints**

Supple and easy-draping! Lightweight mock interlock knits of wonderful, machine-care polyester. Vibrant, multi-colored prints sing of spring. 58"-60" wide.



**Save 23%**

Our Regular 2.97 Yd.

**227**  
Yd.

**Bright Gauze  
Prints, Solids**

Fashion-right gauze...in solid colors and beautiful prints. Create soft, puffy blouses and sportswear with all the easy-care qualities of popular polyester. 59"-60" wide.



**Save 29%**

Our Regular 4.24 Yd.

**297**  
Yd.

**"Fantasia"  
Dress Prints**

Fluid, flowing polyester knits you'll love for soft, feminine fashions. Stunning in brilliant, color-splashed floral prints. Machine wash and dry. 59"-60" wide.

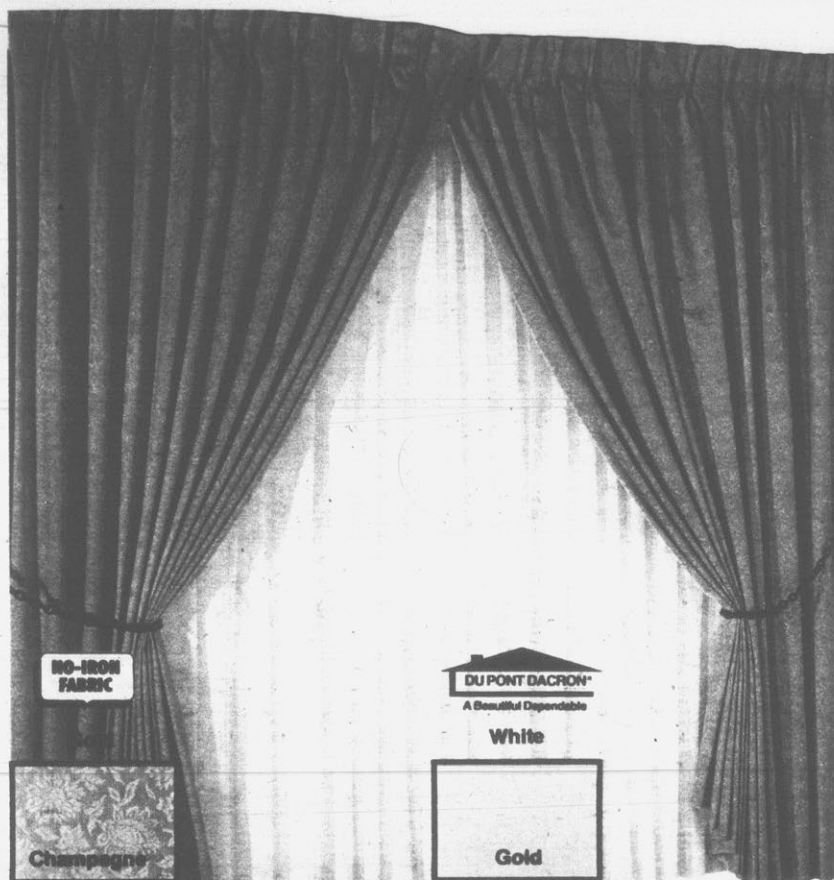

NO-IRON  
FABRIC



White



Gold



Champagne

Save Now  
**10.97**  
Pair

48x84" Pr.

**Insulated No-iron Drapes**

Acetate/cotton/rayon, acrylic foam back.

- 48x63" Pair ..... 8.97
- 72x84" Pair ..... 19.47
- 96x84" Pair ..... 25.97

**Panels of Dacron®**  
52x81" Ea. **2.88**  
Each

**Tailored Polyester Ninon Panels**

Extra-wide, sheer panels are perfect alone or under our insulated drapes.

- 52x45" Panel ..... Each 2.27
- 52x63" Panels ..... Each 2.57

\*Du Pont Reg. TM

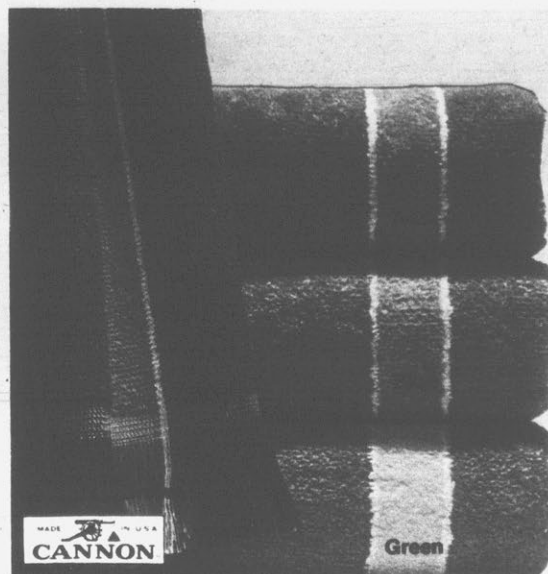

Save 33%  
Our Regular 2.67

**\$2**  
22x42"  
Bath  
Towel

**Cannon® Striped Terry Towels**

Stripes of color on sheared cotton terry softness are yours in these luxurious towels with fringed ends.

- Our Reg. 1.27 Matching Washcloth, 12x12".97¢
- Our Reg. 1.67 Matching Hand Towel, 16x25", 1.27

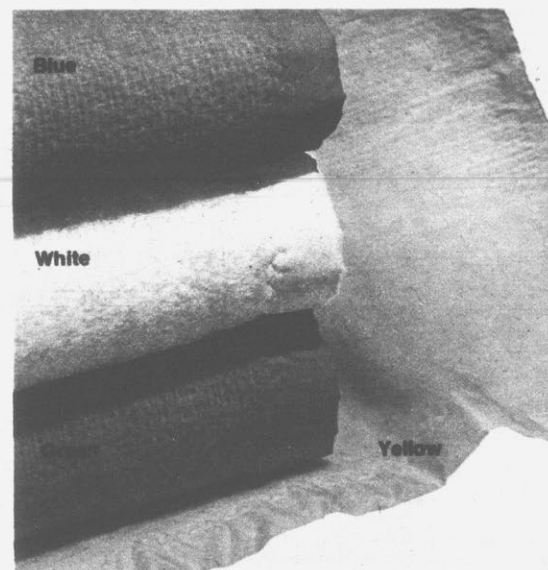

Thermal  
Our Regular 6.97

**5.97**  
72x90"

**Acrylic Blanket for Super Warmth**

Light-in-weight so you sleep ever-so-comfortably. And these colorful blankets machine wash and dry to their original fluffiness. 4" nylon binding

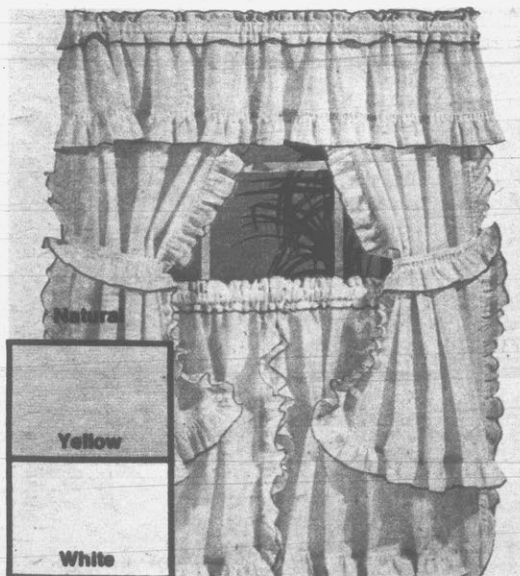

Natural

Yellow

White

Save 32%  
Our Regular 2.88

**1.97**  
60x36" Pr.

**Celanese® Acetate Knit "Cape Cod" Tiers**

Ruffled charm, pearled stitching. Stabilized tricot knit. With tiebacks.

- Our 1.97, 60" Valance, 1.47
- Our 1.97, 60x24" Pr., 1.47
- Our 3.88, 60x45" Pr., 2.97

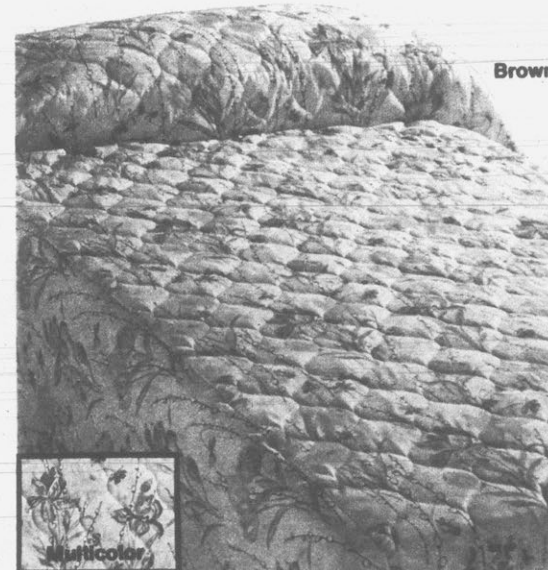

Brown

Save \$3-\$4  
Our Reg. 15.97-16.97

**12.97**  
Twin or Full

**Polyester Quilted Taffeta Spread**

This throw-style spread will lend a look of beauty to any bedroom. Made of lustrous polyester taffeta, quilted to resilient polyester fiberfill. Machine washable.

**Kmart**  
THE SAVING PLACE



**a. Save \$10 on Ramps**  
Car Ramps At Thrifty Spring Savings  
Sturdy auto ramps are constructed  
with a built-in wheel cradle and a  
slip-resistant incline. Safe, handy.

**14<sup>88</sup>**  
Our 24.88

**b. Save on Gumout®**  
Gumout® Additive for Carburetors  
Removes moisture, deposits from  
carburetor, combustion chamber;  
16-oz.\* liquid or 13-oz.\*\* spray.

**99¢**  
Your Choice

\* Fl. Oz. \*\* Net Wt.

**c. Save on Motor Oils**  
K mart® Super All Weather Motor Oil  
Our 10W30 or 10W40 motor oil is com-  
parable to leading brands; meets API  
and SAE specifications. 1 quart can.

**51¢**  
Qt.  
Your Choice

**d. Save 33% on Filters**  
K mart® Dual Oil Filters at Savings  
Dual filtration results in cleaner  
engine operation. In sizes to fit  
most popular domestic cars.

**1<sup>88</sup>**  
Our 2.88

**e. Save on Driving Lights**  
Choice of Rectangular Lights  
Choose clear driving light or  
amber fog lamp. 12-volt. Super  
sale price at K mart.

**2\$7**  
For  
Sale Price

**f. Save \$9 on Digital Clock**  
Smartly Styled Digital Auto Clock  
12V clock has digital readout for  
hours, minutes; flashing seconds. To  
fit on, under or in the dash.

**15<sup>88</sup>**  
Our 24.88

\*K mart Firearms and  
Ammunition Policy  
Firearms and ammunition are  
sold in strict compliance with  
Federal, State and local laws.  
All purchases must be picked  
up in person. Purchaser must  
be a resident of the State in  
which firearms and/or ammuni-  
tion are sold.

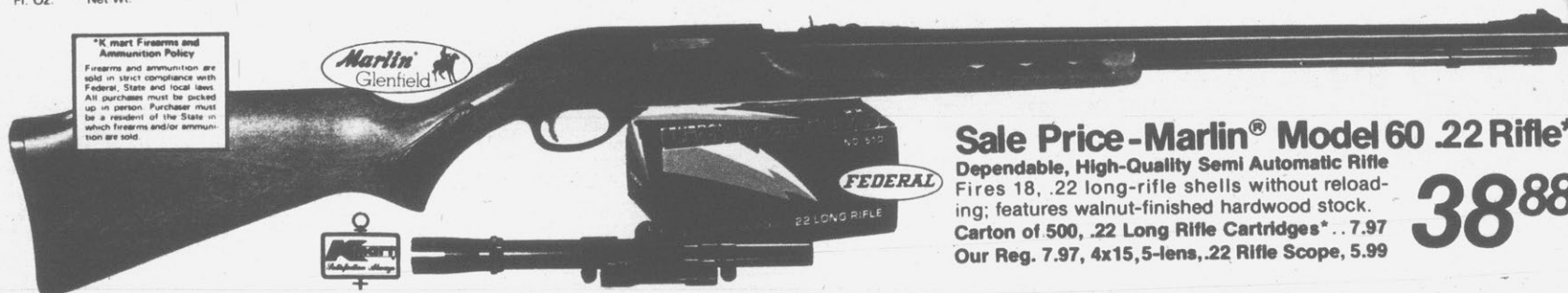

**Sale Price - Marlin® Model 60 .22 Rifle\***  
Dependable, High-Quality Semi Automatic Rifle  
Fires 18, .22 long-rifle shells without reload-  
ing; features walnut-finished hardwood stock.  
Carton of 500, .22 Long Rifle Cartridges\* . . 7.97  
Our Reg. 7.97, 4x15, 5-lens, .22 Rifle Scope, 5.99

**38<sup>88</sup>**

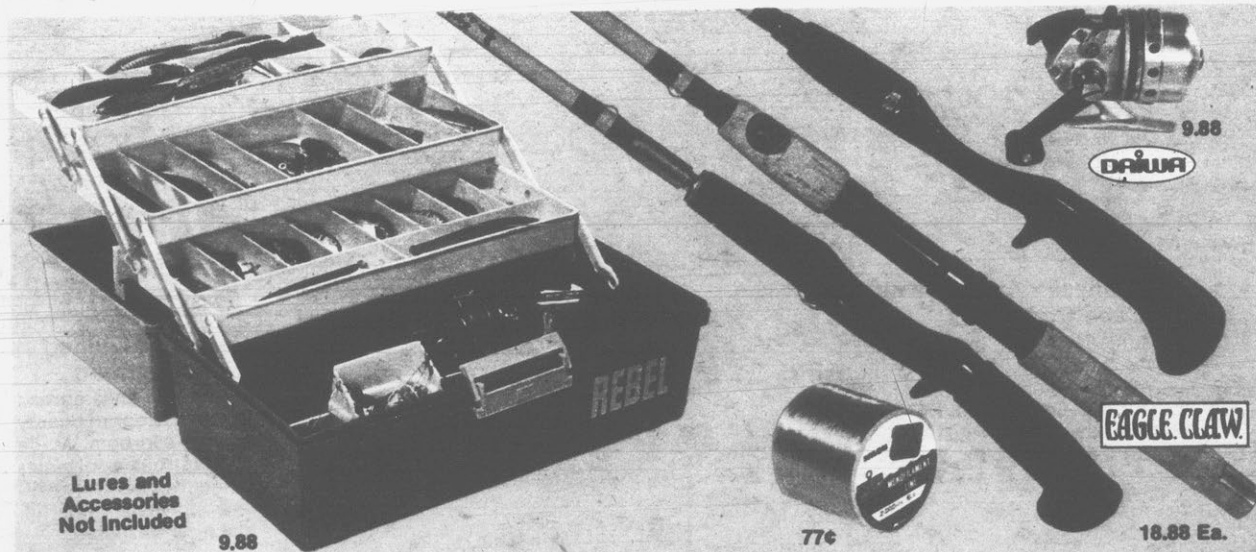

**Save \$5**  
Daiwa® Silvercast™ Reel  
Medium light; gear ra-  
tio 4.1 to 1; all metal  
gearing; prewound.

**9<sup>88</sup>**  
Our 14.97

**Save up to \$5**  
Eagle Claw® Starfire™ Rod  
Assorted fiberglass spin-  
casting/casting, spin-  
ning or trolling rods.

**18<sup>88</sup>**  
Ea.  
Our 21.47-23.97

**Save 44%**  
K mart® Monofilament Line  
¼-pound spool of  
extra-limp nylon line.  
Assorted sizes available.

**77¢**  
Our 1.38

**Save \$3**  
Three-Tray Tackle Box  
Moveable dividers; no-tip  
design; built-in spinner  
bait brackets. Save now.

**9<sup>88</sup>**  
Our 12.88

Lures and  
Accessories  
Not Included

9.88

77¢

18.88 Ea.