

Test Tube Baby Is Born In England; It's A Girl

OLDHAM, England (AP) — Doctors say the 5-pound, 12-ounce British girl believed to be the world's first test-tube baby is "quite normal" and that mother and daughter are in excellent condition.

The baby, nine days premature, was delivered by caesarean section to 30-year-old Lesley Brown at 11:47 p.m. Tuesday in Oldham's red-brick general hospital.

The father, 38-year-old truck driver Gilbert John Brown, chain-smoked in a waiting room outside the fourth-floor operating room. Hospital officials said he was close to tears when told he had a daughter.

Because a blockage in Mrs. Brown's fallopian tubes prevented normal conception, the baby was conceived by removing an egg from one of her ovaries and fertilizing it in a laboratory with her husband's sperm. After five days of nourishment in the test tube, it was planted in Mrs. Brown's uterus to develop normally.

The birth was the culmination of 12 years of experimentation and research by Dr. Patrick Steptoe, one of Britain's leading gynecologists, and Dr. Robert Edwards, a Cambridge University physiologist. A hospital spokesman said Mrs. Brown wants to name the baby Patricia, after Steptoe.

The British government's Medical Research Council said as far as it knows, the Brown baby is the first born after conception outside the mother's body. A spokesman said there has never been any substantive proof of reports that three test-tube babies are alive, two in Britain and one in Italy. And the medical profession put no credence in the claim of an Italian doctor in 1961 that he developed 27 test-tube children.

The Daily Mail, which paid \$600,000 for exclusive rights to the Browns' story, reported the father gasped when he was given a brief glimpse of his child and said:

"It's incredible, incredible... I'm not a religious man, but I thank God that I heard our

little girl cry for the first time. No one can realize what this means to Lesley and myself."

Brown has a 17-year-old daughter by a previous marriage.

A hospital spokesman said the mother was "over the moon with joy." He said she and the baby would probably be able to go home to Bristol in about 10 days.

The doctors knew the baby's sex in advance from chromosomal tests, but Mrs. Brown told them not to tell her because "I don't want to be cheated of the final thrill."

The only problem that apparently arose in the latter stage of Mrs. Brown's pregnancy was a minor blood poisoning known as toxemia, but doctors said it was quickly brought under control.

The birth brought hope to thousands of women unable to have children because of irreparable defects in their physical makeup. But it was expected to rekindle a fierce philosophical and ethical debate on the morality of conception outside the mother's body.

When Steptoe and Edwards first successfully fertilized a human egg and produced a fetus in 1969, the Roman Catholic Church condemned it as an extension of "immoral" artificial insemination.

But amid talk that their work heralded an age of selective breeding along the lines of Aldous Huxley's "Brave New World," Steptoe said: "I'm not a wizard or a Frankenstein tampering with nature. All I want to do is to help women whose child-bearing mechanism is slightly faulty."

The British Medical Association's Ethics Committee also approved. The committee's secretary, Dr. John Dawson, said earlier this month, "Used responsibly, this technique offers no ethical difficulties for doctors. If Mr. Steptoe succeeds, it will be a valuable addition to the treatment for infertile women."

Mrs. Brown was suffering



PIONEERED TECHNIQUE — Doctors Patrick Steptoe, left, of Oldham General Hospital, and Robert Edwards, right, of Cambridge Univ. are shown in 1969 picture. On Tuesday, doctors at Oldham delivered a baby girl conceived in a technique devised by Steptoe and Edwards. (AP Laser-photo)

from a blockage of her fallopian tubes, which carry the egg from the ovary to the uterus and in which fertilization normally occurs. Surgery and other measures to remedy the defect failed, and about two years ago she went to Dr. Steptoe and Dr. Edwards.

In the technique that they use, the woman is treated with hormones to stimulate maturation of eggs in the ovary, then a needle is inserted into the ovary to draw them out. A ripe egg is placed in a dish of blood serum and nutrients and sperm is added for fertilization. When fertilized, the egg is transferred to another dish and divides

into a blastocyst.

The woman then receives more hormone treatments to prepare the uterine lining, the blastocyst is placed in the uterus, attaches to the wall and normal embryo development proceeds.

There have been reports of many test-tube conceptions that failed in pregnancy, including several in experiments conducted by Steptoe and Edwards.

The two doctors teamed up in 1966. Steptoe pioneered laparoscopy, a technique used to see inside the abdomen and other body cavities by inserting a tube with a fiber optic light.

Carter Expected In Eastern N.C.

RALEIGH, N.C. (AP) — President Carter is expected to visit eastern North Carolina on Aug. 5 to campaign for U.S. Senate candidate John Ingram and improve his image with tobacco farmers.

Sources in Washington and Raleigh said details of the president's visit, including exactly where he'll be, may be announced today.

"I am informed reliably from the White House that he is coming Aug. 5," said state Agriculture Commissioner Jim Graham. He said details of the visit had not been worked out Tuesday afternoon.

"All I can say is that (the visit) probably will be east of Greensboro," state party Chairwoman Betty McCain said.

"He's coming to help John Ingram beat Jesse Helms," Mrs. McCain said. Ingram, the state insurance commissioner, is the Democratic nominee challenging Sen. Jesse A. Helms, R-N.C., in November.

Carter has visited the state twice in the last seven months. The last time was in March, when the president delivered a foreign policy speech at Wake Forest University in Winston-Salem. Last December, he stayed overnight in Fayetteville to attend the wedding of his nephew, Scott Stapleton.

Mrs. McCain said the state party was hoping for a second Carter campaign visit this fall to be tied to a fund-raising event for Ingram.

One Democrat said the Ingram campaign hoped the visit would give exposure to Ingram and boost his appeal to farmers. He said Carter was popular with farmers, including tobacco growers, despite the U.S. Department of Health, Education and Welfare's anti-smoking campaign.

But an agriculture official said the main purpose of the visit was to shore up the president's stock in the tobacco state, and that any benefits to Ingram were incidental.

N.C. Border Belt Sales Well Ahead Of 1977's Opening

LUMBERTON, N.C. (AP) —

North Carolina's Border Belt tobacco market opened today with sales running \$10 to \$35 per 100 pounds higher than last year. At the Star Tobacco Warehouse, the top price in the early morning sales was \$155 per 100 pounds, the same top price seen on the Georgia and Florida flue-cured markets last week.

The Flue-Cured Tobacco Cooperative Stabilization Corp. got only a small percentage of the tobacco sold, a sign of high quality in this year's crop.

John Cyrus of the state Agriculture Department said the higher quality of the tobacco in the warehouses and the higher prices were due in part to the decision by many tobacco farmers to leave downstalk leaves in the fields.

He added that he hoped today's sales would encourage farmers to continue to leave those lower-quality leaves unpicked for the rest of the season, a step officials have sought in hopes of easing pressure on the federal price support program.

Eight warehouses opened auctions today, with 10 to 12

buyers on hand, including the American, Liggett and R.J. Reynolds tobacco companies.

Prices ranged from \$93 per hundredweight to the top of \$155.

Agriculture Commissioner Jim Graham said after the Star sale that this was one of the best years for tobacco that he had seen on the border belt since he took office 14 years ago.

Trade Deficit For June Said 'Encouraging'

WASHINGTON (AP) — The United States recorded the smallest trade deficit in more than a year last month as U.S. businesses sold a record \$12.1 billion in products to other countries, the Commerce Department said today.

The June trade deficit of \$1.6 billion was encouraging because the growing trade gap had contributed to inflation at home and the decline of the dollar overseas.

Americans bought \$13.7

billion in goods from overseas, a 2 percent decline from June, the department said. Oil imports, the biggest cause of the deficit, dropped from \$3.32 billion in May to \$3.29 billion in June. Steel imports also dropped markedly.

Exports, totaling \$12.12 billion, were an increase of 3 percent from May, mainly because of strong sales overseas of U.S. aircraft, automobiles, machinery, coal, meat, cotton and steel.

The June trade deficit of \$1.6 billion was smaller than the \$2.2 billion deficit in May and the \$2.9 billion deficit in April. Deficits have been posted for the last 25 straight months.

The report indicated the U.S. trade picture in June was the best since a \$641-million deficit in May 1977.

In the first half of this year, U.S. imports have exceeded exports by \$16.4 billion. If that continued all year, the trade deficit would be \$32 billion, well ahead of the record \$26.5-billion deficit in 1978.

However, the Carter administration says the monthly deficits should become smaller from now on.

Ironically, the decline in the value of the dollar makes U.S. businesses more competitive.

Investigating 8 County Elections Boards In N.C.

RALEIGH, N.C. (AP) — Federal officials confirmed Tuesday that the FBI is investigating allegations that eight county elections boards in North Carolina may have denied college students the right to vote through unfair registration practices.

The agency is investigating student voter registration procedures in Wake, Orange, Durham, Pitt, Mecklenburg, Guilford, Jackson and Watauga counties, according to Herbert L. Monahan, FBI special agent in charge of North Carolina operations. Each of those counties contains a college or university.

The investigation was ordered by the Civil Rights Division of the U.S. Department of Justice after H.M. "Mickey" Michaux, U.S. attorney for the middle district of North Carolina, filed a complaint with the Justice Department over registration practices in Orange County, officials said.

Michaux said Tuesday that the probe was expanded to eight counties after he received complaints about student voter registration practices in other parts of the state.

"Within these counties, there may be more rigorous standards for student registration than the standard requirements for non-students," Michaux said. "As a result, students may be denied their right to vote."

The registration practices may violate the Voter Rights Act of 1965, Michaux said, which prohibits literacy tests or other obstacles to voting, as well as the 26th Amendment, which gives all adults between the ages of 18 and 21 the right to vote.

The complaints levied against the elections boards have to do with special questions asked of students, but not of non-students, about county residency, Michaux said.

He cited as an example a questionnaire that all students at the University of North Carolina in Chapel Hill were required to complete before they could register in the spring elections.

Following a February hearing on a lawsuit filed by a group of Orange County conservatives against the county board of elections, Wake County Superior Court Judge James H. Pou Bailey Jr. ordered the board to ask each student wishing to register to fill out a 15-item questionnaire.

The questionnaire asked student whether they would live in Chapel Hill if the university were not there. The state Court of Appeals later stayed Bailey's order, but voters were challenged at the polls in the May 2 primary.

"It started with Orange County," Michaux said. "Then, as the department got into it, the other counties were included."

Eye-Openers

NEWARK, N.J. (AP) — Can't sleep? Can't stay awake? A sleep researcher is looking for you.

Dr. James Minard, an associate professor at the College of Medicine and Dentistry of New Jersey, is seeking volunteers for a study of such disorders.

"One-third of all patients seen by family doctors have a sleeping disorder," Minard said.

Sleep can be controlled by waking to something pleasant, he said. He told of one person whose clock radio turns on a coffee pot and the 1812 Overture.

"Coffee is permeating the room, and the 1812 Overture starts out gently and builds up to cannons," he said. "If the person stays in the room, the cannons will start going off."

Such a set-up is better than being driven from bed by a raucous alarm.

"Reward is much more effective than punishment," he said.

Ethics Opinion Bars Councilman From Field

By CAROL TYER
Reflector Staff Writer

Greenville City Councilman, Charles M. Vincent, an attorney, has received an opinion from the North Carolina State Bar Ethics Committee "that an attorney who is a member of a City Council cannot represent defendants in criminal proceedings in which police officers of the city are the prosecuting witnesses."

Vincent requested this opinion Dec. 1, 1977, the day before he was sworn in as a Greenville Council member.

The opinion further states that "Neither may any

member of the councilman's firm represent defendants in this particular situation."

Vincent, who serves as Mayor Pro-Tem, said that he will abide by the decision, as will all members of his law firm. He added that three days before he requested the opinion (Nov. 29, 1977) he informed the Pitt County Clerk of Superior Court in a letter that he would take no further cases involving the Greenville Police Department until he could obtain the opinion.

He asked that neither he nor his law partners, David Dufus Jr. and Nigle B. Barrow

Jr., be appointed to any indigent cases involving the City Police Department.

A short time later in a telephone conversation with a member of the State Bar staff, however, he was told that, until he received an official opinion from the Ethics Committee, he and his partners should once again take up the practice of criminal cases in which the City Police might be involved in the prosecution.

He decided within himself, however, he said that until the matter could be officially resolved, he and his partners

would continue to turn down any cases in which they felt they might have to "question the integrity of a police officer."

Early this year he received a request from the Bar for more information. The Ethics Committee wanted to know, he said, the structure of the city government. He replied that the city police officers and even the chief are hired, not by the City Council, but by the city manager; that the grievance appeal system for the police officers stops with the city manager, not the Council; and that only across the board raises for all city

employees, not merit raises or decreases in pay, are voted by the Council.

He was told that his inquiry would be dealt with by the Ethics Committee by March or April. The ruling was dated July 14, 1978.

In a letter to the secretary of the State Bar Association, Vincent has requested that the fact that the city has a full-time police attorney and a city attorney be added to the facts as set forth in the opinion.

He said he sees "potential far-reaching effects" of this

ruling. "Because of this opinion," he said, "attorneys practicing criminal law are virtually excluded from public service in any legislative capacity."

He said he believes this decision "will place a great burden on young attorneys who intend to specialize in trial practice."

He said he will continue to serve on the Greenville City Council and will now be primarily engaged in civil cases, but "will still practice criminal law when Greenville police officers are not the prosecuting witnesses."

REFLECTOR

HOTLINE



752-1336



Hotline gets things done for you. Call 752-1336 and tell your problem or your sound-off or mail it to Hotline, The Daily Reflector, Box 1967, Greenville, N.C. 27834.

Because of the large numbers received, Hotline can answer and publish only those items considered most pertinent to our readers. Names must be given, but only initials will be used. Transcribing is done once a day.

TV TRANSFORMER

I have an Olympic color television set, Model CT-519, which needs a high voltage transformer replaced. I can't find one in this area and have tried to contact the company, but find it's either gone out of business or confined its operations to the West Coast. I don't know how to find out for sure. My tv is useless without this part. J. J.

Hotline suggested first that you check with Shepard Memorial Library about the address of the company. This turned up nothing, though, so we called and talked to a very helpful fellow at Pair Electronics here. He did a thorough check for alternate parts but found there are none for the high voltage transformer you need. (Some of the other parts of Olympics do have alternate parts however, he said.) He said Pair has two to three calls a week from persons having or trying to repair Olympics and that, to the best of his knowledge, the company is completely out of business.

He suggested your only hope is to find someone with an Olympic who is willing to sell it to you for the high voltage transformer and perhaps for other parts you may need later on. The transformer from a used model probably would be satisfactory, he said.

So if any one of Hotline's readers has an Olympic color tv set with which he or she would be willing to part, we ask him or her to call 756-1393.

Commodities Broker Finds Job Exciting; 'It's A Mixture'

By Edward Craig
UPI Business Writer
NEW YORK (UPI) — For better or worse, men have played a very important part in the life of George Williams. Ms. Williams runs the Houston, Texas, office of Conti-Commodity Services Inc., a commodities futures broker. She recently was named by the national board of the Young Women's Christian Association as an outstanding woman manager in international business. Married twice, Ms. Williams set out on the path to her

present career after her first marriage disintegrated and she needed a job; she had two small children to support. This was in 1970, and when she started looking a clerical job was open at the Beaumont office of the Continental Grain Co., parent of Conti-Commodity.

A woman at an employment office, where the job had been registered, told Ms. Williams not to bother going for an interview since she was hardly qualified for it. Fortunately for Ms. Williams, the head of the Beaumont office was Les Strader, a man dedicated to

seeking opportunities to end whatever prejudice existed against women in business. Following a lengthy interview with Strader, Ms. Williams went home, got a phone call a few hours later and went to work for Continental the next day.

"Strader boosted any woman who showed the least bit of initiative," Ms. Williams says.

She left the job in 1973 after rising to secretary and grain buyer for the area covered by the office, and joined Conti-Commodity's Lubbock office, at that time managed by Wade Collins.

"He was another man in the pattern of Les Strader," Ms. Williams says. During the time she spent there, Collins installed a woman in every desk job in the office. Collins is now at Conti-Commodity's Kansas City office.

She was made manager of the firm's Houston office in April, 1977, and she would be content to make Houston her home for the remainder of her working career. It's about 100 miles from her birthplace at Beaumont.

"I figure the Houston office has plenty of growth ahead and I expect to grow along with it," she says.

To the uninitiated, trading in commodities may seem about as thrilling as watching macaroni come to a boil, but Ms. Williams doesn't see it that way.

"My job is exciting because it is a mix of formulating a marketing strategy, selling, executing trades at the right time, and dealing with governmental agencies," she says.

The money is pretty good, too, though Ms. Williams says she doesn't make its acquisition "an obsession." She lives simply with her two children, Jeffrey (eq. 13, and Gina, 9, product of her marriage to Lee Roy Leone, a saxophone player she met on a visit to a night club. The marriage lasted six years. Her second marriage, to Jack Williams, a salesman, in 1974 lasted two years.

Between her career and her children, Ms. Williams finds life too full to think about trying married life again.

Among her outside interests are the choir at the Gethsemane United Methodist Church at Houston, and her "high spot" of the week is Thursday night choir practice. "I find singing very relaxing after a particularly burdensome day at the office," she says.

Some years back she taught

ballroom dancing at night, more to help her unwind than for the financial benefit involved.

Where her children are concerned, Ms. Williams hopes to help them gather "a broad wealth of experiences," particularly along cultural lines. Jeffrey plays the trombone and Gina is a dancer "with a great sense of rhythm."

"If they want to pursue careers like these, I'll give them whatever encouragement they need," she says.

She spends much of her spare time with the children, on picnics or at the beach or camping in the woods.

She grew up in a country setting in Beaumont with the nearest neighbor two miles away. She still misses "the alligators in the marshes, the geese overhead, the wolves howling at night."

She was named after her father — George Wismar — and the extra "e" to her name developed because she was the third child — and third girl — in the family. Her parents had hoped for a boy.

"They wanted to name me 'Last Chance' because no more children were planned, but thank the Lord someone put his feet down," she says.

Family Reunion Held

The descendants of the late Lula and Lonnie Lowe of Columbus, Ga., attended the 15th annual family reunion in Washington, D. C., Friday through Monday. Approximately 150 persons from five states and the capital attended.

Friday, family members toured Washington by subway, followed by a shopping expedition. Burnest Griffin of Glen Arden, Md., hosted a cookout Friday night.

Saturday, members met in Bradbury Heights. After registration and a get acquainted session, Burnest Griffin gave the welcome address.

National reunion chairman George W. Griffin of Havre de Grace, Md., led the business session. Other national officers included treasurer and acting secretary, Pauline C. Brown, Greenville and Harold Lowe, vice chairman, Chesapeake, Va.

Elected officers for the next two years were Mrs. Rosa McNair, chairman, Greenville; Earl Lowe, vice chairman, Washington, D. C.; Mrs. Margaret G. Lloyd, secretary, South Ozone Park, N. Y.; Miss Wanda London, assistant secretary, Washington, D. C.; Mrs. Gladys Lowe, treasurer, Washington, D. C.; Kenneth Lowe, chaplain, Columbus, Ga.

An afternoon program, "A Reflection of Our Roots, Growth and Accomplishments," was presented by the members of the Washington, D. C. area. The program featured a fashion show, featuring Londie Blackwell, Donna Blackwell, Burnest Griffin, Lonnie (Bobby) Lowe, Pamela Lowe, Paula Porter and Rosalind Porter.

Other events included attendance of "The Wiz" at the Kennedy Center and a wine and cheese sip at the home of Lonnie C. Lowe. Members also attended the Sunday worship service at Miles C. M. E. Church.

Local officers who spearhead-

Births

Smith

Born to Mr. and Mrs. Thomas Earl Smith, Rt. 1, Grimesland, a son, Levion Tiras, on July 17, 1978, in Pitt Memorial Hospital.

Barnes

Born to Mr. and Mrs. Jimmy Lee Barnes, Fountain, a daughter, Angel, on July 18, 1978, in Pitt Memorial Hospital.

Doiron

Born to Mr. and Mrs. Thomas Lincoln Doiron, Rt. 1, Sanford, a daughter, Rebekah Elizabeth, on July 18, 1978, in Pitt Memorial Hospital.

Clemons

Born to Mr. and Mrs. Ernest Benjamin Clemons, Rt. 2, Greenville, a daughter, Angela Nicole, on July 19, 1978, in Pitt Memorial Hospital.

Comar

Born to Mr. and Mrs. Paul Gerard Comar, 2410-B E. Third St., a son, Benjamin Paul, on July 19, 1978, in Pitt Memorial Hospital.

Atkinson

Born to Mr. and Mrs. Wilbert Earl Atkinson, 101 Charlie's Lane, a daughter, Tamara Antoinette, on July 19, 1978, in Pitt Memorial Hospital.

Wilson

Born to Mr. and Mrs. Earl Wayne Wilson, Rt. 1, Grimesland, a son, Earl Wayne Jr., on July 20, 1978, in Pitt Memorial Hospital.

Worthington

Born to Mr. and Mrs. Steven Glen Worthington, Rt. 1, Ayden, a daughter, Bethany Susan, on July 20, 1978, in Pitt Memorial Hospital.

Cope

Born to Mr. and Mrs. Donald Ray Cope, Farmville, a daughter, Donna Marie, on July 20, 1978, in Pitt Memorial Hospital.

Tyndall

Born to Mr. and Mrs. William Earl Tyndall, 303 N. Sylvan Dr., a daughter, Shannon Renee, on July 21, 1978, in Pitt Memorial Hospital.



Homemaker's Haven

By Sue B. May
Pitt Home Agent

Blend Styles In Home Decorating

If you want to furnish your home in a unique way, consider decorating the eclectic way. Eclectic is the word used to describe today's carefree way of decorating. It's a day of mix and match.

Contemporary furniture blends well with Shaker styles — both have simple, straight lines. Or you might try mixing the round, bulkiness of late Victorian furniture with contemporary styles.

The boxes, squares and metal hardware of the Campaign look complement Oriental furniture. Or you can try mixing Campaign with Victorian, with wicker or with straightlined styles.

So, experiment with today's carefree decorating ideas, especially if you already have a variety of furniture items. No longer do all end tables have to match. Nor do all woods have to be the same. Old furniture can blend right in with the new.

It's a shame to throw away old furniture without exploring the possibilities of renovating it. Old furniture is often pleasing in design and well-made. Sometimes a professional is needed to put the old piece in good condition — sometimes family members can rework the item. There are many satisfactions to be gained from being a "do-it-yourselfer."

One benefit is the creativity it affords. The individual — distinctly yours. Renovated, restyled or refinished furniture gives you the chance to see your own plans and ideas come to life.

In addition, you can learn new skills as you contribute to the

beauty and livability of your home. There is also an economic benefit. By refinishing and restyling old or discarded furniture, you can save dollars that could go a long way toward buying appropriate fabrics, paints and accessories that can add beauty to your home.

And a fourth benefit is recreation. Reworking old furniture can be an interesting hobby, a family project or a way to earn extra money. Last, but not least, you can help preserve your family's tradition and heritage. Especially if you restore family heirlooms that have a great deal of sentimental value attached to them.

So eclectic decorating, using both old and new, may be the best and the least expensive way to go. It is truly "doing your own thing." It's a matter of mix and match — of blending styles in a pleasing manner.

PLAKTIQUE
"We make it white — you make it bright!"

Come in and see our new selection of white ware.

Painting lessons available!

752-0761
Open Mon. - Fri. 11 - 5:30
108 W. 10th St.
In Photo Arts Bldg.

LEMON CUSTARD PIES

Dieners Bakery
815 Dickinson Ave.

coppes

America's Oldest Continuous Maker Of Custom-built Kitchens 1876-1978

Ariane Clark
Custom Kitchens

Sub-Zero Jenn-Air Thermador
756-4342

Pixy SUMMER SPECIAL

95¢
REG. \$1.95

For one 5x7 portrait or set of four wallets in NATURAL COLOR. (Additional portraits at regular prices; One 5x7 or set of four wallets \$1.95 each. 8x10 only \$3.90)

ALSO SAVE OVER \$3

ON THIS \$15.60 PACKAGE

- One 8 x 10
- Three 5 x 7's
- Twelve wallets

Apply your 95¢ and pay **ONLY \$11.50** more for 16 beautiful portraits.



Age limit 12 years. Select from several poses and scenic backgrounds. Copies and enlargements available at higher prices. Extra charge of \$1.00 for 2 or 3 children together.

Special prices in effect these dates only:

July 27, 28, 29

Hours: 10 A.M. to 1 P.M.
2 P.M. to 6 P.M.

JCPenney

1977 JCPenney Co., Inc.

JCPenney-Pitt Plaza.



Dear Abby

Added Tip Caused Embarrassment

By Abigail Van Buren
© 1978 by Chicago Tribune-N.Y. News Synd. Inc.

DEAR ABBY: Recently our daughter was married to a young Californian. His parents came for the wedding and stayed at our home.

As is the custom, the groom's father hosted a dinner party the evening before the wedding. But being unfamiliar with Milwaukee restaurants, he asked us to make the dinner reservations for him, so we selected a famous German restaurant. When the check was presented to the host, we were embarrassed to find that the waitress had added a \$25 "tip" for herself. When we questioned the practice, she said it was customary for parties of more than 10 people.

It was a very awkward situation for all of us, and we felt especially embarrassed because we had made the reservation.

Have you (or anyone else) ever heard of such a custom? BRIDE'S PARENTS

DEAR PARENTS: Some clubs, hotels and restaurants routinely add "gratuities" to the bill for special services (group dinners, etc.). But when a waitress specified her tip on her own, I would ask for the management's confirmation — and schnell!

DEAR ABBY: I am a 17-year-old-girl who has been in love with a guy I'll call Donny since last summer. He broke up with me because he said I wouldn't let him go out with the boys as often as he wanted to.

I gave in to him a lot, but I was one of the lucky ones who didn't get pregnant. Donny would come and get me, and after he got what he wanted, he'd bring me home and take off to be with his friends. Abby, I never said no to him because I loved him a lot and still do, but he always was in a hurry to get away from me.

He treats me just great when we're together, but when I'm up to his house with his sister, he ignores me. I want to know what Donny really thinks of me, but he won't commit himself. I have told him I loved him several times, but he's never told me that. How can I get Donny back, Abby? NO NAME, PLEASE

DEAR NO NAME: I don't think you can get Donny "back" because you never really had him — for any longer than it took him to "get what he wanted" before taking off. He used you, dear. Now, be a wise girl and make up your mind to forget him. And never let another boy use your again — or you can expect one rejection after another.

DEAR ABBY: I am married and the mother of six. My problem is dogs — seven of them! I like dogs, but not enough to let seven of them live in the same house with me. I can't get my husband to put them outside.

I can't keep my floors clean, and company will not come to my house because the dog odors are so strong. Abby, those dogs even get up on my beds. I am just about nuts from those dogs, but my husband won't cooperate. What should I do? DOG PROBLEM

DEAR PROBLEM: You have a HUSBAND problem — not a DOG problem. Even a dirty dog deserves a decent place to live, whether it's inside or out, but seven dogs sounds like six too many to me. Set up a howl!

CONFIDENTIAL TO L. S. IN BRENTWOOD. I don't know whether they don't want to quit smoking or can't, but three people whose smoking bothers me the most are Johnny Carson, Jerry Lewis and Sammy Davis Jr. Why? Because they are among the most talented entertainers of our time. I would like to see them around for a long, long time — and smoking reduces their chances.

If you put off writing letters because you don't know what to say, get Abby's booklet, "How to Write Letters For All Occasions." Send \$1 and a long, stamped (28 cents) envelope to Abby: 132 Lasky Drive, Beverly Hills, Calif. 90212.

Susan's

Susan's has a wide selection of summer dresses, sportswear, swim suits and jewelry all for...

1/2 Price

331 Arlington Blvd.

Summer Merchandise

all 1/2 off

Let us bag it up for you!

the Snooty Fox

203 East Fifth Street
Greenville, N.C.

Ended By A Thoughtless Act

Dr. Peter Bourne, in one thoughtless moment last week, ended his career as advisor to the president on drugs and narcotics.

Dr. Bourne allegedly wrote a prescription under a fictitious name for a woman member of his staff.

When another woman attempted to have the prescription filled an arrest was made and the Carter administration had an embarrassing incident on its hands.

Dr. Bourne was placed on leave without pay during the day, but the president had a nationally televised press conference scheduled for that night.

The matter was more or less resolved for the administration when Dr. Bourne delivered his letter of resignation to the president during the afternoon.

Nevertheless the Bourne incident was very much on the minds of the news people gathered for the

press conference that night. More than once the question came up, although the president generally stuck to a position of not commenting on the specifics of the case.

The Bourne matter, while relatively small as incidents go at the top level of government, cast a pall over the presidential news conference. It deflected attention from other important issues and almost certainly the president was concerned with the fate of a close political associate.

That, however, is how it goes for one who occupies the White House. Surprises lurk around every corner and unpleasant news can crop up at the very moment of a scheduled news conference. A president frequently has enormous control over world events, but he can't always anticipate or control the actions of those closest to him.

End Of A Difficult Time In New Bern

Last weekend the final police officers who had left their jobs at New Bern three weeks back were reinstated.

They joined their chief, who at one time was fired

by the City Council, in returning to their jobs.

It was a difficult period for one of our state cities, and everyone can be pleased that the New Bern police force is back at work.

THIS AFTERNOON 'Encouraging' Of Growth

By **BILL NOBLITT**
(2nd of 2 Articles)

RALEIGH — Two enormous questions remain unanswered in the discussion paper on Balanced Growth for North Carolina now being circulated and debated as a growth policy proposal is prepared for the 1979 General Assembly.

stated on numerous occasions his conviction that jobs should be provided where the people have their roots in the land.

The Policy outline reflects those concerns. "Small cities are what make up the balance in balanced growth. They are the only real opportunity for the people left behind to have a better way of life. We have to know more about small cities, especially those under 10,000 people. We should have an assessment of their capacity for growth, their needs and general attitude toward development", the report states.

to help revitalize inner cities and provide jobs for low-skill unemployed or underemployed.

Thus, the discussion paper begins to pull into focus a system whereby urban clusters can be identified, and those already overbuilt and those ready for new growth and those unprepared or uncommitted to growth labeled.

potential to support additional growth.

"This means that it has attained a certain minimum size and economic role within its region and has adequate public facilities to support some growth without additional investment.

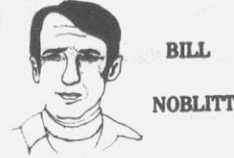

BILL NOBLITT

The result: a Growth Center Classification system, described in the policy discussion paper this way:

Growth Center

"The growth center concept is a way to distinguish between the clusters which can support additional growth now, and those which cannot. A growth center is defined as a community which has a significant

Designation as a growth center would give a community priority for assistance under Balanced Growth Policy."

Some unit of government, then, would pick the growth centers, establish priorities, and control the flow of millions in state and federal dollars into public works projects to make certain communities grow.

Other communities would, necessarily, not get that favored attention ... consequently, growth would be slower or absent for a long time into the future.

The outline for discussion proposes a statewide commission working under the governor's leadership and with the Regional Councils of Government in carrying out the policy once it is written into law by the General Assembly.

TOO BIG TO NEED A SECURITY BLANKET!



An Old Picture Is Best

By **HUGH A. MULLIGAN**
AP Special Correspondent
RIDGEFIELD, Conn. (AP) — Our promotion people have asked me to supply a new photograph of myself to keep up with the changing times. It seems the old high school graduation picture is losing credibility among some editors.

"At 50," said George Orwell, "every man has the face he deserves."

I don't know what I did to deserve this one, which an Army psychologist down at the draft board once described as "pith-canthropeid," except he wrote it on the line marked "religion."

I looked the word up in the dictionary and there was a line drawing of a skull grinning out of a lantern jaw over the caption: "extinct genus of apelike men of the Pleistocene epoch of Java."

Being in the column writing business, I decided it might be best to avoid any associations with corn.

Next, I thought I might have my picture taken brooding out over a typewriter through a thin veil of cigarette smoke, after the manner of Norman Mailer or Noel Coward on a book jacket.

The trouble is I only smoke an occasional cigar on important anniversaries and occasions of state (meaning, when someone gives me one), and a cigar always makes you look like a ward heeling politician or, if your suit is new, a bank director.

Since I covered quite a few wars for The Associated Press in Asia, Africa and the Middle East, the promotion people suggested something in a jeep or getting off a helicopter. There is one of me in a jeep, taken in Da Nang, except there are four or five chorus girls in miniskirts from the Bob Hope show also riding along.

That picture was difficult enough to explain at home the first time around, and I don't care to go into it again, since few people really appreciate the sacrifices correspondents

(Continued on page 5)

By ART BUCHWALD The Answering Service

MARTHA'S VINEYARD, Mass. — What I did on my summer vacation:

I was a telephone answering service. Only people who have children between the ages of 14 and 30 will appreciate what an important function I performed.

I always started after dinner as soon as my daughter Jennifer asked, "Can I use the car?"

"What time will you be back?" I asked.

"Not late. If Debbie calls tell her I went with Tony over to Mike's, and if she doesn't get us there we'll be at David Crohan's Bar in Oak Bluffs."

"I gotcha," I said, writing it down.

Half an hour later the phone rang. "Is Jenny there?"

"Is this Debbie?" I asked.

"No, it's Sarah. And she was supposed to meet me at the Cafe du Port in Vineyard Haven," she said.

"Well, she went with Tony over to Mike's."

"Which Mike?"

"She didn't say which Mike. Is there more than one?"

"There are three. If she calls back tell her I went to the party at Ben's."

"The party at Ben's. I've got it."

Fifteen minutes later the phone rang again. It was Ben who wanted to tell Jenny about the party.

I explained that she was with Tony at Mike's, but was going to David Crohan's Bar.

"Well, if Angel calls," Ben said, "Tell him I need ice and wine."

"Why would Angel call?" I asked.

"To find out where Tony went."

"I gotcha," I said, writing it down. "Tell Jenny about your party and Angel about bringing ice and wine. Do you have any message for Debbie?"

"Who's Debbie?" Ben said.

"I don't know, but she's supposed to call Jenny and

I'm to tell her she's with Tony and they went over to Mike's and then they're going to David Crohan's Bar."

"Well, don't tell Debbie about the party because I don't know how many people will be with her."

"My lips are sealed," I promised.

I got into a hot tub when the phone rang again.

The party on the other end asked for Jenny.

"Who's calling?"

"Gordon Manning."

"You can find her at Mike's, David Crohan's Bar or Ben's party, depending how lucky you are."

"I'm calling from New Hampshire."

"That's too bad. There're lots of great things going on here," I told him.

"Well, will you tell Jenny I'm coming down on Tuesday and ask her to leave my beach pass with Ellen in Edgartown? But tell her not to tell Betsy I'm coming. You got that?"

"Of course I've got it. You think I'm a dummy? Listen, I have to get off the phone because I'm expecting a call from either Debbie or Angel or the police in Chilmark depending how lucky I am."

I started to worry about why Debbie or Angel hadn't called. I was watching Johnny Carson when the phone rang again.

It was Jenny. "We didn't go to David Crohan's. We're at the Phillips' in Lambert's Cove."

"Now you tell me," I said angrily. "Everybody's trying to find you with the exception of Debbie, who never called."

"She's with us," Jenny replied.

"And where the hell's Angel?" I wanted to know.

"He went back to Boston."

"Do you realize Ben was counting on him to bring the ice and wine to his party? Why didn't you call me?"



ART BUCHWALD

THE INSIDE REPORT

Aid-To-Israel Cut Raised

By **ROWLAND EVANS** and **ROBERT NOVAK**
WASHINGTON — Behind the scenes scrutiny of Washington's fat economic aid program for Israel will almost surely result in a cut from the \$800 million level of the past five years.

Although President Carter has repeatedly promised not to use U.S. military aid as a "lever" to pressure Israeli Prime Minister Menahem Begin, no such promise covers economic help — known as security supporting assistance.

Officials refuse to speculate on how deep the reduction may be for fiscal year 1980 — starting Oct. 1, 1979. But Israeli leaders have been quietly led to believe that both the Carter administration and a Congress increasingly restive over Israel's resistance to U.S. Mideast peace proposals will go for a sizeable cut if the peace stalemate continues.

Unlike the annual \$1 billion military aid program, economic aid is loosely earmarked, giving Israel great leeway in its use. Any reduction or new regulations governing its use would damage Israel's ailing economy and probably have a pronounced impact on its overall military strength.

If Israel's hard-line posture on a Mideast peace settlement softens and a comprehensive plan begins to emerge, aid cuts of any kind would be ruled out. The preliminary look now being given to cuts for the 1980 program shows how little optimism really exists inside the administration.

Schlesinger's Hard Line

A major unseen force behind President Carter's decision to slow oil technology transfers to the Soviet Union was Secretary of Energy James Schlesinger, intervening in a national security question for

the second time in recent weeks.

Schlesinger argued that the sale of oil-drilling equipment to Moscow is so sensitive that the President's approval should be required for each transaction — opposing the State Department's position. The former Republican secretary of defense earlier had opposed the State Department, contending that Soviet compliance with a proposed comprehensive nuclear test ban treaty could not be verified.

Schlesinger has been the only high-level administration official supporting national security adviser Zbigniew Brzezinski's tough line on technology transfer. Surprisingly, Secretary of Defense Harold Brown sided with the State and Commerce Departments in opposing any curbs on U.S.-Soviet trade.

A footnote: Secretary of State Cyrus Vance made a strong pitch to the president in Europe against limiting technology transfer. "Cy is just opposed to economic warfare," one insider told us.

Caputo's Help

Rep. Bruce Caputo, who enraged Speaker Thomas P. (Tip) O'Neill and the House Democratic establishment with his conduct in the

Korean scandal investigation, could be the decisive factor in defeating Democratic Gov. Hugh Carey in New York.

A major reason why Caputo, 34, was named to the Republican ticket as lieutenant governor was a startling private poll in critically important Westchester County, giving Caputo only a 1 percent negative rating in his home county.

What's more, the poll indicates dramatic gains in Westchester for state assemblyman Perry Duryea, the Republican nominee for governor, when paired with Caputo — enough to give him a comfortable statewide lead over Carey.

Iraq's Soviet Fear

An edict from Iraqi strongman Saddam Hussein for automatic execution of any Iraqi military officer found to have a connection with Iraq's Communist party marks a new plateau of Arab fear of Soviet political penetrations.

The secret order was circulated after 20 army officers, long held in military jails, were executed recently on charges of plotting with the small but tightly organized Iraqi Communist party.

(Continued on page 5)

Public Forum

Letters submitted for Public Forum must be limited to 300 words.

To the editor:

Pres. Carter has designated July 25-31 as National Farm Safety Week in America. The theme of this year's observance "Manage to Prevent Farm and Ranch Accidents," marks the 35th annual observance.

The observance is sponsored jointly by the National Safety Council and U. S. Department of Agriculture and emphasizes the need for farm safety as a means of reducing costly accidents that hamper agricultural productivity and cause great personal loss to thousands of farm families.

Farmers and ranchers not only have to contend with bad weather, lack of help, disease, cost price, but also accidents which cost over \$3 billion last year. Approximately 5,400 farm residents lost their lives and another 480,000 suffered disabling injuries last year. According to the National Safety Council, farm deaths and injuries to farm and ranch residents accounted for 1,600 and 160,000 of this total respectively.

We can't do much about the weather but we can do much to prevent accidents: 1. Make accident prevention a management goal — develop a safety plan tailored to your operation. 2. Keep informed — follow directions for product use. 3. Inspect and keep equipment in good repair. 4. Train helpers on safety procedures. 5. Keep children off and away from machinery. 6. Know your own physical and mental limitations. 7. Be prepared for medical, accident, fire and weather emergencies.

Let's be farm safety conscious all year long, as well as during National Farm Safety Week.

Joyce Mills, Safety Committee
Pitt Co. Assn. of Insurance Women

40 Years Ago Today

July 26, 1938

More heavy rains sent Eastern North Carolina rivers toward new and higher flood levels today.

Crops in lowlands along the Roanoke, Neuse, Tar and Cape Fear rivers were covered by muddy waters. Small bridges on a number of county roads were washed out and numerous dirt roads were becoming impassable.

The upper Tar River was considerably out of its banks at Lenoir and leaving the banks at Rocky Mount with a heavy flood in prospect.

Mayor M. K. Blount was in Raleigh today attending a meeting of the Legislative Committee of the North Carolina League of Municipalities of which he is chairman.

The league's annual convention will be held in Asheville August 5-6 and the mayor, City Clerk J. O. duval and members of the Board of Aldermen are planning to attend.

Mayor Blount is second vice-president of the league and stands to be elected president of the 1939 confab.

— Lynn Caverly

The Daily Reflector

INCORPORATED
209 Cotanche Street, Greenville, N.C. 27834
Established 1882
Published Monday Through Friday Afternoon and Sunday Morning

DAVID JULIAN WHICHARD, Chairman of the Board
JOHN S. WHICHARD—DAVID J. WHICHARD
Publishers
Second Class Postage Paid at Greenville, N. C.

SUBSCRIPTION RATES
Payable in Advance

Home Delivery By Carrier or Motor Route Monthly	\$3.00
By Mail	
One Year	\$36.00
Six Months	18.00
Three Months	9.00

MEMBER OF ASSOCIATED PRESS
The Associated Press is exclusively entitled to use for publication all news dispatches credited to it or not otherwise credited to this paper and also the local news published herein. All rights of publications of special dispatches here are also reserved.

UNITED PRESS INTERNATIONAL

Advertising rates and deadlines available upon request.
Member Audit Bureau of Circulation.

Strength For Today

LIMITS OF MYSTICISM

Mysticism is today becoming a popular approach to religion. The ultimate religious experience, we are told, is getting in tune with the infinite. When this happens, our role is to be quiet and receptive, and let God speak to us.

This is valid, but a one-sided interpretation of religion. The Christian experience is not only mystical, under some circumstances it becomes downright belligerent. The Christian

must undertake to battle against evil in all of its forms. He cannot lie back and let the spirit of quietness and receptivity overwhelm him. Such a reaction can become retreat and capitulation when the Christian is confronted with the things that need to be changed in this world.

So let us try to have balance in our religion — mysticism where it is indicated and struggle where that is necessary. It takes many sorts of experiences to make religion real to everybody.

— Elisha Douglass

Millions Are Clipping Coupons

By **LOUISE COOK**
Associated Press Writer

Clip and cash.

That's the motto for millions of Americans who are clipping, collecting and cashing in coupons in an effort to cut grocery bills.

The U.S. Department of Agriculture estimates that four out of five families — 80 percent — use coupons today. In 1970, a survey by the Nielsen Clearing House division of the A.C. Nielsen Corp. showed only 65 percent of all households using coupons.

Manufacturers alone are expected to issue almost 70 billion coupons this year, according to the USDA, up from 62 billion in 1977 and 46 billion in 1976. (Those figures do not include the millions of coupons issued by retailers, usually in newspaper advertisements.)

The more than two billion coupons redeemed last year had a face value of \$500 million, the Agriculture Department says. Handling costs totaled \$150 million.

Most manufacturers' coupons — 55 percent — appear in newspapers. Sunday supplements carry 17 percent and magazines have 15 percent. The rest are included in product packages or sent through the mail.

The USDA says the impact of coupons on overall food prices appears to be minimal, even in areas where there is "double couponing," meaning the retailer offers the shopper twice the face value of the manufacturer's coupon.

No one knows whether prices would be lower if coupons were eliminated. The value of coupons last year accounted for only 42 cents out of every \$100 of food store sales; \$3 of every \$100 went for advertising.

Getting the most out of coupons — or any other sale — requires thought and planning. If you buy an item you don't need just because you've got a coupon, you haven't saved money, you've wasted it.

You also should check for strings attached to coupons. Retailers' coupons in particular often require a minimum purchase. A six-pack of soda, for example, may be offered free or at a sharply reduced price if you buy at least \$7.50 worth of other items at the store.

Cooperative extension service specialists from Cornell University in Ithaca, N.Y., say that familiarity with food quality and current price levels is essential if you want to get the best deal. Here are some specific suggestions:

— Make sure prices on sale items are competitive with other brands and alternate products. A national brand, even with a coupon, may be more expensive than a house brand without a coupon.

— Examine meats carefully. Most supermarkets offer one or more meat specials every week. They are a bargain only if they are the same grade and quality as the store's usual cuts.

— Keep track of prices on non-sale items. A retailer may mark down one item to lure you into the store, then boost the prices of other products to make up the difference.

Note: The Federal Trade Commission requires that retailers stock enough of a special to meet reasonable demand. Stores which consistently run out of specials should be reported to the FTC.



HARD WORK—Rogers Davis exhibits one of the sunflowers he grew himself, standing on a ladder to hold the specimen which is several feet taller than the seven-year-old gardener and businessman. Each flower can produce four to five pounds of seeds, which are marketed for \$1 per pound in the Natchez, Miss. area. (AP Laserphoto)

Tito, Now 86, Still Vigorous

By **STEPHEN H. MILLER**
Associated Press Writer

BELGRADE, Yugoslavia (AP) — At 86, President Josip Broz Tito carries a cane, but the World War II guerrilla chieftain is still the strongman of the non-aligned movement he helped found.

When the man in the vanilla-white suit opened the meeting of more than 80 non-aligned nations in Belgrade, there were the usual kisses from a pretty girl in the wings before he moved to center stage.

Then Europe's longest-lasting government chief read vigorously through his opening 3,000-word speech of welcome, showing no signs of strain.

He has long worn glasses, and in some recent official portraits he looks professorial, in contrast to the military man who glares out from older posters on the walls of Belgrade shops and stores.

Longtime sciatica now prompts him to spend two months of the year at an Adri-

atic resort are considered good for such troubles. But persons who attended a reception he gave for the foreign visitors said he showed no sign of any recent decline in health or vitality.

Tito's independent approach to Communism was spurned 30 years ago by the Soviet Bloc. In the years that followed, he, Indian Prime Minister Jawaharlal Nehru and Egypt's President Gamal Abdel Nasser formed the non-aligned movement.

The organization held its first summit meeting of 25 countries in Belgrade in 1961. This year 84 nations are represented, and Nehru and Nasser have been dead for years.

"One may rightly call President Tito the dean of the non-aligned world," said Sri Lanka Foreign Minister A.C.S. Ham-
eed.

Mulligan Col... (Continued from page 4)

have to make for a story.

I also have a picture taken of me with the Shah of Iran at that fabulous party he gave for all the crowned heads of Europe to celebrate the 2,500th birthday of the Persian Empire.

Just one problem there, a waiter with a tray of caviar (golden Caspian, the absolute best) has blocked out part of my face and the shah has turned his head momentarily to chat with Princess Anne up on a camel beneath a parasol that unfortunately shades her royal features and the whole thing is a bit out of focus.

The same luck held when I had that private audience with the pope. The light was bad in the papal apartments, and the 300 other pilgrims at the private audience kept pushing in front of me so that my face is partially obscured.

All in all, the old high school portrait has a lot to recommend: fresh faced, eager, eternally youthful. Almost in focus, too.

Buchwald...

(Continued from page 4)

"I couldn't get to a phone. Who else called?"

"Naval headquarters. They told me to tell you to report back to your ship immediately."

"Dad, are you drunk?"
"Not yet, but by the time you get home I will be."

Brody's
DOWNTOWN
PITT PLAZA

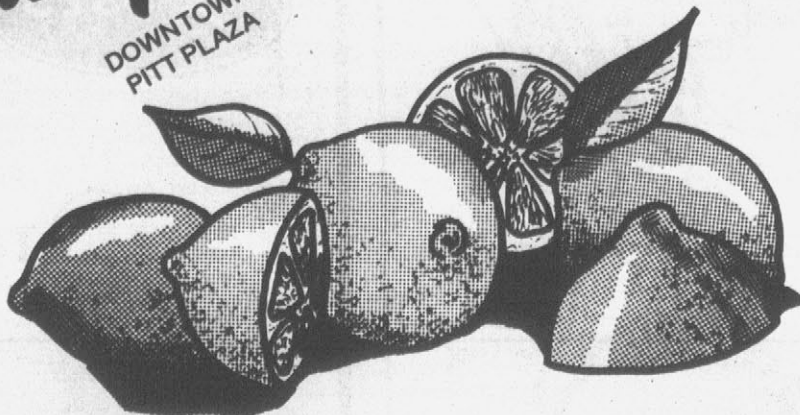

SMART SHOPPERS WILL SAVE A BUNDLE TOMORROW

at our annual
Lemon Sale!!!

LEMON PRICES

SHOES

At Giveaway Prices

You can't complain about the quality of these shoes. You can't complain about the styles. They are super lemons buys. Choose from "Palizzo", "Joyce", "Red Cross", "Amalfi", "Pappagallo and others.

Famous Name Shoes:
were to 23.00 **\$ 10**

Famous Name Shoes:
were 24.00 to 28.00 **\$ 12**

Famous Name Shoes:
were 29.00 to 35.00 **\$ 14**

Famous Name Shoes:
were 36.00 to 40.00 **\$ 17**

LEMON PRICES

BATHING SUITS

Junior & Missy Styles
Several styles and colors
to choose from.

Were to \$19 **\$ 8**

Were to \$24 **\$ 10**

Were to \$28 **\$ 12**

Were to \$40 **\$ 15**

Beach Cover-Ups **1/2 Price**

LEMON PRICES

Junior & Missy SPORTSWEAR

Entire stock of summer coordinates, slacks, shorts, blouses, skirts and more.

Were \$8.00 to \$70.00

LEMON SALE PRICE

\$ 3 To \$ 20

LEMON PRICES

CHILDREN'S WEAR

Summer Sportswear
and Swim Suits

1/2 Off

(Pitt Plaza Only)

LEMON PRICES

CHILDREN'S SHOES

(Pitt Plaza Only)

Summer Sandals (Values to 16.00) Shoes (Values to 22.00)

\$ 4 To \$ 8 \$ 3 To \$ 8

LEMON PRICE

CHILDREN'S SNEAKERS

Keds (Values to 12.00) **5.90**

adidas (Reg. 16.00) **11.90**

(Pitt Plaza Only)

LEMON PRICES

200 Pair CASUAL SHOES BY BERTLYN

Were 14.00 **Now \$ 7**

It was love at first sight! We adored these fashions when we first saw them. As they arrived in our store we became even more infatuated with them. We threw-out our chest in pride over making such wonderful buys. But something happened... The romance has faded. Even our best friends didn't tell us. So now they've got to go... We've come to the parting of the ways. It's Sweet for you-sour for us. Sweet for you-our annual Lemon Sale

LEMON PRICES

DRESSES

We have taken our remaining smart styles in summer dresses and reduced them again. Not many bad lemons in there-R & K, Rona, David Crystal, and other brands you know. Sizes 8-20 and 7-15 and 12 1/2 to 24 1/2.

Were to \$35 **\$ 15**

Were to \$40 **\$ 18**

Were to \$50 **\$ 22**

Were to \$60 **\$ 25**

Were to \$70 **\$ 30**

Were to \$85 **\$ 35**

Were to \$100 **\$ 40**

LEMON PRICES

LINGERIE

SLIPS Reg. \$6-\$8 **2⁵⁰**

BRAS & GIRDLES

Reg. 7.50 to 18.50

Now **\$ 3-\$ 8**

SLEEPWEAR

ROBES & MORE

Reg. 8.00-35.00

Now **3⁵⁰-\$ 15**

LEMON PRICES

HOSIERY

Groups Of Burlington, Hanes and Spirit by J.P. Stevens Discontinued Styles & Colors

1/2 Off

LEMON PRICES

ALL WEATHER COATS

Sizes 8-16
Full Length And
Pant Length.

1/2 off

(Pitt Plaza Only)

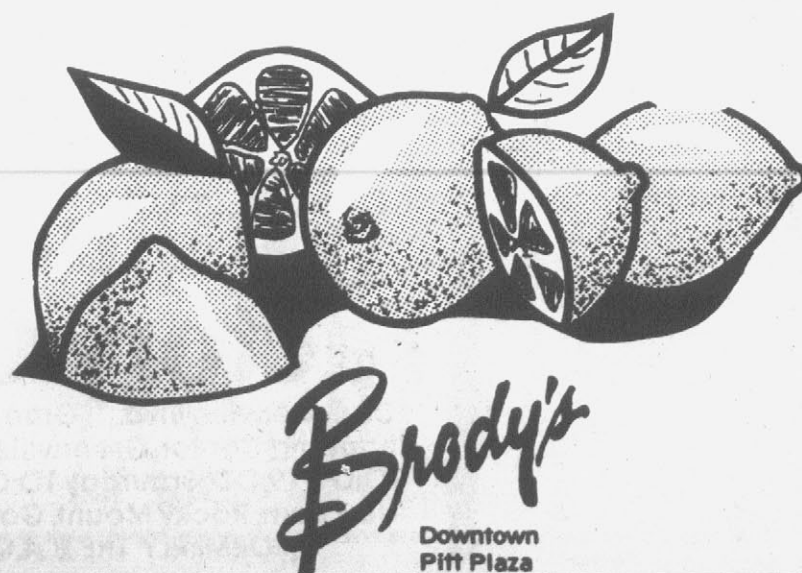

Brody's
Downtown
Pitt Plaza

Travel Reminder!

A Must

Brody's has a 100% Nylon packable lightweight raincoat.—fits in a small bag—ideal for travel! Don't be caught without one.

\$40⁰⁰

Brody's
Downtown
Pitt Plaza

Suit Seeks Force Gift Of Marrow

PITTSBURGH (AP) — The decision whether to force a reluctant man to donate bone marrow needed by his dying cousin whose diseased marrow will not produce blood cells rests today with an Allegheny County judge.

Robert McFall, 39, a former asbestos worker who suffers from aplastic anemia, sued Monday to compel his cousin, David Shimp, 43, a crane operator, to donate marrow if further tests reaffirm the two men are biologically compatible.

Common Pleas Court Judge John Flaherty Jr. said he might rule today after hearing Shimp's attorney argue Tuesday that no Pennsylvania law compels anyone to donate body parts.

Shimp reportedly underwent one test that indicated compatibility, but reneged on a commitment for further tests. Doctors have failed to find a suitable donor among McFall's other relatives or the numerous people who responded to local news accounts of his plight.

"It's rare for a complete recovery if no transplant or chemical treatment is performed," Dr. Louis Pietragallo told Flaherty during oral arguments Tuesday. "But there is some chance of indefinite survival."

A transplant would improve McFall's chances of surviving from 40 percent to 60 percent, Pietragallo said. McFall stands only a 25 percent chance of living a year without the healthy marrow, he said, adding that chemical treatment is available, but not preferred.

"The law of Pennsylvania says there is no legal duty to provide a transplant even if he (the donor) is assuming no risk," Shimp's attorney, John Studeny, argued. "There could be risks and there definitely are inconveniences."

McFall's attorney urged Flaherty to follow English law, which permits court-ordered transplants, and introduced evidence to show that the risks to Shimp are not great.

"The minor procedure will, at most, result in minor and temporary discomfort," attorney John Murtagh Jr. said in a brief. "It won't deprive the donor of anything other than his time."

Pietragallo said the transplant procedure involves 100 to 150 bone punctures in the pelvis, made by a special curved needle.

McFall's disease was diagnosed in June when he was hospitalized with a nosebleed. Doctors believe he developed the ailment because of exposure to asbestos in his work as an insulation installer.

How's The Weather?

FORECAST Until Thursday

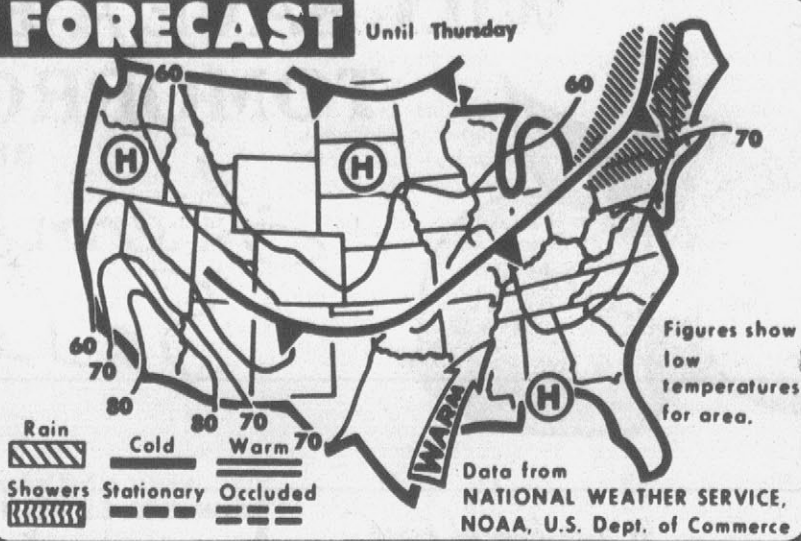

WEATHER FORECAST — Warm weather is forecast today until early Thursday for most of the nation. Rain is expected for much of the Northeast. (AP Laserphoto Map)

By The Associated Press

Some relief was expected in North Carolina today from the hot, humid weather of the last several days. Also, the widespread thunderstorm activity should dwindle to only a few

thunderstorms in the east portion of the state.

High temperatures today were expected to rise only to the 80s with the exception of a few low 90 readings in the east. The forecast calls for fair skies tonight with temperatures generally in the 60s, ranging to near 70.

But Thursday, thunderstorms will be back. They are expected to develop throughout the state but likely will be more numerous in the mountains. Temperatures will remain in the 80s in most areas.

Thunderstorms were widespread across the state Tuesday

but were more numerous in the eastern half. Rainfall generally was less than half an inch although Goldsboro measured more than an inch.

The rains brought some welcome relief from the heat with the day's high temperatures ranging generally in the 80s. There were some low 90s in some places and 70s in some of the higher mountain elevations.

Tide Table

Atlantic Beach			
Thursday			
High	Tide	Low	Tide
AM	PM	AM	PM
—	12:16	5:46	6:38

Adjustments for tide at:

	High	Low
Baefort	+1:08	+1:17
Cape Lookout	.02	.10
Bogue Inlet	+1:29	+1:26
New River Inlet	+1:31	+1:32

Last Street Sweeper Retires

PORTLAND, Maine (AP) — The last of Portland's street sweepers, John "Red" Calvert, retires this week after nearly 40 years on the job. His replacement will be a machine.

Calvert, 62, who got his nickname because of his red hair, has spent his career sweeping city streets with a push broom. But when he retires Friday, all the street sweeping in this coastal city will be done by big, self-propelled machines.

Portland once had 24 "hokey pokey men," as the street sweepers are called, pushing broom carts along cobblestone streets. The term originally referred to men who sold ice cream from a push cart.

On Dean's List At Indiana U.

BLOOMINGTON, IND. — Leah-Sharon Long, 952 Shady Lane, Greenville, was named to the second semester dean's list at the Indiana University here. Long is among 3,324 students to be honored next April at the university's annual Founder's Day.

REUNION NOTICE

Members of the class of 1968, C. M. Eppes High School, are requested to submit their proper dues for the reunion slated for Labor Day weekend in an effort to make bigger and better plans for the occasion.

Police List Collisions

Greenville Police reported an estimated \$2,300 property damage resulted from two traffic collisions investigated yesterday.

Officers reported heaviest damage resulted from a 12:15 p.m. mishap on Greenville Boulevard, 490 feet East of the Arlington Boulevard intersection, involving cars driven by Ruth Marie Kearns of Winston-Salem, Mary Summerlin Rivensbark of Route 2, Greenville, and Robert Ronald Vick of Durham.

Police who charged Miss Kearns with failure to reduce her speed enough to avoid an accident, estimated damage at \$1,200 to the Kearns car, \$600 to the Rivensbark vehicle and \$100 to the Vick auto.

Cars driven by Ricky Lee Blount of Route 2, Greenville, and Kimberly Faye Langley of Winterville, collided about 9:35 p.m. at the intersection of Tenth and Forbes Streets.

Investigators estimated damage from the collision at \$100 to the Blount car and \$300 to the Langley vehicle.

Responded, But

'Not Enough'

NEW YORK (AP) — The Carter administration has responded to the needs of blacks, but not enough, says National Urban League Director Vernon Jordan.

"I think the issue is leadership ... whether there is the tenacity to follow through with the right kind of staff work," Jordan said in an interview with ABC News. Jordan also mentioned the "continuing impatience in the black community despite some response" from the president.

Blue Bell's
\$7.84
Sale
Now thru July 29th
Quality at a lower price

\$15.00 Men's Basic Cords only \$7.84	\$15.00 Men's Basic Jeans only \$7.84
\$8.00 Men's Knit Shirts only \$5.84	Values to \$17.00 Men's Style Jeans only \$7.84 (special group)

First quality and irregular jeans, sportswear, kids-wear, boots, T-shirts, western Shirts, underwear, and more for the entire family ...

ALL AT OUTLET PRICES

Blue Bell Factory Outlet

703 Greenville Blvd., Greenville Square Shopping Center, Greenville. Monday - Friday 10:00 - 9:00, Saturday 10:00 - 6:00. Also in New Bern, Rocky Mount, Goldsboro, Kinston. (FORMERLY THE FACTORY)

Roses Saves You More

Pitt Plaza Shopping Center
Open Daily 9:30 a.m. til 9:00 p.m.
Prices effective Thursday, Friday & Saturday

Tops and Jeans For Girls ... Sizes 4 - 6X and 7 - 14



ROSE'S ADVERTISING MERCHANDISE POLICY
The policy of Roses is to have every advertised item in stock. If for some unavoidable reason the advertised merchandise is not in stock, Roses will issue a rain check on request that can be used to purchase the merchandise at the sale price when the merchandise is available, or comparable merchandise will be offered at a comparably reduced price. It is the honest intention of Roses to back-up our policy of "Satisfaction Guaranteed Always."
ROSE'S STORES, INC.



Girls Sizes 4 to 6X TOPS AND JEANS
TOPS **1⁸⁸** JEANS **3⁸⁸**

Polyester and Cotton girls tops are comfortable and easy care. Many colors to choose from. Durable jeans are made of Polyester and Cotton and keep their shape wash after wash.

Girls Sizes 7 to 14 TOPS AND JEANS
TOPS **3⁸⁸** JEANS **4⁸⁸**

Lightweight easy care girls print tops wear as good as they look. Prewashed denim jeans are comfortable and durable. Both tops and jeans in sizes 7 to 14.



Decorative Hurricane Lamps

19⁹⁷ EACH

Add a touch of elegance with a hurricane table lamp to any room in your home. Accents any decor.



Snack Time Favorites from Sunshine

2/1⁰⁰

Choose 12 oz. Chip A Roos, Chocolate Chip Cookies 10 oz., Cheeze-It, a tasty cheese cracker, or 11 oz. vanilla wafers baked with real vanilla and 100% vegetable shortening.



SAVE 49¢
PLASTIC PITCHER
99¢ EA.

Plastic gallon server in natural colors with multi-color lids. Handy for picnics and parties.



Lemon Pledge

Roses Low Price **1¹⁹**

Lemon Pledge in 12 oz. non-aerosol pump spray for waxed beauty instantly as you dust.



Klean 'n Shine

Roses Low Price

1²³

The foam that cleans and shines furniture, appliances, kitchen surfaces, tile, mirrors. 14 oz. net wt. Contains no fluorocarbons.

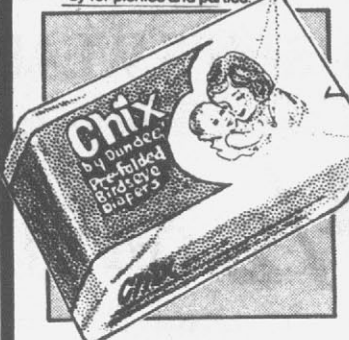

PREFOLDED DIAPERS

Made of soft 100% Cotton these diapers are permanently folded to save time and work. One dozen to pkg. Slightly irregular. **4**



VAPORETTE FLEA COLLARS

Vaporette Flea Collar for dogs or cats. Various sizes to fit your pet's size. **67¢**



BIG SAVINGS

\$1.00 CASH BACK per gallon from Du Pont



DOUBLE SAVINGS! SAVE with our low prices... SAVE AGAIN with Du Pont's \$1.00 per gal. CASH BACK

OUR LOW SALE PRICE **7.47**
LESS DU PONT'S CASH BACK **1.00**
YOUR COST AFTER RECEIVING DU PONT'S CASH BACK **6.47**



OUR LOW SALE PRICE **8.97**
LESS DU PONT'S CASH BACK **1.00**
YOUR COST AFTER RECEIVING DU PONT'S CASH BACK **7.97**

\$1.00 per gallon CASH BACK on other LUCITE Paint, too!

HURRY! Du Pont's \$1.00 CASH BACK applies to all LUCITE gallons purchased between July 22 and August 13, 1978.

Orgy Allegations At Training School Investigated

By MONTE PLOTT
Associated Press Writer
CONCORD, N.C. (AP) — Allegations of a group sex party involving teen age male and female students and two employees at Stonewall Jackson Training School prompted the

suspension Tuesday of two male "house parents" at the facility for juvenile delinquents. "The evidence is circumstantial, but it is strong enough to suspend the two staff members while we complete the investigation," said Ken Foster,

assistant director in the state division of youth services. He was one of two investigators sent from Raleigh to look into the allegations. Dr. Sarah Morrow, secretary of the state Department of Human Resources, pledged a full investi-

gation of the allegations.

The party reportedly began Sunday night, when eight female students were allowed into two boys' cottages. Sexual activity allegedly occurred until the early morning hours Monday, according to statements which the female students made to school officials.

Foster said the girls left their supervised cottage Sunday night in an apparent runaway attempt from the minimum security facility, but "they changed their minds and decided to see some boys."

The Concord Tribune on Tuesday quoted unidentified sources as saying male staffers first indulged in sexual intercourse with female students in the boys' cottages and then invited other students to participate, with between 15 and 20 males involved.

Some youths were reportedly given blankets and told to go to a vacant building. Foster said "an undetermined number of boys was involved," but he discounted reports of an orgy scene.

Staff personnel were searching the grounds for the girls during their absence and would undoubtedly have noticed such activity, he said. One searcher noticed all the lights were out in one boys' cottage but did not investigate because she was called away to check another report on the girls' absence.

But on Tuesday, the talk on the rustic, shady campus with its old red brick buildings was of indiscriminate sexual activity during the incident.

"One dude who was in one of the cottages told me some of the girls stayed inside and some went out with guys into the woods," said a 17-year-old student who asked not to be identified.

"I don't think you could call it girlfriend-and-boyfriend stuff. They all knew each other but they weren't just with one person," another student said.

About 150 students, ranging in age from 10 to 18 and including about 40 females, are housed at Jackson Training School. The school, about 15 miles north of Charlotte, is a co-educational training facility for juvenile delinquents.

Foster declined to identify the two suspended employees but he said both men were in their 20s and had worked at the school for less than a year. Their job was to supervise separate boys' cottages during the night.

If the allegations are proven true, they will be dismissed and could face criminal prosecution, Foster said.

The girls' absence was detected by a female employee and a search that lasted until 3 a.m. was begun. The school's director was on vacation but the assistant director, Martha

Stafford, was called in and helped search for the girls, Foster said.

The girls returned undetected to their cottage by 3 a.m. Monday, Foster said.

"Some time Monday, rumors started coming back to the staff that something had occurred (during the girls' absence)," Foster said. "They got the girls together and they finally started talking."

Interviews with the girls prompted school officials to call officials in Raleigh.

"The staff is very upset by the whole thing," said Foster, who left a meeting with somber-faced school officials to talk with a reporter.

A woman employee who was supposed to be supervising the girls in their cottage is under investigation for possible negligence, Foster said.

Supervision has been tightened for the girls who allegedly took part in the incident. Boys suspected of having been involved were being moved to a cottage with strict security.

Foster said if reports of the incident are true, students involved would probably be disciplined by tighter supervision and fewer privileges.

He said they could be transferred to the state's maximum security facility for juveniles near Raleigh, but he doubted that would happen.

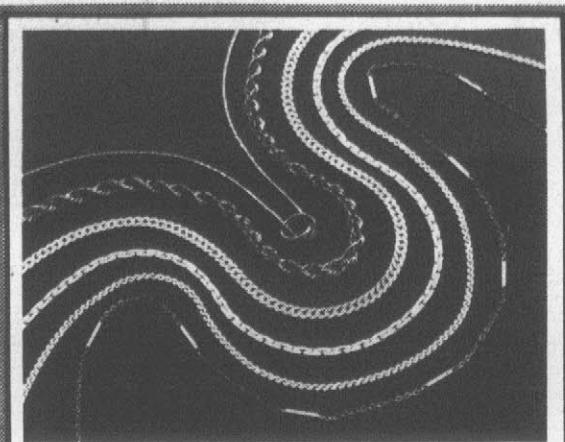

There's only one gift that's as good as gold. Gold.

Nothing else feels like real gold. And nothing expresses your feelings for a special person like a 14 - Karat gold chain, bracelet, pair of earrings, or ring. So, come in and see our selection of Karat Gold Jewelry. Give it on any occasion and you'll make it a special occasion.

Karat Gold Jewelry

Low, low prices

J.D. DAWSON CO., INC.

Catalog Showroom

Jewelry Department
2818 E. 10th St.
Greenville, N.C.

Mastercharge

Layaway

VISA

Pooling Resources In Field Of Psychiatry

Cherry Hospital in Goldsboro and the School of Medicine of East Carolina University are pooling their resources to further education and research in the field of psychiatry. Plans are now being made for the residency training program which will begin early next year.

According to Cherry Director Field Montgomery, by joining faculties and programs the hospital and ECU will be able to upgrade the quality of psychiatric education being offered to medical students and mental health professionals in eastern North Carolina.

"A good, joint training pro-

gram will attract qualified persons interested in gaining clinical experience along with their academic studies. After their training is complete the residents may then decide to become full-time staff members," Montgomery explained. "In the long run it will mean better care and treatment for our patients from highly qualified, experienced residents."

According to Montgomery, psychiatric hospitals without associated programs in research and education historically have had a difficult time recruiting and retaining qualified mental health professionals. Medical

schools have difficulties in providing suitable psychiatric clinical experience and supervision for residents and medical students without the cooperation of state mental health facilities.

"This program will strengthen both Cherry's and ECU's resources," Montgomery added.

In addition to Cherry Hospital, the other three N. C. Department of Human Resources psychiatric hospitals have similar joint programs; Dorothea Dix in Raleigh with the University of North Carolina, Umstead Hospital in Butner with Duke University and Broughton Hospital in Morganton with Bowman Gray School of Medicine.

Employment In Area Increased

According to the Pitt County Employment Security Commission, employment in the Greenville labor area showed an increase of 1,600 between March and May, 1978.

The Pitt County unemployment rate dropped by 410 persons from March to May, decreasing from 2,190 to 1,780 persons in a two month period.

The 5.3 percent March employment figure dropped to 4.2 percent in May for Pitt County, as compared to the state figure of 3.8 percent for May.

Employment in Pitt County tobacco processing plants is expected to increase by about 900 persons by mid-September, according to the

ESC. The Greenville Job Service office is presently implementing a new program Help through Industry Retraining and Employment (HIRE) in its second phase.

The second phase, known as HIRE-II, is directed toward any private-for-profit firms with one or more employees which can hire and retrain one or more additional employees.

The program is targeted for hiring disabled veterans, Vietnam era veterans or any other unemployed veterans.

According to the Job Service, employers who can start each trainee at \$3.50 or more an hour will be reimbursed 50 percent during his training. For more information, call the Job Service at 756-2686.

Hispanics Face School Problem New Coin Will Be Considered

WASHINGTON (AP) — Nearly half of the nation's Hispanic students who usually speak Spanish end up as school dropouts, according to a new government survey.

The National Center for Education Statistics also reported Tuesday that one-third of the students who usually speak Spanish were two or more years behind their age group in high school. Among Hispanics who usually speak English, 18 percent were two or more years behind and 15 percent were dropouts.

WASHINGTON (AP) — A small dollar coin bearing the image of women's suffrage pioneer Susan B. Anthony is expected to be considered by the House Banking Committee later this summer.

A subcommittee approved a bill providing for the coin on Tuesday, and specified that it include the image of Ms. Anthony's face. If Congress gives the legislation final approval this year, the coin could be in circulation before mid-1979.

Belk Tyler
downtown greenville

THE GREAT BOOT LAYAWAY

The boot returns again this fall boasting beautiful leathers, soft, luscious suedes and smartly styled heels. Versatile boots with quality and comfort... boots you can wear with shawls, scarves, tailored outfits. It's bootery at it's best and at a savings too! Choose your boot today and enjoy the savings later!

Sweetbriar

save 3.12 and 7.12 on boots by 'Sweetbriar'

36.88

Price Will Be 40.00 and 44.00 After August 26

A. 'Filly' - Quality, style and comfort in this tricot lined leather boot with simulated stacked heel and 16" side zipper. Sizes AA and B widths. Tan, black, navy and grey.

B. 'Wyoming' - Straight leg boot that's right in style with today's fashions. Genuine suede trimmed with leather, higher stacked heel and 16" side zipper. Sizes AA and B widths. Rust suede/leather, beige suede/leather, brown suede/leather.



CLEARLY A STEP AHEAD

2.00 DOWN HOLDS YOUR LAYAWAY UNTIL OCTOBER FIRST AND SAVE UP TO 7.12 TO BOOT!

\$2.00 holds your boots on layaway until October 1st. On that date, regular monthly payments begin with final payment by November 30th. (Pre-Season Layaway Sale Sweetbriar fashion boots may be charged to your Belk Charge account with no finance charge until September 1st.)

Shop Monday Through Wednesday And Saturday
10 A.M. Until 8 P.M.,
Thursday And Friday
10 A.M. Until 9 P.M.
Phone 756-2178

FINAL SUMMER SALE!

WOMEN'S SHOES
Values to \$35
•FLORSHEIM •VITALITY •MISS WONDERFUL

\$12⁸⁸ Up

MEN'S SHOES
Values to \$50
•FLORSHEIM •RAND

\$19⁸⁰ Up

SHOE STORE
Larry's
• Quality
• Fit
• Service

See An End To Double-Digit Inflation

By DAVID ESPO
Associated Press Writer
WASHINGTON (AP) — Americans can look forward to relief from double-digit inflation in the second half of the year, top economic advisers to President Carter and Congress said today.

Charles Schultze and Alice Rivlin said while prices will continue to rise in the next several months, the increase will not be as great as the current annual pace of 10 percent.

Both economists made their statements to the Senate Budget Committee, which is preparing to set binding spending ceilings for the fiscal year that begins Oct. 1.

Schultze, chairman of the president's Council of Economic Advisers, offered no firm inflation prediction for the rest of

the year, saying only that improvement should be "considerable."

Administration officials have been saying recently they expect inflation to be about 7 percent for the year — up by more than 1 percentage point from what the administration was predicting at the beginning of the year.

Ms. Rivlin, head of the Congressional Budget Office, said she expects prices to rise by an estimated 6.8 percent to 7.8 percent for the entire year, "substantially" above the 6.6 percent inflation rate in 1977.

She also predicted inflation would be somewhere between 6.2 percent and 7.2 percent for 1979.

Schultze reiterated that the administration opposes a large

cut in the capital gains tax, although it believes a "substantial business tax cut" is needed to stimulate investment.

The proposal to slash capital gains tax has wide support in Congress. More than 60 sena-

tors are co-sponsoring a bill to cut the maximum capital gains tax from its current 49 percent.

Also, Schultze and Ms. Rivlin said they don't expect an economic recession in the next several months, despite pre-

dictions from some private economists that one looms ahead.

And on unemployment, which has dropped sharply recently, Ms. Rivlin said joblessness will likely be between 5.2 percent

and 6 percent by the end of next year. Schultze said he expected unemployment to remain close to its present level of 5.7 percent for the remainder of 1978 before falling slowly next year.

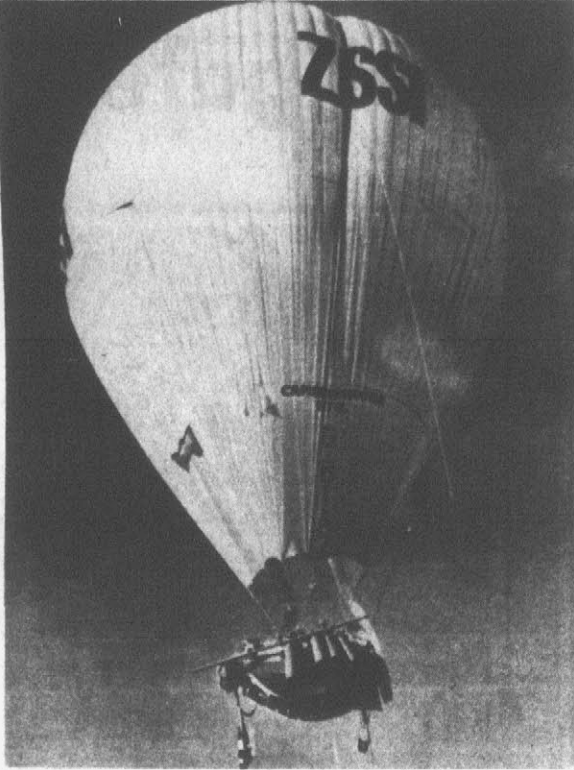

GOING EASTWARD—A balloon carrying Englishmen Christopher Davey and Don Cameron heads skyward early today from St. John's, Newfoundland, going toward Europe in an expected five days. (CP Wirephoto)

Seek Snake Thief

NASHVILLE, Tenn. (AP) — A pet shop employee told police that someone had slithered away with a six-foot-long boa constrictor valued at \$179.

Jan Doster, who works at the Pet Menagerie on the city's northeast side, said Tuesday that the snake was stolen from its tightly secured cage in a mid-day rush on Monday.

The snake, which can go six months without food, had been getting a meal about once every four days while at the pet store, Ms. Doster said.

Its last feeding was on Saturday.

Although the snake is usually docile, Ms. Doster says the person who took it must be braver than the normal customer.

"Only one in 10 is generally willing to touch it. Most won't even go near the cage," she said.

Speaking of Your Health...

Lester L. Coleman, M.D.

How Thorough a Physical Examination?

My brother and I have yearly physical examinations. We go to different doctors. As you would expect, we compare notes. I'm always surprised when he tells me about all the tests he is given. I don't understand why his checkup takes so much longer and is so much more "complete" than mine. It seems to me that either his doctor is unnecessarily fussy or my doctor doesn't give me my money's worth. — Mr. H.D., Ohio.

Dear Mr. D.: Your confusion is understandable. Perhaps by introducing you to the complexities of a general medical examination you will understand how it can happen that your examination is so apparently different from that of your brother's.

A periodic physical examination is the ultimate in preventive medicine. The data that are accumulated can help to prevent or postpone some of the major threats to adult health and life. One acknowledged accomplishment of doctors is the ability to discriminate between particular tests that are essential for each patient. With this approach, unnecessary tests can be eliminated and the cost of the examination markedly reduced.

The fact that both you and your brother are in good health is a testimonial to the judgment of your two doctors. Undoubtedly, your brother's needs are different from yours. His

doctor apparently feels that more elaborate tests are necessary to completely clarify his physical status.

The number of tests is not necessarily indicative of the thoroughness of a general physical examination. Because so many people, like yourself, are confused about this, Dr. Isadore Rosenfeld, a distinguished New York cardiologist, has just written a book for the laymen which should clarify the total concept of a thorough physical checkup. It is called "The Complete Medical Exam" and is published by Simon and Schuster.

In this enlightening book, almost every test is thoroughly explained. In the process of explanation, readers can gain an excellent insight into why certain tests are necessary for some people and not for others. They will then be in a better position to openly discuss with their own doctors tests that are contemplated or omitted.

The world of the physician and the world of the patient are closely intertwined. Pulsating forces constantly flow from one to the other, creating a phenomenon of communication that is unique in our society. Dr. Rosenfeld's book reinforces this valuable relationship and should open horizons of better understanding between doctor and patient.

I must assume that your brother's doctor is not being "unnecessarily fussy" and that your own doctor is surely giving you your "money's worth." The health of both of you seems to be in capable hands.

Kent State U. Hires PR Firm

KENT, Ohio (AP) — Kent State University, site of the 1970 shootings of four students during an anti-war demonstration, has been having trouble keeping enrollments up and has hired the Dix and Eaton public relations firm of Cleveland to improve its image.

John A. Kinley, Dix and Eaton vice president said: "The quality of education received at KSU has largely been a well-kept secret compared with the negative publicity ... growing out of the events of May 4, 1970."

Plan To Fight Order Of FTC

WASHINGTON (AP) — A company that furnishes information on consumers to businesses says it "will vigorously contest" a Federal Trade Commission order that it divest itself of two credit bureau firms.

The commission ruled that the 1970 and 1971 acquisitions by the Atlanta-based Equifax, Inc., violated antitrust law because they could reduce competition in several areas of the country.

SALE STARTS WED. • 4 DAYS

GOOD ONLY WITH THIS COUPON

GOOD THRU JULY 28

FREE Instant Smocked SUNDRESS

BUY ONE REG. PRICE (15¢ INCH) 20-30¢ VALUE

GET SECOND FREE!

SEW IN MINUTES • ONE SEAM • NO ZIPPERS • NO PATTERNS • LIMIT 2 PER COUPON

\$25.00 DRESS FOR LESS THAN \$2.99

piece goods shop

GREENVILLE SQUARE SHOPPING CENTER
Arlington & Greenville Blvd.

Open 119 Mon. thru Sat.

piece goods shop

THE Piecegoods SHOP
DRESS BETTER FOR LESS

What is the truth? ... I am the truth. JESUS CHRIST John 14:6

ONE IN TWO

We're having a tremendous sale on July 26, 27th & 28th... a sale so BIG that we need two locations to display everything! Some items are on display at our Greenville Blvd. shop and at our warehouse on E. 10th St. Extension behind HONDA of Greenville.

(BOULEVARD SHOP)
EVERYTHING ON DISPLAY WILL BE MARKED DOWN
20% TO 40%
LAMPS, PICTURES & ACCESSORIES
40% OFF RETAIL
SAVINGS ON SOME ITEMS AS MUCH AS 40%!

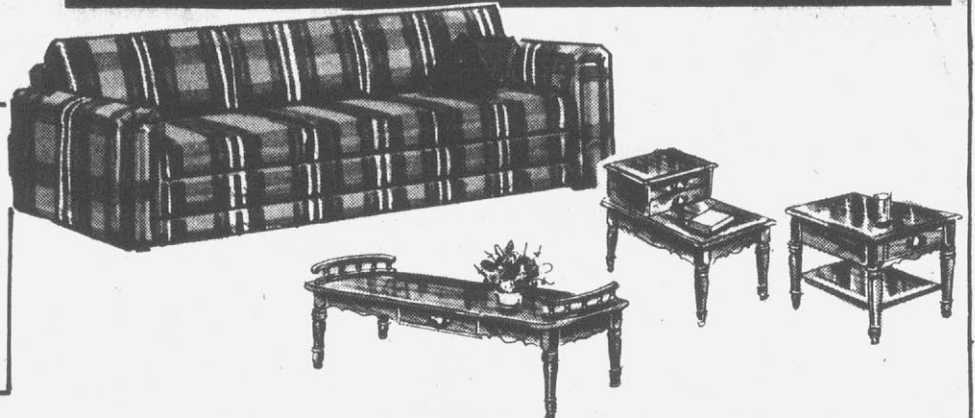

(WAREHOUSE (E. 10th Ext.))

Furniture, end tables, sofas, bookcases, cocktail tables, consoles and much more

NOW ON SALE!

(WAREHOUSE (E. 10th St. Ext.))

RATTAN FURNITURE

Made expressly for Tommie Willis by SHLOMITA ISRAEL, Ltd.

40% off

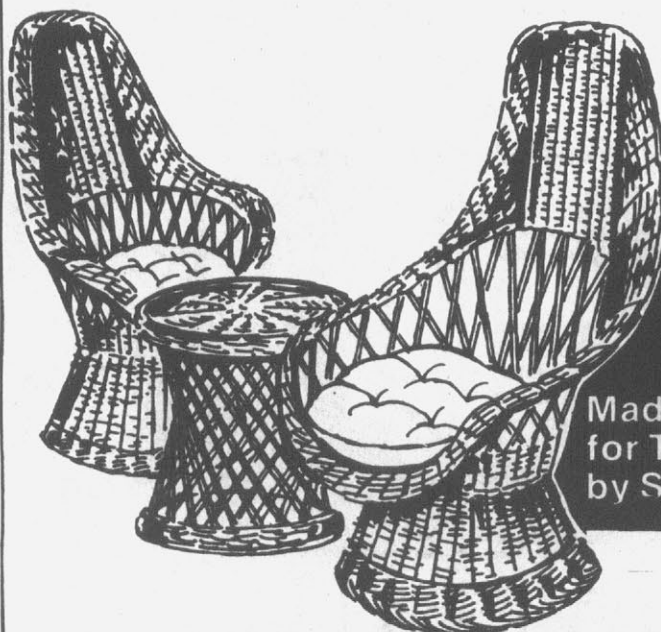

SALE ENDS FRIDAY, JULY 28

Sale Hours 9 a.m. to 5:30 p.m. Daily

Tommie Willis, Inc.

425 Greenville Blvd.

Phone 756-1336

Happy Talk

"Your Youth Apparel Center" In Greenville Square

Today Is Savings!

ALL REMAINING, but LIMITED QUANTITIES.

Summer Stock

1/2 Price!

Girls Shorts, Swimwear, Dresses, & Playwear. Boys Dress Shirts, Infant & Toddler Shorts And Playwear!

School Case Enters Third Day

RALEIGH, N.C. (AP) — The state expects to call three more of defendants as witnesses today as the court battle between

the state and 11 church-affiliated schools enters its third day in court.

Edwin Speas, an assistant attorney general prosecuting the case for the state, said the state will probably rest its case after the testimony of the three.

The prosecution already called three of the defendants to the stand during Tuesday's testimony.

The state sought to weaken the credibility of the defendants' by showing through their written school policies that as late as last year, the same defendants who are now objecting to filing state-required annual reports sought to meet these requirements for state approval.

The Rev. William Vogdes, principal of the Hanover Christian Academy in Wilmington, the Rev. Douglas Davis of the Berean Christian School in Fayetteville and the Rev. Gene Woodall, administrator of the Bethany Christian School in Concord, were among the nine witnesses called Tuesday.

Vogdes said under questioning that his school's employment application asks if prospective teachers are certified. Verification of teacher certification is one of the questions on the annual reports that the church-affiliated schools object to.

Davis was questioned about his school's handbook, drawn up in 1977, which said the school would meet the same state requirements for approval as a non-public school. The fundamentalist schools are objecting to the state's power to approve or disapprove them.

Woodall, too, was questioned about his school's policies, which require a teacher to have a valid teacher's certificate.

In other testimony Tuesday, Craig Phillips, state superintendent of public instruction, was questioned repeatedly by defense attorney William Ball, of Harrisburg, Pa. about whether public schools should be considered representative of quality education in North Carolina. Ball said the standards for non-public schools repeatedly say their operations should be similar to those in public schools.

But Phillips would only say the public schools represented the responsibility of the state Board of Education to supervise education programs for all children in North Carolina.

When asked if it was his view that public schools should be a model for non-public schools, Phillips said, "We have never reached the quality in public schools that we sought."

The state also called two university-level educators who testified that teacher certification is necessary.

Also testifying for the state was Calvin Criner, head of the division of non-public schools, who said the annual reports at issue in the trial are the means by which the state determines

if the non-public schools have met all requirements for state approval.

Criner said that since 1969, most of the non-public schools have been filing the reports, which ask for information on enrollment, teacher certification and courses of study, among other items.

But this year 63 of the schools refused, saying the reports constituted state regulation of religion.

The state took the schools to court for refusing to file the annual reports or filing incomplete ones. While the state named 11 of the church-affiliated schools in its complaint, the suit is aimed at all 63.

Another state witness, 85-year-old H. Shelton Smith of Durham, a James B. Duke professor emeritus, testified that there are differences in the religious beliefs of fundamentalists and Amish.

Ball is the attorney who successfully defended the Amish in Wisconsin in their fight to keep their children out of public schools. He said Tuesday he will bring up the Wisconsin case in the Christian schools case.

ACC Post For Pitt Countian

Zeb M. Whitehurst III, has been named director of college relations at Atlantic Christian College, according to announcement by Dr. Harold C. Doster, president of the college.

A native of Farmville, he received the bachelor's of arts degree from Atlantic Christian College and the master's of education degree from the University of North Carolina at Chapel Hill. Prior to coming to Atlantic Christian he served in the Burlington Public Schools as a teacher, assistant principal, principal and director of audio visuals.

In the newly created position

he will be involved in general development work and fund raising, specifically in the area of alumni, students, parents, businesses and civic organizations.

Whitehurst joined the staff of Atlantic Christian in 1967 at which time he served as director of alumni affairs, a position he held for two years. He afterwards assumed the position of dean of students at Christian for nine years.

Whitehurst is a member of the Southern College Personnel Association, American College Personnel Association, and the N. C. College Personnel Association. He is also a member of the Kiwanis Club and the Elks Lodge.

He is the son of Mrs. Mary B. Whitehurst and the late Zeb M. Whitehurst of Farmville. He and his wife Kathryn have two children.

State Honor For 4-H'er

RALEIGH — Linda Peele, daughter of Mr. and Mrs. Scott Peele of Fountain, was tapped in the State 4-H Honor Club here Monday night.

Peele, a member of 4-H for five years, has completed projects in health and citizenship, presented demonstrations on the American Business System and participated in such programs as the Citizenship Short Course in Washington, D.C.

Peele, currently an active member of the East Carolina

Recall Vote For Durham

DURHAM, N.C. (AP) — The way has been cleared for the Durham City Council to order a recall election for two council members accused of nonpayment of their property taxes.

In Superior Court Tuesday, Judge Hamilton Hobgood dissolved a restraining order obtained by councilman Howard Harris which forbade the council from asking the County Board of Elections to hold a recall vote.

Mayor Pro Tem Margaret Keller was scheduled to meet with the Durham County Board of Elections today to determine what dates were available for an election.

Even though Harris and Clarence Brown gave notice of appeal to the state Court of Appeals, Hobgood said the council is now free to order the recall election.

Petitions asking the recall vote were circulated after it was revealed that Brown had neither listed nor paid property taxes during the entire five years he had lived in Durham and that Harris had not paid city taxes in four of the last five years and had not paid county taxes for 15 of the last 18 years.

Another member of the council, Carolyn Thornton, who reportedly had not listed or paid her taxes in three years, was not included in the recall petition because she had not been on the council the required 90 days at the time the recall move was started.



LINDA PEELE

University Collegiate 4-H Club, served as the Northeastern District president from 1977-78.

Honor Club members select potential members after careful study of their leadership abilities, moral standards, 4-H activities and project achievement.

Less than one half of one percent of all state 4-H members are tapped in the Honor Club.

Federal Govm't Real 'Target'

WASHINGTON (AP) — The president of the National Conference of State Legislatures says the federal government "is the ultimate target" of a taxpayer revolt that began with voter approval of Proposition 13, which slashed property taxes in California.

"The first bullet has hit local governments and the second bullet may hit state government," Jason Boe of Oregon told a congressional hearing Tuesday. "But the federal government is the ultimate target, and the third bullet is already on its way to Washington, D.C."

Offer Help On Own Volunteers

WASHINGTON (AP) — Foreign countries would be given help in setting up their own volunteer programs under a \$112.4 million Peace Corps appropriations bill on its way to President Carter.

The House passed the bill Tuesday and sent it to Carter for his signature. House-Senate conferees had worked out a compromise authorizing the president to help countries develop volunteer programs by furnishing technical assistance, supplies and training.

Ariane Clark

Shows in Classic Design of lifetime quality, the beautifully balanced pieces of tableware and serving accessories by the great name in French Silver.

CHRISTOFLE

228 Arlington Blvd. Come by, we'll find you!

SUPPLIES LIMITED **PRICES GOOD WHILE SUPPLY LASTS!**

FINAL MARKDOWN

on
SUMMER MERCHANDISE



97¢
Reg. 4.99

GIRLS 8 1/2-4
INFANTS 5 1/2-8
White Only



3.87
Reg. 12.95 & 14.95

Mesh, Canvas, Vinyl or Knit



97¢

FINAL MARKDOWN on HANDBAGS

Other styles to choose from.



2.87
Reg. 4.99

Canvas, Red, Navy

MENS 7 1/2-12

- Black
- White
- Nylon Mesh

2.87
Reg. 3.99

Greenville Square Shopping Center

"SHOE SHOW IS GOING TO BE YOUR FAVORITE SHOE STORE"

OPEN DAILY 9:30-9; CLOSED SUNDAY WED. THRU SAT.

Kmart
THE SAVING PLACE

The 'Big Top' is Soft 'n Easy

5.88

Your Choice
Our Reg. 6.96-7.96

Captivating, flirtatious, strictly feminine! Find your look from among our selection of misses' big tops. Many styles: some gauze looks with mandarin collar, crinkly voile smock with 3/4 sleeves, a yoke front or dolman sleeves. Exciting color's on polyester/cotton, polyester/rayon or polyester fabrics.



Misses' Sizes



Master Charge® or Visa® accepted in most areas

ATTENTION

Pipeline Summer Wine Festival

During July & August

With Purchase Of Any Dinner Entree

A Free Glass Of Your Favorite Beverage or "Cooler"

On Mon. And Tues. Nites

A Free Carafe Per Couple

On Saturday Evenings

For Reservations Please Call 752-2320

301 EVANS MALL

PIPELINE

DOWNTOWN, GREENVILLE

Kmart CORNER OF GREENVILLE AND ARLINGTON BOULEVARDS

Cruising On Maine Schooner Is Easy-Going Week



JUST CRUISING — Paying guests turn to as deck hands to make sail aboard the Maine coastal schooner

Isaac H. Evans at the start of a week-long voyage in Penobscot Bay. (UPI Photo)

By **RONALD P. GALLAGHER**
ROCKLAND, Maine (UPI) — Windjammer cruises. Gives you a picture, doesn't it? The Caribbean, sunshine and warm breezes, lounging on deck in your swimvuit all day and half the night?

It can be that. But less publicized, less expensive and a lot of easy-going fun is a week on a Maine coasting schooner that darts among the dozens of islands in Penobscot Bay, harboring each night wherever the wind says to go.

I spent a week on the Schooner Isaac H. Evans, out of Rockland, in mid-June. It was her third cruising week, the first for some sister ships of the coasting fleet and even a week too early for others.

It cost me \$235 — the off-season price that Captains Doug and Linda Lee charge during June and September and \$30 under the July-August fare. Charges for the others that sail from Rockland, Rockport and Camden run about the same, between \$230 and \$325 dollars.

The price includes everything for the week — a cabin with bedding and three square meals a day plus cookies, cheeses and fruits to nibble on and as much involvement as you want in hoisting sail and hauling line.

The Evans, built in 1886 and used in the Delaware Bay as a clammer before the Lees rebuilt and riggered her in 1973, is a two-masted schooner, although there is at least one three-masted vessel, the Victory Chimes.

She makes about 6 knots with a moderate breeze, which to a landlubber like me means absolutely nothing. What I know now after a week on the salt-water is that 6 knots is slow enough to be comfortable and fast enough to get you wet if

you're standing on the bow and the waves are running right when she noses into the water.

Speed wasn't the only thing I learned in a week with 21 others aboard the 64-foot, black-hulled vessel. Mate Mike Waters taught me that all the schooners are vessels — not boats, not ships, but vessels.

I learned what a jib and a stays'l and a fores'l are (and note that's not staysail or foresail, you lubbers!).

I learned how to keep my balance while hanging along the bowsprit furling sail in the rain, and not to whistle aboard a vessel (you might whistle up a storm, you see — or so Mike claimed).

In case anyone ever asks, you coil lines on the deck clockwise, and it's done hand-over-hand to work out the kinks (and dry line coils much easier than wet line). Sails are folded like ribbon candy, the sails shouldn't be allowed to luff in the wind, and a Jersey slippery hitch is something you can use dozens of times a day.

The food is great if you don't have a gourmet's palate for spicy foods. I was raised on large meat-potatoes-and-vegetables meals, and I thought I'd gone home again. I gained at least five pounds on the cruise.

The cabins are small, but there is enough room to sleep and dress. Beyond that, you're on deck or in the galley all the time anyway.

The only mandatory hoisting chore is the morning sail raising. And there are enough hands on that job so that you can enjoy it, even if you're a 60-year-old schoolteacher, as two of my fellow cruisers were.

The charts stay on deck while the schooner's underway, and for those who have never seen a navigation map, it's fun to pick out islands, lighthouses and

buoys and figure out where you are.

And, if you're so inclined, there's often a chance to take the helm — under the captain's watchful eye — and try to keep the schooner on course as she tacks along an angle to the wind.

Tacking, by the way, is another interesting thing you learn. It's the art of sailing into the wind by sailing at angles to it. A schooner tacking into harbor somehow just has more style than a powerboat roving into the dock.

The trips are not long by miles. However, 10 miles could take several hours on a calm day when the Evan's motor launch has to be used to push the schooner along. Some of the

fleet have inboard engines for such situations, making them a bit faster.

Doug Lee, a Mainer who went to engineering college in Brooklyn, will give no quarter when it comes to defending his vessel under sail, though. From the top of the main mast he proudly flies a red banner saying 1977 Champion — more important to him than the trophy that came with the title.

Each season, the captains of the pre-World War I schooners pick a harbor to gather in. Then, the next day, each with a full crew of passengers aboard, they race for a predetermined island in hopes of carrying the trophy aboard until the next year.

It's not always sunny on the bay, but no one ever promised a rose garden or much else about the Maine weather. There's the old saying, "If you don't like the weather, wait a minute. It'll

change."

Lee and Waters have another: "There're two seasons in Maine — winter and the Fourth of July." Seriously, it was foggy at times, sunny at others. It gets cool at night, but a sea breeze keeps it from getting very hot during the day — at least during June.

Swimming, however, is a recommended activity during the warmer months. My group spent one entire day and two nights fog-bound in a channel between two islands, but no one griped. There were board games, a chance to read, sleep and talk. And with a little luck, the IRS won't find out about that \$6 in a friendly card game.

And fog can have its fun points. I probably looked a little foolish straddling the bowsprit pumping on a manual fog horn the next day as we made our way through a fog bank, but it was exciting. The mate was hanging at the forward end, listening for bell buoys and fog horns as we charted our way through fog that clung close to the water.

I learned, by the way, that coastal mariners can tell when they're passing an island by the bird sounds they hear — sea birds, then land birds, then sea birds means they've gone past land.

If you're wondering about washing — no, it isn't a luxury cruise. There's plenty of water available — over the side. Hairwashing from a bucket of

seawater became an art among some of the passengers. Nothing like it at 7 in the morning, I was told.

Fresh water is readily available, along with battery powered lights. But the Evans and her sister ships don't come with bathtubs. It's more like camping in that sense.

A varied crew makes the cruise each week. Some are new to it, like me. But one fellow passenger was an eight-time repeater.

There were three engineers

from a Richmond, Va., firm and one of their wives, three school teachers (two sisters), an accountant from New Jersey, an engineer from the Bronx, two social workers, a nurse, an insurance salesman from Boston and a few others whose occupations I never did find out.

But we all got along, learning to understand each other's accents and live with each other's habits and foibles. It was an interesting exercise in human relations, conducted in a relaxed atmosphere that encouraged getting to know folks.

PUBLIC NOTICE

The public is hereby advised that the VILLAGE OF SIMPSON Budget for FY 78-79 was adopted by the VILLAGE COUNCIL on July 17, 1978. A summary of the adopted budget showing the intended use of Revenue Sharing Funds is available for public inspection during normal business hours in the Office of the Town Clerk. John T. McDonald, Jr. Mayor Village of Simpson, N.C.

**Just Brush On Liquid NutraNail:
Absorbs Into The Pores of Your Nails!**
**Builds Up
Your Nails Naturally**
With Liquid Protein
You Brush On For The
Best Nails Of Your Life.

Contains Vitamins
A, E and D.



Before



...3 days later



...7 days



...14 days later!
See How It Smooths
Cracks & Tips!

See Results
In Just 7 Days.
GUARANTEED!

You'll never again have to say,
"I just can't have great fingernails!"

Just imagine the longest, strongest most perfect, exciting fingernails you've ever seen. On anybody! Only this time the nails are yours. All yours. 100% natural.

And it all happened in just 7 days or less. Well, wake up, it's not a dream. It's reality! Thanks to a new scientific breakthrough in liquid protein. You see, your nails are naturally made of protein... and when they crack and split and weaken, they can be built up again naturally with this liquid protein formula.

Before now, there wasn't much you could do but hope. Now—at last—there's a revolutionary 100% organic liquid protein conditioner that your poor overworked nails will embrace the second you brush it on to help build your nails naturally. It's as organically natural as your fingernails themselves. Your nails are actually so thirsty for NUTRANAIL, the pores, plus the cracks and splits of your nails will soak it right up.

Easier to apply than polish.

Just brush on this clear odorless liquid straight from the bottle... onto your nail. Your nails will look so great, you may not want to put anything else on them. It's instantly absorbed... without drying, burning or leaving a sticky residue.

Now you can play the piano, pound the typewriter, do rough housework, gardening, anything... and still have the best looking nails you've seen on anybody. With visible results within 7 days. Or your money back in full.

Gives You The Long, Strong, Excellent, Flawless Fingernails You Never Dreamed You Could Have.

- Not a Hardener.
- Not a Lacquer.
- Contains No Formaldehyde.
- Needs No Shampoos.
- It contains 100% Natural Organic Protein.
- Helps damaged nails as nothing else can.
- Contains Vitamins A, E and D.

Reg. \$4.95 **\$3.75**

Hollowell's
DRUG STORES, Inc.

Quality • Competitive Prices • Service

No. 1
911 Dickinson Ave.
752-7105

No. 2
6th St. & Memorial Dr.
758-4104

Farmed Out To Learn 'Work'

HAVILAH, Calif. (AP) — Kern County high school boys and girls who have dropped out, been expelled or are on the verge of either are being "farmed out to the woods."

In a program conceived and developed by the county high school district, students are living and working full time in the mountains for nine weeks, and the results are significant.

"They learn what it's like to work 40 hours a week, to care for themselves, how to get along with people and also find out being in school isn't as bad as they thought," explained George Cobb, 43, supervisor of vocational education for Kern County High School.

Human Tool In Mastodon Bones

SEQUIM, Wash. (AP) — Archeologists excavating a site where mastodon remains have been found have uncovered what they believe to be the first human-fashioned stone associated with remains of the prehistoric elephant in the northern hemisphere.

Carl E. Gustafson, a Washington State University anthropology professor who directed the dig, supervised removal of the granite-like stone Sunday. Gustafson said he believes the two-inch, round implement to be between 12,000 and 14,000 years old. It probably was used to butcher the woolly, elephant-like animal whose remains were found at the Sequim site a year ago, he said.

Collection Is Given Museum

WILMINGTON, Del. (AP) — The Delaware Art Museum says it has been given by Helen Farr Sloan the archival collection of her late husband John Sloan, the American artist.

It says the collection includes nearly 600 works of art on paper, many owned by Sloan himself and others of a complementary nature purchased by Mrs. Sloan.

In addition to the art works, the collection includes a large group of photographs of the artist and his family and friends.

SUNDAY CONCERT

FARMVILLE — The Gospel Chargers of Winterville will be in concert at King's Crossroads Church, located near here, Sunday night.

The public is invited to attend.

Pick 'n Pay Shoes

summer sale
1/3 to 1/2 off



Big selection of men's, women's, and children's styles — handbags too! Values to \$10.00 and more. Here's just a sample...

All sale items marked with a yellow sale ticket.

Special group...
\$2
your choice

Special group...
\$3
your choice

Special group...
\$4
your choice

Nobody-but nobody-saves you more.

Master Charge & Visa Welcome
Open evenings

264 BY-PASS ACROSS FROM NICHOLS DISCOUNT CITY

Open Mon. thru Thurs. 10 to 9, Fri. 9 to 9, Sat. 9 to 8

DAKS
Evans Street Mall
Downtown Greenville
752-9965

FINAL CLEARANCE
Entire Stock
Summerwear
1/2 Price

Join the fun. Enjoy summer.
Have a big helping of savings
on fashions you want for now.

Stamps In The News

By SYD KRONISH
AP Newsfeatures

When the crew of Skylab 3 brought back to earth a variety of phenomenal photos showing views of this planet's surface as seen from space, two of the pictures were of Gibraltar. To publicize the space views, Gibraltar has issued a set of two stamp items.

The lowest value of 12 pence depicts the jutting shore on the right side of the Bay of Gibraltar. A souvenir sheet of 25 pence illustrates Gibraltar at the base of the European continent and North Africa. The border shows the rest of Europe, North Africa, the Mediterranean, England and Skylab 3. The inscription at the bottom reads: "Gibraltar From Space."

Also issued by Gibraltar were three new aerogrammes, each featuring a stamp showing a plane in front of the Rock of Gibraltar.

Many countries have already issued stamps commemorating the 75th anniversary of the historic first flight by the Wright Brothers. The U.S. will issue its previously announced pair of 31-cent international air mail stamps to mark the an-

niversary of powered flight on Sept. 23. First day ceremonies will be in Dayton, Ohio.

Sept. 23 was the day when Orville and Wilbur Wright left Dayton with their plane for Kitty Hawk, N.C., where the first flight took place on Dec. 17, 1903.



Further details about the stamps will be reported here as soon as they are released by the U.S. Postal Service.

Speaking of aerial adventures, the 60th anniversary of the first air mail service by Army pilots for the U.S. Post Office has been marked by a Milestone of Flight cover, in the continuing series of commemorative souvenirs sponsored by the National Air and Space Museum of the Smithsonian.

The price is \$1.25 per cover and they can be ordered from: Milestones of Flight, National Air and Space Museum,

Smithsonian Institution, Washington, D.C. 20560. There is a limit of five covers per customer. The check or money order remittance should be made payable to the Smithsonian Institution. Enclose a large, self-addressed and stamped envelope for quicker processing.

What was initially known as the U.S. Aerial Mail Service began as a co-operative venture between the Postal Department and the War Department in 1918, just 15 years after the first powered flight by the Wright Brothers.

The new 2.7-cent embossed envelope intended for use in bulk mailings by non-profit organizations has been placed on sale by the U.S. Postal Service. The third-class minimum per piece rate for non-profit organizations was raised to 2.7 cents on May 29 when all other postal increases went into effect. The background of the single color indicia on the envelope is green with the design embossed in white.

The Republic of China on Taiwan has issued two new stamps of the same design on

the theme of health, focusing attention on cancer prevention. The motif is composed of small squares and crosses — the former symbolizing polluted environment and the latter representing medical treatment, according to the World Wide Philatelic Agency. At the left of each stamp is the emblem of the S.Y. Dao Cancer Memorial Fund.

Firm Matched Gift To ECU

ECU News Bureau
A \$1,000 gift to the department of Chemistry at East Carolina University has come about through the concern of a recent ECU graduate and his employer, the Burroughs Wellcome Co.

Thomas H. Barrett Jr., a 1977 chemistry graduate, made a \$500 contribution to the department and this amount was matched by Burroughs Wellcome under a program in which the company matches contributions made by its employees.

Department chairman Angelo A. Volpe said Barrett is doing graduate study at ECU in addition to his employment by Burroughs Wellcome in its Greenville facility.

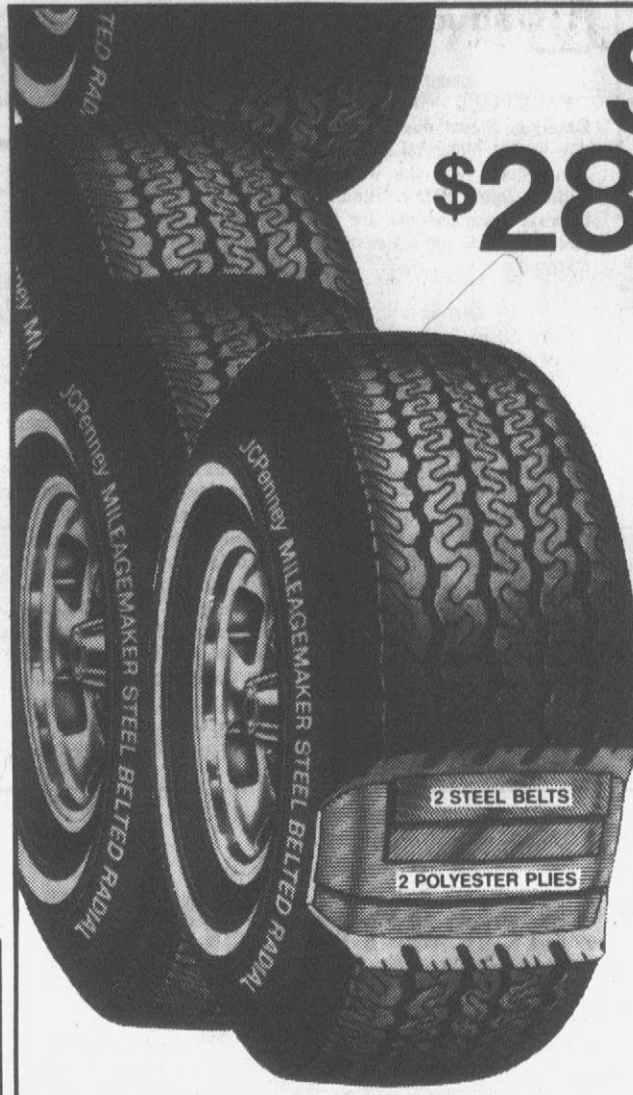

Save \$28 to \$108 on 4 steel-belted radial tires.

The Mileagemaker Steel Belted Radial is constructed of 2 steel belts and 2 polyester cord radial plies. Wide 78 series. Whitewall only. No trade-in required. Tire mounting at no extra cost.

4 for \$140 plus fed. tax

Tire size	Reg.	Sale	+ fed. tax
BR78-13	\$47	\$35	1.99

4 for \$180 plus fed. tax

Tire size	Reg.	Sale	+ fed. tax
DR78-14	\$52	\$45	2.32
ER78-14	\$54	\$45	2.40
FR78-14	\$57	\$45	2.58
GR78-14	\$63	\$45	2.76
HR78-14	\$68	\$45	2.96

4 for \$220 plus fed. tax

Tire size	Reg.	Sale	+ fed. tax
FR78-15	\$64	\$55	2.63
GR78-15	\$66	\$55	2.83
HR78-15	\$70	\$55	3.03
LR78-15	\$82	\$55	3.34

Sale prices effective through Saturday.

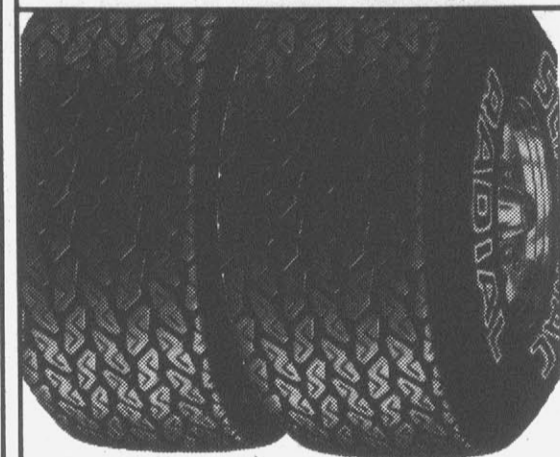

Save \$9 to \$17 each on high performance belted tires.

Scat Trac belted tires feature 2 fiberglass belts and 2 polyester plies. Wide 60 and 70 series profile with raised white letters. No trade-in required. Tire mounting at no extra cost.

Tire size	Reg.	Sale	+ fed. tax
B60-13	38.00	29.00	2.22
E60-14	48.00	36.00	2.67
G60-14	52.00	39.00	3.04
L60-14	60.00	45.00	3.57
G60-15	54.00	40.50	3.07
L60-15	62.00	45.00	3.69
A70-13	34.00	25.00	1.96
D70-14	39.00	29.25	2.27
E70-14	40.00	30.00	2.44
F70-14	43.00	32.25	2.57
G70-14	45.00	33.75	2.73
G70-15	46.00	34.50	2.80
H70-15	49.00	36.75	2.99

Save \$9 on the JCPenney Full 36.



Sale \$28

Reg. \$37 The JCPenney Full 36 has no filler caps. You never have to add water. A great buy for the low mileage motorist needing ample power for accessory loads. Backed by a full 36 month warranty. The JCPenney Battery, \$55 with trade-in The JCPenney Full 48, \$45 with trade-in

Full 36 Month Warranty:

If the JCPenney Full 36 battery fails to accept and hold a charge within 36 months of purchase, we will replace it free. Just return it to the nearest JCPenney facility for prompt service.



Save on 10W40 motor oil. **Sale 52¢**

Reg. 82¢ Great stock up value on JCPenney Premium All Weather 10W40 motor oil.

Sale prices effective through Saturday.

20% off all Igloo® coolers and ice chest.

Sale \$20

Reg. 24.99 Igloo® 48 qt. ice chest is high-impact plastic with polyurethane foam insulation, snap-lock lid and swing-up handles.

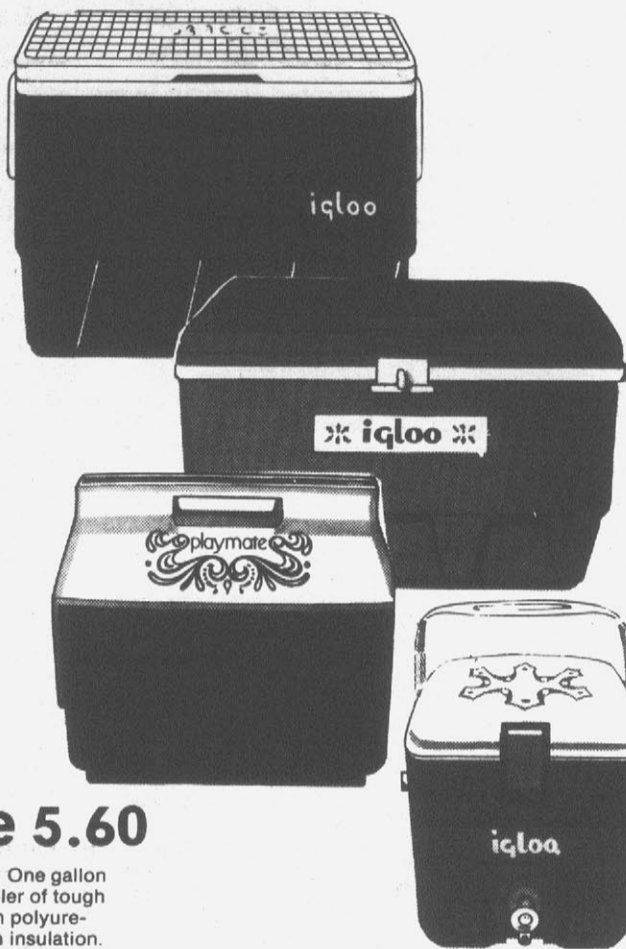

Sale prices effective thru Saturday.

Sale 12.80

Reg. 15.99 Lightweight Igloo® 25 qt. ice chest of tough plastic with polyurethane foam insulation.

Sale 9.50

Reg. 11.88 Igloo® Playmate ice chest with swing-down top is tough plastic. Little Playmate, Reg. 7.88 Sale 6.30

Sale 5.60

Reg. 6.99 One gallon Igloo® cooler of tough plastic with polyurethane foam insulation. Two gallon cooler, Reg. 9.99 Sale \$8

Sale prices effective through Saturday.

25% off Two-man boat kit.

Sale 16.50

Reg. 21.99. Two man boat kit features 3 air chambers, two oars, foot pump and inflatable cushions. 84" x 50".

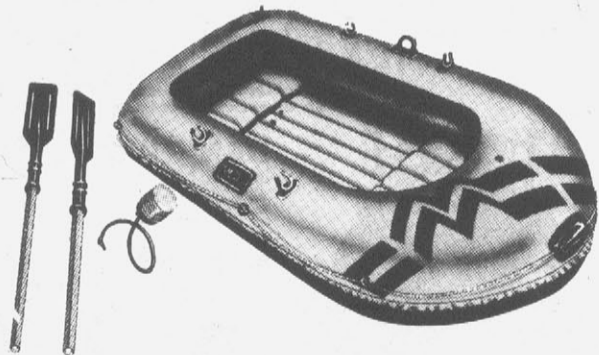

Sale prices effective through Saturday.

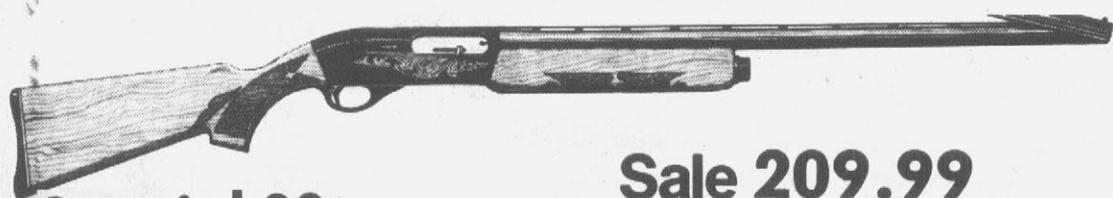

Special 99¢ Box
Thundershot 22 long.

Remington® 12 gauge No. 6 and 8 shot. 2.99 box.

Remington® 16 gauge 2.99 box. 20 gauge No. 8 shot 2.89 box.

Sale 209.99

Remington®

Reg. 229.99 Experienced hunters' automatic shotgun with vent rib barrel, walnut stock.

Winchester rifle. Sale 99.99

Reg. 119.99. 94 rifle 30/30 caliber with lever action.

Keystone dark centered wheels.

All 6" sizes **4/\$139**

All 7" sizes **4/\$149**

All 8" sizes **4/\$159**

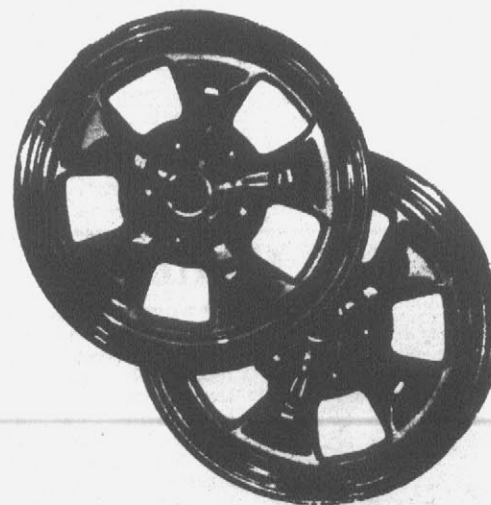

Special buy on in-dash stereos.

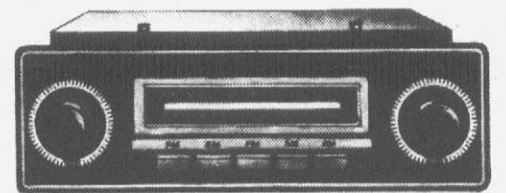

\$88

AM/FM in-dash stereo with 8 track tape features stereo/channel indicators, push button selector, stereo/mono control and balance/boost controls.

This is JCPenney

•Shop 10 A.M. 'til 9:30 P.M.
•Phone 756-1190

JCPenney Auto Center

•Shop 8:30 A.M. 'Til 9 P.M.
•Phone 756-1190 EXT. 251

Stock And Market Reports

Following are selected 11 a.m. stock market quotations:

Burroughs	76 1/2
United Telecommunications	96 1/2
Healthcare	76 1/2
Jiff Pilot	29
Tr. South	16 1/2
Wachovia Realty	5 1/2
Eckerd	78 1/2
Central Soya	14
Hartford	17 1/2
Int'lson	27 1/2
Fidelity	16
Hatteras Income	14 1/2
Vesco	38 1/2
Edison	30 1/2
P & G	89 1/2
DuPont	32 1/2

OVER THE COUNTER

Combined Insurance	18 1/2
Franklin Life	14 1/2
NCHS	5 1/2
Little Mint	7 1/2
Concor Home	5 1/2
Planters Bank	17 1/2
Piedmont Air	12 1/2
Lowe	20 1/2

NEW YORK (AP) — The stock market rose on a broad front in early trading today, continuing the surge begun late in Tuesday's session.

The Dow Jones average of 30 industrial issues rose 5.02 to 844.59 in the early going, and gainers outnumbered losers by better than 3-1. Trading was active.

Tuesday, a late surge by airlines and glamour stocks pushed the market firmly ahead.

Shortly before the market opened today, the government announced better-than-expected trade deficit figures for the month of June. The Commerce Department said the deficit narrowed to \$1.6 billion, the lowest in more than a year.

That could have a positive effect on the beleaguered U.S. currency, which has tumbled recently against most foreign standards, particularly the Japanese yen.

The dollar declined to another record low against the yen in Tokyo today, but rose against European currencies.

Some early stock prices included Honeywell, up 1 at 65 1/2; Burroughs, up 3/4 at 75 1/2; American Airlines, up 1/4 at 15; and Exxon, up 1/4 at 45 1/2.

On Tuesday, the Dow Jones average of 30 industrials climbed 7.97 to 839.57. Advances outnumbered declines by a 9-5 margin on the New York Stock Exchange.

Big Board volume came to 25.40 million shares against 23.28 million in Monday's session.

The NYSE's composite common-stock index rose .38 to 55.26, and at the American Stock Exchange, the market value index was up .60 at 152.26.

RALEIGH (AP) (NCDA) — N.C. Eggs: Market higher on all sizes. Supplies moderate, instances short on large size. N.C. weighted average price for small sales of consumer Grade A eggs in cartons delivered to retail stores: 71.03 cents per dozen for large white; medium 60.51; small 43.13.

RALEIGH (AP) (NCDA) — Grain: No. 2 yellow shelled corn lower at 2.18-2.50, mostly 2.26-2.38 in the east and 2.28-2.60 in the Piedmont; No. 1 yellow soybeans lower at 6.20-6.53, mostly 6.41 in the east and 6.36-6.65 in the Piedmont; Wheat 2.75-3.05, mostly 3.02-3.05; Pats 1.01-1.20; Barley 1.70-1.75. New crop corn 2.08-2.14; Soybeans 5.57-5.74. Prices paid as of 4 p.m. Tuesday by location for corn and soybeans: Wilson (2.40-2.44), 6.41; Washington 2.28, Elizabeth City 2.18; Engelhard 2.26, 6.41; Goldsboro 2.45, 6.25; Selma 2.40, 6.23; Lumber (2.39-2.40), (6.20-6.27); Snow Hill and Saratoga 2.38; Belhaven 2.26, 6.41; Greenville 2.28, 6.41; Farmville 2.38; Raleigh 6.53; Rocky Mount 2.40, 6.41; Kinston 2.27, 6.41; Fayetteville 6.53; Williamston 2.30, 6.23; Clinton 2.40; Rose Hill 2.50; Mt. Olive 2.50; Barber 2.39, 6.36; Mt. Ulla 6.50; Statesville 2.28; Albemarle 2.29, 6.40; Monroe (2.42-2.60), 6.65; Mocksville 2.42; Roaring River 2.42.

RALEIGH (AP) (NCDA) — Graded feeder pig sales: Smithfield - 540 head sold: 40-50 pound No. twos 92.10; No. threes 88.50 per cwt.; 50-60 pound No. one and twos 85.00, No. threes 76.00. Turnersburg - 652 head: 40-50 pound No. one and twos, 91.00, No.

RALEIGH (AP) (NCDA) — Graded feeder pig sales: Smithfield - 540 head sold: 40-50 pound No. twos 92.10; No. threes 88.50 per cwt.; 50-60 pound No. one and twos 85.00, No. threes 76.00. Turnersburg - 652 head: 40-50 pound No. one and twos, 91.00, No.

The Meeting Place

WEDNESDAY
6:30 p.m. — Kiwanis Club meets
6:30 p.m. — REAL Crisis Intervention meets
8:00 p.m. — Pitt County All-Non Group meets at AA Bldg. on Farmville Hwy. Telephone 752-7606 or 752-5284
8:00 p.m. — John Ivey Smith Council No. 6650, Knights of Columbus meet at First Federal
8:00 p.m. — Pitt County Ala-Ten Group meets at AA Bldg. Farmville Hwy. Telephone 756-2501 or 752-5284

THURSDAY
2:00-5:00 p.m. — Game day at Woman's Club
5:30 p.m. — Jaycees meet at Greenville Jaycee Bldg.
7:00 p.m. — Winterville Kiwanis Club meets at community bldg.
8:00 p.m. — Chapter 138 of the Women of the Moose
8:00 p.m. — VFW Auxiliary meets at Post Home

Obituaries

Blount
FARMVILLE — Mrs. Estella Emerson Blount died Wednesday in Pitt Memorial Hospital. Mrs. Blount was the wife of Elder John Henry Blount. Funeral arrangements are incomplete at Joyner's Mortuary, Farmville.

Derrick
COLUMBIA, S.C. — Miss Lottie Derrick, 83, died Tuesday in the Baptist Hospital. Miss Derrick was born in Johnston, S.C. She was assistant director of nurses at Baptist Hospital for 50 years. She was also a member of the First Baptist Church.

Survivors: two sisters, Mrs. Pauline Claxton of Columbia, S.C. and Mrs. Martha Scott of Greenville; three brothers, J. O. Derrick of Greenville, Col. C. T. Derrick of Greenville, S.C. and Wilson Derrick of Aiken, S.C. Funeral services will be held Thursday, 11 a.m., in the Dunlop Funeral Home. Burial will follow in the Phillip Baptist Church, Johnston, S.C.

Women Capture Bridge Crown

TORONTO (AP) — Marilyn Johnson of Houston, Tex., and Mary Jane Farrell of Beverly Hills, Calif., have won the life master pairs championship of North America, becoming the first pair of women ever to take the bridge title.

They scored 1,021.5 in the event Tuesday night at the 1978 summer North American bridge championships to end 2.5 points ahead of Ron Feldman of Berkeley, Calif., and David Sacks of Los Angeles, Calif.

The life master pairs and preceding events have been played since 1930, and up to now there has not been a pair of women as winners.

Mrs. Farrell, many times a North American champion in women's and mixed pairs events, was moved with the announcement that she and Miss Johnson had defeated North

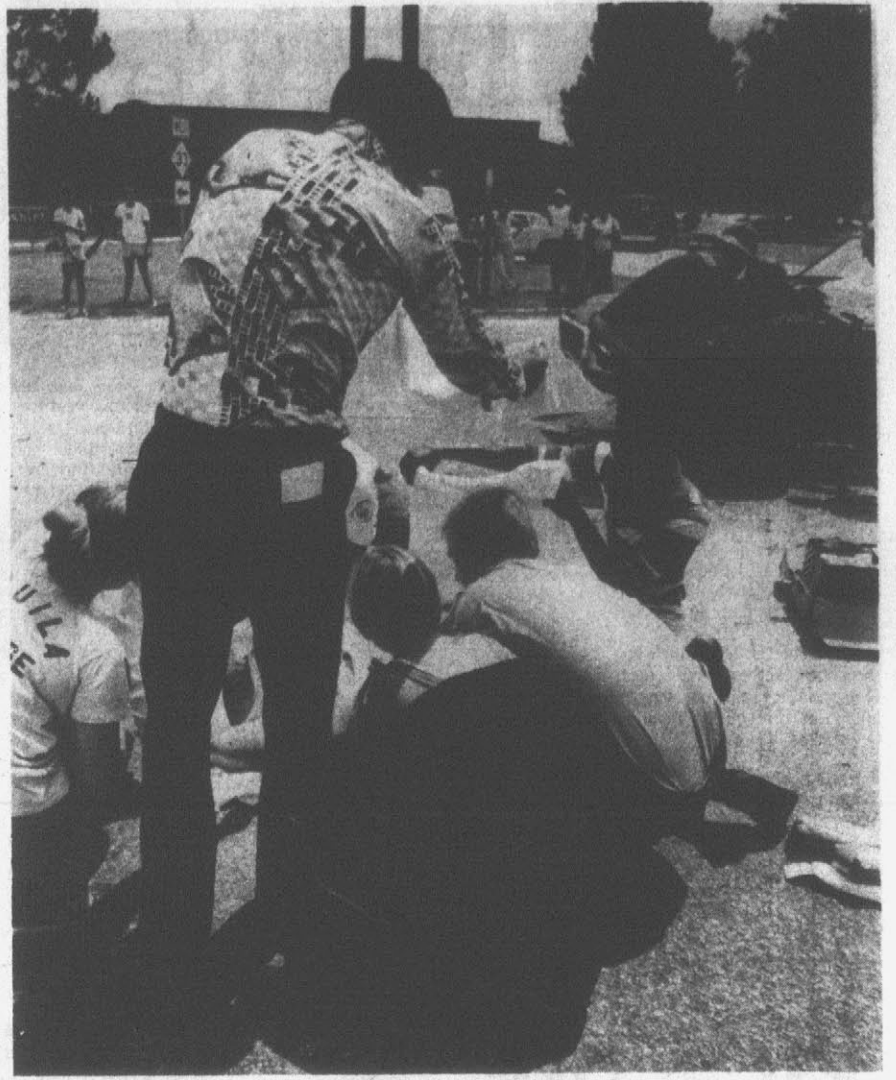

SHADING ACCIDENT VICTIM — Bystanders shade the face of an accident victim after two cars collided on North Greene Street, shortly before noon yesterday. According to North Carolina Highway Patrol officials, the victim was identified as Jackie Ann Petway, of Greenville. It was reported that two vehicles met in the intersection, the second car being driven by Gary Steven Strickland, of Rt. 8, Greenville, and collided. Strickland was also reported injured in the accident. Both cars received heavy damage. (Reflector Photo by Tommy Forrest)

ville. It was reported that two vehicles met in the intersection, the second car being driven by Gary Steven Strickland, of Rt. 8, Greenville, and collided. Strickland was also reported injured in the accident. Both cars received heavy damage. (Reflector Photo by Tommy Forrest)

Storm's Bark Proved Worse Than It's Bite

By REBECCA BUFFALO, Reflector Staff Writer

The storm that swept over the Greenville-Pitt County area last night had a bark worse than its bite, as officials reported only minor damage to electrical equipment and no damage to crops.

Malcolm Green of the Greenville Utilities Commission commented that there were only scattered incidents of electrical difficulty during the storm.

"Last night was pretty different than Monday," Green stated. "Only one troubleshooter worker was called last night and he replaced a few blown fuses at the southern end of the county."

"We had minor difficulties, but no main circuits were affected," Green continued.

The river was measured at 3.8

feet on the national scale this morning, an increase from the 3.5 foot measurement made Tuesday morning. The river temperature was a warm 71 degrees as of 8 a.m.

Leroy James, Pitt County chairman, Agricultural Extension Agency, reported no damage to Pitt County crops and offered some advice for the local farmers.

"Some farmers are asking why their tobacco looks so green," James said. "I'd say it is the fertilizer, which has finally been activated by this heavy rain. The tobacco will turn back to normal shortly."

James urged farmers to let tobacco ripen in the fields before putting it in the curing barns. "Farmers must be patient," James stated. "Patience will show on the market floor with well-ripened leaves."

James also asked farmers not to pack tobacco too tightly in the bulk barns so that air will be

able to flow more freely around the curing leaves.

Tags and suckers should be pulled out of tobacco, according to James.

"Tags and suckers cut down on poundage," he noted.

Overall, James feels that the rain came in just the right time.

"Corn and soybeans are looking good," said James. "Tobacco is coming along fine, as long as farmers will be patient."

Charge Man With Arson

A Rt. 3, Greenville man was charged with arson Tuesday by the Pitt Sheriff's Department following investigation of a Monday night fire at a house near Chocoid.

William Earl Green, 22, of Rt. 3, Box 367, was charged with burning the home of Doris Edwards on Rt. 2, Greenville in an incident that saw Mrs. Edwards and seven others, including six children, escape from the blaze.

Sheriff Ralph Tyson said that Green is scheduled for a first appearance hearing on July 28 in District Court here.

The sheriff said that agents of the State Bureau of Investigation and the Pitt County Fire Marshal's office assisted in the investigation of the fire.

Rape Charge

Woodrow Wilson Daniels of Rt. 1, Box 62, Stokes, was charged with rape Sunday in connection with the alleged assault of a 26-year-old Greenville woman.

Sheriff Ralph Tyson said that Daniels, 28, was arrested around 1 p.m. Sunday and charged with the 3 a.m. Sunday assault which took place some five miles north of Greenville, the victim reported.

Sheriff Tyson said that the assault victim, who was taken to Pitt Memorial Hospital following the incident and then released, told officers the rape occurred in an automobile on a dirt road north of here.

Daniels was jailed without privilege of bond, the sheriff said, with a first appearance court hearing held on Monday.

Papers Sought By Ehrlichman

WASHINGTON (AP) — John D. Ehrlichman isn't exactly sure how much of his private property is being held in the National Archives. But he asks in a federal suit for the chance to do an inventory and then remove personal papers that were stored after President Richard Nixon fired him.

Ehrlichman was fired in the heat of Watergate, on April 30, 1973. Nixon ordered his No. 2 aide's office sealed under FBI supervision, the suit filed Tuesday in U.S. District Court says.

Three months ago, Ehrlichman completed an 18-month prison term for his role in the Watergate coverup and the burglary of the office of a California psychiatrist.

Selected For Youth Camp

Deborah Howard of Grimesland has been selected by the Future Farmers of America to attend the Co-op Youth Camp organized by the Cooperative Council of North Carolina.

Daughter of Mr. and Mrs. Charles Howard, Deborah is a senior at D. H. Conley High School. She will be participating in the Youth Camp at the R. J. Peeler FFA Camp, White Lake. She is among more than 80 young people from across North and South Carolina who will participate this week at camp.

Porn Law Is Overturned

CHARLOTTE, N.C. (AP) — A federal judge has ruled unconstitutional a state law limiting the sale of sexually oriented films, books and devices.

In a ruling Monday, U. S. District Court Judge James B. McMillan said the law violates the First and 14th Amendments to the U.S. Constitution. Those amendments guarantee freedom of speech and equal protection under the law.

Marvin Schiller, assistant state attorney general, said the state will appeal McMillan's ruling to the 4th Circuit Court of Appeals, where an appeal is pending on a similar ruling by U.S. District Judge Franklin Dupree in the Eastern District of North Carolina.

McMillan's ruling came in a suit brought by three adult book stores — one in Charlotte, one in Hickory and one in Gastonia.

The law, which took effect Jan. 1, involves the exhibition of sexually oriented films, the sale of sexually oriented books and the sale of sexually oriented devices. It said no more than one of those selling activities could take place in the same building.

McMillan said the stores' profits would be cut if they had to eliminate any of their products or services.

The law interferes with owners' rights to choose the types of material they will sell or exhibit, and brings about increased overhead cost, McMillan said.

Two Hearings For Thursday

Public hearings on two requests for special use permits are scheduled for Thursday night by the Greenville Board of Adjustments.

The requests were submitted by Ms. Ellen Mayer for a special use permit in order to operate a day care nursery at 310 Hooker Road, and by Mrs. Peggy Willis in order to construct and operate a nursery at 3015, 3017, 3019, 3021, 3023 and 3025 S. Memorial Drive (Lots 22, 23 and 24 of Sedgefield Subdivision).

Other business scheduled for the 7:30 p.m. meeting involves the election of officers and adoption of the board's annual report.

MASONIC NOTICE

Crown Point Lodge No. 708 will hold a stated communication Thursday, 7:30 p.m. All Master Masons are invited to attend.

Amos Leggett, Master
Wylie Christy, Sec'y

AWARD OF EXCELLENCE



Rachel Wahlen

A woman as dedicated to serving people as this woman deserves special recognition. Her skill in family financial planning has earned her our Award of Excellence as the leading representative of her agency for the past month.

Life of Virginia knows that she is well equipped to review your family's financial plans and help secure your future. Why not talk to her soon?

Harold Pittman-District Manager
William Wilson-Sales Manager

1206 Charles Blvd.
Greenville, N.C.
752-6747



The Life Insurance Co. of Virginia Home Office: Richmond Virginia.

FAMILY DOLLAR

DAN RIVER No Iron Muslin SHEETS \$2.44 EACH TWIN SIZE Flat or Fitted

FLAT OR FITTED DOUBLE SIZE SHEETS ... \$3.44
STANDARD SIZE PILLOW CASES, PAIR ... \$2.88

Ladies Fashion BIG TOPS
Assortment includes Balloon Sleeves, Cinch Waist, Tunics & Bib Front Sizes 8-M-L.

\$4.99 Each
Permanent Press SKIRTS Full Fashion Colors Sizes 8-M-L.

\$6.99 EACH

4-BAR PACKAGE IVORY SOAP
3.5 Ounce Bars

2 \$1
Limit 2 Packs
Total of 8 Bars For \$1.00

EXTRA ABSORBENT PAMPERS

BOX OF \$2.29
BOX OF 30 NEWBORN ... \$1.89
BOX OF 12 TODDLER ... \$1.39
Limit 2 Boxes of Each

Big 24 Ounce SCOPE Mouthwash
Reg. \$1.59

99c
Limit 2

Close-Up 4.6 Oz. Tubes AIM OR CLOSE-UP TOOTH PASTE

63c
Limit 2

MEN'S, BOY'S AND YOUTH'S JOGGERS
Men's Sizes 7-12, Boy's 2 1/2-6, Youth's 11-2

\$5
Pair

BAR-B-O-LITE CHARCOAL LIGHTER
Quart Size

2 \$1
Limit 2 For

FOAM CUPS
FOR COLD OR HOT DRINKS. 6.4 OUNCE PKG. OF 51

39c

TRIPLE-PAK PLANTERS POTATO CHIPS
12 Ounces Total

99c

PRICES GOOD AT ALL FAMILY DOLLAR STORES THROUGH THIS WEEKEND WHILE QUANTITIES LAST

WEDNESDAY AFTERNOON, JULY 26, 1978

Rose Breaks Record In Third Inning

NEW YORK (AP) — The plan was to let Pete Rose swing at anything, and to the devil with strategy. It was, after all, his night. Rose, the indomitable sparkplug of the Cincinnati Reds,

made the most of his freedom at the plate Tuesday night, stroking two singles and a double to extend his hitting streak to 38 games, a modern National League record. "I told you I'd be back

tonight," Rose told reporters as he mounted the podium after his record-breaking performance in a 9-2 loss to the New York Mets. "The record feels great, but not the outcome of the game."

Rose broke the record in the third inning. With one out, he was greeted at the plate by a standing ovation from the crowd of 38,158 at Shea Stadium. He took the first pitch from right-hander Craig Swan

for a ball. He fouled back the next pitch, and then he lashed a low line drive into left field. "The first pitch was low and outside," Rose said. "Swan was throwing real hard, so I choked up another quarter of an inch. I fouled off the next pitch, but it felt better. On the next pitch, I just laid it out there in left field."

switch-hitting Rose cracked a 3-1 delivery into left center. It bounced over the fence for a ground-rule double and after taking third on a sacrifice fly, Rose scored on Joe Morgan's grounder to second. Rose hit a weak, broken-bat single into right center in the seventh.

Even if it's a 3-0 pitch, he'll have the swing sign." And swing he did.

Rose came to the plate four times, and for the fifth time in his streak, he got three hits. His only out of the night was leading off the first inning when he took a ball inside, then lofted a routine fly to Met left-fielder Steve Henderson near the foul line.

"Tonight, the ball looked as big as a beach ball," said Rose.

"Tomorrow it may look like a golf ball."

After his third-inning single, the fans at Shea Stadium — where Rose once was the target of boos and flying beer bottles — gave him a three-minute standing ovation. Rose doffed his cap to the crowd and Tommy Holmes, the former Boston Braves' great whose 1945 record Rose broke, rushed out to congratulate him.

Met first baseman Willie Montanez said he "tried to give Rose the ball, but he said, 'No, no. Give it to the other guy (Holmes).'"

"Pete told me last night that if he gets the hit, he would give me the baseball," said Holmes. "But when he gave it to me on the field, I gave it back. It's his honor and his moment."

Asked if he would now give the ball to the Hall of Fame, Rose replied, "I'll keep the ball. I hit it, I'll keep it."

Rose was stranded on first at the end of the inning, but instead of bringing him his glove, as is customary, his teammates made Rose retrieve it himself.

"They didn't carry the glove out to me," said Rose. "They made me come in and get it so they could shake my hand."

Rose's record completely overshadowed a fine pitching performance by Swan, 3-5, who got his second consecutive complete game victory, scattering seven hits. "I got the ball up to him," Swan said of the pitch that gave Rose his third inning hit. "I pitched pretty awful. On a ratio of one to 15, this was a 10. I didn't pitch well until the seventh inning, and that gave him (Rose) quite a chance."

Ken Hutcherson Not All Smiles Despite A Number Of Returnees

By WOODY FEELE
Reflector Sports Editor

The average fan of East Carolina University would probably think that offensive backfield coach Ken Hutcherson would probably have nothing but a big smile on his face as the coming season approaches.

But that's not the case. Hutcherson, who is blessed with some good backs, has suddenly looked around and found that the stable isn't as full as it once was.

Gone are two regulars from last season, part-time starter at fullback Vince Kolanko, along with starting running back Willie Hawkins.

There are adequate replacements, to say the least, but the question now is who is going to back them up.

Back for another year are three experienced runners in halfbacks Eddie Hicks (6-2, 210, Senior) and Tony Collins (5-11, 200, Sophomore), and fullback Theodore Sutton (5-9, 207, Junior). "I look for them to be the starting backfield," Hutcherson said.

"But the big question is who is going to be behind them," he added.

There are several reasons for the problems, some of which may solve themselves. There are a few backs in summer school whose status is still questionable and Hutcherson said he didn't want to talk of them in terms of helping until something was



Ken Hutcherson

certain. A few others have been switched to other locations on the team.

One back who had a fine spring is Doug Banks (5-11, 200, Sophomore), a transfer from the University of North Carolina. He showed great promise then, but Hutcherson points out that he hasn't played any in an actual game yet.

Joining him is a walkon, John Salinsky, whose is small, and this may hamper him.

"We may have to count on incoming freshmen," Hutcherson said.

That group includes several good prospects. Listed by Hutcherson as the top prospects are Marvin Cobb of Raleigh (6-0, 195), Leon Lawson of Virginia Beach, Va., (6-3, 195), Harold Blue of Laurinburg (5-11, 190), Marvin Elliott of Alexandria, Va. (5-11, 185), and Roy Willey of Burlington (6-2, 240), the latter a fullback.

"Our first group is a darn fine group of backs," Hutcherson said. "It's hard to fine a good wishbone blocker, but we have three. Collins can play either fullback or halfback, Hicks is a top prospect, and Sutton, of course, was our leading rusher last season."

The depth problem, Hutcherson hopes, will work out quickly. "Banks is a fine athlete, and our freshmen have to make the jump quickly from high school to college, but we hope two or three will come through in a hurry for us like Collins did last year. Skill-wise it's easy to make the move from high school to college, but the mental part is tough, learning all of the blocking schemes. They can't be hesitant in carrying out their assignments."

Hicks is a proven blocker, and Hutcherson feels he can be one of the most devastating in the game. "Collins is our best overall back, but Sutton will give you everything he's got. For a walkon to come on like he has and become your leading rusher proves this."

Hutcherson is hopeful that the outside game will go a little better this year. Sutton did most of the ball carrying among the backs last year, when the quarterbacks weren't keeping it themselves. "Having a good fullback and two good running backs gives us a good start. We know we can go anywhere with the ball."

While speed and experience among the top three are the biggest pluses, the lack of proven depth will be the biggest minus for the backfield.

"We're just going to have to wait and see what develops between the incoming freshmen and the other people who come back," Hutcherson said.



Hitting The Record

Pete Rose slaps a single in the third inning of last night's game in New York to break the National League record

for most consecutive games hit. Rose's knock gave him at least one hit in 38 straight games. Umpire Joe West of Greenville watches from behind the plate. (AP Laserphoto)

SAAD'S SHOE SHOP
PROMPT SERVICE
Located at College
View Cleaners
113 Grande Avenue
8 To 6 Mon.-Fri., 8 To 2 Sat.

Sports Calendar

Today's Sports
Softball
Women's League tournament
Industrial League tournament

Baseball
State 16-Year Old Senior Babe Ruth tournament

Thursday's Sports
Softball
Women's League tournament
Church League tournament
Industrial League tournament

Baseball
State 16-Year Old Senior Babe Ruth tournament

Just As Sure As The Sun Goes Down!

Scrappy's prices are going down with it!

Glenn is smashing prices throughout the store
Here's just a few

Suits 1/3 to 1/2 off From \$59.99	Sport Coats 1/3 to 1/2 off From \$29.99
Pants 3 groups Entire stock 15%, 1/3 and 1/2 off	Knit Shirts 1/3 off
Dress Shirts Short sleeve 1/2 off	Cooling you down with savings at
Dress Shirts Long sleeve 15% to 1/3 off	
Neckwear 3 large groups 20%, 1/3 to 1/2 off	
Long Sleeve Sport Shirts, Hats, Pajamas and more Slashed to pieces	

Proctor's
the house of name brands

206 East Fifth Street
Downtown Greenville

GOODYEAR For More Good Years In Your Car

SAVE \$14 to \$19 EACH On Steel Belt Radials

Double Belted Polysteel Radial - Keeps Its Feet Even In The Rain!

Whitewall Size	Regular Price	SALE PRICE	Plus F.E.T. No trade needed.
AR78-13	\$67.45	\$53.00	\$1.87
DR78-14	\$75.90	\$60.70	\$2.32
FR78-14	\$82.70	\$68.15	\$2.58
GR78-14	\$87.00	\$68.00	\$2.76
HR78-14	\$92.70	\$74.15	\$2.96
GR78-15	\$89.30	\$71.40	\$2.75
HR78-15	\$95.95	\$78.75	\$3.03

Sale Ends Saturday RAIN CHECK — If we sell out of your size we will issue you a rain check, assuring future delivery at the advertised price.

SALE

Steel Belted Metric Radials For Imports

G600+8... steel belted for strength, polyester for ride, well-grooved tread and shoulder for multi-directional grip. See it today.

\$0.00 to \$7.10 off	Save \$7.25	Save \$8.00	Save \$11.00
\$37	\$40	\$44	\$50
155SR13 Plus \$1.61 F.E.T.	165SR13 Plus \$1.75 F.E.T.	155SR15 Plus \$1.77 F.E.T.	165SR15 Plus \$1.98 F.E.T.

Don't Delay! Sale Ends Saturday!

Smooth Riding Polyester

\$19.75 All Weather 78 878-13 blackwall plus \$1.72 F.E.T. and old tire

Blackwall Size	OUR PRICE	Plus F.E.T. and old tire
E78-14	\$26.00	\$2.03
F78-14	\$27.00	\$2.04
G78-14	\$28.00	\$2.19
G78-15	\$30.00	\$2.38

- Durable Rib Tread
- No Morning Thump
- Dependable
- Bias-Ply
- Polyester For Ride

Just Say 'Charge It'
Use any of these 7 other ways to buy: Our Own Customer Credit Plan
• Master Charge • BankAmericard • American Express Card
• Carte Blanche • Diners Club • Cash
• Goodyear Revolving Charge Account

See Your Independent Dealer For His Price and Credit Terms. Prices As Shown At Goodyear Service Stores In All Communities Served By This Newspaper.

Lube & Oil Change

\$5.88

Includes up to 5 quarts major brand 10/30 oil

PROTECTS MOVING PARTS — ENSURES QUIET OPERATION

- Complete oil change and chassis lubrication
- Ensures smooth performance, reduces the chances of wear
- Please phone for appointment
- Includes light trucks.

Front-End Alignment And 4-Tire Rotation

\$15.88

Additional parts and services extra if needed
Front-wheel drive excluded

IMPROVES TIRE WEAR AND VEHICLE PERFORMANCE

- Inspect and rotate all 4 tires
- Set caster, camber, and toe-in to factory specifications
- Inspect suspension and steering system
- Most U.S. cars — some imports.

Engine Tune-Up

\$39.88 8-cyl. \$34.88 4-cyl. \$46.88 6-cyl.

Includes parts and labor — no extra charge for air conditioned cars. Electronic ignition cars \$4 less.

HELPS ENSURE BETTER GAS MILEAGE AND PERFORMANCE

- Electronic engine, charging, and starting system analysis
- Install new points, plugs, condenser, rotor
- Set dwell and timing
- Adjust carburetor for economy
- Includes Datsun, Toyota, VW, and light trucks.

Goodyear is Open Til 5 P.M. on Saturdays For Your Convenience
WE SERVICE NATIONAL ACCOUNTS

GOODYEAR SERVICE STORES

729 Dickinson Ave. Open Mon.-Fri. 7:30 to 6, Sat. 7:30 to 5. Phone 752-4417. Don Barnes, Mgr.

OFFICIAL NORTH CAROLINA STATE INSPECTION STATION

After Breaking League Mark, Rose Gunning For DiMaggio

By BARRY WILNER
AP Sports Writer

"I'm over halfway there," said Pete Rose and few doubted he could attain the other half.

Actually, Rose is 38-56th of the way to Joe DiMaggio's major league record for hitting in 56 consecutive games. The Cincinnati third baseman extended his hitting string to 38 straight games Tuesday with a third-inning single off New York Mets pitcher Craig Swan. He broke the National League record of 37 games, set by Tommy Holmes in 1945.

Rose had three hits for the night off Swan, who gave up just four more safeties to the Reds in hurling the Mets to a 9-

2 triumph.

Holmes, who held the NL mark and now works with the Mets, was on hand and went on the field to congratulate Rose after the hit.

While Rose was a one-man gang for the Reds, the Mets had everybody hitting. They scored five runs in the fourth inning on five hits, including an RBI double by John Stearns, a run-scoring single by Doug Flynn and a two-run single by Len Randle.

Elsewhere in the National League, Vida Blue won his 14th game as San Francisco rallied to top St. Louis 3-2. Atlanta blanked Philadelphia 4-0, Houston edged Montreal 3-2 in 13 in-

nings. San Diego nipped Pittsburgh 2-1 and Los Angeles beat Chicago 3-1.

Giants 3, Cardinals 2
San Francisco won the type of game that has boosted them to the top of the NL West. Blue, 14-4, carried a five-hit shutout into the ninth, but two-out RBI singles by pinch-hitter Roger Freed and Mike Tyson put the Cardinals ahead 2-1.

But Larry Herndon singled with one out in the bottom of the ninth off Bob Forsch, 9-10, and Mike Ivie pinch-hit a game-winning two-run homer.

Braves 4, Phillies 0
Tommy Boggs, recalled from the minor leagues two weeks ago after posting a 1-5 record

and a 6.75 ERA for the Braves earlier this season, blanked the Phillies on four hits.

Biff Pocoroba hit a three-run homer to support Boggs. Regulars Greg Luzinski and Bake McBride sat out the contest for Philadelphia.

Astros 3, Expos 2
Jose Cruz homered with two outs in the ninth to tie the game, then Art Howe singled home Rafael Landestoy in the 13th to win it for Houston.

Ken Forsch, 6-4, picked up his fourth victory in the last 12 games.

Padres 2, Pirates 1
Dave Winfield's one-out single scored Gene Richards from second in the ninth inning

to lift San Diego over Pittsburgh. Richards singled for his third hit of the game leading off the ninth and advanced on a sacrifice. Pirates relief ace Kent Tekulve walked Oscar Gamble intentionally and Winfield then got his hit.

Dodgers 3, Cubs 1
Tommy John made only his second relief appearance of the season and picked up his first save by retiring the Cubs in the ninth. Rick Rhoden, 8-5, was the winner for Dodgers and Rick Reuschel, 9-8, lost.

Davey Lopes led off the first for Los Angeles with his 11th home run, matching his career high.

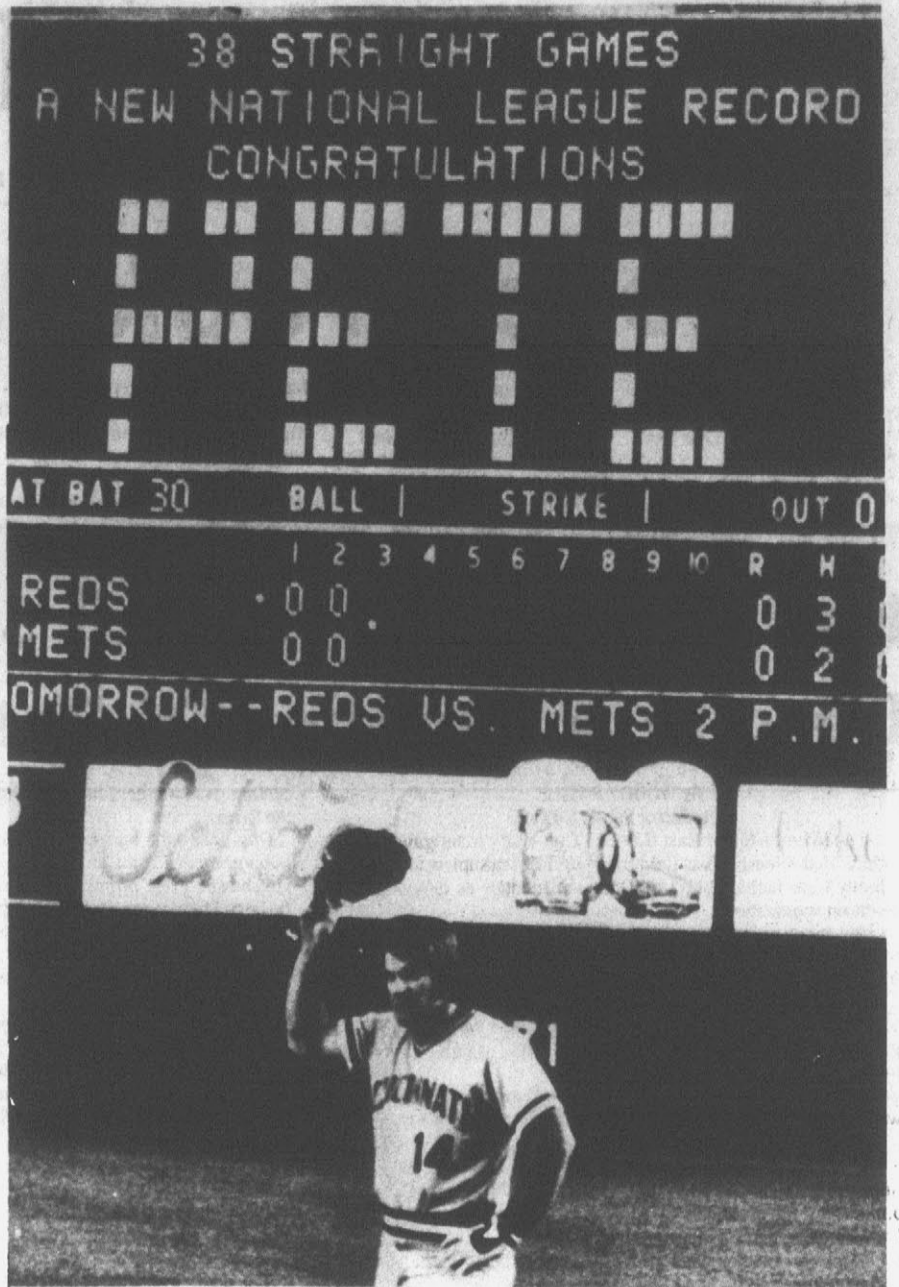

On Board
Pete Rose doffs his cap from first base to the cheers of the crowd as the scoreboard at New York's Shea Stadium records his modern National League record for consecutive games with base hits. (AP Laserphoto)

Guidry Eases Lemon's Debut

By HERSCHEL NISSENON
AP Sports Writer

The next few games figure to be a lot harder for the New York Yankees and Manager Bob Lemon. Ron Guidry, you see, won't pitch again until Sunday.

"It's nice to break in with a 15-1 pitcher going for you," Lemon said Tuesday night after his successful debut as Billy Martin's replacement — a 4-0 victory over the red-hot Kansas City Royals behind Guidry's six-hit pitching.

It was the slender left-hander's second straight shutout as

he stopped the Royals' 10-game winning streak.

In other American League action, the Minnesota Twins knocked off the slumping Boston Red Sox 5-2, the Chicago White Sox beat the Milwaukee Brewers 4-2, the Baltimore Orioles edged the Texas Rangers 7-6, the Cleveland Indians stopped the California Angels 4-2, the Detroit Tigers pounded the Oakland A's 11-2 and the Seattle Mariners defeated the Toronto Blue Jays 4-2.

The Yankees scored the only run Guidry needed against Paul Splittorff in the third inning on

an error, a stolen base and Willie Randolph's double. Thurman Munson, Roy White and Jim Spencer added run-scoring hits in the eighth.

Twins 5, Red Sox 2
Dan Ford drove in three runs with a triple and a single and rookie Roger Erickson won his 10th game with help from Mike Marshall as Minnesota handed Boston its sixth defeat in the last seven games.

White Sox 4, Brewers 2
Bob Molinaro broke an 0-for-12 slump with a fifth-inning homer and Francisco Barrios gained his first victory in eight

starts. The White Sox took a 2-0 lead in the second inning on a walk, singles by Ron Blomberg and Tom Spencer and a double by Bill Nahrordny.

Orioles 7, Rangers 6
Doug DeCinces clubbed two homers, one a grand slam, as Baltimore handed Texas its eighth consecutive setback. DeCinces homered in the fourth and fifth innings off Doyle Alexander as the Orioles captured their 10th victory in 13 outings since the All-Star break.

Indians 5, Angels 1
Solo homers by Bernie Carbo and Johnny Grubb and a two-

run single by Andre Thornton paced Cleveland's victory while Mike Paxton picked up the victory with 12-3 innings of relief from Dan Spillner.

Tigers 11, A's 2
Milt Wilcox fired a five-hitter and Tim Corcoran, Ron LeFlore and Alan Trammell drove in two runs apiece as the Tigers pummeled four Oakland pitchers for 15 hits.

Mariners 4, Blue Jays 2
Leon Roberts' two-run homer in the ninth inning broke a tie after the Mariners tied the score in the seventh on Bob Robertson's solo home run. Rico Carty and Alan Ashby homered for Toronto.



A Pat On The Back
New York Yankee manager Bob Lemon (l) gives coach Dick Howser a slap on the back as they walk out of the dugout to greet the team after the Yankees beat the Kansas City Royals 4-0 last night. It was Lemon's first game and victory as manager of the Yanks. (AP Laserphoto)

Recreation Ball

Industrial Tournament
Public Works 0-6 112-10
GUCCO 0-0 200-6
Leading hitters: PW, Elmer Harrell 2-3, David Phillips 3-5; GU, Mark Suggs 3-3, Willie Eakins 2-3.

Church Tournament
Arlington St. 200 0-0
First Pentecostal 361 4-3
Leading hitters: AS, Mahue Hadlock 3-4, Ken Graham 3-4; FP, Bill Pitgreen 3-4, Hal Knox 5-5.

Memorial Baptist defeated First FWB.

Women's Tournament
Fleetwork defeated Burroughs-Wellcome.
Jackson defeated Strohs.

Sears

Installed continuous aluminum guttering

Installed **166** Linear ft.

New guttering is custom-fit right at your home. Phone for a free estimate.

Ask about Sears credit plans

Satisfaction Guaranteed or Your Money Back

Sears

Where America shops

WEST END SHOPPING CENTER
PHONE 756-2111
OPEN DAILY 9 A.M. - 6 P.M.

BONANZA

ALL DAY Tuesday and Thursday is Family Day at Bonanza

Chopped Steak Dinner \$1.79

Our delicious cooked-to-order Chopped Steak Dinner includes choice of potato, Texas Toast and salad from our FREE all-you-can eat Salad Bar.

Top Sirloin Steak Dinner \$1.99

Our Top Sirloin Steak Dinner includes choice of potato, Texas Toast and salad from our FREE all-you-can eat Salad Bar.

Child's Plate FREE

Includes Hamburger, French Fries and Lollipop.

With FREE Drink

TRY OUR LUNCHEON SANDWICH MENU \$1.19 to \$2.39

Sun. thru Thurs. 11 A.M. to 9 P.M.
Fri. & Sat. 11 A.M. to 10 P.M.

520 North Greenville Blvd., (264 ByPass) Greenville

GENERAL TIRE

vacation value days

Glass Belted New Car Tire

The General Belted Jumbo® 780 features two fiberglass belts, polyester cord body, and a multi-rib tread. It is designed for long mileage and easy handling.

Value Price \$33.95 (size A78-13 Tubeless Whitewall plus \$1.71 Fed. Ex. Tax)

Size	VALUE PRICE	Fed. Ex. Tax	Size	VALUE PRICE	Fed. Ex. Tax
A78-13	\$33.95	\$1.71	E78-15	\$40.95	\$2.31
C78-14	\$36.95	\$1.97	F78-15	\$42.95	\$2.44
E78-14	\$37.95	\$2.19	G78-15	\$44.95	\$2.55
F78-14	\$41.95	\$2.34	H78-15	\$47.95	\$2.77
G78-14	\$43.95	\$2.47	J78-15	\$49.95	\$2.96
H78-14	\$46.95	\$2.70	L78-15	\$50.95	\$3.05

Blackwalls \$3.00 less per tire

Glass Belted Radial Whitewalls

Value Price \$36.95 (size BR78-13 Tubeless Whitewall plus \$1.95 Fed. Ex. Tax)

Larger sizes comparably priced.

The General Jet Radial features a polyester cord body, two tough fiberglass belts for stability and a wide 5-rib tread for traction.

Polyester Cord Tire

Value Price \$22.95 (size A78-13 Tubeless Whitewall plus \$1.84 Fed. Ex. Tax)

Larger sizes and blackwalls comparably priced.

The General Poly-Jet is built with a polyester cord body for a smooth ride and a wide flat tread for traction. A great bias ply tire at a popular price.

Oil Change & Lube Special! \$7.88

We replace your car's oil with up to 5 quarts of Quaker State Super Blend Motor Oil and lube your car to manufacturer's specifications. Grease fittings and additional parts cost extra if needed. Most U. S. cars and light trucks.

Phone for an appointment

FRONT-END Alignment \$12.95

Our Specialists adjust caster, camber, toe-in and toe-out settings to car manufacturer's specifications. Adjust steering... and road test your car.

Sooner or later, you'll own Generals

Suttons Bill's Amoco

SERVICE CENTER
1105 DICKINSON AVE.
752-6121
OPEN MON.-FRI. 7 'TIL 6
SAT. 7 'TIL 4

SERVICE
310 E. GREENVILLE BLVD.
756-4766
OPEN 7 A.M. - 8 P.M.
7 DAYS A WEEK

N.C. STATE INSPECTION STATION

Greenville Game Postponed By Rain In Tourney's First Day

Rain forced an early close to the opening day ceremonies of the state 16-year-old Babe Ruth baseball tournament at Guy Smith Stadium yesterday. Although three of the four games were played, host Greenville had to make up its game with Clark-Griffith of Charlotte this morning.

In the first game yesterday, Central Carolina defeated Lenoir County 4-0. CC scored two runs in the fourth inning and two more in the fifth.

Scott reaching on an error to score both runners. In the fifth, Todd Roberts got a base hit and Mickey Glasscock followed with a home run. Glasscock was the game's leading hitter with three.

Albemarle misplay. Western N. C. added four more runs in the sixth, including a home run by Lenny Metts, who had two in the ballgame. Metts had three hits in the game, while Gary Hunter had two hits for Albemarle County.

All-Stars Win Pair In Tourney Despite A Number Of Problems

STATESVILLE — Greenville's 14-15-year-old Babe Ruth All-Stars survived a problem-filled day yesterday to win two ballgames and advance to today's finals in the state tournament here.

The two victories gave Greenville the championship of the tournament's loser's bracket and puts the team into today's finals against Wilmington. Wilmington defeated Greenville 6-4 Saturday night the team's only loss in the double elimination event. Two victories over Wilmington today will give Greenville the state title.

Greenville exploded for six runs in the fourth to gain its 8-4 victory over Erwin. Erwin scored one run each in the first and second innings, but Greenville took command in the fourth. Walsh started things off with a base on balls and he was doubled home by Mike Pollard.

Williams was the winning pitcher, while Junior Neal had three hits and Brann two. plate Tyson. Dough got a base hit, scoring Fletcher and Brann and Walsh knocked in Douglas with a double.

SCOREBOARD

BASEBALL

AMERICAN LEAGUE

Team	W	L	Pct.	GB
Boston	63	34	.649	
Milwaukee	57	39	.594	5 1/2
Baltimore	53	43	.551	8 1/2
New York	53	43	.552	9 1/2
Detroit	51	47	.520	12 1/2
Cleveland	46	50	.479	16 1/2
Toronto	35	64	.354	29

WEST

Kansas City	54	42	.563	
California	50	47	.510	3
Oakland	50	50	.500	3
Texas	46	51	.474	8 1/2
Minnesota	42	53	.442	11 1/2
Chicago	41	55	.427	13
Seattle	30	64	.360	20

Tuesday's Games

Cleveland 5, California 1
Seattle 4, Toronto 2
Detroit 11, Oakland 2
Chicago 4, Milwaukee 2
Minnesota 5, Boston 2
New York 4, Kansas City 0
Baltimore 7, Texas 6

Wednesday's Games

Cleveland (Waits 7:10) at New York (Beattie 2:4), (n)
Baltimore (Fianagan 13:7) at Detroit (Billingham 9:5), (n)
California (Tanana 13:5) at Milwaukee (Caldwell 12:5), (n)
Oakland (Langford 3:7) at Chicago (Krause 7:8), (n)
Toronto (Moore 4:2) at Minnesota (Boitz 9:4), (n)
Seattle (Parrott 1:2) at Kansas City (Bird 3:4), (n)
Boston (Eckersley 11:3) at Texas (Medley 4:5), (n)

Thursday's Games

Cleveland at New York, 2
Toronto at Minnesota, 2
Baltimore at Detroit, (n)
California at Milwaukee, (n)
Oakland at Chicago, (n)
Seattle at Kansas City, (n)
Boston at Texas, (n)

NATIONAL LEAGUE

Team	W	L	Pct.	GB
Philadelphia	53	41	.564	
Chicago	49	47	.510	5
Pittsburgh	47	47	.500	6
Montreal	47	54	.465	9 1/2
New York	44	58	.431	13
St. Louis	41	61	.396	17

WEST

San Francisco	60	39	.606	
Cincinnati	58	46	.558	2
Los Angeles	58	42	.580	2 1/2
San Diego	48	52	.480	12 1/2
Atlanta	45	53	.459	14 1/2
Houston	43	56	.434	17

Tuesday's Games

Atlanta 4, Philadelphia 2
New York 9, Cincinnati 2
Houston 3, Montreal 2, 13 innings
San Diego 2, Pittsburgh 1
Los Angeles 3, Chicago 1
San Francisco 3, St. Louis 2

Wednesday's Games

Cincinnati (LaCross 1:4) at New York (Espinoza 8:8)
St. Louis (Martinez 4:4) at San Francisco (Halcik 5:3)
Atlanta (P.Niekro 11:10) at Philadelphia (Kaef 5:2), (n)
Montreal (Grimley 12:7) at Houston (J.Niekro 6:8), (n)
Pittsburgh (Bobby 6:4) at San Diego (Perry 10:4), (n)
Chicago (Ribbs 4:4) at Los Angeles (Houston 10:7), (n)

Thursday's Games

Pittsburgh at San Diego
New York at Houston, (n)
Only games scheduled

League Leaders

AMERICAN LEAGUE

BATTING (225 at bats) — Carew, Min., .343; Lynn, Bsn., .321; Rice, Bsn., .319; GBrett, KC., .317; Lezano, Mil., .317.
RUNS — LeFlore, Det., 74; Rice, Bsn., 71; Baylor, Cal., 68; Hulse, Mil., 64; Fisk, Bsn., 62; Thornton, Cle., 62.
RUNS BATTED IN — Staub, Det., 82; Rice, Bsn., 81; Hulse, Mil., 73; J.Thompson, Det., 69; Thornton, Cle., 63.
HITS — Rice, Bsn., 129; Staub, Det., 117; LeFlore, Det., 116; J.Thompson, Det., 115; Carew, Min., 114.
DOUBLES — GBrett, KC., 33; Fisk, Bsn., 29; McRae, KC., 24; EMurray, Bal., 21; B.Bell, Cle., 21; Howell, Tor., 21; Ford, Min., 21.
TRIPLES — Rice, Bsn., 13; Cowens, KC., 7; Carew, Min., 7; B.Bell, Cle., 6; McKay, Tor., 6; GBrett, KC., 6.
HOME RUNS — Rice, Bsn., 24; Hulse, Mil., 23; Baylor, Cal., 22; Thornton, Cle., 20; J.Thompson, Det., 20; G.Thomas, Mil., 20.
STOLEN BASES — LeFlore, Det., 40; Wilson, KC., 32; Dilone, Oak., 32; J.Cruz, Sea., 30; Wilts, Tex., 29.
PITCHING (9 Decisions) — Guidry, N.Y., 151, 9.8; 1.99; Romo, Sea., 111, 8.00; 3.12; Eckersley, Bsn., 113, 7.86; 3.54; Galloway, KC., 112, 8.86; 3.66; Tiant, Bsn., 72, 7.78; 3.26; Gura, KC., 72, 7.78; 2.82; Sosa, Oak., 72, 7.78; 2.82; Tanana, Cal., 72, 7.78; 2.86.

NATIONAL LEAGUE

BATTING (225 at bats) — Clark, SF., .322; Burroughs, Atl., .320; Madock, SF., .317; Bowa, Phil., .313; Whitfield, SF., .311.
RUNS — Rose, Cin., 69; DeJesus, Chi., 65; Clark, SF., 61; Foster, Cin., 60; Griffey, Cin., 59; Lopes, LA., 59; Evans, SF., 59.
RUNS BATTED IN — Foster, Cin., 78; Clark, SF., 76; Whitfield, SD., 67; Montaner, NY., 65; Garvey, LA., 63.
HITS — Rose, Cin., 129; Bowa, Phil., 121; Cabell, Htn., 120; Clark, SF., 118; Garvey, LA., 116.
DOUBLES — Simmons, STL, 31; Perez, Atl., 30; Clark, SF., 30; Rose, Cin., 29; Howe, Htn., 29.
TRIPLES — Richards, SD., 8; Herndon, SF., 8; DeJesus, Chi., 6; Randle, NY., 6; Parker, Pgh.

HOME RUNS

Luzinski, Phil., 23; Foster, Cin., 23; Smith, LA., 20; EValentine, Mil., 17; Winfield, SD., 17; Clark, SF., 17; Taveras, Pgh., 23; Cabell, Htn., 23.
PITCHING (9 Decisions) — Bonham, Cin., 92, 8.18; 3.19; Blue, SF., 144, 7.78; 2.66; McGraw, Phil., 83, 7.72; 2.44; Perry, SD., 104, 7.14; 3.26; Sutter, Chi., 73, 7.00; 1.83; Rau, LA., 105, 6.67; 3.67; Knepper, SF., 116, 6.47; 2.67; Blyleven, Pgh., 95, 6.43; 3.46.

STRIKEOUTS

Richard, Htn., 185; P.Niekro, Atl., 140; Seaver, Cin., 130; MIntosco, SF., 116; Blue, SF., 115.

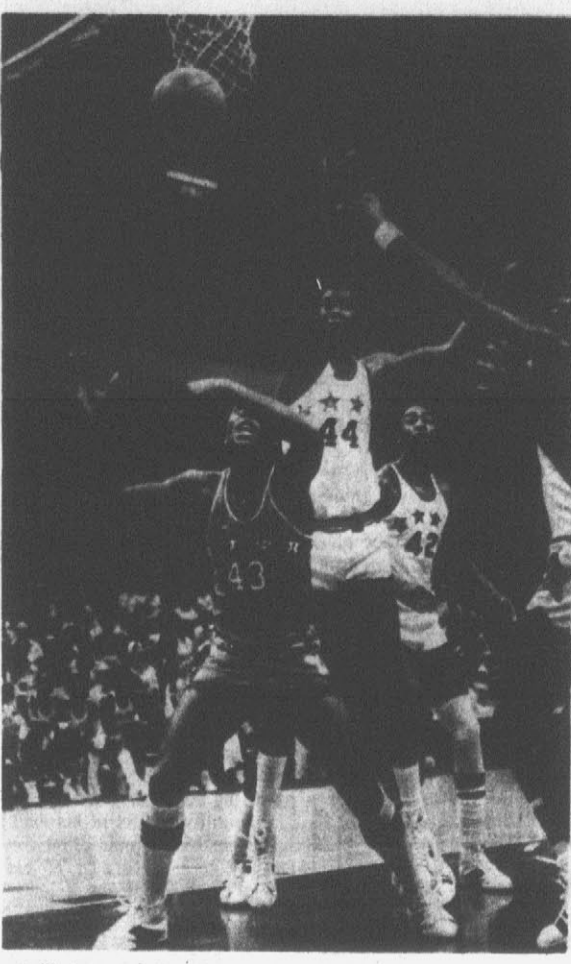

All-Stars Action

William Barnes (44) of Rose High School goes up for a rebound over Johnny Carson (43) of Northwest Cabarrus in last night's East-West All-Star basketball game in Greensboro Coliseum. Looking on is Sheldon Watlington (42) of Chapel Hill. The East won the game 114-93. (AP Laserphoto)

East All-Stars Roll Over West

GREENSBORO, N.C. (AP) — The East was paced by a balanced scoring attack and a tall front line as it knocked off the West 114-93 Tuesday night in the 30th annual East-West High School All-Stars boys basketball game in Greensboro Coliseum.

Watlington of Chapel Hill with 10. Two Greenville cagers also participated in the ballgame. Al Tyson from D. H. Conley scored seven points and was the second-leading rebounder with nine. William Barnes of Rose scored six points and grabbed six rebounds. Tyson is headed to East Carolina, while Barnes is going to Chowan.

Boys Home Pleases Dye

East Carolina University head football coach Pat Dye was well-pleased with the performances of his recruits in the 16th annual Boys Home All-Star football game in Raleigh's Carter Stadium last Saturday night.

Edenton, was injured in practice a few days before the game and had to have an operation on his knee. He is out for the upcoming season, at least, Dye commented.

WATSON ELECTRICAL CONSTRUCTION CO.

ELECTRIC MOTOR DEPT.

3121 BISMARCK STREET
GREENVILLE, N.C.
ONE BLOCK BEHIND PARKER'S BARBECUE

TELEPHONE 756-3100

Nights, Sundays & Holidays
758-6522 Or 748-4855
24 HOUR SERVICE

Sales, New & Rebuilt Motors Up 100 H.P. In Stock.

Guaranteed Rewinding & Repairs On Industrial • Farm & Home Motors.

DOUG BECKWITH, DEPT. SUPERVISOR
GENE VINCENT, SHOP FOREMAN

Firestone

A TRUSTED NAME FOR 78 YEARS!

TRIPLE

DOWN TO EARTH PRICES

Polyester Cord DELUXE CHAMPION

This tough polyester cord tire resists impacts, bruises and breaks and gives a smooth, quiet ride. Aggressive tread design for excellent traction, handling and cornering ability.

6.00 12", 5.60 13", P155, 80D-13", Blackwall	\$22
6.78-13, C78-14, D78-14, 5.60-15", 6.00-15", 6.85-15", 6.45-14", Blackwall	\$26
E78-14, F78-14, G78-14, H78-14, G78-15, H78-15, L78-15, Blackwall	\$32
M78-15, L78-15, Blackwall	\$36

Plus \$1.42 to \$1.50 F.E.T. and old tire. Plus \$1.61 to \$2.01 F.E.T. and old tire. Plus \$2.13 to \$2.60 F.E.T. and old tire. Plus \$2.65 to \$2.93 F.E.T. and old tire.

*Tread design different than shown. WHITEWALLS ADD \$3 EACH.

VACATION TIRE SALE

SAVE \$8 to \$24

Per set of 4

Double Belted Deluxe Champion

4 for \$99

478-13 Blackwall Plus \$1.77 F.E.T. per tire and 4 old tires. WHITEWALLS ADD \$6.25 PER TIRE.

4 for \$124

878-14, C78-14, E78-14 Blackwalls. Plus \$1.92 to \$2.19 F.E.T. per tire and 4 old tires.

4 for \$140

778-14, 15, G78-14, E78-15 Blackwalls. Plus \$2.31 to \$2.47 F.E.T. per tire and 4 old tires.

4 for \$148

H78-14, G78-15 Blackwalls. Plus \$2.55 to \$2.70 F.E.T. per tire and 4 old tires. WHITEWALLS ADD \$2 TO \$3.

4 for \$160

H78-15, J78-15 Blackwall. Plus \$2.77 to \$2.96 F.E.T. per tire and 4 old tires.

4 for \$172

L78-15 Blackwall. Plus \$3.05 F.E.T. per tire and 4 old tires.

WIDE BIAS-PLY PERFORMANCE TIRES: SUPER SPORTS™

Size	Price	F.E.T.	Size	Price	F.E.T.
670-13	\$28	\$1.91	670-14	\$40	\$2.71
670-13	\$28	2.34	670-15	\$48	2.82
670-14	\$36	2.29	670-15	\$48	2.82
670-14	\$36	2.82	H70-15	\$48	2.86

All prices plus tax and old tire.

Firestone Steel-Belted RADIAL 721™

AS LOW AS \$46

- Long mileage.
- Gas economy
- Road-gripping traction
- Easy radial handling

NEW! FULL TWO-YEAR WARRANTY

Firestone 721™

All prices plus tax and old tire. *Slightly different tread design than shown.

WE ARE SO CONVINCED OF THE QUALITY OF OUR 721, we are offering you a FULL TWO-YEAR WARRANTY on this great tire. This means we will replace free of charge including mounting and balancing any 721 that becomes unroadable in the two years after you purchase it because of a defect in workmanship or materials. (Only road hazard and in-service abuse are not covered. Proof of purchase is required. This offer is good on every 721 sold for passenger car use between now and October 31st by any Firestone dealer or store.

WHITWALLS

BR78-13" F.E.T. \$1.99	CR70-13" 195/70R-13, CR78-14", CR78-14", CR78-14" F.E.T. \$2.18 to \$2.40
FR78-14", CR78-14, CR78-15 \$66	NR78-14, NR78-15, NR78-15 F.E.T. \$2.58-\$2.83
LR78-15 \$78	FR78-15, FR78-15 F.E.T. \$3.34
	FR78-15, FR78-15 F.E.T. \$3.34

Blackwalls \$2 less. (CR78-13, 195/70R-13 and CR78-14 not available in blackwall.)

PUGH'S TIRE & SERVICE CENTER

Corner of 5th & Greene Sts. Phone 752-6125

•ROAD SERVICE •FARM & OFF-THE-ROAD SERVICE TRUCKS

•FRONT END ALIGNMENT •ELECTRONIC TUNE-UP •EXPERT BRAKE WORK

CHARGE 'EM OPEN AN ACCOUNT

WE ALSO HONOR

- Master Charge
- BankAmericard
- Shell Credit Card
- optional Billing

Water Heater Savings Cited

RALEIGH, N.C. (AP) — Energy consumers could receive lower power bills if they grant utilities the right to cut off home water heaters during peak demand periods under a proposal presented to the state Utilities Commission by a Virginia Polytechnic Institute economics professor Tuesday.

Residential consumers would save about \$1.50 per month under the program proposed by Dr. Robert M. Spann, associated professor of economics at VPI. Spann presented his report in a hearing on cost-based electrical rates, electric load management programs and conservation programs for Duke Power Co. and Carolina Power & Light Co.

Spann was hired by the Utilities Commission in October, 1977, in cooperation with the U.S. Department of Energy, to aid the commission's public staff in the development of innovative electronic rates, natural gas rates and conservation programs. The research was financed with federal funds.

The commission will decide based on testimony at the two-day hearing whether to require Duke Power and CP&L to adopt new voluntary peak-load rate schedules.

Spann said his study recommended two methods of peak-load scheduling: the shutdown of water heaters in homes during peak electricity usage periods each day for residential customers, and an interruptible

rate program for industrial customers.

Spann said all peak-load pricing would have to be done on a voluntary basis. He recommended that residential customers who allow utilities to cut off their water heaters be given rate compensation, which would increase with the number of hours they are willing to have their water heaters shut down each day.

"This type of voluntary program would involve gradual implementation," Spann said. "The customer must be given time to adjust to the program, and he may even want to terminate it if he feels he isn't getting proper compensation."

For industrial firms, Spann proposed interruptible rates. He said the plan would involve

utilities controlling specific customer loads through radio signals.

He said the interruptible rate program may pose some inconvenience to companies by curtailing production to some degree. But he recommended giving the industrial customer a discount based on his interruptible load kilowatts.

For industrial customers, Spann outlined three different interruptible schedules. One would involve a four-hour interruptible rate with no more than 200 hours of interruptions a year; another would be an eight-hour interruptible schedule with no more than 400 hours of interruptions a year; and the third would be a 13-hour interruptible schedule with no more than 600 interruptible hours a year.

Spann stressed that the industrial rates would be voluntary, with no customer forced to accept utility control of his load. The customer would allow the utility to control part of his load in exchange for a lower electric bill.

Spann said he believed it would be 1980 before either residential or industrial customers could be placed on the programs. He said they would

be implemented in only one or two areas at first and would be gradually put into effect all over the state by 1990. The utilities, he said, could have their equipment to control power usage installed in homes and businesses by 1990 at the latest.

Norris L. Edge, assistant manager of rates and service practices for CP&L, said the utility was in agreement in principle with Spann's study on load management, but that he felt another year of studies were needed before implementing the program. CP&L plans to do further studies and prepare a load management rate schedule to be released in 1979, he said.

Donald L. Denton of Duke Power agreed with CP&L's position, saying that the load management program must be proven to be cost effective before Duke would implement it. He said he felt the program has a good chance for success, but said there was no firm date available from research on the program.

Robert S. Gay of Virginia Power and Electric Co., which serves 1.2 million customers in Virginia and part of North Carolina, said Vepco has tried to determine the cost benefit ratio for customers who have volunteered for load management programs.

He said Vepco is currently studying long-range interruptible studies for industry in Virginia, and a report on the findings will be filed with the North Carolina Utilities Commission.

Claims Case Not 'Closed'

WASHINGTON (AP) — The U.S. Justice Department is still considering possible action in the Wilmington 10 case, a department spokesman said Tuesday.

Terry Adamson, spokesman for Attorney General Griffin Bell, said President Carter had not meant to say last week that the federal government had closed the case.

Carter was quoted as saying there was "no legal basis for further action on the case by the Justice Department."

But Adamson said the department was still actively considering intervention in the case, possibly by filing a friend-of-the-court brief, something that has been talked about in the department for more than a year.

Two habeas corpus petitions seeking release of the members of the group still in prison were filed several months ago in Raleigh.

The Wilmington 10 are nine black men and a white woman convicted in a firebombing during racial violence in Wilmington in 1971. Four members of the group have been paroled, and a fifth is to be paroled this week. All insist they are innocent.

Recycling Unit Here Fridays

"It make a lot of cents to recycle aluminum for Jerry's kids." This is the theme of this year's drive by Reynolds Aluminum to raise funds for Muscular Dystrophy.

Reynolds will have a mobile recycling unit at Pitt Plaza Shopping Center here every Friday in August from noon to 1 p. m. Some 17 cents per pound is paid, but if one wishes he or she may donate the money to Muscular Dystrophy. From now through Labor Day, Reynolds will add a penny to the MDA fund for each 17 cents donated. Anything aluminum, not over three feet long, and free of foreign materials is accepted, according to E. J. Kelly, district recycling manager for Reynolds.



REALLY A DOG'S LIFE — Mandy, a 9-month-old chihuahua, seems all tied up on a Toronto beach where she was taken to get a breath of fresh air in the city's muggy atmosphere. The corset anchor and heavy chain make sure that Mandy doesn't wander off and get lost. (AP Laserphoto)

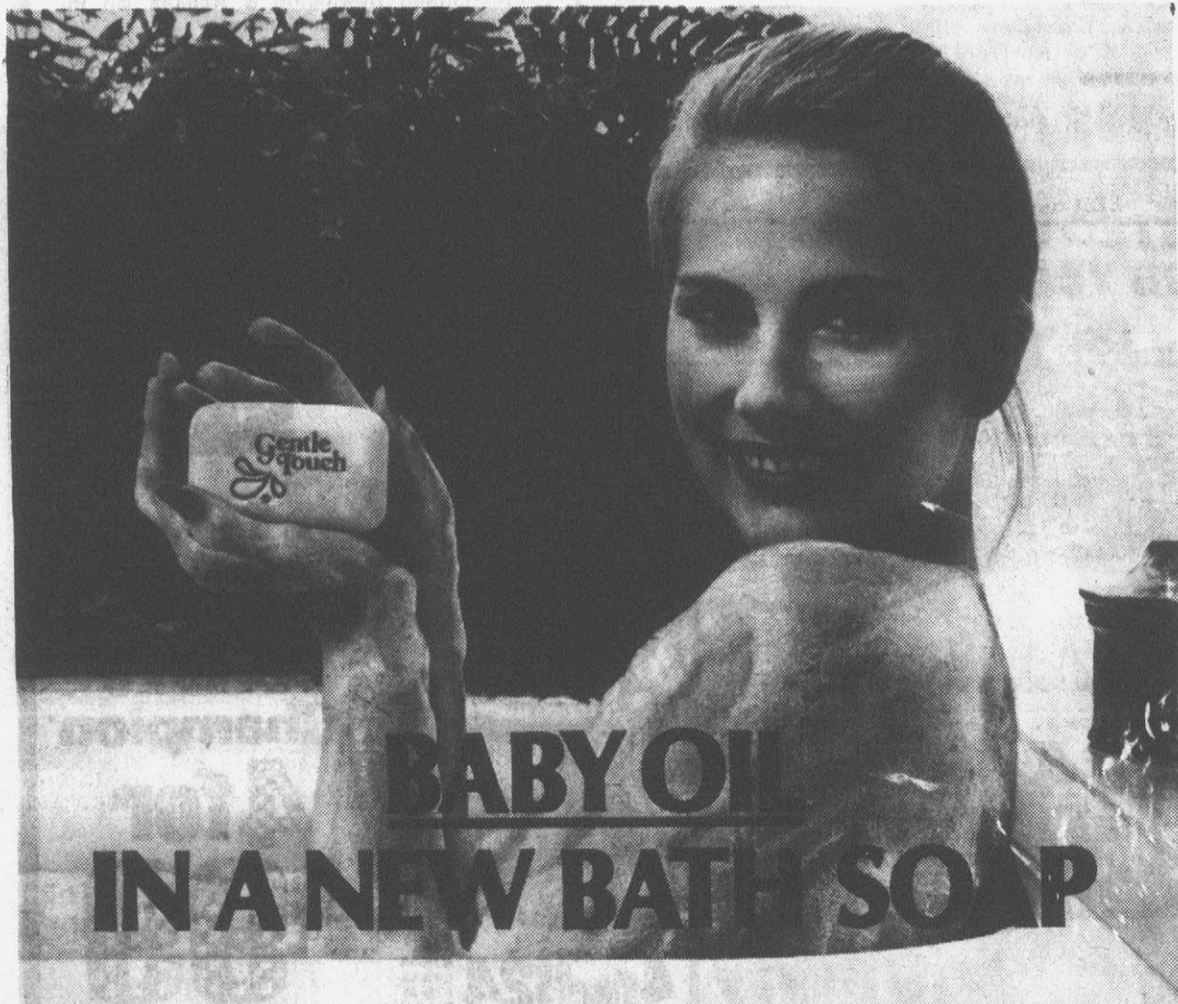

BABY OIL SOAP
IN A NEW BATH SOAP

New Gentle Touch...
Leaves your skin feeling baby soft, baby smooth. Gentle Touch babies your body with every bath. So you step out feeling soft, smooth and clean all over. The fragrance? As gentle as its name. And Gentle Touch lasts and lasts. Go ahead—baby yourself. With baby oil in your new bath soap!

CLIP NOW AND SAVE

GT/28/78GR

7c STORE COUPON

BABY YOUR POCKETBOOK — SAVE 7c

ON GENTLE TOUCH, YOUR NEW BATH SOAP WITH BABY OIL.

Gentle Touch

TO DEALER: You are authorized to act as our agent for the redemption of this coupon. We will reimburse you 7c plus 5c for handling provided that you and the customer have complied with terms of our coupon offer. Limit one coupon per family. This coupon is good only when submitted by a consumer for redemption at time of purchase of specified brand. The consumer must pay any tax involved. This coupon is nonassignable. Invoices proving purchase of sufficient stock

of the brand to cover coupons presented must be shown upon request. Coupons will not be honored and will be void if presented through outside agencies, brokers or others who are not retail distributors of this brand. Coupon is void if prohibited, taxed, or restricted. Cash Value 1/20 of 1c. Coupon expires July 31, 1978. Andrew Jergens Company, Box 1200, Clinton, Iowa 52734

CLIP NOW AND SAVE

GT/28/78GR

7c STORE COUPON

LOOK **We Have Moved!**

MERITA BREAD BOX
Bakery Discount Store
West End Shopping Center
Between Clarks And Clow Drug

SAVE UP TO 50%

FIGHT INFLATION WITH US!

We Redeem Food Stamps

Bread-Rolls-Cake-Pies
Complete Line Of Cookies
Milk And Ice Cream
Free Balloons for the Kids

SUMMER SALE!

PRELL CONCENTRATE SHAMPOO
7 Oz. Tube
Reg. 3.37 **\$1.79**

SCOPE MOUTHWASH & GARGLE
Reg. 2.91 **\$1.19**

SECRET DEODORANT
5 Oz. Dry Formula
4 Oz. Regular Formula
Reg. 1.78 **89c**

CREST TOOTH PASTE
Regular & Mint
7 Oz. Size
Reg. 1.60 **99c**

DR. SCHOLLS FOOT POWDER
Reg. \$1.49 **99c**

MERIT SUPER PROFESSIONAL STYLIST DRYER
1000 Watts
Reg. \$12.88 **\$9.95**

JUSTEN CURLING IRON
Reg. \$14.95 **\$4.88**

VIVA TOWELS
2 Roll Pkg. **89c**

TOWN TALK ICE CREAM
1/2 Gal. **89c**

At HOLLOWELL'S your pharmacist is always ready to fill your prescription or answer any question. And you can rely on him for fast, courteous service. SERVICE and ECONOMY go together at HOLLOWELL'S. Our motto is COMPARE & SAVE.

Everyday Low Price

master charge

Hollowell's
DRUG STORES, Inc.

Quality • Competitive Prices • Service

No. 1 — 911 Dickinson Ave. Phone 752-7105

No. 2 — 6th St. & Memorial Drive Phone 758-4104

VISA

**WE GLADLY
ACCEPT USDA
FOOD STAMPS**

Latch onto these

FOOD SPECIALS

PRICES EFFECTIVE - GROCERY AND PRODUCE - JULY 27 - AUG. 2
MEATS - JULY 27, 28, & 29
QUANTITY RIGHTS RESERVED - NONE SOLD TO DEALERS

FOODLAND MARKETS

MEMBER OF THE FOODLAND SYSTEM

SWIFT PREMIUM
HEAVY WESTERN STEER

**ROUND
STEAK**

FULL
CUT
LB.

\$1.49



SWIFT PREMIUM
HEAVY WESTERN STEER
TOP ROUND STEAK

\$1.89

SWIFT PREMIUM HEAVY WESTERN STEER
**BOTTOM ROUND
ROAST**

\$1.49

SWIFT PREMIUM, HEAVY WESTERN STEER
FRESH, LEAN
GROUND BEEF

99¢

USDA INSPECTED
CAROLINA PRIDE

FRYERS

LIMIT 4
PER CUSTOMER

WHOLE
LB.

45¢



USDA INSPECTED

SPLIT FRYERS

49¢

SWIFT PREMIUM
WHOLE
SIRLOIN TIP

SLICED FREE
\$1.39

LB.

SWIFT PREMIUM
HEAVY WESTERN STEER
**CUBED
STEAK**

\$1.89

LB.

SWIFT PREMIUM
HEAVY WESTERN STEER
**SIRLOIN
TIP ROAST**

\$1.49

LB.

BONELESS SMITHFIELD DUTCHESS
**BUFFET
HAMS**

\$1.99

LB.

SMITHFIELD
FRANKS

79¢

12 OZ.
PKG.

SMITHFIELD SLICED
BACON

\$1.19

1-LB.
PKG.

CRISP
CELERY

STALK

49¢



GOLDEN-RIPE
BANANAS

19¢

LB.

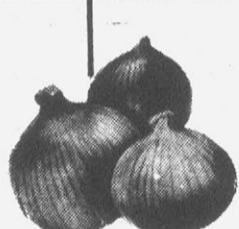

YELLOW
ONIONS

79¢

3-LB.
BAG



CRISP
CARROTS

39¢

1-LB.
BAG

LAND O LAKES
BUTTER

LIMIT 1 WITH 7.50 FOOD ORDER

99¢

1-LB.
PKG.

FROZEN FOODS

BIRDSEYE WHITE
WHOLE CORN

\$1.00

3 10 OZ.
PKGS.

MARSH GARDEN
**SLICED
STRAWBERRIES**

\$1.00

3 10 OZ.
PKGS.

MARSH BRAND
**ORANGE
JUICE**

79¢

12 OZ.
CAN

MORTON
**CREAM
PIES**

59¢

16 OZ.
PKG.

MORTON
**MACARONI
& CHEESE**

\$1.00

4 8 OZ.
PKGS.



SHASTA

SOFT DRINKS

59¢

HALF
GALLON

FOODLAND
CHEESE SINGLES

99¢

12 OZ.
PKG.

POTATO CHIPS
PRINGLES

89¢

TWIN
PACK

PILLSBURY
EXTRA-LIGHT
BISCUITS

79¢

4-PK.

DISINFECTANT CLEANSER
**PINE
SOL**

79¢

15 OZ.
BOTTLE



TODDLER
PAMPERS

\$1.49

12
COUNT
BOX

A-1
STEAK SAUCE

99¢

10 OZ.
BOTTLE



LIPTON
**INSTANT
TEA**

\$1.99

4 OZ.
JAR



JIF
**PEANUT
BUTTER**

99¢

SMOOTH OR
CRUNCHY
18 OZ.
JAR



DEL MONTE
GOLDEN CORN

WHOLE

\$1.00

3 303
CANS

COMET CLEANSER

2" OFF

89¢

3
14 OZ.
CANS

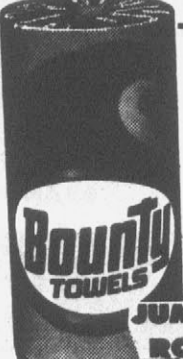

**BOUNTY
TOWELS**

55¢

JUMBO
ROLL



KRAFT GRAPE
**JAM OR
JELLY**

59¢

18 OZ.
JAR



DEL MONTE
SWEET PEAS

\$1.00

3 303
CANS

FABRIC SOFTNER
DOWNY

25" OFF

\$2.49

96 OZ.
BOTTLE



COLD POWER

15" OFF

99¢

GIANT
SIZE



FOODLAND, WHITE
BREAD

\$1.00

3 1 1/2 LB.
LONG
LOAVES

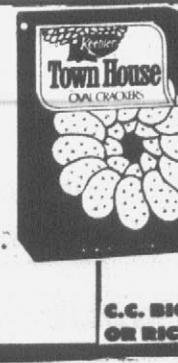

KEEBLER TOWN HOUSE
CRACKERS

3 DOZEN FREE

75¢

16 OZ.
BOX
C.C. BIGGS, C.C. DROPS
OR RICH N CHIPS
YOUR
CHOICE

89¢

SPAIN'S
1414 Charles Blvd.

STORE HOURS:
Mon. Thru Thurs. 8:00 A.M. to 8:00 P.M.
Fri.-Sat. 8:00 A.M. to 8:30 P.M.
CLOSED SUNDAYS

FOODLAND

STORE HOURS:
Mon. thru Sat. 8:30 A.M. to 9:00 P.M.
OPEN SUNDAY 1-7PM

SHOP-EZE
West End Shopping Center

Downtown Market Has New Food, Old Charms

MANKATO, Minn. (AP) — The coffee pot is always on for neighbors who come to shop at Anton's Foods, the last of the family-owned downtown markets in Mankato.

And Millie Anton, the 72-year-old owner and lone employee, greets most of the customers by their first names as they steadily trickle in.

The store was opened for business by Millie and her brother, John, on May 20, 1933 — just over 45 years ago. John died 22 years ago, but Millie continues to hold court in the little store.

Not much has changed over the years. The shelves are the same ones Millie's father, a stone quarry laborer, put up. "He was no carpenter, as you can see, but they're still standing," Millie says.

The wooden floor, swept daily with fresh-smelling sweeping

compound, has been worn smooth by two generations of shoppers. Bare light bulbs, turned on by pulling long metal chains, light the store.

A clock proclaiming the virtues of Nash coffee has held its same place on the wall since the opening day, and a plain brown radio playing in the corner has been Millie's companion for the same length of time. Both have run faithfully for nearly half a century.

Millie opens her grocery store at 8:30 every morning and plans to lock up at 4 p.m., six days a week. And she has a warm relationship with other business people nearby.

"Any time I have a problem, if something goes wrong here, my neighbors fix it for me," she said. "No matter what happens, they're right here to help. Sometimes they even come in and help me stock shelves. My

neighbors are wonderful," she says.

Millie admits she probably couldn't have stayed in business in recent years if she'd had to pay wages for hired help. The only help she has is a woman who comes in on "stock day."

Although her store retains its old-fashioned charm, it carries not only the necessities, but also convenience foods, including frozen products and packaged mixes. From the small meat department in back, she cuts steaks and chops to order.

"I don't like to have them cut ahead," she explained. "Some people like their meat thicker." Millie is proud of her store.

"I think this is a pretty nice grocery store for its age," she said. "The inspector says, 'I never have to check your store because it always looks so

Report Manganese Deficiency Found

According to Gaylon Ambrose, Pitt County associate agricultural extension agent, manganese deficiency has been noted in quite a few county soybean fields this season.

Symptoms of the deficiency are a distinctive lighter color (even to definite yellow) or chlorosis between the veins of the leaves with the leaves retaining a darker color, Ambrose says.

Symptoms initially show up on the top leaves, since manganese is not particularly mobile in the plant. If severe and persistent, stunting may occur, as well as other problems caused by a nutrition deficiency.

Many, if not most of our soils are borderline for a supply of manganese, according to Ambrose. Soils with a higher pH tend to have less manganese, so the deficiency is often noted in well or over-limed soil.

Manganese deficiency begins to show following wet weather when the soil at the rooting depth has been wet a little too long.

This includes thunderstorm weather when the surface may have dried up, but the roots remain in wet soil when ability to take up manganese is restricted. Ambrose says that in this

situation, the tops may be enjoying the weather while aggravating the imbalance between top growth and root supplying capacity.

Drier weather often helps the less severe situations, as well as cultivation to aid air in getting to the roots.

A foliar spray of manganese may help the more severe cases of deficiency, with a second application two to three weeks later for the most extreme situations.

There is a limit to how much manganese a plant may take at one time. Ambrose suggests that

A soil test be made to verify the deficiency before treatment.

Argentina's Atucha Atomic Center generates 10 percent of the nation's electrical power.

BOB'S TV'S 13th ANNIVERSARY SPECIAL!



AXMP70-2

5000 BTU	148.00
10,000 BTU	298.00
18,000 BTU	368.00
21,000 BTU	448.00
25,000 BTU	488.00
29,000 BTU	588.00

Whirlpool Air Conditioner

•7500 BTU •1-Speed
•Air Directors •Thermostat
Instant Mount

\$198⁰⁰

New Low Price

108 E. 2nd St.
Ayden, N.C.
746-4021

C. L. Lupton Bldg.
Memorial Dr.
Greenville, N.C.
752-6248

BOB'S TV

WE WELCOME U.S.D.A. FOOD STAMPS

WIN UP TO \$5,000!

BIG STAR FOODS

OVER \$1,000,000 IN CASH PRIZES!

Get a FREE Million Dollar Match Collector Card at the checkout counter or store office. Get a FREE Game ticket each time you visit a participating store. PLAY 2 EXCITING GAMES ON EACH TICKET!

ODDS CHART EFFECTIVE JULY 8, 1978

PRIZE VALUE	NUMBER OF PRIZES	ODDS FOR ONE GAME TICKET	ODDS FOR GAME TICKETS	ODDS FOR GAME TICKETS PLUS 10 BONUS MARKERS
\$5,000.00	9	1 in 2,303,720	1 in 787,906	1 in 143,920
1,000.00	218	1 in 45,108	1 in 31,703	1 in 5,944
100.00	2,092	1 in 9,911	1 in 3,304	1 in 619
5.00	8,705	1 in 2,382	1 in 794	1 in 149
2.00	27,796	1 in 746	1 in 249	1 in 47
1.00	147,350	1 in 105	1 in 35	1 in 6.5
TOTAL NO. PRIZES	236,170	1 in 87	1 in 29	1 in 5.4

ODDS CHART
Odds are based on number of game tickets you collect. The more tickets you collect, the better your chances of winning.
The game is being played in 348 Big Star and Colonial Stores in Virginia, North Carolina, South Carolina, Georgia, Alabama and Florida. It is also being played in Puerto Rico, Hawaii, Canada, and Mexico. Prizes in Atlantic, Georgia, and Florida are subject to state laws. Prizes in other states are subject to state laws. Prizes in Puerto Rico, Hawaii, Canada, and Mexico are subject to local laws. Prizes in all areas are subject to change without notice. Prizes are distributed on a first-come, first-served basis.

PLAY THE ALL NEW



HOLLY FARMS
U.S. GRADE 'A'
WHOLE
FRYERS

LIMIT 4 PLEASE
LB. **47¢**

MARKET STYLE
SLICED BACON

2 LB. or MORE LB. **98¢**

MIXED FRYER PARTS



HOLLY FARMS FAMILY PAK
2 Breast Qtrs. LIMIT 4
2 Leg Qtrs. PLEASE
2 Wings
2 Necks
1 Back
LB. **45¢**

U.S. CHOICE BEEF
SIRLOIN
TIP ROAST

BONUS BUY LB. **\$1.88**

U.S. CHOICE BEEF
SIRLOIN
TIP STEAK

BONUS BUY LB. **\$1.98**

EMBERS
CHARCOAL

10 LB. BAG **99¢**



•PURE PORK SAUSAGE HOT OR MILD 1 LB. **\$1.18**
•SLICED COOKED HAM 6 OZ. PKG. **\$1.28**

—FIESTA BRAND SALADS—

- POTATO SALAD 16 OZ. CUP **49¢**
- COLE SLAW BONUS BUY 14 OZ. CUP **49¢**
- PIMIENTO CHEESE SPREAD MILD 15 OZ. CUP **98¢**

FROZEN SEAFOOD

- GORTON'S FISH KABOBS BATTER FRIED 1 LB. PKG. **\$1.58**
- GORTON'S FISH STICKS 15 OZ. PKG. **\$1.48**
- SINGLETON'S ROUND SHRIMP GOLDEN FLEET 8 OZ. **\$1.18**
- COOKED SHRIMP SINGLETON'S 6 OZ. **\$1.18**
- FISH STICKS MRS. PAULS LIGHT BATTER 8 1/2 OZ. **98¢**



MAXWELL HOUSE
COFFEE
1 LB. BAG **\$2.99**

OVEN KRISP
COOKIES
10-OZ. PLACE PACK 3PKGS. **\$1.00**

- HUNT'S
- TOMATO KETCHUP 32 OZ. **58¢**
 - PEACHES SLICED OR HALVES 29 OZ. 2 FOR **\$1.00**
 - FRUIT COCKTAIL 16 OZ. 3 FOR **\$1.00**
- KLEENEX FACIAL TISSUE 100 CT. 3 FOR **\$1.00**
 - PAPER PLATES PACKERS LABEL WHITE 100 CT. **68¢**
 - PAPER TOWELS HI-DRI JUMBO ROLL **39¢**

- CORNER BEEF ROUNDS LB. **\$1.78**
- CORNER BEEF BRISKETS LB. **\$1.48**
- BEEF LIVER SLICED DEVEINED AND SKINLESS LB. **78¢**
- CALF LIVER SLICED DEVEINED AND SKINLESS LB. **\$1.18**

- SPARE RIBS PORK LEAN & MEATY LB. **\$1.48**
- PORK ROAST FRESH BOSTON BUTT LB. **\$1.18**
- SLICED BACON WINNER BRAND 12 OZ. **\$1.08**
- SAUSAGE SYCAMORE SMOKED LB. **88¢** \$7.99

- SLICED BOLOGNA JUBILEE BRAND 1 LB. PKG. **\$1.08**
- FRANKS JUBILEE BRAND 12 OZ. PKG. **88¢**

YOUR KIND OF LOW, LOW PRICES

FARM BEST

- VARIETY POPS BUY ONE GET ONE **FREE**
- ICE CREAM FARM CHARM ALL NATURAL 1/2 GAL. **\$1.48**
- COTTAGE CHEESE FARM CHARM, REGULAR & LOW FAT 12 OZ. **49¢**

BIG STAR 100 CT. - BONUS BUY

- TEA BAGS **\$1.29**
- SOUR CREAM SEALTEST - BONUS BUY 1 OZ. **39¢**

FLOWERS FINGERS PLAIN & CHOCOLATE 7 1/2 OZ., RASPBERRY & ORANGE 9 OZ. 2 For **\$1.29**

Sherlock Holmes Fans Turned Back The Clock

TOKELAND, Wash. (AP) — It may have been elementary for Watson, but modern followers of Sherlock Holmes find life a tad more complicated.

For example, there are the weekend get-togethers of the Noble and Most Singular Order of the Blue Carbuncle, a Portland, Ore., club dedicated to

keeping alive the memory and times of the master detective. The members make four or five costume changes daily. Full-ruffled taffeta skirts rustle across the floors, while gentlemen in striped trousers and Prince Albert coats bow over the ladies' hands.

At croquet time it's voluminous knickers and straw boaters for the men, while the ladies are in long skirts and jackets with leg-of-mutton sleeves.

It's nearly full-dress for the

afternoon's high tea, then on to the elaborate lace, feathers, spangles and (for the men) military decorations of the dinner hour.

The members don flannel nightdresses, striped night-shirts and pointed nightcaps for the late night showings of Sherlock Holmes movies.

"I can certainly appreciate blue jeans and sweatshirts now," said Grace Reyom, club secretary, glowing in a waistcinching pink creation with a bustle and train. "But it's worth it," she added hastily.

The Portland society had its birth in 1970 in a night-school class in Victorian literature taught at the University of Portland by Michael Burton.

"Something about the Holmes stories seemed to turn on members of the class, and they formed a literary society, which has grown into this organization," said the tall, scholarly-looking Burton.

He and his librarian wife are

both members, along with 30 other persons including Portland's police chief, teachers, musicians, a planning consultant, a postman, and an interior decorator.

The club spent a recent weekend at the Tokeland Hotel on Washington's coast, a century old structure and National Historic Site.

Between the costume changes there was time for croquet, backgammon and cribbage.

"We do anything we can to keep the memory of the master alive," said B.J. Graves, club president, waving a green leather fan gently to and fro as she waited, in a long, spangled, green gown, to be served dinner.

The darkest day for Holmes detective and his arch enemy, Professor Moriarty, locked together in mortal combat and plunged to their presumed deaths over a waterfall in Switzerland.

The club conducts services at

Multnomah Falls to commemorate the event.

"We appeared in costume at the Portland opening of 'The Seven Percent Solution' (a Holmes movie)," said Mrs. Graves. "And we always remember Dr. Watson's picnic — but because there are dif-

ferent interpretations of when the picnic was, we have it either in July or August, depending on which faction is in control at the time."

"It's escape," observed one member. "Sort of like a vacation from real life, from the 20th century."

Giving Gospel Program Sunday

WINTERVILLE — The Oak Grove Boys of Elm City will render a program of gospel music at the Winterville Free Will Baptist Church Sunday at 7:30 p.m.

The Rev. Bobby Futrell, pastor, and the church members invite the public to attend.

WILL FILL OUT TERM
LUMBERTON, N.C. (AP) — Samuel R. Noble, chairman of the Robeson County commissioners and a longtime county political power, has been named to fill the unexpired state Senate term of Luther J. Britt Jr., who died Saturday.

Final Action

WASHINGTON (AP) — The compromise legislation aimed at saving New York City from bankruptcy faces just one more congressional hurdle before going to the White House for President Carter's signature.

The Senate was expected today to give routine final approval to the \$1.65 billion package which the House passed Tuesday.

The compromise proposal, designed to give the city both long-term bond guarantees and short-term loans, was approved on a 244-157 House vote.

City officials say the legislation is necessary for New York's survival.

Managers of municipal pension funds, whose investments are needed so the city can put together a four-year financing plan, have said they would withdraw unless their investments were guaranteed.

The legislation is also intended to restore New York's financial health and allow it to re-enter the bond market. The city's last bond offering failed in November.

NOTICE TO LOW-INCOME FAMILIES IN PITT COUNTY excluding Greenville and Farmville

The Mid-East Regional Housing Authority announces a new Federal Program to assist the elderly, handicapped, disabled and low-income families in the Pitt County area, excluding Greenville and Farmville. The program will help families rent standard Housing on the private market by paying a portion of the rent.

Interested Families may apply at:
Mid-East Regional Housing Authority
Section 8
Beverly Little or Beverly (Bet) Savage
200 E. Greenville Bd. (264 Bypass)
Greenville, N.C.
756-9312



Maximum Income To Qualify

Family Size	Income Limit
1	6,850
2	7,850
3	8,850
4	9,800
5	10,400
6	11,050
7	11,650
8 plus	12,250

MILLION DOLLAR MATCH

10¢ OFF LABEL

TIDE \$1.18

DETERGENT 49 OZ. BOX

JENO'S CHEESE, SAUSAGE, PEPPERONI, HAMBURGER

FROZEN PIZZA

BONUS BUY 13 OZ. **88¢** JENO'S

SWEET AND JUICY

PEACHES 34¢

LB.

CABBAGE

CRISP GREEN LB. **19¢**

PRICES GOOD THROUGH SAT. JULY 29, 1978
QUANTITY RIGHTS RESERVED—NONE SOLD TO OTHER DEALERS OR RESTAURANTS

BIG STAR FOODS

VISA

WE SELL U.S. CHOICE BEEF

Pitt Plaza Shopping Center
Open Daily 8 A.M. til 10 P.M.
Sunday 9 A.M. til 9 P.M.

OUR PRIDE

BUTTERMILK BREAD

24 OZ. LOAF **\$1.00**

3 For

GOLDEN RIPE

BANANAS

LB. **24¢**

MEDIUM YELLOW

ONIONS 79¢

3-LB. BAG

RED RIPE **TOMATOES 37¢**

9 OZ. PKG.

SHOP BIG STAR for BEER!

- *BUDWEISER CARTONS OF 6 12-OZ. CANS **\$1.84**
- *MILLER BEER CARTON OF 8 7-OZ. BOTTLES **\$1.82**
- *SCHAEFER CARTON OF 6 12-OZ. CANS **\$1.63**
- *ANHEUSER BUSCH-NATURAL LIGHT 12-OZ. CANS CARTON OF 6 **\$1.97**

GREENVILLE STORE ONLY

VANITY FAIR



- BATH TISSUE 4 PACK **69¢**
- PRINT TOWELS JUMBO ROLL **49¢**
- PRINT FACIAL TISSUE 134 CT. **49¢**
- DINNER NAPKINS WHITE 75 CT. **69¢**
- LUNCHEON NAPKINS WHITE 100 CT. **58¢**

BRANDS YOU KNOW & TRUST

- WHITE HOUSE APPLESAUCE 16 OZ.
- RED GATE TOMATOES 16 OZ.
- COMET CLEANSER 14 OZ.
- FRANCO-AMERICAN SPAGHETTI-OS 16 OZ.
- GOLD CORN GREEN WHOLE GIANT KERNEL 16 OZ.
- HOT DOG CHILI TEXAS PETE 10 1/2 OZ.
- PORK & BEANS CAMPBELLS 16 OZ.

EVERYDAY LOW PRICES

- GRAPE JELLY SUN RIPE 28 OZ. **79¢**
- POTATO CHIPS OUR PRIDE 8 OZ. **68¢**
- PUREX BLEACH GAL. **59¢**
- TREND DETERGENT 42 OZ. **78¢**

OUR PRIDE BAKERY PRODUCTS

- OLD FASHION BREAD 16 OZ. LOAF 4 FOR **\$1.00**
- FRENCH BREAD OUR PRIDE 16 OZ. **49¢**
- ITALIAN BREAD OUR PRIDE 16 OZ. **49¢**
- PETITE ROLLS OUR PRIDE 8 OZ. **49¢**

HEALTH & BEAUTY AIDS

- RIGHT GUARD DEODORANT 4 OZ. **\$1.18**
- TRAC II SHAVE CREAM 11 OZ. **\$1.08**
- BUFFERIN TABLETS 60'S **\$1.24**

4 FOR \$1.00

FOR YOUR CHOICE

Crossword By Eugene Sheffer

ACROSS
 1 Papal name
 4 Mesopotamia
 8 Marsh bird
 12 Graceful tree
 13 Distance measure
 14 Lyric poems
 15 Peer Gynt's mother
 16 Lie detector
 18 — Matisse
 20 One of the Caesars
 21 Collections
 24 Funeral song
 28 Confusion of languages
 32 Loved
 33 Author
 34 God of the winds (var.)
 36 Anais —; author
 37 Drive down
 39 Figures with many angles
 41 Vigilant
 43 Body fluids

DOWN
 23 Choir plums
 1 Daughter of Laban
 2 Other
 3 Sign
 4 Encroachment
 5 — de Oro
 6 Completely
 7 Piano parts
 8 Filthy
 9 Harem room
 10 Ribbed cloth
 11 Rowan tree
 17 Disease of sheep
 19 Actor
 Millard
 22 Askev

Average solution time: 26 min.

CRYPTOQUIP 7-26
 ZVKSVK ZWKELC ZVKEH BZ PDBG
 WSCH PDG HBZZLG

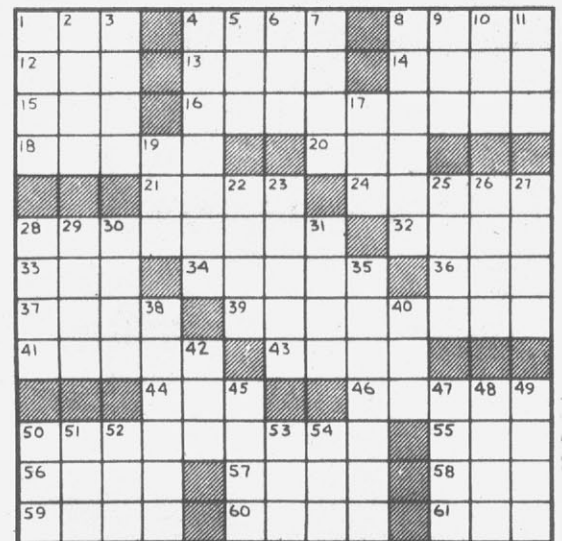

Yesterday's Cryptoquip — MAN OF PRINCIPAL SMOTHERS MOST OF HIS PRINCIPLES.
Today's Cryptoquip clue: W equals A

The Cryptoquip is a simple substitution cipher in which each letter used stands for another. If you think that X equals O, it will equal O throughout the puzzle. Single letters, short words, and words using an apostrophe can give you clues to locating vowels. Solution is accomplished by trial and error.

Rich Era Of Comedy In Movies Recalled On TV

By JAY SHARBUTT
 AP Television Writer
 LOS ANGELES (AP) — "Better close that slow leak under your nose before I vulcanize it," the guy snarls. He's told: "I'll put so many lumps on you, you'll think you've got a skin full of teabags."

Yes, it's a film clip of Jack Benny and Fred Allen, close friends, in their famous "feud." And it's one of the best bits in "Funny Business," an oddly uneven CBS special airing tonight.

Narrated by Walter Matthau, made by film critic Richard Schickel, it uses some 100 film clips in its two-hour tour of the greats of movie comedy in the 1930s and 1940s.

It displays the Marx Brothers, Mae West, W.C. Fields, Laurel and Hardy, Abbott and Costello, Bing Crosby, Bob Hope, and samples of two ace comedy directors, Ernst Lubitch and Preston Sturges.

What it tries to show, in Matthau's words, is that with the advent of talk in movies, word-fun erupted in films and "the result was the richest comic era in the history of the movies."

Alas, the trouble with any look-back show like this is you often find yourself grumbling at the maker's use or choice of old film clips. We plead guilty to such grumbling here.

A few excerpts simply run too long, such as one, with a proper gentleman and a proper lady, that seeks to show how Lubitch satirized amour but "always honored the romantic spirit."

It's slow and only mildly funny. You may wish Schickel had dropped it and opted from a shorter, livelier segment.

No problem, though, with his Mae West study. The venerable

sexbomb was thought quite racy in the '30s. But as Matthau notes, she "blew away a lot of the old Victorian attitudes about sex."

A fine sample of her famed one-liners is exhibited. Such as when a fortune-teller predicts "a change of position" for her. She raises an eyebrow and inquires, "Sitting or reclining?"

The Abbott-Costello piece, including their "Who's On First" bit, features a mild defense of their broad style. The case is weak.

But there's grand fun throughout the show's look at W.C. Fields as boozler, con man, card cheat, pool shark and victim of tots.

Watch for the clip in which Fields, as a store owner, gamely tries to cope with an old blind man who bumbles about,

breaking things. It sounds cruel, but isn't. It's only mighty, mighty funny.

So is the clip where Fields, his neck in a noose, is asked if he has any last wishes. And draws: "Yass, I'd like to see Paris before I die."

The Hope-Crosby segment, with bits from their "Road" films, is okay, but runs too long, and not all the best bits are in.

And I wish there'd been more than a wild Jack Benny broadcast, his too-brief "feud" scene with Allen, and a lengthier study of Hope in the show's examination of radio's impact on movie comedy.

Oh, well, even though flawed, "Funny Business" has enough guaranteed bellylaughs to make it a fun time for viewers tonight.



IN 'VELVET' SEQUEL — Tatum O'Neal, the 14-year-old star of "International Velvet" is photographed in London. Tatum, daughter of actor Ryan O'Neal, will attend MGM's royal gala premiere of the film at the Empire Theater in London Thursday. "International Velvet" is the sequel to the 1944 version of "National Velvet" which starred Elizabeth Taylor. (AP Laserphoto)

MEMBERSHIP GAIN
 DENVER (UPI) — The American Federation of Television and Radio Artists now has 36,000 members, an increase of 2,000 over the past year, president Joe Slattery told the 41st AFTRA convention here.

TV Log

WNCT-TV Ch. 9

WEDNESDAY
 7:00 News
 7:30 Gilligan
 8:00 Family Business
 11:30 Movie

THURSDAY
 4:00 Carolina
 8:00 Morning
 9:00 Kansas
 10:00 The TAC
 11:30 Price is Right
 11:55 Paul Harvey
 12:00 9/Alive News

WITN-TV Ch. 7

WEDNESDAY
 7:00 F Troop
 7:30 Truth or Dare
 8:00 Grizzly
 9:00 Blacksheep
 10:00 Police
 11:00 News
 11:30 Tonight
 1:00 News

THURSDAY
 5:30 Arthur Smith
 6:00 Almanac
 7:00 Today
 7:25 News
 7:30 Today
 9:00 Griffin
 10:00 Card Sharks
 10:30 Squares
 11:00 Rollers

WCTI-TV Ch. 12

WEDNESDAY
 11:30 Family
 12:00 Noon
 12:30 Ryan's
 1:00 Children
 2:00 One Life
 3:00 Hospital
 4:00 Mickey Mouse
 4:30 Star Trek
 5:00 News
 6:00 News
 6:30 News
 7:00 News
 7:30 News
 8:00 Katter
 8:30 Happening
 9:00 Barney
 9:30 Movie
 11:00 Hartman
 11:30 Starzsky & Kottler
 12:00 News

THURSDAY
 5:55 Tidings
 6:00 PTL Club
 7:00 America
 7:25 News
 8:25 News
 9:00 Donahue
 10:00 Douglas
 11:00 Happy Days

GOREN BRIDGE

BY CHARLES H. GOREN
 AND OMAR SHARIF
 © 1978 by Chicago Tribune
 Both vulnerable. North deals.

NORTH
 ♠ A 4
 ♥ A 3
 ♦ A Q 10
 ♣ A Q 10 8 5 4

WEST EAST
 ♠ K 10 8 5 ♠ Q 9
 ♥ K Q 10 9 7 5 ♥ 8 6 2
 ♦ J 3 ♦ 9 8 5 4
 ♣ 7 ♣ J 9 6 3

SOUTH
 ♠ J 7 6 3 2
 ♥ A J
 ♦ K 7 6 2
 ♣ K 2

The bidding:
 North East South West
 1 ♠ Pass 1 ♠ Pass
 3 ♠ Pass 3NT Pass
 Pass Pass

Opening lead: King of ♣.

When your contract seems too easy to be true, that is the time to be most wary. A bad break has been known to sink even the best of contracts.

South was well within himself when he simply rebid three no trump. He devalued his hand somewhat because his high cards were in his short suits, which meant that his long spade suit might not be of any value in the play.

West led the king of hearts and declarer was absolutely enraptured about his prospects. It seemed

merely a matter of how many overtricks he was going to make until he won the ace of hearts and tried to run the clubs. West's spade discard was a severe blow.

Declarer could not afford to give up the lead, for the defenders would cash enough heart tricks to defeat the hand. Yet without the club suit he had only eight tricks. The only hope for a ninth was to find diamonds splitting 3-3. When that failed to materialize, declarer had to accept a one trick set.

A pessimist would have allowed for the possibility of a 4-1 club break, and would have searched for additional chances. Diamonds were a live possibility. Even if the suit did not divide 3-3, there was a hope that one of the defenders had only a doubleton jack. But to benefit from that possibility declarer had to retain an entry to his hand.

After winning the ace of hearts, declarer should first have cashed the ace and queen of diamonds. When the jack dropped, the contract was guaranteed no matter how the clubs divided. Declarer simply cashes the ten of diamonds, returns to his hand with the king of clubs and takes the king of diamonds.

Now he can go after clubs. If that suit splits normally, declarer will make three

overtricks. But as the cards lie, declarer must settle for nine tricks—four diamonds, three clubs and two major-suit aces. Nevertheless, that is game and rubber.

FORECAST FOR THURSDAY, JULY 27, 1978

Your Daily HOROSCOPE
 from the CARROLL RICHTER INSTITUTE

GENERAL TENDENCIES: An excellent time for looking into your assets and liabilities and for working out a plan of action whereby you have greater abundance for whatever you want. But think big in order to get big.

ARIES (Mar. 21 to Apr. 19) You are eager to add to your holdings and can do so now if you use the right methods and act quickly. First have a talk with a financial expert, then follow through in a positive way.

TAURUS (Apr. 20 to May 20) Take the right kind of treatments to improve health and appearance. Later, get into social affairs and make a fine impression on others.

GEMINI (May 21 to June 21) Study new ways to have a greater abundance in the future and put your talents to work. An adviser has his own worries, so wait for a better time to consult him.

MOON CHILDREN (June 22 to July 21) Show more consideration for friends and try to be of greater help to them. Make sure you pay your own way in any social expenses.

LEO (July 22 to Aug. 21) Get involved in community affairs and gain the approval of bigwigs. Pay more attention to details connected with career work also.

VIRGO (Aug. 22 to Sept. 22) You find you can put across a plan successfully if you present it in great detail. Contact one who has his feet on the ground and can help you.

LIBRA (Sept. 23 to Oct. 22) Find a better system for handling that work load and get good results. Show more thought for a loved one and get a better response.

SCORPIO (Oct. 23 to Nov. 21) Carry through with any commitments you may have with partners and reap the benefits. Be charming with one you want to see more of in the days ahead.

SAGITTARIUS (Nov. 22 to Dec. 21) Find the most efficient way to take care of tasks so that you can handle your affairs more easily in the future. Don't lose your temper with a co-worker who may be upset.

CAPRICORN (Dec. 22 to Jan. 20) If you perform the duties you like and don't fret and fume about others, this can be a pleasant day and evening. Be more cooperative with others. Put more thought in planning recreation.

AQUARIUS (Jan. 21 to Feb. 19) The situation at home may be difficult, but if you think of past happiness, you regain harmony. Invite only those persons into your home whom you can trust. Use wisdom.

PISCES (Feb. 20 to Mar. 20) You have to exercise caution in all kinds of motion, especially while driving. Turn on the charm if you expect to get the information you need. Be careful of strangers.

IF YOUR CHILD IS BORN TODAY . . . he or she will be born practical and you must teach early to understand the motives behind any plan before going into it, otherwise your progeny could go in the wrong direction.
 "The Stars impel, they do not compel." What you make of your life is largely up to YOU!
 ©1978 McNaught Syndicate, Inc.)

Final Taping In Philadelphia

PHILADELPHIA (AP) — Mike Douglas tapes the final Philadelphia broadcast of his nationally syndicated talk show tonight before heading for the West Coast.

The Mike Douglas Show moved here from Cleveland in 1965, and has grown to a 90-minute Westinghouse Broadcasting Co. program that is seen in 120 U.S. cities.

Douglas, a low-key host who once was a \$125-a-week singer, has prospered with the show and is now a millionaire.

Douglas, once described by "Tonight" show host Johnny Carson, as "bland as Philadelphia cream cheese," has written in his autobiography that "my goal is bringing pleasure and entertainment, refuge from worldly problems to others."

He said the show is moving West because more guests are available.

264 PLAYHOUSE INDOOR THEATRE
 8 Miles West Of Greenville On U.S. 264 (Farmville Hwy.)

Showing Only The Finest In Adult Entertainment!

ENDS TONIGHT
 This Area First Showing!

Soft Places

starring **ANNETTE HAVEN** and **PHIL TOBIAS**
 Written and Produced by WILLIAM DANCER
 in Luxurious COLOR
 Valid ID Required
 Doors Open 5:45
 Showtime 8:00

Call For Showtime Anytime **756-0848**

PUTT-PUTT
 GOLF COURSES
 756-1820
 For the fun of it!
 Washington Hwy.

Buccaneer MOVIES 1•2•3

GREASE
 Olivia Newton-John Travolta
 8th Big Week!
 Shows 2:30-4:45 7:00-9:30

JAWS 2
 Roy Lorraine Murray Scheider Gary Hamilton
 Must End Thursday
 Shows 2:15-4:30 6:30-9:15
 (R) PG (PARENTS STRONGLY CAUTIONED)

SATURDAY NIGHT FEVER
 . . . Catch it.
 JOHN TRAVOLTA
 Ends Thursday
 Shows 2:45-5:00 7:15-9:45

THE SWARMS is here!

PLAZA Cinema 1&2
 PITT-PLAZA CENTER • 756-0088

STAR WARS
 SHOWS DAILY 2:30-4:50-7:10-9:30
 ALL SEATS \$1.50
 TIL 3:00 P.M. EVERYDAY

PARK
 UPTOWN GREENVILLE
 752-7649

ENDS THURS.!
 KRISTOFFERSON AND MACGRAW . . .
 "The Story of 'A Star is Born' and 'Love Story' as Dynamic Together"

CHINVOY
 SHOWS MON.-FRI.
 3:00-7:00-9:00

CAPRICORN ONE
 SHOWS DAILY
 2:15-4:35-6:55-9:15

STARTS FRIDAY

MICHAEL CAINE KATHARINE ROSS RICHARD WIDMARK RICHARD CHAMBERLAIN OLIVIA DE HAVILLAND BEN JOHNSON

LEE GRANT PATTY DUKE ASTIN BRADFORD DILLMAN FRED MACMURRAY and HENRY FONDA

Coming Soon!
 "Hooper"
 "Foul Play"
 "Coming Home"
 "Heaven Can Wait"
 "Thank God It's Friday"

Mill Outlet Clothing
 Hwy. 264 By-Pass — Across from Nichols

LADIES SUMMER SLEEPWEAR 30% OFF

LADIES SUNDRESSES 40% OFF

LADIES SUMMER SLACKS 40% OFF

POLYESTER (IN SPRING COLORS) PANTSUITS \$12.50 & Up

MEN'S POLYESTER SLACKS \$9.99

MEN'S SPORT COATS \$19.95

*Also A Large Selection Of Ladies And Mens Wrangler Goods.

Open Mon.-Sat. 9:30 til 6:00 Fri. Nights 'til 8:00

Camelot Inn Proudly Announces The Opening Of David's - The Steak Place

Open For Breakfast & Lunch 6:30 to 2:30
Dinner 5:00 to 9:30
Monday Thru Saturday

Featuring 21 Ingredient Salad Bar

U. S. Choice Steaks & Barbecue Beef Ribs

J. David Snow—

The Chef From The Mountains

756-8990

'City Of Faith' Decision Friday

TULSA, Okla. (AP) — With final legal filings dispensed with, the way was clear today for a district judge's decision Friday on the fate of a lawsuit challenging the construction of the City of Faith hospital.

The facility, being built by evangelist Oral Roberts at the site of his futuristic university here, has sparked controversy since its inception. The most active critics have been members of the Tulsa Area Hospital Council. The dozen member hospitals contend the facility, now planned for 294 beds, will aggravate an existing overbedding situation and drive up medical costs in the Tulsa area.

Attorneys for the council have filed a lawsuit seeking to halt construction of the 30-story hospital.

District Judge Ronald Ricketts is scheduled to rule Friday whether that lawsuit will be dismissed or allowed to go to trial.

ORU attorneys have filed a motion to dismiss the lawsuit, arguing that the council lacks legal standing to appeal the Oklahoma Health Planning Commission's approval of the hospital April 26.

The ORU motion claims that

only unsuccessful applicants for certificates of need may appeal an OHPC decision.

But the hospital group contended, in a brief filed Tuesday, that state statutes under the Oklahoma Administrative Procedures Act allow any "aggrieved" parties to appeal such a decision.

The brief also maintained that "current federal guidelines call for a goal of less than four licensed beds per thousand population and will require state agencies in the next decade to take steps to reach that ratio."

"In California and New York, this has already led to moves to close existing hospitals. Since Tulsa and Oklahoma are already well in excess of the four beds per thousand ratio, the prospect of such efforts here is hardly speculative."

Hospital Council attorneys have also asked Ricketts for permission to question persons to determine if improper discussions were held on the facts in the case by planning commission members.

PEANUTS



01 PUBLIC NOTICES

NOTICE
Having qualified as Administrator of the estate of Caley Clyde Sauts, late of Pitt County, North Carolina, this is to notify all persons having claims against the estate to present them to the undersigned Administrator within six (6) months from the date of the first publication of this notice or same will be pleaded in bar of their recovery. All persons indebted to said estate please make immediate payment.

NOTICE
Having qualified as Administrator of the estate of Walter Lancaster Harrington, late of Pitt County, North Carolina, this is to notify all persons having claims against the estate to present them to the undersigned Administrator within six (6) months from the date of the first publication of this notice or same will be pleaded in bar of their recovery. All persons indebted to said estate please make immediate payment.

NOTICE OF COMPLETION
ASSESSMENT ROLL
PUBLIC HEARING THEREON
The public hearing on the preliminary assessment roll for the street improvement project on Browntea Drive extending from Tench Street southerly approximately 1,300 feet to the Parsons property, which was completed on the 18th day of May, 1978, has been prepared by the City Clerk and is available for public inspection in the office of the City Clerk until the date set for the public hearing on the preliminary assessment roll. The City Clerk will hold a public hearing at 8:00 P.M. at the Municipal Building in the City of Greenville, North Carolina, on the 10th day of August 1978, for the purpose of hearing objections to the preliminary assessment roll from all interested parties who appear.

NOTICE
Under and by virtue of an Order of the Superior Court of Pitt County, North Carolina, made in a Special Proceeding entitled "Burney Manning and wife, Doris Manning vs. Sadie Ray Pitt, Twanna Elizabeth Hayes and husband, Gary Hayes, J. T. Manning, Jr. and wife, Rena L. Manning, H. B. Manning and wife, Jean Worthington Manning, Myrtle S. Manning, (widow), James Franklin Manning, (deceased), Goldie A. McLawhorn, Respondents", the said Burney Manning and wife, Doris Manning, undersigned Commissioner will on the 22nd day of August, 1978, at 12:00 P.M. at the Court House in Greenville, North Carolina, offer for sale to the highest bidder subject to the confirmation of the Court, all those certain tracts or parcels of land more particularly described as follows: lying and being in Arthur Township, Pitt County, North Carolina, described as follows:

TRACT #1: BEGINNING at a stake in Southwest corner at Lot #15 the same also being E. Manning's Northwest corner; thence South 89° 15' 15" East 178 feet to a stake in William G. Allen's line (line of #1); thence North 89° 15' 15" East 178 feet to a stake in J. L. Elk's line; thence South 3° 15' West 178 feet to the BEGINNING. Acreage, six (6) acres, more or less, and being all of Lot #15 of the J. Sam Allen home tract division of land situated in the Northwest corner of Mary E. Manning's lot of land situated North 5° 15' East to the William G. Allen line and being the same property conveyed by H. R. Allen to Mary E. Manning by deed dated November 19, 1919, which appears of record in Book 12, at page 52, of the Pitt County Registry.

TRACT #2: BEGINNING in Wainwright's corner in John Jones' line; said line runs North 3° East 34 1/2 poles to a stake in the line; thence South 89° 15' West 92 1/2 poles to a stake in J. L. Elk's line; thence South 3° 48' West 34 1/2 poles to a stake in John Jones' line; said line runs North 89° 20' East 92 1/2 poles to a stake at the BEGINNING, containing 20 acres, more or less, and being the same lands conveyed by J. S. Allen and wife to Mary E. Manning by deed dated May 31, 1902 of record in Book 17, Page 564, of the Pitt County Registry, reference to which is hereby made.

This sale will be subject to Pitt County 1978 ad valorem taxes. The highest bidder of this sale will be required to make deposit of ten per cent (10%) of the bid. This sale is subject to the confirmation of the Court.

This is the 1st day of July, 1978. **RODDELL AVERY** COMMISSIONER July 26, August 2, 9, 1978

ADVERTISMENT
The Pitt County City of Greenville Airport Authority, Greenville, N.C. will accept bids for the Airport Manager's office, Post Office Box 671, Greenville, North Carolina, at 10:00 o'clock A.M. Local Prevailing Time (LPT), August 2, 1978, at which time the proposals will be publicly opened and read aloud for the following project:

REHABILITATION AND STRENGTHENING OF RUNWAY 25.
Approach and Medium Intensity Runway Lights
Contract documents may be examined by bidders during normal office hours at the Pitt County City of Greenville Airport Authority, Greenville, N.C., and at the offices of Sverdrup & Parcel, Consulting Engineers, 8720 Georgia Avenue, Suite 801, Silver Spring, Maryland. Contract documents may also be seen at F. W. Dodge Corporation, 1100 North Glebe Road, Arlington, Virginia.

Contract documents will be furnished upon payment of Fifty Dollars (\$50.00) for each set. Apply to the undersigned for a copy of the gross price bid. Said guaranty is to be a bid bond underwritten by approved Commercial Surety or a certified check, cashier's check, trust company check or bank draft of any national or state bank, made payable to the "Pitt County City of Greenville Airport Authority." **GUARANTY MUST BE FURNISHED AT THE TIME BIDS ARE OPENED AND MUST NOT BE CONSIDERED.** The name of the bidder and project name must be on the bid. The successful bidder will be required to furnish for the faithful performance of the contract under this contract an approved Surety Company. Payment and Payment Bond each in an amount equal to one hundred percent (100%) of the total amount of the bid submitted. As a material part of this Advertisement for Bids, and for the valuable contract is under and subject to Executive Order 11246 of September 24, 1965, as amended, to the equal opportunity clause, and the bidder (proposer) must supply all the information required by the bid or proposal forms.

01 PUBLIC NOTICES

A bidder must indicate whether he has previously had a contract subject to the equal opportunity clause, whether he has filed all report forms required by such contract, and if not, a compliance report (Standard Form (SF) 100) must be submitted with the bid.

Equal Employment Opportunity (EEO) and labor provisions, are included in the contract documents. Contractors and subcontractors must satisfy EEO requirements of paragraph 2 of the EEO contract clause by stating in all solicitations or advertisements for employees that:

All qualified applicants will receive consideration for employment without regard to race, color, religion, sex, or national origin.

By using the phrase "advertise merit in which appears in clearly distinguished type, the phrase: "an equal opportunity employer."

Bidders must satisfy themselves of the accuracy of the estimated quantities by examination of the site and review of the final plans and detailed specifications including addenda.

All bids must be made on the standard form of proposal and shall be sealed and plainly marked.

REHABILITATION AND STRENGTHENING OF RUNWAY 25
The party to whom the contract is awarded will be required to execute the contract and a performance and payment bond within ten calendar days from the date when the written notice of the award of the contract is delivered.

The work under this contract is to be completed within 120 calendar days after the date of Notice to Proceed.

The Pitt County City of Greenville Airport Authority reserves the right to reject any or all bids, to waive any technicality and to award any bid considered advantageous.

PITTS COUNTY CITY OF GREENVILLE AIRPORT AUTHORITY
July 26, Aug. 2, 1978

07 SPECIAL NOTICES
WE ARE FORMING an active women's group in Greenville. If you are interested, call Hester at 752-6912 after 8 p.m.

HAVE YOU OR YOUR BUSINESS put on film in living color and viewed by literally thousands of people per week for less than 55¢ per day. Call Washington, NC, 946-2086 for full details.

AUTOMOTIVE
09 Autos For Sale
Having Engine Trouble? See "The Engine People" Auto Specialty Co. 917 W. 5th St. 758-1131

HASTING FORD has daily rentals at reasonable prices. Call 758-0114.

UNDERCOAT YOUR NEW CAR OR TRUCK
Call 756-3115 For Appointment
HOLT OLDS-DATSUN
101 Hooker Rd. Greenville

WANTED ALL JUNK CARS
Top Dollar Paid. Call Immediately! 752-6124

10 AMC
PACER 1975 White with luggage rack, air, low mileage. Can be seen at 1403 Mill Street, 756-7815.

11 Buick
BUICK LIMITED 1973 One owner. Excellent condition. 756-3438 or 756-7986

12 Cadillac
CADILLAC COUPE DE VILLE 1973, 55,000 miles. Good condition. 756-753-8882.

13 Chevrolet
QUICK-ACTION Classified Ads are the answer to passing on your extras to someone who wants to buy.

14 Chrysler
CHRYSLER 1977 2 door, hardtop, 6,000 miles, loaded. \$4200. 758-8729 after 6 p.m.

15 Dodge
DODGE 1972 Dart Swinger. Air, power steering, brakes, automatic. Excellent condition. Take up payments. 758-6447.

16 Ford
FORD 1978 Fairmont Station Wagon. 2100 miles. \$500 cash and assume payments. Call Mary Burris at 756-3180 extension 48, Monday-Friday, 8:30 till 5.

17 Oldsmobile
LTD 1972 4 door hardtop. Good condition. Must be seen to appreciate. \$995. 756-1152, 7:30 evening.

18 Mercury
COUGAR 1977 Silver, low mileage. Excellent condition. \$4950. 756-2473.

19 Oldsmobile
OLDSMOBILE CUTLASS BRUSHWOOD 1976 Low miles, extras. Excellent condition. 756-2984.

20 Plymouth
PLYMOUTH 1973 Fury II, 4 door, white with green interior, air, power brakes and steering. AM/FM radio. Excellent condition. 792-6211 (Williamston).

21 Pontiac
PONTIAC 1969 LeMans. Air, power steering, power brakes, tilt steering. Good condition. \$900. 758-0930.

22 Foreign
CELICA GT 1976 Blue, air conditioning. \$4000. 798-1291 after 5 p.m.

23 Mercedes
MERCEDES 1973 4 door, air, AM/FM. Excellent condition. Will consider best offer. 758-4801.

24 Datsun
DATSUN B-210 HATCHBACK 1975 AM/FM, new engine. Excellent condition. 758-4019.

25 Opel
OPEL GT 1973 42,000 miles. Good condition. 756-1814.

26 TR-7 1976 Low mileage, air, AM/FM. Excellent condition. \$4300. 752-9674.

27 MG 1969 1 owner. Electric over drive, wire wheels, new top. Call 756-6898 or 756-4933.

28 Volkswagen
VOLKSWAGEN BUG 1968 White, one owner, runs good. \$450. 239 Windsor Road. 756-2027.

22 Foreign

VW 1973 Station Wagon, Air, new tires, CB hook-up, low mileage. Mint condition. 756-5889 after 5 p.m.

BEFORE SCHOOL BEGINS, get extra cash by selling those outgrown items with a Classified Ad.

VW RABBIT 1977 Champagne edition. 116,535 after 5 p.m.

USED BICYCLES for sale. 746-6098 after 6 p.m.

29 Boats For Sale
1968 GLASSPAR G 314 with 1962, 75 HP Johnson, Cox trailer. \$1000. 758-2300 days. 758-1742 nights.

14 CAROLINA, 15 HP Evinrude motor, 2500 lbs. trailer (repainted). 758-1879 after 8 p.m.

MORGAN 27 SLOOP, 1973. Racing equipped with 5 sails including spin daker and winches. Excellent condition. 756-1814.

1977 14' WELLCRAFT 90 HP Chrysler outboard, trailer, and accessories. \$2000. Call 752-5086 or 756-5355 after 5 p.m.

1975 23 FOOT GLASPAR Cabin Cruiser. Depth finder, CB, 225 Mer cruiser inboard outboard motor, Cox trailer. Must sell due to health. Firm \$5000. 825 7661, 825 1121.

19 GALAXY with 140 HP Evinrude, tilt and trim with SST propeller. Cox galvanized trailer. All 1977 models, in good condition. \$4500. 756-2156.

1977 CHECKMATE, 175 HP, Flotation deck, trailer. Will sacrifice. 752-3023.

1973 19' GALAXY with 115 HP Evinrude motor, \$2000 firm. Can be seen at 2500 North Drive.

14' SEAKING, 55 HP motor. Just overhauled. \$1000 firm. Can be seen at 204 North Sylvan Drive.

13 CHRYSLER WITH TRAILER, 45 HP Chrysler motor, 2 gas tanks \$1500. Call between 5:00 and 8:30. 746-6108.

30' CUSTOM CRUISER Trawler. Diesel powered, galley, head, many extras. Priced to sell. 752-8785.

1976 MACKIE 16' semi tri hull boat, 85 HP Johnson power tilt and trim, CB radio, 1977 galvanized trailer. 12' white letter tires, canvas cover. \$3300. 758-5341 after 6 p.m.

1974 19' GALAXIE boat with 140 HP inboard/outboard, on a 1976 galvanized trailer. 746-6946.

BY OWNER, 19' Marquis, 115 HP Evinrude. Fully equipped. 756-7554.

1975 GLASCRAFT 14' boat, (1971) 18 HP Evinrude motor, trailer, Haws motor quide trailing motor. \$1000 firm. 746-4794 after 5 p.m.

1976 V-HULL 19' Renkin, 140 in board/outboard Mercruiser, Com cast, white letter tires, crash bar, pump, blower, lights, 12' canvas, 16' oz vinylized trailer, CB antenna. \$4900. 756-4473.

31 Campers For Sale
BASSER'S CAMPING Center. Good stock of Cruise Air, Class "A" and Cruise Master mini motor homes; also Bays and Starcraft campers. Large parts department, sales and service. Open 9 till 7 Monday-Friday, 9:30 till 6 Saturday. 724-4616, Goldsboro. Same location since 1934.

BUS CAMPER with bath. Runs good. Contact J. T. Williams at Atlanta, Georgia. 404-696-7815.

PUR EXTRA CASH in your pocket today. Sell your "junk" with an inexpensive Classified Ad.

35 Cycles For Sale
1975 HONDA CB 500T. Good to excellent condition. 5100 miles, high rise handle bars, crash bar, pump, bar and new tires. \$850 firm. 758-6919 between 4 and 7 p.m.

1976 HONDA CJ 360. Less than 2000 miles. \$1750. Must sell. Call Jack. 756-7083.

1977 500-FOUR HONDA Super Sport. High rise handle bars, king queen seat, crash bar, pump, helmets, luggage rack, and low mileage. 746-3848, 746-6462 nights.

1977 CUSTOM built sportster by Harley Davidson. \$3200 firm. 758-5596 anytime.

BONNERVILLE TRIUMPH 1972 Excellent condition. Extra handle bars and helmet. Call 752-2540.

1970 350 HONDA. \$400. Can be seen at 1403 Mill Street. 756-7270.

1976 HONDA 1000 GL. 4800 original miles. Garaged. This bike in perfect shape. 752-4777 after 6 p.m.

1977 HONDA 750 Super Sport with extras. \$1675. 758-6791 after 5 p.m.

37 Trucks For Sale
1965 DODGE tractor, 40 series. V-8 engine. Good condition. 756-4766.

1970 TOYOTA Landcruiser with con vertible top. Excellent condition. 756-9123.

1972 FORD V8 TON. Excellent running condition. 1970. 756-5270.

1974 DODGE VAM, V-8, power steering, cruise o/matic, inside customizer. \$3500 or best offer. 758-5596 anytime.

1969 V8 TON pickup. \$795. 754-2103 (Windsor).

1963 FORD V8 ton pickup. 3 speed on floor. 8 cylinder engine, new mag wheels, tool box, CB aerial, trailer hitch. \$850. 756-2897.

40 DOGS & PETS
AKC SAINT BERNARD puppies. 756-5245 days. 756-3286 nights.

AKC REGISTERED Boxer puppies. 758-7453.

HIMALAYAN KITTENS, 6 weeks old. ACFA registered. Blue and blue cream point. Addressed \$200. (919) 926-2871.

AKC REGISTERED blue-eyed Siberian Husky puppies. Parents can be seen. 756-2590.

FULL BLOODED RATT TERRIER puppies for sale. Parents registered from Kansas. 746-6124 or 746-6575.

CHIHUAHUAS \$35 each. After 5 p.m. 756-2012.

GOOD HOME needed for registered 8 year old female Pointer. Call 758-0996.

5 BLACK LABRADOR Retriever puppies. AKC registered. Sire and dam available for inspection. 752-3405 after 6.

AKC MINIATURE DACHSHUND Red males, 6 weeks old, dewormed. 756-6172.

COCKER SPANIEL Golden male. AKC 7 weeks, 958-2792.

MIXED PUPPIES for sale. German Shepherd and Labrador, 7 weeks old. Call Beverly, 752-7111 days. 752-9815 after 7.

NEW SEARS Craftsman tool box and chest combination on wheels. 756-0090 after 5 p.m.

REGISTERED 4 year old male Pointer for sale. All shots and heartworm free. Call 758-0996 after 6.

EMPLOYMENT

42 Help Wanted

SECRETARY Typing, limited bookkeeping. Prefer some shorthand. Excellent working conditions, paid vacation. Salary flexible depending on qualifications. Reply to Typist, P. O. Box 1967, Greenville, NC.

EXPERIENCED SALESPERSON and personal needed for retail furniture business. Reply to Furniture, P. O. Box 2156, Greenville, NC.

MECHANIC NEEDED Experience required. Excellent company benefits. Good working conditions. Apply to Mr. Powell

HASTINGS FORD
E. 10th Street
758-0114

AUTO BODY REPAIR MAN NEEDED
Experience required. Excellent company benefits. Good working conditions. Apply to Mr. Powell

HASTINGS FORD
E. 10th Street
758-0114

SALES TRAINEE Individual with farm background. To learn agricultural equipment business. Experience helpful. Salary in surance, bonus, pension, and paid vacation. Agri Supply Company. 752-3999.

42 Help Wanted

EXPERIENCED HAIRSTYLIST WANTED. 5 days per week. Following already established. 756-5729 after 6 p.m.

A-1 CASHIER stock person. Experience in grocery store necessary. Must have excellent references. 756-4448 after 7 p.m.

EXPERIENCED industrial sewing machine operators. Too Tuff Toos, Inc., Grimsland.

CASHIER. Individual with farm background for cashier position with agricultural business. Some cashing experience helpful. Salary, insurance, paid vacation. Auri Supply Company, 752-2999.

SHEETROCK FINISHERS with experience and laborers. 756-0053.

Auto Body Painter Experience necessary. Good company benefits. Excellent working conditions. Next plant both. Apply to Ronnie Joyner.

Smith-Waldrop Motors Dickinson Ave. 756-4267

EXPERIENCED VINYL floor covering installer. Guaranteed salary. Salary negotiable. Insurance benefits. vacation. Send resume to installer, P.O. Box 1967, Greenville, N.C.

RNs, LPNs. Are you looking for a challenge and a change of pace? Learn the new and growing specialty of Nephrology Nursing while caring for dialysis patients. Complete orientation and training program provided. Excellent fringe benefits. Call Greenville Hemodialysis Center, Greenville, N.C., at 752-1520 between 8:30 a.m. and 5:30 p.m.

100 CLASSIFIED DISPLAY

42 Help Wanted

CARPENTER. Call 756-1163.

MANAGER. 3 years experience in small loan company dealing with consumer finance. Salary open. Fee paid. Betty's Personnel Service, 756-3404.

ACCOUNTS REPRESENTATIVE. Sharp individual to work with collections in small firm. Must be manage ment potential. Betty's Personnel Service, 756-3404.

EXPERIENCED AUTO MECHANIC Must have own tools. Top salary. Good company benefits. Apply to Larry Baker at Smith Waldrop Motors from 8:00 A.M. to 5:00 P.M. Monday through Friday.

DRIVER NEEDED for automatic tobacco primer. One year experience preferred. References. 756-4560.

EXPERIENCED bulldozer operator wanted. Send resume stating previous experience and salary desired to Bulldozer Operator, P.O. Box 1967, Greenville, N.C.

NEED AMBITIOUS people to show exclusive home decorative items. 10 to 40 hours a week. Commission plus bonuses. Opportunities for manage ment, trips and gifts. Be your own boss. Car and phone necessary. 756-6046.

EXPERIENCED SUPERINTENDENT for general contractor. Salary commensurate with ability. Greenville area. Send resume to Dominion Construction, Inc., 1408 Bare Hills Avenue, Baltimore, MD 21209.

MANAGER TRAINEE. Local firm. Excellent opportunity for right person seeking a future. Fee negotiable. Betty's Personnel Service, 756-3404.

100 CLASSIFIED DISPLAY

42 Help Wanted

SALES REPRESENTATIVE wanted. Well established local firm. Travel in 5 county areas of Greenville, no overnight travel. Excellent working conditions, excellent income. Only experienced salesperson need apply. Write for interview. Sales, P. O. Box 469, Greenville, N.C. 27834.

NEED PERMANENT. 3 1/2 11 LPN. Every other weekend off. Starting salary, \$2.75 an hour. Call Mrs. Brannon, 756-4121.

NEED PERMANENT. 3 1/2 11 RN. Every other weekend off. Starting salary, \$5.15 an hour. Call Mrs. Brannon, 756-4121.

LICENSED PRACTICAL NURSE. Part time, 11.7 shift. Oak Manor, Inc., Snow Hill, NC. Apply Monday, Friday, 9:11.5. 747-2868 or 523-8247.

DENTAL ASSISTANT Skilled and experienced applicant preferred. Daytime or nighttime employment. Good salary and benefits. 752-1337.

SECRETARY. Typing, shorthand, dictation skills. Experience need ed. 756-0842.

MAINTENANCE PERSON. Knowledge of mechanical equipment, plumbing and general upkeep of buildings and property. Good opportunity for someone willing to work. 756-0842.

PERSONS WANTED to prime tobacco. Must be at least 18 years old and have transportation. 756-0858 after 6 p.m.

TEMPORARY KEYPUNCH and clerk position. County undertaking. Sizeable keypunch project and additional keypunch personnel required for about 6 months. Positions open on both morning (7 a.m. till 3:30 p.m.) and evening (3:30 p.m. till midnight) shifts. Considerable judgment involved in work to be keypunch ed. Keypunching to CRT. Applicants may be asked to take State Merit Examination in clerical work. Experience in keypunching essential. Salary, \$400/month. Call 752-4711 for an appointment. Monday, Friday, 8 a.m. till 5 p.m.

PERSON WANTED TO KEEP 3 year old child in home. 12:30 till 5:15. Monday Friday. Call 756-5589 after 6 p.m.

EXPERIENCED office worker. Typing essential. 12 midnight till 8 a.m. Good pay and benefits. Call for appointment, 524-5136 between 10 and 4 p.m.

EXPERIENCED GROOMER. Work your own hours. Good pay. Apply in person at South Seas Pet Shop, 30 West Boulevard, BeLo Shopping Center, Williamston, NC.

MAINTENANCE AIDE wanted. Equal Opportunity Employer. Requires general knowledge of painting, carpentry and building maintenance. Must be dependable. Apply Farmville Housing Authority, 172 Anderson Avenue.

AVON SALES man extra money this summer. Over 187 Live in one of these areas: Winterville, Farmville, Ayden? Call 752-7066.

3 ATTRACTIVE PEOPLE for ex tending positions. Apply in person at duction studios. Call 946-2048, Washington, NC.

FULL TIME clerk. Experience in variety store. Apply in person at Pope's Family Center, Farmville.

44 Work Wanted

LOT CLEARING. Backhoe, bulldozer and farm ditching. Call Donald S. Carr, 746-4600 or David H. Smith, 746-3692.

SEPTIC TANK installation. Backhoe, bulldozer work, lot clearing, sand and top soil. Call Sonny Cox, 746-2348 or 746-3414.

ATTENTION single men and women! Tired of doing your own housecleaning, laundry? All of us for experienced, professional care tailored to your special needs. Call 752-4063 late night or early morning.

100 CLASSIFIED DISPLAY

BUSINESS OPPORTUNITY

Holiday Shell Station, Memorial Drive Greenville, N.C.

For rent to responsible person, as Dealer/operator business. Excellent location and facility for building profitable business.

Contact Quality Oil Company Phone 786-3148 Greenville, N.C. Or Jack McLellan Phone 782-7221 Williamston, N.C.

44 Work Wanted

RETIRED PERSON would like minor carpentry repair work. Reasonable. 752-5320.

CHRISTIAN PAINTER needs work. Interior/exterior. Excellent work. Call Mickey Mathew, 758-6974 after 4 weekdays, anytime weekends.

WILL KEEP a child, aged 3.5, in my home. Need good playmate for my 3 1/2 year old son. In the vicinity of Oyster's Grocery. \$25 a week. 756-4988.

WILL KEEP children in my home for working mothers. Hours, 7 a.m. till 6 p.m., Monday-Friday. I will feed them lunch and a snack. If in terested, please come by 400E Rainbow Apartments.

COOL-SEAL your mobile home. All work guaranteed. 7 years ex perience. Reasonable price. 758-4582.

FORMER TEACHER'S AIDE would like to keep children in her home for working parents. Call 825-988.

NEED SOMETHING moved? Garage or storage area cleaned? Call Sandy, 756-2971 after 5:30.

WANTED. Home repair work, remodeling, additions, painting. All work guaranteed. 758-6974 after 4 weekdays, anytime weekends.

46 FOR SALE

46 Farm Equipment 2 LONG BIG BOX BARNs (complete), one Powell automatic harvester with both headers and 3 trailers, one dump for automatic Rowland harvester. \$25,475 or 752-6473.

MASSEY FERGUSON 510 combine with 44 corn head and bean head. Call 756-2528.

USED ROANOKE tobacco harvester. Both headers. 3 trailers. Very good condition. 758-4578 or 752-6473.

50 Garage-Yard Sale

YARD SALE. 1198 Staniel Drive, Greenville. Clothing, furniture, used car. 3 family sale. 9 a.m. till dark. Saturday, July 29.

MOVING. Must sell variety of household items. Vacuum cleaners, men's and ladies' clothes. Free item with each purchase. July 29, 7 till 12. 329 Circle Drive, Hardee Acres.

56 Miscellaneous

STEAM CLEAN your carpet the newest way to professionally clean your carpet at home. Available to all types of pets by George, 756-5718 or 756-5719.

LARGE LOADS of sand, topsoil, field dirt, mortar sand and rock. Also gradework. Jim Hudson, 756-4742.

RENT A Currier piano for as long as you wish! John Adams, President of U.S. and Canada. Buy or rent. Go to Piano Organ Warehouse, next to Penney's Auto Center. 756-2032.

CEMENT STEPS, horse trailers, horse trailers, campers and truck shells. Call 946-0311.

NEW AND USED furniture, TV's and appliances. Ayden Furniture, 112 East 2nd Street, Ayden. 746-3049.

HENDRIX-BARNHILL is your professional landscaper for lawns, lawn and garden equipment.

GROW EARTHWORKS for profit. Free data. American Worm Brokers, Inc., 2400 East Colorado Avenue, Denver, Colorado 80210 or call Mr. Alexander (collect), (303) 778-1029.

FILL DIRT, builder sand, top soil and rock. J. L. McDaniel, 758-7008 days, 756-2351 after 3:30 p.m.

ABSOLUTE SELL-OUT on all 129 component tires. Cost plus 10%. Goodyear Service Store, 729 Dickinson Avenue. 752-4417.

HOOVER SWEEPERS, throw away bags, belts and minor repairs. Home Furniture Store, 701 Dickinson Avenue.

NEED FURNITURE? We have it! Brands you'll recognize. Financing available to fit your needs. Home Furniture Store, 701 Dickinson Avenue.

DO IT YOURSELF and save. Rent the professional carpet cleaning machine. Steamax. Call Larry's Carpeting, 3010 East Tenth Street, 758-2300.

BOOTLEG PRICES. Men's knit slacks and jeans, \$9.99; sportcoats, \$19.99; ladies' pantsuits, \$11.99; slacks, \$5.99; tops, \$4.99. Large selection. Mill Outfit Clothing, 264 Bypass (across from Nichols), Greenville.

CENTPEDE SOD. 752-4994 or 752-5637.

WEAR-EVER Waterless cookware and Cutco cutlery. Western education gifts, service. 752-7898 after 7.

AMAZING NEW wireless home or office security system. Call 756-1944 for free demonstration.

ORIENTAL RUGS in stock. Over 200 to choose from. Machine made and handmade. Larry's Carpeting, 3010 East Tenth Street, Greenville, N.C.

SMALL LOADS of sand, topsoil and stone. Also driveway work. Call Charles Tice, 758-3013.

FOR SALE. Full size box spring, \$35 (mattress free). Econo Travel Motel, 752-0214.

McLAWHON & SONS, your head quarters for Wisconsin engines, lawn and garden equipment and small engines.

THE BOOKTRADER: 919 Dickinson Avenue. Park in on Tenth Street. Trade paperback books for The Booktrader's at 60% off original cost. Hours (daily): 9-7; Sunday, 2-6.

WHIRLPOOL 16 pound capacity dryer. Good condition. 756-6736.

100 CLASSIFIED DISPLAY

AUCTION SALE

Friday, July 28 6:30 P.M. Fine selection of American, English and Oriental anti-ques.

Bobby Langston Antiques 220 Merigold Street Rocky Mount, N.C. License No. 1520 Phone 448-8223

HOLLOMAN'S BRICK, BLOCK, AND CONCRETE SERVICE

20 Years Experience Fireplace and chimney repair, walk-ways, patios, house leveling. All types of masonry work. Dial 753-3503 Day or Night

LAND FOR SALE

15 acre tract located West of Greenville with access to the 264 Bypass. One-half mile from future shopping mall.

CALL 756-0604

56 Miscellaneous

PEACHES. Fresh, ripe. Excellent for cooking, freezing, eating. Blueberries also available. Pick your own, now through August 7. Finch Nursery, Highway 581 North of Bailey Open 7 a.m. till dark (closed Sunday). 735-4664.

EXQUISITELY CARVED ANTIQUE Stairway Grand Ebony and Ivory. Expertly restored. \$500. 752-1387.

KENWOOD RECEIVER 7600. Kenwood cassette KX20, Technics turn table 1510, 2 JBL 100. Make offer. 758-7044.

SEARS KENMORE double oven range. New with automatic timing control. Excellent condition. 756-9123.

FURNITURE PRICED to sell. Couch, chair, 2 solid pine end tables and coffee table. Excellent condition. Call Deb, 758-5547, 738-1530 after 5.

FREE BEAUTIFUL COPPER REGISTER. 4 departments. For further details call 756-6046.

1974 HOTPOINT 14.7 cubic foot refrigerator freezer. Gold-Like new. 756-7732.

USED NATIONAL CASH REGISTER. 4 departments. Excellent condition. Excellent price. 756-5544.

GUITAR. Conn F 11. Like new. With case. \$175 or make offer. 756-5354.

DINETTE SUITE. Wood grain for mica top table with leaf. 6 padded vinyl swivel chairs. Like new. \$125. 758-0107.

56 Miscellaneous

WHIRLPOOL 14.7 cubic foot refrigerator with icemaker. 752-2500.

CULLIGAN WATER SOFTNER. \$200. 746-4501 nights.

BLUEBERRIES ready to pick. Lit It's Nursery, Highway 344 West of Greenville. 756-3626.

ANTIQUE 19TH CENTURY French Provincial sofa with claw feet. \$350. 758-6666, days, 758-4212, nights.

BOY'S SHIRTS MADE to order. \$3 each, with your material. 752-1331.

SANYO CHANNEL matrix 8 track tape player. Never used. Call 746-3141 days, 756-2564 nights.

AIR CONDITIONING unit. 19,000 BTU Carrier window unit. 220 volt. Call 746-3141 days, 756-2564 nights.

PIANO IN STORAGE

Beautiful Spinet Console stored locally. Reported like new. Reasonable party can take on low payment balance. Write before we send truck. Joplin Piano, P.O. Box 3046, Rome, GA. 30161.

GIRL'S BICYCLE (16") Schwinn (like new), \$25; antique 2 drawer oak chest, \$52. 752-4201.

AIR CONDITIONER. 5000 BTU. Good condition. 4 years old. \$95. 756-5369 after 5 p.m.

USED SET of mixed golf clubs, \$40; home made dry bar, \$50; used portable refrigerator, \$100. Will negotiate. 756-2301 between 3 and 7 p.m.

56 Miscellaneous

72" CONSOLE stereo. Quad sound track with 2 speakers, Mederra mean style. Slightly used. \$685 value for \$275. 746-4188 days, 746-4723 nights.

MUST SELL! Moving soon. Whirlpool apartment size washer dryer set. \$250. 756-4877 after 7 p.m.

BCA COLOR TV. \$175. 756-5899 after 4 p.m.

KENMORE AUTOMATIC washer. Nearly new. \$150. Can be seen at #4 Chafel Apartments in Winterville between 9 and 5. 756-8638.

100 CLASSIFIED DISPLAY

56 Miscellaneous

4 DRAWER CHRISTNUT CHEST. Over 100 years old. Original brass pulls. One oak table with claw feet. \$25. \$21 or \$23-4921.

SILVER SKIN PEAS. Pick your own. 756-2434.

SOLID MAPLE DINING ROOM dropleaf table with pads, 4 chairs, china cabinet. \$450. Call 756-4976 after 4.

RECORD-A-CALL automatic answering service. Sears best model 70. Retail \$199; asking \$125. 756-1163.

100 CLASSIFIED DISPLAY

Floyd G. Robinson Jewelers 1970 Cadillac Sedan De Ville Full power, good condition. \$900.00 1972 Lincoln Town Sedan Full power. \$1800 1977 Lincoln Continental Town Sedan Loaded with all extras \$10,600 Call 758-2452 or after 5:30 p.m. 756-1423

FOR SALE A charming 3 bedroom home with 2 baths, den, dining room and living room. Located in Grifton, N.C. \$30,000 CALL US TODAY!! 752-1411 WE BUY WE SELL WE TRADE ECHO REALTY NC 200 W. 4th St. D. G. Nichols Agency 752-4012 Anytime Sam Nelson 524-4003 Ervin Gray 752-1774

The REALTOR'S Corner A New Offering CAMBRIDGE Only Nine Months Old! Just Imagine A Sunken Great Room With Exposed Beams And Built-Ins, Solid Oak Mantle Over The Fireplace. Dining Room, Foyer, Three Bedrooms, Two Baths, Continuous Clean Oven, Energy Saving Dishwasher, Custom Made Privacy Fence, Patio. The Price For This Practically New Home Is Only \$47,700. Duffus Realty, Inc. 756-5395 Anytime Listing Broker Anne Duffus 756-2666

CHARM AND LIVABILITY...are combined to enchant you! A transfer out-of-state makes this 4-bedroom Williamsburg available. Superbly decorated, carpeted throughout, and in immaculate condition, this large home is situated on a huge lot in one of Greenville's most desirable areas. In addition to the cozy family room complete with fireplace and built-in bookshelves, a cheerful kitchen provides a roomy breakfast area while the living and dining rooms create the perfect setting for formal entertaining. There is a large finished game room over the double garage and a large deck off the back. Economical dual heat pump system included. \$78,900. Jeannette Cox Agency, Inc. 756-1322 Jeannette Cox 752-2521 Car: 752-2247 Barbara Hart 752-7806 Anne Reese 758-4713 756-5395

Mavis Butts realty 105 West 3rd St. Greenville 758-0655 NEW LISTING HOME HAS ALOT TO OFFER Carpeted living room and dining room, paneled den, kitchen with lots of cabinets and bar, 3 bedrooms, 2 baths, utility and patio. Has 1903 square feet. Be the first to see this pretty home. \$33,900. FHA-VA. Mavis Butts 752-7073 Ann Bass 752-1663 NEW LISTING BEAUTIFUL RESORT HOME Near Oriental features 4 bedrooms, a great room with fireplace, dining room, two sandecks, a double garage, and an energy-efficient heat pump for year-round comfort with low utility costs. On approximately one-half acre lot, this elegant retreat boasts a breathtaking view of the Neuse River and is available for immediate possession. Don't procrastinate...this one won't be on the market long. \$88,000.

FARMERS We are now stocking parts for the Long Manufacturing Co. tobacco harvester. You can call on us for any welding or repair work that you need. S & S REPAIR SERVICE Winterville 756-9889

FAMILY DOLLAR ATTENTION! STORE MANAGERS, ASSISTANT MANAGERS DEPARTMENT MANAGERS We are a successful variety store chain of over 200 stores located in the Southeast. Due to our massive expansion program, we are now interviewing success oriented women and men for an exciting and rewarding career in retail management. FAMILY DOLLAR offers competitive starting salaries and a full range of company benefits which include: semi-annual bonus program, paid life and major medical insurance, long term disability coverage, liberal vacation program, sick leave, and excellent opportunity for advancement. If you possess a minimum of 1 year experience in retail management and high school diploma or equivalent, contact David Hook, Regional Personnel Director, at our Greenville, N.C. store 756-5442. Mr. Hook will be interviewing Thursday, July 27 and Friday, July 28 from 10:00 A.M. until 6:00 P.M. All applications and resumes are held in strict confidence. (Relocation may be required.) FAMILY DOLLAR P. O. Box 25800 Charlotte, N.C. 28212 Attn: David Hook An Equal Opportunity Employer FIM

Excellent Selection Of Used Cars in Stock 1978 Chevrolet Suburban Electric tailgate window, air condition, cruise control, automatic, tilt wheel, power steering and brakes, rally wheels, AM-FM radio, rear speaker, Silverado equipment, body side molding, Saratoga Silver, red custom interior. Original Price \$10,398.70. Special Sale Price \$8995 1978 Chevrolet Camaro V-8, automatic, power steering and brakes, air. 10,000 miles. 1977 Olds Cutlass Supreme Loaded with equipment. 1977 Chevrolet Caprice 4 door. Loaded with options. 1977 Chevrolet Monte Carlo 13,000 miles, V-8, automatic, power steering, air, local owner. 1975 Buick Electra 4 door. Loaded. 1974 Chevrolet Camaro 6 cylinder, automatic, power steering and brakes, local owner. 1973 Chevrolet Silverado Pickup 1/2 ton. V-8, automatic, power steering and brakes, air, local truck. 1974 Dodge Ramcharger 4 wheel drive. Automatic, power steering and brakes, air, 22,000 actual miles, one owner. 1976 Chevrolet Pickup 1/2 ton custom. 6 cylinder, 3 speed, 27,000 actual miles, local owner. 1970 Chevrolet El Camino V-8, automatic, nice truck. Local owner. 1972 Chevrolet Malibu SS V-8, automatic, air, (new engine) See One Of Our Courteous Salesmen Julian White, Owner Jay Mills Nicky Harris Preacher Edmundson, Sales Mgr. Tommy Cooke Henry Booker 746-3141

56 Miscellaneous

AMATEUR RADIO HW 32, 20 meter transceiver, mini quad. Call 756 2710.

PIANO WURLITZER Perfect shape. \$350. 756 6549 or 758 7099.

58 Sporting Goods

WALTER HAGAN large golf bag with hood covers. \$50. 756 5334.

COLT PISTOL Sale. Colt biber, \$179.95 (list, \$197.50); Colt Cobra, \$249.95 (list, \$265.95). Warren's Farm Supply, 756 4578.

60 INSTRUCTION

RACQUETBALL LESSONS Learn to play the #1 racquet sport in America. Call Greg, 758 1253 after 5 p.m.

62 LOST AND FOUND

LOST TOY POODLE Apricot in color. Answering to the name of Raf. Anyone knowing anything about this dog contact Win Batson, Apartment 24, Village Green, or phone 752 0734 or 752 7341.

LOST lemon and white female English Pointer and gray and liver male German short haired Pointer. Both wearing collars with no tags. Chery Oaks vicinity. Both are pets only. Any information would be appreciated. 752 9548 before 5, 756 8075 after 5.

MOBILE HOMES

64 Mobile Homes For Rent

MOBILE HOMES and lots for rent. City sewer and water. Colonial Park licensed mobile home movers statewide. Also repair work. 756 4413.

12 X 60, 3 bedrooms with air conditioning and 1 1/2 baths. Also one bedroom, fully carpeted with air. No pets. 758 3644.

SOAONE is looking for your unus. power mower. Why not advertise it with a low cost Classified Ad?

2 BEDROOMS, air conditioning, washer, dryer. Private lot, 752 0864.

RESPECTABLE WORKING GIRL needs roommate over 21 to share 2 bedroom trailer. \$78 plus 1/2 utilities. 746 2444.

100 CLASSIFIED DISPLAY

OPEN

EM'S ANTIQUES

Farmville Hwy.

"Look For The Bell"

RECEIVING INSPECTOR

Buehler Products Inc., a manufacturer of small subfractional H.P. motors has an immediate opening for a Receiving Inspector.

Must be familiar with mil Std. 105, gauging practices, and inspection procedures. Experience in Blueprint reading and using measuring instruments. Some supervision background and technical training a plus. Will work without direct supervision.

CONTACT: Personnel Mgr.
Buehler Products Inc.
Box A
Kinston, N.C. 28501

BUEHLER PRODUCTS INC.

An Equal Opportunity Employer M/F

**STOP!!
OPPORTUNITY
KNOCKS**

I will start you with \$1,200 a month guarantee, send you to school expenses paid, train you in the field, selling and servicing established business accounts. Must be over 21, have car, bondable, ambitious and sports minded. Hospitalization and Profit Sharing.

Equal Opportunity Company M/F

Call for Appointment

Ron Cutler

Wednesday, Thursday, Friday Only

946-0519

From 10:00 A.M. to 6:00 P.M.

**WANT A "GREAT LITTLE CAR"!!
AT A "GREAT LITTLE PRICE"!!**

GRANT BUICK - MAZDA, Inc.

603 GREENVILLE BLVD., Greenville, N.C.

"Now Thru July 31st Only"
ALL MAZDA'S GLC'S

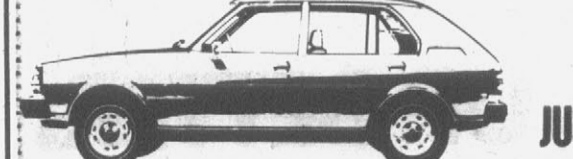

\$ 900

JUST

OVER DEALER IN VOICE

Plus Dir. Prep. & N.C. Sales Tax

EPA GAS MILEAGE RATING

46 MPG (Highway) 35 MPG (City)

DON'T MISS HIS CHANCE FOR

"FANTASTIC SAVINGS"

OPEN: 8:30 to 6:30 Weekdays
8:30 to 2:00 Saturday

Phone: 756-1877 756-1878

*EPA Rating based on a Mazda GLC Deluxe equipped with a 5 speed manual transmission and four cylinder piston engine. Mileage may vary depending on driving conditions.

64 Mobile Homes For Rent

12' WIDE 2 bedrooms, furnished, carpet, air. Good location. No pets. 756 4657.

2 BEDROOMS Furnished, air, carpet. Quiet location. No pets. No children. 756 2671.

12 X 60, 3 bedrooms furnished with air. On one acre private lot with private drive. 756 5527 weekdays, 756 6537 weekends and evenings.

12 X 60, 3 bedroom mobile home for rent. 752 8098 after 5 p.m.

2 BEDROOMS, fully carpeted, air conditioner, washer, dryer. Large lot. 752 5691.

FEMALE DESIRES roommate to share 2 bedroom trailer. Call Phyllis at 752 3831.

66 Mobile Homes For Sale

1978, 14 X 70, 3 bedrooms, 1 1/2 baths, completely furnished, central heat and air. 756 2547.

1970 WINSTON, 2 bedrooms, one bath, partly furnished with air. 756 6169 after 7.

1971 HAVELOCK, furnished with air. Nice wooded lot with 14 X 20 workshop. 756 6973 after 5 weekdays.

1964 MIDWAY with awning, 2 bedrooms, clean. Call 756 9075 after 7.

1968 ROCKWELL, 12 X 80. Clean, furnished. Good condition. 3 miles from campus. \$3500. 756 9622.

MOBILE HOME 8 X 40, 2 small bedrooms, \$750. 756 3194.

12 X 65 OAKWOOD, central air, 2 bedrooms, carpeted, unfurnished. Like new. Small equity and assume loan. 756 2036.

1975, 12 X 48, unfurnished, 2 bedrooms, 1 bath. Set up in park. Payments \$89.20 per month, 3 new 1977 14 X 70 reduced to dealer's cost. 2 rposed low down payment and assume loan. Johnny's Mobile Homes, Inc. 756 4487.

3 MOBILE HOMES, 60 and 65 X 12. Fully rented. \$14,000 annual income. 756 5185. 756 7912 after 5.

1972, 12 X 52 mobile home in Washington, NC. Fully carpeted. U-baths. Ready now. Call 756 5707 after 5 p.m.

1971 MILLCREST, 12 X 60, 2 bedrooms, like new carpet, unfurnished. \$2850. 752 4167 Monday, Thursday, 7 9 p.m.

1973 BEACON, 12 X 65, 3 bedrooms, U-baths. Ready now. Call David Jones, 752 4379.

1974 VOUGE TRAILER, 2 bedrooms. Good condition. Take up payments of \$85.83. Call after 6, 756 7391.

1971 MADISON, 12 X 70, 2 bedrooms, den, sundeck, furnished, washer and dryer, central air and heat. Good condition. Phone 758 4723.

100 CLASSIFIED DISPLAY

66 Mobile Homes For Sale

SPECIAL, SPECIAL, Good clean used mobile homes. Low monthly payments. See J. M. Brown or Greg Harbaugh at Corner Mobile Homes, 264 Bypass or either phone 756 0333.

SPECIAL, SPECIAL, Good used 40 12 X 60 2 bedrooms, less than \$100 a month. See J. M. Brown or Greg Harbaugh at Corner Mobile Homes, 264 Bypass or either phone 756 0333.

1972 MADISON, 12 X 60, 2 bedrooms, one bath, central air/heat, washer/dryer, front porch. \$5300 or small equity and assume loan. 752 6817.

1971 HAVELOCK, 12 X 64. Carpet, air conditioning, furnished, patio and cover. Also wooded lot with 14 X 20 workshop. After 5 p.m., 756 6973.

68 OPPORTUNITY

HERITAGE PERSONNEL OFFERS EXCLUSIVE FRANCHISES

To independent. Management oriented individuals who seek high income, professional status in the community, challenge and personal satisfaction.

Heritage Personnel Service will train you in a proven system and keep you growing in the rapidly expanding personnel placement industry! Initial investment \$7,500 to \$30,000 depending on available facilities.

Call or write Dave Rogers, Director of Franchising, (919) 872 4707, 4021 Barrell Drive, Raleigh, N.C. 27609.

70 PROFESSIONAL

CHIMNEY SWEEP, Call Gid Holloman day or night, 753 3503 in Farmville.

FOR CABINET work, call Roy's Cabinet Shop, 756 6810; 756 7499 nights.

SINGLETON ROOFING, Roofing of all kinds. Work guaranteed. Free estimates. 756 0278.

BILL'S VACUUM Shop. Sales of new and reconditioned machines. Repairs on all types. Carpets shampooed. All work guaranteed. 756 0565 or 756 9515.

72 REAL ESTATE

COMMERCIAL BUILDING for lease. Located at 1404 West 14th Street. Will build to suit tenant. 20 and 40' x 70' units. Call 756 7815.

4 ACRES, fenced, fruit trees, grapes, peaches, 60' mobile home with 2 added bedrooms, machines, large garage with workshop, heat pump, heavily wooded lot. 756 4259 or 758 2432.

HOUSE FOR SALE adjoining Cherry Oaks 3 bedroom townhouse with 2 1/2 baths, formal dining room, den with fireplace. On 3/4 acre lot. \$59,800. 756 4391.

3 BEDROOM brick, No down payment. In Aydon. 746 6355.

FOR RENT or sale. Eight room house. Central heat and air. 103 North Barrell Street, Farmville. 753 3735.

BY OWNER, 2 year old, 2 story house, 3 bedrooms, formal living dining room, den with fireplace, kitchen with 2 complete storage, fully insulated with storm windows, central heating and air conditioning. In good condition. Subdivision. 110 Roanoke Place, 756 3363.

LET OUR HOUSE be your home in Belvedere. 3 bedrooms, 2 1/2 baths, 3 landscaped patios. Call 756 6039 or 756 5289.

TOWNHOUSE, 3 bedrooms, 1 1/2 baths. Call 756 7458 after 5.

BETHEL, NC 3 bedrooms, bath, den with fireplace, owner moving. Call James A. Manning Agency, 825 5631.

NICE HOME in Meadowbrook. All appliances stay with home. Good street home. Only \$79,900. Stacy Kiger Realty, 756 3088, nights, Dianne Whitehurst, 756 7222.

LOVELY 3 BEDROOM brick ranch home in Highway 160 subdivision. Fully landscaped. Only \$34,900. Hookerton, NC. Stacy Kiger Realty, 756 3088, nights, Gene Stack, 752 3366.

NEW LISTING in Englewood. Set into a pretty corner lot, this lovely 3 bedroom, 2 bath living room, dining area, den with fireplace, kitchen, 3 bedrooms, 2 baths, garage and patio. Within walking distance of Elmhurst School. \$44,900. Call Whitely's House Station, 756 6050, nights, 756 4471.

APPROXIMATELY 1/2 acre lot behind Grimesland, near Boyd's Crossroads. \$3500. 756 3278.

BEAUTIFUL WOODED lot. 1.41 acres on Highway 43. Four miles from Greenville city limits. Lot has 213 feet on Highway 43 and 338 feet on Rock Hill. \$12,900. Call Stacy Kiger Realty, 756 3088; Gary Kiger, 756 2718.

BEAUTIFUL WOODED LOT, Lake Clingworth. 1/2 acre. \$10,000. 756 2909. 756 2295.

RIVER SHORE LOTS for sale near South Creek and Aurora by owner. First class waterfront. Swimming, water fishing. Shown by appointment. Call 946 3247 or 372 5317 after 6:00 p.m.

RESIDENTIAL LOTS Only 10 left! Lots front on paved streets with curbs and gutters. City water and sewer. Call Blanche Forbes at Ginger Hackett Realtors, 756 7986. 756 3438.

RESEORT Property For Sale

FARFIELD HARBOR Bulk headed waterfront lot. Across from club house. Golf course, marina, ex frats. \$15,000. 758 4809.

64 RENTALS

UP TO 9000 square feet with loading dock. Reasonable rental. 752 1020.

BUILDING FOR RENT or lease. Approximately 2600 square feet, front and rear employment space, private office, plenty of display and storage space, adaptable. Down town. Call Harris & Sons, Realtors, 758 4711.

66 Apartments For Rent

EASTBROOK AND VILLAGE GREEN APARTMENTS

327 one, two and three bedroom garden and townhouse apartments with heat, air condition, carpet, kitchen appliances, garbage disposal, nice laundry facilities, 3 swimming pools, 2 tennis courts and heat with hot water furnished in some units. No pets or loud parties allowed. Rent from \$140 \$210 per month. Call James A. Manning Agency, 825 5631. Drives off 264 By Pass Call 756 4012, Village Green, 800 North Street off E. 10th Street Call 752 5100.

3 ROOM APARTMENT for single person. Located Port Terminal, 3 miles east on Washington Highway. Come by if interested.

ATTRACTIVE 2 BEDROOM university condominium. \$200. August 1 occupancy. Married couple preferred. No pets. 756 3618, 6 till 8 p.m.

100 CLASSIFIED DISPLAY

78 Houses For Sale

MUST SELL by owner. 2 story, 3 bedrooms, 2 1/2 baths, formal living and dining area, large den with fireplace, kitchen with breakfast bar. \$178,000. In one of the best neighborhoods for recreational facilities. For appointment, call 756 4641 or 756 7888 nights and weekends.

PRICE REDUCTION

Brook Valley. Two story. Over 2600 sq. ft. Four bedrooms, three baths, double garage and screened porch. Priced below appraised value. \$79,900. Call Louise Hodge at Aldridge and Southland Realty, 756 3500, or evenings, 756 5005.

BY OWNER, 3 bedrooms, 2 baths, large family room with fireplace, 2 car garage. Huge yard. \$47,500. 752 1387.

UNIVERSITY AREA Gracious rambing home. Formal living room, dining room, 3 bedrooms, large family room, 2 1/2 baths, formal fireplaces, storm windows, fenced yard, garage. By owner. \$39,500. 752 1260.

BY OWNER, in Ayden, Crown property on well landscaped lot. 7 room home with both garden room with patio, fenced in for privacy. Must be seen to be appreciated. Call 746 6435 after 5:30 p.m. for appointment.

NEW LISTING, Living room, kitchen with breakfast area, utilities with washer dryer hookups, sunken den with fireplace, 3 bedrooms, 1 1/2 baths, detached garage. Assume loan for \$3900. Large lot with trees. \$25,500. Call 756 4030, 5110, 756 4030; nights, 758 0816.

7 1/2% LOAN assumption available. By owner. Belvedere, 206 Stafford Drive, 3 bedrooms, 2 ceramic baths, great room with fireplace and bookshelves, kitchen with separate breakfast area, formal dining room, large garage with workshop, heat pump, heavily wooded lot. 756 4259 or 758 2432.

HOUSE FOR SALE adjoining Cherry Oaks 3 bedroom townhouse with 2 1/2 baths, formal dining room, den with fireplace. On 3/4 acre lot. \$59,800. 756 4391.

FOR RENT or sale. Eight room house. Central heat and air. 103 North Barrell Street, Farmville. 753 3735.

BY OWNER, 2 year old, 2 story house, 3 bedrooms, formal living dining room, den with fireplace, kitchen with 2 complete storage, fully insulated with storm windows, central heating and air conditioning. In good condition. Subdivision. 110 Roanoke Place, 756 3363.

LET OUR HOUSE be your home in Belvedere. 3 bedrooms, 2 1/2 baths, 3 landscaped patios. Call 756 6039 or 756 5289.

TOWNHOUSE, 3 bedrooms, 1 1/2 baths. Call 756 7458 after 5.

BETHEL, NC 3 bedrooms, bath, den with fireplace, owner moving. Call James A. Manning Agency, 825 5631.

NICE HOME in Meadowbrook. All appliances stay with home. Good street home. Only \$79,900. Stacy Kiger Realty, 756 3088, nights, Dianne Whitehurst, 756 7222.

LOVELY 3 BEDROOM brick ranch home in Highway 160 subdivision. Fully landscaped. Only \$34,900. Hookerton, NC. Stacy Kiger Realty, 756 3088, nights, Gene Stack, 752 3366.

NEW LISTING in Englewood. Set into a pretty corner lot, this lovely 3 bedroom, 2 bath living room, dining area, den with fireplace, kitchen, 3 bedrooms, 2 baths, garage and patio. Within walking distance of Elmhurst School. \$44,900. Call Whitely's House Station, 756 6050, nights, 756 4471.

APPROXIMATELY 1/2 acre lot behind Grimesland, near Boyd's Crossroads. \$3500. 756 3278.

BEAUTIFUL WOODED lot. 1.41 acres on Highway 43. Four miles from Greenville city limits. Lot has 213 feet on Highway 43 and 338 feet on Rock Hill. \$12,900. Call Stacy Kiger Realty, 756 3088; Gary Kiger, 756 2718.

BEAUTIFUL WOODED LOT, Lake Clingworth. 1/2 acre. \$10,000. 756 2909. 756 2295.

RIVER SHORE LOTS for sale near South Creek and Aurora by owner. First class waterfront. Swimming, water fishing. Shown by appointment. Call 946 3247 or 372 5317 after 6:00 p.m.

RESIDENTIAL LOTS Only 10 left! Lots front on paved streets with curbs and gutters. City water and sewer. Call Blanche Forbes at Ginger Hackett Realtors, 756 7986. 756 3438.

RESEORT Property For Sale

FARFIELD HARBOR Bulk headed waterfront lot. Across from club house. Golf course, marina, ex frats. \$15,000. 758 4809.

64 RENTALS

UP TO 9000 square feet with loading dock. Reasonable rental. 752 1020.

BUILDING FOR RENT or lease. Approximately 2600 square feet, front and rear employment space, private office, plenty of display and storage space, adaptable. Down town. Call Harris & Sons, Realtors, 758 4711.

66 Apartments For Rent

EASTBROOK AND VILLAGE GREEN APARTMENTS

327 one, two and three bedroom garden and townhouse apartments with heat, air condition, carpet, kitchen appliances, garbage disposal, nice laundry facilities, 3 swimming pools, 2 tennis courts and heat with hot water furnished in some units. No pets or loud parties allowed. Rent from \$140 \$210 per month. Call James A. Manning Agency, 825 5631. Drives off 264 By Pass Call 756 4012, Village Green, 800 North Street off E. 10th Street Call 752 5100.

3 ROOM APARTMENT for single person. Located Port Terminal, 3 miles east on Washington Highway. Come by if interested.

ATTRACTIVE 2 BEDROOM university condominium. \$200. August 1 occupancy. Married couple preferred. No pets. 756 3618, 6 till 8 p.m.

100 CLASSIFIED DISPLAY

86 Apartments For Rent

Ultimate In Apartment Living

1, 2, and 3 bedrooms, washer, dryer, hookups, pools, club house. One blocks from East Carolina University.

Check everywhere else first.

Then Call

TAR RIVER ESTATES

1401 Willow St. 752 4725.

Kings Row

One and two bedroom garden apartment with dishwasher, garbage disposal and drapes. Perfect location. Located just off east Tenth Street.

Call 752-3519

STRATFORD ARMS Apartment. 1900 Charles Boulevard, Building 19. Famous for its charm and quality service. amonks who appreciate quiet, luxury living among congenial neighbors. (919) 756 4800.

GreeneWay

Large 2 bedroom garden apartment. Carpet, drapes, dishwasher, pool. On Country Club Dr. adjacent to Greenville Country Club. 756 6869.

WE HAVE CABLE TV

CHERRY COURT

Luxurious 2 bedroom townhouses and 1 bedroom apartments. Carpet, drapes, compactors, washer dryer hook ups, pool, sauna, tennis court, club house, etc. 752 1557.

A PLACE UNDER THE SUN

Now taking applications for rental. Two bedroom contemporary apartment. Franklin stoves

Fake Worms, Crawdads Lure Fortune

By BRUCE NICHOLS
TYLER, Texas (UPI) — Nick Creme — the man who revolutionized fishing with the plastic worm — rolled a new artificial crawfish across his palm, eyeing it with critical satisfaction. The tiny orange plastic legs twitched.

"You talk to any taxidermist," he said. "When they're gonna mount a bass they cut 'em open. They find crawdads in about every one of 'em. The big problem is color. The one I think is gonna hit is what we call the motor oil color."

To find out, he has sent 400 of them to his "Creme pro staff"

for trial fishing in various parts of North America.

"I'm waiting patiently to see how they do. And I'm waiting to see what color and where. One color will go good in a clear lake but not in a muddy one. I may wind up making various colors. Four or five ought to do it."

The crawfish is a new product of Creme Lure Co., a multimillion-dollar business that grew from \$280 and an idea Creme had in the 1940s as a machinist in Akron, Ohio: fake worms would make for easier fishing.

He talked to a successful inventor, whose name he cannot now recall.

"He said the majority of people make their mistake by trying to invent intricate machinery," Creme said. "You'll make more money by inventing something that a man can't do. It's a vinyl formula that is still a company secret, though unpatented. It was not available then."

A chemist volunteered some basic ingredients to tinker with. Creme read some books. He poured and stirred. He was lucky. He came up with one he liked.

Then, he and his wife, Cosma, made baits at home. Later, they moved down the street. Finally, they expanded to Toronto, Canada, and Tyler, Texas, closing the Akron plant after settling on Tyler as home in 1960.

The invention revolutionized bass fishing, changing fishermen from lures to worms, shifting them to different equipment and broadening the season of the sport.

Now, dozens of Canadians and Texans melt the multicolored plastic under hot lights, pour it into molds and shape and package Creme's "true lures." Creme, 67, is wealthy and semi-retired. Sons Nick and Michael run the business.

But you still can buy a pack of basic nightcrawlers within easy reach of \$1. That is if you prefer them to Creme's crickets, flies, salamanders, shrimp and others ("I haven't found anything I can't make.") In 79 colors.

Fishermen know lures don't have to be realistic to catch fish, a fact that causes some manufacturers to try to lure the sportsman and then the fish. Creme calls this backward reasoning.

He said he makes his collection of oddly spotted or striped worms and other baits, even his human female-shaped worms "Shimmy Gal" and "Shimmy Babe," to catch fish first and then the fisherman.

His most popular worm is purple, a most unnatural color. "It's up to the fish," Creme

said. "I've talked to a lot of professors of biology. They don't know why a bass will hit a black worm or a purple worm. There's no evidence."

"A bass, you don't know what he wants. One'll be hot for a few weeks. Then all of a sudden they get off of it. Well, a smart fisherman, who fishes a lot, he'll find out and start changing."

Creme is a smart fisherman. The only colors he and his field testers have found fish won't hit at one time or another are fluorescents of most colors except green, in which case an odd fluorescent is the only one

fish ever hit. "It's popular in the spring," Creme said. "We've had other greens but they just wouldn't catch on."

Creme said he's grateful to God.

"I owe my business to the Lord. The Lord gave me the idea. He also enabled me to get started. With a lot of help from Him, we kept growing. I said to Him, 'If you'll let me succeed, I'll do things the way the Good Book says."

"I'm not gonna tell you what I've done for the Lord. I'd be a lot richer (otherwise), but just how rich do you want to be?"

Lila's Bar-b-que House

Located beside Pollard's Grocery,
Hwy 43 at Bells Fork

Eat In **756-4448** Carry Out
Bar-b-que Pit Cooked With Wood

Home Cooked Specials Daily
Homemade Biscuits and Baked Cornbread
Other Food Selections Available Also

Breakfast Lunch Dinner

8 A.M. to 7 P.M., Mon thru Sat.

Skywriter Goes Round And Round For 'Script'

By SUSAN CHADWICK
SEATTLE (UPI) — "I'll just break you in with a couple of easy letters to get you used to it," shouted Art Bell, skywriter, to the two gulping passengers belted into the back seat of the little plane.

The red wing dropped down toward the green earth some 8,000 feet below. The reporter screamed with laughter and clutched the seat. The blood drained out of the silent photographer's face.

A grinning Mr. Bell pressed the button on the control stick that let out the smoke "product," and round and round we went.

"See there, that's an 'O,'" said Bell, once the bright red-and-yellow plane was rightside up again. There, indeed, was a big smoky "O" in the hazy blue sky — Bell's Blackboard, as he calls it.

"Now that you're used to that, we'll make an 'A.'" Bell pointed the three-seater plane towards the majestic snow-draped peak of Mount Rainier. Our stomachs dropped into our seats as we climbed into the bright sun.

When the buzzing plane was headed almost straight up, he dropped it to the left and plunged with a hum down the other leg, lifting off the tops of our heads and forcing out more shrieks of laughter. Pens and cameras bounced around the tiny back seat.

Crossing the 'A' was simple enough. We flew around and admired it for several minutes. Next was an 'L,' not so easy as it looks.

"We fly a straight line for

seven seconds. Then we turn." How that was executed was a dizzying mystery. "And then we fly another straight line for seven seconds."

The 'E' was also exciting, better than any amusement park ride, as was the figure '8.' Few pictures or notes were taken as we were drawing these figures.

There are not too many solo skywriters of the old school left in this world, said Bell, owner of Bell Air Service in Seattle (Specializing in Skywriting and Banner Towing). There's maybe three in Los Angeles, Miami, and New York, besides himself, who fly out all the letters themselves, he said.

"It's all a fun thing. I can write anything I like up there," said Bell, who smiled broadly most of the time except when he was explaining some highly technical and serious aspect of the art of skywriting.

Bell earns "enough remunerative results to keep the equipment current." But more often than not he will drive his shining Piper Super Cruiser PA-12, "Smokey," up into the sky to write out a message whenever he is excited about something.

He has, for instance, drawn pictures of whales, smiling faces, the sign of the Rising Sun; he has written "Smile," "Buy Bonds," "Sonic Boom," the name of his favorite radio station, and numerous other greetings and messages on timely subjects just because he feels like it.

A former aerobist and airline pilot, an FAA examiner and

flight instructor, Bell is most pleased when he is introduced as a skywriter. He said he is well-known, has lots of fans, and reporters call him up all the time for interviews.

The letters are written upside down and backwards on a plane parallel with the earth, he explained. "I'm writing for a million people down there," he said, pointing at the floor beyond his feet. "Everything you do is timed, three minutes to a letter."

A clear sky is necessary, with not too much wind. He used to have to draw the letters out backwards and then figure how to fly them. "You can't end up on top of a letter when you should be on the bottom," he explained. Now he writes them from memory and is experimenting with cursive.

"But I can't do 'R's in cursive. They're too violent. I don't write too well, anyway, and I've been accused of being a bad speller."

"N" is a wild one. 'C' is hard."

When he first started out about 18 years ago, the problem was where to practice. "How do you practice in front of a million people?" He sometimes still makes mistakes. When he does he usually crosses it out. "I think the best thing to do is leave the scene."

Suddenly we were going up and down like a roller-coaster, diving and spinning and climbing. The trail of smoke behind us was a big wild knot.

"What letter was that?" "Oh, that wasn't anything. I was just showing off."

20¢ OFF SAYS YOU CAN'T TASTE THE DIFFERENCE

between Holly Farms Chicken Franks and your favorite hot dog.



- 100% chicken meat
- No cereal extenders or fillers
- No by-products
- Nutritionally labeled
- 22% more protein

- 20% fewer calories than regular franks
- 33-1/3 less fat than U.S.D.A. standards for meat franks
- Available in packages of eight or ten



STORE COUPON

NOTHING BUT THE BEST

STORE COUPON (7/78) 0162

NOTHING BUT THE BEST

SAVE 20¢ ON HOLLY FARMS CHICKEN FRANKS OR BOLOGNA

SO IT CLEANS UP BETTER.

25¢ on two

B-218

Save 25¢ on two packages of Viva® Towels

25¢ on two

Dear Retailer: If you receive this coupon in part payment on the retail sale of two packages of Viva Towels to a consumer and if, upon request, you submit evidence thereof satisfactory to Scott Paper Company, we will reimburse you for the face value of the coupon plus 5¢ for handling. Mail properly received and handled coupon to SCOTT PAPER COMPANY, BOX 5000, CHESTER, PA 19016. Cash value 1/20¢. Coupon may not be assigned or transferred. Void where prohibited, taxed or restricted by law. Good only in U.S.A. Consumer must pay any sales tax.

THE USE, REDEMPTION OR HANDLING OF COUPON NOT ACCORDING TO ITS TERMS CONSTITUTES FRAUD. ONLY ONE COUPON PER TWO PACKAGES PURCHASED. MECHANICAL REPRODUCTION OF COUPON PROHIBITED.

STORE COUPON B-218



No New Orleans In A Logical World

EDITOR'S NOTE — In a logical world, New Orleans wouldn't exist — not where it is, anyhow.

By **BILL CRIDER**
Associated Press Writer
NEW ORLEANS (AP) — Some folks say if it weren't for the French Quarter this town would die. Truth is, water pumps and drainage canals, not Bourbon Street and jazz, keep it alive.

"That's one fact that always astounds people and it sort of shows the situation we have here," says Charlie Hartman, who supervises the great pumps.

New Orleans, you see, is so soggy that 30 million gallons of seep water must be drained each day, even when lawns are scorched by lack of rain.

At the beginning, 260 years ago, the city was limited to the some 14 square blocks now called the French Quarter. That's the highest land in these parts. It soars to 14 feet above sea level, high enough to make a swamp dweller's ears pop.

But that high ground is just a hump beside the Mississippi River. From the Quarter, things slide downhill. Much of New Orleans squats on land six feet below sea level.

It is rather like a large saucer, with the Mississippi River levees as the southern rim and the seawall bordering 25-mile-wide Lake Pontchartrain on the other side.

As a consequence, a sudden surge of water can cause big problems.

Though the nearest seashore is 30 miles away, across salt marshes, hurricane winds have driven sea tides into suburban housing developments, should-deep in the living rooms.

The Mississippi, squeezed between 25-foot levees, sometimes

rises so high that crewmen on passing ships look down on city streets.

But on a day-to-day basis, it's rain that puts the load on the 21 pumping stations and 200 miles of canals that make up the nation's most extensive city drainage system.

It rains a lot here. The annual average logged by the weather bureau is 62.06 inches, compared with about 7 inches for Phoenix, Ariz., where they don't need drainage canals but often wish they did.

Every pint pumped out of the saucer that is New Orleans has to be lifted 10 or 12 feet to get it high enough to spew into

Lake Pontchartrain or the Intracoastal Waterway. Water coming from the center of the saucer has to be lifted twice — once to get it out of there, and again at a booster pumping station.

The pumps are huge. The largest are 14 feet in diameter. There are 22 of them, and each can move 392 million gallons a day.

If there are bigger pumps in the world, the Sewerage and Water Board of New Orleans never heard of them.

In addition, there are eleven 12-foot pumps of the same screw type. They were designed in 1912 by a New Or-

leans engineer named A. Baldwin Wood and turned out so well the Dutch government used them to pump dry the Zuyder Zee.

Total pumping capacity of the system is a billion gallons an hour. There are times when twice that wouldn't be enough.

The wettest day that Hartman expects to ever see overwhelmed the system within hours last May 3. It arrived without warning, looking like just another rainstorm.

"It came as a total surprise," says Hartman, supervisor of pumping stations. "I was over at station six when I looked at the rain gauge. It read 2.56

inches. Nothing we couldn't handle. I looked at the gauge 15 minutes later and it read 4.25 inches. We knew then we were in bad trouble."

In keeping with an unwritten law that a bad situation will get worse, winds raised tides in the Gulf. The Gulf leaned against the bays, the bays leaned against the passes into the lakes and the lakes backed up. Pontchartrain was seven feet higher than normal at the drainage outfall canals. The outflow had to fight its way into the lake.

Before it ended, 11.6 inches had been dumped on the city in about eight hours. New Orleans

was awash in water that left an estimated \$103 million in damage to the metropolitan sector. President Carter declared it a major disaster area.

City officials said 71,500 homes and 7,500 stores and businesses were damaged. The suburban count, mainly in adjoining Jefferson Parish (county), was 32,000 homes soaked.

Hartman says no drainage system could have handled the deluge. But he says that 99 percent of the water was pumped off the city within hours.

For those who think only of the French Quarter when they think of New Orleans, it's an idea 260 years too late.

Pitt Internal & Renal Medicine Associates, Ltd.

Alfred L. Ferguson, M.D.

P. Wayne Kendrick, M.D.

announce the association on August 1, 1978 of

Thomas E. Burkart, M.D.

Doctors' Park, Building 6

Greenville, North Carolina 27834

Office hours by appointment Telephone: 752-8880

Handicap In State Laws

SALEMBURG, N.C. (AP) — For the Sampson County town of Salemburg, compliance with state conflict of interest laws has caused no end of inconvenience.

That's because state law forbids local officials who are also businessmen from selling goods or services to their towns.

In Salemburg, that means whenever the town office runs out of manila envelopes, Mayor Walter F. Denton has to make a trip to Clinton, 16 miles away. He used to buy them at C.A. Royal's hardware store, just around the corner. But Royal is a town board member, and the town attorney says his envelopes are off limits.

The only mechanic and only backhoe owner in the town of 750 are also town board members. The town trucks now must be repaired out of town. Water pipes can't be fixed without help from elsewhere.

"The sad thing is that it costs the taxpayers so much more, but that's just the way it is," said S. Leigh Wilson, director of the North Carolina League of Municipalities, adding that dozens of small towns have similar problems.

Before the town attorney made Denton aware of the law, Royal was selling small items to the town at cost and discounting large items like lawnmowers.

Otis Tyndall, the town's only mechanic, did work on town vehicles without charging for labor. Now the town's trash truck has to go to Fayetteville for repairs. Labor alone on the last trip cost \$200.

"It's got the whole town up in arms," Denton said. "We all see the necessity for the law in bigger towns, but there are a lot of things Salemburg only has one of."

"The law, which is based on a state Supreme Court ruling, is so firm and well-entrenched that we've been unable to find a way to help these small towns," Wilson said.

Local Dog Wins Frisbee Contest

Prince Ian, a three-year-old Golden Retriever, won the state finals competition in the K-9 "fetch and catch" frisbee category in New Bern Saturday.

Prince Ian and his owner, Mac McGlowan of Greenville, will travel to Atlanta, Ga., Aug. 5, for the regional competition.

If the dog wins in the regional division, he will go for the national competition to be held at the Rose Bowl, Pasadena, Calif., Jan. 1.

The competition is sponsored by two national companies.

ECKERD'S Summer Savings Sale

... a name you can trust.

LAST 3 DAYS

VLASIC KOSHER DILL PICKLES
32-oz. jar, Reg. 89¢
59¢



SOFT DRINK SPECIAL
64-oz. Coke, Sprite or Tab. Your Choice, Reg. 1.19
89¢



LYSOL TOILET BOWL CLEANER
16-oz. size, Reg. 69¢ each.
2 FOR 99¢



LISTERINE ANTISEPTIC
14-ounce size, Limit 1
79¢



TYLENOL TABLETS
Bottle of 100
1.29



DADDY CRISP POTATO CHIPS
5-oz. Your choice - Sour Cream & Onion, Bar-B-Que or Ripple. Reg. 74¢ each.
2 FOR 1.09



SCHOOL LUNCH KITS
Choose from assorted designs. Includes vacuum bottle. Reg. 3.99
2.99



COPPERTONE SUNTAN LOTION OR OIL
4-oz. bottle.
1.29

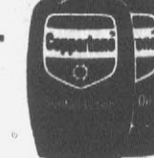

TRIPLE LANOLIN HAND & BODY LOTION
16-oz. size. Reg. 2.95
99¢



VASELINE PETROLEUM JELLY
7 1/2-ounce size.
69¢



MYLANTA ANTACID SUSPENSION
12-ounce liquid.
1.29



10-IN. x 17-IN. HIBACHI GRILL
4.99

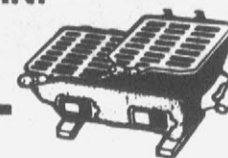

Cast iron construction with two adjustable grids and draft vents. Reg. 7.99.

GALAXY 20-INCH BREEZE FAN
15.88



One speed fan with thermally protected motor, stabilizing support feet. Model #3708. Reg. 19.99.

SHELL ANT & ROACH SPRAY
15 1/2-oz. aerosol. Reg. 1.19
77¢



2-GALLON METAL GAS CAN
Quick and easy to use. Reg. 1.99
1.44



BURGESS FLUIDIC SPRINKLER
Avoids over or under watering. Hundreds of settings. Model 371. Reg. 11.88
7.99



YOUR CHOICE STORAGE BOXES
Underbed or upright style in sturdy cardboard. Wood grain or patchwork. Reg. 1.29
88¢



WOOLITE LIQUID WASH
16-oz. liquid. Safe for all your fine hand washables. Reg. 1.59
99¢



RIDD MILDEW REMOVER
16-oz. size. The mold & mildew fighter. Reg. 1.99
1.39



2-QUART REFRIGERATOR BOTTLE
Milky clear plastic bottle with screw on top. Reg. 99¢
59¢



GALVANIZED MINI PAIL
Heavy galvanized steel pail, great for workshop, patio or party use.
88¢



BOWL BRUSH & HOLDER
Choose white, avocado or yellow. Reg. 1.39
88¢



MEN'S KNIT CREW NECK SHIRT
Assorted colors. Cool & comfortable. Reg. 3.99
2.88



SOUTH BEND ROD & REEL COMBO
Sturdy 2-piece, 6' rod & No. 630 reel in spincast combo. Reg. 8.88
5.99



POLAROID MINUTE MAKER
Takes 2 sizes of 60-second pictures. Electronically controlled shutter. Reg. 24.95
18.88



LADIES' VELOUR SLIPPER
Cross-strap style in assorted colors. Reg. 3.99
2.88



LLOYD'S STEREO PHONOGRAPH
100% solid state amplifier with rotary controls. BSR changer & matched speakers. No. F450-94. Reg. 79.99
59.99



DURACELL 9-VOLT ALKALINE BATTERY
No. MN16043. Reg. 1.79
99¢



MR. COFFEE AUTOMATIC COFFEE MAKER
With Coffee Saver! Brew 2 to 10 cups. Model MSC-200. Reg. 36.99
29.99



KODAK 135-24 COLOR PRINT FILM
24 exposures. Reg. 2.25
1.77



Valuable Coupon

BATH SIZE DIAL SOAP
White or gold. Reg. 2 for 70¢. You must present coupon.
4 FOR 99¢ ★

Coupon Good Thru August 21, 1978

MUST REDEEM COUPON!



ECKERD DRUGS

ECKERD'S FAMOUS PHOTO OFFER

TWICE THE PRINTS Get an extra set of prints with every roll of color or black and white print film developed and printed... TODAY AND EVERYDAY.

TWICE THE FILM When you pick up your developed film and prints, buy two rolls of Kodacolor or black and white print film for the regular price of one... TODAY AND EVERYDAY.

GUARANTEE Buy only the prints you want. No hassle - even if the goof was in the picture taking.

PRICES GOOD THRU SAT., JULY 29TH

ECKERD DRUGS

America's Family Drug Stores



PITT PLAZA SHOPPING CENTER

ECKERD COFFEE SHOPS ARE LOCATED IN STORES WITH THIS SYMBOL



VISA



Hitting Back Via Advocacy Ads

By JOHN F. SIMS
UPI Business Writer
NEW YORK (UPI) — When Big Business feels news coverage of its activities is inadequate or inaccurate it sometimes will use paid advertisements to "set the record straight."

So this article is an attempt to set the record straight. Yes, the media does occasionally distort business news; sometimes because it misunderstands, sometimes because it takes information out of context, sometimes by mere omission.

Occasionally a journalist will allow bias to creep into his stories because of a suspicion, very often unverifiable, that claims made by business are not all they seem to be.

It seems to be accepted that the errors or distortions are not part of a deliberate campaign to put down business.

Newspaper editors have acknowledged that business disinformation is occasionally justified. But they resent the accusation that whatever bias or distortion occurs is deliberate.

But still business feels the need to spend between \$500 million and \$1 billion a year to promote its editorial or institutional point of view over and above the \$33 billion it uses a year to advertise its products and services.

Mobil Oil Corp. has made the practice of advocacy advertising a regular part of its corporate advertising and other oil companies have followed its lead. Steel companies also have felt the need to speak directly to newspaper readers.

Herbert Schmertz, vice president for public affairs at Mobil Oil, explained why Mobil began its advocacy advertising. "Advertising was the only route to effective presentation of information," he said. "We felt the public was being shortchanged by the media, and that includes the electronic media, and still is being short-changed."

Herman J. Schmidt, vice chairman of Mobil, explained more fully in a recent speech: "We know that the news media generally try to do a good job. But we have found that it pays to hit back immediately whenever we feel someone in the media has gone for our jugular."

"We believe there are many benefits in hitting back hard — quickly and factually. For one thing it makes viewers and readers pause and ask themselves: How much of the stuff I see and hear can I believe?"

Schmidt said Mobil had found its methods most effective "when it became clear in 1972-74 that the oil industry was in a fight for its life..."

Continental Oil Co. of Stamford, Conn., had recourse to paid advertising — a full page in both the Washington Post and the New York Times — to clarify a situation it thought had been underreported by the media.

In the winter of 1976-78, a federal investigation team charged that Conoco and other oil and gas companies might be producing less gas than they could from fields in the Gulf of Mexico.

The charges received front-page, headline coverage in many newspapers. But an exoneration issued after a study by the National Academy of Sciences — finding that Conoco was producing gas as fast as possible from the fields in

question — was virtually ignored.

E.L. Shafer, senior vice president for government and public relations at Conoco, said his company's advertisement was not aimed at embarrassing the press.

"Our chief objective was to inform our employees, shareholders and the general public that the charges against the company were not true," he said in a prepared statement.

"However, as far as many businessmen are concerned, the old axiom that 'no news is good news' should be changed to 'good news is no news,'" he said.

"To be fair to the media... it should be recognized that charges by key government officials, prominent consumer advocates, and leading environmental spokesmen are newsworthy, whether they ultimately are upheld or not — and whether businessmen like them or not. The press does have the right, even the responsibility, to report what it considers newsworthy."

"A more valid and serious criticism of the press, in my view, involves the lack of follow-up by the media on charges that they publicized originally. This is one area where the media need to improve their performance."

"Whenever they are remiss in this regard, I think the individual companies or industries have the right — and the obligation — to set the record straight with ads or whatever other vehicles are available to reach the public."

Conoco will do so whenever it feels such action is necessary, he said.

Other companies have used paid advertisements just to present a point of view, whether or not it is contested by the media.

The pharmaceutical industry uses inserts in trade publications to make the point that high prices paid for proprietary brands of drugs are not a ripoff but a consequence of the considerable investment needed in research and development.

Gould Inc., an electrical and industrial products company based in Rolling Meadows, Ill., has plugged the need for R&D in a series of advertisements and "white papers" devoted to a defense of technology.

The advertisements and the white papers all asked the same question: "Science and technology can solve many problems. If they don't, what else will?"

Gould said it initiated the program because "In recent years science and technology have come under attack in the United States. Science and technology have been the target of editorial derision... have been a convenient scapegoat for politicians..."

"The purpose of the program is to help foster a clearer understanding of science and technology and their role in U.S. growth and prosperity up to now and their potential for solving present and future problems," a Gould statement said.

All this seems harmless enough, even salutary.

But strenuous objections have been raised, especially against the oil company advertising, by consumer groups.

Dr. Bernard Rubin, director of Boston University's Institute for Democratic Com-

munications, told UPI the advertisements too often leave the public with a one-sided picture because consumer groups cannot afford to reply in kind.

Part of the problem, according to Rubin and some businessmen, is that many reporters covering business and finance do not know enough of the intricacies and produce only superficial coverage.

Mark Green, director of Public Citizens' Congress Watch in Washington, blames newspaper publishers and editors.

Green criticized the many newspapers that publish without attribution editorials distributed free by the National Association of Manufacturers or cartoons prepared by Mobil.

Green, writing in the Cornell University magazine Executive, complained: "When companies with millions to spend on ad campaigns criticize individuals and organizations in forums that permit no reply or that are financially out of reach, the potential for abuse of the media becomes obvious."

Mobil has often said it would be willing to buy equal time for opponents if it were allowed to use commercial time on television to present its advocacy messages. The networks, however, have not accepted Mobil's proposed

commercial. Mobil has not made the same "equal time" offer for its newspaper advertisements.

Mobil's newest attack on the media comes out of a Supreme Court ruling that struck down a Massachusetts law restricting the first amendment rights of corporations.

For Mobil, the important part of the majority ruling written by Justice Lewis F. Powell was the line "... the press does not have a monopoly on either the first amendment or the ability to enlighten."

Schmertz, appearing before the House subcommittee on commerce, consumer and monetary affairs, made the point that Mobil treats its "issue" advertising — on which it spent \$3.2 million in 1977 — as non-deductible at tax time.

Schmertz asked whether newspapers also refrained from deducting as business expenses the cost of producing their editorial pages "or at least those portions that advocate legislative action or non-action by a government body."

"Why should our messages be subject to greater scrutiny than those of the media corporations, and why should this scrutiny take the form of an examination into whether the regulations, which apply to all businesses including the communications industry, are being enforced

strictly enough against us?" he asked.

One answer has been that newspapers are in the business of providing opinion and that editorial page costs thus are deductible.

But as Schmertz also pointed out, many newspapers are also in other businesses such as pulp and paper products. If an editorial spoke for or against legislation concerning those other businesses, it should perhaps be non-deductible.

The National Association of Manufacturers has taken issue with the Internal Revenue Service on precisely this question.

The IRS in March handed down rulings that prevent the NAM from deducting as business expenses the cost of certain grassroots lobbying and other programs it considers an essential part of its work.

The NAM has brought suit to challenge the IRS rulings, but a decision is not expected for "many months," according to a spokesman.

There probably is no way of avoiding the tension that sometimes exists between business and the media. Reporters will never be as sympathetic to business as businessmen would like them to be, and businessmen will never be as open as reporters would like them to be.

Credit Card Hangover? Homeowners Try Our "BUDGET ADJUSTER LOAN"!

By paying off those credit card and department store charges, we can reduce your monthly payments to make it easier to live within your budget.

We reduce your payments by allowing you a longer repayment term with our BUDGET ADJUSTER LOAN. Often there will be no increase in the rate of interest you pay. You can afford the things you want and need right now. Check the chart below and compare to the rates charged by Visa, Mastercard and most department stores for extended terms.

Add up the balances and monthly payments on all your charge and credit card accounts. If you need extra cash now, add that amount to the total balance. Then call us at the number listed below. Ask the manager to quote you the BUDGET ADJUSTER LOAN monthly payment.

There is no obligation and if you prefer, you don't even have to give your name.

Check our sample BUDGET ADJUSTER LOAN plans listed below and call today!

Total Balances (Amt. Financed)	Monthly Payment	Term Of Loan	Total of Payments	Annual Percentage Rate
\$2426.09	\$ 66.00	48 months	\$3168.00	17.06%
\$3896.45	\$106.00	48 months	\$5088.00	17.06%
\$5006.20	\$116.00	60 months	\$6960.00	15.86%
\$6041.97	\$140.00	60 months	\$8400.00	15.05%
\$7432.58	\$172.00	60 months	\$10,320.00	14.36%

Liberty Loan Corporation

Suite 301 - Cherry Bldg. 301 Evans St.
Greenville, North Carolina 27834

752-6181

"Providing VIP Service to Working Americans"

Timely Products For Summer!

Daylight Savings Time

Shop Lowe's Values To Help Turn Back High Prices

For a limited time only, we're offering excellent values on a variety of home improvement products. Not to mention our regular quick delivery, convenient credit and expert advice. Why save only daylight, when you can save dollars, too?

All materials needed for shelving or other home building projects.

We've got 2" x 2" multi-purpose lumber for shelf support... 1" x 12" particle board shelving, 8' long... and 6 penny, 2" finish nails.

2 x 2 (#04160)10c L. Ft.
1 x 12 (#01381)\$1.84 Pc.
2" Nails (#18512)49c Lb.

*Linear Foot—A one-foot length, regardless of width or thickness.

The beauty of hardwood flooring for less than the cost of carpet!

Hartco

Beautiful 12" oak squares with a cushioned, self adhesive back. Pre-waxed for easy care. Tongue and groove edge for easy installation. #00469-71

\$179 Sq. Ft. In Windsor, Old Brown, and Standard

M. MASONITE

Asphalt shingles help protect against the high cost of wind damage.

#240 asphalt shingles have a sun activated seal which attaches each shingle to the one beneath for a sturdy 1-piece roof, impervious to wind, rain, hail, sleet, snow. #14618

\$1797 Bundle

7 Beautiful Colors To Choose From.

Charge It!

LOWE'S accepts VISA and MasterCard for convenient cash.

When you're remodeling your home, don't forget the garage—give it a new door!

Good looking and sturdy garage door is all wood with 4 windows. It rolls up in 4 sections and measures 8' x 7'. Comes with all hardware. #11042

\$9800

1/3 HP Garage Door Operator #11009 \$108

A. 13 Pc. drill bit set with case. #91772

B. Lightweight electric jig saw. #91781

C. 16' power lock steel tape rule. #99908

Choose any or all of these handy tools at this super low price. A great start to a workshop.

Your Choice... \$900 Each

3/4" variable speed power drill with reverse. #91710 \$2488

7 1/4" circular saw with 1 1/2 horsepower motor. #91844 \$2488

9 inch table saw with two wings, motor, and stand. #91950 \$16988 Reg. \$199.99

Motorized miter box saw with 1 1/2 horsepower motor. #91956 \$21985 Reg. \$259.95

Make unused attic space more easily accessible.

Folding attic stairs are designed for a maximum ceiling height of 8'9". Of clear pine, steps are groove-fitted for safety. #15810

\$2895

Add good looks and extra safety to your front steps.

Handsome black wrought iron railing is easy to install yourself with ordinary tools—no drilling is necessary. Rail is 1" wide. #14215

\$395 4' Section

Add the finishing touch to all your walls.

All our unfinished moulding 8 ft. and under is now priced at 25% off the regular price to help you with your home decorating.

25% OFF

Stop and casing not included.

2728 S. Memorial Dr. Greenville, N.C. Store Hours: Mon.-Fri. 7:30-6 Sat. 8-4 756-6560

Not only a top-quality lockset, but an attractive addition to your front door.

This Georgian style lockset adds a touch of bright brass to your front entrance. It has an outside key—inside button lock. #61006

\$1188

6-panel fir door measures 6'8" x 2'8" x 1 1/4" thick. #10506 \$5988

4-panel wood screened door measures 6'8" x 2'8". #11192 \$2297

2-panel louvered bi-fold door. 6'8" x 2'0" x 1 1/4". #10535 \$2888

Tougher than glass! 100 ga. acrylic glazing. 28" x 30". #11230 \$488 Sheet



Ultra-Vue Plastic Lenses tint of choice in Oscar De La Renta Frame Ladies and Men \$95 Complete Single Vision Photo Gray 24⁵⁰

Oscar De La Renta With Single Vision Plastic Lenses Any Prescription Choice Of Tints Ladies \$48 Complete Men \$58 Complete Photo Gray 36⁵⁰

CLEAR VUE OPTICIANS

GREENVILLE N.C. PHYSICIANS QUADRANGLE BUILDING A 1705 W. 6TH ST. 752-1446

Berkley Mall Goldsboro 114 E. Walnut Downtown Goldsboro

LOWE'S



THE HEATERS—From left, James Demeter, Mercy Bermudez, Phil Cohen, Missy Connell and Maggie Connell.

'The Heaters' Look Like Kids

By MARY CAMPBELL
AP Newsfeatures Writer

The Heaters look as young as high school kids, but they play rock 'n' roll like seasoned veterans.

All five are in their 20s but don't look it. Maybe it's because the three women are short and thin and the two men, though bigger, aren't huge. Maybe it's because they move around with youthful energy — though a lot of rock groups do that. Maybe it's because they wear fitted black pants and vests and narrow black ties.

Lead vocalist Mercy Bermudez, who also plays saxophone, laughs and says the costumes weren't meant to make them look young. They're to make them look like a unified group on stage, and it was what they could afford. Her mother bought black denim and made the women's vests; the men bought theirs in thrift shops. Looking so young has its disadvantages, says Miss Bermudez, Missy Connell, bassist, and Phil Cohen, drummer. Miss Connell says she has to show identification before she can buy cigarettes in Los Angeles and she often has to give her fingerprints in the bank where the group has its account because they don't believe her identification. She also mentions an annoying tone of voice used by some people who think they're talking to "children."

They all get tired of being asked how old they are when they come off stage and then being told they look about 15.

The Heaters have been together for 15 months, most of that time playing in a club called the Rock Corporation in Van Nuys, Calif., where they could play original material. So they got their music tightly together.

Also, they decided they were getting good enough to record. Last November, they made a demonstration record for United Artists, and their manager talked with a number of record companies. Executives from Polydor and Ariola came in to hear them one night, and the next day Ariola signed them.

So they went in the recording studio and cut "The Heaters." A single from it, "Put on the Heat," which they call an up-tempo rhythm 'n' blues-rock 'n' roll song, is being released.

They like 1960s rock, both rhythm 'n' blues and the British rock 'n' roll. But they don't play punk rock, which also harks back to early rock 'n' roll days.

The difference, Missy Connell says, is that punk rock groups simply play faster. "They're more driving and powerful than the 1950s and '60s groups were. They're beefed up to project the atomic age, I guess. And

there's less vocal harmonies in punk than we do."

The Heaters' main writers are Missy Connell and Cohen. Miss Connell says she likes to work with somebody else. She says, about "Cross Fire," "I had this music and a lyric about something caught in a crossfire. I had a feeling Phil should write the rest of the lyrics to it if he wanted to. I feel sometimes as if I've gone as far as I can by myself. The more we are all involved the better I like it."

"Mercy thought of the title 'Put on the Heat,' one day. I wound up writing a song. Maggie plays great boogie woogie which was my inspiration for writing 'Stepping Out at Night!'"

Her sister, Maggie Connell, plays keyboards. Guitarist James Demeter is the only one married, though Cohen thinks he'll be next, and soon.

Cohen, who writes his tunes on a guitar, though he has always been a drummer as a performer, said that "Talk is Cheap" had been a possible title written in one of his notebooks for a long time. Then he got mad at various people telling him all different things and he wrote a song with that title.

The group only recently started to tour and still finds touring an adventure. Their first engagement was at the Psychedeli, a blues rock club in Bethesda, Md., on a bill with a local blues band. Their second show was at the Bottom Line in New York, where they were invited to return for two more performances, in June and July.

Missy Connell explains how they all met. Her parents are both actors. They moved the family to the West Coast, across the street from James Demeter. She and Demeter were in a band called Mad Fat.

"Then the family moved East, where Phil and I met. We were in a band called Moon Baby in New York. We still do some of the songs that started with that band, one I wrote and a couple I co-wrote with Eve Moon.

"We met Mercy when we were auditioning for a top 40 outfit. Phil couldn't deal with the idea, so he stayed in New York and did original material. Mercy and I toured, singing top 40 stuff, for a year. Then we worked with Maggie for a while. All five of us got together 15 months ago."

They picked the group name, Miss Bermudez says, one night at 10 p.m., having been given a midnight deadline. It was the only name they could agree on.

The men's fathers are doctors and Miss Bermudez' mother is a dentist. Her parents were born in Cuba. She was born in Syracuse, N.Y.

JOIN THE HAPPY PEOPLE WHO HAVE WON A SHARE OF \$501,700!

\$2,000 WINNER!
JOHN M. KING
SARFORD, N.C.

\$2,000 WINNER!
JOHN JACKSON
BOANOCK, VA.

\$1,000 WINNER!
BRILAH ABBOTT
BRAMA, N.C.

\$1,000 WINNER!
IRVINE P. PRITH
BOANOCK, VA.

12-OZ. CANS MILLER WINE \$3.29 (Ctn. Of 12)

TAYLOR LAKE COUNTRY WINE \$2.99 (1 1/2-Liter Btl.)

• PRICES GOOD THRU SAT., JULY 29TH • NONE TO DEALERS • WE RESERVE THE RIGHT TO LIMIT QUANTITIES

WE GLADLY ACCEPT FOOD STAMPS

YOU SAVE 70c
ALL GRINDS ASTOR COFFEE \$1.99 (1-LB. CAN)
WITH \$7.50 OR MORE ORDER (LIMIT ONE)

YOU SAVE 20c
THRIFTY MAID SUGAR 89¢ (5-LB. BAG)
WITH \$7.50 OR MORE ORDER (LIMIT ONE)

YOU SAVE 10c
DEEP SOUTH SALAD DRESSING 79¢ (QT. JAR)
WITH \$7.50 OR MORE ORDER (LIMIT ONE)

THRIFTY MAID

GOLDEN CORN • PORK & BEANS
SLICED CARROTS • WHITE POTATOES
MIXED VEGETABLES • PEAS

MIX OR MATCH & SAVE UP TO 66c! \$1.00 (16-OZ. CANS)

WITH \$7.50 OR MORE ORDER (LIMIT 15 OF YOUR CHOICE)

CHEK

ROOT BEER OR COLA

YOU SAVE 50c \$1.00 (2 64-OZ. NO RETURN BTLs.)

WITH \$7.50 OR MORE ORDER (LIMIT 2)

ASSORTED FLAVORS CHEK DRINKS CASE OF 24 12-OZ. CANS \$2.99

THRIFTY MAID JUICE 2 44-OZ. CANS \$1.00

DEEP SOUTH GRAPE JELLY 32-OZ. JAR 99c

THRIFTY MAID FLOUR 5-LB. BAG 69c

THRIFTY MAID CORNED BEEF 12-OZ. CAN 85c

DEEP SOUTH PEANUT BUTTER 40-OZ. JAR \$1.79

CRACKER GOOD SALTINES 2 1-LB. BOXES \$1.00

ARROW WHITE PAPER PLATES 100-CT. PKG. 79c

ARROW COLD CUPS 100-CT. PKG. 89c

ARROW ROASTED PEANUTS 8-OZ. JAR 59c

ARROW ALUMINUM FOIL 3 25-FT. ROLLS \$1.00

DIXIE DARLING BREAD 24-OZ. 2 LOAVES 89c

SUPERBRAND U.S.A. GRADE 'A' LARGE EGGS DOZ. 69c

YOU SAVE 30c ASTOR INSTANT POTATOES 2-LB. BAG 99c

the beef people...

YOU SAVE 70c PER LB.

FRESH PORK SPARE RIBS 99¢ (LB.)

"GREAT FOR GRILLING!"

YOU SAVE 30c PER LB.

BRAND GRADE 'A' BAKING HENS 49¢ (5-7 LBS. AVG.)

(LIMIT TWO AT THIS PRICE, PLEASE)

BRAND U.S. CHOICE

- BEEF BRAISING RIBS** LB. \$1.39
- NEW YORK STRIP STEAKS** LB. \$2.99
- LEAN BONELESS STEW BEEF** LB. \$1.59

BRAND U.S. CHOICE AGED BEEF FAMILY ROASTS \$1.19 (LB.)

BRAND U.S. CHOICE BEEF (WHOLE UNTRIMMED) N.Y. STRIP LOINS \$1.99 (18-22 LBS. AVG.)

HOLLY FARMS FRYER QUARTERS 1-LB. PKG. 85c

BRAND IMPORTED SLICED COOKED HAM 12-OZ. PKG. \$2.39

BRAND OLIVE OR HAM & CHEESE LOAF 8-OZ. PKG. 89c

BRAND REGULAR, THICK OR BEEF SLICED BOLOGNA 1-LB. PKG. \$1.19

GWALTNEY'S BIG 8 FRANKS 1-LB. PKG. \$1.49

BRAND SPICED LUNCHEON, SALAMI OR PICKLE & PIMENTO 8-OZ. PKG. 89c

SUNNYLAND HOT OR MILD PORK SAUSAGE 1-LB. ROLL \$1.29

DELICATESSEN TAKE OUT SPECIAL

- 1 LB. PORK B.B.Q. \$3.99
- 1 DOZ. HUSHPUPPIES ALL FOR \$3.99
- BRAND HAMBURGER \$2.99
- BRAND BEEF FEAST SUMMER SAUSAGE LB. \$2.99

BAKERY DEPARTMENT

- 7-INCH DEVIL'S FOOD OR COCONUT CAKES SIZE \$3.49
- WHOLE WHEAT OR SOUR RYE BREAD 1-LB. LOAF 59c
- GLAZED DONUTS DOZ. 99c

PLEASE CALL FOR SPECIAL ORDERS: Located at the Shopper's Mart Phone: 756-2956

DAIRY Department

SUPERBRAND COTTAGE CHEESE 2-LB. CUP \$1.29

SUPERBRAND ALL NATURAL YOGURT 3 8-OZ. CUPS 89c

SUPERBRAND SLICED AMERICAN CHEESE 12-OZ. PKG. 99c

SUPERBRAND SOUR CREAM 1-LB. CUP 69c

FROZEN FOOD DEPT.

COUNTRY FRESH ALL NATURAL PRESTIGE ICE CREAM (4 FLAVORS) HALF-GAL. CTN. \$1.99

MORTON HONEYBUNS OR GLAZED DONUTS 2 9-OZ. PKGS. \$1.00

MORTON JELLY DONUTS 2 11-OZ. PKGS. \$1.00

MORTON MUFFINS—COBN, ENGLISH, BLUEBERRY PKG. 69c

MORTON CREAM PIES 16-OZ. SIZE 59c

HARVEST FRESH PRODUCE

- LETTUCE** (NO HEAD OVER 99c) LB. 49c
- CALIFORNIA PLUMS** 2 U.S. #1 LB. \$1.00
- WHITE POTATOES** 10-LB. VENT VUE BAG \$1.49
- FLORIDA LIMES** DOZ. 69c
- SWEET & JUICY PEACHES** LB. 39c
- FRESH LEMONADE** 2 HALF-GAL. CTNS. \$1.00

JUMBO 15-SIZE CALIFORNIA CANTALOUPE

2 FOR \$1.00

SUPERBRAND SHERBET OR ICE CREAM

HALF-GAL. CARTON 78¢

YOU SAVE 21c

Located At The Shoppers Mart
Now Open 7 Days A Week 8 A.M.-10 P.M.

Manager
Phillip Ward
Produce Manager
Wayne Radcliff
Market Manager
Charles McGrady

Kmart

THE SAVING PLACE

KMART'S FANTASTIC FOOD WEEK!

THURSDAY SPECIAL

TWO HOT DOGS

Served with mustard, onions and relish, small drink.

\$1.00

11 a.m. to 2 p.m.
4 p.m. to 7:30 p.m.

SALISBURY STEAK

Served with gravy, potatoes, one vegetable roll and butter.

\$1.37

CORNER OF GREENVILLE AND ARLINGTON BOULEVARDS

Superior Court Report



Judge R. Michael Bruce disposed of the following cases during the June 26 term of Pitt County Superior Court:

William Gaydon Liles, Farmville, driving under the influence and fail to secure certification of title, pled guilty to driving under the influence, six months jail suspended on payment of \$400 and costs, spend 48 hours in jail.

Benjamin Franklin Moore Jr., Scotland Neck, vehicle registration violation, dismissal by prosecutor; driving under the influence, driving while license revoked and possession of marijuana, seven months jail, and pay costs.

Walter Earl Best, Route 1, Stokes, breaking, entering and larceny, pled guilty to larceny, 18 months to 3 years jail.

Steve Kirkland Hayes, 1905 East Fourth St., possession of marijuana, pay \$100 and costs.

John Earl Lawrence, Raleigh, speeding, 60 days jail suspended on payment of \$50 and costs.

Bobby Ray Lewis, Highland Trailer Ct., assault on a female, dismissal by prosecutor.

Wayne Clemmons, Route 2, Farmville, trespass, non suit.

Edward Mack Bunting, 2815 Jackson Dr., speeding and fail to stop for blue light and siren, 60 days jail suspended on payment to \$50 and costs.

Albert Thomas McSorley Jr., Route 2, Vanceboro, assault, pled no contest, 30 days jail and pay \$50 and costs.

Jesse Ray Andrews, Simpson, breaking, entering and larceny, 3 to 5 years jail suspended on payment of \$1,000 and cost and three years probation, attempted safe opening, dismissal by prosecutor.

Edward J. Fleet, Simpson, break, entering and larceny, five years jail, 60 days active remainder suspended on payment of \$1,000 and costs and counsel fees, attempted safe opening, dismissal by prosecutor.

James Clinton Daniels, 112 Greenfield Blvd., driving under the influence, 90 days jail suspended on payment of \$200 and costs and spend a weekend in jail.

Mark Lindsey Hardy, Winterville, possession of marijuana, pay \$100 and costs.

Bradford Lee Waters, New Bern, driving under the influence, 60 days jail suspended on payment of \$200 and costs.

Joe Don Henderson, 2215 College View Apts., manufacturing marijuana, pled guilty to possession of marijuana, pay \$100 and costs.

Lonnie Howard, 112 Colonial Ave., assault on a female, 90 days jail suspended on payment of \$150 and costs.

Charlie Harris, Ayden, driving under the influence, pled no contest to reckless driving, 60 days jail suspended on payment of \$100 and costs.

David L. Maye, Route 2, Farmville, taking indecent liberties with child, not guilty.

Lois Ann Lamm, Fountain larceny, one year jail suspended on payment of \$200 and costs.

Robert Sheppard, 1015 Fairfax Ave., worthless check, (2 counts) 30 days jail suspended on payment of \$100 and costs and check, in each case.

William Fred Pollard, Route 1, Pinetops, crime against nature and taking indecent liberties with a child, abated.

Danny Morton Pollard, 402 Oak St., driving under the influence, verdict guilty of driving with 10 per cent blood alcohol, 60 days jail, pay \$100 and costs.

Kenneth Earl Chapman, Route 1, Grifton, driving while license revoked, six months jail suspended on payment of \$200 and costs and spend weekend in jail.

Edward Mack Bunting, 2815 Jackson Dr., speeding 15 miles per hour over limit to elude officer, dismissal by prosecutor.

Bobby Ray Barnes, Wilson, larceny, 12 months jail suspended on payment of \$400 and costs and counsel fees and two years probation.

ths jail suspended on payment of costs.

Paul Joseph Thomas, 1117 South Evans St., driving under the influence, 90 days jail suspended on payment of \$100 and costs and council fees.

William Junior Fleming, Route 1, Farmville, false pretenses, four to six years jail.

Tyrone Newton, Farmville, stop sign violation not guilty.

Danny Ray Fritts, 2315 College View Apts., manufacturing marijuana, dismissal by prosecutor.

Danny O. Bletly, 406 Aztec Ln., assault on a female, non suit.

Daryl Wayne Privette, Kinston, exceeding safe speed, not guilty.

James Weston Hodges, 304 S. Meade St., fail to yield right of way, pled guilty to fail to see safe move, pay costs.

Brian Daniel Waters, River View Est., breaking, entering, and larceny, dismissal by prosecutor.

Judge Robert Rouse disposed of the following cases during the July 10 term of Pitt County Superior Court.

Wallace Harold Strother, 1502 Powell St., driving under the influence of drugs, pled guilty to careless and reckless driving 90 days jail suspended on payment of costs and counsel fees.

Samuel Kevin Price, 1310 Evergreen Dr., passing stopped school bus, dismissal by prosecutor.

Guilmer Nichols, no address, assault with firearm on law enforcement officer, 12 months jail.

Theodore John Dexter Jr., 821 College View Apts., careless and reckless driving, pled guilty to city ordinance violation, pay costs.

Elias Carmon, Winterville, using telephone for obscene calls (two counts), 18 to 24 months jail, in each case; using telephone for obscene calls (five counts) dismissal by prosecutor.

Allan Wayne Edwards, 320 Unstead Dorm, possession of marijuana, manufacturing marijuana, possession of hashish, three to four years jail suspended on payment of \$500 and costs and four years probation.

Stacy Hagans, Route 6, Greenville, assault by pointing a gun, not guilty.

Tony Daniel Vincent, Route 1, Grimesland, discharging firearms into occupied property, dismissal by prosecutor.

Stephen Norwood Sprull, Plymouth, speeding, not guilty.

Byron W. Franks, 107 North Oak St., reckless driving, pled guilty to fail to stop for stop sign and exceeding safe speed, pay costs.

Isaac Tall, Route 1, Greenville, assault on a female, not guilty.

Fleann Woodson Moore, 104G Eastbrook Apts., possession and sale of cocaine, three years jail.

Judge Robert Rouse disposed of the following cases during the July 3 term of Pitt County Superior Court.

Clifford Lee Sullivan, 304 Hardee Cir., driving under the influence and public drunk, dismissed.

Douglas Paul Lucas, Yorktown Sq., exceeding safe speed, pay costs.

Larry Eugene Yaw, Route 4, Greenville, driving under the influence, guilty of reckless driving, 60 days jail suspended on payment of \$50 and costs.

Ronnie Lee Gardner, 600 Vance St., exceeding safe speed, dismissal by prosecutor.

Jeffery Ailesan Jones, La Grange stop light violation, dismissal by prosecutor.

Anne Trimmer Warren, Route 6, Clinton, stop sign violation, pay costs.

Robert Marshall Anderson, Raleigh, stop light violation, dismissal by prosecutor.

Elbert Taylor Jr., Bell Arthur, driving under the influence and driving while license revoked, six months jail on each charge.

Joseph Lee Thompson, Route 2, Ayden, driving under the influence, guilty of reckless driving, 60 days jail suspended on payment of \$50 and costs.

Eugene Stokes, 109 Summit St., worthless check (16 counts) 12 months jail.

Willie Montana Jones, 401 Deck St., driving under the influence and speeding, pled guilty to reckless driving, 60 days jail suspended on payment of \$50 and costs.

Norman Lee Sutton, Route 1, Vanceboro, driving under the influence and driving while license revoked, pled guilty to driving while license permanently revoked, 12 months jail.

Richard Earl Gray, Route 2, Farmville, no operator's license, three days jail; passing stopped school bus, dismissed.

Billy Wayne Briley, ST. Augustine, Fla., driving under the influence, and driving while license revoked, six months jail suspended on payment of \$300 and costs, two years probation.

Henry Earl Tripp, Route 4, Greenville, assault on a female, not guilty.

James Bryant, 1013 West Fourth St., driving under the influence and speeding, 6 months jail.

Stelenius Herby, 413 Bonners Ln., bastardy and non support, six mon-

ths jail suspended on payment of costs.

Assembles Fragments

WASHINGTON (AP) — "No," says Doris Hanford emphatically, she does not do jigsaw puzzles as a hobby. "I did like them at one time," she admits, but she has lost the taste in 27 years of piecing together torn, burned, mangled and mutilated money. You see, the government replaces damaged money — dollar for dollar — as long as you have at least half of each bill. And it's Mrs. Hanford's job, as manager of the examining branch of the mutilated currency division of the Division of Currency Claims, to verify how much money should be replaced when damaged bills are brought in. For example, one man arrived carrying a package of money pieces and asked for a replacement. He had hid the money in a shotgun, forgot it was there and — you guessed it — blasted fragments of federal reserve notes all over a field. Mrs. Hanford began piecing the bits together, sent the man back to the field to search for more fragments and eventually reconstructed more than half of most of the bills. If an individual with currency fragments, or Mrs. Hanford and her staff, cannot reconstruct more than half of a bill, then there is no reimbursement. "We receive money that has been burned, buried, laundered, bleached, subjected to natural disasters, contaminated by chemicals or otherwise," Mrs. Hanford commented.

Now...Enjoy the superb comfort of these Authentic Rockers..

<p>Save 47.50 List price \$100.00</p> <p>TALL BACK SOLID MAPLE ROCKER Nylon tweed and plaid fabric, skirted.</p> <p>\$142.50</p>	<p>Save 30.00 List price \$120.00</p> <p>CONESTOGA OAK ROCKER Steam bent solid oak back of nylon fabric.</p> <p>\$90.00</p>	<p>Save 37.50 List price \$155.00</p> <p>SOLID PINE ROCKER Carefree Herculan tweed fabric, skirted.</p> <p>\$117.50</p>
--	---	---

GIVE YOUR FAMILY AN HEIRLOOM!

Save \$35.00 to \$37.50 on Antique Pine Wood Seat Rocker

List price \$145.00

\$110.00
Decorated
List price \$145.00

\$117.50

COMPARE! SAVE

\$750.00 Bostic-Sugg's Instant Credit Plan

No hassle—just as simple as 1...2...3. Another fine exclusive plan at Bostic-Sugg. Show us your valid driver's license and one major credit card in good standing, along with your name, address, place of employment and listed telephone number and you qualify for \$750.00 worth of instant credit. . .no application to process, no waiting time. . .or select one of our other credit plans.

Bostic-Sugg FURNITURE INC.
401 WEST 10th STREET, GREENVILLE, N.C. PHONE 758-1729 or 758-2513

List price \$530.00
Temple Stuart

Hutch and Buffet
Solid maple, glass doors, 36" wide.

\$325.00

Values to \$80.00 and more

Odd Dining Room Chairs

\$30.00
Some one of a kind

Save \$650.00 on 9 piece "Tremont" Oak Dining Room Group by Bernhardt. Oval shaped table 42" x 64" x 82", 6 side chairs and 50 inch china deck and buffet.

\$1150.00

Save up to 50% on Broyhill Oak, Cherry, & Pine Dining Room Pieces

List price \$687.50	Cherry 52 inch china-Queen Anne	\$342.50
List price \$250.00	Broyhill pine 40 inch dry sink	\$145.00
List price \$355.00	62 inch pine china and buffet by Broyhill	\$195.00
List price \$410.00	Broyhill Oak china and buffet	\$210.00
List price \$360.00	Broyhill oval oak table 40" x 70" with one leaf and 4 side chairs.	\$200.00
List price \$552.00	Broyhill pine square oval table 42" x 70" with one leaf, 2 arm and 4 side chairs.	\$330.00

Compare Bostic-Sugg's Prices on American Drew Queen Anne Dining Room

30% and more off

Every piece in stock now at huge savings. Buy now and really save.

Open til 9:00 on Friday Nites

List price \$120.00

Broyhill Cherry Queen Anne Dining Room Chairs

\$55.00

Fully upholstered seat. Only 15 to sell at these fantastic prices.

Save \$445.00 on 8 piece Dining Room Group

Louis D'or

List price \$1450.00 Bernhardt 8 piece cherry French Provincial Dining Room Group
Senior oval table 42" x 60" with 18" leaf, 5 side and 1 arm chair with cane back and upholstered seat. 49" china deck and base. Grill and interior light.

\$995.00

Save \$366.00 On 7 piece French Provincial Dining Room Group

Calais BY BERNHARDT

8 piece group includes: 5 arm and 1 side chair with cane back and upholstered seat.
•55 inch china with grills and interior light
•Shaped 42" x 64" table with one extension leaf

Special price

\$795.00

Rose's Aunt Emma's

Gar-B-Que & Fries

With Free Ice Tea. only \$1.69

Pitt Plaza Shopping Center

Rose's Cafeteria Hours 6:30 a.m. - 8:00 p.m.

Another Role For Cruise Missile Being Studied

By ROBERT KAYLOR
WASHINGTON (UPI)—Tiny cruise missiles, which a year ago were the downfall of the B1 bomber, now are beginning to make fighter pilots nervous about their jobs.

Less than 20 feet long, the highly accurate, pilotless jets are already well on their way to becoming a major strategic weapon in the 1980s. Between 3,500 and 7,000 of them would be carried by B-52 bombers, and possibly aboard adaptations of wide-bodied jetliners.

Nuclear-armed versions are also being developed for ground, ship and submarine launching. Beyond that, defense officials are now looking at still another potential use in non-nuclear warfare.

Last April a fillip was added to the computerized terrain "map" that guides the

Tomahawk, one of two cruise missile types that will compete for the bomber-launched role. It was a photo of a desert airstrip "target" that could be matched up with the actual view seen by an electronic eye in the missile's belly.

Nicknamed "Smack" (for Scene Matching Area Correlation), the photo system enabled the Tomahawk to zero in on the airstrip after an 800-mile flight with greater accuracy than ever before, dumping dummy bombs squarely across it.

It was the sort of precision bombing normally done by skilled fighter pilots. It brought raves of "remarkable" from senior officers. And it also started shock waves among military power groups who remember President Carter's decision to cancel the B-1 in favor of cruise missiles.

"People who fly airplanes are nervous," said one source involved in the program, "because it points to the direction of at least reducing their jobs if not someday eliminating them."

As one example, the source said, there had been "quite a bit of support for the ground-launched cruise missile in the Tactical Air Command until some bean-counters in (Defense Secretary Harold) Brown's office suggested they might replace two wings of F-111 fighter-bombers."

Far-reaching effects wouldn't involve the Air Force alone. Sources say the Navy, spearheaded by its senior

weapons expert, undersecretary James Woolsey, is starting to look into using the small missiles with aircraft or possibly even launching them directly from aircraft carriers, a potential space and money saver.

The subject is sensitive enough so that Woolsey declined to discuss it at a time when Congress is considering another large-deck super-carrier for the Navy. The Air Force's chief of staff, Gen. Lew Allen, isn't as reluctant.

Allen sees no wholesale threat to piloted planes, which fly much faster, do many jobs that include fighting other airplanes, and can be used more than once. But he also considers "massive" Soviet air defenses that are now deadlier in Europe than the strategic attack route across the northern borders of Russia.

"If the defenses are heavy and we're going to be losing men and \$15 million airplanes, the expense of \$1 million cruise missiles may not be so bad," he says. "The cruise missile is almost bound to find some regions of non-nuclear, tactical applicability."

General Dynamics, maker of the Tomahawk, won't fly its missile in competition with a model being built by Boeing until next year, and there are still unanswered questions about ground-launched missiles.

But cruise missiles are considered a sure bet that the company is already setting up a sprawling

Detroit-style assembly line at a San Diego plant. It has also "borrowed" a giant B-52 bomber from the Air Force, taken it apart to bring indoors, and is now assembling it again to test the air-launch system.

Close in the future, decisions loom in August on whether the ground-launched version may supplant the Army's Pershing 2 missile.

Further ahead, study work is being done on models that

might drop mines in enemy harbors, fly reconnaissance runs, or carry a supersonic tip that would break off at high speed to carry out a mission.

The pilots are watching closely.

Tennis Star Is Now Scientist

By IKE FLORES
Associated Press Writer
HAVANA (AP)—Twenty years ago, Orlando Garrido was an international tennis champion. He played, and often won, against such tennis greats as Pancho Gonzalez, Lew Hoad, Tony Trabert, Vic Seixas.

Today, the University of Miami graduate is still a weekend tennis player—whenever it doesn't take too much time away from his job as a scientist with the Fidel Castro government.

Garrido, now 47, has won international acclaim for his discoveries of a number of new species of birds and snakes while working as a zoologist at the Cuban Academy of Sciences.

His work is his passion now, he says, just like tennis used to be a generation ago.

"I think of those days with great fondness," Garrido told a visiting American reporter over a Cuban "mojito" cocktail recently. "I spent 10 years on the international circuit starting when I was still a student at the University of Miami from 1952 to 1956."

Garrido won 48 international tennis titles over that span and has acquired 49 Cuban national championship trophies from the time he began playing in his teens.

The thin but wiry Garrido

says he's very happy with his job. He rejected all notions of leaving his homeland during the early years of the Cuban revolution.

His mother lives in Miami. His brother, Ray Garrido, was a well-known jai-alai player in the Tampa, Fla., area for years and is now a tennis pro at a club in upper New York state.

"I've got all I want right here," Garrido says. "I don't have much in my pockets. I've made a reputation internationally as a scientist, but that hasn't put any more money in my wallet."

"Still, I would rather be here than anywhere else," says the intense, personable Garrido. "I have important duties here and certain prestige. I probably would not have these anywhere else. Cuba is my home."

And Garrido still plays a good game of tennis, which has been gaining increasing favor in this Communist country in the last few years.

Whenever he isn't trekking through the Zapata Swamp in search of new species of snakes, birds or animals, he's on the courts of the old Vedado Tennis Club, once one of the most exclusive in Havana but now maintained by the Castro government for the use of employees in the various government ministries.

After giving the game up in the middle 1960s, Garrido took up competitive tennis again in 1972.

Show Impact Of Interest

Interstate Securities Corporation

Interest rates are of enormous importance to the direction of stocks, bonds and the economy in general. As a general rule, the higher money rates rise, the lower stocks and bonds decline.

The market's advance since early March of this year has come at a time when short term money rates were actually rising. This can occur over a short period of time. It is extremely rare for such an occurrence to continue for an extended period of time. As an example, most measurements of interest rates turned down well ahead of the bottom in stock prices in 1974. Federal funds peaked in July 1974. By the time the Dow bottomed in December of that year, federal funds rates had fallen almost four percentage points. Certificates of deposit and treasury bills also peaked months ahead of the upturn in stock prices. This is not only typical of major market bottoms of this decade, but it is the rule rather than the exception throughout this century.

Current bond and money market instruments yielding in excess of eight percent continue to offer stiff competition for the investment dollar. Thus there is little wonder that the investment community is watching closely moves by the Federal Reserve and the daily reports of the direction of interest rates.

If history is to be repeated, as it usually is in the stock market, business activity will have to show signs of slowing before we see any sustainable drop in interest rates.

Spanish explorers discovered peanuts in Peru. They took them to Spain for planting and then traded them to Africans, who brought them to North America.

More Requiring Smoke Detector

MINNEAPOLIS (UPI)—Legislatures of 30 states have passed laws requiring smoke and fire detectors in new housing, according to a survey by Honeywell, a leading manufacturer of the life-safety devices.

"In the past three years more than half of the states have passed laws calling for the detectors, and federal law requires them on all manufactured housing and new homes where mortgages are insured by the FHA," said Richard T. Golding, market manager for Honeywell.

States requiring them are Alabama, Alaska, California, Connecticut, Florida, Idaho, Illinois, Kentucky, Louisiana, Maine, Maryland, New Hampshire, Massachusetts, Michigan, Minnesota, Montana, Nevada, New Jersey, New York, North Carolina, Ohio, Oregon, Rhode Island, South Carolina, Tennessee, Utah, Vermont, Virginia, Washington and Wyoming.

A law also has been passed requiring the detectors in new housing in Washington, D.C.

Conventions Up In Kansas City

KANSAS CITY, Mo. (UPI)—A unique combination of national attention and physical growth has spurred a 400 percent increase in tourist activity here since 1972—and a nearly 200 percent gain in the number of convention delegates since 1973.

Convention and tourism activity since 1972 has resulted in \$825.5 million in direct expenditures in the local economy, said William Clarkson, chairman of the Kansas City Convention and Visitors Bureau.

Chief among the ingredients in the city's convention and tourism boom are the impact of the 1976 Republican National Convention, an expanding roster of luxury lodging facilities, a new international airport and a variety of new meeting facilities and vacation attractions.

PHOTOS

Here It Is Mom!



MEMORIES UNLIMITED

Package Includes (2) 8 x 10's, (2) 5 x 7's, 10 Wallet size in beautiful color.

\$8.95

\$3.00 Deposit, 5.95 Balance

No Age Limits, No Extra Charge For Groups, Family Groups Welcomed, 3 Scenic Backgrounds Plus Blue Available. No Checks, Please.



Piggly Wiggly

2105 Dickinson Ave.
Greenville, N.C.
Phone 756-2444

AUG. 4th & 5th

2 BIG DAYS

Make Summer Funner With Free Cold Drinks From Dixie Crystals.

This summer you can get your favorite cold drink FREE from Dixie Crystals sugar. Get a packet of unsweetened powdered mix, or a six-pack carton of soft drink. The choice is yours. And for even more fun, cut out this ad and let your kids color in the fun!

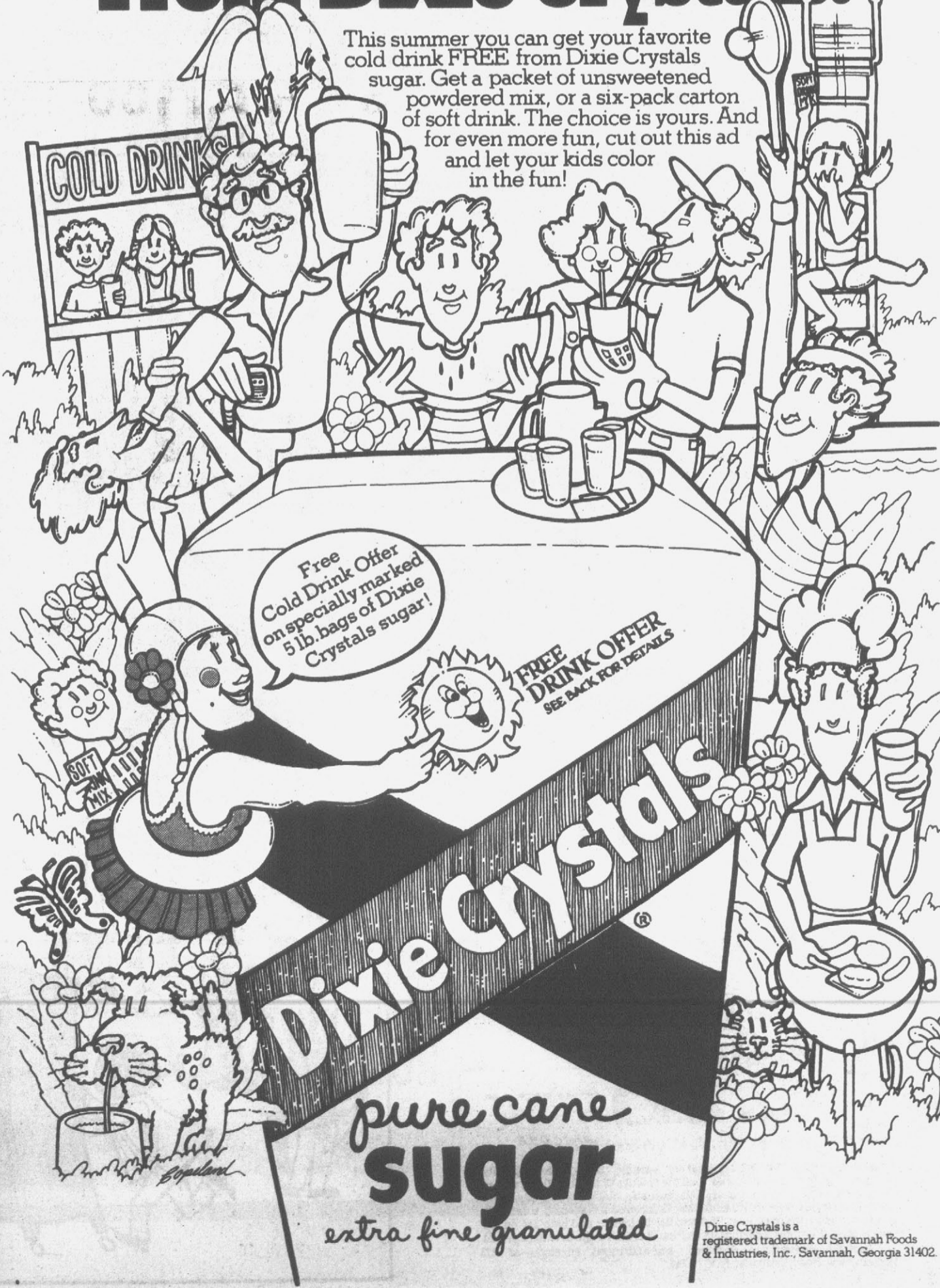

Dixie Crystals

pure cane sugar

extra fine granulated

Dixie Crystals is a registered trademark of Savannah Foods & Industries, Inc., Savannah, Georgia 31402.

FIRST ANNIVERSARY CELEBRATION

A-1 Imports Brings You The Best From All Over The World.

- Crystal from Germany & France
- Pewter from Holland and China
- Hand Carved Wooden Screens and Brass Tables from India
- Hand Made Jewelry from Mexico & Thailand
- China from England & Japan & Norway
- Many other items from Belgium, Poland and Italy.



- Stemware & Drinkware
- Dinnerware in fine Earthenware
- Teakwood salad bowls & trays
- Placemats
- Coffee Mugs (Handcrafted)
- Brass ware
- Pewter
- Wicker baskets & planters
- Handmade Jewelry
- Clothing-Long Dresses Also
- Indian cotton bedspreads



And More



A-1 IMPORTS
THE INTERNATIONAL EMPORIUM
GREENVILLE SQ. SHOPPING CENTER

Scientists Ponder Future Probes Of Planet Mars

By AL ROSSITER JR.
UPI Science Editor

WASHINGTON (UPI) — It will be two years this week since Viking 1 landed on Mars. Both it and its twin are still radiating back periodic pictures and weather reports from a planet man now knows a little better.

But the billion-dollar Viking

mission is winding down. One Mars orbiter will run out of control gas in a week or two and the life of the other is measured in months.

By March 1, the project will be officially over although the space agency hopes to hear occasionally from Viking 1 for another year or two. Viking 2 can't talk directly to Earth and

it will be silenced when the other orbiter quits.

The three-legged robots and their two orbiting relay and reconnaissance helpers have monitored the red planet through an entire 687 Earth-day Martian year, providing a wealth of data to help answer some of the ages-old questions about the fourth planet out from the sun.

"The shroud of time has been pulled back and we begin to see Mars, in a small way, as it may have been during its origin, as it may have been in the path of its history and, much more of course, in its normal, annual and even daily cycles," said chief project scientist Gerald Soffen.

The steady flow of reports from Mars has whetted the appetites of scientists for answers to questions the Vikings could not answer. Scientists and space agency officials are now trying to find the best plan for a return to Mars in the 1980s.

The question is difficult because there are a lot of ways to go. The most productive and most spectacular are also the most expensive. Not only do NASA officials have to weigh the various scientific alternatives, they have to consider what type mission can best be sold to the White House and Congress.

NASA is not expected to make any decisions on a Mars expedition before this fall, but there is considerable interest in an ambitious proposal that would return Mars soil and rock samples to Earth for laboratory analysis.

There are two general ways to do that. A large spacecraft could be sent directly to the Martian surface where it would scoop up selected samples and then take off and fly directly back to Earth. The second way would be to send smaller craft to Mars and have them rendezvous in Mars orbit with an Earth-return ship.

One proposed mission studied by the Jet Propulsion Laboratory at Pasadena, Calif., would involve four spacecraft — two cruisers and two landers.

The two cruisers would be carried into Earth orbit by the space shuttle on Oct. 10, and Nov. 2, 1985 and would fly on to Mars, reaching Mars orbit in February 1988.

Then, on July 4, 1988, two landers would set out from Earth and reach Mars in early 1989. Each might be equipped with a vehicle with limited mobility to gather soil and rock samples to be returned to the ascent section of the lander. Each would then take off four months apart and rendezvous in Mars orbit with the cruisers.

The cruisers then would head back to Earth a few days later, arriving in Earth orbit in April and August of 1991.

A plan given serious consideration last year and then shelved because of cost and the need for further study was a 1984 mission to land roving vehicles on Mars to carry out extensive surface exploration. Such a mission is again under consideration for 1986 or 1988 launchings along with missions using mini-rovers which might travel only a few yards daily.

Other Mars exploration possibilities under consideration

for the next decade include:

— Sending spacecraft into orbit around the planet to carry out geochemical surveys.

— Dropping dart-like devices to place seismic stations in the ground around the planet and carrying out limited surface studies.

— Dropping instrumented rolling balls on the surface.

— Deploying unmanned propeller-driven airplanes to snoop around Mars.

There is no alternative but to go back as far as planetary scientists are concerned. The Vikings found the place too interesting to ignore.

Viking 1 landed on a rock-strewn desert called Chryse on July 20, 1976. Within minutes the first photograph taken from the surface of Mars was flashed 212 million miles back to Earth, showing a Viking footpad resting on a solid surface of rocks and sand or dust.

A panoramic picture later revealed sand dunes and large rocks, including a 10-footer 25 feet away called "Big Joe" by the engineers controlling the

mission from JPL. Color photos showed that the Martian surface had an orange-red tint and the sky was pink.

Viking 2 landed Sept. 3, 1976 on a yellowish-brown desert called Utopia 4,600 miles to the north and west of Viking 1.

The Vikings are still sending occasional pictures back to Earth and to date have produced 3,000 from the surface and 35,000 from orbit.

One of the prime objectives of the dual landings was to conduct the first search for life on another planet. Each lander carried three instrument assemblies to search soil samples scooped up by the craft's digging arm for signs of living micro-organisms.

Scientists back on Earth got "yes" and "no" answers from the Vikings. Two experiments produced evidence biologists could interpret on first glance as being indicative of extraterrestrial life. A third found no evidence of life and another instrument searching for organic compounds in the soil found none.

"The lack of organics, in and of itself, does not rule out the possibility of organisms but it makes the whole idea much less attractive," said Dr. Harold Klein, head of the Viking biology team.

"We also have evidence that the surface material of Mars contains chemicals that are highly oxidizing and could, in and of themselves, interfere with the biological tests and mimic them," he said in a report published by the landers' builder, Martin Marietta Corp.

"Thus we are left with a reproducible set of results on Mars we've never seen with any terrestrial or lunar soils and that are quite unique in our experience. They fit a biological interpretation but also must be regarded very suspiciously because we know that chemicals there could be obscuring or mimicking biological processes."

Klein said what Viking showed was that life on Mars is certainly not rampant. He said there could be some scraggly form of life which the Vikings were not able to detect, or in an environment the Vikings did not see.

"My feeling is we'll not be able to prove any more until we go back to Mars," he said.

The Vikings found Mars to be a cold, dry place with a very thin, predominantly carbon dioxide atmosphere. The spacecraft also found that Mars had, and apparently still has, large amounts of water locked in a subsurface reservoir of ice and in the polar ice caps, previously were thought to be frozen carbon dioxide.

In early 1977, winter came to Mars' Northern Hemisphere where the Vikings are and Viking 2 recorded temperatures ranging from a low of 180 degrees Fahrenheit below zero to a high then of minus 162 degrees.

The first clear indication of frost on Mars was recorded last September, late in the long Martian winter. Whether the white patches among the rocks were frozen water or carbon dioxide is not known.

Summer temperatures climb to a high of minus 25 degrees at the Viking locations.

The two-year stay of the Vikings on Mars show that the planet's climate is now stable, and that Mars is in what apparently is a long-lasting ice age. Clouds are common and diverse, patches of fog seem to hug basins in the mornings and dust blows about in winds up to 40 miles per hour.

Although mostly carbon dioxide, the Vikings discovered the presence of nitrogen in the "air", an important finding with far-reaching implications for the planet's chemical history and atmospheric evolution.

Other instruments showed that surface material is composed of iron-rich silicates, iron oxides (hence the rusty color) and less abundant sulfur and chlorine compounds.

When all the scientific results were put together, said atmospheric scientist Michael McElroy, scientists were able to "really look at a new world in a fairly complete way for the first time."

"I think we got much more out of Viking than we really anticipated."

Same Problems Found All Over

By MIKE WAGNER
Associated Press Writer

CHICAGO (AP) — When Dr. Jack Raba left the emergency room of Cook County Hospital a year ago to work in Alaska and Guatemala, he thought he'd seen his last drunken driver and gunshot victim.

Now back from his 11-month odyssey, Raba said Eskimos are just as frustrated — and just as victimized — as slum dwellers.

Drunken snowmobilers replaced the drunk drivers Raba saw at Cook County, a large public hospital which ends up with many of the victims of violence in the run-down sections of town.

In Alaska, motorists collide with trees and moose instead of mostly with street signs and cars. They, too, shoot each other.

"We had heavy problems of trauma and alcohol at Cook County Hospital, and I saw the same thing in Alaska," Raba said. "The reasons are similar. There is tremendous frustration — both among the poor black patients at County and the natives of Alaska — at not making it in our world."

Young Eskimos he met in remote villages were angered at not inheriting hunting skills from their ancestors. In a fast-growing society, they could no longer survive on their own.

"They're a people with a proud heritage," Raba said. "But they're not making it in their own world or in the other — and that's difficult for them."

Six months of doctoring in and around Fairbanks ended when Raba traveled to Seattle, flew to San Francisco, and hitchhiked through California and Mexico to a tiny Guatemalan village called Chimaltenango.

Treating Mayan Indians at a small clinic there convinced Raba that doctors don't need "high-powered technology" to do a good job.

He learned medicine's simple skills and lived on a high-protein, low-in-meat diet. He'd visited the same village when

he was on leave from Northwestern University medical school five years ago.

"That summer, when I knew nothing, 95 percent of the people I saw got better. We used to hope we were using the right drugs, but sometimes we didn't really know."

"So this time I'm finished with my training, I'm board certified and I know that I can tell you just what the patient has."

"Well, it didn't make a bit of difference. Ninety-five percent of the people still got better."

Raba said the technical knowledge he and a fellow physician at the clinic had "probably made the difference in survival for three patients out of 3,000."

Their healthy yet simple diet convinced him that physicians in this country should practice more preventive medicine and pour less money into expensive equipment.

But Raba, who spent 10 days in jail after leading fellow residents in striking Cook County Hospital's patient care in 1975, says he'd sooner take on Guatemala's health problems than Chicago's.

"If you made me king of Guatemala, I could take care of the health problems myself. If you made me king of Chicago, I wouldn't know where to start."

Still, Raba is back at County, directing residents at an outpatient post in a Spanish-speaking neighborhood.

Pedigreed Mice For Research

AKRON, Ohio (AP) — What has 20,000 feet, squeaks a lot and gets a sheriff's escort?

The 5,000 mice in the Kirschbaum Memorial Mouse Colony, that's what.

The furry research creatures were moved in climatically controlled vans from their temporary home at Akron General Medical Center to their permanent home at Northeastern Ohio Universities College of Medicine in Rootstown Township.

The mice are not ordinary mice. They are the descendants of the original mouse colony started in 1933 by Dr. Arthur Kirschbaum at the University of Minnesota. The inbreeding allows scientists to control genetic differences.

They ended up in Ohio because Dr. Annabel Liebelt, director of the colony, is a professor of anatomy at Rootstown. She became involved with the colony when she began a job as a research assistant at the University of Illinois Medical College in 1952 and worked with Dr. Kirschbaum. She became director of the program in 1959 when Kirschbaum died.



Pay For Your Vacation With A GARAGE SALE

A garage sale is a fun family activity you can have to get that extra cash to help pay for your vacation. Think of all the items you have around your house that you have collected over the years and don't use anymore. All of these items can be turned into money for that vacation. When you have everything listed and priced you're ready to let people know about your garage sale. That's where we, your newspaper, come in. We can help you not only advertise your event but we'll even help you write your ad if you wish. We have qualified ad-visors standing by to help you - give one a call at the number below today.

The Daily Reflector Classified Ads

Phone 752-6166

HOMES FOR AMERICANS

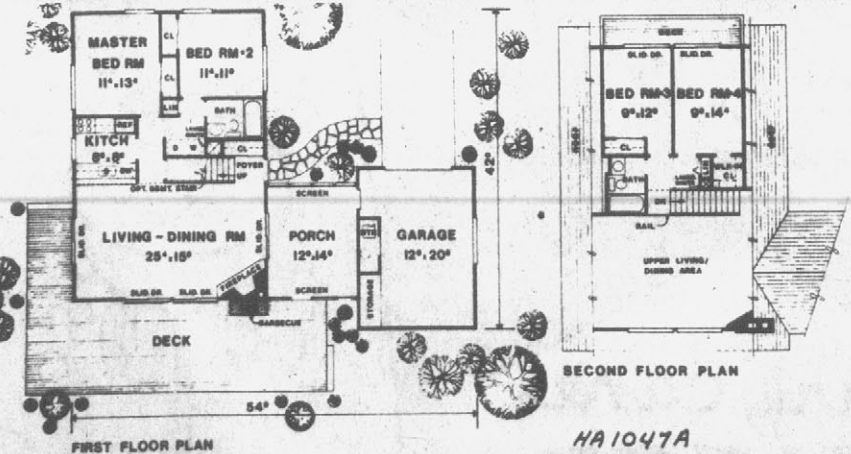
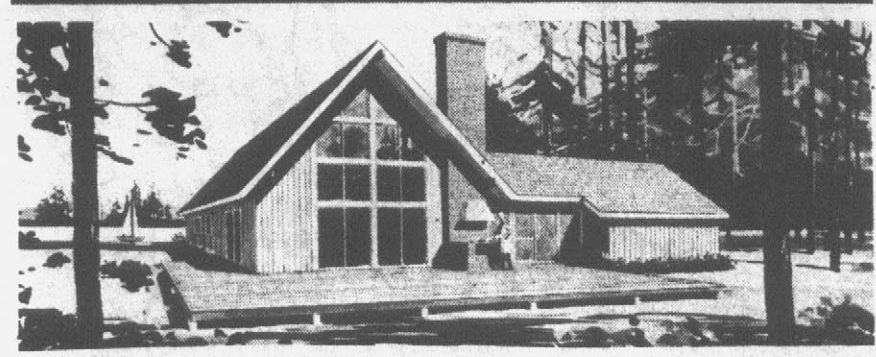

DESPITE APPEARANCES this is not an "A-frame" house, according to its designer. The rafters start higher than the ceilings of the first floor, rather than lower as in a true A-frame. The dramatic 25x15 living-dining room soars two stories high. A kitchen, two bedrooms, a bath and a laundry alcove complete the first floor. Two smaller bedrooms and bath are on the second level. For more information on Plan HA1047A write architect Jerold L. Axelrod—enclosing a stamped, self-addressed envelope—at 275 Broadhollow Road, Melville, N.Y. 11746.

We're Bulging at the Seams With

BIG PIGGLY WIGGLY VALUES

Shop PIGGLY WIGGLY

PRICES EFFECTIVE 7/26 thru 29
 • We reserve the right to limit quantities
 • None sold to dealers or restaurants
 • We gladly accept U.S.D.A. Food Stamps

VIVA TOWELS

JUMBO ROLL **2/99¢**

LIMIT 2 WITH A 7.50 FOOD ORDER

PIGGLY WIGGLY MACARONI & CHEESE

DINNER
7 1/4 OZ.

5/99¢

LIMIT 5 WITH A 7.50 FOOD ORDER

PLAIN OR RIPPLED **PRINGLES** Twin Pack **79¢**

PIGGLY WIGGLY TALL KITCHEN **GARBAGE BAGS** 15 CT. **79¢**

RAGU THICK **Spaghetti Sauce** 15 OZ. **69¢**

PIGGLY WIGGLY **Brown 'N Serve Rolls** 12 Pack. **3/\$1.00**

PIGGLY WIGGLY **Hot Dog & Hamburger BUNS** 8 PK. **3/1.00**

PIGGLY WIGGLY **ANGEL FOOD CAKE** **79¢**

PINE STATE

MILK

Gallon Jug **1.59**

TIDE

49 OZ. **1.19**

Limit one with a 7.50 food order

PIGGLY WIGGLY **ICE CREAM**

1/2 GAL. **Cheerio Ice Cream Bars** 6 PK. **2/\$1**

M&M'S 1lb. size **1.79**

"THE MILK CHOCOLATE MELTS IN YOUR MOUTH—NOT IN YOUR HAND!"

BALLARD BISCUITS 7 1/2 OZ. (4 PK.) **69¢**

SHOUT CLEANER 12 OZ. **99¢**

ROYAL GEM CUT GREEN BEANS 203 CANS **4/\$1**

LYSOL SPRAY DISINFECTANT 8 OZ. **99¢**

SOFT WEVE BATHROOM

TISSUE 2 ROLL PK. **39¢**

LIMIT 2 (2 ROLL PACKS) WITH A 7.50 FOOD ORDER

PIGGLY WIGGLY BUTTERMILK

BISCUITS 10 CT. 4 PACK **55¢**

2 Pet-Ritz **Piecrust Shells**

famous Pet-Ritz PIECRUST SHELLS

2 tender, flaky shells
2 9-inch pie pans

2/\$2.89

KRAFT VELVEETA 1 LB. **1.39**

8 OZ. **SKINNER SPAGHETTI** 3 OZ. **4/\$1**

DEL MONTE NEW WHOLE POTATOES 16 OZ. **3/\$1**

PET WHIPPED TOPPING 9 OZ. **59¢**

PILLSBURY SELF RISING OR PLAIN

FLOUR 5 LBS. **79¢**

PIGGLY WIGGLY 8 OZ.

POT PIES TURKEY CHICKEN OR BEEF **4/99¢**

LIPTON **INSTANT TEA** 3 OZ. **1.69**

LIPTON **TEA** BAGS 100 CT. **1.69**

GORTON'S BATTERFRIED **FISH PORTIONS** 12 OZ. **1.59**

GORTON'S BATTERFRIED **FISH KABOBS** 16 OZ. **1.59**

KRAFT SLICED NATURAL SWISS 6 OZ. **89¢**

KRAFT CHUNK CHEDDAR SHARP 8 OZ. **99¢**

KRAFT SLICED NATURAL MOZZARELLA 6 OZ. **79¢**

KRAFT CHUNK CHEDDAR SHARP 12 OZ. **1.65**

KRAFT ORANGE JUICE 1/2 GAL. **99¢**

KRAFT PARKAY MARGARINE 1 LB. SIZE **2/99¢**

KEEBLER TOWN HOUSE **CRACKERS** 16 OZ. **77¢**

NABISCO OREO **SANDWICH** 15 OZ. **89¢**

PIGGLY WIGGLY **MAYONNAISE** 8 OZ. **39¢**

DEL MONTE **CHUNK LIGHT TUNA** 6 1/2 OZ. **69¢**

FRESH WHOLE **FRYERS** **45¢**

2 PER BAG LIMIT 2 BAGS LB.

FRESH **FRYER MIXED PARTS** 3 Breasts, Leg & Thigh Quarters with Back plus Giblets. **45¢**

FRESH **FRYER Breast Quarters** **59¢**

FRESH **FRYER Choice Parts** LB. **79¢**

FRESH **FRYER Combination pack** Breasts, Legs, Thighs & Wings **79¢**

FRESH **FRYER Leg & Thigh Quarters** **59¢**

SWIFT'S PREMIUM BEEF

The Mark of Tenderness And Quality

BEEF

FULL CUT BONE IN **ROUND STEAK** **1.38**

BONELESS TOP **ROUND STEAK** **1.78**

SIRLOIN STEAK **2.18**

T-BONE STEAK **2.28**

SIRLOIN TIP OR BOTTOM ROUND ROAST **1.78**

SWIFT'S PREMIUM CANNED HAM 3 LB. SIZE **4.99**

JESSE JONES MEAT & MORE WIENERS 24 OZ. PKG. **1.59**

SWIFT'S PREMIUM ALL MEAT FRANKS 12 OZ. PKG. **99¢**

JAMESTOWN FRESH SAUSAGE (2 LB. ROLL 1.85) 1 LB. ROLL **95¢**

LUNDY SLICED BACON **1.29**

SMITHFIELD ALL MEAT SLICED BOLOGNA **1.29**

FRESH BAKING HENS **49¢**

PIGGLY WIGGLY'S WORLD OF PRODUCE

....the Freshest Buys in Town!

FRESH CRISP CELERY **69¢**

SALAD BOWL LETTUCE HEAD **37¢**

RED PLUMS **35¢**

SWEET JUICY PEACHES **29¢**

PIGGLY WIGGLY

We Have Fresh Dill For Your Pickling Needs.

DEL MONTE PEACHES No. 2 1/2 **2/\$1**

ARMOUR PIZZAS **3/\$1**

PIGGLY WIGGLY MUSTARD Qts. **2/\$1**

GERBER STRAINED BABY FOOD Jar **15¢**

2105 Dickinson Avenue

Mon.-Thurs. 8 A.M.-8 P.M.
 Friday 8 A.M.-9 P.M.
 Saturday 8 A.M.-8 P.M.
 Sunday 9 A.M.-6 P.M.

Pollution Fight Turning To Farm Front

By SONHA HILLGREN
UPI Farm Editor

WASHINGTON (UPI) — A cooperative spirit of rural America will bring together 500 volunteers on Aug. 19 to perform five years of soil and water conservation in just one day on a worn-out 245-acre Maryland farm.

Project Clearwater, conceived by local soil conservation officials, is intended to raise farmers' consciousness about conservation, not only to improve crop production, which has been done for years, but also to help clean the nation's waters of agricultural pollution.

Federal law is about to force this cleanup. Transformation of Warren Roelkey's farm is also aimed at showing farmers they can help clean water voluntarily so that the federal government will not strongarm them into compliance with federal law that mandates clean water by 1985.

"If we don't do the job ourselves, we could get a police state," said Paul Anderson, a soil conservationist working closely with the project.

"We're certain the first thing we're going to get out of Washington are strict regulations that won't work anyway," said Paul Edwards, another Western Maryland soil conservation official.

Focus on farm pollution follows the spending of billions of dollars by all levels of government and industry to cut back sewage and industrial wastes, which bureaucrats call "point" pollution.

Just as much or more pollution is caused by what bureaucrats call "nonpoint" sources, such as farms, forests, highways, parking lots, mines, construction projects and urban storm water.

Officials are attacking nonpoint problems — including runoff of soil, pesticides, fertilizers and animal wastes from farms — with better land management instead of complicated technology.

But the government is unable to define the extent of the rural nonpoint pollution problem.

Donald F. Smith, an Environmental Protection Agency agricultural engineer, said an effort to quantify the problem would be a "wild guess."

There are not enough water quality monitoring stations to determine the amount of nonpoint pollution and there probably will not be enough stations until five to 10 years from now.

"We don't have any meaningful way of giving you a

figure we could stand behind," Smith said.

There is also a problem of who is going to pay for agriculture's share of nonpoint cleanup.

Nathan Chandler, a special agricultural assistant to the EPA administrator, said "there isn't enough money in the whole world" to clean up nonpoint pollution, but a federal effort can help identify and clean up the worst areas.

Smith said, "I don't think the American public is ready to foot that bill but maybe on the high priority water quality programs they will."

There is a real possibility, feared by many, that the government will force farmers by regulation to pay a share of the cleanup effort, and if the farmers do not pay, they could be fined or kept out of federal farm programs.

Bureaucrat Chandler said, "I'm hoping it will be primarily

a voluntary program with a regulatory backup."

A similar message came from Harper, Kans., where Lytle Bauer, president of the National Association of Conservation Districts, said, "Through education and persuasion we can get this done on a voluntary basis. I don't think a mandatory program will ever work."

Some farmers do not have the money or might not be convinced of the economic benefit of conservation that does not bring them direct economic benefits. Many times it is the same farmers who cannot afford or do not wish to practice conservation whose farms present the greatest problems.

And farmers would find it hard to pay their share during bad crop years.

Yet two EPA regions in the old West and the Northwest, including Alaska, already have said voluntary efforts must be

backed up with a regulatory program.

There is a yet unfunded Rural Clean Water Program, part of the 1977 Clean Water Act, which calls for 50 percent federal sharing of farmers' water conservation costs.

EPA and the Agriculture Department signed an agreement April 25 authorizing the agriculture secretary to enter long-term contracts between five and 10 years with rural landowners and operators to improve water quality management.

The program is intended to help pay for "best management practices" in areas where pollution problems are most critical.

The cleanup is to be handled through the Soil Conservation Service and the Agricultural Stabilization and Conservation Service because these traditional farm conservation groups have the expertise.

The federal government or state and local bodies could add more than 50 percent for high priority projects, but farmers will get stuck with part of the bill, even if it is only 10 percent.

Congress authorized \$200 million for fiscal 1979 and \$400 million for fiscal 1980 for cost-sharing funds. When the legislation was passed it was too late for the administration to include funds in the fiscal 1979 budget.

The House added to the budget \$25 million for sharing funds for the first three months of the fiscal year and \$4 million for related technical work. The Senate has yet to act on the budget.

Some officials said \$200 million was a drop in the bucket and \$25 million could do little for the program.

Bauer said, "The \$200 million is not going to go a long ways.

But it is going to be a start."

Other starting points are seven pilot projects to determine how effectively funds can be spent.

About \$1.5 million in federal funds is being spent together with local funds to attack specific rural water quality problems in the states of Washington, South Dakota, Colorado, New York, South Carolina, Indiana and Nebraska.

Federal officials said they can learn little from the public relations-oriented Clearwater Project in Western Maryland, but can learn a great deal from the seven pilot projects because they encompass larger areas.

For example, in the project area of Maple Creek watershed 100 miles north of Lincoln, Neb., as much as 25 tons of soil per acre a year is lost into 230 miles of streams that flow through 250,000 acres.

If possible, officials would

like to reduce soil loss in the watershed to five to six tons an acre. Some sediment is needed or else streams will gouge their banks and beds, but too much sediment and chemicals are believed to smother fish spawning beds.

Nitrogen and phosphorus fertilizers and pesticides flowing into the Maple Creek watershed present other problems. About 33,000 acres of the watershed have been chosen for high priority work in the project.

Have You Missed Your Daily Reflector?

First Call Your Independent Carrier. If You Are Unable To Reach Him Call The Daily Reflector

752-3952

Between 6:00 And 6:30 P.M. Weekdays And 8 'Til 9 A.M. On Sundays.

JOIN OUR SENIOR CITIZENS PROGRAM

Register For An Additional 10% DISCOUNT Off Our Already Low Prices

WEST END SHOPPING CENTER

Greenville, N.C.

Open 9 to 9 except Sundays

Phone 756-1281

2nd BIG WEEK CLOW DRUG CARNIVAL OF VALUES WEDNESDAY THRU TUESDAY SALE

**LP. RECORDS
8-TRACK TAPES**
STEREO AND MONO (DISCONTINUED TITLES.)

CLOSE OUT **2 FOR 1.00**
OR 59¢ EACH

PRESUN
FOR SUN SENSITIVE SKIN. 4-OZ. LOTION OR 3-OZ. GEL.
Your Choice **287**
\$4.09 VALUE

PRINGLE'S POTATO CHIPS
TWIN PACK REGULAR OR RIPPLE **73¢**

FRESHEN-UP GUM
(5) 5 STICK PACKAGE
FAMILY PACK CLOW PRICE **49¢**

ASSORTED PLANTER OR FLORAL VASES
CLOSE OUT **8 FOR 1.00**

JOHNSON & JOHNSON SOFF COSMETIC PUFFS
100 Trips **66¢**
\$1.25 VALUE

SUMMER'S EVE
READY TO USE DISPOSABLE DOUCHE
4 1/2-OZ. REG OR HERBAL **3 FOR 1.00**
OR 39¢ EACH

WASH-UP
MOIST TOWELETTES
25s **4 FOR 1.00**

BOX 40 TAMPONS
Reg. or Super **1.49**
\$2.39 VALUE

KERI LOTION
For Dry Skin Care
6 1/2-OZ. **1.66**
\$2.99 VALUE

INK PENS **12 FOR 1.00**
WITH ERASERS OR 9¢ EACH

CLOROX BLEACH
1/2 GALLON
64-OZ. **53¢**
REG. 69¢

NEW OLD SPICE
SOLID DRY...anti-Perisprant
2.5-OZ. SIZE **1.37**
\$2.29 VALUE

INSULIN USERS
Now! The Most Comfortable Syringe Needle Ever Made...
B-D PLASTIPAK MICRO-FINE™ NEEDLE
Available on B-D PLASTIPAK™ 1cc U-100

MECO SWINGER II SQUARE GRILL
21" 4 POSITION REG. \$39.97
31.88

LYSOL SPRAY DISINFECTANT
12-OZ. **1.27**
REG. \$1.85

KODAK COLORBURST 100 INSTANT CAMERA
• Motorized for immediate print ejection.
• Automatic exposure control.
• Easy to use "zooming-circle" focusing aid.
• Beautiful instant color by Kodak with elegant SATINLUX™ Finish.
\$44.95 VALUE
CLOW LOW PRICE **33.87**

FREE! ASK FOR A FREE COMPLIMENTARY PACKAGE OF 5 NEEDLES WITH ANY B&D NEEDLE PURCHASE. WHILE SUPPLY LAST.
Lilly TES-TAPE
URINE SUGAR ANALYSIS PAPER.
Approx. 100 tests **\$3.51 VALUE**
2.59

MULTI COLOR CHAISE LOUNGE
Ideal For Summer!
VINYL WEBBING WITH SMOOTH ARM RESTS.
CLOW PRICE **9.99**

LADIES' WATCH
By WESTCLOX
33318. 100% SOLID STATE
BLUE COLOR **29.88**
\$85.95 VALUE
5 FUNCTION DIGITAL LED CONSTANT TIME DISPLAY LIGHT FOR NIGHTTIME VIEWING. POWER CELL INCLUDED.
LADIES' WATCH
By WESTCLOX
100% SOLID STATE. GOLD
\$110 VALUE **39.95**

Marking Choir's Anniversary

The Senior Choir of Little Creek Free Will Baptist Church will celebrate its anniversary beginning Monday, with different speakers nightly at 8 p.m.

Speakers and choirs are as follows: Monday, Elder Charlie Edwards and the Senior Choir, Little Creek; Tuesday, Elder Elmer Jackson Jr. and the Wilson Ensembles; Wednesday, Elderess Shirley Braxton and the Cherry Lane Choir, Greenville; Thursday, Elder P. D. Blount and Brown Chapel F. W. B., Browntown; Friday, the Rev. Adolphus Holmes and the New Covenant Holy Church, Grifton.

Anniversary events will end Sunday, 3 p.m., with a gospel festival. Different gospel choirs and groups will be present.

Mrs. Mary Jones, president, and Elder Jessie L. Wilson, pastor, invite the public to attend.

Note Decline In Innovation

WASHINGTON, D.C. (UPI) — The number of patents issued to U.S. inventors and corporations continues to decline, according to a study by Intellectual Property Owners, Inc., a non-profit group dedicated to preserving the patent system as an incentive to innovation and creativity.

A total of 81,789 patents was issued in 1971. IPO says, while only 699,371 were granted last year. Because of this drop, President Carter has appointed a committee headed by the Secretary of Commerce to conduct a comprehensive review of issues and problems related to industrial innovation.

SOVIET PRODUCTION
MOSCOW (AP) — Soviet industrial production for the first six months of this year increased by 5.2 percent, down from the 5.7 percent increase for the first half of last year, according to figures released by the Central Statistics Board.

REACH TOOTHBRUSH
cleans away more decay-causing material than the two leading toothbrushes
\$1.12 VALUE **69¢**

TYLENOL
FOR FAST PAIN RELIEF.
100s **1.58**
\$2.60 VALUE

ARM ALLERGY RELIEF MEDICINE
20's **1.27**
\$2.19

BAYER CHILDREN'S ASPIRIN
50¢ Value **3 FOR \$1**
36 TABLETS OR 39¢ EACH

COTYLENOL
LIQUID COLD FORMULA FOR CHILDREN
4-OZ. **1.77**
\$3.13 VALUE

WALGREEN GLYCERIN SUPPOSITORIES
Adult 12s **59¢**
89¢ VALUE

KOLANTYL GEL Antacid
New Easy Pour Spout
12-OZ. **1.29**
\$2.24 VALUE

DRISTAN
NASAL MIST OR VAPOR SPRAY
1/2-OZ. **1.29**
\$1.96 VALUE

Uncertain Outlook For Residents Of Canal Zone

BALBOA HEIGHTS, Canal Zone (UPI) — With only about 15 months remaining before the Panama Canal treaties go into effect, Americans who were born or spent most of their lives here are looking uncertainly toward the future.

The basic dilemma for most is simply whether to stay or to leave. For some, however, it is not that simple.

On the one hand, they view with doubt the idea of living under the jurisdiction of Gen. Omar Torrijos' government despite President Carter's recent personal assurances that they have no cause for worry.

But on the other hand, they have been away from the United States so long they fear they will be returning to their own land as foreigners.

The decision to leave came quickly for some; others will have to leave whether they want to or not — the treaties require a 20 percent cutback in American personnel within five years to make room for Panamanians.

But for those with an option to stay, decisions are likely to hinge mainly on these factors:

—The visible degree of U.S. Panamanian cooperation during the so-called "transition period" of 30 months, which begins as soon as the treaties take effect by Oct. 1, 1979.

—The future level of job benefits from the Federal Government. A key consideration here would be a decision by Washington to exempt the U.S. Zonians from U.S. income tax.

During his recent whirlwind visit, Carter — not exactly the most popular man with the zonians — nevertheless sought to reassure the 3,800 Americans employed here about his concern for their future welfare.

Behind the tropical serenity and American orderliness long associated with the Canal Zone, a combination of nervousness, indifference, uncertainty and resentment seems to prevail among many over what they view as a "sellout" or a "giveaway" to Panama.

The coming U.S. pullout is underscored by the dimensions of what the United States will be leaving behind along the 51-mile waterway, from the Pacific to the Atlantic.

Apart from the Canal itself, the installations, ranging from docks and tugboats to schools and post offices, are far more than some nations possess.

In testimony before Congress last year, Canal Zone Gov. Harold R. Parfitt was asked to put a "net book value" on all Canal property and equipment.

He estimated its worth at \$561.5 million, but also calculated the replacement value — including original acquisition costs — at about six times that figure, or \$3.573 billion.

Another financial yardstick of current construction costs was his estimate that the building of a third set of locks would require at least \$2.6 billion,

while construction of a sea-level canal would mean an expenditure of at least \$5.3 billion.

Presumably all of those figures would be substantially higher today.

In addition to property and equipment, the canal treaties assure Panama of \$60-80 million annually from the 30 cents per ton it will get on all shipping transiting the canal; a fixed amount of \$10 million annually; and an income of up to \$10 million more annually if canal revenue permits.

Panama was receiving only \$1.9 million annually from the United States for the Canal Zone at the time the treaties were approved.

Not later than March 31, 1979 the exchange of treaty ratification documents will become official. Six months later, the treaties take effect.

At that time, the process of phasing out canal zone police, firemen, postmen, customs and similar services will begin.

The 47-mile-long railroad running from ocean to ocean, ports, docks and the bridges spanning the canal will become Panamanian property.

The Panamanian flag will fly over the area. There will be no such thing as the "canal zone."

Both feel the zone "belongs to the United States" and said Carter had no "right" to give it up. Helin also said Carter's recent visit probably "caused more hard feeling" instead of improving the outlook for Americans.

Helin, 35, is uncertain if he will remain through the transition period, when his job will be abolished. He has doubts about the effective operation of the dual police patrols.

His wife was even more skeptical. "Panama says I'm a Panamanian citizen because I was born in the canal zone," she said. "But the United States says I'm an American. If I get arrested by the dual patrols, who is going to make the arrest and who is going to take custody of me?"

Helin said canal zone police are already leaving and most men on the force have job applications in the states.

James J. O'Donnell, 50, is a second generation zonian born at Gorgas hospital in Ancon in 1928.

A power plant supervisor and president of the 800-member local 14 of the American Federation of Government

Employees, O'Donnell is mainly concerned about getting zonians who remain exempted from U.S. income tax.

A provision to that effect is contained in the treaties but U.S. officials are saying that was "not the intent" of negotiators.

O'Donnell explained his concerns to Carter when the president met a selected group of 14 zonians for lunch.

Although Carter only promised to have the comptroller general study the tax issue and expedite a ruling, O'Donnell said he was greatly impressed by Carter's sincerity and interest.

If the ruling is against tax exemption, O'Donnell said, the national AFGE will carry the fight into the courts.

Although he is not militantly against the pact, O'Donnell, a 30-year employee, said, "I'm sad the way it's gone. The canal zone was run very efficiently and its uncertain if that efficiency will continue (once U.S. control ends)."

Douglas C. Schmidt, 44, is another native zonian. His father came to the zone in 1934. Schmidt was born at Gorgas in

1936. Today he is administrative officer for the zone's marine bureau.

"The treaties are completely one-sided," Schmidt said. "We cannot call it a sellout because it's a complete giveaway."

He criticizes Carter for "a stampede to get this thing wrapped up."

Schmidt's wife is also a native zonian and their 9-year-old daughter was born here. They are getting ready to leave reluctantly, but will wait to see what happens when the treaties go into effect.

"We feel our future is deteriorating here," Schmidt said.

Schmidt also said zonians will suffer economic penalties because any purchases made in Panama will be subject to customs duties and other taxes, not applied to current U.S. commodities.

Capt. Wilbur H. Vantine, one of about 200 Panama canal pilots and a 20-year veteran, said he is concerned over what he claimed is less efficient maintenance and lower standards for judging canal pilots.

He fears an attrition among pilots in the next few years

could prove damaging to the operation of the canal.

"I'm afraid we are going to be very embarrassed one of these days by a collision of ships which could close the canal," he said.

Although Panama has established a school for merchant marine cadets, it will

take years to get them into the level of top pilots, he said.

Many of the zonians who lose their jobs in the close down of facilities during transition period will shift to jobs on the bases, which also will take over jurisdiction of zonal schools and hospitals. Amidst all the changes for the living, there

also will be transfer for the dead.

Some 1,333 bodies in Mount Hope cemetery on the Atlantic side of the canal will be excavated and shifted to Corozal cemetery on the Pacific. The transfers are necessary under the terms of the treaty, officials said.

CLIFF'S

Seafood House and Oyster Bar

Washington Highway (N.C. 33 Ext.) Greenville, North Carolina
Phone 752-3172

Thursday Special

(CLIFF'S SHRIMP NIGHT)

Regular Fried Shrimp ~~Reg. 3.95~~ **\$2.95**

A new entity known as the Panama Canal Commission will run the canal. Comprised of five Americans and four Panamanians, it replaces the old Panama Canal Co. which was responsible for canal operations. The commission will be headed initially by an American with a Panamanian as his deputy; beginning in 1990 the positions will be reversed.

Remaining temporarily immune from the immediate transformation in the zone will be the 14 U.S. military bases. But they will be gradually cut back, as the Pentagon decides, until they are phased out by the time Panama gets full control of the canal at noon on Dec. 31, 1999.

However, military spokesmen have indicated the Pentagon's present thinking is to seek a different base agreement with Panama in the next century, paying Panama a rental fee for base rights.

This long-range concept is viewed with skepticism in view of Panama's opposition to the bases and its insistence that the United States established them illegally.

During transition period, canal zone and Panama national guardsmen are to work together. There are to be dual national military patrols in the "zone." At the end of that period there will be only Panamanian patrols.

Officer Stevin Helin has 14 years service with the zone police force. A native of Dixon, Ill., Helin came here during 26 months in the military and stayed. His wife Candy is a zonian, born at the old Coco Solo navy base, and their two children also were born here.

Maxwell FURNITURE

3 DAY SALE

SIDEWALK SALE

Everything At Maxwell's Is On Sale! Maxwell has packed its warehouse to the top with hundreds of famous quality furniture items that MUST BE SOLD NOW. In order to move out this much merchandise, Maxwell has to hold this immense Sale Today with EVERYTHING IN OUR STORE ON SALE! HURRY! Don't be left holding an empty bag. Fill it with SAVINGS at MAXWELL'S!

EARLY BIRD SPECIAL

Melamine 12pc. DINNERWARE SET \$8.88

GINGER JAR LAMPS \$9.88 Each

LARGE 3 SHELF (all wood) PLANT STAND \$12.88 ea.

3 PIECE BEAN BAG SET Mr. Chair, Mrs. Chair, Ottoman 3 Pcs. \$58

WALNUT BENTWOOD ROCKERS \$69 WHILE THEY LAST

There's SOMETHING For Everyone At MAXWELL'S! With Guaranteed Low Prices!

OLD FASHIONED PORCH SWING SALE! \$18.88

- Red Oak Lumber
- Finished in Clear Oak Varnish
- Hardware Included

BARGAIN HUNTER'S DELIGHTS!

3 Piece Oak BEDROOM GROUP \$99
Triple Dresser, Queen Size Bed, 5 Drawer Chest. Used.

HERCULON PLAID LIVING ROOM GROUP \$199
Sofa, Love Seat And Chair. Used.

3 PIECE PECAN BEDROOM GROUP \$99
Triple Dresser, Twin Mirrors, Queen Size Bed, 5 Drawer Chest. Used.

GE MICROWAVE OVEN \$299
Only One To Sell!

SAVE NOW ON BEDDING

SAVE 10% TO 20%

Famous Simmons & Serta is NOW ON SALE

SAVE ON SOFAS, CHAIRS & RECLINERS

We are offering you a real opportunity NOW to select a beautiful sofa, recliner or chair at July Sale Prices.

SAVE 12% To 40%

On La-Z-Boy, Action & other highest quality Recliners, Recliner-Rockers & Wall Savers

EVERY HOME NEEDS ONE & NOW IS THE TIME TO GET IT!

SAVE ON DINING & BEDROOM

Now is the time to get a beautiful new bedroom or Dining Room AT JULY CLOSEOUT PRICES

SAVE 12% TO 30%

SAVE NOW ON FAMOUS NAME BASSETT, BROYHILL, STANLEY BEDROOMS & DINING ROOMS!

BARGAIN HUNTER'S DELIGHTS

QUANTITY	DESCRIPTION	REG.	SALE
2	Early American Sofas	\$299.95	\$199
10	Boston Rockers	\$49.95	\$24
14	38" ALL WOOD LAMPS	\$59.95	\$19.88

Maxwell FURNITURE

604 Greenville Blvd. Greenville, N.C.
Sale Days: Open Thursday, 9 A.M.-6 P.M., Friday 9 A.M.-9 P.M., Saturday 9 A.M.-6 P.M.

\$750 INSTANT CREDIT*

* You may qualify for \$750 instant credit if you have one of these cards:

- MASTER CHARGE
- VISA (Bank Americard) • AMERICAN EXPRESS

GET **2** FOR THE PRICE OF **1**

SUPER CRICKET

by Gillette Disposable Butane Lighter

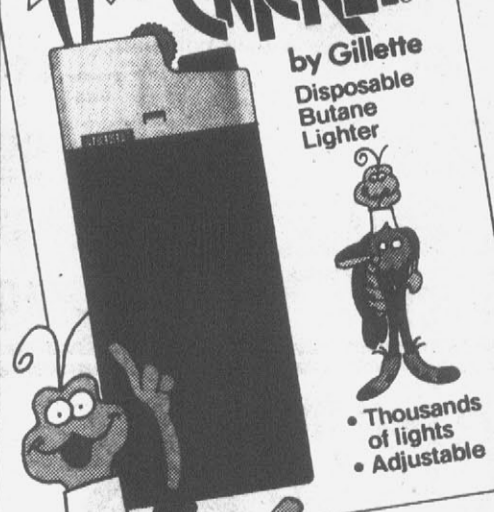

• Thousands of lights • Adjustable

Twice the lights for half the price.

Purchase 2 Super Cricket Lighters and Gillette will mail you a cash refund for the price of one lighter. See details on this special package.

©1978 The Gillette Company, Boston, Mass. Cricket® is a registered trademark of S.T. DuPont S.A., Paris, France.

Assembly Line Work For Blind

By **JEFFERY L. SHELTER**
UPI Auto Worker

LANSING, Mich. (UPI) — Eight hours a day, five days a week, Barbara Yerke stands next to a conveyor at an Oldsmobile assembly plant and loads pistons into a tray, four at a time.

It's monotonous work, but the pay is good. She doesn't complain, and her supervisor is happy with her work.

"I wish I had 26 other people in the department like her," he said.

There are 18 others working at Oldsmobile who are like Mrs. Yerke, at least in one respect. All are legally blind.

Oldsmobile officials, working in cooperation with the Michigan School for the Blind and various state and federal agencies, have actively recruited blind workers for appropriate jobs at the company's three Lansing plants.

It is part of a concerted effort by General Motors to improve its record of hiring the handicapped and to encourage other companies to do the same. So far, GM's efforts have paid off — both for the company and the handicapped.

For Mrs. Yerke, 33, getting hired at Oldsmobile almost a year ago was a personal triumph.

"I was always told, 'No, you can't because you can't see,'" she said. "And I always said, 'Yes, I can. Whether I can see or not, I can still do it.' Don't let anyone tell you can't."

Company officials estimate that GM's total U.S. work force of 580,000 hourly and salaried employees includes 25,000 persons with some form of physical disability such as blindness, deafness, amputated limbs or paraplegia; or disabling conditions such as epilepsy, diabetes or heart disease.

The number of handicapped employees nearly doubles if alcoholism and drug addiction, which the government lists as disabilities, are included.

"A lot of people don't want to admit they are handicapped, and as a result, it's hard to ascertain exactly how many we have," said Laurence L. Vickery, GM's director of employment relations.

Vickery said the company's effort to hire and keep handicapped workers on the payroll "is not done entirely for humanitarian reasons."

The Department of Labor, in a program similar to the Affirmative Action program for hiring women and minorities, requires firms that perform government contract work to hire the handicapped and modify their facilities to accommodate handicapped workers.

"We're not going to hire every handicapped person that knocks on the door," one GM official said. "But we're going to employ as many as we can."

Richard McCarthy, personnel director at GM's Hydra-Matic Division plant at Ypsilanti, Mich., which was named "Employer of the Year" in 1977 by the Michigan Vocational Rehabilitation Agency for its hiring record, said jobs for the handicapped are not a "hand-out."

"This is not a sheltered workshop situation where we create jobs the handicapped are capable of doing," McCarthy said. "We employ the handicapped in the real world. Our employees must be productive. They must be qualified for the job."

At Oldsmobile, a visitor would have difficulty trying to single out the blind employees from their sighted co-workers. They perform their jobs at production pace, move about the plant easily and socialize comfortably with other employees.

"They go through the same employment procedures, do the same jobs and get the same pay as anyone else," said Joe Fritz, an Oldsmobile safety engineer who heads the company's blind placement program. "We only require that they be capable of getting to and from work, into and out of the plant, unassisted."

Fritz cited these cases in point:

—George Ellena, an Oldsmobile employee for 18 years, operates a press in the plant's water pump department. The

job is stationary but requires manual dexterity.

"You wouldn't know he's totally blind — the way he does his job and gets around the plant," Fritz said. "It's unbelievable."

—Russell Watson, who is considered legally blind, has worked at Oldsmobile for eight years. He uses a pneumatic tool to attach a part onto engine crankshafts as they come down the assembly line.

—George Leonard is totally blind. He has worked at Oldsmobile for a year and a half in the rear axle assembly department. "He's so handy, he does several jobs," Fritz said.

There obviously are some jobs the blind cannot perform in an automobile assembly plant, Fritz said. "But it's remarkable what they can do if you give them the chance."

Brewer To Head Scout Roundup

ECU News Bureau
The Commissioner's Round-up, an annual event of the East Carolina Council, Boy Scouts of America, will be headed this year by Dr. Thomas B. Brewer, chancellor of East Carolina University.

Named 1978 chairman at a meeting of the Council's executive board at Camp Bonner, Brewer announced that the kickoff for the round-up will be held at Mendenhall Student Center at ECU on the evening of Sept. 6. He also announced that ECU has designated the ECU-Marshall football game at Fickden Stadium Nov. 18 as "Scout Night" and is hopeful that as many as 3,000 scouts from the 20-county Council area will attend.

Counties included in the East Carolina Council, BSA, are Beaufort, Bertie, Carteret,

Craven, Edgecombe, Greene, Halifax, Hertford, Hyde, Jones, Lenoir, Martin, Nash, Northampton, Onslow, Pamlico, Pitt, Tyrrell, Washington and Wilson.

The goal of the Council's Fall Round-up is to recruit 2,000 new Boy Scouts during the four-month period, according to Bob Mosley of Kinston, field director.

ART SHOW
LOS ANGELES (AP) — "Summer Show" — an exhibition of the works of five southern California artists — is on display at the Los Angeles County Museum of Art through Aug. 3. The artists are Jeanine Breaker, Laurie Brown, Erika Kahn, Pat Shank and Ann Thornycroft.



BARBARA YERKE works eight hours a day, five days a week, and loads pistons into a tray. It's monotonous but the pay is good. She doesn't complain and her supervisor is happy with her work. (UPI Photo)

American Independent Markets

North Green Street & Mumford Road
Greenville, North Carolina

- ★ U.S.D.A. Government Inspected Choice Meats
- ★ Quality Farm Fresh Produce
- ★ Friendly Courteous Service
- ★ Wide Selection of National Branded Items

Food savings

SUPER BUYS MEATS

QUARTER PORK LOIN **GRADE "A" FRYERS**
\$1.29 Lb. 45¢ Lb.

OLD SMITHFIELD SAUSAGE **JUBILEE HOT DOGS** **JUBILEE BOLOGNA**
PER LB. 89¢ 12-Pk. 69¢ PER LB. 89¢

RICHFOOD CUT BEANS 3 15-Oz. Cans \$1.00
RICHFOOD TINY GREEN BUTTER BEANS 2 15-Oz. Cans 89¢
KRAFT BARBECUE SAUCE 18-Oz. Bottle 59¢
REALEMON (BONUS PACK) JUICE 48-Oz. Size 69¢
HI-LO CRACKERS 12-Oz. Pkg. 59¢
RICHTEX (LIMIT 1 WITH \$7.50 ORDER) SHORTENING 42-Oz. Can \$1.19
RICHFOOD IMITATION MAYONNAISE 32-Oz. Jar 69¢
RICHFOOD ELBOW & SHELL MACARONI 2 18-Oz. Pkgs. 79¢
HUNTS (LIMIT 2 WITH \$7.50 ORDER) KETCHUP 32-Oz. Bottle 59¢

PALMOLIVE LIQUID 32-Oz. Bottle 99¢
COLD POWER DETERGENT 64-Oz. Size \$1.99
TONY DOG FOOD 6 15-Oz. Cans \$1
RICH FOOD DRINKS 64-Oz. Size 79¢

THE BIG FEATURES

STARRING

NOW PLAYING AT NEIGHBORHOOD STORES EVERYWHERE

You can't beat Crest for fighting cavities.

9669CS TAKE THIS COUPON TO YOUR STORE

Save 10¢ when you buy any size **Crest**.

LIMIT ONE COUPON PER PURCHASE

TO THE CONSUMER: CAUTION! Don't embarrass your dealer by asking him to redeem coupons without making the required purchase. He must redeem coupons properly to get his money back. REMEMBER: Coupons are good only on the brands called for. Any other use constitutes fraud.

TO THE DEALER: You are authorized to act as our agent for the redemption of this coupon. We will reimburse you for the face value of this coupon, or, if coupon calls for free merchandise, we will reimburse you for such free goods, plus 5¢ for handling, provided that you and the consumer have complied with the terms of our coupon offer. By submitting this coupon for reimbursement you represent that you redeemed it pursuant to these terms. Any failure to enforce these terms shall not be deemed a waiver of any of the conditions. **TERMS OF COUPON OFFER:** This coupon must be redeemed by a consumer at the time of purchase of the brand size indicated with the face value of the coupon being deducted from the dealer's retail selling price. This coupon is non-transferable, and may not be reproduced. The consumer must pay any sales tax and all coupons submitted for reimbursement for which no proof of purchase is shown. Properly redeemed coupons will be accepted for reimbursement only if identified by the retail distributor of our merchandise who redeemed them in connection with sales to the consumer, or the supplier of the products on which the coupons have been redeemed who has by written agreement with Procter & Gamble agreed to accept financial responsibility, or to a holder of our Certificate of Authority acting for them. COUPONS SHOULD BE SHIPPED, AT OUR EXPENSE, TO PROCTER & GAMBLE, 2150 SUNNYBROOK DRIVE, CINCINNATI, OHIO 45221. Cash redemption value 1/30 of 1¢.

PROCTER & GAMBLE 7-78

Secret. Strong enough for a man, but made for a woman.

9673SE TAKE THIS COUPON TO YOUR STORE

Save 10¢ when you buy any size **Secret**.

LIMIT ONE COUPON PER PURCHASE

TO THE CONSUMER: CAUTION! Don't embarrass your dealer by asking him to redeem coupons without making the required purchase. He must redeem coupons properly to get his money back. REMEMBER: Coupons are good only on the brands called for. Any other use constitutes fraud.

TO THE DEALER: You are authorized to act as our agent for the redemption of this coupon. We will reimburse you for the face value of this coupon, or, if coupon calls for free merchandise, we will reimburse you for such free goods, plus 5¢ for handling, provided that you and the consumer have complied with the terms of our coupon offer. By submitting this coupon for reimbursement you represent that you redeemed it pursuant to these terms. Any failure to enforce these terms shall not be deemed a waiver of any of the conditions. **TERMS OF COUPON OFFER:** This coupon must be redeemed by a consumer at the time of purchase of the brand size indicated with the face value of the coupon being deducted from the dealer's retail selling price. This coupon is non-transferable, and may not be reproduced. The consumer must pay any sales tax and all coupons submitted for reimbursement for which no proof of purchase is shown. Properly redeemed coupons will be accepted for reimbursement only if identified by the retail distributor of our merchandise who redeemed them in connection with sales to the consumer, or the supplier of the products on which the coupons have been redeemed who has by written agreement with Procter & Gamble agreed to accept financial responsibility, or to a holder of our Certificate of Authority acting for them. COUPONS SHOULD BE SHIPPED, AT OUR EXPENSE, TO PROCTER & GAMBLE, 2150 SUNNYBROOK DRIVE, CINCINNATI, OHIO 45221. Cash redemption value 1/30 of 1¢.

PROCTER & GAMBLE 7-78

The Prells. For fresh, full-looking hair.

9671PR TAKE THIS COUPON TO YOUR STORE

Save 20¢ when you buy one Imperial Size or two any other size **Liquid Prell or Prell Concentrate**

LIMIT ONE COUPON PER PURCHASE

TO THE CONSUMER: CAUTION! Don't embarrass your dealer by asking him to redeem coupons without making the required purchase. He must redeem coupons properly to get his money back. REMEMBER: Coupons are good only on the brands called for. Any other use constitutes fraud.

TO THE DEALER: You are authorized to act as our agent for the redemption of this coupon. We will reimburse you for the face value of this coupon, or, if coupon calls for free merchandise, we will reimburse you for such free goods, plus 5¢ for handling, provided that you and the consumer have complied with the terms of our coupon offer. By submitting this coupon for reimbursement you represent that you redeemed it pursuant to these terms. Any failure to enforce these terms shall not be deemed a waiver of any of the conditions. **TERMS OF COUPON OFFER:** This coupon must be redeemed by a consumer at the time of purchase of the brand size indicated with the face value of the coupon being deducted from the dealer's retail selling price. This coupon is non-transferable, and may not be reproduced. The consumer must pay any sales tax and all coupons submitted for reimbursement for which no proof of purchase is shown. Properly redeemed coupons will be accepted for reimbursement only if identified by the retail distributor of our merchandise who redeemed them in connection with sales to the consumer, or the supplier of the products on which the coupons have been redeemed who has by written agreement with Procter & Gamble agreed to accept financial responsibility, or to a holder of our Certificate of Authority acting for them. COUPONS SHOULD BE SHIPPED, AT OUR EXPENSE, TO PROCTER & GAMBLE, 2150 SUNNYBROOK DRIVE, CINCINNATI, OHIO 45221. Cash redemption value 1/30 of 1¢.

PROCTER & GAMBLE 7-78

CUT ALONG DOTTED LINES

SWEETHEART BREAD 3 24-Oz. Loaves \$1
SWEETHEART ROLLS 3 18-Pk. Per \$1
Hot Dog, Hamburger Or Brown & Serve Rolls.

SUPER BUYS FROZEN FOODS

MORTON MINI-CREAM (CHOCOLATE-LEMON-BANANA-COCONUT) PIES 3 3½-Oz. Size \$1.00
BANQUET COOKING BAGS 3 5-Oz. Size 99¢
MINUTE MAID REGULAR OR PINK LEMONADE 5 8-Oz. Cans \$1.00
RICHFOOD GRAPEFRUIT JUICE 32-Oz. Can 49¢

SUPER BUYS PRODUCE

CRISP LETTUCE . . . 39¢
CUCUMBERS OR GREEN PEPPERS . . . 5 for \$1
YELLOW MEDIUM SIZE ONIONS . . . per lb. 19¢
FRESH TOMATOES . . . per lb. 39¢

ROUND WATERMELONS 99¢ Each

Bobby T. Garris, Grocery Manager
Robert McLawhorn, Market Manager
Orpha Evans, Produce Manager

Phone 758-1237

Grocery prices effective through next Wednesday.
Meat prices effective through Saturday.

Store hours: 8 a.m. - 7 p.m. Monday through Wednesday
8 a.m. - 8:30 p.m. Thursday, Friday & Saturday

SAVINGS

in every BAGFUL



GRADE "A" WHOLE
FRYERS
45^c
Lb.

SMITHFIELD
SMOKED
PICNICS
WHOLE Lb. **69^c**

PRODUCE

CALIFORNIA
PLUMS
49^c
Lb.
CALIFORNIA
CANTALOUPE
Large 18 Size **49^c** Ea.
CALIFORNIA RED
GRAPES
49^c Lb.
U.S. NO. 1 WHITE
POTATOES
10 Lb. Bag **99^c**

WESTERN
T-BONE STEAK
\$1.99
Lb.
SIRLOIN STEAK
\$1.99
Lb.

WHOLE BEEF
RIB EYES . . . **\$2.59**
Lb.
Cut Into Rib Eye Steaks Free
DINNER BELL
SLICED BACON **\$1.29**
Lb.
BRIARFIELD
SLICED BACON **79^c**
Lb.
DINNER BELL
HOT DOGS 12 Oz. Pkg. **89^c**

LIPTON
TEA BAGS
100 Ct.
INSTANT
3 Oz.
TEA MIX
36 Oz.

\$1.69
YOUR CHOICE Each

HUNT'S
KETCHUP
32 Oz.
59^c

SAVE MORE
GULF
CHARCOAL STARTER
Qt. **69^c**

VAN CAMP'S
PORK & BEANS
2 1/2 Size **59^c**
8 Oz.
4 For **\$1.00**

WESSON
OIL
\$1.89
48 Oz.

SOFT 'N' PRETTY
BATHROOM
TISSUE
4 ROLL
PACK

79^c

SAVE MORE
A-1
STEAK SAUCE
5 Oz. **59^c**

TREND
LAUNDRY
DETERGENT 42 Oz. **89^c**
Pre-Priced



R.C.
COLA **\$1.29**
(Plus Deposit) 16 Oz.



SAVE MORE
HARRIS
MADERITE BREAD
1 1/2 Lb. Loaves **\$1.17**

3 For 1

MADERITE
HOT DOG OR HAMBURGER
ROLLS
8 Pak
3 PKGS. \$1.00 FOR

BRAYO OR MANGO
CORNED BEEF 12 Oz. **99^c**
SUNGOLD
PEANUT BUTTER . . . 28 Oz. **99^c**
HUNT'S
SLICED PEACHES . . . 29 Oz. **59^c**
ARM & HAMMER
LAUNDRY DETERGENT 70 Oz. **\$1.29**
LYSOL
SPRAY DISINFECTANT 18 Oz. **\$1.99**
DADDY CRISP IN CAN REG. OR BBQ
REAL POTATO CHIPS.. **79^c**
EMBERS
CHARCOAL . . . 10 Lb. **\$1.19**
KRAFT CREAMY ITALIAN
DRESSING 8 Oz. **49^c**
BUNKER HILL
HOT DOG SAUCE 10 Oz. **3 For 89^c**

SAVE MORE
DEL MONTE
EARLY GARDEN
SWEET PEAS

No. 303
DEL MONTE
GOLDEN
WHOLE KERNEL
CORN
No. 303

\$1.00
3 For 1

FROZEN FOODS

"OUR OWN" COUNTRY FRESH
ICE CREAM 1/2 Gal. All Flavors **79^c**

JENO'S
PIZZA 13 1/2 Oz. **79^c**
Cheese, Sausage, Pepperoni Or Hamburger

PEPPERIDGE FARM CHOCOLATE, BANANA,
LEMON COCONUT OR BOSTON
CREAM CAKE . . . 12 Oz. **89^c**

HARRIS

SUPER MARKETS, INC.

"Where Shopping Is A Pleasure"

PRICES GOOD THURS. THRU SAT.

Memorial Dr. N. Greene St.

Tenth St.
Main St. Bethel
1104 West 3rd St.
Ayden & Tarboro

QUANTITY RIGHTS RESERVED

DAIRY SPECIALS

TROPICANA
ORANGE JUICE
1/2 Gal. **99^c**

KRAFT CHUNK SHARP
CHEDDAR CHEESE . . . 1 Lb. **99^c**

Asks People Heed Rights Of Animals

MOORHEAD, Minn. (AP) — A philosophy professor at Moorhead State University is trying to help deer, fish and family pets who can't speak up for their rights.

Charles Magel teaches a course in animal liberation, one of the first of its kind in the nation, and says he hopes it will start a trend toward a basic change in the way humans view animals.

Magel, 58, who chairs the university's philosophy department, says he offers his class not as a crusade, but to stimulate thought.

Some of the questions that come up in such a class are: Do humans have obligations to animals? What are they? Have we the unquestioned right to cage, kill, eat, subjugate animals? Where should experimentation be cut off? What is necessary and moral?

Magel says his own thinking on the subject is still progressing.

"I have come to the conclusion that certain things are wrong for humans to do in relation to animals," he said, and has arrived at three moral principles which form the core of his philosophy:

—"It is wrong, when avoidable, to cause suffering or distress to any sentient being.

—"It is wrong, when avoidable, to prevent any sentient being from enjoyment.

—"It is wrong, when avoidable, to destroy any form of life."

Magel agrees that those principles are very general.

"When you start to apply them it gets very sticky," he said. "That's true, of course, in every field."

Magel, who admits he has much to learn, says he believes most people would be shocked by the quantity, type and some of the goals of animal experimentation, especially for luxury items.

"Mascara, for instance, is tested on rabbits to determine its safety. Rabbits have no tear glands, so the mascara is put on their eyeballs to see what effects it has. It doesn't take much imagination to figure out what happens to the rabbits."

He also told of laying hens that are crowded together in cages, debeaked so they won't peck at each other, and kept that way virtually all their lives.

"The argument in these cases," Magel said, "basically is that you and I feel we have a right to the use of our organs. If our nose and part of our mouth were clipped off, I suspect we'd feel it was a violation of our basic rights ... There's a question here of the right of association, too, to mingle with its own kind, to enjoy the sunlight and to breathe outdoor air if that is its nature."

"To what extent does any animal have a right to its natural environment, use of its limbs, association with others and freedom from inflicted suffering?"

Magel, who studied philosophy at the University of Minnesota, said many schools were considering courses similar to the one he teaches.

"If each college would offer one course a year, this would be the beginning of a fundamental switch in human attitudes toward animals," Magel said.

But he admits: "It will take one or two centuries — it's that deep."

Named Poetry Prize Winner

AMHERST, Mass. (AP) — William Dickey has won the 1978 Juniper Prize, an annual poetry award of \$1,000 granted by the University of Massachusetts Press.

Dickey's winning manuscript, "The Rainbow Grocery," is to be published by the press this fall. The work is Dickey's fifth volume of poetry.

Dickey lives in San Francisco and is a professor of English and creative writing at San Francisco State University.

Birthday For USCG Academy

NEW LONDON, Conn. (AP) — The U.S. Coast Guard Academy here will celebrate its 186th birthday Aug. 4 with the inauguration of a new visitors' center.

The center will display special exhibits on the history of the academy and the Coast Guard.

The Butcher Shop

A&P

with supermarket prices.

ADVERTISED ITEM POLICY

Each of these advertised items is required to be readily available for sale at or below the advertised price in each A&P Store, except as specifically noted in this ad.

PRICES EFFECTIVE THRU SATURDAY JULY 29 AT A&P IN GREENVILLE, N.C.

A&P QUALITY CORN FED
PORK CHOPS
10 LBS. OR MORE
ASSORTED LB. PACKAGE
\$1.39

A&P picks the best health & beauty aids

18c OFF LABEL (REG. \$1.33)
ULTRA BRITE TOOTH PASTE 6 OZ. TUBE **99¢**
NORMAL, OILY, OR DRY (REG. \$1.89)
CLAIROL CONDITION SHAMPOO 16 OZ. BTL. **\$1.29**

A&P REGULAR, HARD TO HOLD, UNSCENTED
HAIR SPRAY 13 OZ. CAN **69¢**

Q-TIPS COTTON SWABS
170 CT. PKG. **69¢**

REGULAR OR UNSCENTED
FINAL NET HAIR SPRAY 8 OZ. BTL. **\$1.79**

ITEMS OFFERED FOR SALE NOT AVAILABLE TO OTHER RETAIL DEALERS OR WHOLESALERS



Got a question about pork?

Ask

At A&P you're going to find as fine a selection of pork as you would ever care to see. Unless you are familiar with each cut, and the best way to prepare it, you may never find out just how good all of our Country Farm Pork really is.

There is no need for concern that's why we're here. You'll get the answers you're looking for. Like, what pork cut is best for a particular occasion? How much to buy? Or maybe a hint on its preparation.

When it comes to Country Farm Pork just ask our butcher. He's the man who knows.

U.S.D.A. INSPECTED FRESH WHOLE

FRYERS

49¢

2 IN A BAG, LIMIT 2 BAGS, PLEASE

LB.



A&P is a country farm pork shop

A&P is a poultry shop

RIB PORTION
PORK ROAST LB. **\$1.99**

CENTER CUT PORK CHOPS RIB OR LOIN LB. **\$1.99**
SIRLOIN PORK CHOPS LB. **\$1.69**
MEATY PORK BACK RIBS LB. **\$1.79**
COUNTRY STYLE PORK SPARE RIBS LB. **\$1.69**

U.S.D.A. INSPECTED FRESH FRYER
BOX-O-CHICKEN LB. **49¢**
U.S.D.A. INSPECTED FRESH FRYER
LEG QUARTERS LB. **79¢**
U.S.D.A. INSPECTED FRESH FRYER
BREAST QUARTERS LB. **79¢**

U.S.D.A. INSPECTED BASTED
TURKEY BREAST LB. **\$1.29**
4 TO 8 LB. AVG. WT.

A&P picks the best frozen foods

ANN PAGE
FROZEN LEMONADE
12 OZ. CAN 39¢
5 6 OZ. CANS **\$1.00**

G&W PIZZA
• PEPPERONI
• SAUSAGE
• HAMBURGER
11 1/4 OZ. PKG. **79¢**

ANN PAGE
ICE CREAM
1/2 GAL. CTN. **99¢**
SAVE 16¢

LOOK FOR THE ACTION PRICE SIGN THROUGHOUT YOUR A&P STORE. When A&P buyers make a special purchase at a lower price, we pass the savings on to you. That lower price is an action price. And these Action Prices are in addition to our money-saving weekly specials.

MRS. FILBERT'S
IMITATION MAYONNAISE QT. JAR **79¢**

CRISCO OIL PURE VEGETABLE 38 OZ. BTL. **\$1.79**

PETER PAN CREAMY
PEANUT BUTTER 40 OZ. JAR **\$2.29**

LONG GRAIN ENRICHED
MAHATMA RICE 3 LB. PKG. **89¢**

SHOP A&P FOR A-1
STEAU SAUCE 19 OZ. BTL. **99¢**

KRAFT PLAIN OR SMOKED
BARBECUE SAUCE 19 OZ. JAR **59¢**

MINUTE MAID FROZEN
ORANGE JUICE 12 OZ. CAN **89¢**

ALL VARIETIES
CYCLE DOG FOOD 14 1/2 OZ. CAN **31¢**

ASSORTED
GALA NAPKINS 140 CT. PKG. **59¢**

HEINZ KETCHUP 32 OZ. JUG **79¢**

5 LIVES **CAT FOOD** 2 6 OZ. CANS **49¢**

20c OFF LABEL — MOUTHWASH
LISTERINE YOU PAY 12 OZ. \$1.19 ONLY BTL.

JOHNSON'S
BABY POWDER 24 OZ. CTN. **\$2.48**

REG. • NEUTRAL • OR • FRESH
ULTRA BAN II 3 OZ. CAN **\$1.09**

2c OFF LABEL YOU PAY ONLY 14 OZ. CAN
COMET CLEANSER **28¢**

JOY LIQUID
DISH DETERGENT
20c Off Label YOU PAY ONLY 32 OZ. BTL. **\$1.19**

A&P
INSECTICIDES **99¢**
• ANT & ROACH
• BUG KILLER
• FLYING INSECT
14 OZ. CAN

FREEZER QUEEN ENTREES
• BEEF PATTIES W/MUSHROOM GRAVY
• TURKEY CROQUETTES
• SLICED TURKEY
• BEEF PATTIES W/ONION GRAVY
• SALISBURY STEAK
• SPAGHETTI & MEAT BALLS 2 LB. PKG. **\$1.39**

MORTON'S
POT PIES • BEEF • CHICKEN • TURKEY 3 8 OZ. PKGS. **\$1.00**

ANN PAGE
ICE MILK BARS 12 CT. PKG. **99¢**

ANN PAGE
HANDI-WHIP DESSERT TOPPING 2 8 OZ. CTNS. **\$1.00**

A&P FROZEN
FRENCH GREEN BEANS 8 OZ. PKG. **39¢**

DULANY WHOLE OR
CUT OKRA 2 10 OZ. PKGS. **\$1.00**

WEIGHT WATCHERS DINNERS
LASAGNA 13 OZ. **\$1.49**
TURKEY DINNER 19 OZ. **\$2.19**
CHOP SIRLOIN 16 OZ. **\$2.19**
FLOUNDER DINNER 17 OZ. **\$2.09**
PERCH DINNER 17 OZ. **\$1.79**
\$1.69

VEAL STUFFED PEPPERS 13 OZ. PKG.

OPEN 24 HOURS A DAY 7 DAYS A WEEK

the man who knows

A&P is a butcher shop

A&P QUALITY HEAVY WESTERN GRAIN FED BEEF

RIB STEAKS
\$1.99
 (BONE IN)
 LB.

OR RIB ROAST

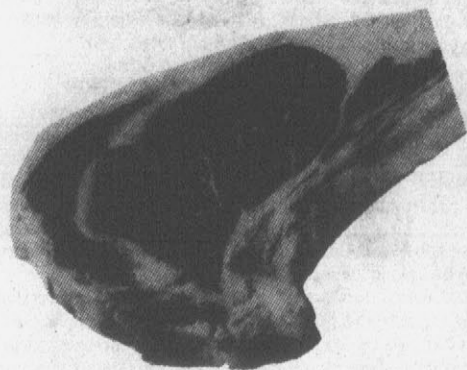

A&P is a deli shop

FRIED CHICKEN 8 Piece Bucket **\$2.69**
BOLOGNA MEAT OR BEEF SLICED TO ORDER 1 LB. **\$1.19**
HOT DOGS READY TO EAT 3 For **\$1.00** Only

A&P COUPON

DIXIE CRYSTALS SUGAR **SAVE 41¢**
5.68¢
 LB. BAG #658
 LIMIT ONE WITH THIS COUPON AND ADDITIONAL \$7.50 ORDER

A&P is a smoked meat shop

F.F.V. OR VIRGINIA FARM **COUNTRY HAMS**

\$1.39
 WHOLE LB.

- HICKORY SMOKED
- 100% DRY CURED
- PEPPER COATED



ARMOUR STAR BONELESS HAMS
 FULLY COOKED **\$1.99**
 LB.

SMOKED SLAB BACON LB. **89¢**

A&P is a sausage shop

HILLSHIRE FARM — ALL VARIETIES **SMOKED SAUSAGE** LB. **\$1.69**
 KAHN'S MEAT OR **BEEF FRANKS** 1 LB. PKG. **\$1.59**
 KAHN'S MEAT OR **BEEF BOLOGNA** (12 OZ. PKG. \$1.19) 8 OZ. PKG. **79¢**
 SMITHFIELD BRAND **SLICED BACON** 1 LB. PKG. **\$1.39**
 SMITHFIELD BRAND FRESH **PORK SAUSAGE** • HOT • MILD 1 LB. PKG. **\$1.29**
 HYGRADE BALL PARK **BEEF FRANKS** OR MEAT FRANKS 1 LB. PKG. **\$1.59**

FRESHLY **GROUND BEEF** 3 LB. CHUB PKG. **\$3.99**
 FRESH WHOLE BONELESS **BEEF BRISKET** LB. **\$1.69**

A&P QUALITY HEAVY WESTERN GRAIN FED BEEF

WHOLE BONELESS BEEF RIBS
\$2.19
 LB.
 CUT FREE INTO BONELESS RIB STEAKS, AND ROAST, OR RIB EYE STEAKS AND TRIMMINGS

A&P is a seafood shop

A&P QUALITY BATTER DIPPED

FISH STICKS 14 OZ. PKG. **\$1.39**
 8 1/2 OZ. PKG. **99¢**
SHRIMP COCKTAIL 3 4 OZ. JARS **\$1.59**
FISH-N-CHIPS A&P QUALITY BATTER DIPPED 1 LB. PKG. **\$1.19**
FLOUNDER FILLETS FROZEN CELLO WRAPPED LB. **\$1.29**

A&P picks the best produce

WESTERN GROWN SWEET

CANTALOUPE
69¢
 EACH ONLY
 18 SIZE NOT THIS
 15 SIZE NOT THIS
 12 SIZE BUT THIS
 JUMBO 12 SIZE

LOCALLY GROWN **GREEN COOKING APPLES** LB. **39¢**
NECTARINES SWEET AND TASTY FULL OF JUICE LB. **49¢**

JUMBO HORGOLD RUSSET **POTATOES** PERFECT FOR BAKING 3 LBS. **\$1.00**
 MARIE'S BLUE CHEESE **SALAD DRESSING** FRESH CRISP 12 OZ. JAR **\$1.19**
CELERY HEARTS PKG. OF 2 FOR ONLY **79¢**
POPCORN A&P BRAND YELLOW 2 LB. BAG **49¢**
LETTUCE • ROMAINE • RED LEAF • GREEN LEAF YOUR CHOICE A BUNCH **39¢**

ITEMS OFFERED FOR SALE NOT AVAILABLE TO OTHER RETAIL DEALERS OR WHOLESALERS

A&P picks the best bakery products

A&P picks the best groceries

OLYMPIC MEAL BREAD THIN SLICED It's a natural winner 24 OZ. LOAF **59¢**
ORANGE CHIFFON CAKE 14 OZ. PKG. **88¢**
PINEAPPLE PIE 22 OZ. PKG. **99¢**

A&P LIGHT **CHUNK TUNA** 6 1/2 OZ. CAN **59¢**
ELBOW MACARONI ANN PAGE 3 LB. PKG. **99¢**
NONFAT DRY MILK A&P INSTANT — MAKES 20 QUARTS 84 OZ. PKG. **\$3.88**
ICED TEA MIX OUR OWN — WITH LEMON AND SUGAR 32 OZ. CAN **\$1.89**

A&P picks the best dairy products

MRS. FILBERTS MARGARINE
59¢
 1 LB. PKG.
 GOLDEN QUARTERS

ANN PAGE **SOUR CREAM** 2 8 OZ. PKGS. **88¢**
 ANN PAGE FRENCH **ONION DIP** 8 OZ. PKG. **53¢**
 MEL-O-BIT **CHEESE SLICES** 12 OZ. PKG. **\$1.09**
 A&P GENUINE WISCONSIN MILD **CHEDDAR CHEESE** (9 TO 16 OZ.) (AVG. WT.) LB. **\$1.79**

MAXWELL HOUSE COFFEE
\$2.59 INSTANT **\$4.39**
 1 LB. BAG 10 OZ. JAR



Shares Home With Many Exotic Pets

By CHARLES CHAMBERLAIN

Associated Press Writer

LISLE, Ill. (AP) — In the tidy living room of the large, modern log cabin filled with antiques, 61-year-old Esther Lewis has a 5-foot-long, 40-pound alligator on her shoulder, holding it as you would to burp a baby.

"Don't mind Eddie hissing," she says. "Dogs bark at strangers, don't they?"

Mrs. Lewis has been collecting reptiles and the like since her childhood in Mt. Ayr, Iowa, where she turned an open pit with a fountain into a "snake museum" and persuaded local grocers to save tarantulas for her when banana shipments arrived.

Talking a mile a minute, Mrs. Lewis leads the way to what would be the family room, where a sliding glass door opens onto a huge, manicured back yard and a wooded section beyond. In the room there is the sound of running water, a play area, partitioned units with sliding doors, glass cages. Everything is spic and span, and odorless.

It's here that the petite Mrs. Lewis, a former model and a founder of the Chicago Herpetological Society, pampers her turtles, snakes, North American alligators, tarantulas and a iguana named Dottie.

Mrs. Lewis has reached into a glass case and has come out with Zaremba, a tarantula with a body the size of a silver dollar. It crawls on her blouse.

"Give me a hand with Gorgeous George," she said later, trying to lift a tongue-flicking python from its case. Out and out it came, all 14 feet, as Mrs. Lewis and a visitor pulled and held.

With Gorgeous George put back, Mrs. Lewis turned her attention to "Tea," a 34-pound alligator. She cuddled him against her shoulder. Tea did not hiss. He even looked as if he was smiling.

"Tea has been held by 8,000 children and taken by leash to shopping centers and other places for charity appearances," said Mrs. Lewis, who hosts school groups, conducting educational programs in herpetology and conchology. In addition to the reptiles, she collects sea shells from the world over and has a half million of them on dazzling display in special rooms.

"When Tea was only 6 inches long, some smart alec tossed him into a public swimming pool at Fort Myers, Fla., and he started scaring people," she related. "We got him out and he's been with us 20 years now. He's trained to go to the toilet in a plastic tub and can climb up an incline to a bed, push away the spread, open the sheets, get between them and rest his head on a pillow. He's been on TV, you know."

"I learned to handle alligators from Seminole Indians in Florida," said Mrs. Lewis, who frequently entertains at parties in her home and has family reunions with 13 grandchildren.

"Alligators love to eat rats. Tea has five once a week. In fact, I use up 40 to 50 rats and mice every week. A woman raises them just for me. The only time my husband ever put his foot down was refusing to let me raise my own rats and mice in the house."

Her husband, John, is senior scientist in the department of drugs at the American Medical Association in Chicago, 25 miles from Lisle.

Mrs. Lewis peels a banana and feeds it to Dottie the iguana.

"Dottie also loves peas, green beans and carrots right out of the can," she said.

Mrs. Lewis said she had no favorites, but considered her rarest reptile to be "Black Beauty," a black boa constrictor.

"When we go on vacations, members of our herpetological society baby-sit for us," she said. "And I baby-sit for their pets. Right now my guest list includes a Burmese python, an Asian green rat snake, a red rat snake and its baby, a sand boa and two crocodiles."

Has Mrs. Lewis ever been bitten by her pets?

"Of course," she said. "An alligator occasionally snaps. So does Lassie."

Historic Span Still Standing

WHEELING, W. Va. (AP) — The historic Wheeling Bridge, constructed in 1849 as the nation's first long-span cable suspension connector, still stands, linking this city with its neighboring island more than half-way across the Ohio River.

Built with money raised by \$25-a-share stock sold to Wheeling citizens, the bridge has served as a model of wire cable suspension design.

Now listed as a National Historic Landmark, the bridge has also been designated a National Historic Civil Engineering Landmark.

Greenville Square Shopping Center

Here's How N.C. Representatives, Senators Voted

By ROLL CALL REPORT
WASHINGTON—Here's how area Members of Congress were recorded on major roll call votes July 13 through July 19.

PIPELINES FOR COAL—Defeated, 161 for and 246 against, a bill to provide for the construction of slurry pipelines to move coal from one region of the country to another. The intent was to provide a transportation mode—in addition to railroads—for moving coal from mines in the West to electric generating plants in the East. Railroads opposed the bill, as did some environmentalists concerned about conserving western water and possible pollution from the slurred coal.

Rep. Morris Udall, D-Ariz., a supporter, said greatly increased coal production in coming decades "will put a strain on the physical capacity of the railroads; coal pipelines can supplement the railroads to make sure the coal is moved safely, efficiently and economically... would be underground, quiet and clean."

Rep. Fred Rooney, D-Pa., an opponent, said: "If railroads are deprived of carrying their share of the additional coal to be used when utilities are converted from gas and oil to coal; they

will be unable to obtain the necessary revenue to provide the capital required to continue providing their essential role in our national transportation system."

Members voting "yea" favored passage of the bill. Reps. L. H. Fountain, D-2, Ike Andrews, D-4, Stephen Neal, U-5, James Martin, R-9, James Broyhill, R-10, and Lamar Gudger, D-11, voted "yea."

Reps. Walter Jones, D-1, Charles Whitley, D-3, Richardson Preyer, D-6, and W. G. Hefner, D-8, voted "nay." Rep. Charles Rose, D-7, did not vote.

COAL LIQUEFACTION—Adopted, 165 for and 132 against, an amendment to spend \$75 million on a demonstration project to develop coal liquefaction technology. It was attached to HR 12163, a Department of Energy (DOE) research and development bill later passed and sent to the Senate. Deriving liquid fuel from hard coal is viewed as a significant source of

energy in the future. The fuel can be used in some industrial processes as a substitute for oil. Under this amendment, private companies such as Gulf Oil would compete for the opportunity to carry out the federally-funded demonstration project.

Rep. Walter Flowers, D-Ala., a supporter, said the demonstration project as envisioned in the bill "is the best way for us to obtain a synthetic fuel from the coal industry in this country in time to meet our needs."

Rep. Richard Ottinger, D-N.Y., an opponent, favored the objective of the bill but said it failed to provide "enough protection for taxpayers in its provision of federal subsidies for private industry."

Members voting "yea" favored the amendment. Jones, Neal, Preyer, Rose, Hefner, Martin and Gudger voted "yea."

Broyhill voted "nay." Fountain, Whitley and Andrews did not vote.

ANDREW YOUNG—Tabled, 293 for and 82 against, a motion to impeach U.S. Ambassador to the U.N. Andrew Young. The motion was provoked by Young's statement to a Paris newspaper that there are "hundreds, maybe even thousands of people I would call political prisoners" in U.S. jails.

Rep. Fortney Stark, D-Calif., a supporter of tabling, said: "There are, indeed, political prisoners in the U.S., as with the Wilmington Ten, who rest now in jail in North Carolina, and in the more prospective sense that...there will be thousands of minority youths who will go to jail because we failed politically to provide them with the opportunities that they need for education and jobs and health."

Rep. John Myers, R-Ind., an opponent of tabling and supporter of impeachment, said: "Of course, everyone is entitled to his own opinion, but speaking as the Ambassador...to the U.N.

goes beyond one's personal opinion..." Members voting "yea" favored tabling the move to impeach Young.

Jones, Whitley, Neal, Preyer, Rose, Hefner, Martin, Broyhill and Gudger voted "yea." Fountain and Andrews did not vote.

HOUSE ENDANGERED SPECIES ACT—Rejected, 22 for and 76 against, an amendment to permit construction of the Tellico Dam in Tennessee, notwithstanding the presence of the small darter. Under a recent U.S. Supreme Court decision, construction is blocked on grounds it would destroy the habitat of the small darter, a fish protected by the Endangered Species Act.

The amendment was proposed to S 2899, a bill extending the act for three years. Among other provisions, the amendment sought to exempt from conflict with the Endangered Species Act federal construction projects that were at least 50 per

cent completed when the act became law in 1973. This language would have affected the Tellico Dam project and hundreds of other projects.

Sen. Jake Garn, R-Utah, the sponsor, said: "Some mechanism needs to be found to keep special interest groups from using the Endangered Species Act cynically... environmentalists' who do not care about some of these endangered species at all (but) are using the act as a way to attack the construction of dams, grazing, drilling, mining and any other activity they think is undesirable."

Sen. John Culber, D-Iowa, an opponent, said: "The ultimate effect of this amendment... would, in my judgment, be to eviscerate the Endangered Species Act."

Senators voting "yea" favored the amendment. Sens. Robert Morgan, D, and Jesse Helms, R, voted "yea." **CONSUMER COOPERATIVE BANK**—Passed, 60 for and 33 against, a bill (HR 2777) to

establish a National Consumer Cooperative Bank. The bank would loan money to consumer cooperatives, which are organizations of individuals banding together to buy a wide range of everyday goods and services at lower prices. Similar federal banks operate for the benefit of farmers, small businessmen and other groups.

HR 2777 authorizes \$300 million in seed money, which sponsors say would be paid back to the U.S. Treasury as the bank raises capital and begins generating profits. Although essentially a government agency, the bank is envisioned as eventually becoming a private, profit-making institution.

Sen. Alan Cranston, D-Calif., a supporter, said the bill "will provide the seed money to start a bank to fill a gap that now exists in the financial markets regarding cooperatives. That is all consumers are asking for—seed money that will be paid in full with interest to the federal

government." Sen. John Tower, R-Tex., an opponent, said: "If we have learned anything in the last several years, it should have been that government cannot be all things to all people. Yet, here we are again considering the establishment of another agency as an easy solution to a complex problem."

Senator's voting "yea" favored establishing the bank. Morgan voted "yea." Helms voted "nay."

CORRECTION

In last week's report, a mistake was made in explaining the issue of whether the Commodity Futures Trading Commission should be abolished and replaced by a new commission with similar but broadened jurisdiction.

The correct information is that Morgan voted to retain the Commission in its present form; Helms voted in favor of creating a new commission.

Roll Call Report regrets the error.

DEEDS

Community Wholesale Oil Co. to James L. Patrick, al no stamps

Jack A. Krol, al to Raymond R. Richard al 40.00

Albert W. Smith, Jr., al to David E. Reeves, al 36.50

Jarvis H. Allen, al to Zeno R. Allen no stamps

John W. Andrews, al to Bobby W. Andrews no stamps

Bobby W. Andrews to Frances D. Andrews no stamps

Louvenia Clark to Barbara W. Ross 1.00

Bill Clark Const. Co., Inc. to Bruce Glenn Wade 41.50

James H. Dupree, al to Dalton R. Davenport, al no stamps

Fleming & Watson to Watson Assoc. of Greenville no stamps

F. Joseph Gossman-Bishop to R. H. Gaskins, al 20.00

Wilbur C. Murphy, al to Donnie Spikes, al 4.00

H. A. Reaves, al to Jerry L. French, al no stamps

Charles G. Rob, al to Robert J. Collins, al 95.00

Speight Realty & Investments, Inc. to James W. Turnage, al 8.50

Mary B. Wynne, al to Robert J. Whitehurst, Jr. 3.50

Weyerhaeuser Real Estate Co. Wm. G. Morrison, al 12.00

Robert Baker, al to Gladys H. Windom no stamps

Elvin Ray Brewer, al to Wm. B. Hargett 75.00

D. H. Briley, Jr., al to Paul B. Stocks, al 6.50

Carey E. Brown, al to Lander Scott, Jr., al 12.50

Benjamin Demain, al to Susan E. Demain no stamps

The Evans Co. of Greenville, Inc. to Willie J. Telfair, St., al 31.00

Doris Cox Haddock to Michael Haddock no stamps

Dorothy R. Kilpatrick to Katie Lou Manning al 12.00

Donnie M. Wynne, al to Donnell L. Wynne no stamps

Glenda E. Wynne, al to Donnell L. Wynne no stamps

E. Cordell Avery, Comr., al to Garland Taylor, al 8.00

Louise H. Moyer, al to Robert C. Waters, al 3.50

Willie E. Braxton, al to Jasper L. Davenport, Jr. no stamps

Charles W. Croom, Jr., al to Sue Evans Meeks 10.00

Fleming & Watson to Russco, Inc. no stamps

Carrie M. Gardner to David W. Stevenson, Jr., al 3.00

Douglas M. Kelly, al to Harold F. Fulford, al 8.00

Tommy L. Little & Assoc., Inc. to Burney S. Warren III al 16.50

Davie Lee Moret to Lynne M. Moret 3.00

June T. Porter, al to Henry J. Manning, al 5.50

Joseph D. Reutter, al to Wm. S. Bost, al 18.00

Samuel H. Pugh, al to Wm. E. Brown, al 49.00

James L. Shelton, al to R. G. Evans, Jr. al 15.00

Doris M. Thomas, al to Alton R. Thomas, al no stamps

Alton R. Thomas, al to Doris M. Thomas, no stamps.

Announce Grants of Half-Million

WASHINGTON (AP) — Grants totaling more than half a million dollars to support special summer projects were announced recently by the National Endowment for the Arts.

A total of 81 separate grants to 37 states and the District of Columbia were awarded.

Kroger Sav-On

COST CUTTERS SAVE YOU MONEY!

YOUR GREENVILLE KROGER SAV-ON LOCATED AT:
600 Greenville Rd.
Phone: 756-7031
OPEN 7 AM-MIDNIGHT MON.-SAT.
OPEN SUNDAY 9 AM-9 PM

STRUCTO
Charcoal Hibachi
\$10.88

MAE MAR
BBQ Tools
69¢
STAINLESS STEEL- WOODEN HANDLES- FORKS, BASTER, TONGS

NOMA
Flat Spit & Grill Baskets
\$1.99

GENERAL FOAM
6 Pack Cooler
\$1.39
KEEPS YOUR DRINKS COOL FOR HOURS

PERFECT STORAGE
Pitcher Decanter
\$1.29
LARGE 80-OZ. PUSH BUTTON LEAK PROOF COVER-ODOR PROOF- UNBREAKABLE

WELLINGTON
Outdoor Chair Pads
2 For \$3.49

COLORFUL
Kites
45¢ UP
ALL SHAPES & SIZES HALF PRICE SALE

WELLS-LAMOUNT
Garden Gloves
1/2 PRICE

SUNBEAM
Grass Shears
\$6.88
ON-OFF SWITCH-SAFETY LOCK-CORDLESS- RECHARGE PK. INCLUDED

SMITH HOME & GARDEN
Sprayer
\$9.88
3/4 GAL. NEW NON-CORROSION RESISTANT PUMP

DECORATIVE
Plastic Fencing
4 For \$4.00
4' SECTIONS- IDEAL FOR FLOWER BEDS

U.S.D.A. CHOICE HEAVY WESTERN BEEF CENTER CUT
Sirloin Steak
\$1.99 lb.
USDA CHOICE

HOLLY FARMS
Whole Fryerslb. 57¢
FRESH PICNIC STYLE
Pork Roastlb. 78¢

KROGER MEDIUM
Grade A Eggs
Doz. 49¢

KROGER 1/2%
Lowfat Milk
Gallon Plastic Ctn. \$1.29

RETURNABLE BOTTLES
R.C. Cola... 8 16 Oz. Btls. 99¢
PLUS DEPOSIT, LIMIT 2 (8 Pkgs.) PLEASE

MRS. FILBERTS QUARTERS
Golden Margarine 1-lb. Pkg. 53¢

CALIFORNIA 27 SIZE
Cantaloupes
Each 69¢

CALIFORNIA FIRM, RIPE
Nectarines
lb. 49¢

STAR-KIST
Chunk Light Tuna 6 1/2 -oz. Can 69¢

DEL MONTE WHOLE KERNEL
Golden Corn 3 17-oz. Cans \$1.00

WHOLE, RED RIPE
Watermelons..... Each \$1.00

SWEET, JUICY CALIFORNIA
Plums.....lb. 59¢

deli-restaurant
Jack & Jill \$1.29
Bologna.. lb. 1.00
GOURMET SANDWICH
Turkey \$1.49
Breast Each 1.00

in-store bakery
White Bread 2 16-oz. Lvs. 98¢
CAKE OF THE WEEK 8-INCHES
Carrot Cake Each \$3.89

COPYRIGHT 1978—KROGER SAV-ON ITEMS AND PRICES GOOD THRU SATURDAY, JULY 22, 1978 IN GREENVILLE, N.C. WE RESERVE THE RIGHT TO LIMIT QUANTITIES.

ADVERTISED ITEM POLICY
Each of these advertised items is required to be readily available for sale in each Kroger Sav-On Store, except as specifically noted in this ad. If we run out of an advertised item, we will offer you your choice of a comparable item, when available, reflecting the same savings or a rain-check which will entitle you to purchase the advertised item at the advertised price within 30 days.

Tokyo Refuge For The Abused Wife

By RICHARD BILL
TOKYO (AP) — In feudal Japan, women fleeing abusive husbands often sought refuge in Buddhist temples. Now they can find safety and protection in a secret hideaway run by the city government in the heart of

Tokyo. In a quiet backwater near the bustling Shinjuku district is the Metropolitan Woman's Counseling Center, the first public institution of its kind in this country. Its exact location is kept secret to avoid pursuit or

reprisals from angry husbands. A three-story complex, the center includes a dining hall, a playroom for children, offices and medical facilities. Japanese-style tatami mat rooms can accommodate up to 30 women and their children. Kaory Kasama, who heads a counselling staff of 50, said in an interview that nearly 600 women had sought help at the center since it opened in April 1977. Some, she said, were beaten so badly by their

husbands that they required immediate hospital attention. Ms. Kasama, a soft-spoken woman in her 50s, said she thought the reaction to the center showed only the tip of the iceberg. She said many family flareups are not reported to authorities and many women are too frightened to leave their homes for fear of what might happen to their children. Another factor may be the role some women are still relegated to in Japanese

society. Ms. Kasama said too many men still regard women as chattels. In addition to wives beaten by husbands, she said the center has received 80 cases of mothers escaping from teenage children who used violence against them. Other cases were mothers and daughters running away from the husband-father who sexually molested the daughter. Many of the others are fleeing from spouses who squander the

family money, or openly carry on a relationship with another woman while refusing a divorce. The main problem faced by the center is how to help these women on the road to independence. The period of stay is limited to two weeks, which is completely free. Although the counselling center tries to help find work and new places to live or to assist with divorce procedures,

some women turn to prostitution as a way out. Another 20 percent find the challenge of living alone too difficult and return to their husbands. Women seeking help can reach the center by telephoning a number which appears on television and is published in newspapers. If a husband calls, the operator has standing instructions to tell the man his wife is not there. Ms. Kasama said.

NO RICKSHAW
SALT LAKE CITY (AP) — People here will have to make do without the services of a "rickshaw" company, the city commission ruled. The commission, acting upon the advice of traffic engineer Gerald Blair, unanimously denied a petition asking for passage of laws allowing a "rickshaw service" in the downtown area.

Kroger Sav-On FOOD AND DRUG STORES SUMMER CLEARANCE

COPYRIGHT 1978 KROGER SAV-ON
SALE ENDS SATURDAY,
JULY 29, 1978. PRODUCT
AVAILABILITY SUBJECT
TO QUANTITIES ON HAND.
NO RAINCHECKS OR SUBSTITUTIONS.

ADVERTISED ITEM POLICY
Each of these advertised items is required to be readily available for sale in each Kroger store, except as specifically noted in this ad. If we do run out of an advertised item, we will offer you your choice of a comparable item, when available, reflecting the same savings or a rain-check which will entitle you to purchase the advertised item at the advertised price within 30 days.

UP TO... 50% OFF

MELNOR PULSATING SPRINKLER
No. 9570
WATERS FULL 75 FT. CIRCLE OR ANY PART
 **\$4.44**

TINY-MITE SUPER HAMMOCK
HEAVY DUTY, FAMILY SIZE
HOLDS UP TO 600 LBS.
 **\$4.44**

THERMOS SIX PACKER
LIGHTWEIGHT, DURABLE
HOLDS TWO SIX PACKS
 **\$7.29**

MARSHALLEN 18" BBQ GRILL
3 POSITION PORTABLE GRILL
 **\$3.33**

CHAMPION TWO-PLY GARDEN HOSE
MIRROR FINISH VINYL WITH BRASS COUPLINGS
 **\$1.59**

REAL KILL ANT & ROACH KILLER
11 Oz. Aerosol Can
Fresh Pleasant Odor..... **79¢**

OUTDOOR CHAIR PADS
100% Solid Foam Filled
Approximate Size—18x36..... **\$2.77**

FREEZE FLEX ALL WEATHER HOSE
100% DUPONT NYLON TIRE CORD
HEAVY BRASS COUPLINGS
 **\$5.29**

EVEREADY COMMANDER LANTERN
WITH BATTERY
POWERFUL LONG DISTANCE BEAM
RESISTS OIL, GREASE, AND MOST CHEMICALS..... **\$3.79**

CAP'N COOK COVERED COOKER
EXTRA HEAVY ALUMINIZED STEEL
EASY HEAT CONTROL
CONSERVES CHARCOAL **\$14.88**

KENT LIFE VESTS
U.S. COAST GUARD APPROVED
FOR SAFE BOATING & SWIMMING
CHILDREN'S OR ADULTS
 **\$3.49**

STOWAWAY PICNIC GRILL
COMPACT—COLLAPSIBLE
HEAVY GAUGE GRILL & STAND..... **99¢**

NAPPA SMITH THERMO-KEEP
WATERPROOF ALL PURPOSE
INSULATED BAG.
GREAT FOR CAMPING, PICNICS,
OR TRAVELING
 **\$1.69**

GRILLS
25% Off Reg. Price
MANY STYLES TO CHOOSE FROM

HOME & GARDEN SPRAYER
3 1/2 Gal. Heavy Duty
NEW CORROSION RESISTANT PUMP
 **\$10.88**

GREEN THUMB GARDEN HAND TOOLS
CULTIVATOR-WEEDER-TROWEL
WOOD HANDLES
HEAVY GAUGE STEEL..... **77¢**

YARD 'N GARDEN TOOL SET
INCLUDES SHOVEL-GARDEN HOE-CULTIVATOR
WITH FREE TOOL HOLDER
 **\$8.88**

LAWN MOWERS
10% Off Reg. Low Prices
PUSH AND SELF PROPELLED, ALL WITH
BRIGGS & STRATTON ENGINES 19"-22"

KROGER SAV-ON...A WHOLE LOT MORE THAN JUST ONE STORE!

BIGGER, BETTER FOODBUYS

CLIP THIS COUPON

Fab Detergent

Giant Box

With Coupon And \$7.50 Food Order Excluding Specials. Limit One Per Customer.



Without Coupon \$1.18 Expires July 29.

98¢

CLIP THIS COUPON

White Cloud Toilet Tissue

With This Coupon And \$7.50 Food Order Excluding Specials. Limit One Per Customer.



Without Coupon 88¢ Expires July 29.

68¢

CLIP THIS COUPON

Ivory Liquid Detergent

With This Coupon And \$7.50 Food Order Excluding Specials. Limit One Per Customer.



Qt. Btl.

Without Coupon \$1.08 Expires July 29.

88¢

KETCHUP

Qt. Jug

78¢

LOOK

SCOPE

24 Oz. Btl.

\$1.48

LOOK

TOOTH PASTE

3 Oz. Tube

2 For \$1.00

CLIP THIS COUPON

Kellogg's Corn Flakes

With This Coupon And \$7.50 Food Order Excluding Specials. Limit One Per Customer.

24 Oz. Box



Without Coupon \$1.08 Expires July 29.

88¢

CLIP THIS COUPON

Minute Maid 100% Orange Juice

With This Coupon And \$7.50 Food Order Excluding Specials. Limit One Per Customer.

12 Oz. Can



Without Coupon 88¢ Expires July 29.

68¢

CLIP THIS COUPON

Ivory Soap

4 Bar Pkg.

With This Coupon And \$7.50 Food Order Excluding Specials. Limit One Per Customer.



Without Coupon 68¢ Expires July 29.

48¢

DOG CHOW

25 Lb. Bag

\$4.88

LOOK

Dog Food

15 Oz. Can

16¢

LOOK

PEACHES

2 1/2 Size Can

58¢

Cake Mix

17 Oz. Box



DELUXE II CAKE MIX

58¢

OVERTON'S SUPERMARKET

3rd AND JARVIS ST.
 master charge
 None Sold To Dealers
 VISA

Tuna Fish

6 Oz. Can



CHUNK LIGHT TUNA

68¢

BACON

12 Oz. Pkg.

\$1.09

LOOK

Prices Effective Wed. - Sat.

LOOK

1/4 PORK LOIN

\$1.49

FIRST CUT PORK CHOPS

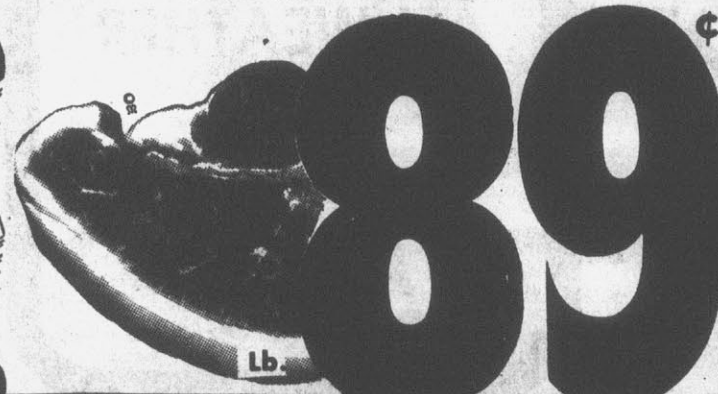

Lb.

89¢

TEN POUND SPECIALS OF THE WEEK

- NECK BONES \$4.90
- GROUND BEEF PATTIES \$12.50
- PORK CHOPS \$12.90
- CHITTERLINGS \$4.99

OUR FOOD PRICES ARE LOWER

Over 200 items everyday low priced. Hundreds of prices have been lowered plus Greenville's lowest meat prices. Shop Overton's Today! No Thrills, No Games, No Gimmicks. Just low, low prices and Greenville's best service.

Del Monte PINEAPPLE



Crushed Or Sliced In Syrup Or In Juice 1 1/2 Size Cans



Pineapple-Grapefruit or Pineapple-Orange Juice 46 Oz. Can

58¢

38¢

COUNTRY HAMS

Half Or Whole

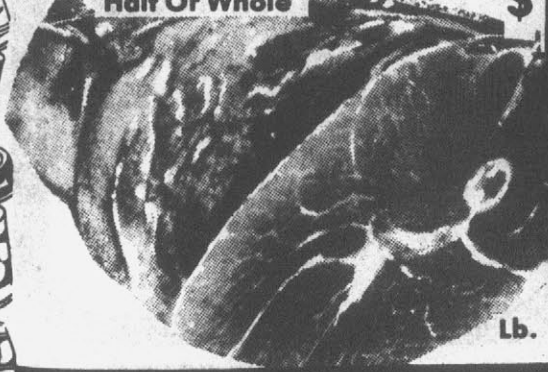

\$

1.29

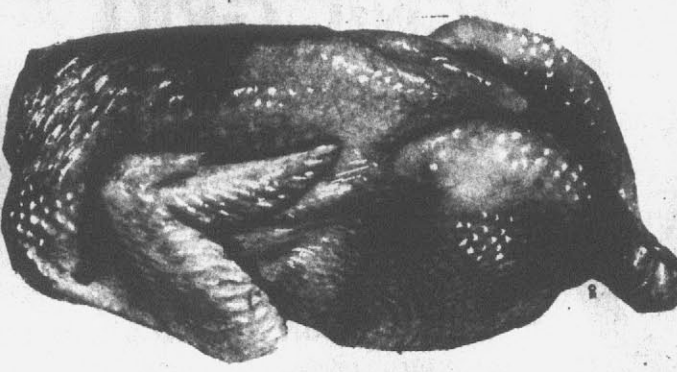

Lb.

46¢

Ground Beef

3 Lb. Pkg. Or More

\$1.29

LOOK

Round Steak

Lb.

\$1.39

LOOK

Peaches

3 Lb.

\$1.00

Cantaloupes



Ea.

58¢

Grapes



Lb.

68¢

Potatoes



10 Lb. Bag

26

98¢

SALE STARTS TODAY THRU MONDAY, JULY 31st

41 GREAT STORES

NICHOLS

we want to be your store!

CHARGE IT!



SUPPLEMENT TO: • Colonial News • Merchandiser-Corning Leader • Elmira Star • Wooster Record • Free Lance Star • Little Falls Evening Times • Hornell N.Y. Tribune • Salisbury Times • Herkimer Evening Telegram/Scene • Watertown Daily Times • Bloomsburg Press And News • Enterprise/Tomac • Greater Reading Merchandiser • Lancaster Intelligencer Journal And New Era Pa • Martinsburg Journal • Hanover Evening Sun • Hartonsburg Journal • Welco Ad Comp. • Winchester Evening Star • Sun Journal • Kapp Advertising • Carteret County Times • Shopping List • Chambersburg Public Opinion • Canandaigua Journal Messenger/Post • Bath Pennsaver • Ocean County Reporter • Amsterdams Recorder • Carrier Boys of America • Auburn Citizen and Moravia Pennsaver • Mohawk Valley Ad Service • Sentinel News • Star Advocate • Crisfield Times • The Adaptor • The Leader • Greenville Reflector/Shopper • Times Reporter • Observer Dispatch • Delaware State News • Queen Anne Journal • Caroline Journal • Salisbury Advertiser.

SAVE 30¢



STP 10W50 15,000 MILE MOTOR OIL

89¢

OUR REG. LOW PRICE 1.19 qt.

"NEW" 15,000 miles of protection between changes or 1 year under normal driving conditions. That's extra protection!



GIRLS SWIMSUITS

\$1

OUR REG. LOW PRICE 2.99-5.99

Choose any 1 or 2 piece girls bathing suit from our entire stock. Not every style in every size. 3-14.

SAVE 1.39



DELTA FLEA COLLARS BY HARTZ MT.

59¢

OUR REG. LOW PRICE 1.98

Kills fleas and aids in tick control. Keeps pets comfortable up to 3 months.

LIMIT 2 PER CUSTOMER

SAVE 88¢



THUMB THING ELSE LIGHTER

288¢

OUR REG. LOW PRICE 88¢ EA.

With the exclusive pre-set metered flame. Eliminates flare up, needs no adjustment, gives over 2,000 lights. Assorted colors.

NICHOLS KNITTING COUPON

LION BRAND PAMELA® KNITTING YARN

69¢ SKEIN

OUR REG. LOW PRICE 97¢ SKEIN

A superior quality knitting yarn. 4-ply knitting worsted weight. 100% virgin acrylic. Machine washable and dryable. Solids & ombres.

LIMIT 6 PER CUSTOMER

GOOD THRU MON. JULY 31, 1978

WITH THIS COUPON

SAVE 40¢



12 OZ. BLACK FLAG HOUSE & GARDEN

139

OUR REG. LOW PRICE 1.79

With improved SUPER SPRAY for great effectiveness against house insects and garden pests.

SORRY, NO RAINCHECKS ON THESE DOORBUSTERS

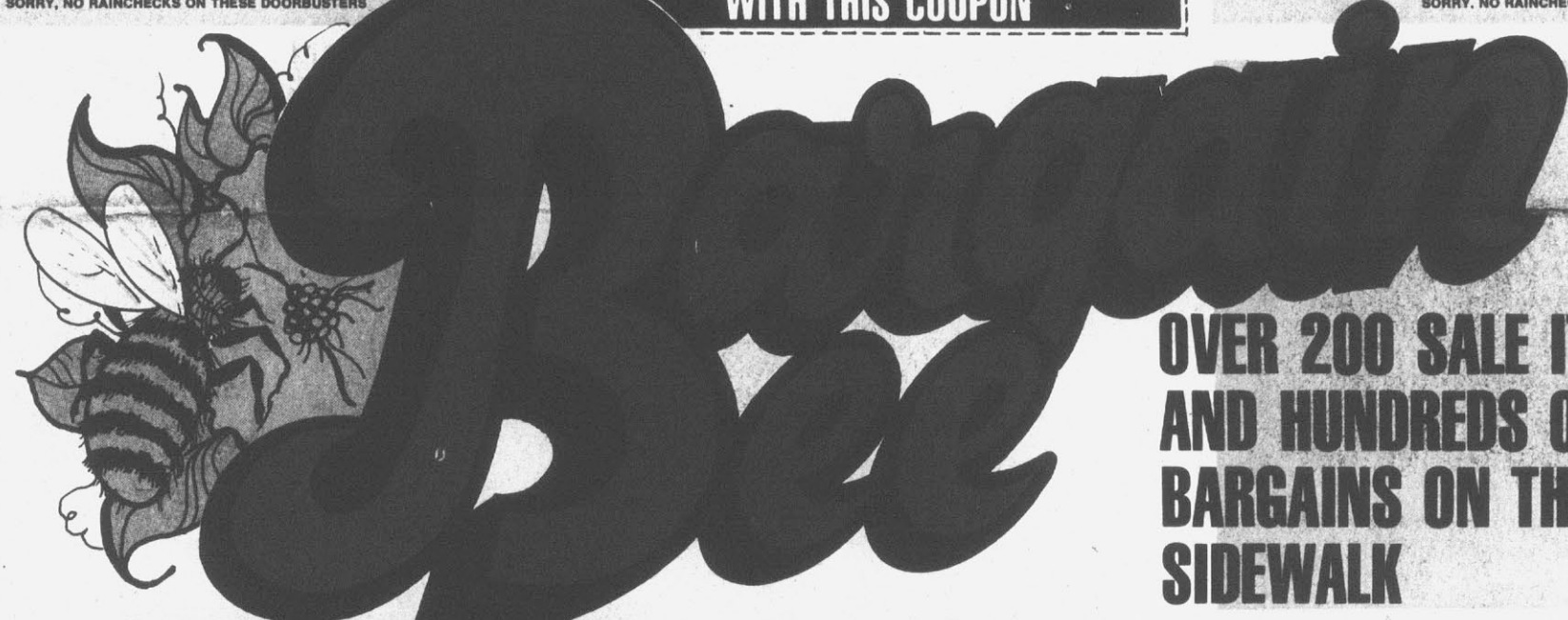

OVER 200 SALE ITEMS AND HUNDREDS OF BARGAINS ON THE SIDEWALK

SUPER BUY! NICHOLS COUPON



2.5 OZ. MENNEN SPEED STICK

Get on the stick. Millions of Americans already have.

WITH COUPON ONLY

79¢ EA.

LIMIT 2 OUR REG. LOW PRICE 1.36

GOOD THRU MON. JULY 31, 1978

GREAT VALUE NICHOLS COUPON



4½ OZ. SUMMERS EVE DISPOSABLE DOUCHE

Ready-to-use, pre-mixed, pre-measured. Use once, then throw away. Regular or herbal.

WITH COUPON ONLY

3 FOR \$1

LIMIT 2 OUR REG. LOW PRICE 2 / \$1.00

GOOD THRU MON. JULY 31, 1978

GREAT VALUE NICHOLS COUPON



11 OZ. NOXZEMA INSTANT SHAVE

Concentrated for closer shaves. Regular, Menthol, Fresh Lime or Wild Forest.

WITH COUPON ONLY

89¢ EA.

LIMIT 2 OUR REG. LOW PRICE 1.29

GOOD THRU MON. JULY 31, 1978

GREAT VALUE NICHOLS COUPON



2.5 OZ. ARRID EXTRA DRY ROLL-ON

New formula anti-perspirant / deodorant. More effective against wetness.

WITH COUPON ONLY

1 09

LIMIT 2 OUR REG. LOW PRICE 1.79

GOOD THRU MON. JULY 31, 1978

SUPER BUY! NICHOLS COUPON



O.B. TAMPONS 30's

Obviously better, more absorbent. Gap-free protection. Natural insertion so you know it's right. Regular, Super or Super Plus.

WITH COUPON ONLY

1 29

LIMIT 2 OUR REG. LOW PRICE 1.86

GOOD THRU MON. JULY 31, 1978

GREAT VALUE NICHOLS COUPON



ANACIN 100's

For fast, long-lasting relief of headache pain and cold miseries.

WITH COUPON ONLY

1 39

LIMIT 2 OUR REG. LOW PRICE 1.73

GOOD THRU MON. JULY 31, 1978

SUPER BUY! NICHOLS COUPON



12 OZ. ALBERTO VO-5 HAIR SPRAY

For an incredible 14 hour hold. Choose from Hard to Hold, Silver - Blonde - Gray - White, Regular or Unscented.

WITH COUPON ONLY

1 17

LIMIT 2 OUR REG. LOW PRICE 1.94

GOOD THRU MON. JULY 31, 1978

GREAT VALUE NICHOLS COUPON



REACH TOOTHBRUSH

Cleans away more of the material that can cause cavities than the two leading toothbrushes.

WITH COUPON ONLY

59¢ EA.

LIMIT 2 OUR REG. LOW PRICE 88¢

GOOD THRU MON. JULY 31, 1978

SUPER BUY! NICHOLS COUPON



3.3 OZ. BASIS SOAP

Super fatted, hypo-allergenic, mildly scented soap.

WITH COUPON ONLY

2 FOR 79¢

LIMIT 2 OUR REG. LOW PRICE 61¢ EA.

GOOD THRU MON. JULY 31, 1978

GREAT VALUE NICHOLS COUPON



24 OZ. SIGNAL MOUTHWASH

New mouthwash and gargle in one. It's more effective than the other.

WITH COUPON ONLY

99¢ EA.

LIMIT 2 OUR REG. LOW PRICE 1.87

GOOD THRU MON. JULY 31, 1978

SUPER BUY! NICHOLS COUPON



3 OZ. JERGENS SOAP

Lotion mild soap with a new fragrance.

WITH COUPON ONLY

8 FOR \$1

LIMIT 6 OUR REG. LOW PRICE 3 / 49¢

GOOD THRU MON. JULY 31, 1978

GREAT VALUE NICHOLS COUPON



7 OZ. BODY ON TAP SHAMPOO

NEW! Brewed with 1/3 real beer for super body, super hold and the shine of your life. Choose from Normal, Dry or Oily.

WITH COUPON ONLY

99¢ EA.

LIMIT 2 OUR REG. LOW PRICE 1.39

GOOD THRU MON. JULY 31, 1978

- | | | | | | | | | | | |
|--|--|---|--|---|--|---|---|---|--|------------------------------|
| DELAWARE
Dover
MARYLAND
Salisbury | NEW JERSEY
Bricktown
Maple Shade
Aberdeen | NEW YORK
Amsterdam
Auburn
Canandaigua
Corning
Gang-Mills | Elmira
Gloversville
Herkimer
Hornell
Marcy (Utica) | New Hartford (Utica)
Watertown
NORTH CAROLINA
Gastonia
New Bern | Greensboro
Greenville
Hickory
Lumberton
Wilson | OHIO
Ashtabula
New Philadelphia
Wooster
Annnville | Bloomsburg
Chambersburg
Ephrata
Hanover
Lancaster | Mt. Penn (Reading)
Muhlenberg (Reading)
Shillington (Reading)
Williamsport | VIRGINIA
Colonial Heights
Fredericksburg
Harrisonburg
Winchester | WEST VIRGINIA
Martinsburg |
|--|--|---|--|---|--|---|---|---|--|------------------------------|

WE RESERVE THE RIGHT TO LIMIT QUANTITIES

NOT RESPONSIBLE FOR TYPOGRAPHICAL ERRORS.

TAB. 428 RUNS WED. JULY 26, 1978

NICHOLS WORLD OF JEANS



4⁹⁹

BOYS "GERANIMALS" DENIM JEANS

Rugged jeans for the into-everything boy, with double knee for extra wear, 2 Western pockets in front and 2 patch pockets in back. 75/25 polyester & cotton. Navy. 8-14 reg. & slims.

5⁸⁸

MENS WESTERN JEANS

Wow what a price for rugged comfort with great looks. 50% polyester and 50% cotton twill for instant wearing comfort, 2 front scoop pockets, 2 back patch pockets, yoke back and belt loops. Navy, black, lt. blue, olive and khaki. 29-38.

8⁸⁸

JUNIORS & MISSES PRE-WASHED DENIM JEANS

A terrific selection at a great low price! All styles pre-washed for softness and comfort. You'll love the selection, but hurry in early, at this price they'll be an early sell-out. 100% cotton denim. Navy only. 5-15 and 6-16.

OUR REG. LOW PRICE 10.97 TO 12.97

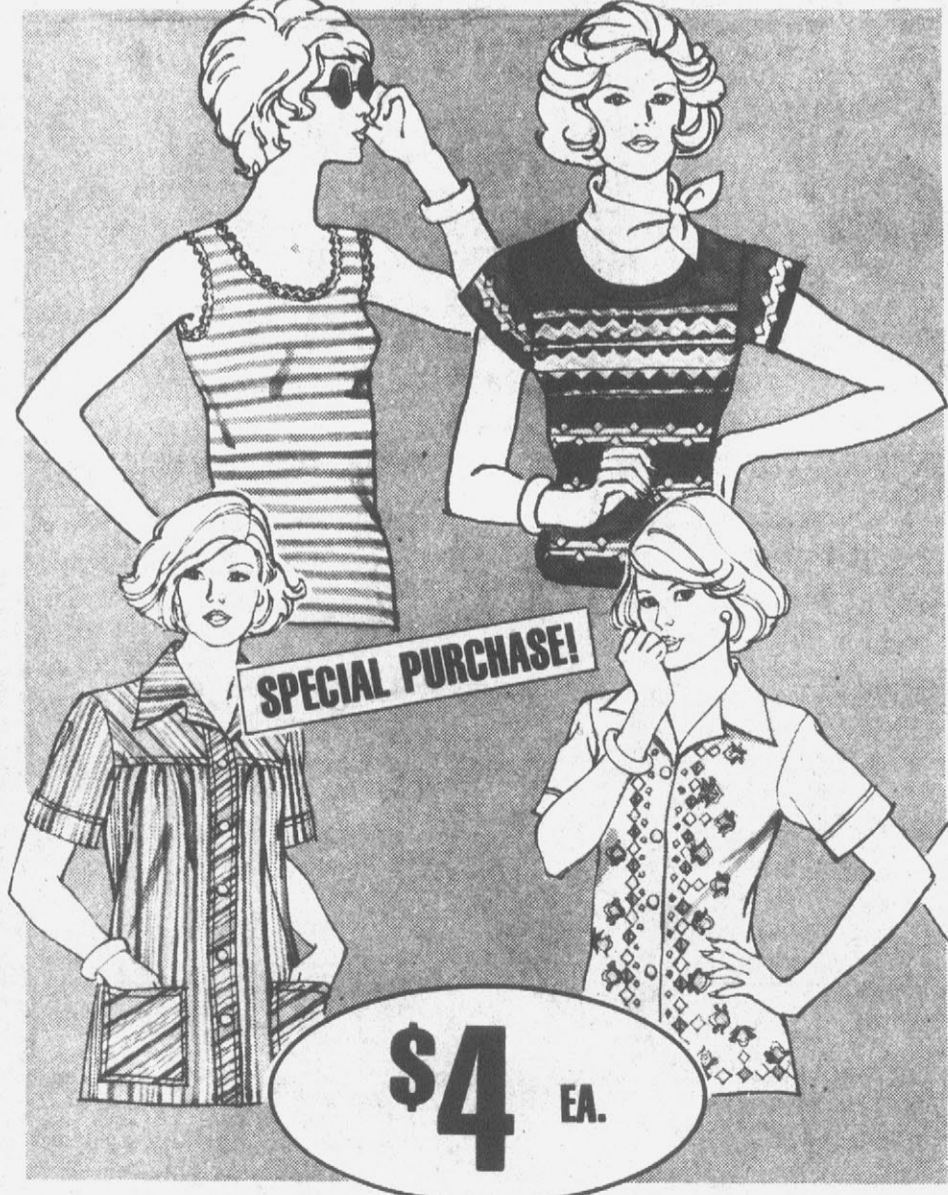

SPECIAL PURCHASE!

\$4 EA.

MISSES & EXTRA SIZE POLYESTER BLOUSES

Add just the right look with a tunic or smock style blouse of easy care polyester in solids, prints and stripes, some with embroidery or lace trim. Colors galore. S-M-L, 38-44.

JUNIOR & MISSES FASHION TOPS

Check out this terrific assortment of styles, colors and sizes in short sleeve, sleeveless and tank styles in machine washable cotton or poly/ cotton, you're sure to find several at Nichols low prices. S,M,L.

STYLES SHOWN ARE REPRESENTATIVE OF THE GROUP. NOT EVERY STYLE IN EVERY STORE.



SPECIAL PURCHASE!

\$2 EA.

MISSES & EXTRA SIZE SKIRTS

\$3

Free and breezy styling including beautifully belted models and some smashing pull-ons. All are carefree polyester or acrylic in a great assortment of colors. Sizes 8-18 and 32-38.

EXTRA SIZE SHELLS & TANKS

Now get two for the original price of one! Cool tops that are pure flattery for the fuller figure. Easy care nylon or polyester in the prettiest colors. 42-44-46. NICHOLS REG. LOW PRICE \$4

MISSES & EXTRA SIZE SKIVVY TOPS

Here's another 50% saving for you! Choose cap sleeve, boat and "V" neck style with lots of details like ric-rac, fancy stitching, lace trims and more. S,M,L, 40-44. NICHOLS REG. LOW PRICE \$4

NICHOLS



GIRLS JUMPERS

The School Bell will soon be ringing to call the young scholars back to their studies. Send her back in a NEW VISA® double knit polyester jumper. She'll love the lace trim and flounce bottom in solid colors and some two-tones. For big and little sister in sizes 4-14.

\$4

SPECIAL PURCHASE!

GIRLS TURTLE NECK TOPS

Great go togethers with pants, skirts and jumpers. 100% rib knit nylon for great fit and easy care. Back zipper. Long sleeves. Lots of colors. Sizes 4-14.

YOUR CHOICE **\$2**

GIRLS SLACKS

Great to wear anytime, anywhere. Double knit polyester flare leg slacks in new fall solid colors. Tunnel elastic waist assures snug fit. Plenty of colors. Sizes 4-14.

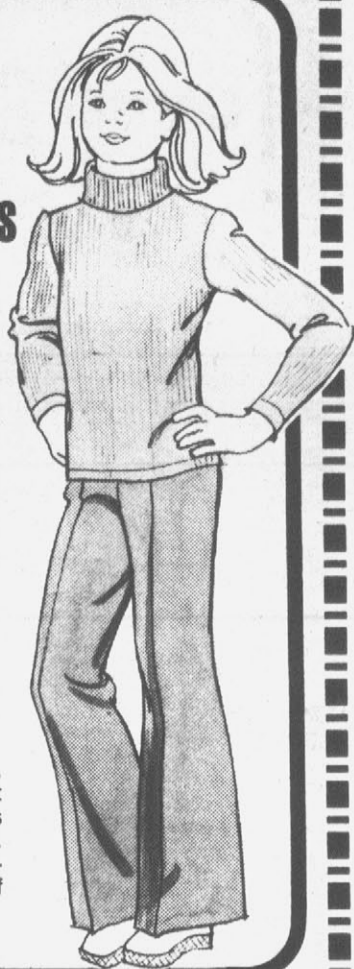

CURITY BABY SPECIALS



SOFT CARE OR PREFOLD DIAPERS

5²⁷

OUR REG. LOW PRICE 7.29

21x40" CURITY GAUZE DIAPERS

6⁹⁷

CURITY DIAPER LINERS... 2.27
OUR REG. LOW PRICE 2.89

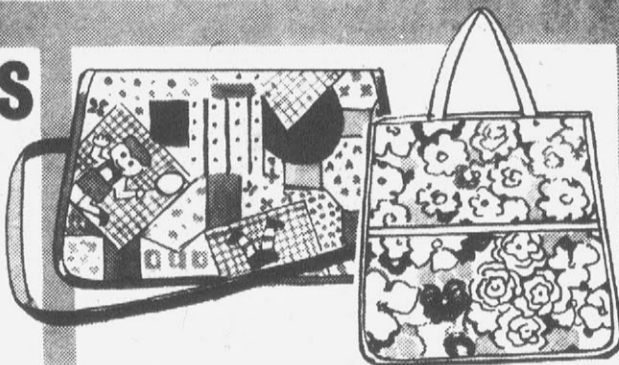

DIAPER BAGS BY DAUST

Choose large tote or carry and shoulder styles. Assorted prints in wipe clean vinyl. Fully insulated.

4²⁷ TO 5²⁴

OUR REG. LOW PRICE 8.29 TO 7.59



Chix by Dundee® INFANTS 80 SQUARE FITTED CRIB SHEETS

WHITE **2²⁴**

OUR REG. PRICE 3.19

PASTELS OR PRINTS **2⁵⁴**

OUR REG. PRICE 3.59

PILLOWCASES **1¹⁹**

SPECIAL PURCHASE!

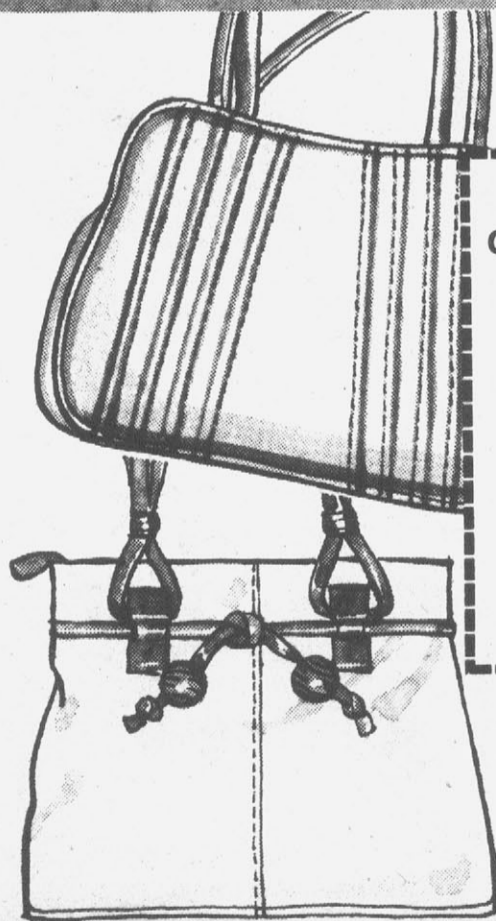

WITH COUPON

\$2 OFF OUR REG. LOW PRICES

REG. PRICED AT 5.44-5.99

LADIES LEATHER LOOK AND CANVAS HANDBAGS

Exciting new styles... all the shapes you love! Swinging shoulder straps, comfortable short shoulders, neat and compact double handle, cut out handle and umbrella bag styles. Black, dark and light tan and burgundy.

GOOD THRU MON. JULY 31, 1978



SAVE \$3

DIAMOND DELUXE CAMERA CARRYING CASE

17⁷⁵

OUR REG. LOW PRICE 20.75

Will hold and protect most 35mm cameras. Also stores lenses, flash units, film, and other accessories.



SAVE \$3

BERKEY KEYSTONE TELE LENS POCKET CAMERA

16⁴⁹

OUR REG. LOW PRICE 19.49

NEW! The XR camera with the extended range capability. The perfect camera to take on your vacation trips.

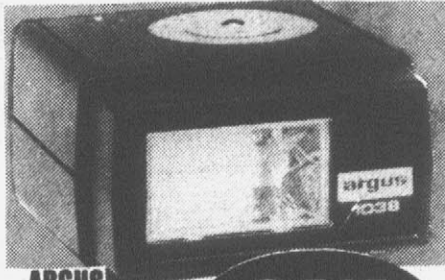

ARGUS AUTOMATIC COMPACT ELECTRONIC FLASH FOR 35mm CAMERAS

24⁹⁵

SPECIAL PURCHASE

Designed especially for all the new compact 35 MM cameras. Don't need flashbulbs.

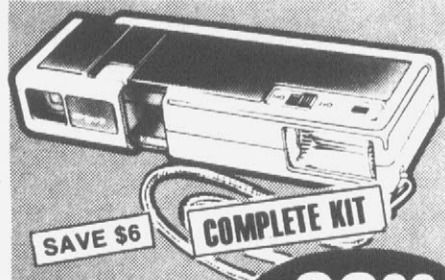

SAVE \$6

COMPLETE KIT

NEW ARGUS MINI PALMATIC 2 WITH BUILT-IN ELECTRONIC STROBE

29⁹⁹

OUR REG. LOW PRICE 35.99

A design award winner that features a fast 1/5.6 all glass, 3 element lens; 1/200 of a sec. speed for freezing action shots and much more. Includes film & batteries.



ELECTRONIC FLASH UNIT BUILT RIGHT IN

SAVE \$6

\$39

OUR REG. LOW PRICE 45.99

Color corrected 1/5.6 coated lens. Uses 126 instant load film. Up to 100 flashes from 2 AA batteries. Electric eye.



SAVE \$25

274⁹⁹

OUR REG. LOW PRICE 299.99

A full featured 35mm camera with a 1/1.7 lens for the photographer who demands professional quality equipment.

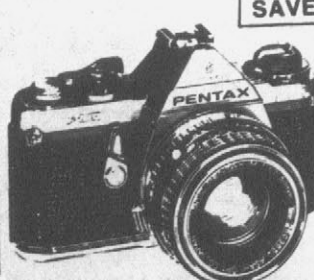

SAVE \$25

THE NEW PENTAX ME

284⁹⁹

OUR REG. LOW PRICE 309.99

The world's smallest, fully-automatic easy-to-use 35mm SLR. Fully automatic electronic exposure system.

NICHOLS

HOME CANNING TIME IS HERE!

MIRSA SHELVING

NICHOLS OFFERS YOU HEAVY DUTY SHELVING TO TAKE CARE OF ALL YOUR HEAVY DUTY SHELVING PROBLEMS AT A PRICE YOU CAN AFFORD.

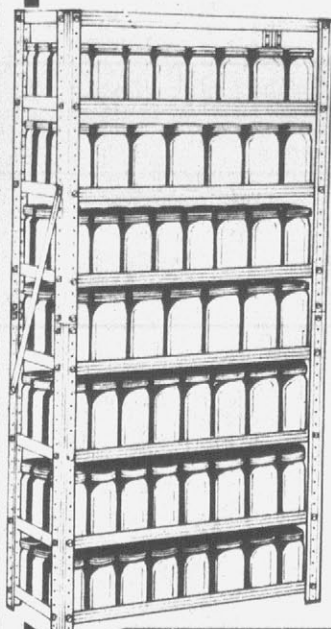

8 SHELF HEAVY DUTY CANNING CENTER UNIT

19⁹⁹

Store jars, cans and other household items. 60"Hx30"Wx12"D.

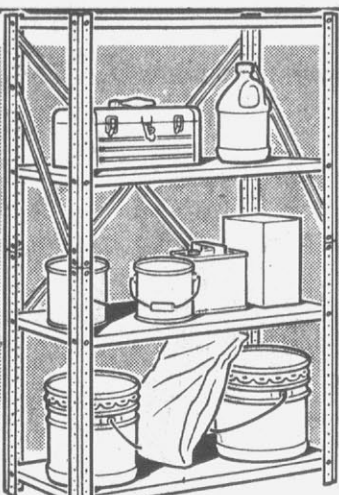

4 SHELF HEAVY DUTY UNIT

Unit measures 60"H x 30"W x 12"D. Store summer tools and accessories.

11⁴⁹

OUR REG. LOW PRICE 15.99



16 QUART PRESERVING KETTLE

5⁹⁹

OUR REG. LOW PRICE 6.49



11 QUART 7 OZ. MINI CANNER

6⁹⁹

OUR REG. LOW PRICE 8.59



21 QUART 16 OUNCE CANNER

8⁹⁹

OUR REG. LOW PRICE 10.59

BE SURE YOU CHECK OUR LOW, LOW PRICES ON QUALITY "BRAND NAMES" OF CANNING AND KITCHEN HELPERS, BOARDS, MEASURING CUPS, BOWLS AND SPOONS AND MANY OTHER ITEMS. ALSO AVAILABLE WHILE THEY LAST

- Canning racks and freezer racks
- Paraffin Wax



BALL STANDARD MASON JARS



1/2 PT. SIZE CASE OF 12

#60

1⁹⁹



1 PT. SIZE CASE OF 12

#61

2⁴⁹



1 QT. SIZE CASE OF 12

#62

2⁸⁹



WIDE MOUTH JARS

1 QT. SIZE CASE OF 12

#67

3²⁹



JELLY JARS

8 OZ. SIZE PKG. OF 12

#808

1⁴⁹



QUILTED JELLY JARS

8 OZ. SIZE PKG. OF 12

#812

2⁶⁹



12 OZ. QUILTED DELUXE

PKG. OF 8 JELLY JARS

#814

2⁷⁹

ALSO AVAILABLE
Standard Replacement Lids . . 3 PKGS \$1
Wide Mouth Replacement Lids 2 PKGS \$1



BALL FREEZER BOXES
1⁴⁹

OUR REG. LOW PRICE 2.09

Choose from:
 • 1 pt. box of 6
 • 1 1/2 pt. box of 5
 • 1 qt. box of 4
 • 2 qt. box of 2



SAVE 22¢

BALL FREEZER BAGS
YOUR CHOICE
39¢

OUR REG. LOW PRICE 61¢ EA.

Choose from:
 • Pint bags box of 30
 • 1 1/2 pint bags box of 25
 • Qt. bags box of 20
 • 2 qt. bags box of 12

SAVE WITH OUR LOW PRICES...SAVE AGAIN WITH DU PONT'S



OUR LOW SALE PRICE **\$7⁹⁹** Reg. 9.99
 LESS DU PONT'S CASH BACK **\$1⁰⁰**
 YOUR COST AFTER RECEIVING DU PONT'S CASH BACK **\$6⁹⁹**

\$1⁰⁰ CASH BACK
 per gallon
from DuPont
 on every gallon of LUCITE you buy!
 Details at store display.

DU PONT RECENTLY ANNOUNCED A PRODUCT PRICE INCREASE FOR THE VERY NEAR FUTURE. NICHOLS IS HOLDING THE LINE ... BUT WE URGE YOU TO BUY YOUR PAINT NOW ... WHILE PRICES ARE LOW!

STOCK UP NOW AND SAVE AT THESE GREAT LOW PRICES

No Limit!

The more you buy, the more you save!



OUR LOW SALE PRICE **\$8⁹⁹**
 LESS DU PONT'S CASH BACK **\$1⁰⁰**
 YOUR COST AFTER RECEIVING DU PONT'S CASH BACK **7⁹⁹** Reg. 11.99



Your cost after CASH BACK **10⁹⁹** GAL. Reg. 13.99



Your cost after CASH BACK **7⁹⁹** GAL. Reg. 10.99



Your cost after CASH BACK **10⁹⁹** GAL. Reg. 13.99

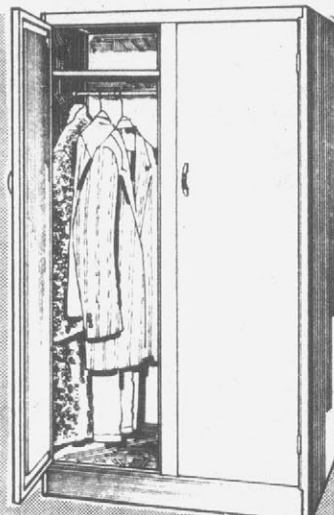

SAVE \$8

DOUBLE DOOR WARDROBE
31⁹⁹

OUR REG. LOW PRICE 39.99

Dimensions measure: 24"W x 20"D x 64"H. Double door and hat shelf. Tan color.

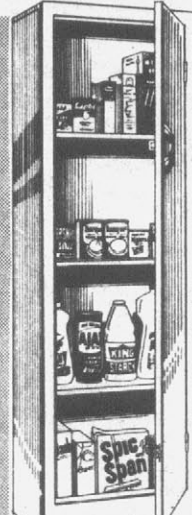

SAVE \$7

SINGLE DOOR UTILITY CABINET
21⁹⁹

OUR REG. LOW PRICE 28.99

Dimensions measure: 18"W x 12"D x 58"H. Single door in white only.

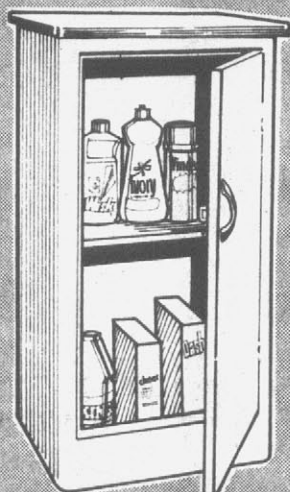

SAVE \$7

SINGLE DOOR BASE CABINET
21⁹⁹

OUR REG. LOW PRICE 28.99

Dimensions measure: 20"W x 16"D x 36"H. Single door and 2 shelves. In white only.

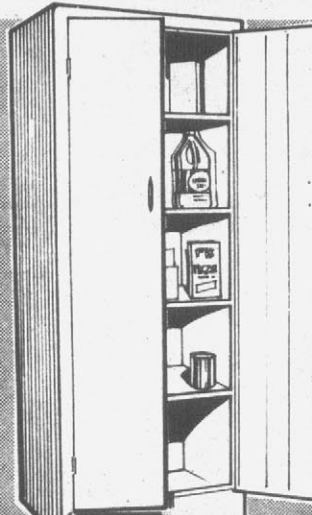

SAVE \$8

DOUBLE DOOR UTILITY CABINET
31⁹⁹

OUR REG. LOW PRICE 39.99

Dimensions measure: 24"W x 12"D x 64"H. Double door with 5 shelves. In white or harvest gold.

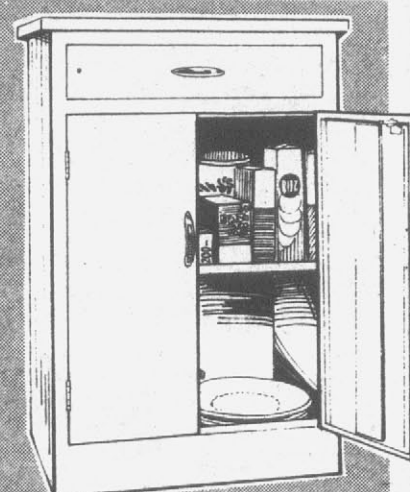

SAVE \$8

DOUBLE DOOR BASE CABINET
31⁹⁹

OUR REG. LOW PRICE 39.99

Dimensions measure: 24"W x 18"D x 36"H. Double door with cutlery drawer and 2 shelves. In white or harvest gold.

BARGAIN BEE SIDEWALK SALE!

NICHOLS



MISSSES TEE TOPS

\$3

Popular styles with cap sleeves, sleeveless and tank tops. Poly/cotton and polyester. Solid & prints. S-M-L.

STYLES SHOWN ARE REPRESENTATIVE OF GROUP.



JR. BOYS WESTERN DENIM JEANS

333

OUR REG. PRICE 4.97
Four pocket models with flare leg and contrast stitching. 100% cotton navy denim. Sizes 4-7.

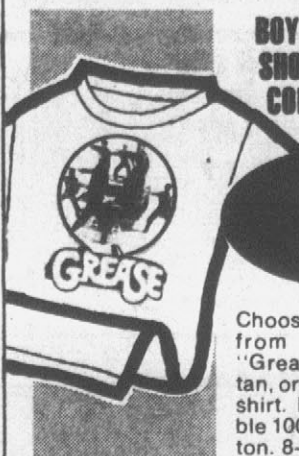

BOYS "GREASE" SHORT SLEEVED COLORED TEES

277

Choose from 4 scenes from the hit movie "Grease" on a blue, tan, orange or gold Tee shirt. Machine washable 100% interlock cotton. 8-18.



INFANTS AND TODDLERS SUMMER CLEARANCE

50c EA

SAVE 50% EA.

OUR REG. \$1.00

Fantastic 50% reduction on all shorts, polos, tank tops, hal- ters, mix 'n' match.



MISSSES POLYESTER PANTS

\$3

Choose solids, novel- ties or jacquards in comfortable pull-on styles of machine washable polyester. 10-18 and limited quantities in 32-38.



SAVE 5.11

Scholl

DR. SCHOLL EXERCISE SANDALS

Once you kick on Scholl exercise sandals you may never want to wear shoes again. Limit 2 pr. per customer.

999

OUR REG. LOW PRICE 13.86

8-TRACK AND CASSETTE SALE

SUPER SAVINGS ON OUR EN- TIRE STOCK OF 7.98 SERIES 8-TRACK AND CASSETTES.

- Conway Twitty/Loretta Lynn
-Honkey Tonk Heros
- Barry ManilowEven Now
- Andy Gibb ..Shadow Dancing
- HeartMagazine
- And Many, Many More.



499

CODE G



SUPER SPECIAL! NATALIE COLE "LIVE"

11.98 LIST

799

CODE DD

11.98 SERIES



MENS GYM TRUNKS

\$2

Action cut with con- trast taped vented leg and elastic top. 50/50 poly/ cotton twill. White, navy, red, green. S-M-L-XL.

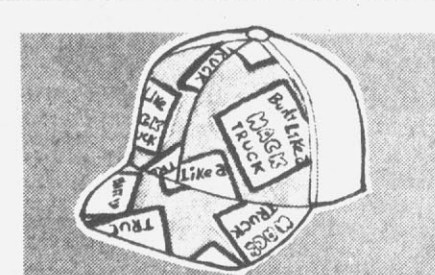

MENS LOGO CAP

\$1

Choose from sev- eral printed logos on a peak front, mesh back and adj. cap in asstd. col- ors.

OUR REG. LOW PRICE 2.49



DOW 17 OZ. BATHROOM CELANER AEROSOL

Let the magic scrub- bing bubbles do the work for you. Just spray and wipe.

SAVE 19¢

88c

OUR REG. PRICE 1.07

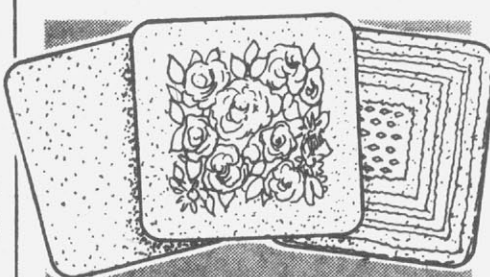

ASSTD'. OF BETTER GRADE WASHCLOTHS

Slight irregularities will not affect the wear or looks. Sol- ids stripes and jac- quards from a fam- ous mill.

2 FOR \$1

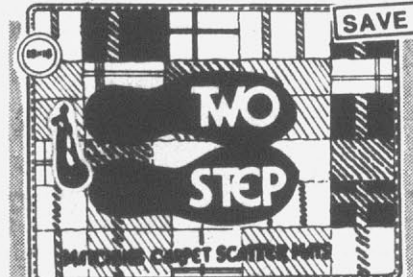

SAVE 30¢

"TWO STEP" MATS

Matching carpet scatter mats for home or car in as- sorted colors. 13"x18" size with foam backing.

69c

PKG OF 2

OUR REG. LOW PRICE 99¢ PKG.

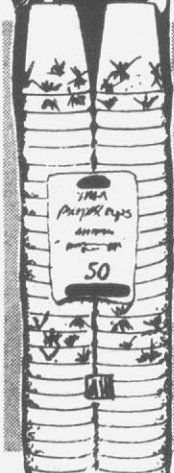

50 COUNT ALL PURPOSE FOAM CUPS

Perfect for indoor and outdoor use. Keeps beverages cold or hot longer. 6.4 oz. size. Limit 2 pkgs. per cus- tomer. #6JP50.

59c



16 OZ. VANISH LIQUID

With Chloride Plus powder to clean, disin- fect and deodorize bathroom bowls in mi- nutes.

SAVE 15¢

49c

OUR REG. PRICE 64¢



WINCHESTER WILDCAT .22 LONG AMMO

Hard hitting shells with non- corrosive priming. Double action smokeless powder will not cause rust or corrosion.

88c

BOX OF 50 OUR REG. LOW PRICE 99¢

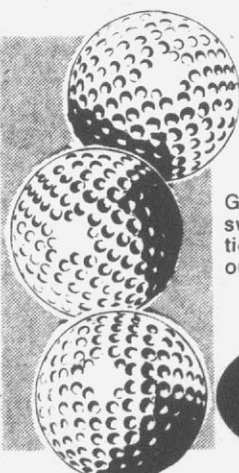

PRACTICE GOLF BALLS

Golfers, sharpen your swing! 36 hollow plas- tic balls for indoor or outdoor practice.

127

OUR REG. PRICE 1.99

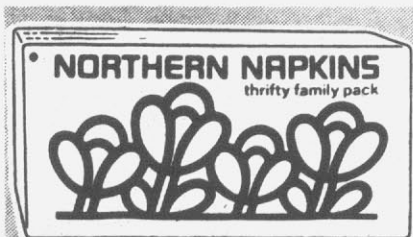

NORTHERN NAPKINS

thrifty family pack

NORTHERN 140 COUNT WHITE EMBOSSED NAPKINS BY DIXIE

Thrifty family pack. Economical for everyday use and pretty enough for entertaining.

49c



4 OZ. TRIAL SIZE SPRAY 'N WASH AEROSOL

4 FOR 99c

Just spray on tough stains and heavily soiled laundry and throw it in the wash.

YOUR SUMMER MEMORIES

NICHOLS FILM DEVELOPING SPECIALS

Color Reprint SPECIAL COUPON

Receive 5 reprints from your favorite color negatives.

Any combination of the same size negatives accepted. No slides or foreign films please.

5 ONLY 99c WITH COUPON

GOOD THRU MON. JULY 31, 1978

GUNK ENGINE BRITE DEGREASER

POPULAR MECHANIC PRICED VALUE

99c

SAVE 60¢

OUR REG. PRICE 1.59

America's #1 engine cleaner. Especially formulated selfemul- sifying degreaser for auto, marine and any other engine.

Enlargement SPECIAL COUPON

99c

WITH COUPON

2-5x7 Photos

FROM YOUR FAVORITE COLOR NEGATIVE

GOOD THRU MON. JULY 31, 1978

Color Print Film DEVELOPING AND PRINTING COUPON

299

20 EXP. ALL SIZES

Coupon must accompany order. Foreign film and slides not included.

GOOD THRU MON. JULY 31, 1978

VENTILATED COOL CUSHION

SAVE 50¢

179

OUR REG. PRICE 2.29

Multi-colored fiber with black binding. 30"x15 1/2" size. #E-15/60-0116.

SCRANTON ALUMINUM EXTENSION LADDERS

18'	OUR REG. 35.88	28 ⁹⁹
20'	OUR REG. 47.88	37 ⁹⁹
24'	OUR REG. 59.88	49 ⁹⁹
28'	OUR REG. 73.88	59 ⁹⁹
32'	OUR REG. 91.88	74 ⁹⁹
36'	OUR REG. 105.88	88 ⁹⁹
40'	OUR REG. 125.88	99 ⁹⁹

SAVE \$7.928

Color Print Film DEVELOPING AND PRINTING COUPON

199

12 EXP. ALL SIZES

Coupon must accompany order. Foreign film and slides not included.

GOOD THRU MON. JULY 31, 1978

Color Print Film DEVELOPING AND PRINTING COUPON

339

35 MM 24 EXP.

Coupon must accompany order. Foreign film and slides not included.

GOOD THRU MON. JULY 31, 1978

NICHOLS APPLIANCE "BARGAIN BEE" CHARGE IT!

UNIVERSAL 10.4 CU. FT. FREEZER
219⁷⁷
 SPECIAL PURCHASE!
 •3 fast freeze shelves
 •Holds approx. 364 lbs. of frozen food
 •Lock & key
 •Full door racks and storage bin.

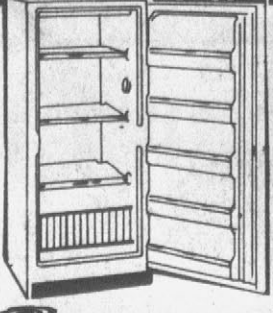

FAMOUS MAKE 12" Diagonal PORTABLE TV
62⁷⁷ **SAVE \$15**
 OUR REG. LOW PRICE 74.88
 •100% solid-state
 •UHF/VHF antenna
 •Modern lightweight cabinet
 •Earphone



G.E. ELECTRIC DRYER
139⁶⁶ **SAVE \$40**
 OUR REG. LOW PRICE 179.66
 •Family size drum
 •Start button
 •Removable up front lint trap.

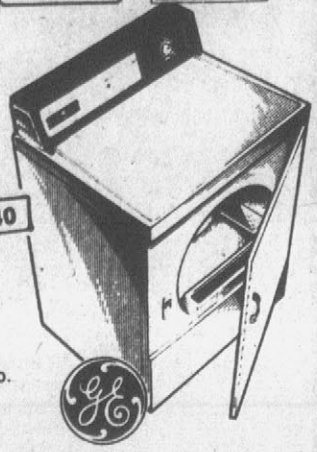

Whirlpool 12.0 CU. FT. REFRIGERATOR
289⁷⁷ **SAVE \$40**
 OUR REG. LOW PRICE 329.88
 •Automatic defrosting
 •2.74 cu. ft. top freezer
 •Slide out shelves
 •Double door



TATUNG 19" Diagonal PORTABLE TV
112⁷⁷ **SAVE \$27**
 OUR REG. LOW PRICE 139.88
 •100% solid state
 •Simulated walnut grain cabinet
 •Advanced design chassis
 •Earphone



G.E. HEAVY DUTY AUTOMATIC WASHER
219⁶⁶ **SAVE \$20**
 OUR REG. LOW PRICE 239.66
 •Big family size tub
 •Heavy duty G.E. motor
 •Filter-flo washing traps lint



UNIVERSAL COMPACT 8.23 CU. FT. CHEST FREEZER
189.77
 OUR REG. LOW PRICE 209.88
 •Holds approx. 288 lbs. of food
 •Lock & Key
 •Slide & store basket
 •Adjustable thermostat
 •Ideal for home use



ZENITH 17" Diagonal CHROMACOLOR PORT. TV
299⁷⁷ **SAVE \$30**
 OUR REG. LOW PRICE 329.88
 •100% solid state
 •Automatic tint guard
 •Brilliant picture tube
 •Automatic color clarifier



GIBSON 5,000 BTU AIR CONDITIONER
169⁶⁶ **SAVE \$20**
 OUR REG. LOW PRICE 189.77
 •115 volts
 •Thermostat
 •2-speeds
 •Easy, quick installation

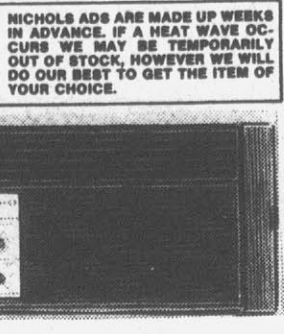

Whirlpool 19.1 CU. FT. REFRIGERATOR W/BOTTOM FREEZER
489⁷⁷ **SAVE \$50**
 OUR REG. LOW PRICE 539.88
 •100% frost-free
 •Big bottom storage
 •4 adjustable shelves
 •Slight charge for color.



ZENITH 23" Diagonal CHROMACOLOR II CONSOLE TV
469⁷⁷ **SAVE \$60**
 OUR REG. LOW PRICE 529.88
 •100% solid state
 •Color sentry system
 •Automatic fine tuning
 •Electronic video tuning
 •Contemporary walnut finish.



Emerson 28" CONSOLE STEREO WITH 8-TRACK PLAYER
239⁷⁷ **SAVE \$20**
 OUR REG. LOW PRICE 259.88
 •Authentic looking "roll-top desk"
 •AM/FM stereo
 •BSR automatic changer
 •Early American maple cabinet



HARDWICK 30" DELUXE GAS RANGE
259⁷⁷ **SAVE \$20**
 OUR REG. LOW PRICE 279.88
 •Variable heat surface burners
 •Oven door window
 •Clock & timer
 •Custom trim kit.



RCA 19" Diagonal COLOR PORTABLE XL-100, EXTENDED LIFE CHASSIS
329⁷⁷ **SAVE \$30**
 OUR REG. LOW PRICE 359.88
 •100% solid state
 •Front controls and speaker
 •Simulated walnut grain cabinet



PRECOR AM/FM STEREO WITH 8-TRACK PLAYER & BSR RECORD CHANGER

•Integrated circuit •Lighted slide rule dial •Stereo indicator
 •8-track program indicator lights
 •Stereo headphone, tape and phono jacks •Many more deluxe features. #0228N/5605

79⁹⁹
 OUR REG. LOW PRICE 99.99

DUST COVER INCLUDED
 SORRY, NO RAINCHECKS-LIMITED QUANTITIES

Emerson. FWAM/LEAF DIGITAL CLOCK RADIO

YOUR CHOICE 19⁹⁹

Emerson. TV1/TV2 FWAM PORTABLE RADIO BATTERY OR ELECTRIC

Emerson. PORTABLE CASSETTE TAPE RECORDER WITH BUILT IN CONDENSER MICROPHONE. BATTERY OR ELECTRIC

BILTRITE PROMOTIONAL SWING W/MOTOR
12⁹⁹ **SAVE \$5**
 OUR REG. PRICE 17.99
 Built for durability, comes with 15 minute motor.

BILTRITE UMBRELLA TYPE STROLLER
14⁸⁸ **SAVE 5.11**
 OUR REG. PRICE 19.99
 Lightweight chrome steel & wheels. Folds flat.

BILTRITE CRIB PLAYGROUND
33⁹⁹ **SAVE \$10**
 OUR REG. PRICE 43.99
 Portable mesh crib playground. Padded top rail. 40"x40"

A. HAIR & FOAM MATTRESS
16⁹⁹
 OUR REG. PRICE 26.99
 Foam core construction for durability. Standard thickness.

B. CAR BED CAR SEAT
29⁹⁹ **SAVE 14.89**
 OUR REG. PRICE 44.88
 Double action reclining mechanism. Deluxe upholstered pad with quard rail & 5 point restraint system.

C. CONTOURED BOLSTER CHAIR
6⁹⁹ **SAVE 1.50**
 OUR REG. PRICE 8.49
 Non-skid, non-scratch bottom. Durable, easy to clean material. Foam padded with sturdy safety straps.

D. NURSERY TRAINING CHAIRS
7⁸⁸ **SAVE \$2**
 OUR REG. PRICE 9.88
 Rugged dowels, high molded plastic contour backs, easy to clean plastic trays, safety straps.

E. 9" ALL AROUND BUMPER
6⁹⁹ **SAVE \$3**
 OUR REG. PRICE 9.99
 Safety guard attachment. Extra height. Comfy foam filled. Vinyl print covered. Elastic tie tapes.

FANTASTIC AUTOMOTIVE BUYS!

NICHOLS

Hallmark DOUBLE BELTED WHITEWALLS

A Division of Kelly Springfield

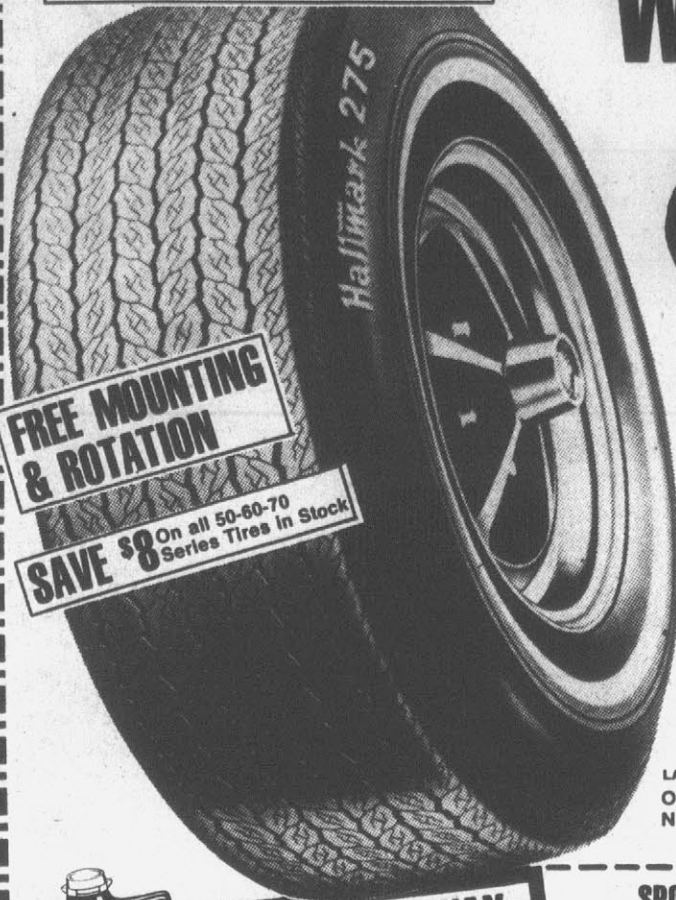

1988

A78-13 PLUS
1.71 F.E.T.

Two plies of polyester cord topped by two fiberglass belts for mileage, resistance from punctures, and stability.

26⁸⁸

B78-13, D78-14, E78-14, F78-14 Plus 1.82 to 2.34 F.E.T. depending on size.

32⁸⁸

G78-14, G78-15, H78-14, H78-15, L78-15 Plus 2.47 to 3.05 F.E.T. depending on size.

LANCASTER CUSTOMERS... VISIT OUR EPHRATA PA. STORE
OUR NEW ELMIRA, N.Y. AND DOVER, DEL. AUTO CENTER
NOW OFFER MORE COMPLETE CAR SERVICE

SHOP SPECIALS

O.E.M. REPLACEMENT SHOCK ABSORBERS

888 EA.

INSTALLED PLUS ANY PARTS NEEDED

Original owner lifetime warranty. 1 inch bore for extra performance. Fits most cars.

LEE PREMIUM MUFFLER

1888

INSTALLED

Leakproof seams. Triple wrapped body sheet metal. Completely welded internal supports.



SPARKOMATIC CO-AXIAL STEREO SPEAKER SET

24⁹⁴

Two 5 1/4" air suspension woofers with built-in 2" tweeters. Black padded press-on grills. #SK-620C

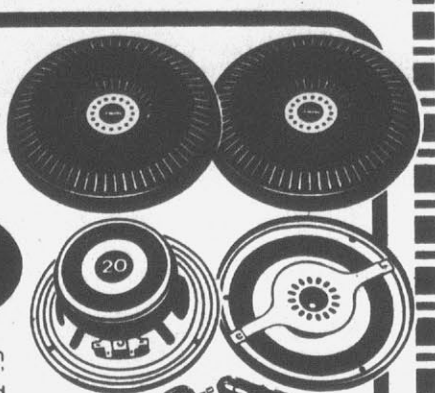

DURABLE AUTO TOP CARRIER

677

OUR REG. PRICE 8.99
Nylon gutter and lashing straps. 42". Ideal for large objects.



ADJUSTABLE 1 1/2 TON JACK STAND

287

OUR REG. PRICE 4.49
Engineered for maximum load capacity. Ideal for cars, boats, trailers, etc.



NEW CAR PLATE

Johnson WAX

SAVE 80¢ **1.99**

OUR REG. LOW PRICE 2.79
Cleans, shines and resists surface rust. For old and new cars.

JR. WEST COAST MIRROR ASSEMBLY

1289

OUR REG. LOW PRICE 15.99
Rod-thru head assembly fits standard windows. Adjustable mounting. Chrome.

SAVE 3.10
#63688

DUAL SPORT MIRRORS

Low, wide custom look w/black head. Can be painted to match car color. Chrome base. OUR REG. PRICE 12.99
CHROME #39510.77 pr.

977

SPORTY WHEEL COVERS FOR THAT CLASSIC LOOK

- | | |
|---|---|
| <p>TRIM RIMS
5⁹⁹ EA.
Chrome trim rings. Fits 13, 14, and 15" wheels.</p> | <p>JET MAGS
7⁹⁹ EA.
GT sport look wheel covers. Fits 13, 14, 15" wheels.</p> |
| <p>GEMINI FULL WHEEL SPORT COVER
9⁹⁹ EA.
Chrome reverse styling. Fits 14 and 15" wheels.</p> | <p>CHROME WIRE SPOKE
17⁹⁹ EA.
A sporty look for 14 & 15" wheels. Stay tight Saf-Loc rings.</p> |

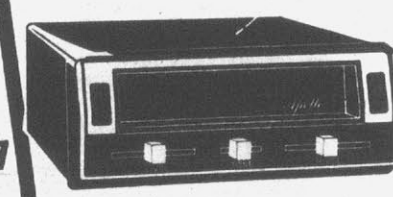

ROMAN 8-TRACK STEREO TAPE PLAYER

1888

#AP15
Compact engineering for a powerful, a reliable player. Individual slide controls for stereo volume, 2 position tone control, track selector.

CHARGE IT!



25% OFF

OUR REGULAR LOW PRICES

PATIO, PICNIC, GARDEN YELLOW TAG SALE

CHOOSE FROM:

LAWN MOWERS, CHAISE PADS, TORCH LIGHTS, BAR-B-QUES, ALUMINUM CHAIRS AND CHAISES, PICNIC CHESTS, PATIO LIGHTS, HIBACHIS, AND MUCH MORE.

STORE STOCK ONLY

SORRY...NO RAINCHECKS. NOT ALL ITEMS AVAILABLE IN ALL STORES. BLACK & DECKER GARDEN TOOLS NOT INCLUDED.



NICHOLS COLORFUL WHITE SALE!

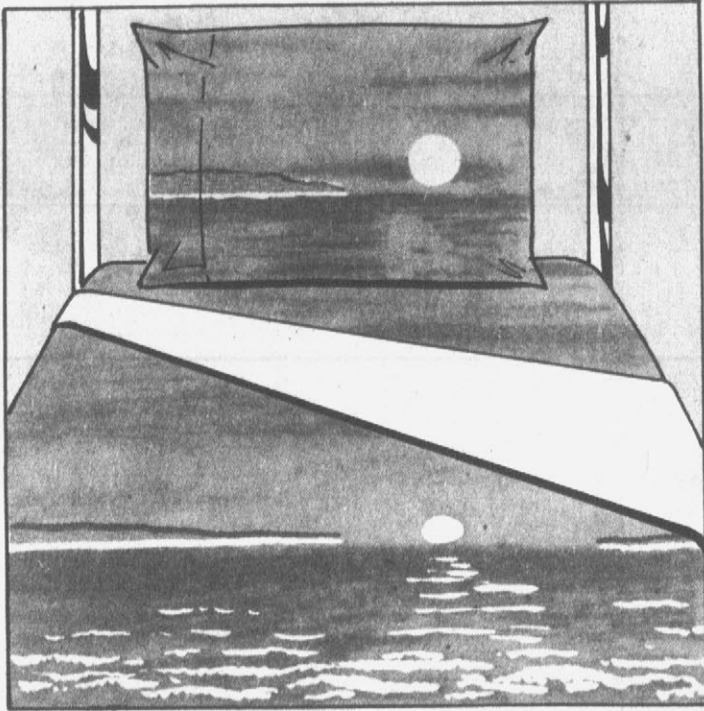

PILLOWCASES
2⁹⁹
pkg. of 2

OUR REG. LOW PRICE 3.79 pkg. of 2

TWIN FLAT OR FITTED
26⁹⁹

OUR REG. LOW PRICE 4.49 EA.

TWIN FLAT OR FITTED
28⁹⁹

OUR REG. LOW PRICE 5.69 EA.

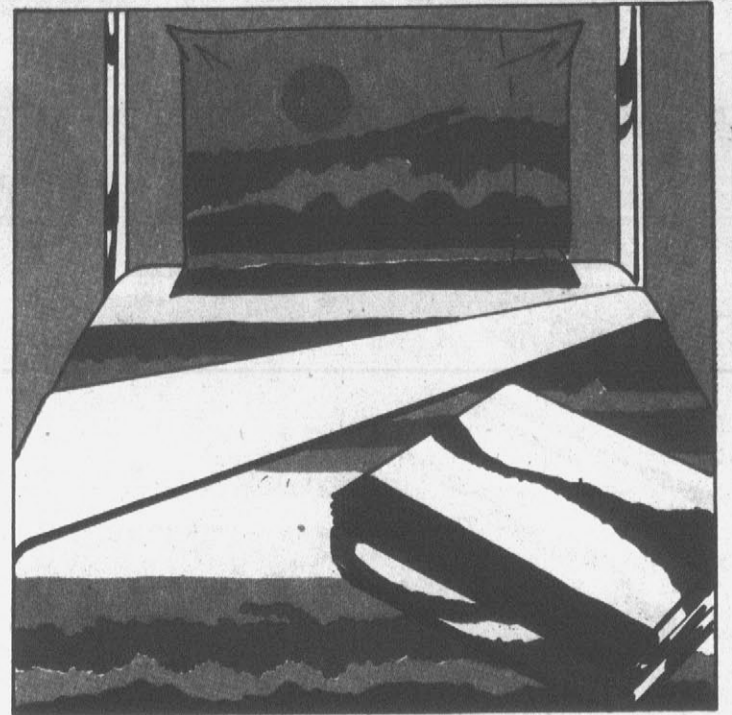

The Co-ordinated Look! MATCHING SCENIC SHEETS-COMFORTERS from MARLBORO™

15⁹⁹ 19⁹⁹

SEASHORE SUNSCAPE

It's like a perfect vacation to enjoy every day of the year! Relax on a beautiful beach at sunrise in soft sea blue and sand. No-iron sheets made of 50% cotton and 50% Fortrel® polyester.

Recapture the feeling of a noon day walk in the warm country air! A bold graphic scenic print will be as easy to enjoy as nature itself, with no-iron sheets made of 50% cotton and 50% Fortrel® polyester.

7⁹⁹

SUPER WIDE TAILORED PANEL 100% DACRON BATISTE

Beautiful window dressing that compliments the entire room. Permanent press. Keeps it's beauty for years. Retains shape. Needs little or no ironing. Hand or machine washable. White or eggshell.

2⁹⁷

OUR REG. LOW PRICE 4.29 PANEL

3⁴⁷

OUR REG. LOW PRICE 4.49 PANEL

3⁸⁷

OUR REG. LOW PRICE 4.89 PANEL

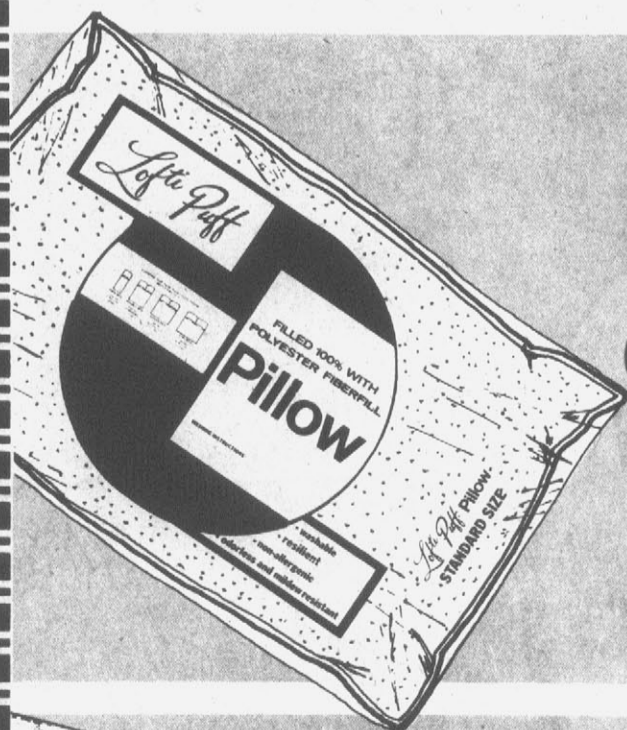
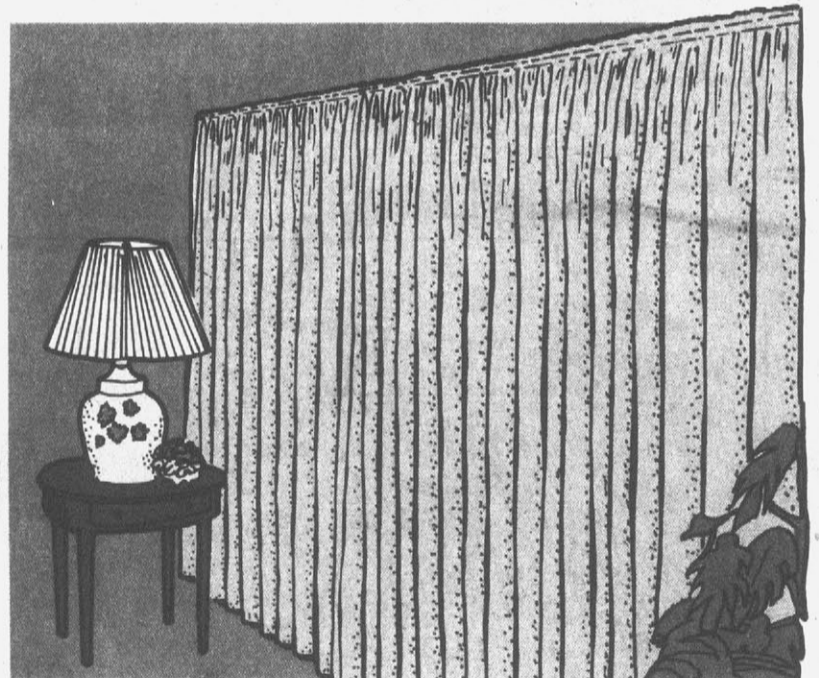

Lofti Puff BED PILLOWS

1⁹⁹
EA.

Polypropylene covering, filled with 100% polyester fiberfill. Standard size. Washable, resilient non-allergenic, odorless and mildew resistant.



St. Mary's MONACO TOWELS

BATH TOWEL
2⁹⁹

OUR REG. LOW PRICE 3.69

HAND TOWEL
1⁹⁹

OUR REG. LOW PRICE 2.49

WASHCLOTH 12"x12" **89^c**

OUR REG. LOW PRICE 1.19

Thick, heavy, super absorbent sheared terry towels with dobby borders in a wide range of vibrant solid colors. 90% cotton, 10% polyester.

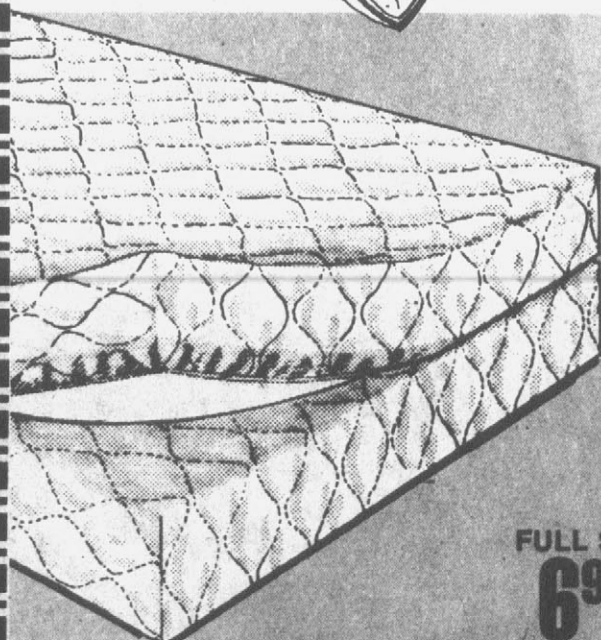

KODEL® BED SAVER MATTRESS PAD

5⁹⁹
TWIN SIZE

OUR REG. LOW PRICE 7.99

Thick poly filled pads covered in long wearing polypropylene, quilted both top and sides without stitches to snag. For mattress or box-spring. *AN EASTMAN FIBER

FULL SIZE
6⁹⁹

OUR REG. LOW PRICE 9.99

QUEEN SIZE
8⁹⁹

OUR REG. LOW PRICE 10.99



VELOUR & WOVEN KITCHEN TOWELS

69^c

IF PERFECT 99¢ to 1.69

Fringed 100% cotton sheared velours and better woven towels in a large assortment of patterns and colors. Slight imperfections will not affect looks or wear.

Kmart

6-Leg Set 89.95



6-LEG GYM SET

Our Reg. 82.86 **64⁸⁶**

With 2-passenger lawn swing, glide ride, 2 swings, and free-standing convertible slide. 2" diam. tubing.



All Bicycles Partially-Assembled in Carton

GIRLS-BOYS 10-SPEED BIKES

Our Reg. 69.88 **58⁸⁸**
4 Days Only

Lightweight 26" bicycles with 10-speed Shimano Skylark gears. Dual caliper, side-pull brakes. Stem-mounted shifter, Maes handlebars, rat trap pedals, welded kickstand. 26x1 3/8" gumwall tires. Ice blue. Save at Kmart.

Our 27" Men's 10-speed bicycle with trigger shift, touring saddle, chrome handle bars, welded kickstand, flamboyant white. **69⁸⁸** Our Reg. 88.88



PHOTO ALBUMS

Our Reg. 8.99 **5⁹⁷** Each

10 magnetic sheets hold, organize favorite snapshots. Hurry in today!

Kmart® ADVERTISED MERCHANDISE POLICY

Our store inventories & displays merchandise for sale in our stores. If an advertised item is not available for purchase due to any circumstance, we will not refund the purchase price. The merchandise is to be purchased at the sale price whether advertised or not. We do not accept returns on advertised merchandise. Merchandise is sold as shown. "As is" merchandise is sold as is. "As is" merchandise is sold as is. "As is" merchandise is sold as is.

Kmart®

THE SAVING PLACE

WED., THURS., FRI., SAT.
OPEN DAILY 9:30-9 CLOSED SUNDAY



FOLDING CHAIRS

Our Reg. 7.77 **4⁹⁶**

Folding Metal Chairs with plastic seats. Assorted colors to choose from.



20" PORTABLE FAN

Our Reg. 19.96 **15⁸⁸**

Five blade 20" electric fan, manually reversible 3-speed fan will help save energy. Save at Kmart!

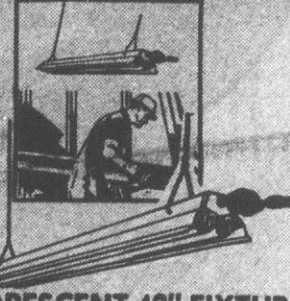

FLUORESCENT 48" FIXTURE

Our Reg. 14.44 **10⁸⁸**

Fixture with cord, chain and 2, 40-watt bulbs. U.L. approved. Save.



Fits Most Automatic Drip Coffee Makers

Kmart® COFFEE FILTERS

Our Reg. 83¢ — 4 Days **2 BOXES FOR 88¢**

Get better tasting coffee when you use disposable filters. 100 filters per box.



BIRD'S-EYE DIAPERS

Our Reg. 4.58 **3⁹⁷**

Closely-woven cotton diapers are strong absorbent. 27x27"



SAVE ON REPLACEABLE FURNACE FILTERS

Sale Price **3/\$1**
Now Only

For more efficient heating and fuel economy change dirty furnace filters often. 1" thick, in wide range of sizes.

20 x 25 x 1, 20 x 20 x 1, 18 x 20 x 1, 14 x 20 x 1, 14 x 25 x 3, 16 x 25 x 1, 18 x 25 x 1, 12 x 20 x 1, 16 x 20 x 1

WED. THUR SAT. SALE

Kmart
THE SAVING PLACE



Master Charge® or
Visa® accepted
in most areas

BANDBOTTOMS ARE TOPS

Our Reg. 4.96-7.96

3⁸⁸-5⁸⁸
4 Days
Only

For a little extra flattery! Bandbottom tops were made to show off your waist, no matter what the style. You'll find a large selection of Today's looks to complement your jeans, pants and skirts including terry casuals, sweater-looks and sensuously smooth, satin looks for dressier occasions. All in a super selection of colors and combinations. Made of easy-care polyester/cotton and other fabric blends, you'll like the way bandbottom tops expand your wardrobe and your budget.

SUNDRESSES FOR SUMMER AND FALL

6.96
Save!

Our Reg. 8.96 sundresses! Worn with tops, they're back-to-school jumpers! Polyester/cotton. 7-14. Our 7.96, 4-6X Sizes, 5.96

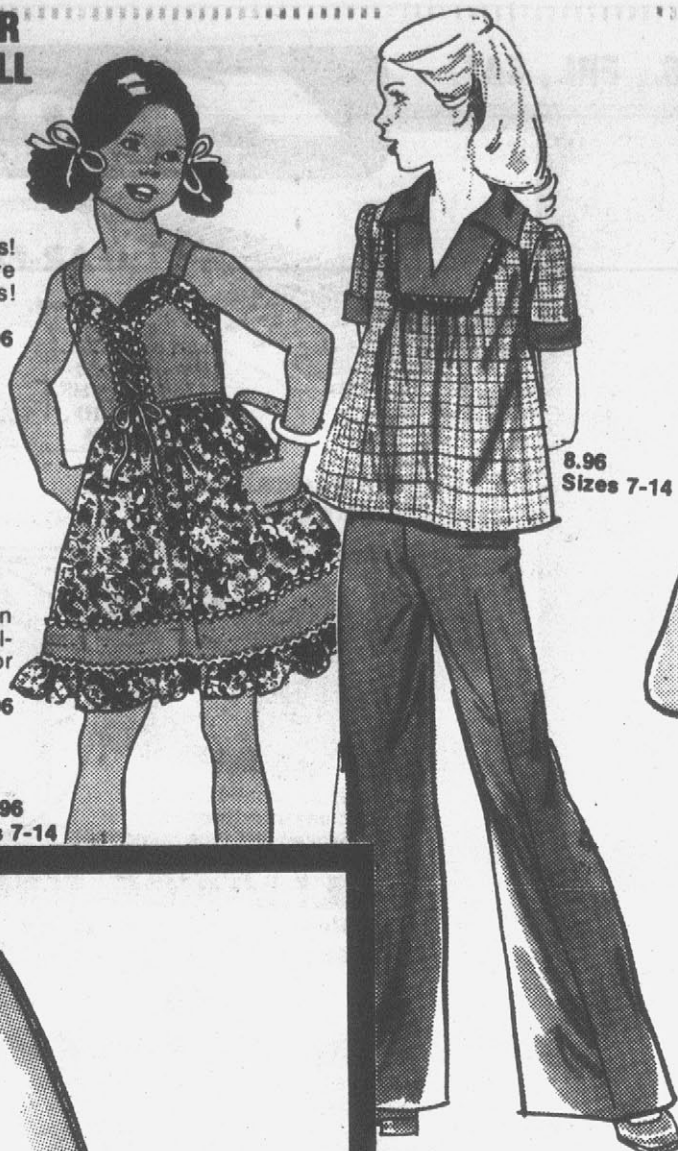

PANTSUITS FOR GIRLS

8.96
Save!

Our Reg. 11.96 pantsuits in wide choice of styles, colors. Cotton, polyester or polyester/cotton. 7-14. Our 10.96, 4-6X Sizes, 7.96

6.96
Girls' Sizes 7-14

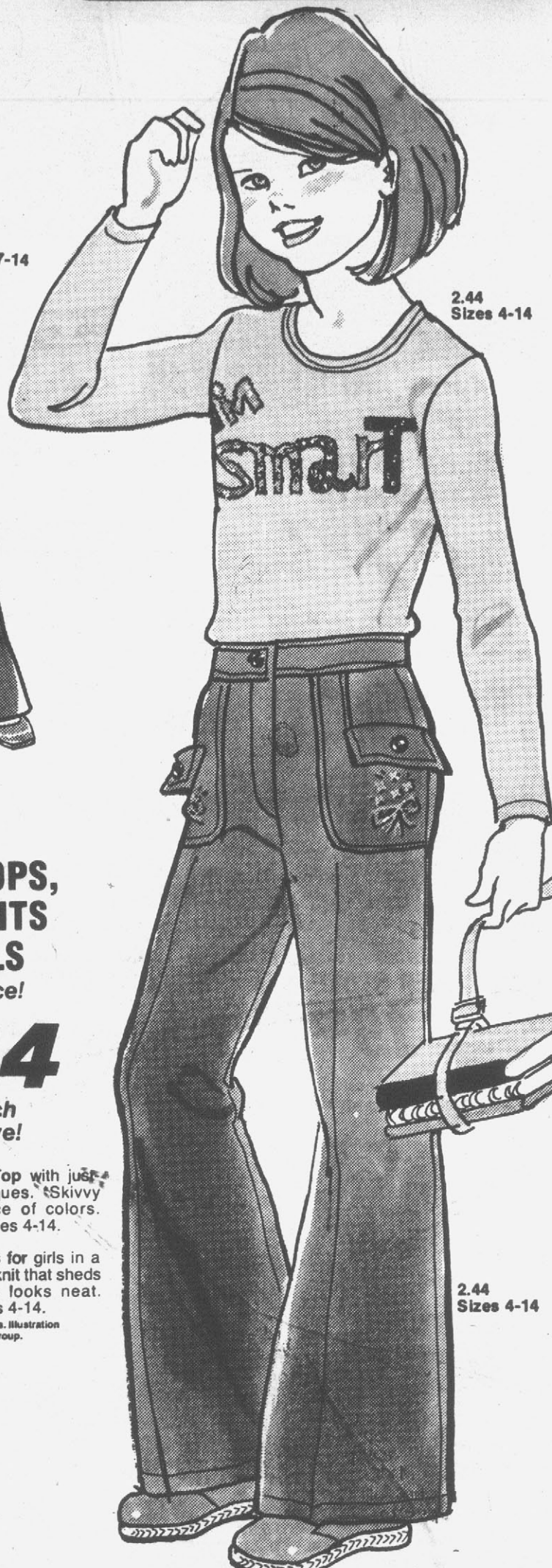

FUN T-TOPS, KNIT PANTS FOR GIRLS

Your Choice!

2.44
Each Save!

Our Reg. 2.96-3.57 Top with just-for-fun novelty appliques. Skivvy neck styles in choice of colors. Polyester/cotton. In sizes 4-14.

Our Reg. 3.96 Slacks for girls in a comfortable polyester knit that sheds wrinkles and always looks neat. Choice of colors. Sizes 4-14.

*Not all appliques in all stores. Illustration is representative of group.

2.44
Sizes 4-14

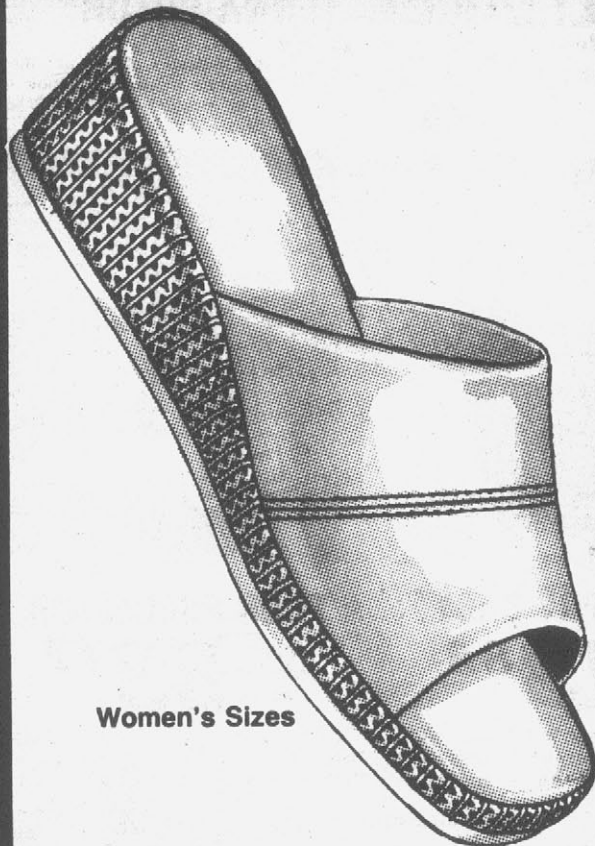

Women's Sizes

WOMEN'S CASUAL ROPE WEDGE SLIDES

Our Reg. 2.80

2.50
Pair
4 Days Only

These comfortable, good-looking slides are the popular choice for casual summer footwear! They come in handsome leather-look vinyl with a soft tricot lining and a fashion-perfect burlap-wrapped "rope" wedge! Durable, long-wearing sole. Choice of teal or navy. Women's sizes.

WED., THURS., FRI., SAT.

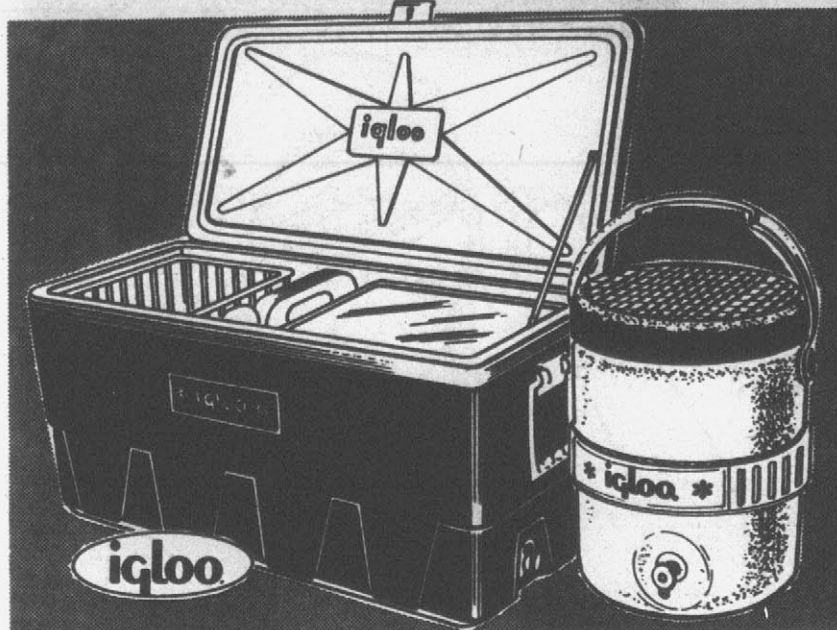

IGLOO® 86-QT. PICNIC COOLER

Our Reg. 54.44 **47⁹⁷**

Complete accessorized, seamless interior is rust-resistant and odor-free; chip-resistant exterior.

2-GALLON SIZE COLD DRINK JUG

Our Reg. 9.97 **8⁸⁸**

Igloo® jug with dispenser faucet. All-plastic, won't rust or corrode or dent or absorb odors. Save now!



FAR-FRINGE ANTENNA

Our Reg. 33.97 **19⁸⁸**

Range: Up to 175 Miles VHF, 90 Miles UHF, 90 Miles FM

UHF-VHF-FM antenna for excellent color, black/white, FM reception.

OUR LOCAL UHF-VHF-FM ANTENNA Reg. 10.88 **7.88**

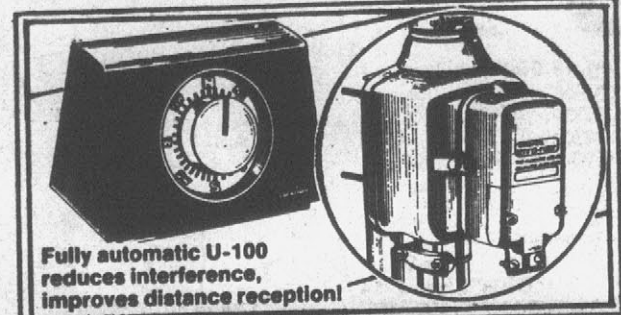

Fully automatic U-100 reduces interference, improves distance reception!

ALLIANCE TENNA-ROTOR®

Our Reg. 41.88 **36⁸⁸**

Set indicator, control unit turns antenna to exact position for best reception, brighter TV picture.



2-BURNER STOVE

Sale Ends Saturday **19⁸⁸**

Coleman® camp stove heats quickly; use Coleman® fuel or white gas. Stove Lighter97*

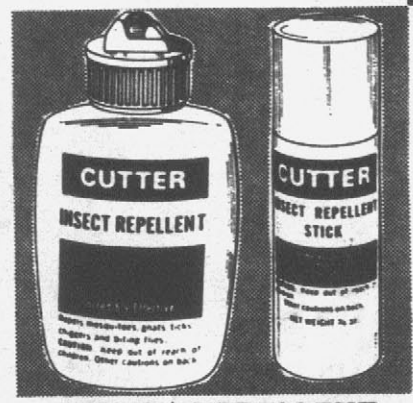

INSECT REPELLENT

Our Reg. 1.86-1.89 **1³³ Each**

Cutter® concentrated cream (4-ozs.)* or stick (¾-oz.)*. *Net wt.



PRESTO® FRY BABY™

Sale Ends Sat. **13⁸⁸**

Fully automatic deep fryer uses only 2 cups of oil, has non-stick Hard Surface inside and out. With snap-on lid.

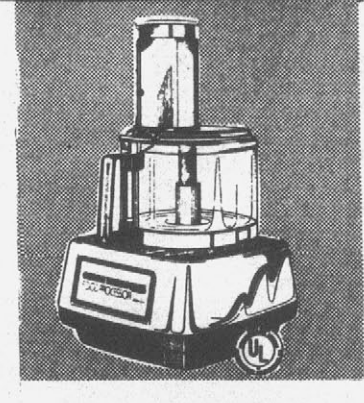

FOOD PROCESSOR

Sale Ends Sat. **53⁷⁷**

Our 'Cuisine Techniques' unit does it all: chops, grinds, slices, shreds and grates. With attachments. Save.



WOOD FRAME FOLDING COT

Our Reg. 10.88 **9⁹⁷**

Canvas top; canvas bed. Our 1.97, Wood Stool, 1.47

PORTABLE OUT-DOOR TOILET

Our Reg. 5.88 **4⁹⁷**

Steel frame; plastic bags. Extra Plastic Bags ...77*

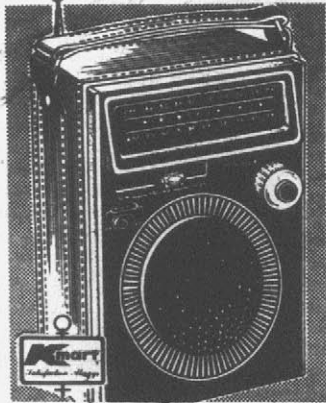

K mart® AM/FM PORTABLE RADIO

Our Reg. 19.97 **14⁹⁴**

Operates on AC or batteries.* Earphone included. *Batteries not included

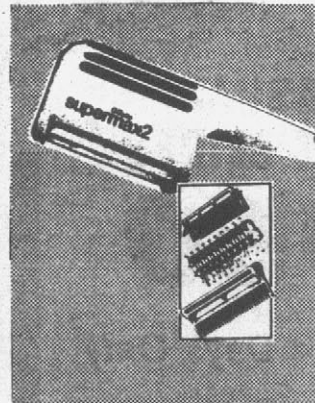

SUPERMAX®

Our Reg. 16.75 **13⁸⁸**

Dry and style any length hair with fast, 800-watt unit. Has 2 settings and 3 attachments.

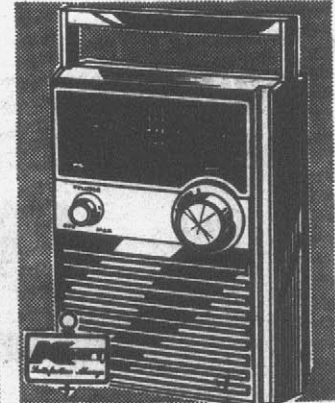

K mart PORTABLE AM RADIO

Our Reg. 9.97 **7⁸⁸**

Slide-rule tuning, rotary control. 3" speaker.

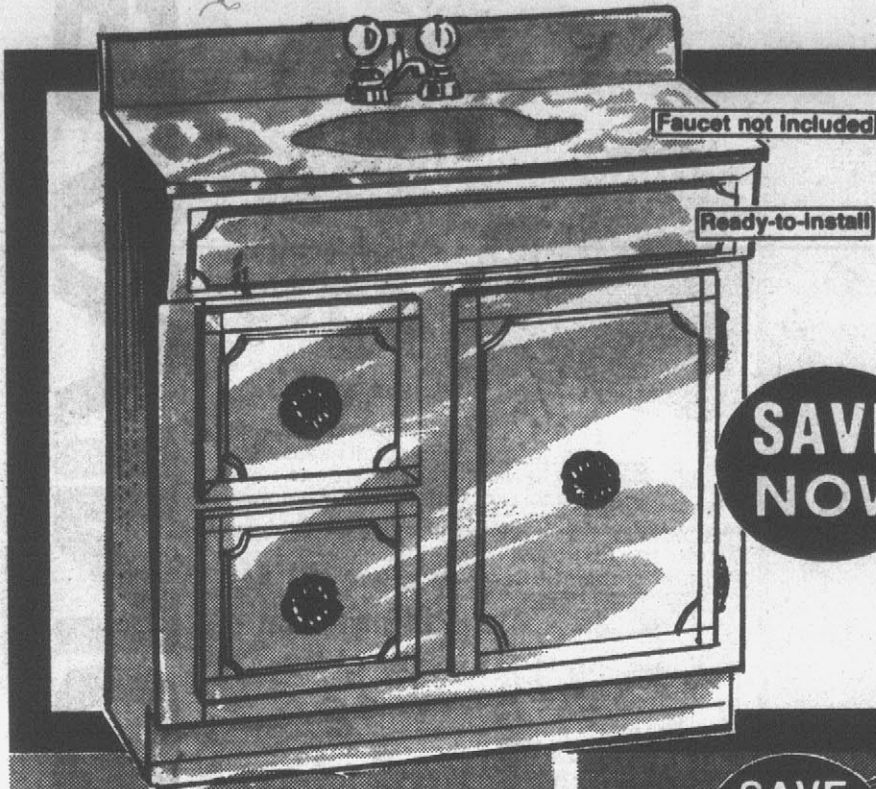

SAVE NOW

BATHROOM VANITY CLEARANCE!

50% off

Try your own bathroom improvement project this summer! Choose from walnut or white/gold cabinet vanities.

2 Only
NO RAINCHECKS



KMART 8 YEAR HOUSE PAINT

5.88
Gallon

Paints your house beautifully. Long lasting latex. White and colors.



K mart® BEST HOUSE PAINT

Our 13.44
Your Choice

9.44
Gallon

"The Performer" in latex gloss or latex flat. White and custom-tinted colors. Gallon.
2" Polyester Paint Brush 98¢



LATEX FLAT OR ENAMEL

5.97
Gallon
Our Reg. 7.97

K mart® Premium one-coat flat in white, colors. Washable.

6.97
Gallon
Our Reg. 8.97

Satin Sheen enamel in white and colors.
9" Roller 97¢

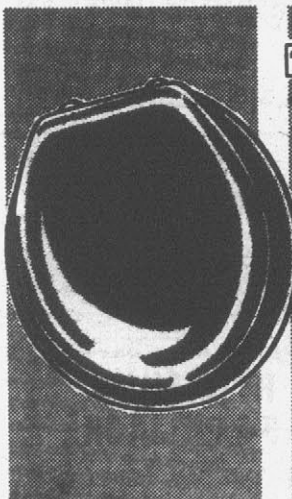

"SOFT TOUCH" TOILET SEAT

7.85
Our Reg. 9.85

Padded vinyl toilet seat available in white, black and pastel colors.

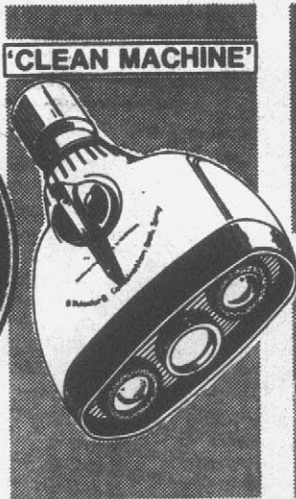

PULSATING SHOWERHEAD

5.93
Our Reg. 7.93

Wall-mount pulsator and combination spray. Fits standard shower.

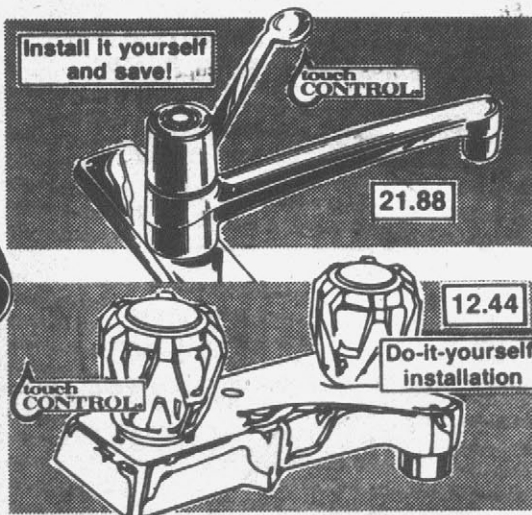

SINGLE-HANDLE SINK FAUCET No. 87501

21.88
Our Reg. 25.67

Washerless, full 180° temperature range. With Spray 27.88
87511



MEDICINE CABINETS

12.47
Our Reg. 17.47

Surface or recessed mount, 16 x 22" frame. Magnetic door catch.

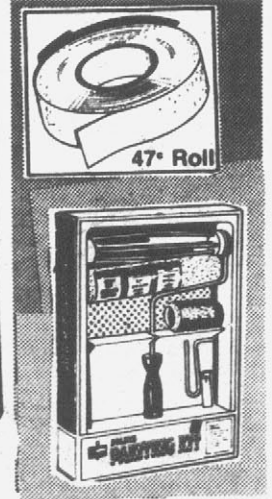

8-PC. DELUXE PAINTING KIT

Our Reg. 5.94

4.44

Pan, 9" roller, cover, trim roller, can opener, more.

SUMMER SAVINGS

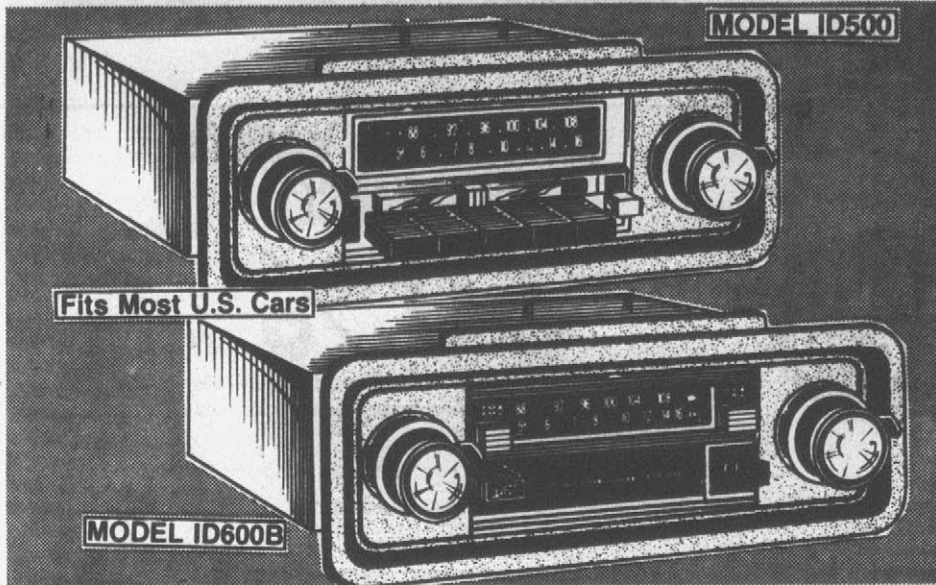

Fits Most U.S. Cars

MODEL ID600B

DELUXE AM/FM INDASH RADIO WITH 8-TRACK OR CASSETTE

Either model indash features pushbutton AM/FM stereo radio with local and distance reception switch. Plus your choice of 8-track tape player or cassette player with fast forward and eject button.

Our Reg. ~~118.88-138.88~~ **\$97**

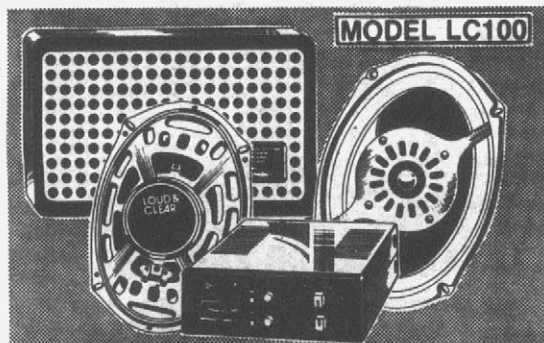

MODEL LC100

LOUD 'N CLEAR SPEAKERS

Our Reg. ~~68.88~~ **56.66** Pair

6x9" coaxial speakers with a full range amplifier. Amplifies the total sound spectrum uniformly. Separate bass, treble control.



FREE ELECTRICAL SYSTEM CHECK

'TRAVWAY' 60' BATTERY

Our Reg. 46.88

42.88

With Exchange

Maintenance free battery never needs water. Calcium lead constructed. Save now.

Sizes to Fit Most Popular Domestic Cars



K mart® DUAL OIL FILTER

Our Reg. 2.88

1.88

4 Days

Dual filtration gives your car cleaner engine operation. Save.

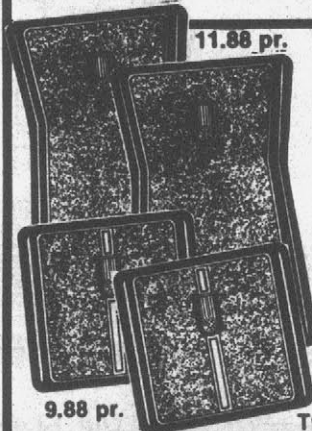

11.88 pr.

CARPETED FLOOR MATS

Our Reg. 14.88

11.88 Pair

Twin front. Durable rubber with the sophisticated styling of cut pile carpet. Colors. Save.

Twin Rear Mats, Pr. 9.88

MORE VACATION-TIME AUTO SPECIALS



SPARK PLUG CLEANER

Our Reg. 9.97

7.88

Do-it-yourself plug cleaner connects to any 12-volt battery. Has plug gapper.



HEAVY-DUTY TUNE-UP KIT

Our Reg. 2.77

1.66

Kit has points, rotor and condenser. Most U.S. and foreign cars. Uniset Kit, 2.77

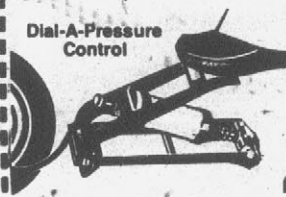

Dial-A-Pressure Control

ADJUSTABLE FOOT PUMP

Our Reg. ~~16.88~~ **13.88**

High pressure. For air pressure 0-120 lbs.



HALOGEN HAND LAMP

Our Reg. ~~16.88~~ **11.88**

Hand lamp plugs into car cigarette lighter. Save.



ELECTRICAL REPAIR KIT

Our Reg. ~~11.88~~ **9.88**

With basic terminals and connectors. Crimp pliers.



HARDWOOD CREEPER

Our Reg. 8.96

6.44

Kiln dried hardwood creeper w' th lacquer finish and headrest.



HYDRAULIC 5-TON JACK

Our Reg. 18.88

13.88

Designed for use on cars, trucks, campers or vans. Shop K mart for savings.

Open Daily 9:30-9
Closed Sunday

WED., THURS., FRI., SAT.

Kmart

THE SAVING PLACE

auto center

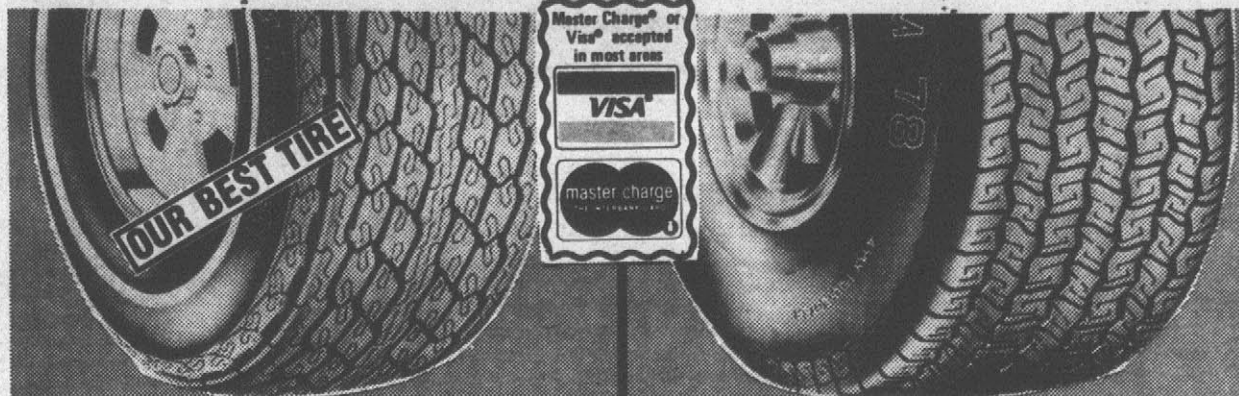

SERVICE INCLUDE:
1. Install 1 pair of coil stabilizers
2. Align front end
3. K mart safety inspection

STABILIZERS AND WHEEL ALIGNMENT

Sale Price

7⁸⁸

Helps improve handling and tire tread wear. Most U.S. cars. At savings!

STEEL BELTED RADIAL WHITEWALLS

SIZES	REG.	SALE	F.E.T.
ER78x14	57.88	37.88	2.40
FR78x14	59.88	40.88	2.58
GR78x14	64.88	45.88	2.76
GR78x15	64.88	45.88	2.83
HR78x14	68.88	48.88	2.96
HR78x15	68.88	48.88	3.03
LR78x15	72.88	52.88	3.34

Our Reg. 49.88
BR78x13

31⁸⁸

Plus F.E.T. 1.99 Each

All Tires Plus F.E.T. Each

MOUNTING INCLUDED — NO TRADE-IN REQUIRED

'KM 78' BLACKWALL 4-PLY POLYESTER CORD

SIZES	REG.	SALE	F.E.T.
878x13	23.88	19.88	1.77
C78x14	25.88	20.88	1.93
F78x14	27.88	21.88	2.13
F78x14	28.88	22.88	2.26
G78x14	30.88	24.88	2.42
G78x15	30.88	24.88	2.45
H78x14	32.88	26.88	2.60
H78x15	32.88	26.88	2.65
L78x15	37.76	30.88	2.93

Our Reg. 21.88
A78x13

17⁸⁸

Plus F.E.T. 1.69 Each

All Tires Plus F.E.T. Each

*Whitewalls Only
Whitewalls 2.88 More Each

MOUNTING INCLUDED — NO TRADE-IN REQUIRED



INSTALLED

HD MUFFLER INSTALLED

Our Reg. 22.94 — Installed

Protected against rust out. Sizes for most U.S. cars. Save **18⁹⁷**
Additional Parts or Services Extra

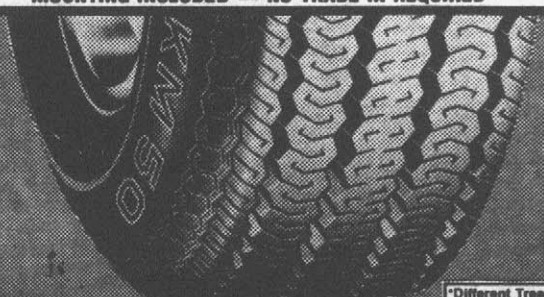

'KM 50' 4-PLY POLYESTER CORD BLACKWALL

Our Reg. 18.47
A78x13

15⁹⁶

Plus F.E.T. 1.69 Each

MOUNTING INCLUDED — NO TRADE-IN REQUIRED
All Tires Plus F.E.T. Each

SIZES	REG.	SALE	F.E.T.
C78x14	24.47	21.96	1.93
E78x14	24.47	21.96	2.13
F78x14	26.47	22.96	2.26
G78x14	27.47	23.96	2.42
G78x15	28.47	24.96	2.45
H40x15	25.47	19.96	1.73
400x15	26.47	20.96	1.78

SALE OF SHOCKS

MAJOR SERVICE HOURS VARY — PLEASE CALL

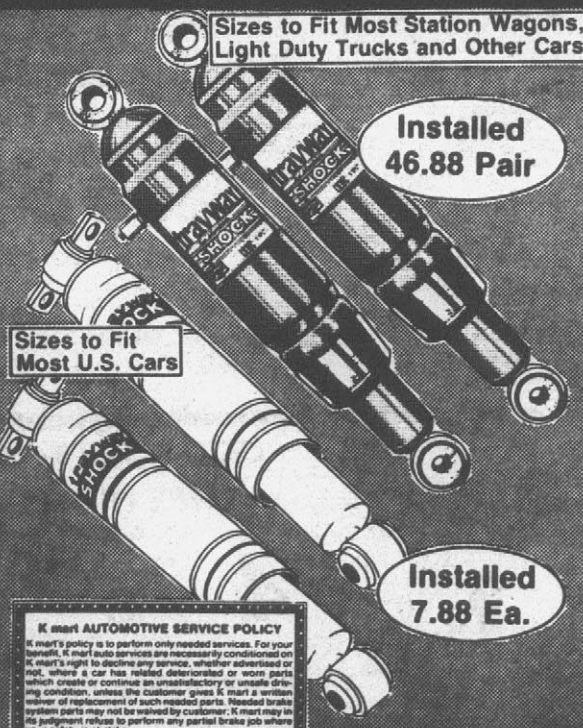

Sizes to Fit Most Station Wagons, Light Duty Trucks and Other Cars

Sizes to Fit Most U.S. Cars

K mart AUTOMOTIVE SERVICE POLICY
K mart's policy is to perform only needed services. For your benefit, K mart auto services are necessarily conditional on K mart's right to decline any service, whether advertised or not, where a car has related deteriorated or worn parts which create or continue an unsatisfactory or unsafe driving condition, unless the customer gives K mart a written waiver of replacement of such needed parts. Needed brake system parts may not be waived by customer. K mart may in its judgment refuse to perform any partial brake job where your safety is at stake.

AIR-ADJUSTABLE SHOCK ABSORBERS

Our Reg. 49.88
4 Days Only **36⁸⁸** Pair

Shocks designed for driving under overloaded conditions. Adjustable air pressure helps keep car level, prevents bottoming out.

HEAVY-DUTY SHOCK SALE!

Our Reg. 7.88
4 Days Only **4⁸⁸** Each

1 1/16" size piston, triple welded mounts, and 1/2" shaft. All-weather fluid for instant action at 50° below to 300° above. Save now.

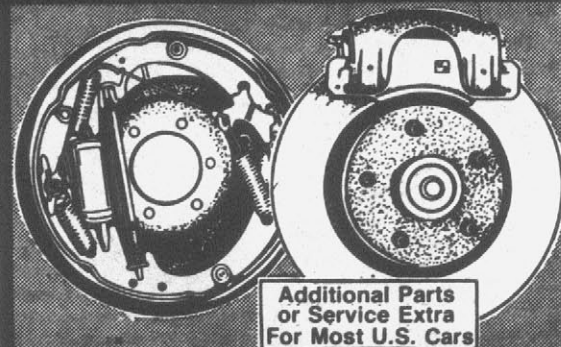

Additional Parts or Service Extra For Most U.S. Cars

DISC/DRUM BRAKES COMBINATION SPECIAL

Sale Price 4 Days Only **78⁸⁸**

We will: install pads on front, linings on rear wheels; Resurface drums, rotors; Rebuild calipers, wheel cylinders if possible; Repack inner, outer bearings; Install new hold down hardware; Replace front grease seals; Bleed hydraulic system, refill; Inspect master cylinder; and road test. Save now.

OPEN DAILY 9:30-9:
CLOSED SUNDAY

WED., THURS., FRI., SAT.

SUMMERSAVINGS



ROSE MILK SKIN CREAM

1.27

For soft skin
12-oz. size

PRESCRIPTION COUPON

COUPON GOOD AT GREENVILLE
K MART ONLY

Telephone 756-1993

PRESENT THIS COUPON AND
RECEIVE \$3.00 OFF ON ANY
NEW PRESCRIPTION.

WORTH TO
\$3
MAXIMUM

COUPON EXPIRES JULY 29th 1978
LIMIT ONE PRESCRIPTION PER COUPON

VALUABLE COUPON

RIGHT GUARD

97¢

5 oz. size
Family deodorant.



BAND-AID® BANDAGES
Sale Price
78¢

Band-Aid® brand plastic strips.

100 TYLENOL® REGULAR
Sale Price
97¢

For those who can't take aspirin.



WASH 'n DRI® TOWEULETTES
Sale Price
58¢ Box of 20

Washes without soap and water.



"PROTEIN 21" HAIR SPRAY
Sale Price
1.27

Regular or Extra-Hold. Unscented.



11-OZ. "FOAMY" SHAVE CREAM
Sale Price
68¢

Regular, Menthol, Lemon/lime cream.
*Net wt.



3-OZ. "ULTRA BAN II" DEODORANT
Sale Price
87¢

Regular, Neutral or Fresh deodorant.
*Net wt.



COCOA BUTTER
1.22

Cream Cocoa Butter, 12 oz.**

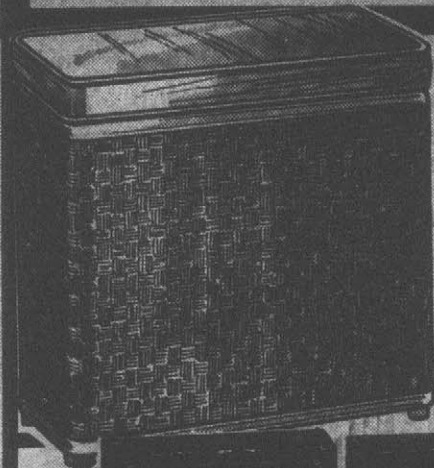

PADDED SEAT HAMPER

Our Reg. 16.96
11.96
20 x 12 x 19"

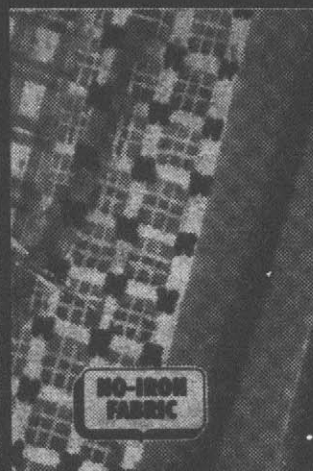

POLYESTER DOUBLE KNIT
Our Reg. 1.97

94¢ Yd.
Yarn dyes, solid colors. **/yd.

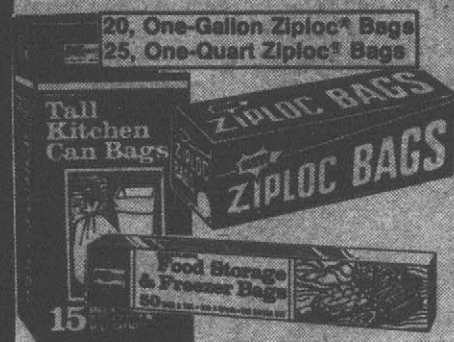

CHOICE OF KITCHEN BAGS
Our Reg. 78¢-88¢

68¢

50 food storage bags, 11x13 1/2"; Ziploc® bags, 15 tall can bags, 44 qt.

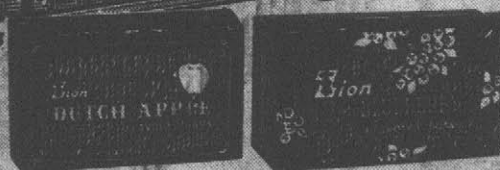

SCHUMPTIOUS FRUIT BARS
Our Reg. 97¢ — 4 Days
1 1/4 lb.* package of fig, blueberry, cherry, strawberry or dutch apple bars.

2/\$1

Limit 2



COMFORT TOP KNEE HIGHS

Our Reg. 6.41

4 PR. FOR **\$7**

Nylon/spandex in sandal foot or reinforced toe style. Fits 9-11.