

Clear and colder tonight with risk of scattered frost inland. Increasing cloudiness Thursday with highs in 60s.

Page 14 — A forger with flair
Page 17 — Six-day ordeal
Page 22 — How they voted

TRUTH IN PREFERENCE TO FICTION

Economic Stimulus Program Seen Snowballing

By EDMOND LeBRETON
Associated Press Writer

WASHINGTON (AP) — The tax cut and spending program launched by President Carter to jog the lagging economy is snowballing through Congress and seems certain to emerge bigger than it started.

How much bigger it will be than \$31.6 billion — the administration's latest two-year estimate — is still a question.

The answer may play a key role in determining whether Carter will be able to fulfill his

promise to balance the budget by 1981.

The House on Tuesday voted a \$23.3 billion appropriation to fund major elements of Carter's program and substantial additions by Congress.

The bill reached the House floor containing \$4 billion for public works this year, twice the amount Carter sought. Amendments backed by the Democratic House leadership added \$707 million to the total.

The House was planning to consider another appropriation bill, a catchall \$27.9 billion measure, late today. More attempts to add

stimulus money were expected, and some were likely to succeed.

The leadership is backing amendments, the exact amount of which were not settled in advance, to add funds for recreational programs and some military construction, advocated as an aid to lagging employment in the building trades.

On top of that, a bipartisan group of House members planned to fight for an amendment adding \$200 million to help low-income persons pay fuel bills swollen by the bitter winter now

ending.

Rep. Robert N. Giaimo, DConn., chairman of the House Budget Committee, estimated the additions made Tuesday and those expected today would increase economic stimulus spending during the present year by \$1.7 billion above Carter's \$15.7 billion estimate.

Spending figures for a given year usually do not correspond with appropriations because of delays in getting programs under way and actually disbursing the money.

Speaker Thomas P. "Tip" O'Neill told reporters the leaders had decided to expand the Carter proposals on the recommendation of Democrats on key committees such as Budget and Joint Economic.

O'Neill said the changes had been discussed with Charles Schultze, chairman of the Council of Economic Advisers, and Bert Lance, director of the Office of Management and Budget. "These are not their proposals, but they are not opposing them," O'Neill said.

Elect New Officers For Hospital Board

By CAROL TYER
Reflector Staff Writer

New officers were elected and three new members were welcomed to the Pitt Memorial Hospital Board of Trustees, held which held its first meeting in the new hospital last night.

Kenneth Dews of Winterville was named chairman; Harry Leslie, vice-chairman; Ephraim Smith, secretary; J. H. Moye, treasurer; and Glenn Strickland, assistant treasurer.

Members of the executive committee are the chairman, the vice-chairman, and the secretary, automatically, plus four elected members. These are Eugene James, William

Neal, Hal Tanner, and Dr. John Wooten.

New members are Moses Moye of Farmville, replacing W. R. Duke who has completed the 12 years maximum allowed under the trustees' bylaws; D. T. Jones of Pactolus, replacing Ed Switzer, also a 12-year member; and Elton Coltrain of Bethel, replacing Delton Perry, still another 12-year man. Duke, Switzer, and Perry were honored with plaques denoting their service to the county.

The Board had dinner in the rehabilitation area of the new hospital, since the dining room is not complete, and met in the conference room adjoining Director

Jack Richardson's office. This will be its regular meeting place.

During the reading of the minutes, it was noted that the appointment of James Cheatham to the Joint Conference Committee last month had to be corrected the next day, since Joint Conference representatives of the hospital board have to be members of the Board's executive committee. Eugene James has been named to fill this job.

Special guests of the Board for this annual meeting included past chairmen Jesse Moye, J. B. Congleton, Woodrow Wooten, Ed Waldrop, Walter Stroud, and Ed Warren and past chiefs of

staff, Drs. E. B. Aycock, W. H. Potts, C. F. Irons, Ray Minges, A. M. Mumford, Howard Gradis, Earl Trevathan, and John Wooten.



KENNETH DEWS

A letter from Secretary of Natural and Economic Resources Howard Lee was read. Lee said that since his use of his time is no longer dictated entirely by himself, he feels that he should resign from the Pitt Hospital Board so as to allow someone with more time to give to the job a chance to serve. His resignation has been accepted.

It was noted that Board member Hal Tanner is a hospital patient and that member Harry Leslie has lost his mother since the last meeting. It was also announced that a new neurologist, Dr. Greg Hardy, will soon be a part of the staff.

Treasurer J. H. Moye reported that the hospital's cash is "real low" and that accounts receivable now total \$1,521,000. He said it is hoped that this figure can be decreased soon.

Requests for equipment expenditures for a Dupont 700 automatic chemical analyzer costing \$79,932.50; storeroom shelving costing \$5,940; an electrophoresis unit to separate blood plasma into its components costing \$8,703; and kitchen equipment costing \$16,355 were approved. It was noted that the last two items will be purchased by the Gifts Committee out of unrestricted funds.

New Room Rate
The Board adopted a new "basic room rate" of \$70 per patient day. This rate for the majority of the private rooms will include the cost of color television and a phone in every room. It is about a \$10 increase over the cost of a private room in the old hospital prices.

The cost of the few larger rooms with larger baths will be \$80.

The Board members expressed relief that the charge will not have to be higher, in view of rates in neighboring hospitals. It was pointed out that, in spite of rising costs, there has been no room rate increase at Pitt Memorial in the past 22 months. The Board has been waiting till the hospital had "something more to offer" in the new hospital.

(Continued on page 10)

Ambushed

BEIRUT, Lebanon (AP) — Kamal Jumblatt, leader of the leftist alliance in Lebanon's civil war, was killed in a machinegun ambush today, police reported.

The 59-year-old socialist leader, target of several assassination attempts in the past, was killed while riding in his car in the mountain town of Baakline, 21 miles southeast of Beirut, the police said.

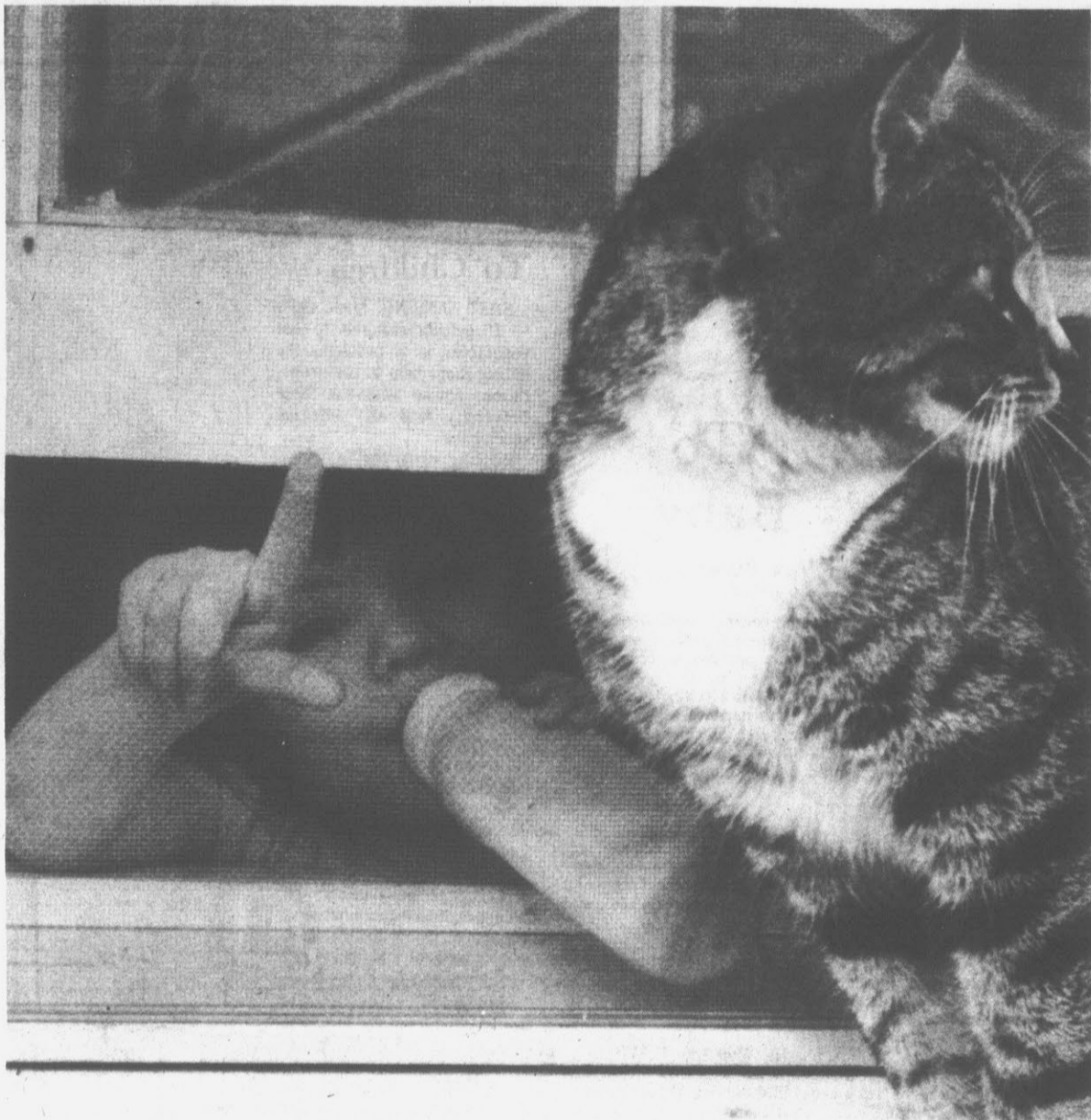

It's Bright, Mild And Good!

HEY! IT'S SPRINGTIME OUT THERE...and I want to be outside with my cat Scamper in the sunshine, seems to be the message two-year-old Eva Maria Collins was trying to get across with her gestures. Daughter of Mr. and Mrs. John R. Collins, Eva was

granted her wish. She was taken outside where she romped about chasing bees and pulling the heads off flowering dandelions. (Reflector photo by Jerry Raynor.)



NEW HOSPITAL BOARD MEMBERS...are D. T. Jones of Pactolus, Moses Moye of Farmville, and Elton Coltrain of Bethel. (Reflector Staff Photo)

REFLECTOR

HOTLINE

752-1336

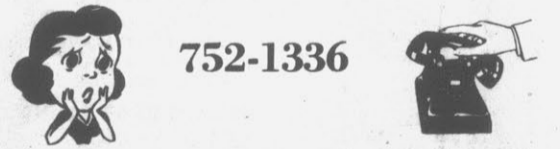

Hotline gets things done for you. Call 752-1336 and tell your problem or your sound-off or mail it to Hotline, The Daily Reflector, Box 1967, Greenville, N.C. 27834.

Because of the large numbers received, Hotline can answer and publish only those items considered most pertinent to our readers. Names must be given, but only initials will be used. Transcribing is done once a day.

ARMY DISCHARGE PAPERS

My husband was in the Army in the 1950's. He's lost his Army discharge papers. Is there any way we can get another copy? Mrs. M. S.

Your husband needs to visit the N. C. Division of Veterans Affairs office in the Tipton Annex, 232 Greenville Boulevard. Cheryl Landreth in this office said there is a special form that they will be glad to fill out and send to St. Louis, where Army service records are kept, requesting duplicates for you. All your husband will have to do is provide the necessary information about when he was in the Armed Forces and sign the form, she said.

SUBSCRIPTION MIX-UP

I had a subscription to Time Magazine which started several months ago. A month or so ago, I started receiving notices that my subscription was due. I have gotten my fourth notice now and they say, because they haven't heard from me, they have had to stop my subscription. In the meantime, I have written to them several times, telling them I paid in advance, but it brings no response. R. L.

Hotline wrote to the Time office, explaining that you paid in advance. You then received a letter, referring to our letter, which said that your one-year renewal was entered on a charge basis. They said a temporary adjustment was being processed to resume mailing of your Time and to advance the expiration date to compensate for the copies missed. However, they asked for proof of your advance payment, which you were able to provide. You now say you're receiving the magazine just fine, that without Hotline's help you would be a Newsweek subscriber by now!

Supplies Are Sent To Zaire

KINGHASA, Zaire (AP) — Belgian weapons and American medical and military equipment have been speeded to Zaire as it tries to repel what it calls an invasion of "foreign mercenaries" from Angola.

Officials of the central African nation said today that the invaders who crossed into copper-rich Shaba Province last week were 5,000 mercenary troops led by "guerrilla and subversive war specialists from across the Atlantic."

The comment was considered a clear reference to Cuban forces which were instrumental in establishing a Marxist regime in Angola. The bulk of the forces, however, are believed to be exile guerrillas from Zaire itself.

Belgium's weapons shipments were the first ones reported by any country since Zaire announced the invasion last week. The Belgian Foreign Ministry said the two plane-loads of light weapons had been ordered earlier and were only being speeded up. Some sources said 5,000 to 7,000 Belgians are still living in the invaded province, which was the Province of Katanga when Zaire was the Belgian Congo.

The Carter administration was hurrying \$1 million in medical and military equipment to Zaire, including communications equipment, parachutes, packs, rations and fuel tanks.

It was Carter administration's first involvement in foreign warfare and a spokesman said Carter himself had made the decision.

U.S. officials said they had no confirmation that Cubans were involved in whatever fighting was taking place.

Voters Of India Go To Polls; Indira's Future Is At Stake

By MYRON L. BELKIND
Associated Press Writer
NEW DELHI, India (AP) —

The world's largest election began today as India's silent masses went to the polls to elect a new lower house of Parliament and to decide whether Prime Minister Indira Gandhi will continue in power.

The voter turnout was reported heavier than usual, a development that Mrs. Gandhi's opponents had said should prove favorable to them.

Voting was scheduled today in 300 of the country's 542 election districts and continues through Sunday. First results were to be announced then, after the last balloting.

The 59-year-old prime minister made a final campaign appeal to the 320 million voters not to believe opposition charges that she had been a dictator since she put the country under a national state of emergency 21 months ago, jailed thousands of her opponents, censored the press and drastically amended the constitution.

"If I had been a dictator, the people would not have been able to talk about dictatorship, and elections to Parliament would not have been possible," she told a rally in her native state of Uttar Pradesh.

A helicopter took her to district after district, seeking votes for her Congress party, India's governing party since independence in 1947. The Congress is opposed by the new Janata (Peoples') party, a coalition of five parties formed to defeat Mrs. Gandhi.

Reports from around the country indicated that the polling was generally peaceful. Only a few incidents of violence were reported, primarily in the Calcutta area, where Mrs. Gan-

dhi's opposition charged Congress party workers "captured" some voting stations to prevent normal polling. The police said they were investigating.

In the last election, in 1971, the Congress party won a two-thirds majority in the lower house, enabling it to amend the constitution without difficulty during the emergency. But Mrs. Gandhi's emergency rule united her opponents as they never had been brought together before and split the Congress party, and neutral observers thought the outcome would be close.

One of the chief issues in the campaign was Mrs. Gandhi's 30-year-old son, Sanjay, who took over the leadership of the Congress party's youth wing during the emergency period and is running for Parliament for the first time.

Mrs. Gandhi's foes charged that she is grooming him to

succeed her and continue the family hold on power that began with her father, Jawaharlal Nehru, who was India's first prime minister. She vigorously denied the charge.

Monday night, Sanjay and his aides reported that shots were fired at his jeep as he was returning to his campaign headquarters, but no one was hit.

The opposition said the alleged assassination attempt was faked.

Equal Rights Struggle Set Back But Goes On

By BARBARA MATHEWS
Reflector Staff Writer

The North Carolina Senate handed proponents of the Equal Rights Amendment a bitter defeat March 1 — but the fight goes on to eliminate sex discrimination from the law.

According to Greenville attorney Nelson B. Crisp, the impact of the defeat will be "substantial", but measures can be undertaken nonetheless to rid our laws of sex bias.

"I feel it was definitely a step backward to fail to follow through with the ratification of the ERA," she said.

"But I hope the failure means the legislators will move quickly to review laws based on sex and that they will use their common sense and excellent sensibilities to remove sex bias from statute and case law.

"There are three methods legislators could use to do this: repeal a sex-biased law completely; make it applicable to 'persons' instead of 'women'; or possibly they could decide whether or not the statute is based on sex."

Mrs. Crisp said she has seen more bias in statutes than in case law.

"There are a lot of old laws dating back to the 1800s," she said.

"For example, GS110-2 says that only boys over the age of 12 can be out before 7 a.m. to deliver newspapers. So girls can't deliver a morning paper."

"There are stipulations that require that women prisoners under the age of 16 or serving less than 6 months not be given work assignments."

"If a wife kills her husband in North Carolina, she is entitled to use one-half of his

estate during the rest of her life, whereas if the husband kills her he can use her entire estate during his remaining years."

The area most in need of correction is alimony law, according to Mrs. Crisp.

"The only way women are going to be able to support themselves is through their own capacities," she said.

"They are not going to be able to get alimony without continually going back to court. And the court can only put her husband in jail, where he can't work, and therefore can't support his family."

"If we pass the ERA or are able to lobby and effect a very valid employment act that will raise the level of compensation for women up to their male counterparts, we will have done more in the area of alimony and support

(continued on page 14)

Deaf Education Majors Get Practice

ST. AUGUSTINE, Fla. (AP) — For Lisa Gray, a recent college graduate, the transition from learning to teaching was a smooth one after she completed her major in deaf education at Flagler College.

She teaches language to 7 and 8-year-old severely and profoundly deaf children at the Florida School for the Deaf and Blind (FSDB), the largest residential school for deaf and blind students in the nation.

Flagler College, a small, co-educational liberal arts college, and the FSDB are located less than two miles apart here.

Students at Flagler College majoring in deaf education begin practical application of their knowledge in their second year by working at the FSDB.

"We teach all the theory everyone else does, but here students are involved in working directly with the deaf from the sophomore year on," said Anne Shreve, coordinator of the deaf education program at the college. "Majors have the opportunity to understand the nature and needs of deaf children individually as well as academically."

Students at Flagler, which has the only undergraduate

deaf education program in Florida, assist in extra-curricular programs at FSDB, such as recreational activities, athletics and religious education.

Later they work as teachers' aides and tutor students on a one-to-one basis before starting student teaching both in the FSDB and in the classroom program for the deaf in the Duval County school system.

Some of the 90 deaf education majors work as house parents in the state school. Miss Gray served as house parent in the girls' honor dorm for 17 to 19-year-olds before graduating and assuming her present teaching duties.

"I feel the experience greatly helped me," said Miss Gray, adding that she was able to see which concepts the older students found difficult so she could bear that in mind with her teaching.

"I lived and worked with deaf girls, and it helped me to enrich my communication skills," she said. "I feel that no matter how much schooling you have, nothing prepares you for the real thing like experience."

The FSDB uses the modified Rochester method of teaching

the deaf, which involves finger spelling and signing, with words and concepts represented by hand movements, while the Duval County program uses the oral-aural method of lipreading and speech.

Flagler graduates are trained to teach both methods, and their student teaching semester is split between the two schools, Mrs. Shreve explained. In addition to majoring in deaf education, Flagler students must major in either elementary or secondary education.

The lack of jobs in many teaching fields does not extend to deaf education, according to Mrs. Shreve. Graduates can expect to be employed in either a residential program like FSDB or a local school system. Legislation in many states has mandated programs for all exceptional children, including the deaf.

"There is a great need for teachers trained in deaf education," Mrs. Shreve said. In Florida, for example, an estimated 417 teachers of the deaf

will be needed by 1980, more than twice the number teaching now.

Many students who major in deaf education have experienced deafness in their families; others, like Miss Gray, are hearing impaired.

"The program is really more exciting than I can describe it. It sounds on paper like the usual course of study, but the

unique thing is the enthusiasm of the students," Mrs. Shreve said.

Fresh Rolls

Diener's Bakery

815 Dickinson Ave.



\$1,000 Given To New Hospital

EARMARKED FOR NEW HOSPITAL — The Pilot Club of Greenville presented a check for \$1,000 to be used for the purchase of equipment to be utilized in the Occupational Therapy Department at the Rehabilitation Center at the new

hospital. Pictured, left to right, are Mrs. Addie K. Jenkins, president of the Pilot Club, Miss Donna Smith, chief occupational therapist, and Alan Gorrod, occupational therapist.



Dear Abby

Send Gift To Couple's Baby

By Abigail Van Buren

© 1977 by Chicago Tribune-N.Y. News Synd. Inc.

DEAR ABBY: A friend of ours recently gave birth to an abnormal child (a Mongoloid). We, her friends, are terribly upset about it, and the poor woman and her husband are in a deep depression.

What should friends do under the circumstances? We certainly can't "congratulate" the parents.

Should we acknowledge the birth of this unfortunate child? Should we send a gift? (What does one send a Mongoloid child?) Or would it be kinder to ignore the tragedy?

BEWILDERED

DEAR BEWILDERED: Perhaps "congratulations" are not in order, but to ignore the birth of a child when you would normally express interest is, I think, cruel. So send a little gift (the same as you would to any other child), and show a continuing interest (not curiosity).

DEAR ABBY: During our two-year marriage, my husband and I have had some very difficult times including separation, a filing for and finally a cancellation of divorce proceedings.

The big problem is this: He thinks I should always be willing to have sex whenever HE feels like it.

Whenever we have an argument, which is often, my husband says some very cruel and cutting things to me, then he says, "I didn't mean what I said. Now can we have sex?"

I think it's nice that he says he's sorry, but I'm in no mood to have sex with him two minutes after he has ripped me up one side and down the other, and hurt my feelings by talking mean and ugly to me.

I need a little time to cool off after an argument, and having sex isn't my idea of cooling off. In an effort to save my marriage, I need your opinion.

NEEDING TIME OUT

DEAR NEEDING: I think you should take all the time out you need. And if your husband expects sex on demand because HE'S in the mood without considering YOUR mood, you may be trying to save a marriage that's not worth saving.

DEAR ABBY: I am a widow who deeply regrets not letting her husband go to "the other woman" 10 years ago. He left me for her once, but I fought him so hard over the divorce settlement that he came back to me but continued to see her.

I knew in my heart that they really loved each other, but I couldn't think of her as anything but a tramp who had stolen my husband.

If I had let him go, I probably could have made a new life for myself, but I hung onto him for security.

As my husband lay dying in the hospital, her name—not mine—was on his lips. If I had let him go when he wanted to, maybe he'd be alive and happy today, for heartaches.

Continued on page 3

Dalton

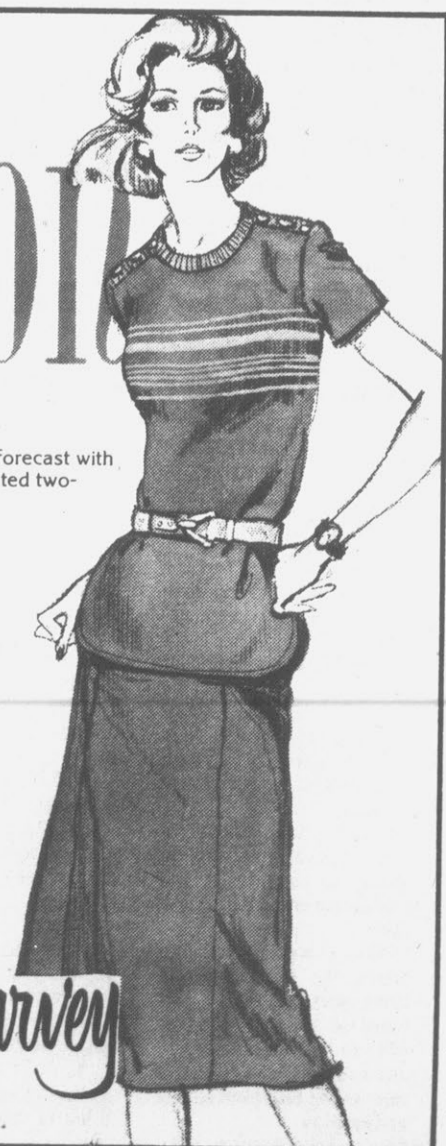

Fresh and breezy is the fashion forecast with Dalton's two tone cotton knit belted two-piece dress. Sizes 6 to 18, \$70

We recommend washing in Woolite For the clothes you care about

Blount-Harvey
Downtown Mall
Shop Daily 10 A.M. to 5:30 P.M.

Vegetables Can Appeal To Children

EAST LANSING, Mich. (AP) — If getting children to eat vegetables is a problem, try letting them help in the preparation, advise Michigan State University food and nutrition specialists.

Husking corn, shelling peas, snapping beans, washing squash or even helping to pick the produce at the market may provide the incentive to eat the vegetables, they point out.

Other suggestions: When the child is beginning to eat the same foods as the rest of the family, give him small amounts of vegetables at the beginning of the meal, when he is hungriest.

Introduce new vegetables along with familiar, well-liked foods. If your child likes casseroles and other combination dishes, include vegetables in them.

Be enthusiastic in presenting new vegetables. Parents' and siblings' attitudes can influence a child to like or dislike something even before he tastes it.

Cook vegetables so they are tender but still crisp. Or serve raw vegetables with meals or as snacks. Children often prefer the crispy crunch of raw carrot strips, celery, bits of cauliflower or turnip strips to the softer texture of cooked vegetables.

If a child rejects new vegetables the first time or two he sees them, offer them again. It sometimes takes time to develop a taste for new foods.

But don't make vegetables the focus of a parent-child power struggle or mealtime a battle of wills. This can affect the child's attitude toward food for a long time.

Personal

Mrs. Rubell Skipper is a patient in Pitt Memorial Hospital, room A-211.

Slice leftover cooked sweet potatoes and reheat in a skillet with a little maple syrup. Quick and good!



For Silver Jubilee

GOLD AND SILVER FOR THE QUEEN'S SILVER JUBILEE — Model Claudia adds sparkle to a set of gold and silver ingots from Shamor to commemorate the Silver Jubilee — the 25th year of Queen Elizabeth's reign. The gold ingots, available in nine, 18 and 22-carat gold bear the royal coat of arms on one side, and enlarged hallmarks on the reverse. The silver ingots bear the royal cipher and enlarged hallmarks. Prices for the ingots were not quoted. (AP Wirephoto)

Cooking Is Fun

By CECILY BROWNSTONE
Associated Press Food Editor
PARTY REFRESHER

Rum Cream Cake Coffee
RUM CREAM CAKE

A reader asked us for a dessert of this kind.

18½-ounce package yellow cake mix

2 eggs

Light rum

1 pint heavy cream

Pinch of salt

1 cup confectioners' sugar

Garnish: sliced strawberries or bananas

Grease and flour two round 9-inch cake pans. In the large bowl of electric mixer, blend the cake mix, eggs, 2-3rds cup rum and 2-3rds cup water; beat at medium speed for 2 to 4 minutes. Turn into prepared pans and bake in a preheated 350-degree oven according to package directions. Cool thoroughly. Split each layer in half horizontally. Beat together the cream, ¼ cup rum, salt and sugar until stiff; spread between layers and over the top of the cake. Chill. Garnish with the strawberries or bananas.

Permanent Removal Of Unwanted Hair

Electrolysis Hair Center

205 E. Third St.
Turnage Real Estate Bldg.
752-2969 10 A.M.-5 P.M.
Mamie Tyson Electrologist



Downtown Pitt Plaza

March Is Shoe Month!

-THURSDAY-FRIDAY-SATURDAY...

Three Days Only!

SPECIAL SAVINGS...



...on "DeLISO" PUMP!

Now your favorite Casual pump at a special savings! Low-heeled comfort in NAVY, BLACK, BONE, WHITE; All Sizes.

(regularly \$29.00)

\$24.90

Brody's
Downtown Pitt Plaza

A Great Team...
Spring and
FAMILY DOLLAR



SUPER-GLO DRIPLESS LATEX WALL PAINT WHITE & PASTELS

\$2 GAL.



9 INCH ROLLER & PAINT TRAY SET

REG. \$1.27 **99c** SET

¾" x 60 YDS. MASKING TAPE 67¢ ROLL
3" to 4" PAINT BRUSHES \$1.17 EACH



DIAMOND FOIL

12" x 25' ROLL
ALUMINUM FOIL

4 \$1 FOR LIMIT 4



BRACHS Malted Milk Balls

ASSORTED VARIETIES

DELICIOUS WINDOW BOX CHOCOLATES

2 \$1 FOR MIX OR MATCH

SAVE UP TO 90¢ EACH ON THESE NATIONAL BRANDS

- HEAD & SHOULDERS SHAMPOO
- 4 oz. LOTION OR 2.5 oz. TUBE
- 7oz. GLEEM II TOOTHPASTE
- LILT HOME PERMANENT SPECIAL OR BODY WAVE
- SURE DEODORANT 1.5 oz. ROLL-ON

REG. TO \$1.69 EA. YOUR CHOICE

79c EACH LIMIT 2 EA.



SIZES 5-10
WHITE AND PASTELS
WOMEN'S
PANTIES

REG. 50¢ PAIR **3 \$1** FOR



MEN'S COTTON T-SHIRT
WITH POCKET
ASSORTED COLORS
S-M-L-XL

REG. \$1.27 EACH **\$1.99**

BUY 4 & SAVE 56¢
DOROTHY REED AND ELIZABETH POST
TOILETRIES

- 12 oz. LOTIONS
- 12 oz. HAIR PREPS
- 12 oz. AFTER SHAVE

AND MUCH MUCH MORE

4 \$1 FOR

HARRIS SHOPPING CENTER
MEMORIAL DRIVE, GREENVILLE, N.C.
OPEN MONDAY THROUGH THURSDAY 9 A.M.-7 P.M.
FRIDAY AND SATURDAY 9 A.M. UNTIL 9 P.M.
CLOSED SUNDAY

PRICES GOOD THROUGH SATURDAY WHILE QUANTITIES LAST

AF Captain Sets Sights On Marathon

BROOKS AIR FORCE BASE, Tex. (AP) — Capt. Mary Ann Hodgson thinks jogging four or five miles around the base is one of the most pleasant ways to spend a lunch hour.

"When I run about 30 or 40 minutes I get loosened up and relaxed. It's a natural way to cool off and think about the day," says the Brooks AFB pharmacist. "When you run that distance, you get a release of adrenalin in your system — it's almost a natural high."

But during last year's New York Marathon, in which she participated, Captain Hodgson's only thought was to finish the 26.2 mile race. She was not out to break any records. Her goal in her first marathon was merely to complete the course.

Prior to this race the most she had run at one time was 16 miles. At the 23-mile point she "hit the wall" — she believed her legs couldn't carry her any farther.

"I felt that if I stopped, I'd never finish," she said. "At that point I couldn't even walk — I was in a shuffle. Then I saw the final mile sign and thought 'Well, there's only one more. I'll shuffle a little bit more.' When I knew there was only two-tenths of a mile left, I got that last spurt."

She finished in four hours and 30 minutes — an excellent time for a beginning marathon runner. The winner of the race ran it in approximately two hours and nine minutes, while the winning female entry crossed the line 30 minutes later.

Captain Hodgson, 31, began jogging in 1968, while still a student at South Dakota State University, but winter running was out of the question because of cold weather. After she graduated in 1969 she was too involved with becoming a registered pharmacist to run regularly.

"I wanted a chance to work on my master's degree and to travel, so I decided to join the Air Force," she said. In the spring of 1976 she began running regularly, building toward the October marathon.

Now she is running at least

four or five miles at lunch and 7 to 14 miles a day on week-ends, working toward cooling her "marathon fever" by entering the biggest, the Boston Marathon, this spring.

"I really like running on base," Captain Hodgson said. "It's a secure feeling. Everybody is very nice — it's a friendly atmosphere."

But that is not always the case for joggers, she adds, noting that drivers occasionally try to run them down or force them off the roadside.

"When I was younger, women in running or sports of any kind just hadn't been sanctioned," said the officer. "It wasn't 'their place' or men didn't think it was feminine. But I can name a lot of women in sports who are extremely feminine."

"I think you're going to see more and more women in sports because they're getting more recognition and discovering that exercise makes them feel better."

For the beginning jogger, male or female, Captain Hodgson suggests a good, comfortable pair of shoes.

"There are over a dozen good shoes for training, which cost about \$25 or so. That's not much money, because if you don't have a good pair of shoes your feet are going to hurt. If your feet hurt your knees are going to hurt. You're going to be uncomfortable and ask why you are going through all this pain."

Some people run in their hiking boots or regular street shoes. Captain Hodgson believes a person should run in whatever shoes are the most comfortable.

The beginning jogger should start out slowly, she cautions, running a quarter mile, walking a quarter mile and then trying to run another quarter mile. The goal for the first day could be one mile, using this alternating run-walk pattern.

"But don't push yourself," she emphasizes. "Once you feel a strain, stop. If you begin breathing hard, feel tired or lightheaded, stop automatically and walk."

Homemaker's Haven By Addie Gore Pitt Home Agent

MENU-MAKING MADE EASY
Family menus can be a study of food customs. It's interesting to explore why certain foods are purchased and eaten at family meals, how cooking techniques

vary in this country and around the world, and why certain foods are grouped and served together. One quickly learns that the availability of food, cooking skills, family traditions and food preferences help determine family food customs and menus.

In one year alone, a homemaker can count on preparing almost 1,000 meals based on our present three-meal-a-day pattern. Fortunately, menu-making and cooking can be a creative outlet. It changes from year to year as the homemaker increases her cooking skills, as the family matures and develops new tastes and as new foods are introduced to the marketplace.

The art of good menu-making doesn't come naturally. There are certain basics that must be practiced. Once learned they will be helpful throughout a lifetime. Planning is basic to

Adoptions Conference Is Planned

WINSTON-SALEM — "Roots for Children" is the title and focus of North Carolina's first statewide adoptions conference to be held here March 29-31 at the Hyatt House.

Elizabeth S. Cole, executive director of North American Center on Adoption, will deliver the keynote address at the noon luncheon Tuesday, March 29.

The conference is open to adoption workers, adoptive parents, adult adoptees and others interested in children who need permanent homes.

Registrations will be accepted until capacity is reached. Conference registration is \$15 per individual and \$20 per adoptive couple. For more information, contact the adoptions units of the local Department of Social Services or Children's Home Society of N.C.

The conference is co-sponsored by Catholic Social Services of the Diocese of Charlotte, Inc., Catholic Social Services of the Diocese of Raleigh, Inc., Children's Home Society of N. C. Inc., Family Services, Inc., Winston-Salem, N. C. Division of Social Services and PACT (Parents of Adopted Children Together).

It's Here Back By Popular Demand

RAMADA INN

264 By Pass

The Daily Reflector, Greenville, N.C.—Wednesday, March 16, 1977—3

good menu-making. It helps make the best use of family resources—including time available for cooking, the amount of money for food purchases and cooking skills. Planning also helps assure that a family is eating foods that supply the nutrients needed for good health.

1. The basics of good nutrition.
2. The basics of food selection and storage.
3. The basics of food preparation.
4. How to combine foods to make them appealing.
5. Family taste preferences.
6. How to time food preparation so that all foods are ready at one time.



STAINED GLASS CLASSES AND WORKSHOP IN GREENVILLE

We are offering our famous five week Stained Glass Course on a ONE TIME ONLY BASIS in Greenville. Basic Course covers: Cutting Glass, Soldering, Leading, making Stained Glass Windows, and "Tiffany" Lampshades. CLASS SIZE LIMITED. For reservations and information call this toll free number:

1-800-654-8466

Engagement Announced

MISS KATHERINE MARIE TYSON, . . . is the daughter of Mr. and Mrs. Louis H. Tyson of Rt. 1, Greenville, who announce her engagement to James Edward Jones, son of Mr. and Mrs. Jessie J. Jones of Greenville. The wedding will take place June 12.

(Continued from page 2)

pressure and frustration can undermine a man's health. I saw it happen. I won the battle but lost the war.
10 YEARS TOO LATE

DEAR 10: Your 20-20 hindsight makes a touching story. And an appropriate time to point out that no one "steals" another person. People are drawn together by a mutual need.

CONFIDENTIAL TO "STILL SEARCHING" IN BALTIMORE: Consider Dr. Donald W. Hastings' philosophy:

"If anyone is searching for peace of mind today, he's searching for a will-o'-the-wisp. Anxiety is a healthy phenomenon—the motivating factor by which we get things done."

Everyone has a problem. What's yours? For a personal reply, write to ABBY: Box No. 69700, L.A., Calif. 90069. Enclose stamped, self-addressed envelope, please.

Belk Tyler

The Hunt is on...The Catch is 'Foxy Teak'... The Results are Tantalizingly Different...

Get set to ride with the winning color this spring! Flori Roberts presents FOXY TEAK . . . the deepest, darkest, earthiest shade of all in a fully coordinated 6-piece collection. It's the deepest, the most startling black maroon of all. FOXY TEAK, whipped in for today's contemporary Black Woman. Intriguing, the way it takes the spotlight without being obvious. Crafty, the way it brings out the

inherent beauty of the Black woman. FOXY TEAK is a trend setter, ties in with deeper, fun fashion colors. FOXY TEAK gets it all together with this 6-piece collection in a new handsome packaging . . . tack box appearance with a unique foxy cover design. It's ever so sly, so do take a peek at what's inside: lipstick, lip polish, face polish, nail polish, eyeshadow duo with applicator and a new eyeliner-lip liner brush combination. You might just love it!

'Foxy Teak'...a prize you'd value at \$22...Now in the winner's circle for just \$6 with any \$5 purchase of the fine Flori Roberts Cosmetics...

Flori Roberts' Representative will be in Our Store:

- Thursday: 11 a.m. to 6 p.m.
- Friday: 12 noon to 8 p.m.
- Saturday: 10 a.m. to 5 p.m.

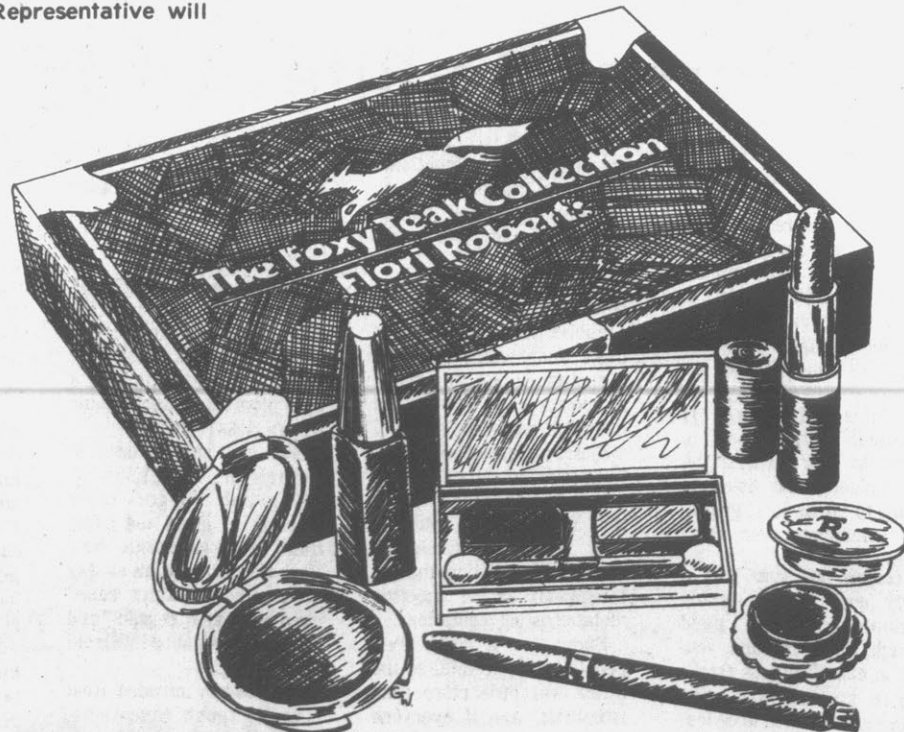

Shop Daily 10 a.m.-6 p.m. Except Thursday and Friday 10 a.m.-9 p.m. Telephone: 758-2176



downtown
greenville



Prices Good thru Saturday
★ Open Evenings ★ MasterCard or BankAmericard

264 BY-PASS ACROSS FROM NICHOLS DISCOUNT CITY
Open Mon.-Thurs. 10 to 9, Fri. 9 to 9, Sat. 9 to 8.

Get to know us; you'll like us.®

Governing Power Is Limited

Recognition dawns slowly among presidents and governors that they can not truly govern....at least as they had dreamed.

They come into office with high ideals and purposes. Always, a streamlining of governmental processes has been promised; and, wearing the euphoria of political victory, the newly-elected step into the new arenas with zest and zeal.

The awakening is cruel. There is a built-in resistance to change. On less exotic levels: foremen experience it, office managers encounter it, businessmen know it (too well), and it's to be found even within families. The condition exists to a greater degree in government. "Entrenched" forces within agencies and bureaus and departments, whose stake in the world is one of survival, are certain to oppose infringements on their authority and power. Too, rivalries within governmental ranks can and do wreck the best-laid plans of even the most painstaking executive.

Small wonder Governor Jim Hunt is reported encountering resistance to his payroll-cutting plan; and, with the march of time and introduction of new ideas to make state government less cumbersome and more efficient, he is going to run into ever greater obstacles.

As for President Carter: ever since the day he was sworn in he has been on collision-course with forces capable of grinding down ordinary mortals to helpless shells of their former selves. The only President we can recall that approached the degree of power all new Presidents presume they had, was FDR. His domination of the U.S. political scene made the so-called "imperial" presidencies of Lyndon Johnson and Richard Nixon look like poor relations.

We tell ourselves that something more than figure-head executives are necessary to accomplish reforms, efficiencies and cost-cutting in the world of government. But is that what the American people really want?

Such Leniency Will Encourage Others

Those who are concerned with the American system of justice had to swallow hard as they observed the leader of a terrorist group in Washington set free after the ordeal ended for the hostages.

The hostages were held for two days and, while the group's leader was arraigned and charged, he

was released without requirement of bond. It apparently was a part of the deal which brought about the hostage's release.

We can't say we would have handled the situation differently, but it is likely that this leniency will encourage other fanatics to try the same thing.

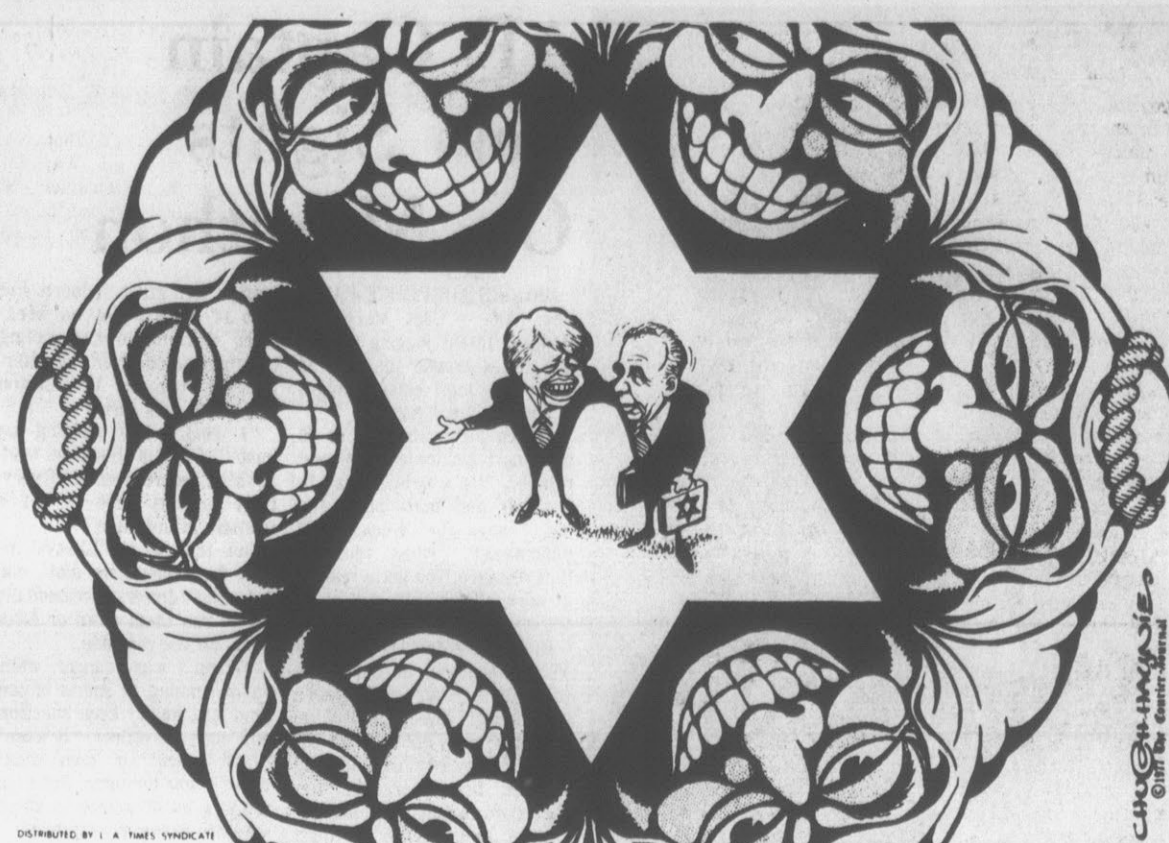

"In the interest of peace, Mr. Rabin, we strongly support 'defensible' borders for Israel!"

By ART BUCHWALD Quizzing Warnikovitch

WASHINGTON—Whether we like it or not "disarmament" is a dirty word for the military-industrial complexes of every country. No one paid any attention to disarmament in the past, but when the nomination of Paul Warnke as arms control chief came up, the halls of the Senate resounded with charges that Mr. Warnke might actually fulfill his function and come up with some kind of a disarmament treaty. The thrust of the anti-Warnke debate was that the head of the disarmament talks has no business discussing methods of stopping the arms race.

Somewhere in the Kremlin is Mr. Warnke's counterpart, who is also looked upon with suspicion and contempt by Soviet military leaders and party hawks. His name is Vladimir Warnikovitch and he's been getting heat from all sides.

At his confirmation hearing the other day he was questioned by the Politburo.

"If you go to Geneva you sell out the Soviet Peoples' Republic."

"It not true," Vladimir protested. "I am looking for a way to stop spiraling cost of military armaments which is costing our motherland billions of rubles."

"How do we know United States is not just trying to trick us to disarm so they can destroy us when our guard is down?"

"We have enough weapons to kill Americans nine times."

"Is not enough. They have weapons to kill us ten times." Vladimir said, "I hope to reach agreement with U.S. so we can only kill each other seven times."

"How can you do that?" "They must give up one of their multi-warhead nuclear missiles and we must give up

one of ours." "But if we each give up one of our multi-headed missiles we will only be able to kill them eight times and they will be able to kill us nine times."

"Aha, Comrade. It depends which weapon they give up. We will ask them to give up a missile that will kill twice as many people as the one we give up, then we'll have a 'kill-ratio party'."



ART BUCHWALD

"Warnikovitch" in 1972 you gave an interview in Pravda in which you said that someday you hoped the Soviet Union and the United States would unilaterally be able to kill each other five times. Do you deny it?"

"No, at the time I thought that would be enough. But since then I've changed my mind. Killing each other five times is not a safe figure."

"How can we trust you when you say one thing in 1972 and something else now?"

"I have the right to change my opinions. When I gave the interview I was not being put in charge of arms control agreement. If I negotiate a new treaty I would never put Soviet Union in inferior position of only having enough weapons to kill Americans five times."

"You don't consider yourself a traitor for wanting to negotiate arms control agreement?" "This position. It is he, not I, who will eventually decide how many times our two countries can afford to kill each other."

"We warn you, Vladimir, if you come back from SALT talks without a superior kill ratio over U.S., you will be stripped of your human rights." "If you feel that way I won't go to Geneva."

"What do you mean won't go? Do you think we want world to believe Soviet Union is not interested in disarmament treaty? We will confirm you as our negotiator, but we will be watching you every

(Continued on page 5)

Carter Is Still Running

By WALTER R. MEARS
AP Special Correspondent
WASHINGTON (AP) — To borrow his phrase, the name is Jimmy Carter and he's still running, a different kind of campaign but a campaign nonetheless.

It's becoming evident that for Carter, campaigning is part of governing. So, in the days of his political anonymity, President Carter is on the road tonight, meeting people, answering questions, spurning a hotel suite in favor of a guest bedroom.

Things are different now, of (Continued on page 5)

40 Years Ago Today

March 16, 1937
Courtesy, Amelia Earhart considered congestion of the radio channels today as likely to prevent an immediate take-off on her equatorial flight of 27,000 miles around the world.

Two Pan-American Airways ships are scheduled to leave for Honolulu as soon as weather conditions permit. Miss Earhart would also use the Pan-American radio system.

"With two ships in the air, I am afraid the addition of my radio demands would perhaps prove too much for the shore stations and might conceivably bring about a mishap," Miss Earhart said.

In a vote of 14 to 2, the state House Committee on Cities, Counties and Towns today favorably reported a measure to extend the incorporated limits of Greenville.

The action of the committee today puts the measure on the House calendar for action, probably tonight or tomorrow.

The measure was introduced in the Senate by E. O. Flanagan and that body passed the bill. It was held up in the House committee by a request of a group of opponents who asked for a hearing in Raleigh.

—Barbara Mathews

THIS AFTERNOON

Do Licenses Pose Threat?

By BILL NOBLITT
RALEIGH — Back in 1949, Sam J. Ervin, Jr. was a member of the North Carolina Supreme Court. That was before his fame spread even wider as a U.S. Senator.

He wrote a decision in the case of the State versus Owen Ballance nearly 30 years ago which is again drawing some attention as there is a growing feeling that proliferating licensing boards are in danger of creating a controlled, monopolistic economy.

In that case, Senator Ervin (and the court) found that the North Carolina Photographers Board was unconstitutional.

In presenting his arguments, Ervin drew up a list of other occupations which, he felt, could legitimately be regulated by the state if, in fact, the regulation of photographers was found to be in the public interest.

A New Board
On that list was watchmaking. Sure enough, in 1967, the N. C. General Assembly created the N. C. State Board of Examiners for

Watchmaking and Repairing. Other state courts at other times struck down state licensing of dry cleaners, tile contractors.

Yet such licensing procedures continue to grow apace. In 1975, the General Assembly created four new boards: foresters, house movers, landscape contractors, and speech and language pathologists and audiologists.

The state now has 35 licensing boards: architect, auctioneer, barber, accountant, chiropractor, contractor, cosmetologist, dentist, electrical, forester, hearing aid, house mover, landscape architect, landscape contractor, lawyer, medical doctor, mortuary, nursing, nursing home, optician, optometrist, osteopath, pharmacist, physical therapist, plumbing and heating, podiatrist, psychologist, engineer and land survey, real estate, refrigeration, sanitarian, speech and language, veterinarian, watchmaker, and well digger.

Public funds do not support these activities, but a number of experts believe the system

is costing the public money.

The boards operate from fees collected from members and applicants. Many boards restrict trade and prohibit advertising, however, and that is costing the public — members of the attorney general's staff compute the cost at \$10 million annually in North Carolina in inflated



BILL NOBLITT

cost of uncompetitive eyeglasses alone.

Moratorium
A group of legislators is pushing to call a moratorium on creation of new licensing boards, and a thorough probe of how to bring them under control with action suggested to the 1979 General Assembly.

Attorney General Rufus L. Edmisten told the legislative committee on licensing chaired by State Rep. Thomas B. Sawyer, D-Guilford, that, "In the past the licensing of occupations has been to protect the public

from harm. The effect of licensing in recent years, however, has often been to protect those licensed from the demands of competition and free enterprise."

In a complicated presentation to the legislative body, members of Edmisten's staff presented data generally designed to show that many boards are made up of people with a vested interest, that a

major problem is a tendency to bar from certain occupations newcomers who might threaten competition, and it is "questionable as to what the public interest is in

maintaining the licensing board of an occupation which functions purely as a monopolist rather than as a quality control mechanism consistent with competition.

But most importantly, the experts concluded, there is "virtually no disagreement among economists that loosening anticompetitive restraints (and allowing advertising) imposed by licensing boards will result in significant benefits to consumers and society at large."

THE INSIDE REPORT

CIA's First Defector?

By ROWLAND EVANS and ROBERT NOVAK
WASHINGTON — Evidence that ex-CIA agent Philip Agee has cooperated with the DGI, Cuba's Soviet-bosomed intelligence service, was the unannounced cause for the highly unusual deportation order served on him last November by British Home Secretary Merlyn Rees.

That means Agee, far from being just another kiss-and-tell alumnus of the Central Intelligence Agency (CIA), is probably its first bonafide defector. Although there is no indication that cooperation started until after his resignation in 1969, Agee ap-

pears to be the first CIA official known to have cooperated with an adversary government.

For what it's worth, then, any untold secrets of CIA operations known by Agee are assumed to be known to Soviet intelligence via the Cuban connection.

Agee, author of the anti-CIA "Inside the Company," resigned after 12 years of service, much of it in Mexico City. Well-informed sources in the intelligence world believe Agee began to collaborate with Cuba's Directorate of General Intelligence (DGI) soon after his resignation.

The relationship between DGI and the KGB is in-

timated. The top Cuban KGB officer had an office right next to the head of the DGI in Havana's Miramar section. The links between the two services are such that DGI has been known as a "subsidiary" intelligence service of the KGB.

After seven weeks in Cuba in the summer of 1971, Agee went to Paris where Western counter-intelligence agents began to track his cooperation with DGI. Those contacts increased after Agee moved to London in late 1972.

During the three years ending in August 1974, Agee made five separate trips to Cuba. MI-5, the British domestic intelligence service, developed its incontrovertible evidence that Agee was trafficking with Cuban intelligence sometime last year. This followed verifiable Agee contacts with agents of Cuba in Algiers and throughout Europe, particularly in Spain and Italy. Although not announced, that was the entire basis for

Rees's action against Agee.

A footnote: Instead of complying with the expulsion decree, Agee went to Scotland, where he is bringing suit under an obscure Scottish law in an effort to escape deportation. That is not expected to work, according to legal and intelligence experts here.

WARNKE'S LOBBYIST

One major reason the embarrassing 40-vote total against Senate confirmation of Paul Warnke as chief disarmament negotiator was not even higher was President Carter's lobbying success with Southern conservative Democrats such as Sen. James O. Eastland of Mississippi.

When pressed to oppose Warnke on ideological grounds, Eastland snapped back angrily that he had given his word to Mr. Carter. Besides, said Eastland, the President had assured him that Jimmy Carter, not Paul Warnke, would be running (Continued on page 5)

Strength For Today

PONDER AND LEARN
Tradition has it that one day as Sir Isaac Newton sat in an orchard, an apple fell from a tree and struck him on the head. The incident seemed to have started a chain of thought which ended in an important discovery. For most people, being struck by a falling apple in this manner would be an experience slightly unpleasant and soon forgotten. Newton, however, pondered what had happened to him, and out of this incident came his formulation of the theory of gravity.

Many of the greatest inventions have sprung from apparently insignificant circumstances. Every event in life has about it the significance of Newton's falling apple. Every meeting with a friend, every chance conversation we have in the street, every miscarriage of our plans, every sorrow, every success, every disaster, has a message for us if we will only heed it.

But God only discloses his secrets to people who ponder the meaning of everything which happens to them. —by Elisha Douglass

The Daily Reflector

INCORPORATED
209 Cotanche Street, Greenville, N.C. 27834
Established 1882
Published Monday Through Friday Afternoon and Sunday Morning

DAVID JULIAN WHICHARD, Chairman of the Board
JOHN S. WHICHARD—DAVID J. WHICHARD
Publishers
Second Class Postage Paid
at Greenville, N. C.

MEMBER OF ASSOCIATED PRESS
The Associated Press is exclusively entitled to use for publication all news dispatches credited to it or not otherwise credited to this paper and also the local news published herein. All rights of publications of special dispatches here are also reserved.

UNITED PRESS INTERNATIONAL

Advertising rates and deadlines available upon request.
Member Audit Bureau of Circulation.

SUBSCRIPTION RATES
Payable in Advance

Home Delivery By Carrier or Motor Route Monthly	\$3.00
By Mail	
One Year	\$36.00
Six Months	18.00
Three Months	9.00

The Corporate Rites Of Spring

By JOHN CUNNIFF
AP Business Analyst
NEW YORK (AP) — The annual reports are in the mail, soon to be received and probably left unread, to be followed by the annual meetings, to be noted in appointment calendars but probably left unattended.

Yes, it's time again for the corporate rites of spring, for the management of American corporations to report to their owners, the shareholders, and listen in return to the owners' gripes, and sometimes even their praise.

Because last year was a fairly good one for many companies — not good enough they'll remind you, just in case Congress thinks they're growing fat — the gripes are expected to be less noisy than in some recent years.

While the environmentalists and con-

sumerists will be active, and the women too, the emotional edge, the cutting urgency, has been somewhat dulled. They have made their point; they are listened to.

They made their point in other ways too. Having taken a public relations licking at these annual forums, some businessmen now would just as soon do away with annual meetings, if they could.

J. B. Fuqua, head of Fuqua Industries, an Atlanta-based conglomerate, once made that very decision, but the New York Stock Exchange unmade it, insisting that to forego an annual meeting violated listing regulations.

Fuqua had a point. Few people came, he said, so the affair was little more than ritualistic. And if everyone sought to come, assuming there were enough planes and trains and buses to take them — well, they just couldn't

have come; Fuqua has 16,000 shareholders.

The tempo and significance of annual meetings has changed since then, in keeping with the times.

One can hardly forget the striped tents billowing in the breeze at a U.S. Steel meeting early in the 1960s, held on the green of a college campus, a vast picnic indistinguishable from a class reunion.

Nor can shareholders of American Telephone & Telegraph forget their meeting at about the same time in a cavernous New York City armory, an all-day get-together at which boxed lunches were served and shareholders gabbed with old acquaintances.

Controversy intruded. Real issues, tough questions, criticism of management. Women, consumers, clergymen, environmentalists insisted on

being heard. The old family spirit was rent with backbiting.

At least, say some shareholders, annual meetings often were turned into real forums of opinion rather than shows staged by managers reluctant to listen, even turning off microphones so critics couldn't be heard.

But what has become of the annual report? It too underwent serious criticism, and it too has been transformed — to some degree. There remain, however, those necessary but impenetrable asterisks and footnotes.

Still, a real effort has been made to improve the product, through better design and layout, by relating company performance to the big issues, by building the company story around people, by clarifying the writing.

Mears Col...
(Continued from page 4)

course. More advance men, a Carter aide remarked, smiling. Carter ruefully recalls the time he gave a news conference in Philadelphia and nobody came. That won't happen again. And back in his early campaign days, he bunked in with supporters to save money. Now it is part of the image.

Carter likes to joke now about "we Washington insiders," the point being that he came to the White House as quite the opposite, and the fact being that he prefers that role. The outsider's billing is a political asset.

So he is using the techniques and lessons of his long campaign for the presidency in a new campaign to cement con-

fidence and public support now that he's there.

It fits his pledge to stay close to the people, and not forsake them for the traditional power centers of Washington. It also fits his need to broaden his own political base.

By every indication, his is a permanent campaign. He has said, in effect, that he considers it part of the job. Carter spent two years campaigning for office, and the techniques he perfected then are the ones he's employing now. Among them:

—Tonight's visit to Clinton, Mass., for a town meeting appearance. Such sessions were a staple of his election campaign, particularly in the early Democratic presidential primaries, when Carter was most effective.

—His two-hour radio call-in show, a first for a president, but not for him. There was a time when Carter grabbed every local radio invitation he could get. They were free, and a handy way to campaign for recognition. So he made dozens of talk shows, in states across the nation.

—The mass mailing from the White House, soliciting advice on the energy policy Carter has said he will announce on April 20. Letters went out to 300,000 people, selected at random by Census Bureau computers, and to 150,000 officeholders and members of environmental and energy groups. They were asked for suggestions on energy conservation, new resources, and environmental concerns, with replies due by March 21.

Evans-Novak...
(Continued from page 4)

arms negotiations with the Soviet Union.

Other Southern Senators inclined against Warnke's views on disarmament but reluctant to oppose the new President included Robert

Wine Club Will Meet Tonight

Five national or international contest-winning wines will be sampled tonight by the Greenville Wine Club. The "tasting" will be at the Moose lodge, beginning at 7:45. Deadline for reservations was March 5.

Morgan of North Carolina, Russell Long and Bennett Johnston of Louisiana, John McClellan of Arkansas and Lloyd Bensten of Texas.

Nevertheless, 40 votes against Warnke amounted to a dismal administration performance considering that only two weeks ago there were probably less than 10 negative votes. Mississippi's other Senator, chairman John Stennis of the Armed Services Committee, originally argued against his committee (which lacked jurisdiction) even holding hearings on Warnke; he ended up voting no.

A footnote: Two Southerners who decided their concern about Warnke outweighed loyalty to the President were from Mr.

Carter's own state of Georgia, Herman Talmadge and Sam Nunn. Nunn's opposition generated talk among Carterites about trying to purge him in next year's Georgia Democratic primary, but neither the President nor his top political advisers want to go down that dreary road.

Buchwald...
(Continued from page 4)

minute so U.S. doesn't pull the wool over your eyes." "Thank you, Comrades. You can't realize what it means to know you have so much faith in me." "Why not? You're the best man for the job."

Pie'n'Pay SHOES



Rope Combined with Canvas Wraps Up the Now Look for Spring 77
Open Toe Canvas Uppers with Rope Wedge and Heel Trim
Reg. \$14.97. Save \$4.53

10⁴⁴

Price Good thru Saturday

*Open Evenings *MasterCharge or BankAmericard

264 BY-PASS ACROSS FROM NICHOLS DISCOUNT CITY
Open Mon.-Thurs. 10 to 9, Fri. 9 to 9, Sat. 9 to 8
Get to know us; you'll like us.®

Shop Bostic-Sugg for eastern Carolina's most complete selection of patio furniture.



CONVENIENT CHARGE PLANS
We'll help you select a personalized plan to best suit your needs.

30-60-90 day cash plan, no interest or carrying charges.
Pay 1/4 down, 1/4 in 30 days, 1/4 in 60 days and 1/4 in 90 days.
Just like paying cash. Revolving charge plan available, take many months to pay.

Showroom hours 8 a.m. til 5:30 p.m.
Monday thru Saturday and til 9 p.m.
on Friday nights



Bostic-Sugg saves you \$55.00 on Patio Dining Group

Large 42 inch round table with place for umbrella, 4 comfortable arm chairs. Now all 5 pieces at one low, low price.

Save Now **\$135⁰⁰** 5 Piece Set

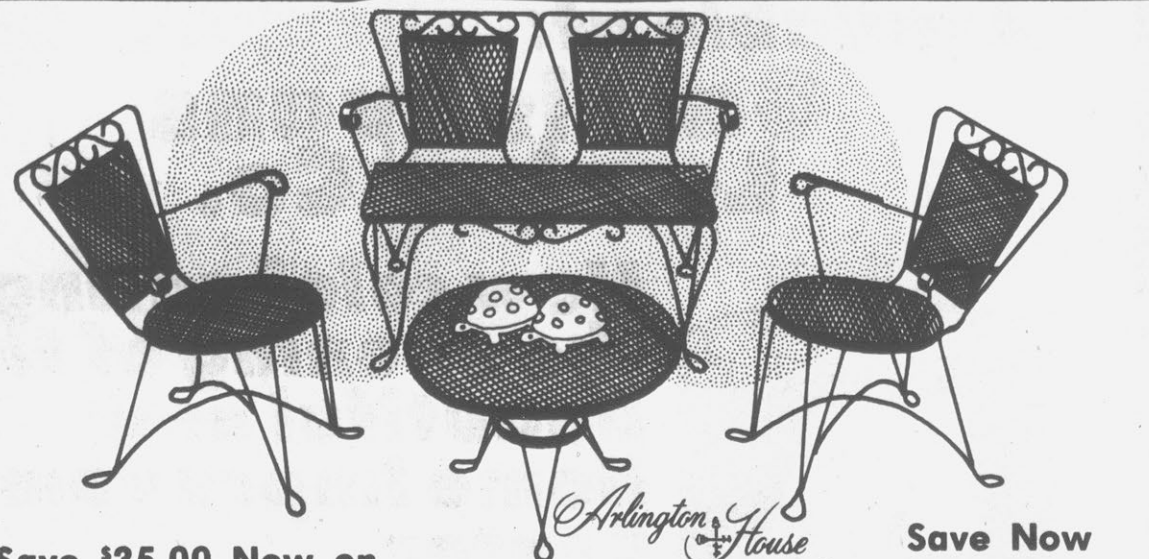

Save \$35.00 Now on 4 Piece Wrought Iron Patio Group

Two seat loveseat plus two arm chairs and a matching round coffee table.

Save Now **\$75⁰⁰**



Save \$45.00 On Deluxe 4 Piece Wrought Iron Patio Group

Sturdily constructed large two seat sofa and two Captain's arm chairs plus coffee table in a choice of 2 colors. White and pump.

Save Now **\$140⁰⁰** 4 Piece Set

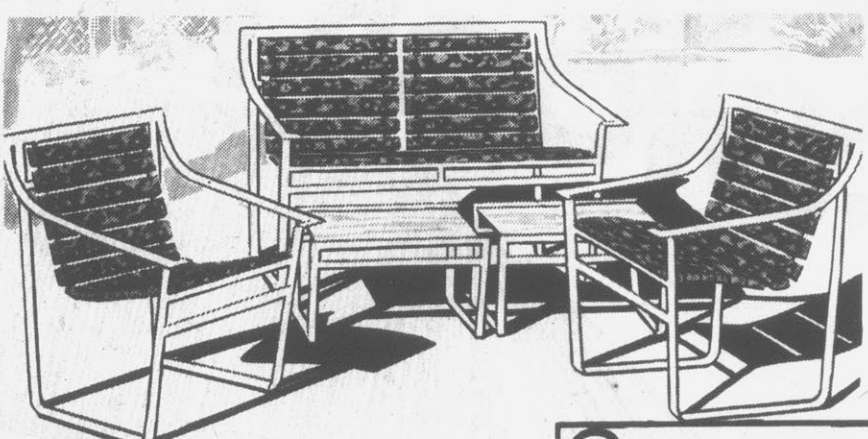

Browse thru Bostic-Sugg's Patio Shop at rear of showroom

Shop Bostic-Sugg's large selection of nationally advertised Samsonite Patio Furniture.

Samsonite Cushionaire II



Samsonite Cushionaire II Group

Special prices now on all Samsonite Patio Furniture. Compare Bostic-Sugg's low price

Classic styling for any patio, sunroom or pool. Samson-Gard 5 year warranty against frame rust failure. Durable steel frames that stay where you put them. Individual flexible slats covered with extra thick outdoor vinyl in beautiful decorator colors — spaced for cool air flow and maximum comfort. Side table tops are made of simulated marble — each top an original design. Chairs stack for easy storage, if you must put them away. If you want quality, try Samsonite

25% Off List Price.

SALE



Pretty Umbrella Table Group

SPECIAL SAVINGS
Compare at \$180.00 and more

\$135⁰⁰ 6 piece set

A real value for those who enjoy summer living... wrought iron furniture by *Scalloy*

6 piece set includes... 36" round Enduro Mesh top table, 4 matching chairs with graceful scrollwork backs, and umbrella

THANKS,

Garris Evans for choosing
Athey as your main paint
supplier.

During your fantastic
Grand Opening, folks can
save 20% on all our paint or
maybe win some Free — just
by playing our "Paint Game."

Athey Paint

Available at:
**Garris Evans
Lumber Co.**



Now celebrating
the opening of their
beautiful new
Home Improvement
Center

701 West 14th Street



STANLEY helps
you do things
right

STANLEY TOOLS, Division of The Stanley Works, New Britain, Conn. 06050



20% OFF
now thru
Saturday

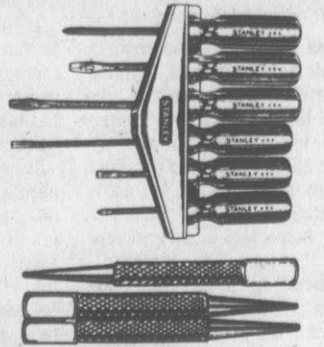

**GARRIS
EVANS**
Lumber Co., Inc.

Congratulations

To
Garris Evans Lumber Co.

On Your
Grand Opening

We appreciate your patronage in the past and look
forward to serving you in the future.

Harris Hardware Company

137 West Main Street
Washington, N.C.

DIAMOND HILL'S TRUCK LOAD SALE

Starting at

3.27

per sheet



AT GARRIS EVANS' GRAND OPENING!
NOW THRU SAT., MAR. 19
701 WEST 14TH



**GARRIS
EVANS**
Lumber Co., Inc.

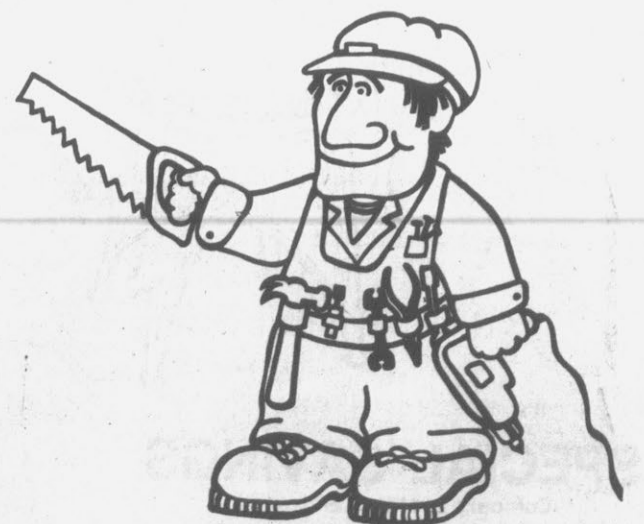

GRAND OPENING

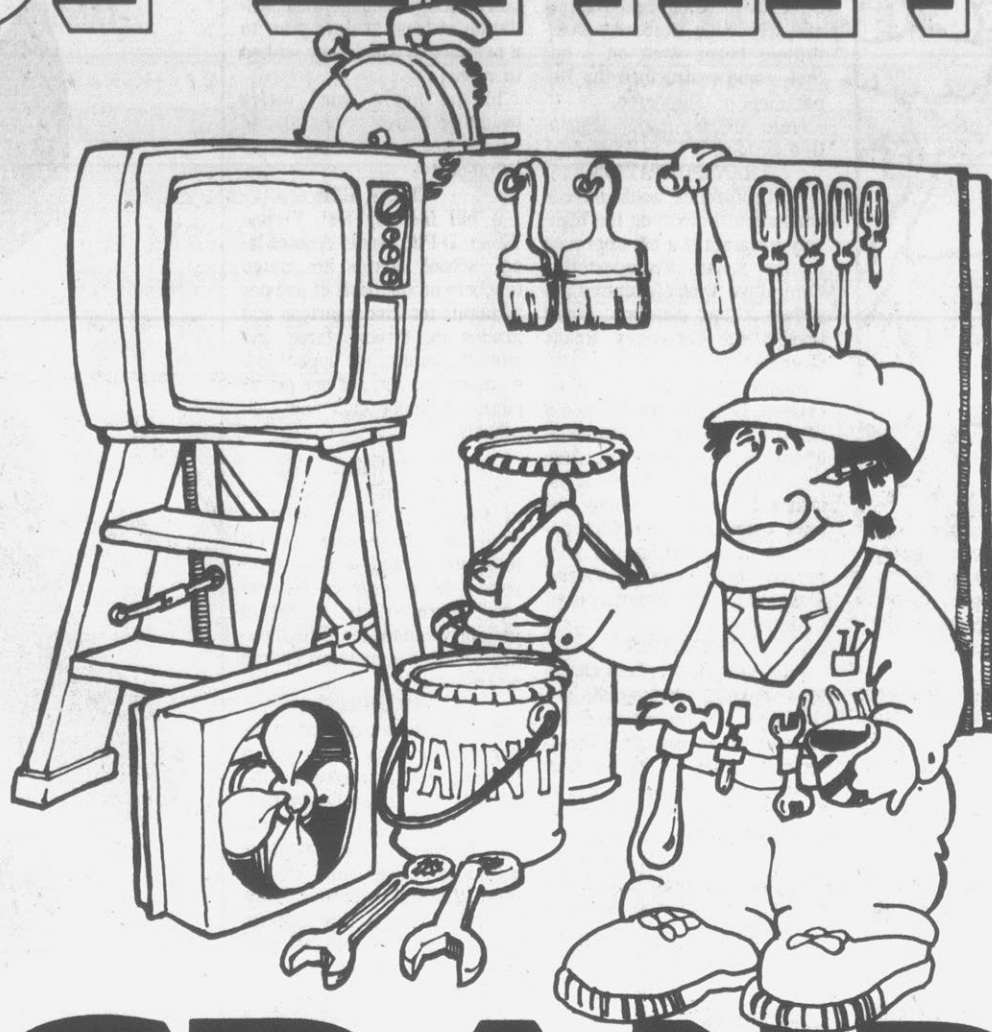

GRAND PRIZES

Thursday, Friday & Saturday - March 17, 18, 19

We're celebrating the opening of our beautiful new store with an extravaganza! Make plans to drop by for a visit and take advantage of the prices and the prizes. There will be a truckload sale of paneling and everything in the showroom will be discounted 20 to 50%!

Register for our grand prize — a Color Television to be given away at 12:30 P.M., Saturday the 19th. And every hour we'll be drawing for door prizes such as Paint, Paneling, a Storm Door, Paint Brushes, a Black

No Purchase Necessary. You Need Not Be Present To Win!

& Decker Saw, a Radio, a Roof Fan, Folding Doors, Plywood, Power Tools and Hand Tools of all kinds, a Step Ladder, and much, much more!

Manufacturers' representatives will be on hand for questions & answer sessions and product demonstrations.

If you get the hungries — we'll be standing by with Free Hot Dogs and Soft Drinks.

Come as often as you like, enjoy the freebies, register for our prizes, take advantage of our low celebration prices, and look us over!



Friday
(afternoon)

Garris Evans' New HOME IMPROVEMENT CENTER



Lumber Co., Inc.
701 West 14th
Greenville

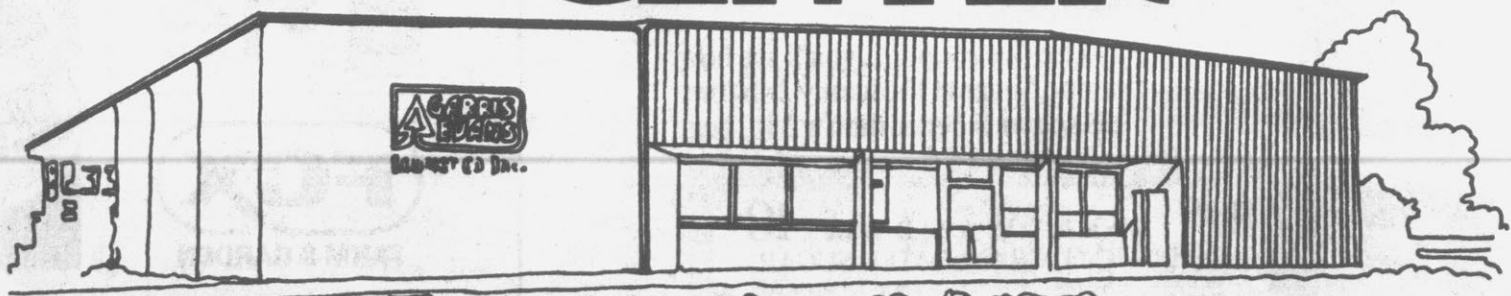

Now on 14th Street, One Block South of Dickinson
(Special Store Hours: Friday, 7:30 a.m. - 8 p.m.; Saturday, 8 a.m. - 6 p.m.)

Hunt's Reorganization Plans Moving In Assembly

Record Skyjack Ended; Police Overpower Man

ZURICH, Switzerland (AP) — An Italian hijacker was overpowered and arrested today at the end of an 8,500-mile pirate flight in a Spanish airliner around Europe and West Africa. It was the longest hijacking on record.

Police said the hijacker, Luciano Porcari, 36, shot and slightly wounded one of the three policemen who seized him inside the plane. No one else was hurt, the police said.

The three policemen entered the plane posing as members of a fresh flight crew that was to fly the Iberian Airlines Boeing 727 to Moscow. They overpowered the hijacker within moments.

The 13 passenger-hostages still aboard the plane and the seven exhausted crew members who had manned the aircraft since early Monday afternoon were released unharmed. The hijacking lasted 44½ hours.

Also aboard was Porcari's 3-year-old daughter by an African mistress, but his estranged Italian wife refused to surrender their 5-year-old daughter to him.

Porcari released seven other passengers in Turin, Italy, and nine in Zurich Tuesday.

The hijacker brought the plane to Zurich from Warsaw where he had agreed to free all hostages in exchange for the new crew to fly him to Moscow. After three hours of negotiations, the Spanish ambassador to Poland, Jesus Millarado, said:

"We can't understand the man's mind. He must be crazy. It has nothing to do with politics. He just thinks he's solving his personal problems."

Porcari, an auto mechanic,

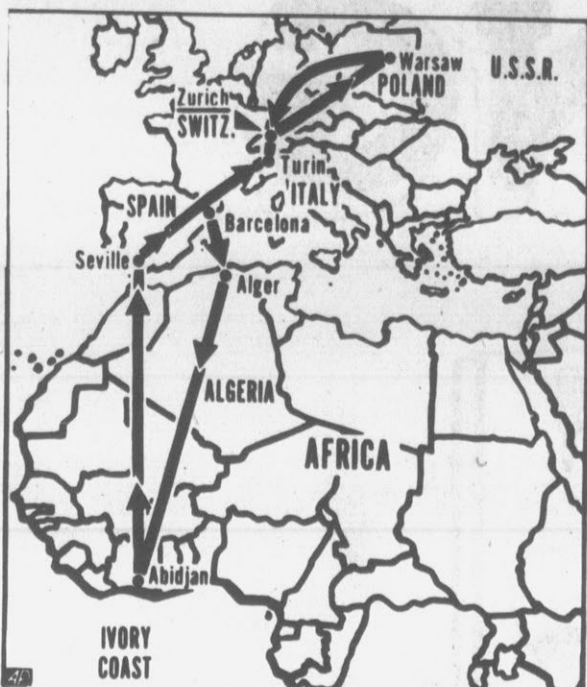

LONGEST HIJACK ENDS — An Italian aerial hijacker was seized in Zurich, Switzerland, today after an 8,500-mile flight in a Spanish airliner. It was the longest hijacking on record. The plane was seized Monday in Barcelona and flown to Algiers, Abidjan, Seville, Turin, Zurich, Warsaw and back to Zurich. (AP Wirephoto Map)

seized the plane on a flight from Barcelona to Mallorca on Monday afternoon. He was armed with a pistol and a rifle and his goal was to get hold of his two daughters.

After a refueling stop in Algeria, the plane flew to Abidjan, the capital of the Ivory Coast, on the under side of the West African bulge. Porcari once worked there, and officials met his demands for delivery of his child by a local woman and \$140,000 in cash.

The plane flew back to Spain, refueled in Seville, and then went to Turin, where Porcari's estranged wife, Bella Zavoli, lives with their 5-year-old daughter, Consuelo. But the mother was adamant, saying: "I cannot leave my daughter in the hands of a man who can commit terrible things."

Porcari ordered the plane to Zurich, negotiated for 90 minutes with an Italian official, ordered the plane into the air, then brought it back in 25 minutes for refueling.

The plane then circled over Turin and Porcari told his elderly mother in the airport control tower he was going to Moscow because "I do not trust the Italian police."

However, there was never

any indication that the Soviets would let the plane land on their territory, and from Turin the airliner went to Warsaw.

The longest previous hijack was a 6,900-mile flight in November 1969 by Raphael Minichiello, a Vietnam veteran born in Italy, who seized a TWA jetliner on a flight from San Francisco to Denver. He had it flown to New York, Maine, Ireland and Rome because he wanted to return to Italy.

Minichiello, then 21, was jailed for 18 months. He is now a waiter in Italy.

RALEIGH (AP) — One of Gov. Jim Hunt's governmental reorganization plans was easily approved by a Senate committee Tuesday while bills were filed to implement some of his campaign promises.

The Senate Transportation Committee approved and sent to the floor Tuesday a bill that would restructure the Department of Transportation and bills were filed to reorganize the state Utilities Commission along the lines advocated by the governor.

Also Tuesday, the House State Government and Natural and Economic Resources committees began work on a bill that would restructure the Department of Commerce.

Here are the major legislative actions:

TRANSPORTATION
North Carolina would have a single board directing the highway program if a bill approved in the Senate Transportation Committee wins legislative approval. The measure would abolish the Secondary Roads Council.

Sponsored by Sen. J.J. Harrington, D-Bertie, the bill would allow the governor to name 20 of the 22 board members while two would come from the legislature. It would also change the laws over DOT to reflect approval of an earlier bill that moved the Ports Authority from DOT to the Department of Commerce.

UTILITIES
Bills were filed in both chambers Tuesday that would put the state Utilities Commission staff under an executive director rather than having the commission oversee its function. The staff would also be charged with representing the public in matters before the commission. Another proposal would require that utility rates be based on the original cost of equipment rather than the current

"fair value" cost which reflects inflation. Utility rates are set to give the company a fair return on investment and if the investment figure is adjusted to account for inflated costs of replacing equipment, it will result in higher rates.

REGISTRATION
On a 106-2 vote, the House passed a bill to change the law dealing with persons registered as independent or no-party voters. Present law permits such persons to adopt a party affiliation on election day and vote in that primary. The bill would require them to change their affiliation at least 21 days prior to a primary in which they wished to vote.

In the future, such voters would be listed as unaffiliated voters instead of independent or no-party.

CLASS SIZE
A bill filed by Sen. Vernon White, D-Pitt, would require local school boards to assign teachers on the basis of one per 26 pupils for kindergartens and grades one through three, one per 33 pupils in upper elementary grades, and one per 35 pupils in junior high and high schools.

TOWING
A bill sponsored by Sen. Jerry Popkin, D-Onslow, to allow hospitals to have autos towed if they are parked in spaces reserved for emergency vehicles was approved by a Senate judiciary committee. The measure allows a maximum charge of \$20.

TRAPPING
The Senate is expected to begin debate this week on a trapping bill approved by the Wildlife Resources Committee. The bill would put some limits on trappers. The measure would ban large traps and require that the trapped animals be protected by having a device attached to the trap that prevents their legs being broken or chopped off.

The measure exempted a number of counties in the northeastern part of the state because trappers in that area hunt otters, which require traps larger than the bill would allow.

TESTS
A spokesman for the state Department of Education said a program of testing the prog-

ress of public school children would be useful and give the public information on pupils' performance.

Several lawmakers said they were worried that the test results may be used to compare schools or children and could cause teachers to alter their teaching methods so that they simply prepare the pupils for

the tests. No action was taken by the Senate and House education committees.

BLIND
A bill was filed that would set up an advisory committee for the blind. It would advise state agencies on needs of blind citizens and be composed of representatives of state government

and organizations for the blind. **MOBILE HOMES**
A bill that would prohibit 14-foot wide mobile homes to be hauled on North Carolina highways was filed by Rep. Myrtle Wiseman, D-Avery. The bill would reinstate the width limit of 12 feet that the state Board of Transportation recently changed.

Prince Calls On Pres. Kenyatta

NAKURU, Kenya (AP) — Prince Charles, heir to the British throne, paid a courtesy visit to President Jomo Kenyatta after a private camping safari in this African country.

Tuesday's visit to Kenyatta was Charles' first public appearance since he flew into Nairobi March 6.

Charles, a bachelor, had been camping in Kenya's Aberdare Mountains. British reporters tried to locate him before Tuesday after unconfirmed rumors circulated that he was accompanied on the trip by a blonde woman.

Book Report Winners Named

W. H. Robinson Primary Reading Lab teacher Althea Weathering, and her assistant, Betty Lou Brock have announced the following book report winners for the fourth six-week period: Bears Class, Ronnie Greene; Cougars, Monica Jones; Giants, Kathy Foskey, Toni King, and Donald Murry; Lions, Robert Carmon; Pirates, Sywanda Carr; and Tigers, Danny Hawkins.

WATER WEIGHT PROBLEM?
USE **E-LIM**
Excess water in the body can be uncomfortable. E-LIM will help you lose excess water weight. We at Clow Drug Store recommend it.
Introductory Offer Worth **\$200**
Cut out this ad — take to store listed. Purchase one pack of E-Lim and receive one more E-Lim Pack Free.
CLOW DRUG
West End Shopping Center

Comfortable Casual

The Regency by Hush Puppies® casuals is designed to provide versatility to your footwear wardrobe...contemporarily designed to be worn handsomely with blazer and slacks, but adaptably casual to be worn comfortably just knockin' around. Available in rain and stain resistant Breathin' Brushed Pigskin®

Hush Puppies
BRAND SHOES

Colors: Hash Brown, Brushwood. Sizes 7½ to 13, C and D widths.

\$28.99

SHOE STORE
Larry's

Quality
Fit
Service

AT 5 POINTS
OPEN DAILY 9 TO 6

So much better than a bag

Domino® Granulated Sugar in the 2-lb. box.

It's handier...pours right from the metal pour spout. (You don't even need a sugar bowl.)
Nothing to tear open...nothing to cut (or spill!)
Stores easier...anywhere you want to keep it.
Costs no more than our sugar in the old 2-lb. bag.

Use this coupon...you'll see how Domino Sugar in the handy 2-lb. box is so much better than a 2-lb. bag.

10¢ SAVE 10¢ ON A 2-LB. BOX OF DOMINO® GRANULATED SUGAR.

Mr. Grocer: As our agent, redeem this coupon for 10¢ on the purchase price of a 2-lb. box of Domino Granulated Sugar. Mail to Domino Sugar, P.O. Box 1772, Clinton, Iowa 52736. We will then pay you 10¢ plus 5¢ handling. This offer void in any state or locality where taxed, prohibited, or restricted by law. Cash value 1/20th cents. FRAUD CLAUSE: Any other application of this coupon constitutes fraud. Invoices proving purchases within 90 days of sufficient stock to cover coupons presented for redemption must be made available upon request. This coupon good for one purchase only. Sales tax to be paid by customer.
Coupon expires May 14, 1977.

10¢

Amstar
AMERICAN SUGAR DIVISION

SAVE NEARLY 25 PERCENT WHEN YOU DRIVE NOW TO AN FCX STORE. QUALITY TIRES, DEPENDABLE BATTERIES ARE SPRING SALE PRICED. ENJOY GOOD DRIVING WEATHER MORE, WITH THE SAVINGS YOU GET FROM FCX.

FCX SPRING TIRE & BATTERY SALE!

MARCH 16 THRU 26

PRICES INCLUDE MOUNTING AND OFF-CAR BALANCING — NO TRADE-IN REQUIRED.

MARK 74 RADIAL			DIRECTOR 120			S.P.D. POLY		
Polyester with 2 Steel Belts Whitewall			2 + 2 Belted Polyester/Fiberglass Whitewall			Full 4-Ply Polyester Whitewall		
SIZE	F.E.T.	SALE	SIZE	F.E.T.	SALE	SIZE	F.E.T.	SALE
DR78-14	2.38	44.15	B78-14	1.88	27.45	A78-13	1.72	23.75
ER78-14	2.47	45.30	E78-14	2.26	29.80	B78-13	1.82	24.85
FR78-14	2.65	47.35	F78-14	2.42	32.25	C78-13	1.97	25.40
GR78-14	2.85	52.95	G78-14	2.58	33.85	C78-14	2.01	25.40
HR78-14	3.04	54.95	H78-14	2.80	36.85	E78-14	2.23	25.95
GR78-15	2.90	54.95	G78-15	2.65	36.85	F78-14	2.37	27.95
HR78-15	3.11	57.10	H78-15	2.88	38.85	G78-14	2.53	30.75
LR78-15	3.44	57.10	J78-15	3.03	38.85	H78-14	2.73	28.05
			L78-15	3.12		F78-15	2.40	31.75
						G78-15	2.59	31.75
						H78-15	2.79	33.75
						J78-15	2.96	33.75
						L78-15	3.09	33.75

*Plus State Sales Tax

CO-OP Brake Fluid SPECIAL \$1.29 12 oz. can

More than a wet battery — More than a dry battery — it's Dry-namic!

DIRECTOR

DR 24 Fits most GM and Chrysler applications; 4-year warranty. 12-Volt. **SALE \$33.29**

DR 24F Fits most Ford applications; 4-year warranty. 12-Volt. **SALE \$33.29**

DR 74 Fits most GM side terminal applications; 4-year warranty. 12-Volt. **SALE \$33.99**

TG-1XHD Fits most 6-Volt farm applications; 1-1/2-year warranty, truck and tractor. 6-Volt. **SALE \$28.19**

FCX FARM & GARDEN

GREENVILLE — Line & Chestnut Streets — 919-758-3173
FARMVILLE — South Fields Street Ext. — 919-753-3492

WILLIAMSTON — Jamesville Road — 919-792-7086
BELHAVEN — West Main Street — 919-943-3136
WASHINGTON — 132 West 5th Street — 919-946-8049

CHECK OUR BARGAINS ON TRUCK AND TRACTOR TIRES TOO!

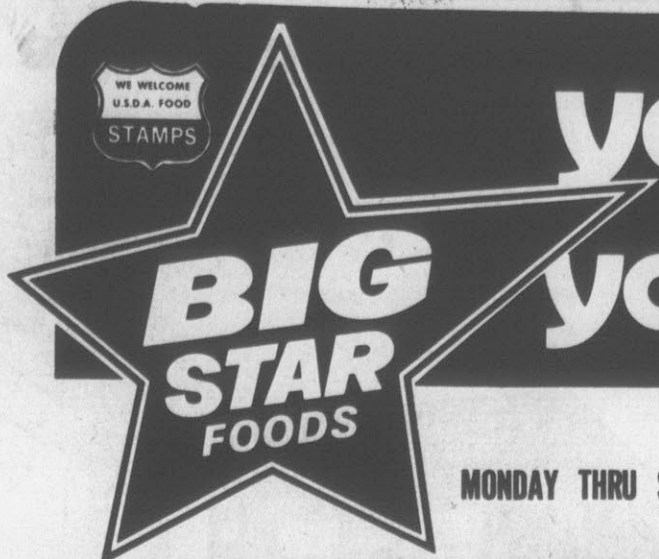

your kind of food store with your kind of EVERY-DAY LOW PRICES

STORE HOURS:
MONDAY THRU SATURDAY 8 A.M.-10 P.M.
SUNDAY 9 A.M.-9 P.M.

FRESH FROZEN CHICKEN LIVERS 5-LB. PAIL **\$1.58**

PRICES GOOD THROUGH SATURDAY, MARCH 12, 1977—QUANTITY RIGHTS RESERVED—NONE SOLD TO OTHER DEALERS OR RESTAURANTS.

U.S. CHOICE BEEF BLADE
CHUCK ROAST
BONE IN LB. **53¢**
BONUS BUY!

FFV OR OLE VIRGINNY
VIRGINIA COUNTRY STYLE
HAMS
• Half Lb. \$1.29
\$1.19 WHOLE LB.
BONUS BUY!

MOTHER'S
MAYONNAISE
QUART JAR **58¢**
BONUS BUY!

When you buy all purpose white potatoes at Big Star, you buy with confidence. All are in see-through poly bags. All are priced at the same everyday low price.
ALL PURPOSE WHITE
POTATOES
10-LB. POLY BAG **86¢**
BONUS BUY!

OLE CAROLINA
BACON
SLICED 1-LB. PKG. **78¢**

BUY "FAMILY PACKS" & SAVE

- ★ RIB EYE-DELMONICO STEAKS Pkg. of 10-8 Oz. Steaks **\$12.88**
- ★ BEEF SHORT RIBS Lean & Meaty 5-Lb. Pkg. **\$3.98**
- ★ BONELESS BEEF STEW Lean 5-Lb. Pkg. **\$5.98**
- ★ CUBED BEEF STEAKS 5-Lb. Pkg. **\$7.98**

FRESH **MUSHROOMS**
LB. **99¢**

OSCAR MAYER
BEEF FRANKS OR **WIENERS** 1-LB. PKG. **\$1.08**
SLICED **BACON** 1-LB. PKG. **\$1.58**

SHOP **BIG STAR** FOR **U.S. CHOICE BEEF**

- ★ 7-BONE ROAST Bone In Lb. **68¢**
- ★ SHOULDER ROAST Bone In Lb. **88¢**
- ★ 7-BONE CHUCK STEAK Bone In Lb. **88¢**
- ★ CHUCK POT ROAST Boneless Boston Roll Lb. **\$1.28**
- ★ SHOULDER ARM STEAK Bone In Lb. **\$1.18**
- ★ WHOLE TOP SIRLOIN Boneless (10-12 Lb. Avg.) (Cut Into Steaks Free) Lb. **\$1.48**
- ★ BONELESS TOP SIRLOIN Or Bone In N.Y. Strip Steaks Lb. **\$1.88**

LARGE FLORIDA
★ **ORANGES** Dozen **74¢**

LARGE FLORIDA
★ **ORANGES** 18 Pack **\$1.09**

FRESH CRISP
★ **CARROTS** 2-Lb. Bag **44¢**

your kind of MEATS

- PORK CHOPS Assorted — 1/4 Loin Sliced Lb. **\$1.08**
- SLICED BEEF LIVER Skinless & Deveined 5-Lb. Pkg. **\$2.38**
- TENDER YOUNG DUCKLINGS Lb. **98¢**
- LAMB LEGS New Zealand "Spring" Lb. **\$1.38**
- OLD FASHION HOOP CHEESE Lb. **\$1.48**
- PORK SAUSAGE Farm Brand Hot Or Mild 1-Lb. **88¢**
- PORK SAUSAGE Farm Brand 2-Lb. **\$1.75**
- SHRIMP PIECES Singleton's Breaded 1-Lb. **\$1.99**
- SALAD SHRIMP Golden Fleet Peeled 12-Oz. **\$1.99**
- FISH STICKS Gorton's Batter Fried 8-Oz. **99¢**
- FISH FILLET Gorton's Cooked 9-Oz. **79¢**
- HORMEL BEEF STEAKS 1-Lb. Pkg. **\$1.39**
- BREADED VEAL STEAKS Hormel 1-Lb. **\$1.39**
- BREADED PORK STEAKS Hormel 12-Oz. **\$1.19**

STOKELY "CANNED FOOD SALE"
★ **GREEN BEANS** Cut Or French Style 16-Oz. Can
★ **GOLD CORN** • Cream Style 17-Oz. Can • Whole Kernel
YOUR CHOICE! 4 For \$1.00

- * HONEY POD PEAS 16-Oz. Can **29¢**
- * FRUIT COCKTAIL 17-Oz. Can **38¢**

VANITY FAIR

- FACIAL TISSUE Save 13¢ 134-Ct. **39¢**
- DINNER NAPKINS Save 20¢ 75-Ct. **59¢**
- PAPER TOWELS Save 8¢ Jumbo Roll **45¢**
- BATH TISSUE Save 20¢ 4-Pak **59¢**
- LUNCH NAPKINS Save 10¢ 100 Ct. **49¢**

your kind of PRODUCE

BANANAS LARGE & RIPE LB. **22¢**

TROPICANA ORANGE JUICE HALF GALLON **78¢**

FARM CHARM PREMIUM QUALITY
ICE CREAM Bonus Buy! 1/2 Gal. **\$1.48**

STOKELY (32-Oz. Bottle...69¢)
TOMATO CATSUP 14-Oz. Bottle **29¢**

VAN CAMP
BEANEE WEENEE 8-Oz. Can **29¢**

VAN CAMP-8 Oz. Can
PORK & BEANS 5 For **\$1.00**

OVEN KRISP COOKIES
* BUTTER COOKIES — 10-Oz. Box
* OATMEAL COOKIES — 10-Oz. Pkg.
* COCONUT MACAROONS — 10-Oz. Pkg.
3 For \$1.00

LIGHT 'N LIVELY YOGURT Sealtest Bonus Buy! 8-Oz. **33¢**

AUNT JEMIMA WAFFLES Frozen Original 10-Oz. **49¢**

SANDWICH BREAD Our Pride 24-Oz. **33¢**

JIFFY CORN MUFFIN MIX 8 1/2-Oz. **19¢**

HEINZ 57 STEAK SAUCE 15-Oz. **98¢**

FARM CHARM YOGURT 8-Oz. **29¢**

LIPTON TEA BAGS 48-Ct. **74¢**

SWIFT'S BEEF STEW 24-Oz. **78¢**

HAWAIIAN PUNCH Fruit Drinks 46-Oz. **49¢**

OUR PRIDE FLOUR 5-Lb. **58¢**

PAT'S POTATO CHIPS 8-Oz. **58¢**

STAR KIST TUNA Chunk Light 6 1/2-Oz. **53¢**

SUN RIPE APPLE JELLY Bonus Buy! 16-Oz. **48¢**

SUN RIPE GRAPE JELLY Bonus Buy! 16-Oz. **48¢**

FARM BEST—BONUS BUY! OR BAR
ICE CREAM SANDWICHES 6-PAK **58¢**

HEALTH & BEAUTY AID BONUS BUYS!

- SOFT COSMETIC PUFFS 260's **68¢**
- ALKA SELTZER (4 Free Pack) 40's **\$1.17**
- CLOSE UP TOOTHPASTE 12¢ Off 4.6-Oz. **68¢**
- BC HEADACHE POWDERS 24's **74¢**
- CERTIFIED ASPIRIN 100's **37¢**

OUR PRIDE • 40% WHEAT BREAD 16-Oz. **39¢**

BAKERY • ROLLS Brown & Serve Butterflake 12-Oz. **37¢**

PRODUCTS • BREAD Buttertop 24-Oz. **39¢**

LIQUID COLD WATER WASH
WOOLITE 32-OZ. BOTTLE **\$2.69**

Stock And Market Reports

RALEIGH (AP) (NCDA) — Cattle Auctions: Monday — Hillsborough 369 head of cattle and 303 hogs. Slaughter cows: utility and commercial 26.00-30.00; canner and cutter 23.50-26.25; vealers (150-250) choice 59.00-62.00; good 48.00-54.00; calves (250-325) choice 56.00-59.00; good 38.00-50.00; bulls (1,000 up) utility and commercial 31.50-36.50; feeder steers (400-500) good 36.00-39.50; feeder heifers (200-300) standard and good 27.00-31.00; (400-500) standard 26.00-29.00; feeder bulls (400-550) good 33.00-36.50; swine (180-240) 37.50-38.00; (240-270) 34.50-35.75; (300-600) 20.00-26.00.

N. Wilkesboro 659 head of cattle and 33 hogs. Slaughter cows: utility and commercial 25.00-30.50; canner and cutter 22.00-24.75; vealers (150-250) choice 58.00-64.00; good 45.00-57.00; calves (325-550) good (400-550) good 35.00-40.75; swine (180-240) 32.50.

RALEIGH (AP) (NCDA) — Feeder pigs: Tuesday — Wallace-Chadbourn 1,755 head; 40-50 lbs No. 1s and 2s 91.25; No. 3s 80.25; 50-60 lbs No. 1s and 2s 78.71; No. 3s 71.00; 60-70 lbs No. 1s and 2s 69.00; No. 3s 64.00; 70-80 lbs No. 1s and 2s 56.00; No. 3s 54.50.

RALEIGH (AP) (NCDA) — N.C. Eggs: Tuesday — Market steady. Supply adequate. Demand moderate to good. Weighted average prices for small lot sales of consumer grade A white eggs delivered to nearby retail stores 71.13 cents per dozen for large; 61.39 for medium and 55.46 for small.

RALEIGH (AP) (NCDA) — State Farmers Market: Tuesday — (wholesale prices) Apples, bushel baskets 5.00-6.00, traprack cartons 8.50-10.00; Cabbage, 50-lb bags 8.50-9.00; Collards, bushel hampers 4.50-5.50; Cucumbers, bushel baskets 18.50-20.00; Oranges, cartons 4.50-6.00; Grapefruits, cartons 3.75-4.75; Greens, bushel hampers 4.50-5.00; Lettuce, cartons 7.00-7.50; Peppers, bushel hampers 18.50-21.00; Irish potatoes, 50-lb bags 3.85-5.00; Sweet Potatoes, bushel baskets 7.00; Strawberries, 12-pint flats 6.25-6.50.

RALEIGH (AP) (NCDA) — Charlotte Cotton: Monday — Market higher. Strict low middling 1-16 inch 77.00 per hundred pounds.

The Meeting Place

- WEDNESDAY**
 6:30 p.m. — Kiwanis Club meets
 6:30 p.m. — REAL Crisis Intervention meets
 7:00 p.m. — Winterville Jaycees meet at Depot Grill
 7:00-9:00 p.m. — Free blood pressure clinic at Moose lodge
 7:45 p.m. — Wine Club meets at Moose lodge
 8:00 p.m. — Pitt County Al Anon Group meets at AA Bldg., on Farmville Hwy., Telephone 752-7606 or 752-5284
 8:00 p.m. — Pitt County Ala-Teen Group meets at AA Bldg., Farmville Hwy., Telephone 756-2501 or 752-5284
- THURSDAY**
 9:30 a.m. — Welcome Wagon ladies bowling at Hillcrest Lanes
 10:00 a.m. — Elm Street Senior Citizens meet
 6:30 p.m. — Exchange Club meets
 7:00 p.m. — Winterville Kiwanis Club meets at community bldg.
 8:00 p.m. — VFW meets at Post Home
 8:00 p.m. — Coochee Council No. 40, Degree of Pocahontas meets at Redmen's Hall

RALEIGH (AP) (NCDA) — Grain: Tuesday — No. 2 yellow shelled corn generally steady at 2.51-2.58, mostly 2.51-2.52 in the east and 2.65 in the piedmont. No. 1 yellow soybeans higher at 8.06-8.27, mostly 8.20-8.27. New crop corn harvest delivery 2.40-2.45. New crop soybeans 6.81-6.86. New crop wheat June-July delivery 2.34.

Following are selected 11 a.m. stock market quotations:

Burroughs	22 1/2
United Telecommunications Pfd.	22 1/2
Heublein	26 1/2
Jeff Pilot	30
Tri South	1 1/2-1 3/4
Wicks	13 1/2
Wachovia Realty	4 1/2
Eckerd's	24
Central Soya	13 1/2
Hardies	9 1/2
Integen	10 1/2
Fieldcrest	17 1/2
Hatters Income	19 1/2
Veeco	14 1/2

OVER THE COUNTER

Combined Insurance	15 1/2-16
Franklin Life	22 1/2-23 1/2
NCNB	11 1/2-11 3/4
Little Giant	7 1/2-8
Conner Homes	2 1/2-3 1/2
Guardian Corporation	3-3 1/2
Planters Bank	16 1/2-18
Daniel International Corporation	19 1/2-20 1/2
Piedmont Air	5 1/2-5 3/4

NEW YORK (AP) — The stock market headed up again today, opening higher for the third straight session.

The Dow Jones average of 30 industrial stocks rose about a fraction in the early going, adding to its two-day advance.

Gainers outnumbered losers by nearly 2-1 among New York Stock Exchange-listed issues.

Analysts felt the market's performance, advancing this week with stepped up trading, was drawing investors back into the market.

In addition, traders got a boost from some good economic news after the market's close.

The industrial production, which fell in January because of the weather, rebounded in February.

Today's early prices included Kresge, up 1/8 to 34; Xerox, down 1/8 at 49 1/2, and General Motors, ahead 3/8 to 72 1/2.

On Tuesday, the Dow Jones average, ahead by more than eight points during the day, was up 6.73 at 965.09 at the close.

Gainers outnumbered losers by nearly 2-1 on the NYSE.

Big Board volume reached 23.94 million shares, against 19.29 million Monday.

The NYSE's composite index was ahead 28 to 55.38.

On the American Stock Exchange, the market value index rose 45 at 111.59.

Driving Rodeo Set Thursday

FARMVILLE — A driving rodeo for the Northeast Region of North Carolina will be held here tomorrow afternoon.

Students drivers from throughout this area will compete on the driving range of Farmville Central High School. There will be both written and driving tests.

Industry Threat Seen In Jeans

TORONTO (AP) — Pierre Cardin, the French designer who brought high fashion into ready-to-wear clothes 17 years ago, says the popularity of blue jeans has been dangerous to the fashion industry.

"And jeans aren't fashion," he said in an interview Tuesday. "Designers can do nothing about it. I can do nothing about jeans."

Cardin has 346 factories in 46 countries producing his clothing and accessories. He employs 70,000 people.

Chlorine Leak Hits Manteo

MANTEO, N.C. (AP) — About 30 persons were treated for gas inhalation and the Dare County courthouse and jail were evacuated when a chlorine gas tank ruptured in the downtown section of this coastal city Tuesday.

Seven persons were hospitalized for treatment, a spokesman for the sheriff's office said.

The 50-pound tank of chlorine gas was on a truck owned by Basnight Construction Company when it exploded, said Sheriff's investigator Sammy Smith.

Jimmy Basnight, driver of the vehicle, said the tank "just started moving" and then ruptured with an explosive sound. The truck was parked at a hardware store near the courthouse and jail.

Among those hospitalized for treatment and observation were Basnight, Mrs. Katie Williams, a motorist, Manteo policeman Bill Cass and sheriff's department dispatcher Mrs. Elmer Wood.

Smith said wind carried the green gas fumes into the courthouse and into an adjacent restaurant, prompting the evacuation. A portion of the city was barricaded off while the injured were removed.

Acting on advice of the Poison Control Center at Norfolk Naval Hospital, persons breathing small amounts of the chlorine were treated at Manteo Memorial Center. Many were given shots to combat possible pneumonia, which can be caused by lung tissue being burned.

Approval was given for the administration to negotiate for the purchase of 236 19-inch color television sets that would have closed circuit capacity, as well as the ability to pick up four local channels and two fm radio stations. The closed circuit capacity would be used for health education for patients and also for them to hear programs in the hospital chapel and possibly view family members who could not be admitted to their rooms. Maintenance of the sets would be performed by an "in-house crew" or by a local dealer under contract.

The Board approved the pursuit of Pitt Memorial's becoming an organ procurement center in cooperation with N.C. Memorial and Duke Hospitals.

Landscaping is being considered, it was reported. The Agricultural Extension Service has been contacted about help with landscaping, but reported that it will be glad to help with education but cannot compete with private enterprise to do actual planning of the hospital grounds beautification.

The county manager has been contacted and a change order has been drafted to allow for the inclusion of exterior lighting, an item removed when money was low some time back. The lighting should be completed by the opening Apr. 30, Construction Manager Ralph Hall reported.

The Board went on record as approving paid parking for hospital visitors. The thinking now is that there will be 50 cents per day charge to cover the cost of maintenance, security, and lighting and to make it so the cost of parking does not have to be included in patient-day costs.

A committee was appointed to study whether to change the name of the medical complex developing on the hospital site, and if so, what to call it.

Hospital Bd...

(Continued from page 1)

Approval was given for the administration to negotiate for the purchase of 236 19-inch color television sets that would have closed circuit capacity, as well as the ability to pick up four local channels and two fm radio stations. The closed circuit capacity would be used for health education for patients and also for them to hear programs in the hospital chapel and possibly view family members who could not be admitted to their rooms. Maintenance of the sets would be performed by an "in-house crew" or by a local dealer under contract.

The Board approved the pursuit of Pitt Memorial's becoming an organ procurement center in cooperation with N.C. Memorial and Duke Hospitals.

Landscaping is being considered, it was reported. The Agricultural Extension Service has been contacted about help with landscaping, but reported that it will be glad to help with education but cannot compete with private enterprise to do actual planning of the hospital grounds beautification.

The county manager has been contacted and a change order has been drafted to allow for the inclusion of exterior lighting, an item removed when money was low some time back. The lighting should be completed by the opening Apr. 30, Construction Manager Ralph Hall reported.

The Board went on record as approving paid parking for hospital visitors. The thinking now is that there will be 50 cents per day charge to cover the cost of maintenance, security, and lighting and to make it so the cost of parking does not have to be included in patient-day costs.

A committee was appointed to study whether to change the name of the medical complex developing on the hospital site, and if so, what to call it.

Truck On The Loose



OVER THE WALL, UP THE HILL... and into the yard of the old Eppes High School was the record of this truck after the brakes failed Tuesday afternoon. The front axle and wheels were knocked loose from the truck and came to rest behind the truck body. (Reflector photo by Jerry Raynor).

Dylan Divorce Data 'Sealed'

SANTA MONICA, Calif. (AP) — Attorneys for singer-songwriter Bob Dylan and his wife, Sarah, have met in court to settle preliminary matters dealing with the couple's divorce, court officials say.

However, the records of the proceedings before Superior Court Commissioner John Alexander were sealed by court order last week, said Mrs. Dylan's attorney, Marvin Mitchell, after Tuesday's proceedings.

Mrs. Dylan's petition for divorce cited irreconcilable differences, which is all California law requires.

On March 1, she was granted temporary custody of the couple's five children and exclusive use of the rambling, dome-topped house of the two built in the coastal Malibu colony.

Greenville Police Reported

that the driver of a truck jumped from the vehicle and was injured when brakes on the truck failed causing the vehicle to collide with a brick wall at the intersection of Fifth Street and Bancroft Avenue about 1:55 p.m. yesterday.

Investigators said William Edward Barnes of Williamson was taken to Pitt Memorial Hospital for treatment of injuries he received when he jumped from the vehicle.

According to police, the truck was traveling down Bancroft Avenue when the brakes failed. The vehicle crossed Fifth Street and collided with a wall, coming to rest 21 feet from the wall.

Damage to the vehicle was estimated at \$2,500 by officers who charged Barnes with having improper brakes.

Investigators said William Edward Barnes of Williamson was taken to Pitt Memorial Hospital for treatment of injuries he received when he jumped from the vehicle.

According to police, the truck was traveling down Bancroft Avenue when the brakes failed. The vehicle crossed Fifth Street and collided with a wall, coming to rest 21 feet from the wall.

Retirees Plan Meet Saturday

The Pitt County Chapter No. 1530, NARFE, will meet at noon Saturday at the Three Steers Restaurant.

Members and interested civil service retirees are invited to attend.

A dutch luncheon will be served.

GOSPEL CONCERT

The Gospel Pearls and The Gospelaires of Greenville will appear in concert at Warren Chapel F.W.B. Church Sunday March 20 at 4:30 p.m. The concert will be sponsored by the Gospel Chorus. Miss Margie Nobles and Roger Ingram will accompany the groups. The public is invited.

Ham, Bacon or Sausage with one egg, grits, toast, jelly	85¢
Two eggs, grits, toast	75¢
Ham, bacon or sausage & egg sandwich	60¢

CAROLINA GRILL

Spring Opening

Weeping Fig Plants
Scheffleras
Rubber Plants
Selloms
False Areilia

All in 6 inch pots

\$ 3.99

Assorted Varieties
Hanging Baskets
 8 Inch Size
\$4.99

Patented
African Violets
\$1.88

EXTRA ATTRACTION
 DIRECT FROM CALIFORNIA
 BEAUTIFUL FRESH CUT FLOWERS

CARNATIONS 4 For \$1.00
 Or Dozen For \$2.89

GLADIOLAS Bunch of 4 99¢

POT MUMS 8 inch pots \$3.99

We have Eucalyptus, pom poms, daisies, iris and floral arrangements.

20% off
On All Tropical Foliage Plants
 (Excluding Specials)

Gardenia Plants \$2.99
 (with buds) 4 Inch Pots

Assorted Varieties
Angel Plants 3 Inch Pots **88¢**

Each plant tagged with name and care instructions

Begonias or Geraniums 4 inch pots **99¢**

Just arrived a nice selection of large plants each including Bambo Palms, Areca Palms, Weeping Figs, Fiddle Leaf Figs and Norfolk Pines.

OVERTON'S INC SUPERMARKET
 3rd AND JARVIS ST.

"Greenville's largest supermarket selection of floral plants at low supermarket prices."

Green Sale.

10¢ off on Liquid Prell.

Discover for yourself Liquid Prell's healthy, lively look.

CUT ALONG DOTTED LINE

TAKE THIS COUPON TO YOUR STORE

save 10c **10c**

WHEN YOU BUY LIQUID Prell

LIMIT ONE COUPON PER PURCHASE

TO THE CONSUMER: CAUTION: Do not embarrass your dealer by asking him to redeem coupons without making the required purchase. He must redeem coupons TO THE DEALER. You are authorized to act as our agent for the redemption of this coupon. We will reimburse you for the face value of the coupon, or, if coupon cashes for the purchase, we will reimburse you for such face value, plus 12¢ for handling. Provide that you and the consumer have complied with the terms of our coupon offer. By submitting this coupon for reimbursement, you represent that you understand and agree to these terms. Any failure to enforce these terms shall not be deemed a waiver of any of the conditions. TERMS OF COUPON OFFER: This coupon must be redeemed by a consumer at the time of purchase of the brand specified with the face value of the coupon being deducted from the dealer's retail selling price. This coupon is non-transferable and may not be reproduced. The consumer must pay any sales tax involved. Invoices giving purchase of sufficient stock of our brands to cover coupons presented must be shown upon request. This coupon will be accepted for reimbursement if identified as being the property of the retail distributor of our merchandise who redeemed them. Reimbursement can be made only to a retail distributor of our merchandise or to a holder of our Certificate of Authority acting for him. COUPONS SHOULD BE SHIPPED AT OUR EXPENSE TO PROCTER & GAMBLE, 2150 SUNNYSIDE DRIVE, CINCINNATI, OHIO 45227. Cash redemption value 1/20 of 1¢.

PROCTER & GAMBLE

Jaguars Rally To Nip Rampants, 4-3

By WOODY PEELE
Reflector Sports Editor

FARMVILLE — Farmville Central, angered by losing a pair of runs on an appeal play, stormed back in the sixth inning to score two runs and gain a 4-3 victory over Rose High School yesterday.

Jerry Rackley in the bottom of the fifth inning, but an appeal play wiped out both of the runs and left Rose in a 3-2 lead despite arguments from Jaguar Coach Linwood Woodard that at least one of the runs should have counted.

"At first, I was arguing that the appeal had been put wrongly," Woodard said. "Then, I felt that we should have gotten at

least one run. But it doesn't matter now."

The bottom of the fifth turned out to be quite an inning. With one down, David Cochran slammed a double off the fence in center field. Emerson Hobgood followed with a single to shallow center, putting men on first and third.

Rose pitcher Danny Hester stepped off the rubber and faked

a throw to third with Donald Holloman at bat. Cochran scooted back and Hester whirled and threw to first, catching Hobgood off the base watching the play.

Holloman then walked, leaving the situation as it was. Rackley followed with a blast to right center, but he was thrown out at third trying to stretch it to a triple.

Rose then appealed that Holloman had not touched second, and the umpires upheld him, saying the "force" became effective and none of the runs counted, and Rackley's hit was voided.

Rose broke into the lead in the game in the second inning with a pair of runs. Greg Lee and Mark Conway both singled and Reggie Spain reached on a fielder's choice. Hester then helped himself with a single to center, scoring both Lee and Conway.

The Jaguars, who had threatened in the first, scored a pair of runs in the second. Hobgood reached on an infield hit and moved up on an error on the play. Holloman walked and Carroll Griffin singled to drive in both runners. Ted Dunn followed with a single, but Griffin was cut down trying to go to third, ending the threat.

Rose regained the lead in the fourth with a run. Lee reached on a bunt and Conway singled, moving up on an error on the play as Lee went to third. Spain then hit a sacrifice fly, scoring Lee.

Rose had threatened in the third, but a double play on a fly to short left killed the threat. Rose got a man as far as second in the sixth, but again, a double play took Farmville out of trouble.

The Jaguars lost a fine chance to score in the fourth with some alert play by the Rampants. With runners at first and second Dunn grounded to short. The ball was played to third, but was off-target. The ball went to the Jag

dugout as Holloman, who reached third safely, headed home. Hester chased it down and threw to home in time for the play, however, getting Holloman.

Finally, in the sixth, Farmville struck for two more, for the win. Griffin led off with a double up the alley in right center. With one down, Mike Jenkins reached on an infield hit, and an error on the play let Griffin score and moved Jenkins to second.

Jenkins moved on to third on an infield out, and scored when David Winborn singled.

Farmville held off Rose in the seventh to take the 4-3 victory.

The win left the Jaguars with a 1-1 record. They play host to Southern Wayne, which earlier defeated them, on Friday. Rose travels to Kinston on Friday, to complete a suspended game at 3 p.m., then to play a regular game at 4 p.m.

J.Kins, ss	3	1	0	C'man, lf	3	0	0
G'don, cf	3	0	1	Shank, cf	3	0	0
W'born, c	4	0	1	Hooks, c	3	0	0
C'ran, rf	3	1	0	A'dger, rf	3	0	0
H'good, lf	3	1	0	Lee, ss	3	2	0
H'man, 2b	0	1	0	Conway, 1b	3	1	0
R'ley, dh	3	0	0	Dunn, 3b	3	0	1
G'fith, lb	3	2	2	H'ter, p	2	0	2
Dunn, 3b	3	0	1	Spain, p	1	0	0
Smith, p	0	0	0	Baker, lf	1	0	0
Totals	24	4	3	Totals	25	3	3

Ayden-Grifton Lacks Experience As It Defends Baseball Crown

Experience and hitting power, important ingredients for baseball success, are both lacking from the Ayden-Grifton team this year, according to coach Claude Kennedy.

The defending conference champion Chargers went 20-3 last year, only to lose in the first round of the state playoffs to Williamston, the eventual 3-A winner. But, nine seniors graduated off that team, seven of them starters, according to Kennedy, and that makes this year "definitely" a rebuilding year.

"We're very inexperienced, young and we're going to make some mistakes," Kennedy said. The Chargers also lack hitting power and "the personnel to have a big inning. We have to depend on our defense and pitching."

"If we can get halfway decent pitching and play fairly good defense, we might stay in a 2-1 or 4-3 ballgame. But, if anyone explodes for a big inning on us, we'll have trouble regrouping."

The team's two returning starters, shortstop Jed Hardy and center fielder Al Butts, will be counted on to provide the infield and outfield leadership, according to Kennedy. Hardy could also be one of the team's leading hitters.

Ayden-Grifton will start either a freshman or a sophomore at catcher, according to Kennedy. Sophomore Ed Coley started in the Chargers' first game, but cut his finger. He will probably share the behind-the-plate duties with freshman Grady Quinn.

Two-year reserve Butch Davis, a senior, will start at first base and another two-year reserve, Sammy Whitehurst, also a senior, will get the nod at second. At third will be either first-year junior Harold Edwards or Paul Setliff, who played on the Ayden-Grifton basketball team and got a late start. Setliff could also play short or second, Kennedy said.

Starting at short, however, will be Hardy, who is "probably the catalyst for our infield," according to Kennedy. In addition, Hardy "could be respectable with a bat."

Jay Phillips will be a back-up infielder, probably at first base, Kennedy said.

In the outfield, first-year junior Mark Cannon will start in left and David Reilly will start in right. Butts will be in center field and the Chargers "look for him to do an above average job defensively. He's quick and has an adequate throwing arm," Kennedy said.

Reserve outfielders include Wayne Newton, a sophomore, Chris Tripp, another sophomore, and freshmen Bill Holland and Richard Smith.

Two experienced pitchers return to the Ayden-Grifton team, senior Tim Shadle and junior Mike Teachey. Shadle,

senior left-hander who was 3-1 last year, started the Chargers' first game this season and "did an outstanding job." His earned run average last year was 1.87.

Teachey was 6-0 last year with a 2.21 ERA. He did a "credible job" in Ayden-Grifton's second game this year.

Other pitchers will be first-year junior Allen Hill and Hardy.

Kennedy sees three clubs as having a shot at the conference title this year. "Farmville Central could win if they get some good pitching, Southern Nash could be a threat and Greene Central could also be at the top."

The Chargers "could conceivably finish in the second division this year," Kennedy said. "We aren't going to be that strong."

Chargers Nip Kinston, 8-7

KINSTON — Ayden-Grifton captured its first baseball win of the year yesterday, downing Kinston, 8-7.

Kinston scored first, getting three runs in the bottom of the second. Lamm reached on an error and stole second, scoring when Whitfield doubled. Jones reached on an error and Williams walked. Wiggs then singled in both Whitfield and Jones.

Ayden-Grifton came up with four in the third to take a 4-3 lead. Edwards walked and Al Butts singled. Sammy Whitehurst singled in Edwards and Mike Hardy singled in Butts. Hardy was cut down trying to advance. Mike Teachey singled in Whitehurst and moved up on an error and Davis doubled to drive in Teachey.

Kinston returned to the lead with three more runs in the fourth. Williams walked and

scored on Spence's triple. Wiggs doubled in the second run, and after Hill walked, Hendricks singled in Wiggs.

In the top of the seventh, the Chargers pushed over four more runs to take an 8-6 lead. Edwards walked and Butts did too. Whitehurst reached on an error, loading the bases. Hardy doubled in two runs and Tim Shadel singled in another. Davis then hit a sacrifice fly to score the other.

Kinston cut it to one run with one in the seventh, but the Chargers hung on to win.

Ayden-Grifton is now 1-2, and hosts Eastern Wayne on Friday. Butts, Hardy and Butch Davis each had two hits for the Chargers, while Wiggs had a pair for Kinston.

A-Grifton 004 000 4-8 10 4
Kinston 030 300 1-7 7 4
Teachey, Shadel (5) and Quinn, Coley (6); Williams, Hill (4) and Keith.

Aycock Tops Jaguars Netters

FARMVILLE — C. B. Aycock High School gained a 6-3 victory over the Farmville Central ten-

nis team yesterday. Aycock won four of the six singles events, and then added two of the doubles for the win.

The loss left Farmville Central with a 1-2 record. The Jaguars visit Rose High on Friday.

Summary:
Stuart James (FC) defeated Gary Kilburn, 6-1, 4-0.
Phil Yelverton (CBA) defeated Chris Fountain, 6-2, 6-0.
Jesse Bradshaw (CBA) defeated Roy Richardson, 6-3, 6-2.
Sobby Allen (FC) defeated Scott Carter, 0-4, 7-5, 6-1.
Don Thompson (CBA) defeated Sully Sullivan, 6-2, 6-3.
John Powell (CBA) defeated Bobby Patterson, 6-2, 6-1.
James Fountain (FC) defeated Kilburn-Yelverton, 8-5.
Bradshaw-Davis (CBA) defeated Richardson-Allen, 8-5.
Carter-Powell (CBA) defeated Sullivan-Patterson, 8-5.

Sports Calendar

Today's Sports
Tennis
East Carolina at William & Mary (3:15 p.m.)
Greene Central at East Carteret (1:30 p.m.)
Old Dominion at East Carolina women (12 p.m.)
Track
Ayden-Grifton, Conley at Greene Central (3:30 p.m.)
C.B. Aycock at Farmville Central (3 p.m.)
Washington at Williamston (3 p.m.)
North Pitt, North Lenoir at Southern Nash (3:30 p.m.)
Softball
Roanoke at Williamston (4 p.m.)
Thursday's Sports
Wrestling
NCAA at Norman, Okla.
Tennis
East Carolina at Old Dominion (2:30 p.m.)
Golf
Rose at Goldsboro (1:30 p.m.)
Track
Kinston at Rose (3:30 p.m.)
Softball
Bear Grass at Roanoke (4 p.m.)

For Rent Well Equipped Restaurant
Call 758-5214 after 6 p.m.

FREE ESTIMATES Don't You Really Wish You Had A Fence?
(Specializing in chain link)
— SPECIAL —
If you order before May 31, '77 You Get A FREE WALK GATE (Chain Link)
Guaranteed Professional Quality At Lowest Prices
EVERETT FENCE BUILDERS
Greenville
Call 756-6388 (After 1 p.m.)
Lester Everett

To Hold Cage Game

AYDEN — The South Ayden Community Service Center, Inc., will sponsor basketball on Thursday at 7:30 p.m. at Ayden Grammar School gymnasium.

A karate demonstration will be given at halftime.

JOIN YOUR FRIENDS AND NEIGHBORS.

Some of the best people in your community are working for one of the best outfits in the country, The Army Reserve. To find out how you can join them

Call Your Army Reserve Recruiter MSG. Robert L. Tripp At 752-2482.

THE ARMY RESERVE PART OF WHAT YOU EARN IS PRIDE.

"When you're in the hospital your expenses don't stop"

Bill McDonald

East 10th St. Ext. Greenville, N.C.

752-6680

See me for State Farm hospital income insurance.
Like a good neighbor, State Farm is there.
State Farm Mutual Automobile Insurance Company. Home Office: Bloomington, Illinois.

GOOD YEAR PAIR SALE

Save \$20 to \$36!



1977 NEW CAR TIRES

'Custom Power Cushion POLYGLAS' WHITEWALLS

A78 x 13 2 for '59 Plus \$1.73 F.E.T. Per Tire. Save \$20.70 per pair	E78 x 14 2 for '65 Plus \$2.26 F.E.T. Per Tire. Save \$25.30 per pair	F78 x 14 F78 x 15 2 for '73 Plus \$2.42 or \$2.52 F.E.T. Per Tire. Save \$24.70 to \$27.30 per pair
G78 x 14 G78 x 15 2 for '74 Plus \$2.56 or \$2.65 F.E.T. Per Tire. Save \$27.80 to \$30.50 per pair	H78 x 15 2 for '84 Plus \$2.88 F.E.T. Per Tire. Save \$28.30 per pair	L78 x 15 2 for '85 Plus \$3.12 F.E.T. Per Tire. Save \$36.60 per pair

No trade needed

Sale Prices on Other Sizes too. Blackwalls \$5.00 Less Per Pair. Sale Ends March 19th

RAIN CHECK — If we sell out of your size we will issue you a rain check, assuring future delivery at the advertised price.

GOOD YEAR

See Your Independent Dealer For His Price. Prices As Shown At Goodyear Service Stores In All Communities Served By This Newspaper.

78-Series 'Tracker' LT Goodyear Tires For Your Pickup, Panel, Van Or Camper

Size & Type	Load Range	PRICE	Plus F.E.T. And old tire
H78-15 TL	C	\$49.00	\$3.50
G78-15 TL	C	\$38.55	\$3.27
H78-15 TT	C	\$44.75	\$3.25
H78-16 TT	C	\$44.75	\$3.46
L78-16 TT	C	\$50.95	\$3.70
L78-16 TT	D	\$58.20	\$3.88

No-Hassle Auto Service Values

Lube & Oil Change \$488 Up to 5 qts. of major brand 10/30 grade oil.	Front-End Alignment \$1188 Any U.S. made car — parts extra if needed. Excludes front-wheel drive cars. • Complete analysis and alignment correction — to increase tire mileage and improve steering • Precision equipment, used by experienced mechanics, helps ensure a precision alignment.	Brakes—Your Choice \$4088 2-Wheel Front Disc: Install new front disc brake pads • Repack and inspect front wheel bearings • Inspect hydraulic system and rotors (does not include rear wheels) OR 4-Wheel Drum-Type: Install new brake linings all four wheels • Repack front wheel bearings • Inspect brake hydraulic system, add fluid.
---	---	---

Ask for our Free Battery Power Check

GOODYEAR SERVICE STORES

729 Dickinson Ave. Open Mon.-Fri. 7:30 to 6, Sat. 7:30 to 5. Phone 752-4417. J.R. Forehand, Mgr.

WE ARE NOW OPEN AT 7:30 A.M. FOR YOUR CONVENIENCE!

Return Of Flowers Blossomed Irish

By CHARLES WOLFE
Associated Press Writer

CHAPEL HILL, N.C. (AP) — Phelps wished North Carolina Notre Dame Coach Digger

Patrick's Day, but his Fighting Irish will be trying to make it

the unhappiest day of Smith's season.

Phelps fervently hopes that Irish eyes will be smiling St. Patrick's Day when fifth-ranked North Carolina and 10th-ranked Notre Dame collide in the NCAA East Regional semifinals at College Park, Md.

Smith held a news conference here Tuesday and Phelps talked with reporters by telephone.

The Irish, 22-6, raced to a 7-0 early season record, including victories at Maryland and UCLA, but the bottom soon dropped out.

Kentucky clobbered the Irish 102-78 in December, the first of four straight losses, but things turned around with the return of injured center Bruce Flowers, Phelps said.

McGuire Feels Warriors Should Be Favored In Midwest Regional

By J. LEE CARRIER
AP Sports Writer

OKLAHOMA CITY (AP) — Marquette Coach Al McGuire believes his team should be the favorite in the NCAA Midwest Regional basketball tournament, starting Thursday night when the Warriors meet Kansas State and Southern Illinois face Wake Forest in semifinal games.

"This team is no fluke or one that's in the NCAA just on sentiment," says McGuire. "These are tough, class kids. What might have been a fluke is our loss to Michigan (69-68 in the regular season finale)."

Marquette broke loose for 13 straight points in the second half in beating Cincinnati in the NCAA Midwest Regional's opening-round at Omaha, Neb. last week.

The Warriors have won five

of their last six games, being led by 6-foot-10 Bo Ellis, described by his coach as a "thoroughbred... a first-round (pro) draft choice (prospect)."

Ellis had nine of his 17 points during the second half against Cincinnati, including six during the 13-point burst.

McGuire is a lame-duck coach, having announced his retirement from coaching after this season. He would like nothing better than to go out a winner.

Kansas State Coach Jack Hartman would love to end McGuire's career, but says he is sad the colorful coach is leaving the field.

"He has added a great deal of color to the game. He has charisma. I am saddened he's not going to be on the scene any longer," Hartman says. "Al McGuire has a great feel-

ing for showmanship. But he's a coach first of all."

The Wildcats will bring Hartman's trademarks—patience and quickness—with them Thursday night.

Wake Forest, which tied Clemson for second place in the tough Atlantic Coast Conference, was down 13 points at the half against Arkansas in their opening-round game, but used a full-court press in the second half in overtaking the Razorbacks.

"Arkansas is similar to Virginia who we play in the ACC," said Deacon guard Skip Brown. "They're so deliberate on offense. But we've never had to work so hard to win a game."

The Deacons had led the ACC for most of January and February before closing their regular season with four straight losses

and a 22-7 record. They had been picked in preseason to finish sixth in the seven-member conference.

Brown said the come-from-behind victory almost has been a standard this year. "We've been in situations like this all year—being as much as 15 points behind with eight or 10 minutes to play. And we had been playing well. If a couple of last-second shots had dropped, we'd have won a couple of those games we lost late in the year."

Southern Illinois edged Arizona in an opening-round game, getting 35 points from guard Mike Glenn.

"We played the way we did all season and I think that surprised a few people," says Southern Illinois Coach Paul Lambert.

Blomberg Is Hitter Again

By HERSCHEL NISSENSON
AP Sports Writer

Hendrick and Jerry Turner in defeating the Milwaukee Brewers 7-4, and the Seattle Mariners scored five runs in the seventh inning and beat the San Francisco Giants 6-4.

Blomberg ought to know. For the past 1½ years, he has been little more than a fan.

Tuesday night, he became a hitter again. A career .302 hitter before suffering a shoulder injury that wiped him out in July, 1975 and limited him to one game and two at-bats last season, Blomberg unloaded a 400-foot two-run homer and a run-scoring grounder as the New York Yankees defeated the Minnesota Twins 9-4 in an exhibition game.

But it was much more than a meaningless spring game to the 28-year-old Blomberg, who is trying to recapture his spot as the Yankees' designated hitter against right-handed pitching.

"This was like a regular-season game for me. The home run felt good, it feels like my swing is coming back," said Blomberg, whose powerful, compact stroke is one of baseball's neatest swings. "If I show them I can swing the bat I'll probably be a part of this team."

Meanwhile, Buzz Capra, who used to pitch in New York for the Mets and is trying to make it back to Atlanta's starting rotation following arm surgery, worked three scoreless innings, allowing two hits, in the Braves' 6-1 triumph over the Houston Astros. Phil Niekro, the Atlanta starter, allowed one hit in four scoreless innings.

The world champion Cincinnati Reds split their squad and made two Canadian clubs happy. One team of Reds bowed to the Montreal Expos 5-2 — ex-Reds first baseman Tony Perez homered in his first game against his former team and later scored what proved to be the winning run — while the fledgling Toronto Blue Jays edged the Reds' other group 9-8 in 11 innings.

The Baltimore Orioles also split their squad with somewhat different results. They downed the Boston Red Sox 3-0 as Rudy May, Dennis Martinez and Fred Holdsworth combined on a two-hitter — Dwight Evans' two-out single in the eighth inning and Fred Lynn's double in the ninth — and also whipped the Texas Rangers 7-3 as Doug DeCinces slugged a tie-breaking two-run homer.

Elsewhere, Dave Kingman hit his second homer in two days as the New York Mets beat the Pittsburgh Pirates 7-2; Tim Lincecum's two-run homer gave the Detroit Tigers a 3-1 triumph over the Philadelphia Phillies in 11 innings, and the Los Angeles Dodgers scored six times in the fifth inning — Rick Monday and Dave Lopes each drove in a pair — and trounced the St. Louis Cardinals 13-3.

Home runs by Ralph Garr and Larry Foster powered the Chicago White Sox to a 4-0 victory over Kansas City in the opener of a doubleheader, but the Royals took the nightcap 10-3 as John Wathan and Luis Silveiro homered; Vida Blue allowed two hits in five scoreless innings as the Oakland A's beat the Cleveland Indians 4-2; Jerry Morales singled in the winning run as the Chicago Cubs edged the California Angels 4-3; the San Diego Padres got homers from George

Bear Grass Downs Chowan

CHOWAN — Bear Grass's four runs in the sixth inning allowed the Bears to stay ahead of Chowan and take a 6-4 win in a baseball game yesterday afternoon.

Bear Grass grabbed a 2-0 lead in the top of the first, but Chowan scored one in the bottom of the inning and two in the second to move ahead, 3-2.

Neither team scored again until the sixth when the Bears made four runs, three of them earned. Chowan could manage but one run in the bottom of the inning.

In the first inning, Alton Cratt led off with a walk for Bear Grass. He stole second and scored on Junie Wynne's single. Three straight walks, by Ray Wynne, Jeff Bullock and Jesse Bullock scored Junie Wynne.

C. Evans doubled for Chowan in the bottom of the frame and went to third on a wild pitch. After Jordan's walk, Evans went home on a double steal.

M. Evans led off the second inning with a single for Chowan. He moved to third on Broome's base hit and both he and Broome scored when Jordan hit a fielder's choice.

In the top of the sixth, Bullock walked and went to second as Robert Harrison got on with an error. Jack Harrison walked to load the bases before Cratt's fielder's choice scored Bullock. Junie Wynne got on with a fielder's choice that scored both Harrison and then scored off of Jerry Wynne's single.

In the bottom of the inning, Evans got his second double and scored when Perry followed with a double.

The win was the third straight for the Bears, who are now 3-0. They will host Jamesville on Friday.

Bear Grass 200 224 0-6 6 3
Chowan 120 010-4 9 2
Wynne and Bullock; Bunch and Perry.

Tigerettes Take Win

WILLIAMSTON — Williamston High School opened its softball season with a 19-17 victory over Bear Grass yesterday.

Joy Lassiter was the winning pitcher for the Tigerettes, and she also added two hits.

Gwen Williams led Williamston's hitting with three, while Lydia Singleton had two, including a triple. Jeannie Rogers also added a pair.

Lydia Hoell led Bear Grass with three hits, including a triple, while Patricia Taylor had a pair, including a triple. Darlene Rogerson had two and Debra Jo Peaks also had a pair.

Williamston is now 1-0, while the Lady Bears are 0-1. Williamston hosts Roanoke today.

Bear Grass 510 533 0-17 13
Williamston 843 031 X-19 19

Rampants Defeated

Washington High School romped to a 7-2 victory over the Rose High School tennis team yesterday.

Washington took five victories during the singles matches to salt away the victory before the doubles competition got underway. They added two more wins in the doubles. Only Michael Hinsley managed a singles win, while the doubles team of Craig Logue and Don Tucker also got a victory.

Rose is now 0-2 overall, and entertains Farmville Central on Friday.

In exhibition matches, Mark Tayloe of Washington downed Tom Johnson, 8-3, and Lee Bowen of Washington beat Lance Cain, 8-5.

Summary:
Watson Pridden (W) defeated Brad Brown, 6-3, 6-2.
Steve Fisher (W) defeated Craig Logue, 6-2, 7-5.
Randy Bridgeman (W) defeated Don Tucker, 6-2, 6-4.
Michael Hinsley (R) defeated Billy Barwick, 6-1, 6-4.
Sam Mordecai (W) defeated John Farley, 6-1, 6-1.
William Cockran (W) defeated Jim Barnaby, 7-5, 6-2.
Louie Tucker (R) defeated Pridden Fisher, 8-6.
Bridgeman-Barwick (W) defeated Brown-Hinsley, 8-2.
Mordecai-Cochran (W) defeated Barnaby-Edgerton, 8-3.

Tarboro Eases Past North Pitt

TARBORO — Tarboro came up with two runs in the bottom of the fifth inning after North Pitt had tied the game to take a 3-1 win over the Panthers in the first contest of the year for both teams.

Tarboro took a 1-0 lead in the second inning when Whitaker singled, moved to third on two walks and then scored on a fielder's choice.

North Pitt knotted the score in the fifth as Jeff Hines hit a double, went to third on an error and came home on Ken Perry's single.

But Tarboro moved back in front in their half of the frame. Braddy walked and stole second, then scored on Squires' double. Squires tallied when Crisp single-

ed to make it 3-1.
Crisp was the leading hitter of the game, getting two of his team's seven hits in three at-bats, including a triple. North Pitt had three hits.

Wilder was the winning pitcher and Lee Andrews the loser. Both went the distance.

North Pitt is now 0-1 on the year and will play again Friday at Roanoke.

N. Pitt
Tarboro
Andrews and Wilson; Wilder and Crisp.

Riggin Shoe Shop
111 W. 4TH ST.
DOWNTOWN GREENVILLE
WE REPAIR ALL LEATHER GOODS

FRONT ROW KISS
HARTFORD, Conn. (AP) — While going from a rebounding basketball, Connecticut's Tony Hanson was pushed out of bounds and into the lap of a little woman sitting in the front row at the end of the court. The team's leading scorer and rebounder got up quickly but before he did he took time to kiss the little lady on the cheek.
The lady he kissed was his mother.

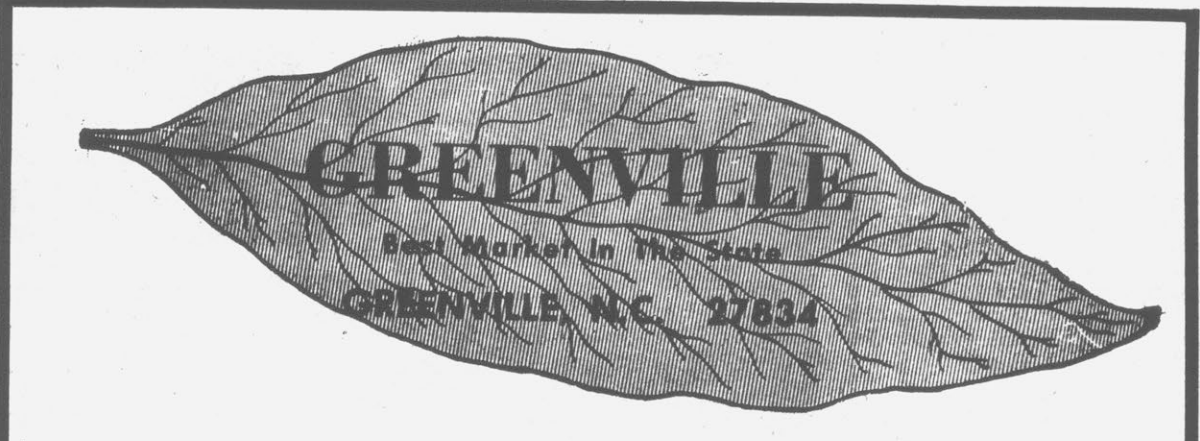

Every Warehouse Firm Has a Guaranteed Sale Every Day

THE GREENVILLE WAREHOUSEMEN INVITE YOU TO DESIGNATE YOUR TOBACCO IN GREENVILLE AND LOOK FORWARD TO SERVING YOU IN 1977

In Greenville your tobacco will be sold on the day and at the time that the warehouseman schedules your tobacco for sale and he assures you the top dollar and best service.

REASONS WHY GREENVILLE IS THE BEST TOBACCO MARKET IN THE STATE:
The Greenville Market began sales in 1890 and has had 86 years experience in the tobacco business.
Greenville has floor space totaling 2,054,280 square feet for sales. The Greenville Market has been scheduling tobacco several years and is experienced in scheduling under the designation program. Grade for grade you're better paid in Greenville. Every major export and domestic company in the world is represented on each of Greenville's sales.

Designate Greenville

The Greenville Tobacco Board of Trade / J. N. Bryan, Sales Supervisor

- Cannon's Warehouse No. 526
- Farmers' Warehouse No. 535
- Growers Warehouse No. 530
- Hudson's Warehouse No. 532
- Keel's Warehouse No. 528
- New Carolina Warehouse No. 529
- New Greenville Warehouse No. 524
- New Independent Warehouse No. 537
- Raynor-Forbes & Clark Warehouse No. 523
- Star-Planters Warehouse No. 531

Firestone UNBELIEVABLE SALE!

DOUBLE-BELTED WHITEWALLS

Compact Cars!
Size A78-13
4 FOR \$116
Plus \$1.73 F.E.T. per tire and 4 old tires.

Small Cars!
Sizes B78-14, C78-14, E78-14
4 FOR \$126
Plus \$1.88 to \$2.26 F.E.T. per tire and 4 old tires.

Medium Cars!
Sizes F78-14, 15; G78-14, 15
4 FOR \$146
Plus \$2.42 to \$2.65 F.E.T. per tire and 4 old tires.

Large Cars!
Sizes H78-14, 15; J78-14, 15; L78-15
4 FOR \$166
Plus \$2.80 to \$3.12 F.E.T. per tire and 4 old tires.

BLACKWALLS 8 LESS PER SET OF 4

CHARGE 'EM! Open an account

MASTER CHARGE BANKAMERICARD SHELL CREDIT CARD

BIAS-PLY AND RADIAL TIRES AT EVERYDAY LOW PRICES!

4-PLY POLYESTER CORD WHITEWALLS
2 FOR \$50 Sizes A78-13, B78-13, C78-14.
Plus \$1.72 to \$2.01 F.E.T. per tire and 2 old tires.

Sizes	Whitewall price (per tire)	F.E.T. (per tire)
D78-14, E78-14, F78-14	2 for \$62	\$2.09 to \$2.37
G78-14, 15, H78-14, 15	2 for \$68	\$2.53 to \$2.79
L78-15	2 for \$74	\$3.09

*A size 5-rib design. All prices plus tax and 2 old tires. Blackwalls \$4 less per pair.

STEEL BELTED RADIAL 500 WHITEWALLS
\$39.95 Size BR78-13. Plus \$2.06 F.E.T. and old tire. Other sizes and blackwalls low priced, too!

Prices in this ad available at Firestone Stores. Competitively priced wherever you see the Firestone sign.

PICKUP, VAN and RV TIRES
Firestone TRANSPORT
\$29
Size 6.70-16 Tube-type
All prices plus \$2.32 to \$3.44 F.E.T. exchange. Black, 6-ply rating.

TUBE-TYPE	TUBELESS
6.00-16 \$28.30	7.00-14 \$33.79
6.50-16 \$29.64	6.70-15 \$4.43
7.00-15 \$33.70	7.00-15 \$8.96
7.00-16 \$34.68	6.50-16 \$43.37
7.50-16 \$38.66	

PUGH'S TIRE & SERVICE CENTER

- Road Service • Electronic Tune-Up
- Farm and Off-The-Road Service Trucks
- Front End Alignment
- Expert Brake Repair Service

Philadelphia Is Back On The Track

By ALEX SACHARE
AP Sports Writer
The Philadelphia 76ers may be back on the track.
Having aired their gripes and spoken their pieces, the 76ers settled down to what they do best Tuesday night and routed the Cleveland Cavaliers 133-102.
"I think the stories cleared the air," suggested 76ers forward George McGinnis, referring to reports of discord on the team which had surfaced earlier this week. "Everybody came into the locker room tonight with a different attitude."
"If this can be a turning point for us, it couldn't come at a better time."
Indeed, if the 76ers are to go far in the National Basketball Association playoffs — which are only a month away — they will have to play better than they did for the past month, when they had difficulty breaking even.

The way they played against Cleveland would be just fine, however.
In other NBA games, the Denver Nuggets beat the Los Angeles Lakers 107-95, the Portland Trail Blazers defeated the New Orleans Jazz 131-104, the Kansas City Kings edged the Washington Bullets 101-99, the Chicago Bulls beat the Boston

Celtics 107-96 and the San Antonio Spurs stopped the New York Nets 118-108.
Julius Erving scored 29 points for Philadelphia and McGinnis had 23, including 13 in the decisive third period. The 76ers led 57-46 at intermission, started the second half with a 10-2 burst and outscored Cleveland 43-25 in the third

quarter, putting the game away.
Nuggets 107, Lakers 95
Baskets by Dan Issel, Jim Price and David Thompson within a span of 16 seconds midway through the third quarter helped Denver beat Los Angeles in a matchup of the two teams with the best records in the NBA. That flurry stretched

the Nuggets' lead to 17 points and the Lakers did not threaten after that.
Thompson led the Nuggets with 26 points while Bobby Jones had 15 points and 12 rebounds.
Blazers 131, Jazz 104
Portland snapped a three-game losing streak behind Li-

onel Hollins and Maurice Lucas, who scored 22 and 20 points, respectively, and handed New Orleans its eighth straight loss.
Kings 101, Bullets 99
Kansas City won its sixth in a row and dealt Washington its fourth straight defeat as Sam Lacey scored two baskets and a pair of free throws in the final minute, climaxing a Kings' rally that erased a 10-point fourth-quarter deficit.
Bulls 107, Celtics 96
Chicago posted its 10th victory in the last 11 games and moved within two games of the .500 mark as Artis Gilmore scored six of his 28 points in the final three minutes against Boston and Norm Van Lier and Wilbur Holland chipped in with five points apiece.
Spurs 118, Nets 108
Mark Olberding scored 22 points and tied his career high with 13 rebounds for San Antonio, which led by as many as 23 points in the third period and eased to victory.

SCOREBOARD

Baseball At A Glance
By The Associated Press
Tuesday's Results
New York (N) 7, Pittsburgh (N) 2
Detroit (A) 3, Philadelphia (N) 1, 11 innings
Montreal (N) 5, Cincinnati (N), (A) 2
Pittsburgh (N), vs. Detroit (A) at Lakeland, Fla.
Minnesota (A), vs. Baltimore (A) at Miami, Fla.
Chicago (A), vs. St. Louis (N) at St. Petersburg, Fla.
New York (N), vs. Cincinnati (N) at Tampa, Fla.
Atlanta (N), vs. Oakland (A) at Mesa, Ariz.
San Diego (N), vs. San Francisco (N) at Phoenix, Ariz.
California (A), vs. Milwaukee (A) at San Jose, Calif.
Chicago (N), vs. Cleveland (A) at Tucson, Ariz.
Boston (A), vs. New York (A) at Fort Lauderdale, Fla.
Thursday's Games
Toronto (A), vs. Philadelphia (N) at Clearwater, Fla.
Detroit (A), vs. Montreal (N) at Daytona Beach, Fla.
Baltimore (A), vs. Kansas City (A) at Fort Myers, Fla.
Boston (A), vs. Atlanta (N) at West Palm Beach, Fla.
San Diego (N), vs. Texas (A) at Pompano Beach, Fla.
Pittsburgh (N), vs. New York (N) at St. Petersburg, Fla.
St. Louis (N), vs. Chicago (A) at Sarasota, Fla.
Houston (N), vs. Cincinnati (N) at Tampa, Fla.
New York (A), vs. Los Angeles (N) at Vero Beach, Fla.
California (A), vs. Oakland (A) at Mesa, Ariz.
Seattle (A), vs. San Francisco (N) at Phoenix, Ariz.
San Diego (N), vs. Chicago (N) at Scottsdale, Ariz.
Milwaukee (A), vs. Cleveland (A) at Tucson, Ariz.

Wednesday's Games
Atlanta at Philadelphia
New York Nets at Houston
Seattle at Washington
Chicago at Detroit
Denver at Knicks
New York Indians at Phoenix
Thursday's Games
Houston at Cleveland
Buffalo at Kansas City
Boston at Milwaukee
New York Knicks at Denver
Portland at Golden State

Tuesday's College Basketball Results
By The Associated Press
National Invitation Tournament
Quarter-finals
Tuesday's Games
Villanova 81, Massachusetts 77
St. Bonaventure 76, Oregon 73

Pro Hockey At A Glance
By The Associated Press
National Hockey League
CAMPBELL CONFERENCE
Patrick Division
W L T Pts GF GA
Phila 43 15 12 98 281 185
NY Isl 42 19 10 94 251 173
Atlan 30 38 9 71 232 235
NY Rng 25 33 13 63 241 274

Smythe Division
St Lou 20 22 6 50 202 232
Chgo 23 38 10 56 215 267
Vancvr 23 40 9 55 204 260
Minn 19 34 17 55 213 271
Colo 19 39 12 50 198 260

Wales Conference
Norris Division
Mont 53 8 11 117 345 163
Pitts 30 20 7 73 214 227
L.A. 28 29 14 70 231 211
Wash 19 39 14 52 181 278
Buff 16 34 9 41 172 266

Adams Division
Buff 42 21 8 92 273 211
Pitts 32 28 11 75 272 244
Cleve 22 37 10 54 204 246

Tuesday's Results
Atlanta 7, Pittsburgh 3
Cleveland 5, Washington 1
Vancouver 7, Detroit 1
Toronto 4, St. Louis 1

Wednesday's Games
Philadelphia at New York
Rangers
New York Islanders at Chicago
Montreal at Minnesota
St. Louis at Pittsburgh
Toronto at Colorado

Thursday's Games
Atlanta at Philadelphia
Detroit at Los Angeles
Buffalo at Boston

World Hockey Association
Eastern Division
W L T Pts GF GA
Quebec 40 27 2 82 300 253
Cinci 35 31 3 73 311 256
Indy 31 32 7 69 322 257
N Eng 29 37 6 64 236 263
Birm 28 40 3 59 249 267
x-Minn 19 38 5 43 136 129

Western Division
Houston 43 20 6 92 274 197
Winnipeg 39 28 2 80 314 245
S Diego 33 33 4 70 231 249
Calgary 28 34 5 61 207 227
Edmtn 28 40 3 59 200 268
x-franchise disbanded

St. Bonaventure Outlasts Oregon In Quarterfinals Of NIT Event

By KEN RAPPOPORT
AP Sports Writer
NEW YORK (AP) — Jim Satalin aged 23 years in 13 seconds.
"I felt I was 53," said the St. Bonaventure basketball coach. Satalin in reality is 30, but it is no wonder he felt older after

St. Bonaventure's 76-73 victory over Oregon in the National Invitation Tournament Tuesday night.
The last few seconds obviously seemed like the longest mile to Satalin, what with the following events occurring:
—Greg Graham hit two foul shots for Oregon with 13 seconds left.
—Kelvin Small hit one foul shot at the 10-second mark for Oregon's 73rd point, then missed another attempt and the ball went out of bounds off a St. Bonaventure player.
—With eight seconds remaining and the score 76-73 in favor of the Bonnies, Oregon inbounded the ball and got it inside to Greg Ballard. But the Ducks' high scorer, looking for

a three-point play, hit the rim and St. Bonaventure's Greg Sanders came down with the rebound at the buzzer.
The way the ball bounced sent St. Bonaventure into Thursday night's semifinals at Madison Square Garden against Villanova, which beat Massachusetts 81-71 in an earlier quarter-final game Tuesday night.
Alabama and Houston, which won quarter-final games Monday night, will play in the other semifinal.
The Bonnies appeared to have the Ducks in tow midway through the second half with a 15-point lead behind the dominating play of Sanders. But then they slowed things down,

giving the Pac-8 team a chance to catch up.
Before the slowdown, though, the Bonnies had been speeding things up considerably behind the omnipresent Sanders. The left-handed shooting forward scored 30 points, including 20 in the second half.
The first game did not have nearly the drama as the night-cap. Villanova broke open the contest with a 20-9 second-half streak behind brothers Keith and Larry Herron. Keith Herron wound up with 20 points and Larry had 16.
Until then, the teams never had been more than four points apart. Villanova held a 45-44 lead at the 16:43 mark before going on its game-breaking streak.

Creswell Nips Bullets, 3-2

JAMESVILLE — Creswell scored two runs in the seventh inning, with the second coming on a squeeze bunt, to defeat Jamesville 3-2 in a baseball game yesterday afternoon.
Jamesville had taken a 2-0 lead in the fourth while Creswell got one in the fifth. Creswell's two seventh-inning runs provided the come from behind win.
In the fourth inning, Danny Lilley led off with a walk for the

Bullets and got to second on Jeff Holliday's single. Both runners advanced on a passed ball and Danny Lilley scored as Victor Lilley got on an error. Glenn Ellis made a base hit to score Holliday.
Creswell made it 2-1 in the fifth as Chambers singled, moved to second on Clifton's sacrifice bunt and scored on Holton's long double to right center.
In the seventh, Holton led off with a single for Creswell and moved to second when Biggs was safe on an error. A sacrifice bunt by Bartley moved the runners to second and third and Holton came home on a single by Jim Clifton. That moved Biggs to third where he scored on a squeeze bunt for the winning run.

Workouts begin today in Rupp Arena for the NCAA Midwest Regional basketball tournament, but North Carolina Charlotte Coach Lee Rose says his 49ers deserve a Purple Heart already.
UNC-Charlotte wrapped up the Sun Belt Conference tournament last Wednesday, edging New Orleans 71-70 for the championship.
The 49ers have since kept busy, defeating Central Michigan 91-86 in overtime in UNC-Charlotte's NCAA debut Sunday in first round action at Bloomington.
"I wasn't about to ask out of our tournament, because it's so important to the overall wel-

fare of the conference," Rose said. "But since we already had the NCAA bid, I was stuck for something to tell the kids. I said, 'Let's prove we deserve to be in the N-AA.' But that's a pretty lame-duck argument."
UNC, ranked 17th, tackles sixth-ranked Syracuse Thursday in the first semifinal game at Rupp Arena; No. 1 Michigan and 12th-ranked Detroit meet in the televised second game.
Michigan Coach Johnny Orr says the Wolverines' game against Detroit will be "the greatest game for fan interest in our state's history."
Detroit will be first to spend an hour getting the feel of the 23,400-seat arena today, followed by Michigan, UNC-Charlotte and Syracuse.

EDENTON — Roanoke High School gained its third straight tennis victory, downing Edenton yesterday, 6-3.
Roanoke won five of the six singles to sew up the victory. They added one win in the doubles.
The win left the Redskins with a 3-0 record. The 'Skins entertain Williamson on Friday.
Summary:
Michael Joyner (R) defeated Norris, 6-3, 6-1.
Tony Joyner (R) defeated Bunch, 4-6, 6-2, 6-4.
Michael Clay (R) defeated D. Cross, 7-5, 6-4.
Gene Burnes (R) defeated Hutchinson, 6-4, 6-2.
Shackelford (E) defeated Randy Leary, 6-3, 4-6, 7-5.
Linwood Knight (R) defeated Bond, 6-4, 1-6, 6-2.
M. Joyner-Clay (R) defeated Norris-Bunch, 8-6.
Criss-Hutchinson (E) defeated T. Joyner-Leary, 8-7.
Shackelford-Bond (E) defeated Burnes-Ricky Smith, 8-6.

Sponsor Tourney In Winterville

WINTERVILLE—The Winterville Jaycees will sponsor an invitational basketball tournament March 25-27.
The tournament will be a 12 team single elimination event. The games will be played at A.G. Cox Grammar School in Winterville. Deadline for entry for the tournament is March 22. For further information about entering the tournament call or write Robert Braxton at 756-4562, Rt. 8 Box 780 Greenville.

Charlotte Had To Prove Bid

LEXINGTON, Ky. (AP) — Workouts begin today in Rupp Arena for the NCAA Midwest Regional basketball tournament, but North Carolina Charlotte Coach Lee Rose says his 49ers deserve a Purple Heart already.
UNC-Charlotte wrapped up the Sun Belt Conference tournament last Wednesday, edging New Orleans 71-70 for the championship.
The 49ers have since kept busy, defeating Central Michigan 91-86 in overtime in UNC-Charlotte's NCAA debut Sunday in first round action at Bloomington.
"I wasn't about to ask out of our tournament, because it's so important to the overall wel-

Redskins Post Win

EDENTON — Roanoke High School gained its third straight tennis victory, downing Edenton yesterday, 6-3.
Roanoke won five of the six singles to sew up the victory. They added one win in the doubles.
The win left the Redskins with a 3-0 record. The 'Skins entertain Williamson on Friday.
Summary:
Michael Joyner (R) defeated Norris, 6-3, 6-1.
Tony Joyner (R) defeated Bunch, 4-6, 6-2, 6-4.
Michael Clay (R) defeated D. Cross, 7-5, 6-4.
Gene Burnes (R) defeated Hutchinson, 6-4, 6-2.
Shackelford (E) defeated Randy Leary, 6-3, 4-6, 7-5.
Linwood Knight (R) defeated Bond, 6-4, 1-6, 6-2.
M. Joyner-Clay (R) defeated Norris-Bunch, 8-6.
Criss-Hutchinson (E) defeated T. Joyner-Leary, 8-7.
Shackelford-Bond (E) defeated Burnes-Ricky Smith, 8-6.

Martin In First Win

EVERETT — Martin Academy opened the 1977 baseball season with a 7-3 victory over Roanoke-Chowan Academy yesterday.
Martin sewed up the victory with six big runs in the second inning, including a three-run homer by James Corey. He also led the hitting with two for the game.
R-Chowan 002 010 0-3 4 0
Martin 060 100 X-7 6 1

Bowling

Ladies Friday
Freedom '76 47 1/2 32 1/2
Nucummers 43 37
NB Tweens 40 40
GO Getters 38 42
Three Of A Kind 36 1/2 43 1/2
Hopelites 35 45
High game, Kathryn Phillips, 183;
High series, Billie Crandell, 490.

Out Of Towners
Go Getters 59 37
Belles 57 39
Swingers 56 40
Ups & Downs 53 1/2 42 1/2
Flounders 49 1/2 46 1/2
Lightweights 49 47
Pin Pushers 47 49
Crazylegs 46 1/2 49 1/2
Bowling Belles 44 1/2 51 1/2
Lucky Ladies 42 54
Dollies 39 1/2 56 1/2
Ten Pins 32 1/2 63 1/2
High game and series, Diane Stamp, 206, 518, calendar

BACK BY POPULAR RESPONSE...

Scrap's UNBELIEVABLE Backdoor Sale

Thursday, March 17 12 Noon 'til 12 Midnight

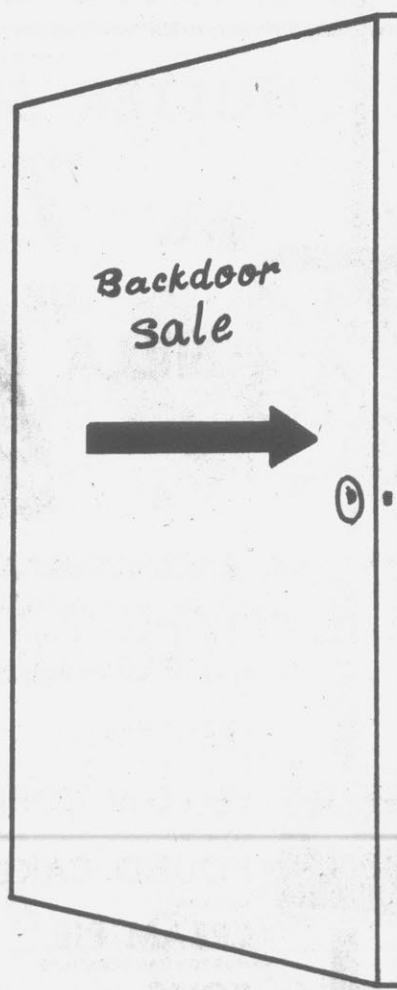

Yes, we're having our Backdoor Sale again. We've got to make room for our new merchandise and offering to you savings up to 80% on 1 to 3 seasons old merchandise. Everything must go! Enter only through Scrap's backdoor. Just pick up the item or items and check it out. Register for a free suit to be given away every hour on the hour . . . You do not have to be present to win. You'll find winter and

summer suits and sportcoats moved in from Proctor's and merchandise from Scrap's such as jeans, jeans jackets, long and short sleeve tops, long sleeve shirts, sweaters, shoes and more! No alterations, no returns, all sales final and everything cash during this sale. Don't miss this once in a lifetime unbelievable backdoor sale. Thursday!

UP TO 80% SAVINGS

12 Hours Of Great Savings...

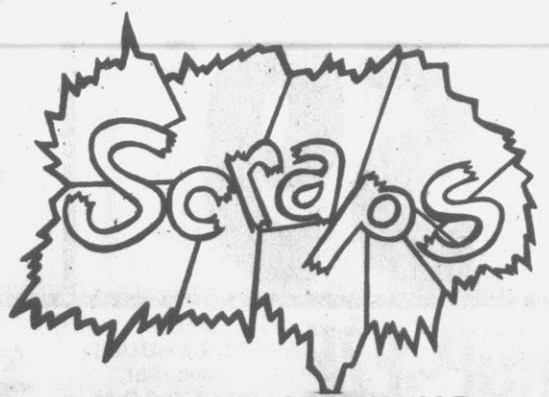

DOWNTOWN GREENVILLE

Forger Had Real 'Flair'

MEMPHIS, Tenn. (AP) — The style of James Melvin Kitchens as a forger apparently impresses even the police.

"He's probably the best check forger I've ever seen," said Lt. Jack Hamby, an investigator with the police fraud and document squad, whose memory for a face once landed Kitchens in prison for two years.

Kitchens, 65, is in the Shelby County Jail here awaiting trial on a 1975 check forgery case. In previous visits to Memphis, police said the Atlanta native forged more than \$30,000 in bad checks.

Hamby remembered Kitchens from 1964 when he set himself up as Clifton Cotton, owner of the mythical firm Earth Movers, Inc.

"He established himself, then began passing around the phonies around Christmas time," Hamby said. "He not only gave the tellers a payroll check, he also deposited a Christmas bonus check. He got \$20,000 — that we found out about."

Kitchens said he selected cities with a population of one million "because I've found that for every 5,000 people, there is a bank."

He would arrive, find out the largest employer in town and when they pay, and rent a room in which to keep his printing equipment.

"Then on a payday, I'll stand in line and offer to give someone cash for their paycheck, telling him I'll deposit his check in my account. They don't lose anything and they

get out of line quicker, so they usually go ahead."

Then he erased the name, the amount and the signature and photocopied the check, producing a blank industrial paycheck. He printed about 100 or so of the bogus checks, he said, and then a complete set of phony identification cards.

His next step was to open bank accounts with at least three banks and write small checks on the legitimate accounts so the tellers and store clerks would get used to seeing him.

Then he struck. He would deposit, say a \$500 payroll check, but withhold \$300 in cash. With 100 bank branches, that's \$30,000.

It worked, usually with flair, Hamby recalled 1964, when Kitchens was portraying Clifton Cotton:

"When he came around to cash the checks, he gave the tellers or store clerks a gold pen engraved with Clifton Cotton, Earth Movers, Inc."

"Just before he left town, he went to a car dealer, peeled off \$100 bills, bought himself a new Thunderbird and drove away."

Kitchens is up for parole early next year from federal prison in Atlanta where he is serving a 15-year sentence for transporting his check printing press across state lines.

But he won't be finished with the law. Authorities in nine states are awaiting his release, either to serve time for some past misdeed or additional time for jail-break or to face new charges.

Equal Rights...

(Continued from page 1)

than has ever been done before."

She also expressed concern for laws relating to carnal knowledge of a female under the age of 12.

"I know of specific instances of boys who have been sexually abused by either men or women," she said.

"The only law that protects them is simple assault or contributing to the delinquency of a minor, both of which are misdemeanors and call for no more than two years in prison."

"The rape statute which applies to the carnal knowledge of females under 12 is the strongest of the rape crimes and is a capital offense."

"In a case like this, 'person' instead of 'female' would be beneficial."

Mrs. Tennala A. Gross of the North Carolinians United for ERA said pro-ERA forces have not given up the fight.

"We have no idea of giving up," she said.

"It is inconceivable that a democracy should continue to discriminate on basis of sex. The majority cannot deny the minority their legal equality."

"We'll have to have it eventually or stop calling ourselves a democracy. So we will keep on until the ERA is ratified."

The pro-ERA coalition plans to maintain its organization to continue to fight.

"We are planning involvement in the upcoming campaigns," said Mrs. Gross.

"We're really trying to get people elected who will vote

for ERA. It was a political football this year — a question of power.

"Many legislators will say they aren't against equal rights for women. I think many of them are jealous of the power they've had and fear equal rights will curtail their power."

Mrs. Gross noted progress is being made in removing sex laws from the books.

"We are slowly taking the sex laws off the books," she said.

"But sex discrimination is so prevalent, it will take a long time. In the meantime, poor, less well-educated women are suffering."

Both Mrs. Gross and Mrs. Crisp placed much of the responsibility for the ERA's defeat on Sen. Sam Ervin, who spoke against the amendment.

"One of the things that helped do us in was Sen. Ervin," said Mrs. Gross.

"He spent most of his productive years in Congress, then he gets up and warns the people of North Carolina that Congress doesn't know how to make law."

"We trusted him when he was in Congress; how can we trust him now when he tells us Congress is untrustworthy?"

Mrs. Crisp agreed. "Sen. Sam Ervin contributed the most to the defeat," she said.

"I think he had the ERA confused with the REA (Rural Electrification Act)!" And both women think the ERA is a necessity.

"The ERA's passage would do a great deal in upgrading the positions of women who work in the home," said Nelson Crisp.

"We would put a much higher value on guiding the children, cooking the meals, running the home, carpooling and organizing the family's life."

"This would be mainly because ERA will put a higher value on women as people — they'll be looked upon more as equals than as people who need protection all the time."

Change is coming, according to Tennala Gross.

"The arguments of the 'con' people are falling by the wayside," she said.

"The amendment will assure us that the laws now being eliminated will not be brought back."

"Men and women need the strength of a constitutional amendment to assure our rights will remain."

FUND-RAISER

The Winterville Jaycees will sponsor a bake sale and yard sale Saturday, March 19 at the corner of Main Street and Mill Street in Winterville. The sale will begin at 9 a.m.

Shootout Is A Re-Match

The ECU Student Government Association will challenge the Greenville City Police, the N.C. Highway Patrol and the ECU Campus Police in a rematch basketball "shoot out" at Minges Coliseum on Wednesday, March 23, starting at 7 p.m.

In the first game, the ECU varsity and junior varsity cheerleading squads will challenge women employees of the City of Greenville, who were last year's victors.

The second rematch will involve the participating police departments and the ECU SGA. The ECU Marching Percussion and Pom Pom Squads will entertain between matches.

Tickets are on sale now at Hargett's Family Care Center on the mall. Tickets will also be on sale at the door. The \$1 donation will be given to the Easter Seal Society.

Participants extend a special invitation to the physically and mentally handicapped citizens of Pitt County and neighboring counties to attend.



MARKETS

QUANTITY RIGHTS RESERVED

NONE SOLD TO DEALERS

MEMBER OF THE FOODLAND SYSTEM

PRICES EFFECTIVE:
GROCERY—1 FULL WEEK
MARCH 17-23
MEATS—MARCH 17, 18 & 19

WE GLADLY ACCEPT USDA FOOD STAMPS

SWIFT PREMIUM
HEAVY WESTERN STEER
CHUCK STEAK

89¢
LB.

SWIFT PREMIUM
HEAVY WESTERN STEER
SHOULDER ROAST

79¢
BONE IN LB.
79¢
BONELESS LB.

USDA INSPECTED CAROLINA PRIDE
FRYERS
LIMIT 4

WHOLE LB. **39¢**

FOODLAND GRADE A WHITE LARGE

EGGS
DOZ. **69¢**

SWIFT PREMIUM
HEAVY WESTERN STEER
CHUCK ROAST

79¢
BONELESS LB.

SWIFT PREMIUM HEAVY WESTERN STEER
CHUCK ROAST

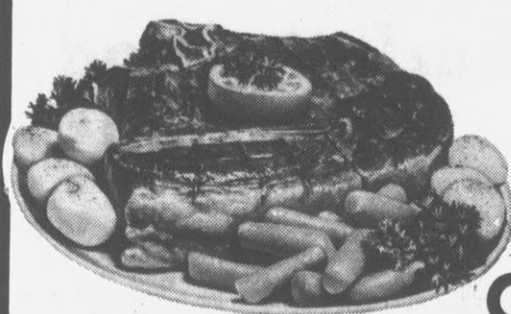

55¢
FIRST CUT LB.
65¢
CENTER CUT LB.

FOODLAND
TOILET TISSUE

LIMIT 2-4 ROLL PKGS. WITH 7.50 FOOD ORDER

4-ROLL PKG. **49¢**

CANDY BARS
BUTTERFINGER OR BABY RUTH

Pkg. Of 7 **59¢**

BAKER'S
CHOCOLATE CHIPS

12 Oz. Pkg. **89¢**

STAR KIST
TUNA

LIMIT 2 CANS WITH 7.50 FOOD ORDER



49¢
6 1/2 Oz. Can

HUNT'S
TOMATO SAUCE

300 CAN **39¢**



DEL MONTE
PEACHES

LIMIT 6 CANS WITH 7.50 FOOD ORDER

\$1.00
3
303 CAN

ALUMINUM FOIL
REYNOLDS WRAP 25' ROLLS **39¢**

NESTLE
COCOA MIX 12 COUNT **99¢**



PILLSBURY HUNGRY JACK 32 OZ. BOX
INSTANT POTATOES **\$1.39**

ROLLER CHAMPION
FLOUR

PLAIN OR SELF-RISING
LIMIT 1 WITH 7.50 FOOD ORDER

5-LB. BAG **49¢**

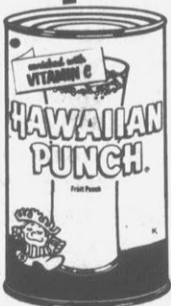

HAWAIIAN RED
PUNCH

46-OZ. CAN **49¢**

NABISCO
NUTTER BUTTER

PKG. **75¢**

OR
NILLA WAFERS

BOX **53¢**



RC COLA

64 Oz. Bottle

59¢



KRAFT PARKAY
MARGARINE

1-LB. PKG. **39¢**

SALE OF FROZEN FOODS

MINUTE MAID LEMONADE Pink or Regular	12-Oz. Can	49¢
DULANY CUT YELLOW CORN	20-Oz. Pkg.	69¢
SARA LEE POUND CAKE	10-Oz. Pkg.	99¢
MORTON CREAM PIE	16-Oz. Pkg.	59¢
MORTON PARKERHOUSE ROLLS	22-Oz. Pkg.	79¢
FOODLAND ICE MILK	Half Gallon	59¢

SHOP-EZE
West End Shopping Center
Mgr. James Williams

STORE HOURS:
Mon.-Sat.
9 A.M. to 9 P.M.
Sunday 1-6 P.M.



STORE HOURS:
MON. THRU THURS.
8:00 A.M. TO 7:00 P.M.
FRI.-SAT.
8:00 A.M. TO 8:30 P.M.
CLOSED SUNDAY

SPAIN'S
1414 Charles Blvd.
Owner: Alton Spain

WE'RE LOADED WITH SUPERFOOD BUYS

FRESH PORK
BOSTON BUTTS
LB. **79¢**
PORK STEAK LB. 89¢

SMITHFIELD
BOLOGNA
LB. **89¢**

SWIFT PREMIUM
HEAVY WESTERN STEER
GROUND BEEF
LB. **79¢**

OLD TAR HEEL COUNTRY LINK
SAUSAGE
LB. **\$1.19**
10 LB. BOX \$11.00

FROSTY MORN
BACON
LB. **89¢**

SWIFT PREMIUM HEAVY WESTERN STEER
RIB STEAK
BONE IN LB. **\$1.19**

SWIFT PREMIUM HEAVY WESTER STEER BONELESS
BEEF STEW
LB. **\$1.19**

FARM FRESH FRUITS AND VEGETABLES

NEW RED
POTATOES
5-Lb. Bag **59¢**

CAULIFLOWER
Head **79¢**
YELLOW ONIONS
3-LB. BAG **79¢**

GOLDEN RIPE
BANANAS
LB. **19¢**

FOODLAND TALL
KITCHEN BAGS
BOX OF 15 **95¢**

POWDER DETERGENT
TIDE
10' OFF
GIANT SIZE **\$1.19**

VIVA
NAPKINS
140 COUNT **49¢**

BAR SOAP 3¢ OFF
CAMAY
BATH SIZE **4/\$1.00**

FOODLAND
SALAD DRESSING
32 Oz. Jar **69¢**

DEL MONTE
PEAS
3 303 CAN **\$1.00**

DEL MONTE CUT
GREEN BEANS
3 303 CAN **\$1.00**

EVERYDAY LOW PRICES
GIBBS
Pork 'N Beans 2 1/2-Can **59¢**

FOODLAND WHITE
BREAD
3 1 1/2 Lb. Long Loaves **\$1.00**

FOODLAND
TEA BAGS
100 COUNT **\$1.29**

RED GLO
Tomatoes 3 303 Cans **89¢**

DUNCAN HINES
Cake Mix 19-Oz. Box **57¢**

BEECHNUT STRAINED
Baby Food 4-Oz. Jar **15¢**

SHOP-EZE
West End Shopping Center
Mgr. James Williams

FOODLAND

SPAIN'S
1414 Charles Blvd.
Owner: Alton Spain

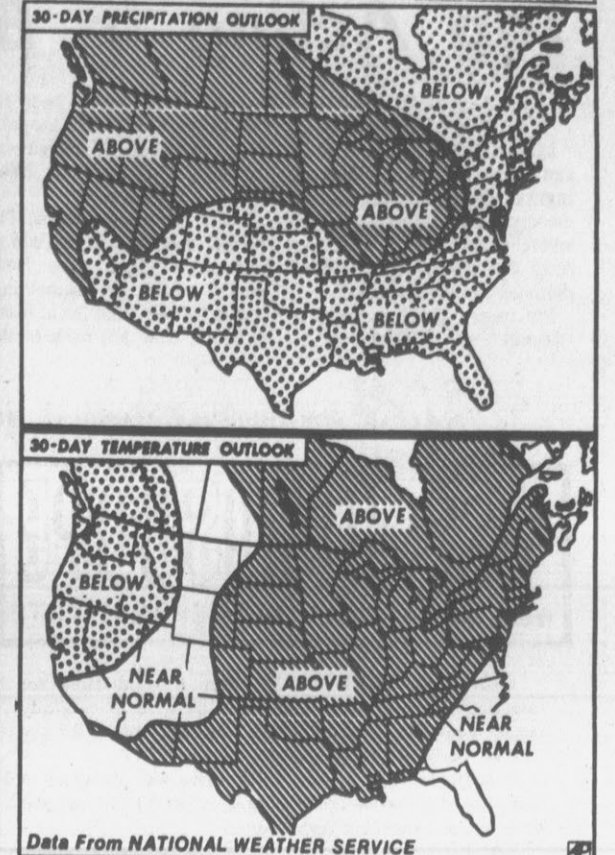

THIRTY DAY OUTLOOK — This is the way the nation's weather looks for the next 30 days in terms of precipitation and temperature, seen by the National Weather Service in Washington, D.C. (AP Wirephoto Map)

Seek Non-Voters

The Pitt County Board of Elections mailed letters to some 5,855 persons in the county who have not voted for several years in their registered precincts.

Margaret Register, Elections executive secretary, said that the letters advised voters "to notify us either in person or by mail within 30 days...or your name will be...removed from our...books, making it necessary for you to register again in order to be eligible to vote."

She noted that the letters were sent to determine if voters still resided at the same address and if they wished to have their names remain on the registration records.

According to Miss Register, the Elections office received 2,400 responses as a result of the mailing.

She added that the law requires that the Board of Elections keep its registration files up to date.

Free Enterprise Teaching Aids

By SUSAN QUINN
Reflector Staff Writer

The Greenville Area Chamber of Commerce members are promoting the private enterprise system to area students by distributing "Economics for Young Americans" in the Greenville City Schools.

For some time, business men and women in North Carolina, and across the country have felt the need for more teaching of basic economics in our secondary schools. The Chamber of Commerce of the United States believes it has developed the tools to aid the schools in teaching the private enterprise system. The chamber's program includes film strips, scripts, ditto sheets, and teacher's guides that are written by teaching professionals.

The Chamber of Commerce Economic Education Committee Chairman, Dr. Louis Zincone, Jr. presented the program kit to the Greenville City Schools Tuesday morning. Glenn Cox, Greenville City Schools Superintendent and Mrs. Kay Whitehurst, Director of Secondary Education for Greenville City Schools received the program for the schools.

Supt. Cox commended the chamber members for their efforts in assisting the schools to teach the private enterprise system.

"I think that this is a real opportunity which will help us to meet the regulations that the 1975 General Assembly emphasized in economic instruction in the schools. The general assembly did not budget for the instruction and we thank the Chamber of Commerce for offering the general program of information," Supt. Cox said.

Dr. Zincone explained that the program will not only include an instructional kit for each ninth grade U.S. History class and each twelfth grade Economics class, but will also possibly include a speakers bureau and participation in the program by the N.C. Council of Economic Education.

Mrs. Whitehurst said that the teachers have already begun utilizing the program distributed by the chamber and will receive the kits this week.

Attends Meet Of Committee

Margaret Register, executive secretary of the Pitt County Board of Elections, is attending a two-day meeting of the Legislative Study Committee of the N.C. Association of County Elections Boards and Executive Secretaries in Raleigh.

During today's session, the committee members were scheduled to meet with Louise D. Rehder, chairman of the committee.

On Thursday, the group will meet with the association's Election Laws Committee to discuss several bills that have been introduced in the General Assembly. A meeting is also scheduled with Alex K. Brock, director of the State Board of Elections.

Parent-Child Relations Class

Pitt Technical Institute will offer a course in Parent-Child Relations beginning Thursday, March 17 at 7 p.m. in room 113 of the Humber Building.

The course is designed to help parents deal with their children more effectively in personal communications. The class will meet each Thursday from 7 to 10 p.m. for ten weeks for a total of 30 hours of instruction. A tuition fee of \$5 will be charged. Rev. Dan Earnhardt will be the instructor. All interested persons should attend the first class meeting. For further information contact the Division of Continuing Education at Pitt Tech at 756-3130, extension 238.

Secretarial Clinic Slated

The Greenville Area Chamber of Commerce and the Business Education and Office Administration Department at ECU are jointly sponsoring a Secretarial Clinic to be held March 23 from 10 a.m. to 4 p.m. at the Candlewick Inn.

Sessions at the clinic will deal with job skills effective oral communications, budgeting of time, handling or responsibility and personal improvement including hair, makeup, carriage, wardrobe, voice, and attitudes.

To make reservations for the clinic, call the chamber office at 752-4101.

EXTENDED WEATHER OUTLOOK FOR N.C.

Partly cloudy Friday through Sunday with chance of showers in the mountains Friday and over the state Saturday, turning fair Sunday. Highs will average in the 60s and overnight lows in the 40s.

Top Acting In Brilliant Drama

By JAY SHARBUTT
AP Television Writer
LOS ANGELES (AP) — I can't help it. I always think of Ingmar Bergman's flicks as gloomy, brooding versions whose sound effects all come from a morose troupe of Scandinavian symbol players.

so good. If you've not seen it, catch Part Two of this six-part series on public TV tonight or the night it airs in your area. This is a must-see.

It first aired on Swedish TV in 1973, then was edited into a long movie that gave New York's smart set something new to twitter about for at least 48 hours. Now it's back in its

original TV form. Its basic premise is that love and marriage don't always go together like a horse and carriage. And it depicts the slow collapse of a seemingly perfect middle-class marriage with sur-

gical precision. The proceedings star Liv Ullman and Erland Josephson (their voices dubbed in English, and excellently, by Paulette Rubenstein and Richard Mulligan), as the gradually unhappy

modern couple. Parents of two kids, veterans of a 10-year marriage, he's a behavioral scientist, she's a divorce lawyer. She's on her second marriage, the first having ended shortly after her first child died in infancy.

Last week's premiere — the gist of which is briefly re-capped tonight — ended on a sad note of abortion, but began amid happy sounds as the "perfect" couple was interviewed for a women's magazine.

Martial bliss was jokingly expressed by Josephson thus way: "It's almost disgusting. I mean, security, order, comfort, loyalty. Such success almost borders on the indecent."

But in that show, a hint of ominous things to come arrived when another couple, while dining at the lovebirds' home, began a shrill, drunken quarrel that was kind of a No-Cal "Virginia Woolf."



Your Daily HOROSCOPE

from the CARROLL RICHTER INSTITUTE

FORECAST FOR THURSDAY, MARCH 17, 1977

GENERAL TENDENCIES: Not a good time for starting a new project. You would be wise to carefully study your true motives. Make long-range plans for the future. Strive for more harmony in your life.

ARIES (Mar. 21 to Apr. 19) Remove any obstacles in the path of progress. Show more affection for the one you love and get excellent response.

TAURUS (Apr. 20 to May 20) Be sure to use diplomacy at any social functions you attend today. Don't neglect to pay important bills on time.

GEMINI (May 21 to June 21) Being more precise in your career work sees you becoming more successful in the future. Find a better method for handling credit.

MOON CHILDREN (June 22 to July 21) Not a good day to start on any new projects, but fine for carrying through with present ones. Use care in motion.

LEO (July 22 to Aug. 21) Come to a better understanding with mate and have more harmony in the future. Avoid on who is too quarrelsome.

VIRGO (Aug. 22 to Sept. 22) Study your agreements with associates and make sure to keep your promise. Take time to engage in favorite hobby.

LIBRA (Sept. 23 to Oct. 22) You have many duties to perform, so persevere and forget about going off on some silly tangent. Try to cooperate more with associates.

SCORPIO (Oct. 23 to Nov. 21) Try to please associates by being more cheerful. Show your mate that you are truly devoted. Avoid one who is troublesome.

SAGITTARIUS (Nov. 22 to Dec. 21) Find out what your mate expects of you and then take steps to please. Don't argue with friends or you will regret it later.

CAPRICORN (Dec. 22 to Jan. 20) Make sure you keep any promises you have made to allies. Avoid one who has an eye on your assets. Express happiness.

AQUARIUS (Jan. 21 to Feb. 19) Study monetary matters that are important to you in the days ahead. Try to be more kindly to family members.

PISCES (Feb. 20 to Mar. 20) Good day to make right arrangements for the future so that you can be more successful. Attend the social with congeniality.

IF YOUR CHILD IS BORN TODAY... he or she will be able to understand others and can do much to make their lives more successful. Give as fine an education as possible and don't neglect religious training early in life. Sports are a must here.

"The Stars impel, they do not compel." What you make of your life is largely up to YOU!

(c) 1977, McNaught Syndicate, Inc.

GOREN BRIDGE

BY CHARLES H. GOREN AND OMAR SHARIF
© 1977 by Chicago Tribune

Neither vulnerable. South deals.

NORTH
♠ A 8 6 5 4
♥ Q 8 7 4 2
♦ A 10
♣ 8

WEST ♠ 10 ♥ 10 3 ♦ J 9 7 5 4 3 ♣ 10 6 5 4
EAST ♠ J 7 ♥ K J 6 ♦ K 8 6 2 ♣ K 7 3 2

SOUTH ♠ K Q 9 3 2 ♥ A 9 5 ♦ A Q ♣ A J 9

The bidding:
South West North East
1 ♠ Pass 3 ♣ Pass
4 ♠ Pass 4 ♦ Pass
4NT Pass 5 ♥ Pass
5NT Pass 6 ♠ Pass
6 ♣ Pass Pass Pass
Opening lead: Five of ♠.

Your play to the first trick could decide the fate of the contract! A writer once remarked: "There's no such thing as a blind opening lead, only deaf opening leaders!" Learn to find the winning attack with Charles Goren's "Opening Leads." For your copy, send \$1.50 to "Goren-Leads," c/o this newspaper, P.O. Box 259, Norwood, N.J. 07648. Make checks payable to NEWSPAPERBOOKS.

The most pleasant tournament on the American Contract Bridge League's calendar is the regional championship held each January in Bermuda. Large contingents from Canada and the New England states flock to this island paradise for a brief respite from the wintry chill.

Players who have been following the Bols bridge tips would have had an easy time on this deal from the 1977 Bermuda Regional, held at the Southampton Princess. The key play, an "intra-finesse," was the subject of Gabriel Chagas' bridge tip.

Although the final contract was not the soundest of undertakings, we can find no fault with the bidding. North was certainly worth a jump to three spades at his first turn, and his fifth trump, second-round club control and ace of diamonds persuaded him to cuebid on the next round. After that, South took over, and settled for a small slam when he discovered that three kings were missing.

West led a diamond and declarer was not prepared to risk his contract by running that to his queen—which was just as well. He won the ace of diamonds, and drew trumps in two rounds, ending in his hand. As is evident to the reader looking only at the North-South hands, declarer's problem was to hold his heart losers to one.

He led a low heart and when West followed low without a care, declarer decided to play East for the king—few Wests would have the fortitude to duck smoothly if they held the king. Therefore, declarer inserted dummy's seven. East won the jack and tried to cash the king of diamonds. Declarer ruffed, cashed the ace of clubs and ruffed a club in dummy, and the crux of the hand had been reached.

After some thought, declarer made the winning

TV Log

WNCT-TV Ch. 9

WEDNESDAY 11:55 Paul Harvey
7:00 Truth Or 12:00 Search For
7:30 Match Game 1:30 World Turns
8:00 Body Human 2:30 Guiding Light
9:00 Maelstrom 3:00 All In
11:00 Newswatch 3:30 Match Game
11:30 Movie 4:00 Marcus Welby
5:00 Gunsmoke
6:00 Newswatch

THURSDAY
6:00 Car. Today 6:30 News
6:00 Morn. News 7:00 Truth Or
9:00 Kangaroo 8:00 Waltons
10:00 Price Right 9:00 Hawaii 5.0
11:00 Dou. Take 10:00 Newswatch
11:30 Love of 10:30 W. F. v. S.U.

WITN-TV Ch. 7

WEDNESDAY 9:00 Douglas
10:00 Sanford &
10:30 Hollywood
7:00 Adam 12 11:00 Wheel of
7:30 Treasure 11:30 Shoot Works
8:00 Adams 12:00 News
8:30 McLean 12:30 Friends
9:00 C.P.O. 1:00 That Tune
9:30 McLean 1:30 Days of
10:00 Unknown 2:00 Doctors
11:00 News 3:00 Another World
11:30 Tonight Show 4:00 Loneranger
5:00 Virginia
5:30 Ironside
6:00 News
6:30 News
7:00 Today 7:00 Adam 12
7:25 News 7:30 Days of Music
7:30 Today 8:00 NCAA
8:25 News 9:00 Best Sellers
8:30 Today 11:00 News
11:30 Tonight Show

WCTI-TV Ch. 12

WEDNESDAY 11:00 Edge Night
6:30 Emergency 11:30 Happy
7:30 Tell Truth 1:00 Don Ho
8:00 Woman 1:30 V.I.P.
9:00 Barretta 1:30 Family
10:00 Angels 2:00 Pyramid
11:00 Hartman 2:30 One Life
11:30 Rookies 3:15 Hospital
2:00 News 4:00 Star Trek
2:10 Sign Off 5:00 News 12
6:00 News
6:30 Emergency
7:30 Tell Truth
8:00 Katter
8:30 Fight
9:00 Hartman 11:00 Hartman
9:00 Morning 11:30 Special
9:00 Douglas 1:00 News
10:00 Dinah 1:10 Sign Off

WUNK-TV Ch. 25

WEDNESDAY 11:45 Media
4:00 Zoom 12:00 Studio See
4:30 Rebob 12:30 All About
7:00 Assembly 12:45 Cover to
7:30 Price 1:00 Environment
8:00 Nova 1:30 Matter of
9:00 Performances 1:55 Mathematics
10:00 Marriage 2:10 Man
11:00 Tennyson 2:30 En Francais
11:30 Sign Off 2:45 Guten Tag
3:00 Rebob 4:00 Sesame Street
4:00 Zoom 5:00 Mister Rogers
5:30 Elect. Co. 5:30 News
6:00 News 6:00 Zoom
8:15 School TV 6:30 Villa Alegre
8:30 Mathematics 6:45 Cover to
8:45 Cover to 7:00 Assembly
9:00 Sesame Street 7:30 L. Thomas
10:00 Elect. Co. 8:00 Firing Line
10:30 Carousal 9:00 Theatre
10:45 Mathematics 10:30 Metamorph
11:00 Showcase 11:00 Sign Off

CROSSWORD PUZZLE

ACROSS
1. Blanche
5. Exasperated
8. Dull surface
11. Man's name
12. Since
13. --- de France
14. Margins
15. System
17. Stout
18. That man's
19. New star
20. Reduce
22. Fault
23. Has debts

DOWN
25. Puff
26. Ragout
29. Fashion
31. Geological period
32. Swing
36. Climb
38. Appreciable
39. Stop light
40. Enliven
42. Arrive
43. Comrade
44. Mayday
45. Stratford-on-
46. Town in Minnesota
1. Uncivilized

SOLUTION OF YESTERDAY'S PUZZLE
47. Type squares
48. Camera's eye

DOWN
2. Old-womanish
3. Cupolas
4. Curlycue
5. Sailor
6. Historical epochs
7. Andiron
8. Sensitive plant
9. Young fish
10. Lessee
16. Amid
18. Chop
21. Pig
24. Dejection
25. Home of 21
Down
26. Blanketlike
shawl
27. Threefold
28. Smoothly
30. Light-hearted
33. Coppice
34. Fruit
35. Blissful places
37. Type square
38. Monad
41. Enzyme
42. Presidential
nickname

Par time 25 min. AP Newsfeatures 3-16

they'll manage to win the prize were after — collective male gull, which gives them unbelievable advantages without lifting a finger.

Some customers have been heard to say the theater version of "Scenes" was windy and laborious, but this version sure isn't. It's strong, meaty drama, with a brilliant pace, brilliant acting.

Women grabbed the best role right from the start, that of the martyr ... and with it,

Ticket-Selling Given Approval

City Manager Jim Caldwell announced approval of a request by Junior Girl Scout Troop 446 for permission to set up a table on Evans Mall and sell tickets to the Easter Seals Pigs versus Freaks basketball game.

The request was submitted by Ms. Cathy Gasior of Greenville.

ATTC ATTIC

Wed.-Thurs. "Spike"
Fri.-Sat. "Sutters Gold"

WATCH TV TONIGHT!

FIND OUT WHY YOU WILL BE TALKING ABOUT ...

Cry for me Billy

WNCT-TV 6:00-6:30/11:00-11:30
WITN-TV 6:00-7:00/11:00-11:30

TOBACCO GROWERS TALK ABOUT VIKING SHIP® CALCIUM NITRATE

"We went all the way with Calcium Nitrate based on my neighbor's experience"

Jim Norris
Timmonsville, S.C.

"This past year it didn't rain for a month after transplanting, but with Calcium Nitrate I didn't have to re-set my crop even once. 'CN' got my crop off to a faster start than 'soda' and then gave out when it's supposed to. My crop matured out quicker and more uniform than before. I'll be using 'CN' again next year."

VIKING SHIP® CALCIUM NITRATE

DISTRIBUTED BY: **W-C-M WILSON & GEO. MEYER & CO.**

East: One Koger Executive Center, Suite 108 Norfolk VA 23502 (804) 461-0925
Coast: P.O. Box 1290 Tampa FL 33601 (813) 223-4127
Home Office: 270 Lawrence Avenue South San Francisco CA 94080 (415) 871-1770
Viking Ship® Calcium Nitrate is manufactured by Norsk Hydro, Oslo, Norway by others may produce different results.

MUCH MORE THAN A GREAT FERTILIZER!

See Your Fertilizer Dealer

Carolina Eastern
Stokes & Congleton
Farmers Agri Supply
Stokes Ayden

abc PITT

EVERYTHING THAT CAN HAPPEN BETWEEN A MAN AND A WOMAN... AND A WOMAN AND A WOMAN... HAPPENS BEFORE YOUR EYES.

Paramount Pictures presents
A Howard W. Koch Production
Jacqueline Susanna's Once Is Not Enough

7:00-9:05
Next "Gumball Rally"

264 PLAYHOUSE

INDOOR THEATRE

6 MILES WEST OF GREENVILLE ON US 264 (FARMVILLE HWY.)

SHOWING ONLY THE FINEST IN ADULT ENTERTAINMENT

ENDS TONIGHT

LES NYMPHO TEENS

Doors Open 5:45 Showtime 6:00

CALL FOR SHOWTIME ANYTIME **756-0848**

WINN-DIXIE

THE BEEF PEOPLE

PRICES GOOD THRU SAT. **MARCH 19TH**

SUNNYLAND BONELESS BAKED HAMS

Lb. **\$2.39**

BAKERY DEPT. SPECIALS!

FREE: Pkg. of 12 Home Style Pan Rolls With The Purchase Of Two 16-Oz. Loaves Of Home Style Bread

DELI DEPT. SPECIALS

FREE: 16 Potato Wedges With Purchase Of Bucket-O-Chicken

• 5 Breasts • Thighs • 6 Legs

ST. PATRICK'S DAY CAKES

7" 2-Lb. Size **\$2.69**

AREN'T YOU GLAD THERE'S A WINN-DIXIE DELI-BAKERY NEAR YOU? PLEASE CALL FOR SPECIAL ORDERS

Located At The Shopper's Mart
Open 7 Days A Week
7 A.M. To 11 P.M.

Phone 756-2956

PLACE CLASSIFIED ADS HERE

752-6166

16 Ford

GRANADA GHIA 1975. 4 door with everything. \$3500. 752-9013 after 5:30 p.m.

FORD 1974 Torino. Air, automatic. Excellent condition. Best offer. 752-7947 after 7 p.m.

18 Mercury

MERCURY STATION WAGON 1977. Fully equipped. 756-2962 after 3 p.m.

19 Oldsmobile

OLDSMOBILE 1974. 96 Regency. 4 door luxury sedan. Full power, radials. 756-5270.

OLDSMOBILE 1976 Delta Royale 88. Assume loan, no equity. 18,000 miles. 756-7563.

20 Plymouth

PLYMOUTH 1973 Fury III. 360 engine, 2 barrel carburetor, air, radio, heater, very clean. \$900 cash and take over payments of \$74.36 a month for 22 months. 752-2475 between 4 and 6 p.m.

21 Pontiac

TRANS AM 1972. Fine condition. 455 HP, automatic transmission, stereo tape, air conditioning, Cragar mags. 756-4025 anytime.

LEMANS 1973. Good condition, clean. \$1650. 758-7863.

GRAND PRIX 1976. Excellent condition. Low mileage. Many extras. 752-4910 after 8 p.m.

PONTIAC 1973. Air, tape player, good condition, green with light interior. Rally II wheels. Call 752-3434 between 5:30 and 10 p.m.

22 Foreign

VW 1972 Super Beetle. Excellent condition. Low mileage. \$1300. 758-7863.

MGB 1974. Like new, new top, low mileage. \$3800. 756-1991.

DATSUN 240Z 1973. 4 speed, excellent condition. 758-0467.

MG MIDGET 1974. Excellent condition. New top. \$2000 or assume payments. 752-6633 after 6:30.

DATSUN 240Z 1974. Excellent condition. All options available. 752-0872.

VW 1965 BUG. Clean, new engine, starter. 756-3688 after 5 p.m.

DATSUN 240Z 1973. One owner. 37,000 miles. 4 speed, air. \$4000. 758-3378 day. 758-1642 nights and weekends.

FIAT 850 Sedan 1971. Good condition. 36 miles per gallon. \$450. 752-8348.

MG 1972 MIDGET. Best offer. Call 756-4099 after 7 p.m.

CORVAIR 1963. Good condition. \$175. 752-6139.

DATSUN 510 Wagon. 1969. New engine, new transmission, extra set of tires, AM/FM radio, cassette player. \$650 or best offer. 756-0976.

TOYOTA 1975 Celica GT. 23,000 miles, air, 5 speed, AM/FM. Price negotiable. 758-9263.

DATSUN 240Z 1973. Red, automatic. 758-4262 after 5 p.m.

27 Bicycles For Sale

RALEIGH-COMPETITION 10 speed. Like new. 758-7019.

29 Boats For Sale

OUACHITA RIVER boat. 14', aluminum, extra wide with flat bottom and galvanized Cox trailer. \$495. 756-6432.

15' CUTTER BOAT. 75 HP Johnson, trailer included. \$450. 752-6887 after 6 p.m.

17' FIBERFORM with Mercury 150 HP. Cox trailer. All accessories including skis. Priced for quick sale. 756-7085, 746-6803.

1973 GRADY WHITE Atlantic Weekender. Cuddy cabin with head sink, VHF radio, CB antenna. 115 HP Evinrude. \$4500. 752-6163 days. 756-3768 nights and weekends.

16' GLASSPAR. 60 HP Johnson, tilt trailer. All ski equipment plus 2 gas tanks included. 756-7473.

1976 MARQUIS 17 1/2 foot long, 115 HP Evinrude motor. Like new. Two way radio, depth finder, compass, speedometer. 752-0764.

17' INBOARD / OUTBOARD Dixie. Fully loaded. Less than 20 hours. 752-3143, extension 224 day, 756-2724 night.

1976, 19' Galaxy with a V8 engine. Excellent condition. 746-3235 after 5 p.m. weekdays.

17' CHECKMATE Open Bow. Excellent condition. Low hours. A beautiful boat. \$3995. 753-4243 after 6 p.m.

1976, 18' DIXIE deep V, 115 HP Mercury, galvanized trailer. Excellent condition. \$4700. 746-8416, 752-3602.

31 Campers For Sale

1975, 24 1/2' Terry Trailer Trailer with air conditioning, 18' awning and other extras. Like new condition. 753-4507 after 6.

CLASSIFIED ADS can make life easier for you!

STARCRRAFT ROLL-UP camper. Sleeps 8, stove, icebox, sink. \$900. 753-5858 after 6.

35 Cycles For Sale

HONDA XR75. Excellent condition. \$250. Also Honda Z50. Excellent condition. \$100. 756-4921 or 756-0220.

1975, 550F Honda. 4100 original miles. Immaculate condition. \$1275. Call 757-6207 mornings 9-12 please or see 209 Lewis Street.

HONDA 360. Low mileage. Windshield, sissy bars, 2 helmets. Excellent condition. \$435 or best offer. 758-0051.

1974 HONDA 450. Excellent condition. Like new. 825-7091, Bethel.

1974, 550F Honda. Excellent condition. \$900. 752-4545.

37 Trucks For Sale

1973 CHEVROLET Pickup. Can be seen at Morgan Grain & Fertilizer Company, 600 West Pine Street, Farmville, N.C. Call between 8:30 a.m. and 12 noon, (919) 753-3183.

1967 FORD Econoline Van. Basket case with rebuilt 240, 6 cylinder engine plus many new parts. First \$250 gets it. 752-2188 days, 752-9922 after 6.

1971 STEP VAN. 30 series. Excellent condition. Best offer. 758-5071.

1974 WAGONEER. 4 wheel drive, power steering, power brakes, air. 28,000 miles. \$3900. 756-5225 days. 746-4415 nights.

100 CLASSIFIED DISPLAY

Building Lots RAGLAND ACRES Winterville, N.C. 756-1016

TARHEEL FENCE CO. Spring Special on Chain Link and Split Rail Fencing. 15% Off. Call Collect For Free Estimates. 244 1265 Van ceboro, N.C.

Haven't you done without a Toro long enough? CLARK & CO. MEMORIAL DR. 756-2557

37 Trucks For Sale

1974 BLAZER. Blue, white top, heavy duty, 4 speed, power steering. \$4100. 752-6451.

1972 FORD F-100. 3 speed, 6 cylinder, radio, air, 47,000 miles. Clean, insulated camper. \$2100. 752-7776.

1973 FORD Ranchero. 56,000 original miles, fully loaded. Excellent running condition. Brand new tires. 756-7985 after 6 p.m.

1975 CHEVY Luv Pickup. Good condition, air conditioning, 18,000 miles. Excellent buy. 756-7066 after 5:30 weekdays, anytime weekends.

1972 MAZDA. Camper top, new paint and tires, very clean. \$1600 or best offer. 756-0267.

1973 TOYOTA Pickup. 39,000 miles, excellent condition. State Employees Credit Union, 758-5247.

40 DOGS & PETS

PERSIAN KITTEN, cfa Registered, champion dame, female cameo color. \$100. 756-4931, 756-0220.

POMERANIAN puppy. AKC registered, female, brown sable color. \$100. 756-4931, 756-0220.

AKC REGISTERED Doberman puppies. Solid red, also black and rust. Championship bloodline. Call Charlie Briley, 825-7241 after 6 p.m.

RED AND RUST Doberman puppies. Also black and rust. 8 weeks old. Champion bloodline. 758-7472 or 756-4929.

WANT MALE bluepoint Siamese cat for stud. 752-0522 between 1:30 and 2:30 p.m.

AKC OLD English Sheepdog puppies. Males. \$150 and \$175. 825-3501; after 5 on weekends. 825-2871.

DUCK HUNTERS. AKC Lab Retriever pups. 1st line breeding. dewormed. \$285-3930.

FULL BLOODED Collie puppies. \$20 each. 756-3811.

OWNER WISHES to find good home for female (spayed) long-haired Dachshund. No small children. 756-5896.

EMPLOYMENT

42 Help Wanted ASSISTANT secretary-receptionist. Monday through Friday. Experienced. Typing and shorthand. Call Mrs. Anderson, 752-4116. Rivers & Associates, 107 East Second Street.

Experienced Oil Burner Serviceworker. Good Starting Salary And Many Other Benefits. Contact R. P. Grady, Allied Petroleum Corp. 615 W. 14th Street Greenville, N.C. 758-1277

PARTS CLERK. 2 years experience as auto mechanic or parts clerk. Contact M. E. Porter, Regional Auto Parts, Inc., 756-1100.

Fine Part-Time Opportunity

Earnings of over \$2.35 per hour, 6 to 8 hours per week, servicing Greeting Card and Gift Wrap Departments in a local discount store, available to a responsible homemaker living in the area of 703 E. Greenville Blvd. Write P.O. Box 410, Taylorville, IL 62568. Please include phone number.

CHARLES POTATO CHIPS has outstanding opportunity for person who wants to own his own business. Earnings potential at an all time high because of the many new snack food products available for delivery to homes and retail outlets. No charge for franchise. \$3000 capital required for inventory and truck. For information, call Lou Scott, 758-7646 or write Bobby Brown, Box 672, Four Oaks, NC 27524.

DRAFTSMAN. Talent essential. Civil/sanitary experience preferred. For employment with expanding branch office of 50 year old consulting firm. Contact Olsen Associates, Inc., Engineers and Surveyors, P. O. Box 93, Greenville, NC 27834. 752-1137.

EXCEPTIONAL individual with sales experience, general business knowledge. Will handle wide range of tasks. Wide knowledge of antiques essential. Submit resume and salary requirements to Antiques, P. O. Box 1967, Greenville, NC.

SECRETARY. Shorthand, good typing and secretarial experience required. Great surroundings and advancement. \$125 per week. Free paid by company. Call Sandy, 752-5188. Burt Associates, Personnel Placement Service.

Wanted, first class body man. Apply Cliff's Body Shop 115 W. Tenth Street

100 CLASSIFIED DISPLAY

Men's Shoes Freeman Free-Flex Foot So Port Allen Edmonds SEE BOB THOMPSON 111 E. 3rd Street Lee Bldg. 752-8778

Mercedes-Benz The Best Engineered Car in the World see it at Tarheel Toyota 109 Trade St. 756-3228

You Are Invited To Sell Your 1977 Tobacco Crop With RAYNOR-FORBES & CLARK TOBACCO WAREHOUSE GREENVILLE, N.C. "A GOOD PLACE TO SELL TOBACCO" PHONE: 756-4090 NO. 523

42 Help Wanted

ADVENTURE-TRAVEL. Guys or girls, 17 and over. Single and free to travel East Coast, beaches and sunny southwest. Transportation furnished plus high earnings and rapid advancement. Driver's license not required. For immediate employment with one of our groups, see Mrs. Eason Thursday only, 10:30 a.m. til 3 p.m., Ramada Inn.

FLOOR COVERING salesperson. Salary based on experience, ability and results. Send resume to Salesperson, P. O. Box 1967, Greenville, NC.

OUTSIDE SALES Representative. Must be neat, aggressive and dependable with management potential. Salary, commission and company vehicles furnished to successful applicant. No previous sales experience necessary. Apply in person only at Singer Company, Pitt Plaza.

TENNIS MATE wanted. Can play anytime; must play excellent tennis. 752-3023.

EXPERIENCED SEWING MACHINE OPERATORS

Apply at: Ayden Division of USI Hwy 11 By-pass Ayden, N.C.

SOMEONE WANTED to live in with elderly lady. Light housework. 825-7461.

COLLEGE GRADUATES wanted for sales positions. Bonuses, no traveling and an opportunity for a very rewarding future. Send resume to P. O. Box 3097, Greenville, NC.

BAUMANN BUILDING & Company hiring carpenters. 6 years experience in all phases of carpentry. References required. After 6 p.m., 746-3421.

BOILER OPERATOR. Minimum 3 years work experience operating oil fired steam boilers. Ability to perform all necessary chemical treatment tests preferred. Qualified candidates contact Personnel Department, ECU, Greenville, NC 27834. (919) 757-6352. An Equal Opportunity Employer, Male/Female.

44 Work Wanted

WOMAN WOULD like to keep children in her home for working mothers. 756-6309.

BRICK MASON work wanted. Afternoons and Saturday work. Will build fireplaces, underpin, etc. 946-0039 between 6 and 10.

BILL'S PAINTING. Interior and exterior and miscellaneous home improvements. 752-2730, ask for Bill.

FREE LANCE sign work. Call Mary, 758-3361.

MOTHER WILL keep children weekly in her home. Lunches included. 756-3536.

BRICK WORK. Underpinning, steps, fireplaces, etc. Call 746-3509 after 7:30 p.m.

46 FOR SALE

WOULD LIKE to purchase your used trailer. Call 756-1875 after 5.

200 110-GALLON fiberglass tanks with racks. Excellent condition. 758-0247 after 6 p.m.

TWO-WHEEL garden tractor and equipment. \$300 or best offer. Contact T. I. Hamilton, Route 1, Box 223A, Winterville, NC. Highway 903 South at Charles McLawhorn Dairy.

ONE ROW pull type tobacco breaker. Used 3 weeks. \$6500. 752-6139.

NEW GASTOBAC bulk barn burner. Also Long racks. 752-4529.

50 Garage-Yard Sale

FLEA MARKET. Pitt County Fairground, located in front of airport. Plenty of good used furniture, glassware and antiques. Open every Friday afternoon and Saturday, 10 til 5.

YARD SALE Saturday, March 19 from 10 a.m. to 2 p.m. 588 rural families. 112 Hardee Road, (in Eastwood). Clothes, records and tapes, toys, odds and ends.

YARD SALE. March 19 from 9 until. Glendale Court, off Hooker Road.

100 CLASSIFIED DISPLAY

5 HP 26" Winston Tillers Chain Drive Hendrix-Barnhill Co. 752-4122

Military Surplus Camping Equipment & Work Clothes ARMY/NAVY STORE 1501 S. Evans Street Hours: 11:30 to 5:30

ANTIQUES

One roll top oak desk, one Tiffany type lamp shade, one gold frame mirror, one ladies chamber pot, one wash bowl, four vases, miscellaneous chairs.

Challenge Yourself To Develop A POSITIVE MENTAL ATTITUDE

You will have two weeks paid training in Raleigh We guarantee 950.00 per month to start Our company offers excellent medical benefits You may participate in our Pension and Savings Plan.

CALL MR. VICK 946-7430 Mon., Tues. and Wed. 9 A.M. to 6 P.M. Long distance call collect An Equal Opportunity Company

HOME IMPROVEMENTS

756-3453 RussCo Greenville, N.C.

Ayden Furniture

112 E. 2nd St. Ayden, N.C. 746-3049

40 Garage-Yard Sale

YARD SALE Saturday at 9 a.m. Pool table, lamps, clothes, furniture, TV, sporting equipment. Behind A & P Store.

54 Livestock

QUARTERHORSE, saddle and bridle. \$175. 746-3719.

56 Miscellaneous

FILL DIRT, top soil, rocks and sand for sale. Large loads. Henry Worthington, 746-3461.

YOU CAN "STEAM" clean carpets. Professionally clean with new portable Rinse-N-Vac. Rent at Rental Tool Company across from Hastings Ford. Now open-Rental Tool Company.

FILL DIRT, BUILDER sand, top soil, and rock. J.L. McDaniel, 756-2351 after 3:30 p.m.

WE ARE BEAUTIFUL head-quarters-bedding hide-a-beds. Home Furniture Company, 701 Dickinson Avenue.

CUSTOM-MADE FIREPLACE screens. \$39.95. Up to 30 inches wide. Home Furniture Store, 701 Dickinson Avenue.

STEAM CLEAN your carpet with Rinse-N-Vac, the newest way to professionally clean your carpet at home. Available to rent at International Carpet, Inc., 752-3523 or 752-3524.

FRUIT TREES. Little's Nursery. Pecan trees, orange trees, grape vines. Complete line of shrubbery and trees and house plants. 756-3626, west of Greenville. 4 miles out.

CLEAN CARPETS last longer. The method recommended most by major carpet manufacturers is Streamer. Available for rent at Larry's Carpetland. Give us a call 758-2300.

DISCONTINUED SAMPLES make excellent door mats and only \$1 each. A price anyone can afford. 2 X 4 foot scatter rugs for only \$4.95 and this is way below our cost. Larry's Carpetland, 3018 East Tenth Street.

PIANOS. Rent with option to buy. \$15 per month. Cha-Rich Music, 208 Arlington Boulevard, 756-1212.

19" QUASAR Motorola color TV with rotary antenna. Less than one year old. \$520. 752-3536 or 758-1991.

BALDWIN pianos and organs for church and home. Cha-Rich Music, 208 Arlington Boulevard, 756-1212.

USED TIRES at reasonable prices. Also new recaps. Fully guaranteed. Stop by Evans Tire Service, Highway 11; just before Pitt Tech. 756-6445.

CARPET BINDING and fringing. Any size from door mat to room size. One day binding service. Whitehurst Carpets, 756-2747.

50 Garage-Yard Sale

YARD SALE Saturday at 9 a.m. Pool table, lamps, clothes, furniture, TV, sporting equipment. Behind A & P Store.

54 Livestock

QUARTERHORSE, saddle and bridle. \$175. 746-3719.

56 Miscellaneous

FILL DIRT, top soil, rocks and sand for sale. Large loads. Henry Worthington, 746-3461.

YOU CAN "STEAM" clean carpets. Professionally clean with new portable Rinse-N-Vac. Rent at Rental Tool Company across from Hastings Ford. Now open-Rental Tool Company.

FILL DIRT, BUILDER sand, top soil, and rock. J.L. McDaniel, 756-2351 after 3:30 p.m.

WE ARE BEAUTIFUL head-quarters-bedding hide-a-beds. Home Furniture Company, 701 Dickinson Avenue.

CUSTOM-MADE FIREPLACE screens. \$39.95. Up to 30 inches wide. Home Furniture Store, 701 Dickinson Avenue.

STEAM CLEAN your carpet with Rinse-N-Vac, the newest way to professionally clean your carpet at home. Available to rent at International Carpet, Inc., 752-3523 or 752-3524.

FRUIT TREES. Little's Nursery. Pecan trees, orange trees, grape vines. Complete line of shrubbery and trees and house plants. 756-3626, west of Greenville. 4 miles out.

CLEAN CARPETS last longer. The method recommended most by major carpet manufacturers is Streamer. Available for rent at Larry's Carpetland. Give us a call 758-2300.

DISCONTINUED SAMPLES make excellent door mats and only \$1 each. A price anyone can afford. 2 X 4 foot scatter rugs for only \$4.95 and this is way below our cost. Larry's Carpetland, 3018 East Tenth Street.

PIANOS. Rent with option to buy. \$15 per month. Cha-Rich Music, 208 Arlington Boulevard, 756-1212.

19" QUASAR Motorola color TV with rotary antenna. Less than one year old. \$520. 752-3536 or 758-1991.

BALDWIN pianos and organs for church and home. Cha-Rich Music, 208 Arlington Boulevard, 756-1212.

USED TIRES at reasonable prices. Also new recaps. Fully guaranteed. Stop by Evans Tire Service, Highway 11; just before Pitt Tech. 756-6445.

CARPET BINDING and fringing. Any size from door mat to room size. One day binding service. Whitehurst Carpets, 756-2747.

100 CLASSIFIED DISPLAY

DOODLE'S AUTO PARTS 105 Trade St. Greenville, N.C. PHONE 756-4422

WE REPAIR SCREENS & DOORS

C.L. LUPTON CO.

ELECTRICIAN HELPERS

Experienced person need to apply. Stuart Shinn, Inc. 612 Norris St. Greenville, N.C.

SALESMEN AND SALESLADIES OPPORTUNITY KNOCKS

Now you can multiply your income by earnings as much as \$10,000, \$15,000, \$20,000, and more the first year!

(1) Are you a person of character?

(2) Are you at least 18 years of age?

(3) Are you sports-minded?

(4) Are you bondable?

(5) Do you have a high school education?

Challenge Yourself To Develop A POSITIVE MENTAL ATTITUDE

You will have two weeks paid training in Raleigh We guarantee 950.00 per month to start Our company offers excellent medical benefits You may participate in our Pension and Savings Plan.

66 Mobile Homes For Sale

1971 VALIANT 12 X 60, 2 bedrooms, central air and heat. 758-7179.
1973 12 X 70, 3 bedrooms, 2 baths, fully carpeted and furnished. Also central air. 752-2569 after 5.
OAKWOOD WELLS. 1 owner, 16 months old, furnished, washer, porch, utility shed, TV antenna and more. Excellent location in one of Greenville's finest trailer parks. This home is completely set up to move in and should be seen to be appreciated. A good investment for people tired of paying rent. \$795. Bank financing available. 758-1071.
1973 12 X 60, 2 bedrooms. Includes all appliances. Well kept. 752-0528 after 5. 758-0180.
TRAILER AND LARGE lot for sale. 758-0180.
1973 REDMAN 12 X 60. Front kitchen, 2 bedrooms, fully carpeted. Never lived in. \$7500 or equity and assume payments of \$109. 524-5694.
1976 VIRGINIAN 12 X 60, 2 bedrooms, fully furnished with washer and dryer and central air. \$800 and assume payments of \$117.77 per month. 756-7233 or 756-0131.

68 OPPORTUNITY

GET IN ON THE PLASTICS BOOM

Both government and private sources are estimating a gross national product for our industry of over \$1 BILLION DOLLARS BY 1980. We are expanding in your area now. We are seeking an individual to join us and to manufacture highly marketable plastic products in this profit orientated industry.

YOUR QUALIFICATIONS ARE:

A sincere interest-ambition-capital investment of \$5,975 and approximately 200 square feet of operating space for mini-factory, we do the rest.

WE WILL PROVIDE

A newly designed mini-factory with complete installation of all equipment and machinery by experts, on the site of your choice.
A thorough complete training course, covering all aspects of operations.
All necessary retail outlets for your finished products, secured by trained company sales representatives.

BE YOUR OWN BOSS JOIN US

MODERN CRAFTS, INC.

Plaza 3 Bldg., Suite 1206
1205 So. Stewart
Springfield, Missouri 65804
Phone 417-881-7572 - 417-881-7573

70 PROFESSIONAL

BRICK, BLOCK and concrete service. All types. Work guaranteed. Call Gid Holloman, 753-3303.

HARDEE'S UPHOLSTERY. Furniture, cars, boats and custom work. Reupholstering and refinishing. Satisfaction guaranteed. 756-2485.

EXPERT SHRUB and tree planting, new lawn construction, old lawns revitalized, planting bed design and preparation, spring clean-up, and Annual Maintenance Plan. B & B Lawn & Landscaping, 756-1978. Free estimates.

BROWN'S PAINTING and roofing. Inside, outside and all roof work. 756-2008 anytime.

72 REAL ESTATE

FOR BETTER BUYS in real estate, see or call E.H. Williford, Realtor, 222-B Colanthe Street, 758-9911. List your property with us.

FOR ALL YOUR real estate needs, call Fleming & Associates, 756-6234.

WANT TO BUY apartments. Seller financing preferred. 756-7766 after 7 p.m.

WE NEED HOME in country near Greenville. Between \$30,000-\$40,000. Stack Kiger Realty, 756-3088; 756-3575 residence.

78 Houses For Sale

1745 BEAUMONT CIRCLE, 3 bedrooms, 2 full baths, living room, den with fireplace, large kitchen with breakfast area, wall-to-wall carpet. Low 50's. Call 756-1373.

100 CLASSIFIED DISPLAY

ROOFING

STORM WINDOWS, DOORS & AWNINGS. C.L. LUPTON CO. 752-6116

USED CARS

REASONABLE PRICES

1976 CHEVROLET

Monte Carlo, Stock no. P-3572-A. Blue, automatic, power steering, air, AM/FM radio, vinyl top. *\$4698

1975 CHEVROLET

Monte Carlo, Red, automatic, power steering, vinyl top, air, AM/FM radio. *\$4198

1975 PONTIAC

Firebird, Beige, AM/FM radio, automatic, power steering, air, rally wheels. *\$4398

1976 TOYOTA

Hilux Longbed pickup, Stock no. R-3505. Demo. White, automatic, AM radio. *\$4098

1976 TOYOTA

Hilux Short bed pickup, Stock no. 3532-A. Red, automatic, radio, heater. *\$3698

1976 TOYOTA

Hilux pickup, Stock no. R-3512. Long bed, 4 speed, radio, heater, red. *\$3698

1974 VOLKSWAGEN

Bus, 4 speed, radio, heater, orange, stock no. 2871-B. *\$3698

1973 PONTIAC

Grand Prix, Stock no. 3473-A. Automatic, power steering and brakes, air, vinyl top. *\$3398

1974 PONTIAC

Lemans Sport, Stock no. D-3401-A. Silver, automatic, power steering, vinyl top, AM/FM radio. *\$3198

1972 TOYOTA

Land Cruiser, 3 speed, 6 cylinder, blue, locking hubs. Stock no. 3270-A. 4 wheel drive. *\$2998

1973 FORD

Gran Torino, Stock no. D-3324-A. Green, automatic, power steering, air, vinyl top, radio. *\$2198

1974 TOYOTA

Hilux pickup, Stock no. 3455-A. Yellow, 4 speed, short bed. *\$2598

1973 PLYMOUTH

Fury III, Stock #3413-A. 4 door, Yellow, automatic, air, radio. *\$1998

1973 DODGE

Dart, 2 door, Beige, automatic, radio, heater, vinyl top. *\$1998

1973 VOLKSWAGEN

Beetle, Stock no. 3506-A. White, 4 speed, radio, heater. *\$1798

1973 TOYOTA

Corolla Deluxe, Stock no. 3240-A. Brown, 4 speed, 2 door, radio. *\$1698

1970 CHEVROLET

Camaro, Stock no. 3206-B. Green, luggage rack, chrome rims, automatic, traction bars, radio. *\$1498

1973 FIAT 128

4 door, Stock no. 2644-A. White, 4 speed, radio. *\$1398

1971 FORD

LTD Stationwagon, Green, stock no. 3392-A. Automatic, power steering, air, luggage rack, radio. *\$1398

1971 FORD

Maverick, Stock no. D-3522-A. Red, Automatic, radio. *\$1198.

Tarheel Toyota Inc.

109 Trade St. Greenville, N.C. Phone: 756-3231 or 756-3228

82 Resort Property For Sale

\$53,900 ATLANTIC BEACH vacation retreat. One block from ocean. Furnished throughout. 5 bedrooms, living room-dining room combination, 27' X 12', completely carpeted, beautiful sun porch, 2-car garage, fenced yard. Stack Kiger Realty, Gary Kiger, 756-3088 business; 756-2718 residence.

84 RENTALS

86 Apartments For Rent

Your Carpet & Vinyl FLOOR COVERING CENTER

Over 200 Rolls of First Quality Carpet in Stock.

International Carpet, Inc.

1806 Dickinson Ave. Phone: 752-3523

LOAN ASSUMPTION. 411 Aztec Lane. 3 bedroom home. Corner lot. Pay equity and assume good loan. \$29,500. Bill Williams Real Estate, 752-2615.

OWNER SELLING 4 bedroom, 2 1/2 bath home with quality features. Great floor plan. Mid 50's. 756-4466.

LYNDALE. Large lot, 4 bedrooms, 2 1/2 baths, 2-car garage. By owner. 756-4329.

1425 SQUARE FOOT brick veneer ranch, 3 bedrooms, 2 baths, kitchen with breakfast area, den, living room, covered patio with barbecue pit, central air heat and air, quiet subdivision. \$37,750. Blount & Ball Realty, Inc., 752-6163; nights, Jon Day, 752-9345.

BY OWNER. 2900 Jefferson Drive. \$35,000. 752-8127 for appointment.

NEW LISTING. Club Pines, 3 bedrooms, 2 baths, large lot. \$49,500. Blount & Ball Realty Company, 752-6163; nights, Lee Ball, 756-3768.

NEW LISTING. Eastern Street, 3 bedrooms, 2 1/2 baths. Lots of potential. \$38,500. Blount & Ball Realty, 752-6163; nights, Jon Day, 752-9345.

BY OWNER. Westhaven Subdivision. 2 bedrooms, 2 baths, living room, dining room, den with fireplace, large eat-in kitchen, fence, 1575 square feet. 756-7839.

BY OWNER. 502 Colonial Street, Ayden, 3 bedrooms, living room, den, fenced yard. \$27,500. 746-3908; 756-7232 after 6 p.m.

3 BEDROOMS, 2 baths, kitchen, den with fireplace, living room, dining room, extra large lot in nice neighborhood. Mid 40's. Call Ed Tipton Agency, 756-0911 or 756-2421 at night.

CONVENIENTLY located to shopping center, schools and churches. 3 bedrooms, 2 baths, den with bookcases and fireplace, living and dining room, on beautiful lot. Has forced air oil heat to help those utility bills come down. Lower to mid 40's. Ed Tipton Agency, 756-0911 or 756-2421 at night.

POSSIBLE FARMER'S loan assumption. Located in Shamrock Terrace, Winterville. Call Ed Tipton Agency to see if you can qualify. 756-0911 or 756-2421 at night.

BY OWNER. 3 bedrooms, living room with fireplace, dining room or den, bath, kitchen with built-in appliances. In Meadowbrook. Will finance. 758-2564.

BY OWNER. Ideal location. Large kitchen, living room and two bedrooms, utility, bath, central heat, outside storage building with garage. 746-3096 between 7 and 9 p.m., 746-6790 days.

BY OWNER. Country home. Centrally located between Greenville and Kingston. On a large lot, 3 bedrooms, 1 1/2 baths, central heat and air. 746-6209.

BY OWNER. Winterville. 3 bedrooms, 1 1/2 baths, large corner lot. Many extras included. Best buy around. 756-3269 for appointment.

BY OWNER in Winterville, Maye Drive. 3 bedrooms, corner lot. \$29,000. Call 756-1648.

1909 EAST 4th Street, 6 rooms, 1 1/2 baths, 2-car garage, storage. Upper 30's. 756-2928.

80 Lots For Sale

CHERRY OAKS. 756-7768 after 5 p.m.

100 CLASSIFIED DISPLAY

86 Apartments For Rent

Greenway Apartments

Beautiful large 2 bedroom garden apartments with wall to wall carpet, draperies, dishwasher and two swimming pools. Located off Country Club Drive adjacent to Greenville Golf and Country Club. 756-6869

Greenway's Mark of Distinction STRATFORD ARMS

An exclusive community designed to provide the ultimate in gracious living. Featuring modern 1,2 and 3 bedroom garden apartments and 2 bedroom Town Houses at reasonable rates. Furnished or unfurnished. All applications are accepted subject to availability.

1900 S. Charles St., Bldg. 19 Tele. (919) 756-4800

New GREEN MILL RUN APARTMENTS

Adjacent to downtown and university. Apartments fully insulated, save on energy cost. 10 inch walls between apartments. Sound and fire retardant. Appliances, drapes, carpeting, swimming pool, tennis court and MORE.

by KEECH & SUTTON, INC. Weekdays 10-4:30, Saturdays 1-5 For Appointment Call 758-2628

Eastbrook Apartments

Two bedroom luxury apartments, with optional dens and all the new amenities including wall to wall carpeting, draperies, dishwashers, individual air conditioning and heating AND MORE. CALL 758-4012

Cherry Court

Most luxurious 2 bedroom townhouses and 1 bedroom apartments in Greenville. Chandeliers, trash compactor, fully carpeted, drapes, etc., plus washer and dryer hook-ups, fabulous pool, sauna baths, tennis court and club room. 752-1557

100 CLASSIFIED DISPLAY

WE BUY Junk Cars

\$5.00 and up. Bob Gouras Used Auto Parts 758-0762.

100 CLASSIFIED DISPLAY

86 Apartments For Rent

Kings Row

One and two bedroom garden apartments. Located just off East Tenth Street. PHONE 752-3519

Ultimate In Apartment Living

1, 2, and 3 bedrooms, washer, dryer hook-ups, pool, clubhouse. Only 5 blocks from East Carolina University. Check everywhere else first, Then Call TAR RIVER ESTATES 1401 Willow St. 752-4225

VILLAGE GREEN

1 & 2 bedroom garden and town house apartments. Located 9/10 mile from ECU, grammar and high school. Two swimming pools and laundry facilities. Please call 752-5100 or better still, come by and see us at 800 Heath Street.

100 CLASSIFIED DISPLAY

100 CLASSIFIED DISPLAY

86 Apartments For Rent

3 ROOMS. One bedroom apartment. Quiet neighborhood. Close to campus. Call Stuart Buchanan, Buchanan Real Estate, Inc., 752-3696.

DON'T MAKE your moving plans until you talk to the people at Regional Storage & Transport Company. 752-1515.

400 LEWIS STREET. One bedroom furnished apartment. Heat, air conditioning, hot and cold water. Call 752-4137 day, 756-0889 night.

3 BEDROOM duplex near University. Central air conditioned. Washer-dryer hook-up, range, refrigerator. Freshly painted. Marrieds. \$178. 756-7480.

88 Houses For Rent

3 BEDROOM house, 1600 square feet, 110 Alexander Circle. 752-3609 or 752-3023.

2 BEDROOMS, electric heat, stove, refrigerator furnished, 403 Hillcrest. Available April 1. 726-3884. Morehead.

4 BEDROOMS, 1 1/2 baths, carpeted, attached garage. 756-2596 or 756-6890.

2 BEDROOMS, appliances furnished. Located in Ayden. \$90 a month. 756-1900.

3 BEDROOM house outside city. Electric heat, central air, carpeted, utility room, refrigerator, stove, large shady lot. \$160 per month. 752-3665 after 6 p.m. for appointment.

3 BEDROOMS, 1 1/2 baths, garage, outside city. \$235 a month. Call Stuart Buchanan, Buchanan Real Estate, 752-3696.

90 Lots For Rent

COLONIAL MOBILE HOME Park. Under new ownership and new management. Large, attractive lots and homes for rent. Park offers city sewer and water and all underground utilities. Also paved streets, swimming pool and children's recreation area. For information, call 758-4411 weekdays between 8:30 and 5:30.

100 CLASSIFIED DISPLAY

100 CLASSIFIED DISPLAY

90 Lots For Rent

MOBILE HOME lot. 752-2884.

91 Office Space For Rent

OFFICE SPACE FOR LEASE. Call Bill Clark at Lanco Realty, 756-5868.

OFFICE SPACE for rent. Suite or individual in new Duffus Realty Building on Commerce and Clifton. Call Duffus Realty, Inc., 756-5395.

OFFICE SPACE for rent. Call Joe Bowen, 752-7194.

9 OFFICE SPACES. Suite or individuals. Utilities, janitorial services, parking, 402 Memorial Drive. 752-2987.

OFFICE OR RETAIL shop for rent. Assume lease till end (September, 1977) with 5 year option. 400 square feet with carpet. Located at 301 Evans, first floor of the Cherry Building, 752-0606 or 756-0120.

RETAIL SHOP space in the University Arcade, Fifth Street. Ideal for businesses catering to University. 758-0491.

NEW STEEL building, 2000 square feet. Office, service or storage building. Available immediately. \$150 per month. Will remodel. Call Ed Tipton Agency, 756-0911 or 756-2421 at night.

OFFICE FOR RENT. 1131 Evans Street. Carpeted, heating and air conditioning furnished. Call 756-1800 day, 752-2498 night.

100 CLASSIFIED DISPLAY

100 CLASSIFIED DISPLAY

91 Office Space For Rent

MULTI-PURPOSE space available April 1. Office, retail, warehouse or storage. Also darkroom. Entrances from Dickinson and Tenth Streets. 758-2508.

EXCELLENT LOCATION on Third Street. For more information, call 758-1111 between hours of 9 and 5.

94 WANTED

96 Wanted To Buy

TOP CASH DOLLAR for your car or truck. 756-6353 or 752-0391.

WANT APPROXIMATELY 8 X 12 metal or wooden storage double door building. In good condition. 758-3016 after 5 p.m.

WE PAY TOP dollar for junk cars. 752-4583 after 4 p.m.

WANT TO BUY good, used high-wheeled lawn mower. 758-0247 after 6 p.m.

100 CLASSIFIED DISPLAY

100 CLASSIFIED DISPLAY

91 Office Space For Rent

MULTI-PURPOSE space available April 1. Office, retail, warehouse or storage. Also darkroom. Entrances from Dickinson and Tenth Streets. 758-2508.

EXCELLENT LOCATION on Third Street. For more information, call 758-1111 between hours of 9 and 5.

94 WANTED

96 Wanted To Buy

TOP CASH DOLLAR for your car or truck. 756-6353 or 752-0391.

WANT APPROXIMATELY 8 X 12 metal or wooden storage double door building. In good condition. 758-3016 after 5 p.m.

WE PAY TOP dollar for junk cars. 752-4583 after 4 p.m.

WANT TO BUY good, used high-wheeled lawn mower. 758-0247 after 6 p.m.

100 CLASSIFIED DISPLAY

100 CLASSIFIED DISPLAY

Row Buster Plows

"The Complete Garden Tool"

Hendrix-Barnhill Co. 752-4122

FAST FOOD FRANCHISE

GOING BUSINESS

TURN KEY OPERATION

Local fast food franchise operation for sale on reasonable terms. This offers you the opportunity to be in business for yourself immediately as part of a national chain operating in 16 states. Total purchase price includes all equipment, fixtures, furniture, product inventory and franchise license fee. While this represents a total value in excess of \$50,000, the franchisor will accept \$10,000 cash and an installment note for the balance. Building and parking area is established on a favorable lease. For immediate action on this once in a lifetime opportunity call:

Mr. Bert L. Spinks Cedrics, Inc. P.O. Box 21307 Columbia, S.C. 29221 (803) 772-8037

Principles only

There's No Substitute For EXPERIENCE!

Guy Mayo and Julian White With 45 Years Combined Experience Are Extremely Proud Of Their Personnel In Their Parts And Service Departments.

PARTS DEPARTMENT

SERVICE DEPARTMENT



Joe Clark Parts Manager 29 Years GM Parts Experience



Byron VanWagen Assistant Parts Manager 3 Years Experience



Guy Braxton Service Manager 20 Years Experience

SCOTTI MUFFLER CENTER



Quinn Bostic Exhaust System Expert

Dual Exhaust Installed - Custom Pipe Bending - Exhaust System Repair

Your Scotti Muffler is guaranteed not to rust out, burn out, or have any manufacturing defect for as long as you own your car. This also applies to any pipes in your exhaust system that are custom bent and installed by Scotti.



Walter Beddard 27 Years Experience Certified Master Technician By Chevrolet 18 Years



Buddy Godley 17 Years Experience Certified Master Technician By Chevrolet 10 Years



Larry Riegel 20 Years Experience Certified Master Technician By Chevrolet 10 Years



One Center Has Improved Heart Transplant Chance

EDITOR'S NOTE — It's still a chancy, last-resort operation, and there are fewer heart transplants now than during their heyday in the late 1960s. But one medical center has greatly improved the survival rate, and there are signs of new interest in this surgery. Second of a series.

By **RICHARD SALTUS**
AP Science Writer
LOS ANGELES (AP) — William Van Buuren has had his second heart for more than seven years now and says, at the age of 47, "I expect to go on for another 20 or 25 years."

At a time when most cardiac surgeons still feel the results of heart transplants don't justify the costs, Van Buuren has this message for those whose hearts are damaged beyond repair: "Take it any time you can; it's your last hope."

The wave of enthusiasm for heart replacements that followed the first successful transplant in 1967 faded.

But there are signs that the operation may soon make a comeback at certain medical centers in this country, where interest reportedly is stirring anew because of the rising success rate of Stanford University surgeons. The steadily improving survival rates are largely the result of a determined campaign by Stanford doctors against the body's rejection of a transplanted heart and against infections that kill many transplant patients.

Nearly four out of five patients are surviving the first year after the operation at Stanford — the only institution in the country regularly performing transplants. Nine years ago, when the program began, only 22 per cent, or slightly more than one in five, of the patients survived for a year or more.

Of 117 patients receiving new hearts at Stanford, 45 patients — including Van Buuren, a building estimator from Mill Valley, Calif. — still are alive; four have survived five years or more.

Worldwide, 70 patients are living, of 328 transplants performed.

"I think the improving results are encouraging surgeons at other institutions to try transplants again," said Dr. Jack Copeland, chief resident in general surgery at Stanford.

In fact, a few days after Copeland made the statement in an interview, doctors at Columbia Presbyterian Medical Center in New York placed a donor's heart in the chest of a dying patient. It was the first heart transplant in the city since 1969.

Copeland, who is moving to the University of Arizona medical school, said transplant programs may begin by 1979 at Arizona and within one to three years at Downstate Medical Center in Brooklyn, N.Y. Surgeons from Harvard Medical School, which has a well-funded research program in animal transplants, are very seriously considering human transplants, he said.

The Stanford surgeons, headed by Dr. Norman Shumway, believe that their operations are justified by the extra years they can offer patients who almost certainly would be dead within a few months.

Van Buuren, who was told in 1970 that he had three months to live, says he had no trouble making the decision. He says he now lives a "more or less normal" life, while patients he knew who decided against the transplant are dead.

There was a flurry of transplants for two or three years

after Dr. Christiaan Barnard performed the first human heart replacement in Cape Town, South Africa, in December 1967.

But most surgeons soon gave up, unable to maintain the delicate balance of suppressing the body's natural rejection of the foreign heart without leaving the patient defenseless against infection.

Rejection and infection still cause nearly all the deaths from heart transplants, but at Stanford some advances have been made on both fronts.

Recently, an antiserum from the blood of rabbits has had striking success in preventing rejection. The antiserum suppresses the body's attempts to destroy the foreign heart. In more than 35 patients treated with the antiserum, called Rabbit ATG (antithymocyte globulin), survival for nearly three years has been about 70 per cent, compared with 33 per cent three-year survival for all patients during the nine years of the program.

With Rabbit ATG "there is a smaller number of rejection episodes and a greater interval between the transplant and the first rejection," said Copeland. This means the patient can be given a lower dose of other immunosuppressive drugs, thereby decreasing the chance of infection.

Another weapon against rejection is a biopsy device that is threaded through a neck vein and deep into the heart's pumping chamber to snip a bit of tissue. Studied under the microscope, the tissue gives early warning when rejection is beginning so that steps to suppress it can be taken quickly.

There have been six cases lately in which a failing transplanted heart was removed by Stanford surgeons and replaced with another — giving the patient his third heart of his life. Three of these retransplant patients survived, two of them for more than one year.

If a transplant renaissance is under way, it has not yet been felt by the prestigious American Heart Association.

"I do not detect any resurgence of interest," said Dr. Russell M. Nelson, chairman of the AHA's Council on Cardiovascular Surgery, a group that helps recommend where research money should be spent. Speaking in a telephone interview from a meeting of thoracic (chest) surgeons in San Francisco, Nelson said, "The real interest is in repairing hearts."

He said that recent "brilliant work in saving hearts has taken the heat off of transplants." He referred specifically to the recently developed coronary

bypass operation which an estimated 65,000 patients will undergo this year to reroute blood flow through blocked coronary arteries.

Nevertheless, Copeland told an AHA science writers forum in San Antonio, Tex., recently that there are more patients awaiting new hearts than there are donors. The patients selected by Stanford are those whose hearts are so severely damaged that they will die in a few months, but who are not so near death that they have little chance of surviving the operation.

What kind of lives do the survivors lead?

"Fairly normal," said Copeland. "There are some limitations — we don't want them to engage in contact sports...they generally wear a surgeon's mask when they are around a hospital (because of their vulnerability to infections), and we have them seek attention quickly for any sign of infection."



OPEN HEART SURGERY — Dr. Norman Shumway, left, and Dr. Edward Stinson perform a recent operation at Stanford Univ. where surgeons have been campaigning against rejection of transplants and the infections that kill many patients who undergo the operation. (AP Wirephoto)

REACT For 2 Age Groups

The Pitt County REACT Team 3133 announced that emergency monitoring programs are available for both adult and junior age levels.

In order to qualify for adult REACT team membership, it was noted, applicants must be 16 years old and live in the house of a Class D license holder or be licensed. In addition, the applicant must be a respected Citizens Band operator and have a base station.

Applicants seeking membership on the Pitt Junior REACT squad must be between the ages of 12 and 17 and be willing to assist the adult team. Proper supervisor will be provided for junior members and they will be able to take part in team ac-

tivities, it was noted. Persons needing further information should contact Betsy Heath at 758-0876 for adult REACT assistance and Nancy Landon at 758-2907 or Marjorie Harris at 758-4532 after 6 p.m. for junior program assistance.

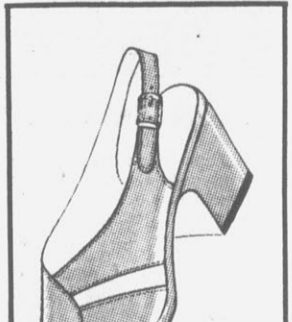

The sunburst sling

Miss Wonderful
SHOES FOR WOMEN

Super-comfortable — open toe, sling back, walking heel. There's more — inside cushioning, slim platform, softest kidskin.

Sizes: 4½ to 12, B, C, D widths available in black patent, malt smooth or white patent.

\$19.99

Larry's
Quality Fit Service

AT 5 POINTS
OPEN DAILY 9-6

ZALES IS THE DIAMOND STORE

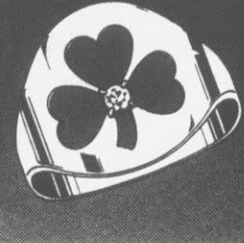

A St. Patrick's Day salute
\$60

Our 1-diamond shamrock ring in 14 karat gold.

Open a Zales account or use one of five national credit plans

ZALES
The Diamond Store

Illustration enlarged.

Pitt Plaza Shopping Center
Open 10 A.M. to 9 P.M., Mon.-Sat.
756-0141

WANTED:

Happy couples who want to dine out NOW at 1940 prices.
Twelve complimentary dinners
Two dine out for the price of one.

To Become A Member
Just fill out and mail the coupon. You will receive your beautiful pocket-size membership card which entitles you to 12 Complimentary Dinners of your choice.

As A Member
You will receive 12 Complimentary Dinners of your choice from our regular menu. Use your membership as often as you wish. All you need to do is to be accompanied by one or more guests. Cost of membership is only \$25.00. A full refund if not delighted and completely satisfied within 30 days.

Membership Strictly Limited Offer Good Until April 30, 1978

Don't set this ad aside thinking you will join later. Memberships are limited. Once our membership list is filled, we must return all applications so Hurry! Don't be disappointed.

JOIN NOW!

Clip And Mail At Once To

Ramada Inn
Dinner Club
301 Greenville Blvd.
Greenville, N.C. 27834

Enclosed is my check for \$25.00. Send me one membership in your Starlight Dinner Club. As a member I will receive 12 Dinners of my choice and I can start using my membership at once.

Name _____ Phone _____
Address _____
City _____ State _____ Zip _____

Mail Above Coupon At Once
or Call Ramada Inn
756-2792
Ask for Mr. Lai



YOUR CHOICE \$66 EACH

- Man-Size Reclining Comfort & Sleek Leather Looks!**
Leather-like vinyl in a handsome russet-brown. **GREEN TAGGED AT \$66**
- A Very Special Touch That Every Room Needs...Elegant Cane Chair!**
Wraparound cane back with luxurious gold velvet upholstery. **GREEN TAGGED ONLY \$66**
- Apartment-Size Dining For Budget-Minded Families...**
30"x40" table in simulated walnut finish. Mar-proof. Cushioned vinyl floral chairs. In cartons. **ALL 5 PIECES GREEN TAGGED \$66**
- Famous Simmons 'Fantasia' Mattress Or Boxspring!**
Extra Firm—312 coil Adjusto-Rest® Support!
TWIN-SIZE OR FULL-SIZE FOR ONE LOW PRICE!
GREEN TAGGED ONLY \$66 ea. pc.

Thur., Fri., Sat.

MAXWELL'S GREEN TAG SALE

3 Days Only

YOUR CHOICE \$118 EACH

- OUR BEST-SELLER... 'Swing-A-Way' Recliner with Heat Massage!**
• Deep Diamond Tutting
• Walk-Hugger Mechanism
• 3-Position Reclining
• Rich, Leather-Look Vinyl
• Built-in Heat & Vibrator with Variable Speeds
GREEN TAGGED ONLY \$118
- G.E. Quality 10" diagonal COLOR**
Look to G.E. for lifelike Color & durable Performance in a ready-to-go portable! Here's a 10" diagonal in a rich, woodgrain-look cabinet. **SALE OF SALES \$248 ONLY**
- 'Fabulous Early Bird SPECIAL! Deluxe Lawn Swing!**
Attractive and comfortable, made of sturdy steel. Supports 870 lbs. **IN CARTON SAVINGS! \$48 SALE OF SALES ONLY**
- The Finishing Touch of Beauty...**
YOUR CHOICE \$68 ea. SALE OF SALES

YOUR CHOICE VERY SPECIAL \$268

- For Unexpected Guests...Our Full-Size Sleeper in Herculon®!**
GREEN TAGGED ONLY \$198
- Create An Extra Guest Room—Our Stylish 9-Pc. Corner Group!**
Seats 9 or Sleeps 2 with a smart, contemporary look! All temporary! Includes:
• 9-Pcs. • 2-mattresses
• 2-woodgrain vinyl foundations on castors, 2-bolsters, 2 coverlets and walnut finish corner table. **ALL 9 PIECES GREEN TAGGED \$188**
- Magnificent Mediterranean Style Cabinetry & Rich, Stereo Sound!**
SAVE \$131.95!
Stereo Console
Reg. \$399.95
GREEN TAG \$268
Limited Quantities!
- Remember When? Maxwell Does With Our All-Wood Child's Rocker**
A favorite with kids, & Mom will love it, too! Select hardwood with a safe, non-toxic natural varnish finish.
GREEN TAGGED ONLY \$688
Limited Quantities!

Maxwell FURNITURE

604 Greenville Blvd.
Greenville, N.C. 27834
Phone 756-3142

Open Monday, Tuesday, Wednesday, Thursday and Saturday 10 a.m. until 6 p.m. Friday 10 a.m. until 9 p.m.

Convenient Credit Terms
Free Delivery & Set-Up
Huge Selection
Competitive Prices



At Piggly Wiggly

You'll Do An Irish Jig For The Savin' O' The Green

PILLSBURY PLUS

CAKE MIX 57¢
Yellow, Batter Recipe & Devil Food (18-Oz.)

PIGGLY WIGGLY

CINNAMON ROLLS 2 Pkgs. For \$1.00

WILSON'S CERTIFIED

Chuck Roast



Center Cut **68¢** Lb.

Semi-Boneless **78¢** Lb.

CHUCK ROAST FIRST CUT **58¢** Lb.

BONE-IN SHOULDER ROAST **88¢** Lb.

SHORT RIBS **68¢** Lb.

CUBED CHUCK STEAK **\$1.48** Lb.

GREAT STEAKS FOR GRILLING!

BONE-IN RIB STEAK **\$1.28** Lb.

BONELESS RIB STEAK **\$1.98** Lb.

BONE-IN CHUCK STEAK **78¢** Lb.

SIRLOIN STEAK **\$1.38** Lb.

1/4 FAMILY PAK PORK CHOPS **1.08** Lb.

CENTER CUT PORK CHOPS **1.38** Lb.

LUNDY'S NO. 1 BACON **98¢** Lb.

FROSTY MORN BOLOGNA **98¢** Lb.

FROSTY MORN FRANKS **68¢** 12-Oz. Pkg.

LUNDY'S BULK SAUSAGE **\$7.90** 10 Lb. Pail.

SLICED PORK LIVER **39¢** Lb.

HOUSE OF RAEFORD TURKEY NECKS **49¢** Lb.

FRYER PARTS WHOLE LEGS & BREASTS **\$2.99** 4 LB. PKG.

FRESH GROUND BEEF **78¢** 3-Lbs. Or More

NEW...from Dannon Yogurt!

FROZEN "DANNY BOYS"

Raspberry, Carob-coated, Boyensberry, Strawberry & Uncoated Vanilla

6 Ct. \$1.69 Pkg.

Also Available In Uncoated 8 Oz. Cups.....59¢ Each



FAMO 5-LB. SELF-RISING FLOUR **49¢**



NABISCO STACK-PACK RITZ **69¢** 12-Oz. Box

SOFT-WEVE BATHROOM TISSUE **39¢** 2 ROLL PK.



JELLO GELATIN **5/100** 3 OZ.

NABISCO FIG NEWTONS **77¢** 16-Oz. Box



DOVE DISH DETERGENT **69¢** 22 OZ.



TROPICANA ORANGE JUICE **69¢** 1/2 Gal.

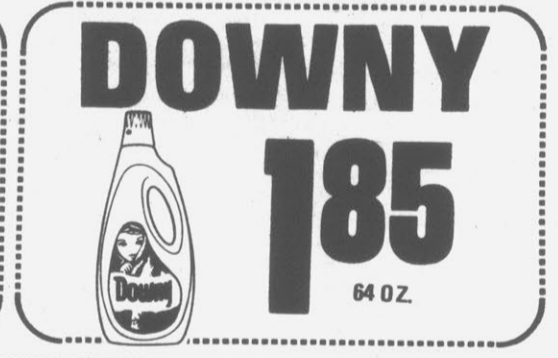

DOWNY **1.85** 64 OZ.



DRIVE STAIN FIGHTING **98¢** GIANT SIZE

COUPON **50¢ OFF** MAXWELL HOUSE COFFEE WITH THIS COUPON (LIMIT 1)

EXPIRES MAR. 19, 1977 (COUPON NO. 4796-7)

DEL MONTE CORN **\$1.00** 3 303 Cans

WHOLE KERNEL OR CREAM STYLE.

ARMOUR VIENNA SAUSAGE **\$1.00** 3 5-Oz. Cans

SUNSET GOLD ICE MILK **58¢** 1/2 GAL.

PIGGLY WIGGLY BREAD **\$1.00** 3 1 1/2 Lb. Loaves

CAL-DIA FROZEN POTATOES **99¢** 5 Lb. Bag

HEINZ KETCHUP **79¢** 32 Oz. Bottle

PITTSBORO GRADE "A" LARGE EGGS **69¢** Dozen

NABISCO NILLA Vanilla Wafers **55¢** 12-Oz. Box

NABISCO NUTTER BUTTER COOKIES **75¢** 13 1/2 Oz. Box

PRODUCE

YELLOW ONIONS (Loose) **\$1.00** 4 Lbs. For

GOLDEN RIPE BANANAS **19¢** Lb.

RADISHES **10¢** Lb.

PURINA 25-LB. BAG DOG CHOW **\$5.99**

PIGGLY WIGGLY

Prices In This Ad Effective Wednesday Through Saturday!

PIGGLY WIGGLY

CURTIS MINIATURE MARSHMALLOWS **49¢** LB. BAG

QUANTITY RIGHTS RESERVED. NONE SOLD TO DEALERS. TWO CONVENIENT GREENVILLE LOCATIONS TO SERVE YOU! 2105 DICKINSON AVENUE AND 1212 NORTH GREENE STREET.

How N.C. Congressmen And Senators Cast Votes

By Roll Call Report
WASHINGTON — Here's how area members of Congress were recorded on major roll call votes March 3-9.

\$50 REBATE Rejected, 194 for and 219 against, a Republican-sponsored move to substitute a permanent income tax cut for the one-shot \$50 rebate advocated by President Carter. The attempt came in the form of a motion to send the overall bill back to committee. Its defeat left Carter's rebate proposal intact.

This vote occurred during debate on the major tax-cut bill originated by the Administration and generally favored by the Democratic majority in Congress.

The bill (HR 3477), later passed and sent to the Senate, provides in part for a rebate of \$50 for each standard deduction claimed on 1976 tax returns; similar payments to the very poor and other non-tax-paying persons; an additional tax cut in the form of a raised standard deduction to take effect with pay checks issued May 1, 1977, and a business tax credit to encourage employers to step up hiring.

Supporters of the permanent tax cut argued it would best generate the disposable income the lagging economy needs. Rep. Barber Conable (R-N.Y.) called it a "much sounder economic strategy than the (\$50 rebate) which offers neither a sharp stimulative impact nor a permanent reduction upon which

consumers can base long-term spending plans." Rep. Al Ullman (D-Ore.) defended the one-shot rebate stimulus. "The package we offered is balanced," he said. "It will go into effect immediately. It will have an early impact."

Reps. Walter Jones (D-1), L. H. Fountain (D-2), Charles Whitley (D-3), Ike Andrews (D-4), Stephen Neal (D-5), James Martin (R-9), James Broyhill (R-10) and Lamar Gudger (D-11) voted "yea."

Reps. Richardson Preyer (D-6) and W. G. Hefner (D-8) voted "nay."

Rep. Charles Rose (D-7) did not vote.

AIRCRAFT CARRIERS Rejected, 161 for and 252 against, an amendment to spend \$81.6 million this fiscal year for development of another nuclear-powered aircraft carrier, the Navy's fifth. It was proposed to HR 3839, a fiscal 1977 budget bill later passed and sent to the Senate.

If it stands, this vote will signal a major shift in U. S. naval tactics, away from the existing large "Nimitz" fueled carriers and toward construction of smaller conventionally-fueled carriers. The latter are less vulnerable to enemy missiles, but require as-yet-unperfected vertical takeoff and landing (V-STOL) jet aircraft.

Rep. Robert Sikes (D-Fla.), a supporter of the amendment, said: "We should have both the

Nimitz carriers and the small carriers. We cannot have both now but we can have the Nimitz carrier. A vote (against) the \$81.6 million expenditure) simply means a backward step."

Rep. Joseph Addabbo (D-N.Y.), an opponent, said that the present secretary of defense and his predecessor both oppose building another Nimitz carrier. "They feel we need two small aircraft carriers that can be easily dispersed, rather than one large sitting duck," he said. "This is what we're debating."

Jones, Fountain and Martin voted "yea."

Whitley, Andrews, Neal, Preyer, Rose, Hefner, Broyhill and Guder voted "nay."

SPORTS PANEL Rejected, 75 for and 271 against, a resolution to continue the Select Committee on Professional Sports. Those voting "nay" opposed the committee, which was created in the last Congress to study anti-trust questions, the hazards of artificial turf and other matters relating to pro sports.

Rep. Frank Horton (R-N.Y.), a committee member and supporter of the resolution, said "we are talking about a very small budget . . . a frugal operation, to look at a very important area of our economy and our society — the sports field."

Rep. Charles Wiggins (R-Calif.), an opponent, said: "I frankly would be embarrassed if I were to vote for it. I suggest it might be a matter of some embarrassment to the Members voting for it. It just might tell the constituents . . . much more than they would want to tell the constituents about our own sense of priorities around here."

Jones, Fountain, Whitley, Neal, Preyer, Rose, Hefner, Martin, Broyhill and Guder voted "nay."

Andrews did not vote.

Senate

WARNKE Confirmed, 58 for and 40 against, the nomination of Paul C. Warnke as chief U. S. negotiator in strategic arms limitation (SALT) conferences with the Soviet Union. Later, by a much wider margin, the Senate confirmed Warnke to serve also as director of the U. S. Arms Control and Disarmament Agency.

Warnke's nomination as SALT negotiator was bitterly contested out of fear he might give too much to the Soviets. Although failing to block his appointment, his detractors succeeded in denying him a two-thirds majority — a symbolic

victory because any new SALT treaty will need a two-thirds vote to be confirmed by the Senate.

One supporter, Sen. Edward Brooke (R-Mass.), said: "Ultimately, the responsibility for any SALT II agreements will rest with the President and the Congress. I am confident that Mr. Warnke can and will provide both branches of government with the information and advice necessary for wise decisions."

Sen. Howard Baker (R-Tenn.), an opponent, said that "two or 20 or 40 votes against the Warnke nomination is significant in the further efforts of mankind to save itself from extinction."

Sen. Robert Morgan (D) voted "yea" and Sen. Jesse Helms (R) voted "nay."



Mr. Farmer

Designate your tobacco with

NEW GREENVILLE, INC.

TOBACCO WAREHOUSE

Code No. 524

Phone 752-2800

We assure every farmer his percentage of selling time.



We averaged above the Greenville market for the year 1976.

Floor Managers

Bill Alcroft and Wayne Dixon

Auctioneer

Ray Oglesby

Elevated Roads Proved Costlier

By GUY COATES
Associated Press Writer
BATON ROUGE, La. (AP) — When Interstate 55 is completed, Louisiana will get a breather from construction of swamp expressways. And that's good news for taxpayers.

A swamp expressway is an elevated highway which costs about \$7 million a mile to build. By comparison, a highway can be built on solid ground like that in north Louisiana for \$1 million a mile.

The Louisiana highway department realized in the 1930s that the ground is so soft in many parts of south Louisiana that roads laid on it tend to sink.

The first elevated highway was a one-mile section of U.S. 61 thrown across the Bonnet Carre spillway in 1935.

Although that structure was built to function as a bridge when the spillway gates are opened, it provided valuable experience.

Since then, another 33 miles of roads on stilts have been constructed — most of it as interstate projects — and a 211-mile elevated stretch of I-55 between Laplace and Hammond is underway.

When completed in three or four years it will be the single longest elevated road in the state, parallel to an existing surface road.

No other elevated roads are on the drawing boards.

The elevated highways are a joy to environmentalists, says highway director W.T. Taylor, who does not always see eye-to-eye with environmentalists.

"The elevated highways don't disturb the flow of water or affect the ecological balance in marsh areas," Taylor said. "And, animals can travel beneath them without danger of being killed."

Such highways can also save human lives, he said.

For example, the old federal-state, two-lane highway that parallels the new elevated portion of I-55 has been closed at times during hurricanes be-

cause of high water. "Motorists won't have any trouble getting out of danger on an elevated highway because it won't go under water," said Taylor.

The spans are held up by prestressed concrete pilings 120 feet long. The pilings are driven nearly 100 feet deep into the swamp, leaving the highways some 24 feet above the marsh.

The 55 miles of elevated roadways either completed or under construction represent a total cost of \$320 million.

"They are built to stay, but at that cost it's sure a pleasure to award a contract for a road built on solid ground," said Taylor.



NOT A BILLIONAIRE? — Houston attorney James Dilworth says the late Howard Hughes may have been a very rich man, but he was never a billionaire. Dilworth, who represents Hughes' aunt, Annette Gano Lumms' says those people who believe Hughes' estate is worth \$2.5 billion are really going to be shocked when a report on the estate's real worth is filed with the courts involved in the probate of the Hughes estate. (AP Wirephoto)

Balentines CAFETERIA

SERVING CREATIVE FOODS

Pitt Plaza Shopping Center

Open 11 A.M. to 2 P.M., 4:45 to 8 P.M.



FEATURING

—THURSDAY—

Roast Turkey & Dressing

—FRIDAY—

Country Style Steak

—SATURDAY—

Liver & Onions

Manufacturing A Home Vault

SANTA ANA, Calif. (UPI) — A bank vault safe deposit box for use in homes and recreational vehicles is new from a manufacturer of bank vault equipment here. The 2-by-5-by-24-inch self-contained unit has a steel sleeve, drawer and double dead bolt lock. The manufacturer says it is designed for mounting in closets, under counters or in existing cabinets, and has a pickproof lock with more than 250,000 key combinations.

(Miles Osborn, Inc., P.O. Box 15210, Santa Ana, Calif. 91705)

CLARKS paints

Sale Ends Saturday, March 19th

Save 3.00 on this big 2 gal. can of latex exterior paint

950

Reg. 12.50 2 gal can

Provides a durable finish for exterior wood or masonry surfaces. Easy soap and water clean up. White only.



WHITE

Save 2.25 on Kem latex house paint

775

Reg. 10.00 Gal.

This fade resistant quick drying paint is available in white and colors. Features easy soap and water clean up.

700

Reg. 8.25 Gal.

DuPont Lucite floor paint. For concrete or wood floors. Dries in one hour. Soap and water clean up.



Save 2.10

875

Reg. 10.85 Gal.

Latex gloss house paint. Quick drying paint is easy to apply. Soap and water clean up. White only.

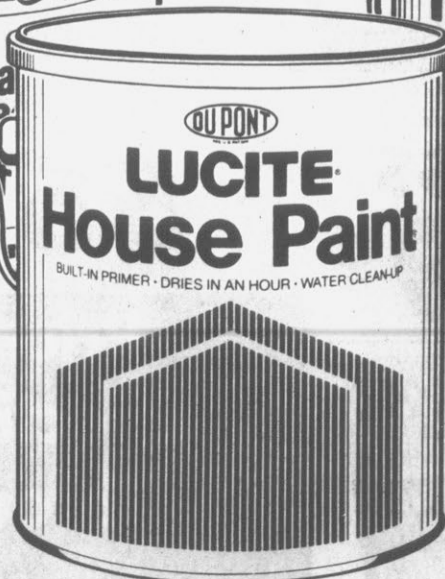

875

Reg. 9.75 Gal.

DuPont Lucite house paint. Features built in primer. Dries in one hour. Easy soap and water clean up. White and colors.

RAINCHECK
If we sell out of any advertised special, you will receive a written order — "Rain-check" which entitles you to buy the item at the advertised price when our stock is replenished (excluding clearance items)

WEST END SHOPPING CENTER, GREENVILLE
Monday thru Saturday 9:30 A.M. to 9:30 P.M.



Just say "CHARGE-IT"

A&P

ADVERTISED ITEM POLICY

Each of these advertised items is required to be readily available for sale at or below the advertised price in each A&P Store, except as specifically noted in this ad.

PRICES EFFECTIVE THRU SAT. MARCH 19 AT A&P IN GREENVILLE, N.C.

WIN UP TO \$1000 — PLAY ALL NEW SERIES IV

36,331 CASH PRIZES
\$141,784 TOTAL PRIZES



Super Cash Bingo Game is available in 63 Eastern North Carolina Great Atlantic & Pacific Tea Company Stores. This promotion is scheduled to end on May 14, 1977. Super Cash Bingo will officially end, however, when all game tickets are distributed.

GAMES	PRIZES	NUMBER OF	ODDS	1	ODDS	13	ODDS	26
\$1000	35	1 in	159,897	1 in	12,284	1 in	5,142	
\$500	338	1 in	15,982	1 in	1,190	1 in	586.5	
\$200	1,420	1 in	3,711	1 in	285	1 in	142.5	
\$80	1,802	1 in	2,703	1 in	214	1 in	107	
\$40	4,478	1 in	1,119	1 in	81	1 in	40.5	
\$20	28,172	1 in	187	1 in	14	1 in	7	
Total Number of Prizes	36,331	1 in	145	1 in	11	1 in	5.5	

CHUCK ROAST

A&P QUALITY HEAVY WESTERN GRAIN FED BEEF

BONELESS ROAST **88¢** LB.
CUT FROM THE CHUCK

BLADE CUT **55¢** LB.

U.S.D.A. INSPECTED FRESH

FRYER BREAST QTRS. **59¢** LB.
OR LEG QTRS.

JAMESTOWN BRAND **COUNTRY HAM SLICES** **1.99** 12 OZ. PKG.

SHENSEN **CORNEBEEF BRISKETS** **1.99** LB.

ANN PAGE **SLICED BACON** **1.19** 1 LB. PKG.

A&P QUALITY HEAVY WESTERN GRAIN FED BEEF

RIB EYES **1.99** LB.
CUT FREE INTO STEAKS

WHOLE OR HALF

HEAVY WESTERN GRAIN FED BEEF

CHUCK STEW **1.19** LB.
BONELESS

HEAVY WESTERN GRAIN FED BEEF

SHOULDER ROAST **88¢** LB.
ARM

WEXFORD CRYSTAL **49¢** EACH
BY ANCHOR HOCKING
FOOTED WINE/JUICE

FEATURE OF THE WEEK

A&P QUALITY CORN FED

PORK CHOPS **99¢** LB.
RIB HALF OR WHOLE PORK LOIN SLICED

A&P QUALITY HEAVY WESTERN GRAIN FED BEEF

GROUND CHUCK **99¢** LB.

A&P QUALITY TENDER FULLY COOKED

SMOKED HAM **68¢** LB.
BUTT PORTION **78¢** LB. SHANK PORTION **88¢** LB.

SEAFOOD FEATURES

FRESH FROZEN DRESSED **FLOUNDER** **99¢** LB.
OR TROUT, CROAKERS, PORGIES

FRESH FRUITS & VEGETABLES

FLORIDA GROWN **ORANGES** **79¢** 5 LB. BAG

CALIFORNIA GROWN FRESH **BROCCOLI** **78¢** LARGE BUNCH

EASTERN WHITE **POTATOES** **1.48** 15 LB. BAG

CALIFORNIA GROWN SUNKIST (140 SIZE) **LEMONS** **1.00** 10 FOR ONLY

WASHINGTON STATE **D'ANJOU PEARS** **3** LBS. **1.00**

PERFECT FOR SLAW - FRESH **CRISP CARROTS** **3** 1 LB. PKGS. **1.00**

FLORIDA U.S. #1 WHITE OR RED **GRAPEFRUIT** **1.00** 32 SIZE 5 FOR ONLY

FLOWER SHOP SPECIAL **BASKETS** (WITHOUT PLANTS) **99¢** 10 INCH SIZE EACH ONLY

CONTAINS RICH BRAZILIAN COFFEES

EIGHT O'CLOCK INSTANT COFFEE **2.49** 10 OZ. JAR
REG. 2.89 SAVE 40¢!

LIMIT ONE WITH ADDITIONAL 7.50 ORDER

A&P COUPON

WESSON OIL **1.39** 48 OZ. BOTTLE
LIMIT ONE WITH THIS COUPON AND ADDITIONAL 7.50 ORDER

SAVE 38¢

LIMIT ONE COUPON. GOOD THRU SAT. MARCH 19 AT A&P C-662

VAN CAMP'S

PORK & BEANS **1.00** 16 OZ. CANS
LIMIT 4 CANS, PLEASE

BOUNTY TOWELS **1.00** 2 JUMBO ROLLS
LIMIT 2 ROLLS WITH 7.50 ORDER

WELCH'S GRAPE JELLY **88¢** 2 LB. JAR

KEEBLER **ZESTA SALTINES** **99¢** 2 LB. BOX

PANTRY PLEASERS

KRAFT'S **1000 ISLAND DRESSING** **88¢** 16 OZ. BTL.

ARMOUR **VIENNA SAUSAGE** **1.00** 3 5 OZ. CANS

MT. OLIVE KOSHER DILL **PICKLE STRIPS** **69¢** 24 OZ. JAR

CHICKEN OF THE SEA **TUNA** **1.00** 2 6.5 OZ. CANS

BAKERY FEATURES

MARVEL SANDWICH SLICED WHITE **BREAD** **1.00** 3 24 OZ. LOAVES

JANE PARKER **APPLE PIES** **69¢** 22 OZ. PKG.

JANE PARKER ORANGE **CHIFFON CAKE** **89¢** 16 OZ. RING

JANE PARKER **DINNER ROLLS** **1.00** 4 9 OZ. PKGS.

OUR OWN **TEA BAGS** **1.09** 100 CT. PKG.

NABISCO **NILLA WAFERS** **53¢** 12 OZ. PKG. (SAVE 12¢)

ANN PAGE ELBOW MACARONI OR REGULAR OR **THIN SPAGHETTI** **39¢** 1 LB. PKG.

HUNT'S **TOMATO SAUCE** **39¢** 15 OZ. CAN

HUNT'S **TOMATO PUREE** **1.00** 3 10 1/2 OZ. CANS

FROZEN FOOD FEATURES

MORTON-BEEF, CHICKEN, TURKEY **POT PIES** **1.00** 4 8 OZ. PKGS.

CHEESE, PEPPERONI, HAMBURGER, SAUSAGE **JENO'S PIZZA** **88¢** 13 OZ. PKG.

BREYER'S (SAVE 50¢) **ICE CREAM** **1.59** 1/2 GAL. CTN.

SEALTEST **SHERBET** **59¢** QUART

DAIRY FEATURES

PILLSBURY BUTTERMILK **BISCUITS** **59¢** 4 10 CT. 8 OZ. CANS

KRAFT PARKAY **MARGARINE** **49¢** 1 LB. PKG.

MEL-O-BIT SLICED **AMERICAN CHEESE** **99¢** 12 OZ. PKG.

PILLSBURY'S READY TO SPREAD

FROSTINGS **89¢** 16 1/2 OZ. PKG.
VANILLA, LIGHT CHOCOLATE, CHOCOLATE FUDGE, LEMON

IRISH SPRING BAR SOAP **55¢** 2 3 1/2 OZ. BARS

BOUNCE FABRIC SOFTENER **1.05** 20 CT. PKG.

LIQUID DISHWASHING DETERGENT **OCTAGON** **89¢** LEMON • WHITE 48 OZ. BOTTLE

PILLSBURY PLUS **CAKE MIXES** **59¢** 18 1/4 OZ. PKG.
• BUTTER RECIPE • YELLOW • WHITE • DEVILS FOOD

ORANGE, GRAPE, OR TROPICAL PUNCH **FRUIT DRINKS** **88¢** 2 46 OZ. CANS

Store Hours: Monday thru Saturday 8:30 A.M. to 10:00 P.M. Sunday 10:00 A.M. to 9:00 P.M.

Conveniently Located At 2808 East 10th Street



HAS GUN — AND A LAWYER — Victor DeCosta poses in Paladin garb as his home in Scituate, R.I. The 68-year-old former rodeo star has been fighting the last 13 years to support his claim to be the true Paladin. (AP Wirephoto)

Songbirds Are A Tasty Dish

By **SUSAN DEFORD**
NICOSIA, Cyprus (AP) — Many small songbirds that land in Cyprus to rest during migrations between Europe and Africa end up on restaurant tables or in pickling jars.

Catching and eating the small migratory birds is a centuries-old practice in Cyprus and other Mediterranean countries, including Southern Italy, France, Greece, Lebanon and Syria.

Cypriot law forbids capturing birds by nets or "lime sticks," the traditional apparatus for snaring the tasty little songbirds. But to date the law has been ineffective, wildlife protection societies complain.

Although no official records are kept, the annual catch in Cyprus during the spring and autumn migrations is "colossal," according to an official of one of the island's two ornithological societies.

Lime sticks are strips of wood coated with a sticky substance made of tree resin and honey. They are placed in trees and bushes to catch the birds as they land.

Hunting "ambelopoulia," or "birds of the vine trees," is centered in the southeast region of Cyprus. Most of the catch belongs to the blackcap-warbler species.

In Ayios Theodoros, a village of 2,200 near the southeast coast of Cyprus, a local grocer defends killing amelopoulia.

"We like the birds, they are beautiful, but it's better to eat them," says Xenophon Pafitis, 70.

The amelopoulia season for this village lasts for a month between September and Octo-

ber. Last fall, the villagers estimate, they caught 48,000 birds and sold them to groceries throughout the island for \$24,000.

"We never have trouble selling the birds," Pafitis said. "They make good meze," appetizers eaten with wine or brandy.

The birds, boiled in water and then placed in vinegar, are smaller than eggs. They have a tangy, light taste and hair-like bones that are eaten along with the rest.

The birds are sent abroad as gifts to friends or relatives, but their importation has been banned in Great Britain and South Africa.

Penalties for catching amelopoulia are stiff, but seldom applied. A first offense is punishable by a fine of \$240 or six months' imprisonment or both. A second offense brings a fine of \$480, one year's imprisonment or both.

"The law is enforced," said Costas Papamichael, a biologist in the ministry of interior's game and wild life service, "but catching the birds is done at night and early in the morning. If no one sees it being done we cannot enforce the law."

Small Rise For Apparel Prices

LINCOLN, Neb. (UPI) — Clothing prices this year are expected to rise, but probably less than the prices of other consumer goods, says an extension family economics and management specialist here.

Kathy Prochaska of the University of Nebraska-Lincoln says the average consumer spent \$345 on clothing and shoes last year, 5.2 per cent more than in 1975. She said a similar rate of increase is expected for 1977.

Ms. Prochaska said about half the increase is due to higher prices, and the other half to increased buying. She said the actual price hike for clothing was only about 3.5 per cent, compared with an average six per cent increase in prices for all consumer goods.

Rustless Pins Are Developed

PHILADELPHIA (UPI) — New stainless steel push-pins with aluminum heads have been developed in response to greater demand for these products in the home, to use in wet-blocking needlework or woolen garments and fabrics where rust-marks would be a problem.

Push-pins traditionally have been used for office, school and home bulletin boards where rust is not a factor. The new type, identified by a large S on the head, withstands repeated exposure to moisture and liquids without corrosive effect, says the manufacturer.

They are recommended also for use in embroidery, macrame, tie-dying and batik work; for stretching canvas, mounting delicate specimens and models and labeling houseplants.

The new type will be sold in packages of 20 pins and in boxes of 100.

Many Resort To Fast Food Fare

WASHINGTON (UPI) — Fast-food restaurant patrons are most likely to come from families with a per capita annual income of \$4,000 to \$7,000, although all income level households buy fast food, too. More than 7 out of 10 persons in a U.S. Department of Agriculture survey said at least one member of their family had bought such food last year. One-third of the families that patronized fast-food restaurants said one member of the family ate there at least once weekly.

NO RUNAROUND
We Give You Fast, Direct Answers On Loans.

NCNB



We're proud of our new office by the river. Stop by and visit with Warren Whitehurst Soon!

758-3471

NCNB
FDIC

SAVE ON HOUSEHOLD CLEANERS

IT'S SPRING TIME... START YOUR OWN PLANTS — **free plant starter kit**
SEED IMPREGNATED PEAT PELLETS PLUS PLASTIC POT
CHOICE OF • Coleus • Tomato • Christmas Pepper • Polka Dot

with the purchase of these household needs

ONE GIANT SIZE MR. CLEAN \$1.09
ONE GIANT SIZE TOP JOB \$1.09
ONE GIANT SIZE SPIC AND SPAN \$1.39
ONE GIANT SIZE REGULAR SIZE COMET 4/\$1.09

BONUS OFFER: PLANT KEEPER GREENHOUSE by mail for only \$5.95 plus proof-of-purchase from 1 Giant Size Mr. Clean, 1 Giant Size Top Job, 1 Giant Size Spic and Span, and 4 Regular Size Comet plus special certificate from our display.

LEO'S



SPICY BEEF
SLICED BEEF
CORNEB BEEF

MIX OR MATCH
2 PKGS.
FOR

89¢

HARRIS

SUPER MARKET

"Where Shopping"



Memorial
N.
Me
1104
Ayd

PUREX DETERGENT

Giant Size (42 Oz.)



89¢

SWIFTS PREMIUM WESTERN BONELESS

CHUCK ROAST

\$1.19



LB.

BETTY CROCKER YELLOW CAKE MIX

YELLOW



49¢

JAMESTOWN SLICED

BACON

LB.

99¢

SMOKED

PICNICS

LB.

59¢

MADERITE

BREAD



\$1.00

1 1/2 Lb. Loaf

3 FOR

BAKING (FRESH)

HENS

LB.

49¢

SMITHFIELD

CHITTERLINGS

(10 Lb. Pail)

\$3.99

BONELESS FULLY COOKED

DUTCHESS HALF PICNICS

(SMOKED) LB.

\$1.89

NABISCO

NILLA VANILLA WAFERS

(12-Oz.)



53¢

HUNTS SLICED PEACHES

2 1/2 Size

49¢

HORMEL

VIENNA SAUSAGE

3 5-Oz. Size For

\$1.00

DIAL COMPLEXION

SIZE SOAP

Bar

19¢

SNOWDRIFT

SHORTENING

3-Lb. Can

\$1.49

HEINZ'S

STEAK SAUCE

5-Oz. Size

49¢

Fill Your Freezer WITH THESE FROZEN FOOD SPECIALS!

GOLDEN FRESH

ORANGE JUICE

\$1.00



3/12-Oz. Size For

CHEF-BOY-AR-DEE PIZZA

(13-Oz. Pepperoni)
(13-Oz. Cheese)
(13 1/2-Oz. Sausage)
(14-Oz. Hamburger)



79¢

FROZEN

FRENCH FRIES

5 LB. BAG

99¢

CLIP THIS COUPON

\$10 WORTH OF GREENBAX STAMPS

★ FREE ★

AT HARRIS SUPER MKTS. WITH THE PURCHASE OF \$15 OR MORE & THIS COUPON

NAME ADDRESS

COUPON EXPIRES SAT. MAR. 19, 1977

FRIS
MARKETS, INC.
"A Pleasure"
Tenth St.
Gene St.
Bethel
3rd St.
Tarboro

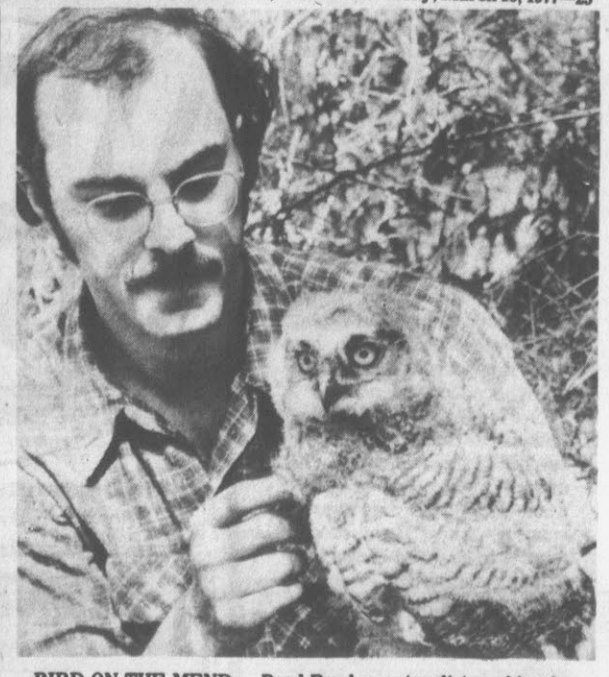

DELICIOUS PRODUCE
ORANGES
5 LB. BAG **69¢**
WASHINGTON STATE RED DELICIOUS
APPLES
3 LBS. FOR **89¢**
GOLDEN RIPE
BANANAS
5 LBS. FOR **\$1.00**

BIRD ON THE MEND — Brad Reed, a naturalist working for Calloway Gardens near Pine Mountain, Ga., finds that Great Horned Owls handle about as well in captivity as most other birds. Reed, along with other naturalists at the Gardens is involved in raising the baby owl shown here, which was found after it had been attacked by crows and left on the ground. (AP Wirephoto)

GRADE "A" WHOLE FRYERS
39¢
LB.

SWIFTS PREMIUM WESTERN BONELESS SIRLOIN
TIP ROAST
\$1.39
LB.

WESSON OIL
48-Oz. Size
\$1.59



57¢



1/4 SLICED
PORK LOIN LB. **99¢**

SOFT 'N' PRETTY
(4 Roll Pack)
69¢



TENDERIZED (WHOLE) 8 TO 17 LB. AVG.
HAM LB. **89¢**

SWIFTS PREMIUM WESTERN
RIB STEAK **\$1.39**
LB.

JAMESTOWN ROLL
SAUSAGE LB. **59¢**

FIELD TRIAL DOG FOOD
(25-Lb. Bag)
\$2.99



FROSTY MORN 12 OZ. PKG.
HOT DOGS **69¢**
MADERITE
HOT DOG & HAMBURGER ROLLS 3 Pkgs. For **\$1.00**

\$1.39
LB.

HEINZ
KETCHUP 32-Oz. Size **79¢**

NABISCO
NUTTER BUTTER COOKIES
75¢
(12-Oz. Size)



SCOT TOWELS
JUMBO ROLL 2 For **\$1.00**

BRAVO
CORNED BEEF 12-Oz. Size **89¢**

APRIL SHOWER
SWEET PEAS 3 303 Cans For **\$1.00**

VIVA
NAPKINS Jumbo Pak **49¢**

PREMIUM WESTERN
ROUND STEAK **\$1.09**
(CUT) (BONE-IN) LB.

DAIRY FOODS

PREMIUM WESTERN
BONE OR SIRLOIN STEAK **\$1.39**
LB.

PILLSBURY
BUTTERMILK BISCUITS
4 Pack For **49¢**

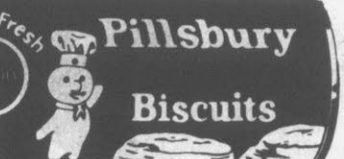

TROPICANA
ORANGE JUICE
Half Gallon
69¢



KRAFT SLICED
AMERICAN SINGLES
99¢
12 Oz. Size

Hands Squeezed For Headaches

By JOHN LEIGHTY (UPI) — SAN FRANCISCO (UPI) — Dr. Howard Kurtland squeezes a lot of hands these days — to cure headaches. The neurologist says his do-it-yourself technique of applying pressure can be used by anyone, even migraine headache sufferers. Dr. Kurtland gave up prescribing drugs for all headaches several years ago. Now he uses an "acupressure" method which he pioneered. "It is an instant cure," Dr. Kurtland says confidently of the use of certain pressure points to relieve pain. To prove it, he has relieved headache sufferers on live television programs, at lectures and during lunches. He usually uses thumbnail pressure at a point in the triangle of flesh between the thumb and the index finger, but there are other points that can be used if pain persists. "If I can do it, you can do it," says Dr. Kurtland. "It's the same technique. And it's medically tested." The method, which involves applying an intense pressure for 15 to 30 seconds, is explained and illustrated in the book, "Quick Headache Relief Without Drugs" (Morrow, \$7.95). Kurtland, a professor of psychiatry at Northwestern University Medical School in Chicago, says the book resulted from a demonstration he gave to a convention of psychiatrists in Anaheim, Calif., in 1975. During a talk to his colleagues, he offered to cure anyone in the audience who had a headache. About a dozen people took him up on the offer — most skeptically — until their cranial throbbing vanished. Kurtland says a Board of Acupressure Medicine has now been formed and, "I think in time it will be part of everyone's medical treatment." Based on the pressure points of acupuncture, the Chinese needle treatment, Kurtland's method removes the need for pain-killing drugs, such as aspirin, which he says Americans consume at the rate of 100,000 pounds a day. "Some over-the-counter drugs contain toxic chemicals I would never prescribe," Kurtland said. He emphasizes that acupressure is a limited medical technique and that physicians should be consulted, particularly if headaches persist.

Project Gives Kids A Taste Of Govm't

MINDEN, La. (AP) — After sentencing a defendant convicted of chewing gum in class, the new city judge here got his first lesson in practical politics. "When's the next election?" the defendant asked as she was led away to pay her 10-cent fine. She was fined another 10 cents for contempt of court. The two participants in that courtroom drama are students at Webster Junior High School. They and their fellow students are learning how local government functions by running their own city government for "Civics City." And Principal O.D. Mims says the students take their government jobs seriously. Mims, too, felt the power of the court when a student judge fined him \$2 for leaving his car too long in a school parking lot. Civics City Court is held each Friday, when students who were issued citations during the week must account for breaking school rules. Fines imposed by the court are used to finance class projects. The students have found each other guilty of such transgressions as throwing paper, chewing gum in class and talking out of turn. Elections are held each month to fill the city jobs — mayor, city commissioners, policemen, judges, attorneys and ward marshals — all of which are elective. "We have few discipline problems in this class," says teacher Nody Parker who began the program in his civics class. "The students are often harsher with each other than a teacher or principal would be. "Our misbehavior has practically stopped. The students are learning and having fun." Mims says the students are having such a good time that they don't realize they are learning something. "And they also remember it," he says. During the gum chewing case, the defendant seemed to be making points with her argument that the government's chief witness could not have seen the crime being committed. But the argument collapsed when the judge noticed the defendant was still chewing gum. "If you didn't have that gum in your mouth now," the judge said, "I might have found you innocent. I fine you 10 cents. "Next case."

Have You Missed Your Daily Reflector?
First Call Your Independent Carrier. If You Are Unable To Reach Him Call The Daily Reflector
752-3952
Between 6:00 And 6:30 P.M. Weekdays And 8 'Til 9 A.M. On Sundays.

Prices Good
Thurs.
Thru Sat.
QUANTITY RIGHTS RESERVED

Search For 'Nessie' Will Be Resumed

By JACQUELINE HUARD
BOSTON (UPI) — Dr. Robert Rines in June will resume his seven-year hunt for the legendary Loch Ness Monster, hoping to silence skeptics who say there is no large creature in the murky Scotland waters.

"We know there is something real there, and if it's what we suspect it is, it may be the natural history find of man's whole existence," said the 54-year-old patent lawyer and founder of Franklin Pierce Law Center in Concord, N.H.

"We have to get close enough to get evidence needed by people who can identify these things."

Rines and photographer Charles Wyckoff, a fellow member of the Boston-based Academy of Applied Science that Rines founded, in January installed underwater cameras in Loch Ness with a revised computer trigger system.

"We tested this out and have refined it to a point so we can make sure that the camera doesn't get triggered by a school of fish until it's one of these big things within camera range," Rines said.

The "big things" Rines referred to are the animals or animal he believes populate waters off the town of Drumnadrochit, Scotland. In 1975, after Rines had been exploring the 900-foot-deep Loch for five years, an underwater camera caught a shadowy shape of what he said appeared to be a large, reptilian looking head with a long neck-like projection.

The photograph, coupled with a 1972 shot of what Rines described as a belly fin, only intensified his belief in Nessie's existence.

"I suppose if I hadn't had the misfortune of seeing the back of one of these things in 1972, I would have walked away," he said.

The expedition team was disappointed but not discouraged last summer by results from more than 100,000 time-elapsed photographs. They theorized a drought had lowered the Loch's level so the usual salmon spawning runs were not taking place to draw the animal from its lower depths to feed.

Rines said sonar equipment in Loch Ness last summer picked up on a sizeable object, but it was below camera range. "The contact coincided with a startling hydrophone detection ... of chip-like or rattle-like sounds which ceased before we could begin tape-recording," he said.

The camera was "shooting blind," Rines said. But he hopes the new trigger system will not activate the equipment unless something "big enough with the right dimensions and characteristics" comes within range.

The revamped cameras are powered from shore instead of by batteries, allowing pictures every three or four seconds for a sequence of shots rather than just one still photograph. He said the team also may use a submarine to retrieve artifacts from the depths of Loch Ness or to explore underwater caves.

"As far as we're concerned, all that's going to happen in the future is we'll get better pictures of the same thing," said Rines, adding he's encouraged other scientists have joined the hunt.

"Now we have independent sonar experts getting exactly the same characteristics. Now it's been reproduced, and not just by me," he said. "It's a vitally important study in the way the scientific community is reacting to good hard data that stretches the imagination."

"We've been challenged to identify what these things are to demonstrate that science has got to have a much more open mind than it has in the past in these areas."

More Mothers Head Families

NEW YORK (AP) — Families headed by mothers have almost doubled over the last decade according to U.S. government statistics. The head of the household in one out of every 13 families is a woman. These 4.4 million women may be divorced, separated, widowed or single and according to the American Council of Life Insurance, their median age is 43.4 years.

The biggest problem in a woman-headed household is often financial, they said. Only a third of the households polled by the Council had earnings of \$10,000 or more. About 54 percent of the women heading families were working in 1975.

SAVE WITH

WINN DIXIE

THE BEEF PEOPLE

Get on down to Winn-Dixie..

• PRICES GOOD THRU SAT., MARCH 19TH • NONE TO DEALERS
• WE RESERVE THE RIGHT TO LIMIT QUANTITIES

SPRINGTIME

FINE CHINA



This Week's Feature

Dinner Plate EA. **79c**

WITH EVERY \$3.00 FOOD ORDER

SERVING PIECES ALSO ON SALE

SALT & PEPPER **\$3.99**

"BORDEN'S CIRCUS SPECTACULAR"

EAGLE BRAND CONDENSED MILK 14-OZ. CAN **59c**

BORDEN'S CREAMORA 22-OZ. JAR **\$1.39**

BORDEN'S LEMON JUICE 16-OZ. BTL. **49c**

SNOW SEAFOOD CHOWDER 18-OZ. CAN **63c**

BORDEN'S BREAKFAST DRINK 22-OZ. SIZE **\$1.59**

BORDEN'S SLICED CHEESE FOOD 12-OZ. PKG. **99c**

YOU SAVE 61c

THRIFTY MAID ^{1/2}

- BARTLETT PEARS
- PEACHES (SLICED OR HALVES)

3 29-OZ. (NO. 2 1/2) CANS **89c**

WITH \$7.50 OR MORE ORDER (LIMIT 6 OF YOUR CHOICE)

YOU SAVE UP TO 50c

THRIFTY MAID ^{1/2} SOUPS

- TOMATO
- VEGETABLE
- VEGETARIAN VEGETABLE
- CREAM OF CHICKEN
- BEAN & BACON
- CHICKEN & RICE
- CHICKEN NOODLE
- CREAM OF CELERY
- MUSHROOM

6 10 1/2-OZ. CANS **\$1.00**

WITH \$7.50 OR MORE ORDER (LIMIT 12 CANS OF YOUR CHOICE)

NICE 'N EASY

HAIR COLOR

2-OZ. SIZE **\$1.88**

TYLENOL

EXTRA STRENGTH TABLETS

BTL. OF 60 **\$1.49**

SAVE

MASSENGIL'S

DISPOSABLE DOUCHE

6-OZ. SIZE **59c**

PROTEIN 21

HAIR SPRAY

13-OZ. CAN **\$1.29**

SAVE

JOHNSON'S

DENTAL FLOSS

50-YD. SIZE **99c**

KAOPECTATE

"FOR TREATMENT OF DIARRHEA"

8-OZ. BTL. **99c**

SAVE

ANACIN

ARTHRITIC PAIN FORMULA

BTL. OF 40 **99c**

ONE-A-DAY

VITAMINS WITH IRON

BTL. OF 60 **\$2.09**

SAVE

CRICKET

LIGHTERS

EA. **99c**

GLAMORENE

RUG CLEANER

32-OZ. CAN **\$1.79**

JOHNSON'S KLEEN 'N SHINE 14-OZ. CAN \$1.29
GLOSS 'N TOSS 14-OZ. CAN \$1.29
LADY SCOTT FACIAL TISSUE 200-CTN. \$5.99
VIVA NAPKINS 140-CTN. \$4.99
AUNT JEMIMA SYRUP 36-OZ. BTL. \$1.03
AUNT JEMIMA PANCAKE MIX 200-CTN. \$2.79
ARMOUR'S VIENNA SAUSAGE 2 12-OZ. CANS \$2.99
BES PAK TRASH CAN LINERS 12-PK. \$2.39

W & D BRAND

GOVERNMENT GRADED U.S. CHOICE

YOU SAVE 50c PER LB.

U.S. CHOICE BEEF WHOLE (18-22 LBS. AVG.)

NEW YORK STRIP LOINS **1.29** LB.

CUT INTO STEAKS & TRIMMINGS AT THIS PRICE

CIRCLE 'A' BRAND

BONELESS CANNED PICNICS **2.89** 3-LB. SIZE

YOU SAVE **\$1.10**

LIMIT TWO AT THIS PRICE, PLEASE

THRIFTY MAID ^{1/2} SLICED CARROTS OR CUT

GREEN BEANS 5 16-OZ. (NO. 303) CANS **\$1.00**

THRIFTY MAID ^{1/2} CUT BEETS 4 16-OZ. CANS **\$1.00**

THRIFTY MAID ^{1/2} PINTO BEANS 4 15-OZ. CANS **\$1.00**

THRIFTY MAID ^{1/2} KIDNEY BEANS 4 15-OZ. CANS **\$1.00**

THRIFTY MAID ^{1/2} POTTED MEAT 5 3-OZ. CANS **\$1.00**

THRIFTY MAID ^{1/2} SPAGHETTI 5 18 1/2-OZ. CANS **\$1.00**

THRIFTY MAID ^{1/2} TOMATO SAUCE 5 8-OZ. CANS **\$1.00**

YOU SAVE 50c

ASTOR ^{1/2} COFFEE

1-LB. CAN **\$2.39**

WITH \$7.50 OR MORE ORDER (LIMIT ONE)

YOU SAVE 39c

THRIFTY MAID ^{1/2} SUGAR

10-LB. BAG **\$1.39**

WITH \$7.50 OR MORE ORDER (LIMIT ONE)

YOU SAVE 20c

SUNSHINE BUTTER

1-LB. CTN. **99c**

WITH \$7.50 OR MORE ORDER (LIMIT ONE)

U.S. CHOICE BEEF

NEW YORK STRIP STEAKS 1-LB. **\$1.99**

U.S. CHOICE BEEF

BONELESS RIB STEAKS 1-LB. **\$2.49**

U.S. CHOICE BEEF

BONELESS FAMILY STEAKS 1-LB. **\$1.49**

U.S. CHOICE BEEF

MEATY SHORT RIBS 1-LB. **89c**

U.S. CHOICE BEEF (FAMILY PACK)

BONELESS RIB EYE STEAKS 5 1/2-LB. PKG. **\$13.95**

U.S. CHOICE BEEF (FAMILY PACK)

BONELESS CUBED STEAKS 5-LB. PKG. **\$9.95**

SUNNYLAND

SKINLESS FRANKS 12-OZ. PKG. **79c**

U.S. CHOICE BEEF

BROAD-BREADED YOUNG TURKEYS

18 LBS. & UP SIZE **59c** LB.

U.S. CHOICE BEEF

FRESH PORK SPARERIBS 1-LB. **89c**

U.S. CHOICE BEEF

FRESH PICNICS 3-LB. **1.59c**

U.S. CHOICE BEEF

SMOKED SAUSAGE 2-LB. **\$2.49**

U.S. CHOICE BEEF

HOLIDAY TIME FRANKS 2-LB. **\$1.99**

U.S. CHOICE BEEF

SMOKED HAM 12-OZ. PKG. **\$1.99**

U.S. CHOICE BEEF

SLICED SALAMI 1-LB. PKG. **99c**

U.S. CHOICE BEEF

SPICED LUNCHEON MEAT 1-LB. PKG. **99c**

U.S. CHOICE BEEF

SLICED BOLOGNA 12-OZ. PKG. **59c**

U.S. CHOICE BEEF

TASTE-O-SEA FRENCH FRIES 12-OZ. PKG. **\$1.09**

U.S. CHOICE BEEF

PERCH OR FLOUNDER FILLETS 1-LB. **\$1.09**

U.S. CHOICE BEEF

TASTE-O-SEA CELLO-WRAPPED TURBOT OR PERCH FILLETS 1-LB. **99c**

SUPERBRAND ^{1/2}

MILD CHEESE 1-LB. **\$1.49**

SUPERBRAND ^{1/2}

SOUR CREAM 1-LB. **69c**

SUPERBRAND ^{1/2}

YOGURT 2 CTNS. OF 2 8-OZ. CUPS **\$1.00**

MERICO BUTTER-ME-NOT

BISCUITS BUY ONE 9 1/2-OZ. CAN AND GET ONE **FREE**

HARVEST FRESH ^{1/2}

Produce

IDAHO SELECT BAKING POTATOES 6 LB. **\$1.00**

WHITE POTATOES 5-LB. POLY BAG **79c**

JUMBO COLORED PINEAPPLES EA. **99c**

CARROTS 2-LB. BAG **49c**

FROZEN FOODS

ASTOR ^{1/2} BABY LIMAS 2 10-OZ. PKGS. **79c**

SPECKLED BUTTERBEANS 2 10-OZ. PKGS. **79c**

SUPERBRAND ^{1/2} WHIPPED TOPPING 12-OZ. CUP **89c**

TASTE-O-SEA PERCH FILLETS 1-LB. PKG. **99c**

FRENCH QUIN MINI-MEALS 2 6-OZ. SIZE **\$1.00**

ARMOUR'S PURE LARD 3-LB. CTN. **\$1.27**

SAUER'S GROUND CINNAMON 1-OZ. CAN **49c**

SUNSHINE VANILLA HYDROX 15-OZ. PKG. **79c**

CHUN KING SOY SAUCE 5-OZ. BTL. **33c**

YOU SAVE UP TO 71c

SUPERBRAND ^{1/2}

- ICE CREAM SANDWICHES
- ICE CREAM BARS
- TWIN POPS
- FUDGE BARS

78

YOUR CHOICE PKG. OF 12 EA.

JUMBO FLORIDA

- WHITE GRAPEFRUIT
- ORANGES

99

YOUR CHOICE 8-LB. BAG

Located At The Shopper's Mart
Now Open 7 A.M. 'Til 11 P.M. 7 Days A Week

Manager
Wayne McKinney

Produce Manager
Wayne Radcliff

Market Manager
Charles McGrady



• PRICES GOOD THRU SAT., MARCH 19TH
• NONE TO DEALERS
• WE RESERVE THE RIGHT TO LIMIT QUANTITIES

WINN-DIXIE PRESENTS A BIG SPRINGTIME CHICKEN-A-RAMA



FEATURING HOLLY FARMS CHICKENS ... CHILL PACKED, NEVER FROZEN OR ICED PACKED. HOLLY FARMS IS THE BEST YOU CAN BUY AND WINN-DIXIE HAS A COMPLETE VARIETY AT LOW, LOW PRICES!

HOLLY FARMS
THE ONE TO PICK TO BE SURE.

The one to pick to be sure.

HOLLY FARMS CHILL PACK
FRYER
BREASTS LB. **89**^c

HOLLY FARMS CHILL PACK
FRYER
DRUMSTICKS LB. **79c**

HOLLY FARMS CHILL PACK
GRADE 'A'
WHOLE FRYERS LB. **45**^c

HOLLY FARMS CHILL PACK
GRADE 'A'
CUT-UP FRYERS LB. **55**^c

HOLLY FARMS CHILL PACK
GRADE 'A' WHOLE
CUT-UP FRYERS LB. **59**^c

COUNTRY STYLE

Holly Farms
The one to pick to be sure.
ROASTING CHICKENS LB. **59**^c

HOLLY FARMS CHILL PACK
FRYER
WINGS LB. **59**^c

HOLLY FARMS
CHILL PACK
FRYER
LIVERS LB. **89**^c

"THE ONE TO PICK TO BE SURE."

The one to pick to be sure.

HOLLY FARMS CHILL PACK
FRYER
NECKS OR BACKS LB. **19c**

HOLLY FARMS
CHILL PACK FRYER
THIGHS LB. **79**^c

HOLLY FARMS CHILL PACK
FRYER
QUARTERS

- BREAST PORTIONS .. 63c
- LEG PORTIONS .. 59c

HOLLY FARMS CHILL PACK
COMBINATION
CHOICE FRYER PARTS LB. **79**^c

- BREASTS
- THIGHS
- DRUMSTICKS

Houseplant 'Hotel' Is His Sideline

By STEVE KIDNEY
FALLS CHURCH, Va. (UPI) — Leaving town and worried about your plants? Concerned because your delicate fern and lovely Swedish ivy are looking peaked?

Take heart. Bob Blakeley's Plant Hotel in this Washington, D.C. suburb will babysit your begonia or resuscitate your rhododendron. Reservations not necessary, rates reasonable.

"Boarding costs are 25 cents per plant per day for any type or size of plant, as long as two men can carry it," said Blakeley in an interview. Pickup and delivery are slightly extra.

The U.S. Patent Office says his is the only business registered as a plant hotel, and he has copyrighted the name and is thinking of franchising.

He keeps his hotel guests in one of several large, sunlit rooms and makes sure they are properly fed and watered. Plant lights provide the closest thing to sunshine during evenings and regulate exposure for each plant.

Speakers provide music to grow by.

"I play all kinds of music — easy listening, classical, pop music," said Blakeley, "I'm trying to break them into country right now. I don't go for that loud stuff. I don't like it, so I figure the plants wouldn't like it either."

Blakeley, a native of Phoenix City, Ala. and a tree surgeon for 18 years, started the hotel as part of a plant store he opened last June. He has had his hands full since: "We took in 1,500 boarders in our first three months."

Increasingly, he found himself nursing sick plants.

"I didn't start out with any idea of a plant hospital, but people came in with sick plants and wanted help," he said. So he created a special intensive care ward.

Sick plants are separated from healthy ones, diagnosed and treated. Treatment may include spraying for insects or disease, pruning, fertilizing, re-potting. One recent patient was a seven-foot Norfolk Island pine.

"He kept my sick plant for two weeks when I went to Florida," says Lucy Wallace of Alexandria. "He talks to them, plays music for them, and puts them to bed at night. When I got it back, it was wonderfully healthy and had grown new shoots."

Blakeley's biggest challenge was transporting a 17-foot split-leaf philodendron to the hotel for a month-long stay while its owners were moving. He built a special crate for the fragile vine.

"We were really worried about what to do with it," said Mrs. John Quick of Gaithersburg, Md. "We were between houses and needed a temporary place for three large plants."

"We heard about the Plant Hotel and called Mr. Blakeley. He was very accommodating and very inexpensive. He did a super job. It's a super service for people with expensive plants."

Blakeley also rents plants by the day or week, and arranges "plant parties." For a party Blakeley will arrive with a couple of dozen different plants, give a brief lecture on care, then answer questions on selection and maintenance.

The plants are for sale, and the host receives free plants and a cash percentage.

Blakeley's full-time employees include his son, Robert Jr., and John Cox, 18, soon to be Blakeley's son-in-law.

"We're coming into our busiest time of year right now," said Blakeley, who stocks his salesroom from his nursery in Ft. Pierce, Fla. "We hope to move to a bigger, street-level location before the end of the year."

Weather Report Put Into Rhyme

LOS ANGELES (AP) — After working 34 years for the National Weather Service, Oscar Nichols, a 57-year-old meteorologist here, decided to do something new. He sent the weather report across the wires all in rhyme.

For example: "Strong winds will develop over the ocean and over the land; Creating in the desert areas of blowing dust and sand."

"Now bright blue skies will bring sunny and warm days; And super visibility since the wind swept out the haze."

The idea for a rhyming forecast came from Wayne McCarter, another weatherman, who, Nichols said "breaks into verse every now and then."

Located At The Shopper's Mart

Now Open 7 A.M. 'Til 11 P.M. 7 Days A Week

Manager
Wayne McKinney

Produce Manager
Wayne Radcliff

Market Manager
Charles McGrady

GRADE A WHOLE

FRIYERS  **Morrell Pride** **T-BONE, SIRLOIN**

STEAKS

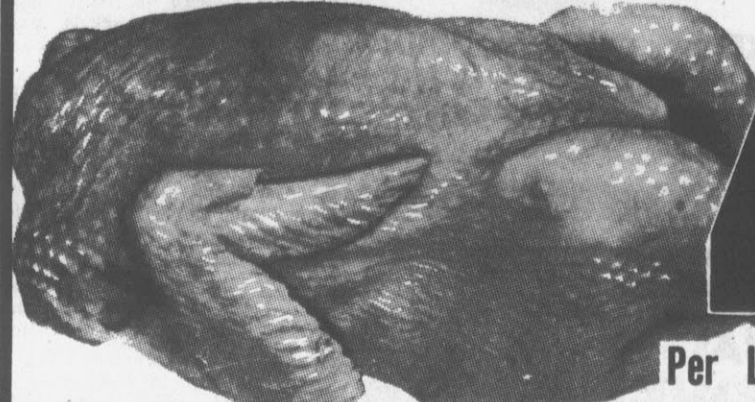
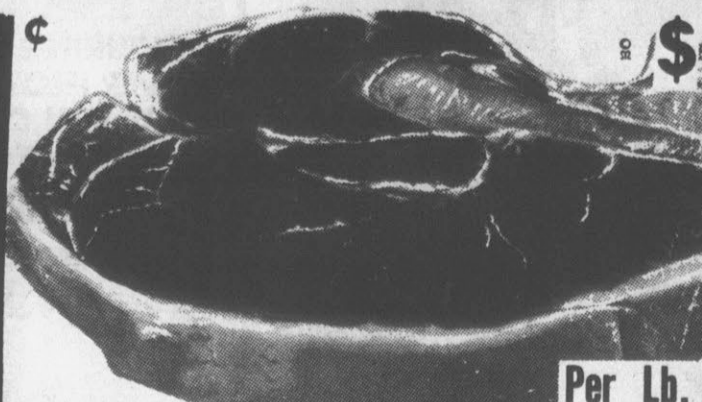
 **41¢**  **1.49**

Per Lb. Per Lb.

THANK YOU FOR SHOPPING OVERTON'S—HOME OF GREENVILLE'S BEST MEATS.

Sliced 7 to 9 Chops
1/4 Pork Loin **\$1.19**
Per Lb.

Bacon **99¢**

 **Gwaltney**
OF SMITHFIELD

1 Lb. Pkg.

OVERTON'S
INC.
SUPERMARKET

3rd AND JARVIS ST.

We Reserve The Right To Limit Quantities!

MORRELL PRIDE FULL CUT
Round Steak **\$1.09**
Per Lb.

OVERTONS FINEST
Ground Beef **79¢**



3 Lb. Pkg. Or More Per Lb.

Gwaltney Sausage Hot or Mild **89¢**
Lb. Pkg.

PRICES EFFECTIVE
WEDNESDAY THRU SATURDAY.

PEANUT CITY OR HARRELLS
Country Hams **\$1.39**
Per Lb.

Dawn Liquid Detergent 22 Oz. **68¢**
Bottle

10 LB. SPECIALS OF THE WEEK:
PORK CHOPS \$11.50
SPARE RIBS \$11.50
NECK BONES \$4.90
PORK CHITTERLINGS \$4.90

(Punch or Grape)
Ideal Fruit Drinks 46 Oz. **2/\$1.00**
Cans

Swiftening Shortening 42 Oz. **99¢**
Can

TREESWEET
Frozen Orange Juice 12 Oz. **39¢**
Cans

KRAFT 1/2 Gallon Size
68¢



FLORIDA

WHITE POTATOES **98¢**



10 Lb. Bag

Quart Size **98¢**



Miracle Whip
Salad Dressing

Dr. Pepper 16 Oz. Ctn. Of 8 **99¢**
+ Deposit

SEE OUR PLANT AND
FLOWER AD ON PAGE 10

New Beef Flavor, 15 1/2 Oz. Can, Ctn. of 6
Ken-L Ration Dog Food **\$1.19**

Giant Roll **48¢**



ABSORBENT
VIVA
...KEEPS ON WORKING
EVEN WHEN WET

Washington State
Red or Golden Delicious
Apples **68¢**



3 Lb. Bag

4 Roll Pkg. **68¢**



NEW!
Charmi

Starkist Tuna Chunk Life 6 1/2 Oz. Can **49¢**

JUICY CALIFORNIA
Lemons **69¢**
Per Dozen

5 Oz. Cans
Armour Vienna Sausages **3/\$1.00**

Qt. Size **68¢**



HEINZ
TOMATO
KETCHUP

GREEN CABBAGE **18¢**

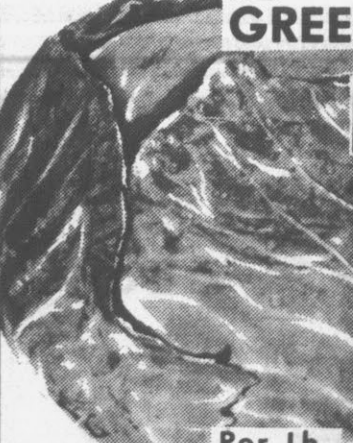

Per Lb.

Giant Box **18¢**

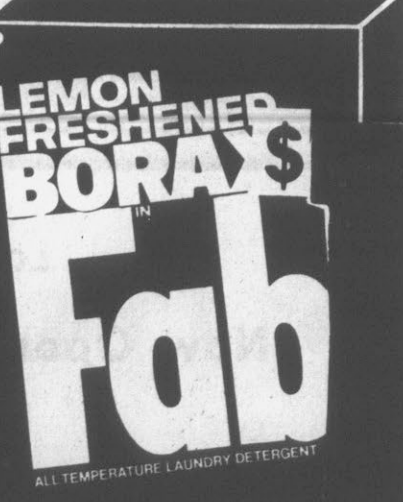

LEMON
FRESHENED
BORAX
Fab
ALL TEMPERATURE LAUNDRY DETERGENT

CLARKS

IRISH OR NOT, SAVINGS WE'VE GOT

Sale Ends
Saturday, March 19th

225
Reg. 2.75

Downy fabric softener. 96 oz. size for softer, whiter, fresher clothes. Limit 4 please.

120

Pampers disposable diapers
Box of 12 toddler size. Limit 2.

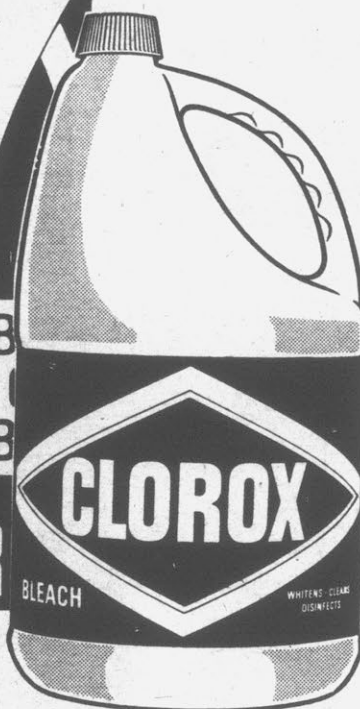

350
Reg. 4.25

Concentrated all. With bleach, Borax and brighteners. 157 oz. size. Limit 4 please.

70¢
Reg. 85¢

Clorox bleach. 1 gallon of Clorox to whiten, clean and disinfect. Limit 4 please.

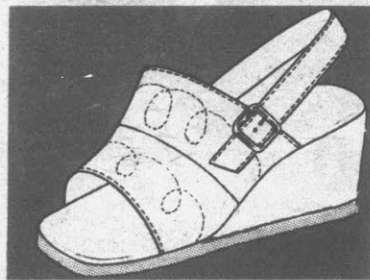

150

Cool and casual slingbacks
Comfortable slingbacks contour to the shape of your foot. 5-10.



200
Reg. 3.00

Men's polo shirts. Choose stripe or solid crew neck shirts of 50/50 poly/cotton. Sizes S,M,L,XL.



50¢ qt.
Reg. 70¢

Quaker State 10W30 super blend. All weather motor oil for engine protection.

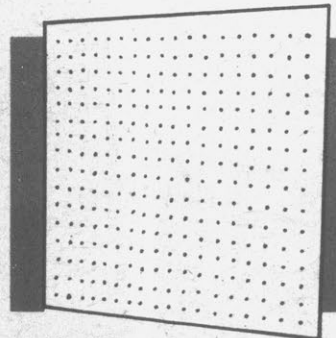

85¢
Reg. 1.45

Handy pegboard. 2'x4'x1/8" pegboard for use in the kitchen or work shop.



85¢

Breck shampoo. Normal, dry or oily formula in 15 oz. size. Limit 2 please.

Wrangler®

500

Reg. 7.00

Men's short sleeve Rugby shirt. Dress in style with a popular Rugby in your choice of white collar with striped body or solids with striped sleeve. Sizes S,M,L,XL.



750

Reg. 9.00

Men's unlined poplin golf jacket. This sharp 65/35 poly/cotton jacket is machine washable and available in assorted colors. Sizes S,M,L,XL.



800

Reg. 13.00 to 15.00

Men's dress shoes. Pliable uppers allow feet their natural freedom. Features fashionable tuck stitching and moderate heels. 6½-12.



Men's fashion make "No Fault" Wranglers

1000

Reg. 14.00 to 15.00

Western style 5 pocket 100% cotton Wrangler flares and straight legs. Bar tacked at all stress points for extra strength. Sizes 29-38 in denim blue.

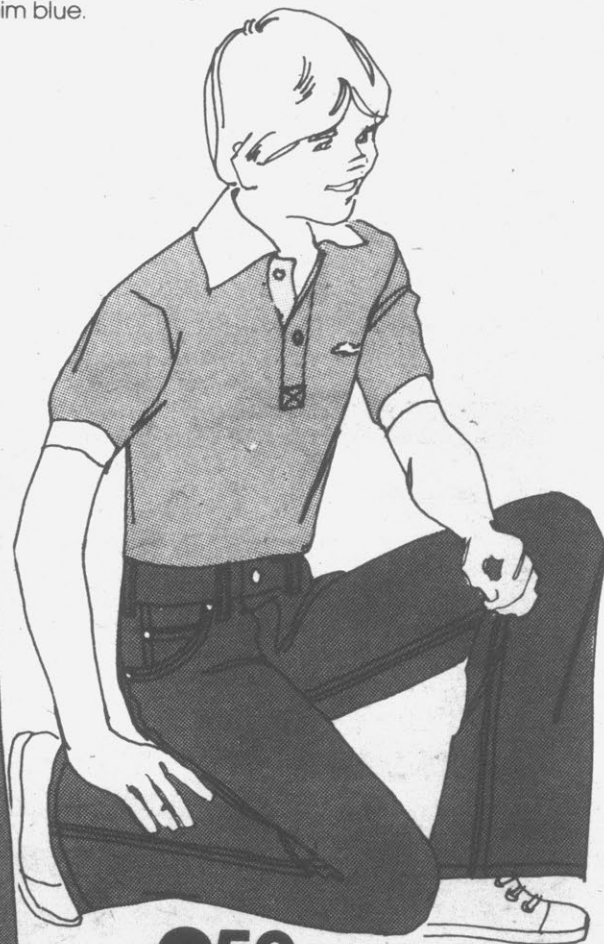

350

Reg. 4.50

Boys' Rugby shirts. Features Rugby collar and solid body of 50/50 poly/cotton. Sizes 8-18.

600

Reg. 8.00

Boys' navy denim super jeans. Sturdy flares of 50% poly/35% cotton/15% nylon are bar tacked for extra strength. Reg. and slim in 8-18.

Perky spring fashions to greet the season

**Good news! We have lots
of T-shirts for only**

Select from our colorful
spring selection of short
and cap sleeve poly-
ester T-shirts in solids or
with matching trims.
Easy machine washable.
Sizes S,M,L.

325



400

Reg. 4.50 to 6.00

**Choose from our entire stock of
ladies' gowns and pajamas
regularly priced from 4.50 to 6.00.**

We have short and long gowns
and pajamas in solids and prints
in 100% nylon, 65/35 dac/cotton
and 100% cotton.

850

Reg. 10.00-11.00

**Enjoy substantial savings on
ladies' denim jeans.** Select
from basic navy or summery
white denim in sizes 8-18.



300

Reg. 4.00

Striking knit pants. 100% double
knit polyester pants in cool spring
shades. Sizes 10-20.

Women's sizes 32-38

Reg. 5.00 4.00

400

Reg. 8.00

Women's canvas playshoes

Your choice of sensational
canvas casuals on woven rope
wedges. Lightweight and
comfortable...your feet will love
them. Sizes 5-10.

Winning values on sports equipment

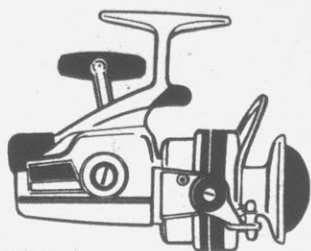

15⁷⁵
Reg. 19.75

Diawa skirted spool spinning reel. Lightweight solid aluminum reel. Features right or left hand retrieve and sealed ball bearings. No. 1500C

67⁷⁵
Reg. 75.00

Pflueger electric trolling motor
Offers 3-speed forward and reverse with 6 position mounting bracket. No. M30

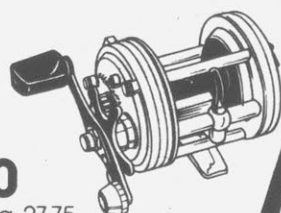

24⁵⁰
Reg. 27.75

Diawa Millionaire bait cast reel. Three element level wind reel with 7 disc. star drag, free spool release button and 5 to 1 gear ratio. No. 3H

24⁵⁰
Reg. 27.75

Power tackle for fresh or salt water
Features Zebco 808 spin cast reel with balanced Zebflex 2-pc. tubular glass rod.

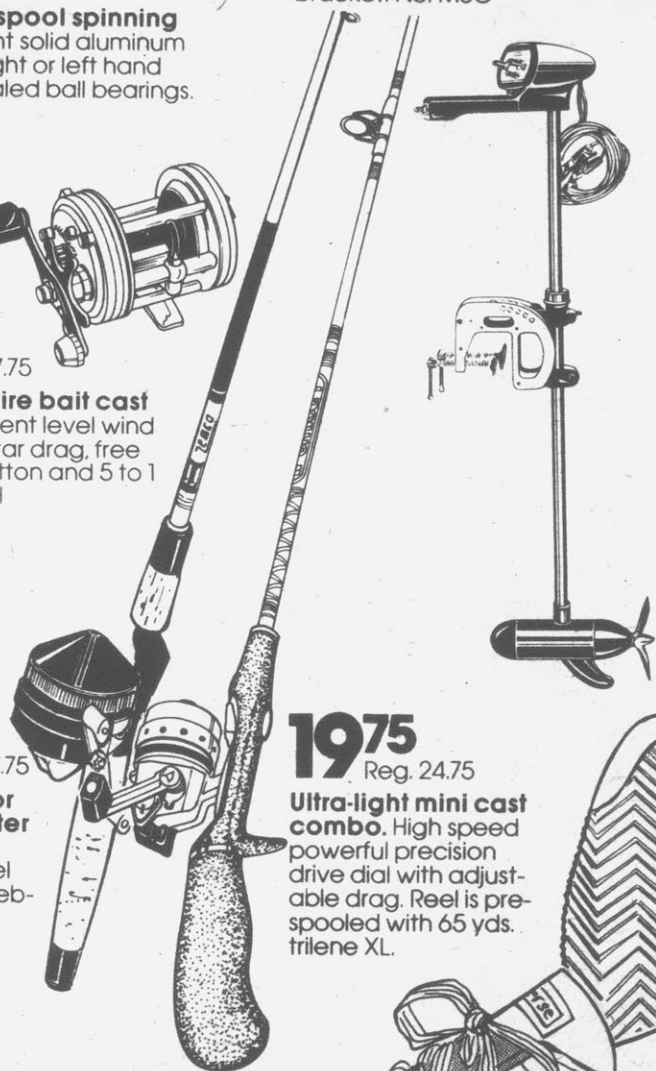

19⁷⁵
Reg. 24.75

Ultra-light mini cast combo. High speed powerful precision drive dial with adjustable drag. Reel is pre-spoiled with 65 yds. trilene XL.

14⁵⁰
Reg. 18.75

Converse joggers. Leather padded collar with molded crepe outsole of double sponge, midsole of nylon and suede uppers. Navy blue with white insoles.

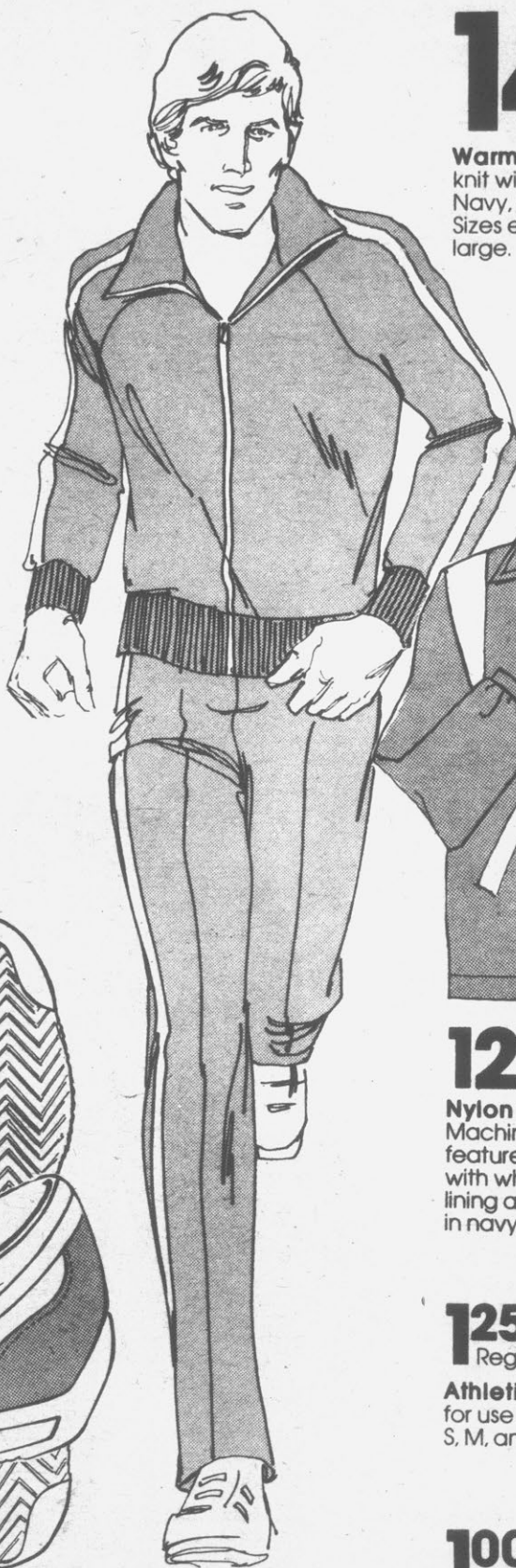

14⁷⁵
Reg. 19.75

Warm up suit. 100% double knit with contrasting stripes. Navy, chocolate and green. Sizes extra small through extra large.



12⁷⁵
Reg. 14.75

Nylon coach warm up jacket
Machine washable jacket features 2 ply 100% nylon shell with white inset trim, cotton lining and water repellant finish in navy, royal, kelly and scarlet.

1²⁵
Reg. 1.55

Athletic supporter. Woven elastic for use in all sports. Sizes X-Small, S, M, and L.

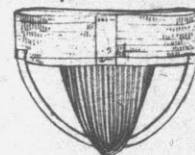

1⁰⁰
Reg. 1.35

Over the calf tube socks. 85% orlon acrylic/15% nylon with 3 color stripes top. Stretch size 9-15.

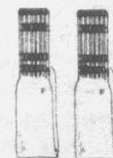

Save some cash on car care

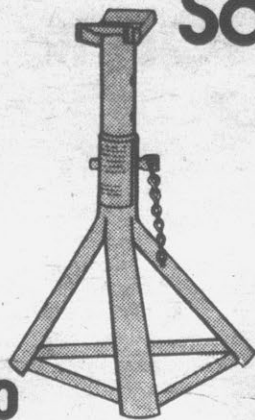

250
Reg. 3.50

Jack stand. 1 ton adjustable height jack stand. No. J-52



800
Reg. 12.75

Chilton 1977 auto manual
Repair and tune-up guides for American and import cars, motorcycles and more.

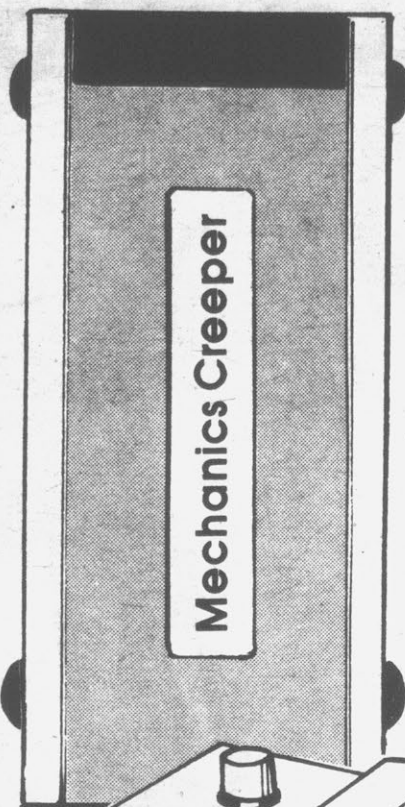

5700
Reg. 89.00

1½ ton floor jack. Quick efficient safe one-man operation. 24" jack length. 3000 lb. capacity.

575
Reg. 8.00

Mechanics creeper. Top grade kiln dried hardware, lacquer finished for optimum resistance to corrosives. Light wt. 9 lbs.

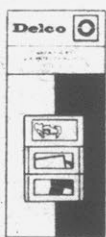
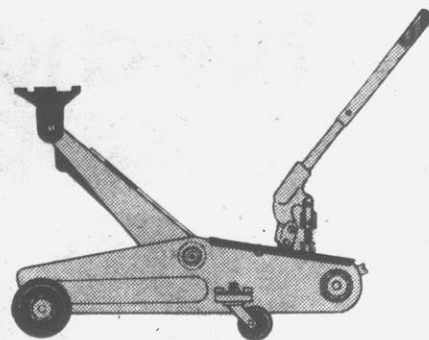

300

O.E.M. tune-up kits. Original equipment tune-up kits. Choose Delco, Mopar or Autolite. Fits most cars.



2675
Reg. 33.00

Maxi tune analyzer. For conventional, breakerless and electronic ignitions. For 4, 6 or 8 cylinder engines. No. 560

2975

Sure Start battery. The extra power battery to meet your needs in extreme climates.

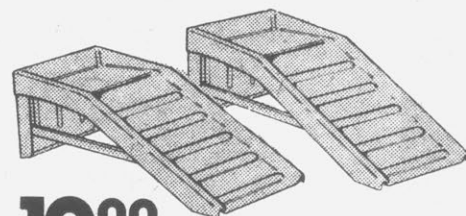
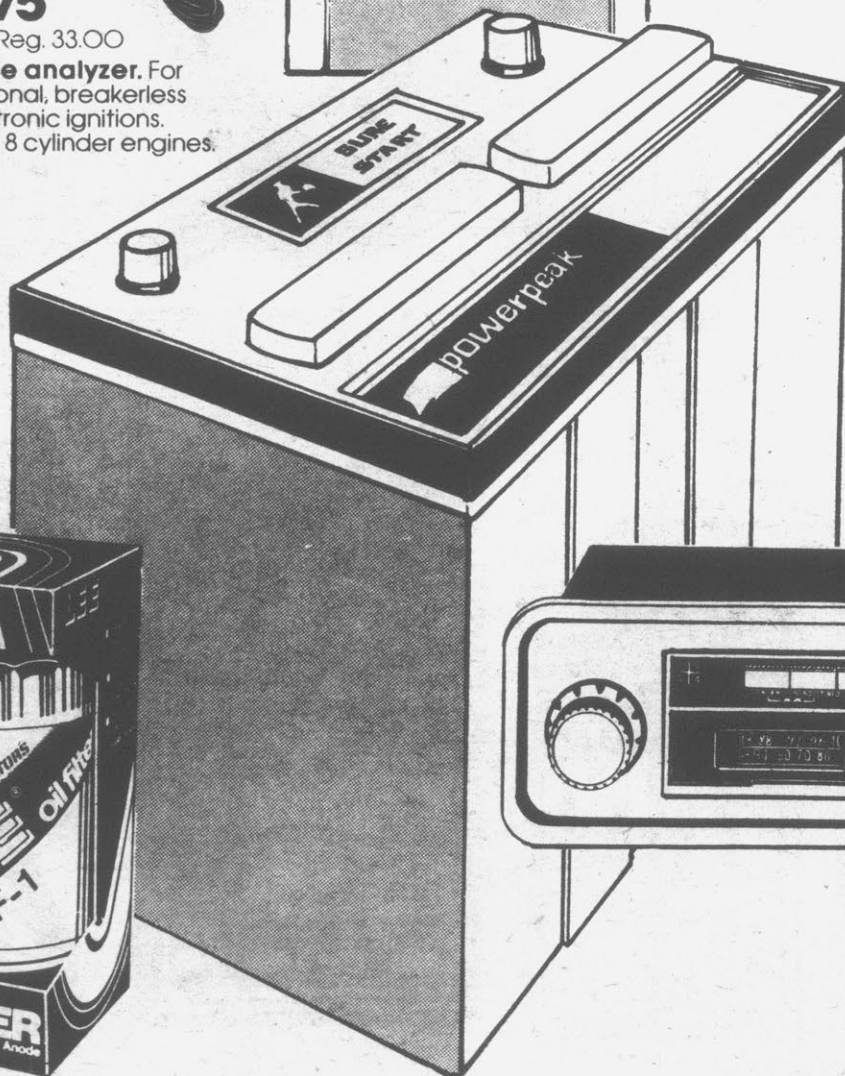

1900
Reg. 24.00

Auto car ramp. Fully assembled with built in wheel wall and tire stop. 5000 lb. cap. per set. Adapts to all passenger size tires.



2800
Reg. 35.00

6x9 coaxial speaker set. 2 rear extended range weather resistant air suspension woofers with built in coaxial 3" tweeters. Use with all type decks and radios. No. SK-6920C

150

Lee oil filters. Sizes to fit most American cars.

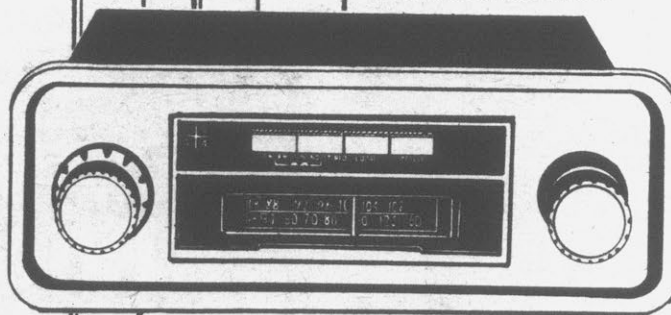

6000
Reg. 75.00

AM/FM/MPX push-button radio. A car radio that fits everyone. It offers outstanding AM/FM performance and is compactly designed to fit any foreign or domestic car. No. 704

Your choice of 3 terrific brand name appliances at 1 great price

900

Your Choice

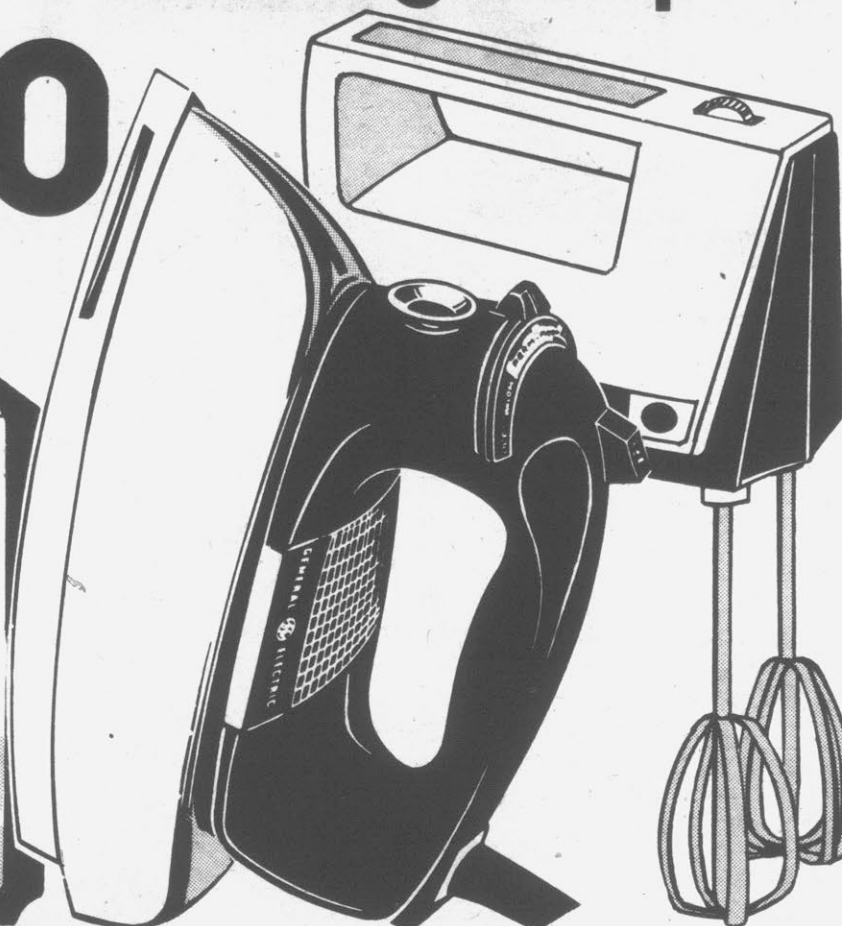
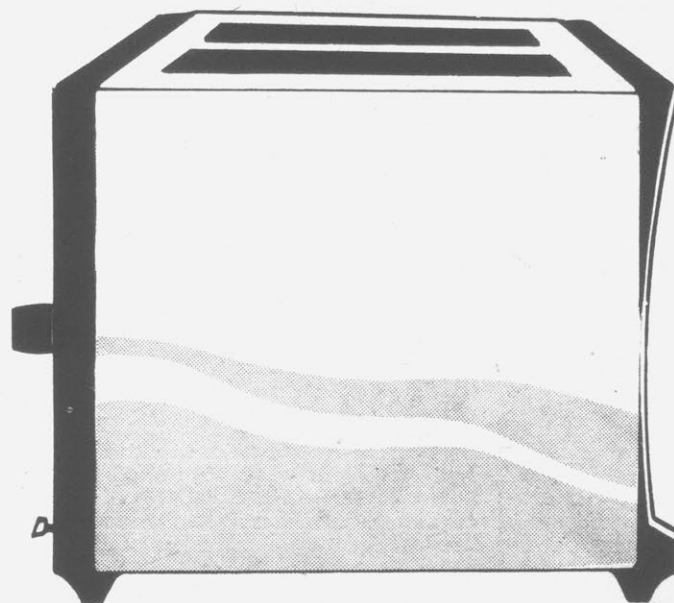

Proctor's automatic 2-slice toaster. This attractive chrome and black finish toaster features snap open crumb tray and color tuner. No. 620B

GE steam and dry iron
Switches from steam to dry at the push of a button. No. F63

Hamilton Beach hand mixer. Features 3 speed fingertip control chrome plated beaters and a beater ejector button. No. 97

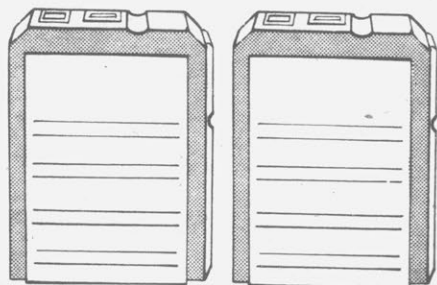

700

National Semiconductor memory calculator. 6 function model adds, subtracts, multiplies, divides, sq. root, % and 4 key memory. No. 835



50¢ EA. 40-minute blank tape
Do your own recording with this blank 8-track cartridge tape.



100

3-M 60-minute blank cassette. Don't miss this special price sale on 2-bag Scotch low noise/high density C-60 cassettes.



75¢

Your Choice

Ray-O-Vac batteries. Choose 9-volt transistor batteries (2 on a card) or pack of 4 1½V AA transistor batteries.

Complete your home workshop with these big values

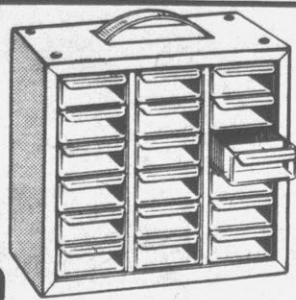

4⁵⁰

Reg. 5.75

18 drawer utility cabinet. Features heavy duty 9½"x10"x6½" steel frame and see thru drawers.

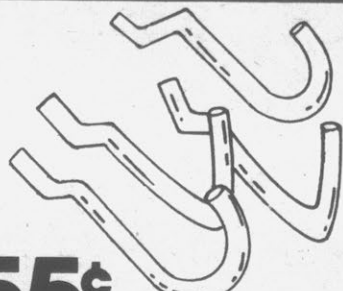

55¢

Reg. 70¢

52 piece pegboard hook assortment. 52 ass't. hooks for pegboard.

14⁷⁵

Reg. 19.75

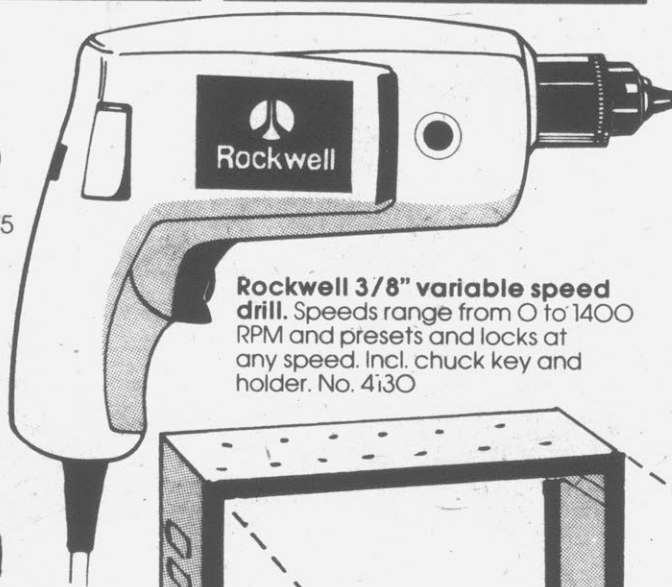

Rockwell 3/8" variable speed drill. Speeds range from 0 to 1400 RPM and presets and locks at any speed. Incl. chuck key and holder. No. 4i30

14⁰⁰

Reg. 17.00

16 gauge steel work bench frame. Assembles to 42¾"Hx 20½"D. Sets up for any length. Lumber not included. No. WB1

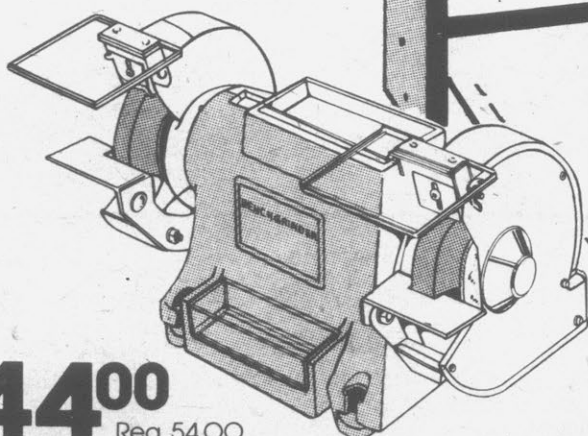

44⁰⁰

Reg. 54.00

Features double insulation, most adjustable parts, ½ HP motor, brake for quick stops, unbreakable housing and durable non-glare finish. No. 1800

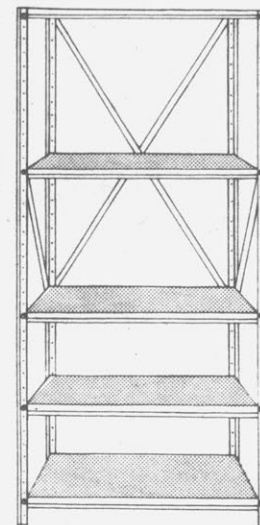
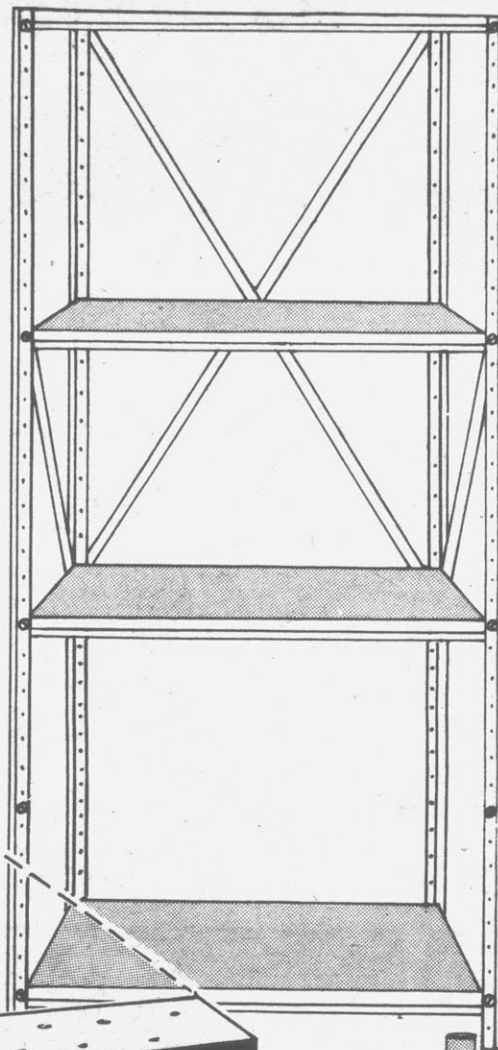

12⁵⁰

Reg. 15.50

Heavy duty shelf. 5 shelves 72"Hx36"Wx16"D. Features strong steel construction with sturdy back and side braces. Easy to assemble.

6⁵⁰

Reg. 8.75

Heavy duty storage shelving. Features strong steel construction with sturdy back and side braces. 12"x30"x60". Easy to assemble.

15⁰⁰

Reg. 19.75

Drill press stand. This sturdy 31" stand turns your drill into an efficient drill press. Fits any ¼" or 3/8" drill.

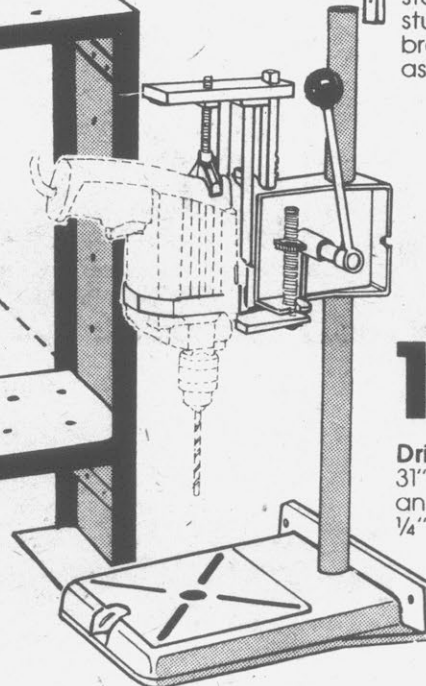

CLARKS HOUSEWARES SALE

Your Choice
200

Plastic laundry baskets. Choose from 1½ bushel rectangular or 1½ bushel round.

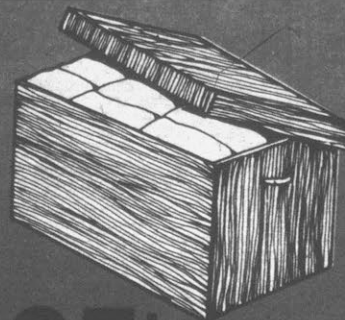
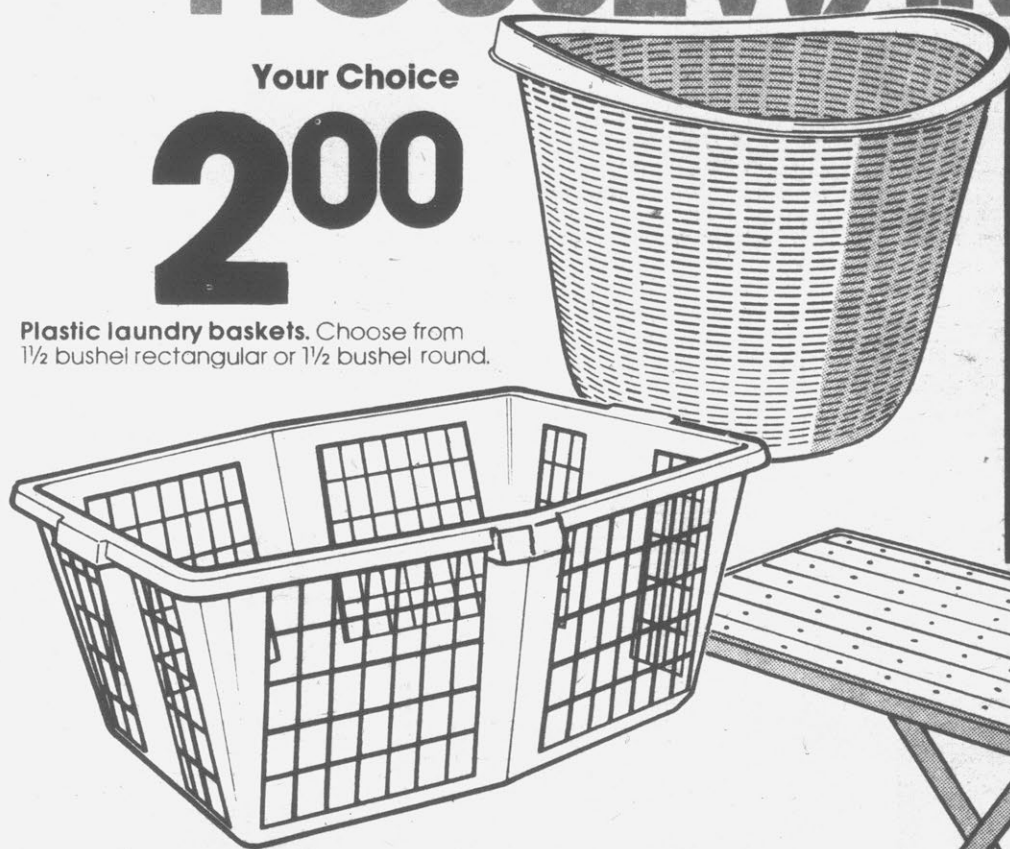

85¢

Utility storage chest. Sturdy woodgrain reinforced chest measures 24" x 13" x 10½". Close fitting lid to keep out dust.

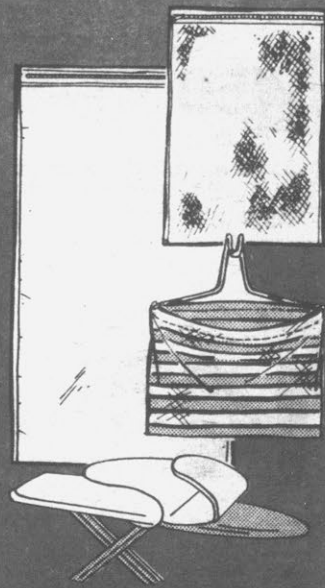

100

Your Choice

Laundry helpers. Choose from clothespin bag, dampening bag, washing machine bag and teflon cover with pad.



70¢

Assorted wooden hangers. Choose from a set of 3 trouser, 3 skirt, 6 dress, 2 suit, and 1 coat hanger.



90¢

Easy-on starch. Guaranteed not to clog, stick or scorch. Regular or lemon scented in 22 oz. size.



Save 2.45 on this Proctor-Silex ironing board

750

Reg. 9.95

Features steam vent top with sturdy long lasting legs and infinite height adjustment. Ivory finish.

New York

632 Upper Glen Street
Glen Falls

North Carolina

Memorial Drive & Farmville Hwy
West End Shopping Center
Greenville

U.S. Highway 158 & Theatre Ave.
Roanoke Rapids

Highway 70 & 17
New Bern

Indiana

710 North Broadway
Peru

Pennsylvania

661 East Main Street
Bradford

South Carolina

Broad Street-U.S. Highway 76 & 378
Sumter

Ohio

Highway 52 & Maybert Street
Portsmouth

Georgia

207 South Dawson Street
Thomasville

Tennessee

814 Memorial Blvd.
Murfreesboro

RAINCHECK

If we sell out of any advertised specials,* you will receive a written order, "Raincheck", which entitles you to buy the item at the advertised price when our stock is replenished.

*(excluding clearance items)

Rmss

ROSES

ROSES MONEY SAVING SALE

Sale Starts
March 16
Sale Ends
March 19

ROSES ADVERTISING MERCHANDISE POLICY

The policy of Roses is to have every advertised item in stock. If for some unavoidable reason the advertised merchandise is not in stock, Roses will issue a Rain Check on request that can be used to purchase the merchandise at the sale price when the merchandise is available, or comparable merchandise will be offered at a comparable reduced price. It is the honest intention of Roses to back up our policy of "Satisfaction Guaranteed Always".

ROSES STORES, INC.

PLEASE NOTE

Due to the many outstanding savings offered, only limited quantities will be available on certain items.

SHOP EARLY

Plenty of unadvertised specials received too late to be included in this tabloid. Shop for these bargains at your Roses store.



UNISONIC® PRINTING CALCULATOR

REG. 97.00 **SAVE \$20** **\$77**

Full 12-digit capacity with memory, % function, change sign key, floating and fixed decimal, round-off control, and all-clear function. Two color print out.



UNISONIC® POCKET CALCULATOR

REG. 11.47 **SAVE 1⁵⁰** **9⁹⁷**

Automatic all clear function at "power-on" condition. Features percentage and square root key, zero suppression and 8 digit capacity. Complete with carrying case.



7 OUNCE
CREST

REG. 1.07 **SAVE 29c** **78c**

Regular or mint flavored with fluoride to fight cavities. Net wt. 7 oz.



LIMIT 2
JERGENS SOAP

ROSES SPECIAL PRICE **14c**

Jergens lotion-mild soap in the convenient bath size bars. Net wt. 4.75 oz.



LIMIT 2
VASELINE LOTION

ROSES SPECIAL PRICE **96c**

New Vaseline Intensive Care Lotion for problem hands. 10 fl. oz.



LIMIT 2
BRECK® CLEAN RINSE

ROSES SPECIAL PRICE **77c**

Three fragrances. Choose Citrus, Meadow, or Honey-suckle. 8 fl. oz.



LIMIT 2
BRECK SHAMPOO

ROSES SPECIAL PRICE **99c**

Breck Shampoo for oily, normal, or dry hair. 11 fluid ounces. Unbreakable bottle.



LIMIT 2
JUMBO ROSE BUSH

REG. 2.57 **SAVE 71c** **1⁸⁶**

Jumbo Rose Bushes with four or more canes. Choose red, pink, yellow, white or two-toned.



MOBIL 10W30 OIL

ROSES SPECIAL PRICE **48c**

Mobil Special 10W30 Motor Oil keeps your car running smoother. Qt. size. **Limit 6 qts.**



**Two-Piece Skirt Sets...
Easy Outfits
in Dazzling Floral
Prints...**

Comfortable, stylish and easy-to-wear skirt sets of 100% Polyester. Several tunic styled tops with self-tie belts to select from. All skirts are pull-on style with elasticized band. Dazzling floral prints in sizes 5 to 15.

888
SAVE
3.11



**Easy-care Tunic Tops
with self-tie belts...**

Made of Polyester and Cotton with roll-up sleeves and self-tie belt. Many prints or solids in sizes 7 to 14.

SAVE \$1 **296**
REG. 3.96

**Floor Length Gowns
of 100% Nylon**

Four floor length styles to choose from. Select V-neck, deep plunge neck or jewel neck with delicate embroidered or lace trims. Many pastels in sizes Sto L.

SAVE 1⁹⁸

296
reg. 4⁹⁸

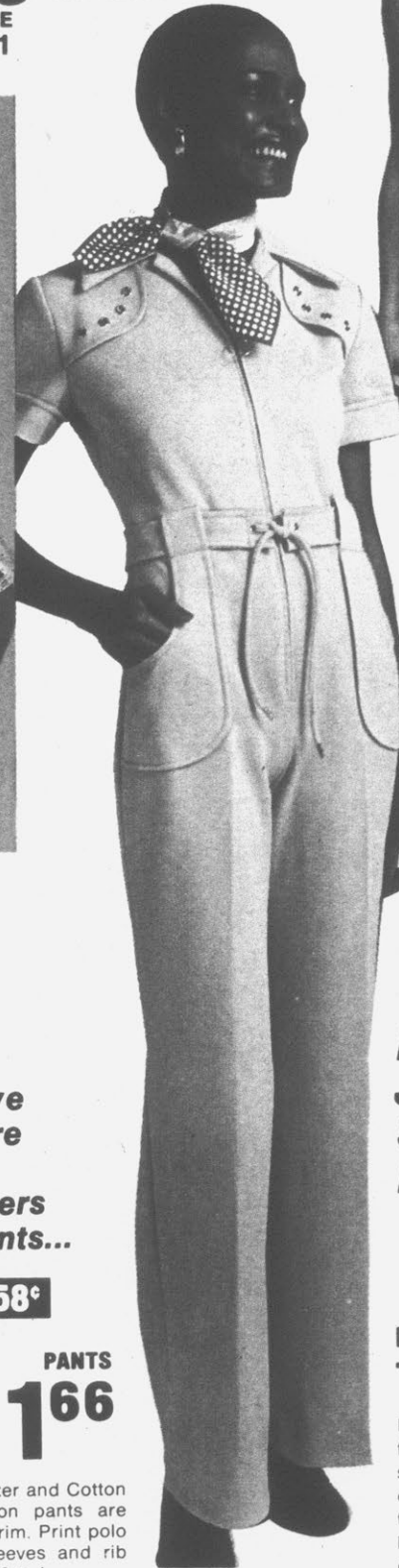

**Easy-fitting
Jumpsuits of
Smooth, Supple
Polyester...**

SAVE 3⁵²

REG. 15⁹⁹ **1247**

Easy-fitting step-in jumpsuits with front zipper opening. Styles with self-tie belt, attached belt with hook closure, short sleeves, cap sleeves, front pockets or plain. All with flare legs. Sizes 7 to 15 in solids, prints or stripes.

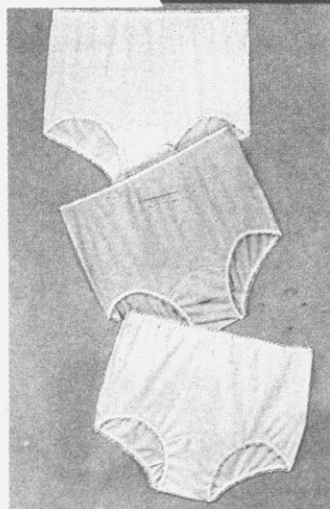

**Package
of three
Briefs of
100% Ace-
tate Tricot...**

SAVE 33^c

REG. 1.66 **133**
pk.

Ladies Acetate Panties with elastic legs. Choose white or pastels in sizes 5 to 10.



**Mom will love
the easy-care
quality of
these Toddlers
Shirts or Pants...**

SAVE TO 58^c

SHIRTS **100** PANTS **166**

Both made of Polyester and Cotton for easy-care. Pull-on pants are plain or with ric-rac trim. Print polo shirts have short sleeves and rib collars. Toddler sizes 2 to 4.



**Ladies canvas Sneakers—
Excellent for casual comfort...**

SAVE 90¢

REG.
2⁶⁷

1⁷⁷

Comfortable canvas sneakers for Ladies. Available in navy blue or white. Sizes 5 to 10. Girls sneakers in navy bl. or lt. bl. denim print. Sizes 12½ to 3.

Rmss

**Sturdy, long-wearing
Basketball Oxfords for
Men and Boys...**

SAVE 60¢

REG.
3³⁷ **2⁷⁷**

Mens, Boys or Youths durable canvas basketball oxfords. Available in navy or light blue. Youths sizes 10½ to 2, Boys sizes 2½ to 6 and Mens sizes 6½ to 12.

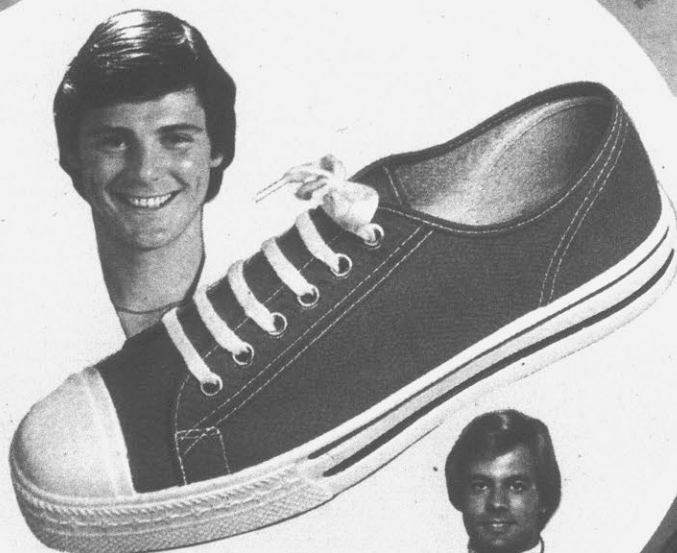

**Children's Canvas Sneakers
with cap toes
for long wear...**

SAVE 50¢

REG.
2²⁷

**1⁷⁷
PAIR**

Long-wearing sneakers for children with durable canvas uppers and capped toes to protect against scuffs. Available in navy blue, red, or lt. blue with print. Sizes 5 to 12.



**Bags to tote 'n top off
today's casual look...**

REG.
5⁹²

**SAVE
2⁰⁴**

3⁸⁸

Select Polyurethane or Canvas shoulder bags. Styles with zipper compartments, button flaps, detachable straps or outside pockets. All vinylized inside. Many basic colors.

**Tie on a
Bandana...
Makes plain
outfits classic...**

**SAVE
50¢** **2^F FOR \$1**

What makes an ordinary outfit classic? Fashion Shade Bandanas. Many ways to tie one on. Each measures 22x22" in spring colors.



**Stunning Head
Gear to
accent your
Spring fashions..**

**SAVE
83¢** **1⁴⁴
REG.
2.27**

Cleopatra styled scarves in a rainbow of solids or prints. An inexpensive, yet stunning way to accent Spring fashions. Made of Gauze.



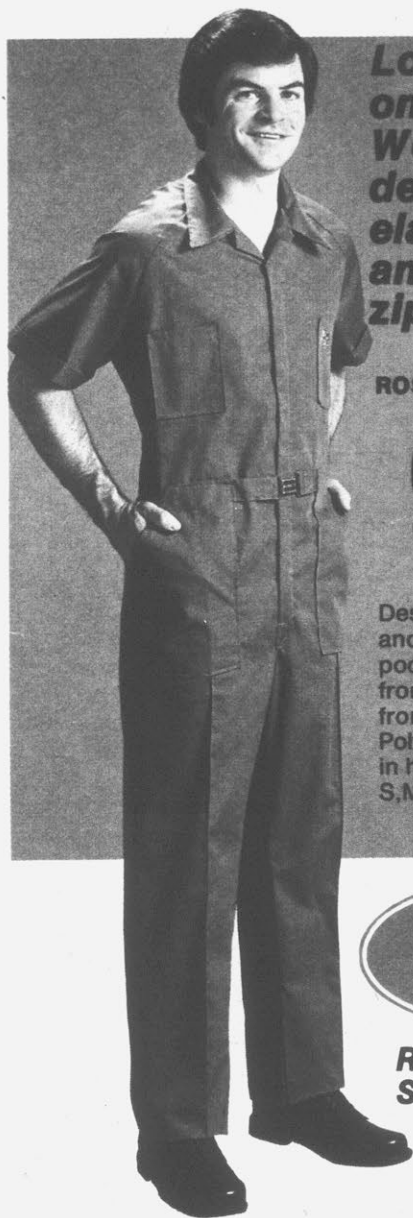

**Long-wearing
one-piece
Work Suits
designed with
elastic back
and 2-way
zipper...**

ROSES SPECIAL PRICE

9⁹⁷

Designed with 2 upper and lower, plus 2 back pockets and 2-way zipper front. Elastic back with front belt for perfect fit. Polyester and cotton blend in handsome colors. Sizes S,M,L,XL.



**ROSES MONEY
SAVING SALE**



**Just say
charge it!**



**Boy's Dress-Up
Jeans of
Brushed Fast-
back Twill...**

**ROSES
LOW
PRICE**

4⁹⁷

Brushed fastback twill jeans styled with flare legs and contrasting top stitching. Double waistband for long wear. Permanent press. Sizes Reg. and slim 8 to 18. Navy, brown, green or rust.

**Whatever your game, you'll be a
winner in easygoing, relaxed
sportswear...**

You'll look and feel like a winner when you combine these carefree casuals. **Sport-shirts** of polyester and cotton are styled for freedom-of-action and easy-care. They're classically designed with sporty placket front. Many colors in sizes S to XL. Slightly irregular. Another sporty classic - **Brushed Denims** from Mr. Wrangler®. Made of 100% comfortable cotton and styled with flare legs and contrasting top-stitching. Blue only. Sizes 29 to 38.

SPORT SHIRTS

2⁹⁷

JEANS

8⁹⁷

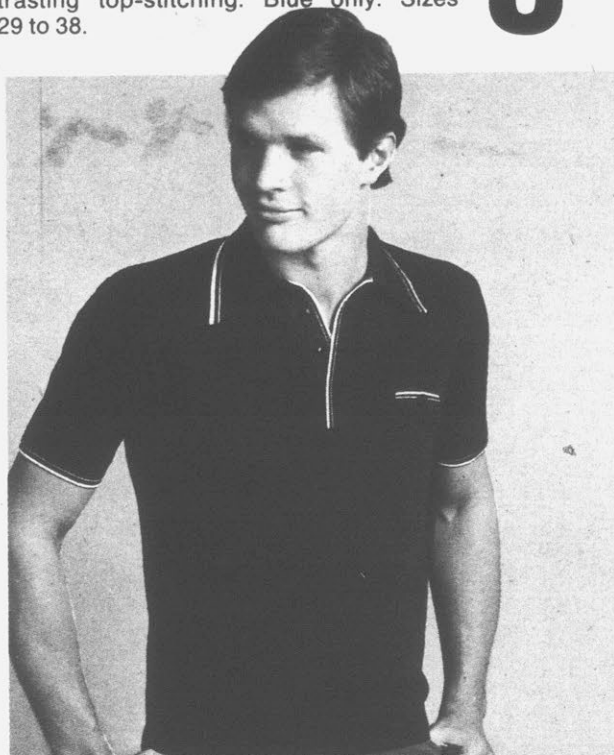

**Casual shirts of 100% Nylon
in two popular styles...**

100% nylon in two sporty styles. Crew neck or placket front, both with short sleeves. Variety of solids with or without trim. Sizes S to XL. Slightly irregular.

**ROSES
SPECIAL
PRICE**

**2³⁷
EACH**

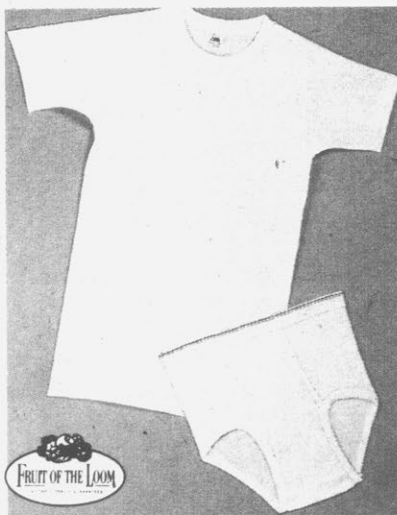

**Men's or Boy's
Basics from
Fruit of the Loom®
SAVE TO 70¢**

**BOYS
BRIEFS**

**2⁴⁹
PKG. OF
THREE**

**MENS
BRIEFS**

**3³⁹
PKG. OF
THREE**

**MENS
T-SHIRTS**

**3⁶⁹
PKG. OF
THREE**

**BOYS
T-SHIRTS**

**2⁶⁹
PKG. OF
THREE**

Mens or Boys 100% comfortable cotton underwear. Boys T-shirts and Briefs sizes 2 to 16. Mens briefs sized 28 to 42, T-shirts sized S to XL. White only.



Wrangler's



Feature-Packed Entertainment Center that sounds as good as it looks...

Features AM/FM/FM Stereo MPX Receiver, Stereo 8 Track and Cassette which records and plays, full size 3-sp. BSR Record changer, Two auxiliary microphones, four speaker matrix sound system and one pair 18" speakers. All enclosed in beautiful walnut grained finish. An entertainment center your entire family can enjoy.

SAVE \$42 → **\$157**



SHARP

12" Black and White TV with 100% Solid State Chassis...

A compact portable TV featuring rapid-on, precision UHF 70-Detent Tuner, front mounted speaker, earphone and jack, all in a choice of cabinet colors-black, white or red.

ROSES SPECIAL PRICE **\$78**



SHIRT POCKET SIZE WALKIE-TALKIES

No license required. 3 transistor - 1 crystal walkie-talkies operate on one 9-volt battery (not incl). Comes with 21" telescope antenna.

ROSES SPECIAL PRICE **\$14.76** PR.



AM-FM DIGITAL CLOCK RADIO

Full fidelity AM/FM clock radio featuring Chronotel lighted dial time display. Wake to music or alarm. White cabinet.

SAVE 5" → **\$19.77** REG. 24.95

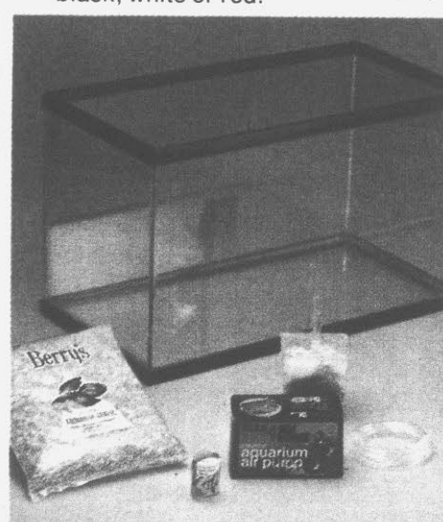

Everything you need to begin raising fish...

10 GALLON STARTER SET

SAVE 4.00 → **\$8.88** REG. 12.88

10 gallon Aquarium starter set includes glass aquarium, pump and filter kit, 5 lb. natural gravel and a food sample. All you need to start an exciting hobby.



CEDAR SHAVINGS

Net wt. 5 lb. bag cedar shavings. Perfect for all small animal cages.

SAVE 95c → **\$1.54** REG. 2.49



WEE WEE PADS

Housebreak your puppy the easy way. Treated to attract your puppy. 9 pads per pack.

SAVE 81c → **\$1.88** REG. 2.69



10-LB. BAG CAT LITTER

For cleaner more lovable pets. Sanitary and absorbent. Net wt. 10 lb.

SAVE 42c → **\$5.77**

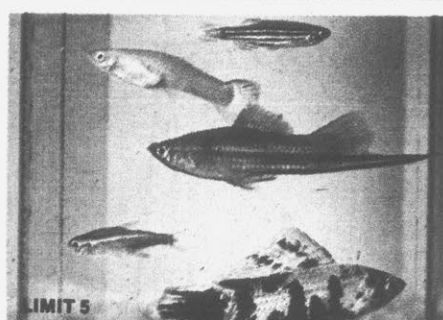

TROPICAL FISH

Select Black Mollies, Brick Red Swordtails, Gold Guppies, Neon Tetras, or Zebra Danios.

SAVE TO 95c → **\$5.00** FOR

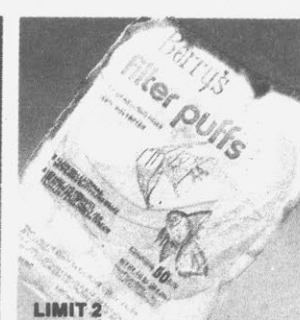

FILTER BALLS

Filter puffs for all aquarium filters. Approx. 50 per bag.

SAVE 34c → **\$66c**

Money-Saving Values for Bed and Bath...

Treat your bed to a new cover by taking advantage of this exceptional buy on Quilted Bedspreads...

Pretty as a picture. "Rhapsody" Bedspread is fully quilted to the floor. Screen printed floral bouquet comes in brown, blue or gold on neutral background. Puff quilted with polyester fiberfill; top fabric polyester and cotton. Full size only.

14⁸⁷
SPECIAL

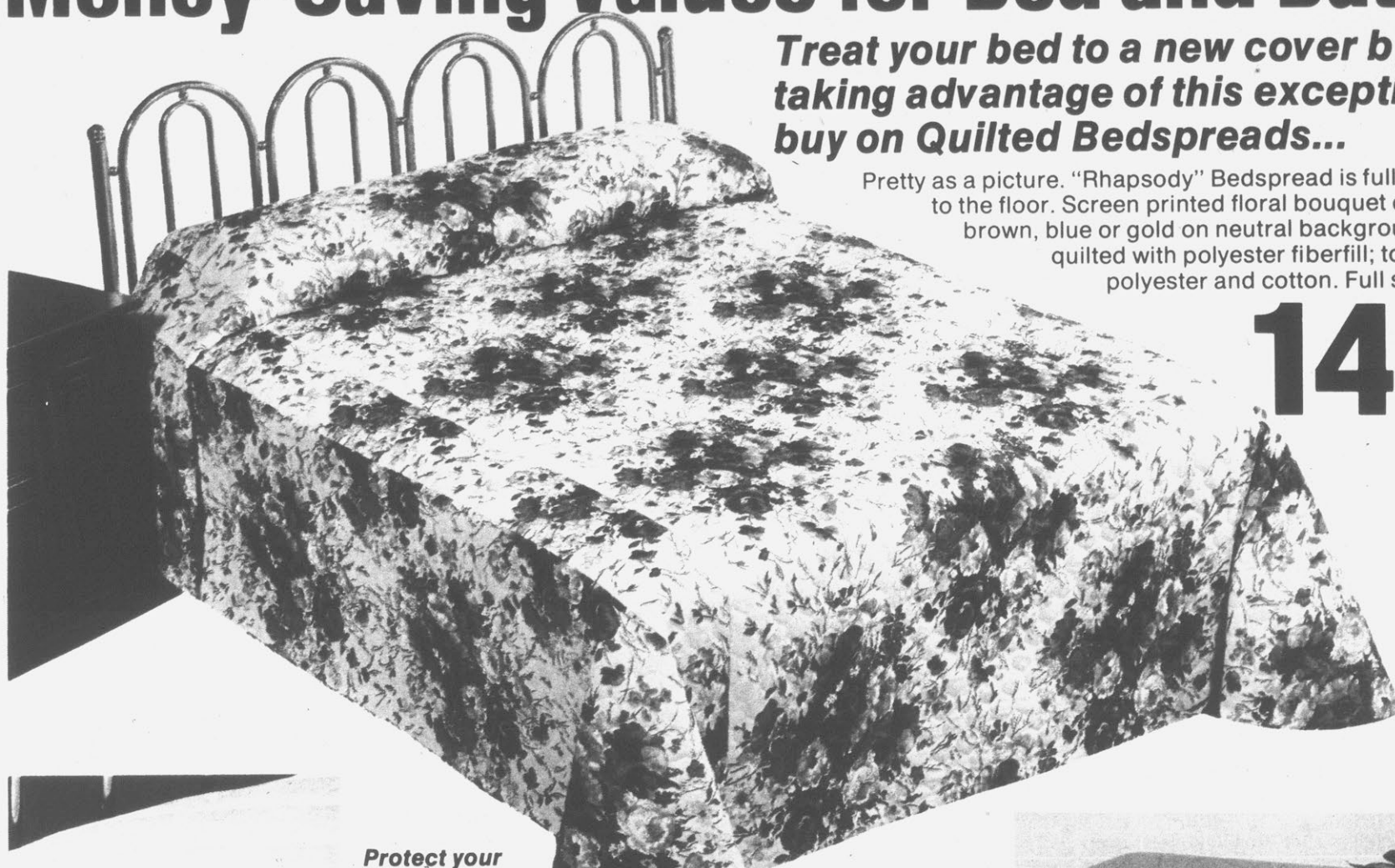

Protect your mattress with...
MATTRESS PADS

TWIN **2⁹²** FULL **3⁹²** QUEEN **4⁹²**

Stitchless mattress pads securely bonded by high-frequency sound waves. Keeps it's shape and fit. 100% polypropylene cover with polyester fiberfill. Selected irregulars.

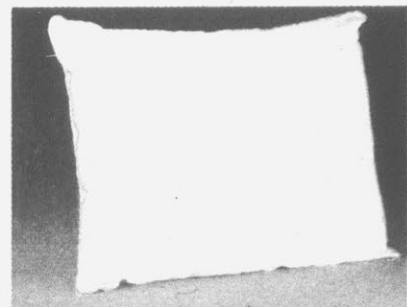
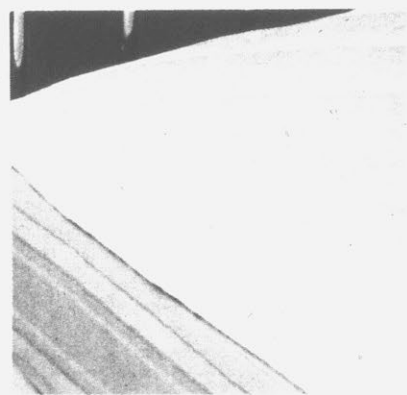

**Polyester fiberfill...
BED PILLOW**

Plump Polyester
Fiberfilled pillows
covered with white
ticking and trimmed
with blue cord.
20" x 26"

ROSES
SPECIAL
PRICE **1⁹²**

**100% polyester...
FIBER FILLING**

Ideal for cushioning,
upholstering and 101
other uses. Wash-
able, non-matting
and resilient. Net wt.
1 lb. bag

ROSES
SPECIAL
PRICE **88¢**

**Cotton and Polyester...
WASH CLOTHS**

12"x12" cotton
and polyester
wash cloths with
whip-stitched
edges.

ROSES
SPECIAL
PRICE **5^F\$1^R**

**Keeps dirty clothes out of sight...
FAMILY HAMPER**

24" clothes hamper with embossed vinyl covering. Hides dirty clothes in the nicest way. Easy to clean with a damp cloth. White, green, gold or brown.

ROSES
SPECIAL
PRICE **9⁹⁷**

Values for Home Decor...

RMS

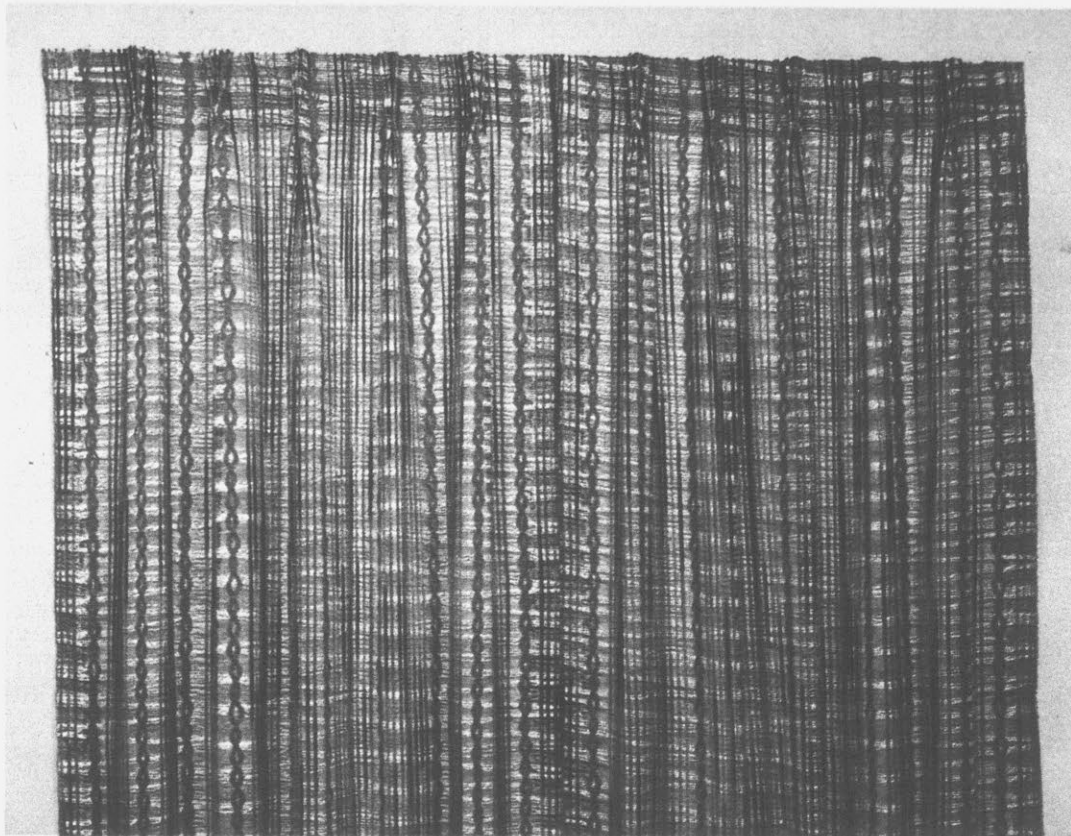

Open-weave Drapes give privacy without blocking light...

Open-weave drapes of Cotton, Rayon, Acetate and Polyester feature full bottom hems, custom blind-stitch side hems, and deep 4" pleats. Rich decorative colors. 50x84" or 50x63".

ROSES
SPECIAL
PRICE

6⁸⁸
PAIR



Ideal Material for draperies and accessories...

Boldly patterned material in Cotton, Chintz or Linen-like fabrics. Perfect for drapes, pillow covers and other accessories. 48/54" widths.

ROSES
SPECIAL
PRICE

\$1
YARD

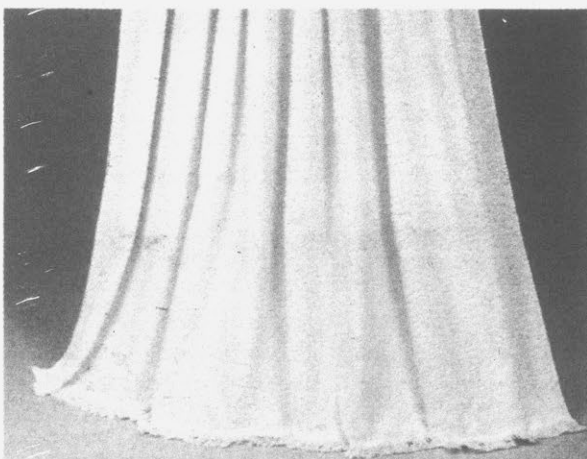

Sheared for softness...

BATH TOWELS

Made of 100% Cotton. Looped on one side for absorbency, sheared on the other for velvety softness. Puckerproof borders. 24"x44" in solid colors.

ROSES
SPECIAL
PRICE

1²⁷
EA.

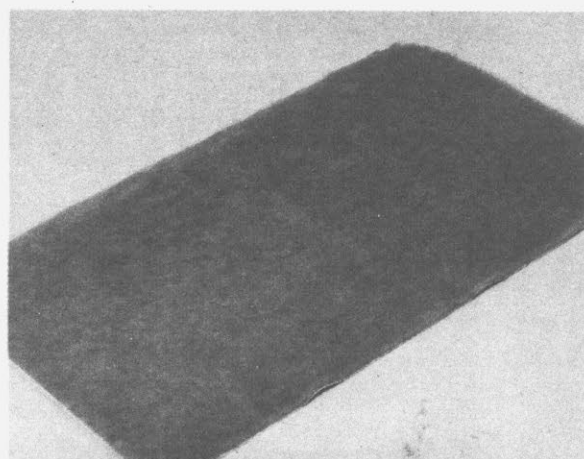

Colorful Polyester and Acrylic...

ACCENT RUGS

Soft, lustrous fur-look pile of Polyester and Acrylic. Backing helps guard against slipping. Machine washable and dryable. 18"x30" rugs come in many colors. Seconds.

ROSES
SPECIAL
PRICE

88¢
EA.

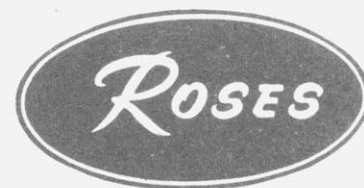

Homemakers will always find better quality and the most reasonable prices at Roses.

Satisfaction Guaranteed Always At Roses

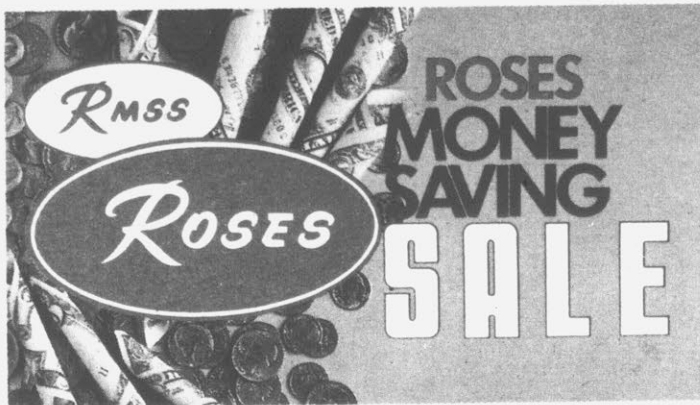

ROSES MONEY



**Sturdy hardwood...
BAR STOOLS**

SAVE TO 2²⁰

24 INCH

777

30 INCH

877

24" or 30" bar stool with 2" padded foam top. Available in green, gold, black or rust.

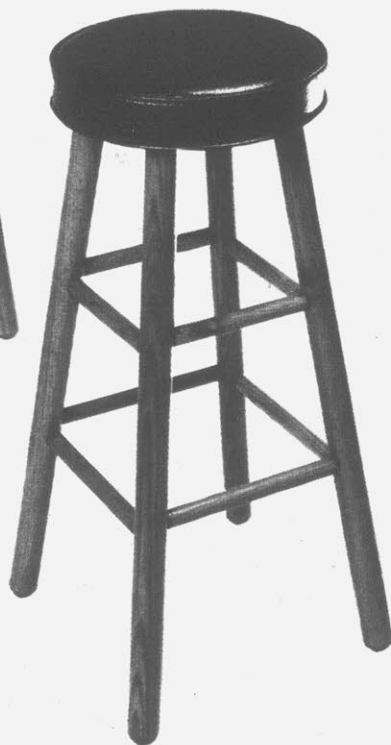

*So simple,
they're elegant...*

**LADDER
BACK
CHAIRS**

SAVE 4⁹⁷

REG.
14⁹⁷

\$10

Simply designed, these chairs are perfect for your dining area, with a desk, or as accent pieces for any room. Ready to finish as you wish.

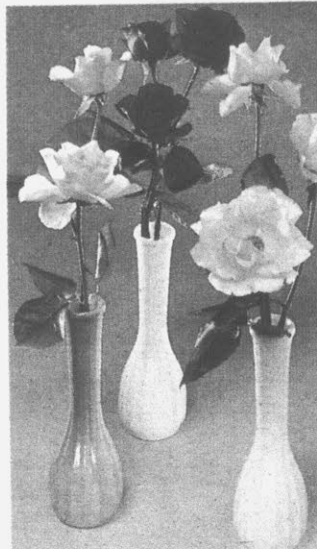

*Delicate table
accents...*

**ROSES
WITH BUD
VASES**

ROSES
SPECIAL
PRICE **\$1**
EA.

Accent any table with plastic roses arranged in matching glass bud vases. Choose white, yellow or green vases. 15 inches high overall.

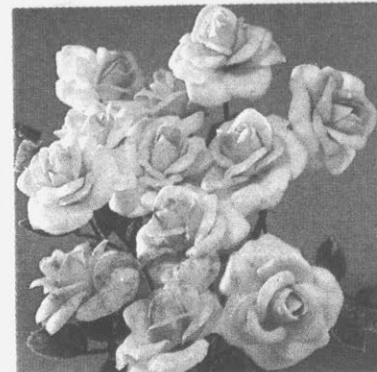

Single stemmed...
ROSES

Lovely individual Roses on a single stem create small or large arrangements. Choose red, pink, white or yellow.

12 FOR 88¢



Folled wrap
POTTED

Artificial roses arranged with artificial fern. Choose ceramic or woven basket containers. Red, yellow or pink.

SAVE 1³⁰

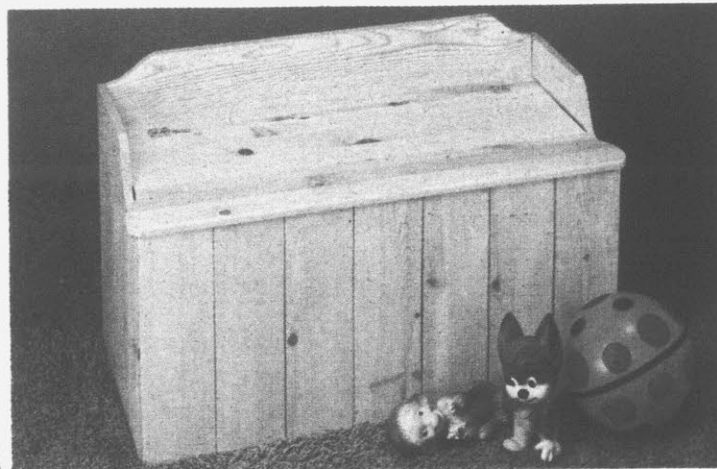

Smooth sanded and ready to finish...
WAGON SEAT TOY CHEST

Completely assembled toy chest features lift-top seat. Smooth sanded kiln dried wood is ready to paint or stain as you wish. Measures 16"x34"x22".

**SAVE
10⁰⁰**

31⁹⁷
REG.
41⁹⁷



*Traditionally
designed...*
**HURRICANE
LAMPS**

SAVE 4²⁰

REG.
15⁹⁷

11⁷⁷

Elegant glass Hurricane Lamps with traditional floral prints on milky white background. A table accent that fits most room decors. Prints in yellow, red or blue.

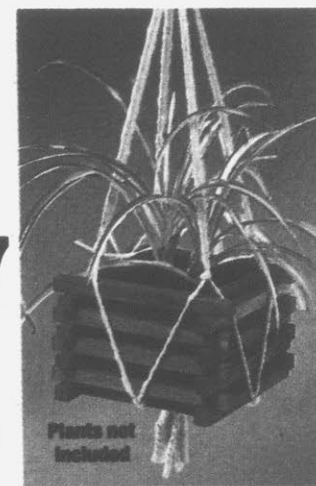

*Redwood
stained...*
**HANGING
PLANTERS**

SAVE 2⁵⁰

REG.
5⁹⁷

3⁴⁷

Redwood stained log hanging planters complete with yarn macrame rope. For indoor or outdoor use. Pot measures 9"x9"x5 1/4 inches.

SAVING SALE



Wrapped...
ROSES

SAVE 1" → **257**
REG. 3"



Ceramic or basket...
ARRANGEMENTS

Artificial roses arranged with artificial fern. Choose ceramic or woven basket containers. Red, yellow or pink.

SAVE 1" → **397**
REG. 5"



Almost like real...

VELOUR ROSE BUDS

ROSES SPECIAL PRICE **10¢** Ea.

Single long stem artificial rose buds with foliage. Deep red velour give buds texture and quality.

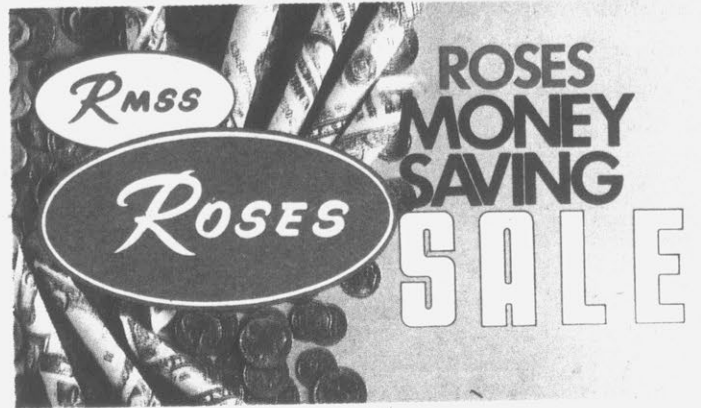

Made of Kiln dried wood with metal pulls...

UNFINISHED 3-DRAWER CHEST

SAVE \$10

REG. **37⁹⁷** **27⁹⁷**

Solid kiln dried hardwood, sanded smooth, suitable for most any paint or finish. Metal pulls on all drawers. Completely assembled. Measures 14"x25"x29".



Ideal decorative seating for porches...

DEACON'S BENCH

Colonial styled Deacon's Bench featuring spindle back, curved armrests, turned legs and arm-posts. Ready-to finish for a distinctive look. Measures 15"x40"x30".

SAVE \$10 → **31⁹⁷** REG. **41⁹⁷**



Ironstone with matching bases...

FLOWER POTS SPECIAL

\$1 Ea.

Ironstone flower pots with matching bases. Perfect for small house plants. Designed with colorful flowers. Available in a variety of colors. Approx. 4" high.



Improves all soils...

PEAT MOSS

SAVE 60¢

REG. **3⁹⁷** **2⁹⁷**

2-cubic feet Peat Moss. Improves all soils. 98% organic, absorbs up to 20 times its weight in water. For roses, trees, shrubs, flowers, etc.

Completely assembled and ready to finish...
THREE SHELF BOOKCASE

SAVE \$5

19⁹⁷ REG. **24⁹⁷**

Just paint, antique or stain for a personal look in most any room. Made of smooth sanded, kiln dried wood. Measures 9"x25"x36".



You save a bundle when you finish it yourself!

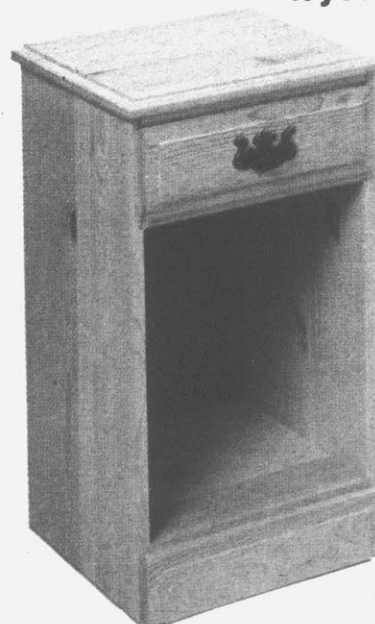

Complete with metal pull...
1-DRAWER NIGHT STAND

SAVE 2⁰⁰

REG. **18⁹⁷** **16⁹⁷**

24 inch night stand has one drawer with a metal pull. Made of kiln dried hardwood, it's assembled and ready to finish. Measures 12"x14"x24".



GE's Surge of Steam Iron features



- 38 steam vents
- Durever® cord set
- Water window

SPECIAL PRICE

15⁸⁸

Highlighted with 38 steam vents for better ironing results. Styled for ironing comfort with wrap and heel rest bar, button nooks and fingertip controls. Steam or dry—it wipes out wrinkles.

Durable Galvanized Clothes Posts... Built to last for years...

SAVE 2⁴⁸

Plastic end caps prevent insects and wasp nests.

SET OF TWO ONLY

9⁹⁹
REG. 12⁴⁷

Well constructed clothes posts are 88 inches high with 2 inch round galvanized tubing. 36 inch cross arm has holes for 5 lines. All necessary hardware included.

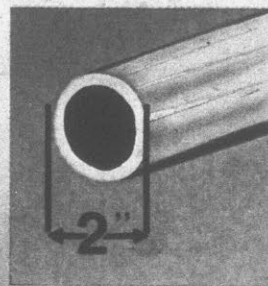

Adjusts from 2 1/2" to 36" IRONING TABLE

Features fully ventilated top, non-skid tips, baked enamel finish and finger tip adjustment.

SAVE 1⁵⁰
6⁸⁸
REG. 8.47



Plastic coated steel...

50-FOOT CLOTHESLINE

SAVE 60¢
1⁹⁷
REG. 2⁵⁷

Sturdy plastic coated steel clothesline will not rust. Fifty foot line is easy to hang.

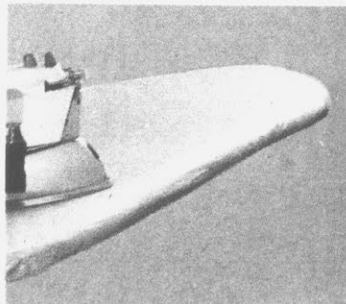
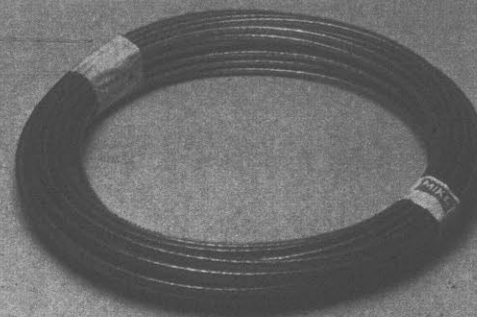

Ironing Board COVER

ROSES SPECIAL PRICE
2^F \$1^R

Silicone coated ironing board cover features elastic stretch on side. Durable, washable and wrinkle free.

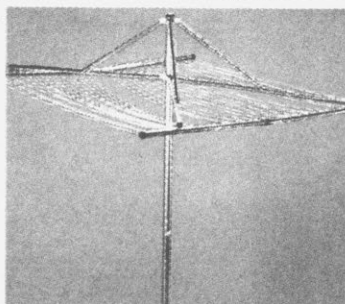

Breezair OUTDOOR DRYER

ROSES SPECIAL PRICE
12⁸⁸

Compact, yet holds big family loads. 30 lines, 182 ft. drying space. All aluminum center post is 1 1/2" thick.



Mini Galvanized PAIL

ROSES SPECIAL PRICE
88¢

Heavy galvanized steel pail. Makes a charming hanging planter. 4 pint or 2 qt. capacity.



Wicker Laundry BASKET

ROSES SPECIAL PRICE
97¢

Handsome wicker laundry basket makes heavy loads easy to carry. Rustproof and easy to clean.



Spring Hinged CLOTHESPINS

REG. 99¢
SAVE 31¢
68¢

Package of 40 double grip wooden clothespins. Spring hinged to hold clothes securely.

RMS

ROSES
MONEY
SAVING
SALE

Economical Cleaning Aids

Sturdy, lightweight Plastics to help make heavy duty work a little easier...

- 18 QT. UTILITY TUB
- 15 QT. E-Z POUR PAIL
- 28 QT. WASTEBASKET
- 1½ BU. LAUNDRY BASKET
- COUNTRY BUSHEL BASKET

YOUR CHOICE

137

ROSES
SPECIAL
PRICE

Handy plastic helpers are easy to clean, lightweight, rust-proof, and attractive. Heavy duty work is made a little easier with these light-to-lift plastics. Select 18 qt. utility tub, 15 qt. E-Z pour pail, 28 qt. rect. wastebasket, 1½ bu. rect. laundry basket or 1 bu. round country basket. Several colors to choose from.

Limit 1 each



Package of ten...
EASY WIPES

Strong, reusable wiping cloths. Each measures 2"x13". 10 per package.
ROSES SPECIAL PRICE **38¢**



Lysol Deodorizing...
SPRAY

Kills household germs, mold and mildew. Eliminates odors. Net wt. 21 oz.
ROSES SPECIAL PRICE **168**



Lysol Deodorizing...
CLEANER

Liquid deodorizing cleaner for almost every washable surface. 15 fl. oz.
ROSES SPECIAL PRICE **68¢**

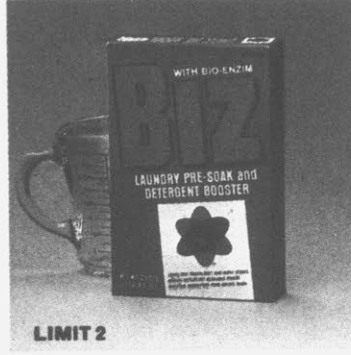

Detergent Booster...
BIZ

Boosts detergent cleaning power. Whitens and brightens whole wash. Net wt. 25 oz.
ROSES SPECIAL PRICE **\$1**



Package of six...
SPONGES

Variety of six cellulose sponges for kitchen, bath, office, anywhere.
ROSES SPECIAL PRICE **48¢**



Four sizes to choose from...
TRASH BAGS

ROSES SPECIAL PRICE **125** BOX

Select 44 qt. Tall Kitchen (Box of 30), 20-23 gal. Trash & Grass (Box of 20), 33 gal. Trash & Lawn (Box of 15) or 6 bu. Leaf bags (Box of 10).

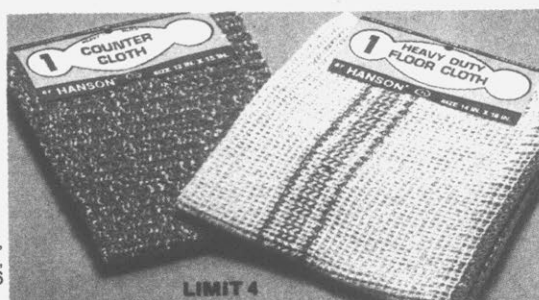

Durable Counter or Floor...
CLOTHS

ROSES SPECIAL PRICE **288¢**

12"x15" counter cloths or 14"x18" floor cloths. Both are absorbent, durable and machine washable.

Exceptional Money-Saving Values....

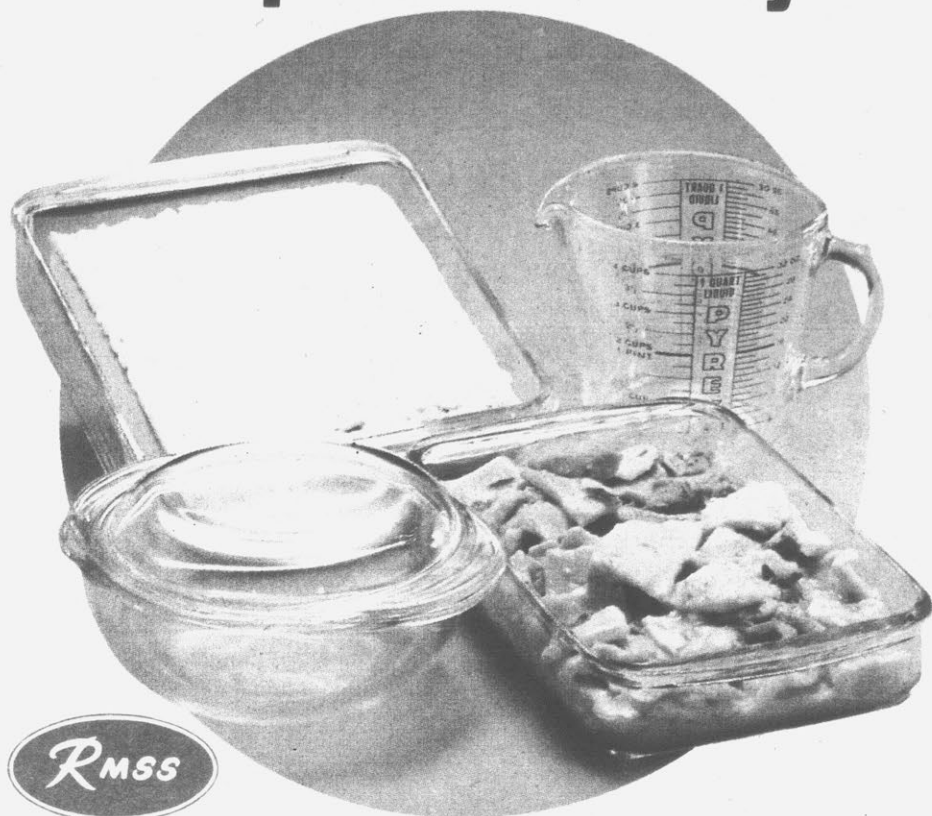

Pyrex®, the durable glassware that goes from freezer to oven to table...

Clear Ovenware—still America's favorite dish because no matter what you do with it—prepare, bake, serve or store—you can tell just what you have. Choose 8" sq. cake dish, 1½ qt. utility dish, 32 oz. measuring cup, or 1 qt. casserole with cover.

SPECIAL 1²⁷ EACH



Fine quality Porcelain ware with classic Williamsburg design...

7 PIECE SET ONLY

16⁸⁸ SPECIAL

Heavy gauge steel cookware with permanently decorated porcelain finish. Features Vapor-seal rim and heat resistant handles. Set includes 1 qt. and 2 qt. saucepan w/cover, 5 qt. covered casserole, and 10" skillet. Brown or green.



Spice 'n Nice... **CANISTER SETS**

ROSES SPECIAL PRICE **2⁶⁶**

Four piece canister set, each with colorful Spice 'n Nice design and tight fitting plastic lids.



Non-stick, double... **FAST COOKER**

ROSES SPECIAL PRICE **12⁷⁷**

Cooks anything you can put between two slices of bread. Non stick, no splatter surface makes clean-up easy.

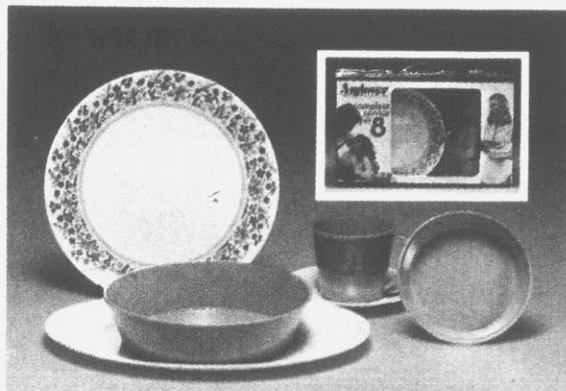

Break and chip resistant...

34 PC. MELAMINE SET

Melamine in Mardi Gras, Meadow Song or Westchester Patterns. Fade proof, stain resistant and dishwasher safe. Set includes 8 each - plates, cups, saucers, and cereal bowls, 1 veg. bowl, 1 oval platter.

ROSES SPECIAL PRICE **9⁸⁸**



Williamsburg...

TEA KETTLE

2 qt. porcelain covered steel tea kettle in Williamsburg pattern. Brown or green.

ROSES SPECIAL PRICE **5⁸⁸**

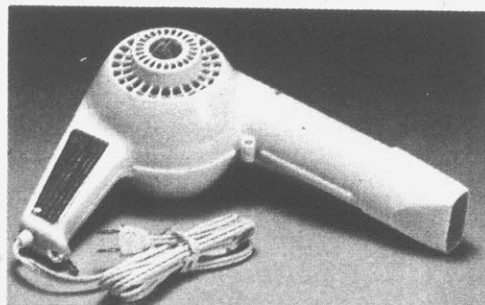

1100 watt...

BLOW DRYER

ROSES SPECIAL PRICE **9⁸⁷**

A lightweight Professional Styler Dryer with 1100 watts of power. Features 3 push button settings.

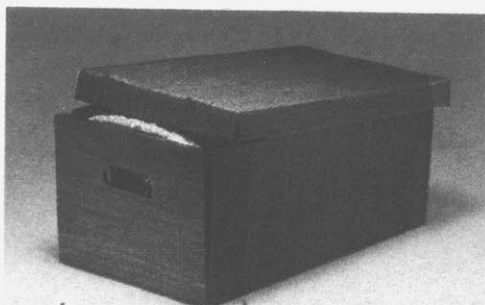

Economy woodgrain...

STORAGE CHEST

ROSES SPECIAL PRICE **88[¢]**

200 lbs. Test Fiberboard chest with dust tight construction. Assembles in seconds. Measures 24½"x13"x10½".

Fun Gear with Sporting Prices



For right
or
left hand...

OLYMPIC ROD AND REEL COMBO

ROSES
SPECIAL
PRICE **18⁸⁸**

Spinning Rod features fuji guides and anodized aluminum reel seats. 1500 VD Reel features anodized skirted spool and double hand lock. Convertible for right or left hand.



Spalding's Tom
Seaver Model...

BASEBALL GLOVE

ROSES
SPECIAL
PRICE **12⁸⁸**

Top Grain leather glove featuring EZ Flex rawhide lacing, nylon stitching, solid web and sweetspot pocket.



Top grain steer
hide...

SOFTBALL GLOVE

SAVE
7⁰⁸ **14⁸⁸**
REG. 21.96

Custom built glove features deep grip pocket, nylon stitching, and rawhide lacing.



Deluxe
Wood Frame...

TENNIS RACKET

ROSES
SPECIAL
PRICE **3⁹²**

Features fibre throat reinforcement, 8-ply vinyl grip and nylon strings.



Winn
Championship
TENNIS
BALLS

ROSES
SPECIAL
PRICE **1⁶⁶**

For play on all court surfaces. Three yellow balls per can.

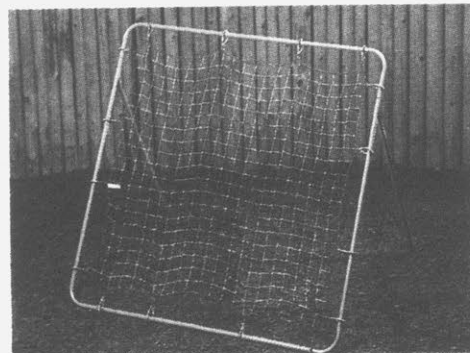

Returns balls from
any distance...

38" x 38" PITCHBACK

ROSES
SPECIAL
PRICE **7⁸⁸**

Durable nylon and steel construction with dull back braces and ground anchors. For indoors or outdoors.

Baseball, Soft-
Ball or Little
League...

BATS

Little League	Soft Ball	Base- Ball
------------------	--------------	---------------

2⁶⁶ 2⁸⁸ 2⁹⁷

Choose solid 31 to 36 inch baseball bats, flame retardant ash softball bat in 33" or 34" lengths or Little League Bat of northern white ash in 27" to 32" lengths.

Softball or Baseball
ROSES
SPECIAL
PRICE **97¢ 1⁹⁷**

H&B official baseball with compressed center or ASA approved softball with wound cork center.

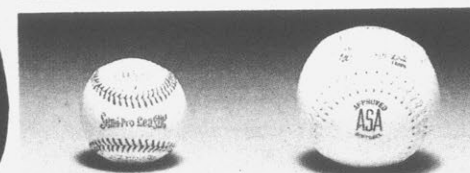
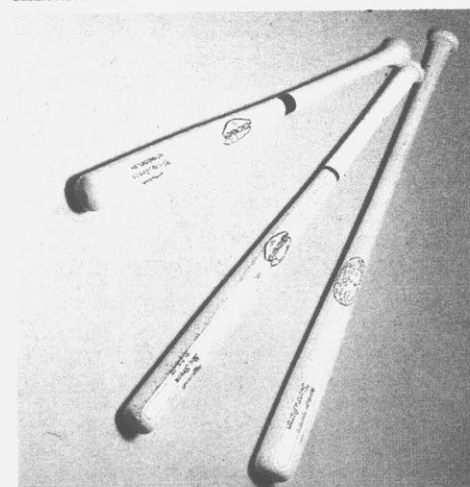

Single Speed
20" Motor
Cross Bike
with Sleek
black finish...

THUNDER ROAD

59⁹⁶
SPECIAL

Rugged twin cantilevered frame lasts for years. Bike features coaster brake, front and side number plates, deluxe HMX style saddle, 20x2.125" knobby tires.





**ROSES MONEY
SAVING SALE**

*Made of heavy duty
polished aluminum...*

CROSSOVER TOOL BOX

**ROSES
SPECIAL
PRICE** **\$88⁰⁰**

Crossover Tool Boxes for fleetside pickups. Features spring loaded lids and adjustable sliding tray with dividers. All your tools in one neatly organized box. Fits snugly against cab to prevent excessive rattling.

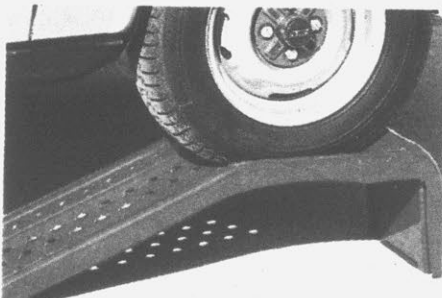
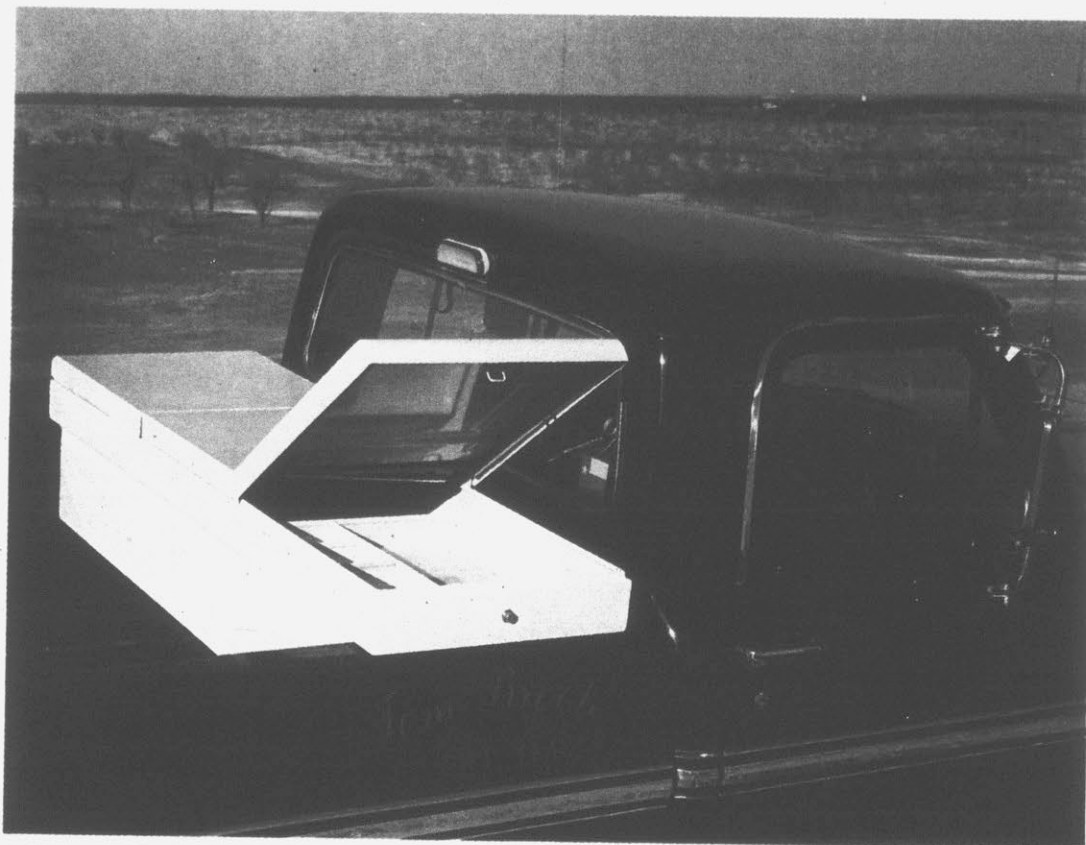

Supports up to 5000 lbs...
AUTO RAMPS

**ROSES
SPECIAL
PRICE** **16⁸⁸**
PAIR

Durable baked enamel, yet lightweight and portable for storage. Supports up to 5000 lbs. in pairs.

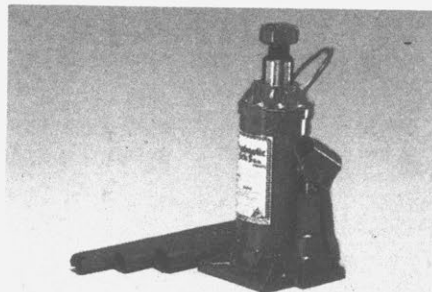

5-ton capacity...Hydraulic
FLOOR JACK

**ROSES
SPECIAL
PRICE** **12⁸⁸**

Offers smooth, easy operation whenever pushing or lifting is required. Three piece locking handle included.

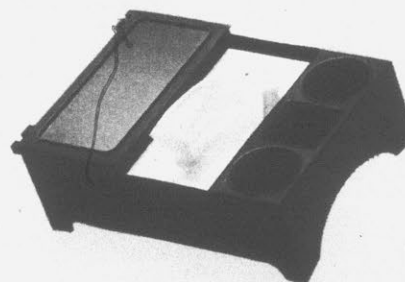

Convenient car...
CONSOLE CENTER

**ROSES
SPECIAL
PRICE** **2⁹²**

Features hinged lid compartment, place for tissues (1 box included), litter basket, snack tray and 2 cups. Black only.

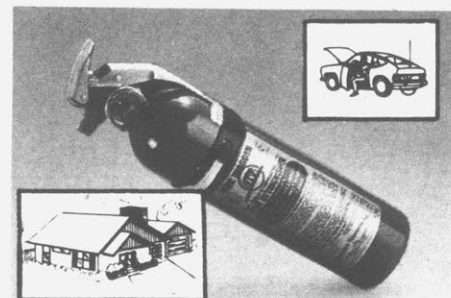

Dry chemical...FIRE
EXTINGUISHER

**ROSES
SPECIAL
PRICE** **6⁸⁷**

Ideal for home, office or car. Lightweight and easy to use. Complete with mounting clamp. For fighting grease, oil or gas fires.

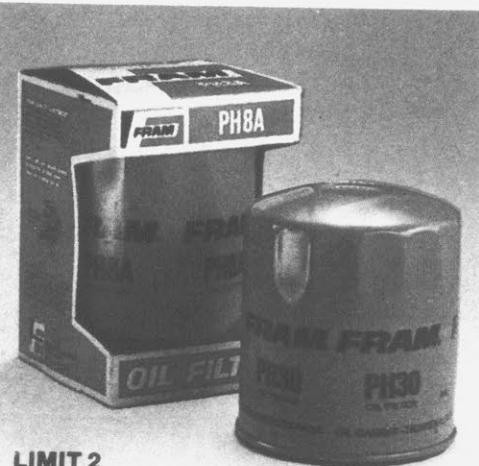

LIMIT 2

*Keeps dirt and rust
particles out...*

FRAM OIL FILTERS

**SAVE
97¢** **1⁸⁸**
REG.
2⁸⁵

Fram "single" oil filters keep your oil cleaner to make your car run smoother. Choose PH8A, PH-25, or PH-30.



*All you need to change
your oil yourself...*

OIL CHANGE KITS

**ROSES
SPECIAL
PRICE** **3³³**
KIT

Kit includes oil pouring spout, filter wrench, galvanized oil pan and oil change instruction booklet.

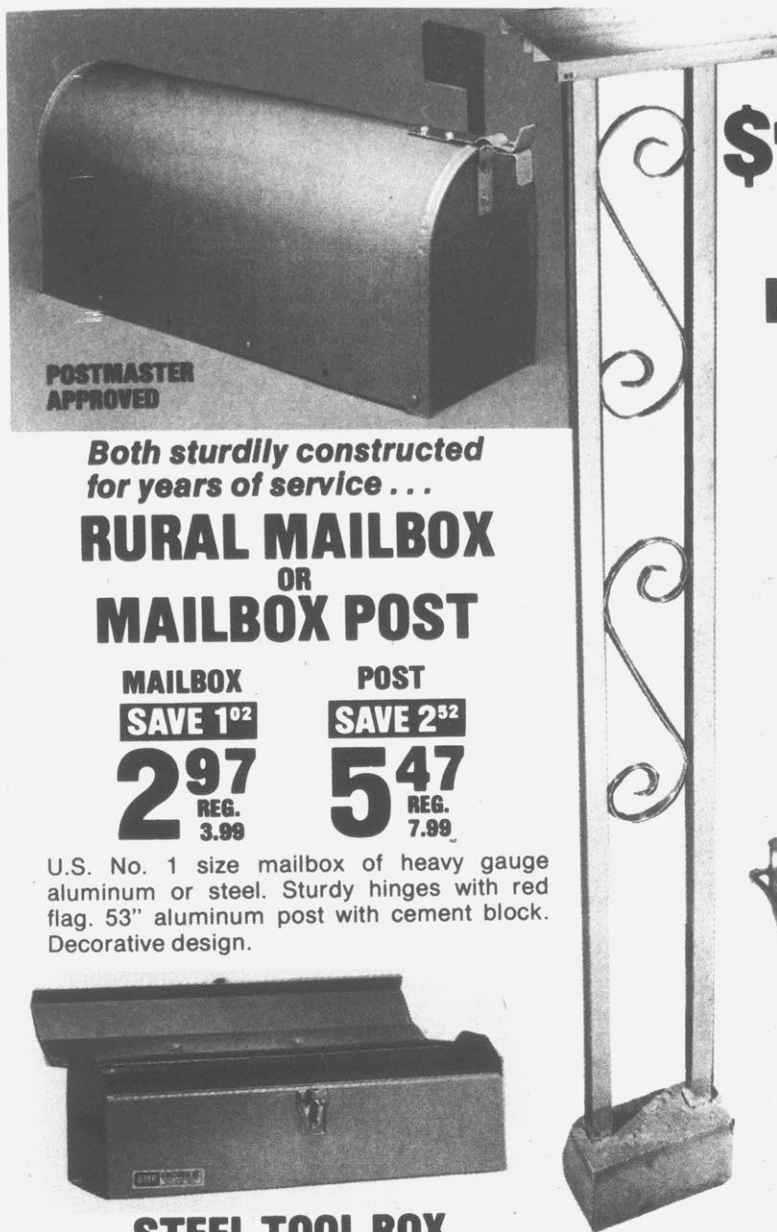

POSTMASTER
APPROVED

Both sturdily constructed
for years of service...

RURAL MAILBOX OR MAILBOX POST

MAILBOX

SAVE 1⁰²

297
REG. 3.99

POST

SAVE 2³²

547
REG. 7.99

U.S. No. 1 size mailbox of heavy gauge aluminum or steel. Sturdy hinges with red flag. 53" aluminum post with cement block. Decorative design.



STEEL TOOL BOX

Heavy steel welded tool box with baked high gloss enamel. Measures 19"x6" and weighs 4 lbs. Steel gray with tray.

ROSES
SPECIAL
PRICE

388



4" POLYESTER PAINT BRUSH

4 in. paint brush with soft polyester bristles and sturdy wood handle.

SAVE 1¹¹
REG. 2.99



LAN-LIN[®] HAND CLEANER

Lan-Lin hand cleaner makes cleaning up easy. Just rub-on, rinse and wipe off. Net wt. 1 lb. jar.

ROSES
SPECIAL
PRICE

148

Do-It-Yourself and SAVE TWICE

\$150 CASH REFUND ON LUCITE[®] PAINT

SAVE WITH ROSES LOW PRICES. THEN WRITE YOURSELF A REFUND FOR ADDITIONAL SAVINGS OF \$1.50 OR MORE.

The more gallons you buy the bigger your refund.



LUCITE[®] House Paint

BUILT-IN PRIMER • DRIES IN AN HOUR • WATER CLEAN-UP

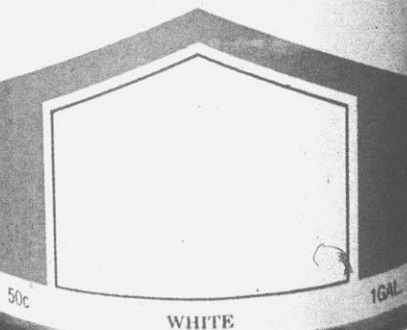

LUCITE[®] Wall Paint

NO STIR • NO MESS • 1/2 HOUR DRY • WATER CLEAN-UP

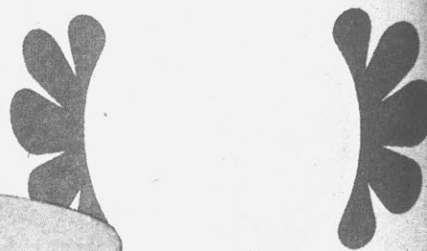

ANTIQUÉ WHITE

LUCITE[®] WALL OR HOUSE PAINT

SAVE TO \$2

WALL
748
GAL.

HOUSE
897
GAL.

No stir, no mess wall paint dries in 1/2 hour. Variety of colors. House paint has built-in primer and dries in 1 hour. Both clean-up with water. White only. 1 gallon cans.



ROSES MONEY
SAVING SALE

MAIL IN CERTIFICATE

\$150 *DO-IT-YOURSELF* Per Gal. CASH REFUND

ONLY ONE COUPON
NEEDED REGARDLESS
OF GALLONS PURCHASED

Offer Good Only On Gallons of LUCITE[®] Paints Purchased Between Mar. 13 & Apr. 11, 1977. Quarts not eligible.

NO. GALLONS PURCHASED _____ X \$150 per Gallon = _____ TOTAL CASH REFUND (Enclose cash register receipt and labels)

- To get your refund check:
1. Send this coupon with complete name and address.
 2. Send your cash register receipt and front portion of labels for each \$1.50 claimed (as illustrated on right) as proof of purchase. Quarts not eligible.
 3. Mail to: LUCITE[®] CASH REFUND
P. O. Box 7818-A/Philadelphia, PA 19101



NAME _____
(Please print)
STREET _____
CITY _____
STATE _____ ZIP _____

Request for refund must be postmarked no later than May 9, 1977. Void where taxed, prohibited, or otherwise restricted. Portion of front labels for rebate claim may not be mechanically reproduced. Allow 6-8 weeks for refund check.

Rmss

ROSES

MONEY SAVING SALE

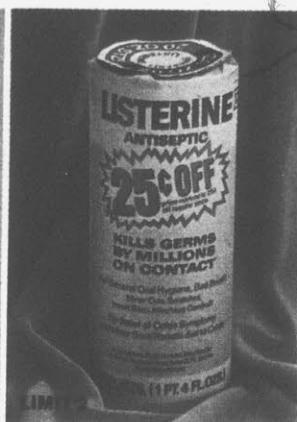

Keeps breath fresh...

20-Fl. Oz.
LISTERINE
ROSES SPECIAL PRICE

99¢

20 fl. oz. of Listerine® Antiseptic mouthwash for general oral hygiene and to help prevent bad breath.



Leaves no film...

ZEST
BATH BAR
ROSES SPECIAL PRICE

28¢ EA.

Zest Deodorant beauty bar in the convenient bath size bar. Makes you feel fresh. Net wt. 5½ oz.

COUPON
CLIP AND SAVE ON FILM PROCESSING

\$1.00 off
Regular price

Present this coupon to your local Roses Store and we'll knock \$1.00 off the regular price of developing and printing film. Good for C110/12, C110/20, C126/12 or C126/20 film.
COUPON GOOD MARCH 16-19, 1977 NO CASH VALUE



Regular or Super...

KOTEX®
TAMPONS
SAVE 50¢

1.27
REG. 1.77

Kotex Stick Tampons with supercotton fibers for super absorbency. Box of 30 individually wrapped. Reg. or Super.



Special Care Lotion...

ROSES 'N CREAM
ROSES SPECIAL PRICE

68¢

Roses own Roses 'N Cream special care lotion. Soothes extra dry skin fast. 16 fluid ounces.

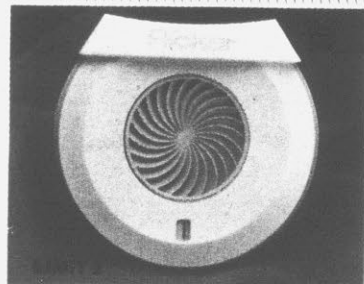

SAFETY SHAVER
FLICKER®

A ladies safety shaver designed to cut hair not skin. Includes five blades.

ROSES SPECIAL PRICE
87¢ EA.



Big enough to share...
KING SIZE
CANDY BARS

Select Milk Chocolate, Fruit and Nut, Almond, Caramelo, Peppermint or Coconut. All net wt. 6 oz. bars.
SAVE 20¢
57¢ REG. 77¢

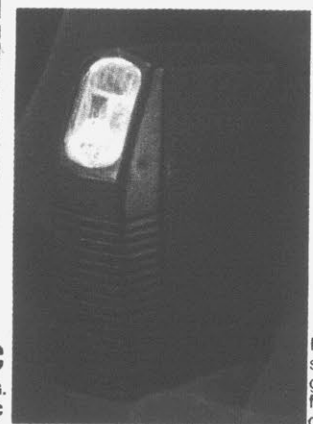

The one year disposable...

ENDURA®
LIGHT
SAVE 12¢

87¢

Features textured grip surface and switch that glows in the dark. Great for camping, home, car, or purse. Fashion colors.



Antiperspirant, deodorant...

TICKLE®
ROLL-ON
ROSES SPECIAL PRICE

99¢

New from Bristol Myers. Four delightful fragrances of Tickle Roll-on deodorant. Keeps you dry all day. 2 fl. oz.

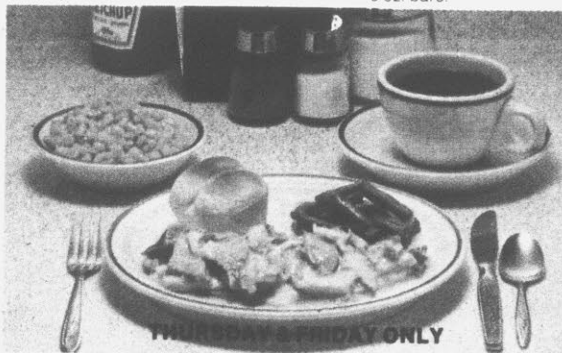

CHICKEN 'N DUMPLINGS
HOT LUNCH

SAVE 20¢
1.37
REG. 1.57

Plate includes Chicken and Dumplings, green beans, corn, rolls, tea or coffee. Available at stores that serve plate lunches.

Satisfaction always guaranteed.

Supplement to Daily Reflector & Reflector Shopper's Guide

Rmss **ROSES**

ALL ITEMS ARE AVAILABLE IN LARGE STORES. MOST ITEMS AVAILABLE IN SMALL STORES. WE RESERVE THE RIGHT TO LIMIT QUANTITIES ON ANY ITEM. ALL SPECIALS WILL BE SOLD ON A FIRST COME BASIS.

PITT PLAZA SHP. CN.
Greenville, North Carolina