

Edmisten Lifetime Tax Record Opened

RALEIGH (AP)—Saying he hoped the issue is finally settled, Democratic attorney general nominee Rufus Edmisten today revealed his income and taxes paid for his "entire adult life."

At a breakfast for newsmen in Raleigh, Edmisten also said he will pay any back taxes owed North Carolina then challenged his opponent, Republican Atty. Gen. James Carson, to reveal his private income and tax records.

Edmisten further said he plans to let the matter drop once he has settled it with the state. He said he would refuse to discuss it in the event Carson supporters continue to push the issue.

Edmisten, a former aide of

retiring Sen. Sam Ervin Jr., D-N.C., admitted last week that he didn't file North Carolina tax returns during the decade he worked in Washington and lived in the Washington suburb of Alexandria, Va. He said he paid Virginia taxes are required by that state's law and didn't file in the Tar Heel state, adding that he didn't know he had to.

The issue was raised by a University of North Carolina law student and Carson supporter during a debate at Chapel Hill. Edmisten has consistently charged, and Carson has consistently denied, that Carson supporters in some manner gained access to confidential records in the Department of Revenue.

In this morning's news conference, Edmisten revealed he paid \$85,099 in taxes over the past 11 years. He called the tax rate "virtually confiscatory."

His federal taxes, however, were joint returns with his wife, an attorney with the U.S. Justice Department. His financial disclosure statement listed only his income but he said his wife's income was about two-thirds of his.

The candidate said he couldn't divide federal taxes applied to his income and his wife's because of deductions and other overlapping factors in a joint return.

His statement showed his 1973 income being more than \$34,000 with \$1,525.77 paid in Virginia taxes. In 1963, his income was \$1,631.92 with a tax of \$4.21 paid Virginia.

Edmisten said he anticipates paying North Carolina back taxes, but only the difference between what he paid in Virginia and would have paid in

North Carolina. The Tar Heel state has a slightly higher income tax than does Virginia.

The candidate also criticized Republican Gov. Jim Holshouser for a statement last week that Edmisten would owe "thousands and thousands of dollars" in back taxes. Edmisten said that simply isn't true, that all he would owe probably would average a "couple of hundred dollars" a year.

Edmisten also disputed an opinion by two Democratic lawyers in the attorney general's office that revealing only whether a person had filed state income tax didn't violate the Revenue Department's confidentiality.

He said a state secrecy law clearly prevented such disclosure. He said it "would be a 1984 situation" if such disclosure were legal.

Ervin To Open Bicentennial

Sen. Sam Ervin, Jr. will be the principal speaker at the opening day's ceremonies of the Greenville Bicentennial Celebration Friday. Following Ervin's address will be the Grouping of the Flags in which each flag flown over the state will be raised. These include the British Colonial flag, which flew at the time Greenville was founded, the Grand Union Flag of 1776, the Confederate Flag, and the Flag of the United States of America. In addition, North Carolina's state flag will be raised.

Music will be provided by the Cherry Point Marine Band and Color Guard, the Rose High School Band, the East Carolina University Band, the Greenville Junior and Senior High School Chorus, and the North Pitt Chorus.

The ceremonies will begin at the Town Common at 5:30 p.m. The merchants of Greenville have been asked to close their stores during this time so their employees may attend.

REFLECTOR

HOTLINE



752-1336



Hotline gets things done for you. Call 752-1336 and tell your problem or your sound-off or mail it to Hotline, The Daily Reflector, Box 1967, Greenville, N.C. 27834.

Because of the large numbers received, Hotline can answer and publish only those items considered most pertinent to our readers. Names must be given, but only initials will be used. Transcribing is done once a day, but the phone service is available 24 hours a day.

\$10 ERROR ON EACH

I went out to Nichols Discount City to buy a circular saw advertised in one of their sale circulars for \$9.88. I was told they had sold 91 that day, all they had, for that price, but they would not give me a raincheck. Why? J.R.D.

Nichols manager Tyrone Potter said the price, \$9.88, was a typographical error which cost Nichols a lot of money. The circulars are printed in Atlanta four months ahead of time, he said. Posted with the circular saw display was a letter of apology from the printer—the price should have been \$19.88. However, the company authorized the sale of all the saws in stock, at the price advertised, so 91 persons got a mighty good deal. Potter said, though, that there was no way the company could give rainchecks on the item and reorder and continue to sell at this price that would cause the company to lose several dollars on every saw they sold.

On the front of each sale circular is a statement that Nichols is not responsible for typographical errors in the circular, he added.

Potter said he regrets your disappointment, but trusts you to understand the company's position in this unusual and unfortunate situation.

NO REFUND

My son visited in Arizona this past summer and decided he wanted to go to school there. He came home for a visit with us, though, and then made up his mind to stay here. He sent in a round-trip ticket he'd bought for \$165 to the Continental Trailways office in Dallas, Tex. He got a letter saying he wouldn't get a refund, and he didn't even get the ticket back. B.H.

Hotline called the refund department of the Continental Trailways Accounting Office in Dallas. We talked to Martha L. Miller, the same lady who had received your son's letter and answered it. She explained that his ticket booklet was an "Eagle pass," which allowed him to travel anywhere in the continental United States within a month after purchase. On the booklet was stated that no unused coupons could be returned for refund.

It's a shame your son did not get full use of the pass, but the time for use of the booklet has now expired.

Picking Jury

WASHINGTON (AP) — U.S. District Judge John J. Sirica today resumed the painstaking process of selecting a jury in the Watergate cover-up trial.

Lawyers familiar with the trial of three of former President Nixon's closest aides said they expect Sirica to be deliberate and careful in the selection process because of the massive publicity surrounding the trial.

As the second day of the trial opened, Sirica advised the new group of 175 prospective jurors to be aware of "the solemnity of your duties."

Some 90 members of an initial pool of 155 potential jurors were excused Tuesday after saying they would be unable to sit through the trial, expected to last at least until Christmas.

For \$20 a day, the 12 jurors and six alternates will be required to shuttle back and forth to Sirica's courtroom from a nearby hotel.

Clot In Nixon's Lung Dissolving

LONG BEACH, Calif. (AP) — A blood clot in Richard M. Nixon's right lung has begun to dissolve, his doctor reports.

In his daily medical bulletin Tuesday, Dr. John C. Lungren said tests showed no new clot had developed since the former president began taking anticoagulants.

Lungren said that the clot that moved from Nixon's left leg through his heart and into the right lung was being naturally absorbed into his system. The clot was created by chronic phlebitis in Nixon's left leg.

Taylor Resigns Schools Office

John H. Taylor Jr. has resigned his position as administrative assistant to the Pitt



JOHN H. TAYLOR, JR.

County Board of Education to accept a position with Procter and Gamble.

The Pitt County Board of Education Tuesday adopted a resolution commending Taylor for his services to the Pitt County Schools during an extremely difficult period of time in the history of the local schools.

A Greenville native, Taylor graduated from C. M. Eppes High School and Shaw University. He has done graduate work at Shaw and East Carolina University.

A veteran of the Korean War, Taylor spent 18 years in the field of education, 13 of those years where with the Pitt County Schools. He began his career in Pitt as a science teacher, junior varsity basketball coach and music program coordinator at W. H. Robinson School. He (Cont'd on Page 13)

Council Agenda Is Set

One of the shortest agendas in recent months is scheduled for consideration at Thursday night's City Council session at city hall.

Among the 13 items are: a report on the status of Community Development Program Planning and consideration of proposed citizen participation process and budget; appointments to the Redevelopment Commission, Sheppard Memorial Library Board, and the City Board of Adjustment;

Public hearings on street improvement petitions; requests for renewal of mobile home permits; consideration of a proposed ordinance amending the City-Code relating to pool rooms and billiard rooms; consideration of two applications for pool table permits; and discussions concerning the proposed Greenville Thoroughfare Plan.

Items scheduled under new business include: approval of a proposal for furnishing lighting fixtures and posts for the Central Business District Urban Renewal Area Pedestrian Way System;

Consideration of bids for purchase of a new motor grader for the Public Works Department; a request by Porter Auto Parts for permission to provide wrecker service for the Police Department; presentation of the annual report of the Greenville Board of Adjustments;

Consideration of approval of an agreement with the Pitt-Greenville Airport Authority for provision by the city of certain financial and personnel services; and a request by the Charles Gray Morgan Veterans of Foreign Wars Post 7032 for waiver of the privilege license requirements.



Midway Sharpshooter

STEP RIGHT UP... "Shoot a Snoopy" and you get a prize every time, Gayle Underwood, 19-year-old of Nashville, Tenn. will tell you, if you pass her shooting gallery booth on the midway of the Pitt County Fair. Here she shows how it's done. Pitt County Fair manager Sam Winchester said crowds Tuesday were estimated at between 4,200 and 4,300 "almost four times as great" as the

Tuesday night attendance last year when heavy rains kept many fair-goers away. The fair, sponsored by the American Legion Posts in Pitt, will run through Saturday night, with more than 40 educational exhibits on display in the exhibit hall and the Buck-Page shows on the midway, featuring rides, shows and novelty concessions.

Grifton School Addition Low-Bidder Is Announced

By BLANCHE HARDEE
Reflector Staff Writer

The Pitt County Board of Education yesterday named J.H. Hudson, Inc., of Greenville as low bidder for general construction for classroom additions to the Grifton School.

Other low bidders were: Stuart Shinn, Inc., Greenville, electrical construction; W.M. Wiggins Co., plumbing construction; and Electricon, Inc., heating construction.

Hudson's bid for the project totaled \$67,670. Other general contractors bidding were: Evans Construction Co., \$81,975; Gardner Construction Company, \$84,517; Hargison Construction Company, \$93,770; J. Leo Hawkins, \$67,853; Stackhouse, Inc., \$68,994; Wells-Leroy Associates, \$97,895; and Wimco Corporation, \$76,646.

Stuart Shinn's bid for electrical work was \$7,070. Other electrical bidders and their bids were: Electricon, Inc., \$7,820; Stackhouse, Inc., \$9,018; Watson Electrical Co., \$7,979.

The low bid for plumbing by W.M. Wiggins Co. totaled \$5,252. Other bids were: Brewer Plumbing and Heating Co., \$7,403; Kinston Plumbing and Heating, \$7,125; Kipco, Piping Co., \$7,600; Stuart Shinn, \$7,979.

Electricon, Inc., was low bidder for heating with a bid totaling \$7,600. Other bids for heating included: Henry Baker Heating Co., \$10,829; Jones Cooling and Heating, \$8,194; Kinston Plumbing and Heating, \$14,680; Southern Piping Co., \$9,090.

Total cost of the project, including architectural fees, is \$91,239. The project, totaling approximately 3,400 square feet, includes two kindergarten classrooms, a vestibule and compact heating for the addition.

Ralph Eaton, director of the State School Food Services, met with the board to discuss full cost accounting and centralization of the county lunch program.

Eaton said the federal government had ordered the school food services department to implement full cost accounting in the state's school lunchrooms.

"The reason for this," Eaton explained, "is because of the large amount of money involved in reimbursements."

Eaton explained that in past years, prior to full cost accounting, his office did not know the real cost of school lunches or what went into the lunch.

"Full cost accounting will determine the cost of the meal so that maximum rate of reimbursement can be received by the schools," Eaton said. "In the past, so many of the schools did not have supported documents so they did not receive full reimbursement." Instead of individual reports

from each of the 21 county schools, only one report for the entire county lunchrooms program will be mailed to the Raleigh office. In turn, one check and one voucher will be sent back to the county office. It will be the responsibility of the county staff with the help of local records to determine how much reimbursement will go to each school.

Eaton told the board that full cost accounting will not be practical with some of the county schools centralized and some of them still conducting independent programs.

"It will mean burning of midnight oil for someone," Eaton added. "I feel all the county schools should be cen-

tralized under one program." Eaton said centralization does not take anything away from anyone. It does not remove the program from the principal's hand.

"The growth of school food service into the era of Big Business due to greatly increased allocation of federal funds for reimbursement of the program, school district consolidations, electronic data processing, and rising operational costs, has established a definite trend and need for the centralized administration of the School Food Service Program," Eaton said.

"Centralization means that the planning of nutritionally adequate meals, purchasing of

food, equipment and supplies, records and reports preparation, accounting, banking, and fiscal control procedures are performed at the local administrative level," Eaton stated.

The administrative unit will be responsible for setting up a budget and ensuring that all funds are properly expended and accounted for in order that the program will be soundly financed on a non-profit basis and to assure that expenses incurred are within available revenue.

The schools which are presently on central menu and buying inctsr^m Stokes Elementary, Falkland, Belvoir (Continued on page 10)

Employ The Handicapped Week Observance Set



NATIONAL EMPLOY THE HANDICAPPED WEEK... October 6-12 is proclaimed for Greenville by Mayor S. Eugene West. Joining him in the brief ceremony is Kendrick Taylor,

center, Veterans Employment Representative, and Charles Coburn, veteran of Vietnam who lost an arm in combat. (Reflector photo by Blanche Hardee)

October 6-12 has been designated as National Employ the Handicapped Week. This is the 30th annual observance of this week.

In Greenville, Mayor S. Eugene West on Monday signed a proclamation to "urge more employers to give consideration in their hiring policies to persons who despite disabilities

nevertheless have the ability to perform well at work."

Designating the coming week as "National Employ The Handicapped Week" in Greenville, Mayor West noted that "handicapped workers have made important contributions to this city through their positions in all phases of our economic life.

"It is appropriate," he added, "that we pay special tribute to their abilities and to their role as participants in the life of our community, and recognize formally their achievements and success."

In the Greenville area, three major agencies devote extensive efforts to providing assistance to (Continued on page 8)

Tutoring Program Spurs AF School In Newark

By CRISPIN CAMPBELL
NEWARK (AP) — What do a junior high school student and a 2-year-old have in common? They both take science, social studies and history.

That is, if the toddler attends Newark's African Free School.

Bibi Amena Baraka, AFS director and wife of poet-playwright Imamu Amiri Baraka, said the school was started five years ago as an after-hour tutoring program.

"The school started when we discovered the public schools were not doing an adequate job of educating our children," he said. "In addition to neglecting black African cultural and historical background, they were not giving children the academics necessary to survive."

"We were teaching drama in the afternoon program and the children were having a hard time learning their lines. Then we finally realized they

couldn't read."

Mrs. Baraka said the school, run by the Temple of Kawaida, the religious organization headed by Baraka, will eventually teach children from pre-school through fourth grade.

Children in the fifth through eighth grades attend the organization's Marcus Garvey school and plans are in the works for establishment of a high school.

In addition to social studies, science and history, the children are taught reading, mathematics, Swahili, karate and the Kawaida religion.

Mrs. Baraka, who has three children in AFS, said a class in karate was offered because the children were "interested in martial arts."

African and U.S. history are taught Monday and Tuesday; European history, Wednesday; world history, Thursday; and Friday is current events day.

The children are graded on a

seven-point system, with the highest grade being 7-wousi, described as "The total African Free School student, with an African personality, to the lowest '1-fwkifunza, a student who needs to study more."

On the 2-to 3-year-old or pre-school level, the children are taught the letter sounds, to recognize and spell their names and addresses, the names of their families and classmates; to count to ten, to recognize numerals and to do simple addition.

The 4-to 5-year-olds learn words in reading and easy addition, while the first-grade class learns language usage.

Mrs. Baraka said students who transfer to AFS from another program are usually behind their students, but the teachers work with them until they reach a level comparable to the others.

The 6½-hour school day for the AFS student begins at 8:30 a.m. with exercise, preparation for class and inspection.

The children line up according to class and height as one child inspects the face, ears and fingernails of the others. If a child fails to pass inspection, he cleans up and a note is sent to the parent.

At 10 o'clock, the students begin a series of 20-minute class periods with time out for lunch and recess.

The children are taught that "to work is an honor" and "you don't come to school to play," Mrs. Baraka said.

In class, the AFS students have a particular way of answering and presenting material.

When the teacher asks a question, those who know the answer indicate this by placing one fist under the elbow of the other arm making an "L" with their arms.

If the child is called upon to recite, he or she rises and assumes the correction position.

The girls assume "salimu," or the position of submission, in which the arms are crossed and the hands are placed on the shoulders of the opposite arms. The boys assume "angulia," or the position of attention, with the arms folded across the chest with each hand on the elbow of the opposite arm.

After assuming the correct position the child says:

"Appreciating what's been said, and if we understand correctly..." and proceeds to give the answer.

Mrs. Baraka said the school is funded through private donations and state and federal educational grants.

She said the AFS teachers must be members of the Temple of Kawaida and adhere to the school's collective approach to education which is taught in special training sessions.

Mrs. Baraka said the curriculum is based on group discipline and teaching subjects in a positive manner.

For example, the school makes its own texts, including readers in which stories are composed of words from a spelling list. One teacher might have, "We are black, beautiful African people and we will win," as the lesson. The spelling-list words from the story would be African, black, people, we win and beautiful.

"We have found that children learn in order," she said. "I know when I was in school, we would learn the spelling list in order and if the teacher switched the words around, we couldn't spell them."

Homemaker's Haven

By Addie Gore

Pitt Home Agent

Need Breakfast

No matter how hectic those mornings are, don't let your children rush off to school without a good breakfast. It's food for thought — and action, too.

Studies show that children who eat a nutritionally sound breakfast can do better in school because they don't get that "mid-morning slump." Also, breakfast eaters can do better in physical activities.

So, what's a good breakfast for school children? Well, any foods that give a fourth of their daily calories requirement and a fourth of their daily protein allowance make up a good breakfast.

The traditional cereal, milk and orange juice breakfast meets this guideline. But so do some not so ordinary breakfasts, such as bacon, cheese and tomato on a bun — with orange juice and milk.

Even hamburger can be a good breakfast food. Just add milk and fruit to the meal. This combination will give children a fourth of their calorie and protein needs for the day.

So get school days off to a good start for your children with a good breakfast. It really is food for thought and action, too.

Herb Garden

If you have parsley and chives in your garden now, plan on moving them inside for the winter. That way you can dress up food dishes with garnish from your own herb garden year round.

First, pot up the herbs. Prepare a soil mixture for potting — using equal parts by volume of soil, granulated peat and perlite. Or in place of the perlite, you can also use sand or vermiculite. These should be available at your local garden store.

Transplant the parsley and chives in five or six inch pots. Then cut back the plants about half way.

Let your herb garden take advantage of the Indian summer days. Just sink the pots in the ground in your garden. Water them often.

Then before the winter frost, bring the plants inside. Parsley and chives need plenty of direct sunlight through the winter, so pick your spot accordingly.

For healthy herb plants — make parsley and chives migrate indoors for the winter. That way you'll have healthy herb plants for next spring's garden, too.

Buying Nectarines

Nectarines have become a popular choice with shoppers over the past few years. For the attractive color and distinctive flavor of nectarines make them a delicious snack or fruit dessert.

When nectarines are on your shopping list, select those that are plump, clean and fresh in appearance. They should be firm — but not hard — and well-colored.

Usually nectarines are orange-yellow to red in color, although certain good varieties may have a greenish tint.

Immature nectarines are

usually hard, and may be dull looking or somewhat shriveled. Over-ripe ones are usually soft, easily bruised and may be leaky. This condition invites decay and detracts from flavor.

Some nectarine varieties may

show noticeable russeting — that is yellow-to-brown staining of the skin. This russeting might affect the beauty of the nectarine, but unless it causes unhealed skin cracks, it should not affect flavor. Those unhealed

skin cracks I mentioned are important because they are subject to mold and decay.

So for good eating at snack time, think plump, clean, colorful and delicious nectarines.

Abby Gives Three Yodels For Swiss



By Abigail Van Buren

DEAR ABBY: I understand that a few years back, you had a letter in your column from someone who asked why the Swiss were such an arrogant people.

The writer stated that a Swiss will let you know five minutes after you meet him that he is not German, French or Italian — but SWISS.

My ancestors came from Berne, Switzerland. Therefore, I am interested in the way you answered that.

DEAR WIS: First, the Swiss are not "arrogant." They are a proud people who have much about which to be proud. They have fresh air and clean government. (Their president serves for one year only, and cannot be re-elected.) They produce the world's finest chocolate, cheeses, watches and precision instruments. Their people are honest, industrious and well-mannered. Their skiing is unbeatable and their banks unbreakable. And if that's not something to yodel about, I don't know what is!

DEAR ABBY: I am a 53-year-old widower. I have a nice home, a responsible position, good health and an adequate income.

Some time ago, I met an attractive widow and we've been seeing a lot of each other. She's pretty, has a good figure and is a fine cook and housekeeper. We have the same tastes in music, the theatre, sports and literature. We couldn't be better matched had we been selected for each other by computer.

We want to get married, but we have a problem. I have a dog who has been my constant companion for eight years. Never having had children, King was a great comfort to us during my wife's terminal illness. He was like a member of my family.

Unfortunately the lady has a dog and cat to whom she is equally attached. We've tried to bring these animals together without success. Both dogs are big and they fight to the point of trying to kill each other.

If I bring King to the lady's apartment, he intimidates her cat, and she snarls and hisses and runs up the curtain.

We've discussed our problem with our friends and they're no help. Frankly, they think we're nuts.

Is there a solution that will work?

DEAR WANTS: The widow has the advantage, two pets to one. Why not find a good home for King? Or flip a coin to see which dog goes. If King "wins," the cat remains a problem — unless the two can adjust. (If you two "perfectly-matched" humans can't overcome the animal barrier between you, you are indeed "nuts.")

DEAR ABBY: A Florida wife gripes because the bug spray her husband uses on their property makes him passionate. This is a problem?

Is it possible to find out what brand of bug spray her husband uses? And if the brand name isn't available, could you please ask her to send her husband?

Everyone has a problem. What's yours? For a personal reply, write to ABBY: Box No. 69700, L.A., Calif. 90069. Enclose stamped, self-addressed envelope, please.

Hate to write letters? Send \$1 to Abigail Van Buren, 132 Lasky Dr., Beverly Hills, Calif. 90212, for Abby's booklet, "How to Write Letters for All Occasions."

District Meet Set For Oct. 13 In Pink Hill

Plans for the district meeting on Oct. 13 in Pink Hill were discussed at the meeting of the VFW Auxiliary Thursday night.

Mrs. Carrie West conducted the business session and a note of thanks from O'Berry Center was read thanking the auxiliary for items which had been sent to the children.

It was announced that a contribution was sent for Christmas cheer for patients at the Veteran Hospital, Fayetteville. Mrs. Etta Gill, Americanism chairman, announced that she will be contacting Rose High School concerning the Voice of Democracy contest, which is sponsored by the local and National Auxiliary.

Members voted to help the post members decorate a float for the Bicentennial parade and to sponsor the Lite-a-Bike project.

Mrs. Leon Evans spent the weekend in Greensboro to attend the official visit of National President Betty Butler. Her theme for the year is "Challenge of Tomorrow."

President West managed the Bicentennial booth at Pitt Plaza Sept. 16-21 and expressed her thanks to the 15 members who assisted.

Hostesses for the meeting were Myrtle Meeks and Lillian Hart.

"Therefore we make the spelling list teach a complete, positive thought."

Mrs. Baraka stressed that there was no competition in AFS and that punishment also was collective and done by the peer group, usually for being selfish or undisciplined, she said.

But, she pointed out that students are instructed to correct the teacher if they believe he or she is wrong in criticism or ideology.

Births

Worthington

Born to Mr. and Mrs. Joseph Wesley Worthington Jr., Rt. 2, Ayden, a son, Joseph Wesley III, on Sept. 22, 1974, in Lenoir Memorial Hospital. Mrs. Worthington is the former Dean Cannon of Grifton.

Williams

Born to Mr. and Mrs. James Lewis Williams, New Haven, Conn., a son, Ramsey Lewis, on Sept. 29, 1974, in the Yale New Haven Hospital. Mrs. Williams is the former Bertha B. Love of Greenville.

Household Hints

Room temperature citrus fruit yields more juice than refrigerated.

New potatoes, which are harvested before the skins are set, do not remain fresh as long as mature potatoes. The new variety is best used within a week or 10 days.

HUDSON'S SEWING ROOM

Specializing In

Dress Making & Tailoring Handmade to fit each individual

Bridal and Bridesmaid Gowns

521 Cotanche St. (in Georgetown Shoppes) 752-3167 Greenville

Greenville Blvd. 244 By-Pass Opposite Pitt Plaza Open Daily 10 'Til 10

KING'S SELF-SERVICE DEPT STORES

Save on Famous Brand Stationery, Health and Beauty Aids!

<p>Pkgs of 10 Wood Pencils 4 for \$1</p>	<p>1500" Roll Scotch Brand Cello Tape 4 for \$1 ½" wide tape</p>	<p>50 envelopes 10" size, pkg of 50 Your Choice 3 pkgs 99¢</p>
<p>BAYER Aspirin 159 Bot of 300</p>	<p>Curad SHEER STRIPS 2 pkgs \$1 Pkg of 100</p>	<p>6"x9" Writing Tablets 4 for \$1 125 Sheets</p>
<p>Q-TIPS Cotton Swabs 2 for 88¢ Pkg of 170</p>	<p>LANDER Baby Shampoo 48¢ 32 oz Size</p>	<p>Johnson's Baby Powder 99¢ 24 oz Size</p>
<p>CLAIROL Final Net 99¢ 8 oz Size</p>	<p>CLAIROL Herbal Essence Shampoo 99¢ 12 oz size</p>	<p>Shell No-Pest Strips 129 Kills mosqui-toes and other flying insects.</p>
<p>Efferdent DENTURE CLEANER 99¢ Pkg of 60 Tablets</p>	<p>MICRIN PLUS Mouth Wash 88¢ Quart Bottle</p>	<p>Arrid Extra Dry Deodorant 2 cans \$1 6 oz Size</p>
<p>Wilkinson Stainless Blades 3 Pkgs of 5 99¢</p>	<p>MAX FOR MEN by GILLETTE STYLER-DRYER 1588 Designed for styling mens hair.</p>	<p>LIPTON Ice Tea Mix 88¢ Bag of 10</p>

Wedding Invitation

Mr. and Mrs. Vernon Weatherington request the honor of your presence at the marriage of their daughter, Judy, to Harold Rayford Lilley Jr. on Saturday, Oct. 5, at 4:00 p.m. at Tranter's Creek Church of Christ. Reception follows in the church fellowship hall. No invitations were mailed.

Try theirs, then try ours...

Pocahontas FANCY

Canned Fruits and Vegetables

The Names You Know and Depend On!

- GENERAL ELECTRIC • GILLETTE
- WRANGLER • BVD • SUNBEAM
- DETECTO • ROYAL • WILSON
- FISHER-PRICE • CLAIROL
- BLACK & DECKER • CANNON
- DUPONT • LADY PEPPERELL

You'll find all these... and countless others throughout King's 127 big depts....all your favorite brands at low discount prices!

KING'S

SELF-SERVICE DEPT STORES
Greenville Blvd.
244 By-Pass Opposite Pitt Plaza
Open Daily 10 'Til 10

Everything for Family and Home!

How Tar Heel Senators And Representatives Voted

By ROLL CALL REPORT
WASHINGTON—Here's how area Members of Congress were recorded on major roll call votes Sept. 19 through Sept. 25.

HOUSE
CONSUMER REDRESS
 Rejected 180 for and 209 against, an amendment allowing the Federal Trade Commission (FTC) to file lawsuits—without going through the Justice Department—in behalf of individual consumers seeking redress from allegedly deficient product warranties.

The amendment was proposed to HR 7917, a bill giving the FTC more legal clout to enforce consumer protection laws and setting higher product warranty standards. The bill is now in the Senate.

The amendment, sponsored by Rep. Bob Eckhardt (D-Tex.), reflected the Consumer Federation of America's contention that consumer redress suffers from being channeled through the Justice Department,

which is less apt to litigate for consumers than the FTC. Eckhardt said the tougher policy is needed because "it is not adequate to slap the violator on the hand and say 'Don't do it again!'"

Opposition centered on the question of the FTC's legal authority. The Justice Department position was that the amendment would give the agency undue entry into prosecutorial areas. Rep. Samuel Young (R-Ill.) called the amendment a "radical" move that would "put the FTC in the business of acting as a collection agent" for consumers.

Rep. Charles Rose (D-7) voted "yea."
 Reps. Walter Jones (D-1), L.H. Fountain (D-2), David Henderson (D-3), Ike Andrews (D-4), Wilmer Mizell (R-5), Richardson Preyer (D-6), Earl Ruth (R-8), James Martin (R-9), James Broyhill (R-10) and Roy Taylor (D-11) voted "nay."

IKE AND SAM REJECTED, 166 for and 169 against, an amendment to prevent special funding for Eisenhower College in Seneca Falls, N.Y., and the Sam Rayburn Library in Bonham, Tex.

The vote left intact a proposal to subsidize both institutions with money raised from the sale of Eisenhower commemorative silver dollars. Up to \$10 million of such sales will be diverted by the U.S. Treasury to the college, which in turn will pass through 10 per cent of the \$10 million to the Rayburn Library.

It is a one-shot federal payment designed to rescue the institutions from financial difficulty. The provision is part of HR 16032, which now goes to the Senate.

Supporters of the amendment called the legislation a special favor for the college and library, arguing that neither was established by Congress as a memorial for the former national leaders. Most criticism was directed at the Eisenhower College funding.

Rep. Edith Green (R-Ore.) said nearly all private colleges need more money and that the Eisenhower College should not receive special treatment. "Any time a college is in trouble they can name it after some great American hero" and then appeal to Congress for financial help, she said.

Opponents said the funding is fair to taxpayers because the \$10 million comes from the sale of Eisenhower coins rather than from general tax revenues. Citing the contributions made by Eisenhower and Rayburn, they said Congress must not let their memorials die from insolvency.



DOWN HOME ON THE BLACK SEA—Country singer Tennessee Ernie Ford, top, and dancers in the 15-member Opryland, U.S.A. troupe tour of the Soviet Union perform Monday in Baku, an oil production center on the eastern coast of the

Black Sea. The tour has visited Yerevan and Tbilisi, and is scheduled to travel to Leningrad and Moscow from Baku. (AP Wirephoto from Tass)

AID TO TURKEY Adopted, 307 for and 90 against, an amendment withholding military aid to Turkey until President Ford certifies that significant progress is being made in negotiating a Turkish military pull-back on Cyprus. The amendment was attached to HJ Res 1131, an appropriations measure, and has not been considered by the Senate.

Supporters said the amendment is necessary to counter Turkey's aggression against Greek Cypriots. Many supporters claimed Secretary of State Henry Kissinger has tilted

U.S. foreign policy in favor of Turkey. Rep. Paul Cronin (R-Mass.) called the aid cut-off a "big stick" which will speed the ongoing Cyprus peace negotiations.

One opponent, Rep. John Anderson (R-Ill.), cautioned against "instant Foreign Policy" being made on the House floor rather than by the Foreign Affairs Committee working in consultation with the State Department. He warned that the amendment would jeopardize the "delicate course" of negotiations.

Jones, Henderson, Andrews, Mizell, Preyer, Rose, Ruth, Martin, Broyhill and Taylor voted "yea."
 Fountain voted "nay."

SENATE
INFLATION Passed, 64 for and 35 against, a resolution rejecting President Ford's request that federal employ pay hikes be deferred for 90 days. The vote means that salary increases for 3.5 million white-collar and military personnel will take effect Oct. 1. It was the new President's first defeat on a major roll call.

Supporters of the resolution (S. 394) called the increase necessary to keep federal wages comparable to those of the private sector. Sen. Robert Dole (R-Kan.) said the deferral would amount to "wage controls for only a portion of the work force." Sen. Gale McGee (D-Wyo.) said that "if we are going to attack inflation by rolling back wages... let us roll them all back."

Sen. Robert Griffin (R-Mich.) opposed the resolution and urged bi-partisan support of Ford's request for a federal example to inspire private groups to follow suit in fighting inflation by holding wages down. He said "the battle against inflation is a psychological battle."

Sen. Sam Ervin (D) voted "yea." Sen. Jesse Helms (R) voted "nay."

DOCTOR DISTRIBUTION Passed, 70 for and 18 against, legislation (S. 3585) whose main thrust is to put more doctors in under-served rural areas and urban slums. Similar legislation is under consideration in the House.

The legislation awards federal scholarships for medical school in a way that insures that 25 per cent of a school's graduates must serve at least two years in doctor-short areas. It was substituted for a bill establishing a "doctor draft" of all medical school graduates administered by the Department of Health, Education and Welfare.

Supporters argued that a doctor-draft is "a cure worse than the disease" and said the scholarship approach will put an estimated 4,000 doctors in under-served areas within four years of the bill's enactment.

Many opponents argued against the legislation on philosophical grounds. Sen. Peter Domenici (R-N.M.) called it "servitude" and Sen. James Buckley (C-N.Y.) said it subsidizes the rich by lowering the "cost of medical training to those very people who can anticipate very high earning during their professional careers." Other opponents fully agreed with the objective but preferred federal inducements other than the scholarship approach.

Ervin and Helms voted "yea."

Regulations Cover Pitt Brush Burning

Pitt County Forest Ranger Mark Webb said that the brush burning permit season for Pitt as well as the rest of the state will run from October 1 until June 1.

During that period, Webb said, "it is unlawful to start a fire outdoors more than 100 feet from an occupied dwelling, from 12 midnight until 4 p.m., without first securing a permit from the county fire warden."

Webb noted, too, that it is illegal to start fires within 500 feet of areas under protection of the state Forestry Service or within any woodland under the protection of the Forest Service, without securing a permit.

He noted that during periods of hazardous forest fire conditions, burning permits may be canceled.

Webb noted that permits are not required for burning within 100 feet of occupied dwellings.

Burning permits or additional information in Pitt County may be obtained from Webb by calling 756-0414.

FIRST DROP
SALEM (UPI) — The first drop ever in Oregon state park tourism occurred in 1973, say state transportation division officials. They blamed the decrease on the gas shortage.

NOISE POLLUTION
PITTSBURGH (UPI) — Traffic is the leading source of noise pollution in this city, says the Allegheny County Health Department. Traffic outranks both industry and heavy road equipment.

Fresh
CANDY APPLES
Diener's Bakery
 815 Dickinson Ave.

REVIVAL!
Hear Dr. John McCormick
 Preacher, Teacher, Educator
 formerly of Tennessee Temple Schools and Dallas Theological Seminary.
Sept. 30 thru Oct. 6
7:30 p.m. nightly
People's Bible Church
 264 By-pass
EVERYONE WELCOME!

ECU BUS SCHEDULE
 Greene Dorm—6:40 p.m.
 Cotton Dorm—7:00 p.m.
 Scott Dorm—7:10 p.m.

Brody's
 DOWNTOWN PITT PLAZA

Jane Holly

the Shirt-Jacket Look...
 From Jane Holly.

In 100 Percent Dacron Polyester ribbed knit; the solid, button-front shirt with convertible collar, side vents, and long sleeves. Marvelous colors of BLACK, BEIGE, BROWN, RED, WHITE, GREEN. \$16. (Sizes 10 to 18).

To match, the 100 Percent Dacron Polyester ribbed knit sleeveless shell; turtleneck with back zip. Colors of BEIGE, RED, RUST, GREEN, BLUE, NAVY, BLACK, MAUVE, BROWN, WHITE. \$12. (Sizes 10 to 18).

DUPONT Dacron
 POSTER

Brody's
 DOWNTOWN PITT PLAZA

SWEATER SEASON IS HERE...

NEW FALL SWEATERS — EACH WITH ITS OWN PERSONALITY!

A. Bulk-knit short-sleeve sweater from BRITISH VOGUE; 85 per cent Nylon, 15 per cent Acrylic. . . . moc-turtie style. S-M-L. in fall fashion colors. \$14.

B. Tied-up sleeveless pullover from BRITISH VOGUE. 100 Acrylic, fall colors. S-M-L. \$12.

C. Cardigans are still in. . . this one from SIDNEY GOULD; 100 per cent Acrylic. S-M-L, fashion colors. \$16.

D. Ribbed moc-turtleneck pullover, zip back. From BRITISH VOGUE, sizes S-M-L. 100 per cent Acrylic in fall shades. \$9.

E. Sleeveless cardigan for casual warmups. . . from BRITISH VOGUE. 100 per cent Acrylic. S-M-L. Fall Colors. \$14.

F. Genuine turtleneck pullover in cable-knit with extra-long back zip. From BRITISH VOGUE. Fashion colors in 100 per cent Acrylic. S-M-L. \$12.

MISSY SPORTSWEAR DEPT.

Brody's
 DOWNTOWN PITT PLAZA

Questions Are Best Answered

It is a little surprising that President Ford has agreed to appear before a House subcommittee to answer questions about his controversial pardon of former President Nixon.

Ford said in a letter to Re. William L. Hungate, D-Mo., he expects to appear personally to respond to the questions raised in two resolutions of inquiry concerning the pardon.

It is rare for a president to appear before a Congressional subcommittee, but the appearance seems to fit in with President Ford's policy of dealing openly with Congress.

It remains questionable as to what he would tell the committee. The President spoke on the matter at a recent news conference and he maintained there were no deals or inside information on Nixon's health which prompted his decision. The pardon granted on grounds of compassion, he indicated.

Since the pardon was granted, Nixon has entered the hospital for treatment of his blood clot and rumors have swirled about the state of his physical and mental health. Even this week his attorneys have maintained that he is not well enough to testify at the trial of Watergate defendants.

There may be no specific answers as to why President Ford granted a pardon to Nixon even before he faced any indictments in the Watergate coverup. Perhaps he did it as an act of compassion. It can't be passed over, however, that Nixon and

Ford were old friends and that Nixon did choose Ford as his vice president, thus making Ford the Nixon successor.

So questions about the pardon decision should be answered and perhaps they can be best answered before the House subcommittee. If President Ford had information about Nixon's health which prompted the decision, we hope he will say so. The unusual handling of this matter should be cleared up once and for all.

Something For All In 'Standard Time' Law

The Congress passed bill which restores Standard Time might be satisfactory to almost everyone.

The bill puts the country back on Standard Time on Oct. 27, which should satisfy those who want "normal" time during the winter months.

On the other hand, it returns the country to Daylight time on Feb. 23. This gives the Daylight enthusiasts something to look forward in late winter.

Maybe everybody can be happy with this arrangement.

ANSWERS DON'T SPRING UP OVERNIGHT!

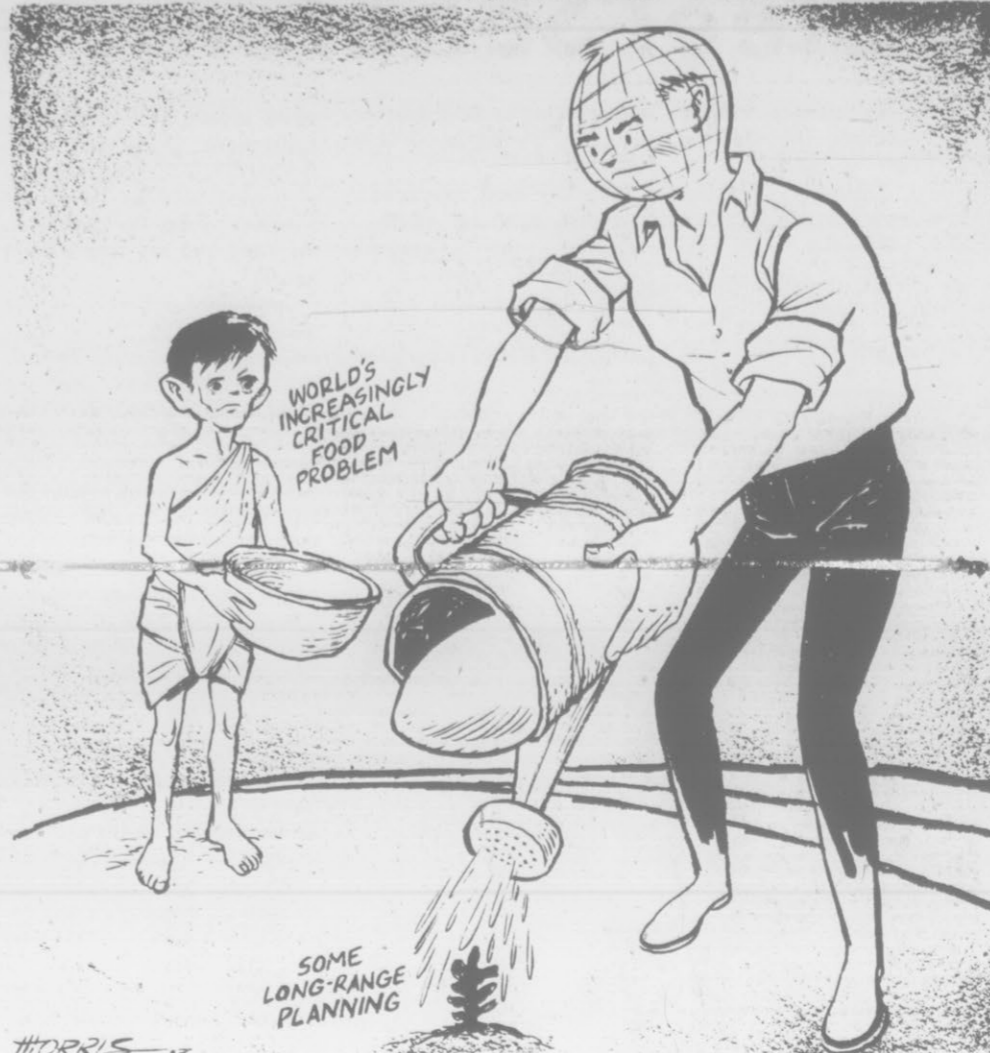

Fearful Over Policy

By R. GREGORY NOKES, Associated Press Writer
WASHINGTON (AP) — A surprisingly large number of countries are fearful that the United States could push the world into a deep economic recession if it rigidly pursues its anti-inflation policies.

"None of us can hope to avoid disaster if there is a severe recession in the United States," said British finance minister Denis Healey at the annual meeting Tuesday of the International Monetary Fund.

Others who have expressed varying degrees of concern include delegates from Italy, Belgium, Japan, Korea, the Latin American nations, and IMF Managing Director Johannes Witteveen of The Netherlands.

More than one delegate has referred to fears of a repeat of the world depression of the 1930s, including Italian Finance Minister Emilio Colombo.

"Clearly, international laissez-faire economics will not do in the circumstances," said Colombo, whose country is in severe financial difficulty resulting in part from high oil prices.

Treasury Secretary William E. Simon sought to put their fears to rest in his speech Tuesday, saying inflation, not recession is the major threat to world stability.

"I do not believe the world is in imminent danger of a drift into cumulative recession — though we must be alert and ready to act quickly should the situation change unexpectedly," he said.

Officials of other nations have no quarrel that inflation is a major problem that must be dealt with, but they are worried that the U.S. is fighting it in the wrong way.

The Ford administration is attempting to pursue twin policies of spending restraint and tight credit, both of which are designed to reduce demand for goods and take pressure off of

(Continued on page 5)

THIS AFTERNOON

Long 'Monitor' Study

By BILL NOBLITT
RALEIGH — Detailed study of the U.S.S. Monitor which rests on her top some 16 miles off the coast of Cape Hatteras will continue for many years, and the odds that the historic ironclad battleship will ever be raised are slim.

Efforts are underway by state officials to have the U.S. Secretary of Commerce designate the site where Duke University searches have pinpointed the sunken gunboat as the nation's first Marine Sanctuary.

The purpose of that protection is to preserve for study the remains of the Monitor—the ship which marked the shift from wooden sailing ships to armored, motor driven warships.

John G. Newton, marine superintendent of the oceanographic program at the Duke Marine Laboratory at Beaufort, and team leader on board the university search ship Eastward, said that while the gunboat lies in 220 feet of water, is swept by the fringes of the Gulf Stream, and is extremely

difficult to reach, the protection as a Marine Sanctuary will insure that the ship is safe from looting or salvage attempts which would destroy information.

Careful Steps
Newton said the first step in that study will be a careful mapping of the ship by taking photographs from all angles, stem to stern, and in the surrounding area to attempt to locate the missing anchor, and two guns.

Next, Newton said, interior inspections will be made, first through holes in the hull where plates are missing and a view of inside compartments can be had; then from moving inside the ship herself.

"But we are talking about years to carry out this process, rather than months," Newton said.

Meanwhile, tentative discussions are going ahead on prospects of a Monitor Museum on the coast, with pictures and artifacts, and the U.S. Naval Academy is moving ahead with construction of a Monitor model, under the code-name "Project Cheesebox."

The project name results

from the description of the Monitor applied by writers when the battleship first went into action in 1862. The ironclad hull floated completely underwater, with only a little deck, the gun turret, and a steam engine exposed, earning her the nickname "cheesebox on a raft."

Newton said the Monitor's condition is "very poor," and that wooden parts have been eaten away, and may rivets and iron pieces decayed from the more than 100 years underwater.

Full details and pictures of the search and find will be featured in the January issue of National Geographic. The Society was a part of the expedition.

Holdes Secrets

The prime reason for excitement over the find, and efforts to protect the ship for study, is the fact that the Monitor was the first ship to use armored plating and a turret for protecting the guns' and the commander during battle. The same technique has been used on all battleships and cruisers since 1880.

The builder of the Monitor

was an acknowledged genius—Swedish designer John Ericsson—and it is widely held that his brainchild will hold many new developments not previously recorded.

Ericsson rushed production of the ship in only 101 days, designing her largely by eye, and rushing out pencil sketches. When the ship was finished, the builder burned even those rough working drawings, so nothing remains describing details of the historic ship and the many innovative techniques which experts are certain must be on board.

The Monitor was launched on Jan. 30, 1862. On March 9, 1862, she engaged the Confederate ironclad gunboat The Merrimac in the famous Battle of Hampton Roads; neither ship was damaged, and no lives were lost.

Later that year the ship was being towed to Beaufort to join a blockade. A storm hit off Cape Hatteras, and the Monitor took on water through vent ports and the base of the turret. She sank in just four hours, taking 16 sailors to their deaths.

By ART BUCHWALD

The Family's Summit

WASHINGTON — We all gathered in the living room for what was the first Family Economic Summit in our history.

I opened the meeting with a brief statement.

"I have called you all together to discuss the grave economic situation that this family faces. As you know, inflation has spiraled the cost of all consumer goods and we could be heading for a serious domestic depression. I would like your advice as to how we can set our house in order."

My son Joel said, "I think your tight-money policies of the past year have contributed greatly to the crisis. It seems to me that if you loosened up on our allowances, it would give us more money to spend and take us out of our doldrums."

"I am not certain that is the solution," I replied. "One of the causes of the family economic woes is that we are spending more money than we're taking in. It was my hope that we could balance the budget before the year is out. Any increases in allowances at this time would only encourage inflation."

My daughter Jennifer said, "The biggest item in the family seems to be education. Why don't we all quit school and take a year off to find ourselves?"

"This is not a practical solution. If you took a year off from school, I would have to subsidize you which would cost more than your tuition. I hardly see a saving there. I don't believe a high unemployment rate in the family would solve anything."

I continued, "It seems to me one of the major causes of the problem is the high cost of gasoline. If everyone turned in his and her gas credit card and paid cash for your fuel, I could see a light at the end of the tunnel."



My daughter Connie said angrily, "A good transportation system in this family is essential to a healthy economy. Making us turn in our credit cards is an extreme measure which should be used only when everything else fails."

"All right then, let us take up the subject of rock concerts. Last year members of this group spent a total of \$250 on rock concerts and \$330 on rock records and tapes. This is certainly an area where costs can be cut substantially."

Jennifer rose in a fury. "You are penalizing the poor and the neediest in this family by taking away from them their major form of entertainment. Why don't you cut some of the fat from Mom's household budget?"

"I was coming to that," I said. "It seems to me that too much money has been spent on slipcovers, drapes and nonessential items such as lamps and rugs. I would suggest a \$500 ceiling on all household expenditures."

"That's out of the question," my wife said. "Applying a meat ax to those few fixed cost-of-living items would only postpone what it would cost us to fix up the house at a later date. We are actually saving money by spending it now."

"I was afraid that would be your response. Well, what about food? Surely it would be no problem to cut there?"

"I would go along with that," my wife said, "with one stipulation. From now on

(Continued on page 5)

40 Years Ago Today

October 2, 1934
Rev. Worth Wicker of Beaufort will begin duties at St. Paul's Episcopal Church Sunday. He will succeed Rev. W.A. Lillycrop who resigned to take over as rector of a church in Florida.

The church has been without a rector for many months, but several ministers have appeared, including Bishop T.C. Darst. Wicker and his family are expected to arrive later this week.

Rev. J.B. Overmeyer of Bluefield, W. Va. has declined a call as pastor of the Presbyterian Church here.

A pastoral committee member, B.W. Moseley, said Overmeyer has accepted the pastoral of the Bluefield where he has been doing supply work for the past few months.

Tobacco soared to a season high average of \$39.15 a hundredweight yesterday according to supervisor K.W. Cobb.

Greenville is leading all other markets in the belt and has been through the tobacco season.

—Susan Price

The INSIDE REPORT

That Flanigan Blunder

By ROWLAND EVANS and ROBERT NOVAK

WASHINGTON — That Republicans will have to undergo unnecessary, embarrassing and inescapably messy hearings this week on the nomination of Peter Flanigan as ambassador to Spain can be traced to two increasingly familiar shortcomings by President Ford: paying too much attention to continuity with the Nixon presidency and not enough attention to protection of his party's interests.

Flanigan, former New York financier and White House aide under President

Nixon, will not enjoy the perfunctory confirmation hearings normally conducted by the Senate Foreign Relations Committee. Sen. Thomas Eagleton of Missouri, leading the attack against his confirmation, wants Flanigan put under oath to answer a long list of accusations.

The most serious by far are sworn accusations by former Nixon attorney Herbert Kalmbach implicating Flanigan in exchanging ambassadorial nominations for political contributions. Though denied by Flanigan, Kalmbach's charges are

strongly supported by Albert Jenner, who interrogated him as a counsel at the House impeachment proceedings.

Even if Flanigan is confirmed, it will revive poisonous memories of Watergate one month before the midterm election. Thus, Republican politicians are talking about Flanigan's nomination as the Nixon pardon in microcosm: A politically self-damaging act fulfilling no ostensible need.

Flanigan, a haughty lace-curtain Irish socialite who bruised feelings all over Washington as a Nixon White House troubleshooter, had no visible support for a diplomatic post. High State Department officials, Republican Senators and many party leaders agree that the nomination needlessly borrows trouble. There is no sign that Secretary of State Henry Kissinger pushed it, contrary to hints privately dropped by Flanigan.

The best explanation is that Mr. Ford signed an ambassadorial commission for Flanigan prepared during the Nixon administration as part of the new President's obsession with continuity during his first days in office. As with the Nixon pardon, there was little, if any, study of political consequences.

Some of the President's closest advisers were not even aware of last July's testimony by Kalmbach, Nixon's former attorney now serving a federal prison sentence. Kalmbach testified he had been told by Flanigan in 1971 to seek a \$250,000 campaign from Dr. Ruth Farkas (later named ambassador to Luxembourg) and that in turn she would be named ambassador to Costa Rica. Flanigan has denied this, contending Kalmbach misunderstood him.

"I would believe Kalmbach's testimony," Jenner told us. Jenner termed

(Continued on page 5)

Other Editors Say Cuba Dialogue

(Christian Science Monitor)

Fidel Castro certainly does not make it easy. His fiery blast at President Ford and strong support for the oil countries against the United States are totally in character. But they do not abet the reasonable effort of those American voices who believe the time has come to restore trade and diplomatic relations with Cuba.

While Castro has drawn back from the export of revolution, he is still a Communist. With two American lawmakers sitting in Havana, he could hardly resist the temptation to defend his old friend Salvador Allende and blame the CIA for his downfall. Perhaps the Cuban leader was getting his anti-U.S. lick in while he comfortably could.

But the salient fact is that the trend toward reconciliation is under way—and it is high time. Pressure for a restoration of ties with Havana is steadily mounting in Latin-American capitals and Congress is carrying the ball for a move in Washington. Pat Holt, chief of staff of the Senate Foreign Relations Committee, recently returned from a mission to Cuba and now Senators Jacob Javits and Claiborne Pell are in Havana.

President Ford, for his part, indicates Washington will go along with the rest of the Organization of American States in any moves to improve relations. With Costa Rica, Colombia, and Venezuela now edging toward a detente, it is only a matter of time before the OAS is likely to lift its sanctions.

In any event, it no longer makes sense to pursue the isolation of Cuba. The American boycott has hurt the Cuban economy but it has not shattered it, and it only enables Castro to blame the U.S. for his economic woes.

In this day and age of detente with Communist nations the continued quarantine of Cuba is anachronistic. Moreover, if the U.S. does not want to appear antiquated it will have to move in step with the nations of the Western Hemisphere, who for ethnic and cultural reasons feel it is time to change course.

South Florida Latins Prosper

By IKE FLORES
Associated Press Writer
MIAMI, Fla. (AP) — A \$16,000 silver Mercedes Benz sports car tooling around the Miami suburb of Coral Gables displays a sticker saying, "Latins are Loaded."

While the whimsical slogan may not be quite true for all 350,000 Latin Americans estimated to be living in the Miami area, it certainly applies to at least 50 millionaires and hundreds of others of slightly less modest means in South Florida.

The editor-publisher of Miami's newest daily newspaper is a wealthy Cuban exile, Alberto Diaz-Masvidal. Miami Mayor Maurice Ferre is a multimillionaire Puerto Rican, nephew of a former governor of the island.

Seven of the city's bank presidents are Cuban refugees.

The elderly Cuban-born boss of the world's largest rum-making firm, Jose "Pepin" Bosch, is a parttime resident of Miami, where much of Bacardi's administrative operations are located.

Across the causeway on Miami Beach, Carlos Prio Socarras, the last constitutional president of Cuba, looks after vast real estate holdings and investments which continue to pile up the pesos.

Latins, in fact, have come to be the "nouveau riche" of South Florida in the past few years.

A Latin "Millionaires Row" stretches from Palm Beach down the Gold Coast

through Miami and its luxurious satellite communities of Key Biscayne and Coral Gables.

Despite the inflation-recession syndrome gripping the country, Cubans in particular have acquired a local reputation for keeping the money moving—working hard to make it, but spending it easily—for clothes, cars, homes, furnishings and entertainment. You name it.

"These people don't know what inflation means," says the manager of a large downtown department store. "We love them. I'd say 60 to 75 per cent of our shoppers are Cubans. We've seen no drop in business from last year. In fact, we may be up."

While there are many rags-

to-riches stories involving Latins, a number of the well-heeled managed to bring their fortunes with them and build upon them over the years.

For the Cubans, how much they have now may depend on when they got here and how much money they had outside the country—or were able to bring out—once Fidel Castro started "redistributing" their wealth.

With one out of every four Miami area residents being of Latin descent, they have a total annual income of about \$1 billion, according to Richard Tobin of Strategy Research Corp., which recently completed a Dade County Latin market study. The estimate has doubled since 1970.

The Daily Reflector

INCORPORATED
209 Cotanche Street, Greenville, N.C. 27834
Established 1882
Published Monday Through Friday Afternoon
and Sunday Morning

DAVID JULIAN WHICHARD, Chairman of the Board
JOHN S. WHICHARD—DAVID J. WHICHARD
Publishers
Second Class Postage Paid
at Greenville, N.C.

MEMBER OF ASSOCIATED PRESS

The Associated Press is exclusively entitled to use for publication all news dispatches credited to it or not otherwise credited to this paper and also the local news published herein. All rights of publications of special dispatches here are also reserved.

UNITED PRESS INTERNATIONAL

Advertising rates and deadlines available upon request.
Member Audit Bureau of Circulation.

Strength For Today

CHRIST AND THE WHIP
Those who picture Christ as nothing more than the pale and weak advocate of non-resistance should read the description in the gospel of how Jesus went into the Temple and drove out the money changers. They were carrying on a crass and sometimes dishonest business within sacred precincts and Jesus did not hesitate to overturn their tables and drive them before him with a whip.

The Christ of the whip! We seldom think of him as such.

He so often referred to himself as meek and lowly of spirit that we have formed our image of him along these lines. We forget that sometimes his eyes flamed with anger and on one occasion resorted to violence.

So in the lives of everyone of us we can be sure that there are times when Christ may use the whip. If we will not listen to his words, we may, by the working of divine grace, be brought to submission by sterner means.

—By Elisha Douglass

New Boost By CP&L

RALEIGH (AP)—Bills of Carolina Power & Light Co. customers are going up again. This was indicated Tuesday when the company put into effect the final 3 per cent of a 21 per cent rate hike it requested a year ago. The state Utilities Commission had allowed CP&L to put the remainder of the increase in effect in the form of interim rate hikes.

The latest boost will add approximately 66 cents to the monthly bill of an average residential customer. The bills of industrial customers will rise up to 10 per cent.

The company put the remainder of the 21 per cent hike into effect under a provision of state law which says a utility can make an increase effective if the utilities commission has not acted on the request 270 days after it suspends a rate hike. The commission suspended the company's rate application last January pending hearings. The commission completed hearings on the \$48 million request a few days ago and has the case under consideration.

Nokes Col. . .

(Continued from page 4) prices.

But Willy de Clercq, the finance minister of Belgium, said such policies have brought "a real risk of an excessive slowing down of activity in the industrial countries," although he did not mention any country by name.

Witteveen also said he thought demand already had slackened in many developed countries, but that prices have not. He urged that price and wage controls be considered as ways of bringing prices into line.

Buchwald . . .

(Continued from page 4)

you will do all the super-market shopping for the family, which I'm sure you'd enjoy."

"Okay, let's forget about saving money on food," I said. "But surely in this family budget there is some place we can cut waste."

My daughter Jennifer said, "Why don't you give up your season ticket to the Redskins games?"

"Now, wait a minute," I replied angrily. "Let's not throw out the baby with the bath water."

Evans-Novak. . .

(Continued from page 4)

Kalmbach "a splendid witness, with a very good memory and excellent records." Flanigan, Jenner added, "played things close to his vest and was careful about what he told Kalmbach."

Although Eagleton today has few allies in the drive

against Flanigan, prospects for confirmation are blighted by one ominous fact: Sen. Robert Byrd of West Virginia, assistant Democratic leader and perhaps the single most potent figure in today's Senate, has announced against him. Whether Flanigan survives or not, even White House aides concede the hearings can only embarrass the

Republican party and the President at a time when his hands are full with more important matters.

Ford and Turkey The overwhelming House vote last week to cut off foreign aid for Turkey takes on particular political significance because of energetic—and wholly unsuccessful—backstage efforts against it.

Mr. Ford placed a

telephone call the morning of the vote to Republican Rep. Pierre du Pont of Delaware, a co-sponsor of the Turkish aid cutoff. Arguing against the amendment, the President obviously wanted du Pont to withdraw as a sponsor or at least tone down his amendment. Du Pont did neither.

On the night before, Mr. Ford made the same pitch at the White House to senior House Democrats. As a

Speaker Carl Albert went into the well of the House the next day to support the President. So did Rep. George Mahon of Texas, powerful chairman of the House Appropriations Committee.

To no avail. The 307 to 90 vote against the President, stunning White House vote counters, was attributed by presidential aides to the fact that there are many more

Greek-Americans than Turkish-Americans, with election day nearing.

But Republican Congressmen on both sides of the issue think the debacle reflects Mr. Ford's grim decline following the Nixon pardon. Before Sept. 8, they believe, it would have been much closer.

Boosting Scoop Sen. Henry M. Jackson, who wants to avoid becoming

The Daily Reflector, Greenville, N.C.—Wednesday, October 2, 1974—5 the "conservative" candidate for the Democratic presidential nomination, may soon get help from the left wing of the labor movement: a public endorsement by Machinists Union president Floyd (Red) Smith.

Smith has been a vigorous supporter of party reform and is allied politically with left-of-center unions against AFL-CIO president George Meany and his top political

HOMEOWNERS POLICY

Call: Bill McDonald East 10th St. Greenville Phone 752-6480



this is
Eckerd's
DRUG STORES
CREATORS OF REASONABLE DRUG PRICES

76TH ANNIVERSARY SALE

PITT PLAZA SHOPPING CENTER
OPEN MON.-SAT. 9 A.M.-9:30 P.M.
SUNDAY 1-8 P.M.

ECKERD'S IS AN EQUAL OPPORTUNITY EMPLOYER

THERE MUST BE A REASON WHY ECKERD'S FILLS OVER 8,000,000 PRESCRIPTIONS A YEAR...

LET US PRICE AND FILL YOUR NEXT PRESCRIPTION

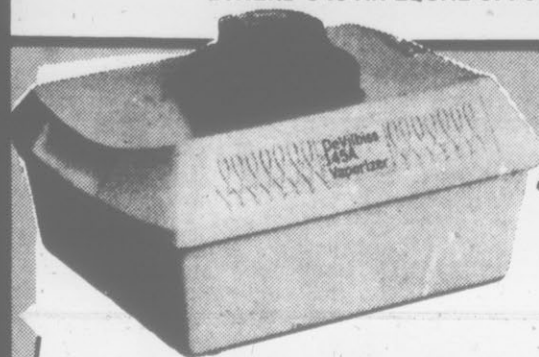

DEVILBISS NO. 145-A
VAPORIZER-HUMIDIFIER

New larger size holds a full gallon of water, steams all night! UL approved.

\$3⁹⁹



Model 200

\$13.67
CRAZY CURL

STEAM STYLING WAND

by Clairol

- Thermatically controlled
- Steam on demand
- Swivel cord keeps you untangled
- Cool tip for safety and ease in winding



KODACOLOR II C126-12
COLOR FILM

96¢



5-oz. IRISH SPRING
Deodorant Soap

4 for 99¢

LAST 3 DAYS OF SAVINGS!

bottle of 100
Excedrin
99¢

5-oz.
AIRWICK SOLID
57¢

GE DELUXE
Toast-R-Oven
TOASTER
Model T93B
\$29⁸⁸

STOCK UP ON
FURNACE
FILTERS
16"x20"x1" • 20"x20"x1"
20"x25"x1" • 16"x25"x1"
2 for 77¢

ARLINGTON
ELECTRIC
BLANKET
Twin Model 3370
Full Model 3371
\$12⁸⁸

32-oz. RIDD
**MILDEEW
REMOVER**
\$1¹⁹

Now... Put your foot down for RAND.

\$19⁹⁹



Sizes 7 1/2 to 12

Wine Patent, Wine Suede
Brown Patent, Brown Suede
Black Patent, Black Suede
Blue Patent, Blue Suede

Here's one from our new collection for Fall. A blend style, quality and value for the man who wants the most for his shoe dollar.

At 5 Points, Downtown
Open Daily 9 A.M.-4 P.M.

SAVE BIG ON THESE HEALTH & BEAUTY NEEDS!

NEW
Alka-Seltzer
Without Aspirin
For ACID INDIGESTION
HEARTBURN-UPSET STOMACH
36 TABLETS IN 18 FOIL PACKS
pkg of 36
Alka-Seltzer
79¢

13-oz. WHITE RAIN
HAIR SPRAY
59¢

Gillette TRAC II
Twin Blade Cartridges
5 shaving cartridges
pkg. of 5 TRAC II
BLADES
88¢

GILLETTE TRAC II
RAZOR
\$1⁹⁹

8-oz. ALPHA KERI
BATH OIL
\$1⁸⁷

30 tablets
Sinutab
For relief of sinus headache and congestion
new handy foil sealed tablets
30 tablets
Warner-Chilcote
pkg. of 30 SINUTAB
Sinus Tablets
\$1¹⁷

bottle of 100 DEPREE
VITAMIN E
400 I.U.
\$5⁴⁹

2.2 oz. SENSODYNE
TOOTHPASTE
53¢

1/2-oz. VISINE
EYE DROPS
88¢

32-oz.
LISTERINE
\$1⁰⁹

Gelusil
Liquid Antacid
12-oz.
97¢

WET ONES
TOWELETTES
77¢

A Stand-Off At Consulate

By IKE FLORES
Associated Press Writer
SANTO DOMINGO, Dominican Republic (AP) — The siege of the Venezuelan consulate enters its sixth day with no sign of freedom for American diplomat Barbara Hutchison and six other hostages and no indication that the Dominican government will meet the terrorists' demands.

Archbishop Hugo Polanco Brito, acting as a go-between, said the leftist guerrillas show no sign of modifying their demands for \$1 million in cash, the release of 37 political prisoners and safe passage to Cuba or Mexico.

President Joaquin Balaguer's government says it will give the terrorists in the consulate safe conduct out of the country, but it won't pay ransom or free any prisoners. The United States government also refuses to pay ransom, a policy it has maintained ever since Latin American guerrillas started kidnaping foreign diplomats.

The archbishop visits the consulate daily, taking food, soft drinks and medicine to those inside and bringing back messages from them. The hostages are all reported in good shape, but the archbishop says one of the terrorists has been wounded. According to one report, he shot himself in the foot accidentally.

Balaguer confers daily with U.S. Ambassador Robert Hurwitch, the Venezuelan charge d'affaires, the archbishop and other diplomats and officials. But there has been no indication of progress toward an agreement freeing the captives.

At least three deadlines set by the terrorists have come and gone, but the guerrillas

have made no move to carry out their threats to kill the hostages.

The most recent developed at 3 a.m. Monday as national police cordoned off the two-story, Spanish-colonial house.

Police began dumping dozens of sandbags in the middle of the intersection. Others carried them off and began building emplacements, one across the street in front of the besieged house.

The activity provoked a prompt reaction from inside the consulate, and all movement ceased as the terrorists' leader, Rafael Mendez Vargas, shouted from a top-floor window:

"Attention! Attention! We have been here a long time. We have not taken any action against the hostages. We are sick, but if you don't abandon the area in two hours, we will not be responsible for the consequences."

After a few minutes, the police resumed stacking up the sandbags. The deadline set by the guerrillas came and went without incident, as at least two others did before. The terrorists have said the consulate is mined and they will blow it up unless they get what they are demanding, but police discount this.

The guerrillas — Archbishop Polanco Brito believes there are six; other officials say there may be seven, eight or nine — are holding out in a second-story front room. Their hostages in addition to Miss Hutchison, the director of the U.S. Information Service in the Dominican Republic, are the Venezuelan consul and a vice consul, two Dominican secretaries, a Spanish priest and a young messenger.

Award Two Grants For ECU Programs

East Carolina University has been awarded two grants to continue its supplementary training programs for child development workers in five North Carolina counties.

An award of \$20,503 was given by the U.S. Office of Child Development, an agency of HEW, to continue ECU's Head Start Supplementary Training Program, and the Goldsboro City Schools have given \$15,522 to continue the Follow Through Supplementary Program.

Allen Churchill of the ECU School of Home Economics, coordinator of the two programs, said each involves about 20 workers in the Head Start and Follow Through programs who are working toward degrees in elementary education or toward a special new certification program, as Child Development Associates (CDA).

The Follow Through program involves staff in the Goldsboro City Schools' Follow Through program, which provides additional aid to former Head Start children through the third grade. While working as assistant teachers in the program, the 20 staff members under the ECU program are earning college credit toward the BS degree in elementary education.

The Head Start Supplementary Training program includes 20 fulltime workers in the Head Start programs in Martin, Nash, Edgecombe, Wayne and Johnston Counties, who are working toward BS degrees or toward CDA certification.

A competency-based program, CDA certification is being developed as a nationally-recognized credential to certify an individual's skill and experience in working with preschool children.

Reveal Student Was A Prince

TOULOUSE, France (AP) — Andy, who spent three weeks as an exchange student at a Jesuit school here, was rated as a bright student and got along well with classmates.

To the family with whom he stayed and who sent their son to Scotland in the exchange, Andy was described as the son of a landowner and a nonworking mother.

It wasn't until after Andy returned to England earlier this week that it was revealed he was Prince Andrew, second in line for the British throne.



WHILE OTHER PRICES ORBIT - YOU'RE IN GROUND CONTROL AT...



SWIFT'S BROOKFIELD
BUTTER
LB. PKG. (QUARTERS)
79¢

Fantastic savings on imported Porcelain-Clad Cook & Serve Ware

5th BIG WEEK SPECIAL!

5th Week—Large Skillet **\$6.95**

Bonus Special Introductory Offer

2 Individual Stoneware Casseroles with handles **\$3.79**

Set of 4 Stoneware Mugs **\$2.49**

On sale throughout promotion

AT YOUR PARTICIPATING PIGGY WIGGLY STORES

PIGGLY WIGGLY
ICE CREAM
1/2 GAL. —ALL FLAVORS
79¢



PIGGLY WIGGLY
CINNAMON ROLLS
2-PKGS.
79¢

Prices in Effective through Ne

QUANTITY RIGHTS RESERVED. NONE S

LOCATIONS TO SERVE YOU! 2105 DICKI

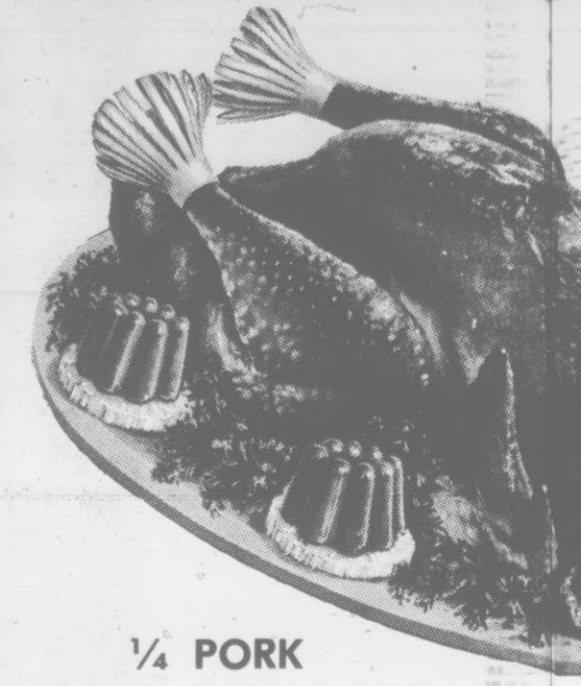

1/4 PORK
LOIN
SLICED INTO CHOPS
98

Roller Champion Self-Rising
FLOUR
10-LB. BAG
\$1.59



Del Monte Cream Style Yellow
CORN
3 303 Cans
\$1.00

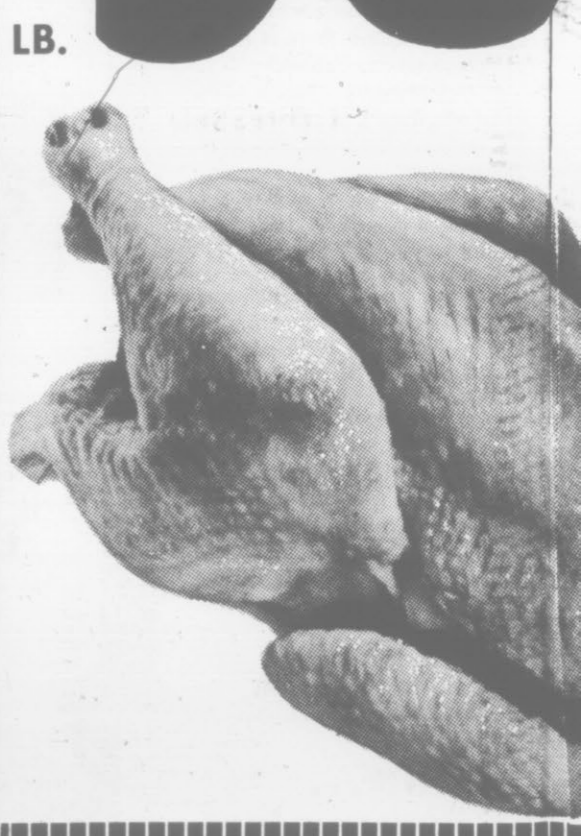

California Red Table
GRAPES
3-LBS.
\$1.00



WHITE
POTATOES
10-LB. BAG
99¢



LOIN END PORK
ROAST PER LB. **9**

MEATY
BACKBONE PER LB. **9**

CENTER CUT PORK
CHOPS PER LB. **\$1**

RED DELICIOUS
APPLES
3 LB. BAG
69¢

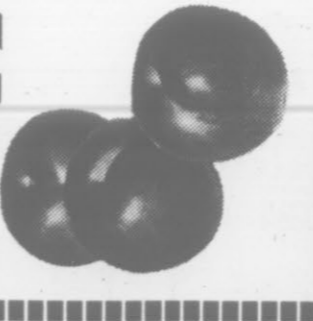

LOCAL SALAD
GREENS
3-LBS. FOR
\$1.00



GWALTNEY ROLL
SAUSAGE
HOT OR MILD

SEA PAK ONION
RINGS
8-OZ. PKG.
39¢

SEA PAK
SHRIMP
IN BATTER
16-OZ. PKG.
\$1.59

COUPON

MAXWELL HOUSE
COFFEE **20¢ OFF** With Coupon

2 LB. CAN

Limit 1 per family. Void after 10/5/74

68

FOR ALMOST 100 YEARS **CROSSED FISH SARDINES** HAVE BROUGHT THE SILVER HARVEST OF THE NORWEGIAN FJORDS TO YOUR TABLE

NORWAY'S FIRST SARDINE WORLD FAMOUS

"Crossed Fish"

TRADE MARK

Look For The **CROSSED FISH LABEL** in your canned meats and fish section of your favorite supermarket. **CROSSED FISH SARDINES** blend in for every occasion when the unusual taste treat is required.

Serve them often.

Imported by
Stafford H. Green P. O. Box 625 Charleston, S. C. 29402

This Adv. Thursday at Wednesday!

TO DEALERS, TWO CONVENIENT GREENVILLE AVENUE AND 1212 NORTH GREENE STREET.

HOUSE OF RAEFORD GRADE "A" YOUNG

TURKEYS

12-14 LB. AVG.

49

LB.



FRESH DRESSED N.C. GRADE "A" WHOLE

FRYERS

39

LB.

LUNDY NO. 1 **BACON** LB. PKG. **98**

GWALTNEY **FRANKS** 12-OZ. PKG. **68**

GWALTNEY **BOLOGNA** LB. PKG. **88**

FRESH CUT-UP WHOLE LEGS & BREASTS OF

FRYERS

4 LBS.

259

MAXWELL HOUSE INSTANT

COFFEE

10-OZ. JAR

189



SNOWDRIFT

SHORTENING

3-LB. CAN

149



GAIN

DETERGENT

GIANT SIZE PKG.

89



SPIC & SPAN

16-OZ. PKG.

37



DOWNY FABRIC

SOFTENER

64-OZ. JUG

149



PIGGLY WIGGLY

TOWELS

3-JUMBO ROLLS

100



BANQUET

POT PIES

4 8-OZ. PIES

100



PET RITZ

PIE SHELLS

3 2-Ct. Pkgs.

100



BLUE BONNET

MARGARINE

LB. PKG.

49

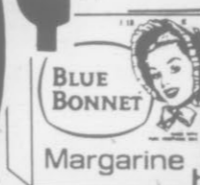

Piggly Wiggly Buttermilk

BISCUITS

4 8-OZ. PKGS.

39

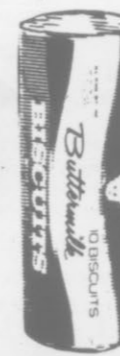

PET **MILK**



4 TALL CANS **100**

GARNER'S TEXAS PETE

CHILI

4 10 1/2-Oz. Cans **100**



RC COLA

8 16-Oz. Bottle Carton **99** PLUS DEPOSIT



Two Convenient Greenville Locations To Serve You! 2105 Dickinson Avenue and 1212 North Greene Street. Quantity Rights Reserved. Prices Effective Thursday, Through Next Wednesday.

Industrial Park Land Is Rezoned

By CAROL E. TYER
Reflector Staff Writer
FARMVILLE—Land on which Farmville's new industrial park is located was rezoned by Town Commissioners here last night. It was changed from residential to light industry.

A resolution pertaining to the Revenue Sharing reenactment was passed. The matter is expected to be considered by the Congress and the President soon.

Discussion of the Revenue Bond Amendment was postponed until more information about it could be obtained.

Estimate No. 7 on the water tank being constructed here was approved, in the amount of \$1,946.25.

Approval was given for the payment of \$4,192.70 on paving and curbing and landscaping the new parking lot at the corner of Wilson and Contentnea Streets.

Clarence Artis and H.M. Leckie were reappointed to the Board of Adjustments.

Appointments to the Planning Board were postponed until it could be determined how the Board should be constituted as to in-town and out-of-town-within-one-mile radius residents.

Improvement of the parking area owned by J.I. Morgan was discussed. Town Attorney John Lewis said he would draft a letter of agreement to be signed by Davis heirs about the town's having control of a proposed parking area along Walnut Street until the owners would either build on or sell it.

The Commissioners agreed on the need for a garbage packer for the town. The town now has one working and one in the shop. The cost will be approximately \$13,000.

The Board gave the town administrator the go-ahead to plan for a temporary dog dropoff pen to be built near the town landfill to house stray dogs until they may be picked up by the county rabies control officer.

Autographing Party Slated

An autographing party for the sponsors of The Bicentennial Book: A Greenville Album will be held Thursday, October 3 at 7 p.m. at the Greenville Art Center where the hardback version of the book will be on view for the first time.

The sponsors of the book will meet with editor-publisher Thomas A. Williams and with contributing authors and persons contributing pictures to the book.

The informal reception at which guests are urged to wear Bicentennial costumes, will be a thank-you to the sponsors for this most significant support of the Bicentennial celebrations.

The book, a compilation of old photographs, articles ranging

over the broad spectrum of Greenville's past, predictions on the city's prospects, and historical oddities, will be on sale October 4 at Bicentennial Headquarters at the corner of Ninth and Evans, the Bicentennial Shop at the Kroger Building, Central News and the Book Barn.

Since only 1,000 copies of the hardback edition were printed, the public is urged to get copies early. The hardback is \$6.95 and the paperback, already on sale, is \$3.95.

Scouts Helping Clean-Up Drive

For the Bicentennial celebration the Boy Scouts and the Greenville Department of Public Works are cooperating in an effort to keep Greenville Clean. The Boy Scouts have begun a clean-up campaign, assisted by trucks and drivers from the Department of Public Works.

The Department of Public Works has also been getting the Town Common ready for the many activities which will be held there during Bicentennial week. Six flag poles have been installed and extra waste cans will be placed around town. Mayo Allen, director of the department, says, "We want to help with the Bicentennial in any way we can."

Work Exhibited By Art Senior

Mary Rebecca Chadwick of Norfolk, Va., senior student in the East Carolina University School of Art, is displaying examples of her work this week in the gallery of the Baptist Student Union on Tenth St.

Included in the exhibition are handwoven pillows, garments, upholstery fabrics and tapestries; some handcrafted jewelry and carved wooden items.

A candidate for the BS degree in art education, Miss Chadwick is at present student teaching in New Bern and Kinston.

'New Life Crusade'



THE HAWKINS TEAM... includes Mary, Sparkey, Irvy and Spunky.

AYDEN—The Hawkins Team are conducting a new life crusade this week at the Community Baptist Church. The services will continue through Thursday and begin at 7:30 p.m.

The team includes Mary, Sparkey, Irvy and Spunky of

Columbia, S. C. The team presents "Magic for the Master," trick and chalk talks and ventriloquism.

The pastor, Stanley E. Wingard, and the church membership invited the public to attend.

Have You Missed Your Daily Reflector?

First Call Your Independent Carrier. If You Are Unable To Reach Him Call The Daily Reflector, 752-6166 Between 6:00 And 6:30 P.M. Weekdays And 8 'Til 9 A.M. On Sundays.

VEPCO Emergency Rate Increase Effected Today

RICHMOND, Va. (AP)—Virginia Electric & Power Co.'s record-high \$97.7 million emergency rate increase went into effect today, increasing the bills of residential customers by as much as \$6.60 a month.

The State Corporation Commission granted Vepco the increase Tuesday. The rate hike is more than double the largest increase ever granted to the company, but falls short of the \$123.7 million requested by the company.

The commission put a ceiling on the amount of the increase to residential customers, applying the 22.5 per cent surcharge only to the first 1,500 kilowatt hours for the residential user. Commercial and industrial customers will pay the surcharge on the total amount of electricity they use.

The rate hike, which will increase Vepco's revenue by about 17.5 per cent, will be applied only to the base rate for electricity and not to the fuel adjustment charged each customer.

All three SCC members agreed that the utility needed additional revenue, but SCC Chairman Preston C. Shannon issued a minority statement saying Vepco should have been awarded much more money.

The majority opinion issued by Commissioners Thomas P. Harwood Jr. and Junie Bradshaw said, "Clearly Vepco is presently in a critical financial position and needs immediate and adequate rate relief."

The commission said the key issue in its emergency rate hearing was whether Vepco's ability to provide adequate, reliable service was in immediate jeopardy because of an emergency.

"It is the judgment of the commission that the question must be answered in the affirmative," the SCC concluded. The commission directed Vepco to seek legislation from the 1975 General Assembly to place electric rates paid by state and local governments under the jurisdiction of the SCC.

Shooting Death Ruled Suicide

The shooting death yesterday of a 16-year-old D.H. Conley High School student has been ruled suicide by Pitt County Coroner and Medical Examiner E. W. Harvey.

The official said Kathy D. White of Route 2, Greenville was found dead in her home near Chicod about 6 p.m. when her mother returned home.

Harvey, who said her mother left home about 2:45, reported Miss White talked with a friend about 3:45 p.m. by telephone, before shooting herself in the chest with a .22-caliber pistol.

She had been dead about two hours, the coroner said, when found in the bedroom of her home.

PTA Meeting Set Thursday

There will be a special meeting of the Sadie Sautler P.T.A. at 8:00 p.m. on Thursday, at the Sadie Sautler School. The purpose of the meeting is to finalize plans for the Barbecue Dinner on Friday, October 25. All parents are encouraged to attend this important meeting.

ADDITIONAL RISK
ALBANY, N.Y. (AP)—Women who become pregnant while taking birth control pills have a greater chance than other women of bearing children with birth defects, according to a State Health Department study.

FOGGY HAZARD
DETROIT (UPI)—When driving in fog at night, use only low beam headlights. High beams tend to reflect the fog ahead and reduce visibility to zero.



WON NOMINATION
MIAMI (AP)—Former Florida Secretary of State Richard Stone has won the nomination of Florida Democrats to seek the Senate seat being vacated by Republican Sen. Edward J. Gurney.

Handicapped.

Continued from page 1)

handicapped persons. The Division of Services for the Blind, a state agency, has an Eastern Regional Office here that serves 33 counties including Pitt.

Mrs. Fran Churchill of the regional office notes "the agency serves blind and visually impaired individuals. A total of 103 blind and visually impaired individuals have been served in the last three months in Pitt County alone."

"The final goal," she said, "is gainful employment."

Another agency whose purpose is to provide a multitude of services to the handicapped is the Division of Vocational Rehabilitation. A state-federal program, the unit office is located at Shore Drive Plaza in Greenville.

"Last year more than 757 handicapped people were rehabilitated in Pitt and adjacent counties," Carlton Hardee, Administrative Counselor of the division said. "It is hoped this year more than 825 handicapped people will be reached and benefitted through this agency. A handicapped person may be referred to us by any other agency, by an individual, or he may be a self-referral."

Kendrick Taylor, Veterans Employment Representative, who is also in charge of the handicapped program at the Greenville Employment Security Commission recently met with other members of the Handicapped Committee which includes Mrs. Churchill; John Anema of the Vocational Rehabilitation office; John Corey from Pitt Technical Institute; Oscar Moore with the N.C. Department of Veteran Affairs; and Sam Whitehead, Senior Citizens Representative to discuss ways of promoting National Employ the Handicapped Week.

"The local employment office works throughout the year in locating suitable jobs for handicapped applicants," Taylor said, "but at this special time we hope that interested citizens, employers, and organizations in Pitt County will join us to inform the public of the problems handicapped workers experience finding jobs."

There are approximately 135 applications of handicapped applicants currently in the active file at the local employment office. Broken down in figures this represents 32 veteran, 35 non-veteran males and 68 non-veteran females.

"For a variety of reasons the disabled veterans coming back from Vietnam have not been absorbed into the working world as rapidly as other young people," Taylor said. "This high unemployment rate is not consistent with the treatment we as a nation have historically accorded our military veterans. However, with the Employment Security Commission, the handicapped veteran receives priority over any other applicant when it comes to referring a veteran to a job."

Taylor urges employers to place their job openings with the local Employment Security Commission located at 1002 South Evans Street in Greenville and to give special consideration to the hiring of qualified handicapped applicants.

TABLOID SALE

Save More Money On Lumber, Plywood, Paneling, Flooring, Roofing, Gypsum, Paint, Kitchen Cabinets,

ENDS SATURDAY!

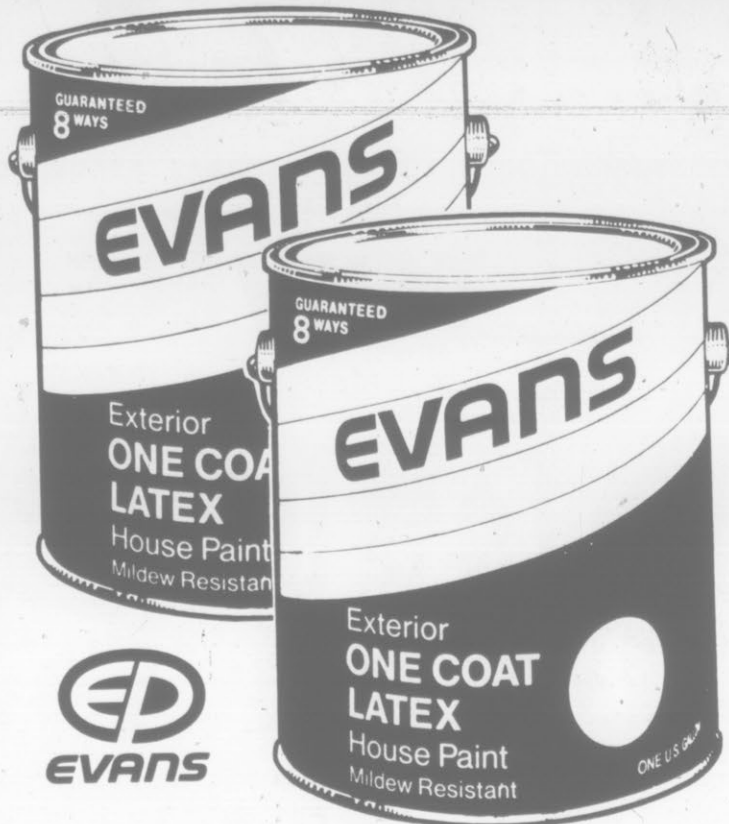

Evans Best 8 Year Exterior Latex House Paint Now Reduced To A Low, Low . . .

849
GALLON

Regularly 9.99!

Our best quality! Long-lasting Evans Deluxe House Paint contains the unique chemical Barium Metaborate to fight mildew growth and development. . . plus durable latex protection to combat the destructive pollutants in the air, moisture damage and fading. Hurry in for savings now on Evans creamy new Williamsburg White and 13 of the handsomest housepaint colors you ever saw, plus Evans bright White. All this plus low "painty" odor and easy soap & water clean-up after painting. You and your home deserve the good life of Evans 8 year paint - from Moore's!



Crescent Maple & Crescent Hickory Prefinished Wall Paneling Priced At Only . . .

Regularly 3.69!

299
each

Remodeling funds limited? No one need ever know if you choose one of these two Crescent series' panelings for your remodeling plans! Prefinished, simulated woodgrain particle board paneling with toned grooving effect for added wall interest. Buy it now & save 70¢ on every panel! 4' X 8' X 5/32"

Woodtoned Electric Baseboard Heater

Reg. 29.95! **2688** each

Stay-cool metal cabinet with automatic thermostat & safety tip-over switch. UL approved. Combo 4500 & 5600 BTU's. 1.95 9.95 6.95

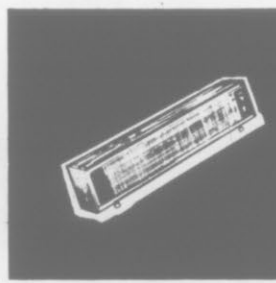

Evans Estates Paneling, Now Only

Reg. 5.99! **399** each

Your choice of medium or deep brown woodtones in Evans prefinished, simulated woodgrain plywood paneling, random grooved. 4'x8'x5/32"

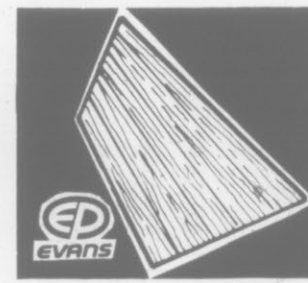

Evans Scenics Series Paneling

Reg. 8.99! **749** each

European street scenes in prefinished, decorative printed plywood paneling. Blue, Green or Gold. 4' x 8' x 5/32"

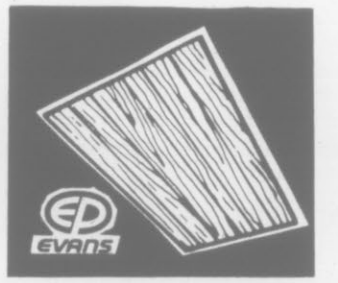

Imperial Accotone Vinyl Floor Covering

Reg. 2.99! **239** sq.yd.

Castilian Regularly 4.99 3.99

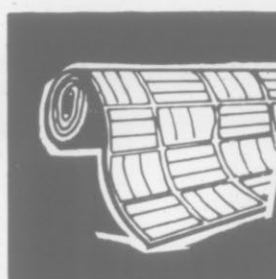

Quikrete — Your Choice Regularly 1.88!

138 bag

Concrete Mix 68lb. Mortar Mix 60lb. Sand Mix 60lb.



Celotex Decorator White 12"x 12" Ceiling Tile

9 1/2 each

Sculptured 16 1/2

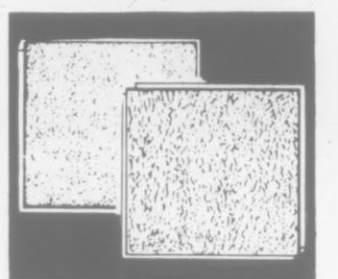

Wrought Iron Rails Add Safety & Beauty

4' section **396** section

6' section 5.94 Easy to install without special tools. Primed black, ready to finish coat to suit. 4 & 6 ft. rails incline to any angle.



Stay Warm With Fiberglas Insulation

Now **490** 70 sq.ft.

Add comfort all year round with 3 1/2" of Owens/Corning Fiberglas Insulation in walls and under floors!



Celotex 12"x 12" Ceiling Tile — Your Choice

Plastic Coated **19c** each

Bahia Rondelay Plastiguard Emerald

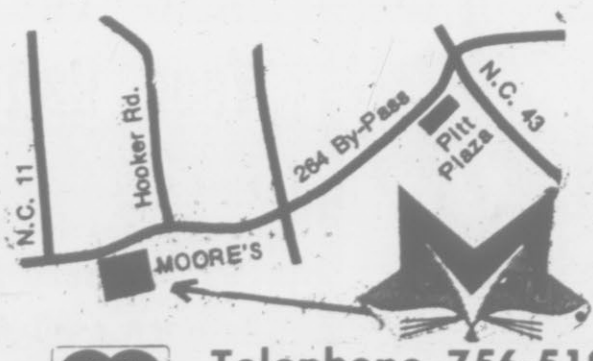
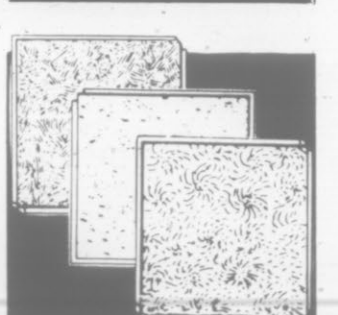

329 W. GREENVILLE BLVD.
(264 BY-PASS)
JUST EAST OF MEMORIAL DRIVE

Telephone 756-5187

OPEN MONDAY THRU FRIDAYS 8 A.M. TO 8 P.M., SATURDAYS 8 A.M. TO 5:30 P.M.

USE BANKAMERICARD OR MASTER CHARGE CARD & Charge It!

Ombudsman Knows About Prison Life

By MARY SCHEIER
Associated Press Writer
LANSING, Mich. (AP) — James Spivey thinks he knows more about prisons than most criminologists because he took a 36-year course in penology the hard way: behind bars.

"After all that time living with prisoners you know what they pull off and you know what the administration is pulling off," the tall, heavily built Spivey said with a laugh.

Spivey, 62, has been free since 1970 and lives in Detroit. He's now married and the father of a 5-year-old son. He is putting what he learned in prison to use as Michigan's legislative corrections ombudsman. He handles grievances both from inmates and prison employees and works as problem solver and reformer.

Spivey was found guilty of murder in 1934 when police said he drove a get-away car after a fatal shooting. His sentence was commuted and his lawyers discovered his trial transcript had been destroyed and his conviction rested on the unsigned confession of another man convicted in the case.

Spivey says he never knew the other man and has consistently denied his guilt.

Since he's been out of prison, Spivey has devoted himself to working with youngsters in trouble, mainly through church organizations.

The legislature created the ombudsman post last year, and Spivey got the job simply by applying for it.

"I studied for this," he said. "I took up sociology, journalism, management, business administration, chess, law ... I stuck with law for about 20 years (through correspondence courses), until I found out that everything was at the judge's discretion.

"We've got too many laws," he said.

"I'm not bitter," Spivey said. He said he waited a long time to try to get his sentence commuted because "You don't have the money, you don't have the knowledge."

Even now, he said, not all prisoners know their legal rights.

"When you're sending a fellow to 10 years or to life and someone says: 'Here's your rights,' do you think he's listening?" Spivey asked. "It's a nightmare you wait to awake from."

Spivey was 22 years old when he entered prison. He spent most of his years behind bars at Southern Michigan State Prison at Jackson.

"I was too shocked to be angry," he said of those first few years. "I was in a daze, not really aware of what had happened. When it hits you, when 'Hey, I'm in for life' really hits you, you build up a hope that the truth will come out."

Spivey said prisons are worse now than in the past. He said that up to the 1940s: "Wardens gave inmates as much leeway as possible. After that it tightened up."

After all those years in jail, why did he decide to take a job that brought him back into a prison?

"What was done to me — that's why," Spivey said. "I don't think it is the meaning of living, that human beings should suppress other human beings lives. I think we should add to each other's life. 'Life is so short.'"

Invites Voices In Planning Role

Jesse Harris, city human relations director, said that the "City of Greenville needs your ideas and participation in planning for the future growth of our city."

He noted that any organization wishing to participate in the planning process should send the name and address of the organization, and the name and telephone number of the chairperson to Community Development, Box 1905, Greenville.

He said that representatives of interested organizations could call him at 752-4137, extension 256.

BATTERY CHECK

DETROIT (UPI) — Car batteries should have their water level checked every two weeks in hot weather. High temperatures evaporate electrolyte, leaving the plates exposed and in danger of buckling or sulphating.



Pitt Plaza
Open Daily 9:30 A.M.-9:30 P.M.



THURSDAY—FRIDAY—SATURDAY

LIMITED QUANTITIES ON SOME ITEMS SUBJECT TO EARLY SELL-OUT

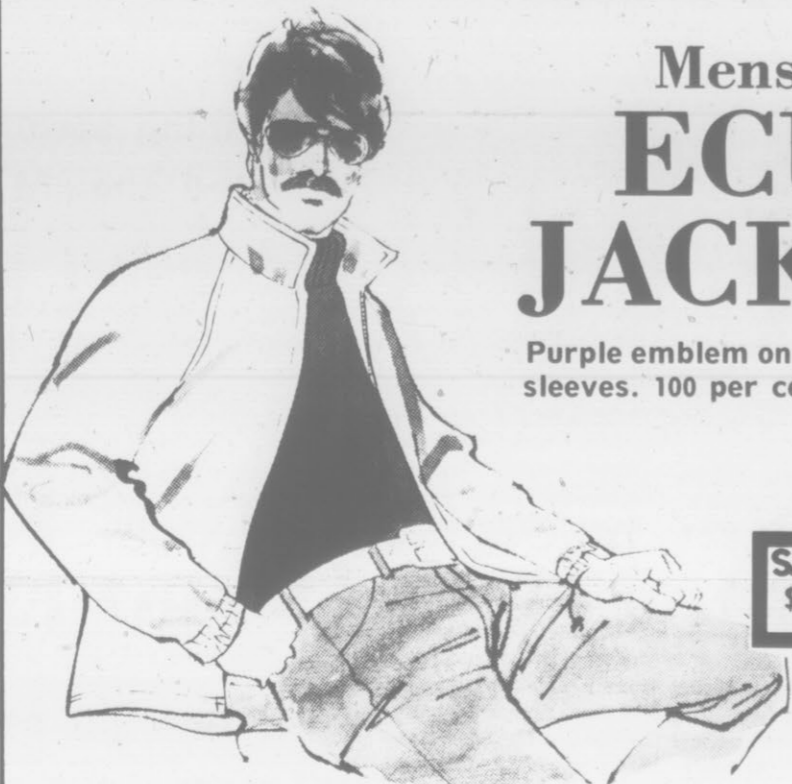

Mens ECU JACKET

Purple emblem on gold. Sizes S-M-L. Long sleeves. 100 per cent nylon.

Reg. \$8.88
SAVE \$3.88
\$5.00

Buy Now And Save

For casual or dress... the latest fall colors and styles in...

LADIES SLACKS

Reg. \$4.99

SAVE \$2.33
\$2.66

Great looking 100 percent bonded acrilan slacks for ladies. Perfect for casual or dress. Sizes 12-18 and 32-38. Has wide straight legs and easy to care for. Machine wash. Colors of navy, brown, black, berry, purple and green.



DECORATOR 2-PIECE ROCKER CUSHION SET



SAVE 98¢
\$3.98

Reg. \$4.97

Rocker Not Included

Durable-Comfortable-Non-Allergenic

Mens SWEAT-SHIRT



Long sleeves. Polyester & cotton. Sizes S-M-L-XL.

Reg. \$3.99

SAVE \$1.00
\$2.99



One Table Ladies SHOES

Values to \$4.99

SAVE to \$2.99
\$2.00

Assorted styles, sizes and colors.

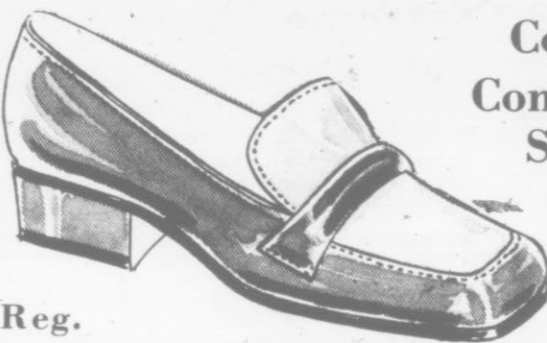

Combine Comfort With Style!

Perfect for work or casual wear with slacks or dresses.

WOMEN'S

CASUALS

Reg. \$5.90
SAVE \$2.90
\$3.00



MATCHBOX CARS

Choose from twenty-four of your favorite die-cast steel matchbox cars. Authentically scaled and designed to look real.

REG. 77¢
SAVE 54¢
\$2.11



MINIATURE LEGENDARY WESTERN CHARACTERS REGULARLY 49¢ EACH

Miniature die-cast metal western characters. Choose from your favorite characters such as Red Cloud, Jesse James, Billy the Kid, and many, many more. Set up your own battle field!

SAVE 96¢
\$4.11

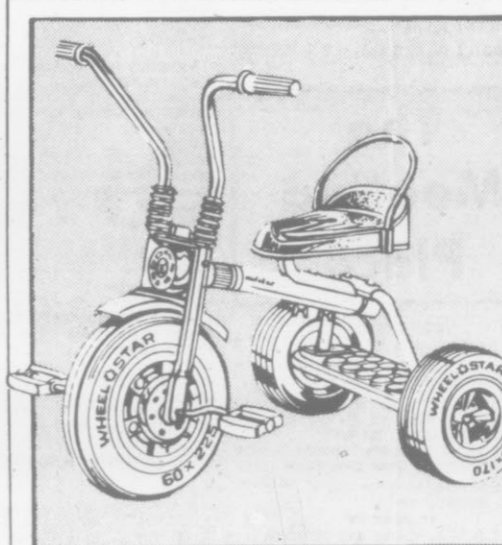

Sturdy steel construction... ROADSTAR TRICYCLE

REGULARLY 13.96
SAVE 4.05
\$9.91

Roadstar tricycle with big, sturdy steel construction. Star of the road! Fat slick oversized "billboard" type tires. Simulated drag type springs. Bright chrome handlebars with soft grips. Front wheel size: 9"x2-3/8"



RUBBERMAID Bathtub Appliques

REG. \$1.98

SAVE 41¢
\$1.57

Adhesive backed, grips tubs securely. Gives safer footing and comfortable sitting.



RUBBERMAID Toilet Bowl Brush Set

Reg. \$3.49

SAVE 92¢
\$2.57

Sanitary brush with plastic handle, stores in compact non-porous caddy.



RUBBERMAID Bathtub Mats

Reg. \$3.79

SAVE \$1.22
\$2.57

New sculptured design with individual suction cups, grips instantly to slickest tub surfaces.

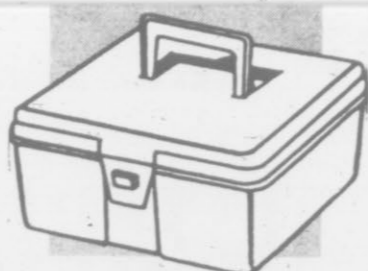

HANDY FILE-A-CHECK

Reg. \$1.00

SAVE 20¢
80¢

Keeps checks near the monthly separators. Overall 8 3/4" x 8 3/4" x 4 1/4".



Smartly fashioned for today's woman... Ladies' All Nude PANTY HOSE

ROSES LOW PRICE

PAIRS **\$3.00**

Limited Supply

Packages of 3 pairs of ladies 100% nylon all nude panty hose. Sizes S-M-L. Choose from Begetone, Spicetone, and Collee. Slightly imperfect but does not affect wearing quality.



Be stylish and stay dry in the rain... Ladies' 100% Vinyl Dome Umbrellas

REGULARLY 1.99

SAVE 1.00
99¢

Ladies 100% vinyl dome umbrellas. Clear plastic dome with decorative color trim and matching plastic handle. Carry strap on handle. Buy now and save \$1.00.



Warm, comfortable poly-filling... Denim Look Sleeping Bag

REGULARLY \$12.88

SAVE \$2.97
\$9.91

Denim sleeping bag with dark blue denim cover and red bandana lining. Poly-filling is warm and comfortable. Has a 100" zipper. Great for camping out or extra sleeping space.

Stock And Market Reports

RALEIGH (AP) (NCDA)—Corn and soybeans were weaker on the state's leading grain markets Tuesday. No. 2 yellow shelled corn was quoted at 3.20-3.45; oats 1.60-1.75; and barley 1.65-2.25.

RALEIGH (AP) (NCDA)—North Carolina egg markets were irregular Tuesday. Supplies were about adequate and demand was fairly good.

Weighted average prices for small lot sales of consumer grade eggs delivered in cartons to nearby outlets: Grade A large whites 70.78, medium whites 66.70, small whites 48.59.

RALEIGH (AP) (NCDA)—North Carolina hogs today were mostly 50 cents higher. Prices were 36.25 at High Falls; 35.50 Tarboro and Bethel; 36.50-37.00 Rocky Mount; 37.50-38.50 Kinston; and 37.00 Salisbury.

RALEIGH (AP) (NCDA)—North Carolina F.O.B. dock broilers were steady today with this week's dock weighted average price at 40 cents per pound. Supplies were about adequate and demand good. Weights mostly desirable. Estimated slaughter 1,070,000.

North Carolina hens were steady on heavy types. Supplies barely adequate to short and demand good. Too few sources reporting to release prices.

NEW YORK (AP)—The stock market pulled out of its latest dive with a mild technical rally in quiet trading today. The 11:30 a.m. Dow Jones average of 30 industrial was up 1.41 at 606.23, while gainers held a more emphatic 2-to-1 edge on losers overall on the New York Stock Exchange.

Brokers said the advance stemmed primarily from forces within the market rather than any notable news developments.

They pointed out that the market rarely moves in a straight line in either direction for long. After the 66-point slide in the Dow over the past seven trading days, they said, it was natural for the market to take at least a temporary upward turn.

The slow pace of activity was cited as a telling sign that investors were still on their guard over inflation and the world oil situation.

Most of the gains were fractional. Among the Big Board volume leaders, for example, Texaco was up 1/4 to 21 1/2, American Telephone & Telegraph rose 3/8 to 40 3/4, and Celanese was ahead 1/4 at 28 1/4.

An exception was Upjohn, up 1 1/4 to 47 1/2. The company said an antiarthritic drug it markets in several other countries is now available in the United States since its approval by the Food and Drug Administration.

Merrill Lynch, parent holding company of the nation's largest

Obituaries School Bd.

Brown
Mrs. Lula Dawson Brown died in the Greenville Nursing Center Sunday night. Funeral services will be held Thursday at 4 p.m. at York Memorial AME Zion Church with the Rev. Luther Brown officiating. Burial will follow in the Brown Hill Cemetery.

Mrs. Brown was a native of Pitt County and spent her life in the Greenville community. She was a member of York Memorial AME Zion Church.

Survivors include her husband, Lidian Brown of 301 Elizabeth St., Greenville and Tony Dawson of Philadelphia, Pa.; one stepson, Melvin Brown of Brooklyn, N.Y.; two step daughters, Mrs. Mary Jane Wilkes of Greenville and Mrs. Agnes Smith of Farmville; two sisters, Mrs. Maggie Woodard and Mrs. Laura Humphrey, both of Greenville; eight grandchildren; one great grandchild.

The body will be at Planagan and Parker Funeral Home and taken to the church one hour prior to the service. Family visitation will be from 8 p.m. to 9 p.m. tonight.

Lofton
Mrs. Alice Lofton of 1306 Colonial Ave., died this morning in Pitt Memorial Hospital. Funeral arrangements are incomplete at Planagan and Parker Funeral Home.

She is the mother of Predy Lofton, Willie Lofton, and Mrs. Girlena Hardy, all of Greenville.

White
Miss Kathy Danez White, 16, died at her home in the Black Jack Community Tuesday. Funeral services will be conducted at four o'clock Thursday afternoon at the Wilkerson Funeral Chapel by her pastor, the Rev. Bobby Bazen, and the Rev. R. M. Stewart, pastor of the Black Jack Pentecostal Free Will Baptist Church. Burial will be in Pinewood Memorial Park.

Kathy spent all her life in the Black Jack Community and was a member of the Black Jack Free Will Baptist Church. She was a member of the Junior Class at D. H. Conley High School.

Surviving are her parents, Mr. and Mrs. Rufus L. White Jr.; a brother, Mike White of near the home; three sisters, Mrs. Michael Clark, Mrs. Walter Gaskins and Mrs. Randall Stokes, all of the Black Jack Community; her maternal grandmother, Mrs. Callie Cannon of near Ayden; her paternal grandparents, Mr. and Mrs. Rufus White of the Black Jack Community; and the paternal great grandmother, Mrs. Iona White Hardee of Shelmerdine.

Fullilove PTA Meeting Set

The PTA meeting for Agnes Fullilove School will take place at the school on Thursday, October 3, beginning at 7:30 p.m. There will be visitations scheduled to classrooms, and all parents are urged to attend this meeting.

Tuesday Leaf Mart

Market	Pounds	Dollars	Average
Ahoskie	no sale		
Clinton	293,912	333,869	113.59
Dunn	276,413	312,858	113.18
Farmville	380,551	433,570	113.93
Goldsboro	316,233	362,761	114.71
Greenville	1,025,847	1,162,841	113.35
Kinston	1,162,368	1,323,529	113.89
Robersonville	231,898	263,525	113.64
Rocky Mount	795,031	906,031	113.96
Smithfield	321,484	363,096	112.94
Tarboro	216,970	245,900	113.33
Wallace	237,984	269,420	113.21
Washington	226,361	255,733	112.99
Wendell	389,885	444,283	113.95
Williamston	309,072	352,357	114.02
Wilson	1,505,546	1,722,613	114.49
Windsor	290,560	329,323	113.34
Totals	7,979,115	9,481,779	113.82
Season Totals	293,894,197	303,803,243	103.37
Stabilization:	23,548		

ministrators, teachers, supervisors, maintenance, transportation, tutors, secretaries, bus drivers, lunchroom workers and custodians who draw an aggregate salary in excess of \$7.9 million each year.

A request from the Ayden Grammar School for a portion of the funds derived from rent of the South Ayden facility to be used for school improvements was tabled until the November meeting.

The money was requested to be used for the purchase of athletic equipment, stage curtains and carpet and air conditioning for the school library.

Alford said he felt the funds could be used to support other programs and needs of the school but that the money should not go into the athletic program.

The board tabled the matter and asked that the Ayden Advisory Council study the situation and give the board a more complete report at the November meeting.

Board members agreed to allow the Grifton Recreation Commission to use the paved outdoor court and the basketball standards and the permanent education structure of the old Grifton Elementary School as a mini park. The area will be supervised by the Recreation Commission and the Commission will assume full responsibility for liability for any injuries sustained by students or other persons using the court and equipment.

A dinner meeting honoring advisory school members, both retiring and new, will be held Tuesday, Oct. 29, at 6:30 p.m. at A.G. Cox Grammar School.

School handbooks from Ayden Primary, Ayden Grammar, A.G. Cox, H.B. Sugg and W.H. Robinson were approved by the board.

A request from a private school to use 16 millimeter teaching films owned by the county schools was denied.

Superintendent Ott Alford was given permission to request additional teaching positions from the State Board of Education for classrooms that exceed the maximum number allowed by the state law.

Several appointments and reappointments were made to local school advisory councils. They include: Ayden, Mrs. Jack Dail, Max Butts and William H. Anderson; Grifton, Eugene

Warn Against Exploitation

WASHINGTON (AP)—Families of servicemen missing in action have been cautioned by the State Department to guard against false hopes that some of the men may be alive.

The warning came against the background of what the agency called exploitation of MIA families by a Chicago minister, the Rev. Paul Lindstrom, who claimed he arranged a Mexico City meeting between Communist agents and

Planning Meet Slated Tonight

The Joint City-County and Greenville Planning and Zoning Commissions will meet tonight at 8 p.m. to handle business that was postponed last week when the commission failed to have a quorum for the regular monthly session.

The same agenda scheduled for last week's meeting will be taken up tonight, including several items that need Planning and Zoning action prior to being considered by the city Council tomorrow night.

Homecoming At Church Sunday

WINTERVILLE—The Winterville Pentecostal Holiness Church will observe homecoming Sunday. The Rev. Lester Ormond of New Bern will be guest speaker.

Dinner will be served at 12:45 p.m. A special singing program is scheduled to begin at 2 p.m. featuring the Forehand Singers of Goldsboro.

Revival services will begin Monday at 7:30 p.m. The Rev. Haywood Price of Greenville, pastor of the Faith Pentecostal Holiness Church will speak.

The public is invited to attend.

two, undecided. With 216 graduates, North Pitt had 53 students who entered college, 50 in trade, business or technical schools, 82 who sought employment, and 31 who joined the military.

"Good Neighbor"
For all your insurance needs see:
CALL
Bill McDonald
East 10th St. Greenville
Phone 523-6480
STATE FARM INSURANCE COMPANIES

Research Grant For Professor

Dr. Lynis Dohm, East Carolina University School of Medicine biochemist, has received a grant of \$5,000 from the U.S. Department of Agriculture for a research project on the influence of physical exercise on the metabolism of amino acids and protein by muscle tissue.

Several aspects of the effect of exercise upon the body's biochemical processes have been studied by Dr. Dohm during his years at ECU.

FIRST FEDERAL

Now paying the highest interest ever on savings accounts and savings certificates.

Now Paying	5 1/4%	Per Annum on passbook savings compounded quarterly and yielding 5.355% per annum if earnings are left on deposit.
Now Paying	5 3/4%	On 6 months savings certificate with minimum of \$1,000 to open and automatically renewable.
Now Paying	6 1/2%	On 1 year savings certificate with minimum of \$1,000 to open and automatically renewable.
Now Paying	6 3/4%	On 30 months savings certificate with minimum of \$1,000 to open and automatically renewable.
Now Paying	7 1/2%	On 4 year savings certificate with minimum of \$1,000 to open.

Existing certificate may be converted to higher interest rates on maturity date.

Federal law & regulations require a penalty for early withdrawal of funds from our savings certificates and reduces interest to Passbook Rate less 90 days interest.

Let a Savings Counselor advise you on selection of proper account to serve your needs.



The Meeting Place

- WEDNESDAY**
6:30 p.m.—Kiwanis Club meets
7:00 p.m.—The Junior Woman's Club at First Federal on the 24th Bypass.
8:00 p.m.—Pitt County Al-Anon Group meets at AA Bldg. on Farmville Hwy. Telephone 756-3222 or 756-5567.
8:00 p.m.—Pitt County Humane Society meets at Planters Bank civic room.
8:00 p.m.—The Matrons Club at the home of Mrs. Bessie Spair.
- THURSDAY**
2:00-5:00 p.m.—Game day at Greenville Woman's Club bldg.
6:30 p.m.—Exchange Club meets
7:00 p.m.—The Woman's Christian Temperance Union meets for a dutch supper meeting at Wilbur's Restaurant on 14th Street.
7:00 p.m.—Winterville Kiwanis Club meets at community bldg.
7:30 p.m.—Pitt County W.B.J. ARC Alumni meets in ARC Central Hall.
7:30 p.m.—American Legion Auxiliary meets at Legion Home.
8:00 p.m.—VFW meets at Post Home.
8:00 p.m.—Cocheset Council No. 40, Degree of Pochontas meets at Redmen's Hall.
8:00 p.m.—Regular meeting of Greenville Elks Lodge No. 1645. Dinner prior to meeting.
- PLEAD GUILTY**
WASHINGTON (AP)—The Greyhound Corp. pleaded guilty today to a misdemeanor charge of making illegal contributions totaling \$16,040 to the 1972 presidential campaigns of George McGovern and Richard M. Nixon.

Take a LONG Look at

Greenville Blvd. 264 By-Pass Opposite PITT Plaza Open Daily 10 To 10

Maybe you've never shopped at King's...maybe you thought "all discount stores are alike". Not true! Let us show you...King's offers better selection, better quality, bigger value! Try us and see for yourself.

Everything for Family and Home!

Jags Invade North Pitt Seeking Fourth

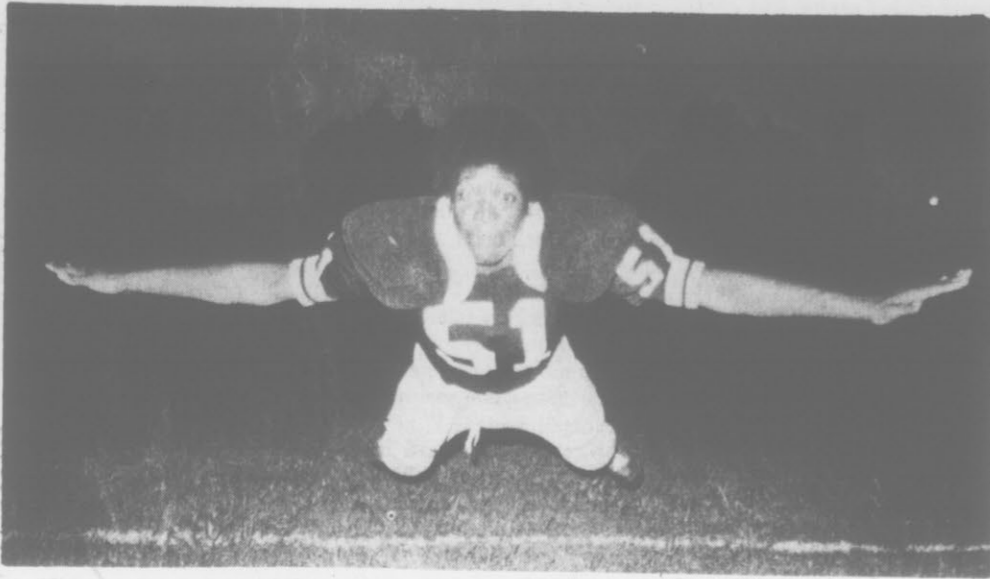

Farmville Central's Wardell Blow

"Second" Hawkins Is Running For Conley

By CHIP LAMBETH
Reflector Sports Writer
HOLLYWOOD—East Carolina has its "Big Horn-Little Horn" combination, D.H. Conley has its "Big Hawk-Little Hawk" combination.

Willie Hawkins "Big Hawk" is now playing for East Carolina as a running back and last year at Conley he rushed for over 1500 yards. Les Strayhorn was a running back for the Pirates and is now with the Dallas Cowboys of the National Football League.

Les' brother Kenny is well known by followers of the

Pirates. Willie's brother Calvin is less well known but plays a role similar to Kenny's on the Conley football team.

Calvin Hawkins is both a running back and a defensive end. While Willie was running last season, Calvin was doing the blocking that opened the holes. This year Calvin is running the ball more but the only pressure he feels is to do his job on the team.

"I don't think there is any added pressure because he was so good last year," the senior said. He does not think that he has to equal his brother's performance.

"Last year we helped each other. I helped him with his blocking because I was blocking most of the time anyway and he told me a little about cuts, running low and holding on to the ball and things like that." While both were in the same backfield Willie did the most work.

Calvin is not just a football player. He also plays basketball and runs track. "I just enjoy participating in athletics. I can't see myself doing nothing during the school year. A lot of kids get jobs and work afternoons and stuff like that. I just... like to stay in sports; I play football and after that is basketball and then in the spring, well, track is about the only thing besides football so I run track."

Playing both ways offensively and defensively presents some problems the main one being the drain on the stamina of the player. "You get tired easier going both ways, but in a way it doesn't affect me. Since I've been playing football going both ways for a school like this, we have a small team, and I realize that some people have to go both ways. It doesn't affect me."

Hawkins did say that switching back and forth does slow him down somewhat but "I can hold out. I get sort of tired but I know how to overcome it. I can find the energy to hold out to the end of the game."

Hawkins said that while he likes both offense and defense, he prefers offense. "I enjoy playing defense. I enjoy playing

a good defensive game."

Calvin likes running outside on sweeps or off tackle type plays but he doesn't "mind mixing it up running inside. I think I can get more yards outside, that is I think I have enough speed to get outside."

When he is not carrying the ball, its back to blocking or faking. On inside plays, plays that go outside the tackle, he blocks the end, if the play goes inside, it is the linebacker.

When football season ends and basketball season starts, Hawkins is in there playing that. "I enjoy playing it and watching it and I think basketball is just as demanding as football as far as physical conditioning. The running you have to do, wow! It takes a lot of stamina to play basketball."

"But I enjoy playing and that is what I do most of the time when I'm in the off season from football. During the winter, in the spring, I play basketball all the time."

While he played on the J.V. team last year, he thinks he will be able to make the varsity this year. The juniors won the conference and tournament titles last year.

In track, he runs mainly the sprints and high jumps. In his time off from sports, what little there is, Hawkins likes to listen to music although he does not have a favorite group singer. "I just like to listen to everybody." He also played some tennis this summer.

Calvin got to see brother Willie in the Pirates' game against Bowling Green and admits he, too, would like to play college football, if he can show himself this year.

Could there be another backfield brother combination at ECU in the near future?

The 1977 PGA championship will be played at Pebble Beach, Calif. Next year the PGA will be held in Akron and in 1976 at Washington, D.C.

While Southern Wayne continues to increase its undefeated string, another dark cloud is looming on the horizon in the Eastern Carolina conference.

Southern Wayne continued its winning habit as the Saints edged Goldsboro 14-13 last Friday night, but in doing so they had to hold off a late Cougar rally and stop a two-point conversion that would have given Goldsboro the win.

In the tri-county area, all but two teams won. D.H. Conley playing out of the ECC, stopped West Craven, 22-0; Farmville Central surprised Ayden-Grifton, 27-14; Southern Nash dumped North Pitt, 39-12; Robersonville blasted South Edgecombe, 57-0; Williamston crushed Roanoke Rapids, 41-0, and Jamesville won its first beating Pantego, 12-0.

In all, the average victory margin was 34 points. The losers only averaged scoring five points to the winner's average of 38.6.

While Southern Wayne was battling with Goldsboro, Farmville Central was taking its third conference win of the season against no losses beating A-G by 13 points. After a close first half which ended in a 14-14 tie, the Jaguars opened things up with a score in the third quarter and added another in the fourth as their victory put the Chargers in a precarious position in the ECC race.

"I think we just beat ourselves," said Charger coach Mike Overton. "Our inexperience was the big thing." The Chargers did not play a bad game, however. They rushed for

243 yards and held the Jaguars to 140. William West had 181 of those yards and Twendie Simpson had both of the A-G touchdowns.

Farmville Central got two first half scores on pass interceptions. "They were just poorly thrown passes," said Overton. "We had the receivers open but the pass was underthrown both times."

"It was probably our best game so far. It just seemed we didn't play good football when we had to."

Farmville's Gene Brewer felt his team played a good defensive game. "We did a good job in the second half but we didn't play a lot of football in the first half." Brewer said that the defense took advantage of A-G mistakes and the offense started blocking enabling them to score. "Greg's (Joyner) passing helped a lot; he got on a hot streak," said Brewer. Joyner hit on nine of 11 passes for 110 yards and a touchdown.

This week the Jags travel to North Pitt. North Pitt has not won yet but Brewer is still worried that the Panthers could surprise the Jags. "They are a competitive team," Brewer said, "They are better now than they have been."

North Pitt dropped its fourth game of the year Friday night losing to Southern Nash. Farmville Central had beaten the Firebirds the week earlier and they present no easy problem to Panther coach Pat Smith.

"If we don't have an improved attitude," he said, "We will get blown right off the field." Smith said the Panthers gave the worst

effort he has seen this year against Southern Nash. The Firebirds ground out 242 yards rushing.

Smith had no praise for his team. "It was the first time I've been disappointed. We did come back in the second half a little." North Pitt scored twice in the

fourth quarter for their 12 points. The Jaguars will be out to get a big win over the Panthers to tune themselves for their clash with Southern Wayne next week.

D.H. Conley's coach Chuck Dunn was complaining a couple of weeks ago that when the defense had a good game the Conley offense was off. When the offense was going good, the defense played poorly.

But last week against West Craven, the two groups started

working together and blanked West Craven, 22-0. "It was the first good game we've played," said Dunn. "They are beginning to realize how hitting helps."

Dunn praised his whole defensive line for their work holding West Craven to only 28 yards total offense. "The defensive secondary only made three tackles."

Viking quarterback Joey Baggett passed for 113 yards and two touchdowns, both to Donnie Cox. Keith Gould added the other. Calvin Clemmons ran for 70 yards to lead the Vikings in that category.

This week is the mid-point of the season as everybody will be playing their fifth game.

A-G hosts Eastern Wayne, Conley visits Greene Central, the Jags are at North Pitt. Elsewhere in the conference, Aycock is at Southern Wayne and North Lenoir is at Southern Nash.

Robersonville hosts Lee Woodard and Belhaven is at Jamesville.



DHC's Calvin Hawkins



NP's Joey Nelson

Tourney Scheduled

The Greenville Tennis Club's men's doubles tournament will get underway Thursday at the Elm Street Tennis Courts. Pairings have been posted on the club's bulletin board at the courts.

Defending champions Ron Hignite and Wes Hanks are top-seeded in the tournament, with Keith Marion and Howard Rambeau seeded second. Third are Norm Rosenfeld and Bill Still, while Jim Bailey and Jim Gaskins are fourth-seeded.

The finals will be played at 1:30 p.m. Sunday.

Entry forms for the mixed doubles tournament are available and must be received by Saturday. The tournament will begin next Thursday. Forms can be obtained from Wes Hanks, 104 Bryan Circle; Bill Still, 124 Oxford Road; or Tom Sayetta, 1117 Hillside Dr. The tournament is limited to Greenville Tennis Club members.

Ron Hignite successfully defended his men's singles title by downing Jim Bailey, 6-3, 6-3, in the finals. Bailey upset last year's finalist, Hanks, 7-6, 7-5.

Texas Tech 27, Oklahoma State 20; But Tech could be in trouble coming off that emotional upset of Texas and with A&M just around the corner.

Louisiana State 17, Florida 13; On the theory that Cholly Mac won't go three games in a row without a win.

Illinois 22, California 15; But the Illini might have their minds on next week's clash with Purdue.

Penn State 42, Army 7; Navy already got Penn State's gravy. Pitt 28, North Carolina 21; Anthony Dorsett on the war-path again.

Rampants Nipped, 5-4

New Hanover High School took two of the three doubles matches to nip Rose High School's girls' tennis team, 5-4, yesterday.

The two teams split the singles down the middle, each winning three matches. But Wilmington came back with the double win in the doubles to gain the victory.

The loss dropped the Rampant record to 3-5 on the season. They continue in action today, traveling to Goldsboro.

Summary:
Margaret Scott (NH) defeated Marty East, 6-0, 6-1.
Kitty Bailey (R) defeated Betty Wagner, 9-7, 6-1.
Carol Knapp (NH) defeated Jill Carney, 6-3, 6-1.

Shera Matney (R) defeated Jill Spivey, 7-5, 7-5.
Sheri Augspurger (R) defeated Pam Bunting, 4-6, 6-0, 7-5.

Susan Spivey (NH) defeated Peggy Barber, 6-1, 6-3.
Scott-J. Spivey (NH) defeated Bailey-East, 8-3.

Knapp-Wagner (NH) defeated Catherine Garrett-Carney, 8-6.
Matney-Cassie Dayton (R) defeated Claudia Thompson-Linda McCoy, 8-0.



AG's William West

Lady Bucs Take First

RALEIGH—East Carolina University's women's tennis team opened the 1974 season yesterday with a 6-3 victory over N.C. State's women.

East Carolina took three of the six singles events, then swept the doubles to take home the victory.

The Pirates next match will be Friday at 2 p.m., when they travel to Wilson to take on Atlantic Christian.

Summary:
Mary Roberts (NCS) defeated Kathy Portwood, 6-1, 1-6, 6-3.
Cynthia Averett (EC) defeated Sue Sneedan, 4-6, 6-3, 6-4.

Ellen Warren (EC) defeated Alicia Jones, 6-4, 6-4.

Ann Archer (EC) defeated Carol Woodard, 6-3, 6-1.

Margie Archer (NCS) defeated Ann Chavasse, 7-5, 6-4.

Lindy Tensor (NCS) defeated Gloria Allen, 6-2, retired.

Portwood-Warren (EC) defeated Roberts-Jones, 8-2.

Archer-Averett (EC) defeated Sneedan-Walker, 8-3.

Tisa Curtis-Lora Dionis (EC) defeated Sizemore-Johnson, 8-6.

Today's Sports

Girls' Tennis
Farmville Central at Williamston (2 p.m.)
Rose at Goldsboro (3 p.m.)

Football
E.B. Aycock at Rocky Mount (4 p.m.)

Soccer
East Carolina at VMI (4 p.m.)

Thursday's Sports

Football
Goldsboro at Rose JV (4 p.m.)
Northeastern JV at Oak City (3:30 p.m.)

Soccer
East Carolina at Madison (4 p.m.)

Girls' Tennis
New Bern at Rose (2 p.m.)

Cross-Country
Rose at Northern Nash (4 p.m.)

GORE
Horse Trailers
And
Stock Trailers
NOW ON
SALE
AT
University
Auto Sales
CALL 756-5608

Save money on your life.

Nationwide has some budget priced life insurance plans* that may save you money. Here is an important way for a young family man to buy the big life insurance protection he needs now, and at low premiums he can really afford.

Find out how you might save money on your life. Call a Nationwide agent today.

NATIONWIDE INSURANCE
Nationwide is on your side

Nationwide Life Insurance Company
Home Office: Columbus, Ohio

F.P. Gid
P.O. Box 2065
Greenville, N.C.
Phone: 753-5019

E. Arnett Harris
P.O. Box 2827
Greenville, N.C.
Phone: 758-4854

L. Henry Hudson
Route 3, Box 227
Greenville, N.C.
Phone: 753-4974

The Candlewick Inn remembers when dining was a pleasure. When the evening's fare called for the finest in food and entertainment. Enjoy the finest—in the warmth and charm of the Candlewick's Colonial surroundings. Our attentive staff and delicious cuisine insure you of an evening in the tradition of old. Join us at the Candlewick Inn and you too will remember the way it used to be.

Open nightly from 5:30 to 10:30 on the Old Stantonburg Road, Greenville. For reservations call 752-3434.

The Candlewick Inn
an affordable luxury

The Candlewick now offers a complete Ribeye Steak Dinner. Included are: baked potato, sour cream, half broiled seasoned tomato garnish, garden fresh salad with choice of dressing, and the Candlewick's own French bread with butter \$5.75

AUCTION
OFFICE EQUIPMENT
STEREO EQUIPMENT

\$25,000 VALUATION HAS BEEN ORDERED SOLD

SALE WILL BE HELD AT
Moose Lodge No. 885
Farmville Hwy. (264)
Greenville, N.C.
10:30 A.M. Friday, Oct. 4

IBM Factory Seals; C Model Executives and Standard IBM's; IBM Selectrics, Royal, Remington, Smith Corona, Olivetti Editor II Typewriters, Office Models and New Portables. All size carriages with assorted type faces.

New and used Adders; such brand names as Remington Rand, Olivetti, Victor, Commodore, etc.; new Remington Rand Manual and Electric Cash Registers; Electronic Calculators; Brand names, all new in original boxes; Remington Rand, Sharp, Friden, Marchant, Printing Calculators; Unicom 1010P, Royal Digital X11, Uniflex, Remington Rand Automatic Multipliers 1011, Paymaster Checkwriters.

Vacuum cleaners, Silverware, stereo component sets, radios, floor model stereo sets, tape recorder sets.

Brand new desks in original cartons: wood, wood & chrome, metal, 36" x 72", 30" x 60", salesman's desks, L-shaped; large assortment of office chairs, secretarial chairs, judges chairs; Files: brand new 2- & 4-drawer files, legal and letter size.

**MANY MORE ITEMS TOO NUMEROUS TO MENTION!
ALL IN GOOD CONDITION
INSPECTION MORNING OF SALE—
CASH OR CERTIFIED CHECK ONLY.**

N.C. Auctioneer Lic. No 398.

Orioles Take Eastern American Title

By ALEX SACHARE
AP Sports Writer

Baltimore Manager Earl Weaver was in no hurry to find out the result of Tuesday night's Yankees-Brewers game ... all he did was keep a phone line open between his hotel suite in Detroit and Milwaukee's County Stadium throughout the game.

Baltimore had gained a share of the American League East title in the afternoon by beating Detroit 7-6, and a loss by the Yankees in their night game at Milwaukee would mean the Orioles would win the AL East outright.

Andy Etchebarren, who drove

in the winning run against Detroit with a looping double in the ninth inning, was the bearer of good tidings on the phone in Weaver's suite. The Yankees and Brewers were tied 2-2, but Milwaukee had the bases loaded with one out in the 10th inning, and slugger George Scott was about to step to the plate.

"Scotty's going to get this hit right here for us," Etchebarren predicted.

He was right. Scott hit the first pitch from the Yankees' Doc Medich for a run-scoring single up the middle, giving the Brewers a 3-2 victory and giving the Orioles the division title

for the second straight season and fifth in six years.

"It's a base hit — we win!" Etchebarren yelled, dropping the phone in his excitement. Weaver jumped out of his chair, let out a shout of joy and dashed about the room, pumping every hand in sight.

Etchebarren and the two other players in the room, Dave McNally and Brooks Robinson, then raced down the hall of the hotel to pass the word to the rest of the players.

Elsewhere in the American League, Minnesota blanked Texas 6-0, Boston beat Cleveland 7-4, Chicago edged Kansas

City 2-1 and California shut out Oakland 2-0.

Baltimore was languishing in fourth place Aug. 29 when it launched a 10-game winning streak, and the Orioles stayed hot down the stretch with a 27-6 record. The victory over Detroit was Baltimore's eighth in a row.

"This is the most satisfying of the division titles because of the way we came back," said Etchebarren, reserve catcher who batted just .225 in 61 games but was the hero Tuesday.

His looping double, a lazy fly ball down the left field line which was held fair by the

wind, drove in Brooks Robinson from first base with the winning run in the ninth.

The Tigers pulled into a 6-6 tie in the eighth inning on singles by Gary Sutherland and Al Kaline, an error by Brooks Robinson, a sacrifice fly by Bill Freehan and a run-scoring double by Dan Meyer. Baltimore avoided further scoring by getting Aurelio Rodriguez to

ground into an inning-ending double play with the bases loaded.

The Orioles had taken a 6-4 lead in the top of the eighth on a two-run single by Tommy Davis.

Earlier, Freehan smacked a pair of home runs for Detroit while Rich Coggins and ex-Tiger Jim Northrup had two-run homers for Baltimore.

Brewers 3, Yanks 2

The Yankees looked like they would take the race down to the final day when they grabbed a 2-0 lead over the Brewers in the seventh inning, Elliott Maddox tripling home the first run and then scoring on Lou Piniella's single.

But the Brewers tied the score off Yankee ace Doc Medich in the eighth on triples by Bob Hansen and Don Money and a sacrifice fly by Sixto Lezcano. They won it in the 10th when rookie Jack Lind led off with a double, moved to third on a sacrifice and, after a pair of walks, came home on Scott's single.

Yankee Manager Bill Virdon, composed as ever following the loss, said the Orioles gained decisive momentum when they swept a three-game series from the Yankees Sept. 17-19.

"I thought we should have won one game from Baltimore in September, but we didn't do it," Virdon said. "I thought that was the difference in the season. If we had won one of those games, I think we would have won the division."

Angels 2, A's 0

California rookie Frank Tanana fired his fourth shutout of the season, scattering six hits and striking out 10 in raising his record to 14-19.

Twins 6, Rangers 0

Dave Goltz stopped Texas on two hits, a disputed single by Toby Harrah off the glove of third baseman Eric Soderholm in the first inning and a clean triple by rookie Pete Mackanin in the ninth.

White Sox 2, Royals 1

Jim Kaat, 21-13, posted his seventh consecutive victory by stopping Kansas City on six hits.

Red Sox 7, Indians 4

Rookie Jim Rice broke a 4-4 tie in the fourth inning with his first major league home run and Steve Barr picked up the victory in his major league debut.

Jaguars In Net Victory

PIKEVILLE—Farmville Central's girls' tennis team gained a 6-1 victory over Charles B. Aycock High School yesterday.

The win boosted the Farmville Central record to 5-2 on the season.

Two matches, the number six singles and the number two doubles did not get completed due to darkness and were not counted in the final score of the match.

Farmville travels to meet Williamston this afternoon.

Summary:

Beth Turnage (FC) defeated Leigh Bolding, 6-2, 6-0.

Jennifer Counterman (FC) defeated Babs Vail, 6-2, 6-3.

Sandra Stoddard (FC) defeated Amelia Dees, 7-6, 6-4.

Nora Baker (FC) defeated Donna Winbon, 6-2, 4-6, 6-3.

Suzanne Patterson (FC) defeated Alma Hooks, 6-4, 6-0.

Turnage-Counterman (FC) defeated Bolding-Vail, 8-2.

Kim Hooks-Rhoda King (A) defeated Liz Ledbetter-Beverly Bell, 8-3.

Eggs Or 3 Hot Cakes With Ham, Bacon or Sausage. \$1.05

Carolina Grill

Any order for take out Open 5:30 A.M. - 3 P.M.

Dodgers In, Bucs Near

By KEN RAPPOPORT
AP Sports Writer

The Los Angeles Dodgers are walking on air and the St. Louis Cardinals are walking on thin ice. Their conditions reflect their positions in the two National League pennant races.

The Dodgers won the West Division Tuesday night with help from the Atlanta Braves. The Braves eliminated the Reds 7-1 and the Dodgers followed with an appropriate 8-5 victory over the Houston Astros.

"I feel fantastic, I love that money," said Bill Buckner, reflecting the cheerful attitude of the champagne-drenched Dodger clubhouse.

In Montreal, there was no joy for the Cardinals, though, after they were beaten 3-2 by the Expos. The loss dropped the Cardinals a game behind the Pittsburgh Pirates in the National League East. The Pirates clinched at least a tie for the division crown by beating the Chicago Cubs 6-5.

"This makes the ice a little thin for us," noted Red Schoendienst, the frustrated St. Louis manager.

In the other National League games, the Philadelphia Phillies trimmed the New York Mets 2-1 and the San Francisco Giants ripped the San Diego Padres 7-2.

Steve Garvey keyed two rallies, one with his 200th hit of the season, to lead Los Angeles over Houston. The Dodgers started celebrating at the end of the fourth inning, when it was announced that Atlanta had eliminated Cincinnati. The game was delayed about five minutes while the Dodgers exchanged congratulations.

Garvey doubled home one

run and Crawford singled in another as the Dodgers took a 2-0 lead in the first inning. Garvey's 200th hit of the year, a single, moved a runner to third base in the third inning and Crawford knocked him in with a grounder.

Pinch-hitters Rick Auerbach and Lee Lacy drove in two more runs with singles in the sixth. Mike Marshall relieved winner Don Sutton after the fifth and allowed four runs on two hits and four walks. Doug Rader's single and John Edwards' grounder scored two runs and Marshall walked home two more runs with the bases loaded.

The Dodgers powered home two more runs in the seventh on John Hale's single. In the previous inning, Hale got his first major league hit, a double.

The night's results triggered a wild-celebration in the Dodgers' clubhouse.

"I don't care who we play, Pittsburgh or St. Louis," said Jimmy Wynn. "Whichever one it is, they're going to have to contend with the best team in baseball — that's us. I predicted this spring we would win it and I never doubted for a minute, not even when the Reds got within 1 1-2 games of us, that we'd win it."

Expos 3, Cardinals 2

Mike Jorgensen's two-run homer in the eighth inning gave Montreal its victory over St. Louis.

Willie Davis singled with two out off Bob Gibson, 11-13, in the Montreal eighth and stole second before Jorgensen belted his 11th homer of the baseball season over the right field fence.

Daring base running by Bake McBride and a single by Mike Tyson helped St. Louis break a 1-1 tie in the seventh.

McBride reached base when he forced Joe Torre at second after Torre had walked off Mike Torrez. With Ken Reitz at the plate, McBride easily stole second but was stunned momentarily when catcher Barry Foote's throw appeared to hit him on his helmet.

But the speedy Cardinal center fielder picked himself up and with Reitz still up, he dove head-first into third. Reitz fanned but Tyson, who entered the game with a .222 batting average, lined a single past third baseman Bob Bailey to score McBride with the go-ahead run.

Pirates 6, Cubs 5

Bob Robertson's two-run homer in the eighth inning gave Pittsburgh a dramatic victory over Chicago. Manny Sanguillen singled with one out and Robertson, batting for Ed Kirk-

patrick, drilled a homer — his 16th of the year — over the left field wall.

Pirate starter Jerry Reuss held a 3-2 lead into the seventh when Steve Swisher singled and took second on a walk by Billy Grabarkewitz. Billy Williams, batting for Cub starter Tom Detore, then clouted a two-run double to left-center to give the Cubs a 4-3 lead.

Left-fielder Willie Stargell threw pinch-runner Ray Burris out at the plate on an ensuing single by Rick Monday off Pirate reliever Ramon Hernandez. But Don Kessinger tagged Hernandez for a triple to score Monday and give the Cubs a 5-3 edge. Pittsburgh rallied for a run in its half of the seventh on a triple by pinch-hitter Paul Popovich off reliever Oscar Zamora and a run-scoring single by Rennie Stennett off Dave LaRoche.

Braves 7, Reds 1

Buzz Capra stopped Cincinnati on four hits, pitching Atlanta over Cincinnati.

Phillies 2, Mets 1

Willie Montanez belted a two-run double in the first inning and Jim Lonborg made it stand up by pitching a four-hitter as Philadelphia defeated New York.

Giants 7, San Diego 2

Chris Speier belted a triple and a run-scoring double and scored three runs to lead San Francisco over San Diego.

Expect Naming Of Robinson

By RICHARD BILOTTI
AP Sports Writer

CLEVELAND (AP) — Frank Robinson, one of the game's greatest stars for nearly two decades, is expected to make baseball history Thursday when he is named manager of the Cleveland Indians — the first black manager in the major leagues.

The Cleveland Indians are expected to name Robinson as a replacement for the fired Ken Aspromonte.

"I didn't chase this job and I haven't heard that I'm going to be the manager," insisted Robinson Tuesday. "But certainly I hope I will. I want to be a big league manager."

"It isn't just becoming the first black. I want the job. I want to manage."

Robinson's appointment will come 27 years after Jackie Robinson became the first black ballplayer. Since then, many black men, including Robinson, have been mentioned for a managerial post but, somehow, none of them were ever hired.

"If it's true, it's fantastic," said former Dodger star Maury Wills, another of those mentioned frequently as a possible manager. "But I won't believe it till I see it."

"My heart is still thumping," said Braves' home run king Hank Aaron, after hearing the news in Atlanta. "I think I'll go out and celebrate."

The Indians picked up Robinson and his estimated \$180,000-a-year salary from the California Angels in September. He has been used mostly as a designated hitter and will probably

continue as a player-manager next season. Lou Boudreau of Cleveland and then Boston was the last player-manager almost 20 years ago.

The Indians also hold the distinction of having the first black player in the American League — outfielder Larry Doby, who joined the team late in the 1947 campaign. Ironically, Doby, now a Cleveland coach, is expected to be released when Robinson assumes command.

Robinson, the only man named Most Valuable Player in both leagues, began his major league career with Cincinnati in 1956. He won the National League MVP with the Reds in 1961 and five years later, won it in the American League with Baltimore when he captured the triple crown with 49 home runs, 122 runs batted in and a .316 average.

He was traded to Los Angeles in 1972 and to California last year.

He carried a .298 lifetime average into the current season and has a career total of 573 home runs, placing him fourth on the all-time list behind Aaron, Babe Ruth and Willie Mays.

Aspromonte, who many feel did a fine job with the Indians this year, will be handling the club for the final time tonight when it finishes up in Boston. He has been kept in the dark about the Robinson developments.

"I don't know anything," said Aspromonte. "Nobody tells me a thing. I'm going to Cleveland, pack up and close my house and then go home to Silver Spring, Md."

Tait, Parker Swaping Praise

By MARSHALL JOHNSON

The mutual admiration society will now form on the right as Art Baker and Jim Tait prepare their teams for Saturday night's crucial Southern Conference football game in which Baker's Furman Paladins meet Tait's Richmond Spiders at Richmond City Stadium.

Since they were upset 7-0 in their opener by Virginia Military's league-leading Keydets, every game has become crucial to the title hopes of the Paladins.

Furman cleared one seemingly high hurdle last Saturday night with a 10-0 surprise over William and Mary's Indians.

The Spiders, a team which seems bent on giving Tait a heart attack before the season is over, came from behind for the third straight time in a 27-24 squeeze past The Citadel's Bulldogs and can tie VMI for the conference lead with a victory.

"It at least keeps us alive," said Baker after the triumph over William and Mary. "We played Richmond a great game down here last year, but they're a big league team, just like William and Mary."

Tait has no less respect for the Paladins.

"If they beat William and Mary, they have a fine football team," says Tait, whose Spiders trailed Villanova and West Virginia by 13-0 before coming back to win and who were down 17-7 at The Citadel before making it three in a row overall.

"Art Baker has done a fine

job."

Furman may be handicapped by a freak injury to starting quarterback David Whitehurst, who hurt an ankle when he was mobbed by his teammates after throwing a 46-yard touchdown pass to Ken Brown in the William and Mary game.

Senior Charles Elvington replaced the sophomore star and directed the Furman attack the rest of the way, drawing praise from Baker for the way he handled the team.

"They've got two quarterbacks they feel they can move the ball with and win," said Tait.

The major surprise in the Furman triumph was the fact the Paladins shut out William and Mary, limiting Indian quarterback Bill Deery to 78 yards on 17 carries. Deery had gone into the game averaging 133.7 yards per game rushing to lead the conference.

"I don't know how they stopped Deery," said Tait. "It must have been a fine effort. We'll have to play well to beat them."

Tait felt his Spiders played a great defensive third quarter at The Citadel, shutting out the Bulldogs for 15 minutes while they had the wind at their backs with Richmond leading 24-17.

The Citadel later tied it, but Richmond won on Terry Carter's 22-yard field goal with 25 seconds left.

As to the Spiders' future prospects, Tait said, "I don't know whether a 3-0 record means that much when there are seven games to go, but we're very pleased so far."

Women's Golfing

Winners have been announced in three recent Play Days held by the Brook Valley Women's Golf Association.

In a low gross-low net affair, winners were Helen Bach for low gross and Janet McGlohon for low net.

Jan Woodworth and Evelyn Ward took first place in a blind partner tournament.

Marion Martin, with 18 puts in nine holes, won a low putts tournament.

Delay In Wedding

HOUSTON (AP) — Chris Evert says tennis commitments have caused about a month's delay in her intended Nov. 8 marriage in Fort Lauderdale, Fla., to Jimmy Connors.

The celebrated Wimbledon champions both have tournaments scheduled the first week in November.

"It's just postponed," Miss Evert said Tuesday. She is here for the women's professional tennis tournament.

"I've still got the ring. The wedding probably will be in December. I can't believe people are making such a big deal out of this."

Bowling

Wednesday Mourners

Go Getter	10	2
The Stompers	9	3
Love Bugs	8	4
Friendly Neighbors	7	5
Ding-A-Lings	6½	5½
Three Aces	6	6
The Streakers	6	6
We Three	5½	6½
Make Believers	4	8
Dingbats	4	8
Dumb Clucks	3	9
The Handicaps	3	9

High game, Jalene Landen, 210; high series, Bernice Moseby, 508.

Monday Men's

Drifters	10	2
Carolina Price	10	2
Sunnyside Eggs	10	2
Downtown Motors	9	3
Brothers Five	8	4
R. C. Cola	7	5
WACOE	7	5
Pin Drifters	7	5
Moose One	6½	5½
Tarheel Toyota	5	7
National Spinning	5	7
The Losers	3½	8½
Unlucky Five	3	9
Pin Busters	3	9
Country Boys	2	10
Moose Two	0	12

High game, Dick Maki, 247; high series, Bo Edgerton, 596

BEACH PROPERTY FOR SALE!

40 White Sandy Beach lots, unimproved at \$1800.00 each or total amount of \$72,000.00. Located on eastern most beach in North Carolina. \$24,000.00 down with a balance of \$48,000.00. Financing available at 6 per cent interest by owners.

For more information contact Mr. Gray at (919) 726-2561. Principles only.

MATCHMAKER SERVICE

STATE FARM'S PERSONALIZED LIFE INSURANCE PLANNING

The State Farm MATCHMAKER can find you a match for life.

State Farm Matchmaker Service is free. And so simple. You tell us a little about yourself, your family, your goals. We feed this information to our computer and in a matter of seconds it prints out a State Farm life insurance program that matches your needs. One you can live with.

See or call:

Bill McDonald

East 10th St. Ext.
Phone 752-6680
Greenville, N.C.

STATE FARM LIFE INSURANCE COMPANY
Home Office: Bloomington, Illinois

ALLIED PETROLEUM CORP.

"YOUR PROGRESSIVE TEXACO DISTRIBUTOR"

IS PROUD TO ANNOUNCE THESE

GRAND "Opening" SPECIALS

Thursday, Friday & Saturday, Oct. 3, 4 & 5

FREE!

Free to the First 100 Customers who fill-up with gasoline during our Grand Opening Thursday, Friday and Saturday. We'll give you a 6 pack of Marvel Long-Life Light Bulbs absolutely Free. . . a \$1.25 Value.

Mr. N. E. Moore is Now Operating Our Modern New Texaco Service Station on Memorial Drive, Adjacent to Carolina Dairies.

Mr. Moore invites his many friends to come by and see him for the best service in town!

Taylor...

Continued from page 1)
 joined the central office staff in 1966 as project coordinator for Title I, Elementary Secondary and Education Act and in 1969 became administrative assistant to the Pitt County Board of Education.
 A member of the executive board of the Pitt County NAACP, Taylor also holds membership in the Pitt County Chapter of the American Civil Liberties Union and the East Carolina Council of Boy Scouts of America. He is a mason.
 Ott Alford, superintendent of the Pitt County Schools, said

Taylor has rendered an invaluable service to the program of public education in the Pitt County Schools.
 "I want to call particular attention to this for, unfortunately, too often Taylor was viewed by many people as a militant individual.
 "To those of us who know the full story of how he attempted to keep the lines of communication open between the school people, governmental officials, law enforcement people and the black community, we can more fully appreciate the most difficult role he had and assumed in a most effective manner as a black leader," Alford said.

"He has served well and I commend him," Alford added.
 Alford said he is considering several possibilities for Taylor's replacement. He added that the position may not be filled for several months.
 Taylor's resignation is effective on Oct. 15. After that time, he will assume his new position as employment manager of Procter and Gamble.
 Taylor is married to the former Peggy Lee Wiggins, also a Pitt County native, and they have one daughter, Roslyn, 16, who is a junior at Rose High School.

Transit Study Grant Is Urged

Representatives of the N.C. Department of Transportation urged the local Transit Advisory Committee to recommend to the City Council that an application be submitted for a federal technical studies grant to aid in financing a detailed mass transit study here.
 Meeting Tuesday night with the advisory board, the representatives presented a report prepared by the Department of Transportation and discussed with committee members the next step the

department feels the city should undertake in planning for a public bus system.
 The officials explained that the application for the technical studies grant would be filed with the U.S. Department of Transportation, Urban Mass Transit Administration. The grant would provide 80 per cent federal funding for the study, it was noted, and the city would be expected to provide 20 per cent local money.
 The detailed study, which would be handled by a consulting

firm approved by the City Council, would provide essential information on the total transit program, including routes, fares, financing, scheduling, market ability and overall costs, it was noted.
 The representatives urged the committee, headed by Councilmen Dr. Frank Fuller and Joe Taft Jr., to view the total program through the study and not to take a piece-meal approach.
 The report prepared by the department indicated that there

are nine cities in the state in our population category and of the nine (Gastonia, Wilmington, Kannapolis, Burlington, Rocky Mount, Wilson, Goldsboro, Chapel Hill, and Greenville), only Greenville and Goldsboro are without some type of bus transportation.
 Fuller said this morning that the cost of the study is estimated at between \$20,000 and \$30,000 and although the U.S. Department of Transportation would not be making the actual study, it would work closely with the city during the study phase.
 The councilman said that it was noted that there are federal funds available now for capital expenditures involving a public bus system but federal money for operation of such systems is tied up in legislation that has passed the U.S. House but not the Senate.
 If the study proves that a local system would be feasible, the federal money might be available for equipment purchases and other matters relating to capital expenditures.



Ride a bicycle...
 Drive your car...
 But see the buys at Bostic-Sugg.

Good Ol' BURGUNDY PICNIC

Folks are taller nowadays - so they should sleep longer!

give yourself the royal treatment

Why wait? Start sleeping better tonight! Retire your outdated bedding set and experience the best night's sleep you have had in years. These roomy queen and king size sets offer all the space you need to really stretch out and relax in comfort.



20% more sleep room in a new queen size

Besides the added width you get with this big 60" queen size, extra length is another plus. Standard size bedding is only 75" long while the queen and king measure 80". Best of all, this mattress and box spring are designed to give the best in comfort.

2-pc. queen size set \$160.00 Regular \$280.00

50% more sleep room in a new king size

This roomy 76x80" king size set, like the queen size, is sturdily designed with hundreds of steel coils, topped by layers of cotton felt and foam, quilted to the handsome ticking for deepest sleeping comfort. Both sets are guaranteed for durable wear.

3-pc. king size set \$220.00 Regular \$399.95

SAVINGS THROUGHOUT THE ENTIRE SHOWROOM!

List Price \$350.00 Kroehler Colonial Sofa \$170⁰⁰ <small>Nylon tweed fabric. Skirted.</small>	List Price \$444.00 Broyhill Premier Colonial Sofa \$247⁵⁰ <small>Bold Herculon matched plaid fabric, wood trim.</small>	List Price \$375.00 Kroehler Colonial Sofa \$170⁰⁰ <small>Herculon plaid fabric. Pillow back.</small>	List Price \$360.00 Broyhill Premier Love Seat Sofa \$210⁰⁰ <small>Nylon floral print. 60 inches wide.</small>
--	--	---	--

REVOLVING CHARGE PLAN AVAILABLE—Take Months To Pay

List Price \$300.00 Kroehler Vinyl Contemporary Sofa \$125⁰⁰ <small>Tufted seat and back. Only one to sell.</small>	List Price \$480.00 Drexel 90 Inch Traditional Sofa \$220⁰⁰ <small>Beautiful green velvet fabric. Lined skirt.</small>	List Price \$350.00 Cut Velvet Traditional Sofa \$175⁰⁰ <small>Gold contrast welt. Loose pillow back.</small>	List Price \$430.00 Broyhill Premier Colonial Sofa \$245⁰⁰ <small>Red plaid herculon fabric, fruitwood trim.</small>
---	--	---	--

90 Days Same As Cash—No Carrying Charges On 90 Day Plan

List Price \$340.00 Cape Cod Kroehler Colonial Sofa \$125⁰⁰ <small>Gold nylon fabric. Biscuit tufted back.</small>	List Price \$360.00 Broyhill Premier Love Seat Sofa \$205⁰⁰ <small>Herculon plaid fabric. 54 inches wide.</small>	List Price \$350.00 Kroehler Tuxedo Vinyl Sofa \$200⁰⁰ <small>Contemporary style deep diamond tuft.</small>	List Price \$450.00 Broyhill Premier Colonial Sofa \$255⁰⁰ <small>Herculon stripe. Box pleat skirt.</small>
--	---	---	---

HIGHPOINT SHOWROOM SAMPLES- LA-Z-BOY RECLINAS, RECLINA-ROCKER SOFETTES, SWIVEL ROCKERS AND HIGH-LOW RECLINAS ALL AT TREMENDOUS SAVINGS

As Low As **\$129⁰⁰**

Special purchase exclusive at Bostic-Sugg. Over 80 La-Z-Boy Chairs now on sale at savings up to 45 percent. Now is the ideal time to purchase a La-Z-Boy for Christmas. Free Storage!

"the Big"

La-Z-Boy® designers have styled a generous size chair that invites the big man to enjoy many hours of luxurious comfort without feeling cramped or hunched up. It features a taller back, that provides the right back support for proper posture when sitting or reclining.

"the Tall"

Give a tall man a chair that will fit him and you'll see a happy fellow. Specially designed for the well over 6-footers who desire high styling in a comfort chair. This La-Z-Boy® features a higher back, deeper seat and extended leg rest. No more tired legs or back when he has a TALL MAN chair by La-Z-Boy®.

"the Small"

Tastefully styled for the smaller man or woman, this comfort - designed La-Z-Boy® fits your every relaxing mood. Though smaller, this chair contains every comfort feature and all the beauty available in the big and tall styles.

• Add extra storage space

• Add a decorator accent

SPACEMAKERS

A Lenoir House design by **Broyhill**

As Low As **\$85.00**

Compare at \$165.00

Only 8 to sell at this low price.

SPECIAL PURCHASE—HUGE SAVINGS

SAMSONITE DELUXE Folding Chairs

\$7.77

Compare at \$11.00 and more

Padded seat and back. Only 48 to sell at this low price.

REDUCED FOR QUICK CLEARANCE

THREE GROUPS OF TABLE LAMPS

One Group at **\$8.88**

One Group at **\$13.50**

One Group at **\$15.50**

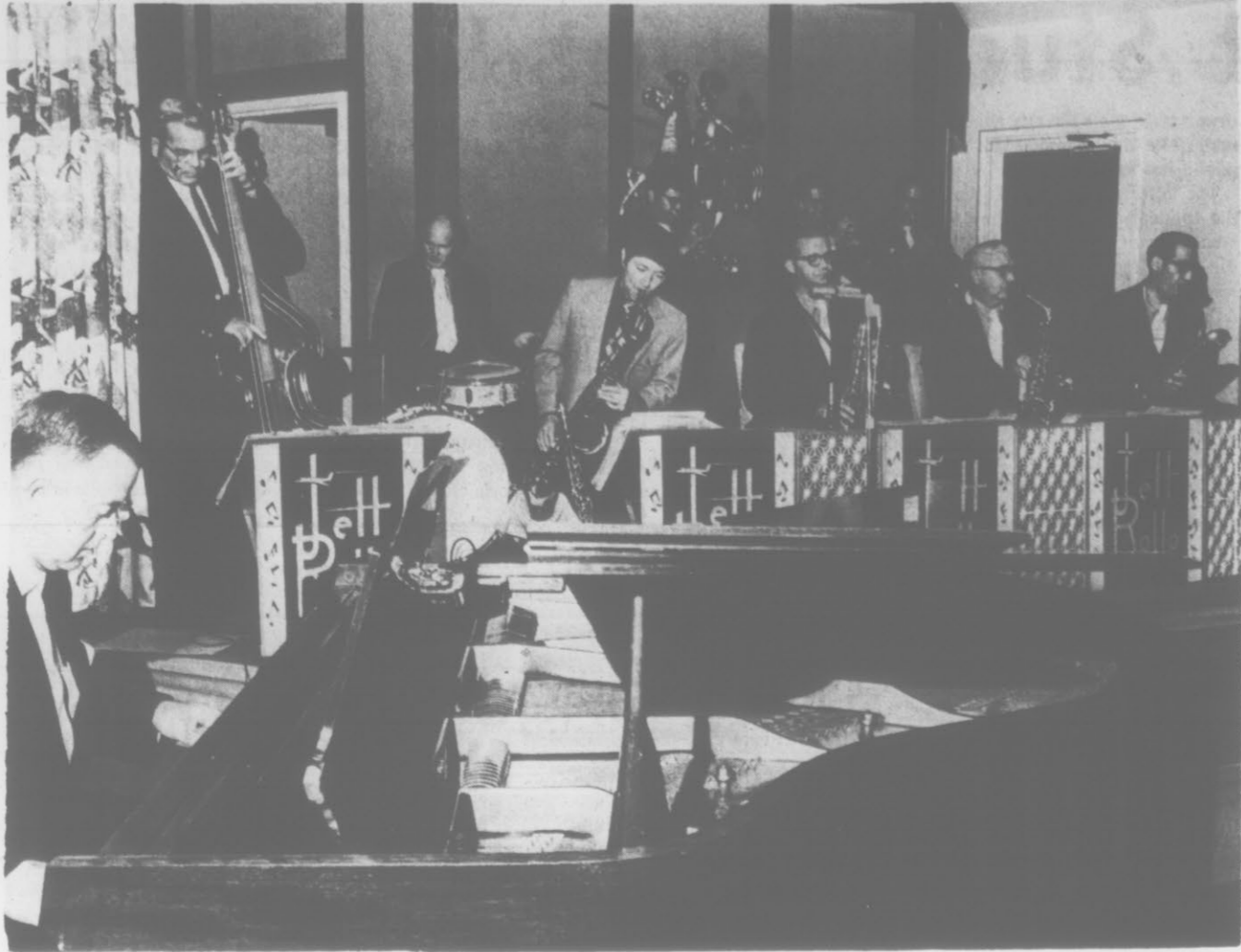

BIG DANCE BAND ERA . . . will be represented in Greenville's Bicentennial by the appearance of the Jett Rollo Orchestra. This orchestra will provide dance music at the Greenville Moose Lodge on Saturday, October 12, beginning at 8:30 p.m. A total of 300 tickets at \$10 (couples only) are available and can be reserved by contacting Bicentennial Headquarters, 752-1919.

Pitt Native Is Director

Mrs. Mildred S. Joyner of New Haven, Conn., was recently appointed director of training for Opportunities Industrialization Center, Inc. (OIC) in New Haven, Conn.



MRS. MILDRED JOYNER

OIC, founded by the Rev. Leon Sullivan of Philadelphia, Pa., is a vocational training operation.

Mrs. Joyner, a Greenville native, is a 1964 graduate of C. M. Eppes High School and a 1968 graduate of Elizabeth City State University with a B. S. degree in business administration.

Mrs. Joyner will be responsible for supervising the teaching staff and coordinating the vocational program with the needs of the business sector.

Mrs. Joyner is the daughter of Mr. and Mrs. Edmond Love Sr. of 613 Hudson St., Greenville, and is married to Edward T. Joyner, formerly of Farmville. The Joyners have one daughter, Monica.

Will Observe Heritage Day

Heritage Day will be observed Sunday at St. James United Methodist Church.

All former pastors have been invited to attend and all charter members will be seated together in a reserved section. A member, who has rendered outstanding service to the church, has been selected for recognition by the church.

The history of St. James will be included in a bulletin insert. Pictures of former pastors will be displayed on the church bulletin board. The names of the first persons baptized and the first persons married in both the old and new sanctuaries will be printed in the bulletin.

Abandon Pine Beetle Battle

ROANOKE, Va. (AP) — The northern tip of the Jefferson National Forest and the southern tip of the George Washington Forest, which meet at the James River between Big Island and Glasgow, Va., are so heavily infested with the southern pine beetle that U.S. forest officials have abandoned control efforts there.

Mike Penfold, Jefferson Forest supervisor, and John Irwin, assistant supervisor of the Washington forest, agreed that control efforts in those areas were useless after a meeting of 16 forest service, Blue Ridge Parkway, and Virginia Department of Forestry officials Tuesday at Jefferson Forest headquarters here.

Asks Tax On Cigarettes

WASHINGTON (AP) — Cigarette smokers would help finance the war against cancer under a proposal which would put an additional two-cent tax on each pack of cigarettes.

The proposal by Rep. Edward I. Koch, D-N.Y., was suggested in a letter Tuesday to Rep. Wilbur Mills, D-Ark., chairman of the Ways and Means Committee.

Koch estimated the two-cent tax would raise about \$600 million annually and "might help to discourage cigarette smoking and this in itself would be helpful."

Koch asked the tax be earmarked for a centrally coordinated cancer research project similar to the Manhattan Project which developed the atom bomb during World War II. Koch also said the funds should be supplemental to funds already appropriated for cancer research.

He said that some 29.2 billion packs of cigarettes were sold in 1973, and that it is estimated that 15 per cent of all cancer deaths could be eliminated if people stopped smoking.

OVERHEATING BAD

CLEVELAND, Ohio (UPI) — An overheated engine causes greater gas consumption and deterioration of engine oil in automobiles, say Boron Oil Co. researchers.

Two Judges Take Oaths

RALEIGH (AP) — Two new Superior Court judges took their oaths of office in Raleigh Tuesday.

Jerry S. Alvis of Raleigh, former chairman of the state Board of Elections, was sworn in by Associate Justice Susie Sharp of the state Supreme Court.

Appeals Court Judge James M. Baley administered the oath to Ralph A. Walker, former county attorney for Guilford County.

Both have already been assigned to hold court. Alvis will conduct a civil court term beginning next Monday in Charlotte and Walker will take on a similar task the following week in Trenton.

Their appointments are expected to end a crunch in court scheduling by the Administrative Office of the Courts which had to cancel a court term in Charlotte last week because no judge was available for the assignment.

WCTU Meets On Thursday

The Woman's Christian Temperance Union meeting has been scheduled for Thursday at 7 p.m. at Wilber's Restaurant, located on 14th Street.

A dutch supper meeting will be held and all members are urged to attend.



pay your carrier on time

Attending school and serving a newspaper route makes every day a busy day for your enterprising Daily Reflector carrier. But, there is a way you can help him budget his time. When he comes to collect have his money ready. In return, he'll see that your Daily Reflector arrives promptly every day.

The Daily Reflector

"Pitt County's Home Newspaper"

this is
Eckerd's
DRUG STORES
CREATORS OF REASONABLE DRUG PRICES

DON'T WAIT!
—SUPPLIES LIMITED—
BUY YOURS TODAY
at ECKERD'S



Let Us Price & Fill Your Next Prescription

Pitt Plaza Shopping Center

COUPON
GOOD ANYTIME . . . DOES NOT EXPIRE
\$1.00 OFF upon presentation of this coupon toward the regular price of any large or giant PIZZA.
Pappi's Pizza den
421 Greenville Blvd., Greenville, N.C.
Phone 754-0825
824 West 15th St., Washington, N.C.
Phone 946-5123
TDR

Henry Gibson Would End 'Laugh-In' Image

By BOB THOMAS
Associated Press Writer
LOS ANGELES (AP) — Henry Gibson plays an egomaniacal bigot in a new movie about country and Western music, and that, he hopes, will put an end to his image as the flower-bearing poet from "Laugh-In."

The sock-it-to-me television series went off the air at the end of the 1972-73 season.

The wispy, sweet-faced Gibson had left it a year and a half before, but the impact of "Laugh-In" on the viewing public was so strong that Gibson seemed locked into character of the poet.

This was despite the fact that he hasn't spouted his rhymes for a couple of years, "frankly, because there has been no demand for them."

Gibson was one of that mad troupe of second bananas who supported the insanity of Dan Rowan and Dick Martin. A Philadelphian with a degree in drama from Catholic University, he made a hit in 1962 with his poems on the Johnny Carson Show and was invited back 25 times. He repeated the character on "Laugh-In," also playing a stuffy parson on the show.

"Those early years of the show were terrific times," the comedian recalled. "We worked 12-14 hours a day, but nobody minded. I couldn't wait to get to work."

After three years during which "Laugh-In" captured the nation with its outrageous comedy, the thrill was gone. The show entered an acrimonious period when its stars and producers argued in public over who had actually created the format.

"We learned to be good listeners," Gibson remarked.

He left "Laugh-In" after three and a half years "because I didn't think I was growing."

But the role of the effete poet clung to Gibson, hindering his

efforts for versatility. He did guest appearances on variety shows and played roles in television films, but always in the same image.

Then one day last year his agent told him to report for an interview with Robert Altman, director of "M-A-S-H."

When Gibson walked in the office, Altman took one look at him and remarked, "I'm so glad. I was afraid the 'Laugh-In' image would be too strong."

The director was making "The Long Goodbye," a Phillip Marlowe detective yarn with Elliott Gould. He cast Gibson as a sinister psychiatrist.

Gibson, who had appeared on Broadway in a Lillian Hellman

play, got good reviews, although "The Long Goodbye" was panned in Hollywood.

"People here thought it was an attack on the Hollywood Establishment," said Gibson. "It wasn't. It was simply a satire on the genre of detective movies."

Altman next cast Gibson in his new movie, "Nashville."

"I play a 60ish, egomaniacal country and Western singer who is sort of 'Mr. Nashville,' a friend of presidents and a man who is accustomed to having his own way," Gibson said.

"He is very powerful and very bigoted. He isn't based on any one figure in Nashville, but is sort of a composite."

CROSSWORD PUZZLE

- ACROSS
1. Hit
 5. Friend
 8. Distraught
 11. Anklebones
 12. Papa
 13. Vanity
 14. Outbursts
 16. Whipped
 18. Morals
 20. Panorama
 21. Vast expanse
 22. Harvest goddess
 24. Kind of bag
 25. Strontium symbol
 26. Trailer-truck
 28. Monster
 29. Maybe
 31. A Roosevelt name
 33. Annex
 34. Beverage
 35. Portly
 37. Sty
 39. Agitate
 41. Tropical fruit
 42. —, amas, amat
 43. Personal pronoun
 45. Greek letter
 46. Sparoid fish

DOWN

1. Emphasis
2. Restaurant worker
3. Greetings
4. Widow monkey
5. Public notice
6. Fairy queen
7. March 15th
8. Bolide
9. Ten percent
10. Recipient
15. Ridicule
17. Thespian
19. Freshet
23. Indian trophy
26. Harass
27. Spring flower
28. Thick juice
29. Form notions
30. Boston's ball-park
31. Living room furniture
32. Constrictor
34. Fencer's warning
36. Eve's grandson
38. Chatters
40. Parson bird
44. Nurse

For time 22 min. AP Newsfeatures 10-2

ROB NAG POLE
ARI OLA OMEN
BAN MUG MOAT
DRAM SPOKE
PRIED ORO
RUNT PROSPER
ORGANIC IRMA
LOG STOUT
SQUID BAYS
AURA JOT AES
LINT ELY IRK
APSE TOR CRY

SOLUTION OF YESTERDAY'S PUZZLE

TV Log

WNCT-TV Ch. 9

WEDNESDAY

7:00 Truth Or	12:00 News
7:30 Tell Truth	12:30 Search For
8:00 Sons & Daugh	1:00 Young and
9:00 Cannon	1:30 World Turns
10:00 Manhunters	2:00 Guiding
11:00 Final Report	2:30 Edge Night
11:30 Late Movie	3:00 Price Right
	3:30 Match Game

THURSDAY

6:00 Arthur Smith	4:00 Mod Squad
6:30 Carolane	5:00 GQ Valley
8:00 News	6:30 CBS News
9:00 Kangaroo	7:00 Truth Or
10:00 Jokers' Wild	8:00 News
10:30 Gambit	9:00 Movie
11:00 You See It	11:00 Final Report
11:30 Love Life	11:30 Late Movie
11:55 Timely	Tips

WITN-TV Ch. 7

WEDNESDAY

7:00 Jeopardy	12:25 NBC Sweep
7:30 Name Tune	1:00 Jackpot
8:00 Prairie	1:30 Jeopardy
9:00 Lucas Tanner	2:00 Days Of Lives
10:00 Petricelli	2:30 Doctors
11:00 News	3:00 Another World
11:30 Tonight	3:30 Marriage
12:00 News	4:00 Sonnets
6:00 Almanac	4:30 Bewitched
7:00 Today	5:00 Lassie
7:25 News	5:30 Farnsworth
7:50 News	6:00 News
8:25 News	6:30 NBC News
8:30 Today	7:00 Bonanza
9:00 Mike Doug	8:00 Wide World
10:00 Name Tune	9:00 Ironside
10:30 Win Streak	10:00 Movin On
11:00 High Roll	11:00 News
11:30 Holly So	11:30 Tonight
12:00 News Noon	

WCTI-TV Ch. 12

WEDNESDAY

7:00 Andy Griffith	2:00 Newswatch
7:30 Price Right	2:30 Girl In Life
8:00 That's Mama	3:00 Gen. Hospital
9:00 Movie	3:30 One Life
10:00 Christie	4:00 Gomer Pyle
11:00 News	4:30 Rascals
11:30 Wide World	5:00 Gulligan
12:00 Split Second	5:30 News

THURSDAY

7:00 Bullwinkle	7:00 Andy Griffith
7:30 Underdog	7:30 Candid Cam
8:00 New Zoo	8:00 Beat Clock
8:30 Montage	8:00 Odd Couple
9:30 Hillbillies	8:30 Walt
10:00 Takes This	9:00 San Francisco
11:00 Pyramid	10:00 Harry O
11:30 Brady Bunch	11:00 News 12
12:00 Password	12:00 World
12:30 Split Second	1:00 News
1:00 My Children	

WUNK-TV Ch. 25

WEDNESDAY

7:00 Lifestation	1:15 About You
7:30 People	2:00 Inside Out
8:00 Movies	2:30 Experiments
9:00 Jeopardy	3:05 Ready
9:00 Jeopardy	3:25 Steady
9:00 Jeopardy	3:45 Bread
10:00 Films	4:00 Mis. Rogers
10:30 Visionaries	4:30 Sesame St.
11:00 News	5:00 Elec. Co.
11:30 News	6:00 Deal
12:00 News	6:30 Gullen Tap
12:30 Split Second	7:00 Consultation
1:00 Cover	7:30 Football
	8:00 Perf. Arts
	8:30 TBA
	9:00 Inter. Perf.
	10:00 Behind Lines

Greenville Retail Sale Figures Top Last Year

Greenville recorded an 11.3 per cent increase in gross retail sales in June over the same period last year, according to statistics released by the N. C. Department of Revenue.

Retail sales here amounted to \$14,466,457, compared with \$12,989,055 recorded in June of 1973.

For the January through June period of 1974, sales totaled \$82,918,175, an increase of 8.2 per

cent over the \$76,622,385 posted over the 1973 six-month period.

Wilson led cities in the immediate area with a 16.3 per cent jump in June figures as sales climbed from \$11,900,084 in 1973 to \$13,846,262 this year. The city also recorded a 17.4 per cent increase in January through June sales as retail figures increased from \$64,909,448 to \$76,205,753 this year.

Other eastern cities and their

June and six-month totals included: Tarboro, \$4,313,826, \$4,994,117, 15.7 per cent, \$23,108,999, \$27,105,185, 17.2 per cent; Jacksonville, \$12,187,596, \$13,736,138, 12.7 per cent, \$68,484,723, \$71,394,140, 4.5 per cent;

Williamston, \$3,179,830, \$3,500,320, 10 per cent, \$17,732,155, \$19,858,967, 11.9 per cent; Rocky Mount, \$18,823,199, \$20,660,061, 9.7 per cent, \$103,583,695, \$116,016,972, 12 per cent; Goldsboro, \$16,382,675, \$17,978,751, 9.7 per cent, \$89,165,199, \$98,483,584, 10.4 per cent;

Roanoke Rapids, \$6,151,544, \$6,677,338, 8.5 per cent, \$33,838,276, \$35,978,616, 6.3 per cent; Elizabeth City, \$6,954,270, \$7,179,100, 3.2 per cent, \$36,665,302, \$40,139,034, 9.4 per cent; New Bern, \$11,383,780, \$12,870,080, 1.3 per cent; \$65,297,053, \$72,695,535, 11.3 per cent; and Kinston, \$12,943,997, \$12,814,483, 1.0 per cent decrease, \$72,195,645, \$73,981,750, 2.4 per cent.

Social Work Dept. Given Large Grant

The Department of Social Work and Correctional Services at East Carolina University has received a matching grant from the N. C. Department of Social Services which amounts to \$131,973 to be used for the further development of ECU's social work program.

Dr. John R. Ball, department chairman, said the grant was the "largest amount" received since ECU began its collaborative relationship with the state Social Services Department seven years ago. The funds originate from HEW's Division of Social and Rehabilitation Services, he said.

"We believe that this is recognition of the fact that we have been very productive in making educational opportunities available to people who desire careers in the broad area of human services," and more particularly, in the Division of Social Services," he said.

"The increase reflected in the funds we received this time will make it possible for us to offer additional educational opportunities which we hope will include more people who are already employed in professional positions."

Dr. Ball said many presently employed social workers have not received professional education in social work, and are interested in earning their degrees in the field.

In addition to developing the ECU social work curriculum to meet the needs of these potential students, the grant will enable ECU to offer more colloquiums, workshops and conference for professional social workers and other Human Resources personnel.

FORECAST FOR THURSDAY, OCT. 3, 1974



CARROLL RIGHTER'S HOROSCOPE
from the Carroll Righter Institute

GENERAL TENDENCIES: You can easily gain your objective by thinking in terms of your long-range plans from the earliest possible moment in the morning and then follow through in every detail. Avoid wishful thinking and impractical daydreams.

ARIES (Mar. 21 to Apr. 19) A good day to talk over your monetary matters with others. You can get best results by dealing honestly with them. Be wise.

TAURUS (Apr. 20 to May 20) Plan how to make yourself look more charming and then plan social events for the future wisely. Follow through on personal aims.

GEMINI (May 21 to June 21) A fine day to contact friends of long standing and make future plans. Avoid a new acquaintance who has little substance.

MOON CHILDREN (June 22 to July 21) Plan how to make your position in the world of activity more worthwhile. Be alert in all your business dealings.

LEO (July 22 to Aug. 21) You have many ideas you want to put in motion so be sure to rely on standard methods that will be successful in the past.

VIRGO (Aug. 22 to Sept. 22) Plan a trip that will bring the data you need. Get your head out of the clouds and go to the right sources for the information you need.

LIBRA (Sept. 23 to Oct. 22) Run your business affairs so that you are appropriately at peace with debtors and creditors. Show more devotion to mate.

SCORPIO (Oct. 23 to Nov. 21) An associate who is stubborn can now be brought around to your way of thinking by showing a more cooperative spirit on your part.

SAGITTARIUS (Nov. 22 to Dec. 21) You are enthused about accomplishing much work, so don't waste time on the unimportant. Sidestep one who is too talkative.

CAPRICORN (Dec. 22 to Jan. 20) Make plans to engage in the kind of recreation that has proven satisfactory in the past. Don't neglect to pay important bill.

AQUARIUS (Jan. 21 to Feb. 19) Don't bore others with trivial matters. Avoid one who has an eye on your assets. Show others that you are a worthwhile person.

PISCES (Feb. 20 to Mar. 20) Go to the right sources for the data you need and then put it to good use. Study reports carefully so mistakes can be avoided.

IF YOUR CHILD IS BORN TODAY... he or she will be indecisive early in life, so see to it that the diet is right and sleep habits good, and then your progeny will understand the importance of making decisions fast and accurately. The talents here are not numerous but could lead to fine security during lifetime.

"The Stars impel, they do not compel." What you make of your life is largely up to YOU!

Carroll Righter's Individual Forecast for your sign for October is now ready. For your copy send your birthdate and \$1 to Carroll Righter Forecast (name of newspaper), P.O. Box 629, Hollywood, Calif. 90028.

(c) 1974, McNaught Syndicate, Inc.)

GOREN ON BRIDGE

BY CHARLES H. GOREN
© 1974, The Chicago Tribune

Both vulnerable. North deals.

NORTH
♦ Q 6 5
♥ Q J 7 4
♦ A K J
♣ Q 7 3

WEST
♦ A 9 4
♥ 6 2
♦ 10 8 4 3
♣ J 10 8 4

EAST
♥ K J 10 8 3 2
♦ 9
♥ Q 9 6
♣ K 9 2

SOUTH
♦ 7
♥ A K 10 8 5 3
♦ 7 5 2
♣ A 6 5

The bidding:
North East South West
1♦ 1♦ 4♥ Pass
Pass Pass Pass
Opening lead: Ace of ♦

Often, there are alternate methods of playing a contract, and it is declarer's task to select one that offers the best chance of making the desired number of tricks. Sometimes the bidding or play will yield enough valuable clues to make the selection of the winning line even easier.

Since North's major suit was hardly biddable, he elected to open the bidding in his lower three-card minor. After East's overall, South opted to bid the full value of his hand, and North was happy to pass.

West led the ace of spades and continued with the nine, declarer ruffing. It appeared that the contract hinged on finding either the queen of diamonds or king of clubs with West, but in view of East's overall and the fact that West had already shown up with the ace of

Unitarians To Meet Sunday

Greenville's Unitarian Fellowship Group will meet Sunday, at the home of Mr. and Mrs. William Carstarphen, 2115 Southview Dr. Speaker for the meeting will be Dr. Blanche Watrous of the East Carolina University Sociology and Anthropology Department.

Dr. Watrous will discuss death with particular emphasis on "Death with Joy in Bali." Her emphasis will be cross-cultural with Balinese attitudes toward cremation being discussed, and the continuity of life and death in Sub-Sahara Africa.

The discussion will be preceded by a pot luck luncheon. Each family is asked to bring one covered dish. The luncheon will begin at 12 with the discussion starting about 1 p.m.

Victorians Will Gather

The fifth annual meeting of the Victorians Institute has been scheduled for the East Carolina University campus Saturday, Oct. 12.

This year's theme, "Victorian Romantics," will be carried out by lectures concerning George Eliot, Ruskin, Marx, Carlyle, Stephen Crane, Rossetti, Swinburne and others.

Director of the 1974 institute meeting is Dr. Donald Lawler of the ECU department of English.

Discussions will follow each of the three morning presentations, said Dr. Lawler. Scheduled to speak in the morning session are:

Dr. Jean R. Halladay, Old Dominion University, on "Sartor Resartus" Revisited: Carlyle Echoes in Crane's "The Red Badge of Courage"; Dr. James LeRoy Smith, ECU, on "Marx and Ruskin: Romanticism and Political Theory"; and Dr. Roger Whitlock, University of Hawaii, on "George Eliot's Last Romantics."

The afternoon session will consist of a business session and an address by Cecil Y. Lang on "Romantic Chemistry: A Study of Romantic Love in the Nineteenth Century."

Expo '74 Has Met Its Goal

SPOKANE, Wash. (AP) — Expo '74 officials say they are planning a big party for the five millionth paid world's fair visitor.

With about five weeks to go before its scheduled closing Nov. 3, officials say the world's fair has met its original projected attendance total of 4.85 million visitors.

September's paid attendance averaged about 20,400 persons a day. Officials say they need about 16,700 a day to break even.

Total paid attendance through Sunday was 4.42 million, officials said.

264 PLAYHOUSE THEATRE
6 Miles West of Greenville on US-264 Farmville Hwy.

ENDS TONIGHT
AT YOUR ADULT ENTERTAINMENT CENTER
LAMPUS GIRLS
Call For Showtime 756-0848

PARK NOW THRU THUR. INCREDIBLE?
NOT FOR THE SUPER SCOPES
SHOWS DAILY 1:30-2:15-3:15-7:00-8:00-9:00
DOORS OPEN 12:30

PLAZA CINEMA
NOW SHOWING!
"BORN LOSERS"
A RE-RELEASE THE ORIGINAL SCREEN APPEARANCE OF TOM LAUGHLIN AS BILLY JACK
Call For Showtime 756-0848

MEADOWBROOK Now Playing
The Directors Company presents
RYAN O'NEAL
PETER BOGDANOVICH PRODUCTION
"PAPER MOON"
PG A Paramount Release

ALSO RYAN O'NEAL IN "WHAT'S UP, DOC?"
TICE DRIVE-IN THEATRE
ENDS TONIGHT
BACK BY POPULAR DEMAND A RE-RELEASE

ALSO "THE HARD RIDE"

Chinese Walls Nearly Intact

RED BLUFF, Calif (AP) — Part of Tehama County's historic heritage lies in the miles of rock walls which were built by Chinese laborers across rangeland east of Red Bluff about 1870 as property boundaries and containment walls for herds of cattle. Although constructed without mortar or adhesive of any kind, the walls still stand virtually intact.

TERMITES OR ANTS?
Don't be half sure. Call a professional pest control operator for an inspection today.
The potential damage to property from termites can exceed the damage from tornadoes, hurricanes and fire. This is why termite protection is as important as a homeowner's insurance policy.
N.E. MOORE
Pest Control Inc.
752-6440

SAVE \$1.50! FRESH-PERKED FLAVOR SALE.

Save 50¢ on your next purchase of an 8-oz. jar of Taster's Choice® 100% Freeze-Dried Coffee, Regular or Decaffeinated, with the coupon below. As an added bonus, send us two 8-oz. inner seals from Taster's Choice, Regular or Decaffeinated, with the refund form below, and The Nestlé Company will refund a dollar. You save a total of \$1.50.

COUPON GOOD SEPTEMBER 30 THROUGH OCTOBER 31, 1974

TO THE DEALER: This coupon will be redeemed only as follows: For amount specified plus 5¢ for handling, provided coupon is received from customer on purchase of listed merchandise. Proof of purchase of sufficient stock of merchandise to cover coupons submitted must be shown on request. If failure to comply may void all coupons submitted for redemption. Redeemable only through brokers or other outside agencies. Coupons are non-transferable and void if used or prohibited, faded, restricted, or license is required. Customer must pay any sales tax. For redemption, present to our salesman or mail to: The Nestlé Company, Inc., P.O. Box 1500, Elm City, N.C. 27828. Offer good only in U.S.A. Limit 1 coupon per family. Expires October 31, 1974.

50¢ OFF on 8-oz jar of Taster's Choice® 100% Freeze-Dried Coffee, Regular or Decaffeinated.

STORE COUPON 5416-73

OFFER GOOD UNTIL JANUARY 31, 1975

\$1.00 REFUND on two 8-oz. jars of Taster's Choice® 100% Freeze-Dried Coffee, Regular or Decaffeinated.

Mail to: The Nestlé Company, Inc., P.O. Box 1574, Elm City, N.C. 27898

Send us two complete inner seals from two 8-oz. jars of Taster's Choice® 100% Freeze-Dried Coffee, Regular or Decaffeinated, and we'll send you a refund of \$1.00.

NAME _____ (PLEASE PRINT PLAINLY)
ADDRESS _____
CITY _____ STATE _____ ZIP _____

Offer expires January 31, 1975. Limit 1 per family. Allow three to four weeks for delivery. Offer is good only in U.S.A. and is void where prohibited by law.

This form must be used to obtain refund

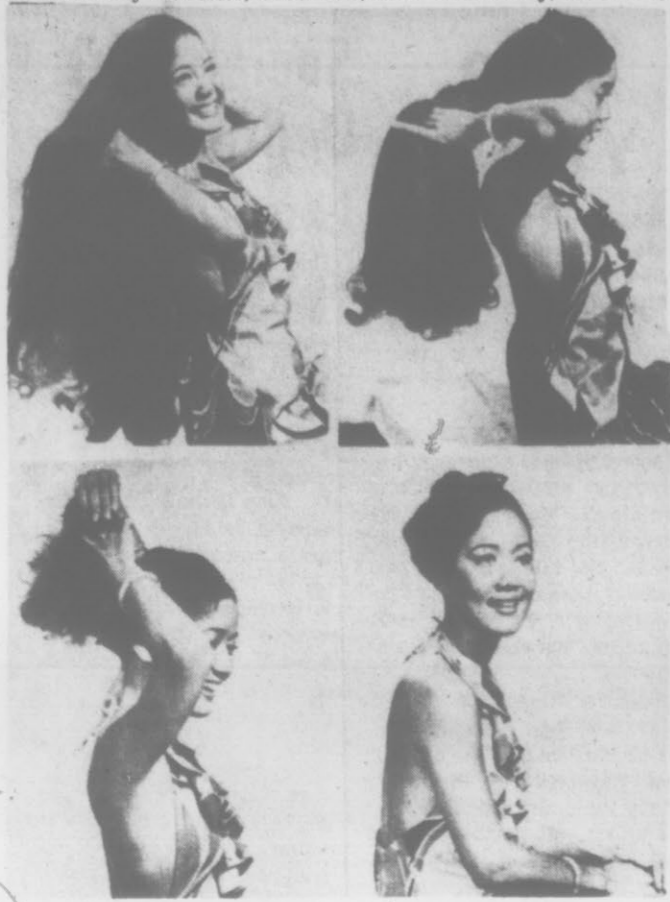

QUICK CHANGE ARTISTE—Some take hours to make long hair into a manageable style, but not Hawaiian entertainer and ex-beauty queen Kathy Horio, who shows how she can form her tresses into a compact hairdo in only five and one-half seconds. (AP Wirephoto)

Morocco Ranch Improving Herds

By MICHAEL GOLDSMITH
Associated Press Writer
ADAROUCHE, Morocco (AP) — The rolling, grass-covered hills look like Texas cattle country. But the cowboys wear turbans, and at sundown many of them kneel down in the direction of Mecca to recite their prayers.

Morocco's King Ranch, was started as an offshoot of the great Texas ranch in 1971. It was an experiment to save the local breed of cattle from extinction and has proved a spectacular success. Moroccan businessmen are so impressed that they are investing their own money to establish new ranches on 125,000 acres of neglected pastureland in other parts of Morocco.

Small local farmers, who viewed the experiment with distrust and skepticism at first, now bring up their cows at dead of night to "steal" the precious seed of King Ranch's Santa Gertrudis bulls.

"We suddenly find Santa Gertrudis strains all over the countryside," said Raoul Estrade, French Manager of the Adarouch King Ranch which now has more than 10,000 cattle and has become by far the largest farming enterprise in North Africa.

"When we flew in the first Santa Gertrudis bulls and cows from Texas and Argentina, the local farmers could hardly believe their eyes. They had never seen such big, healthy cattle."

Estrade's Moroccan ranchhands patrol the 155 miles of wire fencing surrounding the 30,000-acre ranch in jeeps and on horseback. In more than three years of operations, only seven animals have been lost to cattle rustlers, ranch spokesmen claim.

Adarouch is an Arabic word meaning coyote track. The

uninhabited valley was a preserve of coyotes and foxes when Estrade persuaded King Ranch owner Robert J. Kleberg Jr. of Texas that it was the ideal site for the Moroccan experiment.

The French army used the area long ago as grazing land for its cavalry horses, and nomadic Moroccan herders came on occasional visits.

But the grass was sparse and dry, and the Moroccan cows were a feeble, disease-ridden caricature of their ancestors, introduced by Portuguese settlers in the 16th Century.

"The Moroccan breed of cattle has become degenerate as result of inbreeding, disease and sheer hunger," Estrade said. "There is no doubt that, without outside help, the whole breed would soon become extinct."

King Ranch replanted the valley with rich Lucerne grass imported from Australia. Some 800 pure Santa Gertrudis cattle were interbred with 5,000 specially groomed local cows. The first generation of the new breed has proved well adapted to Moroccan conditions, where temperatures range from near zero fahrenheit in winter to more than 100 degrees in summer.

The ultimate aim is to regenerate all of Morocco's estimated 20 million cattle with the new strain bred at Adarouch, and make Morocco — once a major meat exporter — at least self-sufficient in beef production.

Adarouch Ranch is a 12-mile-long strip of land south of Meknes, some 150 miles east of the Moroccan capital, Rabat. The land was contributed by Morocco's King Hassan II. King Ranch Inc. owns 51 per cent of the ranch, and the Moroccan government owns the remainder.

China's Cabinet Posts Unfilled

By CHARLES R. SMITH
UPI Senior Editor
HONG KONG (UPI) — Nothing better illustrates China's continuing political instability than the failure to elect a new legislature and fill cabinet posts vacant for years.

The convening of the 4th National People's Congress (NPC), the highest constitutional body, is almost six years overdue despite many promises by the top leadership that it would be held "soon."

At least three cabinet posts—and maybe more—are vacant. These include the important ministries of defense and finance.

There are rumors, still unconfirmed, that preparations may be under way to convene the 4th NPC in October in connection with the 25th anniversary of the People's Republic of China.

A new draft constitution has been circulated among cadres for discussion and reportedly approved by the leadership, including the arbiter of almost everything in China, Communist Party Chairman Mao Tse-tung.

Mao turned down a previous draft and blocked at least one

NPC session because he objected to having a state chairman (President) as the old constitution, adopted by the 1st NPC in 1954, provided.

"I don't want a state chairman," Mao said at a 1971 meeting. "I have said this six times...But they won't listen, just as though I didn't say it at all."

There have been no other signs of any other preparations for an imminent NPC session. But considering the highly secretive nature of Chinese political activities this means little.

The party's 10th National Congress, for instance, was held in secret just one year ago and few people knew about it until it was over.

At that party congress Premier Chou En-lai promised in his political report that "we will soon convene the 4th National People's Congress."

That promise was repeated, but in less emphatic tones, in the traditional New Year editorial in the party organs last Jan. 1.

The party leadership first decided to hold the 4th NPC at a central committee plenary session August to September, 1970.

CERTIFIED WESTERN
BEEF SALE
BEEF ^{1/2} **CATTLE**
SIDES
Average Weight 300 Lbs.
CUT INTO STEAKS & ROASTS FREE LB.
79¢

HARRIS SUPER MARKETS
"Where Shopping"

SAVE GREENBOX GREEN STAMPS

SAVE GREENBOX GREEN STAMPS

GRAND

HARRIS SUPERMARKETS
THE NEWEST & MOST MODERN SUPERMARKETS
Come One, Buy One.

Free Register for \$125 worth of bicycles 1 (\$125) speed bikes. One will be given away this Saturday Night OCT. 5th.

Free Register for an RCA Color Console TV to be given away Saturday Oct. 5th.

Join us in the Fun of our Grand Celebration

* Must be 18 years or older to be eligible for prizes. * Employees of Harris Supermarkets and their families are not eligible for prizes.

CERTIFIED WESTERN WHOLE BEEF

LOINS \$1.19 LB.
CUT INTO T-BONES & SIRLOINS FREE!

CERTIFIED WESTERN BONELESS SIRLOIN TIP

ROAST \$1.49 LB.

FROSTY MORN SLICED

BACON 99¢ LB.

GRADE "A" HOUSE OF RAEFORD

SELF BASTING

TURKEYS OR **REGULAR TURKEYS** 59¢ LB.
10 To 12 Lbs.

DANDY

SAUSAGE 69¢ LB.

1/4 SLICED

PORK LOIN 99¢ LB.

SAVE GREENBOX GREEN STAMPS

100 GREEN STAMPS — FREE

AT HARRIS SUPERMARKETS WITH THE PURCHASE OF \$15 OR MORE & TOWARDS ANY ITEM. COUPON EXPIRES OCT. 5, 1974.

CERTIFIED WESTERN BEEF

T-BONE STEAK \$1.49 LB.

CERTIFIED WESTERN BEEF

SIRLOIN STEAK \$1.49 LB.

CERTIFIED WESTERN BEEF (FULL CUT) BONE-IN

ROUND STEAK \$1.39 LB.

CERTIFIED WESTERN

FRESH GROUND

BEEF 89¢ LB.

WE RESERVE TO LIMIT QUANTITIES

MEMORIAL DAY

E. TENT

W. FIFTY

R.R. STATION

N. GREEN

Our New

1104 West

Ayde

We Reserve the Limit Quantities

Open Mon.-Thurs.

Fri. & Sat. 8-10

JESSE JONES

HOT DOGS

12 Oz. Pkg.

69¢

JESSE JONES

Bologna

12 Oz. Pkg.

79¢

HARRIS

MARKETS, INC.
"A Pleasure"



Harvest These
PRODUCE
Savings

U.S. NO. 1 WHITE
POTATOES

20 LB. BAG \$1.39



CALIFORNIA
RED GRAPES

3 Lbs. For \$1.00



WHITE
GRAPEFRUIT

5 Lb. Bag 69¢

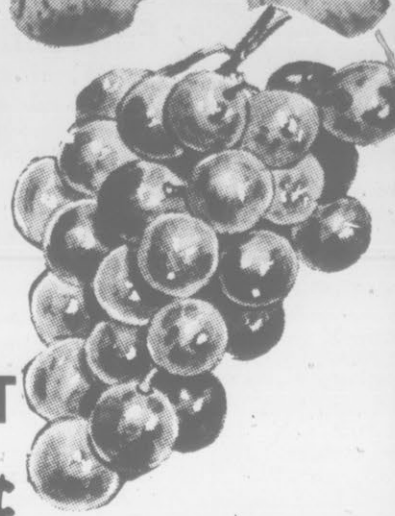

OPENING!

MARKET NO. 6
MARKET IN PITT COUNTY

Week
ening

1104 West Third St. Ayden
STORE HOURS: MON. - THURS. 8 AM - 11:30 PM - FRI. & SAT. 8:30 - 11:00

Free Register for Continental 36 Cup Party Perculator one will be given away this Saturday night

Winners will be posted inside store. No telephone inquiries on winners will be accepted.

GREENBOX STAMPS
MARKETS
CASE OF COUPON
OCTOBER 5, 1974



JERGENS DIRECT AID

Reg. 95¢

58¢



GLOVE KID PEANUT BUTTER

28 OZ. SIZE

99¢



WELCH'S GRAPE JELLY

2 Lb. Size

99¢

DOVE LIQUID DETERGENT

(9's)

(20¢ OFF)

93¢

COMET CLEANSER
ADVANCED CHLORINOL
Disinfects as it cleans

6 1/2 OZ. SIZE

COMET CLEANSER

(2¢ OFF)

5 For

\$1.00



FANCY CUT GREEN BEANS

3 (303 SIZE CAN FOR)

\$1.00

WHOLE GRAIN GOLDEN CORN

3 (303 SIZE CAN FOR)

\$1.00

CREAM STYLE GOLDEN CORN

3 (303 SIZE CAN FOR)

\$1.00

SHOE PEG CORN

3 (303 SIZE CAN FOR)

\$1.00

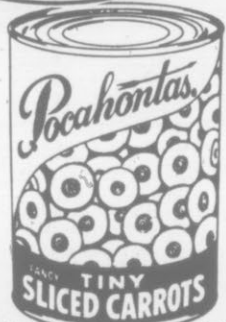

MIXED VEGETABLES

3 (303 SIZE CAN FOR)

\$1.00

SLICED CARROTS

3 (303 SIZE CAN FOR)

\$1.00

LITTLE PRINCESS PEAS

3 (303 SIZE CAN FOR)

\$1.00

ZEST
6¢ OFF 2)
TWO BARS

FROZEN FOODS
Fill the Bill

Pie Shells 2 Pack 39¢

Apple Pies 24 Oz. Size 69¢

ICE MILK
Half Gal.



59¢

PLASTIC SETS 49¢
KNIVES, FORKS & SPOONS

6-pack CANDY BARS 90¢ VALUE



only

69¢

(HARRIS) COUPON

save 30¢
WITH THIS COUPON WHEN YOU BUY A 6 OZ. JAR OF

Maxwell House COFFEE

AT HARRIS SUPERMARKETS
6 OZ. JAR ONLY \$1.09 WITH COUPON

ONE COUPON PER FAMILY • OFFER EXPIRES OCT. 5, 1974

QUIK
2 Lb. Size
\$1.29

the Light Approach to Happy Eating
SERVE DAIRY

ORANGE JUICE HALF GAL. 69¢

BUTTER 89¢ LB.

MARGARINE 59¢ LB.

EGGS 69¢ DOZ.



EYES ON THE FUTURE—Poised on the brink of country music success, Larry Gatlin spends a lot of time these days thinking about his future and his music. (AP Wirephoto)

Music Success Nearly In Grasp

By CHRISTOPHER CABOT
Associated Press Writer
NASHVILLE, Tenn. (AP)—A mellow baritone, a notebook full of songs and a chance meeting with Dottie West brought Larry Gatlin to Nashville.

That was three years ago. Now, after some more help from his friends and two albums, Gatlin, 26, is poised on the brink of big-time country music success.

"I met Dottie in Las Vegas. I had written some songs and she heard me sing them," the stocky, shaggy-headed, singer-writer said. "I gave her some other songs I'd written. And do you know, she sent me a plane ticket to Nashville."

His association with Miss West led to friendships with Johnny Cash, Kris Kristofferson and Fred Foster, head of Monument Records. From there it has been all good news for Gatlin.

Moreover, his songs have been recorded by Elvis, Kristofferson, Johnny Rodriguez and Roy Orbison.

Impressed by his promising start, Monument sent Gatlin on a six-week promotional tour last month through the South and West. Local music promoters and newsmen were first shown a short film—including

accolades from Cash and Kristofferson. Then Gatlin did what he's best at.

"They gave me the opportunity to say, 'Hello. I'm Larry Gatlin,' and then sit on a stool and pick my guitar and sing my songs," Gatlin said last week. "I'm grateful and thankful that they're putting their influence on the line to let me do what I want to do."

Impending stardom hasn't really shaken Gatlin. Although he seems restless and his blue eyes are constantly shifting, he says he's put being a star in perspective.

"I've always wanted to sing, and this gives me the chance to do it. Sure I'd like to be a star, who doesn't? If it comes, fine. But if it doesn't, I'm making a good living and anything beyond that is just gravy."

Despite this come-what-may attitude, Gatlin has pretty specific plans for his future.

"I want to start a group with my brothers and sister again. We used to sing a lot when we were kids. We're great at some four-part harmony and good, hard gospel music."

"I'd still want to sing by myself for 30 or 40 minutes in each show. And I'd love to have a good band to back us up."

"I figure because I got the first big break I should help them along."

With success as a country music artist come pressures to find a so-called cross-over hit—a song that will reach the top of both country and pop charts.

"I'm a country singer," he insists. "I wouldn't mind some pop sales because that sells a lot more records. My roots are country and gospel. I guess you could say I'm in a folk-country bag."

"So I don't want to sit down and say, 'Does this song have cross-over potential?' I like to do a song as it needs to be done, and if it crosses over, fine."

"The biggest and most important thing is to be what you are—not to let the structure of the business hamper your creativity."

Councilmen And Parking Board Meet Today

A special meeting involving the Greenville Parking Authority and the City Council will be held today at 4 p.m. in the council chambers at city hall.

The purpose of the meeting is to review the recommended parking program as presented last April by Wilbur Smith & Associates, consultants to the Parking Authority, and to focus on alternative methods of financing and execution of the program.

A representative of the consultant firm, based on Columbia, S.C., will be here to discuss the program with the Council and Parking Authority members.

The session is open to the general public.

Pate Named To Ass'n Office

Willie M. Pate, Director of Environmental Health, Pitt County Community Health Department, was elected secretary-treasurer of the Environmental Health Section of the North Carolina Public Health Association at the group's 63rd annual meeting recently held in Charlotte.

The 400-member group is composed of professional environmental health practitioners employed by state and local Public Health Departments and other agencies and industries involved in environmental health activities. Pate's duties will include recruiting new members and editing the group's newsletter.

CAGEY COMPANY
WELLINGTON, New Zealand (UPI)—A New Zealand footwear company driven to despair by the pillaging of its shipments now puts all the left shoes in one container and the right shoes in another—and sends them out on different ships.

Thornsby. . .



"If I have to listen to 'The Way We Were' once more, I'll flip out!"



JULIET JONES

Ban Production Of Key Farm Pesticides

By BRIAN B. KING Associated Press Writer WASHINGTON (AP) — The Environmental Protection Agency has banned production of two pesticides used on key farm crops, saying they are possible cancer hazards and that adequate alternatives exist for them.

Several experts say the ban on Aldrin and Dieldrin is unlikely to have a far-reaching effect on the production or price of the crops on which they are used.

In fact, Agriculture Department figures indicate that drought, rains and frost this year caused 27.5 times more damage to the corn crop than the ban will. The pesticides have been used on about 10 per cent of the nation's corn acreage to fight worms and other

soil-born insects. The EPA cited the pesticides, made in the United States only by Shell Oil Co., as probable cancer hazards. Their production for most farm uses was banned Tuesday until hearings on their registration are concluded.

Shell, which said it sold about \$8 million worth of the pesticides to corn farmers this year,

Prices Rose On Farmville Mart

FARMVILLE—Prices continue to rise on the Farmville market, when averages Tuesday reach an all time high. Leaf and cutter grades accounted for most of the increases. Top practical price paid was \$1.15 a pound. Some quality grades and cutters sold for \$1.20 a pound.

Leaf and smoking leaf accounted for approximately 84 per cent of Tuesday's sales, and primings and cutters showed a sharp increase in volume. Stabilization receipts continued to be extremely light.

A total of 380,551 pounds brought \$433,570, for an average of \$113.93 per hundred pounds. To date, the Farmville market has sold 21,278,632 pounds for a total of \$22,131,279 at an average of \$104.00 per hundred pounds.

DISCOUNT RIDES

CHARLOTTE (AP)—Physically handicapped residents of Charlotte will soon get a 15-cent discount on city bus tickets under a program whereby the city subsidizes a portion of the fare.

said it would appeal the EPA's action to the federal courts on both scientific and procedural grounds.

Stocks on hand may still be used, the EPA said.

EPA Administrator Russell Train, accepting the recommendations of an administrative law judge after a three-week hearing, said adequate alternatives exist to Aldrin-Dieldrin but, statistics indicated, at a higher cost.

What effect, if any, use of the higher-priced alternatives could have on food costs, was unknown. Farmer's costs as a portion of food prices are difficult to pin down because farmers alone seldom can determine the price they will get for their crops.

Spot checks with congressional offices from the top five corn-growing states of Iowa, Illinois, Nebraska, Indiana and Minnesota indicated Tuesday that the ban on the two pesticides has not caused a ripple of angry response from farmers, compared with the reaction to EPA's 1972 ban on DDT.

The EPA order still allows production of the pesticides for use against termites, its other principal application.

PUBLIC NOTICES

NOTICE OF ADMINISTRATION
The undersigned, having this day qualified as Ancillary Administrator of the Estate of Dooty Gardner, deceased, of the District of Columbia, this is to notify all persons having claims against the estate of the deceased to exhibit the same, duly itemized and verified, to the undersigned Ancillary Administrator at Greenville, North Carolina, on or before the first day of March, 1975, or this notice will be deemed a bar to the recovery. All persons indebted to said estate will please make immediate payment to the ancillary Administrator.

NOTICE OF SALE IN THE GENERAL COURT OF JUSTICE SUPERIOR COURT
FILE NO. 73 SP 267
North Carolina
NINA BELL SMITH, Widow, et al.
vs
LIZZIE MILLS, et al.
Pursuant to an Order entered by the Honorable Perry Martin, Judge presiding for the Pitt Superior Court for the Third Judicial District, on the 10th day of September, 1974, the undersigned will sell the hereinafter described property at the Court House door of Pitt County, Greenville, N.C.

The property to be sold is described as follows:
Lying and being situate in Pitt County, North Carolina, and BEGINNING in swamps at the corner of Jarvis Mills' land; running with Arden Hudson's line to the late Nasby Mills' land; thence with said late Nasby Mills' land to the line of Calvin Cannon's line; thence with her line to Calvin Cannon's line; thence with his line to the BEGNNING and containing seventy (70) acres, more or less.

There is excepted from the above described tract of land the following three tracts of land: to-wit: certain Will of Possie Mills of record in Will Book 11, page 226, in the Office of the Clerk of the Superior Court of Pitt County.

Lying and being situate in Chicod Township, Pitt County, North Carolina, on the northern side of Mills Road, and BEGINNING at a common corner of the Possie Mills Louis Henry Mills lands in the northern line of said Mills Road, and running thence in a northerly direction along a fence and along the dividing line of the Possie Mills Louis Henry Mills land, to a ditch; running thence in a westerly direction with the center of said ditch to a garden fence; running thence in a southerly direction with said garden fence to the northerly line of Mills Road, and running thence in a southerly direction with said fence to an Oak Tree; running thence in an easterly direction with a fence, to another fence; running thence in a northerly direction with the latter referred to fence to the southerly line of Mills Road running thence in a westerly direction to the point of BEGINNING, containing one (1) acre, more or less, and being as aforesaid, the home presently occupied by Heber Mills, together with an acre of land, more or less, surrounding same.

The sale will be at public auction, and the highest bidder will be required to deposit ten (10) per cent of the bid. The sale is subject to confirmation by the Court. This the 23rd day of September, 1974.
James M. Roberts
Frank M. Wooten, Jr.
Commissioners

NOTICE OF SALE
North Carolina
Pitt County
Under and virtue of the Power of Sale contained in a certain Deed of Trust executed by BILLY GARRIS and wife, SALLIE SCOTT GARRIS to JOSEPH HORTON, Trustee, dated the 19th day of February, 1968, and recorded in Book P 37, Page 30, in the Office of the Register of Deeds of the County of Pitt, and under and virtue of the authority vested in me the undersigned as Substituted Trustee by an instrument of writing dated the 27th day of August, 1974, and recorded in Book 42, Page 291 in the Office of the Register of Deeds of Pitt County, default having been made in the payment of the in-

PUBLIC NOTICES

debtedness thereby secured and the Deed of Trust being by the terms thereof subject to foreclosure, and the holder of the indebtedness thereby secured having demanded a foreclosure thereof for the purpose of satisfying said indebtedness, the undersigned Substituted Trustee will offer for sale at public auction to the highest bidder for cash at the Court House door in Greenville, Pitt County, North Carolina, at 11:00 o'clock A.M., on the 1st day of November, 1974, the land conveyed in said Deed of Trust, the same lying and being in the County of North Carolina and more particularly described as follows:

"BEING Lot No. 9 in Block B as shown on the certain map of Claimant Subdivision as appears of record in Map Book 14, at pages 46 and 46-A, Pitt County Registry, Greenville, North Carolina, and for a more accurate description.

Said lands are conveyed in all respects subject to any restrictive covenants appearing of record in the Pitt County Registry and affecting the same.

This property is being sold subject to a prior Deed of Trust to Home Federal Savings & Loan Association of Farmville, North Carolina.

The night bidder must make a downpayment of \$200.00 on the first \$1,000.00 sale price, plus an additional payment of ten percent (10 percent) of the excess over \$1,000.00, on or before the 18th day of September, 1974.

NOTICE OF SALE
The heirs of J. C. Wynne, Sr. will offer for sale the following described real property in the following manner:

SALE BY SEALED BIDS:
The heirs of J. C. Wynne, Sr. will offer for sale by sealed bids for cash by the submission of sealed bids to the firm of Speight, Watson and Brewer, Attorneys at Law, Greenville, North Carolina 27834, by not later than 12:00 o'clock Noon, Monday, October 7, 1974. All persons interested in bidding on this property shall submit said bid in a sealed envelope to said law firm enclosing a deposit of 10 percent of the bid amount to be subject to acceptance or rejection by the heirs of J. C. Wynne, Sr. Notification within 72 hours after Noon, October 7, 1974 will be required. The highest bid and whether said bid was accepted or rejected. The deposit will be returned to all unsuccessful bidders. Bids not accepted under sealed bids shall be sold as a unit and not separately. Said property is described as follows:

"That certain property formerly known as the 'GE Center', a building and surrounding lots at the corner of Main Street and Highway 202, in the Town of Bethel, County of Pitt, State of North Carolina, comprised of several tracts heretofore conveyed to J. C. Wynne, Sr., et ux, to J. C. Wynne, Sr., dated November 25, 1949, recorded in Book M 25, at page 603, in the Pitt County Registry.

(b) Deed from W. C. Whitehurst, et al. to J. C. Wynne, Sr., dated March 20, 1942, recorded in Book C 25, at page 511, of the Pitt County Registry.

(c) Deed from Isabelle Smith Markley to J. C. Wynne, Sr., dated September 2, 1942, and recorded in Book M 25, at page 283 of the Pitt County Registry.

The aforesaid property is subject to a lease between J. C. Wynne, Sr. and Wynne's, Incorporated, the terms to be furnished upon request.

The heirs reserve the right to accept or reject all bids within seventy-two (72) hours after the date of sale. The property will be subject to any outstanding taxes or municipal assessments.

PUBLIC NOTICES

NOTICE OF SERVICE OF PROCESS BY PUBLICATION IN THE GENERAL COURT OF JUSTICE DISTRICT COURT DIVISION
FILE NO. 74CV D 2210
North Carolina
Pitt County
ALMA JEAN COGHELL
VS
LORENZO DAN COGHILL

TO: LORENZO DAN COGHILL, DEFENDANT:
Take notice that a pleading seeking relief against you has been filed in the above entitled action. The nature of the relief being sought as follows:

Plaintiff seeks an absolute divorce based upon one year's separation. You are required to make defense to such pleading not later than the 11th day of November, 1974, and upon your failure to do so, the party seeking service against you will apply to the Court for the relief sought.

The 26th day of September, 1974.
DAVID E. REID, JR.
Attorney for Plaintiff
Post Office Box 375
Greenville, North Carolina 27834
Telephone: (919) 752-4545
Oct. 2, 9, 16, 23, 1974

NOTICE OF TRUSTEE'S SALE
State of North Carolina
County of Pitt
WHEREAS, the undersigned, acting as Substituted Trustee in Deed of Trust hereinafter specifically identified, having been duly substituted as Trustee in the same Deed of Trust by instrument recorded in the Office of the Register of Deeds of Pitt County, North Carolina on the 18th day of February, 1974 in Book 158, Page 529, and

Deed of Trust referred to above being dated November 1, 1971 executed by Coleman W. Ward, President of C.W. WARD & COMPANY and delivered to Hugh R. Anderson, Trustee and the First National Bank of Asheville, North Carolina, and

WHEREAS, the undersigned Substituted Trustee will offer for sale by sealed bids for cash by the submission of sealed bids to the firm of Speight, Watson and Brewer, Attorneys at Law, Greenville, North Carolina 27834, by not later than 12:00 o'clock Noon, Monday, October 7, 1974. All persons interested in bidding on this property shall submit said bid in a sealed envelope to said law firm enclosing a deposit of 10 percent of the bid amount to be subject to acceptance or rejection by the heirs of J. C. Wynne, Sr. Notification within 72 hours after Noon, October 7, 1974 will be required. The highest bid and whether said bid was accepted or rejected. The deposit will be returned to all unsuccessful bidders. Bids not accepted under sealed bids shall be sold as a unit and not separately. Said property is described as follows:

"That certain property formerly known as the 'GE Center', a building and surrounding lots at the corner of Main Street and Highway 202, in the Town of Bethel, County of Pitt, State of North Carolina, comprised of several tracts heretofore conveyed to J. C. Wynne, Sr., et ux, to J. C. Wynne, Sr., dated November 25, 1949, recorded in Book M 25, at page 603, in the Pitt County Registry.

(b) Deed from W. C. Whitehurst, et al. to J. C. Wynne, Sr., dated March 20, 1942, recorded in Book C 25, at page 511, of the Pitt County Registry.

(c) Deed from Isabelle Smith Markley to J. C. Wynne, Sr., dated September 2, 1942, and recorded in Book M 25, at page 283 of the Pitt County Registry.

The aforesaid property is subject to a lease between J. C. Wynne, Sr. and Wynne's, Incorporated, the terms to be furnished upon request.

The heirs reserve the right to accept or reject all bids within seventy-two (72) hours after the date of sale. The property will be subject to any outstanding taxes or municipal assessments.

PUBLIC NOTICE

having claims against said estate to file them with the undersigned Administrator of the address given within six (6) months from this day of recovery. All persons indebted to the estate will please make immediate settlement.

This the 20th day of September, 1974.
Athlene Garris
Administrator of the Estate of Lester Garris
Rt. 3 Box 444,
Ayden, N. C. 28513
S. O. Worthington,
Attorney
Sept. 25; Oct. 2, 9, 16, 1974

THE DAILY REFLECTOR
Classified Advertising Rates
752-6166
Place your Classified ad for 7 days. The cost is less.

RATES
3 line minimum
1-3 days 35c per line per day
4-4 days 32c per line per day
7 or more 30c per line per day

SEMI-ANNUAL CONTRACTS
4 lines per day 23c per line (Monthly Charge \$23.92)
8 lines per day 21c per line (Monthly Charge \$43.68)

CLASSIFIED DISPLAY RATES
Open Rates \$1.80 per inch 7 or more days \$1.75 per inch

SEMI-ANNUAL CONTRACTS
6 inches per week \$1.70
1 inch per day \$1.60
(Monthly charge \$41.60)

DEADLINES
All lineage deadlines are 12:00 noon on the preceding day. Except Sunday which is 12:00 noon Friday and Monday which is 4:00 p.m. Friday. All display deadlines are 4:00 p.m. two days in advance of publication. Except Sunday which is 3:00 p.m. Thursday and Monday which is due by 12:00 noon on Friday & Tuesday which is due by 4:00 p.m. Friday.

ERRORS
Errors must be reported immediately. The Daily Reflector cannot make allowances for errors after the 1st day.

THE DAILY REFLECTOR reserves the right to edit or reject any advertisement submitted.

Card of Thanks
WE THE FAMILY of the late Dave Wooten wish to acknowledge the many kind services rendered to us during the illness and death of our loved one. The beauty of your services have helped us tremendously. Thank you again for the consolation and for your continuing prayers. The Wooten Family.

AUTOMOTIVE
Auto for Sale
Having Engine Trouble? See "The Engine People" Auto Specialty Co.
917 W. 5th St.
758-1131

CADILLAC 1974 Fleetwood, Brougham d'Elegance. Dark blue, velour trim, all available options, 12,500 miles, \$9,999. Mack Tyson, (919) 483-0887 Fayetteville, after 7, 5095.

CHEVROLET SUPER SPORT Impala '64, 2 door hardtop, 327 automatic, mag wheels, \$400 or best offer. 758-0226.

CHEVROLET 1962, 4 door, 283 motor. Call 756-4608.

CHEVY NOVA '63, \$150. Must sell. 753-5481.

CUTLASS 5 COUPE 1970—This is a one owner car with 43,000 actual miles. Come see or call Holt Olds-Datsun, 101 Hooker Road, Call 756-3115.

FORD CAR PARTS 1962, Call 756-0694 or come by 303 N. Sylvan Drive.

FORD ECONOLINE 200, 1971, Super Van, extra clean, 6 cylinder. Consider trade. \$2175 or make offer. 758-5857.

10 acres late model auto salvage supplying all auto needs since 1962
Regional Auto Parts, Inc.
3 miles west of Hwy. 264 at Frog Level
756-1100

FORD GALAXIE 500, 2 door hardtop \$795, assist in financing if needed. 758-5857.

FORD SALE: Clean, low mileage Corvair. Dial 752-6125.

HASTINGS FORD has daily rentals at reasonable prices. Call 758-0114.

K5 BLAZER 1974, with air, power steering, 3200 miles, still under warranty, \$5200. Phone 752-3496.

MAVERICK 1970, 6 cylinder, automatic, air conditioned, \$1295. Phone 756-1461.

MERCURY COMET '71, automatic, with radio, \$1150. Call after 6, 746-6630.

MGB 1974, burgundy, AM-FM radio, air conditioner, wire wheels, 3,000 miles. 527-8306 anytime.

MIDGET CONVERTIBLE 1960, wire wheels, \$1575 or make offer. Consider trade. 758-5857.

PONTIAC LEMANS 1962, automatic, 4 cylinder, good condition, good condition, \$752-2387.

TRIUMPH GT-6 1973, extra clean. See at 955 Shady Lane or call 758-4881.

VEGA BACKSTRIP '71, silver grey, wire wheels, 39,000 miles. 752-5364.

GUARANTEED Engine transmission, body parts. Free parts locating service.

Crisp Auto Salvage, Inc.
Phone 752-2522 N. Greene St.

Cycles For Sale

HARLEY DAVIDSON, 1973, 74 series, fully equipped, 4,000 miles, \$2,995. Call 758-1222 or 758-4929.

1971 YAMAHA 360 MX—street legal and runs great. Call 758-3962 after 6 p.m.

74 HONDA MT 125 Elsinore. Excellent condition. First \$625. 752-7330.

73 HONDA 350, 3500 miles, like new, \$750. 752-4111 or 756-0792.

SALE: 1972 Honda SL 350. \$400. 758-1679.

1974 HARLEY DAVIDSON Sport—1000 cc, 23,000 actual miles, Barnett racing clutch, drag pipes and custom seats. Come see or call Holt Olds Datsun, 101 Hooker Road. Call 756-3115.

74 KAWASAKI in perfect condition. \$450. Phone 758-0782 after 5.

Boats & Equipment

1974 C&C 27 fully equipped. \$19,500. Call 758-3191, 8 to 5, after 5, 923-8471.

15' THUNDERBIRD boat, motor and trailer. 758-1959 after 4 p.m.

60 HORSEPOWER Evinrude outboard motor. Excellent condition. 752-2788.

72 MODEL 16' Galaxie Spoiler with 74 model Silver Starlite Evinrude motor. Call 746-6551.

72 WORK BOAT for sale. Completely equipped with nets. For more information call 758-3276, nights 758-1505.

Trucks For Sale

ECONOLINE PICKUP... straight, 6 cylinder, radio, good condition. Call 758-0247 after 6 p.m.

1966 VW VAN, \$950. Call 752-7754.

72 EL CAMINO, power steering, power brakes, air conditioner, radial tires, rally wheels. Excellent condition. One owner. Call 756-0844, day; 756-0609, night.

DAY NURSERY

MOTHERLAND NURSERY, ages 3 months and up. Diapers furnished, preschool training. Hot lunches and snacks. \$14 per week. 1708 E. 4th St. Phone 752-2743.

Dogs & Pets

BLUE POINT SIAMESE kittens, 7 weeks old. 758-5645 after 6.

BLACK LABRADOR Retriever pups will start training, if desired. Call 758-3962 after 6 p.m.

FREE KITTENS: 5 cute furry kittens. Call after 1:00. 752-6523.

GERMAN SHORT haired Pointer. Looking for male to breed with pedigree female. Call 752-6140.

BEAGLES FOR SALE: 1 male, 3 females. Call 752-7785.

FREE PUPPIES to good homes. Come by 417 A. West 4th Street after 5 p.m.

IRISH SETTERS AFSB registered. 12 weeks, shots, wormed, males and females available. 756-6383.

AKC MINIATURE Schnauzers, 8 weeks, males and females. \$75. 752-4922.

EMPLOYMENT

Help Wanted

SECRETARY—Must be good typist. No shorthand required. Must be able to use dictaphone. Send resume to P. O. Box 714, Greenville, N.C.

Help Wanted

ATTENTION PRIOR servicemen and prior National Guardsmen. Men of ranks E-4 to E-6 will average \$1400-\$1800 a year for training assemblies with the N.C. National Guard plus greatly increased retirement benefits. For further details contact George L. Pleasant or SP5 Walter Ezzell at the Greenville National Guard Armory. Telephone 752-5693.

WANTED: Beautician, licensed or apprenticed. Call Pauline's Beauty Shop, 746-4011, 216 S. Lee Street, Ayden, 746-3987.

ARE YOU LOOKING for a lifetime career sales opportunity? A chance for rapid advancement and immediate high income! If so, send a brief resume to D. L. Hall, Suite 141, 401 Oberlin Rd., Raleigh, N.C. 27605.

ASSISTANT MANAGER for contract janitorial service. Experience necessary, references required at interview. Interviews held Tuesday, 74, 74, 1:30-5 p.m., Wednesday 10-2, 74, 9 a.m.-12 noon, 3:30-5 p.m., Call 752-4355 or apply to 310-B, Pennsylvania Avenue, Greenville.

WANTED PERSON for full time general office work, knowledge of posting machine helpful. Apply in person at office of town of Farmville Administrator on October 15, 1974. Equal Opportunity Employer.

WAITRESSES AND Dishwashers! Apply in person to YOR House Restaurant on Memorial Dr. No phone calls. Minimum wage plus tips and meals.

NEED A MECHANICS and 3 body shop personnel. Grubbs Chevrolet. Call 746-3141.

WAITRESS WANTED 3 days a week. 6:15 a.m.-2:15 p.m. Apply Village Inn, Ayden, N.C.

SALES AGENTS—Wigs. Agents to sell our world famous afro and black wigs. Also jewelry and track tapes. You will double your money. For details which includes a free wig call Bill, collect at 912-283-8131.

PERMANENT FULL-TIME secretary for local major oil distributors, general office duties. Send resume including work experience and references to Full-Time, Box 1967, Greenville, N.C.

WANTED TWO women over twenty five to sell insurance in the Greenville area. Salary plus commission, \$125 to start. Will train, free life and hospitalization insurance. Send resume to: Insurance Sales, P. O. Box 1967, Greenville, N.C. 27834.

Work Wanted

OFFICE WORKER. Highly qualified. Available as receptionist, administrative assistant or bookkeeper. 753-5387.

FOR SALE

Livestock

Farm Equipment

USED ROANOKE KING peanut combine. Good condition, harvested only 150 acres. 758-2949.

Miscellaneous For Sale

POULAN CHAIN SAWS, America's hottest seller. \$99.88 FOB. Bars-chain-sprockets. R. F. McLawhorn & Sons, 752-3286.

DO YOU NEED your garbage removed. If so contact R. L. Stocks Disposal Service at 746-3705 after 5 p.m.

FILL DIRT, top soil and sand for sale. Large loads. Call 746-3461.

LEADING RUG manufacturers use and recommend the Hoover for thorough removal of all types of dirt and long life of their rugs and carpets. See Smith Electric Company for sales and service. 415 Evans St., Greenville.

FOR SALE: 75 only 48x40, 4 way standard pallets, excellent condition. \$5 each. Call 752-7978.

FOR SALE Raw peanuts shelled or unshelled at Kest Peanut Company Memorial Drive.

ROLL BALANCES—room size rugs and remnants at fantastic savings. All first quality carpet at Larry's Carpetland, 3010 East 10th Street.

WHEELCHAIRS, walkers, crutches for sale or rent. Also other convalescent aids. Call 752-2136.

WE UPHOLSTER ANYTHING. Thousands of yards of fabric and foam cushioning. Jackson's Cleaning & Upholstery, Dickinson Ave., 758-3276 day or 758-1505 night.

LOVELY 42" round pedestal dining table, Spanish oak, like new, \$50. Call 756-3950 after 4.

CLASSIFIED DISPLAY

CLASSIFIED DISPLAY

Miscellaneous For Sale

SEWING MACHINES: Sale of trade-in sewing machines. Portables from \$40.95, consoles from \$149. Zig-Zag machines from \$31.95. Singer Sewing Center, Pitt Plaza Shopping Center, 756-0747 open from 10 till 9.

WELDER FOR SALE, Super Hornet, 300 amps plus trailer and welding leads. Less than 200 hours. Like new, \$1,400. Call after 5, 756-6777.

LOSE WEIGHT With New Shape Tablets and Hydrex Water Pills at Beddingfield Pharmacy.

PIANO—Antique, yellow, upright, \$125. 758-3578.

YASHICA 35 millimeter CAMERA—Electro 35 with automatic shutter. Equipped with carrying case, lens shade and instruction booklet. Camera is just like new. Call 756-5630 at night.

SAVE UP TO 50 per cent on new furniture, scratched and scarred chests, dresser, beds, bunk beds, desks, night stands, maple and pine dinette table and chairs. Thompson's Discount Furniture, 804 Clark Street, 758-3187.

SPECIAL! SENTRY SAFE For Fire Protection \$8950 up Taff Office Equipment Co. 752-2175 569 S. Evans St.

100 WATT AMPLIFIER. 758-1959 after 4 p.m.

6 NEW BIFOLD lowered metal doors, 6'6" tall, 4'10" wide. Half price. Call 756-5234.

POOL TABLE for sale. 4 1/2 x 9, 1 1/2 slate top, complete with balls and sticks. \$600. Call after 6, 756-0549.

FOR SALE: Used furniture, stove, dinette, living room and bedroom furniture. M.E. Sutton, C. L. Thigpen, 756-6121.

1974 STEREO-TAPE player—record player, AM-FM radio. Good condition. \$350. 746-4101.

MOTOROLA RADIO phone, 3 crystals, \$1000. Call 758-3191 8 to 5, after 5, 923-8471.

SPANISH VENEER BEDROOM suites with springs and mattress, \$170. Hardrock maple twin bedroom suites with springs and mattress, \$200. Living room suites, like new. 756-5234.

USED METAL DESKS, 30x60, some smaller, good condition, priced to move fast. Caraway Typewriter Company, 2600 East 10th Street, 752-4661.

DEMOLISHING OLD HOUSE—for sale old lumber, mantels, windows, doors, and brick. Call 753-3918.

RENT A PIANO. Parents if your child is planning to start piano lessons you may rent a new piano for as low as \$8.00 a month. Rent payments will apply to purchase price if you buy. REID MUSIC COMPANY 446-4101, Rocky Mount, N.C.

AIR CONDITION SPECIAL—All air conditioners, wholesale, 25" color T.V., 100 per cent solid state. \$500. Call Fisher's Appliance, 752-3609.

Sporting Goods

20 GAUGE DOUBLE barrel shotgun. \$65.00. Call 756-1461.

MUST SELL 1973 Winnebago Brave, fully equipped, luxury living on wheels. 756-0191 or 756-5252.

Lost & Found

LOST: Male, black and white Pointer Birdog. Lost Saturday night near stadium. Reward offered. Call collect either 639-2804 or 258-6094.

CLASSIFIED DISPLAY

Now is the time to order your sentimental Christmas greeting cards. Complete guide for selecting the socially correct print. See ours soon.

Cox Floral Service 117 W. 4th St. Downtown Greenville, N.C.

CLASSIFIED DISPLAY

CLASSIFIED DISPLAY

Lost & Found

LOST: Between Blount Harvey parking lot and 4th entrance to Blount Harvey Stores, green kid belt with brass buckle. Please return or call Mrs. H. L. Hodges Elm Villa Apartments A 208 S. Elm St. Phone 752-3353.

MOBILE HOMES

Mobile Homes For Rent

FOR RENT—Mobile home spaces with shade, also mobile homes. Call 758-3644.

Mobile Homes For Sale

FOR SALE, 1974 Ritzcraft, 12' x 60". Like new. Take up payments. Phone 752-2099 or can be seen at Lawsons Trailer Park.

FOR SALE: 1970, 12x60 Crestline mobile home, 3 bedrooms, central air, brick fence and porch. Call 758-1608.

12x60 TRINITY, air conditioner, 2 bedrooms, 1 1/2 baths, assume loan. Call 752-5357 after 6.

12x60 WITH 1 1/2 BATHS, garbage disposal, washing machine and dishwasher. Built on 8 by 10 room with bath. Call 753-4850 days, or 752-1555 between 6 and 10 p.m.

48 RITZCRAFT trailer and lot, \$6,000. Phone 752-3179.

Professional

PANELING AND wallpapering. Call 758-0324.

ROOM ADDITIONS, REMODELING, general repairs, large or small, experienced workmen, competent supervision. Call for estimates after 5:00 p.m. 756-5222.

REAL ESTATE

SAVE ENERGY—let WEDCO REALTY do your leg work. We are concerned about your housing needs. Call us at 752-7662.

NOW OPEN Buchanan Realty Company, 512 W. 10th St. Call 752-3696.

Buying or Selling. For Best Results Try Our "Personal Service"

D.G. NICHOLS AGENCY REALTOR 752-4012 anytime

JEANNETTE COX AGENCY, Realtor, Exclusive agents of Beautiful Cherry Oaks. Call 752-7807.

140 ACRES OF WOODLAND with stream. 20 miles south of Greenville on Hwy 43. Call 756-1876.

FARMS WANTED Bought—Sold—Traded Appraisals

Call Carl Darden Farm Specialist Bowen & Darden Realty 752-7194 Nights, Sat. & Sun. 758-1983

FOR QUICK RESULTS WHEN BUYING OR SELLING YOUR HOME OR PROPERTY SEE OR CALL

J.D. REAL ESTATE "Your Neighborhood Broker" Bldg. 19 1900 S. Charles St. Tele. (919) 756-4800

CLASSIFIED DISPLAY

Waitresses wanted for full time employment. Apply at Lemon Tree Inn, Chocowinity, N.C. or phone 946-8001

INDUSTRIAL MECHANIC TRAINEES

Empire Brushes now has openings for individuals with experience, mechanical training, or those with mechanical ability as trainees to work on 2nd shift (3:30 to midnight).

Hospitalization and life insurance, paid vacation and holidays, and pension plan benefits. All replies kept confidential. Apply at: Empire Brushes, Inc. Highway 13 North Greenville, N.C. 27834 Phone 758-4111 An Equal Opportunity Employer.

REAL ESTATE

FOR BETTER BUYS in real estate, see or call E.H. Williford, Realtor, 222-B Cotanche Street, 758-3911. List your property with us.

Farms For Sale

33 ACRES LOCATED in Greene County 5 miles south of Farmville. Approximately 20 acres cropland, 3.38 acres tobacco allotment. Price \$24,500. Call 756-1876.

Houses For Sale

305 CLAIRMONT CIRCLE. 3 nice bedrooms, large living room, large kitchen. Aluminum siding and storm windows. \$17,500. Bill Williams Real Estate, 752-2615.

FOR SALE OR RENT: 3 bedroom house, 2 baths, central heat and air, fireplace, den, carport and workshop, nice lot. Located in Ayden. Phone 746-6394 or 752-5164 days.

LOOK WHAT \$11,900.00 WILL BUY!! Renovated house inside and out on Ward Street. Solid construction, 7 rooms, carpets. A good buy for family or investment. Call 752-5700 or 756-1076.

FOR SALE: 10 1/2 acre tract of land with 2 beautiful homes. Both homes 3 bedroom bath and 1/2 brick veneer. Located in the lovely country section 1 1/2 miles from Greenville near Ayden and Grifton. Well situated for small farm or cattle-chicken business. Call Ed Tipton Agency for more information 756-0911; nights and weekends 756-2719, 756-1769.

MOVE IN FOR ONLY \$1,000.00!! New brick 3 bedroom, 2 baths, living room, den, kitchen and breakfast room combination, garage, patio, utility room, storm doors, storm windows, carpet, central air, plus 8 1/2 per cent loan plus horse stables located nearby. Eight minutes from Greenville. \$34,500. Call Dees Whiteley. Nights 758-0816 Stallworth Realty.

FOR EXECUTIVE MINDED: Beautiful 3 bedrooms, living room, 2 full tile baths, den and kitchen combination. Located on large lot across from swimming pool in Bethel. Call for appointment J. A. Manning, Insurance and Real Estate, Bethel, N.C. 925-5231.

NICE HOME, 3 bedrooms, wall-to-wall carpet, draperies and carport. 1503 East Wright Rd. Call 756-5234.

Lots For Sale

2.2 ACRES IN SMALL pines near Black Jack, 20 minutes from Greenville. Good site for trailer or house. \$1900, will finance. 758-5645 after 6 p.m.

RENTALS

Apartment For Rent

STADIUM APARTMENTS, 904 E. 14th St., adjoins ECU campus, furnished, complete modern, central heat and air. \$125 per month. 752-5700, 756-4671.

APARTMENT HUNTERS Look! Grier Rental Agency has a listing of the best in Greenville. Check with us First! 752-5700.

OAKMONT SQUARE APARTMENTS

2 bedroom townhouses furnished or unfurnished. 6 closets, fully carpeted, disposal, dishwasher, range, refrigerator, air Near Pitt Plaza Shopping Center, schools, churches, and university.

1212 Redbanks Rd. Tel: 756-4151

CLASSIFIED DISPLAY

We need three or four women to sell Sarah Coventry Jewelry on the home party plan. Full or part time work — you can choose your own hours. Car necessary. No experience required as we will train you. For more information call Patricia Hudson at 753-5070 or 753-4390.

For Rent Mobile Home Spaces

Beautifully landscaped lots, City water and sewer, paved streets and parking pads, concrete patios and walks, underground utilities, recreational area, area lights, swimming pool. Also spaces for 24' wide.

Colonial Park Highway 13 — Across from Burroughs-Wellcome. Phone 758-4413 Earl Rayfield

CLASSIFIED DISPLAY

CLASSIFIED DISPLAY

Apartment For Rent

Beautiful 2 bedroom garden apartments off Country Club Drive, adjacent to Greenville Golf and Country Club. Now accepting applications for future occupancy. Phone 756-8869 — Drucker & Falk Management.

STRATFORD ARMS apartments

An exclusive community designed to provide the ultimate in gracious living. Featuring modern 1, 2, and 3 bedroom garden apartments and 2 bedroom Townhouses at reasonable rates. Furnished or unfurnished.

Now accepting applications for future occupancy.

J. DIAZ, Broker 1900 S. Charles Street Tel. (919) 756-4800

Cherry Court

Come see the most luxurious apartments in Greenville. From chandelier to sauna baths to trash compactors, plus fabulous pool and club room. We assure you the best of everything.

752-1557 Drucker & Falk Management

Ultimate In Apartment Living

1, 2, and 3 bedrooms, washer, dryer, hook-ups, pool, club house. Only 5 blocks from East Carolina University.

Check everywhere else first, then call TAR RIVER ESTATES 1401 Willow St. 752-4224

FEATURING Hotpoint KITCHEN APPLIANCES

CLASSIFIED DISPLAY

ROOFING STORM WINDOWS DOORS & AWNINGS C. L. LUPTON CO. 752-6116

CLASSIFIED DISPLAY

For Rent Mobile Home Spaces

Beautifully landscaped lots, City water and sewer, paved streets and parking pads, concrete patios and walks, underground utilities, recreational area, area lights, swimming pool. Also spaces for 24' wide.

Colonial Park Highway 13 — Across from Burroughs-Wellcome. Phone 758-4413 Earl Rayfield

CLASSIFIED DISPLAY

CLASSIFIED DISPLAY

Apartment For Rent

One and two bedroom garden apartments. Located just off East Tenth Street. PHONE 752-3519

"A New Direction For Finer Living" Eastbrook APARTMENTS

Two bedroom luxury apartments with optional dens and all the new amenities including wall to wall carpeting, draperies, dishwashers, individual air conditioning and heating AND MORE.

RECREATION? YES! Pool, Clubhouse, Tennis Courts, Model Open Daily 9:12-5:30 Saturday & Sunday 1:00-5:30 Utilities included.

201 Eastbrook Drive — Off Greenville Boulevard (U.S. 264 By Pass) just south of Tenth Street. Convenient to ECU and everything.

DRUCKER & FALK 758-4012 AN ACCREDITED MANAGEMENT ORGANIZATION

CLASSIFIED DISPLAY

Salesmen Needed

3 Experienced Salesmen are needed immediately. Guaranteed highest pay plan in Pitt County. Apply at: GRUBBS CHEVROLET, INC. Ayden, N.C. 746-3141

CLASSIFIED DISPLAY

CLASSIFIED DISPLAY

The Real Estate Corner

FHA-VA Loans Conventional loans available up to \$55,000.

Guaranteed Lowest Discounts Bowen Mortgage Loan Co. Bowen Building 212 W. 5th St. Phone 752-7194

CLASSIFIED DISPLAY

NORTH HILLS ESTATES Ayden, N.C.

Brick homes with 3 bedrooms, 2 baths, garage or carport, central heat and air conditioning, prices \$30,000 to \$40,000. 8 3/4 per cent financing available.

Call CHESTER STOX at 746-6116 Day and 746-3308 after 6 P.M.

WANT TO SELL YOUR HOME? CALL US!

We will either buy or sell it for you. Compare our service for selling homes: Selling agents... Complete Financing... Total Effort Put Behind E... We List For Sale... Daily Calls From People Moving Into Greenville... And Most of All... Courtesy. Call us at the ED TIPTON AGENCY... We are dedicated to OUR COMMUNITY GROWTH.

ED TIPTON AGENCY 756-0911 TIPTON BUILDERS 756-7717

THE ONE-STOP AGENCY 234 Greenville Blvd.

CLASSIFIED DISPLAY

Before you buy, look around...

Do You Have?

Asphalt Streets w/curb Lake with Boating City Water & Service Adequate Size Pool & Tot Pool Tennis Courts Long Range Development Plan for Investment Protection Storm Drainage (underground) Location to Shopping & Schools City School District Electric Heat Pumps Spacious Landscaped Lots 2000 Sq. Ft. Party House 8 3/4 Percent Financing

PRICES EFFECTIVE THRU SATURDAY, OCT. 5 AT A&P WEO IN GREENVILLE, N.C. ONLY.



ITEMS OFFERED FOR SALE NOT AVAILABLE TO OTHER RETAIL DEALERS AND WHOLESALERS

WEO

WHERE ECONOMY ORIGINATES



Manager's Week Sale ...Look at the Savings!



STOP FOR SAVINGS

DEL MONTE FRENCH STYLE OR CUT GREEN
BEANS 3 16-Oz. Cans \$1.00

DEL MONTE GOLDEN—Cream Style or Whole Kernel
CORN 3 16-Oz. Cans 89¢

DEL MONTE
FRUIT COCKTAIL
2 1-Lb. Cans 89¢

U.S.D.A. INSPECTED GRADE "A"
TURKEYS 10 TO 14 LB. AVG. Lb. 49¢

"SUPER-RIGHT" CORN-FED FRESH
PORK LOIN
12 TO 17 LB. AVG. 85¢
WHOLE OR HALF LB.

Country Style Spare Ribs Lb. 89¢
Center Cut Pork Chops RIB AND LOIN Lb. \$1.29

"SUPER-RIGHT" CORN FED HEAVY BEEF
ROASTS

- BONELESS ROUND
- BONELESS SIRLOIN TIP
- BONELESS RUMP

\$1.38 Lb.

FREEZER SALE
155 LB. TO 180 LB. AVERAGE
WHOLE BEEF HINDQUARTER

SOLD AT HANGING WEIGHT, CUT TO YOUR SPECIFICATIONS INTO T-BONE STEAK, SIRLOIN STEAK, ROUND ROAST AND GROUND ROUND

Lb. 89¢

A&P
GROUND BEEF 5 Lb. Pkg. \$3.89

"SUPER-RIGHT" CORN FED FRESH 1/4 PORK
LOIN 89¢
SLICED INTO CHOPS Lb.

ALLGOOD SLICED
BACON 1-Lb. Pkg. 89¢
2-Lb. Pkg. \$1.77

A&P SMOKED
HAM 1-Lb. Shank Portion 69¢
Center Slices Lb. \$1.29

PRODUCE VALUES
MIX OR MATCH
CARTON — RED RIPE TOMATOES
STALK CELERY
2-LB. BAG — CRISP CARROTS
3 for \$1.00

WHITE ALL PURPOSE
POTATOES 15 Lb. Bag 99¢

MARVEL WHITE
BREAD 3 1 1/2-Lb. Loaves \$1.00

JANE PARKER BAKE N' SERVE
FLAKY ROLLS 3 12-Oz. Pkgs. \$1.00

JANE PARKER
WHEAT WHOLE BREAD 1-Lb. Loaf 49¢

A&P FROZEN
FRENCH FRIED POTATOES 2 Lb. Bag 59¢

SULTANA GRAPE
JELLY 24-Oz. Jar 79¢

ANN PAGE 24-OZ. JARS
PRESERVES 83¢
* RED PLUM * STRAWBERRY PINEAPPLE 99¢

ANN PAGE
PEANUT BUTTER 28-Oz. Jar \$1.19

10c OFF DETERGENT
GAIN 49-Oz. Pkg. \$1.11

LAUNDRY DETERGENT
FAB Giant 49-Oz. Pkg. \$1.13

SWIFT PREMIUM
FRANKS 1-Lb. Pkg. 89¢

OSCAR MAYER BREAKFAST LINKS
SAUSAGE 1-Lb. Pkg. \$1.29 3-Lb. Box \$3.39

OSCAR MAYER SLICED PAC PAK
• ALL MEAT BOLOGNA • BEEF BOLOGNA • COTTO SALAMI • LUNCHEON MEAT • P&P LOAF

YOUR CHOICE 8-Oz. Pkg. 69¢

FROZEN FOOD

VARIETY SHOWCASE — AS ADVERTISED IN READERS DIGEST

FLEISCHMANN'S FROZEN EGG BEATERS	16-Oz. Pkg.	99¢
MINUTE MAID FROZEN ORANGE JUICE	12 OZ. CAN	59¢
MORTON BREAKFAST BAKE SHOP MINI DONUTS	10-Oz. Pkg.	69¢
MORTON BREAKFAST BAKE SHOP FROZEN HONEY BUNS	9-Oz. Pkg.	69¢
MORTON PASTRY SHOP FROZEN CREAM PIES	ALL VARIETIES 16-Oz. Pkg.	65¢
MORTON PASTRY SHOP FROZEN FRUIT PIES	• 24-OZ. PEACH • 22-OZ. COCONUT CUSTARD • 24-OZ. APPLE	Each Pkg. 83¢

• Blueberry • Cherry 24-Oz. Pkg. 89¢

WEO COUPON
THIS COUPON WORTH 45c TOWARDS PURCHASE

8 O'clock BEAN COFFEE
YOU PAY 3 Lb. Bag \$2.74

Limit one coupon per family. Valid thru Sat., Oct. 5

MAXWELL HOUSE
COFFEE 1-Lb. \$1.19

REGULAR DRIP ELECTRA PERK

LAUNDRY BLEACH
GLOROX 1/2-Gal. Jug 47¢

WEO COUPON
SAVE 8c

BETTY CROCKER
HAMBURGER HELPER With This Coupon You Pay Only 5 1/2-Oz. Pkg. 59¢

Limit one coupon. Redeemable thru Oct. 12

WEO COUPON
SAVE 20c

MAXWELL HOUSE
COFFEE With This Coupon You Pay Only 2 Lb. Can \$2.49

Limit one coupon. Redeemable thru Oct. 12

A&P WEO COUPON
SAVE 10c

A&P COFFEE With This Coupon You Pay Only 1-Lb. Can \$1.15

Limit one coupon. Redeemable thru Oct. 12

WEO COUPON
SAVE 10c

MAXWELL HOUSE
COFFEE With This Coupon You Pay Only 1-Lb. Can \$1.27

Limit one coupon. Redeemable thru Oct. 12

WEO COUPON
THIS COUPON WORTH 20c TOWARDS PURCHASE

A&P Vacuum Coffee YOU PAY 2 Lb. Can \$2.25

Limit one coupon per family. Valid thru Sat., Oct. 12

2 LOCATIONS IN GREENVILLE

WEST END SHOPPING CENTER

2800 EAST 10TH STREET

Martha Graham's Wish Is To Dance



MARTHA GRAHAM eyes camera as her troupe rehearses in preparation for the current tour of eight Asian countries as part of a U.S. State Department cultural program. (UPI)

By DIANE YING TAIPEI (UPI) — "I have worked all my life. And if I have anything to give still, I want to share it."

Putting down a cup of jasmine tea, Martha Graham, 80, smiled and spoke slowly. The American modern dance pioneer, sitting on an embroidered sofa in a suite of the palace-style Grand Hotel, held her slight figure regally erect. What Miss Graham is sharing with thousands of Asian viewers is the zest of her life-long dance work and her choreography.

As part of a U.S. State Department cultural program, Miss Graham and her modern dance company are touring eight Asian countries—Taiwan, Hong Kong, the Philippines, Thailand, Malaysia, Singapore, Burma and Japan.

Miss Graham, who danced with her company regularly until the age of 76, now leads the 25-member troupe as its director. She sat every night at the side of the stage during four well received performances in Taipei. She watched her students dance her roles and said she was resigned to "let my dances represent me."

"It breaks my heart sometimes, because dancing is the only thing I would rather do on earth," she said. "It is very hard for me to give it up and to realize that my time is over in that area. If I could choose, I probably would choose to dance rather than to be known only as a choreographer."

However, being a choreographer has its rewards, she said. "The choreography remains the same but each dancer brings a different quality, a different feeling toward the dance. But that is to the advantage, the dance lives. It is very important that each one be an individual," she said.

In a firm and at times girlish voice, Miss Graham recalled that she first learned the essence of dance through her physician father who told her that "movement does not lie." "It tells the temperature of the soul's weather," she said. "So dancers cannot lie. Life dictates and shows through the body everything that you are no matter what the character is."

Nearly 20 years after her first performing tour to Asia in 1955, Miss Graham said dance is an international language that knows no barriers.

"It speaks to the spirit, to the heart. It may not be understood, but understanding has nothing to do with the magic of theater nor with the excitement of life. You don't have to understand it to feel it, to sense it and be a part of it," she said. The first lady of American modern dance and a renowned choreographer of 155 productions says there are great differences between Oriental and Western dances in the symbols employed, costumes, make-up and story lines.

"But there is beginning to be more of a common ground. We used to be three months away from Asia, but now you are not three minutes away from any place, because you can pick up the telephone," she said.

Miss Graham, recalling her world travels, said with a chuckle that her company once was turned down by Russia.

"They said I have a disturbing influence on the young," she said, "and I considered that one of the great compliments of all time."

Demanding as it is, Miss Graham said she has never been bored with dancing.

Ancient Age INTRODUCES



A NEW DRINK SENSATION

Orange Age is a great new drink that's delicious to taste and easy to make. Just one part of smooth Ancient Age Kentucky Bourbon and orange juice to taste over ice and presto... a new drink sensation... Orange Age.



Ancient Age AN 86 PROOF BOURBON

\$3.40 PINT
\$5.35 4.5 QT.
\$11.85 1/2 GAL.

STRAIGHT KENTUCKY BOURBON WHISKEY • 86 PROOF • © 1974 ANCIENT AGE DISTILLING CO., FRANKFORT, KY.

FOODLAND MARKETS

MEMBER OF THE FOODLAND SYSTEM

SALE DATES: OCTOBER 3, 4, & 5

OPEN

MONDAY THRU THURSDAY
8:00 A.M. TO 7:00 P.M.
FRIDAY AND SATURDAY
8:00 A.M. TO 8:30 P.M.

QUANTITY RIGHTS RESERVED
None Sold To Dealers

14TH ST. & NEW BERN HIGHWAY

TAKE A FOODLAND PRICE BREAK

Swift's Premium Round Steak

Full Cut \$1.29 LB.



U.S.D.A. Inspected Carolina Pride Fryers Whole Per LB.

38¢

SWIFT'S PREMIUM Ground Beef LB. 89¢

SWIFT'S PREMIUM

Sirloin Tip Roast LB. \$1.49

SMITHFIELD

BACON LB. PKG. 99¢

SWIFT'S PREMIUM

T-Bone Or Sirloin Steak \$1.59 LB.

OSCAR MAYER ALL MEAT OR ALL BEEF

Franks 16 OZ. PKG. 89¢

FARM FRESH PRODUCE

Green, Firm Heads

Cabbage 8¢ LB.

KRAFT AMERICAN

Cheese 8 Oz. Pkg. Single Slices 59¢

FOODLAND HOT DOG OR HAMBURGER

BUNS 3 PKGS. \$1.00

Juicy

Oranges 79¢ 5 LB. BAG

BAMA — 18 OZ. JAR

Apple Apple-Grape or Apple-Strawberry JELLY 49¢

PILLSBURY HUNGRY JACK

Instant Mashed Potatoes 16 OZ. BOX 79¢

Avocados 39¢ EA.

KEEBLER'S

ZESTA SALTINE CRACKERS 53¢

CRISP, FRESH

Radishes Bag 10¢

MAXWELL HOUSE INSTANT

COFFEE

SAVE 52c 6 OZ. JAR \$1.19 Only

PETER PAN PEANUT BUTTER

SAVE 20c 12 OZ. JAR



PILLSBURY'S BEST UNBLEACHED PLAIN OR SELF-RISING

FLOUR 89¢ 5 LB. BAG

INSTANT MAXIM COFFEE 8 OZ. Jar \$2.79



49¢

FOODLAND

SALT 26 OZ. BOX 10¢



DEL MONTE FRUIT

COCKTAIL 303 CAN 39¢

DAYTIME

PAMPERS BOX — 30 — \$1.99

KELLOGG'S 12 OZ. BOX SAVE 10¢

CORN FLAKES 39¢

— FROZEN FOOD VALUES —

Chef Boy-Ar-Dee 13 Oz. Cheese

14 Oz. Sausage or Pepperoni PIZZA Each 79¢

FOODLAND TOILET

TISSUE

White or Colors

4 ROLL PK. 59¢



Niblets Gold Whole Kernel CORN

4 303 Cans \$1.00

DULANY MIXED

Vegetables

3 10 Oz. Pkgs. \$1.00

TEXAS PETE

CHILI

4 10 1/2 OZ. CANS \$1.00

10c OFF — SAVE MORE

DUZ DETERGENT

Giant Box \$1.09



Dracula Has 'Believers' In Romania

By NICHOLAS LILLITOS
Associated Press Writer
SNAGOV ISLAND, Romania (AP) — This wooded island in the heart of a big Romanian lake resort never has visitors at night. Some say Dracula is buried here.
Among the fervent believers is Romania's Tourist Ministry.
As dusk falls and the last ferry chugs back to the mainland, only four people stay behind—two Christian Orthodox monks and their assistants.
They look after the island monastery where, it is claimed, the "Prince of Darkness" sleeps.
The resting place is a top tourist attraction, despite years of controversy over whether it is the right spot.
Romania's real-life Dracula was Prince Vlad III, born in 1431. A sadistic, blood-thirsty tyrant—German chronicles say he skinned people and boiled their heads in kettles—the prince gave himself the nickname Dracula, meaning son of the devil.
But Vlad was better known to his subjects as Tepes, or in English, impaler. His favorite sport was stickin people on stakes.
One papal nuncio estimated that he impaled 100,000 persons during his reign over the principality of Wallachia. Today it's part of Romanian territory bordering on Bulgaria.
The brave of heart who visit Snagov take a 25-mile drive north of Bucharest. The lush, green, rolling countryside is beautiful and inviting. That is, until you see the island.
Thick with trees, its banks are hidden by tall, drooping water reeds which look as though they've been sapped of their strength.
The grave, said to be Dracula's, was discovered by Romania's eminent archaeologist, Dinu Rosetti, in 1931 after he followed up a folk lore story known only to neighboring villagers across the lake.
The prince, so the tale goes, was buried under a stone slab just inside the monastery's doorway. Worshippers entering it presumably relieved his "troubled spirit" by walking over him.
There, under a pile of brickwork, lay a skeleton complete with skull. Inside the grave was the tattered remains of a very rich costume, also a belt buckle and signet ring. It bore the emblem of Dracula.
Mystery, however, now shrouds the findings in the grave. Shortly after the Bucharest Historical Museum took possession of the ring, clothes and buckle, they inexplicably disappeared. To this day nobody can explain how they were lost.
Despite strong local belief the monastery is Dracula's resting place, one of Romania's leading historians, Constantin Giurescu, maintains Dracula was beheaded by the Turks sometime around 1476. The head was nailed to the gates of Istanbul for everybody to see the infamous impaler, says Giurescu.
Dracula believers say it was common practice in those days for rich families to pay for the delivery of their dismembered kinfolk, and that explains the skull in the monastery grave.
Next year, the Romanian authorities plan a systematic excavation of Snagov to try to confirm the evidence.

Bicentennial Shop Hours Set

The Bicentennial Shop in the Kroger Building will be open prior to the celebrations from 10 a.m. till 6 p.m. each day. All tickets, books, T-shirts, costumes, buttons, application blanks, etc. will be available at the shop, according to Mary Lou Lucas, who is in charge of the shop. The shop is located in the Garden Center Portion of the Kroger Building.

Persons wishing to volunteer for manning booths during the bicentennial exhibition should contact Mrs. Lucas or Bicentennial Headquarters, 752-1919. The shop itself is run by volunteers.

Regular hours for the shop will be from 10 a.m. till 9 p.m. daily October 4-12.

ARTIFICIAL SPAWN
COTTONWOOD, Calif. (UPI) — The federal Coleman National Fish Hatchery near this small Northern California town collects about 35 million chinook salmon eggs and two million steelhead eggs annually for artificial spawning.



WINN-DIXIE CONTINUES ITS SALUTE TO OUR STORE MGRS. - MARKET MGRS. - PRODUCE MGRS. BY FEATURING:
★ 88c SALE
★ BEEF SALE
★ FROZEN FOOD SALE!



QUANTITY RIGHTS RESERVED • NONE TO DEALERS
• PRICES GOOD THRU SAT., OCT. 5TH

Superbrand MARGARINE
288¢
1-LB. CTNS.

ASTOR SLICED OR HALVES
PEACHES 2 88¢
1-LB. 13-OZ. CANS

DIXIE DARLING LAYER
CAKE MIX 2 88¢
1-LB. 3-OZ. BOXES

CHEK ASSORTED FLAVORS
DRINKS 8 \$1.00
12-OZ. CANS

MAXWELL HOUSE
COFFEE 88c
1-LB. BAG

SUPERBRAND
GRADE 'A' EGGS
LARGE DOZ. **73¢**
MEDIUM DOZ. **67¢**

DIXIE DARLING
THIN SLICED SANDWICH BREAD 3 1 1/2-LB. LOAVES \$1.00
BROWN & SERVE FLAKY OR TWIN ROLLS 2 11-OZ. PKGS. 79c
DAINTY DINNER ROLLS 3 8-OZ. PKGS. \$1.00
DUNKING STIX 10-OZ. PKG. 49c

ASTOR "ROASTER" FRESH
COFFEE 78¢
1-LB. CAN
MAXWELL HOUSE COFFEE 2-LB. CAN \$2.59
MAXWELL HOUSE INSTANT COFFEE 10-OZ. JAR \$1.99

LAND O' SUNSHINE
BUTTER 68¢
1-LB. CTN.

DEEP SOUTH SALAD
DRESSING 68¢
QT. JAR

ARROW BLUE, WHITE OR COLDWATER
DETERGENT 68¢
3-LB. 1-OZ. BOX

THRIFTY MAID
EVAPORATED MILK 88c
4 13-FL. OZ. CANS

THRIFTY MAID
GRAPEFRUIT JUICE 88c
2 46-OZ. CANS

THRIFTY MAID
• LIMAS
• GREEN PEAS OR
• CUT GREEN BEANS
488¢
1-LB. CANS

DOLORES
SALMON 88¢
7 1/2-OZ. CAN

STARKIST CHUNK LIGHT
TUNA 2 88¢
6 1/2-OZ. CANS

BOUNTY
TOWELS 2 88¢
120-SHEET 2-PLY ROLLS

FREEZE AND SERVE
FLA-VOR-ICE 68c
PKG. OF 24

YOUR FAVORITE
BABY FOOD

BEECH-NUT STRAINED 4 1/2-OZ. JAR	7c	GERBER'S STRAINED 4 1/2-OZ. JAR	8c
BEECH-NUT JUNIOR 7 1/2-OZ. JAR	13c	GERBER'S JUNIOR 7 1/2-OZ. JAR	14c

STARKIST WHITE TUNA PACKED IN SPRING WATER 7-OZ. CAN 79c	SPAM 12-OZ. CAN 88c	HORMEL CHILI & BEANS 15-OZ. CAN 59c	DINTY MOORE VEGETABLE STEW 1 1/2-LB. CAN 59c	HANDI-WRAP 200' ROLL 69c	PETER PAN PEANUT BUTTER (SMOOTH & CRUNCHY) 12-OZ. JAR 59c	GOLD MEDAL OR RED BAND FLOUR 5-LB. BAG 88c	PAMPERS DAYTIME BOX OF 30 \$2.09 NEWBORN BOX OF 30 \$1.69
---	----------------------------	--	---	---------------------------------	--	---	--

LOCATED AT THE SHOPPERS MART



BEEF

FROM
"THE BEEF
PEOPLE"



SHOP OUR
GENERAL
MERCHANDISE
DEPARTMENT
FOR MANY SAVINGS!

AT WINN-DIXIE WE SELL ONLY U. S. CHOICE BEEF!
CLOSE TRIMMED OF BONE & FAT TO SAVE YOU MONEY. YOU
CAN BE SURE IT'S THE BEST BUY FROM "THE BEEF PEOPLE."

HEAD & SHOULDERS
SHAMPOO
\$2.60 VALUE

11-OZ. SIZE \$1.79

JERGENS
LOTION
(WITH DISPENSER)
\$1.95 VALUE

15-OZ. BTL. \$1.29

RIGHT GUARD
DEODORANT
\$2.69 VALUE

13-OZ. CAN \$1.59

LISTERINE
MOUTHWASH

32-OZ. BTL. \$1.29

ALKA-SELTZER
FOIL PACK
PKG. OF 36 99c

GILLETTE
TRAC II BLADES
(PKG. OF 5 BLADES)
99c

COLGATE
TOOTHPASTE
7-OZ. TUBE 99c

WIPE & DIPE
FLUSHABLE WIPES
BOX OF 100 \$1.39

MUM
CREAM DEODORANT
2 84-OZ. JARS 88c

FOAMY FACE SAVER
SHAVE CREAM
7-OZ. CAN 79c

EXCEDRIN
P. M. TABLETS
BTL. OF 30 89c

VASELINE
PETROLEUM JELLY
7 1/2-OZ. JAR 69c

GLAMORENE
SPRAY & VAC
RUG CLEANER
24-OZ. SIZE \$1.78

KOLOR KRAFT
KNITTING YARN
4-OZ. SIZE 99c

W-D BRAND U. S. CHOICE BEEF NEW YORK STRIP

STEAKS LB. \$1.99

W-D BRAND U. S. CHOICE BEEF BONELESS TOP ROUND

ROASTS LB. \$1.79

W-D BRAND GRADE 'A' BAKING

HENS (4.7 LBS. AVG.) LB. 49¢

W-D BRAND U. S. CHOICE BEEF BONELESS SIRLOIN TIP STEAKS LB. \$1.69

W-D BRAND REGULAR, DINNER OR BEEF FRANKS 1-LB. PKG. 79c

W-D BRAND U. S. CHOICE BEEF BONELESS BONELESS RIB EYE STEAKS 5-LB. PKG. \$14.95

W-D BRAND SLICED COOKED PICNICS 12-OZ. PKG. \$1.49

W-D BRAND U. S. CHOICE BEEF FAMILY PACK BONELESS CHUCK STEAKS 5-LB. PKG. \$7.99

SUNNYLAND SMOKED SAUSAGE 1-LB. 8-OZ. PKG. \$1.89

W-D BRAND LEAN 100% PURE GROUND BEEF 5-LB. HANDI-PAK \$4.49

GWALTNEY H. C. LINK SAUSAGE LB. 89c 10-LB. BOX \$7.99

HOLLY FARMS CHILL PACKED FRYER PARTS (COMBINATION OF CHOICE PARTS) LB. 69c

FROZEN PORK TENDERLOINS 10-LB. BOX \$14.99

HOLLY FARMS CHILL PACKED FRYER BACKS LB. 19c

FRESH PORK SPARERIBS (3-LBS. & UNDER) LB. 99c

W-D BRAND U. S. CHOICE BEEF WHOLE BONELESS

SIRLOIN TIPS

\$1.19

(9-11 LBS. AVG.)

LB.

CUT FREE INTO STEAKS, ROASTS & TRIMMINGS

W-D BRAND U. S. CHOICE BEEF BONELESS TOP ROUND

STEAKS LB. \$1.89

W-D BRAND U. S. CHOICE BEEF BONELESS SIRLOIN TIP

ROASTS LB. \$1.59

SEAFOOD DEPT.		DAIRY DEPT.	
H & G WHITING FISH	1-LB. 8-OZ. BOX 49c	CRACKIN' GOOD SWEET OR BUTTERMILK CANNED BISCUITS	15-CT. 12-OZ. CAN 15c
FROZEN GREEN SHRIMP	5-LB. BOX \$6.99	SUPERBRAND MEDIUM AGED OR LONGHORN CHEESE	LB. \$1.29
FRENCH FRIED FISH CAKES	10-LB. BOX \$4.49		

SUPERBRAND SHERBET OR

ICE CREAM

(ALL FLAVORS)

69¢

HALF-GAL. CTN.

MARINERS **FISH STICKS** 4 8-OZ. PKGS. \$1

ASTOR **CUT CORN** 4 10-OZ. PKGS. \$1

ASTOR WHOLE OR CHOPPED **SPINACH** 4 10-OZ. PKGS. 89¢

ASTOR **BROCCOLI SPEARS** 3 10-OZ. PKGS. \$1.00

TASTE-O-SEA **PERCH FILLET** 1-LB. PKG. 69c

ASTOR **PEAS & CARROTS** 4 10-OZ. PKGS. \$1.00

TASTE-O-SEA **WHITING STEAKS** 3-LB. PKG. \$1.29

DIXIANA GREENS COLLARDS, MUSTARD, TURNIP OR TURNIP WITH TURNIPS 4 10-OZ. PKGS. 99c

TASTE-O-SEA **FISH CAKES** 3 8-OZ. PKGS. \$1.00

DIXIANA CUT CORN, GREEN PEAS OR MIXED VEGETABLES 18-OZ. PKG. 59c

SEA PAK **SHRIMP** 8-OZ. PKG. 89c

AUNT JEMIMA **WAFFLES** 10-OZ. PKG. 59c

TRADEWINDS **HUSHPUPPIES** 2 1-LB. PKGS. 89c

MORTON **GLAZED DONUTS** 10-OZ. PKG. 69c

SEA PAK **ONION RINGS** 1-LB. PKG. 89c

MORTON **JELLY DONUTS** 14-OZ. PKG. 69c

SHOESTRING **POTATOES** 20-OZ. PKG. 39c

BURNY BROS. LOUISIANA **CRUNCH CAKE** 17-OZ. SIZE \$1.29

BANQUET (ALL VARIETIES) **COOK-N-BAG ENTREES** 3 5-OZ. PKGS. \$1.00

PET RITZ **PIE SHELLS** 2 PKGS. OF 2 89c

SLICED **STRAWBERRIES** 2 10-OZ. PKGS. 89c

MORTON APPLE, PEACH OR COCONUT **FRUIT PIES** 24-OZ. SIZE 79c

MORTON CHICKEN, TURKEY OR SALISBURY STEAK **3-COURSE DINNERS** 16-OZ. SIZE 89c

Frozen Food

OLE SOUTH **PIE SHELLS** 4 PKGS. OF 2 \$1

SUPERBRAND **FUDGE BARS** PKG. OF 12 79¢

FOX DELUXE

(HAMBURGER, PEPPERONI, CHEESE OR SAUSAGE)

PIZZA

13-OZ. SIZE

69¢

HARVEST FRESH PRODUCE

U. S. NO. 1 WHITE POTATOES	10-LB. VENT VUE BAG 69c	20-LB. VENT VUE BAG \$1.29	HARVEST FRESH LETTUCE (NO HEAD OVER 3c)	LB. 25c
RED TOKAY GRAPES	3 LBS. \$1.00		N. C. GROWN SWEET POTATOES	6 LBS. \$1.00
VINE RIPENED TOMATOES	3 LBS. \$1.00		YELLOW ONIONS	5-LB. BAG 79c
EASTERN RED DELICIOUS APPLES	12 FOR \$1.00		BARTLETT PEARS	LB. 33¢

OPEN SUNDAY AFTERNOON 1-6 P.M.

'Free Speech Movement' Demands Began Unrest

By ROBERT STRAND
BERKELEY, Calif. (UPI) — Looking back, the crowd of clean-cut college kids that captured a police car on a sunny California afternoon seems sedate, and a bit quaint. On the auto's roof, Mario Savio demanded "rights" long since commonplace. Inside, Jack Weinberg sat for 32 hours as a prisoner of the police in a car that itself was imprisoned by the students.

That was the spawning of a decade ago on Oct. 1, 1964, of the Free Speech Movement at the Berkeley campus of the University of California. It was the birth of a decade of radicalism that brought peace vigils, riots, hippies, bombings and social reform.

It was an autumn when men wore tab collars, pork chops were 59 cents a pound, when students' hair was short, skirts were long, below the knee. If students dabbled in sex or

marijuana, they didn't talk about it.

Probably, the birth of the radical decade was touched off by a complaint of student Goldwater supporters that the Scranton people had recruited demonstrators on campus for the GOP National Convention in San Francisco.

Politics long had been banned on campus, which is state property. The rules permitted buttons and bumper strips, but prohibited political recruiting for off campus activity.

In fact, the rules had long been overlooked at a small space edging the sidewalk at one of the huge campus' entrances, where students occasionally set up a couple of card tables to advertise their causes.

Later, university president Clark Kerr was to say the dispute was "over only 26 feet of concrete but a thousand miles of principle."

Because of the Goldwater

camp's complaint, Vice Chancellor Alex Sherriffs ordered the rules enforced and the battle was on. On Sept. 30 a quiet sit-in occurred in the administrative building, and Mario Savio, 21, a philosophy student, got up on a chair to urge protest. A statement saying "He also manned" the tables was signed by 435, and eight students were expelled. The next day, tables were set up by CORE, the Young Socialist Alliance and the Student Non-violent Coordinating Committee. Jack Weinberg, 24, a former graduate student, was arrested and hustled to the police car.

Instantly, the car was surrounded. The crowd grew to 10,000, and the police stood by helplessly. "We were going to hold a rally, but we didn't know how to get the people," Savio said. "Now, we got them, thanks to the university."

After 32 hours the police car was released when Kerr, a

former labor mediator, negotiated an agreement with students while 500 policemen waited nearby. Kerr said the restoration of "law and order" without police force was "a triumph of common sense, decency, democracy and faith in our fellow man."

Under the agreement, the university did not press charges against Weinberg. A faculty-student committee was set up to discuss political behavior.

In the following two months, politicians spoke angrily of "anarchy," the committee talked and talked, and the university regents changed the rules, but insisted that students could be punished by the university for off campus political action. Unsatisfied, on Dec. 2 a Free Speech Movement group carrying an American flag marched to the administration building for a sit-in. Savio and other beardless men wore coats, white shirts and narrow

ties, and some women wore nylon stockings.

Savio said unless students got their constitutional rights, they would cause "the wheels that operate this machine to grind to a halt."

The university said it would not tolerate lawbreaking, and Gov. Edmund G. Brown said, "We cannot compromise with revolution." Brown directed Kerr to use police, and early the next morning officers arrested and carried off 814 students, who went limp, at the rate of one a minute. They were taken to a jail farm and released on bail. Only a few, including Savio, who served 120 days, went to jail for long periods.

Kerr, addressing a special convocation of 15,000 students in the outdoor Hearst Theater four days after the sit-in, offered to seek liberalized rules and to leave the fate of demonstrators up to the courts. The conciliatory spirit, howe-

ver, was brief. Savio, who had agreed not to address the meeting, walked on stage simply to announce a rally. He was grabbed by police and rushed off stage before an astonished audience.

That the Free Speech Movement had won became apparent the next day when the faculty sided overwhelmingly with the demonstrators. A process began which ended with political activity restricted only by practical considerations of time and place.

Across the nation, other students were almost as surprised as their elders. Even on the Berkeley campus the rebels had been criticized by the student newspaper and student body president for deliberately violating the law.

From Berkeley went the message that when government officials are wrong and unbudging, youth should employ "direct action." In the following decade

were born antiwar activities, endless liberation movements, the hippies and the alternative culture, and the notion of "do your own thing."

In 1965, at Berkeley, nine persons who held up signs with a four-letter word were arrested, and the university was attacked for its "Filthy Speech Movement."

Within a few months the Free Speech Movement faded away, and along with it the nonviolent spirit of student activists diminished. The use of U.S. bombers in the Vietnam War in February, 1965, ignited an angry antiwar movement. The Negro rights struggle shifted into black power themes.

Savio and most of his closest associates—all "A" students—operated around the fringes of new radical groups.

In the immediate aftermath of the 1964 events, the university became a political target. A legislative committee blamed

1964 on "Communist influence." Reagan used attacks on the university in his 1966 campaign and trounced Gov. Brown. Kerr was promptly fired as being too soft. Reagan slashed the university budget deeply and repeatedly, and the regents imposed tuition for the first time.

In the decade of radicalism, Berkeley experienced the same violence as other campuses, but on a smaller scale than some.

Meanwhile, sweeping educational reforms occurred in the university system. Now Berkeley students sit on every administrative committee, voting even on budget matters. Similarly, all across the nation students have been given more voice in their education.

HEIL
The best in Heating & Cooling equipment.
For your needs
Phone 752-3042

STORE HOURS:

MON.-SAT.
8:30 - 10:00
SUN. 1-6 P.M.

KAHN'S
LEAN BONELESS
HICKORY GROVE
SMOKED HAM

WHOLE LB. \$1.18 HALF LB. \$1.28

LAND O' FROST
SLICED TURKEY
BREAST

4 oz. pkg. 55¢

BIG STAR FOODS

**BANQUET
BUFFET SUPPERS**

- BEEF STEW • CHICKEN & DUMPLINGS
- CHICKEN CHOW MEIN • GRAVY & SLICED BEEF OR TURKEY • MACARONI & BEEF • SALISBURY STEAK
- SPAGHETTI & MEATBALLS
- VEAL PARMAGEAN

2 Lb. Pkg. \$1.18

COOKIN' BAGS

- Chicken A La King
- Gravy & Sl. Turkey
- Salisbury Steak
- Veal Parmagean
- Gravy & Sl. Beef

5 Oz. Pkg. 27¢

FRESH PRODUCE

ALL-PURPOSE WHITE
POTATOES

10 LB. "SEE THRU" POLY BAG 74¢

20 LB. "VENT VUE" BAG \$1.28

**U.S. CHOICE BEEF
ROUND
STEAK**

FULL CUT BONE IN **\$1.38** LB.

U.S. CHOICE BEEF ... BONELESS TOP
ROUND STEAK

LB. \$1.58

U.S. CHOICE BEEF ... BONELESS
ROUND or RUMP ROAST

LB. \$1.48

U.S. CHOICE BEEF ... WHOLE 9 TO 12 LB. AVG.
BONELESS BRISKET

LB. 98¢

BONELESS BEEF BRISKET POINT HALF ... LB. \$1.39 FLAT HALF ... LB. \$1.49

SCOTCH TREAT SLICED

BACON 1-LB. PKG. \$1.09 2 LB. PKG. \$2.15

HICKORY MTN. SLICED

COUNTRY HAM 12 OZ. PKG. \$1.68

KAHN'S

HILL SHIRE FARM SMOKED SAUSAGE \$1.19

MEAT OR BEEF FRANKS 1-LB. PKG. 98¢

MEAT OR BEEF SL. BOLOGNA 8 OZ. PKG. 58¢

SLICED BACON 1-LB. PKG. \$1.49

COOKED SALAMI 8 OZ. PKG. 69¢

LUNCHEON MEAT 8 OZ. PKG. 63¢

CHEF'S PRIDE

- POTATO SALAD
- MACARONI SALAD

1-LB. CUP 44¢

Cole Slaw 15 Oz. Cup 48¢

MILD PIMENTO CHEESE SPREAD 15 Oz. Cup 99¢

LAND O' FROST WAFER SLICED

Lunch Meats

ALL VARIETIES 3 OZ. PKG. 43¢

The one to pick to be sure.



U.S. GRADE 'A'

FRYER BREAST

LB. 79¢

FRYER THIGHS

LB. 69¢

SEAFOOD

SINGLETON'S BR. MINIATURE SHRIMP 1-LB. PKG. \$1.29

SINGLETON'S SHRIMP COCKTAIL PKG. OP-3 4 OZ. JARS 99¢

GORTON'S FISH STICKS 2-LB. PKG. \$1.49

GORTON'S OCEAN PERCH 1-LB. PKG. 79¢

Compare...Quality *plus* Savings!

Large Firm
Golden Ripe

Bananas
LB. 18¢

U.S. NO. 1
YELLOW

ONIONS
3-LB. BAG 56¢

N.C. RED &
GOLDEN DELICIOUS

APPLES
3-LB. BAG 79¢

Natural Settings Are Increasingly Sought By Zoos

EDITOR'S NOTE — Small-scale jungles, plains and rocky hills are the home of wild animals in Milwaukee's Zoo. Natural settings are increasingly sought by zoos, says a man who pioneered them, George Speidel. They're a last refuge for endangered species.

By **TIMOTHY HARPER**
Associated Press Writer
MILWAUKEE, Wis. (AP) — From his rocky plateau throne, the lion drowsily but intently gazes at a small herd of gazelle grazing only yards away. He regally yawns and stretches, and a little girl a few more yards away clutches her mother's leg in terror. "Mommy," she cries, "the lions are in the same pen with the deer. They'll eat them." A zookeeper working nearby quickly quiets the child's fears, explaining that a moat invisible to visitors separates the predator from the prey.

The natural setting is common at the Milwaukee County Zoo, model for other zoos throughout the world trying to create realistic scenes for their animals. A German zoo first tried the concept in 1907, but since then few have made such a total commitment to natural settings as the Milwaukee Zoo, which has no barred cages and uses the natural setting in one form or another for almost all its 700 species and 6,365 animals. Milwaukee Zoo Director George Speidel, who was hired in 1949 and engineered construction of the entire complex in the 1950s, is modest about his achievements. "It was a lot easier to make this a good zoo since we started from the ground up," says Speidel, hopping into a six-seat electric cart for one of his daily tours of the 185 acres. Construction at the present site began in 1955, Speidel adds,

as the cart inches through the front gate crowds, and over the next decade animals were moved in from the old zoo at an inner city park. Speidel, whirring quietly now along the broad asphalt walkways, says most of the designs for the natural settings, arranged according to continents, were his own, including the network of underground catacombs where the large animals eat, sleep and winter. "Used to be, zoo directors thought they were in competition or something," says Speidel, who became a family blacksheep 40 years ago when he chucked a promising accounting career to become a keeper. "But now we work together a lot more," he continues, adroitly avoiding a gang of schoolboys trying to hop a ride. "We exchange ideas and information and it's not uncommon any more to lend animals

on a permanent basis to other zoos that need them or can use them for breeding." Speidel's success with the natural settings has put him much in demand as a consultant for construction of exhibits. His work with the hidden moats that separate predator and prey has been the model for natural settings at many zoos throughout the nation, particularly the Bronx, Los Angeles, Brookfield and San Diego zoological gardens. "It also keeps the animals in better shape," he says, nodding toward bison, elk, deer and various waterfowl gamboling within a stone's throw of sleek cougars in a craggy overhang. "Both the predator and prey stay more alert when they can see each other in such close proximity, even though they can't get at each other." He says the natural settings also make animals more at home and more active than the

steamy, cramped barren cages that have characterized most American zoos. The zoo is run by the County Board of Supervisors, currently on a \$2.2-million annual budget. The private Milwaukee Zoological Society, a group of local philanthropists, purchases all the animals. The society also gives Speidel a blank check for travel to tour other zoos, search for rare animals for new exhibits and observe an animal's natural habitat to construct more convincing natural settings. Speidel makes several trips a year, usually including stops in Africa, South America, Asia and Europe as well as the United States. Speidel, who is also laying plans for an extensive wolf woods, believes zoos may become more important as American society becomes more urbanized. "For many people, the only

place they will be able to see these animals, including a number of endangered North American species such as the timber wolf and coyote, will be the zoo," he says. For this reason, one of his dreams is a vast breeding farm to be run by the zoo 30 miles west of the city. Speidel, who will start the breeding farm later this year with cheetahs, says zoos will ultimately rely on their own resources for animals by breeding their own instead of capturing them in the wilds. The San Diego zoo is already experimenting with the concept at a sprawling breeding farm near San Pasquale, Calif., and the Toledo, Bronx, and National zoos are also considering full-scale breeding projects in rural areas. Diminishing animal populations, high prices for expeditions and the reluctance of some countries to allow zoo sa-

faris to take animals will, Speidel warns, encourage zoos to exchange and loan breeding animals just to keep some species from becoming extinct. Breeding farms will combine with natural settings to keep animals from becoming tame. "All our animals are at least semiwild," says Speidel. "We don't want any domesticated animals, simply because that's not the way they really are." He pulls his cart carefully into place near the front gate, and pulls himself together to dispose of paperwork and telephone calls before he begins tomorrow's 14-hour day at 5 a.m. "We may not be the largest zoo," he smiles, "but we like to think we take as good care of our animals as anybody and present them to our visitors in the best way possible."

Sun Undergoing A Solar Storm

BOULDER, Colo. (UPI) — Environmental scientists say the sun is experiencing a solar storm in an area as big as the planet Jupiter and high and low energy particles from the storm are penetrating the earth's atmosphere. Carl A. Posey, director of the National Oceanic and Atmospheric Administration's space environmental laboratory, said the high energy particles would produce minor deterioration of radio communications across the polar regions. He said the low energy particles would enter the earth's environment and produce minor geomagnetic storms.

Health insurance
For person to person health insurance, call:
Bill McDonald
East 10th St., Greenville
Phone 752-6480
STATE FARM MUTUAL
Auto, Life, Health Insurance
Home Office: Bloomington, Ill.

PICK—OF—THE—NEST
GRADE 'A' LARGE FRESH EGGS
73¢
DOZ.
BONUS BUY!

RED RIPE SALAD Tomatoes
28¢
1-LB. PKG.
BONUS BUY!

WE HELP YOU... SPEND LESS!
OVEN KRISP **COOKIES**
● 12 OZ. CHOC. CHIP TWIRLS 12 OZ. FUDGE
● 14 OZ. ICED SPICE **48¢**
OVEN KRISP VANILLA **PKG. 48¢**
WAFERS 12 OZ. BOX **44¢**

BONUS BUY! MOTHER'S CREAMY—SMOOTH **MAYONNAISE** QUART JAR **78¢**
BONUS BUY! KING O' CLUBS **CHARCOAL** 10 LB. BAG **68¢**
BONUS BUY! 20¢ OFF LABEL—DETERGENT **LUX LIQUID** 32 OZ. BOTTLE **87¢**

BIG STAR FOODS
WE WELCOME FEDERAL FOOD STAMPS
PRICES GOOD THRU SAT. OCT 5, 1974
QUANTITY RIGHTS RESERVED
★★★★★

RED GATE TOMATOES 16 OZ. CAN **27¢**
DEL MONTE FRUIT 17 OZ. CAN **COCKTAIL** **45¢**
STAR—KIST CHUNK TUNA 6½ OZ. CAN **54¢**
BOUNTY PAPER TOWELS JUMBO ROLL **47¢**
BLEACH CLOROX HALF GALLON **47¢**

We Help You Spend Less!
SILVER LABEL COFFEE 1 LB. CAN **79¢**
PAMPERS DAYTIME DIAPERS 30 CNT. **\$2.09**
PAMPERS NEWBORN DIAPERS 30 CNT. **\$1.69**
RED BAND FLOUR 5-LB. BAG **\$1.01**
EASY OFF WINDOW CLEANER 15½ OZ. **57¢**
EASY OFF (REFILLS) WINDOW CLEANER 27 OZ. **59¢**
1869 PILLSBURY BUTTERMILK BISCUITS 5½ OZ. **26¢**
PILLSBURY BUTTERMILK BISCUITS 8 OZ. **19¢**
BRISK LIPTON TEA 8 OZ. **95¢**
BAKER'S CHOC. FLAVORED CHIPS 12 OZ. **89¢**
RED GATE Fruit Drinks 46 OZ. **43¢**

More Everyday Low Prices!
Carolina Maid BISCUITS (8 OZ. CAN) **78¢**
SIX PAK
HEINZ STRAINED BABY FOOD JAR **7¢**
OUR PRIDE SANDWICH BREAD 24 Oz. Loaf **32¢**

MORRELL PRIDE 1ST CUT

CHUCK ROAST 59¢

Center Cut LB. 79¢

MORRELL PRIDE Shoulder Roast LB. \$1.09

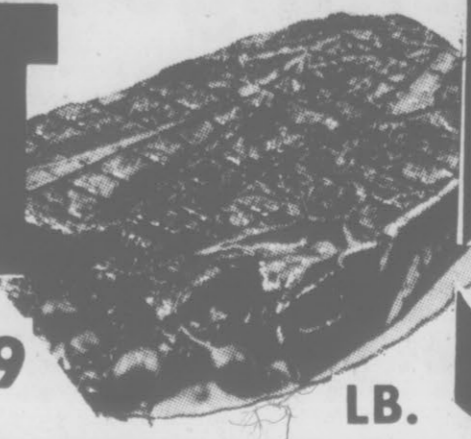

MORRELL PRIDE Ground Beef 3 LB. PKG. OR MORE PER LB. 89¢

WE RESERVE THE RIGHT TO LIMIT QUANTITIES

OVERTON'S INC. SUPERMARKET

3rd AND JARVIS ST.

PRICES EFFECTIVE THURSDAY THRU SATURDAY

MORRELL PRIDE WIENERS 12 Oz. Pkg. 59¢

GWALTNEY 1ST CUT PORK

CHOPS 69¢

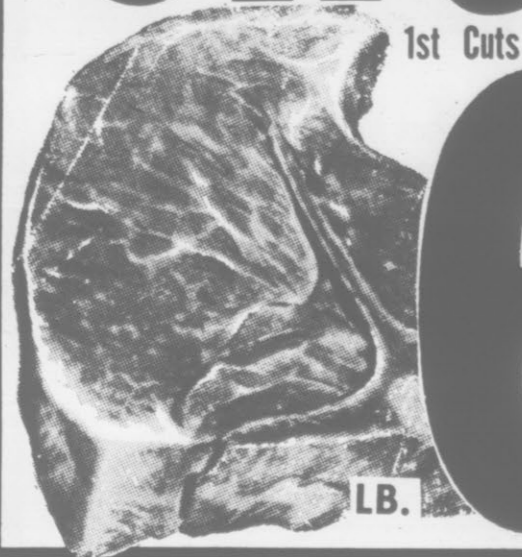

GWALTNEY NO. 1 BACON 99¢

GRADE A WHOLE FRYERS 39¢



GWALTNEY SLICED 1/4 Pork Loins 7-9 Chops LB. 99¢

KRAFT FRESH ORANGE JUICE

PURE ORANGE JUICE from FLORIDA

1/2 Gallon Jug 69¢

Todds Hermitage Virginia Country

HAMS 129¢

Half-Whole LB.

"The Oldest Name In Country Hams—Since 1779—IT'S GOT TO BE GOOD!"

NECK BONES LB. 29¢

GRADE A HUMBLER MEDIUM EGGS 69¢

DOZ.

MORRELL PRIDE WHOLE SIRLOIN TIPS 12-14 LB. AVG. LB. \$1.19

MORRELL PRIDE FULL CUT Round Steak LB. \$1.59

MORRELL PRIDE WHOLE 65 Lb. Average

BEEF LOINS 1.19

Cut & Wrapped Free Into T-Bones, Sirloins, Ground Beef

DOUBLE COLA 16 OZ. CTN. OF 8 79¢

Plus Deposit

YELLOW ONIONS LB. 12¢

NO. 1 SWEET POTATOES LB.

CRISP CUCUMBERS EA.

BELL PEPPER EA.

GIANT BOX GAIN 99¢

UNBELIEVABLE NEW! DETERGENT!

WITH MICRO-BUBBLE ACTION

TREATS STAINS LIKE DIRT

KRAFT Mayonnaise Pint 69¢

ZESTA CRACKERS LB. BOX 59¢

FLORIDA NEW CROP ORANGES DOZ. 59¢

ROLLER CHAMPION FLOUR 5 LB. BAG 89¢

STAR-KIST TUNA FISH 6 Oz. Can 49¢

BAMA APPLE 18 Oz. Jar 39¢

VINE RIPENED TOMATOES 29¢

Giant Roll BOUNTY TOWELS 39¢

JCPenney Days start with 20% savings on selected slacks. reg. \$10 and up.



Sale 8.80

A. Reg. \$11. Proportioned pull-on pants in solid color polyester knit are tailored with stitched-in front crease. Red, white, navy. Sizes 8-18 average, 6-14 petite, 12-20 tall.

Sale \$8

B. Reg. \$10. Proportioned patterned pants in double knit polyester have elasticized pull-on waist. Assorted colors; proportioned 8-18 average, 6-14 petite, 12-20 tall.

Sale 9.60

C. Reg. \$12. Sweater-knit rib-cord polyester pants for a smart new look this Autumn. Red beige, navy, sizes 8-18 average.

Sale prices effective thru this weekend only. Like it? Charge it.

Items A & B
Proportioned Sizes

- Petite (6-14)
- Average (8-18)
- Tall (12-20)

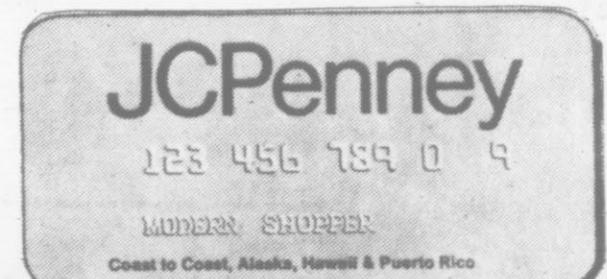

Charge it!

It's the quick and easy way to shop, pick up a bargain on the spot. Next time you're in, ask for a JCPenney Charge Card application. We'll do the rest. Chances are...you can charge the same day.

Event Starts Wednesday, October 2

PITT PLAZA SHOPPING CENTER
714 Greenville Blvd.
Greenville, N. C.
Shop Daily 10:00 am til 9:30 pm

Nylon tricot gowns and matched brunch coats at low JCPenney prices.

\$8

A. Long slip-over sleeveless gown with high neck, bib-shape yoke, lace trim. S,M,L.

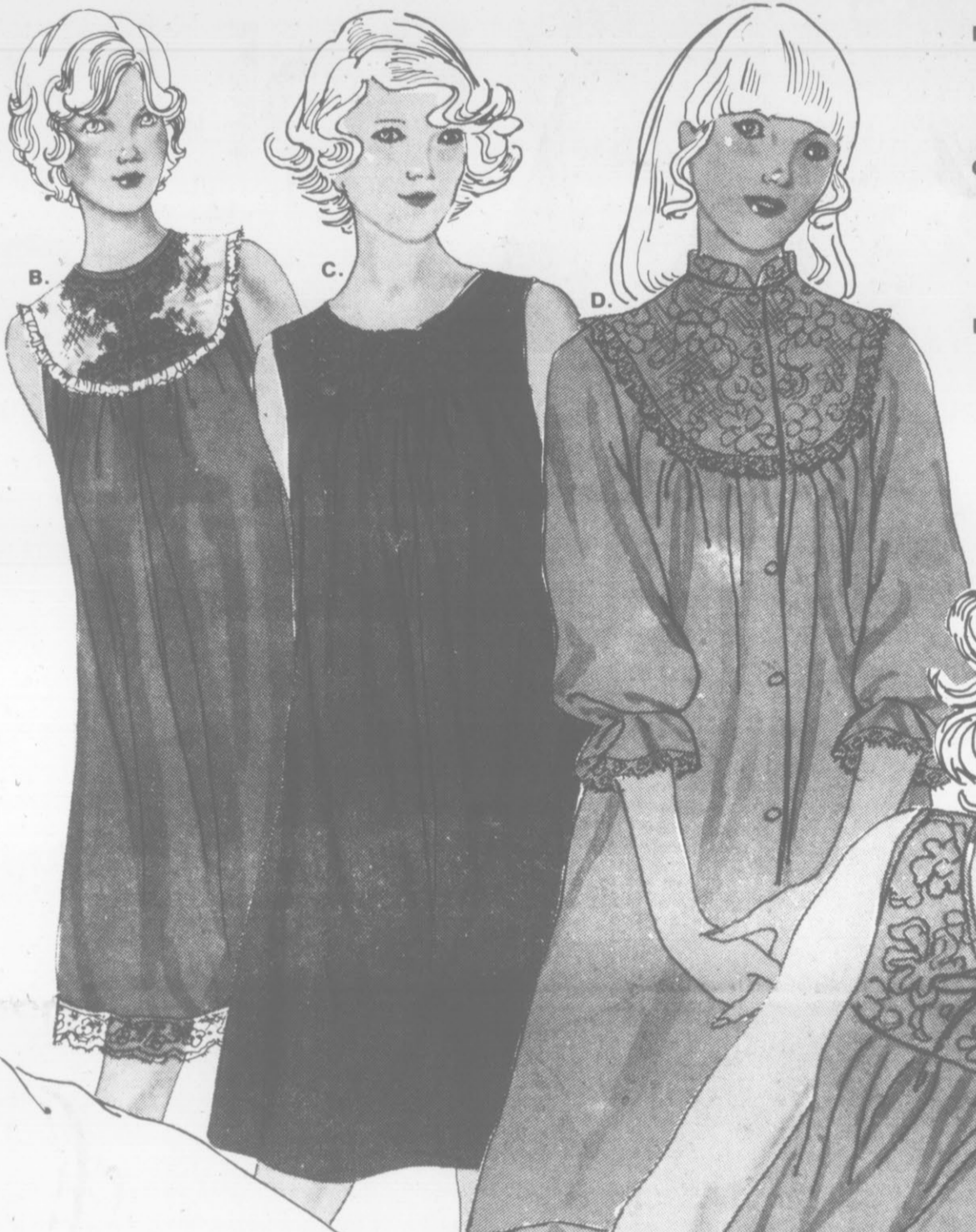

\$6

B. Button-neck sleeveless waltz gown with bib-shaped yoke, sugary lace trim. S,M,L.

\$6

C. Slip-over sleeveless shift gown with wide neck, lace and embroidery trim. S,M,L.

\$8

D. Matching brunch coats in two styles: stand-up collar with bib yoke, lace trim and elasticized sleeves or convertible collar with lace and embroidery trim. S,M,L.

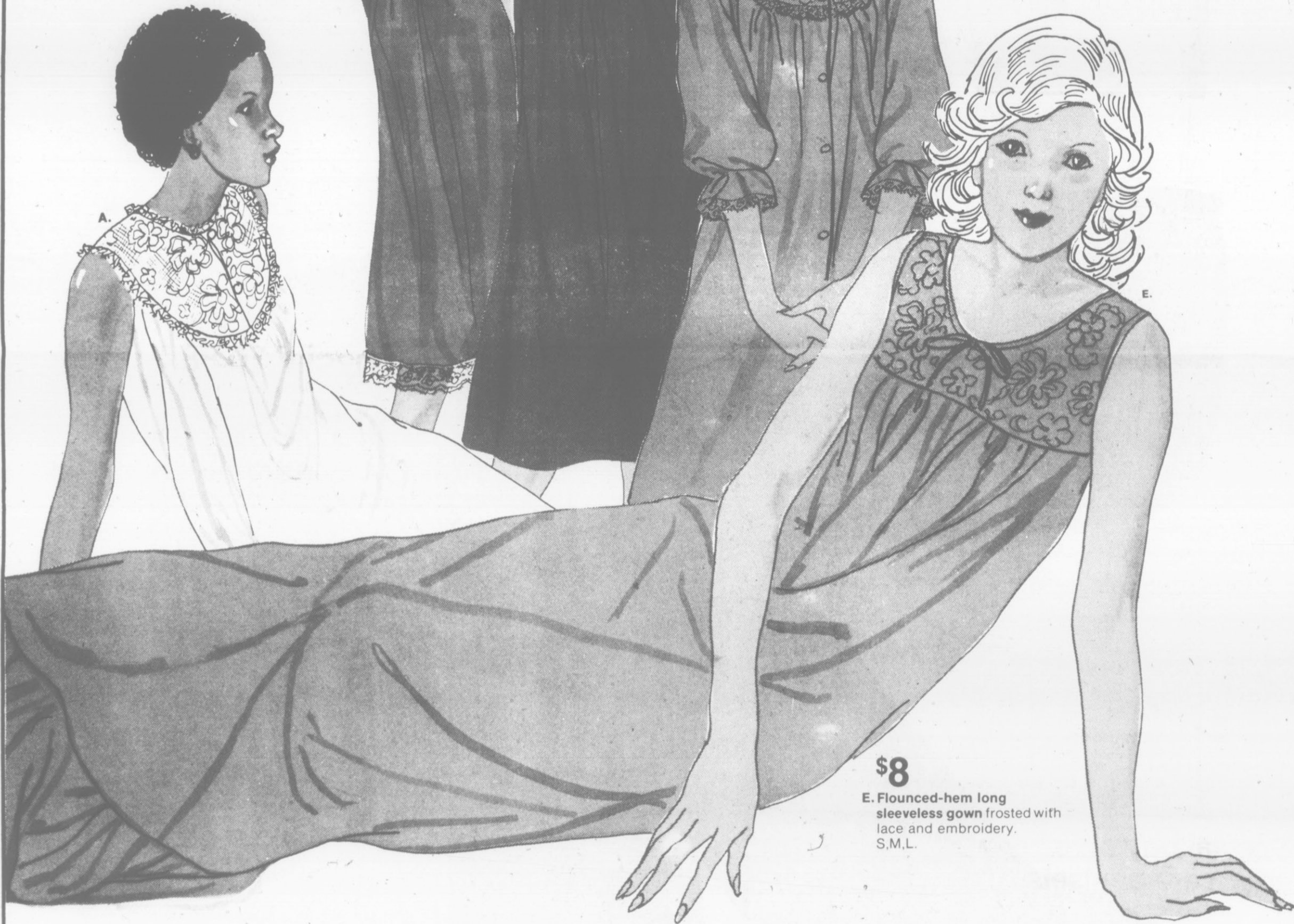

\$8

E. Flounced-hem long sleeveless gown frosted with lace and embroidery. S,M,L.

25% off the JCPenney bra with natural, padded or contour cups.

Sale 3.38

Reg. 4.50. Contour cup seamless bra with molded polyester cups lined with polyester fiberfill and sheer nylon tricot. Adjustable straps. Lycra® spandex sides and back. White, black, nude, pink, blue. 32-36 A,C. 32-38 B.

Sale 3.75

Reg. \$5. Padded cup seamless bra adds a full cup size, has polyurethane foam padded polyester cups lined with sheer nylon tricot, spandex sides and back, adjustable tricot straps. White, nude, black. 32-36 A, 32-38 B.

Sale \$3

Reg. \$4. Natural cup seamless bra for today's softer, natural lines. Molded polyester cups, adjustable tricot straps, Lycra® spandex sides and back. Black, nude, white. 32-36 A, 32-38 B, C.

Sale prices effective thru this weekend only. Like it? Charge it. Use your JCPenney charge account.

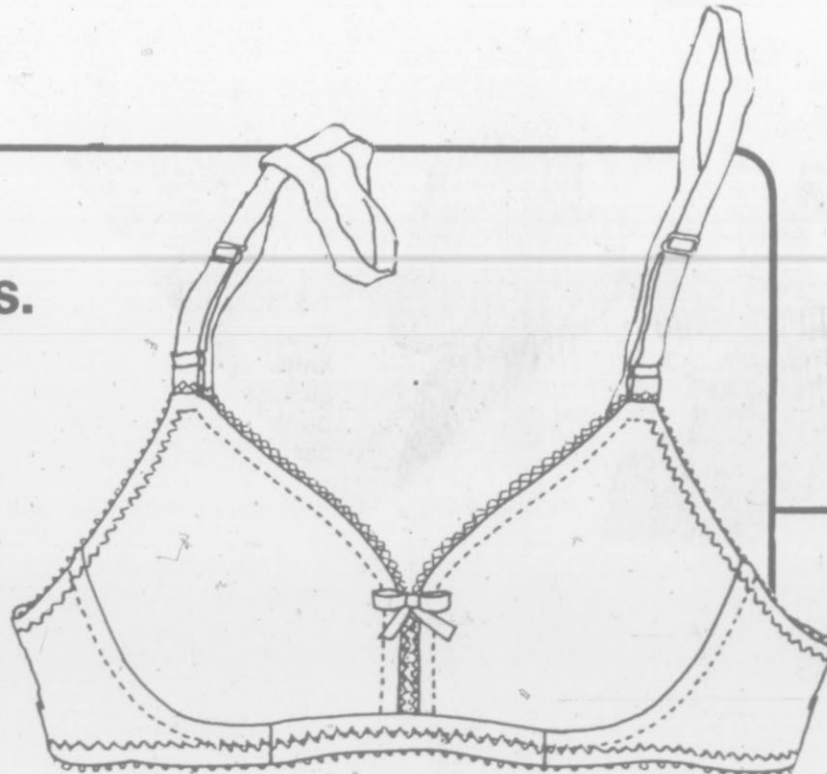

JCPenney

Special prices on the special look of polyester knits in solids and patterns.

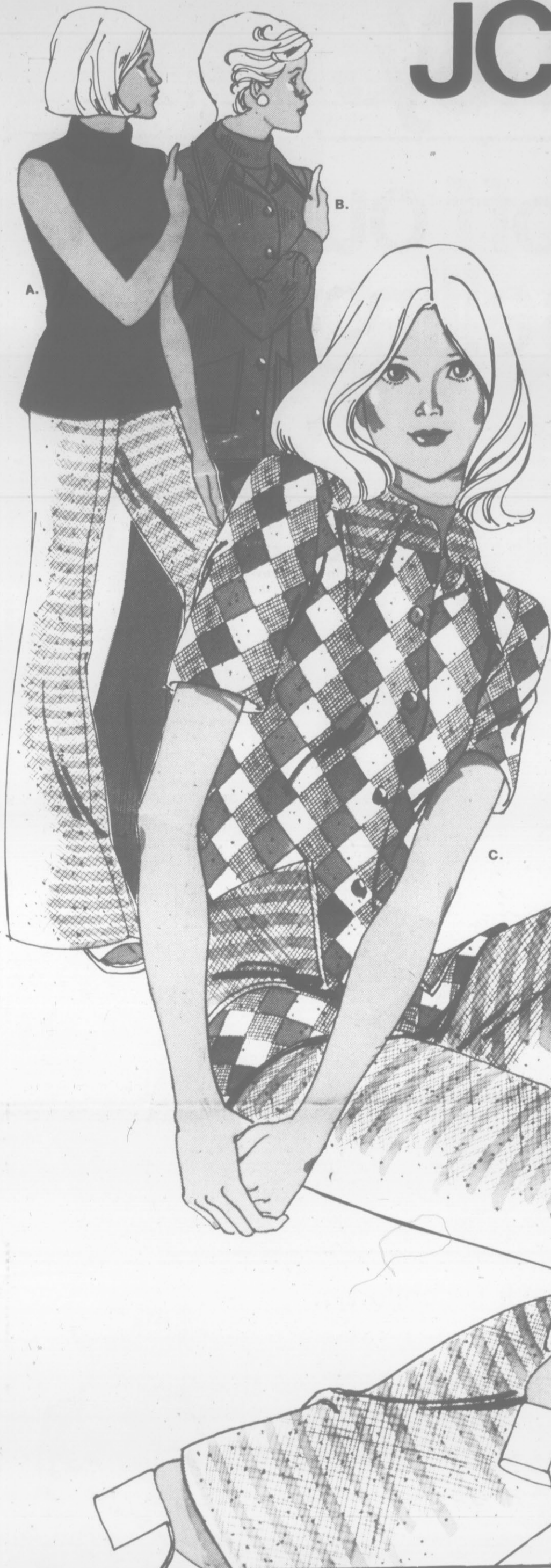

Special 6.88

A. Sleeveless turtleneck shell with easy-on back zipper. Solid colors for sizes 8-18.

Special 10.88

B. Long sleeve button-front shirt jacket. In solid color or argyle pattern; sizes 8-18.

Special 10.88

C. Short sleeve shirt jacket with button trim on the pockets. In solid colors, argyle pattern, or tweed; sizes 8-18.

Special 6.88

D. Pull-on pants with flared legs. In solid colors or tweeds; sizes 8-18.

Like it? Charge it. Use your JCPenney charge account.

Special buy on easy-wear easy-care pantsets.



Special 15.99

Great looking polyester knits team long sleeved shirt jackets with companion pants. In a great and varied assortment of patterns and solids. Your choice of solid over solid, striped top with rib-knit solid pants, pattern over pattern, and more. Colors go from pastels to holiday brights, for misses' sizes 10-18.

Special prices on slingbacks.



Special 7.88

Our walking shoe has a closed toe, open heel, adjustable strap with elastic gore under buckle, comfortable imitation crepe sole. White-stitched black, camel, red, navy; whole sizes 5-10 in medium width.

Special prices on turtlenecks.

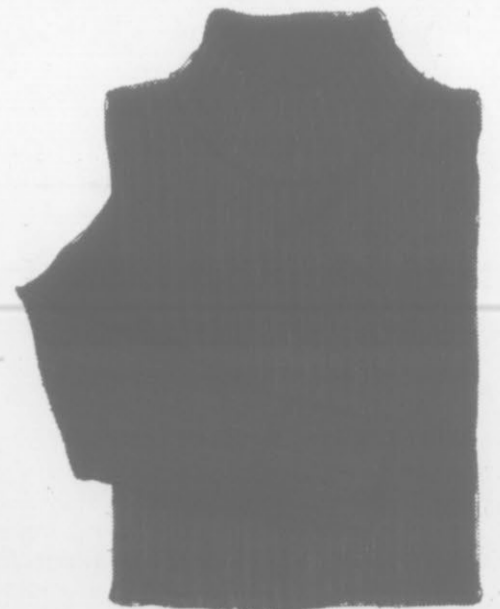

Special 4.99

Rib-knit turtleneck top in all acrylic teams up with pants and skirts in white, navy, gold, green, camel, black, red. S, M, L.

JCPenney

Boys' mock turtlenecks,
and Western jackets.



2.98 Sizes 8 to 18
Pre-school 3-7, 2.49
Short-sleeve polyester/cotton knit has mock turtleneck, raglan styling, embroidered design. Assorted darks, lights and brights.



6.98 Sizes 8-20
5.98 sizes 3-7
Western-style denim jackets of machine wash-tumble dry polyester/cotton with shirt style collar, snap front closures, contrast stitching. Navy, or berry.

20% off our best selling Boys' denim jeans



Sale \$4

Regular or slim 8-20, reg. \$5
Husky 8-20, reg. \$5.50, Sale 4.40
Regular or slim 3-7, reg. \$4, Sale 3.20
Western-style denim jeans of carefree polyester/cotton with round leg, belt loops, flare bottom. (Reinforced knees in sizes 3 to 12.) Choose from navy, 'fade-out' blue or berry. Lots 6841 R 2841R

	3	4	5	6	7	8	10	12	14	16	18	20
Reg.	x	x	x	x	x	x	x	x	x	x	x	x
Slim	x	x	x	x	x	x	x	x	x	x	x	x
Husky						x	x	x	x	x	x	x

Sale prices effective thru this weekend only! Like it? Charge it. Use your JCPenney charge account.

20% off flame-retardant* sleepwear for children.



Sale 4.78

A. Reg. 5.98 ea. Girls' 'football style' sleepwear in long gown, sleepshirt or pajamas with players' numbers. Soft brushed acetate/polyester. 7 to 14.

Sale 3.99

E. Sizes 8 to 16 reg. 4.99. Pre-school 3-7, reg. 3.99, Sale 3.19
Boys' ski-style flannel pajamas of cotton or polyester with rib-knit modacrylic wrists, ankles, crewneck.

Sale 4.31

B. Reg. 5.39 ea. Little girls' Raggedy Ann gowns or pajamas have screen print front, ruffles. Gown has button-back. Pajamas have button-back top, elasticized waist, ankles. Brushed acetate/polyester knit. 3 to 6x.

Sale 4.78

F. Sizes 8 to 18, reg. 5.98. 'NFL' ski-style knit pajamas with National Football League team insignias. Modacrylic/polyester.

*Self-extinguishing when removed from flame. All sleepwear on this page meet the test requirements of Federal Standard DOC FF 3-71.



Sale

C. Sizes 1-3, reg. 4.69, Sale 3.75
Sizes 4-8, reg. 5.29, Sale 4.23
Infants' or toddlers' 2-pc. footed sleepers of print and solid shade modacrylic/polyester knit. Larger sizes have a boxer waist. Smaller sizes a gripper waist. Colors.



Sale

D. Sizes 1-3, reg. 4.19, Sale 3.35
Sizes 4-8, reg. 4.49, Sale 3.59
2-pc. Thermal knit footed sleepers with elasticized ankles. Modacrylic/polyester. Small sizes have gripper waist. Larger sizes have boxer waist. Both in assorted pastels.

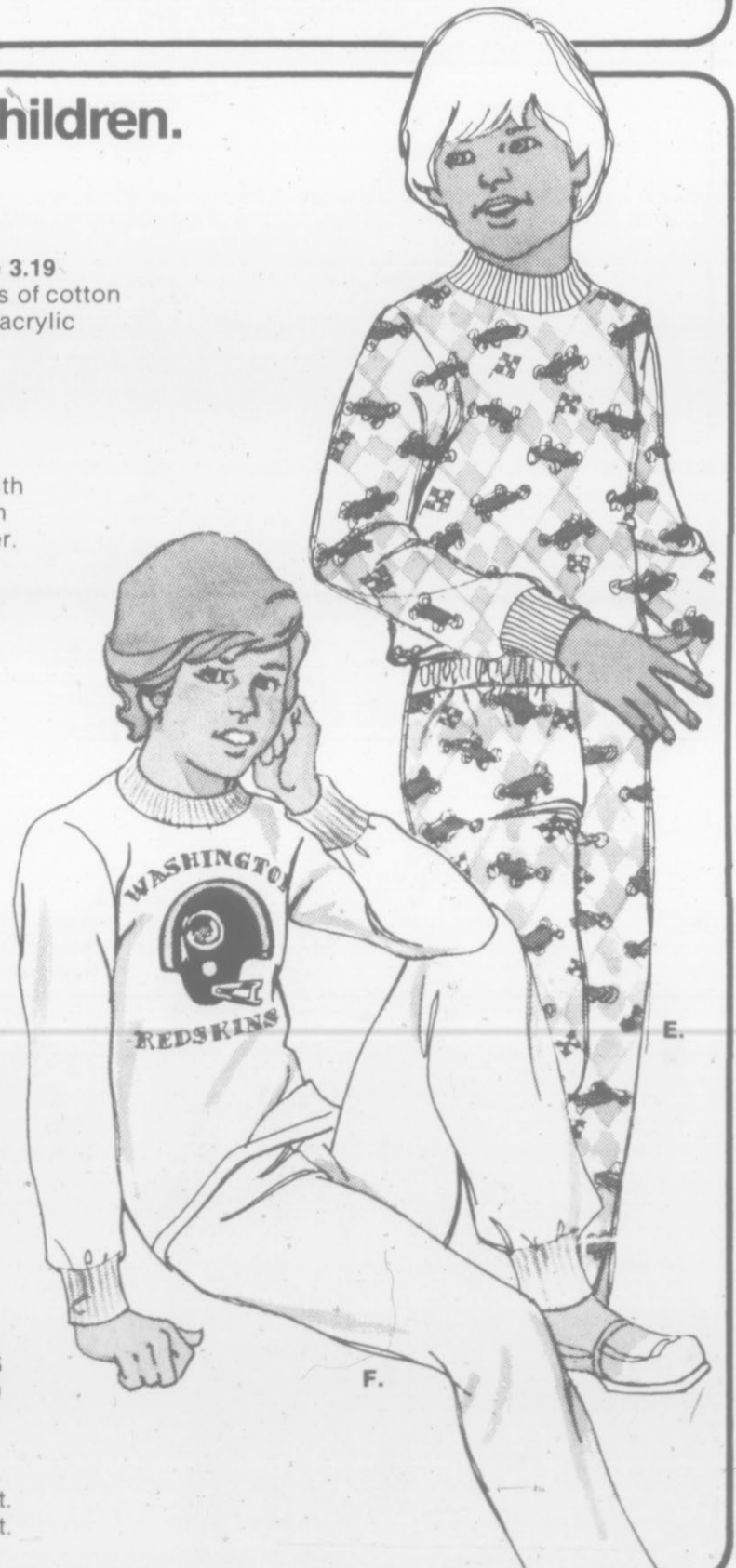

F.

JCPenney

Special on men's polyester 'trio' suit for dress or sport, only 54.88

Solid-color dress suit becomes a handsome sport outfit when you wear the jacket with the extra pair of patterned slacks in coordinated colors. Navy, grey, brown or bottle green texturized polyester. 36-46 regular, 40-46 long, 38-42 short.

Like it? Charge it. Use your JCPenney Charge Account.

Glen plaid coordinates in polyester double knit.



Washable, good-looking color coordinating slacks and shirts in polyester double knits for casual wear.

Glen plaid trimmed shirt with placket front. Navy or green trim on beige ground. S, M, L, XL. \$9

Ribbed solid-color shirt color-coordinated to slacks; navy or green. Sizes S, M, L, XL. \$9

Glen plaid slacks are slightly flared, with belt loops and 4 deep pockets. Navy or green. Waist 32-42. \$15

JCPenney

20% off infants' no-iron knit coordinates.

Sale \$2

A. Reg. 2.50. Boys' crewneck top with long sleeves, applique trim. Red, blue or plaid polyester/cotton. Sizes 1-4.

Sale 2.31

B. Reg. 2.89. Boys' turtleneck polo in solid shades with applique. Multi-color plaids. Polyester/cotton. Sizes 1-4.

Sale 2.23

C. Reg. 2.79. Boys' boxer-waist flare-leg pants in bright solids or plaid pattern. Polyester/cotton. Sizes 1-4.



Sale 2.15

D. Reg. 2.69. Girls' boxer-waist flare-leg pants in solid pastels. Polyester/cotton. Sizes 1-4.

Sale \$2

E. Reg. 2.50. Girls' ruffle-trim blouse with long sleeves, elasticized wrists. Pastels or multi-color pastel patterns. Polyester/cotton. Sizes 1-4.

Sale 2.47

F. Reg. 3.09. Girls' A-line 'angel' top in solid shade/stripe layered look with applique trim or patterned knit with eyelet trim. Polyester/cotton. Pastel shades. Sizes 1-4.

20% off selected girls' tops and jeans.



Sale \$4

A. Reg. \$5. No-iron long-sleeve 'status' shirt. Button front, cuff. Polyester/cotton in white, red, navy, pink, blue, yellow. Girls' 7-14.

Sale 5.60

B. Reg. \$7. Low-riding cotton jeans have snap front closing, wide flare. Regular sizes 7-14.

Sale 4.80

C. Reg. \$6. Polyester knit short-sleeve pullover. Patch or flame-stitch multi-color pattern adds zing to sleeves and neck. Girls' S, M, L.

Sale \$4

D. Reg. \$5. Boy-cut denim jeans with frontier flare. Front snap, zipper. Western and back patch pockets, back yoke, belt loops. Cotton denim in regular and slim sizes 7-14.

Sale 3.99

E. Reg. 4.99. Cable cardigan sweater of soft acrylic knit. Full-fashioned in white and go-with-everything colors. Girls' S, M, L.

Sale prices effective thru this weekend only. Like it? Charge it. Use your JCPenney charge account.

20% off Toddletime® disposable diapers.

Daytime 30's, reg. 1.89, Sale 1.51
Overnight 12's, reg. 99¢, Sale 79¢
Toddler 12's, reg. 1.19, Sale 95¢
Newborn 30's, reg. 1.59, Sale 1.27

Our pinless disposable diapers with self-sticking tape, sealed side seams, pliable waterproof plastic backing. Soft, absorbent filling and liner. White.

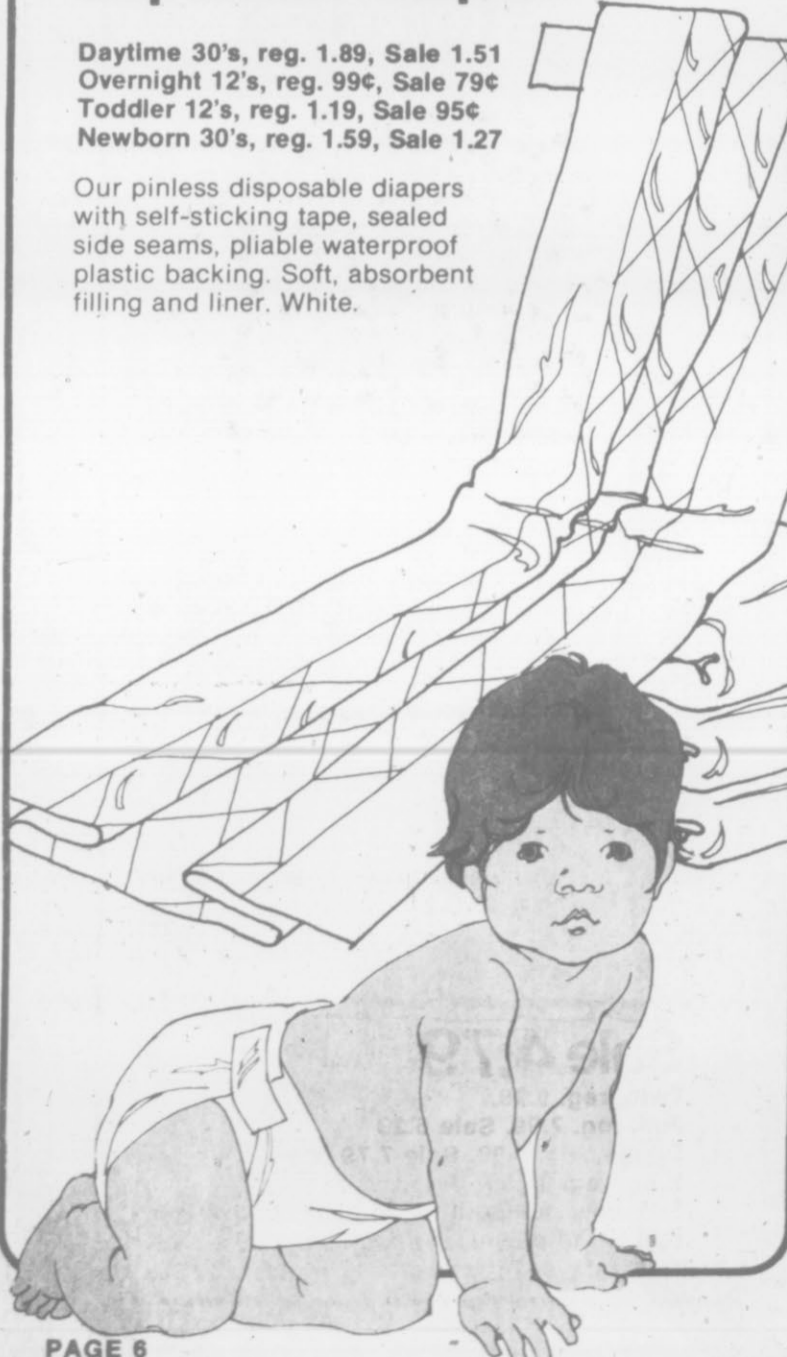

JCPenney

20% off all double knits to mix or match for today's top fashion looks.

Sale 3.19 yd.

Reg. 3.99. yd. Crepe stitch double knit of no-iron texturized polyester in solid shades that range from rich darks to creamy pales plus classic black, white, navy. 58-60" wide.

Sale 3.19 yd.

Reg. 3.99. yd. Coordinated pattern double knits in exciting tweed-looks, plaids, pindots and more, to travel together or team with solids. Texturized. 58-60" wide.

Sale 3.19 yd.

Reg. 3.99. Denim blue coordinated knits of polyester in checks, pinstripes, geometrics and more plus solids in dark or 'fadeout' blue shades. 58-60" wide.

Sale 3.19 yd.

Reg. 3.99. Linen-look solids or patterned knits of texturized polyester. Plaids, neat little pinstripes and dots double up with solids including camel and red. 58-60" wide.

Sale 3.19 yd.

Reg. 3.99 yd. Gabardine twill-stitch knits of texturized polyester in lights, brights, darks, neutrals. No-iron naturals for new 'classic' fashions. 58-60" wide.

Sale prices effective thru this weekend only. Like It? Charge It. Use your JCPenney charge account.

20% off acrylic thermal blankets.

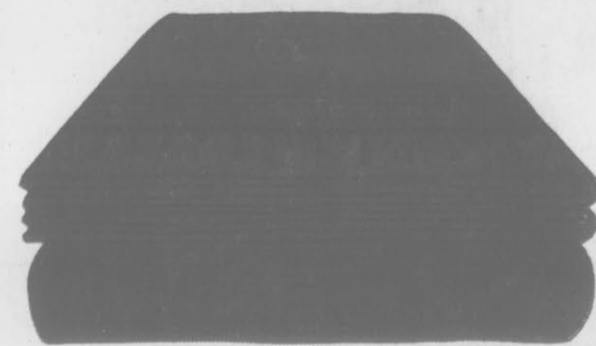

Sale 7.19

Twin, reg. 8.99.
Full, reg. 10.99. Sale 8.79
Queen, reg. 13.50. Sale 10.80
King, reg. 16.50. Sale 13.20

100% woven acrylic thermal blanket with binding can be used all year round. Under cover it keeps in warmth; used alone it 'air cools' in summer. Fashion shades or white.

20% off no-iron foam backed drapes.

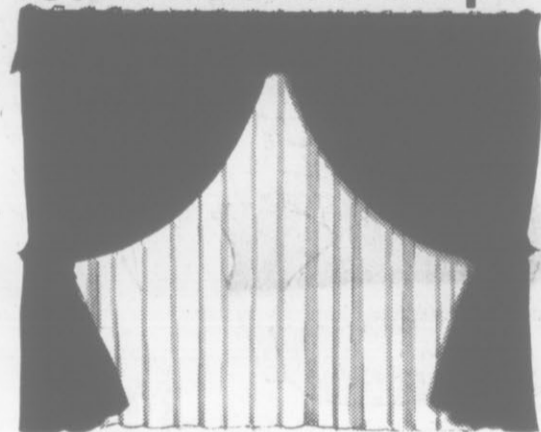

Sale \$12

50x63", reg. \$15 pr.
50x84", reg. \$16 pr., Sale 12.80 pr.
'Jewel-Tex' dobby weave drapes with thermal acrylic foam back for room insulating comfort. Machine-wash cotton/rayon needs no ironing. Comes in many shades. 50 to 125"x 45 to 84" sizes in stock or special order. Plus 100x84" patio panels also 20% off.

Save on pillow pairs and mattress pads.

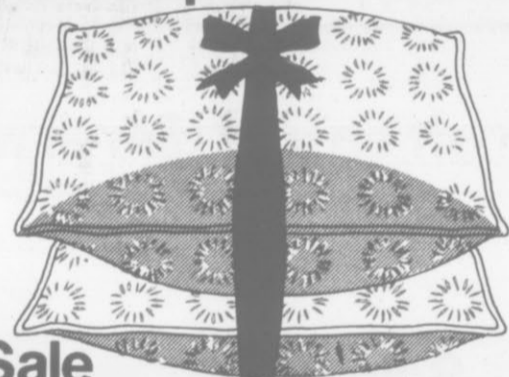

Sale

Standard size, reg. 5.50 ea., Sale 2 for 8.79
Queen size, reg. 6.50 ea., Sale 2 for 10.79
King size, reg. 8.50 ea., Sale 2 for 13.79
Machine washable fiberfill pillows with lofty Dacron II® polyester fiberfill, no-iron polyester/cotton cover.

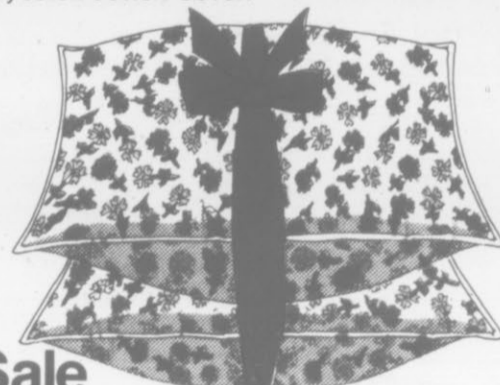

Sale

Standard size, reg. 3.50 ea., Sale 2 for 5.44
Queen size, reg. 4.50 ea., Sale 2 for 7.44
King size, reg. 5.50 ea., Sale 2 for 8.44
Value-priced polyester pillows with plump Red Lable Dacron® polyester fill, sturdy polyester cover.

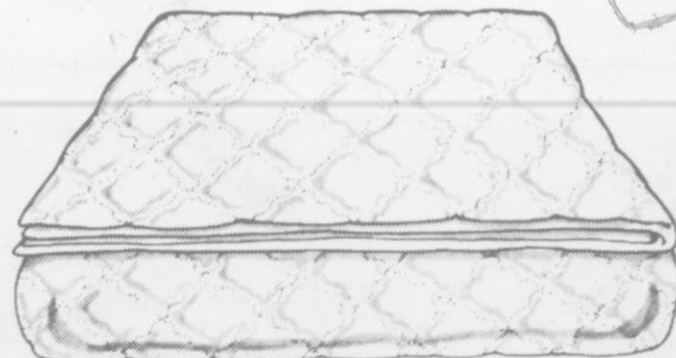

Sale 4.79

Twin, reg. 5.99.
Full, reg. 7.99. Sale 6.29
Queen, reg. 9.99. Sale 7.79
King, reg. 11.99. Sale 9.79
Sonically quilted fitted mattress pad of nylon knit bonded to polyester fiberfill. Machine washes, dries, stays soft and snowy white.

JCPenney

20% off JCPenney small appliances with one year guarantee.*



Sale 13.59

Reg. 16.99. JCPenney glass percolator brews 5 to 11 cups. Stainless steel stem and basket, easy-to-clean-removable bowl.



Sale 15.99

Reg. 19.99. JCPenney electric fry pan with high dome cover. Scratch-resistant Teflon® II inside, porcelain enamel outside.



Sale 8.39

Reg. 10.49. JCPenney 3-speed hand mixer blends, stirs, whips, beats. Beaters eject for easy cleaning. Stands or hangs on wall.

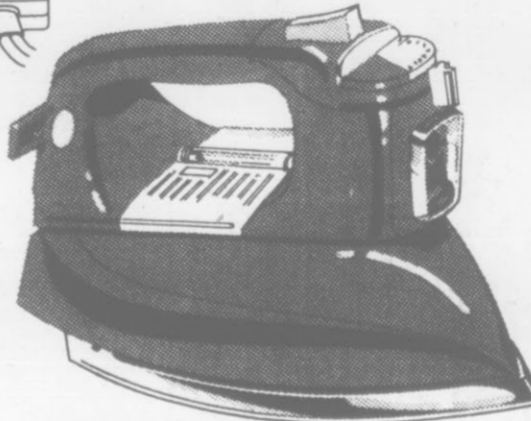

Sale 15.19

Reg. 18.99. JCPenney deluxe spray-steam-dry iron with Teflon®-coated sole plate, 52 steam vents. Avocado, buttercup, poppy.



Sale 9.59

Reg. 11.99. JCPenney 2-slice toaster with color selector, hinged crumb tray. Chrome finish.

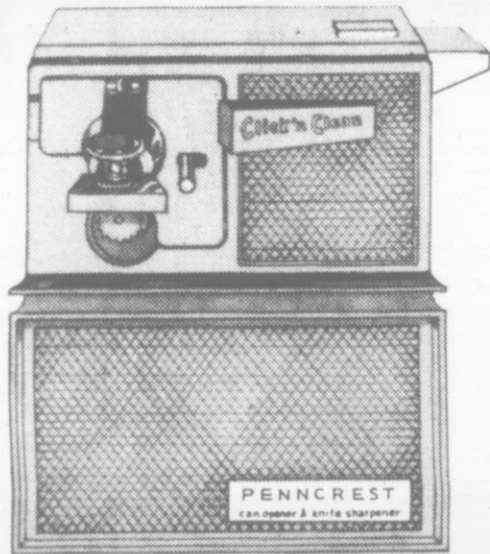

Sale 14.39

Reg. 17.99. JCPenney electric can opener/knife sharpener. Touch 'n Clean removable cutting assembly. Sharpens all non-serrated knives.

*Guarantee: Within one year of purchase we will replace any JCPenney appliance, if defective, with one of equal or superior value. Just return it to JCPenney.

Sale prices effective thru this weekend only! Like It? Charge It. Use your JCPenney Charge Account.

25% off casual dinnerware.

Sale 22.50

Reg. \$30. 'Needlepoint' 20-pc. set of durable earthenware. 4 each: dinners, desserts, soups, cups, saucers. Plum-green-yellow. 5-pc. completer set: vegetable bowl, platter, covered sugar, creamer. Reg. \$16, Sale \$12.



Big savings on
7 and 9-piece cookware sets.

Sale 14.39

Reg. 17.99. JCPenney porcelainized aluminum 7-pc. cookware set. Includes 1-qt., 2-qt. covered sauce pans, 5-qt. Dutch oven, 10" open fry pan.



Sale 27.99

Reg. 34.99. JCPenney triply stainless steel 9-pc. cookware set. Includes 1-qt., 2-qt. covered saucepans, 5-qt. Dutch oven, 8" covered fry pan, 10" open fry pan (uses Dutch oven cover).

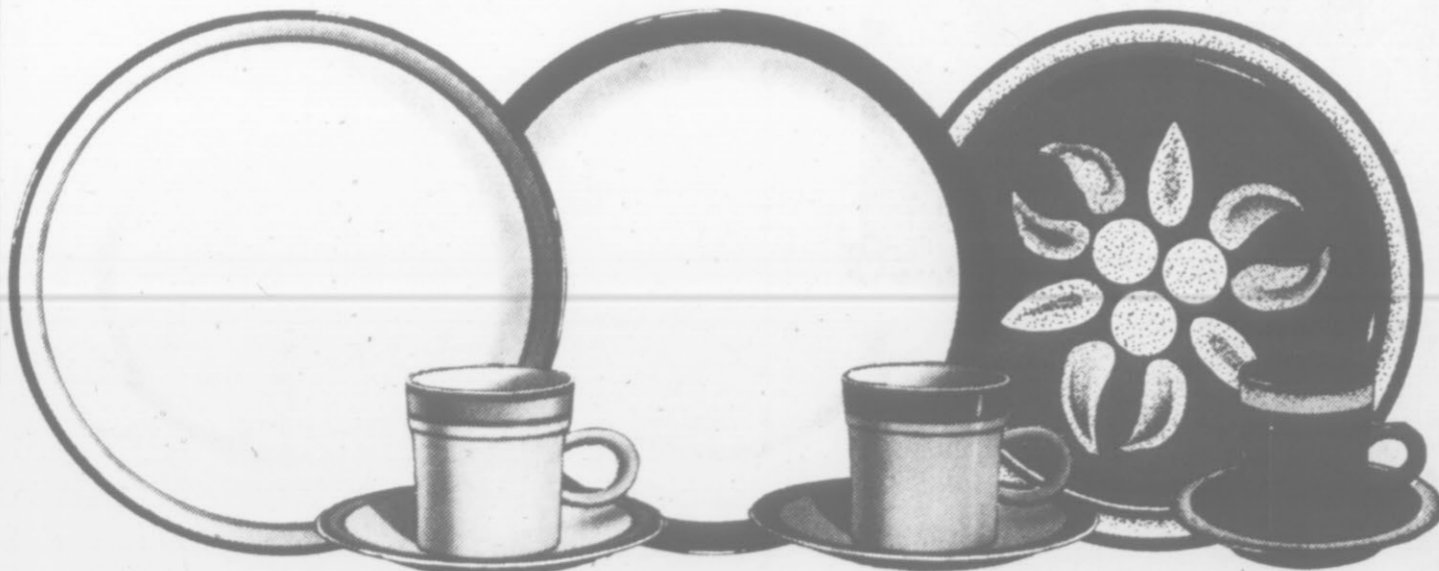

Sale \$15

Reg. \$20. 'Sky Blue' 20-pc. stoneware set. 4 each: dinners, desserts, soups, cups, saucers. Opaque gray with blue rim. 5-pc. completer set: vegetable bowl, platter, covered sugar, creamer. Reg. \$13, Sale 9.75

Sale \$15

Reg. \$20. 'Sea Green' 20-pc. stoneware set. 4 each: dinners, desserts, soups, cups, saucers. Opaque gray with green rim. 5-pc. completer set: vegetable bowl, platter, covered sugar, creamer. Reg. \$13, Sale 9.75

Sale 16.50

Reg. \$22. 'Nadia' 20-pc. set of modern Shino stoneware. 4 each: dinners, soups, desserts, cups, saucers. Brown-and-yellow. 5-pc. completer set: vegetable bowl, platter, covered sugar, creamer. Reg. \$14, Sale 10.50

25% off stainless steel flatware sets.

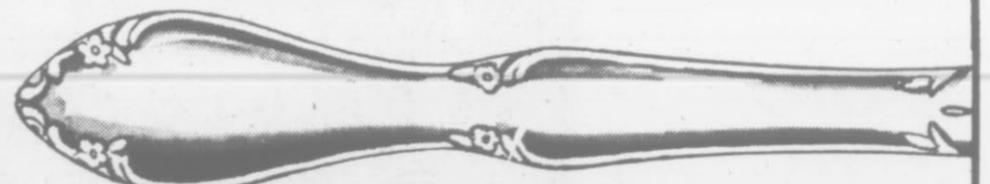

Sale 25.49 Reg. 33.98. 'Berkeley Square' pattern 50-pc. service for 8.



Sale 13.49 Reg. 17.98. 'Hampshire' pattern 42-pc. service for 8.



Sale 13.49 Reg. 17.98. 'Vineyard' pattern 42-pc. service for 8.

JCPenney

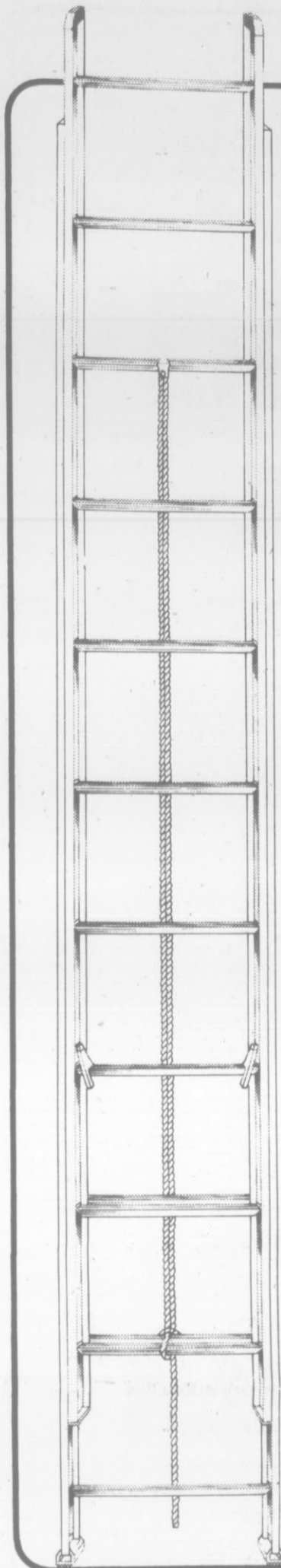

22.99
16' aluminum extension ladder with flat steps, mar-resistant Cyclocac® end caps.



Sale 7.99

Reg. 10.99. Par Excellence, our finest exterior latex, covers in one coat; resists staining, fading, chalking, mildew. Hands and tools clean up in soap and water. Many colors to choose. Par Excellence exterior tint base colors; reg. 10.99, Sale 7.99 gal.

Sale 6.99

Reg. 9.99. One Coat Plus exterior latex covers in one coat; resists staining, fading, chalking, mildew. Choice of many colors. One Coat Plus exterior tint base colors; reg. 9.99, Sale 6.99 gal.

In custom mixed paints, because color intensity differs, the volume of paint per can may, in some cases, be slightly less than a full gallon.



Economy latex caulking, 49¢
JCPenney 4" paint brush with nylon bristles, 1.99

Save a big \$3 per gallon on exterior latex paint.

Save 25% on selected power tools for home or shop.

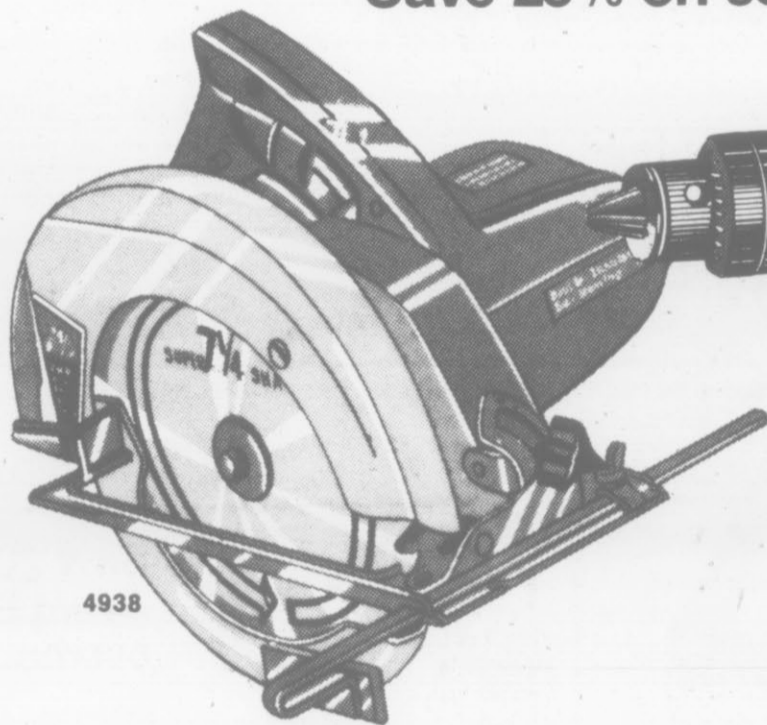

4938

Sale 33.69

Reg. 44.99. 7 1/4" double insulated 2 HP circular saw. Features ball bearing construction, rear blade exposure control and security switch. 5200 rpm. Blade and wrench included.

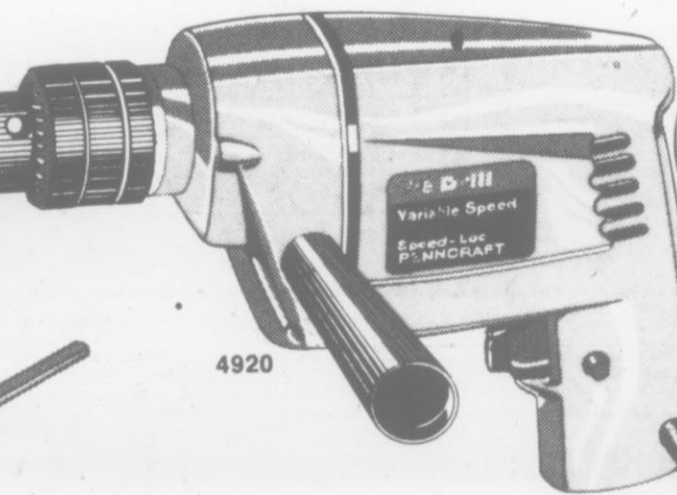

4920

Sale 22.49

Reg. 29.99. 3/8" double insulated variable speed reversible drill. 3.0 amp motor; 1-1,000 rpm. Speed-Loc pre-sets drill at any speed.

Sale prices effective thru this weekend only. Like It? Charge It. Use your JCPenney charge account.

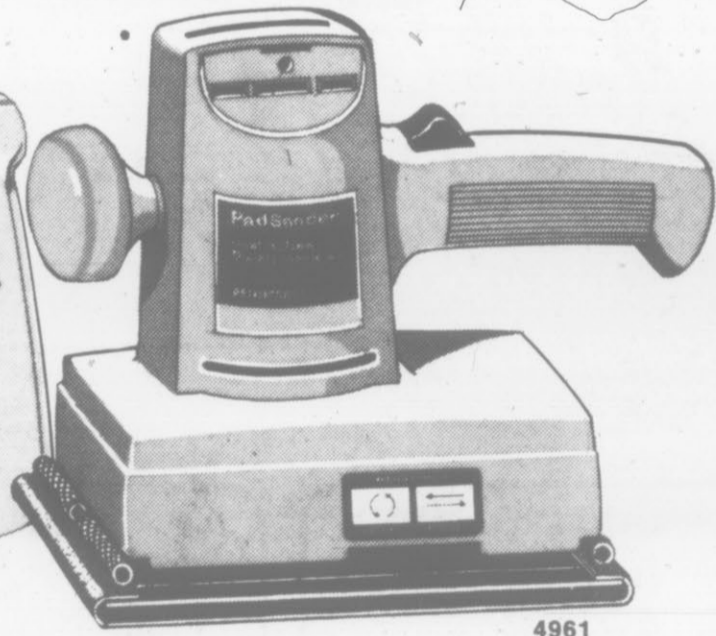

4961

Sale 25.99

Reg. 34.99. Double insulated dual action sander. For straight lines and orbital sanding; 2.5 amp motor delivers 4000 orbits or 8000 straight line strokes per minute. Ball bearing construction.

McCulloch Mini Mac 35 chain saw at a mini price.

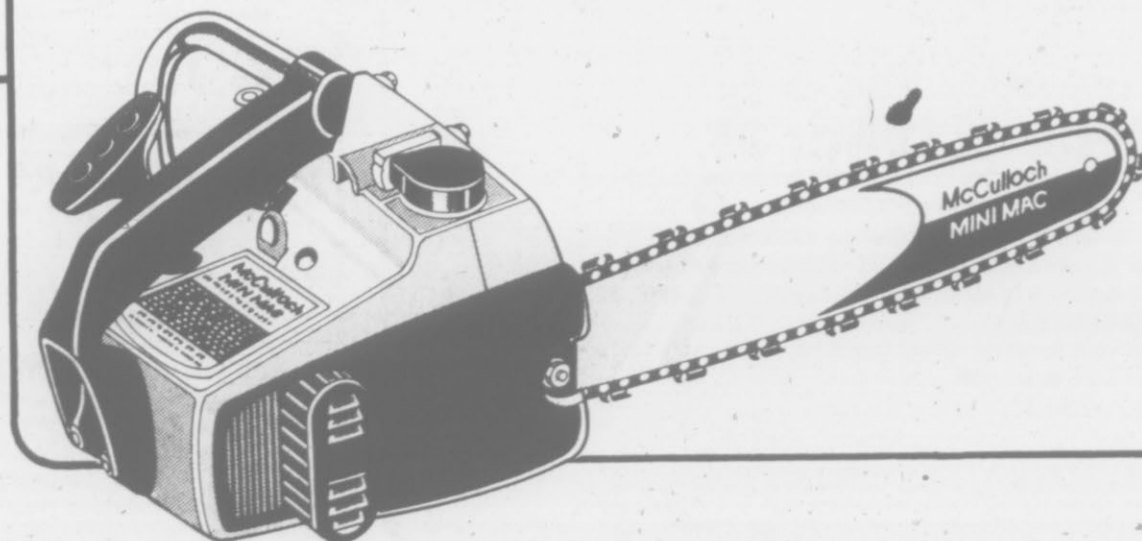

119.99

Seven pound lightweight saw with 14" bar and chain, mastergrip handle with grouped controls, automatic safety clutch, automatic rewind starter. Water resistant ignition; automatic plus manual oiling.

JCPenney

auto center sale

25% off steel belted radial tires.

A. Survivor steel radial tire. Four rayon belts and one steel belt on two radial body plies. 7 ply tread with wrap around design. Wide modern profile. No trade-in required. Whitewall tubeless.

Tire size	Save	Reg.	Sale	+ fed. tax
BR70-13	11.25	45.00	33.75	2.28
ER70-14	13.25	53.00	39.75	2.79
FR70-14	14.00	56.00	42.00	3.04
GR70-14	14.50	58.00	43.50	3.18

Tire size	Save	Reg.	Sale	+ fed. tax
GR70-15	15.00	60.00	45.00	3.22
HR70-15	15.75	63.00	47.25	3.42
LR70-15	16.75	67.00	50.25	3.86

B. JCPenney steel belted sport radial. Four rayon belts and one steel belt on two radial body plies. Wrap-around tread. No trade-in required. Whitewall tubeless.

Tire size	Save	Reg.	Sale	+ fed. tax
155R-13	9.99	39.95	29.96	1.72
165R-13	10.24	40.95	30.71	1.93
165R-14	10.74	42.95	32.21	1.99

Tire size	Save	Reg.	Sale	+ fed. tax
155R-15	10.74	42.95	32.21	1.92
165R-15	11.24	44.95	33.71	2.17

Low prices on polyester cord tires.

C. Reliant Polyester. Four ply polyester cord tire in the wide, modern 78 series profile. Wrap around tread, white sidewalls. No trade-in required. Whitewall tubeless.

Tire size	Price	+ fed. tax
B78-13	17.00	1.83
F78-13	23.00	2.41
G78-14	24.00	2.50

Tire size	Price	+ fed. tax
560-15	17.00	1.78
G78-15	25.00	2.67
H78-15	26.00	2.74



Save \$5 on Survivor 36.

Reg. 27.95 with trade-in. Sale 22.95 with trade-in. Survivor 36. Our low cost 12 volt battery that gives reliable performance. Ideal for the low mileage motorist. And it's guaranteed for 3 years with 12 month replacement at no extra charge. Available in sizes 24, 24F, 22F, 22NF, 29NF, 42, to fit most American cars. Survivor 36 six volt battery, sizes 1 and 19L. Reg. 24.95 with trade-in. Sale 19.95 with trade-in. Without trade-in, add \$3.

Survivor 36 Guarantee
Should any JCPenney Survivor 36 Battery fail to hold a charge within 1 year from the date you bought it from us, just return it to us. We will replace it with a brand new Battery at no extra cost to you. After 1 year, but during the guarantee period, we will replace the Battery charging only for the time you have owned it, based on the price at the time of return, pro-rated over the guarantee period.

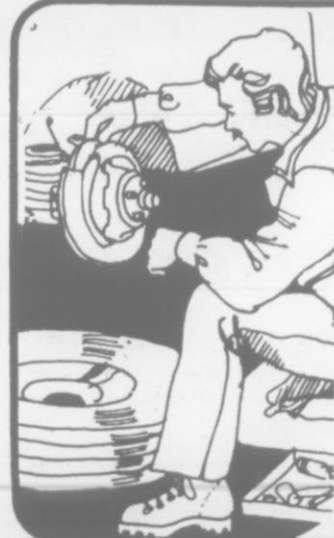

Save 30% Drum Brake overhaul.*

Installation of new JCPenney Stop Action™ linings, rebuilding wheel cylinders, new front grease seals, and more. Save 30% also on our Disc Brake overhaul.

*Most American and many foreign cars.

Sale 1.99

Reg. 2.29 to 2.69. Windshield wiper blades and refills for most cars.



Sale 3.33

Reg. 4.49. 8' 10 gauge booster cable. Shock resistant plastic grips, copper wire.

Special Buy tune-up pkg. 49.88

Package includes a Timing light measures 0 to 1500 RPM. 12 volt only and an Engine analyzer which can be used on 12 volt, 4, 5 or 8 cylinder systems.



Special Buy combo 34.88

You get a 12 volt Xenon timing light and dwell/tachometer set.





**Now
28.99**

Wilson T-2000 steel racket. Closely matched main and cross strings for more effective hitting action, slip-resistant leather grip.

**Now
34.99**

Wilson T-3000 steel racket designed for the more powerful player. Modified crossbar design.

Compare our low prices on famous make Wilson steel tennis rackets.



Big buys on tennis balls.

2.19 Your choice

Pennsylvania Centre Court tennis balls. Regular or heavy duty. Pressurized can of 3.

Spalding championship tennis balls. Regular or heavy duty for all surface courts. Pressurized can of 3.

Slazenger nylon-armoured tennis balls from England. Pressurized can of 3.

Wilson championship tennis balls for all surface courts. Regular or heavy duty. Pressurized can of 3.

Top tennis buys.

\$6

Men's cotton knit tennis shirt with placket front, extra long tail. White, blue, yellow. S, M, L.

10.99

Men's no-iron polyester double knit shorts with 'built-in' stretch, elastic waist, cotton terry pockets. White, blue, yellow. 30-40.

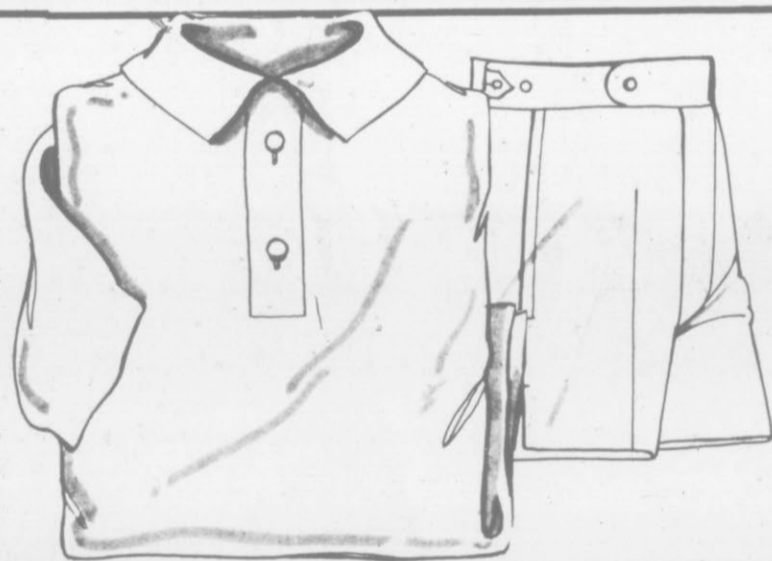

Big buys on back-packer gear.

34.99

Two-man back-packing wall tent. Easy-to-put-up unit measures 5x7', weighs just 4 lbs, has sturdy nylon walls.

22.99

Nylon backpack with frame weighs only 3½ lbs, has water-resistant finish nylon bag, anodized aluminum frame.

13.99

Deluxe nylon rucksack has built-in frame, backband, waist belt, vinyl bottom plus lashing straps to accommodate bow/arrows, shoes, ski poles.



Save 20% on sleeping bags.

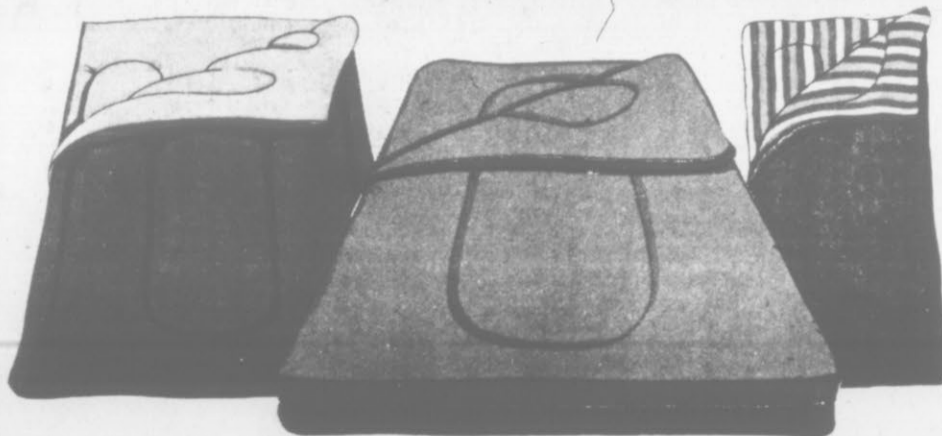

Sale 12.77 ea.

Reg. 15.99 ea. Novelty sleeping bag assortment: Red/white/blue, 'Bud', 'Atheletes', 'Airline' and many other prints. Cotton or nylon shells over polyester fiberfill. Nylon or cotton flannel linings. All with full-separating zippers, all full-size and machine washable.

Sale prices effective thru this weekend only. Like it? Charge it. Use your JCPenney charge account.

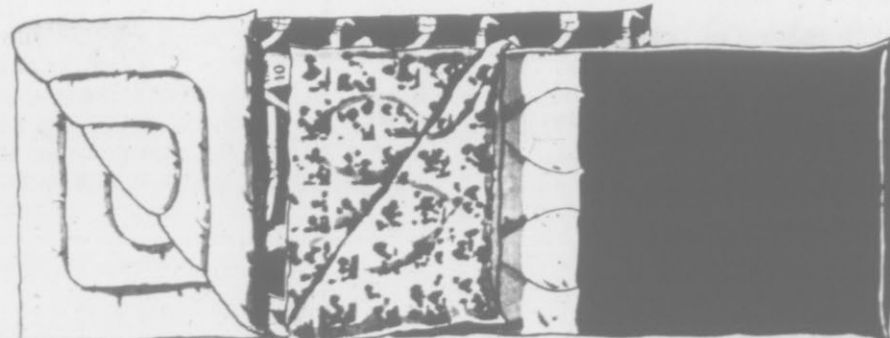

Sale 9.99

Reg. 12.88. Sleeping bag of rugged cotton poplin over 3 lb. polyester fiberfill. Cotton flannel lining, 100' zipper.

Sale 13.99

Reg. 17.88. Extra long sleeping bag of durable nylon over 3 lb. Dacron 88® polyester fiberfill. Nylon lining, 110" zipper.

Sale 18.99

Reg. 23.99. Deluxe sleeping bag of nylon oxford over Dacron 88® polyester fiberfill with cotton flannel lining, 100" zipper.

JCPenney

20% off our entire line of men's dress shirts.



Sale 5.60

Long sleeves, reg. \$7
Short sleeves, reg. \$6, Sale 4.80
Classic light tone polyester/cotton shirt with long point collar, tapered waist. Tan, blue, cream, grey and more. 14½-17.



Sale 5.60

Reg. \$7. White-on-white polyester/cotton shirt with long point collar, tapered waist. 14½-17.



Sale 8.80

Reg. \$11. Fancy Ultressa® texturized polyester shirt with long sleeves, fused long point collar. Neat fashion patterns on white grounds. 14½-17.

Sale \$8

Long sleeves, reg. \$10,
Short sleeves, reg. \$9, Sale 7.20
Ultressa® light tone or fancy shirts of texturized Dacron® polyester with 'stay crisp' fused collar. Choose dobby or satin decorated styles or classic pastels. White, blue, green, tan, more. 14½-17.

Sale prices effective thru this weekend only. Like it? Charge it. Use your JCPenney charge account.

CLARKS IS FOR THE PEOPLE

Prices Effective Wednesday, October 2nd Thru Saturday, October 5th



HOME MAKER'S

SALE



**White Muslin
Twin Fitted Sheets**

2 FOR 3.00

Special purchase of 100% cotton muslin twin fitted sheets with elasticized corners.





**Mr. Coffee II
Coffee Maker**

24.97

Perfect tasting because you can't over perk. Grounds stay in a no-mess filter for easy clean up. 10-cup capacity. No. CB500

Sure Super Dry Antiperspirant

68¢

9 oz. size in regular or unscented.

Limit 1 Please





3 Yds. x 18" Self Adhesive Vinyl

88¢

Reg. 1.48

Easy to cut and long lasting.

Renuzit Solid Air Freshener

39¢

Reg. .67

7 oz. size, assorted scents.

Limit 2 Please



RAINCHECK

If we sell out of any advertised specials, you will receive a written order, "Rain-check" which entitles you to buy the item at the advertised price when our stock is replenished.

* (excluding clearance items)

WEST END SHOPPING CENTER, GREENVILLE

MON. thru SAT., 9:30 A.M. to 9:30 P.M.



Just say "CHARGE-IT"

PENNY-WISE PRICES!



**Slim Jim Taffy Or
Jolly Rancher Stix Kisses**

Your Choice **58¢** EA.

Assorted flavors in taffy rolls or hard candies. 100 slim jims or 18 oz. bag jolly rancher.



**Boyer Mallo Cups
Or Smoothies**

39¢ EA.

Package of 10. Perfect for school lunches or after-school snacks.



**One-A-Day Multiple
Vitamins Plus Iron**

1.99
Bottle of 100.



Scope Mouthwash

69¢
18 oz. size.
Limit 1 Please



**Efferdent Denture
Cleanser**

68¢

40 tablets. New extra strength. Limit 1 Please



Breck Shampoo

79¢

11oz. bottle for normal, dry or oily hair.

Limit 1 Please



Carefree

Carefree Food Wrap & Storage Bags

49¢ EA.

200 ft. of clear plastic wrap or 50 food storage bags.

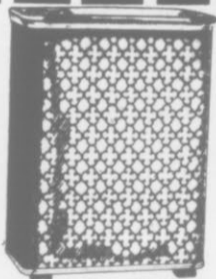

Jumbo Vinyl Hamper

Reg. 13.77 **9.99**

Size 12" x 21" x 29" quilted vinyl with gold colored mylar trim.



**Kitchenette Seat &
Back Replacements**

Reg. 4.94 Per Set **3.49**

Embossed vinyl box type seat with curved, padded back. Bright colors.



Bar Or Step Stools

1 Reg. 11.79 ea. **9.99**

Bar stool is 28" high. Step stool folds to 4 1/2". Both have non-skid caps.



Bath Scale

Reg. 4.49 **3.44**

300 lb. capacity. Self-leveling movement, fully adjustable.



Top 5 LP's

3.77 EA.

Mfg. List Price 6.98

Choose from Bachman - Turner: Not Fragile, Paper Lace: The Night Chicago Died, Bachman - Turner Overdrive II, Rush Or Ohio Players: Skin Tight.

GREAT GIFTWARES!



Ironstone 40-Pc. Dinnerware Sets

Choose from 2 lovely patterns. "Blue Willow" & "Blue Onion". Service for 8 includes: 8 each cups, saucers, 6" soup, 6" plates & 10" plates.

12.99

Reg. Low Price 18.99



No. 793B

General Electric Toaster Oven

23.99

Features removable crib tray; large glass window, toast color control & more! Toasts, browns & bakes!

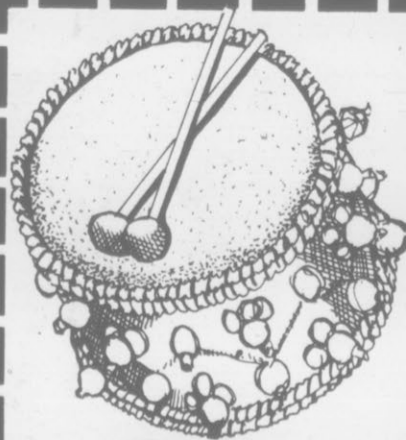

Holiday Drum Ornament Kit

Reg. 1.29 **77¢**

Contains complete trim accessories & instructions.

Ornament Kits

2.49



Fall Bulbs For Spring Blooms

Reg. .99 **77¢**

Top quality bulbs for tulips, hyacinths, crocus & daffodils.



24 Pc. Beverage Set

Reg. 3.99 **2.99**

Set contains 8 each 6 oz. juice, 12 oz. beverage & 9 oz. on-the-rocks glasses. Gold only.



Metal Photo Frames

Reg. to 1.99 **88¢**

5" x 7" & 8" x 10" frames in regular or non-glare glass. Two-way easel & hanger.

16" x 56" Door Mirror

3.33

Reg. 4.99



Copper plated mirrors with 1" natural hardwood frame. Easy to mount. No. SSWN1656



Wrought Iron Giftwares

Reg. 4.97 **3.97** EA.

Your choice of hurricane lamps, wine & chill decanter, 2-tier server with candle, 3 bowl server.



24" x 48" Framed Paintings

4.99

Reg. Price 7.99

Copies of many paintings to fit any decor.



Electric Teapot

Reg. 4.99 **3.99**

Gaily colored ceramic teapot. Ideal for brewing tea in offices, dorms, etc. 4-cup capacity.



Decorator Fruit Basket

Reg. 5.97 **4.97**

Colorful lacquered plastic fruits & vegetables accented with dainty florals & foliage.

Larger size Reg. 7.97 6.97

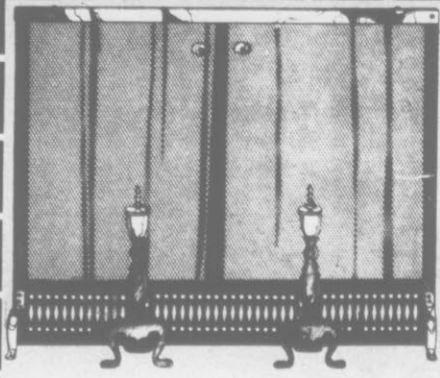

Fireplace Ensemble

34.87

Reg. Low Price 44.87
7-piece in black & brass
finish. 31" x 38".

CLARKS IS FOR THE P

Kar Kare Battery Sale

2 Year
Warranty

17.94

Plus
Exchange

3 Year
Warranty

22.94

Plus
Exchange

Lifetime
Warranty

29.94

Plus
Exchange

Spark Guard Or Log Crib

9.99

Reg. Low Price 13.96

31" x 38" guard has black
screen & trim. 40" diameter-
crib of bonderized steel tube.

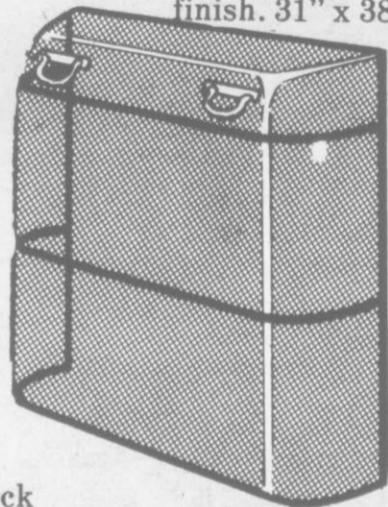

Your
Choice



24" Cast Iron Grate

For coal or wood.

8.88

Reg. Low Price 12.88



Carefree Satin Or Driplless Latex Paint

3.99

GAL

Reg. Low Price 4.97

Satin, a driplless latex
enamel for woodwork, kit-
chen or bathroom.
Driplless, a scrubable
latex for walls or ceiling.

Carefree Latex Flat Wall Paint

2.99

Reg.
3.97

Latex for walls and ceilings.
White and colors.

Golden Carefree One-Coat Interior Latex Wall Paint .. Reg. 5.97 **4.99**

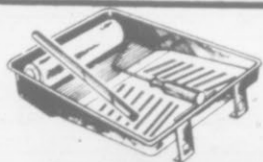

9" Roller Kit

Reg. .99 **77¢**

With tray & handle.



10' x 20' Plastic Drop Cloth

Reg. 2.68 **1.99**



5 Lb. Patching Plaster

Reg. 3.96 **2.96**

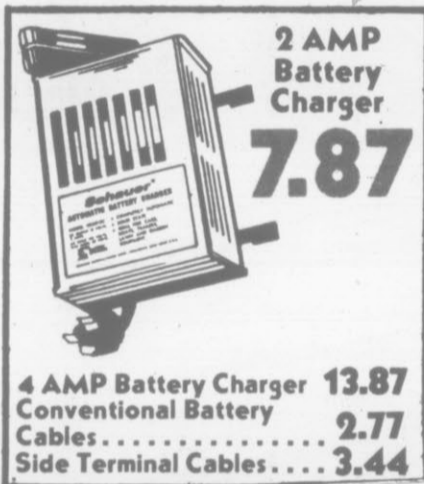

2 AMP
Battery
Charger

7.87

4 AMP Battery Charger 13.87
Conventional Battery 2.77
Cables 3.44
Side Terminal Cables 3.44

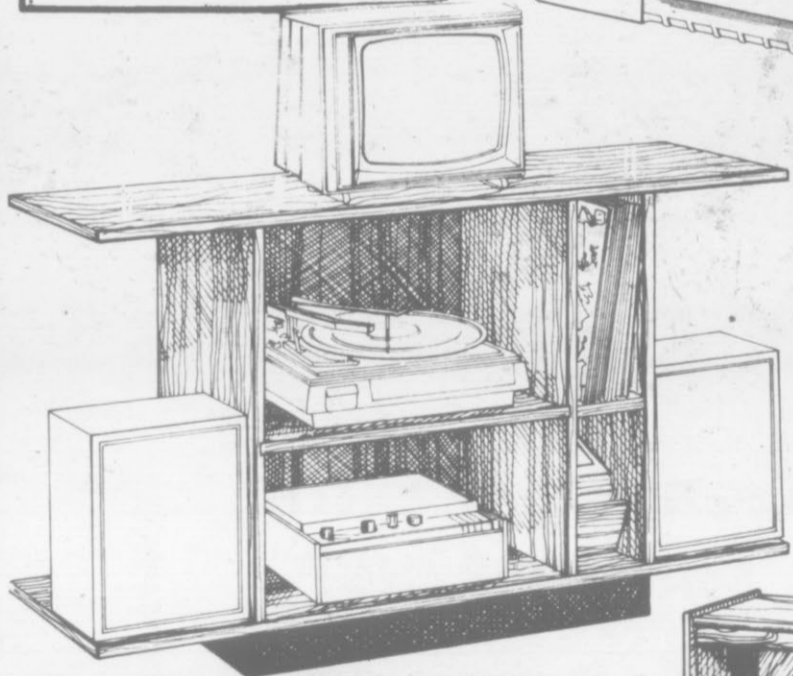

Home Entertainment Center Or 48" Open-Front Bookcase

Reg.
Low Price
28.99 ea.

19.99

Your
Choice

Entertainment center: good sound
reproduction separation, slide-out turn-
table shelf, ample storage. No. 345. Book-
case 31 3/4"H x 48"W x 11 1/2"D. No. 120



OPLE



2 Year Warranty
 Free replacement within 6 mos. of purchase if battery proves defective. After 6 mos. if defective we will replace battery & charge you a prorated price based on length of ownership & regular selling price at time of return.

DURALIFE
 STANDARD

3 Year Warranty
 Free replacement within 12 mos. of purchase if battery proves defective. After 12 mos. if defective, we will replace battery & charge you a prorated price based on length of ownership & regular selling price at time of return.

DURALIFE
 ORIGINAL EQUIPMENT

Lifetime Warranty
 Lifetime warranty is guaranteed to original purchaser for the life of the passenger car. It will be replaced free if it fails to accept or hold charge. Guarantee not transferable to any other car, nor valid if battery failure results from neglect or abuse.

Shelf Bookcase
9.99
 Pine lumber for lasting use. Ready to paint or stain. No. 9236

Storage Bench
 Reg. 19.94 **15.99**
 16" x 34" x 23" ready-to-paint bench of quality construction. No. 9000

3 Piece Set Stack Tables
 Reg. 14.99 **11.99**
 Your choice of marble or walnut look-tops. No. 20S, No. 30S

3 Piece Set Stack Tables
 Reg. 14.99 **11.99**
 Your choice of marble or walnut look-tops. No. 20S, No. 30S



Redecorate With Lighting
Table Lamps
9.99 Reg. Low Price 16.99 to 23.49

Many styles, shapes & colors to complement your decor.

Decorator Swags
8.88 Reg. Low Price 12.99

Exciting chain lights to add richness to your room! Stunning shades with matching trim. Velvet shades. Glass shades with black or brass fittings.

Sorry Not All Styles In All Stores

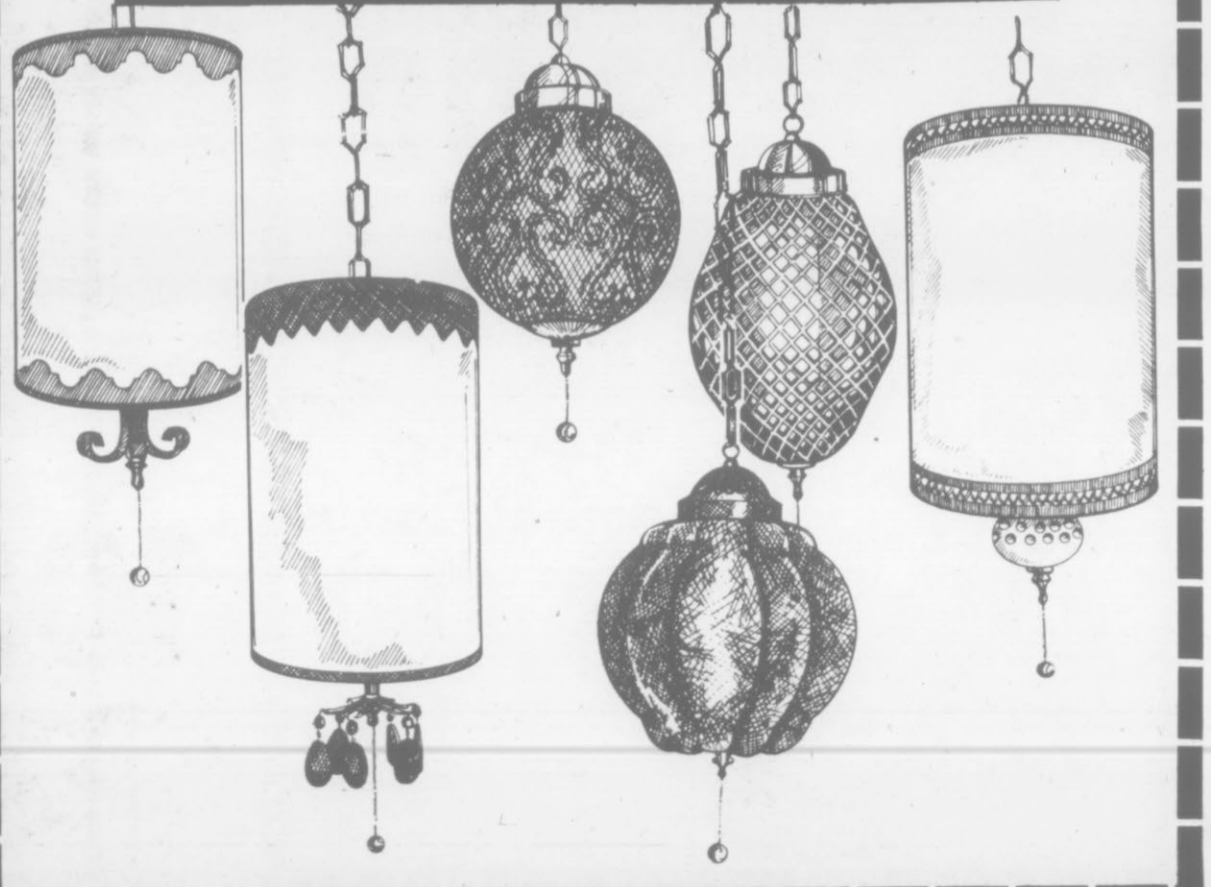

A STRONG CASE FOR SAVINGS!

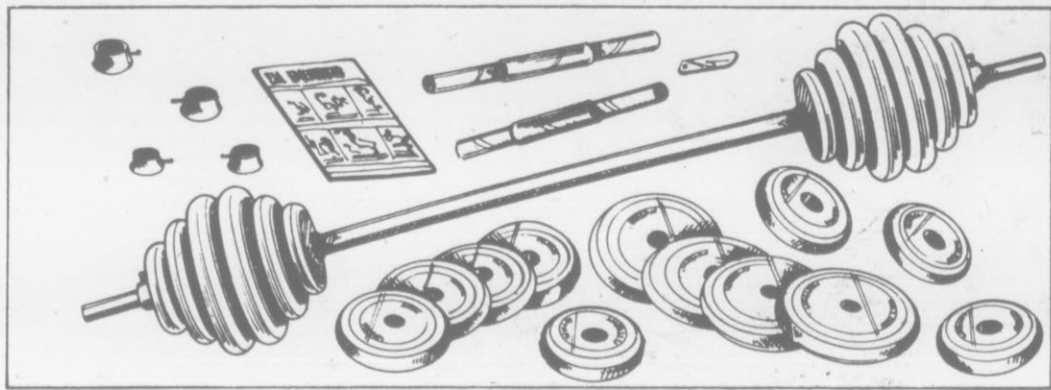

110 Lb. Barbell Set Or Bench Press

Reg. Low Price 19.97

16.88

Padded bench press, steel construction. EB-3. Barbells have 10 lb., 5 lb., 2 1/2 lb. interlocking plates, 2 14" dumbbell bars & 4 collars. No. DG110

B
BILLARD

Exercise Bike

Reg. 44.94
34.94

Reg. Low Price 44.94

16" wheel on 20" welded frame. Adjustable handle bars. Molded plastic hand grips, chain guard & tension control. No. TR25

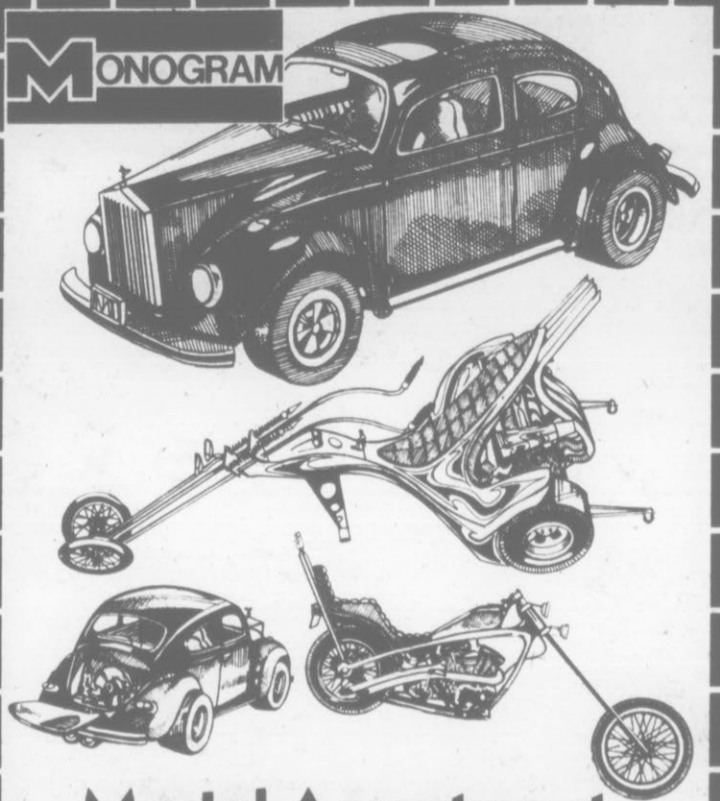
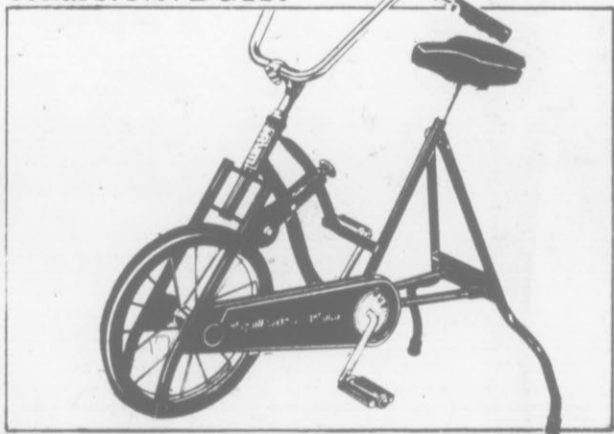

Model Assortment

2.77 EA.

Reg. Price 3.32 ea.

Choose from 5 models: Elegant beetle, Muscle bug, Satan cycle, Grim reaper & Vampire.

LEATHER FOOTING FOR MEN!



Men's Work Oxfords
8.00

Reg. Price 10.99
Full-grain leather, Goodyear welted to soles and heels. Cushion insoles. 6 1/2-12.

Six Inch Work Boots

9.00

Reg. Low Price 11.99

Durable leather uppers; soft suede tongue. Oil-resistant, one-piece bottom. Sizes 6 1/2-12.

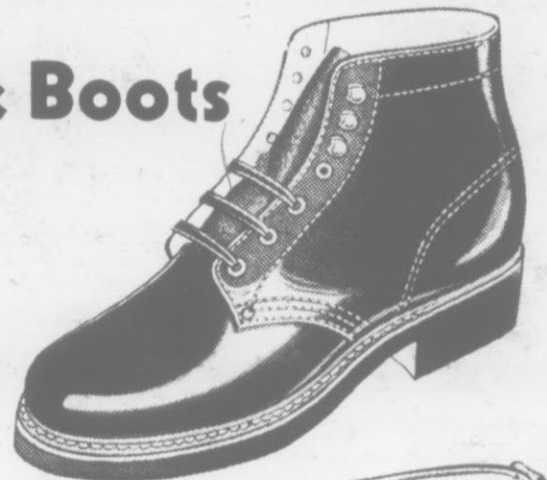

Eight Inch Combat Boots
13.00

Reg. Price 16.99

Genuine leather uppers. Heavy-duty paratrooper boots with extra tough toes & backs. 6 1/2-12.

10.00

Reg. Low Price 13.99

Durable golden leather, stitched for strength. Goodyear welted. 6 1/2-12.



GUYS & GALS WEAR!

Men's Work Coveralls



10.49

100% cotton twill. Fully cut anchored pockets, reinforced seams, & self-lock zipper. Sizes 36-46.

Men's Work Sets Our Own Brand "Big Brad"

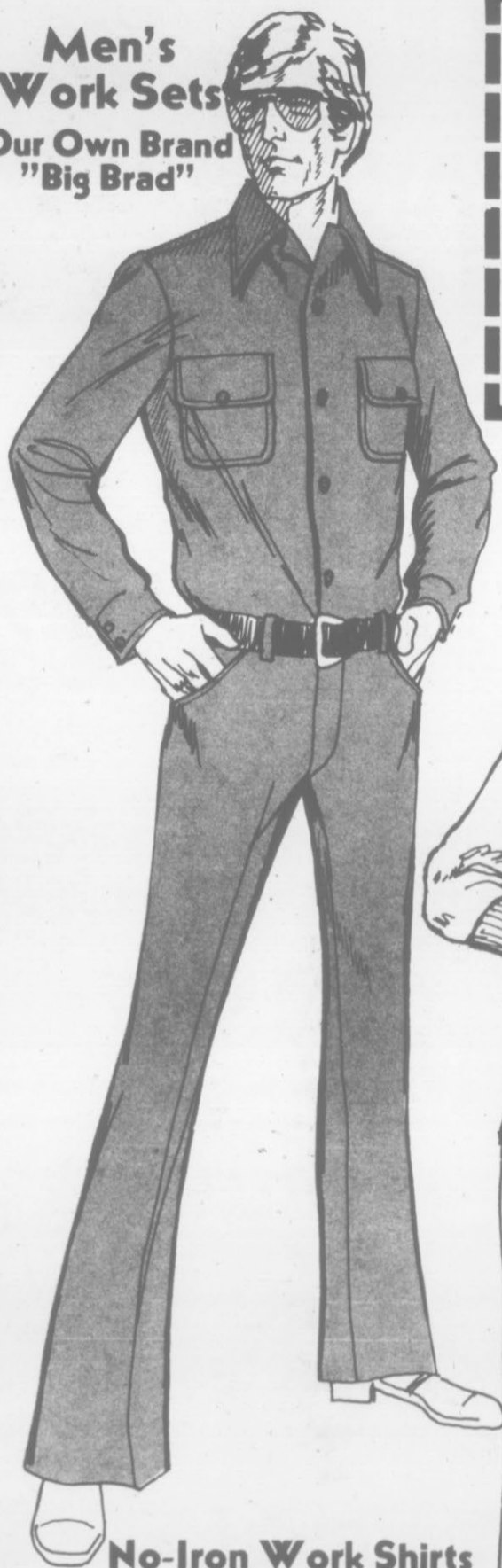

No-Iron Work Shirts

Reg. Low Price 5.69

4.49

No-Iron Work Pants

Reg. Low Price 6.69

4.99

65% Dacron Polyester/35% Cotton. Fully cut shirt & pants. Reinforced seams, anchored buttons & no-iron ease! Waist sizes 29-42, shirt sizes 14 1/2-17.



Men's Work Caps

Reg. 1.79

1.25

Washable polyester & cotton blends. Water repellant. Many colors. Sizes 6 7/8 - 7 5/8.



Men's Jersey Work Gloves

Reg. .79

50¢

Brown cotton jersey with knit wrists. The all purpose glove. Sizes S,M,L.

Men's Chambray Work Shirt



3.99

Reg. 4.99
Long pointed collar in faded blue. 100% cotton chambray weave. Sizes 14 1/2-17.

Men's Denim Dungrees

4.99

Reg. 6.49

100% cotton navy denim jeans. Reinforced seams and straight legs. Waist sizes 29-42.

Men's Work Socks



PKG OF **3 FOR 1.25**

Reg. 3 for 1.99

Stretch cotton & nylon anklets with cushion foot. White only. 10-13.

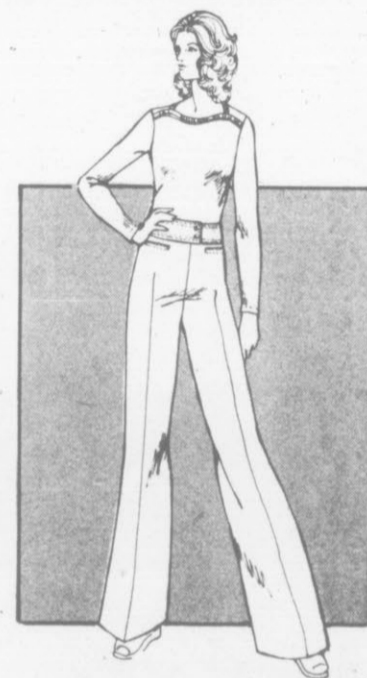

Ladies' T-Shirts

Reg. to 5.99

3.77

Cotton knit t-shirts in white, dusty pastels & fall shades to wear with jeans, slacks & skirts. Sizes S,M,L.

Misses' High-Rise Western Jeans

Reg. 7.99

6.00

Navy cotton denims with 5 pockets. Ivy buckle back. Metal snaps on waistband. Sizes 6-16.



Ladies' Western Belts

Reg. 1.99

1.39

Many styles, sizes & widths in lots of colors, & all in leather to wear with jeans.

CLARKS IS FOR THE PEOPLE

THE GREAT HOMEMAKER SALE!



KODEL

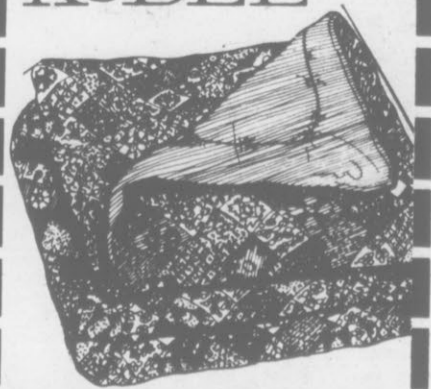

Reversible
Comforters

7.97

Reg. Price 10.99

One side is taffeta print, the other, a contrasting solid. Kodel® Polyester fill for extra warmth. Fits twin or full.



Crushed Velvet
Bedspreads & Drapes

12.99

Twin
Size

Reg. Price 18.99

Machine washable no-iron luxurious crushed velvet bedspreads & drapes in asst. colors.
Full Size . . Reg. 19.99 13.99
84" Drape Reg. 15.99 11.99



Foam-Backed
Throw Covers

Reg. 6.99
60" x 70"

4.99

Damask knit, non-slip furniture throws in a collection of colors. Machine wash.

70" x 90" Reg. 9.99 7.99
70" x 120" Reg. 12.99 9.99

Vinyl
Lace-Look
Shower
Curtains

1.00



Heavy gauge vinyl see-through shower curtains in many colors. 6' x 6' stain & mildew proof.

Sorry, No Rainchecks

Pouff
*The Rug That Revs
Nature's Fur*

"Pouff" Collins And
Aikman Fur-Like
Bath Ensemble

Reg. 2.49
18" x 30"
Rug

1.99

- 2-Pc. Tank Set Reg. 4.99 3.99
- Contour Rug Reg. 3.49 2.79
- 24" x 36" Rug Reg. 4.49 3.79
- 30" Round Rug Reg. 4.49 3.79
- 27" x 48" Rug Reg. 6.49 5.79
- Lid Cover. Reg. 1.99 1.49
- Tissue Box Cover Reg. 1.99 1.49
- Scale Cover Reg. 1.99 1.49
- Waste Basket Cover Reg. 2.99 2.49



St. Mary's
Heavyweight Jacquard
Bath Ensembles

Reg. 2.59

1.77

24" x 44" Bath Size

Reversible, all cotton terry in rich colors. Thick & thirsty.

Hand Towel Reg. 1.69 1.37
Wash Cloth Reg. .79 .67

Sorry, No Rainchecks



Printed Foam
Insulated Draperies

Reg. 6.69
63" Size

3.99

Floral or scenic prints on foam insulated antique satin.

84" Size Reg. 7.69 4.99

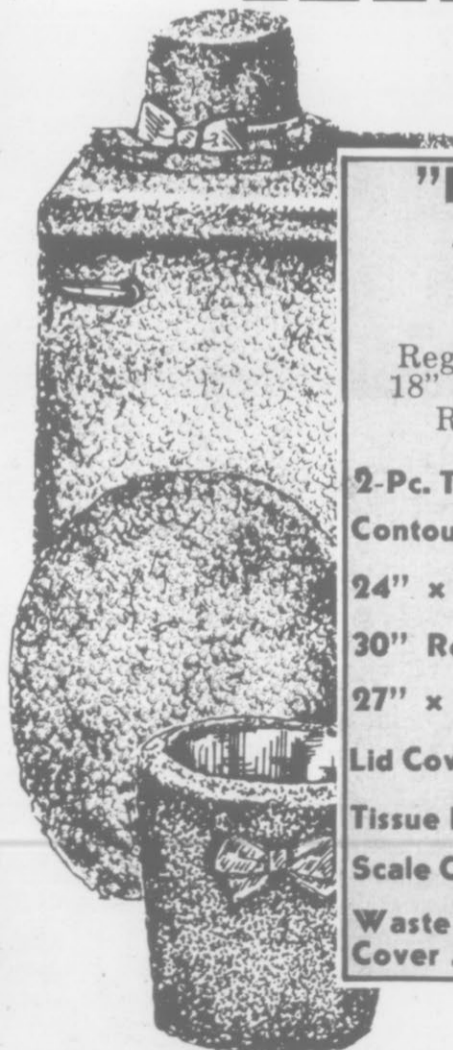

FREE
LAY-A-WAY
PLAN!

36
GREAT
STORES

NICHOLS

DISCOUNT CITY
SALE STARTS TODAY
THRU
WED. OCT. 9th

CHARGE IT
AT NICHOLS

BANK AMERICARD

Your Future

AND

master charge

GUARANTEED
LOWEST PRICES

Nichols will not be undersold. Should any competitor try to undersell us on any item advertised in this circular, bring proof of same and we will match the price.

BRAND NAME
RETAILER
OF THE YEAR
AWARD
TO NICHOLS
1979

BRAND NAMES
CONSUMER PROTECTION



**INFLATION
FIGHTING
SPECTACULAR!**

SHOP NICHOLS FOR THE MOST DYNAMIC PRICE
FIGHTING VALUES...OUR STORES ARE PACKED
WITH SAVINGS IN EACH AND EVERY DEPARTMENT
...SO BEAT THE HIGH COST LIVING WITH OUR
LOW, LOW PRICES!

SEE OUR SPECIAL
SECTION IN THIS
TABLOID FROM
PAGES 7 TO 14
PACKED WITH
SAVINGS ON
HARDWARE
PAINT &
HOME
IMPROVEMENT
SPECIALS!



**GIRLS
PILE COATS**

SIZES 4-6X

\$7

SIZES 7-14

\$8

Keeps her cozy warm when winter winds start to blow. Select from a large group of beautiful full length coats of fully washable pile fabrics. Some with hoods, shawl collars, double breasted styles, quilt lined, contrasting trims, in many yummy colors.

WE RESERVE THE RIGHT TO LIMIT QUANTITIES.

13
GREAT
STORES!
SHOP THE
STORE
NEAREST
YOU

NORTH CAROLINA

GASTONIA-2540 W. Franklin Ave.
Open Mon. thru Sat. 10 AM to 9 PM
Sun. 1 PM to 6 PM

GOLDSBORO-Interstate 70 &
Wayne Memorial Drive
Open Mon. thru Sat. 10 AM to 10 PM

GREENVILLE-Rte 7 & Greenville Blvd.
Open Mon. thru Sat. 10 AM to 10 PM

LUMBERTON-3100 Fayetteville Rd.
Open Mon. thru Sat. 10 AM to 10 PM
Sun. 1 PM to 6 PM

WILSON-1817 U.S. 301 South
Open Mon. thru Sat. 10 AM to 10 PM
Sun. 1 PM to 6 PM

VIRGINIA

COLONIAL HEIGHTS-2600 Boulevard
Open Mon. thru Sat. 10 AM to 10 PM

FREDERICKSBURG-5099 Jefferson Davis Blvd.
Open Mon. thru Sat. 10 AM to 10 PM

HARRISONBURG-Main Street & Moseby Rd.
Open Mon. thru Sat. 10 AM to 10 PM

WINCHESTER-Berryville Ave & Route 7
Open Mon. thru Sat. 10 AM to 10 PM

OHIO

ASHTABULA-North Ridge Road
Open Mon. thru Sat. 10 AM to 10 PM
Sun. 12 Noon to 6 PM

NEW PHILADELPHIA-Bowers & Wabash Ave.
Open Mon. thru Sat. 10 AM to 10 PM
Sun. 12 Noon to 8 PM

WOOSTER-3500 Lincoln Highway East
Open Mon. thru Sat. 10 AM to 10 PM
Sun. 12 Noon to 6 PM

MARYLAND

SALISBURY-Route 13 & Clyde Ave.
Open Mon. thru Sat. 10 AM to 10 PM

SUPPLEMENT TO
• GENEVA TIMES & GENEVA
SHOPPER • THE SUNDAY NEWS
• CITIZEN-ADVERTISER
• WILSON TIMES • THE ADVOCATE
& SKANEATELES PRESS
• CANANDAIGUA MESSENGER
& PALMYRA COURIER-JOURNAL
• TIMES REPORTER • GREENVILLE
REFLECTOR & SHOPPER
• THE WOOSTER RECORD
• EVENING TRIBUNE
• GENESEEWAY SHOPPER
• MERCHANDISER
• BATH PENNSAVER
• WELLSVILLE DAILY REPORTER
• ELMIRA STAR GAZETTE
• LEADER HERALD
• LITTLE FALLS EVENING TIMES
• GOLDSBORO NEWS-ARGUS
• HANOVER SUN • HOPEWELL NEWS
• PETERSBURG PROGRESS INDEX
• MARTINSBURG JOURNAL

• THE LEADER • FREE LANCE STAR
• ASHLAND TIMES GAZETTE
• OBSERVER DISPATCH-DAILY PRESS
• ROME SENTINEL • NEWS-ARGUS
• THE SHELBY DAILY STAR
• DAILY NEWS RECORD
& STAUNTON LEADER
• WINCHESTER EVENING STAR
• GASTONIA GAZETTE
• THE SALISBURY TIMES
• THE CAMBRIDGE BANNER
• THE DELEWARE STATE NEWS
• THE HAGERSTOWN MAIL
• MORNING PRESS • NEWS-ITEM
• UNION COUNTY JOURNAL
• KINSTON DAILY FREE PRESS
• DANVILLE NEWS • MILTON STANDARD
• BERWICK ENTERPRISE
• AMSTERDAM EVENING RECORDER &
COURIER STANDARD ENTERPRISE
• CHAMBERSBURG PUBLIC OPINION
• WAYNESBORO RECORD HERALD
• GETTYSBURG TIMES

SUPER VALUE PACKED SAVINGS!



BOYS' CORDUROY SLACKS

3⁹⁹

- SOLIDS
- FANCIES

Flare legs—solids and fancies—Western scoop pockets—yoke back. Plaids & checks. 100% cotton. Colors: Toast, Navy, Brown, Burgundy. Sizes 8-16.

REPEAT OF A SELLOUT MEN'S NYLON KNIT SHIRTS

2⁴⁴

Casual and comfortable knits in crew necks, collars, or mock necks. 100% nylon. Colors: White, Navy, Tan, Burgundy, Black, Brown, Blue. Sizes S-M-L-XL.

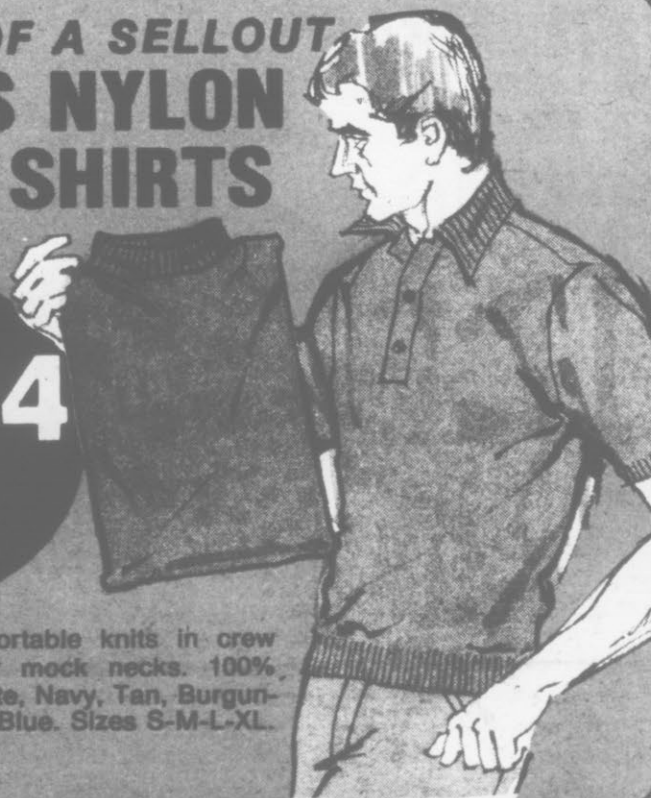

JR. BOYS' CORDUROY SLACKS

1¹⁷
EA.



50% polyester, 50% cotton slacks, with flare leg, full boxer waist, one patch pocket, in easy care permanent press. Navy, Brown, Loden & Tan. Sizes 4-7.

SHOE SAVINGS THAT WILL FIT YOUR ("BUDGET"), FEET



WOMEN'S AND TEEN'S PENNY LOAFERS

2⁴⁷

Moc Toe ... one piece molded sole and heel, penny saddle vamp ... extended sole ... in dark brown ... sizes 5-10.

NICHOLS REG. LOW, LOW PRICE \$3.29



WOMEN'S SIDE BUCKLE STEP-IN

3⁹⁷

Strap and buckle center seam vamp, low one piece sole and heel, knit fit lining, comes in brown. Sizes 5-10.

NICHOLS REG. LOW, LOW PRICE \$4.99



WOMEN'S AND TEEN'S SOFTEE SUEDE OXFORD

Genuine suede upper ... thick one piece molded rubber sole ... 2 eye tie ... made in Spain ... in brown ... sizes 5-10.

NICHOLS REG. LOW, LOW PRICE \$5.97



MEN'S OXFORD

Moc Toe ... 3 eye tie ... low sole and heel for comfort ... comes in brown ... sizes 7-11.

NICHOLS REG. LOW, LOW PRICE \$5.97

YOUR CHOICE
\$4⁸⁸

MEN'S 8" INSULATED WORK BOOT

9⁷⁷

NICHOLS REG. LOW, LOW PRICE \$11.97

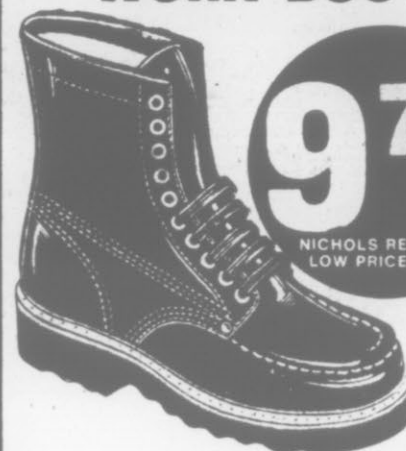

Easy care uppers ... thick cushioned oil resistant sole ... lug sole ... stitched moc toe in brown ... sizes 7-11.

SAVE ON EVERY PURCHASE...AT EVERY COUNTER...EVERY DAY!

CHARGE IT
AT NICHOLS



AND



SENSATIONAL SAVINGS FOR MEN!

REPEAT OF A SELL-OUT MEN'S DENIM DUNGAREES



4.99
EA.

Rugged and durable denims featuring flare legs, contrast stitching, metal rivets at points of strain. 100% cotton, Navy blue, Sizes 30-38. 2 front scoop pockets, 1 coin pocket, 2 back patch pockets.

GUARANTEED LOWEST PRICES

Nichols will not be undersold. Should any competitor try to undersell us on any item advertised in this circular, bring proof as same and we will match the price.



MENS WOOL PLAID C.P.O. JACKETS

Out of our big, brawny collection of men's jackets comes this pile lined C.P.O. jacket! Features 2 flap breast pockets and anchor buttons. Select from assorted color plaids in both light and dark shades. Sizes; S-M-L-XL. Handsomely shaped wool C.P.O.'s for winter activities!

\$12

NICHOLS REG. LOW PRICE 16.73

MEN'S RIB CREW SOCKS



1.66
PKG.
OF 4

Get more for your money with this great 4-pack of 100% combed cotton rib crew socks. White only. Sizes 10-13.

INSTANT EASY CREDIT...ACTION WITH SATISFACTION

CHARGE IT
AT NICHOLS



AND



SHARP REDUCTION FROM STOCK!

SUPER SAVINGS!



SAVE \$2.97 to \$5.97

**LADIES
BLAZERS**

\$8



NICHOLS REG. LOW PRICE 10.97 TO 13.97

Every blazer in stock priced at 10.97 to 13.97 all at one low price **YOUR CHOICE \$8**. A full range of styles, popular flap, button and pocket detailing. Solids, plaids and novelties in easy care fabrics. Sizes 8-18.

**EVERY PANT SUIT
JUNIOR - MISSES HALF SIZES!**



**↓ SUPER COUPON
SAVE 4.54 TO 6.97**

**NOTHING HELD BACK...EVERY PANTSUIT
IN STOCK PRICED AT \$16.54 TO 18.97**

Nichols huge selection of styles and sizes. The most popular fall looks, polyesters & acrylics in solids and jacquards. Sizes 5-15, 8-20, 16½-24½.

NICHOLS SUPER COUPON

**SAVE \$4.54 TO \$6.97
EVERY PANTSUIT
WITH COUPON ONLY...**

WITH COUPON ONLY

\$12

COURTESY...CONSIDERATION...PLUS LOW PRICES!

**CHARGE IT
AT NICHOLS**



AND



OUTSTANDING VALUES FOR YOU!

NATIONALLY ADVERTISED AT \$8 - \$12



FAMOUS MAKER BLOUSES

You'll see the famous label-and you still won't believe the price. Trimly tailored with long sleeves in easy care fabrics. Attractive solids and prints. Latest styles. Sizes 8-16, 32-40.



FAMOUS MAKER TOPS

Quality workmanship and styling ... everything you can always be sure of from a famous maker is here at Nichols' low price. See the famous label for yourself. Many styles to choose from in long sleeve turtle, mock & crew neck. Easy care washable fabrics ... sizes S-M-L.

399



FAMOUS MAKER PANTS

Fantastic group of pants in fashionable cuffed and uncuffed styles in the most wanted fabrics; denims, acrylics, dune-buggys, & corduroys. All Easy Care. Washable. Solids and novelties. Sizes 8-16.

SEE THE FAMOUS LABEL
IN EVERY GARMENT



YOU'LL GET STYLE, FASHION AND SAVINGS...AT NICHOLS!

CHARGE IT
AT NICHOLS



AND



WATCH THESE FANTASTIC SAVINGS!



**MENS & LADIES
HELBROS WATCHES**

\$25

NICHOLS REG.
LOW LOW PRICE \$29.84

FREE
LAYAWAY PLAN
NEVER A
SERVICE CHARGE

MENS MODELS:

Calendars, day date, white and yellow gold, with expansion bands or adjustable heavy link bracelets.

**LADIES HIGH FASHION
AND DIAMOND STYLES**

ON SALE AT **\$35** NICHOLS REG. LOW PRICE 37.84

LADIES MODELS:

Nurses styles, dressy styles with tubular metal bands, tapered bracelets. All watches 17 jewels with unbreakable mainsprings and stainless steel backs for long wear.

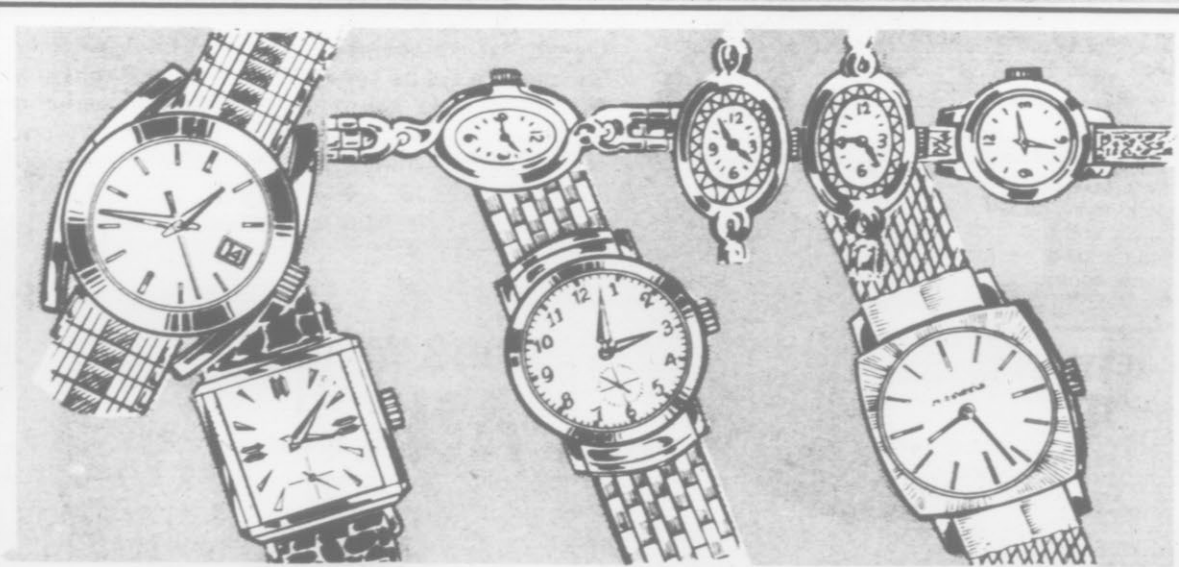

MEN'S & LADIES GRUEN WATCHES

You've heard of the name, but you've never heard of such low, low prices. Choose from a huge selection of '74 styles at '73 prices. Diamonds, day-dates, calendar watches, and more! Hurry and take advantage of this great event.

\$25 & \$30

NICHOLS REG. LOW PRICE 29.97 NICHOLS REG. LOW PRICE 34.97

NICHOLS SUPER COUPON



MFG. LIST
PRICE
4.75

TOTAL
SAVINGS
1.87

ZIPPO BRUSH FINISH LIGHTER

Dependable, long lasting,
lifetime guarantee, with
chrome finish.

NICHOLS REG. LOW
LOW PRICE \$3.49

288

WITH COUPON ONLY

WATCH THESE PRICES... THEY ARE TIMELY

CHARGE IT
AT NICHOLS



AND



NICHOLS

DISCOUNT CITY
SALE STARTS TODAY

THRU

WED. OCT. 9th



THE DO-IT-YOUR-SELF BONANZA

OF SAVINGS FOR THE HANDYMAN

NICHOLS PREMIUM QUALITY PAINT SENSATIONS



EXTERIOR LATEX
HOUSE PAINT

4⁸⁸
GAL.

NICHOLS REG. LOW PRICE 6.99
Remarkably fast drying time of 30 minutes. Bug, rain and dust damage practically eliminated. Breathes moisture for blister control.

LATEX
WALL PAINT

3⁸⁸
GAL.

NICHOLS REG. LOW PRICE 6.27
A flat heavy bodied latex wall paint. Easy to apply - usually dries in 30 minutes under normal condition - smooth appearance.



POLYURETHANE
FLOOR &
PORCH ENAMEL

4⁸⁸
GAL.

NICHOLS REG. LOW PRICE 6.99
Ideal for interior and exterior floors of wood or concrete. Recommended for stairs, porches, boat decks, etc. Abrasion resistant-gloss retention-weather resistant.

INTERIOR LATEX
SEMI-GLOSS
OR HIGH GLOSS

4⁸⁸
GAL.

NICHOLS REG. LOW PRICE 6.59
Excellent for woodwork, bathroom, kitchen walls and other interior surfaces. Easy application - easy clean up. No unpleasant odor.



AT THESE PRICES ... PAINT EVERYTHING!

CHARGE IT
AT NICHOLS



AND



THE DO-IT-YOURSELF BONANZA OF SAVINGS



12" x 12"
SOLD IN PKGS.
OF 6 TILES

MIRROR TILES

Bring new visual excitement to the decor of your home. Easy to install, just press on. Mix or match them and see the charming difference a mirrored area makes in your room or foyer.

NICHOLS REG. LOW LOW PRICE
\$3.88 PKG.

2⁸⁸
PKG.

SAVE 1.00
CLEAR
GLASS

NICHOLS REG. LOW LOW PRICE
\$5.88 PER PKG.

3⁸⁸
PKG.

SAVE 2.00
CLEAR GLASS
W/GOLD VEINS

NICHOLS REG. LOW LOW PRICE
5.88 PKG.

3⁸⁸
PKG.

SAVE 2.00
SMOKED GLASS
W/GOLD VEINS



ONEIDA ONE DROP ADHESIVE

69¢

Space age miracle adhesive. Use it for almost any bonding job. Industrial strength.

PAINT & PATCHING



BOND^{EX} INTERNATIONAL, INC.

SPECIALS



SAVE 50¢

RESURFO SPATCHLING POWDER

98¢

5 LBS.

NICHOLS REG. LOW LOW PRICE \$1.48



SAVE 30¢

PLASTER OF PARIS

68¢

5 LBS.

NICHOLS REG. LOW LOW PRICE 98¢



SAVE 60¢

Quick Plug

1.49

3 LBS.

NICHOLS REG. LOW LOW PRICE \$2.09



SAVE 1.50

ALUMINUM ROOF COATING

4.49
GAL.

NICHOLS REG. LOW LOW PRICE 5.99



SAVE 30¢

PATCHING PLASTER

63¢

5 LBS.

NICHOLS REG. LOW LOW PRICE 93¢



SAVE 2.00

TEXTURED WALL PAINT

3.99
GAL.

NICHOLS REG. LOW LOW PRICE \$5.99 Gal.



SAVE 2.00

MOBILE HOME COATING

4.99
GAL.

NICHOLS REG. LOW LOW PRICE \$6.99 PER GAL.



SAVE 1.50

SILICONE WATER PROOFING

4.49
GAL.

NICHOLS REG. LOW LOW PRICE \$5.99

QUALITY YOU CAN DEPEND ON...AT NICHOLS

CHARGE IT
AT NICHOLS



AND



THE DO-IT-YOURSELF BONANZA OF SAVINGS!

 <p>SAVE 1.00</p> <p>ARCO WHIZZ-DISC Silicon carbide cutting wheel & sanding disc. Cuts steel, wood masonry.</p> <p>1 69 NICHOLS REG. LOW, LOW PRICE \$2.69</p>	<p>ARCO</p>  <p>SAVE 1.00</p> <p>MAGNETIC SCREWDRIVER 4-screwdrivers in one! Magnetic power holds screw & bit in place.</p> <p>2 99 NICHOLS REG. LOW, LOW PRICE \$3.99</p>	 <p>SAVE 1.00</p> <p>REVERSIBLE SPEED REDUCER & SCREW DRIVER Reverses instantly for driving & removing screws, nuts, bolts. Speed reducer increases drill power 11 times.</p> <p>4 99 NICHOLS REG. LOW, LOW PRICE \$7.99</p>	 <p>BERNZ-O-MATIC</p> <p>PROPANE FUEL CYLINDER (TX-9)</p> <p>1 17 NICHOLS REG. LOW PRICE \$1.49</p>	 <p>BERNZ-O-MATIC</p> <p>DELUXE TORCH KIT W/ACRYLIC CUTTER CT25</p> <p>4 99 NICHOLS REG. LOW, LOW PRICE \$6.39</p>	 <p>SAVE 2.60</p> <p>PROPANE JET TORCH</p> <p>5 99 NICHOLS REG. LOW, LOW PRICE \$8.59</p>
---	---	--	---	--	---



NICHOLS PREMIUM QUALITY 100% LATEX ACRYLIC ANTIQUE FINISHING KIT

SAVE 1.11

DON'T THROW IT OUT... ANTIQUE IT!

Change that old piece of furniture into useful elegance with this 100% latex Acrylic Antique Finishing Kit. Just 2 easy steps. Dries in 2 hours.

1 88
NICHOLS REG. LOW, LOW PRICE 2.99



NICHOLS PREMIUM QUALITY SPRAY ENAMEL

13 OZ. CAN

69¢

NICHOLS REG. LOW, LOW PRICE 99¢
Excellent for use on metal & wood toys, indoor & outdoor furniture.

EPOXY SPRAY PAINT

16 OZ. CAN.

1 19
HELPS GIVE APPLIANCES A NEW LOOK
NICHOLS REG. LOW PRICE \$1.89

EPOXY SHADOW TONER

8 OZ. CAN

79¢
NICHOLS REG. LOW LOW PRICE 99¢



9x12

PLASTIC DROP CLOTHS
PKG. OF 3

Protects furniture during painting, protects windshield, toys etc. from foul weather. 101 uses.

69¢



SAVE 1.00

SUNNY DRY WATERPROOF CEMENT PAINT
25 lb. box (Powder)

Nichols low price makes winter preparations easier on the pocketbook.

2 69
NICHOLS REG. LOW, LOW PRICE \$3.69



6 FT. ALL ALUMINUM STEP LADDERS
by SCRANTON

Non-slip rubber end caps prevent marking of surfaces and aid in carrying and storing.

15 88 EA.
NICHOLS REG. LOW, LOW PRICE 20.88



RED DEVIL PAINT PRODUCT SPECIALS

SAVE 30¢ 1/2 PT. TO 1.00 PER QT.

Give a new lease on life to wood and metal indoor and outdoor, furniture, etc. Just apply, let dry, and... it looks new!

<p>ENAMEL</p> <p>1/2 PINTS 89¢ NICHOLS REG. LOW PRICE \$1.29</p>	<p>OIL STAIN</p> <p>1/2 PINTS 69¢ NICHOLS REG. LOW PRICE 99¢</p>	<p>VARNISH STAINS</p> <p>1/2 PINTS 69¢ NICHOLS REG. LOW PRICE 99¢</p>
<p>PINTS 1 39 NICHOLS REG. LOW PRICE \$1.99</p>	<p>PINTS 1 09 NICHOLS REG. LOW PRICE \$1.59</p>	<p>PINTS 1 09 NICHOLS REG. LOW PRICE \$1.59</p>
<p>QUARTS 2 29 NICHOLS REG. LOW PRICE \$3.29</p>	<p>QUARTS 1 79 NICHOLS REG. LOW PRICE \$2.49</p>	<p>QUARTS 1 79 NICHOLS REG. LOW PRICE \$2.49</p>

FIRST QUALITY MERCHANDISE...FULLY GUARANTEED

CHARGE IT AT NICHOLS



AND



NICHOLS



YOUR DYNAMIC PRICE FIGHTER

THE DO-IT-YOUR-SELF

BONANZA

1 YR. AUTOMATIC OVER THE COUNTER EXCHANGE GUARANTEE

EXPECT THE BEST FROM **B&D Black & Decker** FOR LESS THAN YOU EXPECT

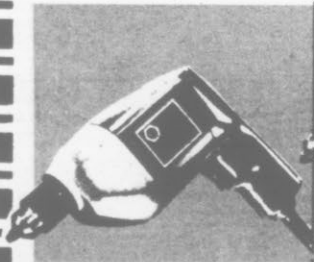

NO. 7004

1/4" DRILL

7⁴⁹

NICHOLS REG. LOW PRICE 8.99

A good choice for light duty work and occasional building or remodeling projects.

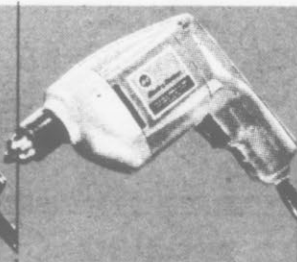

NO. 7104

3/8" DRILL

8⁹⁹

NICHOLS REG. LOW PRICE 10.49

Great general-purpose drill for most home owner and workshop use.



NO. 7307

7 1/4" CIRCULAR SAW

16⁹⁹

NICHOLS REG. LOW PRICE 19.99

A great saw for just about any home carpentry project. Combination blade included.



NO. 7610

ROUTER

36⁹⁹

This tool cuts, routs, grooves, trims and decorates in wood, plastics & composites.



NO. 7504

JIG SAW

8⁹⁹

NICHOLS REG. LOW PRICE 10.49

Makes straight, curved and scroll cuts in wood, metal and other materials.

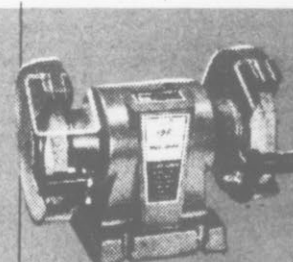

NO. 7900

BENCH GRINDER

25⁹⁹

NICHOLS REG. LOW PRICE 31.99

Includes 5" med. and 5" coarse grit grinding wheels, tool rest, steel guard covers, eye shields and rubber feet.



NO. 7404

FINISHING SANDER

14⁹⁹

Perfect for fine finishing wood, metal and plastics. One or two hand control.

raaco

METAL UTILITY CABINETS w/PLASTIC TRAYS

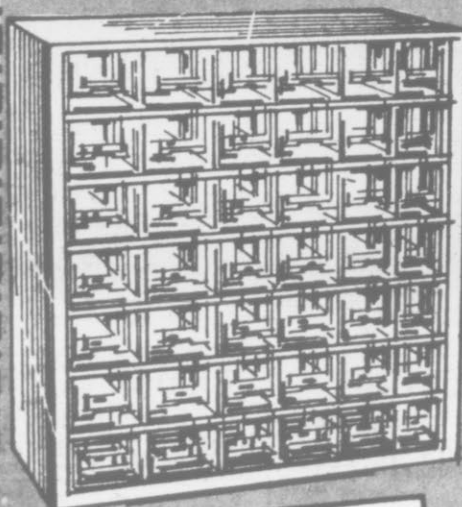

SAVE FROM \$2.00 TO \$3.00

Keep the workshop tidy and all those little articles safely put away ... but always in view for immediate use. Great for sewing notions & hobbies.

U-35 (as shown) 35 PLASTIC TRAYS

w/handles
13"H, 12"W, 5 1/4"D.

6⁹⁹

NICHOLS REG. LOW PRICE 9.99

U-15 15 PLASTIC TRAYS

7" High, 12" Wide, and 5 1/4" Deep

3⁹⁹

NICHOLS REG. LOW PRICE 5.99



TOOL BOX SPECIALS

AA-130 LOW COST UTILITY BOX FOR 1,000 and 30 USES.

13-1/3"Lx6-1/2"Dx5"H. One piece steel unit with steel cantilever tray. For fishermen, home hobbies & motorists.

2⁹⁹

NICHOLS REG. LOW PRICE 3.99

SAVE \$1.00

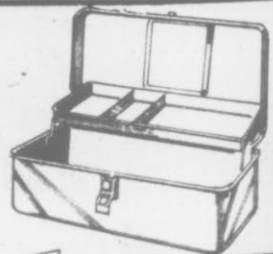

AA-190 LONG AND LOW

19"Lx9"Dx5"H. 19" length is great for long tools. Rugged construction. Full length hinge.

5⁵⁹

NICHOLS REG. LOW PRICE 7.59

SAVE \$2.00



AA-210 THE VALUE LEADER & NO. 1 SELLER

21"Lx8 5/16"Dx9 5/8"H. Storage area full 6" deep, tote tray adds another 3". Grip recess at ends.

6⁸⁸

NICHOLS REG. LOW PRICE 9.88



SAVE \$3.00

NOT RESPONSIBLE FOR TYPOGRAPHICAL ERRORS.

NICHOLS THE LARGEST HOME DECORAT

SAVINGS



NICHOLS RAINCHECK POLICY

If Nichols runs out of any merchandise advertised in this circular during this sale ... Nichols store Mgr. will be happy to write out a RAIN CHECK that will definitely assure you receiving that item soon at the advertised sale price. In apparel dept's we sometimes sell out a style no longer available to us. If so, our dept. mgr's. will help you select an equivalent value. RE: coupons. Sorry no rainchecks on coupon items; however, bring coupons to office for validation, assuring your purchase at the advertised price as soon as stock is replenished.
Signed S.E. Nichols



SAVE \$2.00

FAMOUS FABULON FLOOR FINISH

8⁶⁹

NICHOLS REG. LOW PRICE 10.89



SAVE 80¢

DEFT WOOD FINISHER

The complete wood finish that anyone can use with professional results. Dries in thirty minutes. Leaves no brush marks.

2⁶⁹ QT.

NICHOLS REG. LOW PRICE 3.49



SAVE 60¢

DAP GLAZING COMPOUND

Excellent for tightening windows as the winter winds start to blow.

1⁴³ QT.

NICHOLS REG. LOW PRICE 2.03

SAVE UP TO 60¢



Armo PAINTING & MASKING TAPE

¾"x60 yds.

47¢

NICHOLS REG. LOW PRICE 67¢

1½"x60 yds.

1⁰⁷

NICHOLS REG. LOW PRICE 1.47

1"x60 yds.

67¢

NICHOLS REG. LOW PRICE 88¢

2"x60 yds.

1²⁸

NICHOLS REG. LOW PRICE 1.88



Frost King

ALL SEASON DO-IT-YOURSELF (CONSERVE HEAT) WEATHER-STRIPPING CENTER

FIBERGLASS PIPE WRAP NO. 5P41X

64¢

NICHOLS REG. LOW PRICE 72¢



HAIR FELT

57¢

NICHOLS REG. LOW PRICE 67¢



THERM SEAL ADHESIVE COATED FOAM TAPE

NO. 1341

¾"x¼"x17'

57¢

NICHOLS REG. LOW PRICE 67¢

NO. L342

¾"x¼"x17'

77¢

NICHOLS REG. LOW PRICE 87¢



STORM WINDOW KIT NO. 704

NO. 704

67¢

NICHOLS REG. LOW PRICE 87¢

¼" mil poly with nails and fibre board.

AIR CONDITIONER COVER NO. 824

1³⁶

NICHOLS REG. LOW PRICE 1.88

18" High x 27" Wide x 25" Deep.



FLEXMOLD GASKET NO. 1400/1

2¹⁹

NICHOLS REG. LOW PRICE 2.89



VINYL GASKET W/NAI LS NO. V18

79¢

NICHOLS REG. LOW PRICE 88¢

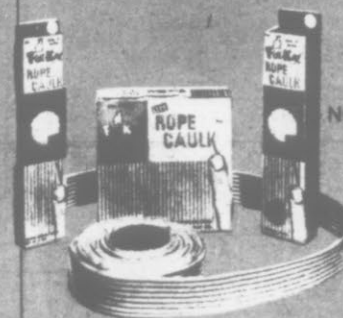

ROPE CAULK

NO. P4

20'

39¢

NO. P24

100'

1⁰⁹

NICHOLS REG. LOW PRICE 1.49

WE RESERVE THE RIGHT TO LIMIT QUANTITIES.

NG CENTER IN THE AREA!

CHARGE IT AT NICHOLS



AND



THE DO-IT-YOURSELF BONANZA OF SAVINGS!!!

PMI PAINT MASTER



**5 PC.
PAINT ROLLER KIT**

Consists of deep wall tray, 9" multi-purpose roller cover & frame, 13" extension pole, 1 1/2" trim brush.

2²⁹

NICHOLS REG. LOW PRICE 3.79



**4" GOLDEN NYLON
PAINT BRUSH**

1³⁹

NICHOLS REG. LOW PRICE 2.39



**9" TWIN PACK
ROLLER COVERS**

2 PER PKG. **58¢** PER PKG.

NICHOLS REG. LOW PRICE 88¢



NASCO TURPEX

Takes turpentine one step further. Removes wax, grease, dirt faster. Cleans brushes and rollers.

1⁹⁹ GAL.



NASCO PAINT THINNER

For thinning oil based paints, varnishes and enamels. Cleans brushes, rollers, equipment etc. No offensive odor.

1⁵⁹ GAL.

SAVE 1.00



**VALSPAR
HIGH OR SEMI GLOSS
VARNISH**

3¹⁹ QT.

NICHOLS REG. LOW PRICE 4.19

Excellent for home use on floors, woodwork, trim, cabinets or outdoor use. Will not turn white.

SAVE 30¢



**6 BIG
STEELWOOL PADS
FOR**

The product of a thousand uses. Essential for proper cleaning especially of metals before painting.

79¢ PER PKG.

NICHOLS REG. LOW PRICE 1.09



3M SANDPAPER

Three sheets per package, all 9"x11" pkgs. Your choice of grits.

57¢

NICHOLS REG. LOW PRICE 87¢

**SEAL THOSE
HEAT WASTING
CRACKS NOW!**



**REYLON
CAULKING
(WHITE)**

39¢

NICHOLS REG. LOW PRICE 59¢

Essential for pre-painting preparation, and winterizing windows.

Stay-Tite BIG SAVINGS ON CAULKING

 ROOF CEMENT NICHOLS REG. LOW PRICE 79¢ 59¢	 MORTARFIX NICHOLS REG. LOW PRICE \$1.57 1¹⁷	 CEMENT PATCH NICHOLS REG. LOW PRICE \$1.57 1¹⁷	 DRIVEWAY CRACK SEALER NICHOLS REG. LOW PRICE \$1.57 1¹⁷
 TUB CAULK NICHOLS REG. LOW PRICE \$1.99 1⁵⁹	 LATEX CAULK NICHOLS REG. LOW PRICE \$1.73 1³³	 PANEL ADHESIVE NICHOLS REG. LOW PRICE \$1.39 99¢	



**WASHAWAY
PAINT
REMOVER**

How! Wash paint and finish away with water. Easily the best paint remover you've ever used.

**PAINT
REMOVERS**

PINTS **1⁵⁹**
NICHOLS REG. LOW PRICE \$2.09

QUARTS **2⁴⁹**
NICHOLS REG. LOW PRICE \$3.09

GALLONS **7⁴⁹**
NICHOLS REG. LOW PRICE \$9.27

CAULKING GUNS



1¹⁹

Perfect companion to the Stay-Tite caulking compounds - just squeeze the trigger for quick and easy application.

YOU'LL ALWAYS SAVE MORE..AT NICHOLS

**CHARGE IT
AT NICHOLS**



AND





PAIN'T YOUR HOME WITH LUCITE

THE DEPENDABLE PAINT FROM 

NICHOLS CARRIES A COMPLETE LINE OF LUCITE—92 COLORS TO CHOOSE FROM



DUPONT LUCITE HOUSE PAINT

FOR EXTERIORS

Dries in one hour to a protective sheet that lets moisture out won't let weather in. Built in primer, soap and water clean-up. 19 colors to choose from.

7⁹⁹
GAL.



DUPONT LUCITE WALL PAINT

FOR INTERIORS

Whatever you cover with Lucite wet stays covered when it dries. Dripless, never needs stirring. Dries fast, soap & water cleanup. Exciting range of colors. 28 colors to choose from.

6⁹⁹
GAL.



DUPONT LUCITE CEILING PAINT

Perfect cover for minor surface defects. Dries to beautiful "flat white" finish. Goes on smooth & easy. Soap & water cleanup.

6⁹⁹
GAL.

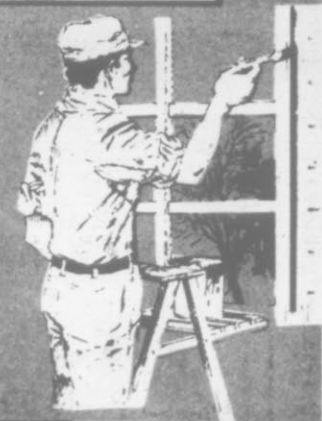

COMPLETE SATISFACTION...OR YOUR MONEY REFUNDED

CHARGE IT
AT NICHOLS

BANKAMERICARD

AND

master charge

STANLEY DO-IT-YOURSELF BONANZA OF COUPON SAVINGS

26 GREAT STORES

NICHOLS

DISCOUNT CITY

SORRY, NO RAIN-CHECKS ON COUPONS

GREAT VALUE NICHOLS COUPON \$

APPLIANCE DOLLIE
High impact styrene. Moves refrigerators, even heavy furniture.

SAVE 61°

WITH COUPON ONLY **1.88** PR.

NICHOLS REG. LOW PRICE \$2.49 PR.

GREAT VALUE NICHOLS COUPON \$

No. 1600 TOILET TANK REPAIR KIT
Stop noisy toilets. Easy installation.

SAVE 1.50

WITH COUPON ONLY **3.49**

NICHOLS REG. LOW PRICE 4.99

GREAT VALUE NICHOLS COUPON \$

SAVE 20c
FRAM AIR FILTERS
Deluxeaire filter means death to dirty air in the home.

WITH COUPON ONLY **39c**

NICHOLS REG. LOW PRICE 59c

GREAT VALUE NICHOLS COUPON \$

ELECTRICAL TAPE
Self Adhesive plastic tape, U.L. approved 3/4" x 20'

SAVE 58°

WITH COUPON ONLY **2/51**

NICHOLS REG. LOW PRICE \$7.99

GREAT VALUE NICHOLS COUPON \$

No. 2510 DRYER VENT KIT **SAVE 2.30**
Includes Vent hood, 8' flexible hose and clamps. Fits all dryers.

WITH COUPON ONLY **3.97**

NICHOLS REG. LOW PRICE 6.27

GREAT VALUE NICHOLS COUPON \$

DURO™ NAVAL JELLY
Chemically dissolves rust from iron and steel. Brush on, wash rust off.

SAVE 1.00

WITH COUPON ONLY **1.99** QT.

NICHOLS REG. LOW PRICE \$2.99

GREAT VALUE NICHOLS COUPON \$

361 ADJUSTABLE SHOWER HEAD
Adjustable spray, self cleaning

SAVE 1.90

WITH COUPON ONLY **3.27**

NICHOLS REG. LOW PRICE \$5.17

GREAT VALUE NICHOLS COUPON \$

No. 1422 SUPER PLUNGER
Essential for unclogging toilets, sinks, drains etc.

SAVE 80°

WITH COUPON ONLY **1.59**

NICHOLS REG. LOW PRICE 2.39

GREAT VALUE NICHOLS COUPON \$

DYNO LABEL MAKER KIT
Label possessions for easy identification. Includes label maker and tape. **SAVE 80°**

NO. 1720

WITH COUPON ONLY **1.69**

NICHOLS REG. LOW PRICE 2.49

GREAT VALUE NICHOLS COUPON \$

No. 1501 BASKET SINK STRAINER
Cuts down on annoying sink stop-ups.

SAVE 40°

WITH COUPON ONLY **87c**

NICHOLS REG. LOW PRICE 1.27

GREAT VALUE NICHOLS COUPON \$

No. 1762 CANISTER AUGER
Clear drains of clog fast.

SAVE 2.60

WITH COUPON ONLY **4.59**

NICHOLS REG. LOW PRICE 7.19



NICHOLS OIL BASE HOUSE PAINT

SAVE 1.50

2.99 GAL.

NICHOLS REG. LOW PRICE 4.49 GAL.
Ideal for all exterior painting on wood, brick, stucco, concrete and metal. Long lasting brightness. Excellent second coat.

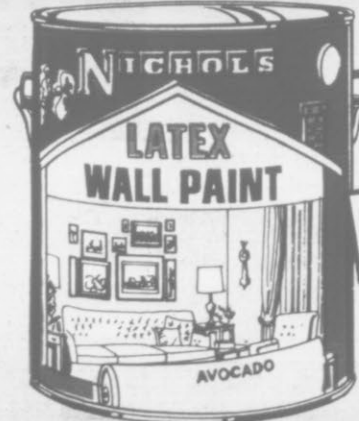

NICHOLS VINYL LATEX WALL PAINT

SAVE 1.00

2.59 GAL.

NICHOLS REG. LOW PRICE 3.59 GAL.
Dripless-Uniform sheen on any interior wall including plaster, wallboard, brick, stone concrete wallpaper and weed trim. Quick drying, washable, easy to apply.

SENSATIONAL SPECIALS!!



25 YR. GUARANTEE!

STRAIGHTLINE PORTABLE

PRECISION BUILT. Full size sewing machine that's easy to carry...easy to use. Easy winding bobbin, sewing light over needle, and handy foot switch. Complete w/fully illustrated manual, and tools for minor repairs.

\$49

NICHOLS REG. LOW PRICE 59.88



25 YR. GUARANTEE!

DELUXE ZIG-ZAG PORTABLE

New streamlined design...auto. bobbin winder...calibrated tension control, & dial stitch length...blindstitching...sewing light over needle...pushbutton drop feed...pop-up drawer...two spool pins for easy bobbin winding...jam proof. Complete with instruction manual and tools.

\$79

NICHOLS REG. LOW PRICE 89.88



**100%
DOUBLE KNIT
POLYESTERS**

SAVE OVER 30%

1.99

NICHOLS REG. LOW PRICE 2.98 YD.

Piece dyed designers solids and vibrant colors of yarn dyes. In 52 to 60 inch sizes. All cut to your specifications.

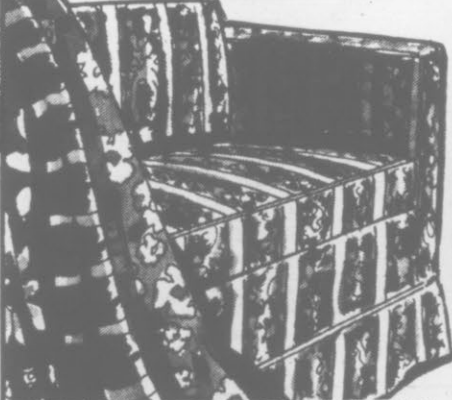

HOME DECORATING FABRICS

\$1

Beautifully woven upholstery, slipcover, and drapery fabrics. Choose from a huge selection of tweeds, damasks, solids, jacquards, and novelty weaves.

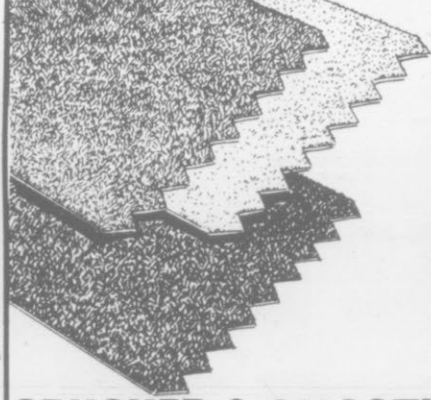

CRUSHED & SMOOTH VELVETS

\$1

NICHOLS REG. LOW PRICE 1.49

Elegant, lush velvets...available with crushed or smooth finishes. Rich fashion shades. SENSATIONAL SAVINGS.

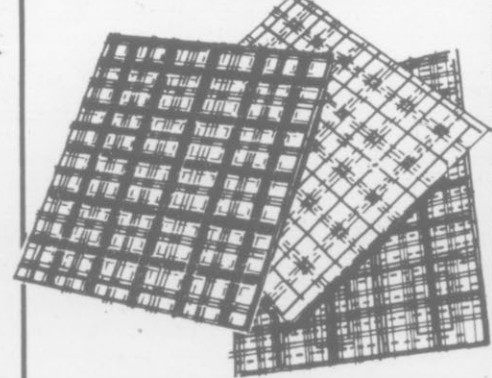

ACRYLIC WOVEN MINI PLAIDS

SAVE 28% \$1

NICHOLS REG. LOW PRICE 1.39

Sensational fashion colors and patterns. 100% acrylic for durability and easy care. Save more at Nichols.

SAVE ON EVERY PURCHASE...AT EVERY COUNTER...EVERY DAY!

**CHARGE IT
AT NICHOLS**



AND



DO IT YOURSELF CRAFTS FOR THE WHOLE FAMILY!



SKILCRAFT POTTERY SHOP

Make your own hand formed ceramic creations—bowls, jugs, sculptures without heat. Then paint & glaze.

6⁹⁹



"POTTERY CRAFT" BATTERY OPERATED POTTER'S WHEEL

Table-top potter's wheel powered by battery operated 3-volt motor with on-off switch. Non Toxic. No baking or firing required. ("D" cell batteries not included.)

10⁸⁸

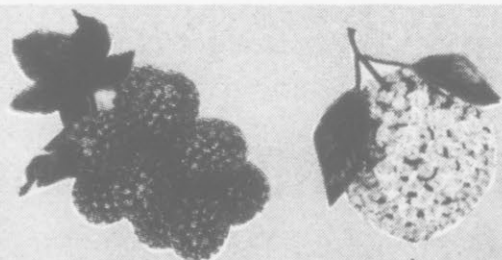

DO-IT-YOURSELF BEADED FRUIT

Contains actual size flocked fruit base, pins and sparkling transparent faceted beads, no glueing or sewing required. Each kit makes two fruits.

1⁹⁹



SKILCRAFT CANDLE MAKER SET

Mount your own "one of a kind" candles. Choose size, shape, color, scent and decoration. Set includes enough wax to make all the candles illustrated.

4⁹⁹



DECOUPAGE PLAQUE KITS

It's fun to finish two authentic full color Currier and Ives prints of either 2 Summer or 2 Winter scenes. All materials and complete instructions included.

2⁹⁹



PRESERVE FOREVER MINIATURETTES

Makes over 15 personalized projects. Kit contains Liquid Plastic, catalyst, 4 reusable plastic molds, jewelry findings, polishing materials, mixing supplies plus unusual trims.

2⁹⁹



BAKE-A-CRAFT GLASS KIT

You can create the famous characters in your own oven, Bugs Bunny, Tweety Bird, Road Runner, Batman, Superman, & Robin. Everything included.

3⁴⁷

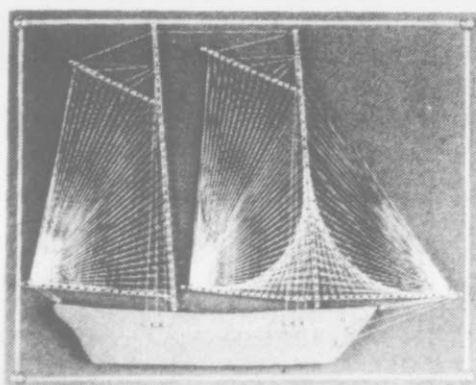

STRING ART PICTURE KITS

4⁹⁹

With a little effort you can create a beautiful replica of a famous racing ship, clipper or yawl. All materials for 18"x24" plaque included.



SEQUINS SEW ONS

Over 1,200 sparkling sequins and rocaille beads are combined with threads, needles, fabric base, patterns and illustrated instructions. Create your own design, it's fun.

3⁷⁷

BE CRAFTY DO-IT-YOURSELF AND SAVE

CHARGE IT AT NICHOLS



AND



SPECTACULARS FOR GIRLS, INFANTS & TODDLERS

GIRLS SKI JACKETS

\$3

Pretty perky prints or smashing solid colored ski jackets in quilted nylon. Fuzzy pile trimmed hood ... zipper front. Assorted colors in sizes 4-14.



GIRLS ACRYLIC SKIRTS

\$1

A variety of neat and sweet styles for your school age girl. Choose plaids or solid colors in woven acrylics. Sizes 7-14



TODDLER BOYS SLACKS

\$2

Solid corduroy and denim faire leg pants with 2 pockets-zip fly-snap front-closing side loops-and buckle belt back. Assorted colors. Sizes 2-4.



BABYS QUILTED BLANKETS

\$2

Cozy warm polyester filled quilts in solids, prints and embroidered with ruffle and novelty border. Cut size 36x-50", in white and assorted pastels.

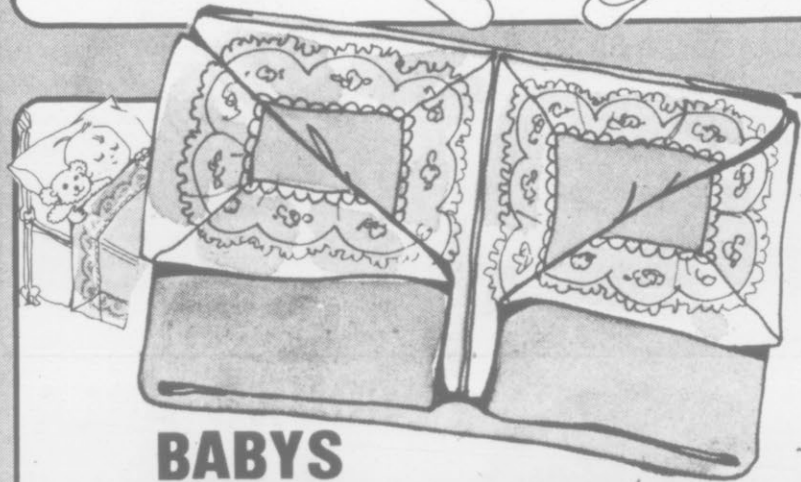

YOU'LL ALWAYS SAVE MORE ... AT NICHOLS

CHARGE IT
AT NICHOLS



AND



DOMESTIC SENSATIONS!

BED SPREAD RIOT!!!



TWIN

9⁹⁹

FULL

11⁹⁹

QUEEN

14⁹⁹

Every better bedspread in our stock is on sale. Quilteds, unquilteds, chenilles, wovens, heirlooms, even tufted overlay patterns! Tremendous savings, great selection and colors, to dress up your bedroom scene. Not every color in every pattern and size, so come early for the best selection. Throws, tailoreds, and quilt top styles in group.

NICHOLS REG. LOW LOW PRICES \$10.99 to 19.99

CRUSHED VELVET THROW PILLOWS



2 FOR \$3

Kapok-filled decorator throw pillow of crushed velvet in a carnival of colors, styles and shapes including oblongs and squares with tassel or button trims.

NICHOLS SUPER COUPON

BLANKETS FROM A FAMOUS MAKER

3⁹⁹

100% acrylic polyester and acrylic blends. Solid colors. 72x90" size for full or twin beds. Many colors to choose from.

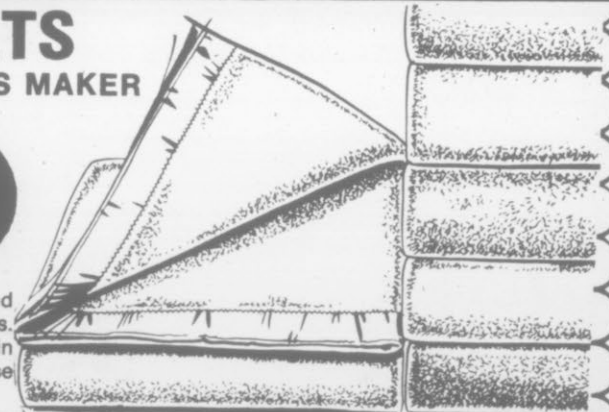

WITH COUPON ONLY!!

ROUND AREA RUGS

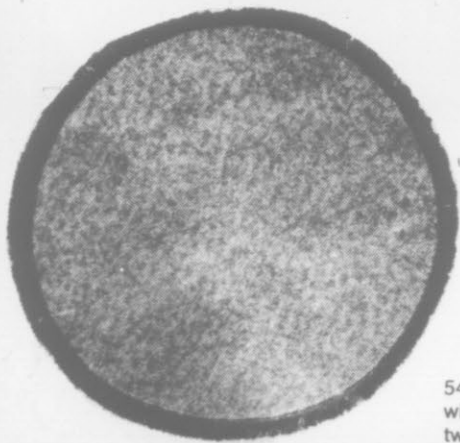

5⁹⁹

NICHOLS REG. LOW PRICE 6.88
54" luxuriously fringed quality broadloom with double jute backing. Nylons, acrylics, tweeds, solids, textured. Add a fashion accent to any room. Many colors.

CARPET STAIR TREADS

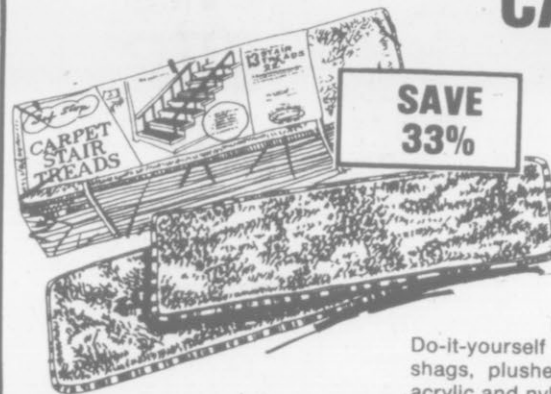

3³³

NICHOLS REG. LOW PRICE 4.99
Do-it-yourself stair tread kits. 13-8"x22" steps of shags, plushes, hi-lo's and textures in polyester, acrylic and nylons. Serged and finished on all sides. All double backed quality broadloom.

NATIONAL BRAND MERCHANDISE...SELF-SERVICE PRICES

CHARGE IT AT NICHOLS

BankAmericard
welcome here

AND

Master Charge
THE INTERNATIONAL CARD

DOMESTIC SPECIALS AT SUPER SAVINGS!

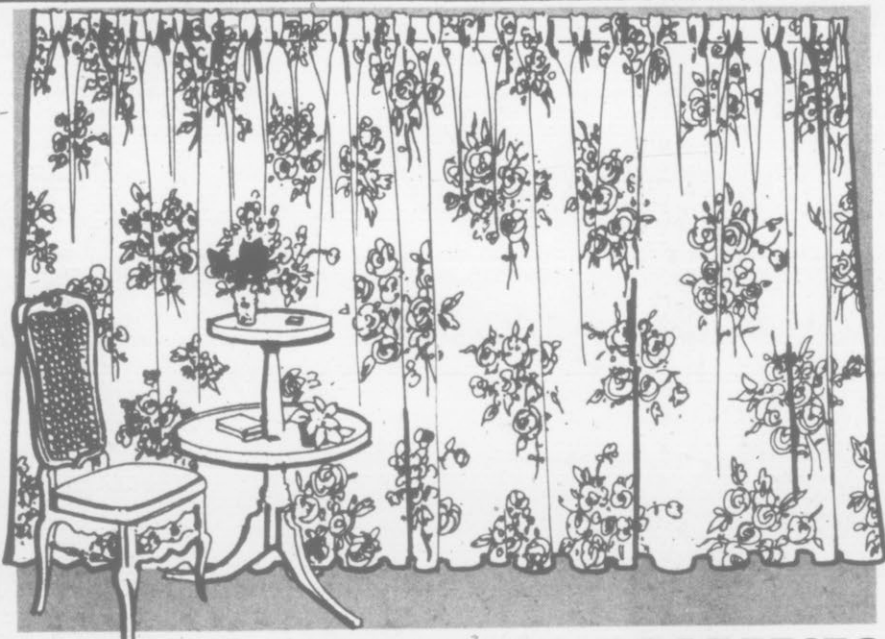

FLOCKED FIBERGLASS DRAPERIES

Easy care, no iron fiberglass with print and flocked floral pattern. Pinch pleated to fall in deep, full folds for luxurious custom look.

48" x 63"

6⁹⁹

48" x 84"

7⁹⁹

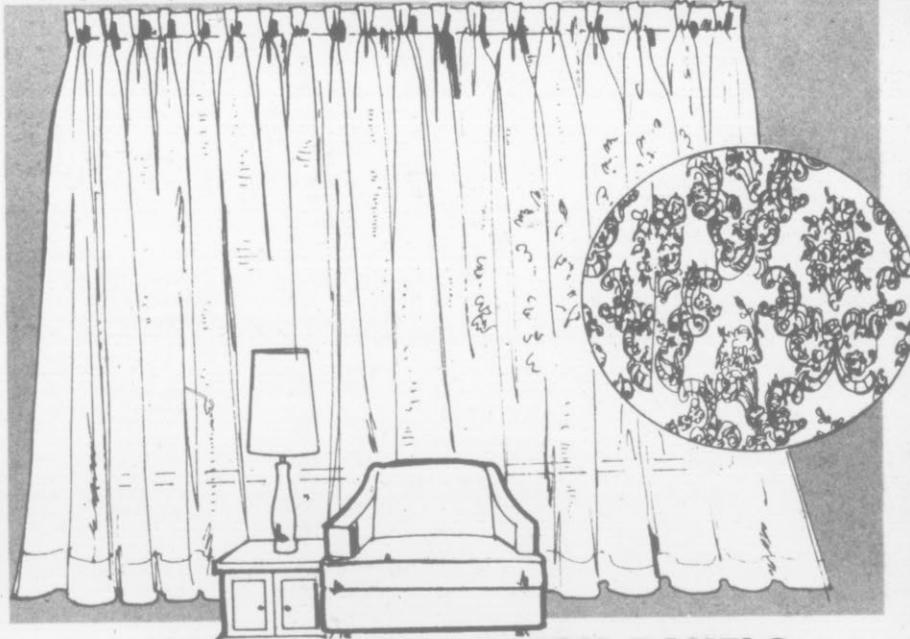

EXTRA WIDE DACRON PANELS

SAVE UP TO 33%

Your choice of floral print or solid colors of white, gold or green. Extra wide for extra fullness. Easy care dacron Batiste is permanent press.

NICHOLS REG. LOW
LOW PRICE \$4.49

63 x 63

2⁹⁹

NICHOLS REG. LOW
LOW PRICE \$5.29

63 x 81

3⁹⁹

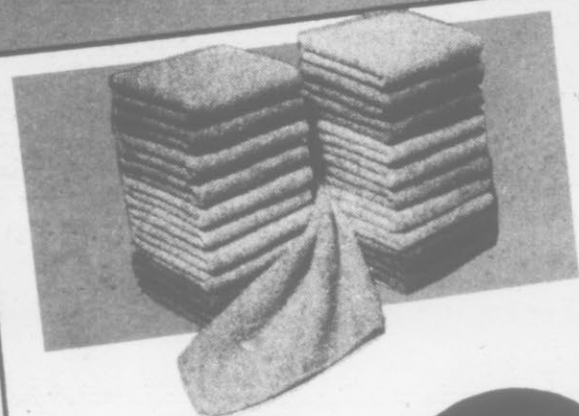

ST. MARY'S WASH CLOTHS

Tremendous value! Luxury quality jacquard and fashion solid colors. Velours and Terry. Many colors. 12 x 12.

3\$1
FOR

PRINTED SHOWER CURTAIN SETS

Fashion florals and geometric patterns on heavy gauge water-proof plastic. One 6 x 6 shower curtain and one tailored window curtain to a set. Many colors to choose from.

1⁹⁹
SET

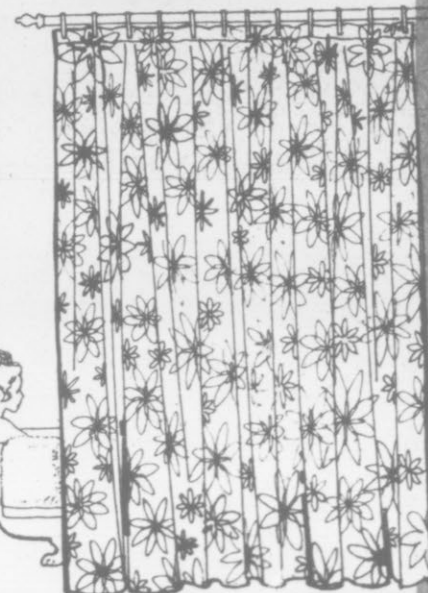

ACRES OF FREE PARKING...OPEN 10 A.M.-10 P.M.

CHARGE IT
AT NICHOLS



AND



36
GREAT STORES

NICHOLS CHARGE-IT!



BANKAMERICARD AND master charge

MFG. LIST PRICE 1.41

NICHOLS COUPON

Total Savings 75¢

**ULTRA BAN
5000 DEODORANT**
REGULAR, UNSCENTED OR
POWDER - 5 OZ.

LIMIT 2 PER CUSTOMER

WITH COUPON ONLY → **66¢**

NICHOLS REG. LOW PRICE 1.04

MFG. LIST PRICE 2.39

NICHOLS COUPON

Total Savings 1⁴⁰

**BRECK
SHAMPOO**
FOR BEAUTIFUL HAIR.
NORMAL, DRY AND OILY - 15 OZ.

LIMIT 2 PER CUSTOMER

WITH COUPON ONLY → **99¢**

NICHOLS REG. LOW PRICE 1.66

MFG. LIST PRICE 1.85

NICHOLS COUPON

Total Savings 89¢

Excedrin
THE EXTRA STRENGTH PAIN RELIEVER

**EXCEDRIN
ANALGESIC TABLETS**
THE EXTRA-STRENGTH PAIN
RELIEVER. BOTTLE OF 100.

LIMIT 2 PER CUSTOMER

WITH COUPON ONLY → **96¢**

NICHOLS REG. LOW PRICE 1.18

MFG. LIST PRICE 1.78

NICHOLS COUPON

Total Savings 1.18

**LAVORIS MOUTHWASH
AND GARGLE**
MORE DENTISTS USE
REFRESHING LAVORIS THAN
ANY OTHER MOUTHWASH. 20 OZ

LIMIT 2 PER CUSTOMER

WITH COUPON ONLY → **57¢**

NICHOLS REG. LOW PRICE 1.38

MFG. LIST PRICE 2.50

NICHOLS COUPON

Total Savings 1.51

**REVLON FLEX BALSAM &
PROTEIN HAIR CONDITIONER**
RESTORES BODY, MANAGEABILITY
AND BEAUTY TO TROUBLED HAIR 17 FL. OZ.

LIMIT 2 PER CUSTOMER

WITH COUPON ONLY → **99¢**

NICHOLS REG. LOW PRICE 1.66

MFG. LIST PRICE 2.11

NICHOLS COUPON

Total Savings 1.00

**JOHNSON'S
BABY POWDER**
PUREST PROTECTION
FAMILY SIZE. 24 OZ.

LIMIT 2 PER CUSTOMER

WITH COUPON ONLY → **1¹¹**

NICHOLS REG. LOW PRICE 1.88

MFG. LIST PRICE 1.88

NICHOLS COUPON

Total Savings 1¹¹

**JOHNSON'S
NO MORE TANGLES**
NO MORE TEARS SPRAY ON
CREME RINSE. 12 OZ.

LIMIT 2 PER CUSTOMER

WITH COUPON ONLY → **88¢**

NICHOLS REG. LOW PRICE 1.58

MFG. LIST PRICE 1.79

NICHOLS COUPON

Total Savings 1⁰²

**CONTACT 10's
DECONGESTANT
CAPSULES**
12 HOUR RELIEF, CONTINUOUS
ACTION DECONGESTANT CAPSULES

LIMIT 2 PER CUSTOMER

WITH COUPON ONLY → **77¢**

NICHOLS REG. LOW PRICE 99¢

MFG. LIST PRICE 2.50

NICHOLS COUPON

Total Savings 1⁰⁰

**BRECK SHAMPOO-IN
HAIR COLOR**
IT'S PRE-CONDITIONED, NOW
WITH LIQUID GOLD PROTEIN
CHOOSE FROM MANY SHADES

LIMIT 2 PER CUSTOMER

WITH COUPON ONLY → **94¢**

NICHOLS REG. LOW PRICE 1.98

MFG. LIST PRICE 87¢

NICHOLS COUPON

Total Savings 1⁰¹

**MACLEANS
TOOTHPASTE**
FOR WHITER TEETH SPEARMINT
AND FRESHMINT FLAVOR
MEDIUM SIZE

LIMIT 3 PER CUSTOMER

WITH COUPON ONLY → **87¢**

NICHOLS REG. LOW PRICE 51¢

MFG. LIST PRICE 1.58

NICHOLS COUPON

Total Savings 69¢

**COVER GIRL
PEEPER STICKS FOR EYES**
FROSTY/SHINY CREAM CRAYONS
FOR EYES. CHOICE OF 8 SHADES

LIMIT 2 PER CUSTOMER

WITH COUPON ONLY → **66¢**

NICHOLS REG. LOW PRICE 1.17

NOT RESPONSIBLE FOR TYPOGRAPHICAL ERRORS.

SORRY, NO RAINCHECKS.

WE RESERVE THE RIGHT TO LIMIT QUANTITIES.



NICHOLS WILL HONOR ANY COMPETITORS ADVERTISED COUPONS

If Same merchandise
is available at Nichols.

All competitors coupons will be
gladly redeemed at Nichols ... at
face value under advertised terms.
NOW ... start enjoying another
NICHOLS' customer shopping con-
venience.

LITTLE ANGEL & SENIOR CITIZEN EXTRA DISCOUNT PRESCRIPTION PLAN

Under 5 of over 60? Enjoy an additional 10% Savings
on our already lowest prices on most prescriptions.

Ask Nichols Pharmacist for full details on
"NICHOLS' LITTLE ANGEL & SENIOR CITIZEN
PRESCRIPTION PLANS".



WE THANK YOU FOR YOUR PURCHASE

Did you know NICHOLS' PRESCRIP-
TION DEPARTMENT WILL PRICE YOUR
doctor's prescription without obligation.
High prices are a bitter pill to swallow.
Nichols' LOW... but really LOW prices on
prescriptions will make the pill sweeter
and the going down easier. Bring your
next doctor's prescription to NICHOLS' to
be priced... You'll enjoy the change.