

TRUTH IN PREFERENCE TO FICTION

Last Link To Outside World

Biafran Air Strip Is Occupied

Major Units Named For Viet Pullout

Surrender

LAGOS, Nigeria AP— Biafra surrendered today after fighting 30 months in an effort to enforce secession from Nigeria.

By MORT ROSENBLUM Associated Press Writer

LAGOS (AP) — Nigerian troops occupied the Uli airstrip, Biafra's last link with the outside world, after massive air attacks reduced the roadbed runway to rubble, reliable sources reported today.

There was no immediate official confirmation, and in Copenhagen the Joint Church Aid headquarters said two of its relief planes landed at Uli with 20 tons of food and medicine early today.

The sources in Lagos said that before the ground troops moved in, Ilyushin 28 bombers flown by Egyptians rained bombs on the jungle airstrip and MIG17s piloted by white mercenary pilots strafed the strip with cannon fire.

Military sources said casualties were heavy among Biafrans who had assembled by the thousands in the area in hopes of catching a ride out of the crumbling enclave.

Marine commando troops bypassed Oguta and raced around a flank to capture the airstrip late Sunday night, the sources said.

Biafran regulars continued to resist on some other fronts but were reported drawing back under heavy federal offensives.

The key town of Orlu, to which many government offices and the governments main radio transmitter were moved after Umahia fell, was in danger of falling, military sources said.

With the Nigerian forces close to victory over the secessionist state, Biafra's leader, Gen. C. Odumegwu Ojukwu, left the country, saying in a prerecorded radio address he was going in search of peace and that he hoped to return soon. Reliable reports said he had taken his family with him.

Britain and the United States readied a massive airlift of food and medicine as soon as the Nigerian government gave the word it would admit the planes.

A British Royal Air Force plane was scheduled to leave London today with 20,000 pounds of medical supplies, the vanguard of new government relief efforts for the war's victims. A British cabinet minister was dispatched to consult with Nigerian officials on the relief program, and preparations were made to send in British medical teams, army trucks for convoys, and engineers to help repair roads, bridges and airfields.

President Nixon ordered eight C130 cargo planes on a standby alert in the United States, with four helicopters to be carried as cargo. They awaited word from Lagos that the Nigerian government would let them operate a relief lift.

Canadian Foreign Minister Mitchell Sharpe said his government also was making plans to provide transport, food, medical supplies and military observers

to help achieve a just settlement.

Hard fighting continued in the southeast corner of the former British colony as Biafran regulars resisted the progress of federal troops. Military spokesmen in Lagos said there were heavy losses on both sides.

A radio report from the French colony of Gabon, to the south of Nigeria, said the latest

Pitt Native Wounded In Washington

WASHINGTON, D.C.—A Falkland native, Spellman Johnson III, was seriously injured when he was shot on the street in southeast Washington Saturday morning.

A police officer at the 11th precinct here said the shooting occurred at the corner of 16th and W Streets here, when a Negro man, apparently a stranger to Johnson, also Negro, fired one shot into his abdomen from close range.

Johnson underwent a nine-hour operation the same day. Doctors said his chance for recovery are good because of his youth and general good health. They said the wound was made by a shotgun.

Police said the owner of a car believed to be involved because of a witness's description is being questioned.

A 1966 graduate of H.B. Sugg High School, Johnson is the son of Mr. and Mrs. Spellman Johnson Jr. of Route 1, Fountain. His wife is the former Ann Tyson of Farmville. They have two children Jerome, four, and Kim, two.

Biafran capital—Orlu—had fallen. Reports from Gabon added that panic-stricken members of the Biafran elite shouldered aside relief workers for the escape seats on the last relief planes leaving Uli.

"Your leader has fled," federal radio broadcasts told Ibo tribesmen, backbone of the secession movement. It urged them to stay at home and await

the arrival of federal troops to ensure their safety. Maj. Gen. Yakubu Gowon, Nigerian chief of state, appealed to the secessionist troops to stop fighting and report to federal commanders. He told his own forces to take special care of displaced persons and urged them to adhere strictly to the code of conduct.

A federal communique said Gowon had "warned all foreign governments, organizations and persons to desist forthwith from meddling in the internal affairs of Nigeria so that the suffering of the population in rebel-held enclaves should not be prolonged."

At his departure, Ojukwu designated the chief of the general staff, Maj. Gen. Philip Effiong, to head the cabinet.

center that intercepted at least 1,400 U.S. operational messages which presumably enabled enemy troops to escape U.S. ambushes, bombing and artillery strikes.

The sources said there was no evidence that the interceptions resulted in any American deaths. Nor were the North Vietnamese able to break any official codes, the sources reported. But they said many U.S. troops use unauthorized or "home-made" codes which the North Vietnamese easily deciphered.

The listening post was located in a bunker complex in the Boi Loi woods about 35 miles north-west of Saigon. The sources said 12 North Vietnamese who were fluent in English were captured and another was killed.

The American troops also captured logs showing interception of 1,500 U.S. radio transmissions, including positions for American ambushes and warnings to other allied aircraft of air strikes that were to be made.

The latest withdrawal, the third ordered by President Nixon, will reduce the authorized U.S. troop ceiling in Vietnam to 434,000. It will bring the total number of American troops withdrawn since last July to 110,000.

The U.S. Command announcement said the 50,000 men being withdrawn in the next three months will include 29,500 Army, 12,900 Marines, 5,600 Air Force and 2,000 Navy men.

A weekly summary also issued today by the U.S. Command showed that American troop strength in Vietnam dropped 6,000 last week, to 467,500, the lowest since November 1967.

This is 16,500 men below the present authorized ceiling, but U.S. spokesmen said troop strength around the Christmas season always falls considerably below the authorized maximum because rotation transfers to the States are expedited to get the men home for Christmas, while replacements are often delayed so the men can be home for the holidays.

Little fighting was reported today. Official sources disclosed that American forces three weeks ago uncovered a major North Vietnamese communications

members. Griffin acknowledged the battle will be tough, the more difficult for Republicans because the Democratic side of the argument is more easily dramatized.

One problem, he said, will be to illustrate more clearly the connection between federal spending and the rising prices confronting Americans.

Furthermore, Griffin said, the additional money added to the education and health budgets is in some cases misdirected, and in many instances cannot be efficiently spent.

Half of the year for which the money is to be appropriated already has passed, with the agencies involved financed by resolutions which continue their spending authority at past rates.

The latest resolution expires on Jan. 30 and it seems certain Congress will have to pass another one while the spending dispute is settled.

Consider Asking Commutation

RALEIGH (AP) — The North Carolina Women to Save Marie Hill will hold a meeting Tuesday night to consider a resolution requesting Gov. Bob Scott to commute the death sentence, of the 18-year-old girl.

Mrs. Edna Richards, executive secretary of the North Carolina Association of Classroom Teachers and temporary chairman of the group, said the committee held an organizational meeting Saturday.

She said the group plans to present the resolution to Gov. Scott Thursday, the birthday of the late Martin Luther King Jr.

Democrats argue they have cut spending on the floor of Congress, and at the same time "reordered national priorities first away from nonessential spending and closer to the health, welfare, educational, social and environmental needs that face this nation ...

"It should be remembered that the additions to these vital domestic programs come to just 20 per cent of the savings made by the Congress in the President's military budget alone ..."

Sen. Robert P. Griffin of Michigan, the GOP whip, said his aides are contacting Republican senators and their assistants to determine their stand.

The question is whether to send to the White House—and an "absolutely" certain veto—a compromise \$19.7 billion appropriation for the Departments of Health, Education and Welfare; Labor, and the Office of Economic Opportunity.

That compromise bill, which still exceeds the Nixon budget by more than \$1.2 billion, already has passed the House, and only a final Senate vote is needed to complete congressional action.

Griffin anticipates passage, expects a veto, and believes the Nixon rejection will be sustained, probably in the House, which would act first.

It would take a two-thirds vote to override a veto.

The National Education Association is mounting a lobbying and letter-writing campaign, urging Congress to override a Nixon veto.

Bryce N. Harlow, counselor to the President, has written Republican senators seeking support for the administration, contending it would be irresponsible to vote the budget-boosting appropriation during a time of inflation.

Earlier part of the year. Thus the burden will fall on Agnew, and his press secretary, Herbert Thompson, says the vice president has already lined up "a back-breaking schedule."

One aide estimated Agnew would spend less than half of February in Washington.

Agnew came to this lush, tropical island Sunday from Singapore for a two-day stay. He flies Tuesday to Australia and on

Thursday to New Zealand, the last two countries on his tour.

Unlike his other stops, all of which were official visits, the trip to Bali was an unofficial stop designed mainly to allow the travelers to rest up a bit after visiting eight different countries in 11 nights.

Like his Asian trip, Agnew's political speechmaking chores are being undertaken at President Nixon's behest, Thompson said.

"He has been assigned as political spokesman by the White House," he added.

He said Agnew's major emphasis will be on raising a war chest for the congressional campaign. Republicans are hopeful of picking up the seven Senate seats they need for a 50-50 tie that would give Agnew the deci-

sive vote in organizing the upper house.

In the House, the GOP hopes to cut into the current 244-189 Democratic margin, but most party leaders doubt the Republicans can gain the 28 seats they need for control.

As for governorships, Republicans will be fighting a defensive battle to hold their current 32-18 margin.

Western N.C. Again Under Snowy Blanket

By THE ASSOCIATED PRESS

North Carolinians plunged back into winter today after a brief respite from frigid temperatures was followed by snowfall that left many points in the western two thirds of the state shivering under a hoary blanket.

Both Charlotte and Greensboro reported two inches of snow, as did Hickory and Asheville. The Weather Bureau said it had unofficial reports of up

Jumbo Jet Flies Ocean

LONDON (AP) — Pan American Airways' Boeing 747 Jumbo jet airliner touched down safely at Heathrow Airport today, launching a new era in the mass moving of the world's restless millions.

The Jumbo carried 361 non-paying passengers and 19 crewmen, the largest number of persons ever to cross the Atlantic in one flight, as a dress rehearsal for the first regularly scheduled commercial flight between New York and London Jan. 21.

The touch down was late because of a three-hour delay in New York due to the traffic jam at Kennedy International Airport and "heavy paperwork," said Tom Flannigan, Pan American vice president for operations.

The passengers were Pan American employees and their families, and some families and officials of the U.S. Federal Aviation Agency.

to seven inches in some mountain areas.

Temperatures remained higher than last week's cold snap, however, sticking in the high 20s and low 30s this morning after rises to around 40 Sunday afternoon. Asheville reported a Sunday high of 39 and Wilmington got up to 47.

But the afternoon began to chill as cloudiness and precipitation moved eastward across the state during the night. Snow, freezing rain and sleet hit inland sections. Mostly rain occurred along the coast, and the Weather Bureau said it was still falling lightly at New Bern and Wilmington this morning.

Predictions were for more scattered snow and sleet today. The Weather Bureau warned of hazardous driving conditions for the inland part of North Carolina.

Clearing and colder weather will creep in tonight and Tuesday, with increasing cloudiness Wednesday, the Weather Bureau predicted.

Today's snow closed schools across a wide area of the western two thirds of the state. Among the units closed were Ashe, Avery, Watauga, Cleveland and Mecklenburg county schools. Announcements of closings also were made in Concord, Shelby and Kings Mountain.

The snow came when a storm system centered over southern Alabama and Georgia touched the whole mid Atlantic coast. The Weather Bureau said a cold front stretching from the western Great Lakes to eastern Tennessee and to southeast Mississippi will begin edging toward the coast today, driving down temperatures.

Bank Counts Fire Loss

DUNN, N. C. (AP) — Fire which swept through a branch of the Waccamaw Bank and Trust Co., Sunday caused at least \$40,000 damage, according to bank manager E. W. Smith.

Firemen, hampered by extensive smoke, fought the blaze for about five hours.

Fire Chief C. J. Hanna says an electrical heating unit's failure set off the fire. Hanna said the blaze caused "no structural damage," but left the bank with a "considerable loss" from damage of interior fixtures.

Asst. Chief John E. Norris suffered injuries to his left shoulder and arm when a fire hose he was unlaying from a truck reel jerked up and threw him to the street. He was hospitalized and was expected to remain bedridden for several days, Hanna said.

The chief said money in the bank vaults had not been burned by the fire. Water and smoke caused most of the damage, he said.

Twenty-Six Die In DC3 Wreck

ATHENS, (AP)—A Greek Air Force DC 3 crashed into a mountain 30 miles northwest of Athens today, killing 26 persons, an official spokesman said. Four survivors were reported seriously injured.

The crash occurred on 4,623-foot Mt. Kithairon.

Rescue teams from a nearby radar base rushed to the scene.

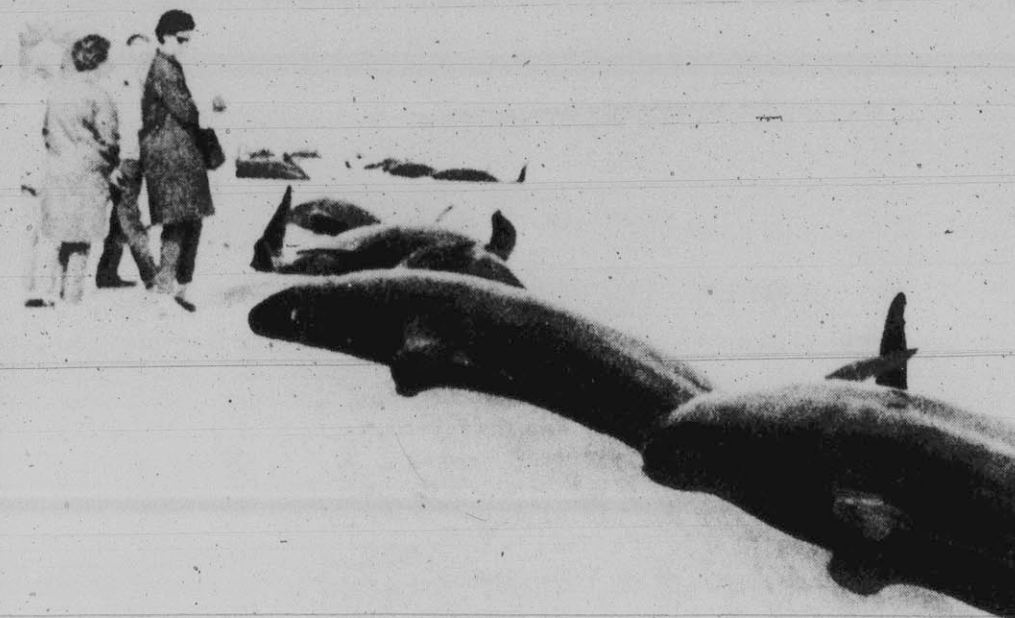

Follow The Leader

DYING WHALES—Pilot whales by the dozens swam ashore near Fort Pierce (Fla.) Sunday in what conservationists say may have been a follow-the-leader movement. Exposed to the sun during the day, many died. Authorities

Follow The Leader

said others among the estimated 200 whales probably would die as they defied efforts by rescue teams to pull them back to sea. (AP Wirephoto)

Confrontation Looms On Funds Allocated To HEW

By WALTER R. MEARS Associated Press Writer

WASHINGTON (AP) — The heat is intensifying in the first congressional battle of the 1970s, a confrontation on education and health spending in which Democrats see a key test of the nation's rating of priorities.

With the second session of the 91st Congress a week away, Republicans are trying to size up their strength on the measure.

Sen. Robert P. Griffin of Michigan, the GOP whip, said his aides are contacting Republican senators and their assistants to determine their stand.

The question is whether to send to the White House—and an "absolutely" certain veto—a compromise \$19.7 billion appropriation for the Departments of Health, Education and Welfare; Labor, and the Office of Economic Opportunity.

That compromise bill, which still exceeds the Nixon budget by more than \$1.2 billion, already has passed the House, and only a final Senate vote is needed to complete congressional action.

Griffin anticipates passage, expects a veto, and believes the Nixon rejection will be sustained, probably in the House, which would act first.

It would take a two-thirds vote to override a veto.

The National Education Association is mounting a lobbying and letter-writing campaign, urging Congress to override a Nixon veto.

Bryce N. Harlow, counselor to the President, has written Republican senators seeking support for the administration, contending it would be irresponsible to vote the budget-boosting appropriation during a time of inflation.

Agnew Rests In Bali; Heavy Speechmaking Tour Awaits Him

By CARL P. LEUBSDORF Associated Press Writer

SINGAPURA, Bali (AP) — Vice President Spiro T. Agnew sat impassively for an hour today as brightly garbed, masked Balinese dancers performed a Barong dance for him and Mrs. Agnew in an ancient temple.

The dance depicted the battle between good, represented by the Barong, and evil, represented by the witch Rangka. When it

was over, Agnew thanked the dancers and returned to his beachfront hotel while his wife went to a wood carving shop and factory.

When Mrs. Agnew tried to buy four carved black ebony hands, for her three daughters and a granddaughter, the shopkeeper presented them to her along with a walking stick with carved dragon head handle for the vice president.

Then Mrs. Agnew bought an ebony carving called Relaxing Lady.

As Agnew nears the end of his 37,000-mile Asian trip, he already is planning some more heavy travelling when he gets home—on the political banquet circuit.

It will enable him to display the knowledge of foreign problems he has been picking up on the 11-nation journey.

Agnew returns home Jan. 20, about two weeks before the start of the traditional Lincoln Day Republican fund raising dinners, and GOP leaders have said he will be the party's chief banquet speaker this year.

President Nixon is planning to play a major role in GOP election efforts next fall, but aides have indicated the President plans to stay out of most partisan political activities in the

earlier part of the year.

Thus the burden will fall on Agnew, and his press secretary, Herbert Thompson, says the vice president has already lined up "a back-breaking schedule."

One aide estimated Agnew would spend less than half of February in Washington.

Agnew came to this lush, tropical island Sunday from Singapore for a two-day stay. He flies Tuesday to Australia and on

Thursday to New Zealand, the last two countries on his tour.

Unlike his other stops, all of which were official visits, the trip to Bali was an unofficial stop designed mainly to allow the travelers to rest up a bit after visiting eight different countries in 11 nights.

Like his Asian trip, Agnew's political speechmaking chores are being undertaken at President Nixon's behest, Thompson said.

"He has been assigned as political spokesman by the White House," he added.

He said Agnew's major emphasis will be on raising a war chest for the congressional campaign. Republicans are hopeful of picking up the seven Senate seats they need for a 50-50 tie that would give Agnew the deci-

sive vote in organizing the upper house.

In the House, the GOP hopes to cut into the current 244-189 Democratic margin, but most party leaders doubt the Republicans can gain the 28 seats they need for control.

As for governorships, Republicans will be fighting a defensive battle to hold their current 32-18 margin.

Farm Scene

Buying, Renting Peanut Allotments

By Henry C. Riddick
Extension Agent

Many farmers will be taking advantage of the new provision for transferring peanut allotments within counties this year. If you plan to do so an accurate record of your cost and returns will be needed to make the right decision. The amount that you can pay to transfer an acre of peanuts will depend on several factors, you expected yield, cost of production, price, and the net income you are now receiving per acre of land on which the peanuts will be planted.

To economically buy an acre of peanuts you must determine what yield you could expect from the added acreage and multiply this by the price you would expect to receive. This will be your "expected" profit. Due to the fact that you already own the machinery, this is fixed cost and will not interfere with your decision to rent or buy peanut allotments. From this profit, now subtract both the cost of producing this acre of added peanuts and the net income you are now receiving from this acre of land. If this acre is double-cropped with wheat and soybeans, you would subtract approximately \$90 depending

upon your individual circumstances. If you intend to receive any income from you management or labor, subtract this also, and the amount left will leave you with a value of cash rent. This is what you can economically rent this acreage for.

If you intend for the added allotment to pay for itself, you will have to divide the number of years in which you would like to recover your investment by one hundred. This will give you the percentage you will have to recover each year. Add this percentage to interest on investment and the interest to cover extra taxes. The total percentage of interest on these items divided into the cash rent will tell you how much you can pay to purchase the added allotment.

Due to different circumstances, it is impossible to set a per acre value on peanut allotments in North Carolina. Some farmers will be in much more favorable position than others to purchase peanut allotments. But make certain you fully understand your position before buying or selling any peanut acreage—it's a buy and sell proposition.

Will Feel Loss Of Advance Payments

RALEIGH (AP)—The Nixon administration's decision not to make advance payments to farmers this year under the feed grain program may leave Tar Heel farmers short of cash at spring planting time.

The change in policy, which is almost certain to apply to the cotton and wheat programs as well as feed grain, was announced by Agriculture Secretary Clifford M. Hardin.

Farmers participating in the programs have since 1961 received about half of their anticipated payments in February and March when they registered for the programs. The rest was paid later in the year.

Jack S. Forlines, an official of the state office of the Agricultural Stabilization and Conservation Service, said these advance payments amounted to approximately \$21.5 million to Tar Heel farmers in 1969.

The advances have served the double purpose of encouraging participation in the cotton,

wheat and feed grain programs and helping the farmers meet the heavy need for cash during planting time.

The effect of the Nixon administration decision may be to cause a substantial drop in the number of farmers signing up for the diversion programs.

Under the programs, the farmers agree not to plant a proportion of their cropland normally devoted to certain crops. The purpose is to keep supplies more closely in line with needs and avoid a buildup of surpluses which would be costly to store and have a depressing effect on market prices.

The issue is almost certain to be brought up when Congress reconvenes next Monday. Sen. Robert Dole, R-Kan., has already announced he will seek a reversal of the decision.

Harvard University had an endowment fund of \$621,795,041 in 1968.

Tobacco TIPS

By S.J. Weeks
Tobacco Agent

One of the elements found in mixed tobacco fertilizer is chlorine. Small quantities of chlorine tend to increase tobacco yields to a moderate extent. However, excessive quantities of chlorine tend to injure plant roots and produce a dingy, dull, grey tobacco with a soggy characteristic and an undesirable odor and poor burn quality. Excessive chlorine also increases the tendency of the tobacco plant to take up ammonium nitrogen.

It has been recommended for several years not to apply more than 50 pounds of chlorine per acre for the production of best quality tobacco. When more than 30 pounds of chlorine per acre is used, it may have no effect, or it may have an adverse effect, producing poor quality tobacco, depending largely upon the season.

When large quantities of chlorine are applied without early periods to leach part of it down, excessive amounts may be absorbed by the plant and seriously affect the quality of tobacco.

In addition to the chlorine applied in mixed tobacco fertilizer, soil fumigants used for nematode control also contribute chlorine. Most of the soil fumigants used supply about 20 pounds of available chlorine when applied in the row.

In the tests conducted by Dr. C.B. McCants in 1964, tobacco receiving 60 pounds of chlorine per acre averaged five per cent less per pound than tobacco receiving 30 pounds. Tobacco receiving 120 pounds of chlorine dropped 18 per cent in price.

The tobacco receiving in excess of 30 pounds of chlorine per acre, when examined by both domestic and export companies, was considered extremely undesirable.

I will be glad to discuss your tobacco fertilization program with you and make suggestions as to how to reduce the amount of chlorine to be applied to your tobacco fields.

MASONIC NOTICE
Grimesland Lodge No. 475 will hold an emergent communication Tuesday at 7 p.m. John J. Payne, Master
G. C. Elks, Sec'y



WEATHER FORECAST—Snow is forecast for the Northeast and the Rocky Mountain states today. Snow flurries are predicted for the Great

Lakes area and snows are expected along the West Coast. Cold weather is in store for the East and Southwest. (AP Wirephoto Map)

At Least 16 Traffic Dead

By THE ASSOCIATED PRESS

A two-car crash that claimed four lives and three double-fatalities pushed North Carolina's weekend traffic death toll to at least 16 persons.

The State Highway Patrol said the large number of weekend fatalities boosted North Carolina's traffic count for the year to 38, only two fewer than the number killed during the corresponding period last year.

Shortly before the weekend death count period ended at midnight Sunday, snow, sleet and freezing rain caused hazardous driving conditions across much of the state. However, no weather-related fatalities were reported by the patrol.

Travelers warnings were in effect across much of the state today as a result of the inclement weather.

The four-death crash occurred on Interstate 95 in Roberson County. Troopers said a car occupied by Raul Bacvasoue, 23, a Ft. Bragg soldier, and Salome

Smithwick, pulled out of a rest area, traveled 1,500 feet in the wrong lane and collided with an oncoming car.

Occupants of the second car, Ernest Pridgen Jr., 46, of Rt. 2, Whiteville, and his 44-year-old wife, were killed, as were Bacvasoue and the Smithwick woman. The Pridgens' three children were hospitalized as a result of injuries they sustained in the crash.

The patrol said Bacvasoue's hometown was El Paso, Tex. Troopers said the age or hometown of the Smithwick woman were not immediately available.

A three-vehicle wreck on N.C. 103 a mile east of Mt. Airy claimed two lives. Dead are

Kinston Arts and Interiors
Erma L. Butcher — Interior Designer
804 N. Queen Street
Kinston, N. C. Phone 527-7708

Minor Fires Over Weekend In County

A series of minor fires and grass fires plagued Pitt County over the week-end, but all were brought under control with generally minor damage, according to Pitt County Fire Marshal Mike Worthington.

The county fires included: —A house fire in the home of Smiley Smith at 1:53 a.m. near King's Cross Roads. The Farmville Fire Department answered the alarm. Minor damage was recorded. Origin of the fire is undetermined.

—At 3:50 a.m. Sunday morning, Stoton House Fire Department answered an alarm for the home of Pete Smith at 707 Mills Street in Meadowbrook. A sofa had been discovered on fire. Fireman extinguished the blaze with damage confined to the sofa. At 1:55 p.m. firemen were again summoned to the Meadowbrook area—this time to put out a fire which was burning in a pasture.

—A house fire with damage amounting to about \$100 occurred in Winterville Sunday. The Winterville Fire Department responded to the call at

10:50 a.m. The fire was due to a broken cement collar around a flue pipe in the chimney, resulting in fire spreading to the wall.

—Sunday afternoon at 2:50 p.m., the Eastern Pines and Winterville Fire Departments reported to Cox's Round-Up, a service station on the New Bern highway. The fire started around a heater and spread up the walls and into the ceiling. Damage has been placed at approximately \$1,000.

—Four grass fires were reported during the weekend period.

YOU CAN AFFORD
A New Ford
Call or See Bill Harris Used Car Manager
Billmyer Ford
East 10th St. Ext. 758-2101

Fine Art For Your Home . . .
Let us show you how to add to the beauty of your home with decorative, tasteful wall pieces. See us, for all your decorating needs at . . .
Tommie Willis Interiors
"Your Complete Home Planning Service"
264 By-Pass Phone 756-1336



SELF-SUPPORTING AT AGE 102—Orlando (Dad) Walking, 102, gathers his main source of food, goat's milk, at his Modesto, Calif. home. Walking provided his own support, fashioning

bull whips and bridles from leather and weaving loops in rope ends for truckers. "I'm paying my own bills", he told an interviewer. (AP Wirephoto)

GET YOUR CONTACT LENSES NOW FOR BACK-TO-SCHOOL

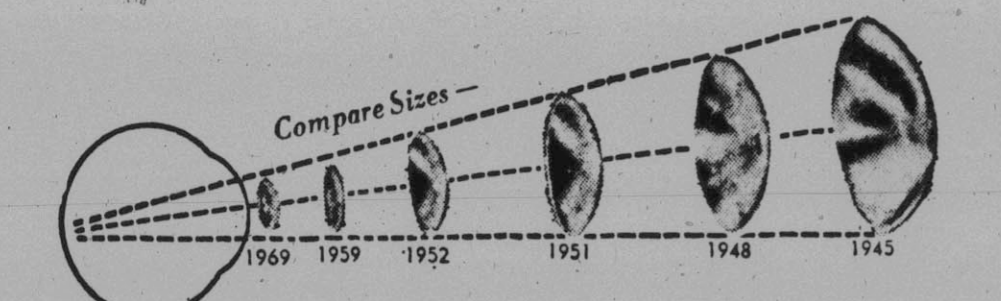

If you are thinking about CONTACT LENSES to start this school year, now is the time to make your appointment! The ideal situation is to allow four to five weeks for your doctor's eye examination, your contact lens fitting, and follow-up visits or check-ups. This is normal time required for your wearing time to progress properly so that you adapt to your new contact lenses before going off to school. Don't put it off . . . Call your eye doctor for an appointment and ask him about the many advantages of contact lenses. If your doctor recommends contact lenses or eye glasses, bring your prescription to us for prompt, accurate service!

First in the Carolinas **Ridgeway's** OPTICIANS, INC. Raleigh Prof. Bldg., 834-3451 804 St. Mary's St. 834-6409 Also in Greenville, N. C. Greensboro Charlotte

Blount-Harvey
COAT DEPT. - SECOND FLOOR

ANNUAL Coat Sale

perfectly simple, perfectly beautiful . . .
the Rothmoor® Coat

Very costly mink peltries!
Very costly wool coatings!

Many styles to select from, similar to illustrations. Costly woollens and natural mink collars that were used in Rothmoor coats regularly to \$198.00.

\$139.00

Costly woollens that were used in Rothmoor coats regularly to \$110.00.

\$88.00

REMAINING STOCK OF
WINTER COATS
Including Novelty furs And Car Coats, All REDUCED . . .
20% TO 40% OFF

World's Best Dressed Personalities Revealed

By ANN HENCKEN
Associated Press Writer
NEW YORK (AP) — Here it is. The parade of often-talented, often-beautiful and almost always-rich people who have made the international best dressed list.

The list is the result of a poll of some 2,000 people in the fashion and social worlds. Names of those chosen for 1969 were announced Sunday by Eleanor Lambert, publicist and co-ordinator of the poll.

Over the years, the selection has become a little more democratic. A men's category has been added. The ranking system

Spain and Denmark, and Baroness Philippine de Rothschild of France.

The women on the 1969 list not professionally connected with fashion are:

—Mrs. Ahmed Benhima (wife of the Moroccan ambassador to the United Nations). She likes designers Dior and Gres.

—Mrs. William McCormick Blair Jr., Washington, D.C. (wife of the former ambassador who now heads the Kennedy Center for the Performing Arts). She wears Givenchy's creations.

—Mrs. Wyatt Cooper (Gloria Vanderbilt) of New York. She is dressed by Adolfo.

—Mrs. Kirk Douglas, Beverly Hills, California (wife of the actor). Molly Parnis fashions suit her.

—Mrs. Ahmet Ertegun, New York (wife of the music publisher). She is another Adolfo fan.

Abby Presents Sex Education Facts

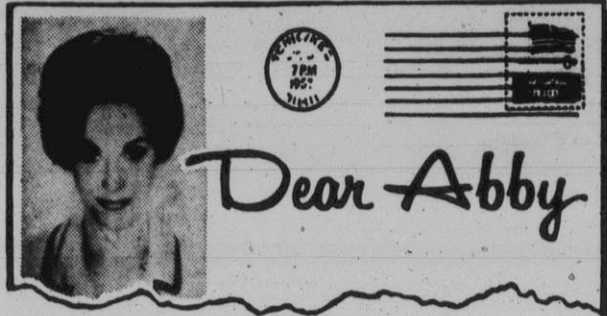

By Abigail Van Buren
[© 1970 by Chicago Tribune-N.Y. News Synd., Inc.]

DEAR READERS: In recent months, since I voiced my approval of sex education in the public schools, I have been deluged with letters from well-intentioned readers, urging me to reverse my stand.

"Look what happened to Sweden after THEY introduced sex education into their schools!" they cry.

I have received mimeographed "facts sheets" [some even distributed by CHURCH groups] stating that Sweden is now a "nation of degenerates—leading the world in suicides, alcoholism, divorce, and venereal disease."

I have been advised that "Stockholm is now the abortion capital of the world—that girls and women are flocking there for abortions because they are performed in hospitals with no questions asked."

These same sources inform me that in Sweden in the last two years, the incidence of rape has increased by 55 per cent!

The charge has also been made that "in Sweden the unmarried mother is glorified and rewarded. In fact, the unmarried mother enjoys the same social acceptance as the married mother."

If statistics bore you, skip this column. But if you are interested in knowing what changes have actually taken place in Sweden in comparison to other countries, the following will interest you. These statistics were obtained from the UNITED NATIONS WORLD HEALTH ORGANIZATION, whose headquarters are in Geneva, Switzerland.

- Sweden no longer leads the world in suicides—as she did 17 years ago. The most recent statistics show that Sweden now ranks NINTH among the nations of the world in suicides. Among the European countries with higher suicide rates than Sweden are Austria, Hungary, Denmark, Czechoslovakia and Finland. [In 1968 there were more suicides per 100,000 population in the state of California than in Sweden.]
- Concerning alcoholism. The people of France and the people of the United States both consume more alcohol per capita than do the people of Sweden.
- Concerning divorce. The most recent statistics reveal that in Sweden one out of every six marriages ends in divorce. In the United States, the divorce rate is one out of every three.
- Concerning abortion. An abortion may not be performed in Sweden unless an application is made, reviewed, and approved by the Royal Medical board. This is the same system used in the United States by those states which have recently liberalized their abortion laws. Interestingly enough, the requirements for obtaining a legal abortion in Sweden are almost identical to those in the state of Maryland. In recent years, so widespread were the rumors of "easy abortion" in Sweden that many misinformed women did flock to Sweden, hoping to be accommodated, but were disappointed.
- As for the alleged shocking increase of "rape" in Sweden, the most recent statistics are as follows:
For 1965 and 1966 the "arrest" figures per 100,000 population were respectively 87 and 78, showing a decrease of 10 per cent—not an INCREASE of 55 per cent!
In a population of 7,847,395, this works out to approximately 1.1 per 100,000 in 1965 and 1.0 per 100,000 in 1966, one of the LOWEST rates in the world.
By comparison, the United States had 10,734 rape arrests in 1965, [or 5.36 per 100,000 population] and increased 7 per cent to 11,609 in 1966—or 5.8 per 100,000 population.
- The facts on venereal disease. The most recent statistics available are for 1967.
The number of cases reported for early syphilis per 100,000 population are:
Finland 2.8
United Kingdom 2.8
Sweden 4.3
Denmark 6.5
United States 10.8
- While the unwed mother in Sweden is not regarded as a "social outcast," neither is she "rewarded and glorified." In Sweden children born out of wedlock are given the same advantages as children born into "families." The reason being that Swedes feel that no child should be made to suffer because his mother is alone, whether she is divorced, widowed or unmarried.

Most of us are inclined to accept as "truths" that which we have heard repeated over and over again. It is for this reason that I have checked out the facts, and present them to you in fairness to a much maligned nation—Sweden.

Very truly yours,
ABIGAIL VAN BUREN

Others in this category include: Mrs. Robert Evens (Ali McGraw, actress); Mrs. Patrick Guinness, Paris and Lausanne, Switzerland; Her Highness Princess Salima, wife of the Aga Khan (former Lady Sarah Crichton-Stuart); Mrs. Graham Mattison, Paris (Brazilian-born wife of the American financier); Mrs. Charlotte Niarchos (former Charlotte Ford); Mrs. William Rayner, New York; Mrs. Charles Revson (wife of the cosmetics manufacturer); Mrs. Robert Sakowitz (former Pamela Zauderer); and Mrs. Harilaos Theodoracopoulos (American-born wife of Greek shipping magnate).

Women best dressed in the fashion world are: model and socialite Marisa Berenson, fashion photographer Berry Berenson, Mrs. Robin Butler, Mrs. Oscar de la Renta, Mrs. David Evins, Lady Pamela Harlech, Mrs. Thomas Kempner, Mme. Minouche Le Blan, Eve Orton, Mrs. Renny Saltzman, Mrs. Frank Schiff and fashion model Veruschka (Countess Vera von Lehndorff in private life).

The men in private life who led the way in 1969 are: Gianni Agnelli (head of the Fiat Company of Italy); Adolphus Andrews (San Francisco business man); Harry Belafonte; Gianni Bulgari (Rome jeweler); Michael Butler (producer of "Hair"); James Coburn (film actor); Wyatt Cooper (New York publisher); Frank Gifford (New York sports broadcaster); George Hamilton (film actor); Jean-Claude Killy (Olympic skier); Baron Eric de Rothschild (member of the international banking family) and David Susskind (television personality).

The best dressed men affiliated with fashion are: Bill Blass, Hubert de Givenchy, Luis Estevez, Robert L. Green, Baron Nicolas de Gunzburg, Walter Halle, Sixten Herrgard, Bernard Lanvin, Patrick, Earl of Lichfield, Robert Sakowitz, Philippe Venet and John Weitz.

CANDIES

Candies made with water and sugar can be boiled quickly on high heat. Those made with milk and sugar require slower cooking, on medium heat, to prevent possible scorching.

If the Shoe Fits...

BY LARRY AVERETTE

Did you know that every time you put on your shoes, you start with the same foot, either right or left? If it is the right foot, you will find that you will also put your socks first on the right foot, then on the left — it feels uncomfortable if you try it in the reverse order.

In ancient Rome there was a popular superstition that it was bad luck not to dress the right foot first. Whichever shoe you put on first, it is important that your shoes have a proper fit. It is good to see a person briskly striding down the street, as evidence of healthy feet and good fitting shoes. This happy condition surely adds to the enjoyment of life.

Larry's

AT 5 POINTS
GREENVILLE, N. C.
TELEPHONE 752-5784
OPEN FRI. TIL 9 P.M.

Calendar Events

MONDAY
6:30 p.m.—Optimist Club meets at Silo Restaurant
7:00 p.m.—Lions Club meets at Moose Lodge

7:30 p.m.—Order of The Rainbow for Girls meets at Masonic Lodge
7:30 p.m.—Greenville Toastmasters Club meets at Pitt Technical Institute.
8:00 p.m.—Lodge No. 885, Loyal Order of the Moose

Births

Niparts
Born to Mr. and Mrs. Herbert Niparts, 400-B Holly St., a son, Janis Voldenars II, on Jan. 7, 1970, in Pitt Memorial Hospital.

Lloyd
Born to Mr. and Mrs. Clifton Lloyd, 2117 Montclair Dr., a daughter, Holly Rose, on Jan. 7, 1970, in Pitt Memorial Hospital.

Whitaker
Born to Mr. and Mrs. Isiah Whitaker, Bethel, a son, on Jan. 7, 1970, in Pitt Memorial Hospital.

Baker
Born to Mr. and Mrs. Denis R. Baker, 1302-B Mills St., a daughter, on Jan. 7, 1970, in Pitt Memorial Hospital.

TUESDAY
9:30 a.m.—Mrs. A E Dubber

Lector Club Meets Tuesday

The Lector Book Club met on Tuesday at the home of Mrs. Charles King for a three-course luncheon. Guests welcomed were Mrs. J. W. Clark Jr. and Miss Vernie Wilder.

Mrs. L. W. Gaylord Jr., president, presided over a short business session.

Mrs. V. E. Wells, program chairman for the afternoon, introduced Mrs. Clark, guest speaker. Mrs. Clark spoke on the life of Jeanne Dixon and Adela Rogers St. John.

Books were exchanged following the program.

will be hostess to the Lakewood Pines Garden Club
10:00 a.m.—Ingis Fletcher Book Club meets with Mrs. Sylvester Green
1:00 p.m.—Mrs. Walter Harrington will be hostess to the Athenium Book Club
1:00 p.m.—Christian Business Men's Committee meets at Silo Restaurant
3:00 p.m.—The Fine Arts Department of the Woman's Club meets at the club bldg.
7:00 p.m.—Creasy K. Proctor, Order of DeMolay meets at Masonic Hall
8:00 p.m.—Withla Council, Degree of Pocahontas meets at Rotary Bldg.
8:00 p.m.—Pitt Co. Alcoholics Anonymous meets at AA Bldg. on Farmville Hwy. Telephone 752-2961

WEDNESDAY
10:00 a.m.—Girl Scout leaders meeting at the home of Mrs. Wyatt Brown
10:30 a.m.—Mrs. David Evans will be hostess to the Brookgreen Garden Club
1:00 p.m.—Worship service at

the Pitt Mearial Hospital chapel
1:45 p.m.—Wednesday Afternoon Duplicate Bridge Club weekly game at Planters Bank
6:30 p.m.—Kiwanis Club meets
7:00 p.m.—Jay-C-Eltes meet at Fiddlers III
8:00 p.m.—Greenville White Shrine meet at Masonic Hall
8:00 p.m.—Pitt County Al-Anon Group meets at Alcoholics Information Center. Telephone 756-3222 or 756-0567

THURSDAY
9:30 a.m.—Ladies day at Brook Valley Country Club
10:00 a.m.—Senior Citizens meet
6:30 p.m.—Exchange Club meets
7:00 p.m.—Winterville Kiwanis Club meets at Community Bldg.
8:00 p.m.—VWF meets at Post Home
8:00 p.m.—Coochee Council No. 60, Degree of Pocahontas meets at Redmen's Hall
8:00 p.m.—Greenville Lodge No. 1645 BPOE meets

FRIDAY
9:30 a.m.—Ladies day at Greenville Golf and Country Club
3:15 p.m.—Mrs. Claud Batts will be hostess to the Greenville

Golf and Country Club. Assisting hostesses are Mrs. C.M. Respass, Mrs. J.A. Piver and Mrs. L.S. Worthington
7:30 p.m.—Redmen meet
7:30 p.m.—Regular session of Faculty Duplicate Club at Planters Bank

SATURDAY
7:30 a.m.—Christian Business Men's breakfast at Silo Restaurant
1:30 p.m.—Regular Saturday Afternoon Duplicate Bridge game at Elm Street Recreation Center
7:15 p.m.—Seventh Grade Junior Cotillion dance at the American Legion Bldg.
9:00 p.m.—Eighth Grade Junior Cotillion dance at the American Legion Bldg.

SUNDAY
12 Noon—Buffet at Greenville Golf and Country Club
3:00 p.m.—The Literacy Council of Pitt County will meet in the Literacy Library Room of the First Presbyterian Church

Lemon Custard Pie
Diener's Bakery
815 Dickinson Avenue

Open Every Night 'Til 9:00!
USE YOUR PENNEY'S CHARGE CARD!

PITTSBURGH PITT PLAZA Penneys

JANUARY WHITEGOODS SALE

ALL OUR FASHION MANOR SHEETS REDUCED!

STOCK UP NOW!
LAST WEEK!
(SALE ENDS SATURDAY JAN. 17)

<p>NATION-WIDE® WHITE MUSLIN Cotton muslin, 133 count.* Twin 72" x 108" flat or Sanforized® Elasta-fit bottom reg. 1.99, NOW 1.38 Full 81" x 108" flat or Sanforized® Elasta-fit bottom reg. 2.29, NOW 1.68 Pillow cases 42" x 36", reg. 2 for 1.09, NOW 2 for 86¢ <small>* bleached and finished</small></p>	<p>PENCALE® WHITE PERCALE Combed cotton, 186 count.* Twin 72" x 108" flat or Sanforized® Elasta-fit bottom reg. 2.39, NOW 2.37 Full 81" x 108" flat or Sanforized® Elasta-fit bottom reg. 2.69, NOW 3.37 Pillow cases 42" x 36", reg. 2 for 1.39, NOW 2 for 1.67 <small>* bleached and finished</small></p>
<p>PENN-PREST WHITE MUSLIN 50% cotton/50% polyester Twin 72" x 104" flat or Elasta-fit bottom reg. 2.59, NOW 1.77 Full 81" x 104" flat or Elasta-fit bottom reg. 3.59, NOW 2.67 Pillow cases 42" x 36", reg. 2 for 1.69, NOW 2 for 1.37</p>	<p>PENN-PREST WHITE PERCALE 50% combed cotton/50% polyester Twin 72" x 104" flat or Elasta-fit bottom reg. 2.99, NOW 1.77 Full 81" x 104" flat or Elasta-fit bottom reg. 3.99, NOW 2.07 Pillow cases 42" x 36", reg. 2 for 1.99, NOW 2 for 1.07</p>
<p>PENN-PREST MUSLIN PRINT 50% cotton/50% polyester Twin 72" x 104" flat or Elasta-fit bottom reg. 3.69, NOW 2.87 Full 81" x 104" flat or Elasta-fit bottom reg. 4.69, NOW 3.87 Pillow cases 42" x 36", reg. 2 for 2.69, NOW 2 for 2.37</p>	<p>PENN-PREST PERCALE PRINT 50% combed cotton/50% polyester Twin 72" x 104" flat or Elasta-fit bottom reg. 4.99, NOW 4.47 Full 81" x 104" flat or Elasta-fit bottom reg. 5.99, NOW 5.47 Pillow cases 42" x 36", reg. 2 for 3.59, NOW 2 for 3.27</p>
<p>PENN-PREST MUSLIN FASHION COLORS 50% cotton/50% polyester Twin 72" x 104" flat or Elasta-fit bottom reg. 2.99, NOW 2.57 Full 81" x 104" flat or Elasta-fit bottom reg. 3.99, NOW 3.57 Pillow cases 42" x 36", reg. 2 for 2.29, NOW 2 for 1.97</p>	<p>PENN-PREST PERCALE FASHION COLORS 50% combed cotton/50% polyester Twin 72" x 104" flat or Elasta-fit bottom reg. 4.19, NOW 3.57 Full 81" x 104" flat or Elasta-fit bottom reg. 5.19, NOW 4.57 Pillow cases 42" x 36", reg. 2 for 3.19, NOW 2 for 2.77</p>

STOCK YOUR ENTIRE LINEN CLOSET NOW AND SAVE!
NO SERVICE CHARGE ON PENNEY'S LAY-A-WAY, CONVERT TO CHARGE LATER!

SONTIQUE PILLOW SALE!

PICK SOFT, MEDIUM OR FIRM DENSITY.

STANDARD 20 x 26" FINISHED SIZE
REG. 7.98, NOW **6.98**

No more trying to plump up a too-soft pillow. No more stiff necks from a too-firm pillow. Pick the one that's just right for you! And there is a size just right to fit your bed, from standard to extra widths. All are Dacron® polyester fiberfilled, non-allergenic and mildewproof. Penn-Prest cotton ticking is nylon zipped, machine washable, tumble dry.

CBD Nearing Action Stage

Hopefully the City Council's approval of use of Parking Authority revenues for meeting the city's share of Central Business District cost will mean this project will move along without undue delay.

The Council authorized the necessary letter which states the Authority has been established and \$860,000 in city cost will be met through Authority revenues last Thursday night.

Action was taken after Redevelopment Director A E Dubber explained that this was the only piece of information which the Redevelopment Commission lacked. He described need for the action as urgent. He explained that Stage one of the CBD project has been completed and Stage two is being put together as a plan of operation. Between now and March 10 the city must hold public hearings and move the plan through the Redevelopment Commission, Planning and Zoning Commission and the City Council so that it can be submitted to HUD for final consideration.

After this the long range downtown improvement project can get underway to convert the CBD to a modern commercial and office area.

Dubber estimated that it may be 1980 before

the project is finally closed out.

Almost everyone agrees that the CBD project is necessary if Greenville is to have a Central Business District which is suitable for the growth that the city seems to have ahead.

The federal funds for the project have been reserved and planning is well along for carrying out the project.

The City Council has acted properly in approving this document which the Redevelopment Commission needed to proceed with its work. We trust that the CBD project will soon be nearing the execution stage.

N. C. Business Holds Up Relatively Well

Despite some softness in retail sales around the nation it appears that North Carolina's sales held up well during December.

Revenue Commissioner I.L. Clayton reported that sales tax brought in \$22.4 million last month for a \$2.4 million gain over December, 1968.

The sales tax collections are a barometer of retail sales in the state. Thus it seems that sales were ahead of the same month of 1968.

There were also gains in other categories by the 1969 Legislature.

In uncertain economic times nationally, the tax figures indicate that North Carolina's economy is still growing.

Agnew Now A Spear Point

By ROWLAND EVANS and ROBERT NOVAK

WASHINGTON — When conversation switched to the 1970 Congressional elections at a recent White House breakfast, Sen. Robert Dole of Kansas turned to President Nixon and said:

"Next to you, Mr. President, Agnew is the one Republican who can get money for us without carrying a gun."

That summed up the remarkable transformation of Agnew from Administration hair-shirt to folk hero, a status change that Mr. Nixon himself had long since perceived to the point of assigning to Agnew the party's top campaign role in the battle for the Senate this year.

With the Senate his number one target, Mr. Nixon himself is laying quiet plans to take an unprecedented share of the campaign load on his own shoulders, but those plans are still tenuous.

Cautious political aides are advising him to guard his prestige and pick his openings with some care, as he did last November. In that election, Mr. Nixon refused to commit himself to campaign in Virginia and New Jersey until both Republican nominees for governor — Linwood Holton and Rep. William Cahill — looked like possible winners.

But no such caution is reigning in Agnew. As Mr. Nixon's campaign spear point, Agnew already has half a dozen statewide fund-raising dinners on his schedule, and they include some places where he would not have been entirely welcome last summer.

Agnew's long-postponed decision to star at the Minnesota Republican party's statewide fund-raising dinner in St. Paul on Feb. 20, for example, has stirred only minimal coolness from liberal party elements. The liberals are still furious over Atty. Gen. John Mitchell's abrupt intervention in the hot Republican Senatorial contest there (between Rep. Clark MacGregor and State Atty. Gen. Douglas Head).

Party leaders now predict

Agnew will raise close to the \$1 million goal.

Agnew is also being strongly pressed to come into New York state any time between now and late April to raise money for the Suffolk County Republican Committee.

Strongly conservative Suffolk County gave the Nixon-Agnew ticket its largest New York state margin in 1968. Although the New York invasion was specifically cleared by state party chairman Charles Lanigan, it will raise embarrassing questions for both Agnew and the party's certain nominee for the Senate, Sen. Charles E. Goodell.

Goodell has attacked Agnew for "inflammatory rhetoric" and "baseless charges" against anti-war demonstrators. Thus, Goodell may find himself unavoidably absent.

With firm fund-raising dates already pinned down in the hospitable South, Midwest, and Far West within the next six weeks, Agnew's election role is certain to grow as the campaign heats up.

Beyond the Agnew assignment, moreover, Mr. Nixon has ordered the Republican National Committee to give Cabinet members elaborate briefings on candidates and issues in states where the Republicans have some chance of picking up Senate seats.

In an effort to block stupid political errors, each Cabinet member (with the sole exception of Secretary of State William P. Rogers) has been told to name one top aide as liaison with the National Committee. The obvious reason: to prevent flat-footed Cabinet-level actions, such as the Agriculture Department's lowering of dairy price supports just before the special Wisconsin Congressional election last year.

Appropriately, Agriculture Secretary Clifford Hardin was the first Cabinet member to get the National Committee briefing.

With all this tooling up to capture the Senate, however, the President's one major

(Continued On Page 5)

Well-Suited To Demo Post

By WILLIAM A. SHIRES

RALEIGH — Gene Simmons is a popular, colorful personality with a way of winning friends and influencing people.

And he was available for the job as chairman of the State Democratic Executive committee, willing to devote nearly full time to the task of shoring up, strengthening and revitalizing the state's long-dominant political party.

Gov. Bob Scott is confident that the peppy Simmons will be able to do this and thus has nominated the 53 year old Tarboro warehouseman to the post vacated last month by Jimmy V. Johnson of Charlotte. Simmons will be elected chairman next Tuesday.

But those years are far enough in the background to erase any sort of conservative or moderate wing label and to belie talk of a "new alliance" between the party forces who supported Scott and Broughton.

The general analysis is that Simmons represents the same, identical political philosophy as Bob Scott and this leans to the liberal side of the party.

Factors — Announcement of Scott's selection of Simmons brought mixed reaction. There was disappointment on grounds that Simmons did not appear to be as well known as some other possible choices.

Other sources however said they were pleased and felt that Simmons will go about the work with zest, zeal, energy and with a keen sense of what the Democratic party must do.

Certain other, perhaps indirectly related factors were being mentioned in Raleigh political circles.

One was the fact that the Scott administration probably feels it strongest political backlash in the next elections will come from Eastern North Carolina because of the newly-imposed tobacco tax.

Well, Gene Simmons is an Easterner. He is a tobacco man himself. He speaks the language of the warehouse as well as the State House.

In the Eastern tobacco heartland they know Gene Simmons well. They remember that it was Simmons who arranged and acted as master of ceremonies at a rousing political rally in Greenville during the 1964 campaign—that the Greenville rally was on behalf of candidate Bob Scott.

Problems — Simmons is well aware that the Democratic party in North Carolina faces problems, deep divisions and a growing Republican threat in all party of the state.

Apparently he told Scott and assured top party leaders that he is ready and willing to tackle these. He has ideas about how to go about it — ideas which Scott likes.

Still, Bob Scott as governor remains titular head of the party in power. On all major policy decisions and actions, Bob Scott will have the last word.



WILLIAM SHIRES

Simmons — Politically it should be remembered that Simmons and Bob Scott not only are close friends but have worked together well since the day Scott won his first elective office, that of lieutenant governor, in 1964.

Scott became president of the Senate. Simmons served as reading clerk of the Senate during the two regular and special legislative sessions over which Scott presided.

He became well versed in the Scott way of doing things, and steeped in the Scott political philosophy.

And he became a staunch Scott political supporter. Reports that Simmons supported and was a county campaign manager for Scott's 1968 opponent, J. Melville Broughton Jr. in Edgecombe County are not true.

Support — The fact is that Simmons worked diligently for Scott in that primary campaign.

It is true that some years earlier, in 1940, a much younger Gene Simmons helped manage the Edgecombe County campaign on behalf of the late J. Melville Broughton—father of the unsuccessful candidate of 1968.

BLESSED BE THE PEACEMAKER

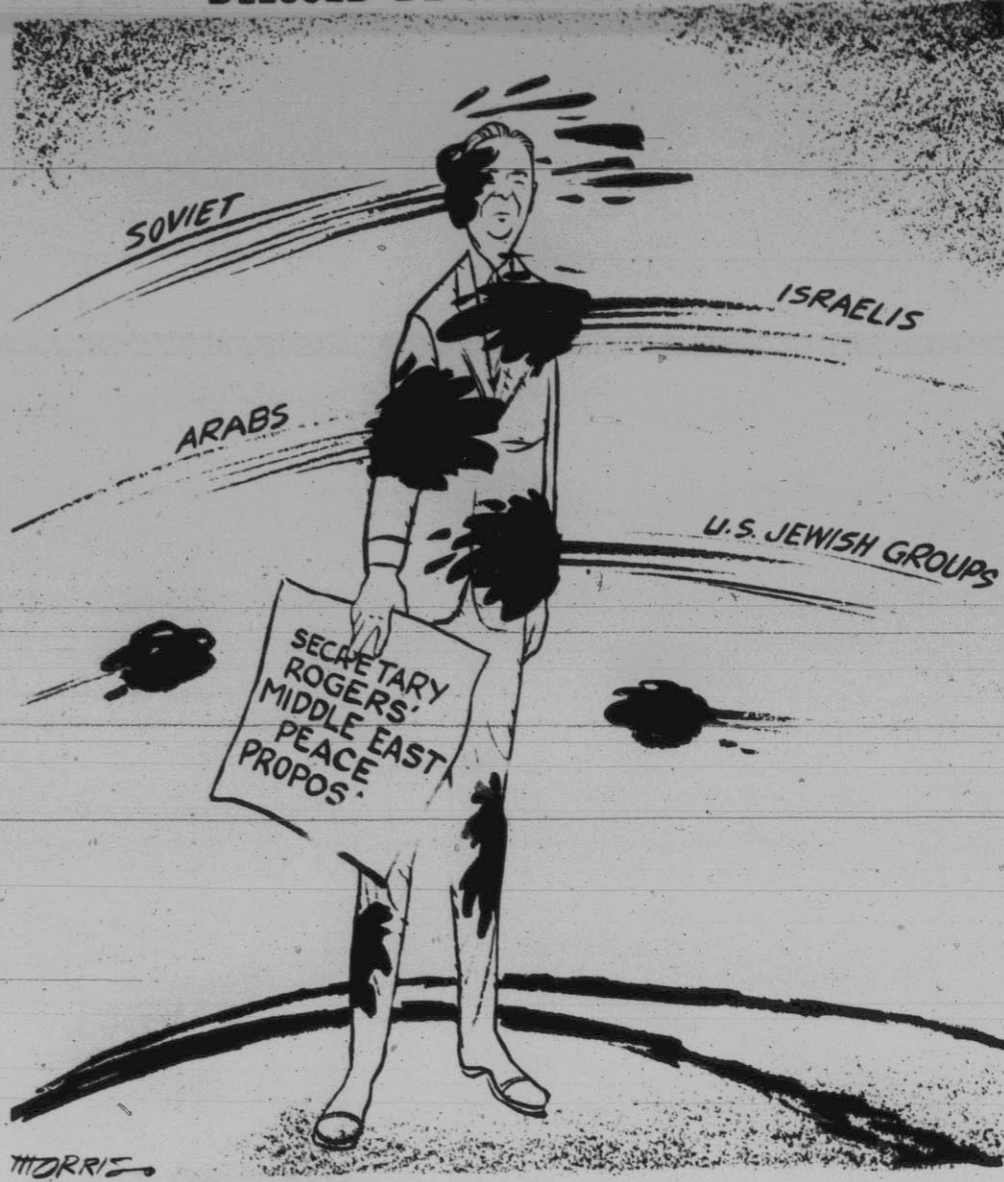

By ART BUCHWALD

Let's Scrap The Courts

WASHINGTON — There has been a great deal of criticism of the courts in this country. Because of the backlog of cases, plus cumbersome appeals, and bureaucratic procedures, it takes longer and longer for a man to be given a fair trial.

Prof. Horace Hafflinger of the Institute of Sustained Jurisprudence has been making a study of the problem and has come to the conclusion that you don't need the courts at all. In today's world of speedy communications, he says, trying a man before a jury and in a courtroom is old-fashioned.

Prof. Hafflinger told me, "It is so much easier and faster to try someone in the press than in a court. Why must a person wait six months to a year for a trial when all the facts of the case

have been laid before the public as soon as the person has been arrested?"

"But, Professor, under our system, isn't a person presumed innocent until proven guilty?"

"Of course," Prof. Hafflinger said. "And I intend to do nothing to change this. But the press is still in a better position to report all the facts than the district attorney."

"Let us take, for example, the Sharon Tate murder case. As soon as the indictments were handed down, the press went to work. One newspaper printed the entire confession of one of the girls; a national magazine went into detail on the sordid life habits of the accused; television reported interviews with lawyers of the people involved."

"The result of all this was that the public knew far more about the case than the prosecutor."

"Adding all this information up, I don't think there is one person in this country who has not made up, his mind on the innocence of the accused people in the Tate murders. Now I ask you, if the public already knows if they are innocent or guilty, why do the people need a trial?"

"To make it legal?" I suggested.

"Hogwash," Prof. Hafflinger said. "All you are doing is using up the taxpayers' money. If the press has done its work properly—and in this case there doesn't seem to be any question that it has—then the accused should be dispatched immediately."

"What about something like the Song My massacres?"

"This is another example of where a trial is unnecessary. Both national news magazines put Lt. Calley on their covers. The public has seen photographs of massacred people. They have read testimony from men who were there. What good is a court martial going to do when it's obvious to the world who was responsible for what happened at Song My?"

"Then what you're saying is that we are helping justice by eliminating the court system?"

"Exactly. The court system was necessary before people could read newspapers and magazines and watch television. But now with all the news media at their command they are in a much better position to evaluate a crime than 12 strangers and a man in a long

office holders themselves.

(Continued On Page 5)



ART BUCHWALD

South Still A Bastion

By ED ROGERS
WASHINGTON (UPI)—A new rating of House and Senate members by the liberal-leaning Americans for Democratic Action (ADA) shows the southern bloc in Congress is still a bastion of conservatism.

With the exception of three senators and three representatives, no lawmaker from 12 Southern states received a "liberal quotient" rating higher than 50 per cent in the scale set up by the ADA.

In its annual study made public Sunday the ADA said the 91st Congress, by its standards, is the first since the Eisenhower years that proved to be more liberal than the President in office.

This has meant trouble for President Nixon, particularly in the Senate, in his dealings with Congress on tax reform, the ABM, defense spending and filling the Supreme Court vacancy created by Abe Fortas' resignation.

Rating Scale
Some of these issues were involved in the 15 House votes and 18 Senate votes the ADA chose for rating the lawmakers on a scale in which solid voting on the liberal side would rate a 100 score.

Six senators and 22 House members achieved that rating during the 1969 session.

The House members were all Democrats.

The senators were Democrats Vance Hartke, Ind., Edward Kennedy, Mass., Philip Hart, Mich., and Gaylord Nelson. The Republicans were Clifford Case, N. J., and Jacob Javits, N. Y.

The only Southern senators receiving "high ratings" were Ralph Yarborough, D-Tex., 78; J. William Fulbright, D-Ark., 67, and Albert Gore, D-Tenn., 61. Scores of 50 per cent were given to Sens. John Sherman Cooper and Marlow W. Cook, both Republicans from Kentucky, and William B. Spong, D-Va.

Three southern House members scored above 50 — Reps. Bob Eckardt, D-Tex., 87; Henry B. Gonzalez, D-Tex., 67, and Dante B. Fascell, D-Fla., 53.

Two Florida Democrats, Reps. Claude Pepper and Sam Gibbons, were each rated 47 while Carl D. Perkins, D-Ky., and Eligio de la Garza, D-Tex., each got a 40 per cent rating.

Outside of a few ratings of 33, 27 and 20 the rest of the southerners in both the Senate and the House made only nominal displays of liberalism.

The ADA ratings are usually borne out in a general way by the mirror-image ratings given each year by the ADA's conservative counterpart, the Americans for Constitutional Action.

Test Votes
Although the two organizations do not pick the same test votes a rating for 100 by the ADA usually means zero by the ACA and vice versa. The ACA plans to announce its ratings next month.

Of the nine senators the ADA awarded zero, five were Southerners—Democratic Sens. James O. Eastland, Miss., and Russell B. Long, La.; and Republicans Edward F. Gurney, Fla.; Strom Thurmond, S.C.; and John Tower, Tex.

Of the 77 zeroes assigned House members 33 went to congressmen from Alabama, Arkansas, Florida, Georgia, Mississippi, North Carolina, South

(Continued On Page 5)

The Daily Reflector
INCORPORATED
Established 1882
Published Monday Through Friday Afternoon
and Sunday Morning
DAVID JULIAN WHICHARD, Chairman of the Board
JOHN S. WHICHARD—DAVID J. WHICHARD
Publishers
Entered at Post Office, Greenville, N.C.
as second class mail matter

ABC

SUBSCRIPTION RATES
Payable in Advance
Home Delivery By Carrier
Motor Route Monthly \$2.25
By Mail.
One Year \$27.00
Six Months 13.50
Three Months 6.75
(Prices include sales tax where applicable)

MEMBER OF ASSOCIATED PRESS
The Associated Press is exclusively entitled to use for publication all news dispatches credited to it or not otherwise credited to this paper and also the local news published herein. All rights of publications of special dispatches here are also reserved.

UNITED PRESS INTERNATIONAL
Advertising rates and deadlines available upon request Member Audit Bureau of Circulation.

Strength For Today

DIVINE REWARDS
What is prayer?
Prayer is the lifting-up of the heart to God, seeking fellowship with God, asking that God will grant our petitions.

All prayer should begin with confession. We are sinners, and we know we are sinners — some great sinners, some little sinners, but all sinners. The first thing we need to do in prayer is to make the weak condition of our moral lives clear to ourselves. The next thing we need to do is to ask God's forgiveness. The third thing we need to do is to offer up, thanksgiving to God. We can be sure that God is more willing to give than we are to receive. God always answers

our prayers, and his answer is Yes or No or Wait or I have something better to give you. Many of us ask for petty gifts out of God. If we were one half as willing to receive God's gifts as He is to give them, we would live in a state of life and joy, of light and understanding.

If what we really want in life is genuine happiness, let us stop blaming God and begin blaming ourselves for the barrenness of our lives. God is the giver of every good and perfect gift. This conviction should lie at the basis of all our praying. If we leave the issues of life in God's hands He will answer our prayers with forgiveness, joy, light, achievement and salvation.

By Earl L. Douglass

Those Premature Predictions

By ELMER ROESSNER
Commerce Secretary Maurice H. Stans has assured American that the new year will see significant progress toward ending the worst inflation in 19 years. He added that part of the inflation fight is ahead.



ELMER ROESSNER

First National City Bank in its January newsletter said that it is "probable" that inflation will lessen this year and that there is a "reasonable chance" that inflation will end in the early 1970s.

Across the nation stores are advertising heavily cut prices, with apparel, appliances and other items being offered at half off.

Before we start burning bonfires from the hilltops, let's look at some other developments.

Clearance Sales Predicted
The cut-price sales were predicted in detail in this column on Dec. 26. It was pointed out that the National Retail Merchants Association had bulletined members to take markdowns early. Many merchants overestimated Christmas sales and had overstocked and there is some intense competition to unload remainders first.

The contracts of the International Brotherhood of Teamsters' and the Chicago Truck Drivers, Helpers and Warehouse Workers Union expire on March 31 and the unions are demanding \$1 an hour raise in each of the next three years which, with rises in fringe benefits, would bring the increase to \$4.50 an hour. Employers say this would increase trucking rates

24 per cent.

The Federal Housing Administration and the Veterans Administration have raised the ceilings on mortgages it backs from 7 1/2 to 8 1/2 per cent.

Monthly fees on Medicare are to be raised from \$4 to \$5.50 on July 1.

A move is afoot in Congress to raise the minimum wage from \$1.50 to \$2.50 an hour, to bring more employers under the law with a \$2 minimum, and set a \$1.75 minimum in retail and service establishments.

Copper producers are raising prices about 8 per cent.

More Wage Boosts
Chicago carpenters have won pay increases of \$1 a hour and this is expected to become the national goal.

New York subway workers, with threats to tie up the city, get an 18 per cent pay increase over two years and

subway rides were increased 50 per cent.

All over the country wage increases are being won. All over the country local and state taxes are being increased and with most state legislatures meeting this year, the state hikes should be wow.

With almost everything costing more to move, it takes a wrong-way slyglass to foresee the end of inflation.

Vandals Boom Sales
Of Unbreakable Glass

Manufacturers of polycarbonate glazing materials (unbreakable glass) report a substantial increase in sales last year, largely to school boards for whom the high cost of replacing windows has become a national problem. Rowland Products, of Kensington, Conn., expects another 25-100 per cent increase this year.

Something Being Done About Our Polluted Planet

By ALTON BLAKESLEE
AP Science Editor
NEW YORK (AP) — At last, something is being done about our polluted planet.

In Florida, Lake Apopka is to be drained of its polluted water. Then, hopefully, the muck-filled lake bed will be sun baked filled with fresh water.

On New Year's Day, President Nixon vowed a "now or never" effort to overcome pollution of water, air and land, in signing a bill creating a three-member Council on Environmental Quality to help guide national policy.

In Erie County, N.Y., a single patrol car prowls on watch for autos emitting excessive exhaust fumes, and drivers can be given summonses under a new law.

On Washington orders, the persistent pesticide DDT—blamed for harming bird and animal life and perhaps human health—is being phased out of all but special use.

On Wall Street, analysts predict companies engaged in or entering the field of air and water pollution control will be new stars in corporate growth and stock market appeal.

On college campuses, youths

are taking up a new supercause—protecting man's environment—and are demanding action now.

More young lawyers are specializing in cases involving conservation of natural resources and suits to halt pollutions.

There are proposals to set up schools of human environment at universities to train professional workers, and proposals to teach school kids early about dangers to the nation's environment.

So—as the 1970's begin—go some signs that the country might veer off from a suicidal course of destroying a livable environment by abuse of land, water and air, and through an avalanche of trash and garbage.

The planet earth is being recognized for what it really is—one huge spacecraft. It has one total environment, and only one, to support more than three billion passengers.

Neil Armstrong stepped out of the carefully protected environment of his spacecraft to become the first man to walk on the moon. That was last July—just a month after the Cuyahoga River in his native Ohio caught fire from oil pollution.

Perhaps there is one generation of time left to reverse the

present course in disrupting nature's chemical balances, says Dr. Barry Commoner, Washington University biologist.

The counterattack against pollution so far has been mainly words. There's been little movement to produce the many billions of tax dollars that will be needed to control pollution, let alone repair damage already done.

But some positive steps are being taken, and here is a sampling:

WATER
Congress appropriated \$800 million for next year under the Clean Water Restoration Act, \$586 million more than the Administration requested. But it may not all be spent in this tight budget year.

Interior Secretary Walter J. Hickel cited the city of Toledo, four steel companies and a mining company for pollution of interstate waters in Oklahoma, Kansas, Ohio and Lake Erie, in the first use of the enforcement provision of the 1965 Water Pollution Control Act. This opened the way to corrective measure if they were in violation.

In New Rochelle, N.Y., an experimental sewage treatment process converts waste to fresh water. Whether it would work in a large-scale operation is not yet known.

Mississippi silverside fish introduced into a California lake are credited with clearing out 80 to 90 percent of algae that had been befouling it.

Looking ahead, Hickel estimated at least \$15 billion will be needed over the next 10 years to clean up the nation's polluted lakes and streams.

private foundations are supporting experiments studying new methods of collecting and disposing of refuse and other wastes.

Among approaches are: turning city trash into lightweight precast concrete panels, blending wastes with coal for furnaces, burning garbage so methane and other gases can be recovered as fuels, fusing metals, concrete, glass and the like into aggregate building materials.

All center on the idea of recycling the things we use—but don't consume—like bottles, cans, autos. Each American throws out five pounds of garbage a day—a total of 183 million tons a year. Factories and other sources burn or dump almost as much.

Says the National Academy of Engineering: solid waste should

be regarded as a major natural resource. "Recycling them for economical use must become a national objective."

"We are running out of an 'away' in wach to throw things away," says Dr. Athelstan Spilhaus, president-elect of the American Association for the Advancement of Science.

NOISE
New regulations by the Federal Aviation Agency require future jet airliners to be half as noisy as existing ones. The Department of Transportation contracted with Serendipity, Inc., an Arlington, Va., firm, to study noise and its cure in transportation systems.

The Labor Department Health Code has set 90 decibels—about the noise of a motorcycle—as the loudest continuous noise a workman can be exposed to during an eight-hour day. Firms

not complying cannot bid on government contracts worth \$10,000 or more.

So some small first steps are being taken to cure America's ailing environment, but it's still a bit on the order of one aspirin tablet.

HOURLY CLEANERS

3-HOUR SHIRT SERVICE
1-HOUR CLEANING
Hour Glass Cleaners
DRIVE-IN CURB SERVICE
11th St. and Charles St.
Corner Across From Hardee's
Complete laundry and dry cleaning service.



Sole Survivor Of Television Series

By BOB THOMAS
Associated Press Writer
HOLLYWOOD (AP) — George Hamilton has the distinction of being the sole survivor of "The Survivors," which is sinking without a trace from ABC television.

Tonight's episode is the last of "The Survivors," which started out the season with much hoopla and the biggest budget in television history. Now no one will ever know what happened to that charming Carlyle family and all their money. Pity.

The \$8 million fiasco is being replaced by an entirely new show called "Paris 7000."

George Hamilton is the sole star. Last fall, when "The Survivors" was 78th in the ratings, a plan was proposed to continue the series with Hamilton only, phasing out Lana Turner, Kevin

McCarthy and the other members of the family. Hamilton was spared that chore.

"At least I have an outside chance with the totally new series," said the actor. "I admit it's pretty far outside.

"I'll be opposite Dean Martin and the CBS movie, which is a death time-slot. And if 'The Survivors' itself didn't make good with Lana and all the others, what chance do I have alone?"

"Still, I'm willing to gamble. At least I'll get a chance in the new series to be me—not the phony facade which has been made up by a tailor and a barber."

The role he is playing in "Paris 7000," on Thursday nights beginning Jan. 22, is that of a minor official in the U.S. Embassy in France.

The history of "The Survivors" is too long and involved to bear retelling here. It began with an idea by best-selling novelist Harold Robbins, who proposed telling one of his jet-set novels in a TV series. ABC paid a million dollars for the plot, then discarded it.

The first two episodes of the series were filmed in the south of France for a million dollars and were never used. Three producers, several directors and a small corps of writers tried to breathe life into characters but failed.

One of the basic problems, said Hamilton, was the patriarchal figure Ralph Bellamy. He was supposed to die in the first episode and the rest of the story was to concern the power struggle to succeed him.

But Bellamy proved so appealing that he was kept alive until the tenth show—"which meant that none of us had anywhere to go in the first ten shows."

Fifteen of the shows were completed before the ax fell. Hamilton will film 10 of "Paris 7000" to finish out the season.

AIR
In 20 of the largest, most polluted urban areas, Air Quality Control Regions have been established, limiting the amount of pollutants industries and other stationary sources can emit into the air. By summer, the National Air Pollution Control Administration expects to have 57 such regions, covering about 90 million people. States or the federal government have power to enforce the regulations.

It is hoped this will significantly reduce the 142 million tons of smoke and noxious fumes poured annually into our atmosphere.

The auto industry says de-

Methodists Call Meet

RALEIGH (AP) — The North Carolina Methodist Conference will hold a special session in Raleigh Feb. 14 to consider a recommendation for restructuring its top-level offices.

The conference represents 216,000 methodists in 56 eastern and Piedmont counties.

Bishop William R. Cannon, head of the Raleigh area of the United Methodist Church, called the special session after the proposed restructuring was approved Saturday by the conference's program council.

The council, which is composed of district superintendents, lay representatives and heads of boards and agencies, approved an executive committee report.

The report proposes to do away with the independent agency concept and center the program of the church in the hands of a council and program staff.

The present system of nine executives working out of the denomination's offices in Raleigh would be changed to a staff of seven — a council director, three associate directors and three coordinators to "correlate, implement and administer" the missions and programs of the church.

The New York City Public Library has a circulation of 12,644,518 volumes.

Buchwald . . .
(Continued From Page 4)
black robe."

"Prof. Hafflefinger, how would you propose that the public make its decision as to the innocence or guilt of the accused?"

"After each story concerning a crime, the newspaper or magazine would be obligated to run a box which said: A—guilty. B—innocent. The reader would mail this in on a post card to the publication, which would then print the results. In the case of television it would be done on a random telephone sampling. In any case, whatever the public decided would be final, and we would do away with the tedious system of court appeals once and for all."

Evans-Novak . . .
(Continued From Page 4)
failure looms larger every day: This is the failure to persuade the classiest Republican prospects to risk their political necks in a race for the Senate.

Mr. Nixon wanted Nevada Gov. Paul Laxalt to run against the vulnerable Democratic Sen. Howard Cannon, Rep. Peter Frelinghuysen to run against New Jersey's vulnerable Sen. Harrison Williams, Rep. Rogers Morton, Republican National Chairman, to run against Maryland Sen. Joseph D. Tydings. All refused.

Rogers Col. . .
(Continued From Page 4)
Carolina, Tennessee, Texas and Virginia.

The other Southerners were given scores of 6 or 7 up to 13 or 17 on the basis of one or two votes the ADA considered to have been cast on the liberal side of issues. But in a large number of cases even these departures from zero performance in the ADA view may have been overratings, because the voting did not follow the liberal-conservative pattern.

Open Every Night 'Til 9:00!

PITT PLAZA

Penneys

January

DRESS JAMBOREE



HUNDREDS OF PASTELS POLYESTER
YOUR CHOICE OF ENDLESS STYLES WITH
LONG OR SHORT SLEEVES. BACIS PLUS!

\$12 TO \$18

Bowed and buttoned polyester crepe with gently gathered skirt, sizes 7-15, **\$15**



Scarved button front in blue, pink, green; 8-18, **\$16**

Sleeveless skimmer in blue, yellow, green; 8-16, **\$15**

USE YOUR CONVENIENT
PENNEY CHARGE CARD!

Painting Or Decorating?

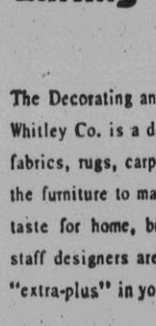
The Decorating and Design Department of the A. B. Whitley Co. is a decorator's adventure! Fine drapery fabrics, rugs, carpets, wall coverings and yes, even the furniture to match. . . for the most discriminating taste for home, business or industry. Professional staff designers are on hand to help you achieve the "extra-plus" in your decorating results.

A. B. Whitley, Inc.
1311 W. 14th St.
Greenville, N. C.

INDUSTRIAL
RESIDENTIAL
COMMERCIAL

OPEN WED. AFTERNOON—CLOSED SAT. OTHER THAN BY APPOINTMENT

Stock And Market Reports

RALEIGH (AP) — (NCDA)—North Carolina live broilers and fryers market steady today. Supplies in balance with good demand. Weights heavy in instances, but snow hampering operations in western areas of the state. Live at farm 14 cents a pound. Hens, supplies adequate for limited needs. Heavy type at farm 17. No light type reported.

RALEIGH (AP) — (USDA)—North Carolina hog market steady to 75 cents lower today, mostly 25 to 50 cents lower. Tops of 26.25-27.25 Rocky Mount; 26.25-26.75 Siler City, Denton; 26.00-26.25 Wilson; 24.50-26.25 Tarboro; 25.00-26.00 Kinston, New Bern, Benson, Alberson, Newton Grove, Lumberton; 24.50-25.50 Bethel; 26.50 Salisbury; 26.25 Greensboro.

NEW YORK (AP) — Stock market prices moved sharply lower today.

GRAIN
Everything remains the same this morning on Pitt County grain buying stations with very little activity and continued cold weather again the report. Most stations are buying a small volume of ear corn and very little of any other grain. All prices continue to hold. Following are price quotes reported at 11:15 a.m.
Greenville: yellow corn, \$1.25; wheat, \$1.20; oats, \$.65; soybeans, \$2.40—all steady.
Ayden: yellow corn, shell, \$1.32; ear corn, \$1.20—steady.
Winterville: yellow corn, shell, \$1.27; ear corn, \$1.17—steady.
Bethel: yellow corn, shell, \$1.30; ear corn, \$1.15—steady.

Following are selected 11 a.m. stock market quotations as furnished by Interstate Securities Corp.

AT&T	50%
Am. Tob.	34%
Burroughs	165%
Carolina Power	31%
United Utilities	23 1/2
Chrysler	34
DuPont	102
Gen. Elec.	72 3/4
Gen. Motors	68 1/4
RCA	32 3/4
R.J. Reynolds	42
Sperry	38
Standard Oil (NJ)	62 3/4
Texas Gulf	21 3/4
Ky. Fried	45 3/4
US Steel	35
Union Carbide	37 3/4
Vir. Elec.	23 3/4
Woolworth	36 3/4
Jeff-Pilot	30

OVER THE COUNTERS
Little Mint 4-4 1/2
Hardees 12 1/4-12 3/4
NCNB 25 3/4-26 1/4
Piedmont Air 9 1/4-9 3/4
Integon 14-14 1/2
Wachovia 52 1/2-53 1/2
Eckerd's 33 1/2-34 1/2
Conner 6 7/8-7 3/8

Revival In 2nd Week

Rev. Earl Wilson of Vanceboro is preaching during the second week of a revival at the Greenville Church of God. Services begin each night from now through next Sunday at 7:30 p.m. at the church located on the corner of Skinner and Spruce Streets. The public is invited to all services.



REV. EARL WILSON

Researcher Will Speak At ECU

Dr. Jasper D. Memory researcher in nuclear magnetic resonance from the University of North Carolina at Chapel Hill will be a speaker at two affairs at East Carolina University today. At 4:00 p.m. he will speak to the Physics Seminar, and at 7:30 p.m. Dr. Memory he will discuss less specialized aspects of magnetic resonance in Room 206 of Flanagan Building. The evening talk is sponsored by the University Sigma Xi Club. All interested persons are invited to attend the lectures.

Leak Addresses Traffic Club

Robert Leak, administrator of the Commerce and Industry division of the North Carolina Department of Conservation and Development, spoke to the Coastal Plains Traffic Club which met here Thursday night. Leak spoke on the importance of transportation as a factor in encouraging industry to come to and expand in this state. He gave a rundown of the "pluses and minuses" of the present North Carolina transportation system and how they affect site selection by prospective industry. Anyone interested in membership in this new club, made up mainly of traffic managers, should contact Bill Roberson of National Spinning Corporation, Box 191, Washington, N. C.

Living Signs Of Happy Marriage

NEW YORK (AP) — More than 400 couples marked their 50th wedding anniversaries in St. Patrick's Cathedral Sunday and received the thanks of Terence Cardinal Cooke. "We are all in your debt," said Cooke, archbishop of New York. "You have provided us with the living signs of the happiness which follows upon the commitment to Christian marriage through the years."

Several thousand children, grandchildren and great-grandchildren of the couples watched the ceremony. As their names were called, the couples walked down the center aisle, received a Golden Jubilee scroll, and kissed Cooke's ring.

Arrest 35 Men At Cock Fight

FRESNO, Calif. (AP) — A fight in a barn in Fowler, about five miles south of here, attracted nearly 100 men, some 50 roosters, and seven sheriff's deputies. When it was over, 35 men were arrested, 70 others had escaped into the fields, and the roosters were in custody of the Society for the Prevention of Cruelty to Animals.



Frozen Water

TURNED—ON ICE . . . Cold weather wouldn't be complete without ice. Graham Jefferson, of Country Club Drive turned on his lawn sprinkler Friday night to create a winter wonderland in his front lawn. The above photo shows some of the ice that resulted from the water. Another reason for the ice was to protect his flowers. (Reflector Photo by Tommy Forrest)

FBI Captures 2 In Kidnaping Case

TEXARKANA, Tex. (AP) — Police burst into an apartment Sunday night and captured two men charged in the kidnaping of a 16-year-old girl. The last of five men sought in the kidnaping, the two were identified as Booker T. Burkhalter, 24, alias Terry Anderson, of Dallas, Tex., and Jonnie Tasby, 21, of Lafayette County, Ark. When the officers entered, the two were lying on a bed watching "The FBI" television program. Herbert Hoxie, special agent in charge of the FBI in Arkansas, said the men offered no resistance. They were unarmed. They had been charged earlier in Thursday night's kidnaping of Karen Vickers, pretty, auburn-haired daughter of a Texarkana, Ark., grocer. Police said she was taken from the home of her parents, Mr. and Mrs. Emmett Vickers, by three armed and masked men and held for 26 hours for \$40,000 ransom.

Begin Two Tax Filing Courses

Two Income Tax Filing Courses for adults will begin tonight at Pitt Technical Institute at 7 p.m. One course will be for persons interested in reporting income tax for individuals. This course will meet in Room 209. The other course is for persons interested in reporting for farm and small business and will meet in Room 12. Each course will be 25 hours in length, meeting each Monday and Wednesday nights from 7 p.m. until 9:30, for five weeks. For additional information concerning this course, interested persons may contact Pitt Technical Institute.

Sewing Course Offered At PTI

Pitt Technical Institute is offering a course in Sewing III, beginning Wednesday at 7 p.m. in Room 24. The course will meet each Wednesday from 7 p.m. until 10 p.m. This will be a 24-hour course and tuition with be \$2.40.

Charged After Sunday Mishap

Helen Lane Randolph, 210 West 15th St. was charged with failing to yield the right of way in a 1:44 p.m. Sunday mishap at the intersection of Ninth and Cotanche Streets. Police reported the Randolph car collided with a vehicle driven by Guy Linwood Evans, 58, of Route 2, Greenville and caused an estimated \$200 damage to the Randolph car and about \$400 damage to the Evans vehicle. Evans was listed by investigators as injured in the collision.

Knitting Class Set For PTI

A Knitting I class will begin Wednesday night at 7 o'clock at Pitt Technical Institute. The course will run 30 hours and will meet each Wednesday from 7 p.m. until 10 p.m. in Room 22. The cost will be 10 cents per hour of instruction or \$3 plus each person providing his own equipment and materials. For additional information, interested persons may call Pitt Technical Institute.

CAP Squadron Meets Tuesday

The Greenville Squadron of the Civil Air Patrol will meet Tuesday at 7:30 p.m. in Room 124 of the New Austin Building ROTC Section on East Carolina University campus. A meeting will be held Wednesday at 7:00 p.m. at Pitt-Greenville Airport for the Basic Ground School Class sponsored by Pitt Technical Institute. The instructor, USMC Major Ed Turcotte, urges all cadets, senior members and friends of aviation to attend both meetings.

Luci Nugent Has Baby Daughter

AUSTIN, Tex. (AP) — Former President and Mrs. Lyndon B. Johnson became grandparents for the third time when daughter Luci Nugent gave birth Sunday to a girl weighing 7 pounds 10 ounces. It was the second child for Mrs. Nugent and her husband, Patrick. They have a son, Patrick Lyndon, who will be three June 21.

Perot Suggests U.S. Ransom

By DON McLEOD
Associated Press Writer
WASHINGTON (AP) — H. Ross Perot, the Texas billionaire who failed in getting two plane loads of supplies to American prisoners held by North Vietnam, has come up with another unusual plan—\$100 million offer to buy the captives' freedom. Perot said Sunday he had made the offer, similar to the tractor deal made with Cuba for release of the Bay of Pigs prisoners, in a cable last week to North Vietnamese Prime Minister Pham Van Dong. Until release of the prisoners is worked out, Perot further offered to supply everything needed to run the prisoner of war camps. And to sweeten the pot, he offered similar nonmilitary goods for needy North Vietnamese civilians. He told of his offer on "Issues and Answers," an ABC television interview program. Later Perot said he wished the \$100 million figure, which he stated in an answer to panelist's question, had not "gone out over television." But he insisted he would do anything he could to get the men freed. "Cost is not the key issue," Perot said at a later news conference. "The key issue is will the North Vietnamese begin talking—is there something they need more than the men."

The offer Perot made to Hanoi was "to build needed facilities and supply food, medicine, or other items needed by the North Vietnamese people in exchange for the release of prisoners of war." "If these proposals are not acceptable to you," Perot cabled Pham, "surely there is some basis on which you will agree to work directly with the people of the United States, allowing us to exchange items badly needed by the North Vietnamese people for these prisoners."

There has been no response to the offer, Perot said. Asked if he would go as high as \$100 million for a prisoner exchange, Perot said, "I certainly would. I know I could raise that much." He said that would average about \$75,000 per man and he said it would be worth it to save the lives of the prisoners. Perot said he became dedicated to the prisoner problem when "I met a 4 1/2-year-old boy who had never seen his father."

Last month Perot spent more than \$600,000 taking two chartered airliners on a 30,000-mile odyssey with guests and messages for the prisoners. After flying to Bangkok, Thailand, Vientiane, Laos, and Copenhagen, Perot was forced to give up Dec. 31 when the Soviets refused him permission to deliver the gifts to Moscow for mailing to Vietnam. Perot, 39, a Naval Academy graduate, parlayed a \$100,000 investment into a fortune in the computer industry. He said he could raise the \$100 million from his own resources.

Gifts Made University

Cherry
WINTERVILLE — Mrs. Lela C. Cherry of Winterville died Saturday in Pitt Memorial Hospital. Funeral arrangements are incomplete.

Moore
WILSON — Mrs. Lillie Mae Moore, 50, of Route 3, Wilson, died late Saturday afternoon in Wilson Memorial Hospital following an illness of four months. Funeral services were conducted today at 3 p.m. from the Bethany Presbyterian Church at Driver's Store by Dr. Frank M. Ryburn. Interment will follow in Evergreen Memorial Gardens in Wilson. Mrs. Moore had been a resident of this community for the past 30 years and was a member of Bethany Presbyterian Church. She is survived by her widower, Herbert B. Moore of the home; two daughter, Mrs. John T. Talton of Wilson and Mrs. Lynwood Williford of Goldsboro; three sisters, Mrs. Samuel Tripp and Mrs. Alton Vandford, both of Greenville, and Mrs. Elbert Jones of Ayden; one brother, Levi Owens of Greenville; and four grandchildren.

Gay
Mrs. Effie Artis Gay died at the home of her daughter, Mrs. Nannie B. Dixon, Rt. 2, Farmville, Saturday morning. Funeral services will be held Tuesday at 2 p.m. at Reid Chapel Missionary Baptist Church, Fountain, by the pastor, the Rev. George Smith. Burial will follow in Sunset Memorial Park, Farmville. She was a member of Reid Chapel Church and a member of Household Ruth Lodge of Farmville who will perform burial rites. Surviving are three daughters, Mrs. Nannie B. Dixon of the home, Mrs. Ezzie Dickens of Greenville and Mrs. Essie Vines of Wilson; seven sons, Ned Artis and Walter Gay, both of Richmond, Va., Charlie and Jesse Gay of Farmville, Joab Gay of Greenville, Willie Anthony of Greenville and Joe Gay of Fountain; 34 grandchildren; 53 great grandchildren; 10 great great grandchildren.

Fornes Named To NCSU Faculty

RALEIGH—Dr. Raymond E. Fornes of Greenville has been named assistant professor in textile technology and physics at North Carolina State University here. Dr. Fornes attended East Carolina University and North Carolina State University. He was one of six new professors named to the NCSU faculty Friday.

Obituaries

The body will be at Hemy Memorial Chapel, Fountain, after 5 p.m. today until one hour prior to the funeral. The family will receive friends between the hours of 7 o'clock and 9 o'clock tonight.

Gifts Made University

Dr. Carlton Heckrotte of East Carolina University's Department of Biology reports that a number of very useful gifts has been received from the Dow Chemical Company. This is part of the company's continuing program of gifts to educational institutions to assist teaching and research needs. Dr. Heckrotte noted that Dow Chemical has donated ten items of equipment and several hundred dollars worth of expendable supplies to the Biology Department in the past two months. The donations have included five quantities of plastic wrap, five clinical centrifuges, as well as large quantities of plastic wrap, styrofoam sheets, and plastic coated paper cups with lids.

YOU CAN AFFORD

A New Ford
Call or See
Lenwood Heath
Billmyer Ford
East 10th St. Ext.
758-2101

Waters Carpet Center

WINTERVILLE, N. C.
S. J. WATERS S. J. WATERS, JR.
YOUR MOHAWK-BIGELOW
CARPET HEADQUARTERS
"Where Quality Installation Counts"
Phone 756-2541 Night 752-3280

TERMITES?
CALL
Ivey Coward
CO., INC.
YOUR
COWARD-DEMAN
Tel. 752-5175
Ask about our \$25,000 termite damage repair warranty.

NOTICE
Of Stockholders Meeting
The Annual Meeting Of The
Stockholders Of
Home Savings & Loan Ass'n.
Will Be Held On
Tuesday Evening, January 20, 1970
At 5:00 P.M.
In The Office Of The Association
H. W. Lee
Exec. Vice President

Belk Tyler
PLAYTEX GIANT JANUARY SALE
SAVE \$1.00
PLAYTEX® LIVING® STRETCH BRA
Only \$3.50, reg. \$4.50. With stretch straps: only \$3.95, reg. \$4.95. 32A-42D (D cup \$1 more).

SAVE \$2.00
PLAYTEX® made with LYCRA® GIRDLES
Double Diamonds® girdle: only \$9.95, reg. \$10.95. Panty: only \$10.95, reg. \$12.95. Long Leg Panty: only \$11.95, reg. \$13.95. Sizes: XS, S, M, L. (XL \$1.00 more).

SAVE \$1.00
PLAYTEX CROSS-YOUR-HEART STRETCH BRA
with stretch sides, back and straps: only \$4.00, reg. \$5.00. 32A-38C.

SAVE \$1.00
PLAYTEX® LIVING® LONG LINE BRAS
(or 3/4 length) with bias-cut side panels: only \$5.95, reg. \$6.95. 34A-44D (D cup, \$1 more). With stretch sides, back and straps: only \$6.95, reg. \$7.95. 32A-44D (D cup \$1 more). Stretch long line with 2" waistband: only \$7.95, reg. \$8.95. 34A-44D (D cup \$1 more).

SAVE \$1.00
PLAYTEX® SOFT-LINE® PADDED BRA
with stretch sides, back and straps: only \$4.00, reg. \$5.00. 32A-38B.

SAVE \$1.00
PLAYTEX CROSS-YOUR-HEART SLIGHTLY PADDED BRA
with stretch sides, back and straps: only \$4.00, reg. \$5.00. 32A-38C.

SAVE UP TO \$200

In Downtown Greenville. Now Open 10 a.m. - 9 p.m. Daily!!

MONDAY MORNING, JANUARY 12, 1970

Dawson Leads Chiefs Past Vikings



Off The Tumb

Kansas City defensive back James Marsalis gets his tumb on the ball as he deflects a pass intended for Minnesota receiver John Hendsen in Super Bowl Action yesterday. The pass had been thrown by Vikings quarterback Joe Kapp. (AP Wirephoto)

By MIKE RATHET
Associated Press Sports Writer
NEW ORLEANS (AP) — "He aged five years this week. You looked into his face and you knew it wasn't the same Len Dawson."

Those words tell better than any the strain that the Kansas City quarterback lived with last week before he went out Sunday in front of a sellout crowd of 80,998 and some 50 million television viewers and led the Chiefs to a stunning 23-7 Super Bowl victory over the heavily favored Minnesota Vikings.

For those words are the words of Johnny Robinson, Dawson's longtime friend and roommate who watched his buddy turn into a solitude-seeking recluse in the cramped quarters of room 838 at the Fontainebleau Hotel during the week after reports linked his name with the nationwide gambling probe.

"Whenever I looked at him it wasn't the relaxed, easy-going Len Dawson I saw," said Robinson. "He was tense; he wanted to be in solitude. It was a tremendous pressure week for him. It was bothering him."

"He had some important things to think about." Dawson thought both about the stories he saw in the newspapers every day following his admission that he had a "casual acquaintance" with a Detroit restaurateur arrested in connection with the gambling probe—and he thought about his wife and two children.

"Lenny was more concerned about his wife and kids back in Kansas City than himself," said Jacky Lee, the Chiefs' reserve quarterback. "They were having to put up with an awful lot of stuff. Lenny knew the public was going to read more into it than is there."

With all that on his mind, Dawson still managed to deal with the other problem he was facing—the Vikings, spending 1½ hours Saturday night going over films with Coach Hank Stram, something the two never do the night before a game. But then Dawson was having trouble remaining calm.

"I had diarrhea," Dawson admitted after the game. "I started to go to bed about 10, but I couldn't sleep. I got up about 4 and read the sports pages to see what people were saying about the game. I still couldn't sleep. I don't think I slept two hours all night."

"I guess it was a 24-hour virus." Others will guess that Dawson's sleepless night was the result of something else, but no

one who saw him perform against the Vikings in the Sugar Bowl would even have thought about what Robinson, Lee and Dawson himself revealed in the game's aftermath.

For during the 60 minutes that he was on the field, Lenny Dawson was Lenny Dawson, quarterback.

Jan Stenerud kicked field goals of 48, 32 and 25 yards and Mike Garrett scored on a five-yard run for a 16-0 halftime lead

that gave every indication that the American Football League champions were heading for a stunning upset of the two-touchdown favorites.

But those 60 minutes belonged to Dawson.

And not even a denial he made to President Nixon when he talked to the White House after the game can blur the picture.

"Thank you, Mr. President, I really appreciate it," said Daw-

son in a low voice as he accepted congratulations. "But it wasn't me, sir, it was the whole team that did it."

It was the whole team that did it, but the glare of the spotlight was on Dawson's shoulders, and he responded.

He was almost as perfect as a passer can be, directing the club almost flawlessly and completing 12 of 17 passes for 142

yards while winding up his performance, and the scoring, with a 46-yard touchdown throw to Otis Taylor.

Saad's Shoe Shop

All Work Guaranteed
Located in College
View Cleaners Main Plant

AUTO CENTER
Penneys
PITT PLAZA

Open Daily
7:30 a.m.-
9:00 P.M.

SPECIAL . . .
3 DAYS ONLY

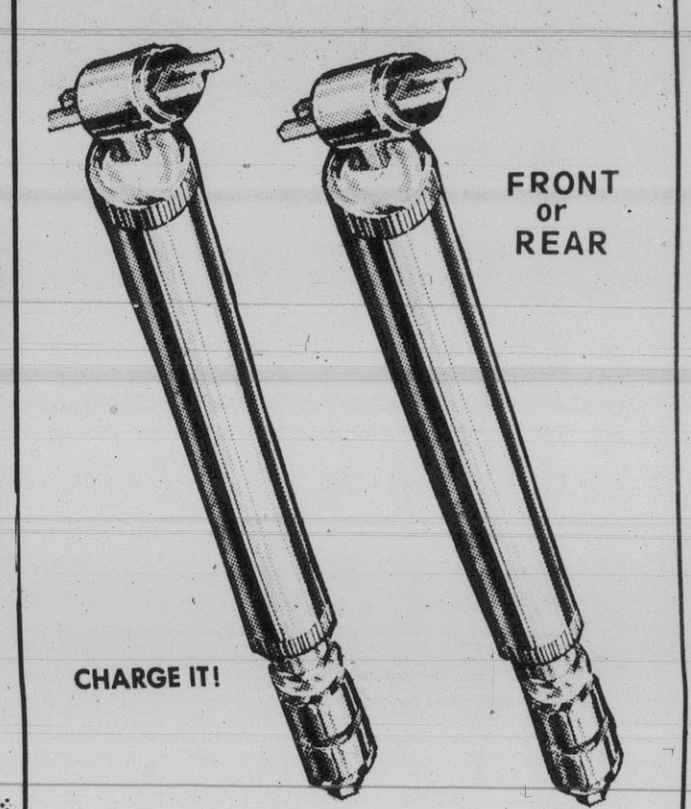

OUR FIRST QUALITY . . .

HEAVY DUTY SHOCK ABSORBERS

COMPLETELY INSTALLED ON YOUR CAR!

\$15.26 PAIR

* U. S. Made Cars Only!

THAT'S RIGHT! PENNEYS WILL INSTALL A PAIR OF OUR PREMIUM QUALITY SHOCKS ON YOUR CAR FOR ONLY 15.26! THIS IS NO GIMMICK. CALL BOB LITTLE, SERVICE MANAGER NOW FOR YOUR APPOINTMENT.

DIAL 756-1190!
BY APPOINTMENT ONLY!

Pirates Stand As Only Challenger

By THE ASSOCIATED PRESS
George Washington's Mike Tallent held tightly to his individual scoring lead in Southern Conference basketball last week while the Colonials collectively were experiencing disaster after disaster.

A 112-88 loss at Davidson Tuesday effectively relegated GW from first - place challenger to just another of many also-rans in the SC's regular-season race, and before the week ended there were losses to Georgetown and Pitt.

This left the Colonials with a four-game losing streak and a dismal 4-9 record. But for Tallent, things stayed normal. He had 65 points in the three losses last week and is averaging 24.1 for 13 games.

Amid wholesale shuffling in the ranks of the other top 10 SC scorers, Davidson's scintillating sophomore, Brian Adrian, zoomed from fourth to second place with an average of 20.5. Adrian pumped home 72 points in a trio of Wildcat victories and, at that rate, soon will be threatening Tallent.

No other conference player is averaging 20 points a game. Richmond's Kenny Foster, No. 2 a week ago, lost ground in two Spider defeats and now is averaging 19.6. William and Mary's Bob Sherwood is next, at 19.1.

Rounding out the conference's top 10 are East Carolina's Jim Modlin, 18.7; The Citadel's Jerry Hirsch, 18.5; Davidson's Mike Maloy, 17.9; Furman's Lisco Thomas, 17.8; his teammate Jerry Martin, 17.5, and William and Mary's Tom Jasper, 16.9.

This week begins with Davidson perched atop the conference standings with a 5-0 record and East Carolina, at 3-1, virtually the only challenger to the nationally eighth-ranked Wildcats have for first place.

This state of things comes to a point of resolution Tuesday night when East Carolina visits Davidson for one of three matches of conference teams on this week's slim nine-game schedule.

ECU's Pirates, who've now won their last four starts, clouted lowly VMI 108-66 in a conference mismatch Saturday night to which Tom Miller contributed

22 points and soph Jim Fairley 25 points and 23 rebounds.

Furman, 1-2 in the league, made good nine of 10 free throws in the last 54 seconds of an overtime period for a 60-56 victory over The Citadel in Saturday's only other meeting of conference rivals. Hirsch had 29 points for the losers, Martin 19 for the Paladins.

Davidson, meantime, kept right on rolling along with a 92-80 triumph over West Virginia, the 10th Wildcat victory in 11 starts. Adrian bombed the nets for 31 points for the Cats in the game at Charlotte.

George Washington and William and Mary, two other teams that met nonconference opponents, weren't nearly so fortunate. Pitt clipped GW 71-61 as Tallent hit a season - low 10 points, and hot-shooting Virginia Tech clobbered W&M 92-72. W&M's Indians now are 5-9 over all.

No conference teams play to-night.

Rose Wrestlers Host R. Mount

Rocky-Mount will visit Rose High for a wrestling match tonight at 7:00 o'clock, in the Rose Gym.

Casper Takes Irwin In Sudden Death

By BOB GREEN
Associated Press Golf Writer
LOS ANGELES (AP) — "Now," said Billy Casper, "I guess I can go to work on the second million."

The placid, rock-steady veteran who went into—for him—a mild decline last year, has just defeated bitterly disappointed Hale Irwin in a sudden-death playoff for the \$20,000 first prize in the Los Angeles Open golf tournament.

The earnings pushed his career total to \$1,001,924.48, second only to Arnold Palmer on the all-time list.

"You just go out and do the best you can," said the quiet, gentlemanly Casper, whose mild, unassuming manner at one time gained him the title "golf's invisible man."

It was a heart-breaking loss for the 24-year-old Irwin, a former football star at Colorado who never before had finished higher than 10th in a regular tour event.

Irwin, the third-round leader, held a two-stroke lead with four holes to play. Then "everything I've worked for for two years, everything I had hopes for, slipped through my fingers."

He bogeyed the 15th when he was short of the green and had only a one stroke lead.

Casper finished a few minutes later with a one-over-par 72 for 276 and was in the clubhouse relaxing and listening to a radio account of Irwin's progress on the final few holes.

winning it myself." Moments later Irwin pushed his tee shot into the rough on 18, hit a tree limb coming out, was on in three and two-putted for a boges that gave him a closing 73 for 276 and forced a sudden-death playoff.

They went to the 11th. Both drove the fairway and Irwin put his second shot in the fringe about 12 feet from the pin. Casper laced a seven iron 141 yards to within four feet. Irwin missed his putt and the quiet veteran of 17 years on the tour dropped his for his 43rd tour triumph.

Casper won only two official tournaments last year and made \$106,000—his lowest figure in four years.

Irwin was inconsolable. "You just don't know what this means," he said. "Winning a tournament—and not having to qualify for a whole year—well, it's worth an immeasurable amount of money."

"He'll win," Casper said. "There will be a lot of first time winners this year. There were 12 last year and for every one of

them there are six more in the wings waiting their turn."

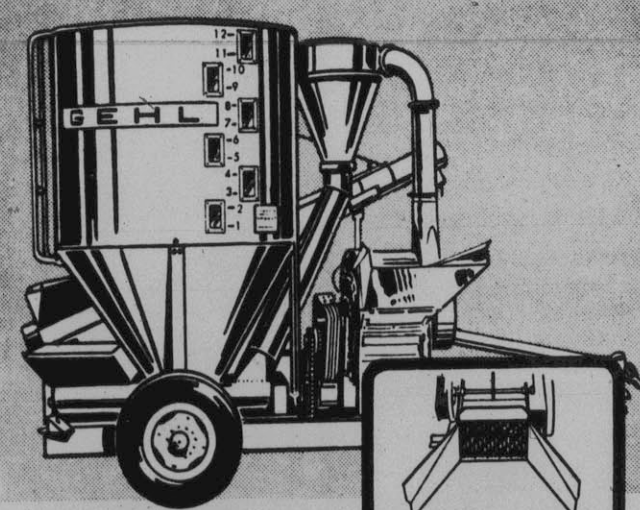

GEHL MIX-ALL
Grinds! Mixes! Delivers!

The Gehl Mix-All, with economy plain feeder and exclusive crusher-feeder attachment, grinds, mixes and delivers the most uniform on-the-farm feed.

Here's proof: Samples of feed grains, ground by Gehl and competitive mills, were compared in a "sieve-shaker" analysis (a grinding uniformity test used also by commercial feed manufacturers). In test after test, Gehl samples were the most uniformly ground. And, the more uniform the grind, the better the mix!

GEHL
Make us Prove it with a Demonstration!
AYDEN TRACTORS, INC.
Snow Hill Highway Ayden, N. C. 28513

YOU CAN AFFORD
A New Ford
Call or See Joe Carr
Billmyer Ford
East 10th St. Ext. 758-2101

WE HAVE MOVED
TO OUR NEW LOCATION
2000 E. GREENVILLE BLVD.
1½ Blocks From Billmyer Ford

ALL NEW 1970 ZENITH
compact big-screen
16" PORTABLE COLOR TV
145 sq. in. rectangular picture

FULL ZENITH HANDCRAFTED QUALITY

- ZENITH HANDCRAFTED PORTABLE COLOR TV CHASSIS for Unrivaled Dependability
- EXCLUSIVE ZENITH CHROMATIC BRAIN SOLID-STATE COLOR DEMODULATOR for the Truest Hues in Color TV
- ADVANCED ZENITH SUPER VIDEO RANGE TUNING SYSTEM for Ultra-Sensitive Reception

ZENITH
The quality goes in before the name goes on®

"We Service All Makes And Models"
To better serve you Hudson Brothers has their own complete service department with expert service and repair men. These men are qualified to do work on any TV, Radio, Stereo or Car Radio.

HUDSON BROS.
RADIO AND TV, INC.
2000 E. GREENVILLE BLVD.
OPEN DAILY 8:30-5:30 752-7682

FREE PIT BOSS SAFETY INSPECTION
ON YOUR CAR WITH NO OBLIGATION ON YOUR PART!

SAVE 5.07 FOREMOST SUPER HIGH VOLT
FOR BIG CARS WITH EXTRA ACCESSORIES

Orig. 23.95
NOW . . . **18.88**
(Fits Most 12 Volt American Cars)

LIKE IT . . . CHARGE IT!

SUPER HIGH VOLT 48 MO. GUARANTEE
Should any Foremost Super High Volt battery fail (not merely discharge) within 18 months from the date of purchase, return it to Penneys and it will be replaced free of charge. After 18 months, but prior to the expiration date of the guarantee, J. C. Penney Co. will replace the battery charging only for the period of ownership, based on the current price at the time of return, pro-rated over the stated guarantee months.

Ecker Gives Bruins Win

By ED SCHUYLER JR.
Associated Press Sports Writer
Meet UCLA's unheralded Mr. E—John Ecker.

Ecker is near the basketball plateau reached by UCLA's heralded and graduated Lew Alcindor—in fact, he isn't even a starter—but the reserve center was a mighty big man in the No. 1-ranked Bruins' 72-71 victory over Oregon State Saturday night.

Ecker replaced Sidney Wicks, who fouled out in the waning moments of the game, and hit the winning basket with four seconds left as the Bruins ran their record to 10-0.

All other members of The Associated Press' Top Ten won, except ninth-ranked Ohio University which was trounced 85-65 by Bowling Green as Jim Connally and Rich Walker gunned in 20 points each for the winners who hit 78 per cent of their field goal attempts.

Dan Issel scored 37 points and grabbed 13 rebounds as second-ranked Kentucky drubbed Florida 88-69, and No. 3 South Carolina stopped Maryland 55-44.

With Charlie Scott connecting on six-of-seven shots in one stretch and totaling 29 points, fourth-ranked North Carolina fought off 19th-ranked Duke 86-78.

Big Bob Lanier banged home 42 points in No. 5 St. Bonaventure's 94-65 romp over Kent State, and sixth-ranked New

Mexico State toyed with Montana State 106-68.

Miami of Florida held 7-foot-2 Artis Gilmore to 13 points but No. 7 Jacksonville still coasted, 121-87 as Rex Morgan sparked the victory with 29 points, while No. 8 Davidson downed West Virginia 92-80 behind Brian Adrian's 31-point performance.

Tenth-ranked North Carolina State got a scare from Wake Forest and needed a 29-point showing from Vann Williford and five points by sophomore Ed Leftwich in the last 85 seconds before winning 75-72.

In the Second Ten, No. 11 Houston topped West Texas State 91-83, No. 12 Tennessee was upset 61-56 by Georgia, No. 13 Marquette downed De Paul 72-60, No. 14 Washington edged Stanford 76-73 in overtime, No. 15 Niagara trounced Canisius 101-75, No. 16 Oklahoma lost 77-56 to Kansas State, No. 17 Columbia walloped Brown 88-54, No. 18 Penn drubbed Harvard 103-71 and No. 20 Louisville nipped Cincinnati 64-63.

Louisiana State's Pete Maravich poured in 44 points in his team's 79-70 loss to Auburn and moved into third on the career scoring list with 2,850. Elvin Hayes, who played at Houston, is second with 2,884, and Oscar Robertson, who starred at Cincinnati, is the all-time leader with 2,973.

LSU doesn't play again until Jan. 24.

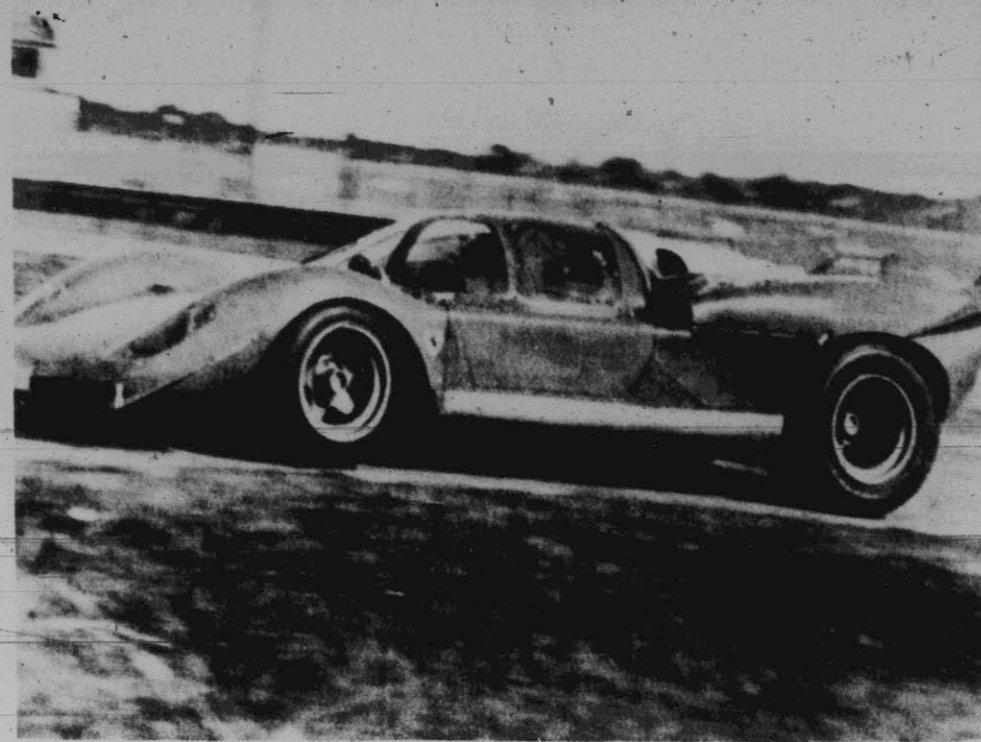

New Ferrari
This is the new Ferrari 512, a V-12 race car that Italian Enzo Ferrari has built to challenge other makes in the World Constructor's series of endurance races this year. The car will make its debut in the Daytona 24 Hour race, January 31 - Feb. 1. (AP Wirephoto)

Colonels Win 110-107

LOUISVILLE, Ky. (AP)—Carolina found out Saturday the truth in the sports maxim about the game not being over until the final buzzer.

The Cougars held a 60-48 half-time lead over the Kentucky Colonels and were up by two in the last three minutes. But when the American Basketball Association contest ended, the Colonels had won 110-107.

How? On the free-throw shooting and ball stealing of Darel Carrier. The Colonel guard dropped into two free throws to tie the game and then swiped the ball twice for layups to give Kentucky a 102-98 lead.

Louie Dampier led the Colonels with 28 points and Carrier totalled 27.

Bob Verga hit 20 points for

NCAA Holds Convention

WASHINGTON (AP)—A change to permit colleges to play an 11th football game and tightening of recruiting practices face delegates to the 64th National Collegiate Athletic Association today.

Those proposals are among the 41 on the agenda of the three-day NCAA convention. Action on the charges is not expected before Wednesday.

Prior to the official convention opening, however, the NCAA Council continued for two more years the probation against Florida State University's strong basketball team for recruiting violations committed while the club was on a year's probation.

Following a Sunday meeting, it was announced that council extended until Oct. 29, 1971, the probation against FSU for recruiting violations and off-season basketball practice involving Coach Hugh Durham.

Carolina in the first half and then cooled a bit after intermission to finish the game with 30.

The Cougars play their next game Wednesday in Charlotte against New York.

Weekend Fights

By THE ASSOCIATED PRESS

TOKYO — Susumu Hanagata, 115, Japan, outpointed Raton Mojica, 115, Nicaragua, 10.

Clemson Faces Terps Tonight

By KEN ALYTA
Associated Press Sports Writer

This is M-Day at Clemson University. Richie Mahaffey, 212-pound, 6-foot-7 senior center, is back and Coach Bobby Roberts has him primed for tonight's home court Atlantic Coast Conference basketball game with Maryland.

The Tigers have been limping along on a 2-5 record, but tonight Mahaffey comes to the rescue, not unlike the U. S. cavalry on those old-time western movies.

He's been on the sidelines waiting for his number to come up. The number is Jan. 12—the date the ACC set for Mahaffey's return to eligibility.

After 10 games last season, the last of four brothers to come out of LaGrange, Ga., and play for Clemson, was through for the year. A shoulder injury shelved him and the Tigers went on to a 6-19 record.

The conference granted him partial eligibility this year to make up for the half season lost a year ago.

In his absence, sophomore Greg Latin has handled the job well. He's averaging better than 17 points and nine rebounds, but the height - shy Tigers need Mahaffey's muscle under the boards and point-making to help, with Latin playing forward.

Butch Zatezalo, ACC scoring champ for two years, delivered 30 points to lead Clemson to a 104-87 home court victory over Virginia Saturday night. A 20-0 spree over six minutes staked Clemson to a 53-37 halftime lead and the Tigers took last half honors 51-50.

The game was the first in ACC play this season for the Tigers and vaulted them into second spot, back of pace-setter South Carolina, 4-0 after a hard-earned 55-44 victory over Maryland.

Completing Saturday's schedule of all-league games, North Carolina toppled Duke 86-78 and North Carolina State edged Wake Forest 75-72.

North Carolina, ranked fourth in the nation, and N. C. State, the No. 10 team, share third place in the conference at 3-1, one game behind South Carolina, No. 3 in the land.

Then comes Duke, the 19th-ranked team, fifth at 2-1. Wake Forest follows at 2-3, with Maryland 1-4 and Virginia in the cellar at 0-6.

Maryland Coach Lefty Driesell, remembering his team's 101-68 loss to South Carolina a month ago, began with a slow down offense on the Gamecock court Saturday night. At halftime it had paid off for a 26-22 Maryland lead. Then the tall and talented Gamecocks lived the pace and took charge, moving ahead to stay on a three-point play by sophomore Tom Riker whose 17 points led all scorers. Will Hetsel led the losing Terps with 16.

North Carolina made it two victories in three meetings with top 20 teams over six days by

downing Duke. Earlier last week, the Tar Heels had lost to South Carolina and beaten N.C. State.

North Carolina led by eight at the half, but Duke three times shaved the lead to one point in the last half. The Tar Heels led 73-72 before All-American Charlie Scott went on a rampage, hitting six of seven shots en route to a 29-point performance. The balanced attack included 18 points by Lee Dedmon and 17 each from sophomores Dennis Wuycik and Bill Chamberlain. Brad Evans was Duke's leader with 15.

N. C. State, which had a 10-game winning streak broken by North Carolina, started a new one—the hard way. Wake Forest led the Wolfpack by five at the half and the score was tied six times in nine minutes in the stretch before State sophomore Ed Leftwich took over. He hit five points in the last 85 seconds after the last tie, at 70-all to clinch it and finish with 15. Vann Williford ignited the early second half State comeback with 17 of his 29 points. Charlie Davis led Wake Forest with 20.

In addition to the Maryland game at Clemson tonight, Virginia is at South Carolina.

The next action comes Wednesday, when Navy is at Maryland and South Carolina at Furman.

On Thursday, North Carolina is at Clemson, East Carolina at N. C. State and Virginia at Wake Forest.

Pro Cage Standings

By THE ASSOCIATED PRESS

NBA Eastern Division

	W.	L.	Pct.	G.B.
New York	36	10	.783	—
Milwaukee	30	15	.667	5½
Baltimore	28	17	.622	7½
Philadelphia	23	21	.523	12
Cincinnati	22	24	.478	14
Boston	17	26	.395	17½
Detroit	15	29	.341	20

Western Division

Atlanta	28	18	.609	—
Los Angeles	21	22	.488	5½
Chicago	21	24	.467	6½
San Fran.	20	24	.455	7
Phoenix	19	27	.413	9
San Diego	18	26	.409	9
Seattle	15	30	.333	12½

ABA Eastern Division

	W.	L.	Pct.	G.B.
Indiana	32	7	.821	—
Kentucky	26	15	.634	7
Carolina	17	22	.436	15
New York	19	26	.422	16
Pittsburgh	14	25	.359	18
Miami	12	31	.279	22

Western Division

New Orleans	24	16	.600	—
Dallas	22	20	.524	3
Denver	21	21	.500	4
Wash'n.	20	22	.476	5
Los Angeles	19	21	.475	5

WINTERVILLE KIWANIS ANNUAL AUCTION SALE

Friday, Feb. 6th, 9:00 AM
One Mile North Of Winterville

Bring Your Surplus Equipment or Miscellaneous Items

Our Thanks to the following Firms for Helping to Make Our 1969 Sale The Best Ever

Moore-King-Sullivan, Inc.	Bell Robertson Oil Co.	Pollard Plumbing Co.
Perkins Oil Co.	Proctors Mens Shop	Mercer Glass Shop
Coastal Chemical	Goodyear Service Stores	Womack Electronics
Home Builders Supply Co.	Speight Seed Farms	DeKalb Seed
J. B. Kittrell	H. L. Hodges Co.	Waters Carpet
Bill Crawford Station	Sunnyside Eggs	Carson Peanut Co.
F. Weathering Store	Cemco Oil Co.	Quality Oil Co.
Britt-Farmer Furniture	Bill and Jacks Buying Station	Harris Super Market
Ayden Piggly Wiggly	Clarence Alexander, Ayden, N. C.	Sutton's Service Center
Leo Venters Motors	Swift & Co.	Cozart's Super Market
City Motor Co., Ayden, N.C.	Armours	Pioneer Seeds
Pete Jones Bar B Que	Weaver Fertilizer Co.	Waller-Forbes
Ayden Fertilizer & Fuel Co.	Cyanamid Company, Ayden, N. C.	Cox Armature Works
Keel Peanut Co.	Fred Webb Grain Co.	Clark Oil Co.
Garris-Evans Lumber Co.	Dixie Queen	Charles McLawhorn Egg Farm
Vincent Electric Co.	Hunsucker Oil Co.	Glidden Paint Co.
Abbott Milling Co.	1 Hour Kortizing	Ayden Transit Co.
Ayden Tractors, Inc.	Sparkle Cleaners	Lutz & Schramm
Eastern Tractor & Equipment Co.	Hazelton Cleaners	Hendrix-Barnhill Company
A. W. Ange Co.	ASGRO Seed	Blount's Fertilizer Co.
Hines Amoco	Nobles Esso	Mobil Chemical Co.
Pitt FCX	Edwards Auto	Pitt-Greene Fertz. & Fuel Co.
		Royster Fertilizer Co., Greenville, N. C.

100% of the proceeds from our sale go toward community services. Over the years we have participated in the projects listed:

Purchased activity bus for school
\$1000 in scholarships each year
Sponsor Boy Scout Troop
Purchased and Maintained Boy Scout hut
Major contributor to recreation program
Sponsored and financed choral group
Contributed to Lake Wacamaw Boys Home
Maintained fund for needy school children
Supported Little League Baseball program
Supported Little League football program
Contributed to Eastern N. C. Training School
Purchased furniture and kitchen equipment for community building
Sponsored Community Easter Egg Hunt

We cordially invite everyone to join us Feb. 6 for a day of fine fellowship, good barbecue, and excellent bargains.

Chiefs Turned Out Not To Be A Joke

By PAT THOMPSON
Associated Press Sports Writer
NEW ORLEANS (AP)—Mrs. Joe Kapp, wife of the Minnesota Vikings quarterback, jokingly bought and wore a hat boosting the Kansas City Chiefs on Bourbon Street the night before the 1970 Super Bowl.

Marcia Kapp didn't realize the Chiefs wouldn't be a joke in Sunday's game.

And the Chiefs took a 23-7 victory in a fashion which had given the National Football League champion Vikings a 19-3 record-counting exhibitions, regular season games and playoffs—by cashing in on the other team's mistakes.

Perhaps Minnesota's biggest mistake was depending too long on its pass defense theory that by giving up the short ones you prevent the long ones.

Kansas City quarterback Len Dawson combined with Otis Taylor for a 46-yard touchdown pass play that ended all Viking hopes for a second half comeback.

"The Chiefs had been running a lot of hitch patterns," said corner back Earsell Mackbee. "The receiver takes two or three steps and stops. The de-

fender needs to come back and give him a good lick.

"If the receiver breaks the tackle, you're in trouble," he added. "The ball got to Otis Taylor about the same time as I did. I felt I gave him a good lick. I fell down and when I got up, I saw the extra point team coming in, so I figured he scored."

But the Vikings already had made several costly mistakes as the Chiefs bolted a 16-0 half-time lead.

Charlie West fumbled the kickoff after Jan Stenerud's third field goal of the game in the second period, and the Chiefs quickly punched in a touchdown.

"Stenerud had been hitting them out of the end zone," West said, "but this one wasn't that far. I saw it all the way. I just dropped it."

Quarterback Joe Kapp drove the Vikings to their only touchdown in the third period. He completed 16 of 23 passes for 183 yards, but with two interceptions, before a shoulder injury forced him to leave the game. His left shoulder was to be X-rayed today to determine the extent of the injury.

In all, the Vikings had three interceptions, lost two of three fumbles and were penalized six times for 67 yards — 20 more than the Chiefs.

"We played a great football team," said Minnesota Coach Bud Grant. "They beat us. It's as simple as that. They came up with the big play, didn't fumble, moved the ball when they had to and were not hurt by the interceptions."

Eppes Takes

38-32 Win

Eppes Jr. High defeated Wilson Jr. High of Rocky Mount in basketball Friday, 38-32. Eppes broke the game open in the second half, after going into the dressing room with a slim 17-16 lead, and into the fourth quarter with it all tied up 25-25.

Eppes hit for 18 in the fourth frame, to push into the lead. Lonnie Payton led the Eppes scoring with 25 points. He has a season average of 20 per game.

Earlier, the jayvees had won their game, 40-15.

Edwards of Rocky Mount will visit Eppes this Friday at 6:30.

"Super-Right" Quality Beef—BONELESS TOP OR BOTTOM ROUND

ROAST

"SUPER-RIGHT" QUALITY BEEF BONELESS 98c
ROUND STEAK Lb.

"SUPER-RIGHT" QUALITY 25 TO 35-LB. WHOLE BEEF RIB Lb. 88c

Cut Into Roast & Steaks Lb. 65c

PRICES IN THIS AD EFFECTIVE THRU SATURDAY, JANUARY 17

We Care

GREAT FOR SCHOOL LUNCHES OR SNACKS!

ROME APPLES 8 Lb. Bogs 69c

SERVE YOUR FAMILY A DESSERT TO-NIGHT, MADE FROM

STRAWBERRIES 3 Pint Baskets 89c

ANN PAGE RICH, RED — TOMATO

KETCHUP 2 14-Oz Btls. 39c 20-Oz Btl. 29c

SULTANA SALAD DRESSING Quart Jar 39c

GOLDEN RISE BIG FLAKY STYLE—WAGON WHEEL

BISCUITS 10c

NORTHERN JUMBO PAPER TOWELS REG. VALUE 9½-Oz. 10-Ct. Pkg. 2/37c

4 150-Ct. Rolls 89c SAVE 35c ON 4 ROLLS!

JANE PARKER FRESHLY BAKED — APPLE

PIE 22-Oz. Pkg. 39c SAVE 10c



GOREN ON BRIDGE

BY CHARLES H. GOREN
(© 1979, by The Chicago Tribune)
ANSWERS TO BRIDGE QUIZ

Q. 1—Both vulnerable, as South you hold:
♠K96 ♥Q9653 ♦Q972 ♣8

The bidding has proceeded: North East South West 1 ♠ Pass 1 NT Pass

What do you bid now?
A.—Two spades. This hand is definitely not the no trump type and preference should be given to rebidding a good six-card suit over returning to partner's hearts.

Q. 2—East-West vulnerable, as South you hold:
♠K96 ♥Q9653 ♦Q972 ♣8

The bidding has proceeded: North East South West 1 ♠ Pass 1 NT Pass

What do you bid now?
A.—Two spades. If you don't speak now it may become inexpedient to do so later. Partner should not play you for substantial values since you failed to double one no trump.

Q. 3—East-West vulnerable, as South you hold:
♠K96 ♥Q9653 ♦Q972 ♣8

The bidding has proceeded: North East South West 1 ♠ Pass 1 NT Pass

What do you bid now?
A.—Pass. Partner's jump rebid in spades is not forcing and you have about the least that the law will tolerate for a one no trump response. If this hand will produce a game, partner would probably have been able to bid it himself.

Q. 4—As South, vulnerable, you hold:
♠KJ3 ♥874 ♦KJ3 ♣J1094

The bidding has proceeded: North East South West 1 ♠ Pass 1 NT Pass

What do you bid now?
A.—You had a substantial one no trump response and we are inclined to take one further step. However, our choice is for three hearts rather than two no trump, as partner's rebid shows an unbalanced hand not suited for no trump play.

Q. 5—Both vulnerable, as South you hold:
♠KQ10743 ♥Q1033 ♦62 ♣52

The bidding has proceeded:

Meeting Slated On Attracting New Industry

RALEIGH (AP) — The first in a series of 10 meetings aimed at helping local efforts to attract new industry was scheduled today in Sylva by the North Carolina Department of Conservation and Development.

Invited to the session were legislators, members of the C&D board, area and local industrial development personnel and county and municipal officials.

The other meetings will be held in Asheville Tuesday, Statesville Wednesday, Charlotte Thursday and Burlington Friday. Next week meetings will be held in Raleigh Monday, Lumberton Tuesday, Burgaw Wednesday, Washington Thursday and Edenton Friday.

TV Log

WITN — Ch. 7	
MONDAY	2:00 Our Lives
7:00 McCoy's	2:30 The Doctors
7:30 My World	3:00 Another World
8:00 Laugh In	3:30 Bright Promises
9:00 Movies	4:00 Name Droppers
11:00 News	4:30 Funny Page
11:15 Sports	5:00 The Munsters
11:25 Weather	5:30 Hazel
11:30 Tonight	6:00 News
TUESDAY	6:15 Sports
6:00 Aspect	6:25 Weather
6:30 Today	6:30 Huell N. Brink
7:00 Father Knows Best	7:00 NBC News
7:00 Show	7:30 Concentration
9:00 David Frost	8:00 Detbebe
10:00 It Takes Two	8:30 Julia
10:25 NBC News	9:00 Movies
10:30 Concentration	11:00 News
11:00 Sports	11:15 Sports
11:30 Hollywood	11:25 Weather
12:00 Jeopardy	11:30 Tonight
12:30 The Who	
12:55 NBC News	
1:00 Divorce	
1:30 Lunketter	

WNCT — Ch. 9

MONDAY	5:55 Paul Harvey	12:30 Search
6:00 News	6:10 Sports	1:00 The Heart
6:25 Weather	6:30 News	1:25 Timely Tips
6:30 News	6:30 News	1:30 World Turns
7:00 Truth or Dare	7:30 Gunsmoke	2:00 Splendor
7:30 News	7:30 News	2:30 Guiding Light
8:30 Here's Lucy	8:30 News	3:00 Sec. Storm
9:00 Mayberry	9:00 News	3:30 Edge of Night
9:30 Doris Day	9:30 News	4:00 Gomer Pyle
10:00 Carol Burnett	10:00 News	4:30 Password
11:00 Final Report	11:00 News	5:00 Perry Mason
11:30 Merv Griffin	11:30 News	5:55 Paul Harvey
TUESDAY	6:00 News	6:00 Sports
6:30 Carolina	6:30 News	6:25 Weather
8:15 Sewing	7:00 News	7:00 Truth or Dare
8:25 Meditations	7:30 Lancer	7:30 Lancer
8:30 News	8:30 Red Skelton	8:30 News
9:00 Kangaroo	9:30 Gov. and News	9:30 Gov. and News
10:00 Lucy Show	10:00 CBS Reports	10:00 CBS Reports
11:00 Anthy	10:30 Felony	11:00 Final Report
11:30 Love of Life	11:00 Final Report	11:30 Merv Griffin
12:00 Noon News	11:30 Merv Griffin	12:15 Weather
12:15 Farm News		

WNBE — Ch. 12

MONDAY	4:30 Lost in Space	12:00 Bewitched
5:30 Flintstones	6:00 Batman	12:30 That Girl
6:30 Frank Reynolds	7:00 Total News	1:00 My Children
7:30 Music Scene	7:30 Music Scene	1:30 Make Deal
8:15 New People	8:15 New People	2:00 Newlywed
9:00 Survivors	9:00 Survivors	2:30 Dating
10:00 Am. Style	10:00 Am. Style	3:00 Hospital
11:00 Total News	11:00 Total News	3:30 One Life
11:30 Movie	11:30 Movie	4:00 Shadows
TUESDAY	7:00 Yogi Bear	4:30 Lost in Space
8:00 Romper Room	8:30 La Lan	5:30 Flintstones
8:30 La Lan	9:00 Theatre	6:00 Batman
9:00 Theatre	11:00 Total News	6:30 Frank Reynolds
11:20 Keys	11:30 Movie	7:00 Total News
11:30 Gourmet		7:30 Automobile

Meadowbrook



TICE Drive-In Theatre



Scott To Attend Demo Luncheon

RALEIGH (AP) — Gov. Bob Scott is scheduled to attend a luncheon Tuesday in conjunction with the meeting of the Democratic executive committee at the Sir Walter Hotel in Raleigh.

Scott began his official activities for the week with a news conference this morning.

At 6 p.m. Saturday, the governor will attend the installation of officers of the state Young Democratic Club in Winston-Salem.

PLAZA CINEMA
134 ONE & DIXIE PLAZA SHOPPING CENTER

Paramount Pictures Presents
Alvin Karpis Production
The Sterile Cuckoo
Technicolor A Paramount Picture

HELD OVER!
AGREES OF FREE PARKING
COMING SOON!
"FUNNY GIRL"
"OLIVER"

AN ACTUAL PERFORMANCE OF THE NATIONAL THEATRE OF GREAT BRITAIN

LAURENCE OLIVIER AS OTHELLO

The greatest Othello ever by the greatest actor of our time.

TECHNICOLOR PANAVISION

STARTS TUES. 2:10-5:06-8:02
Last Day—"Camille 2000"

PITT LUXURIOUS BEAUTY theatre

MYERS
Theatre Ayden

NOW THRU WED.

"THE ANIMAL"
FOR ADULTS ONLY

X-Rating
PLUS CARTOON
Adults—\$1.25
Shows at 7 & 9

Worry Clinic Make Molehills Of 'Mountains'

Tommy needs to learn the secrets of emotional control. Otherwise, he may become an adult temper tantrum, like the famous surgeon described below. And his wife may get a divorce for physical as well as mental cruelty. So will your mothers PLEASE teach your kiddies how to vent their emotions correctly?

By GEORGE W. Crane
Ph. D., M. D.

CASE L-544: Tommy D., aged 7, is a high strung child. "Dr. Crane, my worried mother began, "Tommy flies into terrific rages at his playmates when he doesn't get his own way. "I have tried to teach him to control his anger. But my husband says a female columnist recently urged kiddies to be allowed to kick the furniture as an emotional outlet. "Which-one of us is correct? And what else can I do to help Tommy dissipate his rage?"

Both Tommy's daddy and his worried mother are 50 percent correct in their attitude about emotions. For emotional energy builds up a terrific tension in our nervous system.

It is much like the pressure in a steam boiler. The latter has a safety valve, which permits the steam to expand itself in shrill hissing.

But it is wiser to control the outlet of this excessive emotional ire in a better way than merely kicking a chair to pieces!

Yet many adults still smash dishes and kick their radio or even the TV set when it doesn't work properly!

While I was a surgical intern at Wesley Memorial Hospital, we had a top Chicago surgeon, author of a textbook and a professor in our Northwestern University Medical School, who would throw temper tantrums right in the operating room!

Like many other tense surgeons, he would explode and then blame the nurses when he'd pull too hard on the catgut as he was suturing bleeding vessels.

The catgut would snap, and then this doctor bawl out the head nurse, which is a common masculine attempt at buck-passing.

But one day his anger grew so

great that he seized an entire tray of freshly sterilized surgical instruments and marched over to the window where he threw them all out. Alas, the window was closed, so he even smashed the glass in doing so!

To solve emotional crises with the least tendency to spastic colitis, angina pectoris, peptic ulcers, etc., and to lessen the social friction of outbursts like this surgeon's, follow these psychological rules:

(1) You can't celebrate (think) and also emote at the same time so resolutely force yourself to do some mental task. Remember the old adage, "Count 10 before you explode in anger?"

The mere act of counting is thus a mental act, and so is talking.

(2) Muscular action dissipates emotion, and this includes the vocal cords.

Many people "blow their top" via a torrent of words (not necessarily profanity) and thus drain off their inner emotional tensions.

If you are so irate at bedtime that you can't sleep, then sit down and write a scathing at-

CROSSWORD PUZZLE

ACROSS	28. Affirmative
1. Plant	29. Hebrew measure
4. Espouse	30. Anoint
7. Bespangle	31. Conifer
11. Wallaba	32. Troops
12. Yale	33. Coverlet
13. Circle of light	37. Cake ingredient
14. Moisture	38. Leading man
15. Spotted deer	39. Inventory
17. Foodfish	43. Monkshood
18. Freak	44. Inspect
20. Annealing oven	45. Musical perception
22. Uninteresting	46. Aptitude
23. Windmill sail	47. Pullet
24. Faction	48. Saratoga
25. Invalid's food	

DOWN

1. Adage	2. Uncluse
3. Timepieces	3. Timepieces
4. Toadflax	4. Toadflax
5. City railways	5. City railways
6. Confusion	6. Confusion
7. Food fish	7. Food fish
8. Dismounted	8. Dismounted
9. Hired car	9. Hired car
10. Optimistic	10. Optimistic
15. And not	15. And not
19. Colorer	19. Colorer
20. Ballad	20. Ballad
21. Farm animal	21. Farm animal
22. Dwindle	22. Dwindle
24. Davenport	24. Davenport
25. Scups	25. Scups
26. Goal	26. Goal
27. Thickness	27. Thickness
32. Past	32. Past
33. Bib. King	33. Bib. King
34. Garden party	34. Garden party
35. Broad smile	35. Broad smile
36. Landlord	36. Landlord
37. Tied	37. Tied
40. Formerly called	40. Formerly called
41. Beanie	41. Beanie
42. Generation	42. Generation

Par time 24 min. AP Newsfeatures 1-12

LAMPS MAPPED
AWAIT EMERGE
DALLAS STEIN
LOGIC REST
FEET MASON
EAT LABEL WE
NU HELIX PIN
HOGAN LAND
OVER REGAN
PEARL TOMATO
ARROYO LAMIA
HATRED FRANK

SOLUTION OF SATURDAY'S PUZZLE

DINER'S DICTIONARY

GUESTS (gĕsts), n. 1. Too many people to cook for.

PAR-TY (pär'ti), n. 1. "Good grief, Harry! You mean you asked them to dinner?"

DIN-NER (din'ner), n. 1. Served at The Niblick. You don't lift a finger.

Have your next dinner party at Greenville's finest Steak House. The Niblick for your guests, or just yourself!

Gourmet Salad Bar
Choose-your-Own-Cut Aged Steaks
Complete Accompaniments
Beer Wineist

The NIBLICK
2826 South Memorial Drive
Phone 756-3616

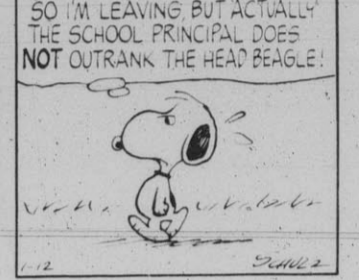
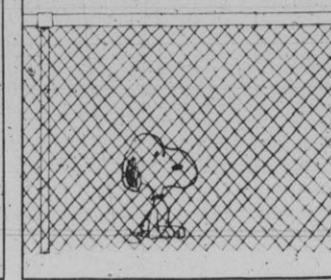

Survivor Is Improving

BENSON, N. C. (AP) — The only survivor of a plane crash which killed three men Saturday near Benson in Johnston County was reported improving Sunday at Memorial Hospital in Chapel Hill.

J. C. Langdon of Benson was taken to Johnston Memorial Hospital in serious condition after a four-passenger-Mooney plane crashed while taking off from an airstrip four miles north of Benson. Langdon was later moved to Chapel Hill.

Three men were killed instantly when the single-engine plane crashed in a wooded area near the airstrip. They were identified by Coroner B. J. Underwood of Johnston County as William Robert Langdon of Benson, James Chester West of Angier and Joseph Earl Wheeler, also of Angier.

Cause of the crash was not immediately determined.

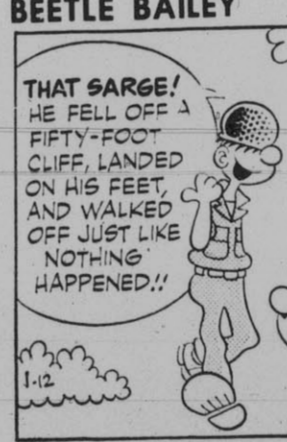
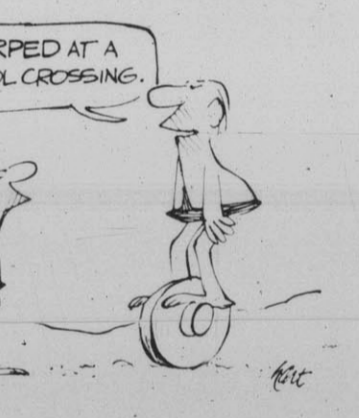

Faster, RUSSYCAT! KILL! KILL!

NOW THRU TUES. SHOWS DAILY AT 1:52-3:15-5:10-7:05-9:00

X- NO ONE UNDER 16 WILL BE ADMITTED.

the STATE theatre
PHONE 752-7649

Want Ad Advertisers Report "BIG RESULTS" Every Day

To put the WANT ADS to work for you

Look! Here's How the want ads are selling for your neighbor.

SOLD!

T. C. Elks of Rt. 3, Greenville sold his car with the following ad.

FALCON 1969-FUTURA, 21,000 miles, new set of tires, perfect condition, still under warranty, cash or pay small equity and assume payments. 700-0000

Mrs. Elks says: "It really worked! We sold the car last night!" (ad ran 1 day)

Dial 752-6166

Pay later when we bill you

EMPLOYMENT

Female Help Wanted

CHURCH SECRETARY. TYPING and shorthand required. Good working conditions and reasonable hours. Write Church Secretary, Box 1967, Greenville, giving references and qualifications.

WORK AT HOME. 10 - 20 hours weekly. \$25 to \$50. Telephone sales survey. Write Box 5473, Raleigh. Include phone.

Male Help Wanted

CONSIDER!!! GOOD SALESMEN ARE TRAINED NOT BORN!

and neither are doctors, lawyers, dentists or engineers.

You can be an outstanding salesman and earn \$8,000, \$10,000, \$15,000, \$20,000 or more a year your very first year.

YOU NEED TO BE:

- Age 21 or over
- Ambitious
- Energetic
- Sports Minded
- Have a high school education or better

YOU WILL:

Attend two weeks of school in Richmond Expenses paid

Be guaranteed \$750 month to start

And, what's more you will derive 40 per cent or more of your income from our established accounts!

IF YOU QUALIFY,

WE GUARANTEE TO:

Teach and train you in our successful sales methods.

Assign you to the sales area of your choice under the direction and guidance of a qualified sales director.

Provide the opportunity for you to advance into management as fast as your ability will warrant.

Fringe benefits include unusual Pension and Savings Plan.

Call now for personal interview.

Robbie Robbins
MON.-TUES.-WED.
910-758-3401
9:00 A.M. to 5:00 P.M.
Long Distance, Call Collect

Male Help Wanted

TERRITORY SALESMAN, tires and performance products, great opportunity for energetic, personable, aggressive man. Must live and travel Eastern N. C. Write Resume for interview to Performance, Box 1967, Greenville.

FULL

or

PART TIME

OPPORTUNITY

Career opening for man or woman interested in opportunity with a reliable nationally known educational firm. Good educational background and experience in teaching social services, civic affairs, or church work will help you qualify. May begin on either part time or full time basis. Very attractive pay scale. Write immediately to:

District Manager
P.O. BOX 2634
GREENVILLE, N. C.

MATURE SALESMAN NEEDED FOR LOCAL AREA

Invest none of your own money but realize a tremendous profit. Interested? The only requisite is honesty and common sense. Excellent opportunity for retired people. Properly oriented individual should earn no less than \$100.00 weekly. No canvassing. Write Mature, Box 1967, Greenville.

Male-Female Help

AMBITIOUS COUPLE INTERESTED in part time or full time work. Call 756-0934.

Work Wanted

RECENT EC GRAD, AB, 24, married, seeks job in area. For further information, call 752-7971.

FARM EQUIPMENT

FARM MACHINERY AUCTION sale. Tuesday, Jan. 20 at 10 a.m. 150 farm tractors, 400 implements. Wayne Implement Inc., Goldsboro, N.C., S. on highway 117, phone 734-4234.

FARMS

Farms For Lease

TOBACCO FOR LEASE, 16,186 lbs. at 12c per lb. Call 756-4302 after 6 p.m.

FOR SALE

Miscellaneous For Sale

USED CONSOLE TV FOR sale. \$25. 758-4306 after 3 p.m.

SENTRY SAFES

These Safes Are Certified UL Label For Fire Protection

79.50 UP

TAFF OFFICE EQUIPMENT

214 E. 5th St. 752-2175

SONY TC630 PROFESSIONAL

tape recorder, dual automatic changer, HA8 sharp earphones, plus speakers and mikes. Complete stereo system. Call 756-3752.

Area Rugs starting at \$39.95 Larry's Carpetland 3010 E. 10th St.

USED SPINET PIANO, \$350. Call M. E. Sutton, 752-5617.

THE ONLY HEATER IN the world with patented Neo-Glo heating elements. Life time guarantee. Smith Electric Co., 415 Evans St., Greenville.

ALL ITEMS DRAMATICALLY reduced for year-end inventory. Come to Fisher's Appliance and Furniture, Dickinson Ave.

PORTABLE SPACE HEATER,

heavy duty with blower. Uses kerosene or fuel oil. \$50. See John Vernelson, Holt Oldsmobile, Inc.

Console TV and AM-FM Stereo

Black and white console TV, just a little shopworn. This TV sold for \$239.95, now only \$169.95. Silver-tone Stereo with AM-FM radio in excellent condition. A real bargain for only \$99. Little or no down payment. Easy terms to suit you.

Heilig-Meyers

SEWING MACHINE. 1969 used Singer Touch & Sew in walnut cabinet. Makes buttonholes, sews on buttons, hems, fancy stitches, etc. all without attachments. Guaranteed good condition. Pay balance of \$75 or terms available. For-free home demonstration call 758-4445.

STEREOS - 8 BRAND NEW

1969 stereos hi-fidelity consoles. All transistor, 4 speaker audio systems, with 4 speed automatic changer. Fully guaranteed. Only \$63 each. Can be seen in showroom of Unclaimed Freight Co., 2904 E. 10th St., Greenville.

SHOP AT STAN'S SPORT

Center, 1025 Evans St., featuring Honda Mini-Trail, Rupp Go-Carts, Admiral color TV's and stereo component systems by Panasonic, Midland and Norelco.

RECORDS - COLLECTION

of over 650, never used and never sold, old 78 rpm records, record rack included. \$100. 3 panel lighted sign, 6 mos. old, \$250. Strobe light, brand new, \$65. Other miscellaneous items for sale also. Sounds Unlimited, 408 Evans St. (behind Tetterton's Jeweler's) call 758-2600 from 5-6:30 p.m.

MEDITERRANEAN COFFEE

table-stereo. AM-FM, Phono. Excellent condition. \$99.50. Call 758-2550.

ARGUS SUPER 8 MOVIE OUT-

fit. Projector, camera, lights, case. Never used. 752-5451.

76" SOFA WITH DARK GREEN

slip covers. \$50. 756-0157.

21" ZENITH BLACK AND

white portable television. Excellent condition. \$50. 756-0157.

CLASSIFIED DISPLAY

HARDWARE - ROOFING

STORM WINDOWS & DOORS AWNINGS C. L. LUPTON CO. 752-6116

Little's Nursery

FRUIT TREES

Apple Peach Pecan Grape Vines Blueberry Plants

Box woods, Hollies, Azaleas, Camilias, and other ornamental plants - Pansey plants and bulbs, pine straw, mulching material.

Open 7 days a week 756-3626

LOST AND FOUND

FOUND-CALICO CAT WITH flea collar. Call 756-3119.

MOBILE HOMES

Mobile For Rent

TRAILER SPACES FOR rent, Gurganus Trailer Court, 752-5362.

3 BEDROOM MOBILE HOME, located Meadowbrook Trailer Park, 758-3566 or 756-1307.

LIVE AT PINEVIEW COURT. Mobile homes and spaces for rent. 758-3644 or 758-4842.

GIRL WANTED TO SHARE 2 bedroom trailer. Available Feb. 1. 756-4790 after 6 p.m.

12 WIDE, 2 BEDROOM, WITH washer and air condition, in Shady Knoll, call 752-7866.

2 BEDROOM, 12 WIDE, Located in city, 756-5851.

2 BEDROOM AIR CONDITION, good location, call 752-3286. Or 825-5391 nights, Bethel.

12' WIDE TRAILERS, ALSO spaces with paved streets. 756-2909.

10 X 55, 2 BEDROOM, 1 1/2 baths, with washer, at Shady Knoll, 746-6223 or 746-3538.

2 BEDROOM, 12 WIDE, AIR conditioned and washer, Shady Knoll, 752-7076 and 758-4997.

Mobile Homes For Sale

1968 COMMODORE, 12 X 60, 2 bedroom, 2 bath, call 756-0333 or 752-4946.

1966, LEXINGTON TRAILER. Call 756-2909.

1968 PARKWOOD, 12 X 60, 2 bedroom, pay small equity and assume payments. 752-5088.

REAL ESTATE

FOR BETTER BUYS IN REAL Estate see or call E. H. Williford Realtor, 313 Cotanche St. PL. 8-3911. List your property with us.

PROPERTY FOR SALE

Home, three bedrooms, living room, dining room, kitchen, bath, completely remodeled, includes automatic heat - excellent location at 302 Biltmore Street. \$16,500.

Waterfront cottage at Rest Haven, N. C. Lot is 60' x 152' deep. 2 bedrooms, with fireplace and space heater. Very good buy - \$13,500 and will finance.

Business Lot at 816 Evans St., 82' x 159'. \$18,500.

Vacant Lot at 618 Clark St., 50' x 90 1/2'. \$2,000.

7 acre farm, completely cleared, divided by Hwy. 1931. Good home-building site. Approx. 18 miles from Greenville. 2 acres on one side of hwy. \$4200 and will finance.

22 acre farm, beginning on Hwy. 43 at a point, with frontage all on road 1797. 9 cleared acres, with barn and house. 1.35 acre tobacco allotment, 4 corn. \$9,500, will finance, available immediately.

One story brick veneer, 3 bedrooms, living room, kitchen, 1 bath, forced air heat. 209 Millbrook Street. \$11,000.

J. L. Harris & Sons

Real Estate Property Management Repairs - Painting 204 W. 10th St. 758-4711

HOME FOR SALE

Home includes 3 bedrooms, living room, dining room, kitchen, hall, enclosed back porch, side porch, and large floored attic. Situated on a large lot in an excellent location. Equipped with air conditioning unit, automatic heat and storm windows and doors. 104 Sylvan Drive.

J. L. Harris & Sons

Real Estate Property Management Repairs - Painting 204 W. 10th St. 758-4711

CLASSIFIED DISPLAY

CLASSIFIED DISPLAY

Now-40% more power for finding the fun spots.

40% more power from a 96 HP overhead cam engine. Packs your camper to out-of-the-way places at up to 25 miles per gallon economy.

The #1 Selling Import Truck

DATSUN

Service available at Holt Oldsmobile and Nationwide.

Drive a Datsun... then decide at:

Holt Oldsmobile Inc. 101 Hooker Road

Houses For Sale

MODERN DUPLEX APARTMENT in Farmville, 2 bedrooms, kitchen, living room, carport, electric heat, tile bath, good location, call nights 753-3503.

NEW AIR CONDITIONED

4 bdrm. house located 3007 S. Elm St., 2 1/2 baths, living room, dining room, foyer and den. Harry Wilson, Builder, 756-0741.

2308 E. 3RD. 3 BDRM., LIVING room, dining room, air conditioned, FHA or VA financed available. \$15,500. Bill Williams Real Estate, 752-2615.

2705 Crockett Drive

Brick home with 3 bedrooms, 1 1/2 baths, kitchen-den combination, living room, carport and storage. \$16,000

2814 Jackson Drive

Frame home with 3 bedrooms, living room with fireplace and logs, 1 bath, kitchen with breakfast area, carport and outside storage. \$17,000

2601 Jefferson Drive

Brick home with 3 bedrooms, 1 bath, living room with fireplace, kitchen and dining area, carport, separate storage. Wooded corner lot. \$17,500

Laura Lane, Winterville

Brick home with 3 bedrooms, 1 1/2 baths, kitchen-den combination, living room, utility area in carport and storage. \$18,500

2310 Deal Place

Aluminum siding, 4 bedrooms, 2 baths, living room with carpeting, 2 bedrooms and den area have carpeting, kitchen-den combination, utility room, side porch, separate 1 car garage with storage. Storm windows and doors, fenced in back yard. \$19,750

2508 Madison Circle

Frame home with 3 bedrooms, 2 baths, foyer, living room with fireplace, dining room, kitchen, utility. 2000 sq. ft. \$19,500

OLD LONDON INN

2710 S. MEMORIAL DRIVE

FURNISHED STUDIOS, ALL utilities furnished. 756-3851.

3 ROOM FURNISHED apartment with private bath. 756-1821 after 4 p.m.

LANDMARK APARTMENTS. 1 bedroom furnished apartment. 1809 E. 5th St., 752-6137 day, 756-3465 night.

2 BEDROOM FURNISHED apartment, \$125. 2 bedroom unfurnished, \$100. Wall to wall carpet, air conditioning, heat and water furnished. 2401 E. 3rd St., call M. E. Sutton or C. L. Thigpen, Jr., 752-6121.

COUPLES SOLVE YOUR parking problem on campus. New STADIUM APARTMENTS located on 14th St. between Coliseum and men's dormitories. 2 apartments available. Phone 756-4671, 756-3450, 752-5700.

D. G. Nichols Agency

752-4012 752-4585 Mrs. Roper 758-4316 Mrs. Stott 752-4364

HOME FOR SALE

Home includes 3 bedrooms, living room, dining room, kitchen, hall, enclosed back porch, side porch, and large floored attic. Situated on a large lot in an excellent location. Equipped with air conditioning unit, automatic heat and storm windows and doors. 104 Sylvan Drive.

J. L. Harris & Sons

Real Estate Property Management Repairs - Painting 204 W. 10th St. 758-4711

CLASSIFIED DISPLAY

CLASSIFIED DISPLAY

CLASSIFIED DISPLAY

CLASSIFIED DISPLAY

CLASSIFIED DISPLAY

CLASSIFIED DISPLAY

CLASSIFIED DISPLAY

CLASSIFIED DISPLAY

CLASSIFIED DISPLAY

CLASSIFIED DISPLAY

CLASSIFIED DISPLAY

CLASSIFIED DISPLAY

CLASSIFIED DISPLAY

CLASSIFIED DISPLAY

CLASSIFIED DISPLAY

CLASSIFIED DISPLAY

CLASSIFIED DISPLAY

CLASSIFIED DISPLAY

CLASSIFIED DISPLAY

CLASSIFIED DISPLAY

CLASSIFIED DISPLAY

CLASSIFIED DISPLAY

CLASSIFIED DISPLAY

CLASSIFIED DISPLAY

CLASSIFIED DISPLAY

CLASSIFIED DISPLAY

CLASSIFIED DISPLAY

CLASSIFIED DISPLAY

CLASSIFIED DISPLAY

CLASSIFIED DISPLAY

CLASSIFIED DISPLAY

CLASSIFIED DISPLAY

CLASSIFIED DISPLAY

CLASSIFIED DISPLAY

CLASSIFIED DISPLAY

CLASSIFIED DISPLAY

CLASSIFIED DISPLAY

CLASSIFIED DISPLAY

CLASSIFIED DISPLAY

CLASSIFIED DISPLAY

Houses For Sale

117 GREENWOOD DRIVE, 3 bedroom, 2 baths, den with fireplace, double garage, percent loan, 756-3119 after 6 p.m.

BY OWNER, 3 BEDROOM, brick, living room, kitchen-den combination, 1 1/2 baths, carport. \$19,500. 507 Pine St. Call 756-0045 after 6 p.m. weekdays.

MOVE IN FOR \$300

327 CLAIRMONT Circle 3 bedrooms (or den), 2 full tiled baths, living room, kitchen-dining combination, aluminum siding, carpet, air conditioning, unit. Like-new condition. \$15,500

includes ALL costs

Bowen Realty and Loan Bowen Bldg.—212 W. 5th St. 752-7194 — Eves 752-2698

RENTALS

TILLERS, LAWNMOWERS, airerators, lawn rakes, edgers, United Rent All, 264 By Pass 756-3862.

APARTMENT HUNTERS look! Grier Rental Agency

FTC Mapping Standards For Light-Bulb Makers

By G. DAVID WALLACE
Associated Press Writer
WASHINGTON (AP) — Anyone who thinks all 100-watt light bulbs give off the same amount of light is completely in the dark.

"The consumer thinks that when he buys a 100-watt bulb it gives off the same amount of light as any other 100-watt bulb," said Federal Trade Commission attorney Raymond L. Rhine.

But, Rhine said, that is not the case.

So he and his colleagues at the FTC are putting final touches on a regulation to require manufacturers to specify how long their bulbs will last and how much light they put out.

The basis of the proposed re-

visions are lumens—units for measuring the amount of light produced by a glowing object.

A standard 100-watt light bulb, for example, puts out about 1,600 lumens. A standard 75-watt bulb produces about 1,300 lumens.

The lumen output among the major standard light bulbs is fairly constant, offering purchasers some idea of how much light they could expect from a light bulb of certain wattage.

But with the advent of three-way and long-life bulbs, the problem has become more complicated.

The reason is that lumens and bulb life are like opposite ends of a see-saw. Decreasing the light output of a bulb gives it a longer-life expectancy.

Thus the 100-watt long-life bulbs last about 2,500 hours compared with the 750-hour life of a standard bulb. But they put out 1,400 lumens, or 200 lumens less than the standard bulb.

And standard three-way light bulbs of the 50-100-150-watt variety, when burning at the 100-watt position, give off only about 1,500 lumens.

The long-life bulbs can be a godsend, however, for those awkward stairway receptacles which can be reached only after mounting a shaky ladder.

The major bulb manufacturers—General Electric, Westinghouse and Sylvania—have been rating their bulbs by lumens and life expectancy for years and provide the information in handbooks distributed to dealers.

The manufacturers did not object when the FTC proposed last September to put the information on most light bulb wrappers, but all three objected to inscribing the same information on the light bulb itself.

Seeks Aid To Accredite Institutes

RALEIGH (AP) — Dr. Dallas Herring, North Carolina's Board of Education chairman, says he is going to seek aid from the U. S. Office of Education in his attempts to secure accreditation for 13 of the state's technical institutes.

Herring's remarks were released in a statement Saturday in which the educator also said he would ask the state's congressional delegation to help in his dispute with the Southern Association of Schools and Colleges.

Herring last week attacked the association's accreditation policies as "stereotyped and backward" and said that 13 institutions in the state's community college system have been denied federal aid because the association has refused to accredit them.

In reply to his criticism, a spokesman for the Southern Association said that his group had "sound reasons" for refusing to accredit the institutes.

Dr. David Kelly, an associate executive secretary in charge of accrediting community and junior colleges, said his organization requires that institutions be governed by relatively independent boards of trustees. He said the 13 institutes in question operate through contracts with local boards of education.

Herring in his statement Saturday said Kelly's statement was wrong and that the institutes are operated by boards of trustees.

Pesticide-Makers Assured Of Review

By DON KENDALL
AP Farm Writer
WASHINGTON (AP) — Pesticide manufacturers worried that government moves to outlaw DDT might be extended to other pest killers have been assured by top Agriculture Department officials no such action will be taken without a detailed review.

Months could elapse before any action is taken, said Dr. Ned D. Bayley, USDA director of science and education. He added the first review of the chlorinated hydrocarbons or hard pesticides would begin in March.

Chemical companies became concerned after a government commission warned that a ban on DDT could result in increased usage of other hard pesticides such as dieldrin, aldrin, lindane, heptachlor and endrin. All are first cousin's of DDT.

Fearing that the Agriculture Department—with the backing of the departments of Interior and Health, Education and Welfare—might quickly shut the

door on all hard pesticides, heads of some chemical companies have attempted to sound out the Agriculture Department on its future plans.

Bayley declined to state what hard pesticides would be included in the first review scheduled to begin in March. But he indicated the first group could involve those chemicals such as dieldrin that are considered more dangerous than other chlorinated hydrocarbons.

The study will entail a review of all uses for which the pesticides are registered, Bayley said.

Instead of a sweeping ban, he continued, the department probably would move to outlaw those uses for which substitute chemicals or alternative methods of treatment are available.

He declined to speculate on the length of time it might take to conclude the studies.

College Founder Dies At Age 59

NEW YORK (AP) — The founder of Black Mountain College, a small institution in the North Carolina which turned out a number of noted writers in the 1940's and 1950's, has died at age 59.

Charles Olson, a poet and literary critic who served as director of the school, died Saturday. He was a visiting professor at the University of Connecticut when he died.

Olson was the author of some 50 books. His students at the Black Mountain school reflected his literary style.

Funeral arrangements are incomplete, but he is expected to be buried in Gloucester, Mass., where he lived most of his life.

YOU CAN AFFORD

A New Ford

- Call or See
- Butch Grubbs General Manager



Billmyer Ford
East 10th St. Ext. 758-2191

EARLY WEEK SPECIALS
SAVE UP TO **40% OFF** OUR LOW DISCOUNT PRICES!

PRICES EFFECTIVE THRU WED. JAN. 14th

CLARKS
A DIVISION OF COOK UNITED, INC.

NEW! RAINCHECK POLICY
WE GUARANTEE TO SELL WHAT WE ADVERTISE
Applies throughout entire ad period. If we sell out of any advertised specials, you will receive a written order "Raincheck" which entitles you to buy the item at these advertised prices when our stock is replenished.



3/4" X 60 yds. MASKING TAPE

28^c OUR REG. 49^c

LIMIT 2 PLEASE



AUTO KEY SALE

BUY ONE FOR 39^c - GET A SPARE FOR ONLY ...

ONE CENT

BOTH FOR ONLY 40^c



PINOCHLE / BRIDGE

PLAYING CARDS

YOUR CHOICE ...

19^c OUR REG. 26^c

PET CARE COSTS LESS AT OUR LOW DISCOUNT PRICES



DOG BED MATTRESSES

• Colors co-ordinated with dog beds
• Bright plaids

77^c OUR REG. 1.19

#1

Size No. 2 1.39
Size No. 3 1.69
Size No. 4 1.89



ASSORTED RAWHIDE DOG TOYS

Your Choice!

25^c OUR REG. 36^c TO 41^c EA.



WICKER DOG BEDS

• Washable, sanitary & non-allergic

97^c OUR REG. 1.39

#1

Size No. 2 1.99
Size No. 3 2.69
Size No. 4 3.39



WOOD 16" GREAT NECK MITRE BOX

• Rock maple mitre box

97^c OUR REG. 1.28



NEW LUSTRE CREME HAIR SPRAY

12 OZ. 67c SIZE

38^c LIMIT 1 PLEASE

CLEARANCE!

MENS FALL & WINTER JACKETS

• Surcoats, bomber, ski & warm-up jackets
• Assorted colors and fabrics
• Sizes S-M-L-XL

8⁰⁰ VALUES 10.00 TO 12.00

CLEARANCE!

LADIES ASSORTED SKIRTS

• Many fabrics and colors to choose from

3⁰⁰ OUR REG. 3.87 TO 3.97

INFANT'S & TODDLER'S SPORTSWEAR & DRESSES

• Jumpers, slack sets, jumpers and assorted playwear
• Assorted fabrics
• Sizes 12-24 mo. and 1-4

2⁰⁰ 3.97 VALUE

OPEN DAILY 9:30 A.M. - 9:30 P.M.

WEST END SHOPPING CENTER

If we sell out of any advertised specials, you will receive a written order, "Raincheck" which entitles you to buy the item at these advertised prices when our stock is replenished. WE RESERVE THE RIGHT TO LIMIT QUANTITIES.

NOW IN PROGRESS



206 E. 5TH STREET

JANUARY CLEARANCE SALE

- ★ SUITS
- SPORT-COATS
- HATS

Reduced **20%** OFF REG. PRICE

★ MANY OTHER REDUCTIONS



206 E. 5th ST.

★ **DOUBLE** ★

Greenbax Stamps

TUESDAY ONLY!

LUTER'S NO. 1 SLICED BACON PER LB. **69^c**

MORTON'S CHICKEN POT PIES 5 PKGS. FOR \$1⁰⁰

DELMONTE CATSUP 3 20 OZ. BOTTLES \$1⁰⁰

OPEN FRIDAY NITES UNTIL 8:30 PM & SAT. TIL 8:00 PM

HARRIS

SUPER MARKETS, INC.

'Where Shopping Is A Pleasure'

PRICES GOOD IN ALL 4 STORES

No. 1 Memorial Dr. No. 2 E. 10th St. No. 3 W. 5th St. No. 4 Bethel, N.C.